

*****3-DIGIT 857
 J750737 D11 9007 5872 969
 BARRY MISHKIND
 2033 S AUGUSTA PL
 TUCSON AZ 85718

Radio World®

Vol 15 No 6

Radio's Best Read Newspaper

March 27, 1991

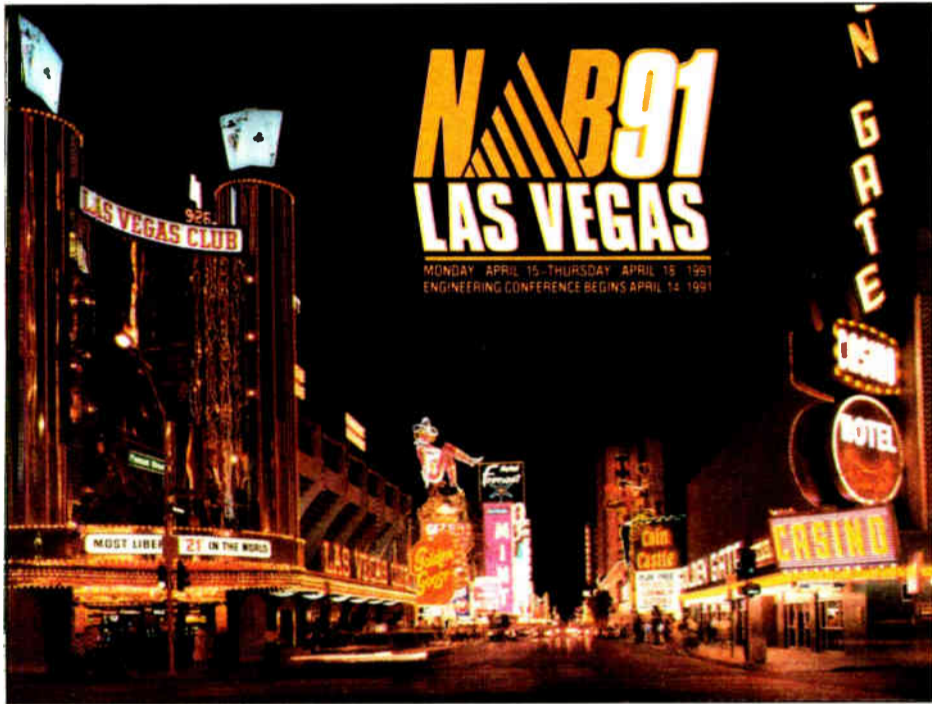

NAB's spring convention returns to Las Vegas. See our preview section for details, p. 39.

Opinions Differ On Eureka Plan

by Alex Zavistovich

WASHINGTON Broadcasters are divided as to whether the NAB should endorse the Eureka 147 digital audio broadcasting (DAB) system, but many agree that the association should not attempt to pursue a North American licensing agreement for the technology.

Of the broadcasters contacted by RW, many believe that NAB's backing of some type of DAB system is appropriate, and that Eureka's effectiveness has been adequately demonstrated for such an endorsement. Others, however, maintain that the NAB is acting hastily in supporting the technology when other proponents have not had time to demonstrate their systems.

Surprisingly aggressive

Most of the broadcasters expressed strong reservations about the NAB developing a licensing agreement for the Eureka system under their for-profit subsidiary, NAB Technologies. They believe such a move could result in the industry losing a valuable forum for discus-

sion of issues surrounding implementation of DAB in the United States.

In a prepared statement, SCI President
 (continued on page 8)

MFM DAB Outlined

MONTEREY, Calif. Mercury Digital has joined the ranks of companies proposing an FM-compatible, "in-band" DAB system.

The company, which announced it had developed a DAB system last August, says now that its system can place a digital signal well within the allotted 200 kHz, as well as providing a number of 16 kbps (kilobits per second) digital subcarriers.

The company's digital modulation technique is called Multi-Frequency Modulation, or MFM, but company representatives have not released specific details on the modulation scheme.

Mercury President Tom Duffy said MFM is a single channel system that provides a "compact disc-quality" signal and overcomes multipath even in "cars traveling as fast as 100 mph."

The MFM plan would put a digital signal in an FM station's first adjacent channel. The company said it can transmit six stereo channels per MHz, without requiring adjacent channel guardbands. According to Mercury, MFM is uncompressed yet "robust" and not subject to problems such as attenuation, frequency offsets and other common channel impairments.

Mercury Digital is proposing its system for FM, cable and satellite, but not for AM stations. The company made a presentation to the FCC Office of Engineering and Technology, but has not petitioned the Commission.

Mercury Digital said its system is in prototype development with initial testing slated for the end of 1991. The company hopes to install the system in cars for consumer tests in the San Francisco area by 1992.

FCC Sets Mod Policy

by John Gatski

WASHINGTON The FCC has issued a public notice in an attempt to alleviate confusion about whether new FM modulation monitoring equipment, such as Modulation Science's ModMinder and Belar's Wizard, meets Commission modulation rules.

The FCC public notice and other modulation-related topics are likely to be addressed during an FM modulation session at NAB '91 that is scheduled to include several rival modulation monitor companies.

The ModMinder has been the subject of some controversy since 1989. Unlike traditional modulation monitors, the ModMinder ignores very brief peaks, which can allow up to 4 dB more in "legal" modulation, according to Modulation Sciences.

Other companies have said this approach to modulation measurement can result in overmodulation. Last year, following a public advisory from the FCC that said the ModMinder appeared to meet commission rules, Modulation Sciences asked the FCC to further clarify its modulation monitor policy.

In its recent public notice, the FCC stated that "despite all technical differences, it has been the experience of the Commission that all commercially manufactured monitors with which it is familiar produce satisfactory results, which agree substantially with the Commission's rules."

According to the public notice, "In

cases where a commercially manufactured monitor has shown that a transmitter is being properly modulated, we have found that Commission measure-

(continued on page 20)

Digital Quality Transmission

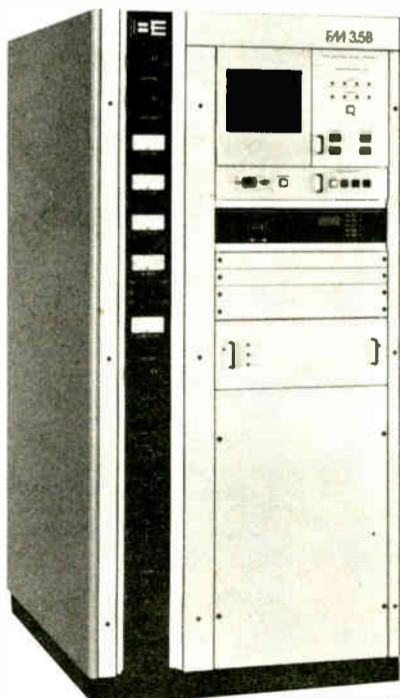

Broadcast Electronics' FM 3.5B 3500 Watt FM Transmitter

- New world standard FX 50 Exciter.
- Guaranteed 85 dB S/N.
- Built-in synchronous AM noise test facility.
- Patented folded half-wave coaxial cavity eliminates plate blocking capacitor and sliding contacts.
- Self Contained solid state broadband IPA in slide out drawer.
- Emergency 250 watt RF patching.
- Automatic power control that maintains constant output power with proportional VSWR foldback protection.
- Optional microprocessor video display system (MVDS) with diagnostics.
- Optional PC Remote Control from MVDS.

With typical performance specifications of 0.02% IMD and 0.01% THD and guaranteed 85 dB FM S/N your listeners will hear the difference from a new FM 3.5B.

BE BROADCAST ELECTRONICS INC.

4100 N. 24th ST., P.O. BOX 3606, QUINCY, IL 62305, (217) 224-9600, TELEX: 250142, FAX: (217) 224-9607

See Us at NAB Booth 1120

Circle 10 On Reader Service Card

NEWS BRIEFS

Sikes Supports Spectrum Auction

WASHINGTON FCC Chairman Al Sikes said that a spectrum auction would be the best method for distributing non-broadcast government spectrum that, under a proposed congressional bill, could be released for commercial use.

Testifying during a recent

House of Representatives subcommittee meeting, Sikes said the spectrum that would be available under the "Emerging Technologies Act of 1991" (HR 541) could alleviate continuing spectrum demand pressures from a multitude of potential users—including digital audio broadcasting.

Sikes endorsed the frequency

auction option as a way to "ensure that frequencies would go to those firms which will make the most efficient use of them, while ensuring that taxpayers benefit directly from the economic value their licensing confers."

SBE Solicits Paper Submissions

INDIANAPOLIS A call for papers has been issued by the Society of Broadcast Engineers (SBE) for its 1991 Broadcasting Engineering Conference.

The abstract submissions due

date is April 1. Topics of interest this year include: automation in broadcasting, using personal computers in broadcasting, MIDI for audio production and broadcast transmitter maintenance. The conference is scheduled for October 3-6 in Houston, Texas.

Sennheiser Acquires Neumann

WEDEMARK, Germany Sennheiser has purchased Neumann GmbH, a major microphone manufacturer located in Berlin. The buyout was

effective Jan. 1.

With the purchase of Neumann, Sennheiser is making a conscious step towards diversification in the international market, according to the company.

To expedite the merger, the companies will concentrate on research and development to explore new avenues, officials said. Neumann products will continue to be manufactured and distributed under the Neumann name.

Increased User Fees Proposed

WASHINGTON A newly proposed user fee could add as much as \$71 million to the FCC's annual budget, according to the agency.

Although spectrum fees are unlikely in 1991, the FCC has proposed an annual user fee for all users of FCC services. This could affect all broadcasters and would be separate from application processing collection fees.

Money from the fees would be used to pay for policy enforcement and other FCC activities.

As in its negative reaction to spectrum fees, the NAB said user fees are a "bad idea" for broadcasters who already spend considerable resources to service the public interest."

SBE Enacts New Fee Schedule

INDIANAPOLIS At the SBE's executive committee meeting in January, a new fee schedule was approved for all levels of SBE members. The new fees are as follows: broadcast technologist, \$35; broadcast engineer, \$50; senior broadcast engineer, \$75; and SBE professional broadcast engineer, \$100.

The new schedule will go into (continued on next page)

Give Your Production People Some POWER!

THE SP-6 IS LOADED WITH FEATURES! Like a powerful equalizer section that gives your talent greater creative freedom; four auxiliary sends that can be used for special effects, headphone feeds, or IFB mixes; both 8-track and stereo bus assigns for multi-track and dubbing work; plus a choice of mono mic/line or stereo input channels. And, to keep things fast and productive, it even includes full machine control logic, control room and studio mutes, plus tally systems—just like you'd expect on an on-air console. The SP-6 provides independent headphone, control room and multiple studio monitors, and (of course) an automatic stereo cue/solo

system. Our unique track monitor section will speed your production pace, allowing simultaneous stereo mixdown during the multi-track bed session.

A powerful group of accessory modules will increase your production control, like a 7-station intercom module that links this console with other Wheatstone consoles and talent stations throughout your complex; a full-function tape recorder control panel; an 8-position source selector to enhance input capability; additional studio modules to accommodate multi-studio installations; and finally, a digital event timer and a precision clock.

So contact Wheatstone, the company with the integrity and experience you can count on.



INDEX

Meet My Listeners by Al Peterson	21
Cures for Computer Viruses by Barry Mishkind	23
FAA Proposal Makes 'Furr' Fly by Harry Cole	24
DAB's Competition Heightens by Steve Crowley	25
KCEV Checks Out For New Facility by Dee McVicker	26
Translators in Tough Terrain by Howard L. Enstrom	28
Industrial-Strength SV-3900 by Ty Ford	29
Workbench	31
Fritz II Mic Makes a Ghostly Appearance by Frank Beacham	32
Choosing a Business Structure by John Cummuta	33
Using a Function Generator by Tom Vernon	34
NAB Preview	37

Wheatstone Corporation

6720 V.I.P. Parkway, Syracuse, NY 13211 (tel 315-455-7740 fax 315-454-8104)

Circle 60 On Reader Service Card

See Us at NAB Booth 1556

(continued from previous page)
effect after the 1991 convention in Houston. For more information, contact Richard Farquhar at 614-837-9222.

New NAB Department Established

WASHINGTON The NAB has opened a Research and Development department, which combines the resources of the Research and Planning Department, Library and Information Center and computer and data operations.

The department is responsible for integrated research, planning, information technology, telecommunications and library services for the broadcasting industry, according to the NAB.

"Integrating these association services will help us more effectively meet our long term strategic needs, as well as more efficiently meet our day-to-day needs for access to a wide range of information," NAB President/CEO Eddie Fritts said.

Inpex Show Slated

PITTSBURGH Inpex, the Invention/New Product Exposition (Inpex), will hold its seventh annual show May 16-18, 1991.

Inpex is a trade show featuring exhibits of inventions of private individuals, and consumer products and technologies. More than 500 exhibits are anticipated this year.

For more information on the Inpex show, call 412-288-1343.

CDRB Calls for More DAB Tests

by Judith Gross

LANSING, Mich. The NAB's approach to licensing the Eureka system is "premature and unfortunate" according to an ad hoc industry group that would like to see all DAB systems in development face off in independent tests.

Skip Pizzi, Committee for Digital Radio Broadcasting chairman, appeared on a DAB panel discussion during the Michigan Association of Broadcasters (MAB) and local SBE meeting here, along with other systems' proponents.

Pizzi called on the industry to support independent tests of DAB systems, including in-band systems currently in development, and suggested a forum like the Advanced Television Test Center (ATTC), which was set up to test HDTV systems.

"The ATTC provides an excellent model and we're suggesting that they could in fact be the forum for DAB tests with some additional equipment and funding," Pizzi said. He added that the ATTC might eventually become a permanent R&D facility for new technologies that will come along in the future.

Not objective

Pizzi also said that NAB would usually be considered the institution to oversee such tests, but that "they took themselves out of the running as an independent forum" when they endorsed Eureka.

He said that with the World Administrative Radio Conference (WARC) less than a year away, the industry should concentrate on first getting spectrum and then deciding what system would be best suited to that spectrum.

Pizzi also said that additional time to

CDRB suggested a forum like the Advanced Television Test Center (ATTC), which was set up to test HDTV systems.

consider various DAB systems would give developers of systems in this country a "chance to catch up."

"We're still on the very early edge of this. Once the decision is made we've got to live with it for 20 to 50 years, so taking a year or two to decide on the best system now is worth it," he said.

NAB Senior VP of Science & Technology Michael Rau, also present at the MAB forum, said later that Pizzi's views, which he expressed as chairman of the CDRB, may not be representative of the industry as a whole.

He explained NAB's swift action on

the Eureka system by saying that "unlike HDTV, the industry doesn't have the time to wait years for comprehensive testing of other systems."

Expensive to test

Rau estimated that it would require eight to 10 years—not just a year or two—to develop a timetable, build a test lab, set up test criteria and actually test DAB systems.

The ATTC, established three years ago, has so far spent \$10 million before testing a single system.

Rau also said that independent tests don't necessarily result in the best technical standard for the industry. He cited current standards in FM stereo and color TV as examples.

He maintained that a rapid timetable is in the best interests of the industry. "There's no need to delay delivery of DAB to listeners; the radio industry wants to implement DAB as soon as possible," he said.

Regarding the CDRB's concern about supporting the best DAB system from a technical standpoint, Rau told the MAB gathering "I know industry engineers have a hard time hearing this, but it's not as important to the broadcast industry to have the best standard as it is to have one standard."

OK, so our booth at NAB isn't very easy to find...

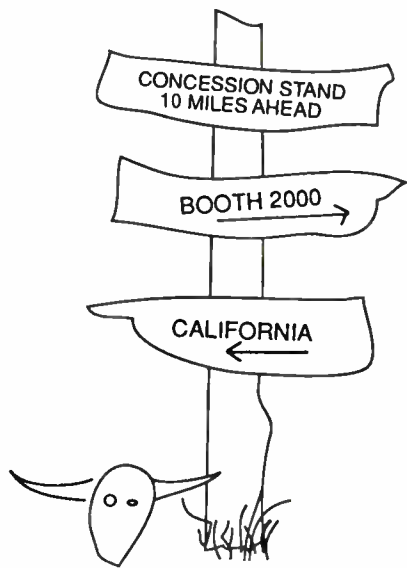

But we're sure you'll like what you find at booth #2000. Like all the latest digital audio gear including the new Otari DDR-10 digital workstation, Denon CD players, Panasonic DAT recorders and much more. So set out early, pack a lunch and watch for rattlesnakes.

Crouse-Kimzey
COMPANY
Our 20th Year

Circle 71 On Reader Service Card

The MOUSE That Roars . . .



ONLY
3½ FEET
TALL

We all know that great things come in small packages. This 1 kilowatt FM transmitter comes complete in a 42" cabinet. Solid-state efficiency with a single phase power source and the ultimate 802A exciter.

FOR MORE INFORMATION, CONTACT

 **Continental Electronics Corporation**
P.O. BOX 270879 DALLAS, TEXAS 75227-0879
214-381-7161 TELEX: 73-398 FAX: 214-381-4949

Circle 125 On Reader Service Card

DAB at the NAB, U-B There 2

by Judith Gross

FALLS CHURCH, Va. Back to Vegas. The uncertainty of winning and losing ... the metallic clinks ... the cries of joy and despair ... and that's just on the convention floor. Wait 'til we get into the casino!

If you've ever read Hunter Thompson's *Fear and Loathing in Las Vegas*, maybe you



can relate. The man knew how to do Vegas. But then, he never went to an NAB convention.

It's going to be a DAB show. Lots of new products, too. More about that in a bit.

Run, don't walk, on over to where the DAB demo bus will be taking off for half-hour listening tours from the convention center. On the days the show runs, there's only going to be room for a total of 4,500 listeners to hear the Eureka DAB system. (Yes, but will the bus be painted as prettily as the one up in Canada was?)

You'll be able to compare a taped music program coming through over-the-air on Eureka DAB (over TV channel 15, from a transmitter on the Hilton Tower), with the same program over 94.9 on the FM dial.

You'll also be able to hear KLUC over its FM and its AM and compare that to the station's signal transmitted over DAB Eureka as well.

The good folks from Europe are even going to simulate multipath, since Vegas is too flat to show the real McCoy. So you can hear that too. I'll take a ride myself and let you know how it sounded. But space is limited, so sign up early.

Then, as long as your ears are fine-tuned, go on over to Gannett's booth and listen to the system it developed

with Stanford Research Institute. The system was being called "Project Acorn," but the name's been changed to USA Digital. ("USA Today," get it?)

They should be demonstrating a prototype transmitter and receiver for the in-band system on an FM frequency and plan to have mobile tests for car listening, oh, say in about six months at the Radio 1991 show in Frisco.

The latest word on the DAB front is that the NAB-Eureka agreement, which was to have been in place by April 1, will be delayed.

There are differing opinions on what the cause is. NAB's John Abel says the Eureka folks, who have their technical act together pretty well, weren't set up on the business end enough to start the negotiations in time.

Then there are those L-band tests. The DAB Task Force, under urging from new member Randy Odeneal of Sconnix Broadcasting (among others), agreed to see how Eureka works in the 1500 MHz range, which is the most likely band for DAB spectrum.

Odeneal and lots of other Radio Operators Caucus members and their chief engineers have their doubts about it and want some performance tests. He asked the Task Force to make sure that no agreement was set in stone until the tests proved satisfactory.

NAB wouldn't be tied down to any test-caused delay, but the point did not need to be pressed, since the delay in talks would make the April 1 date moot. NAB also says that any agreement with the Eureka folks would have clauses stipulating "pending technical review" etc., etc. (In other words, a potential "loophole.")

Still, it's good to know that those with differing points of view and technical concerns are being represented in the decision-making process. I guess we were a little hasty, Randy. Your concerns had technical merit after all.

Oh yes, and you know the plans for NAB to become a Eureka licensor? At first it seemed like it was for North

America only? Well, now it seems to be moving in a broader direction.

The possibility exists that if the U.S. chooses Eureka as a DAB standard, and other countries around the world are persuaded by that, then NAB could get royalties from around the globe. Today, Boise; tomorrow, the world. And to think, it used to be just a vacuum cleaner. (No, the NAB agreement wouldn't cover vacuum cleaners.)

OK, but on to the new products. What hot stuff is happening at the show? Well,



Just keep rollin' those sixes and eights ...

first, there are digital processors. Go see the Unity 2000 from Cutting Edge at the Bradley and Broadcasters' General Store booths. Gentner will have both the Lazer digital stereo generator and the Prizm digital processor; and Audio Animation will have its paragon (with a lower-case "P") digital processor.

QEI will have a digital stereo generator as well. Ditto, Aphex.

Recordable CDs have some surprise companies in on their development. You knew about Denon; Studer plans one, as does Yamaha.

Two companies who have been mainstays of the radio biz for a long time will unveil digital record/play devices. ITC will show DigiForm, a digital cartridge machine. And Broadcast Electronics will introduce Audiovault, a digital record/store/play/inventory device.

And speaking of BE, when you see Larry Cervon, wish him kudos on the award for significant technical contributions to radio broadcast technology, to be presented to him on Sunday morning at the start of the engineering conference. You deserve it, Larry.

Other digital store/play equipment will be on hand from Otari, MicroMedia, Media Touch, 360 Systems and Computer Concepts. Also from two less familiar names: TM Century and Asaca/Shibasoku.

OK, what else? How about new DAT gear from Sony and Panasonic; solid state FM from Nautel, a digital FM exciter from Harris-Allied; a CD-quality STL from Moseley, ISDN gear from Corporate Computer Systems, Comrex, and Intraplex with multiplexing gear from John Leonard at JNS; a processor with daypart timing from CRL; and production consoles from Pacific Recorders & Engineering and Wheatstone.

Want more? There's a digital logging recorder based on DAT from Eventide; audio data compression from Dolby; Broadcast Audio consoles at Fidelipac and a partridge in a pear tree.

And how'd you like a little gizmo that will take out those annoying clicks and pops from your favorite old vinyl collection? Go see the Cedar/Harmonia Mundi Acustica processor at the Gotham booth.

Wee-hew! There's lots more that I don't have time to tell you about, so you'll have to go and see for yourself.

And now that the war is won, there's a country that needs a lot of pitching in to bring things back to normal. RF equipment manufacturer Micro Communications is lending a hand to help rebuild Kuwait radio. A Kuwaiti rep will be at Micro's booth at the show to talk about what needs to be done. Maybe you can help too.

See ya at the one-armed bandits.

Heard a juicy tidbit? Spill your guts to Earwaves by faxing JG at 703-998-2966 or writing to P.O. Box 1214, Falls Church, VA 22041. You might just win one of those mugs yet.



Unattended operation helps you operate your station profitably. All it takes is a satellite or automation program source, a good transmitter control system, and a way to handle EBS.

You take care of the program source... We'll help with the rest.

A transmitter control system from Burk Technology relieves you of the need to keep someone at the station just to take transmitter readings. Add our exclusive Studio I/O and we'll run EBS for you, too.

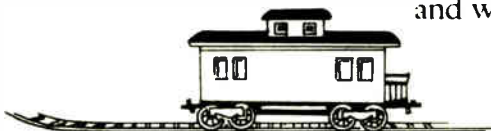

Burk gives you the flexibility to run your station the way you want, and in full compliance with FCC rules.

See us in Las Vegas at Booth 1907. We'll show you a new way to run a railroad.

Call TOLL FREE 1-800 255-8090

BURK
TECHNOLOGY

7 Lomar Drive, Pepperell, MA, 01463 (508) 433-8877

Circle 66 On Reader Service Card

World Radio History

READERS FORUM

If you have comments for *Radio World*, call us at 800-336-3045 or send a letter to Readers' Forum (Radio World, Box 1214, Falls Church VA 22041 or MCI Mailbox #302-7776). All letters received become the property of Radio World, to be used at our discretion and as space permits.

Folded unipole misconceptions

Dear RW,

Recently I've become aware of some misconceptions in the industry regarding the proper operation of folded unipole-type antenna systems. Specifically, some stations are attempting to use folded unipoles and eliminate an antenna tuning unit, with less than desirable results.

Although the theoretical ability to resonate a folded unipole at 50j0 ohms to match the coaxial cable feedline is an attractive way to save the cost of a tuning unit, there are several pitfalls in this method.

First, an important function of an antenna tuning unit is to act as a low pass filter and attenuate harmonic radiation. Failure to properly reduce harmonic radiation can result in significant fines and enforcement sanctions from the FCC. Eliminating the tuning unit also eliminates one line of defense against harmonic radiation problems.

Secondly, the impedance of the folded unipole is determined by its geometrical construction and the specifics of the tower system on which it is mounted. It is not possible, in most cases, to obtain 50j0, necessitating at least a series

resonating capacitor tuning unit in order to match the transmission line.

A further point is that, in my experience with many folded unipole systems, 50 ohms is rarely the impedance where best bandwidth is achieved. At best, it is usually a poor compromise, artificially restricting the inherently excellent bandwidth of a folded unipole system.

The impedance that gives the best possible bandwidth in any given folded unipole system is invariably a complex impedance which requires a suitable antenna tuning unit to match it to the transmission line. Furthermore, with proper design and adjustment, this tuning unit can significantly enhance the bandwidth improvement achieved from proper folded unipole tuning.

The folded unipole is an excellent antenna configuration that can improve AM station operation immensely. However, it is not just a matter of hanging wires on a tower and calling them a folded unipole. Without careful mechanical and electrical design, and knowledgeable attention to details of tuning, a folded unipole installation may be worse than the series-fed installation that it replaces.

I'll be glad to share my experiences with folded unipoles with anyone who is considering this type of antenna. You can call me at 919-757-0279.

Raymond E. Rohrer, P.E.
Greenville, N.C.

The greening of CDs

Editor's note: The following letter was sent to RW News Editor John Gatski, in response to his Cue and Review column of Feb. 6, 1991, on various treatments believed to enhance CD audio quality.

Dear Mr. Gatski,

I have just read your column in the Feb. 6th issue of RW, and you have no idea what you are talking about.

First of all, you do not color the transparent side of a CD with a green felt tip pen. The process involves coloring only the thin outside edge of the disc. Since you didn't know how to do it, you could not have tried it for yourself and then used the ears on the side of your head to listen to see whether it actually makes any difference in the sound.

You are also wrong in saying it's claimed this will "make your worst CD sound like a million dollar production." The only claim is that greening a CD makes a subtle but audible improvement in most discs—smoother and more natural sounding.

The next error is your statement saying it's claimed that coating a disc with Armor All is a cure for "dull sounding CDs." Polishing the surface of a disc with Armor All or some similar product results in a subtle but audible change, not unlike that produced by greening. I have never heard of a "dull sounding" CD. The most common complaint is that they sound too bright, not dull.

It is true, however, that polishing a disc with Armor All is not a good idea since

It's hard to believe that a year has passed since the last National Association of Broadcasters (NAB) spring convention and trade show, but it has. And if ever there was a time to find some way to get to Las Vegas and experience one of the nation's largest engineering gatherings, this is the year.

Judging by the product introductions made at the Paris Audio Engineering Society's show in February, manufacturers will be unveiling a wide variety of innovations for radio broadcasters. In fact, some observers speculate that there may be more new products for radio at this year's NAB than there will be for television.

Convention attendees will also get a chance to experience the technology of digital audio broadcasting. A demonstration of the Eureka 147 transmission system will be going on throughout the show, offering listeners the opportunity to decide for themselves whether DAB may indeed be the wave of the future. Other

Exciting Times At NAB

DAB proponents also will be in attendance, explaining the merits of their own systems.

Of course, there will be other developments in the digital domain. Processing equipment, recordable CDs and disk-based storage and retrieval systems will be among the equipment utilizing the advantages of digital technology to make the broadcaster's job easier.

Exciting, isn't it? But to see all this new equipment—to say nothing of the value of the engineering sessions held during the convention—you have to attend. Wait until next year, and you risk missing out on the cutting edge of engineering.

Some broadcasters may have decided to retain the part of their budget they would ordinarily use for the convention to guard against lean times. Well, without painting an unduly rosy picture of the near future, it may be safe to assume that those lean times are on the way out.

Stock market performance is on the upswing, oil prices are the same as or even lower than they were before the Persian Gulf War—numerous economic indicators suggest that the country is pulling itself out of the malaise in which it has been floundering for the past year.

Attending the NAB convention and trade show is never a waste of time. And this year's gathering heralds the arrival of some of the most powerful tools broadcasters may ever have seen. Join in on the experience, and welcome yourself into the future of radio.

—RW

its long term effects on plastic are unknown.

People who make their livings from digital audio, like mastering engineers, have long complained about differences in sound where no differences should exist. And now, even audio engineers are beginning to admit this. For example, there's an essay by Dr. Roger Lagadec entitled "New Frontiers in Digital Audio," presented at the most recent Audio Engineering Society Convention in Los Angeles. He holds a Ph.D. in Technical Sciences in the field of digital signal processing and is a fellow of the AES. He is now responsible for all digital products at Sony.

In his essay, Lagadec challenges the conventional wisdom that changing a digital signal with a digital fader produces only a change in level accompanied by a slight noise increase. He admits that some previously unidentified phenomena apparently affects the sound.

Dr. Richard Cabot is an authority on audio measurement and testing and is a Vice President of the AES. In a recent interview he says, "there are a lot of measurements that we haven't figured out how to make yet. We really aren't measuring the right things."

Mr. Gatski, stop reading "Stereo (everything sounds the same) Review" where a staffer once said he used to think he could hear differences between amplifiers until it was proven to him that he could not.

Start using your ears, Mr. Gatski. And then, if you can say that you hear no difference, then say it.

Mark J. Weaver
WMAL
Washington, D.C.

Mr. Gatski replies:

Mr. Weaver is correct that green ink must be applied to the edge in order for it to "improve" the sound of a CD. He has,

however, misunderstood the point of the Feb. 6 column.

It was never stated that I had conducted actual listening tests to determine whether the previously mentioned remedies affect CD sound. The column's intent was to show that the green ink theory and other quick-fixes had created a controversy that only can be addressed satisfactorily by scientific A/B listening tests in a controlled testing environment.

At present, I have neither the equipment nor the testing environment to conduct such listening tests. Therefore, any personal listening tests conducted by me would be subjective and unscientific. Unless Mr. Weaver had access to such an environment in his listening tests of green-inked CDs, any conclusion he has reached is subjective as well.

Many audiophiles often think they can hear differences in music, based on unorthodox equipment tweaks that have never been proven through objective scrutiny.

Based on the latest rational information on these CD-enhancing remedies, I concluded that scientific testing likely would prove that these remedies do not alter the sound. Now, if such tests are conducted and the results reveal that people do hear a difference, I will acknowledge such a conclusion. And if there is a difference, engineers and scientists surely will be able to scientifically determine why a colored CD sounds better.

Until then, I stand behind what I've said.

Clarification

A typographical error in the last paragraph of Chris Foreman's article, "SV-3900 DAT Offers Broadcast Solutions" (RW, Feb. 20, 1991) may have confused some readers. The accuracy for locating the SV-3900 to a specific absolute time position under the "Time Search" function should have read ± 1 DAT frame (3.33 ms), and not the values stated in the article.

Radio World
Vol 15, No 6 March 27, 1991

Editor, Alex Zavistovich
Editorial Consultant, Judith Gross
International Editor, Alan Carter
Associate Editor, Charles Taylor
News Editor, John Gatski
Reporters, Benn Kobb, Frank Beacham/L.A.
Editorial Assistant, Debra Green
Technical Editor, John Bisset
Technical Advisor, Tom McGinley

Production Director, Kim Lowe
Chris Freter, Lisa Roach,
Julianne Stone, Lisa Stafford
Ad Production Coordinator,
Regan Deatherage

Publisher, Stevan B. Dana
Associate Publishers, Arthur Constantine
Carmel King

Ad Coordination Manager, Simone Mullins
Circulation Manager, Tiana Hickman
Accounts Receivable, Valerie Mason

Advertising Sales Representatives:
Eastern U.S., Art Constantine
800-336-3045, Fax: 703-998-2966
West & Midwest U.S., Jack Ducart
916-962-2240, Fax: 916-962-2194

Radio World (ISSN: 0274-8541) is published semimonthly by Industrial Marketing Advisory Services, Inc., 5827 Columbia Pike, Suite 310, Falls Church, VA 22041. Phone: 703-998-7600, Fax: 703-998-2966.

Second-class postage rates is paid at Falls Church VA 22041 and additional mailing offices. POSTMASTER: Send 3579 forms and address changes to Radio World, P.O. Box 1214, Falls Church VA 22041. Copyright 1991 by Industrial Marketing Advisory Services, Inc. All rights reserved.

Free subscriptions are available upon request to professional broadcasting and audiovisual equipment users. For address changes, send current and new address to RW a month in advance of the above address. Unsolicited manuscripts are welcomed for review; send to the attention of the appropriate editor.

Next Issue
Radio World
April 10, 1991

Introducing

THE WIZARD™ from Belar FM Digital Modulation Analyzer



Belar, the world leader in RF test and measurement systems, brings you a new generation in FM modulation measurement. The WIZARD™ features include:

- Menu driven—16 character alphanumeric display
- Deviation in percent—0.1 or 1 percent increments
- Deviation in kHz—0.1 or 1 kHz increments
- Up to 0.1% accuracy—function of demodulator calibration
- Self calibration to external calibrating signal
- Pre-set peak mod—adjustable in 0.5% increments
- Pre-set PPM—adjustable from 0 to 100 PPM
- Variable peak hold time—adjustable in 0.5 second increments
- Peak weighting mode—time constants are menu selected
- Real time mode or past time mode
- Provision for pilot injection measurement from FMS-2
- Provision for pilot modulation measurement from FMS-2
- Provision for SCA injection measurement from SCM-2
- Silent sentry alarm—adjustable in time and threshold
- Will accept external alarms—such as off frequencies from FMM-4A
- Alarms read on menu—menu will cycle if two or more are present
- Modulation adjust on two ports—adjustable in 0.5% increments
- RS-232 port—provides computer graphs and remote operation
- Three level password protection—look only, change, and manager
- Either infinite window histogram or sliding window histogram
- Optional FM precision demodulator that will remotely self calibrate
- One rack height panel space—including precision demodulator

Sample PC Output

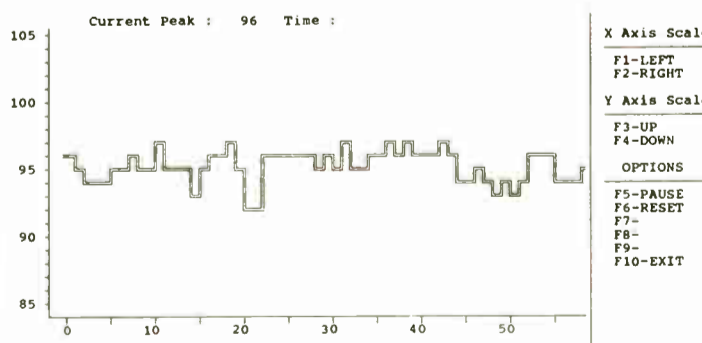
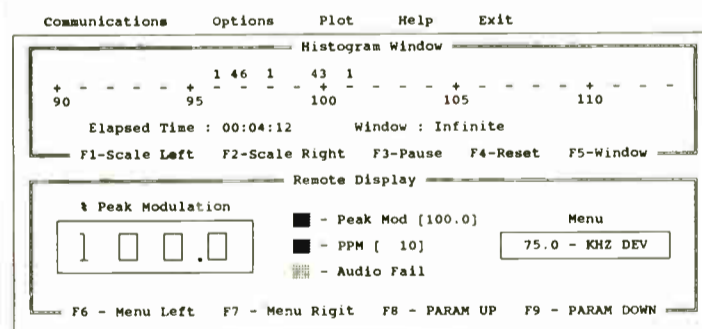
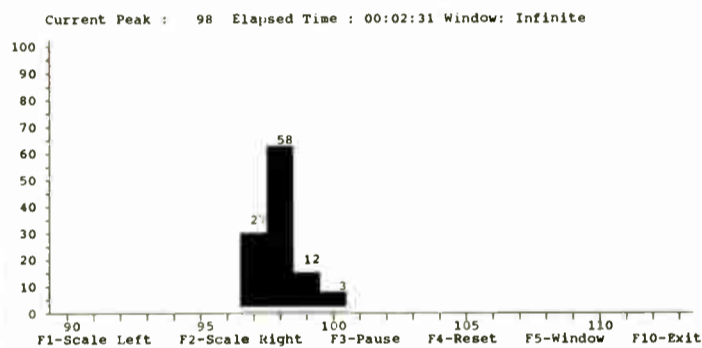
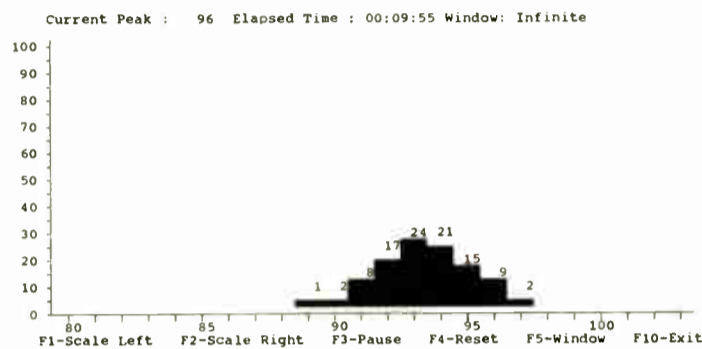

Sample Setup Menus

- SELF CALIBRATION
- SAVE CONFIG
- BLANK - ON
- TIME MODE - REAL
- DEV 75.0 KHZ
- HOLD 1.0 SEC
- PEAK MOD 100.0 %
- REMOTE - OFF
- INFINITE - ON
- PILOT INJ 9.0 %
- SCA INJ 10.0 %
- PK WEIGHT - OFF
- RES- 1.0 PERCENT
- PPM THRESH 10
- PPM COUNT 10
- SENTRY 10.0 %
- SENTRY 30.0 SEC
- MOD ADJ- 0.5 %

For details, price and delivery information, contact Belar or your authorized Belar dealer

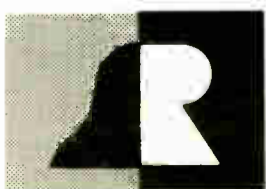

BELAR

ELECTRONICS LABORATORY, INC.

LANCASTER AVENUE AT DORSET, DEVON, PENNSYLVANIA 19333 • 215-687-5550 • FAX: 215-687-2686

See Us at NAB Booth 1448

Circle 104 On Reader Service Card

Where Accuracy Counts ... Count on Belar

DAB Plan's Support Not Total

by John Gatski

WASHINGTON Broadcast equipment manufacturers see both good and bad in NAB's recent endorsement of the Eureka 147 digital audio broadcast (DAB) system, according to company officials' initial reaction.

The NAB's Radio Board endorsed Eureka in January and the association has pledged to work for swift implementation of the system as the future U.S. DAB standard. The NAB also plans to be North America's Eureka technology

licensor through its separate development arm, NAB Technologies Inc.

Some companies have said the NAB knows what it is doing and has enacted a good DAB plan. Others have questioned the need to move so quickly when other systems have not yet been evaluated.

Gentner Electronics Product Development Director Bill Gillman said his company is still evaluating Eureka as well as other DAB systems.

Gillman said NAB's Eureka support and potential licensing arrangement

could be a mixed bag. "The NAB represents existing broadcasters. We are happy the NAB is making a definite decision on something," he said.

Licensing uncertainty

However, he said, there are other systems that have just been introduced that need to be evaluated.

Also, Gillman noted, NAB's objectivity could be influenced since it will be making money from the Eureka licensing and may stick with it no matter what happens. The NAB was similarly involved with FMX, he added, and that technology has not done well.

With all the talk of DAB, some stations may consider delaying new equipment purchases, according to some industry watchers. Gillman said that is unlikely for studio equipment, although management may decide to delay transmitter purchases, depending on how long it takes DAB to become a reality.

Continental Domestic Sales Director Walt Rice said he is disappointed that NAB endorsed Eureka so quickly. "I think it is rather premature to even comment about, let alone embrace it," he said.

He said the NAB should withhold support of any systems until after WARC '92 and after other systems have a chance to be evaluated.

QEI Senior VP Bill Hoelzel said it is too early for companies to worry about DAB at this point. "By the time the dust is settled politically, it will be many years down the road," he said.

Currently, he said his company is looking more into the evolution of solid state transmitters than DAB equipment.

Politics unimportant

Moseley Associates VP Jamal Hamdani said his company does not care which DAB system or standard is ultimately chosen.

Moseley does not plan to involve

itself in the political process of choosing a standard, except for responding to technical questions involving digital transmission, Hamdani said.

"We welcome new technologies as long as they provide real solutions to real problems. Eventually there is going to be digital transmission. It makes no difference to us. Ultimately it comes down to ones and zeros," he said.

Moseley will show a digital STL at NAB that is compatible with Eureka transmission, Hamdani added.

In referring to the NAB's Eureka endorsement and DAB plan, Denon of America President Robert Heiblim said the U.S. should not hastily make a decision about DAB.

"We owe it to ourselves to take a couple of years and come up with a good system," he said.

Heiblim predicted that a U.S. DAB system is still three to five years away.

Eureka Demo Slated

by Judith Gross

LAS VEGAS The first over-the-air demonstrations of the Eureka 147 DAB system are slated to begin with the start of the NAB convention here, April 15-18.

Last year's convention featured a closed-circuit Eureka demo only, but elaborate preparations have been made to let convention-goers judge the quality of a digital signal for themselves.

A Eureka DAB transmitter, capable of sending out eight stereo program channels, is to be set up on top of the Las Vegas Hilton tower. A "gap filler" booster will also be set up at the Golden Nugget hotel in the downtown section of the city.

The gap filler is to be used to introduce signal delay, similar to multipath, to demonstrate the multipath canceling effects of Eureka, since Las Vegas is flat and relatively free of such interference problems.

Up to 2,000 W ERP (200 W per channel, with eight program channels plus two data channels) will be used to transmit DAB signals over UHF-TV channel 15. The eight channels will broadcast stereo programs of different formats—seven of them generated from a DAT tape source and one as an audio feed from Las Vegas station KLUC-AM/FM.

In addition, a low-power FM station will be sent out over 94.9 MHz at a maximum power of 200 W. The FM station will be broadcasting the same program as the DAB stations.

Every half hour, buses specially equipped with a DAB, FM and AM receiver will travel from the convention center on a listening tour. The bus can accommodate 40 passengers and listeners will be provided with headphones.

The listening test will allow a listener to hear a direct comparison between the DAB signal, the FM station on 94.9, and, in the case of KLUC's signal, compare those two signals with over-the-air FM and AM signals.

Unfortunately, the NAB estimates that only about 4,500 listeners will hear the DAB demo during the show, so early sign-up is being encouraged.

In addition to bus tours, DAB receivers and multipath simulation will be set up at the Eureka DAB booth inside the convention center, Eureka partners are traveling from Europe to be present to answer questions, and two sessions on DAB technology are slated.

Multiple Amplifier Arrays
Have them your way!
 Four or eight channels for YOU to easily configure as Microphone, Line Buffer, Distribution and Level Matching Amplifiers. Form sum and difference networks, Interface phone lines, Drive headphones, Make a simple Mixer or Press Box... just by changing jumpers. Gains to 82dB, Low noise balanced inputs. Clean +24dBm active or transformer balanced outputs.

Configurable circuitry... to fit your needs.
 Call or write for free detailed brochure.

AUDIO TECHNOLOGIES, INC.
 328 W. Maple Ave., Horsham, PA 19044
 (215) 443-0330 • FAX (215) 443-0394

Air Cooled Dummy Loads now in power ratings of 5kW, 10kW, 15kW, 25kW, 35kW, 50kW, and 75kW with low VSWR that is stable under power with a frequency range of 60hz to 240Mhz.

QUIET COMPACT PORTABLE

ALTRONIC RESEARCH INC.

For (OMEGALINE) RF Coaxial Load Resistors

WATER AND AIR COOLED MODELS FROM 5 to 200KW

CALL TOLL FREE 1-800-482-LOAD

P.O. Box 249
 Yellville, AR 72687
 (501)449-4093

Broadcasters Differ on Eureka

(continued from page 1)

Ron Strother said, "It's surprising that a trade association would take such an aggressive approach in endorsing, or attempting to license, a technology, especially a foreign technology."

Strother—a long-time advocate of DAB system testing for implementation in the U.S.—said, "There are some very sensitive industry and regulatory issues that arise from any selected DAB system. It is unfair to the (NAB's) membership to endorse, or license, a system before issues such as AM parity, classifications, coverage and licensing have been properly addressed."

CBS Radio Division's Director of Technical Operations Tony Masiello said he had no problem with the NAB pursuing a DAB technology or any major complaints about Eureka as a DAB system. But, he added, the NAB may be "moving too fast on a technical standard."

Masiello, a proponent of Project Acorn—Gannett Broadcasting's in-band DAB transmission system—said problems arise when talking about "adapting the Eureka technology to the U.S. system of broadcasting." These problems are made worse with NAB's endorsement of Eureka, he added.

Masiello said the NAB's selection of Eureka eliminates the most logical forum for DAB discussion. "NAB has been the forum, but the moment they choose to endorse a particular tech-

nology, they can't moderate the process," he said.

Masiello suggested that the NAB put off endorsement of any system for one or two years so alternate systems can be demonstrated. He also pointed out that as of yet there "has been no demonstration of Eureka at 1500 MHz."

Extremely premature

David Doughty, CE for H&D Broadcast Group, which owns seven AM and eight FM stations, said his company feels that Eureka's promotion as a U.S. DAB standard is "extremely premature." Doughty suggested "extensive, real world tests" would be required "to prove the system viable."

H&D believes that the recently introduced Gannett in-band DAB system is more compatible with U.S. broadcasters and would be less expensive, according to Doughty. He noted, however, that practical testing of the Gannett system also is required.

Not all broadcasters think the NAB is acting rashly, however. John Marino, of Marino Broadcast Associates, said he had "faith in NAB's Science & Technology department to come to the correct technical decision" regarding a DAB transmission system.

"At this stage of the game, I think (Eureka) is the best choice. Other proponents don't have enough hard data," Marino said. While he acknowledged

that some data is lacking in Eureka too, Marino pointed out that the system is the furthest along.

Marino is opposed, however, to the NAB being the North American licensor of the technology. "The NAB should guide the industry for a standard, but licensing opens up a lot of questions regarding (the association's) motives. To remain objective, it would be better for the NAB to stay out of licensing," he said.

The industry could lose a valuable forum for discussing DAB issues.

While he stressed that the NAB "probably almost politically had to make decision" on a DAB system, Marino cautioned that the association "should be flexible enough to change their minds" if a better system is proposed later.

Eureka's role noted

National Public Radio (NPR), in a prepared statement, acknowledged the contributions of Eureka 147 to DAB, but cautioned against hastily adopting a system. "Eureka promises improved sound, spectrum efficiency, and freedom from interference, but it has not been field-tested under the conditions found in the United States," the NPR statement read. "NPR supports the move toward digital radio broadcasting, although we believe that adoption of a specific system at the present time would be premature."

Tom Bracanovich, VP of engineering for Malrite Communications, which owns four AM and six FM stations, commented that there was nothing wrong with NAB's endorsement of Eureka and intention to license the technology, "providing broadcasters are accorded terrestrial rights."

Satellite distribution would not be appropriate, he said, because "you can't have diversity" with a satellite system.

Bracanovich added that any concerns

about DAB are premature, as "it's still at least five years before implementation of the system."

At least one broadcasting organization is convinced that Eureka is the right system for the NAB to endorse. Dennis Ciapura, senior VP for Noble Broadcasting, which owns eight AM and ten FM stations, said the Eureka system is "excellent—as good as we probably need to get."

He said the system is still evolving and does not have to be locked into a particular set of parameters at this point.

Misconceptions about Eureka

Many misconceptions exist about the effectiveness of the Eureka system, Ciapura said, including concerns that it might not work at the proposed 1500 MHz frequency, that it may require "millions of watts to transmit" and that it may suffer from coverage problems similar to cellular systems.

The digital signal's propagation characteristics are "more robust" than analog, Ciapura pointed out, disputing concerns about the system's effectiveness at penetrating buildings at 1500 MHz.

As to concerns of higher power requirements for Eureka, he noted that Canadian tests have shown that "while higher power might be required, if you pull the power back to the point that you start to get bare spots, you can fill in with repeaters." The Canadian tests also indicated that the digital transmission holds up better at weak signal levels than analog, Ciapura said.

Allegations that Eureka may suffer from the same problems as cellular systems are "based on the fact that it uses multiple antennas, like cellular systems," he commented. But, Ciapura said, the Eureka system "provides more even coverage than analog systems," and concerns about problems like those in cellular systems are unfounded.

Despite his support of the Eureka technology, Ciapura disagreed with the NAB's efforts to become the North American licensor of Eureka. Having a subsidiary of the NAB owning the technology would pose difficulties if problems are discovered with the system, he said.

"It would be tough for the NAB to be critical if something comes up, as it would have an equity participation" in the technology, Ciapura noted.

NEW!

PORTABLE ONE

AUDIO PRECISION QUALITY IN A PORTABLE TEST SET

PORTABLE—AFFORDABLE—EASY TO USE

Just press a button and take a measurement!

- amplitude
- phase
- two-channel level
- noise
- frequency
- amplitude ratio
- THD + N
- wow & flutter
- crosstalk
- IMD*
- generator load
- AC mains check

The Portable One—a two-channel analyzer at the price of single channel competitors!

\$4,000*

Audio precision

PO, Box 2209, Beaverton, OR 97075
503/627-0832 1-800/231-7350
FAX: 503/641-8906, TELEX: 283957 AUDIO UR

(U.S. Dollars, includes 1 year warranty, excluding IMD option or soft case)

Manager, Technical Regulatory Affairs Staff Engineer

We're looking for two talented professionals who can provide responsive technical support for the Science and Technology department of the National Association of Broadcasters.

As Manager, Technical Regulatory Affairs, your responsibilities would include policy and technical support for NAB's representation of the broadcasting industry before the FCC and other federal agencies; service to NAB member radio and television stations; and representation of NAB on industry and government/industry technical committees.

As Staff Engineer, your responsibilities would include assisting with policy and technical development of Digital Audio Broadcasting (DAB) systems; working with the National Radio Systems Committee (NRSC) and other radio/technical committees to develop technical standards that improve the sound available to radio listeners; and service to NAB members and Conventions.

For either of these positions, you must have a BSEE (or equivalent); strong writing skills; some public speaking experience; and the skills necessary to effectively interact in professional and executive-level environments. Broadcasting experience helpful. NAB offers a competitive salary and benefits package, a challenging work environment, and great people. NAB is an Equal Opportunity Employer.

If your experience suggests an excellent fit with either of the above positions, please send your resume (with cover letter) to:

Professional/Technical Employment
NAB Science & Technology
1771 N St., N.W.
Washington, DC 20036



DAB Demos Held At Paris AES Show

by Alan Carter

PARIS European developments in digital audio broadcasting (DAB) were a number-one item on the agenda at the 90th Audio Engineering Society (AES) European convention, held here in February.

In addition to a session outlining the

that receivers will have to be very versatile.

Comments also focused on "getting the system right" so that first-generation receivers would not become obsolete.

An "affordable" consumer receiver is not expected on the market before the first quarter of 1995, while second generations may be out in consecutive years "at still



The MUSICAM decoding process reconstructs the audio signal with a bandwidth up to 24 kHz, by using a filter network.

work of the Eureka 147 project, a demonstration of the transmission system was held using computer simulation.

The demonstration, organized by the CERIM (TDF) and CCETT—two French research centers—simulated degradation of the transmission channel in 3.5 MHz bandwidth. The computer simulated multipath and the speed of reception in a moving vehicle, and showed the effect within a DAB versus FM comparison.

Although much has been done on the DAB front, a definitive standard for Europe is not expected to be selected until late 1992, according to comments made at AES.

DAB also is not expected to be broadcast in the same frequency range throughout Europe. Germany is considering the range between 174-230 MHz, while the USSR has selected 87.5-108 MHz, according to a European Broadcasting Union (EBU) study.

Because of the possible selection of different frequency ranges, it was stressed

lower prices." No dollar figures, however, were attached to those suggestions.

Terrestrial DAB service is likely by 1995, followed by satellite broadcasting. Eureka, according to its developers, was designed



The MUSICAM algorithm used in Eureka 147 divides the spectrum into a number of sub-band signals and into digital frames.

to be a hybrid system, combining terrestrial and satellite delivery.

Projections are that a Pan-European DAB service could be on line by the year 2000.

A final point in the presentation for broadcasters was that initial operational cost for DAB "will be high" because of simulcasting. The transition period was estimated at 15 years.

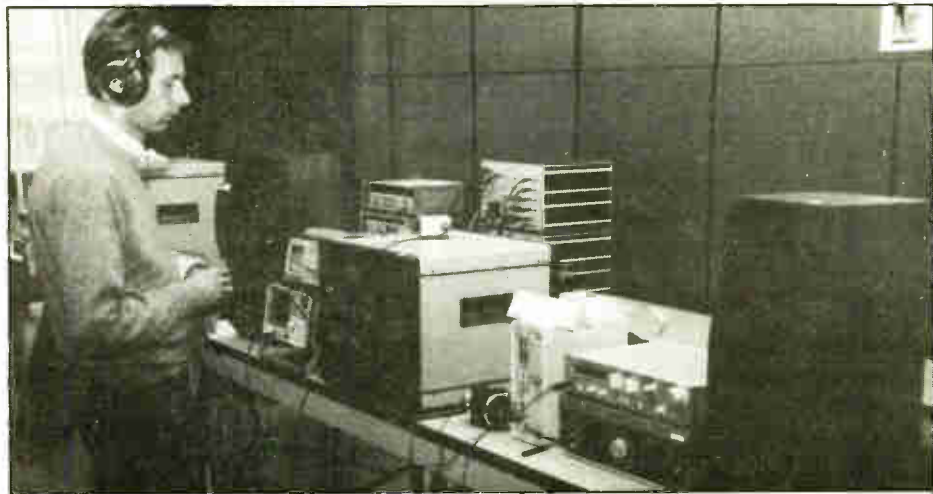

The Eureka 147 demonstration at AES allowed listeners to compare DAB and FM through computer simulation.

One For The Road

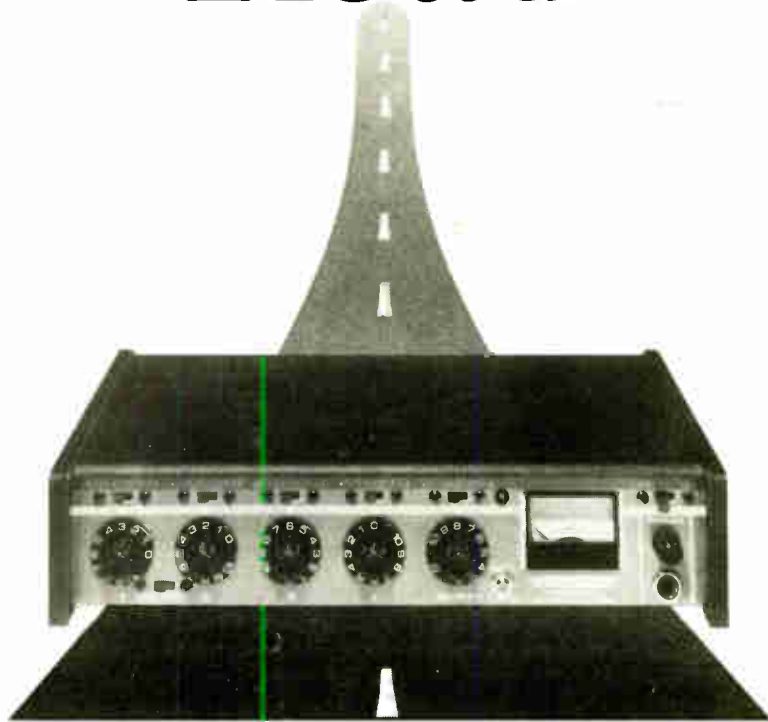

The Shure M267 Mixer

When it's time to take the show on the road, don't take any chances with just any portable mixer... invest in an M267 mixer from Shure and BSW. The M267 is the most popular choice of broadcast professionals who need a mixer designed for field use and field abuse. Features such as four mic/line inputs, transformer balanced output, headphone amplifier, peak limiter, battery and AC power, and tone oscillator make life on the road enjoyable.

Available now for just \$349.00

Visit BSW at NAB Booth #1808

BSW[®]

BROADCAST SUPPLY WEST

America's Full-Time Broadcast Supplier

1-800-426-8434

ORDERS • INFORMATION • SPECIFICATIONS
BSW • 7012 27th Street W • Tacoma, WA 98466 • FAX 206-565-8114

"Folksy" Station Turns a Profit

Small Market S.C. Station's Success Attributed to WRIX Owner's "Personal Touch" Philosophy

by Frank Beacham

ANDERSON, S.C. During his morning broadcast, Matt Phillips takes a phone call live on the air from a blind woman who has lost her dog. By day's end, the dog is found by another listener and returned to its owner. The next morning the blind woman calls in her tearful thanks to Phillips on the air.

A new business opens in town. Phillips drives a mobile broadcast van to the newcomer's parking lot, switches on his Marti transmitter and goes on the air live to welcome the new business. The proprietor, stunned and overwhelmed by the unexpected treatment, signs an advertising contract on the spot.

Phillips and his morning talk show partner, Bev Brandon, begin their three-hour program with a cup of coffee, the morning newspaper and a list of advertisers to plug. When it's time to do a top-priced \$35 one-minute spot on the air, listeners hardly know it's a commercial.

What sounds like chit-chat about old friends is only recognizable as a radio spot at the end when the phone number and address are mentioned. Oh, and forget the clock—60 seconds is only the

starting point for a spot on "The Matt & Bev Show." "We give away a lot more than we sell," Phillips says.

Good times in small radio

Welcome to small town radio and the world of Matt Phillips, owner/operator of WRIX-FM/AM, which covers a handful of small rural towns in upstate South Carolina's Anderson County. In WRIX country, business is better than ever, broadcasting is still fun and radio listeners clearly appreciate their local station.

In fact, Phillips credits his keen attention to the local community as the key reason he has never lost money in the more than 20 years his stations have been on the air. "My ambition has always been small town radio," the modest, soft-spoken Phillips says. "I've never wanted to compete for high numbers. I've tried to prove you can run a down-to-earth radio station and a lot of people out there still want that kind of operation."

Phillips started WRIX-FM in 1977 and six years ago signed on with the AM sister station. WRIX recently doubled its FM (103.1) power to 6,000 W and added a new 400-foot tower. It plays an alternate mix of traditional country music with new country "hits" around the popular morning



WRIX owner Matt Phillips, on the air.

talk show. The AM (1020) side is a 10,000 W daytimer with a gospel format.

When he started his station, Phillips was the little guy in the county beside two 100,000 W FMs. But in recent years the larger stations abandoned the market, seeking bigger ratings and more dollars in the nearby, lucrative Greenville-Spartanburg market. WRIX is now the only FM station in Anderson County.

Phillips is keenly aware of new technologies challenging traditional radio broadcasting, but thinks the future of local radio is brighter than ever. In fact, he is tempted by all the bargains he sees, especially among AM stations.

Small AMs for sale

"We've seen some stations go under in this area. I do get a hankering every now and then to buy one because I know what I could do with that station to make money," Phillips says confidently. "So far I've resisted, but there are some real bargains out there."

Phillips says lack of revenue has

caused several small stations in his area to fail. This is partially due to competing media, especially local spots in cable television that often undercut radio prices, he says.

He blames outside investors, attracted to radio investment when the three-year ownership rule was changed, as being "bad for the radio industry."

"A lot of stations don't remember what they are licensed for," Phillips says. "I think they think they are licensed for 12 (records) in a row and all the commercials they can get on. I see less and less of a community commitment to radio. To serve the community is the purpose of radio."

Phillips believes the key to the success of local radio in the 1990s is community involvement. This means on-air personnel contribute time to civic organizations such as Meals on Wheels, The Salvation Army and Crime Stoppers. Most of his air personalities also sell, write and produce spots on a commission-plus-salary basis.

(continued on page 12)

Ellason E250 Color Radar

Real-time local radar coverage for your entire audience.



- Detects snowfall as well as rain and thunderstorms.
- Five selectable ranges up to 200 miles.
- Operator selection of antenna tilt, receiver gain, two separate graphic overlays, and automatic operations.

- Optional larger antenna to provide better snow detection.
- Picture storage to determine weather changes.

For complete information, call 314/532-3031, or write Ellason Weather Radar, 747 Spirit of St. Louis Blvd. Chesterfield, MO 63005.

1-800-727-2327



ELLASON WEATHER RADAR

Circle 50 On Reader Service Card

Grab a pencil! It's Sine Systems' second annual year end . . .

Pop Quiz

Complete the following section if you currently have a dedicated loop remote control:

- I am paying more than \$20 per month in dedicated loop charges. False True
- My remote control is frequently damaged by lightning.
- My remote metering calibration drifts out of tolerance frequently.
- My remote control requires costly, hard to obtain, and difficult-to-install, parts.
- I often wonder if my remote control will work when I need it the most.
- I would like to check my transmitter remotely without having to go through a DJ.
- I would like direct, emergency access to my transmitter from the nearest telephone.
- The last time my remote control got hit by lightning, I got hit with a \$500 repair bill.

Complete the following section if you currently have a dial-up remote control:

- My remote control is somewhat difficult for non-technical personnel to operate.
- My remote control took more than one hour to install and program.
- I have to consult my instruction book to make a simple programming change.
- I could have put my kid through college with what I paid for my remote control.

Complete the following section if you currently do not have a remote control:

- It would be valuable to control my transmitter or automation system remotely.
- I could reduce staffing or other costs by simulcasting with a sister station a portion of the day with my transmitter remote controlled.
- I would find it beneficial to establish a "control point" outside the station for nighttime or weekend operation.
- I would tell Saddam Hussein his mustache was on crooked for a remote control that could pay for itself and start saving money in as little as 15 weeks.

If you answered two or more questions with "true" you need to call us for a free information kit on the industry's most cost-effective remote control: the RFC-1. It's built to last, yet it's inexpensive, easy to install and simple to operate. Join the ranks of satisfied RFC-1 users all over the country and next year you'll pass our quiz with flying colors!

Now shipping software version 3.06! Call about upgrade kits.

For more information call: (615) 228-3500

Thanks to all for another great year! Best wishes from . . .

SINE SYSTEMS

3704 Inglewood Cir. S., Nashville, TN 37216-3310

Circle 37 On Reader Service Card

NAB: Keep an Eye on Digital

by Mel Lambert

STUDIO CITY, Calif. For me, the dominant technology at the upcoming NAB convention will be digital. As a growing number of broadcasters make the commitment to digital recording and playback hardware, transition to an all-digital production and transmission medium becomes even shorter.

Experimental licenses issued by the FCC will allow more of us in the trenches to experience the enhanced frequency response, reduced noise and multipath elimination available from these emerging digital audio broadcasting techniques.

Within the production and air studio, we are now being offered an increasing number of choices for record and playback systems. As I have discussed previously within these pages, radio broadcasters face possibly unique hardware requirements: They need to trigger the replay of virtually hundreds of audio segments recorded on a variety of media, including vinyl, CD, DAT, hard disk, NAB cart, reel-to-reel and so on.

Until now, accessing that material in a random order, and maybe sequencing it for programmed playback, has either been assigned to an agile DJ or audio technician, or a dedicated, computer-controlled automation system.

Watch the change

The age of digital, of course, is going to change all of that. In Las Vegas, I expect to see an expanding number of disk-based systems that have been designed specifically to streamline the real-time and sequenced replay of music cuts, commercials, jingles, liners, station IDs, news cuts, PSAs, etc.

Also on the immediate horizon are refinements in the user interface of such systems, including developments in touch-screen, "point-and-click" selection, for example, to provide on-line random-access to cuts from a library, as well as to simplify the editing and revision of existing playback sequences.

Just around the technology corner are developments in the areas of complementary hardware/software interfaces, which allow a bank of stop/start switches located on the operator's console to be remapped—and even labeled via convenient LED readouts—to suit the current application.

Recent advances in erasable magneto-optical drives also will pave the way for cost-effective, removable media. Adding or deleting commercials from the station's current library, for example, or enhancing its revolving playlist, will simply require the loading of the appropriate 560- or 1.2-Mbyte platter.

Four, six or more

And the new generation of data-compression systems being demonstrated at NAB will allow four, six, eight or more times as much data to be packed onto magnetic and optical drives, for extended on-line storage and replay times.

A growing number of broadcasters already are using data-reduced terrestrial, satellite and STLs based on T1 and fractional T1 highways. The future can only see an accelerated use of such techniques to ensure CD-plus audio quality

for the material leaving and entering the station via hardware, fiber-optic and microwave channels.

As a viable alternative to hard-disk playback—and also to provide extended replay times—the new generation of remote-controllable DAT machines will also be worth checking out.

An array of DAT transports can be set up under computer control to provide automated music and commercials replay of longer cuts within the air studio, in addition to a variety of playback and mastering duties around a production facility. Pivotal to these and other

uses will be the ability for the various transport and system functions to be controlled from an external computer or automation system.

Several decks are now available that offer either parallel and/or serial control of various transport modes, or come complete with wired/IR hand-held remotes. Bidirectional serial control is the key in most applications, however, simply because it allows a variety of vital information to be extracted from the DAT machine.

Such data might be used to verify that a specific stop/start command had been received by the designated deck, for ex-

ample, and is now being acted upon; to access status functions, such as transport mode, replay levels and interpolated error rates; or to command the transport to output its current PNO location and Absolute Time.

All in all, the upcoming NAB show will allow us to evaluate the various technical and operational alternatives now facing the digital-conscious broadcaster.

■ ■ ■

Now principal of Media&Marketing, a consulting service for the professional audio industry, Mel Lambert can be reached at 818-753-9510.

Only TFT offers you a choice in STL's to achieve digital quality sound

(in 250 kHz RF spacings)



Composite STL

or Reciter™ STL

This new aural STL Transmitter and Receiver combination, evolving from our 20 years of broadcast experience, offers digital quality sound at a reasonable cost. Both transmitter and receiver are frequency-synthesized and field-programmable. Patented IF modulation in the Model 9100 Transmitter insures less than 0.02% THD, at least 90 dB SNR and more than 60 dB stereo separation. The Model 9107 Receiver provides 0.05% THD, 80 dB SNR and 55 dB stereo separation. It has built-in auto change-over feature for hot-standby. Options include built-in stereo and/or SCA decoder. Another TFT first is an exclusive, **STANDARD 5-YEAR WARRANTY.**

For digital quality sound and improved market coverage, the Model 8900 Reciter functions as both an STL receiver and 50-Watt FM exciter. By eliminating the demodulation and remodulation that occurs in a conventional STL, the Model 8900 further reduces noise and distortion. Several Reciters, can form a completely synchronous FM broadcast system, matched in carrier phase, RF delay equalization, and modulation level... all in a system requiring a spectrum efficient space of only 250 kHz.

See your local TFT representative or contact us directly and discover the innovations in STL equipment from TFT.

TFT INC

TFT Inc.
3090 Oakmead Village Drive, P.O. Box 58088
Santa Clara, CA 95052-8088
Tel 408-727-7272, FAX 408-727-5942, 1-800-347-3383

See us at NAB Booth 1420

Sound Quality for 20 Years



WRIX's Phillips conducts a remote broadcast in front of his station's mobile van.

Profitable S.C. Station Responds to Market

(continued from page 10)

"After doing a talk show for nine years, just about everyone in the community knows us by name," Phillips says. "That is a major benefit. Another is remotes."

Remotes are fascinating

"There is still a fascination for people with live remotes. They'll ask us to play a favorite record and stand by until we play it," he says. "It makes a lasting impression for a lot of people. Even if

a big crowd doesn't show up at a business for the remote, the business owner will hear from listeners about it for the next two weeks."

"Remotes are very important to us," Phillips continued. "Marti helps us tremendously. I believe a station should take the money they spend on newspaper ads and billboards and put it into a good-looking remote van and a Marti system. It can work wonders for their image."

WRIX-FM and AM sold about \$500,000 in annual spots before their recent power increase, from a client list of over 1,000 local businesses. Spots range from \$8.00 for 30 seconds to \$35.00 for a morning drive 60-second spot. Remote broadcasts cost \$250.00 per hour.

WRIX owns two mobile units and six Marti transmitters. Some Marti's are left at permanent remote sites such as churches or the live Saturday night bluegrass music show from nearby Hartwell, Ga. "They just turn on the Marti, do the program and turn it off when finished," Phillips says.

Though his station is measured against and is competitive with far larger stations in the surrounding markets, WRIX does not subscribe to a ratings service. Spot sales are very personal, according to Phillips.

"We know most of our sponsors personally and we say—in a joking way—almost anything about them," Phillips said. "We can kid them and good-naturedly insult them."

Results are the bottom line

"We can say how bad their hot dogs are or how lazy the owner is. Some stations sell numbers, but we sell results," he says.

A sign painter for Coca-Cola (they called it "commercial artist") before entering radio 30 years ago, Phillips has owned three stations, learning some hard lessons about station management and ownership.

"I know there are some examples of successful absentee ownership, but that has not been my experience with small stations," Phillips says. "If you want to make money with a station, don't turn it over to somebody else to run. You will never get more involvement from anyone except the owner because it's his hard-earned money invested in the station."

"When I was building this station and was away from another station I owned, I saw it begin to deteriorate. It works best when the owner is involved on the air and in the office," he adds.

Matt Phillips is content these days as he ponders the future. Recession or not, he expects 1991 to be his best year yet in radio. He is confident his formula for successful radio will continue to work.

And he might—just *might*—buy another station if the timing is right. "I've often thought if I could have a maximum power station and run it like a little station that I might have something that would be very popular," he said with a gleam in his eye.

■ ■ ■

Editor's Note: More than 25 years ago, RW's LA writer Frank Beacham, then a high school student, worked with a young disc jockey named Matt Phillips at WHPB Radio in Belton, S.C. Beacham has been watching and learning from Phillips ever since.

Tunable Notch Filters 22 - 900 MHz

For suppression of interference to electronic systems:

- VHF/UHF Systems
- Broadband LAN
- Mobile Radio
- Paging
- CATV
- FM
- TV

The 6367 series comprises 6 separate tunable notch filters, each of which covers an approximately 2:1 frequency range with adjustable 3 dB bandwidth.

In CATV, LAN or other Broadband Data Systems, adjacent channel or FM carriers often interfere with reception of a desired channel or data frequency. The notches offer a convenient means of suppression.

Paging Transmitters often overload CATV and other off air reception systems. The exact frequency is often unknown to the offended party. These filters offer a convenient means of "search and suppress."

Mobile Radio receivers often experience intermodulation in their front end, due to reception of a strong, unwanted carrier. These filters offer "front end" insurance against such intermodulation or desensitization.

Laboratory applications include suppressing discrete, unwanted carriers to increase the accuracy of spectrum noise measurements.

Standard models delivered in 3 days.

Need FASTER delivery? Need a SPECIAL notch filter?

Need any kind of filter 1 MHz - 26 GHz?

Then PHONE or FAX NOW!

Ask for an RF Filter Engineer.

Tunable Notch Filter Type 6367

Standard Models 6367



Model #	Tunable (MHz)
6367-0	22 - 35
6367-1	30 - 50
6367-2	50 - 108
6367-3	108 - 216
6367-4	216 - 450
6367-5	450 - 900

Bandwidth Adjustment
1-5 MHz min.
Notch 20 dB approx. for
Bandwidth=3 MHz
Standard:
75 ohm F conn.
50 ohm BNC

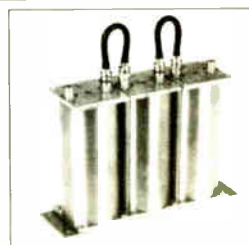

Special models available, including double and triple resonator types with 40 dB and 60 dB notches.

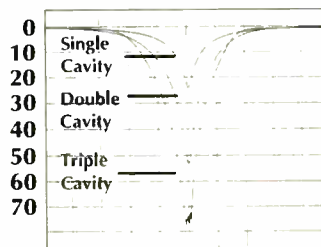

Response of single, double and triple cavity notches with same 3 dB bandwidth.

Other connectors available including SMA, TNC, N, C, UHF.

Standard Models \$152.00 - 3 Days Delivery
Overnight delivery available.

"We Make Filters In A Hurry For Customers In Trouble!"

Details of 6367 series notch filters are given in FREE catalog RF/88, which also describes:

- Low Pass/High Pass
- High Power
- Bandpass
- Bandstop
- Preselectors
- Diplexers
- Tunable Notch

RF/88: RF Filters
0 - 1000 MHz



Also, ask for FREE catalog The Filter Book - FB/87, a guide to specifying microwave filters.

FB/87 Guide To Specifying
Microwave Filters.



Filters For All Electronic Needs: CATV, SMATV, In-House TV/LAN, Satellite, LPTV, FM/TV Broadcast, Mobile Radio, Microwave TV (ITFS/MMDS), RF/MW Communications, Radar, Navigation, Electronic Warfare, Medical/Physics Research

Microwave Filter Company, Inc. •6743 Kinne Street•East Syracuse, NY 13057

Toll Free(USA/Can.): 1-800-448-1666•Collect(NY/AK/HI): 315-437-3953•FAX: 315-463-1467•Telex: 246-613

And now for something completely different

You've never seen anything like it before.
Because no one ever made anything like it before.
You'll simply have to feel it to believe it.
It's called the Auditronics 800 radio console.
It's got a new number because it's all new.
New features. New functions. New technology.
New performance. New ergonomics. New cosmetics.
Built to a new standard of excellence.
For the radio broadcaster who must have the best.

New 800 radio console.
From Auditronics, of course!
See it at NAB exhibit 1258.
Or call us now for detailed information.



Auditronics, Inc., 3750 Old Getwell Road, Memphis, Tennessee 38118 • 901-362-1350 • FAX 901-365-8629

Circle 76 On Reader Service Card

World Radio History

New Products Seen At 1991 AES Show

Digital, Analog Product Lines Unveiled in Paris

by Alan Carter

PARIS The 90th Audio Engineering Society (AES) European convention and exhibition proved the digital revolution in audio continues to gain momentum.

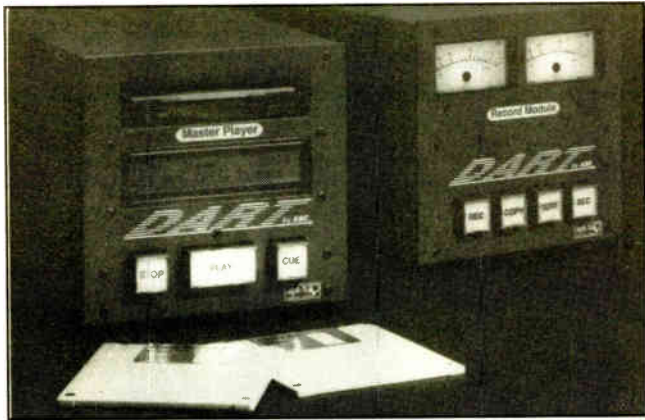

The DART digital audio recorder was developed by ASC and uses a 3.5-inch disk.

But in the European market—where commercial radio is coming into its own and new broadcasting rules and regula-

tions are creating new opportunities — traditional analog products and upgrade packages also attracted attention.

AES, held here Feb. 19-22, showed trends and product developments that can be expected to be seen at the April NAB show in Las Vegas.

Write-once CD

In the digital arena, Studer debuted a write-once compact disc recorder, which the company "hopes" to deliver in July and market worldwide. The D740 recorder may be shown at NAB, according to David Roth, managing director for Studer and Philips CD Systems AG in Switzerland. Studer is marketing the product toward radio and audio production facilities.

Sony also used AES to premiere digital products that it will show for the first time in the U.S. at NAB.

While some products in the PCM-7000

DAT range were shown as prototypes last fall at AES in Los Angeles, the Paris AES was the first time production gear was displayed. NAB is next, Sony officials said.

On the list are the four-head DAT recorder, the PCM-2700, and for production, the DPS-D7 digital delay and DPS-R7 digital reverb.

Looking toward NAB

Barco-EMT demonstrated the EMT 460 Cart Recorder and 461 Cart Player, which

company said the newly developed 20-bit oversampling converter is applicable for LP mastering, high-quality monitoring and broadcasting.

Studer also showed the MacMix, a new software package for the Dyaxis digital audio workstation, which provides real-time equalization and level control.

360 Systems displayed the DigiCart, shown in prototype at NAB '90, and said delivery was expected by late March in the U.S. and by June in Europe.

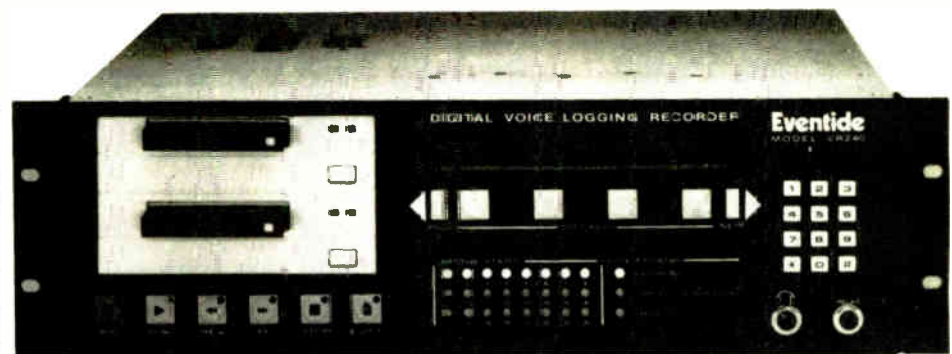
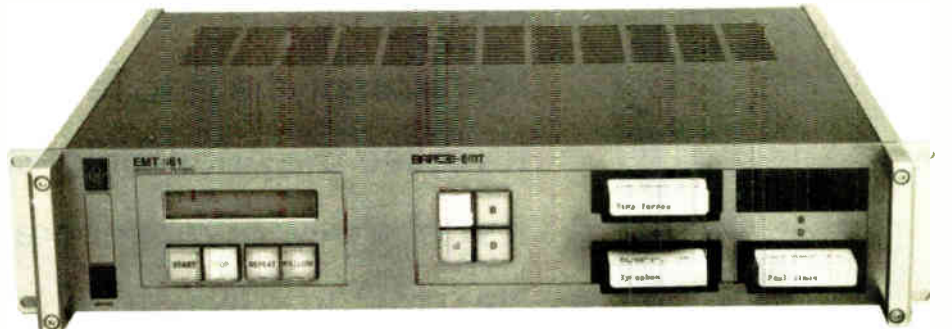

Among the products exhibited at AES in Paris were a Sony DAT recorder (top), the Barco-EMT 461 cart player (center) and the Eventide VR240 digital voice logging recorder (bottom).

was only a prototype last year but will be ready for shipping after NAB. The company also will announce a dealer network at NAB.

At AES, Barco-EMT also showed the EMT 466 BEDAS MOD Recorder, with interchangeable magneto-optical disks. Storage time is 3.2 hours in stereo using the MUSICAM data compression algorithm.

Other products in the digital domain that are likely to show up at NAB will be a digital-to-analog converter from Harmonia Mundi, the bw102/47. The

From AEV, distributed in the U.S. by Bext, there was the Digital Spot Sampler, a new system of digital recording on hard disk with computerized management of contracts and commercial breaks.

One digital product at AES, which could show up in the U.S. at a later date, is the Sonifex Discart, which uses 3.5-inch disks to store 16-bit stereo digital audio. The system uses three disks for six minutes of digital audio, which may be copied or dumped to hard disk.

(continued on page 20)



on air

RDS by R&S

The excellent RDS family



FM Radio Data Decoder DMDC



FM Radio Data Coder DMC

Ask for more information

An independent concern, founded in 1933, 5000 employees, represented in 80 countries. Design and turn-key installation of systems with software and servicing. Calibration, training and documentation.



ROHDE & SCHWARZ

D-8000 München 80 Postfach 80 14 69 Telefax 523 703 (r+s d) Telefax (0 89) 41 29-21 64 Tel. internat. +49 89 41 29 0

See Us at NAB '91 Stand 4101

Circle 67 On Reader Service Card

World Radio History

EBS EQUIPMENT



	Price
Model CEB Encoder-Decoder	\$540
Model CE Encoder Only	\$375
Model CE With Stereo Option	\$405
Model CD Decoder Only (REQUIRED FOR LPTV)	\$320
Receiver can be supplied to drive Decoder	\$100

- Encoder FCC Type Accepted • Decoder FCC Certified •
- Exceeds FCC Specifications •

All interconnections to the EBS equipment are made through a barrier terminal block. No special connectors necessary. In stock—available for immediate delivery.

GORMAN REDLICH MFG. CO

FAX 614-592-3898 • 257 W. Union St. • Athens OH 45701 • 614-593-3150

Circle 40 On Reader Service Card

SYSTEM - 3000

DIGITAL MULTI-HYBRID TELEPHONE SYSTEM

- Digital signal processed hybrid system.
- Microprocessor controlled via standard RS-232 or RS-422 interface.
- Up to eight telephone lines in full multiplex communication, due to the internal MIX-MINUS bus structure.
- No preliminary adjustment or line measurement is required; simply connect it and work!
- Easy to use: the control module can be either a small dedicated console or a standard PC or compatible.
- Line functions and controls are independent for each input module; the technician's job is made easier than ever, even in the software version.
- The switching section handles up to eight telephones, plus the control telephone and the studio telephone.
- Each input module includes:
 - Superb 60 dB sidetone rejection.
 - 128 steps digital adaptive filter.
 - 24 bits coefficients.
 - 16 bits sigma-delta A/D converters.
 - Switched-capacitor antialiasing filter, with 80 dB rejection.
 - Line inputs safety protected against line transients and discharges, according to CCITT regulations.
- Some of the functions included on the digital processed section are:
 - Digital AGC included in the self-adaptive filter.
 - Doubletalk detection, without influence in the adaptive procedure.
 - Noise reduction procedure, using a white noise generator applied in the digital domain.
 - Noise free line switching, using stand by signal timing.
 - Supervisory function of line status, with detection of dialing tones and signalling (busy line, hanged, etc.).

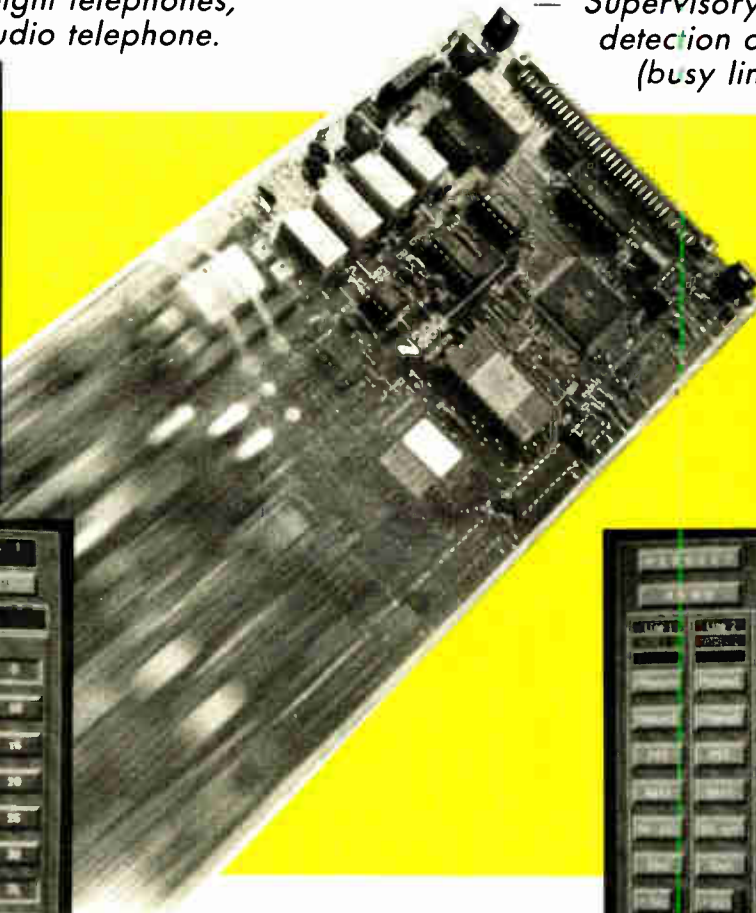

~~Digital~~ THE SPECIALIST ON ~~Analog~~ TELEPHONE LINES

 **aeq**

NAB Booth
No 1249

APLICACIONES ELECTRONICAS QUASAR, S.A.

CENTRAL OFFICE: P.I.Leganés. c/Rey Pastor, 36 - 28914 LEGANES. MADRID. (SPAIN). Tel. 011-34-1-686 13 00 - Fax: 011-34-1-686 44 92

Circle 120 On Reader Service Card

World Radio History

DAB Spectrum Study Analyzed

by Judith Gross

WASHINGTON Part of the NAB's support of the Eureka 147 DAB system hinges on being able to accommodate all existing AM and FM stations in a reasonable amount of spectrum.

The NAB's DAB Task Force recently released the results of a spectrum study done by two consulting firms: Jules

Cohen & Associates and Dattel, to determine how much spectrum would be needed.

The study shows that all AMs and FM's could fit into 57 MHz of spectrum if a three-tiered coverage scheme was used and if the three coverage classifications are integrally related so they fit within each other in a way that is spectrally efficient.

The study used parameters of

the Eureka 147 system and looked at UHF frequencies, even though it is likely that the NAB will seek spectrum in the higher L-band for a DAB system.

Clustered stations

The study considered a service level of F(90,90), even though an IEEE paper done by NAB Science & Technology argued that F(99,99) coverage may be necessary because of the "brick wall"

drop-off at the edge of the Eureka coverage area.

The spectrum study also applied a co-channel desired-to-undesired (D/U) protection ratio of 9 dB and an adjacent channel D/U protection ratio of -6 dB.

Stations were clustered with six stations in a minimum frequency block of 1.5 MHz (six program channels per block).

For purposes of the study, several types of allocation

schemes were considered. The first was that all stations would have uniform coverage area—an idea that has drawn severe opposition within the industry.

The second plan divided all stations into classes depending on coverage areas. This tiered coverage was a more difficult assumption, according to the study, because it could mean fewer stations in each "cluster" and could result in unused frequencies in certain areas.

Three and four classes

The consulting firms attempted to overcome the difficulties in a tiered system by trying two allocations schemes. The first divided stations into four classes with the radii for the largest and smallest classes slightly greater than the class contour distances for existing Class C and Class A FM's (respectively).

Radii for the remaining two classes under the four-class scheme were set roughly in between, limited by the need to keep the ERP and antenna height within reasonable bounds.

Under the three-class system, the coverage area radii were set at integral multiples of the smallest area, so stations could be packed into areas more efficiently.

In addition, the three-class option used a hexagonal grid plan while the four-class scheme used a geographically-based grid. The hexagonal plan was found to be more spectrally efficient, the study said.

FM stations were assigned according to which class corresponded most closely to their current coverages. But for AM stations, nominal existing coverage area sizes were established based upon ranges of daytime pattern RMS.

Three-class system the best

Because of the way the three-class system was defined, it proved to be the most efficient of the schemes in the study, requiring 57 MHz of spectrum to accommodate all existing stations. The uniform coverage scheme was less spectrally efficient, using up 75 MHz of spectrum to accommodate all stations.

Under the geographically-based grid scheme, the four-class system required 157.5 MHz at VHF frequencies and 130.5 MHz of spectrum at UHF frequencies.

The spectrum study has come under criticism from some engineers because of the coverage curves used and because it did not consider the Eureka system at L-band frequencies.

One point of controversy was a table on required ERP included in the study, which was brought out to the higher frequencies. According to that table, power requirements increase dramatically as the frequency increases.

Double-Barreled Noise Patrol



The Noise Gremlins wage a constant battle to make your audio worse than your competition's. They sabotage your ratings by making your carts sound noisier than CD's...making your remote feeds sound remote...and making the audio sound many generations older than the video on your videotape.



Neutralize the Gremlins with proven dbx® Type-II protective processing. Available in two different configurations to suit your logistics and war chest, the dbx Type-II system delivers as much as 40dB of additional quiet to your audio without requiring alignment tones or critical level adjustments.

The results are immediate and obvious, and as close as your favorite hardware supplier. So call today, and let our noise control veterans win the battle for you—so you can get back to winning the ratings war!



A division of
AKG Acoustics, Inc.
1525 Alvarado Street
San Leandro,
California 94577, USA
Tel: (1) 415/351-3500
Fax: (1) 415/351-0500

INDUSTRY STANDARD
COMPRESSOR/LIMITERS • NOISE REDUCTION SYSTEMS • EQUALIZERS • MODULAR PROCESSORS

©1991 AKG® Acoustics, Inc.
dbx® is a registered trademark of Carillon Electronics Corporation.

See Us at NAB Booth 1226

Circle 137 On Reader Service Card

World Radio History

ANNOUNCING

BUY STUDER DIRECT. NEW LOWER PRICES!

Now you can get Studer quality at prices well below that of the competition. All Studer Professional products including the famous A807 range are now available directly from Studer at savings of up to 30%. Never before have Studer products been so affordable. Don't compromise. Buy directly from Studer at prices that won't blow your budget.



A730 CD Player



A764 FM Monitor Tuner with/MPX output



A807-2/2 VUK

A807	2-Track with Overbridge Normal Speed 3 3/4, 7 1/2, 15 ips.	\$5,995*
A730	Professional Tabletop CD Player Simply the most versatile CD player for production and studio use.	\$2,995
A727	Professional Rackmount CD Player The only fully professional radio station "On Air" CD player.	\$1,995
A729	Multi CD System Controller Programs and controls multiple CD players from remote locations.	\$1,995
A721	Professional Rackmount Cassette Deck The only fully professional cassette deck.	\$1,995
A764	Professional FM Monitor Tuner For off air monitoring and remote re-broadcasting. (Includes MPX output and RS 232 Remote Control port.)	\$1,995
A68	Professional Studio Power Amplifier Superior Studer sound at 2 x 100 watts RMS.	\$ 995
2706	Professional Broadcast Monitor A highly accurate 3-way monitor designed for the digital audio era.	\$ 795

*High Speed, Rackmount, & TC versions slightly higher. Floor console not included.

MasterCard and VISA Accepted.

For Ordering & Sales Information Only

800-776-3833

Fax: 615-256-7619

STUDER REVOX

Studer Revox America, Inc. • 1425 Elm Hill Pike • Nashville, TN 37210 • Tel: 615/254-5651
New York 212/255-4462 • Los Angeles 818/780-4234

See Us at NAB Booth 1158

Circle 149 On Reader Service Card

BEDAS

EMT 460 / EMT 461

Cart Recorder / Cart Player

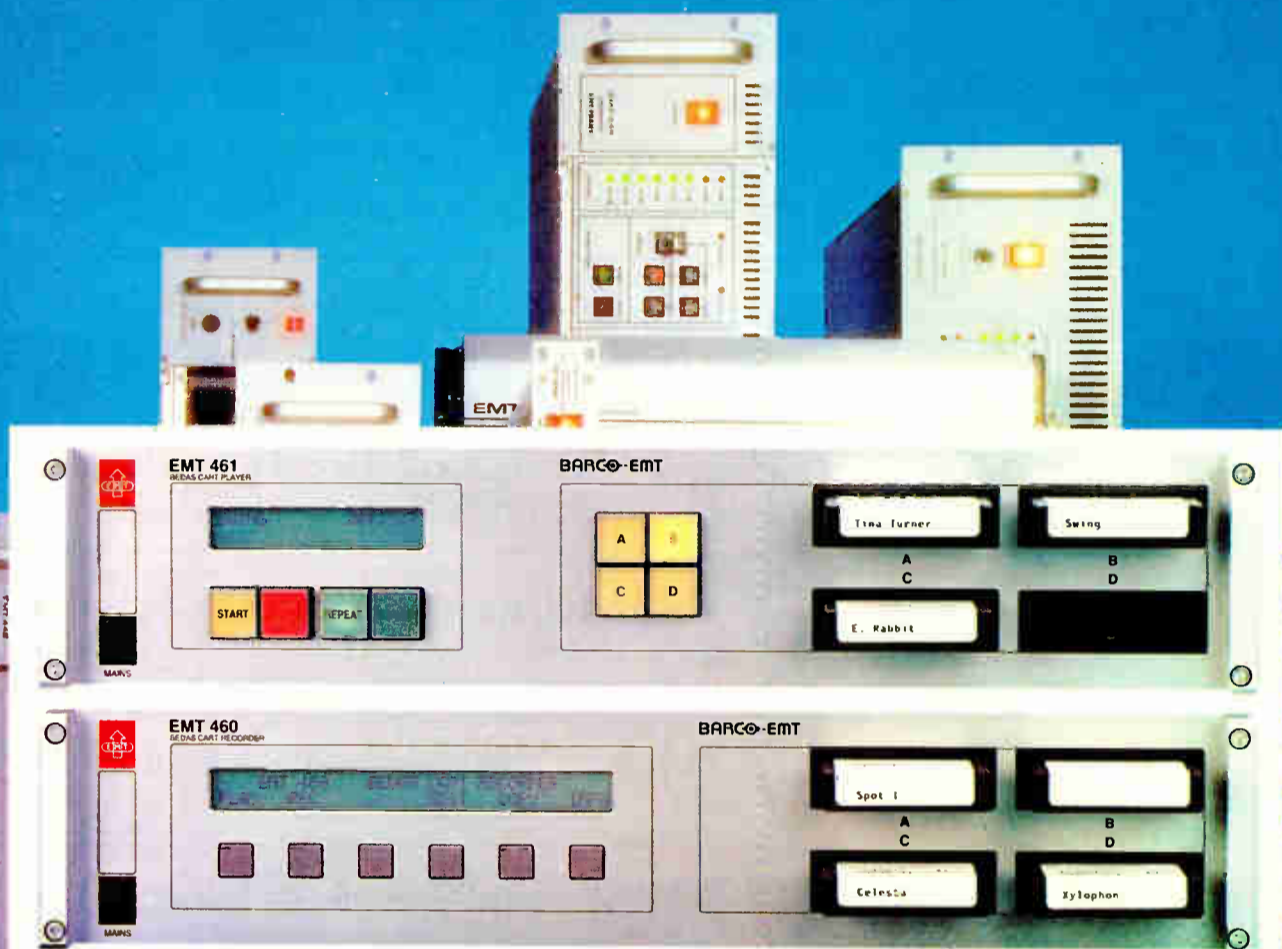

Tape wear, wow and flutter, and positioning times have been eliminated forever with the EMT 460 Cart Recorder and EMT 461 Cart Player.

BEDAS EMT 460 Cart Recorder:

A digital cartridge unit for recording, editing, copying, and playing spots in mono or stereo.

BEDAS EMT 461 Cart Player:

Digital cartridge unit for playback of spots.

• Program Storage without Moving Parts

Electronic, wear-free storage modules (carts) in a handy cassette format are employed. A special storage technique enables recordings to be made in highest studio quality and program line identification to be implemented with a large number of level tones and pauses.

• Instantaneous Spot Access

The storage technology employed enables each spot to be accessed instantaneously. Playback of the spot starts directly at the beginning of modulation, and immediate replay is possible at any time.

• Simple Operation

The handling of the carts and the operation of both units have been conceived for simple, daily use in studio environments.

Each unit is designed to accept four carts that may be played back individually or sequentially.

BARCO, Inc. 1000 Cobb Place Blvd., Kennesaw, Georgia 30144
Phone: (404) 590-7900 Fax: (404) 590-8042

Northeast: (201) 729-0710 Southeast: (912) 436-7786
Midwest: (404) 590-7900 Western: (619) 575-0168

Postfach 1520 · D-7630 Lahr · Telefon (07825) 1011
Telex 754319 · Telefax (07825) 2285

BARCO-EMT
Professionelle Electronic

Ein Unternehmen der Gruppe BARCO n.v. Belgien

Circle 22 On Reader Service Card

World Radio History

Highway FM Scheme Established in Italy

by Dario Calabrese

MILAN, Italy A new FM delivery system, similar to Radio Data System (RDS), was introduced recently by RAI, the Italian government-run broadcasting agency.

Designed by RAI in cooperation with Teko Telecom, a transmitting equipment manufacturer headquartered near Bologna, the system consists of a series of synchronized FM transmitters broadcasting on the same frequency (103.3 MHz).

Known as "Isosfrequenza," (from the Greek word "iso," meaning "constant"), the service broadcasts 24 hours a day. Programming includes excerpts from RAI's regular music, news programs, and frequently updated reports including traffic and road conditions.

The setup allows people driving on Italy's "autostrade"—the toll superhighway—to listen to the same FM radio program without constantly readjusting the tuning controls of their car radios.

Because the transmitters use the same frequency, the system works with any receiver, even if not equipped with Radio Data System (RDS) or any other similar automatic tuning device. The design allows satisfactory reception all along the highway—even while driving through tunnels.

Mono only

The service operates in mono only, due to a decision made by RAI in the early stages of the project. Stereo broadcasts, the company determined, would require a much more complicated system.

As of December 1990, the system was operating along large segments of the A1 highway, from Bologna to San Cesario, and the A10 and A12 highways that extend from the Riviera in France to Ventimiglia. By 1992, it is expected that the entire 4,000-mile network of Italy's toll superhighways—one of the most extensive in Europe—will be covered by this service.

Isosfrequenza owes its success to an elaborate fiber-optic cable network laid along the entire Italian highway system by Autostrade, the government-controlled company in charge of highway management and maintenance.

The cable network contains the transmitted FM signals and other services, such as voice communications for internal service purposes, physical parameter measurements (temperature, humidity, etc.) and signals from roadside surveillance cameras.

The main transmitting station's signal is transduced, through two AM modulators (optical transmitters), into identical optical signals fed to two fiber-optic cables running in parallel.

From this point, the system consists of two identical transmitters: a main and a back-up, which is activated in case the main goes out of order. Activation is accomplished by automatic switchover devices, which are digitally controlled and located at the various local transmitting sites along three to six mile intervals.

Elaborate signal distribution

These transmitting sites, housed in air-conditioned shelters, consist of a pair of optical receivers that extract

the signals from the cables, transducing them back to FM and supplying them, at amplitude levels varying from +3 to +10 dBm, to 20-250 W amplifiers.

From the amplifiers, the signals are fed through a switchover device and the signal is reduced back to one. The single signal then goes to a local FM transmitter and is radiated via a Yagi antenna both to open areas and in tunnels by

(continued on page 20)

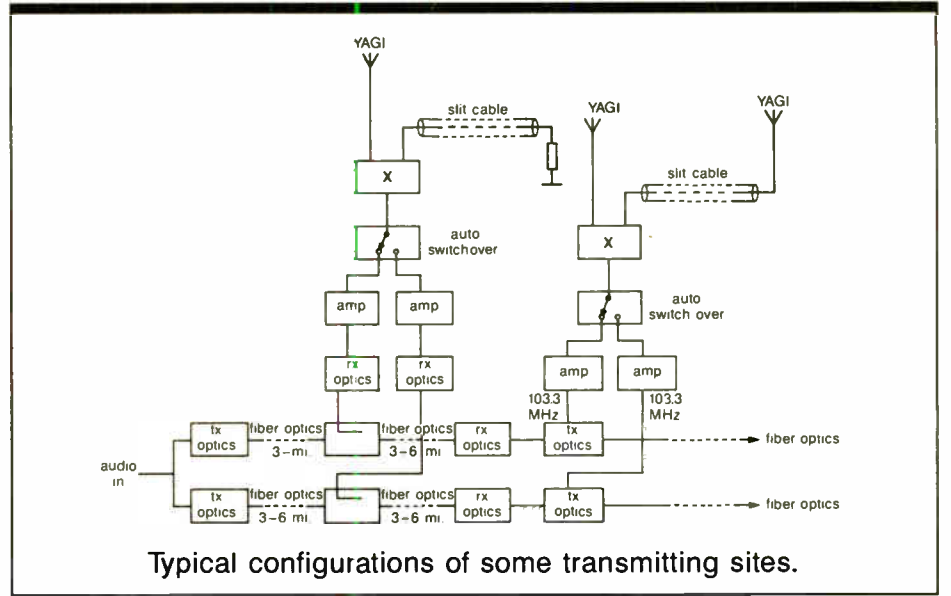

Typical configurations of some transmitting sites.

For The Most Reliable Composite-Stereo STL or Distribution-Amplifier Performance,

CONSIDER FIBER

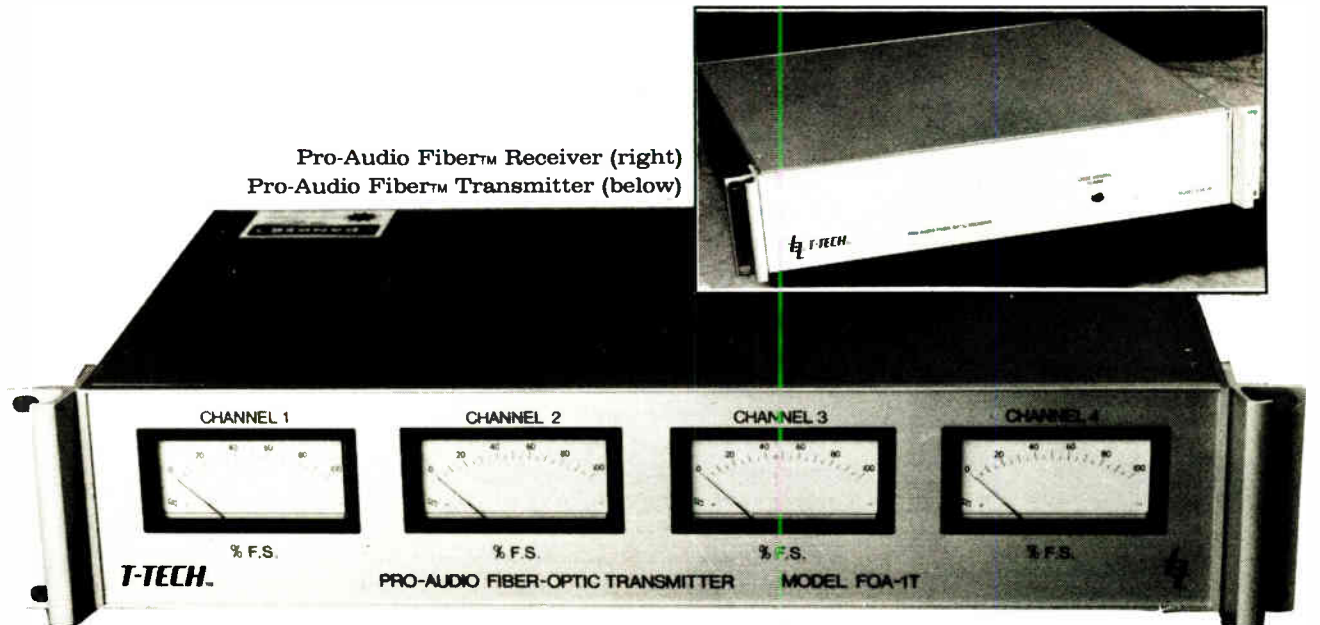

Up to 4 Channels of Digital Audio with DC-67 kHz Bandwidth over single-mode fiber up to 25 miles with error correction, or up to 5 miles using multi-mode fiber.

Advantages:

- Insensitive to rain and other weather effects that can spoil the reliability of microwave STLs.
- Solves spectral congestion problems arising in new RF STL installations.
- Cost Effective when compared to microwave links.
- The only digital audio fiberoptic link made featuring error detection and correction.
- The only fiberoptic audio link made permitting composite stereo transmission over the link offering built-in adjustment to improve stereo separation.
- 20-bit digital audio capability.
- In-house designed fiberoptic circuitry permits ease of customization for other wavelengths or levels and ease of component replacement. No expensive electro-optical modules to replace.
- Peak-reading level meters eliminate A/D converter overload.
- Receiver has loss-of-fiberoptic signal alarm output.
- Can be wave-division multiplexed to share existing video or data fibers if required.



**PO Box 151
Hudson, MA 01749
Phone (508) 562-5820 FAX (508) 568-1219**

New Equipment at AES Show in Paris

(continued from page 13)

ASC also premiered a cart machine that uses 3.5-inch disks, the Dart.

Equipment lines shown at AES that will be displayed at NAB include new software for the LA100 audio analyzer from Lindos, and the Eventide VR240 digital logging recorder, which records more than 180 hours of audio divided among one to 24 channels, all on a standard DAT tape cassette.

Neve used AES to introduce the new 44

Series console, marketed for broadcast and video post production. It may be at NAB, but the company was not positive.

Soundcraft said it would carry its new SAC 100 on-air console to NAB after introducing it in Paris.

Strong showing

Other companies exhibiting included Broadcast Electronics, with the new Air Trak 90 console with six, 12, 18, and 24 channels. Modulation Sciences highlighted its RDS system, StereoMaxx and Modminder. Audiopak displayed its carts. Radio Systems showed the RS-Cart 2000. Rohde & Schwarz had its Audio Analyzer, and Neutrik brought the

New broadcasting rules are creating new opportunities in Europe . . .

A1, which is used for audio testing.

Circuit Research Labs (CRL) displayed its audio processors; Fidelipac, the Broadcast Audio Series VI consoles that caught the attention of Europeans looking for a simple unit. ITC had its cart machines while TFT brought its STLs and other RF products. Dorrrough showed its loudness meter line and Valentino Music brought its sound effects libraries.

Then, keeping a watch on products to come, a U.S. manufacturer who asked not to be identified, was quietly showing a prototype of a small-format 3.5-inch magneto-optical disk for audio recording and playback. Discussions are underway for manufacture, with a product expected "late this year."

FCC Sets Mod Policy

(continued from page 1)

ments give comparable results. In other cases, where the Commission has shown transmitters to be overmodulated, we have found that commercially manufactured monitors also indicate the same overmodulation."

If a station is found to be overmodulating, it is "the result of licensee action and not differences in the technical design of monitoring equipment," the notice said.

FCC Assistant Mass Media Bureau Chief William Hassinger, who will explain Commission policy at the NAB convention, said the policy simply means that "you can use anything you want. You won't get into trouble using any modulation monitor if it is properly installed, maintained and operated."

Modulation Sciences' Engineering VP Eric Small said he was generally satisfied with the FCC's recent public notice.

"We are very pleased," Small said. We went to the Commission and we said, "There is confusion out there. Can you help us alleviate it?"

Under FCC deregulation in the early 1980s, the Commission eliminated rules that required type acceptance of modulation monitors. The only rules that apply now to modulation concern the FCC's criteria for what is considered overmodulation and what action the Commission can take if a station is found to be overmodulated.

Belar Laboratories, which also manufactures modulation monitoring equipment, did not agree with the FCC's public notice. Company President Arno Meyer said he "was very disappointed" that the Commission did not address FCC modulation measurement Rule 73.1570 as it is applied to station monitoring.

He said the notice was inadequate in addressing modulation concerns and its only accomplishment is the approval of "a certain product from another company."

Although the Commission has said it measures modulation using a high quality receiver, an oscilloscope and a signal generator for calibration, Meyer said the FCC still will not reveal what criteria it uses in determining overmodulation.

The rule states that stations with no subcarrier cannot exceed 100 percent modulation or no more than 110 percent with up to two subcarriers. Meyer said, however, that the FCC will not divulge the number of peaks per minute used in considering overmodulation.

Highway FM in Italy

(continued from page 19)

means of a coaxial cable provided with a slit sleeve.

This cable, depending on the geographical situation, can be terminated either on a passive load or on another Yagi antenna. Furthermore, some of the transmitting sites are made to coincide with optical receiver/transmitter pairs, located along the road at longer intervals to compensate for the fiber-optic cable losses.

The entire system was designed by

RAI's Research Center in Turin. The Yagi antennas were built by Telesystem of Arese, Italy and Co. El of Lachiarella, Italy. The optical receivers, transducers and transmitters were built by Teko Telecom, which also supplied the FM transmitting equipment and the switchover devices.

For information, contact Teko Telecom at via dell'Industria, 5, P.O. Box 175, 40068 San Lazzaro di Savena—BO, Italy; or telephone: 39-51-625-6148; FAX: 39-51-625-7670.

BETTER BY DESIGN

COMARK

HIGH POWER RF TRANSMISSION LINES AND COMPONENTS

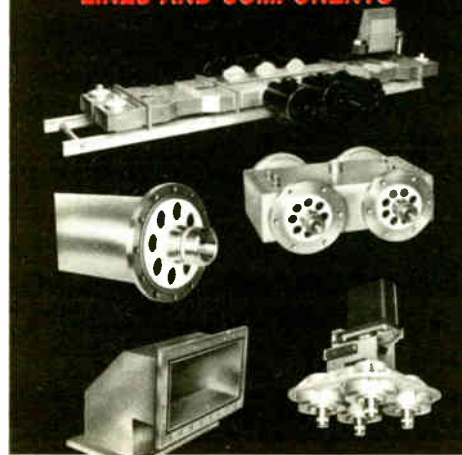

- Commercial or military applications.
- Turnkey or custom designed systems.
- Full line of coaxial and waveguide transmission lines, components and accessories — off the shelf or custom designed, including: FM Antennas • elbows • couplers • diplexers • high power RF filters • color notch filters • RF patch panels • power dividers • quadrature hybrids • RF switches • tuners • transitions • impedance transformers • phase shifters • combiners

See us at NAB Booth #5045

For all of your High Power RF needs from 1MHz to 1GHz and up to 500kW, Write for Comark's Engineers Design Manual/Product Guide.

COMARK
A THOMSON-CSF COMPANY

Contact: Ken Barker
P.O. Box 229

RT. 57, Feeding Hills Road
Southwick, MA 01077
(413) 569-0116 • Fax: (413) 569-0679

Circle 53 On Reader Service Card



KINTRONIC LABORATORIES INC.

YOUR PREMIER SOURCE FOR COMPONENTS AND SYSTEMS FOR AM RADIO TRANSMISSION

● SERVICES OFFERED

- Site Planning
- Custom Fabrication
- On-Site Installation
- Service and Support From a Company Dedicated to Serving the AM Radio Industry For Over Twenty-Five Years

● SYSTEMS

- Directional AM Phasors and ATU's
- Non-Directional or Directional Multiplexed Arrays
- Transmitter Combiners
- Tunable Isolation Units
- Tower Detuning Skirts

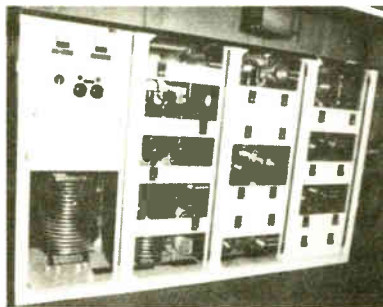

State-of-the-Art Directional Antenna Phasing System (Front Doors Not Shown)

- AM DUMMY LOADS (1-300 KW)
- RF ATTENUATORS FOR PSA & PSSA
- RF COMPONENTS
 - Fixed and Variable Inductors
 - RF Contactors
 - Meter Jack and Switches
 - Static Drain and Tower Lighting Chokes
 - Coaxial Cable Clamp Terminators
 - Lightning Protection Devices
- RIGID TRANSMISSION LINE (7/8", 1-5/8", 3-1/8") AND ACCESORIES
- ISOCOUPERS (STL, TSL, RPU, FM, etc.)

COME SEE US AT BOOTH 2229 AT NAB '91

Phone: 615-878-3141

P.O. Box 845 Bristol, TN 37621-0845

Fax: 615-878-4224

Circle 11 On Reader Service Card

FROM THE TRENCHES

by Alan Peterson



Meet My Listeners

Dear Alex,

Gee, just what I needed—something else to pigeonhole.

WCBS's Bruce Morrow has his "cuz-zins," WTIC's Gary Craig has his "Craig-gies," WLW's Truckin' Bozo has his truckers. I'm still trying to pin down the kind of crowd I attract. One thing's for sure: They make my life pretty interesting.

Take Nicky Stevenson. He stopped by my station two months ago (kinda liquored up) with a cassette of his "songs," asking if we could give them some airplay. He left the tape, which we auditioned. Turns out his "music" was Nicky himself bellowing 90-proof-inspired improvised lyrics into a

Memorable titles such as "Snowball Baby," "I'm a Good Shoe" and "Flower Girl" thundered out of our speakers in stunning 7 kHz mono.

Yorx cassette machine.

Memorable titles such as "Snowball Baby," "I'm a Good Shoe" and "Flower Girl" thundered out of our speakers in stunning 7 kHz mono. This would've been a great joke tape to keep around for yucks if it weren't for somebody suggesting, "Al, you ought to record some music around those."

That was a challenge too good to pass up. If it worked for Suzanne Vega, why not Nicky Stevenson? Two vacation days were spent hacking "Flower Girl" into usable elements, flying in synth, bass and drum parts via Linda Blair (my sequencer), adding a little Aphex enhancement to Nicky's voice, then drowning it in a swamp of reverb.

The result: Nicky's very own hit song—a cheesy, out-of-tune love ballad even funnier than the original. He beamed as he picked up his master reel, no doubt dreaming of next year's Grammys.

Then there's Marie, a neighbor in my apartment complex who just moved out in January. Back in November she dragged me out into an icy New England rainstorm to help her rescue a stray cat she heard mewing out in the woods behind her unit (another cat story).

It didn't take long before that gray chill cut through me to the bone, and for "Here, kitty kitty kitty" to distill down to "Show yourself, you &%*\$ fuzzball!" Fifteen minutes later, I'm back inside trying to warm up when she comes running over nearly in tears wailing, "I hear the cat again!"

Rather than freeze a second time, I decided to employ a little trouble-

shooting in her apartment. Where did she hear the cat? "In my bathroom. The window faces the woods." Where was she when she actually heard him? "Right here," she said as she sat down on the bathroom bowl.

As she did, we both heard a cat ... or so we thought. That "mew" was actually a "fweeep," the sound made by a soft cushioned toilet seat with an air leak.

Right, Alex. I froze in the rain for 15 minutes because good neighbor Marie's got a *whistling toilet seat*.

These are the times I wish I took that job manufacturing helicopter blades in Bloomfield, Conn.

Mercifully, these people are happy and harmless. I stop and think about

the kind of folks that might be lurking around out there and shudder (remember Alan Berg?). Sure, there are some kooks to watch out for and I try to be careful of them.

But folks like I've just described add to the comical day-to-day existence of an otherwise jaded broadcaster. While I certainly wouldn't want my entire listening demographic to consist of Nickys and Maries, I must admit they're fun to have around.

Did You Hear a Cat? —Al

Looking to break a lease? Send Al a cassette and return postage for your own copy of "Flower Girl." Write him at WLAD, 198 Main St., Danbury, Conn. 06810.

Telephone Interface Products

Finally, just what you've been looking for, a really important phone message.

Have you been playing telephone tag trying to solve your telephone interfacing problems? Well, have we got an important message for you. Every telephone interface you could possibly need is available with a single call.

Only Gentner Has A Hybrid For Every Application.

Rapidly growing needs for sophisticated special purpose telephone interfaces have driven our engineers to develop quite a range of products. Here are just a few for you to consider.

If you're looking for an inexpensive, fully automatic 2-way interface for your "listen line," sports line or weather phone, you're looking for our Auto Coupler. Maybe your field reporters need an auto-answer line that triggers a recorder so they can dump their story and run. That's our TC-100. If you need a telephone hybrid for on-air interviews or recording calls in the production studio and newsroom, you can rely on our SPH-3. It's a full blown hybrid that's been the workhorse of many stations for years.

Gentner telephone interfaces give you the on-air presence you need to dominate your market. That's because they're designed to make callers sound like they're right in the studio with you.

New Solutions To Old Problems.

The latest additions to our growing line of hybrids, the DH-2 and SPH-5, take proven Gentner technology to new heights.

Thanks to some real design and manufacturing innovations, we've packed a lot more features into higher performing packages. With 16 bit processing and 2X oversampling, the DH-2 Digital Hybrid gives you auto-nulling, full digital separation of "send" and "receive" signals and a sound quality that rivals analog. The new SPH-5 Analog Hybrid with its "dual coil" hybrid system will give you a great sound at a great price.

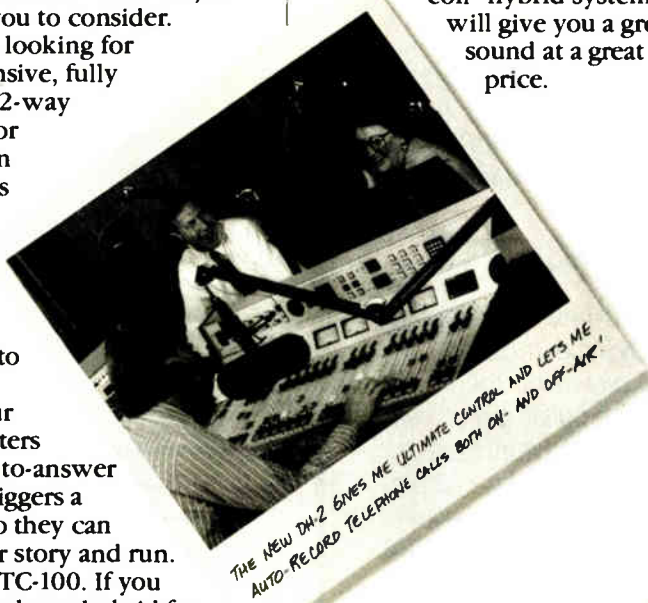

Both the DH-2 and SPH-5 give you a CUE button to toggle send audio between the console and the announcer's mic. This allows your announcer to easily use the hybrid like a speakerphone before putting a caller on-air. And a RECORD button lets you automatically record calls, both on- and off-air, for later playback. Finally, telephone hybrids designed to work the way you work.

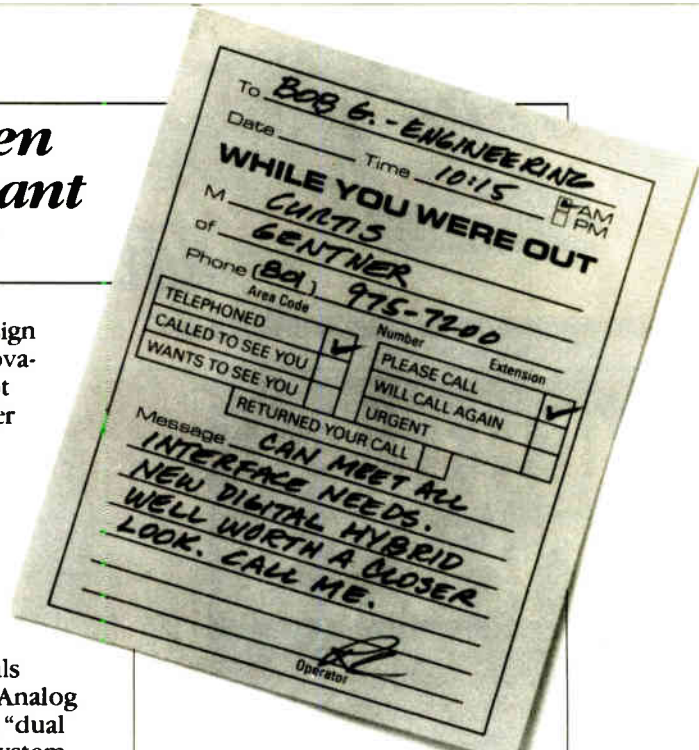

Get The Message?

Your single source, for every telephone interface you could possibly need, is Gentner. Give us a call for the name of your authorized dealer. Our operators are standing by. Hello, you're on the air...

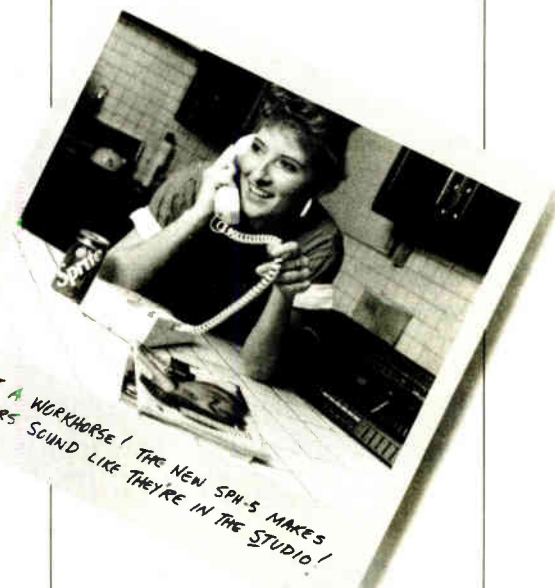

GENTNER

Gentner Electronics Corporation
1825 Research Way
Salt Lake City, UT 84119
(801) 975-7200
Fax: (801) 977-0087

Surviving the NAB

by Ty Ford

BALTIMORE Roller skates and a good "BS" detector—that's what I'd like to take to this year's NAB show.

Oh, I know skates don't roll very well on the industrial indoor/outdoor carpet that lines most convention centers. Tell the hall to keep the carpet out of the aisles and pass the savings on by reducing the ridiculously over-inflated food prices at the concession stands. The money they'd make with skate rentals and liability insurance would greatly exceed the amount they'd lose on carpet anyway.

As for the BS detectors—certainly the technology already exists. A few years back I spoke with a guy in Savannah, Ga., who was working on voice-stress analysis circuitry. After having worked for the FBI for a number of years, he's now doing private research.

The unstressed lie

According to him, most of us, under normal non-stressed conditions, generate frequencies of between 4 Hz and 6 Hz when we speak. Under stressed conditions, like when you're not telling the truth, the muscles in the throat and diaphragm contract, which keeps

those frequencies from being produced.

Granted, there are a few truly gifted salespeople who have mastered "The Unstressed Lie." However, the voice-stress analyzer is much more accurate than the standard optical measurement method first developed for lawyers. As you may know with the optical method, if you see their lips moving, they're lying.

Actually, I do have a few good friends in sales. They work very hard to find out what the customer wants and try to provide it. That, in itself, is not always an easy task. The worst buyers are those who really don't know what they want. They frequently end up buying the wrong thing because they don't know enough to ask the right questions and are too vain to admit it.

The stupidest question is one that is not asked. If you keep nodding along as the salesperson does a product run-down, it can only be assumed that you understand what is being said. If you don't stop the pitch to ask for clarification, it's your own fault.

If you do stop the pitch to ask a question, one of three things will happen: One, you'll learn something; two, you won't understand the explanation because it's over your head; or three, you won't understand what's being said because the salesperson doesn't know either and is trying to bluff you.

In a perfect world, option one happens all the time. If it's two, put the squeeze on. If it's a piece of equipment you're talking about, explain your expected use for it and ask the salesperson to show you how well it does the job.

Don't let yourself be side-tracked. Also, be very wary of claims that the next software release addresses your problem. Put the ball back in the salesperson's court. Let them know how to get in touch with you when the new software is released.

If you get a call a few weeks later, make sure the new piece still has all of the features that attracted you to the previous model. If you're not convinced, ask for a demo.

Firm up delivery dates

The "next upgrade" line is sometimes used as a tactic to keep you from buying a competitor's product. If you can't get the salesperson to give you a firm delivery date, chances

are you're being smoked.

If you do get a delivery date, ask for a guarantee. If that day passes and the product is not delivered, you should get a price reduction, free options or some other kind of make-good. Get it in writing.

If, after a few minutes, the salesperson can't figure out how to explain it to you (or can't find someone at the booth who can), you may be experiencing the third category. Smile, excuse yourself and move on.

When I get to the exhibit hall, I usually waste a few minutes trying to understand the various floor plans. Then I give up and settle on finding an information booth. I usually find that my dozen or so must-sees are nowhere near each other. In a compromise of priority and geography, I chart a map and make an ordered list. There are usually more than enough unexpected attractions that pop up between destinations.

I also try to keep an eye out for out-of-the-way snack stands. If you can remember how to get to them once you're in the fray, you can avoid long lines. I have a friend who bypasses the food thing altogether by tossing a few bagels and a biker's bottle with his favorite liquid into a small backpack. The backpack also is great for carrying all those brochures.

If you do accumulate a lot of paper, consider mailing it back to your home or office like the pros do. There usually are mail drops that also ship boxes.

If you haven't done any endurance training for long stints on the floor, keep a small supply of your favorite analgesic handy. I usually start feeling my legs about two hours before the floor closes. Taken at the first sign of shin splints, a couple of acetaminophen tablets can do wonders for your attitude.

A good sign that you've spent too much time on the floor is the inability to speak in complete sentences.

When this happens, it's time to step outside for a breath of fresh air and regroup. If this happens after less than three hours on the floor, get out of the hall and spend the rest of the day at the pool.

■ ■ ■

Ty Ford is an audio producer/voice talent. Reach him by phone at 301-889-6201, via MCI mail (#347-6635), or via America Online (Tford).

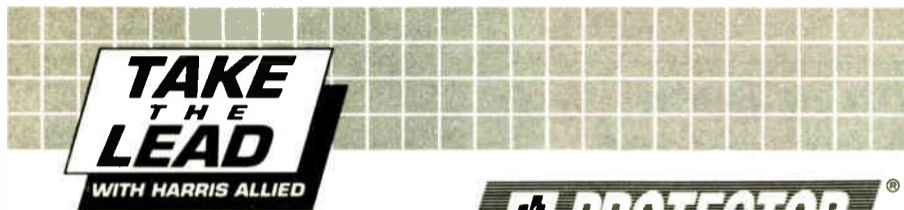

HP SERIES PANEL PROTECTORS CAN BE USED ON UP TO 2000 AMPS & ARE RECOMMENDED FOR ALL BROADCAST TRANSMITTERS

THE PROTECTOR... PROVEN PROTECTION AGAINST LIGHTNING-INDUCED TRANSIENTS!

In February of '89 we installed an IP Protector at our new FM site. On May 12, the FM site went off the air during a heavy electrical storm. Upon arriving at the site, I observed "line fuses" blown on the utility pole feeding the building. Further investigation inside the building revealed the Protector had been destroyed, evidenced by its charred appearance. (Photo above.) It seems obvious there was a direct lightning strike within the immediate vicinity of our transmitter site, and I sincerely believe without the Protector we probably would have sustained major equipment damage and been off the air for a considerable length of time. As it turned out, the only thing damaged was the Protector itself and the time we were off the air was minimal.

—Radio Station KRKZ/KWKW, Oklahoma

The HP Series carries a 10-year warranty and FREE replacement if destroyed electrically for any reason... INCLUDING LIGHTNING!

AVAILABLE THROUGH:



FAX 317-962-8961

800-622-0022

IN CANADA 800-268-3817

With expanded staff and services... our lead keeps on growing!

HARRIS ALLIED ©1991

"Call me, I'm interested." Circle 18.

"Send me literature." Circle 64.

Circle 82 On Reader Service Card

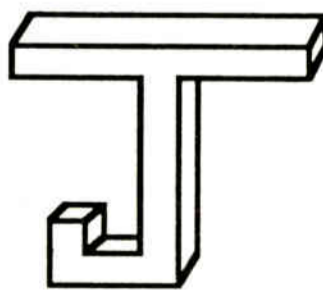

SQUARED
TECHNICAL SERVICE

**2198 HUBBARD LANE
Grants Pass, OR 97527**

503-471-2262

Equipment Repair and Calibration

We service most AM/FM broadcast monitors, remote control systems, exciters, STL's, TSL's RPU's, Etc.

Give Us A Call

Check Our Rates

STL Loaner Program

Cures for Computer Viruses

by Barry Mishkind

TUCSON, Ariz. Statistics sometimes can insulate us from action if we perceive the chances for problems as minimal.

We may refer to events as "one in a million." Or, large MTBF (mean time before failure) numbers can make us feel that our equipment will never die.

KEYBOARD CONNECTION

The chances of your transmitter catching fire and blowing up are quite low. Should you therefore bypass regular cleaning and maintenance? Maybe you'll get away with never having a fire—but maybe you won't.

Similarly, it wasn't long ago that computer magazines dismissed the threat of computer viruses as unlikely. One even said, "There are no such things . . ."

A different tune

Now, however, that writer and many others sing quite a different tune. Computer viruses, worms, logic bombs and trojan horses have become a major worry to computer users. They're no longer confined to large mainframes or university sites.

Virtually any computer anywhere can be compromised, and the sad part is that most users can't see the potential for disaster. Many businesses have *no backup* to their computers should problems occur. And in general, even when there is a true infection, most users blame it on a "computer glitch."

On the other hand, there are some users fearing the Jerusalem virus who won't even turn on their computer any time Friday falls on the 13th.

Or, perhaps you remember the famous incident in November 1988, when Robert Morris, Jr. inserted a virus into the InterNet system of more than 85,000 com-

puters on 1,200 networks. Nearly \$98 million in computing and people time was lost. Projects were delayed, some frozen for up to five days.

Computer infections *are* spreading throughout the world and you should be on the alert.

Identifying the danger

Some definition of terms will help us understand what's happening. A virus is a computer program that actually copies itself into your programs, reproducing itself, usually in .COM and .EXE programs, over and over until it's triggered into action.

Some viruses merely put a humorous (?) note on your screen. Others may delete part or all of your files. Still others are set to change a digit at random, move a decimal point, or similar subtle changes to data that might go unnoticed for months.

Viruses spread from computer to computer as programs are copied or moved. This can happen from a diskette, telephone modem connection, even master diskettes from software companies. Several documented cases exist where an infection came "free" with an expensive program.

Worms are similar, but don't reproduce themselves. Upon entry into your system they simply go to work, changing or destroying data.

Logic bombs are instructions placed inside a program to destroy the program at some prearranged time. Often, these come as revenge or blackmail by a disgruntled employee. A "legitimate" form might be the music program where a new code must be entered periodically to prevent the program from dying.

A trojan horse is a program that looks like it's doing something useful (it may even claim to check for viruses), but is actually destroying things. A cute graphic program may be wiping out your data files while it draws a picture.

Some infections are combinations, or

actually faulty themselves, infecting and re-infecting programs until the system starts to slow down or lock like the Morris virus-affected InterNet.

Courses of action

What should be done about this?

Obviously, the worst thing is to do nothing. Several businesses have been bankrupted by computer infections that destroyed the only copy of financial materials in existence. Without hard copy or backups, the companies were reduced to placing ads saying, "If you owe us, please pay us." *Yes, it really happens.*

It's been estimated that more than 400,000 system infections occurred during 1989 alone. Some hackers have even begun discussing the possibility of affecting computerized election results.

Yet, being overly frightened about viruses isn't productive either. Even if one turns up, you're among some of the largest companies in the world. And, the good news: It can be handled.

It's trite but true that practicing "safe computing" will prevent many problems. Knowing the origin of any disk that's inserted in your computer helps. However, that's easier said than done. One company alone had more than

1,000 computers infected in just one week.

Nevertheless, there is help available to keep your computer infection free and your sanity intact.

VirusCide™ from Parsons Technology is designed to meet the challenge. Developed in cooperation with computer virus expert John McAfee, VirusCide is easy to use and can quickly identify and remove more than 100 different viral strains.

The Norton AntiVirus™ from Symantec is a similar product. It includes Virus Intercept™, a TSR monitoring in the background to prevent viruses from entering your system, even flagging unknown infections by analyzing system irregularities.

The companion Virus Clinic™ scans any drive and can repair the damage from most known infections.

Protection from newer infections

Both VirusCide and Norton AntiVirus have an update policy to add protection from newer infections as they are identified. Norton AntiVirus provides a BBS with the latest information available that the user can easily add to the program.

As a nice bonus for those interested in (continued on page 24)

MORE RADIO PROS ARE TAPING TO THE NTH DEGREE WITH DIC//DAT.

The radio world is turning to DIC//DAT, the one DAT best suited for airplay. Ultra-consistent tape. Ultra-strong shell.

For ultimate performance even faced with the most... enthusiastic use.

Call toll-free for information
1-800-DAT-I-DIC.
In New Jersey, 201-224-9344



See Us at NAB Booth 7733

Circle 72 On Reader Service Card

"We thought we found an outstanding transmitter site. It was affordable, had good access and no interference. But it DIDN'T have 3-phase power, and the utility wanted a fortune to bring it in."

Sound familiar? It happens often. But you don't have to be a prisoner of your utility! The Phasemaster Rotary Converter produces the true equivalent of utility 3-phase from any existing single-phase supply, and at tremendous savings.

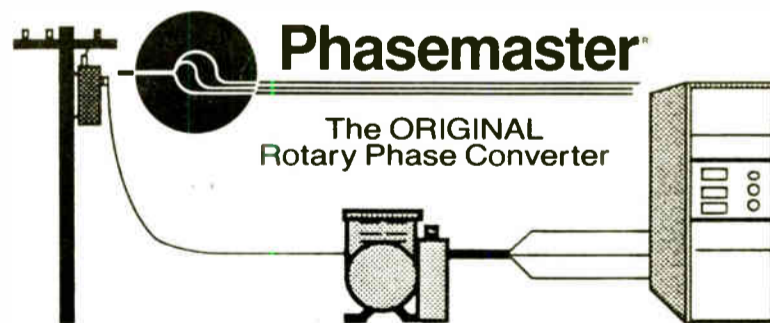

Now you can expand your site selection options and save money, too!

Phasemaster is recommended by industry consultants, utility companies and most major transmitter manufacturers.

Over 500 AM, FM and TV stations are running reliably on Phasemaster converters. If you want to learn more about how Phasemaster can save you big money, we'd like to send you a copy of the NAB Engineering Conference paper about applying Phase Converters on Broadcast Transmitters.

KAY INDUSTRIES, INC.
604 North Hill Street, South Bend, IN 46617
800/348-5257 • FAX 219/289-5932
See us at NAB Booth 1310

Circle 58 On Reader Service Card

FAA Scheme Makes "Furr" Fly

by Harry Cole

WASHINGTON Those of you who have been following the ongoing struggle between the FCC and the FAA over the regulation of electromagnetic interference (EMI) know that struggle has come to resemble some old horror movie like "Godzilla vs. Mothra."

While the two governmental giants slug away at each other, helpless, innocent human beings like you and me get crushed in the process.

When last we visited the EMI matter, the FAA had issued a notice of proposed rulemaking in which it asserted jurisdiction over virtually any change in the transmission facilities of any FM or TV station. Comments were filed with the FAA on that proposal in late December and the matter is now under advisement there.

Many view the FAA's proceeding as an attempt to elbow the FCC out of the picture. Most recently, though, the FCC has announced that it is looking at a proposal submitted by John Furr and Associates, a communications consulting firm. If adopted, the Furr proposal could do to the FAA what the FAA seems to be trying to do to the FCC.

Interagency turf war

As you probably already know, the EMI controversy amounts to a turf war between the FCC and the FAA. In general terms, the evil of EMI is that it can cause interference to navigational radio receivers (generically referred to as "avionics") in aircraft. Obviously, if

you're flying along, you don't want your navigational and landing equipment confused, so there's good reason to want to prevent EMI.

The source of EMI is said to be the intermodulation of multiple signals on the FM and/or TV frequencies. This intermodulation occurs in the amplifier circuits of the avionics themselves. In effect, it creates an additional phantom signal within the receiver which, if it happens to be on the frequency of a nearby navigational transmitter, can interfere with the aircraft's receipt of those navigational transmissions.

COLE'S LAW

If you've followed the discussion so far, you see that the root of the FAA's concern is intermodulation, which can occur in the aircraft's receiver. The primary gripe of the broadcast industry is that, in attempting to determine the likelihood that any such interference might occur, the FAA assumes that *all* aircraft are using antiquated receivers that are far more susceptible to intermodulation than more modern models.

But this "worst-case-scenario" approach makes little sense because it is completely out of touch with reality. In the FAA's view, EMI is likely to occur at many airports as a result of existing radio operations. But it is clear from the fact that planes take off and land every day at those airports that

no problems seem to exist, the FAA's doomsday speculations to the contrary notwithstanding.

The reason, of course, is that the vast majority of aircraft apparently do not rely on the antiquated avionics that are basic to the FAA's EMI thinking. Instead, they use equipment that rejects the type of intermodulation the FAA fears. But the FAA, possibly to avoid imposing any additional costs of any sort on its constituency (aircraft owners and pilots) simply refuses to acknowledge this reality, and instead persists in defining EMI in unrealistic worst-case terms.

Now the FCC is the agency charged with the regulation of the radio spectrum. Thus, to the extent that this issue involves the establishment and enforcement of standards governing radio transmissions and interference, the FCC would logically be the agency responsible for dealing with EMI. But the FAA has for years asserted that the FAA, and *not* the FCC, should have the last word in this area.

Thus far, the FCC has been unable or unwilling to counteract the FAA's unilateral assertion of responsibility in this area. But the Furr petition suggests a means by which the FCC might do just that.

Setting avionics standards

What Furr has suggested is that the FCC establish and enforce standards governing avionics receivers. The simplicity of the Furr proposal is attractive. All the FCC would have to do is devise standards for avionics designed to ensure reliable service in all RF environments. Once such standards were in place, the basis for the FAA's concern would be history, and more appropriate, realistic EMI standards could be adopted.

In purely legal terms, the Furr proposal is not without its problems. Historically, the FCC generally has not sought to regulate receiving equipment (one exception being the all-channel receiver rules applied since the early 1960s to television sets).

That reluctance may stem from the fact that the Communications Act seems not to address that question directly one way or the other. The FAA (or its supporters)

might thus argue that the FCC does not have the necessary authority to get into this type of regulation. Such concerns might sway the Commission away from avionics regulation.

The alternative, though, is hardly acceptable. If the FCC walks away from the question, the FAA will presumably continue to force its unrealistic notion of EMI on broadcasters (and everyone else, for that matter).

The result will be equivalent to forcing all drivers to abide by 1940s-era traffic rules just because some drivers *might* be behind the wheel of 1940s-era cars, and despite the fact that the vast majority of drivers are using modern cars.

In practical terms, FM and TV broadcasters could continue to expect extensive delays (and additional costs for consultants, appeals, etc.) in virtually any effort to upgrade their operations. In fact, substantial numbers of upgrades might ultimately be rejected just because of FAA EMI policies.

In view of the clear impact that the FAA's policies already are having (and will continue to have) on the broadcast industry, it does appear that the FCC will have to do something if it wishes to retain control over the process of authorizing broadcast stations to serve the public. Reports circulating in Washington indicate that the FCC is indeed attempting to deal directly with the FAA on this matter.

Bargaining chip

The Furr proposal may prove to be a useful bargaining chip in those discussions. Right now, all the Commission has done has been to announce that the proposal was filed and to invite comments regarding it. But that is enough to signal to the FAA that the proposal is at least under consideration.

If the FAA wishes to keep the Furr proposal from gaining momentum, the FAA may have to abandon the hard-line approach that it has taken thus far. Failure to do so may prod the FCC either into issuing a notice of proposed rulemaking looking toward adoption of some variation of the Furr proposal or, ultimately, into regulating avionics as proposed. Whatever happens, this is almost certain to remain an interesting situation for the foreseeable future.

Harry Cole is a partner in the Washington-based law firm of Bechtel & Cole, Chartered. He can be reached at 202-833-4190.

Computer Virus Cures

(continued from page 23)

the subject, ViruCide includes a free copy of a book written by John McAfee, "Computer Viruses, Worms, Data Diddlers, Killer Programs and Other Threats to Your System" (St. Martin's Press).

This book provides interesting insights into these subjects and not only shows how vulnerable many systems are, but simple, prudent steps to take for protection.

Another book that you might want to put on your bookshelf is Jonathan Mayo's "Computer Viruses" (Windcrest, 1990). A combo deal similar to ViruCide, you buy the book and a free disk of antiviral utilities is enclosed.

And for an even more detailed and comprehensive look at the subject, a solid reference is the "Computer Virus Handbook" by Richard Levin (McGraw-

Hill, 1990).

A further indication of industry sensitivity to the needs of users is found in diagnostic programs like Checkit™ from Touchstone and QA Plus™ from DiagSoft. Both now include system infection checkers. Checkit uses SCAN™, a McAfee shareware program; QA Plus has its own IntruderAlert™. Neither can remove a virus.

You may never have an infection in your computer. On the other hand, waiting until you get one before learning about them and how to prevent file destruction might be an expensive education.

Cart machine, transmitter or computer-preventive maintenance pays off.

Barry Mishkind is a consultant and contract engineer in Tucson. He can be reached at 602-296-3797, or on FidoNet 1:300/11.

CCA

Evolution.

CCA has delivered more than 3,000 Broadcast Transmitters over the past 25 years. For 25 years our designs have been refined and improved. The result is the Evolution of the world's most perfected, most tested, most reliable, Radio Transmitter.

- * Grounded Grid Triode
- * Longest Tube Life
- * Auto Power Control
- * VSWR Power Foldback
- * Single Phase Optional

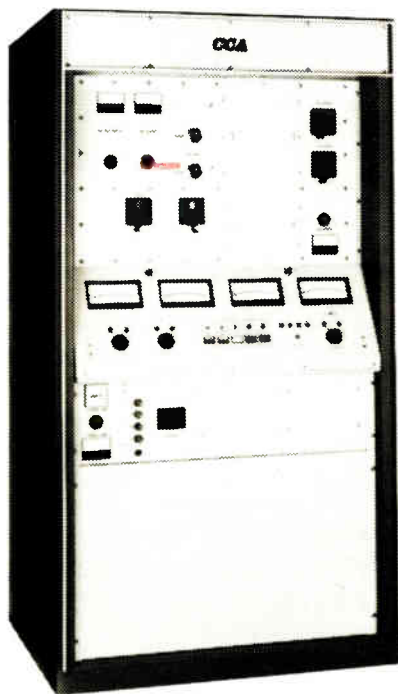

CCA Electronics, Inc.

P.O. Box 426

Fairburn, GA 30213

(404)964-3530 FAX (404)964-2222

DAB's Competition Heightens

by Steve Crowley

WASHINGTON In a move to improve the performance of its digital audio broadcasting (DAB) system, Satellite CD Radio Inc. has proposed modification of its transmission technology. Details are provided in filings Satellite CD Radio has made with the FCC. Since Satellite CD Radio's original filing at the FCC in May 1990, engineers have been concerned with its single channel per carrier (SCPC) modulation scheme.

Transmitting all the data for a program on one frequency means that multipath interference can destroy the data at any one location. Previously, it proposed to overcome this problem by using more than one antenna. The latest modification eliminates the need for multiple antennas by transmitting the audio for each program on a sequence of closely spaced frequencies.

CONSULTANTS CORNER

Since multipath is frequency dependent, it won't occur on all frequencies at the same time. Most of the frequencies and hence, most of the data, will be available at any instant. By interleaving multiple programs in the same bandwidth, no increase in spectrum is necessary beyond that required by transmitting the programs continuously on the same frequencies.

Stanford at the helm

The system's inventor, Stanford Telecom, calls the process dynamic SCPC, or D-SCPC. It is said to maintain sound quality even in the presence of fading of over 30 percent of the signal.

Satellite CD Radio has shed some light on the details of its system. In less than 4 MHz of bandwidth, 12 programs may be carried. The transmit frequencies for the 12 programs are interleaved using a 12x12 crosspoint switch that routes the 12 input digital streams to 12 output streams. The blocks are 1074 symbols in length with a time duration of 2 milliseconds. The crosspoint is switched—and the transmitted frequency for any one program is changed every two milliseconds.

An analogous coding scheme is used by the Eureka 147 system's Coded Orthogonal Frequency Division Multiplexing process. Both systems use an error control process that increases the transmitted data rate by a factor of two. The stereo program data rate of 256 kilobits per second (kbps) is increased to 512 kbps. This process generates a coding gain that reduces transmitter power requirements.

Spreads out the data

D-SCPC also takes advantage of time-interleaving of the data. The coded data stream is processed by a block symbol interleaver that achieves a two millisecond time separation (1024 symbols) at the interleaver output for any symbols spaced less than 37 symbols apart at the input. This spreads out the data in time and thus makes it less susceptible to propagation problems

at any instant of time.

The block interleaver also inserts about 50 overhead symbols required by

time delay and amplitude of the received RF signal.

The 50 leading symbols are the first

Most of the frequencies and hence, most of the data, will be available at any instant.

the receiver for synchronization and its adaptive equalizer. Adaptive equalization is a digital process that mitigates intersymbol interference by varying the

seen by the receiver in each block of data and are used to adjust the adaptive equalizer amplitude and delay for each block of data. The equalizer tries to col-

lect all the energy in the multiple signals arriving at the receiver.

According to the filing, Stanford Telecom already has developed the necessary component parts of its DAB system through its work in other digital systems, such as those used in defense electronics. The company is seeking a patent on its DAB process.

■ ■ ■

Steve Crowley is a registered professional engineer with the consulting firm of du Treil, Lundin & Rackley, Inc. in Washington. He can be reached at 202-223-6700 or by FAX at 202-466-2042.

'WOLF!'

You've heard people crying wolf about FM digital multi-processors for a while now. Well... the real Wolf is here, and it's ready to go!

Introducing the UNITY 2000SM from Cutting Edge, the only full-function FM Digital Processor that gives you everything you need for your broadcast audio chain in one chassis.

Each component in the UNITYSM stands on its own as the best in its class. The way the UNITYSM brings these components together allows you to achieve an on-air sound that you never dreamed possible. Regardless of your format, you WILL sound better.

For all of its versatility, the UNITY 2000SM is extremely easy to use. An intuitive, menu driven interface lets you concentrate on the sound while providing a direct visual correlation to your settings.

Experience the power of Unified ProcessingSM. It gives you unprecedented control over your sound, and its price won't leave you howling.

See Us At NAB Booth 2007

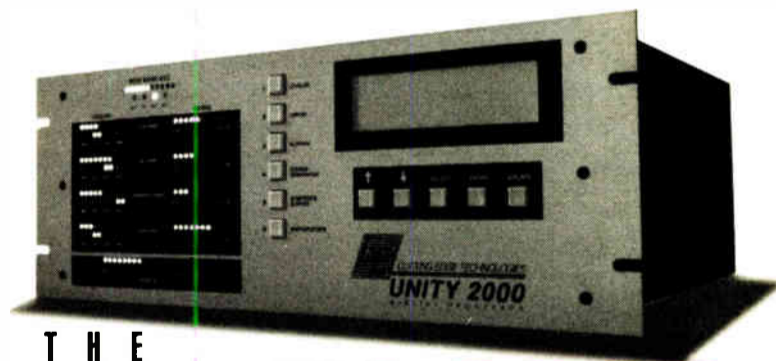

**THE
UNITY 2000
DIGITAL PROCESSOR**

- SELECTABLE DIGITAL WIDE BAND AGC
- SELECTABLE LOW FREQUENCY EQUALIZER
- DIGITAL 4-BAND LEVELER/PREPROCESSOR
- DIGITAL 4-BAND LIMITER
- DISTORTION CANCELING CLIPPER
- DIGITAL STEREO GENERATOR
- SELECTABLE COMPOSITE CLIPPER



CUTTING EDGE TECHNOLOGIES

2501 West Third Street • Cleveland, OH 44113 • Telephone: 216.241.3343 • FAX: 216.621.2801

Circle 94 On Reader Service Card

KCEV Checks Out For a New Facility

by Dee McVicker

WICHITA, Kan. In September 1988, a small station checked into a 13-unit motel in downtown Wichita. It was from there that KCEV-FM launched its educational and religious broadcast service at 88.3 on the dial.

FACILITIES SHOWCASE

Then in January 1991, KCEV checked out. Favoring a small suburban community over the city congestion of Wichita, the management at KCEV decided to move its station from the old motel to a new facility six miles from the city.

Knock on the door

Compared to the centrally located motel in downtown Wichita, where it wasn't uncommon, said GM Bill Endsley, "for people to knock on the door wanting to know if we had rooms," KCEV now is located in the quiet rural area of Derby, Kan. In leaving behind the city congestion,

however, KCEV also left behind the amenities of the old motel, which contained a bathtub and shower in each office—including the air studio. "That's something we left out of the new building," related Endsley.

But what the station did include in its new facility was state-of-the-art broadcasting equipment. During KCEV's stay at the downtown motel, most of the equipment in use fell under the catalog heading of professional audio gear.

"When we started out, we needed a new transmitter, a new tower and all those types of things," said Endsley, adding that the station operates strictly on a cash-and-carry policy. As a non-commercial station relying on listener support for its income, KCEV got by on equipment rated for professional audio use until a new studio—and ultimately a new building—could be afforded by the station's listeners.

On Jan. 7, that day arrived. In a testimony of its strong listener support, KCEV paid cash for its new custom-built, 800-square-foot building. It also paid cash for the equipment it needed in order to outfit a professional broadcast stu-

dio, which now doubles as an on-air and production studio.

Retiring its old 24-channel professional audio console, the station purchased a new ATI Vanguard Series console. Although the old board, according to Endsley, "did well considering the RF environment it was in," the new ATI outshines previous console capability by several counts. "This ATI board is half the size, and will do at least what (the old console) did," he said, adding that the new board has touchsense control.

KCEV also moved up to the ReVox PR99 MKIII and Otari MX5050BII reel-to-reel recorders. "ReVox and Otari are known for being the standard workhorses in this part of the country," Endsley said.

Timing is everything

Previously, KCEV had been using a consumer-grade recorder, and linear counters were a recorder luxury not afforded the station's operators. "Timing is very important in our production," said Endsley. "We do some of our own programming; we have two church services and a Bible teaching service on Sunday."

For the majority of programming, however, KCEV relies on a satellite feed from Bible Broadcast Network, which pipes its programming to some 53 stations nationwide. While the ReVox is used primarily to record feeds from the satellite network, with cue tones for automation, the Otari is used primarily for production.

For music fillers in between satellite programming, the station takes advantage of a Technics SL-P1300 compact disc player. The CD player also is used for music bits for the station's 30-second announcements. In addition, a Technics 1200 turntable is used for the occasional music cut on vinyl.

Like most stations today, KCEV is limited by cash flow and sought the most

cost-effective means for outfitting its new facility. "We operate our station for a month on what one station here operates on for eight hours," Endsley said.

In keeping within its cash flow con-



An ATI Vanguard Series console, and ReVox and Otari recorders, are the centerpieces of KCEV's new facility.

straints, KCEV houses production and on-air in a single 13x14 square-foot studio. With production and on-air control located in one studio, Endsley concedes that the scheduling of equipment use is critical. "We have certain days we do certain productions. Sunday's production is



Satellite feeds downlinked from the Bible Broadcast Network comprise most of the station's programming.

usually done on Fridays, and Mondays are sort of a catch-up day from the week before. We try to stay a week ahead," he said.

In building the new 800-square-foot facility, Endsley also tried to stay within reasonable cash flow restrictions. Although small by most stations' standards, the new facility, he said, is functional and laid out well. Of particular importance to Endsley and the staff at KCEV are three large windows looking out from the studio to the Derby countryside.

"I worked in a lot of radio stations where the announcer in the air booth didn't have visibility to the outside. You wouldn't know if it was summer or winter; you'd be reading the forecast but you weren't sure if that's what was going on outside or not," he said. The studio windows in KCEV's new facility are heavy weather gauge for nominal sound isolation, even though traffic and other pedestrian noises are virtually non-existent near the facility.

In the new facility since January, the staff at KCEV is, for the most part, glad to leave the amenities of the old motel behind—even the showers and bathtub in the on-air studio. But, Endsley noted, "Our transmitter (building) is still located at the motel, and it has a tub and shower."

Dee McVicker is a free-lance writer and regular contributor to RW. To inquire about her writing service, call 602-899-8916.

Exciting Products! New Lower Prices! Twenty-One Year History of Customer Satisfaction!

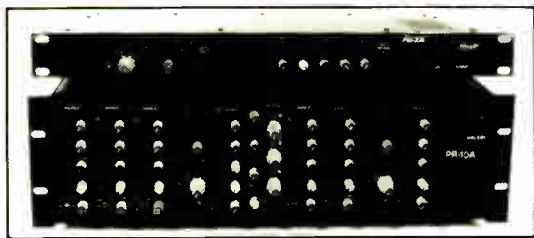

PR-2A Two-position rack for 800 series with XLR connectors **\$250.00***
PR-10A Ten-position powered rack for 800 series with XLR connectors **\$450.00***

- 810-KEPEX II** Noise gate/expander for "quieting" unused "open" mics and performing noise reduction **\$290.00***
- 811-GAIN BRAIN II** Variable ratio limiter for precise control of audio level with freedom from "pumping" **\$290.00***
- 812-MAXI-Q** Fully parametric 3-band equalizer for enhancement of broadcast on-air and production program material **\$290.00***
- 815-DSP** Dynamic Sibilance Processor for effective removal of offensive sibilance for FM broadcast production purposes **\$290.00***
- 817-COMMANDER** Compressor/Expander/AGC for effective control over the dynamic range of audio signals with freedom from background noise **\$290.00***



400-MIC PROCESSOR The "industry standard" for broadcast on-air and production voice processing **\$679.00***



430-DYNAMITE Two-channel (stereo) multi-function dynamics processor offering compression, limiting, noise gating, and expansion modes. Just perfect for production **\$375.00***



450-GATEX Four-channel noise gate/expander for capably "quieting" unused open mics in multiple mic talk show formats and providing noise reduction capabilities for production work **\$425.00***

490-HH 2X2B Two-channel (stereo) +4/+8 to -10 level and impedance matching interface with low noise, low distortion performances **\$179.00***



Call your favorite broadcast dealer OR speak with us for further details
1-800-800-4345

See us at NAB Booth 1161 & 1163

*Suggested retail price. Actual selling prices determined by Valley International Dealer.

Circle 69 On Reader Service Card

DETAILED FM INTERFERENCE STUDY AND 3 ARC SECOND (DMA) TERRAIN DATA

- Invaluable For Short-Spaced FM Stations
- Determines Interference Received And Generated
- Directional Antennas Considered
- Examines 360 Radials Using 3-Sec or 30-Sec Terrain Data
- Retrieves All Potential Interfering Facilities
- Compares Protected Contours of Proposed and Conflicting Facilities
- Computes Allowed ERP & Signal Strength For Each Radial Azimuth

For further information, please call the Sales Department at (800) 368-5754 or (301) 652-8822 in the Washington, DC area.

dataworld
A Service of DW, Inc.

P.O. Box 30730, Bethesda, Maryland 20814

FAX (301) 656-5341

(301) 652-8822 (800) 368-5754

Circle 56 On Reader Service Card
 See Us at NAB Booth 1609

Fortunately for us, most radio engineers look before they leap.

You've always been an analytical bunch, so we're sure you know that our MX-55NM 2-track not only gives you the features you need, but that it's also priced several thousand dollars below its nearest competitor.

We know you're not about to overlook *major* features, like HX-Pro™ bias optimization, or gapless seamless punch-in punch-out, or that famous Otari sound. However, here's some fine points to examine as you do your "apples-to-apples" with our competitors.

For example, the MX-55NM incorporates a printed-circuit capstan motor (like that used on our MX-80 multitrack machine).

This not only gives you low wow and flutter right out of the chute, but very fast start times.

It's also worth noting that EQ selection and Reference Fluxivity values can



Three cue locations and a zero memory can be accessed via the MX-55NM's built-in locator.

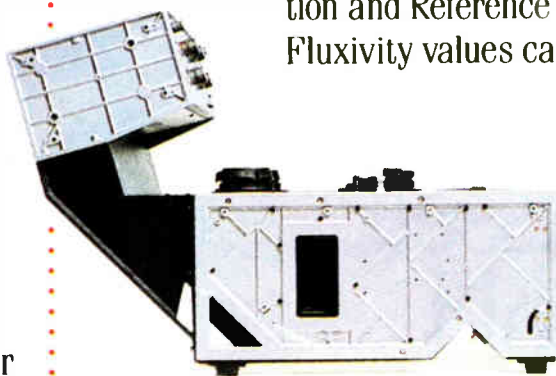

A 1.5" cast alloy deckplate, plus cast side frames give the MX-55NM the rigidity and ruggedness you've come to expect from Otari. (Do our competitors show you the inside of their machines?)

be changed with a flip of a switch. And as you put the deck

through its paces, notice that the variable speed control

provides 0.01% step resolution. This means you can make precise changes, and perhaps more importantly, you can repeat a change *exactly* when necessary.

For your convenience, an optional voice editing module maintains normal pitch at twice normal speed. And the meter-bridge keeps knobs and switches out of the way while you're editing.

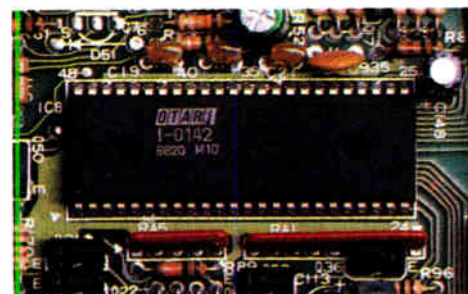

Because we know how hard you use our machines, we use a double-sided glass epoxy transport circuit board, and we silkscreen both sides of our PCBs so you can locate the components easily.

In the Otari tradition, we make the MX-55NM easy to service. Only four screws get you into the transport electronics. And when you get there, all servicing can take place with wiring intact. We also hinge all service panels, and use locking cable interconnects.

The specs? Why not call your nearest Otari dealer, or Otari at (415) 341-5900 and check them out. Like everything else, you'll find them "right on the money."



OTARI®

See Us at NAB Booth 1801

Circle 116 On Reader Service Card

Translators in Tough Terrain

by Howard L. Enstrom

MOUNT DORA, Fla. In last month's column, we looked at four translator examples and compared cost per square mile of coverage, using omnidirectional Cp radiation over flat terrain east of the Mississippi River. Interference was no issue, variable parameters affecting ERP were used, and we saw what increasing antenna HAAT does to the predicted F(50,50) contour distance. But terrain is not always flat, and there can be incoming

and outgoing interference concerns.

Consider this: A circularly patterned signal might be launched at site, but terrain elevation changes can distort its coverage pattern.

Put another way, radial distances to the reference contour are not all the same. An extreme case would be a mountainside translator using an omnidirectional antenna. It is far above and far below immediately surrounding terrain in various directions, making for widely differing site-to-contour distances.

To propagate equally in all directions is to invite built-in signal multipath reception. A directional antenna with minimal backside radiation is more appropriate, such as a log-periodic type. While such hardware reduces multipathing, its actual coverage pattern must be calculated by accounting for radial elevations.

Incidental to this is whether the antenna system for such a site has appreciable vertical gain, because the translator signal might overshoot a close-in, lower elevation community.

It Has
Outperformed,
Outclassed,
Outsold,
Outdistanced
And
Outlived
Every Mixer
That Ever Hit
The Road.

SEE WHAT'S NEW
FROM SHURE
IN PORTABLE MIXERS
AT NAB
BOOTH 1414.



Nothing compares to the Shure M267 Mixer. Nothing even comes close. The M267 is the most rugged, reliable, remote mixer ever made. And it has a road record to prove it. In fact, there's only one word to describe it: Outstanding.

Call 1-800-25-SHURE. The Sound Of The Professionals®...Worldwide.

SHURE®

Circle 145 On Reader Service Card

World Radio History

Instead of tilting the antenna or structure, electrical beam tilt can be introduced.

A signal coverage pattern can be graphically portrayed by plotting the calculated contour distances as a function of elevation changes on radials of polar graph paper.

Radically different

The pattern that emerges from connected points may be radically different from the antenna manufacturer's published pattern, where instrumentation measures antenna gain or loss at close radial increments within a controlled environment. In antenna engineering, horizontal or azimuthal patterns are likely to be labeled "E-plane."

All antennas, of any type and polarization mode, radiate and intercept wave energy in two dimensions. In addition to the E-plane aperture, the one pertaining to the vertical, or elevation pattern is the "H-plane."

Visualize putting a really fat doughnut on a pencil held upright. Its volume and shape is similar to that of radiation from a single vertically polarized half-wave dipole antenna. Now cut the thing in half. The laid-over figure eight cross-section area depicts radiation in the H-plane.

LOWPOWER LOWDOWN

Without influence of terrain or atmospheric dielectrics, the field intensity is equidistant in the E-plane, and maximum at 0 degrees elevation, progressively diminishing at plus and minus angles in the H-plane. At high plus angles, wave energy is hurled through the atmosphere into an endless, wasteful journey in space.

At high minus angles toward terra firma, radiated energy converts to heat or reflects wildly, some up to space. Most FM listeners and DX stereo music lovers on Pluto never hear audio recovered from a single-pathed signal. Astronomers complain about light pollution from civilization's cities, but did you know they also complain about RF pollution?

Vertical gain is achieved by vertical stacking of antenna bays to compress lobe energy in the H-plane. As a general rule, doubling the number of bays adds 3 dB gain, doubles power (G) or ERP. The same goes for horizontal stacking of bays to narrow pattern width in the E-plane. The stacking distance between bay centers may be less than a wavelength—about 10 feet at FM frequencies—for somewhat less gain.

Stacking effects

What does stacking do to a pattern? At HPBW (half power beam width, where the radial arc in degrees is measured at the .707 point), 3 dB stacking gain reduces beam width to around half.

Suppose we have a Scala CA-2 two-element Yagi antenna mounted for horizontal polarization. Its gain is 4.0 dBd, the horizontal (E-plane) HPBW is 72 degrees, and the vertical (H-plane) HPBW is 80 degrees.

Add a second bay above or below, configuring to a type CA-4. The gain increases to 7.0 dBd, the E-plane HPBW remains at 72 degrees, but the H-plane HPBW decreases to 46 degrees.

If we add another pair of bays—making four—add 3 more dB, making

(continued on next page)

528

VOICE PROCESSOR

The perfect choice *for less-than-perfect voices.*



(and for whimpy sound effects,

lumpy music beds, mushy

agency dubs...)

Why do more stations rely on the 528 Voice Processor?

- ▼ The power of five processors—mic pre-amp, de-esser, expander, compressor/limiter, 3-band parametric EQ—in one rack space.
- ▼ Straightforward controls make it easy to “dial in” *your* sound.
- ▼ Easy installation—mic level (XLR) and rear panel line level (barrier strip) inputs and outputs (balanced or unbalanced), facilitate patch bay connection.
- ▼ Each processor stage can be used separately with rear panel barrier strip patching connections.

Where does your signal chain need help?

In the on-air studio, the 528 turns good voices into great voices with a combination of flexible signal processing power and outstanding audio quality. The 528's powerful, easy-to-use controls give you total command of your sound.

In the production studio, one Voice Processor can smooth out copy reads, add extra “oomph” to sound effects and “tweak” samples. With a stacked pair of 528's, you can EQ and compress stereo music beds, brighten up dull-sounding agency dubs and clean up background noise on final dubs for on-air playback.

In the newsroom, the 528 gives you an assortment of tools to clean up actualities. If unnatural high frequencies are a problem, use the de-esser. If background noise is intrusive, the expander will push it out of the way. If the feed sounds dull the parametric EQ can even out the frequency response. Is hum or interference a problem? Notch it out with the parametric.

On live remotes where you're using a P.A., you can notch out feedback with the parametric. The combination of expander and compressor allows you to “punch up” the vocal mic without feedback.

Proven reliability

The 528 Voice Processor, like all Symetrix products, is designed and built for non-stop, no-slowng-down professional applications. We use double sided, plated-through glass PC boards, top-quality pots and heavy-duty connectors. Fully regulated ± 15 V bi-polar power supplies maximize available headroom (the 528's outputs are capable of +24 dBm). Hundreds of stations around the country know they can count on their 528s to perform flawlessly—any time and every time.

Broadcaster-designed features

The blueprint for the 528 grew out of long talks with radio people. For instance, we learned that more and more stations are turning to top of the line condenser mics. So the 528 has switchable phantom power built in. Production directors emphasized that every voice is unique: the “one size fits all” type of signal processing doesn't work. That's why the 528 gives you total control of gain, tonal balance, and dynamic range (including noise reducing downward expansion).

528 On-Air Set-Ups

Mix and match the EQ, dynamics and de-esser settings to get the right sound for your format.

- “Presence” EQ
- That “big round sound”
- “Filter mic” telephone simulation
- Gentle dynamic control for “smooth talkers”
- Tight dynamic control for “screamers”
- Heavy de-essing at 8 kHz gets rid of excessive sibilance
- Mild de-essing at 2 kHz softens over-emphasized fricatives

Production Power with the 528

For maximum flexibility in production, you can access each section of the 528 separately through the rear panel barrier-strip terminals. There are also compressor side chain, effects send/return and stacking connections for even more possibilities.

- Low frequency shelving EQ gets rid of “thump” from third-generation tape dubs
- Loudness compensation makes music beds sound full under voiceovers
- With a high Threshold, the expander makes sound effects even more dramatic

- With high Threshold and Ratio settings the compressor becomes a limiter.
- A combination of high frequency shelving EQ and expansion gives you single-ended noise reduction unit. By patching the equalizer's output into the side chain input, you can make the expander especially sensitive to the high frequencies. Use a stacked pair to clean up the final mix.

Cleaning up news feeds with the 528

- 60 Hz hum filter with the parametric
- 15,750 sync leakage filter using parametric
- A gentle high-frequency boost can often enhance intelligibility
- De-essing gets rid of HF “garbage” from phone lines and remote feeds
- Combine compression and expansion to “tighten up” the dynamic range without increasing background noise
- Live remotes run more smoothly with the 528
- Parametric EQ gives you three separate notch filters to tame PA feedback
- Compression plus expansion lets you “tighten up” the jock's monitor without risking feedback

We only have room here for a few of the ways broadcasters are using the 528 to improve sound quality everywhere in the station. But now that you know some of the possibilities, what are you waiting for? Contact your broadcast distributor. Or call Symetrix toll-free at 800-288-8855—we'll be happy to send you our 528 applications note and tell you about our other dynamics processors, headphone amplifiers, mic preamps, telephone interfaces, precision meters, noise reduction and automatic level controllers.

Industrial-Strength SV-3900

by Ty Ford

BALTIMORE In the increasingly crowded field of R-DATs on parade, the Panasonic SV-3900 appears remarkably understated. Don't let the utilitarian front panel throw you off.

PRODUCER'S FILE

The computer-accessible architecture within, whether connected to Panasonic's SH-MK390 remote controller, to a computer via the RS-422 serial ports or to the eight-pin parallel port, make the SV-3900 an impressive machine.

Sure, the 64-times A/D converters and 18-bit D/A converters make it one of the better-sounding R-DATs on the market. But what's really interesting is that Panasonic's goal seems to

The controller also sports other new features, like a 2.5 second auto fade-in and five second auto fade-out. These are not my favorite features because they stair-step and glitch both on the way in and on the way out. Make sure the audio you record is after the fade-in and before the fade-out and you'll be fine.

Transport search speeds on the SV-3900 are selectable between 250 and 400 times normal speed. Using a 90-minute R-DAT cassette, it took the transport between 29 and 30 seconds to get from beginning to end, regardless of the speed setting.

Reverse search from the end of the tape back to program number one took 27 seconds at fast speed and 35 seconds at slow speed. Cue time for cuts that were only a few minutes away from each other on the tape took between five and six seconds.

The large LCD display is easy to read and backlit for use in low-light areas. There also is a set of dip switches on the remote controller that programs the SV-3900 into dedicated dubbing, continuous playback, continuous recording, search

operation. It also determines the SCMS ID6 status for the AES/EBU inputs and can be adjusted for "Copy Free," "No Further Copies" or "One Copy Allowed" operation.

Incidentally, the SCMS status of an R-DAT recording can

include transport, system control and supervisory functions that will be capable of controlling large networks of SV-3900s.

Point and click or keyboard command controls, programmed play functions and "Time Search" allowing one or

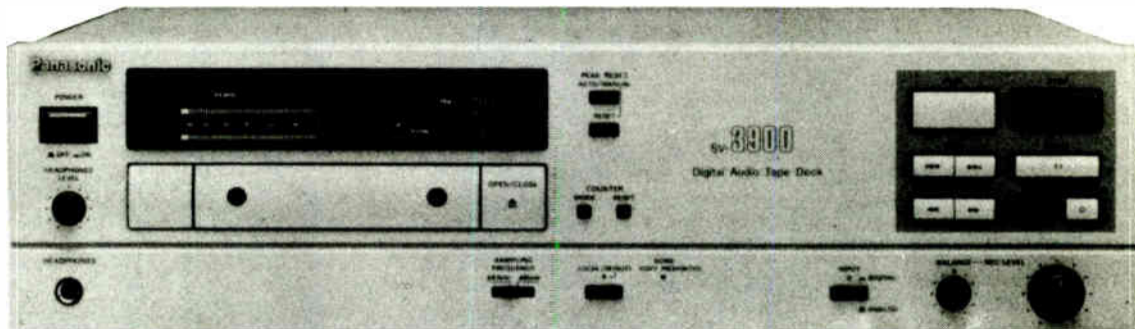

The SV-3900 professional DAT recorder from Panasonic

and play, search and pause or test mode.

Still, it's not until you take a look at the back of the SV-3900 that things really get interesting. In addition to the

be displayed on the front panel of the SV-3900 by simultaneously pressing the Counter Mode, Reset and Pause buttons on the front of the unit. If the Counter Mode is pressed again, the display reads the error rate.

The parallel remote DIN port on the back panel is configured to be used to control 43 transport functions (including the familiar skip forward, play, FF/cue, skip backwards, rewind/review, pause, record and stop). You also can connect a computer to the parallel port and get all of the basic functions the SH-MK390 remote controller provides except for shuttle capability. The computer interface also operates the open/close and unload functions.

The back panel also provides "In" and "Through/Out" RS-422 nine-pin D-sub ports and communicates by ES bus or P2 protocols.

Software package coming

According to Panasonic sources, the software package "SV-3900 Developer's ToolKit," written in high-level C language for both IBM PC-compatible or Macintosh systems will soon be available. These utilities will

more SV-3900s to locate by absolute time within ± 1 DAT frame (3.3 ms), are expected to be part of the Developer's ToolKit's expanded capabilities.

The Digital Through Put Mode allows a number of playback machines to be cascaded via their AES/EBU I/Os to a master recorder. Because the system works both ways, you can assemble-edit from many playback machines onto the master recorder, or use the master recorder to feed the other machines for duplication.

One last note: As this column was going to press, I learned that Panasonic will, sometime after NAB, be selling a remote controller with cue, stop and play buttons; a time display; and shuttle wheel for designating the PNO to be played.

List price on the SV-3900 is \$2,100. List on the SH-MK390 Remote Controller is \$400. For information, contact Chris Foreman at Panasonic: 714-373-7232, or circle Reader Service 136.

■ ■ ■

When not writing for RW, Ty Ford spends most of his time beta testing new audio production gear and sorting his sock drawer. His MCI mail number is 347-6635; his America Online screen name is Tford; or call him at 301-889-6201.



The SH-MK390 remote controller for the SV-3900

be positioning the SV-3900 as the cog in a wheel of a much larger design—a design in which there will be not just one or two SV-3900s, but up to 32 of them.

But I'm getting ahead of myself. First, a few basic improvements should be noted.

Forget the zero

Remember how you used to have to punch in 01, 02, 03, 04, 05, etc. when you wanted your machine to go to single-digit addresses? Remember how you hated doing it? With Panasonic's SH-MK390 remote controller you can forget the "0."

Remember how auto-start ID circuits were pretty much a waste because they cut off the first moment of your selection during playback? Panasonic also sharpened the auto-start ID circuitry so it really works. I tried to sneak some wimpy synth lines in and got them all the way down to -40 dB before they failed to trigger the start ID circuit.

Like every R-DAT machine I've seen, except the new Sony series with RAM start that starts at \$6,000, there is a delay between the time you hit the start button and the time you hear the audio. By my stopwatch, cues recorded with the auto start ID function took between 1.2 and 1.38 seconds to get out of the machine from pause.

I didn't try to reposition the start IDs to get closer. Elapsed time from pause to audio out anywhere on a track clocked in at 1.1 to 1.2 seconds by my stopwatch.

Well-built remote control

All of the basic controls you've come to expect are conveniently placed on the 5.25" x 9.75" SH-MK390 remote controller. In addition, there's end search, auto program number, a data input pad with 0-9, "all" and "enter" buttons, counter mode selector and a shuttle search wheel that allows you to shuttle the tape like a video machine.

analog XLR I/O with 0/+4 output switch, the digital XLR AES/EBU and RCA IEC Type II I/Os, there are a few other features that deserve mention.

The dip switch mounted in the digital I/O section allows you to switch between the AES/EBU and IEC Type

When Terrain Is Tough

(continued from previous page)

the array gain about 10 dBd. This further narrows the HPBW beam width. Of course, stacking antenna bays horizontally narrows the HPBW in the E-plane, and a more complex antenna array would be a composite of vertical and horizontal stacking. Now we begin to achieve some focusing to illuminate a target community or area discretely, and minimize interference with other services.

For reinforced radiation through stacking bays, each is driven in the same electrical phase, with equal power from a power divider or coaxial line harness. Interconnecting lines (jumpers) must be the same length or a halfwave multiple more, accounting for the velocity of propagation factor (except, when electrical phase is purposely offset for beam-tilt reasons).

Two FM antenna bays occupy but 10 feet of vertical tower space, but four take 30 feet. If tower leasing is based on footage, there's quite a difference in a fixed operating expense, hardware investment and windloading. Using higher equipment power output, or more efficient line in marginal cases, could yield a better cost-effective figure.

I believe FM translators deserve attention similar to that for a full-service FM station. The consultant integrates FM channel information, FCC rules, service objectives, interference considerations, site conditions and budget limits to design a good system. And sometimes circumstances combine to make such impossible.

■ ■ ■

Howard Enstrom is president of FM Technology Associates. He can be reached at 904-383-3682; or by FAX: 904-383-4077.

CHECKMATE

In one move, you can checkmate all the problems that may arise during your transmitters' operation. With the new ELENOS RF DIAGNOSTIC system, you and your equipment are brought together

RF DIAGNOSTIC is a new telemetry and remote control system for tube-type power amplifiers.

All the useful parameters needed to prevent malfunctioning or to intervene in the operation of malfunctioning equipment are transferred by either radio link or telephone to a personal computer (IBM or compatible with an MS-DOS operating system).

A unique software system created by ELENOS, available in various languages, enables the user to obtain:

CURRENT DATA

PAST DATA

GRAPHIC DATA

Moreover, if the amplifier in question is manufactured by ELENOS, the computer screen will produce a picture of its front panel (with high graphic resolution) including all current meter readings. Of particular interest to the engineer are:

- ◆ a ZOOM function which allows enlargement of any detail for easier reading
- ◆ the HELP function: an online troubleshooting manual that guides the user to assess the causes of malfunctions, and in some cases comes up with solutions.
- ◆ the use of a MOUSE and icon representation which allows even inexperienced computer users to be able to work with the PC.

Direct access and automatic saving of data means that the readings of all functional par-

ameters prior to an event are stored and therefore even occasional anomalies can be isolated and treated. It is also possible to send all data of such parameters directly to ELENOS, or to your service center to receive analysis, advice and diagnosis.

Please call or write for more information on the ELENOS RF DIAGNOSTIC system today.



ELENOS

BROADCAST EQUIPMENT COMPANY

Via G. Amendola, 9 Tel. 39/532829965
POGGIO RENATICO (Fe) Italy Fax 39/532829177

DEALER INQUIRIES INVITED

Circle 77 On Reader Service Card

World Radio History

WORKBENCH

Dollars and Sensors

by John Bisset

FAIRFAX, Va. In our last installment, we spoke about defeating the infrared sensors on consumer-tuned broadcast gear.

There may be some instances, however, in which the sensors with their remote controls are useful. For just such occasions, the engineer needs a sure-fire way of determining whether the remote control infrared LEDs are really working.

Larry Albert from Murray State University provides the following circuit for testing infrared devices. The test fixture can

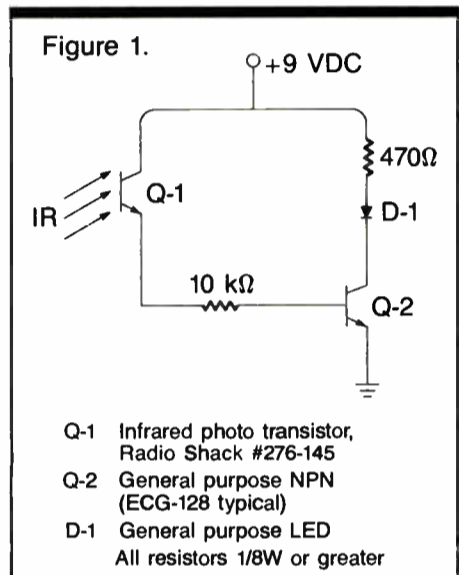

be assembled for less than \$5, and none of the parts are critical (See Figure 1).

With the exception of the infrared photo-transistor (Q-1), the parts are probably in your junk box. Q-2 is an ECG-128, though any general purpose NPN transistor could be used. Larry chose the 470 ohm resistor, because the LED he used was marked 20

mA maximum. He also decided that it was a good idea to limit the base current to Q-2, and chose the 10K resistor for that.

A 9 V battery was selected to drive the fixture due to its size, and does not require a holder like a group of AA cells would. Using the fixture is as easy as pushing a button. Just bring the remote near the detector and push any button on the remote. The red LED on the test fixture should light. Larry cautions that some remotes are one-shots, and will need to have the button depressed several times in rapid succession.

Watch closely while you do this—the LED will not appear very bright, due to the duty cycle of the remote control's LED. The fixture will not identify bad data, but will confirm output from the remote. Larry Albert can be reached at Murray State University's Television Department by calling 502-762-4664.

For many of us, this month marks the time we can start to forget about winter. So as you make the rounds in your transmitter field, perhaps conducting the first quarterly tower inspection for 1991, you may want to consider protecting your fence and door locks with a simple, yet effective ice barrier.

Sure, you can squirt WD-40 into the keyhole, but even better than that is the rubber flap suggested by Charlie Hallinan. It is pictured in Figure 2, and is easily con-

structed out of pieces of old inner tube. Basically, the inner tube is cut to form a square. This square is mounted above the door lock or keyhole. The flap hangs down to prevent water, ice or snow from being blown into the lock or keyhole—and

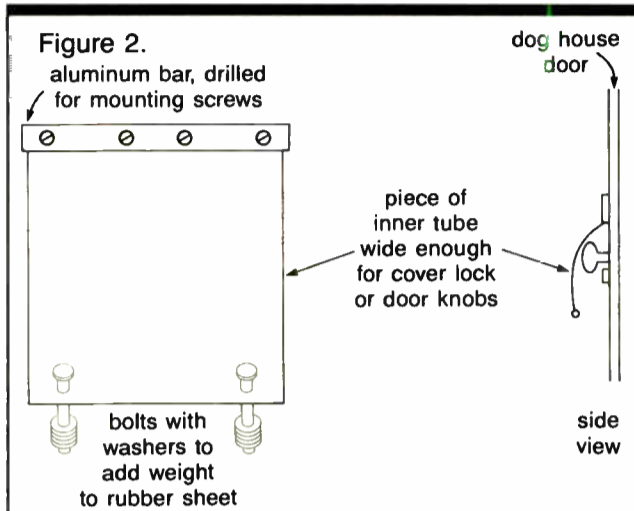

the resultant freeze-up.

I got to see Charlie's invention in action in upstate New York. It works. Charlie suggests swapping a station T-shirt for an old (or new) inner tube at a service station. Hang some bolts or crimp on a piece of metal at the bottom to keep the flap from blowing around.

The washers keep the mounting bolts or screws from tearing the rubber. If your doghouse or shed has a metal hasp, consider extending the rubber sheet past the edge of the door.

Charlie Hallinan can be reached at 607-724-5608. He was one of the founders of the first SBE Chapter—Chapter #1 in Binghamton, N.Y.

Our alarm circuits prompted a reply by Les Jamison of WANN. Les rigged up two consumer cassette recorders to begin recording when either an EBS message or

test or weather alert comes through. The remote mic contacts of the cassette recorders are used and wired into either the TFT (or equivalent) EBS decoder relay or the Gorman-Redlich Weather Receiver.

The beauty of the system, aside from its simplicity, is that there now is no excuse for not getting the EBS message or weather alert correct. Les can be reached at 301-269-0700.

John Bisset recently left Delta Electronics to concentrate on Multiphase Consulting, a contract engineering company. He can be reached at 703-379-1665.



For Excellence In Antennas

- A complete line of TV and FM Broadcast Antennas
- Modern 7,000 ft. test range facilities
- Innovative Engineering Careful construction
- Two Year Warranty on Product and Workmanship

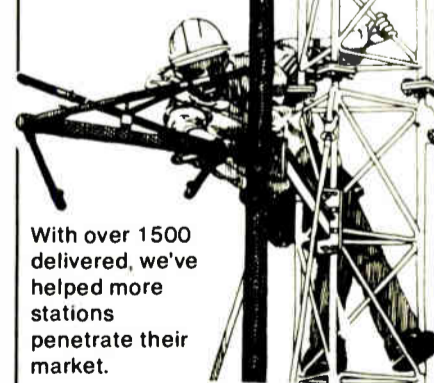

With over 1500 delivered, we've helped more stations penetrate their market.

FCC Directionals
 Pattern Studies
 Multi-Station Arrays
 Full Scale Measurement

JAMPRO ANTENNAS, Inc.
 6939 Power Inn Road
 Sacramento, CA 95828
 (916) 383-1177 TELEX 377321

Ergonomic Elegance...

SEE THE FUTURE

At NAB '91
 Fidelipac Booth #1041

MURPHY
 STUDIO FURNITURE

▲ 4153 N. BONITA STREET ▲ SPRING VALLEY, CA. 92077 ▲ TEL (619) 698-4658 ▲ FAX (619) 698-1268 ▲

First Choice...

...For Durability



At stations around the world, you'll find that one brand of cart dominates the library—"true blue," genuine original Audiopak. Why? Because no "copycart" can copy our reputation for proven longevity.

When you pull a cart from the library, you want that song, spot or promo *for sure*—without dropouts, bias fluctuations or phase problems. With specially developed oxide formulations and proprietary back-coatings, blue Audiopak AA-4s, AA-3s and black A-2s deliver—time after time, cart after cart.

...For Consistency



One thing you *don't* want from a cart is surprises. That's why Audiopak is the first choice of more stations around the world.

When you push the Start button, you know "true blue" Audiopak AA-4s, AA-3s and A-2s will deliver consistent bias, phase and frequency response and dropout-free performance—cart after cart after cart. Our proven performance record is something no "look-alike" cart can match.

...For Reliability



The last thing you want from a tape cart is on-air failure. That's why the one cart more stations count on is Audiopak.

Whether you use carts for music, spots or special effects, Audiopak AA-4s, AA-3s and A-2s deliver "true blue" mechanical performance—spot after spot, song after song, cart after cart. Yet another record no "look-alike" cart can match. No wonder demanding broadcasters have made Audiopak the best-selling cart worldwide. After all, why would you trust your signal to anything less? Make sure your new carts are the real thing. Look for the molded-in Audiopak logo and our Quality Assurance seal on every cart.

audiopak
BROADCAST CARTRIDGES



P.O. Box 3100
Winchester, VA 22601
Tel: (800) 522-CART
or (703) 667-8125
Fax: (703) 667-6379

Fritz II Mic Makes a Ghostly Appearance

by Frank Beacham

PASADENA, Calif. One suspects the famed British writer Sir Arthur Conan Doyle would have appreciated a "ghostly" encounter of his characters with "Fritz II," the Neumann binaural microphone shaped like a human head.

Doyle's 100-year-old short story, "Selecting A Ghost," a radio drama production by the California Artists Radio Theatre, was a week away from production when I received a phone call from Juergen Wahl, Gotham Audio's West Coast representative, with news that Fritz II was in town and available for a demo.

It was the perfect match. In Doyle's story, a group of colorful ghosts audition to become head ghost at a feudal castle. With Fritz II, the sounds of the ghosts would acquire a stunning three dimensional quality on headphones while maintaining a conventional stereo effect over speakers.

What? A mic

When Fritz II was set up in the studios of KPCC-FM, the actors were curious as to why they were speaking into what appeared to be a mannequin on a microphone stand. An explanation was in order.

I told the cast that Fritz II is a replica of the human head with microphones placed in the ear canals. When sound is recorded using this "binaural" method and played back on headphones, the reproduction is so realistic listeners think they are present at the live event. And, due to Neumann's tricks with diffuse field equalization, Fritz II also produces a good stereo image on traditional loudspeakers.

There also was a strange curiosity in the studio regarding Fritz's rubber-like ears. Wahl explained that the ears are the result of about 50 ear impressions from German college students who were made into plaster models. Using the models and a computer, Neumann researchers mathematically computed the form of an average pair of human ears.

After the actors had become comfortable with Fritz and were told to treat him simply like the audience, director Peggy Webber and sound engineer Marty Halperin began recording the stormy ghost sequence. A pinch of reverb and some howling wind sound effects were added as the actors screamed, cried, howled and swirled under, above, behind and in front of Fritz.

Give me some headphones

On headphones, the effect was breathtaking. On speakers, the results were as advertised—the stereo sound image of a conventional stereo microphone. It quickly became apparent that Fritz was a tool with amazing production possibilities.

At a cost of \$5,000, this Neumann binaural microphone is not a common item in most microphone lockers. In Europe, the microphone is generally sold to government-supported broadcast networks for applications ranging from binaural orchestral recording to radio drama. Neumann, in the past year, sold

30 Fritz II clones to Italian radio.

One owner and longtime American user of Fritz II is Tom Lopez, whose ZBS Media in Ft. Edwards, N.Y., produces audio drama for public radio and cassette sales. He produced 13 half-hour programs with Fritz II, including Stephen King's horror tale "The Mist," which has sold more than 70,000 copies through Simon & Schuster Audio.

"The series was experimental in the sense of trying different things," said Lopez. "What I really want to do is write specifically for Fritz. We've joked about creating a story called 'Cheap Tricks' that would highlight all of the things we can do with Fritz."

New radio listening

Though he called Fritz "technically terrific," Lopez said the resistance of people to wear headphones while listening to radio has restricted his use of binaural sound for broadcast. "For radio, it's hard to get people to put on headphones," Lopez said. "While Fritz makes good stereo on speakers, it doesn't make great stereo."

Lopez feels the best outlet for binaural sound is the compact disc, due to its ability to deliver wide dynamic range without the compression required for radio broadcast. Feedback from reply cards included with "The Mist" convinced Lopez that younger listeners, not their elders, are the best audience for headphone listening.

"The comments mainly came from young people in their 'teens and early 20s," he said. "They were knocked out by the sound. Those kids were born with headphones on."

Binaural programming is also available from The Binaural Source of Ross, Calif., which offers a catalog of recordings from around the world. John Sunier of The Binaural Source also hosts "Audiophile Audition," a national weekly radio program for audio buffs. Twice yearly, Sunier offers a special all-binaural edition of the program. The next all-binaural program will be broadcast in July.

For those who just can't abide wearing headphones, a special binaural circuit in the Lexicon CP-1 Digital Audio Environment Processor allows speaker playback of any binaural recordings with results very similar to headphones.

Meanwhile, back at KPCC, there were quite a few "wows" from cast members as they passed the headphones to hear the ghost scene recorded with Fritz. Peggy Webber, director of the radio theatre organization, vowed to use Fritz on future broadcasts. And KPCC planned to encourage its listeners to wear headphones for the broadcast.

If only Sir Arthur Conan Doyle could have been there. Fritz II might even have turned up a character in one his stories.

For information on the Fritz II, contact Juergen Wahl on the West Coast at 818-785-2211, or Gotham Audio on the East Coast at 212-765-3410. Tom Lopez can be contacted at ZBS Media, Route 1, Box 1201, Ft. Edwards, N.Y. 12828. Information on binaural broadcasts of "Audiophile Audition" or The Binaural Source catalog can be obtained by writing Box 1727, Ross, Calif. 94957.

Choosing a Business Structure

by John Cummuta

DOWNERS GROVE, Ill. Last month we began the adventure of moving out into the entrepreneurial career of contract or free-lance engineering.

Maybe it's something you'd like to do on the side from your regular gig, or it might be your dream to be completely independent. The fact is that opportunity abounds out there for communications electronics engineering people to ply their trade for a number of businesses beyond the one paying their salary today.

Since we happen to be in what the news media insists on calling a "depressed economy," let me take a moment to philosophize. The reality is that someone is always thriving, even during depressed economies. There were people who made fortunes during the Great Depression of the 1920s and 1930s.

ENGINEERING MANAGER

You see, the economy is never really good or bad "out there." The economy is either good or bad between your own ears. If you're not one of those timid souls that seem to populate Wall Street, you can make something work for yourself regardless of the economy—and if you're really smart, *because* of the economy.

The courtship of business

Now on to the topic of this month's column: The structure you will choose for your business. Let's look at a similar situation.

Some men and women are what might be called "dating." They have no formal structure to their relationship, but it is a relationship. Others could be classified as "going together," or what my generation called "going steady." And then there are the people who are officially "married."

These all are forms of having arrangements or relationships with another. They represent increasing formality and longevity of the relationship and they all have their purpose.

These examples are loose analogies to the business structures of sole proprietorship, partnership and corporation. Each business structure has its level of formality, longevity and purpose, and each may be right or wrong for your needs, depending on your plans and goals. Let's look at them one at a time.

First, the sole proprietorship is just what it sounds like: You, doing business by yourself. That doesn't mean that you can't have people in the business with you, as either employees or managers. What it does mean is that you are the "sole" owner of the company, and that all the company's profits and losses, assets and liabilities are 100 percent yours. That can be both wonderful and horrible.

If the company becomes wildly successful and makes tons of money, everything left over after cost is yours. But if the company gets deeply into debt, your personal assets are subject to be liquidated to satisfy those debts.

When it comes to sole proprietorships, the Internal Revenue Service makes *no* distinction between the business and the

However, it also should be said that you can enjoy some wonderful tax deductions as a sole proprietor that are

ing your income taxes one cent. In fact, running a business from your home is probably matched only by mortgage interest deductions in terms of their tax value to the average taxpayer.

If the company becomes wildly successful and makes tons of money, everything left over after cost is yours.

person owning the business. The profits of your business will be considered direct income to you and you will be liable for the appropriate taxes.

not available to the average taxpayer. These deductions can help you pay for your home, your car, your phone bill, even your vacations, while not increas-

Up to you

Another significant advantage of the sole proprietorship is that you don't have to share decision-making authority with anyone.

This can be more valuable than you might realize, because partnerships and corporations are more like marriages, in

(continued on page 35)

7.5kHz or 15kHz Dial Up Audio....

You can choose what's right for you.

For two years CCS' Micro56 has been setting the standard for 7.5kHz audio over digital dial telephone lines. Now CCS is proud to announce the first commercially available MUSICAM™ 15kHz CODEC for use with the same dial up digital lines. Whether you're AM or FM, news or music, CCS' family of digital audio CODECS gives you *Crystal Clear Digital Audio™* over any 56/64Kbs digital facility. Rack mount, desk top, PC based, rate adaptable, ISDN compatible, 15kHz or 7.5kHz it's your choice. Only from CCS Audio Products.



CCS Audio Products

Crystal Clear Digital Audio™

A Division of Corporate Computer Systems
33 West Main Street Holmdel, New Jersey 07733 U.S.A.
908-946-3800 Fax: 908-946-7167

Hear Us At



Booth No.2123

Using a Function Generator

by Tom Vernon

HARRISBURG, Pa. Many small market engineers lust after some of the newer computer-based audio test centers, but find most of them out of their price range. Still, the requirements for high-end audio make simple sine wave testing somewhat inadequate.

For many, the bridge between these two worlds is an inexpensive function generator, which will be the subject of this month's column. The most basic function generators deliver sine, square and triangle waveforms. More expensive units deliver pulse and sawtooth functions as well.

Still more elaborate units are programmable, allowing you to make up your own waveforms and store them in memory. AM and FM modulation of the waveform is typically included, as is DC offset and sweep. Some units include both linear

STATION SKETCHES

and logarithmic sweep functions. Digital readout of frequency and amplitude also may be included. Unlike RC audio oscillators, the bandwidth of most function

generators far exceeds the audio range.

Typical response runs from .01 Hz to around 10 MHz, with more expensive units having an even greater bandwidth. This response range makes the function generator useful not only for audio, but for RF video and logic applications as well. The inexpensive function generator is not without its limitations, but the savvy engineer knows how to use it to his advantage.

Since this generator has multiple waveforms or functions, it cannot deliver the same purity of waveforms one would expect from a dedicated sine, square or triangle generator. Sine wave tests with a function generator are typically done to verify flatness of amplifier response. Since the sine wave is usually derived from an amplitude regulated triangle wave, a flat response within millivolts across the band is normal.

Bounce and bumps

Compare that with the half and quarter dB bumps of an RC oscillator, plus the bounce of its lamp-derived AGC cir-

Figure 1.

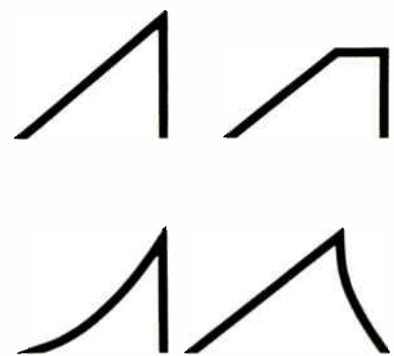

Typical waveforms from sawtooth tests. The leading edge of the waveform tests low frequency response of an amplifier, while the trailing edge checks HF response.

Square and triangle waveforms usually fare much better than sine waves in our generator. The use of square waves for testing audio equipment is well understood, but we'll review some basics here. The biggest plus is that you can judge a system's overall performance just by glancing at your oscilloscope.

One myth about square wave testing is that you can determine an amplifier's bandwidth simply by multiplying the input frequency by five.

Thus, if a device can pass a 4 kHz square wave relatively unmangled, response should be good to 20 kHz. This rule is simply untrue. It is based on the premise that square waves are made up of fundamental frequency and higher odd-order harmonics. What is missed is the fact that harmonic amplitude decreases with increasing

frequency, invalidating any quantitative HF measurements.

But don't despair. There is a quick and accurate way to check bandwidth with square waves. It requires use of the formula: Bandwidth = 0.35/rise time.

Triangle and sawtooth waveforms aren't as popular for amplifier testing as square waves, but they do have some advantages. While square waves are made up of odd-order harmonics, triangle and

(continued on next page)



Market Share Generator

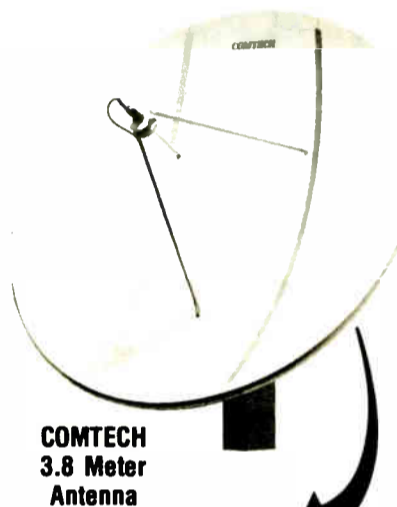

COMTECH 3.8 Meter Antenna



MICRODYNE 1100-FFC-X1 RDC(L) SCPC Satellite Downlink Receiver



MICRODYNE 1100 PCDR-5 SCPC Demodulator

Leading stations all over the nation are adding market share by providing the information and entertainment their audience wants. With over 75 radio networks available via satellite, programs are available to boost your market share. Most sports-nets, state news-nets, and agri-nets are available through SCPC audio satellite.

Microdyne SCPC downconverters are the industry standard — none better for less. Microdyne PCDR-5 demodulators are feature-loaded . . . more standard features than others offer as options! To complete the package, Harris Allied recommends the Comtech 3.8M high performance satellite antennas.

Now more than ever, no one gives you more choices in satellite equipment — or more help making the right choices — than Harris Allied. More people; expanded resources: That's what we mean by taking the lead.

HARRIS ALLIED
SATELLITE EQUIPMENT

SEE US AT NAB BOOTH #1100

FAX 317-962-8961

317-962-8596

IN CANADA 800-268-6817

With expanded staff and services . . . our lead keeps on growing!

HARRIS ALLIED ©1991

"Call me, I'm interested." Circle 9.

"Send me literature." Circle 108.

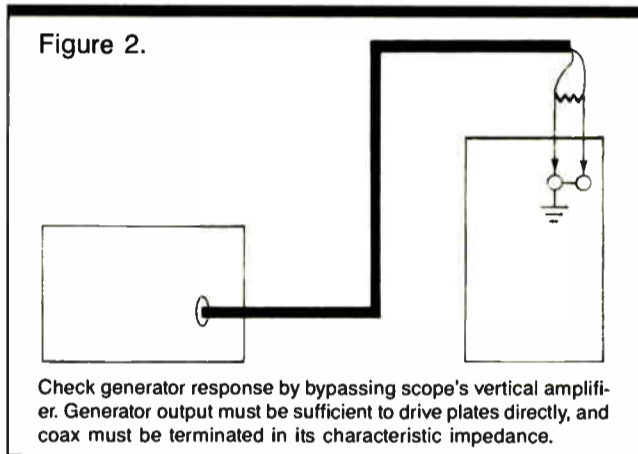

Figure 2.

Check generator response by bypassing scope's vertical amplifier. Generator output must be sufficient to drive plates directly, and coax must be terminated in its characteristic impedance.

uits and you can see that our function generator can save you lots of time, since you don't have to measure the input voltage as you're doing frequency sweeps.

The bad news with function generator sine waves is that their distortion is much worse than mediocre RC oscillators. Figures around 1 percent or a little higher are not uncommon.

Frequency accuracy and stability also is lacking with these units. Testing for amplifier distortion is best left to old faithful.

7.5 kHz—15 kHz Digital Audio Is Here

For Remotes—STLs—News Gathering—Sporting Events

Northern Transdata Networks Inc.

Specialized Broker for the Phone Companies

Brings you one stop shopping

- We provide a low cost alternative to satellite feeds
- NTN will order your Switched 56/ISDN digital phone lines and modems, and coordinate end to end service
- We're your single point of contact for hassle free service and provisioning
- We provide latest LEC tariff info for both U.S and International connections
- NTN has provided high quality digital audio lines for our clients—ABC, BBC, CBS, Capitol Radio Networks and NPR

Call for details on how we can help you

NORTHERN
Transdata
NETWORKS Inc.

Visit us in Las Vegas at the Flamingo Hilton
Call toll free 800-347-9919 to confirm our suite location

Choosing a Business Structure

(continued from page 33)

that almost every decision has to be agreed to by both or all parties—and as your own personal relationship might indicate, coming to a consensus is not always easy.

A partnership is essentially a multiple sole proprietorship. It offers no additional tax benefits, and it provides no greater protection of your personal assets than the sole proprietorship. It simply spreads the load—and the profits.

If the business goes bad, you are only responsible for your share of the debts. But if it goes great, you only get your share of the profits. It's a sweet and sour way of doing business.

Most people who choose a partnership structure for their business do so for one of three reasons: They need something the other person(s) can bring to the table to make the business work, they love working with the other person(s) or they're terrified of trying a business on their own.

If your motivations fall into categories two or three, think once, twice and a dozen more times before formalizing the relationship. More friendships have been destroyed by starting a partnership business than anything other than marriage (sad to say). Unless you are highly compatible in your thinking, your temperament, your ethics and even your morality—don't do it.

If you do decide to form a partnership, I recommend that you have a lawyer draw up an agreement that spells out not

only the distribution of debt and profit, but what happens if one or more partners die or decide to sell. And delineate how decisions are made if there is a tie vote. Add in any other potential problems you can imagine. Believe me, they'll come up.

A corporation has two other main advantages. First, you are forming a legal entity in and of itself with its own responsibility for debts and liabilities, thereby protecting your personal assets. Second, corporations are perceived in the marketplace as being more "real bus-

inesses" than are sole proprietorships and partnerships.

There are essentially two kinds of corporation structures: "S" and "C" corporations. The advantages of an S corporation are that it is simpler to manage from a paperwork standpoint and that it does not have to pay taxes on its profits. You and the other shareholders pay taxes on the profits—whether or not you take the money out of the company.

The C corporation pays taxes on its own profits, but if you then take the money out, you will have to pay taxes

again on the same money as personal income to you. So, in effect there is double taxation with a C corporation. But there are other offsetting benefits to a C corporation if you plan to become a large business.

Talk to your accountant and your lawyer to see which corporate structure would be best for your needs.

Next month we'll get into the pricing, billing and cash flow issues that I didn't have room for in this issue. Stay tuned, because few adventures in life can compare with running your own business.

■ ■ ■

John Cummuta is president of Advanced Marketing Concepts, a broadcast management and marketing consulting firm. He can be reached at 708-969-4400.

Employing Function Generators

(continued from previous page)

sawtooth waves are composed of all harmonics, thus even order anomalies may be observed. Since some amplifiers attenuate even order harmonics, their distortion would not show up with square wave testing.

Amplifier crossover distortion

Triangle waveforms are useful in spotting amplifier crossover distortion. Feed a 10 kHz wave into an amp working into a load resistor. Scope the output and look for notches in the slopes at the zero crossing point. The solution to this problem is usually to tweak the bias adjustments.

Another advantage of these waveforms is that amplifier clipping is very visible on the oscilloscope. Clipping will chop off the top and bottom of a waveform, but this is hard to see with square waves and not so precise with sine waves. Figure 1 illustrates some typical scope traces with sawtooth waveforms.

OK, so now you found some overshoot or tilt on square waveforms. How do you know whether it's the generator

or scope which is at fault? You could try another oscilloscope or swap function generators. But what if you only have one of each? If your function generator is capable of putting out about 15 V peak-to-peak in its rated load, there is an alternative.

It involves connecting the output of the function generator directly to the deflection plates of the oscilloscope. This will bypass the vertical amplifier; any limitations it may be imposing are displayed linearly. See Figure 2 for a typical setup. Be sure to check your scope manual for specific information.

The beauty of even an inexpensive function generator lies in its versatility. While it may not outperform dedicated sine or square wave generators, it is a universal signal source with applications in audio and RF testing throughout the station.

■ ■ ■

Tom Vernon, a regular RW columnist, divides his time among broadcast consulting, computers and instructional technology. He can be reached at 717-367-5595.

More Power To You.

MAXIMUM VELOCITY AND MINIMUM ATTENUATION

That's what MYAT rigid line and RF components deliver. We manufacture them using highest quality pure copper or aluminum, and thoroughly test each one before shipping. Princeton University's Plasma Physics Laboratory evaluated MYAT performance, and chose our components for their research reactor.

RELIABILITY AND LONGEVITY

They're important to you—and to us. So we use non-galling silver plated beryllium copper contact springs, brass elbow reinforcements and pure virgin Teflon inner supports. Every MYAT rigid line section and component is warranted for a full year. That's why you'll find the bright blue MYAT logo in transmitters and systems by Harris, Acrodyne, QEI, Micro Communications and Broadcast Electronics. And at thousands of broadcast stations worldwide.

SERVICE AND SUPPORT

Need a replacement fast? Check our catalog—virtually every item listed is ready for immediate shipment. Not sure what you need? Ask a MYAT engineer for technical assistance. Unusual requirements? Our computerized design and testing facilities turn them into "routine" projects. We did it with high-power 9 $\frac{3}{16}$ " 50 Ohm line for KGON-FM's multi-station tower, and we can do it for you.

Whether you're planning a new tower, upgrading an older installation, or coping with an emergency, MYAT power is as close as your phone. Put it to work in your RF transmission system. Contact your RF distributor, or phone us at (201) 767-5380.

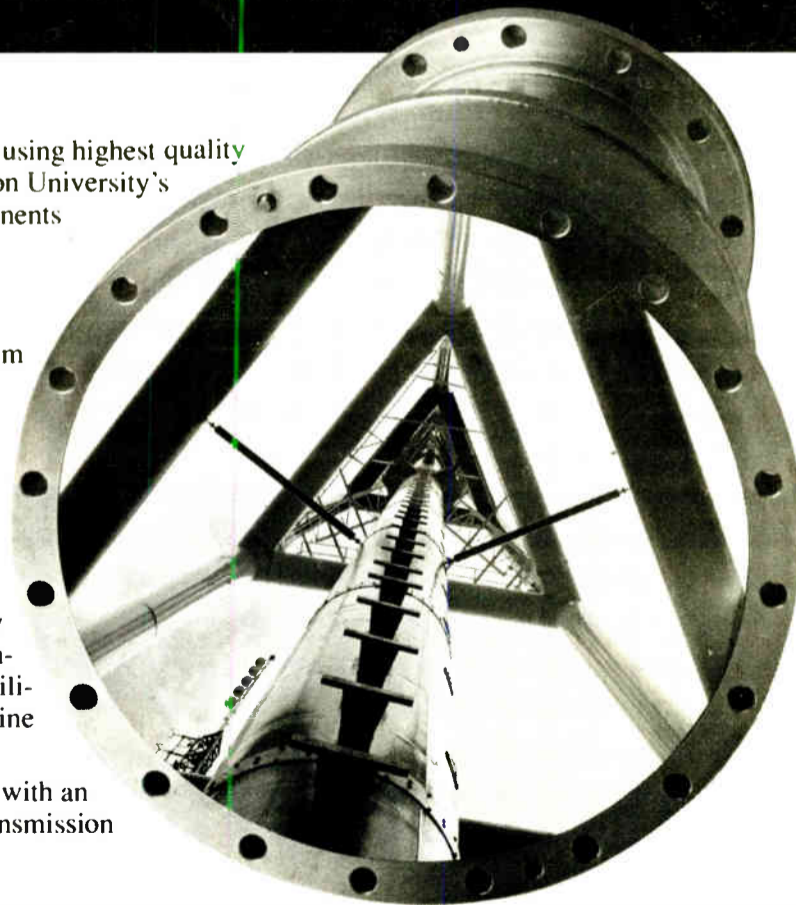

MYAT, INC.

Manufacturers of RF transmission equipment since 1951.

40 Years of Experience, 40 Years of Excellence.

380 Chestnut Street • P.O. Box 425 • Norwood, NJ 07648 • Tel (201) 767-5380 • Fax (201) 767-4147

Now Available:

Modulation Readings You Can Trust.

With its new internal DeModulator, ModMinder is calibrated at our factory and certified accurate for two years.

ModMinder's advanced digital circuitry makes it the most accurate, temperature-stable modulation monitor ever made. Now it has a front end that maintains the same level of precision, reliability and stability.

When you order a ModMinder™ with the internal DeMod Board, or have Modulation Sciences upgrade your ModMinder, we actually seal the modulation calibration control. We also send you a certificate of calibration valid for the next 24 months.

How can we do that? DeMod™ is the first and only demodulator whose calibration is traceable to an NBS (NIST) reference. Modulation calibration is totally stable from freezing to 122° F. It's also immune to mechanical shocks, so we certify calibration not only at our factory, but at your station. In addition, DeMod works with an exceptionally wide range of RF levels – from 10 mW to 1 W, without any user adjustment.

ModMinder and DeMod eliminate the uncertainties that have plagued modulation measurement. There's no calibration drift due to temperature fluctuations. No need to calibrate for modulation and RF level before each measurement. No meaningless moving pointers. Instead, you get high-resolution, instantly readable, totally reliable numerical readouts. You can get those readouts anywhere there's a modem-equipped PC, too – with ModMinder Remote software. It's free with every ModMinder, and it includes a unique Modulation Histogram that gives you important insights into your station's modulation.

ModMinder has revolutionized the way hundreds of stations measure modulation. Now the optional internal DeMod card turns it into a standalone dynamic modulation measurement and analysis system – the most accurate ever made. Of course, for precision, convenience and reliability, ModMinder has been standing alone from the very beginning.



modulation sciences, inc.

12A World's Fair Drive • Somerset, NJ 08873
Tel (908) 302-3090 • Toll Free (800) 826-2603
Fax (908) 302-0206

©1991 modulation sciences, inc.

Las Vegas

April 14 - April 18

New Technology Graces NAB

by John Gatski

LAS VEGAS The annual NAB spring convention returns to Las Vegas for 1991 and attendees will get a chance to look at and listen to technologies that could change the face of radio.

NAB has scheduled the U.S.'s first demonstration of the Eureka 147 Digital Audio Broadcasting (DAB) system during the show, and several engineering sessions will go into detail on digital broadcasting's future.

NAB also will be the host of Japanese broadcast company NHK's annual technology exhibit, the first time it has ever been held outside of Japan. The exhibit will include several prototype technologies for radio and television.

NAB has returned to Vegas because the renovation that was on-going in 1990 is now nearly completed. Last year, NAB held the show in Atlanta, while the Las Vegas Convention Bureau modernized the convention center halls and the rotunda. The rotunda is still under renovation, but most of the convention hall space and exhibit space at the nearby Las Vegas Hilton will accommodate the expected broadcast product companies.

Weekday schedule

The NAB will have 430,000 square feet of total space for the more than 700 companies displaying their latest products, according to the association.

Because of the remaining renovation, the convention center's main entrance has been moved to the South Hall and the rotunda will not be used. The West Hall will be used for extra exhibits and guest registration.

"The impact of the renovation on the show will be negligible," NAB Conven-

tions and Exhibits Senior VP Rick Dobson said.

Unlike past years, the NAB will run from Monday to Thursday instead of Thursday to Tuesday, to allow the hotels to reserve more rooms for weekend gamblers.

NAB Exhibitors Advisory Committee Chairman Pete Rightmire said 17,000 rooms were reserved, but conventioners who come without registering early should book Friday or Sunday because hotels are full on Saturdays.

The NAB doesn't expect to greatly exceed the record 50,000 persons that came to the 1990 show in Atlanta, but it expects an increase presence from European broadcasters.

"International attendance has been rising rapidly over the past few years," Dobson said. "This is the one opportunity European broadcasters have to see everything at once."

This year's international attendance is expected to top 6,000 from 50 different countries, according to the NAB.

Eureka, it's here!

NAB attendees will have a chance to hear a demonstration of the Eureka 147 DAB system, April 14-18.

The Eureka demonstration will include a direct comparison of FM and DAB. Every half hour, a 40-passenger coach bus will traverse Las Vegas streets with both analog and digital receivers that will receive a variety of music formats. Las

Vegas station KLUC will broadcast both the analog and digital signals.

The NAB said 4,500 bus passes will be available, which means those interested in hearing the mobile demonstration should sign up as soon as they get to the show.

NAB also will operate a DAB booth at the convention hall staffed by Eureka officials who will answer DAB questions and provide yet another audio demonstration.

NHK's special display will include 6,000 square feet of new and prototype audio systems including an advanced FM multiplexing system.

NAB '91 engineering sessions cover many aspects of radio broadcasting and begin the day before the show officially opens on April 14. Sessions will cover DAB, AM systems engineering, international technical updates,

FM advances, FM systems engineering, EBS systems, test, measurement and safety/environmental concerns.

Two sessions that are likely to be highly attended include forums on FM modulation measurement and the jurisdictional dispute between the FAA and the FCC regarding purported electromagnetic interference to air navigation equipment.

Among the ceremonial highlights, Marti Electronics Chairman of the Board George Marti will receive the 1991 Radio Engineering Achievement Award, April 16, during the engineering luncheon, to



Las Vegas welcomes back the NAB show after a year in Atlanta.

be held at the Hilton. The Ham Radio Operators Reception also will be held at the Hilton, April 17.

It won't be all serious business for showgoers, however. Las Vegas' reputation as an after-hours hot spot is well-established among those who have attended past NAB shows. Gambling, live entertainment, fine food and special attractions are among the activities that are available in the city.

NAB also will provide special tours of Las Vegas area radio stations. The bus fee is \$20.

DRY AM-FM LOADS

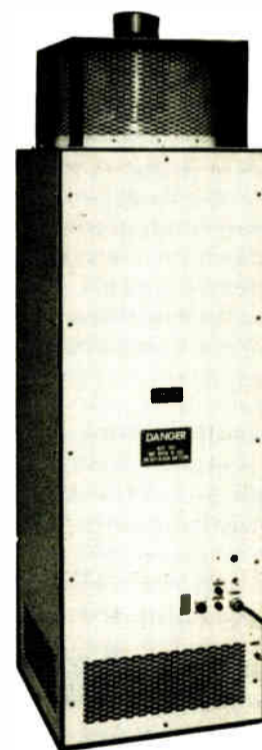

DPTC-50KFM

NOW ONLY \$5,975

ALWAYS IN STOCK

IDEAL FOR 35-55 kW TRANSMITTERS

ELECTRO IMPULSE LABORATORY, INC.
1805 CORLIES AVENUE, PO BOX 278
NEPTUNE, NJ 07754-0278 U.S.A.

FAX: 908-776-6793
PHONE: 908-776-5800

DIELECTRIC

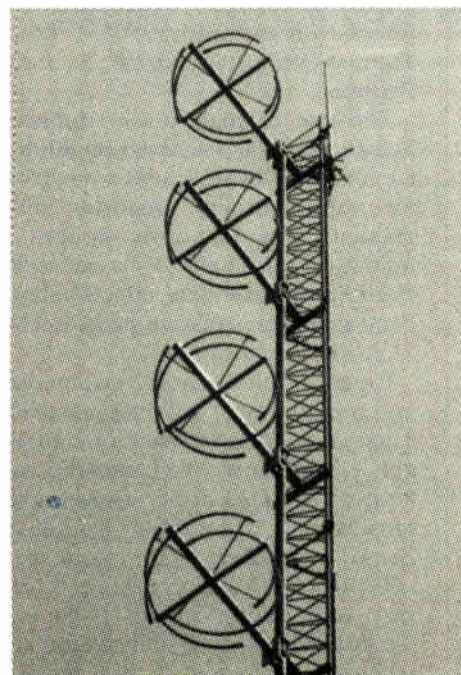

FM Antenna . . . 5-year system warranty

An exclusive offer from Dielectric. Manufacturers of FM antennas and FM products for over 35 years, our full line includes single and multi-station antennas, combiners, filters, switches, and transmission line. The Dielectric advantages:

- Improved technology for the 90's
- Directional patterns for FM upgrades
- Antennas for every power and bandwidth requirement
- Variable spaced antennas for limited tower apertures
- Minimum downward radiation

Full 5-year warranty on every complete Dielectric system!

Dielectric Communications

Raymond, ME 04071 • 1-207-655-4555 • 1-800-341-9678 • FAX: 207-655-4669

Engineering Sessions Cover Diverse Topics

by Janet Elliot

LAS VEGAS The 45th Annual Broadcast Engineering Conference begins on Sunday, April 14, one day before NAB '91 officially opens.

The conference includes a mix of technical sessions, equipment exhibits, and special Digital Audio Broadcasting (DAB) and Radio Broadcast Data System (RBDS) demonstrations to give engineers a look at the changing technology of broadcasting.

Larry Cervon, past president of Broadcast Electronics, Inc. in Quincy, Ill. will open the radio sessions with a very special series of interviews with radio pioneers. They include Dr. George Brown, Jim Weldon, Parker Gates, and Jack Moseley. These pioneers, whose contributions have made them a part of radio history, discuss what they believe have been the most significant technical developments in radio broadcasting.

The remainder of the opening session will be devoted to new technologies of digital audio including a recordable compact disc tutorial by Laura Tyson, Denon; low-cost sampling rate converters by Sangil Park, Motorola; spectrum efficient digital audio technology (SEDAT) by Kent Malinowski, Scientific-Atlanta; an integrated digital system for broadcast audio by David Evers, Broadcast Electronics; and an all-digital CD quality studio-transmitter link for 950 MHz by Howard Friedenber, Moseley Associates.

DAB sessions abound

Digital audio broadcasting (DAB) will also be featured in two of the radio technical sessions. The first session, DAB System Concepts (Tuesday, April 16, 2:30 p.m. to 4:40 p.m.) is a report on current

DAB studies and testing. Presentations include a LinCom DAB tutorial, an update on the Eureka 147 DAB transmission scheme by Daniel Pommier, CCETT; the results of digital audio coding listening tests in Sweden from Christer Grewin, Swedish Radio; DAB testing in Canada by Gerald Chouinard, Communications Research Centre; and the results of the NAB spectrum study from Alan Gearing, of Jules Cohen and Associates.

On Wednesday, April 17, from 1:30 p.m. to 4:30 p.m., DAB proponents from the Eureka partners, Mercury Digital, Kintel Technologies, Radiotechniques, RadioSat, Satellite CD Radio and Gannett will present their systems and also participate in a panel discussion.

Participants in the AM Systems and Engineering session (Sunday, April 14, 1:30 p.m. to 4:05 p.m.) will discuss AM engineering techniques including AM tower maintenance by Robert Sundius, S.G. Communications and Owen Ulmer, Stainless, Inc.; medium wave DA feeder system design, Ronald Rackley, du Treil, Lundin and Rackley; and implementing antiskew antenna technology by Timothy Cutforth, Vir James Consulting Radio Engineers.

Thomas F. King, Kintronics Laboratories, will present how to use isolation transformers to lease AM tower space and George Yazell will report on tests of a "noise free" AM radio system.

Two technical sessions will be focused upon during the FM Systems Engineering and Improvement Engineering sessions. In the Advances in FM System Design sessions (Monday, April 15, 3:05 p.m. to 4:50 p.m.), Harrison Klein will report on advances in airborne antenna pattern measurements. Harris-Allied's Gerald Collins will present a summary

NAB '91 Schedule At a Glance

Sunday, April 14

9 a.m. Digital Audio Integration
1:30 p.m. AM Systems Engineering and Improvement
4:30 p.m. Radio Reception

Monday, April 15

9 a.m.-6 p.m. Exhibit Floor Open
9 a.m. International Technical Updates and Agendas
9 a.m. Broadcast Auxiliary & Satellite Systems
11:15 a.m. EBS Forum
12 Noon All-Industry Luncheon
1:30 p.m. Audio/Radio Test and Measurement Workshop
3:05 p.m. Advances in FM System Design
5 p.m. Reception for International Registrants

Tuesday, April 16

9 a.m.-6 p.m. Exhibit Floor Open
9:15 a.m. FM Modulation Monitor Forum: What Does the FCC Expect?
9:15 a.m. Broadcast/Aeronautical Compatibility
11:05 a.m. Antenna and Transmission Workshop
11:05 a.m. Contract Engineers Workshop
12:15 p.m. Radio Leadership Luncheon
12:30 p.m. Engineering Luncheon
2:30 p.m. Digital Audio Broadcast System Concepts

Wednesday, April 17

9 a.m.-6 p.m. Exhibit Floor Open
9 a.m. FM Systems Engineering and Improvement
9 a.m. FCC Staff Panel
10:30 a.m. Digital Audio Broadcasting
10:50 a.m. Computer Applications for Broadcast Engineers Workshop
1:30 p.m. Digital Audio Broadcast Methods and Systems
1:30 p.m. Safety and Environmental Concerns
2 p.m. Radio Station Bus Tours
2 p.m. Regulatory Roundtable: a.m. & FM Station Improvements
3:30 p.m. Regulatory Roundtable: FCC Rule Enforcement
6 p.m. Ham Radio Operators Reception

Thursday, April 18

9 a.m.-4 p.m. Exhibit Floor Open
9 a.m. Audio System Design and Measurement
9 a.m. International Regulations
8 p.m. Closing Entertainment

Convention schedule is subject to change. Check with NAB.

of a new exciter designs. Gerald LeBow is scheduled to present the status of RDS in the U.S., and an NRSC representative

will give an update on FM subcommittee activities.

FM's future

Subjects covered during the second part of the FM Systems Engineering and Improvement sessions (Wednesday, April 17, 9:00 a.m. to 11:35 a.m.) include an FCC regulatory update presented by William Hassinger, assistant chief, engineering, Mass Media Bureau; and a forecast on the future of FM radio by Thomas Keller, Broadcast Technology Partners.

The use of high power, multi-user boosters will be discussed by Bill Ruck, CE for KFOG/KNBR, and a new design for multi-user FM antennas will be presented by Eric Dye, Jampro Antennas. Charles Kelly, of Broadcast Electronics, will review the effects of limited bandwidth transmission paths in FM on SCA/RDS performance.

Papers devoted to audio system design and measurement will be presented on Thursday, April 18, 9:00 a.m. to 11:10 a.m. Digital expert Mel Lambert presents a tutorial on DAT applications for radio broadcasting. Richard Cabot, Audio Precision, will discuss fast frequency response and distortion testing of broadcast audio and William Gillman, of Gentner Electronics, will outline audio processing for radio in the digital domain.

William Franklin, Fidelipac, looks at
(continued on next page)

Just What the Doctor Ordered...

You've got a bright, contemporary sound that's the envy of your competitors — but your playlist includes a lot of material from a different era — a time when things sounded great but, well, "dull." On top of that, those old disks and carts are noisier than your new equipment, and they aren't getting any quieter!

Not a "generic" prescription

The Orban 290R continuously analyzes your audio and adds just the correct amount of sparkle and space for each tune or spot. Used in transfers, it gives your

library the contemporary sound you need while its **Open Sound™** single-ended noise reduction cleans up hiss and surface noise.

Strong Medicine

The Orban 290R — three unique processing functions in two independent channels of audio problem solving power. Don't let tired audio undermine your 90's sound. Call your favorite equipment supplier today and try out a 290R. You'll be feeling fine in the morning!

orban®

LISTEN TO THE DIFFERENCE.

a division of AKG Acoustics, Inc.
1525 Alvarado Street
San Leandro, California 94577 USA
Tel 415/351-3500 Fax 415/351-0500



Orban and Open Sound are registered trademarks of AKG Acoustics, Inc.
Copyright 1991 AKG Acoustics, Inc.

Diversity in Sessions

(continued from previous page)

the future of analog audio cartridges, as contrasted by digital cart machine technologies presented by Robert Easton, 360 Systems. Brian McGettigan, New Zealand Radio, will follow these presentations with a discussion of a novel studio acoustic design.

An international flavor

During the International Updates and Agendas session (Monday, April 15, 9:00 a.m.), experts will report on the International Telecommunication Union preparations for a major frequency allocation conference that may allocate digital audio broadcasting frequencies, WARC-92, and the continuing CCIR agenda that affects U.S. broadcasting interests.

Representatives of the European Broadcasting Union (EBU) and Nippon Hoso Kyokai (of NHK, the Japan Broadcasting Corporation) discuss their approaches to establishing technical standards and the impact of new technology implementation on U.S. broadcasters.

If you are looking for computer information, you should attend the Computers for Broadcast Engineers session (Wednesday, April 17, 11:15 a.m.)

There will be demonstrations of software and hardware on everything from modem communications to technical documentation on a PC for this session. Thomas Osenkowsky, a radio engineering consultant, will provide an overview and

introduction to computers for broadcast engineers. Dr. Walter Black will follow with a discussion of computerized documentation—an engineer's friend or foe.

Learning to say no is an essential skill for effective management. Saying yes when a person should say no adversely limits time management, increases stress levels and diminishes the ability to be an effective manager. The Professional Development session (Sunday, April 14, 10:25 a.m.) examines why people feel uncomfortable saying no, presents easy and effective standards on when to say no and helps you learn how to say no with a minimum amount of adverse reaction or resistance.

Judith E.A. Perkinson, The Calumet Group, Inc. of Hammond, Ind. will lead the discussions.

FAA/FCC dispute

During the Broadcast/Aeronautical Compatibility session (Monday, April 15, 9:00 a.m.), participants discuss why FM, TV and even AM facility changes face objections from the Federal Aviation Administration. Federal authorities and industry experts will discuss the present and future prospects to use broadcast spectrum while protecting aeronautical frequencies.

Participants from the FCC, Federal Emergency Management Agency (FEMA) and radio stations will discuss proposed changes and improvements to

the EBS during the Emergency Broadcast System (EBS) Improvement session (Monday, April 15, 11:15 a.m.).

Likely to be heavily attended, the FM Modulation Monitors: What the FCC Expects session (Tuesday, April 16, 9:15 a.m.) will feature views of several modulation monitor manufacturers and representatives of the Federal Communications Commission. Find out how the FCC measures for overmodulation and how today's monitors are designed to interpret the rules.

Panelists will encourage routine radio performance measurements during a technical workshop session set for Monday, April 15, 1:30 p.m. Guy Berry, Potomac Instruments, and Kent McGuire, Sound Technology, will present demonstrations of the ways in which stations can keep a high level of audio and RF performance, using current, straightforward measurement methods.

Dean Sargent, D.W. Sargent Broadcast Service, will conduct a workshop on the proper maintenance of FM/TV antennas, Tuesday, April 16, at 11:05 a.m.

Among the planned NAB demonstrations, DAB looks to be the most exciting. In cooperation with the Eureka 147 project partners, NAB is organizing a demonstration of the Eureka 147 DAB system. A temporary transmission site at a location near the Las Vegas Convention Center will be constructed to provide for a comparison signal.

RDS

The RDS booth will be located in the lobby of the East Meeting Rooms of the

Las Vegas Convention Center (LVCC), near the Engineering Conference meeting rooms. Companies including CUE, Delco, RE Instruments, Rohde & Schwarz, Sage Alerting, and VG Electronics are scheduled to participate in the demonstration of FM subcarrier data system technologies.

The Engineering Luncheon will be in the Las Vegas Hilton on Tuesday, April 16. During the luncheon, NAB will present the 1991 Radio and Television Engineering Achievement Awards, the industry's most prestigious engineering honors. The Engineering Achievement Award for radio will be presented to George Marti, chairman of the board of Marti Electronics, and developer of Studio-Transmitter Link (STL) systems and radio remote pickup units (RPU's).

Featured speakers at the luncheon include Keiji Shima, chairman of NHK and Raymond Dolby, chairman of Dolby Laboratories.

A popular NAB event for radio engineers is the annual Ham Radio Operators Reception on Wednesday evening, April 17, at 6:00 p.m., in the Las Vegas Hilton. Some great prizes will be awarded to lucky attendees. (Last year, one of every seven attendees won a prize.)

All of the engineering sessions will take place in the East Meeting Rooms of the Las Vegas Convention Center. If you would like more information on the 45th Annual Broadcast Engineering Conference, please call NAB Science and Technology at 202-429-5346.

SCALA

GET IT RIGHT THE FIRST TIME.....

Scala offers you the World's most complete line of professional antennas and antenna systems for:

- Aural STL and ICR Systems
- TV Microwave Relays
- FM and TV Translators and Boosters
- Precision FM Off-air Monitoring
- Remote Pickup Systems
- Precision TV Off-air Monitoring
- Land-Mobile Communications
- CATV Headends
- LPTV Systems

You can depend on Scala professional antennas for maximum performance and reliability. Since 1954 Scala has designed and manufactured ruggedized antennas for a variety of systems in every part of the World. Our experience and quality will help you get it right the first time.

Whatever your antenna requirement in the broadcast auxiliary, monitoring or communications services, 30 MHz to 3 GHz and above, let us help you achieve the highest levels of performance and reliability. Contact Scala for technical assistance and product information and let us help you discover the Scala difference. We look forward to hearing from you!

Visit us at NAB - Booth 4161/4163

SCALA ELECTRONIC CORPORATION

P.O. Box 4580, Medford, Oregon 97501 (USA)
Phone: (503) 779-6500 Fax: (503) 779-3991

Circle 140 On Reader Service Card

TTC

Spring 1991

TTC's Open Letter to all Broadcasters:

Broadcasting stands in the beginning of a new decade. A decade that guarantees to be full of technical changes. Isn't it good to know one thing will not change, our commitment to Broadcast and you. We are TTC, a proven leader in the Broadcast Transmitter arena.

TTC continues to lead the way with state of the art, affordable transmitters. Visit us at NAB, April 15-18th in Las Vegas, Booth 3066. For our European customers, we will be in Montreaux, Switzerland from the 14-18th of June 1991. Stop by and see us there in Booth 5904.

TTC Products with Pride and Integrity

Television Technology Corporation, USA
(303) 665-8000 ext. 456 * TWIX: 910-938-0396TTC COLO

Circle 17 On Reader Service Card

Panasonic

MEMO

Date: January 23, 1991
To: Head of Technical Planning
From: Director of Facility Marketing
Re: Next Generation DAT Recorders

Charlie,

What's the bottom line on these next generation SV-3900 Pro DAT decks from Panasonic? We heard them at NAB and AES Shows -- outstanding audio quality! I'd like your input on their technical features and functions.

With its serial control capabilities, this machine may be limited only by our imaginations.

Pete

From the desk of
Charlie Johnson

ES BUS

+

P2 PROTOCOLS

- STANDARD 9-PIN SERIAL INTERFACE
- HANDLES UP TO 32 DECKS ON ES BUS.
- INDUSTRY STANDARD PROTOCOLS.
- FULL BI-DIRECTIONAL CONTROL/INTERROGATION.
- ANY DECK DISPLAY ON REMOTE.
- PROGRAMMABLE FOR GO-TO ABSOLUTE TIME.

LET'S RETHINK THE P.O. FOR THE TIME CODE DAT. WE CAN GET 4 SV-3900'S FOR THE SAME PRICE!

SV-3900

Digital Audio Tape Deck

DAT
Digital Audio Tape



- rs. Full ES-Bus and P2 serial control protocols.
- Parallel hardware interface of transport functions.
- s. Front panel error rate display.
- Switch selectable SCMS status.



SH-MK390 Remote Controller

- Network control of single/multiple SV-3900 decks.
- Shuttle wheel with ± 0.5 to $\pm 3x$ speed in Pause Mode, plus ± 3 to ± 15 in Play Mode for flexible cueing.
- PNO, Counter, Absolute, Program Time displays.
- Start/Skip ID Write/Erase, Renumber, Fade in/out.
- Direct access of PNO's for random access cueing.
- Flexible Program Play Sequences.
- Auto Changeover Function Keys for record/replay.
- Auto Start Function Keys for dubbing/editing.

BENEFITS

- CENTRALIZED CONTROL OF MASTERING DECKS.
- RANDOM ACCESS MUSIC & EFFECTS LIBRARIES.
- AUTOMATED MUSIC/COMMERCIALS REPLAY.
- COMPUTERIZED SATELLITE NETWORK BROADCASTING/RECORDING.
- COMMERCIAL DAT DUPLICATION.
- AUDIO PLAYBACK FOR INSTALLED SOUND SYSTEMS.

DAT ENSURES MEDIA COMPATIBILITY WITH OUR CUSTOMERS.

See Us at NAB Booth 4513

Circle 42 On Reader Service Card

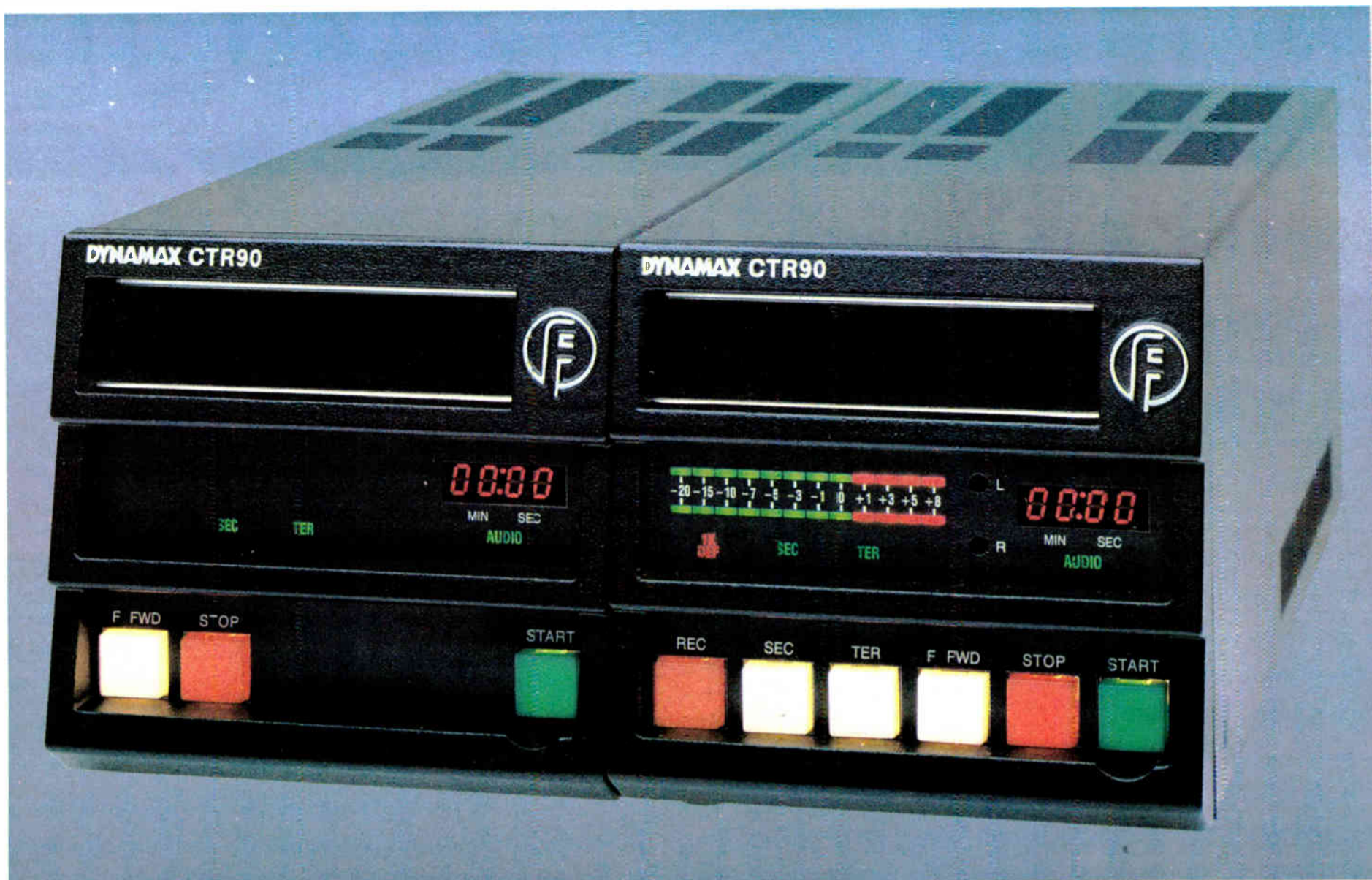

The New Dynamax® CTR90 Series Sounds as good as CD on the air

With a -81 dB signal to noise ratio, the new Dynamax CTR90 Series is the best piece of equipment that we have ever built. And, we're convinced, the best cartridge machine ever built. What's more, the CTR90 Series outperforms other elements of the broadcast chain, including typical STLs, excitors, transmitters, and even the best audiophile quality receivers.

In addition to Dolby HX Pro™ Headroom Extension and DNR® Dynamic Noise Reduction, the CTR90 Series provides many useful features including Extended Scale VU/PPM Metering, a Real Time Minutes & Seconds Timer, Active Balanced

Inputs & Outputs, and both XLR and "D" type Input/Output Connectors. All models are ruggedly constructed to Dynamax standards, with toroidal transformer based powering, constant current solenoid drive, DC/PLL motor control, and an improved high stability Head Bridge with non-interactive adjustments.

And, believe it or not, the new and fully loaded Dynamax CTR90 Series is about the same price as our CTR10 Series, the most widely accepted cartridge machine worldwide for the past 4 years. So, if you want top value, and cartridge performance comparable to CD, try the Dynamax CTR90.

Call your Dynamax Dealer or Fidelipac for a complete CTR90 Series brochure.



Fidelipac Corporation □ P.O. Box 808 □ Moorestown, NJ 08057 U.S.A. □ TEL 609-235-3900 □ FAX 609-235-7779 □ TELEX 710-897-0245

CTR90 Series Signal to Noise Ratio

-81 dB, "A" Weighted, referenced to 250 nWb/m, with DNR active. -70 dB, "A" Weighted, referenced to 250 nWb/m, with DNR inactive.

Dolby HX Pro Headroom Extension originated by Bang & Olufsen and manufactured under license from Dolby Laboratories Licensing Corporation.

DNR is a registered trademark of National Semiconductor Corporation under U.S. Patents 3,678,416 and 3,753,159.

Spotlight On: George Marti

The NAB Engineering Achievement Award Winner Talks with RW

Editor's note: This year's NAB Radio Engineering Achievement Award goes to George Marti, chairman of the board for Marti Electronics. Marti became involved in broadcasting in 1937 when he obtained his First Class radio-telephone operator's license. He built his first transmitter in 1947 for his then new station, KCLE in Cleburne, Texas. Besides his many years of broadcasting involvement, Marti also has been very active in providing scholarship money for students in the Cleburne area. RW News Editor John Gatski recently talked with Marti about his 54 years in broadcasting.

RW: Congratulations on your selection as the NAB's 1991 Radio Engineering Award recipient. What was your reaction to being recognized for many years of involvement in broadcasting?

Marti: It is quite an honor to be recognized by your peers for having made a contribution to a great industry. I've been involved since 1937. This industry has been my life. I've been involved in every phase of this industry from engineering, programming, news, management to ownership.

RW: How has the STL/remote pickup (RPU) technology and the attitude toward it changed since you first became involved in the business?

Marti: Originally when we started doing RPU back in the 1940s, telephone lines were unavailable. So as a process of involvement, I built my first remote transmitter in 1949. Other Texas broadcasters would come by and say, "Marti, I heard you do a remote from so and so. Was it a telephone line transmission?" I'd say, "No, that was my remote pickup transmitter."

The first RPUs were big, heavy and all

tubes. The technology has definitely improved. The first ones had 60 kHz bands. Of course, today we now have 25 and 30 kHz bands. Back in those days we could use sloppy LC filters in the receivers and it would be very satisfactory. Today, we have to have elaborate ten-pole crystal filters to eliminate the adjacent channel from 25-30 kHz away to keep it from interfering.

RW: Why did you eventually decide to manufacture remote equipment and transmitters?

Marti: My original equipment was made for my station and friends. When I sold my local station KCLE in

1960, I was going to semi-retire and maybe build a few transmitters. But Art Collins' radio broadcast division up in Cedar Rapids, Iowa sent one of his representatives down to make a deal with me. He said, "We want to sell your remote transmitters all over the world."

So I made a deal with Collins back in 1960. I gave him a five-year exclusive except in New Mexico, Texas, Louisiana and Arkansas. In 1960, I first showed my equipment at the broadcast booth at NAB in Chicago. I became a member of NAB in 1947 and have not missed a show.

RW: What kind of role will STL/RPU equipment have in digital audio broadcasting (DAB) if it is adopted in the near future?

Marti: For STLs, the main thing is to have better specifications. The STL has to have the same specifications as digital broadcasting. Remotes probably won't be used as much with DAB. DAB will have an impact on remotes, but it is a few years down the road in my opinion. Digital could be used on remotes, but not in the present channels because of the bandwidth.

RW: Looking to the future, do you see any other technologies on the horizon that will affect broadcasters?

Marti: Right now, the biggest impact on broadcasters for STL equipment is this process of tying together two or three stations that are located 30 or 40 miles from each other. For instance, a station is in market A, a town of 20,000. Then you have two or three small stations in nearby towns of 5,000 that are struggling to get by. You will see more and more of those stations tied together under common ownership, programmed and managed from the central stations. It is more or less satellite, but with local advertisement and local impact.

RW: Returning to the present for a moment, how are equipment companies responding to STL/RPU band crowding that has occurred in many urban areas?

Marti: If the FCC and all these coordinating groups would use a little common reasoning and do what I suggest, there would not be a problem. Frequency coordinating is really the secret. There are enough channels in the 450-455 MHz band for every station in the U.S. to be properly served. All we have to do is divide 200 MHz bands into 25

kHz bandwidths. No 50 or 100 kHz bandwidths.

For example, put the base stations, airplanes and helicopters on the top half of one of the 1 MHz channels and use 1.5 MHz for the mobile units. If you do that, every station in America—even the big cities—will have adequate channels. But the way it is now, they will put, for example, a base station next to a broadcaster trying to do a portable remote. Your interference signals are so great that it takes real elaborate filters. Basically, with a little engineering and reasonable thinking, we would have plenty of bandwidth to eliminate the interference.

RW: Are STL/RPU companies able to comply with the tighter FCC-required tolerances for their equipment?

Marti: The tighter requirements are wonderful. They should have done it 10 years ago. The STL frequency tolerance is going to be .0005 percent. Our frequency tolerance has been .0005 for 20 years. No problem. We have had our STL and remote pickup type-approved for years; we thought you were supposed to. The reason you have to have tighter tolerances is because you have 25 kHz channels and 10-pole crystal filters. If the tolerance is off two or three kilohertz, you get distortion.

RW: You have been involved in broadcasting for many years. Do you see yourself continuing to play an active role in the industry?

Marti: Let me put it this way. Something that has been your life the last 54 years, it would be real hard to walk off from it.



George Marti

If these two agree,

we must be on to something.

It's a constant battle: technology versus the budget. The Engineer wants equipment to provide better control. The General Manager wants equipment that produces a better bottom line.

Now there's a system that does both. The new Digital Commercial System (DCS) from Computer Concepts.

General Managers love it because it produces CD-quality sound while cutting operating costs. Engineers like the way its hard disk storage and super-sophisticated software increase their technical capabilities and reduce their workload.

Both like DCS' flexibility **FREE DEMO DISK!** references and for our FREE demo disk.

Computer Concepts CORPORATION

8375 M.Irose Drive, Lenexa, KS 66214 FAX: 913-541-0169

Represented in Australasia by Techtel Pty, Ltd. and in Europe by Audio Design.

Satellite Quality Audio...

COMREX, the leader in remote audio broadcast transmission via standard telephone lines, now sets the pace with satellite-quality audio transmission using standard dial phones or digital circuits. Since 1961, Comrex has been consistently delivering the most reliable equipment and personalized response to broadcasters world-wide.

COMREX gives you a choice of options:

- 1, 2 or 3 line frequency extenders with up to 8 KHz bandwidth on dial telephone service
- Digital Audio Codec systems for ISDN
- Plus . . . a full range of telephone interface products including couplers, hybrids and portable mixers

Performance so good, we invite you to try it before you buy it. Hear the difference for yourself.

by Telephone.

COMREX
Specialists in Remote Broadcast Audio Transmission

Comrex Ltd.
75 The Grove, Ealing, London, W5 5LL, UK
081-579-2743 / FAX: 081-840-0018

Comrex Corporation
65 Nonset Path, Acton, MA 01720 USA
(508) 263-1800 / FAX: (508) 635-0401

Glimpsing Japan's View of the Future

by Alan Carter

LAS VEGAS Radio broadcasters can catch a glimpse of audio's future—from the Japanese perspective—at NAB '91 when, for the first time, the Japanese Broadcasting Corp. (NHK) brings a version of its spring "Open House" to a venue outside Japan.

NHK's annual exhibition usually is

For the first time, NHK's Open House will be held outside of Japan.

held in Tokyo where the Japanese public broadcasting corporation displays its latest technological developments. Technology displayed at the show can reach the market within a year, or it can be "ideas" that require years of R&D. The same can be expected of the technology to be displayed by NHK at NAB.

Why was NHK willing to undertake this task? "We think that NAB is one of

the best opportunities for broadcasters to communicate with each other," NHK Deputy Director of Development and Engineering Yozo Ono said. Ono is responsible for coordinating the event with NAB.

"Among the broadcast world, if we could propose any questions to obtain ideas and create an exchange for a cultural benefit, we would be very pleased to do that," he said.

Ono noted that many countries around the world have the same broadcast transmission system. "We can share technology," Ono said. "That is our main goal."

The exhibit will be held at the HDTV World '91 Conference & Exhibition and will cover 10,000 square feet—more than half the size of the 17,000-square-foot Sony booth. It will be TV oriented, but there is an audio section that radio broadcasters will not want to miss. The developments are quite interesting:

- **FM Multiplex Receivers.** This technology offers a new service by multiplexing digital signals in the high frequency area of the baseband spectrum. Applications include: stereo tuner with teletext functions, stand-alone color LCD information display, notebook and pocket-size information displays, color traffic infor-

Digital Processing

by John Gatski

LAS VEGAS Just because there are now several digital processors on the market doesn't mean they are being used to their fullest potential.

Gentner Electronics' William Gillman will highlight methods and tips of how to get the most out of digital processing during the "Audio Processing in the Digital Domain" session, Thursday morning, April 18.

Because the technology is relatively new for engineers, Gillman said that digital processing techniques are still an education process for them.

"It takes a kind of different viewpoint" to process with digital, he said. "There are some new things we've learned how to do."

Gentner offers two processors: the Lazer Prism and the Prism. The Lazer Prism was scheduled to be introduced last year at NAB, but was delayed until later in 1990.

With digital, processing is very mathematical, Gillman explained. "You can do a much higher degree of limiting with much less distortion," he said.

Gentner has been working on new digital limiting techniques. Unlike analog, "you have to look at new mathematical algorithms to do it," Gillman said.

Processing will not be done the same way with DAB as it has been with analog radio, but it will be a necessary product, he added. "For example, limiting won't be an issue," Gillman said.

Right now, Gentner's Lazer Prism would not be compatible with DAB, but the Prism would be, according to Gillman.

mation display for automobile dashboards, and color CRT display for traffic information.

- **Telemusic.** Telemusic is described as the future data broadcasting system in which coded music data is sent to the home to an electro-mechanically driven music instrument, such as a piano, achieving the delivery of live music.

- **Ultra-Miniature Microphone.** Developed for high definition television applications, this 4 mm cylindrical microphone is one of the smallest microphones for broadcasting use in the world.

- **Acoustic Design of Multipurpose Halls.** NHK's expertise in acoustical design and application of electro-acoustics to vary the acoustics of performance space will be demonstrated.

- **3-1 Quadraphonic Sound System for HDTV.** This multichannel sound technique uses three frontal signals and one rear sound signal to achieve a more realistic sound field to accompany the visual realism of HDTV.

- **Distance Control of a Sound Image for 3-D TV.** This three-dimensional sound imaging technique was developed for eventual use with 3-D television to provide a better sensation of reality.

What is missing from the exhibition, however, is developments for digital audio broadcasting (DAB).

"We are studying the fundamentals and conducting work in this area," Ono said. "But for the open house, we do not have the items ready."

Ono asked that attendees be patient at the exhibit, particularly because some of the NHK representatives who will be working at the display are unfamiliar with the trade show atmosphere. "I am concerned about the language barrier and operation outside Japan," he added.

But Ono, who worked for NHK in New York as chief engineering manager before returning to Tokyo, is confident his concerns will be addressed. "I am trying to make it easy for people to understand our exhibition."

This news report ran in Radio World and we received many inquiries. We're pleased to run it again:

Silver Plating Ploy

by Jim Wenstrom, CE KFLS/KKRB

Klamath Falls OR. OK, your edge connectors don't connect. Or you want to plate your own PC creations but don't want to bother with electro-plate solutions. The plating on the socket for that 4CX15000 has worn off and no longer makes reliable contact. Your budget was shot months ago. What are you going to do now?

"Give the people at Cool-Amp Company a call. They have a silver plating compound I have used for the past couple of years that solves all of the above problems and more.

"This white powder has an indefinite shelf-life, is inexpensive, and easy to use... It will actually put a silver plate on copper or brass... There are no messy or dangerous chemicals.

"Application couldn't be easier. Use a cotton swab or ball and a little bit of water and just rub it on. In minutes you can silver-plate a circuit board or replate a power amp tube or socket. It has saved me time, money and my sanity."

9/26/90

Thanks Jim Wenstrom for the original report and for permission to run it again.

Call us at the factory for information—or to order direct. We'll also send you a brochure on our other product, Conducto-Lube—the silver-based conductive lubricant.

COOL-AMP

Cool-Amp Conducto-Lube Company

15834 Upper Boones Ferry Road • Lake Oswego, Oregon 97035
(503) 624-6426 • Fax (503) 624-6436

Circle 39 On Reader Service Card

Reduce Bandwidth 75% for Digital Audio Transmission



Intraplex PT/PR-150 modules use 16-bit coding and compression algorithm to transform 15 kHz audio into 128 kb/s bandwidth; 7.5 kHz into 64 kb/s.

- 4:1 bandwidth compression
- Selectable bandwidths 15 & 7.5 kHz
- Two circuits per module stereo or monaural operation
- Remote programmability
- Plug-in modules for use with Intraplex Multiplexers.

Intraplex

Intraplex, Incorporated, 80 Taylor Street, Littleton, MA 01460-3427
TEL: (508) 486-3722 / FAX: (508) 486-0709

Circle 47 On Reader Service Card

Denon to Show Recordable CD

by Charles Taylor

LAS VEGAS Denon of America plans to introduce its market-ready recordable CD system at the NAB show in April.

Ken Furst, Denon's marketing VP, estimated that the system will be ready for shipping by the fall.

Yamaha also will introduce a prototype CD recorder at the show, according to a company spokesman. Studer ReVox, meanwhile, will show its D740 CD recorder.

Both Kenwood and Pioneer showed prototypes of their own recordable CD systems at the Consumer Electronics Show (CES) in January; however, neither was ready for actual delivery.

The Denon system will utilize a write-once disc, capable of recording 63 minutes of material. The disc is manufactured using materials that are



Denon's CD cart recorder will have its U.S. debut at the NAB

vacuum deposited on the surface. During the recording process, a laser with higher power than is customarily

used on a player is used to "excite" the surface.

"All it does is raise the temperature to the point that it raises a little bubble. Then, during the playback, the bubble has a different reflective characteristic and gives you essentially the same effect as a compact disc," Denon consultant Almon Clegg said.

The unit's applications will include station jingles, music storage and data storage, according to Furst.

"We do feel it can take the place of tape cartridges," he said. "It can also take the place of tape to a large degree for small runs of things that people might want to distribute on compact disc."

"We definitely see uses for record companies after they've done the sequencing of a CD and they're pretty sure how they're going to package the CD. This will allow them to give a copy to the artist to sign off on."

Denon's CD cart recorder made its official bow in Canada at the Canadian Association of Broadcasters convention earlier this year. The company's decision to show it to CAB before NAB was based on a number of reasons, according to Furst.

"First, we wanted to help the guys in Canada establish a presence in the professional market," he said. "Also, while we could have shown a recordable machine at the Consumer Electronics

Show (in the U.S.) in January, we opted not to because it is a professional product. That's the consumer show. We just don't want to give the idea that recordable compact discs for consumers are right around the corner. We felt NAB was the appropriate setting."

"The United States is such a huge market that, during the initial production period, we just simply will not be able to produce a large enough quantity to go around the world," Clegg added.

For information on the Denon CD cart recorder, contact Ken Furst at 201-575-7810; or visit booths 3001 and 3003 at NAB.

FAA, FCC Square Off

by Arthur Cole

LAS VEGAS The ongoing dispute between the FAA and the FCC over which one regulates broadcast facilities will find its way to NAB '91 during a session at the convention's radio engineering conference.

A panel discussion entitled Broad-

The FAA and FCC will face off at NAB over who should have control of tower placement and EMI authority.

cast/Aeronautical Compatibility will feature top officials from both groups as well as the NAB and a private consulting firm. It is scheduled to take place at 9 a.m., April 16.

The discussion will feature comments on FAA evaluation procedures of broadcast tower compatibility with avionics (air navigation) systems as well as the FAA's recent proposal to establish EMI policies.

The discussion will include brief presentations from five officials before launching into a general discussion.

FCC Field Operations Chief Richard M. Smith said his presentation on FAA/FCC

coordination will focus on the electromagnetic compatibility between commercial broadcasting and avionics, as well as problems surrounding the fact that FM broadcasts and aviation frequencies are adjacent.

"There is no question in my mind that broadcasters should be regulated," Smith said. "It is the extent to which they should be subjected to standards that is the sticking point."

Also scheduled for a presentation is William P. Suffa, of Lahm, Suffa and Cavell Inc., who will update the group on FAA EMI processing.

"I will discuss the current status of the FAA interference model and the evaluation process the FAA uses to determine whether broadcast facilities will interfere with aviation receivers," Suffa said. "I will also review the FAA interference criteria and how it works technically."

David Morse and Gerald Markey will present the FAA perspective on the matter; FAA Mass Media Bureau Chief Roy Stewart will discuss FAA-FCC coordination.

WEATHER RADIO Model CRW

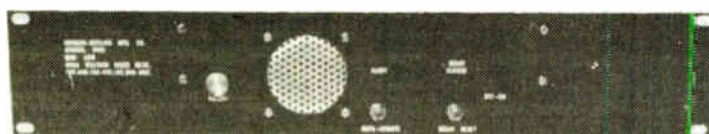

Price \$540.00

Sensitivity .28 microvolts for 12 dB quieting. All 3 frequencies. Alert tone demutes receiver, closes relay and gates audio to 600 ohm rear terminals. Another set of rear terminals has continuous 600 ohm audio output. Double conversion crystal controlled, crystal filter in first I.F., ceramic filter in second I.F. Dual gate MOS FET front end. 50 ohm coaxial input. Adjacent channel (j25 kHz) down to 70 dB. 19" rack mount, 3 1/2" H, all metal enclosure. In stock—available for immediate delivery.

GORMAN REDLICH MFG. CO

FAX 614-592-3898 • 257 W. Union St. • Athens OH 45701 • 614-593-3150

Innovative Broadcast Products:

- ▶ Automation Systems
- ▶ Direct-To-Disk Recorders
- ▶ Digital Sampling MPX Encoders
- ▶ Portable Telephone Line Mixers
- ▶ Feedforward/Limiter/Compressors
- ▶ Flat Wide Band Studio Monitors

From
ACUTRON ELECTROACUSTICA, LDA.
Urbanizacao Quinta Nova
Impasse I - Lote 134
2685 SACAEM - PORTUGAL
Phone 351-1-9414087
Fax: 351-1-9417509
International Distributors Wanted!

Circle 8 On Reader Service Card

CONFUSED ABOUT WHICH FIDELIPAC CART MACHINE TO BUY?

The RS-2000 from Radio Systems offers the best features of all of them!

Designed by the engineer who invented the Dynamax 100 and 10 series cart machines, the RS-2000 actually out-performs the high-end CTR-100, yet sells for less than the CTR-10 and 90 series.

For value this good you've got to go factory direct.

.....
RADIO SYSTEMS INC.
Manufacturers of Professional Broadcast Equipment
110 High Hill Road • P.O. Box 458
Bridgeport, NJ 08014-0458
609/467-8000 • 800/523-2133
FAX 609/467-3044

Circle 84 On Reader Service Card

Circle 24 On Reader Service Card

QEI QEI QEI QEI QEI QEI QEI QEI QEI QEI

WHY QEI?

24 Hours.

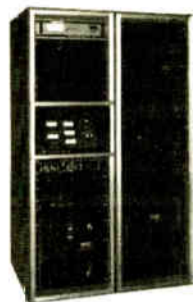

Our 24 hour service hotline number is 609-728-2020.

Call us toll free at 800-334-9154 for all the facts on QEI

"New Reliables" FM transmitters from 1kw to 30 kw.

Power Up.



With our FMQ 3.5/5/10 kW or 20/30 kW FM transmitters, you can upgrade power in the field.

Call us toll free at 800-334-9154 for all the facts on QEI "New Reliables" FM transmitters from 1kw to 30 kw.

No Extras.



We never charge you extra for single phase power. Not on our FMQ 10000 or our FMQ 20000B—not even on our 30 k FMQ 30000B.

Call us toll free at 800-334-9154 for all the facts on QEI "New Reliables" FM transmitters from 1kw to 30 kw.

Less is More.



All of QEI's FM transmitters have no plate blockers or sliding contacts.

Call us toll free at 800-334-9154 for all the facts on QEI "New Reliables" FM transmitters from 1kw to 30 kw.

Free.



Our FREE spares kits include every solid state component of the transmitter, exciter and remote control.

Call us toll free at 800-334-9154 for all the facts on QEI "New Reliables" FM transmitters from 1kw to 30 kw.

The Longest.



Our PA tube warranty is the longest in the business — 15,000 hours.

Call us toll free at 800-334-9154 for all the facts on QEI "New Reliables" FM transmitters from 1kw to 30 kw.

Single Phase 30 kW.

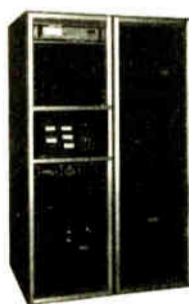

Our new FMQ 30000B is the only 30 kW transmitter available with a single phase power supply.

Call us toll free at 800-334-9154 for all the facts on QEI "New Reliables" FM transmitters from 1kw to 30 kw.

Built-in Backup.



QEI's constant 50 Ohm interstage impedance lets you bypass the IPA or PA in the unlikely event of a problem.

Call us toll free at 800-334-9154 for all the facts on QEI "New Reliables" FM transmitters from 1kw to 30 kw.

QEI CORPORATION
ONE AIRPORT DRIVE • P.O. BOX D • WILLIAMSTOWN, N.J. 08094
TEL (800) 334-9154 • (609) 728-2020 • FAX (609) 629-1751

QUALITY • **E**NGINEERING • **I**NNOVATION

See Us at NAB Booth 1035

Circle 14 On Reader Service Card

Emphasis on Digital Marks Trade Show

Manipulation of Audio In the Digital Domain

LAS VEGAS A veritable explosion of digital processing products will mark this year's NAB convention. Whether used to process program audio, store audio in compressed form, or manipulate audio in the digital domain for production purposes, the technology will be one of the hottest tickets at the show.

The following is just a sample of what convention attendees can expect from manufacturers in the way of digital

gon, a touch-screen processor which combines fully-digital dynamics control and frequency equalization in a single unit.

Symetrix will exhibit its new hard disk DPR44 recording and editing station in a prepared demonstration room off the main convention floor. Each discrete sound segment or track on the full-color controller screen can be assigned the attributes of a graphics "object" for intuitive editing and sound manipulation via a custom-designed graphics control tablet.

Arrakis has developed the Digilink system, a digital audio recorder that records full stereo CD quality audio on

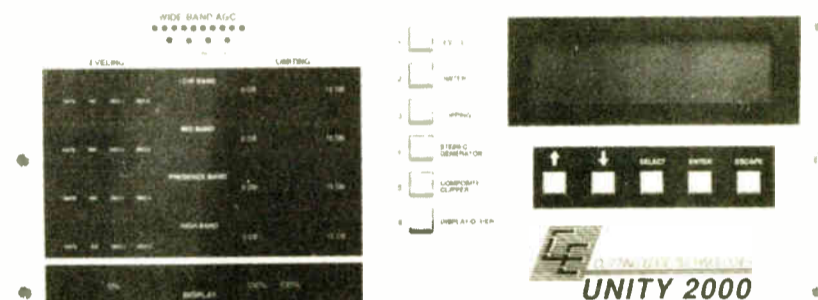

The Unity 2000 from Cutting Edge is part of the industry's trend toward digital hardware.

products.

Cutting Edge Technologies will debut its Unity 2000 digital audio processor. The Unity 2000 combines wideband automatic gain control, selectable low frequency equalization, digital four-band leveler/pre-processor and limiter, distortion canceling clipper drive, digital stereo generator and a selectable composite clipper. One keypad and LCD display control all component functions.

The Digital Unity 2000 will be on hand at both the Bradley Broadcast and Broadcasters General Store booths.

Audio Animation will display the para-

floppy disks, hard disks, removable hard disks or any other SCSI based digital storage medium.

On exhibit from QEI will be the Model

Digital will be one of the hottest tickets at NAB . . .

710 digital stereo generator. The unit has balanced input and both digital and analog output, with left and right 15 kHz low pass input filters and common mode rejection greater than 60 dB.

Computer Concepts Corporation will unveil a data reduction board as an option for its Digital Commercial System (DCS). The new apt-X™ co-processor board fits in an expansion slot of the DCS machine, doubling storage capacity while retaining sound quality.

The company will also make available a demonstration diskette for the DCS. A user-operable demonstration of the product, it is available in IBM-compatible format on 5.25-inch or 3.5-inch diskettes.

At the Gentner Electronics booth, both the Lazer and the Prizm will be displayed. Both all-digital processors, the Lazer and Prizm deliver what Gentner terms "total modulation control."

New from Studer ReVox is the Tele-Hybrid and a MacMix 3.1 software upgrade for the Dyaxis hard disk digital recording and editing system. The company will also show its D820-48 digital recorder.

Moseley Associates will unveil the DSP-6000 digital encoder/decoder system for use with conventional 950 MHz analog FM STLs.

Intraplex plans to show its fixed and variable-rate multiplexers that provide enhanced digital audio channel capacity over hardware, satellite and microwave links.

CONSISTENCY LONGEVITY PERFORMANCE

audiopak
The best selling cart worldwide.

Call AV Technology Int'l. for the Audiopak carts you need. Selection, service and fast shipment from stock make us a "best seller" too.



AV Technology Int'l.

P.O. Box 97 • 432 Cherry Street
West Newton, MA 02165 USA
Tel: 617-965-3866 Fax: 617-965-1865

Circle 100 On Reader Service Card

Mic Makers to Debut Models

by Frank Beacham

LAS VEGAS It will be another bountiful harvest for microphone manufacturers this year as dozens of new models make their debut on the NAB '91 stage.

One of the more unusual new models comes from Crown International. Called the "Tridudent" microphone, this model features three mono cardioid condenser capsules in a single microphone body. Thus, three independent microphone feeds can be obtained from a single microphone fixture. Presumably, such a triplay would be reserved for people with very important things to say, such as presidents, dictators and such.

Crown also will display its established PZM handheld lavalier and SASS (Stereo Ambient Sampling System) series of stereo microphones.

The "Tridudent" microphone features three mono cardioid condenser capsules in a single microphone body.

Electro-Voice will introduce two new broadcast and production microphones utilizing Neodymium magnet technology. The RE-38N/D has a 16-position equalization switch for multipurpose studio and sound recording applications. The RE-27N/D offers excellent transient response and low distortion output at high sound levels, according to the company.

Shure will introduce a new microphone in its VP series. The VP64 is a professional omnidirectional microphone designed for news production in radio and television. Also on display will be the previously introduced VP88 Mid/Side Stereo microphone and the L Series wireless microphone system, as well as a vast line of established field and studio microphones and circuitry.

Beyerdynamic will introduce three new microphones and two wireless systems at NAB. The MC742 is a new studio stereo microphone and the M59 is a large diaphragm dynamic microphone for on-air studio and field production. The MCE50 is a miniature lavalier microphone. The DS 170H and DS 170P are new handheld and body pack diversity wireless microphone systems.

A new micro-miniature lavalier microphone will debut in the AKG booth. The Model C407, only .3 inches in diameter, features a vocal-flattering frequency response and an omnidirectional capsule, making it well-suited for conferences, spot miking, live recording and on-camera applications.

Sennheiser has three new microphone models for NAB. The MD422 is a rugged cardioid microphone that, with its spring suspended element and ability to handle high SPLs, can be used for vocal applications in live shows. The aluminum voice coil gives it a transparent sound.

The BF530 has an adjustable sound inlet basket allowing vocalists to change the proximity effect of their mics for optimal performance. It has a very accurate supercardioid polar pattern for greater gain before feedback. The MKE300 is a supercardioid with a shoe assembly for mounting on most camcorders. It also is shock mounted and includes a windscreen to eliminate structure and wind noises.

A new type of microphone shock mount also is being introduced by Sennheiser. The MZS100 can be adjusted to filter out specific noises.

Several new microphone models are coming from Audio Technica. The AT831 is a subminiature unidirectional lavalier. The ATM61HE is a hypercardioid for very noisy environments. The AT804 is a field production microphone, while the ATM35 is a miniature condenser designed for musical instruments.

The AT4033 is a studio condenser for dialogue and voice-over and the AT40 is a miniature, head-worn series for hands-free broadcasting. The AT40 studio series and current microphone line also will be displayed.

Telex will launch some new wireless microphone products at NAB while showing its existing line of wired and wireless intercom systems, headsets and wireless microphone systems. Television Equipment Associates will show a new line of Hi Noise headsets. Canare, the microphone cable manufacturer, will exhibit its Star Quad cable.

NAB PRODUCT SHOWCASE

See these products and services at the NAB convention.

marantz PROFESSIONAL AUDIO PRODUCTS



The PMD line of professional portable cassette recorders has long been the standard for broadcast field recording. The PMD222 updates that tradition with the inclusion of an XLR microphone input. The balanced input makes the PMD222 perfect for all critical recording situation, providing a locked connection with microphone cables and preventing signal degradation due to RF, fluorescent lights, or other random electrical signals. And the PMD222 retains all of the features that make PMDs the preferred choice for field reporters: direct telephone interface, pause/play functionality, large VU meters, three head construction, low battery indicator, and much more.

The PMD222 will be available in May and will have a suggested retail price of \$399. The PMD222 will be on display at Booth #1100. 718-492-5300

READER SERVICE NO. 7

"AUTOMATE WITH CD'S"



Lee Hurley, Sentry Systems

Whether you are live or automated, FORMAT SENTRY makes it simple to play back your CD's with ease!

- Never touch a CD again. FORMAT SENTRY interfaces with multiple CD systems and most ALL other audio devices.
- Interface with many music and traffic software systems.
- Three modes: LIVE ASSIST, FULLY AUTOMATED and SATELLITE.
- See and hear FORMAT SENTRY and our new Hard Disc Audio System at NAB in Las Vegas. Allied Booth# 1100

Call Mike Bettelli at BP for more information:

1-800-426-9082 Fax: 206-441-6582

SENTRY SYSTEMS
Seattle, Washington

READER SERVICE NO. 96

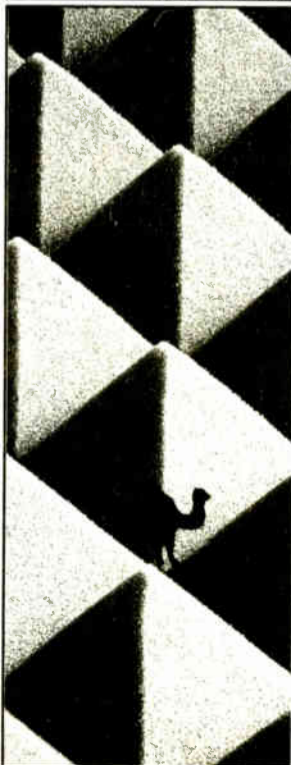

DISCOVER the Secrets of The Pyramids

AZONIC Acoustical Foam

- Superior Performance
- Uniform Pattern
- UPS Shippable

Acoustical Solutions Inc. licensee

Alpha Audio Acoustics

1-800-782-5742
NAB Booth 3081-83

READER SERVICE NO. 27

NEW!!! from AVCOM PSA-65A Portable Spectrum Analyzer & SCPC-2000E Single Channel Per Carrier Receiver



PSA-65A Portable Spectrum Analyzer - \$2855

AVCOM's PSA-65A Portable Microwave Spectrum Analyzer covers a frequency range from less than 2 MHz to 1000 MHz. The broad frequency coverage and high sensitivity of the PSA-65A make it ideal wherever a low cost, compact spectrum analyzer is needed. The light weight, battery or line operated PSA-65A Portable Spectrum Analyzer from AVCOM is the perfect instrument for field testing of RF systems, classroom instruction, satellite system alignment, electronic countermeasures, cable TV maintenance, cellular and production use.



SCPC-2000E SCPC Satellite Receiver - \$1875

AVCOM's Single Channel Per Carrier Receiver, model SCPC-2000E, has been developed for the reception of FM SCPC signals from satellites operating in the 3.7 to 4.2 GHz band. The SCPC-2000E is a complete receiver that can tune up to 4 specific crystal controlled audio or data channels from a given transponder and adapt to a variety of de-emphasis requirements. The SCPC-2000E is available in either wide or narrow band models and may be used with the SS-1000 (\$1027) Slave for simultaneous reception of additional channels.

AVCOM OF VIRGINIA 500 Southlake Blvd., Richmond, Va. 23236
Bringing High Technology Down to Earth Phone 804-794-2500 / Fax 804-794-8284

READER SERVICE NO. 109

Affordable Excellence!

Audio Distribution Amplifiers

- 131 dB dynamic range / 0.0008% THD
- Remote Gain & Remote Mode Control
- Mic-Pre DA & Router Modules

Metering Systems

- Peak & VU Metering Systems
- PPM Conversions for Existing VU's

Interface Equipment

- Complete Interface Systems & Devices

Microphone Preamplifiers

- Considered by Many to be the Worlds Finest!

Stop and see the "LoudMouth" along with other new products at NAB '91.

Benchmark ...the measure of excellence.™

BENCHMARK MEDIA SYSTEMS, INC.
5925 Court Street Rd Syracuse, NY 13206
800-262-4675 or 315-437-6300 FAX 437-8119

See us at Booth # 2212 in Las Vegas

READER SERVICE NO. 62

Measure Up With Coaxial Dynamics Model 81070 WATTCHMAN Transmitter Protection System.



SEE US
AT NAB '91
Booth #1338

WATTCHMAN—protects your transmitter and transmission line system. A permanent 19 inch rack installation used with any dual socket line section 7/8", 1-5/8", 3-1/8" and elements (additional) to monitor CW, TV, and FM power. Model 81070 features two easily read meters to monitor both forward and reflected power. The reflected meter provides a front panel adjustable set point which controls the trip level for fast transmitter shut down and alarm. Abnormal load conditions quickly cause transmitter shut down in less than 15 milliseconds including control relay. Both visual and audible alarms indicate system malfunction. Contacts provided for remote alarm and reset switching. Contact us for your nearest authorized Coaxial Dynamics Representative or Distributor in our World Wide Sales Network.

COAXIAL DYNAMICS, INC.
15210 Industrial Parkway • Cleveland, Ohio 44135
(216) 267-2233 or 1-800-COAXIAL • Fax: (216) 267-3142
Service and Dependability... A Part of Every Product

READER SERVICE NO. 74

Tape and Cart Gear Highlight NAB 1991

by Frank Beacham

LAS VEGAS Though most of the new hardware may be digital at NAB '91, a breakthrough product for analog audio recording is a highlight for the multitude of radio broadcasters working with tried and true reel-to-reel formats.

3M's new 996 Audio Mastering Tape offers 42 percent higher output and vastly improved print-through protection over earlier tape formulations. It's capable of recording at an operating level of +9 with virtually no distortion, the company announced.

"It's the first analog audio mastering tape to come close to digital sound quality," 3M Marketing Director Don Rushin said.

The tape, which uses a new generation of binders and polyester backing, is available in quarter-, half-, one- and two-inch sizes. A Library Box delivery system for archival quality storage is also new from 3M. The TapeCare storage box features a double wall of tough, recyclable high-density polyethylene and has dust seals and a locking system to prevent accidental openings in transit. It is designed to offer better protection than traditional cardboard box storage.

ITC will debut the DigiForm at this year's NAB. Touted by the company as a practical and cost effective digital operating platform system with on-air and production capabilities, DigiForm is based on "AT class computer concepts, with proprietary ITC software and digital signal processing hardware," according to ITC.

Digital hardware

On the DAT front, there appears to be a slowing of new hardware products at NAB after a burst of introductions at earlier audio trade shows.

Sony will, however, introduce the PCM-2700 DAT recorder to replace its aging PCM-2500 model. The company will also show its PCM-7000 series timecode DAT editing system, previously introduced at AES.

Otari and Yamaha also plan to introduce new DAT recorders at the NAB exhibition. Panasonic, while not revealing any new DAT models prior to NAB, did announce a new software developer's tool kit as an enhancement to its computer-controlled SV-3900 professional DAT deck. The tool kit, available in Macintosh and DOS versions, will allow easy construction of software programs to control the machine for many

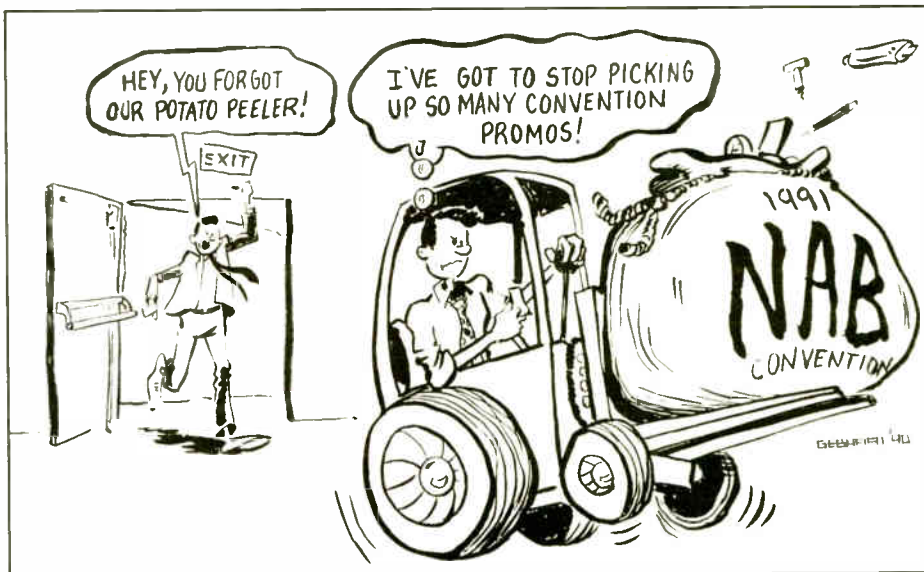

different applications, according to the company.

Despite rumors to the contrary, no Japanese manufacturer announced plans prior to NAB for a new portable timecode DAT with confidence features. Sony's Clayton Blick said his company would not be introducing such a machine at NAB and Panasonic's Chris Foreman would only offer a "no comment" on the subject. At previous trade shows, Stellavox and Fostex have shown such portables in prototype.

CD cart recorder unveiled

Denon will introduce its DN-7700R CD cart recorder, which will allow the recording of radio spots on compact discs. The company also will show the DN-970FA production CD cart player with Auto Track Select, which limits and controls track selection for on-air playback. This prevents jocks from playing the wrong CD track on the air. Used with the recordable CD, client ads can be controlled with bar coding.

360 Systems will show its DigiCart random access digital audio cart media. The new HDS-400 external hard disk drive for DigiCart will be introduced at the NAB show. Neve will introduce the new Mitsubishi X-86E Razor-Edit, a two-channel digital audio tape recorder for stereo master recording, while Radio

Systems will display its previously-introduced RS-1000 digital audio tape machines.

On the analog hardware front, Radio Systems will introduce the new RS-2000 audio cart machine with built-in phase and flutter correction, front-panel azimuth control, timer, fast forward, three cue tones and splice corrector.

Otari will introduce a new MX-5050 Series of recorders as well as a full slate of new two-, four- and eight-track models. The company also will show its DDR-10 disk-based, two-track recorder/editor along with 32 and 64-track digital recorders.

Pacific Recorders will display the Tomcat and Micromix cart machines and Dolby SR noise reduction for cart recorders. Audi-Cord will display its RDLs and RSS Series recorder/reproducers, while Accurate Sound will introduce a recorder/logger.

Tascam will display its BR-20 series analog mastering recorders. Broadcast Electronics will exhibit Phase Trak 90, Dura Trak 90A and Splice Trak 90 cart machines.

Audiopak will show its A-2, AA-3 and AA-4 endless-loop NAB audio broadcast tape cartridges and lubricated tape formulas 605, 613 and 614 for use in tape carts and cassettes. DIC Digital will show its line of DAT cassettes.

With the whole world turning to Stereo ...

Why in the world broadcast in AM Mono?

Modernize with C-QUAM® AM Stereo!

Face it. We live in a stereo world. And you join a family of winners when you choose C-QUAM AM Stereo. You'll find ...

- Over 800 C-QUAM AM stations around the globe
- Over 20 Million C-QUAM decoder IC's shipped to receiver manufacturers
- 4 countries to date with a C-QUAM AM Stereo standard
- IC technology, broadcast equipment, receiver design, international seminars and technical/marketing support ... from studio to listener, Motorola is totally committed to AM Stereo!

For details on the Motorola C-QUAM Stereo system, call Don Wilson collect at 708/576-0554. Fax 708/576-5479.

MOTOROLA
C-QUAM® SETTING THE INDUSTRY STANDARD

C-QUAM® IS A REGISTERED TRADEMARK OF MOTOROLA, INC.

OMNIBRIDGE

PORTABLE LINE BRIDGING Headset Amplifier

- HIGH LEVEL LOW IMPEDANCE OUTPUT
- WIDE FREQUENCY RESPONSE - LOW DISTORTION
- WIDE INPUT LEVEL ACCOMMODATION
- A TRUE ISOLATED TRANSFORMER INPUT
- MULTIPLE INPUT AND OUTPUT CONNECTIONS
- SELECTABLE DC LINE TERMINATION FOR TELEPHONE CIRCUIT HOLD AVAILABLE FROM STOCK

CIRCUIT DEVELOPMENT CO., INC.
50 20th ST. BROOKLYN, NY 11232 USA
TEL. (718) 768-4889 • FAX: (718) 768-3958
(800) 628-3461

New Consoles to Be Unveiled

by Frank Beacham

LAS VEGAS A hybrid of digital and analog technology highlights new audio console introductions at NAB '91 with the arrival of Audiotronics Destiny 2000 radio console with all-digital control.

A high-speed digital data bus con-

nects these controls to analog electronics mounted in a standard equipment rack located anywhere within the station. This permits expansion, maintenance and upgrades of the system without interference at the operating position.

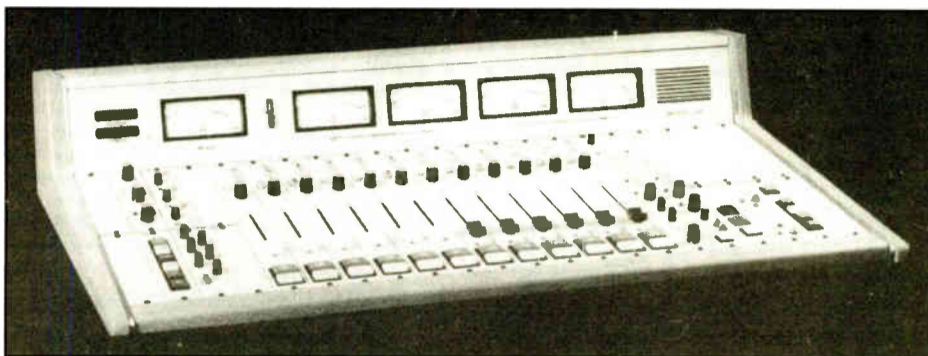

The Model 210 console from Audiotronics

In announcing the new system, Audiotronics looked toward the all-digital future. As technology continues to advance into the digital domain, existing analog electronics for the Destiny series consoles may be replaced with appropriate digital electronics on a plug-in basis, the company said.

The Destiny series also offers a choice of four types of input modules, separate music/voice buses for selective signal processing, built-in "smart" telco with four simultaneous telephone inputs, a host of digitally controlled signal processors and built-in full tape machine control logic.

Audiotronics will also introduce the 210

Fully digital console

Adding a fully digital console to its line will be Yamaha Corp. of America, with the introduction of the fully-automated DMC1000 digital console. The company

will also display a line of analog mixing consoles.

Pacific Recorders & Engineering will introduce its Productionmixer, a cost-effective production version of its popular Radiomixer.

The Productionmixer includes all the features of the Radiomixer and thus can be used in the on-air studio as well as the production room.

Pacific Recorders also is introducing three new utility stereo audio mixers. The LS-5, LS-10 and LS-20 switchers all use passive designs that incorporate gold-contact interlocked switches with self-indicating buttons in EIA rackmount packages.

Wheatstone Corp. will introduce three new analog consoles at NAB. The SP-42 offers program and audition buses, one stereo aux send and one mono aux send, three-band EQ, comprehensive telephone, intercom and other special modules, extensive logic features and direct machine interfaces. The SP-44 has four group buses; the

SP-48 has eight group buses.

The Wheatstone A-500 Radio "On-Air" console, the A32ex Radio "On-Air" console, broadcast control room furniture and audio processing equipment also will be displayed.

Linear console from BE

Broadcast Electronics will feature three new product introductions. The Airtrak 90, mid-priced, high performance linear audio console will be shown in six-, 12-, 18- and 24-channel versions. The CORE 2000 program control system with live-assist capability and the Audiovault digital record/playback and inventory storage facility for radio broadcast use also will be shown.

A new series of modular water resistant consoles will be shown at NAB by Logitek. The Mariner series will be available in five-, eight-, 12- and 18-mixer modular mainframes. The Mariners include two stereo mix buses, two mono mix-minus buses, headphone and speaker outputs, cue amplifier and machine control.

Logitek also will display its TR2 12-mixer, modular compact console, Stereorack six-mixer portable console and a line of distribution and monitor amplifiers, switches and metering unit.

Amek will introduce a new broadcast console with many features for stereo production, such as image width controls. Such controls were previously available only on the larger and more expensive Amek Classic console system.

Neve will introduce the Orion series of broadcast and production consoles and feature its previously-introduced 66 Series consoles for broadcast and production.

LPB Inc. will showcase its audio consoles and AM transmitters in a working low-power radio station at NAB.

Arrakis will show its cost-effective systems based around the 12.000 Series

modular consoles and broadcast furniture, as well as its established SC series turbo consoles and 5000, 10,000 and 17,000 Series consoles.

Radio Systems will display its RS Series broadcast consoles, Audio Technologies will show its Vanguard series eight- and twelve-mixer on-air consoles and Neotek will exhibit its Elite series.

Finally, a new face in the crowd of console suppliers will be Fidelipac, which earlier this year purchased Broadcast Audio Associates. The company will have on hand its Series IV and Series VI mixing consoles.

WHY BUY THE STRIPPED DOWN ITC SERIES-I CART MACHINE?

When you can get a full-featured Radio Systems RS-2000 for less!

And, with features like active phase and flutter correction, and front panel azimuth adjust, the RS-2000 actually out-performs an ITC-99, at less than half the cost.

For value this good you've got to go factory direct.

.....

RADIO SYSTEMS INC.
Manufacturers of Professional Broadcast Equipment

110 High Hill Road • P.O. Box 458
Bridgeport, NJ 08014-0458

609/467-8000 • 800/523-2133
FAX 609/467-3044



Meet with a Broadcast Replacement Component Specialist at the National Association of Broadcasters Convention.

To "do anything and everything" for the customer is a value each Richardson employee shares. This attitude provides us with our greatest reward: customer satisfaction.

Stop by booth 4565 at NAB for a look at service the "good old-fashioned way." It's the only way Richardson knows.

You'll also see our newest products at NAB, including the NL347 and YL1057 transmitting tetrodes. Stop by for a beverage in our "diner," discuss your needs or air your concerns. We're here to listen and respond.

Richardson Electronics, Ltd.

Canada: Ontario (800) 387-2280; Quebec (800) 363-1323
England: Lincoln (0522) 542631; Leatherhead (0372) 379414
France: Colombes (1) 47.60.05.15
Germany: Puchheim 089/80 02 13-1
Italy: Firenze (055) 68.52.92
Japan: Tokyo (03) 3874-9933
Singapore: 298-4974
Spain: Madrid (1) 228 37 00
U.S.: Headquarters - LaFox, IL (708) 208-2200.
Sales: (800) 348-5580



Las Vegas Offers Tourist Attractions

by Debra Green

LAS VEGAS For booth-weary attendees of the 1991 NAB convention, Las Vegas can provide some necessary distractions. Performers such as Crystal Gayle, Don Williams and a bevy of casinos, restaurants and clubs are

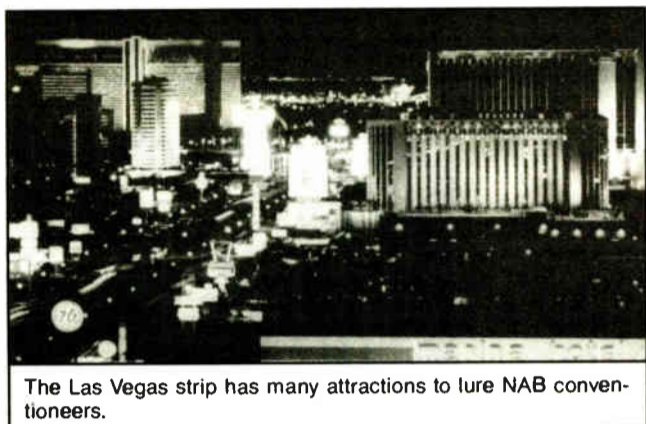

The Las Vegas strip has many attractions to lure NAB conventioners.

cluding "21," craps, keno, bingo, poker, baccarat and roulette.

Las Vegas hotels can provide more than just rooms. A typical hotel on the strip may offer any number of amenities including casinos, restaurants, cabarets and other entertaining activities.

Cabarets are popular, and several are shown along the strip at venues such as the Golden Nugget, Caesars Palace and the French Quarter at the Four Queens.

Many hotels also offer comedy routines and magic shows. Aladdin's Bagdad Showroom, Imperial Palace Theatre and The Dune are known for such entertainment.

However, if none of these activities is appealing,

guaranteed to provide diversion for even the most ardent engineers and broadcasters.

Dubbed the "Jewel of the Desert," Las Vegas has been a favorite convention spot because its many alternative activities can please all types of people. The Convention Center has more than one million square feet of space, and in the two-mile radius around the center, there are enough hotels to accommodate 73,000 people.

More than rooms

In addition to the accommodations for conventioners, Las Vegas obviously is known for gambling.

Casinos lining the "strip" house 85,000 slot machines with playing costs of one cent to \$500 per pull. Gamblers also can select from a long list of other games, in-

cluding others are at hand. Las Vegas is home to more than 21 golf courses, 200 tennis courts, 70 racquetball courts and eight bowling centers.

Like other world-class cities, Las Vegas has many museums. Among the more popular are the Las Vegas Entertainers' Hall of Fame, the Las Vegas Art Museum, the Liberace Museum and the Guinness World of Records Museum.

If an excursion is in order, the perimeter of the city is lined with interesting destinations and activities. Two miles outside of the Convention Center is the beginning of the Boulder Highway. The Highway is peppered with tourist meccas, including Hoover Dam and Lake Mead.

Action Helicopters, Aerleon Professional Aviation, Helicop-Tours and Lake Mead Air are within driving distance of

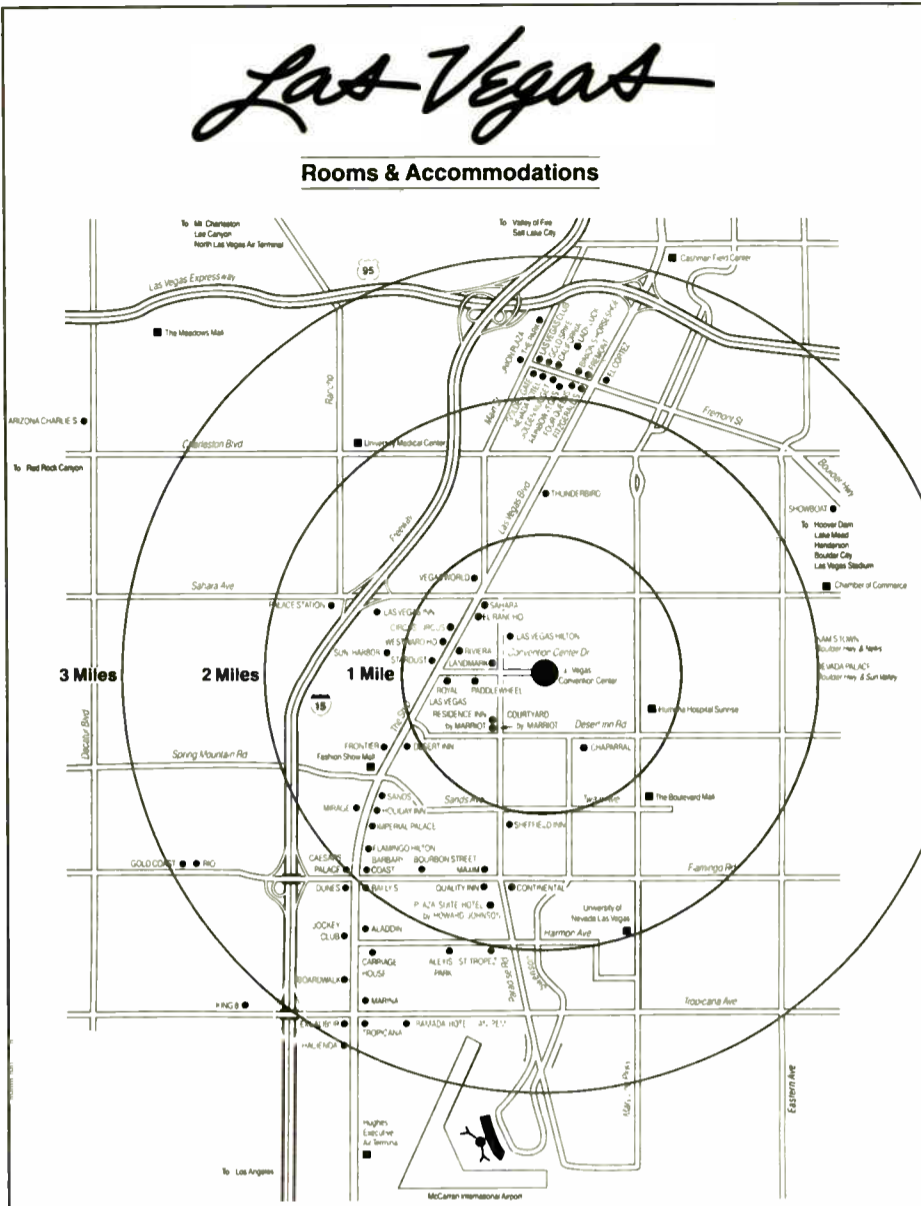

the city. All offer helicopter tours to local attractions.

The way to the heart

More than 700 restaurants are open to satisfy every type of palate. Several hotels have dining rooms and buffets are offered at many casinos.

The Riviera, Bally's Grand, Caesars Palace and the Las Vegas Hilton all have restaurants in their casinos. The Riviera offers Italian fare; Bally's Grand has French. The Bacchanal Room at Caesars Palace serves a seven-course meal in a Roman setting.

The Las Vegas Hilton, adjacent to the Convention Center, boasts a Benihana Village with three Japanese restaurants

in one for Hibachi, Tempura and Robata Yaki.

Among the recommended restaurants are Alias Smith and Jones, and The Flame. Smith and Jones is an American fare restaurant, featuring burgers and salads, with a Cajun/Mexican accent on the dinner entrees. The Flame is known in Las Vegas for its Black Angus steaks.

Buffets are offered at the Golden Nugget, Bally's Grand, Caesars Palace and Circus Circus. At Caesars, the buffet is served across from a video wall of sporting events so diners don't miss a punch. Circus Circus' buffet is one of the largest in the world with at least 45 items to choose from.

JNS CD Quality Switchers

Two families of audio routing switchers - 8300 & 9000

- ALL with CD level performance
- from 1 x 10 to 60 x 60
- with level metering
- with relay crosspoints
- optional machine control
- from LED indicator switches through PC/computer control

8310
10 stereo in
1 stereo out
\$895.00!!



8310

NAB Special - 8310 only \$495.00 during April

NEW for NAB 1991

- 8310B Switcher - Expandable to 100 inputs, machine control option, local and remote control, PC control, and much more
- New modules for the 8000 series - 'the FRAME' A Digital Audio Level Display module, Mic-to-Line module and more

See us in NAB Booth 1700,1702,1704

J.N.S. Electronics, Inc. 408/729-3838 FAX 408/926-1003

P.O. Box 32550, San Jose, CA 95152

Circle 34 On Reader Service Card

Broadcast furniture & systems.

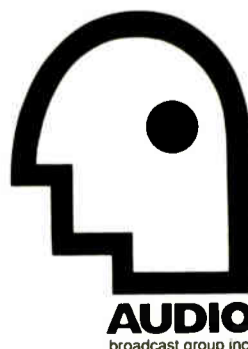

AUDIO
broadcast group inc.

Call us today!

1-800-999-9281

Audio Broadcast Group, Inc.
2342 S. Division Avenue Grand Rapids, MI 49507-3087
Phone (616) 452-1596 • FAX (616) 452-1652

After you've seen the rest, get the best!

- Over 150 systems delivered and installed.
- Outstanding workmanship.
- Stunning performance.
- Delivered on time, within a budget.

Ask for user's list.

See Us at NAB Booths 1701/1703

Circle 1 On Reader Service Card

CTE'S COMMITMENT TO ENGINEERING EXCELLENCE; A 5KW SOLID STATE TRANSMITTER SETTING NEW LIMITS FOR SIZE AND COST EFFICIENCY.

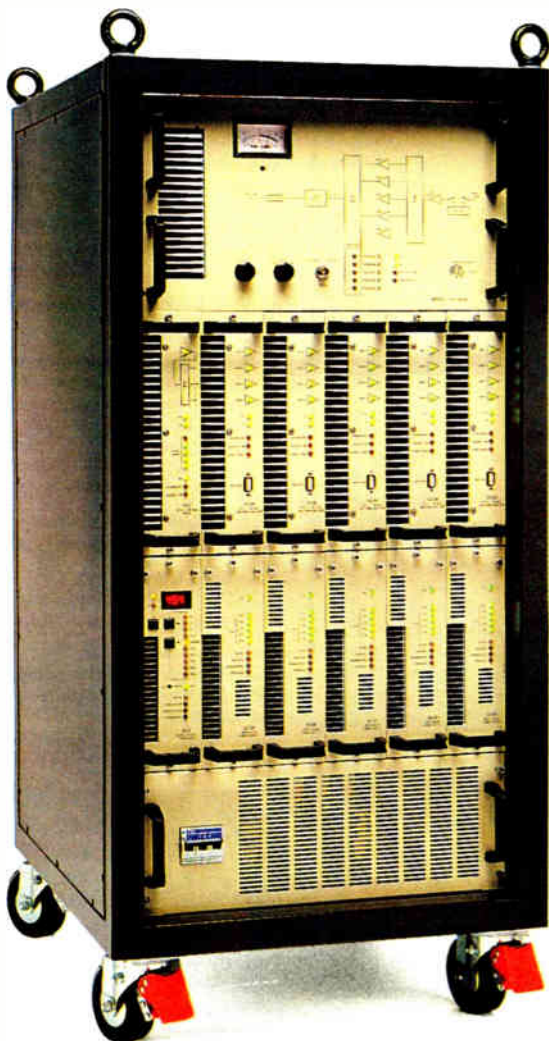
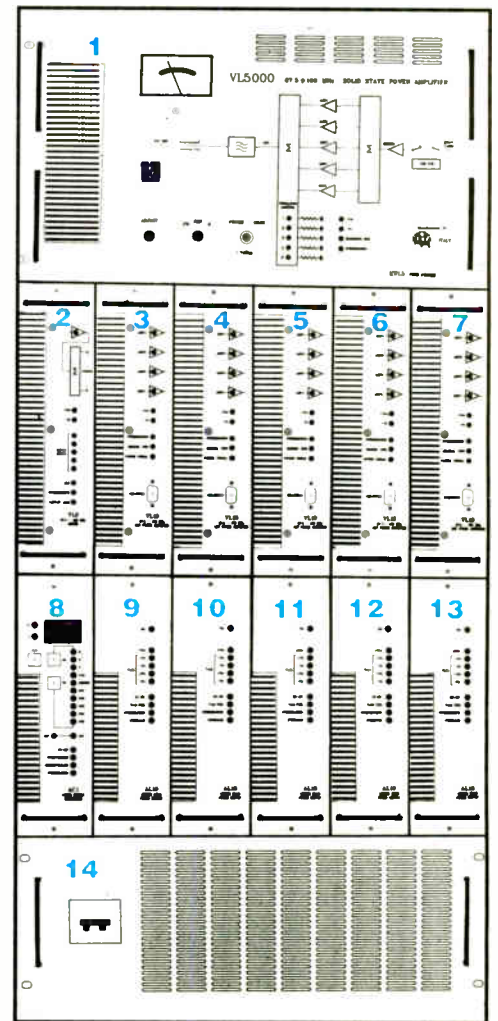
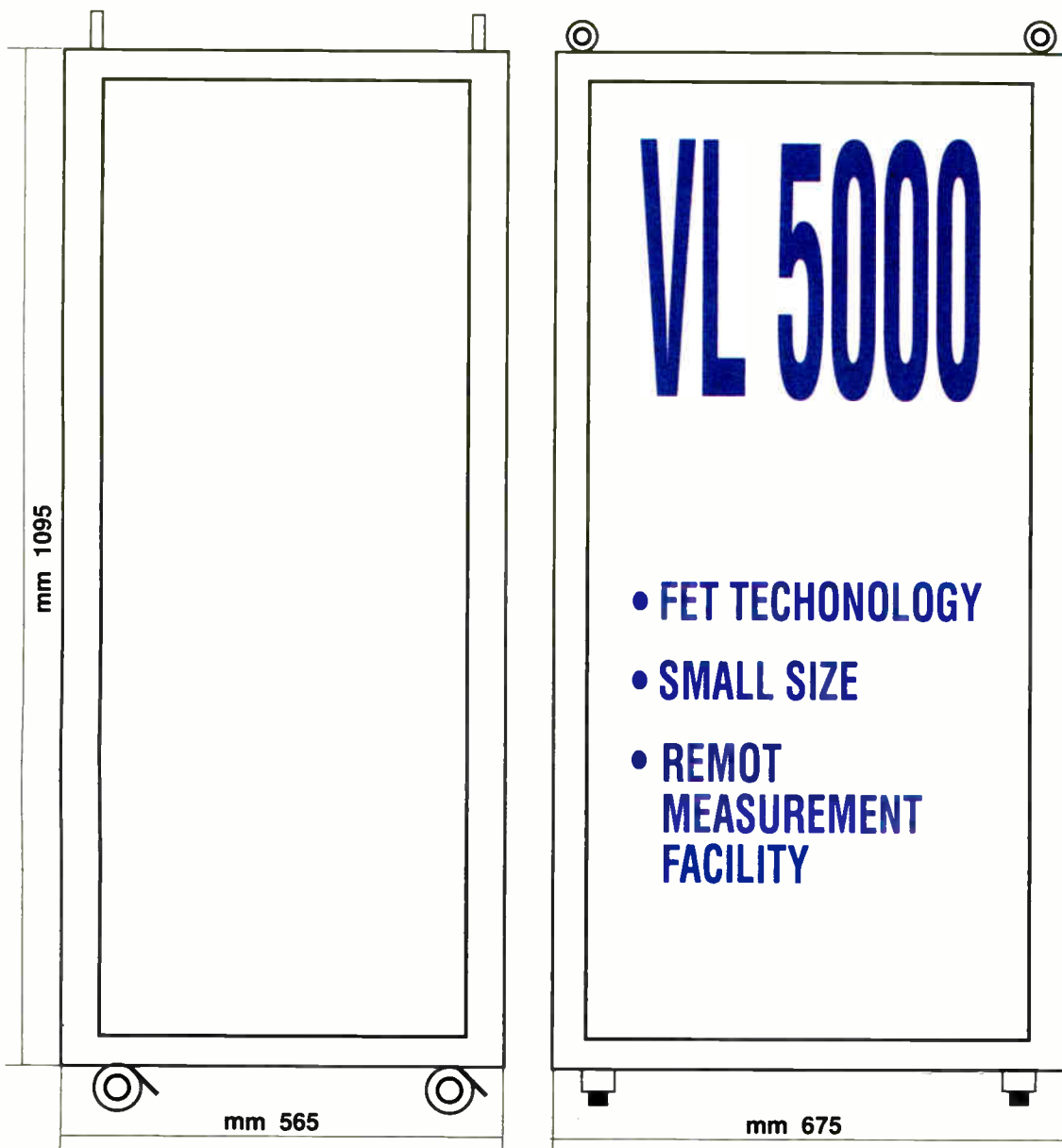

1 Output Coupler Unit

This unit includes the output coupler of the 1 KW-5 Modules, the resistive terminals, the power meter, the output power as well as the over-heating, unbalance condition and excessive SWR indications. A BNC connector provides an output voltage sample attenuated by 60dB. The output connector is EIA I and 5/8 flange.

2 Driver Module

A good driving is the basic step for a good amplification. This operation is assured, in any input condition, by a 300% oversized feedback, controlled by a detector circuit with output dipendent on working frequency. Also this module is protected against over-heating and excessive SWR values at the output.

3 1 KW Module

4

5 The CTE 1 KW Module is composed by 4 basic amplifiers, combined both in input and output by a coupler circuit conceived and developed in our labs.

6

7 The use of the coupler permits a good SWR on the whole frequency band, even without one or more basic units. A sophisticated control device, assures a balance condition, also in case of damage of one of the modules. This circuit acts on the circuits' power supply within short time, reducing the values to safety leves. A special connector placed on the front panel of the amplifiers modules allows the reading of the different values that, addressed by a 4 bit code and analyzed by an optional tester, permits to verify the good operating of the unit.

8 Power Supply Controller

This module provides all the necessary values concerning the operations of the unit's power supply. These operations are: input and output voltage auxiliary voltages, total and partial current of each single amplifier.

9 Switch Mode Power Supply.

10

11 A switching power supply assures a tolerance on the power supply voltage of +/- 20%. Each module can supply up to 40 A and is complete with luminous leds, indicating input and output voltage, auxiliary voltages, overload, overheating and stand-by position of every single power supply.

12

13 This unit has a three-phase insulating transformer, gas discharger and a thermal-magnetic main switch, besides of course a complete net of fast protections for the main voltage.

ITALIAN TECHNOLOGY, FOR WORLDWIDE MARKETS

BEEM COMPANY

2322 South Second Avenue
Arcadia, CA 91006 Tel. (818) 446-3468

CTE INTERNATIONAL s.r.l. Via R. Sevardi, 7 - 42100 Mancasale Reggio Emilia - Italy
Tel. 0039-522-47441 - Telex 530156 CTE I - Fax 0039-522-47448





The cart room at WLTW-FM, New York, a Viacom station

Vincent Marchese

Carts with Dolby SR give us a reliable, time-proven playback system with all the quality of CD's."

"So far, there's no digital 'solution' that compares to our carts with Dolby SR for performance, reliability, and convenience versus cost. And should that day come, Dolby SR will keep us competitive without having to spend another dollar.

"With Dolby SR, everything we air sounds clean and noise-free, including commercials. After all, our sponsors deserve the best quality audio as much as our listeners."

Bob Tarsio, Chief Engineer

"Dolby SR has brought us to a new level of on-air fidelity in the competitive New York market. Yet there are none of the gaffes that crop up with CD's, like playing cuts out of order or accidentally cueing up a cut that doesn't fit the format.

"Except for initial set-up, Dolby SR is completely hands-free. Our production and air staff make and play back carts the same as they always have: quickly and easily.

"The sound is more transparent than I could have imagined. Dolby SR recordings really do sound like the original."

Al Bernstein, Production Director

Call us at (415) 558-0200 for more information on how you can benefit from Dolby SR.



Dolby SR: now 50,000 channels worldwide

Dolby Laboratories Inc. • 100 Potrero Avenue San Francisco, CA 94103-0213 • Telephone 415-855-0800 • Telex 34409 • Facsimile 415-853-1373
348 Clapham Road London SW9 9AP • Telephone 071-720-1111 • Telex 819109 • Facsimile 071-720-4118
Dolby and the double-D symbol are trademarks of Dolby Laboratories Licensing Corporation © 1991 Dolby Laboratories B990718



The 1991 NAB Exhibitors Directory is a listing of information provided by exhibitors who responded to an NAB Radio questionnaire survey. Past and potential NAB exhibitors were asked about new and established radio products scheduled to be shown at the NAB this year.

The questionnaires were mailed to vendors in January 1991. Those returned by the deadline are included in this directory.

Note: In alphabetizing, upper case listings appear first.

COMPANY BOOTH

A _____
ADC Telecommunications, Inc. 6026

AEQ 1249
Intro: A complete line of broadcast audio consoles.
Contact: Javier Lizuain
Pol Ind Leganes c/Rey Pastor 36
E-28914 Leganes
Madrid, Spain
011-34-1-686-13-00

AKG/Orban/dbx 1226
Intro: AKG C407 miniature condenser microphone with vocal fluttering frequency response and omnidirectional capsule, .3 inches in diameter with a detachable tie pin and clip. The dbx 363X half-rack noise gate with two independent or stereo strappable channels with separate threshold, hold and release rate controls with key input, engage, key monitor, bypass and stereo modes. Orban 4000A Transmission Limiter, available in single or two-channel version, provides transparent limiting of audio program by average-sensing.
Contact: Dave Roudebush
1525 Alvarado St.
San Leandro, Calif. 94577
415-351-3500

AMCO Engineering Co. 4201-4205
Intro: Monitoring systems enclosures for audio or video or security type applications. Shielded or non-shielded, single or multibay configurations for STD or special design applications. Full line of cooling devices for cabinets, enclosures also available.

AMS Industries 6322

ATI-Audio Technologies Inc. 1058, 1060
Intro: HD1000 expandable, multi-output headphone amplifier features stereo, balanced line level inputs summed with a mono microphone input. PB2X8 press box distribution system with two switchable mic/line inputs and eight balanced outputs. Mixminus adapter eliminates telephone caller's voice from cueing feed.
Also: Vanguard series eight- and 12-mixer on-air consoles. MicroAmp series and Encore series audio amplifiers; microphone, line, turntable, distribution, power and IHF interface amplifiers. Emph'aSizer microphone processor; VU800 two-to-eight-channel VU plus PPM LED studio metering system.
Contact: Ed Mullin
328 W. Maple Avenue
Horsham, Pa. 19044
215-443-0330

AVCOM of Virginia, Inc. 5951
Intro: PSR-1000A portable surveillance receiver and MVT-1000A microwave video transmitter, for the broadcaster who needs a microwave link with audio demodulation capability. The system is also well suited for government, military, and security surveillance systems.
Also: PSA-65A, PSA-37D, PSA-35A portable spectrum analyzers; PTR-25A portable test receivers; SCPC-97, SCPC-2000E, SCPC-3000E, SCPC-500-70 single channel per carrier receivers; COM-96T satellite receiver; microwave components (power dividers, amplifiers, DC blockers, etc.)
Contact: Pete Gaggio
500 Southlake Blvd.
Richmond, Va. 23236
804-794-2500

Accom, Inc. 2026

Accu-Weather, Inc. 5552, 5554, 5556
Intro: FeatureFone voice response system is a turn-key system for newspapers, TV and radio stations to provide news and features by telephone; one-stop satellite delivery of data and graphics with the Alden/Zephyr on C and Ku bands; UltraGraphix 386 AT PC weather graphics system.

Accurate Sound Corp. 1117
Intro: AS-100 reel-to-reel magnetic tape transport; AS-4000 cassette recorder/logger.

Acoustic Systems 2020-2022

Advanced Designs Corp. 6005

Advent Communications Ltd. 7041

Alamar Electronics USA, Inc. 5857-5968

Alden Electronics, Inc. 5237

On Display: Zephyr and Alden will show the WS5500 weather workstation which plays live satellite images, color weather radar and NWS facsimile weather charts. This service is displayed on our VIS system and displays all of the cloud-to-ground lightning strikes that occur, in real time.

Allen & Heath 7109-7111

Allied Broadcast Equipment Corp. 1100

See Harris-Allied Broadcast Equipment

Allied Tower Co. 1031

On Display: Broadcast communication tower services—design, fabrication and installation.

Alpha Audio Acoustics 3081, 3083

Intro: Portable audio booth; portable take-down booth (STC 29); Azonic ceiling tiles.
Also: Azonic acoustical foam; SoundTex acoustical wall fabric; acoustical barrier material; audio seal barrier and absorber blankets.
Contact: Michael Binns
2049 West Broad Street
Richmond, Va. 23220
804-358-3852

Alpha Audio Automation Systems 3075-3083

Altronic Research Inc. 1463, 1465

Intro: Model 9725, 9750 water-cooled loads, 25 kW, 50 kW respectively; unibody replacing model 5725; 5750. Model 6401, a 1 kW dry load with a frequency range from 60 Hz to 240 MHz.
Also: Omega line of RF coaxial loads including 6705, 5 kW air load, 6775, 75 kW air load, along with water-cooled models 5780, 80 kW and 57200, 200 kW.
Contact: Doug Starkey
P.O. Box 249
Yellville, Ark. 72687
501-449-4093

Amber Electro Design 1411-1413

Amek-TAC U.S. Operations 2021

Intro: AMEK will introduce a new broadcast console with many features for stereo working, such as image width controls, previously only available on the larger AMEK Classic. TAC will introduce the B2, a low cost video post-production console. TAC will also introduce the SR6000, a mid-priced TV production, monitoring and sound reinforcement console with up to 34 independently mixable outputs, and VCA grouping on both inputs and outputs.

Andrew Corporation 5533

Intro: Maxline inner conductors, with patented bellows design.

Anixter Bros. Inc. 2047

Antenna Technology 6416

Intro: L-band switching system; receivers; Inmarsat system.

Aphex Systems 6336

Intro: Digicoder PPDMM stereo generator and Compellor model 320 compressor/leveler, both for the Audiofile Air Chain. Compellor 320 has features such as dual mono operation. The Digicoder uses a proprietary modulation scheme for digital stability.

Applied Research & Technology 1411

Arrakis Systems Inc. 1802

On Display: Modulink pre-wired studio systems, based around the 12,000 series modular consoles and furniture line for on-air, newsroom and interview studios. Also, SC series turbo consoles, 5000 series modular consoles, 17,000 series modular console systems 6,12 and 18; 10,000 series modular consoles; turret support for 12,000-10,000 consoles.

Asaca/Shibasoku of America 3048

Intro: AAM-800 magneto-optical disk audio file.

Audi-Cord Corporation 1012

On Display: "DL" series recorder/reproducers and "S" series recorders/reproducers.

Audio Accessories, Inc. 2010, 2012

On Display: Audio jack panels and jacks; pre-wired audio patch panels; patch cords; patch cord holders and video panels.

Audio Action 7131

Audio Animation, Inc. 2021

Intro: Audio Animation will introduce the paragon, a fully-digital dynamics controller and frequency equalizer. The paragon includes many functions that are normally associated with stand-alone analog processors.
Contact: James M. Ruse
6632 Central Ave. Pike
Knoxville, Tenn. 37912
615-689-2500

Audio Broadcast Group Inc. 1701-1703
 On Display: Human-engineered studio systems for both "on-air" and production applications.
 Contact: David Spoeliat
 2342 South Division
 Grand Rapids, Mich. 49507
 616-452-1596

Audio Developments, Ltd. 5201-5203
 Audio Kinetics Ltd. 1358-1360

audiopak, Inc. 1512-1514
 On Display: Genuine audiopak true blue A-2, AA-3 and AA-4 endless-loop NAB audio broadcast cartridges. A-2 for general purpose applications, spots, commercials, music; AA-3 for stereo phased AM/FM broadcasts; and AA-4 for critical AM/FM stereo reproduction where extended frequency response and expanded headroom are required, particularly digital source material. Lubricated tape formulas 605, 613, and 614 for use in all endless loop cartridges and/or cassettes.
 Contact: Gordon Stafford
 P.O. Box 3100
 Winchester, Va. 22601
 703-667-8125

Audio Precision Inc. 2211
 Intro: Portable One field audio test set; fast audio system test multitone test software.
 Also: System One, System One + DSP, System One dual domain.
 Contact: Thomas Mintner
 5465 SW Western Ave. Suite J
 Beaverton, Ore. 97005
 503-627-0832

Audio Services Corp. 7218, 7220, 7222
 On Display: Nagra, DAT and multitrack recorders, microphones, shockmounts, windscreens, boom poles, mixers, wireless, sync playback equipment, sound-carts, cellular and radio communications equipment, cables and adapters.

Audio Technica U.S., Inc. 2235
 Intro: Sub-miniature lavalier condenser unidirectional lavaliers (AT831). AT804 field mic, ATM611E hypercardioid handheld for very noisy environments where omnis don't work. ATM35 miniature condenser ATM71 miniature head-worn condenser for hands-free broadcasting.

Auditronics, Inc. 1258
 On Display: 310 series production console; 400 series production console; 1200 series stereo distribution amplifiers; 1100 series rackmount amplifiers; 201 series radio on-air console; Destiny 2000 series radio on-air consoles.
 Contact: Duncan Fuller
 3750 Old Getwell Road
 Memphis, Tenn. 38118
 901-362-1350

Autogram Corp. 1500, 1504
 Intro: 618 Pacemaker—six slide pot, 18 input audio console.

B

B&B Systems, Inc. 2056
BTC Test & Measurement 5320-5322

Barco-EMT, Inc. 7601
 Intro: CVM 2000 series, offers automatic setup accepting all current composite and component formats, extended keyboard functions, rack-mountable. HDM 2048L high definition television monitor series to offer all standard broadcast features including auto-setup.
 Also: CVS series, the first grade one broadcast monitor to provide microprocessor control of every display parameter and control function; AVM series grade two monitor incorporating automatic alignment of image parameters, routing switchers, cable and satellite equipment and audio equipment.
 Contact: Dan Desmet
 1000 Cobb Place Blvd.
 Kennesaw, Ga. 30144
 404-590-7900

Barrett Associates 2032
Beaveronics Inc. 1520-1528

Belar Electronics Laboratory 1448
 Intro: The Wizard FM digital modulation analyzer; RFA-4 FM RF amplifier.
 Also: FMM-2 FM modulation monitor; FMS-2 FM stereo modulation monitor; FMM-4A FM digital frequency monitor; SCM-2 SCA modulation monitor; AMM-2B AM modulation monitor; AMM-3 AM modulation monitor with automatic carrier leveling.
 Contact: Arno Meyer
 P.O. Box 76, 119 Lancaster Ave.
 Devon, Pa. 19333
 215-687-5550

Belden Wire & Cable 6424-6432

Benchmark Media Systems, Inc. 2208-2212
 On Display: System 1000 audio distribution amplifiers with remote features; SPM 2.3 meter systems; VU, PPM and peak hold meter systems; MIA 4 and MIA 4x4 microphone preamps; MIA 4x2 two-channel portable microphone preamplifier; Loudmouth reporter control station.
 Contact: Mark Potterbaum
 5925 Court Street Rd.
 Syracuse, N.Y. 13206-1707
 315-437-6300

Beyerdynamic, Inc. 5314-5316
 Intro: Diversity wireless microphone system.

Bradley Broadcast Sales, Inc. 2007
 Intro: Cutting Edge Unity 2000, a digital FM processor for all formats; ComStream digital audio satellite equipment; Telos 1M interface, to interconnect two-wire and four-wire intercom systems.

Bext, Inc. 1020
 Intro: 10 W UHF transmitter.
 Also: TEX-20 FM exciter—a PLL exciter of two to 20 watts; LC STL composite aural STL system; PJ series of FM broadband solid state amplifiers, 100 to 1000 watts; NS series of UHF TV amplifiers; T-1200 single tube FM amplifier from 800 to 30,000 watts; HPT FM translator, receiver and exciter in one frame.
 Contact: Dennis Pieri
 Suite 7A, The Gaslamp Ct.
 San Diego, Calif. 92101
 619-239-8462

Brite Voice Systems 7807-7808
Broadcast Automation Inc. 1912
 Intro: 360 Systems DigiCart digital cart machine; automation interface for DigiCart.
Broadcast Electronic Services 5969
Broadcast Marketing 7545
Broadcast Microwave Services 3027, 3029, 3031, 3033
 Intro: BMT-40GP portable transmitter, BMR-40KP portable receiver

Broadcast Electronics, Inc. 1120
 Intro: Core 2000—Full-featured program control system including live-assist capability; AudioVault-digital record/playback and inventory storage facility for radio broadcast use; Air Trak 90—six-, 12-, 18- and 24-channel mid-priced/high performance linear audio console.
 Also: "B" series FM transmitters with FX50 exciter from 50 W to 35 kW; Mix Trak 90 modular linear audio consoles in 12-, 18- and 21-channel main frame configurations; Phase Trak 90. Dura Trak 90 and Splice Trak 90 audio tape cartridge machines.
 Contact: Jim Ulm
 4100 North 24th St., P.O. Box 3606
 Quincy, Ill. 62305
 217-224-9600

Broadcast Products 7237
Broadcast Video Systems Ltd. 5221-5225
Broadcasters General Store, Inc. 2223
 Intro: R-Tec DTMF controller, ComStream digital satellite receiver, automute; Cutting Edge Unity 2000, a digital FM processor for all formats.

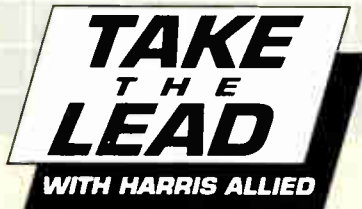

Audio logging has come down to this.



Eventide's new VR240 Digital Audio-Logger stores an entire week's worth of audio on a single DAT cartridge.

A whole week of programming. If you've ever struggled with finicky reel-to-reel loggers (or tried to make do with standard audio cassettes), you know what a mountain of tape that adds up to. Now the whole thing can fit in your shirt pocket.

Come to NAB Booth #1100. We'll show you how easy logging can be with Eventide's new VR240 Digital Audio-Logger.

The VR240 turns logging into a truly cost-effective competitive weapon for program directors and sales managers. With up to 24 channels, you can record your AM, FM and TV audio in stereo—plus your crosstown competition, even the local police and fire channels. On playback, the VR240 locates any audio segment in less than a minute.



With expanded staff and service...our lead keeps on growing.
800-622-0022

FAX 217-222-7041 STUDIO EQUIPMENT ■ HARRIS RF PRODUCTS ■ SATELLITE GEAR ■ TURNKEY SYSTEMS IN CANADA 800-268-6817

See Us at NA8 Booth 1100 "Call me, I'm interested." Circle 138. "Send me literature." Circle 52.

Lindos

LA100 Audio Analyser



Sound sense in audio measurement

The Lindos LA100 Audio Analyser is a versatile audio measurement system comprising the LA101 Synthesized Oscillator and the LA102 Audio Measuring Set available as separate portable units or combined in 19" rack mount form (2U high).

- **Automatic sequence testing** (using FSK transmitted over the signal path) permits lines, tape machines and other systems to be completely evaluated in less than a minute. The results with pass/fail indication may be displayed on the graphic LCD or printed on any standard printer. Test sequences, tolerance limits and configuration settings can be easily entered into non-volatile memory using the front panel keyboard or a PC.
- **Superb accuracy** is achieved by the use of laser-trimmed resistors combined with software calibration (no trimmers, no drift).
- **Synthesized low distortion oscillator** (0.003% THD) with quartz stability can generate accurate tone bursts and frequency sweeps with no amplitude bounce.
- **Extreme Versatility:** Measurements including level, frequency, noise, crosstalk, distortion, frequency response, phase, jitter, wow & flutter, speed, rumble and quantising distortion.
- **Mains and rechargeable battery operation.**
- **PC Compatible:** RS232 interface built-in. PC Support software provides disk storage etc.
- **Fully floating and electronically balanced oscillator outputs and balanced inputs.**
- **Test tapes and discs** will be available soon but our smart test modes can be used with tones and sweeps on your existing tapes and discs to plot frequency response graphs.
- **Proven in use worldwide:** Launched in the UK 5 years ago; all major UK broadcast and telecommunications organizations have over 100 units.
- **\$5200 including LA101 Oscillator, LA102 Measuring Set and air mail delivery.**

Output: 5Hz-38kHz, -100dBu to +26dBu in 0.01dB steps, 10Ω, 75Ω or 600Ω, two channels, XLR sockets. Level accuracy: ±0.03dB. 5 frequency and 5 level presets. Input: -110 to +28dBu (with fast autoranging), two channels, XLR sockets. Accuracy ±0.05dB. Level: true rms 2-100kHz, 22-22kHz (-3dB), VU, PPM, VU A weighted, rms A weighted. Noise: CCIR 468-4 weighted & unweighted quasi-peak, CCIR/ARM, CCIR rms, weighted & unweighted rumble (BS4852). Residual noise: -97dBu (CCIR weighted, q-peak). Crosstalk: 40, 100, 315, 1k, 6.3k, 10k, 15kHz, 80-400, 1.8k-21k, 12k-21kHz (12dB/octave bandpass filter). Distortion: 40, 100, 1k, 6.3k, 10kHz THD & 315Hz (3rd harmonic). Wow & flutter: IEC386, DIN45507 weighted & unweighted quasi-peak, weighted & unweighted rms. Oscillator weightings: RIAA, CCIR, 50µs and 5 user weightings. Tone-bursts fully programmable, 0.1ms resolution. Monitor: built in. Scope/phones output: BNC socket. Battery life: 5 hours.

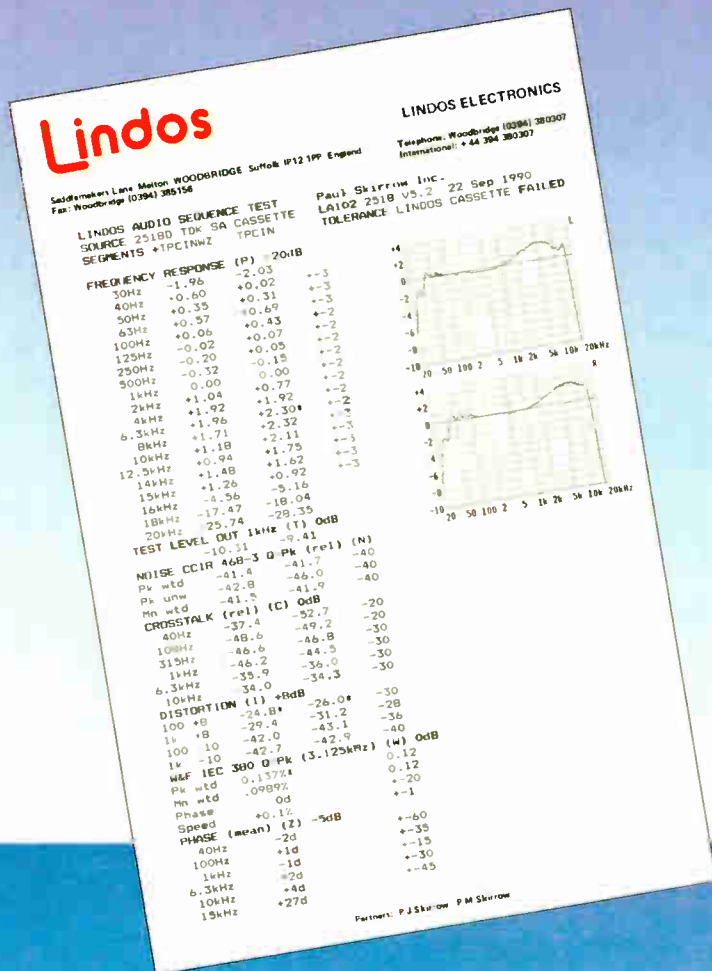

**Booth 2605
NAB, Las Vegas
15-18 April**

Please write or call our NEW USA OFFICE:
LINDOS AMERICA, PO Box 125, Elm PA 17521
Tel: (717) 664-4595 for a brochure.
or LINDOS ELECTRONICS, Saddlemakers Lane, Melton
WOODBRIDGE, Suffolk, 1P12 1PP, ENGLAND
Tel: 011 + 44 394 380307 (24 hrs) Fax: 011 + 44 394 385156

BSW-Broadcast Supply West 1808
On Display: Studer Dyaxis digital workstation, 360 Systems DigiCart.
Contact: Tim Schwieger
7012 27th St. West
Tacoma, Wash. 98466
800-426-8434

Bruel & Kjaer Instruments Inc. 7811

Bryston Vermont Ltd. 2404-2406
Intro: 7B-800 W mono amplifier capable of peaks of 120 amperes.

Burk Technology 1907
Intro: Model ATS-1000 automatic transmission system, operates in conjunction with the ARC-16 system to provide fully automatic control of the entire broadcast facility; user-friendly interface for simple operation.
Also: TC-8 transmitter remote control system, eight-channel full-time control system with digital display, operates with telco or subcarrier links; ARC-16 transmitter remote control system with 16 channels in a single unit—multisite configurations are available.
Contact: Peter Burk, President
7 Lomar Drive
Pepperell, Mass. 01463
508-433-8877

CBSI—Custom Business Systems, Inc. 1452

CCA Electronics 1025
Intro: FM 30G 30 W FM exciter.
Also: FM 4000G 4 kW FM transmitter; FM 25000G 25 kW FM transmitter.
Contact: John Binsfeld
P.O. Box 426
Fairburn, Ga. 30213
404-964-3530

CMC Technology 4549-4547

Cablewave Systems, Inc. 1148
On Display: Line of horizontally and circularly polarized FM antennas for low, medium and high power applications; Flexwell foam and air dielectric cables, connectors, couplers and low pass filters; Flexwell Waveguide cable, microwave parabolic antennas.
Contact: William Meola, Nat'l Sales Mgr
60 Dodge Avenue
North Haven, Conn. 06511
203-239-3311

Calculated Industries Inc. 4573

Canare Cable Inc. 6040, 6042
On Display: L-4E6S "Star Quad" mic cable.

Central Tower, Inc. 2014, 2016, 2018
Intro: Exportable tubular/solid bolt-together guyed and self-supporting towers designed for optimal performance at economical prices.
Also: Full range of guyed, self-supporting and monopole tower designs for any application.
Contact: Terrence Becht
2855 Highway 261
Newburgh, Ind. 47630-8642
812-853-5310

Chester Cable Corporation 6319
Intro: EF series audio cables, available in single or multiple pair jacketed versions. The EF cables use a shield bonded to the inner jacket and a ripcord, which facilitates stripping and termination time. Video 20CL2 is a UL listed, .325-inch, solid core, double shielded, PVC jacketed precision 75 ohm video cable compatible with the industry standard KC-59-299 connector.

CRL—Circuit Research Labs Inc. 1814
Intro: Daypart timer, timer control unit for the Audio Signature processor. SEC-850 four band compressor stereo system.
Also: AM and FM processing equipment; Dynafex single-ended noise reduction system; MBL-100 medium shortwave processing; SCA and FM stereo generator.
Contact: William L. Ammons
2522 W. Geneva Dr.
Tempe, Ariz. 85282
800-535-7648

Clear-Com Systems 3009, 3011, 3013, 3015
Intro: MS-812 programmable eight- or 12-channel master station; "LFS" digital station for use with matrix plus intercom. DTMF matrix card model MTX-3 for use with matrix plus digital intercom, to allow inward access from telco or other matrix system. TWC-104 4-channel rackmount adapter for TWC-style packs.

Clipper Products 7731

Coaxial Dynamics, Inc. 1338
On Display: Precision equipment for measurement and termination of RF power. Several models of wattmeters and loads are available for power ranges from 0.1 W to 100,000 W.
Contact: John Ittel
15210 Industrial Parkway
Cleveland, Ohio 44135
216-267-2233

Columbine Systems, Inc. 4022
Intro: News and production systems featuring automation interface, closed captioning and teleprompter.

Comband Technologies Inc. 6326

Comprompter, Inc. 6345, 6343
Intro: VGA teleprompter incorporating all standard ENR features and a producers interface. An Abekas interface will also be shown.
Contact: Ralph W. King
141 South 6th Street
La Crosse, Wisc. 54601
608-785-7766

Computer Concepts Corp. 1063
Intro: A data reduction board for the digital commercial system (DCS). The board will be an add-on option to DCS.
Also: DCS, combining a digital audio board and software to allow digital recording to a hard disk and instantaneous on-the-air playback of an entire inventory of audio commercials, liners, jingles, etc.
Contact: Donna Greeling
8375 Melrose Drive
Lenexa, Kansas 66214
913-541-0900

Computer Music Consortium 7216

Comrex Corporation 1240
Intro: Digital audio codecs for 7.5 kHz duplex audio on 56 or 64 kilobits per second digital telephone services.
Also: Frequency extender systems for up to 8 kHz audio on dial telephone lines. Telephone coupler and hybrids and wireless cue systems.
Contact: Lynn Distler, VP Sales
65 Nonset Path
Acton, Mass. 01720
508-263-1800

Comtech Antenna Systems, Inc. 1508, 1510
On Display: Satellite antenna systems for the broadcast industry. Antenna sizes range from 2.4 to 7.3 meters; 3.8 or 5.0 meter E1/Az systems for SCPC downlink; offset antenna, 5.5 x 2.4 meters, for SCPC uplink requirements.
Contact: Tom Christy, VP Marketing
3100 Communications Road
St. Cloud, Fla. 34769
407-892-6111

Concept Productions 1059

Conifer Corp. 5859-5967

Connectronics Corporation 3073
Intro: Range of one-piece adaptors

Conquest Sound Inc. 7353

Continental Electronics 1220
On Display: Complete line of AM and FM radio transmitters; antennas; loads; SCA units; processors and other related broadcast equipment.
Contact: Steven A. Claterbaugh
4217 S. Buckner Blvd.
Dallas, Texas 75227
214-381-7161

Control Concepts Corp. 5246

Corporate Computer Systems 2123
Intro: Micro 15K—MUSICAM compatible 15 kHz digital audio codec; Micro 66R—rackmount version of the CCS 7.5 kHz codec with selectable digital bit rates of 56 kbps or 64 kbps.
Also: Micro 56 and 64 7.5 kHz codecs using the CCITT standard G.722 ADPCM algorithm.
Contact: David Lin
33 W. Main St.
Holmdel, N.J. 07733
908-946-3800

Cortana Corporation 7113
On Display: Stati-Cat lightning prevention system; Radial Chaser II.

Crouse-Kimzey 2000
Intro: Otari DDR-10 digital workstation; Panasonic SV3900 DAT recorder, Denon DN-9750FA production CD player. We will be demonstrating new concepts in digital audio production.
Also: Arrakis 12,000 console, Tanney monitor speakers, Ramsa power amps, Forman AC conditioners and regulators, Anvil flight cases and ART digital processing.
Contact: Chuck Hair
P.O. Box 155999
Ft. Worth, Texas 76155-0999
800-433-2165

Crown International 2040
Intro: Tridundant microphone.

Current Technology 7230-7232

Cutting Edge Technologies 2007, 2223
Intro: Unity 2000, the first digital FM audio chain in a single chassis.
Also: The Dividend composite filter.
Contact: F. Joseph Foti, Vice President
2501 West 3rd Street
Cleveland, Ohio 44113

DDA 1919
Intro: DCM 224V post production console; profile recording console; DMR-12 recording console; D-series "pre-lay" console.

DHK Group, MacroMedia 7618, 7620
Intro: Digicorder, a compact digital audio recorder/ player unit. Capable of storing up to 400 minutes of 15 kHz stereo audio material in a 3.5-inch high chassis. Material is available for instant playback from the front panel controls and/or external commands via serial and parallel inputs. "Smart Audio" design allows the unit to play and record simultaneously so playback can begin any time, not just after the recording is finished.
Contact: Tim Valley
1320 Liberty Court
Northfield, Minn. 55057
507-645-5970

DIC Digital 7733, 7735
Intro: MQ series DAT tape for professional use (master quality), available in 15, 30, 48, 62, 92, 122 minute cassettes; new packaging features include professional J-card which has spots for data regarding contents of tape.
Also: Digital audio tape (DAT).
Contact: Kevin Kennedy
222 Bridge Plaza South
Fort Lee, N.J. 07024
201-224-9344

DSI Products, Inc. 5725

Dataworld 1609
Intro: Three-second terrain data; FM and LPTV detailed interface studies; further enhancement of mapping services, detailed coverage maps, population and power density maps, terrain shadowing maps; received signal level maps; advanced presentation graphics.
Also: AM, FM, TV, LPTV directories; wireless cable (ITFS, MDS, MMDS, OFS), allocation and interference studies; population counting; flag service of FCC releases; terrain elevation retrieval programs; FM and TV area-to-locate studies; AM groundwave calculations; unused call-sign listings; AM daytime channel studies. On-line 24-hour remote access, no CPU or time charges.
Contact: Shirley Ostmann, General Manager
P.O. Box 30730
Bethesda, Md. 20814
301-652-8822

dbx—A Division of AKG Acoustics 1226
See AKG/Orban/dbx

DeWolfe Music Library 3023

Decision, Inc. 2041

Delta Electronics, Inc. 1000

Intro: Audio monitor amplifier; TCA transient suppressor assembly; RFI/EMI shielded weatherproof enclosure for the TCA system; high power toroidal current transformer; rackmount for stereo noise generator.

Our STL's give you one distinct advantage.

Front panel programmability

Engineers who rely on BEXT STL's as backups because of their easy frequency selection have learned two more significant facts: First, that our STL's outperform expensive competitors, and second, that our field response is quick, accurate and thorough.

Both the high value LC Series and the high performance SD Series offer the unique convenience of front panel programmability.

Both are modular systems: in the rare event that you need more than the standard 15W to reach your transmitting site, it is easy to add our 15W amplifier.

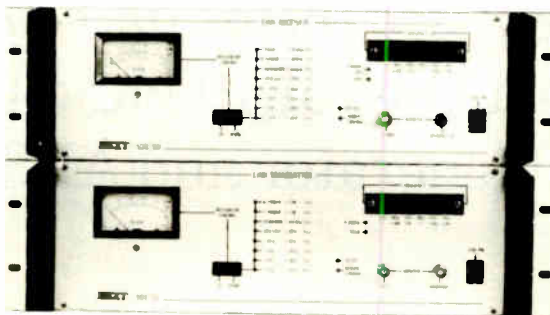

The LC Series is so affordable, even small stations can justify a backup system (remember — backup composite means full stereo redundancy.) It handles main program and subcarrier frequencies up to 100 kHz.

The SD Series offers top performance, and supports all

subcarrier frequencies up to 200 kHz. The SD receiver's RF bandwidth is adjustable to optimize reception in your environment.

These reliable STL's are available with prompt delivery, direct from our San Diego offices. Call today for more detailed information.

Suite 7A
739 Fifth Avenue
San Diego, CA 92101 USA
619-239-8462



©1990 BEXT, Inc.

See Us at NAB Booth 1020

World Radio History

Circle 2 On Reader Service Card

Denon America, Inc. 3001, 3003
Intro: DN-7700R CD cart recorder, records spots, etc. on CD; DN-970FA with auto track select limits and controls track selection for on-air playback. Prevents jocks from playing the wrong music from CD on the air. Track exclusive, track priority and track prohibit modes available; DN-970FA with seamless looping for production.

Di-Tech, Inc. 5733
On Display: Audio DAs, audio routing switchers, audio monitor amplifiers.

Dielectric Communications 4539

Intro: Universal switch control panel designed to provide control of one or two coaxial or waveguide switches at either manned or unmanned transmitter stations. Controller provides active transmitter interlocks, which turns the transmitter off prior to activating the RF switch.

Also: Coaxial switches, patch panels, FM panel and rig antennas, transmission line, variable transformer, radomes, combiner, etc.
Contact: Colleen Mitchell
Tower Hill Road
Raymond, Maine 04071
207-655-4555

Digital Audio Labs 1913

Digital Audio Research Ltd. 1901

Digital Equipment Corp. 7231

Dolby Laboratories 1404

On Display: DP501/DP502 digital audio encoder/decoder and AC-2 audio coding technology; Model 363 two-channel general purpose NR unit switchable between Dolby spectral recording and A-type noise reduction; XPSR series—up to 24 channels of Dolby SR; MT series—up to 24 channels switchable between Dolby SR or A-type noise reduction; Model SEU4/SDU4 Surround Encoder/Decoder units for encoding and monitoring of Dolby surround productions.

Contact: Kevin Tam
100 Potrero Ave.
San Francisco, Calif. 94103
415-558-0200

Dorrrough Electronics 1608

On Display: Loudness meter model 40-A, displays both average and peak on the same LED scale. Ballistics are paralleled to neither the VU nor the PPM. Scale configurations have been added and peak-hold functions are available. The meter is part of the stereo signal test model 1200, offering left, right, check and sum formats reference checks of stereo audio.

Dreamdata, Inc. 7615

Dynair Electronics, Inc. 4459

Intro: Series 400 audio and video transmitters and receivers; Series 450/460 HDTV fiber transmission system; DynaMite Composite D2 router; Series 1200 digital fiber transmission system; DynaMite HDTV router for RGB graphics switching; Dynasty MP-9230 control router with built-in floppy disk, keyboard and display.

E

EEG Enterprises Inc. 4559-4561

EEV, Inc. 6400

On Display: Power tubes for AM/FM transmitters including 15 kW tetrode type 4CX15,000A and 35 kW tetrode type 4CX35,000C.

ERI Installations, Inc. 2500-2506

On Display: Antenna and tower installation and emergency repair services specializing in ERI antenna and tower products.

ESE 4233, 4235

Intro: ES244-bi directional audio level interface, ES-246 quad 1x6 audio distribution amplifier, ES237 100 MHz video distribution amplifier.

Econco 1165

Intro: Tube models 4CX3500A; 4CX7500A; 4CX12000A; 8990/4CX2000A; 4CX2000B; 4CX2000C; 4CX2000D; YC130 used in new transmitters.

Also: Rebuilt power transmitting tubes and klystrons.

Contact: Debbie Storz
1318 Commerce Ave.
Woodland, Calif. 95695
916-662-7553; 800-532-6626

Electro Impulse Lab Inc. 1113

Intro: 50 kW load (Model DPTC-50kFM)—smaller, lower weight and improved VSWR.

Also: Dry, forced air-cooled RF dummy loads for FM, RF calorimeters, RF attenuators and dry, convection-cooled loads.

Contact: Mark Rubin
1805 Corlies Ave., P.O. Box 278
Neptune, N.J. 07754-0278
201-741-0404

Electro-Voice, Inc. 1011

Intro: RE-27N/D variable D, N/Dym dynamic cardioid microphone; RE-38N/D dynamic cardioid microphone with a 16-position equalization switch.

Electronics Research Inc. 2500-2506

Intro: Lambda antenna sections, optimized, antenna side-mounting tower sections; Guyed and self-supporting towers; Invisi-shield, electronically transparent ice shield.

Electrosonic Systems, Inc. 7822-7825

Emcor Products/Crenlo Inc. 2201

Intro: Fan trays and fan panels.

Equipment Broker, The 7654-7656

Eventide Inc. 1600, 1602

Intro: VR240 digital logging recorder designed for audio logging applications. The VR240 records over 184 hours and 1 to 24 channels of audio on a standard DAT tape cassette. An unattended VR240 will log over a week's worth of audio.

Excalibur Industries, Inc. 5151-5153

F

FMX Broadcast Technology Part. 6218-6220

Fidelipac Corporation 1041

Intro: Series IV and Series VI mixing consoles manufactured by recently acquired Broadcast Audio division of Fidelipac.

Also: New Dynamax CTR990 series cartridge machines and CTR10, CTR30 and CTR100 series tape cartridges; bulk tape, magnetic erasers, eraser/splice detector, storage racks and accessories.

Contact: Roger Thanhauser
P.O. Box 808
Moorestown, N.J. 08057
609-235-3900

FirstCom 1062-1064

Flash Technology, Inc. 1342

On Display: FTB-205 high intensity obstruction light; FTB-301 medium intensity obstruction light; SC-110 lighting system controller.

FloriCal Systems, Inc. 6325-6329

Focal Press 7200-7202

Intro: The Electronic Media Guides (EMG) series of books with titles such as "Managing Electronic Media" by Elizabeth Shimer Czech-Beckerman, "Radio Music Directing" by Donna Halper and the "Federal Communications Commission" by Robert Hilliard.

Contact: Kevin Kopp
80 Montvale Avenue
Stoneham, Mass. 02180
617-438-8464

Fort Worth Tower Co., Inc. 1312-1316

Fostex Corporation of America 1530-1536

Future Productions, Inc. 4575

G

GE American Communications Inc. 4538

On Display: GE Americom offers satellite communication services to the radio and TV broadcast industry. GE facilities include five C-band and two high power Ku-band satellites as well as several interconnect facilities with international satellites. Specific applications include broadcast TV syndication, satellite newsgathering, international/occasional television, digital audio and SCPC network programming and business video.

par•a•gon \ ' par-e-, gän, -gen \ n 1: a fully digital transmission processor for all broadcast environments.

2: *Featuring:* No clipper, meaning no clipping artifacts; 4-band compressor and 4-band limiter; 9" VGA touch-screen equipped video monitor; factory-loaded sound library; on-air A/B comparison; remote controllable. *User installable options* will include a Digital 10-band Graphic EQ, Stereo Generator and AES/EBU digital I/O.



paragon
digital audio transmission processor

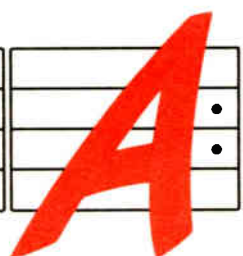

**AUDIO
ANIMATION
INCORPORATED**

6632 Central Avenue Pike ■ Knoxville, Tennessee 37912 ■ (615) 689-2500

See Us at NAB Booth 2021

Circle 54 On Reader Service Card

GE Support Services/RCA Broadcast 7535
 On Display: Support services for RCA broadcast studio transmission equipment and stage and studio lamps. Services include field maintenance service, parts support through a 35,000 line item inventory, technical assistance, manuals, training and 24-hour emergency service.

GLW Enterprises, Inc. 1440
 Intro: ARS 9 audio routing switcher up to 256 x 256; new graphics card for Seriesten B which can drive two monitors—one for automation data, the other for graphic representation of channel settings of the Seriesten B.

GML, Inc. 7354

Garner Industries 3053-3055
 On Display: Garner Industries manufactures a complete line of bulk tape erasers for audio and video. On display will be the model 4000 for metal particle tape, the model 680 for 1/2-inch, 3/4-inch and S-VHS cassettes, the model 1400 for one-inch tape and the model 105 for audio tape.

Gentner Electronics Corporation 2033
 Intro: Lazer—an all-digital processor; Prizm—four-band digital audio processor for total modulation control; Acoustic telephone interface with acoustic echo cancellation for full duplex audio conferencing without echo.
 Also: Telephone interface products, frequency extension, transmitter remote control system, audio routing and distribution products, audio processing products for AM and FM.
 Contact: Cory Guttu
 1825 Research Way
 Salt Lake City, Utah 84119
 801-975-7200

Gorman Redlich Mfg. Co. 1024
 On Display: CM digital antenna monitor for AM directional arrays where remote control is not required; CMR digital antenna monitor for AM directional arrays; CRW NOAA weather radio 162.4, 162.475, 162.55 MHz rack-mounted all-metal enclosure. Models CEB, CE and CD emergency broadcast system encoders and decoders.
 Contact: Jim Gorman
 757 Union St.
 Athens, Ohio 45701
 614-593-3150

Gotham Audio Corp. 1400
 Intro: Digital declick processor, developed between CEDAR Audio and Harmonia Mundi Acustica, as part of the BW 102 system to remove clicks from phonographs and other audio sources in real time; DSP workbench software and hardware system based on an IBM PC with a 8192 point FFT analyzer running in real time.

Graham-Patten Systems, Inc. 6312
 Intro: D/ESAM 800 digital edit suite audio mixer for videotape editing accommodating as many as 56 input tracks of audio, digital or analog, mixes 16 channels to four digital and analog outputs. "Virtual Flexibility" allows instant control of assignment, previewing and other control and routing. D/ESAM 800 operates with ESAM II protocol and numerous eavesdropping and direct control interfaces.



Sierra Automated Systems
The SAS 32000 Series Routing & Mixing System sets new standards in audio routing and automation!
NEW ALPHA CONTROL & MORE! NAB #1362/4



Our full unlimited summing capability permits Mix-Minus, Teleconferencing, Automated On-Air Mixing, Monitoring Systems, and flexibility for any application. We listen to your needs, custom and turnkey systems are our specialty!

Features: Advanced Multi-Processor Architecture, Dual Redundant self-contained Power Supplies, High Density Central Matrix, +28dBu Max. Input/Output Level, PC/Terminal Interface, > 114dB Dynamic range, Easy Field Expandability, and more!

Our Clients Include: ABC Radio Network, Ameritech Corp., NPR, Walt Disney Studios, Westinghouse Broadcasting, WTVN, & others.

Manufactured by **Sierra Automated Systems**
 2112 N. Glenoaks Blvd., Burbank, CA 91504
 TEL: 818-840-6749 FAX: 818-840-6751

Distributed by **RAM Broadcast Systems Inc.**
 P.O. Box 3100, Barrington, IL 60011-3100
 TEL: 708-382-7575 FAX: 708-382-8818

H. L. Dalis Inc. 6044
 On Display: Belden Wire and Cable; Kings connectors; Switchcraft, Neutrik connectors; Panduit wire straps.

Hallikainen & Friends, Inc. 1121
 Intro: DRC 200 transmitter remote control unit using remote intelligence with a video display terminal and modem; SAT201 remote control and steering of multiple satellite dishes and receivers with a scheduler included.

Harris-Allied Broadcast Equipment 1100
 Intro: PT 5FM, 10FM 5 kW and 10 kW FM broadcast transmitter; HT500FM FM transmitter; paragon, FM processing; Wegener series 1800 C/Ku band satellite receiver; Colorado Magnetics Sat Cue 500 switcher; Environmental Technologies ADH-2 automatic dehydrator.
 Also: DX50 transmitter; SX-1A AM transmitter; phasors; HT 20FM transmitters and FM antennas; MacroMedia storage system and Audisk; Air Corp 500 mic processing unit; PFT modular cabinets and AKG DSE 7000 digital audio workstation.
 Contact: Ron Frillman
 3200 Wismann Lane, P.O. Box 4290
 Quincy, Ill. 62305-4290
 317-962-8596

Hi-Tech Furnishings 2127-2131
Hiptronics Inc. 1125

Holiday Industries, Inc. 1449
 Intro: Instruments for measurement of electric and magnetic fields radiating from CRT equipment such as computer monitors and television sets. VLF instrument (HI-3603) covers 10 kHz to 300 kHz, ELF instrument (HI-3604) covers 50 Hz to 100 Hz.
 Also: Complete RF radiation exposure measurement system. Measures both magnetic and electric fields and provides ANSI standard time-averaged values in real time. Data can be stored in data logger memory for later recall or printout.
 Contact: Burton Gran
 14825 Martin Drive
 Eden Prairie, Minn. 55344
 612-934-4920

Hughey & Phillips Inc. 1817
 Intro: Dual lighting systems for tall towers (red and white) controlled by a single control system.

IDB Communications Group, Inc. 7417
 Intro: "The Switch," customer-controlled audio routing service. Advanced switching capabilities for audio signal transmissions routed through the 24-hour technical operating center at 60 Hudson St. in Manhattan. The service will utilize a BTS 3000 routing switcher capable of handling up to 400 inputs by 400 outputs.



CENTRAL TOWER, INC.

- ▲ Complete Manufacturing of Communication Towers
- ▲ Total In-House Engineering Service
- ▲ Turn Key Systems
- ▲ Total Construction Services
- ▲ Antennas & Coaxial Lines
- ▲ Annual Service Agreements

2855 Hwy. 261
 Newburgh, IN 47630-8642
 812/553-0595 • Fax# 812/553-6652

IGM Communications Inc. 1006
 On Display: Program automation systems. PC-based controllers for satellite and live assist operation, multideck cart playback systems: Instacart, Go-Cart 24.

ILC Technology 7015

ISS Engineering 7551-7553

ITS Corporation 6833
 Intro: ITS-1230 1 kW solid state transmitter; ITS-222A 100W UHF translator; ITS-1610E 20 W wireless cable transmitter; ITS-675E 50 W wireless cable amplifier.

Innotech Systems, Inc. 5438
 On Display: Stereo audio consoles, audio distribution amplifiers, stereo source selectors, stereo meters, serial controlled interface.

Inovonics Inc. 1700, 1702, 1704
 Intro: "Sentinel" all-mode station monitor receiver with comprehensive diagnostics for meaningful and easily interpreted evaluation/comparison of broadcast signals. Receives AM/AM stereo, FM/FMX™, and displays 12 separate parameters of the demodulated program including loudness, dynamic range, stereo image and spectral profile. Modular "front end" assures eventual DAB applicability.
 Also: Audio processing equipment for AM, FM, TV and shortwave broadcast, including programmable processors under local or remote RS-232 control. Processing is quasi-digital, using pulse width modulation. Also "budget" and full-featured FM stereo generators with digital synthesis of composite signal. Recording electronics for studio recorders and mag-film applications will be on display as well.
 Contact: Jim Wood
 1305 Fair Ave.
 Santa Cruz, Calif. 95060
 408-458-0552

Intelligent Resources 7452

International Music Company 7031

International Tapetronics Corporation—ITC 1249
 Intro: DigiForm, digital operating platform based on "AT class" computer concepts with proprietary ITC software and on-air and production capabilities.
 Also: ITC will be exhibiting the 99B master recorder/reproducer; Delta series including the Delta I reproducer, Delta III three-deck reproducer and Delta IV record amp; the Series I recorder/reproducer and the ESL V eraser/splice locator.
 Contact: Bruce Helling
 2425 S. Main St., P.O. Box 241
 Bloomington, Ill. 61702
 309-828-1381

Intraplex 7632
 Intro: 3800 VRM variable rate multiplexer audio, voice and data interfaces with RS-449 or V.35 fractional T1 aggregate data output for satellite transmission; 4500 MDAC multichannel digital audio codec; 4800 DDATLINK discrete digital audio transmission link.
 Also: PT/PR-150 stereo/dual 15/7.5 kHz program transmitter/receiver; TDM-153/155 T1 multiplexers with electrical and fiber output and a full line of voice, data and program audio traffic interface modules.
 Contact: J. Peter Eadie
 80 Taylor St.
 Littleton, Mass. 01460
 508-486-3722

Intelco USA 6839

JBL Professional 1434
 Intro: Control micro personal monitor loudspeaker; Control SB micro sub-bass system.

WANT A CART MACHINE WITH PHASE CORRECTION, BUT CAN'T AFFORD A B.E.?

The RS-2000 from Radio Systems has better active phase correction circuitry than the BE Phase-Trak®, yet costs less than their cheaper Duro-Trak® line!

Plus, the RS-2000 has many other premium features like a built-in splice finder, advanced cart hold-down and guidance system, and front panel azimuth adjust.

For value this good you've got to go factory direct.

RADIO SYSTEMS INC.
 Manufacturers of Professional Broadcast Equipment
 110 High Hill Road • P.O. Box 458
 Bridgeport, NJ 08014-0458
 609/467-8000 • 800/523-2133
 FAX 609/467-3044

Communications technology experts in the field

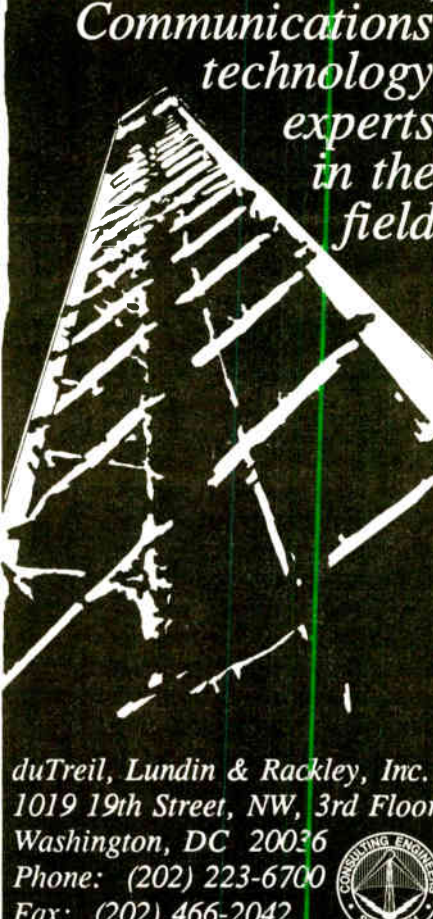

duTreil, Lundin & Rackley, Inc.
 1019 19th Street, NW, 3rd Floor
 Washington, DC 20036
 Phone: (202) 223-6700
 Fax: (202) 466-2042



JNS Electronics 1700-1704
Intro: D-MUX digital audio multiplexing for T1 or ISDN applications. Modular and expandable with selectable audio responses from 3 kHz to 20 kHz. 8310B audio routing switcher for CD quality with up to 50 stereo inputs, remote control or PC control.
Also: CD quality audio routing switchers: 8300 series; 9000 series for mono/stereo, custom and PC control; Modular rackframe systems 8000 series modules for audio and video distribution, audio monitoring, audio and video switching, audio test, RF demodulation and program changeover functions.
Contact: John E. Leonard, Jr.
P.O. Box 32550
San Jose, Calif. 95152
408-729-3838

James Grunder and Assoc., Inc. 3024

Jampro Antennas Inc. 1200
Intro: JBBP—broadband balanced side-mount FM antenna system allowing combining of frequencies with separation as great as 10 MHz. JBPF-bandpass filters.
Also: Complete line of FM antennas and related pattern services including JAHD arrowhead dipole panel antenna; JSDP broadband cavity antenna; JTC top-mounted spiral FM antenna producing azimuth circularity of ± 25 dB, state of the art directional systems and certification meeting FCC requirements.
Contact: Alex M. Perchevitch
6939 Power Inn Road
Sacramento, Calif. 95828
916-383-1177

Jefferson-Pilot Data Services, Inc. 3058
Intro: SalesLine, an integrated sales management system linking sales department PCs to other areas. CableXchange sales/research system for cable networks. BIAS, an on-line integrated traffic, sales, management and general accounting system now available on Digital Equipment Corp.'s VAX computers.

K

Kahn Communications 1005
On Display: ISB independent sideband AM stereo system.

Kalamazoo Technical Furn. 2111

Karl Heitz, Inc. 3019, 3021
On Display: Gitzo microphone fishpoles including 555 Loisir fisher; 556 weekend fisher; 557 sport fisher; 563M reporter fisher; 564LM studex compact fisher; 566M mini studex fisher; 7680 studex fisher. All have two soft grips and two holes for microphone cord, clamp adapter to attach microphone fishpoles to tripods, heads, stands, etc.

Kavouras Inc. 6815

Keystone Communications 2163

Killer Music 1528
Intro: New syndicated radio jingle packages from WPLJ-FM in New York and WVBF in Boston.

Killer Tracks 1526
Intro: Two CD sweepers and stingers production elements with 180 different effects; one CD of keyed and non-keyed effects and another CD with a variety of music beds.



Modulation Sciences' FM ModMinder digital modulation display with remote interface.

Kay Industries, Inc. 1310
Intro: Phase converter specifically for mobile use, containing starting controls, switches and connectors for the single-phase incoming line, all wired and ready to produce three-phase on site for any type of mobile equipment including satellite uplink stations and portable production facilities.
Also: Phasemaster single to three-phase converters. Used to change single phase utility line to three-phase, to operate broadcast transmitters in remote locations or any site not served by utility three phase.
Contact: Kathy Deming
604 N. Hill Street
South Bend, Ind. 46617
219-234-0171

Kings Electronics Co., Inc. 5338, 5340
Intro: Serial digital jackfields-miniature and standard size; 75 Ohm BNC connectors; cable management.

Kintronic Laboratories, Inc. 2229
Intro: HF log periodic antenna.
Also: AM directional antenna phasing and matching equipment; rigid transmission line; AM dummy loads and standard weatherproof equipment racks; isocouplers; AM diplexing equipment; RF power attenuators; vacuum and standard RF contactors; RF power attenuators; AM diplexing equipment; fixed and variable inductors; lighting chokes; patch panels.
Contact: Gwen King
144 Pleasant Grove Road
Bluff City, Tenn. 37618
615-878-3141

Kintronic Labs Inc. 2229

Klark-Teknik Electronics 1919
On Display: DN360 dual 1/3 octave graphic equalizer; DN410 10-band parametric equalizer; DN500 dual channel compressor/limiter/expander; DN504 quad compressor/limiter; DN510 dual noise gate; DN514 quad auto gate.

Kline Towers 7621

L

LDL Communications, Inc. 4647
On Display: FM panel antenna with Spearhead dipoles for an omni or directional pattern and a FM combiner, both manufactured by Alan Dick and Co.—enable several full power FM stations to combine their RF outputs into a single master antenna.

LPB, Inc. 1049
On Display: LPB audio consoles and AM transmitters will be showcased in a working low power radio station featuring the Signature series audio console and the Denon DN-950 FA CD cart player. LPB AM transmitters are available in 5, 30 60, and 100 watt models for use in commercial broadcast low power authorizations, travelers' information service (TIS) systems, carrier current and many other applications. LPB transmitters are FCC type accepted for Part 73 commercial broadcast and Part 90 TIS use.
Contact: John Tiedeck
28 Bacton Hill Road
Frazer, Pa. 19355
215-644-1123

Laserdub, Inc. 7343

Lexicon Inc. 3038
Intro: LFI-10 digital format interface, Lexicon 300-digital effects system, LXP-15 digital effects processor; OPUS version 3.0 software featuring AutoMix, CPEX-tune, compression/expansion and machine control.

Logitek Electronics Systems, Inc. 1540
Intro: Mariner modular water on-air resistant console; five-, eight-, 12-, 18-mixer mainframes. Includes two stereo mixer busses, two mono mix-minus busses, headphone and speaker outputs, cue amplifier, machine control.
Also: Bright-VU LED audio meters; TR2 12 mixer, modular compact console; Stereorack six-mixer portable console; MAS system modular distribution and monitor amplifiers; Mon-10 10-input monitor and metering unit; Pre-10 10x2 switcher in mono and stereo.
Contact: Tag Borland
3320 Bering Drive
Houston, Texas 77057
800-231-5870

Lightning Eliminators & Cons. 4262
On Display: Dissipation array systems for prevention of lightning strikes to towers, power lines and buildings; high performance surge and transient preventors to protect against power surges, transients and RF bursts; rechargeable Chem-Rod grounding electrodes to minimize ground resistance through continuous soil conditioning.

Lindos Electronics TBA

Intro: LA100 software providing many new features including a mode which allows the LA102 to be used with existing test tapes and CDs. The frequency response graph can be displayed on the LCD, printed or tested against a tolerance specification for pass/fail testing.

Lindsay Specialty Products 7149

M

MacroMedia 7618, 7620, 1100
See DHK Group

Magnum Towers Inc. 1348-1350

Manhattan Production Music 2113

Marconi Communications Inc. 4556

Mark IV Audio Broadcast Group 1011
Intro: Electro-Voice broadcast and production microphones—RE-38N/D, which offers 16 position equalization switch for multipurpose studio and sound recording applications, and the RE-27N/D with transient response and low distortion for output at high sound levels.

Marti Electronics, Inc. 1034
On Display: STL-10 system for audio and data transmission on the 150 MHz to 960 MHz band. A complete line of RPU equipment including the RPT-30, RPT-15 and RPT-2 transmitters, the CR-10 base receiver and the AR-10 mobile receiver. The Marti PA series of parabolic antennas including the PA-48, four-foot antenna; the PA-60, five-foot antenna and the PA-72, six-foot antenna.

Maze Broadcast, Inc. 6927

Media Computing Inc. 5946-5950

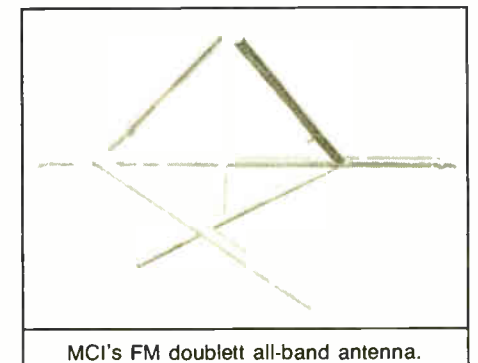

MCI's FM doublet all-band antenna.

Media Touch Systems 1458
Intro: The MTS Midas Touch is a multi-user integrated digital audio system with mass storage using 386/486 PC technology as a stand-alone or networked to provide record, edit, storage and playback of all audio material in stereo or mono including satellite delivery. Also, CAT (control assist tablet) mini-control console for MTS products.

Metro Lab Center 6224-6226

Micron Audio Products Ltd. 6337-6341

Micron Tool—Canmate 7335-7337

WIRELESS CABLE DATABASE
(ITFS - MDS - MMDS - OFS
A1 Thru H3 Plus 1, 2 & 2A)

CURRENT
ALL 50 STATES
ON-LINE
24-HOUR ACCESS
CALL NOW!

dataworld
A Service of DW, Inc.

P.O. Box 30730, Bethesda, Maryland 20814
FAX (301) 656-5341
(301) 652-8822 (800) 368-5754

B Burlington
Audio / Video Tapes, Inc.
106 Mott St. Oceanside, N.Y. 11572
PHONE: 516-678-4414
FAX: 516-678-8959
IN US & CANADA TOLL FREE:
1-800-331-3191

3M Video & Audio Tape

Call for Free Catalog
Shipped from Stock - Priced Right
Immediate Delivery
Reels • Boxes • Custom Cassettes
Leaders • Splicing Tapes

HARD TO GET ACCESSORY ITEMS

Live! . . . in concert!
ALL the Time

CP 2013
THE COMPOSITE PROCESSOR OF THE FUTURE HERE TODAY

- ★ Low second harmonic clipper — flat to 420KHz!
- ★ Separation exceeding 60 dB
- ★ Ultra smooth, fast acting AGC, builds stereo image without the grunge!
- ★ 1½ dB louder than any other composite clipper
- ★ Multiple outputs plus remote control

AVOID THE RUSH — CALL NOW
hnat hinders inc
42 Elaine Street • R.R. 1 • Thompson, Connecticut 06277 • (203) 935-9066 • (203) 935-9242

Circle 154 On Reader Service Card See Us at Booth 1609

Circle 98 On Reader Service Card

Circle 70 On Reader Service Card

Micro Communications, Inc. 5432
Intro: FM side mount antenna, FM band, doublet design, no downward radiation, high power isolators.
Contact: Jennie E. Allen
P.O. Box 4365
Manchester, N.H. 03108-4365
603-624-4351

Microsonics Inc. 6704

Microwave Radio Corporation 3000

Midas 1919
Intro: Midas XL3-40 live performance console; Midas XL88 line level matrix mixer.

Milab 1919
Intro: VIP-50 large diaphragm condenser microphone; DC-96B; VM-44 small diaphragm condenser microphone.

Mitsubishi Electronic Sales America 6723

Modulation Sciences Inc. 2400, 2402
Intro: ModMinder DeMod card either installed at the factory or retrofitted to any existing ModMinder; card has modulation calibration, is control sealed and certified accurate by MSI for 13 months. Readings can be transmitted to the studio using ModMinder's remote control interface or with a 1200 bits/second modem and a PC. ModMinder Remote software allows full user control from any PC.
Contact: Eric Small
12A World's Fair Dr.
Somerset, NJ 08873
908-302-3090

Mohawk Wire and Cable 7523

Moseley Associates 1210
Intro: All new digital CD-quality studio to transmitter link; new family of program multiplex and SCA products.
Contact: Terry Mehr
111 Castilian Drive
Santa Barbara, Calif. 93117
805-968-9621

Motorola C&E/AM Stereo 1048
On Display: Two-way radio communication equipment ranging from display paging receivers to portable hand-held two-way radios to mobile units for vehicles.
Contact: Ken Kohlman
1216 Remington Road
Schaumburg, Ill. 60173
708-576-6626

Murphy Studio Furniture 1041
Intro: Futura series studio furniture—new top of the line studio furniture; blend of glass and wood materials.
Also: Elite series modular studio furniture.
Contact: Dennis Murphy, President
4153 N. Bonita St.
Spring Valley, Calif. 91977
619-698-4658

Myat, Inc. 7115
Intro: Myat will be displaying its new 8 3/16-inch 75 ohm transmission line.
Also: Rigid coaxial transmission line, components and accessories; 7/8-inch; 1 5/8-inch; 3 1/8-inch; 4 1/16-inch; 6 1/8-inch; 50 and 75 ohm, 8 3/16-inch 75 ohm and 9 3/16-inch 50 ohm.
Contact: Phillip Cindrich, Pres.
380 Chestnut St., P.O. Box 425
Norwood, N.J. 07648
201-767-5380

NEC America Inc. 4449

NPR Satellite Services, Inc. 7135
On Display: NPR Satellite Services offers domestic interconnection and satellite services to radio broadcasters including fixed and transportable uplinking, SCPC audio transmission, downlinking, digital fiber optic audio channels and service to Westar, Galaxy and Satcom.

Nady Systems Inc. 6412-6414

Nagra Magnetic Recorders 5719

Narda Microwave Corp 1815

National Supervisory Network 7010,7012
Intro: "Be your own bell" service for station groups to tie their existing telephone lines to the satellite system for toll-free voice links between stations across the country.

Nationwide Tower 7638

Neotek Corporation 7531, 7533
On Display: Elite series consoles for broadcast use in the U.S. and Europe.

Network Music Inc. 1410
On Display: Network's Production Music Library—95 CDs updates monthly; Network's Sound Effects Library—50 cds.

Nautel 2207
Intro: Nautel solid state modular FM broadcast transmitters available initially for 3-7 kW operation.
Also: Nautel solid state modular AMPFET ND series AM broadcast transmitters available in all powers to 100 kW and more.
Contact: Jorgen B. Jensen, Mgr Best Svcs
201 Target Industrial Circle
Bangor, Maine 04401
207-947-8200

Neutrik USA, Inc. 2107,2109
Intro: R-Series one piece all plastic XLR receptacle; horizontally PC mounted; CCITT 0.33 test sequences for the TT402A.

Neve 1248
Intro: Neve Orion series of consoles; Mitsubishi X-86E two-channel digital audio tape recorder for stereo master recording.

New England Digital 4601
Intro: NED's version of LucasArts SoundLroid software allowing spotting of effects, dialogue and Foley from any Apple Macintosh II series computer. Cuesheets, ADR scripts and "to be recorded" lists can be created and printed.

Numark Electronics 1123
Intro: DM 1475 eight-second digital sampling rack-mount four-channel mixer; three-channel mixer with assignable crossfader and separate DJ mic channel rackmountable; DJ mixer DM1175 with four channels; DJ mic control; six-band graphic equalizer

Opamp Labs, Inc. TBA
On Display: Audio press feed model A-24/2ML and A-24/2ML/B internal rechargeable battery version.

Optima Enclosures 7547-7549

Orban Associates 1226
—A Division of AKG Acoustics
See AKG/Orban/dbx

Otari Corporation 1801
Intro: MX-5050 series including BIII, MK-IV-2, MK-IV-4, MK-IV-6, BQIII recorders, DTR-900II digital 32- and 64-track recorders; MTR-90III 24-track recorder; DDR-10 disk-based two-track recorder/editor; R-DAT recorder; DISKMIX-3/film moving fader automation.
Also: Otari will show open reel audio recorders, from 1/4-inch mono to 32-channel analog, and 32- and 64-channel digital recorders; automatic and semi-automatic audio loading equipment; audio record/mix consoles and DISKMIX 3 moving fader automation system.
Contact: Sally Olson Saubolle
378 Vintage Park Drive
Foster City, Calif. 94404
415-341-5900

PAS-Professional Audio Supply 1603
On Display: Full line of audio equipment.



The World Prefers Nautel Transmitters

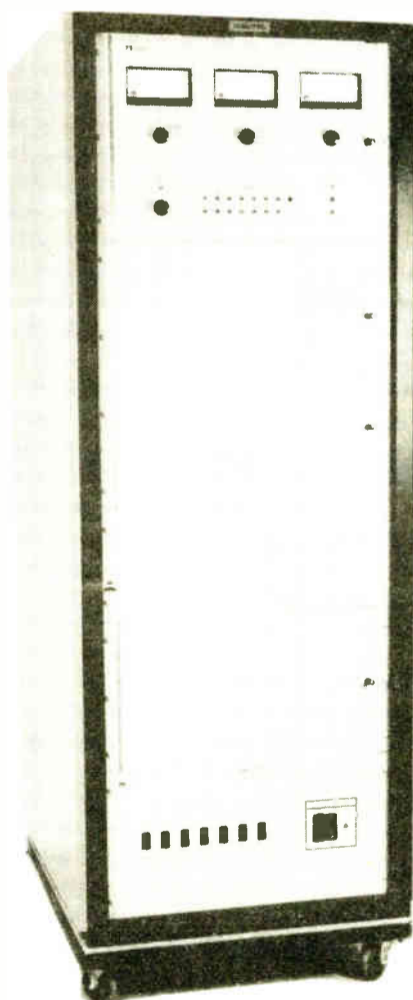

AM and now also FM Solid State Transmitters.

FM Broadcasters are invited to view the introduction of the Nautel solid state modular 7kW FM transmitter at NAB '91.

This new product brings to FM the benefits of performance serviceability and economy enjoyed by our many friends now broadcasting with Nautel solid state AM transmitters.

AMPFET ND series second generation solid state AM transmitters from 400W to 100kW and more.

PLEASE VISIT US AT NAB '91
BOOTH 2207

AMPFET FM7

Phone: (902) 823-2233 Canada • Fax: (902) 823-3183 • Telex: 019-22552

Nautel
(Nautel Electronic Laboratories Limited)
R.R. #1, Tantallon, Halifax County,
Nova Scotia, Canada B0J 3J0

Nautel Maine Inc.
201 Target Industrial Circle
Bangor, Maine 04401 U.S.A.



PRODUCT SHOWCASE

For more information on the products shown below, circle the appropriate Reader Service No.(s) on the enclosed Subscription/Reader Service card or contact the advertiser directly.



The South's
Premier Broadcast
Systems Supplier

AUDIO PRODUCTS

- Aphex • ATI • Audicord
- Audiopak • Autogram • Beyer Dynamic
- Broadcast Electronics • Bryston • Eventide • Fidelipac
- Gentner Electronics • JBL • Logitek • LPB • Orban
- Otari • Panasonic Industrial • QSC Audio Products
- Ramsa • Shure • Soundcraft • Symetrix

RF PRODUCTS

- Altronic Research • Andrew
- Belar • Best Power Technology • Bird
- Broadcast Electronics • Burk Technology
- Cablewave • Coaxial Dynamics • Electronics Research
- Gentner Electronics • Kintronic Laboratories
- Mark Antenna Products • Marti
- Moseley Associates • Nautel Maine
- Scala • Shively Laboratories • TFT

P.O. Box 2630 Covington, LA 70434
(800) 544-AMFM(2636) Fax: (504) 893-4025

READER SERVICE NO. 65

Davilyn
CORP.

4CX250B/7203 EIMAC
\$175.00/PAIR

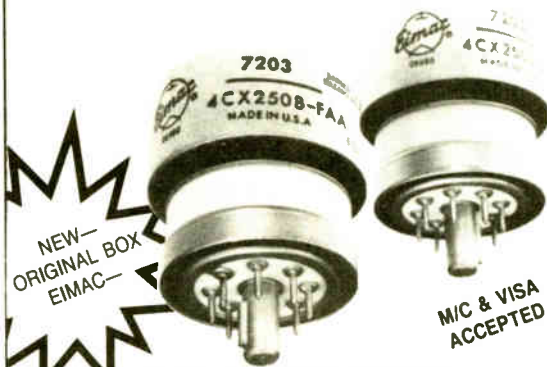

13406 SATICOY STREET
N. HOLLYWOOD, CA 91605-3475
TEL: (818) 787-3334 FAX (818) 787-4732
(Inside U.S.A.) 800-235-6222

READER SERVICE NO. 135



KEEP IT
ON THE AIR

AUTOMATICALLY

- Switches to backup or tertiary stereo audio source when main audio source loses a channel or is missing
- Switches both outputs to the channel with audio when one channel is missing from a stereo source
- Corrects audio polarity if it is reversed
- User programmed time delays and sequencing
- FULL alarm outputs and total remote control
- ON-LINE audio monitoring and stereo audio switching
- Locate at Transmitter site for full REDUNDANCY
- Locate at Studio site to monitor studio audio and make instant corrections for console, cart/tape, or satellite programming errors.

AND MUCH MORE... CALL FOR DETAILS
Model **MLW-1**

TITUS
TECHNOLOGICAL
LABORATORIES

77 Kreiger Lane Glastonbury, CT 06033
(203) 633-5472

READER SERVICE NO. 123

CONSOLE UPGRADE WITHOUT THE BIG EXPENSE

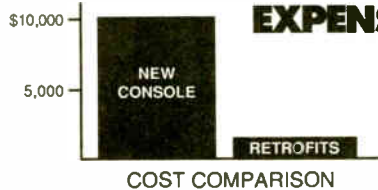

If you own one of these consoles and can't afford a new console with similar capabilities, BDI has the answer. Our updated electronics retrofits can make that old workhorse sound like today's best!

Harris Executive
Harris Diplomat
Harris Ambassador
Harris President
Harris Stereo Statesman
Harris Gatesway II
Harris Dualux II
RCA BC-7

If your console isn't listed - call us, we may be able to help. Most retrofits are plug-in and ready to go with no hassle. A typical console can be upgraded for as little as \$1,000! Call today for details!



Broadcast Devices, Inc.

5 Crestview Avenue
Peekskill, NY 10566
(914) 737-5032

READER SERVICE NO. 139

DIGITAL PERFORMANCE

TELOS ONE TELEPHONE HYBRID ANALOG PRICE



1991 NAB BOOTH 2007



216-241-7225 FAX: 216-241-4103

READER SERVICE NO. 93

Digital DJ™

The *first* programmable low-cost Digital Audio hard disk system for broadcasters

- Scrap Your Cart Machines
- Retire Your Carousels™
- Bury Your SuperSwitch™ & Spot Reels

Digital DJ replaces all your old audio Cart sources with high quality *digital* audio from a computer hard disk.

Complete Satellite Systems From \$260.00 / Mo
Multi-day Satellite programming is a snap. Full ID, liner rotation and live assist options. Easy operation. Eliminate your paper Log. It's all on the screen including live rotating tags & copy, news and lists.

Traffic & Billing Systems

New Low Prices:	New	Original
EZ Log:	\$ 695.00	\$ 995.00
Simple Log:	1,495.00	1,995.00
Super Log:	2,495.00	2,995.00

All Traffic systems *interfice* to Digital DJ
Call for 60 page brochure - Our 11th Year
900+ Stations

The Management

1-800-334-7823 - 1-817-625-9761
P.O. Box 1-36457 Ft. Worth, Tx. 76136

READER SERVICE NO. 115

WireReady Newsroom Software

Cut your AP and UPI paper bills by \$1000/yr



WireReady captures AP, UPI, and other newswires and gives your newsroom all the features it needs for a one-time fee of \$549. Automatically print just what you need as is, or edit the news before you print it. **NO WEEKLY FEES.** 24 hour toll-free phone support and upgrades available for only \$99 per year. Even if you don't have a computer, we'll include a brand name computer system with on-site service and let you pay as little as \$70 a month for the ENTIRE package. This is half your current monthly paper and ribbon cost!

We can also capture NOAA weather wire, Learfield, ABC, NBC and CBS data.

Installations all over the U.S.A., from the Virgin Islands to Alaska

(800) 833-4459

Gerstmann Software Technologies

P.O. Box 2356 Framingham MA 01701 (508) 820-7284

READER SERVICE NO. 153

ANDREW HELIAX® Cable & connectors

Cable up to 2-1/4", connectors up to 6".
Cable cut to length, pressurized, connectors attached. Cable hardware too!

In Stock....Ships Next Day!

Call for our FREE 92 page pricebook



CARTWRIGHT
COMMUNICATIONS COMPANY

7812 Red Sky Drive
Cincinnati, Ohio 45249

800-543-8614

READER SERVICE NO. 97

Pacific Radio Electronics 7355-7357

Pacific Recorders & Engineering 1134
Intro: Productionmixer—a production version of the Radiomixer, with multitrack, communication, equalization, and telephone capabilities. Line switchers, rackmount line switchers with various input and output configurations.
Also: X-class consoles (ABX, AMX, BMXIII); Radiomixer air console; Stereomixer and news-mixer rack mountable special application mixers; Tomcat and Micromax cart machines; Dolby SR for carts; Primeline systems cabinetry; peripheral equipment including DAs, switchers, patch bay systems and logic control systems.
Contact: Michael Dosch
2070 Las Palmas Drive
Carlsbad, Calif. 92009
619-438-3911

Paco Electronics U.S.A. Inc. 6025

Panasonic Professional Audio Systems 4513
Intro: SV-3900 software developers "tool kit."
Contact: Steve Woolley, Sales & Mktg. Mgr.
6550 Katella
Cypress, Calif. 90630
714-373-7177

Patch Bay Designation Company 6609

Peerless Sales Co. 6007-6009

Penny & Giles Inc. 1453-1455

Potomac Instruments, Inc. 1015

Intro: Type 1900 AM directional antenna monitoring system, made up of the Type 1901 antenna monitor, with front panel display, local operating controls and interface capability; Type 1902 monitor display for extension manual control and reading of monitors; and the Type 1903 monitor without its own display and controls, for control from a 1902 only.

Premier Metal Products 7634-7636

Pro Co Sound 7254

Radio Design Labs 7813
Intro: ACM-2 amplitude component monitor for FM; STA-1M line amp; ST-MX3 line level mixer; ST-MMX3 mic to line level mixer; ST-MPA2 microphone phantom adapter; ST-PH1 stereo phono preamp; ST-GCA2 fast gain control amplifier; ST-ACR2 extended audio control relay, additional accessories.
Contact: Jerry Clements
P.O. Box 1286
Carpinteria Beach, Calif. 93013
805-684-5415

Radio Systems Inc. 1028
Intro: RS-2000 audio cart machine with built-in phase and flutter correction, front panel azimuth control, timer, fast forward, three cue tones, splice detector.
Also: RS series broadcast consoles; RS-1000 digital audio tape machines; and Radio Systems distribution amplifiers; phono preamps; timers and the new RS-2000 cart machine.
Contact: Paul J. McLane
P.O. Box 458
Bridgeport, N.J. 08014
609-467-8000, ext. 110

Rohde & Schwarz, Inc. 4101
Intro: DMC radio data system (RDS) encoder; DMDC RDS decoder; UAF video analyzer; TIF video timing analyzer.
Also: EMFT TV test demodulator; SGMF TV test generator.
Contact: R. Matthew Straeb
4425 Nicole Drive
Lanham, Md. 20706
301-459-8800

Register Data Systems 1300

Intro: RDS system six and system seven are new, multi-user systems.

Sennheiser Electronics Corp. 2100

Intro: MD-422 cardioid microphone with spring suspended element and ability to handle high SPLs; BF530 microphone with adjustable sound inlet basket; MKE300 supercardioid microphone with shoe assembly for mounting; MZS100 shock mount for filtering out specific noises.

Sentry Systems 1100
Intro: Disk Sentry I (DS-1); Hard disk audio recorder.
Also: Format Sentry FS12C complete operating system with CDs, reel-to-reel, go-cart, hard disk, digital audio subsystem, (Sentry systems DS-1).
Contact: Mike Bettelli
2211 Fifth Ave.
Seattle, Wash. 98121
206-728-8651

Sescom Inc. 4308-4312
Intro: Hand-held audio test equipment, audio generator, two-inch oscilloscope, distortion analyzer, frequency meter, audio tester sweep function, generator and loudspeaker impedance meter. The Field Pro series, designed for field use of audio devices; isolator series of transformers to eliminate ground loops, hum and buzz.
Contact: Franklin J. Miller
2100 Ward Dr.
Henderson, Nev. 89015
702-565-3400

Shively Labs 1234

Intro: Bandpass filters for FM. The 2500 series offers both forced convection and ambient cooled models, in 13-inch to 24-inch cavity sizes. Bandpass filters allow a one-time purchase to protect the station from all future interferences. New 9 3/16-inch motorized coaxial switch.

Shook Electronics USA, Inc. A-220

Intro: Model 20-27B Ku-band up-link with production area. Self-contained with a 40 kW diesel generator and Andrew 2.4 meter offset feed antenna, MCL antenna mounted TWT and LNR exciters. Model 12-19 live eye microwave van built on a E-350 Ford supervan with microwave RF equipment, TMD 42 feet pneumatic mast.

Shure Brothers, Inc. 1414
Intro: Model VP64—professional omnidirectional, ENG audio/video production microphone; Model FP410: four channel, portable, automatic mixer for field or studio production use.
Also: VP88 MS stereo microphone, L series wireless microphone systems, the SM microphone series, and the FP (field production) circuitry line.
Contact: Davida Rochman
222 Hartrey Avenue
Evanston, Ill. 60202
708-866-2200

Signature Music Library 7030

Intro: Volumes 8-9—50 full-length three- to five-minute music beds for AV; Volume 1—inspirational music series for religious media productions; Volume E—50 spot-length songs, 100 :30 and :60 cuts.

Singer Products Inc. 1603

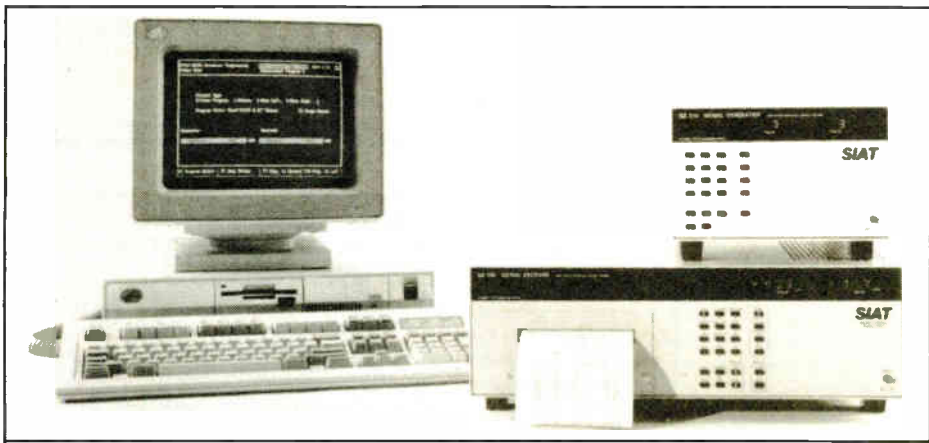

Schmid's short interval audio testing (SIAT) system.

Production Garden Library 1115

On Display: Production Music Library on compact disc. Broadcast and "A/V" Series. Sound effects also available. CDs and Library demo available for listening at Production Garden booth. "Air Assault" stagers, stingers, sweepers, lazars, etc. with market exclusive licensing; three new broadcast "100" series CDs; four new A/V "200" series CDs.

Professional Design Products 7055

Profit Plus 7555-7557

Promusic Inc. 2220

Intro: New releases in the library and new record labels. Computer software for easy organizing of the library.

Q

QEI Corporation 1035
Intro: 710 digital stereo generator with isolated input and output level adjustment, stereo/mono mode selection, pilot on/off, pre-emphasis on/off, composite metering, test configurations including main into sub.
Also: Solid state single output tube FM transmitters to 30 kW features 15,000 hour tube warranty, on-site check-out, spare parts kit, grounded grid triode performance, CAT-Link digital STL/TSL digital delivery of your high quality composite stereo to transmitter along with other channels.
Contact: William Hoelzel, III
P.O. Box 805
Williamstown, NJ 08094
609-728-2020

QSI Systems Inc. 5845-5944

R

RAM Broadcast Systems 1362-1364

RF Technology Inc. 5833

Radio Computing Services 7511-7515

Intro: Tracker digital logging system capable of storing a week's worth of station audio on a single DAT tape. Single channel record/playback and three-channel record/one-channel playback models are available.

S

SG Communications West, Inc. TBA

On Display: Complete broadcast tower, antenna, and transmission line turnkey packages. Broadcast tower and antenna installation maintenance and service. Emergency "burnout" repair with standby antennas available. Services including physical and electrical antenna system inspection services; antenna system reharnessing /refurbishing; microwave system tower and antenna installation, maintenance and service.

SWR Inc. 5147

Intro: SWR FM/TV antennas.

Saki Magnetics Inc. 1461

Samson Technologies Corp. 2001

Scala Electronic Corp. 4161, 4163
On Display: Full line of antennas and accessories for broadcast auxiliary systems, such as STL, RPU, translator, booster and off-air monitoring.
Contact: Ellis Feinstein
P.O. Box 4580
Medford, Ore. 97501
503-779-6500

Schafer World Communications 1028

Intro: Gotham CD production system; Spot 90 CD-R; Digital Audio spot system.

Schmid Telecommunication 2004-2008

Intro: SIAT short interval audio test—an automated system which can conduct audio tests in service, during program breaks or station IDs. Measures up to 10 audio parameters in under five seconds. Test can be done automatically or manually.

Scientific Atlanta Group 3010

Intro: Spectrum Efficient Digital Audio technology (SEDAT) providing CD quality audio transmitted via bit streams as low as 129 kbps, it uses an audio compression technique, including encoding algorithms and special coding for satellite transmission.

INTRODUCING
THE HALL
Electronics
ITC Replacement
Audio & Cue Cards

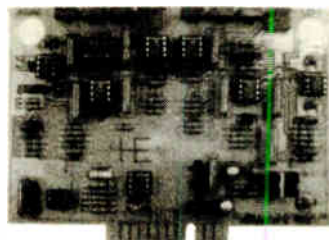

Update your ITC Premium Series Cart Machines to State-of-the-Art Performance Levels & Greatly Improve Reliability Too!

Call for Specs, Pricing & ITC Rebuilding Services
(804) 974-6466

1305-F Seminole Trail, Charlottesville, VA 22901

Circle 128 On Reader Service Card

INTERNATIONAL TAPETRONICS CORPORATION
2425 S. Main, P.O. Box 241, Bloomington, IL 61702-0241 USA
TEL: (800)447-0414, (309)828-1386 FAX: (309)828-1386



If you do nothing else at NAB 1991, see DIGIFORM at Booth #1249

DIGITAL AUDIO CARTRIDGE MACHINE
SATELLITE AUTOMATION and PROGRAM CONTROL
and much, much more...
An integrated, modular and expandable
DIGITAL AUDIO PLATFORM



Circle 51 On Reader Service Card

Sierra Automated Systems 1362-1364

Intro: ANC-8 alphanumeric control panel, output control panel for the SAS-32000 series switcher with eight-character alpha display. GPI-1600SI sequencer interface for the SAS 32000 switcher allows programmable salvo sequences; seven-day, 24-hour program schedule, 16 self-contained form C relays.

Also: SAS-32000 stereo audio routing switcher and mixer XCP-3 XY controller, GPI 1600 relay interface. The SAS-32000 series is a stereo 32x16 routing switcher and miking system, multi-microprocessor with full summing capabilities, dual redundant power supplies, with many applications including mix-minus/IFB and teleconferencing.

Contact: Al Salci, VP
2112 N. Glenoaks Blvd.
Burbank, Calif. 91504
818-840-6749

Skotel Corp.	6348
Solid State Logic	1426
Solutec Ltd.	5959-5961
Sonic Solutions	7717

Sony Business and Professional Group 4401

Intro: PCM-2700 DAT recorder, portable professional DAT technology. CD player for broadcast market; DPS-D7 digital hyper delay; DPS-R7 digital reverb; MDR-range professional headphones; ECM-S10, ECM-530 professional microphones.

Sound Ideas 4427
Intro: Series 5000 "Wheels" sound effects library.

Soundmaster International Inc. 7430-7434

Spectra Image, Inc. 7249

Sprague Magnetics Inc. 1407

Intro: Long-wearing heads for ATR100 series Otari MX series and MTR 10, 12, 20 and ARS series; MCI/Sony JH110 series and also long-wearing film heads.

Sound Technology, Inc. 1001

On Display: 3000 series transmission/audio test system; 1510A tape recorder/audio test system; RTA-4000 real-time program audio/analyzer; 1530A MTS/ stereo analyzer.

Contact: Kent McGuire
1400 Dell Avenue
Campbell, Calif. 95008
408-378-6540

Stainless Inc./S.G. Comm. 1548, 1550, 1552, 1554

Intro: New tower designs for cellular and microwave applications.

Stanton Magnetics Inc. 1016

On Display: Turntable cartridges; replacement styli; turntable mats; preamplifier/equalizer; professional headphones; DJ starter kit; announcer/newscaster earphones; record care products; DJ equipment cases; SRS-275 headphone.

Stantron 6601-6607

Steenbeck Inc. 6418-6420

Stellavox Digital Audio Tech. 7814

Storcel Corporation 5433

Intro: RS2/10-tape storage; DS4/6-double drive mobile tape storage system.

Studio Technologies, Inc. 3051

Switchcraft Inc. 2226-2228

On Display: Audio jacks, plugs, connectors, cable assemblies, switches and audio patch panels.

Systemation Corporation TBA

Contact: Maureen Bellinger
337 N. Walter Street
Decatur, Ill. 62523
217-428-7101; 214-458-8807

Studer ReVox America, Inc. 1158

Intro: Tele-Hybrid, MacMix 3.1 software upgrade for Dyaxis.

Also: A727/A730 CD players; A729 CD controller; A807 two- and four-track recorders with center-track timecode; Dyaxis hard disk digital recording and editing system; D820-48 digital recorder; A779 mixing console; A721 cassette deck; A764 professional monitor tuner; 2706 monitor speaker; A68 professional power amplifier; C270 series recorders; PR99 recorder; A827 and A820 24-track recorders; A812 2/2 VU recorder.

Contact: Sandra Hale
1425 Elm Hill Pike
Nashville, Tenn. 37210
615-254-5651

Symetrix Inc. 2708, 2710

Intro: DPR-44 four-track, four-layer digital audio editing station for recording, editing and assembling multi-channel mixes from dialog, music, effects and other elements. Four simultaneous tracks of 18/24 bit record playback at all industry sampling rates. The SX208 stereo compressor/limiter for news feeds, production voice-overs and music beds, and as a satellite line limiter. Main adjustments include level, ratio, fast/slow response and output gain.

Also: 528 voice processor; 501 compressor; 511A single ended noise reduction; 525 gated compressor/limiter; A220 stereo monitoring amp; 202 mic pre-amp; 203 telephone interface; 204 headphone amplifier; 205 precision digital meter; 206 multidynamics processor.

Contact: Dane Butcher, Pres.
4211 24th Ave. West
Seattle, Wash. 98199
800-288-8855

Systems Wireless Ltd. 7054

Intro: New UHF wireless microphone systems on display by Vega and Lectrosionics. Clear-Com's new MS-812 programmable master station and matrix intercom system.

T**TFT, Inc. 1420**

Intro: Fully synthesized composite STL, Model 9100 transmitter and model 9107 receiver.

Also: FM Reciter/booster in a "live" listening/measurement demonstration of FM IF repeater and booster applications; Model 886/887 EBS systems with shortened tone capability. 884 and 844A FM modulation monitors featuring peak modulation duration differentiation. Frequency-agile remote pickup transmitters and receivers with DTMF encoding/decoding for frequency change, bandwidth change, repeater operation.

Contact: Henry C. Wu
3090 Oakmed Village Drive
Santa Clara, Calif. 95052-8088
408-727-7272

TM Century, Inc. 1053

Intro: Digital commercial system, hard disk stereo record-playback system, with a minimum of two hours of stereo playback, or expanded to more upon request. Will store 240 30-second spots or 120 60-second spots.

Contact: Dave Scott
14444 Beltwood Parkway
Dallas, Texas 75244
214-934-2121

Tannoy-TGI North America Inc. 1459

On Display: Tannoy studio reference monitors.

Tapscan Inc. 2200-2202**Tascam 4239**

On Display: BR-20 and BR-20T mastering machines; BR-20T has coincident center track time code. CD-701 CD player system.

Contact: Bill Stevens
7733 Telegraph Road
Montebello, Calif. 90640
213-726-0303

Techni-Tool, Inc. 7238-7240**TTC—Television Technology Corporation 3066**

On Display: FMS-4000 4 kW FM solid state transmitter. This series of transmitters will come in power levels of 1 kW, 2 kW, 4 kW and 8 kW. We will also display an FM 25kW transmitter.

Contact: Alexander De Lay
P.O. Box 1385
Broomfield, Colo. 80020
303-665-8000

Telex Communications, Inc. 4359

Intro: SAP612 RTS source assign panel, six inputs and 12 outputs; SSA324 intercom interface; P515 intercom power supply; FMR-100 advanced technology diversity wireless mic system; FMR-30 professional wireless system; R-10 ProStar series wireless products.

Some of our best ideas are up in the air.

From antennas to shelters, Cablewave Systems designs, manufactures and installs a comprehensive line of innovative broadcast, RF and microwave products. All of which reflect over 35 years of experience. So make Cablewave Systems your single source. Because getting your broadcast facility up and running is our top priority.



Cablewave Systems

DIVISION OF RADIO FREQUENCY SYSTEMS, INC.
60 Dodge Avenue, North Haven, CT 06473
(203) 239-3311 Fax: (203) 234-7718

"Signals of Excellence"

Visit us at the NAB Show, Booth 1148

Circle 31 On Reader Service Card

World Radio History

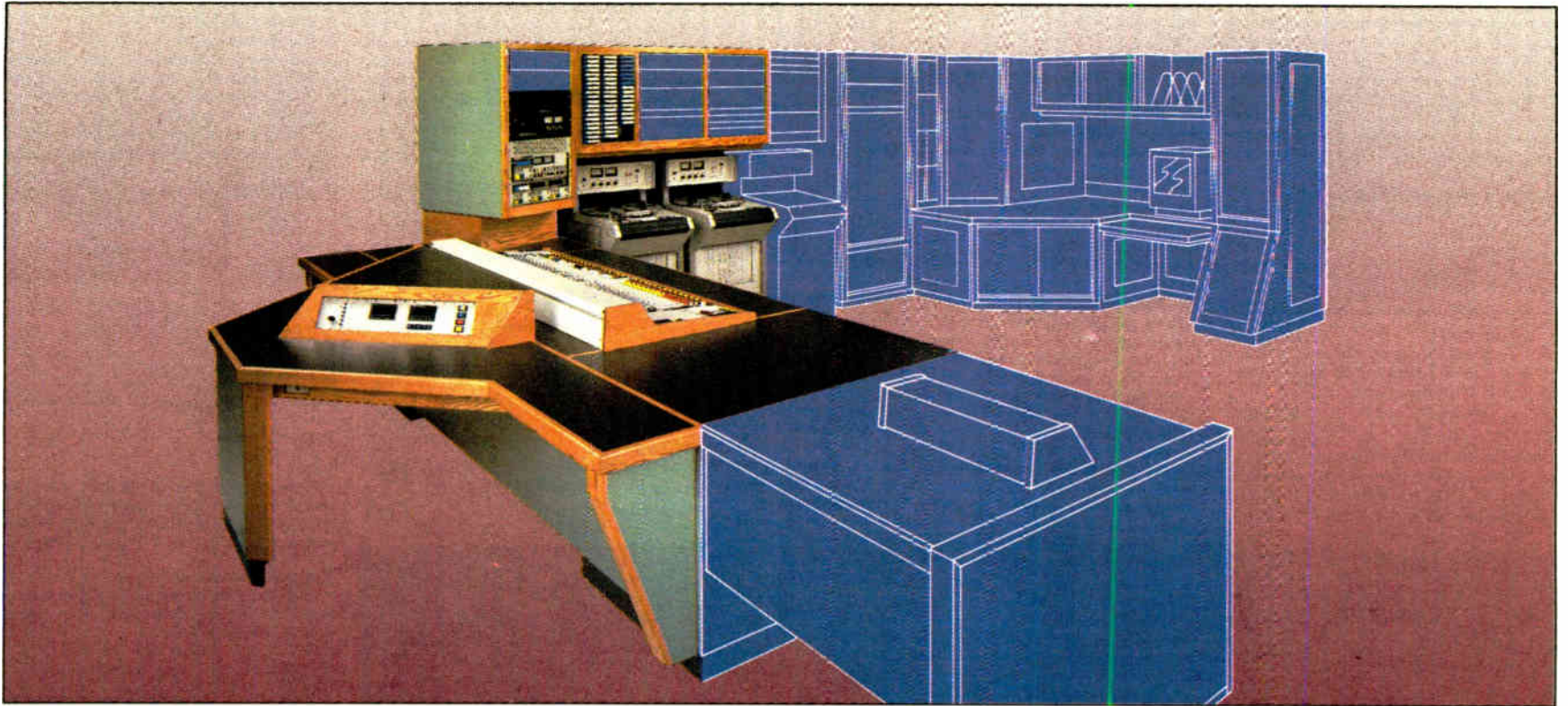

That's one reason successful professionals at major market stations and networks—the broadcasters with the most experience in systems work—turn to the experts at PR&E time after time. So do small market leaders who know that quality design delivers the best long term value.

We put over 100 man-years of front line experience to work on your problems. This real world expertise helps us balance the many interdependent factors involved in planning, designing and installing your system.

Here are a few of those factors, randomly chosen:

- Time frame
- Sightlines
- Documentation
- Drawings
- Wiring
- Installation
- Delivery dates
- Budget
- Operating requirements
- Electrical service
- Floor loading
- Space planning
- HVAC calculations
- Format

Overlooking even one of these considerations (or many others that are equally important) could be the first step on the way to an expensive disaster. Our new brochure on broadcast studio systems can help you avoid the pitfalls.



Broadcast studio systems seldom fit together this easily.

Now, the brochure can't tell you *everything* we've learned since 1973, the year we installed our first broadcast system. That would take an encyclopedia. But it will broaden your understanding of successful systems design, and give you a better grasp of the many complex questions you need to answer *before* the construction crew arrives to begin work on your new or renovated studios.

Call us at (619) 438-3911, and ask for your copy of our broadcast systems brochure. Just reading it may save you a significant amount of money. Of course, if our brochure can do that all by itself, there's no telling how much the entire PR&E team of experts can accomplish for you.

SYSTEMS



Pacific Recorders & Engineering Corporation
2070 Las Palmas Drive • Carlsbad, CA 92009
Tel 619-438-3911 • Fax 619-438-9277

© 1990 Pacific Recorders & Engineering

Telos Systems 2007
On Display: 100 digital hybrid duplex on-air phone conversation; digital telephone interface; One-M two- to four-wire interface provides an interface between McCurdy and RTS intercoms; direct interface module for connection to central office lines without a P ABX or key system. 1001A2 interface between a Telos hybrid and a key system; 100 switch console and Telos PR&E panels for line selection.
Contact: Trish Ristagno
1729 Superior Ave.
Cleveland, Ohio 44114
216-241-7225

Tennaplex Systems Ltd. 4157, 4159
On Display: Kathrein Broadcast Antenna systems; BGMI MMCS music and commercial management systems; SCA data systems.

Tentel Corp. 4223-4225

Texar, Ltd. TBA

Intro: Microprocessor facilities controller, a master unit with expandable sub-systems which facilitate the control of radio and TV transmitters; TXMN.24.3 "minimation" digital/analog animation controller.

The Express Group 1249, 1912
Intro: Series 2000 studio furniture, offering showroom beauty and a price for the budget-minded.

Thermodyne Int'l. 6406

Thomas J. Valentino, Inc. 1811-1813
On Display: The Valentino production music and sound effects libraries on compact disc.

Thomson Electron Tubes 6342
Intro: TH 341, TH 343, TH 346, TH 546; 10, 25, 60 and 100 kW FM tetrodes. All are air-cooled except the TH 546.

3M Professional Audio 4501
Intro: 3M 996 audio mastering tape, an analog audio mastering tape capable of operating at +9 with virtually no distortion. Also 3M's audio TapeCare library box made of polyethylene, moisture resistant and eliminates cardboard debris contaminants.

Toby Arnold & Assoc Inc. 1159

Torpey Controls & Engineering 5558

Trompeter Electronics Inc. 5239-5241

360 Systems 1900
Intro: AM-16/R remote control station for use with AM-16/R audio switchers. Provides multistation remote capability for X-Y or salvo switching via serial interface buss; HDS-40 external hard disk system for DigiCart digital audio cart machines.
Contact: Don Bird
18740 Oxnard St.
Tarzana, Calif. 91356
818-342-3127

U,V

U.S. Tape & Label Corp. 1143

UNR-ROHN Construction Group 1819

UREI 1434

On Display: Broadcast signal processing electronic products.

Union Connector Co., Inc. 6728-6734

Utility Tower Company 1021

On Display: Samples of tower sections for AM, FM, TV, CATV and microwave communications.

Vacuum Tube Logic 7505

Valley International, Inc. 1161, 1163
Intro: PR-2A two-position powered rack for 800 series modular signal processing devices, featuring power supply design, mechanical design, RFI and EMI shielding and XLR connectors for all audio inputs, outputs and external outputs. PR-10A 10-position power rack for 800 series modular signal processing device.
Also: Model 400 microphone processor, 440 single channel limiter, compressor, dynamic sibilance processor, 610 dual compressor/expander, HH2X2B balanced level matching interface, model 430 dynamite multifunction dynamic processor, Model 450 GATEX four-channel noise gate/expander.
Contact: Norman Baker
616 Bradley Court
Franklin, Tenn. 37064
615-370-5901

Varian Associates 4546

Vega 1011

Intro: The upgraded Q-plus wireless intercom system with new dual-mode squelch; the UHF handheld wireless transmitter; the VX-20 portable wireless system with a T-28 or T-29 handheld transmitter.

Vortex Communications 1240

Intro: NICAM digital audio distribution amplifier; line identifier for audio and video; studio clocks; portable stereo mixer.

W,Y

Ward-Beck Systems, Ltd. 4147

Wegener Communications, Inc. 6827

Intro: Series 1900 DBS audio receiver-direct broadcast satellite audio and/or data receivers. The series 1900 features addressability, 7.5 or 15 kHz bandwidths, audio fader, expandability, small size.

Wheatstone Corporation 1556-1564

Intro: SP-42 audio production console with programming and audio buses, three-band EQ, comprehensive telephone, intercom and other special modules; SP-44 audio production console with four group buses; SP-48 audio production console with eight group buses.

Also: SP-6 television and radio audio production console; SP-5 8-bus audio production console; A-500 radio "on-air" console; A32ex radio "on-air" console; 3224 24-bus multitrack recording console; broadcast control room furniture and broadcast audio processing.
Contact: Michael Shane
6720 V.I.P. Parkway
Syracuse, N.Y. 13211
315-455-7740

Wheelit, Inc. 7600-7602

Whirlwind 6100-6108

Intro: "Press Power" active press feed box featuring 12 mic outputs, four line outputs, two mic/line inputs, battery or AC power; "Mix 5 Broadcast" five-channel mic/line mixer featuring stereo outputs, battery or AC power; Whirlwind/US Audio "P12" power amp featuring 12 W pr side stereo and an output selector switch.

Also: Whirlwind problem solver boxes—mic splitters, phantom power, "Line Balancer" and "Hot Box" direct boxes.
Contact: Michael Laiacona
P.O. Box 1075
Rochester, N.Y. 14603
716-663-8820

Wide Range Electronics Corp. TBA

Intro: WRE 7000 videotape eraser.

Will-Burt Co. 5955, 5957

Intro: New finish on telescoping masts for durability and prevention of freeze ups, a Sanford Hardlube with teflon lubricate.

Winstead Corporation 5139

Intro: D-2 tapecube cassette storage system; system/90 post production console, the "Literack" vertical rack series.

Wireworks Corporation 3047, 3049

Intro: 12-channel microphone multicable components; 12-channel multipin-disconnectable cabling components, suited for many mid-sized applications.

Wohler Technologies 4581, 4583

Intro: MSM series multiple source metering with arrays of LED bargraph meters available in a variety of groupings across a one rack unit high panel. ARS series audio routing switches, up to 20 mono or stereo inputs to independent or ganged balanced buffered outputs.

World Tower Company Inc. 1415-1417

Yamaha Corp. of America 2017

Intro: DMC1000 all digital mixing console. All functions can be automated to SMPTE time code. Also, a CD recorder and several close field monitor speaker systems. R-DAT recorder; the DMR8 digital mixer/eight track recorder; DRU8 digital recorder and mixing consoles.

Probably not. But the new Shure VP64 microphone could go on with show, after show, after show.

The new Shure VP64 is good news for broadcasters — and their audiences.

In short, it delivers all the qualities you demand for a broadcast microphone — and then some. A high-energy neodymium magnet in the VP64 maximizes signal-to-noise

ratio. Result: your on-the-scene reports cut through background clutter to make sure your audience gets the message. What's more, the frequency response is tailored for unbeatable speech clarity and crispness, while all but eliminating boominess and low frequency background noise.

And you won't find a better looking,

easier-handling microphone anywhere. All of which makes the competitively priced VP64 the best value in it's class.

See the biggest news in broadcast microphones today at your Shure dealer. For more information, call 1-800-25-SHURE.

The Sound Of The Professionals®...Worldwide.

SHURE®



If You Were Dropped
6 Feet, Head First,
Would You Still Be Able
To Cover The Story?

EMT 981

Professional CD Player

Easy to Operate • Logically Arranged • Task-Oriented • Compact

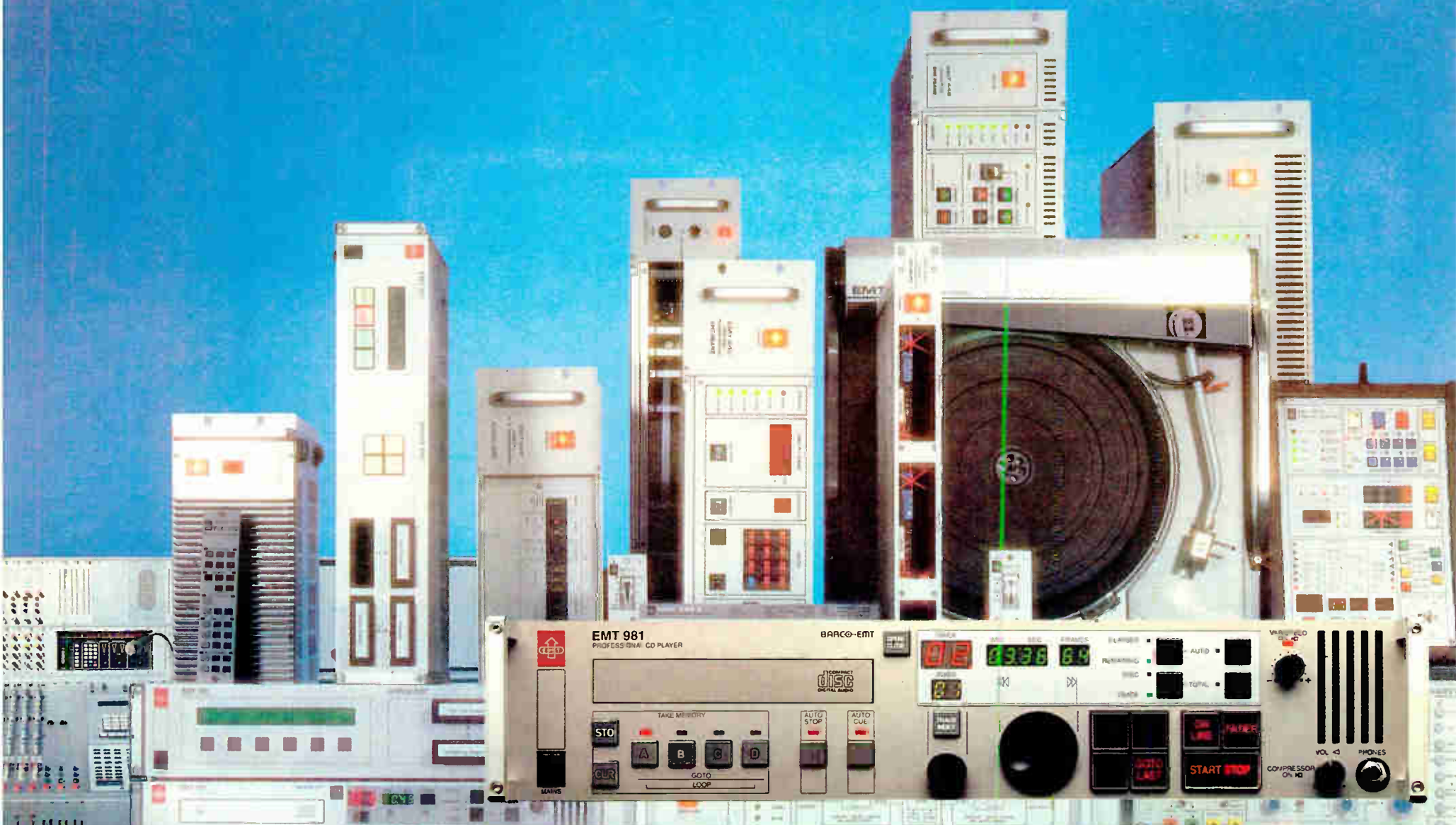

- **Easy to Operate**

defines the fundamental concept of the EMT 981 Professional CD Player, which has been designed especially for live broadcasting and production work.

- **Logically Arranged**

operating controls and displays.

- **Task-Oriented**

functions provided in the EDIT and ON-LINE modes. EDIT includes various prelistening alternatives for cueing.

The standard connections and outputs satisfy all common studio requirements.

- **Compact**

construction: 19" chassis in rack or desktop version.

- **Remote Control Capability**

for as many as three EMT 981 Professional CD Players with the EMT 981 S Remote Control Cassette, which continually indicates the operating state of the CD players.

BARCO, Inc. 1000 Cobb Place Blvd., Kennesaw, Georgia 30144
Phone: (404) 590-7900 Fax: (404) 590-8042

Northeast: (201) 729-0710 Southeast: (912) 436-7786
Midwest: (404) 590-7900 Western: (619) 575-0168

Postfach 15 20 • D-7630 Lahr • Telex (0 78 25) 10 11
Telex 7 54 319 • Teletax (0 78 25) 22 85

 **BARCO-EMT**
Professionelle Electronic

Ein Unternehmen der Gruppe BARCO n.v. Belgien

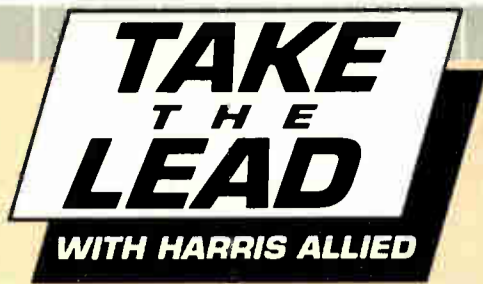

Map Out Your Future At NAB '91

Where is RF technology headed? The signs of times are easy to read at Harris Allied, booth 1100. That's where you'll find the show's most innovative FM and AM transmitters. Don't miss these products, and more new and exciting RF developments—from Harris, the RF leader.

Platinum Series™ FM ▶

Solid State FM Transmitters

- World-proven Platinum 100% solid state technology
- Redundant design for unprecedented on-air reliability
- Easy operation—no tuning, loading or matching required
- Simple controls, minimal maintenance requirements
- Wideband FET output devices for top performance
- Lowest incidental AM noise ever

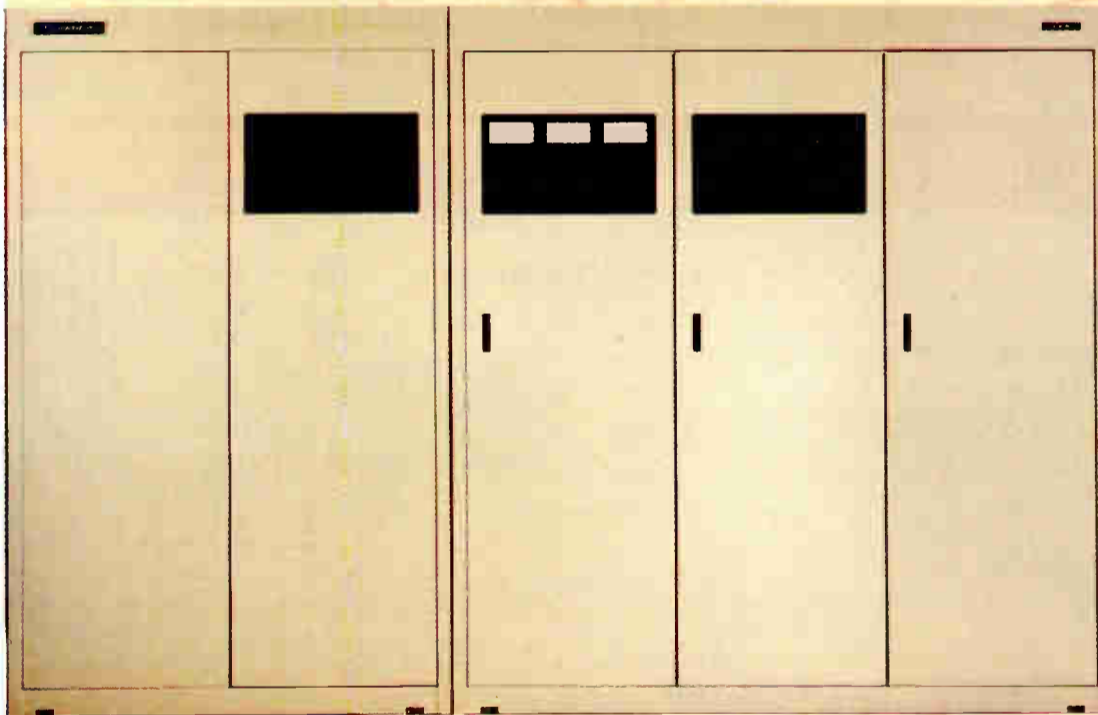

◀ DX Series

Digital Solid State AM Transmitters

- Patented digital modulator for transparent signals
- 86% overall efficiency cuts power costs
- The world leader in MW broadcasting
- Power levels from 10 to 100 kW and beyond

HT 500FM ▶

Containerized 500 Watt Solid State FM Transmitter

- Available 24 hours a day, 365 days a year for emergency backup
- Frequency-agile design needs no tuning
- On-site and on the air in 24 hours anywhere in the continental US
- THE-1 exciter for reliable performance

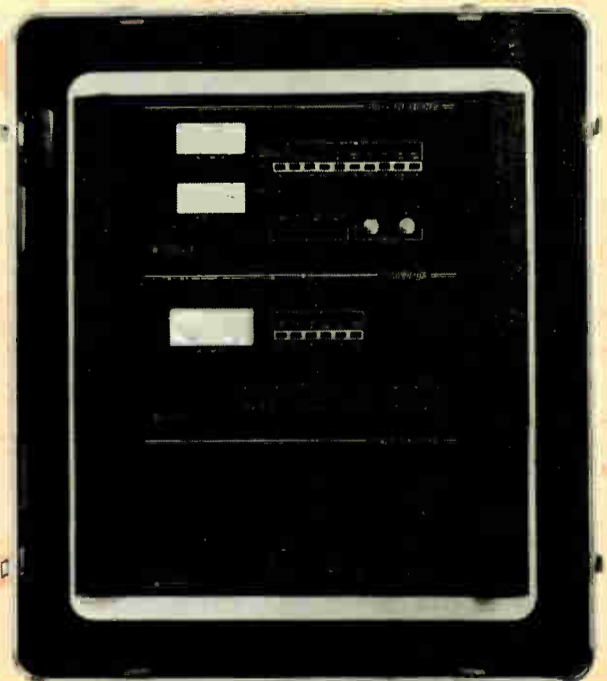

**TAKE
THE
LEAD**
WITH HARRIS ALLIED

Map Out Your Future At NAB '91

The show's largest selection, the show's hottest technology... the best show in Vegas is right here at Booth 1100.



Gentner

Lazer Digital Processor/Stereo Generator

Digital processing minimizes crosstalk and noise, delivers precise, drift-free control of pilot injection, limiting threshold, etc. Lazer lets you program the sound you want—exactly.

Audio Animation

paragon-transmission

All digital processing with instant-attack limiting for today's cleanest, most competitive FM sound, tomorrow's digital broadcasting. Multiple setups can be edited, saved and loaded on-air for dayparting.



Arrakis

Digilink

Five modes—stereo production, on air/live assist, satellite automation, full automation or news. CD-quality digital recording, instant cueing, powerful and flexible computer control and maintenance-free digital storage... yet Digilink actually costs less than the analog equipment it replaces.

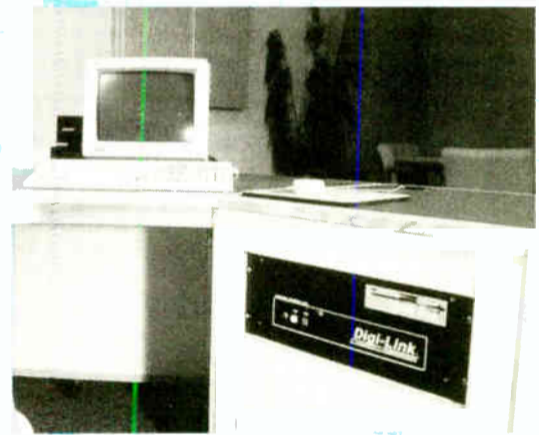

AKG

DSE 7000 Digital Sound Editor

This is the digital audio workstation designed for radio. Familiar analog-style controls eliminate the learning curve. The advanced RAM-based editing system makes production studios three times faster. Spots, spec, promos... stations across the country are out-producing the competition with the DSE 7000.



Audisk

Satellite or live assist automation

This cost-effective PC-based system offers stereo record and playback and gives you up to 6 days of walkaway time. You'll love it!



**HARRIS
ALLIED**
BROADCAST EQUIPMENT

With expanded staff and services... our lead keeps on growing!

800-622-0022

FAX 317-962-8961

STUDIO EQUIPMENT ■ HARRIS RF PRODUCTS ■ SATELLITE GEAR ■ TURNKEY SYSTEMS

IN CANADA 800-268-6817

MEMORANDUM



FIDELIPAC®

Broadcast Tape Products

Fidelipac Corporation
P.O. Box 808 • Moorestown, NJ 08057 • USA
TEL: (609) 235-3900 • FAX: (609) 235-7779

TO: All Broadcasters
FROM: Scott Martin, Director of Sales
Fidelipac Corporation
DATE: March 11, 1991 - Effective Immediately
SUBJECT: **BROADCAST AUDIO ACQUIRED BY FIDELIPAC -
WARRANTY EXTENDED, PRICES REDUCED**

- I. Fidelipac is pleased to report that the acquisition of Broadcast Audio transpired very smoothly. We have been shipping new consoles and spare parts from New Jersey since early February.
- II. Broadcast Audio consoles are installed in every one of the 50 states in the USA. During the past 13 years, over 1,400 consoles have been delivered and virtually every one remains in use today. That's why we decided to offer a **5 year warranty** on all new units.
- III. We also decided to issue **substantial price reductions** because engineering and development expenditures have been fully amortized, and redundant operating overhead was eliminated since fully consolidating all manufacturing within Fidelipac's facilities in Moorestown, New Jersey.
- IV. New pricing for the Series IV and Series VI is illustrated below. But don't be fooled by the competitive prices. These audio consoles sound great, are easy to use and employ proven reliable electronics for absolute dependability.

NEW BROADCAST AUDIO PROFESSIONAL PRICES

	6 Mixer	8 Mixer	12 Mixer	16 Mixer	20 Mixer	24 Mixer
Series IV Mainframe	4650	6,650	9,200	11,300		
Series VI Mainframe	6,350	7,350	10,250	12,500	14,800	17,400

Top quality construction is employed throughout. Double-sided ground plane motherboards assure minimum noise and cross-talk as well as superior RFI immunity. We use premium Penny & Giles faders exclusively. Ribbon cables aren't used for audio signal paths. We don't cut corners.

All mixer modules can be interchanged freely because console logic is not programmed on the module and each module is switchable between mic and line levels. Mixers and output amplifiers can be removed or inserted with power on. Additional flexibility is provided by three stereo busses and a mono mix-minus bus. In short, quality construction and audio performance are uncompromising.

- V. To put the icing on the cake, we are offering a **package discount with the purchase of three or more Dynamax cartridge machines** and a Broadcast Audio console. We particularly recommend our superb Dynamax CTR90 Series with Dolby HX Pro and DNR Noise Reduction.
- VI. Call Fidelipac for the name of your nearest authorized Broadcast Audio Division dealer. And visit us at the **NAB, Booth #1041 for a demo.**

BUYERS GUIDE

Monitors, Microphones, Turntables & Preamps

WBCN Falls for EV 635A Mic

by James Rakiey, CE
WBCN-FM

BOSTON WBCN is officially known as "The Rock of Boston," but in recent months, the station has become famous for its spectacular "drops."

From heights of more than 100 feet in the air, everything from Massachusetts' largest pumpkin (329 pounds) to turkeys (featuring live commentary from "Les Nessman" of the television series "WKRP in Cincinnati") to Santa Claus, have spiraled to the earth below to the delight of thousands of WBCN listeners.

To promote the unveiling of our new van, WBCN decided to lift our old vehicle

USER REPORT

100 feet into the air via crane and drop it. To complete the demolition, a five-ton concrete block then would be dropped on what remained of the van.

To convey the magnitude and excitement of the action, we decided to put a microphone inside the old van before the drop.

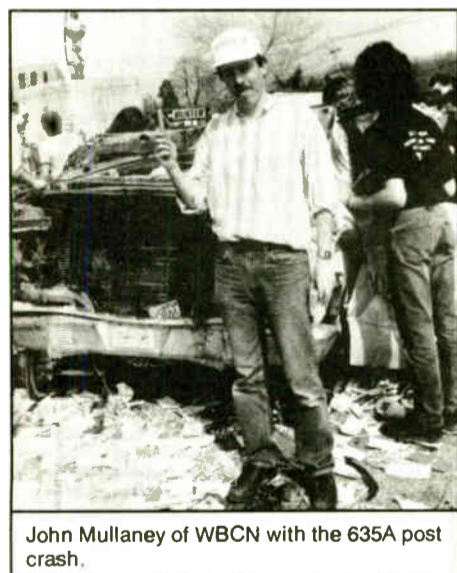

John Mullaney of WBCN with the 635A post crash.

ment of the action, we decided to put a microphone inside the old van before the drop.

Destructive force

The obvious problem was to find a mic that could withstand this kind of destructive force without adding to the national debt. Our logical choice was the Electro-Voice EV 635A dynamic omnidirectional microphone.

I have used the EV 635A mic for many years and had tremendous luck with it even in severe and adverse conditions. Rain, snow, sleet and even baby drool have never stopped the 635A (the latter test was accomplished with the help of a curious nephew and a poorly placed 635A). I knew it was a strong contender for what we planned, because in more than 15 years of broad-



The Electro-Voice 635A takes a beating and keeps on transducing.

casting, I have yet to find a mic that can compare in durability as well as sound at a reasonable cost.

D-Day (Drop Day) finally arrived and John Mullaney (the best remote man in Boston) was on site to coordinate the mechanics. The 635A was put into the old WBCN van and hauled 100 feet above the asphalt surface. Six thousand WBCN fans were present to witness the ultimate demise of the van—and hopefully not the 635A.

Bone-jarring crunch

The bone-jarring crunch of the impact was picked up perfectly by the mic, including the shattering of glass and the wrenching of metal. The WBCN listeners truly received the full effect of what had taken place. Our little electronic daredevil survived the first test without a scratch and stiffened his windshield for the second assault.

Next, the five-ton block of concrete was raised to 100 feet and again the crowd counted down. The most amazing sound was heard when the block hit squarely on top of the old WBCN van—something like the sound made when a bottle is thrown against a rock.

The fans went hysterical and rushed the flattened van to grab any piece as

a souvenir; unfortunately, this included our 635A microphone. By the time John Mullaney got to the van, he found only the mic cable that it had been attached to.

Over the air

We announced the loss over the air, and the listener in possession came forward with the mic. John then put the 635A through its paces and discov-

ered that aside from a few scratches, the mic was in perfect condition.

The fan who took the mic explained that to grab it, he had to remove lots of glass and debris and then bend a large piece of metal back before the 635A could be removed. Since the fan had gone to such extremes to get a souvenir, it was only fair to let him have it. So, we took pictures of the 635A and returned it to him.

The ability of this microphone to produce a quality sound even under severe conditions has been demonstrated to me repeatedly over the years. Electro-Voice calls the 635A "rugged." I suggest that when it's put to the WBCN "Rock Drop" test, they start calling it "indestructible."

■ ■ ■

For information on the at-very-least rugged EV 635A, call Keith Clark at Electro-Voice Inc., in Buchanan, Mich. at 616-695-6831; FAX: 616-695-1304; or circle Reader Service 78.

BUYERS GUIDE INDEX

- Electro-Voice 635A Microphone**
by James Rakiey, WBCN-FM **69**
- Acoustic Technology Alphon FC-100**
by John Schauer, Audio Engineer **71**
- Shure VP64 Microphone**
by Kevin Bradley, WTLC/WTUX **72**
- H&E Micro-Trak 6411 Preamp**
by Thomas R. Ray III, WTIC AM/FM **73**
- Benchmark 4 x 4 + Microphone Preamp**
by Joel Gordon, WGBH-FM **74**
- Also: Technology Updates from ATC; Studer-ReVox; and Russco Electronics.**

POWER TO THE PRESS.

Being the best in broadcast journalism means being the best equipped to gather information. At a press conference, the task of physically gaining access to that information can become an impossible feat for even the most seasoned pro. Whirlwind's PRESSPOWER active press box provides the superior solution.

The PRESSPOWER takes two transformer isolated XLR mic/line inputs and distributes them to sixteen transformer isolated XLR outputs (12 mic/-50dB, 2-line/0dBV, 2-line/variable). Enough so that everyone in the room can get a clean feed. Additionally, a headphone output is provided with a level control, plus, to expedite setup, a 1kHz tone is available.

Powered by four 9V batteries or AC (110/220), the PRESSPOWER can be rack mounted or used with the included carrying case. This makes it ready to go for any situation.

Whirlwind's affordable PRESSPOWER gives you the power to get the news... not waste your time figuring out how to.



See Us At NAB! Booth 6100.

The **whirlwind PRESSPOWER**
Active Press Box

WHIRLWIND MUSIC DIST. INC. • 100 BOXART ST. • ROCHESTER, NY 14612 • TELEPHONE: 800-733-9473 • 716-663-8820 • FAX: 716-865-8930

Circle 23 On Reader Service Card

More Stereo, Higher Output Mics Offered

by Bruce Bartlett

ELKHART, Ind. The past year saw two main advances in microphones for broadcasters: more high output microphones and more stereo microphones.

GUEST OVERVIEW

Several classic dynamic microphones were upgraded with neodymium (N-Dym) magnets, which provide better output, improved signal-to-noise and more extended highs.

For example, Electro-Voice came out with an N-Dym version of its RE-20, the popular DJ booth mic. The new model, called the RE-27 N/D, is a variable-Dym dynamic cardioid for broadcast announce and voice-over. EV also has the RE-45 N/D, an N-Dym short shotgun mic for field news gathering.

Other manufacturers are upgrading to N-Dym. Shure's Beta 58 is much like the world-standard SM-58, but with an N-Dym magnetic structure. Shure also debuted an N-Dym omnidirectional dynamic microphone for news gathering. Peavey introduced the 520 TN, an N-Dym cardioid that won "Music and Sound Retailer's" award for Most

Innovative Product of the Year.

What are the advantages of an N-Dym dynamic microphone for a broadcaster? You get the hot signal, low noise and sparkling highs of a good condenser mic, but without the need for a phantom power supply. Plus, you get the extra reliability and higher overload point of a dynamic.

Manufacturers of studio condenser microphones are keeping up with the demand for lower noise as well, offering models that are nearly noise-free. A good example is the Sennheiser MKH 40.

Stereo mics

Stereo mics are another area of growth. The progress of stereo TV has created a need for easily portable stereo microphones. Radio broadcasters use these for stereo ENG, remote broadcasts of classical music, audience reaction and stereo interviews.

Some examples of newer stereo microphones: Shure Brothers introduced its VP88, an MS microphone with stereo or MS outputs, switchable stereo spread on the microphone and a low-cut switch. Beyerdynamic revealed its new MC742, an XY or MS microphone. Suitable for remote broadcasts of concerts, it has a rotatable upper capsule and remote-adjustable polar patterns. Also included are a 10 dB



Latest from AT

STOW, Ohio Audio Technica has introduced the Hi-Energy ATM microphone series featuring neodymium magnets for high output level and improved signal-to-noise ratio.

The ATM41HE and ATM61HE Hi-Energy dynamic mics also feature a double-dome diaphragm, providing smooth extended high frequency response; CCAW (copper-clad aluminum wire) voice coil for low mass and a floating diaphragm.

The Hi-Energy design combines the floating diaphragm with a special double-isolated element housing for minimum handling and case noise.

The ATM41HE features a 50 Hz to 17,000 Hz frequency response; the ATM61HE features a 50 Hz to 18,000 Hz frequency response. Both have a sensitivity of -55 dBm.

The company also has debuted the PRO 4C microphone, designed specifically for close-up vocal use.

The PRO 4C encloses a condenser element inside a ball-type multistage protective screen to reduce wind noise and "popping" when users are extremely close. The mic offers a 50 Hz to 18,000 Hz frequency response, -60 dBm sensitivity and handles up to 130 dB SPL input sound level.

For information, contact Audio-Technica at 216-686-2600; FAX: 216-688-3752; or circle Reader Service 28.

pad and a low-cut filter.

Sony is offering the ECM-MS5, a lightweight MS electret condenser mic designed for ENG, sampling or music recording. It has internally adjustable stereo spread, a low-cut switch, phantom or AA battery power, plus an optional DC power supply. Outputs are left and right via a dual XLR-type cable.

Crown's SASS-P PZM stereo microphone is a novel configuration. It uses two ear-spaced pressure-zone microphones on five-inch-square boundaries that are angled apart, with a foam baffle between them. This construction provides directional patterns that aim left and right, plus time cues due to the mic spacing.

These features are said to provide sharp, accurate imaging due to the mic's head-related localization cues. In addition, the SASS is claimed to be mono compatible because the foam baffle limits crosstalk at high frequencies.

Binaural microphones

Closely related to stereo is binaural sound. It's making a comeback in radio drama, especially now that lightweight headphones are popular.

Binaural (two-ear) recording begins with an artificial head or dummy head—a model of the human head with a flush-mounted microphone in each ear. These mics capture the sound waves arriving at each ear. You record the mics' signals. When you play this

recording over headphones, you hear the sounds that were present at the ears of the dummy head. That is, the headphones reproduce the original sound at each ear.

Dummy-head recording with headphone playback is especially accurate in its localization and sense of spatial environment. Sound-source locations and room ambience are recreated with startling realism. The listener often can hear sounds all around the head—behind, in front, to the sides, above and so on.

An artificial head distorts the sound field it is in, causing a non-flat frequency response. So some dummy heads come with built-in equalization that results in a net flat response.

One example is the Aachen Head model HMS II. With this head, the option most useful for broadcasters is the unit with Schoeps mic capsules, two XLR-type outputs and switchable EQ. Another example is the Neuman KU 81i, a simplified head with internal mics and equalization for natural sound.

Although it seems microphones have been around forever, microphone companies manage to come up with innovations or improvements each year, and the current period is no exception.

Bruce Bartlett is a microphone engineer and technical writer with Crown International. His Line Out column appears monthly in RW.

CRL SPOTLIGHT

Have a news/talk/sports format?

Want to improve coverage of your station?



MBL-100 AM NEWS/TALK PROCESSOR

The MBL-100 news/talk AM audio processor was designed for you. The MBL-100 provides very high levels of average modulation density or loudness. The added density it provides helps to overcome noise and interference problems. The MBL-100 is useful for filling in null areas and reducing the effects of powerline reradiation. And if your antenna bandwidth or symmetry is not that great, the 7.5 kHz bandwidth of the MBL-100 will make life easier for your transmitter. The MBL-100 is designed to give your station better coverage area. To learn more about the MBL-100 call or write now for details. The MBL-100 is available on our two week trial program.



Circuit Research Labs, Inc.
2522 West Geneva Drive
Tempe, Arizona 85282-3192 U.S.A.
(800) 535-7648 (602) 438-0888 FAX (602) 438-8227
Bulletin Board System (602) 438-0459

The Complete RF Exposure Measurement System from Holaday Industries

Measure Both E and H fields

ANSI RF exposure standard requires measurement of both the electric and magnetic field.

Automatic Self-zero

Completely automatic self-zeroing eliminates drift, improves accuracy of readings.

Recognized by Federal Agencies

Evaluated and used by NIOSH, OSHA, EPA and CDRH, as well as state, local health departments and consulting engineers.

Call or write for more information on these reasonably priced systems. Rental systems also available.



HOLADAY INDUSTRIES, INC.
14825 Martin Drive
Eden Prairie, MN 55344
Telephone: (612) 934-4920
Telex: 29-0922 FAX: 612/934-3604

NBS Probe Design

Isotropic probe design originated by National Bureau of Standards.

Displays Time Average Reading

Real-Time display of the current six minute relates directly to the ANSI RF average exposure standard.



Engineer Gains from FC-100

by John Schauer
Audio Engineer

BUENA PARK, Calif. How many times have you attended a meeting and had to strain to hear the presenter, while the sound system in the room is ringing from impending feedback?



The FC-100 cuts the feedback while bringing out reticent voices.

That's what happened to me on several occasions when I was attempting to reinforce a soft-spoken speaker or one who wanted to place a lapel mic in the tie clip position.

I was introduced to the Alphon FC-100 feedback controller by Allen Groh of Acoustic Technology as a means to help remedy these problems. He gave me a quick and convincing demonstration by placing a microphone right in front of a speaker and raising the fader on the console up to the point of feedback. I marked this position while Allen put the FC-100 in line between the microphone and the console.

Raising the fader

I raised the fader again up to and past the mark I had made until feedback occurred again. I noted about 10 dB more gain on the fader this time. Also, it seemed that when feedback did occur, it was more difficult to get the system to stay "feeding back," as if it was somehow adjusting itself to keep this from happening.

Allen explained that the unit selectively inverts the phase of the frequency where feedback is about to occur. I ran

a sweep frequency generator through the unit, hoping to gain some understanding of how all of this occurs. I looked at both input and output signals fed into a dual trace scope, but found the same waveform in either trace. It had passed the signal through with no effect whatsoever.

I finally got to really "road test" the unit several days later when I needed to reinforce a speaker using a wireless lapel microphone system. Connecting the unit in-line between the wireless receiver and console, I powered the unit with 48 V phantom power off the board and adjusted the "set up level" control on the FC-100 to minimum.

Sounded quite natural

I then EQ'd the system for the sound I wanted and began raising the "set up level" control, listening for any coloration or effect it might have been having on the sound. It seemed to begin to roll off high

USER REPORT

frequencies at about 60 percent of "set up level," so I backed the control off to 50 percent and was quite impressed. I was able to gain approximately 6 dB of additional headroom, and the speaker sounded quite natural.

Since then, I've used the FC-100 on many occasions. I still believe you should try to overcome as much of the feedback problem as you can with EQ, speaker and microphone placement, etc., then insert the unit in-line only on the microphones that are the most prone to howling. This is when the beauty of the FC-100 really shows.

The unit is housed in a sturdy aluminum chassis with no protruding parts. The only

control on the FC-100 is the "set up level" control. Connecting the unit is easy—simply plug the cable from the microphone into the "in" of the controller, and a cable from the "out" jack to the input of your console.

Power can be obtained from either phantom power via your console or by a DC power pack connected to the power jack on the unit. An LED on top of the unit lets you know it has power. The knob on the

"set up level" control is flush with the case, so you'll need a screwdriver to adjust it.

All in all, the Alphon FC-100 is a useful tool for getting a bit more gain from your PA system. My only suggestion: I would like to see a multichannel unit, perhaps in a rackmount package, for easier access and to reduce the chance of theft (the unit is only 2.5" x 4.5" x 1.25").

■ ■ ■

For information on Acoustic Technology's FC-100 feedback controller, contact Allen Groh at 817-430-3351; FAX: 817-430-3351 (the FAX is not on a dedicated line); or circle Reader Service 118.

ATC Monitor Enticing

by Steve Angel, Sales Manager
HHB Communications

GLOUCESTERSHIRE, England The monitoring market must develop to accommodate the performance that new recording technology can deliver.

While many monitors have served the industry well in the past, most popular near-field designs simply are no longer capable of providing the necessary standards of reference.

With that, ATC has developed the SCM20 after almost four years of research and development. Establishing itself as a new near-field reference for any broadcaster, the SCM20's two-way design features a driver with a magnet weighing a massive 20 pounds, coupled with the same "Vifa" tweeter implemented in ATC's other speaker models.

The ATC range consists of seven models that span all applications from main studio monitoring to critical broadcast and near-field reference. All models in the range, from the SCM300 to the highly compact SCM20, share sonic resemblance, due to a hemispherical soft dome midrange design pioneered by ATC.

The SCM300 and SCM200 main studio monitors both feature dual bass drive configurations that deliver high SPLs with a noticeable absence of the distortion that often affects traditional horn-loaded designs.

The compact SCM20, meanwhile, has found favor with a number of HHB customers, including BBC Radio and Depeche Mode producer Gareth Jones. The speaker recently picked up a "Best Buy" award in "HiVi," a Japanese audio-visual publication. In Australia, meanwhile, the SCM100A received a CESA Sound and Image award.

■ ■ ■

HHB Communications is the exclusive U.K. and European distributor for ATC's SCM series of studio monitors. For information, contact Steve Angel at +44-081-960-2144; FAX: +44-081-960-1160; or circle Reader Service 114.

TECHNOLOGY UPDATE

SWEET & LOW.

If you're into audio for video, our message is short and sweet: The Tascam BR-20T is the lowest priced 1/4" professional centertrack timecode deck on the market.

The BR-20T is a professional audio-for-video recorder specifically designed for 2-track mastering and video post playback. Its center timecode track employs Tascam's innovative in-line head and timecode optimization system, neatly eliminating the need for timecode level monitoring and adjustments.

Other pro features of the BR-20T include full servo-controlled transport for quick, accurate response and gentle tape handling while under external synchronizer control. Easy, front-panel accessibility to all major audio calibration controls. And gapless/seamless punch in/out and spot erase.

The \$2,999* BR-20T. The sweetest little audio-for-video machine you'll ever see. At the lowest price you'll ever hear.

Check it out, post-haste, at your nearest Tascam dealer.

TASCAM®

© 1990 TEAC America, Inc., 7733 Telegraph Road, Montebello, CA 90640. 213/726-0303. *Manufacturer's Suggested Retail Price.

See Us at NAB Booth 4239

Circle 103 On Reader Service Card

Shure Mic Meets the Standard

by Kevin Bradley, Reporter
WTLC-FM/WTUX-AM

INDIANAPOLIS It had to be fate.

What else could explain my connection with the Shure Co. and its new

USER REPORT

model VP64 Omni-directional Dynamic Microphone? How could I have known what an ally I had gained in the locker room and on the street?

Fishing For A Phone Number?

Catch it in

1991 Radio World Directory Issue

— The Industry Source for Manufacturer, Supplier, NAB and FCC Phone Listings, as well as Product Information, Company Profiles, Buyers Guide Reprints, RW's 1990 Editorial Index, Reference Material, and More...

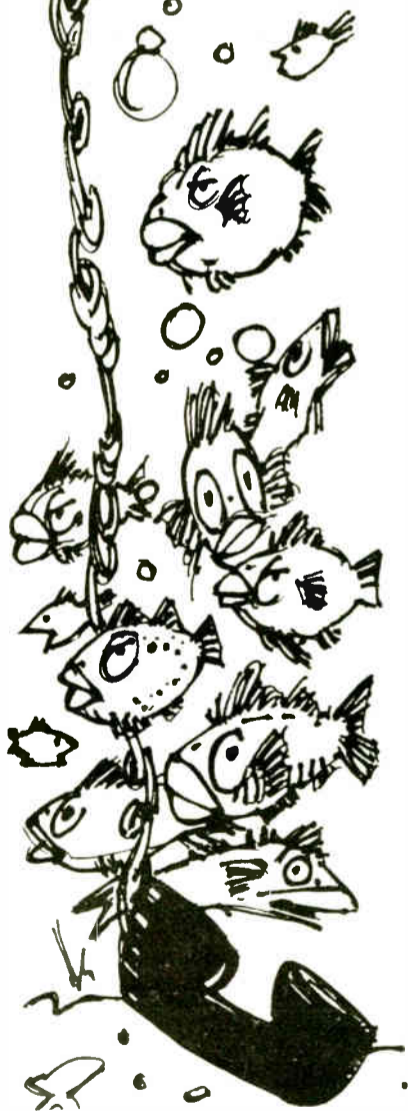

Send \$14.95 for each copy to:
RW 1991 Directory Issue
P.O. Box 1214
Falls Church, VA 22041

For the past four months I have been doing research on developing a home theater, and it was the Shure HTS 5300 Surround Sound Decoder that prompted me to call Chris Potter, the technical marketing specialist at Shure in Evanston, Ill.

Little did I know that Chris had left the HTS Division and was now in the professional products division.

The horse's mouth

Shure has long been known for its quality in professional broadcast equipment. After seeing the HTS 5300 Processor ranked as the only Class A surround sound processor in "Stereophile" Magazine's Recommended Component Guide (October 1990), I had to have more from the horse's mouth.

One talk with Chris and a personal listening excursion to Evanston and I was convinced that the Shure processor had to be the brains of my system. Since I was so sold on the processor, Chris asked me if I would be interested in becoming a beta test site for the new VP64.

The Shure Model VP64, with its matte-black finish and sleek smooth lines, is a handsome, rugged piece of equipment. As a sports reporter for the statewide radio network, Network Indiana, and as a news reporter for WTLC Radio in Indianapolis, the need for solid-state equipment and quality in recording is paramount. The VP64 fits the bill.

Over the past few weeks I have taken it on one-on-one interviews with NBA stars in crowded locker rooms, on press conferences with elected officials and on the street for natural sound—and the VP64 has proven itself a winner in every arena.

The omnidirectional polar pattern enhances the pick-up axis and provides for a consistent audio quality even if subjects are "off mic." The VP64 has a way of drawing in non-primary subjects at press conferences and it also is great in

providing sufficient ambient sound in interviews where others are present.

The high energy neodymium magnet in the VP64 also maximizes signal-to-



The Shure VP64 microphone was the one to hold onto at WTLC.

noise ratios to make sure whatever the situation, the message delivered gets to the listener's ear.

The VP64's frequency response is rated at 50 Hz to 12,000 Hz. It has a moderate upper midrange presence rise, which maximizes crispness and clarity, and its low-end rolloff minimizes boominess and low frequency background noise.

Features of the VP64 include an in-

tegrated pop/blast filter and a wind-screen, which hardly caused a "P" to be popped and eliminated wind noise even in high wind situations.

Head-to-head match

As a reporter, I have been trained to be skeptical of handouts in any form; therefore I decided to perform a totally unscientific head-to-head matchup with the industry standard, the Electro-Voice 635-A.

I set both mics side-by-side about three feet away from myself and connected them into separate Radio Shack Realistic CTR 68 tape recorders. I then proceeded to produce a 40-second voicer on each machine. In my opinion, in terms of clarity, presence and sensitiv-

As a sports reporter for Network Indiana, the need for solid-state equipment and quality in recording is paramount.

ity, the VP64 won hands down.

Another valuable characteristic for street reporters' microphones is ruggedness. Face it: news directors, tape recorders and microphones get dropped. No matter how careful reporters are with their equipment, on occasion there are instances when both reporter and equipment are mugged, slugged and drug in their attempt to bring back the story.

While testing this unit it was unintentionally dropped twice—once on a wooden floor from four feet and another time on a concrete bridge in the rain from six feet. In both instances the VP64 got off the mat and performed like a true champion, even in light of the abuse it had taken.

As far as I am concerned, there is a new industry standard in field broadcast mics—the VP64.

For information on the Shure VP64 microphone, contact Chris Potter at 708-866-2586; FAX: 708-866-2279; or circle Reader Service 59.

UNDISPUTABLE AUDIO BROADCAST MONITORING

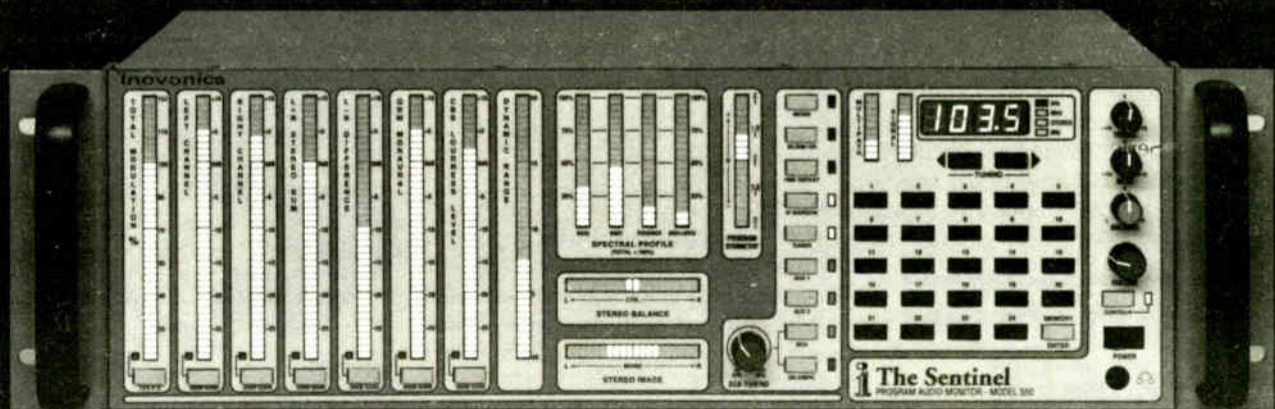

"Sounds fine to me!" Does it really? Hearing varies from person to person and from day to day. Be certain of what you *really* sound like by letting **The Sentinel** objectively diagnose your program audio.

12 key parameters and characteristics of interest to programmers—including Relative Loudness, Dynamic Range, Spectral Profile, Stereo Balance and Image—are graphically displayed with meaningful and useful numbers. **The Sentinel** has all-mode reception: NRSC AM/AM-Stereo, FM/FMX™ -Stereo and SCA.

Instantly compare your audio with anyone else on the dial with the press of a button (24 presets). This invaluable information will enable you to intelligently respond with your own processing adjustments.

See **The Sentinel** at NAB booths 1700/1702/1704

i Inovonics — Audio Recording, Signal Processing and Instrumentation
1305 Fair Ave., Santa Cruz, CA 95060—CALL: (800) 733-0552 or FAX: (408) 458-0554

WTIC Sold on H&E Preamp

by Thomas R. Ray III, CE
WTIC-AM/WTIC-FM

HARTFORD, Conn. I remember vividly my first encounter with the H&E/Microtrak ST6411 turntable preamplifier.

It was several years ago, and I was CE of a Big Band AM/Beautiful Music FM station. We had just converted the AM to C-QUAM stereo, and were about to start recarting the entire big band library—more than 3,000 carts.

USER REPORT

Most of our music was reprocessed and on reel-to-reel. A considerable amount, however, was on LP and 78s. At the time, we had no stereo production facility, so my assistant and I threw together a little home grown console and a stereo dubbing room was born.

Unfortunately, we had spent so much money purchasing new carts, cart machines and the AM stereo system that we had almost nothing cashwise to work with. We needed a preamp for the turntable—one that could handle the new digitally mastered recordings of the New Glenn Miller Orchestra, as well as the scratchy old 78s. It also had to be inexpensive and reliable.

A consultation with one of our local suppliers yielded a solution—the H&E/Microtrak ST6411. I ordered one on a trial basis.

When the unit arrived, I remember thinking to myself that I really couldn't be expected to take this preamp seriously. It

mastered Glenn Miller recording and started tracking the first cut. The audio was very good. Even more amazing was the fact that we didn't have to mortgage the station to buy the ST6411. Granted, we weren't playing a compact disc, but the audio was comparable.

We spent the next hour or so tracking various records from 45s and 78s, experimenting with the ST6411's switching high-frequency boost/cut filters and its flat/RIAA equalization curve modes. By using the special equalization features of the ST6411, we were able to get fairly good audio off of almost any source.

In another instance, while I was CE at an oldies station here in town a few years ago, I was again in the process of recarting the library. The production room turntables had old 1966 vintage Gates turntable preamps—state of the art for 1966, but far from it in 1988.

We had found a good deal of our library available on compact disc, but a considerable amount of material was still on old vinyl 45s and LPs. Trying to deal with the excess hum and distortion these preamps were dishing out was next to impossible.

Another problem was that the AM signal got into everything at this station, making it virtually impossible to cart anything with serious low-level passages—unless, of course, that song was playing on the AM at the same time you were carting it.

I called my supplier to see if the ST6411 was available. It was. I ordered one for each turntable. I knew from previous experience that the ST6411 could clean up our vinyl carting process, and that we would notice an immediate difference on the air from the low IMD figures. I also

when I took over were the ST6411s in the two AM air studios.

Our FM is strictly on CD now, as are the libraries for both stations' production rooms. But the AM still plays records at times. Everything from LPs from two years ago to the syndicated Sounds of Sinatra, to 78s on the legendary Bob Steele Show. And the ST6411 handles it

all beautifully.

We take great pride in our AM audio here at WTIC, and I'd like to think that part of that pride comes from having top-notch equipment to work with, plus the fact that my assistant and I are perfectionists about equipment performance. You can bet that if we need to replace any of the preamps at WTIC, the H&E ST6411 will be our preamp of choice.

■ ■ ■

For information on the ST6411 preamp, contact Bill Stacy at H&E at 413-733-8743, or circle Reader Service 15.



The Micro-Trak 6411 phono preamp brought clarity to more than 3,000 music tracks for Thomas Ray.

was relatively small, about six inches by two inches high: Serious broadcast equipment has got to be big and bulky and complicated, right? Boy, was I wrong.

The size of the ST6411 impressed me immediately when it came time to install the unit. It was small enough to fit almost anywhere. The inputs were standard RCA connectors, which were a perfect match for the cable from our Audio-Technica ATP-12T tonearm.

The output was active balanced, and terminated in a barrier strip. The first thing we did was to establish operating level into the console. We tracked our test record and set a perfect left-to-right balance with the recessed 10-turn pots on the front plate of the ST6411.

We then ran a response run off the test record and found both channels to track extremely close and fairly flat with our Stanton 861A cartridge. But as everyone knows, the only real test is actually hearing the unit's performance.

We switched in the ST6411's switchable rumble filter, grabbed our new digitally

knew that the rumble filter and adjustable high-frequency filters would come in handy in trying to equalize some of our 1950s-era rock to our standards. What I didn't know was how the ST6411 would handle our high-RF environment.

When the units arrived, I went to work installing them and setting levels into the console. Everyone agreed that I had made the correct choice. But something bothered me. I felt that I had left something out during installation.

Then it occurred to me. I didn't have to chase down and eliminate the RF from the preamps. They were virtually immune while everything else in the production room took forever and a day to install because of the RFI elimination process. Now I was sold on the ST6411. The unit was compact, used a fairly uncomplicated circuit design with common op-amps, sounded fantastic, was equalization-versatile and virtually immune to RFI.

Now I'm CE here at WTIC. I have 10 studios to oversee, plus five transmitters to look after. One thing I was happy to see

THE BIGGEST PENNY PINCHER IN RADIO SINCE JACK BENNY.

Mr. Benny certainly knew a great bargain when he made one. And we think he'd appreciate the brilliance of the bargain-priced Tascam BR-20 Broadcast Production Recorder.

The BR-20 is built to do one thing—broadcast production—and to do it exceedingly well. It's a rugged, reliable 2-track with features that make every job easier and more efficient. Like independent reel-size selection. Splice block. Built-in monitor speaker. Independent L/R record for monitoring on one track while recording in sync on the other for overdubs and voiceovers. Fader start. And Quick Cue with Auto-Repeat.

The \$2,299* BR-20. It's got everything you need in a broadcast production recorder. Including a price even your station manager can live with.

Come see it today at your nearest Tascam dealer.

TASCAM®



© 1990 TEAC America, Inc., 7733 Telegraph Road
Montebello, CA 90640 213/726-0303
*Manufacturer's Suggested Retail Price.

See Us at NAB Booth 4239

Circle 30 On Reader Service Card

Benchmark Preamp Aces FM's Field Tests

by Joel Gordon, Producer, Music Projects WGBH-FM

BOSTON In my experiences as a producer of classical music recordings and programs for WGBH Radio in Boston, and a producer and engineer of classical CDs for several record labels, I've had the chance to try out a lot of different equipment.

Over the past year, I have used the Benchmark 4x4+ microphone preamplifier system to record 10 CDs and numerous concert and studio performances. By this time, I'd say we're com-

countered. Whether feeding a console in a studio session or functioning alone in a concert situation, the Benchmark remained transparent, uncolored and free of any internal or external noise.

USER REPORT

I spent several months recording village music on location in rural Transylvania using the unit as my sole mixer with wonderful results.

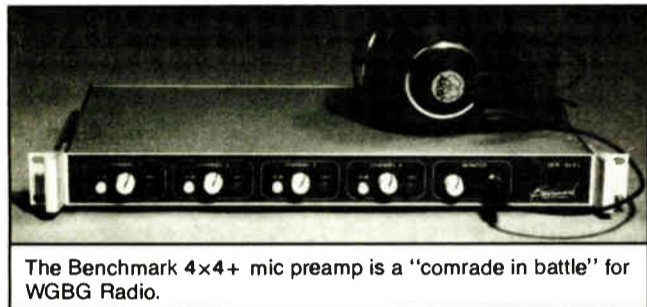

The Benchmark 4x4+ mic preamp is a "comrade in battle" for WGBH Radio.

Benchmark specs

The unit is one-rack unit high, 16.7 inches wide and weighs 16 pounds. It offers a quad preamplifier system with four inputs to four balanced outputs, with switchable phantom power and 20 dB pad. Company

rades in arms.

The Benchmark has performed with quality, consistency and sonic purity in basically any situation and with any instrumentation I have en-

specs say that total gain range, including the pad is -2 to +73 dB. For low AC line interference, the PS-10 power supply has its own separate chassis.

SHRUNK TO FIT!

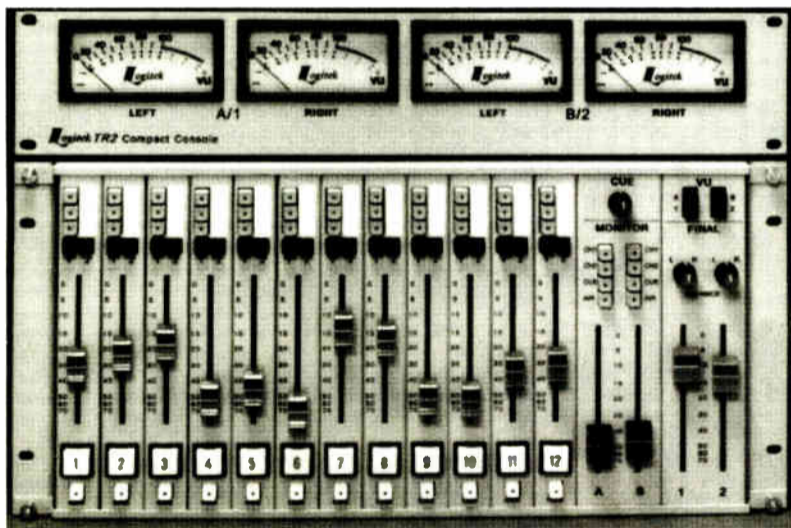

The Logitek TR2 Console

- A Full-size Console in a 19" Rack
- 12 Mixers with 36 Inputs
- 12 Mic Preamplifiers
- 4 Metered Outputs with DAs
- 2 Monitor Drivers plus Cue
- Machine Control & Tally Outputs
- Modular Construction

Call 1-800-231-5870 for your nearest dealer!

or write us at 3320 Bering Drive ■ Houston, TX 77057

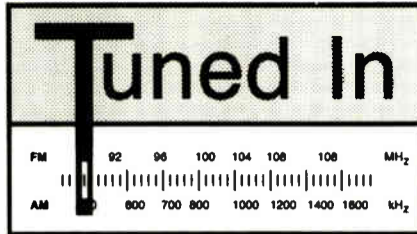

Business . . . RF Technologies Corp. has introduced its own line of broadcast RF products. Formerly, RFT designed broadcast equipment for other manufacturers.

Richardson Electronics, Ltd. has announced a distribution agreement with **BKC International Electronics**. The agreement allows Richardson to distribute BKC's line of semiconductors, which includes Germanium, Switching and Zener Diodes.

Bird Electronic Corp. appointed the Burlington, Mass.-based company, **Tritek, Inc.** as its New England representative. Trittek will represent Bird for sales to OEMs, industrial and calibration labs and the federal government.

People . . . AKG Acoustics has announced a restructuring program within its offices that resulted in promotions of several employees. David Roudebush was named corporate marketing manager; David Angress was named director of national sales; and Howard Mullinack is director of international sales.

JVC named Matthew Weiner to the new position of professional audio sales representative. Weiner formerly was employed as an applications engineer for Martin Audio.



JVC's Matthew Weiner.

The National Supervisory Network in Avon, Colo., named Muffy Montemayor director of marketing and national sales manager. Montemayor said she hopes uniting these positions will nurture more consistency in NSN's presentation to the industry.

The MIA can function as a rudimentary 4x2 mixer, summing inputs 1 and 3 to a left output and 2 and 4 to the right, providing phantom power and a high-quality headphone amp—essentially all the basics one needs for the kind of minimal microphone techniques common to many classical recording situations.

I have no complaints about the MIA 4x4+—only a couple of wishes: First, that Benchmark would come out with a mixer version of this preamp box, adding pan pots, a highpass filter and some metering. The company, I understand, is working on such a product.

ever was conceived as a field mixer for use in the Transylvanian countryside, but with such reliability and clean sonic characteristics, I tend to take it everywhere.

Finally, the power supply emits a low but audible hum. When using the unit in a control room, this problem can be easily remedied simply by locating the power supply box away from your listening area. Using the unit in the same room as a quiet chamber group would, on the other hand, be a bit of a problem. Benchmark is fixing this problem if they haven't done so already.

All told, the clean, transparent sound and the consistent reliability of the unit makes the MIA 4x4+ a pleasure to use and a very good value as well.

Transylvania countryside

Second, I wish the unit were designed a bit more for the road. At present, the 4x4+ seems to be designed for rack living, but is a bit delicate for use as a field mixer (a relatively mild-mannered Romanian border guard easily dinged the headphone pot in the course of an only slightly obnoxious inspection).

Of course, I doubt that the unit

"*Transylvanian Morning*," a disc recorded with Benchmark preamps and recorded and produced by Joel Gordon, will be released on New Albion Records this spring. For information on the MIA 4x4+, contact Mark Potterbaum at Benchmark Media Systems, 315-437-6300; FAX: 315-437-8119; or circle Reader Service 41.

SUBSCRIPTION/READER SERVICE FORM



March 27, 1991 Issue Use until June 27, 1991

FREE Subscription/Renewal Card

I would like to receive or continue receiving **Radio World** FREE each month. YES NO

Signature _____ Date _____

Please print and include all information:

Name _____ Title _____

Company/Station _____

Address _____

City _____ State _____ ZIP _____

Business Telephone () _____

Please circle only one entry for each category:

- I. Type of Firm**
- D. Combination AM/FM station
 - A. Commercial AM station
 - B. Commercial FM station
 - C. Educational FM station
 - E. Network/group owner
 - F. Recording studio
 - G. TV station/teleprod facility
 - H. Consultant/ind engineer
 - I. Mfg, distributor or dealer
 - J. Other

- II. Job Function**
- A. Ownership
 - B. General management
 - C. Engineering
 - D. Programming/production
 - E. News operations
 - F. Other (specify) _____

- III. Purchasing Authority**
- 1. Recommend
 - 2. Specify
 - 3. Approve

Reader Service

Please first fill out contact information at left. Then check each advertisement for corresponding number and circle below. NOTE: Circle no more than 15 numbers, otherwise card will not be processed.

- 001 023 045 067 089 111 133
- 002 024 046 068 090 112 134
- 003 025 047 069 091 113 135
- 004 026 048 070 092 114 136
- 005 027 049 071 093 115 137
- 006 028 050 072 094 116 138
- 007 029 051 073 095 117 139
- 008 030 052 074 096 118 140
- 009 031 053 075 097 119 141
- 010 032 054 076 098 120 142
- 011 033 055 077 099 121 143
- 012 034 056 078 100 122 144
- 013 035 057 079 101 123 145
- 014 036 058 080 102 124 146
- 015 037 059 081 103 125 147
- 016 038 060 082 104 126 148
- 017 039 061 083 105 127 149
- 018 040 062 084 106 128 150
- 019 041 063 085 107 129 151
- 020 042 064 086 108 130 152
- 021 043 065 087 109 131 153
- 022 044 066 088 110 132 154

BUYERS BRIEFS

Innovations in Monitors, Microphones, Turntables & Preamps

PLAINVIEW, N.Y. Stanton Magnetics Inc., has announced the 890AL professional turntable cartridge, adaptable for back-cueing, scratch mixing and slip-cueing in demanding sound environments.

The 890AL is manufactured with a suspension system that is highly responsive to extremes in groove modulation changes. Its design features a small, powerful magnet, plus a computer-balanced four-coil body that virtually eliminates crosstalk and hum.

The cantilever and suspension system is combined with an ultra-high polished diamond that allows the system to perform optimally at a tracking force of two to seven grams. The 890AL is supplied with an extra stylus.

For information, contact Jean Kapon at Stanton: 516-349-0235; FAX: 516-349-0344; or circle Reader Service 73.



ATLANTA Yamaha Corp. of America has developed the MS60S monitor speaker system, offering three inputs and a built-in power amplifier.

The MS60S is a compact two-way loudspeaker with an eight-inch low frequency speaker and a bullet-type high-frequency unit. It features Yamaha Active Servo Technology (YST), which, by using a negative output impedance amplifier, yields extended low frequency response and improved sound quality.

For information, contact Yamaha's



professional audio division at 714-522-9011; FAX: 714-527-0155; or circle Reader Service 48.

Comtech's 3.8 Meter has the Extra Performance Margin Needed for Crystal-Clear Audio Reception. Why Settle for Less?

Major network affiliates all over the country are specifying Comtech's 3.8 Meter Antenna. The reason is simple: No other antenna in its size category can deliver a gain of 42.9 db at 4 GHz.

This increased performance margin means outstanding audio reception on SCPC sub-carrier signals, and digital even in low EIRP areas.

Comtech's leadership in satellite antenna design is no accident. They pioneered the exclusive 3-piece "splice-strap" parabolic reflector with a superior sur-

face tolerance unequalled by mesh or other home-type antennas. The result is higher efficiency, optimum side-lobe performance and increased gain. This is the extra margin of performance that only a Comtech Antenna can provide. That's why literally hundreds of Comtech 3.8 Meter Antennas are operating today at radio stations throughout the U.S.

So why settle for marginal performance when you can have a performance margin today and in tomorrow's 2° spacing environment.

Allied Broadcast Equipment distributes Comtech Antenna systems to the radio industry nationwide. Call today for more information.

317-962-8596



3712 National Road West
P.O. Box 1487
Richmond, IN 47375

Comtech Antenna Corp.—Taking the lead in Satellite Antenna Systems

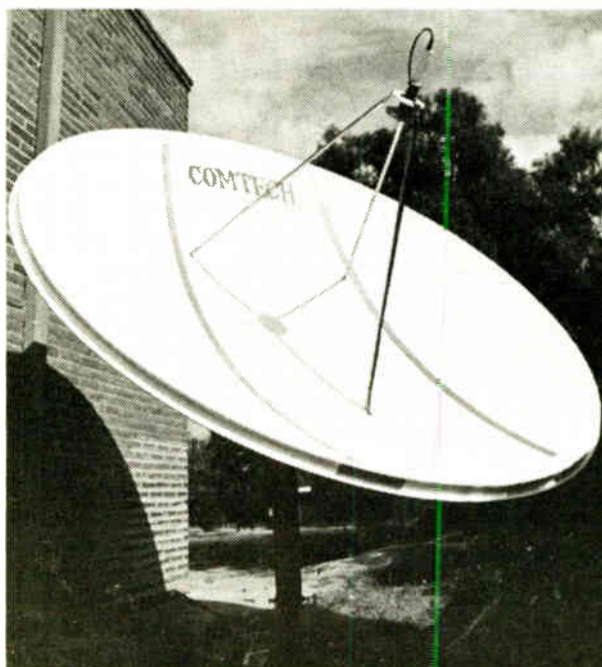

Radio Station KAIR/JOY, Inc.
Tucson, Arizona
3.8 Meter Antenna Installation



ANAHEIM, Calif. AKG Acoustics has introduced the C580E slimline gooseneck condenser microphone. The frequency response and pickup pattern have been tailored to provide consistent, high-quality sound with the speaker moving between one foot and four feet away from the mic and side to side across a 60 degree pick-up window.

For information, call David Ogden at AKG: 415-351-3500; FAX: 415-351-0500; or circle Reader Service 33.



MONTVALE, N.J. Sony has expanded its microphone range to include the new ECM-510 electret mic. The unit, designed especially for ENG applications, weighs only six ounces and provides optimum voice pick-up by incorporating an omnidirectional capsule for optimum sound quality.

For information, contact Sony's Marketing Manager Ron Remschel at 201-358-4196; FAX: 201-358-4907; or circle Reader Service 90.

Studer A623: Small Wonder

by James A. Kurowski,
Dir. Tech. Ops.,
Studer ReVox America

NASHVILLE, Tenn. Best known for Swiss precision and craftsmanship of analog and digital multitrack tape recorders, Studer ReVox has been quietly producing loudspeakers for nearly 20 years.

The A623 is the newest member of the family, drawing on the strengths of its larger brother, the self-powered, tri-amped A723. Both employ acoustic and electrical technology gained from years

of development and manufacture of loudspeakers, tape recorders, amplifiers and varied digital products.

The A623 is a two-way, bi-amped, self-powered monitor. It is intended for use in smaller rooms—editing suites, OB vans, near-field applications and continuity rooms.

No additional space

Since the two 100 W amplifiers and electronic crossover are self-contained, no additional rack space is needed for those items, nor need there be any concern over crosstalk or losses in the loud-

speaker cables. Although it is not large, the A623 is capable of 103 dB SPL at one meter and has a flat frequency response from 60 Hz to 20 kHz.

It is a well-known fact that because the different elements of a multi-way loudspeaker are mounted at different depths in the enclosure, the distance the sound travels from its point of origin to the surface of the speaker varies among the drivers. This results in the individual frequencies arriving at the listener's ears at different times—an effect known as dispersion.

Qualitatively, dispersion can manifest itself as level, frequency response and spatial aberrations. The Studer

The amplifiers themselves have numerous convenience and safety features. Connection is made with a standard three-pin XLR connector. The input is balanced and can accept either a balanced or unbalanced signal.

A stepped sensitivity control that can



Studer's new A623 monitor speaker is a smaller version of the popular A723.

be adjusted over an 8 dB range, as well as a vernier, are provided to match studio line level. Also present is a bass de-emphasis control to roll off the low end to compensate for less than optimum placement.

In the event of excessive level, soft clipping protects the drivers. For thermal overload, a self-restoring switch disconnects the speakers. For power supply or amplifier failure, a high-speed switch will open the lines. Test points are provided for calibration.

We think the Studer A623 offers the user superb reproduction in a small package. Furthermore, it is a product designed and built with typical Studer quality, and backed by a worldwide network of agents.

For information on the Studer ReVox A623 monitor, contact the company at 615-254-5651; FAX: 615-256-7619; or circle Reader Service 127.

TECHNOLOGY UPDATE

A623 overcomes this problem by using a high-order, all-pass filter delay circuit (whose delay is constant beyond the transmission range) to delay the HF signal to be in exact acoustical phase with the lower frequencies.

Single most important

But while sound is the single most important aspect of a loudspeaker, nuts and bolts are important, too. The self-contained A623 power supply employs interference suppression to IEC-65, as well as a line voltage selector.

■ ■ ■

**TAKE
THE
LEAD**
WITH HARRIS ALLIED

So what are you waiting for?



Pick up the phone and call Chuck or Jim.

These guys really know the business and are ready to help you. You're guaranteed the most knowledgeable broadcast assistance in the industry and you'll get the fairest price for your used equipment.

Our Used Equipment Exchange can stretch your equipment budget — it's just one of the ways that Harris Allied gives you more. We've expanded to put more people and more resources to work for you. That's what we mean by taking the lead.

**HARRIS
ALLIED**
EQUIPMENT EXCHANGE

SEE US
AT NAB
BOOTH #1100

FAX 317-966-6321

317-962-1471

BUY—SELL—TRADE

With expanded staff and services... our lead keeps on growing!

Rebuilt Power Tubes **Econco**

Approximately
One Half The Cost Of New
3,000 Hour Unconditional Guarantee
Some Of The Tubes We Rebuild

3CX2500F3	3CX3000A1
3CX3000F7	4CX5000A
4CX10000D	4CX15000A

5762 / 7C24

Call For Our Price List



Econco

1318 Commerce Avenue
Woodland, CA 95695 USA
Telephone: 916-662-7553
Fax: 916-666-7760 Telex: 176756

MARKETPLACE

Radio World's Marketplace, a compendium of new and recently introduced radio broadcast products, appears monthly in Buyers Guide.



Fault location

Telecommunications Techniques Corp. (TTC) has a fault location option for its portable T-BERD 209A and 211 T-Carrier analyzers.

The option identifies cable problems like bridge taps, opens and shorts by indicating the fault type and distance on a display. Both automated and user selectable configuration and fault interpretation are offered.

For information, contact **Susan Hale at Telecommunications Techniques: 301-353-1550; FAX: 301-353-0734; or circle Reader Service 110.**

MIL-STD automatic link

Harris RF Communications Group introduced the RF-5121ALE MIL-STD automatic link for the RF-5000 Tactical HF Communications systems.

The RF-5121ALE simplifies operation of the HF radio system by eliminating the need for manual selection and tuning of frequencies.

For information, contact **Debra Maroney at Harris Corporation RF Communications Group: 716-244-5830; or circle Reader Service 144.**



Stereo delay-synchronizer

The Bel BDE-7000S from Michael Stevens & Partners provides a programmed stereo delay for synchronizing audio with video and rectifying time differences generated as a result of audio traveling different routes.

The unit provides 660 msec delay in stereo which can expand to 1.32 seconds. Eight user-defined programs can be stored for future use and a lock button can prevent unauthorized use.

For information, contact **Michael Stevens & Partners Ltd.: +44-081-460-7729; FAX: +44-081-460-0499; or circle Reader Service 151.**



RF tetrode

The TH558 from Thomson Tubes Electroniques features high gain, Pyrobloc grids for high stability and an operating frequency of up to 50 MHz.

The coaxial metal-ceramic tetrode has an output power of more than 500 kW in SW and more than 600 kW in MW/LW. Recently, the VOA chose the TH558 to equip its Morocco and Thailand posts.

For information, contact **Helene Maggiar at Thomson: +33-1-49-09-28-28; FAX: +33-1-46-04-52-09; or circle Reader Service 43.**

Audio level interface

The ES-244 4X4 audio level interface from ESE is a bidirectional IHF to PRO level/impedance interface for connecting semi-pro equipment with professional studio gear.

The ES-244 is a bidirectional unit with four impedant amplifiers for stereo input and output interfacing, RF shielding and output level adjustments.

For information, contact **Robert Mayers at ESE: 213-322-2136; or circle Reader Service 92.**



Clarification

Marketing Manager Sandy Cohen should have been listed as the contact for Raltron Electronics' oven-controlled crystal oscillator, highlighted in RW's Feb. 20 Marketplace. She can be reached at 305-593-6033; or by FAX: 305-594-3973.

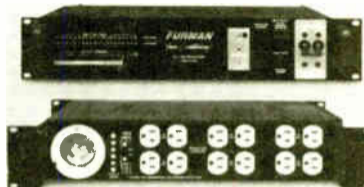

Line voltage regulator

The AR-PRO line voltage regulator from Furman Sound supplies regulated AC power at each of 12 rear panel and two front panel outlets. A 120 V AC output can be supplied from any input from 88 to 264 V.

The regulator can handle 30 amps through a twist lock connector, and 21-LED bargraph meters for input voltage and current are included.

For information, contact **Joe Desmond at Furman: 415-927-1225; FAX: 415-927-4548; or circle Reader Service 4.**

Join the LPB Signature Console Crowd



Over 1000 licensed U.S. radio stations
Hundreds of international stations
Hundreds of college stations

Discover *why* the LPB Signature may be radio's most popular console:

- an unparalleled record of reliability and longevity
- clearly labelled screw-terminal connections for painless installation
- modular electronics for easy maintenance
- superior RFI immunity

Signature's standard features set new standards of flexibility:

- 3 inputs per channel
- 2 identical output buses
- remote starts
- tape outputs for each bus
- internal monitor, headphone and cue speaker amps
- mono/stereo input switches (on stereo consoles)

Signature options add even more versatility:

- mix-minus plug-in module (mounting kit for mono consoles)
- mono mixdown plug-in module for stereo consoles

Signature is available in a size to fit your station and your budget:

- stereo 6, 8, 10 or 12 channel
- mono 6, 8 or 10 channel

It's easy to join the LPB Signature Console Crowd—just call your broadcast distributor. For full information and specifications, contact LPB.

LPB[®]

28 Bacton Hill Road • Frazer, PA, 19355 USA • Tel: 215-644-1123 • Fax: 215-644-8651

DIGITAL ANTENNA MONITORS

In Stock — Available for Immediate Delivery

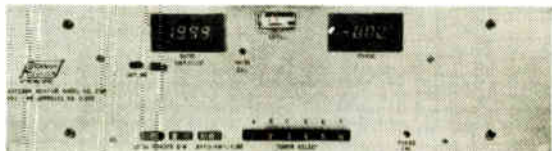

Price \$2400.00 2 Towers Will operate with any remote control equipment.



Price \$1780.00 2 Towers For AM directionals with studio located at transmitter site.

These monitors are state-of-the-art instruments of unequalled accuracy. (.5% or better on ratio and .5° or better on phase) and stability. With typical modulation the true ratio readout of these monitors is a factor of 10 more stable than instruments that measure normalized amplitude, and their phase readouts are rock solid. Phase sign is automatic, no extra operation. In addition to the analog DC outputs for remote control the Model CMR has a multiplexed BCD digital output which can be used to drive the Remote Indicator Model CMR-1. RF inputs have dual protection. Gas discharge tubes across the sample line terminations plus relay protection.

GORMAN REDLICH MFG. CO

FAX 614-592-3898 • 257 W. Union St. • Athens OH 45701 • 614-593-3150

Circle 63 On Reader Service Card

See Us at NAB Booth 1049

Circle 38 On Reader Service Card

CONSULTANTS

EVANS ASSOCIATES
Consulting Communications Engineers

FCC Applications, Design & Field Engineering
Broadcast Engineering Software

216 N. Green Bay Rd.
Thiensville, WI 53092

(414) 242-6000
Member AFCCE

W. LEE SIMMONS & ASSOC., INC.

BROADCAST TELECOMMUNICATIONS CONSULTANTS

1036 William Hilton Pkwy
Ste 200F
Hilton Head Is., SC 29928

(803) 785-4445

Moffet,
Larson &
Johnson, Inc.

Consulting Telecommunications Engineers

Two Skyline Place
5203 Leesburg Pike # 800
Falls Church VA 22041

703-824-5660
800-523-3117

Member AFCCE

Consulting Communications Engineers

- FCC Data Bases
- FCC Applications and Field Engineering
- Frequency Searches and Coordination
- AM-FM-CATV-ITFS-LPTV

OWL ENGINEERING, INC.

1306 W. County Road. F.
St. Paul, MN 55112
(612)631-1338 "Member AFCCE"

SOFTWARE
FM CHANNEL SEARCH

FM Database pool
MSDOS
EGA Graphics-Color
Broadcast Technical Consulting

Doug Vernier
Broadcast Consultant
1600 Picturesque Drive
Cedar Falls, IA 50613
319-266-8402

MULLANEY ENGINEERING, INC.
Consulting Communications Engineers

- Design & Optimization of AM Directional Arrays
- Analysis for New Allocation, Site Relocation, and Upgrades
- AM FM TV LPTV Wireless Cable (MDS/MMDS/ITFS/OFS)
- Environmental Radiation Analysis
- Field Work • Expert Testimony

9049 Shady Grove Court
Gaithersburg, MD 20877
(301) 921-0115 Fax:(301) 590-9757
Member AFCCE

HEAD RELAPPING/REPLACEMENT
All tape and film formats
30 years experience

iem

350 N. Eric Drive
Palatine, IL 60067
708-358-4622

RADIO SYSTEMS ENGINEERING

FCC Applications • Design
• Installation • Field Service
Experienced & Affordable

4289 Roanridge
Las Vegas, Nevada 89120

24 Hr: **(702) 454-2085**
FAX: **702-458-2787**

Huntsville Antenna Engineering

There is hope for AM radio!
AM station unipole antennas with circular polarization & beam tilt.
Broadband your present AM tower Series R shunt fed.

205-353-9232 205-353-6747

Kenneth Casey
Consulting Radio Engineer

Teletech, Inc.

BROADCAST CONSULTANTS AND ENGINEERS

- FCC Applications & Field Engineering
- Frequency Searches & Coordination
- Tower Erection & Maintenance
- Facility Design & Construction

CONTACT:
Kenneth W. Hoehn
23400 Michigan Ave
Dearborn, MI 48124
(313) 562-6873

We Now Accept

Visa & MasterCard



Lahm, Suffa & Cavell, Inc.
Consulting Engineers

- Interference Resolution
- Coverage Improvement
- RF Hazard Studies
- Custom Software
- AM Antenna Improvement
- Former Chief Engineers
- Suburban Washington Based

3975 University Dr., Suite #450
Fairfax, Virginia 22030
Phone 703-591-0110
Fax 703-591-0115

SERVICES

Communications Data Services, Inc.

- Real World Propagation™ Studies
- On-Line Services
- 3 Second Terrain Data on CD-ROM
- FCC and FAA Data Files for PC
- FCC's AM, FM & TV Data Files for PC
- PC Programs

Richard L. & Richard P. Biby, Principals

Communications Data Services, Inc.
6105-E Arlington Blvd. • Falls Church, VA 22044
(703) 534-0034 • (800) 441-0034

MIRKWOOD ENGINEERING

Rural & Remote Site
Field Engineering

50 Park Ave.
Claremont, NH 03743

603/542-6784

PARAMOUNT COMMUNICATION SYSTEMS

INSTALLATION AND SERVICE OF BROADCAST ANTENNA SYSTEMS/TOWER MAINTENANCE & ERECTION

WESTMONT, NJ (609) 869-0222

TOWER SERVICES
Light Replacement
Routine Maintenance
Ground Systems
Painting
20 years Experience

John Nix

PO Box 13244 Salem, OR 97309
503-581-4056
1-800-321-4056

WIDEST & FINEST CHOICE OF PRODUCTION MUSIC & SFX

PROMUSIC

Call For Our Free Demo & Information On
BROADCAST Plus
Annual Rates.

1-800-322-7879

Don't gamble with your advertising dollars.

Advertise in Radio World and reach 18,000+ subscribers. Call 1-800-336-3045 today!

The Skimmer's Edge

by Ken Blake, CE
KJOY/KJAX

STOCKTON, Calif. A "music skimmer" is sometimes used by radio programmers to assist in logging the music played by a competitor.

Simply described, the skimmer is a timer set to start a cassette recorder to tape approximately 10 seconds of another station's audio at intervals of two and a half to three minutes. The result is a series of random 10-second bits of program to help identify the songs played.

TECHNOLOGY UPDATE

It occurred to me that it would be helpful to not only identify a station's playlist, but also to keep a tally of its client commercial list—without spending hours of unproductive time monitoring a radio.

The resulting product I developed after three years of research and testing—the model CIA-1 commercial skimmer—is being manufactured and marketed by Russco Electronics out of Fresno, Calif.

The skimmer is linked between a cassette recorder and a radio, yielding a recorded tape that contains portions of commercials, contest promos, DJ witticisms(?), PSAs, etc. The purpose is to provide enough of the talk portions to identify the sponsors and anything new the competitor has up its sleeve.

Depending on DJ ramblings and other incidental talk, one side of a 90-minute cassette could represent four to five hours



Russco's CIA-1 can give an edge over competition.

of a competitor's schedule. With auto reverse, the tape could contain the salient spoken items of a nine- to 10-hour period of unattended monitoring.

Our sales manager has enjoyed the use of the prototype. With the CIA-1, he has monitored a tape for only 40 minutes and logged commercials recorded during a four hour period. It is a relatively quick and easy method of garnering leads. The wise sales team profits from that knowledge.

For information on the CIA-1 commercial skimmer, contact Russell Friend, CEO of Russco, at 209-291-5591; FAX: 209-291-9601; or circle Reader Service 142.

ADVERTISER INDEX

This listing is provided solely for the convenience of our readers. Radio World assumes no liability for inaccuracy.

Page No.	Advertiser	Reader Service No.	Page No.	Advertiser	Reader Service No.	Page No.	Advertiser	Reader Service No.
46	A/V Technology Int'l	100	25	Cutting Edge	94	20	Kintronic Labs	11
47	Acoustical Solutions	27	26	Datavorld	56	54	Lindos Electronics	26
45	Acutron Electroacustica, LDA	8	58	Datavorld	154	74	Logitek	105
15	AEQ, SA	120	60	Davityn	135	77	LPB	38
7	Altronic Research	107	16	dlax	137	47	Marantz Professional Audio	7
7	ATI	16	23	DIC Digital Supply	72	12	Microwave Filter	111
56	Audio Animation	54	37	Dielectric Communications	12	36	Modulation Sciences	49
50	Audio Bdct Group	1	52	Dolby	132	48	Motorola	117
8	Audio Precision	36	57	du Treil, Lundin & Rackley	5	31	Murphy Studio Furniture	29
60	Audiomedia Associates	65	76	Econco	124	35	Myat	32
32	Audiopak	46	37	Electro Impulse Lab	131	8	NAB	—
13	Auditronics	76	30	Elenos S.R.I.	77	59	Nautel	25
47	AVCOM of Virginia	109	10	Elkason Weather Radar	50	34	Northern Transdata	101
18	Barco-EMT	22	42	Fidelipac	6	38	Orban	146
65	Barco-EMT	112	68	Fidelipac	91	27	Otari Corp	116
6	Belar	104	21	Gentner	21,85	63	Pacific Recorders	126
47	Benchmark Media	139	60	Gerstman Software	153	40-41	Panasonic	42
55	Bext	2	45	Gorman Redlich	24	46	QEI	14
1	Broadcast Electronics	10	77	Gorman Redlich	63	45	Radio Systems	84
60	Broadcast Devices	86	60	Telos	93	49	Radio Systems	45
9	BSW	55	61	Hall Electronics	128	57	Radio Systems	88
4	Burk Technology	66	22	Harris-Allied Bdct Equipment	18,64	49	Richardson Electronics	119
58	Burlington Audio Tapes	98	34	Harris-Allied Bdct Equipment	9,108	14	Rohde & Schwarz	67
62	Cablewave Systems	31	53	Harris-Allied Bdct Equipment	52,138	39	Scala Antenna	140
60	Cartwright Comm.	97	66	Harris-Allied RF Equipment	44	47	Sentry Systems	96
24	CCA Electronics	102	67	Harris-Allied Bdct Equipment	—	28	Shure Brothers	145
57	Central Tower	87	76	Harris-Allied Bdct Equipment	—	64	Shure Brothers	68
48	Circuit Development	79	58	Hnat-Hindes	70	57	Sierra Automated Systems	89
47	Coaxial Dynamics	74	70	Holaday Industries	81	10	Sine Systems	37
20	Comark	53	72	Inovonics	121	17	Studer Revox	149
43	Computer Concepts Corp.	148	44	Intraplex	47	19	Tech	19,35
43	Connex	95	61	ITC	51	71	Tascam	103
75	Comtech Systems	75	22	J Squared Tech. Service	82	73	Tascam	30
3	Continental Electronics	125	50	J.N.S.	34	11	TFT	61
44	Cool-Amp Conducto-Lube	39	31	Jampro	113	60	The Management	115
33	Corporate Computer Systems	134	23	Kay Industries	58	60	Titus Technology Lab	123
70	CRL	20				39	TTC	17
3	Crouse-Kimzey	71				26	Valley International	69
51	CTE International	122				2	Wheatstone	60
						79	Wheatstone	57
						80	Wheatstone	13
						69	Whirlwind Inc.	23

Advertising Sales Representatives:

Eastern U.S., Art Constantine: 800-336-3045 Fax: 703-998-2966
Western U.S., Jack Ducart: 916-962-2240 Fax: 916-962-2194

Wheatstone's Bright Idea!

Just When You Thought All Furniture Was Alike

We've wedded the latest precision NC metal components to high grade solid wood trimmed laminated panels and counter surfaces. Added to this design breakthrough is the implementation of true 1-1/2" thick counters and vertical structural panels that put an end to warping, racking and delaminating problems. What's more, our wood trim comes flush to the counter surfaces to eliminate exposed laminate edges (so tempting to idle hands). In fact, the counters are separately trimmed to eliminate unsightly and short-lived formica seams.

Naturally, with all of our experience at building and interfacing consoles, we've worked out the details: like convenient hinged down punchblock panels for easy installation and maintenance, really generous cable pathways between enclosures, and equipment turrets with both back and side door access. Our rackmount base cabinets have mount-

ing rails on both sides, so equipment can be mounted any way desired or even switched at a later date. Concealment doors can be placed on cabinets intended for future electronic installation. Continuous length floor risers assure even cabinet-to-cabinet alignment. We've even included heavy duty ground bonding terminals.

This furniture family is complete, with both stand-up and sit-down versions, angled equipment turrets in two heights (with or without risers), concealed, fully isolated turntable cabinets, auxiliary wallmount equipment cabinets, wall and cabinet mount cart and CD storage, utility and file cabinet pull-out drawers, reel-to-reel tape deck mounts, interview counters—practically anything you can imagine. With this much variety, Wheatstone's rock solid construction and major market look, there really is no comparison.

So contact Wheatstone, the people with the reputation and expertise you can count on.



 Wheatstone[®] Corporation

Furniture

6720 V.I.P. Parkway, Syracuse, NY 13211 (tel 315-455-7740 / fax 315-454-8104)

World Radio History

Circle 57 On Reader Service Card
See Us at NAB Booth 1556

The Closer You Get...

WE MEAN IT—we really DO provide the quality, performance, technical support, and innovation we promise!

Our model A-500 is a thoroughly engineered on-air console: it delivers the level of performance your clients now expect, and DAB demands. All components are selected for long life—gold bus connectors, gold I/O connectors, all gold contact switches, gas-filled relays, triple burned-in integrated circuits, solid state ON/OFF lamps, and precision laminated Lexan control surfaces for a lasting, wearproof finish. And we back that up with a 3-year parts and labor warranty, complete with

factory support from a technically competent and responsive staff.

We've also handled your special requirements as well with a super family of accessories, including a choice of three different telephone modules, an intercom module, an off-line mixer module for your remote feeds, talent control stations, accessory panels, failsafe power supplies, and auto cart and CD sequencing options.

So take a close look: we've got the quality, we've got the innovations, and you've got our commitment to top-notch support.



The Better We Look!

A-500