

CD Sound Is Ready For Phone Delivery

by Frank Beacham

CAMBRIDGE, Mass. Bellcore Labs can now deliver CD-quality "personalized" radio and television services to homes through existing twisted-pair telephone wire.

The new service—another potential competitor to radio broadcasters—could be operating on an experimental basis in parts of the country as early as this year and available to American consumers on a widespread basis within two to three years.

"In recent years we've realized that the information carrying capacity of twisted-pair wires is much greater than we imagined. It is highly feasible to send rates up to 1.5 megabits or more over existing telephone wire that goes to houses," said Jules A. Bellisio, executive director of Video Systems and Signal Processing Research at Bellcore Labs in Red Bank, N.J.

"One of the services that could be offered is dial-up digital audio—audio on demand," he added.

A customer could use the telephone keypad to select a particular music re-

lease for casual listening or recording on a home taping device. The sound quality would be equivalent to that on compact discs.

Other potential applications include dial-up VHS-quality movies, remote-controlled CD-I software and high speed access to huge databases, such as libraries and museums. One unique application, Bellisio suggested, is a "virtual computer." A customer could use an at-home video display and keyboard and rent the computer configuration of choice over the phone line.

Digital with a twist

Bellisio said Bellcore has proposed two new "twisted pair" digital services to its clients, the regional phone companies. One is called ADSL (Asymmetrical Digital Subscriber Line) for homes and HDSL (High Speed Digital Subscriber Line) for businesses.

ADSL would offer 1.544 megabits per second (Mbps) transmission in one direction plus a low speed control circuit that would allow the customer to communicate via terminal to the central office.



The first annual Radio Creative Fund Awards dinner was held in New York recently. On-air talent Tom Joyner and Bert Berdis of the Bert & Barz agency look on as a robot accepts a Mercury bronze award. Winners walked away with a total \$200,000 for excellence in radio creative.

See this month's Running Radio, pp. 27-38

POTS (plain old telephone service) would also operate simultaneously with other services on an ADSL line.

HDSL offers 1.544 Mbps in both directions and could prove a useful new system for broadcast remotes.

The new services could be implemented immediately in about 75 percent of the United States, Bellisio said. The only areas that cannot receive the services are those in which load coils are currently used in the telephone circuits. (Load coils act as a low pass filter and are used to neutralize capacitance.)

Potential is there

Whether ADSL will be used to deliver personalized radio services to homes is up to the individual phone companies and their subcontractors, Bellisio said.

"Business decisions will have to be made to determine the actual services offered to customers. Obviously there are many potential applications. We are a laboratory and are simply giving the regional phone companies technology options.

Although "thin wire television," as the new technology is nicknamed, is a major technological breakthrough for the phone companies, it is not seen as a threat to the ideal distribution medium of fiber optics, Bellisio said. In fact, he noted, ADSL could serve as a logical evolutionary "bridge" between today's home phone systems and fiber.

"As the system grows, fiber will get closer and closer to the customer. It then becomes more and more economical to complete the fiber network . . . that's the evolutionary bridge," Bellisio said.

ADSL is far more simple and economical
continued on page 6 ▶

NEWSWATCH

Harsh Words for FCC

WASHINGTON The FCC's recent decision to increase radio station ownership limits continues to receive intense criticism from Congress.

The FCC decision increased ownership to 30 AMs and 30 FMs per market, much to the chagrin of several members of Congress and some elements within the industry. These include minority owners who fear the strong broadcast companies would swallow up stations and reduce or even eliminate programming diversity.

The latest barrage comes from House Energy and Commerce Committee Chairman John Dingell (D-Mich.). He accused the Commission of altering the draft report and order, released in April, because it did not contain the same facts as were in the original decision text released following the March decision. He said the latest report and order was "extensively revised to conform to the decision reached by the Commission on March 12."

Dingell also said that the requested material used to make the FCC ownership rule change decision, which was provided to him by Commission staff, did not support the decision.

"It is the apparent lack of analytical support for the ideas and opinions reflected in most of the material you

continued on page 2 ▶

THE FUTURE BELONGS TO THE EFFICIENT

HARRIS ALLIED

DX-10 Solid State AM

Harris Allied has today's most efficient & reliable AM & FM transmitters from 500W to 300kW

Call 800-622-0022

NEWSWATCH

► continued from page 1

sent that compels me to write this letter," Dingell said. "Speculative opinions offered without substantive justification or reference to the record are a form of policy gossip, which is unworthy of the FCC or any other federal agency engaged in a rulemaking."

Dingell said the FCC's decision was based on a preoccupation "with the profitability of the radio business and (it) cares little

about the benefits of diversity to the public."

In response, FCC Chairman Al Sikes said the decision was justified.

John David Appointed NAB Senior VP/Radio

WASHINGTON NAB VP of Broadcaster/Congressional Relations John David, has been appointed to succeed Lynn Christian as the

association's senior VP/Radio. David held his previous post since 1989, and prior to joining the association, David was owner and executive VP of J.R. Broadcasting Co.

Duggan Indicates Satellite DAB Support

MONTREUX, Switzerland Another FCC commissioner has indicated willingness to support a national satellite digital

audio broadcasting (DAB) system.

At the NAB/Montreux International Radio Symposium here in June, Commissioner Ervin S. Duggan, called DAB a technological "imperative."

Creating a terrestrial digital radio system is "critical," Duggan said. He pointed out, however, that some constraints on DAB in the U.S. prevent its development along the same lines as in other nations.

Duggan offered a "dual solution" to DAB. Such a solution, he said, would offer DAB benefits to broadcasters while keeping open "possibilities for new services to develop: satellite services for example, with

national or regional reach."

Duggan is not the first FCC commissioner to show support for satellite DAB service. At the NAB's Radio '91 convention in San Francisco, Commissioner Sherrie Marshall indicated that satellite delivery could not be excluded from any consideration of DAB.

BE President Named To SBEA Board

ANNANDALE, Va. Broadcast Electronics President John Nevin has been appointed to the Small Business Exporters Association Board of Directors (SBEA).

Nevin also serves on the board of directors for Plexys Corp. and Trescomp Inc.

The SBEA's philosophy for U.S. business includes a major emphasis on international markets. "It is our true belief that if many U.S. manufacturers are not international by the year 2000, they probably will no longer exist," Nevin said. "We

continued on next page ►

Something Very Good Just Got BETTER!



A-32EX On-Air Console

Finally engineers confined to tight budgets can choose a console that won't compromise station reliability or signal integrity. After all, the A-32 is a Wheatstone console. It borrows from the componentry and design of our larger A-500 consoles, currently installed in major markets all over the country, from frontline independents to national networks.

Our new A-32EX is even better, with ample expansion room for additional inputs and a powerful family of accessory modules, including our new MP-32 talkshow module (that neatly interfaces multiple hybrids, tape recorders, announcer mics and studio-to-caller feeds), our ICM-32 six station intercom module (letting you communicate with other console locations and announce studios), and our SC-20 studio module (to provide comprehensive studio monitor, automatic muting, and talkback functions), plus multiple line selector and machine control modules, and a complete family of studio turret components.

The A-32EX console features modular construction, a fully regulated rackmount power supply, logic follow, full machine control and of course, an all-gold contact interface system. It has two mic channels and fourteen stereo line modules, each with A/B source select and Program/Audition bus assign, plus Cue switches on the line modules. Standard features include Program and Audition VU meters, digital timer, and a monitor module for control room and headphone functions. The console is also available in a smaller version (the A-20) with two mic channels and eight stereo line input modules.

The A-32EX is a perfect choice for stations planning an upgrade in signal quality and control room image. It's also a natural choice for the newsroom. So profit from Wheatstone's experience and reputation—call us today for immediate action!

 Wheatstone Corporation

6720 V.I.P. Parkway, Syracuse, NY, 13211 (TEL 315-455-7740 / FAX 315-454-8104)

Circle (118) On Reader Service Card

World Radio History

Index

FEATURES

Tips for a Successful Contracting Career by Barry Mishkind 8

Prepare Your Hard Drive For Digital Audio Editing by Bruce & Jenny Bartlett 8

WWIS Uses Own Brand Of "Call Forwarding" by Dee McVicker 10

Problems and Answers to Digital Storage Needs by Mel Lambert 12

Workbench 13

TRANSMISSION SPECIAL

Is Re-radiation Affecting Your Antenna? by W.C. "Cris" Alexander 15

Preventive Transmission Line Maintenance by Tom Vernon 16

A TDR Can Help Identify Trouble In Line by John Bisset 20

The Future of STLs in Broadcasting by Paul Rebmann 17

The Advantages of Switching To an FM Combiner System by Ernest H. Mayberry 18

Field Experience In Solid State Design by Russ Erickson 22

RUNNING RADIO

"Bear" Finds Niche In Chicago Market by Bruce Ingram 27

What the FCC's 30/30 Rules Can Mean for You by Phil Simon 27

Fight Tougher for AM as FM Technology Improves by Charles Taylor 28

Quality Control Equals Superior Sound by Jeff Loughridge 32

Consider All the Angles When Building a Studio by Edwin Bukont 34

Get the Most from Network Affiliation by Karl Baehr and Harry Nelson 36

► continued from previous page
need to intensify our efforts to produce products that are globally competitive."

ID Logic Goes Shortwave

CHICAGO ID Logic, the internal computer-driven technology that allows format selection of broadcast stations, will soon be added to shortwave radios.

ID Logic developer PRS Corp., the BBC, and VOA have agreed to cooperate on adapting ID Logic for shortwave use (ID Logic SW).

"The new application of ID Logic technology will enable shortwave radio users to find the desired programming at the touch of one button and to search by desired languages," PRS Corp. President Pierre Schwob said.

According to PRS, BBC and VOA engineers will help develop common data protocol, and will provide transmission program and language schedule information.

FCC Meeting Tapes Available

WASHINGTON Not everyone can attend the FCC's monthly open meetings, but tape copies are now available.

Audio cassettes, VHS, and U-Matic videotapes are available through Telespan International in Washington, D.C. VHS videotape duplication plus tape costs are \$23. A 90-minute audio cassette duplication plus tape is \$15. Same day or next day delivery is available for an additional fee.

Customers should be prepared to provide the date and agenda item number unless they want the contractor to search for it for an additional charge of \$18 per hour. Agendas are available from the FCC one week prior to the meeting.

Tape copies can be delivered by mail or can be picked up at the Telespan offices. Customers can also send their blank tapes to be recorded. Copies will be available three days after the meeting.

For more information, write Telespan International, Inc., 1111 14th St. NW, Suite

720, Washington, D.C. 20005, or call 202-682-1226. For more information about agendas, call the FCC at 202-632-5050.

Lack of Tower Lights Results In Fine

MILLEDGEVILLE, Ga. The FCC has fined WSKS-FM \$8,000 for violations of the tower lighting regulations.

The FCC said it first inspected the station's tower in August 1991 and found that none of the lights were on and the Federal Aviation Administration had not been notified as required by law. The station owner, Alexander Mitchell Communications Corp., was fined for "willful and repeated violations of the Commission rules."

The FCC warns broadcasters that they are responsible for ensuring compliance with FCC tower lighting rules even if the station does not own the tower.

Pirate Station Owner Fined

CHAMBERSBURG, Pa. A "pirate" radio station operator has received a steep fine of \$17,500 from the FCC.

Andrew R. Yoder, of Chambersburg, was fined for "willful and repeated operation" of an unlicensed broadcast station.

The FCC said that Yoder operated his illegal station, called "Radio USA," on 7415 and 7416 kHz in 1990-91 from various locations, including Pennsylvania, Michigan, Ohio, New York, Tennessee, Virginia and West Virginia.

The fine also took into account Yoder's refusal in February to allow an FCC official to inspect his parents' home, to which the pirated signal had been traced.

Westinghouse Developing Faster Transistors

PITTSBURGH, Pa. Westinghouse Electric Corp. is planning to develop silicon technology for transistors that could boost the speed of the circuitry. Such high-speed transistors have applications including radar, cellular phones and digital radio, the company said.

Westinghouse is developing the silicon-on-insulator technology, called MICROX™, under contract with the U.S. Navy Research Laboratory. Experimental MICROX microelectronic circuits already have achieved high operating speeds—up to 30 GHz, with higher speeds anticipated.

"We believe these to be the highest frequencies ever reported for linear MOS (metal-oxide semiconductor) silicon transistors," said Michael C. Driver, manager of microelectronics at the Westinghouse Science & Technology Center.

The U.S. Navy contract for \$625,000 extends through the end of 1993. It calls for the further development of MICROX for applications in which microwave radio and digital functions are combined in the same chip.

Public Broadcasting Gets Involved In DAB

WASHINGTON The Corporation for Public Broadcasting (CPB) is preparing to select a proposal that will result in a contract to develop digital audio broadcasting (DAB) strategies for public broadcasting.

In April, CPB's Office of Policy Development and Planning issued a Request for Proposals (RFP) to 71 separate universities, broadcasters, equipment manufacturers and consultants. Proposals were due by May 29, and the CPB set a target date of July 17 to select an offer that will lead to contract negotiation.

A list provided with the RFP indicates that proponents of the American

Digital Radio and Project Acorn DAB schemes were contacted to submit proposals, as was Satellite CD Radio. Neither Strother/LinCom nor Eureka 147 proponents appeared on the list, however.

According to the corporation's Senior Policy Analyst Charles Wilk, the CPB has set aside \$350,000 for the project. A timetable of 15 months has been set for completion of the project.

The RFP is divided into nine tasks, including creating scenarios for DAB's evolution; forecasting potential new or improved programming and non-aural services; assessing benefits to public broadcasters and user demand for services; identifying transmission, programming and marketing requirements for DAB service; and determining how both aural and non-aural services will be received by consumers.

The RFP tasks also include a cost-benefit analysis of CPB's involvement in the technology, and the design of experiments to test new services.

Wilk acknowledged that the RFP was so comprehensive that the CPB expects the winning bidder to act as a prime contractor, subcontracting elements of the project to other companies.

"We're looking at what's possible and practical (in DAB)," said Wilk. "We're reaching out and trying to determine what the public is willing to pay for."

"Some people have said that this plan is too ambitious, and too early," Wilk continued. "But we have the opportunity to shape the kind of services that will be available in the future. Now's the time to be daring."

BROADCAST EQUIPMENT AND HUMAN ENGINEERED STUDIO SYSTEMS

PRE-WIRES & TURNKEY NOBODY CAN MATCH OUR 30-YEAR REPUTATION FOR EXCELLENT SERVICE

Studio Systems

for AM • FM • TV audio

- Delivered on time
- Within budget
- Outstanding workmanship
- Stunning performance
- Pre-wires, turn-key

Let's get our heads together!

Call 1-800-999-9281.

AUDIO BROADCAST GROUP
2342 S. Division
Grand Rapids, MI 49507
FAX 616-452-1652

OVER 100 EQUIPMENT LINES SERVING THE BROADCAST INDUSTRY FOR OVER 30 YEARS

OVER 180 SYSTEMS DELIVERED & INSTALLED YOU'LL LIKE THE WAY WE DO BUSINESS

Speak Easy

with the **Comrex Talk Console™**

Radio just took a big step forward with this Talk Radio Package. Easy to set up and easy to use anywhere, it includes everything needed to put callers on the air.

It conferences one or two phone lines with two microphone channels for host and guest. The second mic channel will also accept inputs like CDs or tape decks.

"CUE" lets you talk with the caller off air.
"HOLD" puts callers on hold and feeds program back to them. Integral mix-minus circuitry insures that callers won't hear their own echo when on air.

The Comrex Talk Console for:

- Syndicated Talk Programs
- Radio Features Production
- Remote Talk Show Broadcasts
- Newsroom Interviews

A sophisticated solution in a simple package.

COMREX

Comrex Corporation
65 Nonset Path, Acton, MA 01720
800-237-1776 In MA 508-263-1800
Fax 508-635-0401

Comrex (UK) Ltd.
75 The Grove, Ealing
London W5 5LL, UK
081-579-9143 Fax 081-840-0018

Circle (50) On Reader Service Card

Circle (147) On Reader Service Card

Who's running the ship?

Unattended operation is one way to keep your station profitable, but you still have to mind the store.

The acclaimed Burk Technology ARC-16 Remote Control System is the first step. You can control transmitter and studio from any phone.

But wait. There's more!

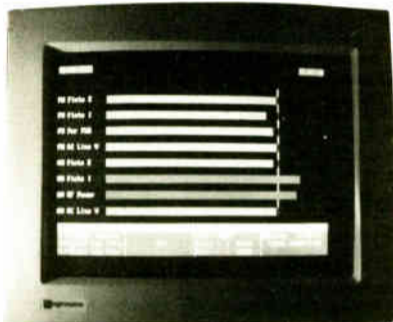

Introducing AutoPilot™ from Burk Technology.

AutoPilot is break-through computer software that makes automatic operation of your studio/transmitter facility a dream come true.

Automatic power changes
Automatic pattern changes
Automatic site changes
Automatic power trim
Automatic fault recovery
Automatic logging

Now your imagination is the only limit.

The new FCC fine schedule is imposing. Why risk a big penalty when AutoPilot can help you stay within the rules?

Call us at 508-433-8877
or toll free at
1-800 255-8090
for more information
and a FREE DEMO.

BURK
TECHNOLOGY

Circle (165) On Reader Service Card

Mercury, Messenger of the Radio Gods

by Alex Zavistovich

WASHINGTON Well, the first Mercury Awards competition for creative excellence in radio spots has come to an end. The winner was a spot for the Motel 6 chain, one of many spots its agency submitted for judging.

I heard all of the nominees on a CD compilation that was distributed during the awards program. On first listen, that disc worried me a little.

I mean, I had been hoping that we'd hear lots of spots done by radio stations. Instead, there was a flood of contributions from national agencies representing big-time concerns like Motel 6, NYNEX and L.A. Gear. Hey, we know these slick cosmopolitan ad agencies can come up with creative spots. They'd better; that's their job. It's creativity on a smaller level that ought to be nurtured, and it seemed to be overshadowed among the award nominees by national agencies.

Then I remembered that the Mercury Awards are the brainchild of a major group owner, and that the two granddaddy radio rep firms are on the advisory board. Suddenly, it all made sense again.

Why? Well, look: The Radio Advertising Bureau's monthly assessment of radio sales has been reporting flat sales growth over the same time last year. Local dollars are up; national dollars have dipped slightly, or have remained the same.

On an agency level, that implies that the people with a direct line to the purse strings have not been recommending radio for proposed ad campaigns. What radio needs, then, is a goodwill gesture that will return the agencies' focus to all that radio has to offer, right?

And there's no better way to show good will than to host an awards ceremony for some of the better work that ends up on radio, right? No, wait, there is one better way: Offer the winner of the award a \$100,000 cash prize. Nothing makes you remember somebody better than if he gives you a pile of money.

I'll bet the next time The Richards Group (the author of the Motel 6 winning spot) wins a major ad contract, someone at the agency

will push pretty hard for radio in the budget.

Hey, there's nothing wrong with that; most awards programs stroke the winners with an ulterior motive in mind. There's no such thing as a free lunch, you know. And the Mercury Awards are a good idea. I just hope that as the event matures we'll see a wider range of nominees. There's creativity in radio spot production on every level, not just among the big guns. It all deserves recognition.

★★★

Economists will tell you that we're no longer in a recession. We're actually in a slow recovery, they say. From where I sit, it's been painfully slow so far, but certain signs in the industry definitely suggest that things may be getting better a little faster now.



The RAB reports I mentioned earlier really are rather encouraging. Considering that advertising budgets are generally among the first to be cut when a company is suffering financially, the RAB sales reports have turned out to be pretty good news. If any new ads are being sold by radio, that means business has been good for the companies that bought the spots.

As a station broker acquaintance of mine pointed out once, radio revenues track linearly with retail sales growth. In other words, when business is good in retail sales, it's reflected in ad sales at the radio station, for which retail outlets represent a sizeable proportion of total spots sold.

Business can only be good in retail sales if the trend among consumers is to spend instead of save. That trend implies more dis-

cretionary income available. People are buying things.

★★★

You can see this economic turnaround within the broadcast industry itself. Take transmitter manufacturers, for example. It's been a busy few months for a number of these firms. Personnel changes and additions, as well as equipment introductions, have been taking place throughout the first half of the year.

Continental, for example, has an agreement with David Solt of Omnitronix to market his company's AM transmission products. Solt was on hand at Continental's NAB '92 exhibit in Vegas. What's more, QEI, Nautel and Energy-Onix each showed new transmitters.

At CCA Electronics in Atlanta, Steve McElroy was promoted to VP of Sales in June. McElroy joined CCA in 1990, as a sales engineer. Some months earlier, CCA hired Glen Clark, founder of the audio processing company Texar.

Business must be pretty good for TTC, too. Growth at that company prompted an undeniable surge in the number of dealers representing TTC products through the first quarter of the year.

In February the company added seven dealers; in March, they signed on four more. In a nutshell, the new representatives and their territories are:

- Peter Finch of Norcom for the Pacific Northwest;
- Marty Jackson of Marcom for Northern California, Nevada, Hawaii and the Pacific U.S. possessions;
- Carroll Cunningham of Dyma Engineering for New Mexico, Arizona, Utah, Colorado;
- Mark Bradford of Crouse-Kimsey for Texas, Louisiana, Oklahoma and Arkansas;
- Kathleen Karas of Crouse-Kimsey for South Carolina, North Carolina, and most of the mid-Atlantic states;
- Don Denver of DENCO for Nebraska, Kansas, Missouri, Iowa, and North and South Dakota;
- Mike Cruz of Barret Associates for Southern California and Arizona;
- Bill Shute and Kandy Clark of Broadcasters General Store (BGS) for Florida, Georgia, Alabama, Mississippi and Tennessee;
- Dave Kerstin of BGS for most of the Midwest and Great Lakes states; and
- Steve Vanni of Steve Vanni Associates for the northern states from Rhode Island to Maine.

Whew. The point is, transmitters are a big-ticket item, and I believe they reflect the buying mood in the market. A small station—heck, even a bigger station—that's not doing real well is not going to go out and spend money on a new transmitter right away. The management is going to try to squeeze the last few hours out of the old one first.

But transmitter manufacturers, who have relatively high overhead costs, are not going to invest piles of money on product development, or expand their sales team, or add new executives, unless they think people are going to buy what they've got to sell. Somebody knows something. It's not just wishful thinking: After all, there's money involved.

It's no secret that the economy hasn't been well. But here's hoping that what we've been seeing here is evidence of a speedy recovery.

That's it for now. Tune in next time,

Alex

A Digital Cart Machine with built-in phone interface

- 4 minutes of audio playback
- Fully remote-controllable
- Instant re-cue
- Auto-answer/auto-disconnect
- Single or continuous play
- Mic or line input
- Ideal for info lines

\$350 LIST PRICE



DIGISTOR™ BY HENRY ENGINEERING

BROADCAST SERVICES/EME

The Davis Communications Group, Inc.

Northeast/Mid-Atlantic 800/345-7112

Central 800/525-1037 Southeast 800/525-1037 West 800/523-1037

Circle (12) On Reader Service Card

READERS FORUM

If you have comments for **Radio World**, call us at 800-336-3045 or send a letter to Readers Forum (Radio World, Box 1214, Falls Church VA 22041 or MCI Mailbox #302-7776). All letters received become the property of Radio World, to be used at our discretion and as space permits.

Do you really have an EBS plan?

Dear RW,

This is in response to a broadcast station chief engineer's letter about setting standards for the use of the Emergency Broadcast System (RW, April 22, 1992).

I have been involved with the Emergency Broadcast System (EBS) since we created its model prototype in 1960 in Hawaii. I feel somewhat qualified to know what works and what doesn't.

It's appropriate and proper that every station carry every NWS (National Weather Service) **WARNING**.

It is irresponsible and frivolous to use the EBS for NWS **WATCHES**, advisories and simple weather reports.

Now, ask yourself the following:

1. Is your OAECC (FCC Operational Area Emergency Communications Committee) comprised of station owner/managers and not non-decision makers? The EBS long ago ceased being a technical issue—it is purely a management matter today.
2. Do you use the (FCC 1990) "Repeat Tone" method for your EBS activations?
3. Does your SECC (State Emergency Communications Committee) have hands-on, active leadership and on-going cooperation with your state emergency management agency and the NWS?
4. Does your OAECC have hands-on leadership and on-going cooperation with your local emergency management, public safety, and NWS?
5. Does your EBS plan clearly state how the NWS and local government agencies activate the EBS and typically for what reasons?
6. Does your NWS telephone the CPCS-I with every **WARNING** and **REQUEST TO ACTIVATE THE EBS**?
7. Does your EBS plan clearly identify those stations who (will or do) participate in local activations—and those who do not?
8. Is your plan updated at least every three years?
9. Does your plan have numbered Communications Operations Orders attached? (Note: Without them most plans cannot be easily implemented and thus will fail.)
10. Do broadcasters and emergency manage-

ment agencies fully understand the difference between the EBS (a **WARNING**) and emergency information (which does *not* require the use of the EBS Attention Alert tones)?

11. Does your FCC Operational Area conduct a monthly or quarterly *simulcast* EBS broadcast by all AM, FM, and TV stations originating from the local government Emergency Operations Center? (A proven axiom: Any EBS Operational Area system not so tested—live and end-to-end—will not function when really needed. Exceptions: When the Operational Area has several real and successful EBS activations a year.)

12. Has your OAECC appointed an EBS Operations Manager from your broadcast industry to coordinate tests, real activations, training, EBS plan updates, and fulltime liaison? (No, you will not find this in any FCC or FEMA literature.)

13. Does your OAECC Chairman conduct an annual committee meeting? The committee means broadcast station management (authorized decision makers), the National Weather Service, representatives from the local government "EBS activating" agencies, and the State chair and/or vice-chair.

If the answer to ANY of these questions is "no," ... **YOUR EBS MAY NOT WORK.**

The decades-old FCC EBS plan is both archaic and useless. It is destined to failure because it fails to state exactly who does what in simple, executable terms. Any plan that does not have Communications Operations Orders (or separate and specific SOPs by whatever title) is doomed to failure. A plan must have them to describe exactly (and on separate pages) what your NWS does, what the CPCS-I does, what all other participating stations do, who monitors which stations, and the monthly testing format.

When the EBS has to be used, for example, the NWS doesn't have to rifle through an EBS plan; they simply pull up Communications Operations Order No. 1—National Weather Service Procedures. The same applies to the CPCS-I, the other stations, the local government, and so forth. Each has only to refer to the one Comm Ops Order that applies to them. (Yes, I know, you won't find this in any literature or so-called model plans from the FCC either. But it's the result of really figuring out who does what—besides taking a paperwork exercise and dropping it behind the file cabinet.)

In closing, the letter writer said, "By the way, there was not a federal activation when we went to war this past year. Isn't that what the system was designed for in the first place?" No. There was no sudden threat to the U.S. populace, no incoming missiles over the polar icecap. Yes, we want the EBS to be used—not abused.

For the first time in many years, the FCC has been holding regional meetings to breathe new life, instructions, information, and interpretations into the EBS. I found the meeting I attended in Las Vegas prior to the NAB to be just what was needed and long overdue. On the negative side was the failure to attend by some station representatives from the most populated areas of the country.

I wonder how they will fare in the questionnaire above? Are they that confident they have a good EBS? Or do they wish the EBS would simply go away?

The public overwhelmingly tells me that they will switch to any station that gives them

Rising to a Challenge

Bellcore's development of a technology that allows full bandwidth CD quality audio to be passed via standard twisted pair wire issues a challenge to the broadcast industry. The challenge is to use it as a tool or to feel its competitive pressure.

Understandably, at first glance, the technology could be considered bad news for broadcasters and

certain equipment manufacturers. It effectively puts the phone company into the business of music programming and delivery, despite the NAB's efforts to the contrary. Joining digital audio delivery by cable, twisted pair delivery must be acknowledged as potential competition to broadcasters in some markets.

What's more, among its possible applications, the Bellcore development seems to make Switch 56 and ISDN technology—as well as related and supporting technology—a moot point.

In fact, however, the twisted pair technology has opened the door to digital transmission a little wider.

It's good news for telco equipment manufacturers, suggesting whole new products or at least significant refinements of existing products. STL and RPU equipment manufacturers should learn what they can about the technology, as well, to determine how it can be applied to their respective products. This will ensure that these companies benefit from the technology, rather than feel threatened by it.

Broadcasters, in turn, can make use of the benefits to be derived from affordable transmission of digital audio. Studio to transmitter links, remote broadcasts and studio call-in shows are among the aspects of station operation that could immediately benefit from the technology; its advantages in those applications are numerous. Further benefits to the industry are limited only by how manufacturers choose to incorporate the technology into their products.

These days, developments in audio technology are occurring with great frequency. Some developments seem destined to be long-term projects. The Bellcore twisted pair delivery technology, however, could have significant impact on broadcast operations in the near term.

—RW

news and information about a threat or an emergency event. As a long-time newsmen, I've always felt that the EBS has been one of the best news bulletins going. I have never hesitated to tell the public and the media what stations *not* to listen to in an emergency.

If any station's management disagrees and doesn't support an "all or nothing" approach to local EBS, that is their prerogative—but the public has a right to know that. If a

CPCS-I doesn't subscribe to and demonstrate such support of the EBS, the OAECC and SECC shouldn't hesitate to change the designated CPCS-I. That's their job. Let the sour grapes fall where they may. You have read them already in RW.

Stanley E. Harter, Vice-Chairman
California State Emergency
Communications Committee
Sacramento, Calif.

GUEST EDITORIAL

Taking AM Stereo to Court

by Stephen L. Karty

VIENNA, Va. There seems to be a great deal of confusion about the Kahn AM stereo system and the competing Motorola AM stereo system. I would like to clear up some misconceptions by reviewing the history of these systems.

Early in the competition, Mr. Kahn had invented circuitry to use with the existing Motorola AM stereo integrated circuits to automatically decode whichever AM stereo system was being broadcast, either Kahn or Motorola. Motorola was not interested at that time. Additional analysis of the Motorola AM stereo integrated circuits revealed an interesting surprise: Mr. Kahn maintains that Motorola AM stereo integrated circuits incorporated one of his own patented designs and Motorola was using Mr. Kahn's inventions without permission.

Motorola's apparent infringement of Mr. Kahn's patent is still being fought in the courts. It appears that Mr. Kahn will win and then act very much like Polaroid did after winning its instant-camera suit: Just as you can no longer buy film for Kodak instant cameras, you will not be able to buy integrated circuits or receivers for the Motorola AM stereo system.

I have used Motorola equipment professionally, and it has always been top-notch. However, the superiority of the Kahn AM stereo system lies in its simplicity. The Kahn system can be thought of as Independent Sideband (ISB), with the left stereo channel in the lower sideband and the right channel in the upper sideband, and it becomes obvious when

displayed on a spectrum analyzer.

Understanding the Motorola system requires an in-depth review of phasors. There is nothing inherently wrong with complex systems, as long as they provide some benefit to offset the effort required to understand them. I believe that the Motorola AM stereo system has several disadvantages, however, including platform motion.

Finally, as one who has used a lot of Single Sideband (SSB) equipment, I am greatly impressed with Mr. Kahn's unique refinements of SSB and ISB techniques which afford existing AM broadcasters an opportunity to make their signals more robust. For example, Kahn's latest innovation, the **POWER-side™** system, is now being used all over the U.S. to provide increased coverage and improved clarity for a great number of AM broadcasters.

For more information on the Kahn AM stereo system, please write directly to: Kahn Communications, Inc., 222 Westbury Avenue, Carle Place, NY 11514.

□□□

Steven L. Karty is a graduate electrical engineer (BSEE 1968 from Washington University in St. Louis, Mo.); he became both a licensed amateur radio operator and a General Radiotelephone Operator license holder in 1960 when he was 14 years old. He is also an Extra Class amateur radio operator. Karty lives in Vienna, Va. with his wife and two sons. Please address your comments to him through RW.

The opinions of Guest Editorial authors do not necessarily reflect those of RW's editorial staff.

Radio World

Vol 16, No 13

July 8, 1992

Editor Alex Zavistovich
Managing Editor Lucia Cobo
International Editor Alan Carter
Associate Editor Charles Taylor
News Editor John Gatski
Contributors Frank Beacham/N.Y.
Bruce Ingram, Pamela Watkins, Nancy Reist
Technical Editor John Bisset
Technical Advisor Tom McGinley



Radio World (ISSN: 0274-8541) is published semi-monthly by Industrial Marketing Advisory Services, Inc., 5827 Columbia Pike, Suite 310, Falls Church, VA 22041. Phone: 703-998-7600, Fax: 703-998-2966. Second-class postage rates are paid at Falls Church VA 22046 and additional mailing offices. POSTMASTER: Send 3579 forms and address changes to Radio World, P.O. Box 1214, Falls Church VA 22041. Copyright 1992 by Industrial Marketing Advisory Services, Inc. All rights reserved.

**Next Issue of
Radio World
July 22, 1992**

Military Radar Eyed in SEDAT Outages

by Paul Rebmann

LAKELAND, Fla. An FCC regional engineer suspects that military AWACS-type radar may be interfering with the satellite reception of south Florida radio stations, a recurrent problem over the past two years.

Richard Breen, EMU engineer at the FCC monitoring station in Powder Springs, Ga., said that the FCC began receiving interference complaints in late January, prompting his investigation. He has taken the EMU (Engineering Measurement Unit) out in the field to investigate the problem. The EMU is the only vehicle the FCC has

in the southeast U.S. that can handle interference resolution above 1 GHz.

The interference, which has affected mostly coastal stations, has been most noticeable on reception of ABC's SEDAT digital transmission from Satcom C-5. It is usually characterized as a short outage every 9.8 seconds, with the problems more numerous in the afternoons for days or weeks, and then not occurring for as many as three months, according to area engineers.

Mysterious interference

Bill Young, service engineer for Scientific Atlanta Broadcast Radio and Data Sys-

tems in Melbourne, Fla., said he was not aware of the interference problem in Florida. Scientific Atlanta is the developer of SEDAT, which went into service in 1991, and its predecessor, DATS.

However, a muting problem with the SEDAT system was the subject of an RW investigative article earlier this year and a subsequent follow-up article provided to RW by Scientific Atlanta engineers. In the Scientific Atlanta article, engineers claimed the brief muting were caused by station downlink site problems, including poor maintenance.

Several of the stations affected by the Florida interference have made their own studies of the problem. Gary Minker, CE of WIRK/WBZT West Palm Beach, Fla., said he has been analyzing the interference with his own RF test equipment, including a spectrum analyzer. Minker said his normal satellite reception has a carrier above noise of between 12-18 dB, but that the interference comes in at 15 dB above the carrier.

Wilson Welch, CE of WFLZ/WFLA Tampa, Fla., hired Vidsat from New Port Richey, Fla. to come in and take measurements. Mark Wilson of Vidsat described the interference as a "a pulsed signal every 20 MHz through the entire C band."

Detection difficulty

"It is a very low signal, and very fast. So fast you will not notice it on analog
continued on next page ▶

CD Sound Via Twisted Pair Wires

▶ continued from page 1

than existing ISDN and T-1 lines, which already carry digital data, he noted. "ADSL, like T-1, is a transport technology. Both are just raw technologies that carry bits," Bellisio explained. "But T-1 is a very stressful system used to carry high bit rate data transmission on different wire pairs between central offices. It requires clean wires and a digital repeater every 6,000 feet. It's not economical for the residential market.

"ISDN, on the other hand, is an entire system concept with a rich array of protocols and signal messages that can carry 64 kbps and upward."

Twisted-pair wire was invented more than a century ago. In fact, Alexander Graham Bell got a patent on it shortly after inventing the telephone. He created twisted-pair wiring as a way to reduce crosstalk between circuits that were close to each other.

HARRIS
ALLIED
70TH ANNIVERSARY

TUNED TO
TOMORROW



Harris HT Series FM Transmitters From 3.5-35 kW.

HT Series transmitters are engineered to give you high efficiency and unsurpassed performance. HT FM transmitters have proven their reliability and exceptional lightning survival capabilities in installations around the world. Here's why HT Series transmitters are the choice of demanding broadcasters:

- 55 Watt THE-1 FM Exciter with ultra-linear VCO operates at final carrier frequency with inaudible noise and distortion
- Quarter-wave cavity offers twice the bandwidth of folded half-wave designs to pass more of the FM signal without distortion
- Low velocity, high-efficiency direct drive cooling system
- Modular solid-state IPA and conservatively operated final tetrode PA
- High overall efficiency lowers AC power bills
- Broadband solid state RF driver uses FETs for highest reliability
- Solid state controller with automatic RF power control, proportional VSWR foldback, auto-restart
- Opto-isolated remote control/status interface, fully transient protected
- Exclusive FLEXPatch™ design allows easy bypassing of low-level stages to keep you on the air during emergencies

Call Harris Allied today at 800-622-0022 for more information on rugged, reliable, efficient HT Series FM transmitters.

Also available: 100% solid state 250 W, 500 W and 1kW HT Series transmitters.

HARRIS
ALLIED

BROADCAST EQUIPMENT

800-622-0022

Tel (217) 222-8290 • Fax (217) 224-2764 • Telex 650-374-2978 HARIS UR

© 1992 Harris Corporation

Circle (185) On Reader Service Card



More stations play their music on the world's best-selling tape carts.

audiopak
BROADCAST CARTRIDGES

P.O. Box 3100 • Winchester, VA 22601
Tel: (800) 522-CART or (703) 667-8125
Fax: (703) 667-6379

Circle (79) On Reader Service Card

Radar Prime Suspect in SEDAT Outages

► continued from previous page systems," Wilson said.

Minker installed a C-bandpass filter on his system in early May, but is not sure that it has helped. He noted that recently the station has experienced only an occasional "one-shot blip." Other stations also have reported a recent lull in the interference.

Rick Rowland, CE of WGUF Naples, Fla., stated that his station had been plagued with problems ever since its satellite equipment was installed. One day one of the staff came in and said that they heard the same thing happen on another station. Rowland be-

gan calling around and found that others were having the same problem.

Since he had recently installed a computer in place of the ABC Data printer to save on paper, Rowland said he modified his program to log the time of each loss of sync. These logs have been provided to the FCC to help in solve the problem, he added.

Rowland said he would be willing to provide information and software on how to monitor a station to engineers interested in checking their own.

Although the interference has lessened recently, Rowland said there was one week in

early April that was especially bad, and that even the TV stations in the area were reportedly having problems.

FCC working with the military

As for the interference in south Florida, Breen said there are probably three times more stations affected by the interference than have reported to the FCC. Breen said that FCC staff in Washington are working with the military, but added: "the time frame is taking much longer than usual to resolve the problem."

The reported problem has been on the west

coast of Florida from Tampa to Naples and on the east coast from West Palm Beach to the keys, Breen said, with the interference pattern changing over time. Early reports indicated both coasts were having the problem at the same time. Then the west coast stations were affected about an hour before the east coast. Lately, all of the problems have been on the west coast only.

Rob Lankton, CE at WDUV/WBRD Bradenton, Fla., said he has had occasional problems with SEDAT going on and off repeatedly for a couple of minutes, but it does not affect his DATS card (SEDAT's predecessor) and has not happened enough to worry about.

ID Logic B Proposal Is Likely NRSC Standard

by John Gatski

CHICAGO Negotiations to get the ID Logic station format ID system incorporated into the proposed Radio Data Systems (RDS) receiver standard went smoothly during a recent industry subcommittee meeting, according to sources who attended the meeting.

The NRSC's RDS subcommittee met in early June to work with ID Logic inventor Pierre Schwob on designing a version of his technology, known as ID Logic B, for AM. Also, an AM data stream technology proposal was heard from a California company, Real Time Design.

ID Logic is a technology that would allow a receiver to identify stations by formats in any area of the country, based on internal computer information that must be updated annually.

According to NAB Manger for Technical Regulatory Affairs John Marino, Schwob made a detailed proposal for including ID Logic B into an RDS receiver standard.

RDS is a European-developed broadcast subcarrier technology for FM that can relay a variety of information to an RDS receiver including: automatic format selection, call letter/frequency text display, automatic switching between transmitters, and emergency alerts.

Earlier this year, the standard was in danger of falling apart because of an NAB threat to pull its support. The NAB claimed that AM stations would be slighted by the standard because RDS is an FM technology. The NAB also contended that the standard effort was being driven by consumer audio manufacturers who wanted to quickly adopt an FM standard because

the costs would be less using the already developed European technology.

The Electronic Industries Association (EIA) said it was not ignoring AM, but would work later to incorporate it into the standard when adequate technology became available.

A compromise was reached at the NAB show when the RDS subcommittee agreed to examine ID Logic as a way to include format selection for AM in the RDS standard. To make it workable, it has been proposed that a designated RDS FM station in each area could update the AM station changes in the ID Logic computer each year.

Although an actual data stream was thought to be unworkable for AM (a German technology would provide similar functions to RDS FM, but will not work with AM stereo), Real Time Design's Robert Clark said his system is AM capable.

Clark declined to comment on the specifics of his system until the RDS subcommittee's working group met in June.

As a result of the Chicago meeting, the working group was formed and met in Washington later in June to discuss a "course of action for ID Logic B" and to study the feasibility of eventually incorporating the Real Time Design technology into the RDS receiver standard, Marino said.

"My impression is that ID Logic will definitely be included in the standard and that concept will probably be submitted to the full (NRSC) committee in July," Marino said.

He added that a standard could be adopted by September. Prior to the NAB's dissent on the RDS-only-for-FM standard, the NRSC had hoped to approve the standard in April.

WHEN YOU WANT MORE THAN JUST AN ANTENNA

JAMPRO has been providing the broadcasting industry with state-of-the-art antennas for over 35 years, longer than any other US antenna manufacturer. With over 3000 antenna systems delivered, at JAMPRO you don't just buy an antenna, you invest in experience.

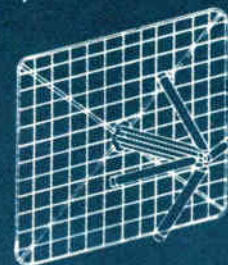

JAHDP CP Arrowhead Screen Dipole

THE LEADERS IN ANTENNA TECHNOLOGY

- Complete line of FM & TV broadcast antennas
- RF components, Filters & Combiners
- Modern 7000 ft FULL SCALE test range
- Directional antennas and pattern studies.

Call or fax us your needs today.

(916) 383-1177

Fax (916) 383-1182



6340 Sky Creek Drive
Sacramento, CA 95828

Circle (191) On Reader Service Card

Audio DA's for a

BROAD RANGE

of applications

- For every requirement and every budget.
- Single rack units to 4 in by 16 out.
- Modular mix and match to 10 in by 60 out.
- Multiple mic and line amplifiers, 4 to 8 channels.
- Transformer and active balanced outputs to +30dBm

AUDIO TECHNOLOGIES INCORPORATED

CALL OR WRITE NOW FOR FREE DETAILED BROCHURE.

328 Maple Ave. Horsham, PA 19044, USA (215) 443-0330 FAX: (215) 443-0394

Circle (126) On Reader Service Card

ECLECTIC ENGINEER

Tips for a Successful Contracting Career

by Barry Mishkind

TUCSON, Ariz. The economics of engineering in the 1990s has certainly taken an interesting turn. Engineers often spend as much time worrying about the budget as maintaining the station's equipment.

Given the financial pressures that have pushed many stations to the limit, it's understandable to see cuts in the technical budget, as well as the loss of many positions. Many engineers take such situations as opportunities to go out on their own and service clients on a part-time basis.

Getting started really isn't too hard. Often asking around will turn up the names of one or more stations in need of help. A brief resume with some references might get you an interview.

Plan carefully

Your first client may even be your current boss. As we discussed last time, there are both advantages and disadvantages to such an arrangement.

Setting fees can be harder than you may think. For example, \$15-\$20 an hour may sound like a fortune to an engineer that has been working for \$1,000 a month. But remember, your overhead has also jumped substantially. Many of the "bennies" you used to get now come from your own pocket.

Not only must you pay all your taxes (including FICA of about 15 percent), but you need to budget for liability insurance, health insurance, vehicle costs, tools and

maintenance fees.

Another matter that can have a major effect on your bottom line is how you plan to serve and charge your clients—by the hour, by retainer, or a combination of both.

My personal preference has always been to start with a flat rate retainer, augmented for special projects (and for excessive calls at stations failing to train their staff to handle minor matters such as head cleaning, etc.).

Included in the retainer is a basic number of routine maintenance hours. An arrangement like this accomplishes two important goals: It provides a predictable stream of income from month to month, and it sets the engineer up to inspect the facility on a regular basis to catch problems before they get to the critical phase.

A new work environment

On the other hand, technical deregulation has removed many of the routine maintenance procedures that the FCC had been mandated for years. As contract engineer Mark Persons points out, more than ever before "management today determines at what level a station is engineered. They then choose how often the technician comes."

Persons serves some 40 client stations from his base in Brainerd, Minn. None are on retainer. All pay the hourly rate when they need help. Mark does endeavor to help the stations moderate their costs by training the staff to handle all but the worst

problems before calling for assistance.

Identifying the technical attitude of a station can be the key to a good business relationship. Persons noted, "Some managers don't care as long as the station is on the air." Others appreciate the technical facets of the operation but "don't care to pay sufficiently for engineering." Working for such operations will only lead to frustration and burnout.

Mark identifies with the syndrome. He used to take every station's condition as a matter of pride. If a client was cited and/or fined, he took it personally. Eventually he realized "one has to detach oneself from the station. If the engineer is doing his job, he's not responsible for any fines."

Accountability

As a contract engineer, you really aren't totally safe, but since all your economic eggs aren't usually in one basket, you normally can't get hurt badly if some GM tries to save his butt by sacrificing yours. Don't forget to use the station logs to document matters and protect yourself.

LINE OUT

Prepare Your Hard Drive For Digital Audio Editing

by Bruce Bartlett
with Jenny Bartlett

ELKHART, Ind. In the last column, we stepped into the wonderful world of digital audio editing.

With a digital audio editor, you can record CD-quality digital audio, from either your DAT machine or CD player, onto your computer's hard disk. Then you edit the program on-screen with a mouse. You play the edited recording and record it back onto your DAT.

A hard look

Let's focus on the hard disk drive in this system. Digital audio imposes special requirements on the hard disk, and we'll cover them here.

First, digital audio can consume a lot of space on a hard disk—hundreds of megabytes. How much hard disk capacity do you need? At a sampling rate of 44.1K and 16 bits (two bytes) per sample: 44,100 samples/sec \times 2 bytes/sample \times 60 seconds/min = 5,292,000 bytes/min (or 10,584,000 bytes/min for stereo).

So you need at least 11 megabytes (Mb) of disk space per minute of stereo audio. If you want to store a few promos totalling five minutes, you need at least 55 Mb of free space on the drive. A half-hour talk show might consume 330 Mb, and a one-hour show would use at least 660 Mb.

Allow extra disk space for temporary data files, such as cut buffers—material you removed but might want to replace later. If you also want to use the drive for your regular computer programs, allow space for them.

In addition to high capacity, you need high speed. Disk speed is measured in access time and throughput. "Random access time" is the average time it takes to access and read a random spot on the disk. The shorter the better—28 milliseconds or less.

The current economic conditions have led to a lot of belt tightening. The result is that where the GM used to call the engineer and say "I want you to do this," now the engineer is often required to bid the work as an isolated project.

In fact, some stations go months without any real technical attention. At numerous facilities, engineers haven't been seen on site for a year or more. With today's more reliable gear, quite a few stations figure it's cheaper to hire an engineer only when a real disaster strikes.

All of which is to emphasize again: If you're going out on your own, consider carefully your overhead against the potential work in the area. You may find that \$35 or \$40 an hour is quite necessary. After all, if the car dealer is charging you \$45 an hour to work on your car, you have to be worth at least as much to get a station back on the air.

Now, suppose you're a manager and need an engineer. Next time, we'll explore how a manager with limited technical expertise can bring a good engineer on board.

□□□

Barry Mishkind, aka RW's "Eclectic Engineer," is a consultant in Tucson. He can be reached at 602-296-3797, BMISHKIND on MCI Mail, or "barry@coyote.datalog.com" on Internet and CompuServe.

We maintain a Double Standard

Audio Precision offers two different standard-setting product lines.

The automated System One —

the industry standard for bench and factory.

- Graphic results on PC screen with hard copy to printers
- Automated proof procedures & limits testing
- State-of-the-art performance and speed

The self-contained Portable One Plus & Portable One —

for service bench and field.

- Compact and affordable stereo test sets for applications not requiring automation
- Both offer comprehensive capability & high performance in a rugged package
- Portable One Plus adds sweeps, graphs and printer port

The System One and Portable One... two families of test sets designed for different jobs, each with the quality and performance that you have come to expect from Audio Precision.

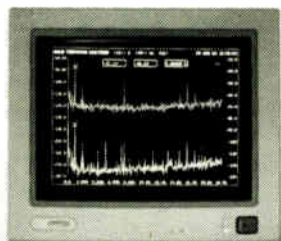

Audio precision

P.O. Box 2209, Beaverton, OR 97075
503/627-0832 1-800/231-7350
FAX: 503/641-8906, TELEX: 283957 AUDIO UR



Circle (10) On Reader Service Card



First Order of Business P R O F I T

Control Costs to Protect Your Future

Digital Automation Systems Are Saving Radio Operators Lots of Money

PROBLEMS:

- How do I get CD quality?
- How can I save my station lots of money?
- How do I best maximize efficiency?
- How do I eliminate tape?
- How can I cut staffing demands?
- How can I reduce play list errors?



Hard disk systems like DigiLink can be programmed for a week or more of walk away time.

Harris Allied Will Help You Choose the Right Digital Automation System

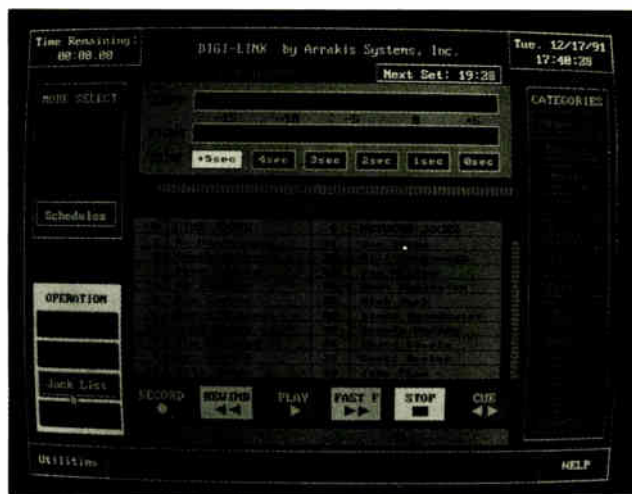

From production, news and automation to scheduling, traffic and billing, networkable systems like DigiLink can computerize your entire station.

SOLUTIONS:

- The cost-effective digital audio recorder-reproducer
- Replaces cart machines for manual on-air play
- Prescheduled live assist operation
- Satellite, CD tape and hard disk automation
- Network all your studios
- A complete radio station with a single system

Harris Allied Digital Automation Systems ARE the Difference Between loss and PROFIT.



800-622-0022

Fax (317) 966-0623 • In Canada (800) 268-6817

OFFBEAT RADIO

WWIS Uses Own Brand Of "Call Forwarding"

How One Station Works The Phones for Remotes

by Dee McVicker

BLACK RIVER FALLS, Wisc. The voice of radio is being heard loud and clear on 800 MHz, the carrier frequency for cellular phones and the newest carrier for broadcast remotes.

With a small, hand-held phone, a special line jack, and the enthusiasm of radio staff, stations are broadcasting on-the-go via cellular phone.

microwave links on 2 GHz, 4 GHz, 6 GHz, 18 GHz, or 23 GHz to a switching location and eventually a telephone company exchange, and then on to the receiving party, the cellular phone signal can be compromised at several points in the system.

Digital a factor, too

Digital technology, however, is expected to curtail many of these problems. Already, the vast majority—at least 99 percent, by Cyr's estimation—of the transmission from a cell site to a central telephone exchange office is digitally transmitted.

The bottom line, said Lent, "is the use of cellular can help smaller, rural radio stations break new ground in broadcasting."

"It's a quick, economical way to get out of the station and on the air," commented General Manager Nelson Lent of WWIS-AM-FM in Black River Falls, Wisc., who purchased a cellular phone recently for a remote broadcast of his area's annual Jackson County Farm Show.

The cellular phone is interfaced to the station's remote equipment through a line jack developed by Cellabs, allowing the phone to act as a microphone, and has since been used for sporting events, community programs, and other advertising promotions.

Rural expansion

WWIS first became interested in the technology for remotes when cellular phone service was expanded to rural areas. With highly populated metropolitan areas having been provided cellular service over a five year period, rural areas are now being provided the carrier stations for these mobile telephones.

Explained Phil Cyr, director of engineering for United States Cellular in Chicago, a phone carrier service that builds cellular sites, "What's happened is the FCC has licensed the carriers to provide cell site service in these areas, and that second wave of development is now underway."

Not all remote locations, however, can expect to be covered by cellular phone—at least not in the foreseeable future. "To say that every remote location is going to be covered, we're still a ways from that yet," said Cyr. "But, we are moving in that direction."

Cellular phone technology also is still a ways from the audio specifications many stations would like to see. Ironically, one of the culprits is the 4 kHz bandwidth of existing rural lines between cellular services and telephone company service providers.

Then too, said Cyr, "By the very nature of the technology, (cellular phones) will provide something less than optimal program quality as far as signal to noise is concerned."

Typically starting at the 800 MHz carrier link between the phone and a nearby cell site, and moving through one or more

Still badly needed is wider bandwidth performance. Said Cyr, "There's a lot of work being done with digital transmission over cellular. And of course TDMA (Time Division Multiple Access) cellular technology is now being prototyped in Los Angeles and New York. When that technology is placed in operation, then we'll have the ability to use wider bandwidth communication and you'll be able to get wider bandwidth transmissions from the phone to the cell site."

This wide audio bandwidth can be carried through to switching locations and telephone exchanges, he added, with the use of T1 leased lines or even 56 kilobits per second (kbps) digital links.

Other technology is also being researched to solve another cellular problem, that of indoor reception. Given the often poor signal strength inside buildings, combined with the lower power of hand-held cellular phones, the service has a reputation for limited indoor use.

To combat this problem, new microcell technology is now circulating standards committees to provide cellular stations with limited coverage inside auditoriums, shopping malls and the like.

In the meantime, stations like WWIS aren't complaining. Compared to land lines, according to Lent, cellular phones offer the most flexibility for the money, and if used to potential can increase advertising revenue dramatically.

The bottom line, said Lent, "is the use of cellular can help smaller, rural radio stations break new ground in broadcasting."

For stations interested in using this service for remotes, Cyr recommends replacing cellular phone whip or omni-directional antennas with directional arrays or small yagis for better signal to noise. Most transportable cell phones have a connector for this purpose.

Additional information can be obtained by contacting local cellular phone carriers, listed in the Yellow Pages under Cellular.

□□□

Dee McVicker is a free-lance writer and regular contributor to RW. She can be reached at 602-545-7363.

REVOX
PR99

REVOX

Designed specifically for broadcast professionals, the ReVox PR99 delivers the highest quality audio, outstanding performance and reliability, year after year. Precision engineered with advanced audio electronics, the PR99 offers an impressive list of operating features such as: • balanced and floating inputs and outputs • a solid die-cast aluminum transport chassis and head block • a true Autolocator with Zero Locate and Address Locate functions • rack mounts standard • full "solid state" transport control with motion sensing • easily accessible modular electronics • varispeed control • the service and support of the only company backed by over 40 years of engineering excellence. Providing outstanding flexibility in live on-air broadcasts, remotes or commercial production tasks, the industry proven PR99 is the top choice among professionals. Call today for more information.

REVOX®

1425 ELM HILL PIKE - NASHVILLE, TN 37210
TELEPHONE 615-254-5651 TELEFAX 615-256-7619
IN CANADA 416-510-1347

® ReVox is a registered trademark of STUDER
REVOX AG, Regensdorf, Switzerland.

Circle (100) On Reader Service Card

Why Auditronics' 210 console remains radio's virtual standard

The contemporary 210 console contains exactly those features and qualities your on-air people tell us they need to do their best work. Nothing more, nothing less.

The Auditronics 210 has the best record for up-time of any radio console. It just plain works, elegantly, all day, every day, all year, every year.

And, most important in this age of cost concern, we've made our production more efficient, so we can deliver today's 210 console at a price less than that of over a decade ago.

It's no wonder the 210 console continues to be the on-air mixer of choice among quality-conscious broadcasters. Choose the Auditronics 210 for your next console replacement or upgrade. Call 901-362-1350 today for complete information.

This Auditronics 210-18 in KPFA-Berkeley's on-air studio is one of four 210s in use at the Pacifica Foundation station.



auditronics, inc.

3750 Old Getwell Road, Memphis, Tennessee 38118 • 901-362-1350 FAX 901-365-8629

DIGITAL DOMAIN

Problems and Answers to Digital Storage Needs

by Mel Lambert

STUDIO CITY, Calif. Radio production facilities that have made a long-term commitment to disk-based recording and editing workstations have discovered that digital audio requires a great deal of storage space.

At the common sampling rate of 44.1 kHz, storage media fills up at an alarming rate: some 86.13 kilobytes per second per channel, or just over 10 megabytes for a minute's worth of stereo material. Not surprisingly, many users are looking for convenient and fast ways of archiving such material at the end of a session, prior to perhaps inloading several gigabytes of new sound effects, music and dialog elements required for the next editing session.

Several solutions immediately present themselves. One is to design the system so that routine inload and offloading can be performed as a background task. In other words, the system takes care of transferring the contents of a hard-drive, for example, to/from a Data DAT, Exabyte data cartridge or removable optical drive, while the master microprocessor is idle for several processing cycles.

Alternatively, the workstation might be configured to record directly to and replay from one of the newer generation of high-speed magneto-optical or phase-change drives, in which case the entire system is ready to start as soon as the drives are loaded. A separate *inload station* might be made available in larger stations simply for the task of off-line load-

ing of material onto an optical drive ready for the editing session.

Removable hard drives

Some workstations are offering removable hard drives that serve the same function as optical units, which usually offer access and data-transfer rates much higher than current-generation MO/PC drives. Finally, a number of recorders and editing systems are being made available with optional data compression. Dependent upon the selected algorithm, such compression can extend the storage size of hard drives and optical drives by between four and six times their conventional capacity.

But many workstation users are looking for more than simple high-speed archiving and inload via a high-capacity storage media such as optical disks.

As I have pointed out in previous columns, until the digital audio workstation market finally settles down and we begin to see the emergence of maybe three or four systems as technology leaders, we're still faced with the problem of how to transfer material from one brand of editor to another.

It is not uncommon for a station to use maybe a simple two-channel random-access workstation to edit music and other material, while a full-function, four- or eight-track system is available for more complex layering and mixing projects. If both of the systems are supplied by the same vendor—or, in a restricted number of cases, utilize the same Macintosh or DOS-based controller PC and conventional file

formats—then it may be possible to transfer storage media directly from one system to another, thereby avoiding the time-consuming digital I/O transfer process.

But what if these systems, as is likely, are destined to be replaced during the next couple of years as the station's requirements expand and develop? It would be extremely important for any future system to be configured easily to read files being generated on today's systems. Developing such a "universal data interchange format" has been the subject of long and hot debate between the various workstation and editor manufacturers with, to date, little success.

A recent development, however, looks set to offer a great deal of promise in establishing a viable file format for removable media that can be output and then read by virtually all current and future systems.

This new "Rosetta Stone" for the digital domain was developed by Avid Technology, a firm whose primary focus is the innovation of a video editing system called Media Composer. Realizing that the future of its products was strongly interlinked with the ability to freely exchange video, audio and multimedia data with other platforms, Avid has spent a great deal of time developing its Open Media Framework, or OMF. This framework allows virtually any workstation to record data in a standardized format and file structure that can be understood by any other OMF-compatible system.

In its most simple terms, file interchange can be envisioned like a wheel: Workstation manufacturers are positioned around

the rim, with the OMF interchange as the hub of the wheel. Each firm is then free to either directly implement the OMF format for data and file storage, or (more likely) to develop the corresponding *spokes* that allow proprietary files and edit information to be converted into this exchange format.

Open Media Framework

Unveiled at the recent NAB Convention in Las Vegas, Avid Technology's Open Media Framework (OMF) is described as a "multi-vendor open platform program designed to allow various media, including sound files, to be imported and exported between audio and video systems." According to Avid President Curt Rawley, the goal of OMF is to enable media integration, "(thereby) allowing many different applications to communicate with one another, share and combine media, and provide an integrated application environment to the end user."

Already several workstation manufacturers, including New England Digital, Digidesign and others, have announced plans to implement OMF within their respective systems.

Open Media Framework allows both the content and descriptions of edited program material to be shared, exchanged and augmented, as necessary. At the heart of the proposal are a series of APIs (Application Programming Interfaces) that translate file structures from a proprietary format to one that can be read by other OMF-compatible systems.

In OMF parlance, digital media files become *ingredients* for a designated project, while the program descriptions—how the native sound files, etc., are arranged and

continued on page 39 ►

Perfect Fit.

★ MYAT PRODUCTS FIT YOUR APPLICATION.

Our new 40th anniversary catalog has the widest selection of radio and TV hard line and components ever to wear the bright blue MYAT logo. It also has technical specifications and a complete engineering

section to help you locate an emergency repair item—or completely outfit a new tower. There's seldom a wait for delivery, either, because virtually every item listed is in stock for immediate shipment.

★ MYAT QUALITY FITS YOUR REQUIREMENTS.

We've been perfecting MYAT rigid RF transmission line and components for four decades. Today, computer assisted design /computer assisted manufacturing is just one of

the advanced techniques we use to turn pure brass, copper and aluminum and other high-quality materials into finished components of unprecedented precision and consistency.

★ MYAT DURABILITY—FIT FOR LONG LIFE.

To ensure the highest standards of longevity and reliability, we concentrate on details like non-galling silver plated

beryllium copper contact springs, brass elbow reinforcements and rigid, pure virgin Teflon supports.

★ MYAT SERVICE FITS YOUR NEEDS.

Our engineering staff is always ready to provide advice—or to turn special requirements into "routine" projects with our computerized design and testing facilities. MYAT expertise is a resource for the industry's leading transmitter manufacturers, the U.S.

Navy, the newest TV tenants in New York City's Empire State Building, and broadcasters all over the world. Contact us for your copy of the new MYAT catalog, and let us deliver for you. Just phone 201-767-5380 or fax 201-767-4147.

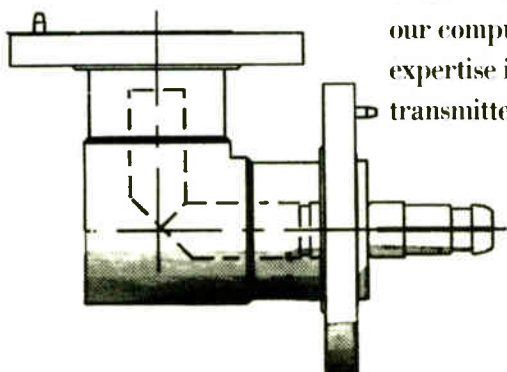
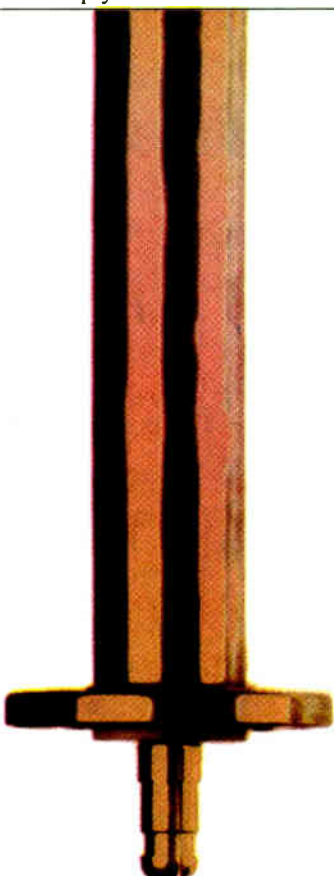

Manufacturers of electronic transmission equipment since 1951.

40 Years of Experience.
40 Years of Excellence.
380 Chestnut Street
P.O. Box 425
Norwood, NJ 07648
Tel 201-767-5380
Fax 201-767-4147

WORKBENCH

New Slant on an Old Verse

by John Bisset

FALLS CHURCH, Va. We've got to start the column off with the winning phrase in Clark Wire and Cable's BBROYGBVGV resistor/wire color code contest. The first place and \$200 cash prize goes to Jim Riggs, a meteorologist at WEAU-TV in Eau Claire, Wisc. His winning ditty went: "Before Bad Ratings Overcome You, Go Buy Very Good Wire."

Marty Berlinger, the CE at WDAY(AM) in Fargo, N.D. won \$100 and second place with: "Big Beautiful Roses or Yellow Gladiolus Bring Very Good Wishes." Third place went to Sean Haley, a producer at KLTW(TV) in Houston. His entry was: "Betty Broderick Ran Over Your Great Big Very Gorgeous Wife."

Clark President Sue Clark's favorite, "Barbara Bush Recently Offered Yeltsin George's Best Vodka, Guaranteeing Wozziness," came from Jack Gilbert at WCHS(AM) in Charleston, W.V.

A fun contest; congratulations to all the entrants! By the way, Clark Cable has jumped on the digital bandwagon by offering a new digital audio cable that sports a 12.5 picoFarad (pF) capacity rating. Most audio wire has a capacitance of 30 pF. Circle **Reader Service 104** if you'd like information.

★★★

Have you ever wondered just how much work your dehydrator does in a week?

Bob Clinton, CE at WKYS-FM here in Washington recently wrote with a neat solution to monitoring the dehydrator. He found an elapsed time indicator in the Hosfelt Electronics Catalog (800-342-6342) No. 39-135, \$14.95, which met his needs exactly. The indicator runs on 5 VDC, so Bob mounted a transformer inside the dehydrator and brought the low voltage AC out to a connector on a bud box.

The bud box formed the enclosure for a DC power supply, with a diode, a 200 µF capacitor, and a 5 volt regulator. Mounting flanges are provided on the timer, so it will easily mount to the outside of the box. By checking the accumulated time on the indicator every week, a leak can be quickly detected. Based on the amount of elapsed time, the magnitude of the leak can be determined.

If you're working inside your dehydrator, look to see if the unit has low or high pressure alarm switches. These disk-like pressure switches provide either a contact closure, or open when either low or high pressure occurs.

The use of the low pressure switch is obvious in showing that you have a leaking line. Such switches are good to have even if you don't have a dehydrator, because they'll tell you when the nitrogen bottle is empty. The high pressure warning switch can prevent a dehydrator with a stuck pressure valve from damaging your line by pumping it up to 20 psi! Bob Clinton can be reached at WKYS-FM: 202-686-4560.

★★★

The Technics SL-PI01 is probably the best-priced CD player around (under \$8,150) that still features "auto-cue." The

player has a remote jack, but no instructions for its use. A *Workbench* reader has inquired about how to hook up this jack. Apparently, the information is contained in

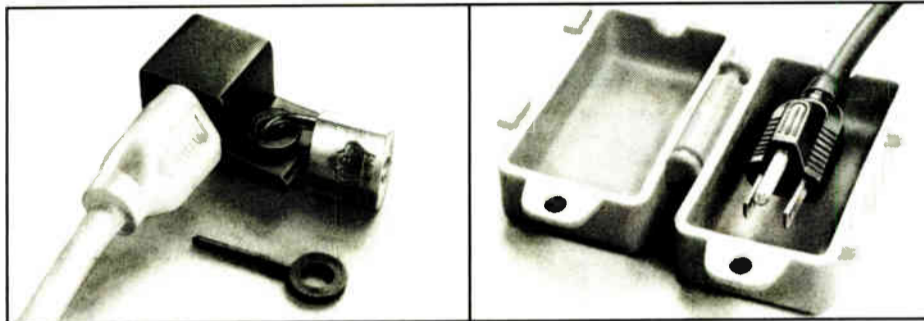

Two styles of electrical plug lockout boxes are available from Panduit Corporation.

a very costly maintenance handbook, but not in the instructions provided by Technics. If you've gotten this feature to work, fax or mail your solution to *Workbench*. Your fellow engineers will appreciate it.

★★★

We've heard from a number of engineers who endured (and passed with flying colors) the FCC field inspections of their AM directionals. One of the primary inspection areas was EBS, and several en-

gineers have incorporated a procedure that ensures compliance with the send and receive tests. An EBS compliance sheet is prepared each week. In it are blanks for when the tests were sent and received. This information is copied as the logs are reviewed.

At the end of each month, the information is transferred to a master sheet that is

stapled inside the cover of the file folder for that month's logs.

The organizational effort is worth the time. At one inspection, the CE was told to close the file drawer without even removing a folder of logs; the inspector noted that anyone with files as organized as his was sure to be in compliance with EBS!

★★★

If you encounter problems with unauthorized equipment use, the new plug lockouts

manufactured by Panduit are worth consideration. Two styles are shown in Figure 1. These lockouts comply with OSHA regulations, and are described in bulletin ID-LOK-1A. Phone toll free at 800-777-3300, extension 7337 for your copy, or circle **Reader Service 162** for more information.

□□□

John Bisset is a principal with Multiphase Consulting, a contract engineering and projects company. He can be reached at 703-379-1665.

NEW AM RULES

AMSTUDY

DAYTIME ALLOCATION STUDY

- Both Dataworld and FCC Databases Studied
- Utilizes NEW (Corrected) Groundwave Curves
- NEW Adjacent Channel Protection Ratios Employed

AMNIGHT

NIGHTTIME INTERFERENCE STUDY

- Utilizes NEW FCC Skywave Propagation with Greatly Improved Accuracy
- Calculates Extent of Nighttime Interference Received (Detailed Individual Night Limit)
- Provides Allowable Vertical Radiation to All Pertinent Stations (AM Night Permissible Radiation)
- Includes All Co-Channel and First Adjacent Records

GWAVE

GROUNDWAVE (Daytime) COVERAGE CONTOUR STUDY

- Utilizes NEW (Corrected) Groundwave Curves
- Allows Input of Measured Soil Conductivity Data
- Counts Population Within Coverage Area Using 1980, 1986 and 1990 Census Data

SKYWAVE

SKYWAVE (Night) COVERAGE CONTOUR STUDY

- All AM Nighttime Coverage Contours Have Changed Size and Shape
- Utilizes NEW FCC AM Skywave Propagation Model
- Counts Population Within Contours Using 1980, 1986 and 1990 Census Data

dataworld®

P.O. Box 30730, Bethesda, Maryland 20824

FAX (301) 656-5341

(301) 652-8822

(800) 368-5754

IT'S NOT SO LONELY AT THE TOP!

In fact, it's everywhere!

We're enjoying... And the only way to achieve maximum efficiency, reliability, increased immunity to lightning, transparent audio specifications and cost-effectiveness is with TTC's FMS Series Transmitter.

Come join us at the top! Contact TTC Today.

650 S Taylor Ave. Louisville, CO 80027 (303) 665-8000. Fax (303) 673-9900

Circle (97) On Reader Service Card

World Radio History

Circle (144) On Reader Service Card

An affordable, easy to learn multitrack disk recorder for radio.

For around \$7000, Roland's DM-80 will speed up your spot and promo production amazingly! This

WITH EVERY NEW TECHNOLOGY, THERE COMES A DAY WHEN PRICES DROP AND PERFORMANCE JUMPS. TODAY IS THAT DAY.

means you'll have the freedom to experiment with many different approaches—a creative process that will make your programming more exciting. And,

because you can remove and add lines almost instantly, updates are a snap!

And there's no computer shock! The DM-80's optional controller makes it "look" like a tape recorder, so it's extremely easy to learn, and even faster to use.

The DM-80 is easily upgraded from 4 to 32 tracks, and for on-air applications you can add SCSI compatible disk drives for



Roland's custom VLSI chips give the DM-80 amazing power at a price that will astound you!

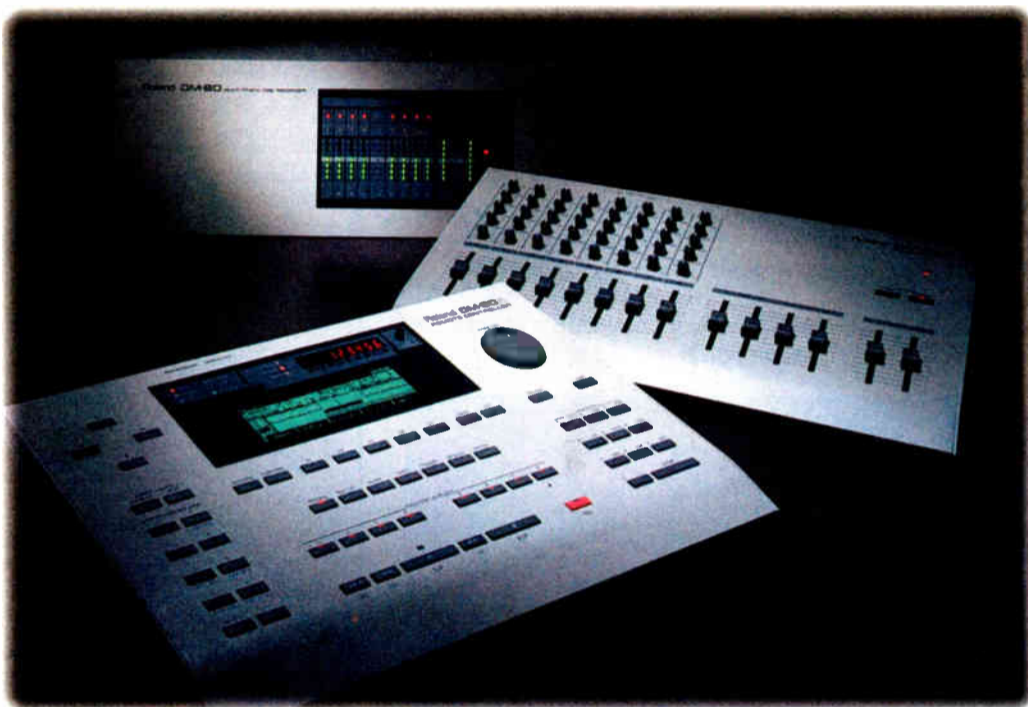

up to 12 hours of recording time per 4 tracks.

And because it all comes from Roland, you'll get great service, too!

Call (213) 685-5141, ext. 337 for a brochure, or to schedule a demo at your station.

Roland®

ProAudioVideo

Roland Corporation US, 7200 Dominion Circle, Los Angeles, CA 90040-3696

© Roland Corporation US 1992

Circle (53) On Reader Service Card

World Radio History

FEED LINE

Is Re-radiation Affecting Your Antenna?

by **W.C. Alexander**

DALLAS Suppose that you have a high monitor point, as was the case in the last installment of *Feed Line*. In this case, however, after running all the checks on the sampling system and antenna monitor, you have run a partial proof of performance on the radial and have found that the radial is indeed high.

As you stand outside the transmitter building scanning the horizon for some revelation, you notice the new water tower that has just been built.

Let's put a pencil to the problem and see if the new structure is likely to be the source of your woes.

The RF power density at any location can be calculated based on the field strength at that site. To find the worst case (no loss) field strength at this point, divide the inverse distance field (IDF) for that particular bearing by the distance. Then, find the

RF power density by dividing the field strength by the impedance of space (120π or about 377 ohms/meter).

Because the amount of power that can be absorbed by any antenna (as a worst case, we'll assume our water tower is an antenna) is directly related to its area, the next step is to find that area. The effective area (aperture) of a half-wavelength dipole is equal to 0.13081 times the wavelength squared.

Now, since the effective area of any antenna is a function of its gain, the effective area of the re-radiating structure can be calculated by multiplying its gain relative to a half-wavelength dipole by the effective area of the half-wavelength dipole as calculated above.

One good way to find the gain of a vertical antenna over a perfect ground is to use Fig. 8 of Part 73.190 of the FCC Rules. Using the "theoretical" curve on that graph, find the effective field (IDF) using the height of the re-radiating structure in wavelength. The latest version of this chart is in mV/m per kW at one kilometer; earlier versions are in mV/m at one mile.

If the version you are using is not metric, convert by multiplying the IDF value read off the chart by 1.609. Now, divide this figure by 221.4, the IDF for a half-wavelength dipole antenna at one kilometer for one kilowatt. The square of this ratio is the gain of the re-radiating structure relative to a half-wavelength dipole. The effective area of the re-radiating structure can now be found by multiplying the gain by the effective area of the dipole.

Let's assume for the purpose of making a worst case calculation that the potential re-radiating structure behaves like a uniform cross-section narrow antenna with sinusoidal current distribution and grounding through an impedance equal to its conjugate impedance, with no losses. In this case, the power absorbed by the structure is equal to the power density in watts per square meter multiplied by the aperture in square meters.

As is true in any case, the maximum transfer of power occurs when a load has the same impedance as the source (equal resistance, equal but opposite reactance). Under these conditions, half the power absorbed by the structure is dissipated in the load and half is re-radiated.

With all this done, we can now calculate the worst case inverse distance field at one kilometer that will be produced by our re-radiating structure. Do this by taking the inverse distance field for the structure from Fig. 8 of Part 73.190 of the FCC Rules, converting it for watts (divide by the square root of 1000), and multiply by the square root of half the power absorbed by the structure.

Depending on the height of the structure, the re-radiated field will usually be between three percent and seven percent of the incident field strength at the structure. If this value is less than half of the licensed maximum IDF on any given radial, the DA can probably be adjusted to compensate. If it is greater, then you could have a problem.

If the calculated re-radiated IDF is less than 10 percent of the lowest value of the directional pattern maximum IDF, then re-radiation from this structure is not likely to be the problem.

Let's walk through a sample calculation.

In this example, let's assume the following:

Frequency = 1500 kHz
 $\lambda = 200$ meters

Re-radiating structure = 40 meters high
 $\lambda = 0.20$

Distance = 1.2 km

Source IDF = 300 mV/m at one km

Start by finding the no-loss incident field strength arriving from the antenna at the location of our potentially re-radiating object:

$$FS = 300 / 1.2 = 250 \text{ mV/m} = 0.25 \text{ V/m}$$

Now, calculate the RF power density at that location:

$$PD = 0.25^2 / 120\pi = 1.66 \times 10^{-4} \text{ watts/cm}^2$$

Find the aperture of a half-wavelength dipole antenna:

$$\lambda/2 \text{ Aperture} = 0.13081 \lambda^2 = 5,232 \text{ square meters}$$

continued on page 20 ►

Hard Drives for Digital Audio

► continued from page 8 used: MFM and RLL. The latter packs more data in the same disk space. The controller card must be the same interface type and encoding scheme as the drive. It's best to buy the controller and drive as a matched pair from a single vendor.

When you order a hard drive, be sure it will be compatible with your computer. Check the BIOS date that shows on power-up. Ask the drive vendor if the drive you want will work with this date of BIOS.

Once you have the drive, you're ready to install it. Using your computer's setup program or drive-installation software, set the BIOS cylinders/heads/sectors count to match that of the drive (this is unnecessary with a SCSI drive). Partition and format the drive. Then use your computer's setup program to tell the computer that you've installed a new hard drive.

Finally, install the digital editing software onto your hard disk drive C. Tell the software to store the audio on drive D. After hooking up the appropriate cables, you're ready to edit!

□□□

Bruce Bartlett is a microphone engineer and technical writer for Crown International, and the author of Stereo Microphone Techniques published by Focal Press. Jenny Bartlett is a technical writer. Bruce can be reached at 219-294-8388.

Clipping creates **LOUDNESS**... Composite clipping is the **LOUDEST**

The trick is to keep distortion low...

Introducing

SE-1 LOW DISTORTION COMPOSITE PROCESSOR

Distortion-canceling circuitry allows more clipping (loudness) with less distortion. Simple Installation & Setup. Only **\$395.00** Complete!

The SE-1 allows you to increase your loudness up to 6 db over using no composite clipping. Distortion is negligible up to 3 db of clipping with a gentle rise at 6 db.

There is no finer composite processor on the market today.



SOMICH ENGINEERING... Loudness WITH Quality
800-334-3925

Processing Tools for Competitive Broadcasters

Circle (32) On Reader Service Card



MODEL 450 DUAL FM SUBCARRIER

Tectan's Model 450 is a frequency agile, synthesized FM subcarrier unit designed specifically for narrow band multi-channel applications. Each unit contains two completely independent transmitters or receivers for stereo applications over terrestrial microwave, satellite or analog fiberoptic facilities. Call your friendly Harris Allied salesperson today for complete details. Thanks!



317-962-8596

Fax (317) 962-8961 • In Canada (800) 268-6817

© 1992 Harris Allied

"Call me, I'm interested." Circle (18)

"Send me literature." Circle (163)

STATION SKETCHES

Who's running the ship?

Unattended operation is one way to keep your station profitable, but you still have to mind the store.

The acclaimed Burk Technology ARC-16 Remote Control System is the first step. You can control transmitter and studio from any phone.

But wait. There's more!



Introducing AutoPilot™ from Burk Technology.

AutoPilot is break-through computer software that makes automatic operation of your studio/transmitter facility a dream come true.

- Automatic power changes
- Automatic pattern changes
- Automatic site changes
- Automatic power trim
- Automatic fault recovery
- Automatic logging

Now your imagination is the only limit.

The new FCC fine schedule is imposing. Why risk a big penalty when AutoPilot can help you stay within the rules?

Call us at 508-433-8877
or toll free at
1-800 255-8090
for more information
and a FREE DEMO.



Circle (48) On Reader Service Card

Preventive Transmission Line Maintenance

Editor's note: Tom Vernon's Station Sketches is running in RW's transmission special issue; his byline will not appear in the July 22 issue. Look for Station Sketches again in the August 19 issue of RW.

Always use the utmost care and follow good engineering practices when working with or around electrical equipment. RW will not assume responsibility for loss or injury.

by Tom Vernon

HARRISONBURG, Pa. Transmission line is the vital link between transmitter and antenna. That it is often at an unattended site and inaccessible makes it all the more so. This column looks at ways to protect transmission line, and how some of the protective devices work.

The simplest devices to save your transmission line and transmitter from damage are

devices are electromechanical. Some transmitters, like the old AEL units, had the relay meter built in—but it was also available as a separate rack mount unit.

In either case, operation was pretty much the same. The DC output from the reflected directional coupler was fed to a meter relay, which drove an external relay with healthy contacts. Response time was typically about 10 microseconds.

The normally-closed contacts were typically wired in series with the transmitter interlock circuits. Provisions were included for remote reset, and sometimes remote metering of reflected power. A delay relay held off operation for one or two seconds when the transmitter was turned on.

In order for these protective devices to be effective, they must be calibrated properly. The first step is to calibrate the unit for 100 percent forward power. To do this, adjust the transmitter power to 100 percent as measured on the output meter. Next, remove the forward output cable from the transmitter and connect it to the VSWR protection unit.

Adjust the calibration control until the unit's meter reads 100 percent. You may want to set the unit's trip point full clockwise so that it doesn't become a nuisance while performing this step.

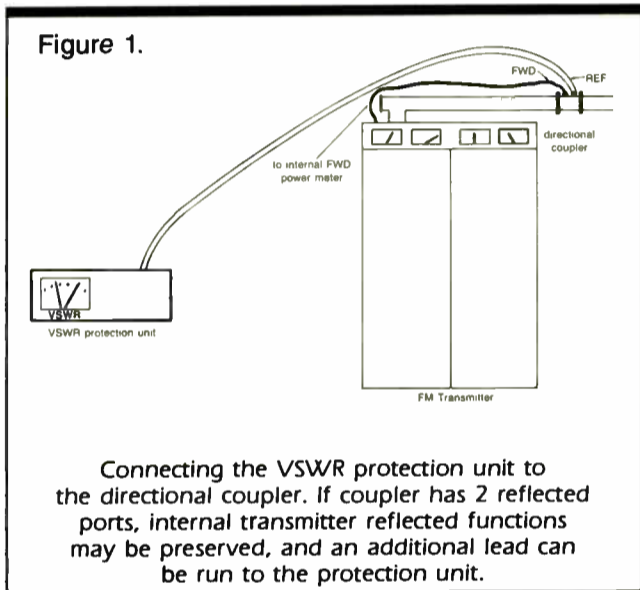

line monitors that shut the transmitter down when the vertical standing wave ratio (VSWR) exceeds a predetermined threshold. Newer units are all solid state, while older

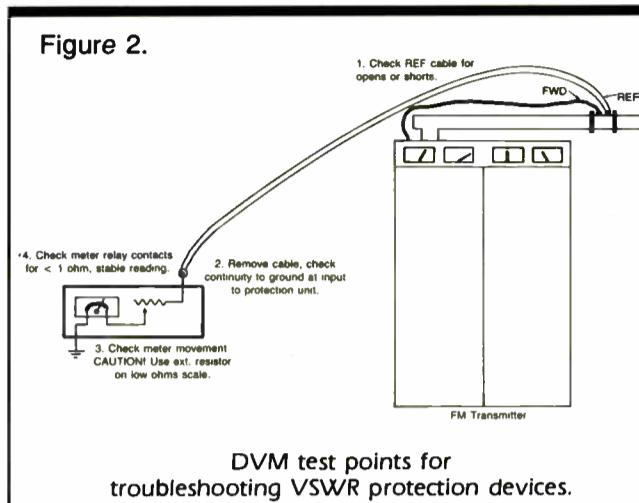

units were electromechanical. Some transmitters, like the old AEL units, had the relay meter built in—but it was also available as a separate rack mount unit.

The trip point is adjusted next. Reduce the transmitter output power until the unit's meter reads about 1:1. Set the trip point for 1:3, as this is a nominal value for normal operation. Increase output power until the unit trips. It should be at 1:3, and should be consistent for several repetitions. Finally, connect the reverse cable to the protection device, and return the forward cable to the transmitter. The final setup is illustrated in Fig. 1.

Some directional couplers have two outputs for forward and two for reverse power. One set feeds the transmitter's meters, the other set is left for customer use. In this case, an additional cable may be run from the second reverse connector to the VSWR protection unit. Under no circumstances should meters be paralleled. This invalidates calibration and degrades accuracy.

Icy conditions

If you don't have antenna de-icers, or if they're defective, the unit may trip the transmitter off during periods of sleet or icing. This is to be expected, as ice effectively changes the length of the antenna elements and detunes them. In this case transmitter power will have to be reduced, as this will also lower the reflected power.

Maintenance of these devices is quite simple. Make a yearly check of calibration as previously described. As part of monthly maintenance, connect the forward cable to the unit and verify the trip point. This may be done at the same time other transmitter overload circuits are checked.

On older units, the meter relay pointer may be touching the limit contact but fail to shut the transmitter down. Often this is traced to corroded contacts, a common problem in damp environments. Before you become aggressive and disassemble the meter, however, hand your DVM across the contact terminals and check the resistance.

Remember to zero out lead resistance or subtract it from your reading. It should be less than one ohm, with a stable display. Erratic readings or anything over one ohm makes the meter relay suspect.

Handle with care

If disassembly is required, first make a drawing of how the meter is wired into the unit. Then remove the meter, gather up your jeweler's screwdrivers and other small tools, find a quiet, dust-free work space, and begin disassembly. Very carefully polish the delicate contacts with crocus cloth.

Again check continuity with your DVM while gently bringing the contacts together. You may want to dab on some renewal spray. Some engineers have had great suc-

continued on page 20 ►

dataworld® MAPS

DO YOU KNOW YOUR MARKET? YOUR COMPETITION DOES!

DATAWORLD MAPS CAN

- Depict your coverage!
- Market orient your sales people!
- Target your ethnic/demographic markets!
- Identify marginal signal areas!
- Plot any special requirements!

MAP OPTIONS

- SHADOWING (TERRAIN SHIELDING)
- CONTOUR COVERAGE
- POPULATION DENSITY
- ZIP CODE BOUNDARIES
- RECEIVED SIGNAL LEVEL
- SPECIAL REQUIREMENTS

dataworld®
A Service of DW, Inc.

(301) 652-8822 (800) 368-5754

"Doing things for successful FM translators"

FM TECHNOLOGY ASSOCIATES, INC.

Talk with Howard Enstrom, veteran broadcast consultant who, in the 70s switched to FM translators as a specialty.

FMTA services: Feasibility studies, frequency searches, system design-engineering, FCC applications. Publisher of The SIGNAL SOURCE, bi-monthly newsletter all about FM translators. BEST EQUIPMENT PRICES.

FM TECHNOLOGY ASSOCIATES, INC.
30925 Vista Vista
Mount Dora, FL 32757
(904) 383-3682 FAX (904) 383-4077

Circle (19) On Reader Service Card

Circle (174) On Reader Service Card

The Future of STLs in Broadcasting

by Paul Rebmann

LAKELAND, Fla. Many developments are occurring in the aural STL band, even though some improvements have been hampered by the failure of the FCC to adopt new regulations to alleviate congestion problems.

With the extended deadline for all STL transmitters to be type notified about a year away, the anticipated availability of digital STL systems has become a reality. The type-notification deadline was enacted in FCC Rule Part 74.550 in 1985 and was originally scheduled to go into effect two years ago. Before the rule went into effect, the FCC amended Part 74.550 allowing stations until July 1, 1993 to replace non-compliant transmitters.

"Rumors and innuendo"

Moseley Associates' National Sales Manager Dave Chancey said that the type-notification issue is surrounded by "rumors and innuendo" and the date issue is viewed by many as changeable. He added that the company has had "lots of people calling and saying that the deadline is going to be extended again, even though the FCC indicates that this will not happen."

TFT Director of Marketing Darryl Parker mentioned problems in the used equipment market and stated that "people are buying STL systems without realizing that the equipment will be out of date soon."

Although Moseley can type notify PCL-

505's and TFT can modify its 7700 transmitters (7700B units are already type notified), both companies mentioned that most of these upgrades are for backup equipment, and stations without any type-notified transmitters are usually buying new systems to take advantage of the improved sonic quality over the older models.

Digital STL systems are available from TFT, Moseley and now Dolby (see "Innovations in STL," RW May 20, 1992) and all meet the type notification requirements. TFT is also marketing its Reciter STL system, which eliminates any audio at the transmitter site by deriving an exciter output directly from the received microwave signal.

A variation on this system will be available from TFT this fall, according to Parker, which allows the station to use any FM exciter, placed at the studio with the RF output being fed to an IF interface STL transmitter and a Reciter to feed the FM transmitter. Parker said that the IF interface STL will allow stations to take advantage of fully digital FM exciters, which will probably be on the market soon.

Hudson, Mass.-based T-Tech is approaching the field from a different angle, by combining fiber optic and digital audio transmission technologies into the Pro-Audio-Fiber System. The product consists of two rack-mount units—the transmitter and the receiver. The transmitter accepts four analog inputs, converts these to a digital bit stream, adds error correction cod-

ing and synchronizing data and ultimately modulates a laser diode.

An intervening run of single-mode optical fiber, up to 45 miles in length, couples the laser's energy to the receiver. Following the receiver's optical detector, filtering and amplification are employed to reduce inter-symbol interference. Four levels of error-correction are applied; digital to analog conversion follows, resulting in four analog outputs.

FCC Inaction

But technology may be racing ahead of the regulatory machine. Dane Ericksen, chief of the SBE's FCC Liaison Commit-

tee, said that "the SBE lost out on its proposal to have the FCC extend minimum antenna requirements to the 950 MHz band."

The SBE's Petition for Rulemaking also included tighter frequency tolerance as well as transmitter power limits and specified desired-to-undesired ratios to existing co-channel and first adjacent channel stations. The petition, submitted to the FCC in early 1990, was dismissed without action after about a year, according to Ericksen.

Richard Rudman, chairman of the SBE Frequency Coordination Committee, said, "We don't understand the fact that the FCC has not given the proposed requirements the attention the SBE believes they deserve." He added that "the requirements for spectrum efficiency are tools necessary for the local frequency coordinators to accommodate users."

continued on page 18 ▶

Digital automation for engineers

As a professional engineer, you worry about things like electronic switching, balanced inputs and outputs, RFI suppression, and overall system reliability.

Those "silly things" that most digital automation makers overlooked. Whoops!

So, if "crazy details" like field serviceability, clean sound, professional design, and top-notch technical support matter to you, make the call.

You don't need another headache.

You need a Desk Jockey.

the Desk Jockey™
Digital automation that makes sense



**BROADCASTERS
GENERAL STORE**

2480 Southeast 52nd Street
Ocala, Florida 32671-7500
(904) 622-9058
FAX: (904) 629-7000

Circle (30) On Reader Service Card

SWEET & LOW.

If you're into audio for video, our message is short and sweet: The Tascam BR-20T is the lowest priced 1/4" professional centertrack timecode deck on the market.

The BR-20T is a professional audio-for-video recorder specifically designed for 2-track mastering and video post playback. Its center timecode track employs Tascam's innovative in-line head and timecode optimization system, neatly eliminating the need for timecode level monitoring and adjustments.

Other pro features of the BR-20T include full servo-controlled transport for quick, accurate response and gentle tape handling while under external synchronizer control. Easy, front-panel accessibility to all major audio calibration controls. And gapless/seamless punch in/out and spot erase.

The \$2,999* BR-20T. The sweetest little audio-for-video machine you'll ever see. At the lowest price you'll ever hear.

Check it out, post-haste, at your nearest Tascam dealer.

TASCAM®



© 1990 TEAC America, Inc., 7733 Telegraph Road, Montebello, CA 90640. 213/726-0303.
*Manufacturer's Suggested Retail Price.

Circle (33) On Reader Service Card

Are You Getting the Kind of Service That You Expect?

KOFOX 103
KTFX - FM 103.3
8107 E. Admiral Place
Tulsa, Oklahoma 74115

January 1, 1992

(918) 836

The President
Continental Electronics Corporation
P. O. Box 270879
Dallas, Texas 75227-0879

Dear Sir:

I am the owner of a 100,000 watt FM station in Tulsa, Oklahoma. I got into the FM business back in 1962 when FM wasn't anything!

I want to thank you for such wonderful employees like Cliff Koch (in the past), Ken Branton and Dave Chenoweth. I cannot begin to tell you how important their re-assuring voices on the other end of the phone have been when we were "off the air." I THANK YOU FOR YOUR 24 HOUR SERVICE!

As we move into 1992, I assure you that I would not consider buying any other product than Collins or Continental. YOU BACK UP WHAT YOU SELL AND I CAN NEVER FORGET THAT!

I hope you will suggest that others call me. I have nothing to gain by recommending CONTINENTAL. I recommend you only because you are REAL 24 hrs. a day. Your response time has always been a LIFESAVER.

Thanks for Steve, Dave, and Ken who really care about me and my old 835G.

Yours Truly,

Bill
William H. "Bill" Payne
President & Chief Engineer
Senior Broadcast Engineer

SOUND BROADCASTING
358 FURBY ST., WINNIPEG, CANADA R3B 2V5 (204)

January 9, 1992

Mr. Steve Claterbaugh,
Continental Electronics
P.O. Box 270879
Dallas, Texas
75227

Dear Steve:

It is always nice to communicate with Continental and particularly when it is to say "Thank you!"

Christmas Day proved to be an eventful day for Sound Broadcasting when our client, CIFX, was suddenly in dire need of an exciter loading resistor. As you are aware this is a part that NEVER needs replacing and a spare was nowhere to be found in the immediate area. A phone call to your parts department put me in touch with Bill Cooke, who performed beyond the call of duty. Within hours he had the right component on a plane to us. A little fancy footwork with the customs office and we were back in business before Boxing Day was over.

I would appreciate you passing my personal thanks on to Bill, and of course a very Happy New Year to you and everyone at Continental.

Best regards,

Sheila R. East
Sheila R. East
General Manager.

24 Hour Service

Technical Service
214-388-5800

Service Parts
214-388-3737



Continental Electronics Corporation
P.O. BOX 270879 DALLAS, TEXAS 75227-0879
214-381-7161 TELEX: 73-398 FAX: 214-381-4949

Circle (102) On Reader Service Card

The Advantages of Switching To an FM Combiner System

by Ernest H. Mayberry

LAUREL, Md. In the competitive world of FM broadcasting, the sharing of transmitting facilities may appear contradictory to a station's individual interests. However, the need for available, economical transmit facilities and the desire for state-of-the-art performance points to combined transmitting systems as the solution.

Most FM stations lease aperture space for side mounting their antennas. With the advent of Docket 80-90, Class C stations required antenna heights of 300 meters height above average terrain (HAAT). Aperture space at 300 meters available for lease certainly is not plentiful. Multiplexed systems offer the most efficient use of available aperture, allowing multiple stations to locate on and lease only one aperture.

Superior antenna performance is another benefit of combined systems. Complete FM band operation is only provided by wrap-around panel antennas. These panel designs provide excellent omnidirectional performance by directing the signal away from the tower in sectors which vectorially add to provide a circular azimuth pattern.

Azimuth pattern circularities in the range of ± 2 dB to ± 3 dB are typical, depending on the tower/panel configuration. Contrast this to the average FM bent-ring antenna with an azimuth pattern that varies greatly with angle, producing pattern minimums that can range 10 dB or more below the maximum. Today's combined antenna systems also provide excellent impedance bandwidth with a vertical standing wave ratio (VSWR) of less than 1.10:1 at carrier ± 200 kHz for each of the channels operating on the system. Therefore, excellent stereo and SCA performance is assured.

Besides the bandwidth requirements, power rating considerations also necessitate the use of panel antennas. Eight-bay systems typically use 35 kW transmitters with TPOs around 30 kW while a 12-bay system uses 25 kW transmitters operating at approximately 20 kW. Total combined powers can range from 200 to 300 kW for 10-channel systems.

Dual transmission line runs to feed the antenna top and bottom halves provide redundancy to keep the system on the air in the event of a line or antenna failure.

Each individual station in the combined system requires its own constant impedance bandpass module tuned to its frequency.

A State-of-the-Art Combiner System

- Wrap around panel antenna (8-12 bays)
- Dual input, redundant transmission line
- Bandpass combiner modules
- Low power group delay correctors
- Emergency combiner module bypass
- Monitor/protection system with micro-processor controller

Bandpass modules furnish the best combination of transmission transparency, inter-modulation product control, and input-to-input isolation. These designs typically produce transmission performance of better than ± 0.1 dB amplitude and ± 25 nanoseconds group delay variation for carrier ± 150 kHz. Input-to-input isolation exceeds 50 dB.

Emergency bypass of a module is a desired feature. In the event of a problem with a module, that module can be removed from the system, input patch link repositioned, and output bypass link inserted to allow the affected station to remain on the air into the wideband port of the system.

The monitor/protection system typically monitors input and output VSWRs and the states of all patch panels and bypass links. Its function is not only to display the status but to shutdown or reduce power from the transmitters in response to VSWR faults, abnormal power levels, or altered patch link positions.

The large number of inputs and outputs and logic decisions necessitates a microprocessor controller. Besides local display and periodic printout of status reports, the controller allows remote status reports by modem.

The most compelling reasons to participate in combined systems are to obtain economically a desirable site location at the required height, and state-of-the-art transmission performance.

A prime example of this type of premium system is the Shoreview FM system, serving the Minneapolis/St. Paul market. This system was supplied by LDL Communications and Alan Dick & Co. and was put into operation with eight Class C stations in the fall of 1991.

□ □ □

Ernest Mayberry is the systems engineer for Laurel, Md.-based LDL Communications, Inc. For more information, contact LDL at 301-498-2200.

The Future of STLs in Radio

► continued from page 17

Rudman noted that the proposed antenna requirements are sometimes being followed voluntarily—usually in "instances where it is the only way to accommodate a new user." However, he added, "absent FCC action, people tend to do minimal engineering." Ericksen said that the proposed desired-to-undesired ratio would have clarified what is expected in the way of protection to existing users.

Ericksen did applaud the FCC for adding "question 16" pertaining to frequency coordination to Form 313, although he pointed out that other services are required to provide formal evidence of frequency coordination efforts. He added that the FCC's auxiliary services branch has been known to do ran-

dom spot checks on 313 applications and check to make sure the local frequency coordinator has been contacted by the applicant.

The FCC has attempted to provide for more users in the 950 MHz band by breaking the band into 25 kHz segments and urging FM stations to use no more than 300 kHz bandwidth and for AM stations to limit themselves to 200 kHz. Ericksen stated that the "effective date of this channel utilization is still in question, and even when it does go into effect, use is not mandatory."

He felt that few stations would be able to take advantage of the FCC's incentive of allowing broadcasters to sell extra space on their STL for non-broadcast purposes if they only used the 300 or 200 kHz bandwidths.

OVER
5 MINUTES
OF 15 KHZ STEREO AUDIO
ON EACH 13MB FLOPPY DISC



Digital Made Simple

The New Dynamax DCR1000

Digital Cartridge Recorder

The Recorder

- Selectable sampling rates
- Secondary and Tertiary cues
- Extended scale peak metering
- AES/EBU digital input
- Start on audio
- Direct digital dubbing from CD
- PC keyboard for titling

The Reproducer

- Simple cart-like operation
- No on-air personality training
- Just three front panel buttons
- Instant start and cue
- Maintenance-free design
- No head cleaning or alignment
- Awesome audio quality

The Media

- 13MB stores over 5 minutes stereo audio with 15kHz bandwidth and 15 minutes mono with 10kHz
- Standard low-cost 2MB floppy disk holds 60-second commercials

The new Dynamax DCR1000 is available now, and it's priced like an analog cart machine. You will be amazed by its versatility. Call Fidelipac for more details.



Fidelipac Corporation □ P.O. Box 808 □ Moorestown, NJ 08057 U.S.A. □ TEL 609-235-3900 □ FAX 609-235-7779

Circle (70) On Reader Service Card

World Radio History

A TDR Can Help Identify Trouble in Line

by John Bisset

FALLS CHURCH, Va. A time domain reflectometer (TDR) can be an excellent diagnostic tool for verifying coaxial transmission line performance.

There are two basic types of TDRs—low power and high power. The low power TDRs are great for shorter cable runs, and for sites where there is no induced RF from other transmitting antennas.

For longer runs of transmission line, often the low power TDR cannot generate a pulse strong enough to make it to the end of the line, and false pictures of the line's condition may occur. If RF from adjacent transmitting antennas is present, the sensitive front end of the low power TDR can be damaged by the induced voltages.

The high power TDR is immune to these two problems. A variable low current, high voltage (5 kV) pulse overcomes long line length, and produces clear fault echoes even with full power stations operating on the same tower. The high power TDR is capable of withstanding up to 1 kW of power coupled into it from adjacent sources.

Operation of either TDR is basically the same. A short duration pulse with a fast rise time is generated by the TDR and coupled into the cable being investigated. Inconsistencies in the transmission line will cause some of this energy to be

reflected back to the TDR, where it is displayed on a screen or a chart recorder.

The nature of line faults can be determined based on the shape of these reflected or echoed displays. For example, a large negative-going pulse indicates a short circuit. A large positive-going pulse indicates an open circuit.

In addition to displaying the condition of the transmission line, a TDR can be used to measure accurately the distance



The sine wave shapes echoes seen from left to right represent hard line bullets. The "hump" located to the right of the picture illustrates a faulty bullet.

to the fault. Using a table that determines the distance per centimeter displayed on the CRT screen (based on the type of cable—air, foam, or poly dielectric), cable faults can be pinpointed.

□ □ □

John Bisset can be reached at 703-379-1665.

Preventive Line Maintenance

► continued from page 16

cess by rubbing the contacts with mercury.

If your meter still insists on misbehaving, it will have to be replaced. Some of these have been out of production for about 20 years. With patience, however, you may be able to scavenge a replacement through one of the surplus electronic catalogs, or here in RW's classifieds. If not, it's time to throw in the towel and spring for a new unit. Reliability is critical, and a cranky VSWR protection circuit is simply not worth the risk.

You may notice at some time the meter reads 0 VSWR, and this should be investigated as soon as possible. Remove the cable from the unit and return it to the reverse position on the transmitter and check operation. If there is still no reading, remove the forward diode and put it in the reverse position.

If the meter now operates, the reverse diode was probably a victim of lightning and must be replaced. If there is still no response, lightning may have damaged the cable from the directional coupler, the meter movement, or the meter's relay contacts.

Trouble-shooting is simply a matter of checking continuity with an ohmmeter. Start by removing the reflected cable from the transmitter end and work back towards the meter. It's usually wise to remove the protection device from the transmitter interlock circuits before beginning. This will avoid accidentally shutting the transmitter down while making repairs.

Remember to use your DVM's low ohms position or insert a resistor in series with the leads when checking the delicate meter movement for continuity. Meter relays with open movements or burned contacts are usually not repairable and must be replaced. Our repair procedure is illustrated in Fig. 2.

VSWR protection units, whether old relay types or new solid state devices are often ignored during transmitter maintenance. Their reliable operation depends on frequent checks and prompt repairs.

□ □ □

Tom Vernon, a regular RW columnist, divides his time between completion of a Ph.D. and consulting. He can be reached at 717-367-5595.

Is Re-radiation Affecting You?

► continued from page 15

Next, find the IDF of a 0.2λ vertical radiator from Fig. 8 of Part 73.190 of the FCC Rules. This is given as 191.94 mV/m at one mile for one kilowatt. Convert to metric by multiplying by 1.609344. The IDF is then 308.9 mV/m at one kilometer for one kilowatt. Now find the gain of our vertical radiator over a half-wavelength dipole:

$$\text{GAIN} = (308.9/221.4)^2 = 1.947$$

Calculate the power absorbed by the structure:

$$\text{PA} = 0.13081 \lambda^2 \text{GAIN} \times \text{PD}$$

$$\text{PA} = (0.13081)(\lambda^2)(1.947)(1.66 \times 10^{-4}) = 1.69 \text{ watts}$$

Finally, calculate the amount of re-radiation: $\text{IDF} = 308.9 / \sqrt{1000} \times \sqrt{0.845} = 8.98 \text{ mV/m}$ at one kilometer

Note that the re-radiation, 8.98 mV/m, is only about 3.5 percent of the incident field strength arriving at the structure.

Of course, there are a lot of other variables that we cannot easily consider in our calculation. Things such as top loading (as you would have with guyed towers, some water towers, etc.) can influence the efficiency of a re-radiator. But the bottom line is that if the power isn't there, it cannot be re-radiated.

If you suspect that a re-radiating structure is causing problems with your pattern, start with the calculations shown here. The results are by no means conclusive, but they will tell you whether you are barking up the right tree.

If your maximum radiation on a null radial is, say, 16 mV/m in the example given above, then it is possible that the re-radiating object is the source of your troubles. If the maximum is 30 mV/m, you will probably need to look elsewhere.

□ □ □

Cris Alexander is director of engineering for Crawford Broadcasting. He can be reached at Box 561307, Dallas, TX 75356.

CCA

Evolution.

CCA has delivered more than 3,000 Broadcast Transmitters over the past 25 years. For 25 years our designs have been refined and improved. The result is the Evolution of the world's most perfected, most tested, most reliable, Radio Transmitter.

- * **Grounded Grid Triode**
- * **Longest Tube Life**
- * **Auto Power Control**
- * **VSWR Power Foldback**
- * **Single Phase Optional**

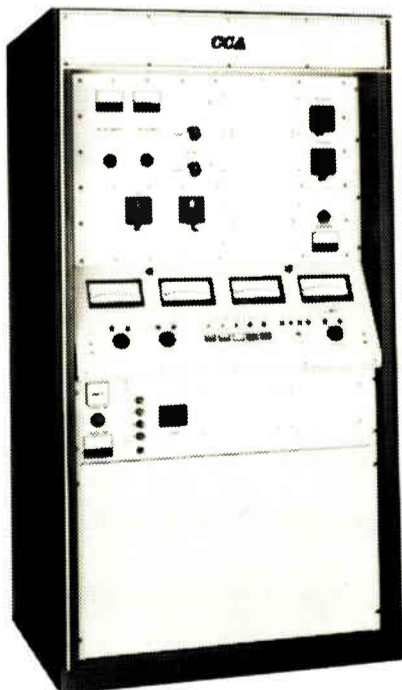

CCA Electronics, Inc.
P.O. Box 426
Fairburn, GA 30213
(404)964-3530 FAX (404)964-2222

SUBSCRIPTION/READER SERVICE FORM

Radio World

July 8, 1992 Issue Use until October 8, 1992

FREE Subscription/Renewal Card

I would like to receive or continue receiving Radio World FREE each month. YES NO

Signature _____ Date _____

Please print and include all information:

Name _____ Title _____

Company/Station _____

Address _____

City _____ State _____ ZIP _____

Business Telephone () _____

Please circle only one entry for each category:

I. Type of Firm

- | | |
|------------------------------|---------------------------------|
| D. Combination AM/FM station | F. Recording studio |
| A. Commercial AM station | G. TV station/teleprod facility |
| B. Commercial FM station | H. Consultant/ind engineer |
| C. Educational FM station | I. Mfg, distributor or dealer |
| E. Network/group owner | J. Other _____ |

II. Job Function

- | | |
|-----------------------|---------------------------|
| A. Ownership | D. Programming/production |
| B. General management | E. News operations |
| C. Engineering | F. Other (specify) _____ |

III. Purchasing Authority

- | | | |
|--------------|------------|------------|
| 1. Recommend | 2. Specify | 3. Approve |
|--------------|------------|------------|

Reader Service

Please first fill out contact information at left. Then check each advertisement for corresponding number and circle below. NOTE: Circle no more than 15 numbers, otherwise card will not be processed.

- 001 023 045 067 089 111 133 155 177
- 002 024 046 068 090 112 134 156 178
- 003 025 047 069 091 113 135 157 179
- 004 026 048 070 092 114 136 158 180
- 005 027 049 071 093 115 137 159 181
- 006 028 050 072 094 116 138 160 182
- 007 029 051 073 095 117 139 161 183
- 008 030 052 074 096 118 140 162 184
- 009 031 053 075 097 119 141 163 185
- 010 032 054 076 098 120 142 164 186
- 011 033 055 077 099 121 143 165 187
- 012 034 056 078 100 122 144 166 188
- 013 035 057 079 101 123 145 167 189
- 014 036 058 080 102 124 146 168 190
- 015 037 059 081 103 125 147 169 191
- 016 038 060 082 104 126 148 170 192
- 017 039 061 083 105 127 149 171 193
- 018 040 062 084 106 128 150 172 194
- 019 041 063 085 107 129 151 173 195
- 020 042 064 086 108 130 152 174 196
- 021 043 065 087 109 131 153 175 197
- 022 044 066 088 110 132 154 176 198

Copy & Mail to: Radio World, PO Box 1214, Falls Church VA 22041

PRODUCTS & SERVICES SHOWCASE

For more information on the products shown below, circle the appropriate Reader Service No.(s) on the enclosed Subscription/Reader Service card or contact the advertiser directly.

Improve Your Voice!

Clear the cobwebs out of your mic signal path with the new Benchmark MP-3 Mic Preamp

- 1 dB noise figure
- THD = 0.005% (2 kHz at A=40 dB)
- Variable gain +26 to +65 dB
- Balanced output
- +48 V Phantom power input
- Jack mount anywhere!

\$95



Benchmark
...the measure of excellence!

Contact your pro audio dealer or call
BENCHMARK MEDIA SYSTEMS, INC.
800/262-4675 315/437-6300 FAX 315/437-8119
READER SERVICE NO. 146

Nearly 3,000 in use worldwide



LPB Signature Series consoles; very reliable, simple to operate, easy to install, easy to maintain seven models, excellent value. Radio stations worldwide depend on LPB. Call, fax, write or circle our Reader Service number.

LPB®
28 Bacton Hill Road, Frazer, PA 19355 USA
Tel: +1-215-644-1123, Fax: +1-215-644-8651
READER SERVICE NO. 27

TELE-VOTE

Multi-line Telephone Polling System



Features:

- Can answer and pole up to 6 telephone lines simultaneously
- Each caller hears your custom greeting message (up to 6 min)
- Callers vote by pressing 1 to 5
- Votes instantly tallied on a LCD display
- Message is digitally recorded—no tape

RACOM
PRODUCTS INCORPORATED

5504 State Rd., Cleveland, OH 44134
Phone: 216-351-1755 or 800-722-6664
Available thru HARRIS-ALLIED at 800-622-0022
READER SERVICE NO. 115



Econco

REBUILT POWER TUBES



Approximately One Half
the Cost of New
3,000 Hour Unconditional Guarantee
Call for Our Price List

Econco 1318 Commerce Ave. Woodland, CA 95695
Phone: 916-662-7553 Fax: 916-666-7760 Telex: 176756
Toll Free: 800-532-6626 From Canada: 800-848-8841
READER SERVICE NO. 65

WireReady™

Offering a real choice for today's radio news

STOP WASTING PAPER

SAVE TIME & MONEY

COMPUTERIZE YOUR NEWS



- Print just what you need
- Split-Screen editing
- Easy-to-Install
- Simple-to-Use

Manages: AP, UPI, Reuters, ABC, CBS, NBC, NOAA, CNN, and many others.
Hundreds of Users: AM/FM music, AM news/talk, State Networks, U.S. Gov't agencies.

WireReady Newswire Systems Inc. 31-H Union Ave., Sudbury MA 01776 USA
(508) 443-8181 (800) 833-4459 FAX (508) 443-5988
READER SERVICE NO. 187

NEW PRODUCT!!!



"THE AUDIO LOGGING SCAM"

ESE announces the ES-ACM7, Seven Channel Audio Multiplexer (S.C.A.M.).

The ES-ACM7 enables a radio station to log their own stations and/or monitor as many as seven other stations simultaneously by recording audio onto the video channel of any VCR. On playback, the ES-ACM7 receives the encoded video signal and provides an output of the selected channel. A front-panel thumbwheel switch provides this selection. Two more sources of audio or time and date data can be recorded on the audio tracks of the VHS tape giving the user a total of nine audio sources recorded on one VHS tape.

With up to 8 hours of record time available on a single VHS tape this is a very efficient and cost effective means of logging/monitoring.

ESF 142 Sierra Street, El Segundo, CA 90245
Phone: 310-322-2136
READER SERVICE NO. 23

PRECISION BROADCAST CABLES

NEC CL2



AUDIO

- One pair, 22-gauge
- Flexible jacket
- Available in 7 colors
- One-step stripping



VIDEO

- Low loss .7 db @ 10 MHz
- Flexible jacket
- Same size as RG-59



SNAKE

- 2-24 pair
- Each pair numbered

Complete line of broadcast interconnect products, connectors, custom panels and cable preparation tools.

NEMAL ELECTRONICS, INC.
12240 N.E. 14 AVE., NO. MIAMI, FL 33161
OFFICES IN NEW YORK & FLORIDA

Please call or fax for your copy of our 44-page Cable & Connector Selection Guide
US:(800)52-CABLE (522-2253) • Fax:(305)895-8178 • Intl.:(305)899-0900
READER SERVICE NO. 155



WHY LEAVE THEM IN THE DARK...

...when you can reach over 18,000 radio professionals with your product showcase ad? Gain valuable exposure for your products or services at minimal cost.

For more information

1-800-336-3045
or
FAX 1-703-998-2966

Field Experience in Solid State Design

by Russ Erickson

LOUISVILLE, Colo. The wide range of climates, geographies and operating conditions in which TTC has installed its line of FMS Series solid state transmitters has allowed us to learn a great deal about how to make a transmitter more rugged and reliable. Our units are in service from Ireland to Cyprus, from Thailand to Venezuela, and even in the United States.

Field experience has proven to be invaluable to our engineers, giving us the ability to improve on the performance of solid-state FM. The following is a brief review.

Special consideration has to be given to

lightning immunity for solid state transmitters. In areas like Venezuela and the Gulf Coast of the U.S., lightning wreaks havoc on most transmitter sites.

Band-pass filtering

For the RF output, we found that a band-pass type output filter is much more effective than the typical low pass filter used in a tube type transmitter. In a band-pass design, the high pass section attenuates low frequency energy caused by nearby lightning strikes.

A DC short incorporated in the output filter provides a low resistance path to ground, which helps eliminate static build-

up on the antenna by allowing a free flow of electrons to flow from the antenna to the cloud bank.

Constant power

Another major consideration for lightning strikes is the AC input. A conventional power supply is adequate; in the harsh environments of transmitter sites, a switchmode supply is questionable. We settled on a ferro-resonant type of supply because of the excellent reliability realized in translators and low power television transmitters.

The approach is quite straightforward. It is the same design some tube transmitter manufacturers use to regulate filament voltage in the final tube. The goal is to have an absolutely constant voltage regardless of voltage swings and spikes on the AC line. By using a saturated core transformer with a capacitor bank to balance the incoming AC, a ferro-resonant supply can tolerate voltage swings of ± 15 percent.

Addition of metal oxide varistors (MOVs) in front of the power supply adds protection. An MOV is a simple device that clips the incoming sine wave if it exceeds a predetermined amplitude.

The best approach TTC found for AC line protection was to use a fused disconnect, followed by a thyristor-style surge suppressor, followed by the transmitter's circuit breaker, through a set of MOVs to the power supply. This has proven, over the years, to provide excellent reliability.

The installation of an external surge suppressor is also valuable in the design of solid-state FM transmitters. A simple unit that utilizes a thyristor from each leg to ground is generally adequate when used with the above-mentioned supply.

Another important concern in a high lightning area is the type of devices used in the transmitter controller. TTC has found that CMOS devices are preferable to TTL or microprocessors. TTL devices require too little change in voltage to change state,

and microprocessors have proven to be too unpredictable to be reliable as a master transmitter controller.

Excessive heat, high humidity

Design challenges we faced in regards to heat and humidity ranged from the damp island climate of Cyprus to the torrential rain of Thailand. Overrating of power supply components for current is generally sufficient, but we found that additional consideration needed to be made, especially for transmitters intended for operation near the equator. Some early problems which occurred in hot, humid climates were

Cooling of the power amplifier devices is very important.

solved by changing to an even more robust transformer design.

Cooling of the power amplifier devices is very important. We use two blowers feeding a plenum at 700 CFM. This allows full performance ratings to 12,000 feet above mean sea level (MSL) up to 122 degrees Fahrenheit (50 degrees Celsius). If a blower should fail, shutters in front of the blower close, allowing the remaining blower to pressurize the plenum.

If both blowers stop, the vertical orientation of the amplifier modules allow for natural convection cooling. If convection cooling is inadequate, a power foldback function turns the amplifiers down to an acceptable operating level.

This foldback function operates individually on each amplifier module; if there is uneven heating, each module can contribute an appropriate amount to the total output power. We have found that this vertical orientation combined with the temperature foldback is essential to the long transmitter life.

Intermodulation

Intermodulation, or the mixing of two or more signals, is also an important consideration. A solid-state FM transmitter is very broadband, typically in excess of 2 MHz, with a synchronous AM noise figure of -60 dB. Again, a pass-band type filter must be used in order to maximize return loss from the antenna.

If the return loss is inadequate, a notch filter may need to be installed between the solid-state transmitter and the antenna. Although this is not recommended, reality dictates that you may need to actually make your transmitter more selective in a multiple signal environment.

□ □ □

Russ Erickson is the manager of radio products for TTC. The company offers the FMS Series, which was introduced in 1989, in power levels from one kilowatt to 16 kW. For more information, contact TTC at 303-665-8000.



WE BUY WE SELL WE TRADE

WE SAVE YOU MONEY!

Since 1960 we've been here when you needed us and we're still here to assist the broadcast community. It really makes sense to consider trade-in value when you buy new — or to sell that gear you don't need anymore to get cash flow.

Our inventory changes every single day. We've got a lot of great buys to help you upgrade your station or bail you out when those "emergencies" arise.

A lot of you folks caught in technology changes — and budget squeezes — can help yourself with our available equipment whether it formerly was demo items, scratch & dent, overstock, or refurbished used. Just remember to contact us when you need economical equipment solutions. Thanks!

**HARRIS
ALLIED**
EQUIPMENT EXCHANGE

317-962-1471

Fax (317) 966-6321

Measure Up With Coaxial Dynamics Model 81070 WATTCHMAN Transmitter Protection System.



WATTCHMAN—protects your transmitter and transmission line system. A permanent 19 inch rack installation used with any dual socket line section 7/8", 1-5/8", 3-1/8" and elements (additional) to monitor CW, TV, and FM power. Model 81070 features two easily read meters to monitor both forward and reflected power. The reflected meter provides a front panel adjustable set point which controls the trip level for fast transmitter shut down and alarm. Abnormal load conditions quickly cause transmitter shut down in less than 15 milliseconds including control relay. Both visual and audible alarms indicate system malfunction. Contacts provided for remote alarm and reset switching. Contact us for your nearest authorized Coaxial Dynamics Representative or Distributor in our World Wide Sales Network.

COAXIAL DYNAMICS, INC.

15210 Industrial Parkway • Cleveland, Ohio 44135
(216) 267-2233 or 1-800-COAXIAL
Fax: (216) 267-3142
Service and Dependability...
A Part of Every Product



Circle (93) On Reader Service Card

Call
CORTANA

For Affordable Lightning Protection
505-325-5336

P.O. Box 2548, Farmington, N. M. 87499
FAX 505-326-2337

Circle (17) On Reader Service Card



Track Record.

Take a close look at the trend setting BMX.

With installations at over 85% of the Top-10

market leaders, BMX is the standard by which

all other broadcast consoles are judged. That's

why others attempt to say their consoles are

just as good as ours. But mere talk can't

change the fact that BMX has the track record

of providing the features, performance, re-

liability and bottom-line value the leading

broadcasters demand. When you're ready to

own the best, PR&E has the consoles for you.



Pacific Recorders & Engineering Corporation

2070 Las Palmas Drive

Carlsbad, CA 92009

619-438-3911 FAX 619-438-9277

DESIGNS THAT MAKE THE DIFFERENCE

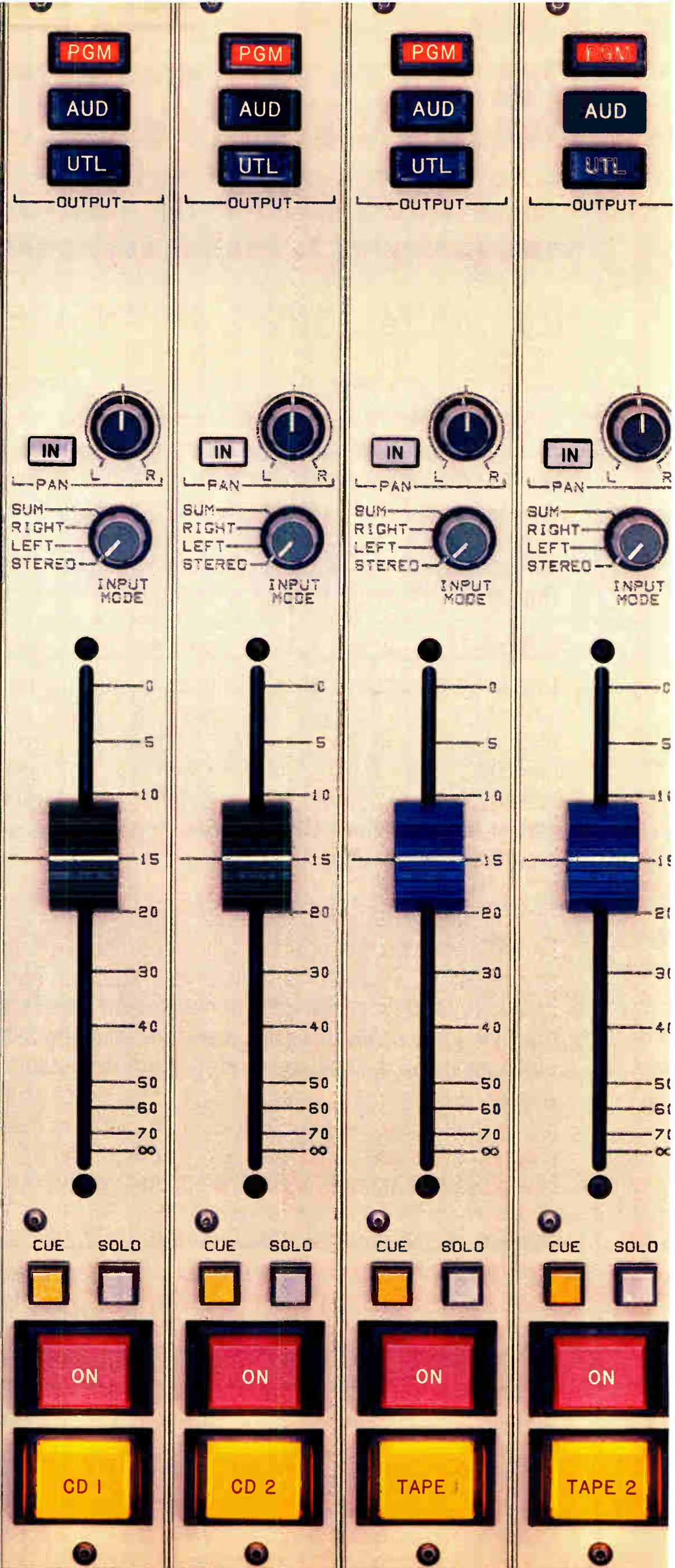

DIGILINK

...a revolution in radio studio technology

THE DIGITAL AUDIO ADVANTAGE...

Introduced in April of last year, Digilink is a digital audio workstation that saves your station money. There is no more routine maintenance, it has a 15 year average life, *and* you have total automation capability for nights... weekends... or whenever you need it. It comes complete in a 5 1/4" high, rack mounted cabinet that converts ordinary analog audio to CD quality digital audio which is stored on a computer hard drive. It does this just like you would store a business letter on your home computer. Digilink can then call up and play any digital audio file in milliseconds off its internal hard drive. Basically, you can think of Digilink as a huge multideck cart machine or cart carousel where you can line up and play thousands of carts or audio cuts sequentially. A single Digilink can therefore replace all of your cart machines in production, On Air, or in automation.

Digilink is a perfect cart or reel machine replacement...

Digilink is the perfect replacement for magnetic tape based cart or reel machines. With Digilink, you can replace your cart machines with CD quality digital audio that requires no calibration, no maintenance, and the media has a 15 year average life. You can replace your reel to reel machines, razor blades, and tape with fast, nondestructive, CD quality, on screen waveform editing. You can cue virtually instantaneously. Digilink even costs less than comparable analog cart or reel machines. Digilink is the perfect audio record and play system for professional radio broadcast applications.

Digilink performs ALL types of automation...

With Digilink you can operate fully live or mix various automation types into your daily programming. You can store all of your audio on hard disk at an incredible price or you can use hard disk for only commercial material recording. Digilink has an internal audio switcher with machine logic control. Digilink therefore supports satellite automation, reel and DAT tape automation, CD automation, and full hard disk automation all out of one compact box. Because Digilink is a computer, you can print out a log of what you have scheduled to play *or* print out a log of what really did play. With Digilink, you can be live on the air with full CD quality audio or program the system and walk away forever. Digilink even interfaces with all major traffic and billing systems through a Digilink import-export routine.

Digilink is engineered and manufactured by Arrakis...

Digilink is not simply a hardware package assembled from parts built by *other* computer manufacturers and run under our software. Arrakis is the *only* manufacturer to build nearly all parts of the digital system in-house. We build our own *Arrakis* DSP board, SCSI board, I-O board, switcher board, cabinet, and cabling. Because Arrakis builds the system and doesn't simply mark up someone else's hardware, Arrakis can offer you Digilink with broadcast features and performance unmatched by anyone *and* at a truly remarkable price !!!

2619 Midpoint Drive, Fort Collins, CO. 80525

..... at an incredible price. !!!!!!!

SALE \$7,995
under \$9,000
for a COMPLETE 6 hour stereo system

whether you lease for under \$300 a month or buy, with Digilink you can literally make money by ...

- reducing maintenance,
- reducing staff demands,
- improving On Air sound,
- improving Production,
and improving all areas of your station performance !!!



FEATURES

- Simultaneous record- play !!!
- Uncompressed CD quality audio or mix 2:1 or 4:1 compression
- Use keyboard, mouse, trackball, or even a touchscreen
- Digital Waveform Editing
- Mix mono and stereo files

- Live Cart Machine replacement
- Reel to Reel machine replacement
- Satellite Automation
- Tape Based Automation
- CD Automation
- Hard Disk Based Automation
- Traffic and Billing Interface
- supports digital networks

SPECIFICATIONS

all tests performed at 1:1 compression

Digital Signal Processing System (DSP)

Sampling System- 16 bit linear PCM, 2 channels
 Sampling Rates- 44.1,32,22kHz, fixed filter on routing switcher
 Compression- 0,2,4...adaptive differential PCM

Controller -

Floppy Disk- 3 1/2" 1.44M capacity, System Hard Disk- 40MB
 Printer Support- IBM compatible, parallel port

Audio Performance- Digital Record playback

THD- .008%, Dynamic Range >85dB,
 Freq Response- (+)(-).5dB 10Hz-15kHz

Physical Specifications

Dimensions- 19" Rack mounted- 19"W x 5 1/4" (3RU)H x 16"D
 Weight- 60lb's , Power- 110/220VAC, 50/60Hz, 100W

Audio Performance- Routing Switcher

THD- .005% typ, S/N < 100dB below +4dBm
 Dynamic Range- >120dB,
 Freq. Response- (+)(-).1dB 20Hz-20kHz

by ARRAKIS SYSTEMS inc.

Voice (303) 224-2248, FAX (303) 493-1076

TOTALLY TRANSPARENT TRANSMISSION PROTECTION.



TRANSMISSION LIMITER 4000

Pure Sound.

Protecting transmission systems from peak overload without audible artifacts—while stringently preserving natural sound quality—is the primary objective of many of the world's finest broadcast operations. That is why so many facilities around the world are choosing the Orban Transmission Limiter 4000. The 4000 provides the peak control they need, without audibly adding, subtracting or interfering with their signal in any way.

Don't Take Our Word for It.

The 4000 provides transparent limiting with any source. Blind tests confirm that the sound of the Orban Transmission Limiter 4000 is virtually indistinguishable from the original source when driven as much as 15dB into limiting—even to trained listeners. Try it for yourself and hear what your facility can deliver when it is protected, not just restricted.

Sophisticated, Easy to Use.

Orban engineers took years to develop the complex algorithms which permit the 4000 to protect inaudibly. Yet, they kept the front panel of the 4000 clean, clear and businesslike. The precision LED displays indicate any action of the compressor or HF limiter circuitry. The only adjustments are for INPUT level and OUTPUT level. The built-in tone generator and test mode permit rapid system setup and alignment.

Orban Signature Quality.

The Transmission Limiter 4000 is one of a family of reliable, quality Orban products designed for demanding broadcast applications. Call your local Orban dealer for a hands-on demonstration of the Orban Transmission Limiter 4000—another breakthrough product from the leaders in broadcast audio processing.

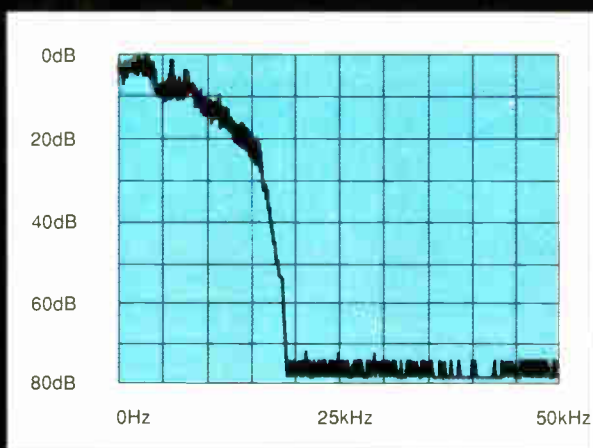

Power spectral density at the 4000's output using "maximum peak hold" measurement. (10kHz/div. horizontal; 10dB/div. vertical)

'Bear' Finds Niche in Chicago Market

by Bruce Ingram

CHICAGO After four format changes in 10 years, tiny, suburban WCBR-FM has finally settled on what seems to be a winning strategy—New Rock.

The 3,000 watt, Class A station, broadcasting from the northwest suburb of Arlington Heights, went on the air officially with its new format 18 months ago, after a gradual six-month transition from adult contemporary.

Now, with The Lemonheads, The Goo Goo Dolls and They Eat Their Own taking the place of Wilson Phillips, Gloria Estefan and Hall & Oates, WCBR-FM Program Director Tim Disa says the station is more successful than it has ever been.

Finding an Identity

"This station is an entity now," Disa explained. "It never was before." (Even during the brief period a few years back when

the station changed its calls to WSEX, a gambit that drew more attention from the FCC than local listeners.)

Though WCBR-FM has never had enough of a presence in the overall Chicago market (its signal covers roughly half of the city) to be ranked by Arbitron. Disa reports the station is now performing remarkably well in terms of sales.

He expects 1992 revenues to increase by 50 percent over last year. In addition to the small, local businesses that make up the bulk of the station's buys ("at Smile World, Dr. Rosen will build you the smile you've always wanted"), Disa says WCBR-FM is now attracting ad agencies for the first time, based on demographic information gathered during their many promotions.

New Rock programming, he said, along with a smattering of blues, reggae and less-familiar songs by familiar artists, has struck a chord with the 25- to 34-year-old urban

professional types who have migrated to the north and northwest suburbs along with the corporations that employ them.

Sears, for example, is in the process of moving from downtown Chicago to suburban Hoffman Estates. "We're geographically correct," Disa says with a laugh.

During a recent U2 concert ticket giveaway, WCBR-FM received more than 500 faxed entry forms (each containing demo specifics, of course) in 10 hours—nearly one a minute. The station also draws sizable crowds to the "Bear Bashes" it sponsors at the rate of 10 per month in local clubs.

Astute alternative

Alternative music was clearly an astute choice on Disa's part, coming as it did nearly a year before the current wave of interest in the New Rock format. Even so, he seems to have been surprised at the way it caught on with his listeners.

But there will be staff reductions in most other departments, and with the same number of people chasing fewer jobs, salaries will stagnate or decline. This cloud does have a silver lining: A three-station combo operation in a medium market could be a pretty big operation, capable of paying a good wage to workers who don't like the hassle of living in a major market.

Promotion costs (advertising) are a big part of the budget of major market stations. Some cost savings might be possible here, if the combo stations had some type of common image. This would be like promoting Baskin-Robbins as an ice cream brand, instead of chocolate and vanilla as individual flavors.

Companies that provide services to broadcasters will also suffer. Fewer, larger radio companies will have more negotiating clout to get better deals. And large groups won't have to contract for research, direct mail, and advertising services—with 60 stations, they can justify doing it in-house.

Contract engineers will hurt, too; they get

At launch time, Disa felt that AOR was the most viable option to attract suburban baby boomers. However, he knew he could not compete with heritage alternative rock station WXRT-FM, which has enjoyed a strong following among listeners in his area for the last 20 years, on its own terms.

continued on page 32 ▶

What the FCC's 30/30 Rules Can Mean for You

by Phil Simon

WASHINGTON The FCC's new 30-30 ownership rules could lead to some fascinating changes in radio. It's a chance to look into a crystal ball and try to predict the future. Let's not get sidetracked by the Commission's stated policy goals and the lobbying position of the NAB and existing broadcasters. We'll try to follow the money, and see where it leads.

At this writing, it's possible that Congress will scale back the FCC's proposal; but as it stands, the rules allow one broadcaster to own up to 30 AM and 30 FM stations, with more than one AM and one FM in the same market.

This could bring some really big players into radio; a blue chip company like Disney could swallow CBS Radio, Bonneville, Shamrock, Sconnix, Westwood and some others, all at once. Now that's big.

A new way of thinking

Up until now, there weren't enough zeros in radio to interest a company that size. I'd expect to see a large group operate with very centralized management and standardized operations. That could stifle creativity, but it could lead to effective cross-pollination, with successful ideas adopted by all the group's stations.

I think AM stations are a speculative investment at this time. The AM share of the audience has been shrinking for years, and most major markets have only a handful of competitive AM stations. Maybe AM will revive, survive, or transform itself with niche programming, news/talk, or DAB, but it's a risk.

So it seems the key provision of the FCC change is allowing two or three FMs to be co-owned in a market. Smart owners will choose complementary, not competing formats, and the large combined share of these

combos will make them a must-buy for many advertisers.

The reduced competition will lead to higher spot rates. This will increase broadcasters' revenue.

Profit in numbers

Combo broadcasters can also reduce expenses, but most of the savings come only when the operations are combined under one roof. Three stations wouldn't need much more office space or studio facilities if they were co-located.

The savings in salaries would be tremendous. You wouldn't need to triple the size of the business department, or news, or engineering, or traffic and continuity; you wouldn't need three general managers, three airborne traffic reporters, or three receptionists; you don't need three office computer systems, three phone systems, etc.

Some of today's big groups don't operate this efficiently with their AM-FM combos, but the leaner entrepreneurs will pioneer these efficient techniques.

Such huge cost savings will drive co-owned stations to co-locate as soon as possible. We'll probably see a lot of new studios and offices built as these combo operations come on line.

Programming and sales won't be affected as seriously. Combo stations have to be programmed differently to maximize the combined audience, so no consolidation is really practical. There's no real motive to cut the sales staff as long as they're paid on commission.

MUSIC SCHEDULING SOFTWARE

Setup & Assistance for Selector & Others

LA PALMA BROADCASTING
(714) 533-5633

Circle (76) On Reader Service Card

Dueling FM Playlists

Following are head-to-head comparisons of songs played during the 6 p.m. hour Monday, June 8, on WXRT-FM and WCBR-FM.

WXRT-FM

- "Time Will Crawl," David Bowie
- "I Feel So Good," Richard Thompson
- "Whiskey Trail," Los Lobos
- "Salt of the Earth," Rolling Stones
- "Welcome to Happy Hour," Ted Hawkins
- "Be the One," Poi Dog Pondering
- "The One I Love," R.E.M.
- "The Whole of the Moon," The Water Boys
- "Eyes Without a Face," Billy Idol
- "Gloria's Eyes," Bruce Springsteen

WCBR-FM

- "Family of Man," The Farm
- "We Hate It When Our Friends Become Successful," Morrissey
- "Growing Old," The Origin
- "Beep," Pylon
- "Sellouts," The Levellers
- "Wave of Mutilation," The Pixies
- "Little Wing," Stevie Ray Vaughan
- "We Are Each Other," Beautiful South
- "Do It Clean," Echo and the Bunnymen
- "Making a Big Mistake," Royal Crescent Mob

Ever wish you could do your traffic and billing on a Macintosh?

You can...

Nordic Software, Inc.

917 Carlos Drive • Lincoln, Nebraska 68505-2059
402-488-5086

Circle (159) On Reader Service Card

USAIRPLAY

Fight Tougher for AM as FM Technology Improves

by Charles Taylor

LYNCHBURG, Va. Lynchburg is a city of 70,000 set off by the picturesque backdrop of the Blue Ridge Mountains. It is served by a local daily newspaper, two local television stations and more than a dozen FM and AM radio stations.

Twelve years ago, one of those AMs, WWOD 1390, owned a large slice of the listening audience. As the only country music station in the market, the 5 kW day, 1

kW nighttime station had enjoyed consistent success since it went on the air in 1946.

It was at this thriving station that, back in 1980, I cut my teeth in the radio industry. For the most part, I worked the midnight to 6 a.m. shift, spinning country records for truckers, all-night diners and people whose worries wouldn't let them sleep.

Today, however, those tuning into 1390 AM in Lynchburg will find nothing but dead air. Late last year, the station turned

Once an AM powerhouse, now just a memory—the studios of WWOD(AM) in Lynchburg, Virginia.

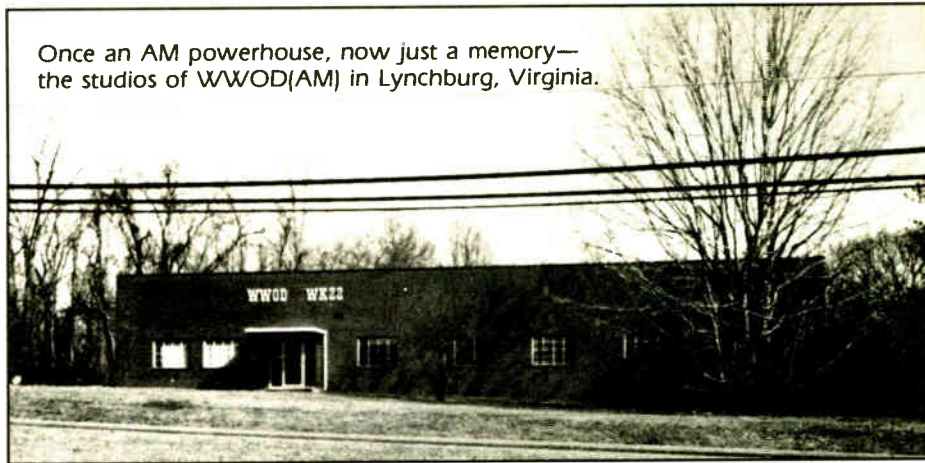

the power off and closed its doors.

A number of factors contributed to its demise. For one, in 1981, WYYD(FM) brought stereo country to the market, robbing WWOD of listeners with a technically

superior sound. The station fought back unsuccessfully by simulcasting its country format on sister station, WKZZ(FM) in 1983. It finally changed to satellite-fed news programming in the late 1980s.

GO ALL-DIGITAL. NOW.

BP DIGITAL DELIVERY AND SENTRY SYSTEMS ONLY BROADCAST PROGRAMMING OFFERS IT ALL...

FULLY-RESEARCHED FORMAT CHOICES

BP mainstream and niche formats, based on the latest research, directed by the nation's most respected programming experts.

AC
Soft AC
Country
CHR
Classic Rock
Adult Rock
Oldies
Urban
Easy Listening

PROVEN ALL-DIGITAL CD TECHNOLOGY

Your BP Digital Delivery™ format is delivered on custom compact discs, the industry's most widely used digital music source.

Use your present studio CD players for live operation or automate with Sentry Systems' Format Sentry™, one of the top-selling controllers on the market.

Sentry Systems' hard disk audio completes the package, providing an all-digital local sound at a surprisingly low cost.

ALL-LIVE OR ALL-DAY WALKAWAY

Operate live, with our song-by-song hour-by-hour playlists, or automate your station for all the walkaway time you need...nights, weekends, or 24 hours a day.

WE STAY ON TOP OF THE MUSIC.
YOU STAY ON TOP OF YOUR MARKET.

STAYING POWER

BROADCAST PROGRAMMING

AMERICA'S LEADING PROGRAMMING COMPANY (800)426-9082

A closed door

Still, it faltered.

"It was a combination of things that finally led to closing down," says Wanda Burns, former WWOD general manager. "There are 17 radio stations in this town—that's a lot for the area. Running AM stations and small FMs is difficult, and we were beat out by the bigger stations."

Sadly, the setting at WWOD is not uncommon. As of April 1992, the FCC reported that 184 U.S. AM allocations had been silent for six months or longer. Since 1988, the number of AM stations has grown a sluggish 1.5 percent, to 4,982 as of March 1992. FM stations, meanwhile, have increased 12.3 percent, to 6,147.

AM listenership has diminished greatly since its heyday. Twenty years ago, the band commanded 75 percent of the audience, versus 25 percent on FM. Over the past three years, Statistical Research Inc. in Westfield, N.J., reports that only 24 percent of the audience at any given time is tuned into AM. As of December 1990, the most recent figures available, show that 81 percent of teenagers listen solely to FM stations. (Among those 55 and older, a more conservative 28 percent are exclusive to FM.)

Erosion in the U.S.

This erosion is disturbing, but not surprising. With few exceptions, AM has not been able to compete with the higher fidelity of FM. Likewise, audio fans—particularly younger listeners—are accustomed to the digital quality of CDs. And as we know, overcrowding of the AM band has made interference prevalent enough to turn some listeners away.

Ironically, in some nations, AM not only has held its own against FM, but leads in a thriving competitive marketplace. The primary reason: the emergence of AM stereo. Motorola's C-QUAM AM stereo system has been nationally sanctioned in six countries so far—Japan, Australia, Hong Kong, Mexico, Canada and Brazil. It is broadcast in at least 17 nations.

Here in the States, the FCC fumbled with that issue when it was asked to select a standard in 1981. The Commission hesitated, insisting that the marketplace should choose the superior system.

As a result, we wound up a nation divided. While the majority of stations signing up for stereo chose C-QUAM, a number went with Leonard Kahn's ISB, leaving receiver manufacturers no clear leader; the marketplace decision was an embarrassing blunder. Today, only 30 percent of U.S. AMs broadcast in stereo. Even fewer consumers have the gear to hear it.

continued on page 33 ►

SMART'S JOCK-IN-THE-BOX

COMPLETE TABLE TOP STATION AUTOMATION

By John Schad, President
SMARTS Broadcast Systems

Visiting with a fellow broadcast equipment manufacturer recently, we discussed a concept of designing a "radio station in a box." Something so complete that it would do everything needed to produce continuous broadcast programming—feed it to a transmitter and you're on the air.

Reflecting on that conversation, I took a closer look at a new product we have developed here at SMARTS and realized how close we are to that concept. This system is probably the most amazing piece of broadcast equipment I have ever seen. It uses CDs as a music source, can handle over 540 CD's on line in up to 32 decks, each deck holding 18 CD's. That's over 540 hours of random access music, in a system that fits on a table top!

The really amazing thing is the way our system handles the problem of knowing when a CD ends. We don't have to use special encoding, you can run CD's in our system from K-Mart. You don't have to type in all the running times of the CD's. You don't have to depend on a silent sense, you can actually segue out of the

CD to produce overlap and beautiful transitions to the next cut. Our computer programmers have made the Jock-In-The Box learn the music it has to play, and know when the end of the cut is coming, without tones, special encoding or time consuming entry of running times! As I write these words a test system is running in the next room. It works flawlessly, and the music transitions are so good it brings tears to your eyes.

We have also addressed another problem with CD audio, excessive programming time needed to run the system. In the open reel system the programmer needed to tell the system which deck to play for the music, and which carousel and tray to play for the spots. Even this is very time consuming.

With a CD system, the problem is multiplied many times. You must specify which deck, which magazine within that deck, which CD within that magazine, and which cut on that CD. In other words, four times the information needs to be entered to program the CD system verses conventional automation.

Here at SMARTS, we solved

that problem by using special music rotation software. The Music Master, developed by one of our own programmers, is a complete rotation system that picks the music for you, allows you to make any changes you want, then programs the Jock-In-The-Box to find the right cuts at the right time.

Of course Jock-In-The-Box also joins news networks, making smooth network switches after top-of-the-hour ID's, or any other time you want the network on the air.

The SMARTCASTER digital audio system, which is part of the Jock-In-The-Box, allows simultaneous record and playback. You can even record the network and play it back at the end of a CD so you can make a perfect net join without regard to timing. Production can be done at the same time the unit is playing spots, CDs or sitting on a network.

The spot scheduling can go in one of three ways; directly programming spots into the system, transferring from our own SMARTS billing, accounting and traffic system, or transferring from one of several other billing systems that have interfaces to the SMARTCASTER.

We take this system, and place it in a custom built table top cabinet that uses standard 19 inch rack mounting. These cabinets are built especially for the Jock-In-The-Box, and don't look like industrial equipment, you'd be proud to put one of these cabinets in your living room.

The system is pre-wired, tested, and shipped with everything possible already mounted. The remainder of the installation can be done by your own engineer.

Adding the SMARTS Billing, Accounting and Traffic System, we are very close to that "radio station in a box" concept. This equipment really does it all, from order entry to on-the-air play.

SMARTS has many products for many purposes, including digital units to replace cart machines for under \$1,000.00; satellite based automation systems for under \$5,000.00, and full CD based automation that fits on a table top for about half the cost of conventional, analog systems.

And please remember, we back up our products and services with free support, 24 hours a day, 7 days a week. We won't leave you out on a limb. Call us anytime for more information.



SMARTCASTER

DIGITAL AUDIO

SMARTS BROADCAST SYSTEMS

BOX 293, EMMETSBURG, IA 50536.

(800) 747-6278

Phone (712) 852-4047 Fax (712) 852-3061

BRING MAGIC TO WITH AUD

There has been quite a bit of confusion and, frankly, disbelief concerning Audio Wizard. We don't blame you—Audio Wizard is such a powerful system that it is hard to believe. To clarify what our system can do, we have taken this blueprint from one of our stations. Just look how Audio Wizard can bring a little high-tech magic to all parts of your station.

MAIN CONTROL 1 & 4

Audio Wizard really shines in the control room. For instance, up to 16 control rooms can be playing the same spot at the same time! Even if you want, your DJ can be doing production at the same time he is playing a block of commercials over the air.

NEWS BOOTH 2 & 3

The news booth will benefit from Audio Wizard because they can control their own actualities from the booth. You don't have to tie down an engineer in the control room just to play spots. Plus the news person can take phone calls and record them, play commercials and even pull up copy from the last news cast on the screen—all at the same time.

PROGRAM DIRECTOR 6

The program director can use his Audio Wizard terminal to edit the salepeople's copy, check on how each control room is doing and even check in on the production rooms to see what is going on. Plus he can take over the control room and run the station right from his office!

PRODUCTION ROOM 5 & 7

The real time digital production capabilities of Audio Wizard makes top line production a snap. Plus while you are recording you can be reading from the copy that was typed in by a salesperson. Audio Wizard uses the highly acclaimed AC-2 audio storage algorithm provided by Dolby Labs so you know that your audio will be the best in town.

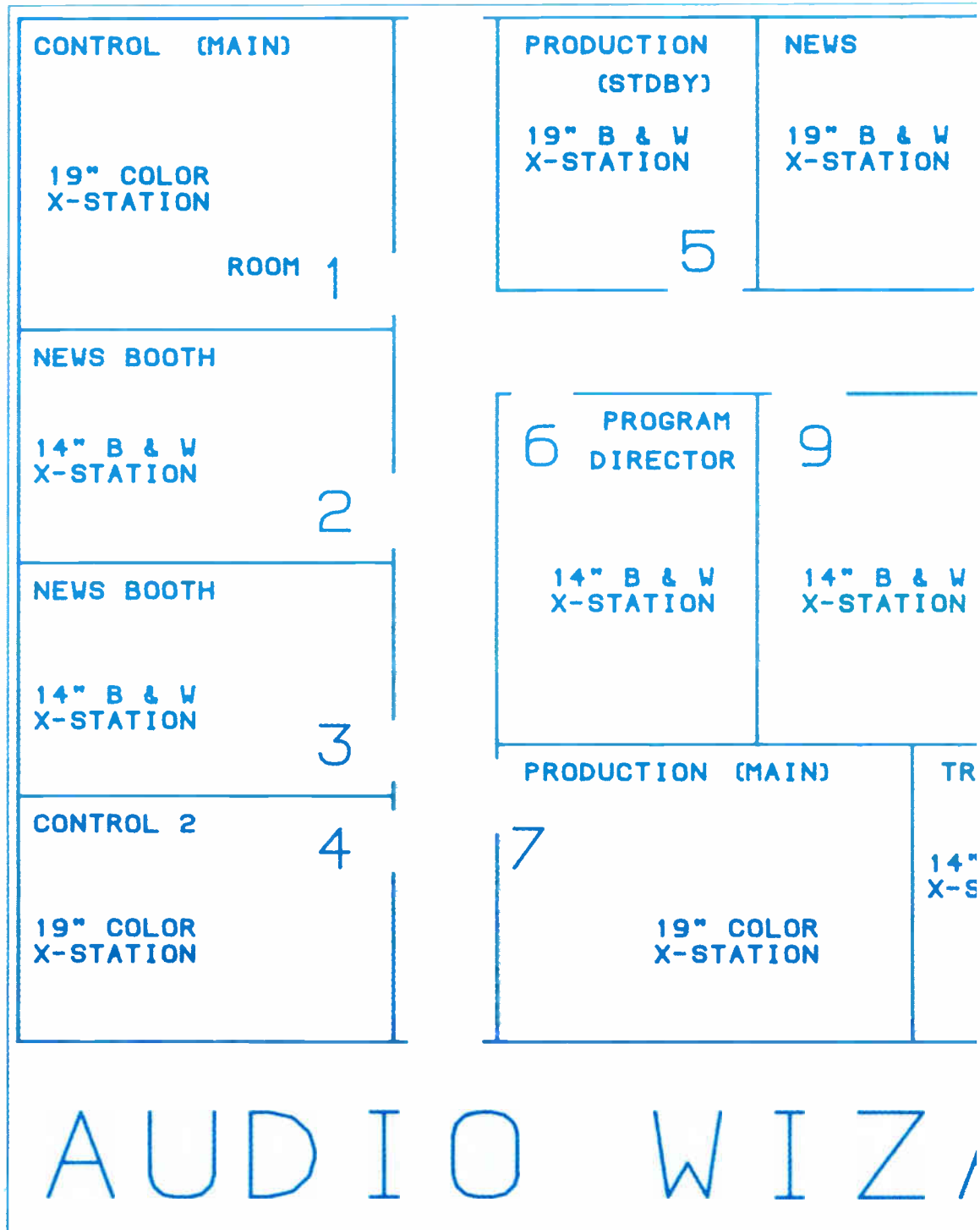

CHIEF ENGINEER

Your engineer will love Audio Wizard. We have used the absolute best components we could find. Names such as:
Audio digitizing from Crystal Semiconductor
Audio compression from Dolby Labs.
Cables and connections from 3M Corp.
Computers from Digital Equipment Corporation (D.E.C.)
X-stations from Tektronix, Inc.

Also we have made Audio Wizard a breeze to configure. Just attach ALL of your audio wires to one central location and your done. Plus you can adjust the levels of each source from any x-station. No more twiddling small pots located in unwieldy locations! All levels are fully software controlled. The Audio Wizard Audio Controller can be expanded to handle up to 32 stereo inputs, 32 stereo outputs and 32 fully Dolby digitized storage and playback paths in and out of the computer. With all of these sources and our software controlled digital gain/attenuation you can even use the Audio Wizard as a basic production or control board.

YOUR STATION IO WIZARD!

GENERAL MANAGER

The general manager never had it so good. Any part of the stations operation can be controlled right from his office.

He can edit copy, change the log, check on sales reports, change the playlist and even lock the doors!

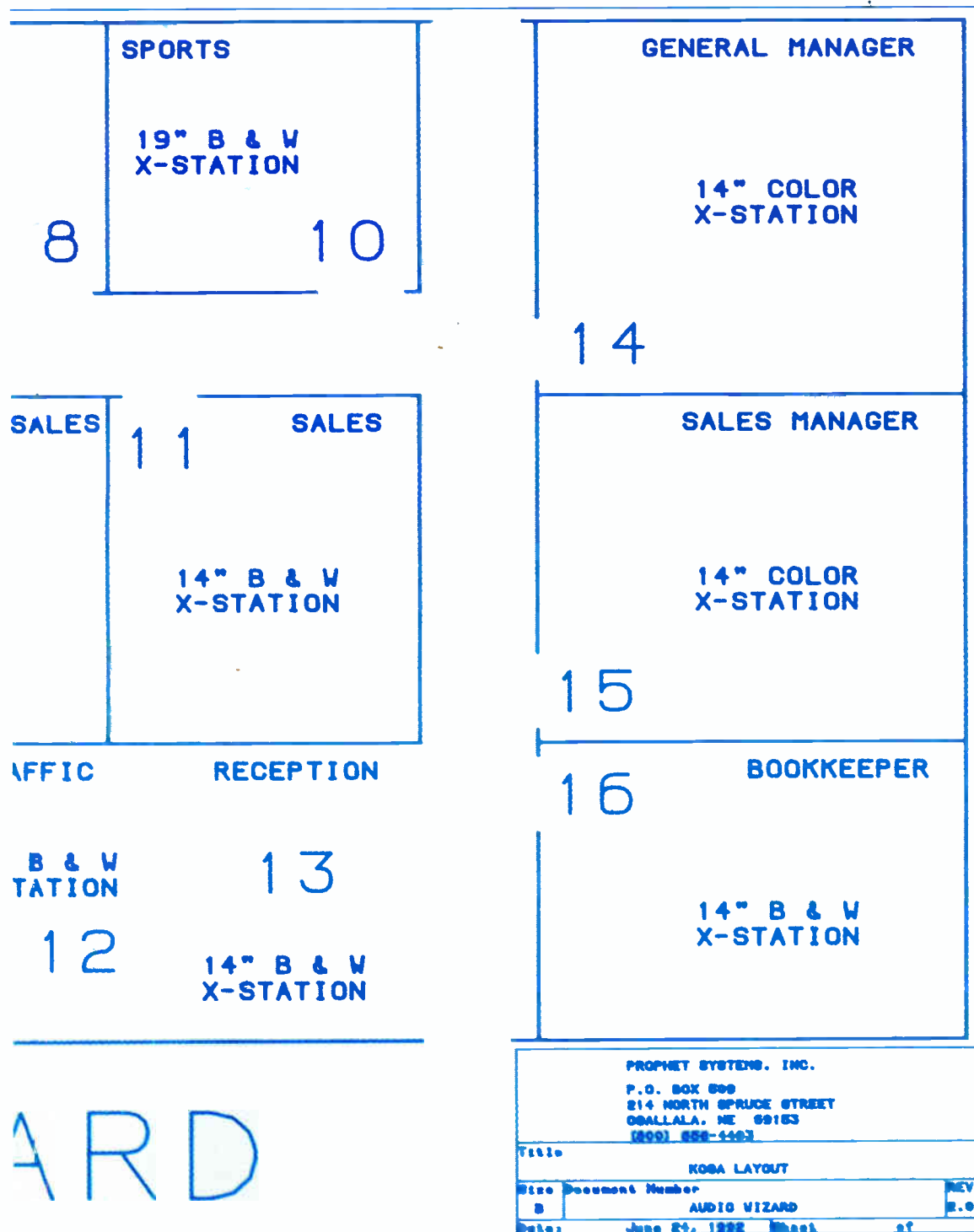

NEWS AND SPORTS

8 & 10

The real time digital news and sports audio editor will keep your information team ahead of the competition. They can record all of their tracks into the computer directly from the phone (without even having a phone in their room). While the actuality is recording they can be editing out the bits they don't want! Putting a news or sports cast together is a snap for Audio Wizard.

SALES

9, 11 & 15

The sales staff will love typing copy into our copy editing system. Also, if you choose the fully integrated traffic system provided by Decision, Inc., they can check on vital sales reports without even leaving their desks.

BOOKKEEPER

16

The bookkeeper can check in on the traffic and sales reports or run and accounting system that can be purchased at your corner computer store.

TRAFFIC AND RECEPTION

12 & 13

Decision, Inc. and Prophet Systems, Inc. has teamed up to provide you with a total centralized computing package. We provide the control of the radio station and they provide their comprehensive traffic and billing package. We have integrated the two so you do not have to buy two separate hardware packages. Buy one Audio Wizard and you get a main computer that will run your control rooms, allow you to do real time production and we include a hot standby backup that will run your traffic system faster

Prophet Systems, Inc.

P.O. Box 509—214 North Spruce Street
Ogallala, NE 69153

308-284-3007 or 800-658-4403

Quality Control Equals Superior Sound

by Jeff Loughridge

Part II of V

RICHMOND, Va. Last month we defined some common terms used in audio, and put audio processing in general in perspective. This month we will discuss, in depth, the foundation that is essential to a superior sound.

We will be discussing engineering procedures and topics, but I must stress that this is in no way intended to usurp the authority or procedures of your engineer. I will include some ideas and suggestions based on my experience, but these are by no means the only way to achieve audio excellence.

Quality is paramount

The essential element to a superior sound is quality control. Quality must be the first consideration when purchasing equipment and carts, when deciding what music sources to use, when and where dubbing takes place, who does the dubbing, and how much time to allocate to each dub.

The importance of quality control must be instilled in your staff as well. They use the equipment every day, hear a dub countless times and should be your first line of defense against poor quality. Let's look at quality control as it relates to each of these areas.

Selecting equipment is one step that

can't be undone if you realize you made a mistake. Technically and sonically, most of the mainstream equipment available today is more than adequate. Difference in price comes down to features (some of which relate directly to quality control), construction, and materials.

It is important to realize that the figures relating to frequency response, distortion, and so on are cumulative. In other words, let's say you have a cart that is recorded with optimum frequency response and no distortion. To get on the air it has to pass through your cart deck, your console and your studio-to-transmitter link (STL).

Say your cart machine plays back with 0.25 percent distortion, your console produces 0.3 percent distortion, and your STL generates 0.5 percent distortion. Adding these distortion figures, you can see that your perfectly recorded cart will be heard on-air as if it had 1.05 percent distortion!

Keep it clean

What this means to the listener is some frequencies will be exaggerated or reduced. This causes unnatural peaks in, or loss of, certain elements of the music. I hope you can see why it is therefore important to view your equipment purchases as a system, focusing on their cumulative effect, rather than their individual performance.

Equally important is the ease of main-

tenance of the equipment. If a cart machine or reel-to-reel is designed so it is very easy to clean heads and pinch rollers, it is relatively easy to have your staff make it part of their daily routine, which it should be.

Some tapes shed oxide (the magnetic material that stores the recorded information) more easily than others, and this causes a dulling of the high end and loss of stereo separation. This is where it is important to have your air staff act as your first line of defense.

A superior sound is the result of a coordinated team effort with each person recognizing and fulfilling his or her role. When machines are cleaned at the start of each shift, you are assured of a clean reproduced signal from those machines. If the person on the air hears something out of the ordinary, he or she can write it up and the cart can be re-dubbed or the machine checked.

Mistakes happen, carts wear, things get old! These effects cause an inconsistency in the sound of your station that will stand out and severely reduce the sonic impact of your product. If the person on the air notes the problem, it will be the last time that inconsistency is heard.

We can also draw a direct relationship between consistency and Time Spent Listening (TSL). Suppose the majority

of your music sounds crisp and clean but one of your six cart machines is out of alignment, or a bad dub is in medium rotation. Each time that bad machine is used or that bad dub plays, the change in quality is excruciatingly obvious.

This could prompt a listener to change stations. He or she could go from your muddy or distorted song to a cleaner sound on your competition. The listener may be left with the perception that your station sounds muddy compared to your competition. Before long he may not think of you as a station to listen to for more than one or two songs. All because of one machine or dub.

Commitment to quality will produce the greatest effect when it is practiced by your entire staff. When staff members listen at home or in their cars, they should always be thinking of quality control.

Consistency in sound

Virtually all stations use CDs in some form or another on the air, either direct from disk or dubbed from disk to cart. In my opinion, it is best to select one or the other and use it uniformly. The reasons for this are firmly rooted in a commitment to consistency.

Suppose you divide your library 50/50 between direct from CD and CD dubbed to cart. There is a sonic difference between a song played direct from CD and played from a cart.

My experience has shown that dubbing to cart will tend to "soften" the high

continued on next page ▶

The "Bear" Finds a Niche

▶ continued from page 27

As a practical measure, Disa chose new releases from alternative bands (an element that accounts for roughly 30 percent of WXRT-FM's programming mix by his estimate) as his chief stock in trade. Niche programming, plain and simple.

"They're a station that plays New Rock," he said. "We're a New Rock station." There can be no denying, however—and Disa doesn't deny it—that one key reason for the success of WCBR-FM is its close proximity to WXRT-FM on the FM dial.

WCBR-FM, at 92.7 MHz, is so close to WXRT-FM at 93.1 MHz, that it is often possible, particularly with an old analog tuner, to listen to the station for long stretches believing it to be WXRT-FM. With its near-zero budget for advertising, that sort of exposure has been priceless for "The Bear" (WCBR-FM's station ID). In particular, it has brought them directly to the attention of the audience they are targeting.

"Are we drawing listeners away from WXRT? Yes," Disa says. "In droves? Nah. But they are sharing more with us than they have in the past."

Harvey Wells, general manager of WXRT-FM and WSCR(AM), acknowledges that WCBR-FM is a competitor "in a select area." But Wells emphasized that he does not consider The Bear any more a threat to WXRT-FM than other suburban stations like WABT-FM ("The Rabbit"), a mainstream AOR station operating out of Dundee.

Enough for everyone

"We have different missions," Wells said. "Theirs is to serve part of the pie. Ours is to serve the entire pie." As for WCBR's effect on their listenership, Wells simply pointed out that WXRT scored the highest ratings in the station's history during the

past year, even ranking first in the key 25-54 demo.

Wells also is unapologetic for his station's programming mix. "Our goal is to achieve the widest acceptance of new music that we can without alienating our longtime

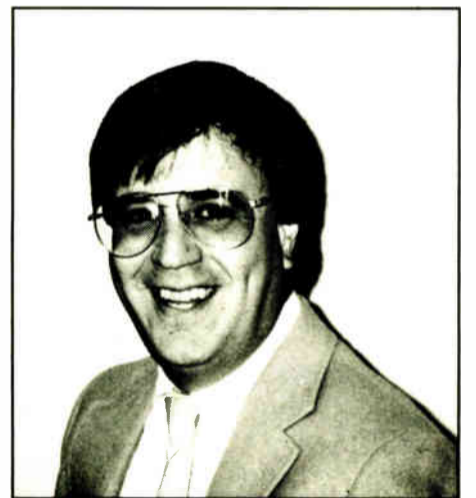

Harvey Wells,
general manager, WXRT-FM

listeners by playing nothing but new music," he said.

Besides, Wells added, much of the more established music played on WXRT-FM was once broken on the station years ago when it was new. "The music we've been playing for the last 20 years is part of our identity. It's our roots."

All of this is fine with Disa, whose attitude toward WXRT-FM is hardly hostile. After all, WXRT-FM's programming provides WCBR-FM with its successful niche—its first successful niche in quite a while.

"We're stable now," Disa said. "I think we're going to be around for a long time because we're making money. We won't be switching to all-Polka anytime soon."

Digital vs. Analog Have You Puzzled?

Call RF Specialties.

NORTHWEST
(206) 546-6546

WEST COAST
(805) 682-9429

MIDWEST
(816) 635-5959

NORTHEAST
(412) 733-1994
(215) 322-2410

SOUTHEAST
(904) 678-8943

SOUTHWEST
(806) 372-4518

We don't just sell equipment. We know how the pieces fit together.

- RF & Audio Equipment.
- Over 120 Product Lines.
- Specializing in Digital Integration.
- Competitive Pricing.
- The Largest Number of Full Service Offices Nationwide.

RF Specialties® Group

-each RF Specialties office is independently owned and operated-

Circle (142) On Reader Service Card

Quality Control Equals Superior Station Sound

► continued from previous page
end somewhat. This is not a negative effect by any means, but it can contrast when played before or after a direct from CD cut. You will find if you set up your processing to sound best for music direct from CD, a cart dub will sound a bit dull by comparison. This is because you don't need as much high end boost from your processing, due to the excellent response of the CD.

Conversely, if you set your processing to sound best for music off cart, a direct from

Fight Tougher For AM Radio

► continued from page 28

Legislation was introduced in Congress last June that would finally *require* the FCC to select an AM stereo standard. A nice idea, but its passage is unlikely. Besides, a decade later, the damage has been done.

The FCC's ambitious docket 87-267 is another attempt to rejuvenate the band. The Commission's action to rewrite technical regulations governing AM, finalized in 1991 after four arduous years of deliberation, aims at reducing the number of stations on the crowded band, as well as improving sound quality.

Industry reaction has been mixed. Proponents of the band claim the proposals do too little and will take too long.

Long-awaited debut

Also in works is the NAB "Super Radio," which made a long-awaited debut in April at the NAB show in Las Vegas. Built by Denon, the tuner is based on the company's high-end TU-660 tuner that has been on the market for two years. The new TU-680 includes a number of features aimed at improved AM performance.

The price for the tuner, however, falls in the audiophile range—\$450. That will do little to re-introduce the AM band to younger listeners, which is essential for future long-term success. It will instead offer better quality for already avid AM listeners.

What is the future for AM radio? It is doubtful that a mainstream music format—even if it were high-power, 24-hour stereo with some of the best on-air talent in town—can compete with the same on FM. Consumers have been conditioned to expect high-quality sound. To most, particularly in younger demographics, AM has proven to not even be an option.

Years of taking AM for granted has resulted in the increased popularity of FM over AM as the prime listening band in the U.S. Having given up that ground to FM, it will take innovation, creativity and drive for AM broadcasters to continue their competition with that band.

The future of AM is in the hands of those stations that have come up with niche programming tailored specifically for demographic segments—all-sports, all-news, all-business or ethnic programming, for example. The stations nationwide who sustain these formats and market them well are tomorrow's leaders in both market ratings and billings.

CD cut will sound too bright by comparison. This is because you will "brighten" the sound of a cart with increased high frequency boost in your processing.

A compromise between the two will not allow either to sound their absolute best. For this reason, I recommend to all of my clients that they select a either cart or CD for their on-air music source and stay with that as a standard.

Standardize cart tape

It is also critical to standardize your cart library. A common situation I have found is a hodgepodge of cart manufacturers and models in use at the same station at the same time. While this is certainly a factor in playback, it is a recipe for disaster in a recorder.

When your engineer sets up your cart machines, he should be using a recently purchased Standard Reproduce Alignment Tape. *Do not use an "in house" tape.* These are at best marginal and can cause serious problems if you do dubs for other stations or agencies. It will set up your machine to the condition of the machine that is was recorded in.

Depending on their use, I generally replace alignment tapes every six months to a year. Remember, this is your station's standard. Compromise here and you will hamper your efforts everywhere else.

When you order this tape, you specify the manufacturer and model of the cart you use. That way, the alignment cart is in the exact same housing as your carts and has the exact same tape as your carts. The housing is critical in aligning heads of azimuth, penetration, and zenith.

Azimuth is the "tilt" of the head from left to right. Misalignment here will cause a loss of high frequencies and poor mono reproduction. Penetration is how far into the shell the heads protrude. This is important for proper tape travel over the heads and can depend on whether your carts have pressure pads or not. Zenith is the head tilt from front to rear. This should be perfectly vertical.

Your playback machines are aligned with the standard tape. Then the playback section of your recorder is aligned with the standard tape. At this point, your engineer gets a cart off the rack. This is where it becomes critical to have a single cart type in the station.

Each cart manufacturer uses different tape formulations in its various models. Your recorder can only be set up for one formulation at a time. This affects frequency response and distortion when another tape type is used. Different formulas require more or less bias (a high frequency signal recorded on a tape to allow the recorder to operate in its most linear or "flat" region).

Oversaturation or undersaturation of a tape will cause uneven frequency response and increased levels of distortion. For this reason it is critical to decide on one cart manufacturer and one cart model and stick with it. Set up your machines to this standard and you will have a uniform, consistent sound from your carts.

Next time, we will continue talking about quality control and focus on the dubbing process, equipment, and procedures.

□□□

Jeffrey Loughridge is president of Audio Concepts & Engineering, a technical consulting firm that designs and renovates studios. He can be reached at 1-800-777-4172.



WHY QEI?

24 Hours.



Our 24 hour service hotline number is 609-728-2020.

Call us toll free at 800-334-9154 for all the facts on QEI

"New Reliables" FM transmitters from 1kw to 30 kw.

Power Up.



With our FMQ 3.5/5/10 kW or 20/30 kW FM transmitters, you can upgrade power in the field.

Call us toll free at 800-334-9154 for all the

facts on QEI "New Reliables" FM transmitters from 1kw to 30 kw.

No Extras.



We never charge you extra for single phase power. Not on our FMQ 10000 or our FMQ 20000B—not even on our 30 k FMQ 30000B.

Call us toll free at 800-334-9154 for all the facts on QEI "New Reliables"

FM transmitters from 1kw to 30 kw.

Less is More.



All of QEI's FM transmitters have no plate blockers or sliding contacts.

Call us toll free at 800-334-9154 for all the facts on QEI

"New Reliables" FM transmitters from 1kw to 30 kw.

Free.



Our FREE spares kits include every solid state component of the transmitter, exciter and remote control.

Call us toll free at 800-334-9154 for all the

facts on QEI "New Reliables" FM transmitters from 1kw to 30 kw.

The Longest.



Our PA tube warranty is the longest in the business — 15,000 hours.

Call us toll free at 800-334-9154 for all the

facts on QEI "New Reliables" FM transmitters from 1kw to 30 kw.

Single Phase 30 kW.



Our new FMQ 30000B is the only 30 kW transmitter available with a single phase power supply.

Call us toll free at 800-334-9154 for

all the facts on QEI "New Reliables" FM transmitters from 1kw to 30 kw.

Built-in Backup.



QEI's constant 50 Ohm interstage impedance lets you bypass the IPA or PA in the unlikely event of a problem.

Call us toll free at 800-334-9154 for all the

facts on QEI "New Reliables" FM transmitters from 1kw to 30 kw.

QEI CORPORATION
ONE AIRPORT DRIVE • P.O. BOX D • WILLIAMSTOWN, N.J. 08094
TEL (800) 334-9154 • (609) 728-2020 • FAX (609) 629-1751

QUALITY • **E**NGINEERING • **I**NNOVATION

Circle (35) On Reader Service Card

The Angles on Building a New Studio

► continued from previous page
else does will cause you to lose site of what you need to do.

Price versus cost

Perhaps the two areas of project management most often misunderstood by station management are the differences between price and cost and the concept of the triangle.

Price is what you pay for a specific item, or the service to install that item or to maintain that item. Cost includes the sum of item price, shipping charges, installation labor and installation materials and other applicable charges.

The cost of future maintenance must be figured against any savings that might result from purchasing a lower priced item. Particularly when purchasing major items such as audio consoles and transmitters, find out what "extras" are standard, optional or not available from each manufacturer.

The better manufacturers include some form of basic spare parts kit in their standard package. Their lower-priced competition may not. Ask the lower-priced company to provide you with a cost for at least one of each unique semi-conductor device, switch or control device used. Be sure that any special tools are included as well.

When you add the price of the spares to the less expensive console, you will start to see that the cheaper console is not as inexpensive as you thought it was. Some dealers can put pressure on a reluctant manufacturer to provide spares, even free of charge, that they might not otherwise provide. But don't ask for a free spare tube!

My favorite example of the difference between price and cost was a client whom I had advised to buy an audio power amp with balanced inputs for driving his control room speakers. I told him to expect to pay around \$500 for the amp. The client called his favorite vendor who instead sold him "something similar, of equal power" for only \$300, but it did not have the stipulated balanced inputs.

The control room could not operate without the proper interface between the purchased amp and the console. The client eventually spent an additional \$409 for the interface, extra connectors, changes to documentation and labor to install the added device. His actual cost was \$209 over the original budget.

The triangle theory

Our second area of project management concerns The Triangle. This is an equilateral triangle to which we assign one variable per side. The base is our desired level of service. Service includes the delivery schedule, the integrity of the sales staff, follow-up and long-term support provided.

To the left is cost (sum of all prices) and on the right is quality. Simply put, you can emphasize any two of the three sides with a complementary loss on the third. I prefer to refer to the loss as the opportunity cost.

If I want something by a particular date, and of a particular quality, I may have to give some on the price. If I want a high quality item and a discount rate, I may have to wait for delivery until business is slow. If I want a good price and a good service, I may have to sacrifice quality—but this is a bad choice.

The last subject of this installment concerns the impact of a move upon employee morale.

Round 'em up, move 'em out

Something that is particularly true of the staff of established stations, that may have

been employed for many years, is that their choice of home community may be based upon where your studios are located. If you are planning to move a fair distance and if you hope to accomplish that move with a minimum of disruption to your operation, then let me suggest that employee morale matters.

I am not suggesting that you try to please everyone, but do think of the impact on your employees. Will the new location require an extended drive for your employees? Will they now have to drive over toll roads or pay for parking in some downtown garage? What allowances in work schedules or pay can you offer to either temporarily or permanently ease the transition of those employees who are most severely affected by the move?

If you are moving into a downtown location, start thinking about after-hours security in common areas beyond your control—such as parking lots and elevator lobbies.

That team spirit is what you need to build a user-friendly new studio facility. You need the input of all of your staff and you will need their patience and cooperation during the coming months of construction, testing, training and "working out the bugs."

Bring in your CE before you sign the lease for anything or purchase any equipment. If you don't have a full-time CE, get some engineering expertise on your team before you buy. For better or worse, radio requires a sound technical footing to be on the air and good engineering support is

what can make it happen.

In the next installment, I will review the roles of each team member including the engineer, PD, OM, business manager, a representative from your full-time and your part-time (weekend/overnight) airstaff, traffic manager, front office personnel, GSM, middle managers (music director, news director, promotions director) and anyone else you feel can assist the team.

We will also discuss some of the general questions that go into choosing a studio site and preparing the lease of your space. Realtors may say "Location, location, location," but in the 24-hour-a-day world of radio broadcasting, you need to say "Service, service, service."

□□□

Edwin Bukont is CE at WPGC-AM-FM Washington, D.C. He can be reached at Suite 800, 6301 Ivy Lane, Greenbelt, MD 20770.

LOG 14 DAYS OF AUDIO ON ONE DAT, PLAY IT BACK WHILE STILL RECORDING!

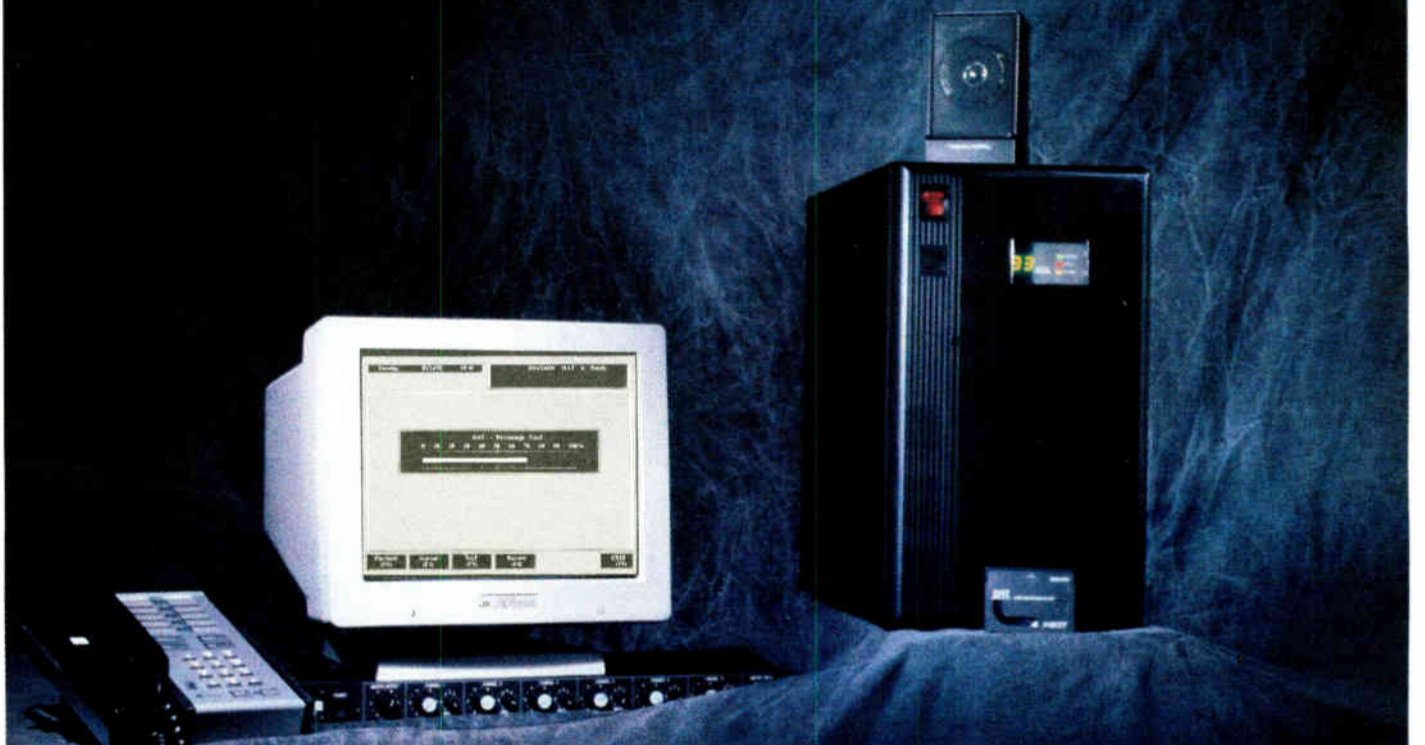

MDL-14



RCS TRACKER

The RCS TRACKER records up to 3 stations simultaneously, and provides random access to any logged time segment - even by phone - without interrupting the recording.

The RCS TRACKER consistently sounds better, costs less to operate, and is easier to use than any other logging technology.

The RCS TRACKER is a complete hardware-software system.

RCS

2 Overhill Road, Suite 100, Scarsdale, NY 10583
Voice (914) 723-8567 Fax (914) 723-6651

Circle (64) On Reader Service Card

UPLINK

Get the Most from Network Affiliation

by Karl Baehr
and Harry Nelson

ALBUQUERQUE, N.M. This month in *Uplink*, we will lay the groundwork for creating a successful working relationship between an affiliate and a provider network. That is, what each should expect of the other and how to make the most of the affiliation.

For most satellite affiliates and potential affiliates, the first contact made is by a network regional manager. The regional manager is a sales person, yes, but may become the only source of regular contact between the network and affiliate. If this is the case, the creation

of a functional relationship with the regional manager is vital, both for the affiliate and the network. We talked with Tony Belzer, regional manager for the JSA Radio Network.

RW: What should affiliates or potential affiliates consider with regard to maximizing their network relationship?

Belzer: I've found that when a station affiliates, it usually falls into one of two categories. There are those stations that basically put the format on the air and walk away. Even though they might receive regular contact from the network, they may never reach their full performance potential because they don't

really interact.

Then there are those that don't wait for us to call them, they call us. They look at their network affiliation in the light of "Now I don't have to worry about programming, I can focus on other aspects of my operation, and I now have the resources of this big network to tap into."

Those are the guys who really make it happen, the ones that look to the network as a source for more than just a format.

RW: When a station affiliates with a network, it gives up a certain degree of control. How do you deal with that? What do you tell them to expect?

Belzer: Giving up control is a major issue, and I don't discount it by saying we have better this, we have better that. If you look at a satellite format for what it is, it is a way to create a consistent base for a station's programming. It doesn't have to be the only source of programming.

RW: If a station wanted to generate local programming, how would you address that? Would you discourage it?

Belzer: Absolutely not. Every station situation is different. Local programming is important, and we realize that. It is important for a station to be able to run local sports, news, local music programming.

Local programming can create revenues. What JSA has done, and most providers strive to do, is to make it as easy as possible for our affiliates to localize when, where and however needed.

It depends entirely to what degree a station needs to or is able to generate local programming, and to what benefit.

RW: Sounds great—but really, if a station is considering satellite, isn't it usually a cost-cutting measure? At that point they may not be able to afford any local programming. What do you tell them then?

Belzer: Here is where the interaction we discussed earlier comes into play. A potential affiliate should be persistent with regard to asking questions to qualify the network. Satellite is cost effective. Helping a station program more effectively is what we're all about.

RW: What are the right questions to ask a network?

Belzer: Keep in mind that as an affiliate you are a paying client. Make sure you know exactly what you're getting for your money before you affiliate. Do you want sales support? Does the network offer it? Make them show you.

Are music libraries for the format available if you decide to do local programming? Does the network offer research? If so, what kind, how does it work, who uses it? What regular type of interaction is available between the network and the affiliate regarding programming and policy changes?

Who are the people in charge of programming, production, sales help, traffic, billing, clearance? When I have a question or problem, whom do I call—you? What other products, services or resources are available to me when I affiliate? Pin down the specifics, make the network show you. *It's your money.*

Know all your options

What is important to realize when exploring satellite is that there are options. Check them all before making a decision. Come up with a list of specifics regarding what you feel you need to succeed in your market and find out who best fits the bill. Because, as with anything else, it is largely up to the consumer to qualify the product. The lowest price does not necessarily mean that a particular service will perform like you need it to.

Once the decision to affiliate is made, make sure you cover your bases. Were you offered sales help? A TV commercial? A station visit?

Get it in writing and hold the network to it. It is a relationship you are entering into, and a relationship takes both parties to make it successful. A relationship also takes time.

Be tactful

"The first eight months of affiliation are critical," Tony Belzer said. "During that time both the affiliate and the network need to communicate regularly. This is the time where any concerns, problems or special needs will become apparent. This is when the relationship takes on the characteristics it will most likely retain for its duration."

As with any relationship, tensions or differences of opinion are bound to arise. A

continued on page 38 ►

SEE SPOTS RUN.

On-screen traffic log display

Filler Window. This special pop-up window gives you quick access to PSAs, jingles, promos and other fillers.

Record Line. Shows what DCS is currently recording.

Queue Window. Just click on a listing, to place recordings in the queue for playing.

"Gas Gauge". Indicates what percentage of the system is available for recording.

The Play Line. Shows what's currently playing on-the-air, with a count-down timer.

- Flexible recording options -- choose stereo or mono, varying sample rates and storage methods on a cut-by-cut basis.

DESIGNED BY RADIO PEOPLE FOR RADIO PEOPLE.

Computer Concepts is one company you can count on---we've provided automated business systems to the radio industry for over seventeen years. We know how radio stations work and how to make them work more efficiently. That's why the DCS interface is so easy to learn, so simple to use.

ASK ABOUT OUR AFFORDABLE ENTRY-LEVEL SYSTEM.

To find out more about our entry-level system, or to receive a free DCS demo disk, call or FAX us today. You'll soon see one thing very clearly. You just can't manage as well without us.

FREE UPDATED DEMO DISK!
(800) 255-6350
OR FAX (913) 541-0169

Computer Concepts
CORPORATION

8375 MELROSE DR. LENEXA, KS 66214

ADVANCED FEATURES ENGINEERS DEMAND...

- **Digital Audio Editing.** The quickest and most flexible real-time editing function available makes editing news stories and commercial cuts simple.

- **Satellite /Live-Assist Operation.** Total support, including automatic back-fill of breaks.

- Support of multi-cut "carts"
- Complete audit of all DCS activity -- airplay of audio, relays, etc.

...PLUS FEATURES OTHERS DON'T OFFER!

- **Simultaneous Play/Record features.** Handle three stereo sources simultaneously -- overlap two spots for a tight segue, and record from another source at the same time.

- **High quality data reduction, without distortion**

- **No pre-allocation of disk space required.**

Replace the chaos of carts with the speed and precision of the Digital Commercial System (DCS) from Computer Concepts.

By combining a standard industrial-grade PC with an advanced stereo audio board, DCS lets you program a day, a weekend, even entire weeks!

AUTOMATE EVERYTHING, FROM PRODUCTION TO BILLING.

Production Studio. DCS simplifies board work and replaces the muddy sound of analog tape with crisp CD sound quality.

Control Room. No more manual logs! DCS handles all your paperwork automatically, posting a commercial's actual airtime next to that listing. And DCS interfaces with traffic!



BROADCAST ELECTRONICS



The world leader in radio broadcast technology

From its recognized position as the manufacturer of the world's finest FM transmitters driven by the industry-acclaimed FX-50 Exciter, to solid state AM stereo transmitters, digital systems and world class audio consoles, Broadcast Electronics manufactures more products for the radio industry than any other company in the world.

Digital Products

- AudioVAULT™—simultaneous, multi-user digital central storage and satellite controller.
- CORE™—digital program controller and satellite interface.
- Disc Trak™—digital cart machine, record, edit, playback.
- DV-2—RAM based audio storage device.

RF Products

- Solid state AM transmitters.
- Solid state FM transmitters.
- FM transmitters to 70 kW.
- FX50 high performance FM exciter.
- AM stereo generators and monitors.

Studio Products

- Mix Trak 90™—high performance modular consoles.
- Air Trak 100™—configurable linear consoles.
- Air Trak 90™—affordable linear consoles.
- 150/250 Series—rotary consoles.
- Phase Trak 90™—phase correcting cart machine.
- Dura Trak 90™—high value cart machine.
- Splice Trak 90™—splice finder/eraser.
- 5000 Series—3-deck cart machines.
- 2100 Series—economical, playback cart machines.

Broadcast Electronics...your single source for world class radio broadcast technology.



4100 N. 24TH ST., P.O. BOX 3606, QUINCY, IL 62305-3606 U.S.A., PHONE (217) 224-9600, TELEX 250142, FAX (217) 224-9607

Circle (81) On Reader Service Card

World Radio History

STATION SERVICES

News and Services for Business, Programming & Sales

Megarep Restructures Sales

NEW YORK The Katz Radio Group has consolidated its KRG New Business Development, KRG Network and KRG Syndication units into one Sales Division. Stu Olds, KRG executive vice president and general manager, announced that former KRG Network Senior Vice President and General Manager Bonnie Press will supervise the new division.

Press will lead the new divisions efforts to develop new dollars for radio, to administer the marketing service manager program, and

to service and sell existing and potential non-wired network business. For information, contact Darlene Fiscus at 212-424-6483; or circle **Reader Service 74**.

Unistar Combines Formats

NEW YORK Unistar Radio Networks has merged its Special Blend format into Format 41. The company explained that the Special Blend format has evolved to the point where it is not significantly different than Format 41.

The company expects that the conversion of all interested Special Blend affiliates to

Format 41 will occur in time for the fall Arbitron survey period. For information, contact Renee Casis at 212-373-4977; or circle **Reader Service 16**.

More Motor Sports

JOHNSON CITY, N.Y. Sportscom Associates will begin production of "Radio Road Test" on Sept. 1, 1992. The five-minute program will be hosted by Paul Kaminski, and is designed to give listeners driving impressions of American- and foreign-made cars and trucks.

Kaminski will be test-driving cars in

"real-life situations," such as grocery shopping, lumber hauling, and short trips. "Radio Road Test" will be distributed via satellite and Comrex frequency extended phone line, on a barter basis. For information contact Paul Kaminski at 800-462-5677; or circle **Reader Service 195**.

SRA Marketing Tool Available

NEW YORK The Station Representatives Association (SRA) radio marketing group has published a new sales tool in the form of a booklet titled, "Maximum Results Using Spot Radio." The booklet will be distributed nationally to advertisers and ad agencies by SRA member firms and through a direct mail campaign.

Radio station personnel can obtain a copy at the NAB Radio Show in the fall in New Orleans. For information, contact Danny Flamberg at 212-595-5292, or Don McFarlane at 212-687-2484; or circle **Reader Service 46**.

New Westwood President

CULVER CITY, Calif. Westwood One has appointed Greg Batusic president of its Network Radio division. Batusic had been serving as the company's executive vice president and director of sales since 1987.

In his new position, Batusic will oversee the daily operations of Westwood networks, including: the Mutual Broadcasting System; the NBC Radio Network; NBC Talknet; The Source and Westwood One Radio Networks. For information, contact Katie Garber at 310-840-4383; or circle **Reader Service 87**.

The Best Sounding Stations Run Unattended



Shown above are the Ultimate Digital Studio™ computer screen, microphone, Sony juke boxes for CDs, and DigiCart™ for commercials, jingles, time announcements, and voice tracks. Works great with live announcers, unattended remotes, or unattended operation with voice tracks.

Several Shifts and Save Money!

Now you can run the smoothest local radio stations ever! TM Century's *Ultimate Digital Studio™* delivers:

- **Local control of all music and all commercial breaks** with an IBM-style computer;
- You select **all music from great-sounding CDs:**
 - juke boxes or "6-pack" magazine players;
 - GoldDiscs™, HitDiscs™, or ordinary CDs;
- Instant access to voice tracks, commercials jingles, promos, and sweepers on **DigiCart™ hard disc digital audio player;**
- Automatic loading of computer traffic logs and music schedules;
- Your **personalities can record a 4-hour show in 20 minutes**, or voices are available.

Less than \$15,750 for complete air studio!

TM century™

(800) TM Century

(800) 937-2100 or (214) 934-2121

FAX: (800) 749-2121 or (214) 448-0000

14444 Beltwood Parkway
Dallas, Texas 75244-3228 USA

Get the Most

► continued from page 36

word of advice: Be constructive in the criticism you offer or seek. Contacting a network with "the format stinks, the air personality stinks, where's my damn TV commercial," accomplishes nothing.

Offer solutions with critique. Discuss your mutual concerns. Remember, you are both supposed to be on the same team. If you do not feel that this is the case, if you feel that your needs are not being met or that you're not being "taken seriously," perhaps you should reconsider your choice of network.

Don't ever lose sight of the fact that you are a client that is paying for a service provided by the network. Be firm in making sure you get the service you were promised and are paying for.

Our thanks to Tony Belzer at The JSA Radio Network for his candor during this interview. You can contact Tony directly at 800-876-3303.

Next month, we'll look at network compensation: What is its worth to you and what is its worth to them?

□□□

Karl Baehr is president of KBE Broadcasting By Design, a consultancy offering a variety of services to satellite affiliates. Baehr is a former programmer and air personality. Harry Nelson is president of Harry Nelson & Associates, a satellite consultancy and an Operations Manager at Satellite Music Network for nearly a decade, programmer and former air personality of the year. Harry Nelson can be reached at 800-67-RADIO and Karl Baehr can be reached at 505-264-0450.

Circle (95) On Reader Service Card

World Radio History

BOTTOMLINE BROADCASTER

Building a Mic Preamp on a Budget

by Jim Somich

BROADVIEW, Ohio Designing a high-performance mic preamp is a formidable task, much more difficult than the line amplifier we did last month. To build a top-notch mic preamp on a budget is an even greater challenge. Most simple designs suffer from high noise levels. A mic preamp must handle signals as low as -50 dBm without contributing significant noise.

One way some designers improve preamp noise figures is to use a voltage step-up transformer at the input to an opamp stage. High quality microphone transformers are very expensive, especially if you are building more than one channel of amplification.

Performance on a budget

Bottom line broadcasters need a better way to achieve high performance without mortgaging the farm. This month we will take a look at a transformerless design utilizing the Burr-Brown INA103 monolithic instrumentation amplifier.

A high performance instrumentation amplifier has many advantages when used as

a mic preamp. It can provide a true balanced-to-ground input without the use of a transformer and if it is realized with high performance opamps its noise figures

For best results, you must use good construction techniques when building this circuit. Sloppy designs will suffer from high noise and instability. The power pins on the INA-103 and OPA-627 should be double-bypassed to a ground plane using both small ceramic capacitors and 10 μ F tantalums.

PC over perf

The ceramics will bypass well at higher frequencies, but the tantalums are necessary for good low frequency bypassing. You can construct the circuit on perf board, but a PC board is better. If you point-to-point wire on perf board, keep leads short and direct.

Establish a good ground plane and keep all grounds short and straight. In most cases, you can borrow some

power from the console ($\pm 9V-25V$ is spec). I recommend you keep supply voltage above $\pm 15V$ to maintain good headroom.

This microphone preamp module can be used in rebuilding old, outdated audio con-

without a big investment. If you want more than one or two modules, this is the only way to go.

A unique chip

The INA103 is a unique chip that can be used in many critical audio circuits. The noise spec is quite low, and the common mode rejection is greater than 110dB. It has a unique distortion-cancelling network in the input stage to reduce THD (total harmonic distortion) to extremely low levels (typically less than 0.002 percent from 20 Hz-20 kHz). The INA103 is an upgrade chip for the Burr-Brown AD625 instrumentation amplifier.

Amplifiers constructed with chips of this caliber are truly state-of-the-art at beer budget prices. I have heard of Burr-Brown selling the INA103 for as little as six bucks in small quantities. Contact your local sales office.

Next month we will take a break from circuit design and discuss a topic of interest to all Bottom Line Broadcasters: How to process competitively on a limited budget. With the introduction of practical digital signal processors, processing options are greater than ever. The big question for the Bottom Line Broadcaster is what works best for the least money!

Some of the answers might surprise you. Be sure to tune in next month as we tackle the controversial topic of how to be the

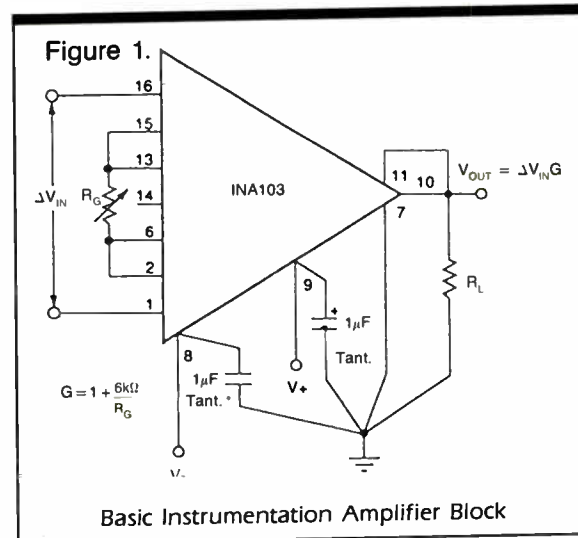

can rival a preamp built with an expensive step-up transformer.

Fig. 1 shows a basic instrumentation amplifier circuit. This is the same topology we recommend for a balanced-to-unbalanced input stage.

It has super common-mode rejection and very low noise. Fig. 2 shows the instrumentation amplifier configured as a very high quality microphone preamp with no input transformer necessary.

- This circuit has the following advantages:
- Switchable phantom power for condenser microphones
 - Switchable 20 dB pad for high output microphones
 - gain trim
 - direct DC coupling with servo

The DC restoration circuit using the Burr-Brown OPA-627 opamp has a low frequency cutoff of 1.59 Hz, and automatically removes DC offsets from the amplified output signal. We could have used a coupling capacitor at the output, but this can degrade audio fidelity.

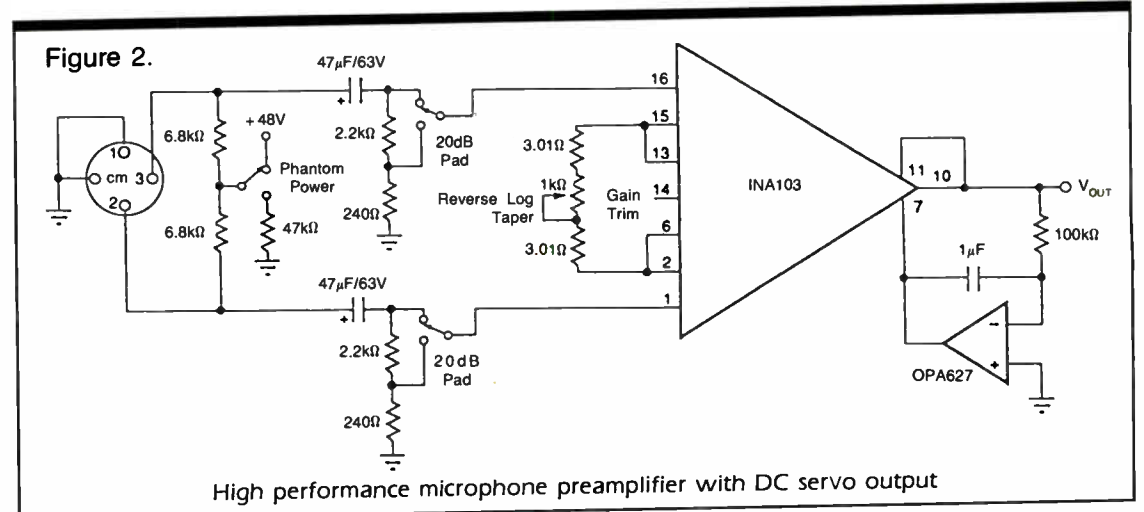

soles for impeccable performance without breaking the bank. Most projects like this will benefit from using a small PC board with ground plane rather than point-to-point wiring on perf board.

In a future column, I will cover several ways you can construct your own boards

loudest station in your market using the equipment you already have.

□□□
Jim Somich is president of Somich Engineering and chief engineer of WOIO (FM) Cleveland. He can be reached at 216-526-4561.

Digital Audio's Storage Needs

► continued from page 12
mixed, edited and otherwise processed—are referred to as recipes.

Ingredients can comprise a wide variety of media, ranging from animation frames to digitized audio. OMF media can also be interchanged through specified OMF-compliant formats, in addition to optional software modules that exchange media with other digital audio storage formats.

OMF recipes also support EDL-style information, allowing the timecode-based data from more advanced systems describing edit points, crossfade profiles, multitrack source/destination assignments and signal-processing data to be standardized via the appropriate file structures. Avid is actively canvassing opinion and reactions from the broadcast industry, and plans to publish a draft version of the OMF by mid-summer.

OMF Engine

During the fall, the firm will also be introducing OMF Engine, a common software platform for media integration via open, published interfaces that translate between proprietary file and data formats.

By offering sufficient data and information bandwidth for exchanging sound files from one platform to another, OMF certainly offers a great deal of creative potential to users of workstations and random-access editing systems.

And for fueling the expansion and wide-scale acceptance of digital audio recording, editing, mixing and processing in a variety of broadcast applications, OMF may be just what the doctor ordered.

□□□
Mel Lambert has been intimately involved with the production and broadcast industries on both sides of the Atlantic for many years. Now principal of Media & Marketing, a consulting service for the professional audio industry, he can be reached at 818-753-9510.

**HAVE THE BEST SOUNDING STATION IN TOWN...
FOR A LOT LESS MONEY!**

J.R. Nelson is offering his services to your radio station on a **market exclusive basis** now at **an incredible price!!**

ID/SWEEPERS/STAGERS PACKAGE (25 cuts) from \$300.*
new 1992 BEDS & EFX PACKAGES FROM \$75.*

J.R. Nelson
PRODUCTIONS

30% DISCOUNT FOR MULTIPLE STATION ORDERS. MONTHLY RETAINERS.

CALL/FAX FOR DEMO & RATE CARD:
(216) 239-2752 FAX: (216) 239-1359

* = market size 100+

Broadcast Equipment Exchange®

"Broadcast Equipment Exchange" accepts no responsibility for the condition of the equipment listed or for the specifics of transactions made between buyers and sellers.

AMPLIFIERS

Want to Sell

Crown Micro-Tech 1200 stereo power, 320 Wchnl 8 ohms, 495 Wchnl 4 ohms, 700 Wchnl 2 ohms, 1315 Wmono 4 ohms, new cond, 3 yr warr, \$700. B Fisher, KPOK, Box 477, Bowman ND 58623. 701-523-3883.

Decent & low-med wattage single rack height audio amp, \$100. P Wells, KJOY, 625 Broadway #1200, San Diego CA 92101. 619-238-1037.

Marantz tube mdl 9, 8-B, FM tuner 10-B, preamps mdl 1, 7-C. D deForrest, 305-866-5401.

Crown Microtech 1000 (4), will reduce price if bought as group, excel cond, \$590 ea. G Fern, Best Audio, POB 2366, Van Nuys CA 91404. 818-763-2378.

Crown D-75, excel cond, \$150. G Fallus, WZMX, 10 Exec Dr, Farmington CT 06032. 203-677-6700.

Auditronics AUD-1100DAGLC (2) dist amps in (2) AUD-1100-MF 10-input mainframes w/AUD-PS60 RM external pwr sply, \$1220+s/h. B Lord, Lord Bldg, 13313 SE 208th St, Kent WA 98042. 206-631-2374.

Panaxis Universal stereo preamp for mic, tape, phono w/plans, spare parts, heavy duty pwr sply, impedance converted to 600 ohm balanced line, \$50. Ron, 419-893-7968.

RCA BTE-15 w/2 SCA generators, extender board & book. 503-774-0459.

New 250 W solid state amp, \$1800. Call for details. Bill Hoffman, 518-583-9490.

RCA, Altec tube mic pre's & tube amps & mixers; Langevin AM-16's, sale or trade. Tracy Eaves, 615-621-6099 (evenings before 10PM EST).

Want to Buy

Tube amps & remote mixers, RCA/Gates/Collins; WE 23-C mdl. W Davies, Virgo Prods, 5548 Zimer Ave, N Hollywood CA 91601, 818-761-9831.

Cash for McIntosh mdl. C-11, 20, 22 or Mc 30, 40, 60, 75, 225, 240, 275. R Glenn, WIGK, 1718 Shenandoah, Wimauma FL 33598. 813-634-1940.

ANTENNAS & TOWERS

Want to Sell

Large stock of gd used tuning/phaser parts for AM coils, caps, great prices. T McGinley, WPGC, 6301 Ivy Ln Ste 800, Greenbelt MD 20770. 301-441-3332.

130' of 1 7/8" Coax cable w/fittings; **120'** Utility tower, 18" face w/guy & strand wire. 509-276-8816.

Utility 340 (3) 220' AM series radiators w/18" face, 2 1/4" legs, ready to ship, \$5000 ea. J Weitzman, New World Radio, 11417 Hound Way, Rockville MD 20852. 202-682-3536.

ERI M 1105 2A 2-bay, CP, 97.7 MHz, 5 KW w/mounting, \$1200. 5-bay FM horizontal only, 102.5 MHz, \$1000. G Kenny, KCL, POB 932, Nesho MO 64850. 417-451-1440.

ERI 2-bay tuned to 105.5 MHz, BO. C Jerome, WAUW, 6690 N US 1, Ft Pierre FL 34946. 407-567-1055.

Jampro JHCP-7, 1° tilt, 75 nullfill, tuned to 94.7, 7 yrs old, \$7000. B Leembruggen, 213-957-1170.

RCA BFH-3 100.1 MHz w/headers, 3 bays, \$1500. T Andrews, WLKI, POB 999, Angola IN 46703. 219-665-9554.

AM directional pkg w/Kintronics 4-twr phasor, 4-chnl dig ant mon, (3) 300' Rohn 450G towers w/Kintronics LTUs towers w/guys, insulators, 1 twr w/lights & painted, 1 RCA F.I. meter, system in use, 5 1/2 yrs old, will part out, buyer take down & haul. R Meredith, 615-487-1380.

ERI 37CP6 6-bay FM tuned to 102.1 MHz w/deicers. J Church, WLUM, 2500 N Mayfair, Milwaukee WI 53226. 414-771-1021.

Rohn SSV (7) sections, heavy duty bottom, starts at 11'; leg to leg, 140', excel cond, \$5000. B Piller, Bens Sport Sply, 2941 Wagner St, Strsburg CO 80136. 303-622-4407.

ERI 37CP8 8-bay FM tuned to 107.3, negotiable. K Reising, 812-378-1073.

Cablewave 1 5/8" air 60', new, \$450/BO; (6) angle member adapters, \$3.60 ea; (55) cable hangers for 1 5/8" cable, \$1.40 ea. C Scherer, 215-370-9046.

Steel galvanized FM tower, 18" face w/aper to 13" w/red lighting system & guy hardware, 268' tall, nds paint, you ship or pay s/h, BO. M Casey, WKXS, Drawer 1, Johnston SC 29832. 803-275-4444.

Andrew 78" foam 150' w/female N conns on both ends, less than 1 yr, \$600/BO; (36) angle member adapters, \$4 ea. C Scherer, 215-370-9046.

Shively 6913 1/2 wave spaced, 3-bay tuned to 94.3 MHz, J Paoli, Bdct Eng, 16715 Kalisher St, Grand Hills CA 91344. 818-774-5378.

Cablewave new, 1 5/8" hangers, BO. D Tabor, WLCK, Box 158, Scottsville KY 42164. 502-237-3149.

Rohn 55G 150' tower in 10' sections w/guy wire, can group to 400', \$1500. M Jones, 314-431-1216.

Continental ERI GSCPM-2E 2-bay med tuned to 98.3, pole mtg, you pick up, \$2200. S Somet, WZOE, Box 69, Princeton IL 61356. 815-875-8014.

Scala HDCA 10-102.3 MHz, 10-element, 250 W, Yagis 7556 input, \$150 ea, 4-50' lgh 1/2" helix w/conns, \$75 ea. D Rose, KAAA, 2534 Hualapai Mtn Rd, Kingman AZ 86401. 602-753-2537.

Andrew/Cablewave (62) 1/2"; (62) 1 5/8" insulated hangers & angle mounting hardware; (100) 1/2"; (50) 1 5/8" non-insulated hanger kits & angle mounting hardware. BO. C Fox, 4853 Man-or Hill Dr, Syracuse NY 13215. 315-468-0908.

Rohn 45G 200', top beacon, flasher unit & control. BO; Delta TCA-5EX ant current base & remote meters, \$350. A Ibarquien, WKTJ, POB 590, Farmington ME 04938. 207-778-3000.

INVITATION TO BID: Oklahoma State Univ offers for sale by sealed bid a 400' guyed tower, bdct feedline, a 20'x12' concrete block bldg & 17 acres. Bids will be accepted for individual items or for all items total. For more information, contact Dan Schroeder, KOSU, 302 Paul Miller JTB Bldg, Stillwater OK 74078. 405-744-6352. Bid closes August 17, 1992 at 1:30p.m.

Want to Buy

Leg brackets, support bracket & anti-rotation hardware for 3-bay ERI FMXL. M Casey, WKXS, Drawer 1, Johnston SC 29832. 803-275-4444.

440' tower to spt 3-bay FM, can be taller/shorter, reasonable. P Delaney, 507-895-2065.

FM 103.3 3-bay pref ERI & 350' cable w/conns & accessories. C Tiemann, WAIV, POB 103, Spring Valley IL 61362. 815-663-8221.

8-bay tuned to 100.9 MHz, no heaters, gd cond. K Austin, KFXI, 1101 Hwy 81, Marlow OK 73055. 405-658-9292.

AUDIO PRODUCTION

Want to Sell

Eventide BD-932 stereo bdct audio delay; Orban 245E stereo synthesizer, both excel cond w/manuals. H Ginsberg, WMEE, 2915 Maples Rd, Ft Wayne IN 46816. 219-447-5511.

Orban 622 2-chnl, 4-band parametric EQ, excel cond, \$450. T Stine, KCGQ, 106 Farrar Dr, Cape Girardeau MO 63701. 314-335-9099.

Orban 622B parametric equalizer, \$350/BO. T Weizel, KEXO, Box 2450, Grand Junction CO 81502. 303-243-1230.

API 312 mic preamps, \$100; Neumann PV-46, \$100; U.A. 1008. tube, \$150; U.A. 1108. \$100; Neumann 3-band EQs, \$175; API 553. \$175; API graphic 559, \$225; API 562 parametric, \$200; Neve 3331A limiters, pair wired w/supply & meters, \$2700. M Linett, 818-244-1909.

SAVE \$300 ON T T 144 POINT PATCH BAYS
brokers of fine and coarse used equipment
audio village 619/320-0728

CBS FM Volumax 4110 w/manual, working cond, \$250. R Miller, WCNL, 815 W Dean, Virden IL 62690. 217-965-3388.

Rane HC6 6-chnl headphone amp, \$300; fast twd time code reader/gener/re-gener, \$900. K Keller, Chez Flames Rcdg, 1229 Annunciation St, New Orleans LA 70130. 504-595-8623.

Shure M-675 Bdct Prod Master, \$75; (2) M-63 Audio Master \$40 ea; M-64 stereo pre-amp, \$25. E Ribner, Sounds That Matter, 3532-A Wyoming St, St Louis MO 63118. 314-771-2155.

CASSETTES • CARTS • REELS

J & I AUDIO/VIDEO

A wholesaler in the Radio and Television market. Now running SPECIALS on audio and video:

BASF CASSETTES-AMPEX R-Rs

AUDIOPAK, FIDELIPAC & ITC CARTS

For more information

call Kris Elliot at

1-800-942-1711

or write to: J&I Audio/Video

20899 Kelvin Pl.

Woodland Hills, CA 91367

Circle (8) On Reader Service Card

Want to Buy

Harmonizer HB000B for college station, used, reasonable price. J Szoka, 216-391-9813.

Sony MX-16 audio board for rcdg on location/studio, 8 chnl for input/output, portable, clean, \$450. Jaye, Nimbus Pro, POB 5903, Takoma Pk MD 20913. 301-507-3358.

WANTED DEAD OR ALIVE! PULTEC EQ'S

Fairchild & Teletronix Limiters; Neumann, Telefunken, AKG, RCA, & Schoeps microphones. Tube McIntosh or Marantz amps & pre-amps. Sontec, ITI, & Lang EQs. Neve or API equipment. Boxes of old tubes; Urei, Orban, United Audio, DBX, & other outboard gear. Ampex ATR102s or 104s. Parts for MC1 JH110/114 recorders. Altec 604s/crossovers/Tannoy speakers, JBL 2231; Altec 288h drivers; Misc. equipment of all types.

Please Call:

Dan Alexander Audio
5935 Market St.
Oakland, CA 94608
1-(415) 644-2363
FAX: 1-415-652-4022

SAE 5000 phono record noise filter. T Houston, Custom Audio, 929 California Ave, Bakersfield CA 93304. 805-324-0736.

SCMS FM Audimax 4450A stereo, working cond w/manual, would trade for CBS FM Volumax 4110. R Miller, WCNL, 815 W Dean, Virden IL 62690. 217-965-3388.

Stereo mic preamp high end for dig recording, 2 chnl. L Crescenti, 203-799-9785.

AMCO 10 or 20 position stereo audio/video switch boxes. TKV, 301-445-5450.

Aphex Compellers. Chuck Spencer, Radio Resources (800) 547-2346.

Yamaha SPX-90 processor. Chuck Spencer, Radio Resources (800) 547-2346.

AUTOMATION EQUIP

Want to Sell

Systemation Superswitch like new, used 8 mos, \$250; IGM GoCart 24, like new, used 8 mos, \$1500/BO. Jeff, WMMW, 900 E Main St, Meridian CT 06459. 203-634-1470.

SMC DP-1 system w/control center & programmer, AS20 switcher, (4) ITC 850 R-R decks, (7) 350 Carousels, (5) racks, taken off line 11/91. BQ. J Slager, WKTJ, POB 26, Cleveland WI 53015. 414-693-3103.

IGM 48-tray Instacarts; (1) stereo, gd cond, \$2000; (1) stereo, nds motor, \$1750. T Teagarden, KELI, POB 3834, San Angelo TX 76902. 915-855-5483.

IGM Automation syst w/5) R-R & 1 cart, \$1000. M Jones, 314-431-1216.

Schafer 903 will part out; (4) stereo Audiofiles, \$1500/\$500 per column. C Lawson, WXBG, POB 1389, Bristol VA 24203. 703-669-8112.

Format Sentry FS 12C w/UPS system, Tandy 1000 TL/3 computer, CM-5 color mon, both 2/2 yrs warranty, 6 mos old, \$3500; (3) IGM 504D dual 25 Hz detectors, excel cond, \$125 ea/\$300 both; Conex 25G tone gener, 2 mos use, mint, \$250. Pegi, Global American, 1768 Coral Way N, Vero Bch FL 32963. 407-231-4800.

Conex tone gener, \$250. M Jones, 314-431-1216.

Sentry Systems FS12-C PC-based auto controller, less than 2 yrs old, excel cond, \$2500. 301-334-4272.

IGM Instacarts (3) stereo 48-tray, gd cond, BO. W Vox, KGMI, 2219 Yew S Rd, Bellingham WA 98226. 206-734-9790.

Instacart (3) 48-trays w/interface, BO; Harris 9001 system w/2) Tec70 terminals, printer, (12) source cards, BO. B Brown, WEAT, 2406 S Congress Ave, W Palm Bch FL 33406. 407-965-5500.

IGM Go Cart stereo, very gd cond, \$800; (2) Harris 350 Carousels, stereo, gd cond, \$400 both. R Hathaway, WDEC, Americus GA 31709. 912-924-1290.

Harris System 90 w/2) Instacart machines w/room for 48 carts, (4) R-R machine, brain, keyboard, printer, manuals & racks. KFJB, 515-753-3361.

Basic A (1) IGM w/48-tray stereo Instacart; (1) 24-tray mono Instacart w/extra cards. 509-276-8816.

Schafer 901 system remote, keyboard display 903, rebilt IGM Instacart, mon amp, Sonomag 252, Carousels, labels, manuals, BO. C Jerome, WAUW, 6690 N US 1, Ft Pierce FL 34946. 407-567-1055.

Sonomag ESP II ESP 2 w/7 Carousels, 5 R-R, 6 single play decks, remote control, great shape. J Miller, ST Bdctg, 908 Frontview, Dodge City KS 67801. 316-227-4444.

Harris 9000 system, complete. (3) IGM Carousels, (3) SMC Carousels, will sell in pieces or enter system. Ken Dillard/Rick Crago, 502-683-1558.

Harris System 90, working w/cables, \$800; Harris 90 for parts, \$400; (2) encoders for System 90, \$100 ea; TI 733 silent printer, \$400; (5) Harris racks, bolt together w/end, \$500; ITC rec delay/play cart deck, \$500; (4) ITC 770 stereo PB decks, \$450 ea; (2) Harris encoders, \$100 ea. F Konwinski, WSOY, 1100 El Pershing, Decatur IL 62524. 217-677-5371.

Instacart machines (2) 48-hole w/Sentry firing systems & IBM-PC w/software. 503-774-0459.

SMC 250 Carousel, rblt & aligned, gd cond, \$350+s/h. R McDaniel, KJRG, 209 Meridian Rd, Newton KS 67114. 316-283-5150.

SMC 350RS Carousel, \$350; RSC-100 random access selector, \$350, both w/manuals. R Miller, WRFV, 815 W Dean, Virden IL 62690. 217-965-3388.

IGM EC (5) Go-Cart 24, UPS, 4 BE 2100 carts, set up for Unistar ACIL format, gd cond, \$25000. E Duellman, WQMT, POB 1385, Manitowac WI 54221. 414-682-0351.

SMC stereo carousels (2) 350s, \$350 ea; (2) 370s for parts, \$100 ea; (3) 250s, \$350 ea; (1) 250 for parts, \$100. F Konwinski, WSOY, 1100 El Pershing, Decatur IL 62524. 217-877-5371.

Schafer, not being used, BO. L Henley, WDAK, POB 95, Opelika AL 36803. 205-705-0368.

IGM Go-Carts (2), 24-trays, excel cond, 1 1/2 yrs in svc, \$1000 ea. C Jenkins, WAVG, POB 1897, Louisville KY 40201. 502-587-0970.

Schafer 903 encode center 1 & 2 cards, Infoton computer, Extel printer, \$250; SMC 350 RS, 24-cart carousel, \$200. D Rose, KAAA, 2534 Hualapai Mtn Rd, Kingman AZ 86401. 602-753-2537.

Cetec 7000 (4) ITC 7-70 R-R PBs, (2) 24-tray Carousels, (1) 48-tray Audiophile, (2) terminals batt backup, \$11000. D Greene, WGMM, 3037 Palmer Rd, Big Flats NY 14814. 716-433-5944. 602-753-2537.

CAMERAS (VIDEO)

Want to Sell

Hitachi FP 50S (2) w/CCU cable & controls, \$500 ea+s/h. F Spinetti, KCEA, POB 2385, Atherton CA 94026. 415-321-6049.

Sony M3 3-tube color w/Fuji 12x9 lens, eng w/all access, new cond, \$2800. B Bridges, KCAM, 827 Meridian St, Nashville TN 37207. 615-226-1122.

CART MACHINES

Want to Sell

ITC 3D Premium stereo, 3-tone w/WRZ, record amp & head, remote start box, gd cond, \$1400/BO. R Reeves, Voice At Large, 5080 Bainbridge Ct, Lilburn GA 30247.404-925-8888.

ITC SP (2) stereo of newer vintage recapped, 1 w/new head, spare output card, \$1100. P Hess, WPPJ, 134 Derwent, Pittsburgh PA 15237. 412-366-1249.

ITC RP rec, mono, very gd cond w/new heads & rack mount, \$700. K O'Malley, 804-446-2731.

Scully 8300 holds 3 carts, play only, gd cond, \$300. Jaye, Nimbus Pro, POB 5903, Takoma Pk MD 20913. 301-507-3358.

IGM Instacarts (2), very gd cond, mono, \$4300 ea, discount for both. K Roberts, 512-345-9300.

ITC 99B stereo encoder, excel cond, \$3200. B Watson, KSAK, 1384 W Foothill #14, Upland CA 91786. 714-946-6249.

Want to Buy

UMC Beaucart 10/20 any cond. Ray, KYTT, 455 N Broadway, Coos Ba OR 97420. 503-269-2022.

CASSETTE & REEL-TO-REEL RECORDERS

Want to Sell

Ampex servo motor w/pwr supply for AG-440, new, \$250. M Linett, 818-244-1909.

Scully 280 parts, motors, cards; Tascam duplicators, T-2640, 8 to 1 spd, 3 slaves, cass to cass, expandable. Richard, 203-269-4465.

Tandberg 1/4", 7" reels, gd mach, needs some work, BO. S Winthrop, Winthrop Prods, 156 W 94th St, NY NY 10025. 212-662-8685.

Otari 1000 (3), 25 Hz tones sensor; (3) ITC 750; (1) Roberts deck; (3) 25 Hz tone detector; (2) Ampex 350. 509-276-8816.

Value & Economy for Tough Economic Times

- ☆ Rebuilt & New equipment at 'bottom line' prices
- ☆ Replacement electronics & update kits for ITC, Harris, Autogram & other brands
- ☆ Full rebuild & repair service for ITC, BE and other popular cart & reel equipment.
- ☆ Tacsam and Otari factory authorized service center
- ☆ Tape heads, transformers, RF & other engineering supplies

THE SMART CHOICE!

HE

CASSETTE . . . WTS

MCI JH-110B w/dbx elect in tan high-profile roll cabinet, \$1500. P Wells, KJQY, 625 Broadway #1200, San Diego CA 92101. 619-238-1037.

TEAC 35-2B 7.5" & 10" reels at 7.5 & 15 ips, 1/4" tape, 2-trk stereo, RCA plugs, dbx II, wood grain, remote, xport & elec/mon bridge stackable/separated w/10" adaptor hubs, \$400. R Brancato, KUSA, 10155 Corp Sq, St Louis MO 63132. 314-997-5594.

EXPERT REVOX REPAIRS
Fast Turnarounds — Competitive Rates
Rebuilt A77s \$800
Capstan shaft resurfacing, \$35.
JM TECHNICAL ARTS
30 Music Sq. W. #5
Nashville, TN. 37203 (615) 244-6892

Otari ARS-1000 great shape, \$750. D Tabor, WLCK, Box 158, Scottsville KY 42164. 502-237-3149.

Otari ARS-1000 stereo PB, gd cond w/manual, \$500/BO. J Slager, WKTT, POB 26, Cleveland WI 53015. 414-693-3103.

Nakamichi 1000 2XL rack mount in cab w/Dolby C unit, \$500. B English, DJ Entertainment, 382 Old Seneca Tpke, Skaneateles NY 13152. 315-685-3814.

Nakamichi LX-5 3-head. J Mueller, Family Stations, 290 Hegenberger Rd, Oakland CA 94621. 510-568-6200.

CLEAN PATCH BAYS
NO DOWN TIME



VERTIGO BURNISHERS AND INJECTORS RESTORE ORIGINAL PERFORMANCE TO YOUR PATCH BAYS
Please write for address
\$34.95 Ea.
VERTIGO RECORDING SERVICES
12115 Magnolia Blvd. #116 818-907-5161
North Hollywood, CA 91607 fax 818-784-3763

Ampex 450 14", 3 ips, 25 Hz detector, reels of pro recorded bckgrnd music, 214-233-8516.
Otari 5050B 1/2" 4-trk w/case & remote, very gd cond, \$4250. G Fern, Best Audio, POB 2366, Van Nuys CA 91404. 818-763-2378.

Otari ARS 1000 (2) stereo, very gd cond w/25 Hz tone sensors & manuals, \$695 ea. T Teagarden, KELI, POB 3834, San Angelo TX 76902. 915-655-5483.

Cabinets, (2) rolling 19" w/adjustable tilt top for Otari, \$100 ea. T Wetzel, KEXO, Box 2450, Grand Junction CO 81502. 303-243-1230.

Tascam 48 1/2" 8-trk w/dbx noise red, remote control foot pedal & manual, excel cond, \$2200. J Maples, WMYU, 8419 Kingston Pike, Knoxville TN 37919. 615-693-1020.

Technics RS1500 2-trk; Sony/MCI JH110C on roll around metal cabinet, both excel cond; Dynaflex NR system D2B. J Gelo, 813-642-6899.

Tascam CD501 several avail, nd little work, BO. J Walker, 804-924-3194.

Ampex 350 (2), \$150 ea; (2) Scully 280 rec mono, \$200 ea; RCA RT21 stereo rec, \$250. F Konwinski, WSOY, 1100 El Pershing, Decatur IL 62524. 217-877-5371.

HEAD RECONDITIONING

Restore your worn heads to original (new) performance specifications at a fraction of the replacement cost. Our laboratory services include:

- Digital/Optical & Electrical inspection
- Precision recontouring of heads
- Complete digital/optical alignment of assembly
- Exclusive "Audio Magnetic Head Test Report" & Data Sheets

We also carry a full line of replacement heads and parts. Our 25 years of experience and reputation are unmatched in the industry.

JMP MAGNETIC SCIENCES
249 Kennedy Road
P.O. Box 121 • Greendell, NJ 07839
Tel (201) 579-5773
Fax (201) 579-6021

Circle (136) On Reader Service Card

MCI/Sony JH-110B rec w/manual & roll around stand, K Anderson, WBVN, POB 1126, Marion IL 62959. 618-997-1500.
Scully 280 parts, not 280-B, motors, cards; 8-trk, 1" R/P combo & erase heads for Scully 100; Tascam duplicators T-2640, 8-1 spd, 3 slaves, cass-cass, expandable. R Robinson, 203-269-4465.

Otari MX5050B MKIII stereo rec w/over-bridge, excel cond, \$2900. B Watson, KSAK, 1384 W Foothill #14, Upland CA 91786. 714-946-6249.

Tascam DA-50 DAT rec, excel cond, \$800. B Watson, KSAK, 1384 W Foothill #14, Upland CA 91786. 714-946-6249

HEAD RELAPPING/REPLACEMENT
All tape and film formats
30 years experience

iem

350 N. Eric Drive
Palatine, IL 60067
708-358-4622

Otari ARS 1000 (3) 2-chnl w/25 Hz tone sensor, cue tone relays & rack, \$875. R Chambers, KSUE, 3015 Johnstonville Rd, Susanville CA 96130. 916-257-2121.

Ampex 350 mono w/Novonics R/PB elect, \$400; Ampex 350-2 w/opamp, PB only, 2-trk, \$400. C Irwin, C Irwin Prods, 85 Union C004, Memphis TN 38103. 901-521-1466.

Studer/Revox B77 1/2-trk, 15 ips, 7 1/2 ips, 10" stainless steel hubs, remote, blank tape, \$800. L Crescentini, 203-799-9785.

For Details on Space Availability Contact Simone Mullins at 703-998-7600

DAT Sony PCM 2500, \$1400; JVC DSDT900N time code DAT, \$2400, both low hrs. K Keller, Chez Flames Rcdg, 1229 Annunciation St, New Orleans LA 70130. 504-595-8623.

Ampex ATR 800 2-trk for parts only, BO. D Gaydos, NYU, 721 Broadway 11th flr, NY NY 10003. 212-998-1665.

Ampex 600/602 (4), 2 good, 2 parts, all w/cases & manuals, blank tape avail, \$250/4 or BO. E Ribner, Sounds That Matter, 3532-A Wyoming St, St Louis MO 63118. 314-771-2155.

SCULLY TAPE RECORDERS PARTS AND SERVICE

SEQUOIA ELECTRONICS
1131 Virginia Ave.
Campbell, CA 95008
(408) 866-8434

Revox PR-99 (4) MKII 1/2-trk stereo, play w/25 Hz sensor, \$1100 ea. D Peluso, 2880 E Flamingo Rd Ste E, Las Vegas NV 89121. 702-732-2200.

Nagra #4 hi fi, full-trk, excel cond, \$800. Jaye, Nimbus Pro, POB 5903, Takoma Pk MD 20913. 301-507-3358.

Sony TC 153-SD port stereo Dolby cass rec, new, \$150/BO. E Ribner, Sounds That Matter, 3532-A Wyoming St, St Louis MO 63118. 314-771-2155.

Otari ARS-1000 (2), \$875 ea. Joe, 508-548-3102.

3M M79 24-trk, excel cond, \$9950. W Gunn, POB 2902, Palm Springs CA 92263. 619-320-0728.

Scully 100-16 w/8-trk heads, \$2900. W Gunn, POB 2902, Palm Springs CA 92263. 619-320-0728.

Otari MX-70 16-trk 1", mint cond, \$10,500. W Gunn, POB 2902, Palm Springs CA 92263. 619-320-0728.

Want to Buy

3M 56 2" 16-trk, play. F Clark, Great Passion, POB 471, Eureka Sprgs AR 72632. 501-253-8559.

Scully '100' recorders, record/play amplifiers, 8, 16, 24 track heads, Sequoia Electronics, 1131 Virginia Ave, Campbell CA 95008. 408-866-8434.

Ampex ATR100 taperecorders for parts. Circuit cards, heads, motors, machine parts, or electronic parts. Call 818-907-5161.

MCI/Sony capstan & reel motors, any cond., recdg heads, most migs, machines, new, used. Relapped then sold. Amp Services, 224 Datura St No 614, W Palm Beach FL 33401. 800-826-0601, in FL 305-659-4805.

CD's

Want to Sell

60-disc CD 600 (2), 1 IBM RS232 hook up w/warranty \$1200, we ship UPS; 1 used, BO. Keith, ALI, 9 Roxbury, Keene NH 03431. 603-352-8460.

AC music library of approx 2200 songs, 93 Goldies & 230 misc, used 6 mos, \$5100 +s/h. B Lord, Lord Bdctg, 13313 SE 208th St, Kent WA 98042. 206-631-2374.

Want to Buy

COMPUTERS

Want to Sell

Mac (10) 820 kb standard internal drive for Plus, SE, P Russell, Bowdoin Coll, Sills Hall, Brunswick ME 04011. 207-725-3066.

CONSOLES

Want to Sell

Ramko DC5RA mono mixer 5-chnl w/mon amp, \$250. K O'Malley, 804-446-2731.

Altec 10 4-in & 1-out console. 509-276-6816.

Neotek Series I 16x4x2, \$3500. D Gaydos, NYU, 721 Bwy 11th flr, NY NY 10003. 212-998-1665.

Shure M-267 w(4) inputs, mic/line level switchable, limiter, lo-cut filter, lighted VU meter in +4 & +8 ranges, headphone jack w/volume, mix bus, balanced & isolated outputs for direct telco conn, \$275. R Brancato, KUSA, 10155 Corp Sq, St Louis MO 63132. 314-997-5594.

Sparta AS40B 8-pot, excel cond w(2) TT & phono preamps, \$700. B English, DJ Entertainment, 382 Old Seneca Tpke, Skaneateles NY 13152. 315-685-3814.

Autogram IC-10 10-chnl stereo, (2) mics, (8) lines, prog & aud out, many new mods, very clean, \$4500. T Stine, KCGQ, 106 Farrar Dr, Cape Girardeau MO 63701. 314-335-9099.

Yamaha PM-2000, 24-chnl w/2 pwr splys & road case, excel cond, \$13500/BO; M-151A, 16-input stereo board w/road case, illuminated meters, travel/stationary, gd cond, \$4500; M-916, 16-chnl 11 mixing buses, 5x4 matrix, 19 outputs, switchable meters, \$3000. G Fern, Best Audio, POB 2366, Van Nuys CA 91404. 818-763-2378.

Auditronics (3) 200 VC mic compressors for 200 series, (2) 201 PEQ mic equalization mods for 200 series w/personality plug-in mods, both work fine, gd cond w/documentation. H Ginsberg, WMEE, 2915 Maples Rd, Ft Wayne IN 46816. 219-447-5511.

Altec 1220 10-chnl mix board, nds work, you pay s/h, \$300; Carvin 18-chnl mixing board. S Russell, 616-782-9258.

Ward Beck R1200 dual stereo 12-chnl, \$4500 +s/h. B Dorweiler, KVI, 7th & Olive, Seattle WA 98101. 206-223-5700.

Gates 5-pot stereo w/cab, pots, switches, meters, \$200; Ampex AG-440 1/2-trk stereo, solid state elec, nds new motor, \$200. G Kenney, KCL, POB 932, Neosho MO 64850. 417-451-1440.

MCI JH-618 non-automated, 18-input, 16-output, VGC w/patch bay & VU meters, \$6200/BO. B Petrucci, A-Z Music, 5050 Tamarus #269, Las Vegas NV 89119. 702-736-2303.

Interface 16x8 expandable to 24 inputs, gd cond, light use w/manual, \$1000/BO. Bob, 212-219-3670.

Neotek Series I 16x4x2 w/patchbay, \$3500. D Gaydos, NYU, 721 Broadway 11th flr, NY NY 10003. 212-998-1665.

Gates Gatesway 80 partially stripped, w/pots, switches & gd wiring harness & cabinet, BO. E Smith, POB 1341, Florence MS 39073.

Arrakis 500SC 8-chnl, 21 input w/pwr sply, nds tune up, \$1000 +s/h. F Spinetti, KCEA, POB 2385, Atherton CA 94026. 415-321-6049.

MCI JH-618 non-automated, 18-input, 16-output, vgc w/patch bay & VU meters, \$6200/BO. B Petrucci, A-Z Music, 5050 Tamarus #269, Las Vegas NV 89119. 702-736-2303.

MCI 428 28x24, 336 pt patchbay, prod desk, \$7500. W Gunn, POB 2902, Palm Springs CA 92263. 619-320-0728.

Want to Buy

Howe 7000 & 7500 need accurate parts list & suppliers for A&B rotary pots & mon power amp, espec MA700 IC. J Paoli, Bdct Eng, 16715 Kalishier St, Grand Hills CA 91344. 818-774-5378.

Langevin AM1A need amp cards/spare unit. D Gaydos, NYU, 721 Broadway 11th flr, NY NY 10003. 212-998-1665.

Langevin AM4A w/documents. J Gangwer, 942 32nd St, Richmond CA 94804. 415-644-2363.

DISCO & SOUND EQUIPMENT

Want to Sell

Duntech Sovereign loudspeakers, mdl 2001, light oak, local only, \$6000. D deForrest, 305-866-5401.

BBE Sonic Maximizer 422A (1) rack space stereo audio proc w/dual low contour & definition controls, RCA & 1/4" conns, new cond, \$150. B Fisher, KPOK, Box 477, Bowman ND 58623. 701-523-3883.

Tannoy CPA5 & 12 never used, CPA-5, \$230; CPA-12, \$750 w/warranty. Keith, 603-352-8460.

Martin 4-way spkr system w/Crown amps in road case for outdoors/large bldg. F Clark, Great Passion, POB 471, Eureka Spgs AR 72632. 501-253-8559.

Westone elec guitar, excel cond, BO; Wuritzer elec piano, BO; Shure PA head & columns, BO. S Winthrop, Winthrop Prods, 156 W 94th St, NYC NY 10025. 212-662-8685.

Dolby 361 (4) NR units, \$550 ea. W Gunn, POB 2902, Palm Springs CA 92263. 619-320-0728.

FINANCIAL SERVICES

Want to Sell

EQUIPMENT FINANCING "LOANS BY PHONE"

- NO FINANCIALS REQUIRED FOR TRANSACTIONS UNDER \$35,000
- NEW OR USED EQUIPMENT
- \$2,000 to \$200,000
- NO DOWN PAYMENT
- SALE-LEASEBACK EQUIPMENT FOR WORKING CAPITAL

TO APPLY OR REQUEST ADDITIONAL INFORMATION CONTACT MARK WILSON

ENF EXCHANGE NATIONAL FUNDING
(800) 275-0185
FAX: (214) 235-5452

FURNITURE

Want to Sell

Ruslang roll around R-R stands, \$150 ea. Joe, 508-548-3102.

LIMITERS

Want to Sell

Harris M-6543 mono, solid statesman w/manual, \$150. T Rosen, KBCC, 1129 Acacia Ave, Bakersfield CA 93305. 805-871-6094.

SOUND YOUR BEST ON THE AIR!

CART MACHINE SERVICES:
CART MOTORS REBUILT to quiet flutter-free perfection—shafts resurfaced
Single \$110.00 Triple \$130.00

CART HEADS RELAPPED guaranteed to perform like new
Same day turnaround
Replacement heads and motors available

REEL TO REEL SERVICES:
HEADS RELAPPED and precise digital/optical
ASSEMBLY ALIGNMENTS performed for maximum response & head life
CAPISTAN & REEL MOTORS REBUILT for MCI, OTARI and more.

For peak performance from your recording equipment, call The Audio Magnetic Professionals.

AMP SERVICES
224 Datura Street, Suite 614, West Palm Beach, FL 33401
Call 1-800-826-0601 for "Same Day Service" in Florida (407) 659-4805
Authorized Parts Dealers for: MCI • OTARI • TEAC/TASCAM

Circle (121) on Reader Service Card

PHONE: 703-998-7600 FAX: 703-998-2966



Call Simone Mullins, Classified Ad Manager, to reserve space in the next issue. Use your credit card to pay, we now accept VISA and MASTERCARD.

Radio World
5827 Columbia Pike, Ste 310
Falls Church, VA 22041

Select from these categories for best ad positioning:

| | | |
|----------------------------|---------------------------|-------------------------|
| Acoustics | Consoles | Stereo Generators |
| Amplifiers | Disco-Pro Sound Equip. | Switchers (Video) |
| Antennas & Towers & Cables | Financial Services | Tapes, Carts & Reels |
| Audio Production (Other) | Furniture | Tax Deductible Equip |
| Automation Equip. | Limiters | Test Equipment |
| Brokers | Microphones | Transmitters/Exciters |
| Cameras (Video) | Miscellaneous | Tubes |
| Cart Machines | Monitors | Turntables |
| Cassette & R-R Recorders | Movie Production Equip. | TV Film Equip. |
| CATV-MATV Equip. | Receivers & Transceivers | Video Production Equip. |
| CD's | Remote & Microwave Equip. | Video Tape Recorders |
| CD Players | Satellite | Positions Wanted |
| Computers | Software | Help Wanted |
| | Stations | |

Display Rates for Classified Advertising Effective January 1, 1991

| | 1x | 3x | 6x | 12x |
|---------------------------|------|-----------------|----|-----|
| 1-9 col inch (per inch) | \$55 | 53 | 50 | 45 |
| 10-19 col inch (per inch) | 50 | 48 | 45 | 40 |
| Distributor Directory | 90 | 85 | 80 | 75 |
| Professional Card | 60 | 55 | 50 | 45 |
| Classified Line Ad | | \$1.50 per word | | |
| Blind Box Ad | | \$10 additional | | |

To compute ad costs: Multiply the number of ad inches (columns x inches) by the desired rate schedule for your per unit cost. Example: a 3" ad at the 1x rate is \$165, at the 3x rate \$159, at the 6x rate \$150, at the 12x rate \$147, etc.

LIMITERS . . . WTS

Mod Sci CP803 comp clipper, excel cond, \$500; Digimod 2000 cards for Optimod 8000A, \$1200; Gentner RCF-1 card, \$200. Gary, 314-581-5500.

Optimod 8000 gd cond, \$1650. G Vaile, KITA, 723 W 14th St, Little Rock AR 72202. 501-375-1440.

**We buy Optimod
8000A's and 8100A's
414-482-2638**

Orban 8100A/75 spotless, \$3000. D Igou, KMMZ, 8435 Twisted Oaks, San Antonio TX 78266. 512-333-0050.

Optimod 8000 excel, \$1500. S King, KMLL, 1703 Avondale St, Amarillo TX 79106. 806-355-9777.

Optimod 8000 gd cond, just svcd, \$1650. Gary, 501-433-1077.

CRL SEC-800 stereo 4-band compressor/lim, \$750; APP-800 dual band AGC unit, \$350. D Dybas, WPNT, 875 N Michigan, Chicago IL 60611. 312-440-3100.

UREI LA-3A (2), gd cond, \$375 ea. C Lawson, WXBQ, POB 1389, Bristol VA 24203. 703-669-8112.

Aphex Compellor 300 less than 2 yrs old, perfect cond, \$800. R Reeves, Voice At Large, 3080 Bainbridge Ct, Lilburn GA 30247. 404-925-8868.

Optimod 9100-B w/NRSC mon rolloff filter, works perfect, \$2500; Gates Solid Statesman M-6631, \$150. A Ibarquien, WKTJ, POB 590, Farmington ME 04938. 207-778-3000.

UREI LA-4 comp/limiter rack mounts, XLR adaptor, excel cond, \$425. D Meyer, 818-785-2324.

Mod Sci comp clipper, mint cond, \$300. T Noordyk, WTIQ, 1501 Deer, Manistique MI 49854. 906-341-8444.

Gentner RCF-1 for Orban 8100A, never used, \$170. G Faltus, WZMX, 10 Exec Dr, Farmington CT 06032. 203-677-6700.

dbx 160, \$325; (5) Scamp S31, \$325 ea; (2) Scamp S30 exp/gates, \$325 ea; Scamp rack/pwr sply, K Keller, Chez Flames Rcdg, 1229 Annunciation St, New Orleans LA 70130. 504-595-8623.

Gates Solid Statesman (2) AM, \$100 ea; CBS Audiomax, \$100 ea; (2) CBS FM, \$100 ea; (2) Gates STA-level, \$50 ea. F Konwinski, WSOY, 1100 El Pershing, Decatur IL 62524. 217-877-5371.

Moseley TFL-280B (2), \$300 pr Joe, 508-548-3102.

Want to Buy

Orban Optimod 8100A in gd cond. T McGinley, WPGC, 6301 Ivy Ln Ste 800, Greenbelt MD 20770. 301-441-3332.

Aphex Compellor in gd cond. G Vaile, KITA, 723 W 14th St, Little Rock AR 72202. 501-375-1440.

Aphex Compellor stereo, gd cond. Gary, 501-433-1077.

Orban 8000A or 8100A Optimod. Chuck Spencer, Radio Resources (800) 547-2346.

MICROPHONES

Want to Sell

EV RE-20 w/309 shock mount, like new, \$400. P Choroas, PCE, 192 Tacoma Ave, Buffalo NY 14216. 716-875-4352.

RCA classic ribbon, send for list. W Davies, Virgo Prods, 5548 Zimer Ave, N Hollywood CA 91601. 818-781-9831.

EV RE-20 recording w/cable, \$275. S Russell, 616-782-9258.

RCA 88 mint cond, salt shaker mic, BO. R Miller, KUAI, 490 Ulamalu, Haiku HI 96708. 808-572-5534.

Desk mics (hiZ), EV-Shure mic stands, also baby booms (3); tubes, new (32) RCA, GE, Sylvania; Sams tube sub books #8 & #6; RCA tube manual; Sony head demagnetizer (new); jack femal connectors; EV 502 transformer primary/secondary. Mr. Oliver, 212-874-7660/0274. Call afternoons till 10PM.

Telefunken U-47, Neumann U-67, KM-54 mint; RCA ribbon mics (2) KU3A's 10,0001, (3) 77-DX, (1) 44-BX, (2) BK-5; Altec tube mics M-11, M-20, M-30; 639 film version mic ect. Trade or sale. Tracy Eaves, 615-821-6099 (evenings before 10PM EST).

Want to Buy

RCA ribbon 44E/77E. W Davies, Virgo Prods, 5548 Zimer Ave, N Hollywood CA 91601. 818-761-9831.

Carbon, old. T Ryan, WGOL, Rt 3 Box 467-B, Rustburg VA 24588. 800-877-2652 ext 6027. 11B G06B EV RE20 w/boom; Sennheiser MD421U w/boom. D Jackson, WQGL, POB 566, Butler AL 36904.

Electro-Voice RE-18 or RE-20 mics. Chuck Spencer, Radio Resources (800) 547-2346.

MISCELLANEOUS

Want to Sell

Racks (2), 1 is double, 1 single. 509-276-8816.

Gorman/Redlich CEB EBS encoder/decoder, excel cond, \$250; Kintronics 5 kW AM load w/RF relay, perfect cond, \$1000. D Igou, KMMZ, 8435 Twisted Oaks, San Antonio TX 78266. 512-333-0050.

Shalico 320Q-2B3 (7) step attenuators in VGC, 600 ohms in/out, \$50 ea/\$300 all. P Hess, WPPJ, 134 Derwent, Pittsburgh PA 15237. 412-366-1249.

CD JukeBox 06060 (2), 1 slightly used 60-disc, BO; 1 w/warranty & RS232 interface, \$1200. Keith, ALI, 9 Roxbury, Keene NH 03431. 603-352-8460.

Step attenuators, audio, for Gates & RCA, \$50; Simplex, analog, master clock +8 slaves, \$400. F Konwinski, WSOY, 1100 El Pershing, Decatur IL 62524. 217-877-5371.

Rotron Blowers for Elcom, CCA, CSI, McMartin, Harris, rebuilt & new.
Goodrich Enterprises Inc.
11435 Manderson St., Omaha, NE 68164
402 493 1886 FAX 402 493 6821

Up timers (3) new, 2" readouts, counts to 9:59 & resets, momentary closure resets to 0.00, \$57.50 prepaid; Audio Dig mdl TC-2 dig delay unit, new, \$1345; misc audio/RF tech manuals for Sparta Elec Corp equip. D Peluso, KJUL, 2880 E Flamingo Rd Ste E, Las Vegas NV 89121. 702-732-2200.

Sony SRF-A1 AM stereo walkmans, new, several, \$89. C Fox, 4853 Manor Hill Dr, Syracuse NY 13215. 315-468-0908.

AZP-4 blue (32) 2x2 squares of acoustical foam, \$12.50 per sq. M Tait, Tait Rcdg, 1347 S Capitol St SW, Washington DC 20003. 202-488-3905.

Panasonic WV-LK11 studio conversion kit for VW 6000 camera. G Hill, 408-749-0784.

Want to Buy

SBE Optiscan Scanner prog book. D Seavy, KROC, 122 SW 4th St, Rochester MN 55904. 507-286-1010.

UTC LS series xformers; Western Electroacoustic Labs schematic for Mic PS#120A. Richard, 202-269-4465.

Eventide 1745M cheap, damaged/working. S Russell, 616-782-9258.

1936 Zenith Stratosphere radio rcvr; EH Scott, McMurdo Silver, Lincoln rcvrs. D Hauff, KDFD, Box 16351, Minneapolis MN 55416. 612-374-9739.

Macintosh stereo tube components, disc rec equip by Fairchild, Neumann, Westrex, 457/78 records. K Gutzke, Custom Rcdg, 7134 15th Ave S, Minneapolis MN 55423. 612-866-6183.

5-100W AM 530-1610 kHz, used, tunable. F Smith, WBSV, 2408 Chamberlain Ave, Chattanooga TN 37404. 615-624-7126.

Jazz record collections, 10" LP/12" LP bebop, swing, dixie, highest prices paid. B Rose, Program Recdgs, 228 East 10th, NYNY 10003. 212-674-3060.

MONITORS

Want to Sell

Belar AM, \$350; (1) 101 equip rack, \$100; (1) CBS Volumax 4000, \$300. B Kidd, Airwaves Co, 510 W 2nd, Rayville LA 71269. 318-728-4574.

Belar AMM-2B, \$500. A Ibarquien, WKTJ, POB 590, Farmington ME 04938. 207-778-3000.

Want to Buy

TFT 7604 AM mon/gener; Belar AM mod mon/eqv on 1570 kHz, under \$500. R Miller, KUAI, 490 Ulamalu, Haiku HI 96708. 808-572-5534.

Any older McMartin mod monitors. C Goodrich, 11435 Manderson, Omaha NE 68164. 402-493-1886.

MOVIE PROD EQUIP

Want to Sell

Arriflex S 16mm movie camera, (2) 500' magazines, lens, mic, (2) motors, crystal sync, batt cable, \$3500. Jaye, Nimbus Pro, POB 5903, Takoma Pk MD 20913. 301-507-3358.

RECEIVERS & TRANSCEIVERS

Want to Sell

SCA decoder, high quality micro-miniature 6792 kHz, prewired & ready to install, \$15. D Jackway, Background Music Eng, 5742 Fairoak, Springfield MO 65810. 417-881-8401.

McMartin EBS AMR-1 & decoder EBS-2, both excel cond w/new Pana NHE & HFQ hi-temp capacitors, remote conns & relay closures, like new, \$220 both. R Brancato, KUSA, 10155 Corp Sq, St Louis MO 63132. 314-997-5594.

GE Delta (2) 45 W & (2) 100 W VHF radios, preamp on rcvr, PL boards, accessories, clean, \$150 ea. P Russell, Bowdoin Coll, Sills Hall, Brunswick ME 04011. 207-725-3066.

AM STEREO RECEIVERS

Portable, Home/Studio, Auto
RRADCO GROUP
708-513-1386

Com-Spec SS-32P tone encoders, (3) Osisit, (3) Vega, (2) encode-decode, \$10 ea. P Russell, Bowdoin Coll, Sills Hall, Brunswick ME 04011. 207-725-3066.

Magnum Dynalab FT-101 tuner made in Canada, fact return w/FM-SCS modification, \$425+\$8 sh; GE 7-2885 Superradios modified w/FM-SCS, tunable from 57-92 kHz, \$100 post-paid. B Elving, Box 336, Esko MN 55733. 218-879-7676.

DISTRIBUTOR DIRECTORY

The following distributors serving the broadcast industry would be glad to help you with any of your requirements

... getting tired of the price/quality/performance puzzle? ...

... That's our game.

RADIO! The beat goes on!

**CROUSE-KIMZEY
OF ANNAPOLIS**

tops in broadcast equipment

1-800-955-6800

ask for Kathleen

**CORNELL-DUBILIER
MICA CAPACITORS**

FROM STOCK

**JENNINGS VACUUM
CAPACITORS**

FROM STOCK

**JENNINGS VACUUM
RELAYS**

SURCOM ASSOCIATES

2215 Faraday Ave., Suite A
Carlsbad, California 92008
(619) 438-4420

**SPENCER
BROADCAST**

Supplying Radio Stations
Nationwide. Call us for
SAVINGS and SERVICE

**CALL 602-242-2211
FAX 843-2860**

Serving Radio Since 1979

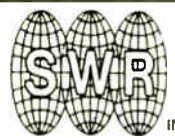

INC.

SYSTEMS WITH RELIABILITY

FM-Antennas

Outstanding performance and quality you can be sure of. All antennas are completely tested on SWR's test range. Custom directional patterns are available.

Contact **JIMMIE JOYNT**
800-279-3326

THE SOURCE

CALL US FOR ALL
YOUR NEW BROADCAST
EQUIPMENT NEEDS

Toll free: **800-HOT-AMFM**
(800-468-2636)
305-651-5752

FAX: 305-654-1386

18620 N.E. 2nd Ave.
Miami FL 33179



Transmitters FM-TV-LPTV

Translators FM-TV-LPTV

STL Transmitters

Receivers and Antennas

Exciters-TV & FM

Stereo Generators

- Financing Available -
Factory Direct Sales

CALL **719-531-0124**

EMPLOYMENT

To place ads in this section, use the ActionGram form. To respond to box numbers, write Radio World, PO Box 1214, Falls Church, VA 22041, Attn: _____

POSITIONS WANTED

Gen/Station/Ops Mgr PD w/10 yrs bdct exper, BET degree, working on business. D Koehn, 609 S 15th, Quincy IL 62301. 217-228-2115.

CE seeks employment, BSEE, exper small to large operations, air shifts, quality prod, mgmt, long/short term, travel OK. G.B., 805-481-1426.

CE w/18 yrs exper w/high pw FM & AM, audio & construction, 3834 W 55th Pl, Chicago IL 60629.

Personality/Prod/Promos energetic, dedicated team plyr w/exper in AOR/metal looking for anything PT/FT in Chicago area. Tony, 708-499-3035.

Energetic & hard working former GM seeks FT pos at small/mkt station, willing to relocate. J Rushton, 10 Windemere Rd, Worcester MA 01602. 508-799-7537.

13 yrs of Metro NY exper can be put on your airwaves, avail for prod. Zal, 718-252-5274.

Seeking new opportunities, gd pipes, high energy, will relocate anywhere, team plyr, top 100 sound CHR/HOT ac/ac 8 yrs. D.K. Pierce, 800-683-4272.

Exper AT seeks rated AC/oldies/country/classic rock/AOR outlet in South, AM/PM. Jack, 919-671-1162.

Contract engineer wishing to relocate to Southern California area. 26 years in radio, low rates and reliable 24 hours service. Inquiries to: Radio World, POB 1214, Falls Church VA 22041. Attn: Box 06-24-01RW.

NYC prod, writer w/6 yrs exper, bd ops, prod, creative, talk, music background, excel knowledge of bdct ops. Robert, 212-863-0745.

Talented unemployed morning man, newsman, copy, PD, prod, 23 yrs exper, team plyr, prefer mgmt post, ltd announcer duties. Larry, 717-653-2500.

Sharp, sultry prof w/9 yrs on air/prod/news exper seeks pos in Tampa/Sarasota/Orlando area, any format/shift. Mary, 616-784-9215.

GM/News Director w/over 25 yrs bdct exper seeking GM/News Dir pos in SE. Bill, 803-245-3128 AM/803-245-2127 PM.

Program/news public svc director exper in board/remote ops. J Lipenski, 904-683-9059.

Energetic, informative Golden Era show w/lots of trivia & facts, seek AT opening in E/SE, avail on tape. E Pell, 201-791-4610.

Director of Engineering in search of a new home. Over 12 yrs of Top 20 Market exper including high power AM & FM directional antennas & multitrack studio design. Send inquiries to Radio World, POB 1214, Falls Church VA 22041. Attn: RW07-08-01.

Recent budget cut seeks PD/on air pos w/11 yrs exper in prod, copy, promotions, prog & on air. Brad, 407-262-2713.

Engr w/heavy duty exper for any job, anywhere w/great refs, audio, RF, automation, xmtrs, ants/construction, domestic/intl, freelance. 813-849-3477.

1 yr & 2 wks exper on the air & 1 month Prog Dir exper, seeks pos in radio anywhere in USA, 814-266-1173.

Newlywed & unemployed air talent w/7 yrs exper from board monkey to ops mgr, will relocate anywhere & consider any opportunity. Randy, 704-596-4864.

Larry Branot, voice of AC/oldies, exper DJ/BC seeking AM/FM pos in OH valley reg. Award winning! Loves prod/remotes/sales, keen mind, quick wit. 7083 Wes Ct, Newcomerstown OH 43832. 614-498-8507.

Prod/Personality exper creative talent, unld voices/accents, solid & conversational w/winning attitude & team spirit. S Matthews, 615-526-7099.

Goal-oriented personality avail, exper team plyr, prefer AM/afternoon, drive-in rated mkt in USA. J Reynolds, 919-671-1162.

Seeking responsible, challenging position w/company or association that can provide opportunities to match my qualifications & experience as Corporate/Association Exhibit Manager or Marketing Events Meeting Planner. With 20 yrs exper, my strongest assets are interpreting work situations, coordinating effectively w/all levels of mgmt, organizing & guiding projects to completion & providing team leadership. Will relocate if necessary. Robert Schwartz, 10934 Woodchuck Ct, Penn Valley CA 95946. 916-432-4722.

HELP WANTED

Cleveland's #1 AM & FM combo needs an experienced radio broadcast engineer. Assistant to chief, familiar with directionals, transmitters, studio projects. Team player. Contact Ted Alexander, CE, WDOK/WRMR, 216-696-0123. E.O.E. FAX 216-579-WDOK.

Engineer for Class C FM with Big Stick and Class 4 AM. Must have experience in all areas. Could work into engineer for Group. David Shepherd, KWIX/KRES, Box 619, Moberly MO 65270. 816-263-1500.

EMPLOYMENT SECTION

HELP WANTED: Any company or station can run "Help Wanted" ads for \$1.50/word or buy a display box for \$55/column inch. Payment must accompany insert, use your MasterCard or VISA; there will be no invoicing. Blind box numbers will be provided at an extra charge of \$10. Responses will be forwarded to listee, unopened, upon receipt. Call 800-336-3045 for details.

POSITIONS WANTED: Any individual can run a "Position Wanted" ad, FREE of charge (25 words max), and it will appear in the following 2 issues of Radio World. Contact information will be provided, but if a box number is required, there is a \$10 fee which must be paid with the listing (there will be no invoicing). Responses will be forwarded to the listee, unopened.

Mail To: **BROADCAST EQUIPMENT EXCHANGE**
PO Box 1214, Falls Church, VA 22041

REMOTE & MICROWAVE EQUIP

Want to Sell

Gentner VRC-2000 w/2000, cmd relay unit, 2 barrier strip units & batt backup unit, used 60 days. \$3000. D Igo, KMMZ, 8435 Twisted Oaks, San Antonio TX 78266. 512-333-0050.

TFT 7610/7620/7630 30-chnl dig system w/status panels. \$1200. T McGinley, WPGC, 6301 Ivy Ln Ste 800, Greenbelt MD 20770. 301-441-3332.

MCI DRCR-9/RCT-9 9-chnl widig read-out, wire line ORSCA, \$1200; MCI PLG-10 41-185 kHz SCA gener, \$300. R Castro, KRPO, 6640 Redwood Dr #202, Rohnert Pk CA 94928. 707-584-1058.

Moseley TRC-15 (2), 1 set up for SCS, 1 set up for telco, great cond, \$700 ea. C Gennaro, WJMS, 222 S Lawrence, Ironwood MI 49938. 906-932-2411.

Telexfax w/mics, \$250. M Jones, 314-431-1216.

9-chnl wirelay interface, great shape, \$1200. D Tabor, WLCK, Box 158, Scottsville KY 42164. 502-237-3149.

Moseley MRC 1800 16-chnl remote mon & controller, \$1500/BO. J Slager, WKTT, POB 26, Cleveland WI 53015. 414-693-3103.

COMREX RENTALS
1, 2 and 3-Line Extenders
Switched 56 Systems
Call Steve Kirsch for details
Silver Lake Audio
(516) 623-6114

Moseley (2) CSA-3 DC amp mods; (1) MMA-1 mod mon adapter; (2) J-Pole ants for 450 MHz RPU use. H Ginsberg, WMEE, 2915 Maples Rd, Ft Wayne IN 46816. 219-447-5511.

TFT 7610-C w/7630 chnl, expander remote control unit & spare parts, \$1300. George, WWCR, 1300 WWCR Ave, Nashville TN 37218. 615-255-1300/77.

TFT 7610, 7630, 7640, 7832, 7840, 7841, ADS-01 & PSU-01, gd cond. G Jablonski, WHMI, POB 935, Howell MI 48844. 517-546-0860.

Telos 10 10-line phone system, used 6 mos, storage, \$975+s/h. B Lord, Lord Bldg, 13313 SE 208th St, Kent WA 98042. 206-631-2374.

Marti RPT 15, RPT 30 & CR10 at \$455.65/450.05. T Noordyk, WTIQ, 1501 Deer, Manistique MI 49854. 906-341-8444.

TFT 7771 (2) composite STL rcvrs in sep mainframes & configured for auto switchover, excel cond w/documentation; Potomac Instr RMP-19D (21) dig remote meter panel for use w/AM-19/D, PM-19/112 ant monitors, excel cond w/manual; Potomac Instr DAP-11 dig ant mon proc system for auto logging of ant mon directional parameters w/PTR-11 printer & manuals. H Ginsberg, WMEE, 2915 Maples Rd, Ft Wayne IN 46816. 219-447-5511.

RENTALS RENTALS RENTALS
COMREX
3-line extender
Frank Grundstein 215-668-6434
Audio/Video Consultants 215-642-0978

Want to Buy
Gentner EFT-3000 3-line freq extender. J Sanders, Ambassador, 515 E Commonwealth Ave, Fullerton CA 92632-2000. 714-738-1501.

Scala paraflectors for 950 MHz STL; 1/2" heliex. K Austin, KFXX, 1101 Hwy 81, Marlow OK 73055. 405-658-9292.

SCPC ntwk nds equip for expansion, Harris, Adcom, Avcom etc. M Sagnelli, Great Lakes Media, 2929 Covington Ct, Lansing MI 48912. 517-371-2142.

Gentner or Comrex multi-line freq extenders. Chuck Spencer, Radio Resources (800) 547-2346.

STEREO GENERATORS

Want to Sell
Gates 994-6533-001 (2) mods for use w/TE-3 FM exciter. H Ginsberg, WMEE, 2915 Maples Rd, Ft Wayne IN 46816. 219-447-5511.

Moseley SG-8, \$200. S King, KMML, 1703 Avondale St, Amarillo TX 79106. 806-355-9777.

Delco/GM 12.5 kW, 230 V AC gener, diesel eng, recently rebit, \$2500. H Pearce, WTVG, 142 Skyland Blvd, Tuscaloosa AL 35405.

Marti SCG-10 subcarrier gener, SCD-10 demod w/comparing, like new, \$350 ea. C Scott, EME Comms, Rt 3 Box 485C, Moultrie GA 31768. 912-890-2506.

SWITCHERS (VIDEO)

Want to Sell
360 Systems AM-16B 16x16 audio crosspoint, \$800. J Church, WLUM, 2500 N Mayfair, Milwaukee WI 53226. 414-771-1021.

SATELLITE EQUIP

Want to Sell
STS MBSR stereo, audio, 70 MHz, remote controllable, excel cond, \$100. G Gabriele, WFOG, 215 Brooke Ave, Norfolk VA 23510. 804-622-6771.

Prodelin 1 mtr KV dish w/mount & LNB, excel cond, \$80+s/h. G Faltus, WZMX, 10 Exec Dr, Farmington CT 06032. 203-677-6700.

Wegener 1601 mainframe & (2) 1610 cards, excel cond. K Anderson, WBNV, POB 1126, Marion IL 62959. 618-997-1500.

TFT EBS rcvr w/FM rcvr, encode, decode mods, nds repair, \$150. K Austin, KFXX, 1101 Hwy 81, Marlow OK 73055. 415-658-9292.

NEED CASH?

We buy:
Fairchild DART 384
Scientific Atlanta
7300/7325
Unistar
AM Only/FMT 41
Oldies AC-II/CNN
Microdyne
1100 Series
SCPC

We sell quality
Reconditioned
units with a
30 Day
Guarantee

New Avcom &
Microphase SCPC
Satellite Systems
(719) 634-6319
(Fax) 635-8151

SERVICES

Tower Sales & Erection
Turnkey Site Development
Installation & Maintenance
AM/FM Broadcast, TV,
Microwave Systems,
Antennas & Towers
TOWERCOMM
Communications Specialists
Ben Wall
President
6017 Triangle Dr.
Raleigh, NC 27613
(919) 871-3496
Fax: (919) 871-6454

TENCO TOWER
Lic. No. 357096
Installation & Maintenance of
Broadcast & Communications
Towers & Antennas
Donald J. Tenny
(916) 362-6846
(916) 638-8833
9723 Folsom Blvd. Suite A
Sacramento, CA, U.S.A. 95827 FAX: (916) 638-8858

BROADCAST DESIGN & CONSTRUCTION, INC.
• Facility Relocation
• R.F. Systems
• Soundproof/Acoustical
• Custom Cabinetry
24 HOUR EMERGENCY SERVICE
(313) 465-3226

Columbia Career Consultants
Serving the staffing needs of
the broadcast industry on a
national basis. Call us today
to discuss your employment
needs!
317-923-1550
1815 N. Meridian St., 101
Indianapolis, IN 46220

REMOTE EQUIPMENT RENTALS
Hear 50-8000 Hz audio response from
your next remote for much less than
costly TELCO loops by renting the:
GENTNER EFT-3000
— or —
COMREX 3XP/3XR
3-line frequency extension system.
MARTI and TFT-8888 RPU
equipment also rented. Call Dwight:
**WELLER AUDIO-VISUAL
ENGINEERING**
410-252-8351

**SPECIALIZING IN ERECTION,
REPAIRING, PAINTING
AND MAINTENANCE
RADIO, TWO-WAY, TV, TOWERS
AND FLAG POLES**
A STEEPLEJACK CO.
PAINTING AND STEEPLEJACK
CONTRACTORS
FULLY INSURED FOR YOUR PROTECTION
DON HIGLEY 3722 ROMA
713-462-6105 HOUSTON, TEXAS 77080

Communications Data Services, Inc.
Richard P. & Richard L. Biby, Principals
Real World Propagation™ Studies
Online/Remote Access Services
3 Arc Second Terrain Data
1990 Population Data
FCC & FAA Databases
For more information call:
(703) 534-0034 • (800) 441-0034

FROM STOCK
**Low Pass Filters
Directional Couplers**
**CONNECTICUT
MICROWAVE
CORPORATION**
10 B Trakside Business Park
Cheshire, Connecticut 06410
203-250-9678 fax: 203-250-9688

**Don't gamble
with your
advertising dollars.**
Advertise in Radio World
and reach 18,000+
subscribers. Call
1-800-336-3045 today!

Quik Disk 1 computer animation w/hard drive
for R/PB in mono, 2 yrs old, excel cond,
\$6000. D Brook, WNLB, POB 602, Rocky
Mount VA 24151. 703-483-7011.

Sci Atlanta 7300 & 7325 w/7.5k, 15k, VoiceCue, RFS 4/1/92 recent svc, \$7500. W Geesman, CGN, 6310 16th E, Tacoma WA 98424.

STS MBSR stereo, audio, 70 MHz, remote controllable, excel cond, \$100. G Gabriele, WFOG, 215 Brooke Ave, Norfolk VA 23510. 804-622-6771.

CONSULTANTS

Huntsville Antenna Engineering
There is hope for AM radio!
AM station unipole antennas with
circular polarization & beam tilt.
Broadband your present
AM tower Series R shunt fed.
205-353-6747
Kenneth Casey
Consulting Radio Engineer

MIRKWOOD ENGINEERING
Rural & Remote Site
Field Engineering
50 Park Ave.
Claremont, NH 03743
603/542-6784

**T.Z. Sawyer
Technical Consultants**
1-800-255-AMDA
AM Directional Antenna Proofs
AM-FM-TV-LPTV
FCC Applications & Exhibits
Station Inspections
6204 Highland Drive
Chevy Chase, MD 20815-6610
Telefax 301-913-5799

Congratulations! You've found THE CARD!
Radio Systems Engineering
"For all your Engineering Needs"
AM - FM - TV - Translators - LPTV
FCC Applications - Design - Installation
Call, fax, or write **today!**
(800) 551-1667
fax: (702) 898-8731
4289 Roonridge - Las Vegas, NV 89120

MULLANEY ENGINEERING, INC.
Consulting Engineers
• Design & Optimization of
AM Directional Arrays
• Analysis for New Allocation,
Site Relocation, And Upgrades
AM FM TV LPTV
Wireless Cable
(MDS/MMDS/ITFS/OFS)
• Environmental Radiation Analysis
• Field Work
• Expert Testimony
9049 Shady Grove Court
Gaithersburg, MD 20877
Phone: (301) 921-0115
Fax: (301) 590-9757

Moffet, Larson & Johnson, Inc.
Consulting Telecommunications
Engineers
Two Skyline Place
5203 Leesboro Pike # 800
Falls Church VA 22041
703-824-5660
800-523-3117
Member AFCC/E

Consulting Communications Engineers
• FCC Data Bases
• FCC Applications and Field Engineering
• Frequency Searches and Coordination
• AM-FM-CATV-ITFS-LPTV
OWL ENGINEERING, INC.
1306 W. County Road. F,
St. Paul, MN 55112
(612) 631-1338 "Member AFCC/E"

W. LEE SIMMONS & ASSOC., INC.
BROADCAST TELECOMMUNICATIONS CONSULTANTS
1036 William Hilton Pkwy
Ste 200F
Hilton Head Is., SC 29928
1-800-277-5417
803-785-4445
FAX: 803-842-3371

EVANS ASSOCIATES
Consulting Communications Engineers
FCC Applications, Design
& Field Engineering
Broadcast Engineering Software
216 N. Green Bay Rd.
Thiensville, WI 53092
(414) 242-6000
Member AFCC/E

PC - SOFTWARE
AM-FM-TV Search Programs
Contour Mapping - STL Paths
RF HAZ - 1990 POP Count
FAA Tower - Draw Tower
Broadcast Engineering
Doug Vernier
Broadcast Consultant
1600 Picturesque Dr
Cedar Falls, IA 50613
800-743-DOUG

GOODRICH enterprises, inc.
Parts and technical service for all
MCMARTIN TRANSMITTERS, CONSOLES
EXCITERS, RECEIVERS
TRANSMITTER AND INDUSTRIAL TUBES.
11435 Manderson St.
Omaha, Nebraska 68184 U.S.A.
PH: 010-1-402-493-1886 FAX: 010-1-402-493-6821
TELEX: 940103 WUPUBLTX BSN

Where In The World Are You?
Reach radio professionals
worldwide by advertising in
Radio World's international
edition. Call Simone for
more information.
1-800-336-3045

Contact Radio World Newspaper for availabilities.
P.O. Box 1214 • Falls Church VA • 22041
1-800-336-3045

World Radio History

MasterCard

C.F. Ellis, P.E.
Communications and
Electromagnetic Consulting
Applications, Propagation,
Safety, System Design
0.5 MHz-50 GHz
30 years experience Cost sensitive
1103 LaNeuville
Lafayette, LA 70508
Phone: 318-984-2420
FAX: 318-989-8037

STATIONS

Want to Sell

FM-CP 25 kW in N Calif, 2-station mkt, \$45,000; FM-CP 25 kW in Rockies, \$40,000, serious inquiries only; FM-CP 25 kW in mid-west, gd mkt, \$150,000; AM in Mississippi, off air, gd bldg & land, facilities, excellent terms, 608-233-5148.

1000 W AM fulltime, N Calif mtn resort location, ideal family operation. T Collins, 510-547-4388.

AM/FM combo \$100,000 down & assume w/real estate & bldg, great opportunity, 216-331-8012.

WLLN, 5000 W AM non-comm educ, full pwr from sunrise-sunset, 24 hr license to operate at 49 W at night, directional w/3 towers. Located on approx 10 acres in Harnett City, Lillington NC, \$200,000. Dr. O Talmade Spence, 919-892-9322.

AM/FM C3CP in central Michigan w/real estate, \$350,000. L Henley, WDAK, POB 95, Opelika AL 36803. 205-705-0368.

Complete facility set up for talk, news & music, high qual equip, 14'x30' 2-axle mobile studio, less than 5 yrs old w/AC & restroom. 503-774-0459.

KMCM 92.5 FM, KMTA 1050 AM, Miles City MT, reg cvg, excel equip, steady economy. Paul, 612-222-5555.

For Sale or Trade
100 kW Central Wyoming at 106.9 FM.
Fax interest and qualifications
702-883-5704

ACTION-GRAM

Equipment Listings

Radio World's Broadcast Equipment Exchange provides a FREE listing service for all broadcast and pro-sound end users. Simply send your listings to us, following the example below. Please indicate in which category you would like your listing to appear. Mail your listings to the address below. Thank you.

Please print and include all information:

Contact Name: _____

Title _____

Company/Station _____

Address: _____

City _____ State _____ Zip _____

Phone Number: _____

Brokers, dealers, manufacturers and other organizations who are not legitimate end users can participate in the Broadcast Equipment Exchange on a **paid** basis. Line ad listings & display advertising are available on a per word or per inch basis. Call 1-800-336-3045 for details.

I would like to receive or continue receiving Radio World FREE each month. YES NO

Signature _____ Date _____

Please circle only one entry for each category:

I. Type of Firm

- | | |
|------------------------------|---------------------------------|
| D. Combination AM/FM station | F. Recording studio |
| A. Commercial AM station | G. TV station/teleprod facility |
| B. Commercial FM station | H. Consultant/ind engineer |
| C. Educational FM station | I. Mfg, distributor or dealer |
| E. Network/group owner | J. Other _____ |

II. Job Function

- | | |
|-----------------------|---------------------------|
| A. Ownership | D. Programming/production |
| B. General management | E. News operations |
| C. Engineering | F. Other _____ |

WTS: WTB: Category: _____

Make: _____ Model #: _____

Brief Description: _____

Price: _____

WTS: WTB: Category: _____

Make: _____ Model #: _____

Brief Description: _____

Price: _____

WTS: WTB: Category: _____

Make: _____ Model #: _____

Brief Description: _____

Price: _____

*Closing for listings is the first and third Fridays for the next month's issue. All listings are run for 2 issues unless pressed for space or otherwise notified by listee.

Broadcast Equipment Exchange

703-998-7600 PO Box 1214 • Falls Church VA • 22041 FAX: 703-998-2966

TRANSCOM CORP.

Serving the Broadcast Industry Since 1978

Fine Used AM & FM Transmitters and Also New Equipment

For the best deals on Celwave products, Andrew cable and Shively antennas.

| | | | |
|-----------|--------------------|-----------|----------------------|
| 1 kW FM | 1964 Gates FM1C | 1 kW AM | 1982 Cont. 314R1 |
| 1 kW FM | 1978 Collins 831C2 | 1 kW AM | 1974 Harris BC1H1 |
| 2.5 kW FM | 1978 CCA 2500R | 1 kW AM | 1968 Harris BC1G |
| 3 kW FM | 1975 CCA 3000D | 2.5 kW AM | 1982 CCA 2500D |
| 20 kW FM | 1974 RCA BTF 20E1 | 2.5 kW AM | 1976 McMartin BA2.5K |
| 25 kW FM | 1988 TTC 25,000 | 5 kW AM | 1968 Harris BC5H |
| 30 kW FM | 1981 BE FM-30 | 5 kW AM | 1972 CCA AM5000D |
| | | 5 kW AM | 1977 RCA BTA 5L |
| | | 10 kW AM | 1972 RCA BTA 10U |
| | | 50 kW AM | 1977 CCA AM5000D |

1077 Rydal Road #101
 Rydal PA 19046

800-441-8454 • 215-884-0888 • FAX No. 215-884-0738

Circle (92) On Reader Service Card

1 kW AM KRRU in Pueblo, highest bidder over \$99000 w/gd terms. G Erway, KRRU, 4211 N Elizabeth St, Pueblo CO 81008.

Mid-Ohio 24-hour AM in fastest growing market. Discount for quick sale to cash buyer. Write PO Box 1314, Lima, Ohio 45802.

Want to Buy

CPs/dark stations in resort/college mkts. Dr Pollock, 1st Bldg, Box 691, Wilmette IL 60091. 312-774-1860.

Veteran Christian radio mgr, engr, DJ seeks AM/FM station, no down, owner financing, any situation. E Smith, POB 1341, Florence MS 39073.

FT AM/FM want to lease w/option to buy, pref upstate/northern NY. W Tinsley, 315-788-0914.

10" of 1/4" high quality 1/2 mil tape, 40 mins per reel. BO. R Taylor, WHEN, 620 Old Liverpool, Liverpool NY 13088. 315-457-6110.

7" (17) 1/4" & 1/4-trk, classic rock/DJs of 70's, \$50. D Pulwers, Dave's Price, 310 N Howard #103, Alexandria, VA 22304. 703-751-9346.

Audiopak AA-4 (55) 20-sec, (62) 40-sec, low usage. \$2 ea/BO. C Scherer, 215-370-9046.

Scotchcart II stereo black, 20 sec-5/2 mins, excel cond; Scotchcart stereo brown; Audio-Pak stereo blue, \$2.75 ea; Audio Pak A-2 mono 20 sec-5/2 mins, very gd cond, \$1.50 ea. J Garabo, Garabo Creative, 32 Brightwoods Ln, Rochester NY 14623. 716-427-7369.

650 Scotchcart IIs various lengths w/country & AC, used up to 6 mos w/few passes, \$2 ea + s/h. B Lord, Lord Bldg, 13313 SE 208th St, Kent WA 98042. 206-631-2374.

SOFTWARE & DATABASES

Want to Sell

FOR SALE: Ron Balonis' Broadcast Engineer's Computer Toolbox for IBM compatible computers. Send for details to COMPUTER TOOLBOX, 118 Rice Street, Trucksville, PA 18708-1628.

TAPES/CARTS & REELS

Want to Sell

Scotch Cart II 6 1/2 min, new. M Phelps, WLTJ, 28411 Northwestern, Southfield MI 48034. 315-354-9300.

ARMSTRONG TRANSMITTER

World Leaders in rebuilt transmitters!

AM-FM-TV TRANSMITTERS, FM ANTENNAS, STL'S

TRANSMITTERS are available:

- Tuned & Tested on YOUR Frequency
- Guaranteed
- Parts and technical support with every purchase
- Expedited Service Available

TRADE INS GLADLY ACCEPTED

See your transmitter WORKING in our showroom BEFORE you take it home!

NO ONE ELSE OFFERS YOU MORE

ARMSTRONG TRANSMITTER
 Corporate Office

5046 Smoral Rd.
 Syracuse, NY 13031
 PHONE (315) 488-1269
 FAX (315) 488-1365

Over 500 customers in 30 countries

ARMSTRONG SOUTHWEST
 Phone 512-599-0789
 Fax 512-599-0799
 San Antonio, TX

HABLO ESPANOL
 Phone 305-471-1175
 FAX 305-471-1182
 Miami FL

ARMSTRONG SOUTHEAST
 Phone 615-822-0256
 FAX 615-826-0082
 Hendersonville, TN.

TAPES . . . WTS

Capitol Audiopak A-2 1400 A-2s, most 2:30 & 3:30 length, some 5 mins, 3 yrs use, rec w/oldies, \$1500/BO. C Hahh, WAHZ, POB 640, Westfield MA 01086. 413-562-7666.

**A&D
Cartridge Rebuilding
Service**

We clean, load & pack. Serviced within 10 work days! Work guaranteed!
**3706 Vold Ct., Eau Claire, WI 54701
(715) 835-7347**

MARATHON PRODUCTS COMPANY

Audio Cartridge Rebuilding Division

Rebuilding/reloading, like new, all brands, any length up to & including 3.5 minutes,
\$1.75 ea. FOB out plant, 48 hrs delivery.

New NAB Marathon cartridges prices on request.

35 Years professional experience!

Lifetime member AES R.D. MYERS Sr.

Manufacturers of Audio Devices, Continuous Tape Mag.

69 Sandersdale Rd.

Charlton, MA 01507

1-508-248-3157 or 1-508-853-0988

Circle (129) On Reader Service Card

Want to Buy

Beautiful music format, prefer stereo & 10 1/2" reels, for collector not air, 414-794-1800.

Source of programming for gospel non-comm educ FM under construction. F Hollon, WAHI, Box 195, Augusta IL 67311. 217-392-2340.

TAX DEDUCT EQUIP

Media tech prog low on cash seeks donations of audio prod gear, repairable cond OK. Judy, Bunker Hill Comm Coll, Rutherford Ave, Boston MA 02129. 617-241-8600 x255.

Virgin Islands non-prof youth radio nds FM xmtr & related equip, auth pwr is 3 kW, we pay s/h. P Church, POB 7009, St Thomas US-VI 00801. 800-533-9273.

Bdct/cable Mktplace old editions, we pay s/h & rcpt. Dr Newcomb, Grand River Radio, 19130 Nelson-Parkman, Garrettsville OH 44231. 216-693-4125.

Non Profit School AM station nds used mono STL for new station, will pay s/h. E Smith, POB 1341, Florence MS 39073.

Monte Vista Christian School, would appreciate any donations of used TV broadcast equipment. T Quinn, 408-475-0423.

Eng student desiring donation of old bdct equip (anything) in repairable cond, will pay all shipping charges, EE student at Purdue. C Gill, POB 371, Indianapolis IN 46206. 317-923-2800.

TEST EQUIPMENT

Want to Sell

Tektronix 1405 3 sideband gener, never used, \$5500; TFT 851 TV stereo mon, never used, \$8500. R LaRue, 813-681-6822.

HP 334A dist/audio analyzer w/switchable low-pass filter & padded alum carry case; Tektronix TM515 suitcase port mainframe w/SC502 oscilloscope, DC502 freq counter, SG502 oscillator & storage mod; Altec-Lansing decade step attenuator. H Ginsberg, WMEE, 2915 Maples Rd, Ft Wayne IN 46816. 219-447-5511.

HP 206A audio osc, \$250. F Korwinski, WSOY, 1100 El Pershing, Decatur IL 62524. 217-877-5371.

Patch bays (4) ADC single inputs (24) rack mount; Dynakit pre-amp PAS 2; manuals for Ampex recorders 601, 351, 350 also for Gotham PBF 150 W amp & Neuman lathe 131 disc cutter. Mr. Oliver, 212-874-7660/0274. Call afternoons till 10PM.

GR 916AL RF bridge, \$400/BO; GR 1330-A bridge oscillator, \$300/BO; GR 546-C audio freq microvotter, \$100; GR 1601-A VHF bridge, \$200; GR 1602-B admittance meter, \$300; GR 1900 audio wave analyzer, excel, \$300; GR 821-A twin-tee RF impedance measuring bridge, \$150; Wayne Kerr B601 RF bridge, \$300; Wayne Kerr R261 bridge detector, \$100; HP 403B AC voltmeter, new batts, \$150; HP 331A distortion meter, \$300; Empire Devices NF-105 field strength measuring system, all plug-ins, xport cases & antennas; Delta RG-3 rovr-gener, \$2000/BO, all in very gd cond. M Bowers, 703-389-7473.

Want to Buy

EIA 1 5/8 flange 50 ohm for dummy load, able to dissipate at least 5 kW on EIA 1 5/8 flange, water loads OK. J Hoge, WTLN, POB 607000, Orlando FL 32860-7000. 407-682-9494.

TRANSMITTERS

Want to Sell

RCA MDS w/Andrews ant, nds tube. Brad, KZPI, POB 2207, Deming NM 88031. 505-546-0944.

Exciters: **McMartin B-910** tuned and calibrated to your frequency, guaranteed: Mono, stereo, SCA. Goodrich Ent. Inc. 11435 Manderson St., Omaha NE 68164. 402-493-1886 FAX: 402-493-6821

Harris MX15 like new cond, will put on your freq, \$3600. G Gabriele, WFOG, 215 Brooke Ave, Norfolk VA 23510. 804-622-6771.

RF Coils, Contactors, TCT's, Hot Line Jacks, Complete Phasors:

GELECO

Electronics, Ltd.
2 Thorncliffe Pk. Dr. U28
Toronto, Ont M4H 1H2

— Since 1960 —

**Ph: 1-416-421-5631
Fax: 1-416-421-3880**

RCA AVQ-10 radar w/fiat ant, pwr supply, spare parts, BO. A Ramsey, WTW0, Box 299, Terre Haute IN 47808. 812-696-2121.

CCA AM1000 nds work, \$500. B Kidd, Airwaves Co, 510 W 2nd, Rayville LA 71269. 318-728-4574.

Harris SX-1A 1000 W 1985, solid state, used 5 yrs, \$12000/BO. W Smith, WHHM, POB 203, Henderson TN 38340. 901-989-5981.

LPA AM-25 PSSA/PSRA solid state, \$500; LPB Mdl T-8 power line interface, \$100. M Bowers, 703-389-7473.

NEC 4763A FM, 20 kW w/(3) 4CX 15000As, \$25000; 25 kW dummy load, \$2000. R Miller, KUAU, 490 Ulumalua, Haiku HI 96708. 808-572-5534.

Gates M-609S FM exciter 10 W, 88.1 w/manual, \$300. T Rosen, KBCC, 1129 Acacia Ave, Bakersfield CA 93305. 805-871-6094.

**CAPACITORS
OVERNIGHT**

• **Power Supply**
computer grade: up to 450 VDC
• **Transmitting-MICA**
Sangamo, Comell-Dubiller
• **Oil Filled**
Non-PCB Oval, Rectangular
1-800-323-0460
FAX 1-802-425-3664
Kellner Electronics, Inc.
Charlotte, VT 05445

Circle (6) On Reader Service Card

Harris TE-3 10 W amp, \$150; spare semiconductor kit for TE-3, \$150. G Kenny, KCL, POB 932, Neosho MO 64850. 417-451-1440.

Collins 830 D 1 kW FM, \$2500; Harris 20 kW FM, excel cond w/spare parts, \$18000. M Jones, 314-431-1216.

GE BT-25A 50 kW AM, tuned to 1540 kHz, gd working cond, has PCBs, free if you pay for disposal, disassembly & haul. P Thurst, WPTR, POB 12279, Albany NY 12212. 518-456-1144.

Gates FM-1C working, w/o exciter, \$1500; RCA FM-10C 10 W, working, \$400. A Weiner, WHVW, 3007 Voler Ave, Hyde Park NY 12538. 914-471-9500.

Bext T-800 800 W wideband PA, 1.5 yrs on air, pristine cond, \$4500. J Paoli, Bdct Eng, 16715 Kalisher St, Grand Hills CA 91344. 818-774-5378.

Sparta 680 solid state FM exciter, works OK w/composite input, excel cond w/manual. H Ginsberg, WMEE, 2915 Maples Rd, Ft Wayne IN 46816. 219-447-5511.

Gates BC-5B 580 kHz; RCA BTA-5T 1380 kHz, BO, both gd for parts, you pick up. J Batten, WCHS, 1111 Virginia St E, Charlestown WV 25301. 304-342-8131.

LPB RC-25B 20W, works well w/books, \$100. Ron, 419-893-7968.

Burk Tech TC-8 remote xmtr & studio control unit w/manual, 8 metering sources on dot matrix array, push button set up, \$1295. R Chambers, KSUE, 3015 Johnstonville Rd, Susanville CA 96130. 916-257-2121.

McMartin BA-1K (used), one kW AM xmtr tuned & tested on your freq, guaranteed, excel cond. Goodrich Ent, 11435 Manderson St, Omaha NE 68164. 402-493-1886.

TRANSMITTERS

- 15 watt FM Versa-Count Exciter
- 30 watt FM B-E FX-30 Exciter
- 250 watt FM Wilkenson 250E
- 1 kW FM 1975 Harris 1H3
- 3 kW FM 1975 Harris 3H3
- 5 kW FM 1967 Gates 5G
- 20 kW FM 1990 B-E 20B
- 25 kW FM 1977 AEL 25KG

PMA Marketing, Inc.

"Transmitting Savings to You"

414-482-2638 FAX 414-483-1980

McMartin 10 kW FM (used), completely reconditioned, tuned & tested to your freq. Goodrich Ent, 11435 Manderson St, Omaha NE 68164. 402-493-1886.

Wilkenson 10 kW FM 3-phase, tuned to 105.3 MHz. used 1 yr, \$20000; McMartin 1 kW tuner at 106.3 MHz. B Smiley, 305-743-3740.

Plate xformer for TTC 10 kW, 3 phase, \$500; Harmonic filter for 40kW, full band SUT, 3 1/2" conns, \$400. K Austin, KFXI, 1101 Hwy 81, Markov OK 73055. 405-658-9292.

Marti studio xmtr link, dual system w/STL-8 xmtrs & R-200 rcvrs, excel cond, \$3900. R Chambers, KSUE, 3015 Johnstonville Rd, Susanville CA 96130. 916-257-2121.

50 kW AM Transmitter

Continental 317C transmitter in good condition! Some spare parts also available! Call 806-372-5130 for specific information! This transmitter is available now!

Harris FM 2.5 H3, 2.5 kW w/TE3 exciter tuned to 95.9 MHz, \$8000; TTC XLFM, (2) TVK 1-code identifier boards, (2) modulator boards, \$200 ea. D Rose, KAAA, 2534 Huaipai Min Rd, Kingman AZ 86401. 602-753-2537.

WE 189D xformers, new, \$35/pair; UTC LS-141 hybrid xformer, new, \$50. R Robinson, 203-269-4465.

Used & New Transmission Line, many sizes & lengths, many like new. 412-733-1994.

RECTIFIERS: molded replacements and open assemblies available. Upgrade kits for older transmitters. DEALERS WELCOME. Repairs on open assemblies. Plastics Technology Inc, 205-633-6277 or FAX 205-633-3202.

RCA TT25FL tuned to Channel Six. RCA 7717FH tuned to Channel Twelve. Both are in good condition. J.S. Broadcast Service (915) 772-2243.

Want to Buy

Collins 830-D FM xmtr & a Versa Count Mdl 322 exciter. R Vinikoor, WNTK, POB 2295, New London NH 03257. 603-526-9464.

Continental 5 kW FM for 103.3 & exciter. C Tiemann, WAIV, POB 103, Spring Valley IL 61362. 815-683-8221.

**USED TV
TRANSMITTERS,**

antennas, cable, rigid line, etc. one watt to 110 kW. Bext FM Line BUY — SELL

BROADCASTING SYSTEMS

602-582-6550

FAX: 602-582-8229

Kenneth Casey

7 1/2/10 kW FM in gd cond. B Kelso, WAAQ, 220 1/2 S Michigan, Big Rapids MI 49307. 616-796-7000.

Harris MW1/5X1 AM, no tubes under 10 yrs old, 1 kW around 1400 kHz. C Mellon, WILL, 720 Man St, Willimantic CT 06226. 203-456-1111.

Collins 21E manual, will pay copy costs. J Poole, KWHN, 423 Garrison Ave, Ft Smith AR 72901. 501-782-8888.

FM BROADCASTERS!!

We can meet all your FM transmitter needs!!

SOLID STATE

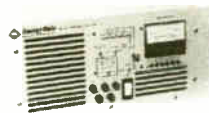

Amplifiers and transmitters are available at the popular levels of 25, 100, 300, 500, 1000, 1500, 2000, 2500, 3000, 4000 and 4500 watts. All units are broadbanded and designed for local and remote operation.

ZERO BIAS GROUNDED GRID TRANSMITTERS

SINGLE TUBE—MEDIUM POWER

Offered at 1.5, 3.5, 5.5, 7.5 and 12KW. These transmitters include a broadbanded solid state IPA, which can be used as emergency transmitters and a single zero biased grounded grid triode in their PA.

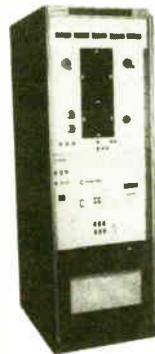

TWO TUBE—HIGH POWER

These transmitters utilize two grounded grid triodes and are available at standard outputs of 15, 22, 25, 30, 40 and 50KW.

"The Transmitter People"

Energy-Onix

752 Warren Street, Hudson, New York 12534
(518) 828-1690 FAX (518) 828-8476

A Wise Enterprise

Circle (167) on Reader Service Card

PETER DAHL CO.

Save \$\$

Heavy Duty Replacement Transformers, DC Filter chokes and capacitors for AM & FM transmitters manufactured by: AEL, CCA, CSI, COLLINS, CONTEL, CONTINENTAL, BAUER, GATES, GE, HARRIS, ITA, McMARTIN, RAYTHEON, RCA, SINGER, SINTRONIX, WILKINSON.

Many other models also available.



FAST Delivery and FREE Technical support.

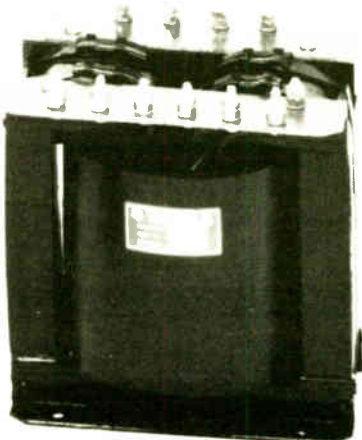

5869 WAYCROSS AVENUE EL PASO, TEXAS 79924
**(915) 751-2300 TELEX: 76-3861 PWDCO
FAX: (915) 751-0768**

Circle (56) on Reader Service Card

TRANSMITTERS . . . WTB

10 kW gd cond, prefer single phase. K Austin, KFXI, 1101 Hwy 81, Marlow OK 73055. 405-658-9292.

UTC LS series xformers; schematic for Western Electroacoustic Labs Cond Mic PS#120A. R Robinson, 203-269-4465.

WE BUY
MOSELEY PCL-303, 505, & 606's
414-482-2638

5-100W AM 530-1610 kHz, used, tunable. F Smith, WBSV, 2408 Chamberlain Ave, Chattanooga TN 37404. 615-624-7126.

2-12kW FM transmitters, any type, in working cond. Chuck Spencer, Radio Resources (800) 547-2346.

McMartin AM/FM xmtr, any model, exciter or stereo modules. Goodrich Ent., 11435 Mar-derson, Omaha NE 68164. 402-493-1886.

TUBES

Want to Sell

RCA/Syl 645, 810, 828, 8008, some new, BO. R Glenn, WIGK, 1718 Shenandoah, Wima-ma FL 33598. 813-634-1940.

For the Best Prices
& 24 Hr service on transmitting tubes call 402 493 1886 day or night. FAX 402 493 6821. TELEX 940103 WU PUB TLX BSN

RCA 6806 (1) new, (2) used, (1) conversation piece (dvd), 25 kW for RCA TTU-12 & TTU-25; UHF-TV xmtrs, BO. C Fox, 4853 Manor Hill Dr, Syracuse NY 13215. 315-468-0908.

ECONCO

Quality Rebuilt Tubes

Approximately 1/2 the Cost of New

Call for Our Price List

800-532-6626

916-662-7553

FAX 916-666-7760

Circle (2) On Reader Service Card



FACTORY NEW TUBES

3CX10000A3, 3CX1500A7, 3CX2500A3, 3-500Z, 4CV10000C, 4CX1000A, 4CX1500B, 4CX10000D, 4CX250B, 4CX300A, 4CX3500C, 4CX350A, 4CX5000A, 4-400A, 4-400C, 572B, 6146B, PL328/TH328, PL347/TH347, 807, 813, 833A, 833C, and more...

CALL 1-800-783-2555

JoLida Tube Factory
Annapolis Junction, MD

Audio generator, TE22 (Lafayette), Sencore translator tester (portable); Cannon plus, male & female 3 prong (new); new & used cable w/Cannons or without. Mr. Oliver, 212-874-7660/0274. Call afternoons till 10PM.

REBUILT ELECTRON TUBES

Partial List: 6623, 23791, TH150, 6425F, 5604, 6696, 6697, 5681, 5682, 5671, 7804, 3CX10,000H3, 3CX20,000H3, 4CX5000A, 4CX35,000C

Vacuum Tube Industries, Inc.

1-800-528-5014
508-584-4500 X75

4-1000A, 8877, 4CX250B, 4CX1500B, 4CX3000A & more. We carry large inventory all major brands. Eimac, Amperex, RCA, etc. Call Stew 1-800-842-1489.

EIMAC 3CX10,000H3 transmitting tubes (2), \$500 each/BO. C Degges, Ross Industries Inc. 703-439-3271.

Want to Buy
ML 6623 & 6427 rebuildable duds for GE xmtr. G Black, WCRJ, 5900 Pickettville Rd, Jacksonville FL 32205. 904-693-1530.

ELECTRON TUBES Vacuum Tube Industries, Inc.

1-800-528-5014
508-584-4500 X75

Details on space availability

Call 1-800-336-3045

ML 6623 & 6427 rebuildable duds. G Proctor, Sat Cable, POB 5386, Galveston TX 77554. 409-737-2142.

TUBE REBUILDING

FREELAND PRODUCTS

Since 1940
SAVE ABOUT 50%
-We buy dud tubes-
800-624-7626
504-893-1243
FAX 504-892-7323

TURNTABLES

Want to Sell

RCA 70-C1 transcription TT 16" 78/33 rpm w/Gray Rsch viscous damped arm, GE elec low impedance carts. 214-233-8516.

Technics SP-15 w/Audio Technica 12T tonearm on heavy BSW black shock mount base & Radio Systems PA-1 preamp, very gd cond, \$500. T Sline, KCGQ, 106 Farrar Dr, Cape Girardeau MO 63701. 314-335-9099.

RTS-405 stereo phono preamp, used 6 mos, storage, \$125+s/h. B Lord, Lord Bdcg, 13313 SE 208th St, Kent WA 98042. 206-631-2374.

Technics SL1015 DD quartz, 3345/78 w/+10% spd adj, Technics arm, Rosewood base, dust-cover, \$900. B Rosenberg, WVXU, 3684 Saybrook, Cincinnati OH 45208.

Technics SP-15 gd cond w/Harris PX-91 pre-amp, \$300. G Faltus, WZMX, 10 Exec Dr, Farmington CT 06032. 203-677-6700.

Want to Buy

Disc rec equip by Fairchild, Neumann, Westex, Macintosh stereo tube components, 45/78 records. K Gutziak, Custom Rodg, 7134 15th Ave S, Minneapolis MN 55423. 612-686-6183.

VIDEO PROD EQUIP

Want to Sell

Sony LDP-1000A (4) laser video disc phys, CAV & CLV int/ext drive, gen lockable RS232C port w/remote, manual & cables, excel cond, \$400 ea; 3M CRL (3) NTSC encoders, RGB in composite NTSC out, complete signal proc, \$300 ea, \$700 for all. J Krepol, RNDL, 7 Dustin Dr, Claymont DE 19703. 302-798-4076.

Leader LVS-58508/LBU-5860A vectorscope & waveform mon, \$2400; (2) JVC TM-22U 5" port mons, \$300 ea; (2) Microtime T-100 TBCs, \$1500 ea; Pallex ABR-1A A-B roll editor w/Panasonic TR-930 mon, \$3500; Chyron VP-2 char gener, \$2800, all in new cond. B Bridges, KCAM, 827 Meridian St, Nashville TN 37207. 615-226-1122.

Want to Buy

Sony RM 580. Also AMCO 10 or 20 position stereo audio/video switch boxes. TKV, 301-445-5450.

VIDEO TAPE RECORDERS

Want to Sell

Sony CP5000U (2), \$125 ea; CP5200U, \$150, both 3/4" U-Matic. J Krepol, RNDL, 7 Dustin Dr, Claymont DE 19703. 302-798-4076.

Sony SL series 5800 & 2300, 1/2" Beta machines for parts, gd heads, \$20 ea. P Russell, Bowdoin Coll, Sills Hall, Brunswick ME 04011. 207-725-3066.

Sony VO-5800 front loading, search knob, low hrs, excel cond, dub, \$1900. Jaye, Nimbus Pro, POB 5903, Takoma Pk MD 20913. 301-507-3358.

Sony 5850 edit/rec, new cond, \$3500. B Bridges, KCAM, 827 Meridian St, Nashville TN 37207. 615-226-1122.

This Month's Crossword

by Steve Walker

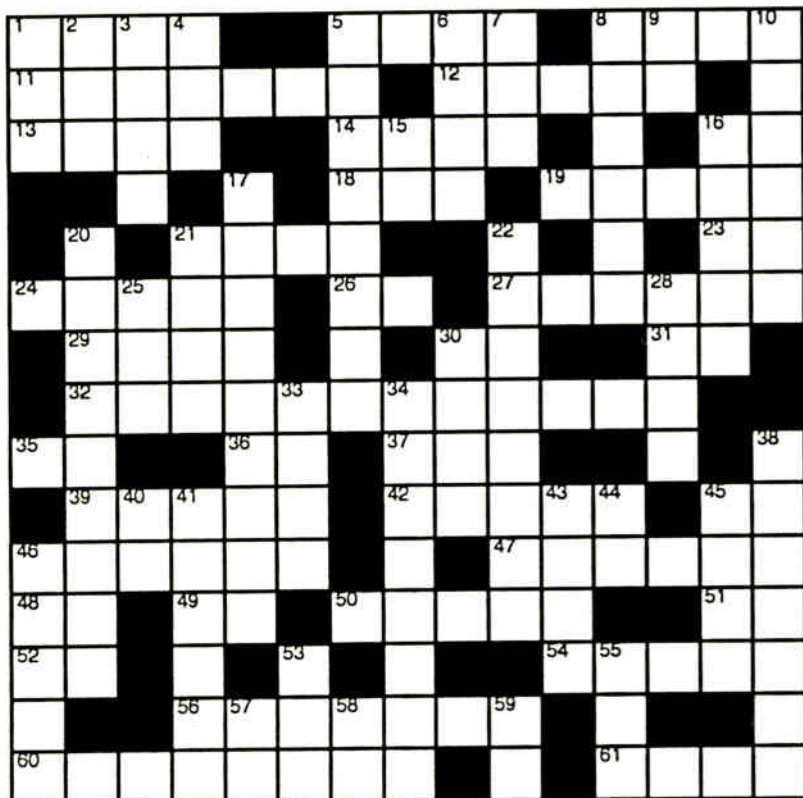

solution in next issue of RW.

ACROSS

1. Small amount
5. Slimy, greasy substance; slang
8. Pure sine wave at audible freq.
11. Logging device from RCS
12. Pennsylvania monitor co.
13. _____'s Law
14. So be it
16. Semiconductor material; abbrev.
18. Force open with a crowbar
19. AS-101 audio switcher
21. Low, mid, _____
23. Badger state
24. Nut; state tree of Texas
26. Chip
27. Borrowed piece of equipment
29. Breach of duty?
30. Latin "and"
31. Logical operator
32. "Six lines no waiting"
35. Older
36. Author Mandino's first name
37. PC video mode
39. Princess, wife of Charles
42. Traveler
45. _____-Wrap; brand of cable fastener
46. Honest; open
47. Starting point
48. Exclamation of hesitation
49. Dept store's initials
50. Rectifier
51. Per unit; abbrev.
52. Prairie state
54. Warning siren
56. Howell Laboratories' antenna div.
60. Thankful, as in _____ Dead
61. Cable type

DOWN

1. "The options get even better"
2. Prefix referring to mountains
3. Popular AM radio format
4. Half a deuce
5. "Radio is listening to us" Communication _____
6. Follow instruction
7. Writing instrument
8. Broadcast Supply West city
9. Logical operator
10. Potion
15. Male courtesy title
16. Waste disposal system
17. Custom AM RF
20. Custom transformers
21. Stringed instrument
22. Hnat Hinds processing
25. Last name, as in Wally
28. Negative
30. Frozen waffle
33. Exclamation
34. Inovonics station monitor rcvr
38. "Digital made simple"
40. Contained by
41. Tweak
43. Given by integral
44. Short for 39 across
45. Level
46. Readyng for play
53. PC graphics file extension
55. Resin
57. Pronoun
58. Measure of audio levels
59. You, medieval

ADVERTISER INDEX

This listing is provided solely for the convenience of our readers. Radio World assumes no liability for inaccuracy.

| Page No. | Advertiser | Reader Service No. | Page No. | Advertiser | Reader Service No. |
|----------|-----------------------------------|--------------------|----------|-----------------------------------|--------------------|
| 41 | AMP Services | 121 | 15 | Harris-Allied Broadcast Equipment | 18,163 |
| 41 | ATI | 126 | 22 | Harris-Allied Broadcast Equipment | — |
| 24,25 | Arrakis | 157 | 6 | Harris-Allied Radio RF Products | 185 |
| 3 | Audio Broadcast Group | 50 | 40 | J&I Audio/Video | 8 |
| 8 | Audio Precision | 10 | 39 | J.R. Nelson | 22 |
| 6 | Audiopak | 79 | 41 | JRF Magnetic Services | 136 |
| 11 | Audiotronics | 107 | 7 | Jampro | 191 |
| 21 | Benchmark Media | 146 | 45 | Kellner | 6 |
| 37 | Broadcast Electronics | 81 | 21 | LPB | 27 |
| 28 | Broadcast Programming Inc. | 43 | 27 | La Palma Broadcasting | 76 |
| 4 | Broadcast Services/Henry | 12 | 45 | Marathon Products | 129 |
| 17 | Broadcasters General Store | 30 | 12 | Myat | 26 |
| 4 | Burk Technology | 165 | 21 | Nemal Electronics | 155 |
| 16 | Burk Technology | 48 | 27 | Nordic Software | 159 |
| 20 | CCA Electronics | 139 | 26 | Orban/AKGlobal | 189 |
| 22 | Coaxial Dynamics | 93 | 23 | Pacific Recorders | — |
| 36 | Computer Concepts Corp. | 112 | 45 | Peter Dahl Co. | 56 |
| 3 | Comrex | 147 | 30,31 | Prophet Systems | 153 |
| 18 | Continental Electronics | 102 | 33 | OEI | 35 |
| 22 | Cortana | 17 | 32 | RF Specialties | 142 |
| 16 | Dataworld | 19 | 21 | Racom Products | 115 |
| 13 | Dataworld | 144 | 35 | Radio Computing Service (RCS) | 64 |
| 21 | ESE | 23 | 34 | Radio Mail | 178 |
| 21 | Econco | 65 | 45 | Radio Resources | 4 |
| 46 | Econco | 2 | 14 | Roland | 53 |
| 45 | Energy Onix | 167 | 29 | SMARTS Broadcast Systems | 133 |
| 16 | FM Technology | 174 | 15 | Somich Engineering | 32 |
| 19 | Fidellpac | 70 | 10 | Studer Revox | 100 |
| 21 | Gerstman Software | 187 | 38 | TM Century | 95 |
| 40 | Hall Electronics | 40 | 13 | TTC | 97 |
| 1 | Harris-Allied Broadcast | 83 | 17 | Tascam | 33 |
| 9 | Harris-Allied Broadcast Equipment | 14,148 | 44 | Transcom | 92 |
| | | | 2 | Wheatstone | 118 |
| | | | 47 | Wheatstone | 182 |

PublisherStevan B. Dana
Associate PublisherCarmel King
Marketing ConsultantAlbert Leon
Production DirectorKim Lowe
Production ManagerJulianne Stone
ProductionLisa Lyons, Lisa Stafford
Ad CoordinatorRegan Deatherage
Ad Coordination ManagerSimone Mullins
Circulation DirectorTiana Hickman
Circulation ManagerRebecca Seaborg

Accounts ReceivableValerie Mason

Advertising Sales Managers:

East CoastSkip Tash
800-336-3045, Fax: 703-998-2966

West/MidwestDale Tucker
510-935-1470, Fax: 510-937-2280

Headquarters
1-800-336-3045, Fax: 703-998-2966

Free subscriptions are available upon request to professional broadcasting and audiovisual equipment users. For address changes, send current and new address to RW a month in advance at the above address. Unsolicited manuscripts are welcomed for review; send to the attention of the appropriate editor.

The New Wheatstone Production – Air Console



In Fact, a Whole New Console Family...

These consoles give you full multitrack production capability while at the same time providing familiar program and audition busing so your production room can double as a back-up on-air facility. They free up your primary Air studio for routine calibration and maintenance sessions. They are a perfect solution for complex talk or news formats.

Beyond its on-air capability the SP-4 is a powerful production console offered in 2, 4 and 8-track formats. Production crews will love the smooth sounding equalization, the auxiliary send buses, and, of course, the full on-air type machine and console logic. There's also plenty of room for those special functions: like a phone module that can handle multiple callers, yet

doesn't tie up your line inputs; an intercom module that lets you communicate with other Wheatstone consoles and rackmount locations throughout your facility; plus a studio control module, line preselectors, tape controllers, and automatic timers.

And, of course, there's the componentry: all gold contact switches for the ultimate in reliability, gold bus connectors, gold I/O connectors, solid state on/off lamps, and triple burned-in ICs. Naturally, each console is also triple-tested.

The fact is, Wheatstone's got the features, the componentry, the reliability, the performance and the reputation you can depend on.

Call us.

SP-44/4-Track

The Closer You Get...

WE MEAN IT—we really DO provide the quality, performance, technical support, and innovation we promise!

Our model A-500 is a thoroughly engineered on-air console: it delivers the level of performance your clients now expect, and DAB demands. All components are selected for long life—gold bus connectors, gold I/O connectors, all gold contact switches, gas-filled relays, triple burned-in integrated circuits, solid state ON/OFF lamps, and precision laminated Lexan control surfaces for a lasting, wearproof finish. And we back that up with a 3-year parts and labor warranty, complete with

factory support from a technically competent and responsive staff.

We've also handled your special requirements as well with a super family of accessories, including a choice of three different telephone modules, an intercom module, an off-line mixer module for your remote feeds, talent control stations, accessory panels, failsafe power supplies, and auto cart and CD sequencing options.

So take a close look: we've got the quality, we've got the innovations, and you've got our commitment to top-notch support.

The BETTER We Look!

 **Wheatstone**® Corporation

6720 V.I.P. Parkway, Syracuse, NY, 13211 (tel 315-455-7740/fax 315-454-8104)

Circle 69 On Reader Service Card