

*****MIXED STATE
J759737 D11 9007 S420 805
BARRY HISHKIND
2033 S AUGUSTA PL
TUCSON AZ 85710

Radio World



See pp. 15-32

Vol 18, No 4

Radio's Best Read Newspaper

February 23, 1994

Universe of Broadcasters Returns to Vegas

by T. Carter Ross

LAS VEGAS, Nevada Broadcasters, manufacturers and others from across the country and from around the world are expected to converge on the 1994 National Association of Broadcasters (NAB '94) convention here March 20-24.

The theme for the show, hosted at the Las Vegas Convention Center, is "Innovation Everywhere You Turn!" Emphasis will be

on new products, innovative technologies and fresh ideas in both the seminars and the exhibition.

Approximately 250 technical seminars and workshops are scheduled, while more than 800 exhibitors will show their equipment at the NAB '94 exhibition, which covers 500,000 square feet.

The separate Radio/Audio Exhibition will offer a variety of radio and audio equipment, including radio transmitters, studio and audio equipment, consoles, CD players, digital production workstations and DAT machines.

In 1993, 64,510 people attended the show, and 11,523 came from outside of

the U.S. Based upon early registration indications, NAB officials expect even larger crowds to attend NAB '94.

The All-Industry Opening Session keynote address will be delivered Monday morning by FCC Chairman Reed Hundt.

On Tuesday, Peter Coors, vice chairman and CEO of Coors Brewing Co., will deliver the radio keynote address at the NAB/RAB luncheon. Also at the luncheon, The Crystal Radio

Awards will be presented for the best in community service radio, and Chicago Cubs sportscaster Harry Carey will be inducted into the NAB's Broadcasting Hall of Fame.

A number of seminars, workshops and special meetings are on the agenda for NAB '94. There are also numerous luncheons, receptions and other opportunities to network with broadcasters, engineers and manufacturers from across the U.S. and around the world.

The NAB Broadcast Engineering Conference will explore issues relating to digital technology, HDTV, data broadcasting, radio transmission, satellite and

auxiliary services and more. Meetings will be held Sunday through Thursday.

The Radio Advertising Bureau Sales and Marketing Conference offers a series of interactive sessions to help expand

sales and promotions goals. Meetings will be held Tuesday and Wednesday.

The NAB Radio Management Conference offers seminars and workshops to

continued on page 33 ▶



Audio Recording of Chicago installed the SSL SoundScreen. For information on this and other DAWs, see **Buyers Guide**, pp. 83-103.

in depth

All Problems Solvable Say Algorithm Experts

by Randy Sukow

WASHINGTON Much of the radio industry discussion of digital audio data compression over the past year has centered on the various ways compression damages the sound.

Concern among broadcasters has diverted at least some of the effort that has in the past been devoted to developing new, more sophisticated and applications-specific compression algorithms to searches for ways to prevent current, sometimes incompatible systems on the marketplace from unduly damaging studio and broadcast audio quality.

The searches already seem to be yielding results. About a half dozen possible solutions, ranging from individual station testing before purchasing compression equipment, to the ultimate goal of a "lossless" compression algorithm are being discussed. (See story, page 69.)

Also, expect considerable attention to be paid to a technology approach that will be unveiled at the coming NAB spring convention by a new West Coast company, California Digital Audio Systems Inc. (CDAS).

CDAS's "digital audio Xpress" (daX) system could potentially cure many compression artifacts by eliminating most of

the digital/analog and analog/digital conversions in the studio and in RF routing. (See story, page 68.)

Nearly a year has passed since the 1993 National Association of Broadcasters Convention, where the term "dueling algorithms" became an in-vogue term for many radio engineers.

Herb Squire, chief engineer, WQEW (AM)-WQXR-FM New York, suggested during an NAB technical session that incompatible compression systems will create audio impairments—transcoding artifacts—and played tapes of his test results to demonstrate. (See story, page 66.)

Most equipment vendors say the dueling algorithm issue has not hurt sales. The benefits of compression still appear to far outweigh all other concerns.

"A vast majority of our customers have real straightforward operations and the possibility of compression stacking never really comes up. On a weekly basis, I am discussing the situation, but it's generally with about 10 percent of the people I'm talking to," said Brad Harrison of Register Data Systems, Perry, Ga., manufacturer of The Phantom recording and playback with AC-2 compression.

continued on page 64 ▶

CCA Broadcast Transmitters...
Built First to Last.

NAB Booth 4442

30 YEARS

360 Bohannon Road • Fairburn, Georgia, USA 30213
(404) 964-3530 • FAX: (404) 964-2222
24-HOUR SERVICE, 365 DAYS-A-YEAR

CCA

Circle (74) On Reader Service Card

See Us At NAB Booth 4220

NEWSWATCH

DCI Joins With Metro Info Services

SAN FRANCISCO Differential Corrections, Inc. (DCI) has joined forces with Metro Information Services to provide real-time traffic reports to commuters equipped with vehicle navigation systems.

According to DCI, the initial site will be the San Francisco area, but will later include the 50 other U.S. cities served by Metro.

The combination of the Radio Data Systems (RDS) technology and the satellite-based Global Positioning System

(GPS) enables users to receive accurate traffic information with regard to their location. The tracking system, using RDS and GPS, is accurate to within 10 meters, according to DCI.

Quello to Be Honored For FCC Service

LAS VEGAS Longtime FCC Commissioner James Quello, who served as interim FCC chairman in 1993, will receive a distinguished service award at NAB '94.

Quello, who has served on the FCC for 20 years, is being recognized for his ser-

vice as interim FCC chairman and his many years of service as a commissioner.

"Commissioner Quello has always had a deep understanding and appreciation for the special role broadcasting plays in American society," NAB Joint Board chairman Wayne Vriesman said.

CBS Awarded Rights To '98 Winter Games

NEW YORK CBS was awarded the broadcast rights to the 1998 Olympic Winter Games, including radio and TV coverage. The games will be held in Nagano, Japan.

CBS Radio was the broadcaster of the 1992 Winter Games and was scheduled to broadcast more than 300 reports for the 1994 Games in Lillehammer, Norway,

which began February 12.

CBS's 1998 TV and radio right package cost the network \$375 million.

Sony Sponsors 'JazzSet' Program

NEWARK, N.J. Sony is sponsoring the syndicated jazz program "JazzSet with Branford Marsalis," by providing DATs and analog cassette to WBGO-FM, where the show is produced.

"JazzSet" is produced entirely on Sony Pro DAT Plus. "We are delighted to assist WBGO in its capture and presentation of some of the finest jazz performances today," said Tom Evans, promotions manager for Sony's Professional Media Division.

continued on next page ▶

When looking for a digital audio system for automation of satellite programming or live assist, there would appear to be many choices. But if you're looking for a system which is flexible enough to give you total control without sacrificing your sanity, there is only one choice. The Phantom by RDS.

You will see the difference as soon as you see the Phantom in action. The display provides you with all of the information you need to see in a clean, concise manner, without the crowded look that you'll find in other systems. If you are familiar with the most popular software on the PC, then you may already know how to use the Phantom. The Phantom's pull-down menus guide you through all of the steps involved in setup and daily operation, from creating and scheduling clocks to creating and editing logs.

The PHANTOM Digital Audio Automation

The Phantom ends the confusion of automation by keeping everything organized. The Phantom simplifies your daily operations by keeping information such as input changes, voice changes, and clock changes in their own individual schedules rather than in the log. You can leave those liners and other voice drops out of the log because the Phantom will do them for you. The Phantom allows you to date new schedules to begin weeks, months, or even years in advance. When your satellite network informs you that there will be a voice substitution on Thursday, two weeks from today, you can prepare for it *today*.

The Phantom can retime spots to fit them cleanly into a satellite break without inserting silence, overlapping, or running late. The Phantom



can create reports to keep you informed on a number of topics, from a list of expired spots to an analysis of potential mistakes in your log. The Phantom also maintains a history of system activity.

The Phantom has the features that others would want you to believe are theirs exclusively. The Phantom remains *completely* functional during recording, sensing relay closures and starting breaks as easily as it does when it is not recording. The Phantom can fill incomplete breaks with spots from a list you specify without ruining product separation.

While other systems tie your hands and limit your flexibility by only offering 3 or 4 inputs, the Phantom gives you 6 stereo inputs, using its AMX-84 solid state switcher, with the option of increasing the number of inputs to 14 or more. If your station is News/Talk, you know how important this can be.

The Phantom allows you to change the sampling rate, digital format, and stereo/mono settings at will to meet your needs for an individual spot. The Phantom offers a number of digital formats, including the new Dolby AC-2 format, as an option.

Call us today to find out how your station can benefit from the advanced technology of the Phantom and the experience of RDS.

1-800-521-5222
912-987-2501 • FAX: 912-987-7595
P. O. Box 980, Perry, GA 30169



**REGISTER
DATA
SYSTEMS**

Index

STUDIO SESSIONS

Second Generation CD-R from Marantz	by Rich Rarey	15
Benchmark, dbx: Dueling Mic Preamps	by Ty Ford	17
Visual Sound Mixing Now a Reality	by Frank Beacham	19
D.W. Fearn Goes 'Retro' with VT-1	by John Diamantis	20
CD Quality from Marantz	by Ken C. Pohlmann	22
Multi-Uses for Digital Domain VSP-P	by Rich Rarey	27

NAB '94 PREVIEW

Universe of Broadcasters Returns to Vegas	by T. Carter Ross	1,33
Digital and Analog Topics Will Dominate the Engineering Conference	by Andy Butler	33
Morgan Ushering in New Technology	by John Gatski	36
NAB '94 Product Stories		38-49
Exhibitor Listings		51-63

FEATURES

How to Meet FCC Sample System Code	by Fred Greaves	75
Workbench	by John Bisset	76
Where to Find AM Modulator Ills	by Tom Vernon	78
Business Software for Engineers	by Barry Mishkind	79

BUYERS GUIDE

USER REPORTS		
SSL Proves Versatile for Radio Production	by Mike King	83
Quick Productions with AKAI DR4d	by Mark Ridder	84
CCS Makes Virtual Editing Easy	by Kenneth Tankel	86
Korg SoundLink Is Full of Useful Features	by Frank Scales	87
Flexible DM-80 Means More Choice	by Bill Robinson	91
VoxPro Brings DAWs into On-Air Studios	by Tom McGinley	92
DAWs: No Longer Just for Production	by T. Carter Ross	94

TECHNOLOGY UPDATES

Studer	95
BASYS	95
Micro Technology Unlimited	95
Studio Technologies	98
Spectral Synthesis	98
International Tapetronics	98
Sonic Solutions	99
Orban	99
Digital Audio Labs	99
Otari	101
The Management	101
Enco Systems	101
TASCAM	101

RDS/RBDS Slowly Gains Acceptance

by John Gatski

LAS VEGAS Carrying over the momentum of 1993, acceptance of the Radio Data System technology continues to grow at slow, but steady pace. The 1994 Consumer Electronics Show (CES) in Las Vegas saw consumer radio receiver companies displaying new and improved models. Many of them are promising delivery of the new products as early as next month.

RDS is a 57 kHz subcarrier technology, developed and used in Europe for nearly ten years, that allows stations to transmit numerous types of information to equipped receivers including: call letter display, name of artist/song title display, traffic alert, EBS alert, station selection by format, relay of transparent technical information from studio to station and vice versa and automatic transmitter/translator switching.

The U.S. approved an RDS standard in early 1993 called Radio Broadcast Data Service (RBDS). Between 90-100 stations are now on the air with RDS. Although the cost of adding the subcarrier is less than \$2,000 for a basic encoder, many stations say they are waiting for more receivers to become available.

Some receiver companies have responded with promises of more RDS radios this year. The latest RDS receivers shown at CES are less costly and have added features such as scrolling radio text (64

characters). The new Denon TU-380RD home tuner will list for under \$300 when it begins shipping next month. The TU-650RD will list for about \$50 more but offer slightly better tuner performance, according to Denon. The company also makes two auto RDS receivers; none with radio text yet.

Blaupunkt showed its Houston RCM84 car receiver which has the radio text feature. Availability is summer 1994,

Some receiver companies have responded with promises of more RDS radios this year.

according to the company. Panasonic will have five RDS model available this year, and Goldstar will have three models.

Onkyo has manufactured a home tuner since last year, and now has another model. Grundig has a shortwave/AM-FM portable that is RDS-equipped. Philips also makes RDS radios for the U.S. market as do several other companies.

Although there were more receivers at this year's CES, many companies have said they were waiting for more broadcasters to go on the air before they make a big RDS marketing effort.

The EIA is trying to help move broadcasters toward RDS. The association

announced at CES 1994 that it would launch a new promotion aimed at stations in top radio markets, including: Atlanta, Boston, Dallas, Los Angeles, Miami, New York, Philadelphia, San Francisco, Seattle/Tacoma and Washington.

Each station will get a chance to try out an RE-533 encoder, (courtesy of Harris Allied) for 30 days. EIA will work with the station on RDS promotions and survery them at the end of 30 days.

Denon is conducting a similar program for major market stations to help stimulate the fledgling technology. EIA and Denon will coordinate in markets they are both pushing RDS. A similar effort was made in Las Vegas last year during the CES. RE America also offered a 60 day RDS trial to Chicago stations at the summer CES.

At CES 1994, there were a number of RBDS service providers including CouponRadio and Sage Alerting, an RDS EBS system, hardware and software manufacturer.

Musicboard software was demonstrated on a small scale at the Convention Center. The software allows stations to transmit the song, artist and other text information to RDS receivers while the music is playing. The Musicboard service also can be used on radio station billboards.

NEWSWATCH

► continued from previous page

NAB Endorses Proposed RF Radiation Standard

WASHINGTON The National Association of Broadcasters (NAB) endorsed the Institute of Electrical and Electronics Engineers (IEEE)/American National Standards Institute (ANSI) RF radiation standard (C95.1 1992), which is being considered by the FCC.

The NAB also urged the FCC to confront the "widespread and growing problem of state and local regulations (regarding RF radiation) that have delayed or halted the construction or use of FCC-licensed stations."

For Your Information

Due to space limitations, Radio World will feature coverage of radio's involvement in the Los Angeles earthquake in the March 9 issue.

Also due to space limitations, Steve Rowland's final installment of "Producing a Radio Documentary" will run in the March 23 Studio Sessions.

TRUE BLUE FOR THE MORNING ZOO.



Drive time is your busiest time, so make sure your spots, liners and music are on the cart more stations count on.

audiopak
BROADCAST CARTRIDGES

P.O. Box 3100 • Winchester, VA 22601
Tel: (800) 522-CART or (703) 667-8125
Fax: (703) 667-6379

Circle (161) On Reader Service Card

Hit the Jackpot in Vegas

See what's new
in transmitters at NAB

Booth #3418

AM and FM
Transmitters from
50W to 70kW

Call Continental First



Continental Electronics Corporation

P. O. BOX 270879 DALLAS, TEXAS 75227-0879
214-381-7161 TELEX: 73-398 FAX: 214-381-4949

Circle (30) On Reader Service Card

Marching to a Positive Drumbeat

WASHINGTON It's NAB time again. It seems like only yesterday I was writing my first *Page Four* and telling you about the great **RW** flood of 1993. Here it is, February 1994 and suffice it to say, NAB preview time has struck again. This year, the storm was ice (I'm sure many of you were iced under as well) and the end result—at least in my case—was a fractured elbow.

That's right, **RW**'s reigning klutz (me) broke an elbow whilst trying to purchase a dozen donuts for the office. 'Nuff said. My typing is a kind of one-handed "hunt and peck" routine, but it hasn't otherwise stopped the onslaught of good information from getting passed on to you.



And as the NAB show approaches, a steady stream of good news continues to pour in. At last year's writing, I remember mentioning that better times must be ahead because of the wealth of new products being introduced, and because companies like Sony were unveiling entire product lines targeted to radio. The soothsayers appear to have been right: Business is booming.

The Radio Advertising Bureau (RAB) reports that 1993 was a banner year for the industry. Radio advertising revenue grew at a rate of 9.3 percent in 1993 to an estimated \$9.568 billion, up from \$8.755 billion in 1992.

The RAB breaks out its numbers by local spot, national spot and network.

Local spot accounts for roughly three-fourths of all radio ad revenue. Last year, local spot grew at a rate of 9.2 percent, national at 10.2 percent, and network ad revenue at 8.1 percent.

I mention these figures to you because they represent the industry's best year of growth since 1985, when radio ad revenue grew at a rate of 11.5 percent, according to the RAB.

★ ★ ★

Analyzing revenue growth from a different perspective yields other interesting data. BIA Publications recently published *Investing in Radio 1994*. According to BIA's projections, there are now 13 radio markets that will have revenues of more than \$100 million in 1994.

In spite of the earthquake, Los Angeles still is projected to rank No. 1 with \$460 million. In descending order, the other markets are as follows: New York \$375.2 million; Chicago \$291.4 million; San Francisco \$176.8 million; Dallas \$174.9 million; Washington \$174.1 million; Houston \$153.7 million; Philadelphia \$152.3 million; Boston \$149.7 million; Detroit \$141.8 million; Atlanta \$131.1 million; Miami \$116.7 million, and Seattle \$109.2 million.

As owners continue to consolidate stations, the now-growing revenue pie will be shared among fewer operators, hopefully ensuring better economic health for those of you who managed to hang on through the rough times.

★ ★ ★

What to do with all that money? The NAB spring convention is certainly a good place to spend it. Peruse this issue before

you go to the show. The NAB expects a record turnout this year, once again, including a record international contingent.

For those of you unable to attend the Vegas show, we at **RW** will scout out the new and exciting stuff on the floor for you. We are so determined to root out the bold and the innovative that we've put together a panel of experts whose mission at the NAB is to find the *Cool Stuff*.

The **RW** panel of experts will walk the floor the entire week of the show and make note of any product (small or large,

simple or complex) that stops our experts in their tracks and makes them exclaim, "cool stuff!"

On the last day of the show, we'll be stopping by to let you know if your product has been awarded a *Cool Stuff Award* (CSA). All winners will be pictured in the May 5 **RW**,

in our NAB product wrap-up. Good luck! (I'll let you in on who the experts are after the show.)

On another convention-related note, Computer Concepts' Sean Bowers, the driving force behind the **RW** Dream Team, informs me that game No. 4 is scheduled for Thursday, March 24 at 6 a.m. The Dream Team consists of distributors versus manufacturers in a game of basketball, and is a trade show ritual.

Once again arrangements have been made for the game to be held at the Las Vegas Sporting House at 3025 Industrial Ave., just west of the Stardust Hotel. The game is open to all. The gym will charge a one-time \$15 fee per player, but that will entitle you to access to all of the club facilities. Hope to see you there!

The RW experts will walk the NAB Show floor and make note of any product that stops them in their tracks and makes them exclaim, "cool stuff!"

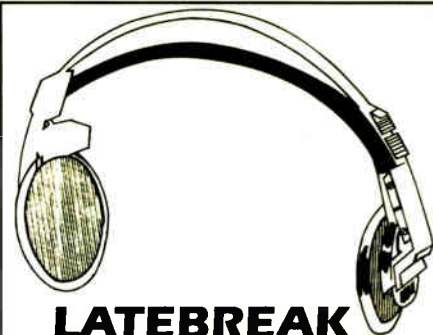

LATEBREAK

Corinne Baldasano joined the Unistar Radio Networks as vice president of programming in the company's Valencia, Calif., office. Baldasano most recently was vice president of programming for ABC Radio Networks and has 24 years of programming experience. Her various roles in the business include programming radio stations as well as her network experience.

National Public Radio (NPR) President Delano E. Lewis was appointed co-chair of the U.S. Advisory Council on the National Information Infrastructure (NII). The NII Council is an initiative of President Clinton, and was created to advise the administration on building and operating the NII.

Frank DiMatteo was named regional vice president and general manager of Beasley Broadcasting's WRXK-FM, WXKB-FM and WWCN(AM) in western Florida. DiMatteo relocates to Fort Myers, Fla., from Chicago, where he was vice president and general manager of the company's WBIG(AM)-WYSY-FM.



Norm Pattiz and Mel Karmazin

Westwood One Inc. and Infinity Broadcasting completed the previously announced purchase of the radio network business of Unistar Radio Networks for approximately \$101.3 million.

In a related transaction, a subsidiary of Infinity Broadcasting acquired (1) five million newly issued shares of common stock of Westwood One for \$3 per share, and (2) a warrant to purchase an additional three million shares of Westwood One common stock also at \$3 per share.

Infinity will manage Westwood One pursuant to a management agreement. Infinity/Unistar Chief Executive Officer Mel Karmazin (pictured above right) has become CEO of Westwood One, and Norm Pattiz (pictured above) will remain chairman of the board of Westwood One.

Now, Burk pushes the right buttons for clean, clear audio switching.



Get ready for unattended operation that doesn't hiccup when a source drops out. The Burk LX-1 Stereo Audio Selector offers 6 audio channels in a 1 rack unit switcher that's ideal for remote studio control and EBS operations. With individual channel control signals, main and loop outputs, plus line mixing, the LX-1 is the versatile choice for new studio designs.



The LX-1 will run loops around traditional alternatives like patch panels and relay switchers. With configurable line levels, 100 dB isolation, and common mode rejection that exceeds 110 dB, the LX-1 can actually improve your air chain quality. And the LX-1 is especially easy to interface with existing studios and a variety of remote control configurations, including those from Burk.

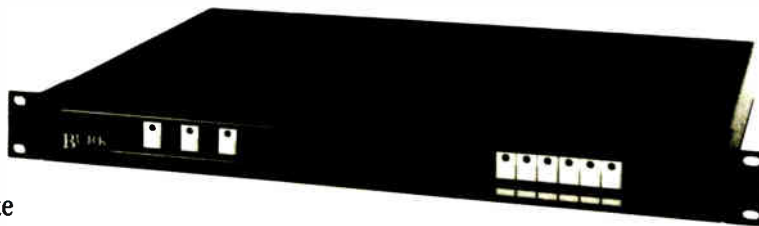

Place the Burk LX-1 in your audio chain and you're getting the best mix of features, reliability, and performance. All at a price that truly pushes the right buttons for the 90s. Stow the old patch cords away. And take the first step toward putting the LX-1 to work for you. Call Burk Technology at 1-800-255-8090

BURK
TECHNOLOGY

READERS FORUM

If you have comments for Radio World, call us at 800-336-3045 or send a letter to Readers Forum (Radio World, Box 1214, Falls Church, VA 22041 or MCI Mailbox #302-7776). All letters received become the property of Radio World, to be used at our discretion and as space permits.

GUEST COMMENTARY

by John Abel
Executive VP/Operations
National Association
of Broadcasters

The digitization of human communication is creating a revolution. The concept of the "information superhighway" would not be possible without digitization. Today, voice, video, audio, photographs, print, are created and manipulated digitally, and are being stored and retrieved using digital devices. When we couple digital with the tremendous benefits of wireless communication, it becomes possible for broadcasting to participate in the future information infrastructure. Radio broadcasters have a chance in the transition to digital to reinvent themselves and become multimedia broadcasters—broadcasters who can provide multiple services on a flexible basis. Who says that digital radio broadcasting must be limited to sound?

When we digitize the transmission path, broadcasters have a chance to make a quantum leap over analog transmissions. We can gain the ability to provide multiple mass and personalized services within the same transmitted bit stream. Because of the ability to intermix the bits related to different services in the same broadcast bit stream, these services can be simultaneously supplied to different kinds of digital receivers, including desktop and laptop computers, fax machines, personal digital assistants, pagers, and so on.

Because all human communication can be reduced to bits, compressed and then broadcast, it really comes down to how much information we can cram into a channel. Obviously, it requires more bits to represent some forms of communication than others. Voice takes far fewer bits to represent the communication than does full motion video. A page of text takes far fewer bits to represent the communication than a photograph.

The more bandwidth, the more bits or

information we can broadcast. Radio is somewhat limited in bandwidth relative to television broadcasting. The entire AM band is just over 1 MHz, while the entire FM band is 20 MHz and the TV bands occupy about 400 MHz. Using current technology, we believe that if there were no analog signals occupying a channel, in a single vacant AM channel (10 kHz of bandwidth), using digital transmission, we could broadcast between 30 and 80 kilobits per second (kbps). In a vacant FM channel (200 kHz of bandwidth) we could transmit between 600 and 800 kbps and in a TV channel (6 MHz) we could transmit between 18 and 24 megabits per second (Mbps) (or between 18 and 24 million bits per second). To put this in perspective, a page of text is about 2 kilobits; therefore, an AM station could transmit between 15 and 40 pages of text in a second, an FM station could transmit between 300 and 400 pages of text in a second, and a TV station could transmit between 9,000 and 12,000 pages of text in a second.

Now, let's consider the digital receivers of the future. We need to think of the differences between computers and broadcast receivers. A radio receiver is a "real time" appliance. The listener can hear only what is being broadcast, when it is being broadcast. In contrast, computers are non-real time appliances. But, when we transition to digital broadcasting, we will have digital receivers that are computers. The new capabilities make possible additional processing, storage and manipulation of information that can take place in non-real time for retrieval and display at the will of the consumer.

The new receiver may have outputs for audio, the fax machine, the computer, etc. If a consumer is interested in following four stocks listed on the NASDAQ, the consumer programs his/her computer to "capture" the stock information for these stocks out of the bit stream coming to the special digital receiver attached to the computer. The computer then displays the information on these stocks at the will of the consumer. Certainly advertising can accompany this captured broadcast (for those of you stuck on how to make a buck) or the broadcaster could charge a subscription fee, or you could do both.

The possibilities are endless and are limited only by imagination and creativity not by technology. Here are some potential applications for multimedia broadcasting using the limited bandwidth of radio broadcasting:

- multiple audio signals could be embedded into a digital data stream.
- separate bit streams could be allocated to e-mail, paging, PDAs, signaling devices like utility load management, data transmissions, fax machines, differential global positioning system (DGPS), RBDS.
- real time traffic updates, weather updates, other emergency announcements to be displayed/played at the will of the consumer.

In addition, broadcasters could distribute services that are packaged by others, just as you do today when you carry a network broadcast. Many of these service packagers exist today, such as CompuServe, America Online, Dow-Jones, Prodigy, etc. Many, if not most,

Broadcasters Are Willing To Ride

As recently as last month, the NAB and associations representing such media as land-mobile radio and direct broadcast satellite services worried that Congress and the administration were paying too little attention to the new infrastructure's wireless components.

"The NII has failed to include broadcasting as an integral part of its vision of the nation's information infrastructure," the NAB Joint Board said last month in a resolution asking the government for "flexibility to utilize allocated broadcast spectrum to offer competitive digital services."

One way to insure broadcaster participation is to review and relax the FCC's radio and TV station ownership limits, beyond the deregulation of 1992, which boosted the radio industry so well.

Presidential policy advisor Larry Irving said the administration favors such a review. Earlier this month, Senate Commerce Committee Chairman Ernest Hollings (D-S.C.) introduced a bill that would direct the FCC to eliminate all ownership rules that are not needed to maintain "media diversity."

These are exciting developments. Consumers will want access to the superhighway through mobile receivers—the kind of access broadcasters can provide if given the chance.

The radio industry has already begun preparing for the future by actively working for a DAR standard and exploring the possibilities of RBDS and other data transmission systems.

FCC Chairman Reed Hundt estimates that communications will be a \$1 trillion industry by 1996, if NII bills now before the Congress are passed. It could represent about a sixth of the U.S. economy by the year 2000, he said.

Broadcasters will be glad to accept the chance to become major contributors to this new GDP growth.

—RW

networks have already digitized their distribution system. Tomorrow they will be adding additional bits that represent other forms of communication.

The marriage of digital technology with wireless communication opens up remarkable advantages:

- Wireless broadcast transmissions provide near universal coverage. Broadcasting is more universal than any medium. ninety-nine percent of households have a radio, 93 percent have a telephone, 63 percent have cable.

- Wireless is mobile. Unlike wired technologies, wireless transmissions can be where the customer is. The benefits to consumers who use laptop computers, personal digital assistants, or portable televisions and radios are obvious.

- Wireless is inexpensive. Wireless transmission is the most efficient form of transmission. There is no need for expensive fiber, coaxial or copper cable.

- Wireless can involve a mix of support mechanisms. Wireless can be totally free, it can be advertiser supported, it can be addressable for subscription fees, or it can be encrypted for specialized rates. It is very unlikely that any wireline provider can meet the standards of wireless.

For all of what I have discussed here to happen, there are some very complicated public policy and business issues that need to be addressed. Here is my list:

1. The current public policy on digital broadcasting has a very specific and limited vision of what our role in the digital world of tomorrow is going to be: DAB. We should ensure that policymakers allow us to be full citizens in the digital media marketplace. This involves both flexible uses of the spectrum and the adoption of appropriate transmission standards.

2. There are a variety of outdated regulatory restrictions on broadcasters' ability to participate fully in the new information infrastructure. Even though it is technically possible to do multimedia

broadcasting, the outdated regulatory restrictions that prevent us from doing so need to be changed.

3. In the digital world new economic and business models will be created as we have already seen in related industries (cable and telco, in particular). Few of the multimedia deals announced in 1993 involved broadcasters. Why? Because of harsh and limiting ownership restrictions which apply only to broadcasting.

4. From the consumers' perspective, the keys to whether convergence makes sense is how it affects their choice, control and connectivity. Broadcasters need to get involved in the cross industry working groups now determining the standards of consumer devices and software. We need to ensure that the offramps and garages on the information highway are compatible with what we broadcasters do and can do in the future.

5. Broadcasters need to rethink what business we are really in. I'll end with these suggestions:

- Think content, not channel. Consider yourself an information/entertainment provider and get to your customers however you can.

- Rethink over-the-air distribution systems.

- Think value, not commodity. Bandwidth on demand is increasingly a commodity. In the information marketplace, one more broadcast channel won't make a difference, unless it adds something unique to the mix.

- Think multiple revenue streams. Advertising revenue alone may be insufficient as competition for a limited supply of ad dollars increases.

- Think demand, not supply. Consider not just what you have to sell now, but what your customers want. Then work to provide it.

- Think strategically, let the tactics follow. Broadcasters are great tacticians, but probably the familiar tactics of the past will not be very helpful in the future. We must develop strategies.

Radio World

Vol. 18, No. 4 February 23, 1994

EditorLucia Cobo
Managing Editor.....Randy Sukow
News/Studio Sessions Editor.....John Gatski
Associate Editor.....T. Carter Ross
Contributors.....Frank Beacham/N.Y.
Bruce Ingram, Pamela Watkins, Nancy Reist
Technical Editor.....John Bisset
Technical Advisor.....Tom McGinley
Editor (International).....Alan Carter
Managing Editor (International).....Charles Taylor

Radio World (ISSN: 0274-8541) is published bi-weekly by Industrial Marketing Advisory Services, Inc., 5827 Columbia Pike, Suite 310, Falls Church, VA 22041. Phone: 703-998-7600, Fax: 703-998-2966. Second-class postage rates are paid at Falls Church VA 22046 and additional mailing offices. POSTMASTER: Send 3579 forms and address changes to Radio World, P.O. Box 1214, Falls Church VA 22041. Copyright 1994 by Industrial Marketing Advisory Services, Inc. All rights reserved.

—PRINTED IN THE USA—

Next Issue of
Radio World
March 9, 1994

Why would anybody put 50 compact discs into something like this?

So broadcasters would never have to so much as touch a CD again. No matter what.

No matter what size their CD library, 100 or 1000. No matter what they want to program for when. No matter what kind of computer equipment they have. No matter what goes wrong with a CD, a player, the changer.

No matter what.

High capacity CD players are all but a must these days, no question of that. How high a capacity, that's a question. Which one's the easiest to load, that's another good question. And what brand is the most reliable, that's probably the best question.

Introducing the 100-CD "Instant Library Change" CD Player/Changer from NSM of Germany.

It's the answer to all those questions. And a lot more.

Put simply, our Model 3101 is the most efficient, totally flexible, all-but-infallibly reliable CD Player/Changer ever made for broadcasters.

The snap-in/snap-out 50-CD magazines are the key.

Once CD's are loaded in the magazine's numbered slots, you never have to touch them again. You simply snap-in two magazines, 100 CD's worth, into our 3101 Player/Changer. Then any of its 100 CD's are all but instantly accessible. It takes an average of less than five seconds for our 3101 to find and begin playing any one of them.

You can change the entire library in just about the same time ... just by snapping out the two magazines, snapping in another pre-loaded set.

What happens if our 3101 breaks down?

We won't say it could never happen. We will say that it'll be rare. Our 3101 has the highest reliability rating in the industry, way above all the others. Its MSBF (Mean Swaps Between Failures) is over 200,000 and our current units in laboratory

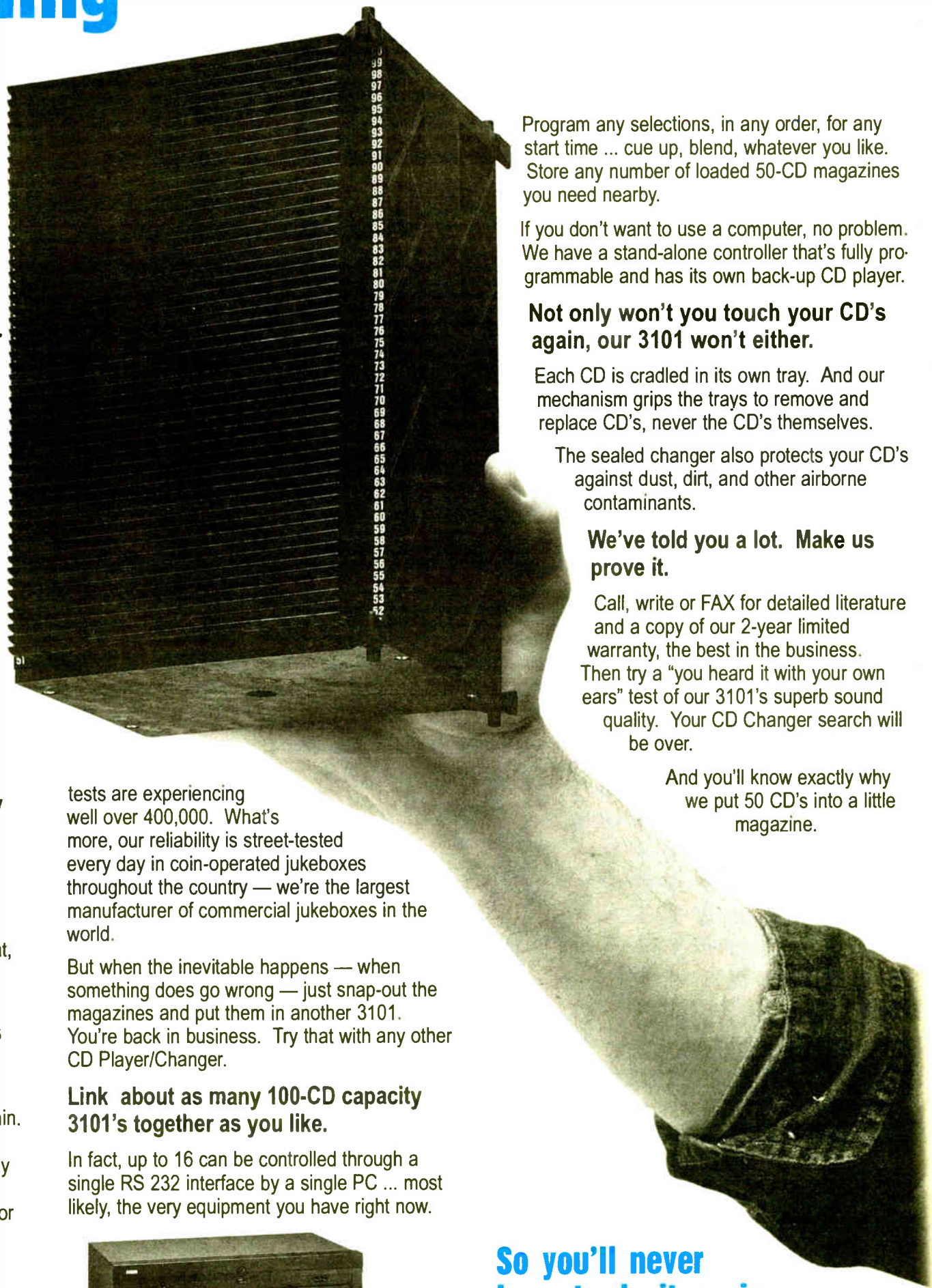

tests are experiencing well over 400,000. What's more, our reliability is street-tested every day in coin-operated jukeboxes throughout the country — we're the largest manufacturer of commercial jukeboxes in the world.

But when the inevitable happens — when something does go wrong — just snap-out the magazines and put them in another 3101. You're back in business. Try that with any other CD Player/Changer.

Link about as many 100-CD capacity 3101's together as you like.

In fact, up to 16 can be controlled through a single RS 232 interface by a single PC ... most likely, the very equipment you have right now.

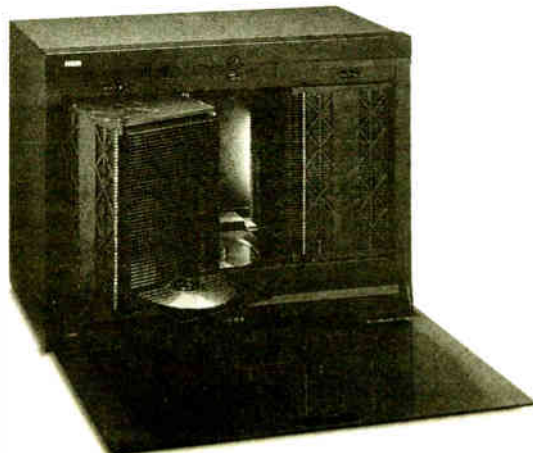

Program any selections, in any order, for any start time ... cue up, blend, whatever you like. Store any number of loaded 50-CD magazines you need nearby.

If you don't want to use a computer, no problem. We have a stand-alone controller that's fully programmable and has its own back-up CD player.

Not only won't you touch your CD's again, our 3101 won't either.

Each CD is cradled in its own tray. And our mechanism grips the trays to remove and replace CD's, never the CD's themselves.

The sealed changer also protects your CD's against dust, dirt, and other airborne contaminants.

We've told you a lot. Make us prove it.

Call, write or FAX for detailed literature and a copy of our 2-year limited warranty, the best in the business. Then try a "you heard it with your own ears" test of our 3101's superb sound quality. Your CD Changer search will be over.

And you'll know exactly why we put 50 CD's into a little magazine.

So you'll never have to do it again.

NSM
Consumer Electronics

40 Cain Drive • Brentwood, NY 11717
Phone: (516) 273-4200 FAX: (516) 273-4240

© Copyright, 1994, NSM - Bingen, Germany; Bensenville, IL; Brentwood, NY

DAB Testing Begins a Little Behind Schedule

by Randy Sukow

CLEVELAND As of the end of January, all five digital audio radio (DAR) transmission system developers had almost finished installing their equipment at NASA's Lewis Research Center in Cleveland and were ready to begin the months-long testing process.

Testing started a little late, nearly a month after the original Dec. 31 installation date set by the test sponsors, the Electronic Industries Association (EIA) and National Radio Systems Committee (NRSC). The delay was blamed on holiday conflicts and other minor factors.

At the end of the testing, EIA and NRSC are expected to submit their separate recommendations for an FCC-approved DAR transmission system to the FCC.

There is no exact target date for the end of testing, although laboratory tests in Cleveland are likely to last well into the third quarter of 1994. Subjective tests will be held concurrently at the Canadian Research Center (CRC) in Ottawa.

By the time broadcasters reach the National Association of Broadcasters (NAB) Convention in Las Vegas next month, the DAR lab tests are expected to be through the initial, set-up phase, which involves calibration of power-level, spectrum-measurement, point-of-failure and other test systems.

As published last fall (RW, Sept. 8, 1993), about 50 separate tests in 13 different test categories will be conducted in the months to follow. Among the more important tests planned will be DAR-to-DAR and DAR-to-analog measurements, both with and without multipath; the effectiveness of digital error correction at the receiver end when noise is injected into the signal, and the robustness of radio broadcast data systems and other

subcarrier signals under various conditions.

EIA/NRSC has not yet announced a schedule for field tests, which are to follow the laboratory rounds in Cleveland.

The system proponents' attentions will be dominated by the testing in Cleveland this spring, so they will not as prominent in Las Vegas as they usually are at NAB conventions. None of the five announced plans for system demonstrations in Las Vegas.

"Las Vegas is just too far away" to transport the necessary equipment for a demonstration, said Don Messer of Voice of America, speaking for the developers of VOA/NASA Jet Propulsion Lab (JPL) system. VOA/NASA has very tentative plans to make the shorter trip from Cleveland to Toronto for a demonstration at the Second DAB Symposium, scheduled for the week before NAB. But time and equipment for that trip also appears to be scarce.

All proponents, however, are planning to present updates on their systems during an NAB technical session, scheduled for Wednesday afternoon, March 23.

DAR speakers will include: Paul Ratliff of the BBC, for Eureka 147; Messer for VOA/JPL; Nikil Jayant of AT&T Bell Labs for the AT&T in-band, adjacent-channel system; John Bingham of Amati Communications Corp. for the Amati/AT&T in-band, on-channel (IBOC) system, and Paul Donahue of Gannett Radio and E. Glynn Walden, Group W Radio, on U.S.A. Digital's FM and AM IBOC systems.

Representatives of EIA and NRSC will hold a Wednesday morning NAB session to give a full update on the Cleveland test and new details on future testing plans.

Digital DJ Sets Up Demo

LAS VEGAS As announced last fall, Digital DJ (DDJ), San Jose, Calif., will set up a field demonstration of its high-speed digital data transmission system for FM subcarriers.

DDJ is the U.S. marketer for the Japanese-developed level-controlled minimum shift keying (LMSK) technology, which transmits 16 kilobits per second (kbps) over the 76 kHz subcarrier, compared to current RDS/RBDS systems, which transmit 1.2 kbps over the 57 kHz subcarrier.

A special working group of the National Radio Systems Committee (NRSC) is currently studying a number of high-speed data technologies, including DDJ and a system developed by Seiko Telecommunications Systems Inc., Beaverton, Ore., which is now serving 10,000 subscribers in the Portland, Ore., area using a network of FM stations.

The Seiko system, which was demonstrated at NAB 1993, will not be demonstrated this year, but Seiko's Gary Gaskill will present a technical paper, updating the latest improvements in the system, including refined techniques for smooth coordination of data signals between FM stations, and ways to transmit multiple data streams.



\$329

Clean up your act!

M100 Ultimike Microphone Amplifier

Eliminate dimmer noise, RF pickup, hum and rolloffs due to long mike cable runs by mounting this small, rugged, full featured preamp right at the source.

Features: • switchable gain • low cut filter • 48 volt phantom power • phase reverse switch • output limiter • DC remote gain trimmer.

The unusually quiet, servo controlled, instrumentation amplifier input has excellent hum and RF rejection and accepts up to +20dBu. A unique output driver provides distortion free transformer isolation, absolutely necessary for driving long lines.

Self contained power supply, Dual rack mounting.

Free Detailed Brochure
& Full Specifications
Available

AUDIO TECHNOLOGIES, INC.
328 W. Maple Ave., Horsham, PA 19044
(215) 443-0330 • FAX (215) 443-0394



QEI meets all your FM broadcast transmitter needs.

Selection

- 10 Watt - 1250 Watt Solid State
- 1 kW - 30 kW Single Tube
- Choice of Single or Three Phase Power Supply on 3.5 kW to 30 kW models

Service

- 24-Hour Service Hotline: (609) 728-2020
- **Free** Initial On-Site Checkout for FMQ-Series Transmitters
- **Free** Spare Parts Kit with every FMQ-Series Transmitter
- Extended PA Tube Warranty—the **only one** in the Business

Reliability

- Ultra-Low Maintenance
- Single Tube Design Eliminates Driver Tube
- No Sliding Contacts—Avoids Wear-Out
- Positive Pressure Cabinet to Prevent Dust Infiltration

Experience

- Over 20 Years of Field-Proven Designs
- RF Products for Broadcast, Scientific and Military Applications
- Total In-House RF Design and Manufacturing

Learn more about the finest FM broadcast transmitters in the business. Call Jeff Detweiler today toll free—**(800) 334-9154**.



QEI Corporation
One Airport Drive • P.O. Box 805
Williamstown, NJ 08094

Tel: (800) 334-9154

Fax: (609) 629-1751

24-Hour Service Hotline

Tel: (609) 728-2020

Mercury Plunges, Radio Is There

by Bob Kirby

KANSAS CITY The third week of January brought rumbles to Los Angeles broadcasters and shivers to stations in the upper-Midwest. The severity of invading arctic air, by midweek, had frozen the federal government's gears in Washington and provided plenty of overtime for many stations' staffers.

"This weather was remarkable even for our location," said John Vigested, farm news director for KCJB(AM)-KYYX (FM) and KXMC(TV) Minot, N.D. "In the 20 years I've lived in Minot, I don't remember having a wind chill of -91 degrees (fahrenheit). That's what we had, with the winds continuing for several days," and overnight readings of -30 and daytime highs around -20 degrees, he said.

Such severe cold poses immediate risk to life. "The National Weather Service said with wind chills of -90 degrees, frostbite occurs in seconds, and you'll freeze in minutes," Vigested said. "Amazingly, I don't think we've had one storm-related death. People here are used to it. We don't do as many dumb things as people might do who aren't familiar with cold weather."

Many announcements

For four or six days, Vigested's stations aired many cancellations and postponements. "On a continual basis, you'd spend a couple minutes every half-hour announcing cancellations. But we didn't encounter situations requiring broadcasting emergency announcements," he said.

Vigested lives in the country and missed work two days before the snow plows could clear the roads, "but most of the staff live in town and were able to get here," he said.

The cold's effect

Small market stations weren't the only broadcasters airing programming as pro-saic as school closing announcements.

"We broadcast school closings Monday afternoon (Jan. 17) continuing through Wednesday," said Wes Bleed, assignment editor at WGN(AM) Chicago. "It almost turned into a constant thing. When the lists got so voluminous, we ended up reading them in entirety three or four times during peak drive periods. Each of those times took a half-hour to read if not more," Bleed said.

Chicago has a centralized school closing reporting service for media and individuals. "We have a service owned by another segment of our company (Tribune Broadcasting)," Bleed said. "It's a sister relationship, but most of the other broadcasters also subscribe. The Emergency Closing Center is a Touch Tone entry by the members, the school superintendents and principals involved in announcing closings. Also, any faculty member, and I think parents, can call the system and determine whether school is closed," he said.

WGN news staffers reported traffic problems and broken water mains and followed the mayor, who held regular briefings on city services affected by a record low of -21 degrees Tuesday

(January 18). "With power outages, airport delays, shelter issues and weather warnings, the stories were filled without having to think about enterprise reporting," Bleed said.

WHK(AM) Cleveland morning news anchor Cliff Baechle complained that the all-time record low of -20 degrees early the morning of Wednesday (Jan. 19) only added to this winter's misery. "For the past month, every week it's been either snow or cold with no let up. Since before Christmas in many areas, we've had a couple feet of snow on the ground," he said in late January.

School closing announcements faxed to media subscribers by Cleveland's Metro Traffic Service occupied most windows at top and bottom of the hour in WHK's talk programming.

Poised on the eastern shore of Lake Erie, Buffalo, N.Y., residents were spared the worst of the bitter cold owing to the lake's moderating effect on the weather. It only dipped to -8 degrees.

Still, "at the height of it all, we had about 400 cancellations," WBEN(AM)-WMJQ(FM) News Director Tim Wenger said. He praised the closing and cancellation software that was written in-house.

"It's funny. I was listening to winter storm broadcasts out of New York City and earthquake reports from KNX in Los Angeles on satellite. Some of the biggest markets, and when they do cancellations it's an absolute mish-mash. Our cancellation reports are even alphabetized," Wenger said.

Nothing moved

In Tomah, Wis., 40 miles east of La Crosse, wind chill reached -96 degrees on Jan. 18. "Everything here was just locked up," WBOG(FM) Owner/General

Manager David Magnum said. "All you saw was smoke coming out of chimneys. That was the only movement."

Magnum reported the customary school closings and postponements. He sees that sort of public service reporting not as a necessary evil, but rather as an opportunity.

"We've got to understand, as frustrating as it is answering that question 'Is there school today?' for the bazillionth time, that this is one of radio's real opportunities to show off," Magnum said. "Radio listenership is at its highest, obviously, during these times when this hot information is only available on radio....This is one of radio's shining moments," Magnum said.

Small market broadcasters are especially hampered when weather makes it impossible for the sign-on crew to get to work. Magnum is convinced anticipation, by owners and managers, is key to providing reliable service during intensive listenership periods when the weather is disruptive.

"Book rooms for your staff at a nearby motel. That's what we did. Make it a social event. Arrange taxi service to the station for your key morning people. Don't let them go home, because you know their cars won't start the next day, and you'll be sitting there without staff," he said.

Magnum, also a representative of Jones Satellite Network, suggested that broadcasters provide auxiliary heating for transmitters. "I've had a lot of my JSN clients up in this neck of the woods who didn't do that, and they've really had some problems. They assumed, wrongly, that if they lost building heat that their transmitters would generate sufficient heat," he said.

□ □ □

Bob Kirby is a free lance writer and public radio news producer in Kansas City, Mo. He can be reached at 816-941-4356.

NEW!

LEVEL A 0.59 dBm LEVEL B 0.47 dBm PHASE A-B 0.1 deg

-15.00 dBm AUTORANGE 15.00 dBm

PORTABLE ONE

AUDIO PRECISION QUALITY IN A PORTABLE TEST SET

PORTABLE - AFFORDABLE - EASY TO USE

Just press a button and take a measurement!

- amplitude
- phase
- two-channel level
- noise
- frequency
- amplitude ratio
- THD + N
- wow & flutter
- crosstalk
- IMD*
- generator load
- AC mains check

The Portable One—a two-channel analyzer at the price of single channel competitors!

\$4,000*

Audio precision

P.O. Box 2209, Beaverton, OR 97075
503/627-0832 1-800/231-7350
FAX: 503/641-8906, TELEX: 283957 AUDIO UR

* (U.S. Domestic price, standard unit not including IMD option or soft case)

Circle (8) On Reader Service Card

See Us At NAB Booth 3402

You can measure...

with the best monitor and the most accurate test set.

The FMM-2/FMS-2 series monitors provide an even greater degree of precision measurement than ever before... **You can measure S/N below 90 dB, You can measure crosstalk below 85 dB, You can measure separations of better than 70 dB, You can measure frequency response to better than 0.25 dB, You can measure distortions to lower than 0.01%, and much more...** Our uncluttered panels and autoranging voltmeters make these measurements a dream.

BELAR (610) 687-5550
ELECTRONICS LABORATORY, INC.
LANCASTER AVENUE AT DORSET, DEVON, PENNSYLVANIA 19333
Call or write for more information on Belar AM, FM, Stereo, SCA and TV monitors.

Circle (167) On Reader Service Card

See Us At NAB Booth 2508



In



broadcast, timing



is



everything.

Radio Systems manufactures a complete line of analog and digital master and stand alone clock and timing products.

Features:

- Mix analog and digital displays
- Serial master clock or timer link
- 12/24 hour clocks
- External 10 or 1 Hz sync
- External 60/50 Hz (line) sync
- Time zone hour offset
- Daylight savings time catch-up
- All digital displays act as master or slave units
- Top of hour relay closure
- Top of hour clock reset
- 00:00:00 timer relay closure

Options:

- TCXO super stable oscillator
- Remote keypad
- Lead acid long life battery
- Rack mount
- Wall mount

Models:

- 2" Wall Timer (DWT-6)
- 2" Wall Clock (DWC-6)
- Desktop Up/Down Timer (DTT-6)
- Desktop Clock (DTC-6)
- Desktop Clock and Up/Down Timer (DTCT-6)
- Analog Master Driver (AMD-1)
- 12" Analog Clock (AC-12)
- Desktop Up Timer only (TM-3)



RADIO SYSTEMS INC.

110 High Hill Road • P.O. Box 458 • Bridgeport, NJ 08014-0458 • (609) 467-8000 • FAX (609) 467-3044

Circle (92) On Reader Service Card

World Radio History

Orban: 25 Years of Audio Ideas

by Dee McVicker

LOS ANGELES In the late 1960s, Neil Armstrong set foot on the moon, pop art was in and many listeners were tuning into the FM band for the first time.

Also, a young Robert Orban was just striking out into the broadcast world after graduating from Princeton University

with a bachelor's degree in electrical engineering.

A few years later, after moving to California to study at Stanford University for his master's, Robert Orban founded Orban Associates, now part of AKG Acoustics. He developed many products for the professional audio and broadcast industries, including parametric equalizers and most

notably, audio processing.

Orban delivered his first product to a radio station in New York City. The station was WOR-FM, an early album rock station, and the product was a stereo synthesizer—the first of Robert Orban's 24 patents. That visit marked the beginning of Robert Orban's 25 years in broadcast equipment manufacturing.

Here is a recent interview with Orban conducted for *RW*.

RW: You're sometimes credited with being the grandfather of FM processing. Are you?

Orban: I wouldn't call myself the grandfather. If anyone was the grandfather it was the team at CBS Laboratories. They did deal with the pre-emphasis problem the first time with a sliding filter, and got a patent on that. I also have to give credit to Mike Dorrough, who had the DAPs out in the early '70s.

RW: That was also about the time you started development on the Optimod 8000. What encouraged you to introduce a new processor for FM at that time?

Orban: What I recognized was that all these devices that claimed to prevent overmodulation actually didn't. And the reason wasn't that they weren't doing their job, but the filters in the pre-emphasis in the stereo generator were messing up the peak levels.

RW: How did you develop the first 8000?

Orban: A friend of mine, after we got out of school, had bought a small Class A in California, so I did some engineering for him and actually built my first FM level controller for that station. In the course of trying to figure out why we were getting overmodulation on this little Class A when I knew that the peaks coming out of my first audio processor were properly controlled, I was talking to Arno (Arno Meyer, founder of Belar) and he said, "Well, the filters are overshooting in the stereo generator."

So I went up to the top of the mountain with an oscilloscope and poked around up there and sure enough, that's what was happening. So then it occurred to me that the only way to solve



Bob Orban

this problem any graceful way is to make a system where you have an audio processor and a stereo generator, and put it all in one box.

So I worked on this for a while and made a little vector board and got it working well. (I took) it to (Eric Small, who founded Modulation Sciences), who had some major market experience at that point. (I told him) to hook this thing up to your Belar and watch what happens. And he was very impressed because the meter was going up a lot further than he had ever seen and the (monitor) lights weren't going on.

RW: Certainly "loudness wars" were prevalent even then. What is your personal opinion on the loudness wars?

Orban: I always thought the

continued on page 12 ►

DAWN... THE SATELLITE COMMUNICATIONS SPECIALISTS

Professional

Before Dawn, end-users were in the dark about details relating to satellite communications equipment. Dawn Satellite specialists are meeting the product and service needs of today's commercial satellite users.

As product providers for the Radio, CATV, Broadcast TV, and Educational markets, we employ experts who can competently advise you on all your communications needs.

And, unlike some companies, our commitment to you does not end there — we continue to provide engineering and technical support even after the sale.

Dawn Satellite delivers only quality products with unparalleled service, in a very cost-effective manner. We will prepare you to meet the dawn of a new age in satellite communications.

**Call Toll Free
1-800-866-6969**

Expertise

Dawn Satellite is dedicated to shedding light on all of your satellite communications requirements. Some products and services provided are:

Products:

- ◆ Digital Ready LNB's
- ◆ Satellite Antennas
- ◆ Block Translators
- ◆ Downconverters
- ◆ Satellite Receivers
- ◆ Cable and Connectors
- ◆ Antenna Motorization Systems
- ◆ Accessories

Services

- ◆ Technical Assistance
- ◆ Design and Engineering
- ◆ Installation
- ◆ Field Service

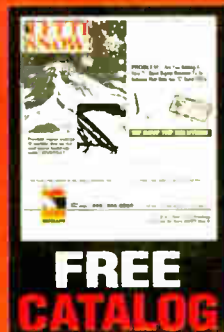

**DAWN
SATELLITE**

*The Satellite Communications
Equipment Specialists*

1190 South Lapeer Rd., P.O. Box 628, Oxford, MI 48371 (313) 969-0010 Fax: (313) 969-0377

YOU DON'T KNOW WHAT YOU'RE MISSING

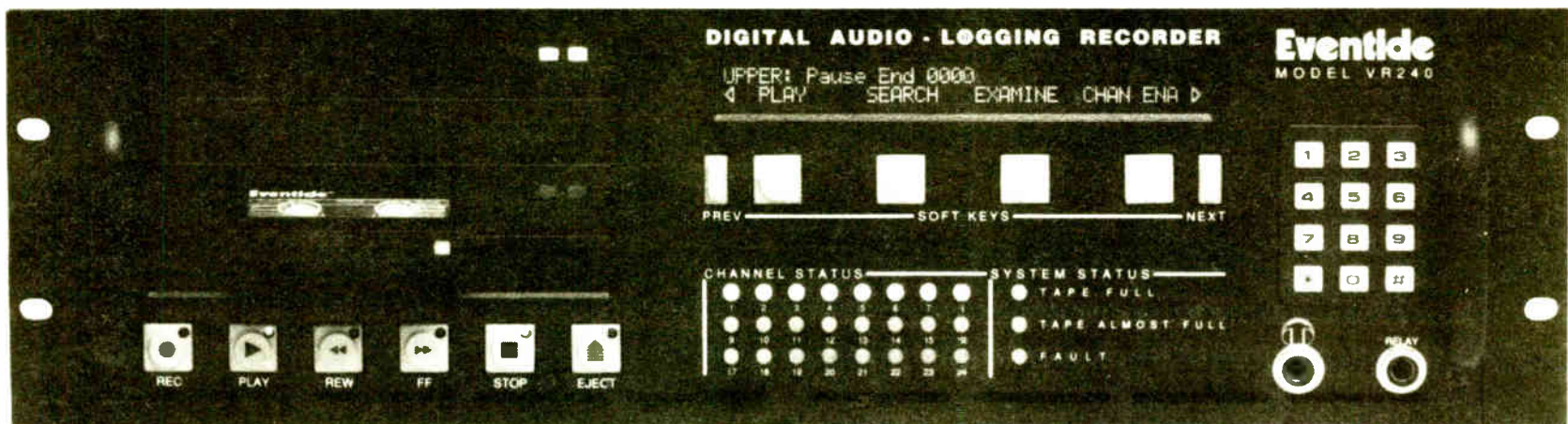

If you don't have an Eventide® VR240 Digital Broadcast Logger, you're missing the easiest, most efficient way to keep track of everything that goes out on your air, and more. There's no bulky, high maintenance, hard-to-use hardware, because Eventide has compressed a complete 8-to-24 channel digital broadcast logging system into one easy-to-use three-rack-space device. There's no need for a tape warehouse, either—the VR240 records up to ten days worth of audio on a single ultra-compact DAT cassette. With the dual-drive option, total unattended logging time stretches up to three weeks. And yes, you can search and play a tape on one deck while simultaneously recording audio on the other.

Without an easy, practical, multi-channel logging system, you're missing what's going on with your crosstown competitors, what your talent (and call-ins) *really* said on the air, when that commercial *actually* ran, who called your contest lines, what the police and fire

dispatchers said. The VR240 even records modem, fax, and transmitter remote control telemetry transmissions. The advantages of logging have always been clear. Now the Eventide Digital Broadcast Logger gets rid of the disadvantages.

There's no broadcast logging system as advanced as the VR240. And with hundreds of Eventide-built digital loggers already in service worldwide, there's no other digital logger with our track record of reliable service. So don't miss out—call Eventide or your broadcast distributor for full information on the logger that makes full-time logging practical: The Eventide VR240 Digital Broadcast Logger.

Eventide

One Alsan Way • Little Ferry, New Jersey 07643 USA
Tel: 201-641-1200 • Fax: 201-641-1640

Orban Analysis of Digital Future

► continued from page 10

whole concept of loudness wars was pretty peculiar because when you think about it, radio is really the only popular mass medium that consciously degrades the technical quality of its finished product.

RW: Why is that?

Orban: I think that there is a paranoia built into the system. Being the program director of a radio station doesn't translate to job security, and so if a program director believes that being louder is going to help him with the next book, he's probably not

inclined to take the risk that that might not be true.

RW: Do you think one station being louder than the next has a favorable impact on ratings?

Orban: If stations have equivalent audio quality, the louder one is probably going to get a little bit more attention from the listenership. But it's a very fleeting thing, because you only hear the comparison when you punch the button on your car radio. And some people think that that translates to the notion that it's a more powerful radio station.

RW: Is there such a thing as listener fatigue?

Orban: I think that Jim Schulke, back when he was syndicating his beautiful

the audio quality. The more degraded, the shorter the time spent listening.

RW: But certainly compact discs have brought some quality to the radio station?

Orban: My impression is that, mostly, the compact disc has allowed people to

"Some people think that (loudness) translates to the notion that it's a more powerful radio station."

—Bob Orban

music format back in the late '70s, did more research than anybody else. At least in that format, (he) showed that time spent listening was proportional to

process harder. I think there have been attempts at clarity wars from time to time, but I think this all has a very secondary effect compared to the actual programming of the radio station.

RW: You're viewed as bringing audio processing to the digital age, so naturally we're curious where you think digital will take radio. And second, how will processing fit into the digital age?

Orban: First of all, I think that digital audio radio is going to happen, but it's going to happen fairly slowly because it's going to be fairly costly to build into the radios at first. And it's also going to be a hard sell to convince (people) it sounds that much better than FM. It's certainly not going to be the big leap that FM was over AM. But I think it's going to happen eventually, mostly because it's going to eliminate the picket fencing in mobile FM reception.

I strongly suspect that, at least in the U.S., we're going to see loudness wars on digital. The reason is that people are probably going to have a little bit more signal parity than they did on FM, and the only thing left to get people's attention is how the audio sounds.

I think that it's really naive to think that because suddenly we're on a digital delivery medium, people are going to stop processing. I mean, people have been saying for 10 years that the compact disc is going to cause people to stop processing. Of course, that isn't true, because CD and radio are entirely different media. They are consumed in different ways.

RW: What about RBDS?

Orban: I think it's going to be a valuable ancillary service for FM. It doesn't cost that much to add, and it's going to provide the consumer with very useful information and features. I think it's very practical. It's eventually going to be obsoleted by the digital delivery media; they're going to have the opportunity to embed whatever data they want in the digital bit stream.

RW: Any other technologies on the horizon that you see affecting radio?

Orban: I know that existing broadcasters are worried about the possibility that they're going to have competition from satellite delivered DAB, for example. That's an understandable and reasonable concern because the country doesn't seem to be able to support even the number of radio stations it has right now. So I think (if) you have that sort of service, you're going to hurt a lot of the local broadcasters and probably result in overall quality degradation because there's going to be less money to do good programming.

□□□

Dee McVicker is a free-lance writer and regular contributor to **RW**.

From San Francisco to Singapore From New Zealand to New York

CCS Audio Codecs Connect the World



CDQ1000 Mono Codec

- 10 kHz, 8.2 kHz or 7.5 kHz operation.
- CCITT G.722 and MUSICAM compression for universal compatibility.
- Bi-directional transmission.
- Ideal for news feeds, talk shows or voice-over announcements.



CDQ2001 Stereo Codec

- 20 kHz CD quality transmission.
- New 18-bit A/D converter.
- Selectable 32/48 kHz sampling rate optimized for FM broadcasting or recording studios.
- Remote controllable via dial-up PC modem.



Discover Crystal Clear Digital Audio Discover CCS



CCS Audio Products
33 West Main Street
Holmdel, NJ 07733, USA
908-946-3800 FAX: 908-946-7167

COME HEAR US
AT NAB '94
BOOTH #4826



CCS Europe GmbH
LudwigstraBe 45
D-85399 Hallbergmoos, Germany
49 811 5516 0 FAX: 49 811 5516 55

JNS ELECTRONICS

NEW AT NAB 94
BOOTH 2306-2308

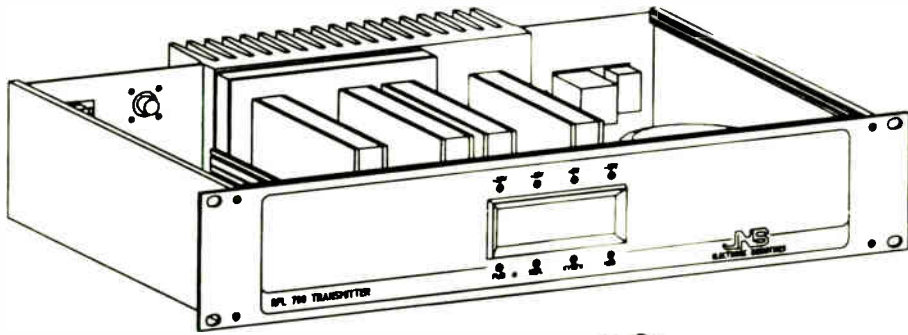

NEW

DRFL 700

"Digital Terrestrial Microwave Link"

Highly Spectral Efficient.

1 Mbit/1 MHz Bandwidth.

2 Mbit - 10 Mbit data capability

1.4 to 2.5 GHz frequency capability

Digital QPSK modulator/demodulator (multi-speed)

Implementation loss less than 0.6dB.

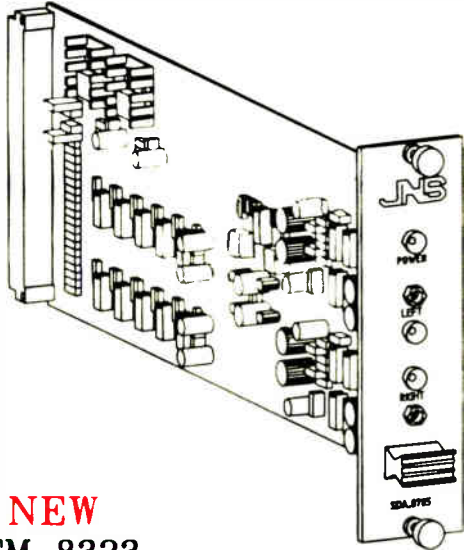

NEW

SDA 8705 Series 2

5-Stereo/10-Monaural audio outputs

Low Noise < -97 dBu

S/N -121dB

Ultra Low distortion 0.002%

< 10Hz to 30kHz bandwidth @ 0dBu

Crosstalk < 100dB

Frequency Response ±0.1dB

10Hz to 100kHz Time Code Compatible

Active outputs for optimum isolation

Peak Detector (adjustable)

-2 to +22dBu factory set @ 0dBu

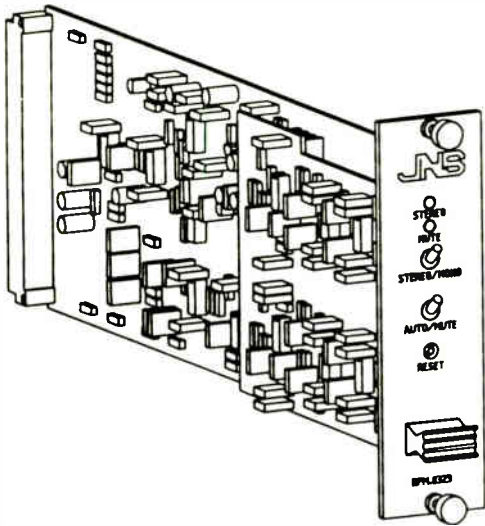

NEW

RFM 8323

High Quality Low Cost F.M. Receiver

RF input 1.5V Max, Sens 3µV,

Composite output 1V P-P 75Ω - carrier fail detect

Wide - Narrow IF bandwidth optional

Capable Re-Broadcast applications

L & R outputs at line level 0 to +26 dBu 50/600Ω bal

Distortion < 0.6%

Frequency Response 20 Hz to 15 kHz 0.5dB

Stereo Separation > 50dB

NEW

IRF 2000

Intelligent Rack Frame System

Processor Controller System

Modules Remote/Local Controllable

Control capability via PC computer - modem

Control/Monitoring of Status

Level adjustment - De-Modulation signals

for both send and receive applications

Complete on line signal monitoring

Full parameter signal failure monitoring.

Signal comparison-low signal-high signal.

Automated alarm functions.

Capable of large/small installation applications

Easily expandable single to multi-rack applications

International control capability.

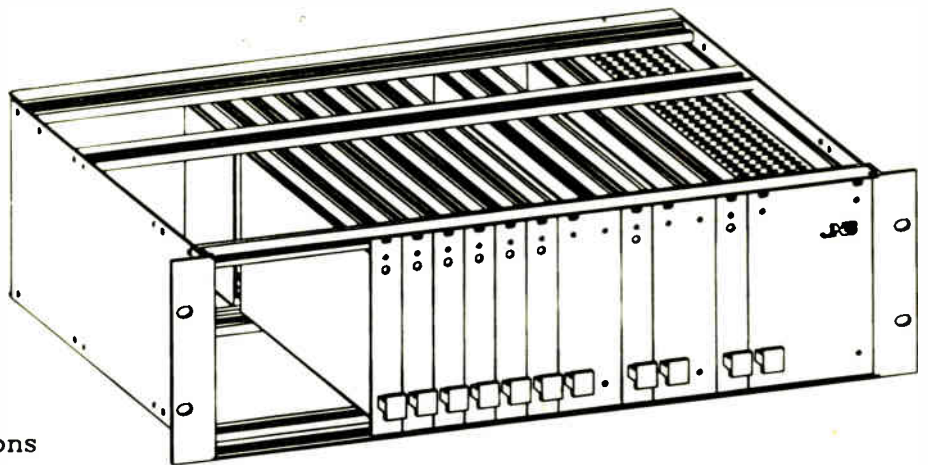

J.N.S. ELECTRONICS, Inc.

Post Office Box 32550

San Jose

CA 95152

U.S.A.

Voice 408/ 729-3838

Fax 408/ 926-1003

J.N.S. ELECTRONIC INDUSTRIES

Post Office Box 85

Rosanna

Victoria 3084

Australia

Voice 613/ 439-1000

Fax 613/ 431-1197



Quality

Endorsed

Company

Lic No 3315

ISO 9001

AS 3901

Distributors

West Europe - Aerowave, Hofweg 1, 3274 BK Heinoord, The Netherlands

Voice 31-1862 3866, Fax 31-1862-3677

Canada - M.S.C. Electronics Ltd. 147 West Beaver Creek Road, Richmond Hill, Ont. L4B1C6

Voice 905-731-9500, Fax 905-731-5195

Circle (52) On Reader Service Card

World Radio History



Where can you get a feel for digital audio production?

Now's the time to get your hands on SoundLink —the first Random Access Digital Audio Multi-Track system with all the critical functions you need at a price you can live with.

An all-in-one system, SoundLink provides hard disk recording, mixing, non-destructive editing, signal processing and MIDI recording in one comprehensive and affordable package.

If you want a whole new feeling about digital audio production, please call Korg Professional Audio at 800-645-3188 Ext: 280. In NY, call 516-333-9100.

SoundLink™
KORG™
Professional Audio

Studio Sessions

The Swiss Army
Knife of Digital
Problem Solving
See Page 27

Equipment and Applications for Radio Production and Recording

PRODUCT EVALUATION

Second Generation CD-R from Marantz

by Rich Rarey

WASHINGTON At last! An economical means of pressing your own compact disc from an analog or digital source has arrived! The Marantz CDR-610 CD Recorder is a modest-sized box with good sonic performance and plenty of usefulness.

Everyone at your station will want to be

ing, the \$4,500 CDR-610 can do it all. And the finished product is playable on any CD player.

Easy hookup

To speed CD-R into the pro audio workplace, Marantz has made it as easy as possible to get signals in and out of the CDR-610. It accepts AES/EBU or IEC-958-II digital inputs at a balanced XLR connector, or IEC-

format output. Without exception, the CDR-610 digital inputs *must* have a 44.1 kHz sampling frequency.

The CDR-610 requires no formal instruction: the layout is like any CD

player, except for the RECORD button and several related controls.

For instance, the following "Quick Start" steps will produce a CD recording:

- Put a recordable CD in the CDR-610.
- Plug in an audio input.
- Press REC, then PLAY.
- Record the audio.
- Press FIXUP, then the REC button to make a permanent CD.

continued on page 20



The Marantz CDR-610: For Benchtest, see page 22.

able to record audio on a "standard" CD including the production and sales departments. From music stingers, jingles and sound effects, to spots and news archiv-

958-II via an RCA, or via a TosLink optical input. Digital outputs appear on companion connectors, except the output XLR requires the user to choose between IEC and AES

LOCK THE DOORS AND GO HOME!

NOW YOU CAN OPERATE YOUR RADIO STATION
LEGALLY
WITHOUT AN OPERATOR IN YOUR STATION

Let Our FCC Licensed Operators
Monitor Your Transmitter
Take & Log Your Readings
Monitor & Control Your EBS
And Fax You A Log Each Day

ALL FOR JUST \$275.00 PER MONTH

CALL US TODAY FOR MORE INFORMATION

Southern Communication, Inc.

StationWatch

(803) 773-7370

Circle (53) On Reader Service Card

DIGITAL EVOLUTION

Technology evolves. The market develops.
DIC Digital excels.



As one of the original suppliers of DAT tape to the professional, DIC Digital recognized industry demands. As a result, we were the first DAT supplier to offer a truly professional DAT cassette.

Once again DIC Digital is leading the way by introducing recordable CD's. Our discs are fully compatible and bear the "compact disc" logo. DIC Digital's CD-R's are readily available in 18, 63 and 74 minute lengths. Call today for the name of your nearest DIC Digital dealer.

THE ULTIMATE IN SOUND

DIC DIGITAL™

Glen Pointe Centre West

500 Frank W. Burr Blvd., Teaneck, NJ 07666

Phone: 201-692-7700 Fax: 201-692-7757

Circle (173) On Reader Service Card

See Us At NAB Booth 16043

OVER
5 MINUTES
OF 15KHZ STEREO AUDIO
ON EACH 13MB FLOPPY DISC



The Dynamax DCR1000 with New Version 2.0 Software

THE OBVIOUS DIGITAL SOLUTION TO CART MACHINE PLUG-IN REPLACEMENT

The Recorder

- Selectable sampling rates
- Secondary and Tertiary cues
- AES/EBU digital input
- Start on audio
- Direct digital dubbing from CD
- PC keyboard for titling
- New* • Cut & paste editing
- New* • Variable length beds
- New* • Kill date checking
- New* • Disk label printing

The Reproducer

- Simple cart-like operation
- No on-air personality training
- Just three front panel buttons
- Instant start and cue
- Maintenance-free design
- Awesome audio quality
- New* • Rotation & chaining
- New* • Replay lockout
- New* • Count-up/count-down timer
- New* • RS232 logging/remote control

The Media

- 13MB stores over 5 minutes stereo audio with 15kHz bandwidth and 15 minutes mono with 10kHz
- Standard low-cost 2MB floppy disk holds 60-second commercials
- New* • Non destructive media diagnostic test

New Year's Special!

FREE Record Module with purchase of 3 players

8:00 a.m. to 8:00 p.m. EST • 1-800-622-0022 • Fax 317-966-0623
Canada 1-800-268-6817 • Toronto 416-731-3687

**HARRIS
ALLIED**

PRODUCT EVALUATION

Benchmark, dbx: Dueling Mic Preamps

by Ty Ford

BALTIMORE The two best reasons for getting a new mic preamp are that (hopefully) it sounds better than your existing preamp, and it may offer additional features not found on your present preamp; features like phantom power, phase reversal and additional outputs.

I suggest you first narrow down the field by features, check the specs and then go for what sounds best. Unfortunately, most manufacturers wander a bit when establishing specs. I don't have a problem with this editorial privilege, but it does make the direct comparison of similar circuits by spec sheet virtually impossible.

Cost per feature

If you like solid state mic preamps, read on to find out what happened when we evaluated the dbx 760X (\$349) and the Benchmark MPS-420 (\$1295). Direct comparisons are impossible, of course, because of the different features each pre-

L/R outputs and the four-conductor XLR power supply jack. The external power supply is switchable between 110V AC and 220V AC and provides separate 15V

MPS-420 can run unbalanced, there are no unbalanced output jacks.

The left and right mix outputs of the MPS-420 require a bit of explanation.

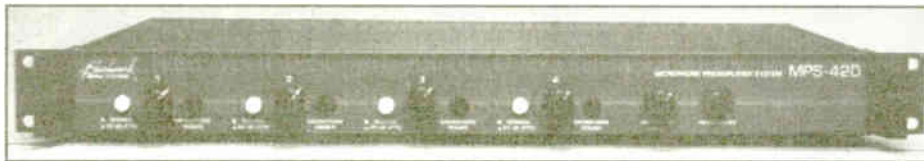

Benchmark MPS-420 microphone preamp

DC operational power and 48V DC phantom power. The manual provides modification information for 48V, 15V, 12V, AB and T mic powering. Although the

Each mic preamp has its own individual output. In addition, the combined output of preamps 1 and 2 is available at the Left Mix output. The combined output of

preamps 3 and 4 is available at the Right Mix output. So if you want to have any one mic available through both mix outputs, you have to use a splitter mic cable to feed mic preamps 1 or 2 as well as 3 or 4, adjusting their relative levels to obtain the required pan across the Left Mix and Right Mix outputs.

On the front panel, each of the four pre-amp modules has a gain control, a 20 dB pad switch and a phantom supply switch. There is also a headphone monitor module with a quarter-inch TRS jack and gain control. The output of the headphone amp is sufficient to power my AKG 240 phones to my liking, and I do like them loud.

If you're into (or want to be into) the math of gain stages, noise figures and solid state theory behind the design of the MPS-420, the manual provides an extensive

continued on page 19 ▶

Product Capsule: Benchmark MPS-420

	Thumbs Up	Thumbs Down	
✓ headphone output		✓ no clip lights	
✓ 20 dB mic pad			
✓ mix output			

For more information, circle **Reader Service 73**, or call Benchmark at 315-437-6300.

amp offers. Actually, if you add up the cost of their modular parts, the cost of functionality between the two units is about the same. Compared to the dbx 760X, the Benchmark MPS-420 has twice as many preamps (4), plus a head phone amp and a separate semi-mixable output. The only things they have in common are that neither uses tubes or I/O transformers, they both use external power supplies and neither has a power switch.

The 760X

The dbx 760X is a two-channel, single-space, half-rack unit that is designed for table-top or rack mounting. The half-rack size makes it a nice box for portable two-mic DAT sessions. A filler panel is supplied for single rack space mounting. Back panel inputs are XLR balanced.

Outputs are both XLR balanced and TS unbalanced. Pins 2 and 3 of the inputs and outputs are floating, active balanced. The SSM 2017 input chip and input circuit will handle up to a 0 dBu input. The unbalanced output operates independently from the balanced output, allowing both to be used simultaneously. The 18V AC wall wart power supply jack is also on the back panel.

The front panel features gain control, polarity and phantom supply switches, and LEDs for clip level, polarity and the presence of phantom power for each of the two channels. There is also a power LED, but no power switch. The 760X manual is sparse, but does include schematics and thorough information for I/O connections.

The MPS-420

The Benchmark MPS-420, formerly the MIA-4x4+, is a single full-rack space unit that houses four mic preamps, a separate two-channel output module and a headphone amp. The back panel features balanced XLR inputs and outputs, a pair of

Owning a Real Neumann Just Got a Lot Easier

You've put a lot of money into your studio... expensive consoles, recorders, processing, etc. But your recordings just don't measure up to your expectations. Chances are, the problem is with the most important (and most often overlooked) part of your signal chain... the microphones.

Virtually every major recording produced during the last 50 years has utilized Neumann microphones on vocals and critical tracks. And with good reason. Neumann microphones sound better. The warmth. The texture. The velvety smooth richness that cannot be duplicated. It's called the "Neumann Sound."

The TLM 193 is a large diaphragm cardioid condenser microphone with state-of-the-art specifications. Frequency response of 20Hz to 20kHz, dynamic range of 130dB, self noise of 10dB-A, and maximum SPL of 140dB.

Mics like the U 47, U 67, U 87, and the TLM 170 are legends in the industry. Now, with the TLM 193, you can have Neumann performance in the classic tradition for less than \$1300 us!

Make your next recording a classic. Use Neumann... the choice of those who can hear the difference.

Introducing the TLM 193
Large-Diaphragm Condenser Microphone

Neumann/USA

6 Vista Drive, PO Box 987 • Old Lyme, CT 06371
Tel: 203.434.5220 • FAX: 203.434.3148
West Coast Tel: 818.845.8815 • FAX: 818.845.7140

Neumann/Canada

221 LaBrosse Ave., Pointe-Claire, Quebec H9R 1A3
Tel: 514.426.3013 • FAX: 514.426.2979

Neumann
TLM 193
\$1,295⁰⁰ US

Circle (19) On Reader Service Card

The Aphex Audiophile Air Chain



Higher Quality *and* Extended Coverage!

Smart broadcasters know that quality sound is essential to attract and keep loyal listeners ... and advertisers.

That's why premier stations around the U.S.A., and around the world, rely on the Aphex Audiophile Air Chain.

Now there's one more reason to turn to Aphex — better coverage of your listening area.

Stations that have installed the powerful combination of the Aphex *Compellor*® Model 320, *Aural Exciter*® Type III, *Dominator*™ II Model 720 and the *new Digicoder*™ digitally controlled stereo generator — as well as their listeners — are raving about better signal quality and a reduction in multipath.

"A surprise bonus has been the apparent increase of coverage in fringe areas — we are getting very positive responses from listeners in Sacramento, 100 miles away,"
- Tim Pozar, CE, KKSF-FM, San Francisco.

"Immediate improvements in fringe signal quality were noted. These improvements included a reduction in multipath and picket-fencing,"
- Gary Greth, CE, KLON, Long Beach, CA.

APHEX *Improving the way the world sounds*SM
SYSTEMS 11068 Randall Street, Sun Valley, CA 91352 ■ (818) 767-2929

Compellor, Dominator, Aural Exciter and Digicoder are trademarks of Aphex Systems Ltd.

©Aphex Systems

Circle (76) On Reader Service Card
World Radio History

SIGNAL-TO-NOISE

Visual Sound Mixing Now a Reality

by Frank Beacham

NEW YORK For one who grew up behind a coffin-sized RCA console with huge glowing meters and control knobs the size of grapefruit, it's a bit of a leap to enter David Gibson's world, where all the elements of a sound mix float in the air between the stereo speakers in the studio.

Yet, Gibson, owner of the California Recording Institute in Menlo Park, California, is pioneering a new way to mix sound through the use of visual representations. It started as a better way to help his students understand the dynamics in music and how those dynamics can be created with audio processing equipment in a studio. The idea may end up as a new type of interface to several professional mixing products.

Visual editing

In order to better understand the dynamics that can be created in sound mixes, Gibson devised a system that uses visuals (floating see-through spheres) to represent

the imaging of the sounds between the speakers. These visual spheres are used to create a map that helps one see how the studio equipment can be manipulated to create different types of mixes for different styles of music.

Gibson quickly realized the same visuals that could help teach audio mixing could

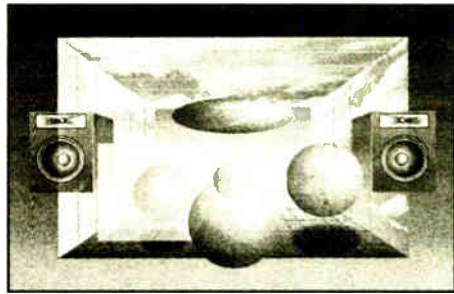

Visual representation of Imaging illustrates the whole world of dynamics available to the recording engineer.

also be used to control the audio mix itself. So the visual map has now become the basis of a new kind of user interface for computer-assisted mixing.

By pointing and clicking with a computer mouse, the spheres can be moved around on a Macintosh display screen, controlling the actual sound mix on a MIDI audio board. Thus, the virtual mixer is born.

3-D

As innovative as the visual mixing interface is now, it's the next step, one that Gibson is currently developing, that's the showstopper. It's here that the visuals become three-dimensional and float in the air between the stereo speakers.

The engineer, wearing 3-D glasses and a "data glove," mixes the sound by reaching up and grabbing a floating sphere (which represents a track on the multitrack) and physically moves it around in the space between the actual speakers.

If the engineer wants a track to be near the left speaker, the sphere is simply moved there by hand. The computer will tell the mixing console to make the change, and the engineer will hear it as it moves. Sound mixing with this process, Gibson said, "will be as simple as finger painting."

If you like chip sleuthing, try figuring out what chips are in the input stage. Burdick noted that Benchmark purposely removed the markings from some of the components to obscure their identity.

Burdick also said that the chips used provide lower IM distortion at higher frequencies than the SSM2017 chips

continued on page 30 ▶

The Benchmark, dbx Duel

▶ continued from page 17

tutorial, with a component-by-component explanation of what's going on inside and why. It also contains a 19-page supplement called, "A Clean Audio Installation Guide" that you may find useful in sussing out problems in your own studio.

The dbx 760X has clip LEDs, there are none on the MPS-420. The reason, per the Benchmark manual, is that, "The output clip point of the microphone preamplifiers is typically as high or higher than the

that +29 dBu with the 20 dB pad in. Unlike pads on less expensive preamps, the three-resistor mic pad network on the MPS-420 did not noticeably change the frequency response of the preamp.



dbx 760X microphone preamplifier

Product Capsule: dbx 760X	
<p>Thumbs Up</p> <ul style="list-style-type: none"> ✓ easy to carry ✓ phase reversal switch ✓ clip lights 	<p>Thumbs Down</p> <ul style="list-style-type: none"> ✓ no pad ✓ no headphone output
<p>For more information, circle Reader Service 152; or call dbx at 510-351-3500</p>	

input of the device receiving the signal in which case the metering is not necessary, and indeed is an expensive redundancy."

Need for LEDs?

In a perfect world, where life is a serene and productive continuum, this is true. In my world, I enjoy the help such an LED can offer, especially if I'm dealing with a lot of inputs.

Benchmark President Allen Burdick confirmed that maximum level to the mic input can be as high as +9 dBu. Make

ARE YOU READY FOR COMPRESSION?

New DIGI-READY™ Phase-Locked Commercial LNBS from Cal-Amp

These new *Digi-Ready™* LNBS fulfilled the need for phase-locked downconverters necessary to receive digitally compressed satellite programming signals. Although some digital compression formats are undefined, phase-locked commercial LNBS, which maintain low Bit Error Rates, are recommended to ensure proper reception of digitally compressed signals. *Please call your commercial distributor for additional details.*

DIGI-READY™ LNB Specifications:

- Input Frequency 3.7-4.2 GHz
- Output Frequency 950-1450 MHz
- 45° K Noise Figure, Typical
- Phase Noise -80 dBc / Hz @10 KHz
- PLL Oscillator Stability ± 2.3 ppm (± 12 KHz)
- Input VSWR 1.5:1 (Isolated Model: Part No. 31814)
- 2 year Warranty
- Made in the USA

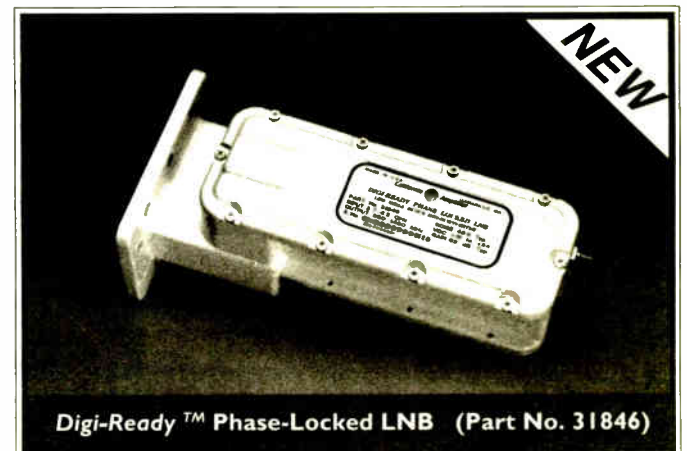

Digi-Ready™ Phase-Locked LNB (Part No. 31846)

California Amplifier, Inc.

460 Calle San Pablo Camarillo, CA 93012
Phone (805) 987-9000 Fax (805) 987-8359

California Amplifier

Circle (143) On Reader Service Card

See The
New EBS System
In Booth 2800

**SAGE
ALERTING
SYSTEMS**

D.W. Fearn Goes 'Retro' with VT-1

by John Diamantis

WASHINGTON Gotcha hooked for a second look? Great! Just a quick thanks to those of you who called to say hi and talk about tubes after my first column.

For this issue, I've tested a new product from a new company. According to the manual, the D.W. Fearn VT-1 Vacuum tube microphone preamplifier (manufactured by Doug Fearn in Pocopson, Pennsylvania) is a "re-creation of the classic tube preamps of the 1960s, updated with improved modern passive components and computer-aided circuit optimization. Because of the unique sound quality of vacuum tubes, the VT-1 has a warm and musical sound that is different from solid state preamps." While the description of this device is verbatim from the well-written instruction manual, it pretty much sums up what the VT-1 is all about.

The D. W. Fearn VT-1 was originally created to satisfy the curiosity of its designer, who, while listening to some recordings he had produced in the '60s, marveled at their clarity and warmth. After doing his circuit research and determining good parts were available, Fearn set out to build first one, then a second prototype. After several rounds of real world testing, and some minor circuit adjustments, the VT-1 was ready for limited production, which began in 1993. The VT-1 is shipped with the tubes in a separate, cushioned container to prevent damage in transit. After removing the top cover, and installing the tubes in their respective sockets as per the supplied instructions, I buttoned the VT-1 back up, plugged it in and let it "cook" for a couple of days on the bench.

The front panel of this box makes quite a statement! It's three rack units high, has three large black knobs, one each for input, gain and phase, a real "retro," Simpson VU meter, three heavy-duty toggle switches, for AC power, phantom power, meter on/off and a large pilot lamp. The panels are painted with a high gloss red that looks several coats thick.

The case is heavy duty, using thick gauge aluminum sections, held together by machine screws and threaded inserts. Very vintage looking. The audio circuit consists of a four stage r/c coupled (that's tube circuit jargon for resistance/capacitance) amplifier using two miniature (9 pin) 12AY7 medium-mu twin triodes (two matched amplifiers in one tube envelope), with transformer coupling on the input and output. All audio circuitry is hand wired, point to point. All audio coupling capacitors are high quality polypropylene. All four power supplies (filament, phantom power, B+ and meter amp) are solid state

The case is heavy duty, using thick gauge aluminum sections, held together by machine screws and threaded inserts. Very vintage looking.

The audio circuit consists of a four stage r/c coupled (that's tube circuit jargon for resistance/capacitance) amplifier using two miniature (9 pin) 12AY7 medium-mu twin triodes (two matched amplifiers in one tube envelope), with transformer coupling on the input and output.

All audio circuitry is hand wired, point to point. All audio coupling capacitors are high quality polypropylene. All four power supplies (filament, phantom power, B+ and meter amp) are solid state

and fully regulated. The input and output transformers are Jensen's best. Overall parts and built quality is first rate.

Bench measurements

I measured performance of the VT-1 with an Audio Precision System One, with DSP installed to allow spectral analysis of the output signal. The unit met most of its published specifications.

Gain was 53 dB. Noise was 72 dB down, set for 50 dB gain. The spec is 74 dB down. This noise was predominantly hiss; there was no noticeable hum.

The THD + Noise was <0.2 percent at +4 dBm out, either terminated into 600 ohms, or bridging at 100 k-ohms. This meets spec. More importantly, when viewing these distortion products spec-

continued on page 25 ►

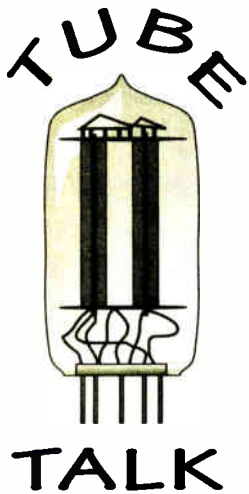

Make Your Own CDs with The Marantz CDR-610

► continued from page 15

To get the most out of the technology, a rudimentary knowledge of CDs is helpful. Marantz has prepared two informative white papers, "CD-Recordable Basic Principles," and "The Basics of Recording With the CDR-600-610."

To briefly summarize, there are two industry standards observed in audio CD recordable technology: the "Red Book" and the "Orange Book." The "Red Book" defines the standard which conventional CDs must meet to be playable on any CD player. The "Orange Book" defines how the CD-Recordable technique—the method of the CDR-610—can be used to make CDs that, while not erasable, are convertible to the "Red Book."

CD-R technology

To briefly summarize, there are two industry standards observed in audio CD recordable technology: the "Red Book" and the "Orange Book." The "Red Book" defines the standard which conventional

CDs must meet to be playable on any CD player. The "Orange Book" defines how the CD-Recordable technique—the method of the CDR-610—can be used to make CDs that, while not erasable, are convertible to the "Red Book."

Probably the most important feature of the "Orange Book" standard, from the user's perspective, is the ability to record a CD incrementally, track-by-track if desired, instead of having to record an entire CD in one pass.

Until the user invokes the CDR-610's FIXUP function, the compact disc conforms to the "Orange Book," and is playable only on CD players that recognize the "Orange Book" standard (presently, only CD-R recorders do this). After the FIXUP, which is essentially writing the table of contents, the disc meets the "Red Book" standard, and therefore is playable on any CD player.

Real world tests

For our tests of the CDR-610, typical

applications were chosen that a broadcast station or production house might use. We used blank discs manufactured by several companies including 3M (provided by Harris Allied), DIC Digital and Marantz's own brand.

During the CD mastering process, we found that preparing for CD recording requires more care and consideration than for erasable media recording; once audio is recorded on the CD, it cannot be erased, and any mistakes are embedded forever on the \$20 discs.

As our informal tests found, incrementing the TRACK number reliably proved to be more difficult than recording audio onto the CD-R. The track incrementing is analogous to writing an index on a DAT, but is as permanent as writing the audio, and just as important.

If an increment occurs "late," after the audio has begun, the CD will normally cue to the start of the track, and the audio will be upcut. All of the audio is still there, but the end-user must manually cue the CD to a point just before the audio begins, rather than just pressing the number of the desired track.

The track increment dilemma is compounded by the CDR-610 design to give the audio signal processing priority (as it should) over a track increment command. Further frustrating the simple automation of track incrementing is the format difference of a DAT START ID and the CDR START ID subcode; they're not compatible.

Fortunately, there are several techniques that can simplify this tedious process.

Various methods

The easiest method is to make hookups via the analog outputs of the DAT and the analog inputs of the CDR-610—one track at a time. The process is similar to recording a cart; cue up the playback tape, engage the CDR-610 into record, and start the playback. After each track is recorded, pressing PAUSE returns the CDR-610 to the record ready state, and the track number is automatically incremented—ready for the next session.

An attempt to use the CDR-610's AUTO LEVEL SENSE to automatically increment the track had poor results; the level sense is internally set at -60 dB, but the mechanism does not react quickly enough, or reliably enough, to write a track increment. Playback of the final "Red Book" CD showed that the manual method works better than any other for ensuring that the CD audio will have a "tight cue" to the start of a track.

Another recording method is the CD-to-CD clone using a "Red Book" CD player

continued on page 22 ►

THE SIMPLE SOLUTION FOR DIGITAL AUDIO TRANSPORTATION

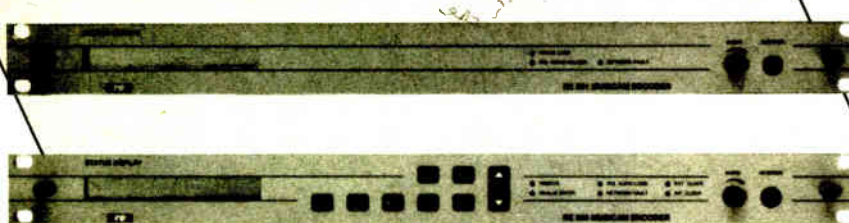

- ▲ MUSICAM ISO/MPEG Layer 2, 2A
- ▲ Switched 56, 64 kbit/s, ISDN, Fractional T-1
- ▲ User data channel from 300-9600 baud
- ▲ Easiest set-up locks to network or internal clock
- ▲ Fully automatic decoder reduces operator set up
- ▲ Multiplex or redundant two times 56/64 for 112/128 kbit/s
- ▲ Mono, Dual Mono, Stereo, Joint Stereo operation
- ▲ AES/EBU and SPDIF digital interface *included*
- ▲ Two-times V.35, X.21 or RS 422 interface *included*
- ▲ Headphone monitor *included*

The RE 660/661 **MUSICAM** Digital Audio Codec was developed to enhance MUSICAM technology, providing up to 20 kHz of audio bandwidth. From satellite networks to switched 56 telephone lines, the full-featured RE 660/661 is completely bit rate flexible up to 384 kbit/s. Applications range from network program distribution to remote pick-ups for sports, concerts, special events, news gathering, STL back-up, audio backhaul, recording and post production studios.

When it comes to digital audio transportation, nothing comes close to the RE 660/661 for providing quality audio with hassle free set up. Backed by 55 years of experience in analog and digital audio products, the RE 660/661 is the simple MUSICAM solution for all your digital audio transmission needs.

Available through Broadcasters General Store, Harris Allied and RF Specialties



RE AMERICA, INC.
31029 Center Ridge Rd. ▲ Westlake, Ohio 44145
Phone: (216) 871-7617 ▲ Fax: (216) 871-4303

See Us At NAB Booth 3801 & 3802

PRODUCT GUIDE

Companies with new product announcements for Studio Sessions Product Guide should send them to Radio World, c/o Studio Sessions Editor, 5827 Columbia Pike, Suite 310, Falls Church, Va. 22041

Denon DN-990R MD Cart Recorder

Denon has embraced the MiniDisc technology for replacing analog cart recorders with its DN-990R. Boasting CD-like specs, the MD records and plays on the three-inch MD disc with near instant track access. Features include Instant Start and balanced analog inputs. Signal-to-noise is rated at better than 80 dB.

For more information, contact Mike Stelts at Denon, 201-575-7810; or circle Reader Service 170.

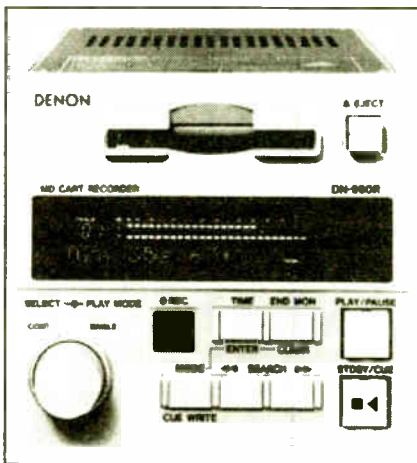

Digital Audio Labs Digital Only CardD

Digital Audio Labs has introduced the Digital Only CardD, a digital input/output module that plugs into IBM compatible computers.

The card is designed to allow direct digital transfer from a DAT recorder in the S/PDIF format. The card comes with a Windows audio waveform driver.

For more information, contact Jeff Wilson at Digital Audio Labs, 612-473-7626; or circle Reader Service 211.

continued on page 28 ►

Digidesign Session 8 For Macintosh

Digidesign now has a Macintosh version of the Session 8 digital recording and editing system. The card, interface and software program system was first introduced for PC in 1993.

The workstation system is designed for home, project music and broadcast production studios.

For more information, contact Digidesign at 415-688-0600; or circle Reader Service 149.

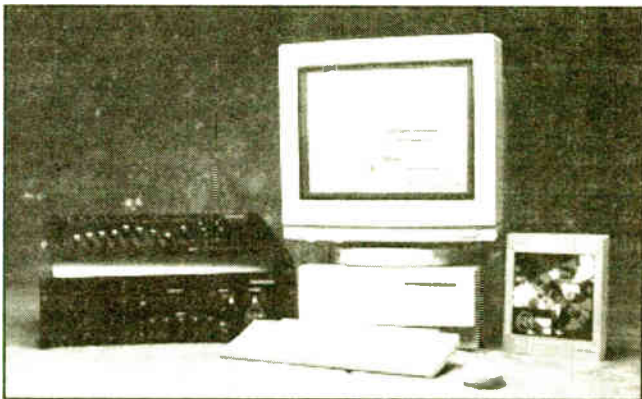

STATION SERVICES

BUY - OUT MUSIC

•Industrial •Technical •Logos
•Dramatic •Romantic •Variety
•Contemporary •Sports •Travel

11 Great Volumes! Low Buyout Pricing!
Multi-Unit Discounts! CDs And Cassettes!
Free Catalog!

ENERGETIC MUSIC
P.O. Box 84583 • Seattle, WA 98124
1-800-323-2972

READER SERVICE 49

427 SOUND EFFECTS
\$89.00

For a 5-CD set with a 30-day
money-back guarantee.

Take an extra \$10 off if you mention this ad!

Send \$79 to Ghostwriters
2412 Unity Ave. N., Dept. RW
Minneapolis, MN 55422

For credit card orders call
(612) 522-6256

READER SERVICE 71

CUSTOMIZED AIRCHECKS ARE HERE!



Broadcast Historian Ed Brouder offers
customized airchecks of Top 40
legends • Over 2,700 airchecks
available • Use our catalogue to build
your own collection • Perfect for Oldies
Programmers, Collectors, Jocks.
We have them all!

Send \$10 for our catalogue, \$5 for cassette.

MAN FROM MARS PRODUCTIONS
159 Orange Street
Manchester, New Hampshire 03104

READER SERVICE 28

Station Services are
a great, economical way
to get your company's
message to Radio
Station and Recording
Studio owners/managers
and engineers. Call
Simone now and your ad
could be in the next issue
of Radio World.

ATTENTION PROVIDERS!

Promote your services to **Radio World's** 22,000+ readers. Reach Radio Station and Recording Studio owners/managers and engineers with your message. For information on affordable advertising call **Simone** at **1-800-336-3045**.

FM ANTENNAS

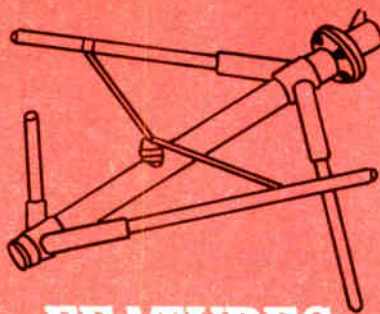

FEATURES

Multi-Element Arrays

Input Powers from
100W to 240 kW

Circular, Vertical, or
Horizontal Polarization

Custom Directional Antennas

Quality Construction
Built to Last



Systems With Reliability

1-800-762-7743

Systems With Reliability

Transmission Lines & Antennas
Celebrating Our 25th Year

Cambria County Industrial Park
Ebensburg, Pa. 15931-0856
Fax: 814-472-5552



Quality* Power Tubes

4X150A
4CX250B
4CX250BC
4CX250R
4CX350A
4CX15,000A
4CX15,000J
5CX1500A
5CX1500B
8560AS

□□□□□

- Watch this list grow.
- Manufactured in Russia's largest power tube factory.
- Generous* warranty based on high quality.
- Honest prices based on quality at low cost.
- Shipment from USA stock.

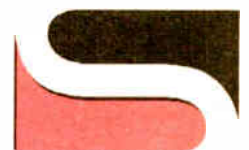

Broadcasters
Call: 800-239-6900
FAX: 205-880-8077

OEMs, Distributors,
Volume Purchasers
Call: 415-233-0429
FAX: 415-233-0439

CD Quality from Marantz CDR-610

by Ken C. Pohlmann
Hammer Laboratories

CORAL GABLES, Fla. Without question, the compact disc is the most impressive piece of audio technology since Edison's cylinder. The only problem with the CD, it seemed, was its lack of recordability. Now, that has been remedied.

Following the introduction of early CD recorders which were bulky and expensive, models such as the \$4,000 Marantz CDR-610 have suddenly made CD

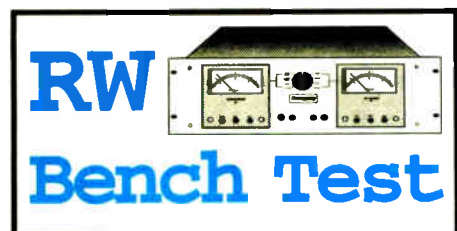

recording a temptation for many, many radio stations and studios.

At first glance, the CDR-610 may look like an ordinary CD player and indeed it functions like one—playing playback-only (Red Book) or write-once (Orange Book) CDs with equality. However, a knob marked RECORD LEVEL and a RECORD button arouse suspicion that this is a CD recorder.

Orange Book II

The CDR-610 adheres to the Orange Book II multisession standard that lets you record part of a disc, remove it and add more tracks later, however, the disc is playable only in Orange Book players because of its incomplete Table of Contents. When you're finished recording the disc, the automatic FIX-UP process (it takes about three minutes) writes a final table of contents so the disc can be played on Red Book players—additional recording is not possible.

A professional user must be assured that any device in the audio chain does not

diminish audio fidelity. In this case, according to our measurements, the reviewed CDR-610 was quite strong in this respect.

Performance check

Both playback and record/playback frequency response was flatter than a motel carpet. There was, however, a very slight channel imbalance in the latter test. Phase response was excellent too. Playback residual noise was below 100 dB, but increased slightly to 95 dB in record/playback mode. THD+N measurements showed that distortion was a low -88 dB in playback mode, and was increased only to -85 dB in record/playback. Similarly, SMPTE IM distortion (50 Hz + 7 kHz, 4:1) measured -90 dB at 1 kHz in playback and -88 dB in record/playback.

Playback channel separation at 20 kHz measured 100 dB, but decreased to 86 dB at 20 kHz during recording. D/A converter playback linearity erred by -7 dB at -90 dB. This is somewhat high by modern standards and should be better in a professional unit. Interestingly, nonlinearity in the A/D converters was the inverse, resulting in an error of -2 dB at -90 dB when the signal made a complete trip through the recorder.

Denon Test CDs

Throughout these tests, record and playback measurements were made through the balanced analog inputs. Incidentally, the new Denon Professional Test CDs were used in the evaluation. This triple-disc set is the best collection of tones you'll find anywhere; there's

even CD+G subcode with information about track contents.

From a technical standpoint, analog in/out performance of this recorder is similar to that of many consumer CD players—that is to say, it is quite good. Of course, in many applications, you will use the digital input or output, avoiding half of the recorder's analog circuitry. The only measured weakness is the low level linearity error—something that

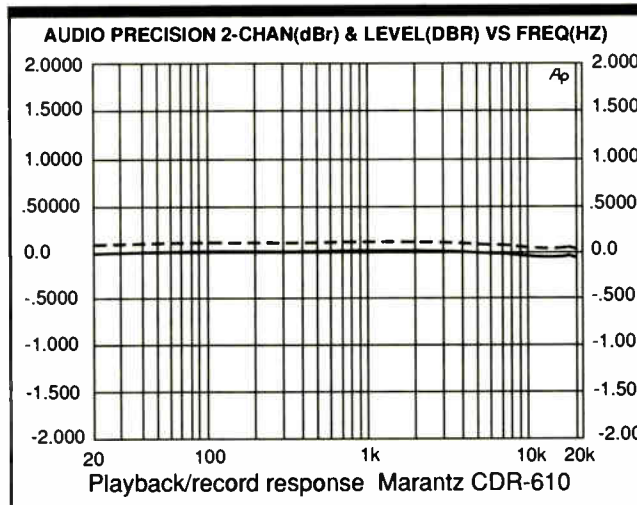

from a practical standpoint is certainly not a major problem because it would be audible only under extraordinary conditions.

From a functional standpoint, the recorder is easy to use. Entering track number flags is the only thing that requires skill; it would be nice if there were a rehearse mode with a buffer memory and a couple of nudge buttons to help place flags exactly where needed.

In addition, given that this is a professional unit, I think that error correction/concealment indicators would make a nice addition.

Quibbles aside, if you're into sound bites, sound effects, commercial spots, archives, music bumpers, test discs, in-house production or anything else that

could benefit from CD recording, the CDR-610 recording/playback is fully up to the task.

Ken Pohlmann is director of music engineering at the University of Miami in Coral Gables, Fla., and a contributing writer to RW.

CD Recorder Has Place In Studio

continued from page 20
linked to the CDR-610 via a TOSLink Optical input. In this test, we cloned a well worn CD-R disc that was made three years ago for an NPR program. (Users of the CDR-610 may want to consider cloning "work copies" of their important CDs for day-to-day use, and preserving their master CDs).

CD cloning

The CDR-610 immediately locked to the optical output of the Technics SL-P1300. According to the Marantz white paper, there is one small quirk in CD cloning: The CDR-610 must be set to MANUAL TRACK INCREMENT before the clone has begun, then switched to AUTO TRACK INCREMENT during the first track to ensure that the track numbers on the CD-R match the track numbers on the playback CD. Otherwise, the first track increment is transmitted from the CD source and the CDR-610 advances to Track 2, when the CD source is still on Track 1.

The cloning process worked perfectly until the source CD played a scratched

Product Capsule: **Marantz CDR-610**

<p>Thumbs Up</p> <ul style="list-style-type: none"> ✓ affordable CD-R technology ✓ easy to use ✓ excellent sound 	<p>Thumbs Down</p> <ul style="list-style-type: none"> ✓ inconsistent auto track timing ✓ needs remote for external track increment control
--	---

For more information, circle **Reader Service 158**; or call Marantz at 708-820-4800.

track. Although no audio glitches were heard, the data stream was somehow corrupted, dropping the CDR-610 into REC Ready mode. The transfer was successful after careful cloth buffing of the source CD, although the clone now has "unusable" tracks on it.

DAT to CD-R cloning can also be accomplished by linking the DAT's 44.1 kHz output, in this case—a Sony 7010, to the CDR-610's AES/EBU input.

Connecting DATs

This test involved dubbing over 100 indexed DAT selections into the CDR-610. The selections are music buttons used by an NPR news program—some as short as three seconds and others as long as 29 seconds.

To manually record each selection to the CDR-610 would take hours, so we prepared the DAT master with carefully placed START IDs, typically five frames (1/6 second) ahead of the audio. At this point, we plugged the CDR-610's wired remote control box (model RC610CDR) into the CDR-610. The remote control has a general purpose interface that allows users to connect external contact closures

continued on page 30 ▶

DIELECTRIC

FM Antennas



Switches, Loads Custom Systems

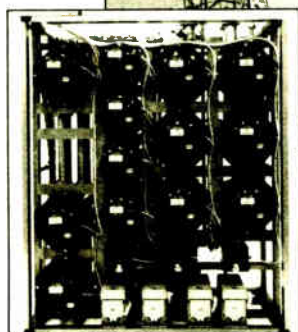

The Dielectric name is recognized worldwide for quality and workmanship in RF communications.

Our products include FM antennas, transmission line, switches, loads, filters, combiners and dehydrator pressurization equipment, everything from transmitter output through the antenna.

Dielectric also designs and manufactures RF equipment for custom applications in addition to our standard television products. Call us with your requirements...

Coaxial Transmission Line



Multistation Combiners

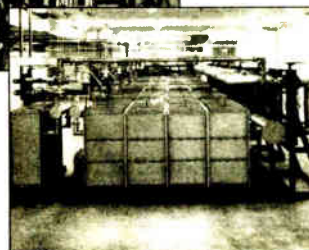

Serving the Radio Broadcaster for Over 45 Years!

Dielectric Communications * P.O. Box 949 * Raymond, Maine USA 04071 * 207-655-4555 * FAX 207-655-7120



The Dynamax MX Series

**"E" Models From 8 to 18 Channels
New Beige Finish or Metallic Gray**

- True modular design
- Ultra-reliable motherboard construction
- VCA mixer and monitor control
- Active balanced line inputs, transformer isolated mic inputs
- Active balanced main and monitor outputs
- Full monitoring/cueing facilities with VCA level control and active source selection
- Built-in cue amp with speaker and amplified stereo 8-ohm headphone output
- Independent remote start for each "A" and "B" input
- Opto-isolated remote module on/off
- Selectable fader start
- Optional 5-band mic EQ module with pan
- Two inputs per module, mic/line or line/line – line inputs may be mono or stereo, consumer or professional format
- Four assignable outputs – two stereo plus two mono
- Available in 8, 10, 12, 14, 16, or 18 channel models
- Independent level controls for each "A" and "B" input
- Separate audio and logic power supplies
- Sturdy, all-steel construction
- Durable Lexan overlay control surfaces
- Count-up event timer standard
- Two input expansion switches standard
- Excellent RF immunity

New

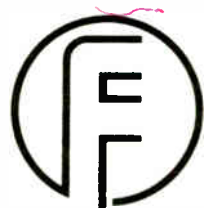

DYNAMAX[®]
BROADCAST PRODUCTS BY FIDELIPAC[®]

Fidelipac Corporation □ P.O. Box 808 □ Moorestown, NJ 08057 U.S.A. □ TEL 609-235-3900 □ FAX 609-235-7779

Circle (193) On Reader Service Card

See Us At NAB Booth 1920

Affordable Custom Furniture



**JUST ASK
SOME OF OUR
CUSTOMERS**

WPGC
WSOC
WMXC
WYXR
WXTU
WRVV
WPOP
WKYS
WJRZ
WDSN
WMAS
WTEL
WIOQ
WPLY
WWLG
WTDR
WRFY

**SOUND
CREATIONS**

AND OTHERS...

Delivered and installed by:

**STUDIO
TECHNOLOGY**

4 Pennsylvania Avenue, Malvern, PA 19355
Phone: 800-676-0216 • Fax: 610-640-5880

D.W. Fearn's Tube Mic Preamp Test

► continued from page 20

trally, they were almost entirely second harmonic, which would be audibly masked by the fundamental tone, and therefore, inaudible. The SMPTE IMD was <0.08 percent at +4 dBm out, bridging at 100 k-ohms, 0.14 percent terminated into 600 ohms. Spec was measured at -20 dBm, <0.02 percent. All fine results.

Maximum level is specified as +22 dBm unterminated, bridging (I know, all you letter writers, dBm is a power measurement, where 0 dBm is equal to 1 mW or 0.775V across a 600 ohm termination. Just look at the level, not the power, and put down your pencil), and the VT-1 provided this level, at 1.0 percent THD + Noise.

A minor quibble

However, the maximum level terminated into 600 ohms is specified as +18 dBm, but all I could coax out of this box was about +9 dBm. After swapping some tubes around and checking everything again, I gave Doug Fearn a call.

After debating measurement techniques, and assuring him I was set up properly, we discussed real world usage of the VT-1, and input impedances likely to be encountered. While it may be true that in nearly all cases the VT-1 would be



Hand-built D.W. Fearn VT-1

connected to a bridging impedance, and operate flawlessly at this level, in my opinion, if a product is specified to drive terminating impedances to 18 dBm, then it should—and at less than 3 percent or higher distortion, tube circuit or not.

Petty complaining out of the way, it was time to start some serious listening sessions with the VT-1. These first tests were performed in a radio production room, with a Neuman U89 condenser microphone, connected to the VT-1 which was patched directly into either an Otari MTR-10 analog reel-to-reel machine or a Panasonic SV-3700 DAT machine. For comparison, the same U89 was plugged into the studio console mike module input, and also a good solid state mike preamp.

Full, clean sound

In listening tests, the male voice sounded much improved through the VT-1 compared to the console preamp, and was fuller and slightly cleaner than the solid state preamp. A slight buzz or edge heard through the solid state preamps was less evident through the VT-1. Sibilant sounds were cleaner as well.

Acoustic guitar sounded bigger through the VT-1; not that it had more bass. It was as though you were hearing less of the strings and more of the wood. If anything, it sounded less like a recording of

the guitar, than either of the other two preamps that were used.

The next test involved sticking the preamp on the main control room microphone, also a U89, and, thus, in the station's air chain. Although the change was not dramatic (the existing preamps were good), it was audible, again removing a slight buzz or harshness from the announcer's voice.

Interestingly, the announcer noticed the change immediately, even though he was not aware we had made any equipment changes. His reaction to the VT-1 was very favorable.

One additional note: While listening, at

moderate to high playback levels, with low, or no direct sound into the microphone, I could detect a very slight hiss from the VT-1 that was not evident on either of the solid state units. Let me stress that this noise was completely swamped by tape noise when using the analog recorder and not an issue under normal circumstances.

I did encounter the effects of tube microphonics, in the way of a "ping-g-g" sound, when changing a switch position with the preamp active. Obviously, moving switches, or hitting the unit while in use is to be avoided.

The D. W. Fearn VT-1 vacuum tube

microphone preamp lived up to its reputation as device that re-creates the warm sound of classic tube preamps, and combines that classic sound with state-of-the-art components and topnotch hand construction. These qualities don't come cheap, and the cost of the VT-1 reflects that. The unit lists for \$2,000 and is available directly from D. W. Fearn. Fearn did tell me, however, that a two channel unit, complete with independent power supplies for each channel, will be available soon for \$2,500.

For more information, contact D.W. Fearn at 215-793-2526; or circle Reader Service 116.

□□□

John Diamantis is director of technical operations at WBIG-FM, WGMS-FM and WTEM-AM in Washington, D.C.

HELIAX[®]

Accept No Substitute

To meet the challenges of today's high performance communication systems, you cannot afford to settle for anything less than the best coaxial cable assembly available. That's why you have to "Ask for HELIAX" coaxial cable and connectors.

Unlike braided cable, only HELIAX coaxial cable can handle the current proliferation of higher frequencies, multichannels and higher average power levels. Its solid copper outer conductor combines both strength and flexibility to accommodate the tightest applications.

When fabricated with Andrew premium performance connectors, HELIAX coaxial cable assemblies optimize electrical and mechanical performance, protecting against EMI-RMI interference and intermodulation.

HELIAX
is a registered
trademark
of Andrew
Corporation.
So if it's not
from Andrew,
it's not the best
coaxial cable
in the business.

ANDREW
10500 W. 153rd Street
Orland Park, IL 60462 U.S.A.

For complete details, call our Customer Support Center
at 1-800-255-1479 Ext.11, or fax us at 1-800-349-5444.

Circle (142) On Reader Service Card

See Us At NAB Booth 15674

COMPETITIVE EDGE.



Today's AMs face too much competition for too few advertising dollars. That's why Orban's OPTIMOD-AM has become the weapon of choice for competitive broadcasters in every market.

OPTIMOD-AM produces maximum loudness, consistency and clarity on all types of AM radios, using every last watt of your authorized power to extend your listenable area and increase your billing opportunities.

A powerful six-band limiter and patented distortion-canceling multi-band peak controller deliver deep, tight lows and clean, transparent highs. You get the closest thing to FM sound, with maximum intelligibility in the essential voice frequencies.

Comprehensive controls and metering

allow you to easily fine-tune your sound, keeping it distinct and aggressive in a changing marketplace.



Fully NRSC and EBU/CCIR compliant

and with mono units easily field-upgradable to stereo, OPTIMOD-AM meets today's standards and protects your investment as you grow.

And Orban's superior customer service is there if you need it to provide world-class support for you and your in-house or contract engineering staff.

Give your programming a chance by making sure it gets heard. Call your Orban dealer today for an on-the-air evaluation, and put OPTIMOD-AM to work protecting your bottom line.

© 1993 AKG Acoustics, Inc.
Orban and Optimod are registered trademarks of AKG Acoustics, Inc.
AKG is a registered trademark of Akustische u. Kino-Geräte Ges.m.b.H., Austria.

orban[®]
A Division of AKG Acoustics, Inc.
1525 Alvarado Street, San Leandro, CA 94577 USA
Tel: (1) 510/351-3500 Fax: (1) 510/351-0500

FIRST IMPRESSION

Multi-Uses for Digital Domain VSP-P

by Rich Rarey

WASHINGTON Digital Domain President Bob Katz calls his VSP-P Digital Control Center "a digital swiss army knife." After using the VSP-P to route and sample-convert digital audio, we're inclined to agree. It's an invention born of need.

Burgeoning digital operations, including broadcast production suites, typically use a mixture of professional and consumer digital gear, sampling frequencies, and optical and wire transmission paths. Often users must resort to patch cords of one type or another to connect inputs to outputs.

A useful tool

Users will find the VSP-P (for professional) at \$1,995 a useful tool to match a device's hardware connector and software protocol to another. Katz, a recording engineer, invented the box for his own use.

Its four impedance-matched, transformer-isolated inputs and two optical inputs are easily selected by front panel buttons to the record bus and/or to the monitor bus. The record bus then feeds six digital outputs simultaneously, and the monitor bus feeds three outputs. The VSP-P becomes a simple distribution amplifier, properly matching output impedance to the device.

The monitor section can be used to feed external D/A converters so other digital signals can be monitored while dubbing. A front panel button FOLLOW RECORD forces the monitor outputs to follow the record output instead of the monitor selector, very handy for comparing any two sources.

Sample rate converter

A process module, containing an external digital send and receive for outboard processing gear, a sample rate converter and a PRO format converter, is the best part of the VSP-P. This module can be switched between the monitor and record busses as desired via the PROCESS TO MONITOR button.

This ability makes it possible to distribute same-frequency signals on one bus, and frequency-convert and distribute signals independently on the other. For example, you can record a 48 kHz clone from a 48 kHz master on the monitor bus, and simultaneously record a converted 44.1 kHz clone of the same 48 kHz master on the record bus.

Note, however, that a bus without the process module switched to it is essentially a "straight wire" distributed path, and does not receive any software conversion.

The VSP-P's sample rate converter is

engaged by a front panel button and accepts any incoming frequency rates between 32 kHz and 56 kHz. According to the product literature, the VSP-P accepts "non-standard rates typical of varispeed sources" and outputs a 44.1 kHz signal.

Passing the test

In our tests, we fed a 48 kHz DAT into the VSP-P's AES inputs, thru the converter, and into our loaner Marantz CDR-610 CD recorder's AES input. The CDR-610 locked immediately to the VSP-P's output signal and made a flawless conversion all though the CD recording process. We heard no degradation of the converted signal in our subjective listening tests. The quality of the

affect short-term clock accuracy in CD players and DAT transports.

No jitter

Routing signals thru the VSP-P's sample frequency converter—even material already at 44.1 kHz—will eliminate this jitter by relocking the signal to the VSP's internal crystal controlled clock.

Unfortunately, some digital devices demand an extremely well-regulated sample frequency above the AES standard, and are not immediately usable with the VSP's converter.

In our initial test, we connected a Sony 7030 DAT recorder's AES output into the VSP-P and fed the VSP-P's AES output to a Sony 7030 DAT recorder's AES input. The object was to make a 44.1 kHz



Digital Domain President Bob Katz created the VSP-P out of necessity.

sample rate converter makes the VSP's \$2,000 list price a bargain.

The product literature for the VSP-P introduced another use for its sample rate converter: jitter elimination. As all digital signals depend on precise clock pulses to manipulate the data in an orderly fashion, any disturbance of the clock will adversely affect the audio—typically by high-frequency distortion and lowering of the signal-to-noise ratio.

According to designer/engineer Bob Katz, a digital device's clock instability can be produced by noise in a digital interface, ground loops and mismatched impedances between source and load in a transmission system, and power supply deficiencies that

clone of a 48 kHz tape. While recordings were possible with the sample rate converter bypassed, the recording DAT machine would not lock to the VSP-P's signal and refused to record at 44.1 kHz.

Katz explained that the problem was with the narrow frequency tolerance of the Sony 7000 series, and that an internal VSP-P trim capacitor adjustment is necessary. Such an adjustment, according to Katz, can be made in the field with a suitable frequency counter, or easily made at the factory.

□ □ □

For more information on the Digital Domain VSP-P, contact Bob Katz at 212-369-2932; or circle Reader Service 165.

63 Years Ago

Reprinted from Radio World (June 6, 1931).

Editor's note: The RW of old, printed for a time in the 1920s and 1930s and today's RW are unrelated except in name.

TRADE FLOCKS TO SHOW, FULL OF ENTHUSIASM

Chicago.

From all parts of the United States and Canada, as well as from across the seas, radio manufacturers, jobbers, dealers and others interested in the trade gathered in this city to attend the fifth annual Radio Trade Show. More than 150 manufacturers had contracted for booths at the show, which was held in the Stevens Hotel, under the auspices of the Radio Manufacturers Association. More than 20,000 manufacturers, jobbers and dealers were expected to visit the show.

Much interest was shown in the advance being made in preparation for the commercial advent of television, particularly as there were some televisions for exhibition, and also television tubes, including photo cells for transmission and neon lamps for reception, besides other apparatus, e. g., scanning discs, screens and short-wave receivers.

Interest in Tubes

Tubes came in for their just share of attention, interest focusing on the new exponential or variable mu tube, the 235, which, in circuits that vary the grid bias or the screen voltage, serve to reduce greatly interference due to crosstalk and crossmodulation, also hissing sounds and other extraneous noises. The tube is exclusively a radio frequency amplifier, in its present use. It is not serviceable as a detector, and its use as an audio amplifier has not been encouraged.

Another tube that had the attending forces talking was the pentode, a power tube that has higher sensitivity than any other used in broadcast sets. This tube provides much more volume for a given input than does the 245. There are also a 2 volt pentode for battery sets (233) and a 6.3 volt one for autos (238).

Optimistic on Business

Midget sets, which comprised about half the set market for the present season, appeared with the new tubes in them, for the coming season, when it is expected the compact mantel type receiver and the pier clock or thin upright models for floor use will absorb 75 per cent. of the set business.

Members of the trade were optimistic of business conditions, frankly admitting they are not good now, but reporting improvement, with expectation of gradual restoration of more auspicious conditions. The worst was over, was the consensus, and business will improve until it becomes actually good, around the holidays.

Lower prices prevail in all lines. Sets and tubes were outstanding in their lower prices, compared with last year. Parts also are at lower list prices. There was considerable interest in parts, including assemblies from kits for which parts manufacturers supplied the components.

Other Bodies Meet

The Institute of Radio Engineers held a convention at the same time, and the annual Furniture Mart, due to the close association of the furniture and the radio industries, added to the radio trade show attendance. Radio manufacturers' associations held meetings, as did the Newspaper Radio Editors' Associations and the Radio Press Association.

See The
New EBS System
In Booth 2800

**SAGE
ALERTING
SYSTEMS**

VACUUM CAPACITORS

**Broadcast Capacitors for transmitters,
couplers and phasers**

- Variable or Fixed Capacitance
- Capacitance Ranges from 3 pF to 6600 pF
- Peak Test Voltages from 3 kV to 100 kV
- Current Ratings to 1000 Amperes
- Custom Designs Available on Request

COMET NORTH AMERICA, INC.

11 BELDEN AVE. • NORWALK • CT • 06850
203-852-1231 • FAX: 203-838-3827

Circle (75) On Reader Service Card

PRODUCT GUIDE

Companies with new product announcements for Studio Sessions Product Guide should send them to Radio World, c/o Studio Sessions Editor, 5827 Columbia Pike, Suite 310, Falls Church, Va. 22041

► continued from page 21

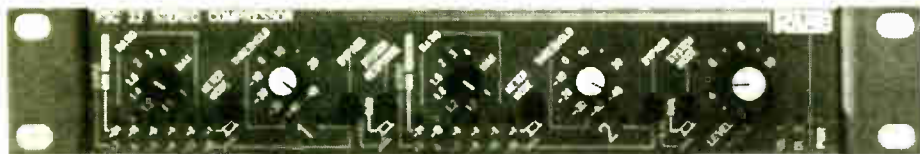

Rane FSC 22 Stereo Compressor

The Rane FSC 22 is housed in the compact HR module for vertical or two-across 19-inch rack mounting. Features include separate threshold and ratio controls for each channel as well as switchable attack/release time and dual function metering. The FSC 22 uses Analog Devices VCAs.

For more information, contact Ellen Allhands at Rane, 206-355-6000; or circle Reader Service 162.

WELCOME TO THE DIGITAL WORLD OF DIGILINK

- Replace cart machines live On Air while adding walkaway CD, Satellite, or Tape automation
- On Air Base Price starts under \$8,000
- 8 Track Editor base price starts under \$5,500
- Smallest systems start at 10 hours stereo audio storage (20 hours mono)
- Network more than 15 Digilink workstations

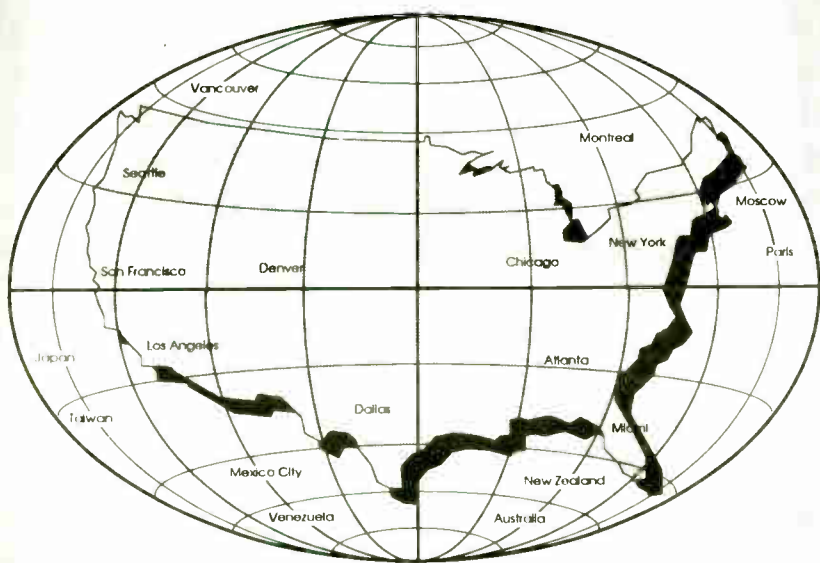

With over 500 workstations sold worldwide in the last 18 months and more than 400 of those workstations sold in the U.S.A, it is little wonder that Digilink is the #1 choice for a digital audio hard disk workstation for professional radio broadcasting. Whether for On Air, Production, News, or Automation... Digilink does it ALL.

For more information about the #1 selling digital audio workstation for Radio, call or write...

303-224-2248

ARRAKIS

© 1993 Arrakis Systems inc. 2619 Midpoint Drive, Fort Collins, CO. 80525

Electro-Voice RE36ND Microphone

The RE36N/D is a low-profile cardioid microphone, designed for broadcast, sound reinforcement and production applications.

The mic features the Dynadamp-based vibration-isolation system and hum-bucking coil.

For more information, contact Electro-Voice at 616-695-6831; or circle Reader Service 88.



Alesis Monitor One Studio Monitors

The Monitor One features a 6.5-inch woofer and one-inch silk dome tweeter. The speakers is only 8.5 inches tall, but can produce 45 Hz to 18 kHz (within 3 dB). The outside coating is made out of non-slip polymeric rubber. The pairs are sold mirror imaged.

For more information, contact Alesis at 310-558-4530; or circle Reader Service 94.

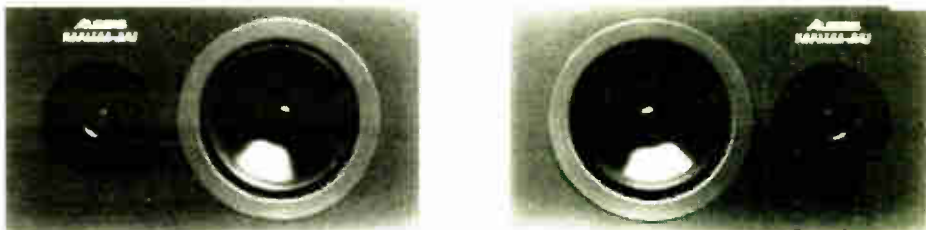

Demeter VTMP-2b Tube Mic Preamp

The Demeter VTMP-2b is said to provide the sound of the classic Neve and API preamps as well as modern 990 op-amp. based mic preamps.

The two-channel features Jensen JT-13K6C input transformers, polypropylene capacitors, metal film resistors among its components. Controls include, variable gain, 20 dB mic pad, rotary faders, LED peak indicators and switchable 48V phantom 48V power.

For more information, contact Demeter at 818-986-7103; or circle Reader Service Number 122.



BIG...RICH...FULL DIMENSION CONCERT SOUND

The CP2013 is the only composite processor with a fast, peak responding AGC. *Why?* Because most AGC amplifiers are too "envelope destructive" to be used this way.

The Benefits?

- Incredible spatial effect due to enhanced L-R
- Eliminates excessive subsonic energy
- Much cleaner than conventional composite clippers
- 1.5dB louder, due to low second harmonic clipper, converts "would be" distortion into useful modulation.



Other features include two composite outputs, and a new zero phase shift pilot feed-through circuit requiring no setup.

BIG SOUND...MEANS BIG NUMBERS
CALL NOW!!

HNAT HINDES inc

42 Elaine St., Thompson CT 06277
203-935-9066 or 203-935-9242
FAX: 203-935-9919

Products & Services Showcase

For more information on the products shown below, circle the appropriate Reader Service No. (s) on the enclosed Subscription/Reader Service card or contact the advertiser directly.

INTELLIGENT TRANSMITTER OPERATION

INTELLIGENT DIGITAL REMOTE CONTROL. The ITO177 from Hallikainen & Friends, allows fully automatic operation of a Moseley TRC-15 remote control equipped with a TEL171 Digital Telemetry Adaptor. The ITO177 plugs into the memory expansion port of a Commodore-64 personal computer and to the TEL171 data port. Automated transmitter site control of the TRC-15 and access to the meter reading displayed on the TEL171 is by BASIC statements and functions built in to the ITO177. An "auto-boot" feature allows the control program to re-load and run in the event of a power failure. 2K of nonvolatile memory saves information from power loss. Make the intelligent choice today based on time tested tradition.

See Us At NAB Booth 1712

ITO177
PROGRAMMABLE EXPANDABLE AFFORDABLE

HALLIKAINEN & FRIENDS
141 Suburban E4, San Luis Obispo, CA 93401-7590 USA
805-541-0200

READER SERVICE NO. 61

CONSOLE UPGRADE WITHOUT THE BIG EXPENSE

COST COMPARISON

Approach digital quality with your yesteryear audio console by using BDI plug-in retrofit electronics. If the cost of a new console is depriving you of a competitive air sound then BDI electronics are the answer. Better headroom, lower noise, lower distortion, dynamic range approaching 90dB and improved reliability are just some of the advantages of our easy to install upgrades. Call us today direct for a competitive air sound tomorrow!

Our retrofit electronics currently support most:

- Gates/Harris Consoles
- RCA Consoles
- McMartin Consoles
- McCurdy Consoles

bdi Broadcast Devices, Inc.
5 Crestview Avenue
Peekskill, NY 10566 (914) 737-5032

READER SERVICE NO. 23

NEW!!! from AVCOM
PSA-65A Portable Spectrum Analyzer & SCPC-2000E Single Channel Per Carrier Receiver

PSA-65A Portable Spectrum Analyzer - \$2855
AVCOM's PSA-65A Portable Microwave Spectrum Analyzer covers a frequency range from less than 2MHz to 1000MHz. The broad frequency coverage and high sensitivity of the PSA-65A make it ideal wherever a low cost, compact spectrum analyzer is needed. The light weight, battery or line operated PSA-65A Portable Spectrum Analyzer from AVCOM is the perfect instrument for field testing of RF systems, classroom instruction, satellite system alignment, electronic countermeasures, cable TV maintenance, cellular and production use.

SCPC-2000E SCPC Satellite Receiver - \$1875
AVCOM's Single Channel Per Carrier Receiver, model SCPC-2000E, has been developed for the reception of FM SCPC signals from satellites operating in the 3.7 to 4.2 GHz band. The SCPC-2000E is a complete receiver that can tune up to 4 specific crystal controlled audio or data channels from a given transponder and adapt to a variety of de-emphasis requirements. The SCPC-2000E is available in either wide or narrow band models and may be used with the SS-1000 (\$1027) Slave for simultaneous reception of additional channels.

AVCOM OF VIRGINIA 500 Southlake Blvd. Richmond, VA 23236 U.S.A.
Bringing High Technology Down to Earth Phone 804-794-2500 / Fax 804-794-8284

READER SERVICE NO. 1

Shively

A good FM antenna is crucial to quality broadcasting. An antenna that is merely adequate will compromise the performance of even the best studio equipment and transmitter. Shively regularly includes standard features that other companies either provide only as options or simply do not offer. At Shively, we design and build antennas of uncompromising technical quality and performance. And, we build them to last.

See Us At NAB Booth 4224

call or write for more information

Shively Labs

A Division of Howell Laboratories, Inc.
19 Harrison Road, Bridgton, ME 04009
207-647-3327 FAX 207-647-8273

READER SERVICE NO. 213

PORTABLE OFF SITE EBS MONITOR \$350⁰⁰

Tuneable AM/FM Receiver and FCC Certified Decoder Model C.D.

See Us At NAB Booth 4812

Ideal for use during hours of unattended operation at the studio and transmitter site. With modern remote control equipment the alert message can be put on the air with a telephone. Decoder in a minibox (price \$250⁰⁰) is available for use with receiver of your choice, or the decoder can be driven by phone line audio.

Gorman Redlich Mfg. Co.
257 W. Union St. Athens, Ohio 45701
FAX 614-592-3898 • Phone 614-593-3150

READER SERVICE NO. 26

Excalibur Electronics CDA-1

Composite Distribution Amplifier

This 1 in, 3 out distribution amplifier allows you to distribute stereo composite and/or subcarrier signals as easily as audio.

- DC-100 kHz frequency response
- 90 dB signal/noise ratio
- +6 dB to -20 dB gain range
- Individual 20-turn output trimmers
- 1 3/4" rack mount enclosure

EXCALIBUR ELECTRONICS, INC., CHANTILLY, VIRGINIA
Please circle our bingo number for a data sheet and a dealer list.

READER SERVICE NO. 45

TOWER AND OBSTRUCTION LIGHTING PRODUCTS

FLASHER FS155-30T

ALARM RELAY SCR430T

SHORTED FLASHER ALARM SFA430T

PHOTO CONTROL PCR11

SSAC offers a complete line of solid state products to control and monitor the lights on communication towers and other tall structures. SSAC solid state products have proven performance and reliability with years of infield use. Flash single or multiple beacons. Sense lamp failure in the beacon, side lamps, or other obstruction lighting with an alarm output. The PCR11 Photo Control with its all plastic housing is ideal for turning on complete tower lighting at dusk (factory calibrated).

PHONE OR WRITE FOR FREE TOWER CONTROLS MANUAL
TELEPHONE (315)638-1300 • FAX (315) 638-0333

SSAC P.O. Box 1000 • Baldwinsville, NY 13027

READER SERVICE NO. 197

CD Storage Systems

Rugged ABS cabinets designed for high density storage of CD's. Storage from 500 to over 1000 per cabinet, based on storage format and type of CD.

CD DENON CD-ROM BERNOULLI

Built-In Non-Breakable Aluminum Dividers

Tape Storage Systems
Tripp Communications Sales • TCS
P.O. Box 5267, Walnut Creek, CA 94596
Tel: 510-256-6006 Fax: 510-256-6007

READER SERVICE NO. 190

Make Your Own CDs with Marantz CDR-610

► continued from page 22

to control such things as REC, START, STOP and TRACK INCREMENT on the CDR-610.

By wiring the TRACK INCREMENT pins to the DAT's START ID SENSE pins on the 7010's rear panel connector, we let the TRACK INCREMENT occur when the DAT read each START ID on the tape. The dub was started and left unattended. After fixup, the CD was played at random cuts, one to 99 (although there were over 99 START IDs on the tape, the CDR-610 will not increment tracks beyond 99).

All tracks played without upcut as expected. The delay between TRACK INCREMENT and audio is lengthened using this method—probably because of processing delays in the CDR-610. The manual method will give better, tighter cueing, but requires more effort. When this many tracks are present, the user should expect noticeable "seek" time when skipping from one track to another.

HHB indexer

We also tried DAT-to-CD-R cloning, using the Sony DAT at 44.1 kHz passed through an HHB CDR Indexer, available from Independent Audio. The HHB Indexer is one of a growing number of add-on devices that help dubbing digital material to CD-R.

While its primary function is to trigger

track increment commands from a DAT source, the HHB indexer also can manipulate AES status flags. In this test, the IEC output from the DAT was fed into the HHB indexer, and the IEC output fed into the CDR-610.

During dubbing, the HHB recognizes DAT START IDs within the IEC code, and translates the start ID data into TRACK INCREMENT data, which the CDR-610 will recognize. In this way, consumer DATs can easily trigger a track increment without having to have an exterior control connector.

More features

An additional feature of the HHB, which may be unacceptable to those needing tightly cued track increments, is a delay of 185 milliseconds in the digital signal passing through it. HHB literature ascribes this delay to the translation of the data stream, and to compensate for users' late ID marks on DAT tapes which have been created by a DAT's AUTO-ID feature. After fixup, there was a short, but noticeable delay between the start of the track and the start of the audio.

The HHB can also interface AES/EBU signals for CD recording, but the DAT must have a START ID SENSE pulse output that needs to be plugged into the HHB. The HHB then sends IEC signals into the CDR-610 as before, translating the DAT's START ID hardware pulse

into a IEC increment command recognized by the CDR-610.

In summary, no matter what method you use to feed audio to the CDR-610, affordable CD-R technology is here for the professional, and it is up to the artisans, production folks and consumers to put it to work.

For more information on the HHB CD-R indexer, contact Independent Audio at 207-773-2424, or circle Reader Service 13.

□□□

Rich Rarey is technical director for National Public Radio's Weekend Edition and a contributing writer to RW.

New Microphone Preamps From Benchmark and dbx

► continued from page 19

used in the 760X. So, if you're planning on recording glockenspiel or the local symphony, the extra engineering is probably worth consideration. I don't have a glock in the studio, so I proceeded with testing the two preamps by plugging their line level directly into my AKG/Orban DSE-7000 workstation (15 kHz bandwidth) and recording voice tracks with a good condenser microphone.

How they sound

Both preamps sounded remarkably similar. If there was any difference in frequency response of the two preamps, it was above the 15 kHz limitation of the workstation or lost in the dithering.

In an effort to eliminate workstation artifacts from obscuring the results, I fed

a nominal amount of tone through both preamps, matched their output levels, and fed them to a balanced set of monitors.

The Benchmark produced slightly less hiss than the dbx with both preamps' inputs unterminated. With the dbx input terminated and the Benchmark unterminated, the hiss levels of both preamps were equal. The Benchmark, when terminated, was noticeably quieter than the unterminated dbx.

Would the difference be noticeable if both preamps had to make their way through your console or if the signal ever hit analog tape? Probably not. Both boxes have their advantages and, as usual, perfection has its price.

□□□

Ty Ford's book, "Advanced Audio Production Techniques," is available by calling 800-366-2665.

**50
DIGITAL
STEREO
TRACKS
UNDER
\$4,000!**

~And We'll Prove It!



Plays 50 simultaneous stereo tracks without bouncing!

- Add to your 386/486 computer
- Up to 2,900 segments available per project
- Non-destructive, precision digital edits in under a second
- -110 db noise floor & phase-linear filters
- Non-brittle, crystal clear sound quality
- Backs up to audio DAT
- Easy to install, easier to use!

"Excellent sonic quality... incredible freedom"
EQ Magazine, October 1993



Complete Work Stations Available!

Call For Your Free Catalog Today!

919/870-0344

FAX/870-7163

MICRO SOUND
Digital Audio Workstations



Micro Technology Unlimited • P.O. Box 21061 • Raleigh, NC USA 27619-1061

Circle (32) On Reader Service Card

World Radio History

Value

R A D I O M I X E R
P R O D U C T I O N M I X E R



Many broadcasters know that PR&E provides the consoles and systems for market-leading radio stations and network facilities throughout the world. Unfortunately, with a client list that reads like a "who's who" of the industry, some broadcasters with more modest budgets feel that PR&E consoles are out of their reach. We'd like to introduce you to Radiomixer™, a first-class on-air console at a coach-class price.

Created by the same team of designers and engineers responsible for major-market "showcase" facilities, Radiomixer offers the reliability, performance, and many of the features of our world-famous BMX, at a price guaranteed to satisfy the most demanding budget. Using top quality components, Radiomixer delivers advanced features including the most elegant telephone mix-minus system available, along with uncompromising sound quality and reliability.

And when you add multitrack production power on top of the Radiomixer's standard features, you have Productionmixer, the most affordable high-performance production console in broadcasting. There isn't another console family in the price class that can offer the total value of Radiomixer and Productionmixer.

Why settle for less, when you can have genuine PR&E features, quality, reliability and service? Call today for your full color brochure.



Pacific Records & Engineering Corporation
2070 Las Palmas Drive, Carlsbad, CA 92009
Tel: 619-438-3911 Fax: 619-438-9277 GSA: GS-03F-2057A

DESIGNS THAT MAKE THE DIFFERENCE

Circle (123) On Reader Service Card

World Radio History

See Us At NAB Booth 3612

THE RECORDABLE CART GOES DIGITAL! INTRODUCING THE DENON MD CART.

As the company that first employed digital technology to record music, it's not surprising that Denon has become the broadcast standard for on-air CD playback with its CD Cart™ Players. Now, Denon is about to repeat its ground-breaking tradition with the introduction of Denon MD Cart™ Recorders and Players.

Based upon digitally recorded, removeable MD technology, Denon has created the DN-990R MD Cart Recorder and DN-980F MD Cart Player... and in the process has effectively replaced the 25 year-old NAB Cart.

Erase and re-record for commercial/spot production and playback using widely available blank MDs. Record and re-record with CD-like sound quality, durability and reliability.

Audition Denon MD Cart machines today. And remember, whenever digital broadcast equipment is made better, it will be made by Denon.

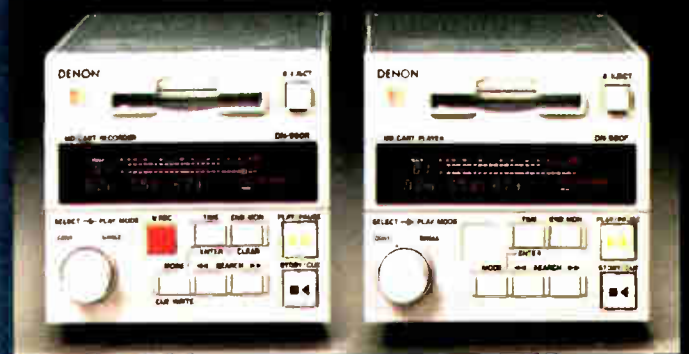

DENON
The First Name in Digital Audio



PREVIEW

"INNOVATION EVERYWHERE YOU TURN!"

Sunday, March 20 — Thursday, March 24 • Las Vegas Convention Center

INSIDE THIS SECTION:

Product Stories • Interviews • Exhibitor Directory • Previews

NAB Exhibition Is Broadcast Tech Mecca

Digital and Analog Topics Will Dominate The Engineering Conference at NAB

by Andy Butler

LAS VEGAS Radio engineers will find a vast assortment of technology seminars and programs at the National Association of Broadcasters (NAB) convention

Effects. The SMPTE sessions are a full multimedia experience that includes extensive audience participation. Be sure to sign-up early before the limited number of slots are gone.

The cost of the SMPTE workshop is

included in the normal conference registration fee for NAB '94.

Methods and procedures

The Broadcast Engineering Conference opens on Sunday, 20 March at 9 a.m. with remarks by veteran consulting engineer Jules Cohen. In a career spanning more than 40 years, Cohen is instrumental in developing many of the methods and procedures that have defined the broadcast industry. He now plays a crucial role in developing viable RFR exposure measurement procedures for broadcasters. Find out what he sees coming in the future as he reflects on Broadcasting: Past, Present and...?

Digital telephone and satellite services have dramatically increased options for transporting high-quality audio. WMAQ Director of Engineering Margaret Bryant assembled a group of experts to explore alternatives in ISDN and T-1 Transmission, beginning at 9:30 a.m.

Angela DePascale begins with an overview of industry commercial delivery over ISDN. Jim Switzer from RE America

offers practical suggestions for picking the best digital alternative in New Broadcast Decisions: Digital Network Costs Versus Required Bit Rate for Desired Audio

continued on page 35 ▶



March 20-24 at the Las Vegas Convention Center.

Beginning with a special series of pre-convention seminars on Saturday, 19 March and continuing with The Broadcast Engineering Conference and NAB MultiMedia World '94 Sunday 20 March through Thursday 24 March, relevant information will abound to help you make the right decisions in 1994.

IEEE tutorial

On Saturday, 19 March at 9 a.m., The Institute of Electrical and Electronic Engineers (IEEE) Broadcast Technology Society will present the Digital Transmission Tutorial. This in-depth seminar is designed to ease the transition from today's broadcast technology to tomorrow's.

Charles Meyers from Boonton Electronics and John Hernandez from Public Broadcasting Service (PBS) expanded the tutorial that played to rave reviews at the Broadcast Technology Society's symposium in Washington last September. It now includes an Introduction to Digital Transmission, Survey of Modulation Techniques, Applications and Examples of Digital Transmission Technology, and Test Methods for Digital Transmission System Performance.

Attendees registered for any conference at NAB '94 can attend the IEEE tutorial without additional charge.

The Society of Motion Picture and Television Engineers also will be active at NAB on Saturday, presenting the SMPTE Post Experience. This day-long seminar takes attendees on a detailed tour of the world of video post production. Radio engineers will be interested in the sections on Digital Sound Editing, Foley Artistry, Automated Dialog Replacement and Audio

Highlights of NAB '94

▶ continued from page 1

help stay ahead of competitors. Legal, programming, financial, personnel, sales and marketing guidance all will be offered. Meetings will be held Sunday through Thursday.

On Tuesday, the Society of Broadcast Engineers will hold a full day of educational sessions for broadcast engineers, including an in-depth program dedicated to technical problem solving.

The Broadcasters' Law and Regulation Conference includes top communications lawyers and FCC officials discussing and analyzing issues and government regulations. Sessions include the latest information on retransmission consent and must-carry, fairness doctrine, duopolies and LMAs, children's television and other emerging issues. Meetings will be held Monday through Wednesday.

Among seminar highlights are engineering sessions on digital audio processing systems, data broadcasting, digital audio workstations, ISDN and T-1 transmission, towers and transmission equipment, and an RFR update.

Two engineering seminars on digital audio broadcasting (DAB) will be held. The first looks at multipath propagation test results and a status report on DAB testing in the U.S. The second seminar includes updates on various DAB system tests, including a report from Paul Ratliff of the British Broadcasting Corp. (BBC) on the recent Eureka-147 trials in London. DAB system updates will also be made by NASA/VOA, AT&T, Amati Communications, USA Digital Radio FM and USA Digital Radio AM.

An engineering session on satellite and auxiliary services also is scheduled. Wegard Holby and Noah Samara of Worldspace will discuss direct broadcast satellite sound and Anthony Campbell of Andrew Corp. will discuss how the new FCC rulings for earth stations will impact broadcasters.

Two seminars will attempt to demystify new technology for broadcasters. In the first, radio managers will discuss what technologies on the exhibit floor are important to radio. In the second, multimedia experts will explain what equipment in the Multimedia World exhibition will affect the future of radio.

Several sessions are dedicated to selling, financing and promoting radio, including a meeting with the Best of the Best Radio Promotions contest winners.

Other seminars, meetings and events include the Broadcast Education Association Convention, HDTV sessions, production and post production sessions, idea swaps, and the NAB and Interactive Multimedia Association's joint NAB MultiMedia World.

Two new Saturday seminars were added to NAB this year. On March 19, the SMPTE Post Experience promises a day-long, detailed tour of the world of post production. Also on the 19th is a new half-day seminar sponsored by the Institute of Electrical and Electronics Engineers (IEEE) broadcast technology society. The IEEE seminar includes a survey of modulation techniques and an introduction to, applications of, test methods for and a demonstration of digital transmission technology. Both seminars require full NAB '94 conference registration.

Question: Ever wonder why transmitter manufacturers operate Altronic dummy loads at NAB and other trade shows?

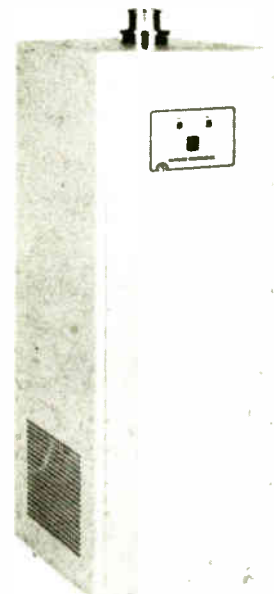

Answer: The best performance and the most dependable dummy loads built.



ALTRONIC RESEARCH INC.

WATER AND AIR COOLED MODELS FROM 1000 WATTS TO 1,500,000 WATTS

P.O. Box 249 Yellville, AR 72687 (501) 449-4093

Circle (189) On Reader Service Card

Here's To A Great Broadcast Future!



Now that TTC is part of LARCAN we've got a lot to celebrate, because we've combined the resources of two great transmitter companies. On the radio side, we already have more solid state FM transmitters in the field than all other domestic companies. In TV, LARCAN is today's market leader with the popular M Series solid state VHF transmitters and our new cutting-edge solid state UHF line. LARCAN-TTC excels with the ultra-efficient, high power UHF HDR Series IOT transmitters and our complete low power UHF/VHF lines. And LARCAN-TTC is definitely HDTV-ready—*right now*. The engineering resources and corporate strength of LARCAN-TTC will insure you a great broadcasting future. Visit us at NAB '94, booths 15758 and 15708 to see products worth celebrating.

LARCAN TTC

LARCAN: 228 Ambassador Drive, Mississauga, Ontario L5T 2J2
TEL: 905-564-9222 FAX: 905-564-9244

LARCAN-TTC: 650 S. Taylor St. Louisville, CO 80027
IN U.S.: 1-800-TTC HDTV TEL: 303-665-8000 FAX: 303-673-9900

High Power U.S. Sales: LDL Communications:
14440 Cherry Lane Court, Laurel, MD 20707 TEL: 301-498-2200 FAX: 301-498-7952

Circle (119) On Reader Service Card

World Radio History

SBE, IEEE and SMPTE Take Part in Sessions

► continued from page 33

Bandwidth and Quality.

Steve Church from Telos Systems considers the effects of digital data compression in ISO/MPEG Layer III Audio Coding and ISDN. Lynn Distler of Comrex Corp. will then brief you on Selecting a BRI ISDN Terminal Adaptor. Doug Lane, in charge of technical support for the National Basketball Association and an early user of switched 56 technology, will discuss the latest transmission system changes in the NBA, changing from Switched 56 to ISDN.

John Kelly from Intraplex will conclude the session with a look at The Growing Importance of Digital Transmission for Broadcast Applications.

Information highway

Your station can act now to stake out a position on the "information highway." Find out how when Chairman Jim Ary from Great American Communications presents Data Broadcasting: Radio on Sunday at 9:30 a.m. A series of presenters will discuss the latest developments in data transmission, including David Kelley with Terrapin Corp.'s global positioning system; Gary Gaskil with the Seiko High Speed Subcarrier System; Tetsuro Miyazaki with NHK's Multiplex Data System; and Miller Gardner with Mainstream Data's information service.

Data services can earn substantial revenues today and pave the way for even greater returns in the future.

The emphasis shifts from digital data to digital audio on Sunday afternoon as Fred Morton from KMGZ-FM hosts Digital Audio Workstations and Storage at 1 p.m. Production guru and RW writer Ty Ford opens with, Confessions of a Digital Workstation User.

Laura Tyson of Broadcast Supply Worldwide follows with Saving the Goods: A Survey of Digital Storage Alternatives. Jeff Wilson from Digital Audio Labs has suggestions to help convert a desktop computer into a production powerhouse in Configuring a Digital Audio Workstation for Broadcast. Jim Hauptstueck from Harris Allied follows with a detailed study of Technology that Pays—Evaluating Digital Alternatives.

As industry debate continues over the

audible effects of transcoding errors, Richard Becvar from California Digital Audio Systems presents an interesting alternative in, "A Systems Approach to Non-transcoded Audio Delivery" (see page 68). Willem Bakker from International Tapetronics concludes the session with his profile of A New Device for Digital Audio Storage.

Monday morning, following a convention keynote by new FCC Chairman Reid Hundt, radio engineers will return to the Broadcast Engineering conference at 10:30 a.m. for Digital Audio Processing and Systems, hosted by Carl Davis from Voyager Communications.

Geoffrey Mendenhall of Harris Allied kicks off the morning with suggestions for maintaining a 100 percent digital path from the studio to the "on-air" RF signal. Greg Urbiel from CBS Radio updates participants on international standards activities with State of the Standards: Coding and Connectivity.

Robert Orban shares thoughts on utilizing second-generation transmission processors for audio and Eric Benjamin from Dolby Labs concludes the session with his consideration of the interaction of audio processing and low bit-rate coding for broadcast applications.

The management tasks facing broadcast engineers have changed dramatically in recent years. Keeping up to date on the latest equipment and design techniques just is not enough. Margaret Bryant of WMAQ radio offers an overview of critical non-technical challenges in her session, Managing in Broadcast Engineering at 10:30 a.m.

Gerry Robinson from Hearst Broadcast-ing has a stern wakeup call for his fellow engineers at 1 p.m. during his session on towers and other transmission support equipment. Craig Snyder from Sioux Falls Tower addresses the topic, Understanding and Preventing Guyed Tower Failure due to Anchor Shaft Corrosion.

J. Cabot Goudy from Structural Systems Technology continues with Controlling Corrosion on Broadcast Towers: A Subject you Can't Afford to be Rusty On.

Once you are sure the tower is okay, your next step is inspection, maintenance and troubleshooting of UHF/VHF/FM Antennas by A.J. Skalina of Dielectric Communications. Ronald Tellas from

Andrew Corp. wraps up with a look at a new solution for burning bullets in his survey of the Performance of a Transmission Line Having a Rigid Outer Conductor and a Corrugated Inner Conductor.

Near your tower or on the other side of town, you are responsible for protecting the public from harmful levels of radio frequency exposure under the proposed new RFR guidelines. As debate over the standard rages in the industry, NAB's Kelly Williams gathers a group of experts to share their opinions during the RFR Update beginning at 3:30 p.m. Monday.

The panel, produced in cooperation with the NAB Legal Department, will include Dr. Robert Cleveland from the FCC in Washington, Bill Hammett from Hammett and Edison Consulting Engineers, Jules Cohen of Jules Cohen and Associates, Richard Strickland from Loral Microwave-Narda Corp., Dave Baron from Holaday Instruments and David Hilliard of Wiley, Rein and Fielding in Washington.

This diverse group represents every possible viewpoint on RFR; consulting engineers, federal regulators, communications lawyers and measuring instrument manufacturers. Be sure you know enough to protect yourself as the new standards take shape.

SBE Day

Tuesday, March 22 is SBE Day at NAB '94. All of the day's sessions are organized and supervised by the Society of Broadcast Engineers, a professional society for technical personnel in broadcasting and related industries.

There is a lot of life left in traditional technologies; a session on AM/FM improvement, hosted by independent technical author and consultant Jerry Whitaker, brings you the latest ideas for improving your station's performance. Walter Johnson from Voice of America (VOA) has made an exhaustive study of techniques to extend the service life of high-power vacuum tubes. You will be amazed at the possibilities. No matter how much power you make, it is wasted if your anten-

na system shoots most of it into space. Find out how to improve your antenna's performance when Jim Cutforth, PE, presents Broadband Implementation of a Physically Short, Highly Top-Loaded Anti-Skywave Antenna.

Even the best designed antenna system needs some extra care and attention. Tom Osenkowsky has just the right prescription in his Tuneup Guide for AM Broadcast Antennas. Your antenna is only half of your signal delivery system. Larry Paulausky looks at maximizing the hidden half in Modern Practical Techniques for Installation and Repair of AM Antenna Ground Systems.

Despite advances in transmit antenna system design, FM stations are still haunted by the multipath devil. The answer may lie at the receiving end. Richard Zerod from Ford Motor Co. offers help with FM Diversity Reception Systems. Everybody is talking about DAB but digital starts long before the transmitter. Engineering Consultant Skip Pizzi has tips for the front end in Preparing for Radio Multicasting and the R-LAN Environment.

The tests are over, bushels of reports have been filed and the industry is waiting for a final verdict on EBS. On Tuesday afternoon at 3:30, consulting engineer Dane Erickson from Hammett and Edison brings you the latest on The New EBS System.

Paul Montoya from Broadcast Services of Colorado opens the session with his report on Testing the New Technologies for Emergency Alerting Systems. The FCC's Richard Smith continues with his observations in This is No Longer a Test. The new EBS includes cable systems. Ken Wright from Jones Intercable considers how that portion of the new system will work in cable TV and the new EBS. Nothing will work if your operators can't understand it.

Richard Rudman from Group W has some practical advice for the industry in User Friendly EBS. Canada also has overhauled its emergency systems. Patricia Lok from Metromedia profiles its progress in All Channel Alert: Canadian Emergency Broadcast System. The session concludes with a final look at the testing process for

continued on page 75 ►

TXL-110, TXL-210

Transmission Limiters

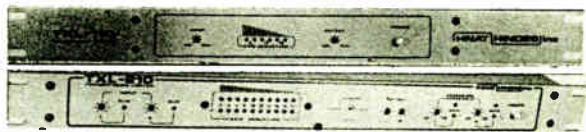

ENVIRONMENTALLY SAFE... NO EAR POLLUTION...
Just CLEAR, BIG DIMENSION SOUND.

Today's digital audio imposes a new requirement on broadcast transmission systems, particularly audio processors.

The TXL series Transmission Limiters are designed to preserve your program resource and deliver it intact to the transmission system, without the familiar processing residue that cost rating points.

The TXL series limiters are also safe to your FINANCIAL ENVIRONMENT... (No slick, multicolor full page ads to pay for).

CALL TODAY... For more on the TXL-110 & TXL-210 capabilities.

HINAT HINDES Inc

42 ELAINE ST., THOMPSON, CT 06277
203-935-9066 / 9242 FAX 203-935-9919

Circle (104) On Reader Service Card

EMF METERS

NEW
HI-4000
RF/MW HAZARD
MEASUREMENT
SYSTEM
from **HOLADAY**

The HI-4000 RF/MW Measurement System introduces fiber optic technology to minimize field perturbation in RF & Microwave hazard measurements. A fiber optically isolated remote readout/control is used with Holaday's electric and magnetic field probes to provide a wide range of field measurements.

- Wide Frequency Response (10 kHz - 40 GHz)
- Wide Dynamic Range • LCD Readout in selectable electric and magnetic field measurement units • Datalogging
- Recorder Output (0-5 VDC) • Rechargeable Batteries
- Optional Computer Interface

For further information, call or write:



HOLADAY INDUSTRIES, INC.
14825 Martin Drive, Eden Prairie, MN 55344
612/934-4920 Fax 612/934-3604



Circle (87) On Reader Service Card

Morgan Ushering in New Technology

Charles T. Morgan will be the recipient of the NAB Engineering Award for Radio for 1994. Morgan is senior vice president and vice president of engineering for Susquehanna Radio Co. which operates 16 radio stations throughout the U.S.

He has been chairman of the National Radio Systems Committee (NRSC) for the past eight years and has been instrumental in a number of broadcast industry standards, including those affecting AM and the recent RBDS (Radio Broadcast Data Service). He also has authored six books on radio broadcasting.

Morgan's career began in his hometown of Pittston, Pa., in 1953, when he helped build the community's first radio station. The father of three children, Morgan currently resides in Avoca, Pa., with his wife Genevieve.

Recently, News/Studio Sessions Editor John Gatski talked to Morgan about his career, the current state of radio and the NRSC.

RW: How did you decide on a career in radio?

Morgan: I first developed an interest in radio and electronics while in high school. This interest led me to a technical school that offered curriculum on all aspects of radio and TV including the preparation for obtaining an FCC license. I became more interested in the broadcast end of the business, and shortly after receiving my first class ticket, a job became available at a

new station in my hometown. I took the job and have been broadcasting ever since.

RW: What particular aspect of engineering interested you when you first started out?

Morgan: My first job was to help build a new station and, I guess, that has always been the part of broadcasting that I liked best. Since joining Susquehanna 34 years ago, I have been involved in building more studio and transmitter sites than I can remember, and in the early days I spent a lot of time wiring studios and installing transmitters. As Susquehanna grew, so did the caliber of our station engineers, and my part of these projects evolved from the actual construction to overall planning and supervision.

RW: Tell us how you got involved with the NRSC and your eventual leadership of that organization.

Morgan: I was chairman of the NAM AM Improvement Committee, which after a very complete investigation of the problems with AM and its potential future, issued a very comprehensive report. This report, among other things, suggested reconvening the NRSC to look at the entire broadcast system, including the transmitter, allocation system and the receiver to determine what, if anything, could be done to save what appeared to be a dying medium. I guess it seemed reasonable that they ask me to serve as chairman of this committee.

RW: Have the various NRSC standards that you have been involved with improved the quality of radio broadcasts?

Morgan: Yes, I believe AM sounds better today than it did five or 10 years ago. The adherence to the maximum pre-emphasis curve cut down on much of the excessive high frequency boost that many stations unrealistically expected to overcome the deficiencies of many poor-quality receivers. Unfortunately, this approach provided more distortion and splatter without ever getting these high frequencies to the speaker terminals. The "occupied bandwidth" standards that followed will soon become very effective, with the FCC requiring bandwidth measurements in the near future.

Unfortunately, the receiver industry has not moved as fast as we would like in providing new receivers that comply with this standard. It is important to realize that these are voluntary standards, and the best we can hope for is that we will get these receivers whenever these manufacturers provide new designs or the marketplace prompts them to make the changes. New receivers that I have seen do sound better, and this is particularly true in auto radios.

RW: Although there have been a lot of technical improvements in AM broadcasting, and recently the long overdue enactment of an AM stereo standard, AM radio is not considered as good as FM by listeners. What will it take to change that impression? Can it be changed?

Morgan: That's a complex question. Let me first address the AM stereo question. Yes, the AM stereo decision was long overdue, but I have never believed that a stereo standard would have any real effect on (reversing) the decline of AM. The differences that exist between AM and FM are quality, dynamic range and immunity to interference and noise. Stereo is simply a dimensional effect, and without better quality receivers it would simply provide two channels of poor audio. As we improve the quality of receivers, stereo

will follow.

In its early days, good AM on a good receiver sounded great because we generally compared it to a phonograph disc heard on speakers similar in design to that in the radio. Today, AM is compared to CDs, high-quality tape and FM. The best-sounding AM station heard on an average AM receiver will always sound inferior to FM. Bandwidth and noise immunity coupled with our allocation system provide limitation that simply do not exist in FM. As we improve the receiver, we will get quality that is closer to FM. In addition to the NRSC receiver standard, the implementation of automatic bandwidth receivers and noise blanker could help close this quality gap.

RW: Can you tell us about the progress on some of the new NRSC standards? DAB? RBDS? High-speed data SCAs?

Morgan: First, let's talk about RBDS. That standard was adopted last year. The time lag that occurs between the publication of a standard and getting equipment in the hands of the consumer can be extremely long, but RBDS is a top priority of receiver manufacturers. The design is not new, manufacturers are making similar equipment for Europe, and only minimal software changes are required to meet the U.S. standard. All major manufacturers have these receivers in the pipeline, and receivers will be available in some 1994 automobiles by mid-year.

The standardization of SCAs using high-speed data is the most recent undertaking of the NRSC, and the request for proposals are due shortly. A number of service providers utilize SCAs for the distribution of high-speed data, and generally they use a data stream of their own design for their own specific purpose. The problem with this approach is that they require the SCA full time and can not share it with other users. With a standard, it is our hope that several services can share the same SCA, thus providing greater efficiency, with more providers utilizing SCAs at a lower cost and more income for FM stations. There is a great deal of interest in this standard setting process, but it is too early to determine the outcome.

continued on page 50 ►

MARTI



STL-15C Composite Transmitter

MARTI's broad range of radios, with the latest developments and the most advanced designs are actually less expensive to build than the competition. So our higher performance cost less. Call or write for more information.

MARTI Electronics, Inc.

PO Box 661

Cleburne TX 76033-0661

Phone: (817) 645-9163 • FAX: (817) 641-3869

See us at NAB Booth 3918/3919

GEPCO INTERNATIONAL

Audio, Video & Broadcast Cables

GEPCO
2225 W. HUBBARD ST., CHICAGO IL 60612-1613
(312)733-9555 FAX (312)733-6416 (800)966-0069

Why should every radio station have at least one VMC-16™ Voice Remote Control System?

1. Because you can call VMC-16 from any touch tone phone, and monitor or completely control up to 20 different functions of your transmitter, satellite downlink or program automation. Dial it up and a voice tells you what's going on. Your computer can talk with it, too. In data, of course.
2. Because if any parameter you've set is exceeded, VMC-16 automatically phones you and up to two other people and tells you what's going on.
3. Because you can even listen to what's going in the room; VMC-16 has a built-in microphone. Or check the air temperature with its built-in sensor.

Why should you buy a VMC-16 from Broadcast Electronics?

1. Because VMC-16 is so affordable and handles so much work, we'd have to go off our ad format to tell you everything. (Like the 99 preset control functions you can schedule.)
2. Because we back every piece of equipment we ship with 24-hour technical service. And our 30-year reputation.
3. Because we're standing by to tell you more about VMC-16 right now. Why not dial us up? You'll get a live voice.

1-217-224-9600



**BROADCAST
ELECTRONICS, INC.**

WORLD LEADER IN BROADCAST TECHNOLOGY

4100 N. 24TH STREET • QUINCY, IL 62305 • (217) 224-9600 • FAX: (217) 224-9607
2211 FIFTH AVENUE • SEATTLE, WA 98121 • (800) 426-9082 • (206) 728-2741 • FAX: (206) 441-6582

Circle (184) On Reader Service Card

World Radio History

Product Stories: Test & Monitoring • Automation • Mics & Monitors • STL, Remote, Telco & ISDN • Source Equipment • Studio Gear • DAWs • Antennas, Towers & Cable • Audio Processing • RF Equipment • Consoles • Products & Services

TEST & MONITORING

Improved Test Meters and Monitors Designed for Smooth Daily Operation

LAS VEGAS With the day-to-day operation of complex broadcast equipment, good test and monitoring equipment is a necessity.

At NAB 1994, look for several companies to introduce new lines and display their existing products.

Wohler Technologies will show its full line of monitors and meters including the 2 RV 20 channel LED audio metering display.

Inovonics will demonstrate its line of test and monitor gear including the "David" FM processor/Stereocoder, the Sentinel and Model 530 FM modulation monitor.

Besides its RDS encoder and SCA generators, **Modulation Sciences** will show its ModMinder modulation monitor/analyzer.

FM Systems will show its AVM digital Audio Volume Meter, a true-RMS program audio volume meter, and the AMM audio modulation meter.

Asaca/ShibaSoku will showcase its full line of video and audio test equipment including analyzers and routing switchers.

Tektronix will show the much-anticipated AM 700 audio measurement systems, a fully integrated test instrument for professional troubleshooters.

Logitek is introducing the Super-VU bargraph audio meter with simultaneous display of loudness and peak levels. Selectable functions include peak hold, maximum hold, phase, density and sum display.

Audio Services Corp. is introducing the DK Audio MSD-550 master stereo display, which monitors signal level, phase indication and stereo imaging on a backlit LCD screen.

Schmid Telecommunications plans to

display its SIAT (Short Interval Audio Test systems) an automated system designed to tests across transmission paths during program breaks or station IDs without disturbing the audience.

Potomac Instruments will show its AA-SIA, a new improved version of the Automatic Audio Analyzer, and other assorted test and monitor gear.

Holiday Industries will have its established lines of RF and MW instruments plus EMF meters.

Gorman Redlich Mfg. will show its existing line of test gear as will **Faraday Technology**.

Look for the **Dorrough Electronics** line of audio level meters and stereo signal test set Model 1200, a gain set for stereo line measurements of level, balance, crosstalk, signal-to-noise and phase with a 96 dB range.

Delta Electronics will be promoting its Splatter Monitor, ASM1- AM stereo monitor, AAM-1 analog antenna monitor and PRH-1 high power reflectometer.

Belar will introduce a new digital FM stereo monitor/analyzer. Its well-known Wizard for AM and FM, and FMM-2/FMS-2 FM test set will also be featured.

Avcom of Virginia will debut its BNG-1000A broadband noise generator for use with spectrum analyzers.

Audio Precision will show an improved, reduced-bit-rate/encoder/decoder testing software as well as its popular audio test sets: the Portable One Plus, System One, and Systems One plus DSP.

Ward-Beck Systems will show its established M405P portable extended-range VU meter.

AUTOMATION

Automated Audio Storage and Playback Assumes Important Share of Work Load

LAS VEGAS A constant over the past several years has been advancement in automated audio and storage and playback technology for the radio studio.

More and more can be stored in smaller spaces and accessed more quickly thanks to the sinking costs of computer memory, the development of data compression systems and improved, user-friendly software.

Among the new products for 1994 is a hard disk, live-assist and music automation system from **Register Data Systems (RDS)**. The so-far unnamed system features simultaneous record and playback and audio overlap of music or commercials. Dolby AC-2 compression is optional.

RDS will display new network interfaces for its Phantom automation system, which was introduced at NAB 1993. The Phantom is designed to automate satellite program sources and live assist. It features dynamic spot retiming for quick and easy fits during commercial breaks.

New RDS traffic and billing software is designed to work with Windows 3.1. The company has other software packages for tracking traffic, accounts receivable, accounts payable, payroll and general ledger.

The DAD 486x Digital Audio Delivery System from **Enco Systems** will be on display at the **Harris Allied** booth. The hard disk, off-the-shelf system features unlimited expansion and user-friendly graphic interface.

AEQ will display its MAR System. Introduced at the Fall Radio Show, MAR (Management of Audio Resources) is a combination hard-disk system and digital audio workstation.

The **ITC DigiCenter** digital audio management will be displayed with new, enhanced CD player and jukebox controls and 4 gigabyte and 9 gigabyte hard drives. DigiCenter-NEWS is a new networking feature, linking

audio and text workstations in the newsroom. It offers event scheduling and audio/text editing capability.

An Italian company, **AEV Electronic Professional Equipment**, is introducing the Aurad System 2 Evolution, which connects up to 64 digital audio devices storing up to 40 hours of digital audio each.

Broadcast Electronics, will introduce two new digital audio storage systems from the "BE Sports Bar" at its booth: the D.A. Box system and the enhanced AudioVAULT-100 storage system with networking capability. BE's established CORE Program Automation System and Sentry system will also be displayed.

Broadcast Programming, a music programming services company, also offers a line of digital audio storage and automation systems. It will introduce Digitalease, a low-cost package of automation equipment designed to convert radio studios to digital operation in one low-cost step.

Radio Computing Services feature the Master Control digital live-assist and full automation system, introduced at NAB 1993. The RCS spot scheduler and Selector music scheduler are among the established software products to be shown.

Fidelipac Corp. will show its Air Marshal hard-disk system.

Design Financial Reports (DFR) is a new software option for **CBSI/Custom Business Systems Inc.**'s InterAct general ledger/accounts receivable system. It is written to be equally efficient for the accounting needs of small, single-market stations to large station groups.

PowerPlus, a third new CBSI package, offers agency management, advanced sales analysis, scheduling and transmission certificate capabilities. It interacts completely with the CBSI Classic system.

Software products scheduled for NAB display by **Jefferson Pilot Data Services** include: JDS2000/1000 broadcast management software with interfaces to traffic, billing, accounts receivable and sales management systems; SALESLINE, a sales management system with local and national contract routing and approval, account profiles, activity tracking, inventory tracking, inventory tracking, rate card, competitive and historical buy information, and PC SESAMI, a PC-based system for writing proposals and researching accounts, with interface to SALESLINE.

Ednews, a radio news editing software system that lets the news staff share text and audio files, will be introduced by **Dalet Digital Media Systems** of Paris. Dalet will also show two new applications to its Sneak Preview software, including a news editing option and traffic scheduling.

The Dalet Windows Multitasking system allows playback of one audio file while recording another, and offers programming logs, operating with PC Windows.

A-Ware Software will show an updated version of the MusicMaster scheduling system, with improved average turnover control and interfaces to most available automation and traffic systems. Foreign language and government reporting modules are available.

SEE what's NEW for FM at NAB '94

RBDS: We have come up with some interesting ideas on how this new technology can help your image and your profits!

"DAVID": Our popular FM-Stereo Processor—Generator, plus the full line of very affordable, Inovonics quality broadcast products.

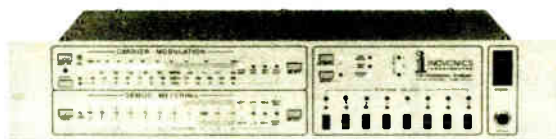

OFF-AIR FM-STEREO MOD-MONITOR

The new Model 530, already in hot demand! Find out why.

Booth 2306

Inovonics, Inc.

1305 FAIR AVENUE — SANTA CRUZ, CA 95060
TEL: (408) 458-0552 — FAX: (408) 458-0554



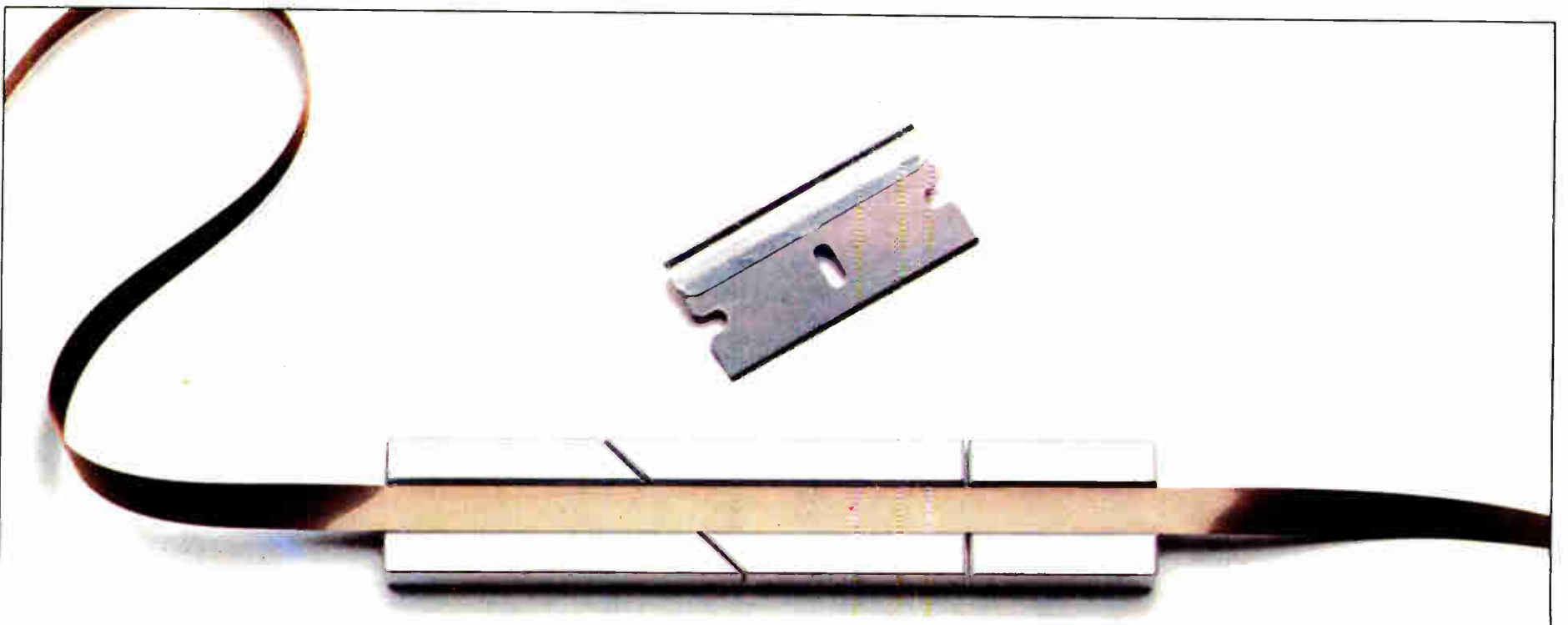

Just Say "No!"

D-CART lets you record, edit and playback instantly, without touching a single piece of tape.

Welcome to the revolutionary world of D-CART, the digital audio system that completely replaces costly and time-consuming tape formats. D-CART allows a large number of users to gain simultaneous access to any number of audio items, all in real-time.

D-CART can accept audio material from virtually any source, including field recorders, satellite feeds, or telephone, and put them immediately to air. You can initiate recordings either from the system or the field. With D-CART, your station jingles, commercials, promos, sound effects, high-rotation tracks, and news actualities will all benefit from digital processing.

And easier operation and improved audio quality are just the beginning. D-CART significantly cuts operational costs by eliminating consumables, decreasing maintenance, and allowing you to do more work in less time.

Developed by the Australian Broadcasting Corporation and distributed and supported by BASYS Automation Systems, D-CART is backed by all the resources of the world's leader in broadcast solutions. And, as with all BASYS products, you'll enjoy our unsurpassed 24-hour service and support.

So throw away your blades and instantly improve the speed and quality of your on-air audio presentation with D-CART.

It's the best cut you'll ever make.

For details, call 1-800-869-7009.

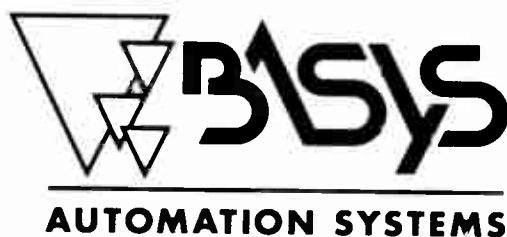

See Us At Booth #19247 At NAB Las Vegas

MICS & MONITORS

Array of Microphones Displayed Wireless Wonders; Reliable Standbys

LAS VEGAS Microphones and monitoring systems will receive a fair share of attention at NAB this year.

Wireless ways

In wireless systems, Vega will introduce the VegaNet networkable wireless mic system, incorporating Lone Wolf's MediaLink technology for real-time computer-based control and monitoring on an open architecture network.

The system consists of the new R-662B PRO PLUS UHF receiver and up to eight Model NE-2 interface modules. Because each module can interface two receivers, a

network can have up to 16 receivers per frame.

The new R-662B receiver features LAN interface capability and a control and monitoring access port for the interface units, allowing networked monitoring of key receiver functions and control of numerous receiver parameters, such as frequency.

Nady Systems will introduce the 950GS UHF wireless system available in 10, 40, 100 or 160 channel models. Listing at \$2,749 for 40 channels, the system uses a proprietary UHF RF link featuring patented noise reduction technology that Nady

claims is up to 20 dB quieter than competing systems.

Other features include switchable balanced level out, 115/220V AC power with a 20-25V DC power option, bass boost and front or rear-mounted antennas.

Nady will also showcase its existing UHF and VHF wireless systems.

Telex will demonstrate a number of wireless products, including the FMR-450 UHF receiver, the HT-450 UHF hand-held transmitter and the WT-450 UHF all-metal belt pack. Also from Telex is the HT-200 hand-held transmitter, the BP-1000 single-channel belt pack and the BP-2000 two-channel belt pack.

Shure Brothers will introduce the SC wireless mic system featuring a battery fuel gauge, frequency agility, and tone key squelch.

Audio Services Corp. will have on hand the Lectrosonics line of UHF diversity wireless microphone systems.

New intercoms

Systems Wireless will exhibit the HME System 800 UHF wireless intercom system that interfaces to Clear-Com, RTS and most cabled systems. Featured are tone squelch control, 2000-foot range and the ability to tie-in two-way radios.

Systems Wireless will also bring out Vega's full line of wireless mics and IFB systems, including the new VegaNet, as well as Clear-Com party line and Matrix intercom systems.

Clear-Com will exhibit its line of two-, four-, eight- and 12-channel wired and wireless intercom systems, as well as the Matrix Plus II 100x100 central matrix. The Matrix Plus system features software adjustment level controls "intelligent Linking" between systems and DTMF access from touch-tone phones.

Studio Technologies will showcase its IFB Plus two-channel mobile IFB system.

In microphones, Orban will show the AKG C3000 mic designed for radio announcing. Listing at \$699, the unit has a large diaphragm and an internal wind-screen and is switchable between cardioid and hypercardioid patterns.

Along with its full line of existing microphones, Crown will exhibit the new CM-312 head-worn microphone designed for hands-free operation. The mic has a hypercardioid pattern with superb off-axis rejection and high gain-before-feedback.

Also showing a head-worn mic is Professional Sound Corp., which will display the PSC Headset Microphone. The unit has three-wire positive bias, noise canceling, an electret element and a cardioid pattern. PSC will also show the OmniPlate tabletop microphone that can be plugged into any 9-52-volt PH or 12-volt (AB) or T mic input.

In addition to its wireless systems, Shure will display the VP88 stereo microphone and the Beta 87 condenser mic.

Sanken will introduce the CSS-5 stereo shotgun microphone. The unit can be operated in mono mode for definition below 2 kHz, normal shotgun mode for stereo localization along the hypercardioid pattern, and wide mode for expanding the stereo image to 140 degrees.

Sanken will also display its full line of studio, MS stereo, field production and lavalier microphones, including the dual-capsule CU-41 studio mic and the COS-11 miniature lavalier.

Electro-Voice will highlight its RE27N/D and RE36N/D dynamic cardioid microphones.

Richardson Electronics will have a complete line of Shure and Sennheiser products.

A few monitors

Monitoring systems will see a smattering of product introductions.

Audio Services Corp. will display the new DK Audio MSD-500, a master stereo display for signal level, phase indication and stereo imaging on a back-lit LCD screen.

Studio Technologies will demonstrate its StudioComm series, particularly the Model 50/51 and Model 55/56 central controller and control console combinations for monitoring and communications.

Mark IV will display Electro-Voice concert series speakers.

In addition to its microphones, Electro-Voice will show its S-40 compact monitor system.

More channels. More power. More versatility.

Only Dolby DSTL systems offer you more.



The original Dolby DSTL already handles the most demanding of paths, with better sound quality and more spectrum efficiency and freedom from interference than any other STL, digital or analog. But we heard you wanted more.

More Channels

Look no further than our new 4-channel DSTL, ideal for taking advantage of the new LMA/duopoly rules or when you just need additional capacity. It conveys four program channels and two RS-232 data channels in only 400 kHz of bandwidth.

All without giving up the features you need or the value you expect.

More Power

If the 1 Watt output of the DSTL can take you 50+ miles in a single hop, 2 Watts gives you added margin

for even lower outage times and greater peace of mind. This new feature for both the 2- and 4-channel versions can also be extended to existing DSTL systems.

More Versatility

Where hot standby capability is a must, the HS1 and HS2 units are optimized to intelligently control two sets of DSTL systems. Add our unique Analog Interface unit (Model AI2), and you can control an analog backup STL and even a third signal path.

Wait, here's more

Call us at 415-558-0200 with your path details. We'll send you complete information plus a customized path analysis showing you just how efficiently and affordably the DSTL can meet your needs.

Expanded capacity, increased output, unequalled flexibility. No STL system offers you more.



STL, REMOTE, TELCO & ISDN

STLs, Remote Pickups and ISDN Links Fall Well Within the Digital Domain

LAS VEGAS Perhaps nowhere else in radio facilities have digital audio and data compression technologies caught on quicker than in the area of studio-to-transmitter links (STLs), satellite links, radio data system/radio broadcast data system (RDS/RBDS) generators and other ways to move audio signals.

Digital signals are maintain higher quality than analog after several passes, are often cheaper to work with (especially when using compression) and are becoming increasingly simple to plug into a station operation.

One illustration of this is the StarLink 9000 all-digital modular system for simplex or full duplex transmission, to be introduced by **Moseley Associates Inc.**, at NAB 1994.

A partial list of the features and functions (what Moseley calls "Personality Modules") that can be computer controlled with StarLink includes: 16-bit linear digital audio; ISO/MPEG and sub-band-ADPCM source compression;

Bradley will also show the Telos ONE-x-Six talk show system, a digital hybrid, six-line phone system for on-air teleconferencing.

The G2500 and G3200 "Superhybrid" telephone systems that **Gentner** introduced at the 1993 Radio Show will be back, along with the new TC-101 telephone interface and the ET-100 Personal Teleconferencer.

Burk Technology will offer expanded software options for its ARC-16 transmitter remote control system, available in single-unit, stand-alone operation or two-unit, studio/transmitter and multi-site systems. ARC-16 can also control studio equipment, including EBS generators, automated playback systems and STLs.

Intraplex is introducing STL+, an uncompressed digital link for T1 lines, with 16-bit discrete stereo capability. It is now available, starting under \$9,000. **Bext Inc.** will show its established line of STLs, from 1.5 watts (\$3,980) to 15 watts (\$48,995).

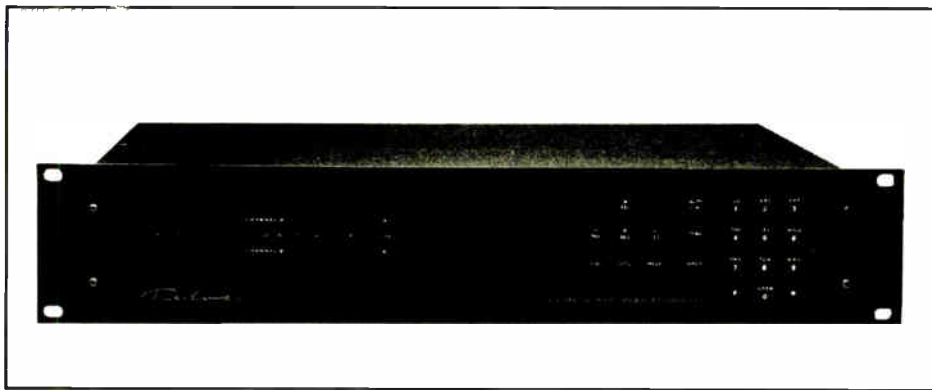

Telos' Zephyr

1-3 bit-per-second selectable efficiency channel coder; drop/insert and variable-rate multiplexers; digital stereo, SCA and RDS generators, and T1/E1/ISDN/Switched 56 drivers.

Moseley will also offer new ISO/MPEG codec and built-in AES/EBU rate converter options to its established DSP 6000 STL. (The DSP has been available with apt-X compression.) The MRC 2 transmitter control system will be shown with new optional interfaces for satellite controllers and audio video switchers, as well as an optional programmable intelligent co-processor.

Marti Electronics will introduce the STL-15C frequency-agile composite system for export frequencies 150 MHz to 480 MHz. Other Marti systems on hand will be the STL-10 SCPS available in 150 MHz to 960 MHz, and the RPT-30, RPT-15 and RPT-2 remote broadcast systems.

QEI Corp. is introducing real-time, uncompressed digital remote pickup (RPU) and transmitter-to-studio links (TSL).

Dolby Laboratories is now offering its DSTL, introduced at NAB 1992, with two-watt power output to provide improved reliability over difficult terrain. The DSTL features Dolby AC-2 compression.

The **Telos Systems Zephyr** Digital Transceiver for ISDN phone links, featuring ISO/MPEG Layer III compression, will be shown at the **Bradley Broadcast Sales** booth. The Zephyr system can be used for remote broadcasts, satellite links and several other networking applications.

Audio Processing Technology (APT) of Belfast, Northern Ireland, is introducing its DSM100 digital audio transceiver to the U.S. market. The system is already used in Europe to deliver compact-disc quality stereo over ISDN and other low-capacity digital telephone circuits.

APT is also introducing the Pro-link ISDN terminal adapter. It can be combined with the DSM100 for secure, full duplex 24 kHz stereo transmission.

Corporate Computer Systems (CCS) will have the first showing of its CDQ2001 audio codec with MUSICAM compression, an upgrade of the CDQ2000 introduced in 1991. It features an 18-bit analog-to-digital converter, 32 kHz sampling rate for audio response up to 15 kHz, and a new remote control data port allowing for control from a PC modem. (The CDQ2000, which can send 20 kHz stereo with 112 kbps, will also be a featured product.)

CCS's CDQ1000 MUSICAM/G.722 codec, introduced last fall, will also be displayed. It will transmit 10 kHz audio on a single 56 kbps or 64 kbps digital telephone circuit.

Comrex Corp. is offering a number of new stereo and mono digital codecs, including the Model DX-100 with apt-X compression, and the DX-200, DX-210, DX-230 and DX-240 "MusicLine" codecs. Established Comrex products to be displayed include a 7.5 kHz digital audio codec; one-, two- and three-line frequency extenders; telephone couplers, and a wireless cue system.

ComStream will introduce the ABR75B satellite digital audio receiver, designed for business music applications.

It will also introduce the Remote Performance Monitoring (RPM) system, for PC modem control of telephone audio links.

ComStream's established product line includes digital satellite network components, such as the ABR200 and ABR75/75B receivers, currently used in 25 different countries.

RE America, best know for its RDS/RBDS encoders, will introduce a line of MUSICAM and ISDN audio codecs at NAB. They will be on display at the **Harris/Allied** booth.

Along with STL+, Intraplex is showing a new line of codec modules to use with its STLs and broadcast transmission multiplexers. The PT/R 350 transmitter and receiver for 16-bit linear uncompressed audio. It can transmit 7.5 kHz or 15 kHz audio, sampled at 16 or 32 kHz.

Intraplex is also introducing the PT/R 355 system for 15 kHz discrete stereo transmission over T1 circuits. Both PT/R 350 and 355 are now available for under \$2,000.

DB Elettronica Telecomunicazioni of Italy will introduce its TD4/16-RD4/16 16-bit coder and decoder for four channels of 15 kHz audio. They can be used in combination with existing analog

STLs without modification.

TFT Inc. will show the latest models of its EIS 911 and 912 Emergency Information System manager and generator, the key components in TFT's proposed new Emergency Broadcast System technology. The FCC is currently rewriting EBS technical standards using EIS and other company's systems as models.

Wegner Communications Inc. will show its established line of digital audio SCPC transmission systems with addressable network control. **AEV Electronic Professional Equipment** of Italy will show its ERDS 3100 and RDSM 3900 RDS systems.

Hallikainen & Friends is introducing its DRC200 transmitter control software. It provides support for multiple logical channels on packet radio systems and provides an unlimited number of user-defined screens.

IDB Broadcast is offering 15 kHz Switched 56 digital sports interconnect services, and **DDD-2 Direct Digital Audio**, a high-quality audio transmission system designed for recording studios.

Among the satellite services, **PanAmSat** and **NPR Satellite Services** will feature their established lines.

SOURCE EQUIPMENT

Vast Selection of Hard Disk, Mini-Disk And Tape-based Gear Available

LAS VEGAS With the proliferation of new disk- and tape-based source equipment, broadcasters have more products to choose from. Many of those products will be on display at NAB 1994.

Hard disk haven

Akai plans to demo its \$2,500 DR4d four-track digital hard disk recorder and DD1000i recorder/editor that utilizes magneto optical disks.

Harris Allied will show a number of products including the new MiniDisc professional cart machines from **Sony**, **Denon** and **Otari**. Also look for the **ALR** digital cart that uses 128 megabyte magneto-optical disks in the uncompressed format. Other products from Harris Allied will include the **Audio-Metrics** CD-10 CD cart player and the **Tascam** DA-88 multitrack Hi8 audio recorder.

The DigitCart/TC digital audio hard disk recorder is scheduled for introduction by **360 Systems**. It is a random-access recorder with SMPTE timecode synchronization and interfaces with videotape recorders. Other features include: chase/lock, transport control, playlist generation, insert-edits, jog/shuttle control and remote control.

360 systems will also feature the DigiCart/II digital audio recorder, and eight-hour hard disk system with editing functions, at its booth.

HHB will show the PORTADAT line of portable DAT recorders. The four-head, four-motor digital recorder comes in the PDR1000 version and the PDR 1000TC for those who need time code.

ITC plans display of its Delta and Series 99 cart machines as well as the **ESV V** and Series 1 and Series 2. The company also refurbishes older machines for resell.

From **Sony**, expect the new DAE-D5000 digital audio workstation that uses the PCM 9000, the full line of MiniDisc cart recorder/players and players and the PCM-E7700 DATStation, a

dual deck DAT editor. Other existing products include the full line of professional studio DAT recorders and tapes.

Studer will show its full line of recorders, plus will have the NAGRA-D, a four-channel, self-contained professional open reel digital audio recorder.

Fingertip control

New from **Scott Studios**, the CompuCarts, 16-bit digital audio player has computer touchscreen control and a cart recorder for production. Digital audio is stored on hard disk and accessed through on-screen data bases. Other products will include an uncompressed option for CompuCarts featuring the Turtle Beach software, Light Pen CD jukebox controller and CD controller for Pioneer's CAC-V180M.

Otari will show its full line of recorders, including the quarter-inch, two-track analog machines to one-inch, 32-track digital, and professional DATs and ProDisk-464 work station. Also look for the MR-10 MiniDisc cart recorder, (shown in prototype form) at the 1993 AES, and a new high capacity CD changer.

Audio Services Corp., will show the Fostex PD-2 DAT recorder with timecode and Tascam DA-88 eight-track digital recorder.

Garner Industries will display its full line of tape erasers including the CF 750 Type II/IIA extended range degausser.

The **Audiopak** display will include its line of NAB carts—the A-2, AA-3 and AA-4s—as well as lubricated audio tape carts and cassettes, including the formula 605, 613, and 614.

3M will show its complete line of digital audio and analog recording tape, and magneto and CD-R media, including the 3M 908 tape for the Nagra open reel recorder.

Maxell will have an array of media including DAT, three-quarter inch digital, CD-R, MO, analog cassette, reel-to-reel and 8 mm.

STUDIO GEAR

The Little Things Often Count the Most in the Search for the Best Fitting Studio Accessories

LAS VEGAS With all the equipment made for broadcast studios, there are many accessory and associated products that are required to make it work. At NAB 1994, the product category will be full as usual.

Clark Wire and Cable will introduce the Clark 1300 Series audio snakes, Hannay Cable Reels as well as a planned display of established products.

Cole Wire and Cable Co. will have its line of audio and video transmitter cables. **Henry Engineering** plans display of the new StereoSwitch, a three-input line switcher.

New gear

NVision will show its NV 1050 four-channel sample rate converter, NV 1055 four-channel digital audio/mix/minus and routing module, NV 1060 digital delay compensator module and BNC-/I-volt digital I/O interfaces for other NVision products.

Besides its workstations and recorders, **Pacific Recorders** will show its complete line of studio equipment and peripherals including furniture and wiring.

Richardson Electronics is scheduled to show new components including RD Transistors Pallets, Directional Couplers, Amphenol connectors, Unilators and WL Gore cable assemblies.

Sonex will showcase its sound control products including Sonex Fabrex. **SESCOM** will be displaying its assortment of audio accessories. **Sandar Electronics** plans to have an array of products for digital and analog audio including routers, conference equipment, distribution amplifiers and equalizers.

Expect the latest in audio cables from **Nemal Electronics**. **Lemo USA** plans to display connectors for single, coaxial, triaxial, multicontact, high voltage, fiber optics applications.

ESE will demonstrate the new ES-185 GPS master clock, ES-2940 dual audio and video D.A.s and five output black burst generator, ES195 GVG Master 21 interface/master calendar and the new

LUX-line product family.

Connectronics will show its full line of audio cables, patchbays and terminating connectors. **Audio Accessories** will showcase its audio panels, jacks, patchbays, patch cords and Edan connectors.

Acoustic Systems will demonstrate and show its various acoustically

designed broadcast and studio enclosures.

Symetrics Inc., will introduce its 420 stereo amplifier, designed to replace the earlier A-220 model. It offers 20 watts RMS and 40 watts of bridged mono, and fits in one rack space. A front-panel "speaker-mute" button is included for those wanting to alternate between head-

DAWs

Digital Audio Workstations Developed For Cleaner Audio, User Friendliness

LAS VEGAS As is evident in this month's Buyers Guide (see pages 83-103), digital audio workstations (DAWs) combine digital accuracy with ease of use for applications ranging from producing commercials and promos to cleaning up phone calls in the on-air studio.

New DAWs, as well as established products and upgrades, are slated to be seen at the NAB 1994 exhibition.

VTR interface

360 Systems will introduce its DigiCart/TC digital audio hard disk recorder this year. The DigiCart/TC is designed for SMPTE time code synchronization applications between video and audio and it interfaces with VTRs.

360 Systems will also display its DigiCart/II digital audio recorder. The DigiCart/II features a 68-minute removable disk, an internal eight-hour hard disk, workstation editing functions, playlisting functions, visual read-out, instant access to cuts and comprehensive library and utilities management.

Roland Corp. will introduce its Version 2.0 firmware for the DM-80 digital audio workstation. The firmware upgrades the DM-80 with more than 40 new or improved features.

Roland will also introduce its DM-80-S 2.0 Version of Multitrack Manager Macintosh System software for the DM-80. This software will allow a user to lock up to four DM-80 recorders together to provide up to 32 tracks of synchro-

nous digital recording, all under the control of a single computer.

The Australian company **Fairlight** will introduce a third generation of products based on its MFX digital audio workstation. The standard MFX3 can be configured from four to 24 tracks, and includes DSP functions such as real time clip-based EQ. The MFX3 "Mini" can be configured from four to eight tracks. Both units are available in a rack-mount or portable chassis.

ASC Audio Video Corp. will introduce its New Virtual Recorder that features digital random access replacement for VTRs. The New Virtual Recorder will be demonstrated in combination with commercial spot insertion systems and audio workstations.

It records and plays 60 field broadcast video, two-channel audio and SMPTE time code. Recorded material is instantly available for commercial insertion, audio workstations and video-on-demand.

On-air DAW

Audion Labs will introduce its VoxPro workstation, which is designed for on-air use. The VoxPro includes custom "folders" for on-air personnel to store liners, jingles, sound effects, etc., as well as rapid, intuitive editing.

Henry Engineering will introduce its Fast Trac II voice-over audio workstation. While not specifically a DAW, the Fast Trac II is a "studio in a box," well suited for use with digital editing systems. It works just like a console, with

phones and monitors.

Studio Technologies Inc., is introducing Studio Tools, a series of distribution amplifiers. The Model 80 amplifier is for analog stereo operation, with one stereo input and eight outputs. The Model 85 operates in AES/EBU digital audio, and features transformer-coupled inputs and outputs and a front-panel switch to assign its one input and eight outputs.

Ward-Beck Systems will show its established D8212 audio distribution amplifier system. **Fidelipac Corp.** will show its Dynamax SRC digital audio sample rate converter.

five stereo line inputs, plus mic input with automatic ducking.

AKG-Orban will introduce the Orban DSE 7000 workstation, which is designed specifically for radio production.

CCS will display its computerized audio editing system, PACE. PACE is based on the MUSICAM ISO 11172.3 Layer II compression standard, and is designed specifically for newsrooms and radio stations. The human interface of PACE is designed to aid non-technical users in using the system.

Human interface

PACE's operator interface provides users with icons of the equipment they are already familiar with—carts, tapes, recorders, tape racks, mixers and even a television set. Because PACE users understand how to edit audio manually, they can quickly learn how to use PACE.

Also at NAB '94 will be **Pacific Recorders & Engineering**, offering a streamline version of its ADX digital workstation.

ENCO Systems will display its DAD486x digital audio delivery system.

BASYS Automation Systems will display the Australian-designed D-CART digital audio record, edit and playback system, which offers simultaneous multi-user capabilities. BASYS also will show its NetStation for Windows, PC-based newsroom system workstation.

Harris Allied will show the Orban DSE 7000, ENCO DAD486x, **Tascam DA-88** and Roland DM-80 DAWs. And **Broadcast Supply Worldwide (BSW)** will offer the Arrakis Digilink and Track*Star systems and **Korg** and **DigiDesign** DAWs.

First class quality

First class performance

Incredible price! -- \$995*

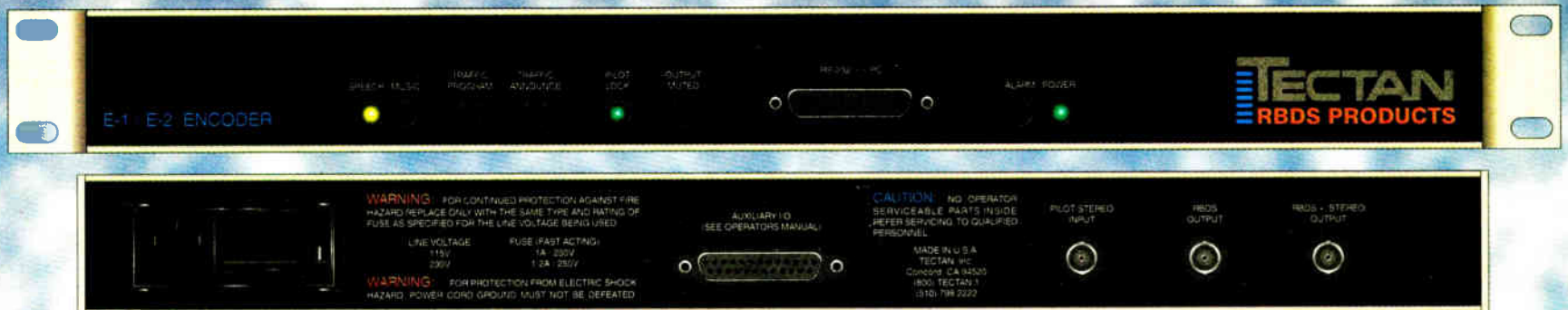

No-compromise RBDS just became affordable!
Phone 1-800-TECTAN-1 for details.

* Limited time introductory price for E-1 Encoder. Introductory price for the E-2 Encoder is \$1195. Shipping & handling \$25 additional for 2-day air shipment anywhere in the U.S.A.

ANTENNAS, TOWERS & CABLE**New Antennas to Be Unveiled Along with Cables to Help Get Radio Signals on the Stick**

LAS VEGAS No matter how good a station sounds, no matter what digital gear or processing equipment used, without an antenna, a signal cannot reach listeners. NAB 1994 will include new products and exhibitions from many antenna and tower manufacturers.

Jampro Antennas Inc. will introduce the JCPD flat panel circularly polarized antenna and the JADP cavity-backed panel antenna. Both the JCPD and the JADP are broadband antennas.

Jampro will also introduce a new combiner, the JIDC inter-digital combiner and the JIDF inter-digital filter. The Penetrator series of FM antennas will also be shown.

Andrew Corp. will introduce a new VHF panel antenna, MR-050 series

DryLine dehydrators and SD-002 series static desiccators. Also on display will be a variety of coaxial cable products, 3M Cold Shrink weatherproofing kits and ESA Systems antenna control products.

Comtech Antenna Systems will introduce the new EC8 microprocessor control system with optional IBM-compatible software. The EC8 can control the Comtech line of satellite antenna systems by local or remote control.

Comtech also offers a 3.8-meter motorized antenna system of receive applications. It is reportedly in use by hundreds of radio stations for high quality SCPC reception. Comtech also offers the Offsat

antenna for SCPC uplink requirements.

The British company **Advent Communications Ltd.** will introduce New-Swift, a new generation of digital flyaway and vehicle-mount SNG systems. Other Advent products also making debuts are C Band MANTIS, C-band flyaway; NOMAD, cabin-based satellite uplink systems; MIGRA, lightweight trailer-based satellite uplink systems, and the AVR 2950, satellite video receiver.

Advent will also display its VSAT and DAMA systems and LYNX range of fully integrated satellite newsgathering vehicles.

RF Industries will feature its universal flush-mount wall plate system to connect telephone, cable TV or local area networks. **Cole Wire & Cable Co.** will introduce high-voltage transmitter cable.

LDL Communications will show its

Low Windload Spearhead FM CP antennas and FM band pass combiner, both of which are designed for use in multistation operations. Also on display will be LDL's FMAC series FM broadcast circularly polarized antenna.

Electronics Research Inc. (ERI) will display its side mount FM antennas in circular, vertical-only or horizontal-only polarization; master, multi-stations antennas, filters and combiners, and its Lambda antenna mounting systems for increased predictability of antenna pattern gain.

Details were unavailable at press time, but **Kintronic Labs Inc.**, **Will-Burt Co.**, **Utility Tower Co.**, **Shively Labs**, **MYAT Inc.**, **Cortana Corp.** and **Central Tower Inc.** are also scheduled to appear at the 1994 NAB equipment exhibition.

AUDIO PROCESSING**New Processing For Just the Right Sound**

LAS VEGAS This is one of those chicken or egg questions. Which is more important to a radio station—sound or programming? Perhaps one is no more important than the other. Would you venture out on a limb and say they're on equal footing?

But if developing the sound for your station is your job, the exhibit floor is the place to shop for the latest gear and the most recent upgrades for the wide variety of audio processing equipment on the market.

Cutting Edge will introduce the Unity AM processor and demonstrate the Unity 2000i FM processor. Also on display will be the new VIP-1 programmable voice processor. Other products Cutting Edge will show includes the Dividend Composite Filter that provides full spectral protection, including RBDS and other SCA signals.

Inovonics will demonstrate its line of signal processing equipment, including the Model 530 FM Modulation Monitor, the "Sentinel" all-mode diagnostic receiver, and the "David" FM processor/stereocoder.

From **Dolby**, on display will be the Model 740 Spectral Processor for broadcast and post-production audio processing.

UREI will exhibit the LA Series of compressor/limiters and the Platform Modular rack-mount signal processor with a new delay module.

Circuit Research Labs (CRL) will show the Amigo AM audio processing system for C-QUAM AM stereo. CRL said that if you plan to go stereo but need to improve your processing now, the Amigo AM will maintain your station's mono loudness and coverage.

FM Systems will exhibit the ALM771 Audio Level Master. It regulates audio program levels so that the sound volume as perceived by the human ear will be consistent even when the source material differs in amplitude by as much as 25 dB.

Among its line of broadcast equipment, **Sony** will introduce the HR-MP5 multieffects processor.

Products from the **Mark IV Pro Audio Group** include the 500 Series of compressors and gates from Klark Teknik and its programable stereo graphic equalizers.

Symetrix will introduce the 528E Voice Processor to replace the 528. Improvements include improved gain reduction metering, a rugged "E" series chassis, program-adaptive compressor and expander release times, and easy-access rear panel patching.

Simply perfect

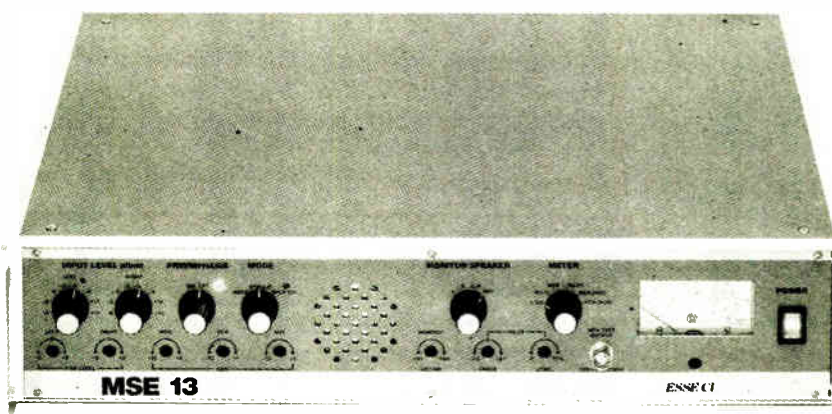
**STEREO ENCODER MSE13**

Professional Stereo Encoder, specially designed to comply with specifications of government broadcasting authorities and able to meet the requirements of professional broadcasting at any level.

It is not a chance that this apparatus shows characteristics which may not likely be found in other apparatus of same price: besides the indispensable RH and LH channel inputs, it features 3 fully independent auxiliary channels, 3 separate multiplex outputs and one pilot frequency synchronization output for a possible RDS generator.

Further technical data: S/N >90dB;

Distorsion <0,01%;

Audio passband 20Hz ÷ 15Hz ± 0,1dB;

Crosstalk between channels >70dB.



SIEL Sistemi elettronici

Via Bari, 26- 20143 MILANO- ITALY-

tel. (+39-2)-89150150

fax. (+39-2)-8136038

Who's running the ship?

Unattended operation is one way to keep your station profitable, but you still have to mind the store.

The acclaimed Burk Technology ARC-16 Remote Control System is the first step. You can control transmitter and studio from any phone.

But wait. There's more!

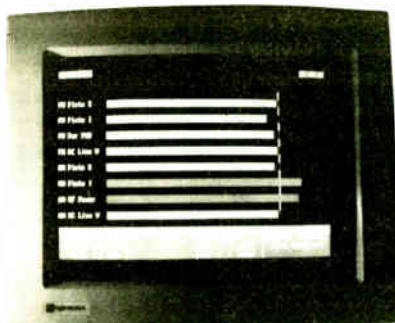

Introducing AutoPilot™ from Burk Technology.

AutoPilot is break-through computer software that makes automatic operation of your studio/transmitter facility a dream come true.

- Automatic power changes
- Automatic pattern changes
- Automatic site changes
- Automatic power trim
- Automatic fault recovery
- Automatic logging

Now your imagination is the only limit.

The new FCC fine schedule is imposing. Why risk a big penalty when AutoPilot can help you stay within the rules?

Call us toll free at
1-800 255-8090
for more information
and a FREE DEMO.

BURK
TECHNOLOGY

Circle (127) On Reader Service Card
See Us At NAB Booth 4818

RF EQUIPMENT

Solid State FM and Digital Exciters Top Bill In Crowded Hall of Transmitters and RF Gear

LAS VEGAS RF and transmission gear will flood the NAB 1994 equipment show, offering everything from gadgets to the guts of station operation.

Harris Allied's RF offerings will include the new Harris Quest 1 FM transmitter, a compact 1,000 W FM unit featuring all solid state broadband design.

Also on hand will be the Harris Platinum Series PT 10FM transmitter with DIGIT digital FM exciter; the DIGIT itself, which combines digital and solid state technologies; the Harris DX 20 and DX 100 digital solid state AM transmitters; Harris AMS-G1 C-Quam stereo exciter, and Harris HT 10FM and HT 25 FM transmitters.

Broadcast Electronics will feature among new products the FM-3C 3 kW solid state FM transmitter; D.A. Box digital audio storage system, and AV-100 networked digital audio storage system. BE also will display the FM-1C 1 kW solid state FM transmitter; FM-30B 30 kW FM transmitter; AM-5 5 kW AM transmitter, and RBDS equipment.

From **Circuit Research Labs (CRL)**, participants can see the DAA-50 digital audio analyzer, designed at low cost with features to identify digital audio signals, determine their integrity, be easy to use and highly

portable. Also on display will an upgraded version of the Amigo AM audio processing system for C-QUAM AM stereo; the RBDS-SC-100, and CRL's real-time Event Sequencer.

Modulation Sciences will feature the new RDS/RBDS data receiver and a software upgrade for the Model RDS-1 RDS/RBDS encoder. Also on display will be the FM ModMinder, StereoMaxx spatial image enlarger and the CP-803 composite processor.

Cutting Edge Technologies will demonstrate the new Unity Remote software, which enables transmitter processing control from anywhere by modem. The company also will introduce the Unity AM processor and demonstrate the Unity 2000i FM processor. Also new is the VIP-1 programmable voice processor.

Bext will show the new SF Series solid state MOSFET FM amplifiers, from 100 to 1,000 nominal output, and the LEX 25 programmable FM exciter with continuously variable output power of 0-25 W.

Continental Electronics promises new products at NAB, along with its line of AM and FM transmitter, FM antennas and associated RF equipment.

CCA Electronics will demonstrate AM,

FM and shortwave broadcast transmitters, and display its high-performance 60 W FM exciter.

Altronic Research will show the Model 67150 150 kW megawatt air-cooled dummy load for the first time at NAB, as well as a processor-based calorimetry system for air or water systems, and an assortment of Altronic 6700 Series of air-cooled loads and 9700 water-cooled loads.

DB Electronics will show a new version of the TD4/16 16-bit digital coder for 4x15 kHz; and the RD4/16 16-bit digital decoder for 4x15 kHz. Also on display will be the Vivaldi digital stereo coder; PE 21 0-22 W out FM exciter, and the PM 100/PM 250 100 W/250 W out FM exciter.

Inovonics will demonstrate its entire line of audio recording, signal processing and instrumentation equipment for broadcast. Featured will be the Model 530 FM modulation monitor, Sentinel all-mode diagnostic receiver and David FM processor/stereo coder. An operational RBDS display also is planned.

J.N.S. Electronics will display its D-Mux 500 Series stereo or mono audio multiplexing systems using full 16-bit technology for multiple 15 kHz, 7.5 kHz or 3 kHz audio feeds, and RFL-700 Series 1.5 to 2.3 GHz digital microwave link for the D-Mux. Also at the show will be the 8000 Series Frame modules for audio and video amplification and distribution, audio monitoring, audio switching, audio test, RF demodulation, off-air reception and program changeover functions.

QEI Corp. will introduce the Model 675-B FM exciter. Also on display will be the Automod closed loop Automatic Gain Control for FM, and solid state and single tube FM transmitters at power levels from 10 W to 30 kW.

Richardson Electronics Ltd. will offer RF transistor pallets, directional couplers, unilator capacitors, along with numerous transistors and a variety of miscellaneous RF products.

Telos Systems will display the Zephyr digital audio network transceiver. Zephyr is capable of transmitting bidirectional 15 kHz stereo audio over a single ISDN line. It also is appropriate for Switched 56 and other digital audio links. The Telos range for the broadcast-to-telephone interface also will be demonstrated, including the Telos 100 Delta, the Link, the One plus One and Call Screen Manager software.

RE America will display the RE 532 RDS/RBDS encoder, a full-featured unit in a stand-alone 1U rack-mountable chassis.

The new **Nautel NE50** digital FM exciter will further enhance the performance of solid state Nautel FM exciters. The exciter uses direct digital synthesis to generate the modulated FM carrier. The company also will exhibit a full range of Ampfet Series AM and FM solid state transmitters featuring high-efficiency modular redundancy and on-air serviceability.

Energy-Onix will display the SSA/SST Series of low-power solid state FM trans-

continued on page 50 ▶



"Bigger is better"

"A penny saved is a penny earned"

"If it ain't broke, don't fix it"

(common myths some antenna manufacturers would like you to believe)

At JAMPRO, we say

NOT!!!

Take a new look at the JAMPRO PENETRATOR FM antenna.
You'll like what you see.

Outstanding performance. Rugged durability. Unexpected affordability.

Go with the Pro. JAMPRO.



JAMPRO ANTENNAS, INC.
6340 Sky Creek Drive
Sacramento, CA 95828
(916) 383-1177 phone
(916) 383-1182 fax

Circle (99) On Reader Service Card

World Radio History

See The
New EBS System
In Booth 2800

**SAGE
ALERTING
SYSTEMS**

Products & Services Showcase

For more information on the products shown below, circle the appropriate Reader Service No. (s) on the enclosed Subscription/Reader Service card or contact the advertiser directly.

Cellcast

REMOTE BROADCAST STUDIO

The CELLCAST RBS-400 1.8 offers complete portability and flexibility for remotes. Complete with a 4-channel mixer, frequency extender, cellular transceiver and landline capabilities, 600 ohm line out, and Vu meter. It is powered by 10 Ni-Cad rechargeable batteries, 12v adaptor, and AC power supply. 24 hour product support standard.

Call Bridget Taylor today for our \$195.00 2 week trial at



1-800-852-1333

READER SERVICE NO. 133

AUTO-ANSWER TELEPHONE COUPLER

Ideal for unattended situations such as listen lines, IFB feeds, dial-up networks, remote transmitter sites & satellite links.

- Clean connection to phone line
- Easy to install
- Send or receive program
- F.C.C. registered



COMREX

Comrex Corp., 65 Nonset Path, Acton MA 01720
Tel: 1-800-237-1776 Fax: 508 635-0401

READER SERVICE NO. 48

WEATHER RADIO

Model CRW



Price \$540.00

Sensitivity .28 microvolts for 12 dB quieting. All 3 frequencies. Alert tone demutes receiver, closes relay and gates audio to 600 ohm rear terminals. Another set of rear terminals has continuous 600 ohm audio output. Double conversion crystal controlled, crystal filter in first I.F., ceramic filter in second I.F. Dual gate MOS FET front end. 50 ohm coaxial input. Adjacent channel (j25 kHz) down to 70 dB. 19" rack mount, 31/2" H, all metal enclosure. In stock—available for immediate delivery.

GORMAN REDLICH MFG. CO

257 W. Union St. • Athens, Ohio 45701
Phone 614-593-3150 • FAX 614-592-3898

See Us At NAB Booth 4812

READER SERVICE NO. 51

DON'T GAMBLE WITH LIGHTNING!



BOOTH 3704

ELEVEN YEARS EXPERIENCE PROVIDING AFFORDABLE TOWER LIGHTNING PROTECTION TO THE BROADCAST INDUSTRY.



Write to us today for a FREE brochure!
P.O. Box 2548, Farmington, N.M. 87499
Call (505) 325-5336 FAX (505) 326-2337

READER SERVICE NO. 219

The CircuitWerkes AC-2 Autocoupler



More Features. Better Price.

- Auto-connect and disconnect.
- FCC Pt.68 registered.
- Two-Year limited warranty.
- LED Indicators for audio clipping, incoming rings and line status.
- Answers on user selectable number of rings.
- Momentary or latching dry contacts at pickup.
- Momentary open collector output at pickup.
- Defeatable pickup inhibit function for cart decks, etc..
- Can be combined with CircuitWerkes DTMF decoder board to form a dial-up DTMF remote control.
- Optional ComboLok provides for secured access.

CircuitWerkes

6212 SW 8th Place
Gainesville, Florida 32607
(904) 331-5999
fax (904) 331-6999

READER SERVICE NO. 91

Don't let their size fool you.

STEREO HEADPHONE AMPLIFIERS



HD-1000 MASTER

- Drives Four Independent Headsets
- High Output for 8 to 600 ohm Headsets
- Stereo Balanced Line Inputs
- Panned Microphone Input for Announcements
- Stereo or Left Only-Mono Output
- Balanced Line Out to HD-100
- Half Rack or Desk Mount

HD-100

- Drives Single Headset
- High Output for 8 to 600 ohm Headsets
- Stereo Balanced Line Inputs
- Loop-thru Inputs Feed Multiple Positions
- AC Powered, Compact
- Ideal for Offices and Study Carrels

See Us At NAB Booth 13603/4

CALL OR WRITE NOW FOR FREE DETAILED BROCHURE.



AUDIO TECHNOLOGIES INCORPORATED

328 W. Maple Ave. Horsham, PA 19044, USA
(215) 443-0330 • FAX: (215) 443-0394
(800) 959-0307

READER SERVICE NO. 178

"ITC" The Only Affordable Spectrum Analyzer

THREE FULL FUNCTION ANALYZERS TO CHOOSE FROM 600 MHz - 1000 MHz - 1800 MHz

80 dB ON SCREEN DYNAMIC RANGE.

With ITC's Exclusive EFPLA Log Amp. (pat. pend.)

-110 dBm SENSITIVITY AT ALL SPAN WIDTHS.

ITC Analyzers have -110 dBm .7uv. sensitivity at all Resolution Band & Span widths.

HIGH STABILITY (<1KHz per Hr. after warm up)

FEATURES Baseline Clipper, Video Filter, 5"CRT, Preset plus variable Dispersion settings from 0 - 50 Mhz per/div, 100:1 tuning ratio for easy Center Frequency selection, & More.

ITC INSTRUMENTS

9222 Chesapeake Dr. Suite A
San Diego Ca. 92123 USA

MADE IN THE USA

TERMS: M/C, VISA, AE, CHECK, MO, COD, P.O. (OAC)

SA600A 600 MHz \$1295.00 Opt.1 50 MHz marker \$200.00
SA1000A 1000 MHz \$1595.00 Opt.3 +/- 5 KHz Filter \$350.00
SA1800A 1800 MHz \$1895.00 Opt.5 Tracking Gen. \$250.00
Opt. 6 Center Frequency Display \$275.00

**FOR MORE INFORMATION & INTRODUCTORY OFFER
CALL 1-800-232-3501 619-277-4619 FAX-277-6736**

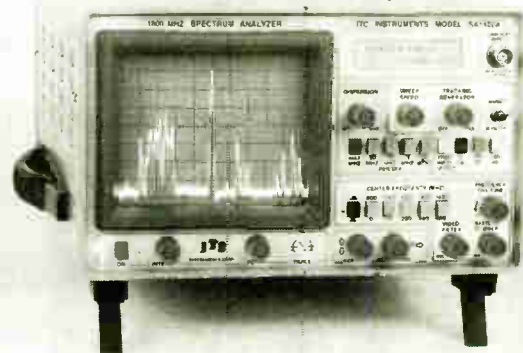

PRICES START AT

\$1295.00

MODEL SA600

A MUST FOR:

AM-FM-SW-TV Stations-CATV

CHECKING SUB-CARRIES

SATELLITE FEEDS

UP LINKS, DOWN LINKS

AUDIO-VIDEO-SIGNAL LEVELS

HEAD-IN SYS. & MODULATORS

CHECK FCC REQUIREMENTS

ITC Analyzers are the perfect low cost choice for All AM, FM Broadcast-VHF, UHF TV maintenance depts., and FCC compliance testing. You will save time & money with a ITC low cost Spectrum Analyzer.

READER SERVICE NO. 58



"SR"

the original ANTENNA SYSTEM DESIGN SOFTWARE, already adopted by the CCIR, now available from ITALY!

- Multiple patterns comparison
- Up to 100 antennas each system
- Field strength forecast (rec.370 CCIR) up to 100 locations
- Tri-lingual operating (English, French, Spanish)
- Personalized outputs
- 450 antenna patterns already included
- New antenna patterns (amplitude & phase) can be generated
- MS-DOS PC
- 3" 1/2 HD diskette
- VGA screen

only **695 US\$** • shipping charges (credit cards accepted)

SEND YOUR PURCHASE ORDER TODAY BY FAX:
+ 39 - 2 - 90390475



TELECOMUNICAZIONI ALDENA s.r.l.
20090 Cusago (MI) Via A. Volta 13
Tel.: + 39 - 2 - 90390461

READER SERVICE NO. 93

CONSOLES

Custom Configuration, Hard Disk System Interfaces Among Top Console Features

LAS VEGAS As you roam the NAB exhibit floor in search of new consoles next month, take note. There are a number of introductions you won't want to pass by.

Be sure to stop by the Sony booth for a look at the new MXP-700 audio production console. It's available in three frame sizes—the MXP-716, with 16 positions in which modules can be installed; the MXP-728, with a 28-position frame, and the MXP-744, with a 44-position frame. Surface mount component technology allows for a very compact console.

Users may custom-configure the MXP

console by selecting from 20 available soup-to-nuts options, including a dynamics module to provide assignable dynamics processing (such as a limiter/compressor); multiple "clean feed" outputs; an automatic power supply switch-over unit; a VU meter, and a console stand. Completely configured, an MXP-716 will sell for about \$28,000, and an MXP-744 will sell for about \$60,000, according to Product Manager Karl Kussmaul.

Digital control

Another console Sony plans to show is the DMX-E2000, with digital audio

sound quality and 10 stereo inputs. The unit carries a price of about \$17,000.

Sony will have the DAE-D5000 digital audio workstation, using the PCM 9000 for storage. Although it is a high-end editing system aimed at pre-mastering and mastering houses, the technology is certainly worth a look.

Auditronics promises its new Destiny 2000 Program On-Air Management console and computer, designed to be used in conjunction with hard disk storage systems such as Computer Concepts' DCS system and multi-player jukebox technology. It offers complete control of both music and traffic log systems, combining them into one on-air management system in a "live-assist" situation. The console can also operate in auto mode, operating from satellite sources or in "auto."

The company will also bring along its established product line, including the AirMaster 90 on-air console, the 210, 800 and 850 Series on-air consoles, and the 1900 Series IFB/mix-minus system.

Ward-Beck will be on the floor with its new Renaissance Radio Console Series. The Renaissance is automation-ready for live assist broadcasting. Features include illuminated electronic switching throughout; digital shaft encoder controlling monitor VCAs;

modular design, and three standard frame sizes (for eight, 16 and 24 modules). Those placing orders by March 31 will receive an M405P portable extended range VU meter.

Wheatstone will display what it calls its finest radio console, the A-6000. Users can customize the console with a family of more than 125 input module combinations. Features can include a built-in routing switcher with individual alpha channel displays; Wheatstone's own "Bus-Minus" system; four mix-minus busses; logic-controlled program and mix-minus busses; stereo and mono send controls, and an equalizer option.

One of the A-6000's best options is

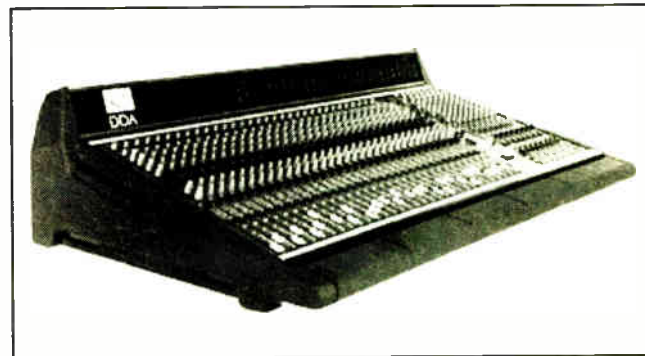

DDA Q11 Console

that it has no options: all module slots are configured exactly the same, so any module can be plugged into any slot.

Mixing

Logitek Electronic Systems will show a host of new products, including its continued on page 48 ▶

JOIN THE HUNDREDS WHO HAVE USED DIGILINK TO ACHIEVE ECONOMIC RECOVERY

- ☐ 10 hours of stereo digital audio storage for \$7,995* complete
- ☐ Satellite, CD, Tape, and Hard Disk Automation
- ☐ Simultaneous Play, Record, & Network transfer
- ☐ Digital Editor with Waveform Editing for tight production
- ☐ Crossfade CD's, sources, and hard disk audio
- ☐ Music Scheduling system built in for basic CD automation
- ☐ Digital Networking for transfer of audio and schedules

Digilink is the #1 selling digital audio hard disk system in radio today. You can replace your cart machines for live On Air and have an automation system for walk away at the same time! Link over 15 workstations & scheduling computers on our digital network and transfer audio and schedules between your studios.

For more information, call or write ARRAKIS,

(303) 224-2248

the premier broadcast manufacturer of consoles, furniture, Digilink and Trak*Star digital audio products.

Consoles
Modulux
Trak*Star
Digilink
Modulink

ARRAKIS

* Suggested retail price. Complete system

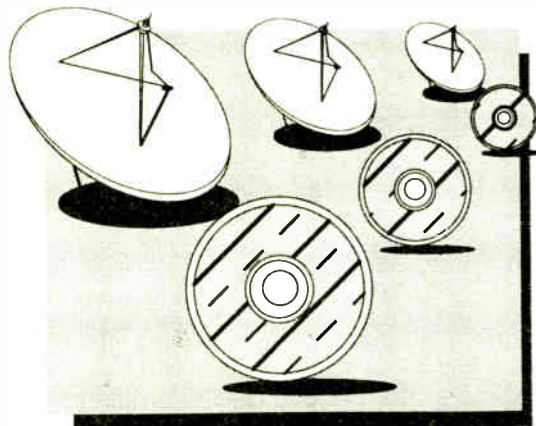

© 1993 Arrakis Systems inc. 2619 Midpoint Drive, Fort Collins, CO. 80525

Circle (96) On Reader Service Card

See Us At NAB Booth 3912

A simple diagram for setting up a new FM station in under 10 minutes.

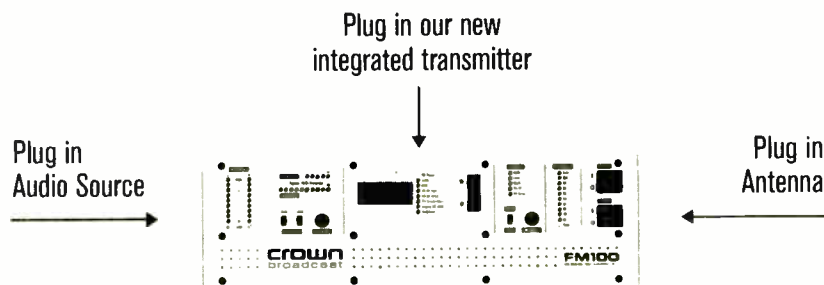

Setting up a new station has never been easier, thanks to our new integrated transmitters. Featuring a unique design that combines stereo generation, audio processing and RF generation into one compact, cost-effective unit, you can now "plug and play" in only a few minutes.

Ideal for a variety of broadcast applications, the integrated design makes setup simple and quick, while making it so easy to use that it requires little technical expertise for regular operation.

Perfect for community and satellite network operations, these units are also an excellent choice as an emergency backup

transmitter or exciter/driver for larger transmitters.

Additional features include built-in metering and diagnostics, remote monitoring and control, and a dial-selectable 87-108 MHz frequency range.

Engineered for long-term reliability in the harshest environments, all Crown Broadcast transmission systems feature 100% solid-state construction and are backed with an outstanding warranty.

Crown broadcast

A Division of Crown International, Inc.
1718 W. Mishawaka Road
Elkhart, Indiana 46517
(219) 294-8000 • FAX (219) 294-8329

See us at NAB Booth # 4400

Circle (140) On Reader Service Card

NEW DIGITAL CLARITY

CLARITY OF PURPOSE:

"Design and build an actual digital replacement for the analog cart machine utilizing individual, Magneto-Optical discs."

CLARITY OF DESIGN:

"Meet operator needs in form, fit, and function. Minimize space requirements and maintenance. Maximize reliability and ease of operation."

CLARITY OF EXECUTION:

"Familiar controls...no keyboards, no touch screens, no hard drives, no operator training."*

Clear, Clean,
Uncompressed, Uncluttered

AIR cart · mo™

- The clarity of 3.5 inch Magneto-Optical media
- Individual, affordable
- Clarity in operation, a true replacement for cart machines
- Linear, familiar and reliable
- Conforms to the ASPECT® standard
- Clearly superior

*Keyboard needed for production labeling.



AIR corp
SYSTEMS

• 1845 W. Hovey, Normal, IL 61761 • TEL: 309-454-4900 • FAX: 309-452-0893

See the **AIR cart · mo** at NAB '94 in the Radio Hall • Right turn just inside the doors, Booth #3926

Circle (155) On Reader Service Card

World Radio History

CONSOLES

Consoles with New Functions Set for NAB Debut

► continued from page 46

four-channel automated mixer, the Crossfire II, that provides local or remote control of levels and crossfades. Its RS-232/422 port accepts ESAM-2 commands. The established Mariner on-air modular console will also be displayed.

Among the new products from the Mark IV Pro Audio Group will be the DDA QII console, a true LCR (left, center, right) console with choice of eight mono groups, eight stereo groups or four true LCR outputs.

Soundcraft plans on several product introductions, including the Series IOS

live-on-air mixer, Series 30 live-on-air/production mixer and Spirit Studio LC console. (Details were not available as of press time.)

The MXE Series console will be featured at Fidelipac's booth. It provides up to 18 channels.

Neotek Corp. will display its Esprit Series console system, offering eight auxiliary busses and a mix-minus from every input module. Features include live mic sensing, fader switch logic and a talkback/return talkback system.

Pacific Recorders & Engineering Corp. will bring its full line of consoles

and other products.

Bradley Broadcast Sales announced it will be the exclusive exhibitor of the Audioarts line of broadcast mixing consoles for on-air and production studios, including the A-50 air board, the low-cost R-10 and the MR-40 production/air mixer.

Graham-Patten Systems will show an enhanced version of its D/ESAM 800 digital edit suite audio mixer, with an improved processor board allowing for 18-bit analog and 20-bit digital signal paths; an improved audio delay function for delay up to 16 frames per channel, and processing loop module for four

AES/EBU digital outputs and four digital inputs.

Audio Technologies Inc. will show its established Vanguard Series on-air, mixer/dual stereo consoles, available with six, eight and 12 outputs.

New products scheduled for display by Audio Developments Ltd. of England include: ADO66-12 line level MS/AB converter, a portable monitor and insert system; ADO66-13 Flex EQ four-band parametric equalizer; AD146, a portable pro mixer, available in six-12 inputs and four outputs, and AD261 MS-compatible, four-input mixer.

Audio Developments established products for display include its complete line of Port A Flex limiters and stereo mic pre amps, as well as: ADO62 and AD145 edit mixers; ADO81 Flexilink mixer, and AD150 studio racks.

Another British company, Penny & Giles Studio Equipment, is introducing the VCA16 audio control module, the second in the company's new venture into digital gear. The VCA16 offers 16 channels of VCA audio with full MIDI capabilities.

PRODUCTS & SERVICES

New Formats and New Digital Sound Packages Will Fill the Halls

LAS VEGAS In an effort to keep up with the growing demands of radio and production, a number of companies will have programming and automated services on hand at this year's NAB.

OMNIMUSIC will feature the OMNIMUSIC Sound Effects Library offering 12 digitally-recorded compact discs, a complete cross-referenced index, a computer search program, and a library organized by location or application (such as "Around the House" or "On the Road"). In addition, each disc contains "environments" or ambient atmospheres pertaining to the title.

Broadcast Programming will hit the ground running with a number of new offers. Digital AC Christian is an up-tempo Adult Contemporary Christian format available on CD; Chartbreakers is a monthly compact disc with Adult Contemporary hits, and DigitalLease is a package of digital automation equipment.

Valentino Production Music and Sound Effects Library will show its Sound Production Libraries, including the Music Library with over 75 CDs and the Sound Effects Library with over 50 CDs. New this year are collections in the CD-ROM Multimedia format for IBM, Windows and Mac formats. The company will offer its collection on computer for audition purposes at the booth.

TM Century will unveil its TM Mix and TM Country GoldDisc libraries; its Ultimate Digital Studio II with full audio control (set for delivery this spring); the Slam Dunk production library; jingles, including "We Play the Hits" and "Ridin' with KSCS;" TM Century Television customized spots; PowerPlay music scheduling software, and TM Comedy Network.

Sound Ideas will show its Ambience II Series 7000, containing 325 contemporary atmospheres on 14 CDs; the Mix Broadcast Music Library; the Warner Bros. Sound Effects Library, and the Hanna-Barbera Sound Effects Library.

Two items slated to be hot at the Radio Express booth are HitDisc E, a weekly compilation of breaking European hits and

continued on page 50 ►

Quality, Value, dB-CART...

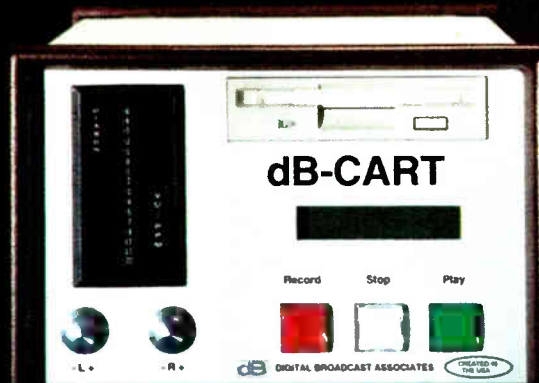

Quite a bit has been written about audio quality, length of recording, central vs. distributed storage. Finally there is a digital cart machine system that combines all of these features in a package that is surprisingly affordable, fully upgradable and so easy to use that your on air talent will think that it was custom designed for them. dB-CART.

dB-CART seamlessly integrates all of your current cart functions with the features and benefits you expect in a digital machine. dB-CART provides the only line of digital cart machines covering all of your cart needs. From our Value Line plug and play analog cart replacement to our full featured Advantage Line, dB-CART has the machine you're looking for.

All of our dB-CARTs offer full bandwidth stereo without compression and still deliver over 10 minutes per disk. Add compression and you get a whopping 60 plus minutes per disk. And because our products conform to the ASPECT standard, your digital dB-CART recordings can be played on other machines.

Record/Play prices start at \$2,495. So whether you're looking for a digital cart machine to do the basics or a full featured machine with all the bells and whistles, 10 minutes or 24 hours, compressed or non-compressed, look to the Sound Approach to Broadcasting, dB-CART.



Digital Broadcast Associates • Telephone (503) 639-6341 • Fax: (503) 620-5440

See Us In Booth #1500

Circle (163) On Reader Service Card

World Radio History

EVERYBODY TELLS US THAT BROADCAST ENGINEERS ARE VERY CONSERVATIVE. OKAY. READ THIS AD NOW AND THEN BUY A CR-1604 IN FIVE YEARS.

We understand why broadcast engineers have a wait-and-see attitude about new products. Your station (and your job) depend on rock-solid reliability and sonic performance you can count on.

We'd like to introduce you to Mackie... even if we do probably seem like a wet-behind-the-ears newcomer compared to some manufacturers. We've been around six years now. During that time we've gained a serious reputation for building high-value, trouble-free mic/line mixers.

Mixers with legendary headroom, ultra-low noise and unique features that make using them easier.

Mixers so good that they're regularly used to create major label compact discs, feature movie soundtracks, and more commercial production work than you can shake an RE20 at. For example, our CR-1604 16-channel mic/line mixers are used nightly on the Tonight Show, Arsenio Hall, Conan O'Brian and David Letterman Shows¹.

Our mixers have also covered hundreds of thousands of miles with acts like Peter Gabriel, Madonna, Whitney Houston, Paula Abdul, Bruce Springsteen, Reba McIntyre, Alabama and Michael Jackson¹. Compared to the relative security of a station production room, a six-month world tour is about the most brutal test that any electronic component can go through. Our mixers have a reputation for being bullet-proof on the road — even when loading dock mishaps and power surges have taken out everything else in the same rack.

As for use at broadcast facilities, well, we're not total newcomers. A quick scan of our warranty database shows that over 70 U.S. radio stations already have Mackie mic/line mixers in place.

Does that mean you folks aren't as conservative as everybody says? If so, call your favorite broadcast supply house, or dial us toll-free for complete information on Mackie's line of mixers.

If you are conservative, keep an eye on us, anyway. We want your business even if we have to wait five years.

3-band equalization done right: $\pm 15\text{dB}$ at 80Hz, $\pm 12\text{dB}$ at 2.5kHz (perfect for voices), $\pm 15\text{dB}$ at 12kHz. Far more useful than traditional 100Hz, 1KHz, 10KHz EQ.

Sealed rotary potentiometers resist contamination from dust, liquids and smoke. Plus they have a smooth, positive feel without a trace of wobble.

The Mackie Designs 16x2 **CR-1604 Mic/Line Mixer**. Suggested retail price, \$1095¹. Available at America's top broadcast supply houses.

Six recording studio-grade microphone preamps with +48VDC phantom power. Discrete circuitry with four conjugate-pair, large-emitter geometry transistors delivers -129.6dBm E.I.N., 300K bandwidth, 0.005% THD...and incredible headroom. A Very Famous Maker of Expensive German Microphones uses a CR-1604's preamps to demo their mics at tradeshows.

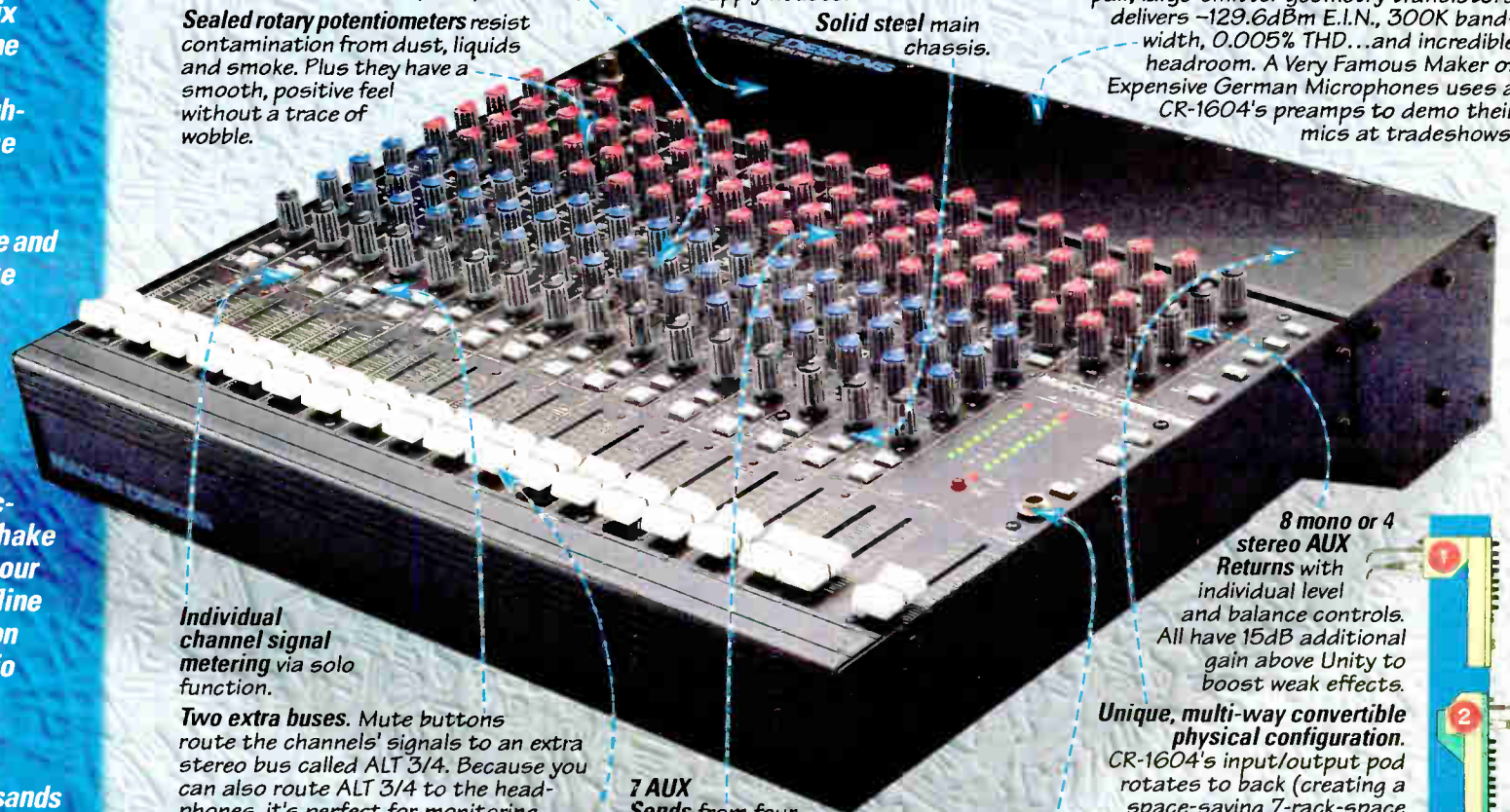

Individual channel metering via solo function.

Two extra buses. Mute buttons route the channels' signals to an extra stereo bus called ALT 3/4. Because you can also route ALT 3/4 to the headphones, it's perfect for monitoring advance audio cues: Preview a signal that hasn't been brought up in the mix yet...then add it by unmuting the channel.

UnityPlus gain structure gives high headroom and low noise at the same time. Set the fader to center-detent Unity Gain, press channel solo to monitor the channel via the CR-1604's LED meters, adjust the input trim ONCE, and you're ready. Because there's 20dB MORE gain available on the fader, you

won't need to constantly re-adjust the trim.

Maximum RF protection. Most compact mixers use plastic jacks that transmit RF to the main circuit board where it's re-radiated and picked up by anything that rectifies (A). The CR-1604 uses metal jacks and washers plus a shunting



capacitor to de-rail RF before it gets to any circuit traces (B). A *Radio World* reviewer tested a CR-1604 on a transmitter hill with 3 VHF TV and 1 FM sticks plus several microwave repeaters and shortwave transmitters. When he plugged in a notoriously RF-prone microphone, he detected NO RF.

Not shown: Inserts on Chs. 1 thru 8, main left/right bus inserts, phantom power switch, balanced/unbalanced main stereo outputs and separate mono output. XLR10 Mic Preamp Expander connects to the CR-1604 pod to provide 10 more preamps complete with trims and phantom power.

Solid steel main chassis.

7 AUX Sends from four knobs. AUX 1 can be used as an effects send or headphone monitor cue via the MON. Sends 3 & 4 become AUXs 5 & 6 when the SHIFT button is pressed. All sends give you 15dB more gain above Unity so that you can get tons of effect even when the channel fader is pulled down.

Powerful headphone amp (with volume control) drives any phones to head-banging levels even an AOR production person will appreciate.



A chip off the old block: Perfect for remotes, our MS1202 12x2 Mic/Line Mixer has 4 of the same superb mic preamps that distinguish our larger CR-1604, plus phantom power, 2 AUX sends/ch., 2 stereo AUX returns, channel patching, 2-band EQ, 3-way 12-LED peak metering, headphone monitor amp with level control, built-in power supply. Suggested retail is just \$399¹!

8 mono or 4 stereo AUX Returns with individual level and balance controls. All have 15dB additional gain above Unity to boost weak effects.

Unique, multi-way convertible physical configuration.

CR-1604's input/output pod rotates to back (creating a space-saving 7-rack-space mixer shown in Fig. 1), or to front (10 rack spaces, shown in Fig. 2) with our optional RotoPod bracket. Use the CR-1604 on a tabletop with jacks on the same plane as the controls via the RotoPod bracket (Fig. 3 below), or jacks to top (Fig. 4 below). Our XLR10 Mic Preamp Expander can also be added in any of these configurations.

Rugged design and construction. Including mil-spec, double-sided, thru-hole-plated fiberglass circuit boards (horizontally-mounted on brass stand-offs for impact-resistance), double-parallel-wired faders for 2-times redundancy, and electronic protection against power surges, impedance mis-matches and static discharges.

Better-than-digital specs and headroom. The CR-1604 has a dynamic range of 108dB and an internal S/N ratio of -116dB (versus compact discs' 96dB dynamic range.) This means you're getting a mixer that can handle the output of digital workstations, CDs and DAT tapes without overload.



¹ Mention in this ad denotes documented usage only. Mention is not intended to infer endorsement by any of the television shows listed.

² Price is slightly higher in Canada.

MACKIE.

MACKIE DESIGNS INC. • 20205 144th Ave NE • Woodinville, WA • 98072 • 800/998-3211
FAX 206/487-4337 • Outside the U.S. call 206/487-4333 • Represented in Canada by S.F. Marketing 800/363-8855

Circle (12) On Reader Service Card
World Radio History

RF EQUIPMENT

Where to Discover the
Finest in New RF Gear

► continued from page 44

mitters from 100 to 500 W; the Legend Series of medium-power solid state FM transmitters from 1 kW to 5 kW, and the MK Series of grounded grid triode tube FM transmitters in powers from 1.5 kW to 50 kW.

Dataworld will offer its full line of services, including AM, FM and wireless cable databases, customized maps, directories, allocation and interference studies, population counting, FCC Flag service, terrain elevation retrieval, FM and TV area-to-locate studies, AM daytime and nighttime channel studies and unused call sign listings.

Varian Associates will promote its power grid tubes for AM, FM and shortwave radio and will offer a new service—remanufacturing of power grid tubes for radio transmission.

Larcant-TTC will show the FMS4000 4 kW solid state FM transmitter and FMS100 100 W solid state FM transmitter, among other products.

Econco will feature its high-quality rebuilt power tubes and klystrons for radio and TV transmitters.

Superior Electric will feature the WHR Series Stabiline Automatic Voltage Regulators, high-power units that correct wide fluctuations in input voltage that can cause damage to components. The company also will have its full line of power pro-

tection products, including uninterruptible power supplies, power conditioners, transient voltage suppressor/RFI filters and automatic voltage regulators.

Itelco will offer its new FM exciter-transceiver with output power from 100 W to 250 W. Features include a MOSFET amplifier; ultra-broadband working for OIRT and CCIR standards in the range of 50+120

MHz, and Automatic Power Control.

Elenos will show the SF Series of amplifiers, based on MOSFET solid-state technology. It features compact design, ease of maintenance, high output power, stability, output protection and the company's "Smart protection system." Also on hand will be exciters, radio links, filters, combiners, aerials and RF diagnostic gear.

PRODUCTS & SERVICES

Program Services Give
Stations More Choices

► continued from page 48

alternative rock, and Weekly Programming, featuring American Top 40, Hot Mix, American Gold and American Country Countdown.

Manhattan Production Music will introduce new releases from Chesky Records Classical Series and MPM 49 High Energy Rock III.

New in 1994 for **Halland Broadcast Services** is the "Halland Country Hits" CD music library, a 461-song compilation of the best contemporary country hits from the 1980s and 1990s. Also new is "The Nineties" AC/CHR library update featuring more than 75 songs of 1993. A number of the established libraries will also be on display.

Energetic Music Inc. will introduce its EZ-1 Easy Listening #1 Light middle-of-the-road background music, Jewish Party Volume I, Jewish Party Volume II and 427 Sound Effects.

Capitol/OGM Production Music will display its production music for contemporary markets in broadcast, film, cable, home video, satellite programming, CD-ROM and electronic publishing.

FRESH/The Music Library will show its line of music libraries, and **Focal Press** will have its broadcast- and communications-related publications at the show.

Finally, **International E-Z Up Inc.** will display its instant shelters, which can be set up in less than 60 seconds.

Morgan's Contributions

► continued from page 36

From the broadcaster's standpoint the most important issue before the NRSC is DAB. A very exhaustive system of tests is presently under way at the NASA Lewis Research Center in Cleveland. Seven systems will undergo identical laboratory and subjective listening tests conducted jointly for the NRSC and EIA subcommittees. Once testing is completed, the NRSC will analyze and evaluate the data for all in-band/on-channel systems and, if appropriate, recommend a standard for the United States. Only the NRSC will evaluate the three FM systems and the single AM system that are considered in-band/on-channel. The three remaining systems that use satellite, new band and adjacent FM channel delivery systems will be evaluated in a similar manner by a separate committee of the EIA. If all goes well and there are no roadblocks or unanticipated delays, we could

have recommended standards by early 1995.

RW: Are there other new technologies on the horizon that can enhance radio's technical quality?

Morgan: I guess. I consider DAB to be still on the horizon because it is not here yet. I don't question the technical feasibility of any of the various systems proposed. The real question is: Are they practical, economically feasible and how do they fit in the overall spectrum plans of our government? For the FM broadcast, in-band/on-channel is the perfect answer to providing enhanced quality for existing facilities without requiring new spectrum. For the AM broadcaster, DAB offers the most dramatic improvement, which, if successful, will truly be the rebirth of AM.

It is hard to imagine enhancements beyond DAB for radio, but as long as there are people with ideas, there will be new technologies on the horizon.

THE RF EXPERTS KNOW—MYAT DELIVERS

MYAT DELIVERS QUALITY

You can rely on MYAT rigid line and components to deliver a clean, powerful signal to your antenna. Pure highest quality copper, brass and silver plus computer-aided design and manufacturing ensure consistency and accuracy. No wonder demanding broadcasters worldwide choose MYAT products for their passive systems. We take Quality Control very seriously.

MYAT DELIVERS RELIABLE PERFORMANCE

Our non-galling silver-plated beryllium copper contact springs, brass elbow reinforcements and virgin Teflon inner supports are designed for maximum velocity, minimum attenuation and long service life. Every MYAT component is tested before shipping and backed with a full one year warranty. MYAT products are built for the long run.

MYAT DELIVERS WHEN YOU NEED IT

Major transmitter manufacturers with strict production schedules rely on MYAT to deliver quality components on time and within budget. So do leading broadcasters like the Empire State Building's newest TV tenants. At MYAT, commitments are kept.

LET MYAT DELIVER FOR YOU

Whether you're planning a new tower, upgrading an older installation, or coping with an emergency, you can depend on MYAT rigid line and components. Thousands of RF experts around the world already do. Contact your RF distributor, or phone us for our catalog, installation planning guide and engineering reference. Its detailed drawings can help you put together an efficient, trouble-free transmission line that will last for decades. For a free copy call 201-767-5380 or fax 201-767-4147.



RIGID LINE: RADIO'S EFFICIENT CHOICE

40 YEARS OF EXPERIENCE. 40 YEARS OF EXCELLENCE.
380 Chestnut Street • P.O. Box 425 • Norwood, NJ 07648
Tel 201-767-5380 • Fax 201-767-4147

Exhibitor Directory

The 1994 Exhibitor Directory is a listing of information provided by exhibitors who responded to an RW NAB questionnaire. Past and potential NAB exhibitors were asked about new and established products scheduled to be shown at NAB this year. Questionnaires returned by the deadline are included here. TBD for booth number means a booth assignment had not yet been made.

COMPANY BOOTH #

360 Systems 5420

Introducing: The DigiCart/TC, a random access digital audio hard disk recorder designed for SMPTE time code synch applications between video and audio.

Also: The DigiCart II digital audio recorder and the A16/B audio routing switcher.

Contact: Doug Leighton, Marketing Manager
18740 Oxnard Street
Tarzana, Calif. 91356
818-342-3127

3M 16605

On display: The 908 analog recording master tape for Nagra recorders, featuring 75 dB signal-to-noise ratio, and line of recording media.



A-Ware Software 5120

On display: MusicMaster music and scheduling maintenance system, which interfaces with almost any automation and traffic system. Also Closeline, a school and business closing management system.

Contact: Scott Wirt
A-Ware Software, Inc.
22600 Arcadian Avenue
Waukesha, WI 53188
414-521-2890

Acoustic Systems 12807

On display: Modular broadcast/recording enclosures including the BB/Econoline and BB/Proline series of voice-over booths.

AEQ 2300

On display: The Management of Audio Systems (MAR) digital audio workstation and storage device. Company line of studio gear, including power amplifiers, audio monitors, consoles, portable mixers and telephone hybrids.

Contact: Gerard Vargas
AEQ
2211 South 48th Street, Suite H
Tempe, AZ 85282-1008
602-431-0334

Akai 4602

On display: The DR4d self-contained four-track hard disk recorder and DD1000i re-writeable magneto optical recorder, both now utilized in broadcast and radio production environments. Other products will include the S-Series of digital samplers.

AKG/Orban/dbx 2806

Introducing: The Orban DSE 7000 digital audio workstation and the Optimod-FM 8200 digital processor. AKG's new C3000 microphone, designed for radio announcers, also will be in the booth.

Contact: Amy Herndon
1525 Alvarado St.
San Leandro, CA 94577
510-351-3500

Altronic Research 2700

Introducing: The model 67150 150 kW medium wave, air-cooled dummy load, processor-based calorimetry system for air or water systems, and the Model 6700 and 0700 series of dummy loads.

Contact: Doug Starkey
P.O. Box 249
Yellville, AR 72687
501-449-4093

Andrew Corp. 15674

On display: The MR-050 Series DryLine Dehydrators, SD-002 Series Static Dessicators, IEC connectors for HELIAX, VALUFLEX HELIAX jumper cable assemblies, and 3M Cold Shrink weatherproofing kits.

Contact: Bobbi Rick
10500 W. 153rd St.
Orlando Park, IL 60462
800-255-1479

Aphex Systems 3924

Introducing: Expander Gate Model 622, featuring Logic-Assisted Gate circuitry. Four-channel Logic-Assisted Gate Model 105, featuring VCA 1001 for pristine audio quality and high-speed performance. Easyrider four-channel compressor Model 106.

Also: Audiophile AirChain, including the Compellor Model 320, aural exciter type C2 with Big Bottom Model 104, Dominator II Model 720 and Digidocder. Full line of professional audio processing equipment.

Contact: Chrissy McDaniels, Sales Coord.
11068 Randall St.
Sun Valley, CA 91352
818-767-2929

Arrakis Systems 2412

Introducing: MixStar consoles, including the 22,000 20- and 30-input modular consoles; the 1,200-5S compact, five-input console; 1,200-10-S 10-input console; and the 1,200-TRT four-channel turret for news/talk operation. Deskstar furniture line.

Also: DigiLink digital audio system. TrakStar digital audio editor. 12,000 Series consoles.
Contact: David Burns
214 South 19th St.
Richmond, IN 47374
317-935-7087

ASACA 16619

On display: Audio analyzers, switchers, magneto optical recorder and other audio equipment.

ATI 13603-13604

Introducing: The Nanoamp Series of low-cost utility amplifiers, which includes expandable mixers, microphone, and line amps. Also: The MicroAmp and Encore Series of amplifiers.

Contact: Ed Mullin
328 W. Maple Avenue
Horsham, PA 19044
215-443-0330

ASC Audio Video Corp. 19753

Introducing: The Virtual Recorder, a digital random access replacement for VTRs, in combination with commercial spot insertion systems and audio workstations.

Audi-Cord Corp. 3926

On display: Full line of DL Series NAB cartridge machines, available in either mono or stereo configurations. Dual recorder reproducer for simultaneous recording or cartridge copying.

Contact: Andy Rector
1845 W. Hovey Ave.
Normal, IL 61761
309-452-9461

Audio Accessories 13041-13042

The company will show its audio panels, jacks, patch panels and cords.

Audio Developments 16125/16225

Introducing: The ADO62 and AD145 location and edit mixers, AD081 Flexi Link Systems and ADO150 Series 19-inch 1U studio rack equipment.

Audio Precision 3402

Introducing: An improved bit-rate digital encoder/decoder testing software.

Also: The Systems One, System One Plus DSP, and Portable One Plus.

Contact: Tom Minter
P.O. Box 2209
Beaverton, OR 97075-3070
800-231-7350

Audio Services 4506

Introducing: The DK Audio MSD-550 Master Stereo Display.

Also: The Fostex PD-2 portable DAT, and TASCAM DA-88.

I COULD HAVE BOUGHT A DIGILINK!

Are you thinking about replacing your old cart machines with 'Digital Carts' such as floppies, flopticals, Bernoullis, or Optical??? Well, think about it a little more! Add up the list price for a digital cartridge recorder, just a single player, AND the floppy disks--- and you will find that you could have bought a DigiLink workstation for \$7,995 that gave you 'Live' -AND- 'Automation' capabilities!!!

A DigiLink workstation stores audio on an internal hard disk and comes out of the box with a capacity of 547 one minute, stereo carts for only \$7,995. Even better, the DigiLink hard disk has an average 15 year life. Imagine how many floppies you will break, wear out, lose, and replace over 15 years. That doesn't count all of the floppy disk mechanisms that will jam, break, and simply fail...

Consoles
Modulux
Trak*Star
DigiLink
Modulink

Also with a DigiLink, you get much more! You can stack up hundreds of 'carts' in the play list and just walk away. You get satellite automation in the DigiLink workstation and can optionally add CD players. A digital audio cut and splice editor even comes standard with DigiLink. Because DigiLink will play and record at the same time, you can play a spot to air while it starts a scheduled network autorecord. You can even network delay with DigiLink.

With all of these features, it is easy to see why there are more than 500 DigiLink workstations around the world from Paris to Moscow to Taiwan to Jamaica and in your own backyard. Don't suddenly come to the realization that you could have bought a DigiLink! Call Arrakis now...

(303) 224-2248

ARRAKIS

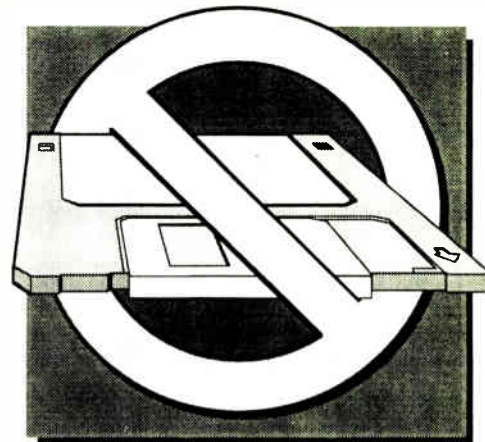

© 1993 Arrakis Systems Inc. 2619 Midpoint Drive, Fort Collins, CO. 80525

TAG 2020

TELEPHONE AUTOMATIC GAIN

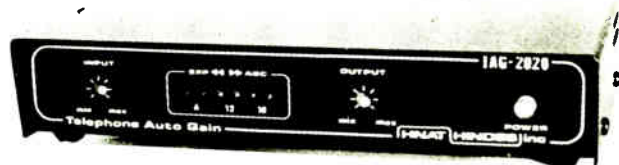

A PROCESSOR FOR ALL SEASONS

- ★ BASEBALL SEASON
- ★ BASKETBALL SEASON
- ★ FOOTBALL SEASON
- ★ HOCKEY SEASON

FEATURES: BROADBAND OR BANDPASS FILTERED
MIC OR LINE INPUT (SELECTABLE)
OPTIONAL AUTO-ANSWER BOARD
DIFFERENTIAL LINE OUT

HNAT HINDES Inc

42 ELAINE ST. THOMPSON, CT 06277 TEL203-935-9066/9242/9919FAX

Circle (86) On Reader Service Card

Circle (217) On Reader Service Card

See Us At NAB Booth 3912

APT 4306
Introducing: The Pro-link, which combines an ISDN terminal adapter with six channel I-MUX. Also: The DSM100 digital audio transceiver, ACE 100 Series of PC and Macintosh expansion cards, and X-console.
Contact: Steve Cheung
Edgewater Road
Belfast BT3 9JQ
Northern Ireland
0232-371110

Audiopak Inc. 4018
On display: NAB standard continuous-loop audio carts, including A-2, AA-3 and AA-4 for the recording and broadcast of spots, jingles, announcements and music. Lubricated audio tape for use in all types of endless loop cartridges and cassettes, including Formulas 605, 613 and 614.
Contact: Gordon Stafford
P.O. Box 3100
Winchester, VA 22604
703-667-8125



LMA/DUOPOLY CONTOUR MAPS

The **DATAWORLD** LMA/DUOPOLY Market Survey Contour maps present a precise electronic verification of overlapping and intersecting contours.

AM 5 mV/m and FM 3.16 mV/m City Grade contours are shown in full color, including transmitter site indicator. The map is supported with a printout showing all of the stations which appear on the map.

Daily updating of **DATAWORLD'S** AM and FM databases protects against errors and omissions.

OTHER MAP OPTIONS

- SHADOWING (TERRAIN SHIELDING)
- CONTOUR COVERAGE
- POPULATION DENSITY
- ZIP CODE BOUNDARIES
- RECEIVED SIGNAL LEVEL
- SPECIAL REQUIREMENTS

1990 CENSUS

WHO ARE YOUR LISTENERS?

1990 BUREAU OF CENSUS POPULATION COUNTING

- Comprehensive Ethnic and Demographic Data
- Ethnic/Demographic Data Available for Each Zip Code Within Coverage Area
- Age Analysis Reflected in Ethnic Breakout
- Resolution Increased to Block Level
- Percent of County Coverage Shown

ETHNIC PIE-CHART DISPLAY

- Projects Ethnic Population in Multi-Color Pie Chart Form

dataworld®

800-368-5754 FAX: 301-656-5341

Auditronics 2302
Introducing: The Destiny 2000 on-air management console for use with hard disk storage. Also: The Airmaster 90 on-air console, 210 Series, and 800 series.
Contact: Murray Shields
3750 Old Getwell Rd.
Memphis, TN 38118
901-362-1350

Autogram Corp. 4520-2
On display: MM-8A and MM-12A low-cost 8 slide pot audio console. PM 1032, part of the Pacemaker Series of 6, 8, 10 and 16 slide pot consoles. R/TV-20 top-of-the-line slide pot audio console.
Contact: Ernest T. Ankele Jr.
1500 Capital Ave.
Plano, TX 75074
800-327-6901

AVCOM 11607
Introducing: The BNG-1000A broadband noise generator that can be used with spectrum analyzers. Also: The GAE-1575 GPS antenna extension.
Contact: Charles Odom
500 Southlake Blvd.
Richmond, VA 23236
804-794-2500

b

BASYS Automation Systems 19247
Introducing: The NetStation for Windows, a PC-based newsroom system workstation. Also: The D-Cart digital audio record, edit and playback system.
Contact: Kristin Schleiter
5 Odell Plaza
Yonkers, NY 10701
914-376-4800

Belar 2508
Introducing: A new digital FM stereo monitor analyzer. Also: The Wizard modulation monitor and company's established line of products.
Contact: David Hirsch
119 Lancaster Avenue, P.O. Box 76
Devon, PA 19333-0076
610-687-5550

Benchmark Media Systems 11059
On display: The Jr. Audio Director Plus, an eight-input, two-output monitoring device; RGM-10 remote gain and metering control, AudioWorld Interface, MDA-101PA microphone preamp, DA-102M and DA-111 and DA-112 stereo distribution amplifiers.
Contact: Rory Rall
5925 Court Street Road
Syracuse, N.Y. 13206-1707
315-437-6300

BEXT 2414
Introducing: The SF Series of solid state MOS-FET FM amplifiers from 100 to 1000 watts, and the LEX 25 programmable FM exciter. Also: The line of FM amplifiers and STLs.
Contact: Dennis Pieri
739 Fifth Avenue
San Diego, CA 92101
619-239-8462

beyerdynamic Inc. 11315
Introducing: DT 190 sportscaster headset/microphone combo. DT 150 monitoring headphone. MC 834 large diaphragm condenser microphone for on-air voice work. MEM 86 set shotgun microphone system. MCE 50 Series miniature clip-on microphones. M424 control room talkback microphone. VHF and UHF wireless microphone systems. NE 700 TE2 two-channel diversity receiver.
Also: RR 7000 TG 12 12-channel UHF diversity receiver. NEM 191 and 192 neck-worn mics. Complete range of professional microphones and headphones.



Benchmark's Jr. Audio Director

Bradley Broadcast 4002
On display: The Telos Zephyr digital transceiver that uses ISDN lines, and the Telos One-x-Six Talk Show System, a digital hybrid six-line phone/console system. Other products will include Digidesign's Session 8 digital studio and the Audioarts line of broadcast mixing consoles.

Broadcast Electronics 3424
Introducing: The FM-3C 3 kW solid state FM transmitter, the D.A. Box digital audio storage system and the AV-100 networked digital audio storage system.
Also: The FM-1C 1 kW solid state FM transmitter; FM-30B 30 kW FM transmitter; AM-5 5 kW AM transmitter; RBDS; MT-90 12-channel console; AT-90 12-channel console; AV-100 digital audio storage system; CORE automation system; Sentry automation system and VMC-16 voice remote control system.
Contact: Kim Winking
4100 N. 24th St.
Quincy, IL 62301
217-224-9600

FM BROADCAST POWER AMPS

... the low-cost way
to increase power

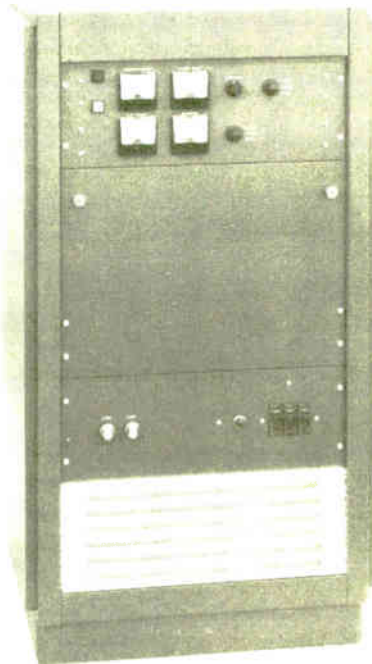

HENRY FM Broadcast Power Amplifiers are a significantly less expensive way to upgrade to "Class A" service. The initial cost is low, and maintenance is easy.

HENRY amps are also suitable for new construction or backup service at high power stations. Eimac ceramic triodes are used in grounded grid... a design that is conservative, reliable, stable and very economical.

All HENRY amps are type accepted for use with any type-accepted 10 watt exciter. Input and output low-pass filters are built in for service as a primary or backup transmitter.

Call or write today for additional information, prices and specifications.

HENRY RADIO

2050 South Bundy Drive
Los Angeles, CA 90025
Phone (800) 877-7979
or (310) 820-1234
FAX 310-826-7790

Broadcast International 17582, 17682, 17782
No information available at press time.

Broadcast Marketing International 19328-19329
New products to be displayed are: Kobold ENG 200 compact lighting system and Noriyuki time code equipment.

Broadcast Supply Worldwide 4820
On display: The Arrakis DigiLink and TrakStar systems as well as the KORGE and DigiDesign digital workstations.
Contact: Tim Schwieger
7012 27th Street West
Tacoma, WA 98466
800-426-8434

Burk Technology 4818
Introducing: Software options for the ARC 16 transmitter remote control system.
Also: The LX-1 six-input stereo selector.
Contact: Phil Halter
7 Lomar Drive
Pepperell, MA 01463
508-433-8877

e

Cablewave Systems Inc. 15753
Introducing: Cablewave broadcast antenna pattern computer software for pattern viewing with database of product information. N and 7/16 DIN series cable connectors with im-

proved water blocking design.
Also: Flexwell air and foam coaxial cables. Cablewave BU series of side-mount and top-mount broadcast antennas. Rigid line coaxial cables. CP-1000 and HP-1000 FM antennas.

California Amplifier 15383-5
Contact: Tom Ellsworth
460 Calle San Pablo
Camarillo, CA 93012
805-987-9000

Capitol/OGM Production Music 12905
On display: A full line of production music for contemporary markets including the new Archives line.

CBSI 1624
Introducing: Broadcast accounting and traffic department software including Design Financial reports, Custom Reports and PowerPlus. Also: The Classic and Elite Traffic and Billing systems, as well as the InterAcct. software.

CCA 4220
On display: The full line of AM, FM and short-wave broadcast transmitters as well as company's 60 watt FM exciter.
Contact: Steve McElroy
360 Bohannon Road
P.O. Box 426
Fairburn, GA 30213
404-964-3530

Central Tower 1906
On display: Antenna support towers, guyed towers and welded sections.

Clark Wire & Cable 19537-8
Introducing: Clark 1300 Series audio snakes. Hannay cable reels.
Also: Bulk audio and video cable and connectors. Remote composite cables, patchbays and terminated reels. OEM custom terminated cable assemblies and harnesses.
Contact: Julie Clark
151 S. Pfingsten Rd., #B
Deerfield, IL 60062
708-272-9889

See The
New EBS System
In Booth 2800

**SAGE
ALERTING
SYSTEMS**

Circle (84) On Reader Service Card
See Us At NAB Booth 1918

Circle (175) On Reader Service Card

World Radio History

Clear-Com Intercom Systems 18015

On display: AMS-1022 stereo audio monitor. Wired and wireless two, four, eight and 12 channel partyline intercom systems. Pro-40 lightweight headset product line. Matrix Plus II digital 100x100 central matrix intercom system.

CRL 3015

On display: The DAA-50 digital audio analyzer, a digital audio interface tool for analysis and decoding of AES/EBU and consumer digital audio signals. Other products include RBDS-SC-100 generator and the Real Time Event Sequencer.

Coaxial Dynamics Inc. 5116

Contact: John R. Ittel
15210 Industrial Pkwy.
Cleveland, OH 44135
216-267-2233

Cole Wire and Cable 10759 & 10859

On display: Cable and wire for audio and video. High voltage transmitter cable.

Comark 16113

On display: IOX TV transmitter lines, IOT and the S Series transmitters.

Communications Data Services 4019

On display: Data and computer applications for radio and GIS industries.

Comrex 12206

Introducing: 20 kHz mono/stereo digital audio codecs, DX-100 apt-X, Model DX-200, DX-210, DX-230, and DX-240.

Also: Established lines including 7.5 kHz digital audio codecs.

Contact: Lynn Distler
65 Nonset Path
Acton, MA 01720

Comstream 4000

Introducing: A desktop version of its ABR75B satellite digital audio receiver that is suited for business music applications. Also: The ABR 200 and ABR75/75B integrated receivers.

Comtech 13402-13403

Introducing: The EC8 microprocessor control system with optional IBM compatible software for control of the company's line of satellite antenna systems.

Continental 3418

On display: Full line of broadcast transmitters and other RF equipment. New product information was not available at presstime.

Contact: Steve Claterbaugh
P.O. Box 270879
Dallas, TX 75227
214-381-4949

Corporate Computer Systems (CCS) 4826

Introducing: The CDQ2001 MUSICAM codec, an enhanced version of the CDQ2000, with 18 bit A/D converter.

Also: The CDQ1000, CDQ2000 and the PACE MUSICAM digital audio editor.

Contact: Doreen Avleth
33 West Main St.
Holmdel, N.J. 07733
908-946-7167

Connectronics 13628

On display: Line of audio and video cables including JB9600 Easy-Wired TT Patchbays and XB range of modular patchbays.

Cortana 3704

On display: Stati-Cat lightning prevention system.

Contact: David Stockmar
P.O. Box 2548
Farmington, NM 87499
505-325-5336

Crown International Inc. 4400-3

Introducing: CM-312 head-worn microphone. Also: Line of Crown microphones and amplifiers for broadcast purposes.

Contact: Bob Herrold
1718 W. Mishawaka Rd.
Elkhart, IN 46517
219-294-8000

CTE International Srl

Contact: Enrico Antoniazzi, Comm. Dept. Mgr.

Via R. Sevardi, 7
42010 Mancasale
Reggio Emilia, Italy
39-522-516660

Cutting Edge Technologies 5200

Introducing: New Unity Remote Software, Unity AM processor and will demonstrate the Unity 2000i FM processor. The new VIP-voice processor also will be shown as will the Dividend Composite Filter.

Contact: Danielle Cline
2101 Superior Avenue
Cleveland, OH 44114
216-241-3343



Dalet 3803

Introducing: Ednews news editing software. Traffic scheduling system.

Also: Cart replacement, satellite automation, non-destructive audio editing and walk-away music automation digital audio systems.

Dataworld Inc. 1918

Introducing: Customized maps, including international.

Also: AM, FM, TV, LPTV and wireless cable databases. Customized maps, directories, allocation and interference studies. Population counting. FCC Flag service. Terrain elevation retrieval. FM and TV area-to-locate studies. AM daytime and nighttime channel studies. Unused call-sign listings.

Contact: Jack Neff
4827 Rugby Ave., Ste. 200
Bethesda, MD 20814
301-652-8822

Dawn Satellite Inc. 17779

Contact: Rose Prete
1190 S. Lapeer Rd., Ste. 100
Oxford, MI 48371
313-969-0010

DB Elettronica TBD

On display: TD4/16 and RD4/16 16-bit digital decoders. Vivaldi digital stereo coder. PE 21 FM

exciter for new analog and digital audio processors. PM 100/PM 250 FM exciter. KN 500/KN 1000 FM solid state amplifier. DCV Series STL translator.

Delta Electronics TBD

On display: The Delta Splatter Monitor, as well as the ASE-2 AM stereo exciter, ASM-1 AM stereo monitor, OIB-1, OIB-3, and CPB-1,1A impedance bridges, RG-4 receiver/generator, TCA RF ammeters, 6730E, 6740B transfer switches, AAM-1 analog antenna monitor and PRH-1 high power pulse reflectometer.

Contact: Joseph S. Novak
Delta Electronics
5730 General Washington Dr.
Alexandria, VA 22312
703-354-3350

Denon America 4303-4

Contact: Michael Stelts
222 New Rd.
Parsippany, NJ 07054
201-882-7460

DIC Digital 19183

Introducing: Beta Cam SP metal particle tapes. Also: HQ DAT cassette for multipurpose applications and live recording. Digital MQ Series studio two-pack for safe DAT cassette storage and transportation. CD-R recordable CD, available in 18-, 63- and 74-minute recording times. CR-4000 4mm/DAT and CR-8000 8mm dry, non-abrasive cleaning system. Complete line of DAT tape. Professional MQ Series and HQ Series

Contact: Rich Mancuso
500 Frank W. Burr Blvd.
Teaneck, NJ 07666
201-692-7700

Dielectric Communications 15719

Introducing: digitLine-broadband rigid transmission line designed to transmit any VHF, FM or UHF frequency with extremely low VSWR. Improved DCR-M quadropole antenna-broadband FM antenna with low VSWR bandwidth in excess of 10 MHz.

Also: TDM, TCL and TUP television broadcast antennas. DCR-C.C.P. FM antenna. Model 200B automatic dehydrator for pressurization of broadcast feedlines. 50000 Series RF switches. 5000 Series oil load and 4000 Series dry load. 7000 series calorimeter.

Contact: Jay S. Martin
P.O. Box 949
Raymond, ME 04071
207-655-4555

Dolby Laboratories Inc. 1620

Introducing: Four-channel DSTL® digital aural STL system. AC-3 digital audio coding. DP521 codec for AC-3 coding. DP501 codec for AC-2 coding. Also: Model 740 Spectral Processor. Dolby SR professional noise reduction. Dolby Surround. Dolby film sound products.

Contact: Kevin Tam
100 Potrero Ave.
San Francisco, CA 94103
415-558-0200

Dorrough Electronics 18815

On display: Audio Level Meters. Stereo Signal Test Set Model 1200.

Econco 2210

On display: Rebuilt power tubes and klystrons for radio and TV transmitters.

Contact: Debbie Baker
1318 Commerce Ave.
Woodland, CA 95776
800-532-6626

Electronics Research Inc. 3212

On display: Side mount FM antennas. Master, multi-station antennas, filters and combiners in medium and high power configurations. Master antenna remote monitoring and reporting equipment. Lambda™ antenna mounting systems. Antenna support towers and structural engineering services. Turn-key construction and emergency repair services.

Contact: David Davies
108 Market Street
Newburgh, IN 47630
812-853-3318

Electro-Voice 15716

On display: RE27N/D microphone, a professional quality dynamic cardioid mic. RE36N/D microphone for broadcast applications. S-40 compact monitor system.

Elenos SRL 1024

On display: SF series amplifiers based on MOSFET solid state technology. Range of radio broadcasting products including FM power amplifiers, exciters, radio links, filters combiners, aeriels, remote control RF diagnostics.

ENCO Systems Inc. 5121-5122

On display: DAD486x digital audio delivery system.

Contact: Larry Lamoray
1866 Craigshire Dr.
St. Louis, MO 63146
314-453-0060

Energetic Music Inc. 3921

Introducing: EZ-1 Easy Listening #1, light "middle of the road" background music. Jewish Party Music volumes I & II, music for Bar and Bat Mitzvahs, weddings, anniversaries, Horas and folk dancing. 427 Sound Effects library.

Also: Energetic Music Buy-Out Library.
Contact: Monty Smith
P.O. Box 84583
Seattle, WA 98124
800-323-2972

Energy-Onix 5408-5410

Introducing: New line of transmitters. Also: SSA/SST Series of low power solid state FM transmitters. Legend Series of medium power solid state FM transmitters. MK Series of grounded grid triode tube FM transmitters. AM and short-wave transmitters.

Contact: Ernie Belanger
752 Warren St.
Hudson, NY 12534
518-828-1690



Did you know?



Broadcast CD Libraries: 1100 cuts \$2495.00
Weekly CD Top Hits U.S.A. - \$16.95/week
Format Services - \$295.00 per month

It doesn't take a genius to recognize a great deal. RPM has a library of 6,000+ cuts digitally remastered for superb on-air quality. We also offer on-time weekly CD hits. Best of all, our services are priced for the 90's. Call for our catalog listing all 6,000 cuts and a sample disc. We're in our 25th year of serving broadcasters and we'd like to work for you.



RADIO PROGRAMMING AND MANAGEMENT, INC.

50 States & Canada: 800-521-2537
Over 1700 clients Worldwide!

Fax: 810-681-3936
Top Hits U.S.A. and Ultrasonic-Q Radio Disc are trademarks of Radio Programming and Management, Inc., 4198 Orchard Lake Road, Orchard Lake, Michigan 48323. The Ultrasonic-Q system is Patented.

8-Track Digital Audio Editing Station For Under \$10,000



See the Session 8 on display at BSW NAB booth 4820

The Digidesign Session 8™

Digidesign's award winning Session 8 brings together virtually every leading edge recording technology available today such as: direct-to-disk digital multi-track recording, digital mixing and track bouncing, random access "cut and paste" style editing, and digital signal processing.

One of the first things you'll notice about Session 8 is how good it sounds. It supports 16-bit audio for 20 Hz to 20 kHz frequency response. It also has the simplest user interface available in a computer based editing system. If you know how to use a recorder and mixer, Session 8 will be a snap!

Session 8 includes it's own on-screen mixer, digital equalization, insert points and patch bay so it can be used as a stand alone studio or in conjunction with your existing mixer and effects. The optional RI controller offers remote control with real analog style faders.

Now Session 8 operates on either PC or MAC platforms, and even with a computer, is still under \$10,000.

Best of all it's available from Digidesign, the manufacturer with more workstations in broadcast production than any other, and BSW, the industry leader in service and selection, with over 20 years experience in serving broadcasters.

**For More Information Or To Order Call The BSW
Digital Specialist Nearest You**

East of the Mississippi, Contact:

Laura Tyson

Voice: 800 • 762 • 5566

Fax: 908 • 459 • 5540

West of the Mississippi, Contact:

Rick Kemp

Voice: 800 • 426 • 8434

Fax: 800 • 231 • 7055

BSW
BROADCAST SUPPLY WORLDWIDE

7012 27th Street West • Tacoma, WA 98466 USA

Circle (64) On Reader Service Card

World Radio History

ESE 12808-12809
 Introducing: ES-185 GPS master clock/time code generator. ES-2940 dual 1x4 and video distribution amplifiers and a five output black burst generator. ES-195 VVG master 21 interface/master calendar. New LUX-Line product family.
 Also: master clock systems, clocks and timers. Time code products. Audio and video distribution amplifiers. Audio level indicators and interfaces.
 Contact: Brian Way
 142 Sierra St.
 El Segundo, CA 90245
 310-322-2136

Eventide Inc. 4809-10
 Introducing: H3000-D/SX Studio Dynamic Ultra-Harmonizer. H3000-D/SE Studio Enhanced Dynamic Ultra-Harmonizer with new 3D speaker-based spatial imaging effects.
 Also: DSP4000 Ultra-Harmonizer. VR240 digital broadcast logger. BD980 broadcast delay.
 Contact: Gil Griffith
 One Asian Way
 Little Ferry, NJ 07643
 201-641-1200

f,g

Faraday Technology Ltd. 19123-19124
 On display: Video filters. Video delay lines. Cable Clone for testing integrity of serial digital signals.

Fidelipac Corp. 1920
 On display: Air Marshal digital hard disk system. MX E Series console. Dynamax SRC digital audio sample rate converter.
 Contact: Bob McNeill
 97 Foster Rd.
 Moorestown, NJ 08057
 609-235-3900

FM Systems 19528
 Introducing: ALM 771 audio level master.
 Also: AVM audio volume meter. AMM audio modulation meter.

Focal Press 13404-13405
 On display: Books about broadcasting.

Fostex 19185
 Contact: David Oren
 15431 Blackburn Ave.
 Norwalk, CA 90650
 310-921-1112

FRESH/The Music Library 2000
 On display: TBA

Garner Industries 13622-13623
 Introducing: Model CF 750 Type II/III extended range degausser.
 Also: Line of tape erasers for all formats.

Gentner Communications Corp. 2612
 Introducing: G2500 and G3200 telephone Superhybrids. TC-101 telephone interface. ET-100 Personal Teleconferencer.
 Also: Line of telephone interface products including couplers, hybrids, call directors and audio bandwidth extenders. VRC-2000 remote control system. Audio routing and distribution products. On-air audio processing equipment. Teleconferencing products and services. Assistive Listening System for ADA compliance in public buildings.
 Contact: Elaine Jones
 1825 Research Way
 Salt Lake City, UT 84119
 801-975-7200

Gorman Redlich Mfg. Co. 4812
 On display: Off-site EBS monitor. Models CM and CMR digital antenna monitor. Model CEB EBS encoder-decoder.
 Contact: James T. Gorman
 257 W. Union St.
 Athens, OH 45701
 614-593-3150

Graham-Patten Systems Inc. 11551
 On display: D/ESAM® 800 and D/ESAM 400 digital edit suite audio mixers.

Halland Broadcast Services Inc. 3700
 Introducing: Halland's Country Hits CD music library. The Nineties AC/CHR library update.
 Also: The Seventies AC/Gold CD library. Rock 'n' Roll Graffiti Oldies library. The Eighties Plus AC/CHR library.
 Contact: Steve Steinberg
 1289 East Alosta Ave.
 Glendora, CA 91740
 818-963-6300

Hallikainen & Friends 1712
 Introducing: DRC200 transmitter control system software update. Election Central software.
 Also: DRC190 transmitter control system. TEL 171 digital telemetry adaptor. ITO178 board and software for controlling a Moseley TRC-15A with a TEL 171. TVA series of audio mixers.
 Contact: Harold Hallikainen
 141 Suburban Road, Building E4
 San Luis Obispo, CA 93401-7590

Harris Allied
 Introducing: Harris Quest 1 FM transmitter. AIRcart digital cart machine. Audisk. Cylink. Band spread spectrum modems. ENCO DAD486x digital audio delivery system. Gentner telephone hybrids. Mini Disc recorders/players. nVision digital interface products. Orban DSE-7000. RE America digital audio codecs.
 Also: Harris Platinum Series® PT 10FM transmitter. Digit™ digital FM exciter. Harris DX 10 and DX 100 digital solid state MW transmitters. Harris AMS-G1 C-QUAM® stereo exciter. Harris HT 10FM and HT 35FM FM transmitters. Audio-Metrics CD-10 CD cart player. Tascam DA-88. Roland DM-80. Auditronics consoles. RE America RDS/RBDS equipment. Harris Allied radio studio systems.
 Contact: Martha Rapp
 3200 Wismann Lane
 P.O. Box 4290
 Quincy, IL 62305-4290
 217-222-8200

continued on page 59 ▶

ACCESS THE MAX! RDS Global Messaging



Join the telecommunications revolution!
 Enter the lucrative paging and personal communications market with
Access 3000/RDS . . .
 The most technologically advanced alphanumeric message transfer system (in any language) available today. Use your existing FM radio station for effortless paging, message and information transfer.

- ✓ TURN-KEY SYSTEM . . . AT AN AFFORDABLE PRICE
- ✓ NO MAJOR CAPITAL INVESTMENT . . . YOU ALREADY HAVE THE FM SUB CARRIER CAPABILITY
- ✓ JOIN THE NETWORK . . . BE PART OF A NATIONALLY FRANCHISED PAGING SYSTEM
- ✓ GREATER COVERAGE AREA . . . PERFORMANCE YOUR COMPETITION CANNOT MATCH
- ✓ READY MARKET . . . WITH VIRTUALLY UNLIMITED GROWTH POTENTIAL
- ✓ PROFIT POTENTIAL . . . WITH RECURRING REVENUE



Access USA Communication Corp.
 6620 Riverside Dr., Metairie, LA 70003 • (504) 889-9800 • FAX (504) 887-0950
Sparton Electronics
 P.O. Box 788, DeLeon Springs, FL 32130 • (904) 985-4631 • FAX (904) 985-9855



RELIABILITY & CTE GO HAND-IN-HAND

With C.T.E. equipment, there is an effectiveness you cannot ignore. In fact, C.T.E.'s manufacturing process includes quality control checks that make all products masterpieces of reliability. At the same time, CCIR, FCC and OIRT requirements are fully complied with and prices are kept reasonable. Our team of professional engineers is always on hand to provide any assistance you may require. C.T.E.'s impressive number of installations and next-door service demonstrate our achievements. At C.T.E., we believe that technical innovation and its continued implementation are the most important ingredients for success. And when you buy a C.T.E. product, you share in this success.



HEADQUARTERS : CTE INTERNATIONAL S.r.l. via R. Sordani, 7 • I - 42010 MANCASALE - RE, Italy
 Tel. +39 - 522 - 516663, Fax +39 - 522 - 921248
ITALIAN TECHNOLOGY FOR WORLDWIDE MARKETS



Ultimate Digital Studio

MUSIC IS FROM COMPACT DISC (TM CENTURY GoldDisc® MUSIC LIBRARIES ARE AVAILABLE IN ALL POPULAR FORMATS)

COMMERCIALS, JINGLES AND LINERS ARE FROM HARD DISK.

THE SOURCE IS CLEARLY DISPLAYED AT ALL TIMES

The screenshot displays the Ultimate Digital Studio interface. At the top, it shows 'TMC I 2:22 PM ULTIMATE DIGITAL STUDIO Tuesday 01/04/94'. The main area is divided into several sections:

- ON THE AIR 1:04:** DECEMBER, 1963 (source: PIONEER #16, Slot:13, Cut:12, Music:433, Sked at:02:25P, Sked on:01/04). Below it, FOUR SEASONS (Time: 2:13, Intro:13, End:F).
- READY TO AIR:** IT HIT ME LIKE A HAMMER (source: CD JUKEBOX #2, Slot:41, Cut:09, CD ID:9108, Sked at:02:28P). Below it, LEWIS, HUEY & THE NEWS (Time: 3:53).
- NEXT T:** SET THE NIGHT (Time: 4:33). Below it, FLACK, ROBERTA WITH (Time: 4:33).

A blue pop-up window titled 'VIEW EVENTS ESC to Exit.' is overlaid on the interface, showing a list of events:

Time	Source	Event	Source
2:19 PM	4	Hormel #1	DIGITAL AUDIO
2:20 PM	D	Pizza Hut #1	DIGITAL AUDIO
2:20 PM	D	Mix 105 #3	DIGITAL AUDIO
ON AIR		DECEMBER, 1963	FOUR SEASONS
02:28 PM :15		IT HIT ME LIKE A HAMMER	LEWIS, HUEY & THE NE
02:32 PM :01		SET THE NIGHT TO MUSIC	FLACK, ROBERTA WITH

Other interface elements include a 'System AUTO/SEGUE LOADING LOGGING:ON TIME UPDATE' box and an 'F1 Help' button.

UDS clearly shows you WHAT'S ON THE AIR, WHAT EVENT IS READY TO AIR NEXT, AND WHAT IS NEXT TO FOLLOW

USER FRIENDLY WINDOWS POP UP WITH ONE KEY STROKE

View what has played and what is coming up without access to schedule

TM CENTURY HAS DELIVERED OVER 400 Ultimate Digital Studio systems worldwide. The software and hardware components that comprise the UDS are highly reliable and proven.

Call your sales representative for information about the many other features that are incorporated into the Ultimate Digital Studio.

(800) TM CENTURY

TM CENTURY[®] Inc.

TM CENTURY would like you to see the screens you live and work with BEFORE you've made your choice for AUTOMATION or LIVE ASSIST...

Annotations:

- Endings are clearly shown as Cold (C) or Fade (F)
- Large countdown clock shows the exact time before the vocal begins! It can't be wrong!
- Get help at any time without interrupting any part of the program
- Switch to manual play if you need or choose to stop the program
- Edit events allows access (can be password protected) to schedule to find songs by title, artist, or length on the fly in real time without interrupting play.

Interface Content:

TMCI 2:46 PM ULTIMATE DIGITAL STUDIO Tuesday 01/04/94

ON THE AIR 0:04
I WONDER WHY
STIGERS, CURTIS
Time: 4:06 Intro:28 End:F

READY TO AIR
Raid Max
DIGITAL AUDIO
Time: 0:29 Intro:00 End:C

NEXT TO FOLLOW
CERTS
DIGITAL AUDIO
Time: 0:30 Intro:00 End:C

System
AUTO | SEGUE
LOADING: 1
LOGGING: ON
TIME UPDATE

F1 Help
F2 Manual
F3 View Events
F4 Edit Events

Copyright 1990 - 1994 TM Century, Inc. Dallas, Texas

Total time, intro length, elapsed time, and all important information is always clearly shown.

WE DON'T LOCK YOU INTO ONE TYPE OF MUSIC SCHEDULING SOFTWARE, TRAFFIC AND BILLING SOFTWARE, CD JUKEBOX OR HARD DRIVE. INTERFACES FOR MANY COMBINATIONS ARE AVAILABLE. YOU DECIDE WHAT COMBINATION YOU LIKE BEST.

FOR YOUR PERSONAL SALES REPRESENTATIVE CALL:



360

invented the DigiCart® recorder to bring CD quality audio to broadcasting. Our on-going technical efforts provide customers with the service, upgrades and confidence expected in the broadcast community.



DIGICART/II

DIGICART/II

THE PROVEN UPGRADE FROM ANALOG CARTS

STANDARD FEATURES

- Instant access to any of 10,000 cuts
- 2-hour internal hard disk
- 68-minute Bernoulli cartridge drive²
- 16-bit linear recording for true CD quality
- Selectable Dolby AC-2 Data Reduction¹
- Normal operation provides 20 kHz stereo audio
- Digital Editing
- DSP generated fades & levels changes
- Bright 40-character display shows cut name, ID#, running time, and helpful user prompts
- Pre-program breaks and spot rotation
- Automatic record-on-audio
- Five year hard drive warranty
- Five year Bernoulli disk life
- Worldwide sales and service

BREAKTHROUGH PRICING

- Only \$4,995 record/play stereo, including a 2-hour hard disk. Other models from \$4,250 less hard disk. DigiCart/II is by far the lowest priced digital cart recorder on the market.
- Low-cost media—Only \$1.42 per minute²

OPTIONAL FEATURES

- Mini keyboard for titling and remote control
- Two new remote controls include LCD display
- "Hot Keys" give instant access to 16 spots
- Larger hard disks store 4 or 8 hours of stereo
- External hard disk arrays store up to 48 hours
- AES/EBU and SPDIF digital I/O³
- Toolkit for developing custom serial port programs

FOR A FREE 12-PAGE BROCHURE, CALL 818.342.3127

360 Systems

PROFESSIONAL DIGITAL AUDIO

360 SYSTEMS 18740 OXNARD STREET, TARZANA, CALIFORNIA 91356 818.342.3127 FAX 818.342.4372

DigiCart/II

¹User-selectable. ²150 MB Bernoulli Disk. ³SMPT/EBU Time Code board and Digital I/O available 1994. Stated specifications are with Dolby AC-2 operation.

DIGICART IS A REGISTERED TRADEMARK OF 360 SYSTEMS. DOLBY IS A TRADEMARK OF DOLBY LABORATORIES, INC. ©1993 360 SYSTEMS

Circle (164) On Reader Service Card

World Radio History

Henry Engineering 3700
 Introducing: Fast Trac II voice-over audio workstation. Stereoswitch three-input stereo line switcher.
 Also: Matchbox. Telephone Information System. USDA. Twinmatch. Micromixer. Logicconverter. MixMinus-Plus. Superelay.
 Contact: Hank Landsberg
 503 Key Vista Drive
 Sierra Madre, CA 91024
 818-355-3656

HHB Communications 1403
 Introducing: New recording media product and an addition to the company's CEDAR range of audio restoration products, among other new products.
 Also: The PORTADAT range of portable DAT recorders, featuring 4-head, 4-motor transports derived from DDS technology. The advanced media products range of HHB DAT tape, and the CEDAR DC-1 de-clicker, the CR-1 de-crackler, featuring buzz removal and distortion reduction as well as the CEDAR II production system. The HHB CDR Indexer, and the ATC range of studio control monitors and the Coles line of mics.

Holiday Industries Inc. 3920
 On display: RF and MW instrumentation and EMF meters.
 Contact: Michael Leighton
 14825 Martin Dr.
 Eden Prairie, MN 55344
 612-934-4920

IDB Broadcast 5226 & 5227
 On display: Information on company's 15 kHz Switched 56 Digital Sports Interconnect Transmission services. Also 3D2 - direct digital audio, high quality audio transmissions for recording studios.

Inovonics 2306 - 2308
 Introducing: Operational RBDS display.
 Also: Line of audio recording, signal processing and instrumentation equipment for broadcast, including the Model 530 FM modulation monitor, "Sentinel" all-mode diagnostic receiver, and "David" FM processor/stereo coder.
 Contact: Jim Wood
 1305 Fair Ave.
 Santa Cruz, CA 95060
 408-458-0552

Intraplex Inc. 5118
 Introducing: The PT 350 and PR 350 are program audio transmitter and receiver modules that transmit in 16-bit linear uncompressed format. The Intralink STL+ is a fully integrated STL package for transmitting high quality, uncompressed linear stereo audio over T1 lines.
 Also: Line of high speed digital communications equipment.

International E-Z Up 5212-5213
 On display: World's Fastest Shelter free-standing canopy. Instant Shelter canopy.

International Tapetronics Corp. 1218
 Introducing: A series of enhancements to company's DigiCenter digital audio management system, including DigiCenter-EDITOR, an integrated multitrack waveform production editor operating on a workstation; DigiCenter-NEWS, a networked array of workstations offering collection, editing and management of both audio and text information for news applications; DigiCenter-PLUS, expanded networking capabilities for background file transfers, backups and maintenance, and the DigiCenter-LITE, a low-cost entry level system in a computer tower hardware platform.
 Also: The DigiCenter audio management system; digital program repeater, a solid state, full bandwidth mono recorder and reproducer; audio routing switcher with adjustable input levels, mono/stereo switching, various remote controls and RS 232/422 control; ITC Cart II cartridge machine, as well as the Delta and Series 99 cart machines and the ESL V, and Series 1 and 2 cart machines. ITC will offer remanufactured versions of all varieties of its cart machine line.
 Contact: Charlie Bates
 2425 South Main St.
 Bloomington, IL 61704
 309-828-1381

ITELCO S.p.A. 19414
 Introducing: New FM exciter-transceiver with output power from 100 W to 250 W, MOSFET amplifier, automatic power control built-in switched power supply and plug-in construction.

J.N.S. Electronics Inc. 2306 - 2308
 On display: Digital audio program transmission equipment, including the D-Mux 500 series, a stereo or mono audio multiplexing systems using 16-bit technology for multiple 15 kHz, 7.5 kHz, or 3 kHz audio feeds, and the RFL-700 Series 1.5 to 2.3 GHz digital microwave link for D-Mux. Modular rack frames, including the 8000 Series "the Frame" modules for audio and video amplification and distribution, monitoring, switching, audio test, RF demodulation, off-air reception and program changeover functions. Audio routing systems, including the 8300 Series stereo to 100 X 1 and the 9000 Series, mono/stereo to over 100 X 100.
 Contact: John Leonard
 P.O. Box 325000
 San Jose, CA 95125
 408-729-3838

JBL Professional 15713
 Introducing: MPA series amplifiers. SR6670A power amplifiers.
 Also: 4400A series studio monitors. Models 4206 and 4208 studio monitors.

Jampro Antennas Inc. 1915
 Introducing: JCPD flat panel circularly polarized antenna. JADP cavity backed panel antenna. JIDC inter-digital combiner. JIDF inter-digital filter.
 Also: Penetrator series of FM antennas.
 Contact: Marlene D. Young
 6340 Sky Creek Dr.
 Sacramento, CA 95828
 916-383-1177

Jefferson Pilot Data Services Inc. 13811
 On display: JDS 2000/1000 broadcast management system that interfaces with traffic, billing, accounts and sales; BIAS, on-line integrated traffic sales, management and general accounting system; SALESLINE, sales management linking sales to traffic and accounting, and PC SESAMI, a PC-based avail system that provides proposals and research information.

Kintron Laboratories, Inc.
 On display: AM/MW antenna matching. HF open wire transmission line switch. HF open wire feedline. HF feedthrough panel. AM/MW multiplexed antenna systems and tuning units. Air-cooled dummy loads. AM/MW directional antenna phasing system. Open frame and vacuum RF contractors. Rigid transmission line. RF patch panels. Equipment racks. Isocouplers. Fixed and variable inductors. Meter jacks and plugs. Coaxial cable clamps. Static drain chokes. Lighting chokes.
 Contact: Tom King
 P.O. Box 845
 Bristol, TN 37621-0845
 615-878-3141

Klark Teknik 2412
 Introducing: DN3600 programmable graphic equalizer, a digitally controlled analog unit includes two special function keys that allow user to alternate between an EQ curve, relative fader position for channel A or B, or a combination.

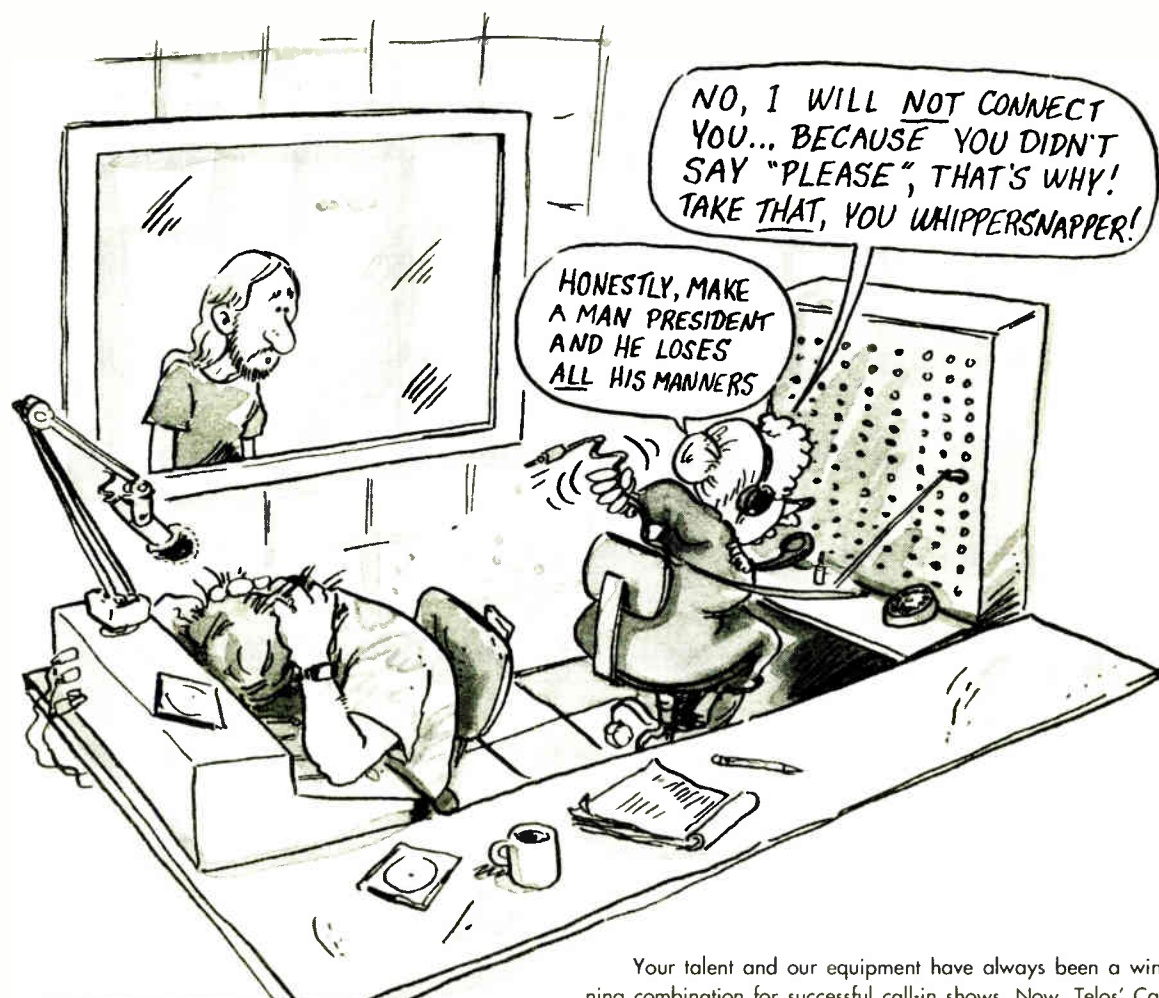

**Current Users:
 Call or fax for your FREE upgrade!!**

Call Screen Manager
 Talk Show Management Software



Your talent and our equipment have always been a winning combination for successful call-in shows. Now, Telos' Call Screen Manager software compliments our advanced multiline talk show systems by helping your screener/director provide your talent with information on each caller.

Call Screen Manager uses inexpensive IBM-compatible PCs and peripherals and you can choose two different screen views, so information is always displayed in the most useful, easy-to-interpret format. Features include real-time display of line status; full page and quick messages that may be stored and sent with simple keystroke combinations; a caller information database module with modifiable data fields and report and export capabilities; and the ability to accomplish most critical screener functions from the computer keyboard.

Two versions of Call Screen Manager are available. Host Software provides for a director position and any number of talent positions using a single PC. Remote Software allows communications between the studio and talent located at a remote site via modem.

So hire the best and give them the tools they need. Isn't it time you experienced the pleasure of great phones?



2101 Superior Avenue • Cleveland, Ohio 44114
 216.241.7225 • FAX: 216.241.4103

Lakeside Associates 1159
On display: Designers/builders of broadcast, recording and production facilities.

LDL Communications 15758
On display: Low windload spearhead FM CP antennas designed for multiplex operation of several FM stations. FM band pass combiner for use in multi-station operations. FMAC series of FM broadcast circularly polarized antenna, designed to be side mounted to an existing or new tower.

Logitek Electronic Systems Inc. 3215
Introducing: Super-VU precision bargraph audio meter with simultaneous display of loudness and peak levels with selectable functions including peak and maximum hold phase density and sum display; Crossfire II four-channel automated mixer, local or remote control levels and cross-fades as well as RS 232/422 computer port; Serial Scund SS-SRC sample rate converter that accepts AES/EBU or S/PDIF data at ±50 percent of output sample rate.
Also: On-air modular console with frame sizes that hold 6, 12 or 22 mixers. Mixer modules feature DCA faders. Optional RS-232 control.
Contact: Tag Borland
3320 Bering Dr.
Houston, TX 77057
800-231-5870

Maxell Corp. of America 1661
On display: Professional audio and video products, including audio cassettes, R-DAT cassettes and reel-to-reel products. Product line includes 3/4-inch digital audio tape, optical disks and CD and CD-R.

McCurdy Radio Industries Ltd. 13111
On display: DCS 3000 DSP serial digital intercom system, using advanced technology to meet demanding local and network broadcast requirements. MICRO-COMPACT digital intercom system for small mobile units and studios. M/2000 automation system. McCard digital audio storage and multi-channel playback system. UMD-32 tri-color 32-character under monitor display units. ATS-100 stereo audio test set. ATS 2656 stereo audio monitor with integral 6x1 switcher. UIO-80 universal interface unit for serial/parallel machine control interface. 9000 Series audio and video distribution amplifiers and accessories.
Contact: Dan Kupiec
108 Carnforth Rd.
Toronto, Ontario M4A 2L4
800-267-8800

Media Touch Systems Inc. 1006
Introducing: Media Touch digital audio editing program. Pick 'N Play studio control software package. "Auto-Record" workstation.
Also: OpLOG live assist/automation control system. MediaDISK digital audio system.
Contact: Jim Waterman
50 Northwestern Dr., Unit 11
Salem, NH 03079
603-893-5104

Modulation Sciences Inc. 11102-11104
Introducing: Software upgrade for Model RDS-1 RDS/RBDS encoder; RDS/RBDS data receiver.
Also: RDS/RBDS coder, FM ModMinder, Modulation Monitor/analyzer, StereoMaxx spatial image enlarger, CP-803 composite processor, Sidekick audio and data subcarrier generators. DSCA-1 data SCA receiver, composite D/A, wired STL.
Contact: Arthur Constantine
12A World's Fair Drive
Somerset, NJ 08873
908-302-3090

Moseley Associates Inc. 2824
Introducing: The StarLink 9000, all-digital modular system for simplex/full duplex transmissions, including 13 Personality Modules. Two new options for the DSP 6000: ISO/MPEG source codec and built-in AES/EBU rate converter. Optional programmable intelligent coprocessor module and interfaces for VM 700A video analyser, satellite controllers and video/audio switchers for the MRC 2.
Also: The MRC 2 transmitter control system, the MRC 1620 transmitter control system, the RPL 4000 remote pickup link system, the DSP 6000 digital audio codec for RF and T1 applications.
Contact: Jamal Hamdani
111 Castilian Dr.
Santa Barbara, CA 93117
805-968-9621

MYAT Inc. 4619-21
On display: Adjustable quarter wave stub second harmonic filter and line of rigid coaxial transmission line products and components.
Contact: Robert Hilsdorf
P.O. Box 425
380 Chestnut St.
Norwood, NJ 07648
201-767-5380

Nady Systems Inc. 11327
Introducing: 950 GS UHF wireless microphone system, a wireless receiver, rack-mount true diversity frequency synthesis unit with selectable channels arranged in groups for easy access.
Also: Line of established company wireless microphone systems.

NAGRA Lysis 1213
Introducing: Integrated Information System to provide a user-friendly environment with plug-in modules for sound editing, scheduling, broadcasting, administrative tasks and news editing. It is an open system based on distributed computing, client-server architecture, high speed networks, high capacity storage and multitask and multi-user needs.
Contact: Tom Jenny
1865 Air Lane Dr.
Nashville, TN 37210
615-391-3399

Nautel Maine Inc. 1912
Introducing: NE50 Digital FM Exciter uses direct digital synthesis (DDS) to generate the modulated FM carrier. NE50 accepts composite, mono and SCA inputs using a/d technique designed for ultra low-noise and distortion.
Also: Company's full range of AMPFET Series AM and FM solid state transmitters.
Contact: Jorgen Jensen
201 Target Industrial Cir.
Bangor, ME 04401
902-823-2233

Nemal Electronics Inc. 13619
On display: Composite audio/video cables. Audio snake cables. Custom audio/video interface panels. Audio/video cable and patch cords. RF connectors and adaptors.

Neotek Corp. 2226-2227
On display: Esprit Series console system for broadcast production, offering eight aux busses and mix-minus from every input module. Mono/stereo configuration. Information will be available on company's line of consoles for multitrack recording, broadcast production and editing.

NPR Satellite Services 4807-8
On display: Audio interconnection services, including fixed and transportable uplinking, digital audio transmission, digital fiber links and service to Galaxy and Satcom.

Neumann/Sennheiser 12136
Contact: Albert C. Zang, Jr.
6 Vista Dr.
Old Lyme, CT 06371
203-424-9190

Neutrik USA 3906
Intro: NanoCon three-pole sub-miniature connector. Models NC3FX and NC3MXY solderless/screwless insulation displacement connectors. Model NJ*FD-V vertical 1/4" jack.
Contact: James E. Cowan
195 Lehigh Ave.
Lakewood, NJ 08701
908-901-9488

NVISION Inc. 20081
Introducing: NV1050 Four-channel Sample Rate Converter, accepts AES/EBU signal, sample rates 32-50 kHz. NV1055 Four-channel Digital Audio Mix/Minus and Routing Module. NV1060 Digital Audio Delay Compensator Module, provides up to 20 video fields (330 mS) of delay. Optional BNC/1-volt Digital I/O interfaces for NV1000, NV3064 and NV3512.
Also: NV1000 modular terminal hardware. NV2000 digital audio transmission systems. NV3512 expandable digital routing switchers. NV3064 compact digital routing switchers. NV4448 sample rate converter. NV 5500 5200/5100 sync generators.



Omnimusic 19201-2
On display: Omni-FX sound effects library on 12 CDs, organized by application.
Contact: Jerry Burnham
6255 Sunset Blvd., Ste. 803
Hollywood, CA 90028
800-828-6664

Omnitronix 4806
Introducing: 2,800 W panel for Omni-50 50 kW AM broadcast transmitter.
Also: Omni-5000 5000 W AM broadcast transmitter.
Contact: John Solt
113 Dickerson Rd.
North Wales, PA 19454
215-699-2400

Otari Corp. 1209
Introducing: MR-10 MiniDisk recorder. A high-capacity CD changer. A new broadcast console and a line of lower-priced consoles with Concept I-type features.
Also: Line of professional audio recorders from 1/4-inch two-track analog to 1-inch 32-channel digital. R-DAT recorders. ProDisk 464 digital audio workstation. Automatic and semi-automatic audio and video cassette loaders. Pancake and in-cassette audio duplication systems. T-700II TMD high-speed video duplicator.
Contact: Deborah Bryce
378 Vintage Park Dr.
Foster City, CA 94404
415-341-5900

Pacific Recorders & Engineering 13047-9
Introducing: ADX Basic, streamlined version of company's ADX workstation.
On Display: ADX Digital Workstation. Turnkey broadcast systems. Studio furniture. Consoles. Peripherals.
Contact: Jim Miller
2070 Las Palmas Dr.
Carlsbad, CA 92009
619-348-3911

PanAmSat 15171
On display: Satellite transmission services.

Penny & Giles 4527
Introducing: MM16 MIDI Management System, real-time control for production/post-production applications. VCA16 Audio Control Module.
Also: PGF 8000 and 3000 Series linear faders. Analog and digital T bars. E-belt digital controllers.



Manhattan Production Music 13635
On display: Company's line of Audiophile Sound Effects Series. Chesky Records Classical Series, and 42 CDs of production music.

Mark IV Pro Audio Group 1000
Introducing: Klark Teknik DN3600 stereo programmable graphic equalizer; DDA QII console, a true LCR (left, center, right) unit with choice of eight mono, stereo or four true LCR outputs.
Also: Klark Teknik's 300 Series graphic and parametric equalizers, 400 Series parametric equalizers, 500 Series compressors and gates, 700 Series digital delays, 800 Series crossovers, DDA's QMR, PROFILE and INTERFACE consoles. MIDAS' XL3-16 broadcast remote console.

Marti Electronics 3918-3919
Introducing: STL-15C frequency agile composite STL link, now available in export frequencies from 150 MHz to 480 MHz.
Also: STL-10 SCPS STL systems available from 150 MHz to 960 MHz. Systems for remote broadcast, the RPT-30, RPT-15 and RPT-2.
Contact: Dan Rau
1501 N. Main St., P.O. Box 661
Cleburne, TX 76033
817-645-9163



If You Think We Only Supply Cable Harnesses ...

Think Again.

You should see the quality and pricing on Clark Wire & Cable bulk cable and connectors.



Clark Wire & Cable has industry standard audio and video cables available in as many as ten jacket colors. Our customized A/V cables are designed with your needs (and pocketbook!) in mind.

1-800-CABLE-IT!
151 S. Pfingsten Road #B
Deerfield, IL 60015

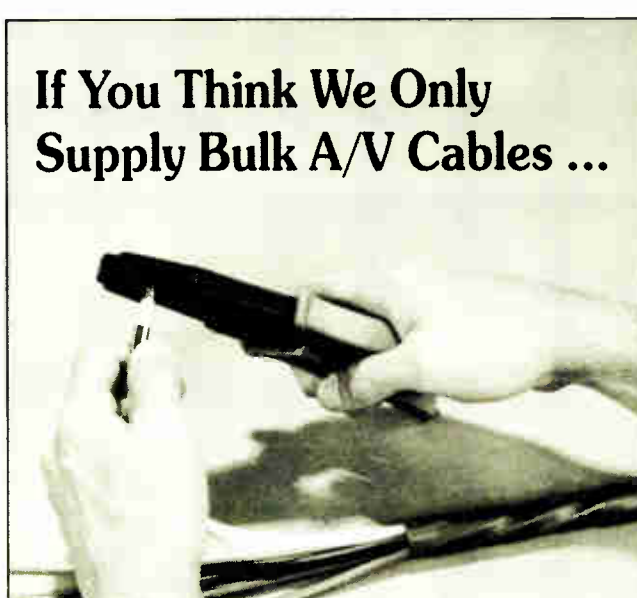

If You Think We Only Supply Bulk A/V Cables ...

Think Again.

Clark Wire & Cable provides custom high quality cables, cut to length and terminated to your specifications.

- Patch Cords
- ADAT Harnesses
- DA 88 Harnesses
- DT 12 Audio Snakes/Harnesses
- RGB Cables
- Remote Camera Cables
- Digital A/V Assemblies
- Complete Facilities
- And More!



1-800-CABLE-IT!
151 S. Pfingsten Road #B
Deerfield, IL 60015

See The New EBS System In Booth 2800

SAGE ALERTING SYSTEMS

Potomac Instruments 2310
 Introducing: AA-51A automatic audio analyzer, compatible with test software on NAB CDs.
 Also: AG-51 audio generator. FIM-41 AM field meter. FIM-71 VHF field meter. FIM-72A UHF field meter. 1900 antenna monitor. RC-164 remote control. 1500-PC remote control. SD-31 synthesizer detector. SMR-II AM monitor receiver. 1700 Series remote control interface products, including the 175-TLM tower light monitor.
 Contact: David G. Harry
 932 Philadelphia Ave.
 Silver Spring, MD 20910
 301-589-2662

Professional Sound Corp. 5124-5
 Introducing: PSC IntelliSlate SMPTE time code slate devices. able to read and generate time code on 24, 25, 29.97 and 30 frame rates, and 29.97 and 30 drop frame. Headset microphone. PSC OmniPlate microphone. PSC Universal Shock Mount System. Solar panel/rechargeable power supply.

Promusic Inc. 13148-9
 On display: Promusic production music library of over 1,000 CDs, with an average of 15 new releases per month. The Match production music library. Digiffects and Sound Ideas SFX library. The Big Whoosh, containing over 250 production elements.

Prophet Systems Inc. 5222
 Introducing: CD and hard drive automation module & copy editing module for Wizard for Windows.
 Also: Wizard for Windows digital editing/automation system, utilizing Windows 3.1 and Novell 3.12 technology.
 Contact: Kevin Lockhart
 111 W. Third St.
 Ogallala, NE 69153
 800-658-4403

Pristine Systems Inc. 3800
 On display: Pristine digital control system for digital radio programming; uses Pioneer 6- and 18-slot CD players and Tascam DAT machines for music and Dolby AC-2 digital hard disk audio for commercials, promos, voicetracks, liners, etc. Music Plus music scheduling software.
 Contact: Boyce Williams
 8489 W. Third St., Ste. 1017
 Los Angeles, CA 90048
 310-670-7500

QEI Corp. 4218
 Introducing: Digital remote pickup system. Digital transmitter-to-studio link. 675-B FM exciter.
 Also: CAT-LINK digital STL/TSL featuring Q-MAX 16-bit digital discrete audio card and digital composite system cards. AUTOMOD closed-loop automatic gain control for FM. Solid state and single-tube FM transmitters at 10 W-30 kW.
 Contact: Jeff R. Detweiler
 1 Airport Dr., P.O. Box 805
 Williamstown, NJ 08094
 800-334-9154

Radio Express TBD
 Introducing: TM Century's HitDisc E, weekly compilation of new breakers in European hits and alternative music.
 Also: Weekly syndicated programs: American Top 40; Hot Mix, including top 40, modern, techno, and retro versions; American Gold; American Country Countdown.

Radio Design Labs 5406-7
 Introducing: Additions to the "Stick-On" line of products, including ST-OSC2A and ST-OSC2B audio oscillators, ST-SX4 audio switcher and ST-RG-1 ramp generator with remote control.
 Also: Complete line of "Stick-On" products, over 33 items in all. Complete line of "Rack-Up" products. ACM-2 AM Noise Monitor. AMX-84 8x4 stereo audio switcher/combiner.
 Contact: Jerry Clements
 P.O. Box 1286
 Carpinteria, CA 93014
 805-684-5415

Radio Systems Inc. 3012
 Introducing: DDS digital audio delivery system for on-air delivery, built on a multi-user operating sys.
 Also: RS Series consoles. RS-1000 professional DAT machine. TI-101 telephone interface. Super Clock analog and digital master clock/timer systems. Mono and stereo distribution amplifiers.
 Contact: Daniel Braverman
 601 Heron Dr.
 Bridgeport, NJ 08014
 609-467-8000

Products & Services Showcase

For more information on the products shown below, circle the appropriate Reader Service No.(s) on the enclosed Subscription/Reader Service card or contact the advertiser directly.

ARE YOU LOOKING FOR A COST EFFECTIVE ALTERNATIVE TO MANUFACTURER SERVICE?

SERVICE, REPAIR & CALIBRATION

- STL's • RPU's • TSL's
- Exciters • AM/FM Broadcast Monitors • Remote Control Systems

SPECIALIZING IN EQUIPMENT BY

- Belar • Marti • Moseley • McMartin • TFT • And others...

An authorized TFT service center

IN CASE OF EMERGENCY

We can help get you back on the air with our STL Loaner Program. We have STL's available that will be set to your frequency prior to shipping. We also provide over-the-phone technical assistance.



2198 Hubbard Lane, Grants Pass, OR 97527

(503) 471-2262

READER SERVICE NO. 70

ETS
 EAGLE TOWER COMMUNICATION SERVICE
 Dunn & Bradstreet #808336994
 419-424-0020

NATIONWIDE

- Lightning Deterrent Systems Sales & Install
- Slot Cover Replacement Deicer Repair
- Strobe Sales & Service
- Custom Antenna Sales & Service FM-STL 2 way
- 8mm/VHS inspection & written reports
- Core-lube rustproofing & guywire replacement
- Custom Ice Shield & Mounting Hardware Sales & Installation
- Tower Painting
- Earth Station Sales & Services
- Guywire Tensioning

SS or Guyed Tower Sales, Installation & Service

Contract ETS for your annual tower & lighting maintenance

Nationwide Rates

- A. \$490 a day + parts, travel included
- B. \$155 mo. + parts, tension & plumb included
- C. \$45 mo. per lighting unit includes parts, travel, labor, tension & plumb

We offer a 15-40% reduction in list prices from 60 manufacturers

Feedline Sales & Service
 Tower Plumb

"OUR BUSINESS IS CLIMBING TO NEW HEIGHTS"

READER SERVICE NO. 113

WILL-BURT
 Telescoping Antenna Masts for Remote Broadcasting

- Easily installed on your van or promotional vehicle
- Quick erecting for fast set ups
- Cost effective when compared to equalized telephone loops
- High quality audio from mast mounted RF links
- Pneumatically raised in minutes
- Rugged construction for long dependable life
- Extended heights of 20 to 34 ft. for greater range on remote broadcasts

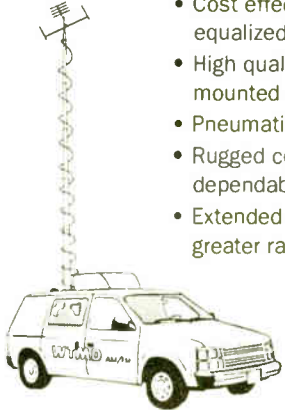

WILL-BURT
 P.O. Box 900
 Orrville, Ohio 44667-0900
 Phone 216-682-7015
 FAX 216-684-1190

COME SEE US AT NAB 94 BOOTH #19203

READER SERVICE NO. 79

Attention Advertisers!

Reach 22,000 + Readers worldwide. RADIO WORLD's Product Showcase provides a perfect medium for test marketing your products and services. It's an efficient, effective and affordable advertising option.

For more information, including rates and deadlines, Fax SIMONE at **1-703-998-2966** or Call **1-800-336-3045**

GPS MASTER CLOCK/TIME CODE GENERATOR
 WORLDWIDE TIME

Locked to the Atomic Clock in the Global Positioning Satellite System, you can have time, date and time code within nanoseconds of UTC, anywhere in the world!!

ES-185 **\$2495.00**



STANDARD FEATURES INCLUDE:

- SMPTE/EBU, ESE, IRIG-B & ASCII Time Code Outputs
- 1PPS Output
- 6 Satellite Tracking
- Battery Back-up
- GPS Locked Indicator
- Automatic Daylight Savings Time Correction
- Time Zone Offset
- Antenna
- AND MORE!!

OPTIONAL FEATURES INCLUDE:

- Parallel BCD Output
- 1 KPPS
- 10 MHz Output
- 220 VAC
- 12 VDC
- Video Inserter
- Video Sync-Generator

3 YEAR WARRANTY

142 Sierra St., El Segundo, CA 90245 • (310) 322-2136 FAX: (310) 322-8127

See Us At NAB Booth 12808

READER SERVICE NO. 176

Radio Computing Services Inc. 5202
On display: MASTER CONTROL digital on-air studio. PRO-SONIX digital multitrack editor. RCS Traffic spot scheduler. SELECTOR music scheduler.

RE America 3801-2
Introducing: RE 4500 ETSI digital video codec. RE 660 MUSICAM encoder. RE 661 MUSICAM decoder. RE 532 RDS/RBDS encoder.
Also: RE 533 slim-profile RDS/RBDS encoder. RE 8720 tie line encoder. RE 8739 tie line decoder.
Contact: Andrew Bosworth
31029 Center Ridge Road
Westlake, OH 44145
216-871-7617

Register Data Systems 4508
Introducing: Windows-based traffic and billing system. Hard disk-based live-assist and music automation. Also: Phantom digital audio automation system. PC-based traffic and billing software packages.
Contact: Brad Harrison
P.O. Box 980
Perry, GA 31069
800-521-5222 or 912-987-2501

Richardson Electronics Ltd. 12901
Introducing: Sennheiser and Shure audio products. RF transistor pallets. Directional couplers. Amphenol connectors. Unilator capacitors. WL Gore assemblies. Also: EIMAC power grid tubes and accessories. Amperex and National power grid tubes. Motorola, SGS-Thomson, M/A Com and Philips RF transistors.

Roland Corp. US, Pro Audio Division 3406
Introducing: Version 2.0 firmware for DM-80 digital audio workstation. DM-80-S version 2.0 Multitrack Manager Macintosh System software for DM-80 workstation.
Contact: Laurel Cash
7200 Dominion Cir.
Los Angeles, CA 90040-3696
213-685-5141, ext. 338

RF Industries 19481
On display: Universal flush-mount wall plate system for telephone/CATV cable connection. SMA cable connectors. RFA-4084 "Gripper Nipper" wire cutter.

s,t

S.W.R. Inc. 16043
Contact: David K. Edmiston
Rd. #3, Box 182
Industrial Park Rd.
Ebensburg, PA 15931
814-472-5436

Sandar Electronics A/S 3703
Introducing: 16x16 video/stereo audio router. Also: Audio/video program routers and conference equipment. Distribution amplifiers and equalizers. Routers and distribution amplifiers for 34-140 megabits per second.

Sanken Microphones 2002
Introducing: The CSS-5 stereo shotgun microphone featuring three modes of operation. mono, normal and wide.
Also: Full line of studio. MS stereo, field production and lavalier mics.

Schmid Telecommunications America Inc. 1606-8
On display: SIAT (short interval audio test) System. SIAT-MAX hand-held automatic audio test generator. RESCO Windows-based remote monitoring and control system for broadcast and data transmission.

Scott Studios 4020
Introducing: CompuCarts. 16 digital audio players on a computer touchscreen and cart recorder in production. Uncompressed mode for CompuCarts or Production Bank digital audio. Light Pen version of Scott CD juke box controller. CD Player controller for Pioneer CD players.

Selco Products Co. 4618
No display information available at presstime.
Contact: Celeste Favata
7580 Stage Rd.
Buena Park, CA 90638
714-521-8673

Sescom Inc. 13601-2
On display: Audio accessories for broadcasting, recording and live sound reinforcement.
Contact: Franklin J. Miller
2100 Ward Dr.
Henderson, NV 89015-4249
702-565-3400

SG Communications Services Inc. 16627
Introducing: New line of small tower to meet the demands of the communications business. Complete turnkey site development service for domestic and international communication systems. HDTV stress analysis and investment planning studies. Installation and maintenance of lighting systems. Custom-designed inspection and maintenance programs. Planning and coordination of projects in compliance with governmental regulations.
Contact: Dan Ferguson
1100 Northmeadow Pkwy., Ste. 112
Roswell, GA 30076
404-475-0212

Shively Labs 4224
On display: Side-mount and panel FM broadcast antennas. Multi-station combiners. Rigid transmission line. Pressurization equipment. Pattern work.
Contact: Jonathan R. Clark
19 Harrison Rd.
Bridgton, ME 04009
207-647-3327

Shure Brothers Inc. 11901
Introducing: FP32A portable stereo mixer for EFP, ENG, film production and audio recording. FP22 headphone amplifier. SC Wireless Series of wireless microphone systems.
Also: FP410 portable automatic mixer. EC Series and L Series wireless microphone systems. VP88 stereo microphone. Beta 87 condenser microphone.
Contact: Davida Rochman
222 Hartrey Ave.
Evanston, IL 60202
708-866-2200

Siel Sistemi Elettronici S.R.L. 6206-7
Contact: Antonio Orizzonte
Via Bari, 26
20143 Milano, ITALY
39-2-89150150

Sigma Electronics Inc. 16260
On display: The Series 1000 for RGB.

SONEX Acoustical Products Div. 2103
Introducing: Fabrix acoustical material, with fiber-free, semi-rigid melamine, and an asst. of deco fabric covers.
Also: Full line of acoustical products.

SMARTS Broadcast Systems 5224-5
Introducing: Line of Ultimatum products, fully digital automation systems that store all audio on a bank of computer hard drives; includes new SMARTS Music Master music rotation system. Also: Line of SMARTCASTER automation and SMARTS office equipment.
Contact: John Schad
2102 Main
Emmetsburg, IA 50536
712-852-4047

Sony Professional Media Products Group 11711
Introducing: HMPX Hi8 metal particle tape. HMEX Hi8 metal evaporated tape. DAE-D5000 digital audio workstation that uses PCM 9000 for storage. MXP-700 audio mixing console. HR-MP5 multieffects processor. Also: BCT-D Series Digital Betacam cassettes. UVWT-MA Series Betacam SP cassettes. ProDAT Plus Series Digital Audio Tape cassettes. MD gear. Digital studio line. DATStation editor.

Sound Ideas 11703-4
Introducing: Ambience II Series 7000 sound library. The Mix broadcast music library.
Also: Warner Bros animation sound effects library. the Hanna-Barbera SoundFX Library.

Soundcraft 15713
Introducing: Series 10S live-on-air mixer. Series 30 live-on-air/production mixer. Spirit studio LC console. Also: LM-1 portable location mixer. BVE100 audio for video mixer. B100 bdct console. Vienna II production console.

Studer Editech Corp. 1213
On display: Nagra-D four-channel self-contained professional digital audio recorder.
Contact: Tom Jenny
1865 Air Lane Dr., Ste. 12
Nashville, TN 37210
615-391-3399

Studio Technologies Inc. 13618
Introducing: Studio Tools family of distribution amplifiers. Also: StudioComm series for digital audio workstations. IFB Plus System. AN-2 and Generation II stereo simulators. Mic-PreEminence microphone preamplifier.

Superior Electric 4914-5
Introducing: Catalog WHR692 describing WHR Series and Catalog WHR692-S, which describes the series in Spanish.
Also: WHR Series STABILINE automatic voltage regulators. STABILINE rack mount voltage regulator. UPSY Series STABILINE power supplies.
Contact: Ted Gladis
383 Middle St.
Bristol, CT 06010
203-585-4500

Svetlana Electron Devices 10262, 10362
Introducing: The 3CX3000A7 zero bias triode.
Contact: George M. W. Badger
3000 Alpine Rd.
Portola Valley, CA 94028
415-233-0429

Symetrix Inc. 4622
Introducing: Symetrix 420 stereo amplifier.
Also: SX201 parametric EQ/preamp. SX202 mic preamp. SX204 headphone amp. SX208 stereo comp/limiter. 402 dual output delay. 421 AGC/leveler. 425 dual compressor/limiter/expander. 501 peak-RMS compressor/limiter. 571 and 572 SPL computers. 601 digital voice processor.
Contact: Sherri Swingle
4211 24th Ave. W
Seattle, WA 98199
206-282-2555

Systems Wireless Ltd. 13636
Introducing: Vega-Net, a network-based wireless control and monitoring system. Demo of the Lectrosonics DC1B computerized microphone level controller.
Also: HME System 800 UHF wireless intercom system that interfaces to Clear-Com, RTS and other cabled systems. Vega's full line of wireless microphones and wireless IFB systems. Full line of Clear-Com party line and Matrix intercom systems.

Tascam 15669
Contact: Bill Mohrnoff
7733 Telegraph Rd.
Montebello, CA 90640
213-726-0303

CONTROL AND FLEXIBILITY IN YOUR REMOTE EVENT TRANSMISSION



The AEQ Portable Mixer MP-10

- ◆ Ideal for remote event transmission.
- ◆ Easy to install and operate.
- ◆ Provides portability and autonomy.
- ◆ Carrying case included.
- ◆ Great value for your money.

Special features:

- ◆ Five transformer balanced inputs selectable Mic/Line.
- ◆ Front panel input controls.
- ◆ Capable of linking mixers together to improve # of inputs.
- ◆ Transformer balanced outputs.
- ◆ Internal NiCad rechargeable battery provides 4-hour autonomy.
- ◆ Automatic switch to battery if power fails.
- ◆ Dialing keypad, dual mode tone/pulse.
- ◆ Three headphone output jacks.

Introductory price of \$1295
Call us for more information:



AEQ 2211 South 48th St., Suite H
Tempe, Arizona 85282
Phone (602) 431-0334 • FAX (602) 431-0497



DREAM METER

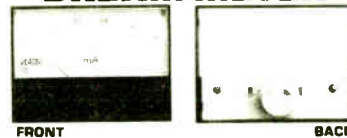

80% SMALLER MOVEMENT, 66% FEWER PARTS.

Core magnet design • Dramatically reduced total volume • Taut band suspension
 Accuracy to $\pm 1.5\%$ of full scale
 Four sizes • AC and DC versions
 Standards conformance
 Custom Marking Services

SELCO ▲ ▼ SELCO

HANDSOME



COLLET KNOBS

Selco's collet knobs meet the highest standards of precision, durability, performance, and beauty. Solid brass hardware is permanently bonded to a matte-finish, 94V-2 nylon body. Black or gray, with snap-on caps in a wide selection of standard and special colors. Full range of sizes, types, and accessories. Attractive OEM prices.
Request full-color knob catalog today.

selco PRODUCTS CO.
7580 Stage Road, Buena Park, CA 90621
(310) 921-0681, (714) 521-8673, or (800) 229-2332
FAX (714) 739-1507

Tektronix Inc. 17119
Introducing: AM700 audio measurement set. ASW-100 Series audio switchers.

Telex Communications Inc. TBD
Introducing: The FMR-450 UHF wireless receiver, the HT-450 UHF handheld mic transmitter, the WT-450 UHF all metal belt pack, the HT-200 handheld mic transmitter, the BP-1000 single channel beltpack and the BP-2000 two-channel beltpack.
Also: Full line of headsets, headphones, wired and wireless mics, intercom systems and high speed audio tape duplicators. The RTS intercom line, including two-wire as well as digitally controlled four-wire matrix intercom systems.

Telos Systems 5200
On display: Zephyr digital audio network transceiver. Telos 100 Delta digital hybrid. The Link. The ONE plus ONE dual hybrid. Call Screen Manager software for talk show production. ONE-x-Six talk show system.
Contact: Danielle Cline
2101 Superior Ave.
Cleveland, OH 44114
216-241-7225

TFT Inc. 1908
Introducing: DSS92, a digital subcarrier system for television. EIS911 and 912 emergency information system manager and generator.
Also: DMM92 digital modem and multiplexer for digital STL transmission. Modulation monitors/analyzers. Analog STLs. Remote pickup transmitters and receivers. Emergency Broadcast equipment.
Contact: Darryl E. Parker
3090 Oakmead Village Dr.
Santa Clara, CA 95051
408-727-7272

Television Technology Corp. 15708
On display: FMS4000 4kW solid state FM transmitter. FMS100 100W solid state FM transmitter.

TM Century TBD
Introducing: TM Mix and TM Country GoldDisc libraries. Slam Dunk production library.
Also: GoldDisc CD library. HitDisc weekly compilation CDs. Ultimate Digital Studio II. Production libraries. Jingles on CD. TM Century television. PowerPlay music scheduling software. TM Comedy Network weekly CDs.
Contact: Stuart McRae
2002 Academy
Dallas, TX 75234-9220
800-299-2121 or 214-247-8850

Tripp Communications Sales 15380-1
Contact: Ted Tripp
P.O. Box 5267
Walnut Creek, CA 94596
510-256-6006

Utility Tower Co. 2326-7
On display: Samples of tower sections for AM, FM, TV, CATV, LPTV and microwave communications.

Valentino Inc. 12203-4
Introducing: Production music and sound effects libraries in CD-ROM multimedia format for IBM Windows and Mac formats.
Also: Production music library. Sound effects library.
Contact: Thomas Valentino
500 Executive Blvd.
Elmsford, NY 10523
914-347-7878

Varian Associates 16101
Introducing: New service of remanufacturing power grid tubes for radio transmission.
Also: Power grid tubes for AM, FM and shortwave radio.

Vega Wireless 15716
Introducing: VegaNet, a wireless microphone system with network capabilities. 600 Series UHF wireless microphone receiver.

Ward-Beck Systems 12501
Introducing: Renaissance radio control series.
Also: M405P portable extended range VU meter. D8212 audio distribution amplifier system.
Contact: Eugene L. Johnson
841 Progress Ave.
Scarborough, Ontario
Canada M1H 2X4
416-438-6550

Will-Burt Co. 19203
On display: NightScan remote control elevated lighting system. Pneumatic telescoping masts.
Contact: Steve Pinkley
P.O. Box 900
Orville, OH 44667
216-682-7015

Wegener Communications Inc. 5414
On display: Digital audio SCPC transmission provided with Addressable Network Control System (ANCS).

Wohler Technologies 19539
Introducing: Surround Sound monitor. Digital VTR (AES/EBU) audio monitor.
Also: Line of 1RU visual level and phase displays. ARS Series of audio routing switchers.

Wheatstone 5108
On display: The Wheatstone A-6000 audio console.
Contact: Ramon Esparolini
6720 V.I.P. Parkway
Syracuse, NY 13211
315-455-7740

RadioSoft TELLER Database — Think of it as a crystal ball, but faster (and a whole lot more accurate, too)

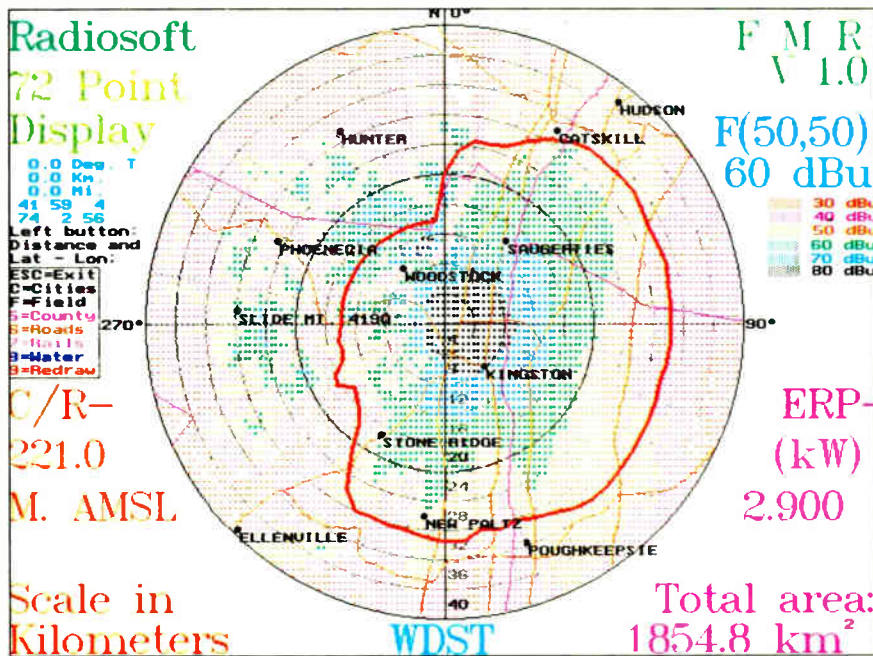

This versatile software package has something for everyone:

- > A manager's presentation to a bank or broker
- > A sales presentation to clients new and old.
- > A market analysis for the Network Program Director
- > An engineering study of translator/booster/upgrade sites, or possible sites.
- > A consultant's complete tool kit in one program

RadioSoft's FMR Database contains more information about more broadcast stations than any competitive program, including the one used by the FCC! And it's all current, easy, very accurate, . . . and incredibly **FAST!**

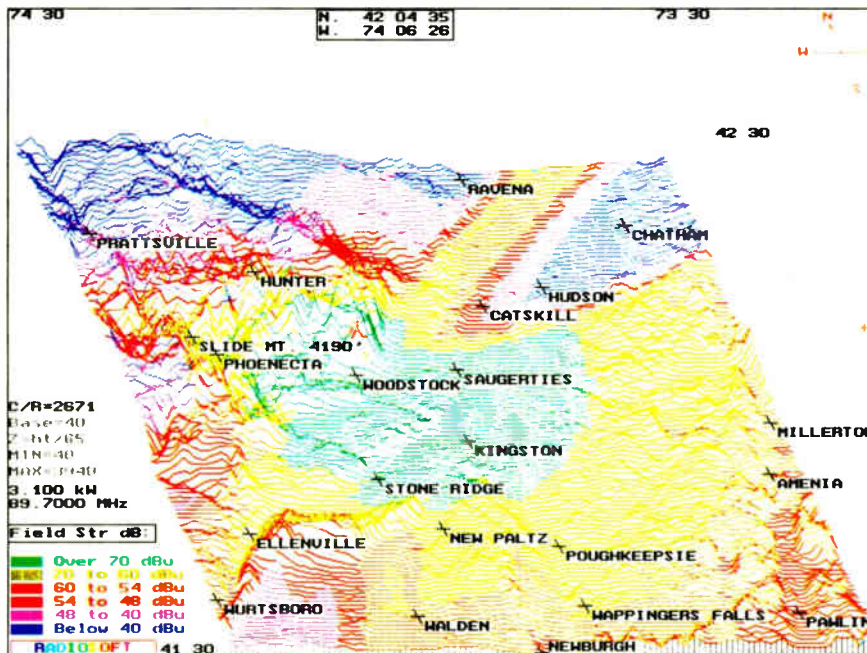

3DFM, included with FMR package as NAB SPECIAL:

- > Signal contours of any FM station, existing or proposed
- > Advanced shadow studied to show "real world" reception
- > Choice of display scales and striking 3D views for which the program is named.
- > All displays can be printed to any laser printer, or in brilliant color, to any HP compatible.
- > Program may be run directly from FMR, with new large scale Shadow Matrix displays drawn on FMR charts.

RadioSoft will give 3DFM (\$535) away with purchase of FMR through March 22, 1994. Call (904) 426-2521, or write 120 North Riverside Drive, Edgewater, FL 32132 **NOW!**

Member, Global Programs Cooperative. Programs require mouse and VGA display. FMR includes HT4X5, FM2SITE, FM6070, and FMSERV.

Circle (177) On Reader Service Card

MOVING?...

Don't leave us behind!

Mail or fax your current label and new address (with effective date) to:

Circulation, RW,
PO Box 1214
Falls Church, VA 22041, USA
or FAX 703-998-2966.

Address changes will be processed within four weeks of receipt.



Compression Menu of Hard Choices

► continued from page 1

But most of the manufacturers, vendors and compression system developers contacted by **RW** say Squire was on to something. There is no dueling-algorithm emergency today, they say, but there could be one someday if broadcasters and compression developers ignore the problem.

Crowded field

It is difficult to say exactly how many data compression schemes have been invented and marketed worldwide. Systems have been developed to compress several forms of data besides audio, such as video, text from computer files

and telephone voice communications.

So far only a handful of systems have had a serious effect on U.S. radio broadcasters. The most famous of them is the International Standards Organization/Moving Picture Expert Group (ISO/MPEG) Layer II standard, better known as MUSICAM-Surround, a versatile, European-developed technology that has already been applied to a wide number of studio and RF applications, as well as audio for video and integrated service data networks (ISDN).

The ISO/MPEG Layer I standard, used primarily today in Philips' Digital Compact Cassette (DCC) digital audio

tape format, is a simplified version of MUSICAM.

MUSICAM is related, but not entirely compatible with the recently completed Layer III. The question of whether Layer II or III fits best for most applications is currently a source of high controversy in Europe. (See story, page 72.)

Dolby Laboratories, San Francisco, has also developed a series of compression, or audio coding (AC), systems for a wide variety of applications. AC-2 is the most commonly used Dolby system in the radio industry, where manufacturers have been licensed to include the algorithm in audio storage and automation

systems, as well as studio-to-transmitter links (STLs) and other RF uses.

The apt-X system, developed by Audio Processing Technology (APT), Belfast, Northern Ireland, is found in a similarly wide number of radio broadcast applications, but is considered especially useful in RF links because of its comparatively short coding delay.

Other compression systems are used in a few, specialized applications. Sony Corp.'s Adaptive Transform Acoustic Coding (ATRAC) system was developed for its consumer MiniDisc (MD) magnetooptical system. Professional MD players and recorders have just been made available for the radio industry in the last year.

Another specialized system, Scientific Atlanta's Spectrum Efficient Digital Audio Technology (SEDAT), may be present in more radio stations than any of the other forms of compression because it is used to feed audio to hundreds of ABC Radio, CBS Radio and other network affiliates.

Weighing the merits

Stations benefit from compression systems in many ways. "I'll say our coder is very good, but I never like to use the word 'transparent.' It's like car salesmen saying a car is 'perfect,'" said Louis Fielder, manager of Dolby's digital audio coding group. But compression saves money in almost every case, while maintaining analog quality or better, he said.

"There are a number of applications-specific issues that people must bear in mind, but no matter what algorithm you select, in the end there are strong, tangible benefits that outweigh any perceived damages," said Jamal Hamdani, executive vice president, Moseley Associates, Santa Barbara, Calif., which offers the DSP 6000 STL with apt-X compression.

"Generally, the thing you really save is antenna costs" when buying a digital STL, Hamdani said. Digital antennas are smaller and less expensive than equiva-

Now Hear This.

With more digital STL transmission systems on-air than all other competitors combined, we'd like to let our customers do the talking for us...

"The increase in system gain using the DSP 6000 allowed us to eliminate one of the hops in our STL system."

Robert Reymont, KVMY, Phoenix, AZ

"It's truly amazing to drive 120 miles from the studio, hear an FM broadcasting with a totally quiet signal, and know it originated five hops back."

Jim Travis, Family Life Network, Bath NY

"The DSP 6000 allowed us to run both our FMs from one studio over one STL. We got cost savings and digital fidelity."

Chris Reid Murray, KMGE & KGNU, Eugene, OR

"Best sound for the buck in broadcasting today!"

Robert Lear, KTWV, Hollywood, CA

Moseley

111 Castilian Drive
Santa Barbara, CA 93117-3093 • USA
Telephone (805) 968-9621
Fax (805) 685-9638



lent analog equipment.

STLs, TSLs and electronic newsgathering equipment transmitting compressed digital signals operate at lower power than their analog counterparts, saving electricity and reducing the chance of interference with other microwave signals.

The digitally compressed bandwidth of satellite signals take up less transponder space than analog uplinks, which saves money and greatly increases satellite capacity.

Some say that the future cost of computer memory will be low enough for all stations to economically store and play back uncompressed music and other audio material in the studio. But it is currently less expensive to store compressed audio on computer hard disk systems.

"There is a hidden benefit in the number of channels we can play from a single box, the start and stop reaction time and the editability. Slowing the data rate

continued on page 66 ►

A Picture Is Worth A Thousand Words



And Then Some...

The DSE 7000 is the fastest, most efficient Digital Editor you can buy. But, don't take our word for it. Take theirs.

"When they told me they were going digital, I was ready to quit my job. But within a week I was thinking how did I ever live without it?"

Dan Alexander, Production Director
WCXP/WCPZ, Alexandria, VA

"We had all the other machines in here. This was the only one we could actually start up and start using in five minutes. No setup, no confusion, no trouble."

Vito Colonna, Production Director
WNCN, New York, NY

"We're very, very happy with the DSE 7000. It has exceeded everyone's expectations. Most jocks can operate it after just 15 to 30 minutes of training. The DSE is in use an average of 15 to 16 hours a day."

Fred Miller, Chief Engineer
WRIF, Detroit, MI

"I'm in production heaven! The DSE is at the top when it comes to production capability, freedom and safety. UNDO is the best thing that's happened to radio since the invention of tape."

Greg Williams, Production Director
WMC AM/FM, Memphis, TN

"It just blows everything else away."

Carl Harris, Production Director
WHVY, Annapolis, MD

"As far as I'm concerned, it's the best workstation on the market. The one negative thing I have to say about it is that we only have one. We joke about how a line forms around the studio with the DSE, and nobody touches the other one."

Chris Thornton, Chief Engineer
WSBT, South Bend, IN

"It has speeded up our editing process so much that now the guys who 'wanted it yesterday' can actually get it yesterday! The on-air guys love it for their production. If they took it away from me, I think I'd give up the business."

Bob King, Program Director
KEX/KKRZ, Portland, OR

"Without question, the DSE has increased the quality and creativity of our production."

Bob Duckman, Program Director
WXTR, Washington, D.C.

Start making your life a lot easier while making a profit for your station. See the DSE 7000 in our NAB Booth, #2218. We'll tell you all about the added features

1-800-622-0022
Fax 317-966-0623

 **HARRIS**
ALLIED

Squire Tests Still Are Controversial

A rising concern among broadcasters, following the audio degradation associated with D/A-A/D conversion and the general loss associated with any compression algorithm, is the possibility that additional artifacts are created by using different, incompatible compression algorithms in the same broadcast chain, as WQEW(AM)-WQXR-FM's Squire suggested last year (RW, May 26, 1993).

The Squire tests ran signals through equipment employing different com-

pression algorithms beginning with two passes and going up to as many as 20 passes.



Squire's equipment for the tests included: a ComStream Corp. Ku-band VSAT downlink (apt-X); a SEDAT link from ABC Radio; a Corporate Computer Systems CDQ 2000 digital codec (MUSICAM); a Moseley DSP 6000 STL (apt-X), and Sony MD and Philips DCC player/recorders.

According to a written description of

the tests released during Squire's follow-up dueling algorithm presentation at NAB's 1993 Radio Show, D/A and A/D conversions were made during each compression pass.

"There were no digital-to-digital connections because in an actual broadcast all outside world connections to mixers, consoles, etc., would still be analog," Squire said.

Audio after 20 passes was severely impaired by veiling, chirping, clicking and other annoying artifacts. Two- or three-pass signals sounded acceptable, except for random,

continued on page 68 ▶

Compression Plusses and Drawbacks

▶ continued from page 64

down provides practical systems that the broadcaster needs," said Greg Dean, founder of Computer Concepts Corp., Lenexa, Kan., which is licensed to provide apt-X compression in its Digital Commercial System (DCS).

Whatever digital audio broadcasting system is selected in the U.S., in-band or out-of-band, it will depend on compression technology to fit into narrow RF channels and avoid interference with other stations or other analog services.

Weighing the demerits

The list of compression drawbacks is somewhat shorter, but noteworthy.

The increased use of digital equipment has increased the number of digital-to-analog and analog-to-digital conversions in the broadcast chain, which tends to significantly damage audio with each pass.

If all or some of the D/A-A/D passes are done with compressed digital, the problem is compounded. Compression systems squeeze audio into narrower bandwidths by eliminating bits of original digital information, most of which are not recovered in the decoding process.

Algorithm developers, with the benefit of detailed psychoacoustic research, have determined that the missing information is imperceptible to the human ear. But artifacts do become noticeable after multiple passes of compression, during which bits of information are repeatedly removed from the signal.

(The very title of this report, "In Depth: Audio Compression," will likely be controversial to some RW readers who insist that the term should be "digital audio data reduction." Some compression system manufacturers and vendors prefer the safer, but vague term "coding." However, most manufacturers and their clients in the audio, video and broadcast industries, continue to use the word "compression" without confusion.)

The element of loss after every compression pass leads many equipment suppliers to advise using compression only when it is necessary. "Use compression only when bandwidth is expensive," said Steve Church, president, Telos Systems, Cleveland, manufacturer of the Zephyr ISDN transceiver, the first U.S. product licensed to provide ISO/MPEG Layer III compression.

"We compress things as little as possible," said Dave Anderson, vice president, operations and engineering for IDB Communications, Culver City, Calif., which offers its DDD-2 apt-X-compressed links. "If we have a feed that has two or three different stops, we move the maximum amount of compression to the final step at the back of the link whenever we possibly can."

But sometimes it is not possible to limit compression. "It is totally driven by what the customer wants to do. We have problems, for instance, when doing sports backhauls because the requirement there is typically to keep the operating costs as low as possible," Anderson said.

YOU CAN RELY ON LPB®

Everyone knows the LPB Signature Series is the industry standard for rugged reliability.

The LPB tradition of durable, reliable, easy-to-use consoles continues in our new linear fader consoles.

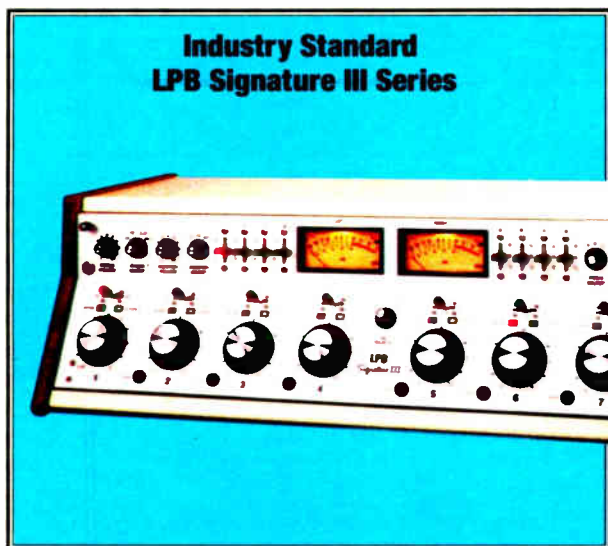

With over 3,000 units in operation worldwide, the LPB Signature III console represents a standard others are still unable to match. The Signature Series has proved its ability to perform on 6 continents, in settings ranging from metropolitan to jungle. With an incredible record of ruggedness and easy maintenance, it's no wonder over half of the Signature console owners have more than one. Features include 3 inputs per channel, two output buses and plug-in electronics. LPB Signature III consoles are available in 6, 8, 10, and 12 channel stereo and 6, 8, and 10, channel mono models.

The LPB 7000 Series takes the standards of the Signature III a step further, adding more features than any other console in its price range. With front panel switches rated for 5,000,000 operations, gold contacts, plug-in modular electronics and more, the LPB 7000 Series has the durability radio and TV stations worldwide expect from LPB. Features include two inputs per channel, three stereo output buses with one mono-mixdown standard and two more optional, user configurable muting and remote starts, and much more. Available in 12 and 18 channel stereo models.



It doesn't matter which LPB board you choose, you'll get a console you can count on 24 hours a day. One you'll keep for a long time. Ask any LPB console user - they're all around you.

LPB®

28 Bacton Hill Road • Frazer, PA 19355 • (215) 644-1123 • Fax (215) 644-8651

Products & Services Showcase

For more information on the products shown below, circle the appropriate Reader Service No.(s) on the enclosed Subscription/Reader Service card or contact the advertiser directly.

Big Voice!

Small Price....

New! Model 401 Mic Processor

Specially designed to enhance the power of an on-air or voice-over announcer, the Valley Audio Model 401 Microphone Processor is a high performance update of the industry standard Model 400, with 48V phantom power built-in.

Nothing Sounds Better!

- Quiet wide dynamic range mic preamp.
- Internal phantom power for condenser mics.
- 3-band EQ with voice-tailored frequencies.
- The industry's best sounding compressor.
- Interactive expansion/gating for noise control.
- Normal or heavy duty "D-S" sibilance control.
- Multiple input, output and insert connections.
- New easier-to-read control function graphics.

Call for more information!



Valley Audio
9020 W. 51st Terrace
Merriam, KS 66203

1-800-800-4345

READER SERVICE NO. 171

Byte it with



A Digital Recorder specifically designed to record phone calls and play them back quickly and easily.

Fast nondestructive editing.

Easy access and fast stacking of bits.

The most powerful way to record and air phone-bits.

The Blue Group

1001 Ridge Avenue
Clearwater, FL 34615
TEL 813 442 1665

READER SERVICE NO. 135

Digital Dream System \$9,995.00!

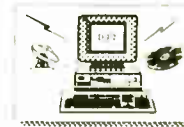

Just \$9,995.00 for this dual digital audio Satellite control with Production system. You get two powerful 486SX-25 computers, VGA color monitors and 535 meg hard disk (9+ hours mono storage), LAN and DMX-4 audio switcher. Includes interface and control hardware. Nothing else is required! This pricing is good for a limited time..

- Great Sound: Premium apt-X™ audio card standard
- Simultaneous record play for *time shift* PBR recording
- Separate Production room system with LAN net connect to Control for complete backup & safety.
- Satellite system handles all standard formats
- CD system option from \$1,500 uses Pioneer single or triple 6 packs or 300 disc jukeboxes
- Live assist included, ready for Traffic & Music interfaces
- Many options: External button boxes, more audio & I/O

The Management

1-800-334-7823 1-817-625-9761 FAX: 817-634-9741
P.O. Box 1-36457 Ft. Worth, TX. 76136
1600+ Stations - Our 13th year

* Extra charge for combined Satellite & CD systems. No holds or splits, larger hard drives available at extra cost.

READER SERVICE NO. 90



Econco REBUILT POWER TUBES



Approximately One Half the Cost of New

3,000 Hour Unconditional Guarantee

Call for Our Price List

Econco 1318 Commerce Ave. Woodland, CA 95695
Phone: 916-662-7553 Fax: 916-666-7760 Telex: 176756
Toll Free: 800-532-6626 From Canada: 800-848-8841

READER SERVICE NO. 6

1200L Digital Message Announcer

Answers the telephone line and plays your message



The 1200L will play a 3 part message to incoming callers consisting of a greeting message (usually an advertisement spot), the information you are providing (sports scores, weather, etc.), and a closing message (also an ad spot). This creates a captured audience for your advertising clients and helps generate revenue for your station. These messages can ever be updated remotely over the telephone (password required).



5504 State Road, Cleveland, OH 44134
Local: (216)351-1755 Fax: (216)351-0392
National: 800-722-6664

READER SERVICE NO. 145

DIGITAL ANTENNA MONITORS

In-Stock-Available for Immediate Delivery



Price US\$2400.00 2 Towers
Will operate with any remote control equipment.



Price US\$1780.00 2 Towers

For AM directional with studio located at transmitter site.

These monitors are state-of-the-art instruments of unequalled accuracy (.5% or better on ratio and .5° or better on phase) and stability. With typical modulation the true ratio readout of these monitors is a factor of 10 more stable than instruments that measure normalized amplitude, and their phase readouts are rock solid. Phase sign is automatic, no extra operation. In addition to the analog DC outputs for remote control the Model CMR has a multiplexed BCD digital output which can be used to drive the Remote Indicator Model CMR-1. RF inputs have dual protection. Gas discharge tubes across the sample line terminations plus relay protection.

GORMAN REDLICH MFG. CO.

257 W. Union St. Athens, Ohio 45701
Phone 614-593-3150 • FAX 614-592-3898

See Us At NAB Booth 4812

READER SERVICE NO. 112

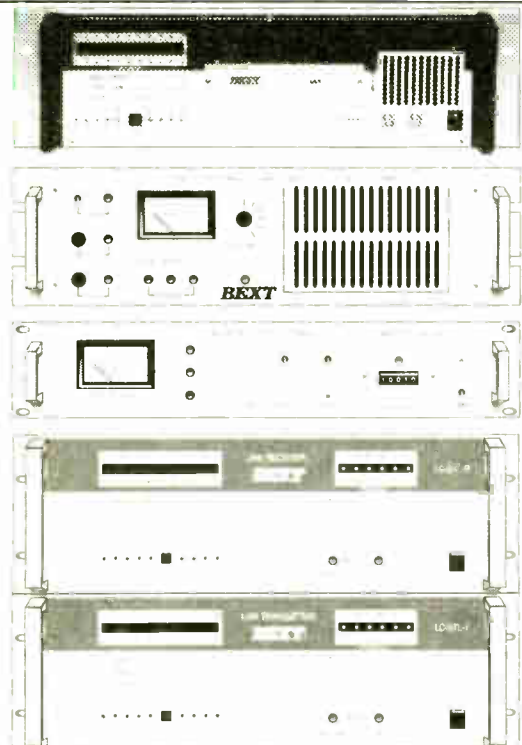

BEXT

High performance RF

Exciters
Amplifiers
Translators
Transmitters
STL's

Backed by our two-year warranty and the BEXT 24-hour engineering hotline.

619-239-8462
FAX: 239-8474

1045 10th Ave.
San Diego, CA 92101

READER SERVICE NO. 198

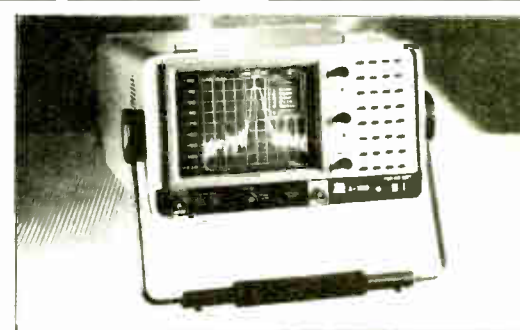

A-7550... 10 kHz to 1 GHz PORTABLE SPECTRUM ANALYZER

Synthesized tuning and phase locked frequency stabilization enable accurate swept frequency measurements over calibrated span widths from as wide as 100 MHz/div to as narrow as 1 kHz/div. A standard 300 Hz resolution bandwidth filter and peak hold mode provide NRSC measurement capability. Other A-7550 features include:

- +30 to -120 dBm measurement range
- DC operation from 12 to 30 volts (Built-in battery optional)
- Optional built-in tracking generator
- Optional built-in AM/FM/SSB receiver
- Optional IEEE-488 or RS-232 interfaces

For more information or a demonstration of the A-7550 contact:

IFR SYSTEMS, INC.

10200 West York St., Wichita, Kansas 67215
Phone (316) 522-4981 Ext 207 FAX (316) 524-2623
DIRECT FACTORY RENTAL PLAN AVAILABLE



READER SERVICE NO. 9

A Way to Let Ds be Ds

A technology recently developed by a small company, California Digital Audio Systems Inc. (CDAS), Moorpark, Calif., may soon make it practical for a station to operate with one pass of compression. Test versions of CDAS' "digital audio Xpress" (daX) system are in a handful of test sites.

The system is designed to replace many of the functions of various pieces of audio and video studio equipment to reduce the number of different compression algorithms and D/A-A/D conversions necessary. The system is currently developed to the point that all but one D/A-A/D conversion has been eliminated before transmission.

The one remaining conversion to analog is for mixing applications, such as voiceovers. "But we've got people working on that," said CDAS Vice President Richard J. Becvar.

The diagram at right illustrates what CDAS estimates would be the worst-case scenario for a daX system operating with MUSICAM at 256 kilobits per second (kbps). Audio quality is initially impaired by a D/A and A/D conversion at the remote site, but is maintained at the same level through the rest of the chain.

Once digital audio radio service to the public begins, CDAS estimates signals routed through the daX system under this worst-case scenario, would deliver 18 percent of original compact disc source

material to the listener.

CDAS calculates the worst-case non-daX, multiple-transcoded DAR signal would whittle the original source down to about 0.003 percent by the time it reached the listener.

CDAS has worked closely with Gannett Broadcasting in the development of daX and other projects, such as the application of digital compression technology to VSAT transmission (RW, Sept. 22, 1993). In fact, Paul Donahue, vice president, engineering, Gannett Radio, is a technical consultant to and investor in CDAS.

It is, therefore, not surprising that daX has been developed with MUSICAM as a model. Gannett is a chief partner in the U.S.A. Digital consortium, developing in-band, on-channel DAR transmission systems that operate with the MUSICAM algorithm. The daX approach is not system-specific—any compression system could be applied, Becvar said.

Becvar will provide more information on the system during a technical paper session at the National Association of Broadcasters Convention in Las Vegas, scheduled for Sunday afternoon, March 20.

At press time, Becvar could not say whether CDAS would have a hardware demonstration of the system at NAB, but he said a public demonstration should be ready before the end of 1994.

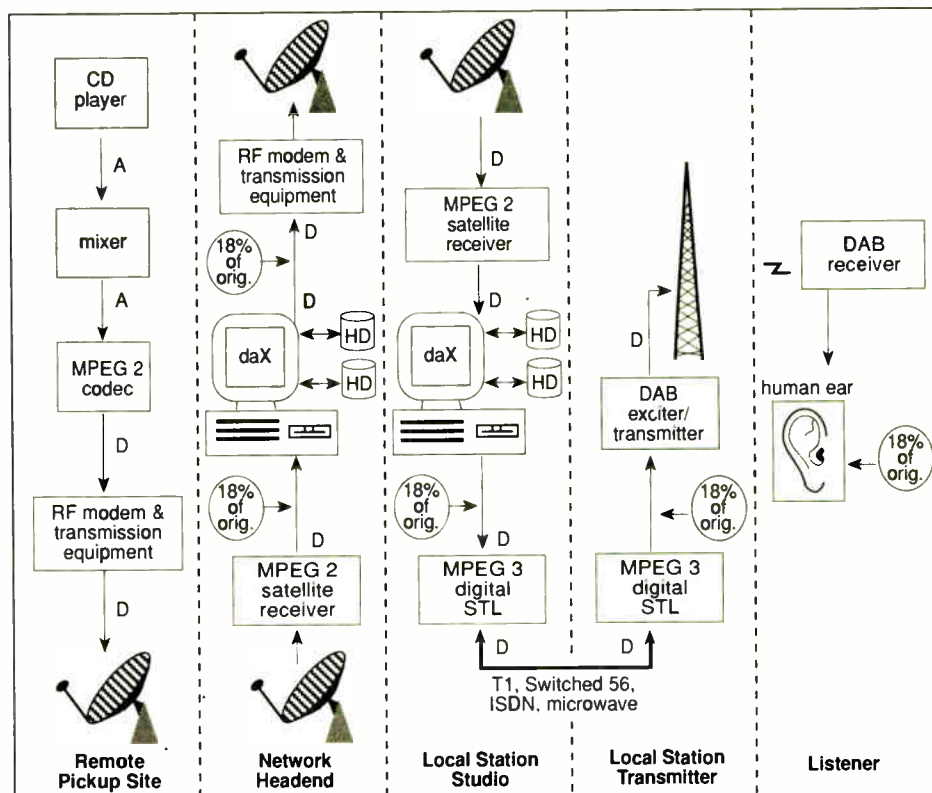

Tests, Press Draw Fire

► continued from page 66

unpredictable glitches.

Squire's test procedures and results have drawn fire from several critics. "Who knows what Herb was doing, but it was not real-world testing," said Don Bird, general manager, 360 Systems, Tarzana, Calif., which offers the DigiCart/II playback system with optional AC-2.

Test critics

"The coders that he cascaded were not upper-end quality. Some of them were very low-quality at 64 kilobits per second (kbps)," said Louis Fielder of Dolby Labs. Overall, it was a worst-case scenario that does not match what most stations are using, he said.

The most common complaint was over Squire's decision to demonstrate degradation of compression after 20 passes,

which happens very rarely, perhaps never, in today's radio industry.

"The local broadcaster interfacing with networks and having an STL is looking at the problems associated with third generation," Greg Dean of Computer Concepts Corp. said.

Transcoding artifacts are not rare sounds in audio development labs, where researchers purposely try to find the breaking points of compression systems. But most compression developers and compression system manufacturers say they have never heard a transcoding artifact from an over-the-air signal.

Considering other possible impairments created in the broadcast chain or in the transmission path, transcoding algorithms might be hard to distinguish from other noise, especially on FM car radios that have frequency responses of 15 kHz or less.

Others complained about the lack of control samples to make an adequate judgment of how severely compression systems affect signals. Tapes of 20-generation compressed digital audio should have been compared to 20 generations of analog audio on the low end and 20 generations of uncompressed digital audio on the high end, they say.

The results might have shown severely damaged compressed audio, but better quality than might have been produced at an all-analog station.

Twenty D/A-A/D conversions producing artifacts should surprise no one, some Squire critics say. Even if the same compression system were used throughout a 20-pass test, the degradation would be easily audible. In fact, there is no way to distinguish the multi-generational artifacts from the transcoding artifacts, they say.

Protest

"The methodology (Squire) used was quite slack," said Michael Smyth from APT's Los Angeles office, whose brother, Stephen, developed apt-X. The few transcoding artifacts that do reach the airwaves do not sound as bad as the artifacts recorded in Squire's tests, he said. "I believe the artifacts he was listening to

continued on next page ►

THE IDEAL COMBINATION

TH-02EX



TLE-02

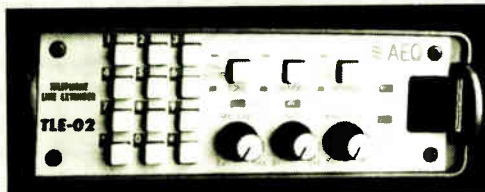

Digital Telephone Hybrid - TH-02EX

- ◆ Frequency Extender Mode as standard feature.
- ◆ Works with one or two telephone lines.
- ◆ The second line provides full multiconference mode. The operator and two callers can talk and listen to each other simultaneously.
- ◆ Hybrid Null of 60 dB's.
- ◆ No adjustments required.
- ◆ Ideal companion to work with AEQ Portable Digital Line Extender TLE-02.

The TH-02 EX introductory price is \$1295.

Portable Digital Line Extender - TLE-02

- ◆ On-Air phone call with audio presence, depth and clarity of voice without the "telephone sound."
- ◆ Easy to use. Designed for the non-technical user.
- ◆ Ideal for field reporters, totally portable. Light weight: 3.3 Lb.
- ◆ Great operation autonomy, uses 8 AA batteries.
- ◆ Dialing pad in front panel and pulse/tone selectable.
- ◆ Independent level control of mic/line input, auxiliary input and headphones.

The TLE-02 is available to all broadcasters for the amazing introductory price of \$895.



2211 South 48th St., Suite H
Tempe, Arizona 85282
Phone (602) 431-0334 • FAX (602) 431-0497



Circle (83) On Reader Service Card

See Us At NAB Booth 2300

Gotham Superior Audio Cables

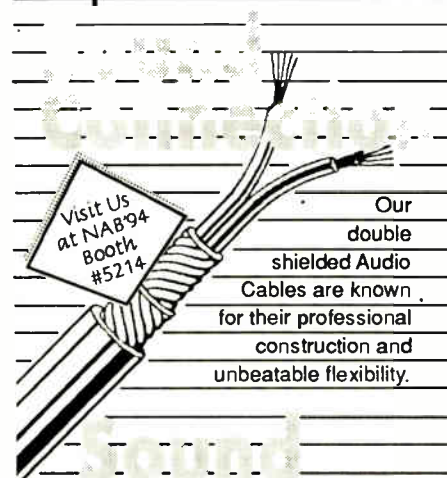

Our double shielded Audio Cables are known for their professional construction and unbeatable flexibility.

DELTRON Superior Connectors

DGS 800-292-2834

P.O. Box 170426, Arlington, TX 76003

Circle (105) On Reader Service Card

Algorithms Are Still Dueling a Year Later

► continued from previous page

are not the ones that are actually out there in the field at this stage."

Squire has nearly as many defenders in the radio industry as he has critics.

"I think it is a real problem. Herb didn't manufacture it...I think Herb's results represent a real-world picture of what can happen," said Bob Donnelly, general manager of ABC Radio's network satellite operations, in response to those who say Squire's tests lacked controls.

"Herb issued a cry for reasonableness, and sometimes to make people think in reasonable ways, you have to create some kind of dramatic episode," Donnelly said.

"There was a lot of discussion around about what would happen if you cascaded compression algorithms, but he actually sat down and did the testing rather than just theorize," said Bill Harland, director, domestic sales, Broadcast Electronics, Quincy, Ill., which sells the AudioVAULT 100 MUSICAM audio storage and playback system.

The trade press has attracted some of the same criticism that has been directed at Squire. News stories on compression and incompatible algorithms have dwelt on "a non-issue" and overplayed the seriousness of the situation, said 360 Systems' Bird.

Overblown

"My view is that Squire has overblown it and (the press) has reported it, perhaps giving it more publicity than it is due."

said Jack Fenster, director, broadcast radio product management, Scientific Atlanta's (SA), Melbourne, Fla., facility.

"Customers are as confused as ever. The media could do a lot to alleviate the confusion," Bird said.

Powerless pen?

Trade press reports on the disadvantages of compression may have been harsh, but they did not hurt sales. But many customers have been asking more questions about compression systems before buying and tend to be more aware of how to properly apply the systems to their radio operations, vendors say.

"Frankly, (the dueling algorithm debate) has legitimized compression. Now, instead of asking, 'Is it compressed?,' customers have been asking, 'How is it compressed?'" said Adrian Charlton of The Management, Fort Worth, which manufactures and markets the Digital DJ audio automation system with apt-X compression.

The trade press "is just the messenger telling people about things that need to be dealt with," said Scott Slocum, a salesman for Computer Concepts.

"I would not want a doctor who would not want to tell you have cancer," said Ben Umberger of BLU Electronics, Clearwater, Fla., which sells the DigiStation digital automation system with AC-2.

One of Bird's most specific criticisms of the press is its failure to clearly explain

that both compressed and uncompressed audio equipment is available.

Digital audio technology and compression have merged to represent the same technology in some customers minds,

Quest Begins for 'Lossless' System, Other Noise Cures

Whatever compression-related audio impairment broadcasters may have to face, manufacturers have suggested remedies. Some developers are working on long-term cures.

One of the most popular suggestions for the near-term is a new, more formal round of dueling algorithm tests.

Many say that the Herb Squire tests were good, as far as they went, but that follow-up testing is now needed with a goal in mind. Instead of simply illustrating the problem, the data could be used to develop solutions.

A similar round of tests might be helpful if they yielded a blueprint of how each compression algorithm transcodes to others in particular applications. "It is a system-design kind of research," said Ron Renschel, marketing manager, Sony Pro Audio, Park Ridge, N.J.

Only a few organizations have the facilities where transcoding tests could go through enough passes of compression to

prompting them to avoid all digital audio equipment purchases, Bird said.

Broadcasters are reminded that many digital studio systems are sold with no compression capability at all. Many units are switchable, such as 360 Systems' DigiCart, which gives the broadcaster the option of working in AC-2 or full-bandwidth digital audio.

get valid results—the commercial networks.

ABC's Bob Donnelly agreed that such testing is needed, but said it should be done on an informal basis, rather than ISO-style testing with an eye toward developing a standard. The most effective approach would be to form groups of users "who come together and share experience. Broadcasters talk to each other when they have common war stories," he said.

The alternative would have to be formal testing on an on-going basis. New compression algorithms, along with improved and refined versions of old systems, are introduced every year. Test data on dueling algorithms could be obsolete very quickly.

An alternative many vendors suggest is case-by-case testing. Before signing the contract for a new hard-disk storage system or DSTL, a station manager or engineer is often given a chance to test the model with the station's existing facilities.

continued on page 71 ►

FEEL LIKE THE CHAIRMAN OF THE BOARD



IN COMPLETE CONTROL AND SECURE IN YOUR JOB. THAT'S THE FEELING OF WORKING WITH A DATEQ BROADCAST CONSOLE.

GREAT SOUND QUALITY, RF IMMUNITY, AND INNOVATIVE FEATURES MAKE DATEQ CONSOLES VERY FAMILIAR YET UNIQUELY DIFFERENT. JUST THE RIGHT COMBINATION OF FAMILIARITY AND KEY FEATURES MAKES THEM EASY TO USE, YET DIFFICULT TO MISUSE.

IMAGINE... A NEW CONSOLE WITH THE RIGHT FEATURES, THE RIGHT PERFORMANCE, AND THE RIGHT COST.

NAB'94 BOOTH 5000



DATEQ
audio technologies

FOR MORE INFORMATION CALL: QMI, 25 SOUTH STREET, UNIT B, HOPKINTON, MA 01748 PHONE: (508) 435 - 3666 FAX: (508) 435 - 4243
DATEQ, DE STEIGER 193, 1351 AV ALMERE-HAVEN, HOLLAND. TEL.: (+31) 36 - 5 31 23 76 FAX: (+31) 36 - 5 31 77 76

Circle (186) On Reader Service Card

World Radio History

When you spell it out in black & white...

LPB[®]

1. Since 1960, LPB has manufactured the best low power broadcast transmitters in the world.
2. LPB Signature Series Consoles
More than 3,000 sold worldwide making it the #1 console series in the world.
3. New LPB 7000 Series Consoles
Already operating in Asia, Europe, North and South America.
4. Quite simply, we don't put the LPB name on anything that isn't the highest quality and reliability you can get for your money.

The Competition

1. Hasn't.
2. Can't compete.
3. Can't match LPB in quality, features, and value.
4. No comparison.

...there is no competition.

LPB introduces

**THE NEXT GENERATION
DIGITAL AUDIO SYSTEM.**

NAB Booth # 1924

LPB[®]

28 Bacton Hill Road • Frazer, PA 19355 USA • Phone 610-644-1123 • Fax 610-644-8651

Circle (20) On Reader Service Card

World Radio History

Ask for a Test Drive

► continued from page 69

This approach carries the same problem of rapid obsolescence of test data, and sometimes stations do not have access to all the sample models of digital equipment they may need. But where possible, case-by-case testing can be effective.

If a new piece of compression equipment produces artifacts, a station may opt to send it back or find some way to adjust it to the existing studio or transmission gear.

Compression equipment often features data-rate control of the level of compression. If the bandwidth of a compressed signal must be widened to avoid audio impairments, reprogramming is a simple matter.

"From our perspective, you must get as much headroom as possible," said Steve Church of Telos Systems.

"If (Squire) had used high-data-rate MUSICAM systems, I think he would have had very different results," Dolby's Louis Fielder said. "The degradation would have been small and manageable."

Flexibility is even easier to achieve if compression equipment is open-architecture. Manufacturers could leave it up to individual broadcasters to buy and install the desired digital compression computer card.

"To us, as component suppliers, (the form of compression used) doesn't make a lot of difference. We predicted that this (dueling algorithm debate) would happen to some degree. Most of the cards we are shipping today have a choice of five or six algorithms on them," said James Antrim of Antex Electronics, Gardena, Calif. Antex builds compression components in Dolby AC-2, the MPEG standards and others.

"If (customers) wish to have something different than what we provide them, they should have that choice. That, in my opinion, is the more responsible way," said Moseley's Jamal Hamdani. Moseley already offers open-architecture DSTLs, he said.

Open-architecture equipment would make it easier for stations to design their digital facilities for single-compression-system operation.

The CDAS daX system could also go a long way toward making it practical to use just one compression system from origination to transmission by keeping signals in the same compressed digital state throughout the chain. Other developers, such as Scientific Atlanta, are likely to eventually introduce similar systems and begin working for a D/A-A/D conversion standard.

"We haven't really done much with it except come up with a concept. We haven't spent any time with the standards organizations because we haven't had the technical people available to develop the product," Scientific Atlanta's Jack Fenster said.

Some are looking to the day when a technical solution erases all transcoding issues. "At some point somebody's going to figure out how to do a lossless compression algorithm," said Bill Harland of Broadcast Electronics.

No one can say when, but the ever-improving art of squeezing audio signals into narrow channels may be advanced to the point that no 1s or 0s need ever be removed.

"Algorithms developed in the future will be 20:1 compression and lossless. Not only will the customer want it, but I'll put it on

my board as soon as I can get one," Antex's Antrim said.

Others are more skeptical about losslessness. If an algorithm developer chooses to leave audio data intact, other forms of data must be sacrificed. One possibility is greater time delay beyond the milliseconds of delay with current systems. Unless that problem is resolved, lossless systems would be impractical in real-time broadcast applications.

"I've trapped myself in years past by saying, 'Oh, I don't think anybody can do that.' I'm not going to say that, but boy, I'd be impressed," said Computer Concepts Corp.'s Greg Dean.

If equipment manufacturers and vendors agree on anything, it is that a single, standard compression algorithm for all applications will never exist in the U.S. Standards are just not Americans' style.

"Dolby, being a typical American company, has a little different philosophy than some of the European organizations, although we have been active in the (European) standards activity," Fielder said. But regardless of the system Europeans standardize, stations will determine their best options on their own, he said.

In a sense, however, compression systems have already begun to be standardized. Dolby's AC-3, a 5.1-channel, surround-sound upgrade of AC-2, has been chosen by the FCC's Advisory Committee on Advanced Television

Service to be the audio component of the high definition television transmission standard, which the commission is expected to approve in 1995. That standard could have an indirect effect on compression in the radio industry.

The FCC's eventual selection of a DAR standard could have even greater influence. MUSICAM and AT&T's PAC (Perceptual Audio Coder) are the only compression systems involved in the current Electronic Industries Association/National Radio Systems Committee tests of DAR transmission systems. (See story, page 7.)

One possible eventuality may be elimination of some compression systems in the marketplace as equipment manufacturers seek commonality with the most

continued on page 72 ►

total processing control

unity remote software

You're driving in your car wondering how your station would sound with just a little more boost in the high-end. Well, stop wondering and start processing. Because with Unity Remote Software, you can control your processing from your office, your home, and even your car.

Unity Remote Software provides you with the same information found on the Unity's front panel display so that you can see, as well as hear, the effects of your changes. Day-part processing events may also be programmed remotely. Unity Remote runs on an IBM-compatible computer running DOS and supporting VGA graphics.

How much does Unity Remote Software cost? *Absolutely nothing.* Because now it is included free with every Unity 2000i FM and Unity AM stereo processor. The best sounding processors in the world are sounding better all the time.

the unity
the world's best sounding radio processors

CUTTINGEDGE

2101 SUPERIOR AVENUE • CLEVELAND, OHIO 44114 • TEL: (216) 241-3343 • FAX: (216) 241-4103
Current Unity owners should call or fax Cutting Edge for your free software.

Free remote software??
Why didn't I think of that?

Europeans Differ on MPEG Options

by Alan Carter

ERLANGEN, Germany To call ongoing discussions surrounding the use of Layer II and Layer III algorithms for digital audio transmission at low bit rates a debate is an understatement.

Developers behind the two schemes have their respective arguments. But there is more at stake than meets the eye.

For broadcasters the issue focuses on three main factors: sound quality at different bit rates and modes; audio degradation with multiple coding and decoding, and problems encountered with delay.

Both Layer II and Layer III support: four

modes (single-channel, dual-channel stereo and joint stereo), three sampling frequencies (32, 44.1 and 48 kHz) and bit rates in a range of 32 to 384 kilobits per second (kbps) for Layer II and 32 to 320 kbps for Layer III.

At the Fraunhofer-Institut für Integrierte Schaltungen, located north of Nuremberg in Erlangen, proponents who completed much of the work on Layer III argue that the algorithm is the strongest of the MPEG audio codecs.

Layer III is especially useful to achieve the best compromise between audio sound quality and bit rate at low data rates near or less than 64 kbps per audio channel,

according to the Fraunhofer.

The Fraunhofer also interprets international tests and draft recommendations within the International Telecommunication Union (ITU) Radiocommunication Study Group—formerly the CCIR before an ITU reorganization—as making Layer III “the clear leader in audio coding technology.”

But a two-hour drive south to the Institut für Rundfunktechnik (IRT) in Munich where development of Layer II is centered, engineers claim that the same tests prove their system “is and in the future will continue to be the best choice in the world of audio coding technology.”

Who's right? Who's wrong?

“I think we are seeing a domino effect,” said Karlheinz Brandenburg, head of the audio/multimedia department for the Fraunhofer. “We see at the low-bit rate, more and more people are interested in Layer III.”

Harald Popp, senior engineer at the Fraunhofer, admitted that complaints by Layer II proponents about the complexity of Layer III and delay are a drawback.

However, he said, some decoders will have all three layers on one chip and the next generation of encoders “may be” less complicated.

“I think delay is a weak argument,” he also said. “Yes, it is true. But how much effect or influence does feedback have?”

Gerhard Stoll, head of the psychoacoustic section at the IRT and a chief developer involved in Layer II, said the recommendation from the task group of

continued on next page ▶

Hard Disk Recording Doesn't Have To Be Hard On Your Wallet.

“...in a price/performance comparison, the DR4d would be hard to beat. Thumbs up on this one.”
George Petersen,
MIX Magazine



“...great sound, useful features, and friendly operation... sure to set a new standard in affordable recording”
David Frangioni,
EQ Magazine

“If you're a broadcast engineer.... the DR4d may seem like one of the greatest inventions in the history of audio.”
Geary Yelton, Electronic Musician Magazine

If you're involved in production for radio, then you're aware of the increasing demand for digital audio quality. So your next multitrack recorder should be digital, but which format: tape or hard disk? You've heard about the great editing tricks offered by disk-based systems, but there's a problem.... don't all hard disk systems require expensive add-in hardware and software, to already expensive computers? Not anymore!

The DR4d is the solution for those looking for an alternative to expensive, complex computer-based systems, or the limitations and mechanical uncertainty of tape recorders. It offers a perfect combination of hard disk recording benefits with an easy-to-use interface.

The DR4d can record up to four tracks simultaneously to standard SCSI hard disks, either internal or external drives. An optional 213MB internal disk offers 40 track minutes of recording (44.1kHz) right out of the box. To expand your recording time, simply connect external drives to the DR4d's supplied SCSI port.

With standard tape machine-style controls the DR4d is by far the easiest hard disk recorder to operate, which means that you can get to work immediately, rather than setting up and operating a computer system. Punch ins/outs can be performed manually or automatically from the front panel, or by footswitch, just like you'd expect.

Now you can start to take advantage of the power of random access editing. You can cut, copy, and paste sections of audio with ease. Our Jog/Shuttle wheel lets you scrub through the audio at various speeds, forwards or backwards. Try out different arrangements. Create perfect tracks by combining the best sections from multiple takes. Whatever. And you can edit with confidence, be-

cause if you change your mind you can instantly Undo your last edit - even after the power is turned off and on again! Imagine it. Do it. It's that simple.

Another DR4d advantage is not having to wait for tape to shuttle back and forth. You can instantly move to 108 memorized locations at the touch of a button, and these locate points may be entered manually or on-the-fly. It's also simple to set up seamlessly looping repeat sections, so it's easy to jam over tracks. No more wasting time on rewinding tape!

Of course, how the DR4d sounds is as important as how it works. Advanced 18-bit oversampling A/D and D/A converters insure crystal clear sound, and with a full 96dB dynamic range, the DR4d offers no-compromise specs. The four balanced 1/4" input and output jacks are switchable between -10 and +4 operation, and 2-channel digital I/O is included (XLR and RCA).

Backups can be made to a standard DAT machine.

Need more than four tracks? Four DR4d's can be linked to create a 16-track system. And for synchronization to other gear, just add the optional MIDI or SMPTE interfaces.

And best of all, the DR4d is an affordable reality: suggested list is only \$2495.00 (or \$1995.00 w/o hard disk)! Multitrack disk recording is within your

reach! Please call or write for further information.

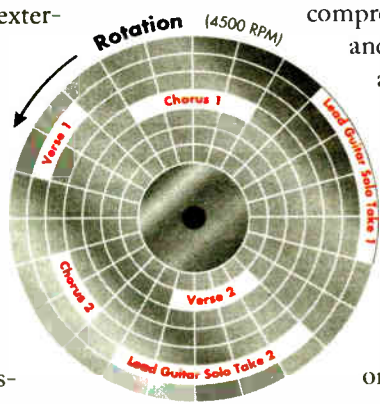

On a spinning hard disk, the various sections of music can be accessed almost instantaneously by the moving heads of the drive mechanism. This allows you to seamlessly output different parts in any order, with no time spent rewinding. Audio can be moved and rearranged in ways not possible with tape!

DR4d **AKAI**
DIGITAL

P.O. Box 2344 Ft. Worth, TX 76102
(817) 336-5114 Fax 870-1271

Circle (107) On Reader Service Card

World Radio History

Artifact Solutions

▶ continued from page 71
established standards.

“The choice may narrow down to two or three...but we'll probably go through many more generations,” Hamdani said. Many developers continue to seek the next level of sophistication, he said.

“There are certainly going to be some that fall by the wayside. There is a natural evolutionary process,” IDB's Dave Anderson said. MPEG standards, apt-X and others that have already gained international acceptance will have the advantage, he said.

However, some believe that compression developers will continue to invent algorithms for specialized situations. “Application-specific algorithms, I believe, are what will happen. I don't believe you're going to get fewer algorithms; you'll get more,” Michael Smyth of Audio Processing Technology said.

Whatever the final outcome, it is clear that the already strong position compression systems have in the radio industry will only get stronger.

The one message compression developers and marketers hope to send is that there is no reason to avoid buying these systems today.

If compression creates audio glitches, there will always be a way to treat them, if not cure them altogether, as long as the industry keeps track of the rapidly changing technology.

“When the first CD players came out on the market, they sounded good, and people said, ‘This is it. We've gone digital,’” ABC's Donnelly said. “But there have been quantum improvements in digital playback that are noticeable because people right away said, ‘Make sure you do this and make sure you do that.’”

The same is true with compression, Donnelly said. It's digital, but people still have to pay attention.

□□□

The conclusion of this report will appear in the March 9 issue, with a look at equipment users' experiences with compression, Herb Squire's response to his critics and a closer look at some of the more important audio compression systems in use today. Those attending the NAB convention will find the March 9 issue at the Radio World booth, No. 4309.

► continued from previous page
the ITU Radiocommunication Bureau (ITU-BR) is "bad news" for Layer III.

While the document recommends Layer III for commentary—low data rate transmission for music and speech in such modes as ISDN—Layer III does not meet specifications under acoustical testing at 60 kbps mono using headphones, Stoll said. Layer III, however, meets the specifications at 60 kbps mono and stereo using loudspeakers.

Yes, this appears to be an insignificant point, but Stoll said users can obtain "the same, maybe better" quality using Layer II with a lower sampling rate. And, as Layer II proponents always suggest, the scheme is easier and cheaper to implement.

As expected Popp does not agree with Stoll. "Of course if you reduce the sampling rate you get different results," Popp said. "But there have been no listening tests of Layer II or Layer III at lower sampling rates. All the arguments are just claims."

According to draft revision from the task group making the recommendation that goes before a review committee in March, different layers of the coding system with increasing complexity and performance can be used depending on the application.

Application is one point on which all proponents agree.

Stoll said he believes the recommendation will allow the market to determine which system gains what share of the different audio sectors.

"You don't get a free lunch," Brandenburg said. "You have to be careful on how you use this equipment."

The recommendation addresses the full spectrum of audio algorithm schemes and applications.

Layer I contains the basic mapping of the digital audio input into 32 sub-bands, fixed segmentation to format the data into blocks, a psychoacoustic model to determine the adaptive bit allocation, and quantization using block companding and formatting. One Layer I frame represents 384 samples per channel.

Layer II provides additional coding of bit allocation, scale factors and samples. One Layer II frame represents 3 x 384=1,152 samples per channel.

Layer III introduces increased frequency resolution based on a hybrid filter band (a 32 sub-band filter band with variable length Modified Discrete Cosine Transform). It adds a non-uniform quantizer, adaptive segmentation, and entropy coding of the quantized values. One Layer III frame represents 1,152 samples per channel.

The recommendation said that there are four different modes possible for any of the layers: 1. Single channel; 2. dual channel (two independent audio signals coded within one bit stream, e.g., bilingual application); 3. Stereo (two left and right signals of a

stereo pair coded within one bit stream).



The fourth mode is joint stereo, which exploits the stereo irrelevancy and redundancy, and can be used to increase the audio

quality at low bit rates and/or to reduce the bit rate for stereophonic signals.

The history of the algorithms dates back to the development of MUSICAM and ASPEC. Layers I and II came directly from the developers of MUSICAM: IRT, Philips and the CCETT. Layer III is a combination of MUSICAM and ASPEC, but mostly ASPEC, which was developed by the Fraunhofer, AT&T, Thomson Brandt and CNET.

However, the lead proponents are the IRT and the Fraunhofer.

The IRT is the standards setting organization for German public

broadcasters, the ARD, and fully government funded. The Fraunhofer is a private research organization that receives some government funding but mainly supports itself as a research and development consulting firm for private corporations and other institutions.

The recommendation now before the ITU followed subjective tests that made a comparison to compact disc quality for applications including emission, such as digital audio broadcasting; distribution, or transmission among member network organizations; and contribution, one-way trans-

mission from the field to a studio.

For emission the results showed that at 2 x 128 kbps independent channels, the specifications were met by: ISO/IEC 11172-3 Layer II; ISO/IEC 11172-3 Layer III, and Dolby AC-2. At 192 kbps joint stereo: ISO/IEC 11172-3 Layer II and ISO/IEC 11172-3 Layer III.

The evaluation for distribution passed a signal through three codecs in tandem at 120 kbps per independent channel. In order not to have the exact same audio signal before each new encoding, repopulation of the binary codes

continued on page 74 ►



The original Shure FP32 set the standard in field production for portable stereo mixers. Now, with the new FP32A, you can count on getting even less. Noise, that is...30dB less! In fact, the FP32A is so quiet and improved that it's perfect for use with DAT and other digital recording media.

Professional Mixing You Can Take Anywhere.

The Shure FP32A is a 3-input, 2-output portable mixer specifically designed for:

- remote audio recording
- electronic field production
- electronic news gathering
- location film production

The FP32A weighs just 3.5 lbs and is only 2-1/4" H x 6-3/8" D x 7-1/4" W in size.



With 8 hours use from two 9V alkaline batteries — or powered by any 12 to 30 VDC source — the FP32A goes wherever you do. And since it's from Shure, you can count on its durability and ruggedness.

So Many Features In So Little Space.

You get all the features of the original FP32 plus:

- 48V phantom power
- pop-up pan pots
- input level LED indicators
- mix bus jack and cable
- headphone mode switch
- mixer/monitor switch
- adjustable peak output LEDs
- stereo link for inputs 2 and 3
- more than 30 other new features and improvements

So go to your nearest dealer and pick up an FP32A. Once you use it, you'll see why we're making so much noise about something so quiet.

For the Shure FP dealer nearest you, call 1-800-25-SHURE.



The Sound of The Professionals®...Worldwide.

Layers of Disagreement

► continued from page 73

was performed by applying a 0.1 dB gain reduction in the linear pulse-code modulation (PCM) domain. The ISO/IEC 11172-3 Layer II codec was the only system that fulfilled the requirement.

For contribution, the signal was passed through five codecs in tandem at 180 kbps per independent channel. The tandeming was performed using a resolution of 18

Advanced Features of Layer II

- Low complexity and low power consumption of the decoder.
- Low coding delay of approximately 45 to 50 ms in advanced implementations.
- High error ruggedness of the coded bit stream.
- Simple access in disk-based editors because of constant length of audio frames.
- Room for further improvements of the audio quality by optimizing the psychoacoustic model and joint stereo coding in the en-coder.
- Dynamic Range Control (DRC) with individual adaption to the listening conditions.
- Backward compatible extension to 5⁺¹ multichannel audio.
- Extension to lower sampling frequencies providing improvements of subjective quality in the range of 16 to 64 kbps per mono signal.

—Source: Institut für Rundfunktechnik

bits linear PCM. Again, repopulation of the binary codes was performed by applying a 0.1 dB gain reduction in the linear PCM domain. The ISO/IEC 11172-3 Layer II codec was the only system that fulfilled the requirements.

And finally, for commentary, the basic audio quality of speech signals reproduced after decoding was to be equivalent to that of a 14-bit linear PCM original.

The actual tests used a 16-bit linear PCM format. Perceptible levels of impairments were tolerated for music sequences of compact disc quality.

In tests conducted in 1992 with loudspeakers at 60 kbps per mono channel only the ISO/IEC 11172-3 Layer III codec alone performed satisfactorily on speech, and it was, on average, the best for music signals.

On speech signals, the grades were always higher—perceptible but not annoying—in both mono (60 kbps) and stereo (120 kbps joint stereo) modes.

Based on those tests, Layer III is recommended for commentary.

But in subsequent tests in 1993, the results obtained using headphones and listening to assess the performance of a 60 kbps Layer III mono commentary codec indicated that this did not meet the required quality with a speech signal. The recommendation calls for additional tests at 60 kbps.

Based on the tests performed for emission, contribution and distribution, ISO/IEC 11172-3 Layer II is recom-

mended for all of these applications. For emission, the recommended bit rate is 2 x 128 kbps. In tests conducted in 1992, the ISO/IEC 11172-3 Layer II only marginally fulfilled the requirements at 192 kbps, and the task group decided that improvements would be required for the use of this bit rate to be reconsidered. A phrase here that Layer III proponents draw attention to states that ISO/IEC 11172-3 Layer III clearly meets those requirements.

Further tests conducted in 1993 did not show improvements at this stage. Additional studies at 192 kbps using joint stereo mode would be required for the use of this bit rate to be reconsidered.

The complexity evaluation for the decoders used for emission showed that Layer II and the Dolby AC-2 decoders are of the lowest complexity.

Layer II was chosen for emission because this codec provides commonality with the distribution and contribution applications. Further, it provides flexibility to improve the encoder and this codec was tested at both bit rates—192 and 256 kbps per stereo program. Eureka-147 decided in 1991, after the ISO/MPEG test results were available, to use ISO/IEC 11172-3 Layer II as the audio coding system in EU147-DAB.

The recommendation concludes by stating that network verification tests were conducted in 1993 with a complete broadcast chain, including five contribution codecs at 180 kbps in tandem, three distribution codecs at 120 kbps in tandem and one emission codec. The results show that the basic audio quality at the extremity of

such a chain is not satisfactory.

Tests also were conducted with eight codecs at 180 kbps in tandem that proved to be a satisfactory configuration for maintaining an acceptable quality.

□ □ □

For information on the various layers, contact the Fraunhofer Institute, Wetterkreuz 13, D-91058 Erlangen, Germany at: 49-91-31-7760; fax: 49-91-31-776-399. Contact the IRT, Floriansmühlstrasse 60, D-80939 Munich, Germany at: 49-89-32399-1 or -318; fax: 49-89-32399-415.

Advanced Features of Layer III

- High Frequency Resolution. Layer III uses 576 frequency bands instead of only 32. A higher resolution allows a more effective bit allocation.
- High Code Efficiency. Layer III exploits the statistical properties of audio signals, reducing the redundancy in the coded data stream.
- Bit Reservoir. Layer III saves unnecessary data bits, using them in critical sequences to suppress artifacts that could become audible otherwise.
- Dynamic Bit Rate Switching. Layer III allows within the ISO standard the free choice of any data rate. For audio memory applications, the encoder may work with a variable data rate to code the signal with any audible artifacts.

—Source: Fraunhofer-Institut für Integrierte Schaltungen

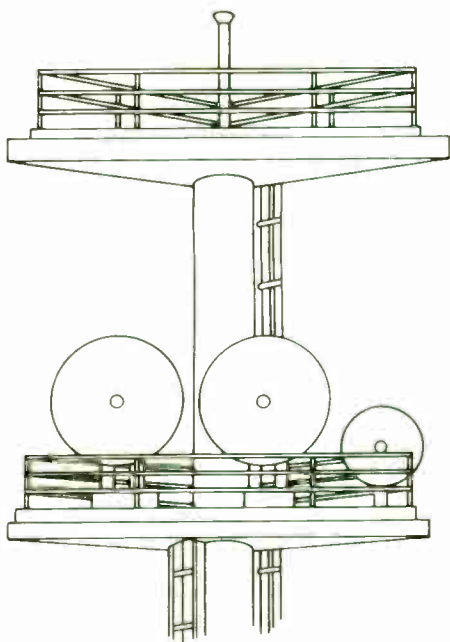

"I recommend STABILINE® Voltage Regulators for any brand of transmitter that is being placed in a harsh operating environment."

— Steve McElroy, CCA ELECTRONICS

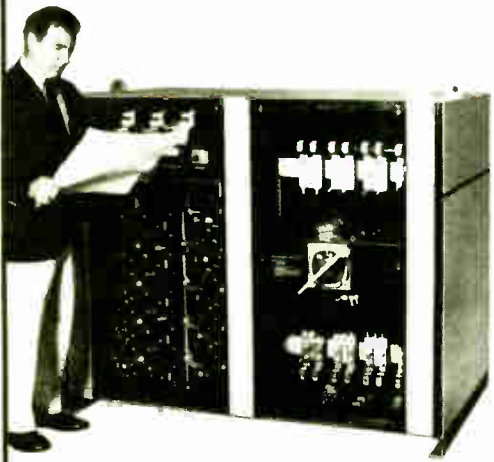

3-phase, 500 kVA WHR Series Voltage Regulator

How to tame transmitter power problems.

WHR Series STABILINE® Voltage Regulators for AC power systems up to 660 volts.

Transmitters placed in remote, unattended locations such as mountain tops and wilderness areas depend on long utility power lines for service. Unfortunately, the lines often produce poor voltage regulation and other damaging power aberrations. Poor regulation can reduce power tube life by as much as 70% and the performance of associated equipment is similarly affected.

For example, a 15% undervoltage can decrease power tube life because cold operation promotes contaminant buildup in the tube. Conversely, a 10% overvoltage decreases life because increased temperature accelerates the decarburizing process.

The problems can be easily corrected.

Cost-effective WHR Series STABILINE® Voltage Regulators are the preferred choice of broadcasters worldwide for use with transmitters, receiving stations, studios and mobile production vehicles. These high power voltage regulators maintain constant voltage to your sensitive equipment even when the power line input voltage and system load vary widely.

Features include:

- Hold output voltage within $\pm 1\%$
- Power ratings from 2 to 1680 kVA

- Maintenance bypass plus other standard options
- 99% typical efficiency
- High overload capacity
- 19-inch rack mount versions
- Designed for UL and CSA approvals

A host of options allow you to customize your application.

Standard options include:

- Single or three phase models
- Analog or digital control
- Bypass switch
- Ammeters
- Frequency trip meter
- Tropicalization
- Manual raise-lower switches
- Zig-zag neutral generation
- Single or individual phase control
- High energy transient suppression
- Input voltage range alarm contacts

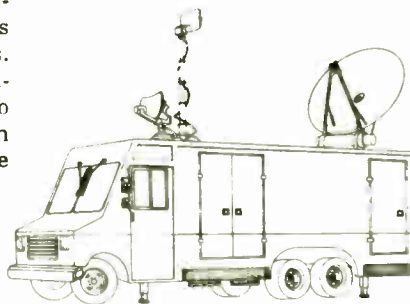

"Our production vehicles don't leave without one."
— Tom Crockett, SHOOK ELECTRONICS



For Catalog WHR692 and to learn how WHR Series STABILINE® Voltage Regulators can be the solution to your power problems, write, fax or phone Ted Gladis at

1-800-446-6161

SUPERIOR ELECTRIC
WARNER ELECTRIC

383 Middle Street • Bristol, CT 06010
203/582-9561 • Fax: 203/582-3784



How to Meet FCC Sample System Code

by Fred Greaves

YORK, Pa. Just what does the FCC mean when it refers to "approved sampling systems?" Ask three different engineers and you will more than likely end up with three different answers.

Part 73.68(a)(1) for the FCC Rules states:

Devices used to extract or sample the current and the transmission line connecting the sampling elements to the antenna monitor must provide accurate and stable signals to the monitor (e.g., rigidly mounted and non-rotatable loops and all system components protected from physical and environmental disturbances).

It is fairly simple to comply with this—install sample loops mounted on the tower or install torroid coils at the base of the tower.

Going one step further, Part 73.68(a)(2) states:

Sampling lines for non-critical directional antennas may be of different lengths, provided the phase differences of signals at the monitor are less than 0.5 degrees between the shortest and longest cable lengths due to temperature variations to which the system is exposed.

Temperature variations affect the operation of transmission lines. The main effect is in the phase delay of the line. Phase sta-

bilized line should always be used.

The term "phase stabilized" simply means that the line has been subjected to severe temperature variations for at least three cycles of change. The manufacturers actually bake and freeze the lines to meet this criteria. If your lines have been in place for three years or more, they are phase stabilized, whether or not they were when they left the factory.

Lines should be installed in such a way that they are all affected equally by environmental changes. Do not bury one tower's sample line and leave another tower's line above ground. Common sense prevails when designing or changing a system.

The remaining problem is proving to the FCC that the phase variation between the

longest and shortest lines will not exceed 0.5 degrees. This can be determined as follows:

$$\text{Phase change (in degrees)} = 3.66 \times 10^{-7} \text{ P L T F where}$$

P=Phase temperature coefficient.
(-5 to +5 PPM/deg. F)

L=Difference in length of lines (longest to shortest).

F=Operating frequency in MHz

T=Average temperature range for the area in which lines are installed. (Call the National Weather Service for the average temperature range for your area. Ask for the average high temperature in July and the average low temperature in January.)

For example, a system was put in operation in 1988 someplace where the average high temperature in July was 86.8 degrees and the average low in January was 22.5 degrees, for a temperature range (T) of 64.3 degrees.

The longest line at this station was 7551.6 feet and the shortest was 457.3 feet. The operating frequency was 910 kHz.

$$P = (3.66) (10^{-7}) (5) (294.3) (64.3) (.91) = 0.032 \text{ deg.}$$

This information was submitted to the commission, along with a partial proof, and the license came back stamped "sampling system approved."

Fred W. Greaves is assistant director of engineering, Susquehanna Radio Corp., York, Pa. He can be reached at 717-852-2127.

DAB, EBS on Tech Agenda

► continued from page 35

of TFT has A Participant's Review of the FCC Conducted Tests Leading toward a New Emergency Broadcast System.

Each day more broadcast engineers are opening their own businesses as contract engineers. A bitter truth is that many of them are great engineers and lousy business people. Get a crash course in the basics during The Business of Contract Engineering with SBE Vice President, Terry Baun. Chip Morgan shares his thoughts on Avoiding the Pitfalls in Contract Engineering.

Paul Montoya suggests some Sound Business Practices for Contract Engineers. SBE General Counsel Chris Imlay concludes the session with some suggestions for Jumping through the Hoops: Tips for Keeping Your Contract Business Legal. Remember, one good idea from this session could save your business.

1994 will be a critical year for broadcasting. What are the most important issues for broadcast engineers? NAB's Michael Rau will pose that question to a group of distinguished industry professionals during the FCC-Industry Panel beginning at 9 a.m. Wednesday, March 23. The group includes Buck Perry from Moffet, Larson and Johnson; Bill Hassinger from the FCC; Glynn Walden from Group W and USA Digital; Harvey Arnold from The University of North Carolina; SBE President Chuck Kelly, Dr. Robert Cleveland from the FCC, and Dave Taylor from DirecTV/Hughes Communications. Bring your questions and opinions to share with the group.

DAB is still the hot technology for 1994. The system testing process has begun under the watchful eye of the National Radio Systems Committee. NAB's Ken Springer has recruited two of the NRSC's prime contractors to discuss the testing process during DAB-1 on Wednesday 23 March at 10:30 a.m. Robert Culver from Lohnes and Culver opens with Multipath Propagation Test Results and Implications for DAB. Consultant Tom Keller continues with a full test profile during his NRSC/EIA DAB Test Report.

The DAB debate resumes Wednesday afternoon at 1. Each proponent who delivered a system to the EIA for testing will present a profile of their system. The BBC's Paul Ratliff begins with DAB on Trial—Eureka 147. Don Messer from VOA continues the out-of-band profiles

with the NASA/VOA System Update. Nikil Jayant will offer the AT&T DAB System Update, while John Bingman discusses the closely allied Amati Communications System Update.

Paul Donahue from Gannett Broadcasting presents the USA Digital Radio FM DAB System Update while Glynn Walden of Group W offers the USA Digital Radio AM DAB System Update. The day concludes with the traditional "DAB Bakeoff." System proponents will form a panel to answer questions about the technology.

Thursday morning, Margaret Bryant of WMAQ brings a new feature to NAB 1994 when she hosts the Radio Transmitter Maintenance Workshop. Bill Harland and Tim Bealor from Broadcast Electronics, Dave Chenoweth from Continental Electronics, Jeff Mendenhall from Harris Allied, Jorgen Jensen from Nautel Main Inc., and Steve McElroy from CCA begin by giving you the latest tips for maximizing their companies' transmitter performance. They will then form an expert panel to answer your toughest questions on transmitter performance and maintenance.

NAB Multimedia World also offers several sessions that will appeal to radio engineers. The first, Multimedia Bootcamp, is Sunday 1-5:30 p.m. Tutor David Nash will start at the beginning and give attendees a tool-by-tool, machine-by-machine, process-by-process overview of Multimedia. It is a perfect way to find out what these new technologies can do for you and be ready to make the most out of your time on the exhibit floor.

Also be sure to check out the series of Platform Profiles, presented throughout the day Tuesday through Thursday. These special sessions will examine the capabilities and practical uses of multimedia systems, ranging from the

See The
New EBS System
In Booth 2800

**SAGE
ALERTING
SYSTEMS**

Macintosh to the General Instrument set-top converter. You may find the perfect tool to solve your latest problem. Be sure to see the NAB program booklet for the full session schedule.

Without a doubt, NAB '94 will restock your technical arsenal for 1994.

Andy Butler is a staff engineer with the National Association of Broadcasters Department of Science and Technology.

For last-minute program, registration and hotel information, contact the NAB FAX-On-Demand service 24 hours a day using a touch-tone telephone at: 1-301-216-1847.

A Broadcast Industry BEST KEPT SECRET

Mono Record Play

\$1420

Stereo Record Play

\$1640

F.O.B. Factory

Reliable / Rugged / Professional Design

- All Metal Housing with Cast Aluminum Front Panel
- Half Inch Thick Aluminum Deck with Stainless Steel Overlay
- Air-Damped Solenoid with Telfon™-Coated Plunger
- Direct-Drive Capstan Motor
- Three-Point Adjustable Head Mounts
- Input & Output Transformers
- CMOS Logic
- Straightforward / Serviceable Design
- Available as Dual Record/Play for Simultaneous Record or Cartridge Copy
- 30-Day Guarantee of Satisfaction / 1-Year Warranty

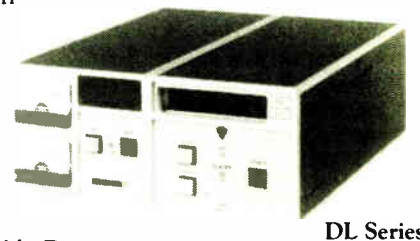

DL Series

AUDI-CORD CORPORATION

1845 West Hovey Avenue, Normal, Illinois 61761 USA
Phone 309-452-9461 - Fax 309-452-0893

Available Through Your Regular Distributor

Constructing a Better Plate Breaker

by John Bisset

FALLS CHURCH, Va. Workbench shared Art Crane's solution to resetting the plate breaker on a CCA 20 kW transmitter last fall (RW, Sept. 22, 1993). Art used a solenoid and string assembly that could be connected to the breaker handle, which was reset by remote control.

(One engineer wrote to take us to task for exposed AC terminals shown in the photo. The protective cover over the solenoid was removed for the picture.)

Well, we haven't heard the last of the breaker reset solutions. Bob Hawkins, the transmitter engineer for WRZQ-FM Columbus, Ind., installed Art Crane's circuit with good results. Bob says that the correct Grainger part number for the solenoid is 4X242 (we were in error).

While looking to mount the solenoid, Bob found that the two holes in the two-inch filler panel about a foot above the plate breaker were perfect. You'll remember Art mounted his solenoid and control relay together on a panel that was mounted to the transmitter.

Bob ran the wires to the solenoid behind the swing-out meter panel, and through a hole at the top of the transmit-

ter. He then mounted his control relay on top of the remote control equipment rack.

He tested the reset solenoid and found that sometimes only two or three phases of the breaker would reset when a single string connecting the breaker to the solenoid was used. The problem was solved by running two strings from the solenoid and connecting each to one side of the breaker.

Even in the flatlands of Indiana, Bob said, the plate breaker will occasionally trip, resulting in 45 minutes of downtime. Thanks to Bob for his follow-up on

If you already have a logo in the computer, and don't mind black ink, you can do the entire business card on a computer.

this circuit. Maybe we can talk CCA into offering this as an add-on modification.

★ ★ ★

Looking to get into the contract business, but don't want to spring for several hundred dollars in business card and stationery printing? Avery-Dennison (the

cart label people) have introduced a new product that produces high-quality, professional-looking business cards from a laser printer. Considering the turnover in radio business, this product is a godsend.

A box of Avery-Dennison's 2 x 3 1/2 inch sheets (total of 250 cards) and a printing guidelines tips booklet costs only \$4.95. Avery-Dennison's Jan Unger said the sheets can be sent to a quick printer to have the station's logo printed in color. As new staffers arrive, the business card is customized with the employees' names.

If you already have your logo in the

computer, and don't mind black ink, you can do the entire business card on your computer.

For information, circle Reader Service 120.

★ ★ ★

One of the more common complaints about the Studer A-810 is that the tension arms stick, or do not move smoothly. The tension arms are dampened by pneumatic dashpots that are, over time, contaminated with dust.

Before replacing the dashpots, try a thorough cleaning. Removal is straightforward. The dashpot is mounted either by a screw into the barrel (on old type dashpots), or by a nut onto a threaded shaft. The optical sensor can be slightly bent back or removed to permit removal of the dashpot barrel.

Carefully clean the dashpot barrel using an acetone-soaked cotton swab. Be sure your work area is properly ventilated

when using acetone, and heed the warnings on the product's label.

Now dry the barrel, but make sure that the barrel bore and plunger are completely free of any contaminants before replacing it. Even a few cotton fibers can prevent the reassembled dashpot from working properly.

If the arm quickly develops the same problems, then the barrel bore or plunger have been scored by the dirt and the assembly will have to be replaced.

If you're puzzled by a particular problem with Studer equipment, call Phil Blyveis at Audio Advantage in Nashville. Phil is a former Studer technician who is willing to share his solutions to problems with Studer equipment.

Phil can be reached at 615-742-3834. For more information on Audio Advantage services, circle Reader Service 131.

★ ★ ★

Ralph Messer at WAJR(AM) in Morgantown, W.Va., was following up on an earlier column on the alternative power supplies for Scientific Atlanta satellite equipment (RW, Nov. 23, 1993), found a couple of mistakes.

The +/- 15 volt Lamda supply can be replaced with an Astec Model 12D1 1.7 supply. The 5 volt Lamda supply can be replaced with a Sola Model SLS-05-030-1.

Kathy Maxwell at Newark Electronics in Richmond, Va. (804-282-3109), would be happy to take your order, or answer any questions. Thanks to Ralph for correcting the part numbers for our readers.

□ □ □

John Bisset is a principal with the contract engineering group Multiphase Consulting. Submissions to Workbench can be sent to his attention, in care of RW, or faxed to 703-764-0751. Published submissions qualify for recertification credit for all SBE certification levels. John Bisset can be reached at 703-323-7180.

VALUE & PERFORMANCE



AEQ Mixing Console BC-500

The AEQ Mixing Console BC-500 is designed for those radio stations seeking great audio quality at a competitive price. Its designers paid great attention to the control layout; the logical control design ensures a quick learning period as well as trouble-free operation. Advanced true modular design allows total flexibility. The 20-module chassis has built-in meters and speakers and comes in a standard configuration with the following capabilities:

- ◆ Six dual stereo inputs.
- ◆ Four mono inputs Mic/Line selectable.
- ◆ One telephone hybrid interface.
- ◆ Studio control Intercom Monitor.
- ◆ One main stereo output plus mono sum output.
- ◆ One stereo auxiliary output plus mono sum output.
- ◆ Power supply for On Air signaling.
- ◆ The BC-500 comes with 4 blank modules to enhance this configuration.

All this value and performance for the introductory price of...

\$4095!

AEQ 2211 South 48th St., Suite H
Tempe, Arizona 85282



Phone (602) 431-0334 • FAX (602) 431-0497

Circle (147) On Reader Service Card

See Us At NAB Booth 2300



REFURBISH AND REPAIR MX 5050 OTARI MACHINES



- Low Cost Refurbishment
- Quick Turn-Around
- 5 New Athan Modifications
- High Quality Test Equipment

NEW HIGH SPEED MODIFICATION FOR MX 5050 BII & MX 5050 MKIII

Our high speed modification increases tape speed to 30 ips.
Call (415) 589-5206 for more information.

50 SO. LINDEN AVE., #10 • SOUTH SAN FRANCISCO • CA 94080

Circle (126) On Reader Service Card

Products & Services Showcase

For more information on the products shown below, circle the appropriate Reader Service No.(s) on the enclosed Subscription/Reader Service card or contact the advertiser directly.

Payola? Bribe?



Nope... just a little spiff!

Here's the offer...

We've reduced the price of our MusicPakill retail jingle packages from \$1500.00 to \$999.00, and then we throw in a \$200.00 spiff for you! Your client gets a six piece custom written jingle package with the major market sound, and we get the opportunity to show you what Radio Concepts is all about... And of course, we offer a money back guarantee!

Radio Concepts, Inc.
Hot Sound... Great Price!

**LIMITED TO FIRST
50 STATIONS WHO
CALL US TOLL-FREE
1-800-950-5787**

READER SERVICE NO. 46

The CircuitWerkes AC-12 Telephone Autocoupler Bay



Get up to 12 couplers in a neat, compact chassis

- Auto connect & disconnect.
- Dual audio busses reduce messy wires for mass feeds
- Cards can individually select either buss or direct card I/O
- LED indicators for audio clipping, incoming rings power and line status.
- Ring counter answers on user settable ring number
- Momentary or latching dry contacts at pickup
- Remove & install cards without affecting the rest.

The AC-12 rack-mounted coupler bay is the best way to eliminate a wall or cabinet full of yesterday's couplers. Our unique dual audio buss feature eliminates the tedious and messy wiring associated with networks and other mass feeds. Each card can also individually either send or receive telco audio

CircuitWerkes

6212 SW 8th Place
Gainesville, Florida 32607
(904) 331-5999 / fax 331-6999

READER SERVICE NO. 199

ONE GOOD TURN AFTER ANOTHER

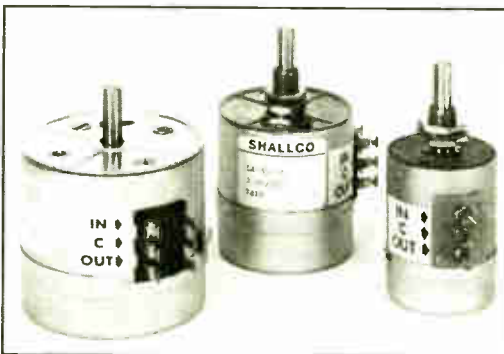

Is the success story for Shallco/Daven style step attenuators. Over 50 years of combined service to the broadcast industry. You can depend on us for reliable products and service. Request *New Catalog A20* for additional information.



READER SERVICE NO. 108

EBS EQUIPMENT



Model CEB Encoder-Decoder.....	\$540
Model CE Encoder.....	\$375
Model CE with Stereo Option.....	\$405
Model CD Decoder Only	
(REQUIRED FOR LPTV)	\$320
Receiver can be supplied to drive Decoder.	\$100

- Encoder FCC Type Accepted •
- Decoder FCC Certified •
- Exceeds FCC Specifications •

All interconnections to the EBS equipment are made through a barrier terminal block. No special connectors necessary. In stock—available for immediate delivery.

See Us At NAB Booth 4812

GORMAN REDLICH MFG. CO.
257 W. Union St.
Athens, Ohio 45701

Phone 614-593-3150 • FAX 614-592-3898

READER SERVICE NO. 179

NEW IS BETTER THAN OLD!

*PRISTINE'S QUARTERLY SOFTWARE
UPDATES KEEP YOUR SYSTEM
STATE OF THE ART AND
PROTECT YOUR INVESTMENT*

PRISTINE CD DIGITAL AUTOMATION SYSTEM including: 2 heavy duty 486/33/DX computers • 8+ hours of Dolby AC-2 stereo hard disk audio • music scheduling system • traffic system interface • digital editing package • 8 Pioneer TM-3 CD Players • CD audio mixer & amp • installation & training • leasing available



\$18,995

See Us At NAB Booth 3800

Distributed Nationally by
PROFESSIONAL MANAGEMENT SERVICES, INC.
803/370-2400 • FAX 803/370-2314
INTERNATIONAL 310/670-7500 • FAX 310/670-0133

READER SERVICE NO. 3

The Power of Digital From Roland® and Audio Broadcast Group



If you're a Progressive Broadcaster ready for the power of Digital Audio workstations, you must seriously consider the Roland® DM-80. With no computer to be concerned with, the DM-80 is extremely easy to learn. It's unparalleled combination of features, speed, stability and low cost are unmatched in the industry!

Please Call Today and Feel The Power

For over 32 years

MAIN SALES OFFICE
2342 S. Division Avenue
Grand Rapids, Michigan 49507
Phone: 800-999-9281
Fax: 616-452-1652

SOUTHEASTERN SALES OFFICE
200 Fareway Drive, Suite 2
Smithfield, North Carolina 27577
Phone: 800-369-7623
Fax: 919-934-8120

WESTERN SALES OFFICE
P.O. Box 1638
Palmdale, California 93550
Phone: 800-858-9008
Fax: 800-273-3321



**AUDIO
BROADCAST
GROUP**

READER SERVICE NO. 192

STATION SKETCHES

Where to Find AM Modulator Ills

by Tom Vernon

Part II of II

HARRISBURG, Pa. To follow up last month's column on the repair of errant modulators in AM transmitters (*RW*, Jan. 26), this piece focuses on the problems that exist outside the modulator feedback loop, which covers a lot of territory.

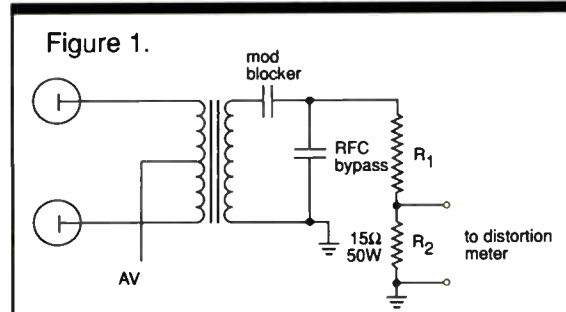

A modulation transformer may develop a few shorted turns and continue to operate, but with degraded audio performance.

The best way to check for this problem is to remove the leads, connect 120 volts alternating current (VAC) to the secondary transformer and measure the voltage across each side of the primary transformer. These voltages should be within 10 percent of one another.

Ohm meter tests might give misleading results, as some transformers are designed with an imbalance in the primary. Likewise, checking a modulation transformer or choke with an impedance bridge may be inconclusive. These bridges typically measure impedance at 1 kC with a very low voltage and will not indicate how modulation components will perform at full load, with high voltage (HV) and elevated temperatures.

If problems with the modulator, modulation transformer and tubes are ruled out, the problem must be in the modulation reactor, blocking capacitor, HV supply or power amplifier (PA) stage.

The quickest way to check modulation reactors is to take them out of the circuit,

connect the modulation transformer for series modulation, reduce power to 25 percent and check performance. If it improves, you have found the problem. If not, move ahead.

Poor low-frequency response and distortion figures suggest a bad blocking capacitor. These are easily checked by substitution.

Problems in the HV supply typically show up as flat topping of the modulation envelope with sine waves, negative carrier shift or clipping, especially at low frequencies.

Oil-filled capacitors are the most frequent offender. Check for oil leaking around the terminals and seams. Replace all capacitors showing signs of leakage. Other suspects include bad rectifier diodes in one phase or an imbalance in three phase

transformers.

Several problems may reside in the PA stage. Poor efficiency is one of the most common. (See *Station Sketches*, Aug. 25, 1993) A transmitter with poor efficiency must work harder to produce a given level of modulation.

Low-grid drive, as a function of a weak driver tube or related adjustments, could be the cause. Defective fixed-bias (if that's what is used) or improper neutralization of the PA stage should also be

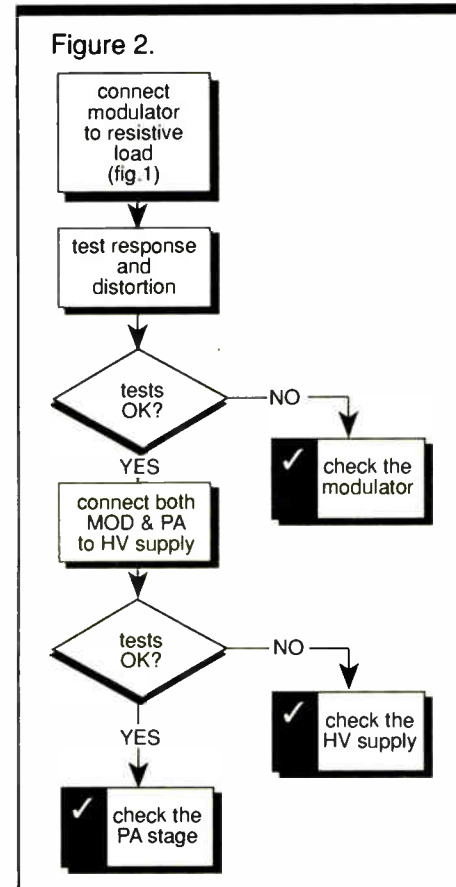

investigated.

When all else fails, testing the modulator at full power into a dummy load may shed some light on the problem. The procedure involves isolating the modulator from the PA, testing it, then testing with HV applied to the power amplifier. Proper safety precautions regarding high voltage must be followed throughout the procedures.

First divide the PA plate voltage by plate current to arrive at the load impedance of the mod transformer secondary.

Next, construct a resistive load of this value having a power capacity equal to the transmitter output power. Connect it to the modulation transformer, as shown in Figure 1.

Apply sufficient audio for 100 percent modulation. Check response and distortion across R2. If all looks well, the problem is in the HV supply or PA.

Connect the PA RF choke so that the modulator and PA both load the supply and repeat the measurements. If degraded performance is now observed, check the

power supply. If, on the other hand, response and distortion figures are correct, suspect the PA stage. Procedures for testing the modulator at full power are outlined in Figure 2.

Although not under the heading of modulator repairs as such, there are some modifications to the modulation transformer that may improve noise, response and distortion figures. Simply reversing the leads to the primary of the modulation transformer can improve high-frequency distortion and noise, as one arrangement usually gives better performance than the other.

In some instances, improvement to HF distortion may be obtained by connecting a .001-.004 μ f capacitor between the high side of the secondary transformer and one side of the primary. Sometimes improvements in HF response can be had by connecting an inductor between the high side of the secondary transformer and the modulation reactor.

These procedures should only be used to improve audio performance of the transmitter, not to try and compensate for deficiencies that lie elsewhere.

□ □ □

Tom Vernon divides his time between consulting and completion of a Ph.D. He can be reached at 717-367-5595.

The Transistor Elevated Solid State Technology

This revised course offers an introduction to the theory and practical application of active electronic devices. The course will give examples of how the devices work as well as ideas on how to use them.

Continuing Education Units will be offered to all who register with Northern Virginia Community College. You will be required to read all of the articles and participate in an exam that will be mailed to you at the completion of the course. You can register for the class any time while the series is running in *RW*.

To register, contact the Community Education Office, Annandale Campus, 8333 Little River Turnpike, Annandale, Va. 22003. The fee for the course is \$30.

Please make every effort to secure all of the articles yourself. Northern Virginia Community College and *RW* are not in a position to supply readers with back issues.

by Ed Montgomery

Part IV

ANNANDALE, Va. As solid state technology developed, the diode PN

junction evolved into the transistor.

It was developed in 1947 by Bell Laboratories to replace the vacuum tube in telephone switching circuitry. The transistor would also prove to be a very good amplifying device. Transistors operate at a fraction of the power of vacuum

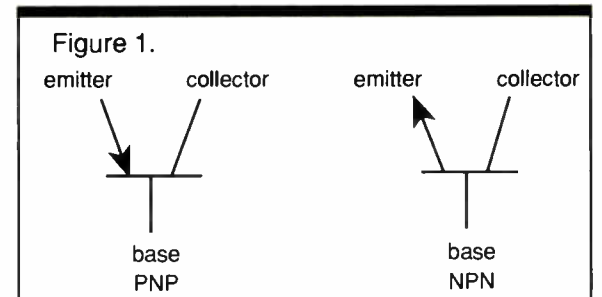

tubes while performing essentially the same task.

The word "transistor" is coined from the phrase, "transferring current across a resistor." The component is grown out of a crystal material (either germanium or silicon) and doped to have three separate sections.

Two of the sections are doped with the same charge while the third section is doped with the opposite charge. The three partitions are known as the emitter, base and collector. A schematic for an NPN and PNP version is illustrated in Figure 1.

continued on page 80 ▶

SONEX!
NEW PRODUCTS.
NEW APPLICATIONS.
NEW BROCHURE.

Send for your FREE copy today!

illbruck
Minneapolis, Minnesota
1-800-662-0032
(612) 520-3620

SAS 32000 Audio Routing & Mixing Systems Continue to Set the Standard! COMPLETE AUDIO DISTRIBUTION & MANAGEMENT SYSTEMS

Ideal for plant, transmitter routing, satellite and remote distribution. Full summing allows mix-minus, IFB, studio intercommunications, voice-over and more! Superb specifications & flexible control.

- ◆ Advanced multi-processor architecture for unsurpassed reliability.
- ◆ Full summing for mix-minus, IFB, mixer emulation & more.
- ◆ DAS9600 allows remote digital precision adjustment of levels.
- ◆ Complete control via RS-232, terminal, local panels and modem.
- ◆ Rack and/or Console mounted 8-character alphanumeric panels.
- ◆ We listen to you! Custom & turnkey systems our specialty.

SIERRA AUTOMATED SYSTEMS & ENGINEERING CORP.

2112 N. Glenoaks Blvd., Burbank CA 91504 TEL: 818-840-6749 FAX: 818-840-6751

Distributed by: RAM Broadcast Systems, Inc.

P.O. Box 3100, Barrington, IL 60011-3100 TEL: 800-779-7575 FAX: 708-382-8818 In Canada 800-433-2458

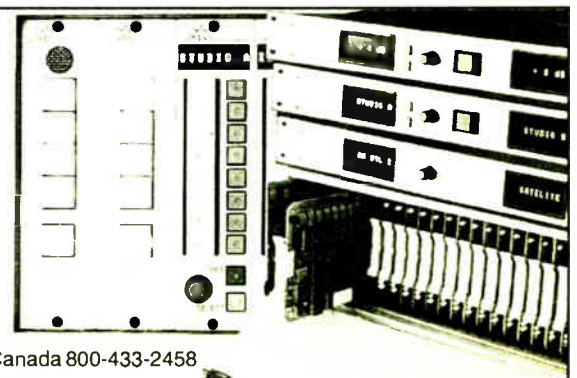

See us at NAB Booth #402
Circle (137) On Reader Service Card

KEYBOARD CONNECTION

Business Software for Engineers

by Barry Mishkind

TUCSON, Ariz. You can tell 1994 is well underway because those W-2s and 1099s have arrived. Next stop: the accountant's office for the annual list of nasty financial surprises.

It is a good time to check out some financial management software that might make it easier to keep track of your money and avoid some surprises next year.

To be sure, no one really needs a computer to balance their checkbook. But a computer will help you focus on your income sources and expense categories and foresee potential tax liabilities ahead of time.

More business-oriented programs will automate your invoices and accounts receivable.

The big name in personal accounting is Intuit's Quicken, (DOS version 7, Windows version 3). It features an easy-to-use interface, and the necessary tools for financial analysis. Microsoft's Money is a similar Windows-compatible system. Both sell for about \$27-\$40; Quicken is a tad higher, but has more features.

Quicken and Money have interfaces that look a lot like your checkbook. Income and expenses are entered much as they would be in a real checkbook, with the added benefit of having the computer "guess" your entry.

For example, after you enter the name of your phone company, future entries take only a couple of keystrokes. Simply enter the transaction amount, and the computer refers to previous entries, fills in the words for you and prints the check.

The real payoff is in what happens after an entry. Quicken and Money automatically file entries in different categories you designate. You can quickly see or print some or all of your income and expenses. Built-in modules help calculate mortgage and investment accounts.

Quicken also links to CheckFree, an electronic service that makes all your payments via computer, without any envelopes or stamps.

The Intellicharge credit card account compiles your Quicken Visa card purchases and sends them to you by modem or diskette. The program then automatically sorts your purchases, categorizes them and pays the bill.

Contract engineers may need something more than Quicken and Money. Both will handle two checking accounts, but they are just not designed to handle all business needs, such as invoices, inventory and sales tax accounts.

You probably do not need a full-sized accounting package if

you are operating a small business. QuickBooks from Intuit, Profit from Microsoft or Instant Accounting from DacEasy are good options. All are currently at Version 2.

Would you like to bill a client for several hours of work and include the ICs and caps you used? Do you need to know your available inventory? Do you need to calculate IRS and state tax each month?

You can generate such reports,

as well as accounts receivable, customer histories and listings for mailing labels. Instant Accounting also features a fax interface.

Various preset default categories for income, expense and inventory items, pre-printed checks and forms are also available, similar to the personal packages, although you can customize the features.

Each business's requirements are unique, so decide on the fea-

tures you want and spend a few minutes shopping at your local software store. The OLD RADIO infobase of pioneer radio stations mentioned in an earlier "Keyboard Connection" (RW, Sept. 22, 1993) has drawn a great response. It has grown and I have begun to add historic details about stations on the air in 1928, tracing them from their origins to the present.

If your station has a printed history, especially anniversary books or records, interesting facts or anecdotes about personalities over the years, please send them to me at 2033 S. Augusta Place, Tucson, AZ 85710, and I

will add them to the infobase.

Dorsey Jennings of DacEasy has kindly offered to help with the project by contributing some copies of DacEasy Instant Accounting and Instant Rolodex. I'll be looking through the material sent to OLD RADIO and awarding a copy of one of these programs to those with the best submissions.

OLD RADIO is available on IBM-compatible 3.5-inch or 5.25-inch diskettes for \$7.50.

□ □ □

Barry Mishkind can be reached at 602-296-3797, or on FidoNet at 1:300/11.3 or "barry@coyote.datalog.com" on Internet.

ITC

For 25 Years I.T.C. Has Brought Standard Setting Audio Products to Radio.

NOW

DigiCenter™

ITC's Digital Audio System for Radio

BEGINS THE NEXT 25!

- All the benefits of a complete audio management and delivery system.
- All the proven value and dependability of an ITC product.
- All the advantages of digital technology.

That's DigiCenter... Another significant advancement in broadcasting that will expand your capabilities in programming, management, and delivery of pure digital audio sound.

DigiCenter is brought to radio by ITC—the company serving you so well for 25 years. And, we'll be around for another 25, continuing our reputation for benchmark products, and for customer service.

See DigiCenter in action. We'll give you a hands-on demonstration of how DigiCenter will expand your horizons both operationally and economically. Find out how DigiCenter improves audio quality, personnel performance and station profitability. Call us and begin your future today.

25

1-800-447-0414

THE BENCHMARK IN
For the past 25 years...

BROADCASTING AUDIO
For the NEXT 25 years

ITC Corporation • 2425 South Main Street • Bloomington, IL 61702 U.S.A. • (309) 828-1381 FAX: (309) 828-1386

Bias Determines Transistor Usage

► continued from page 78

It might appear as if the emitter and collector are interchangeable when a transistor is in operation. This is not the case. When grown, the emitter is much smaller

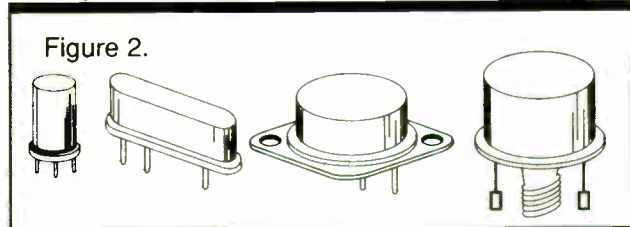

Figure 2.

than the collector. The base of the device is very thin and lightly doped in relation to the emitter and collector.

Figure 3 illustrates how a bipolar transistor is constructed using the alloyed method. Notice how thin the base of the transistor is.

Transistors come in many shapes and sizes, as illustrated in Figure 2. The size of the case is often determined by how much heat the device must radiate or dissipate while it is operating.

Transistor manufacturers maintain a rather loose standard for labeling the emitter, base and collector. Check the manufacturer's diagram or a

cross-reference guide before installing a replacement transistor.

The transistor must be biased to make it operate. Both forward and reverse bias is used within the transistor (see Figure 4). The emitter-base junction is forward-biased and the base-collector junction is reverse biased. The reverse bias voltage is several times greater than the forward bias on the emitter base junction.

With the base of the transistor being very thin, nearly 99 percent of the current carriers that flow out of the emitter will be attracted to the collector. This is known as transistor action.

If the emitter-base junction is reverse biased or shut off, all current between the emitter and collector ceases to flow. The 1 percent of current that does not flow to the collector can control the total current

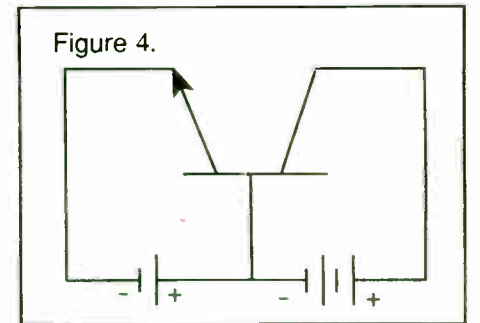

Figure 4.

flow of the device.

In its simplest form, the transistor acts like a switch. Applying forward bias to the emitter-base junction will allow current to flow to the collector.

A transistor can act as an amplifier when the current between the emitter and base is varied. Any small variation of emitter-base current will create a much larger collector current variation.

More details on transistors can be found in many reference texts, including the "American Radio Relay Leagues Handbook."

□ □ □

Ed Montgomery is a communications teacher at Thomas Jefferson High School for Science and Technology. He has taught broadcast engineering at Northern Virginia Community College and worked as a broadcast engineer for several radio stations. He can be reached at 703-750-5090.

Figure 3.

NPN configuration
emitter — "N" doped
collector — "N" doped
base — "P" doped

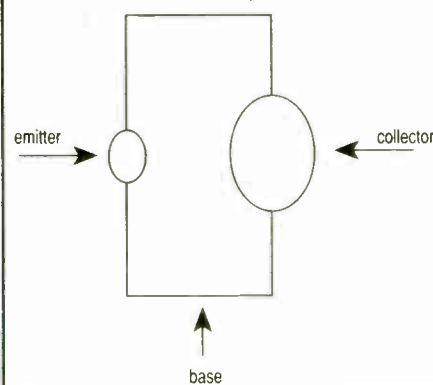

WHEN QUALITY COUNTS

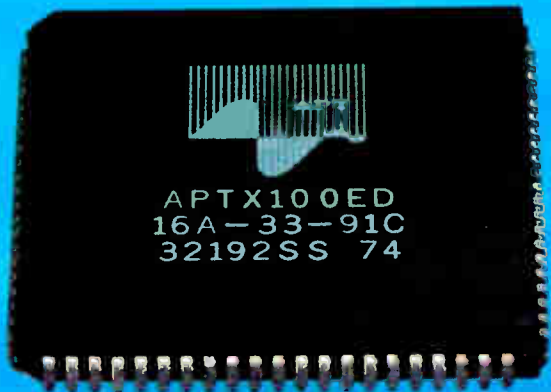

It has to be apt-X100 - the only true single chip audio compression solution - adopted by the world's leading manufacturers of broadcast equipment.

In professional broadcast, telecommunications and recording applications, the benefits of APT's predictive audio compression system are clear. Higher resistance to tandem coding errors, lower coding delay and a higher immunity to data errors mean less noise - so if you need to exploit the advantages of compression without risk - you'll be using the most appropriate solution. For details of both single chip and board level solutions - call APT.

Audio Processing
Technology
Edgewater Road
Belfast BT3 9JQ
Northern Ireland
Tel 0232 371110
Fax 0232 371137

Audio
Processing
Technology



Audio Processing
Technology
6255 Sunset Boulevard
Suite 1026
Los Angeles
CA 90028 USA
Tel 213 463 2963
Fax 213 463 6568

apt-X and apt-X are registered trademarks of APT

Circle (138) On Reader Service Card

See Us At NAB Booth 4306, 4307 & 4308

We Have What You Need!



COMPACT DISC PRODUCTION MUSIC AND SOUND EFFECTS LIBRARIES

Call, write or send us a fax and it will be a pleasure for us to send you a complete catalog of our compact disc libraries free of charge. Our catalogs have a large variety of what you need for your productions. For your convenience, we will be pleased to send you a demonstration compact disc containing all the information you need to place your order. But we can't send you our catalog until you get in touch with us.

**Take the first step
and contact us today!**

Valentino

... a complete library of production music and sound effects in an exclusive binder system.

Valentino

... Our products are used for productions around the world.

Valentino, inc

500 Executive Blvd., P.O. Box 534, Elmsford, NY 10523 USA
TEL: +1-914-347-7878 FAX: +1-914-347-4764

Circle (160) On Reader Service Card

TOMORROW RADIO.

Tomorrow Radio is here. AudioVAULT 100 OnLINE™ harnesses the full power of today's advanced digital networks. Now you can provide recorded audio to every studio and information about that audio to every desk. Now you can achieve total station connectivity, and total station productivity. Start big or small. Start today.

START NOW.

GET OUR
AudioVAULT 100 OnLINE
INFORMATION PACKET.

(800) 426-9082

FAX (206) 441-6582

TODAY.



AudioVAULT 100 OnLINE

BE BROADCAST
ELECTRONICS, INC.

WORLD LEADER IN BROADCAST TECHNOLOGY

Circle (62) On Reader Service Card

World Radio History

If We Don't Have It You Don't Need It.



Serving broadcasters on six continents and in more than 100 countries, we have become the world's leading distributor of studio, production, and satellite equipment, offering the widest range of radio products from a single source.

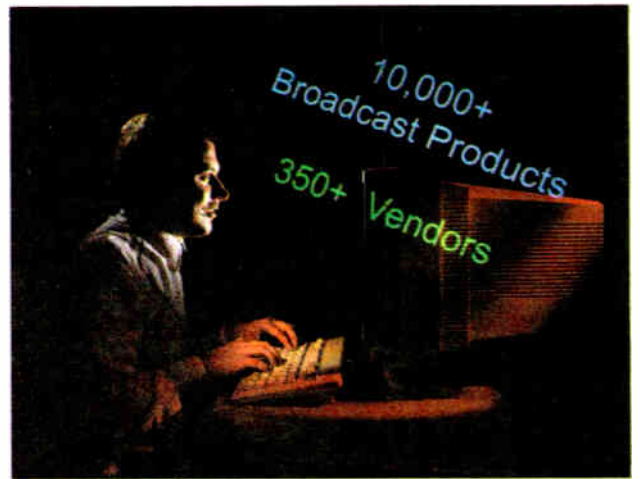

Our experienced broadcast professionals are working when you are—Monday through Friday, 8:00 a.m. Eastern to 8:00 p.m. Pacific. When you know what you need, you'll get the right price. When you don't, you'll get experienced advice.



We deliver when you need it. Over 90% of our orders are shipped within 24 hours. Computer technologies and experience in transportation management, packaging and rate negotiations has resulted in the most efficient shipping and receiving department unsurpassed by our competition.



Satellite products we distribute include reception equipment for digital or analog SCPC, audio or video subcarrier data, uplink and downlink antennas and support products. We are your primary source for the most innovative and effective technology.



With today's growing shortage of broadcast engineers, many broadcasters lack the technical staff to evaluate, maintain and service their equipment. We provide unparalleled customer support with experienced, certified service technicians.



Customer satisfaction is number one. Customer service representatives are ready to check your orders and answer any questions you might have. You can always count on fast, friendly service.

1-800-622-0022

 **HARRIS
ALLIED**

USER REPORT

SSL Proves Versatile for Radio Production

by Mike King
Owner
Audio Recording Unlimited

CHICAGO In our business, everything needs to be done yesterday and so speed is of the essence. As a result, several years ago we were looking for an audio workstation that was fast, flexible and provided our clients with a high-quality product.

While attending the 1989 NAB show, I first came into contact with Solid State Logic's (SSL) ScreenSound and saw what it could do. I was very attracted by the architecture of the system, but I also felt comfortable dealing with a company with SSL's reputation. In fact, you only have to look at the upgrades and software enhancements made over the past three years to see how serious SSL is in its commitment to work with its users.

In 1990, Audio Recording Unlimited became the site of Chicago's first ScreenSound digital audio editor and SoundNet multi-user digital audio network, and I cannot stress how flexible and reliable the hardware is.

One of the system's great features is its

magneto-optical (MO) drive. We tend to create custom sound effects for our clients, and these are produced in ScreenSound. We then store them to the MO drive, making them instantly retrievable in case we need them again.

For radio production work, this is extremely helpful, because sound effects, music stings and special effects frequently are used more than once. The MO drive, for all practical purposes, loads these into your working disk instantaneously.

Typical day

Let me give you an example of a typical afternoon at Audio Recording:

The producer or writer comes in with a script, and we cut a voice track. Occasionally, not everyone involved is available at the same time, so we record each person individually and leave holes to slot in the missing voice tracks.

ScreenSound gives us immense flexibility in moving individual pieces of audio around, should the client like one better than another. It also lets us try many variations. But we are secure in knowing that we can return to our original at any time.

We are able to place and move tracks around, as well as tighten the final production piece, saving us valuable time and ultimately, the client's money.

With ScreenSound's eight discrete outputs, effects can be added after the fact. For example, imagine a spot that features a telephone call between two parties—one calling from a pay phone on a street corner and the other in an office. I always record voice tracks separately from the effects, because otherwise they then cannot be modified.

The track is recorded in full bandwidth. Then the echo, background traffic noise and additional effects are manipulated after the penultimate version has been mixed on the ScreenSound's decks. As a variety of room presences and microphone techniques are often needed, the ability to record everything flat-out and then modify it to get the required effect is incredibly time efficient.

Multiple projects

Unique to SoundNet is the ability to back up and restore projects off-line. This feature is invaluable. Backups and restores are done on an exabyte 8500

tape system.

I have three working drives on my ScreenSound, and multiple projects frequently are carried out on the same drive. I can back up one drive and copy the files of a second project to another disk. I can then return to separate files.

SoundNet allows me to work on ScreenSound, yet restore or backup a file to another drive—all without slowing me down.

Radio production is a difficult medium, sometimes much more complex than audio-for-video, because you rely solely on sound to get your message across. As a friend of my mine once said: "Television without picture is radio. And television without sound is surveillance."

ScreenSound and SoundNet are real time-saving investments. I admit that they are not cheap, but you get value for every dollar spent. After 20 years of manually cutting tape, switching to a machine that "cuts tape" via pen and tablet is a totally amazing concept.

□□□

For information, contact Solid State Logic in New York at 212-315-1111; fax: 212-315-0251; or circle Reader Service 185.



50 Northwestern Drive, Unit #11
Salem, NH 03079
(603) 893-5104
Fax (603) 893-6390

"The only complete digital audio and control system deliverable today"

See Us At NAB Booth 1006

Circle (168) On Reader Service Card

NEW TECHNOLOGY!

Gentner

Will revolutionize
the way you use
telephone interface
products!

Introducing

DCT

Don't miss it!
NAB Booth #2612

Gentner Communications Corporation
Professional Audio Products
1825 Research Way
Salt Lake City, Utah 84119 USA
(801) 975-7200
(801) 977-0087 fax

Circle (220) On Reader Service Card

USER REPORT

Quick Productions with AKAI DR4d

by Mark Ridder
Mark Ridder Productions

NASHVILLE, Tenn. I am like a lot of people involved with audio, I guess. There is a studio in my home where I do audio production for agencies and radio stations. It is not a big operation, but I stay busy.

About a year ago, the business began to take its toll on me. All of my work was being performed on analog multitrack units which meant that I spent a great deal of time locked up in the studio when clients wanted to go back and edit and re-edit a spot.

As business boomed, I knew I needed to get into some kind of digital workstation but the thought of spending \$10,000 or \$15,000 depressed me. Some of my peers already had dropped the big bucks for their studios and I was seeing my future on the line. So, I went to the summer National Association of Music Merchandisers (NAMM) show in Nashville to look at all this stuff.

I picked up some literature on this new thing from AKAI that was supposed to do digital editing on a hard disk and cost about a fourth of what the other guys were asking. I paid my regular equipment dealer a

visit and asked about the AKAI DR4d. The salesperson took me right over to it and said, "Here, play with it." I was intimidated by the thought of just walking up to anything with the word "computer" attached to it—even though I own computers and use them a lot. But I've read all the stories about how big the learning curve is on screen-based workstations and even though this thing looked like a DAT machine on steroids, I knew there was a hard drive inside of it.

Like a pro

The salesperson said, "Look, this AKAI has play, rewind, pause, stop and record, just like your analog gear at home." In about 10 minutes, I was using it like a pro. The best part of the AKAI DR4d is you can edit, move, copy, insert, delete and undo audio just like you would printed text on a Mac or PC word processing program.

You don't like the edit you just did between a couple of music beds? Undo it with the press of a button. You want the last 10 seconds of what you said to be the first 10 seconds of your spot? Move and insert it ... no problem. Your client wants to change the middle of the spot? Delete and re-insert with new copy, music, SFX, or whatever they wanted with little or no effort.

It didn't take long before I realized that we also needed the AKAI DR4d at the radio station where I work. It is a machine that everybody can learn to use quickly. I could never imagine trying to train six people on a screen-based computer workstation. I know Pro Tools and the others

are fine machines with more bells and whistles, but I'm telling you that the client does not know the difference. All they know is that you can crank it out faster and change it at will with little or no effort at all. And you have more time for yourself.

Does everything

I do most of my work on the DR4d. One unit gives me four tracks, but with the super tight editing features I use it like an eight-track. In fact you can slave four of them together for 16 tracks. I can back-up onto a regular DAT machine. I can record at 32, 44.1 or 48 kHz. This gives you about 20 minutes worth of record time at 44.1, but you can hook up to seven SCSI hard drives for almost unlimited recording. It has "vari pitch."

You can store SFX, voice tags, etc. on 108 different location points so you can pull them out and use them over and over again without having to re-record them onto the hard drive. It can do SMPTE and MIDI. A remote control is available. And, I heard that AKAI is developing a MAC-based software program for it.

Because it was so inexpensive, I was able to pay cash for it. I bought it for \$1995 with a 200 MB hard drive installed internally. I took it home and hooked it up to my analog studio in about 30 minutes.

I have run this machine into the ground and it continues to perform flawlessly. The scrub wheel is the only thing I have noticed a little wear on, but even so, it still works better than any other wheel in its present condition.

□ □ □

For information on AKAI products, contact James Martin in Texas at 817-336-5114; fax: 817-870-1271; or circle Reader Service 216.

8 TRACK DIGITAL EDITING BREAKS PRICE BARRIER \$5,495*

- ☐ A digital audio editor designed for *Radio* production
- ☐ Learn to use in minutes, *much faster than tape*
- ☐ Cut, splice, move, and fade up to 4 stereo tracks
- ☐ Use Scrubbing to edit with your ears
- ☐ Use visual waveform editing to edit with your eyes
- ☐ An UNDO button enables you to go back and fix mistakes
- ☐ Digital Networking to transfer audio to your On Air machine
- ☐ Add Trak*Star-8 software to a Digilink for only \$2,000

Trak*Star-8 is the first cost effective multitrack digital audio editor designed for the radio broadcast professional. Fast and easy to use, produce your commercials on Trak*Star and then transfer them in digital straight to the Digilink in your On Air studio. Dramatically reduce production time and save money !!!

For more information, call or write
ARRAKIS,

(303) 224-2248

the premier broadcast manufacturer of consoles, furniture, Digilink and Trak*Star digital audio products.

ARRAKIS

* Suggested retail price. Complete system

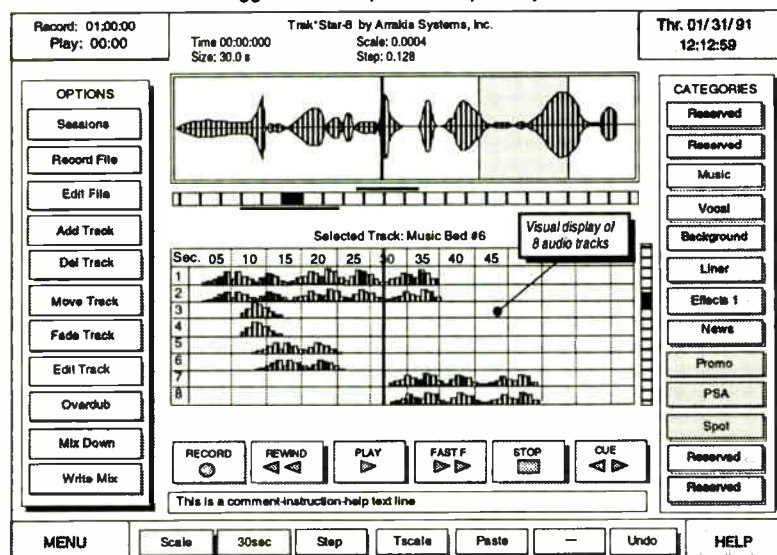

© 1993 Arrakis Systems inc. 2619 Midpoint Drive, Fort Collins, CO. 80525

Circle (118) On Reader Service Card

See Us At NAB Booth 3912

USER REPORT

Arrakis Helps Station to Give up Its Razor Blades

by Larry Wilkins
Director of Engineering
Colonial Broadcasting

MONTGOMERY, Ala. As more and more stations discard their razor blades and analog tape machines for digital workstations, one major problem arises: Which one do you choose?

With no less than 20 different digital workstations on the market, picking the right one is quite a chore.

When WLWI-AM-FM made the change, we chose the Arrakis Digilink and

Trak*Star. The main reasons were ease of installation and setup, ease of learning to operate and ease on the budget.

The Digilink software is used for on-air operation, either in a fully automated mode with satellite or CDs, or in a live-assist mode. Our FM operates in the live-assist mode and the AM in the satellite mode.

Eight-track production

The Trak*Star software operates on the same CPU and shares a hard drive (SCSI) with Digilink. It allows for full eight-track production, with all the features of analog editing, plus a lot more.

Editing is straightforward. You simply "mark" the section of audio; then you can cut, copy, move, or fade the mark section.

Voice, music, effects, etc. can be recorded in any order, and later moved to the correct location in the production. This saves a lot of time over the "old way" of trying to time copy and music/effects inserts.

If you are not happy with any edit, simply undo the last one and redo. It does not matter how many times you make or change an edit, since it is digital it is always first generation.

The Trak*Star includes a "scrub" feature that simulates rocking a reel back and forth for really tight edits. Tracks can be deleted, added or mixed down at

continued on page 89 ▶

AEV

a leading Italian and European manufacturer of audio broadcasting equipment, particularly aimed at FM radio studios, is looking for dealers willing to market its products all over the US territory.



AEV Snc
via Saviolo, 1/E
I-40017 Le Budric di Persiceto, Italy
tel. +39-51-950249 +39-51-950350
fax +39-51-950201

Circle (89) On Reader Service Card

Products & Services Showcase

For more information on the products shown below, circle the appropriate Reader Service No.(s) on the enclosed Subscription/Reader Service card or contact the advertiser directly.

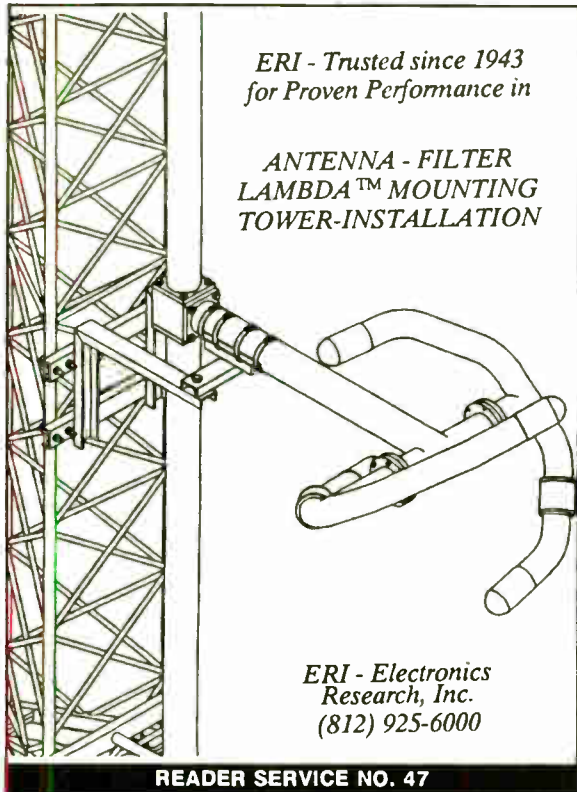

ERI - Trusted since 1943
for Proven Performance in

ANTENNA - FILTER
LAMBDA™ MOUNTING
TOWER-INSTALLATION

ERI - Electronics
Research, Inc.
(812) 925-6000

READER SERVICE NO. 47

ProGold™

Maximum Performance & Protection for Connectors

The Ultimate Contact Enhancer & Protector!

- Improves Conductivity
- Maintains Optimum Signal Quality
- Reduces RFI and Intermittent Signals
- Reduces Wear & Abrasion

Even the finest equipment cannot guarantee noise-free operation. One "dirty" connection anywhere in the signal path can cause unwanted noise, distortion & signal loss.

ProGold conditioning treatment improves and maintains the performance of all electronic equipment and parts.

From the company that brought you Cramolin.

CAIG Products ... used by those who demand the best!

Bosch	Honeywell	Switchcraft
Detroit Inc.	John Fluke Mfg.	Tektronix
Dolby Laboratories	McIntosh Labs	Texas Instruments
General Electric	Motorola	Xerox Corp.
Hewlett Packard	RCA	& many more!

16744 West Bernardo Drive
San Diego CA 92127 1904
Phone: (619) 451-1799
FAX: (619) 451-2799

READER SERVICE NO. 5

The CircuitWerkes TeleRadio Remote Controlled Listen Line



You can find out what's going on the air in all of your markets without ever leaving your chair!

With the TeleRadio and a phone, you are ready to check up on your station and all of your competitors in real-time. You'll never have to get another station air-check and you can punch around the dial as if you were right there. As soon as the TeleRadio answers, its internal radio begins playing down the line to you. You control the tuner with the buttons on your phone. The TeleRadio is the next best thing to being there yourself.

The TeleRadio features include:

- Ten random memory presets
- Remote scanning, tuning, band change & memory set.
- Remote controlled external audio jack lets TeleRadio double as a standard coupler for IFB, etc.
- List price is just \$659.

CircuitWerkes
6212 SW 8th Place
Gainesville, Florida 32607
(904) 331-5999 / fax 331-6999

READER SERVICE NO. 68

1 Balanced Input 5 Balanced Outputs

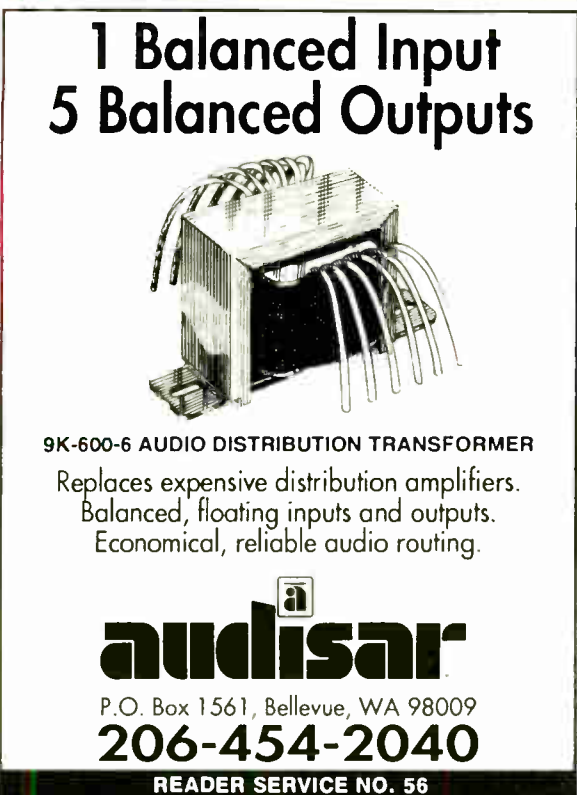

9K-600-6 AUDIO DISTRIBUTION TRANSFORMER

Replaces expensive distribution amplifiers. Balanced, floating inputs and outputs. Economical, reliable audio routing.

audisar
P.O. Box 1561, Bellevue, WA 98009
206-454-2040

READER SERVICE NO. 56

The VSP™

DIGITAL AUDIO CONTROL CENTER



It makes your life easier and sounds better, too!

- Record and monitor selection
- Sampling frequency and format conversion
 - External processor loop
 - Distribution amplifier
 - Complete jitter elimination

Sources sound better, CDs sound like their source DATs (and vice-versa)

Guaranteed!

- All in one rack-mount box

For the small to large Digital Production Studio.
Integrate your DATs, CD players, workstations, etc., from one Central Control Point.

Digital Domain™ Audio for the Golden Ear...
309 E. 90 St. - B - New York, NY 10128
(800)DIGIDO-1 / (800)344-4361
NYC (212)369-2932 / fax (212)427-6892

(the folks who brought you the FCN-1 Format Converter)

READER SERVICE NO. 36

EVEN THE BEST CAN BE MADE BETTER

Introducing the new

MINI-MIX 12A

THE COMPACT MIXER WITH A COMPACT PRICE FROM THE QUALITY LEADER



\$3499 **12 Channels**
25 Stereo Inputs

Service & Affordable Quality for Over 23 Years

AUTOGRAM CORPORATION

1500 Capital Avenue (214) 424-8585
Plano Texas 75074-8118 1-800-327-6901
FAX (214) 423-6334

READER SERVICE NO. 154



ZEPHYRUS

Quality, service, delivery, and reliability have come to SCPC

The Zephyrus 300 family of satellite subcarrier receivers is trusted by thousands of broadcasters. Carrying on the tradition of excellence (at a fair price) is our 700 series analog SCPC line. Entry of all operating frequencies is done on a front-panel keypad. "Old fashioned" meters monitor RF and audio levels.

ZEPHYRUS ELECTRONICS, Ltd.
171 S. 122 E. Ave, Tulsa, OK 74128
918-437-3333 Fax 918-438-7322

READER SERVICE NO. 117

Introducing (ta-da) The Jr. Audio Director Plus™!

It's an 8 input to 2 output ON LINE or monitoring device.

\$550



The new Benchmark Jr. Audio Director Plus™ brings more to the party! It brings more control and selection features, and a stereo headphone amplifier, along with the performance and value that are traditionally a Benchmark for the industry.

In a half wide, 1RU high chassis, the Jr. Plus has two input switch banks which allow left and right outputs to select between eight sources. Additional switches provide a Mono Mix, with adjustable gain reduction of 3 to 6 dB, and a Right Channel Polarity reversal. LEDs indicate switch action. Inputs may be passively mixed ahead of the input amp by depressing two or more buttons.

Installation is "instant" with a No-Mod™ Rack Mount adapter and plugable Euro-Style barrier strips.

Available now.

BENCHMARK MEDIA SYSTEMS, INC.
Phone 800-262-4675, or 315-437-6300, FAX 315-437-8119

READER SERVICE NO. 156

USER REPORT

CCS Makes Virtual Editing Easy

by Kenneth Tankel
Director Technical Operations
East Coast Region
CBS Radio

PHILADELPHIA Among the powerful capabilities computers offer news organizations is the ability to collect, categorize, file, edit, retrieve and share text information. Realizing the capabilities of a character-based newsroom computer system in an audio system is a daunting task.

Corporate Computer Systems (CCS), in cooperation with CBS Radio, developed the Personal Audio Computerized

Editing system (PACE) to address specifically the needs of news environments.

PACE can be used either as a stand alone workstation or as part of a larger network of PACE workstations. Its operator interface emulates analog tape editing and production. The intent was to create a computer-based system that simulated the equipment found in an edit booth—to make the computer work the way a news person works, and not to make a news person work a computer.

While computer-based audio editing systems are relatively common today, more than 20 are currently available, the user interface and networking capability of the PACE make it unique.

The PACE user interface provides both physical and on-screen controls. The physical controls include four motorized faders with associated start buttons and a shuttle wheel with eight associated buttons. All of the buttons are LCD display buttons, which automatically re-label depending on the task at hand.

There is also an 84-key PC keyboard, a trackball, headphone and monitor level controls and an LED bar graph audio meter. Speaker and headphone amplifiers are built into the unit as well.

The MS Windows-based screen display is largely icon driven. The user sees icons for two tape machines, a mixer, a tape duplicator, a "Robo-Editor," shelves for storing audio and carts, and master reels that represent audio in the system.

Virtual taping

Double clicking on any icon opens that virtual device for use. For example, opening the tape machine icon allows you to begin recording. You can title the recording, select an input, set a timer to automatically start and stop the recording, and there is a note pad area.

When the tape machine is chosen the physical buttons relabel to show transport controls, Start, Stop, Record, etc. Also, a single fader shows "Input Trim" and is used to set the record level. As soon as an input is selected, its audio is heard and the levels can be adjusted.

Once the machine is set up, it can be reduced back to its icon. The icon is surrounded by a flashing red border which indicates that it is recording. Two recorders can be used simultaneously.

If the recorder is left open, you can take notes while you record. Pressing the F1 function key flags an incue and the F2 function key flags an outcue as you make

your notes. F1 and F2 also force a carriage return on the note pad. Elapsed time from the start of recording is automatically entered in the margin with every F1 and F2 keystroke.

When the recording is stopped, you click the "Unload" button and a reel of tape, with its title below it, appears on the screen. If you did not enter a title for the recording, you are prompted to do so before you Unload.

Clicking on the reel moves the focus of the editor to that recording. Buttons relabel to allow "Play," "Stop," "FF," and "Rewind." Now the tape can be played.

Double clicking on the reel opens the editor. There is a global view, showing the entire recording, a zoomed view around the section you are working on and a wave form display to facilitate in making difficult edits.

There are also multiple time indicators showing the real clock time of the recording, elapsed timing from the beginning of the recording and elapsed time between edit marks.

Cart icons

Clicking between flags on the tape moves the notes to the chosen flag. Likewise, clicking on a particular note moves the "play head" to the appropriate flag. You place virtual grease pencil marks on the tape to indicate edit points. Edits can be auditioned and there are both edit-start and edit-end audition buttons.

Unwanted audio can be edited from the master and actualities can be "Cut" into virtual carts. The carts appear as cart icons on the desktop and have complete cart labels.

All editing is entirely non-destructive and edits can be undone nearly endlessly. A "snippet editor" allows an arbitrary number of audio snippets to be cut from the master and played in any order. The resulting audio is made into either a new master or a cart. (The difference between a virtual cart and a virtual master is that carts cannot be edited.)

Icons of carts and master reels can be on the desktop or filed in virtual racks. The racks can be named and racks can

continued on page 89 ▶

Measure Up With Coaxial Dynamics Model 81070 WATTCHMAN Transmitter Protection System

NEW!
4-1/16 and 6-1/8
series line sections and
elements to add to our
exciting line-up



WATTCHMAN—protects your transmitter and transmission line system. A permanent 19 inch rack installation used with any dual socket line section 7/8", 1-5/8", 3-1/8" and elements (additional) to monitor CW, TV, and FM power. Model 81070 features two easily read meters to monitor both forward and reflected power. The reflected meter provides a front panel adjustable set point with controls the trip level for fast transmitter shut down and alarm. Abnormal load conditions quickly cause transmitter shut down in less than 15 milliseconds including control relay. Both visual and audible alarms indicate system malfunction. Contacts provided for remote alarm and reset switching. Contact us for your nearest authorized Coaxial Dynamics Representative or Distributor in our World Wide Sales Network.



Coaxial Dynamics, Inc.

15210 Industrial Parkway
Cleveland, Ohio 44135
(216) 267-2233

OR

1-800-COAXIAL
Fax: (216) 267-3142

**Service and Dependability...
A Part of Every Product**

Factors in the Digital Automation Decision

By John Schad, President, SMARTS Broadcast Systems

This digital audio business is getting to the point it's almost impossible to point out the features of your product without publishing a phone book size document!

What makes matters worse, is that there are a lot of digital automation products on the market. All have their good and bad points, but there are real differences that station owners need to know about when making buying decisions!

Let's take one feature as an example. We here at SMARTS Broadcast systems have pioneered in the development of "stretch and shrink". This feature allows a station to "fudge" a bit on the lengths of their spots, and still get the spots into a fixed length break on a satellite network.

We jump through a lot of hoops to create a smooth, natural sounding break. First we evaluate the actual length of the break, and compare it with the spots and other material needed to fill that break. If the break will come up short, we first attempt to find an acceptable PSA, jingle, or other audio to drop in the hole. We might drop in any combination of 60's, 30's, 10's or 5 second spots.

That process will bring us into a 5% window we have established for acceptable stretch and shrink. Now we work some digital magic to actually stretch or shrink the entire break to exactly fit into the allocated time frame.

Our program then gives you other elements of control. You can overlap the audio from spot to spot, and vary the overlap according to the content of the spot so it "sounds right". You can overlap the local break audio with network audio, so you can smooth transitions back into the network music.

This whole package of services is what we mean by "stretch and shrink". However, when we look around, we find others who also claim "stretch and shrink" that do nothing but vary the overlap on the spots so they can cram them into a break, or stretch them out until the last note of the guitar in the background has long since faded, then start the next event. The only thing these things have in common is the name, "Stretch and Shrink".

A station owner looking at competing systems is likely to have two quotes, both of which contain "stretch and shrink" as a feature. But that owner can't know the real difference.

As a PC Based system, SMARTCASTERS perform a wide variety of tasks. We have units switching among multiple satellite signals, recording some, and simply relaying others to provide a continuous programming stream to a satellite serving the Pacific Rim. We are installing units in Europe that will slave remote transmitters to a single studio, allowing for centralization of all logging, billing and production, but localization of the on the air sound. And of course, we have hundreds of units in more conventional broadcast applications, pulling music from satellite networks, CD's or music on hard drive.

These systems are used in so many different applications that it's rare to find two running in exactly the same mode.

If you're a talk station, for example, you might have scheduling conflicts that force you to delay one of two programs being fed simultaneously. This is easy. What's hard is figuring a way to automate that delayed program. Not only do you need to record the program feed itself, you also need to store some sort of signal to tell you when to play the spot breaks.

SMARTCASTER does it, and few, if any other systems will. Our software specialists have developed a way to reproduce not only the feed itself, but also the breaks. We also can make the breaks any length you want, so you are not limited to the break lengths of the original feed.

Our experience base is the biggest in the industry. We have had signal automation systems in the field since 1989, and now serve literally hundreds of facilities worldwide. We have also developed a support system that is second to none. That support becomes very important when you find yourself off the air at 2 am on Sunday. We have an entire department of people dedicated to support, and someone is there to help you 24 hours a day, 7 days a week. We offer an extended warranty plan that will overnight a loaner unit in case of catastrophic failure, even years after you bought the initial machine.

In short, our broadcasting background and expertise shows. We remain a small company at heart, and treat our customers accordingly. The peace of mind of knowing that you have help on the way when trouble happens, should be a major factor in making your decision.

What SMARTS really sells is solutions to problems. We can trim costs, increase your profit margins, simplify your operations. Our people are dedicated to helping you find ways to use SMARTS office systems and SMARTCASTER digital automation in your operation.

Give us a call at 800-747-6278
International call +1-712-852-4047
or FAX us at 712-852-3061

SMARTS Broadcast Systems
Box 293
Emmetsburg, IA 50536

USER REPORT

Korg SoundLink Is Full of Useful Features

by Frank Scales
Production Director
KLBJ-AM-FM

AUSTIN, Texas If you plan to change to digital production, get the workstation that works best for you. I selected the Korg SoundLink for the LBJ Broadcasting Company's digital production studio last February. It delivers all the features I need, and gives me plenty of room for expansion.

The SoundLink is an eight-track digital multitrack made up of the mixing/control console, disk storage unit and audio unit. The control deck has familiar transport controls, a digital mixer, visual display, track select buttons, MIDI control master and a control center for the rest of its functions.

To prevent the need for tons of switches, knobs and buttons, the SoundLink has convenient mode buttons. Within each mode there are several pages of function choices. SoundLink modes include: miscellaneous, disk, audio, mixer, effect, MIDI and mark.

In the audio mode, the SoundLink is a multitrack recorder. With audio "specs" as good as or better than any CD, it consistently delivers amazingly clean audio. And despite the myth, digital can sound warm. Recording is simple: choose the track, press record and play, and go to work.

The next feature is sound editing. I use this edit feature in audio mode ("splice" page) to move sounds, cut out breaths and pauses, copy tracks and to do music edits and spot updates.

Thanks to the SoundLink's built-in crossfade feature, music-to-music splices sound as good as track-to-track crossfades. The splice page offers three useful functions: move track, erase track and copy track. Simply put the cursor on the beginning and end of a sound and execute one of the functions. All three save a lot of time.

Mixing down in mixer mode on the SoundLink is done easily. Mixing can be either automated or done live. I use the automation "remembers" how you mix. If I mix down a spot to my liking, but think the "sfx: large door slam" needs to be louder, I can go back and update that one track. The rest of the mix is left in place. The updating process can be repeated on any and all tracks until the perfect mix is achieved.



Korg SoundLink Random Access Multitrack Digital Audio System

Like its automated audio mixing, the SoundLink also memorizes track panning, individual track EQ and reverb. These settings also are controlled in the mixer mode, and can be changed endlessly during a spot.

For musicians, the SoundLink includes a built-in 16-track sequencer and a MIDI master control. Although I use a different outboard sequencer for my keyboard work, I do use the SoundLink's sequencer for sending program and volume changes to my Eventide H3500 and Korg A1

effects gear over MIDI.

Another useful feature is time compression and time expansion. If I need a 55-second voice part to be 53 seconds, the SoundLink's time compression takes over. Although variable speed is available, the process is not done with speed change. Instead, the sound wave is squeezed or expanded to the length you want with vocal pitch remaining normal.

"Trigger Record" saves me a lot of time when I'm laying down music or effect tracks. I can turn on the Trigger function, put the SoundLink in record and pause, fire off my CD, and the SoundLink starts recording as soon as it senses audio.

SoundLink also features programmable auto punch in/punch out—a lifesaver when I need to be five feet away at my keyboard.

Auto repeat comes in handy when I'm doing a large dubbing job. I can set the SoundLink to repeat back to the beginning of the spot, roll tape, leave the room and come back with dubs done. Unfortunately, the SoundLink doesn't do labels.

Audio outputs include a left-right two-mix from the SoundLink mixer, eight individual track outputs and two digital outputs. I use the digital outs to send to my DAT deck and Korg A1 effects processor.

We installed the basic SoundLink unit with one hard drive, which gives us a total of 100 track minutes. The unit's backup is an 8mm tape drive. Backup tape costs about \$15 each and come with enough storage room to backup the entire drive.

I must take a moment to praise Korg for its customer support. Anytime a question comes up, they are on the phone within minutes. Korg also provided one-on-one training with all of our staff when the SoundLink was installed.

The Korg SoundLink has been a great discovery for me. Korg has been synonymous with top-shelf quality musical gear

for decades.

If you are in the market for a digital workstation, shop around, test as many of them as possible and talk to people who use them. There are several good workstations on the market, but if you want a great digital workstation, moderately priced and loaded with easy to use features, try the Korg SoundLink.

□ □ □

For information from Korg, contact Matt Appelbaum in New York at 800-645-3188 ext. 280; fax: 516-333-9108; or circle Reader Service 38.

You
Won't
Want
To
Miss It

Push Here.

The programmable 601 Digital Voice Processor.
Pushbutton perfection for every on-air voice.

206.282.2555 800.288.8855

128 User Programs
De-essing
Parametric EQ
Compression • Limiting
Automatic Gain Control (AGC)
Dynamic Noise Reduction
Downward Expansion
Echo • Doubling • Modulation

Symetrix

HARRIS ALLIED

Circle (17) On Reader Service Card

Circle (203) On Reader Service Card
See Us At NAB Radio Show Booth 2218

GO WITH THE WINNERS.

**DYNAMAX DCR1000 SERIES
DIGITAL CARTRIDGE RECORDER**

"Our DYNAMAX DCR1000 machines produce superb audio with clean highs, full bass, great clarity and definition. Everybody loves the consistent, CD quality sound."

Bob Kanner
Chief Engineer
KRTH-FM
#1 Oldies Station
Los Angeles, CA



DYNAMAX™
BROADCAST PRODUCTS BY FIDELIPAC™

Fidelipac Corporation
□ P.O. Box 808
□ Moorestown, NJ 08057
□ USA
□ 609-235-3900
□ FAX: 609-235-7779

Arrakis Unites Football Networks

► continued from page 84

any time in the production. This allows an unlimited number of tracks to be mixed into the production.

After the production is finished, the file can be compressed (if desired) and transferred to the Digilink for use on air.

We discovered that just sitting down and editing is the best way to learn how to operate the Trak*Star. Nothing that you do can break the machine. The screen is arranged so that anyone who can edit on a tape machine easily, in an hour or so, can pick up the Trak*Star.

Loop feature

Our station handles a lot of agency business, and early on Al Mason, production director, discovered the "loop feature." As the name implies, this feature plays a file over and over. It is an excellent way to make multiple dubs for clients.

A comment or two on the Digilink software: Our station has three units and just ordered two more. All of these units, plus two traffic computers are linked together with Lantastic Network. This allows instantaneous transfer of audio and traffic schedules between units.

Our AM station operates with a satellite format, and the Digilink operates

unattended most of the day, switching between several satellite channels, inserting liners, commercials, etc.

The timed record feature is helpful at WLWI-AM-FM. Digilink auto records any audio from any input on its switcher, and plays that file back at any time without prompting. This means no more missing a network feed.

Last year, I installed Arrakis Digilinks for both the Alabama Sports Network and the Auburn Network. As most people know, when it comes to state college foot-



The Arrakis Trak*Star and Digilink help Larry Wilkins smooth over old football rivalries.

ball rivalries, none compare to the annual Auburn versus Alabama game.

Alabama and Auburn fans are about as far apart as night and day, but the networks agree that the Digilink makes the

entire broadcast run smoothly.

Both networks take advantage of the sequence feature on the Digilink. Board operators "build" pre-game, in-game, halftime and post-game sequences, which includes pre-game countdown, opening, commercials and features. If last minute changes come up, the sequences can be edited after they are set up.

This is helpful during the game, because there may be 20 or so spots. By halftime you may be at spot number eight or nine, depending on time-outs, etc. Digilink allows you to insert the halftime sequence at that point, and it resets the remaining in-game spots to start after the halftime sequence is over. That lets you return to where you left off in the game rotation.

Sequences, not carts

In the past, there were carts sitting everywhere and it took a second person just to keep the carts in order for the breaks. Now it can be done by a single operator.

Two hours or so before air time, the networks normally send a network identifier to the satellite so affiliates can check their satellite. Frequently an "endless loop cart" with no stop tone was used. However, the edit function of the Digilink can make a file play over and over.

After a game, a "played log" can be printed or, in the case of the Auburn

Network, put on a disk. Later it is imported to the office word processor for billing.

WLWI-AM-FM and both Sports Networks have been very pleased with the Arrakis products, and especially with the support from the programmers at Arrakis. Like any computer controlled system, it has had a few minor bugs, but Arrakis programmers always respond and correct the problem. They also are very receptive to customer suggestions on features and changes to the software. Updates for both Digilink and Trak*Star are furnished via an Arrakis BBS (computer bulletin board service) at no charge.

□□□

For information from CCS, contact David Lin, product manager, in New Jersey at 908-946-3800; fax: 908-946-7167; or circle Reader Service 150.

CCS Icon-Based System Simplifies Editing

► continued from page 86

even be stored in other racks.

Opening the mixer icon, you find four channels and the four physical faders relabel as "Mix One" through "Mix Four." The other buttons have labels for special mixer functions. The mixer allows carts, masters, and external sources to be loaded in the four channels.

While only four sources can be mixed simultaneously, the external inputs and carts and reels can be stacked in the four channels allowing an infinite number of sources to be presented to the four channels one after another. The output of the mixer can be made into a new master reel or a cart, or it can be output from the PACE. The mixer has a mix-minus bus, for recording live newscasts and interviews directly to disk.

Robo-Editor

The Robo-Editor is a unique feature of the PACE editor. After recording a news piece it is quite common to send it to a number of different stations, each with a unique intro and outro. The Robo-Editor has three "stacks." In the first stack are the intro carts, in the last the outro carts. In the middle stack goes the news piece.

By pressing the "Make It So" button, PACE assembles the items—intro 1, news, outro 1, intro 2, news, outro 2, etc.—until all of the intro-outro pairs are used. If you place a second news item in the middle stack, it is then assembled with the intros and outros until all the news pieces are assembled with all the intro-outro pairs.

The result is one or more master tapes that can be played back to the network

for the participating stations to record. Inclusion of unique signal tones at the start of each intro can allow automated recording by each affiliate.

These are just a few of the features of PACE, the ones most directly concerned with editing.

It should be noted, that all PACE operations occur in the digital domain. Audio is stored using ISO/MPEG Layer II audio bit rate reduction (CCS MUSI-CAM). The maximum storage time on an individual PACE is approximately 18 hours stereo at a 5.5:1 (256 kbps) com-

pression ratio.

Control of external devices, networking capability, audio file, storage and searching, archiving, additional features of the recorders and mixer, and many user-defined capabilities are all part of the PACE workstation.

PACE workstations are currently in use at CBS Radio's Washington News Bureau.

□□□

For information from CCS, contact David Lin, product manager, in New Jersey at 908-946-3800; fax: 908-946-7167; or circle Reader Service 107.

Reduce Operating Costs!

- Totally Solid State**
- PMD Efficiency**
- Modular Reliability**
- Hot Swap Power Amplifiers**
- Industry Standard Part Numbers**

Our Solid State AM Transmitters directly reduce your operating costs. Let us show you how.

OMNITRONIX

So you can be heard!

Call us for the lowest factory direct prices on 1000 watt to 50 KW Solid State AM Transmitters

Tel: (800) 446-6648

Fax: (215) 699-2323



Circle (111) On Reader Service Card

See Us At NAB Booth 4806

**Only
Harris
Allied
Has
One**



Circle (77) On Reader Service Card
See Us At NAB Booth 2218



*Perfect tools for
professionals:
CD and CD-R
players from
STUDER*



The new professional D730 and D731 CD players hold several trump cards. The operating concept is identical on both the desktop and rack-mount version. Not only are the RED book standards implemented, but also important parts of the ORANGE book standard. A special scan function allows the user to play CD-Rs on which the TOC has not yet been written: Once the TOC has been created, coded skips are correctly processed. In addition, the remaining time is displayed with great accuracy. This is of special benefit in the intro mode with its high-precision count down.

Safety features are an integral part of both models: The status preservation which guarantees that even after a «power down», the laser is repositioned exactly on the last address; a quality indicator that provides information on the CD playability; program-controlled customization of all operating procedures, comprehensive remote facilities, integrated optional interfaces for special functions, and, what is more, access to all CD sub-code information via the AES/EBU output for advanced data processing.

STUDER
PROFESSIONAL AUDIO EQUIPMENT

Worldwide:

STUDER, a Division of STUDER REVOX AG, Althardstrasse 30, CH-8105 Regensdorf, Switzerland
Telephone +41 1 870 75 11, Telefax +41 1 840 47 37

Subsidiaries:

Austria: +43 1 470 76 09/10
U. K.: +44 81 953 35 33
France: +33 1 453 35 858
Germany: Berlin +49 30 72 40 88

Japan: +81 3 3465 2211

Singapore: +65 250 72 22

Canada: +1 416 510 1347

USA: Nashville +1 615 391 3399

San Francisco +1 415 326 7030

USER REPORT

Flexible DM-80 Means More Choice

by **Bill Robinson**
Production Director
WQCD(FM)

NEW YORK When I went looking for a digital editing system, I spent a full year, trying every system I could get my hands on. After awhile, I started playing a game called "if only," as in "if only machine number one had the editing feature of machine number two," or "if only machine number three cost what machine number four did."

In the end I chose the **Roland DM-80** and to this day, I have never said "if only I had bought a different system."

When Tom Stephenson from Roland first demonstrated the DM-80 for me, I loved it. It had everything from simple, intuitive controls that emulate a tape machine to its own mixing board with EQ. However, I was troubled by the way the editing wheel worked. Most of the other machines I had seen had scrub editing and/or waveform editing, both of which I thought were essential.

Editing wheel

The editing wheel on the DM-80 allows you to hear what is before or after the edit. For the first few days of using it on my own, I had trouble understanding what I was hearing. I was confused, but I kept at it.

At first, I thought "if only the DM-80 had scrub editing," but a couple of days later, it finally clicked. At that moment my decision was made.

Now, two years later, I still marvel at the technology of the system. Day in and day out I use the Roland DM-80 for producing spots and promos, and when I think about how it has changed my life, the first thing that comes to mind is the flexibility it gives me.

I cannot tell you how many times I have played a promo or spot for someone at the station and they make a suggestion like "Why don't you try interchanging the second music bed with the third one?" If I was still using tape I would probably scream, but with the Roland, the whole process literally takes only seconds, as does putting it back the way it was.

This flexibility allows me to experiment more, and it gives the program director different versions of a promo to choose from.

Updating a spot or promo also used to be time consuming. With the Roland, updates are done with just the push of a button. With 16 available markers, you can replace something in one location with an update without any guess work.

Markers are also great when you need to hit the musical post. Once again, there is no guessing. And once again, the end result is a great sounding promo.

Easy editing

On the latest software update, waveform editing had been added to the DM-80. I cannot believe that I would ever say this, but I have yet to use it. That in itself is a testament to how easy and efficient editing with the Roland is.

I have learned that when you need to make an edit, whether you can see the sound or not, in the end you have to make the edit based on what you hear.

Price is always a factor in purchasing equipment for a radio station. Before I



tested the Roland DM-80, I intended to buy on a system that was nearly three-times as expensive. After seeing the Roland, however, I weighed the pros and cons of each machine. In the end there was no way I could justify spending three-times as much money when I wasn't getting three-times the machine.

In fact, while I was trying out the Roland, a salesman for the other system stopped by and asked me to show him what the DM-80 could do. It was the first time I have ever seen a salesman speechless.

All in all, the Roland DM-80 has fulfilled all of my expectations for a digital editing system.

□□□

For information from Roland, contact **Bob Todrank** in California at 213-685-5141, ext. 335; fax: 213-722-0911; or circle Reader Service 59.

SEND YOUR AUDIO ACROSS THE STREET OR AROUND THE WORLD™

When you think digital audio, think California Digital. We provide satellite/digital technology to make all these options available at low cost:

- ▮ Syndicate your top personality or format
- ▮ Add affiliates - gain revenue sources
- ▮ Share programming, talent and costs
- ▮ Off-site announcer feeds
- ▮ Create events with remotes
- ▮ CD-quality live coverage of news, sports, and concerts

California Digital offers expertise in:

- ▮ Digital Satellite Networks - C or Ku
- ▮ Regional, National, International Nets
- ▮ Remote Broadcasts
- ▮ Rugged Fly-away Systems
- ▮ Custom Ku Power Control Software
- ▮ System Design & Engineering
- ▮ FCC Licensing; Installation and Training
- ▮ Equipment sales, leasing and financing
- ▮ Switch 56 & ISDN program distribution

TOP TALENT IS LOCALIZING NATIONAL SHOWS WITH OUR LOW COST TECHNOLOGY
ASK US HOW YOU CAN DO IT TOO!

CALL: CALIFORNIA
DIGITAL AUDIO

West Coast Office (805) 523-2310 Fax (805) 523-0480
Midwest Office (612) 631-5064 Fax (612) 631-5010

**MAKE MONEY BY CREATING A
MUSIC PROGRAMMING NETWORK!**

Circle (208) On Reader Service Card

PRODUCT EVALUATION

VoxPro Brings DAWs into On-Air Studios

by Tom McGinley
Chief Engineer
WPGC-AM-FM

MORNINGSIDE, Md. A 20-year veteran of morning show broadcasting has created a new digital audio editing system for "on the air" use in control rooms and newsrooms.

Charlie Brown, morning show host at KUBE(FM) in Seattle, and his new company, Audion Laboratories, developed VoxPro™—the first digital audio workstation (DAW) specifically designed to replace reel-to-reel tape recorders in radio control and newsrooms.

As the host of a top-rated morning show, Brown knows a lot about the

on-air personalities seemed to avoid DAWs because of their complexity and cost.

His research confirmed that essentially the DAWs currently on the market are designed primarily for production room use. They reproduce sound better than analog tape, but their complexity is a hindrance in the control room.

Beta test

Rather than wait for a more suitable product to come along, Brown, along with other broadcast veterans, formed Audion Laboratories and began developing VoxPro.

Over the past few months, Audion Laboratories tested VoxPro at several

sound—recording and editing become as easy as "cut, copy and paste."

"This is the first time we have ever used digital audio on the air," said Jhani Kaye, program director at KOST. "We couldn't be more pleased. VoxPro has provided a massive reduction in the editing time of listener call-ins. We love it."

"All of our on-air people have absolutely fallen in love with Audion's VoxPro," added Jay Stevens, program director at WPGC-FM. "There's no more fumbling with tapes, and telephone drop-ins have become a breeze."

The key to VoxPro's success in the control room is the combination of several unique capabilities. These features give the user simple, intuitive editing, with results that are easy to save or archive.

For example, the "Record Insert" feature, dubbed the "glibilizer," allows a user to select a position anywhere inside an existing recording, and then begin a new recording at that point. New sound is automatically and seamlessly inserted into the original recording. This gives a DJ the chance to use the snappy comeback he thought of right after the caller hung up.

Features

Other "speed enhancing" features include:

- Across the top of the VoxPro remote control unit are 10 assignable "Cart Keys." These can be set to any recorded audio—sound effects, jingles, interviews, etc. Once assigned, pressing the cart key plays the selection instantly.
- The "Record" command automatically creates a new file and begins recording instantly.
- VoxPro cuts, copies, and pastes recorded sound from one recording to another.
- A visible waveform simulates tape moving across a tapehead, letting a user

see recorded sound and enabling the "visual" editing of sound.

- A "bleep tone" or dead space deletes unacceptable word.
- Personalized audio items can be stored in one of 20 "jock folders" with password protection.
- On-line pull-down help screens are available for any function.

Fresh sound

"The record insert feature in VoxPro makes me sound quicker on my feet than I really am," said Bob Case, operations manager and air personality at KUBE. "No other digital audio product lets me

The "Glibilizer" gives a DJ the chance to use the snappy comeback he thought of right after the caller hung up.

audio requirements of an on-air studio or newsroom versus a production room. "Analog tape machines work equally well in production rooms and news/control rooms, but the same does not hold true for digital workstations," says Brown.

Time critical

"In a control/newsroom, operations are time-critical. Audio must be captured, edited and replayed very quickly," said Brown. "These performance demands have restricted the use of conventional digital audio products, which are designed primarily for production rooms."



Two years ago Brown began talking with friends and colleagues about DAWs and their potential use in the control/newsroom. He determined that

major market radio stations. They examined the suitability of VoxPro in a variety of demanding control/newsroom environments.

This beta test program involved installing VoxPro at several well-known stations including: KHIS-AM-FM and KOST(FM) in Los Angeles; KYKY(FM) in St. Louis; KKSJ-FM in Portland, Ore.; KIRO-AM-FM and KUBE in Seattle; and WPGC-AM-FM in Washington.

According to the disc jockeys and program directors who have seen and used VoxPro, it is user-friendly and quick to learn. It also costs less than other DAWs.

In the time that it takes to learn how to edit with an old Ampex machine, a user can learn the VoxPro and gain the benefits of digital editing. Others compare VoxPro's operation to that of a word processor for

Product Capsule: Audion VoxPro	
 Thumbs Up	 Thumbs Down
<ul style="list-style-type: none"> ✓ very intuitive ✓ very fast in and out of edits ✓ specifically designed for control/newsrooms 	<ul style="list-style-type: none"> ✓ not an IBM PC-based version ✓ not true stereo configuration
For more information, circle Reader Service 209 ; or call Audion at 206-842-5202.	

add comments to a telephone conversation, after the fact."

In fact, Case's comment points to another advantage of VoxPro. It potentially can make live programming sound fresher, more alive, more focused and more entertaining. VoxPro makes a host sound more informed and more in control of call-ins and interviews.

VoxPro gives hosts and control/newsroom personnel the ability to add important content, to delete dead air or elements that detract from the key points being made by a guest or the host, and to keep the overall program focused on important or entertaining points.

In its present form, VoxPro samples audio at 44.1 kHz, yielding frequency response to 22 kHz. No compression or bit rate reduction is used, so one minute of two-channel input audio summed to a mono output consumes 5 Mb of hard disk space.

Options

A future enhancement will provide 2:1 compression in the form of digital AGC (automatic gain control). Another 2:1 will be available with a selectable 22 kHz sampling rate for 11 kHz response, if desired. With 4:1 total compression, a 60-second recording can be copied and stored to a 1.4 Mb floppy disk.

An external magneto-optical (MO) hard drive option is currently available. It allows the use of removable 160 Mb "floptical disks," each holding about 30 minutes. DJs can use their own disks for all their own recordings and edits.

VoxPro will be available in the United States in March, at a suggested retail price of \$6,495. The system comes complete and ready to use. It includes the VoxPro software plus a Macintosh Quadra 605 computer with 160 Mb hard-disk drive, color display monitor and related peripherals.

For those unsure about the benefits of digital audio in the control room, Audion is offering a bold solution: VoxPro comes with an unconditional, 60-day money back guarantee. You can try it without risk for two months and return it for a full refund if you are not satisfied.

□ □ □

For information from Audion Laboratories, contact Charlie Brown at 206-842-5202; fax: 206-842-6029; or circle **Reader Service 209**.

Wizard for Windows™

by Prophet Systems, Inc.

The Premier Digital Audio System Designed by Broadcasters

Wizard For Windows features:

- * WINDOWS and NOVELL Network Technology.
- * DESIGNED BY BROADCASTERS....We know what you need!
- * INSTANT ACCESS to all audio from multiple terminals simultaneously!
- * Windows DIGITAL REAL-TIME EDITOR that's also easy to use!
- * HARD DRIVE AUTOMATION, put all your music on hard drive.
- * Fully Integrated CD AUTOMATION SYSTEM.
- * On-line COPY SYSTEM, integrate your sales and programming.
- * BLOCK STRETCH/SQUEEZE, insures that spot blocks time out to the right length every time for seamless integration with satellite services.
- * Advanced database design with over 40 REPORTS and simplified log entry/modification.
- * Innovative DIGITAL REEL-REEL, automatically records network feeds including PROGRAM BREAKS!
- * Advanced MUSIC LIBRARIAN system, generates your song play list automatically while you sleep.
- * Supports SATELLITE, MANUAL ASSIST formats plus FULLY AUTOMATED PROGRAMMING.
- * Full Audio, Data & Equipment Redundancy to PROTECT your valuable data.
- * Traffic and Music System INTERFACES for most major systems.

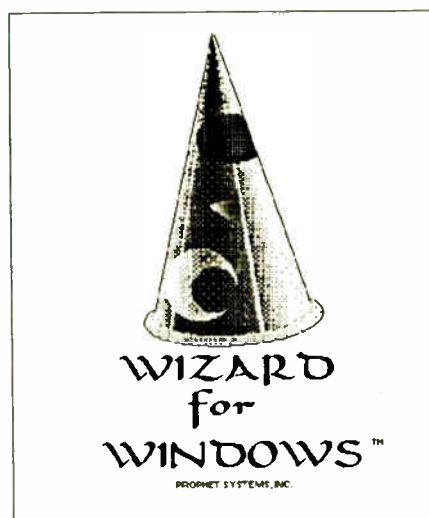

SEE THE SYSTEM THAT EVERYONE IS TALKING ABOUT at BOOTH #5222 at the N.A.B. SPRING SHOW or Call PROPHET SYSTEMS at 1-800-658-4403 for a full information packet.

In Australia or New Zealand, contact Broadcast Solutions Pty Limited at (02) 439-6662.

Windows is a Registered Trademark of Microsoft Corporation. Novell is a Registered Trademark of Novell, Inc.

Full function RDS for only \$1750



When you're ready for RDS, Modulation Sciences is ready for you. You already know us as the world's largest supplier of subcarrier equipment for radio and TV, with more Sidekick® SCA generators in use worldwide than all other brands combined.

Now we've made it easy and affordable for you to enjoy *all* the

benefits of broadcasting an RDS signal. Our RDS generator plugs right into your PC. And our included software gives you access to the entire CENELEC or U.S. RDS or RBDS Standard feature set.

So why buy an RDS coder offering only part of the RDS standard when, for even less money, you can have the whole thing?

Modulation Sciences is a worldwide supplier of ModMinder® FM modulation monitors, StereoMaxx™ spatial image enlargers, composite audio processors and distribution amplifiers, Sidekick® subcarrier generators and receivers for FM and TV, Wired STL™ line drivers & receivers, TV stereo generators, SAP and PRO channel generators, and the remarkable new PROceiver™

For details on the RDS-1 System or any MSI product, contact your MSI dealer or

modulation sciences, inc.

12 A World's Fair Drive • Somerset, NJ 08873 USA

Toll Free (800) 826-2603 • FAX (908) 302-0206 • Outside USA (908) 302-3090

Circle (205) On Reader Service Card

World Radio History

INDUSTRY ROUNDUP

DAWs: No Longer Just for Production

by T. Carter Ross

WASHINGTON As a quick perusal of this month's Buyers Guide reveals, digital audio workstations (DAWs) are adding features and capabilities. Some units are specialized, high-end multitrack machines, geared toward commercial and program production. Others are designed to be more multipurpose. Some DAWs are being integrated with other equipment, particularly automation systems, while others are replacing cart machines or other studio source equipment.

They all have the capability to reshape

audio items and thus fulfill the function historically performed by reel-to-reel decks, analog tape and razor blades. But it remains to be seen whether future DAWS will be more specialized or more integrated with other units, acting as studio source, automation and editing gear, all in one.

Processor limits

Adrian Charlton of The Management said that at present, the functions of workstations are limited by the processors. "Even the fastest IBM-compatible PCs are not as fast as the slowest digital editor currently on the market. A proces-

sor surrounded by RAM gives DAWs an edge by letting you work in real time.

"DAWs are real one-trick ponies. They can handle 12MB to 18MB of audio, and maybe eight tracks of that in memory in real time," Charlton said. "That's eight times as much as a 486 can handle."

But for the short-term future at least, Charlton feels there will be a well-defined line between playback and editing devices because of the cost and processors.

James Goodman at Otari Corp. notes that the versatility of DAWs is one of their strengths. "One of the things you

find when you go into a workstation, is that depending on the software it uses, it can have applications over a broad range of applications: from post production for video to straight editing to radio production," he said.

Similarly, Larry Lamoray of ENCO Systems sees an eventual convergence of automation systems, DAWs and studio source equipment. "Many of the systems currently on the market are still in their infancy. Eventually they will take over a lot of the equipment functions in a studio."

Mike Palmer of Arrakis agrees that DAWs will assume a larger role: "The goal of all DAW manufacturers is to replace all tape equipment."

Although broadcasters may want more technology to be merged, there are limitations on what manufacturers can offer. According to Lamoray, "Market demands at this point are really forward of what we are able to accomplish technically." Lamoray clarified that the limiting factor is primarily hardware related, not software.

A processor surrounded by RAM gives DAWs an edge by letting you work in real time.

Palmer further noted that manufacturers and customers are not sure where to head next. "Everyone's comfortable with old style studios with different source gear for each major function," he said.

Logical step

Charlie Brown of Audion Labs believes that incorporating voice recognition is the next logical step for DAWs. "For instance, being able to say to your DAW, 'Find the interview with the word fusion.' The software will search its hard drive storage system for any occurrence of the word spoken in any of the recordings stored there."

With increased similarity in the advanced features of these systems, companies are looking for ways to make their own systems unique.

David Lin of CCS said that in the development of its DAW, the company relied heavily on broadcasters and radio news organizations in particular for feedback on making PACE user friendly. "We aimed to incorporate a human interface, at the insistence of broadcasters. We've replaced cart machines with a cart machine icon."

Goodman also said that Otari hopes its dedicated hardware will help make DAWs more user friendly. "People want them to be easy to use. There's still a push in that direction, but it is hard to make DAWs super easy to use. Our dedicated hardware control panel, which is like a tape control panel, but with more functions—cut, edit, scrub—on the panel, is a step in making this kind of device more user friendly," Goodman said.

Charlton notes that The Management designed AXS as a modular system, allowing a consumer to buy enough modules to do the tasks at hand, but always with the option to expand.

AN EXCLUSIVE EVENT.

BROADCAST AUDIO PROCESSOR **EXCLUSIVE FM**
AUDIO GOLDEN SERIES

There are moments in the course of a manufacturing Company's life that become historical milestones, not only for the Company itself, but for the whole industry. EXCLUSIVE FM, AEV's newest FM broadcasting processor, represents one of such milestones. It's an event. A truly extraordinary event, setting a faster pace in the evolution of FM broadcasting. To emphasize only some of EXCLUSIVE FM's features would be like diminishing it. AEV is pleased to invite Radio and TV Broadcasters the world over to contact its Dealers for detailed information, as well as to verify, in the course of a hands-on demonstration, the meaning of the word "extraordinary".

AEV
GOLDEN SERIES
Precious TOOLS

AEV ELECTRONIC BROADCAST EQUIPMENT Phone 39 + 51 + 950249 / 950350 Fax 950201

Circle (159) On Reader Service Card

TECHNOLOGY UPDATES

STUDER

Dyaxis Includes 'Plug and Play' MO Option

MENLO PARK, Calif. The modular, multi-track Dyaxis II digital audio workstation from **Studer Editech** provides up to 24 I/O channels and 48 playback tracks in four-channel modules. Designed to provide real-time performance and creative flexibility, Dyaxis II features playback of an unlimited number of "virtual" audio events, regardless of system size.

Each eight-track Dyaxis processor is a complete, independent system equipped with up to nine digital signal processors for the ultimate in real-time editing and completely digital mixing.

Modular design makes Dyaxis II expandable simply by adding processors.

Recent additions to the Studer workstation include the "Plug and Play" option and the MultiDesk hardware control console.

Plug and Play uses cost-effective 3.5-inch optical media, providing instant interchange between projects. Changing between projects is now as

simple as changing tape.

The MultiDesk control console provides moving fader automation, dedicated keys for editing, positioning and transport control within an integrated ergonomic surface.

Dyaxis II is the connectivity workstation, featuring multi-format digital I/O, file format capability with the many audio workstations on the market and machine control over most popular tape machines.

More than 1,000 Dyaxis systems are installed in broadcast production, post production and music recording studios around the world.

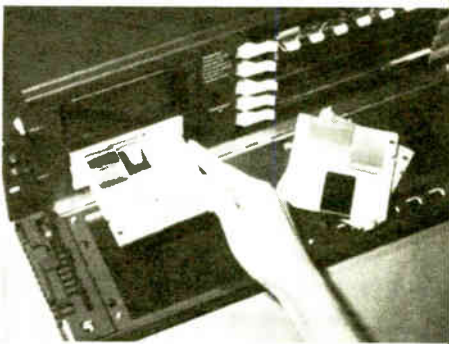

For information, contact Gerry Kearby in California at 415-326-7030; fax: 415-326-7039; or circle Reader Service 69.

BASYS

D-CART System Integrates Multiple Users

LANGLEY, England The D-CART system, distributed by **Basys Automation Systems Ltd.**, works with news/talk and music formats, as well as for a range of non-broadcast applications. It records, edits, replays, playlists and stores audio material without using tape. D-CART also supports a variety of semi- or fully automated operations.

Standard computer terminals, PCs or a range of studio interfaces can control record and replay functions. A shuttle wheel facilitates rapid and accurate editing at the screen. The shuttle wheel has a duplicate set of transport controls for users needing to switch between D-CART and another application. Finished items can be linked to each other in a playlist for either assisted or automated playback.

A single D-CART system supports a large number independent projects, or multiple users can edit or audition the same item simultaneously. The current SCSI drives allow approximately 34 users to access a single item on a mirrored system simultaneously.

Current changes in drive technology offer dramatic improvements in both the number of simultaneous users and disk

capacity. Audio storage (uncompressed) is based on high capacity random access mirrored-write hard-disk technology, providing simultaneous database driven access to all audio stored within each D-CART system.

Special purpose signal processing options include: stereo/mono conversion, fading and mixing and level normalization.

One of D-CART's biggest attractions is its reliability. D-CART system components rarely require maintenance attention, and system redundancy means virtually no risk of on-air problems.

For information, contact Kristin Schleiter in New York at 914-376-4800; fax: 914-376-0865; or circle Reader Service 33.

MTU

MicroSound Workstation from MTU Features Trackless Project-Editing on 386/486 PCs

RALEIGH, N.C. Sophisticated, yet easy to use, the MicroSound™ digital audio workstation from **Micro Technology Unlimited (MTU)** uses 386/486 computers to provide two to four balanced analog channels with 100 track simultaneous playback without bouncing.

With its trackless Project-Editing, you can move any audio event exactly where you want it—instantly hearing it overlapped with the other audio—digitally mixed for perfection.

MicroSound lets you change gains up or



down, with up to three minute fades computed on the fly. "Donut" copies can be made for repetitive work in seconds, which saves both time and money. Time change, noise remove, and non-destructive delete edits are made instantly and are modifiable in any order.

MicroSound excels in cost, performance and ease of use, which makes it perfect for any audio production, from short spots to long productions. It lets you perform your work in a fraction of the time versus tape machines or tape-emulating workstations.

Whether used as a single workstation, or multiple units networked together to share resources, users have found MicroSound very easy to use.

For information, contact Warren Keyes in North Carolina at 919-870-0344; fax: 919-870-7163; or circle Reader Service 204.

10

If you see this as a ten, not a binary two, we've got the digital audio system for you.

The DAD486x Digital Audio Delivery System combines the benefits, reliability, and economics of modern computer technology to provide a powerful CD quality digital audio system that does not require a programmer to operate it. With DAD on the job, you can instantly switch between Live Assist and fully Automated formats, and reap the advantages of instantaneous access to hundreds of tracks or completely controlled programming.

Operating DAD requires virtually no learning curve, as it emulates the equipment that you have always used. The optional Touchscreen is the ultimate in intuitive operation, or you can use the same fader starts or other remote controls that you do now. The super fast Graphic Waveform Cut and Paste Editing will make you wonder how you ever tolerated grease pencils and razor blades. And interface to satellite program networks is so easy that it takes only minutes to install, no special software required.

Maybe the most remarkable feature of DAD is that it runs under DOS, the most

commonly utilized software in the world, and on standard off the shelf hardware. Maintenance support, parts, and expansion hardware can be easily obtained anywhere. And you are assured that as computer technology continues to evolve, DAD will grow with it. You never need to be out of date. There are no monthly licensing fees and upgrades are free for the first year.

DAD can be configured to fit any size facility, from a stand alone Workstation that does double duty for both Production and On-Air to multiple Workstations, each equipped for a specific application, operating on a true Local Area Network. Redundancy and backup features can be configured to meet any need or budget. And DAD talks to CD Jukeboxes, Routing Switchers, and more.

DAD486x rates a "Ten" as the ultimate digital audio system!



To receive more information call us at 1-800-ENCO-SYS



1866 Craigshire Drive, St. Louis, Missouri 63146 USA
Tel: 800-362-6797 or 314-453-0060 Fax: 314-453-0061

See
The
1st
Digital
Radio
Station
at
NAB
Booth
2218

HARRIS
ALLIED

Why not get everything professional Digital Audio Workstations have to offer?

Create your best part out of 10 recordings and use it in five different places... record 100 takes in the same place, on the same track... synchronize sound FX to a picture in less than a second... erase a word and bring it back a week later... and do all this on a machine that gives you instant access with incredible editing speeds, the sound quality you want, and the reliability you can count on, project after project.

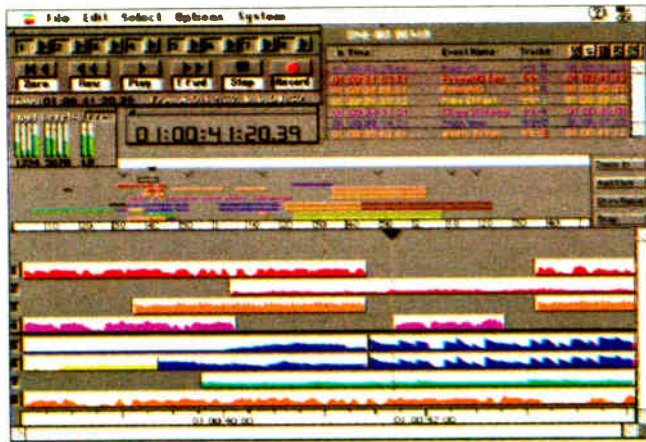

Optional DM-80-S Multitrack Manager control for the Macintosh*— easy to learn, fast to use.

the Word.

Problem is, many DAWs just can't give you all of these things.

Here's why:

Problem: Some systems use a single computer for graphic user interface *and* for audio information processing. This slows the whole system down, and makes you wait.

The Answer: A workstation that separates the hardware "engine" from the user interface computer. This way, audio information processing is not slowed down by the user interface, and the interface computer operates without the load of additional tasks. And you save time and money.

Problem: A system crash in the middle of a complicated project could cost you as much in time lost as some of the less professional DAWs are worth. You should expect reliability you can count on from your DAW, and get it.

The Answer: First, call around. Check the reputation of DAWs. We have DM-80s working every day all over the world in high volume production environments. Our customers will tell you they're reliable.

Problem: Some systems don't give you a user interface that's familiar and easy-to-use.

The Answer: Buy a DAW that lets you choose either a dedicated hardware remote that gives you familiar tape recorder controls, or computer software control that is simple to understand and easy to operate.

Problem: Some DAWs are the weakest link in the audio chain. The DAW you buy should deliver sonics as good or better than any piece of audio equipment you own.

The Answer: Choose a DAW from a company that knows professional audio, not just a company that knows computers. But most of all, ask audio professionals who own one.



We believe you'll find all these answers and more in: the Roland DM-80 Digital Audio Workstation. Call us at (213) 685-5141, ext. 337, or FAX (213) 722-0911 for a brochure. Or better yet, schedule a demo. You're going to like what you hear.

"The thing is just impossible to screw up! The DM-80's non-destructive editing is the only way to go—revisions are extremely easy, and very quick."

— DAVID ESCH
DIRECTOR OF COMMERCIAL PRODUCTION
WPNT CHICAGO



"Edits fast, sounds great, and doesn't break. The DM-80's multilayering capabilities and simultaneous recording on all tracks gives us the flexibility to do whatever we want."

— JOEL VALENTINE
PRESIDENT
21ST CENTURY SOUND DESIGN, HOLLYWOOD
("NORTHERN EXPOSURE")

the Word on the street.

"The first DM-80 paid for itself in two months, so we bought a second one... I like the editing ease—no waiting. It's my 'word processor' for audio."

— MICHAEL STANTON
COMPOSER/ARRANGER
AUDIO PRODUCTIONS, INC., NASHVILLE



"The DM-80 is our secret weapon! It's a very enabling technology."

— MAZ & KILGORE
GRAMMY NOMINATED PRODUCERS
NEW YORK

"What goes in... comes out! And the sound is wonderful. Easy editing, plus easy sync to video lets me concentrate on the creative aspects of the production."

— RICHARD FREITAS
EMMY AWARD NOMINATED AUDIO PRODUCER
THE DOVETAIL GROUP, CONNECTICUT

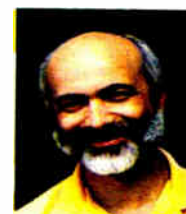

"Operational speed and ease of editing make the DM-80 the greatest thing since sliced bread! We use it for all our production."

— VINCENT FUMO
SENIOR EDITOR
INDEPENDENCE BLUE CROSS, PHILADELPHIA

"The DM-80's power and speed allow me to complete a half-hour television documentary every week. As an investment, the DM-80 has proven to be a very smart choice."

— JIM HEFFERNAN
EMMY AWARD WINNING SOUND DESIGNER/PRODUCER
VIDEOSMITH, INC., PHILADELPHIA
("1ST FLIGHTS WITH NEIL ARMSTRONG")

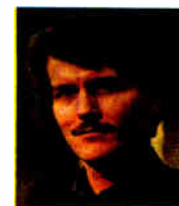

STUDIO TECHNOLOGIES

StudioComm Series Provides Flexible Monitoring System

SKOKIE, Ill. The StudioComm series from Studio Technologies lets radio stations set up a flexible, great sounding monitoring and communications system for their digital audio workstations.

A full system consists of the one-rack space Model 50 central controller, the desk-top Model 51 control console and at least one Model 35 or Model 38 talent amplifier. Used together, they supply control room and studio monitoring, an integrated headphone system and a dub output.

The Model 50 central controller has seven stereo line inputs that accept the balanced or unbalanced output of workstations, DAT recorders, etc. Several outputs are available: two sets of balanced stereo line level outputs for control room monitors; one studio monitor output; a dub output; and a

headphone output.

The Model 51 contains all routing, switching and level-setting controls. A built-in microphone provides wide-range voice pick-up for talking to the studio and the control room, or sending voice audio to the dub output.

The Model 51 connects to the Model 50 with a five-pin, five-conductor, MIDI-type cable. The units communicate using system-exclusive MIDI messages.

The headphone output feeds up to four StudioComm talent amplifiers. Both the Model 35 and Model 38 cue modules drive high-impedance headphones. Power and audio reach them via a single, three-pin microphone-type cable. The Model 38 also lets the user adjust the mix in her or his headphones.

With all of their features, StudioComm products help to increase production efficiency.

For information contact Barbara Govednik in Illinois at 708-676-9177; fax: 708-982-0747; or circle Reader Service 134.

SPECTRAL

AudioEngine Provides up to 256 Virtual Tracks

SEATTLE The AudioEngine from Spectral Synthesis currently is used by radio and television facilities around the world for fast, high-volume production of spots, promos, voice tracking and full-length programs.

The system provides up to 256 virtual tracks for recording, a built-in digital mixer and patch bay and up to 16 channels of input and output (soon to grow to 24). It also offers extensive signal processing capabilities, but only takes up the same amount of space as a traditional open reel recorder. Windows-based to keep purchase cost and training time low, the AudioEngine has been installed in more than 350 systems worldwide.

The familiar Windows interface enables the AudioEngine to be operated by a wide range of facility personnel, and the system can be installed in virtually any modern Windows-capable PC. It features a built-in high-speed digital audio bus, plus a SCSI controller for external hard drives or other removable media. The "host" PC is used only to run the system control software. Other approaches to workstation design are limited by relying on the host computer's CPU for signal processing, according to Spectral.

The AudioEngine, on the other hand, is so independent that it can withstand a warm boot ("ctrl-alt-del") of its host computer, while playing up to 16 tracks of audio without interruption.

For information, contact Mark Doenges in Washington state at 206-487-2931; fax: 206-487-3431; or circle Reader Service 22.

ITC

ITC EdItor Designed for Fast, Easy Operation

BLOOMINGTON, Ill. The ITC EdItor from International Tapetronics Corp. (ITC), is a simple waveform multi-track editing tool designed specifically to meet broadcasters' needs. The EdItor is able to record; edit from two or more channels; change pitch speed; edit non-destructively; perform edits using real-time crossfades to eliminate pop; and record all tracks in mono and playback stereo.

The EdItor has 16-bit linear resolution with multiple sampling rates up to 48 kHz performance without compression. All data remains fully intact instead of permanently discarding audio data information.

When partnered with the cut editor feature on ITC's complete digital audio system, the DigiCenter, the EdItor allows cue tones, intro and outro marks, and Vari-Time—an ITC feature that adjusts cut lengths without changing pitch. EdItor files can be networked to DigiCenter.

In addition to these radio-specific benefits, the EdItor is designed for fast, easy operation; uses standard commands like cut, copy, paste, undo, mix, level set, auto or custom fades and splices, and EQ; and operates on a DOS-based platform.

For information, contact Charlie Bates in Illinois at 800-447-0414; fax: 309-828-186; or circle Reader Service 174.

THE BETTER DIGITAL STL SYSTEM

MORE PERFORMANCE



FOR LESS EXPENSE

Digital technology is revolutionizing and improving our lives daily, and Studio-to-Transmitter Links are no different. If superior audio quality is important to your listeners, TFT's DMM92 Digital STL is your choice.

Superior Audio
The STL doesn't have to be the weakest link in your programming chain. With the TFT DMM92, digital quality of 0.05% THD, 85 dB SNR and stereo separation is transmitted faithfully from studio to transmitter. As more digital studio and transmitter equipment becomes available, the TFT DMM92 is ready thanks to built-in AES/EBU inputs/outputs.

Six Channel Capacity
Now two or more stations can operate from the same studio, using the DMM92/ TFT 9100 STL. The system can deliver four: 15 kHz program channels and two voice/data channels to multiple sites. Plus, its spectral efficiency permits operation of analog FM subcarriers well within the FCC legal limits.

Choice of Audio Compression
With a decision on an audio compression standard in flux, the TFT DMM92 doesn't force an irrevocable choice. It accommodates changes when new encoding algorithms are available.

Better Price Value
DMM92 audio quality, spectral efficiency and flexibility make life easier for programmers, engineers and for owners is the most economical digital STL solution today.



DMM92E, 9100Tx, 9107Rx, DMM92D and Digital STL Primer (available upon request.)

TFT

INC. Sound Quality for over 20 years

3090 OAKMEAD VILLAGE DR. SANTA CLARA, CA 95051 • 800/347-3383 • 408/727-7272 • FAX 408/727-5942

SONIC SOLUTIONS

Sonic Solutions Offers Mac-Based Editor

SAN RAFAEL, Calif. The Sonic System™ is a family of digital audio workstations for engineers and producers whose bottom line is speed, flexibility and sound quality. The Sonic System is ideal for dialog and music editing, radio spot production and mixing and editing multi-track radio programs.

Based on the Apple Macintosh computer and advanced signal processing cards from **Sonic Solutions**, the system is easy to use and entirely modular and expandable. All Sonic Systems include high productivity features such as 12 channels of continuous audio from a single hard disk, non-destructive editing and background recording to the hard disks.

Sonic offers a complete line of software options including EQ and mixing, time compression/expansion, digital reverb, sample rate conversion, PQ editing, CD recording and NoNOISE sound restoration.

Multiple Sonic Systems can be lined together through MediaNet, a high speed FDDI or CDDI network. MediaNet supports up to 100 channels of real time digital audio and allow engineers to share soundfiles and processing resources transparently between workstations.

Sonic System can be configured from two channels of digital I/O (12 tracks of playback) to 24 channels of I/O (72 tracks of playback); prices start at \$4,995.

For information, contact Rolf Hartley in California at 415-485-4800; fax: 415-485-4870; or circle Reader Service 7.

ORBAN

Orban DSE-7000 Uses Unique RAM Architecture

ALLSTON, Mass. The Orban DSE 7000 is an eight-track digital sound editor designed especially for radio production. The system combines powerful editing features like automatic backtiming with flexible transport features like vari-speed play.

Transport and mixer controls work and feel just like tape. Edits are marked either by "rocking the reels" or making marks on the fly from any play or transport speed. All mixing is in real time, so there is no need to set up complicated "mixer automation."

All eight tracks and two effects returns can be bounced down to one or two tracks. The screen display is easy to understand, and any edit or mix operation can be undone. On-line help is available at all times.

The system is intuitive, fast and easy to use. Most new users can do full productions in about an hour. No training seminars or computer knowledge is necessary, and there are no DOS or mouse commands, windows or icons.

The system is always ready to record, edit or mix.

The DSE 7000's RAM architecture is unique among DAWs. Up to 70 minutes of audio is stored in RAM at all times, making it much faster and more responsive than hard disk-based workstations. Audio is simultaneously "shadowed" to a hard drive for up to eight hours of secure disk storage. A DAT backup option provides unlimited long term storage.



The system is shipped as a complete unit, including a control panel with full size mixer and tape transport controls, a monitor screen and custom hardware operating on a PC platform.

Frequent software upgrades keep DSE units up to date. Orban plans to release its Version 4.0 software and new digital I/O hardware options this Spring.

For information, contact Orban in California at 510-351-3500; fax: 510-351-0500; or circle Reader Service 180.

DAL

EdDitor and CardD Upgrades Expand Functions

MINNEAPOLIS Digital Audio Labs updated its EdDitor for Windows program and The CardD board. The EdDitor Plus and The CardD Plus offer expanded editing functions and capabilities.

With simultaneous record/playback capability, The CardD Plus plays two channels while simultaneously recording another two channels. The EdDitor Plus waveform display editor takes advantage of this CardD Plus feature.

The EdDitor Plus plays one file in the bottom waveform-display window, and records new sound into the top window. When the record/play operation is completed, the time scales of the two windows are locked and synchronized. It also can playback two recordings together, mixing four channels of audio down to two channels in real time.

The "Preset Punch-in" feature helps re-record a section of the top window. Multiple punch-ins can be done, with the EdDitor Plus remembering up to 10 takes that can be compared with "Edit History." A scrub feature is also new. The mouse scrubs the waveform, and the velocity-sensitive playback provides the feel and sound of scrubbing analog tape.

Adding The I/O CardD provides an input and output for direct digital transfer to and from a DAT recorder. It works in the S/PDIF format.

For information, contact Jeff Wilson in Minnesota at 612-473-7626; fax: 612-473-7915; or circle Reader Service 102.

How Many New Features Can You Find On Potomac's New AA-51A?

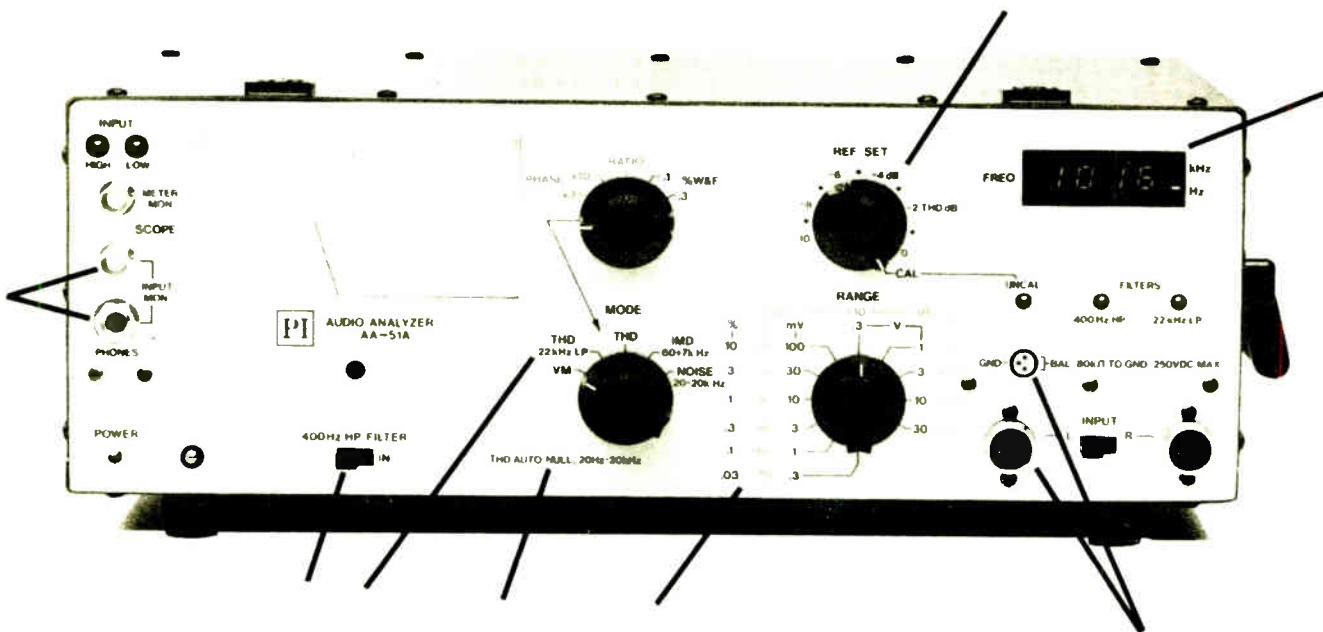

Multiple Choice

- A. None
- B. 1 to 4
- C. 5 to 9
- D. 10 or more

Send us your answer (from the table above) on your business card or on a post card containing your name and address. You will receive the correct answer and become eligible to win a Hewlett Packard scientific calculator in a random drawing on April 15, 1994.



Potomac Instruments, inc.

932 Philadelphia Avenue, Silver Spring, Maryland 20910 • (301) 589-2662 • FAX (301) 589-2665

Products & Services Showcase

For more information on the products shown below, circle the appropriate Reader Service No.(s) on the enclosed Subscription/Reader Service card or contact the advertiser directly.

TAPECASTER® X-701 Series Cart Machine

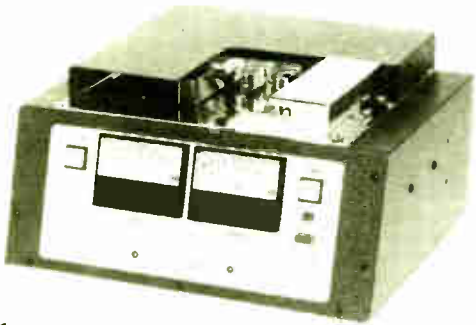

**1/2 Price With Trade-In
Call Now!**

TAPECASTER, INC.

7174A 302 Industrial Dr.
Southaven, MS 38671

Tel: 1-601-349-2881 • Fax: 1-601-349-2882
Toll Free: 1-800-638-0977

READER SERVICE NO. 65

LOWER THAN FACTORY PRICES!



TELEWAVE, INC.
SITE MANAGEMENT EQUIPMENT



- Wideband Wattmeters
- Bandpass Cavities
- Low Noise Preamplifiers
- Receiver Power Splitters
- Loads ■ Duplexers



ALSO IN STOCK:

RFI
CONNECTORS
CABLES • KITS
ACCESSORIES

WHELEN
STROBES &
LIGHTS for
your REMOTE
VEHICLES

Call Tim for Your FREE Catalogue!

1-800-548-2484

FREE
Tuning

Sharp
COMMUNICATION

SAME DAY
Shipping

WHOLESALE DISTRIBUTOR

3403 Governors Drive - Huntsville, AL 35805

READER SERVICE NO. 130

AUDIO SWEEP GENERATOR



- Flat Frequency Response
- 1% Frequency Accuracy
- 1% Distortion
- Battery Powered

This compact generator provides low distortion sine waves at fixed, variable or swept audio frequencies. The output amplitude, once set, remains flat from 20 Hz to 20 KHz ($\pm 1/4$ dB). The sine wave output is adjustable from 0 to 1.5 volts p.p. Size 5 3/4" x 3 1/2" x 1/8". Two models available.

**production
devices**

215 Denny Way, El Cajon, CA 92020
TOLL FREE (800) 824-4226

READER SERVICE NO. 39

A New Dats/Sedat Digital Satellite Receiver Shipping Now!

Ariel



Replace your Dart, S/A Dat 32 7300

- Dart 384 Compatible - Dats/Sedat/McCurdy
- Uses consumer-grade LNB & RG-6
- Adapts easily to current LNA systems
- 5 card slots
- Extra heavy duty power supply
- New 7.5/15 KHz switchable Dats card

**We Repair & Rebuild all
major brands of Satellite Receivers
48 Hour Turnaround
Zephyrus SCPC & Subcarrier**

Satellite Systems 24 Hour
(719) 634-6319 Phone / Fax
(Fax) 635-8151 Technical Support
All Networks & Receivers

READER SERVICE NO. 85



If you see it in the
pages of Radio World,
we can finance it for you!



Assisting you with all your
new & used equipment needs.

PLC 1-800-999-9546
(ext. 132)
Priority Leasing Corporation

READER SERVICE NO. 42

The CircuitWerkes DTMF-16 TouchTone Decoder



Inexpensive & Convenient Control

- Decodes all 16 DTMF tones.
- Bridging input & high current opto-isolated outputs.
- Jumper selectable beep-tone acknowledges commands.
- Momentary or Interlocked Latching output modes.
- Available with built-in AC-2 autocoil to form a dial-up remote control.
- Suggested list price is an economical \$169.

The DTMF-16 is excellent for interfacing various networks to automation, controlling remote satellite receivers, repeaters, etc. The compact, light & rugged DTMF-16 can be put almost anywhere to provide the remote controls that you need. For more info, contact your favorite broadcast supplier or call us.

CircuitWerkes

6212 SW 8th Place
Gainesville, Florida 32607
(904) 331-5999 / Fax 331-6999



READER SERVICE NO. 109

WE REPRESENT THE FINEST MANUFACTURERS OF BROADCAST AND RECORDING STUDIO EQUIPMENT

AUDIO BROADCAST GROUP INC.

A new beginning for an
Industry standard!
Now with 3 sales offices to
more efficiently provide all your
broadcast equipment needs.

For additional information on how we can serve you, please call today

MAIN SALES OFFICE 2342 S. Division Avenue
Grand Rapids, Michigan 49507
Phone: 800-999-9281
Fax: 616-452-1652

SOUTHEASTERN SALES OFFICE 200 Fareway Drive, Suite 2
Smithfield, North Carolina 27577
Phone: 800-369-7623
Fax: 919-934-8120

WESTERN SALES OFFICE P.O. Box 1638
Palmdale, California 93550
Phone: 800-858-9008
Fax: 800-273-3321



For over 32 years

**AUDIO
BROADCAST
GROUP**

READER SERVICE NO. 18

Uniformity. Durability. Dependability.



BROADCAST CARTRIDGE SERVICE, INC.
15131 Triton Lane, Suite 108
Huntington Beach, CA 92649
(714) 898-7224

READER SERVICE NO. 114

OTARI

Quick and Easy Editing Possible with ProDisk

FOSTER CITY, Calif. The Otari ProDisk 464 digital audio workstation includes a host of powerful features designed to make broadcast production faster and easier.

Expandable from four to 64 channels, track arming, sound levels, scrubbing, cutting, pasting, track slipping and fades all can be easily seen and changed either from the optional CB-158 control panel, with all dedicated function buttons, or performed on the screen with a mouse/trackball and qwerty keyboard. Off the shelf MIDI-driven fader panels can be easily plugged into the ProDisk for cost-effective hardware control of gain and panning.

The ProDisk's standard +4 balanced analog I/O make it easy to interface with other professional broadcast equipment. Digital I/O also are available.

The standard four-track system comes with a 650 MB fixed hard drive for 120 total track minutes, but can be expanded to 180 minutes with an optional 1 GB drive.

Projects can be easily transferred between multiple ProDisk systems if they

are equipped with the SoundShare™ option. SoundShare uses either removable magneto-optical or removable hard drives for fast and easy transfers.

An 8 mm Exabyte tape drive for storage and backup is standard.

Otari's new time compression/expansion option allows you to compress or expand a file in time with no change in pitch. Simply set the edit in and edit out

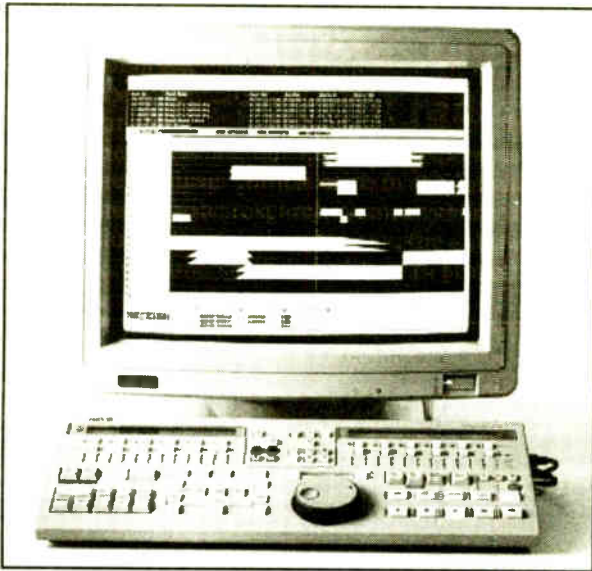

points on the "Guide" screen, push one button and the selected sound file or region expands or compresses to fit the edit in and out points. No time consuming calculations are necessary.

For information from Otari, contact Matt Ward in California at 415-341-5900; fax: 415-341-7200; or circle Reader Service 146.

THE MANAGEMENT

AXS Includes Digital Cut Editor

FORT WORTH, Texas AXS (ax'sess), created and marketed by The Management, is designed as a direct replacement for cart machines both on air and in the production room. Its design allows a single computer to replace cart playback machines and carts in the control room.

With up to three overlapping audio playback sources and one independent record/play source operating simultaneously, there is no end to the flexibility AXS offers on-air personnel.

EOM control is set by individual audio cut for smooth overlap of multiple sources, and spontaneous playback of audio cuts is as easy as pushing a button.

AXS runs on a 486-based computer with 2MB RAM, two serial ports, one parallel port, VGA color monitor and 512k adaptor. Hard disk storage at 32 kHz sample rate (16 kHz frequency response) is approximately 1MB per minute for mono. 2MB per minute for stereo.

Options include a PC-based four-channel switcher, an external eight-channel, Dual buss design, button box, digital cut editor and more, but all of the basics are

already in the system.

AXS uses the apt-X compression algorithm for clean, crisp reproduction with sampling rates up to 48,000. Log-based operation allows for instant information and easy log editing. On screen tags and "copy with preview" mode give your on-air staff unprecedented flexibility and easy of use.

Systems start at \$3,500.

For information, contact Adrian Charlton in Texas at 800-334-7823; fax: 817-624-9741; or circle Reader Service 191.

ENCO

ENCO DAD486x Uses Graphic Waveform Editing

ST. LOUIS The DAD486x digital audio delivery system from ENCO Systems offers users a cost effective solution for total system needs, functionality, future growth and hardware compatibility and a capability of support by any competent computer technician.

As a digital audio workstation, the DAD486x uses visual graphic waveform editing. This editing mode lets a user hear and see the results of head/tail trimming, cue tone placement, cuts and pastes, and segue fade points.

Features of the DAD486x include: production with graphic cut and paste assembly editing; multi-output on-air capabilities for both live assist and automated operations; scheduling management; and interface to other studio equipment. The DAD is simple to learn, easy to use and requires no computer expertise to operate.

The DAD486x operates on MS-DOS, the world's most widely used operating system, and standard off-the-shelf hardware.

DAD486x can be configured for any size facility from a single standalone workstation with simultaneous on-air and production capabilities to large, integrated multi-workstation systems, operating on a conventional high speed local area network (LAN).

Small systems can easily grow large, utilizing the same basic hardware and software.

For information, contact Larry Lamoray in Missouri at 800-362-6797; fax: 314-453-0061; or circle Reader Service 125.

TASCAM

TASCAM Designed for Low-Cost Digital Production

MONTEBELLO, Calif. The TASCAM DA-88 is designed specifically for low cost digital multitrack production.

Using Hi8 tape for 108 minutes of recording time, the DA-88's tape transport is designed for the abuse that production studios dish out. It is quiet, fast, accurate and solid. The shuttle wheel moves the tape at one-fourth to eight-times the normal play speed. And the location is easily viewed on the DA-88's eight-digit absolute time display.

The DA-88 works logically and like an analog deck, all functions are operated from the front of the deck. Punch-ins and -outs, for example, can be done on single tracks on the fly by

hitting the track button at the punch-in point or with an optional foot switch. Or, for multiple tracks, select the track numbers and use "Record" to punch-in, "Play" to punch-out. Or, for frame accurate punch-ins, there is an auto-punch feature. In any case, TASCAM's variable digital crossfade technology makes the punch-ins and -outs seamless.

Pitch is user-selectable +/-6 percent, as are crossfade and track delay times. Either 44.1 kHz or 48 kHz sampling rate can be selected. Flat frequency response is 20 Hz to 20 kHz and the dynamic range is greater than 92 dB.

With the addition of the optional SY-88 synchronizer card, the DA-88 becomes SMPTE and MIDI compatible.

For information, contact Bill Mohrhoff in California at 213-726-0303; fax: 213-727-7635; or circle Reader Service 141.

This could be the last cassette deck you'll buy this century.

Since cassette decks are still standard equipment in any studio, it makes sense to turn to a deck that you can rely on both now and in the future: the TASCAM 112 MK II. Because even on the worst of days, the 112 MK II will be the one thing you can always depend on to work right. No prodding, kicks or angry swats needed.

Of course, the 112 MK II offers you key features like three locate points, cue and review and an optional easy-to-install kit for adding +4dBm balanced XLR inputs and outputs.

It's rugged. It's reliable.

It's powerful. What more could you ask for from a professional stereo cassette deck that takes its job just as seriously as you do — and is bent on outliving most of the other equipment that you have in the studio. Pick up a 112 MK II today and make it the last deck you'll buy this side of the 20th century.



The popular 112 MK II, available with a balanced XLR input/output kit, is the industry's rugged and reliable cassette deck for broadcast and production studios.

TASCAM
Take advantage of our experience.

©1993 TEAC America, Inc. 773; Telegraph Road, Montebello, CA 90640 213/726-0303.

Circle (202) On Reader Service Card

See The
New EBS System
In Booth 2800

**SAGE
ALERTING
SYSTEMS**

People, Promotions and Appointments

Broadcast Programming tapped radio veteran **Ken Moultrie** as a national programmer and consultant.

Shape Inc. expanded its professional and associated products division with the addition of **John Schattin** and **John Kay**.

Schattin is the new director of associated products sales and is developing a national network of professional and retail distributors and dealers for Shape products.

Kay is professional products sales manager responsible for dealing directly with studios, engineers and other professional users.

Cartwright Communications appointed **David Little** to its engineering ser-

vices department. Little's responsibilities include providing technical assistance to customers and designing custom combiners, duplexers and filters.

Richard A. Klein announced his retirement from **UNR-ROHN** after 37 years with the company. Klein remains available to the company on a consulting and advisory basis.

Dale Electronics tapped **Mike Bogen** as director of pro audio sales. Prior to joining Dale, Bogen was vice president of **Martin Audio/Video Corp.** and director of sales for the **AFA/Martin Pro Audio Group**.

Otari Corp. announced changes in its sales and marketing department. **James Goodman** was promoted to marketing

manager and **Lee Pomerantz** was promoted to national sales manager.

Andrew Corp. expanded **Barry Cohen's** responsibilities as broadcast antenna products business unit manager

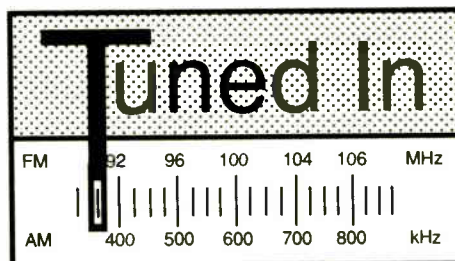

to include the design, manufacture and marketing strategy of Andrew's broadcast antenna product line worldwide.

Also, Andrew Corp. promoted **Debra Huttenburg** to broadcast systems busi-

ness unit manager.

Analog Devices Inc. selected **Christian Kermarrec** to lead the product development group for its new line of RF products. Analog Devices is focusing on complete chip-set solutions for portable and mobile phones.

Symetrix Inc. added **Sherri Swingle** to its team as marketing administrator. Swingle is responsible for implementing all marketing programs, advertising and public relations activities.

Company News

Avid Technology appointed **AudioTechniques** its exclusive representative for the New York metropolitan area. AudioTechniques will represent Avid's Media Composer, digital non-linear editing system, and AudiVision, track lay-up system to sync-lock digital picture to audio.

Clark Wire & Cable opened a new full-service custom cable termination facility at its Deerfield, Ill., headquarters. The facility is staffed by five full-time cable termination specialists to help supply customers with audio, video and A/V cable specifically tailored to individual needs.

Pioneer New Media Technologies Inc. announced the delivery of 34 Pioneer CAC-V3200 300-disc CD autochangers to **Digital Cable Radio (DCR)**. DCR is a satellite-delivered digital audio service, offering subscribers commercial-free music in specialized formats.

Scientific-Atlanta Inc. received approval of its **MariStar-M** and **MariStar Multi-M** satellite communications terminals from **Inmarsat** to provide maritime facsimile services.

Sabine Musical Manufacturing Co. doubled its factory space and production capacity. The company now covers 20,000 square feet in the Gainesville North Industrial Park in Florida.

Sabine manufactures electronic metronomes and accessories, as well as instrument tuners and feedback control devices.

Wegener Communications supplied **DR180** digital audio subcarriers to **USA Overnight**, a new radio network providing entertainment news and music programs to affiliate stations across the U.S.

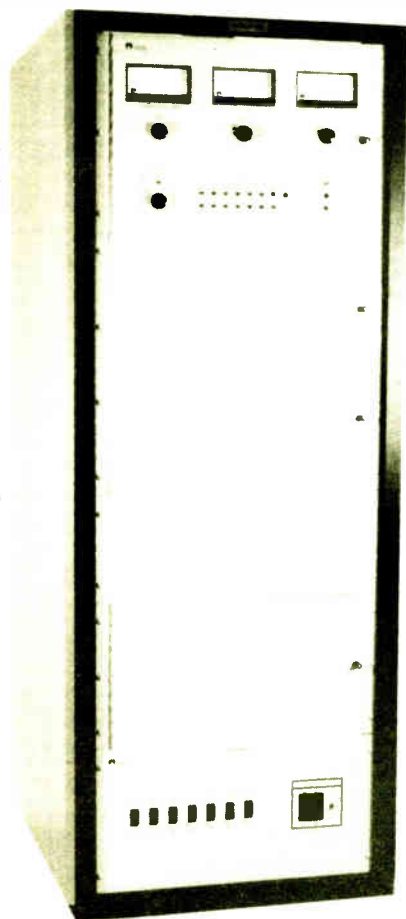

The inventor of high powered solid-state AM has perfected solid-state FM

You know us as worldwide suppliers of cost-effective, power-efficient solid-state AM transmitters.

Now we're proud to offer Nautel reliability, efficiency and serviceability in two new solid-state FM transmitters.

AMPFET FM4 4kW
AMPFET FM7 7kW

Get the full story on our complete line.
Call, write or FAX today.

Phone: (902) 823-2233 Canada • Fax: (902) 823-3183 • Telex: 019-22552

Nautel
(Nautical Electronic Laboratories Limited)
R.R. #1, Tantallon, Halifax County,
Nova Scotia, Canada B0J 3J0

Nautel Maine Inc.
201 Target Industrial Circle
Bangor, Maine 04401 U.S.A.



MOVING?...

Don't leave us behind!



Mail or fax your current label and new address (with effective date) to:

Circulation, Radio World
PO Box 1214
Falls Church, VA
22041, USA
or FAX 703-998-2966.

Address changes will be processed within four weeks of receipt. — Thanks!

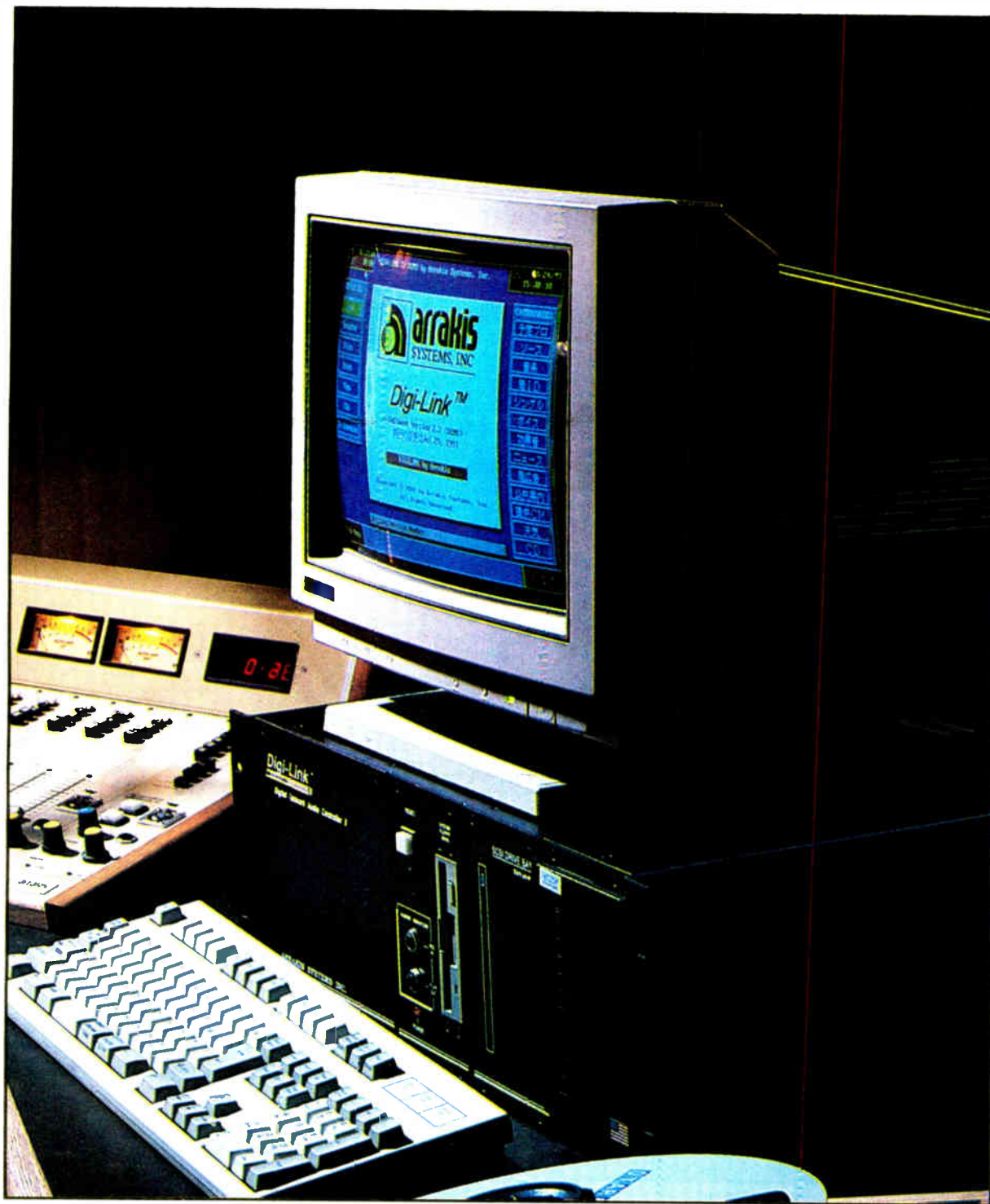

Join the Digital Revolution

Digilink by Arrakis is a digital audio workstation that does it all while increasing your profits.

You can replace your live on air cart machines while adding CD or satellite automation for nights or weekends. You can use just one workstation or network as many as 15 and send your spots & schedules in perfect digital between your studios. Add a Arrakis*Star eight track digital audio editor for under \$5,500 and you can quickly and easily produce spots that would have taken forever

or been impossible with tape.

Digilink is also easy to schedule. You can use the standard Digilink traffic & CD scheduling system or import music

and traffic schedules from all of the most popular 3rd party programs.

Features like simultaneous Play, Record, & Network transfer; hard disk to hard

disk & CD crossfade; cart rotation; Autofill; Smart-squeeze; Macros; and incredible ease of use make Digilink perfect for live & automation studios.

Digilink is #1---with more than 600 workstations sold worldwide from Moscow, to Japan, to Barbados, to your own back yard. When you make the decision to join the digital revolution at your station, call the experts at BSW.

The Digilink screen above is in Japanese, one of the many languages that Digilink 'speaks,' and is reprinted with the permission of Otartec

For Digilink

call

BSW

BROADCAST SUPPLY WORLDWIDE

1-800-426-8434

Arrakis System inc. — 2619 Midpoint Drive, Fort Collins, CO. 80525 --- Voice (303) 224-2248. FAX (303) 493-1076.

HARRIS PLATINUM SERIES®

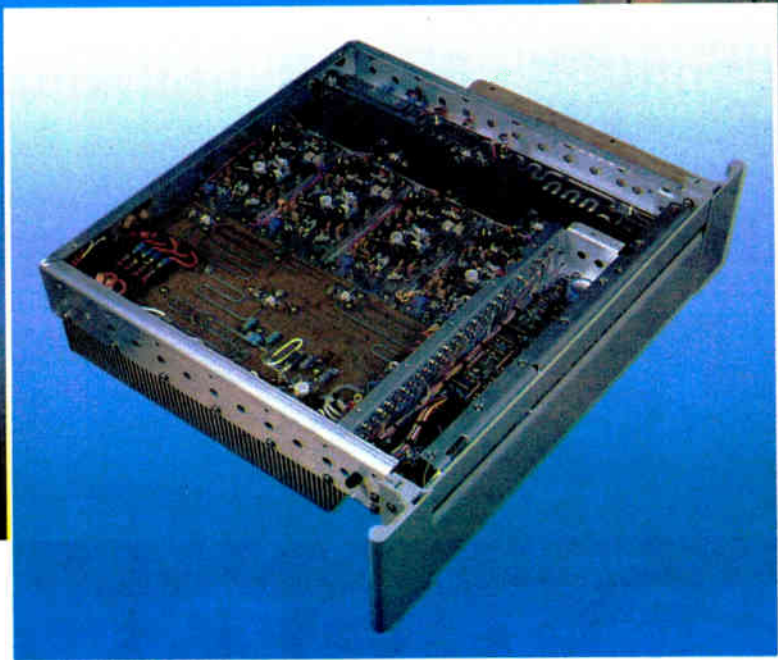

200,000 Hours' Fault-Free Performance. And Counting.

That's the level of reliability more than 70 users of Harris Platinum Series® 2-20 kW FM transmitters are experiencing from our FET solid state modules.

Broadcasters from Cyprus to Australia. New York to Madrid. China to Malta. Argentina to Slovenia. Toronto to Taiwan. North Dakota to Arkansas.

Beyond continuous transmitter availability, Platinum users are enjoying such benefits as:

- On-air service capability, up to 90% less routine maintenance and no requirements for tuning or adjustment;

- Superb signal quality under any combination of operating extremes;

- Immense flexibility in system design with such options as the world's first truly digital FM exciter with CD performance, N+1 capability, and switchless combining for high power transmitters.

To learn how a Platinum Series FM transmitter can work for you, please contact us:

U.S. and Canada:

Telephone: 217-222-8200

FAX: 217-224-1439

International:

Telephone: 217-222-8290

FAX: 217-224-2764

 **HARRIS
ALLIED**

Radio World

Broadcast Equipment Exchange

"Broadcast Equipment Exchange" accepts no responsibility for the condition of the equipment listed or for the specifics of transactions made between buyers and sellers.

ACOUSTICS

Want To Sell

STUDIOFOAM
SOUND ABSORBENT WEDGES
TESTS UP TO 40% BETTER THAN SONEX
* COSTS LESS * BETTER COLORS * BETTER CUT *

SONOMATT
470x2" Sheets • \$29.99 Ea. In Pairs • NRC .70 • STOPS LPS

VENUS 12" x 24" 4-MHC 1.30 • Rat 10K-125Hz
Then They Really Kick In (125Hz NRC =
BASS TRAP) • 1631 • Charcoal Gray • 2 For Just \$150!

USA From • Box 2039 • Indianapolis IN 46220 • (317) 251-2992

1-800-95-WEDGE

Circle (72) On Reader Service Card

AMPLIFIERS

Want To Sell

RTS-405 stereo TT preamp (2), \$145/ea + shpg, used 6 mths. B Lord, Lord Bldg, 13313 SE 208th St, Kent WA 98042. 206-631-2374.

Perma-Power S-102 amp w/S1420 batt pack, mobile/portable PA unit, 12 W out, excel cond, \$4100. R Sumner, CAVU Corp, 3322 Applegate Ct, Annandale VA 22003. 703-968-8894.

New 10 kW FM amp under \$24,000. Call for details. Bill Hoffman, 518-743-1601.

Dynaco stereo 120 solid state, rack mt \$229, Dynaco stereo 70 tube amp all new tubes! Dynaco PAT 4 preamps \$59. W Gunn 619-320-0728.

ANTENNAS/TOWERS/CABLES

Want To Sell

HJ8-50B, 3" Heliac, 350', new, \$5000 or best offer; 87R/87N/87L-3, 1-5/8" connectors, new, \$110 each. MBS Test Equipment Sales Corp, 305-477-6192.

Copper wire for radials also copper strap/screen, BO, ASAP. E Prendergast, KAOK, 318-882-0243, FAX 318-882-6731.

ERI FMH 12AC parts for old miter cut antenna, cheap; Myat 301-007 3" rigid transmission line, Myat & Phillips EIA flange, \$100/ea. T Wortmann, WJAG/KEXC, 309 Braasch, Norfolk NE 68701. 402-371-0780.

ICE KRACKERS, INC.
Inexpensive permanent protection of guy wire anchor hardware from guy wire ice slides. Average cost \$400 for 400-foot tower. ICE KRACKERS sized by guy wire diameter. All sizes available.
273 Circle Drive, Springfield, IL 62703
(800) 747-8921 or (217) 529-8921
Ask for Jim Newbanks

Jampro JSLP 6 bay on 97.9 MHz, excl cond, replaced for upgrade, incl 45' of 1 5/8" coax & one EIA connector, BO. A Crane, KWAZ, 2636 Hwy 95 #10, Bullhead City AZ. 602-763-5227.

ERI FML-3 3 bay tuned to 95.9, \$1000. F Troiani, WMRF-WIEZ Radio, 12 1/2 E Market St, Lewistown PA 17044. 717-248-6757.

Andrew 5" air coax 500' on I-80 in Iowa, connectors incl, \$10000. R Henry, WPJO, 505 Josephine St, Titusville FL 32796. 407-267-3000.

Andrew EW63A waveguide w/ends, (2) new rolls, 75' & 140' in boxes, BO/trade. M Kestler, KAWZ, 241 Main Ave W, Twin Falls ID 83303. 208-733-3133.

FM - ANTENNAS

Designed and built for your frequency. Choose from 1 to 12 bays and five power levels. Financing available. Call Jimmie Joynt at S.W.R. 214-335-3425

RCADielectric BCF-6B antenna, 6 bay tuned to 90.5, \$4000, (6) radomes, \$1500. A Clawson, WFFF, 1715 Michigan St, Sturgeon Bay WI 54235. 414-743-7443.

Jampro JMPC-10 10 bay circular FM antenna on 107.1, new cond, stored inside, \$9500/BO. B Zellmer, 303-353-6522.

Phelps Dodge CFM-LP3 3 bay FM on 92.1 MHz, removed 12/93, \$2500/BO; Cablewave HCC158-50J, 1-5/8" air coax, approx 260', \$800/BO. G Reinheimer, WYYD, POB 4108, Lynchburg VA 24502. 804-237-4700.

Andrews various 3" & 1 5/8" connectors, 100' of 3 1/8" Andrews line, (2) RF chokes Continental 814B + manual, BO; Continental ERI Rototiller tuned to 97.7, 3 bay, 1 5/8" lead, 1.5588 gain, BO/trade. B Hill, KACK FM, 106 S Jefferson, Mt Pleasant TX 75455. 903-577-9730.

ERI FMH-10AC 10 bay antenna, CP tuned to 105.5, \$19,500. M Wodlinger, WIXI, 3337 Tamiami Trail N, Naples FL 33940. 813-262-1000.

Phelps Dodge CFM-3, 3 bays, tuned to 98.3 MHz, gd cond w/heaters, \$1500. D Heinen, KRSE, POB 127, Yakima WA 98907. 509-248-1390.

Windcharger 200, 100', on ground, BO. J Kesler, WOBZ, POB 220, Livingston KY 40445. 606-843-9999.

Want To Buy

Coax switch (4) port 1 5/8" motorized, Bird 5 kW dummy load, RCA 11706 on-air light. L Lindstrom, WPOK, 315 N Mill, Pontiac IL. 815-844-6101.

3 or 4 bay antenna tuned to 90.7 MHz with brackets for small tower, w/w heaters or raydomes. K Austin, KFXI, 1101 Hwy 81N, Marlow OK 73055. 405-658-2556.

Used 700-980' tower; (2) used 400-500' towers. K Kuenzie, KFXE, 511 W 5th St, Washington MO 63090. 314-239-6800.

Looking for (4) 1 5/8" connectors to go on 1 5/8" cable. K Diebel, KTJC FM, 318-728-5852 days, 318-728-3578 nights.

ERI G5CPM tuned to 96.7, 180' Andrew HJ5-50 7/8" line. A Clawson, WFFF, 1715 Michigan St, Sturgeon Bay WI 54235. 414-743-7443.

AUDIO PRODUCTION

Want To Sell

CRL Dynafex DX-2 single ended stereo noise reduction, \$225; Belar Audio Sentry AS-1 (4), 3 years old, \$95/ea; Aphex M250 Aural Exciter III, \$415; Gentner TC100R w/DTMF decoder, \$245; (5) Trimm/ADC 2 rows of 1/4" jacks, half-normalled, brought out to ADC Ultrapatch, \$165/ea. Wes, 818-798-9128.

Eventide Ultra Harmonizer H3000, excl cond, \$2300. J Webb, KBZN Radio, 257 E 200 S #400, SLC UT 84111. 801-364-9836.

dbx 155 4 chnl encode/decode Type I NR (2), \$200 ea/\$375 both. P Cibley, Cibley Music, POB 751 Murray Hill Sta, NYNY 10156. 212-986-2219.

Kurzweil Midboard, \$1199; Kurzweil 1000 Px Plus sound module, \$799; Kurzweil 1000 Hx sound module, \$699; Kawai Q-80 sequencer, \$199; all mint. M Osborne, WKSQ, POB 9494, Ellsworth ME 04605. 207-667-7573.

Looking for Audio Bargains?

We BUY * SELL * TRADE
QUALITY USED EQUIPMENT
317-962-8596



Sparta 25 Hz tone gen & filter, \$200; (3) Sparta cart PB w/rack, mono, \$900; Sparta A-20B 8 chnl mono 1973 console, \$1000; (2) Sparta TTs w/tonerms & mono preamps, \$300 ea. P Bridges, KGKO, 202 E Cross, Benton AR 72015. 501-778-8257.

Correlation / Phase Indicator



A compact alternative to X/Y displays for Stereo / Mono Compatibility Checks
Tape Head Azimuth Adjustment
Transmission Path Evaluation
Stereo / Mono Identification
Signal Polarity Testing
CPI-300 — \$ 265

recording studio services
PO Box 3004
Hendersonville, TN 37077
Ph: 615-824-9300 Fax: 615-824-9303
Compuserve: 75366,311

Circle 98 On Reader Service Card

Digidesign Audiomedial digital recdgy & editing system, analog in & out, stereo w/Audiomedial Vol 2 software & deck 1 4-trk automated mix software, manuals. J O'Leary, 1717 Euclid St NW, Washington DC 20009. 202-332-8377.

Demeter 4 channel rack mount tube direct box NEW \$795. W Gunn 619-320-0728.

Sine Systems Stereo Watchdog, rides stereo balance, phase flip, subs loss of left or right chnl, \$425/BO. D Evans, KALW, 2576 Harrison, San Francisco CA 94110. 415-695-5740.

SAVE \$300 ON TT
96 & 144 POINT PATCH BAYS
brokers of fine and coarse used equipment
audio village 619/320-0728

UREI 537 33 band graphic equalizers (3), gd cond, will sell separate or together, \$250/ea or 3/\$600. Jeff, 703-297-1188.

Eventide digital delay, excl cond electronically, scratch on top cover when removed from equip rack. B Hill, KACK FM, 106 S Jefferson, Mt Pleasant TX 75455. 903-577-9730.

ADC 96 & 144 Pr TT patchbays, excel cond, 1 rack space, 3 rows of 48, top 2 rows normalled, \$149, 96 is 2 row normalled, \$129 (you remove old wiring) or we totally refurbish w/new front panel, ready to install, \$199-229. TT cords up to 10 per bay at \$9 ea, reg \$13.95, also 1/4" bays. Audio Village, 619-320-0728, or Fax 619-320-2454.

Want To Buy

Fairchild 600 conec or 602 Conex high freq limiters. J Gangwer, 942 32nd St, Richmond CA 94804. 415-644-2363.

AUTOMATION EQUIPMENT

Want To Sell

Cetec 7000 automation system w/terminal encoder & cables, (3) ITC PB reels w/rack, (3) IGM 42 tray Go-Carts w/racks, (2) IGM tray Go-Carts w/racks, 3" disk drive for backup, printer, case of paper 12-6" rolls, all cards, cables, switches for system, all machines have been rebuilt by fact & in service, will deliver within reasonable distance. T Yarbrough, WCDD, Winchester TN. 615-967-2201.

SMC DP 2 automation system, stereo, 2 Carousels, 3 Otari R-Rs PBs, PDC 5 clock, DS 20 switcher, computer, \$3500. P Bridges, KGKO, 202 E Cross, Benton AR 72015. 501-778-8257.

SMC MSP-1 automation system, complete w/4 Otari ARS-1000; (3) 350RSB Carousels, SMC 712 dual cart plyr, Universal interface, all in 3 matching SMC custom deluxe racks, manuals, in use, \$6000/BO; Harris 9001 automation incl 2 Otari ARS-1000, (2) IGM 24 Go-Carts, (2) sngl play ITC cart decks & 2nd system for spares or standby which incl brain, switcher, pwr spy, terminal, keyboard & manuals, \$4000/BO. R Wynne, KFLS/KKRB, 503-882-4656.

Control Design 25 Hz tone sensor, rack mount, \$150. P Bridges, KGKO, 202 E Cross, Benton AR 72015. 501-778-8257.

Panasonic SV-3500 DAT mach (2), \$750/ea. P Fowle, Common Mode, 50 Northfield Ave, West Orange NJ 07052. 201-736-7191.

Harris 9002 (5) ITC 750/770 PBs, 48 tray mono Instacart, 3 count deck PBs, 2 VDTs, manuals & schematics, now in use. J David, KMPL/KSTG, POB 907, Sikeston MO 63801. 314-471-1520.

Sono-Mag Mini-Pro w/remote head, (2) RS-350 Carousels, RSC-100 random programmer, (4) PR-99s, will sell sep or together, \$2750. S King, KGFL/FKPK, Box 33, Clinton AR 72031. 501-745-4474.

SMC 350 stereo Carousels (6), will sell one or all, you pay shpg, \$300/ea. J Leutz, KFBS, 2620 Dogwood Rd, Joplin MO 64801. 417-624-1310.

Auto Jock, gd cond, \$1000/BO. M Skinner, KSGI, 341 S Bluffs St, St George UT 84771. 801-628-1000.

Smartcaster 8 kHz hard drive audio computer, 4 hrs storage time, interfaces to major satellite networks or live assist, recently reconditioned, \$3000. R Miller, WTM/WCNL, Taylorville IL 62568. 217-824-3395.

Sparta automation system, stereo, 2 Carousels, 2 Revox R-Rs, 2 tone sensors, clock, RS 250 random access, 1052 program controller, silence sense, \$2500. P Bridges, KGKO, 202 E Cross, Benton AR 72015. 501-778-8257.

Sentry Systems cntrlr/interface automation w/16 Pioneer PD TM3 CD plyrs, XT computer, complete AC CD library & Computer Concepts DCS, under 1 yr old, \$26K/all or priced separately. M Rollings, Rollings Comm, POB 882, Chesterfield MO 63006. 314-458-5595.

HE HALL Electronics

1305-F Seminole Trail Charlottesville VA 22901

LPB 7000 Series Consoles

12-Channel and 18-Channel Stereo Consoles



- Front panel switches rated for 5,000,000 operations
- Gold contacts throughout
- Modular electronics behind unitary front panel
- Penny & Giles 3000 Series linear faders
- It cost less to own quality LPB equipment than you might think!

Call us for the best NEW & REBUILT equipment! (804) 974-6466 Fax: (804) 974-6450

Circle (207) On Reader Service Card

World Radio History

Inovonics, Inc.



530 FM MODULATION ANALYZER

- Eight station presets for comparative modulation measurements.
- Preset alarms indicate insufficient signal strength or excessive multipath effects.
- Three measurement ranges for Total Modulation, plus a calibrated Peak Flasher.
- Peak measurement integration characteristics are user-program mable.
- 80dB dynamic range for demodulated program level and noise readings.

List Price \$2,200 - HE Price much less!

HENRY RADIO



100W to 500W
Solid State

- Single tube grounded grid output with solid state IPA
 - Modular construction using quality standard components
 - CD quality audio
 - Power levels from 100W to 20KW
 - Full 1 year warranty
- Order NOW beat April price increase!

AUTOMATION EQUIP...WTS

SMC 452 bi-directional, stereo Carousels, \$800 ea. R May, KULF, 306 E Main, Brenham TX 77833. 409-836-9411.

Harris 9001 automation w/(2) Otari ARS-1000, (2) IGM 24 Go-Carts, (2) single play ITC cart decks; also second system for spares or standby w/Brain, switcher, pwr supply, terminal, keyboard & manuals, \$4000/BO. R Wynne, KFLS, POB 1450, Klamath Falls OR 97601. 503-882-4656.

Schafer Series 7000 w/(4) Audiobles, (2) R-R, (3) racks, unknown cond, gd for parts, BO. G Reinmeimer, WYYD, POB 4108, Lynchburg VA 24502. 804-237-4700.

Smartcaster 8K mono, will interface w/satellite, (2) 60 MEG hard drives, \$3900. B Hill, KACK FM, 106 S Jefferson, Mt Pleasant TX 75455. 903-577-9730.

Scully automated system, useful for non-commercial AM/FM, BO. J Kesler, WOBZ, POB 220, Livingston KY 40445. 606-843-9999.

SMC MSP-1 automation system, complete w/(4) Otari ARS-1000, (3) 350RSB Carousels, SMC 712 dual cart player, universal interface, all in 3 matching SMC custom deluxe racks, manuals, in operation, \$6000/BO. R Wynne, KFLS, POB 1450, Klamath Falls OR 97601. 503-882-4656.

CART MACHINES

Want To Sell

ITC PDII mono, R/P, gd shape, \$250 + shpg. W Wawro, WFAA, 606 Young St, Dallas TX 75202. 214-977-6260.

Tapecaster R/P cart mach (2), \$1500/BO. M Skinner, KSGI, 801-628-1000.

ITC R/P stereo cart machine, gd cond, \$950 plus shpg; ITC 3 deck stereo PB cart machine, all tones, gd cond, \$900 plug shpg. R Statham, WSTU, 1000 NW Alice Ave, Stuart FL 34994. 407-692-1000.

Audi-Cord DL Series stereo R/PB, \$700/BO. R Wynne, KFLS/KKRB, 503-882-4656.

Great Prices on original equipment tape heads for ITC, BF, Fidelipac, Otari, Tascam & others!



(804) 974-6466 • FAX 6450

Audi-Cord DL series stereo R/PB, \$700/Best Offer. R Wynne, KFLS, POB 1450, Klamath Falls OR 97601. 503-882-4656.

Audi-Cord DL Series (3) stereo play only, \$3500 ea, DL/RS R/P, \$900. R May, KULF, 306 E Main, Brenham TX 77833. 409-836-9411.

No matter how you stack it...



Nobody reconditions tape heads like JRF.

- Heads restored to new performance spec at a fraction of new cost
- Cart machines and all open reel formats
- Full line of replacement heads for all manufacturers

Experience the difference experience makes. Ask around. Nobody treats you or your heads better than JRF.



249 Kennedy Rd., Greendell, NJ 07839
(201) 579-5773 Fax (201) 579-6021

Harris triple deck stereo cart machine, totally recond, looks/operates like new w/all connectors, \$900. G Jones, SW Mediacast, 110 Sierra Rd, Kerrville TX 78028. 210-367-4587.

Electro Audio/Video presents 10% off for a 10 day sale

- ◆ Repairs & reconditions
- ◆ Motor rebuilds to quiet, flutter free operation
- ◆ Over 2,000 manuals for support
- ◆ 10,000+ parts for supply

Surplus Special: ITC 3D Top Bearings \$45.00 ea.

M. O'Drobinak (619) 758-0888

BE 5300C tripledeck, stereo, PB, mint less than 50 hrs, BO. R Kaufman, Pams Prods, POB 462247, Garland TX 75046. 214-271-7625, after 3PM CDT.

Want To Buy

ITC 3-D stereo w/tones or Delta 3 stereo, stereo SP's ok, need not be in wrkg order. L Lindstrom WPOK, 315 N Mill, Pontiac IL. 815-844-6101.

ITC PD-II, need one R/P unit, one PB for simple newsroom operation, nothing fancy, no junk. A Sutton, WBCU, POB 70, Union SC 29379. 803-427-2411.

ITC, BE, Fidelipac cart machines: single, triple, mono, stereo, play & record/play. Call M O'Drobinak @ 619-758-0888.

CASSETTE & REEL-TO-REEL RECORDERS

STUDER SERVICE SPECIALIST

Thousands Served • Unbeatable Rates
Precision Capstan Resurfacing
Audio Advantage

Tel (615)742-3834 FAX (615)254-8826
PRICE-QUALITY-SERVICE
Let Us Prove It

Want To Sell

Conex CG 25A 25 Hz tone gen, adjust tone levels, timing intervals. Paul, 612-222-5555.

Studer B67 1/4" 2-trk 7.5, 15 & 30 ips w/stand, gd cond, \$1500. D Harris, Studio B Prod, 1018 Central Ave, Charlotte NC 28204. 704-372-9661.

Marantz PMD 360 port, gd cond, \$135 + shpg; Otari 5050 full trk, remote, gd cond, \$650/BO. J Rudisill, Audio Independence, POB 640742, San Jose CA 95164-0742. 408-321-8373.

ITC erase, splice finder machine (2), one in gd cond, other needs work, \$800/both plus shpg. R Statham, WSTU, 1000 NW Alice Ave, Stuart FL 34994. 407-692-1000.

Revox A-77 R-R R/P tape machines (2), \$600 ea. P Bridges, KGKO, 202 E Cross, Benton AR 72015. 501-778-8257.

REVOX PARTS/SERVICE

Cassette-CD-Open reel Rebuilt B77s, \$900.⁰⁰
Capstan resurfacing, ALL BRANDS.
JM TECHNICAL ARTS
30 Music Sq. W. #156
Nashville, TN 37203 (615) 244-6892

Ampex 350 transports (3), \$35 ea or all for \$100 plus shpg. L Houck, Rollin Recdg, 210 Altgelt, San Antonio TX 78201. 210-736-5483.

Tascam 688 cassette multitrack recorder/mixer, mint condition, \$1900/BO + shpg; Revox PR99 recorder 7.5-15 ips w/carry case & speaker, good condition, \$800/BO + shpg. W Wawro, WFAA, 606 Young St, Dallas TX 75202. 214-977-6260.

Uher 4200 Report Monitor, R-R stereo 1/2 track portable, 3 heads, 4 speeds, new in box, \$500. R Sumner, CAVU Corp, 3322 Applegate Ct, Annandale VA 22003. 703-968-8894.

Otari MX 5050, \$1800. R May, KULF, 306 E Main, Brenham TX 77833. 409-836-9411.

Revox B-77 open reel recorder, 7.5-15 ips, 1/2 track, good condition, \$575; Sony PCM-F1 digital recording system, F1 digital processor modified with Apogee input filters & external sync input, \$1500/complete system, \$1000/F1 processor only. R Streicher, Pacific A/V Enter, 545 Cloverleaf Way, Monrovia CA 91016. 818-359-8012.

HEAD RELAPPING/REPLACEMENT

All tape and film formats
30 years experience



350 N. Eric Drive
Palatine, IL 60067
708-358-4622

Telex 235 3:1 cassette duplicator, like new, \$650 plus shpg. S Russell, 60410 Klett Dr, Decatur MI 49045. 616-782-9258.

Scully '100' recorders, record/play amplifiers, 8, 16, 24 track heads. Sequoia Electronics, 4646 Houndshaven Way, San Jose CA 95111. 408-363-1646.

Otari ARS 1000 (2) gd cond, w/25 Hz, \$400/ea. B Hill, KACK FM, 106 S Jefferson, Mt Pleasant TX 75455. 903-577-9730.

STUDER/REVOX

Factory Authorized Service
"Superlative Service"

Over 14,000 units serviced! Fast turnaround w/War. Huge parts inventory. New/Used Equip., Capstan shaft resurfacing.

STUDIO-SONICS
450 W. Rand Road
Mt. Prospect, IL 60056
708-670-0025

Tascam 34B 4 trk R-R, all manuals, cables, roll-around stand, very little use, excel, \$650. A Selk, Selk Prod, 1391 Normandy Dr #1, Atlanta GA 30306. 404-876-8894.

OTARI FACTORY DIRECT

Accessories Clearance
Call (415) 341-5900
Fax (415) 341-7200

Otari Corp.
378 Vintage Pk. Dr.
Foster City, CA 94404

Up to 50% Off Limited Time Offer

Otari Mark II-IV 1/2" 4-track, multi-track, mint, less than 50 hours, Best Offer. R Kaufman, Pams Productions, POB 462247, Garland TX 75046. 214-271-7625, after 3PM CDT.

Otari 5050 MK III-8 trk, heads excellent, \$2450. Wayne Gunn 619-320-0728.

Otari ARS-1000 (2), mint cond, BO. J Kesler, WOBZ, POB 220, Livingston KY 40445. 606-843-9999.

SCULLY TAPE RECORDERS

PARTS AND SERVICE

SEQUOIA ELECTRONICS
4646 Houndshaven Way
San Jose, CA 95111
(408) 363-1646
FAX (408) 363-0957

Recordex 6 cassett rewriter \$100; Tascam 40-4 4 trk 10" in flight case w/free dbx \$750; MRL new short test tapes \$39 for 1/4" to \$199 for 2". W Gunn 619-320-0728.

16 track 2" \$3450, MCI JH110C-8 \$2800, 110C-8 play only \$500, ATR800 mono or Tascam 7300 or 2502 \$600 ea, MCI Localor III \$1195, Tascam 52 2 trk \$1200, Ampex AG350 electr \$50/ch. W Gunn 619-320-0728.

Want To Buy

Ampex tube recorders and mixers. W Gunn, 619-320-0728.

EMPLOYMENT

To place ads in this section, use the ActionGram form. To respond to box numbers write Radio World, PO Box 1214, Falls Church, VA 22041. Attn: _____

POSITIONS WANTED

Hands On Engineer with over 30 years of AM/FM/TV. MF/HF/JHF background, desires position with Int'l SW bdcg facility, FCC Gen SBE Cert, IEEE, AE Degree. Lou, 904-383-8457.

Freelance writer available for radio/TV infomercials, rare combination of direct mktg & bdcg skills, 24 hr FAX. Call Doug, 510-531-2404.

Ready to go to work for your station, young prod man w/multi-media exper, willing to relocate, recent graduate. Brad, 405-329-5632.

Broadcast engineer w/high pwr RF exper, instructor in training & safety skills, seeks career opportunity. Ed C, 207-732-5185.

If you master analog music tapes for radio stations & need more assistance, I have exper/equip. R Bass, 4100 O'Hare, Mesquite TX 75150-4454.

Creative, fun radio is only a call away! Dedicated, experienced air personality, recent morning gig w/prod skills, will relocate, AC/CHR/Oldies. Kevin, 609-863-1991

20 year vet in radio announcing & some part time sales, seeks full time announcing in AR, OK, MO, KS, TX. Call after 5PM, 501-337-5249.

Mama's Dead radio talk host David F Diamond is ready for new, major market. 901-761-5577

Agree experience isn't only years, tapes? Hire Janet 502-895-5888. FT announcing, programming aspirations. Computer literate, in radio since 1980 PT announcing, marketing exper, serious only..

Proven travel program personality writes, performs, produces ratings thru roof show, can handle callins, British accent. Phil, 408-866-8542.

Custom Voice IDs, spots, breakers, promos, etc, 25 year pro of Boston, NYC, Philly & DC. Write: JLC, Box 2733, Spring PA 19609.

Creative air personality, producer & copy-writer seeks music intensive country station in midwest, 12 years exper-encer. Tom, 319-568-2198.

Arizona only, chief engineer, experienced all phases of high power AM & FM, 20 yrs experience incl Top 50/100 mkt, dry warm climate, chief, group chief or contract. Send replies to: Radio World, POB 1214, Falls Church VA 22041. Attn: Box 94-01-26-01 RW.

Radio pro for hire, programming, management, versatile. Roger, 615-235-6889.

Radio dynamo seeks news job at medium mkt station, call for tape. M Kunkle, 814-226-9259 or 412-744-3270.

HELP WANTED

TOO MANY OPENINGS!

We have too many openings & not enough people to fill them. If you're serious about your career, we're just as serious about taking you to the next level! Hundreds of openings for air talent, news, mgmt, prod & sales, also many engineering positions available in all aspects of broadcasting...all you do is subscribe. **No % of your pay, no contracts!!** Besides our pub., we also have our BBS & Rapid Line (jobs by phone) up & running. Ask about our FREE referrals & resume bank. You'll be surprised at how inexpensive we are, check us out!

BROADCAST EMPLOYMENT WEEKLY
1-800-922-JOBS
1125 W Boone Ave., Nampa, ID 83651
BBS 1-208-467-4110

AUDIO CONSOLE TEST ENGINEER

Manufacturer of high quality audio mixing consoles for the television and radio broadcast markets currently seeks to fill a position in our console testing/quality assurance department.

The ideal test engineer will be at least an ASEE with a solid analog and TTL electronics background. This is a hands on testing/troubleshooting position in a fast paced manufacturing environment. Pro Audio, PC and Audio Precision experience are all big pluses. Send resume and three professional references to:

Test Engineer
PO Box 70
Mattydale, NY 13212

HELP WANTED

FEDERAL PROGRAM LETS YOU WORK FROM YOUR HOME

- ☆ IN YOUR SPARE TIME
- ☆ SET YOUR OWN HOURS
- ☆ NO EXPERIENCE
- ☆ NO TRAINING NEEDED
- ☆ GUARANTEED INCOME
- ☆ BE YOUR OWN BOSS

CALL NOW
713-587-5407
1-800-618-8554
D. & K. ASSOC.
6180 Hwy, 6 N. Ste. # 257 Houston, TX 77088

Radio World

Broadcast Equipment Exchange

"Broadcast Equipment Exchange" accepts no responsibility for the condition of the equipment listed or for the specifics of transactions made between buyers and sellers.

ACOUSTICS

Want To Sell

STUDIOFOAM
SOUND ABSORBENT WEDGES
TESTS UP TO 40% BETTER THAN SONEX
* COSTS LESS - BETTER COLORS - BETTER CUT *

SONOMATT
478K2 Sheets • 39.99 Ea. In Pairs • NRC .70 • Strips UPS
VENUS 12" x 2' x 4" NRC 1.30 • Real 10K-125Hz
Then They Really Kick In 125Hz NRC
BASS TRAPS 11631 • Charcoal Gray • 2 For Just \$150!

USA Form • Box 203 • Independence, MO 64220 • (317) 251-2932
1-800-95-WEDGE

Circle (72) On Reader Service Card

AMPLIFIERS

Want To Sell

RTS-405 stereo TT preamp (2), \$145/ea + shpg, used 6 mths. B Lord, Lord Bdcg, 13313 SE 208th St, Kent WA 98042. 206-631-2374.

Perma-Power S-102 amp w/S1420 batt pack, mobile/portable PA unit, 12 W out, excel cond, \$4100. R Sumner, CAVU Corp, 3322 Applegate Ct, Annandale VA 22003. 703-968-8894.

New 10 kW FM amp under \$24,000. Call for details. Bill Hoffman, 518-743-1601.

Dynaco stereo 120 solid state, rack mt \$229, Dynaco stereo 70 tube amp all new tubes! Dynaco PAT 4 preamps \$59. W Gunn 619-320-0728.

ANTENNAS/TOWERS/CABLES

Want To Sell

HJ8-50B, 3" Heliac, 350', new, \$5000 or best offer; 87R/87N/87L-3, 1-5/8" connectors, new, \$110 each. MBS Test Equipment Sales Corp, 305-477-6192.

Copper wire for radials also copper strap/screen, EO, ASAP. E Prendergast, KAO, 318-882-0243, FAX 318-882-6731.

ERI FMH 12AC parts for old miter cut antenna, cheap; Myat 301-007 3" rigid transmission line, Myat & Phillips EIA flange, \$100/ea. T Wortmann, WJAG/KEXC, 309 Braasch, Norfolk NE 68701. 402-371-0780.



ICE CRACKERS, INC.
Inexpensive permanent protection of guy wire anchor hardware from guy wire ice slides. Average cost \$400 for 400-foot tower. ICE CRACKERS sized by guy wire diameter. All sizes available.
273 Circle Drive, Springfield, IL 62703
(800) 747-8921 or (217) 529-8921
Ask for Jim Newbanks

Jampro JSLP 6 bay on 97.9 MHz, excl cond, replaced for upgrade, incl 45' of 1 5/8" coax & one EIA connector, BO. A Crane, KWAZ, 2636 Hwy 95 #10, Bullhead City AZ. 602-763-5227.

ERI FML-3 3 bay tuned to 95.9, \$1000. F Troiani, WMRF-WIEZ Radio, 12 1/2 E Market St, Lewistown PA 17044. 717-248-6757.

Andrew 5" air coax 500' on I-80 in Iowa, connectors incl, \$10000. R Henry, WPIO, 505 Josephine St, Titusville FL 32796. 407-267-3000.

Andrew EW63A waveguide w/ends, (2) new rolls, 75' & 140' in boxes, BO/trade. M Kestler, KAWZ, 241 Main Ave W, Twin Falls ID 83303. 208-733-3133.

FM - ANTENNAS

Designed and built for your frequency. Choose from 1 to 12 bays and five power levels. Financing available. Call Jimmie Joynt at S.W.R. **214-335-3425**

RCA/Dielectric BCF-6B antenna, 6 bay tuned to 90.5, \$4000, (6) radomes, \$1500. A Clawson, WPF, 1715 Michigan St, Sturgeon Bay WI 54235. 414-743-7443.

Jampro JMPC-10 10 bay circular FM antenna on 107.1, new cond, stored inside, \$9500/BO. B Zellmer, 303-353-6522.

Phelps Dodge CFM-LP3 3 bay FM on 92.1 MHz, removed 12/93, \$2500/BO; Cablewave HCC158-50J, 1-5/8" air coax, approx 260', \$800/BO. G Reinheimer, WYYD, POB 4108, Lynchburg VA 24502. 804-237-4700.

Andrews various 3" & 1 5/8" connectors, 100' of 3 1/8" Andrews line, (2) RF chokes Continental 814B + manual, BO; Continental ERI Rotobiller tuned to 97.7, 3 bay, 1 5/8" lead, 1.5588 gain, BO/trade. B Hill, KACK FM, 106 S Jefferson, Mt Pleasant TX 75455. 903-577-9730.

ERI FMH-10AC 10 bay antenna, CP tuned to 105.5, \$19,500. M Wodlinger, WIXI, 3337 Tamiami Trail N, Naples FL 33940. 813-262-1000.

Phelps Dodge CFM-3, 3 bays, tuned to 98.3 MHz, gd cond w/heaters, \$1500. D Heinen, KRSE, POB 127, Yakima WA 98907. 509-246-1390.

Windcharger 200, 100', on ground, BO. J Kesler, WOBZ, POB 220, Livingston KY 40445. 606-843-9999.

Want To Buy

Coax switch (4) port 1 5/8" motorized, Bird 5 kW dummy load, RCA 11706 on-air light. L Lindstrom, WPOK, 315 N Mill, Pontiac IL. 815-844-6101.

3 or 4 bay antenna tuned to 90.7 MHz with brackets for small tower, w/w heaters or raydomes. K Austin, KFXI, 1101 Hwy 81N, Marlow OK 73055. 405-658-2556.

Used 700-980' tower; (2) used 400-500' towers. K Kuenzie, KFXE, 511 W 5th St, Washington MO 63090. 314-239-6800.

Looking for (4) 1 5/8" connectors to go on 1 5/8" cable. K Diebel, KTJC FM, 318-728-5852 days, 318-728-3578 nights.

ERI G5CPM tuned to 96.7, 180' Andrew HJ5-50 7/8" line. A Clawson, WPF, 1715 Michigan St, Sturgeon Bay WI 54235. 414-743-7443.

AUDIO PRODUCTION

Want To Sell

CRJ Dynafex DX-2 single ended stereo noise reduction, \$225; Belar Audio Sentry AS-1 (4), 3 years old, \$95/ea; Aphex M250 Aural Exciter III, \$415; Gentner TC100R w/DTMF decoder, \$245; (5) Trimm/ADC 2 rows of 1/4" jacks, half-normalled, brought out to ADC Ultrapatch, \$165/ea. Wes, 818-798-9128.

Eventide Ultra Harmonizer H3000, excl cond, \$2300. J Webb, KBZN Radio, 257 E 200 S #400, SLC UT 84111. 801-364-9836.

dbx 155 4 chnl encode/decode Type I NR (2), \$200 ea/\$375 both. P Cibley, Cibley Music, POB 751 Murray Hill Sta, NYNY 10156. 212-986-2219.

Kurzweil Midiboard, \$1199; Kurzweil 1000 Px Plus sound module, \$799; Kurzweil 1000 Hx sound module, \$699; Kawai C-80 sequencer, \$199; all mint. M Osborne, WKSQ, POB 9494, Ellsworth ME 04605. 207-667-7573.

Looking for Audio Bargains?

We BUY * SELL * TRADE
QUALITY USED EQUIPMENT
317-962-8596



Sparta 25 Hz tone gen & filter, \$200; (3) Sparta cart PB w/rack, mono, \$900; Sparta A-20B 8 chnl mono 1973 console, \$1000; (2) Sparta TTs w/tonerms & mono preamps, \$300 ea. P Bridges, KGKO, 202 E Cross, Benton AR 72015. 501-778-8257.

Correlation / Phase Indicator



A compact alternative to X/Y displays for Stereo / Mono Compatibility Checks
Tape Head Azimuth Adjustment
Transmission Path Evaluation
Stereo / Mono Identification
Signal Polarity Testing
CPI-300 — \$ 265
recording studio services
PO Box 3004
Hendersonville, TN 37077
Ph: 615-824-9300 Fax: 615-824-9303
Compuserve: 75366,311

Circle 98 On Reader Service Card

Digidesign Audiomedia I digital recd & editing system, analog in & out, stereo w/Audiomedia Vol 2 software & deck I 4-trk automated mix software, manuals. J O'Leary, 1717 Euclid St NW, Washington DC 20009. 202-332-8377.

Demeter 4 channel rack mount tube direct box NEW \$795. W Gunn 619-320-0728.

Sine Systems Stereo Watchdog, rides stereo balance, phase flip, subs loss of left or right chnl, \$425/BO. D Evans, KALW, 2576 Harrison, San Francisco CA 94110. 415-695-5740.



SAVE \$300 ON TT
96 & 144 POINT PATCH BAYS
brokers of fine and coarse used equipment
audio village 619/320-0728

UREI 537 33 band graphic equalizers (3), gd cond, will sell separate or together, \$250/ea or 3/\$600. Jeff, 703-297-1188.

Eventide digital delay, excl cond electronically, scratch on top cover when removed from equip rack. B Hill, KACK FM, 106 S Jefferson, Mt Pleasant TX 75455. 903-577-9730.

ADC 96 & 144 Pr TT patchbays, excel cond, 1 rack space, 3 rows of 48, top 2 rows normalled, \$149, 96 is 2 row normalled, \$129 (you remove old wiring) or we totally refurbish w/new front panel, ready to install, \$199-229. TT cords up to 10 per bay at \$9 ea, reg \$13.95, also 1/4" bays. Audio Village, 619-320-0728, or Fax 619-320-2454.

Want To Buy

Fairchild 600 conec or 602 Conex high freq limiters. J Gangwer, 942 32nd St, Richmond CA 94804. 415-644-2363.

AUTOMATION EQUIPMENT

Want To Sell

Cetec 7000 automation system w/terminal encoder & cables, (3) ITC PB reels w/rack, (3) IGM 42 tray Go-Carts w/racks, (2) IGM tray Go-Carts w/racks, 3" disk drive for backup, printer, case of paper 12-6" rolls, all cards, cables, switches for system, all machines have been rebuilt by fact & in service, will deliver within reasonable distance. T Yarbrough, WCDD, Winchester TN. 615-967-2201.

SMC DP 2 automation system, stereo, 2 Carousels, 3 Otari R-Rs PBs, PDC 5 clock, DS 20 switcher, computer, \$3500. P Bridges, KGKO, 202 E Cross, Benton AR 72015. 501-778-6257.

SMC MSP-1 automation system, complete w/4 Otari ARS-1000; (3) 350RSB Carousels, SMC 712 dual cart plyr, Universal interface, all in 3 matching SMC custom deluxe racks, manuals, in use, \$6000/BO; Harris 9001 automation incl 2 Otari ARS-1000, (2) IGM 24 Go-Carts, (2) sngl play ITC cart decks & 2nd system for spares or standby which incl brain, switcher, pwr sply, terminal, keyboard & manuals, \$4000/BO. R Wynne, KFLS/KKRB, 503-882-4656.

Control Design 25 Hz tone sensor, rack mount, \$150. P Bridges, KGKO, 202 E Cross, Benton AR 72015. 501-778-8257.

Panasonic SV-3500 DAT mach (2), \$750/ea. P Fowle, Common Mode, 50 Northfield Ave, West Orange NJ 07052. 201-736-7191.

Harris 9002 (5) ITC 750/770 PBs, 48 tray mono Instacart, 3 count deck PBs, 2 VDTs, manuals & schematics, now in use. J David, KMPL/KSTG, POB 907, Sikeston MO 63801. 314-471-1520.

Sono-Mag Mini-Pro w/remote head, (2) RS-350 Carousels, RSC-100 random programmer, (4) PR-99s, will sell sep or together, \$2750. S King, KGFL/FKPK, Box 33, Clinton AR 72031. 501-745-4474.

SMC 350 stereo Carousels (6), will sell one or all, you pay shpg, \$300/ea. J Leutz, KFSB, 2620 Dogwood Rd, Joplin MO 64801. 417-624-1310.

Auto Jock, gd cond, \$1000/BO. M Skinner, KSGI, 341 S Bluffs St, St George UT 84771. 801-828-1000.

Smartcaster 8 kHz hard drive audio computer, 4 hrs storage time, interfaces to major satellite networks or live assist, recently reconditioned, \$3000. R Miller, WTIM/WCNL, Taylorville IL 62568. 217-824-3395.

Sparta automation system, stereo, 2 Carousels, 2 Revox R-Rs, 2 tone sensors, clock, RS 250 random access, 1052 program controller, silence sense, \$2500. P Bridges, KGKO, 202 E Cross, Benton AR 72015. 501-778-8257.

Sentry Systems cntr/Interface automation w/16 Pioneer PD TM3 CD plyrs, XT computer, complete AC CD library & Computer Concepts DCS, under 1 yr old, \$26K/all or priced separately. M Rollings, Rollings Comm, POB 882, Chesterfield MO 63006. 314-458-5595.

HE HALL Electronics

1305-F Seminole Trail Charlottesville VA 22901

LPB 7000 Series Consoles

12-Channel and 18-Channel Stereo Consoles



- Front panel switches rated for 5,000,000 operations
- Gold contacts throughout
- Modular electronics behind unitary front panel
- Penny & Giles 3000 Series linear faders
- It cost less to own quality LPB equipment than you might think!

Call us for the best NEW & REBUILT equipment! (804) 974-6466 Fax: (804) 974-6450

Circle (207) On Reader Service Card

World Radio History

Inovonics, Inc.



530 FM MODULATION ANALYZER

- Eight station presets for comparative modulation measurements.
- Preset alarms indicate insufficient signal strength or excessive multipath effects.
- Three measurement ranges for Total Modulation, plus a calibrated Peak Flasher.
- Peak measurement integration characteristics are user-program mable.
- 80dB dynamic range for demodulated program level and noise readings.

List Price \$2,200 - HE Price much less!

HENRY RADIO



100W to 500W Solid State

- Single tube grounded grid output with solid state IPA
 - Modular construction using quality standard components
 - CD quality audio
 - Power levels from 100W to 20KW
 - Full 1 year warranty
- Order NOW beat April price increase!

AUTOMATION EQUIP...WTS

SMC 452 bi-directional, stereo Carousels, \$800 ea. R May, KULF, 306 E Main, Brenham TX 77833. 409-836-9411.

Harris 9001 automation w/(2) Otari ARS-1000, (2) IGM 24 Go-Carts, (2) single play ITC cart decks; also second system for spares or standby w/Brain, switcher, pwr supply, terminal, keyboard & manuals, \$4000/BO. R Wynne, KFLS, POB 1450, Klamath Falls OR 97601. 503-882-4656.

Schafer Series 7000 w/(4) Audiolies, (2) R-R, (3) racks, unknown cond, gd for parts, BO. G Reinmeimer, WYYD, POB 4108, Lynchburg VA 24502. 804-237-4700.

Smartcaster 8K mono, will interface w/satellite, (2) 60 MEG hard drives, \$3900. B Hill, KACK FM, 106 S Jefferson, Mt Pleasant TX 75455. 903-577-9730.

Scully automated system, useful for non-commercial AM/FM, BO. J Kesler, WOBZ, POB 220, Livingston KY 40445. 606-843-9999.

SMC MSP-1 automation system, complete w/(4) Otari ARS-1000, (3) 350RSB Carousels, SMC 712 dual cart player, universal interface, all in 3 matching SMC custom deluxe racks, manuals, in operation, \$6000/BO. R Wynne, KFLS, POB 1450, Klamath Falls OR 97601. 503-882-4656.

CART MACHINES

Want To Sell

ITC PDII mono, R/P, gd shape, \$250 + shpg. W Wawro, WFAA, 606 Young St, Dallas TX 75202. 214-977-6260.

Tapcaster R/P cart mach (2), \$1500/BO. M Skinner, KSGI, 801-628-1000.

ITC R/P stereo cart machine, gd cond, \$950 plus shpg; ITC 3 deck stereo PB cart machine, all tones, gd cond, \$900 plug shpg. R Slatham, WSTU, 1000 NW Alice Ave, Stuart FL 34994. 407-692-1000.

Audi-Cord DL Series stereo R/PB, \$700/BO. R Wynne, KFLS/KKRB, 503-882-4656.

Great Prices on original equipment tape heads for ITC, BF, Fidelipac, Otari, Tascam & others!

IE HALL Electronics

(804) 974-6466 • FAX 6450

Audi-Cord DL series stereo R/PB, \$700/Best Offer. R Wynne, KFLS, POB 1450, Klamath Falls OR 97601. 503-882-4656.

Audi-Cord DL Series (3) stereo play only, \$3500 ea, DL/RS R/P, \$900. R May, KULF, 306 E Main, Brenham TX 77833. 409-836-9411.

No matter how you stack it...



Nobody reconditions tape heads like JRF.

- Heads restored to new performance spec at a fraction of new cost
- Cart machines and all open reel formats
- Full line of replacement heads for all manufacturers

Experience the difference experience makes. Ask around. Nobody treats you or your heads better than JRF.



249 Kennedy Rd., Greendell, NJ 07839
(201) 579-5773 Fax (201) 579-6021

Harris triple deck stereo cart machine, totally recond, looks/operates like new w/all connectors, \$900. G Jones, SW Mediacast, 110 Sierra Rd, Kerrville TX 78028. 210-367-4567.

Electro Audio/Video presents 10% off for a 10 day sale

- ◆ Repairs & reconditions
 - ◆ Motor rebuilds to quiet, flutter free operation
 - ◆ Over 2,000 manuals for support
 - ◆ 10,000+ parts for supply
- Surplus Special: ITC 3D Top Bearings \$45.00 ea.
- M. O'Drobinak**
(619) 758-0888

BE 5300C tripledeck, stereo, PB, mint less than 50 hrs, BO. R Kaufman, Pams Prods, POB 462247, Garland TX 75046. 214-271-7625, after 3PM CDT.

Want To Buy

ITC 3-D stereo w/tones or Delta 3 stereo, stereo SP's ok, need not be in wrkg order. L Lindstrom WPOK, 315 N Mill, Pontiac IL. 815-844-6101.

ITC PD-II, need one R/P unit, one PB for simple newsroom operation, nothing fancy, no junk. A Sutton, WBCU, POB 70, Union SC 29379. 803-427-2411.

ITC, BE, Fidelipac cart machines: single, triple, mono, stereo, play & record/play. Call M O'Drobinak @ 619-758-0888.

CASSETTE & REEL-TO-REEL RECORDERS

STUDER SERVICE SPECIALIST

Thousands Serviced • Unbeatable Rates
Precision Capstan Resurfacing
Audio Advantage
Tel (615)742-3834 FAX (615)254-8826
PRICE-QUALITY-SERVICE
Let Us Prove It

Want To Sell

Conex CG 25A 25 Hz tone gen, adjust tone levels, timing intervals. Paul, 612-222-5555.

Studer B67 1/4" 2-trk 7.5, 15 & 30 ips w/stand, gd cond, \$1500. D Harris, Studio B Prod, 1018 Central Ave, Charlotte NC 28204. 704-372-9661.

Marantz PMD 360 port, gd cond, \$135 + shpg; Otari 5050 full trk, remote, gd cond, \$650/BO. J Rudisill, Audio Independence, POB 640742, San Jose CA 95164-0742. 408-321-8373.

ITC erase, splice finder machine (2), one in gd cond, other needs work, \$800/both plus shpg. R Slatham, WSTU, 1000 NW Alice Ave, Stuart FL 34994. 407-692-1000.

Revox A-77 R-R R/P tape machines (2), \$600 ea. P Bridges, KGKO, 202 E Cross, Benton AR 72015. 501-778-8257.

REVOX PARTS/SERVICE

Cassette-CD-Open reel
Rebuilt B77s, \$900.⁰⁰
Capstan resurfacing, ALL BRANDS.
JM TECHNICAL ARTS
30 Music Sq. W. #156
Nashville, TN 37203 (615) 244-6892

Ampex 350 transports (3), \$35 ea or all for \$100 plus shpg. L Houck, Rollin Recdng, 210 Altgelt, San Antonio TX 78201. 210-736-5483.

Tascam 688 cassette multitrack recorder/mixer, mint condition, \$1900/BO + shpg; Revox PR99 recorder 7.5-15 ips w/carry case & speaker, good condition, \$800/BO + shpg. W Wawro, WFAA, 606 Young St, Dallas TX 75202. 214-977-6260.

Uher 4200 Report Monitor, R-R stereo 1/2 track portable, 3 heads, 4 speeds, new in box, \$500. R Sumner, CAVU Corp, 3322 Applegate Ct, Annandale VA 22003. 703-968-8894.

Otari MX 5050, \$1800. R May, KULF, 306 E Main, Brenham TX 77833. 409-836-9411.

Revox B-77 open reel recorder, 7.5-15 ips, 1/2 track, good condition, \$575; Sony PCM-F1 digital recording system, F1 digital processor modified with Apogee input filters & external sync input, \$1500/complete system, \$1000/F1 processor only. R Streicher, Pacific AV Enter, 545 Cloverleaf Way, Monrovia CA 91016. 818-359-8012.

HEAD RELAPPING/REPLACEMENT

All tape and film formats
30 years experience



350 N. Eric Drive
Palatine, IL 60067
708-358-4622

Telex 235 3:1 cassette duplicator, like new, \$650 plus shpg. S Russell, 60410 Klett Dr, Decatur MI 49045. 616-782-9256.

Scully '100' recorders, record/play amplifiers, 8, 16, 24 track heads. Sequoia Electronics, 4646 Houndshaven Way, San Jose CA 95111. 408-363-1646.

Otari ARS 1000 (2) gd cond, w/25 Hz, \$400/ea. B Hill, KACK FM, 106 S Jefferson, Mt Pleasant TX 75455. 903-577-9730.

STUDER/REVOX

Factory Authorized Service
"Superlative Service"

Over 14,000 units serviced! Fast turnaround w/War. Huge parts inventory. New/Used Equip., Capstan shaft resurfacing.

STUDIO-SONICS

450 W. Rand Road
Mt. Prospect, IL 60056
708-670-0025

Tascam 34B 4 trk R-R, all manuals, cables, roll-around stand, very little use, excel, \$650. A Selk, Selk Prod, 1391 Normandy Dr #1, Atlanta GA 30306. 404-876-8894.

OTARI FACTORY DIRECT
Accessories Clearance
Call (415) 341-5900
Fax (415) 341-7200
Otari Corp.
378 Vintage Pk. Dr.
Foster City, CA 94404

Up to 50% Off Limited Time Offer

Otari Mark II-IV 1/2" 4-track, multi-track, mint, less than 50 hours, Best Offer. R Kaufman, Pams Productions, POB 462247, Garland TX 75046. 214-271-7625, after 3PM CDT.

Otari 5050 MK III-8 trk, heads excellent, \$2450. Wayne Gunn 619-320-0728.

Otari ARS-1000 (2), mint cond, BO. J Kesler, WOBZ, POB 220, Livingston KY 40445. 606-843-9999.

SCULLY TAPE RECORDERS

PARTS AND SERVICE

SEQUOIA ELECTRONICS

4646 Houndshaven Way
San Jose, CA 95111
(408) 363-1646
FAX (408) 363-0957

Recordex 6 cassett rewriter \$100; Tascam 40-4 4 trk 10" in flight case w/free dbx \$750; MRL new short test tapes \$39 for 1/4" to \$199 for 2". W Gunn 619-320-0728.

16 track 2" \$3450, MCI JH110C-8 \$2800, 110C-8 play only \$500, ATR800 mono or Tascam 7300 or 2502 \$600 ea, MCI Locator III \$1195, Tascam 52 2 trk \$1200, Ampex AG350 electr \$50/ch. W Gunn 619-320-0728.

Want To Buy

Ampex tube recorders and mixers. W Gunn, 619-320-0728.

EMPLOYMENT

To place ads in this section, use the ActionGram form. To respond to box numbers write Radio World, PO Box 1214, Falls Church, VA 22041. Attn: _____

POSITIONS WANTED

Hands On Engineer with over 30 years of AM/FM/TV. MF/HF/UHF background, desires position with Int'l SW bdcg facility, FCC Gen SBE Cert, IEEE, AE Degree. Lou, 904-383-8457.

Freelance writer available for radio/TV infomercials, rare combination of direct mktg & bdcg skills, 24 hr FAX. Call Doug, 510-531-2404.

Ready to go to work for your station, young prod man w/multi-media exper, willing to relocate, recent graduate. Brad, 405-329-5632.

Broadcast engineer w/high pwr RF exper, instructor in training & safety skills, seeks career opportunity. Ed C, 207-732-5185.

If you master analog music tapes for radio stations & need more assistance, I have exper/equip. R Bass, 4100 O'Hare, Mesquite TX 75150-4454.

Creative, fun radio is only a call away! Dedicated, experienced air personality, recent morning gig w/prod skills, will relocate, AC/CHR/Oldies. Kevin, 609-863-1991

20 year vet in radio announcing & some part time sales, seeks full time announcing in AR, OK, MO, KS, TX. Call after 5PM, 501-337-5249.

Mama's Dead radio talk host David F Diamond is ready for new, major market. 901-761-5577.

Agree experience isn't only years, tapes? Hire Janet 502-895-5888. FT announcing, programming aspirations. Computer literate, in radio since 1980 PT announcing, marketing exper, serious only.

Proven travel program personality writes, performs, produces ratings thru roof show, can handle callins, British accent. Phil, 408-866-8542.

Custom Voice IDs, spots, breakers, promos, etc, 25 year pro of Boston, NYC, Philly & DC. Write: JLC, Box 2733, Spring PA 19609.

Creative air personality, producer & copy-writer seeks music intensive country station in midwest, 12 years exper-encer. Tom, 319-568-2198.

Arizona only, chief engineer, experienced all phases of high power AM & FM, 20 yrs experience incl Top 50/100 mkt, dry warm climate, chief, group chief or contract. Send replies to: Radio World, POB 1214, Falls Church VA 22041. Attn: Box 94-01-26-01 RW.

Radio pro for hire, programming, management, versatile. Roger, 615-235-6889.

Radio dynamo seeks news job at medium mkt station, call for tape. M Kunkle, 814-226-9259 or 412-744-3270.

HELP WANTED

TOO MANY OPENINGS!

We have too many openings & not enough people to fill them. If you're serious about your career, we're just as serious about taking you to the next level! Hundreds of openings for air talent, news, mgmt, prod & sales, also many engineering positions available in all aspects of broadcasting...all you do is subscribe. No % of your pay, no contracts! Besides our pub., we also have our BBS & Rapid Lane (jobs by phone) up & running. Ask about our FREE referrals & resume bank. You'll be surprised at how inexpensive we are, check us out!

BROADCAST EMPLOYMENT WEEKLY
1-800-922-JOBS
1125 W Boone Ave., Nampa, ID 83651
BBS 1-208-467-4110

AUDIO CONSOLE TEST ENGINEER

Manufacturer of high quality audio mixing consoles for the television and radio broadcast markets currently seeks to fill a position in our console testing/quality assurance department.

The ideal test engineer will be at least an ASEE with a solid analog and TTL electronics background. This is a hands on testing/troubleshooting position in a fast paced manufacturing environment. Pro Audio, PC and Audio Precision experience are all big pluses. Send resume and three professional references to:

Test Engineer
PO Box 70
Mattydale, NY 13212

HELP WANTED

FEDERAL PROGRAM LETS YOU WORK FROM YOUR HOME

- ☆ IN YOUR SPARE TIME
- ☆ SET YOUR OWN HOURS
- ☆ NO EXPERIENCE
- ☆ NO TRAINING NEEDED
- ☆ GUARANTEED INCOME
- ☆ BE YOUR OWN BOSS

CALL NOW

713-587-5407
1-800-618-8554

D. & K. ASSOC.

6180 Hwy, 6 N. STE. # 257 HOUSTON, TX 77088

CASSETTES/R-R...WTB

Sony TC-105, need motor. D Meish, Mobile Radio Comm, Box 100, Chester SD 57016. 805-489-2497.

Sony TCD-5M stereo cass recorder in bad to fair condition for parts/salvage. J O'Leary, 1717 Euclid St NW, Washington DC 20009. 202-332-8377.

Tascam 58 1/2" 8 trk wanted to buy or trade for Otari 5050 MK III-8 or...? Wayne Gunn 619-320-0728.

Ampex ATR100 taperecorders for parts. Circuit cards, heads, motors, machine parts, or electronic parts. Call 818-907-5161.

Spotmaster TP-60B tape timers from cart tape winders (TP-1A or TP-1B). Mel Crosby, 408-363-1646.

CD PLAYERS

Want To Sell

Sony PCM-1630 CD mastering system in excellent condition, system including PCM 1630, DABK 1630/31, DMR 4000, DTA 2000, 9" monitor, printer, comp manuals, (2) rd cases, call for price. N Sarikananda, Masterworks Rec, 1020 N Deaware Ave, Philadelphia PA 19125. 215-423-1022.

Audiometrics AMCD5-1000A multi-disk (100) CD players with RS232 control interface (2) avail, new optics, \$1000 ea. J Stromquist, WNCB, 2828 Piedmont Ave, Duluth MN 55811. 218-722-3017.

COMPUTERS

Want To Sell

Heathkit H89 has floppy drives, \$50. T Wortmann, WJAG/KEXC, 309 Braasch, Norfolk NE 68701. 402-371-0780.

Tandy 6000HD w/at least 1 floppy drive. Mel Crosby, 408-363-1646, FAX 408-363-0957.

CONSOLES

Want To Sell

Gates Executive 10-chnl stereo board w/manuals, some modules missing, taken out of service 1/93, \$500. R Miller, WCNL/WTIM, Taylorville IL 62568. 217-824-3395.

Soundtracs MR Series 24x8x2 recording console with 16 monitor returns, excellent condition, \$4000/Best Offer + shipping. W Wawro, WFAA, 606 Young St, Dallas TX 75202. 214-977-6260.

Arrakis 500 stereo 1986 console, \$2000. P Bridges, KGKO, 202 E Cross, Benton AR 72015. 501-778-8257.

McCurdy SS8808A broadcast console, 10 chnls, 2 chnls have multi-input selectors, 3 spare power supplies, BO. P Fowlie, Common Mode, 50 Northfield Ave, West Orange NJ 07052. 201-736-7191.

Teac 15, 24 in mixing board, \$2500. HL Sewell, Oakridge Music, 2001 Elton Rd, Haltom City TX 76117. 817-838-8001.

Ramko DC-8 mixer, needs work w/some parts, \$150. D Heinen, KRSE, POB 127, Yakima WA 98907. 509-248-1390.

Dynamax stereo 8 channel for air or production, like new condition, \$3200/Best Offer. Terri, GMN Inc, Box 2205, Cincinnati OH 45201. 606-572-9446.

Arrakis 500 SC excellent condition, 8 chnl stereo, will trade for studio or on air processing, \$1750. B Hill, KACK FM, 106 S Jefferson, Mt Pleasant TX 75455. 903-577-9730.

LPB S12 5 pot 10 input stereo, excellent condition, very clean, \$1295; LPB S13C 8 pot 24 input stereo in excellent condition, good clean working order, \$1895. J Travis, WCIK, POB 506, Bath NY 14810. 607-776-4151.

BE 450, \$1500. R May, KULF, 306 E Main, Brenham TX 77833. 409-836-9411.

Soundcraft Spirit 163 mixing console, \$1550; Quantum 12A mixing console, \$1300 complete; Fostex 2050 line mixer, \$100. R Streicher, Pacific A/V Enter, 545 Cloverleaf Way, Monrovia CA 91016. 818-359-8012.

Collins/Autogram IC10, good condition, \$2500. Mike Starr, WKLS-FM/Atlanta, 404-325-0960.

Want To Buy

BE 5M-5250A or 4M50A for simple newsroom operation, no junk. A Sutton, WBCU, POB 70, Union SC 29379. 803-427-2411.

DISCO-PRO SOUND EQUIP

Want To Sell

JBL ceiling speakers (2), \$35/each, used in suspended ceilings, incl hous-ing, speaker & control knob. B Lord, Lord Broadcasting, 13313 SE 208th St, Kent WA 98042. 206-631-2374.

Cerwin-Vega DM-1 mixer, \$125/Best Offer; JVC BP-5 biphonic processor, converts bialural to stereo, \$125/BO. J Rudisill, Audio Independence, POB 640742, San Jose CA 95164-0742. 408-321-8373.

Rane AC23 crossover, \$250; JBL 2445 horns 12" mid mounted in cabinets, excl cond, \$1400; JBL crossover, \$90. D Kocher, Digital Sound Makers, 1901 Hanover Ave, Allentown PA 18103. 215-776-1455.

Want To Buy

dbx 902 (2), 903 (4), & 905 (2), not frame, just modules. R Streicher, Pacific A/V Enter, 545 Cloverleaf Way, Monrovia CA 91016. 818-359-8012.

Roland DEP5 needed. S Russell, 60410 Klett Dr, Decatur MI 49045. 616-782-9258.

Advertising Close Date for March 23, 1994 Radio World: February 25, 1994

FINANCIAL SERVICES

EQUIPMENT FINANCING
ON ALL RADIO EQUIPMENT

- Easy to qualify
- Fixed-rate, long-term leases
- Any new or used equipment
- 100% financing, no down payment
- No financials required under \$50,000
- Refinancing existing equipment

ENF EXCHANGE NATIONAL FUNDING

Call Mark Wilson (800) 275-0185

LIMITERS

Want To Sell

CRL APP 400 audio prep processor, PMC 300A peak mod controller, SPF pre emphasis filter, \$1000. P Bridges, KGKO, 202 E Cross, Benton AR 72015. 501-778-8257.

CRL FM-3G SGC-800/SEC-800, like new, \$2500. G Leonard, KWWR, POB 475, Mexico MO 65265. 314-581-5500.

Orban Optimod 8100 A/1 with Texar Card 5 & original card 5 included, excellent condition, (2) Texar audio Prism, excellent condition, MSI CP-803 composite clipper, all equipment comp with manuals & will be sold as complete processing system for 1 price, \$6000/all. Tommy, KNFM-FM, 2911 La Force Blvd, Midland TX 79711. 512-563-5636.

Valley People 440 limiter, compressor & sibilance processor, excl cond, little use, \$300. P Russell, Baudoin College, Sills Hall, Brunswick ME 04011. 207-725-3066.

Optimod 8000A (2), one works, one doesn't, \$1900/both. R Henry, WPIO, 505 Josephine St, Titusville FL 32796. 407-267-3000.

Optimod 8100A/ST studio chassis only, gd cond, \$400. D Heinen, KRSE, POB 127, Yakima WA 98907. 509-248-1390.

Orban 414A dual chnl stereo compressor/limiter, \$425/BO; Aphex 700 studio dominator multi-band audio processor, \$600/BO. D Evans, KALW, 2576 Harrison, San Francisco CA 94110. 415-695-5740.

Want To Buy

Orban 8100A1 w/XT2 chassis, MSI CP-803 composite clipper, Valley 400 mic processor, Orban 412A or equiv stereo comp/limiter. L Lindstrom, WPOK, 315 N Mill, Pontiac IL. 815-844-6101.

Gates Sta Level audio level amp, will consider other brand, up to \$50. E Lightman, WEDL, 550 Merchant St, Ambridge PA 1500C.

Volumax 4000A, UREI LA-4, needed. Tom Scher, 716-634-2545 10AM-4PM EST.

Fairchild 670 or 660 tube compressor/limiter, Teletronics LA-2A tube compressor/limiter or UREI LA-3A solid state compressor/limiter, call after 3PM CST. 214-271-7625.

MICROPHONES

Want To Sell

Shure EQs (3), \$75 ea; Shure remote sports pkg, mixer, 2 headsets & HP amp, \$350. P Bridges, KGKO, 202 E Cross, Benton AR 72015. 501-778-8257.

RCA 77DX gd cond w/yoke, \$650; RCA 74B in clean gd cond, \$350. AC Elliott, Quiltman Bldg, POB 33, Quiltman MS 39355. 601-776-6197.

Electro Voice RE27ND's (2), new, still in case, \$425 ea/\$800 both. W Harris, WNPC, POB 189, Newport TX 37821. 615-623-8743.

RCA 77DX-44BX, chrome, excel cond, BO over \$800 for ea. RF Burns, RF Studios, 1326 High Meadow Dr, Garland TX 75040. 214-271-4386.

AKG C422EB in excel cond, \$1850; AKG D-140 dynamic cardioid mic, \$225/pr; HME System 82 diversity wireless mic system, complete, \$425. R Streicher, Pacific A/V Enter, 545 Cloverleaf Way, Monrovia CA 91016. 818-359-8012.

AKG C34 stereo mic w/remotes, cable, Suspensoon mount, windscreen & caring case, \$1450; (2) AKG 414B ULS matched pr, \$1600; (2) Nakamichi CM300 w/2 capsules & case, \$600. J Burke, Reels on Wheels, 2824 Sherwin, Chicago IL 60645. 312-338-1977.

Manley Labs CR3A, new, \$795 w/shockmount, windscreen & case, no risk trial in your studio. Also have used mics & everything else. Get our catalog! Liberal trade policy too. Audio Village, 619-320-0728.

Want To Buy

Shure SM-5B reasonable, EV RE-20 w/shockmount. L Lindstrom, WPOK, 315 N Mill, Pontiac IL. 815-844-6101.

Hewlett-Packard 15109, 15108, 15119 & 15118 lab reference mics, any cond. S Dansey, WCWM, Williamsburg VA 23185. 804-229-1547.

RCA 77DXs/44BXs ribbon, chrome/TV grey, gd cond, BO. R Kaufman, Pams Prods, POB 462247, Garland TX 75046. 214-271-7625, after 3PM CDT.

77-DX's, 44-BX's, WE KU-3A's On-Air lights, recording lights & audition lights. Top price paid. Fast response. Bill Bryant Mgmt, 2601 Hillsboro Rd, G12, Nashville TN 37212. 615-269-6131, FAX: 615-292-3434.

Neumann U87s, KM84s, AKG 451s, EV RE20s, Sennheiser 421s. W Gunn 619-320-0728.

MISCELLANEOUS

Want To Sell

LII Miss Moffat 48 volt Phantom power supply, (2), \$20/each; (2) new 6' rack rails, \$20/each; other size pieces available, free with purchase, all items + shpg. B Lord, Lord Bldg, 13313 SE 208th St, Kent WA 98042. 206-631-2374.

Topaz 93550 AC line regulator 50 KVA 3 phase 208Y/120, \$400; Topaz 93445-21 isolation transformer 45 KVA 3 phase 208Y/120, \$400. T Wortmann, WJAG/KEXC, 309 Braasch, Norfolk NE 68701. 402-371-0780.

Northern Technologies TCS-LAPE surge supressor, 240 V, 3 phase Delta config, 3 years old, great condition, \$700 + shpg; Magnatek 223-3212 Jefferson Electric dry transformers (2) input 240 V Delta, out 208 V WYE, \$700/ea + shpg. D Morgan, KJYE-KNZZ, 1360 E Sherwood Dr, Grand Jct CO 81501. 303-241-9230.

360 Systems AM161B, 16x16 digital patchbay w/XLR Elco breakout box, \$800. W Sarokin, Sarokin Films, 23 Rutland St, Mt Kisco NY 10549. 914-666-0233.

Time & Temperature TTA-1 PC based telephone service, 2 lines with forecast option & commercial rotation, on line now demo, like new, \$3000. B Wilson, WTND, 207 Glenburnie Dr, New Bern NC 28561. 919-514-2100 X124.

Choke 15 hy 5 kv 400 mA, not swinging, will trade an MC-60 amp & C-8 audio compensator by McIntosh, amp has bad output xfmr. Fred, 6922 Furness Ave, Oxon Hill MD 20745. 301-567-2012 (eves).

Want To Buy

Cutting lathes, Neumann, Westrex, Gramplan, tube amps, 16" tables/arms, 45/78 records. K Gutzke, Custom Recording, 7134 15th Ave S, Minneapolis MN 55423. 612-866-6183.

Jazz record collections, 10" LP/12" LP be-bop, swing, dixie, highest prices paid. B Rose, Program Recordings, 228 East 10th, NUNY 10003. 212-674-3060.

Radio transformers by Chicago, UTC, Triad, Peerless, Freed, Sola, send list. J Gangwer, 942 32nd St, Richmond CA 94804. 415-644-2363.

MONITORS

Want To Sell

TFT EBS rcvr, decoder & encoder, does not work, problem unknown, \$100 + shpg. K Austin, KFXI, 1101 Hwy 81N, Marlow OK 73055. 405-658-2556.

Belar FM RF amp currently tuned to 107.1, \$400/BO. R Wynne, KFLS/KKRB, 503-882-4656.

Belar FM RF amp currently tuned to 107.1, \$400/BO. R Wynne, KFLS, POB 1450, Klamath Falls OR 97601. 503-882-4656.

Want To Buy

Belar FMM-2 & FMS-2. M. O'Drobinak, 619-758-0888.

C-QUAM modulation monitor, must be in gd cond. M Mauney, KCON, POB 1406, Conway AR 72033. 501-327-6032.

FM mod & stereo monitors needed immed for new non-commercial 90.3 FM going on air in March, working/solid state only, inexpensive or donations, will pay shipping. M Sophos, WDFH, 21 Brookside Ln, Dobbs Ferry NY 10522. 914-693-3963, 4PM-midnight.

McMartin (buy & sell) any model. C Goodrich, 11435 Manderson, Omaha NE 68164. 402-493-1886 or fax 402-493-6821.

RECEIVERS & TRANSCEIVERS

Want To Sell

Yaesu FTS-6 tone encode decode for FT 1123, 1143, 209, 727, 109, 409 radios, (2), \$20/ea; Motorola Spirit VHF tone & voice pagers w/chrg & tone rcvrs, (3), \$20/ea. P Russell, Baudoin College, Sills Hall, Brunswick ME 04011. 207-725-3066.

AM STEREO RECEIVERS
From \$34.95 Portable, Home, Auto
RRADCO
Phone/FAX 708-513-1386

Mexon Drop-In chrg for CP/CS-510 UHF, CP/CS-510 VHF & SP-5000 series chrg CA-1110A, chrgs CA-1450 NiCads, holds radio & 1 batt, brand new in box, \$100. MRG Prod Assoc, 516-447-1041.

PHONE: 703-998-7600 FAX: 703-998-2966



Call Simone Mullins, Classified Ad Manager, to reserve space in the next issue. Use your credit card to pay, we now accept VISA and MASTERCARD.

Radio World
5827 Columbia Pike, 3rd Floor
Falls Church, VA 22041

Select from these categories for best ad positioning:

- | | | |
|----------------------------|---------------------------|--------------------------|
| Acoustics | Consoles | Software |
| Amplifiers | Disco-Pro Sound Equip. | Stations |
| Antennas & Towers & Cables | Financial Services | Stereo Generators |
| Audio Production (Other) | Leasing | Tapes, Carts & Reels |
| Brokers | Limiters | Tax Deductable Equipment |
| Business Opportunities | Microphones | Test Equipment |
| Cart Machines | Miscellaneous | Transmitter/Exciters |
| Cassette & R-R Recorders | Monitors | Tubes |
| CD Players | Receivers & Transceivers | Turntables |
| Computers | Remote & Microwave Equip. | Positions Wanted |
| | Satellite Equipment | Help Wanted |

Classified Advertising Rates Effective January 1, 1994

	1x	3x	6x	12x
1-9 col inch (per inch)	\$60	58	54	49
10-19 col inch (per inch)	55	52	49	44
Distributor Directory	100	95	90	85
Professional Card	65	60	55	50
Classified Line Ad		\$1.50 per word		
Blind Box Ad		\$10 additional		

To compute ad costs: Multiply the number of ad inches (columns x inches) by the desired rate schedule for your per unit cost. Example: a 3" ad at the 1x rate is \$180, at the 3x rate \$174, at the 6x rate \$162, at the 12x rate \$147, etc.

DISTRIBUTOR DIRECTORY

The following distributors serving the broadcast industry would be glad to help you with any of your requirements.

... Canada, the Caribbean, Shannon to Shanghai, the dynamite Fifty ...
RADIO! The beat goes on!

CROUSE-KIMZEY OF ANNAPOLIS

tops in broadcast equipment
1-800-955-6800
ask for Kathleen

CORNELL-DUBILIER MICA CAPACITORS

FROM STOCK

JENNINGS VACUUM CAPACITORS

FROM STOCK

JENNINGS VACUUM RELAYS

SURCOM ASSOCIATES
2215 Faraday Ave., Suite A
Carlsbad, California 92008
(619) 438-4420

RECEIVERS/TRANSCIVERS...WTS

Zenith TransOceanic AM SW port tube type, wkg gd cond, \$50 + shpg. E Lightman, WEDL, 550 Merchant St, Ambridge PA 15003. 412-266-2802.

SCA RECEIVERS—ALL TYPES

Reading Service / Ethnic / Data Professional / Table Will work to meet your receiver needs

DAYTON INDUSTRIAL CORP. (Manufacturer) 2237 Industrial Boulevard Sarasota, FL 34234 Tel: 813 351 44545 FAX: 6081

Regency 20 W mobile units (3), 161.7 MHz, \$100 ea. P Bridges, KGKO, 202 E Cross, Benton AR 72015. 501-778-8257.

Professional SCA demod card with excellent crosstalk rejection, \$20. Superadio III with SCA, \$85, performance guaranteed. 1-800-944-0630.

600+ Nicad SCA portable radios. Xtal tuned \$20 ea or make offer on lot. Evan 1-800-583-7799.

REMOTE & MICROWAVE EQUIPMENT

Want To Sell

Marti STL 8 950 MHz xmtr & rcvr w/2-4' parabolic antennas, 250' jacketed coax w/4 connectors, \$2715; Marti M30 BT RPU xmtr & rcvr, mic & antennas, 161.7 MHz, \$1750. P Bridges, KGKO, 202 E Cross, Benton AR 72015. 501-778-8257.

Marti STL-10 2 TX, 2 RX, stereo w/manuals, excl cond, \$4200. J Salov, WHGR, POB 546, Jackson MI 49204. 800-968-4636.

TFT 7610 remote cntrl has 20 chnl monitoring w/7615 status monitoring/direct cntrl units, some spare parts, \$600. E Gehringer, WKEE Radio, 134 4th Ave, Huntington WV 25701. 304-525-7788.

Harris Sentinel 16 remote cntrl w/manuals, just taken out of service, \$500. R Miller, WCNL/WTIM, Taylorville IL 62568. 217-824-3395.

COMREX RENTALS

1, 2 and 3-Line Extenders
Switched 56 Systems
Call Steve Kirsch for details
Silver Lake Audio
(516) 623-6114 FAX: 377-4423

Gentner SPH-3A telephone interface system, excel cond w/manual, \$325. R Sumner, CAVU Corp, 3322 Applegate Ct, Annandale VA 22003. 703-968-8894.

RENTALS
RENTALS
RENTALS

COMREX
3-line extender

Frank Grundstein 215-642-0978
Audio/Video Consultants

TFT STL units (2) rcvrs, (2) xmtrs, on pair on 450.98 & other on 450.01, both work great. Jeff, 703-297-1188.

Marti STL 8 & STL 10 type approved on 951.5 & 947.125 both in gd cond, STL10/\$2000, STL8/\$1500. J Black, KSEN, 830 Orfield Ave, Shelby MT 59474. 406-434-5241.

QEI Cat Link, needs repair, not in service, \$6000/BO. D Fielder, WVLT, 638 Landis Ave, Vineland NJ. 609-692-8888.

Moseley MRC-1600 telco boards, \$40. S Swanson, KBNL, Box 440029, Laredo TX 78044. 210-724-9211.

Marti STL-10 stereo (2) xmtrs (2) rcvrs on 950.375 & 950.625, type approved under new rules, \$3000/both. J Gallagher, WBEC, 211 Jason St, Pittsfield MA 01201. 413-499-3333.

Want To Buy

UHF Marti RPT-30 or 25 xmtr & rcvr, 2 chnl preferred but 1 chnl ok. L Lindstrom, WPOK, 315 N Mill, Pontiac IL. 815-844-6101.

TFT 8300 receiver unit. P Lotsof, KAVV, Box 18899, Tucson AZ 85731. 602-290-9797.

Harris 9161 remote control, mainframe, CEPs, electr memory modules & high speed comm modules. B Lockhart, KXXY, 101 NE 28th, Oklahoma City OK 73105. 405-528-5543.

Mark 4' grid dish. M Grubbs, NTL, POB 1047, Luling TX 78648. 210-875-2555.

SATELLITE EQUIPMENT

Want To Sell

Adcom/SA 7550 sat rcvr on Unistar AC II format ready to go, took out 12/93, stereo w/block down converter, all manuals, \$3500. J Leutz, KFSB, 2620 Dogwood Rd, Japlin MO 64801. 417-624-1310.

Drake sat rcvr, tuneable audio great for networks such as USA, PRN, Salem, etc, used w/30 day warranty, \$65. D Littleton, WAZF, POB 47, Yazoo City MS 39194. 601-746-2372.

Universal SCPC-100 audio receiver, front panel tuning, 50 channel memory, receiver C & Ku band, new, \$425 plus shpg. D Littleton, WAZF, POB 47, Yazoo City MS 39194. 601-746-2372.

Equitorial 5100 controller/receiver, \$60. T Wortmann, WJAG/KEXC, 309 Braasch, Norfolk NE 68701. 402-371-0780.

Fairchild Dart 7.5 & 15 Khz audio cards for Dart 384 receiver. Paul, 612-222-5555.

OuterSpace Experts!

We SELL ★ TRADE ★ BUY
SATELLITE EQUIPMENT
317-962-8596



Adcom 7550 excellent condition, Best Offer or trade. B Hill, KACK FM, 106 S Jefferson, Mt Pleasant TX 75455. 903-577-9730.

Scientific Atlanta 15 khz DATS cards (2), \$750 ea or \$1500/both. S Tefft, WWSC, 217 Dix Ave, Glens Falls NY 12601. 518-793-4444.

Want To Buy

Wegener system for Unistar, need spare cards. L Lindstrom, WPOK, 315 N Mill, Pontiac IL. 815-844-6101.

SOFTWARE/DATABASES

Want To Sell

PC SOFTWARE for Broadcasters. Traffic, Billing, & Accounting. Powerful, inexpensive. Works with automated, satellite or live operations. INTERFACES with popular DIGITAL AUTOMATION SYSTEMS. Try it for 90 days, no obligation. **Absolute Broadcast Automation** Naples, Florida (813) 643-3689

STATIONS

Person to lease/purchase FM station for small beach town in West coast of FL, mthly payments as low as \$4000. Bill, 806-359-4000.

5 kW AM DA/3 kW FM WC3 upgrade pending, Cuba MO. K Kuenzie, KSLQ, 511 W 5th, Washington MO 63090. 314-239-0209.

1 kW AM FT in South-Central Virginia single-station town, fully equipped w/3 yr old Nautel xmtr, \$50,000 cash/BO, real estate for lease or sale. G Jones, WODI, 1230 Radio Rd, Brookneal VA 24528. 804-376-5534.

5000 W AM directional, good market area in Colorado, great opportunity. Write to: 412 Nile, Aurora CO 80010 or call 303-344-0838.

STEREO GENERATORS

Want To Sell

Moseley SCG-3T, stereo gen, gd cond, \$350. D Heinen, KRSE, POB 127, Yakima WA 98907. 509-248-1390.

TAPES/CARTS/REELS & CD's

Want To Sell

Scotchcart II's 320 3.5 min, \$2/ea; also some longer sizes, \$2.25/ea; lite use for up to 6 mo, some new music lengths avail also. B Lord, Lord Bdcg, 13313 SE 208th St, Kent WA 98042. 206-631-2374.

Fidelipac 300s, approx 100 40s, 70s, some usable as is, some need reloading, \$1/ea for lot. B Oostenburg, KCKY, POB 6, Coolidge AZ 85228-0006. 602-723-5448.

SERVICES

OBSTRUCTION LIGHTING

Beacons lights accessories

FAX inquiries on your letterhead to:

ROHN
P.O. Box 2000
Peoria, Illinois 61656
PH: (309) 697-4400
FAX: (309) 697-5612

LOCATION SERVICES IN THE UNITED KINGDOM

Planning remotes from the U.K.? we provide a comprehensive service

- we organize venues for your shows
- we provide temporary equipment
- live links via ISDN/Switched 56
- experienced radio engineers
- we help you line-up guests

Contact New York (212) 229-9118
Good Morning from Great Britain
Wired for Sound Ltd., London N15

EVANS ASSOCIATES
Consulting Communications Engineers

TV • FM • AM • ITFS • Satellite
FCC Applications, Design and Field Engineering

Video/Data/Voice • Light Fiber & Microwave • Wide-Area Networks & STL's

216 N. Green Bay Road
Thiensville, WI 53092
(414) 242-6000 • FAX (414) 242-6045
Member AFCCE

REMOTE EQUIPMENT RENTALS

COMREX and GENTNER
1, 2 & 3-Line Extender Systems
Now With The New GENTNER EFT-3100
MARTI VHF/UHF RPU Systems
Switched-56 Systems
Call or FAX Dwight Weller
WELLER AUDIO-VISUAL ENGINEERING
Baltimore, MD
Phone: (410 or 800) 252-8351
FAX: (410) 252-4261

Tower Sales & Erection

Turnkey Site Development
Installation & Maintenance
AM/FM Broadcast, TV
Microwave Systems,
Antennas & Towers

TOWERCOMM
Communications Specialists

6017 Triangle Dr.
Raleigh, NC 27613
(919) 781-3496
Ben Wall
President
Gen. Contractor #25891 Fax (919) 781-6454

North America RF & Audio

Mirkwood Engineering Services
Broadcast and Telecommunications Consultants

Multidiscipline Engineering and Planning Firm including • Application & Allocation Services

- Project, Engineering & Construction Management • Site Acquisition
- Rural & Remote Site Installations
- Field Service • Studio Design & Installation

50 Park Ave. Claremont, NH 03743
(603) 542-6784

Get Legal!

How are we going to comply with the new emission rules for AM stations without a splatter monitor or spectrum analyzer?

For \$500, you can comply with the new \$73.44 spec. Call Tony Dinkel at Microwave Frequency Services.

Services available in Southern/Central CA, AZ and NV. Service area will expand if demand dictates.

1-800-2-GET-LEGAL
or fax at 310-425-6299 both #'s 24 hrs.

Where In The World Are You?

Reach radio professionals worldwide by advertising in Radio World's international edition.

Call Simone for more information.
1-800-336-3045

MLJ
Moffet, Larson & Johnson, Inc.
Consulting Telecommunications Engineers

Two Skyline Place, Suite 800
5203 Leesburg Pike
Falls Church VA 22041
(703) 824-5660
FAX: 703-824-5672
Member AFCCE

CONSULTANTS

T. Z. Sawyer Technical Consultants
AM-FM-TV-LPTV

- FCC Applications & Exhibits • Frequency Studies
- Experimental Authorizations • Class Upgrades
- AM Directional Antennas • LPTV Applications
- High Power Antenna Arrays • Station Inspections
- Site Selection Assistance • STL Applications
- Antenna Measurements • LMA/Duopoly Studies

1-800-255-2632

FAX: (301) 913-5799 • 6204 Highland Dr. • Chevy Chase, MD 20815

PC - SOFTWARE

AM FM TV Search Programs
Contour Mapping-STL Paths
RF HAZ-1990 POP Count
FAA Tower-Draw Tower

Doug Vernier
Broadcast Consultant
1600 Picturesque Dr
Cedar Falls, IA 50613

800-743-DOUG

W. LEE SIMMONS & ASSOC., INC.
BROADCAST TELECOMMUNICATIONS CONSULTANTS

5 Gracefield Road
Hilton Head Is., SC 29928
1-800-277-5417
803-785-4445
FAX: 803-842-3371

Contact Radio World Newspaper for availabilities

P.O. Box 1214 Falls Church VA 22041

1-800-336-3045

TAPES/CARTS/REELS...WTS

Ampex 10 1/2" metal reels, hubs, boxes, \$1.50/ea + shpg. J Rudisill, Audio Independence, POB 640742, San Jose CA 95164-0742. 408-321-8373.

Audiopak AA-4 over 1000 avail, gd cond, music lengths, \$1.75/ea; Soundstacker II storage racks for 1000+ carts, \$.25/cart. G Jablonski, WHMI, POB 935, Howell MI 48844. 517-546-0860.

AOR prod facility deleting classic rock collection, all on 7" reels, \$300. 703-751-9346.

Ampex 407 mastering tape, 10.5" reels, 1/4" x 3600', new in box, \$10/reel, \$90/box of 10; 3M/Scotch #20 1/2" x 1000', 2.5 mil uncoated white paper on 7" reel, \$4/reel, \$3/reel/quantity. R Sumner, CAVU Corp, 3322 Applegate Ct, Annandale VA 22003. 703-968-8894.

Radio sales training tapes, 16 VHS tapes covering 30 topics, excel, \$2500. R Trumbo, KNLF, 800-397-4146.

Carts, 1500, all kinds & length, ail or part, we pay shpg, \$.50/ea. J Bacon, KTAN Radio, POB 2770, Sierra Vista AZ 85636. 602-458-4313.

TAX DEDUCTIBLE

Want To Sell

Educ/non-profit AM-FM needs lw pwr xmtrs, prod, studio equip, s/h & receipt provided. Dr Newcomb, Grand River Radio, 19130 Nelson-Parkman, Garrettsville OH 44231. 216-548-2053.

School in ME needs 1 kW amp or FM xmtr, modulation monitor or misc studio gear, will pay shpg. 207-255-4735 days; 207-255-4722 nights.

Christian mission needs studio equip, stereo gen, exciter, 175' twr, 600' 1 5/8" or 3" coax for FM, will pay shpg & PU. L Harper, Western Indian Ministries, POB F, Window Rock AZ 86515. 505-371-5587.

New non-comm has its CP, need all types of studio equip, CD & cart machines, consoles, TTs, EBS, mics, etc 501(c)3. J Wong, KOOP-FM, POB 49340, Austin TX 78765. 512-472-5667.

TEST EQUIPMENT

Want To Sell

Hitachi V1150 quad trace 150 MHz scope w/on screen counter & DVM, will display in dbR, \$1085; Sound Tech 1700B distortion measurement syst w/auto set level, \$765. Wes, 818-798-9128.

Tek spectrum analyzer 7L18 plug in freq range 1.5 - 60 GHz, also 453 Tek scope, will trade for needed equip. 207-255-4735 days; 207-255-4722 nights.

Custom transmission measuring set, L, R, L&R, L-R, preset mod levels, precision attenuators, transformer isolation. D Johnson, DC Electronics, 2815 Pleasant Valley Rd, Cogan Sta PA 17728. 717-998-3169.

Heathkit 10-4510 scope needs work, will sell cheap, 15 MHz dual trace. T Wortmann, WJAG/KEXC, 309 Braasch, Norfolk NE 68701. 402-371-0780.

Nems-Clark 102E AM FS meter, case fair, panel meters clean, \$450. AC Elliott, Quitman Bdcy, POB 33, Quitman MS 39355. 601-776-6197.

Nicolet Scientific 44A computing spectrum analyzer, \$100. B Dickerson, WEAG, 1421 S Water St, Starke FL. 904-964-5001.

HP 334A 5 Hz to 600 Hz, auto nulling, 0.1% distortion, AM detector covers 550 kHz to 65 MHz, excel cond w/manual, \$795; Bruel & Kjaer 2033 high res FFT sound & vibration analyzer, 0-20 kHz, 11 baseband ranges, amplitude of 40 dB, 80 dB & linear, excel cond w/manual, \$3995. R Sumner, CAVU Corp, 3322 Applegate Ct, Annandale VA 22003. 703-968-8894.

Potomac Instruments AT-51 audio test set, complete w/IX-51 transformers, cables, books, mint cond, \$5000. J Seaman, 301-540-2089.

Tektronix 529, mod 188D waveform monitor, multi-standard version w/PAL frame selector, excellent condition, \$525; Tektronix 520A NTSC vector scope, measures amplitude & phase of color video signal, excellent condition with manual, \$1495; Tektronix 454A portable 150 MHz dual trace oscilloscope, calibrated sweep delay, excellent condition with manual, \$495. R Sumner, CAVU Corp, 3322 Applegate Ct, Annandale VA 22003. 703-968-8894.

HP 5245L microwave freq counter w/(2) plug-in freq converters 5253B & 5255A, other converters avail thru surplus sources, \$800. J Seaman, 301-540-2089.

Bird 3128 wattcher alarm/RF power monitor, up to 10 kW, 450 kHz to 2300 MHz, mint condition with manual, \$350. R Sumner, CAVU Corp, 3322 Applegate Ct, Annandale VA 22003. 703-968-8894.

Want To Buy

Neutrik test set, AP System One or Portable One. Wes, 818-798-9128.

TRANSMITTERS

Want To Sell

Harris MW1A 1 kW tuned to 1340, gd cond, off air 12/8/93, \$7000. John, Silver City NM. 505-538-3396.

DEMOED EQUIPMENT

BEXT Inc. has a few demoed excitors, amplifiers and STL's for sale. All demoed systems are sold first come first served and have the same 2 year warranty as BEXT's new equipment. For information: **619-239-8462**

Collins 814-R1 excellent condition, available due to power up-grade, no exciter, new tube, \$5000. F Troiani, WMRW-WIEZ Radio, 12 1/2 E Market St, Lewistown PA 17044. 717-248-6757.

\$\$\$ TRANSMITTERS FOR LESS \$\$\$

1 KW AM	Gates BC-1G	1 KW FM	Collins 830D1
1 KW AM	Gates Vanguard	1 KW FM	Gates FM-1G
1 KW AM	Collins 820D1	2.5 KW FM	Collins 831D1
1 KW AM	Harris SX-1A	5 KW FM	Harris FM-5H
1 KW AM	Gates BC-1F	5 KW FM	RCA BTF-5D
1 KW AM	RCA BTA-1D	10 KW FM	Harris FM-10H2
5 KW AM	Gates BC-5P2	10 KW FM	RCA-BTF 10D
5 KW AM	Harris BC-5H	20 KW FM	RCA BTF-20E1
5 KW AM	RCA BTA-5H	20 KW FM	Harris FM-20H
10 KW AM	Continental 316F	25 KW FM	AEL 25-KG
10 KW AM	RCA BTA-10H		
50 KW AM	Continental 317C2		
50 KW AM	Harris MW-50A		
50 KW AM	RCA BTA-50H		

***All transmitters are tuned and tested on your frequency
*** See your transmitter working in our plant before you take it home

ALSO CALL ARMSTRONG TRANSMITTER FOR:

- Custom built shortwave transmitters from 1 to 100KW
- Hard to find parts and custom fabrication for any transmitter
- Rebuilt FM antennas tuned to your frequency
- Custom built antenna tuning units and phasers
- STL's, STL antennas and other microwave products
- New and used transmission line, connectors and accessories
- UHF and VHF TV transmitters, antennas and diplexers
- Field service and installation on any transmitter
- Complete turnkey service for any AM, FM and shortwave facility

ARMSTRONG TRANSMITTER CORPORATION

ARMSTRONG MAIN OFFICE
4835 North Street Road
Marcellus, NY 13106
Tel: 315-673-1269
FAX: 315-673-9972

ARMSTRONG INTERNATIONAL
3100 N.W. 72nd Avenue
Miami, FL 33122
Tel: 305-471-1175
FAX: 305-471-1182

Hablo Español

Gates FM5H 5 kW FM transmitter on 95.9 with McMartin BFM8000 exciter, just taken off air, with transmitter harmonic filter, \$10K/pkg. R Miller, WCNL/WTIM, Taylorville IL 62568. 217-824-3395.

Energy Onix MK30 30 kW FM transmitter, 3 years old, mint condition, with exciter, on 100.1 MHz, available early '94, with spare tubes/parts, \$27500. H Kneller, WEEJ, 3151 Cooper St, Punta Gorda FL 33950. 813-639-1112.

Collins 21-E 5 kW AM tuned to 550 kHz, very good condition, still in use, \$5000 FOB Puerto Rico. A Gimenez, WPAB, Box 7243, Ponce PR 00732. 809-840-5550.

Gates Harris FM5C complete with manuals, good condition, no exciter, \$3800/BO. M Kestler, KAWZ, 241 Main Ave W, Twin Falls ID 83303. 208-733-3133.

RCA BTF-5B 5 kW FM on 92.1 MHz, removed 12/93, no exciter, \$3500/Best Offer. G Reinmeimer, WYYD, POB 4108, Lynchburg VA 24502. 804-237-4700.

RCA BTA 1R1 AM 1963 xmtr, \$2500; RCA AM mod mon, \$200. P Bridges, KGKO, 202 E Cross, Benton AR 72015. 501-776-8257.

NEW 3 kW FM transmitters for under \$14,000.
Call for details
Bill Hoffman
518-743-1601

ITA FM-15000B, 15000 W power amp, 1000 W in, 10000-15000 W out, BO. A Weiner, WHVW, 507 Violet Ave, Hyde Park NY 12538. 914-471-9500.

MARATHON PRODUCTS COMPANY

Audio Cartridge Rebuilding Division

Rebuilding/reloading, like new, all brands, any length up to & including 3.5 minutes, \$1.95 ea. FOB out plant, 48 hrs delivery. (New rate effective 9/1/93)

New NAB Marathon cartridges prices on request.

35 Years professional experience!
Lifetime member AES R.D. MYERS Sr.
Manufacturers of Audio Devices,
Continuous Tape Mag.

69 Sandersdale Rd. Charlton, MA 01507
1-508-248-3157 or 1-508-853-0988

Circle (169) On Reader Service Card

A/C Gold Disc library, approx 1400 songs w/complete list in original binder, BO. 800-728-5097.

Hot AC music library, mid 60's to 1991, Scotch Cart II & Mastercart Gold, over 1500 songs labeled & timed, computerized list of inventory. G Osborn, WLKI, Box 999, Angola IN 46703. 219-665-9554.

Reels, 10.5" & boxes (30), \$35; 5" reels & boxes, new (125), \$45. L Houck, Rollin Recog, 210 Allgelt, San Antonio TX 78201. 210-736-5483.

10" reels (450), Bonneville Ultra format for production use, \$5/ea or \$2000/all. B Hill, KACK FM, 106 S Jefferson, Mt Pleasant TX 75455. 903-577-9730.

Pams Jingles ref tapes, 1951-1976, BO. R Kaufman, Pams Prods, POB 462247, Garland TX 75046. 214-271-7625.

Karak's rewind loop carts. Also sell reconditioned carts. Service guaranteed. Call 605-348-9928.

Want To Buy

45 rpm record library's, all types, hits, promo, etc. D Schmidt, Midatlantic Radio, POB 11502, Wilmington DE 19850. 302-323-0338.

Fidellpac/Audiopak Mastercart II gold or AA-4 light blue in 2:30 through 4:00 lengths, must be in vgc, call after 3PM CST. 214-271-7625.

TRANSCOM CORP.

Serving the Broadcast Industry Since 1978

Fine Used AM & FM Transmitters and Also New Equipment

For the best deals on Celwave products, Andrew cable and Shively antennas.

1 kW FM 1978 Collins 831C2	1 kW AM 1974 Harris BC1H1
2.5 kW FM 1978 CCA 2500R	1 kW AM 1978 Harris MW1A
3 kW FM 1975 CCA 3000D	1 kW AM 1988 Harris SX1A
3 kW FM 1982 Elcom Bauer 603B	5 kW AM 1968 CCA AM5000D
3 kW FM 1974 Harris FM3H	5 kW AM 1979 Continental 315F
5 kW FM 1979 CCA FM5000E	5 kW AM 1968 Harris BC5H
5 kW FM 1968 Harris FM5H	5 kW AM 1977 RCA BTA 5L
5 kW FM 1987 Harris FM5K	10 kW AM 1983 Harris BC10H
10 kW FM 1975 ITA FM1000C	

1077 Rydal Road #101
Rydal PA 19046

800-441-8454 • 215-884-0888 • FAX No. 215-884-0738

This is One Crate Opening You Can't Afford to Miss!



If a new transmitter is in your plans...
Plan now to see the **'Next Generation'** of FM transmitters
We'll uncrate the **Transmitter of the Future** at NAB Booth #5408

Building FM's Future... Today!

"The Transmitter People"
Energy-Onix
752 Warren Street
Hudson NY 12534

518-828-1690
FAX: 518-828-8476

Circle (100) On Reader Service Card

TRANSMITTERS...WTS

Harris MS-15 exciter, just removed from service & in excellent condition, \$2500. C Murray, KMGE. 503-484-9400.

Spare parts for CCA AM50,000D, include HV transformer, mod. transformer, mod. reactor, HV filter choke, tube sockets and more. Call Transcom Corporation 800-441-8454 or 215-884-0888.

FM - TRANSMITTERS

Factory new not used. Why buy a used Transmitter when you can own a new FM Transmitter for about the same cost? Call JIMMIE JOYNT at 214-335-3425.

Harris MW-1A solid state 1 kW AM, excellent condition, on air 1410 kHz, spares, \$8500. 816-628-5959.

Harris THE-1 FM exciter, like new condition, \$3000. J Gallagher, WBEC, 211 Jason St, Pittsfield MA 01201. 413-499-3333.

Full Class A FM package with mix of new & used. Harris FM-2.5H3 transmitter, 8000A Optomod, ERI antenna, coax, studio, etc. Call 816-628-5959.

Want To Buy

Gates 250 GY manual w/schematics. J Cunningham, KEOR/KHKC, RT 2 Box 113B, Stonewall OK 74871. 405-265-4496.

Modulation reactors for 1 kW AM transmitter, Collins 20V or 20V2 AM transmitter in good condition, Buffalo NY area. T Scher, 716-634-2545. 10AM-4PM EST.

Bext 20 W translator. A Clawson, WPFF, 1715 Michigan St, Sturgeon Bay WI 54235. 414-743-7443.

Harris BC5H audio driver for BC5H. G Patschke, KIJN, Box 458, Farwell TX 79325. 806-481-3318.

AM Transmitters up to 2.5 kW, prefer solid state Harris, Nautel or similar. Also want Optomod AM 8100B and AM Polomac FIM. Maxfield, FAX: 011-44-892-66-8118. (U.K.)

McMartin AM/FM xmtr, any model, exciter or stereo modules. Goodrich Ent., 11435 Manderson, Omaha NE 68164. 402-493-1886.

TUBES

Want To Sell

4CX250B, 4-400, 833, 813, 5CX1500, 4-1000, all types, full warranty EIMAC, Amperex, RCA. Westgate 800-213-4563.

ECONCO

Quality Rebuilt Tubes

Approximately 1/2 the Cost of New

Call for Our Price List

800-532-6626

916-662-7553

FAX 916-666-7760

Circle (201) On Reader Service Card



Svetlana ELECTRON DEVICES

Quality* Power Tubes

4X150A 4CX15,000A

4CX250B 4CX15,000J

4CX250BC 5CX1500A

4CX250R 5CX1500B

4CX350A 8560AS

- Watch this list grow.
• Manufactured in Russia's largest power tube factory.
• Generous* warranty based on high quality.
• Honest prices based on quality at low cost.
• Shipment from USA stock.

Broadcasters

Call: 800-239-6900

FAX: 205-880-8077

OEMs, Distributors, Volume Purchasers

Call: 415-233-0429

FAX: 415-233-0439

Circle (16) On Reader Service Card

Want To Buy

Tube amplifiers: Brook; Hadley; Pederson. Jim (414) 281-8364 evenings.

RCA 8021 transmitting tubes. A Weiner, WHVW, 507 Violet Ave, Hyde Park NY 12538. 914-471-9500.

WANTED!

Transmitting Tubes

We BUY & SELL all types of transmitting/receiving tubes.

C&N Electronics

Harold Bramstedt
6104 Egg Lake Road
Hugo, MN 55038

(612) 429-9397 ext.23

(800) 421-9397 ext. 23

FAX (612) 429-0292

Circle (194) On Reader Service Card

TURNTABLES

Want To Sell

JVC 44-DD-5 quadrophonic disc demodulator, low hours, \$50. D Pulwers, Dave's Price Audio, 310 N Howard St #103, Alexandria VA 22304. 703-751-9346.

JVC CD-4 disc demodulator, lw hrs, \$50. 703-751-9346.

ORK-Russco TTs (3), \$40 each or all for \$100 plus shipping. L Houck, Rollin Recording, 210 Altgelt, San Antonio TX 78201. 210-736-5483.

Rek-O-Kut TT w/teararms & stereo preamps, \$300 ea. P Bridges, KGKO, 202 E Cross, Benton AR 72015. 501-778-8257.

Technics SP-25 direct drive turntables (3), good condition, \$150/each or Best Offer. M Skinner, KSGI, 801-628-1000.

Technics SP-15 (4), excellent condition, tonearm, case, manuals, isolator feet, \$350. J Rarst, KRRV, 1515 Jackson St, Alexandria LA 71301. 318-442-1410.

Several Russco, Gates & Quick-Kut TTs with or without tonearms, \$50/each. R Miller, WCNL/WTIM, Taylorville IL 62568. 217-824-3395.

ADVERTISING SPACE AVAILABLE!

CALL

800-336-3045

for more info!

ADVERTISER INDEX

This listing is provided for the convenience of our readers. Radio World assumes no liability for inaccuracy.

Table with 7 columns: Page No., Advertiser, Reader Service No., Page No., Advertiser, Reader Service No., Page No., Advertiser, Reader Service No. Lists various advertisers and their corresponding page numbers.

Table with 2 columns: Role and Name. Lists staff members such as Publisher, Associate Publisher, Marketing Consultant, etc.

Advertising Sales Representatives

Table with 2 columns: Region and Contact Info. Lists representatives for U.S. East, U.S. West, International, Europe, and Japan.

Free Subscriptions are available upon request to professional broadcasting and audiovisual equipment users. For address changes, send current and new address to RW a month in advance at P.O. Box 1214, Falls Church, VA 22041.

SUBSCRIPTION/READER SERVICE FORM

Radio World

FREE Subscription/Renewal Card

I would like to receive or continue receiving Radio World

FREE each month. Yes No

Signature Date

Please print and include all information:

Name Title

Company/Station

Address

City State ZIP

Business Telephone ()

Please circle only one entry for each category:

I. Type of Firm

- D. Combination AM/FM station
F. Recording Studio
A. Commercial AM station
G. TV station/teleprod facility
B. Commercial FM station
H. Consultant/ind engineer
C. Educational FM station
I. Mfg, distributor or dealer
E. Network/group owner
J. Other

II. Job Function

- A. Ownership
G. Sales manager
B. General management
E. News operations
C. Engineering
F. Other (specify)
D. Programming/production

Reader Service

Feb. 23, 1994 Use until May 23, 1994

Please first fill out contact information at left. Then check each advertisement for corresponding number and circle below.

Purchasing Authority

- 1. Recommend 2. Specify 3. Approve

Table with 4 columns of numbers for reader service tracking.

Copy & Mail to: Radio World, PO Box 1214, Falls Church, VA 22041, or FAX to: 703-998-2966

Radio World

Broadcast Equipment Exchange

Is read by over 22,000 Broadcast Equipment Users Every Month! Sell Your Used Equipment Here. Call or FAX Simone Mullins for Information on Affordable Advertising Rates.

PHONE

1-800-336-3045

FAX

703-998-2966



Andy & Debbie Montgomery and Capt'n. Pat Adams, the morning team at KIX-106 in Memphis, Tennessee.

We Make a Good Team!

KIX-106 is the number one country music radio station in the Memphis area. When they decided to remodel and expand their studios, the most carefully researched item on the equipment list was a new console for their on-air studio.

So they purchased the Auditronics 800 Series console.

Doug Gossett, their engineer, said some really great stuff about it, but we didn't want to get technical. Let's just say the specs are definitely superior.

However, Andy Montgomery, one-third of the KIX-106 morning team, said some really good stuff too... "Our entire studio is designed around the Auditronics 800. You might say that the 800 and, of course, Debbie are at the center of everything (Debbie's my wife, so I had to say that). It's reliable and it's sturdy. Have you ever spilled a cup of coffee or a soda on your console and everything shuts down? I don't recommend it, but so far this hasn't been a problem for the 800. It's so versatile. It does everything I need and it always works. That sure makes my job a lot easier. Debbie, Cap'n Pat, the 800 and I make a good team."

"It's hectic on our morning show and we get lots of phone calls, especially Debbie. This new telephone mix minus system makes them so much easier to handle."

"There are always the three of us on the air in the morning, but it's not unusual to have 5 or 6 people in the studio and on the air at the same time ... plus the music, the commercials and the phone calls. And we still haven't begun to max out the console. It's so reliable that I don't think Doug has had to make even a minor adjustment or anything since we started using it."

If you want to find out what Doug and other users had to say about the Auditronics 800 console, call your favorite Auditronics dealer or Auditronics today.

The Sound Of Perfection
AUDITRONICS

3750 Old Getwell Road, Memphis, TN 38118
 901-362-1350, FAX: 901-365-8629

The Closer You Get...

WE MEAN IT—we really DO provide the quality, performance, technical support, and innovation we promise!

Our model A-500 is a thoroughly engineered on-air console: it delivers the level of performance your clients now expect, and DAB demands. All components are selected for long life—gold bus connectors, gold I/O connectors, all gold contact switches, gas-filled relays, triple burned-in integrated circuits, solid state ON/OFF lamps, and precision laminated Lexan control surfaces for a lasting, wearproof finish. And we back that up with a 3-year parts and labor warranty, complete with

factory support from a technically competent and responsive staff.

We've also handled your special requirements as well with a super family of accessories, including a choice of three different telephone modules, an intercom module, an off-line mixer module for your remote feeds, talent control stations, accessory panels, failsafe power supplies, and auto cart and CD sequencing options.

So take a close look: we've got the quality, we've got the innovations, and you've got our commitment to top-notch support.



The Better We Look!

A-500