

\*\*\*\*\*3-DIGIT 857  
J750970 D08 9402 81188 1313  
TOM HILLER  
ASST CE  
KTZR  
2033 S AUGUSTA PL  
TUCSON AZ 85710

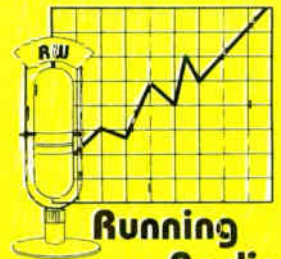

Running  
Radio  
See pp. 9-26

# Radio World

Vol 13, No 11

Radio's Best Read Newspaper

June 1, 1994

## Spanish Radio in U.S. Heats Up the Airwaves

by Alan Haber

**WASHINGTON** Spanish language radio networks and stations are blazing a hot trail across the United States, forging a strong cultural bond with Hispanics here and in Latin American countries. With a population of more than 22 million Hispanics in this country, according to 1990 U.S. Census data, and a projected increase to over 31 million by the year 2000, the market potential for Spanish language radio is enormous.

### Four networks

Spanish language radio may not be a new concept, but it's certainly a flourishing one; witness the announcement that CBS has

joined up with UPI to create CBS Americas, the fourth Spanish radio network, and the Spanish programming excitement being created at stations across the country.

Formerly known as the CBS Hispanic Radio Network, which was formed in 1990, CBS Americas will begin broadcasting, on June 27, a total of 47 newscasts a week, anchored by UPI correspondents in Washington, D.C., under the banner of Noticias CBS Americas.

CBS began its ties with Spanish-speaking listeners in 1976, when it broadcast the Major League Baseball All-Star Game and World Series in Spanish to Latin American listeners. According to the network, CBS Americas will reach 85 percent of the U.S.



CBS Americas' All Star Team includes (l to r) Gustavo Lopez Moreno, Billy Berroa, Jaime Jarrin and producer Armando Talavera.

Hispanic population with 40 affiliates in this country.

Jerry Villacres, general manager of CBS Americas, said that among the factors that will enable the network to be successful, is the Spanish-speaking communities' ability "to maintain the language, much more so than in previous generations."

### News and information

Ninety-nine newscasts are offered each week to 64 domestic and four Latin American affiliates of CNNRadio Noticias. The network's staff includes five anchors, three producers, three editors, and supervisor

Herb Sierra, all based at the CNN Center in Atlanta.

The five and a half minute newscasts, some of which include feature sections, cater to the network's philosophy of providing news and information of interest to Hispanics in the United States. CNN audio sources are utilized; some soundbites are begun in English and fade into a Spanish translation. Caballero Spanish Network in New York maintains domestic distribution rights for the network; CNN owns international distribution rights.

Sierra believes that communicating to the Spanish community has become a national marketing trend. "Hispanics are now in the mainstream," he said.

### Hollywood style

Supplying programming 24 hours a day to 61 U.S. affiliates (an additional 32 affiliates are located in Guatemala, El Salvador, Puerto Rico and Mexico), the eight-year-old Cadena Radio Centro (CRC) originates all but three of its top of the hour newscasts from its studios in Hollywood, Calif. (the others come out of Mexico City). Boasting a staff of professionals from around the world (Richard Santiago, CRC's general manager, said "There's a whole U.N. here"), CRC allows its affiliates to pick and choose from the program elements on offer; some stations, Santiago said, run everything the station produces.

CRC says it reaches 22.2 million Hispanics, or "87 percent of the U.S. Hispanic population over 12 years of age." In addition to hourly newscasts, a variety of special programming is produced, such as "Cristina Opina," a three-and-a-half minute weekday segment featuring opinions on a variety of subjects.

### Cultural exchange

Offering 168 five-minute hourly newscasts each week, the 24 hour Spanish Information Service (S.I.S.) Notisat also counts a 15-minute week-

continued on page 6

### COMPANY PROFILE

## CRL's Road to Success

by Alex Zavistovich

**TEMPE, Ariz.** Ask Ron Jones or Gary Clarkson, the two owners of Circuit Research Labs (CRL), to name a defining moment in the audio processing company's development, and they'll both tell you about their days as engineers for KUPD-FM in Tempe.

A talented staff of programmers and air talent helped lift the station to Arbitron dominance, then scattered to all corners of the country. Each of them remembered Jones and Clarkson, however, and enabled Tempe-based CRL to

establish a substantial national market for their products almost from the company's inception.

That early support from programmers and air talent has allowed CRL to grow into a significant force in the audio processing arena, with some 30 employees, a significant international reputation, and annual retail sales of almost \$3 million dollars. This year marks the company's twentieth anniversary, and the two founders look to a future of increased international presence and product diversification.

### How it started

In the early 1970s, Jones and Clarkson, then recent graduates of a technical trade school, began doing contract engineering work at Arizona radio stations to pay their way through Phoenix College, winding up ultimately in Arizona State

University's electronics engineering curriculum. While in Phoenix College, however, the pair had formalized their relationship, founding CRL as an engineering service. With a significant number of

continued on page 37

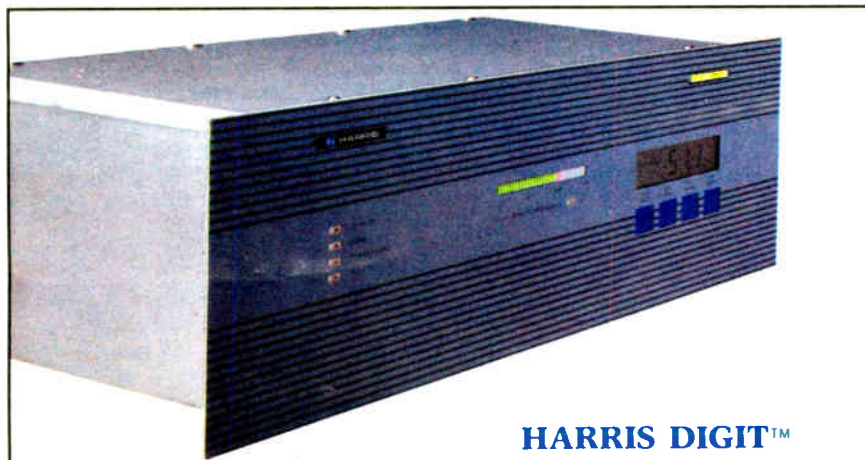

HARRIS DIGIT™

## Digital Excitement!

The world's first truly digital 50 watt FM exciter provides 32-bit Direct Digital Synthesis precision. The Harris Digit™ will deliver exceptional signal quality on the day of final test, and a year, even a decade, after installation.

Phone: 800-622-0022 Fax: 317-966-0623

HARRIS  
ALLIED



# NEWSWATCH

## Emmis' Smulyan To Head ITU Group

**WASHINGTON** Jeffrey Smulyan, chairman of the board for Emmis Broadcasting, has been selected as head of the U.S. delegation to the Plenipotentiary Conference of the International Telecommunications Union (ITU), which is scheduled Sept. 19-Oct. 14 in Kyoto, Japan.

The ITU is the United Nations agency devoted to telecommunications matters. The Plenipotentiary Conference convenes

every four years with representatives from 183 countries.

## FCC Stands Behind AM Stereo Decision

**WASHINGTON** In a recently released supplemental order, the FCC has stood behind last fall's adoption of the C-QUAM as the U.S. AM stereo transmission standard.

The supplemental order addressed comments that supported the Kahn system—specifically the use of the Kahn

POWERSide to limit adjacent channel interference and enhance tuning. The FCC re-emphasized what it had said in last fall's report and order—that stations using POWERSide could continue to do so if the program material fed to both channels is identical in content.

## AES Show Scheduled For Nov. 10-13

**SAN FRANCISCO** The 97th Audio Engineering Society (AES) is scheduled for Nov. 10-13 at the Moscone Center in San Francisco.

Exhibitors are expected to occupy 150,000 square feet in

the main hall, and there will be 11 demonstration suites. Besides exhibits, there will be an extensive number of technical papers and 14 workshops.

For more information, contact the AES at 212-661-8528.

## NAB Wants Quick Action On 'Info Highway'

**WASHINGTON** The NAB has urged Congress to move quickly on passing legislation that would enact rules for the so-called "information highway."

According to the NAB, broadcasters fear that congressional inaction will stymie develop-

ment of a competitive national information infrastructure.

"Absent any direction from Congress, the Regional Bell Operating Companies will just continue arranging the future of telecommunications in their best interest," NAB President and CEO Eddie Fritts said.

## Hearing Workshop Slated for August

**NORMAN, Ind.** The Synergetic Audio Concepts will hold the "What We Know About Hearing" workshop Aug. 18-20 at the Indiana University School of Music in Bloomington.

Speakers from Bell Laboratories, Indiana's University speech and hearing department, and Etymotic, Inc. will discuss research and test results about the complexities of human hearing. Audio and acoustic measurement technology is just beginning to exploit the two-channel uniqueness of the human ear/brain systems, the company release said.

For more information about the workshop, contact Synergetic Audio Concepts at 812-995-8212 (phone), 812-995-2110 (fax); or write: 12370 W. Co. Road., 100 N, Norman, IN 47264.

# Only AUDIOARTS Has It...

**WHEATSTONE'S STRENGTH!** With Wheatstone's professional experience, engineering know-how, support capability and corporate stability behind it, this AUDIOARTS console design is the right choice.

The A-50 is cost effective through clever engineering and the latest advances in CAD design and electronic assembly procedures. It was developed by the same design team that creates Wheatstone's high end equipment. This console's performance is light years beyond the competition.

Naturally, it has all of the most important features: machine control functions, programmable channel logic, and three busses (Program, Audition, and Telephone). It also has the monitors you need: control room, studio and headphone—each with its own level control. It's designed so you can expand or add accessory modules as your needs grow.

You can benefit from our major market experience. Take advantage of Wheatstone's expertise and reputation; call us today for immediate action.



**AUDIOARTS ENGINEERING**  
7205 Franklin Blvd., Suite 100, San Diego, CA 92121  
Tel: (619) 552-5000 / Fax: (619) 552-0160

## Index

### RUNNING RADIO

<b>On the Air with Radio's Cousin Bruce</b> by Alan Haber	9
<b>Off-Air Events Reap both Fun and Profit</b> by Alan Haber	11
<b>Cable Audio Services Target Radio Listeners</b> by Frank Beacham	12
<b>Mining Those Market Development</b> by Bob Harris	13
<b>Euro Disney Can Help Make On-Air Magic</b> by Alan Carter	14
<b>AM/FM Transmission Focus at NAB</b> by Tom Osenkowsky	14
<b>Promotions a Tough But Rewarding Choice</b> by Mark Lapidus	17
<b>Putting Perspective on DAB Debate</b> by Judith Gross	19
<b>Policy Manuals Are Valuable Tools</b> by Sue Jones	21
<b>Ins and Outs of Station Promotion</b> by Karl Baehr	24

### FEATURES

<b>Opamps Simplify In-House Design Projects</b> by Ed Montgomery	38
<b>Three Jocks Survive Arson Attack</b> by Dee McVicker	41
<b>Treasured Memento of Early Stereo</b> by Read G. Burgan	42
<b>FCC Considers Modernized DA Rules</b> by W.C. Alexander	44
<b>EPM Details to Ponder before June 30</b> by Harold Hallikainen	45
<b>DOS 6.2 Mends Some Network Potholes</b> by Richard Mertz	47
<b>Watch Out for Slow-Paying Stations</b> by Phil Simon	48



# Yamaha Unveils All-Digital Mixer

by Mel Lambert

**LOS ANGELES** Targeted squarely at the all-digital radio-production market, Yamaha introduced its new ProMix 01 mixing console last month amidst considerable fanfare. The press conference was held at the House of Blues Club in Hollywood May 5 with a full contingent of industry people, trade press and Yamaha executives.

The new product is remarkable in several respects. On the surface, the ProMix 01 is a compact 18-input mixer equipped

with 16 balanced mic/line inputs (plus a dedicated stereo input), phantom power, four Aux Sends, two stereo effect returns, three-band parametric EQ, solo, input metering and three stereo outputs.

with 16 balanced mic/line inputs (plus a dedicated stereo input), phantom power, four Aux Sends, two stereo effect returns, three-band parametric EQ, solo, input metering and three stereo outputs.



Yamaha's ProMix 01 mixing console

with 16 balanced mic/line inputs (plus a dedicated stereo input), phantom power, four Aux Sends, two stereo effect returns, three-band parametric EQ, solo, input metering and three stereo outputs.

Add to that basic description a sophisticated moving-fader snapshot/dynamic automation system, a pair of built-in digital-effects processors and three assignable compressor-limiters, and you might predict a user price in the range \$8,000 to \$10,000. But the good news is that the new ProMix 01, scheduled to be available by mid-August, has a suggested user price of under \$2,000.

### A radio natural

A large number of radio production studios will likely consider adding such a function-packed, low-cost console to a hard-disk recording and editing system. In fact, all that is lacking on the ProMix

01 are digital inputs to allow direct connection to, for example, workstations and DAT recorders (currently only analog inputs are featured). A single S/P DIF digital output, however, is available for sending a two-channel master mix to an outboard DAT recorder or similar device.

"The ProMix 01 provides considerably more power and versatility than what is ever possible in the analog world," said Michael MacDonald, Yamaha's marketing manager for professional audio products.

"The greatest benefit is memory, which makes it remarkably easy and convenient to recall all mix settings at the touch of a button. We expect the [radio-production] market will come to the conclusion that a mixer without memory is only half a mixer," he said.

The ProMix 01 mixer's programmable Memory and Automation features will make it an ideal choice for production studios. A single compressor/gates eliminate the need for outboard equipment. All effects and dynamic settings are stored as part of a snapshot mix. Metering is via pair of 12-segment LEDs connected across the mains stereo outputs.

Sonically, according to Yamaha's specifications, the ProMix 01 offers over 105 dB of dynamic range, courtesy of new 20-bit, 64-times oversampling A/D converters and 20-bit, eight-times oversampling D/A converters. The unit's three-band parametric EQ is the same type used in Yamaha's flagship digital console, the DMC1000. Two duplicate

compressor/gates eliminate the need for outboard equipment. All effects and dynamic settings are stored as part of a snapshot mix. Metering is via pair of 12-segment LEDs connected across the mains stereo outputs.

### Built-in effects

Two built-in digital effect processors, and three assignable, full function stereo

stereo ana...  
+4 dB bala...  
RCA/phono con...  
dedicated monitor...  
The ProMix 01's...  
seems easy and intuitive...  
by a large 240-by-64-seg...  
LCD screen. Information abou...  
er parameters can be accessed v...  
both numeric and graphic display, allowing the operator to view, for example, a picture of an EQ curve or compressor/gate settings. Also displayed are pan settings,

**A large number of radio production studios will likely consider adding such a function-packed, low-cost console to a hard-disk recording and editing system.**

compressor/gates eliminate the need for outboard equipment. All effects and dynamic settings are stored as part of a snapshot mix. Metering is via pair of 12-segment LEDs connected across the mains stereo outputs.

Sonically, according to Yamaha's specifications, the ProMix 01 offers over 105 dB of dynamic range, courtesy of new 20-bit, 64-times oversampling A/D converters and 20-bit, eight-times oversampling D/A converters. The unit's three-band parametric EQ is the same type used in Yamaha's flagship digital console, the DMC1000. Two duplicate

fader groups and input channel levels. The ProMix 01 measures just 19 by 17 inches, and is 5 inches deep; weight is just over 26 pounds. System options includes wood side panels, side rails for rack mounting, a carrying case and color coded fader knobs.

For more information, contact the Yamaha Corporation of America, Professional Audio Products, P.O. Box 6600, Buena Park, CA 90622-6600; telephone (714) 522-9011.

Mel Lambert is a regular contributor to RW.

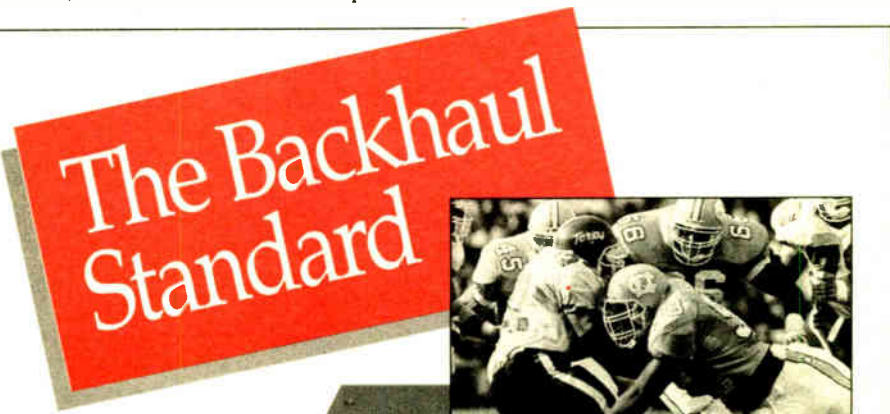

### Features:

- Transmits 50 Hz - 5 KHz via Two Dial-up Phone Lines
- Provides Quiet Program Channel, Even on Noisy Long Distance Circuits
- Rugged, Portable Field Encoder



NCAA football photo courtesy of Host Communications

So many Comrex Two Line Frequency Extenders are in use throughout the world that they have become the industry standard for transmitting sports, news and other remote broadcasts. Because they work on normal analog telephone lines, the Two Line Extenders can be used anywhere. Ruggedly built for reliable, on-the-road duty, these "backhaul workhorses" provide high quality broadcasts across continents or just across town.

Call or fax us for complete information, including our "Try It Before You Buy It" offer.



Comrex Corporation  
65 Nonset Path, Acton, MA 01720  
800-237-1776 508-263-1800  
Fax 508-635-0401

Comrex (UK) Ltd.  
75 The Grove, Ealing  
London W5 5LL, UK  
081-579-9143 Fax 081-840-0018

## Need a New Digital Satellite Receiver for DATS/"SEDAT"?

**New DATS 7.5/15? New 3.5 Voice Cue? "SEDAT" Cards? We are shipping now! We can even convert your S/A 7300/7325!**

**Zephyrus for JSA**  
**Zephyrus 700 SCPC**

**We Repair & Rebuild all Popular Receivers Quick Service! 24 Hour Tech Support**



Fairchild Dart Compatible LNB-Type

**Satellite Systems**  
(719) 634-6319  
"SEDAT" is a Trademark of Scientific-Atlanta, Inc.



# On the Road for Radio Opportunities

**WASHINGTON** If you have not quite made it to the editorial yet, this time out we're raising the flag on license renewals for radio. In about a year, many of you will undergo a long and important process designed to determine whether you are worthy of being a radio licensee. Same story, every seven years.

It is no exaggeration to suggest the process will resemble the unleashing of a swarm. It is a good idea to begin meeting with your attorneys and devise strategies to protect yourselves from challenges that are sure to come from many fronts.

You can count on us to keep you abreast of the ongoing issues. We will soon begin a series of articles, providing facts, figures and analyses that will hopefully help you prepare for what is to come. By all means, write with any questions, experiences or concerns you might have.

★ ★ ★

Just the other day I had the rare opportunity to travel to Richmond, Ind., and spend some time with the folks at Harris Allied and more than 30 of the vendors the company represents.

The reason for my trip was EXPO '94, a



one-day event offering hands-on training and seminars for radio and television station managers, engineers and program directors.

Held at the Leland Hotel (a quiet and elegant hotel nestled in the heart of downtown Richmond), EXPO '94 drew more than 200 registrants.

The event was organized for Harris Allied by Radio Networks principal, Dave Burns. (I'll write more on that technology expo in the next issue of *RW*).

I spent some time visiting the Harris Allied facility out there. Gene Schultz, the company's manager of worldwide marketing, was kind enough to offer me a tour of the installation, built back when the company was Allied, before the merger with Harris.



I've included a picture of Tim Elstro (r) and Gary Hardwick, who work in the service shop... you know, the guys who you all know but never get to meet. It was great to see the entire setup and meet the guys who keep the equipment running.

Special thanks on my part go to Gene Schultz for his time and the tour. Gene is a long-time friend of *RW* and I was sorry to hear that he has decided to retire from the business at year's end. He is leaving a terrific legacy of brochures, catalogs, ads, fliers, shows, mailers and other material.

This last catalog he has put together for Harris Allied (just off the presses) is beautiful. All-inclusive, for worldwide distribution, the catalog features a hologram of the world on the cover. Nice job (or as Gene put it in his parting words written in the publication, "This catalog is essentially my 'swan song.' Thanks to all my broadcast friends worldwide.").

Kudos to Harris Allied for organizing the regional expo. The event drew from as far away as West Virginia. Many broadcasters who are unable to attend the big conventions can reap the rewards of these small expos, with the added bonus of spending quality time with the vendors, asking questions and playing with the gear. Again, more on that in my story in the next *RW*.

★ ★ ★

The concept of going out to the people who cannot or will not come to you is a good one, and one that other entities in the radio business also put to practical use.

The Radio Advertising Bureau (RAB) just concluded its board of directors meeting in Atlanta. In addition to its semi-annual gathering, 50 of radio's executives broke into teams to visit marketing and advertising directors from 19 companies, including Coca-Cola, Holiday Inn and Home Depot.

As in the past, the RAB's objective is to help radio assess its advertisers' needs.



On hand to greet registrants at the Expo '94 in Richmond, Ind., were Harris Allied's (l to r) Tom Harle, Ron Frillman, and Gene Schultz.

and determine what it can do better to help those companies achieve their marketing goals (preferably using radio, of course).

The meetings have been conducted successfully now for two years. There is no

pressure for a real sale to happen; the RAB and its board members are merely on an educative and goodwill-engendering mission. In addition, the radio industry can collect information on what it should be doing to better serve its clients.

Good job, RAB.

★ ★ ★

On a related note, the RAB reports the first quarter of 1994 gave radio a 13 percent increase in total revenue, compared to the first quarter figure for 1993. March was a banner month for national spot revenue, posting an 18 percent gain over the same month in 1993.

Both national and spot grew at double digit rates across every region of the country during the first quarter. Local revenue was up 12 percent through the end of March, and national spot revenue escalated to 16 percent for the same period.

Margaret Bryant joins ABC Radio Networks as director of engineering and technical operations for the company's Dallas facility. She joins ABC from Group W's WMAQ(AM) in Chicago where she was engineering manager.

Her experience prior to WMAQ includes positions as engineering manager at KQXT-FM San Antonio, Texas, and contract engineer at WBOW(AM) Scranton, Pa. As partner in Wireless Engineering Associates, Bryant worked on radio studio and transmitter sites. She also worked a stint at WKOP(AM)-WAAL-FM in Binghamton, N.Y. as chief engineer.

Bryant also contributes occasionally to *RW* and sister publication, *TV Technology*.

The National Association of Broadcasters (NAB) promoted Lee Ann Burr to vice president, conventions and exhibitions. Burr, who had been director of convention operations for the NAB, joined the association in 1986 from the field of hotel sales and management.



## Get on the right track...

**U**nattended operation helps you operate your station profitably. All it takes is a satellite or automation program source, a good transmitter control system, and a way to handle EBS.

You take care of the program source... We'll help with the rest.

A transmitter control system from Burk Technology relieves you of the need to keep someone at the station just to take transmitter readings. Add our exclusive Studio I/O and we'll run EBS for you, too.

Burk gives you the flexibility to run your station the way you want, and in full compliance with FCC rules.

Call us now. We'll show you a new way to run a railroad.

TOLL FREE 1-800 255-8090

**BURK**  
TECHNOLOGY

7 Lomar Drive, Pepperell, MA, 01463 (508) 433-8877



## READERS FORUM

If you have comments for Radio World, call us at 800-336-3045 or send a letter to Readers Forum (Radio World, Box 1214, Falls Church, VA 22041 or MCI Mailbox #302-7776). All letters received become the property of Radio World, to be used at our discretion and as space permits.

### Compression dispute

Dear RW,

Randy Sukow's article "Broadcasters Are Careful Compression Customers" (RW, March 9) refers to the experiences of Chief Engineer J. Gibson Prichard with a Moseley DSP6000 RF STL at WRLT(FM) Nashville. Prichard attributes some problems, namely "damage to male voices and other low-pitched audio" to apt-X, the compression system adopted by Moseley for their STL.

This unsubstantiated and incorrect assertion adds nothing to the valuable debate currently airing in the columns of RW. Indeed, it suggests that not all broadcasters are fully aware of the problems associated with tandem coding where the robustness of the algorithm is all-important.

For the record, there are now over 80,000 channels of apt-X compressed audio in professional daily use and the system has been widely adopted by manufacturers of high-quality professional equipment.

Fred Wylie,  
Audio Processing Technology,  
Belfast, Northern Ireland

### Expo benefits radio

Dear RW,

Thank you for this opportunity to respond to your editorial, "Do Not Forget Radio" (RW, April 20).

It is not true that radio managers and engineers are slipping away from the spring National Association of Broadcasters convention. Attendance at the 23 NAB radio and Radio Advertising Bureau sessions at NAB '94 was slightly higher than the 18 radio sessions at NAB '93, despite continuing shrinkage in total radio industry employment. It is radio attendance at the fall Radio Show that has been declining in each of the past three years.

NAB's focus on radio at both conventions is sharp and reflects months of

planning. The separate radio/audio exhibit hall at the spring convention was created at the request of exhibitors, and they reconfirmed their wish to continue that separate hall during the show last March.

Radio/audio exhibitors tell NAB that the persons visiting their NAB '94 booths were qualified radio and audio buyers, and that this is much more important to them than attracting larger crowds, which may include many non-radio executives.

The NAB Radio Show, in particular, is planned each year by radio broadcasters, and the involvement of RAB has increased substantially in the past two years. The 1994 NAB Radio Show will continue this single-minded focus on radio. TV will play no part in the radio show.

The show's sessions will be held in meeting rooms that are completely separate from the locations of the other concurrent conferences. Radio executives attending need not even be aware of the other conferences going on half a city block away. They will have their own headquarters, hotels and their own daily newspaper reporting on the Radio Show, as before.

In Los Angeles this October, only the exhibit hall will combine the NAB exhibition with those of the Radio-Television News Directors Association and Society of Motion Picture and Television Engineers, and even there, radio exhibitors will be in a special pavilion.

The only expanded exhibits will actually strengthen the radio-only conference, because NAB will use expanded exhibit revenues to enhance the Radio Show's programs with the aim of reversing the downward trend in attendance by radio broadcasters.

Wayne Vriesman, Chairman,  
NAB Joint Board &  
Vice President, Radio Group,  
Tribune Broadcasting Co., Chicago

### RF sickness

Dear RW,

The article about engineering firms weathering the freeze (RW, April 20) was good, but after attending the National Association of Broadcasters convention, I think these firms have a windfall coming their way out of the broadcasters' pockets.

Did anyone notice or attend the ANSI seminar? The FCC is planning to change the RF threshold to a fraction of the present level to protect us from a fate that has yet to be seen. The radiation from our stations may be making us sick.

I bought a measuring device for \$800 and use it faithfully around our transmitters and towers. It never goes off. It is supposed to trigger at 50 percent of the threshold six-minute level. I wonder about how real the RF threat is.

Engineers and manufacturers at the NAB convention told me without exception that they are not concerned about an unproven, perceived threat. They are in the business of making test equipment and writing reports. The fact that RF standards and people getting sick has never been correlated is irrelevant to them.

## The Countdown Begins

Exactly one year from today—June 1, 1995—the FCC begins reviewing radio station license renewal applications. Like some varieties of locust, the commission returns every seven years.

The swarm of forms, lawyers, challenges, hearings and appeals will descend like a plague on those licensees who are unprepared. The unusually high amount of turnover in station ownership over the past

seven years ensures that a high percentage of licensees will be going through the process for the first time.

The National Association of Broadcasters, commendably, is off to an early start on its series of seminars to help station owners and managers prepare. Many of the rules have changed enough so that renewal veterans may want to sit in on the meetings, which will be held at sites nationwide over the next several months.

It is already clear, by the focus of the first seminars and the questions broadcasters are asking, that the FCC's Equal Employment Opportunity (EEO) regulations are the highest concern.

As RW columnist Harry Cole says (April 20 issue), the rules "are so vague that a licensee could conceivably get tagged with an initial violation in spite of good-faith efforts to comply with all the rules." The standard fine for an EEO violation has been increased to \$12,500.

This magnifies the importance of concentrating on renewal minutiae immediately. The more vague the rule, the greater the need for exhaustive, detailed documentation to support a station's claims. The stiffer the penalty, the more gravity past violations will have during a hearing in front of an administrative law judge.

The new EEO rules, the proposed new RF radiation standards and other FCC initiatives that are likely to put dents in station revenues anger many broadcasters. But it appears broadcasters will have to live with them, at least through the 1995 renewal phase, before any perceived injustices will be corrected.

The practical thing for most broadcasters to do at this point is meet with their attorneys and devise strategies to protect themselves from challenges that are sure to come from many fronts.

—RW

We are being hustled by the very engineering firms who used to do our applications for facilities upgrades. Now that we are a "mature industry," there has to be another route to our pockets.

We have a vast resource available to us, present and retired transmitter engineers. Has anyone ever tapped that study group to see what effect, if any, RF had on them? Maybe we will get around to the reality-versus-theory question when broadcasters are told to shut down their all-of-a-sudden dangerous transmitting facilities.

This sleeping giant is going to catch the industry with its britches down if we do not get real and stop these theorists before they run us over.

The next time you talk to your consulting engineering firm, ask about the real-world correlation between RF and health threats. The answer will make you sick.

Lawrence J. Tighe Jr., President,  
WRNJ-AM-FM Hackettstown, N.J.

### State news note

Dear RW,

I enjoyed the *Uplink* feature by Karl Baehr about localizing news (RW, May 4). I would add that stations in nearly three-fourths of the nation are served by state news networks. Satellite-delivered audio news and sports at the state level can integrate well into local or stand-alone local programming.

Taxes, gun control, workplace and lifestyle laws that affect every citizen in many ways make up coverage of state capitals, while special event coverage and stringer reports are also provided. We're worth a look and a listen.

Ben Kiningham, State Bureau Chief,  
Illinois News Network, Springfield

### Not first

Dear RW,

The headline "WBBR Is First Audio

Superstation" on your March 23rd cover story is both misleading and inaccurate.

WFMT(FM) Chicago became the first audio superstation in 1979 when its 24-hour signal was fed "piggy-back" with WGN-TV Chicago to hundreds of cable systems served by United Artists Video of Tulsa, Okla.

Consumers receive WFMT's fine arts programming through a link between their cable TV boxes and their stereo audio receivers where WFMT is placed on an open FM channel in each local market. Today WFMT is heard in more than 200 markets in 35 states, serving more than a million households.

While your article makes clear that WBBR(AM) New York is the first to be distributed by direct satellite to homes, your headline is grossly inaccurate.

John Kavanaugh, Director,  
Corporate Communications,  
WFMT(FM) Chicago

### BW-150 explained

Dear RW,

James Sorenson's letter directed to me (RW, April 20) at last identifies FCC Form BW-150. He's one up on me, having actually received such a form.

I'll let Jim and everyone in on my little secret: I've never heard of any such form. As I wrote the March 23rd "From the Trenches," it was 1:50 a.m., and BW stands for "bad words," which were first mentioned in the mock quiz question dealing with obscene and/or indecent language.

Al Peterson, Production Director,  
WNNK-FM Harrisburg, Pa.

### Correction

KLZ-KLTT Denver is an AM duopoly and not an AM-FM combo, as listed in the May 4 "Readers Forum."

# Radio World

Vol. 18, No. 11 June 1, 1994

Editor.....Lucia Cobo  
Managing Editor.....Randy Sukow  
News/Studio Sessions Editor.....John Gatski  
Associate Editor.....T. Carter Ross  
Contributors.....Frank Beacham/N.Y.  
Bruce Ingram, Pamela Watkins, Nancy Reist  
Technical Editor.....John Bisset  
Technical Advisor.....Tom McGinley  
Editor (International).....Alan Carter  
Managing Editor (International).....Charles Taylor  
Editorial Assistant.....Whitney Pinion

Radio World (ISSN: 0274-8541) is published bi-weekly by Industrial Marketing Advisory Services, Inc., 5827 Columbia Pike, Suite 310, Falls Church, VA 22041. Phone: 703-998-7600, Fax: 703-998-2966. Second-class postage rates are paid at Falls Church VA 22046 and additional mailing offices. POSTMASTER: Send 3579 forms and address changes to Radio World, P.O. Box 1214, Falls Church VA 22041. Copyright 1994 by Industrial Marketing Advisory Services, Inc. All rights reserved.

—PRINTED IN THE USA—

Next Issue of  
Radio World  
June 15, 1994



# Seminar Focuses on Info Highway

by Randy Sukow

**ARLINGTON, Va.** It has barely begun meeting, but President Clinton's industry panel on the National Information Infrastructure (NII) has already begun concentrating on the contentious question of whether the government should mandate "universal access" to the "information superhighway."

"Just what does (universal service) mean? Who can be connected? What's the cost? What are the subsidies?" are all matters of debate, said the co-chairman of the NII panel, Delano Lewis, who is also the newly appointed president and chief executive officer of National Public Radio.

"We should make the highway as inclusive as we can. That's going to be a tall order," he said.

But other industry leaders, especially cable TV companies and the regional Bell operating companies (RBOCs), say progress in infrastructure construction has already been checked by excessive government regulation, and could be choked to death by even more.

Lewis appeared last month with other communications industry representatives at the Infobits '94 Symposium, sponsored by the National Science Foundation, MCI and businesses in the Ballston neighborhood of suburban Washington (where NSF is headquartered).

Thirty members are currently on the NII panel. NPR's Washington offices have served as the meeting place for the group, which has a two-year charter from the Commerce Department to study aspects of the NII and offer policy proposals.

The panel is broken into subgroups looking at: "visions and goals" for the technology (such as improved education and health care applications); electronic business applications, and criminal justice applications.

Lewis approaches the task from two

perspectives, as a public broadcaster and former executive of RBOC Bell Atlantic (see interview, *RW*, May 18). Telco investors hope Lewis' RBOC background influences the committee as it attempts to define universal service.

"Customers will dictate where the information superhighway goes," said Michael N. Gilliam, president, SBC Media Ventures. "I don't think it should be a social obligation to make the information superhighway universally accessible to each person. We should be talking more in terms of what services those people want."

SBC Media is a subsidiary of Southwestern Bell Corp., which took control of cable systems in Arlington and

nearby Montgomery County, Md., earlier this year, to become the only RBOC to own cable systems in the U.S. Other RBOCs will likely follow if Congress passes proposed NII legislation to allow cable-telco crossownership.

But cable-telco consolidation did not get off to a great start, Gilliam said. Within a few months after taking over the Washington-area systems, the FCC revised its cable rate regulation to force 10 percent rollbacks of cable system revenues.

Gilliam returned to the U.S. to manage the SBC properties after a number of years running Southwestern Bell's cable systems in the U.K., where he predicts consumers will feel the benefits of

advanced communications services long before consumers in the U.S.

"We're putting fiber within a hundred yards of every single home in the (U.K.)," Gilliam said. The difference, he said, is British cable TV regulation that encourages broadband network construction, compared to thousands of pages of costly cable regulation in the U.S.

As for NPR's future in the NII, Lewis said the network will evolve into a "content provider" on several different levels besides broadcasting. It will establish itself as an information source, in partnership with other companies that will handle transmission or distribution. But it is not yet clear what technologies it will use.

"You can have 'All Things Considered' coming with text over your hand-held computer. There are lots of things we're going to explore," Lewis said.

## Spanish Radio in U.S.

► continued from page 1

day radio magazine, sports and special features among its program offerings to its more than 60 U.S. and 70 Mexico affiliates.

Jose Luis Madrigal, president, said the network's philosophy is to keep Spanish people in the United States aware of what's going on in this country, and what's going on in their own countries. One of the network's programs, "Noches de Fiesta," or

**CBS**   
**AMERICAS**

Party Nights, has toll-free telephone numbers for Mexico and the United States that listeners can call to send greetings or dedicate songs to their friends and family on the air.

Spanish language radio stations carrying network affiliation are more than satisfied

with the arrangement. For example, Gene Hogan, general manager of CBS affiliate KNTA-AM in San Francisco, said "Being with a network, particularly CBS Hispanic, we're getting the type (of) programs we couldn't get being just an independent." And Paul Gamache, station manager of WONQ-AM in Orlando, Florida, looks at his affiliation with CNRRadio Noticias as a matter of economics. "We can't afford to staff a good news department in order to cover national and international events and news."

Is the process of choosing the news for a Spanish radio network different than for an American operation? Yes and no, according to Gustavo Szulansky, director of programming for CBS Americas, and executive producer of Noticias CBS Americas. "No, because what's news on a global basis usually affects everybody, and yes, because certain avenues are obviously of more concern to... people of Latin American Origin."

The strong trend toward Spanish-

language programming is revenue driven, according to Armando Trull, news director of CBS Americas, and director of Spanish broadcast services at UPI.

### Spanish programming is hot

Networks aren't the only Spanish language broadcasters heating up the airwaves in this country. At stations from coast to coast, Latinos are tuning in to a variety of uniquely satisfying programming.

Multi-ethnic programmer WTCC-FM in Springfield, Massachusetts, for example, runs 15 hours of Spanish language programming a week targeted to Latinos from Central and South

America, and Puerto Rico. Programming includes "Ecos del Ritmo," which features a mixture of old and new Spanish music weekdays, and "Cantares Latino Americanos," a specialty show, broadcast half in English and half in Spanish, which includes interviews with local figures, bands from Central and South America, old music from Peru, Bolivia, and Colombia, and Latin jazz.

Tejano, the hot tex-mex sound creating excitement in Texas, New Mexico, Arizona and California, is the order of the day at 1,000 watt clear channel KATK-AM in Carlsbad, New Mexico. The bi-lingual format helps to draw the "younger



**CNNRADIO**  
**NOTICIAS**

Hispanic audience...back into their Hispanic roots," Program director Scott Vera said.

### Going Tejano

The switch was made to Tejano from traditional Spanish music about a year-and-a-half ago, according to Vera, because the traditional sound "was reaching an older audience (and) advertisers wanted to reach a younger crowd."

Music and news are not the only ingredients in today's Spanish-language programming mix. For example, KECR-FM, a Christian broadcaster in El Cajon, Calif., reaches Spanish-speaking listeners as far north as Temecula, and as far south as Tijuana, with "programming that's uplifting to the Christian believer and provides eternal hope to the nonbeliever who tunes in," said Lois Claussen, director of Spanish broadcasting. Spanish programming airs 6:00 to 8:00 a.m. seven days a week.

## On Target.

Performance, value, and reliability through innovative technology.

5 models available.

- BC6DSL
- BC6DSR
- BC8DSL
- BC8DSR
- BC12DSL

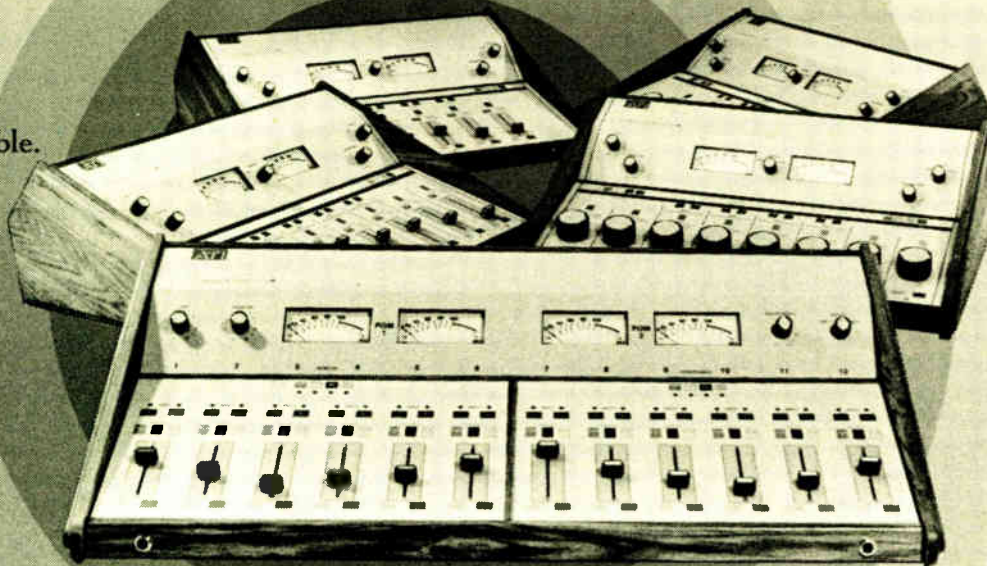

Vanguard Series™ STEREO BROADCAST CONSOLES

**ATJ** AUDIO TECHNOLOGIES INCORPORATED

Call or write for free detailed brochure.

328 W. Maple Ave. Horsham, PA 19044, USA  
(215) 443-0330 FAX: (215) 443-0394



SONY

# GET OUT OF THE SAME OLD LOOP.

Tired of going around and around with your old cart machine?  
Then it's time to head straight for Sony's digital MiniDisc Cart. A direct  
result of Sony's leadership in MiniDisc technology, the MiniDisc Cart is a simple  
plug-in replacement for your NAB cart. And it gives you what your analog simply  
can't deliver. Like superior sound quality, random access and time/track-recordable  
discs with up to 74 minutes of record time each, and more. Learn how you  
can get out of the "same loop." Call 1-800-635-SONY ext. MD.

INNOVATION AT WORK.



Sony Inc., and Professional Products Group, 4700 E. Irving Blvd., Englewood, NJ 07631. ©1997 Sony Electronics Inc.  
Reproduction in whole or in part without written permission is prohibited. All rights reserved. Sony and the MiniDisc logo are trademarks of Sony.



San Francisco

Wilkes-Barre/Scranton

Nashville

Greenville-New Bern

St. Louis

Mobile-Pensacola

Lansing

Panama City

Buffalo

Utica-Rome

Denver

And

Tulsa

More!

# GERRY

# HOUSE



# HOUSE

# FOUNDATION



**AMERICA'S #1  
SYNDICATED COUNTRY  
MORNING SHOW!**

**PREMIERE  
RADIO NETWORKS**

Circle (145) On Reader Service Card

Contact your Premiere Radio Networks representative at (818) 377-5300

World Radio History



# Running Radio

Keeping  
An Eye on  
Cable Audio.  
page 12.

Your Resource for Business, Programming & Sales

## On the Air with Radio's Cousin Brucie

by Alan Haber

Part I of II

**NEW YORK** It's a double-play weekend at New York's oldies station, WCBS-FM. Engaging his coveted "New York microphone," legendary broadcaster Bruce "Cousin Brucie" Morrow reaches out to his loyal listeners—his "cousins"—for requests.

"Allright, my friends, remember now, the phones are open," he chimes to listeners of all ages in the tri-state area of New York, New Jersey and Connecticut. "Give your 'Cuz' a buzz!"

**Could be 1965**

The sight of four Denon DN-951FA CD players pumping the sounds of such oldies stalwarts as Johnny Maestro and the Brooklyn Bridge and the Four Seasons through two JBL model 4312 Control Monitors hardly conceals the overwhelming feeling that this night could just as well be occurring in 1965 as in 1994.

Cousin Brucie—for those of you who grew up in New York listening to Bruce Morrow, he will always be your Cousin—is a proud borough of Brooklyn baby who, despite some time spent working outside of the Big Apple early in his career, is most at home behind his New York microphone.

After starting WCAG, the first radio station at New York University, in 1953, his pockets bulging with 20 dollars for

wire, Bruce Morrow worked briefly at ZBM radio in Bermuda, then at WINS in New York City. After detouring to WINZ in Miami, he arrived in 1961 at



Bruce Morrow broadcasts to his 'Cousins' on WCBS-FM New York.

the powerhouse home of personality radio, WABC(AM).

Cousin Brucie spent 13 amazing years at the New York giant, leaving on August 7, 1974 for rival WNBC(AM), where he stayed until 1977.

**"Cousin" Owner**

These days, Cousin Brucie wears a magical hat that allows him to be what he calls "Cousin Owner," as well as "Cousin Broadcaster." Morrow is chairman of the board and co-chief executive officer, and Michael G. Ferrel is President and co-chief executive officer, chief operating

officer and a director, of Multi-Market Radio Inc. The publicly-traded company owns WHMP-AM-FM, and WPKX-FM, all operating in the Springfield/Northampton, Mass., market; WYAK-AM-FM, in Myrtle Beach, S.C.; WRXR-FM in Augusta, Ga.; and WKBG-FM in Martinez, Ga. (Multi-Market Radio acquired WRXR-FM on April 4; WKBG-FM signed on the air on April 14 and also serves the Augusta market. The two stations are being operated as a duopoly).

**Ownership**

Multi-Market Radio is not Morrow's first stint as "Cousin Owner," however. In 1979, Morrow and his partner Bob Sillerman,

operating as Sillerman-Morrow Broadcasting Group Inc., began purchasing eight radio stations and one television station—WATL in Atlanta (Sillerman owns a large amount of non-voting stock in Multi-Market Radio, and Sillerman Communications Management Corp. is Multi-Market Radio's primary financial consultant).

In 1983, Inc Magazine dubbed Sillerman-Morrow the 13th fastest growing private company for the period beginning in 1978 and ending in 1982.

In the comfortable living room of his spacious, three-story townhouse in New York City's Greenwich Village, surrounded by a mint-condition Wurlitzer 78 rpm jukebox and showcase-quality old radios and televisions, Bruce Morrow waxed poetic about his reasons for crossing the line between broadcaster and radio station owner.

He looks back on the 1970s as a time in which "we started getting owners that were not really broadcasters, and there's quite a difference between an owner and a broadcaster. And I always thought that broadcasting people should own radio

continued on page 12 ►

# AP Makes All News Radio Affordable.



Thanks to AP All News Radio, stations everywhere can afford to take advantage of one of radio's most successful formats. Call The Associated Press for details.

800-821-4747

## MONEY IN THE BANK!



## "No Place Like Home"

voiced by Mayberry's own

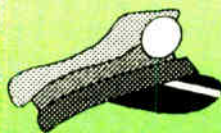

## DON KNOTTS

Laugh all the way to the bank with this whimsical and entertaining shop local campaign!

## Call 1-800-950-5787

## Radio Concepts, Inc.

Circle (82) On Reader Service Card

World Radio History

Circle (205) On Reader Service Card



**Audiences *never* age.**

**Music *never* changes.**

**Formats *always* stay the same.**

**And Digital is *just* a passing phase.**



*The Optimod-FM 8200 Processor*

**Damn.**

We created the first successful all-digital sound processor to give FM stations absolute flexibility. Be able to adapt to new music, personalities, or formats. Tailor sound to attract new audiences. And have the ability to upgrade with simple, inexpensive software—instead of tossing out an entire capital investment.

Somehow, that makes a lot more sense to us than trying to compete in today's radio market with outdated analog technology. But we could be wrong. Dead wrong. After all, digital could be just a passing phase. Elvis could really be living in Cincinnati. And WKRP could be the future. Damn.

**orban®**

**H** A Harman International Company

1525 Alvarado St., San Leandro, CA 94577 USA Phone 1•510•351•3500 Fax 1•510•351•0500.  
© 1994 AKG Acoustics, Inc. Orban and OPTIMOD are registered trademarks of AKG Acoustics, Inc. All other trademarks are property of their respective companies.

Circle (201) On Reader Service Card  
World Radio History



# Off-Air Events Reap both Fun and Profit

by Alan Haber

**WASHINGTON** Radio air time is starting to resemble an overstuffed suitcase, packed so tightly with commercials and on-air promotions that the act of offering added visibility to a station's advertisers is becoming more of a lofty creative challenge than a routinely carried-out service objective.

But this act is indeed being carried out off-air by stations from coast to coast in the name of revenue building and client satisfaction. And, with more creativity than you can shake a promotional stick at.

## Creative muscles

Radio stations are flexing their creative muscles to great effect with off-air promotions that are mutually beneficial to themselves, their clients, and their local communities.

Take Washington, D.C.'s WTEM Sports Radio 570, tackling and hitting home runs for itself and its clients with imaginative and rewarding events. Bennett Zier, vice president and general manager, said that off-air event marketing is good for radio stations. "What you want to do is provide a full marketing service for your clients," he said. "That can include more than just selling radio spots."

Zier feels that off-air event marketing helps stations "service their listeners, (and) creates higher awareness...and if [off-air marketing] also produces some revenue for the radio station, it gives them a chance to reinvest a lot of that back into the radio station."

## Super Bowl showdown

A Super Bowl showdown between the 1992 Dallas Cowboys and 1992 Washington Redskins, played out on a basketball court at Washington, D.C.'s George Washington University last May, was a strong money maker for all-sports WTEM. The station sold a title sponsorship, two major sponsorships, and 10 lower-level sponsorships—six of the lower-level sponsors showed their products to the station's listeners who attended the event at booths provided to them as an off-air component of the event promotion package.

Other off-air components included a sponsored VIP reception, a half-time shoot-out for a car, sponsored by one of the station's advertisers, and a lot of on-site signage. Different packages were sold by the station—some included on-air advertising leading up to or during the event, the play-by-play of which was broadcast by the station's Redskins announcing team.

## Healthy outlook

Health was in the air in the City of Brotherly Love on April 23 and 24 when talker WWDB-FM held its tenth annual Health and Fitness Fair at the Valley Forge Convention Center. Although final attendance numbers are not in for this year's event, the fair has attracted 50,000 people in the past (admission is free).

The health, fitness and wellness-oriented event, during which some of WWDB's personalities did their shows live, was targeted to the entire family, and was a revenue

producer for the station. "We offered advertisers booth space to display their products and give out literature and meet the people," said David Gorab, the station's promotion director.

"A lot (of advertisers) do sampling of



The karaoke booth is but one of the many attractions of the "KIIS and Unite" event.

their products (and) giveaways." The booths were sold as part of packages that usually included on-air advertising.

## All About Kids

Off-air event promotions can be targeted locally, as well as to broader lifestyle interests. Tropics 106.7 (WTPX-FM in Miami/Fort Lauderdale, Florida), which last July fine-tuned its adult contemporary music mix from a softer approach, is looking forward to the third-annual All About Kids show this August. The 100,000 square-foot-plus off-air event, a syndicated event idea started by a child psychologist, is a revenue builder for the station, and is promoted on-air, according to Debra Towsley, marketing director for the station.

The popular sales and community service promotion features six major and other smaller-sized theme areas, which are sold as radio packages to clients. Individual booths are purchased by sponsors and local retailers—everybody from major corporate

sponsors to an insurance salesman wanting to sell college insurance plans.

"To me, it's a win-win situation," said Towsley. "Not only is it a revenue builder for (us), but we also create a lot of good will and touch a lot of our marketplace and (realize) additional promotional value for the station."

## KIIS and Unite

Tie-ins with national charities and foundations are good opportunities for stations to give something back to their audience. Take Los Angeles powerhouse KIIS-AM-FM's "KIIS and Unite," which was held in April 1993 and April 1992.

The event, which included a concert featuring A-list acts like Luther Vandross, Richard Marx and Celine Dion, raised money for the national Pediatric AIDS Foundation. It was sponsored by Sega, which underwrote the costs of the concert. KIIS sold around 25 booths to its clients, each of which represented their product category exclusively and paid a sponsorship fee to be on-site. A radiothon was held at the 1992 event, raising \$235,000 for the Foundation; a silent auction held during the 1993 event raised close to \$150,000.

## Other events

All over the country, radio's best creative minds are cooking up new food-related ideas for off-air event promotions. At classic rocker KKFM-FM in Colorado Springs, Colo., the KKFM Classic Colorado Championship Chili Cookoff is expected to attract around 15,000 chili lovers this summer (CHR sister station KKMGM-FM also promotes the event and has on-site presence; both stations broadcast live with remote breaks). According to the station's

marketing director Rusty Keys, 10-foot by 10-foot booths are sold in sponsorship packages which include commercials. Keys said the event is a revenue builder for the station at a time when commercial time is sold out. "To be able to do this and offer people the booth space without the spot inventory is a great way to make extra money," he said.

Food and non-alcoholic beverage sampling are the tasty ingredients in The Big Munch, an off-air event held in January by news/talker WTMJ(AM) and sister station adult contemporary WKTI-FM in Milwaukee, Wis. Held in a local mall, the stations sell booth space to clients (which comes along with spots that advertise their participation in the event).

Country-formatted WFMS-FM in Indianapolis is looking forward to its food-related-in-name-only annual Fan Jam listener appreciation day this September. Sponsorship packages attached to the Jam's concert are sold to help defray the costs of putting on the overall event; an expo hall is filled with booths purchased by advertisers that are part of available packages. The revenue-producer, tickets to which will sell for around five dollars each, featured a midway, children's area and concession last year.

## Think revenue

Look to the skies if you're thinking about getting on the off-air promotion bandwagon. As KIIS's Karen Tobin, vice president and director of marketing, said, "I always say look outside the box—any event you become involved with has off-air sponsorship or revenue-generating possibilities."

And, the last, most succinct, thought-provoking words for stations thinking about producing an off-air event may very well belong to Kay Feeney-Caito, promotions manager for WFMS-FM: "What are you supposed to do after you're sold out?"

# THE SECRET'S OUT—DIGITAL FURNITURE

**MODULAR  
FLEXIBILITY  
WITH A  
CUSTOM FIT**

*We Offer Six Elegant  
Lines of Studio Furniture*

▼

**4153 BONITA STREET  
SPRING VALLEY, CA 91977  
PHONE 619/698-4658  
FAX 619/698-1268**

**MURPHY**  
STUDIO FURNITURE

▲ STEALTH SERIES ▲



# Cousin Bruce Is Radio Entrepreneur

► continued from page 9

stations...when outside people start getting control, garnering control over broadcasting facilities, it scares me."

After surveying the seventies radio scene, he said he wanted to become an owner to not only "see if I could correct this in my own small way, but to make enough noise with my name, to alert people that broadcasting must be run by broadcasters."

In 1979, Sillerman-Morrow purchased its first radio properties—WALL-AM-FM in Middletown, N.Y. He insisted that the WALL stations and the six subsequent radio station purchases made by the company be run with a hands-on approach.

## Unique approach

Morrow took a rather unique approach to surveying, and ultimately choosing, which stations to purchase. "I'd hop down [to the city where each station was located] with Bob [Sillerman], and we'd look over the market," he said. "And, while Bob would look over the books, I would walk around the town. And what I would do is I would listen and I'd talk to people—not as Cousin Bruce, [but] as a citizen. You know, what do you listen to, what's happening with the town, how many people moved in. I wanted to know what was happening with the area, what was the growth, what was the potential...in other words, I wanted to know the market."

Before purchasing WALL, Morrow and Sillerman spent two days in Middletown. "I went to city hall, I went shopping, I went to the supermarkets," he said. "I bought things, talked to people. Meanwhile, Bob was at [WALL], looking at the books." When he got together with Sillerman the next day, they decided to take the plunge. "WALL radio was my child, my baby," the proud papa said. "We took that station, which was really...a small-market station, and we made it sound like a big-market radio station."

Build stations and operate them with

talented people—that's Morrow's credo. "Everybody we surround ourselves with or get involved with...really believes in



Cousin Bruce on the air with the "Fab Four"

radio," he proclaimed.

These people, part of the fabric of every radio station, are always first and foremost in Morrow's mind. "A radio station is...a living, breathing organ. It's an extension of the human experience," he said.

## An eclectic medium

Morrow looks at radio as always having been "an eclectic medium." "I never really believed that radio should just be narrow-cast," he noted, adding that he takes the word "broadcast" very seriously. "I'm not a narrowcaster, I never will be," he said.

Broadcasting from another Sillerman-Morrow property, WRAN, in Dover, N.J., for example, involved an eclectic mix of new, contemporary music,

recurrents and oldies for an adult audience, topped off with a generous dollop of community news. Morrow decided to

leave the coverage of national news to larger stations. "Nobody can replicate or duplicate or report on local or regional news like a local radio station...a lot of people miss that," he said.

He was born, he said, with the notion

"that local radio should be local radio and not try to be the national purveyor of information."

Another unique facet of Morrow's philosophy of radio station ownership is his desire to completely please each of his radio station's local communities. This desire is so strong in Morrow that he and his wife Jodie moved to and lived in each of the eight cities in which Sillerman-Morrow had properties.

And that wasn't all. The locals in each city wanted Cousin Bruce on the air, and, true to his unique nature, that is exactly what they got. "Every week, I either flew or drove to every one of those radio stations where I was on the air," he remembered. Whether live or on tape, he said he "serviced all of my stations," which included training everyone on the air at each station.

## A turning point

In 1984, Morrow and Sillerman considered the state of the United States economy and its effect on businesses, and decided to divest their portfolio of stations at this time. Sillerman purchased WHMP-AM-FM on his own; Multi-Market Radio later bought these stations from Sillerman.

Just prior to divesting, however, while broadcasting on WRAN, Morrow was visited by Joe McCoy, program director, and Rod Calarco, then general manager of New York's Oldies Station, WCB5-FM (Calarco is now vice president of CBS-owned FM stations).

□□□

(In part two, Cousin Bruce returns to New York City radio, and Multi-Market Radio is born. Stay tuned).

## Cable Audio Services Target Radio Listeners

by Frank Beacham

**HORSHAM, Pa.** Flush with investments from three of the world's largest record companies, Digital Cable Radio—the premium digital audio service—has fine tuned its marketing strategy and re-branded itself "Music Choice."

Though the corporate name—Digital Cable Radio (DCR)—remains the same, the new Music Choice programming lineup is now being delivered to more than 130,000 cable television households and is poised for a major launch this summer on DirecTV, the GM Hughes-owned direct broadcast satellite programmer.

Though DCR, based in Horsham, Pa., insists it does not compete with traditional radio broadcasters, the company has engaged in major new marketing

research over the past year to determine what listeners want today in audio programming. The results of that research, which included market tests, consumer attitudinal studies and music industry analysis, say a lot about audio consumers in general and led DCR to re-vamp about one-third of its original 30-channel programming lineup.

"As an audio programmer, we are very interested in delivering our product through a number of distribution channels," said Dave Del Beccaro, president of DCR. "With the upcoming launch of our service on DirecTV, we needed to design a universal product name that complements multiple distribution systems."

The Music Choice brand name was chosen after months of evaluation and testing. Focus groups were assembled

continued on page 23 ►

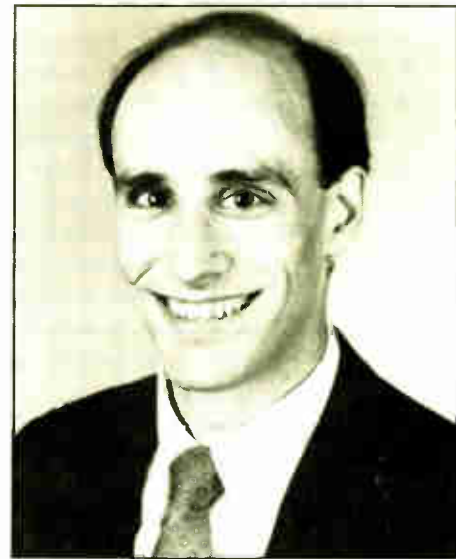

David Del Beccaro  
President, Digital Cable Radio

## ATTENTION P.D.s

Schedule the best in "OLD-TIME RADIO" with

# When Radio Was...

Hosted by ART FLEMING, original star of "JEOPARDY"

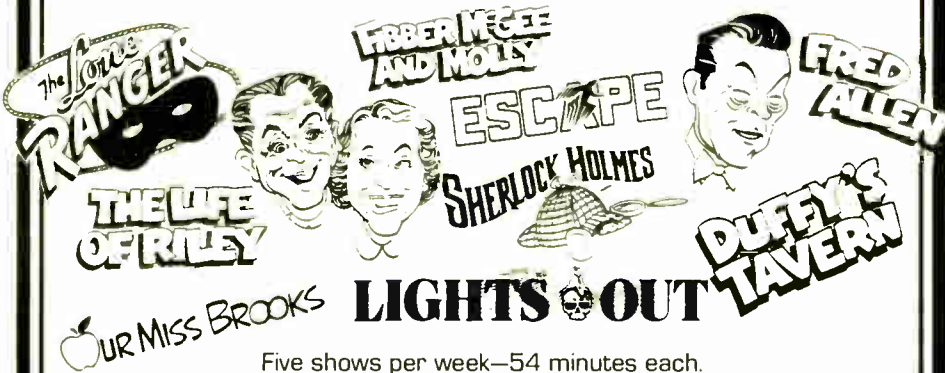

Five shows per week—54 minutes each.

**BARTER, NO CASH PAYMENTS!**

Delivered via Satellite (SATCOM).

For more information contact David West at

**DICK BRESCIA ASSOCIATES (201) 385-6566**

*When Radio Was* celebrates its 4th year on 100 stations.



# Mining Those Market Development Funds

by Bob Harris

**DALLAS** Radio needs new revenue sources to grow its share of the advertising pie. Food manufacturers must be a major target for radio for the last five years of the '90s.

Food manufacturers spend millions and millions of dollars on the local level for grocery advertising programs. The money is called "trade promotion" or MDF (market development funds) and is not considered advertising. Radio has never understood how to get this money.

Many stations and their sales consultants confuse local grocery marketing programs with "vendor" programs. Grocery vendor sales programs do not work for radio because most grocers already run incredibly successful, and profitable, "vendor" programs.

The advertising department of the typical multistore grocery chain is a major profit center. The food manufacturer, through his local sales agent, the food broker, pays the grocer what amounts to a 500 percent co-op ad allowance. Virtually every item and price newspaper ad returns 4 to 5 times its actual cost to the grocer.

In Dallas, one grocery chain's weekly TV ad package sells for \$26,000. The manufacturer gets his product shown briefly, along with three other food products, on nine TV commercials, three outdoor billboards and a front page newspaper circular ad feature. (The grocer sells six to eight of these packages every week, plus hundreds of smaller ad feature packages.)

For a radio station to break through to the food manufacturer or food broker, it must understand the "power concepts of grocery marketing." These are the concepts that drive the grocery marketing business and, as a result, the concepts that radio must understand if it wants even a small piece of the pie.

*Power concept No. 1: "Push marketing"*

Push marketing is the technique that food manufacturers' sales departments and their local sales agents (food brokers) use to achieve profitable sales volumes. Push marketing means the food broker sells, or pushes, the maximum number of cases of the product into the grocer's warehouse.

At that point, the food broker's job is done. Now it is up to the grocer and/or the manufacturer's marketing department to convince consumers to buy the product (pull marketing). This explains why food brokers don't have advertising money, let alone radio budgets.

*Power concept No. 2: Cases*

The only thing that really counts to the food broker and the manufacturer's RSM (regional sales manager) is cases, truckloads and train-car loads of cases of one product sold to one chain. The cases are sold before any consumer promotion begins.

Most food manufacturers budget \$1 in promotional support (read potential radio advertising) for each incremental case of merchandise sold. Remember that there are usually 12 or more items per case. For your station to justify a \$10,000 advertising investment by the manufacturer or broker, you will have to convince someone that the program will sell close to 10,000 cases, or 120,000 individual items.

*Power concept No. 3: "Incremental funding"*

To be successful in local grocery

marketing, radio must tap "incremental funds." Both the food broker and the RSM can, and do, request incremental funding from the manufacturer. This money, normally from marketing, hopes to return one case per dollar but is normally invested to build brand equity at the local level.

Incremental funds are not nearly as case sales-critical as the regular money (MDF) the manufacturer doles out. It's very risky for a broker to spend \$10,000 to \$25,000 on a radio program from his regular manufacturer funds and not get close to the equivalent number of cases he would get by buying a grocer's ad program.

If the broker doesn't make the manufacturer's annual case quota, he may risk losing the product line to another broker (all broker-manufacturer contracts have a simple 30-day out clause for either party).

*Power concept No. 4:*

*"It's not for everybody"*

Concept No. 4 is a radio concept. This type of sophisticated local grocery marketing is tough. It takes a long time for something to happen. Sometimes nothing happens. It's hard work. It's not providing avails and CPPs, it's not picking up tapes from an agency.

Selling into the food manufacturer is not for everybody on your sales staff.

Consultants who preach that everyone on your sales staff should be making these kinds of calls are wrong, dead wrong.

This kind of selling is not for everybody. Don't burn the grocery industry any more than radio already has by sending poorly-trained people who really don't understand grocery marketing into the breach.

I'll have more grocery marketing power concepts for you in future RW columns.

□□□

*Bob Harris is a sales and marketing consultant to the food manufacturer, food broker and broadcasting industries, based in Dallas, Texas. His 30-year career includes radio sales promotion and management; radio syndication sales; newspaper sales; TV promotion; ad agency owner; sports, event and grocery marketing.*

## EVOLUTION OF DESIGN

"The Best Is Now Even Better"

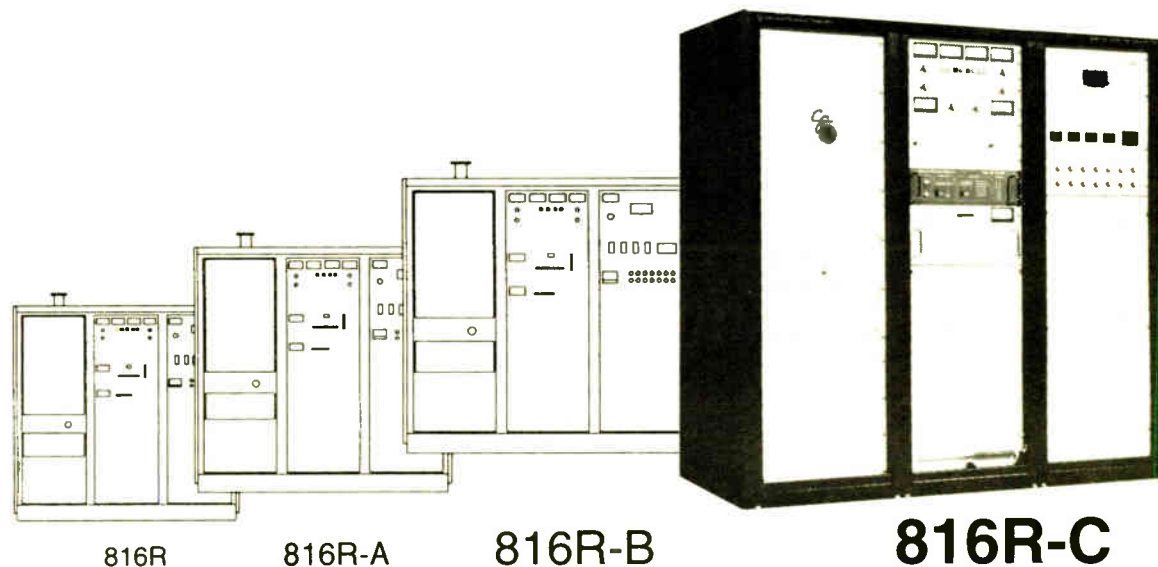

### New Continental 816R-C Series FM Transmitters 21.5kW 25kW 27.5kW 30kW 35kW

They may look alike . . . but each generation 816R is a landmark design enhancement. We keep those qualities that make this the World's most reliable, high performance transmitter. We make changes only where new technology improves the performance and dependability of the 816R.

#### WHAT'S THE SAME:

- Self Neutralized 1/4 Wave Cavity
- Exclusive Solid-State Softstart™
- Self-Contained\* in Single Cabinet
- Built-in Filament Voltage Regulator
- No External Harmonic Filter
- Positive Air Pressure Cabinet
- Continental's Two Year Warranty

\*Separate HV Power Supply in 35kW

#### WHAT'S NEW:

- New Digital Synthesized 802B Exciter
- Solid State IPA In Roll Out Drawer
- All PC Cards Now in Front Panel
- Complete Power Supply Access
- Improved Metering Positions
- Designed for Ease of Maintenance
- New Continental Colors



**Continental Electronics Corporation**

P. O. BOX 270879 DALLAS, TEXAS 75227-0879 214-381-7161 TELEX: 73-398 FAX: 214-381-4949



# Euro Disney Can Help Make On-Air Magic

by Alan Carter

## MARNE-LA-VALLÉE, France

When the final leg of the Tour de France starts from Main Street USA here in Euro Disneyland on July 24—heading toward the Champs Elysée in Paris—your station can be part of the festivities with a remote to anywhere in the world.

Radio broadcasts from Euro Disney, whether or not associated with a special event like the world-famous bicycle endurance test, play an essential role in promotional campaigns the park plans for the 1994 summer and fall travel seasons.

About the only thing you have to do is show up with a disc jockey, a console and a technician.

*Voilà.* You are on the air.

## The Magic Kingdom

In return, Euro Disney wants you to recreate the magic of Euro Disney over the air through promotions and broadcasts to attract visitors to the park, which is about 20 miles east of Paris and easily accessible by motorway, train or direct shuttles from Orly and Roissy-Charles de Gaulle international airports.

"We really consider Euro Disney a perfect studio," said Benoît Peyrefitte,

director of promotions and marketing. "We are more than a city, we are a world."

Among the criteria Euro Disney considers before offering a station the opportunity to broadcast, are ratings, listener demographics and coverage area. But how "creative" your idea may be for a promotional campaign also is important.

"We are very keen to work with radio stations," Peyrefitte said. "When we reach people through a radio promotion, we know that the effect is not immediate. But they come two or three months later."

In addition to working with stations in Europe and the United Kingdom, Euro Disney wants inquiries from the U.S. KHS-FM in Los Angeles is one of the stations that broadcast from the theme park.

Promotions that Euro Disney finds successful include listener call-ins to questions about the theme park. Another idea that works is having radio stations' roving reporters award Euro Disney prizes to passengers in cars displaying a theme park sticker.

Euro Disney worked with Mattel and Europe 1 (a French radio network) in a needy children's Christmas charity by giving free entry to the park in combination with a live show.

Other promotions often include free trips to Euro Disneyland for listeners. An added bonus sometimes includes a car.

## Attendance no problem

Doom-and-gloom reports about Euro Disney were hard to believe on a recent

of Europe's worst recessions. Sales of souvenirs in the many shops are slow, and Euro Disney is holding hotels that it otherwise would sell to chains if the real estate market were not depressed.

But the financial restructuring of Euro Disney seems in place, apparently ending speculation that the Magic Kingdom would close. Construction is underway throughout the park for additional attractions including the eventual presence of Disney MGM Studios-Europe, similar to the set-up in Florida.

Euro Disney offers radio stations all the technical support and broadcast operations needed to transmit from the park, whether by telephone line, satellite or some combination.

"We consider that we

are here to help them," said Valérie Léger, who is in charge of broadcast productions. "The set-up can be a total infrastructure. It depends on the size of the event."



Euro Disney has complete broadcast facilities for traveling radio personalities.

spring-like day in March, when at 10 a.m., the park was filled with visitors. Many were families on holiday during a Dutch school break.

As a Disney official explained, the park opened in 1992 during the midst of one

## Broadcast operations

Basic operations offered include a two-wire, one 7 kHz dedicated line, two telephones and four electrical outlets (240 V/50 Hz French standard plugs). You also get a table for your mixer, three chairs and one sign for your station logo, if provided at least two weeks ahead.

If the remote cannot be in the center of the main activity—even though the promotions department makes every effort to accommodate requests—the park is wired with fiber for a closed circuit television system, and monitors are provided so DJs can see all activities live.

You need to bring the essentials, however: mixer, headphones, mics, stands, portable cassette recorders, spare power strips (16 amps), spare fuses and batteries, and a folding hand truck to haul equipment because no vehicles are allowed to access all radio remote locations. And do not forget adapters to French standard plugs.

Léger said she can arrange ISDN connections if a stations wants, and she plans to have the park wired for regular service by 1995.

So far, the remotes have worked successfully, Léger said. There were more than 100 live hours in 1993 broadcast by more than 80 stations; in 1992 more than 100 stations broadcast from the park, which opened April 12.

"I'm lucky because we've never had any problems," Léger said, with her fingers crossed. "But I'm very strict. We test all the time and no less than 30 minutes ahead of going on the air."

One of Léger's most difficult operations will be this summer with a worldwide connection among Disney theme parks in France, Japan, Florida and California.

□ □ □

For information from Euro Disneyland, contact Benoît Peyrefitte or Kevin Church in France at telephone: 33-1-64-74-54-36; fax: +33-64-74-54-32.

# AM/FM Transmission Focus at NAB

by Tom Osenkowsky

**LAS VEGAS** SBE Day at NAB '94 drew focus on transmission and reception quality aspects of AM and FM broadcasting.

Many AM and FM transmitters, especially the high power variety, rely on power vacuum tubes.

Getting the most useable hours out of a tube means cost savings for the station. Walter Johnson of the Voice of America (VOA) explained what steps can be taken to ensure long life operation of power tubes.

The most critical parameter affecting tube life is filament voltage. Proper filament voltage management can greatly extend the life of a tube.

Johnson presented several graphs showing the effect of decreased filament voltage versus tube life as well as the effect of cycling a transmitter on and off for various periods. Johnson explained that through proper care of power vacuum tubes, one VOA site realized annual savings in excess of \$300,000.

With carefully monitored, regulated filament voltage and proper cooling power tube life can be significantly extended compared to the "out of sight, out of mind" posture, he said.

Timothy Cutforth of Vir James Engineers enlightened the audience to the benefits of top-loading physically short vertical radiators. Top-loaded antennas are often associated with poor bandwidth and difficult adjustment. Cutforth demonstrated two important techniques employed on an actual antenna used at KIAM in Nenana, Alaska.

Top-loading adjustment was made easier by relocating the top hat tuning box

from the top of the tower down to the base via a carefully placed "transmission line" configuration. Bandwidth was improved by taking advantage of the rather severe reactance slope of the tower and using a parallel resonant tank to cancel the slope.

Thus, the base impedance curve was easily matched using a simple Tee network, with a resultant flattened impedance sweep. The benefits of top-loading are extended service area due to increased groundwave signal and reduced vertical energy (sky-wave) due to the compression of the vertical lobe down toward the horizon.



I presented a paper explaining simple methods that can be used to adjust and maintain AM broadcast antenna systems. Emphasis was placed on DA sample system design and maintenance in light of the recent FCC Notice of Inquiry on directional antenna adjustment and monitoring.

For AM DA stations, a properly designed and maintained sample system is crucial to optimum performance. Network design and optimization was explained with practical examples given throughout the presentation. Measurement and troubleshooting techniques for components and transmission lines were also discussed. Bandwidth was addressed, both in terms of DA pattern bandwidth as well as the more familiar impedance bandwidth.

Methods to improve bandwidth were touched upon, bearing in mind that each antenna system has unique characteristics.

Ground systems play an important role in AM broadcast signal transmission and radiation efficiency. Most engineers experience a ground system replacement or overhaul only once in a career.

Larry Paulausky of WPEN, Philadelphia treated the audience to a step-by-step slide presentation on how Greater Media's WPEN "did the job right". Paulausky detailed the layout of each tower base area's ground screen, radial intersection bonding, radial placement, and welding techniques. A ground system must stand up to year round weather, vegetation growth, ice and flooding conditions. Proper mechanical layout and electrical continuity are of the utmost importance. The practical advice on ground systems in this presentation are sure to benefit those who face the task of ground system maintenance in the future.

We often address topics relating to transmission of broadcast signals. Richard Zerod of the Ford Motor Company explained FM diversity reception techniques that may be employed in automobiles.

Multipath distortion is perhaps the greatest evil facing FM reception in a mobile environment. Multipath occurs when an FM signal is reflected off an object(s) creating additional signal paths to the receiver which are displaced in time with respect to the main signal. Diversity reception involves the use of two receiver antennas, placed at different locations on the automobile.

Special circuitry in the receiver continually evaluates reception quality from both antennas and makes appropriate selections based on the received signals.

continued on page 37 ►



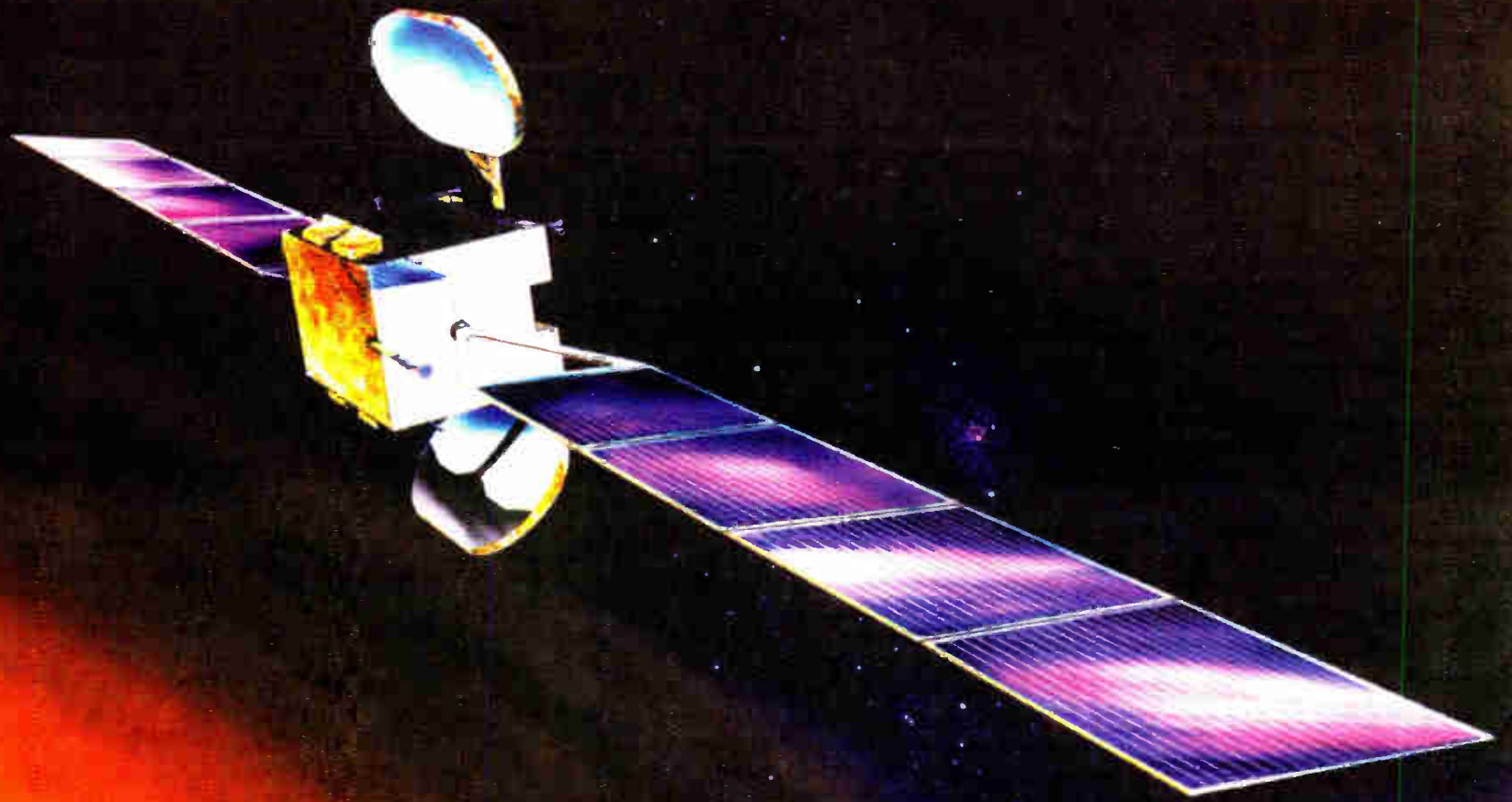

# FIRST THINGS FIRST - INTERSAT WAS FIRST!

**FIRST TO MERGE DIGITAL AUDIO WITH  
MULTIPLE HIGHSPEED ANCILLARY DATA.**

Imagine audio, station logs, news services, weather services, E-mail, fax, plus other options, all broadcast simultaneously.

**FIRST WITH SATWARE™.**

The easiest to use, most cost effective control system, but with unmatched power and convenience. Prevents analog pirating without the expense of most encryption schemes.

**FIRST IN FLEXIBILITY.**

"LOAD & GO" broadcast communications, digital store and forward with software controlled remote relay access.

**FIRST WITH "LOW COST CONVERSION CONCEPT" SM.**

If you're up and downlinking with analog, INTERSAT can convert your operation to digital for much less than you'd imagine.

**FIRST TO ACCOMPLISH ALL THIS WITHOUT VAPORWARE!**

The handwriting's on the wall. Those who don't embrace digital soon will probably end up as road kill along the Information Superhighway.

**IF YOU WANT TO BE FIRST IN LINE  
FOR HIGHER PROFITS, CALL INTERSAT!  
312/441-2700**

**BE SURE TO ASK ABOUT INTERSAT'S  
"BEAM ME UP FREE" OFFER.  
AVAILABLE FOR ONLY A LIMITED TIME.**



International Satellite Communications Corporation  
10 S. Riverside Plaza, Suite 1240, Chicago, IL U.S.A. 60606  
Tel. 312/441-2700 FAX 312/441-2709

© 1994, International Satellite Communications Corporation. Printed in U.S.A.

**We've been quiet long enough. No matter what you've heard from others, just remember, Intersat was first!**



# "Easy ISDN"

## \$368 per mo. or \$6,995\*

ANALOG & DIGITAL AUDIO

RE 660 MUSICAM Encoder

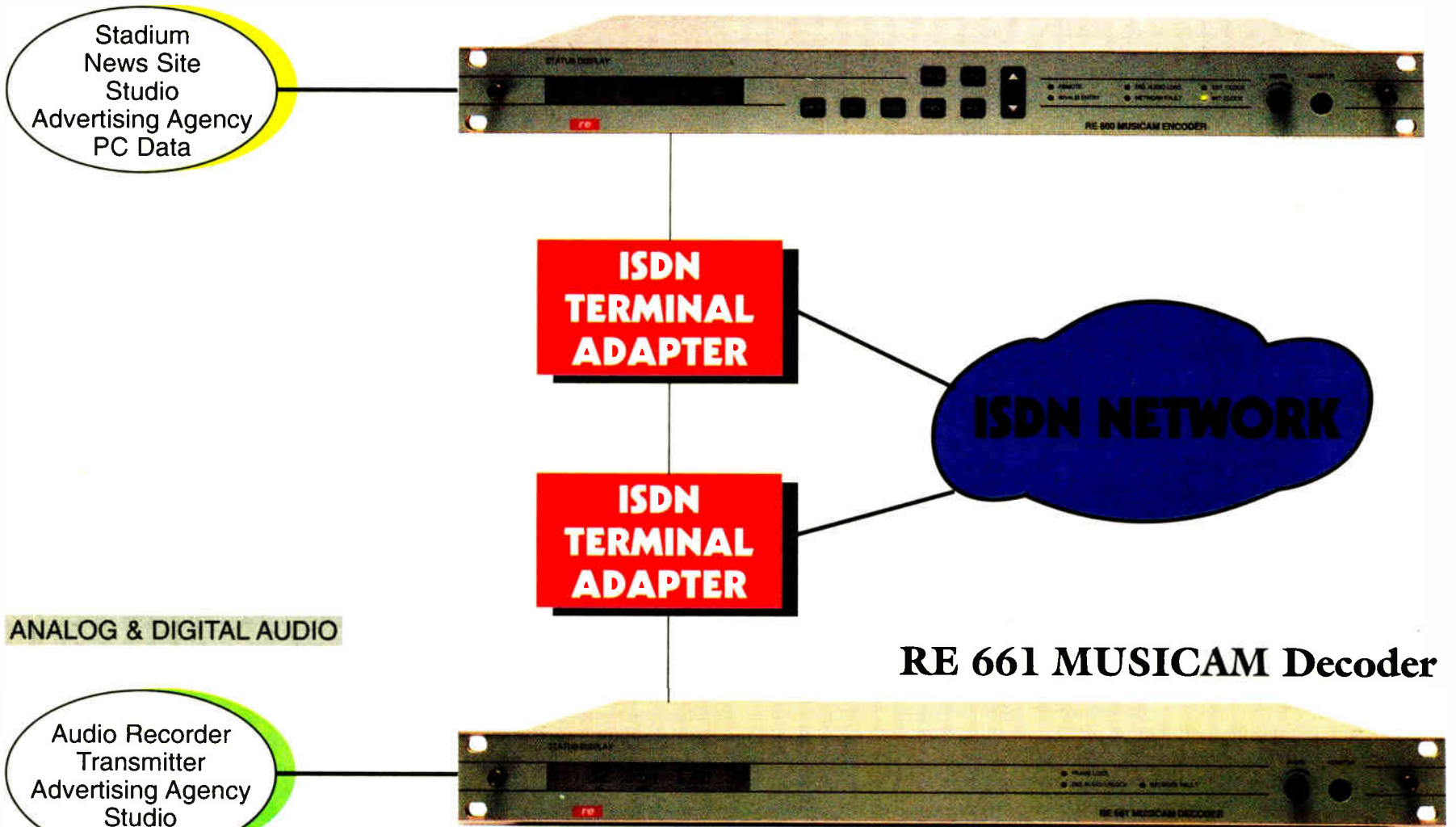

RE 661 MUSICAM Decoder

Everything you'll need to link up with the world in one neat package. One great price. One reliable source: Harris Allied. A complete digital audio transport solution for \$368 per month\* or \$6,995\*:

- RE 660/661 ISO/MPEG Layer II Digital Audio Encoder and Decoder
- Two Adtran ISU 128 Terminal Adapters
- NT-1s included in the ISU 128s
- Set of V.35 Connector Cables

In addition you will receive the RE Support Program that includes a step-by-step installation guide; a digital network access guide; a DIGIFON digital dial-up list (the subscription to ISDN Yellow Pages) and 1-800 Helpline & ISDN check-out lines.

Setting up a private network can be expensive, but has been necessary in broadcast applications. The widespread availability of the ISDN digital network offers a new high-quality, low cost means of audio programming. The RE 660/661 MUSICAM Codec gives you an audio pipeline to the ISDN digital networks.

ISDN is becoming part of the broadcast and audio industry's daily lives. ISDN is also becoming as easy to order and as inexpensive as plain old telephone service. Think of it — now you can "phone-in" CD-quality 20 kHz stereo or two channels of mono audio from just about anywhere on a single ISDN line.

With the Easy ISDN package, you simply enter and store phone numbers in the Adtran ISU 128 connected to the RE 660 Encoder or RE 661 Decoder. It's that easy to dial-up on demand your own digital audio transport system and send audio in real-time. There's even an easy way to upgrade your system with future enhancements as they are made to the ISO/MPEG Layer II standards.

The call is free. The package is a must. But, the price is only for a limited time. Call us today and ask for the "Easy ISDN" package.

**8:00 a.m. to 8:00 p.m. Eastern**  
**1-800-622-0022**  
**Fax 317-966-0623**

 **HARRIS ALLIED**

\*Offer good in North America. No quantity discounts apply. All orders subject to credit approval. Standard terms and conditions apply. Financing based on 24 months at \$368 per month. ©1994 Harris Corp.



## PROMO POWER

# Promotions a Tough But Rewarding Choice

by Mark Lapidus

**WASHINGTON** Are you ready for the next step in your career? It's when the boss walks in and says, "I've got good news and bad news. The bad news is that the radio station's just been sold. The good news is they say they're not changing a thing!"

I am not embarrassed to admit that I've been rejected by some of the best in our business. The job application process taught me many things over the years. I learned how to put together great airchecks and slick resumes; I also learned persistence, coping with rejection and how to ask a lot of questions without hesitation or embarrassment.

When kids coming up in radio ask me if they should apply for a certain job, I always say yes. Rejection is terrific experience. Considering today's environment of duopolies, automation and satellite delivery, let's venture into that deep dark no-man's land of unemployment and come out on the other side in the land of opportunity.

## What to know

First is this for beginners: If you've got a friend or relative thinking about radio promotion as a career, cut out this column for them. It may save that person a lot of time and anxiety. Every few months I receive a call from somebody who is dying to get into radio promotion. Most of the time, the call comes from a son or daughter of a station client.

They're rarely thrilled with what I have to say to them. If they're over 25, aren't willing to move or want to make more than \$20,000 a year for an entry-level job, I tell them to find another field. Those who don't fit into this grouping are encouraged to get experience by interning or working part-time in a commercial radio station's promotion department.

As an intern or part-timer, they should be willing to do any type of work, any time it's available. This means driving the station van, putting up the inflatable mascot, hanging banners, putting bumper stickers on cars, hanging out in bars late at night handing out prizes, making deliveries, typing, filing, answering the telephone for DJs and even taking out the trash.

## Who you know

Contacts are the key here, for beginners as well as those already in the trenches. Every person you meet while you're working is a potential contact for future employment. Many people assume that only those in radio qualify as part of an effective job network; nothing could be further from the truth. Clients and even journalists can be great contacts. Many hear more about what's happening in your market than other promotion directors do. It's a lot more likely that a big-spending client can get you in for your next interview than another person in radio.

As for journalists, they make their living by being wired. If they don't know somebody you want to reach, the odds are good that they know somebody who knows somebody that can be of assistance. The truth is that you need good relationships

with these people anyway if you're going to be effective in your job. Those who disregard clients and journalists are being naive about the role they play in the success of a radio station operation.

The station you work for has just been sold...Should you jump? One thing you shouldn't do is jump to conclusions! Keep your options open. The new company taking over your property may be the best thing that's ever happened to your career. On the other hand, until you have a firm indication that you're part of future plans, you should begin sending out feelers.

Most of those around you will have a negative reaction when the big takeover announcement is first made. No matter the profession, people just don't like change. Your challenge is to take a positive approach; it will help if you realize that change happens every day. Look around the office. How many faces do you recognize from three years ago?

## Embrace change

One of my best radio friends is fond of saying, "Embrace change before it embraces you." (I'm sure he stole this

from someone, but great concepts are meant to be applied liberally.) Don't forget that you can control your own destiny. This may seem obvious, but many people feel like they're losing control when a new owner moves in. You can always depart later if your situation doesn't work out to your liking.

Between the time of the takeover announcement and when the new company comes in to interview the staff, do a little advance work. Write a letter and then call your new general manager or

continued on page 24 ►

**YOU CAN SHARE PROGRAMMING  
AMONG YOUR RADIO STATIONS ...  
At a Lower Cost Than Ever Before!**

Share programming among your station group or with other stations by sharing day parts, entire formats or by delivering your top-rated talent to other markets coast to coast. You can spread overhead costs, increase the quality of programming at the local station and build your audience by creating a satellite radio network. And now new digital satellite technology makes radio networking more affordable than ever before. Let us offer you a complete solution for your radio networking needs.

**Call us at (202) 414-2626**

**NPR SATELLITE SERVICES®**  
Has moved to:  
635 Massachusetts Ave., NW, Washington, DC 20001-3753  
(202) 414-2626

Circle (118) On Reader Service Card

World Radio History





# The Dynamax MX Series

"E" Models From 8 to 18 Channels  
New Beige Finish or Metallic Gray

- True modular design
- Ultra-reliable motherboard construction
- VCA mixer and monitor control
- Active balanced line inputs, transformer isolated mic inputs
- Active balanced main and monitor outputs
- Full monitoring/cueing facilities with VCA level control and active source selection
- Built-in cue amp with speaker and amplified stereo 8-ohm headphone output
- Independent remote start for each "A" and "B" input
- Opto-isolated remote module on/off
- Selectable fader start
- Optional 5-band mic EQ module with pan
- Two inputs per module, mic/line or line/line – line inputs may be mono or stereo, consumer or professional format
- Four assignable outputs – two stereo plus two mono
- Available in 8, 10, 12, 14, 16, or 18 channel models
- Independent level controls for each "A" and "B" input
- Separate audio and logic power supplies
- Sturdy, all-steel construction
- Durable Lexan overlay control surfaces
- Count-up event timer standard
- Two input expansion switches standard
- Excellent RF immunity

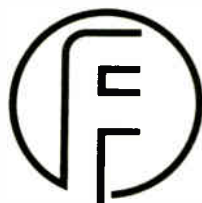

**DYNAMAX**<sup>®</sup>  
BROADCAST PRODUCTS BY FIDELIPAC<sup>®</sup>



## TECH TALK

# Putting Perspective on DAB Debate

by Judith Gross

**LAS VEGAS** Eureka's proponents went on the offensive at NAB to try to triumph over narrowband IBOC. At a convention where there were few new technology demos, where, in fact, the colorful image of DAB bus trips through downtown Las Vegas was no more than a misty memory, it would be difficult to imagine any burning interest in the by-now over-worked issues involved in bringing digital radio transmission to U.S. broadcasters.

But, now that I've had a few months to digest this year's NAB convention, one particular afternoon of the engineering conference stands out as a lively footnote to a harried but mostly routine show.

## Lively debate

It came late in the convention, on Wednesday, on a full day devoted to DAB. By now you may have read the reports of how DAB I and II brought a diverse crowd of radio engineers and managers into the conference hall. To be sure, there was real progress reported on ongoing DAB tests and the usual rehashing of the systems in development.

The debate turned especially lively because of a growing undercurrent of international sentiment which surfaced about a week before the NAB Convention got underway. "U.S. bashing" was the term I heard bandied about, a more or less informal characterization of an international DAB symposium held in Toronto in early March.

Of course, nearly any "international" discussion of DAB these days would by its nature be shaky ground for U.S. DAB proponents. With Canada and some European broadcasters, most notably the BBC, already implementing Eureka-147 DAB systems, there is still strong sentiment, at least on the part of government broadcast agencies in Europe, toward making Eureka-147 a worldwide standard.

## DAB Day

It was in this uncertain atmosphere that DAB Day at the NAB show convened. The morning session focused on various DAB tests. Engineer Bob Culver gave an

update of the EIA Digital Subcommittee's VHF characterizations tests. Then Tom Keller reported on the status of the NRSC/EIA tests taking place in Cleveland.

Gerald Chouinard, from the Communications Research Centre in Ottawa, then outlined subjective listening tests of DAB systems, which are to take place this summer. He also asked for volunteers to become expert listeners. I don't know if they've met their quota yet, but anyone with two weeks or so to spare can volunteer to become a listener, which involves traveling to Canada and sticking around for the duration of your participation, at your own expense.

The afternoon session rounded up all

ently not afraid to speak his mind; and speak it he did, abrasive humor and all.

## Gauntlet is down

Ratliff took it upon himself to become the chief nemesis of the current U.S. broadcaster position on DAB, and the results made the remainder of the afternoon memorable. He first had some substantial progress to report on the BBC's Eureka-147 implementation, and on receiver chips for Eureka DAB radios. He emphasized recent developments in Eureka technology which allow broadcasters to vary the coverage to imitate the current multitiered economic structure of radio in the U.S.

Ratliff talked about Eureka penetration

**Of course, nearly any "international" discussion of DAB these days would, by nature, be shaky ground for U.S. DAB proponents.**

the usual suspects, so to speak. There were updates from U.S. DAB proponents: Nikil Jayant on AT&T's system; John Bingham on the Amati/AT&T system; the USA Digital "tag team" of Gannett's Paul Donahue, CBS's Tony Masiello, Group W's Glynn Walden, plus entertaining support from Barry Carlin of Z-Tron, the company which developed the USA Digital AM system.

In addition, Don Messer reported on the NASA-JPL satellite DAB system supported by the Voice of America. He began his presentation asking the rhetorical question: "Why are we using your tax dollars to develop satellite DAB?"—a question terrestrial broadcasters might do well to ponder themselves.

The afternoon session was set to conclude with the by-now traditional debate among DAB proponents, moderated by me. The tone for debate was set, however with the lead-off presentation by Dr. Paul Ratliff of the BBC. Ratliff is a man appar-

tests done in a home in Britain where, he noted smugly, "the owners thought we had come to exorcise the ghost of FM." But in addition to extolling the virtues of Eureka DAB, Ratliff had an impressive videotape of its ability to eliminate multipath.

The video contrasted the movement of a multipath fade, or notch, first throughout a wideband signal, then a narrowband one. Clearly, in the presence of such a deep fade, the wideband signal is better equipped to recover sufficient signal than is the narrowband.

IBOC's proponents, most notably USA Digital, have done their own characterization of multipath and argue that Eureka's proponents and other IBOC nay-sayers exaggerate the presence of severe multipath to tilt the scale of engineering opinion. But Ratliff was set to do more than offer an engineering challenge. He hit a raw IBOC nerve when he closed his presentation by saying: "Eureka DAB is certain to become a

standard in the world. Is there a place for it in the U.S.A., or is the U.S.A. going to bury its head in the narrowband sand?"

Other proponents were quick to rise to the challenge. The VOA's Messer, next on the roster, introduced himself as "one who enjoys wallowing in the narrowband sand" and subsequent proponents were quick to call themselves "narrowband sand wallowers" and "DAB sand crabs." No one seemed adverse to becoming identified with the "head in the sand gang," which should give Ratliff his answer.

## No foregone conclusions

Messer also pointed out that Eureka as the world DAB standard is far from a foregone conclusion. And indeed, every time the Europeans seem determined to slip a vote past some engineering forum, the U.S. and others have been successful at thwarting it. So where does this leave things, both in the sand and above ground?

Well, the \$64,000 question about DAB still remains: Will IBOC work? That is what ongoing tests are designed to determine. But what seems clear from the stand of U.S. broadcasters is not, whether it will work better or as well as Eureka-147. Instead the question is: Will it work well enough to become an enhancement to our current analog system?

That means:

- 1) reduce multipath;
- 2) generally duplicate our basic coverage areas;
- 3) be compatible with analog signals;
- 4) offer modest improvement in the quality of AM signals; and most importantly,
- 5) allow us to keep our current allocations with no new spectrum.

No matter what you hear about current DAB tests, these are the real underlying criteria which U.S. broadcasters will use to judge DAB. If IBOC can fulfill those modest requirements, U.S. broadcasters are firmly committed to making it a U.S. standard, at least, and who's to say that other, uncommitted broadcasters around the world might not follow our lead?

And as for Eureka proponents, well, the U.S. broadcast position is clear: they can go and play in their own sandbox.

□ □ □

Judith Gross is VP/Head Copywriter for Media/Scan, an advertising and public relations firm specializing in broadcast and pro-audio. She can be reached at 212-929-6108.

## CD Format Services....'90s Style!

Since 1991 we've offered music libraries & current hits on Ultrasonic-Q CD's. Our library of 6,000+ tracks has every flavor of A/C, Top-40, CHR, Country, Oldies and Classic Rock. We now have over 2000 clients worldwide!

If you deal with Broadcast Programming, TM Century or another service, call for our catalog and sample discs. See what you'll get and how little you'll pay with RPM. Complete format service starts at \$295.00 / month\*. Current & Recurrent hit update service is \$16.95/week or \$49.95/month.

Program your station 90's style. Get a high quality service at a fair rate. If you don't use CD's, you're missing a chance to make a big improvement in your sound. Our personal professional service will be a real pleasure too.

50 STATES & CANADA:

**800-521-2537**

\*Rates for markets of 50M population or less. surcharge for larger markets.

Top Hits U.S.A. & Ultrasonic-Q Radio Disc trademarks of Radio Programming and Management, Inc., Orchard Lake, MI. Ultrasonic-Q system is Patented

02-THE ONES YOU LOVE (EDIT)  
RICK ASTLEY -(412)-405/F/10-B

03-WITHOUT YOU - MARIAH CAREY -(325)-318/F/6 -AP

04-THE LADY IS A TRAMP  
FRANK SINATRA W/ LUTHER VANDROSS -(322)-320/C/7

10-FM IN THE MOOD (East 87th Mix) - CECE PENISTON -(400)-353/F/1 -A

11-A DEEPER LOVE (C&C Hot Mix) - ARETHA FRANKLIN -(441)-439/C/0 -A

12-ROCK & ROLL DREAMS COME TRUE (Radio) - MEATLOAF -(359)352/F/4-B

13-(LAY YOUR HEAD ON MY) PILLOW - TONY TONI TONE -(435)-428/F/23-A

14-MR JONES - COUNTING CROWS -(429)-427/C/5 -B

15-DESIRE (EP VERSION) - EN VOGUE -(351)-344/F/2 -N

**FORMAT - CUTS**  
AC: 02 - 04  
CHR: 10 - 17  
COUNTRY: 20 - 25

ULTRASONIC-Q  
**RADIO DISC**  
FOR BROADCAST ONLY

**TOP HITS U.S.A.**  
December 31, 1993  
DISC ID: T204

**rpm** RADIO PROGRAMMING AND MANAGEMENT, INC.  
Since 1970  
4198 Orchard Lake Road  
Orchard Lake, MI 48323  
800-521-2537 MI: 810-681-2660

16-RAINBOW MAN - GIOVANNI SALAH -(410)-403/F/40-B

17-DIRTY DAWG - NKOTB F/ NICE AND SMOOTH -(412)-405/F/7 -B

20-WHERE WAS I - RICKY VAN SHELTON -(306)-259/F/14-N

21-TRYIN' TO GET OVER YOU - VINCE GILL -(343)-341/C/17-B

22-LIFE #9 - MARTINA MC BRIDE -(359)-352/F/15-B

23-(Who Says) YOU CAN'T HAVE IT ALL - ALAN JACKSON -(324)-321/C/8 -A

24-IDA RED - ASLEEP AT THE WHEEL  
With Jody Nix-Huey Lewis-Willie Nelson-Ran Benson  
(302)-300/C/17-A

25-ALREADY GONE - TANYA TUCKER -(415)-408/F/14-A



# Running Radio

## A Supermarket of Radio Station Services

For information on the services shown below, circle the Reader Service number on the enclosed card or contact the advertiser directly.

**Good Times - Great Oldies!  
Celebrity Guests...**



**Elvis  
Pat Boone  
Niel Sedaka  
The Beatles  
Herman's Hermits  
James Brown  
The Grassroots  
Lesley Gore  
Johnny Rivers  
The Supremes  
...And Others**

Here's Your Chance To  
"Make The Grade"!

For A Demo Of This Weekly, 4-Hour Show:

**1-800-985-2665**

Distributed by COPRA Media Productions, Inc.  
4444 Westgrove Drive, Suite 210, Dallas, TX 75248

Reader Service No. 27

### FORMAT Professional Audio Products

Item Code	Brand	Description	Price
ACD5B	DENON	CD cart shells (25 units)	\$7.50 case
R-20DM	DENON	20 min. 'demo' master DAT	5.69 each
R-60DT	DENON	60 min. master DAT	5.99 each
R-90DAT	DENON	90 min. master DAT	6.99 each
R-120DT	DENON	120 min. master DAT	7.99 each
MQ 15	DIC Digital	Master Quality 15 min DAT	4.99 each
MQ 30	DIC Digital	Master Quality 30 min DAT	6.15 each
MQ 48	DIC Digital	Master Quality 48 min DAT	6.29 each
MQ 62	DIC Digital	Master Quality 62 min DAT	6.89 each
MQ 92	DIC Digital	Master Quality 92 min DAT	8.29 each
MQ 122	DIC Digital	Master Quality 122 min DAT	9.39 each
CDR-63	DIC Digital	Blank 63 min recordable CD	15.99 each
CDR-74	DIC Digital	Blank 74 min recordable CD	16.99 each
DA-R16	TDK	16 min 'demo' master DAT	4.99 each
DA-R60	TDK	60 min master DAT	6.99 each
DA-R90	TDK	90 min master DAT	7.99 each
DA-R120	TDK	120 min master DAT	8.99 each
CD W12EL	TDK	74 min recordable CD	16.99 each
CD W12	TDK	60 min recordable CD	15.99 each
CD W08EL	TDK	21 min (3.15") recordable CD	12.99 each
CD W08	TDK	18 min (3.15") recordable CD	11.99 each
MD XG60	TDK	60 min recordable Minidisc (MD)	10.49 each
MD XG74	TDK	74 min recordable Minidisc (MD)	13.49 each

**FORMAT  
PRODUCTIONS**

Broadcast Division  
P.O. Box 466  
Portland, Oregon 97207  
Phone: 503-223-4 MAT  
Fax: 503-222-6408  
TollFree: 1-800-440-4 MAT

Reader Service No. 96

### HOT COUNTRY from HALLAND!

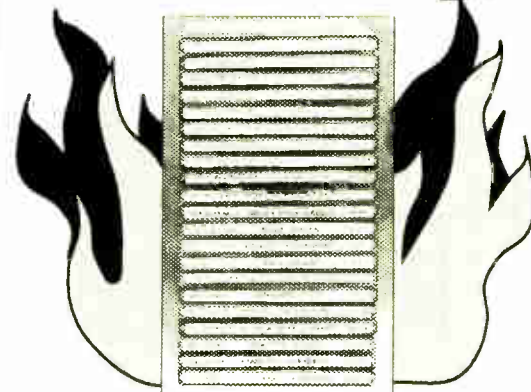

**HOT OFF THE PRESS!** Our NEW 712-song CD library of the best Country hits on radio! On 34 compact discs... in spectacular digital stereo... perfect for today's contemporary country formats! Great selection, great audio, great price! Call Halland today for details.

**1-800-HALLAND** Halland **818-963-6300**  
(1-800-425-5263) Broadcast Services, Inc. fax: 818-963-2070

1289 East Alosta Avenue, Glendora, CA 91740

Also available: CD libraries for Oldies, AC-Gold, & AC/CHR

Reader Service No. 119

**Turn Sunday  
INTO  
Money-Day  
WITH**

**NASCAR RACING**

CALL

**(904) 254-6760**

**MRN  
RADIO**

1801 International Speedway  
Daytona Beach, FL 32114

Reader Service No. 22

**Jingle &  
EXPRESS**  
RETAIL CLIENT JINGLES

**Just \$799  
plus shipping**

**Major Market Sound!**

**Unconditional Money Back Guarantee!**

**30 Days To Final Product!**

**Call for FREE DEMO KIT**

**1-800-950-5787**

**Radio Concepts, Inc.**

Reader Service No. 65

**Free Demo  
(805) 543-9214  
Call Collect**

**SYNDICOM:  
presents**

**Sound  
Bite**

**Trivia**

Original,  
Authentic Voices  
& Themes

*The Way Trivia Should Be  
Done On RADIO!*

Reader Service No. 211



**Expose yourself with a minimum of risk.**

Today's level of fierce competition demands that you prominently display your name every chance you get. Theft, vandalism and loss are an expensive reality.

Roll-A-Sign offers a better way. Up to four vibrant colors printed on durable,

high quality 4 or 6 mil plastic film display your logo and message brilliantly. Now you can afford to display a bright new sign at every public event. They even make great cost-effective promotional giveaways. Just roll off what you need and cut.



Call today  
and get exposed.

**800/231-2417**

Reef Industries, Inc. • P.O. Box 750245 • Houston, TX 77275-0245  
713/484-6892 • 713/947-2053 FAX

©1994 Reef Industries, Inc.

Reader Service No. 19

### RED NECKERSON



**OUTRAGEOUS  
1 MINUTE  
COMEDY  
EDITORIALS**

Free Demo  
Call SYNDICOM®  
Collect  
(805) 543-9214

Reader Service No. 88

World Radio History

**E**fficient & \$  
**E**conomical \$  
\$\$\$ \$\$\$\$\$

Radio World's Running Radio Marketplace reaches over 22,000 radio station owners, managers, programmers and consultants every month.

To advertise your services,  
contact Skip Tash at  
**703-998-7600**



## MANAGER'S NOTEBOOK

# Policy Manuals Are Valuable Tools

by Sue Jones

**BURKE, Va.** Does your staff know what to do if the press calls your station for a statement? Does your staff know what to do if the FCC appears unannounced at your office? How well would your station operate if you had surgery and had a six-week recovery period at home?

How much time do you and your senior managers spend on personnel issues? Have you ever had staff complaints because they believe that others receive preferential treatment? Could you provide a clearly written policy to a court in your defense if a former or current employee charged your station with sexual harassment?

If any of these questions make you uneasy, you should check your station's policy manual. Is it current and consistent with the labor laws? If your station does not have a written policy manual, your station would be at a disadvantage in federal and state courts.

## Gathering dust

Everyone has heard the argument that policy manuals just gather dust on the shelf and no one ever reads or consults them. In response to this argument I would ask: Is the manual written clearly and concisely to explain your station's policies? Does your senior management staff refer to it frequently to assure consistent compliance with the policies? A policy manual is another management tool that offers many benefits.

Sound human resource policy is a necessity in the growth of any station. Recognition of this necessity may occur when management realizes that an increasing amount of time is being devoted to human resource issues: time that could be devoted to production, marketing and planning for growth.

Effective, consistent and fair human resource decisions are often made more time-consuming by a lack of written, standardized policies. Moreover, when issues concerning employee rights and company policies come before federal and state courts, the decisions generally regard company policies, whether written or verbal, as being a part of the employment contract between the employee and the station.

There are several benefits to a comprehensive policy manual including:

✓ *A set of written guidelines for human resource decisions.* The process that your station management will undertake in comparing the policy alternative, understanding their importance and evaluating your current practices will help you enhance/develop your station's guidelines and procedures. It is the most cost effective way to explain the station's policies to newly hired personnel.

✓ *A means of communication with staff.* A manual serves first and foremost as a way to communicate with your staff about policies that are important to the management and the smooth operation of the station. It demonstrates awareness of and interest in the staff's individual security needs. It helps to organize and announce management's plans for growth, and it communicates that station's investment in its employees.

✓ *A framework for consistence and*

*fairness.* A manual defines management's standards for making decisions on the various personnel and organizational issues such as compensation, vacation and sick leave, and employment guidelines. Clearly defined procedures and standards express the station's intent to make consistent and evenhanded decisions.

✓ *A way to promote the station philosophy.* The policies will reflect the station's philosophy of business and employee relations as they demonstrate your problem solving abilities, the competi-

tive position of the station in providing a variety of employee benefits and the respect and appreciation for human resource management.

✓ *A tool for saving management time.* Carefully drafted and standardized policies save the station countless hours of management time. The consistent use and interpretation of such policies, in an evenhanded and fair manner, reduces management's concern about legal issues becoming legal problems.

✓ *A means of protecting the legal interests of the station.* A station's policy

manual defines the rights and obligation of the employee and the station. The policy manual is an expression of the rules governing the employment relationship. More than ever before, a station must protect its rights within that relationship by adopting policies that are fair to both sides, clearly stated and legally permissible.

## Policy manual

If your station does not have a policy manual, you should get started immediately. One way is to establish a committee of three to five staff members selected from operational employees and management. Broad representation will bring different viewpoints and perspectives to the discussions and help to develop a better set of policies.

continued on page 36 ►

# PRIME SPORTS RADIO

## THE POWER OF LIBERTY SPORTS.

*Prime Sports Radio* is principally owned by Liberty Sports, the dominant force behind regional sports networks nationwide. PSR will draw on these tremendous resources, which includes Prime Network's 42 million HH strong national television audience. We've got the right gameplan for success. Put these resources to work at your station.

Call Gary Wendt at (214) 401-0972 before your competition does.

- *High quality*
- *Highly marketable*
- *24-Hour Turnkey*
- *Straight Barter*
- *A major league opportunity!*

**Premiering Soon!**



*The Power Of Liberty Sports...  
Your Competitive Edge.*



# STATION SERVICES

News and Services for Business, Programming and Sales

## Selling Groceries

**DALLAS** Bob Harris will present an informative seminar on the "Power Concepts of Grocery Marketing," complete with slides and actual local grocery marketing campaign examples at no charge to any non-profit radio broadcast group or trade association.

Harris is the only radio sales person to ever win the coveted Golden Penguin Award given annually by the National Frozen Food Association.

For information, contact Bob Harris in Texas at 214-902-8552; fax: 214-956-9885; or circle **Reader Service 157**.

## What's Your Sign?

**ARLINGTON, Texas** Howard Sheldon, the man Regis Philbin calls "the best astrologer in the world," offers daily horoscopes for listeners. Designed for morning drive shows, the three 50-second segments (a total of 2.5 minutes of programming per day) include horoscopes for four astrological signs.

The order of the forecasts is varied through out the week, encouraging listeners to stick around for the entire show to make sure they hear their horoscope.

For information, contact Mary Gaines in Texas at 817-469-8631; or circle **Reader Service 36**.

## Multi-Level Marketing Entity

**TYNGSBORO, Mass.** Consumer Media Marketing (CMM), a division of Team Enterprises, offers a full-service marketing approach from the creation of a promotion to advertising placement.

CMM was formed by Chis McWade, former general sales manager for WJMN(FM) and national sales manager for WFXT-TV in Boston.

CMM serves as the media buying arm of Team Enterprises; Music Transit Company is Team's music consulting arm; and Direct Product Marketing is the on-site promotion arm.

For information, contact Janet Prenskey at Aigner Associates in Massachusetts at 617-484-5151; fax: 617-484-7142; or circle **Reader Service 194**.

## Toonces the Flying Cat

**SAN JOSE, Calif.** "Travels with Uncle Phil," the radio travel show, reports that cats are becoming a common traveling companion on both business and pleasure trips.

Recent reports indicate that several thousand pets are in the air every day, and airlines and hotels are becoming more accommodating to travelers with companion animals.

For information, contact Phil Dryan in

California at 408-241-5626, ext. 350; fax: 408-249-9214; or circle **Reader Service 87**.

## CD-ROM Sound Libraries

**SAN FRANCISCO** OSC offers two more non-traditional CD-ROM sound libraries for people craving something strange, new and different. They were created by an international group of sound designers who live by the credo: "No French horns."

"A Poke in the Stick with a Sharp Stick, volume III" includes more than 1,700 sounds, effects, loops and clip-tunes.

"Textural Ambience" contains long, evolving atmospheres, soundtracks and beds. Its overall tone is dark, moody, dramatic and menacing.

For information, contact Marsha Vdovin Public Relations in California at 415-826-1121; fax: 415-826-2292; or circle **Reader Service 61**.

## Cowboy Poetry

**BOULDER, Colo.** "Voices from the Trail," a five-part radio series on three cassettes, celebrates the American art form of cowboy poetry and music. The artists are authentic; they live the life they write about.

Most of the material in the series was recorded live at gatherings across Colorado.

For information, contact Gnu Maverick Productions in Colorado at 303-449-4885; or circle **Reader Service 94**.

## The Revolution Will Not Be Televised

**MINNEAPOLIS** On May 2, KREV(FM) and WREV-FM made their debut, simulcasting at 105.1 and 105.3 MHz, in the Twin Cities. REV 105, as the two stations are jointly known, broadcasts modern/alternative rock presented by live announcers, along with a large number of specialty programs that air daily. The station slogan is "Revolution Radio."

REV 150 is owned by Cargill Communications Inc., who's National Alternative Network produces syndicated radio programming, including SPIN Radio, which is heard on more than 300 commercial and college radio stations across the U.S.

Future plans include satellite and digital distribution of Revolution Radio programming, as well as information services, publishing, merchandising and video.

For information, contact Revolution Radio General Manager Brian Turner in Minnesota at 612-341-1700; fax: 612-341-1701; or circle **Reader Service 43**.

## Real Country Gospel

**NASHVILLE, Tenn.** "Gospel Country," a new radio program launching nationwide this summer, combines the young country sound with traditional gospel messages.

The show's host, Michael Wilson, stresses that "Gospel Country" is not Southern gospel, it is "the real country sound" heard on secular stations.

The program is produced in Nashville for weekly distribution to affiliate stations. In addition to music, the program features national contests, artist interviews and special concert and entertainment features.

For information, contact Jim Hennessey in Tennessee at 615-291-4185; or circle **Reader Service 217**.

## Urban-Oriented Talk Network

**WASHINGTON** T-P Telecommunications Inc. launched in January a new national syndicated urban-oriented news and talk radio network, TPT News.

The TPT News Network's slogan is: "A new standard in news and information." Its programming has an urban and worldwide perspective.

TPT News offers 24-hour national and world news coverage, sports and daily talk and public affairs programming.

For information, contact Tom Pope in the Washington at 202-662-1220; fax: 202-662-1221; or circle **Reader Service 199**.

# STUDIO/STATION SERVICES

## BUY-OUT MUSIC — \$99

Sixty 60-second music beds for . . . \$99  
198 :30 & :60 music beds for . . . \$198  
2200 Hanna-Barbera (C)  
Sound Effects for . . . \$495  
110 Lasers & Sweepers for . . . \$99

For FREE DETAILS on production music, sound effects, call

Ghostwriters (612) 522-6256

READER SERVICE 91

## CUSTOMIZED AIRCHECKS ARE HERE



Broadcast Historian Ed Brouder offers customized airchecks of Top 40 legends • Over 2,700 airchecks available • Use our catalogue to build your own collection • Perfect for Oldies Programmers, Collectors, Jocks. We have them all!

Send \$10 for our catalogue, \$5 for cassette.

**MAN FROM MARS PRODUCTIONS**

159 Orange Street  
Manchester, New Hampshire 03104

READER SERVICE 20

## Dump the file cards!

### HOT MIX

music scheduling software  
Get better and fresher rotations  
Buy-out price only **\$495.00**  
Programming Services Available  
Music Logs/Programming  
Format Restructuring

Call us today!

**LA PALMA BROADCASTING**

(714) 778-6382

READER SERVICE 188

## 427 SOUND EFFECTS \$89.00

For a 5-CD set with a 30-day money-back guarantee.

Take an extra \$10 off if you mention this ad!

Send \$79 to Ghostwriters  
2412 Unity Ave. N., Dept. RW  
Minneapolis, MN 55422

For credit card orders call  
(612) 522-6256

READER SERVICE 91

## The HOTTEST and CLASSIEST way to make your Radio Station . . .

# STAND OUT!

The J.R. Nelson Collection Volumes 1&2  
Market exclusive beds & EFX package designed for the **ULTIMATE** image!  
Each GOLD-MASTERED CD contains **99** cuts of the hottest beds ever heard before!

### OUT OF THE BOX

Lee Logan/KSAN-FM San Francisco  
Jim Graci/KBS G-FM Seattle  
Ken Carson/WROQ-FM Carolinas  
Tim DeCapua/WLKK Erie  
That's Country Oldies Classic  
ROCK & News/Sports/Talk!

**REALISTIC 1-TIME ONLY BUY-OUT FEE STARTING AT \$ 300**

This is the one you've been saving your money for! **IT'S REALLY WORTH IT!**

**FAX/PHONE FOR DEMO/RATES: (IN THE U.S.) 1-803-268-6521**

## ATTENTION PROVIDERS!

Promote your services to **Radio World's** 22,000+ readers. Reach Radio Station and Recording Studio owners/managers and engineers with your message. For information on affordable advertising call **Simone** at **1-800-336-3045**.



# Cable Audio Targets Radio Listeners

► continued from page 12

and in-market tests were conducted in Bakersfield, Calif.; Omaha, Neb.; Springfield, Ill.; Richmond, Va.; Savannah, Ga., and Portland, Maine.

Spearheaded by Tim Gregor, DCR's senior vp of marketing, the research identified two primary target groups for music programming: 18 to 29-year-old "musically-involved" adults and 30 to 49-year-old baby boomers.

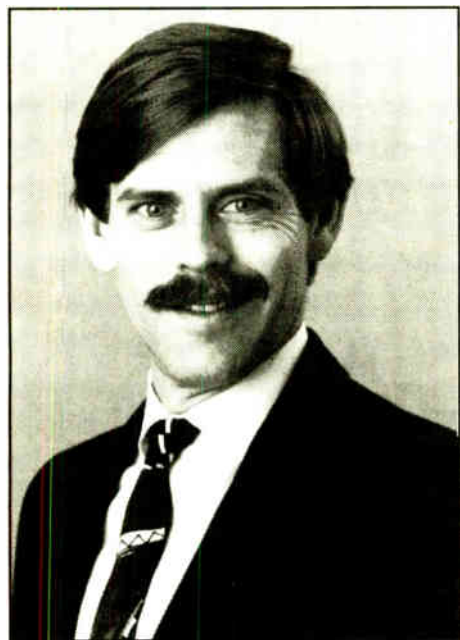

Tim Gregor

The two most important music genres for these groups, Gregor found, were rock & roll for the young adults and jazz and blues for the boomers.

Armed with this information, DCR expanded the genres most listened to by its targets into a variety of narrowcast "niche" formats to provide more depth and breath. Added to the line-up were two new "stations" called "Jazz Plus" and "Rock Plus." It's here that Music Choice breaks with the past and goes beyond uninterrupted music programming to offer artist profiles/tributes, concerts, rock blocks and exclusive programming.

"We found that people listen to three to five different channels over different periods of time," Gregor said. "These 'plus' channels offer an option a listener can sort of graze into at times to hear to different types of programming.

"However, all of the programming is associated with music. Nothing gets off that common territory."

Other expanded programming on Music Choice includes:

- Underground Rock ("cutting edge, addresses the youth market")
- Progressive Country ("enormous popularity among both youth and adult audiences")
- Body & Soul ("targets African Americans," who make up 21 percent of DCR's subscribers)
- Singers & Standards ("targets the adult audience")
- Gospel ("serves African American listeners of all ages")
- Tu Alternativa Musical ("serves the growing Hispanic market; addresses western regional cable subscribers")

In addition to changing its brand name and refining program content, DCR concluded that a sustained, integrated marketing approach is the best way to sell premium audio.

Packaging audio programming with

basic cable channels in concepts such as "Sight & Sound" promotions is highly effective, DCR found. Two advertising methods—TV spots and bill inserts—create the highest consumer awareness levels, the research confirmed.

In re-vamping its service, DCR also had the help of some powerful music industry partners. Sony Software Corp. and Warner Music Group, two of the world's largest record companies and equity partners in DCR, used their corporate resources to help map the new direction for the service. Then, last April, EMI Music, another of the world's leading record companies, invested an estimated \$10 million in DCR

to become an equity partner.

EMI's investment is expected to help fund an aggressive expansion of the DCR's services and make it a major audio player on the developing information superhighway. "Ultimately we believe you will see an explosion in audio just as with video on these various (emerging) networks," Del Beccaro said.

The company has major plans for the future. "In the next few years, DCR's Music Choice service will expand its distribution beyond cable and satellite delivery and will offer up to 250 stations of audio programming, including additional music, information/news, sports,

talk, foreign language and pay-per-listen stations," DCR said in press materials that accompanied the recent EMI investment.

If that future sounds like a major expansion of the components of traditional radio don't try to convince Del Beccaro. "The word channel had far too much of a video connotation," he said, contending that some things make more sense in a radio context.

"However, I think we are getting further and further from radio," Del Beccaro said of his company's programming. "In fact, part of the reason we are changing the name from Digital Cable Radio to Music Choice is because people said to us the product is way different from radio and that name made people think it was too much like radio."

## THE NAME OF THIS GAME IS MAKING MONEY.

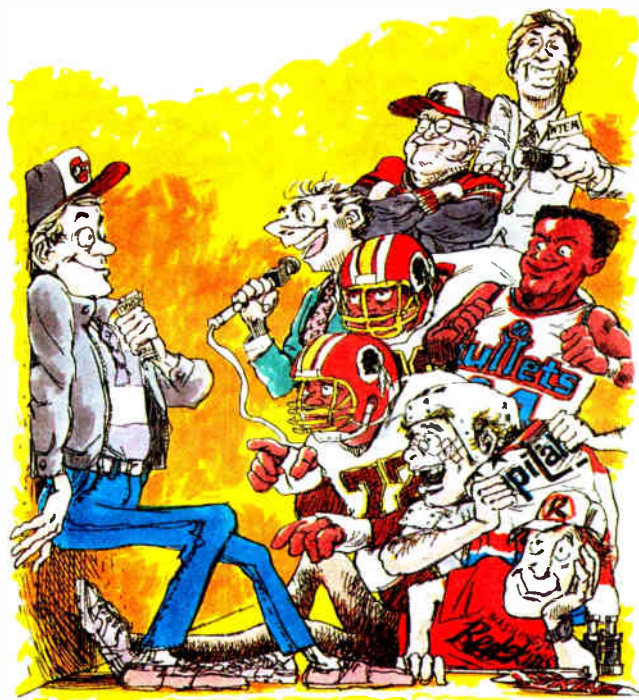

Lots of money. Because The Team Sports Radio is a format specifically designed to generate revenue. How? Three ways. First, it's unique. It's your chance to grab the sports/talk niche in your market and run with it. Second, The Team Sports Radio has a proven ability to create a core audience of loyal, passionate listeners. And third, The Team Sports Radio is more than just another radio buy. It gives you the chance to offer lucrative sports event marketing... as well as merchandising and promotional opportunities that your competitors can only dream about.

The Team Sports Radio... it's made to make money. Call Mike Tyler today at 1-800-876-3303 for full information and a free demo. You're the winner... when you join The Team!

**The Team**  
SPORTS RADIO

**1-800-876-3303**

For national advertising sales, call Media America at 212-302-1100

Circle (74) On Reader Service Card

World Radio History



UPLINK

# Ins and Outs of Station Promotion

by Karl Baehr

**ALBUQUERQUE, N.M.** Many believe that the job of "selling" your radio station is the exclusive job of the sales department. In fact, promotions are what "sells" your radio station to its audience, maintains and influences that audience to participate. To this end, let's look at "promotion" within the context of anything on or off the air that encourages building the station's audience or sales participation.

I've heard it before: "We don't have any money for promotions."

Let's start with those liners you get from

the network. Not many people would consider liners promotional tools. They should be. Consistently positioning your radio station to your audience and reinforcing that positioning is critical and does not have to be difficult. Who are you? "All Hit Q106." "Mix 107.9." "Star 95." "Your source for news and more." This is who you are.

Tell your audience often, say it clearly and concisely. Answer the questions: "Who am I listening to? Why should I listen and what am I going to hear when I listen?" I do not suggest throwing a bunch of positioning statements at people. Formatically, pick one or two

that emphasize who and what you are. Make sure they complement/reinforce the network positioning of your format.

Cross promote your personalities and any special programming you run. "Hi, this is Johnny St. John St. Owens. Join me from 2 to 6 Monday through Friday afternoon here on Classic Rock 104!" A great way to accomplish this is to have each network air personality cut a promo for his or her show. Rotate these throughout the day, and don't forget to keep them fresh. Have the host of any special network programming cut promos for that programming.

If you run non-network special programming, you can always get liners from the host to incorporate into promos. Don't forget to reinforce your position during the program. "Hi, this is Liz Wayborne, and you're listening to the Hot 5 at 5 on Star 92.3."

Don't start throwing money at people unless you can (a) keep it up or (b) keep it up. If your audience comes to expect money and then one day it's not there, they can become disappointed and that's not good. Money promotions can be good

continued on page 26 ▶

## Radio Career Options in Promotions

▶ continued from page 17

owner. If the response you receive is either lukewarm or non-existent, one of two things is probably happening. You're dealing either with very busy people or with someone who takes the "no prior control" issue to the extreme.

Your object in making contact is to let the people at the new company know you exist and to express your interest in working with them. Sometime before the sale is finalized, the new owners (or new manager) will arrive to interview you. If this interview is not scheduled a few weeks prior to closing, the odds are good that you're part of this radio station's history. However, if the feelers you've been sending out result in an appetizing offer, let your new owners know before you take it. They may suddenly focus on you and match it or offer you something better. This allows you to bargain from a position of strength.

You've done everything possible concerning the new owners and your contacts. Unfortunately, unemployment still has become a reality. File for unemployment immediately; don't assume you can't qualify because of severance or bonus, as this varies from state to state.

Take a part-time job at another station, which will give you a base to work from and will keep you connected to the market. Don't rule out applying for a position because something about it doesn't sound appealing. You can always turn down jobs; the object is to get offers. Do something about getting a job every day.

After a few weeks, you should have a feel as to whether or not anything is happening locally. If not, expand your search nationally. Look for openings in all the trade publications and cold call/mail a few stations each day. It can get pretty tough at times. It may get to the point where it seems that there are no openings. Remember, just like marriage, all it takes is one good choice.

There is a way to avoid the "u" word. Plan your career. Set goals as to where you want to be in one year, three years, five years and ten years. Make the moves before they're made for you. It seems simple enough, but very few people do it. Enough for this month. I need time to plan my next move!

□ □ □

Mark Lapidus is the director of marketing for Liberty Broadcasting. Liberty owns properties in Washington, D.C., Richmond, Va., and Long Island, N.Y.

# Prices Plummet for Music on Hard Drive

Copyright 1994 by Scott Studios Corp.

10:14:18A	<b>Without You</b> Mariah Carey :14/3:33/F HIT HM0105 10:14 # 1 for 2 Weeks in March, 1994	<b>:14</b>	Delete Del	Jingles & Spots 7	Music Library 8	
<b>* Air *</b> 3:33	<b>Start F2</b> Streets of Philadelphia Bruce Springsteen :25/4:03/F HIT HM2608 10:17	Auto 6	Jingles A	Appl- ause B	Sweep- er C	Jingles & Spots D
<b>Start F3</b>	Win It Before You Can Buy It Q: The Sound of the Tones :00/0:18/C PRO TO2214 10:21	F7 Move Up	Wear- ther E	News Open F	News Close G	Rim- shots H
<b>Start F4</b>	McDonald's 2 for \$2 Special JT Q: Thru Saturdays Only. :00/1:00/C COM DA1103 10:21	F8 Move Up	Morn- ing Jin. I	Oldies Jingle J	Legal ID K	Animal Noises L
<b>Start F5</b>	Bob's Bargain Barn BW Q: At Westland & East Park. :01/1:00/C COM DA4310 10:22	F9 Move Up	Top 8 at 8 M	Crowd Boos N	Happy B'day O	More Events 9
<b>Start F6</b>	Uptempo Jingle Q: Kiss FM. :00/0:06/C JIN DA1037 10:22	F10 Move Up	Contest Theme Q	Crowd Cheer R	Weath'r Service S	Options 0

If you've been waiting for hard disk prices to drop before you make the move from cart tapes to high quality digital audio, now's the time. Scott Studios now offers complete hard disk music and commercial systems at the best values ever! And, for a limited time, we're offering *free* digital transfers of your music from the best noise-reduced CDs to our hard disks!

### Play Any Audio At A Touch

Scott Studios delivers 24 digital players on a computer touchscreen in your air studio. Six events (on the left of the screen) come in automatically from your traffic and music computers. Jocks can use the arrow keys to rearrange things at a touch.

Eighteen unscheduled jingles, sounders and effects are "always ready" (at right). You also get other screens with unlimited "walls of carts" that play instantly. Pick and play spots, jingles, comedy or song requests sorted ten ways.

### Simple and Paper-free

Weather, live tags, promo copy and any part of the day's log pops up on Scott Studios' screen.

### Multi-Studio Digital Audio

When spots are produced (or new songs are dubbed), they're electronically transferred to all your air studios. There's no time wasted carrying carts down the hall or redubbing for additional stations.

Compared to mere months ago, hard disk digital audio value is way up. And we offer excellent financing and lease plans. Call for details.

**Scott Studios Corp.**

13375 Stemmons Freeway, Suite 300  
Dallas, Texas 75234 USA

**(800) 330-3004**



ALESIS  
MONITOR ONE™  
STUDIO REFERENCE MONITOR



ALESIS  
MONITOR ONE™  
STUDIO REFERENCE MONITOR



# The Truth From Left To Right

The truth...you can't expect to find it everywhere you look, or listen. But when mixing music, hearing the truth from your monitors will make the difference between success and failure. You'll get the truth from the Alesis Monitor One™ Studio Reference Monitor.

## Room For Improvement

Fact: most real-world mixing rooms have severe acoustical defects, with parallel walls, floors and ceilings that reflect sound in every direction. These reflections can mislead you, making it impossible to create a mix that translates to other playback systems. But in the near field, reverberant sound waves have little impact, as shown in the illustration. The Monitor One takes advantage of this fact and is built from the ground up specifically for near field reference monitoring.

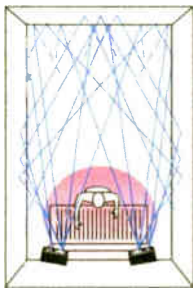

The pink area in the illustration shows where direct sound energy overpowers reflected waves in a typical mixing room. The Monitor One helps eliminate such complex acoustic problems by focusing direct sound energy toward the mixing position.

## The Truth From Top To Bottom

The Monitor One's proprietary soft-dome pure silk tweeter design delivers natural, incredibly accurate frequency response while avoiding high frequency stridency and listener fatigue—typical of metal-dome tweeter designs. The Monitor One overcomes wimpy, inaccurate bass response—the sad truth about most small speakers—with our exclusive SuperPort™ speaker venting technology. The design formula of the SuperPort eliminates the choking effect of small diameter ports, typical in other speakers, enabling the Monitor One to deliver incomparable low frequency transient response in spite of its size.



Alesis SuperPort™ technology gives you the one thing that other small monitors can't: incredibly accurate bass transient response. No, the SuperPort doesn't have a blue light, but it makes the picture look cool.

The result? A fully integrated speaker system that has no competition in its class. You'll get mixes that sound punchier and translate better no matter what speakers are used for playback. The Monitor One's top-to-bottom design philosophy is a true breakthrough for the serious recording engineer.

## Power To The People

While most near field monitors average around 60 watt capability, the Monitor One handles 120 watts of continuous program and 200 watt peaks...over twice the power. The Monitor One provides higher output, more power handling capability, and sounds cleaner at high sound pressure levels. If you like to mix loud, you can.

## The Engine

Our proprietary 6.5" low frequency driver has a special mineral-filled polypropylene cone for stability and a 1.5" voice coil wound on a high-temperature Kapton former, ensuring your woofer's longevity. Our highly durable 1" diameter high frequency driver is ferrofluid cooled. Combined, these two specially formulated drivers deliver an unhyped frequency response from 45 Hz to 18 kHz,  $\pm 3$  dB. The five-way binding posts provide solid connection, both electronic and mechanical. We even coated the Monitor One with a rubber textured laminate so when your studio starts rockin', the speakers stay put. Plus, it's fun to touch.

A cross section of the Monitor One's proprietary Alesis-designed 6.5" low frequency driver.

1. 1.5" voice coil.
2. Mineral-filled polypropylene cone.
3. Damped linear rubber surround.
4. Kapton former.
5. Ceramic magnet.
6. Dust cap.
7. Spider.
8. Pole piece.
9. Front and back plates.

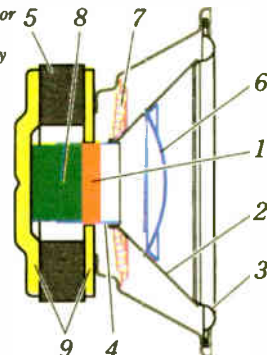

## The New Alesis Monitor One™

You don't design good speakers by trying hard. It takes years and years of experience and special talents that only a few possess. Our acoustic engineers are the best in the business. With over forty years of combined experience, they've been responsible for some of the biggest breakthroughs in loudspeaker and system design. The Monitor One could be their crowning achievement. They're the only speakers we recommend to sit on top of the Alesis Dream Studio™.

See your Authorized Alesis Dealer and pick up a pair of Monitor Ones. Left to right, top to bottom, they're the only speakers you want in your field.

For more information about the Monitor Ones and the Alesis Monitoring System, see your Authorized Alesis Dealer or call 1-800-5-ALESIS. Monitor One, SuperPort, and the Alesis Dream Studio are trademarks of Alesis Corporation. © Alesis is a registered trademark of Alesis Corporation.

Alesis Corporation 3630 Holdrege Avenue Los Angeles CA 90016





# Ins and Outs of Station Promotion

► continued from page 24

if they're tied in with an event. "The Power 99 \$10,000 Bikini Bash," "Cash Calls," which creates a daily event.

A few TV stations have started "Guaranteed Weather" promotions. Money should be looked at as a bonus or prize, not positioned as a primary reason for listening. It's kind of like selling with numbers. "You live by the book, you die by the book," so it goes that "when the well runs dry your listeners may look for another place to drink" if all you do is try to ply them with bucks.

## Contests

If you do run contests, including network contests, make sure you have a complete

copy of the rules available at the radio station. A mishandled contest can mean serious penalties for a station. Why take the risk? Check the FCC guidelines governing contests before you start up. It is suggested that management assume the ultimate responsibility for contest clearance because of these ramifications.

Contests on your station should: Add to the entertainment value of the station; be in good taste; be structured clearly with easy-to-understand rules that are also available at the station by request (and include any restrictions on eligibility). Be fair and equitable concerning intent and presentation. They must be fair and honest.

Contest rules should cover where, when, how often and how to enter, who is eligible/ineligible, the nature of the prize(s) and how they will be rewarded (also, if a tie occurs, what happens?), and when entry for the contest ends. These rules should be clearly stated regularly on the air during the entire life of a contest. This again can be accomplished through produced promos.

Extreme caution should be exercised when creating contests so as not to constitute a lottery. I would be curious if you approached the person responsible for promotions at your station and asked them "What three things constitute a lottery?" what the response would be. Do

you know?

The three elements that, when combined, constitute a lottery are: prize, chance and consideration. Exceptions apply to the promotion of state lotteries. Check with your legal beagle and be absolutely sure of what you can and cannot promote.

## Diary watch

Another practice that isn't good is the practice of potentially distorting, ratings-related positioning promotions. I've heard some real beauties. "Send us your diary, we'll fill it in for you." "Hey you, if you happen to get something in the mail from (fill in the blank), call us and we'll pay you \$5." Aside from being unethical, there could be penalties involved regarding these practices. The Electronic Media Rating Council has information regarding these practices and possible penalties.

When conducting outside promotions such as remote broadcasts, all station personnel should be (a) encouraged to drop by and (b) understand that they are representing the station when they do drop by. Outside promotions are great. They offer the opportunity for the public to meet the personalities and vice versa.

Outside promotions are a great visibility and community reinforcement too, until the first time somebody from the station has a bit too much to drink and cuts down the other guy's banners or worse. Make sure that when going on location, you have giveaways, information available for sales and programming, etc. Always be ready to promote any aspect of the radio station. You never know who's going to show up at these things.

Outside promotions can be great community-oriented, public affairs events as well. Blood drives, charity auctions, benefit concerts/sporting events can all help your community and reinforce a positive impression of your station in that community.

Look at developing quarterly or seasonal promotions for sales and programming. Work these promotions through well in advance so that you don't wind up being rushed. Make sure that no matter what you do that it is compatible with what you're doing on the air. Don't throw your audience a curve ball just to get the buy. They won't buy it.

## Concerts

With regard to concerts, again exercise caution in exploring actual underwriting of a concert event. Better to "present" or "welcome" a concert than have capital risk in a show. Ticket giveaways are great both on air and on location.

Consult reference materials. You don't have to have all the answers. You just have to know where to look them up. The NAB has several promotional idea books. NTC Business Books has several good ones as well. I would be happy to discuss some of the promotions we've done with stations over the years as well. Ask me about the "(frozen) Jell-O Jump" sometime, or the "Silver Screen" nightmare. Then there was "Bus 9 to Paradise" that turned into the road trip from hell.... Maybe you should just get the books.

□ □ □

Karl Baehr is president of KBE "Broadcasting By Design," a radio consulting firm providing support services for satellite radio stations and produces the Actual Radio Measurement (ARM) electronic survey system. He can be reached at 505-828-0488; or fax: 505-821-4226.

## SEND YOUR AUDIO ACROSS THE STREET OR AROUND THE WORLD™

**When you think digital audio, think California Digital. We provide satellite/digital technology to make all these options available at low cost:**

- ! Syndicate your top personality or format
- ! Add affiliates - gain revenue sources
- ! Share programming, talent and costs
- ! Off-site announcer feeds
- ! Create events with remotes
- ! CD-quality live coverage of news, sports, and concerts

**DIGITAL AUDIO**

### California Digital offers expertise in:

- ! Digital Satellite Networks - C or Ku
- ! Regional, National, International Nets
- ! Remote Broadcasts
- ! Rugged Fly-away Systems
- ! Custom Ku Power Control Software
- ! System Design & Engineering
- ! FCC Licensing; Installation and Training
- ! Equipment sales, leasing and financing
- ! Switch 56 & ISDN program distribution

**TOP TALENT IS LOCALIZING NATIONAL SHOWS WITH OUR LOW COST TECHNOLOGY**

**ASK US HOW YOU CAN DO IT TOO!**

**CALL: CALIFORNIA  
DIGITAL AUDIO**

West Coast Office (805) 523-2310 Fax (805) 523-0480  
Midwest Office (612) 631-5064 Fax (612) 631-5010

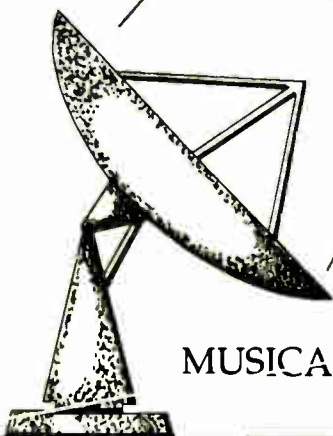

MUSICAM™

**MAKE MONEY BY CREATING A  
MUSIC PROGRAMMING NETWORK!**



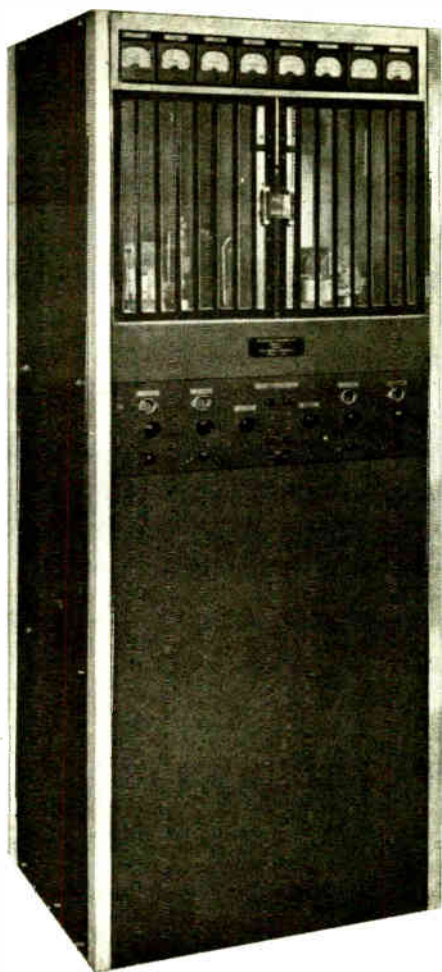

### **GATES 250 (c. 1934)**

- *15% efficiency*
- *Low-cost tube complement*
- *100% peak modulation capability*

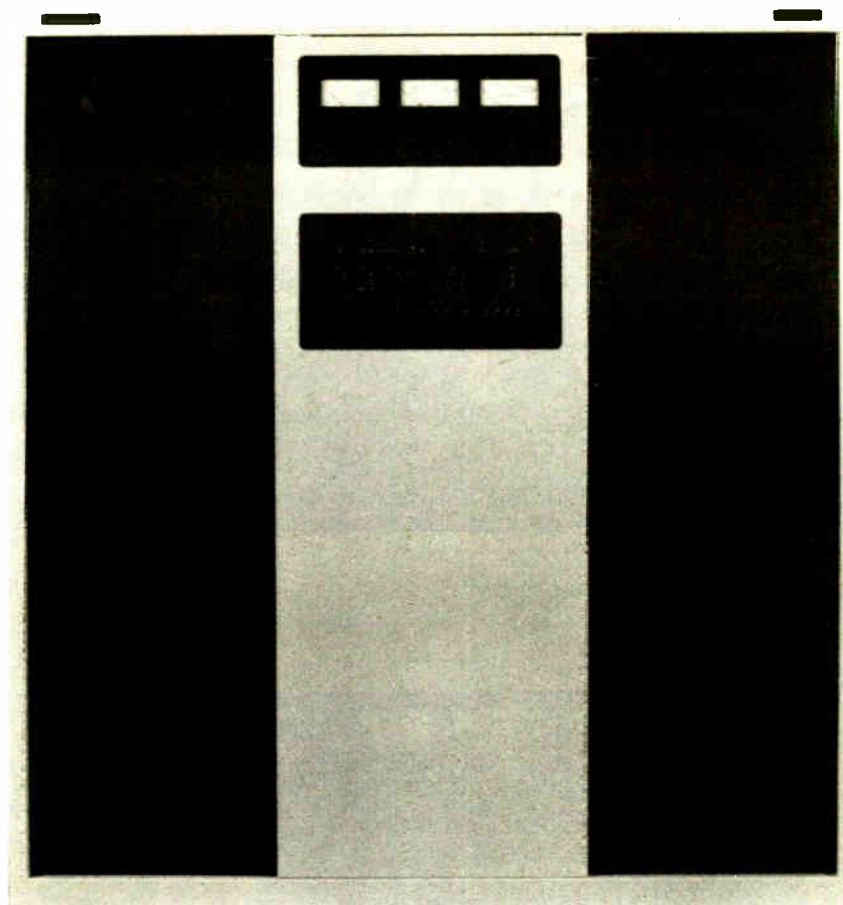

### **HARRIS DX 10 (c. 1987)**

- *86% efficiency*
- *Digital solid state*
- *145% peak modulation capability*

## **Our 60 Years of Continuous R&D Have Benefitted MW Broadcasters Who Don't Even Use Our Transmitters.**

Make a dramatic improvement in a Medium Wave (MW) transmitter and you're bound to get some attention.

It might even become a world standard.

We know, because this has happened with many Harris innovations during our 60 years of continuous investment in MW transmitter research and development.

Harris breakthroughs such as PSM, PDM, PPDM and the first

solid state transmitters have progressively expanded limits of reliability, performance and efficiency. And, as world standards, they've benefitted virtually every MW broadcaster—regardless of who manufactured their transmitters.

Our latest MW advance—Digital Amplitude Modulation—is again redefining customer expectations. Just ask the more than 400 users of Harris DX Series transmitters worldwide.

Whether you need the most up-to-the-moment 1kW MW transmitter or a two megawatt digital MW system, we invite you to contact us.

#### **U.S. and Canada:**

Telephone: 217-222-8200

FAX: 217-224-1439

#### **International:**

Telephone: 217-222-8290

FAX: 217-224-2764





from Moscow to NY & from Paris to Tokyo...

# MORE STATIONS BUY ARRAKIS!!!



## DIGILINK... THE #1 DIGITAL SYSTEM starting at under \$8,000

- 10 hours of stereo digital audio storage for \$7,995 complete
- Satellite, CD, Tape and Hard Disk Automation
- Simultaneous Play, Record, & Network transfer
- Digital Editor with Waveform Editing for tight production
- Crossfade CD's, sources, and hard disk audio
- Music Scheduling system built in for basic CD automation
- Digital Networking for transfer of audio and schedules

Digilink is the #1 selling digital audio hard disk system in radio today. You can replace your cart machines for live On Air and have an automation system for walk away at the same time! Link over 15 workstations & scheduling computers on our digital network and transfer audio and schedules between your studios.



## TRAK\*STAR-8 THE 8 TRACK DIGITAL EDITOR starting at under \$5,500

- A digital audio editor designed for Radio production
- Learn to use in minutes, much faster than tape
- Cut, splice, move, and fade up to 4 stereo tracks
- Use Scrubbing to edit with your ears
- Use visual waveform editing to edit with your eyes
- An UNDO button enables you to go back and fix mistakes
- Digital Networking to transfer audio to your On Air machine
- Add Trak\*Star-8 software to a Digilink for \$2,000

Trak\*Star-8 is the first cost effective multitrack digital audio editor designed for the radio broadcast professional. Fast and easy to use, produce your commercials on Trak\*Star and then transfer them in digital straight to the Digilink in your On Air studio. Dramatically reduce production time and save money!!!

2619 Midpoint Drive, Fort Collins, CO. 80525

Voice (303) 224-2248



## 12,000 Series Consoles



Standard Tabletop Mainframe displayed above

- Totally Modular Console-Input-output-monitor
- Three Mainframe Sizes - 8, 18, 28 input channels
- High Quality Construction-P&G Faders, etc.
- Polycarbonate overlay-for scratch resistance
- VCA Controlled Faders-for ultra reliability
- Universal Mainframe-any module in any position
- Inputs-2 per channel
- Outputs-3 stereo, Pgm, Aud, Utl
- CR Monitoring-stereo Monitor, Earphone, & Cue
- Studio Monitoring-two studios supported
- Talkback-two studios w/monitor dim
- Telephone interface-2 internal mix minus buses
- Timer-60 minute digital up timer standard
- Options-DA module, Remote selector module, Dual Machine Control Module

Deluxe thru-table mainframe displayed below

### Typical List Price

**\$4,000 - \$7,000**

From France...to Moscow...to Japan and Taiwan, and around the world...the 12,000 console is On the Air.

The 12,000 is the #1 selling Arrakis console line from the #1 console manufacturer. With three stereo output buses and two mix-minus buses for telephone interface, the 12,000 can fill any application. The 12,000 also supports a control room and two studios standard. Panning or Mode select are available on the four models of input modules, VCA control of audio delivers reliability and performance.

Quality, performance, and durability make Arrakis consoles the leader around the world.



14 1/4" x 20 3/4"

**Arrakis Systems is a world leader in radio studio technology. In Japan, Digilink is a brand name for hard disk audio for radio. For use around the world, the United States Air Force chose the 10,000 series console from among all competitors as its console of choice. When the United Nations needed 6 entire studios with consoles and furniture for a rush shipment to Cambodia early this year, they chose Arrakis 10,000 consoles and Modulux furniture. In Jamaica, Tahiti, and elsewhere, entire factory assembled and tested Arrakis studios are on the air. Around the world and of course in the United States...more stations buy Arrakis for their digital audio, console, and furniture needs!!!!**

FAX (303) 493-1076

by **ARRAKIS SYSTEMS inc.**



# A Few Words About

# The New Marantz PMD101

Normal & Half-Speed Recording

±20% Pitch Control

Built-in Mic/Speaker

1/4" Mic Input



Cue & Review

Metal Chassis

AC or Battery Operation

Headphone Jack with Level

Tone Control

## Only \$199.00

For Orders and Information Call BSW  
Phone: 800 . 426 . 8434 Fax: 800 . 231 . 7055

*Equipment Solutions To Keep You Number One*

**BSW**  
BROADCAST SUPPLY WORLDWIDE

7012 27th Street West Tacoma, Washington 98466

Circle (97) On Reader Service Card

World Radio History



# Digital Audio Workstations Hold Interest

by Ty Ford

**LAS VEGAS** Judging by the attendance at the recent NAB convention, interest continues to grow for information about digital audio workstations. The "Digital Audio Workstations & Storage" session, moderated by Fred Morton of KMGZ-FM, drew a crowd of almost 300. Those who attended the session were split down the middle: Half of the audience came for the latest information to guide their buying decisions. The other half, comprised of digital audio system owners, came to hear how far the technology had moved on since their purchases.

Writer/Producer Ty Ford's paper entitled "Confession of a Digital Audio Workstation User," tracked his experiences as a three-year user of AKG's (Now Orban) DSE-7000. He included anecdotal information concerning how, when and what to consider when choosing workstations, and how to take care of them.

## No free rides

Ford described how dynamic visual waveform displays and well-designed edit buffers can significantly improve an operator's mixing ability and the impact of the production. Ford also gave support to the idea that, "there are no free rides on the digital highway, you get what you pay for."

He advised those who had not already made a purchase to wait until the demise of their existing equipment was imminent or (for production facilities) until they had a client-base that generated enough revenue to pay for the system within three years. Ford observed that, "because workstations are so computer intensive, they will be faster, cheaper and better six months from now than they are today."

Laura Tyson, who recently moved from BSW to Roland Corporation, gave a paper entitled, "Saving The Goods: A Survey of Digital Storage Alternatives." Tyson spoke of the new alternatives to cart machine technology, citing at least 25 different approaches including: digital cart, digital cart with hard disk storage, digital carts with network capability, digital tape formats, recordable CD, MiniDisc (MO), M/O disk and floppy disk formats.

## Cart obsolescence

While conceding that cart machines, if properly maintained, can offer acceptable audio, Tyson also suggested that at some point, the cost of maintaining old cart machines may make moving up to digital technology more economical.

Tyson suggested that each operator approach the buying decision by first determining the amount of storage needed, and by analyzing the existing system on a cost-per-spot basis. While warning that some digital systems may not be reliable as carts yet, Tyson also noted that, "features offered by some of the newer systems, such as automatic kill-date warnings, auto-record and the possibility that some digital systems are cheaper and occupy much less space than their analog counterparts," may make them attractive to buyers.

Digital Audio Technologies' Jeff Wilson's paper, "Configuring a Digital Audio Workstation for Broadcast", outlined the operation of a low cost DOS-based digital editing system from DAL called Fast Eddie that for a total cost of about \$2000, consists of a 386 40 MHz machine with 8MB of RAM, a sound card and windows-compatible software.

Wilson also discussed the operation of Software Audio Workshop from Innovative Quality Software, a multi-track environment operating on a 486 66DX2 platform, that is capable of playing back four stereo sources. According to Wilson,



Roland's DM-80 digital audio workstation

sustained throughput for computer-based systems should support 800 KB/second for mono operation and 1.5 MB/sec for multi-track operation.

## No caching

He advised against using caching because audio always uses a fresh run of data, and against data compression because it slows the process down. Wilson suggested that using IDE drives is a good choice with local buss controller, but that,

because of the DOS problems you should have a SCSI device for disks of over 500MB.

"A Systems Approach to Non-transcoded Audio Delivery: A Step Toward Digital Compatibility," presented by Richard Becvar of California Digital Audio Systems, suggested that data reduction at the rate of 256 KB per stereo channel was the maximum amount of reduction before audible degradation. He also spoke in support of the MPEG standard and maintaining it throughout a system as a way to reduce objectionable audio artifacts, referencing his knowledge of its use at the Children's Satellite Network.

Becvar noted that one of the next issues to be addressed will be serial mixing. "We may have pure serial digital mixing," he said. "DAX, that would allow for digital mixing, is not yet available. You can't mix MPEG signals yet."

## A new approach

"A New Device for Digital Audio Storage," delivered by ITC's Willem Bakker centered on the issue of a "mission critical" approach to a digital audio system. Using "the business model of achieving your objectives for radio" Bakker spoke of establishing an audio management model, an audio library specification, three channels of stereo output (program, promo and commercials) and no data compression. Bakker downplayed reliability concerns of audio-on-disk systems, citing MTBF (Mean Time Between Failure) figures of 400,000 for hard drives.

"Keyboards, CRTs and the mouse are the most unreliable part of most of these systems," he added. Bakker also cautioned that systems with switching-type power supplies are not as reliable as linear power supplies.

During "Compression Algorithms: The Good News and the Bad," John Knapton focused on the main types of audio degradation that are the result of data reduction. "High frequency smearing, low frequency flutter, intermodulation distortion, destruction of the stereo image, and various audible artifacts such as birdies and chirps are the most obvious problems," Knapton said.

When data reduction is designated, Knapton recommended using the highest bit rate and the shortest processor delay. "If there's nothing to be gained by compression, don't use it," he suggested.



## LMA/DUOPOLY CONTOUR MAPS

The DATAWORLD LMA/DUOPOLY Market Survey Contour maps present a precise electronic verification of overlapping and intersecting contours.

AM 5 mV/m and FM 3.16 mV/m City Grade contours are shown in full color, including transmitter site indicator. The map is supported with a printout showing all of the stations which appear on the map.

Daily updating of DATAWORLD'S AM and FM databases protects against errors and omissions.

## OTHER MAP OPTIONS

- SHADOWING (TERRAIN SHIELDING)
- CONTOUR COVERAGE
- POPULATION DENSITY
- ZIP CODE BOUNDARIES
- RECEIVED SIGNAL LEVEL
- SPECIAL REQUIREMENTS

## 1990 CENSUS

### WHO ARE YOUR LISTENERS?

### 1990 BUREAU OF CENSUS POPULATION COUNTING

- Comprehensive Ethnic and Demographic Data
- Ethnic/Demographic Data Available for Each Zip Code Within Coverage Area
- Age Analysis Reflected in Ethnic Breakout
- Resolution Increased to Block Level
- Percent of County Coverage Shown

### ETHNIC PIE-CHART DISPLAY

- Projects Ethnic Population in Multi-Color Pie Chart Form

dataworld<sup>®</sup>

800-368-5754 FAX: 301-656-5341

**You can measure... with the best monitor and the most accurate test set.**

The FMM-2/FMS-2 series monitors provide an even greater degree of precision measurement than ever before... **You can measure S/N below 90 dB, You can measure crosstalk below 85 dB, You can measure separations of better than 70 dB, You can measure frequency response to better than 0.25 dB, You can measure distortions to lower than 0.01%, and much more...** Our uncluttered panels and autoranging voltmeters make these measurements a dream.

**BELAR ELECTRONICS LABORATORY, INC.** (610) 687-5550  
LANCASTER AVENUE AT DORSET, DEVON, PENNSYLVANIA 19333  
Call or write for more information on Belar AM, FM, Stereo, SCA and TV monitors.

Circle (16) On Reader Service Card

World Radio History

Circle (184) On Reader Service Card



## GUEST COMMENTARY

# High Speed Subcarrier Is Wave of Future

by Lyle Henry

Before hitching their wagons to a new technology and heading out to seek their fortunes on the so-called "information superhighway" by broadcasting digital data, FM radio station owners should give some thought to the emerging standards for digital data transmissions via FM subcarriers. Hitch your station to the wrong technology and you may end up limiting both the reach and capability of your data broadcast system. Or, even worse, you may end up degrading your main audio

signal and/or existing subcarriers.

Late last year, the National Radio Systems Committee (NRSC) endorsed the Radio Broadcast Data System (RBDS) as a standard. RBDS, which is based on the earlier European Radio Data System (RDS) standard, is the designated slow lane for digital data broadcasting. RBDS is suitable for such limited tasks as transmitting radio text or billboard information. It is unsuitable for faster, higher capacity tasks such as transmitting paging messages or stock quotes.

The NRSC is now evaluating proposals

for high speed data transmission standards. Among the criteria, or "goals," the NRSC has set for the new high speed standard are:

- RBDS compatibility
- Subcarrier transparency
- No unacceptable FM signal degradation
- Multiplexing capability with other services
- Allowing use of low-cost receiver/decoders
- Suitability for use in mobile environments (automobiles, hand-held computing and communications devices).

One proposed standard, the High Speed

Data System (HSDS), developed by Seiko Telecommunication System Inc. (STS) in Beaverton, Ore., meets these criteria. It promises to deliver a technology that will fulfill all NRSC goals.

The HSDS protocol is now used by 13 FM stations in and around Seattle and Portland, Ore. Together, these stations broadcast paging messages and other data to approximately 12,000 MessageWatch wearers.

(The MessageWatch combines a Seiko electronic timepiece with a versatile pager and personal data receiver in a standard-sized wrist watch.)

## HSDS protocol

HSDS is based on a packet-oriented, time-division multiplexed (TDM) scheme. The HSDS subcarrier channel is centered at 66.5 kHz, to be compatible with international standards of 53 to 75 kHz and the (stereo-compatible) U.S. standard of 53 to 99 kHz. The center frequency is 3.5 times the 19 kHz stereo pilot which allows phase-locking to the pilot for ease of receiver implementation. The raw data rate of the system is 19 Kbps. The HSDS subcarrier is summed onto the FM station's baseband signal with a typical modulation of 10 percent (7.5 kHz deviation).

A critical feature of any subcarrier signal is that it not interfere with the main audio channel in a way that would affect listeners' perceptions of audio quality. There are two principal considerations in this regard: The first relates to the transmission filter and the out-of-band filter attenuation. HSDS filtering at the transmitter is implemented digitally with a finite impulse response filter. The subcarrier energy is attenuated more than 60 dB at the channel edges.

As an added safety feature, the HSDS subcarrier signal generator features an out-of-band detector. If the subcarrier signal somehow does stray, the system automatically shuts itself down to protect the integrity of the main audio channel.

The HSDS spectrum is completely compatible with RBDS. After thorough testing of RBDS receivers, STS has determined that the HSDS modulation spectrum degrades RBDS by an average of less than 1 dB, based on an RBDS sensitivity of a bit error rate of .01 and injection of 2.66%.

A second interference source in nonlinear mixing of the subcarrier with the audio due to multipath. To combat this, HSDS randomizes data to approximate "white noise" without perceptible beat notes. Extensive testing and operation experience in Seattle and Portland have demonstrated that HSDS has no noticeable interference with the main channel audio.

## ACTT, the low-cost receiver

Another goal the NRSC has established for the high-speed data standard is the ability to use low-cost receivers that are suitable for mobile environments such as automobiles, hand-held computers and personal communications devices. Here again, HSDS more than meets the mark.

Paging messages and other data broadcast in the HSDS protocol are received on the Advanced Communications and Timekeeping Technology (ACTT) chip set developed by STS. A highly miniaturized (30 mm x 26 mm x 4 mm) package of three integrated circuits, the ACTT chip set boasts the longest battery life (up to 18

continued on page 34 ►

**Talk Radio**  
 Can Be **Difficult.**  
 Your **Phone** System  
 Shouldn't Be.

Weirdo on line one. Bitter psycho on two. Irritated mom on three. Religious zealot on four. Talk radio seems so simple. At least your phone system is, if it's the new TS612 from Gentner.

The TS612 is a six-line (expandable to 12) Telephone System. It features Gentner's Direct Connect Technology™, which allows you to hook it into a regular phone line. Plus, its built-in handset and keypad eliminate the need for another screening phone. With the TS612, you can talk to callers (even the Pizza Guy) off-air, while other callers are on-air.

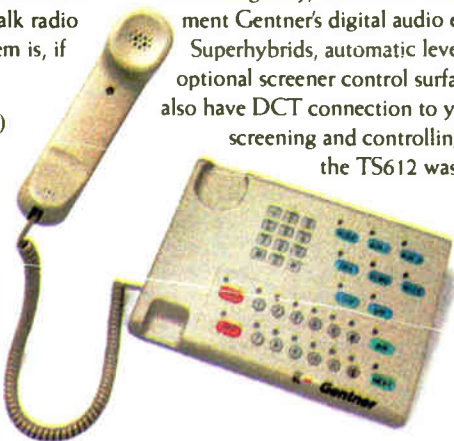

Technologically, the TS612 features built-in mix minus, to complement Gentner's digital audio enhancement. It has two DCT Superhybrids, automatic level control, dual air control surfaces, optional screener control surface, and dual audio bus operation. You also have DCT connection to your hard disk or studio PC, for screening and controlling calls. But what would you expect — the TS612 was designed specifically for talk shows.

See your Gentner rep today, or call 1-800-945-7730 and make your life easier with the TS612. After all, that psycho's still on line two.

**Gentner**

1-800-945-7730





# Systems with Style

When KABC/KLOS decided to rebuild from the ground up, they called Pacific Recorders & Engineering to provide its expertise in studio systems planning and execution. After all, when you're dedicated to winning, you don't gamble with success. PR&E has a proven track record of building the world's leading broadcast facilities for over twenty years. This record translates into the uncommon depth and breadth of experience which we bring to each new project. From news to rock, talk, or full-service, we're comfortable and conversant with all formats.

When you see the attention to detail, the design elegance, and the fanatical commitment to quality, you quickly realize why PR&E consoles and studio systems are found in nearly every leading broadcast facility in the nation.

But what may really surprise you is how much money you can save by working with us. That's right, save money. You see, we design and build so many world-class studio systems, we avoid the "surprises" by having the details down to a science. Why don't you give us the opportunity to work with you on your next studio project? We think you'll be pleasantly surprised at how easy it is to realize the operational efficiency and benefits of a genuine PR&E system.



Pacific Recorders & Engineering Corporation  
2070 Las Palmas Drive, Carlsbad, CA 92009  
Tel: 619-438-3911 Fax: 619-438-9277 GSA: GS-03F-2057A

**DESIGNS THAT MAKE THE DIFFERENCE**

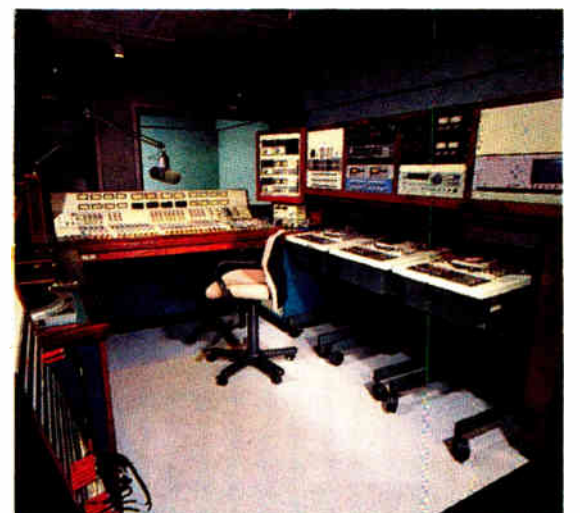



# High Speed Subcarrier Holds Promise

► continued from page 32

months on a single 3-volt lithium watch battery) of any paging device now on the market. Its meager power requirements and tiny footprint make it ideal for mobile applications.

The ACTT chip set is currently used in a single product application, the MessageWatch by STS. MessageWatch wearers receive paging messages and other data, such as local sports scores and weather forecasts, on a standard-sized wrist watch.

Thanks to economies of scale achieved through mass production, the cost of the ACTT chip set has fallen sharply. Freed from the inherent space and power constraints of a wrist watch application, many of the future devices will be capable of receiving a wide range of information, everything from stock market quotes to full text E-mail.

Among applications now on the drawing boards of STS and its allies is a Differential Geographical Positioning System that will someday be able to tell drivers their exact whereabouts anywhere in the U.S.

The HSDS protocol is a very flexible, one-way communications protocol. The system permits very small receivers with extremely low power requirements. Receivers, with duty cycles ranging from continuous operation to as low as 0.01%, provide product designers the flexibility to select message delay, data throughput and battery life.

Unique to HSDS protocol is the ability to

use multiple-station transmissions and retransmissions of paging messages and other data to ensure very high reliability, especially in signal multipath situations—such as those where radio signals bounce off hills, tall buildings and other structures, causing signal “collisions” and loss of data. Multiple broadcasts from multiple stations are accommodated by frequency-agile receivers, precise time offset message transmission from each station and transmitted lists of nearby stations broadcasting each message.

By transmitting the same message from one or more stations, utilizing short time

**The ACTT chip set is currently used in a single product application, the MessageWatch by STS.**

delays (offsets) between transmissions, the HSDS protocol affords ample time for a patented frequency-agile ACTT FM receiver module and patented automatic antenna tuner to change their tuned frequency to a clear signal containing a message packet. The multiple-station and retransmission capabilities of HSDS make it very reliable for use in demanding reception situations—such as in automo-

biles or hand-held computers.

This multiple-station capability also allows FM stations to be easily networked together into a single HSDS system. It does this through the following technique. Each HSDS protocol packet contains a list of surrounding FM stations using the protocol. By reading the list and then automatically adjusting its subcarrier receiver to an available signal, an ACTT receiver-modules can operate continuously as it moves out of one FM station broadcast area and into another.

Another consideration when evaluating subcarrier data broadcast systems is capacity. HSDS has virtually unlimited capacity—up to 2.1 billion individual addresses. This means that a set of radio stations in a market may be able to reach millions of subscribers.

STS plans to expand its network of FM radio stations to cover all major metropolitan areas in the U.S. by 1995. It is also working to establish paging networks in a number of other countries, including France, Japan, Canada, Germany and the Netherlands. Because HSDS is centered at 66.5 kHz, it is believed to be the only high speed data protocol compatible with the international standards of 53 to 75 kHz.

Another key consideration for broadcasters is the amount of space, power and staff attention a subcarrier lessee requires. The HSDS subcarrier signal generator, the single piece of equipment STS installs at FM stations, requires only 17.5 inches of rack

space, or 10 standard EIA slots. Space permitting, STS prefers to install its own equipment rack.

Power requirements include an isolated line with its own 20 amp circuit breaker. Also needed is an RF sample of 1 volt RMS from a sample section of the transmitted signal. An emergency generator is preferred but not required.

The RF sample is used to drive a modulation monitor provided by STS. These monitors measure subcarrier injection, stereo pilot injection and total modulation, and provide a pilot reference for the subcarrier. In the subcarrier generator, the modulation and other internal parameters are encoded and returned to the ACTT computer via the 56 Kbps data link.

With the system in place, STS continually monitors the FM station's broadcast signal. If something goes out of spec, STS can immediately detect the error and report it back to the station engineer.

The STS system has been designed with the capability to send emergency broadcast messages to MessageWatches and other receivers equipped with the ACTT chip set. Because the system continually tests its send and receive capabilities and can distribute EBS-type messages, STS believes its HSDS may someday eliminate the current FCC requirement for weekly on-air tests of the Emergency Broadcast System—guaranteed tune-outs for any radio station.

□□□

Lyle Henry is director of engineering for KUSC and the radio stations of the University of Southern California. He can be reached at 213-743-5851.

## THE RF EXPERTS KNOW—MYAT DELIVERS

### MYAT DELIVERS QUALITY

You can rely on MYAT rigid line and components to deliver a clean, powerful signal to your antenna. Pure highest quality copper, brass and silver plus computer-aided design and manufacturing ensure consistency and accuracy. No wonder demanding broadcasters worldwide choose MYAT products for their passive systems. We take Quality Control very seriously.

### MYAT DELIVERS RELIABLE PERFORMANCE

Our non-galling silver-plated beryllium copper contact springs, brass elbow reinforcements and virgin Teflon inner supports are designed for maximum velocity, minimum attenuation and long service life. Every MYAT component is tested before shipping and backed with a full one year warranty. MYAT products are built for the long run.



### MYAT DELIVERS WHEN YOU NEED IT

Major transmitter manufacturers with strict production schedules rely on MYAT to deliver quality components on time and within budget. So do leading broadcasters like the Empire State Building's newest TV tenants. At MYAT, commitments are kept.

### LET MYAT DELIVER FOR YOU

Whether you're planning a new tower, upgrading an older installation, or coping with an emergency, you can depend on MYAT rigid line and components. Thousands of RF experts around the world already do. Contact your RF distributor, or phone us for our catalog, installation planning guide and engineering reference. Its detailed drawings can help you put together an efficient, trouble-free transmission line that will last for decades. For a free copy call 201-767-5380 or fax 201-767-4147.

### RIGID LINE: RADIO'S EFFICIENT CHOICE

40 YEARS OF EXPERIENCE. 40 YEARS OF EXCELLENCE.

380 Chestnut Street • P.O. Box 425 • Norwood, NJ 07648

Tel 201-767-5380 • Fax 201-767-4147



**LISTENER IMPRESSION**

# Sony SW-100 Packed with Features

by Frank Beacham

**NEW YORK** Back in 1987, Sony introduced an amazing world band radio about the size of a pack of cigarettes. Called the ICF-SW1, this tiny receiver quickly became the mini-radio of choice for travelers wanting complete coverage of short, medium and longwave bands along with stereo FM.

Now Sony has done it again with the introduction of the ICF-SW100, a shirt pocket-sized receiver jam-packed with features far beyond those offered in the company's venerable classic, the portable ICF-2010.

Slightly larger than a plastic audio cassette box and weighing only 7.8 ounces including two AA batteries, the U.S. version of the radio features AM coverage from 150 through 29999 kHz and FM coverage from 76 to 108 MHz. The miniature radio is the first of its size to include synchronous detection and a fifty page memory that allows station names and frequency.

Since its release in March, the SW100 has earned kudos from avid world band listeners who call it a major breakthrough in receiver design. In response to an electronic mail request by *RW* over the Compuserve on-line service, early SW100 owners had these comments:

**Favorable reviews**

• "The ultimate travel portable. Having SSB (single side band) and an effective sync detector in a box small enough to fit in your pocket is quite mind-blowing." Michael Schuster, Staten Island, NY.

• "One thing that impressed me about this radio is its ability to handle strong signals. I connected it to my Classic 33 Tri-band Yagi at 50 feet and it copied SSB on the very busy 20 meter ham band like a desktop radio. This is an amazing radio." Tom Delano, Duxbury, MA.

• "The radio is quite selective, and fairly sensitive—for a portable. The synchronous detector is great for tuning in signals suffering from selective fading and aural fluttering. If a signal has a strong heterodyne beating (whistling) against it, you can tune the sideband farthest away from the offending signal and make an unreadable signal readable." Michael Gilchrist, Ft. Myers, Fla.

• "I feel the SW100 is the best portable SW radio available on the market, regardless of price, and hope it sets a new standard for Sony's next generation of SW radios." Steve Share, Milpitas, Calif.

• "A modern classic, providing the flip-up lid doesn't break off." Rick Flynn, Newington, CT.

In a user test by this writer, the SW100 proved to be a new breed of world band receiver. Unlike previous Sony designs, this radio resembles a baby-size personal computer that folds together like a clam shell. In the lid is a 1.62-inch diameter ported speaker (with unexpectedly good sound) and a backlit liquid crystal display about two inches wide and just less than 1.5 inches high. There are 28 interior push-button controls for dozens of functions.

To get better audio fidelity, the radio has a stereo headphone jack for private listening and a stereo line output that will

feed any sound system or tape recorder. An external antenna jack with phantom power is also available to connect with an active outboard antenna supplied with the U.S. model.

**Computing power**

Sony also applied some computing power into the SW100 that was previously used in its SW55 and SW77 receivers. In the case of the SW100, the user can store up to 50 stations with alphanumeric labels into memory. The memory is divided into "pages," with each page holding five pre-set frequencies with ID labels.

The radio comes pre-programmed with groups of frequencies used by the BBC, Voice of America and Radio Japan. By grouping the frequencies together on a single page, the user can simply flip to the program service supplied and push the pre-set buttons until a station can be heard clearly.

This feature is equally useful for domestic stations. For example, in New York I assembled several groups of

stations by category. One page included all-news stations while another page included all stations that carry public radio programming.

Having lived with the SW100 several weeks for program listening, I found its performance comparable with the best of the larger portables. I have received shortwave and domestic stations in New York's RF jungle on the SW100 with its built-in telescoping antenna that lesser radios couldn't touch with an outdoor antenna. It is clear that with the SW100 Sony has come up with another world band winner.

The SW100 is being sold in two packages. The SW100 S version, being sold in the U.S., includes an active antenna, AC power supply, case and ear phones. List price is \$449.95. The SW100 E version (sold outside the U.S.) omits the AC power supply and active antenna and includes a roll-up wire antenna.

For more information, contact Sony at 800-222-7669.



Sony ICF-SW100

## CCA Broadcast Transmitters

The Standard for Reliability Throughout the World.

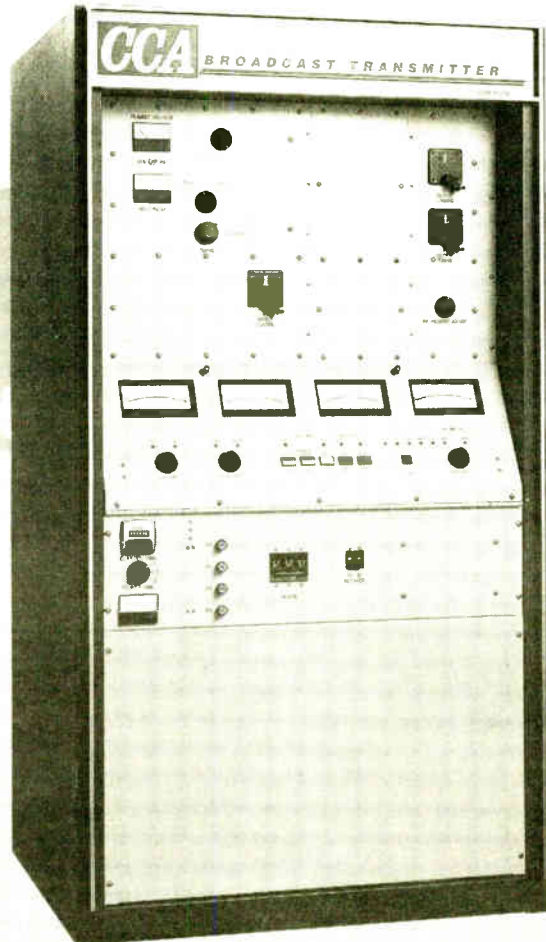

**Available FM Transmitters:**

- 2.5 KW 20 KW
- 4 KW 25 KW
- 5 KW 27.5 KW
- 8 KW 35 KW
- 10 KW 45 KW
- 12 KW



**CCA Electronics, Inc.**

P.O. Box 426 • 360 Bohannon Road  
Fairburn, Georgia USA 30213  
(404) 964-3530 • FAX: (404) 964-2222

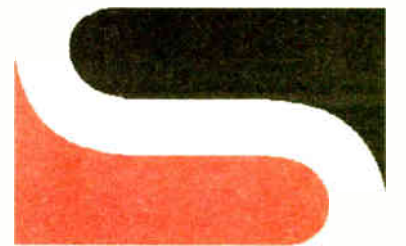

**Svetlana**  
ELECTRON DEVICES

## Quality\* Power Tubes

- 3CX15,000A7
- 3CX10,000A7
- 3CX3000A7
- 3CX3000F7
- 3CX2500F3
- 3CX2500A3
- 3CX2500H3
- YC130
- 4CX15,000A
- 4CX10,000D
- 4CX5000A
- 4CX5000F
- 4CX3500A
- 4CX1500A
- 4CX350A
- 4CX350AC
- 4CX250B
- 4CX250BC
- 4CX250R
- 4X150A
- 5CX1500A
- 5CX1500B
- 811A
- 813
- 833A
- 8560AS
- 

- Watch this list grow.
- Manufactured in Russia's largest power tube factory.
- Generous\* warranty based on high quality.
- Honest prices based on quality at low cost.
- Shipment from USA stock.



**Svetlana**  
ELECTRON DEVICES

Broadcasters  
Call: 800-239-6900  
FAX: 205-880-8077

OEMs, Distributors,  
Volume Purchasers  
Call: 415-233-0429  
FAX: 415-233-0439



# Policy Manuals Can Be Very Valuable

► continued from page 21

The involvement of management ensures that the station's philosophies regarding business, broadcasting and employee satisfaction are included. You may also find an instruction book for developing policy handbooks that would guide a committee or individual in developing one. You could also contract out the project by finding a business writer to draft one for your review and modification.

Some companies offer pre-written specialized policy manuals. These pre-written manuals can save your staff considerable time and effort but will require some changes and management review.

If this is your first policy manual,

consider a staff orientation meeting. During the meeting, the general manager should comment on the importance of the manual and its purpose. One of the committee staff members could present a brief discussion of the manual's organization, the major policies and the reasons for including them in the manual. Give staff members an opportunity to ask questions about the policies.

An important part, prior to presenting the manual to the staff, is to ask your attorney to review the contents for consistency with the state and federal laws.

## Only the beginning

Publication of the first manual does not complete the project. As the station

grows and the workforce becomes larger and more diverse, new issues/laws will have to be faced and policies developed to cover them. You may choose to maintain the committee to make revisions or to develop new policies. Or you may appoint one person, possibly a committee member or department head, for this purpose.

When the manual is published, consider numbering each copy and having a master log identifying the person or department that received each manual. Numbering the manuals assists in their distribution and revision as well as maintaining control of them. You may not want the manual distributed outside the station or kept by employees who leave

the station.

Management should review the manual annually. These reviews will assure that the manual reflects management desires, and philosophies, business strategies and policies that comply with all current laws.

Policy manuals can save considerable amounts of management time in resolving human resources questions and problems. The time and effort spent in developing/maintaining them is considerably less compared to the amount of time required to resolve personnel issues when misunderstandings occur or to prepare a defense in a law suit. It is time and money well spent.

□□□

Sue Jones is a Senior Manager for Computer Data Systems Inc. in Rockville, Md. She can be reached at (703) 323-0491.

## Products & Services Showcase

For more information on the products shown below, circle the appropriate Reader Service No.(s) on the enclosed Subscription/Reader Service card or contact the advertiser directly.

### Wizard for Windows

The Premier Digital Audio System  
Designed by Broadcasters



#### Wizard for Windows features:

- Windows & Novell Network Technology
- Fully Integrated Copy Editing: on screen copy production
- Hard Drive & CD Automation
- Block Stretch/Squeeze: insures that spot blocks time to the right length every time for seamless integration with satellite services

Prophet Systems  
1-800-658-4403

READER SERVICE NO. 18

### ARE YOU LOOKING FOR A COST EFFECTIVE ALTERNATIVE TO MANUFACTURER SERVICE?

#### SERVICE, REPAIR & CALIBRATION

- STL's • RPU's • TSL's
- Exciters • AM/FM Broadcast Monitors • Remote Control Systems

#### SPECIALIZING IN EQUIPMENT BY

- Belar • Marti • Moseley • McMartin
- TFT • And others...

An authorized TFT service center

#### IN CASE OF EMERGENCY

We can help get you back on the air with our STL Loaner Program. We have STL's available that will be set to your frequency prior to shipping. We also provide over-the-phone technical assistance.



2198 Hubbard Lane, Grants Pass, OR 97527

(503) 471-2262

READER SERVICE NO. 40

### ONE GOOD TURN AFTER ANOTHER

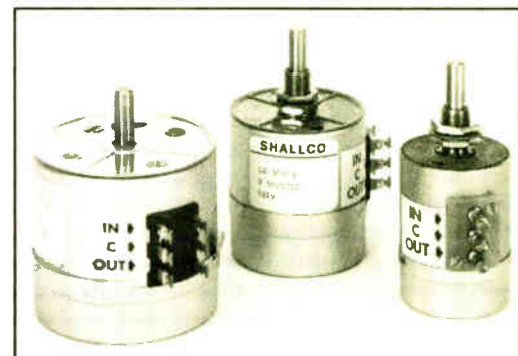

Is the success story for Shallco/Daven style step attenuators. Over 50 years of combined service to the broadcast industry. You can depend on us for reliable products and service. Request New Catalog A20 for additional information.



SHALLCO, INC.  
PRECISION ELECTRICAL COMPONENTS  
P.O. BOX 1089 • SMITHFIELD, NC 27577 • TEL 919/934-3135

READER SERVICE NO. 126

### Introducing (ta-da) The Jr. Audio Director Plus™!

It's an 8 input to 2 output ON LINE or monitoring device.

\$550



The new Benchmark Jr. Audio Director Plus™ brings more to the party! It brings more control and selection features, and a stereo headphone amplifier, along with the performance and value that are traditionally a Benchmark for the industry.

In a half wide, 1RU high chassis, the Jr. Plus has two input switch banks which allow left and right outputs to select between eight sources. Additional switches provide a Mono Mix, with adjustable gain reduction of 3 to 6 dB, and a Right Channel Polarity reversal. LEDs indicate switch action. Inputs may be passively mixed ahead of the input amp by depressing two or more buttons.

Installation is "instant" with a No-Mod™ Rack Mount adapter and pluggable Euro-Style barrier strips.

Available now.

Benchmark  
...the measure of excellence™

BENCHMARK MEDIA SYSTEMS, INC.  
Phone 800-262-4675, or 315-437-6300, FAX 315-437-8119

READER SERVICE NO. 64

### Attention Advertisers

Reach 22,000+ broadcast equipment buying prospects at AM, FM and AM/FM radio stations, networks and groups, recording studios, engineering and consulting firms every month.

Products & Services Showcase appears monthly in Radio World.

To advertise your product or service, contact Simone Mullins at

**RADIO WORLD**

P.O. Box 1214

Falls Church, Va 22041 USA

Tel: 1-800-336-3045

FAX: 703-998-2966



# AM/FM Session Focus

▶ continued from page 14

The degree of multipath distortion is dependent on terrain in the vicinity of the receiver. Placement of antenna locations on the automobile is a function of aesthetics and choosing an optimum phase differential to afford best reception. Zerod presented measured data from numerous field tests which depict the improvements afforded by diversity architecture versus various geographic conditions.

Skip Pizzi of Broadcast Engineering spoke on Multicasting and the R-LAN Environment. Recent trends in LMA/duopoly ownership rules and consolidation of broadcast facilities bring on the need for interconnection of not only audio lines, but a myriad of other communication links as well. Many radio stations utilize one or more satellite feeds in their daily programming. Data links are necessary to connect traffic and billing computers for multiple sites where local commercial inserts differ among each site.

The R-LAN system of today varies considerably from that of a few years ago. The horizon holds for us new adventure in the world of digital audio broadcasting (DAB/DAR) and wired services via cable and local telcos.

Pizzi explained what hardware and software is available to meet the challenges of today's digital audio media and how new delivery services might merge into the world of radio broadcasting as we know it today.

# CRL Celebrates 20th Anniversary

▶ continued from page 1

Arizona radio stations as clients—at one point, seven of 32 in the market—Jones and Clarkson began tinkering with audio processing, custom-designing devices to give their stations a competitive advantage in loudness.

Both Jones, CRL's president, and

department, CRL uses distributors for sales in the radio market. "We're with all the majors," Jones said, "but we deal from the top guys all the way down to the local territorial reps." On the television side, according to Jones, CRL sells direct a complete line of MTS stereo processing gear.

for over 50 percent of the company's retail sales. Clarkson said the international market is expanding not just for CRL but for all U.S. broadcast equipment manufacturers.

"It's pretty much where everyone's going," Clarkson said. Privatization of radio and a need to disseminate information in the politically shifting international environment has caused foreign broadcasters to look to the U.S. for technological answers.

"The technical people (abroad) are very highly educated, but they're behind in development," Clarkson said. "They're looking for information."

Another area of growth for CRL is diversification in product offerings—particularly digital test and measurement equipment. Jones and Clarkson licensed to Tektronix in June the right to market a digital audio analyzer CRL had called the DAA-100. It will be manufactured and sold under the name Audio Pathfinder, according to Jones.

Whichever direction Circuit Research Labs will take, however, its founders are determined to continue their commitment to customer service. As former chief engineers themselves, Jones and Clarkson are keenly aware of the needs of those who keep the stations on the air.

□ □ □

*Alex Zavistovich is former editor of RW and is principal of Positive Spin Communications.*



CRL headquarters in Tempe, Ariz.

Clarkson, secretary-treasurer, agree that their contract engineering experience gave them a clear idea of the processing requirements for a variety of formats. "We had experience with Gospel, Spanish, got involved with Beautiful Music, and of course, Rock," Jones said. "(The programmers) were always asking for something better—louder and cleaner, the two magic words. Things haven't changed a whole lot," he laughed.

A few years earlier, Bob Orban had come out with the FM Optimod. So Jones and Clarkson took the initiative, and CRL found itself in the equipment business.

The earliest prototype CRL processor, the APP-300L, was introduced in 1973, according to Jones; the first production model was sold in 1974. Jones said that the company's first access to radio was on the AM band, installing a four-band processor pre-loaded with the AM pre-emphasis curve. Before long, however, the contacts Jones and Clarkson made at KUPD-FM began to pay off, and CRL was boasting audio processors at stations in San Diego, Denver, and Pittsburgh, on both the AM and FM bands.

Those early units were "black boxes" in the truest sense of the phrase, Clarkson said. He recalled how programmers would use electrician's tape to cover the CRL name on the black faceplate of the company's products. Some programmers went so far as to lock the devices in a closet to protect the identity of their "secret weapons."

The company formally incorporated in 1978 and began producing the official line of CRL audio processors. The company has the capability to do all manufacturing in-house, but subcontracts the higher volume circuit board work for production efficiency. This allows CRL employees to concentrate on final assembly and quality control testing, Jones said.

Although the company has a marketing

In 1983, CRL went public, and was listed on the NASDAQ exchange. CRL began to embrace the international market, until now foreign purchases account

## THE LINEAGE CONTINUES...

## Today's **1900 Series** Antenna Monitors



### FEATURES

- 2 to 12 towers—Modular construction
- Fully Compatible with AM Stereo
  - Suited to diplexed arrays
  - Moveable Control & Display Panel option
- Jitter-free "True Ratio" Display
  - Unambiguous positive or negative angle sign display
  - Continuous remote outputs of all phase and ratio measurements
  - Microprocessor remote control system compatibility
- From the world's leading antenna monitor manufacturer

For complete information, contact your authorized Potomac distributor, or

**POTOMAC  
INSTRUMENTS**

932 Philadelphia Avenue • Silver Spring, MD 20910  
Phone: (301)589-2662 • FAX: (301)589-2665

...THE STANDARD FOR THE NEXT GENERATION

## MOVING?...

Don't leave us behind!

Mail or fax  
your current label  
and new address  
(with effective date) to:

Circulation, RW,  
PO Box 1214  
Falls Church, VA  
22041

or  
FAX 703-998-2966.

Address changes  
will be processed  
within four weeks of receipt.

Thanks!





# Opamps Simplify In-House Design Projects

This revised course offers an introduction to the theory and practical application of active electronic devices. The course will give examples of how the devices work as well as ideas on how to use them.

Continuing Education Units will be offered to all who register with Northern Virginia Community College. You will be required to read all of the articles and participate in an exam that will be mailed to you at the completion of the course. You can register for the class any time while the series is running in **RW**.

To register, contact the Community Education Office, Annandale Campus, 8333 Little River Turnpike, Annandale, Va. 22003. The fee for the course is \$30.

Please make every effort to secure all of the articles yourself. Northern Virginia Community College and **RW** are not in a position to supply readers with back issues.

by Ed Montgomery

## Part XI of XII

**ANNANDALE, Va.** There was a time when a broadcast engineer used discrete devices, both active and passive, to design circuits for a specific need.

He consulted the receiving tube and transistor manuals and built the amplifier, remote switch or whatever, component by component. The project usually started as an experiment on a breadboard and, if

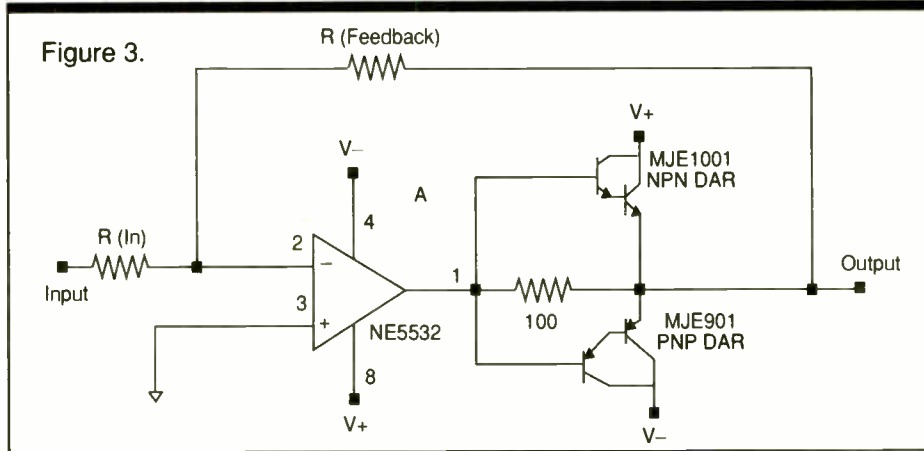
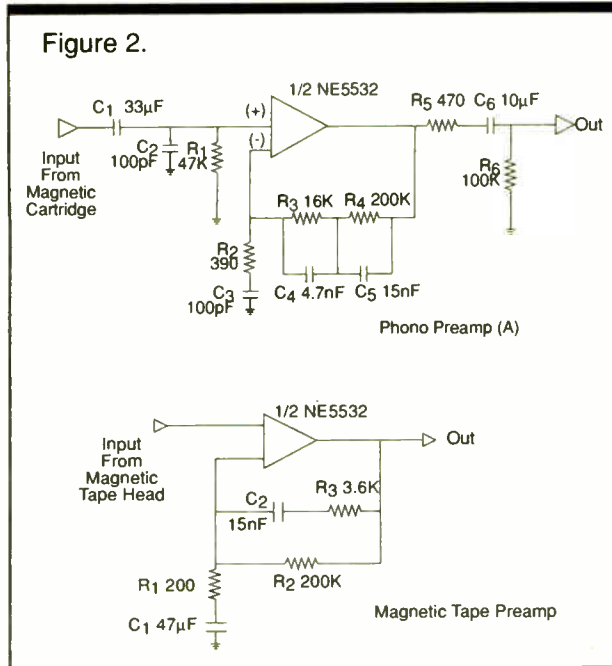
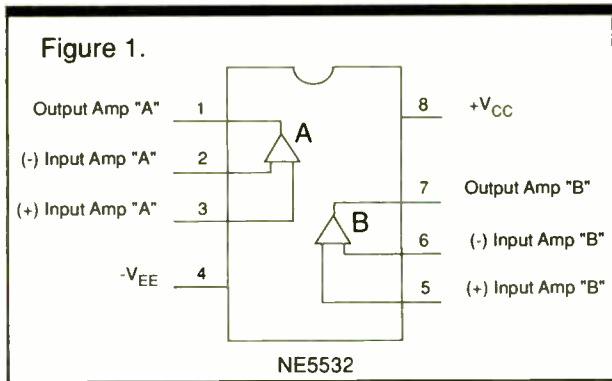

successful, a printed circuit board was etched and the final product assembled.

Much of this work has been simplified over the past 30 years. The operational amplifier (opamp) has replaced much of the traditional bench testing and experimentation. There are opamps for almost every conceivable circuit.

The opamp chip consists of several prepackaged transistors, resistors and capacitors. The manufacturer identifies specific functions the device performs in data books.

All opamps have a differential amplifier that can remove hum and noise, or create a mix-minus for sum and difference signal processing. Opamps have high input impedance to protect other circuits from being "loaded down." Output impedance is usually low.

Opamp technology has simplified electronic circuit fabrication. The NE5532 opamp, for example, is an eight-pin DIP (dual in-line package) that is good in several applications. Figure 1 gives a simplified idea of what is in the device.  $I_n (-)$  and  $I_n (+)$  feed the differential amplifier used for common-mode rejection.

The NE5532 can effectively supply the needs of an old, but still reliable turntable. It is hard to find a turntable preamp these days. Figure 2A shows how this chip can be used to make a preamp. Figure 2B is another variation of the same amplifier, designed to receive a signal off of a tape head. It has NAB playback characteristics.

In an earlier issue of **RW** (Oct. 7, 1992), engineer Jim Somich demonstrated the Darlington power amplifier,

which uses the NE5532 as a driver stage feeding another prepackaged device. The Darlington amplifier has a high gain, high input impedance and a low output impedance in the 8 ohm area, which is perfect for loudspeakers.

The circuit is configured as an emitter-follower. Note that two Darlington transistors are used, one PNP and the other NPN, to create a complementary-symmetry amplifier with one amplifier handling the positive signals while the other handles the negative signals (see Figure 3).

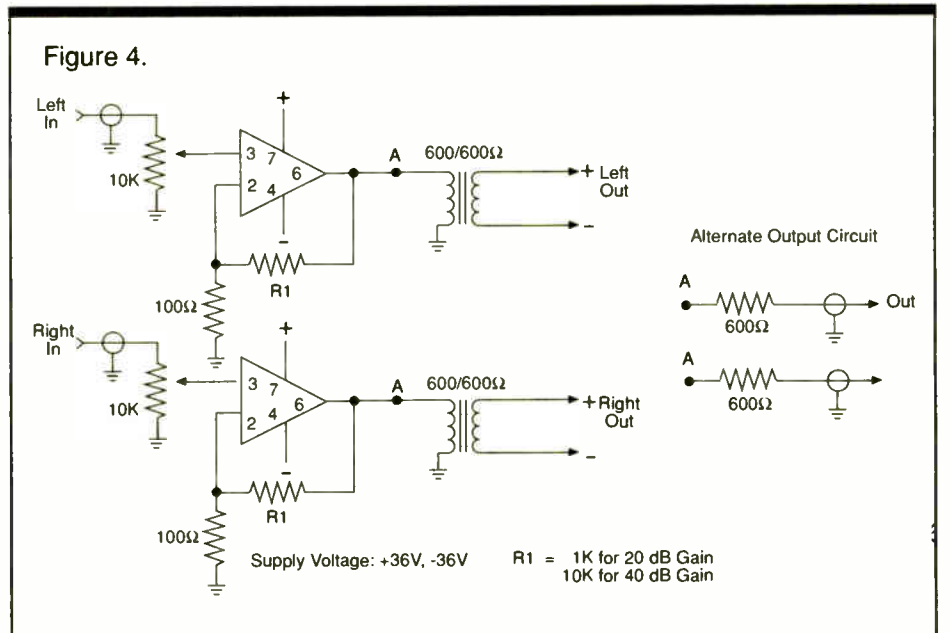

A matched pair of Darlington amplifiers reduces distortion to a minimum in a design like this. They come in several power ratings. Voltage gain is determined by the value of  $R_{(Feedback)}$ , which is equal to  $(R_{(Feedback)}/R_{(Input)})$ . Input impedance of the NE5532 can be anywhere between 30,000 and 300,000 ohms.

continued on page 45 ▶

## DON'T WORRY, I'LL CALL YOU IF THERE'S A PROBLEM

With the Sprint-7000 series of programmable SCADA controllers, you can rest assured that all of your vital systems are being monitored 24 hours a day. The 16 analog or digital inputs can be configured to send alarms to your alphanumeric or digital pager with whatever message text you desired. 16 relay outputs are standard, providing remote control from your PC terminal. The Sprint is fully programmable allowing unlimited system configuration. Call SMC at 1-800-527-1079 for more information.



P.O. Box 1607  
Tomball, TX 77377  
Call: (800) 527-1079  
Fax: (713) 356-0099



# The Best Way to Hear from There

Only Zephyr™ gives you full-fidelity stereo on a single phone line.

No longer will your outside broadcasts be constrained by high cost and complicated equipment. Now all of your remotes can have near-CD quality sound. Using Integrated Services Digital Network (ISDN) telephone lines and the most advanced digital audio compression technology available, Telos makes setting up a remote as easy as sending a fax.

Zephyr is capable of transmitting broadcast quality audio virtually anywhere in the world for about the same price as an ordinary voice call.



To compress the program audio signal for transmission, Zephyr uses ISO/MPEG Layer III coding.



It is the ideal solution for remote broadcasts, ad hoc networks, backup to microwave and satellite links, as well as many other applications.

Several international listening tests have already demonstrated Layer III's superior performance at data rates of 64kbps or less per channel.

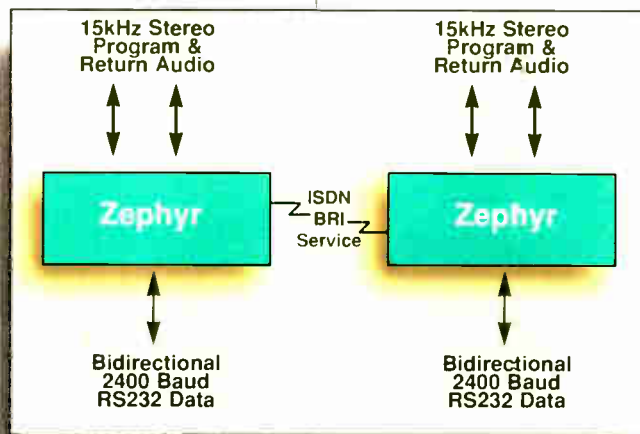

*only from*



2101 Superior Avenue  
Cleveland, Ohio 44114  
216.241.7225  
FAX: 216.241.4103

- Full duplex 15kHz stereo operation on one ISDN line or two Switched 56 lines using Layer III coding.
- Compatibility with older 7.5kHz codecs that use G.722.
- 2400 baud RS-232 bi-directional data for communications and control.
- Four "end-to-end" simple parallel contact closures for summary alarm and control of recorders and other devices.
- Split channel mode allows individual mono signals to be transmitted to separate sites.
- The ISDN terminal adapter is built-in and no separate boxes are needed.
- V.35/X.21 port allows Zephyr to be connected to one or two Switched 56 lines, spread spectrum wireless modems, satellite links, and other data paths.
- Designed for simple operation with full metering, analog audio limiting, and straightforward controls.
- Each unit can serve as either a transmitter or receiver.



**Telos Zephyr** DIGITAL NETWORK AUDIO TRANSMITTER





## Meat And Potatoes à la Fidelipac

### Cartridge Machines

The DYNAMAX CTR10 Series needs no introduction. Over 10,000 units are installed in all four corners of the globe. Over the years, the unit has been refined and now includes a brushless DC servomotor. The CTR10 Series combines good value, reliability and high quality audio.

### Tape and Tape Cartridges

DYNAMAX COBALT Cartridges provide excellent high frequency response, high sensitivity and increased head room, and are ideal for top quality reproduction from a digital audio source.

The AUDIOMAX 4000 offers premium quality as well as phase and bias compatibility with more expensive Type AA-4 cartridges and is suggested for stereo applications requiring elevated recording levels.

The MASTER CART yields maximum performance at standard operating levels and is well suited for general purpose stereo recording.

The MODEL 300, workhorse of the broadcast industry for thirty years, this cartridge is intended for monophonic use at standard recording levels.

DYN-400X Professional Back Lubricated Recording Tape is a low noise mastering tape for use at standard recording levels and is available on NAB hubs or 7 inch reels.

### Magnetic Erasers

The DYNAMAX ESD10 uses dual full-track erase heads to ensure deep cart erasure of 75 dB or more. The patented splice detector which requires no sensitivity adjustments rapidly locates the splice and positions it perfectly before recording.

The BLANK-IT hand held eraser is molded of rugged plastic for light weight, easy to handle, quick and accurate tape erasing in any setting.

The MODEL 400 table-top eraser features a hardwood case, scuff resistant laminate top and removable aluminum pivot pin permitting erasure of audio, video or computer tape reels up to 11 inches in diameter x 1 inch wide.

### Other Accessories

Fidelipac offers CARTRIDGE STORAGE SYSTEMS in numerous configurations including a 25 slot vertical wall rack, a 200 slot mobile carousel rack mounted on heavy duty casters, and table-top units which hold 96 cartridges or up to 48 cartridges (as shown above).

Fidelipac's world standard WARNING LIGHTS are available in eight different languages plus custom versions on request. Back illuminated brilliant red letters on an opaque black foreground command attention and visibility.

In addition, other useful accessories (not shown) include alignment cartridges and precision gauges for head insertion and right angle zenith calibration.

**For a complete menu or information about our digital audio products, call Fidelipac.**



**DYNAMAX**  
BROADCAST PRODUCTS BY FIDELIPAC®

Fidelipac Corporation □ P.O. Box 808 □ Moorestown, NJ 08057 U.S.A. □ TEL 609-235-3900 □ FAX 609-235-7779

Circle (149) On Reader Service Card



## OFFBEAT RADIO

# Three Jocks Survive Arson Attack

by Dee McVicker

**MODESTO, Calif.** Three jocks at KVFX(FM), known locally as The Fox, kept their cool and acted quickly enough to save themselves from a senseless and possibly premeditated act of violence.

A little past midnight on January 23, they smelled what they thought was an unattended, burning cigarette in an adjoining room. One of them went out to find the entrance to the entire two-story studio building on Modesto's Carpenter Road, engulfed in flames.

Paul Richards and Kris Taylor were changing shifts and Wyatt Jennings was hanging around doing voice work when the smoke began rolling through the station from the front of the building.

Richards was the first to investigate. The large wooden pillars on the face of the building were on fire and the stairwell leading up to the building's second floor was smoking "like a chimney," he said.

He ran back inside to grab a fire extinguisher, hoping to put the fire out himself. He found a small kitchen extinguisher, but soon realized the situation was too serious for him to handle alone. "I looked at the fire and looked at this pea shooter of a thing, and thought, 'This isn't going to work,'" he said.

Richards ran inside to get the other two. Someone—no one remembers who—had

the presence of mind to dial 911, and all three of them ran for the front door, the only exit in the building, which was surrounded by flames. Somehow, the three were able to run through the flames and the red-hot metal screen door, and lunge to safety.

The fire department, which was luckily located across the street, arrived seconds later. The station was off the air for three hours while fire fighters put out the blaze.

The fire destroyed most of KVFX's front office, but the studios in the back were spared. The entire office complex on the second floor was severely damaged. (No one had been upstairs in the complex at the time.)

The station is still trying to piece together what police believe was arson and attempted murder. Little physical evidence survived the fire, but the bottom and metal handle of a plastic, five-gallon container were recovered in the debris.

Police believe the arsonist used the pail to douse gasoline on what he or she knew was the only way out of the station. They do not know whether one of the three jocks was a specific target, said KVFX's Program Director Joe Kelly.

"Who knows, the nature of radio is that sometimes there are undesirable characters who have an axe to grind. We haven't had any threats, we haven't had any bad vibes in the community. Everything was fine, until someone tried

to burn us down," Kelly said.

The attendant on duty at a gas station a few blocks away reported that the man filled a gas container there a few minutes before the fire started, Kelly said. Other witnesses reported seeing a car leaving the scene.

There have been no arrests so far. "The fire investigator and the detective from the police department think they know who the fellow is but they don't have enough evidence to pin the crime on him," Richards said.

KVFX now has armed guards patrolling

the building and parking lot 24 hours a day. It has refurbished the front of the building and returned operations to normal.

Meanwhile, the jocks are trying not to take the incident personally. "From what I understand the attack wasn't a personal attack against anybody. It was more just a random act of violence, a random act of terrorism just against some authoritative entity," Richards said.

"It's a little scary these days," he said. "Years ago when I got into radio all you needed was a bad attitude and a couple of records. Now you need armed security guards."

□ □ □

*Dee McVicker has been covering the broadcast beat for five years as a regular correspondent for RW. She can be reached at 602-545-7363.*

## PROOFS IMPROVED

**FM and TV-BTSC AUDIO PROOF TESTING** is reduced from hours to minutes with System One from Audio Precision... Automatic proofs run properly at constant deviation, plotting the required generator amplitude... and when finished, the results are stored in graphic form for your records.

**SPLIT SITE** proofs are simple with System One's available separate generator and analyzer configuration. With immediate capability to view and control both instruments, it's like being in two places at once.

**THE REST OF THE TIME** System One is the universal audio test set for maintaining any audio device or channel... STLs, consoles, carts, cassettes and RDATs, digital recorders and workstations... System One is the only product that can completely test both your analog and digital audio.

Call 800/231-7350 for our 36 page color catalog... and when you're ready our representative will arrange for an on-site demonstration.

**Audio precision**

P.O. Box 2209  
Beaverton, OR 97075-3070  
503/627-0832, 800/231-7350  
FAX: 503/641-8906



Circle (105) On Reader Service Card

## QEI meets all your FM broadcast transmitter needs.

### Selection

- 10 Watt - 1250 Watt Solid State
- 1 kW - 30 kW Single Tube
- Choice of Single or Three Phase Power Supply on 3.5 kW to 30 kW models

### Service

- 24-Hour Service Hotline: (609) 728-2020
- **Free** Initial On-Site Checkout for FMQ-Series Transmitters
- **Free** Spare Parts Kit with every FMQ-Series Transmitter
- **Extended PA Tube Warranty—the only one in the Business**

### Reliability

- Ultra-Low Maintenance
- Single Tube Design Eliminates Driver Tube
- No Sliding Contacts—Avoids Wear-Out
- Positive Pressure Cabinet to Prevent Dust Infiltration

### Experience

- Over 20 Years of Field-Proven Designs
- RF Products for Broadcast, Scientific and Military Applications
- Total In-House RF Design and Manufacturing

Learn more about the finest FM broadcast transmitters in the business. Call Jeff Detweiler today toll free—(800) 334-9154.



QEI Corporation  
One Airport Drive • P.O. Box 805  
Williamstown, NJ 08094

Tel: (800) 334-9154

Fax: (609) 629-1751

24-Hour Service Hotline

Tel: (609) 728-2020

Circle (50) On Reader Service Card



# Treasured Memento of Early Stereo

by Read G. Burgan

**LAKE LINDEN, Mich.** I confess to being a shameless record collector. Despite friends' complaints that I already have far more than any reasonable person can hope to listen to in a lifetime, I continue to search for more treasures.

One day recently, I slit open the duct tape on a medium-sized cardboard box sent from a friend in another state, who promised to send me phonograph records from various garage sales.

What treasure awaited?... a Cook Binaural album. The words leapt out at me.

I could hardly believe my good fortune.

I had heard of the Cook Binaural record series, but I never actually expected to see one. In a day when DAT, DCC, recordable CDs and other media are vying for survival, here was a tangible example of a leading-edge technology that did not survive.

I doubt if my friend even knew the uniqueness of the album. In the early 1950s, Cook Laboratories of Stamford, Conn., developed a means of producing stereophonic phonograph records. They did not call it stereo, but binaural.

The term "binaural" has had many connotations over the years. The National Center

for Audio Experimentation in Madison, Wis., produced a series of binaural dramas for National Public Radio in the 1970s,

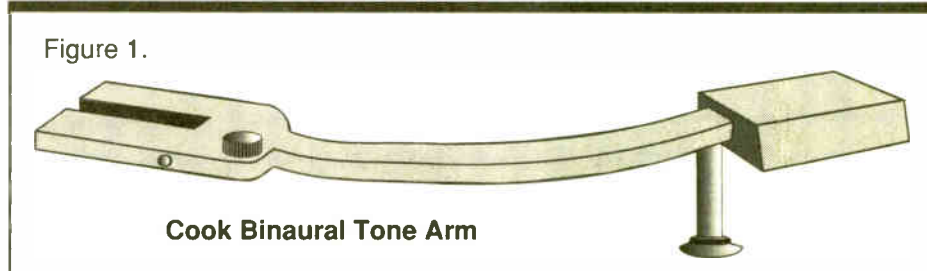

which served to narrow the term.

Binaural today refers to recordings

designed to reproduce the 360-degree sense of sound as humans hear it. True binaural sound, by this definition, can only be experienced by headphones.

The Cook recordings were not binaural by this definition, but they provided genuine two-channel reproduction on a 12-inch LP. To the casual observer, the Cook

LP looked like any other, except there were only two cuts per side. One cut contained left-channel information and the other cut contained the right.

It was a simple, but ingenious system. But the Cook process restricted the length of material that could be recorded on a side to about 10 minutes, maximum. To compensate for the usual frequency compression applied to the inner grooves of records, the outside cut was designed to be played with a compensating frequency curve that attenuated frequencies 12 dB at 10 kHz. Aside from that, the record was conventional for its period.

My Cook recording features the Boston Recording Festival under the direction of Willis Page. Claude Debussy's nocturne "Clouds Festivals" is on one side and his "Afternoon of a Faun" is on the other. Each cut on side one runs 14 minutes and 54 seconds, which is pushing the limits of the format. Side two runs a more normal nine minutes and 37 seconds.

A special tone arm is required to play the record as intended (See Figure 1.). The 1953 Gates Radio Catalog shows a picture of the arm on page 206, priced at \$35. This was actually less than the two standard Gray broadcast tone arms of that period, which were \$45 and \$56.

The Cook arm was similar to conventional units except it branched out at the end to form what looked like a tuning fork. Both of the fork prongs contained a phono cartridge mounted at precisely the correct distance for playing the appropriate left and right bands on the record.

Each cartridge head had independent action and the arm was suitable for all of the popular GE variable reluctance cartridges, according to the Gates catalog. In addition, the advertising copy claims the arm could be used to play conventional records as well (one assumes by removing a cartridge).

Gates probably sold few of these tone arms to broadcasters. There was no FM stereo until the early 1960s, by which time the current stereo phonograph standard had been adopted. There was probably little or no attempt at stereo simulcasting at stations with both AM and FM facilities.

I can play the record, one cut at a time, with a conventional tone arm. The sound is every bit as good as other phonograph records of that period. But I can't hear it as it was intended to be heard, in glorious stereo.

I still hold out the hope that I will find a genuine Cook Binaural tone arm at a garage sale or antique store someday. Until then, I will hang on to my two GE VR-2 cartridges and spare styli.

□ □ □

Read G. Burgan is a writer, producer and photographer and a former public radio station manager. He can be reached at 906-296-0652.

## FlexRoute

**THE SATELLITE DIGITAL AUDIO NETWORK BUILT FOR TO-DAY, FLEXIBLE FOR TOMORROW.**

The *FlexRoute* system was created in response to the present and future needs of our customers. The expertise of our customers, gained from operating thousands of sites in diverse systems worldwide has been combined with the design and manufacturing experience of International Datacasting Corporation to create this revolutionary new satellite based digital audio system. The open architecture of the *FlexRoute* system encourages network operators to implement the ISO/MPEG audio encoder of their choice to take advantages of the continuing improvement in encoders. QPSK modulation, which minimizes the recurring space segment costs, is complemented by the flexibility of dual speed operation at either 128kb/s or 256kb/s. Initial implementation of networks using SCPC *FlexRoute* minimizes space segment costs in the early years of network operation, yet leaves the 2CPC mode for future, low cost expansion of the network. The 2CPC mode can be used to partition the channel into an audio service plus a high speed data service, thus enabling multimedia applications through one receiver platform. Two additional auxiliary data channels are implemented to facilitate E-mail, data broadcasting, paging or RDS applications. Full network control and addressability is available with the use of the optional RadioNet addressable network control software package.



- SCPC/2CPC QPSK with 1/2 FEC
- Switchable Rates (128kb/s or 256kb/s)
- ISO/MPEG Audio coding
- Addressable Network Control
- 2CPC Partitions for Audio and/or Data  
256 or 192+64 or 128+128kb/s  
128 or 64+64 or 96+32kb/s



INTERNATIONAL  
DATACASTING  
CORPORATION

Worldwide call:  
2680 Queensview Drive  
Ottawa, Ontario  
Canada, K2B 8H6  
Tel: (613)596-4120  
Fax: (613)596-4865

In USA call:  
3850 Holcomb Bridge Road  
Norcross, Georgia  
USA, 30092  
Tel: (404)446-9684  
Fax: (404)448-6396

Distributors: Argentina - Cozin Comunicaciones, Buenos Aires, Republica Argentina, Tel: 54-1-545-0675, Fax: 54-1-545-0677 Australia, New Zealand, Papua New Guinea - COMSYS PTY Ltd., North Ryde, NSW, Australia, Tel: 61-2-878-1188, Fax: 61-2-878-5522 Brazil - Intersave Ltda., Rio de Janeiro, Brazil, Tel: 55 21 325-9221, Fax: 55 21 451-5137 Colombia - Edmundo Vega, Sumedo de Bogota, Colombia, Tel: 57 1 269-2155, Fax: 57-1-269-2401 Europe - IGP, Nardens, Holland, Tel: 31-2159-44098, Fax: 31-2159-48641 Hong Kong - Patrick Trading Corporation, Wanchai, Hong Kong, Tel: 85-2-827-9977, Fax: 85-2-519-6180 India - Phonophone Ltd., New Delhi, India, Tel: 91-11-527-4044, Fax: 91-11-327-8187 Israel - RCM Ltd., Tel-Aviv 61397, Israel Tel: 972-3-6487885, Fax: 972-3-6487299 Japan - APT K.K., Tokyo, Japan, Tel: 81-3-3520-1020, Fax: 81-3-3520-1022 Mexico - Vari S.A. De C.V., D.F., Mexico, Tel: 52-5-604-6946, Fax: 52-5-605-9656



# Products & Services Showcase

For more information on the products shown below, circle the appropriate Reader Service No. (s) on the enclosed Subscription/Reader Service card or contact the advertiser directly.



## Econco REBUILT POWER TUBES



Approximately One Half  
the Cost of New

3,000 Hour Unconditional Guarantee  
Call for Our Price List

Econco 1318 Commerce Ave Woodland, CA 95695  
Phone: 916-662-7553 Fax: 916-666-7760 Telex: 176756  
Toll Free: 800-532-6626 From Canada: 800-848-8841

READER SERVICE NO. 35

## Zercom 25Hz Tone Processors



\$390

Zercom Corporation's dual 25Hz detector and dual program amplifier 25Hz notch filter accurately detects tones and removes them from programming.

One unit converts a remote controllable reel-to-reel machine into the equivalent of an Otari ARS-1000DC or Revox PR99 reproduce only machine. The other converts two mono reel-to-reel machines or one stereo machine.

Designed as a reel-to-reel playback interface for automation or live assist, some automation systems are using the 25Hz Tone Processor as a program amplifier. The 25Hz filter is only 6Hz wide at the 3 dB point, allowing good bass response of the audio. This is far better than the usual 50Hz high pass filter that removes ALL bass. Maximum output per channel is +17 dBm or +23 dBm with the active balance output option.

Some users are interfacing cassette machines with the 25Hz Tone Processor. A number of stations are using it as a 25Hz detector and filter on satellite networks, including the Beethoven net.

Call today for more information, including pricing.

**ZERCOM**

Box 84, Merrifield, MN 56465 • 218-765-3151

READER SERVICE NO. 12

## S.C.M.S., Inc. Charlotte, N.C.

Low Prices – Experienced Staff  
New and Re-built R.F. and Audio

**This Month's Special**

**EFI #505 UPS**

**500 WATT, COMPLETE  
WITH SURGE SUPPRESSION  
EQUIPMENT WARRANTY  
& GUARANTEE**

**SPECIAL PRICE — \$294.00**

Toll-Free 800-438-6040

FAX 704-889-4540

READER SERVICE NO. 215

## DIGITAL ANTENNA MONITORS

In-Stock-Available for  
Immediate Delivery



Price US\$2400.00 2 Towers

Will operate with any remote control equipment.

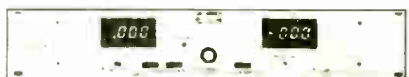

Price US\$1780.00 2 Towers

For AM directionals with studio located at transmitter site.

These monitors are state-of-the-art instruments of unequalled accuracy (.5% or better on ratio and .5° or better on phase) and stability. With typical modulation the true ratio readout of these monitors is a factor of 10 more stable than instruments that measure normalized amplitude, and their phase readouts are rock solid. Phase sign is automatic, no extra operation. In addition to the analog DC outputs for remote control the Model CMR has a multiplexed BCD digital output which can be used to drive the Remote Indicator Model CMR-1. RF inputs have dual protection. Gas discharge tubes across the sample line terminations plus relay protection.

**GORMAN REDLICH MFG. CO.**

257 W. Union St. Athens, Ohio 45701

Phone 614-593-3150 • FAX 614-592-3898

READER SERVICE NO. 58

## LOWER THAN FACTORY PRICES!



**TELEWAVE, INC.**  
SITE MANAGEMENT EQUIPMENT



- Wideband Wattmeters
- Bandpass Cavities
- Low Noise Preamplifiers
- Receiver Power Splitters
- Loads ■ Duplexers



ALSO IN STOCK:

**RFI**  
CONNECTORS  
CABLES • KITS  
ACCESSORIES

**WHELEN**  
STROBES &  
LIGHTS for  
your REMOTE  
VEHICLES

Call Tim for Your FREE Catalogue!

**1-800-548-2484**

FREE  
Tuning



SAME DAY  
Shipping

**WHOLESALE DISTRIBUTOR**

3403 Governors Drive - Huntsville, AL 35805

READER SERVICE NO. 81

## CONSOLE UPGRADE WITHOUT THE BIG EXPENSE

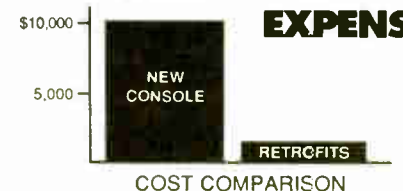

Approach digital quality with your yesteryear audio console by using BDI plug-in retrofit electronics. If the cost of a new console is depriving you of a competitive air sound then BDI electronics are the answer. Better headroom,

lower noise, lower distortion, dynamic range approaching 90dB and improved reliability are just some of the advantages of our easy to install upgrades.

Call us today direct for a competitive air sound tomorrow!

Our retrofit electronics currently support most

Gates/Harris Consoles  
RCA Consoles  
McMartin Consoles  
McCurdy Consoles



**Broadcast Devices, Inc.**

5 Crestview Avenue  
Peekskill, NY 10566

**(914) 737-5032**

READER SERVICE NO. 4

## SOUND YOUR BEST ON THE AIR!



**CART MACHINE SERVICES:**

**CART MOTORS REBUILT** to quiet flutter-free perfection-shafts resurfaced  
Single \$120.00 Triple \$140.00

**CART HEADS RELAPPED** guaranteed to perform like new

Same day turnaround

Replacement heads and motors available

**REEL TO REEL SERVICES:**

**HEADS RELAPPED** and precise digital/optical

**ASSEMBLY ALIGNMENTS**

performed for maximum

response & head life

**CAPISTAN & REEL MOTORS REBUILT**

for MCI, OTARI and more.

For peak performance from your recording equipment, call  
The Audio Magnetic Professionals



224 Datura Street, Suite 614, West Palm Beach, FL 33401

Call 1-800-826-0601 for "Same Day Service" in Florida (407) 659-4805

Authorized Parts Dealers for: MCI • OTARI • TEAC/TASCAM

READER SERVICE NO. 196

**AUDIO BROADCAST GROUP, INC.** is proud to introduce the latest in its fine line of professional broadcast studio furniture. Specifically created for the high tech, digital 90's, the new Euro design features rounded radius corners, angled turrets, pull out keyboard drawers and functional PC work stations.

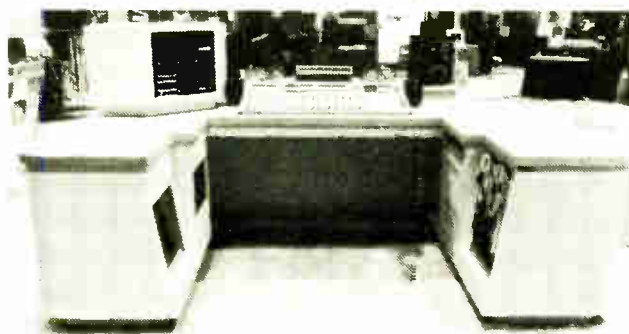

For additional information on how we can serve you, please call today

For over 32 years

**MAIN SALES OFFICE**

2342 S. Division Avenue  
Grand Rapids, Michigan 49507

Phone: 800-999-9281  
Fax: 616-452-1652

**SOUTHEASTERN SALES OFFICE**

200 Fareway Drive, Suite 2  
Smithfield, North Carolina 27577

Phone: 800-369-7623  
Fax: 919-934-8120

**WESTERN SALES OFFICE**

P.O. Box 1638  
Palmdale, California 93550

Phone: 800-858-9008  
Fax: 800-273-3321



**AUDIO  
BROADCAST  
GROUP**



## FEEDLINE

# FCC Considers Modernized DA Rules

by W.C. Alexander

**DALLAS** Many of the FCC's current AM directional antenna (DA) rules were adopted in 1939 as part of the commission's former "Standards of Good Engineering Practice."

There have been amendments to these rules, but the overall structure has not changed. We essentially run proofs today the same way they were run in the 1940s. These methods are not particularly valid in today's typical DA environment.

Fortunately, the FCC has begun to be aware of the situation. It received numerous comments from a wide range of interested parties in response to an inquiry released last year. There could soon be some welcome changes.

## DA realities

A typical AM directional antenna is made up of two or more radiating elements. The amplitudes and phases of the signals arriving from all the elements at a point in space determine the vector sum field strength at that point. Spacing between elements and the phase relationship of the RF being radiated determine the timing (or aggregate phase) of each element's signal.

If the signals are in phase, the signals add; if they are out of phase, they

subtract. The relative amplitudes of the signals from the array elements determine the amount of the cancellation or addition.

At the "zero null" point, signals from the array elements are completely out of phase with equal amplitude so that they completely cancel. Substantial field strength arrives at the point from each element, there appears to be no signal at all.

Broadcasters use DA patterns to avoid interference to co-channel and adjacent-channel stations while (hopefully) maximizing the signal over the desired service area. These two objectives are not always compatible, but a compromise is often possible through careful selection of site location and good array design.

Once a directional pattern is designed and constructed, an engineer tunes the array to the theoretical parameters, adjusting the phases and amplitudes of the RF in the various elements to match the design parameters.

The field strength at several locations along each of the null radials is then measured during both nondirectional (ND) and directional operation. The DA/ND

ratios along these radials are averaged and the result is multiplied by the nondirectional inverse distance field (IDF) for each radial.

This "cut-and-try" method has been used since the first directional array went on the air. If the engineer is very lucky, the directional IDFs will be below the FCC's construction permit limits.

Usually the engineer is not so lucky. This process can take several hours or perhaps several months, as he makes small changes to the array parameters and repeatedly measures the field strength at several locations along each null radial.

## Proof problems

Once the engineer determines that the array has been properly adjusted, a full proof of performance must be completed. The DA proof is used to establish and prove the proper operation of a directional array at the time of licensing.

The FCC requires the proofs and specifies how the measurements are to be made. The most recent full DA proof is kept on file as the "reference proof." Subsequent "partial proofs" are run

whenever something changes in the array or environment. For example, if an FM antenna is to be mounted on an AM array element tower, a partial proof is required.

A full proof traditionally begins with a set of nondirectional measurements starting at five times the height of the ND element. Measurements are generally required at approximately equal sets of intervals so that there are 15 to 20 measurements within the first three kilometers.

Twenty to 24 more measurements are required on the remainder of the radial out to between 24 and 32 kilometers. These measurements are made on each of the null radials and on a sufficient number of other radials, including at least three radials in the major lobe, to establish the pattern shape and size of the field.

The results of the measurements are then plotted, field strength versus distance, for each radial and then graphically analyzed to determine the unattenuated nondirectional inverse distance field along that radial.

The next step is to switch the array to the directional mode and measure again at all the same points, beginning at the first point that is greater than ten times the spacing between elements.

## Costly process

Obviously, this is a long and complex process that usually involves many people, hundreds of measurements and a lot of walking and driving. The cost of a full proof can easily run up to about \$25,000.

continued on page 48 ►

**The cost of a full proof can easily run up to about \$25,000.**

## How to tame transmitter power problems.

### WHR Series STABILINE® Voltage Regulators for AC power systems up to 660 volts.

Transmitters placed in remote, unattended locations such as mountain tops and wilderness areas depend on long utility power lines for service. Unfortunately, the lines often produce poor voltage regulation and other damaging power aberrations. Poor regulation can reduce power tube life by as much as 70% and the performance of associated equipment is similarly affected.

For example, a 15% undervoltage can decrease power tube life because cold operation promotes contaminant buildup in the tube. Conversely, a 10% overvoltage decreases life because increased temperature accelerates the decarburizing process.

The problems can be easily corrected.

Cost-effective WHR Series STABILINE® Voltage Regulators are the preferred choice of broadcasters worldwide for use with transmitters, receiving stations, studios and mobile production vehicles. These high power voltage regulators maintain constant voltage to your sensitive equipment even when the power line input voltage and system load vary widely.

#### Features include:

- Hold output voltage within  $\pm 1\%$
- Power ratings from 2 to 1680 kVA

- Maintenance bypass plus other standard options
- 99% typical efficiency
- High overload capacity
- 19-inch rack mount versions
- Designed for UL and CSA approvals

A host of options allow you to customize your application.

#### Standard options include:

- Single or three phase models
- Analog or digital control
- Bypass switch
- Ammeters
- Frequency trip meter
- Tropicalization
- Manual raise-lower switches
- Zig-zag neutral generation
- Single or individual phase control
- High energy transient suppression
- Input voltage range alarm contacts

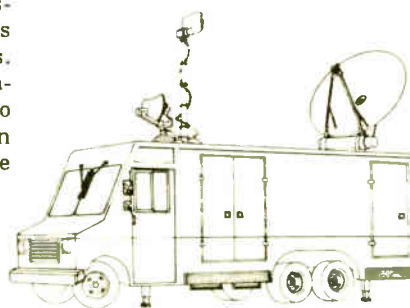

"Our production vehicles don't leave without one."  
— Ron Crockett, SHOOK ELECTRONICS

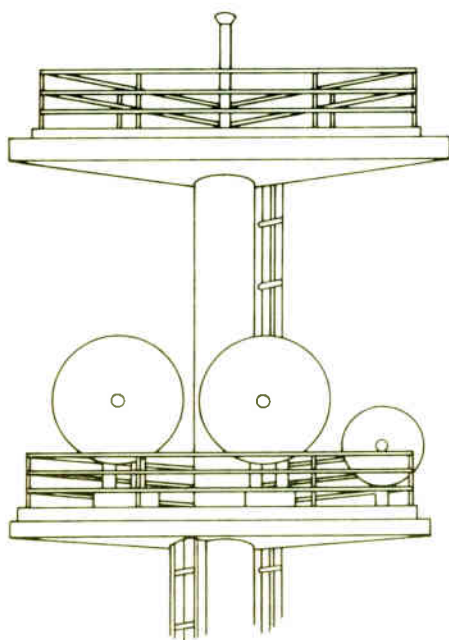

"I recommend STABILINE® Voltage Regulators for any brand of transmitter that is being placed in a harsh operating environment."  
— Steve McElroy, CCA ELECTRONICS

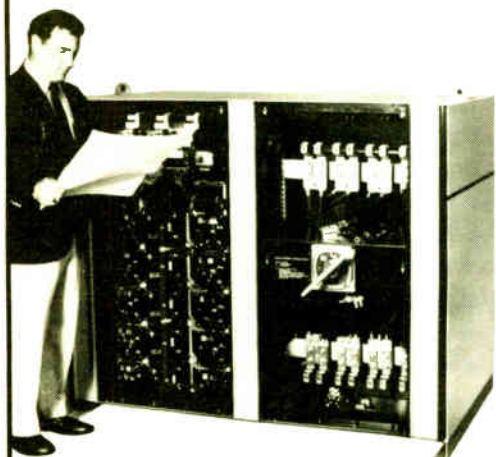

3-phase, 500 kVA WHR Series Voltage Regulator



For Catalog WHR692 and to learn how WHR Series STABILINE® Voltage Regulators can be the solution to your power problems, write, fax or phone Ted Gladis at

1-800-446-6161

**SUPERIOR ELECTRIC**

WARNER ELECTRIC

383 Middle Street • Bristol, CT 06010  
203/582-9561 • Fax: 203/582-3784





INSIGHT-ON-RULES

# EPM Details to Ponder before June 30

by Harold Hallikainen

**SAN LUIS OBISPO, Calif.** There has been considerable confusion about the equipment performance measurement (EPM) rules over the years. It is important to have a full understanding of these rules as the June 30 deadline for compliance with the FCC-mandated National Radio Systems Committee's "RF mask" standard (NRSC-2) approaches.

In 1990, when the FCC adopted NRSC-2, which decreases AM occupied bandwidth from +/-15 kHz to +/-10 kHz, many stations complained that compliance would increase their costs, even though the FCC had already required RF spectrum measurements for several years and no new costs were being imposed.

NRSC-2 opponents generally favored NRSC-1, which specified an audio pre-emphasis and upper cutoff frequency. But the FCC wanted to stay out of the audio specification business, concentrating instead on interference concerns, such as occupied RF bandwidth.

As a compromise, the FCC adopted NRSC-2 RF specifications but waived the annual EPM requirement until the end of this month, June 30, 1994, for stations using the NRSC-1 audio specifications. Most stations took advantage of this grace period. AM stations, as of this month, must do an EPM annually with no more than 14 months between successive measurements.

Under Rule 73.1580(d), EPMs are required every two years at the transmitter or transmitter control point. Some overzealous FCC inspectors have cited stations for not having EPM data available under this provision, even though stations were not required to have do measurements during the grace period. (When you receive a violation notice from the FCC, do not assume they are right. FCC mistakes are rare, but they do happen.)

Rule 73.44 specifies how the measurements are to be completed. A spectrum analyzer (with specified peak hold time, video filtering and resolution bandwidth), or a specialized receiver/monitor (such as the Delta Splatter Monitor) are permissible. Spectrum analyzer data takes precedence when there is a discrepancy with the results of another monitor.

**Modulation limits**

The rule also specifies how far below carrier the signals are to be, as a function of how far the component is from the carrier frequency. These specifications apply to sideband energy, spurious radiation, harmonics and intermodulation products. Those limits are:

10.2 to 20 kHz	25 dB
20 to 30 kHz	35 dB
30 to 60 kHz	5+1dB/kHz
60 to 75 kHz	65 dB

At over 75 kHz, the limit is 43+10LOG(power in watts) or 80 dBm whichever causes less attenuation, except  $tx < 158$  watts, where attenuation is at least 65 dB.

The FCC occasionally places tighter specifications on an individual station in certain cases in order to eliminate harmful interference, but this is rare.

I have seen station engineers do EPMs using an RF tap at the output of a transmitter. One time I watched a transmitter factory representative do this while installing a couple of new AM transmitters in New York. Type acceptance tests on transmitters are done at this tap, but not station measurements.

An EPM at an existing station should be done at ground level, about a kilometer from the center of the antenna. Lower-power stations may have difficulty with these measurements if their field strengths at a kilometer are low enough to cause a significant

noise floor on the spectrum analyzer.

One engineer I know suggests using a shielded loop antenna to drive the spectrum analyzer. He uses a surplus Lorán loop.

Rule 73.44(d) places a very strange

## Expect strict enforcement of the AM RF mask rule.

requirement on directional stations. It does not specify that measurements be taken in the major lobe, but that is where it makes sense to take them. The "carrier frequency reference field strength" is required to be the same as that of a nondirectional antenna operating at the same power.

This section could require some stations to operate with a major lobe 10 dB above nondirectional to have components at 15 kHz from carrier down 35 dB instead of 25 dB. This seems to be the meaning of this rule, but I have not found anybody who is measuring this way. The AM Branch at the FCC says it is still developing an interpretation. The FCC field offices I contacted were unfamiliar with this requirement.

**EPM tools**

The Splatter Monitor is available from Delta (phone 703-354-3350) for \$3,485.

It runs on 12 volts DC. An active whip antenna is available as an option.

The Tektronix 2712 (\$11,950, and available through Tek's many field offices) seems to be the most popular spectrum analyzer. Its optional printer interface makes it quick and easy to write reports.

Spectrum analyzers are also available for rent from various places. The price was \$355 per week at the company I contacted.

Several technical contractors are available to do station EPMs. One contractor, George Whitaker (phone 817-472-5094), is traveling nationwide with his associates on an EPM tour. They will conduct the measurements and provide a report for \$250, all expenses included.

Some may wonder whether the FCC will strictly enforce this deadline. Years ago it allowed stations leeway when installing EBS equipment due to a short compliance period and manufacturers' backlogs.

This deadline was set years ago, so do not expect flexibility. I strongly suggest completing these measurements by June 30.

□□□

Harold Hallikainen is president of Hallikainen and Friends, a manufacturer of transmitter control and telemetry systems. He also teaches electronics at Cuesta College, San Luis Obispo. He can be reached at 805-541-0200. He can also be reached on internet at ap621@cleveland.freenet.edu.

## Specialized Opamp Uses

► continued from page 38

Another idea using opamps, submitted to *RW* by Steve Johnston, is a way to increase the line-level output from consumer grade equipment up the +8 dB

input level of most broadcast equipment (see Figure 4). An NE5534 opamp is used with an output impedance of 600 ohms.

Figure 5 shows a method of providing a 600 ohm output without using a transformer.

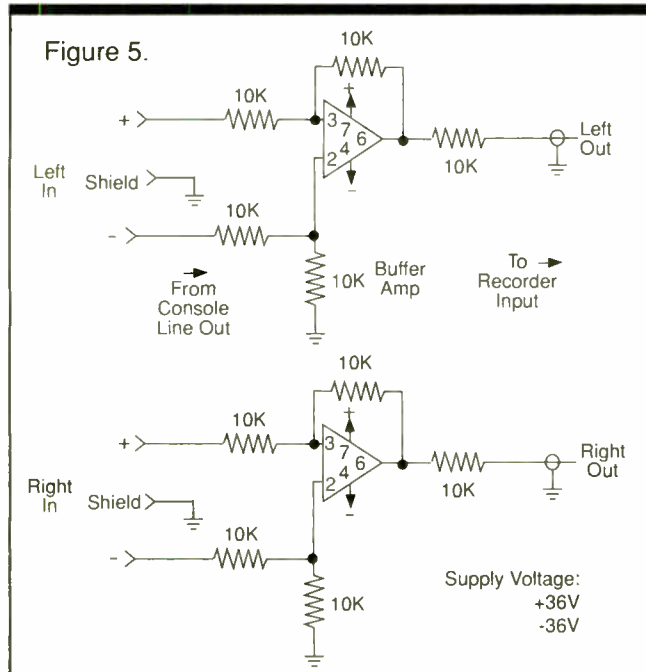

There are several books available that describe the various wiring arrangements for opamps. Opamps provide quite a cost-effective and time saving way to design at the workbench.

□□□

Ed Montgomery is a communications teacher at Thomas Jefferson High School for Science and Technology. He has taught broadcast engineering at Northern Virginia Community College and worked as a broadcast engineer for several radio stations. He can be reached at 703-750-5090.

**TRUE BLUE FOR THE BLUES.**

More stations play their music on the world's best-selling tape carts.

**audiopak**  
BROADCAST CARTRIDGES

P.O. Box 3100 • Winchester, VA 22601  
Tel: (800) 522-CART or (703) 667-8125  
Fax: (703) 667-6379



# Products & Services Showcase

For more information on the products shown below, circle the appropriate Reader Service No. (s) on the enclosed Subscription/Reader Service card or contact the advertiser directly.

## MUSIC ON HARD DISK INCLUDING MUSIC SCHEDULER!

- Dolby AC2 Quality and Compression
- Overlapping Hard Disk Audio
- Access to Your Entire Song Library
- No Player/Tray/Disc Conflicts
- Combine Hard Disk Music with CD's
- Complete "Redundant" On-Line Backup
- Live Assist or Unattended Walkaway
- Provide Computers and CD Players or Buy/Lease Complete System from Us

*Pristine*  
**SYSTEMS**  
INCORPORATED

Distributed Nationally by  
**PROFESSIONAL MANAGEMENT SERVICES, INC.**  
803/370-2400 • FAX 803/370-2314  
INTERNATIONAL 310/670-7500 • FAX 310/670-0133

READER SERVICE NO. 127

## EVEN THE BEST CAN BE MADE BETTER

Introducing the new

### MINI-MIX 12A

THE COMPACT MIXER WITH A  
COMPACT PRICE FROM THE  
QUALITY LEADER

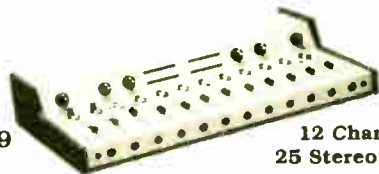

\$3499

12 Channels  
25 Stereo Inputs

Service & Affordable Quality for Over 23 Years

**AUTOGRAM**  
CORPORATION

1500 Capital Avenue (214) 424-8585  
Plano Texas 75074-8118 1-800-327-6901  
FAX (214) 423-6334

READER SERVICE NO. 15

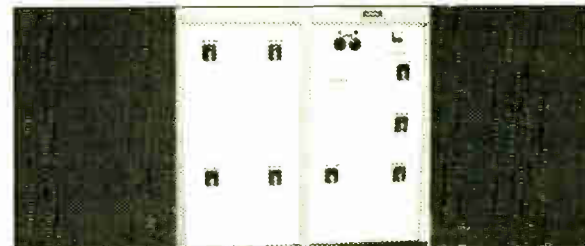

- CUSTOM ANTENNA PHASING SYSTEMS
- ANTENNA CONTROL SYSTEMS
- AM/MF ANTENNA TUNING UNITS
- DIPLEXERS & MULTIPLEXERS
- TRANSMITTER COMBINERS
- DUMMYLOADS (WITH MATCHING NETWORK)
- ASSOCIATED RF COMPONENTS
- CALL OR FAX FOR MORE INFORMATION

*PHASETEK INC.*

550 CALIFORNIA RD. UNIT 11  
QUAKERTOWN, PA 18951

PHONE: 215-536-6648  
FAX: 215-536-7180

READER SERVICE NO. 130

## Unique!

Shively FM Antennas offer stand-  
ard features often unique in the industry:  
Our unique fine-matching transformer,  
included as standard equipment on Shively  
commercial antennas, can correct VSWR  
mismatches of up to 1.5:1 to compensate  
for tower effects. Unlike most others, it is  
tunable both under power and pressure, so  
it requires no disassembly of the system,  
and no adjusting of taped slugs for tuning.  
This means a better match, with less  
rigging time and costs. Watch future  
issues of **Radio World** for other unique  
Shively features.

## Shively Labs

A Division of Howell Laboratories, Inc.  
19 Harrison Road, Bridgton, ME 04009  
207-647-3327 FAX 207-647-8273

READER SERVICE NO. 173



MADE  
IN  
U.S.A.

I HAVE TO DRIVE TO  
THE TRANSMITTER?  
... AGAIN ?!?!

Why drive when you can call? Using Monroe's  
6000 Series Remote Controls and your telephone,  
two-way radio, microwave link or other audio path  
you can have complete control over a remote site.  
For over 15 years Monroe Electronics has supplied  
the broadcast industry with reliable and affordable  
DTMF remote control systems.

Let us help reduce your driving time, call Monroe  
Electronics today.

Distributor and Representative inquiries invited.

**ME MONROE**  
**ELECTRONICS**  
LYNDONVILLE, NY 14098 800 821 6001  
716 765 2254  
FAX 716 765 9330

READER SERVICE NO. 176

## WIRELESS IFB SYSTEM

Used by hundreds of TV stations for  
van-to-field cueing in ENG & SNG  
applications. Transmitter provides  
mix of program and instructions to  
rugged, pocket receivers.

- 100% duty cycle
- Wideband audio
- Excellent operating range



**COMREX**

Comrex Corp., 65 Nonset Path, Acton MA 01720  
Tel: 1-800-237-1776 Fax: 508 635-0401

READER SERVICE NO. 84

**Omega Scientific**  
Corporation

## RF MATCHING NETWORKS

Phasors,  
Diplexers,  
ATU's  
Intercept  
Filters

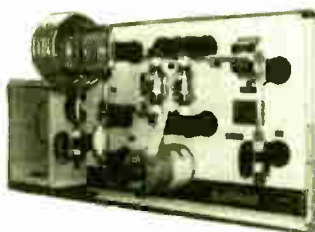

Custom Design and/or Manufacture

Call or FAX for RFQ info sheet

Ph: (210) 599-0789

FAX: (210) 599-0799

4246 Gate Crest, San Antonio, TX 78217

READER SERVICE NO. 38

## Digital Dream System \$9,995.00!



Just \$9,995.00 for this dual digital audio Satellite control  
with Production system. You get two powerful 486SX-25  
computers, VGA color monitors and 535 meg hard disk (9-  
hours mono storage), LAN and DMX-4 audio switcher.  
Includes interface and control hardware. Nothing else is  
required! This pricing is good for a limited time.

- ☐ Great Sound: Premium apt-X™ audio card standard
- ☐ Simultaneous record/play for time shift PBR recording
- ☐ Separate Production room system with LAN net connect  
to Control for complete backup & safety.
- ☐ Satellite system handles all standard formats
- ☐ CD system option from \$1,500 uses Pioneer single or  
triple 6 packs or 300 disc jukeboxes
- ☐ Live assist included, ready for Traffic & Music interfaces
- ☐ Many options: External button boxes, more audio & I/O

### The Management

1-800-334-7823 1-817-625-9761 FAX: 817-634-9741  
P.O. Box 1-36457 Ft. Worth, TX. 76136  
1600+ Stations - Our 13th year

\* Extra charge for combined Satellite & CD systems. No holds or splits, larger hard  
drives available at extra cost.

READER SERVICE NO. 107

## Radio World

Vol. 18, No 11 Radio's Best Read Newspaper June 1, 1994

### Attention Advertisers!

Product Showcase ads  
always get impressive results!

Reach 22,000+ readers  
world wide. **Radio  
World's Product  
Showcase** provides a  
perfect medium for  
test marketing your  
products and services.  
It's an efficient, effec-  
tive and affordable  
advertising option.

Advertise in  
the Product  
Showcase  
Directory!

"It Works! It's Great!"

For more information,  
including rates and  
deadlines,  
Fax Simone at  
1-703-998-2966  
or call  
1-800-336-3045

Advertising  
is good for  
business!



# DOS 6.2 Mends Some Network Potholes

by Richard Mertz

**ROCKVILLE, Md.** If you have tried to build a peer-to-peer network similar to the one I described in recent articles (RW, Jan. 12, Feb. 9 and April 6), you may have run into some "potholes" along the way—those problems that arise on a network when you try to run applications without adequate available memory.

I have recently had some luck treating this problem by installing the new MS-DOS 6.2.

## Reluctant convert

For a long time, I avoided MS-DOS 6.0 and 6.2 because I did not see any need to make the change. I wait to jump on the bandwagon usually when a new version of software is released because initial releases come with bugs. Companies in the highly competitive world of software are eager to release an upgrade to keep up with the competition. DOS 6.0 was no exception.

Then I recently began installing a peer-to-peer network. The files required to operate it, in some cases, took up too much room in the first 640K of RAM for other applications to operate. Whenever I tried to start Windows, I would get the initial logo screen followed by a text message that I was out of memory and suggesting I remove some TSRs from memory.

TSRs are memory resident programs that are dormant until needed. The TSRs in this case were the network control files. I tried loading the network files in high memory using the DOS "Loadhigh" command. In some cases this worked, in others I was stuck with applications that would not run.

I bit the bullet and bought DOS 6.2, after waiting for the version 6.0 bugs to be corrected.

After installing 6.2 on the hard drive, run the DOS program MEM.EXE /c. This shows which programs are loaded in regular memory and which are loaded in extended memory. You immediately know how much memory is available for applications.

The first time I ran MEM, I had about 450K of memory available—not good.

If this happens to you, run MemMaker.EXE, a new program with DOS 6.0. It reads the computer configuration files and automatically determines which programs are loaded in conventional memory, high memory and extended memory. If you select "Express Setup," the program will read the autoexec.bat and config.sys files to determine which programs can be loaded into high memory and which will remain in conventional memory.

I tried this option first and it added about 20K, not much of a change, so I ran MemMaker again and selected "Custom Setup." This time MemMaker gave me a series of options. I could select the drivers and programs I wanted MemMaker to optimally load into high or extended memory.

Custom Setup worked. I cleared 596K of free memory for applications, which paid for the cost of DOS 6.2. I was also able to begin using Windows.

In addition to MemMaker and the disk doubling software, DOS 6.2 has antivirus and backup programs. The backup program looks and runs very much like

Norton Backup, which backs up hard drive files in a compressed format onto floppies. The backup and restore screens are similar in function and operation.

## Other features

DOS 6.2's antivirus program is the same Central Point system I had already been using, except it is upgraded to scan for more viruses. There is also the resident Vsafe program that warns of changes in executable programs and of attempts to write to the hard drive and floppy drive boot sectors.

On a "sort of" networking note, DOS 6.2 has an Interlink series of programs

that allow connection of one DOS computer to another by connecting a serial null modem cable or a parallel cable, assuming that your computers have bi-directional parallel printer ports. Interlink is similar to LapLink except that the remote computer not only copies files from the host (server) computer, but can run programs stored on the host.

Before you can use the program, both computers must have access to the Interlnk.exe and Intersvr.exe programs. If the remote computer (client) does not have these programs, interlink solves the problem by transferring from the host computer to the remote computer using

the "DOS Mode" command. Once transferred, both computers config.sys must have the line "Device=interlnk.exe /drives:5" added.

When both computers are rebooted the newly added device driver loads and automatically scans for available ports, either serial or parallel. You should run Intersvr.exe to configure the server computer. Run Interlnk.exe. to configure the client station. Interlink logs the remote computer onto the host computer, mapping unused drive letters to the host.

□□□

Richard Mertz is a partner at the consulting engineering firm of Suffa and Cavell, Fairfax, Va. He can be reached at 703-591-0110 or through Compuserve, 73020,3026.

## Our panel of experts agrees with your listeners! The Unity 2000i high end sounds better.



Their high end sounds artificial. Female voices sound harsh and some harmonics from the original source seem to disappear.



Thanks to our Linear Response Algorithm™, the Unity 2000i high end sounds more musical and natural, with greater perceived loudness.



The Unity 2000i. The world's best sounding FM processor. Better sound, more listeners, bigger profits. That's what it's all about.



CUTTING EDGE

2101 SUPERIOR AVENUE, CLEVELAND, OHIO 44114 • TEL: (216) 241-3343 • FAX: (216) 241-4103



## CONSULTANTS CORNER

# Watch Out for Slow-Paying Stations

by Phil Simon

**WASHINGTON** When you begin a business relationship with a station, put your expectations of the new client and its expectations of you in writing. A properly written contract will protect you if things go wrong in the future.

This may seem unimaginable to you now, and it may never happen, but even the most reasonable people can become unreasonable under stressful conditions.

It is your responsibility to protect your interests at all times and under all circumstances if contract engineering is more than a hobby

or sideline. Your business may be your only source of income or the sole income for employees who depend on you.

The contract should eliminate all ambiguity with specific payment terms and penalties, and your duties and responsibilities.

## Setting terms

Who is responsible for tools, test equipment and parts? Are you authorized to purchase or charge items for the station? If so, on whose authority and under what conditions?

What is the term of the contract? Does it automatically renew? What is the cost of early termination? Does the station waive homestead rights?

It is best to have legal guidance when writing a contract for the first time. It can be customized for each client without changing the overall meaning or intent. Never let the client write your contract or dictate your terms.

Consider your contract a tool to use when negotiating a settlement. Should a dispute go to court, penalties and interest charges will be the first to be eliminated by a judge trying to negotiate a compromise. Make these charges high enough to

leave room to negotiate, but low enough to not be thrown out entirely by a judge.

Contract engineers make their living by serving a limited number of customers. We are not like telephone or cable companies with tens of thousands of customers that can cut off service when one of them is late with a bill. You may have five or 10 clients, and every contract is important to you.

I always work with a slow-paying client. If necessary, I will modify the payment

terms to make it easier to pay. There should be no limit to the arrangements you can make to facilitate the payment of a bill. You will find that the more versatile, cre-

ative and sincere you are, the more appreciated your services will be and the more sincere the effort to pay the bill.

One of my clients pays half the bill twice a month, which is better coordinated to the station's cash flow. I have agreed to trade equipment for services, with clients that have a temporary dry spell.

If, after making concessions on your terms, working with payment options and appealing to the decency of the manager or owner, your bill is still ignored, it might be time to take action.

Only you can assess when enough is enough, and it is no longer profitable to provide service to a problem client. For me, it is when the grief and aggravation exceeds the benefit of compensation I receive at some date in the distant future.

I once had a customer who agreed to the terms of a contract and signed it. The station was to pay due bills within 15 days of receipt, which is not a problem for most of my customers. At the time, I offered a five-percent discount if the bill was paid in 10 days.

This station rarely paid my bill on time and, to add insult to injury, took the five percent discount, even on bills paid over

a month late. My attempts to recoup the discount and collect a finance charge were met with, "The home office never pays late fees."

Once I attempted to collect a bill approaching 60 days past due. The office manager told me I should manage my money better so that I wouldn't need to come to them and ask for my check. It never occurred to him that I was entitled to prompt payment for services rendered.

"What's the problem, Phil? It hasn't even been 90 days," the general manager asked me on another occasion.

I came closer to pushing the flush button the time I was told: "I've done all I can. I'm not going to make any excuses for the home office. That's just the way they do things."

## Termination

For three years, I put what pressure I could on this station. If asked for payment of past-due balances before repairing an off-the-air problem, the station simply threatened to call someone else in to fix it.

I put their calls at the bottom of my priority list and regularly told the manager that if client A pays its bill in full on time and client B drags its feet for months, I would spend my hours at client A first

and take care of client B when there were no other paying clients that need work.

The station eventually replied by saying that its equipment was in worse condition after my years there, due to my neglect. That is when I terminated contract.

I now had no leverage to entice this station to pay its bill. I waited several months and finally contacted my attorney to file a Warrant in Debt in General District Court.

On the day the case was to go to court last September, seven months after I terminated the contract, I received a check for the principal amount. The contract called for payment of interest, court costs and attorney fees, but my attorney advised me to take it since those items would have been the first to go if the judge were to hear the case.

I took the settlement and have lived a life of peace and tranquility since. The problem client is now on its fourth contract engineer since I left and there are no more in town.

What is the solution to clients like these?

1. Protect yourself as best you can with a legally enforceable contract, even though you may give in on part of it later.

2. Be fair and work in good faith with your customers. Develop a relationship based on mutual trust.

3. Provide high-quality service and use this to your advantage when you can't get paid.

4. Let the competition have the headaches.

# Commission Tries to Push DA Measurement Rules into '90s

► continued from page 44

The process gets even more complicated as the terrain changes in modern urban environments where it is often impossible to measure according to the intervals called for in the rules. An obsolete topographical map will show a measurement point in farmland or forest, where a strip mall stands today. Just try to run a partial proof with a reference proof that is more than a few years old.

In this company (Crawford Broadcasting), we have eight directional AM stations and it is a constant battle to keep the licensed monitoring point (MP) descriptions and directions current. If you find a monitoring point under a freshly poured slab for some new building, the burden is on the station to designate another MP.

What if you measure a point inside a newly opened yogurt stand and find the field strength to be far above the licensed limit? Is this because the array is out of adjustment or because zillion-volt power lines were just installed across the road? Again, it is the licensee's responsibility to find and designate a new MP in the clear.

Remember, a partial proof must be run along the affected radial whenever an MP is changed—good luck finding all the original measurement locations.

## Better ways

Some propose deletion of close-in ND measurements for determining the IDF of a radiator, and instead using the graph contained in Figure 8 of FCC rule 73.190. The graph has worked well, in my experience, in predicting ND IDF and makes a lot of sense as a standard.

There must be some method for detuning towers in the array during ND

operation before the graph results can be considered valid. Otherwise the ND pattern will be distorted.

Some forward-thinking engineers have experimented with computer modeling using moment method magnetic field (I call it M<sup>3</sup>F for short) measurements for both array tune-up and DA performance verification.

These engineers have repeatedly used computer modeling to predict the driving point impedance, voltage, current and phase of each element in an array, then tuned up the array to the predicted values. Field measurements show the predicted shapes and sizes are right on the money.

As for performance verification, these engineers (working mostly outside the U.S.) have used M<sup>3</sup>F modeling to predict the value of the near-array magnetic field at points on a grid. The measured value of the magnetic field at each point was then compared to the modeled value. Where the measured fields all agreed within a specified tolerance (say 1 dB) of the predicted value, it was assumed that the array was in proper adjustment.

The M<sup>3</sup>F process first removes ground conductivity from the DA proof equation. Measurements are made on foot just outside the transmitter site—no driving necessary. There is also no need for ND measurements. M<sup>3</sup>F provides a more accurate picture of array performance at a fraction of the cost of a traditional DA proof.

I think a new day is coming for DA proofs. Hopefully things will change for the better by next year.

□ □ □

Cris Alexander is director of engineering for Crawford Broadcasting. He can be reached at Box 561307, Dallas, Texas 75356.

## RDS / RBDS

RBDS technology for FM broadcasting is emerging as a new revenue source for your station. Beat your competition. Be a leader in your market with RDS / RBDS technology from CRL.



**SC-100**  
Features:

- Easy loop-thru installation
- Two expansion slots for future DSP card upgrades
- Fully programmable from the front panel ASCII keyboard

*Watch your profits soar!*

**Call Today for a free demonstration.**



**Circuit Research Labs, Inc.**  
(602) 438-0888 (800) 535-7648  
FAX (602) 438-8227



# Radio World

## Broadcast Equipment Exchange

"Broadcast Equipment Exchange" accepts no responsibility for the condition of the equipment listed or for the specifics of transactions made between buyers and sellers.

### RADIO RESOURCES

1201 S. SHARP ST.  
BALTIMORE, MD 21230

**PRE-OWNED EQUIPMENT LIST VIA FAX:**  
Just call 1-800-832-2329 ext. 737 to receive a faxed list of many fine equipment items currently available. The list will be updated on the 1st and 15th of each month.

**NEED A COPY OF OUR TECHNICAL NECESSITIES CATALOG?**

Call 1-800-547-2346 to request your free copy.

**TEST EQUIPMENT AVAILABLE TO RENT:**

Potomac Field Strength Meters  
Tektronix Spectrum Analyzer (for AM splatter measurements)  
Delta Impedance Bridge  
Delta Receiver/Generator

**HAVE EXCESS EQUIPMENT YOU WANT TO SELL?**

We need late model AM/FM transmitters. Orban Optimods, Potomac Field Strength meters, STL and RPU equipment plus many other items.

Call Steve or Chuck  
**1-800-54-RADIO**  
**1-410-783-4635 FAX**

Circle (92) On Reader Service Card

### AMPLIFIERS

#### Want To Sell

McIntosh MC-75 tube power amp, good condition, original electronics, KT-88 tubes, \$700; McIntosh C-11 tubed stereo preamp, near mint, \$525. R Links, Links Sound, 1656 California St, Berkeley CA 94703. 510-845-5557 eve.

Dynaco stereo 120 solid state, rack mt \$229, Dynaco stereo 70 tube amp all new tubes! Dynaco PAT 4 preamps \$59. W Gunn 619-320-0728.

### ACOUSTICS

#### Want To Sell

**STUDIOFOAM**  
SOUND ABSORBENT WEDGES  
TESTS UP TO 40% BETTER THAN SONOMAX  
\* COSTS LESS \* BETTER COLORS \* BETTER CUT \*

**SONOMATT**  
4'x8'x2" Sheets \$29.99 Ea. In Pairs-NRC 70-Ships UPS

**VENUS** 12" x 2' x 4" NRC 1.30 Flat 10K-125Hz  
Then They Really Kick In (125Hz NRC)  
1.631 Charcoal Gray 2 For Just \$150!

**BASS TRAPS** 1.631 Charcoal Gray 2 For Just \$150!

USA Power Box 20384 Indianapolis IN 46220-0175-1-800-95-WEDGE

Circle (23) On Reader Service Card

### AMPLIFIERS

#### Want To Sell

New 10 kW FM amp under \$24,000. Call for details. Bill Hoffman, 518-743-1601.

SAE impulse noise reduction amplifier (scratch filter) stereo, \$75; SMC SPA-10 20 W stereo line amplifier, \$50. P Bridger, KGKO, 202 E Cross, Benton AR 72015. 501-778-8257.

#### Want To Buy

**WANTED:**  
Pultec EQ's; Fairchild, Teletronix, dbx, UREI, Sontec Limiters. Neumann, Telefunken, AKG and RCA mics. MacIntosh or Marantz Gear; Lang, Neve and API gear. Misc old tubes and guitars.

**DAN ALEXANDER AUDIO**  
1340 Mission Street  
San Francisco, CA 94103  
(415) 252-7102  
FAX: (415) 252-7524

Marantz Model 1, audio console pre-amp, single or pair, and Model 6 stereo adapter. P Chance, Imperial Analog, 925 Clinton St, Philadelphia PA 19107. 215-574-8147.

### ANTENNAS/TOWERS/CABLES

#### Want To Sell

Harris/ERI, 3 bay, low power, \$3000. T Beschta, WAQE, POB 703, Rice Lake WI 54868. 715-234-9059.

Shively 6813, 2 bay w/radomes, rebuilt and in factory boxes, 95.4 MHz, \$2400. B Bailey, WHYR, POB 567, Saco ME 04072. 207-284-9600.

200' 6" hard line, 20' sections, connectors & elbows, FM or TV, call for prices. K Crosthwait, WTNN, 13206 Buttermilk Rd, Knoxville TN 37932. 615-690-8807.

### FM - ANTENNAS

Designed and built for your frequency. Choose from 1 to 12 bays and five power levels. Financing available. Call Jimmie Joynt at S.W.R. **214-335-3425**

Andrew transmission line air compressor, 3.8 lbs/sq in, \$425. R Chambers, 3015 Johnstonville Rd, Susanville CA 96130. 916-257-2121.

Andrew 75R coax line coupler, 7/8" flange (2), \$50 ea; Andrew 1860 reducer 1 5/8" to 7/8" (2), \$75 ea. K Crosthwait, WTNN, 13206 Buttermilk Rd, Knoxville TN 37932. 615-690-8807. Want To Buy

Rohn 45 tower, want 14 sections in gd cond; 3 or 6 bay CP FM antenna to handle 3 kW input at 99.5 MHz; 1 5/8" flange connectors to fit Andrew foam cable (2). K Diebel, KTJC FM, Rayville LA 71269. 318-728-5852.

FM antenna 5 or 6 bay tuned to 95.1 or 95.3 MHz, prefer ERI or Jampro; 340' and 540' tower in gd cond. L Fuss, WDTL-FM, POB 1438, Cleveland MS 38732. 601-846-0927.

### AUDIO PRODUCTION

#### Want To Sell

SAE 5000 Click and Pop remover, mint, \$125. R Links, Links Sound, 1656 California St, Berkeley CA 94703. 510-845-5557 evenings.

Yamaha SPX 90 effects processor, \$500. T Lewczyk, WLTJ FM, 7 Parkway Ctr #780, Pittsburgh PA 15220. 412-922-9290.

### Looking for Audio Bargains?

**We BUY \* SELL \* TRADE**  
**QUALITY USED EQUIPMENT**  
**317-962-8596**



Used audio equip; consoles, carts, reels, processing, call for list. B Weiss, KMXV/KUDL, 3101 Broadway Suite 460, Kansas City MO 64111. 816-753-0933.

Orban 245 E, stereo synthesizer, mint cond, will trade for click & pop filter for records, \$200. C Jennings, CJ Recording, 1300 Robeson St, Reading PA 19604.

Demeter 4 ch rack mt tube direct box NEW \$795. W Gunn 619-320-0728.

### CASSETTES • CARTS • REELS

### J & I AUDIO/VIDEO

A wholesaler in the Radio and Television market. Now running SPECIALS on audio and video:

**BASF CASSETTES-AMPEX R-Rs**  
**AUDIOPAK, FIDELIPAC & ITC CARTS**

For more information call Kris Elliot at **1-800-942-1711**

or write to: J&I Audio/Video  
20899 Kelvin Pl.  
Woodland Hills, CA 91367

Circle (46) On Reader Service Card

ADC 96 & 144 Pr TT patchbays, excel cond, 1 rack space, 3 rows of 48, top 2 rows normalled, \$149, 96 is 2 row normalled, \$129 (you remove old wiring) or we totally refurbish w/new front panel, ready to install, \$199-229. TT cords up to 10 per bay at \$9 ea, reg \$13.95, also 1/4" bays. Audio Village, 619-320-0728, or Fax 619-320-2454.

#### Want To Buy

UREI-1176 LN, Inovonics Map II, Autogram/Collins K-10A or K-6A console, need immediately. G Goldsmith, POB 5786, Beverly Hills CA 90209. 310-696-0177.

### ITC

### REPAIR • REFURBISHMENT • UPGRADE

Remanufactured machines available for sale or rent.

Direct from the only qualified ITC Cart Machine Repair Center

• All work warranted for 1 year minimum  
• Service contracts available

Call Rusty

**(800) 447-0414**  
**(309) 828-1381**



International Tapetronics Corporation  
2425 South Main Street  
Bloomington, IL 61704

TM Century Ultimate Digital Studio, CD jukebox controller w/7 Pioneer 18-disk CD players, \$6000; TM Century Gold Disk library for country format, B/O. L Fuss, WDTL-FM, POB 1438, Cleveland MS 38732. 601-846-0927.

Cetec 7000 II, w/Go-Cart 78 (4), Go-Cart 24 (2), Otari ARS-1000 (2), Instacarts w/interface (2), all mounted in racks, B/O. M Stockwell, KEZR, POB OR 97601. 503-882-4656.

### AUTOMATION EQUIPMENT

#### Want To Sell

Cetec/Shafter 7000 w/10 Audiofiles (2), IGM stereo instacart, Wegener satellite receivers (2), all or part, BO. KAZZ FM, POB 1369, Deer Park WA 99006. 509-276-8816.

SMC DP-2 stereo automation system, 3 R-R, 2 Carousels, \$3500. P Bridger, KGKO, 202 E Cross, Benton AR 72015. 501-778-8257.

Sparta 25 Hz tone generator & filter, \$200. P Bridger, KGKO, 202 E Cross, Benton AR 72015. 501-778-8257.

Control Design 25 Hz tone detector, \$150. P Bridger, KGKO, 202 E Cross, Benton AR 72015. 501-778-8257.

Audiofile II, single column, 10 slots, 3 Audiofile I, various shape, 903 boards. B Bailey, WHYR, POB 567, Saco ME 04072. 207-284-9600.

360 Systems Digicart hard disk audio storage syst, handles 3 1/4 hrs in stereo, \$4000. L Fuss, WDTL-FM, POB 1438, Cleveland MS 38732. 601-846-0927.

Cetec 7000 II, w/Go-Cart 78 (4), Go-Cart 24 (2), Otari ARS-1000 (2), Instacarts w/interface (2), all mounted in racks, B/O. M Stockwell, KEZR, POB OR 97601. 503-882-4656.

Otari ARS-1000 (5), Carousels (3), SMC 712 dual-cart player, IGM go cart 24 (2), BO all or part. R Wynne, KFLS/KKRB, POB 1450, Klamath Falls OR 97601. 503-882-4656.

Harris 9001 incl brain, switcher, power supply, TEC-70 terminal and keyboard, manuals, also second system for backup, BO. R Wynne, KFLS/KKRB, POB 1450, Klamath Falls OR 97601. 503-882-4656.

BE Control 16 inc IGM Go-Carts (7), Otari reels (2), exc cond, priced to sell. M Young, WJON, POB 220, St Cloud MN 56302. 612-251-4422.

Schaffer 903 comp automation system, victim of simulcasting, 60" racks (5), ITC-750 (4), SMC Carousels (6), printers, battery backup, 25 Hz generator, TTY for encoding, all works, will sell parts, \$2000 FOB Portland OR. M Everhart, KXYQ, 111 SW 5th, Portland OR 97204.

## HALL Electronics

1305-F Seminole Trail Charlottesville VA 22901

Here are just some of the bargains we have in stock:



ITC 3D Mono Cart Player -	Rebuilt	\$ 1,295
Fidelipac CTR-12 Stereo Play Cart Machine -	Rebuilt	\$ 895
Harris CC-II Mono RP Cart Machine - Closeout -	Rebuilt	\$ 395
Revox PR-99 Reel Player w/ 25Hz Sensor -	AS NEW	\$ 495
ATI Stereo BC8SR 8 Pot Console - (List \$ 3,595)	Rebuilt	\$ 995
Ramko DC-5RA 5 Pot Rack Mount Mono Mixer -	Rebuilt	\$ 195
Telos 10 Digital Hybrid -	Rebuilt	\$ 695
TRC-15-AW 15 Ch. Remote Control -	Rebuilt	\$ 695
Belar SCM-1 SCA Monitor -	Rebuilt	\$ 695
Dielectric 4 Pot 15/8" EIA Motorized Coax Switch -	Unused	\$ 1,295
Marti SCR-8H 67KHz SCA Demodulator -	Rebuilt	\$ 245
CBS Radio NET ALERT III -	Tested	\$ 145
Samson SAWS-22GTR Guitar Pack Wireless Mic -	NEW	\$ 298
Tektronix 7704A 4-trace 200MHz Scope /modules -	Tested	\$ 795
Tektronix 1225 Digital Logic Analyzer (less probes) -	AS NEW	\$ 195
Microtrak 303 12" Tone Arms -	NEW	\$ 99

### SM-1 AM Splatter Monitor



Beat July 1st Deadline!  
NRSC-2 Monitoring Requirement.

- Contract Engineers - Additional Income Opportunity
- Inexpensive means of verifying FCC compliance
- Easy to operate and interpret measured results
- 450 KHz to 1800 KHz phase-locked operation
- Portable operation from 12 VDC supply
- Alarm output permits remote control monitoring

DELTA ELECTRONICS



## SINE SYSTEMS

### Announcing New Crisp Voice

The RFC-1/BHV3 provides transmitter power control, has alarm dial out for 6 numbers, and provides up to 64 channels of control and metering.

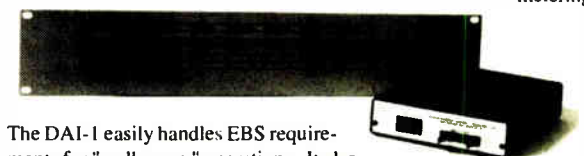

The DAI-1 easily handles EBS requirements for "walk away" operations. It also allows direct access to the air chain in addition to providing remote broadcasts. The best & lowest cost 'dial-up' remote control available.

#### Spring Specials:

SP8 Heavy Duty Surge Protector \$ 99  
SU-5 Voice/Software Upgrade \$ 159

Complete system under \$ 1300

Fax: (804) 974-6450



## AUTOMATION EQUIP...WTS

Cetec 7000 programm automation system, 5046 event memory, terminal, racks, source cards, 350 series Carousels (4), 250 series Carousels (3), Audiophile (2), ITC 760 R-R (2), PB decks, more w/spares & extra cards, \$2500 for all or will sell separately. E Moody, KJEM/KESE, 216 N Main St, Bentonville AR 72712. 501-273-9039.

BE Control 16 brains w/audio switchers (2); Otari ARS 1000 R-R in exc cond (5); working SMC Sonomag Carousels (2); SMC Sonomag Carousels good for parts (3); ITC triple stacker cart machine w/R/PB; ITC triple stacker w/PB only, cabinets included. M Jones, WZKB, POB 520, Wallace NC 28466. 910-285-4900.

Harris 9000 perf for sat operations, ITC 750, Carousels (3), triple deck, CRT & cables, \$2000. T Beschta, WAQE, POB 703, Rice Lake WI 54868. 715-234-9059.

## CART MACHINES

## Want To Sell

SMC 590, cart recorder in gd cond, mono R/P, newer style head gasket w/many spare parts, \$150. B Bailey, WHYR, POB 567, Saco ME 04072. 207-284-9600.



Great Prices on original equipment tape heads for ITC, BF, Fidelipac, Otari, Tascam & others!

**HE HALL**  
Electronics

(804) 974-6466 • FAX 64150

Ampro mono play (5), gd cond, \$100 ea; Ampro mono R/P, gd cond, \$200. G Kornbluth, A&J Recording, 225 W 57th St, New York NY 10019. 212-247-4860.

ITC 99B stereo (4), mono PB (6), Harris stereo PB, Audi-Cord stereo PB. J Phillips, 414 Washington Ave, Defiance OH 43512. 419-782-8591.

Gates Cartrite II, R/P, \$300; play deck, \$200, ITC 760 R-R, \$250. E Moody, KJEM/KESE, 216 N Main St, Bentonville AR 72712. 501-273-9039.

BE tape delay R/P, like new; Gates/ATC mono cart w/1 record amp (6), lots of spare modules. J Kuenzie, KFEX, 511 W 5th St, Washington MO 63090. 314-239-0209.

ITC SP stereo reproducers (3), need work, \$350 ea. T Lewczyk, WLTJ FM, 7 Parkway Ctr #780, Pittsburgh PA 15220. 412-922-9290.

Spotmaster 505, gd heads, looks and works like new, \$250. R Franklin, SSS, 1004 Dekalb St, Norristown PA 19404. 215-646-7788.

ITC 99-B cart record/play deck, all options, \$3500; (2) ITC SP's, modified to 99-B specs, \$700 each. All equip like new, home use only. 810-435-3932.

ITC PD-II (3), mono, \$250 ea or all \$600. L Fuss, WDTL-FM, POB 1438, Cleveland, MS 38732. 601-846-0927.

ITC Delta R/P, exc cond, less than 1 yr old, stereo, \$1500/BO. C Scherer, WZAK, 2510 St Claire, Cleveland OH 44114. 216-621-9300.

Digicart w/one gigabyte, \$5950. J Hepler, WOLV-FM, 234 Union St, Millersburg PA 17061. 717-362-1099.

3 deck mono all tone, \$750/BO. Jim, 419-782-8591.

ITC 99B PBs (3), mono PB (6), Audi-Cord stereo PB (2). J Phillips, 414 Washington Ave, Defiance OH 43512. 419-782-8591.

ITC Delta I stereo play, \$800; ITC RP mono 3 tone, \$550. Both recently rebuilt and warrantied. S Yates, (804) 978-2888.

BE 5300C tripledeck, stereo, PB, mint less than 50 hrs, BO. R Kaufman, Pams Prods, POB 462247, Garland TX 75046. 214-271-7625, after 3PM CDT.

## Want To Buy

ITC, BE, Fidelipac cart machines: single, triple, mono, stereo, play & record/play. Call M O'Drobinak @ 619-758-0888.

Sony TC-399 R-R, stereo, gd cond, \$35. J Cunningham, KEOR/KHKC, Rt 2 Box 113 B, Stonewall OK 74871. 405-265-4496.

## CASSETTE &amp; REEL-TO-REEL RECORDERS

## STUDER SERVICE SPECIALIST

Thousands Serviced • Unbeatable Rates  
Precision Capstan Resurfacing  
**Audio Advantage**  
Tel (615) 742-3834  
**PRICE-QUALITY-SERVICE**  
Let Us Prove It

## Want To Sell

Tascam T-2600 cassette duplicator & slave. J Phillips, 414 Washington Ave, Defiance OH 43512. 419-782-8591.

## REVOX PARTS/SERVICE

Cassette-CD-Open reel  
Rebuilt A77s, \$850.00  
Capstan resurfacing, ALL BRANDS.  
**JM TECHNICAL ARTS**  
30 Music Sq. W. #156  
Nashville, TN 37203 (615) 244-6892

Wollensak 1520 AV R-R w/built in compressor, 10 W amp & spkr, w/some new blank tapes, \$80. R Franklin, SSS, 1004 Dekalb St, Norristown PA 19404. 215-646-7788.

Otari ARS-1000 (5), BO. R Wynne, KFLS/KKRB, POB 1450, Klamath Falls OR 97601. 503-882-4656.

Teac AH101S like new w/box, \$150; Teac A1500U, like new, low hrs, \$200; Pioneer RT 701, new heads, \$300; Viking Telex RD84 record amps (3), \$80 ea. J Parsons, Parsons Sound Service, 2781 Fayson Circle, Deltona FL 32738. 904-532-0192.

Ampex, ITC, Scully Reel-to-Reel Tape Recorder Spare Parts, Accessories Motor Remanufacturing.

**VIF INTERNATIONAL**  
PO Box 1555  
Mtn View CA  
94042 U.S.A.

Inside USA: 1-800-848-4428  
Outside USA: 1-408-739-9740  
FAX: 1-408-739-0809

Tascam 1/4" 4 trk, R/R, like new, 3 yrs old, \$1750; Tascam 1/4" 2 trk, R/R, like new 3 yrs old, \$1250. Kacee Production Agency, POB 712, Luverne MN 56156. 507-283-4588.

Ampex 440C, 4 tracks, 4+2 track head stacks, roll around, needs work, pick up only, \$350; Uher 4200 + 4000, need work \$100 for all. Bob, 212-219-3670.

Otari MX5050 IIB, Tascam 40-4, 24-2, Technics 1520. J Phillips, 414 Washington Ave, Defiance OH 43512. 419-782-8591.

Revox 77A (2), 1/4" 2 trk 7.5/15, port case, very fine cond, \$500 ea; Scully 280A 1/4" 2 trk, 7.5/15, Ruslang console cabinets, very fine cond, \$500 ea. G Kornbluth, A&J Recording, 225 W 57th St, New York NY 10019. 212-247-4860.

Recordex Stereo X, 5 copies from cass master, heads need alignment, gd cond, \$1000 or trade for reel recorder. C Jennings, CJ Recording, 1300 Robeson St, Reading PA 19604.

Otari MX5050 III BRC, MX5050 4 track, Tascam 25-2, Teac 40-4, Technics 1520 & MX5050 parts only. Jim, 419-782-8591.

Tascam 32 7.5 & 15 ips, gd cond, ltd use, \$500. F Reagan, Special Bdct Svc, 203 Westville Ave, Danbury CT 06811. 203-743-7433.

Radio Systems RS-1000 DAT machines, automation ready, rack mounted, almost new, \$1500/BO. S Hill, KCAM, POB 249, Glenallen AK 99588.

Otari ARS-1000 (6), w/spare parts/cards, exc cond; Scully 280, 14" w/stereo R/P electronics; Ampex 351 (2) R/P, new heads; Spotmaster 505 PB. J Kuenzie, KFEX, 511 W 5th St, Washington MO 63090. 314-239-0209.

Ampex 350 7.5 & 15 full track unmounted, good condition, \$250; Scully 280 7.5 & 15 speed, unmounted 2 track stereo, needs refinishing, heads & electronics very good condition, with manual, \$350; Telex 6120, deck & electronics mounted in cabinet, needs heads, 16:1 ratio, \$750. C Jennings, CJ Recording, 1300 Robeson St, Reading PA 19604.

16 track 2" \$3450, MCI JH110C-8 \$2800, 110C-8 play only \$500, ATR800 mono or Tascam 7300 or 2502 \$600 ea, MCI Locator III \$1195, Tascam 52 2 trk \$1200, Ampex AG350 electr \$50/ch. W Gunn 619-320-0728.

Recordex 6 cassett rewriter \$100; Tascam 40-4 4 trk 10" in flight case w/free dbx \$750; MRL new short test tapes \$39 for 1/4" to \$199 for 2". W Gunn 619-320-0728.

Scully '100' recorders, record/play amplifiers, 8, 16, 24 track heads. Sequoia Electronics, 4646 Hounds-haven Way, San Jose CA 95111. 408-363-1646.

Otari Mark II-IV 1/2" 4-track, multi-track, mint, less than 50 hours, Best Offer. R Kaufman, Pams Productions, POB 462247, Garland TX 75046. 214-271-7625, after 3PM CDT.



**VERTIGO BURNISHERS AND INJECTORS RESTORE ORIGINAL PERFORMANCE TO YOUR PATCH BAYS**  
**\$34.95 Ea.**  
12115 Magnolia Blvd. #116 818-907-5161  
North Hollywood, CA 91607 fax 818-784-3763

Otari MX5050, Mark III-8 8 track, mint condition, with 8 channels or dbx 150 noise reduction, dust cover, remote, very low hours, \$2500. Larry, 212-463-9426.

Otari 5050 MK III-8 trk, heads excellent, \$2450. Wayne Gunn 619-320-0728.

## Want To Buy

Ampex tube recorders and mixers. W Gunn, 619-320-0728.

Tascam 58 1/2" 8 trk wanted to buy or trade for Otari 5050 MK III-8 or...? Wayne Gunn 619-320-0728.

Ampex ATR100 taperecorders for parts. Circuit cards, heads, motors, machine parts, or electronic parts. Call 818-907-5161.

Otari MX5050BII (2) at DIRT CHEAP prices for P/T at NCE-FM station. Robert 214-226-2949.

## CD PLAYERS

## Want To Sell

TEC SLP101, \$150. Kacee Production Agency, POB 712, Luverne MN 56156. 507-283-4588.

MSD superdisk drive for Commodore-64 & VIC-20 w/many programs, \$100. R Franklin, SSS, 1004 Dekalb St, Norristown PA 19404. 215-646-7788.

Denon 950F. J Phillips, 414 Washington Ave, Defiance OH 43512. 419-782-8591.

Denon 950FA, perf cond, \$650. K Thomas, Rebel Recording, 5555 Radio Lane, Jacksonville FL 32205. 904-388-7711.

Denon 950 (2), mint. J Phillips, 414 Washington Ave, Defiance OH 43512. 419-782-8591.

## COMPUTERS

## Want To Buy

Tandy 6000HD w/at least 1 floppy drive. Mel Crosby, 408-363-1646, FAX 408-363-0957.

## CONSOLES

## Want To Sell

Harris Stereo 80, 8 chnl, solid state, \$1000; Harris Gateway 80, 8 chnl mono, solid state, \$800. L Fuss, WDTL-FM, POB 1438, Cleveland MS 38732. 601-846-0927.

Realistic stereo mixing console 32-1200B, \$100; Sparta A-20B, 8 chnl mono console, \$1000; Meteor Clubman 1-5 stereo sound mixer, \$75; Shure M-63 audio master, \$75. P Bridger, KGKO, 202 E Cross, Benton AR 72015. 501-778-8257.

Russco 505 mono (2), 1 rack mount, 1 table top, \$250 ea. J Parsons, Parsons Sound Service, 2781 Fayson Circle, Deltona FL 32738. 904-532-0192.

BE 10S350A 10 chnl stereo slide fader, mint, complete docs, \$2300. G Kornbluth, A&J Recording, 225 W 57th St, New York NY 10019. 212-247-4860.

Gately pro-kit, manual, rough, \$75. Bob, 212-219-3670.

Cetec 5 chnl mono, mounted in prot console cabinet w/cue speaker, program speaker & equip shelf, \$750. E Moody, KJEM/KESE, 216 N Main St, Bentonville AR 72712. 501-273-9039.

ADM ST 160II, 4 track, audio prod console with many extras, Best Offer; Andrew HJ5-75 7/8" air coaxial cable, 407' roll, 422' roll, 650' roll, new in 1981, stored, never used, still in shipping reel, Best Offer, you ship & remove from building. J Book, WOC Radio, 3535 E Kimberly Rd, Davenport IA 52807. 319-344-7000.

Tascam 8 channel, like new, \$850. Kacee Production Agency, POB 712, Luverne MN 56156. 507-283-4588.

Presto 900-A1 antique portable mixing amp (1940's), used with early disk & tape recorders, 3 balanced mic inputs, \$250. R Franklin, SSS, 1004 Dekalb St, Norristown PA 19404. 215-646-7788.

Shure MG7, mic mixers (2), excellent condition, \$300 for both or \$160 ea. 818-785-2324.

**AMPRO CONSOLES & CART RECORDER PARTS AND SERVICE**  
**SEQUOIA ELECTRONICS**  
(408) 363-1646

UREI Mod One, 5 pot, slide faders, \$400. M Everhart, KXYQ, 111 SW 5th St, Portland OR 97204.

Ramco DC5AR 5 channel mixers, vgc, \$175 each. 916-725-2434.

## DISCO-PRO SOUND EQUIPMENT

## Want To Sell

JBL speakers 2404 HF, 2445 horns, 2204 mids in 2 cabinets, \$1400; HME MX 10, stereo 8 ch rack mixer, \$300. D Kocher, Digital Sound Makers, 1919 Hanover Ave, Allentown PA 18103. 610-776-1455.

TEC SBCX300 8" 2-way speakers (2), \$250. Kacee Production Agency, POB 712, Luverne MN 56156. 507-283-4588.

JBL ceiling speakers (2), used in suspended ceilings, incl housing, speaker, control knob, \$30 ea; Lil Miss Moffat 48 V phantom power supply (2) \$18 ea; new 6' rack rails (2), \$18 ea, other sizes available free w/purchase, all items plus shipping. B Lord, Lord Broadcasting, 13313 SE 208th St, Kent WA 98042. 206-631-2374.

## FINANCIAL SERVICES

## EQUIPMENT FINANCING

ON ALL RADIO EQUIPMENT

- Easy to qualify
- Fixed-rate, long-term leases
- Any new or used equipment
- 100% financing, no down payment
- No financials required under \$50,000
- Refinancing existing equipment

**ENF** EXCHANGE NATIONAL FUNDING

Call Mark Wilson  
(800) 275-0185

## FURNITURE

## Want To Sell

Revox PR-99 roll around cabinet accessory, used 3 mos, \$250. F Reagan, Special Bdct Svc, 203 Westville Ave, Danbury CT 06811. 203-743-7433.

## EMPLOYMENT

To place ads in this section, use the ActionGram form. To respond to box numbers write Radio World, PO Box 1214, Falls Church, VA 22041. Attn: \_\_\_\_\_

## POSITIONS WANTED

**Be Unorthodox!** Call and hire Janet, FT announcing, programming aspirations, computer literate, in radio since 1980, PT announcing, marketing exp. Metros, bedroom communities preferred. Janet, 502-895-5888.

**Broadcasting grad,** AM/FM/TV, 19 yrs exp, Gen/Radar, SBE cert, asst eng exp, prod, CD. 606-523-0901.

**Mama's Dead** radio talk host, David F Diamond is ready for new, major market. 901-761-5577.

**Husband/Wife broadcast professionals** w/25+ yrs exper, wishing to relocate to small market. Interested in FM only, or AM/FM combo, in NW Ohio, Michigan, Wisconsin, Minnesota, or N. Dakota only. We will locally own and operate station. We have good track record for sales, operation, and community service. Send rate card, description of assets and property, year end statement, and terms. All replies will be kept very confidential. Serious replies only! Send replies to: Radio World, POB 1214, Falls Church VA 22041. Attn: Box #94-06-01-1RW.

**Country/A/C** current A/C morning drive/MD w/great phones & brains, prefer anywhere east of CA. Mike, 510-988-9005.

**Broadcaster with 16 yrs experience,** sales training by J Jennings, degree, concert promoter, will relocate. 908-671-6491

**Straight out of school and ready to go to work,** sales, on-air, promo, prod, reporting. Jason, 405-733-2511.

**High energy,** positive personality, perfectionist, reliable, team player, fun and common sense, attitude is everything, innovative, desire announcing, programming, prod position. Gee, 405-722-8720.

**Hard working guy** willing to work in country or contemporary Christian stn, can handle on-air, production or news. S Weller, 918-358-5154.

## ABOUT OUR EMPLOYMENT SECTION

**HELP WANTED:** Any company or station can run "Help Wanted" ads for \$1.50/word or buy a display box for \$60/column inch. Payment must accompany insert, use your MasterCard or VISA; there will be no invoicing. Blind box numbers will be provided at an extra charge of \$10. Responses will be forwarded to listee, unopened, upon receipt. Call 800-336-3045 for details.

**POSITIONS WANTED:** Any individual can run a "Position Wanted" ad, FREE of charge (25 words max), and it will appear in the following 2 issues of Radio World. Contact information will be provided, but if a blind box number is required, there is a \$10 fee which must be paid with the listing (there will be no invoicing). Responses will be forwarded to the listee, unopened.

Mail to: BROADCAST EQUIPMENT EXCHANGE  
PO Box 1214, Falls Church, VA 22041  
Attn: Simone Mullins

## HELP WANTED

## TECHNICAL SUPPORT SUPERVISOR

Pacific Recorders and Engineering is expanding its manufacturing, development, marketing, and support operations in response to increasing worldwide demand for superior-quality audio equipment and studio systems. A key position in our carefully-managed growth plan is that of Technical Support Supervisor, and we are currently seeking a highly-qualified individual for that position. The successful candidate will have thorough knowledge of the broadcast studio technical environment, including audio consoles, analog tape recorders, and digital audio workstations. This position requires competency in analog and digital troubleshooting to the component level, very strong leadership and human relations skills, and the desire and ability to develop a technical support operation consistent with the high standards and established reputation of Pacific Recorders. Previous experience in a telephone-based technical support environment is a plus. Minimum 5 years of large or major market broadcast engineering experience and one or more years of formal electronics training are required.

Send resume: Ms. Patti Watson  
Personnel Manager  
Pacific Recorders & Engineering Corp.  
7070 Las Palmas Drive, Carlsbad, CA 92009

■ Pacific Recorders is an equal opportunity employer. We maintain a multi-cultural workplace and encourage qualified men and women of all backgrounds to apply for this position.



## LIMITERS

### Want To Sell

**Kahn Symmetra-peak SP 58 1A (AM)** \$25. P Bridger, KGKO, 202 E Cross, Benton AR 72015. 501-778-8257.

**UREI BL-40** Modulimiter mono compressor limiter, \$150. R Chambers, 3015 Johnstonville Rd, Susanville CA 96130. 916-257-2121.

**Wilkinson LA2-CS** stereo limiter, \$75; Wilkinson LA2-C mono limiter, \$50; MAP 1694 audio equalizer, \$50; Shure SR 107 audio equalizers, \$75. P Bridger, KGKO, 202 E Cross, Benton AR 72015. 501-778-8257.

**Composite clipper and Aural Exciter**, buy or trade. E Moody, KJEM/KESE, 216 N Main St, Bentonville AR 72712. 501-273-9039.

**Orban 8100/XT2**, DADs (2), CRL SEP-800, PMC-300, Dynaflex DX-2, Aphex II exciter, UREI LA-3 (2). J Phillips, 414 Washington Ave, Defiance OH 43512. 419-782-8591.

**Harris MSP95/MSP90** stereo generator, AGC & limiters, \$2500. T Beschta, WAQE, POB 703, Rice Lake WI 54868. 715-234-9059.

**Orban XT 2** accessory chassis, \$1500, UREI stereo pair LA 4 compressors, \$500 pr; Orban 418 stereo limiter, \$500; Vigilante stereo processor, \$1500. T Lewczyk, WLTJ FM, 7 Parkway Ctr #780, Pittsburgh PA 15220. 412-922-9290.

**Orban XT-2** 6 band limiter for 8100A, DAP 310 (2), CRL SEP 800, CRL PMC-300, CRL Dynaflex DX-2. Jim, 419-782-8591.

**CBS Labs Volumax** limiter, \$50. M Everhart, KXYQ, 111 SW 5th, Portland OR 97204.

### Want To Buy

**Gregg Labs 2530** tri band AGC processor, need urgently, J Mauk, KMJ/KSKS, POB 70002, Fresno CA 93744. 209-266-5800.

**Fairchild 670** or 660 tube compressor/limiter, Teletronics LA-2A tube compressor/limiter or UREI LA-3A solid state compressor/limiter, call after 3PM CST. 214-271-7625.

## MICROPHONES

### Want To Sell

**EV RE-20**, Sennheiser 421, in boxes. Jim, 419-782-8591.

**EV RE 20's**, J Phillips, 414 Washington Ave, Defiance OH 43512. 419-782-8591.

**RCA 77DX (1)**, RCA 44BX (1), both in exc cond, BO over \$800 for either. R Burns, RF Studios, 1326 Highmeadow Dr, Garland TX 75040. 214-271-4386.

**Lectrosonics CR185-M185** VHF wireless mics (2), mint cond, \$1100 ea; Vega 67B-77D2 wireless mics, exc cond, portable (2), \$1000 ea. Don, Scales Film Sound, 3142 Market Place, Bloomington IN 47403. 812-339-4446.

**EV Variable D** cardioid mic, comp w/arm & bench mount, \$500. Kacee Production Agency, POB 712, Luverne MN 56156. 507-283-4588.

**Sennheiser MD421**, J Phillips, 414 Washington Ave, Defiance OH 43512. 419-782-8591.

**Collins 212Y** circa 1930, orig case, exc cond, BO. F Reagan, Special Bdct Svc, 203 Westville Ave, Danbury CT 06811. 203-743-7433.

**Manley Labs CR3A**, new, \$795 w/shockmount, windscreens & case, no risk trial in your studio. Also have used mics & everything else. Get our catalog! Liberal trade policy too. Audio Village, 619-320-0728.

### Want To Buy

**Neumann U87s**, KM84s, AKG 451s, EV RE20s, Sennheiser 421s. W Gunn 619-320-0728.

**RCA 77DXs/44BXs** ribbon, chrome/TV grey, gd cond, BO. R Kaufman, Pams Prods, POB 462247, Garland TX 75046. 214-271-7625, after 3PM CDT.

**77-DX's, 44-BX's, WE KU-3A's** On-Air lights, recording lights & audition lights. Top price paid. Fast response. Bill Bryant Mgmt, 2601 Hillsboro Rd, G12, Nashville TN 37212. 615-269-6131, FAX: 615-292-3434.

## MISCELLANEOUS

### Want To Sell

**Tube output transformers**, UTC LS 18, WE 618. RQ Studio, Larson Rd, N Reading MA, 01864. 508-664-0174.

**Rotron Blowers** for Elcom, Harris, CCA, CSI, McMartin, rebuilt & new. Goodrich Enterprises Inc. 11435 Manderson St, Omaha, NE 68164. 402 493 1886 FAX 402 493 6821

**BE Phase Trak 90** manuals (4), \$25 ea; projection TV w/o stereo, \$500/BO. T Lewczyk, WLTJ FM, 7 Parkway Ctr #780, Pittsburgh PA 15220. 412-922-9290.

**Peerless S-542 F**, output transformer, \$45. R Links, Links Sound, 1656 California St, Berkeley CA 94703. 510-845-5557 eve.

**Electro-impulse 10 kW**, air cooled dummy load; Omega line 80 kW water cooled dummy load, 50 SL, 10 GPM; Scala PR 450, 940-960 MHz paraflector STL antenna. M Everhart, KXYQ, 111SW 5th, Portland OR 97204.

## AUDIO TRANSFORMERS

MODEL	IMPEDANCE (Ω)	POWER (W)	PRICE
MA-12	15000	10000	18
MA-14	15000	10000	20
MA-16	15000	10000	22
MA-18	15000	10000	24
MA-20	15000	10000	26

PREPAID ORDERS RECEIVE FREE AIR PARCEL POST WORLDWIDE

**FREE CATALOG OF AUDIO ACCESSORIES**  
ORDERS (702) 565-3400  
FAX (702) 565-4828  
**SESCOM, INC.**  
2100 WARD DR.  
HENDERSON, NV 89015 USA  
TECH LINE: (702) 565-3993 M-Th 8 am to 4 pm (PST)  
\*Line will be answered by our technician. No answer by 4 another time

Circle (207) On Reader Service Card

**Novatel HS-3300**, cellular phone w/12V battery pac, carry case, full 3W, gd cond w/antenna, \$100. J Cunningham, KEOR/KHKC, Rt 2 Box 113 B, Stonewall OK 74871. 405-265-4496.

### Want To Buy

**Tube output transformers** by WE, UTC, Triad, or any sideband audio transformer for output, esp UTC LS-40, LS-57, Triad HSM-184, WE 618B, 171A/C. RQ Studio, Larson Rd #4, N Reading MA 01864. 508-664-0174.

**Jazz record collections**, 10" LP/12" LP be-bop, swing, dixie, highest prices paid. B Rose, Program Recordings, 228 East 10th, NUNY 10003. 212-674-3060.

## MONITORS

### Want To Sell

**Gates MO-2696**, monitor amp, line amp, used GLG output tubes, \$200. R Franklin, SSS, 1004 Dekalb St, Norristown PA 19404. 215-646-7788.

**McMartin TBM 4500** modulation monitor, needs calibration, \$500. T Lewczyk, WLTJ FM, 7 Parkway Ctr #780, Pittsburgh PA 15220. 412-922-9290.

**TFT 760** EBS encoder/decoder with AM receiver, good condition, works fine, no manual, \$200/BO. J Raynor, WLQE, 16 Village Sq, Moneta VA 24121. 703-297-1188.

**Gates FM & SCA** modulation monitor; TFT EBS receiver-encoder. Jim, 419-782-8591.

### Want To Buy

**McMartin (buy & sell)** any model. C Goodrich, 11435 Manderson, Omaha NE 68164. 402-493-1886 or fax 402-493-6821.

## RECEIVERS & TRANSCEIVERS

### Want To Sell

**AM stereo tuner**, \$25. P Bridger, KGKO, 202 E Cross, Benton AR 72015. 501-778-8257.

## SCA RECEIVERS—ALL TYPES

**Reading Service / Ethnic / Data Professional / Table**  
Will work to meet your receiver needs

**DAYTON INDUSTRIAL CORP.**  
(Manufacturer)  
2237 Industrial Boulevard  
Sarasota, FL 34234  
Tel: 813 351 4454 FAX: 6081

**RCA tube type AM** modulation monitor (1963), \$200. P Bridger, KGKO, 202 E Cross, Benton AR 72015. 501-778-8257.

**AM STEREO RECEIVERS**  
From \$34.95 Portable, Home, Auto  
**RRADCO**  
Phone/FAX 708-513-1386

**Muzak SCA rcvr** for 104.5, Realistic stereo AM tuner. J Kuenzie, KFEX, 511 W 5th St, Washington MO 63090. 314-239-0209.

**Broadcast quality SCA modules.** Why pay a bundle when you can buy factory direct from Background Music Engineering, 1-800-944-0630.

### Want To Buy

**HH Scott FM** receivers w/green or gray front panels. RQ Studio, Larson Rd, N Reading MA, 01864. 508-664-0174.

## REMOTE & MICROWAVE EQUIPMENT

### Want To Sell

**Martí STL 8**, 950 Mhz, xmtr & rcvr, 4' parabolic antenna (2), 250' coax & connectors, 949.5 Mhz, \$2715. P Bridger, KGKO, 202 E Cross, Benton AR 72015. 501-778-8257.

**TFT 7610** needs repair, \$400. T Lewczyk, WLTJ FM, 7 Parkway Ctr #780, Pittsburgh PA 15220. 412-922-9290.

**TFT telemetry return** links units, 8000 xmtr (2), 8100 rcvr (2), one on 450.01, one on 450.98, exc cond, work great, \$1000 ea/BO. J Raynor, WLQE, 16 Village Sq, Moneta VA 24121. 703-297-1188.

**Moseley TCS 8**, clean, \$1000/BO. J Huffman, KMCC. 800-288-5116.

**Burk TC-8** exc cond, orig purchased in 1987, w/manual, \$1100 shipping prepaid. J Murphy, WMXO, Olean NY, 716-223-3951.

**Moseley STL 303** mono xmtrs & rcvrs; Martí SCG8H 38 kHz generator & rcvr. J Kuenzie, KFEX, 511 W 5th St, Washington MO 63090. 314-239-0209.

**Burk ARC-16** w/IP-8 relay panel & voice card, 1 yr old, \$2200; Moseley MRC-1600, exc cond, \$1200; Gates RDC-10, BO. B Spitzer, KKLS, Box 460, Rapid City SD 57709. 605-343-6161.

**RENTALS**  
RENTALS  
RENTALS  
**COMREX**  
3-line extender  
Frank Grundstein 610-642-0978  
Audio/Video Consultants

**Martí tube receiver** 450 MHz, antennas, 200 ft 1/2 feedline, mobile sound systems, 12 VDC, complete. Jim, 419-782-8591.

**Lanier 7200**, ltd use, remote PU & rec activator, \$200. F Reagan, Special Bdct Svc, 203 Westville Ave, Danbury CT 06811. 203-743-7433.

**Comrex 3XR** 3-line decoder, with remote control. Perfect condition. \$2950. S Kirsch, Silver Lake Audio, 2590 Hillside Ct., Baldwin NY 11510. 516-623-6114.

### Want To Buy

**QEI ATS** system for FM. E Moody, KJEM/KESE, 216 N Main St, Bentonville AR 72712. 501-273-9039.

## SATELLITE EQUIPMENT

### Want To Sell

**15C 105A Wegener** mainframe and mini-mainframe for Unistar country. P Baillon, KMCM/KMTA, 1218 Pioneer Bldg, St Paul MN 35101. 612-222-5555.

**Wegener** satellite electronics for Unistar's AM only fnt, comp package \$3500; Wegener satellite card for CNN news, \$500. P Bridger, KGKO, 202 E Cross, Benton AR 72015. 501-778-8257.

**OuterSpace Experts!**  
We SELL \*TRADE\* BUY  
SATELLITE EQUIPMENT  
317-962-8596  
HARRIS ALLIED

**Fairchild 384 Dart** receiver, incl down converter, 15 kHz DATS card, 20 kHz SEDAT card, \$4500; 10' fiberglass dish. T Lewczyk, WLTJ FM, 7 Parkway Ctr #780, Pittsburgh PA 15220. 412-922-9290.

**Scientific Atlanta DAT 32**, 15 kHz audio cards (2), voice cue decoder cards (2), for parts or repair cheap. J Kuenzie, KFEX, 511 W 5th St, Washington MO 63090. 314-239-0209.

**Ariel**  
Need a New Digital Satellite Receiver for DATS/"SEDAT"?  
New DATS 7.5/15?  
New 3.5 Voice Cue? "SEDAT" Cards?  
We are shipping now! We can even convert your S/A 7300/7325!  
Zephyrus for JSA  
Zephyrus 700 SCPC  
We Repair & Rebuild all Popular Receivers Quick Service!  
Satellite Systems (719) 634-6319

15 kHz card for Dart 384 receiver. P Baillon, KMCM/KMTA, 1218 Pioneer Bldg, St Paul MN 35101. 612-222-5555.

### Want To Buy

**Adcom 7550** SCPC satellite, buy or trade. E Moody, KJEM/KESE, 216 N Main St, Bentonville AR 72712. 501-273-9039.

PHONE: 703-998-7600 FAX: 703-998-2966



Call Simone Mullins, Classified Ad Manager, to reserve space in the next issue. Use your credit card to pay, we now accept VISA and MASTERCARD.

# Radio World

5827 Columbia Pike, 3rd Floor  
Falls Church, VA 22041

### Select from these categories for best ad positioning:

- |                            |                           |                          |
|----------------------------|---------------------------|--------------------------|
| Acoustics                  | Consoles                  | Software                 |
| Amplifiers                 | Disco-Pro Sound Equip.    | Stations                 |
| Antennas & Towers & Cables | Financial Services        | Stereo Generators        |
| Audio Production (Other)   | Leasing                   | Tapes, Carts & Reels     |
| Brokers                    | Limiters                  | Tax Deductable Equipment |
| Business Opportunities     | Microphones               | Test Equipment           |
| Cart Machines              | Miscellaneous             | Transmitter/Exciters     |
| Cassette & R-R Recorders   | Monitors                  | Tubes                    |
| CD Players                 | Receivers & Transceivers  | Turntables               |
| Computers                  | Remote & Microwave Equip. | Positions Wanted         |
|                            | Satellite Equipment       | Help Wanted              |

### Classified Advertising Rates Effective January 1, 1994

	1x	3x	6x	12x
1-9 col inch (per inch)	\$60	58	54	49
10-19 col inch (per inch)	55	52	49	44
Distributor Directory	100	95	90	85
Professional Card	65	60	55	50
Classified Line Ad		\$1.50 per word		
Blind Box Ad		\$10 additional		

To compute ad costs: Multiply the number of ad inches (columns x inches) by the desired rate schedule for your per unit cost. Example: a 3" ad at the 1x rate is \$180, at the 3x rate \$174, at the 6x rate \$162, at the 12x rate \$147, etc.

**RENT IT HERE!** Call Steve Kirsch for Details

- COMREX 1, 2, & 3-Line Extenders Switched 56/ISDN Systems
- TELOS Zephyr Digital Phone Hybrids
- GENTNER EFT 3100 3-Line Extenders
- SHURE FP-410 Automatic Mixers
- REMOTE AUDIO PACKAGES

SILVER LAKE AUDIO • 516-623-6114 • FAX: 516-377-4423

**Gentner VCT 1000** dial-up remote control w/command relay acc, \$1200. P Bridger, KGKO, 202 E Cross, Benton AR 72015. 501-778-8257.

**Wegener** mainframe and mini-mainframe for Unistar. P Baillon, KMCM/KMTA, 1218 Pioneer Bldg, St Paul MN 55101. 612-222-5555.

## DISTRIBUTOR DIRECTORY

The following distributors serving the broadcast industry would be glad to help you with any of your requirements.

... country, top 40, news, urban, talk, jazz, the classics, mixed bag ...

**RADIO! The beat goes on!**

**CROUSE-KIMZEY OF ANNAPOLIS**

tops in broadcast equipment  
1-800-955-6800  
ask for Kathleen

**CORNELL-DUBILIER MICA CAPACITORS**  
FROM STOCK  
**JENNINGS VACUUM CAPACITORS**  
FROM STOCK  
**JENNINGS VACUUM RELAYS**  
**SURCOM ASSOCIATES**  
2215 Faraday Ave., Suite A  
Carlsbad, California 92008  
(619) 438-4420



## SOFTWARE/DATABASES

### Want To Sell

**PC SOFTWARE** for Broadcasters. Traffic, Billing, & Accounting. Powerful, inexpensive. Works with automated, satellite or live operations. INTERFACES with popular DIGITAL AUTOMATION SYSTEMS. Try it for 90 days, no obligation.  
**Absolute Broadcast Automation**  
Naples, Florida (813) 643-3689

**U.S. RADIO STATION DATABASE:** stand-alone program containing 11,700+ stations. Many searches, prints mailing labels. MAC/IBM (specify disk size). Visa/MC \$99.95/yr. (+quarterly updates):  
**1-800-626-2360 ext. 300**  
**BBH Software, Inc.**

Circle (8) On Reader Service Card

## STATIONS

### Want To Buy

Looking for dark or troubled AM, FM, or AM/FM combo, with little or no money down, we have expertise to turn it around. FAX info to 219-665-6427.

You could own a working 100,000 Watt FM Radio Station for \$25.00. For information send \$3.00 to: Business Ventures PO Box 642, Rock Springs, Wyoming, 82902

LBA, CP or DARK, South and East of Ohio and Mississippi Rivers, Florida included. D Gibson, 214-684-4907.

## STEREO GENERATORS

### Want To Sell

Collins stereo generator for 310 series. J Kuenzie, KFEX, 511 W 5th St, Washington MO 63090. 314-239-0209.

# SERVICES

## NRSC PROOFS

For \$500, you can comply with the new \$73.44 spec & have the documentation in hand to prove it!  
**MICROWAVE FREQUENCY SERVICES**  
Services available in Southern/Central CA, AZ and NV. Group discounts available.  
**Call 1-800-2-GET-LEGAL**  
fax 310-425-6299 avail 24 hrs

## Tower Sales & Erection

Turkey Site Development Installation & Maintenance  
AM/FM Broadcast, TV Microwave Systems, Antennas & Towers  
**TOWERCOMM**  
Communications Specialists  
Ben Wall President 6017 Triangle Dr Raleigh, NC 27613 (919)781-3496  
Gen Contractor #25#91 Fax (919)781-6454

## REMOTE EQUIPMENT RENTALS

**COMREX and GENTNER**  
1, 2 & 3-Line Extender Systems  
Now With The New GENTNER EFT-3100  
MARTI VHF/UHF RPU Systems  
Switched-56 Systems  
Call or FAX Dwight Weller  
**WELLER AUDIO-VISUAL ENGINEERING**  
Baltimore, MD  
Phone: (410 or 800) 252-8351  
FAX: (410) 252-4261

## LOCATION SERVICES IN THE UNITED KINGDOM

Planning remotes from the U.K.?  
we provide a comprehensive service  
• we organize venues for your shows  
• we provide temporary equipment  
• live links via ISDN/Switched 56  
• experienced radio engineers  
• we help you line-up guests  
Contact New York (212) 229-9118  
*Good Morning from Great Britain*  
Wired for Sound Ltd., London N15

**Fidelipac** 300 carts, \$10 for lot + shpg. Ampex 7 boxes, as new, 40/\$12 + shpg; Ampex 407, 7 reels, used, no splices, 2/\$5 + shpg. M Saady, First City Rcdg, 213-05 75 Ave, #22, Bayside NY 11364.

**Huge music format w/3200+ hit songs** from 50's-80's, on Scotchcart II's, used for 6 mos, \$8500; Scotchcart II's, 310 3.5 mins, \$2 ea. B Lord, Lord Bdcgt, 13313 SE 208th St, Kent WA 98042. 206-631-2374.

**TAPE WORLD 1-800-245-6000 Only 4.98 Shipping!**  
We'll beat any total price! FREE CATALOG Fax 413-233-8258

SONY	MAXELL	TDK	FUJI
DAI 120 7.49	XL11 90 1.79	E-120HS 1.89	new 1274 11.49
DAI 120 mc 9.99	XL11 590 2.29	E-120HG 2.59	SVHS120 7.89
T 120V 2.39	XL11 5100 2.69	SA 90 1.69	BMA 120 3.49
E-120HG 3.29	DAI-120 2.99	SAX 90 2.19	JVC
L-750HG 3.99	T120HG 2.99	HL-8-120 5.99	T120SX 1.79
new 74 11.99	SVHS120 7.49	DAI-120 6.99	SVHS120 6.99

M-F, 8-5 VISA, MC, DISC. 220 SPRING ST. BUTLER, PA 16003  
COVER 400 DIFFERENT BRANDS • SAME DAY SHIPPING

**1960's & 1970's records**, easy listening, 12 in, stereo, gd cond, \$99 for 100. R Franklin, SSS, 1004 Dekalb St, Norristown PA 19404. 215-646-7788.

**ABCO stainless steel, wire carousels** (2), hold 500 carts, like new, \$100 ea/\$175 both. KFEZ Radio, 8615 W 72nd Terr, Overland Park KS 66204. 913-432-5072.

**Format Forty-One:** 52 reels dig mastered w/legends, \$500; Drake/Che-naull Great Gold, 52 reels w/legends + 7 reels of Xmas music, \$350; Scotch-carts, 1500 total, most 3-5 mins, avail 6/1, \$1800. Dave, WCIT/WLSR, 1301 N Cable Rd, Lima OH 45804, 419-228-9248.

**Fidelipac Mastercart II**, new in boxes of 10, :20 and :40; Dynamax cobalt tape carts, 5.5 min, 250 carts avail, BO B Gyorgy, El Dorado Communications, 163 Fail Lane, Placerville CA 95667. 916-622-3818.

**Pams Jingles** ref tapes, 1951-1976, BO. R Kaufman, Pams Prods, POB 462247, Garland TX 75046. 214-271-7625.

### Want To Buy

**Pre-recorded open reel tapes**, including master dubs, RCA, Mercury, Livingston, Westminster, etc, 2 track, in-line or stacked heads, all categories, labels and artist. P Chance, Imperial Analog, 925 Clinton Street, Philadelphia PA 19107, 215-574-8147.

**10" music reels** from TM Programming, all fm's, exp stereo rock; Rick Dees weekly top 40 records & CDs. J Egloff, TKR Cable, 5582 Rapid Run Pike, Cincinnati OH 45238. 513-922-7049 after 5 est.

**Fidelipac/Audlopac Mastercart II** gold or AA-4 light blue in 2:30 through 4:00 lengths, must be in very good condition, call after 3PM CST. 214-271-7625.

## TAX DEDUCTIBLE

### Want To Sell

**Off shore missionary network** needs STL, non FCC approved ok, will pay shipping or PU. K Starcher, 1570 Meriline, Cuyahoga Falls OH 44221. 216-920-8035.

## TEST EQUIPMENT

### Want To Sell

**Leader LBO 518** 100 MHz scope. J Phillips, 414 Washington Ave, Defiance OH 43512. 419-782-8591.

**Leader LBO 518** 100 MHz scope. J Phillips, 414 Washington Ave, Defiance OH 43512. 419-782-8591.

**US Army TS 303/G**, made by RCA, radio test set w/orig manual, \$50. J Cunningham, KEOR/KHKC, Rt 2 Box 113 B, Stonewall OK 74871. 405-265-4496.

## TRANSMITTERS

### Want To Sell

**RCA BTA 1R1** AM xmtr 850 khz, 1963, will return to any freq, \$2500. P Bridges, KGKO, E Cross, Benton AR 72015. 501-778-8257.

**DEMOED EQUIPMENT**  
**BEXT Inc.** has a few demoed exciters, amplifiers and STL's for sale. All demoed systems are sold first come first served and have the same 2 year warranty as BEXT's new equipment. For information:  
**619-239-8462**

**Harris FM 2.5**, 1980 w/exciter, \$8500. T Beschta, WAGE, POB 703, Rice Lake WI 54868. 715-234-9059.

**McMartin BF 3.5M** w/current exciter, can be modified to 5.5 kW, new in '82, selling due to power increase, \$15,000/BO; 1 kW Wilkinson in gd cond, Gates FMIC for parts, McMartin 15K; Wilkinson 4K, Gates 1K. F Morton, KMGZ, POB 7953, Lawton OK 73506. 405-536-9530.

**CSI 3kW 1981**, single phase, exc cond, \$10,500; 1989 QEI, 30,000 W, exc cond, \$28,500 J Davis, SCB, POB 7762, Amarillo TX 79114. 806-355-1187.

**For the ABSOLUTE LOWEST PRICES on any size transmitters made in the U.S.A.**  
Call Bill Hoffman for details at **518-743-1601**

**LPB 30 W**, traveler info xmtr w/antenna & tuning unit. J Kuenzie, KFEX, 511 W 5th St, Washington MO 63090. 314-239-0209.

## FM - TRANSMITTERS

Factory new not used. Why buy a used transmitter when you can own a new FM Transmitter for about the same cost? Call JIMMIE JOYNT at 214-335-3425.

**Blonder Tongue MAM**, FM on 88.5, 100 VAC, 19" rack mount, vgc, BO. B Gyorgy, El Dorado Communications, 163 Fail Lane, Placerville CA 95667. 916-622-3818.

**Collins 831D-2FM** (4), currently on air w/new tube. D Royer, WBBC, PO Drawer 192, Blackstone VA 23824. 804-292-4146.

**New McMartin 20 W, BIM-8000** FM exciters. New McMartin IBM1005D 1M relay/rebroadcast rcvrs; also some used McMartin B910 exciters 15W. Goodrich Inter., 11435 Manderson St., Omaha, NE 68164. 402-493-1886 fax 402-493-6821

**CCA 1 kW, 1280 kHz**, rebuilt, works exc, used tube, \$7000 or \$8000 on your freq w/new tubes + ship. Fax: J Velazquez, 809-840-1588.

# CONSULTANTS

**COMMUNICATIONS TECHNOLOGY ASSOCIATES, P.A.**  
• AM/FM/TV/MDS FACILITY DESIGN & FIELD ENGINEERING  
• DIRECTIONAL ANTENNA DESIGN AND OPTIMIZATION  
• FCC APPLICATIONS AND ALLOCATION STUDIES  
• COMPREHENSIVE COMPUTER-ASSISTED ENGINEERING SERVICES  
TED LONG, P.E. BARRON HOFFMAN  
**910-688-3632**  
FAX/DATA 910-490-3298  
INTERNET CTAVAL.COM

**PC - SOFTWARE**  
AM FM TV Search Programs  
Contour Mapping-STL Paths  
RF HAZ-1990 POP Count  
FAA Tower-Draw Tower  
**Doug Vernier**  
Broadcast Consultant  
1600 Picturesque Dr  
Cedar Falls, IA 50613  
**800-743-DOUG**

**EVANS ASSOCIATES**  
Consulting Communications Engineers  
TV • FM • AM • ITFS • Satellite  
FCC Applications, Design and Field Engineering  
Video/Data/Voice • Light Fiber & Microwave • Wide-Area Networks & STL's  
**210 S. Main Street**  
Thiensville, WI 53092  
(414) 242-6000 • FAX (414) 242-6045  
Member AFCCE

**W. LEE SIMMONS & ASSOC., INC.**  
BROADCAST TELECOMMUNICATIONS CONSULTANTS  
5 Gracefield Road  
Hilton Head Is., SC 29928  
**1-800-277-5417**  
**803-785-4445**  
FAX: 803-842-3371

**MAL2 FM STUDY SOFTWARE**  
since 1987  
was \$995 — now only \$195  
inexpensive quarterly data updates  
from the *Maltech Company, Inc.*  
**602-703-1009**

North America RF & Audio  
**Mirkwood Engineering Services**  
Broadcast and Telecommunications Consultants  
Multidiscipline Engineering and Planning Firm including • Application & Allocation Services  
• Project, Engineering & Construction Management • Site Acquisition  
• Rural & Remote Site Installations  
• Field Service • Studio Design & Installation  
50 Park Ave. Claremont, NH 03743  
(603) 542-6784

**MLJ**  
Moffet, Larson & Johnson, Inc.  
Consulting Telecommunications Engineers  
**Two Skyline Place, Suite 800**  
5203 Leesburg Pike  
Falls Church VA 22041  
(703) 824-5660  
FAX: 703-824-5672  
Member AFCCE

**MULLANEY ENGINEERING, INC.**  
Consulting Engineers  
• Design & Optimization of AM Directional Arrays  
• Analysis for New Allocation, Site Relocation, and Upgrades  
AM-FM TV LPTV  
Wireless Cable (MDS/MMDS/ITFS/OFS)  
• Environmental Radiation Analysis  
• Field Work  
• Expert Testimony  
9049 Shady Grove Court  
Gaithersburg, MD 20877  
Phone: (301) 921-0115  
Fax: (301) 590-9757

**Consulting Communications Engineers**  
• FCC Data Bases  
• FCC Applications and Field Engineering  
• Frequency Searches and Coordination  
• AM-FM-CATV-ITFS-LPTV  
**OWL ENGINEERING, INC.**  
1306 W. County Road. F, St. Paul, MN 55112  
(612)631-1338 \*Member AFCCE\*

**JEFFREY W. PEARCE**  
Professional Broadcast Technical Consultant  
General Engineering Services  
• Transmitter & Studio Site Upgrades  
& New Construction • STL/TSI Systems • RPU/RENG Systems • Remote Control Systems  
• Satellite Systems • Station Inspections  
3131 N. Lewis Ave., Waukegan, IL 60087  
**Phone 708-249-9140**  
**FAX 708-336-6497**

**T. Z. Sawyer Technical Consultants**  
AM-FM-TV-LPTV  
• FCC Applications & Exhibits • Frequency Studies  
• Experimental Authorizations • Class Upgrades  
• AM Directional Antennas • STL Applications  
• High Power Antenna Arrays • Station Inspections  
**1-800-255-2632**  
FAX: (301) 913-5799 • 6204 Highland Dr. • Chevy Chase, MD 20815

**Contact Radio World Newspaper for availabilities**  
**P.O. Box 1214 Falls Church VA 22041**  
**1-800-336-3045**





**TRANSMITTERS...WTS**

Spare parts for CCA AM50,000D, including, HV transformer, mod. transformer, mod. reactor, HV filter choke, tube sockets and more. Call Transcom Corporation 800-441-8454 or 215-884-0888.



**NEW McMARTIN BF-5K**  
Lowest priced tube replacements

5500 W FM, broadband grounded grid output circuit, VSWR protection, excellent efficiency 75-80% automatic recycling & overload status. Fully remote controlled. FCC approved to 5500 watts.

**Goodrich Enterprises, Inc.**  
11435 Manderson Street  
Omaha, NE 68164  
402-493-1886  
FAX: 402-493-6821

**Want To Buy**  
Need 1 kW AM xmtr, prefer operational, RCA BTA-1, Gates BC-1, etc, will arrange shipping. G Goldsmith, POB 5786, Beverly Hills CA 90209. 310-696-0177.  
RCA 3TF 3E1 or CSI 3 kW. Fax: Henberto Velazquez, 809-840-1588.  
McMartin AM/FM xmtr, any model, exciter or stereo modules. Goodrich Ent., 11435 Manderson, Omaha NE 68164. 402-493-1886.

**TUBES**

**Want To Sell**  
4CX250B, 4-400, 833, 813, 5CX1500, 4-1000, all types, full warranty EIMAC, Ampere, RCA. Westgate 800-213-4563.

**REBUILT ELECTRON TUBES**  
Partial List: 6623, 23791, TH150, 6425F, 5604, 6696, 6697, 5681, 5682, 5671, 7804, 3CX10,000H3, 3CX20,000H3, 4CX5000A, 4CX35,000C  
Worn out power tubes purchased  
**Vacuum Tube Industries, Inc.**  
1-800-528-5014  
508-584-4500 X75

**ECONCO**  
Quality Rebuilt Tubes  
Approximately 1/2 the Cost of New  
Call for Our Price List  
800-532-6626  
916-662-7553  
FAX 916-666-7760  
Circle (54) On Reader Service Card

**For the Best Price**  
& 24 Hr service on transmitting tubes call 402 493 1886 day or night. FAX 402 493 6821.



**Svetlana**  
ELECTRON DEVICES

**Quality\* Power Tubes**

3CX15,000A7	4CX1500A
3CX10,000A7	4CX350A
3CX3000A7	4CX350AC
3CX2500F7	4CX250B
3CX2500F3	4CX250BC
3CX2500A3	4CX250R
3CX2500H3	4X150A
YC130	5CX1500A
4CX15,000A	5CX1500B
4CX10,000D	811A
4CX5000A	813
4CX5000R	833A
4CX3500A	8560AS

- Watch this list grow.
- Manufactured in Russia's largest power tube factory.
- Generous\* warranty based on high quality.
- Honest prices based on quality at low cost.
- Shipment from USA stock.

**Broadcasters**  
Call: 205-882-1344  
FAX: 205-880-8077  
**OEMs, Distributors, Volume Purchasers**  
Call: 415-233-0429  
FAX: 415-233-0439  
Circle (31) On Reader Service Card

**D and C Electronics Co.**  
**Lowest Price on Tubes including:**  
4-1000A/3-1000Z/8877/4CX250B/833A  
4-500/5-500/4-400/4CX 3500/5CX1500  
and much more!  
Factory Warranty!  
**1-800-881-2374 (904) 688-2374**  
Se habla Español  
FAX: (904) 683-9595

20 kW 50 dummy load, air cooled, 115 volt blower, flat to 30 MHz, \$2950 FOB NC. J.S. Betts Co, 704-526-5482.

**Want To Buy**  
VACUUM POWER TUBE REBUILDERS SINCE 1940  
**Freeland Products, Inc.**  
"If you don't need TO SAVE MONEY we can't help you."  
However, if saving money interests you... WE CAN REBUILD YOUR DUDS (used tubes) for about 1/2 the cost of new tubes!  
Call TODAY 1-800-624-7626 For a FREE Information Packet  
WE BUY MANY TYPES OF USED TUBES

**WANTED!**  
**Electron Tubes**  
All Kinds & Quantities  
Metal Case Caps  
Black Beauties  
*Howluff Enterprises*  
**CHARLIE DRIPPS**  
4331 MAXSON RD.  
EL MONTE, CA 91732  
(818) 444-7079 • (800) 334-8223  
FAX (818) 444-6863

**TURNTABLES**  
**Want To Sell**  
**Audiometrics QEC TP84** preamp, \$250; SL-1200MK2 turntable system, like new, \$350. Kacee Production Agency, POB 712, Luverne MN 56156. 507-283-4588.  
**RTS-405** stereo preamp (2), used 6 mos, \$140 ea + shipping. B Lord, Lord Broadcasting, 13313 SE 208th St, Kent WA 98042. 206-631-2374.  
**Sparta** w/stereo preamp equalizers (2), \$300 ea; Rek-O-Kut w/mono preamp equalizers (2), \$200 ea. P Bridger, KGKO, 202 E Cross, Benton AR 72015. 501-778-8257.

CB77 (3) w/arms & cartridges; Russco mono preamp, Russco stereo preamp; Gates mono preamp. J Kuenzie, KFXE, 511 W 5th St, Washington MO 63090. 314-239-0209.

**ADVERTISING SPACE IN RADIO WORLD'S BROADCAST EQUIPMENT EXCHANGE IS AVAILABLE!**  
Call **800-336-2045** for more information!

**TRANSCOM CORP.**  
Serving the Broadcast Industry Since 1978  
Fine Used AM & FM Transmitters and Also New Equipment  
For the best deals on Celwave products, Andrew cable and Shively antennas.

300 watt FM 1989 TTC 300J	1 kW AM 1974 Harris BC1H1
1 kW FM 1978 Collins 831C2	5 kW AM 1968 CCA AM5000D
2.5 kW FM 1978 CCA 2500R	5 kW AM 1979 Continental 315F
3 kW FM 1975 CCA 3000D	5 kW AM 1977 RCA BTA 5L
3 kW FM 1980 CSI 3000E	10 kW AM 1983 Harris BC10H
3 kW FM 1974 Harris FM3H	50kW AM 1986 Continental 317C-3 with spare parts
5 kW FM 1991 BE FM5B	50kW AM 1982 Harris MW50B with spare parts

1077 Rydal Road #101  
Rydal PA 19046  
800-441-8454 • 215-884-0888 • FAX No. 215-884-0738  
Circle (146) On Reader Service Card

**Dare to Compare!**  
We challenge you to find all these features in any other transmitter.... at any price!

- ✓ Built-in Solid State Emergency Transmitter
- ✓ Exclusive Controller Override System
- ✓ Built-in Line Surge Protection
- ✓ Exclusive '8 Time' Fault Recycling
- ✓ Automatic Power Level Control
- ✓ VSWR Foldback & Protection
- ✓ Lowest Operating Cost

**The 'MK' Series**  
FM Grounded Grid Transmitters from 1.5kW to 50kW

Meeting the needs of Broadcasters Worldwide  
"The Transmitter People"  
**Energy-Onix**  
752 Warren Street  
Hudson NY 12534  
518-828-1690  
FAX: 518-828-8476  
Circle (192) On Reader Service Card

To advertise in Radio World's BROADCAST EQUIPMENT EXCHANGE...  
**Radio World**  
World Radio History  
Contact **Simone Mullins**  
Phone: **800-336-3045**  
FAX: **703-998-2966**



# ACTION-GRAM

## Equipment Listings

Radio World's Broadcast Equipment Exchange provides a FREE listing service for radio stations and recording studios only. All other end users will be charged. Simply send your listings to us, following the example below. Please indicate in which category you would like your listing to appear. Mail your listings to the address below. Thank you.

Please print and include all information:

Contact Name \_\_\_\_\_ I would like to receive or continue receiving Radio World FREE each month.  Yes  No

Title \_\_\_\_\_ Signature \_\_\_\_\_ Date \_\_\_\_\_

Company/Station \_\_\_\_\_ Please Circle only one entry for each category:

Address \_\_\_\_\_

City/State \_\_\_\_\_

Zip Code \_\_\_\_\_

Telephone \_\_\_\_\_

Brokers, dealers, manufacturers and other organizations who are not legitimate end users can participate in the Broadcast Equipment Exchange on a paid basis. Line ad listings & display advertising are available on a per word or per inch basis.

**I. Type of Firm**

D. Combination AM/FM station F. Recording studio  
 A. Commercial AM station G. TV station/teleprod facility  
 B. Commercial FM station H. Consultant/ind engineer  
 C. Educational FM station I. Mfg. distributor or dealer  
 E. Network/group owner J. Other \_\_\_\_\_

**II. Job Function**

A. Ownership G. Sales Manager  
 B. General management E. News operations  
 C. Engineering F. Other (specify) \_\_\_\_\_  
 D. Programming/production \_\_\_\_\_

WTS  WTB  Category: \_\_\_\_\_

Make: \_\_\_\_\_ Model: \_\_\_\_\_

Brief Description: \_\_\_\_\_

Price: \_\_\_\_\_

WTS  WTB  Category: \_\_\_\_\_

Make: \_\_\_\_\_ Model: \_\_\_\_\_

Brief Description: \_\_\_\_\_

Price: \_\_\_\_\_

WTS  WTB  Category: \_\_\_\_\_

Make: \_\_\_\_\_ Model: \_\_\_\_\_

Brief Description: \_\_\_\_\_

Price: \_\_\_\_\_

WTS  WTB  Category: \_\_\_\_\_

Make: \_\_\_\_\_ Model: \_\_\_\_\_

Brief Description: \_\_\_\_\_

Price: \_\_\_\_\_

WTS  WTB  Category: \_\_\_\_\_

Make: \_\_\_\_\_ Model: \_\_\_\_\_

Brief Description: \_\_\_\_\_

Price: \_\_\_\_\_

\*Closing for listings is every other Friday for the next month's issue. All listings are run for 2 issues unless pressed for space or otherwise notified by listee.

## Broadcast Equipment Exchange

PO BOX 1214, Falls Church, VA 22041 • Tel: 800-336-3045 • Fax: 703-998-2966

# ADVERTISER INDEX

This listing is provided for the convenience of our readers. Radio World assumes no liability for inaccuracy.

Page No.	Advertiser	Reader Service No.	Page No.	Advertiser	Reader Service No.
43	AMP Services	196	23	Jones Satellite	74
6	ATI	29	22	La Palma Broadcasting	188
25	Alesis Corp.	165	22	Man From Mars	20
28,29	Arrakis	124	52	Marathon	123
9	Associated Press	205	46	Monroe Electronics	176
43	Audio Broadcast Group	150	20	Motor Racing Network	22
41	Audio Precision	105	11	Murphy Studio Furniture	129
2	Audioarts/Div. of Wheatstone	53	34	Myat	136
45	Audiopak	214	17	National Public Radio	118
55	Auditronics	2	46	Omega Scientific	38
46	Autogram	15	10	Orban/AG/Dbx	201
52	BBH Software	8	33	Pacific Recorders	117
30	BSW	97	46	Phasetek	130
31	Belar	16	37	Potomac Instruments	71
36	Benchmark Media Systems	64	8	Premiere Radio Networks	145
43	Broadcast Devices	4	21	Prime Sports Radio	121
4	Burk Technology	115	46	Pristine Systems	127
35	CCA Electronics	59	36	Prophet Systems	18
48	CRL	131	41	QEI	50
26	California Digital	181	9	Radio Concepts	82
3	Comrex	212	20	Radio Concepts	65
46	Comrex	84	19	Radio Programming & Management	57
13	Continental Electronics	163	49	Radio Resources	92
20	Copra Media Productions	27	12	Radio Spirits	100
47	Cutting Edge	175	20	Reef Industries	19
31	Dataworld	184	43	S.C.M.S.	215
43	Econco	35	38	SMC Wireless	85
53	Econco	54	3	Satellite Systems Inc.	34
53	Energy-Onix	192	24	Scott Studios	138
40	Fidelipac	149	51	Sescom	207
18	Fidelipac	169	36	Shalco Inc.	126
20	Format Productions	96	43	Sharp Communications	81
32	Gentner	103	46	Shively Labs	173
22	Ghostwriters	91	7	Sony	—
43	Gorman Redlich	58	44	Superior Electric	219
20	Halland Broadcast	119	35	Svetlana Electron Devices	101
49	Hall Electronics	161	53	Svetlana Electron Devices	31
27	Harris Allied	142	20	Syndicom	211
16	Harris Allied	209	20	Syndicom	88
1	Harris Allied	76	39	Telos	24
42	International Datacasting Corp	47	46	The Management	107
15	Intersat	5	53	Transcom Corp.	146
49	J & I Audio/Video	46	49	USA Foam	23
36	J Squared Technical Service	40	56	Wheatstone	69
22	J.R. Nelson	77	43	Zercom	12

Publisher .....Stevan B. Dana  
 Associate Publisher .....Carmel King  
 Marketing Consultant .....Al Leon  
 Marketing Assistant .....Annette Deutscher  
 Production Director .....Kim Lowe  
 Production Manager .....Julianne Stone

Production .....Vicky Baron, Lisa Lyons, Lisa Mamo  
 Ad Coordinator .....Kathy Jackson  
 Ad Coordination Manager .....Simone Mullins  
 Circulation Director .....Rebecca Seaborg  
 Accounts Receivable .....Steve Berto

### Advertising Sales Representatives

U.S. East: Skip Tash .....703-998-7600 Fax: 703-998-2966  
 U.S. West: Dale Tucker .....916-721-3410 Fax: 916-729-0810  
 International: Stevan B. Dana .....+1-703-998-7600 Fax: +1-998-2966  
 Europe: Dario Calabrese .....+39-2-753-0274 Fax: +39-2-753-2697  
 Japan: Eiji Yoshikawa .....+81-3-3327-2688 Fax: +81-3-3327-3010

Free Subscriptions are available upon request to professional broadcasting and audiovisual equipment users. For address changes, send current and new address to RW a month in advance at P.O. Box 1214, Falls Church, VA 22041. Unsolicited manuscripts are welcomed for review; send to the attention of the appropriate editor.



**Don't gamble with your advertising dollars.**

Advertise in Radio World and reach 22,000+ subscribers. Call Simone at **1-800-336-3045** today!

## SUBSCRIPTION/READER SERVICE FORM

### Radio World

#### FREE Subscription/Renewal Card

I would like to receive or continue receiving Radio World FREE each month.  Yes  No

Signature \_\_\_\_\_ Date \_\_\_\_\_

Please print and include all information:

Name \_\_\_\_\_ Title \_\_\_\_\_

Company/Station \_\_\_\_\_

Address \_\_\_\_\_

City \_\_\_\_\_ State \_\_\_\_\_ ZIP \_\_\_\_\_

Business Telephone ( ) \_\_\_\_\_

Please circle only one entry for each category:

#### I. Type of Firm

- D. Combination AM/FM station F. Recording Studio  
 A. Commercial AM station K. Radio Station Services  
 B. Commercial FM station G. TV station/teleprod facility  
 C. Educational FM station H. Consultant/ind engineer  
 E. Network/group owner I. Mfg. distributor or dealer  
 J. Other \_\_\_\_\_

#### II. Job Function

- A. Ownership G. Sales manager  
 B. General management E. News operations  
 C. Engineering F. Other (specify) \_\_\_\_\_  
 D. Programming/production \_\_\_\_\_

#### Reader Service

June 1, 1994 Use until September 1, 1994  
 Please first fill out contact information at left. Then check each advertisement for corresponding number and circle below.

#### Purchasing Authority

1. Recommend 2. Specify 3. Approve

- 001 023 045 067 089 111 133 155 177 199  
 002 024 046 068 090 112 134 156 178 200  
 003 025 047 069 091 113 135 157 179 201  
 004 026 048 070 092 114 136 158 180 202  
 005 027 049 071 093 115 137 159 181 203  
 006 028 050 072 094 116 138 160 182 204  
 007 029 051 073 095 117 139 161 183 205  
 008 030 052 074 096 118 140 162 184 206  
 009 031 053 075 097 119 141 163 185 207  
 010 032 054 076 098 120 142 164 186 208  
 011 033 055 077 099 121 143 165 187 209  
 012 034 056 078 100 122 144 166 188 210  
 013 035 057 079 101 123 145 167 189 211  
 014 036 058 080 102 124 146 168 190 212  
 015 037 059 081 103 125 147 169 191 213  
 016 038 060 082 104 126 148 170 192 214  
 017 039 061 083 105 127 149 171 193 215  
 018 040 062 084 106 128 150 172 194 216  
 019 041 063 085 107 129 151 173 195 217  
 020 042 064 086 108 130 152 174 196 218  
 021 043 065 087 109 131 153 175 197 219  
 022 044 066 088 110 132 154 176 198 220

Copy & Mail to: Radio World, PO Box 1214, Falls Church, VA 22041, or FAX to: 703-998-2966



# Auditronics reinvents radio with...

# THE *Destiny* 2000

## PROGRAM MANAGEMENT SYSTEM



**The most exciting NEW advance in radio broadcasting since the advent of computer technology!**

You won't have to scrap your existing computer equipment. When the Destiny 2000 Program Management System and Console are installed, it will integrate your current computers and equipment into one master program management system. Your music schedule and traffic schedule computers, as well as your production room hard disk computers, can be networked into one system,

all controlled by the Destiny 2000 console and computer.

It's the control room of tomorrow! The clutter is gone. The commercial copy, the music and traffic logs are in the computer. The CD's are in the jukebox and the tape carts are in the hard disk storage. The control room of tomorrow is here today... tapeless and paperless.

*The Sound Of Perfection*

**AUDITRONICS**

3750 Old Getwell Road • Memphis, TN 38118 • (901)362-1350 • FAX (901)365-8629

Circle (2) On Reader Service Card



# Every City Has One.

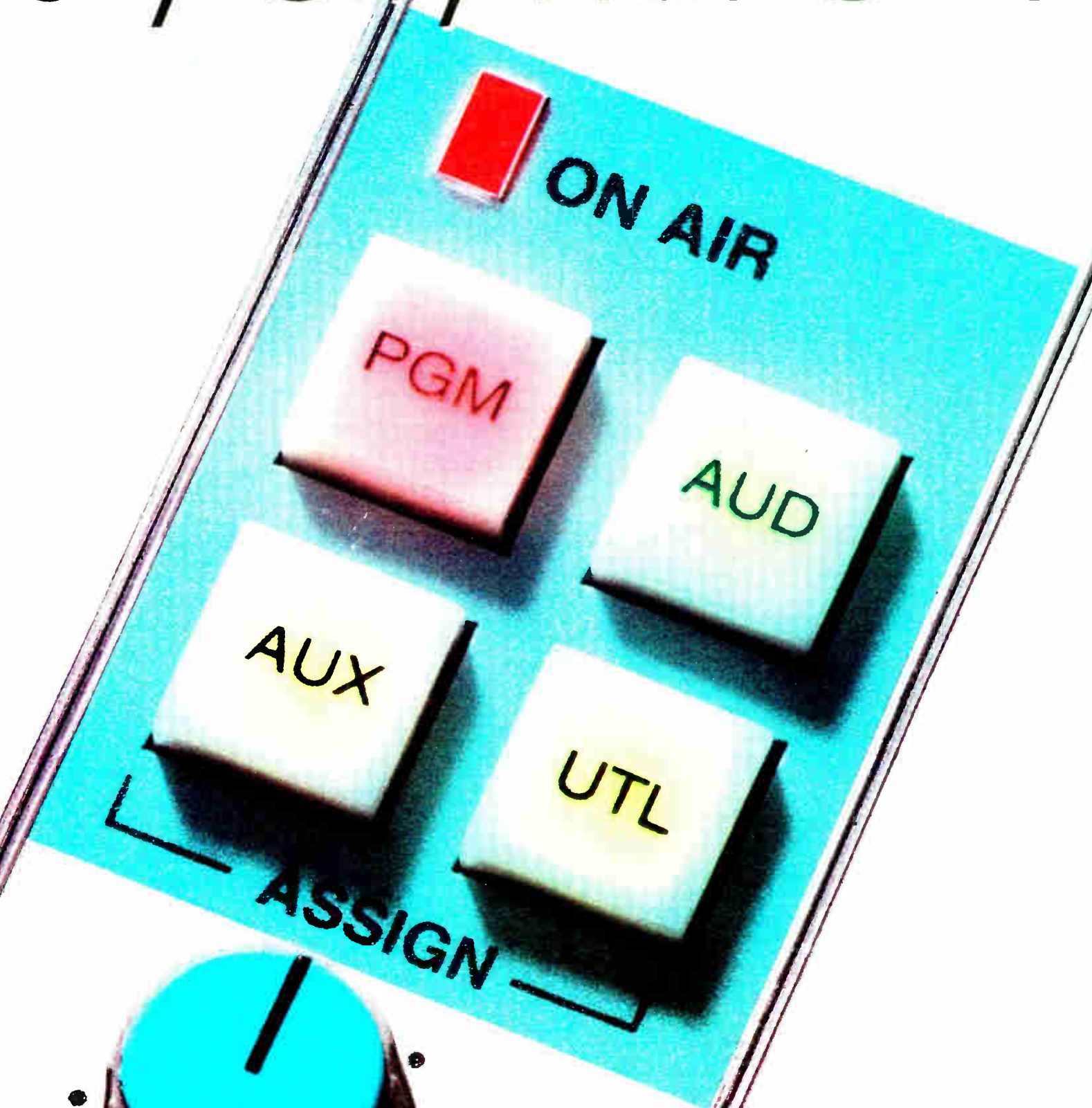

**A Number One Station.**

The A-6000 On-Air Console is for you.

Wheatstone<sup>®</sup> Corporation

7305 Performance Drive, Syracuse, NY. 13212  
(tel 315-452-5000 / fax 315-452-0160)

Circle (69) On Reader Service Card

World Radio History