

# Radio World



Vol 19, No 18

Radio's Best Read Newspaper

September 6, 1995

## 'High Stakes Musical Chairs'

### New Radio Ownership Regulations Will Affect All Market Sizes

By Lynn Meadows

**WASHINGTON** It is a good time to be a broker.

It also is a good time for radio owners to reassess their business strategies.

The House and Senate passed different versions of the Communications Act of 1995, both of which lift ownership limits on how many radio stations one owner can own. Lawmakers returning from their August recess must meet to work out a compromise bill.

However the bill is slashed, radio ownership deregulation is sure to make the final cut.

And despite veto threats from President Clinton—unless lobbyists manage to change some votes at the last minute—the legislative margins in both houses are veto proof.

#### History repeats itself

"It is 1987, '88 and '89 all over again," said Robert Mahlman, partner in The Mahlman Company, referring to the duopoly rules passed in the 1980s that prompted a buying and selling frenzy.

Even if the telecommunications bill

somehow fails to pass, brokers expect the consolidation to continue.

Bill Steding, managing director of the Star Media Group, said that most of what his company completed this year was driven by the duopoly rules, and most of his current work involves consolidation.

Radio owners have had "a taste" of what they can do, he explained. With or without the legislation, Steding said he believes they will figure out a way to continue.

Media broker Ray Rosenblum from Pittsburgh said he agrees that the consolidation will happen regardless of the bill.

## WJDM Moves to 1660 kHz

**ELIZABETH, N.J.** In October, after years of waiting, WJDM(AM) here will be the first station in the U.S. to broadcast from the expanded AM band.

Six years ago, President Bush signed a law that WJDM should be at the top of the list of stations that will move to the new frequencies because Elizabeth is the largest city in the country without nighttime service.

The Federal Communications

If the legislation does not pass this year, he said he doubts it would get as far next year in a presidential election year.

According to Steding, about half the stations in the United States have doubled up with another station either in duopolies or LMAs (Local Marketing Agreements). Consolidation brings savings when studios, sales teams and production teams are combined. The negatives include layoffs and less diversity.

#### Market by market

How a market will be affected by lifting the ownership caps depends on the size of the market.

Steding said he eventually sees one or two

continued on page 6 ▶

The latest in headphones, monitors and PA equipment showcased in Buyer's Guide.



45,000 Watts of HeadBansin  
ButtKickin Power  
45,000 watts • No Combiner • Less than 21 sq. ft.

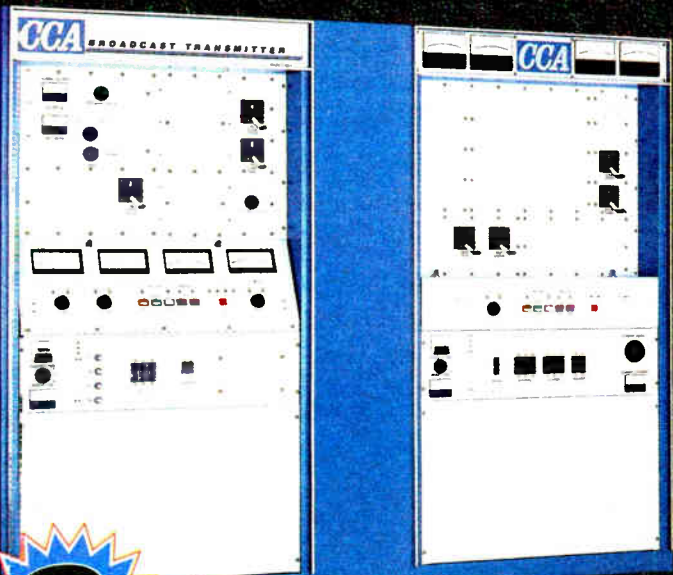

- Single-ended PA in separate cabinet from driver.
- Driver may be connected directly to antenna in case of emergency.
- DC grounded-grid triode.
- 24-hour service, 365 days-a-year.

# CCA

**3**  
YEAR WARRANTY

**CCA Electronics**  
P.O. Box 426 • 360 Bohannon Road  
Fairburn (Atlanta), Georgia 30213 USA  
1-770-964-3530 • FAX: 1-770-964-2222

Circle (9) On Reader Service Card  
See Us At WME Booth 635

World Radio History

—Lynn Meadows



# NEWSWATCH

## Arbitron Offers New Service

**NEW YORK** The Arbitron Company will introduce a qualitative, local market research service for radio stations, TV stations and cable systems in 38 medium-sized markets next year.

RetailDirect will provide broadcasters with detailed profiles of the consumers in a local market including how they read local newspapers, shop at local retailers, and how they patronize restaurants, banks, and other local market businesses.

RetailDirect will replace Arbitron's LocalMotion services in 11 markets. Arbitron will also offer training on how to use the information. General Manager Pierre

Bouvard said the philosophy is to help stations focus on a retailer's business and customers rather than the station's audience.

## Local Legend Sells

**RENO, Nev.** A new group owner is moving into the Reno radio market. Long time Reno station owner Lorraine Arms is selling KRNO-FM, KWNZ-FM, and KCBN(AM) to Patterson Broadcasting for \$4.1 million.

The two signed an agreement in August. Arms is a 29-year radio veteran. She started as a sales person in 1966 at KFBB in Great Falls, Mont., and moved up through the ranks to become owner of KCBN(AM) in Reno in 1970.

She put KRNO-FM on the air in 1974 followed by KRLV-FM in Las Vegas in 1987. Arms became the first woman president of the Nevada Broadcasters Association serving two terms. She was also the first woman president of the Reno Chamber of Commerce and the Reno Advertising Club.

Arms had been planning to retire for a long time. She expects to divide her time between a yacht offshore in Mexico and children and grandchildren in Montana.

## Harris Allied First

**QUINCY, Ill.** Harris Allied powered up the world's first 1000 kW digital solid state transmitter this summer. The Voice of America ordered the unit last year to replace an aging transmitter in Thailand.

The water-cooled unit is divided into five 200 kW power blocks. Each power block

can be turned off individually for maintenance while the station remains on the air.

The transmitter features a touch pad control screen that can be accessed from remote and used to make sure all the components are working right. A second 1000 kw transmitter will be built for shipment to the Philippines.

## Regulatory Fees Due

**WASHINGTON** The deadline for paying the Regulatory Fees to the Federal Communications Commission for Fiscal Year 1995 is Sept. 20. Late payments are

continued on next page ▶

# Index

## FEATURES

<b>RF Software Solutions Proliferate</b>	11
by Barry Mishkind	
<b>KTNN Pulls Navajo Nation Together</b>	14
by Dee McVicker	
<b>Applying the Theory Behind Kirchoff's Law</b>	14
by Harold Hallikainen	
<b>Cooling System Key Design Factor</b>	16
by Jon Banks	
<b>Installing a LAN on a Radio Budget</b>	17
by W. C. Spenn	
<b>Look at All Facets When Designing a New Site</b>	20
by Cris Alexander	
<b>Workbench</b>	22
by John Bisset	
<b>Neural Nets Aid Audio Processing</b>	45
by Tom Vernon	
<b>Elements of STL Transmissions</b>	64
by Jack Layton	

## STUDIO SESSIONS

<b>Digital Noise Eliminator for PC</b>	25
by Reid G. Burgin	
<b>Projects Go 'Absolutely' Digital</b>	27
by Bruce and Jenny Bartlett	
<b>Out of the Trench: AI Is Back!</b>	27
by Alan Peterson	
<b>dbx Reverb Is Easy and Inexpensive</b>	28
by Chris Crump	
<b>Nureality Makes 3D Audio Magic</b>	30
by Frank Beacham	
<b>Evaluate Audio with Mac, AD-1 Analyzer</b>	30
by Mel Lambert	
<b>Zippy Sound from Dynaudio BMS</b>	32
by Bruce and Jenny Bartlett	
<b>Popless Passes Wolfman Test</b>	33
by John Bisset	
<b>FM Book Is Worthy of Attention</b>	33
by Rich Rarey	
<b>Active Studio with Passive Hybrid</b>	34
by Iy Ford	
<b>Use Mini-Mackie for Production</b>	30
by Alan Peterson	
<b>Wireless 'Phone from Sennheiser</b>	40
by Iy Ford	

## BUYERS GUIDE

<b>USER REPORTS</b>	
<b>JBL PA System Looks and Sounds Good</b>	49
by John Bisset	
<b>Futuristic KRK 'K-Rok' Monitors</b>	50
by Matthew Flexter	
<b>'See' Signal with Wohler Monitors</b>	53
by Jeff Zigler	
<b>AKG K240M Headphones Consistent</b>	53
by Philip Moore	
<b>CBC Winnipeg Winner with Tannoy</b>	54
by Christopher McPherson	
<b>Mixing and Mastering with Digital Designs</b>	54
by Glenn Barratt	
<b>Connecting Studios with Digital Tools</b>	55
by Dwight Small	

## TECHNOLOGY UPDATES

Dynaudio	56
beyerdynamic	56
Audix	58
Sennheiser	58
Sony	59
Audio-Technic	59
Genelec	59
Roland	59
Crown	61
Speakerkits	61

When looking for a digital audio system for automation of satellite programming or live assist, there would appear to be many choices. But if you're looking for a system which is flexible enough to give you total control without sacrificing your sanity, there is only one choice. The Phantom by RDS.

You will see the difference as soon as you see the Phantom in action. The display provides you with all of the information you need to see in a clean, concise manner, without the crowded look that you'll find in other systems. If you are familiar with the most popular software on the PC, then you may already know how to use the Phantom. The Phantom's pull-down menus guide you through all of the steps involved in setup and daily operation, from creating and scheduling clocks to creating and editing logs.

## The PHANTOM

Digital Audio Automation

The Phantom ends the confusion of automation by keeping everything organized. The Phantom simplifies your daily operations by keeping information such as input changes, voice changes, and clock changes in their own individual schedules rather than in the log. You can leave those liners and other voice drops out of the log because the Phantom will do them for you. The Phantom allows you to date new schedules to begin weeks, months, or even years in advance. When your satellite network informs you that there will be a voice substitution on Thursday, two weeks from today, you can prepare for it *today*.

The Phantom can retime spots to fit them cleanly into a satellite break without inserting silence, overlapping, or running late. The Phantom



can create reports to keep you informed on a number of topics, from a list of expired spots to an analysis of potential mistakes in your log. The Phantom also maintains a history of system activity.

The Phantom has the features that others would want you to believe are theirs exclusively. The Phantom remains *completely* functional during recording, sensing relay closures and starting breaks as easily as it does when it is not recording. The Phantom can fill incomplete breaks with spots from a list you specify without ruining product separation.

While other systems tie your hands and limit your flexibility by only offering 3 or 4 inputs, the Phantom gives you 6 stereo inputs, using its AMX-84 solid state switcher, with the option of increasing the number of inputs to 14 or more. If your station is News/Talk, you know how important this can be.

The Phantom allows you to change the sampling rate, digital format, and stereo/mono settings at will to meet your needs for an individual spot. The Phantom offers a number of digital formats, including the new Dolby AC-2 format, as an option.

Call us today to find out how your station can benefit from the advanced technology of the Phantom and the experience of RDS.

**1-800-521-5222**  
912-987-2501 • FAX: 912-987-7595  
P. O. Box 980, Perry, GA 30169



**REGISTER  
DATA  
SYSTEMS**



# ROC Wields Power Behind Scenes

## Ad Hoc Group Has Powerful but Quiet Influence in Industry

by Lynn Meadows

**INDIANAPOLIS** One spring night in 1989, on the eve of the "Radio, What Would Life Be Without It?" campaign, Jeff Smulyan, part owner of Emmis Broadcasting Corp. invited several other group owners out to dinner.

Dinner and discussion followed, and the Radio Operators Caucus (ROC) was born.

Six years later, the ROC quietly influences and steers the radio industry. DAB, deregulation, DARS: All issues that bear the mark of the ROC. Those comprising the caucus are found on various boards at the National Association of Broadcasters (NAB).

In the beginning, the group filled a void for the group owners. There was no single voice, at that time, for big market group owners, said Steve Crane, president of Emmis. Randy Odeneal, partner in Sconnix Broadcasting Co. and ROC member, said the group formed at a time when larger market broadcasters felt they were under represented on the NAB.

Although the NAB Radio Board is more representative now with group owners serving in leadership positions, the ROC

continues to be a quiet influence on the radio industry.

Since its informal start, the ROC has helped shape the direction of the radio industry. Anyone familiar with the caucus will describe the ROC's involvement in deciding how digital audio should be integrated in the United States.

When the NAB first considered digital audio technology, they publicly supported the out-of-band system, Eureka-147, developed in Europe. But members of the ROC did not approve of a system that would require reallocations and broadcast parity. Alan Box, president of EZ Communications and ROC member, said it would have "totally upset the landscape of what we have today."

### Successful lobby

The ROC successfully lobbied the Federal Communications Commission (FCC) and talked with the National Telecommunications Information Administration (NTIA), speaking in favor of an in-band, on-channel (IBOC) digital system.

In the end, the ROC position prevailed. The NAB abandoned Eureka-147 and began

pushing for IBOC technology. The group "wields an awful lot of clout," said Odeneal.

Another issue the ad hoc group has actively pursued is ownership deregulation starting with duopolies. More recently, ROC members have supported the 1995 telecommunications bill that will remove group ownership limits. Dick Ferguson of NewCity Communications, a Radio Board and ROC member, testified before the commerce subcommittee in the House in favor of lifting ownership caps.

Steve Crane said the ROC has been instrumental in educating the radio industry, regulators, and congress.

No formal rules or bylaws define the Radio Operators Caucus. "The ROC works when needed and on an ad-hoc basis," said Crane. Crane is the default moderator and keeper of the membership mailing list.

The membership count stays between 30 and 35 members, said Crane, depending what groups are bought and sold. Odeneal estimates that approximately 500 stations are represented by members of the group.

Part of what makes the ROC effective, said Crane, is the informal, private meetings. The group meets at the spring and fall shows unless an issue arises that members feel has particular significance for group owners.

Crane believes the privacy allows members to state their views without worrying about

misstating an opinion. That makes for quick and efficient airing of opinions and leads to what Crane calls "sometimes vigorous debate."

According to another member, money issues are handled just as informally. He gets a letter in the mail once a year telling how much the caucus has spent and how much each member needs to send back.

### ROC and Radio Board

Except for the DAB issue, the ROC and NAB have disagreed only a few times, said one member. That is "not to say either group pressured the other," said Odeneal. "The pressing issues of the day have affected all radio operators, large and small, pretty much the same."

Another reason the two parties agree could be because group owners are no longer under-represented on the board. According to Crane, most ROC members are NAB members and most group owners on the Radio Board are ROC members. Another member said they have never found a situation where the two groups cannot work together.

The ROC was expected to meet before the Radio Show this week. Odeneal said the "issues are all pretty obvious to everyone." Crane said the ROC will continue to play an effective role in Digital Audio Broadcasting. He expects the group will have a voice in how and when satellite radio is coordinated. He added that the ROC will continue to monitor the current telecommunications bill. ☐

## EAS System Easy on Station Bottom Line

**WASHINGTON** The Emergency Alert System (EAS) is a boon for broadcasters because it will drastically reduce operating expenses, according to a study by broadcast equipment manufacturer TFT Inc.

The TFT study revealed that the current Emergency Broadcast System (EBS) costs the radio industry around \$60 million annually primarily in lost airtime, record-keeping, system maintenance, and staff training expenses. The new EAS is expected to cost the industry less than one-tenth of that amount.

The Denver-based Eagle Group performed a separate survey of 400 people between the ages of 25 and 54. They found that 44 percent of a station's driving audience tunes out when the 24-second two-tone EBS test begins on their car radio.

The new weekly EAS test will be shorter and does not necessarily have to be

conducted in the daytime which will keep listener loss down.

TFT has been conducting EAS field tests this summer with its EAS 911 encoder/decoder and EAS 930 receiver. The equipment was tested in Baltimore on WBAL(AM) and WWMX-FM as well as on WANN(AM) in Annapolis. The National Oceanographic and Atmospheric Administration (NOAA) also took part in the Baltimore test.

In August, the company conducted a field test in the San Francisco bay area using KCBS, the San Mateo Office of Emergency Services, and Viacom Cable.

According to TFT, the tests confirmed that TFT's equipment can encode, receive, decode and correctly route emergency messages even with no operators in attendance.

—Lynn Meadows

▶ continued from previous page  
subject to a 25 percent penalty even if they are delayed in the mail.

If you need more information, contact the Fees Hotline at 202-418-0220.

### Inductees Announced

**CHICAGO** The Radio Hall of Fame announced the 1995 Radio Hall of Fame inductees. The induction will be broadcast from the Hyatt Regency in Chicago on Sunday, Oct. 29.

Posthumous inductees include Jesse Blayton Sr. of WERD in Atlanta who was the first black radio station owner; Andrew Carter, pioneer African American broadcaster from KPRS(FM) and KPRT(AM) in Kansas City, Mo.; and Yvonne

Daniels, the voice of the "smooth jazz" format.

Other inductees include Jack Buck, long-time voice of the St. Louis Cardinals on KMOX(AM); Stan Freberg, satirist and radio advertising genius; Hal Jackson, trailblazing African American radio personality of WBLS(FM) in New York; Herb Kent, one of Chicago's pioneer African American disc jockeys; Edward McLaughlin, the radio executive influential in the careers of Paul Harvey and Rush Limbaugh; and Bob Steele, long-running morning personality for WTIC in Hartford, Conn.

The Radio Hall of Fame will also induct the long running "The CBS World New Roundup" which helped establish the importance of radio news. ☐

## Small, Reliable, and Runs Nearly Forever



### Sound Familiar?

OK, so it may not be quite as familiar to you as that other shape, but Continental's 814H 1 kW FM broadcast transmitter delivers surprisingly powerful performance for such a small package.

Only about the size of your average four-drawer file cabinet, the completely self-contained 814H features continuously adjustable power from 150 to 1000 watts\*, solid-state electronics, digital modulation indicator, and superior audio performance. And of course,

Continental's quality design and construction means years of trouble-free operation in all types of environments. Plus, in the unlikely event your 814H needs repair, Continental's team of trained professional technicians is available 24 hours a day.

Even the other little guy couldn't say that!

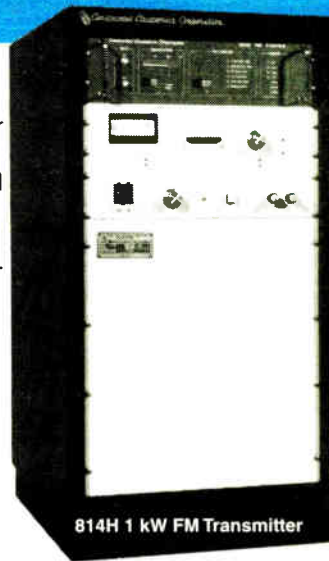

Call 800-733-5011

\* Using the power output of a Continental 802B exciter. 4.95.103

For nearly 50 years, Continental Electronics has provided excellence in broadcast transmission products worldwide. Refuse to compromise... call Continental first!

**Continental Electronics Corporation**  
P.O. BOX 270879 • DALLAS, TEXAS 75227-0879  
214-381-7161 • FAX 214-381-4949

Circle (126) On Reader Service Card



# RBDS Doings and Folks Getting Married

**WASHINGTON** Long-time readers of *RW* are familiar with John Bisset's *Workbench* column and, perhaps less obviously, with his influence on this publication as a friend and adviser.



Four years ago, I started the *Running Radio* section of the paper and signed on Sue Jones as the author of *Manager's Notebook*. John had suggested Sue as a potential management writer and he was right on: She is a terrific writer and has written some top-flight articles for the paper.

Well, they got married. That's right. Sue Jones and John Bisset tied the knot earlier this year. And though I've already congratulated them in person, I wanted to do so in print and share their good news with you. Best wishes to both!!!

★ ★ ★

And speaking of married folk, Mary Matalin, former deputy campaign manager for former President George Bush (now married to James Carville, infamous campaign strategist for President Clinton) joined the CBS Talk Radio network with a three-hour afternoon broadcast set to debut in January, 1996.

Matalin, on the air at CNBC since 1993 as host of "Equal Time," and political commentator for the "Today" show on NBC, is co-author with her husband, of the best-seller, "All's Fair: Love, War and Running for President."

CBS Radio is promising a special appearance by Matalin at World Media Expo in New Orleans on Friday, Sept. 8 (for a complete line-up of which talk show hosts will be dishing it out, see page 9).

But radio's best gabbers will not be the only ones on the spot at the show. Yours truly will be moderating a panel Friday morning on "A Radio Manager's Guide to RBDS and Data Broadcasting."

I'm relying on some of the best in the business to fill you in on what is going on at a station level (Mark Humphrey from WPLY-FM Philadelphia), the manufacturer's level (John Casey, Denon Electronics and Bill Ammons, Circuit Research Labs) and the software level (Allen Hartle, Specialized Communications).

Mark your calendars and come on by. It will be your chance to grill these guys on what's what with RDS.

Industries Association (EIA) launched a national campaign in which it aims to equip 500 FM stations with RBDS.

John, Mark, Allen and Bill will bring you up to date on a whole new world of "smart" radios and what benefits some in the business are already reaping.

If you are really interested in its progress, check out this issue's RBDS Roll Call. We are up to 349 stations and growing. If you haven't already, look into what this new technology might mean for your station.

★ ★ ★

On another RBDS note, if you would like an easy-to-read primer on RBDS, Bill Ammons and the folks at CRL have

prepared just the thing for you. "RBDS for your Station" is a 12-page booklet that synthesizes the issue for you.

Available for free from CRL, the booklet defines RBDS and how it works, defines what exactly "smart" radio can give your listeners, how your station can make money using RBDS, how to get online with RBDS, what is coming down the pike, and last but not least, a glossary of common RBDS terms. It doesn't get any easier than this. That's it on RBDS for now.

★ ★ ★

Back in March we reported on the VirteX buyout of CCS, now known as MUSICAM USA, and some of the ideas driving the entire enterprise. At the NAB spring show, VirteX and Infinity Broadcasting announced a joint venture, MUSICAM EXPRESS, and all sorts of plans for the future.

Well, the action has started to unfold on the MUSICAM EXPRESS front. Rollout of the pilot program began the last two weeks of August at Infinity's flagship

WXRK-FM New York, KROQ(FM) and KRTH-FM Los Angeles and WJFK(FM) Washington.

Essentially, the stations will initially receive Westwood One's programming and commercials via the WinDaX system, a proprietary file server and store and forward system manufactured by VirteX. Audio distribution is over ISDN using MUSICAM USA's CDQ Prima codec.



Mary Matalin

Eventually, the company wants to place a WinDaX producer unit in every advertising agency and music recording studio, replacing existing music and commercial distribution with instant, high quality digital audio using the company's MUSICAM compression system.

More announcements are on the way, so stay tuned.

★ ★ ★

But not all radio news is coming from the show. As I write this, the inauguration broadcasts of the Rock 'n' Roll Hall of Fame are going on in Cleveland. Something like 50 stations are doing remotes back to their studios. The friendly folks at Telos are heavily involved in all the action. Look for a complete story in an upcoming issue of *RW*.

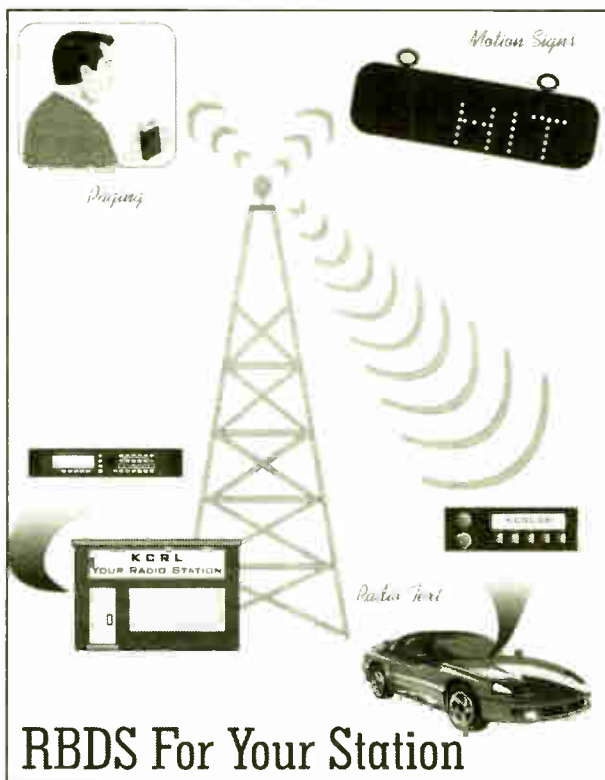

## RBDS For Your Station

Bill Ammons authored this CRL booklet.

The whole idea behind the session is to describe how RBDS is evolving into a promotional tool and a potential source of revenue for FM stations. As you may recall, back in April, the Electronic

and all sorts of plans for the future.



**ARC-16: the logical choice for LMA and duopoly transmitter control.**

For more information on the ARC-16 family of transmitter controls, contact Burk Technology.

**1-800 255-8090**

**BURK TECHNOLOGY**

7 Beaver Brook Rd., Littleton, MA 01460  
Phone (508) 486-0086, Fax # (508) 486-0081  
email danrau@burk.com

COUNTRY WESTERN  
 CLASSIC ROCK  
 A.M.

Put us in your sites.



## READERS FORUM

If you have comments for Radio World, call us at 800-336-3045 or send a letter to Readers Forum (Radio World, Box 1214, Falls Church, VA 22041 or MCI Mailbox #302-7776). All letters received become the property of Radio World, to be used at our discretion and as space permits.

### Improving on perfection

Dear RW,

America enjoyed AM radio for over 60 years before we decided to try to improve it. First, we attempted to broadcast in stereo. America was force-fed a system that rotates the stereo platform causing seasickness nationwide instead of the one that really works.

Then, we decided we could improve neighborhood relations by going lo-fi with NRSC. Who needs power-side? An AMAX radio cannot receive high fidelity if all broadcasting rolls off before 10 kHz! Now, we can broadcast AM digital stereo as long as we can convince the owners of millions of analog radios to ignore the sound of swooshing waterfalls created by the USA Digital system. You won't notice the digital encoding noise when it is masked by the sound of light dimmers, fluorescent lamps and CPUs all churning away. Part 15 can lead AM station owners to Chapter 11!

Maybe Armstrong was right. Who needs AM anyway? I challenge anyone to design a system that provides wide area coverage as simply and solidly as AM radio. Want to hear a direct satellite broadcast on a \$5 radio inside a steel building? Rebroadcast it on good old monophonic AM. You can't improve on perfection!

Karl J. Zuk  
Croton-on-Hudson, NY

### No sigh of relief

Dear RW,

No one I know of in public broadcasting is breathing a sigh of relief as you indicate in "Time to Face Facts," (RW, May 31). In the same issue you report that ABC Radio and NPR are now offering audio service worldwide via Internet. You report about how BBC engineering and reporting expertise sent top-notch audio live from Oklahoma City. Seems to me these examples show that

public broadcasting is already operating just like commercial radio in areas that are consistent with its non-commercial, education mission.

You write that public radio must come up with new and creative ways to fund itself like commercial radio does. Public radio has made gigantic strides in streamlining promotion and fundraising in the last five years with John Sutton's On-Air Partnership project at NPR. Enhanced underwriting guidelines bring public radio contributor acknowledgements very close to being commercials without the reverb even now.

Freshly off the road from six days of finding nothing new (that is not entirely true — I did hear my first lesbian love ballad!) and creative on commercial broadcast stations in the mid-Atlantic and northeastern states. I thank you for writing that noncommercial broadcasting must be preserved. However, your suggesting that public broadcasters turn into commercial broadcasters without a consequent programming transformation strikes me as untenable.

If we think that quality programming is "too valuable to miss," then shouldn't we work through our Congressional representatives to insure that a non-commercial funding entity survives for public broadcasting? If we are worried about the dumbing of America, shouldn't we make the effort to preserve sanctuaries of intelligence like libraries and public broadcasting?

Kate B. Lochte, Station Director  
WKMS-FM, Murray, KY

### Weakening the medium

Dear RW,

The radio industry has been an American success story. Unlike other telecommunications services, it has not been dominated by a few, powerful media barons. Instead, competition has thrived in radio, a multiplicity of competing radio companies have helped ensure a diversity of voices on important community issues.

Competition in the radio industry, however, is facing a potentially debilitating threat: legislation has passed the Senate (S.652) and the House Commerce Committee (H.R. 1555) that allow a few conglomerates to dominate the radio industry.

What is shaping up, is an unprecedented and unhealthy concentration of media ownership that makes it possible for one person or company to own a VHF-TV station, a UHF-TV, the local cable company and an unlimited number of radio stations, the local newspaper and perhaps the local telephone company.

You'd think the broadcast, cable, publishing and telephone industries were broken the way Congress is trying to "fix" them. In radio's case, how much fixing does an industry need that counts 95 percent of the American public as weekly listeners? Congress is legalizing monopolies, price fixing and restraint of competition. Not to mention the unwarranted government meddling in the free market.

The playing field is no longer level for the single station operator to compete with a large competitor that gives discounted or free advertising on one or more stations tied to the purchase of time on its other stations. Since duopolies, our audience

## Keeping AMs in Contention

The pioneer band has had its share of boom years and busts throughout its history, but throughout it all, no one person could dispute that the right programming, clean sound and healthy competition make AM work.

As the onset of digital audio radio nears, a strong and competitive AM band is more important than ever.

The 1991 Federal Communications Commission (FCC) AM Improvement project took a three-

pronged approach: an attack on interference on the dial, migration to the expanded band and consolidation of the existing band. A special consideration was given to AM stereo stations as well.

Technical concerns were well cared for in the 1991 rules. Those rules protect adjacent stations and stations on the same frequency with protection ratios that must be maintained.

As for consolidation, those stations choosing to stay in business rather than turn in their licenses have survived with the help of LMAs, new automation and live-assist equipment and sheer perseverance.

As stations migrate to the expanded band and give up their existing frequency (after five years), stations remaining in the original band can apply for increases in nighttime power.

As the story on page 1 indicates, the first AM station at long last will make the move to the expanded band. John Quinn's WJDM Elizabethtown, N.J., will — 25 years after going on air — migrate to 1660 kHz and provide its community of license with local nighttime service.

Not a moment too soon.

By year's end, the FCC will receive a recommendation from the EIA and the NRSC as to which digital audio radio system is best suited for the United States. The winner will likely be an in-band system.

The move to DAB will not happen overnight, but it is within striking distance. Only those players equipped with clean signals, sound businesses and solid programming will have the capacity to make the move to the digital level.

In the long run, the industry is healthier if the band is healthier. The time to put your station in contention is now.

—RW

share has increased substantially while revenue has gone in the opposite direction.

In Spokane three group owners now control a dozen stations with inordinate leverage in setting advertising rates.

Deregulation of telecommunications is a laudable public goal. But a scheme hatched by the lobby of big broadcasters, under the guise of deregulation, that promotes monopoly ownership at the expense of market competition and diversity, is hardly what the public needs.

John H. Rook, President  
Rook Broadcasting Inc.  
Coeur d'Alene, ID

### Radio loss

Dear RW,

I am writing about the loss of one of the most colorful men in broadcasting in the Boston area.

This man, Simon Geller, had been broadcasting from his cluttered living room above a car wash for over 20 years. He had no money and was in very poor health. He relied totally upon listener generosity.

He had 3,000 W so he could reach Boston, however, some competition put a 15 W college station on the air right on top of him so he lost some of his "good" listeners. He was frequently sabotaged ... a mysterious fire in his studio, and other things to discourage him.

The Grandbanke Corporation tried to get his license for years so that it might turn the station into another rock station — as if we needed one. He fought them in the courts with the help of a lawyer who served him without charge — and he beat them.

He recorded only music by dead composers with no heirs, because he could not afford to pay royalties. We heard Bach, Beethoven, Brahms, Mozart, etc. No Bernstein or modern composers.

Some time ago, Reader's Digest did a nice article about him and his fight with the big money. He was a gruff, unkempt, grouchy, but he had a lot to be grouchy

about. His health was bad, he had barely enough money to stay on the air and eat, and when I last saw him, he was about 68 years or so old, and he told me that he wanted to get married, but couldn't afford to.

He finally sold the station to nice people who changed the call letters from WCVA(FM) to WBOQ(FM) (W "Bach") who improved the station and kept the classical format. Bless their hearts!

I think it would be nice if you remembered him in your next issue. He was very important in radio in the East and someone should say something nice about him.

Bob Meuse, Muse Audio Arts  
Mountain View, CA

### Pet Peeves

Dear RW,

For years advertising personnel have ignored proper English when promising the prospective consumer that in purchasing a certain product one realizes a *savings*.

Webster describes a *saving* (singular) as "that which is saved." The deliberate (or thoughtless) coupling of the single article (a) with a plural noun (*savings*) is a gross error that for too long has been committed in not only the print media but, to our shame, in radio and TV advertising as well.

If one argues that this mis-speak is proper, it then follows that one can correctly say "I have a *automobiles*" or "I have a *studios*," or "I have a *transmitters*," etc.

Realistically and properly it can be suggested that, while shopping in one store on a given day, *savings* can accrue as the welcome result of having made multiple purchases, each at a *saving*.

But to actually promise a *savings*? ... not very profound. One suspects that our English professors have been taking a vacations.

Ken Blake,  
Broadcast Electronics Consultant  
Stockton, CA

# Radio World

Vol. 19, No. 18

September 6, 1995

Editor in Chief.....Lucia Cobo  
Technical Editor.....Alan Peterson  
Associate Editor.....Whitney Pinion  
Staff Writer.....Lynn Meadows  
Contributors.....Frank Beacham/N.Y. Bruce Ingram,  
Pamela Watkins, Nancy Reist, Alan Haber  
Technical Advisors.....John Bisset, Tom McGinley  
Editorial Director.....Marlene Lane  
Assistant Editorial Director/Audio.....Alan Carter



Radio World (ISSN: 0274-8541) is published bi-weekly by Industrial Marketing Advisory Services, Inc., 5827 Columbia Pike, Suite 310, Falls Church, VA 22041. Phone: 703-998-7600, Fax: 703-998-2966. Second-class postage rates are paid at Falls Church VA 22046 and additional mailing offices. POSTMASTER: Send 3579 forms and address changes to Radio World, P.O. Box 1214, Falls Church VA 22041. REPRINTS: Reprints of all articles in this issue are available. Call or write Regan Deatherage, P.O. Box 1214, Falls Church, VA 22041; (703) 998-7600; Fax: (703) 998-2966. Copyright 1995 by Industrial Marketing Advisory Services, Inc. All rights reserved.

—PRINTED IN THE USA—

**Next Issue of  
Radio World  
September 20, 1995**



# RDS Rollout Is Slow but Steady

by Lynn Meadows

**WASHINGTON** In mid-August, four months into the year-long campaign promoting the Radio Data System (RDS), a Texas station became the 50th to sign an agreement with the Electronic Industries Association (EIA) to add RDS capability.

The campaign goal is to introduce RDS to the top 25 markets by next April. The campaign is sponsored by the EIA, Delco Electronics Corp., Denon Electronics and Pioneer Electronics. The EIA expects 500 stations to start using RDS technology thanks to this effort.

Although the EIA has contacted well over 200 stations in the top five markets,

progress is slow because stations need to review the contract they are required to sign. In return for a free encoder, software, and training, the station must pledge to make sure the encoder works through 1997.

The EIA also asks for \$5,000 in advertising time or underwriting credits to promote RDS and increase public awareness. Most stations do not sign the contract immediately, said Lisa Fasold of the EIA, preferring to review their contracts.

Only the pre-Westinghouse CBS Radio group said "no" to the program outright. The group said it would wait until an AM RDS standard is developed, said Fasold.

RW's *RBDS Roll Call* this month lists

more than 300 stations. For many stations, being able to transmit text is a byproduct of subcarrier agreements.

California-based DCI, for instance, provides stations with equipment which it uses to sell Differential Global Positioning Services to farmers, surveyors, local governments, and other businesses who need it. DCI shares the revenue from these services with stations owners.

At the same time, stations can use the equipment to transmit text. Jim Bradley, Vice President of Radio Station Operations for DCI, said stations generally start with the text message "If you see this message call —"

That was the message displayed by WPLY-FM in Philadelphia when it began using RDS in December 1992. Director of Engineering Mark Humphrey said they received several calls right after Christmas from people who been given Denon Prologic Receivers. Most of the

people who called had not realized their receivers were RDS equipped.

Humphrey said the EIA program is good, but that there is a "communications breakdown at the retail level" and a general lack of listener and retailer awareness.

The EIA is sympathetic. It is encouraging manufacturers to have receivers ready for the CES show in early January, 1996.

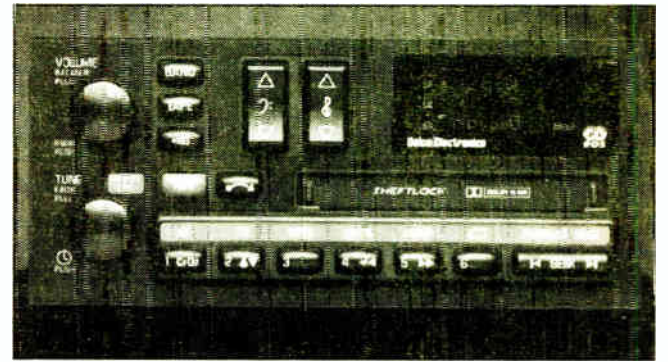

Delco's RBDS car receiver

## 8 TRACK DIGITAL EDITING BREAKS PRICE BARRIER \$5,495\*

- A digital audio editor designed for *Radio* production
- Learn to use in minutes, *much faster than tape*
- Cut, splice, move, and fade up to 4 stereo tracks
- Use Scrubbing to edit with your ears
- Use visual waveform editing to edit with your eyes
- An UNDO button enables you to go back and fix mistakes
- Digital Networking to transfer audio to your On Air machine
- Add Trak\*Star-8 software to a Digilink for only \$2,000

Trak\*Star-8 is the first cost effective multitrack digital audio editor designed for the radio broadcast professional. Fast and easy to use, produce your commercials on Trak\*Star and then transfer them in digital straight to the Digilink in your On Air studio. Dramatically reduce production time and save money !!!

For more information, call or write  
ARRAKIS,

(303) 224-2248

Consoles  
Modulux  
Trak\*Star  
Digilink  
Modulink

the premier broadcast manufacturer of consoles, furniture, Digilink and Trak\*Star digital audio products.

## ARRAKIS

\* Suggested retail price. Complete system

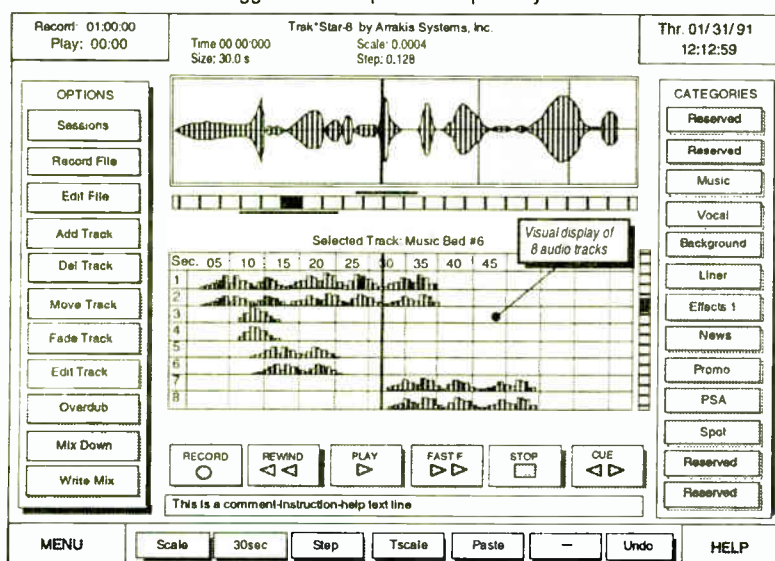

© 1993 Arrakis Systems inc. 2619 Midpoint Drive, Fort Collins, CO. 80525

Circle (130) On Reader Service Card

## 'High Stakes' Radio

► continued from page 1

owners in small markets, three to five in medium size markets and five to eight in the largest markets.

Rosenblum said he does not expect the large-market owners to be interested in small markets. Instead, he sees consolidation occurring between owners within the same sized markets.

For the large markets, Steding said there is "only so much of the game that can actually be played."

Smaller and mid-size markets may move more quickly toward consolidation, he continued, since they have more compelling reasons to do so. Small-market station owners may want to buy sooner rather than later. Steding said, so they are not the only ones left competing with a local group.

"It is good for the large broadcaster because now they can expand into large and medium markets," said Mahlman. He said those companies can "get the attention of Wall Street," something that would be more difficult with the current 20AM/20FM limit.

But the majority of radio stations, Mahlman said, are family operations or small businesses. He questions the broad stroke of the new bill that sets no limits on ownership in any size market. The fear is that someone with deep pockets will come into a small market and buy up stations. For the owners who are left, Mahlman said, "the only recourse is to go to the Justice Department and claim monopoly," and wait for a decision that could take years.

"Small-market radio needed the consolidation the most to remain economically viable," said Dick Blackburn of Blackburn & Company, Inc. He points to stations that offer less to the community now than they once did because they cannot afford to support as many news and public service programs

Blackburn said he has gone over statements with clients and watched as they were forced to drop services to meet the bottom line.

In one instance, a full service broadcaster was competing with a "jukebox" station across town. Offering news and public service programs left the owner with a lot of expense relative to the owner of the other station. Meanwhile, the other station could afford to sell advertising for less.

Steding said he expects when the legislation is finally approved, a "high stakes game of musical chairs" will follow. Mahlman predicted "there will be a big spurt" one to three months after the bill passes. Many buyers are signing deals which will be consummated after the fact.

American Radio Systems' (ARS) \$42 million purchase of WTIC-AM/FM in Hartford, Conn., and tower facilities in Avon, Conn., is one example. ARS already owns two FMs and one AM in Hartford and plans to wait for the legislation to pass before completing the transaction.

Harkening back to the recession in the early '90s, Rosenblum said "without readily available credit, little of this would happen." He added that the good news for small stations is a recent ruling that the Small Business Association can guarantee radio station loans. Since early 1993, he said, money has really loosened up.

Blackburn agreed. He said like 1987 and 1988, 1994 and 1995 have been terrific years for the brokerage business.

Most brokers agreed that the new law is another reason to plan ahead. Stations "must make a decision to either sell or expand," said Mahlman.

Blackburn said now is a good time for stations to reassess.

"I don't know that the industry is used to thinking that way," he said. He pointed out that the world has changed a lot since the last rule change, and stations must be ready for the future. ☺



# RDS Rollout Progresses

generates tune-in response when people go by," said Humphrey. People check to see that the artist displayed is actually playing.

Advertisers are buying time on the station's RDS system in week-long blocks mainly for the billboard exposure. The asking price, said Humphrey, is "a few thousand" dollars for one message which is displayed during every break for a week.

When the jackpot was high, the Pennsylvania lottery bought time and displayed "PA Lottery" and the amount. "To be effective," said Humphrey "we need lots of receivers out there."

## Several Ideas

Bill Baker, general manager of WKKD-FM in Aurora, Ill., signed the EIA contract in March. Although the station is not yet online with RDS, he has several ideas for how to use the technology.

To enhance the local angle of his suburban Chicago station, he intends to display scores from Friday night high school football games and other local sports events.

At KALW-FM in San Francisco, Engineering Manager Dave Evans has been using his RE-533 system since July of 1994. He has a computer program that changes the text display based on the both the time of day and the day of the week.

"The amazing thing is the people that call and have the RDS radios are really impressed," said Evans. Some people have told him they just sit and watch it.

Evans said he is willing to help other engineers code their systems. "I'm a little disappointed that more people aren't doing stuff with it," he said.

## Side effects

Both Evans and Humphrey say they have had no negative audio side effects using RDS. Evans at KALW-FM said it is "totally invisible" as far

as causing any interference.

According to Humphrey at WPLY-FM, signal degradation has not been a problem with RDS. "The injection level of RBDS is

only three percent," he said and there has been no significant reduction on loudness.

Humphrey has tried putting the encoder at the transmitter and at the studio. He said the only difference was that having it in the studio is more convenient.

Although the National Association of Broadcasters Radio Board is not

involved in the RDS program, Fasold says they are giving the technology a boost by holding an RBDS seminar at World Media Expo. That will be held on Friday, Sept. 8 at 10:30 am.

Between now and mid-October, the EIA campaign will contact stations in Washington, Baltimore and Boston. ☺

## INTERNATIONAL UPDATE

# Set Technology to Help Shortwave

by Ian McFarland

**POINTE CLAIRE, Québec** Many shortwave listeners these days are convinced that satellites will take over international broadcasting, relegating shortwave (SW) radios to little more than ornaments of a bygone era.

The truth is that over the coming decade, satellites will increasingly be used for international broadcasting, especially when satellite-based Digital Audio Broadcasting (DAB) comes on the scene. But, as several facts indicate, shortwave is far from dead.

## New relay site

The BBC World Service (BBC WS) is constructing a new relay site in Thailand that will have an active life of at least 10 to 20 years. Even more ambitious is the multimillion dollar upgrade and revamping of the Radio France International (RFI) Allouis and Issoudun SW transmitter sites.

Currently being installed at the Allouis site are a dozen new 500 kW Alliss transmitter/antenna modules. The installation was developed by Thomecast and Télédiffusion de France (TDF), the technical services provider for RFI.

These unique, self-contained modules incorporate a complete transmitter unit and a reversible, rotatable curtain array antenna covering 24.75 square meters. The antenna can be rotated 360 degrees in approximately three minutes.

Obviously, broadcasters like BBC WS and RFI would not invest so heavily in a broadcast medium whose death is imminent.

Another interesting new technology that should instill hope in the hearts of avid SW listeners is ID Logic. ID Logic is good news for SW listeners, constantly frustrated by the semiannual frequency and schedule changes of favorite stations.

Basically, the ID Logic system allows a SW receiver maintain a built-in file of information on a variety of radio stations. For SW, the system allows a receiver to "know" the schedule of each major broadcaster in advance, letting a listener easily find the frequency of a given station by going through a menu and selecting the best frequency.

Eventually, a top-of-the-line receiver equipped with ID Logic might automatically use the system to tune in the strongest frequency for a listener-selected station.

## Periodic updating

Since SW stations normally change frequencies several times a year due to changes in propagation conditions, data in the receiver ID Logic system requires periodic updating. This is done by means of digital data transmitted either during or after a broadcast.

Data can be transmitted silently, more or less continuously during a broadcast, by phase modulating the station carrier. This is known as the Amplitude Modulated Data System (AMDS), which is similar to the Radio Data System (RDS). The audible method of data transmission is by transmitting a short burst of data using the Frequency Shift Keying (FSK) mode of transmission. It sounds similar to a fax signal

or radio teletype transmission.

The silent AMDS method has the decided advantage of being transmitted frequently enough during a broadcast to overcome any problems caused by fades in the SW signal. Conceivably, a high-end

continued on page 46 ▶

## Question:

Ever wonder why transmitter manufacturers operate Altronic dummy loads at NAB and other trade shows?



## Answer:

The best performance and the most dependable dummy loads built.



**ALTRONIC RESEARCH INC.**

WATER AND AIR COOLED MODELS FROM 1000 WATTS TO 1,500,000 WATTS

P.O. Box 249  
Yellville, AR 72687  
(501) 449-4093

Circle (47) On Reader Service Card



## IHF ↔ PRO Level and Impedance Converters

### BI-DIRECTIONAL FOR

- Reel to Reel and Cassette Recorders
- Graphic Equalizers and Noise Reducers
- Audio Effects Processors and Digital Reverb
- Dual Line Amp, DA, Splitter or Combiner

### UNI-DIRECTIONAL FOR

- Digital Compact Disc Players
- ENG Cassette Dubbing
- Off-Air Monitor Tuners
- Console Audition Outputs

Interface consumer/industrial IHF (-10db) stereo source equipment and signal processing devices into professional studio +4dBm, 600 ohm systems without loading distortion, crosstalk, hum, response roll-off or RF pick-up.

True transformer output isolation, balance and protection with less than .01% THD even at 20Hz and +22dBm peak output!  
102 db dynamic range...greater than a Compact Digital Disc system!  
Self contained power supply, Velcro™ and dual rack mounting.  
Free Detailed Brochure and Specifications Available

**AUDIO TECHNOLOGIES INCORPORATED**



328 Maple Avenue, Horsham, PA 19044, USA  
(215) 443-0330 • FAX (215) 443-0394

Circle (160) On Reader Service Card  
See Us At WME Booth 910

World Radio History





[ The DSE 7000 Version 5.0 ]

# With a workstation this fast, nothing can slow you down.



▲ "With time compression, the DSE has added ten years to my creative career."

*John Frost... Creative Director  
KROQ-FM, Los Angeles*



▲ "The ear is faster than the eye. And the DSE is still the best editing system for radio."

*Gerdof Weber... Tonmeister  
Producer MDR life, Leipzig, Germany*



▲ "Anyone can learn to do anything on the DSE in an hour. And UNDO it in a second."

*Debby DeLuca...  
Commercial Production Director  
HOT-97, WQHT-FM, New York*



▲ "Three stations, 36 commercials a day, who has time to fool with a waveform editor?"

*Peter Bell... Chief Engineer  
Radio 10, Amsterdam*



▲ "I've stopped looking for a better digital workstation for radio. With upgrades, the DSE is future proof."

*Russell Kerr... Planning & Development Manager  
IBC, Auckland, New Zealand*

From Auckland to Amsterdam, the DSE 7000 has earned a reputation as the fastest editing system for radio. Now, with time compression and expansion, nothing can slow your creativity down. The DSE is the only digital workstation that lets you edit by ear in real time. You don't

have to stare at a complex waveform screen, "name" every sound, or mix with a mouse. Just cut, leader, erase, move, loop, copy and mix in a completely natural manner. The DSE 7000. Now with Version 5.0 the New Speed of Sound is making quick work of the world of radio.

**orban**

**H** A Harman International Company

© 1995 Orban and DSE 7000 are registered trademarks. 1525 Alvarado St., San Leandro, CA 94577 USA  
Phone 1•510•351•3500 Fax 1•510•351•0500 E-mail custserv@orban.com

Circle (114) On Reader Service Card  
World Radio History



# RDS Rollout Progresses

generates tune-in response when people go by," said Humphrey. People check to see that the artist displayed is actually playing.

Advertisers are buying time on the station's RDS system in week-long blocks mainly for the billboard exposure. The asking price, said Humphrey, is "a few thousand" dollars for one message which is displayed during every break for a week.

When the jackpot was high, the Pennsylvania lottery bought time and displayed "PA Lottery" and the amount. "To be effective," said Humphrey "we need lots of receivers out there."

## Several Ideas

Bill Baker, general manager of WKD-FM in Aurora, Ill., signed the EIA contract in March. Although the station is not yet online with RDS, he has several ideas for how to use the technology.

To enhance the local angle of his suburban Chicago station, he intends to display scores from Friday night high school football games and other local sports events.

At KALW-FM in San Francisco, Engineering Manager Dave Evans has been using his RE-533 system since July of 1994. He has a computer program that changes the text display based on both the time of day and the day of the week.

"The amazing thing is the people that call and have the RDS radios are really impressed," said Evans. Some people have told him they just sit and watch it.

Evans said he is willing to help other engineers code their systems. "I'm a little disappointed that more people aren't doing stuff with it," he said.

## Side effects

Both Evans and Humphrey say they have had no negative audio side effects using RDS. Evans at KALW-FM said it is "totally invisible" as far

as causing any interference.

According to Humphrey at WPLY-FM, signal degradation has not been a problem with RDS. "The injection level of RBDS is

## INTERNATIONAL UPDATE

# Set Technology to Help Shortwave

by Ian McFarland

**POINTE CLAIRE, Québec** Many shortwave listeners these days are convinced that satellites will take over international broadcasting, relegating shortwave (SW) radios to little more than ornaments of a bygone era.

The truth is that over the coming decade, satellites will increasingly be used for international broadcasting, especially when satellite-based Digital Audio Broadcasting (DAB) comes on the scene. But, as several facts indicate, shortwave is far from dead.

## New relay site

The BBC World Service (BBC WS) is constructing a new relay site in Thailand that will have an active life of at least 10 to 20 years. Even more ambitious is the multimillion dollar upgrade and revamping of the Radio France International (RFI) Allouis and Issoudun SW transmitter sites.

Currently being installed at the Allouis site are a dozen new 500 kW Alliss transmitter/antenna modules. The installation was developed by Thomcast and Télédiffusion de France (TDF), the technical services provider for RFI.

These unique, self-contained modules incorporate a complete transmitter unit and a reversible, rotatable curtain array antenna covering 24.75 square meters. The antenna can be rotated 360 degrees in approximately three minutes.

Obviously, broadcasters like BBC WS and RFI would not invest so heavily in a broadcast medium whose death is imminent.

only three percent," he said and there has been no significant reduction on loudness.

Humphrey has tried putting the encoder at the transmitter and at the studio. He said the only difference was that having it in the studio is more convenient.

Although the National Association of Broadcasters Radio Board is not

involved in the RDS program, Fasold says they are giving the technology a boost by holding an RBDS seminar at World Media Expo. That will be held on Friday, Sept. 8 at 10:30 am.

Between now and mid-October, the EIA campaign will contact stations in Washington, Baltimore and Boston. 

Another interesting new technology that should instill hope in the hearts of avid SW listeners is ID Logic. ID Logic is good news for SW listeners, constantly frustrated by the semiannual frequency and schedule changes of favorite stations.

Basically, the ID Logic system allows a SW receiver maintain a built-in file of information on a variety of radio stations. For SW, the system allows a receiver to "know" the schedule of each major broadcaster in advance, letting a listener easily find the frequency of a given station by going through a menu and selecting the best frequency.

Eventually, a top-of-the-line receiver equipped with ID Logic might automatically use the system to tune in the strongest frequency for a listener-selected station.

## Periodic updating

Since SW stations normally change frequencies several times a year due to changes in propagation conditions, data in the receiver ID Logic system requires periodic updating. This is done by means of digital data transmitted either during or after a broadcast.

Data can be transmitted silently, more or less continuously during a broadcast, by phase modulating the station carrier. This is known as the Amplitude Modulated Data System (AMDS), which is similar to the Radio Data System (RDS). The audible method of data transmission is by transmitting a short burst of data using the Frequency Shift Keying (FSK) mode of transmission. It sounds similar to a fax signal

or radio teletype transmission.

The silent AMDS method has the decided advantage of being transmitted frequently enough during a broadcast to overcome any problems caused by fades in the SW signal. Conceivably, a high-end

continued on page 46 

## Question:

Ever wonder why transmitter manufacturers operate Altronic dummy loads at NAB and other trade shows?



## Answer:

The best performance and the most dependable dummy loads built.



**ALTRONIC RESEARCH INC.**

WATER AND AIR COOLED MODELS FROM 1000 WATTS TO 1,500,000 WATTS

P.O. Box 249  
Yellville, AR 72687  
(501) 449-4093

## Match-Maker™

## Disc-Patcher™



## IHF ↔ PRO Level and Impedance Converters

### BI-DIRECTIONAL FOR

- Reel to Reel and Cassette Recorders
- Graphic Equalizers and Noise Reducers
- Audio Effects Processors and Digital Reverb
- Dual Line Amp, DA, Splitter or Combiner

### UNI-DIRECTIONAL FOR

- Digital Compact Disc Players
- ENG Cassette Dubbing
- Off-Air Monitor Tuners
- Console Audition Outputs

Interface consumer/industrial IHF (-10db) stereo source equipment and signal processing devices into professional studio +4dBm, 600 ohm systems without loading distortion, crosstalk, hum, response roll-off or RF pick-up.

True transformer output isolation, balance and protection with less than .01% THD even at 20Hz and +22dBm peak output!

102 db dynamic range...greater than a Compact Digital Disc system!

Self contained power supply, Velcro™ and dual rack mounting.

Free Detailed Brochure and Specifications Available

**AUDIO TECHNOLOGIES INCORPORATED**



328 Maple Avenue, Horsham, PA 19044, USA  
(215) 443-0330 • FAX (215) 443-0394



# No Faster Access To 1,000 Cuts. Just Push.



Instantaneous cueing of audio for on-air, news, spot and promo production is now a reality.

Just push one of Instant Replay's 50 Hot-Keys and get immediate playback of your stored library of music samples, sound effects or spots—in stereo, and with superlative quality.

Instant Replay is the newest addition to 360 Systems' stable of audio hard disk recorders. It's completely self-contained, sports a four hour hard drive,\*

## Introducing **Instant Replay™** The New Hard Disk Audio Player from 360 Systems.



and can store up to 1,000 cuts. A set of professional features such as sample rate conversion, analog and digital I/O, automatic head trims, and even a printer port for hard-copy listing of cuts make this machine agile and genuinely easy to use. Of course, there's no limit to the

length of a cut, and no waiting for floppy disks to load. Best of all, it's only \$2,995.

Instant Replay is a new breed of digital audio player—especially designed for high-powered productions. For a quick demonstration in your facility, just push (818) 991-0360.

**360 Systems**  
PROFESSIONAL DIGITAL AUDIO

360 Systems • 5321 Sterling Center Drive • Westlake Village, CA 91361 USA • Phone (818) 991-0360 Fax (818) 991-1360

\*8-hour hard drive optional. Instant Replay and Hot-Keys are trademarks of 360 Systems. © 1995 360 Systems

Circle (35) On Reader Service Card

World Radio History



# New Orleans Hosts Radio Talkers

by Alan R. Peterson

**NEW ORLEANS** Live remote broadcasting has been a radio mainstay for decades. And in the best tradition of radio's 75th anniversary, the NAB Radio Show will be a hub for live network broadcasts featuring some of the best talent and biggest names the industry has to offer.

This list was prepared for *RW* by the NAB and is accurate as of Aug. 10, 1995. The talent lineup and live broadcast locations are subject to change. All times shown are Central Time (CT).

## Westwood One

Westwood One Entertainment will have a strong presence in several locations Thursday and Friday, Sept. 7 and 8.

Talk host G. Gordon Liddy will broadcast live from the lobby of the New Orleans Convention Center from 9 a.m. to 1 p.m.

Westwood One's afternoon team of Don Geronimo and Mike O'Meara (Don and Mike) will broadcast their syndicated afternoon drive show in the lobby as well from 2 until 6 p.m.

From the exhibit floor of the convention center, Mike Walker will be live from 9 to 11 a.m., followed later by comedian/host David Brenner from 2 to 5 p.m.

Pat O'Brien's in the French Quarter will host three Westwood One talk stars, including "The Tom Leykis Show" Thursday and Friday from 5 to 9 p.m. Thursday, Sept. 8 only. "I love phones" with Dr. Judy Kuriansky will be live 9 to 11 p.m. and Scott Ferrall's "Ferrall on the Bench" sports show will air 9 p.m. to midnight.

## Voice of America

Shortwave broadcasts carried over the Voice of America (VOA) will originate from the exhibit floor of the convention center Thursday and Friday, Sept. 7 and 8.

"Talk to America" with Barbera Klein and Meredith Buehl will be live from the floor 12 p.m. to 1 p.m.

"Titulares de la Tarde" airs at 4:30 p.m., hosted by Alejandro Escalona with Washington co-anchor Betty Andara.

VOA's Mandarin and Russian language services will also do live reports from the floor.

## CBS Radio

The CBS Radio Network will be broadcasting "The Gil Gross Show" from the



New Orleans will serve up cafe au lait and radio's best talkers.

# Diagnostic Software for RDS Ready

by Scott Wright

**KOKOMO, Ind.** There is often a time lag between the introduction of new technology and the introduction of effective tools that can aid in applying it.

RBDS is an exception to this rule as the European version of RDS, has been around for more than 15 years. Because our European colleagues are well ahead of us, we can utilize equipment developed in Europe and adapt it for use here in America. Thus is born RDS Checkup, developed by German engineer and RDS expert Dieter Nohse.

RDS Checkup requires hookup to the Clock and Data output of the RDS demodulator IC found in any RDS receiver. The supplied cable connects to the parallel printer interface of an IBM or compatible computer.

The diagnostic software can be used in countless ways, but real-world examples may be the best method of communicating some of the possibilities.

## Hardware design

When developing hardware, it is nice to know that your application software is not a problem. If you are working on a system problem, you need to differentiate quickly between hardware and software difficulties. The RDS Checkup allows you to eliminate or condemn the application software rapidly. In developing new systems, considerable effort must take place to have evaluation software. RDS Checkup allows the hardware developer to design and test receiver and RDS demodulation systems before any software is written.

After connecting to the system, vital parametric data (such as RDS sensitivity) may be measured before creating specific software. This takes a tremendous load off the hardware developer who needs a consistent software standard to test hardware implementations and perform design analysis.

## Software design

When performing system testing and debugging, RDS Checkup can be used as the reference standard. The program incorporates easy-to-read menus with all RDS data displayed in a logical format. This information allows you to determine the location of a problem quickly without tearing away at the software.

Test equipment setups are often the culprit — it is easy to transmit incorrect information — and hours are wasted before realizing erroneous data was entered and the system actually works appropriately.

RDS Checkup can function as a real-time RDS monitor for transmitted data. You can monitor your competitor's signal to see which RDS features they are using. A useful feature allows you to record up to three minutes of actual transmitted data to disk for later replay and analysis.

A visual quality indicator can show how different

lobby of the Hilton Hotel. Gross' live show will emanate from the lobby 7 to 10 p.m. on Thursday and Friday, Sept. 7 and 8.

Sports broadcasts will also originate from New Orleans, courtesy of the One-On-One Sports Radio Network and the Sportsfan Radio Network.

Baseball great Pete Rose and co-host John Handley will air "The Pete Rose Show" live over the SportsFan Radio Network. Pete Rose's show will originate from the Westin Canal Place lobby, 5 to 7 p.m., Wednesday through Friday, Sept. 6 through 8.

Thursday and Friday Sept. 7 and 8, One-On-One will feature Kevin Wall from 11 a.m. to 3 p.m., followed by Papa Joe Chevalier from 3 to 7 p.m.

One-On-One's live broadcasts will be presented from the lobby of the convention center.

injection levels affect the RDS data error rate: load RDS Checkup into a laptop computer to verify RDS data integrity for a given injection level compared to the main audio channel. A separate menu shows the mix of broadcast RDS data groups over the last 60 seconds. This is a great aid in determining proper allocation of the available data bandwidth.

## Convenient capabilities

The monitoring capabilities of RDS Checkup are convenient for both broadcaster and equipment manufacturer. One problem I encountered involved a receiver's Traffic Program icon flashing on and off every few seconds. Was the problem with the receiver or the station?

By connecting the RDS Checkup, I determined the receiver was not to blame and isolated the data groups with the errant information. A phone call to the broadcaster was much easier because all the required information was at hand.

Each screen of the RDS Checkup offers a different level of detail depending on the crisis at hand. The main menu shows received data for each of the primary RDS functions in an easy-to-read format. The data group screen displays the groups received as well as their bandwidth use, expressed as a percentage. The Enhanced Other Networks (EON) screen shows all the cross-referenced networks and alternate frequencies.

There are separate screens for radio paging, traffic message channels, in-house data and transparent data channels. The Help menus offer definitions of the RDS acronyms as well as detailed information on RDS bit structure.

The logic analyzer allows data triggering and filtering when searching for a specific event. Summary and detailed reports for received data may also be printed.

The RDS Checkup program brings to RDS what the oscilloscope brought to electronics. It is a powerful learning tool that bridges the gap between the standard and reality as well as being an invaluable tool for hardware and software design and broadcast analysis, allowing you to see data in a meaningful fashion.

If you have ever tried to troubleshoot a dynamic circuit with a voltmeter, you understand what I mean when I say a picture is worth a thousand data points. RDS Checkup is a serious tool if you are even remotely serious about RBDS for your station.

□□□

For more information, contact Boyd Baker, RDS Diagnostix, 74 Hanover Road, Mountain Lakes, N.J., 07046 or at 201-334-7858.

Scott Wright is with Delco Electronics in Kokomo, Ind., and can be reached at 75764,2745@compuserve.com; or telephone 317-998-0913.

## EZ Communications Building 'Net' Ramps

**FAIRFAX, Va.** The Radio Data Group Inc. and Xing Technology Corp. signed an agreement for hardware, software, and technical services necessary to place radio stations live on the Internet.

Radio Data Group is a subsidiary of EZ Communications which owns 21 radio stations in eight markets. Using the StreamWorks software package from Xing, EZ Communications will put audio from stations KMPS-AM-FM and KZOK-FM in Seattle on the Internet first. This is the next step in EZ Communications' previously announced plan to provide Internet access "on-ramps" for listeners in all its markets.

The company expects revenue to come from one-time sign-up fees that listeners will pay to get on-line and usage fees that are charged if a minimum number of hours is exceeded. The Radio Data Group also hopes advertisers will find an on-line site attractive. They are preparing rate cards for services.

How the group will handle music licensing fees for ASCAP and BMI over the Internet is still being discussed. Also undetermined is who will listen to radio over the Internet and why.

At a press conference, it was suggested that someone whose local station does not pick up a particular show might listen to a station on the net that does. Michael Rau, president of the Radio Data Group said "I don't know how people are going to use it." He expects an answer to that question in a few months.

The address for country stations KMPS-AM-FM is <http://www.kmps.com>. To listen to '70s station KZOK-FM, the address is <http://www.kzok.com>.





[ The DSE 7000 Version 5.0 ]

# With a workstation this fast, nothing can slow you down.



▲ "With time compression, the DSE has added ten years to my creative career."

*John Frost...Creative Director  
KROQ-FM, Los Angeles*



▲ "The car is faster than the eye. And the DSE is still the best editing system for radio."

*Gundolf Weber...Tonmeister  
Producer MDR lhr, Leipzig, Germany*



▲ "Anyone can learn to do anything on the DSE in an hour. And UNDO it in a second."

*Debby DeLuca...  
Commercial Production Director  
HOT 97, WQHT-FM, New York*



▲ "Three stations, 36 commercials a day, who has time to fool with a waveform editor?"

*Peter Belt...Chief Engineer  
Radio 10, Amsterdam*



▲ "I've stopped looking for a better digital workstation for radio. With upgrades, the DSE is future proof."

*Russell Kerr...Planning & Development Manager  
IBC, Auckland, New Zealand*

From Auckland to Amsterdam, the DSE 7000 has earned a reputation as the fastest editing system for radio. Now, with time compression and expansion, nothing can slow your creativity down. The DSE is the only digital workstation that lets you edit by ear in real time. You don't

have to stare at a complex waveform screen, "name" every sound, or mix with a mouse. Just cut, leader, erase, move, loop, copy and mix in a completely natural manner. The DSE 7000. Now with Version 5.0 the New Speed of Sound is making quick work of the world of radio.

**orban**<sup>®</sup>

**H** A Harman International Company

© 1995 Orban and DSE 7000 are registered trademarks. 1525 Alvarado St., San Leandro, CA 94577 USA  
Phone 1•510•351•3500 Fax 1•510•351•0500 E-mail custserv@orban.com

Circle (114) On Reader Service Card  
World Radio History



KEYBOARD CONNECTION

# RF Software Solutions Proliferate

by Barry Mishkind

**TUCSON, Ariz.** Life is full of hazards. Some are merely inconvenient, like hazards on the golf course. Others are more serious, and can be life threatening. The hazards I will write about this time relate to those encountered around transmitter sites and inside computers.

During the 1970s and 1980s, the Environmental Protection Agency and several states began to focus on the amount of RF exposure received by workers or the general public from broadcast transmitter sites.

Eventually, standards were developed and published by the American National Safety Institute (ANSI 95.1-1982), setting specific limits. Some states went even further, setting some controversial limits that essentially prohibited RF transmission.

This created an number of situations where transmitter sites had to be modified or even moved to meet the standards. Other sites have had to put up additional fences to restrict access or have stations reduce RF power when workers were present.

Additionally, the FCC now requires any station over 100 watts to certify that RF exposure is below maximum limits, and has issued its formulas for determining the contribution of each transmission antenna (see O.S.T. No. 65).

At AM frequencies, it is not too hard to calculate minimum distances from the tower bases, and typical tower base fences provide sufficient safety. For example, at 5 kW, anything beyond 5 meters from the tower base is essentially safe. Access inside the fence by station personnel for maintenance purposes can be on a "time-controlled basis" to prevent overexposure.

FM is another matter. The variety of antenna styles, number of bays and spacing and the effects of co-located stations make calculating the critical distances more difficult. Fortunately, computer pro-

grams could be a problem if any other antenna contributed more than about 240 mV/m at the tower base or 100 mV/m at 7 meters. By inputting other co-located antennas, RFHAZ helps calculate total exposure at any working distance.

RFHAZ is available in DOS or Windows versions. For more information, call Doug

same sites, 80 percent reported an encounter with a virus. While the percentage of sites reporting file interference or system lockups due to these viruses declined to 2.7 percent from 41 percent in 1991 and corrupted file problems dropped from 38 percent to 4.5 percent, the production of new viruses continues, reaching

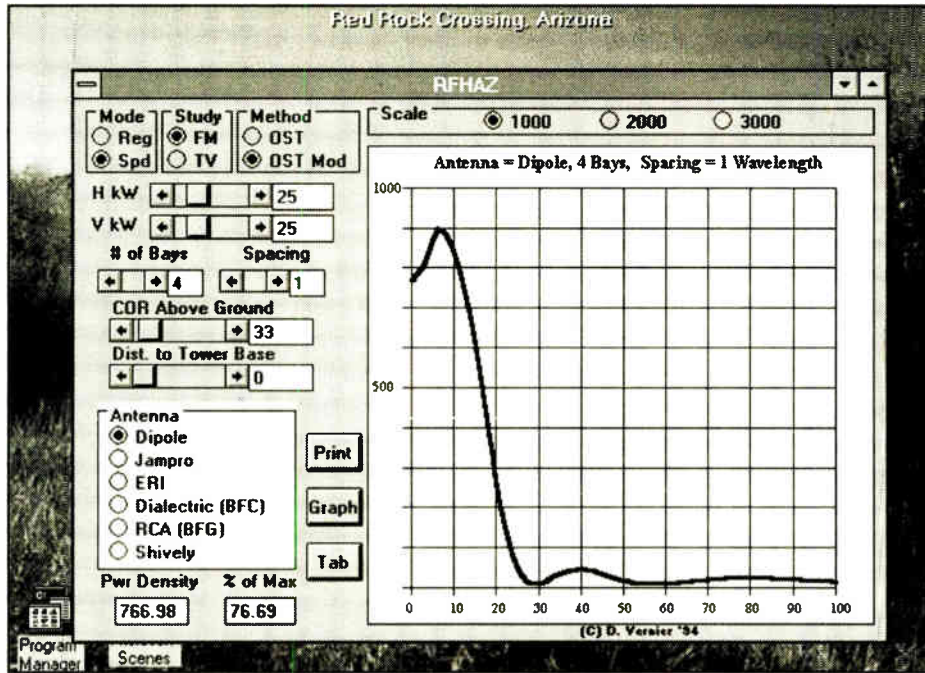

RFHAZ calculates radiation density.

Vernier at 1-800-743-DOUG.

This is another hazard which can create havoc in your life. It occurred to me the other day that I had not heard much in the mainstream media about computer viruses, at least not at the level of the Michelangelo Virus a few years ago.

Almost as if on cue, I received an interesting phone call. It seems a major producer of dictionary software had shipped new product complete with a destructive boot sector virus. Because there has not been

over 6,000 at the present time.

As was true the last time we looked at the subject, there is a variety of choices, ranging from the anti-virus program made part of MS-DOS 6, to shareware and commercial programs.

Why would you want to pay for a virus scanner if there are free programs? One main reason is access to updated information. With 3,000 new viruses and variants reported in 1994, the program you bought last year is already out of date. Also, as some recent viruses self-mutate to hide from scanners, newer methods of detection have been developed.

Symantec produces two main products: the Norton Anti-Virus (NAV) version 3 for DOS and Windows, and Central Point AntiVirus (CPAV) version 2.2 for DOS. Additionally, Symantec makes available a free utility for detection of the Michelangelo virus. For more information, call 1-800-441-7234.

Another package is Dr. Solomon's Anti-Virus Toolkit from S&S Software. Based in England, S&S fields calls from all over the world as new viruses are discovered. The research team has uncovered and developed detection methods for some very shadowy viruses, such as one double-hidden virus that displays porno-

## The program presents a graph summarizing the reflective RF radiation at ground level up to 100 meters from the antenna.

grams are available to help determine where the hazardous areas might be found. RFHAZ from Doug Vernier is one such program.

RFHAZ calculates radiation density for a wide range of FM and TV antennas. To operate RFHAZ, you set the power, number of bays, spacing, height above ground for the center of radiation (COR), and the manufacturer of the antenna. The program presents a graph summarizing the relative RF radiation at ground level up to 100 meters from the antenna. You then select a desired distance from the antenna or click on the graph display to instantly see the power density and percentage of maximum allowable RF at that point.

In the photograph, a four-bay dipole antenna with one wavelength spacing is fed with 25 kW at 33 meters COR above ground. The graph displayed shows that at about 7 meters (22 feet) from the antenna the RF density peaks out at about 900 mV/m. The radiation levels then fall rapidly, dropping well under 100 mV/m at approximately 25 meters (79 feet) from the antenna.

While within ANSI standards, this site

much attention to viruses recently, I called Ana Thorne at Symantec to find out if viruses were still a large problem.

She told me that viruses were indeed still proliferating. However, many users have gotten the message over the past several years. According to an industry study of over 600,000 business PCs in 1993, 98 percent now have anti-virus software installed.

Yet this is not a total solution. Of those

### 61 Years Ago

Reprinted from Radio World November 10, 1934.

Editor's note: The RW of old, printed for a time in the 1920s and 1930s and today's RW are unrelated except in name.

### The Twelve Equations Expressing Ohm's Law

$W = EI$	$I^2R$	$\frac{E^2}{R}$	$\frac{W}{R}$
$E = IR$	$\sqrt{WR}$	$\frac{W}{I}$	$\frac{W}{I^2}$
$I = \frac{E}{R}$	$\sqrt{\frac{W}{R}}$	$\frac{W}{E}$	$\frac{W}{E^2}$
$R = \frac{E}{I}$	$\frac{W}{I^2}$	$\frac{W}{E^2}$	$\frac{W}{I^2}$

F = Voltage  
 I = Current in Amperes  
 W = Watts  
 R = Resistance in Ohms  
 Ohm's Law has been referred to many times. However we believe that this fundamental law cannot be over-emphasized, as almost all electrical theory is based on it or its derivations. Many people know the law only as Voltage (E) equals Cur-

rent (I) times Resistance (R) and do not realize that there are really twelve equations which may be formed using the four factors W, E, I, and R.  
 Thus knowing any two of these factors the other two may be readily calculated. For instance, assume that a 1,000-ohm resistor has a voltage of 110 volts across it. What is the current through the resistor and what wattage must the unit dissipate? By looking at the table above we see that I equals E divided by R; therefore the current in our resistor will be 110 divided by 1,000 or 0.11 amperes. The wattage will be E<sup>2</sup> divided by R or 12,100 divided by 1,000 which is 12.1 watts. Any other problem involving these factors can easily be solved, it being only necessary to select the equation which shows the unknowns in terms of the known factors.  
 —Ohmite News.

graphic male images while reformatting the hard drive. The virus hides inside what is supposed to be a screensaver.

One of the advantages of the Dr. Solomon's Anti-Virus Toolkit is its subscription service. Instead of users downloading or requesting updates, it is sent automatically, reminding them to load them on their system.

For further information on the Toolkit, call 1-617-273-7400.

In the March 8th issue of RW (page 29), an article appeared by Fred Greaves on T-Networks. Included was a BASIC program to calculate and adjust AM matching networks. Since not everyone is comfortable loading and entering the code in BASIC, Fred has kindly allowed me to compile the code into an .EXE file and make it available to you.

TSOLVE.EXE will run easily from a C: prompt or from Windows. The program is available at my ftp site at comm-data.com in the /pub/old radio subdirectory. Look for the file TSOLVE.EXE. A copy of the BASIC listing is also there as TSOLVE.BAS.

Have you ever needed a manual or a schematic for a piece of gear, and either never got the manual or could not find it? If you are seeking help on something from Radio Systems, Gerrett Conover recently told me of a new service the company is making available for users.

Conover has placed the Radio Systems' manuals on computer, and will make them instantly available to users via modem. If you have a need, call Gerrett at 1-609-467-8000, or e-mail him at 75021.3416@compuserve.com.

Last but certainly not least, the SBE now has a site on the Internet. Dave Biondi is the administrator, and can be reached at dbiondi@sbe.org. Board member Jim Bernier is also available at jbernier@sbe.org. And the SBE home page is at <http://www.sbe.org/> with information on the SBE activities at the Radio Show in New Orleans.

□ □ □

Barry Mishkind can be reached at 602-296-3797, or [barry@AzStarNet.com](mailto:barry@AzStarNet.com) via the Internet. You can find his new home page at: <http://www.AzStarNet.com/~barry/>.

## Communications Data Services

Incorporated

### Online Engineering Services

- **LPTV Studies** - essential for filing LPTV station applications
- **FM Studies** - conduct spacing and interference studies for proposed FM facilities
- **Distance to Contours** - produce distance to contour tabulations and maps of predicted coverage area
- **Population Count** - produce detailed population analysis studies for a given facility
- **Zip Code Analysis** - produce zip code analysis studies to analyze market coverage
- **Terrain Data Analysis** - calculate HAAT and produce terrain profiles
- **Coverage Maps** - complete Real World™ propagation prediction services

**6105 Arlington Blvd.**  
**Falls Church, Va. 22044**  
**800-441-0034/703-534-7884 (fax)**  
**Richard P. & Richard L. Biby - Principals**







# RBDS MANUFACTURERS

## RBDS Equipment Manufacturers/Distributors

AEV (Encoder)  
Via Saviolo Budrie  
Di S. Perisceto  
Bologna, Italy

**Bela Electronics Labs Inc.**  
PO Box 76  
Devon, PA 19333  
Contact: David Hirsch  
610-687-5550  
Reader Service 57



Broadcast Supply Worldwide (Encoder)  
7012 27th St., West  
Tacoma WA 98406

**Circuit Research Labs**  
(Encoder)  
2522 W. Geneva  
Tempe, AZ 85282  
Contact: Valerie Hummer  
602-438-0888  
Reader Service 3



Harris Allied (Encoder)  
3712 National Road West  
Richmond, IN 47374

**Inovonics** (Encoder/Decoder)  
1305 Fair Ave  
Santa Cruz, CA 95060  
Contact: Anne Chaney  
408-458-0552  
Reader Service 140



**Modulation Sciences**  
(Encoder/Monitor)  
12A World's Fair Drive  
Somerset, NJ 08873  
Contact: Judy Englert  
908-302-3090  
Reader Service 179  
**modulation sciences**

**RDS Diagnostix**  
(Test/Decoder)  
74 Hanover Road  
Mountain Lakes, NJ 07046  
Contact: Boyd A Baker  
201-334-7858  
FAX: 201-299-8431  
Reader Service 131

**RDS Diagnostix**

Audio Broadcast Group (Encoder)  
2342 S Division Avenue  
Grand Rapids, MI 49507

**RE America, Inc.**  
(Encoder)  
31029 Center Ridge Road  
Westlake, OH 44145  
Contact: Soran Pihlman  
216-871-7617  
Reader Service 75



AZTEC S.A. (Encoder)  
31 Rue du Chemin de Fer  
67200 Strasbourg  
France

Rohde and Schwarz (Encoder)  
4425 Nicole Drive  
Lanham, MD 20706

SCA Data Systems (Encoder)  
2912 Colorado Avenue, Suite 200  
Santa Monica, CA 92404

Teli AB (Encoder)  
14980 Nunashamn  
Sweden

Tectan (Encoder)  
Box 27157  
Concord, CA 94527

VG Electronics (Encoder)  
Theaklen Drive  
Hastings, East Sussex TN34 1YO  
England

## RBDS Receiver Manufacturers (with current U.S. models)

**Advanced Digital Systems**  
(PC RDS Receiver)  
13909 Bettencourt Street  
Cerritos, CA 90701  
Contact: Mike McCoy  
800-888-5244  
Reader Service 29



Access (Paging)  
6620 Riverside Drive, Suite 200  
Metairie, LA 70003

AZTEC S.A (Mobile Data Receiver)  
31 Rue du Chemin de Fer  
67200 Strasbourg  
France

Delco Electronics (Car)  
1 Corporate Center  
Mail Station CT-16A  
Kokomo, IN 46904

**Denon** (Car/Home)  
222 New Road  
Parsippany, NJ 07054  
Contact: John Casey  
201-575-7810  
Reader Service 61

**DENON**

Grundig (Portable)  
3520 Haven Avenue, Unit L  
Redwood City, CA 94063

Indy Automotive Electronics  
2420 E 55th Place  
Indianapolis, IN 46220

Modulation Sciences (Data)  
12A World's Fair Drive  
Somerset, NJ 08873

Onkyo (Home)  
200 Williams Drive  
Ramsey, NJ 07446

Philips Car Stereo (Car)  
9600 54th Avenue  
N. Minneapolis, MN 55442

Pioneer (Car)  
2265 East 220th Street  
Long Beach, CA 90810

## RBDS Service Providers

Access/Spartan (Paging)  
6620 Riverside Drive, Suite 200  
Metairie, LA 70003

**DCI** (Global Positioning)  
10121 Miller Avenue  
Cupertino, CA 95014  
Contact: Jim Bradley  
408-446-8350  
Reader Service 53



Coupon Radio  
(Information Services)  
10 Rockefeller Plaza  
New York, NY 10020

Sage Alerting (EBS)  
700 Canal Street  
Stamford, CT 06902

SATX  
(Data Broadcast Software)  
Milestone Technologies  
2221 Mariner Circle  
Raleigh, NC 27603

**Specialized Communications**  
(Music Information)  
1638 153rd St. SE  
Bellevue, WA 98007  
Contact: Allen Hartle  
206-641-9043  
Reader Service 142



Terrapin  
(IVHS Services/Diff-GPS)  
11958 Monarch Street  
Garden Grove, CA 92641

If you would like to feature your company's logo and information on the RBDS Roll Call page, contact your Radio World sales rep

## 63 Years Ago

Reprinted from Radio World May 14, 1932.  
Editor's note: The RW of old, printed for a time in the 1920s and 1930s and today's RW are unrelated except in name.

## Stations Donate Time for Salvation Army

Radio stars and broadcasting company executives who take part in the Salvation Army United Appeal for \$1,090,000 will work with Alfred J. McCosker, director and general manager of WOR, Newark, N. J. Mr. McCosker will be associated in this work with Major Edward Bowes, managing director of the Capitol Theatre, New York, and known to millions of radio listeners as the head of the "Capitol Family." Major Bowes is acting as chairman of the amusement section in the United Appeal.

As the money asked for in the united appeal will enable the Salvation Army to continue its emergency relief work and to carry on its institutional welfare work, the broadcasting companies are cooperating by donating time on the air. Through the courtesy of the broadcasters Salvation Army officers will be heard weekly over WEAJ, WABC, WOR, WNYC, WOV, WFOJ, WMIL and WBBB.

The Salvation Army officers are telling of the work the Army is doing. As a result some unusually interesting human interest stories are being "aired" for the first time.

# MODULATION WAR?

If you're getting your face pushed in the dirt by the guy across the street, it doesn't have to be that way. In these major markets, where competition is fierce and the rewards are large, broadcaster after broadcaster has picked the COBALT BLUE™ Neural Network power booster for the Optimod 8100\* in A/B comparisons.

**Atlanta**                      **New York**  
**Charlotte**                **Orlando**  
**Cincinnati**               **Providence**  
**Indianapolis**             **Washington, D.C.**

COBALT BLUE™ is the world's first Neural Network audio processor. It's a whole new technology. If you need more power and you need it now... if you have an existing Optimod 8100 preceded by a Compellor\*\* or a pair of Audio Prisms\*\*\*, call (814) 235-1410. We'll do the rest.



208 West Hamilton Avenue - P.O. Box 20  
State College, PA 16804-0020  
Phone: (814) 235-1410 Fax: (814) 235-1462

\* Optimod is a trademark of AKG Acoustics, San Leandro, California  
\*\* Compellor is a trademark of Apex Systems, Ltd., Sun Valley, California  
\*\*\* Audio Prism is a trademark of Gentner Electronics, Salt Lake City, Utah

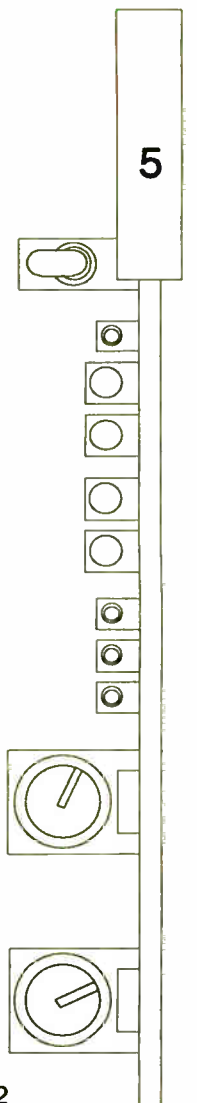



OFFBEAT RADIO

# KTNN Pulls Navajo Nation Together

by Dee McVicker

**TUCSON, Ariz.** Out in the deserts of New Mexico, Arizona and Utah, the voice of radio is an omnipotent presence that can be heard booming out of Sony Walkmans and old tube radios alike, a contrast to the din of sheep herding and other sounds of Indian life.

The sound is KTNN(AM), a 50 kW clear channel licensed to Window Rock, Ariz., and in many parts of the Navajo Nation, it is the only modern communications heard for miles around.

"It wasn't until KTNN came along that everyone on the reservation got communications in Navajo by Navajos," said Tazbah McCullah, the general manager of the Navajo owned and operated AM. KTNN was put on the air in 1986 for this purpose, and within a few years received a coveted Crystal award because of its much-needed service to a community in which there are more residents without telephones than with.

**Tribal council grant**

KTNN was started with a grant and capital investment from the Navajo Tribal Council, the body of government that presides over the vast 25,000-square-mile reservation, but it is now approaching five years that the station has been financed primarily by commercial means, according to McCullah.

It remains today the only AM radio station to reach the interior of the reservation, preceding FM, television, cable, and in some areas of the reservation, electricity. A repeater signal in Chinle, Ariz., from an AM bordering the reservation will be piping in its programming soon, but currently KTNN dominates the market.

KTNN's audience inside the Navajo Nation numbers at around 200,000, but more than twice that number are potential listeners in nearby Gallup, N.M., a tourist market a few miles outside the reservation. Gallup increases from 19,000 to 500,000

people during any given weekend with Indians coming in from Hopi, Zuni and Navajo communities.

McCullah estimates that KTNN holds at least 60 percent of the market share, in a market where 82 percent of the population does not have phones.

The advertisers that broadcast their messages on this commercial station are not unlike advertisers elsewhere: restaurants, tourist shops, and other retail merchants. Local businesses and tribal governments also purchase KTNN air time to promote services and products.

**Heard around the world**

"We serve the particular language needs and the cultural interests of Navajos, that is our primary target. But we also have a regional audience at night that we don't really know much about," commented McCullah, who has received letters as far away as New Zealand from listeners who have picked up the clear channel there.

While KTNN's 50 kW signal extends to 13 Western states at night, its market is also extending its reach away from the Navajo Nation.

Said McCullah, "We're entering a different age now. We see more and more diversity because the kids have grown up, there's a second or third generation now that has been able to get off the reservation, get educations, see the world. And they've had a taste of different things and are coming back with more diverse interests."

The Navajo Nation is making preparations to operate a 100 kW FM on the reservation to bring in more diversity and to service a growing market. "We are scrambling to keep up with new technology — fiber optics, the Internet — so now the Nation is going through the process of revising our telecommunications regulatory commission," explained McCullah.

Language on KTNN is equal parts English and Navajo; its format is predominantly Country Western because, in

McCullah's words, "The market demands it. We're a market-driven station." The Navajo community has an affinity for Country music, she said, dating back to when dances were a common occurrence at the chapter houses, or local governments.

**Sunday night specials**

Over the past three years, KTNN also has been airing a number of traditional and contemporary native American music, including Sunday night special cultural programming unique to the Navajo people. More recently, KTNN, which is staffed with 20 employees — the majority of whom live on the reservation — co-sponsored a Native American music festival which included 30 native American artists of local and international fame.

Because the station serves a large audience base of young and old, and a vast

region of remote listeners, it is a study in programming taste, a microcosm of American media. Station programming includes talk shows from Navajo Nation journalists, Christian programming, sports coverage, and even sheep herding bulletins.

"We do funeral reports, we do healing ceremony announcements, we talk about what livestock is missing, we announce jobs," said McCullah.

Not surprisingly, the station does more than its share of public service announcements. KTNN airs approximately \$300,000 worth of public service announcements each year, roughly 50 to 80 public service announcements a day, an exorbitant number for the 108 Navajo chapters and its relatively small market base.

There are more than a few that say the air time is well spent.

□ □ □

Dee McVicker is a regular contributor to Radio World. She can be reached by phone at 602-545-7363, or e-mail: roots@primenet.com.

CIRCUIT THEORY

## Applying the Theory Behind Kirchoff's Law

by Harold Hallikainen

**SAN LUIS OBISPO, Calif.** Last time out I reviewed how to use Kirchoff's Current Law (first described by German physicist Gustav Robert Kirchoff, 1824-1887) to do node voltage analysis. This month, I'll show you how to apply Kirchoff's Voltage Law (KVL).

KVL states that the sum of the voltages around any closed loop in a circuit is zero. This may be the sum of the voltage "rises" or the sum of the voltage "drops." If you are using voltage rises, a voltage drop or decrease is expressed as a negative number.

Figure 1 shows a circuit with the voltages across each component shown. The

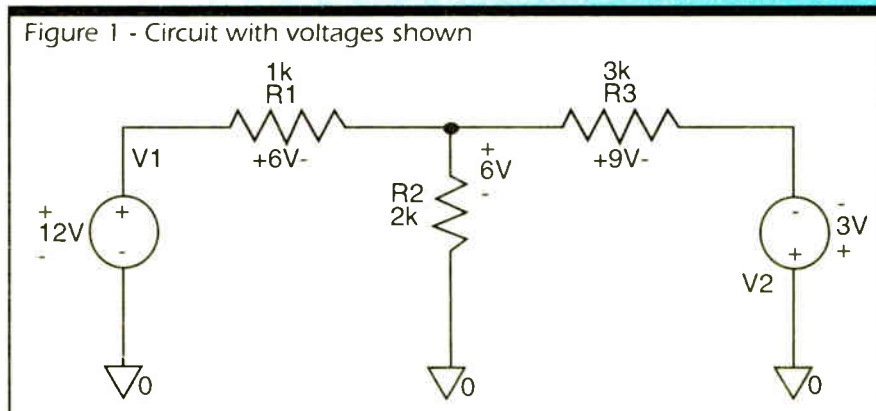

notation method shows the voltage and polarity. A loop is any closed path around the circuit. For example, if you start at the ground end of V1 and go through R1, R3 and V2, you can record the voltage rises as shown in Table 1.

Similarly, you can go around any loop, adding the rises and getting a total of 0 volts. If you reverse polarity of the voltages you are adding, you add voltage drops, once again yielding a total of 0 volts.

Table 1 - Voltage rises around a typical loop

Component	Voltage Rise	Comment
V1	+12	Going clockwise, you "come out" the positive side
R1	-6V	Coming out the negative side, you go down in voltage
R3	-9V	Going to right, you drop 9 volts
V2	+3V	Going down, you increase 3 volts, closing loop at ground
<b>Total</b>	<b>0V</b>	

**Mesh Analysis**

A mesh is any loop that contains no other loops. The loop described above is not a mesh, because it contains a couple smaller loops. The circuit of Figure 1 has two meshes. These include V1, R1 and R2 in one mesh, and R2, R3, and

continued on page 19 ▶

# RBDS

EASILY  
INSTANTLY  
INEXPENSIVELY

... with these two, brand-new products, INOVONICS has you covered, coming and going!

**710 ENCODER:** Just \$995 and **no computer required!** The non-volatile memory holds 16 separate frames of program and format identifiers, alternate frequencies, radiotext messages and traffic or emergency flags. A built-in data interface lets you upgrade later to full dynamic operation for revenue-generating paging, GPS, coupons, contests, etc.

**510 DECODER:** Connects to your existing FM Mod-Monitor. The front-panel LCD display shows RBDS injection level and allows you to scroll through and read all the data groups. An RS-232 port gives unlimited access to raw RBDS data for telemetry and other in-house functions.

## Inovonics, Inc.

1305 FAIR AVE., SANTA CRUZ, CA 95060 U.S.A.  
TEL: (408) 458-0552 — FAX: (408) 458-0554







# Harris Platinum FM Transmitters aren't falling. But their prices are.

If you haven't priced a Harris Platinum FM Transmitter lately, you're in for a pleasant surprise.

Not only has Harris lowered the price on these ultra-redundant all-solid state transmitters, but now **every** PT-CD FM transmitter includes Harris' DIGIT digital FM exciter as well!

DIGIT, the world's first and only FM exciter capable of accepting a studio digital signal, is available with either a digital or an analog input module.

*\*Digital Signal Processing*

The digital input incorporates a DSP\* stereo generator for unsurpassed stereo performance and separation and a Digital Composite Limiter with "look-ahead" circuitry to predict and eliminate overmodulation peaks before they occur.

Even if you don't have a digital signal to your transmitter, you can get DIGIT's benefits by using the analog input now and upgrading to a digital input when you are ready.

Beyond Harris' Clearly Digital sound, a PT-CD transmitter will

give you hot-pluggable RF modules with an MTBF exceeding 240,000 hours; no IPA module; VSWR foldback, and more.

Let us surprise you. To learn more about Harris PT-CD Transmitters, please contact us:

**U.S. and Canada:**  
**Tel 217-222-8200**  
**Fax 217-224-1439**

**International:**  
**Tel 217-222-8290**  
**Fax 217-224-2764**



 **HARRIS  
ALLIED**

Circle (112) On Reader Service Card  
See Us At WME Booth 1109  
World Radio History

© 1995 Harris Corporation



# Cooling System Key Design Factor

by Jon Banks

**WASHINGTON** Last year, I got to build a transmitter site from scratch. Our station, WARW(FM) was just starting a 20-year lease, so I could take a long term perspective.

One thing I wanted was a better cooling system — something efficient, reliable, and not too expensive to install. Our old site had used 100 percent recycled air, which is expensive and unnecessary. I am no expert on air conditioning, so I hired a mechanical engineer to plan the system.

When I met with him, he asked questions about our plans for the site, the equipment we were going to use, and whether the site

needed to be comfortable for people. We had a good idea what we wanted, and he helped us understand the trade-offs.

## Hot D.C. summers

Summers here are pretty hot; we'll top 100 degrees about five days each year. It is often very humid, too.

We decided that we would cool the room to 68 degrees if we could do it for free with outside air, and only to 80 degrees if we had to run the air conditioners. We knew we needed a backup cooling system, completely separate from the main system, although it could be smaller and simpler.

Our transmitter power is about 26 kW, and we gave the engineer the manufacturer's

specs for exhaust air temperature and flow. He calculated that we would need a 10-ton air conditioner, based on the transmitter output, the other equipment we expected to have, and heat coming in through the walls and ceiling, plus some safety margin.

He suggested a split unit, two five-ton units in one housing. That is more efficient, because on all but the hottest days, only one of the units will run. He sketched out a system of ducts, dampers, exhaust fans and thermostats to regulate the temperature.

I wanted to know how he came up with his design, so I could understand the system better, and be sure it was right for us.

Our transmitter exhausts 130 degrees air at about 1400 cubic feet per minute (cfm). That air is too hot to cool and re-use efficiently, so it is ducted through a hood to an exhaust fan that pulls almost exactly 1400 cfm and exhausts it outdoors. On a very cold day, we would use that exhaust for heat, so a thermostat shuts off the exhaust fan at 68 degrees and lets the hot air spill out of the hood into the room.

Because we are always taking 1400 cfm out of the room, we have to bring the same amount in. Actually we bring in a bit more; the room stays cleaner at positive pressure. Our mechanical engineer accomplished this by letting the air handler in the 10-ton air conditioning unit run continuously. It moves about 3700 cfm of air, and dampers adjust the air intake so 1500 cfm is outside air, and 2200 cfm is recirculated within the room.

When the room temperature rises above 76 degrees, the first stage of cooling comes on, and at 78 degrees, the second stage fires up.

Another thermostat senses the outside air temperature. If the outside air is cool enough (under 72 degrees) the 10-ton air conditioner is locked out, and another thermostat shifts dampers in the ductwork, so the 2200 cfm of recirculated room air is replaced with 2200 cfm of outside air to cool the room.

At outside air temperatures above 72 degrees, we use just enough outside air to make up the transmitter exhaust. A lot of air conditioning is wasted removing the

moisture from the air, so it is more efficient to recycle the inside air (at about 78 degrees, but dry) than to use outside air with all its humidity. Finding the most efficient point is actually more complicated, but in our climate, this is close enough.

Instead of making the backup air conditioner identical, we chose a smaller, cheaper, five-ton unit. It simply recirculates room air, and it is controlled by its own thermostat. That way, it will operate properly even if the main system has a control failure. While it might be a little under-sized on the hottest summer afternoon, it will keep the transmitter from roasting.

I asked the engineer to specify individual thermostats, rather than a programmable microprocessor controller, for simplicity, and so all the units would not be controlled by a single brain.

There were a few other touches ... gravity dampers to allow excess room air to spill outside, dampers so a single exhaust fan would draw air from whichever transmitter was on, smoke sensors in the air handlers as required by code, and lots of hysteresis in the controls.

When I asked about better air filtration, he suggested some 2-inch thick air filters we could use. They are not much more expensive than household furnace filters, but they trap a lot more dust.

## Small efficiencies

His complete plans showed duct, damper, and grill sizes and placement, motor horsepower and rpm, and the specific air handlers, condensers, and blowers to be used. We spent a few hundred dollars to have the mechanical engineer come check out the system when it was installed, and that was money well spent. He found a dozen small problems that were easy to correct, but hurt the efficiency of the system.

I bought a max/min thermometer for the transmitter room so I could see how the room temperature varied, and added a temperature sensor on the remote control.

After a year, I think the system is a winner. It was difficult to understand and operate at first, but it has worked out well. It was a great chance to learn how these systems are designed.

□ □ □

Jon Banks is chief engineer of WARW(FM) Bethesda, Md. Reach him care of RW.

**Listen-Up Software has developed a system called the Digital Juke Box that will allow you to record all music, jingles, commercials, talk elements and any other elements of your broadcast day onto the computers hard drive to be recalled at any time for jock assist or full automation.**

- ☛ 4.2 Gb Hard Drive Storage (over 50 hours of Stereo Storage or about 900 average length songs)
- ☛ 24 bank relay input/output board for controlling devices like network news, reel to reels, cart machines, ebs, etc. . .
- ☛ Dolby™ AC-2 Hard Drive storage format for the highest quality audio.
- ☛ Dual overlapping stereo. This means that your music will segue from one song to the next.
- ☛ Sampling rates through 48Khz
- ☛ Ability to play requests
- ☛ CD quality Audio

**\*\* 30 days money back \*\***

3 years manufacturers warrantee on all hardware  
Import Music data from your music scheduling system  
Import traffic data from your traffic system

If you like the sound of a cd, you will love the sound of The Digital Juke Box system.

**Introductory Offer**  
**\$6200.00**

The Digital Juke Box even comes with a 30 day money back guarantee.

This offer will end on 10/1/95. For the month of September only, you can purchase a Digital Juke box for just \$6200.00 That's about a 30% reduction in price. Furthermore, you will get one year of upgrades to the system at no cost.

Call us today to discuss your future in Digital Automation.

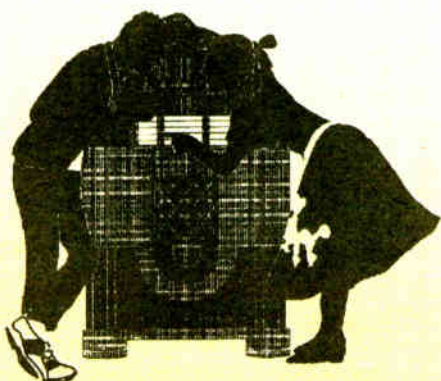

## The Digital Juke Box

by Listen-Up Software  
111 Sandy Avenue  
Moundsville, WV 26041  
Ph (304) 845-4767  
FAX (304) 845-0038

Circle (54) On Reader Service Card

## NOTE

Here's the GOOD news!  
Digital audio systems  
you can trust are made  
by I.T.C., the company  
you know for dependable  
radio products. Let us  
show you REAL solutions  
for your audio needs.  
Call 1-800-447-0414

THE BENCHMARK  
For the past 25 years...



IN BROADCASTING  
For the NEXT 25 YEARS

International Tapetronics Corporation, 2425 S. Main Street, Bloomington, IL  
Phone: (800) 447-0414, (309) 828-1381, Fax: (309) 828-1386

Circle (100) On Reader Service Card





**MUSICAM USA®**

# MUSICAM NEWS

Vol. 1 No. 1

September 1995

## MUSICAM EXPRESS™ Begins Roll-Out: Infinity Stations Launch In Three Cities

**MUSICAM EXPRESS™, the joint venture between Infinity Broadcasting and VirteX announced in April, has begun its roll-out at four Infinity-owned stations in three key cities.**

Launching the last two weeks of August were Infinity's flagship WXRK in New York; KROQ and KRTI in Los Angeles and WJFK in Washington D.C.

These four comprise the pilot program; the remaining Infinity owned and operated stations will come on board in the coming months with a general roll out involving thousands of other stations to follow.

The eventual aim is 3500 stations in major markets across the country.

"We agreed in concept to this venture with Infinity Broadcasting a mere four months ago and we're pleased to announce we're on schedule with the general roll-out," said Paul Donahue, President of VirteX.

"The technology has performed as well or better than expected, and Infinity has told us they're happy with the system."

The technology involves the new WinDaX™, a unique file server and store and forward system manufactured by VirteX; audio distribution over ISDN using MUSICAM USA's CDQPrma™ codec and additional flexibility with the VirteX Jock Box™ for quick, convenient manipulation of stored digital audio files.

For satellite distribution where desired, the revolutionary new StarGuide II™ receiver is also available.

The first MUSICAM EXPRESS™ stations will initially receive Westwood One's programming and commercials via the system.

But the goal of MUSICAM EXPRESS™ is to put the WinDax™ producer unit in every advertising agency and music recording studio.

MUSICAM EXPRESS™ will thus replace existing commercial and music distribution by slow mail delivery, or by low-tech modem technology (DCI and DGS) with instant, high quality digital audio using MUSICAM™—the best sounding digital audio available.

Through MUSICAM EXPRESS™, ad agencies will enjoy instant turnaround and reduction in delivery costs, while music studios can get breaking music on targeted stations within minutes of wrapping up a new recording.

Since MUSICAM EXPRESS™ will target stations in the top 20 markets, program distributors can use it as a high-quality, low-cost instant pipeline for their products.

An added plus is that all

MUSICAM EXPRESS™ stations, by standardizing to MUSICAM™ digital audio, will be prepared to embrace DAB in the future, since DAB's leading systems also rely on MUSICAM™.

## StarGuide II Configurable Satellite Receiver Changes History With Successful First Tests



*StarGuide II Satellite Receiver*

The new VirteX StarGuide II™, a ground-breaking digital multimedia telecommunications system via satellite, proved its mettle in its first critical tests at South Mountain near Valencia, CA.

The August 17 tests took place at the South Mountain Earth Station—at GE's satellite monitoring facilities with a second test at Mutual's teleport in Arlington Virginia.

In the tests, Westwood One music formats were down-linked from the C-5 satellite and re-uplinked for reception by StarGuide II™.

The results were flawless: perfectly synched, high quality digital audio. Three music formats: '70s, Adult and a local format, were used for the tests and all came through with pristine audio quality.

"This is the greatest technology of the 20th Century; it changes everything we thought about satellite receivers," said engineers monitoring the StarGuide II™ tests.

StarGuide II™ slashes satellite distribution costs because it instantly and remotely matches a user's band-

*Continued on page 2*



# FieldFone Is Here!

## Digital Audio Over A Regular Phone Line

Throw away  
your frequency  
extenders...

Forget about  
your RPU...

Your remotes  
are now  
entering the  
21st Century  
with FieldFone.

MUSICAM USA's FieldFone™, which won the Triple-Crown of awards at this year's spring NAB show, is ready for orders and will highlight booth 927 at the World Media Expo in New Orleans. It will also be shown at select distributor booths throughout the show.



Jerome Navies, Director of Radio Station News Services for CBS Radio, demonstrated FieldFone™ to the amazement and acclaim of news directors at the spring show.

FieldFone™ also won special pick of the show awards by Radio World, TV Technology and BE Radio.

In addition to working models at the MUSICAM USA booth, FieldFone™ will be featured at a presentation at the NAB's Digital Radio Seminar on Thursday, September 7.

FieldFone™ is portable and uses specially enhanced 28.8 modem technology to send broadcast quality digital audio over one, plain old telephone line from anywhere to anywhere in real time.

It's bidirectional and features mic and line audio and local and remote monitoring. And it's easy to set up and use, with no engineering required and no licenses, no line-of-site or hard-to-find frequencies needed.



**FIELDPHONE**

## Successful First Tests

*(Continued from cover page)*

width requirements, compression and network configuration with channel availability. It delivers any combination of audio, video, multimedia, software or data services to one receiver or a group of receivers.

StarGuide II™ software

controls and low-cost plug-in modules allow for future upgrades and expandability.

StarGuide II's revolutionary MX3 multiple service, channel and carrier transmission makes the most efficient and cost effective use of channel bandwidth

and power.

For the first time users can configure the system to work best for them.

StarGuide II™ will have its official unveiling at the MUSICAM USA booth, 927 at the World Media Expo in New Orleans.

It's one more guarantee that the future of radio is MUSICAM™.

### How to Contact Us...

Art Constantine, VP Sales & Marketing  
David Lin, Product Manager  
Sam Agin, Technical Specialist

MUSICAM USA, Inc.  
670 N. Beers St., Bldg. 4  
Holmdel, New Jersey 07733  
Tel: 908-739-5600 Fax: 908-739-1818



# Did You Know...

## CDQPrima™ Beat the Zephyr™ In Recent Tests

Did you know that the Zephyr™, using five-year old Layer III technology, has an exasperating half second delay in each direction, making headphone monitoring virtually impossible?

Did you know that the telephone company rejected delays less than those encountered in Layer III as being entirely unacceptable?

And that MUSICAM eliminates the lengthy delay problem?

And that MUSICAM sounds better than Layer II or Layer III?

That the CDQPrima™ with MUSICAM has much lower distortion and much better dynamic range than Zephyr™?

That CDQPrima™ is compatible with other Layer II technology as certified by the IRT?

That it can even make other brand Layer II decoders sound better?

That the Zephyr's™ Layer III can only talk to other Zephyrs™?

No wonder Telos chose to confuse the issue with "New Math!"

In fact, engineer Larry Paulausky at Greater Media station WMGK recently compared CDQPrima™ to Zephyr™ and decided on Prima, hands down.

Here are the facts, judge for yourself.

Read enough?  
There's more!

Stop by the  
MUSICAM USA  
Booth, 927,  
at the  
World Media Expo

Or call  
908-739-5600  
for a complete  
list of 40 ways  
CDQPrima™ bests  
the Zephyr™.

Then ask yourself  
which one really  
makes you feel  
"safe."

CDQPrima™ with MUSICAM® Model 120 w/TA	Telos Zephyr™ Model 9200 w/TA
World standard MUSICAM™ compression, compatible with USADR DAB, 50,000 professional channels worldwide, over 1 million consumer channels worldwide and compatible with Layer II technology	Layer III, compatible only with other Zephyrs™
Coding delay: 80 milliseconds	Coding delay: 500 milliseconds
18-bit A/D & D/A converters Total harmonic distortion: 0.01%	16-bit A/D & D/A converters Total harmonic distortion: 0.03%
Dynamic range: >89 dB	Dynamic range: 80 dB typical
Analog, plus AES/EBU & S/PDIF digital audio inputs and outputs with automatic rate adaption	Analog I/O only
Speed dial: stores 256 addresses, each containing up to six 20-digit ISDN numbers, plus all parameters for connection, including automatic algorithm and rate detection	Speed dial: stores 20 speed dial addresses, each containing 2 numbers, maximum
Full remote control—over 150 commands	Limited remote control—14 commands
Bit rates: 24, 32, 40, 48, 56, 64, 80, 96, 112, 128, 144, 160, 192, 224, 256, 320, and 384 kbps	Bit rates: 56, 64, 112, 128 kbps
Electronic software upgrades via ISDN and RS232	Electronic Software upgrades via ROM change only
Previous codec experience: 8 years, 17 models, first to make and market codecs to radio and pro audio	Previous codec experience: none
Price: \$4950 US list	Price: \$4980 US list



## CCS Becomes MUSICAM USA

In case you haven't already heard, CCS Audio Products, manufacturers of CDQPrima™ and CDQ1000 codecs for ISDN, as well as the FieldFone™, has changed its name to MUSICAM USA.

It was only natural that the developers of MUSICAM, the first and only enhance-

ment to MPEG Layer II, would adopt the name of the technology that has become the world standard for high quality, great sounding digital audio throughout the world.

MUSICAM USA, which is owned by VirteX, owns the exclusive rights to the MUSICAM name in the U.S.

Only products made and marketed by MUSICAM USA and its licensees guarantee the best sounding digital audio.

The company's European sister, CCS Europe GmbH, will keep the name CCS Europe.

## IRT Certifies MUSICAM

The Institut Fur Rundfunk Technik (IRT), research and development center of public broadcasters in Germany, Austria and Switzerland and developers of digital audio standards, completed testing and certified MUSICAM for full compatibility with MPEG Layer II.

This assures compatibility between MUSICAM encoders and MPEG Layer II decoders in digital audio applications throughout the world.

The IRT certification insures that MUSICAM encoders can be used with MPEG Layer II decoders (that ad-

here to the standard) without fear of incompatibility.

In addition, MUSICAM quality enhancements over MPEG Layer II guarantee the use of MUSICAM encoders will make any brand of MPEG Layer II decoder sound better.

# Full Agenda For MUSICAM USA At World Media Expo

## Westwood One Remotes Top the List

New Orleans will be hopping with more than just jazz as the World Media Expo gets underway September 7-9.

And MUSICAM USA (Booth 927) has a full slate of exciting new products, papers and presentations and broadcasts of Westwood One's live remote programs as part of the MUSICAM EXPRESS roll-out.

In addition to its highly acclaimed CDQPrima™ codec for ISDN, the exhibit floor booth will feature the revolutionary Starguide II™ configurable satellite receiver, the new WinDax™ file server and the FieldFone™ plain old telephone line codec.

Two Westwood One shows

will broadcast live via MUSICAM EXPRESS™ using CDQPrima™ ISDN right from the booth.

*Mike Walker* will be on the air from 9-11AM and the popular *David Brenner* will broadcast from 2-5PM Thursday and Friday during the show.

In the convention center lobby, also via MUSICAM EXPRESS™ with CDQPrima™ ISDN, will be Westwood personalities *G. Gordon Liddy* from 9AM-12 noon and *Don & Mike* from 2-6PM, also on Thursday and Friday.

And host *Tom Leykis* will be using the same technology to broadcast his show to a national audience from Pat O'Brien's in the French quar-

ter each evening from 5-9PM.

Several panels will also feature MUSICAM USA technology.

On tap at the NAB's Digital Radio Seminar on Thursday, September 7, are Art Constantine at 10AM with a presentation on FieldFone™ and VirteX's Paul Donahue at 11:20AM talking about MUSICAM EXPRESS™.

Also on Thursday, a panel on Radio's Technical Revolution at 3:45PM will feature Dr. Larry Hinderks, Chief Technical Officer of VirteX and Caryn Beemer also of VirteX talking about the latest digital toys featuring MUSICAM.



**MUSICAM USA®**

© Copyright 1995 MUSICAM USA



## FIELD IMPRESSION

# Installing a LAN on a Radio Budget

by W. C. Spenn

**SAN ANTONIO, Texas** It is almost impossible to run a business without a computer. In fact, it is almost impossible to operate a business without two computers. But the minute you add a second one, you realize how much trouble it becomes to move data between them.

Almost always, the data you need on one computer is on the other, and someone is using it. If you are expecting a large productivity increase by adding a computer, remember, any productivity gain is usually non-existent or negative.

A local area network (LAN) allows data and resource sharing. However, money and time costs to install and maintain a LAN can, just like adding another PC, remove any expected gain.

**Live with it**

Until recently, unless I was dealing with a larger company, I would have told you to just "live with it." Because, after years of testing numerous low-cost LANs and LAN alternatives, I had not found any without major deficiencies. Every small LAN installation became a major research and testing project both at my office and the customer site. I quickly learned I could not sell any of the low-cost LANs if I expected to keep my customers and make enough money to stay in business.

Imagine my surprise when I received product information on a very reasonably priced, full-function LAN product from CBIS called Desk to Desk. This time I was less skeptical, because I had installed the full priced version of this LAN at various customer sites; I and my customers were very happy with the LAN product.

I called CBIS to confirm that the pricing was truly only \$129, and the price was for up to 255 users. I was assured both were correct. In fact, to prove they have a

is called a non-dedicated server and the node functions as both a network server and a workstation. If a node does not share any resources, it is simply a workstation. CBIS offers a Desk to Desk dedicated server, if you should need one, at an additional cost.

I was amazed that Desk to Desk LAN software runs on older XT and 286 PCs. Usually if you do not have at least a 386, it is not welcome on the network. Even more amazing is, one of



these older machines can be used as a Desk to Desk network server.

In other words, you do not have to upgrade your hardware to get the advantages of a LAN. However, if you wish to load Desk to Desk into upper memory (conserving precious conventional memory) a 386 or greater PC is required.

Desk to Desk supports both DOS and Windows, which can be mixed throughout the network. CBIS feels its LAN is Windows-robust enough to state, "Users can run Windows from a network server for centralized control." Naturally if you expect to run Windows, you need a 386 or greater PC.

**Features**

One of the best features for LANs is printer sharing. Printer sharing lets you work on a PC while waiting for the printer — this is very cost effective but can also be the biggest headache for most networks. I have a few sites that use their network only for this feature. If you spend big money for a fast, high quality

Remote PC setup and configuration keeps you out of someone else's office and off their PC. Supervisory monitoring and interaction, an excellent training tool, is also available.

**Getting it together**

CBIS claims Desk to Desk is so easy to install that "even novice users can be up and running in minutes," so I decided a novice should do the first install.

I provided my first time installer with

the LAN software, two Ethernet NE-2000 NICs with manuals, 50 feet of coaxial cable with terminators and a multi-screwdriver tool to open the PCs and install the NICs.

My only instructions were to use Interrupt Request (IRQ) 10 rather than IRQ 3 on the network cards, install the DOS version on one PC configured as a server and the Windows version on the other configured as a workstation. As an afterthought, I suggested installing the online documentation first, and checking the diskettes for "readme" files.

The first step was installing the NICs and connecting the cable. Following the instruction manual, installation and cabling was easy, according to my installer. The online documentation installation also went well, but using the documentation was not a good experience.

**Bugs in the system**

After numerous tries, we could not get the documentation to work properly. Because I was familiar with other CBIS LANs, I felt that it might be best to proceed to the actual LAN installation. I could call CBIS technical support later.

The DOS network server (the first install) went well until a password was required for configuration. The enter key did not take, so I suggested trying "password." It worked. There were no more questions for the rest of the installation.

With the DOS installation complete, my installer felt the network would start up and run. After all, the installation had gone well with only the password getting in the way. The network would not start. It did not like the network card. After checking and double checking the card and software to assure both matched, it was time to call technical support.

CBIS technical support was very helpful once we registered Desk to Desk. The serial number is on the box, not the diskettes and it took a few minutes to dig out the box (I wrote the serial number on the diskettes and suggest you do the same). Technical support asked us to run the Desk to Desk start up program with the ARGS option.

It turns out IRQ 10 was entered in decimal code and Desk to Desk wanted the IRQ as hexadecimal 0A. With the change made, the representative stayed on the line until he made sure the server was running.

The Windows workstation installation went much better, after we solved

another configuration password problem. "Password" did not work like it did under DOS, but no password did. The decimal IRQs were not a problem under Windows; the only selection allowed is hex code.

**It's alive!**

My installer was really excited to use disk drives and printers on a PC down the hall. The CD-ROM, however, was not working across the network. It was my turn to look at the problem. Everything looked fine, so it was time to call tech support again. The representative once again immediately solved the problem. I had to load MSCDEX after the network software. Some changes to the AUTOEXEC.BAT, and the CD-ROM was available on the network. Since then, Desk to Desk has run as smoothly as the high priced version.

Even though the box is still the same, CBIS has resolved the above problems in the current release. The biggest problem — the on-line documentation diskette — has been replaced with a user guide which you turn over depending on whether you want DOS or Windows information.

The biggest problem solver is the just-released "Desk to Desk Complete Reference Guide," which is a complete user guide and extensive system administration, management, and troubleshooting lifesaver. You might want to add this reference guide to your collection for the chapters on network planning, ODI drivers, optimizing and troubleshooting, no matter what type of network software you use.

There are two unresolved Desk to Desk problems. The first is the user guide, which is out of date. It still mentions on-line documentation, which is no longer available. The second is the "no technical support" policy (according to the complete reference) of the image mirroring feature, prominently promoted in their brochure and on the box as a major selling point. Not only is image mirroring valuable for training, but also for remote network maintenance and troubleshooting using remote access software via modem.

I have received technical support for  
continued on page 20 ▶

## Every small LAN installation became a major research and testing project both at my office and the customer site.

great product. CBIS offers a 30-day, no questions asked guarantee. I did not hesitate. I gave them my credit card number and would have the product in two days.

Two days later, I received a 9- by 8- by 3-inch four-color printed box containing an envelope with three diskettes—two were the LAN software, the other was the user guide. I also found two papers in the box: one was a slick brochure for Desk to Desk, the other was toll-free telephone product registration information required for free support.

**Point-by-point comparison**

The brochure allowed me to compare the Desk to Desk features to CBIS' full-priced LAN. I was surprised to find only small variations, none of which I considered worth the difference in price.

Desk to Desk is a peer-to-peer LAN, where any network node can share resources (disk drives, CD-ROM drives, directories and printers) with any other node on the network. You do not need a LAN if there is no resource to share.

If a node shares any of its resources, it

printer, it should be available to everyone. Desk to Desk allows you to monitor printer traffic and reorder, remove, and switch jobs among printers. This means needed printing can be moved to the front of the queue or to another printer with ease if necessary.

If security is an issue, you can restrict resource access to almost any level you wish. Desk to Desk allows extensive network security flexibility. You can also attach security to a user profile. That way, your personal network privileges and connections can be the same no matter which network PC you use.

Desk to Desk uses industry-standard network cards and protocols: Ethernet, ARCNet, and Token Ring. Open Datalink Interface (ODI) support provides compatibility for most notebook network interface cards (NICs). Because of industry-standard compatibility, Desk to Desk can coexist with other networks.

Also included in the extensive Desk to Desk feature set is a suite of network management utilities. Traffic monitoring helps track down LAN problems.

## MOVING?...

Don't leave us behind!

Mail or fax  
your current label  
and new address  
(with effective date) to:

Circulation, RW,  
PO Box 1214  
Falls Church, VA  
22041

or  
FAX 703-998-2966.

Address changes  
will be processed  
within four weeks of receipt.

Thanks!





# Your Best ISDN Solution.

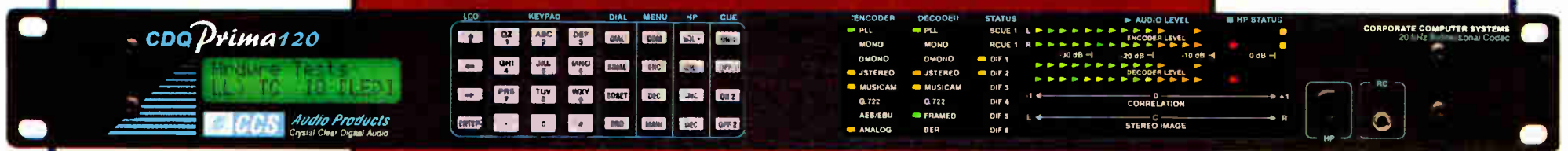

## Money Back Guaranteed!

Only **CDQPrima™** with **MUSICAM®** is guaranteed to make your ISDN digital audio sound the best!

**MUSICAM®** is today's digital audio standard. Only **MUSICAM®** has enhancements designed to sound best over ISDN phone lines. Only **MUSICAM-USA®** gives you a 30-day money back guarantee.



Don't just take *our* word . . .

Ask over 10,000 **MUSICAM®** codec users worldwide

•

Ask USA Digital Radio DAB

•

Ask RCA DirecTV, LucasFilm and Top Recording Studios

We guarantee compatibility with MPEG II.  
Prima will even make your other brand decoder sound great!

Don't stake your next ISDN remote on five-year old Layer III or Layer II technology.

**Call MUSICAM-USA® for the facts!**



**MUSICAM USA**

670 North Beers Street  
Building 4  
Holmdel, NJ 07733 USA  
Tel: (908) 739-5600  
Fax: (908) 739-1818

Formerly:  
Corporate Computer Systems





# Applying Kirchoff's Law to Problems

► continued from page 14

V2 in the second mesh. These two small loops mesh like a set of gears meshing where they intersect (at R2).

Mesh analysis provides a method by which you can write a series of equations for the circuit by inspection. You will derive the method of mesh analysis for this simple circuit.

Figure 2 shows the two mesh currents, Ia and Ib. Ia passes through all

**This final set of equations, however, can be written by inspecting the circuit.**

the components of mesh A (V1, R1, R2), while Ib passes through all the components of mesh B (R2, R3, V2). Note that R2 is in both meshes A and B.

The voltage across R1 can be determined using Ohm's Law as (Ia)(R1). Because Ia passes through R1 left to right, going into the left side, the left side of R1 will be positive with respect to the right side (assuming Ia is positive). The total current through R2 is either Ia-Ib "going down" or Ib-Ia "going up." This number may be either positive or negative.

For mesh A, use the going down current. This makes the top of R2 positive with respect to the bottom (again, assuming Ia-Ib is positive). You can

$$A: (R1+R2)(-Ia) + (R2)(Ib) = -12$$

Combine like terms

$$B: (R2)(Ia) + (R2+R3)(-Ib) = -3$$

$$A: (R1+R2)(Ia) - (R2)(Ib) = +12$$

Change signs to reduce number of negatives

$$B: -(R2)(Ia) + (R2+R3)(Ib) = +3$$

I find adding voltages rises more intuitive, but the final set of equations you get will correspond to adding the voltage drops (it changed when you reversed signs). This final set of equations, however, can be written

by inspecting the circuit.

In equation A, the coefficient of Ia is the self resistance of mesh A. It is simply the sum of all the resistance in mesh A (in this case, R1+R2).

### Mesh resistance

In mesh A, the coefficient of Ib is the mutual resistance between meshes A and B, with a minus sign. R2 is in common between these two meshes, so -R2 is the coefficient of Ib.

Finally, the number on the right side of the equal sign is the voltage source (in the loop). The polarity is determined by the side of the source you come out of as we go around the mesh in the direction indicated by the mesh current arrow (which is, by convention, clockwise).

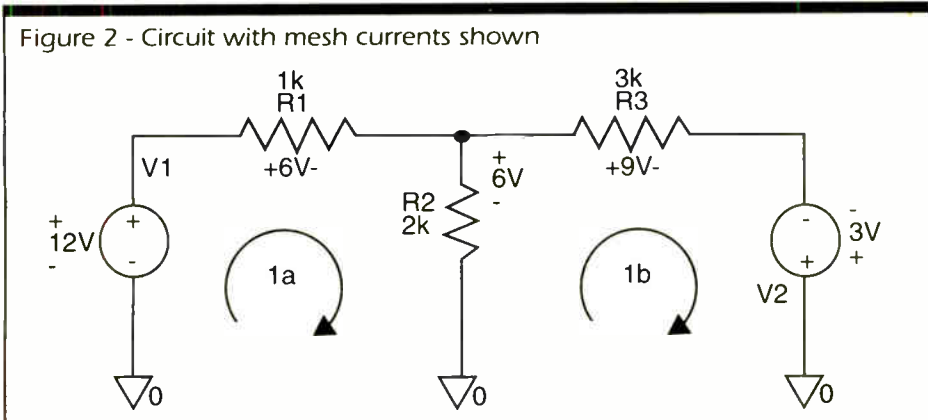

now apply KVL to mesh A. You get the following equation, adding the voltage rises in a clockwise direction around mesh A:

$$+12 - (Ia)R1 - (Ia-Ib)R2 = 0$$

For mesh B, it is simpler if you assume the bottom end of R2 is positive with respect to the top end (all the resistor voltages have the same polarity in the equations). For the bottom end of R2 to be positive, the current must go up through R2. As previously mentioned, the current through R2 is (Ib-Ia) going up. Adding the voltage rises in a clockwise direction around mesh B, you get the following equation:

$$-(Ib-Ia)R2 - (Ib)R3 + 3 = 0$$

Putting these two equations together as a system of two equations with two unknowns and organizing them, you arrive at the following:

$$A: +12 - (Ia)R1 - (Ia-Ib)R2 = 0$$

$$B: -(Ib-Ia)R2 - (Ib)R3 + 3 = 0$$

mathematician, 1777-1855) came up with a systematic method of manipulating the matrices such that all the elements of the first column, except the top left, became zero. This vastly simplifies calculation of the determinants. Various other methods are available, but, for now, stick with Cramer's Rule because of its simplicity, even if it does get tedious for large problems.

For generalization, say you have a three mesh circuit that result in a set of equations of the form shown below:

$$ax+by+cz = d$$

$$ex+fy+gz = h$$

$$jx+ky+mz = n$$

Take the coefficients of x, y and z and form the matrix below:

a	b	c
e	f	g
j	k	m

The determinant of this matrix is the denominator of the solutions for x, y, and z. Substituting the column to the right of the equal signs in column 1 and taking the determinant of the resulting matrix results in the numerator of x.

Substituting that column for column 2 (while restoring the other columns) and taking the determinant results in the numerator for y. Finally, substituting the column to the right of the equal signs in column 3 and taking the determinant of the resulting matrix results in the numerator of z.

continued on page 21 ►

## WELCOME TO THE DIGITAL WORLD OF DIGILINK

- Replace cart machines live On Air while adding walkaway CD, Satellite, or Tape automation
- On Air Base Price starts under \$8,000
- 8 Track Editor base price starts under \$5,500
- Smallest systems start at 10 hours stereo audio storage (20 hours mono)
- Network more than 15 Digilink workstations

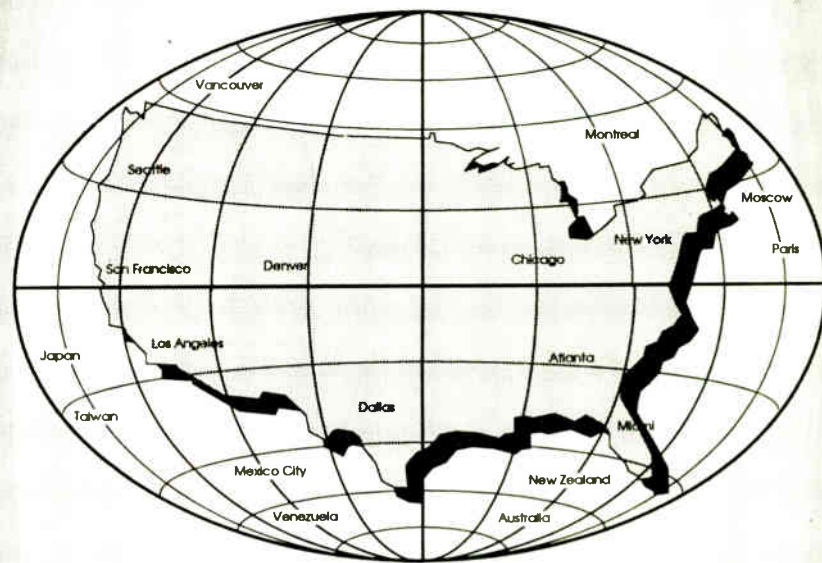

With over 500 workstations sold worldwide in the last 18 months and more than 400 of those workstations sold in the U.S.A, it is little wonder that Digilink is the #1 choice for a digital audio hard disk workstation for professional radio broadcasting. Whether for On Air, Production, News, or Automation... Digilink does it ALL.

For more information about the #1 selling digital audio workstation for Radio, call or write...

303-224-2248

# ARRAKIS

© 1993 Arrakis Systems inc. 2619 Midpoint Drive, Fort Collins, CO. 80525

Circle (210) On Reader Service Card



# Look at All Facets When Designing New Site

## Part I

by W.C. Alexander

**DALLAS** It is not very often that most engineers are tasked with designing a new transmitter building. For some, a new site may be a once-in-a-lifetime project; for others, such undertakings may be routine.

Around this office, we work up designs for new AM and FM transmitter buildings all the time. Because this is an infrequent exercise for most of us, let me share with you the benefit of my successes and mistakes in this area.

### Many factors

A lot of factors go into the design and layout of a transmitter building. *Numero uno* on the list is available budget. It does not take a lot of money to build an excellent site, but money misspent is money wasted. For instance, unless the site is to be manned frequently, there is little need to install creature comforts such as plumbing and the like.

Other items, such as ventilation and electrical, are very important and require a lot of planning. Let's look at some of these areas and the options we have in each.

Start by sketching out a proposed floor plan. For the moment, forget about building size and shape. Lay out the equipment the way you want it. If you have a CAD (computer aided design) program of some sort, here is a great place to put it to use. That is what I do. I create blocks that accurately represent the dimensions of each piece of equipment (transmitter, combiner, phasor, rack, etc.) to be installed. I can then move them around on the screen to my heart's content until I find that perfect arrangement.

As you are placing your equipment on the floor plan, keep in mind how certain items will be used. Ask yourself if you will have a line-of-sight between devices where such is needed. For instance, will you be able to see

the modulation monitor displaying AM noise while tuning transmitter IPA stages? Will you be able to see the antenna monitor while cranking on the phasor?

You may do well not only to locate equipment racks containing such monitoring equipment adjacent to the devices that affect the resulting readings, but also to turn the racks 90-degrees so that you can see the indications face-on and without parallax. This may not always be practical, but whenever possible, locate equipment where you can see it when you need it.

Another alternative is to place your

Steel equipment racks provide a good amount of electromagnetic shielding, but additional physical space between transformers and sensitive equipment will provide an additional degree of isolation.

This is particularly important in transmitters that use SCRs to control the AC waveform to the power transformers. Some sharp pulses can be present, depending upon how far back the power has been cut, and these sometimes produce noise in nearby equipment.

Once you have your basic floor plan done, you can decide what size building you need. A good rule is to have at least six feet of

that much horizontal space between the transmitter output port and the egress point. If you have ever tried to install a line with a minimum-radius bend, you know that while it is possible, it is tough!

A good rule is to allow space for twice the minimum bending radius. You won't use quite all of it, but you will be glad for the room while hooking up the line.

For AM stations where egress is through the floor, you will need a bend coming out the top of your phasor or transmitter and another to transition downward toward the floor. In these cases, allow four times the minimum bending radius of the largest line in use at the site between the phasor or transmitter output port and the egress point.

### Run proofs

Directional AM stations must run proofs. This is, for the moment, as certain as death and taxes. Proofs require lots of 7 1/2 minute topo maps, and to plot radials on these topo maps you will have to lay them out end-to-end or side-by-side on a flat surface. Keep this in mind as you determine your new building's size. While you can use the hood of your car to lay out maps, the wind, humidity and precipitation make this a very unattractive alternative. The transmitter building floor is a much better place to work. Leave room to lay out two or three maps.

Once you have determined how much space is needed around your equipment, determine the likely dimensions of the building interior. I usually adjust the interior dimensions to a standard size based upon the materials to be used. Multiples of 4-feet work well for gypsum board and ceiling tile while multiples of 16-inches work well for cinder blocks. In the end, the builder can make just about anything work, but if you can avoid wasted material and unnecessary cuts, do it. It will save on construction time and costs in the long run.

Here is where a CAD program will come in very handy. You can use such a program to draw the exterior walls

continued on page 43 ▶

## It does not take a lot of money to build an excellent site, but money misspent is money wasted.

equipment in two parallel and inward-facing lines. In this way, you need only look over your shoulder to see the appropriate monitor while cranking on a control.

### Little choice

Some aspects of equipment layout leave you little choice. For example, when using combined transmitters, the dictated layout usually places the racks containing the exciters, switching controls, line stretchers and the like between the two transmitters. This makes for a long line of equipment (and usually a lot of waster floor space), but it is best to follow the manufacturer's recommendations whenever possible. On the other hand, it is you and not the manufacturer that will have to live with the layout. There is no harm in asking the manufacturer if an alternative layout is possible.

If possible, keep sensitive audio and control equipment on the opposite side of your transmitters from the power supply area.

room all the way around your equipment. My personal preference is ten feet. This will give you room to remove access panels, cabinet doors and the like and work with your tools and test equipment scattered about. Nothing is worse than a cramped, crowded transmitter room.

At one of our stations, we share a transmitter building with another station's generator. There is barely room to turn around in there, let alone work on anything. I cannot imagine working in there with that genset running! It is a good thing we have good, reliable equipment there! We are working on a new site for that station, one in which we will have plenty of room.

Another very important consideration is transmission line bending radius. If you are using flexible-type transmission line and do not plan on investing in expensive 90-degree elbows, the line will have to transition from a vertical to a horizontal run as it leaves the transmitter and heads outside.

Check the manufacturer's specifications carefully and leave yourself plenty of room. For example, 3-inch flexible transmission line has a minimum bending radius of something like 30-inch. You would need at least



**You can measure... with the best monitor and the most accurate test set.**

The FMM-2/FMS-2 series monitors provide an even greater degree of precision measurement than ever before... **You can measure S/N below 90 dB, You can measure crosstalk below 85 dB, You can measure separations of better than 70 dB, You can measure frequency response to better than 0.25 dB, You can measure distortions to lower than 0.01%, and much more...** Our uncluttered panels and autoranging voltmeters make these measurements a dream.

**BELAR ELECTRONICS LABORATORY, INC.**  
LANCASTER AVENUE AT DORSET, DEVON, PENNSYLVANIA 19333  
Call or write for more information on Belar AM, FM, Stereo, SCA and TV monitors.

(610) 687-5550

Circle (101) On Reader Service Card

## Budget LAN That Works

▶ continued from page 17

image mirroring from CBIS, but that may be because of my networking consultant status. I firmly believe if you place software on a distribution disk, you should support it.

Yes, a novice can install Desk to Desk. Especially with the newer documentation and the excellent CBIS technical support. However, no matter how excellent the software and support, it is useless without quality LAN hardware and cabling. CBIS offers excellent, helpful hardware tips on Desk to Desk.

Most cheaper network cards are just plain cheap, and most expensive network cards are just expensive. Moderately priced NICs (\$55 to \$99 for one) with hardware jumpers are your best bet: sooner or later you will encounter problems with NIC software configurations and it is a lot easier to look at jumpers to verify configuration than look inside an integrated circuit. A good source for quality, moderately priced, network

cards is Clone Star. You can reach them at 713-256-2886.

Finally, remember once a LAN is operational, 96 percent of all problems involve cabling. If there is a LAN problem, it is probably the cable, even if it is only 50 feet long and connects two PCs.

For only \$129, Desk to Desk has no competition in price, features, and node count. Even though there are unresolved problems, they do not affect LAN operation. Buy the reference guide. I cannot emphasize this enough; with the 30 day money back guarantee, at the very least, you will be much more knowledgeable about local area networks.

You can reach CBIS at 800-835-DESK. When you contact them, ask for information about Desk to Desk add-on products.

□□□

W. C. Spenn is a networking and communications consultant for Dove Data Systems in San Antonio, TX. He can be reached at 210-656-8011.



# Apply Kirchoff's Law

► continued from page 19

$$\begin{vmatrix} d & b & c \\ h & f & g \\ n & k & m \end{vmatrix} = x$$

$$\begin{vmatrix} a & b & c \\ e & f & g \\ j & k & m \end{vmatrix}$$

The determinant of a 1x1 matrix (a number by itself) is the number itself. The determinants of larger matrices may be calculated by using the elements of any row or column and multiplying it by its cofactor, which is +/- times the "minor" of that element. So, for simplicity, find the determinant of the 2x2 matrix shown below.

$$\begin{vmatrix} a & b \\ c & d \end{vmatrix}$$

Start with a + sign in the upper left corner. If you decide to calculate the determinant of this matrix using the elements of the first column, do "a times its minor minus c times its minor." The "minor" is the matrix that is left when you remove the row and column of the element you are working with. If you are working with "a"

**Most readers probably already know how to calculate the determinant of a 2x2 matrix.**

and remove the first row and column, all that remains is a 1x1 matrix containing "d." And, from above, you know that the determinant of the 1x1 matrix is the single element itself, so you have, so far, a\*d.

Moving down the first column, subtract "c" times its minor. You subtract because you alternate + and - signs starting in the upper left corner. So, now you get -(c\*d). The determinant of the matrix above is (ad)-(cb).

If you had worked across the top row, you would get (ad)-(bc), which is, of course, equivalent.

If you had worked across the second row, you would do -c times its minor (b) plus d times its minor (-cb+da), which is again equivalent.

Note that if you evaluate using the second row or column, you start with a minus sign.

Most readers probably already know how to calculate the determinant of a 2x2 matrix. It is just one cross-product minus the other cross-product. However, using this "cofactor expansion" method simply demonstrates the technique and yields an answer you expect.

This method is expandable to any number of elements of a square matrix, though the calculations get a little cumbersome after a while.

See if you agree with my expansion of the determinant of a 3x3 matrix below, expanding on the first column.

$$\begin{vmatrix} a & b & c \\ e & f & g \\ j & k & m \end{vmatrix} = a(fm-kg)-e(bm-kc)+j(bg-fc)$$

Which column or row should you expand upon? If you can find one with zeroes in it, a considerable number of calculations may be skipped.

To get a zero, however, you must have had no mutual resistance between a couple meshes or no voltage in a mesh. It does happen, but not frequently enough!

For larger circuits, we'll use Spice! By inspection, you can write the equations below for the circuit of Figure 2.

A:  $3K1a - 2K1b = +12$   
 B:  $-2K1b + 5K1c = +3$

Applying Cramer's Rule, you find the denominator of Ia and Ib.

$I+3K -2K1$   
 $I-2K +5K1 = (3K*5K)-(-2K*(-2K)) = 11e6$

Substituting for the first column to find the numerator for Ia, you find,

$I+12 -2K1$   
 $I+3 +5K1 = (12*5K)-(-2K*3) = 66e3$

Substituting for the second column to find the numerator of Ib, you find,

$I+3K +12I$   
 $I-2K +3I = (3K*3) - (-2K*12) = 33e3$

Finally, combining all this,  
 $Ia = 66e3/11e6 = 6mA$   
 $Ib = 33e3/11e6 = 3mA$

These numbers agree with the currents you got last time. Because Ia alone goes through R1, and goes to the right, the current through R1 is 6 mA to the right. Because Ib alone goes through R3, and goes to the right, the

current through R3 is 3 mA to the right, or -3 mA to the left. If you assume the current through R2 is going down, the current is Ia-Ib, or 3 mA.

If you assume the current is going up, it is Ib-Ia, or -3 mA. From these currents, you can calculate the voltages across components as shown in Figure 1 or compare the results with the currents you calculated last month using node voltage analysis.

□□□  
 Harold Hallikainen is president of Hallikainen & Friends, a manufacturer of transmitter control and telemetry equipment. He also teaches electronics at Cuesta College and is an avid contradancer. He can be reached at 805-541-0200 (voice), 805-541-0201 (fax), ap621@cleveland.freenet.edu (e-mail), and <http://stonet.org/~hhallika/> on the World Wide Web.

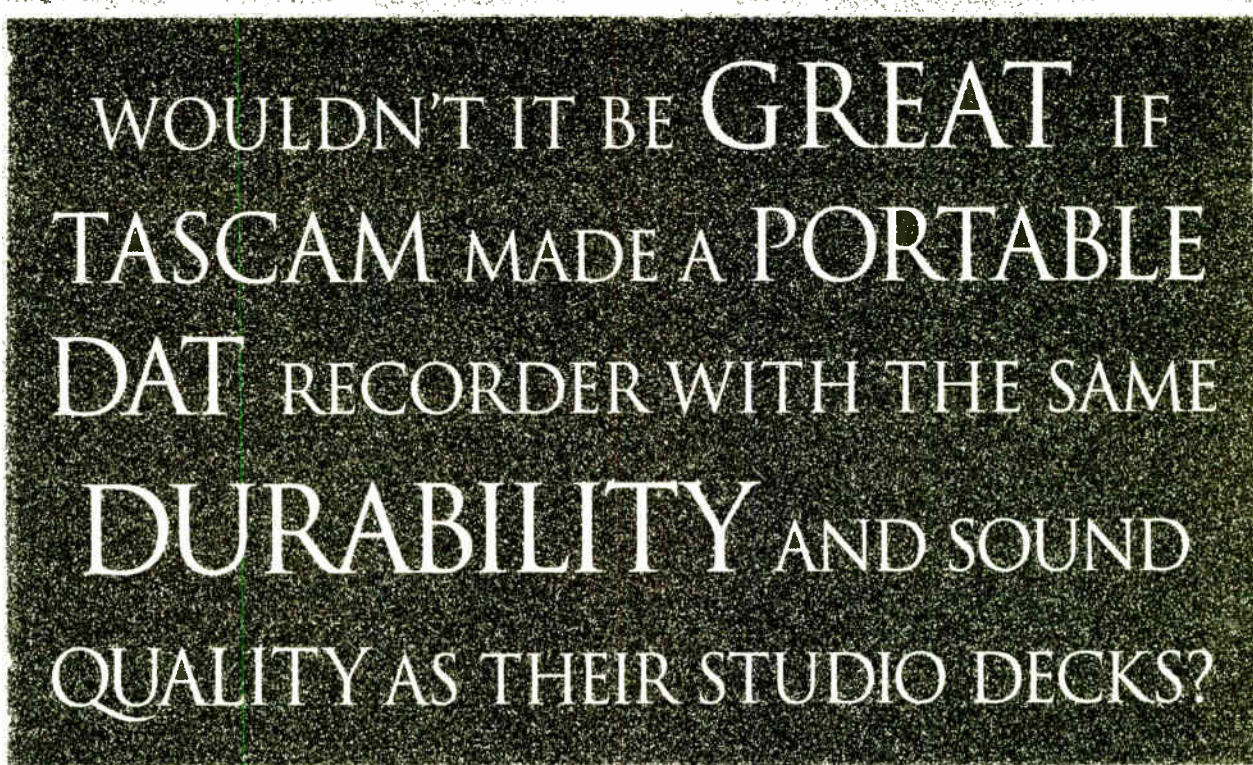

It's here. The TASCAM DA-PI. The ideal portable DAT for field recording in broadcast applications.

You need a durable and high-quality DAT recorder for your team to take into the field. You'll get higher quality digital audio, plus be able to dump it to a digital audio workstation for quick and easy editing. That's why TASCAM makes the DA-PI. It has the features demanded by broadcast professionals. Things like XLR-type MIC/LINE inputs with phantom power so you can use a wide range of microphones and input devices. A 20dB pad, and a versatile, easy-to-read display. But field reporters and production personnel will love the DA-PI's extended life 2-hour battery that recharges in just 1 1/2 hours.

If you can get the DA-PI back from your field personnel, you'll find it performs outstanding in the studio, too.



With a built-in SPDIF direct digital I/O, it integrates with DAW's, and other digital gear. Also, it supports multiple sample rates (48, 44.1 and 32 kHz) and utilizes next-generation A/D and D/A converters delivering studio-DAT quality sound.

Standard accessories include a shoulder belt, AC adapter and battery — carrying case optional.

So if you're torn between a new recorder for the field, or a DAT for the "B" suite, think no more. Pick up a DA-PI. You get the best of both worlds. In fact, once you get your hands on a DA-PI, you may want to buy two. So get to your dealer today and order your new portable DAT from TASCAM.

**TASCAM**  
 Take advantage of our experience.

MSRP \$1,899. For complete specs and information via TASCAM FaxBack, call 800-827-2268 document #7150. © 1995 TEAC America, Inc. 7733 Telegraph Road, Montebello, CA 90640 (213) 726-0303. TEAC CANADA LTD. 340 Brunel Road, Mississauga, Ontario L4Z 2C2 Canada (905) 890-8008.

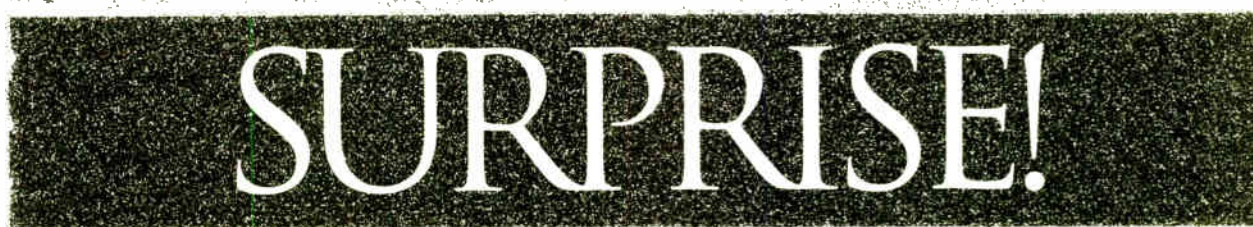



# WORKBENCH

## Inspect Site for Signs of Trouble

by John Bisset

**SPRINGFIELD, Va.** Now that the weather is not quite as bad outside, it is time to take a leisurely walk around the studio and transmitter plants.

At the studio, if you have satellite dishes, take a look at how the connectors are taped. Check that mounting bolts and support cables and struts are all in place. Loose or missing hardware can cause a dish to more easily deform when loaded with ice and snow. If you are new to the facility, check for "trouble makers" like the open conduit shown in the photo.

Insects, or worse, water, can fill openings like this, causing no end of problems. Plug the hole with a clay-based sealer — it is easier to remove than caulk or urethane foam.

Although not shown in the photo, another wise move is to mark the orientation of the dish with a vertical line, using a permanent or paint marker. Kids love to spin dishes, it seems, and without the appropriate alignment equipment, getting the dish back on the satellite can be a chore.

The orientation marks will be a life saver if vandals strike.

Fall weather is a good time to wax your dish. A sponge or rag taped to the end of a broom can be used to apply a thin film of wax. The waxed surface will make knocking ice out of the dish a breeze when winter comes.

One last thing to check is the feedhorn assembly. Hopefully, nesting insects like bees haven't made the feedhorn a home. I've made it a rule to spray the outside of the feedhorn with a brief burst of hornet killer in the spring and fall. The smell lingers for weeks, and keeps stinging pests away.

If you don't have a heat pump/air conditioner maintenance contract, shame on your management for cutting it out of the budget! Grab a hose and spray down the condenser coils on the outside heat pump. Start from the top and work your way down, walking completely around the unit to remove all dirt. Dirty coils will make the compressor run harder, you'll lose system efficiency, and the system will fail prematurely.

Remove weeds and grass from around the outside unit, and take a look at the fuse box on the wall. Do you have a couple of spare fuses?

Midnight electrical surges can cause a fuse to blow, and waiting until morning to find a replacement won't win you any points with the overnight and morning air talent.

Inside your building, make sure the filter has been changed on the air handler. Most companies recommend once a month changes. If you're not using the pleated "high efficiency" air filters, make the switch. They cost a little more, but they trap a lot more dirt and dust - you'll find the savings in cleaner equipment.

Most maintenance contracts include cleaning the condensate drain. If you're doing the work yourself, blow it out to keep dirt, algae, or mold from blocking the drain and causing a flood. If you use a drain cleaner or bleach to clean the condensate piping, make sure the pipes are thoroughly flushed with clean water to eliminate any residue.

These maintenance tips are courtesy of Dwyer Service Corporation — a Washington Metro based AC/Heating/Plumbing contractor. Its service division can be reached at 703-751-9505.

★ ★ ★

Like most engineers, Bill Jones of Charleston, S.C., has a lot of "wall warts" taking up space in his outlet strips. There are chargers for handie-talkies, the cellular telephone, the power screwdriver, etc. A solution to the problem was found at a local video game store.

The SEGA Company makes an outlet strip for use with its game systems. It has five outlets which are spaced far enough apart that plugging in a wall wart does not cover the adjacent outlet. The strip doesn't have the normal keyholes on the back for screw-mounting, but it can sit on the floor, or mounted to the side of a desk or rack with double-stick tape. At less than \$10, the SEGA

outlet strip freed up a lot of space on the *Workbench* outlet strip. Bill Jones can be reached at 803-767-7880.

★ ★ ★

Jon Banks, engineering manager at CBS' WARW(FM), here in Washington, faxed me a note about his one year old BE FM-35 transmitter. Occasionally, when the transmitter came on or reset after a power glitch, it would only make two-thirds of the normal plate voltage and current - and half the power. Otherwise, the transmitter was fine.

Sometimes the transmitter corrected itself, with no outside intervention. Other times, restarting the transmitter would return the readings to normal. After some intense searching, Jon found that the plate contactor was only

closing two of the three phases. Only the plate supply was affected, so the blower and other systems were fine. Partially disassembling the contactor is easy (make sure your main breaker is OFF), allowing you to inspect the contacts.

Jon found that the spring-loaded moving halves of the contacts were held in place by metal retaining clips. The clips were so tight that the springs couldn't push the contacts together on one phase.

It is pretty easy to remove the spring/contact assembly, and bend the clips apart a tiny bit. After seeing the condition of the contacts, Jon decided to stock some spares. Though his problem was solved, the contacts are easy to replace, and save you the cost of a new contactor. Jon Banks can be reached at WARW by calling 301-984-6000.

★ ★ ★

I don't want to knock Radio Shack — it has bailed too many of us out in an emergency — but I felt it my duty to inform you of one store manager's assessment of DAT, when I went in recently looking for a DAT cleaning tape for a client.

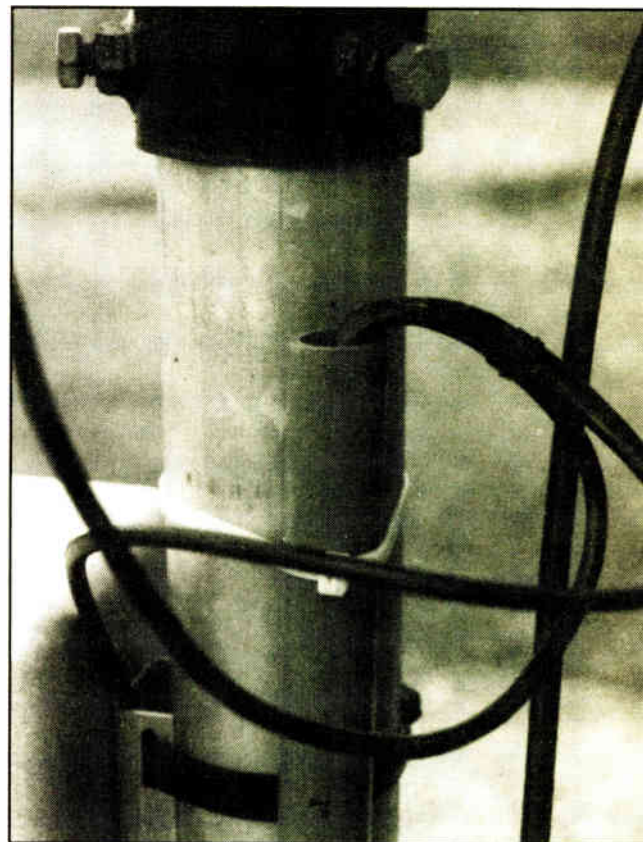

Open conduits can be troublemakers.

"Aww, that technology is out - no one uses DAT any more." He neglected to tell me what was taking DAT's place - maybe 8-track cartridges will make a resurgence!

By the way, if you need a DAT cleaning tape, save the trip to Radio Shack. Try either a musician's supply store, or your favorite professional broadcast equipment vendor.

□ □ □

John Bisset is a principal with Multiphase, a contract engineering and special projects company based in Washington. He can be reached at 703-323-7180. Fax submissions for *Workbench* to 703-764-0751. *Workbench* can be reached on-line at: [wrwbench@aol.com](mailto:wrwbench@aol.com). Printed submissions qualify for SBE Certification credit.

## MIX IT UP.

High-Performance Rack-Mount Mixers from U.S. Audio™



MIX-8 • 8 stereo line inputs, headphone monitoring, remote mute, stereo aux sends on inputs 1-4, pans on inputs 5-8



MIX-6 • 4 mic/line XLR + TRS inputs, 1 stereo RCA input, 1 stereo TRS input, mic/line XLR & TRS stereo out, phantom, limiter, headphone



MIX-5S • 4 mic/line inputs with pans, 1 aux input, mic/line XLR & TRS stereo out, phantom power, Left & Right Master Controls



MIX-5 • Features / Performance of MIX-5S in a mono version

## whirlwind

Compact, feature rich, with the performance you want and the reliability we're famous for — it's the U.S. Audio rack-mount mixer series from Whirlwind.

Designed and built in the U.S. at our own factory, these mixers reflect years of real-world experience in broadcast, sound reinforcement, and institutional applications.

They deliver carefully planned flexibility and recording studio sonic performance — day in, and day out — at prices that fit today's budgets.

So call today and order a mixer from U.S. Audio. We're confident it *won't* be your last.



99 LING RD. ROCHESTER, NY 14612. PHONE +1 716-653-8820. FAX +1 716-655-8930

Circle (40) On Reader Service Card



out there



on the CUTTINGEDGE



change the way your listeners **think**

**unity 2000i fm & unity am**  
**broadcast processors**



CUTTINGEDGE

2101 SUPERIOR AVENUE • CLEVELAND, OHIO 44114 • TEL: (216) 241-3343 • FAX: (216) 241-4103 • e-mail: info@cuttingedge.zephyr.com

Circle (56) On Reader Service Card

World Radio History



# OUR PHYSICAL CONSOLE ISN'T AN OPTION. IT'S THE WHOLE IDEA.

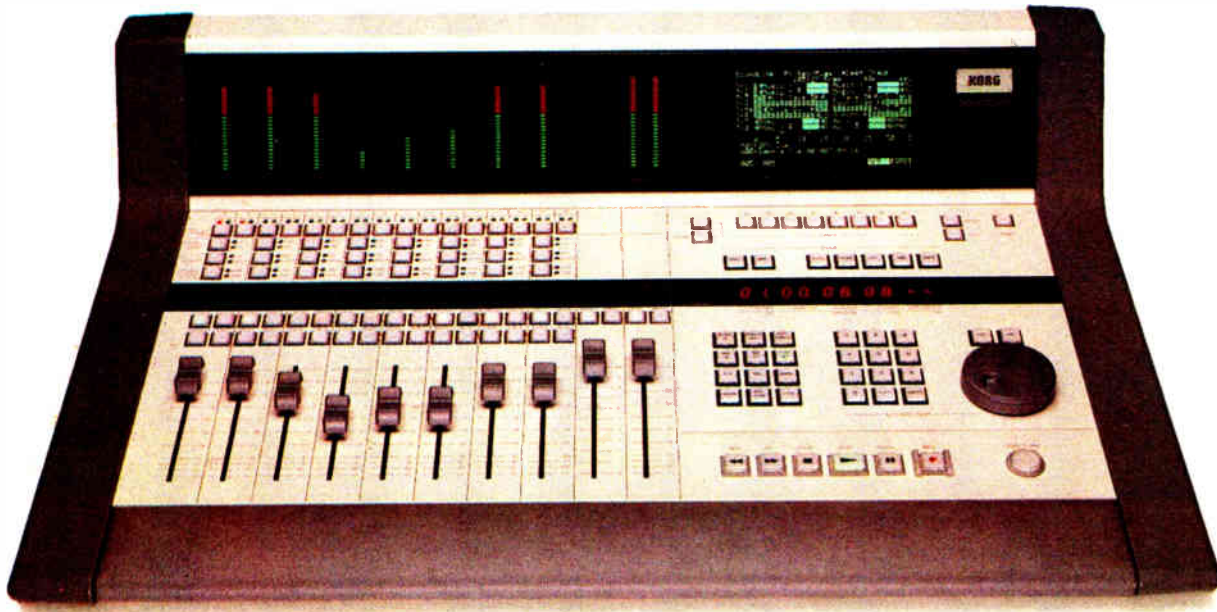

## Random Access Digital Audio Production by SoundLink.

**No mousing. No fumbling. And no nonsense. We designed the SoundLink Digital Audio Production System just as our most demanding customers asked us to: Without compromise.**

**We built an intuitive, full-featured console to give you complete control of random-access digital recording, editing and audio mixing. Along with digital signal processing, machine control, MIDI capabilities and synchronization.**

**So if you're working in radio or any other audio environment, now you can enjoy all the benefits of random-access digital editing with**

**the advanced features you need.**

**And instead of being forced to work on an imaginary desktop, you get all the comfort of the real thing.**

**Best of all, SoundLink is a perfectly integrated system, rock-solid and hassle-free—not a fragile mix of components.**

**For more information, just pick up your physical telephone and call Korg Professional Audio at 800-645-3188, ext. 280.**

*"SoundLink has not only made every production operation faster, it's also expanded my creative capabilities to include things I could never tackle with analog equipment."*

— Rick Wiggins, Creative Director  
WJR-AM, Detroit  
Capital Cities/ABC, Inc.

*"It's one of the few pieces of equipment at the station I don't have to worry about."*

— Fred Holub, Chief Engineer  
KLAX-FM/KXED-AM, LA  
Spanish Broadcasting System

*"This is the 90s production room solution. Its integrated digital console, storage and editing combine to make one of the most efficient and cleanest operating studios you can find anywhere."*

— Roy Pressman, Tech. Director  
WLVE-FM/WZTA-FM/WINZ-AM  
Paxson Broadcasting, Miami

**If you need complete control over your digital production, anything less really isn't an option.**

**SoundLink® KORG**  
Professional Audio

© 1994 Korg USA, 89 Frost St., Westbury, NY 11590. SoundLink is a registered trademark of Korg USA.

Circle (33) On Reader Service Card

World Radio History



# Studio Sessions

3-D Audio  
From Nureality

See p. 30

Equipment and Applications for Radio Production and Recording

## Telos DIRECT CONNECTION

...TOP SAN FRANCISCO AM/FM COMBO USES ZEPHYR TO SHAPE "LIVE" SOUND



KFOG's Live from the Plant uses Zephyr to broadcast from venues such as Yoshi's Nightspot in Oakland. Pictured, the Dave Matthews Band.



One is a hip, urbane, "triple A" (Adult Alternative Album) station whose menu features the likes of the Cowboy Junkies, Smitherens, and Toad the Wet Sprocket. The other is a brash 50,000 watt sports/talk powerhouse that serves up Giants baseball, Golden State Warriors basketball and lots of hot sports talk.

There's little family resemblance between San Francisco sister stations KFOG-FM and KNBR-AM. What they do share is a reputation for cooking up juicy remotes. Whether the order specifies the intimacy of a recording session at a Bay area club or the roar of the crowd at Candlestick Park, both stations rely on the Telos Zephyr as a key ingredient in defining their on-air sound.

Engineering Manager Bill Ruck encountered Zephyr at its NAB debut in 1993 and was immediately struck by its ability to exploit the then emerging ISDN (Integrated Services Digital Network) technology for remotes. He was eager to say goodbye to satellite and dedicated phone lines with their high costs and scheduling hassles, and hello to reliable,

economical switched digital telephony. Ruck lobbied for and got two of the first production Zephyrs just as PacBell was making ISDN easier to obtain in California.

A live concert remote featuring the neo-big-band sound of the Brian Setzer Orchestra was the first test for Zephyr and the phone

"The sound is crystalline."

company. "Then [almost two years ago], the phone company needed at least 10 days lead time to provide ISDN service, and even with that, they only got it working at 8:30 P.M. for a ten o'clock live broadcast," says Ruck. "Now they can do it with two days notice. In a few years when ISDN is ubiquitous, we'll laugh at the early days."

Ruck recorded two versions of the Setzer concert—one back at KFOG's studio taken from the Zephyr ISDN feed and one directly from the remote truck just

→ BACK PAGE d.c.

d.c.12  
Supplement  
to Radio  
World

Sept. 6,  
1995

Dr. Z  
Answers  
YOUR  
Toughest  
ISDN  
Questions  
Page 2

ISDN Money  
Saving Tips  
Page 2

CNBC Knows  
a Great  
Hybrid is  
More Than  
Meets the Ear  
Page 3

Add Layer II  
Capabilities  
to Your  
Zephyr for  
FREE!  
Page 4

d noise, it beat the hard-noise processor hands produced a recording that significantly quieter than

It is important to note as two overall settings for processor: Music and Music Because the human voice producing bursts of energetic impulsive noise disturbance RT provides the second e this factor into account. was processing program i speech, I used that set-very nature, this setting is ve than the music setting e more noise. But DART ns that include locating ks in the soundfile for re-

med in on the soundfile, I y recognize the larger ise areas. By limiting the outlier to a small block, I t to the more aggressive and readily eliminate the disturbances without ecting the program mater-takes some time to do It is a very quiet record-

s detection threshold can range that extends from 3 ange is set too low, it can sensitive and eliminate m material. If it is set too ecome too insensitive and noise disturbances. By



ration Technology (DART)

threshold setting, you can ith different settings and hat is appropriate for the aterial on the particular you are processing. You

can also re-run the outlier on previously processed material, either by using a new setting or just maintaining the original setting. This is the equivalent

continued on page 29 ▶

How well does its first product work? What does it take to run it? How much does it cost? Tracer Technologies is still lining up dealers for its product, but you can purchase it directly for \$299.

sion, you can always go back to the previous soundfile.

The bad news is that it does not take much time before these soundfiles have eaten up a large portion of your

Finally I created a soundfile consisting of the same material as processed through DART using its default settings in Easy Run.

While DART did not remove all of



## LINE-OUT

# Projects Go 'Absolutely' Digital

## PART I OF II

by Bruce Bartlett  
with Jenny Bartlett

**ELKHART, Ind.** For decades we recorded radio spots on tape. Now many stations have switched to digital workstations. What is the transition like? Is a computer easier to work with than tape? Does digital audio sound better?

To find out, I interviewed Dave Miller, owner and chief engineer of Absolute Recording here. He switched from analog production to digital six weeks ago.

Dave has won dozens of awards —

some national — for his radio and TV spots. In addition, he does voice-overs and video sound tracks for corporate sales and training.

"I'm finally starting to shake the analog mindset after 22 years in audio," said David. "It is hard to break old habits. But I'm willing to; it is an exciting evolutionary process."

His studio took on a new streamlined look when he replaced his large mixing console with a computer and digital recording software.

## Analog production

I asked Dave how he used to produce spots in the analog world. "I would record the voice, edit the voice tape with a razor blade, dump that to one track of a multitrack, layer in the music (controlling its timing as I punched in), then do a final mixdown to two-track."

"I saved several spots on eight-track multitrack tape. Three tracks might be one radio spot and the other five tracks might be a different spot."

## The big decision

What prompted Dave to make the change to digital? "I always thought of myself as wanting to be cutting edge, doing the latest, greatest stuff. I was

getting too complacent with analog."

Dave was not scared to go digital. In fact, he was looking forward to it and was telling clients of his plans to change to digital production.

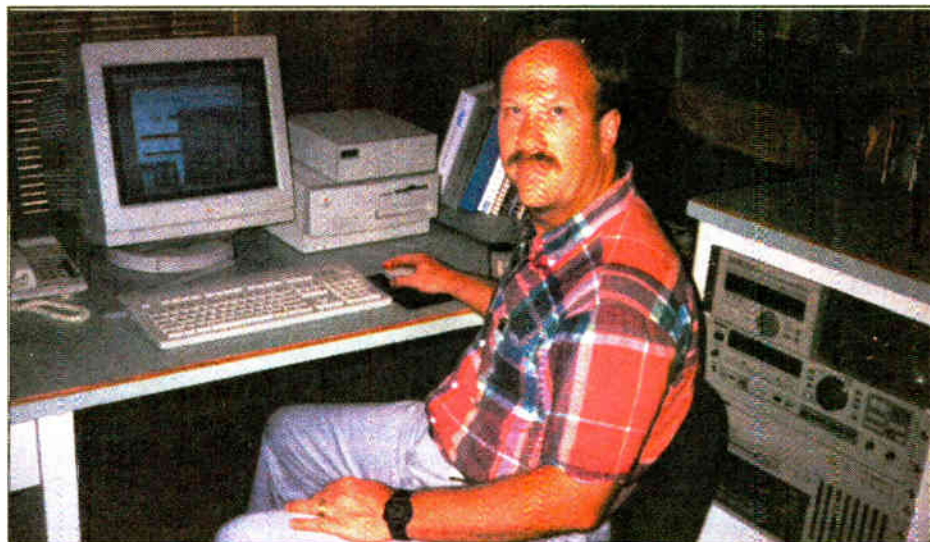

"Digital Dave" Miller running Pro Tools on the Power Mac

"I found a lot of excuses why I could not do it. I did not have the money, or I was waiting to find the right vendor. When digital first became popular and affordable, I wanted to wait until the

standards settled in. I did not want to end up with obsolete equipment."

One morning he realized it was time to switch. "I'm losing ground now because I'm holding on to analog too long," he said. "It is time to expand my professional boundaries and offer the newest technology to my clients. If I do not do it now, I'm never going to do it."

So he got on the phone, settled on what

he was buying and from whom, and sent in an order.

Some people make only a partial switch to digital; using analog mixers with computer workstations. But Dave wanted to cut the cord. "If I was going digital, I wanted to go all digital. I wanted to keep it completely on disk, in the software domain," he said.

## Equipment

Previously, Dave used a big Tascam 20x8 mixing console. Now he uses a Power Mac 7100 with Digidesign Pro Tools software: an eight-track digital audio workstation. To learn how to use it, Dave took a training course from Digidesign.

Dave stores his audio on a 2-gig external hard drive. "I have not filled it up yet. I've had many projects on there at one time, but they're all fairly short." He can load a project on disk back into the computer for re-editing.

Some other equipment in his studio includes a Panasonic SV-4100 20-bit DAT with time code, a Tascam DA-88 modular digital multitrack recorder, and a Sony CD-601 CD player with digital outputs.

The Pro Tools outputs feed both analog and digital signals. On the inputs, Dave physically assigns analog or digital audio.

## Digital production

How was the change from analog? "Going to digital was a pretty smooth transition," said Dave. "because I started with easy projects and stepped up. I began by doing only narration. No music to mix. It allowed me to concentrate on editing, and moving regions of audio around. Then I got a session where I did a music mix. Later, I did a 12-minute piece where I continuously segued music. Now I feel that I can handle almost any production."

Here is how Dave does a typical spot with Pro Tools. "I put talent in the booth, record their voice right to disk, and edit it. Then I add the production music from CD. I might open up eight tracks that include two voices, two tracks for CD-1.

continued on page 27 ►

## Think of Them as Reference Monitors You Can Wear

When you need to hear exactly what you've recorded... nothing more, nothing less... then only Sennheiser's HD 25 SP will do. Excellent isolation, with clear, accurate reproduction are the trademarks of these reference-quality headphones. Plus, they're MUCH more comfortable than wearing speakers.

Your project studio is incomplete without the HD 25 SP. Check them out today at your local Sennheiser dealer.

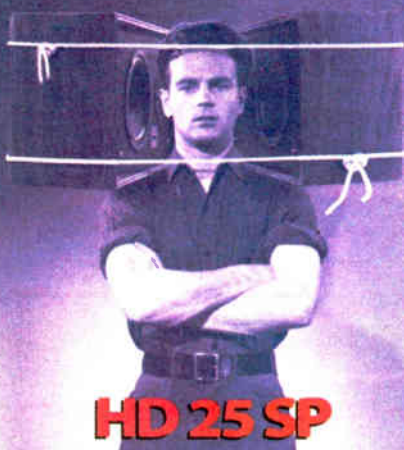

**HD 25 SP**



**SENNHEISER**

6 VISTA DRIVE, P.O. BOX 987, OLD LYME, CT 06371  
TEL: 203-434-9190 • FAX: 203-434-1759  
IN CALIFORNIA: 4116 WEST MAGNOLIA BLVD. SUITE 100,  
BURBANK, CA 91505 • TEL: 818-845-7366 • FAX: 818-845-7140  
IN CANADA: 221 LABROSSE AVE., PTE-CLAIRE, PQ H9R 1A3  
TEL: 514-426-3013 FAX: 514-426-3953

Circle (16) On Reader Service Card

## Now Paging You... via RBDS

Did you know that you can use your RBDS signal for paging applications?

The **SC-100 RBDS Generator** from CRL makes it easy for your station to produce new revenue streams from RBDS today. You can lease out group 7 of your RBDS signal for paging networks. Or you can use the built in mini-terminal program system that will support up to 300 pagers. This small in house network takes only minutes to program!

In addition to paging you can use RBDS to control automated billboard signs, and send additional text streams to special receivers. Or lease out group 3 of the RBDS signal for global positioning localizer information.

The CRL SC-100 fully supports the RBDS standard and is built to grow with RBDS as you do. Many of the RBDS generators on the market today support just part of the standard. What they are missing could cost you money!

RBDS is an exciting new technology that can increase your stations revenue today. The SC-100 lets you take advantage of all that RBDS has to offer. We have a comprehensive guide that explains all of the ways that RBDS can benefit your station now. Call, or fax us for a free copy today!

The CRL SC-100 lets you *light up* your listeners' new "smart radios" and make money from RBDS today!  
Order yours now!

*Call today for a free booklet -  
"RBDS For Your Station"*



**Circuit Research Labs, Inc.**

2522 West Geneva Drive • Tempe, AZ 85282

602 438-0888 • 800 535-7648

FAX 602 438-8227

Circle (65) On Reader Service Card



# Telos DIRECT CONNECTION

**...TOP SAN FRANCISCO AM/FM COMBO USES ZEPHYR TO SHAPE "LIVE" SOUND**



*KFOG's Live from the Plant uses Zephyr to broadcast from venues such as Yoshi's Nightspot in Oakland. Pictured, the Dave Matthews Band.*



One is a hip, urbane, "triple A" (Adult Alternative Album) station whose menu features the likes of the Cowboy Junkies, Smitherens, and Toad the Wet Sprocket. The other is a brash 50,000 watt sports/talk powerhouse that serves up Giants baseball, Golden State Warriors basketball and lots of hot sports talk.

There's little family resemblance between San Francisco sister stations KFOG-FM and KNBR-AM. What they do share is a reputation for cooking up juicy remotes. Whether the order specifies the intimacy of a recording session at a Bay area club or the roar of the crowd at Candlestick Park, both stations rely on the Telos Zephyr as a key ingredient in defining their on-air sound.

Engineering Manager Bill Ruck encountered Zephyr at its NAB debut in 1993 and was immediately struck by its ability to exploit the then emerging ISDN (Integrated Services Digital Network) technology for remotes. He was eager to say goodbye to satellite and dedicated phone lines with their high costs and scheduling hassles, and hello to reliable,

economical switched digital telephony. Ruck lobbied for and got two of the first production Zephyrs just as PacBell was making ISDN easier to obtain in California.

A live concert remote featuring the neo-big-band sound of the Brian Setzer Orchestra was the first test for Zephyr and the phone

**"The sound is crystalline."**

company. "Then [almost two years ago], the phone company needed at least 10 days lead time to provide ISDN service, and even with that, they only got it working at 8:30 P.M. for a ten o'clock live broadcast," says Ruck. "Now they can do it with two days notice. In a few years when ISDN is ubiquitous, we'll laugh at the early days."

Ruck recorded two versions of the Setzer concert—one back at KFOG's studio taken from the Zephyr ISDN feed and one directly from the remote truck just

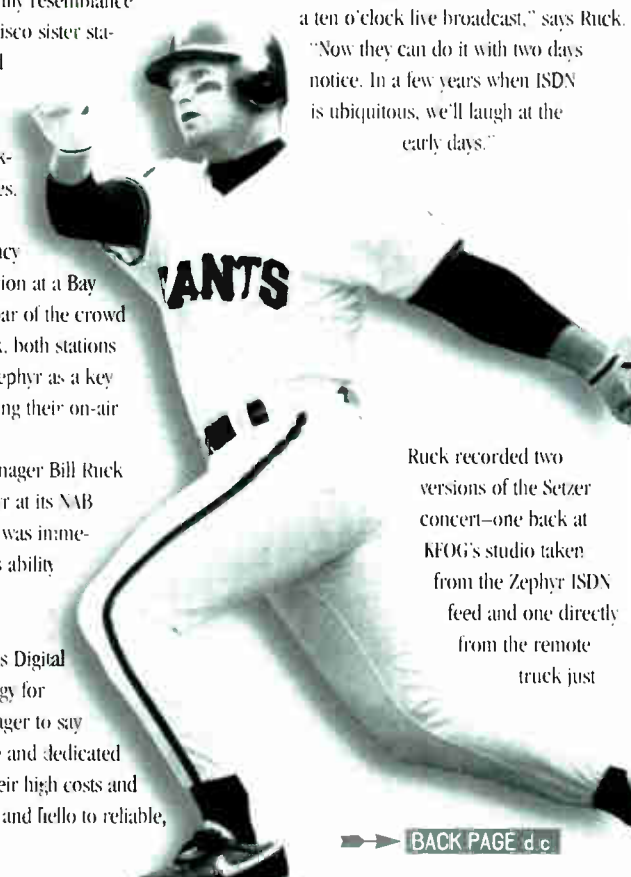

➔ BACK PAGE d c

d.c.12  
Supplement  
to Radio  
World

Sept. 6,  
1995

Dr. Z  
Answers  
YOUR  
Toughest  
ISDN  
Questions  
Page 2  
:  
ISDN Money  
Saving Tips  
Page 2  
:  
CNBC Knows  
a Great  
Hybrid is  
More Than  
Meets the Ear  
Page 3  
:  
Add Layer II  
Capabilities  
to Your  
Zephyr for  
FREE!  
Page 4







# ASK DR. Z

This issue we introduce a new column to answer frequently asked questions on ISDN to help Zephyr users exploit the full potential of digital dial-up bandwidth. Dr. Z welcomes queries from users. Send e-mail to [info@zephyr.com](mailto:info@zephyr.com).

**Q** We got to our remote site only to discover that the ISDN (Integrated Services Digital Network) circuit was provisioned wrong. What did we miss?

**A** ISDN is a very powerful technology with lots of features. Because it transmits coded digital audio data, Zephyr's requirements are simple. The phone companies can configure the line many different ways and may provision the line incorrectly by adding too many features.

Contact us and we will send you a free copy of Telos' *The ISDN Basic Rate Interface, Zephyr, And You*. It tells you everything you need to know about ordering ISDN and includes a handy form to fax to the phone company.

**Q** OK, so we're connected to the ISDN line, but we cannot place any calls. Why does this happen?

**A** There are many reasons, but the most common is that your TA (terminal adapter), either inside the Zephyr or external to it, is programmed wrong.

In the US, there are several different types of ISDN BRI (Basic Rate Interface) available, depending on the type of equipment at your local phone company switch. Your terminal adapter needs to know that ISDN type. In addition, SPID (Service Profile Identification) numbers may need to be programmed into the TA to identify your unit on the phone company's network. Incorrect or missing information programmed into the ISDN type and/or SPID fields can keep your unit from working.

**HINT** Don't let the installer walk out the door without confirming your ISDN type and SPIDs. If he says you have BRI, he is not telling you enough! Zephyr gives you two programming choices for ISDN type. Set Telco to PTP for AT&T custom point-to-point (PTP) and NATL I-1 for all other line types. (Note that Zephyr does not support AT&T custom point-to-multipoint.)

For AT&T PTP, SPID numbers are not to be entered. For other ISDN types, enter SPIDs 1 and 2 in the SPID menu. If the installer inserts dashes into the SPID numbers, ignore them.

Do not enter numbers in the Directory 1 and 2 fields. These fields are for very rare ISDN configurations.

**Q** My terminal adapter is programmed correctly, but calls still cannot be placed. What now?

**A** This could be caused by any of a dozen different factors. So, the Zephyr terminal adapter provides plain English error messages. Contact Telos Customer Support and we will help you use those codes and some test calls to define your problem.

**HINT** Before calling us--

Place some calls that will shorten the troubleshooting process:

- Determine if the indicator LEDs on your NT-1 show that the line is present and that there are no error LEDs lit on the NT-1.
- Call yourself by dialing your second B channel from your first. This is a local call. To do this press DIAL, then YES, then enter the 7 digit phone number of your second B channel, and press DIAL again. You should get a series of messages that say, "Answering, Line 1 Connected, Line 2 Connected". If this call works, you know you are connected to the central office and your Zephyr is programmed correctly.
- Call the Telos test line numbers listed in your manual. If these work, but you are unable to place calls to other long distance destinations, try placing the call at 56kbps instead of 64kbps. If this does not work, the problem lies with the local phone company or the long distance carrier.

Putting the far-end unit through the above steps can further assist in the troubleshooting process. ~

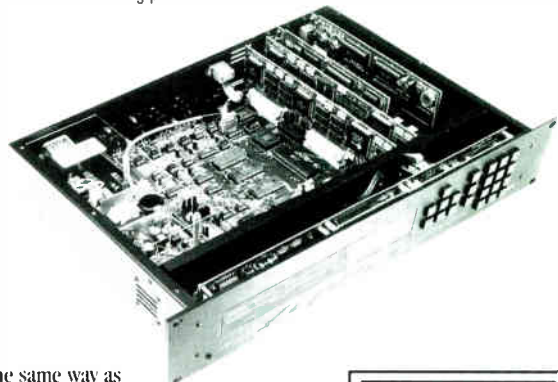

## ISDN

Money Saving Tips



ISDN long-distance services are purchased the same way as long-distance for your POTS (plain old telephone service) phones. Only the largest providers, such as AT&T, MCI, and Sprint, offer ISDN connectivity for the entire US. Contact them to discuss pricing for their "switched data" services for ISDN and Switched 56. If you are a frequent ISDN user, you can often get a volume discount and you may be able to combine your POTS and ISDN billings for even more savings.

ISDN has two B channels and call charges are invoiced for each channel individually. If you can take advantage of Zephyr's Layer III mono capabilities, you can reduce your call charges by 50% over a call placed using two channels. Remember, Zephyr transmits and receives high-fidelity audio in both directions completely independently. ~



# CNBC Bullish on Telos Hybrids

When it's a matter of dollars and sense—whether late-breaking market news, economic trends, personal finance tips or informative talk—Telos is CNBC's bottom line for great sounding phones.



Telos equipment is working 'round the clock in every control room and studio at both CNBC and its younger sibling America's Talking. Telos ONE and 100 Delta digital hybrid interfaces and 1A2 and Direct Interface Module multiline telephone systems can be found at their Fort Lee, New Jersey headquarters and at their Burbank, California facilities.

A continuous stream of correspondents, experts, analysts, guest commentators, newsmakers and just plain folks fuel CNBC's programming engines—business all day and talk all night. Virtually every show, from *The Money Wheel* to *Real Personal*, takes calls. Chief Engineer Jim Albro trusts Telos hybrids to produce the seamless, two-way conversations that are the shows' hallmark. "Telos puts callers on air with as few artifacts as possible," he says. The hybrids are great at extracting high quality caller audio despite often troublesome phone lines, he adds.

Albro first encountered Telos performance and reliability at the Olympics in Seoul, Korea. Afterward, when specifying equipment for the new CNBC facility, he opted for Telos equipment exclusively. "We wanted to avoid the pitfalls of analog. There was no competition: Telos was the pioneer in DSP (digital signal processing) for hybrids. The gear is well thought out, easy to use and offers a lot of interfacing possibilities."

Albro explores those possibilities nightly with *Equal Time*. The verbal sparring match on political issues refereed by Mary Matalin and DeeDee Myers originates in Washington, DC but is produced at CNBC's New Jersey HQ.

**CNBC's Mary Matalin and DeeDee Myers trust Telos Hybrids for the call-in segments on their show *Equal Time*.**

From Washington, live, clean studio video and audio are sent to the main control room in Fort Lee where tape packages, supers, commercials, music and audio sweetening are added.

Coordination between sites hundreds of miles apart is especially critical in live television. Behind the cameras and in the control room, Telos 100s readily interface with programmable RTS and McCurdy intercom systems. The advanced hybrid technology facilitates continuous, full duplex communication between the director and studio production staff, regardless of their location.

During the 30-minute gabfest, a Telos Direct Interface Module (DIM) provides clean, quiet and reliable switching among the nine lines that light up continuously in Fort Lee. Connected to the DIM is a

desktop Switch Console that furnishes all caller control functions. A Mitel phone is used for call screening. Caller information is relayed via remote intercom connections that ride ordinary dial-up lines to DC. There, the

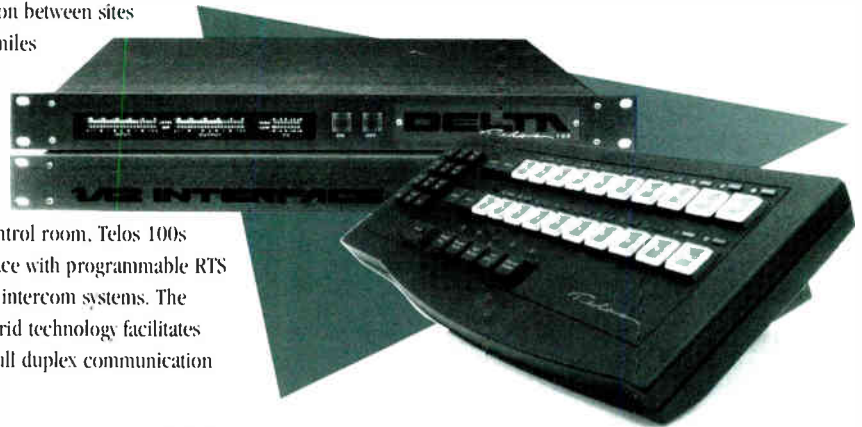

hosts read a caller's name from a teleprompter while studio guests monitor the callers through open speakers and respond on mic without fear of feedback.

With two 24-hour-a-day cable services so dependent on live, interactive talk programming, every call must go the distance. Using Telos hybrids, Albro has one less thing to worry about. "We just plug them in right out of the box and they work." ~





## ►► San Francisco

outside the venue. "In an A/B test you can't tell which is which," says Ruck. "One pass is transparent to anyone but the most expert ears."

KFOG uses Zephyr for its *Live from the Plant* series which features artists such as Hootie and the Blowfish, Shawn Colvin, Boz Scaggs, and the Rembrandts. According to Jude Heller, KFOG's marketer, "The sound quality is crystalline and best of all we can always depend on it. These hour-long, live performances from the Plant's Sausalito recording studios have given us a specific edge. We're known as *the* live concert music station," she says, then adds "KFOG is now number one in the market with adults 25-44."

Both stations are complete converts to switched digital remotes. "Our policy is this: We prefer MPEG Layer III via ISDN, but will use Switched 56 and G.722 if we have to. As a last resort, only in an emergency, if we're really desperate will we go to a two-line POTS (plain old telephone service) frequency extender," says Ruck.

"We were spending \$3000 a month for analog telco lines," Ruck notes. "With ISDN, the charges have dropped to a fraction of that. We paid for our first pair of Zephyrs from the money saved on the first few KFOG music remotes alone." The two stations now own six Zephyrs.

As for features, both Ruck and his colleague, KNBR Engineer Raul Velez, cited Zephyr's "human engineered" front panel set-up. They agree "it's easier to program and use than the competition's." For communications and control, Velez prefers to hook up his laptop to the Zephyr's RS-232 serial port. He especially appreciates that "since Zephyr is a software driven device, it allows for easy upgrades."

Both engineers also praised the built-in TA (Terminal Adapter). Everything required for the ISDN connection is included, and connection to the telephone network is via a single modular cable. "With other TAs you can go nuts trying to program new SPIDs and telephone numbers at each site. Not with Zephyr," says Ruck.

"What drives us to use Zephyr most is cost. In today's 'save money' environment, ISDN is cheaper and more convenient than the alternatives."

**KNBR 68**  
THE SPORTS TALKER

**KFOG**  
**104.5**

Ruck and Velez have organized pools of fellow broadcasters to share the initial installation costs and monthly charges for maintaining permanent ISDN circuits at a number of key venues. To cover

major league baseball, KNBR has joined forces with KFMB, San Diego and KOA, Denver to secure and share the expense of ISDN circuits at every National League ball park. This makes setting up and providing backhaul for the games as easy as plug in and play-by-play.

In addition to cost savings, long-term ISDN installations give the stations enormous versatility. It's there when they want it. No need to book in advance.

KNBR first used Zephyr at the 1994 Super Bowl. Since then it's become the standard for all sports remotes.

**"Zephyr is so easy to use and so flexible it's habit forming."**

"Zephyr is so easy to use and so flexible it's habit forming," quips Velez. "Once you've plugged it in you want to use it more and more."

Which is precisely what he's done. Velez enjoys pulling off some 'sleight of hand' tricks tapping the two B channels on one ISDN line. He often uses a single Zephyr to send two separate feeds to discrete locations. "I was in Las Vegas to cover a fight for KNBR," he recalls. "A couple of Chicago radio station jocks who had lost their satellite link back home approached me, desperate for help. In 20 minutes, I was able to put them live on the air to Chicago using Zephyr's G.722 feature.

"Another time, during a Giants broadcast, I was able to use one B channel for KNBR's Spanish language play-by-play feed to KIQI in San Francisco and the other B channel for an English language feed to Colorado after that station's usual link failed." ~

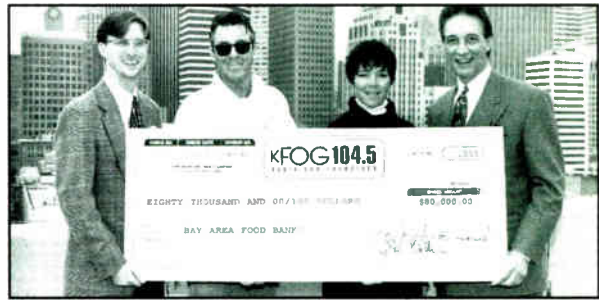

**KFOG presents a check for \$80,000 to Bay Area Food Banks, February 1995. The money was generated from the phenomenal sales of KFOG's "Live from the Archives" CD, a compilation of tracks from KFOG live broadcasts, many using the Telos Zephyr. Left to Right: KFOG PD Paul Marszalek, contributing artist Boz Scaggs, Deirdre Moynihan of San Francisco Food Bank, and Tony Salvatore, VP/IGM of KFOG/KNBR Radio.**

## Telos to Zephyr Owners: Add Layer II, Absolutely Free!

Zephyr owners who want to add Layer II compatibility may send their units to Telos for the necessary hardware and firmware changes. The modifications are free; users need only pay to ship their units to Telos. We'll pick up the return cost.

In late August, registered users will be faxed a notice with complete program details. Not sure whether your units are registered? Fax Telos at 216.241.4103 or send e-mail to [info@zephyr.com](mailto:info@zephyr.com) for a registration form.

All work will be performed by appointment. We'll schedule a convenient date for the work to be done and guarantee to return

your units four working days later. Work will include: changing required motherboard parts; installing EPROMs with new firmware, and giving the unit a thorough factory once-over.

Initial modifications for both Layer III and Layer II operation will add compatibility with most installed Layer II units. In the future, as Telos develops more compatibility packages for Zephyr, firmware exchanges will be offered at no charge and may be performed in the field.

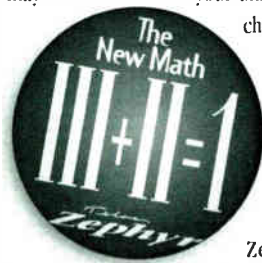



PRODUCT EVALUATION

## Digital Noise Eliminator for PC

by Read G. Burgan

**LAKE LINDEN, Mich.** If you wanted to remove pops, clicks and related noise on vinyl long-play records, you had only a couple of choices. You could use hardware-based processors like the Burwein/KLH Transient Noise Eliminator (If you could find one!), or Macintosh-based software like that produced by Digi Designs or Sonic Solutions where you could easily spend \$10,000 to \$25,000 or more. Until now.

Tracer Technologies Inc. of

**If you take the time to become adept with its features, you will find all the tools necessary to clean up a truly noisy recording.**

Dallastown, Pa., recently introduced a PC-based software designed to eliminate the noise associated with analog-based recordings — at a fraction of the price normally associated with digital noise reduction software.

The software, Digital Audio Restoration Technology (DART) is actually a crossover product: It is designed to appeal to both the professional and the consumer markets.

### Inexpensive but professional

On the consumer side, the program is inexpensive, runs on the ubiquitous PC and is very easy to use. In fact, if you are willing to accept the default processing values, you can begin processing as soon as the program is installed on your computer.

But do not let its inexpensive price and its ease of operation fool you. This is a professional product. If you are willing to take the time to become adept with all of its many features, you will find all the tools necessary to clean up a truly noisy recording. DART is a very powerful program.

DART was created in Poland by a team of scientists located in Gdansk. It is marketed in this country by a new company called Tracer Technologies Inc. that is made up of former sales and marketing people from Turtle Beach.

According to Jeff Klinedinst, Tracer Technologies is dedicated "to bringing innovative and new products to a worldwide market and to giving them a chance for access to channels usually only available to large and wealthy companies."

How well does its first product work? What does it take to run it? How much does it cost? Tracer Technologies is still lining up dealers for its product, but you can purchase it directly for \$299.

DART requires a 486 computer with Windows 3.1, a 16-bit sound card and a large hard drive. How large a hard drive? A stereo soundfile recorded at a sampling rate of 44 kHz can require up to 11MB per minute. In addition, when DART processes your soundfile, it will make at least one duplicate of it.

### Requires Smartdrive

I installed DART on a 486 DX-50 (not a clock-doubled machine) with 16MB RAM, a Turtle Beach Monterey sound card and a 1GB SCSI hard drive that was already dedicated to digital

audio files. I had no trouble installing DART and its two disks only used about a meg-and-a-half of space on my hard drive — a pleasant experience, considering most Windows programs hog 20MB or more.

At first I had a lot of trouble getting DART to work properly. When the audio was not stuttering, the program was crashing. As it turned out, the fault was mine. DART requires SMARTdrive to be operational on the hard drive containing the soundfiles. I also use Innovative Quality Software's Software Audio Workshop (SAW) which suggests that you turn Smartdrive off.

Once I edited my autoexec.bat file to turn Smartdrive back on, the problems cleared up and DART began to perform flawlessly, almost.

Recording is straightforward. Clicking on the record menu gives you a screen with controls that emulate a cassette recorder (Rewind, Stop, Fast Forward, Play, Record and Pause). In addition, it has the equivalent of a bar graph representing the left and right recording signals in decibels. Recording in DART is as easy as recording on an analog cassette machine.

### Space hog

When you've finished recording, DART will ask if you want to "register" the recording. This means it wants to make a working copy. Each time it processes a soundfile, it will continue to create more working copies. The good news is that if you do not like the results of a particular processing session, you can always go back to the previous soundfile.

The bad news is that it does not take much time before these soundfiles have eaten up a large portion of your

hard drive. You can tell DART to make its processing changes to one of your existing files, but if you do not like the results, you will lose all of the other changes on that soundfile as well. DART keeps detailed information on the particular processing changes it makes to a soundfile, including the number of interventions and the particular settings for the noise reduction components. You can access this information at any time by clicking on the information icon. I found this a particularly useful feature after I had made a half dozen different processing attempts and could no longer remember exactly what I had done to each soundfile.

DART uses three tools to remove analog noise. For those working with phonograph records, the most important is the outlier, which detects and removes impulsive disturbances; i.e., pops, clicks and crackling noise. The outlier works much like the original hardware-based transient noise-reducing units. When it finds an impulsive noise, it removes it and replaces it with a sample of sound taken from an area immediately adjacent to the noise.

How well does it work? To test the unit, I recorded a short portion from a 1935 16-inch broadcast transcription of a radio program. The program had

the associated noise, it beat the hardware-based noise processor hands down and produced a recording that was indeed significantly quieter than the original. It is important to note that DART has two overall settings for its outlier processor: Music and Music and Speech. Because the human voice is capable of producing bursts of energy that mimic impulsive noise disturbances, DART provides the second setting to take this factor into account. Because I was processing program material with speech, I used that setting. By its very nature, this setting is less aggressive than the music setting and will leave more noise. But DART offers options that include locating specific blocks in the soundfile for re-processing.

### Zero in

When I zoomed in on the soundfile, I could easily recognize the larger impulsive noise areas. By limiting the action of the outlier to a small block, I could reset it to the more aggressive music mode and readily eliminate the remaining disturbances without adversely affecting the program material. While it takes some time to do this, the result is a very quiet recording.

The outlier's detection threshold can be set from a range that extends from 3 to 10. If the range is set too low, it can become too sensitive and eliminate actual program material. If it is set too high, it can become too insensitive and miss small noise disturbances. By

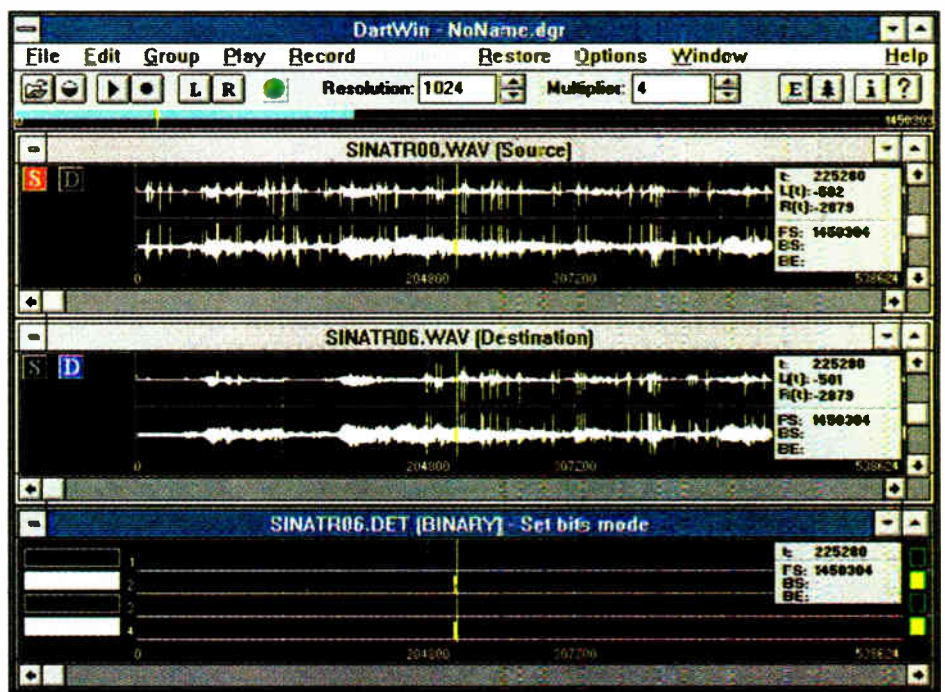

The main screen of Tracer Technologies Digital Audio Restoration Technology (DART)

plenty of noise. I then made several test recordings. The first was with no noise reduction applied at all. The second utilized my KLH transient noise suppressor and dynamic noise filter. Finally I created a soundfile consisting of the same material as processed through DART using its default settings in Easy Run.

While DART did not remove all of

adjusting the threshold setting, you can experiment with different settings and find the one that is appropriate for the noise and material on the particular audio source you are processing. You can also re-run the outlier on previously processed material, either by using a new setting or just maintaining the original setting. This is the equivalent

continued on page 29 ►



## LINE-OUT

# Projects Go 'Absolutely' Digital

## PART I OF II

by Bruce Bartlett  
with Jenny Bartlett

**ELKHART, Ind.** For decades we recorded radio spots on tape. Now many stations have switched to digital workstations. What is the transition like? Is a computer easier to work with than tape? Does digital audio sound better?

To find out, I interviewed Dave Miller, owner and chief engineer of Absolute Recording here. He switched from analog production to digital six weeks ago.

Dave has won dozens of awards —

some national — for his radio and TV spots. In addition, he does voice-overs and video sound tracks for corporate sales and training.

"I'm finally starting to shake the analog mindset after 22 years in audio," said David. "It is hard to break old habits. But I'm willing to; it is an exciting evolutionary process."

His studio took on a new streamlined look when he replaced his large mixing console with a computer and digital recording software.

## Analog production

I asked Dave how he used to produce spots in the analog world. "I would record the voice, edit the voice tape with a razor blade, dump that to one track of a multitrack, layer in the music (controlling its timing as I punched in), then do a final mixdown to two-track."

"I saved several spots on eight-track multitrack tape. Three tracks might be one radio spot and the other five tracks might be a different spot."

## The big decision

What prompted Dave to make the change to digital? "I always thought of myself as wanting to be cutting edge, doing the latest, greatest stuff. I was

getting too complacent with analog."

Dave was not scared to go digital. In fact, he was looking forward to it and was telling clients of his plans to change to digital production.

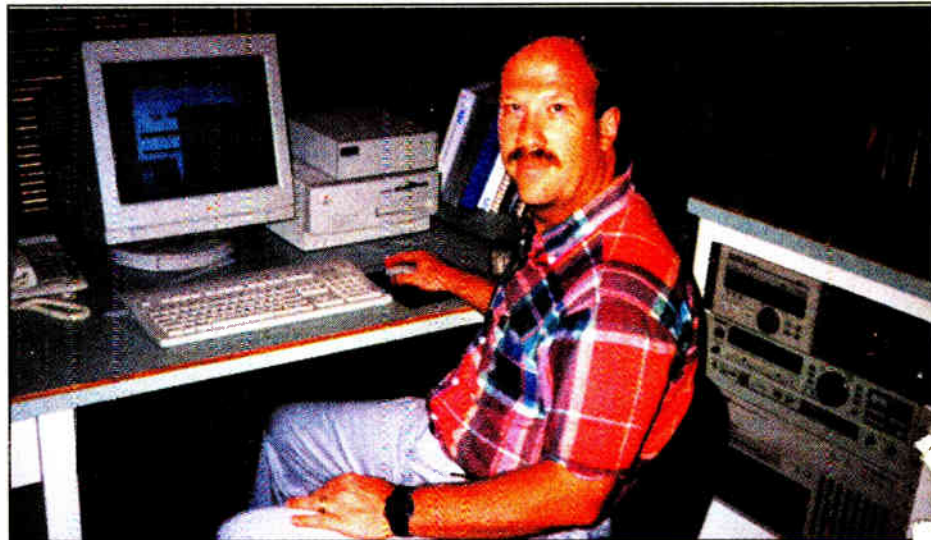

"Digital Dave" Miller running Pro Tools on the Power Mac

"I found a lot of excuses why I could not do it. I did not have the money, or I was waiting to find the right vendor. When digital first became popular and affordable, I wanted to wait until the

standards settled in. I did not want to end up with obsolete equipment."

One morning he realized it was time to switch. "I'm losing ground now because I'm holding on to analog too long," he said. "It is time to expand my professional boundaries and offer the newest technology to my clients. If I do not do it now, I'm never going to do it."

So he got on the phone, settled on what

he was buying and from whom, and set in an order.

Some people make only a partial switch to digital: using analog mixers with computer workstations. But Dave wanted to cut the cord. "If I was going digital, I wanted to go all digital. I wanted to keep it completely on disk, in the software domain," he said.

## Equipment

Previously, Dave used a big Tascam 20x8 mixing console. Now he uses Power Mac 7100 with Digidesign Pro Tools software: an eight-track digital audio workstation. To learn how to use it Dave took a training course from Digidesign.

Dave stores his audio on a 2-gig external hard drive. "I have not filled it up yet. I've had many projects on there at one time, but they're all fairly short." He can load a project on disk back into the computer for re-editing.

Some other equipment in his studio includes a Panasonic SV-4100 20-bit DAT with time code, a Tascam DA-88 modular digital multitrack recorder, and a Sony CD-601 CD player with digital outputs.

The Pro Tools outputs feed both analog and digital signals. On the inputs, Dave physically assigns analog or digital audio.

## Digital production

How was the change from analog? "Going to digital was a pretty smooth transition," said Dave. "because I started with easy projects and stepped up. I began by doing only narration. No music to mix. It allowed me to concentrate on editing, and moving regions of audio around. Then I got a session where I did a music mix. Later, I did a 12-minute piece where I continuously segued music. Now I feel that I can handle almost any production."

Here is how Dave does a typical spot with Pro Tools. "I put talent in the booth, record their voice right to disk, and edit it. Then I add the production music from CD. I might open up eight tracks that include two voices, two tracks for CD-1.

continued on page 27 ▶

## Think of Them as Reference Monitors You Can Wear

When you need to hear exactly what you've recorded... nothing more, nothing less... then only Sennheiser's HD 25 SP will do. Excellent isolation, with clear, accurate reproduction are the trademarks of these reference-quality headphones. Plus, they're MUCH more comfortable than wearing speakers.

Your project studio is incomplete without the HD 25 SP. Check them out today at your local Sennheiser dealer.



**HD 25 SP**



**SENNHEISER**

6 VISTA DRIVE, P.O. BOX 987, OLD LYME, CT 06371  
TEL: 203.434.9150 • FAX: 203.434.1759

IN CALIFORNIA: 4116 WEST MAGNOLIA BLVD, SUITE 100,  
BURBANK, CA 91505 • TEL: 818.845.7366 • FAX: 818.845.7140  
IN CANADA: 221 LABROSSE AVE., PTE-CLAIRE, PQ H9R 1A3  
TEL: 514.426.3013 FAX: 514.426.3953

Circle (16) On Reader Service Card

## Now Paging You... via RBDS

Did you know that you can use your RBDS signal for paging applications?

The **SC-100 RBDS Generator** from CRL makes it easy for your station to produce new revenue streams from RBDS today. You can lease out group 7 of your RBDS signal for paging networks. Or you can use the built in mini-terminal program system that will support up to 300 pagers. This small in house network takes only minutes to program!

In addition to paging you can use RBDS to control automated billboard signs, and send additional text streams to special receivers. Or lease out group 3 of the RBDS signal for global positioning localizer information.

The CRL SC-100 fully supports the RBDS standard and is built to grow with RBDS as you do. Many of the RBDS generators on the market today support just part of the standard. What they are missing could cost you money!

RBDS is an exciting new technology that can increase your stations revenue today. The SC-100 lets you take advantage of all that RBDS has to offer. We have a comprehensive guide that explains all of the ways that RBDS can benefit your station now. Call, or fax us for a free copy today!

The CRL SC-100 lets you *light up* your listeners' new "smart radios" and make money from RBDS today!  
Order yours now!

*Call today for a free booklet -  
"RBDS For Your Station"*



**Circuit Research Labs, Inc.**

2522 West Geneva Drive • Tempe, AZ 85282

602 438-0888 • 800 535-7648

FAX 602 438-8227

Circle (65) On Reader Service Card



# Out of the Trench: AI Is Back!

by Alan R. Peterson

**WASHINGTON** Welcome to the first installment of *App*: the evolutionary successor to *From the Trenches*. For six years I've dealt with the humorous side of station life, especially where I had little to do with it (read: related my supervisors' royal screwups and got paid for it). For your support of *Trench* over the past six fun and frenetic years, I thank you.

Now that I'm at **RW**, *App* will be similar, but will also track technical and programming trends as applied to radio studio operations, hopefully still with a humorous slant. With so much going on, it sometimes takes the warped mind of a real live studio rat to put it into perspective.

Having survived good and bad stations, moron and mastermind program directors, "Suits" and "Sandals," less-talk versus more-talk philosophies, and CHR morning drive and robotic Soft Urban, I believe I qualify.

Now and again a little *Trench* may cut through because I don't intend to leave studio life entirely behind me. It's in my blood as much as yours. Feel free to call me here at **RW** with story ideas and suggestions; the number is in the masthead and I would love to hear from you.

Oh, just a warning: I am a big fan of puns, especially "groaners." The more painful, the better. Be ready for anything. Now, on with the show.

Long before broadcasting, my big passion was music. While studying for my degree in the pre-MIDI '70s, I experimented tirelessly with guitar electronics. Many times I came up with very slick circuitry, only to find out someone had beat me to it 30 years prior.

Undaunted, I began to strip cheap calculators for parts, combining them with TTL chips and eventually came up with some interesting controller circuits that could be stuffed into electric guitar bodies. Levels, light shows and effects were controllable from a keypad on the instrument.

I explored pulse trains and relay steps (primitive attempts at serial data) for greater control. Imagine a guitar with a telephone dial. The more holes I drilled, the more cables that ran off my instrument, the greater potential I saw in my creation. I was obsessed with building as much junk as I could. I didn't know when to stop.

The day I soldered in actual telephone circuitry—so I could answer calls right from my instrument—was the day I realized it was time to rein in the madness.

Why do I mention this? Only because the digital '90s have forced the issue. Witness the timeline of seemingly wild ideas that have been brought to fruition.

Climb up on my knee, sonny boy, and listen to my story when AM was king, FM was just "there" and TV was TV. Cable was a rarity called CATV and was for communities in fringe areas. The computer was a monster they kept in the university basement and fed punch cards to. The galaxy was stable and all was well.

Enterprising FMs began using their SCA

channel for background music and news reader services. Top 40 moved to FM. AM went stereo ("AM stereo? Impossible!"). FM perfected a way to transmit data and RDS was born.

TV went from Big Three to Big Zillion. Cable companies moved from having one premium service to dozens. Home dishes "beautified" neighborhoods.

If one could not fit on the lawn, it could on the roof next to the '70s vintage solar collector.

Computers grew from the Altair 8080 to today's screamers. Modems jumped from 300 baud to Warp 5.

FM and TV tuner cards for PCs were developed. Teom shortwave receivers became tunable via PC control. A lowly 386-16 SX developed enough computational oomph to literally perform a complete lunar landing mission.

Today, it is the Internet that's redefining all the rules of the game. RealAudio transmits audio through the phone line to your PC.

Gee, audio over phone lines... how revolutionary.

In a Sept. 6, speech at the SMPTE Honors and Awards luncheon in New Orleans, former NAB Executive Vice President of Operations John D. Abel

proposes the next step of broadcast delivery of data to the home Internet user. Imagine: *wireless access to the Net!*

No, even better: imagine home Net access, your FM radio, a shortwave receiver, your favorite cable channels and phone/fax capabilities all together in one box in one corner of the room.

For the production room, this kind of accessibility means almost immediate downloading of sound effect files, transfer and exchange of copy ideas, remote operations of recording devices halfway around the globe, and the ability for clients to participate in their sessions and to check on the effectiveness of their campaigns without having to leave their offices.

In the on-air room (assuming we will still have one in the near future), it could mean realtime feedback of a song's popularity, instant response to the talk show host and a whole new slant to "be the 100th caller."

Radio programmers with less-than-honorable intentions might even try to upload a "remote hack" into those tuner cards so home receivers could leap to their station at command. Yuck.

So what does all this have to do with surgery on guitars? Again, the subject is "wild ideas brought to fruition."

Had the obsession of my youth taken greater roots, consider how the present would have unfolded. The Internet, telephone, radio, ATM access and remote control for TVs and garage doors might be done today not from a computer keyboard, but from a little panel of buttons on an electric guitar.

Either I quit entirely too soon or way too late.

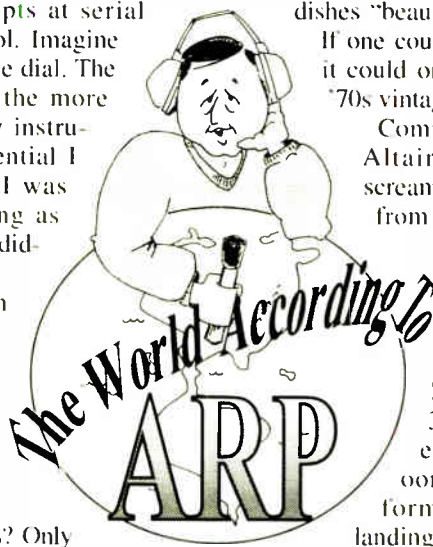

## Staying Competitive With Digital Tools

► continued from page 26

two tracks for CD-2, and two tracks for sound effects on CD: ambience, traffic and so on. I mix it all with Pro Tools' automation system."

The final format sent to stations is an analog tape reel. "They're used to that," said Dave, "but I'm working with local stations to supply them DATs."

How does Pro Tools work?

"On screen you can open a window that looks like an eight-channel mixer. You can label each track. It is an easy interface because it resembles a mixer," he said.

Pro Tools has MIDI jacks as well as audio connectors. You can record both audio and MIDI tracks. "I do not use MIDI" said Dave, "because I don't play a keyboard instrument. Instead, I use production music CDs."

Pro Tools has 16 "voices," eight of which can be output at any time. It is possible to record up to 55 virtual tracks of MIDI or audio. During a silent spot on a single track, you can play one of those virtual tracks instead. It is a way of getting more tracks out of an eight-track system.

### Hands on

Dave demonstrated how he edits a sound track. It looks very easy. Using just a mouse, he zooms into sound tracks, making them wider or taller to

see the waveform in detail. Zooms are instant. He scrubs a track to find edit points. In shuffle mode, when he deletes an unwanted sentence, everything else moves to fill up the space. It is instant. In slip mode, he moves sound regions in time.

There is a volume line under each track. Dave grabs the line with the cursor and adjusts the level at various points in the track. This adjustment can be used to duck music under voice. Or he can use the track's fader in the mixer window. The volume line and the fader track each other. He shows me how to group faders and assign them to a submaster fader.

"For backup, I copy the eight computer tracks to my Tascam DA-88 via a digital interface. Edit data is not saved. However, Digidesign is coming out with Pro Tools 3.1, which will back up audio and editing data to the DA-88 as well as the Fostex ADAT."

Next time: Pros and cons of digital, and looking toward the future.

□□□

Bruce Bartlett is a microphone engineer and technical writer for *Crown International*, and the author of *Practical Recording Techniques* published by Howard Sams. Jenny Bartlett is a technical writer. Bruce can be reached at 219-294-8388.

## Which Digital Audio Workstation Allows Professionals To Be Productive In 1 Hour?

"I've been using MicroSound™ for nearly 4 years and love its quiet, pristine, squeaky clean editing and mixing capabilities. It was very easy to learn, even though I'm not a computer wizard. *I was able to edit our first program within an hour of turning on my MicroSound Workstation.* Thanks to MicroSound, top quality audio is heard in our broadcasts every day worldwide.

Only the prices look as good as the specs."

—Bob Vermeulen,  
Engineer,  
Words of Hope



"After years of producing programs on everything from analog 8-track to ADAT, I increased my output the very first week. But more amazing, MicroSound improved the quality of my work immeasurably. *I achieved that elusive perfect mix the very first time I used MicroSound!*

Whether I'm producing one spot or cranking out 6 hours of programming, MicroSound has become an

invaluable tool. I can't imagine how I ever did without it."

—Todd Chatman,  
Operations Manager,  
CCM Radio

## microsound™

Discover the industry's best kept secret, polished for 18 years. MicroSound records crystal clear sound with -110dB noise from 8K-48KHz sampling rates. The 56-bit DSP based MicroEditor™ software gives you the true non-linear freedom of Project-Editing™ — every sound free floating in an audio palette mixing up to 100 tracks. Radio spots • Multimedia • Multi-hour audio for video • CD mastering. With MicroSound you will proudly say "I master with MicroSound" ...ahead of schedule!

Peripherals from \$2,995 • Workstations from \$6,995.

**"Quality Digital Audio Workstations Since 1977"**

Isn't it time to revolutionize your studio or station? Call, fax, or write now.

**Micro Technology Unlimited**

PO Box 21061, Raleigh, NC 27619-1061 USA  
Voice: (919) 870-0344, FAX: (919) 870-7163

Circle (76) On Reader Service Card



## PRODUCT EVALUATION

# dbx Reverb Is Easy and Inexpensive

by Chris Crump

**ORLANDO, Fla.** Several years ago, I was lucky enough to get my hands on a great-sounding reverb box for under \$600. Quite a treat, considering it listed for just under \$1000. It was one of my favorite pieces of gear until I loaned it to a friend named Bob who "borrowed" it and subsequently disappeared to Los Angeles.

I vowed to get the money together to put a "hit" out on Bob, but never considered replacing the reverb because I never thought I'd be able to find a deal that good ... until recently.

New from dbx Professional Products is

its Project 1 line of consumer market effect units geared toward the small studio/home studio user. dbx's new Stereo Reverb 290 is the first of the line that I've been able to get my hands on and it certainly fits my criteria for purchase. The Stereo Reverb 290 is inexpensive, sounds decent, is moderately attractive and fits in a single rack space.

The fact that this unit is inexpensive is a definite plus. It lists for just under \$300, which makes it attractive for anyone spending his or her own hard-earned dollars. But because of the low price, there are a couple of trade-offs.

Some of the features that you would see on

a costlier box are absent. There is no front panel bypass switch, high/low pass filter adjustment or attack parameter setting. What you do get though, is a very easy-to-use, easy-to-understand box.

### Simple interface

The front panel of the 290 gives you a very simple interface that features LED-lit rocker button switches for selecting the type of reverb you desire (room, hall, chamber, plate, et al), the size/gate shape and the "color" (a basic EQ setting for dark, medium or bright). Potentiometers control the decay rate, mix, input and output. A four-level

LED shows your stereo input level.

The back panel is very basic as well with 1/4-inch balanced TRS inputs and outputs, a 1/4-inch footswitch jack, MIDI and an AC Power adapter input.

The footswitch jack is nice because it allows you to put the unit in standby mode with an optional momentary footswitch, and will also scroll through program presets using a three-switch-type footswitch (also optional).

The MIDI input offers a wide range of possibilities limited only by your studio setup. The 290 can receive program control changes on MIDI channels 1-16, or in Omni mode. There are 54 preset program combinations—the 290 does not allow you to write your own programs into the box. Continuous controller and MIDI channel changes are affected by using the front panel LED-lit buttons.

### Hide and tweak

A neat "hidden" feature on the 290 is the built-in four-level noise gate. I say "hidden" because it is not controlled by a front panel potentiometer, but by the LED-lit buttons. The noise gate is pre-reverb, which means that the reverb tail will not cut off prematurely.

Obviously, dbx was concerned with keeping the cost of the Project 1 line at a minimum while making sure that the functionality of the boxes gave the consumer maximum flexibility. It was able to

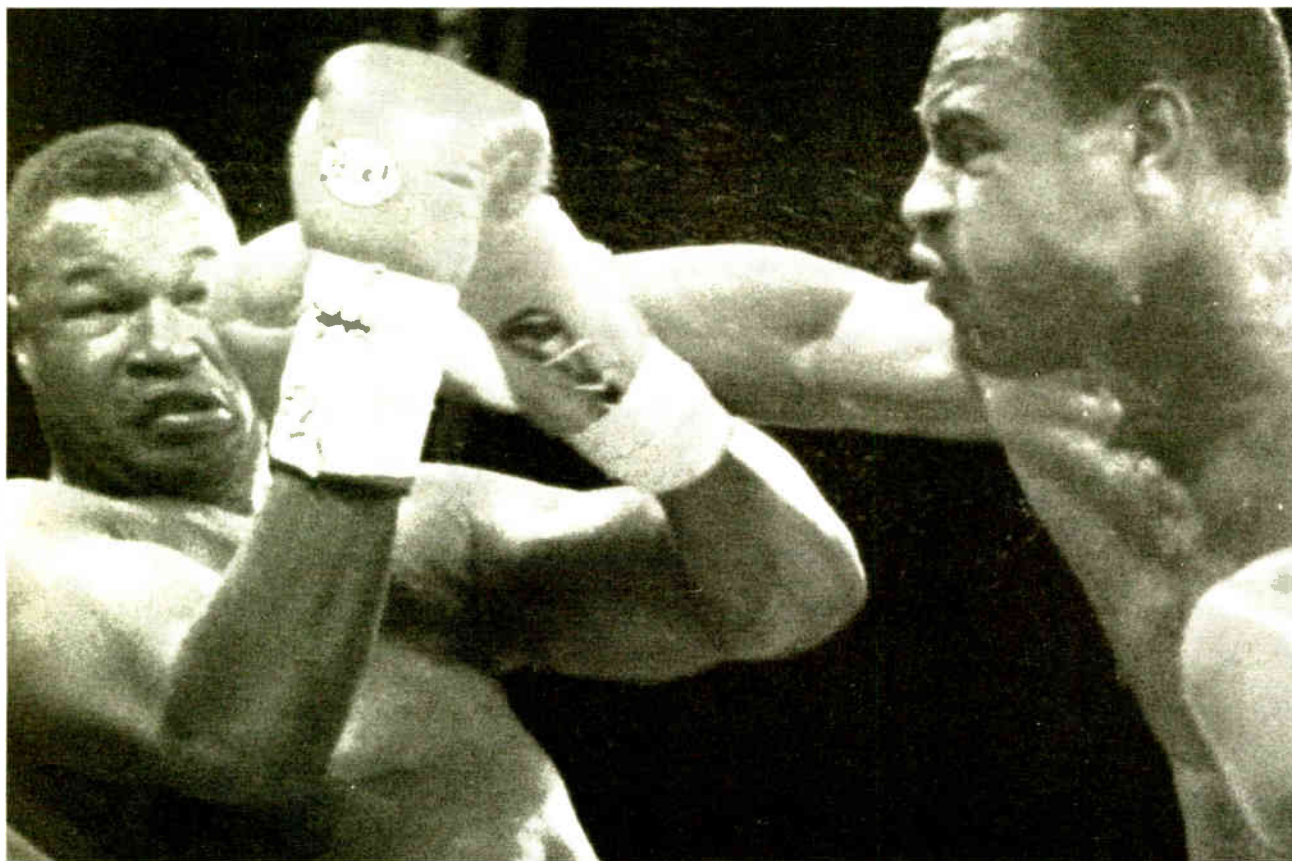

UPI News Picture, Holmes vs. McCall, Las Vegas, Nevada, 04 08 '95

# Is Your News Wire Sockin' it to Ya?

Are you spending too much money for a wire that's too hard to get ready for air?

United Press International has the solution!

Our broadcast services offer the most selectivity in the industry. You only pay for what you want. So, you don't waste paper or computer space.

UPI has bulletins, spotlights, weather, sports and stocks with more show-prep features than any other wire.

For stories with the right length, right punch and, best of all, the right bottom line — you need United Press International. Call toll-free to discuss pricing and get samples of our broadcast products.

If it's time for you to get the upper hand, call UPI — the only news service written by Broadcasters for Broadcasters.

**800.503.9993**

Worldwide Headquarters 1400 Eye Street NW, Washington, DC 20005

Circle (90) On Reader Service Card

World Radio History

### Product Capsule: dbx Stereo Reverb 290



**Thumbs Up**

- ✓ MIDI
- ✓ inexpensive
- ✓ simple front panel
- ✓ scroll/bypass footswitch

**Thumbs Down**

- ✓ rough decay
- ✓ no high/low pass
- ✓ attack setting



For more information contact dbx at 801-568-7660; or circle **Reader Service 28**

achieve this by keeping the number of extraneous switches and gadgets to the bare minimum. Various functions that normally require individual switches are executed by various combinations of the front panel LED-lit buttons. A bypass switch, for example, was conspicuously absent on my first lookover; but the function is accomplished by simultaneously pressing the ROOM and CHAMBER keys.

The manual that comes with the 290 is very simple. Everything is fully explained in less than 15 pages. There is even a layman's overview of what reverb is and what each setting will do.

The sonic performance of the 290 is very reasonable, considering the cost of the unit. The A/D converter is 16 bit PCM with an 18 bit PCM D/A converter, with an overall sampling frequency of 40 kHz. The frequency response is listed as 20 Hz to 20 kHz, +0, -3dB.

In my opinion, the decay is a little on the "grungy" side compared to some higher-end boxes (like the one that Bob stole) but the gated reverb is particularly nice. Aesthetically, the 290 has a pleasant and simple appearance and looks right at home in my rack full of gear. The rocker buttons on my demo unit were the slightest bit off kilter, which may be annoying to hyper-picky people like myself.

Overall performance, simplicity and cost will probably make the dbx Stereo Reverb 290 a staple in cost-conscious home and pro studios. This one already has a home in our production room.

□□□

Chris Crump is the creative services director of Paxson Communications of Orlando and a contributing writer to RW.

**UPI**  
UNITED PRESS INTERNATIONAL



# DART on Target in Reducing Noise

► continued from page 25

of running the material through a series of cascading filters.

## Separate file

In addition, DART creates a separate digital binary file every time it processes a soundfile. This file contains markings for all of the interventions the software has made in your soundfile. If you think it has missed an area or has targeted an area that is not really noise, you can edit the detection file to reflect this. Then you can select the re-run option which will re-process the soundfile using your corrected digital binary file as the basis for its noise reduction.

If you like, DART will create a comparison file in which it will subtract the processed soundfile from the original. This creates a file that contains all of the impulsive noise that it has removed from the original soundfile. Why would you want such a file? This gives you an opportunity to hear firsthand what DART has removed. If it selected any program material, you will hear it here.

In many cases, the outlier may be all you need. But DART has two other noise reduction/restoration components. The DART manual describes the Smoothing Factor as "a special adaptive version of a device known as the Kalman filter." It can be set in a range of 0 to 2. Tracer recommends that it be used during the first pass with the outlier.

DART also includes a post-filtering factor designed to deal with wideband noise including tape hiss and record surface noise. It is particularly designed to suppress noise in the quieter portions of the recording without affecting the louder portions. Its range is adjustable from 0 to 2.

## Vintage piano

When I received DART, I was working on a project to transfer 1950s' vintage piano solo recordings to a digital format. Using DART, I was able to remove about 95 percent of the pops, clicks and associated noise. In regions of the sound file where the music was loudest, the program let a few large pops sneak through. This is understandable for two reasons: First, the very nature of the material — piano music provides content that is itself impulsive and therefore mimics the very impulsive noise that the software is designed to remove. Secondly, the program material was so loud that it effectively masked the noise. While the human ear could hear it, the software could not.

I found it easier to finish the noise reduction using Innovative Quality Software's SAW, in part because I have been using it for several months, and in part because I find it easier to move around in SAW. Using SAW, I simply marked both sides of any remaining noise disturbances and cut them out.

After working with DART for a short time, I did find some problems. For example, at the top of the screen, DART displays a long narrow window called the Overview which is designed to represent the entire sound file. To move around in the sound file, you

simply click on a portion of the Overview and press play. At least, that is the way it is supposed to work.

In reality, if your sound file is much longer than three minutes, the cursor will not click on any portion other than the beginning of the sound file. To move around in a sound file, you have to click on a sound file window, which contains only a few seconds of a sound file. You can then move around by clicking on the ribbon beneath the sound file window. Unfortunately,

## Digital Audio is no longer only an option for well-heeled radio stations and production facilities.

because you can only see a few seconds of the sound file at any moment, it is extremely tedious to locate a particular portion of a long soundfile. Tracer is now aware of this problem and its programmers are seeking a solution.

## Square one

In addition, even when the cursor works in the Overview section (on a file three minutes or less), when you press stop, the cursor returns to its original starting position. I find this extremely irritating when I have just located a noisy area several minutes into the sound file that I would like to mark and process. What I need is for the cursor to stop right where it is when I press the stop function so that the spot will then be represented on the zoomed-in portion in the soundfile window. Instead I have to try to relocate that exact spot and it can take a number of attempts. Tracer has not indicated if it intends to add an option that will allow the cursor to remain where it is when you stop playing the sound file. I hope they do.

DART contains other useful tools including Scale, Maximize, Mute, Reverse and filtering including Lowpass, Highpass, Bandpass and Notch filtering. Scale and Maximize allow you to adjust the level of the signal. Mute erases a portion of the signal and Reverse allows you to run the soundfile (or a portion) backwards.

Backwards? Yes, backwards. Why? Sometimes the nature of the recorded material is such that the outlier can more readily distinguish between the impulsive noise and the program material by processing it in reverse. Actually, it is a nice touch. Just do not forget to reverse the material after you are done!

The filters work pretty much as their hardware equivalents. The lowpass filter removes high-frequency material while allowing the low-frequency material to pass through. The highpass filter removes the low-frequency material while allowing the highs to pass through.

The bandpass filter allows you to affect both the high and low frequency areas simultaneously. In effect, these three filters provide a shelving function that lets you pick one or more frequencies and set the amount of attenuation per octave. The Notch filter lets you remove frequencies from a very

narrow frequency — 60-cycle noise being the most common example. While you can set the frequency of the notch and its depth, you cannot set its width.

## Graphic equalizer

DART also contains a graphic equalizer with eight bands. While adequate, it is essentially a device for attenuating frequencies. It would be helpful if the equalizer operated like its hardware equivalent, with a standard cen-

ter position allowing you to boost or attenuate frequencies as necessary.

Some caveats. DART is not the answer to all of your noise reduction and elimination needs. No product is, not even a digital one. Consider it one more tool in your arsenal of weapons to eradicate noise and improve your audio product. I am not about to give up my Aphex 250 Aural Exciter or my Alesis Quadraverb Plus, even if they are analog devices.

Neither is DART a silver bullet. If you are looking for a program where all you have to do is push a button and all of your noise will be magically eradicated, keep looking. But if you are willing to take the time to master all of DART's tools and spend a significant amount of time in applying them, you can turn a very noisy soundfile into an acceptably quiet one.

DART still has some bugs to work out. Every time I attempted to use the Easy/Run/Block option, the program crashed. It crashes once in a while in other modes. But DART is still in its first version, and most new software

has bugs that only get discovered and eliminated after it has been out in the real world for a while.

## Tool for the studio

If you want to do full-scale digital audio production, you will need more than DART can offer. The ability to fade, crossfade, do multitrack mixing, etc. A good all-around starting digital package, would include Tracer Technologies' DART and Innovative Quality Software's SAW and SAW Utilities package. For a total street price of under \$1,000, you can have digital audio tools that until now would have cost you \$10,000 to \$20,000.

Digital Audio is no longer only an option for well-heeled radio stations and production facilities.

In the end, DART is an amazing product. It is fast. While its actual operating speed will depend on the base computer, I found that it took an average of slightly more than five times the length of the sound file it was processing. Many of the costlier software systems take much longer. Will it remove every vestige of noise in your worst analog recordings? Probably not. Nor is it likely that any other product will. For its modest price, it provides incredibly effective tools for reducing nearly all of the noise associated with phonograph records and other analog recordings. It is easy to use and it does what it claims. If you want to remove the noise from your analog recordings, you are not likely to find a better product at a price that even approaches DART.

□ □ □

For further information: DART: Tracer Technologies Inc., P.O. Box 188, Dallastown, PA 17313; telephone: 717-747-0200; or e-mail at 102037.2437@compuserve.com.

SAW: Innovative Quality Software, 2955 E. Russell Rd., Las Vegas, NV 89120; telephone: 702-435-9077.

Read Burgan is a free-lance writer and a former public radio station manager who can be reached at 906-296-0652 or through e-mail at AH746@detroit.freenet.org.

## Introducing the finest solid state FM technology now available up to 5 KW

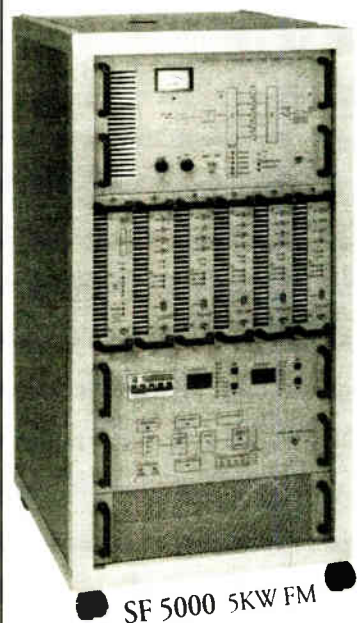

SF 5000 5KW FM

The new BEXT SF Series amps come in ten power levels from 150 watts to five kilowatts, with the excellent stability and consistent performance of very high efficiency Mosfet amplifiers.

Is the quality of BEXT FM truly world class? Your fellow engineers think so—we'll send you a user list, with phone numbers, along with with a full catalog at your request.

Find out more about BEXT and the finest in great-sounding exciters and STLs, amplifiers and complete transmitter systems.

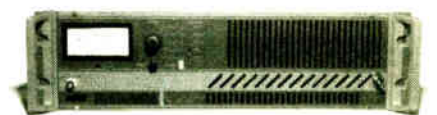

SF 500 500 Watt FM \$5,695

1045 10th Ave.  
San Diego, CA 92101  
619-239-8462 FAX: 619-239-8474

**BEXT**

Circle (26) On Reader Service Card



## SIGNAL-TO-NOISE

# Nureality Makes 3D Audio Magic

by Frank Beacham

**NEW YORK** There aren't a lot of cheap solutions in audio these days but I think I've found one. How about a device of audiophile quality that converts mono to stereo and then, if you choose, enhances that synthesized stereo to 3D surround sound? And what if that device had a street price of under \$75?

Got your attention? Now what if this device could be used in the air chain by a radio station to do real-time conversion of mono recordings to stereo? Or used in a radio production studio to convert old mono records into pre-recorded carts with built-in surround sound requiring no external processing by the station or the listener?

I stumbled into this idea while listening to a CD demo produced by Nureality of Santa Ana, Calif., to showcase a line of consumer audio processors that use the Sound Retrieval System (SRS) 3D sound technology. On the disc is a demo of how SRS rejuvenated the mono rock classics "Great Balls of Fire" by Jerry Lee Lewis and "Blue Suede Shoes" by Carl Perkins. The results were dramatic, what one might call "turbo mono."

SRS is primarily thought of as a consumer playback technology that can immerse a listener in a life-like three-dimensional audio environment through a pair of standard stereo speakers. It works in several stages.

## Ambience information

First, SRS extracts ambience information from a normal stereo audio signal. This is the sound that originally came from the rear and sides—the sound that creates a sense of acoustic space. SRS then takes this information and uses corrections based on Head Related Transfer Functions (HRTF) to cause the ear to perceive these sounds in their original spatial relationships. The technology simulates directional cues through frequency shaping, a process that applies a different amount of amplification to each of the sound's frequencies.

Because the SRS technology does not use time delay or phase shift, it has no "sweet spot" or critical listening area. This means that the full effect of the 3D sound can be heard from any location in the listening room.

To date, all of the products using SRS technology have been targeted to consumers for use in audio playback systems. However, SRS can also be effectively used in the front end of the audio

## A radio station . . . could use the mono-to-stereo synthesis in the air chain without adjustment.

production process, including broadcast and pro recording applications, says Alan Kraemer, engineering director at SRS Labs. When used this way, the SRS process is embedded in the recording. The listener does not need SRS equipment to hear the enhancements through a stereo radio receiver.

"We haven't marketed SRS to radio stations because we've concentrated on the home audio and multimedia markets," said Kraemer. "But it's a very clean technology solution for radio. In fact, the audio performance of that little box would amaze you."

The "little box" Kraemer refers to is the Nureality Vivid3D Plus, a basic model SRS processor (list \$79.95) designed for portable audio, video game and multimedia applications. This low end unit, said Kraemer, is just as good sonically as the more expensive units manufactured by Nureality, an SRS licensee. In fact, Kraemer pulled a "Plus" randomly from the assembly line for use in producing the Nureality demo CD.

"The only difference between (Nureality) models is form, factor and control," he said. "The audio in terms of quality is as good on the little box as it is on the big box. For recording studios or

radio stations, the only real technical issue is balancing the device, getting it up to +4 levels."

Kraemer said all Nureality SRS units feature two distinct processes: the SRS 3D audio process and the stereo synthesis. A radio station, he said, could use the mono-to-stereo synthesis in the air chain without adjustment. "The mono-to-stereo is very robust," he said. "There is no adjustment there. It could be used

as a real-time process." SRS, on the other hand, is program dependent. For broadcast use, SRS processing should be done only in the production studio and adjusted for each music or program segment. If this is not done on a custom basis, there is the danger of not only actually degrading the audio but of over-

modulating the difference carrier in the signal.

Used properly, however, the dual functions of one of Nureality's processors can breath new life and energy into mono recordings used in broadcast applications.

## Vivid 3D speakers

In researching this column, Nureality let us audition their new Vivid 3D Speakers, a pair of small wood-enclosure speakers containing four Neo-radial drivers, a total of 35 watts of amplification and built-in SRS processing. Vivid 3D speakers, with a list price of \$199.95, are primarily designed for multimedia computing or portable stereo applications.

The results, as with all of the SRS products we've experienced, were impressive. Now, we wonder, when some enterprising manufacturer is going to build SRS into a high-quality self-contained radio receiver.

□ □ □

Obtain the Nureality demo CD from Nureality, 2907 Daimler St., Santa Ana, CA 92705; Telephone: 800-501-8086. Contact SRS Labs at 714-442-1070.

Frank Beacham's address is 163 Amsterdam Ave. #361, New York, NY 10023. E-Mail: beacham@radiomail.net. Visit his Internet web site at: <http://www.beacham.com>.

## DIGITAL DOMAIN

## Evaluate Audio with Mac, AD-1 Analyzer

by Mel Lambert

**LOS ANGELES** All of our digital gymnastics mean little if we cannot measure the level of a signal, which in the digital domain should be relatively easy. After all, we already have the data in 16/20/24-bit format; simply load the numbers into a fast computer, and away we go.

As many of us now realize, it is not as simple as it seems. The cost and complexity of current analyzers and metering devices testify to the fact that you need to throw some significant DSP and display technologies at the problem.

It is refreshing then, to come across a new device—or rather a piece of software—that sells for just \$249, and requires a simple Mac-based platform to display wickedly sophisticated, full-color VU/PPM meters, phase and waveform displays plus third-octave spectrum analysis.

The firm responsible for the new AD-1 Pro Audio Analyzer is Intelligent Devices, whose designers and senior principals might be better known for their elegant work on the Symetrix 602 Stereo Digital Processor's computer-control program and the user interface/screen displays for the remarkable new Spectral Prisma Music workstation.

## Hardware requirements

The AD-1 Pro Audio Analyzer is designed to run on any standard Apple Macintosh that is capable of accepting the Digidesign Audio Media II card (this covers the Mac IIci and II Series, PowerPCs 7100 and 8100 and Performa 600 units). Normally, the AM II card is used in conjunction with Digidesign's Sound Designer II and Session software, which

provide multitrack recording/playback to hard disk plus multichannel mixing, as well as third-party software such as OSC Deck.

What makes the new AD-1 all the more remarkable is that the designers have found a way to load DSP code into the Audio Media II card's on-board Motorola 56000 ICs and use the chips to perform a series of real-time computations on the signals being monitored thorough the card. The results of these high-power computations are displayed on the Mac's color screen.

## On the screen

The Macintosh display is divided into four basic areas, as can be seen from the accompanying screen-dump graphic. To the left is a bank of meters for the stereo channels, plus a central assignable meter. The left- and right-channel meters offer simultaneous display of both peak and VU ballistics, with color coding for levels above and below nominal "zero" reference levels of 10/14 dB from clip.

The meter's peak hold feature can be set to normal, long or infinite settings via a pull-down menu. The latter would be very useful for determining the loudest section on a jingle package DAT tape prior to making a CD-R for air playback. Release times can also be adjusted, from a setting labeled "scary," through fast normal to slow. As an alternate to mouse-driven menus, a series of keyboard shortcuts can be used to change any or all system parameters in real time without screen flash.

A separate clip light can be set to display levels that are within 1, 0.5, 0.1 or 0.05 dB of overload. User preferences select a variety of trend characteristics for those

continued on page 32 ►

## STATION/STUDIO SERVICES

### BUY-OUT MUSIC — \$99

Sixty 60-second music beds for . . . \$99  
198 :30 & :60 music beds for . . . \$198  
120 production effects "Zings, Zaps  
and Zoodads" for . . . \$99  
122 New Lasers & Sweepers for . . . \$99

For FREE DETAILS on  
production music, sound  
effects, call

Ghostwriters (612) 522-6256

READER SERVICE 37

### 427 SOUND EFFECTS \$89.00

For a 5-CD set with a 30-day  
money-back guarantee.

Take an extra \$10 off if you mention this ad!

Send \$79 to Ghostwriters  
2412 Unity Ave. N., Dept. RW  
Minneapolis, MN 55422

For credit card orders call  
(612) 522-6256

READER SERVICE 37

## ATTENTION PROVIDERS!

Promote your services to **Radio World's** 18,000+ readers. Reach Radio Station and Recording Studio owners/managers and engineers with your message. For information on affordable advertising call **Simone** at **1-800-336-3045**.





The new Gary Burbank show syndication studios now equipped with Radio Systems DDS Digital Delivery System.

The "Broadbank Burbcasting Corp." is now in syndication with 17 stations receiving the Jacor Communications' satellite distributed *Gary Burbank Show* live from its new studios equipped with the DDS Digital Delivery System from Radio Systems and Harris Allied.

The digital system utilizes eight Cart Machine emulators and three Sound Slate 176-key, direct access keypads. Spread across three studios and two floors of the WLW facility in Cincinnati, the system

components allow instant access and transfer of the comedy cuts and liners that keep this fast-paced show exciting and unique.

Chief Engineer, Al Kenyon, chose DDS when he saw the system

at a demo at the facilities of Harris Allied, Richmond, Indiana, where it worked "right out of the box." That's the dependability and performance that the show will rely on every day for the new

syndicate program. Mr. Kenyon was similarly impressed when he saw the system a second time at last year's World Media Expo where Gary Burbank also saw and approved the system.



Call Harris Allied toll-free for complete details on a DDS Digital Delivery System for your station.

**1-800-622-0022**  
**FAX 317-966-0623**

 **HARRIS ALLIED**



## SHORT-TAKE

# Zippy Sound from Dynaudio BM5

by Bruce Bartlett  
with Jenny Bartlett

**ELKHART, Ind.** Take some high-end speaker drivers made in Denmark. Put them in a small ported cabinet that's tuned just right. You get the model BM5 from Dynaudio Acoustics, a remarkably transparent monitor.

This is a two-way ported nearfield monitor using a 6.7-inch poly woofer and 1.1-inch soft-dome tweeter. The drivers are magnetically shielded, so you can put the speakers near your workstation's monitor screen. They will fit easily, measuring only 12.2-inch by 8-inch by 9.9-inch and weighing in at 12.1 pounds each.

Supplied with the BM5 is a pair of foam

plugs that you can insert in each speaker's port. The plugs make the speaker more like a sealed cabinet. This tightens the bass but reduces maximum SPL.

What a clear, listenable sound the BM5 has! You can hear into the mix. Each instrument is clearly etched. You can "see" into an orchestra and easily sort out individual musical lines in a complex arrangement.

Overall, the sound is smooth and bright. The highs are bumped up a bit, so that cymbals are sizzly and tambourines are zippy. Because of this, you might not mix in enough treble, and wind up with a dull mix. Still, the highs are sweet rather than harsh. There are no midrange resonances, so vocals are uncolored. Vocals sound

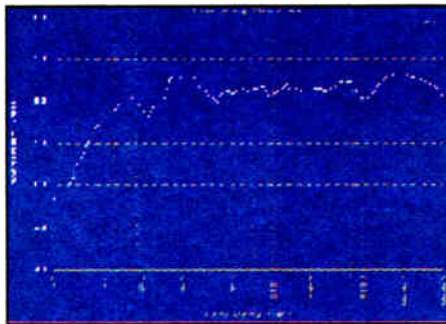

Response chart of BM5 monitors

warm without being tubby.

You will hear great detail in strummed guitar strings, and amazing definition of the bass. Imaging is nice and sharp. There is a good sense of depth. I liked the exciting

## AD-1 Audio Analyzer

► continued from page 30

of us who like to know what overload conditions are being detected; in other words, if equipment further downstream such as

based display into a more conventional type that closely mimics the response of an analog analyzer to pink noise signals. The spectrum display level can be boosted by 6 or 12 dB to bring low-level signals into a more accurate display range, although you might not need to, since the display features a 70 dB log range.

Below the analyzer is a real-time stereo, sum or difference waveform display that can be set to scroll left to right or right to left.

Last but by no means least, a small phase meter in the lower left of the screen will display traditional Lissajous figures. The display can be set for traditional 45-degree left versus right orientation, or vertical for in-phase and horizontal for out-of-phase conditions.

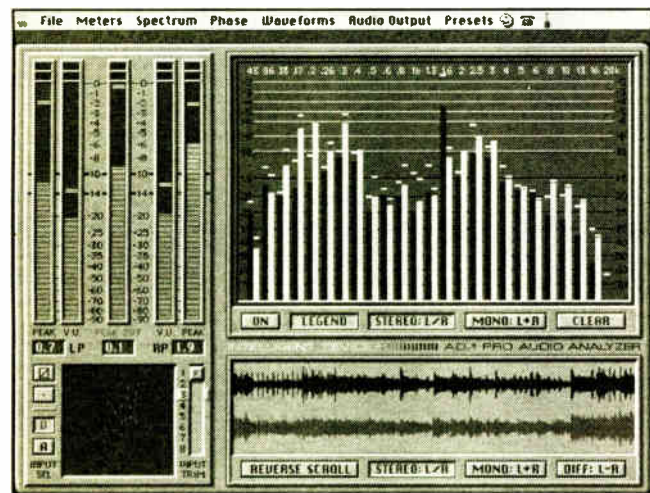

AD-1 Pro-Audio Analyzer display

STLs are able to handle the occasional short-duration full-modulation signal ... or if we are finally running out of usable head room and our CD-R's laser has transitioned into terminal meltdown.

The assignable center meter can be set to read L+R peak levels, L+R average (useful for monitoring mono/stereo compatibility), L-R peak or L-R average (the latter two might be useful to prevent excessive phase cancellation). And if LED-type displays do not appeal, you can set the metering for plasma or continuous mode; the former mimics a 128-element display, while the latter resembles a ribbon of light moving up and down the scales.

A large spectrum analyzer section to the right of the screen displays a third-octave readout of either discrete left and right channels, or summed mono. Strictly speaking, a third-octave display should include a low-frequency 20 Hz band but I'll avoid nitpicking. Each band can be set for a user-selectable range of update rates with fast, medium or slow decay, plus infinite hold.

On certain slower Macs, the main processor may run out of DSP power while driving all of the on-screen elements. In this case, the screen-update rate might be reduced to share usable horsepower amongst the various screens. Again, a single peak-reading element can be set for fast, medium or slow decay; plus infinite hold, or turned off to save computational power.

A useful pink-noise curve fit can be turned on to convert the Fast Fourier Transform-

As Intelligent Devices' president and primary designer Stephen St. Croix points out, "The AD-1 is a very accurate final-mix monitor that displays a variety of information, such as sum and difference signals, which quickly reveal phase anomalies, head-azimuth errors, etc. The phase display, for example, clearly shows any difference between left and right channels. We have unearthed a [well-known] CD Test Disk that claimed to be all-digital—a 'DDD'—but which produces a smeared phase display for mono bands, indicating that the source materials had been replayed from an analog deck with inherent azimuth errors. It's a very revealing tool for the radio broadcaster."

The Intelligent Devices AD-1 Pro-Audio Analyzer is being marketed through Marshall, Inc., P.O. Box 438, Brooklandville, MD 21022. Phone 410-484-2220, fax 410-486-0280.

Mel Lambert has been intimately involved with the production and broadcast industries on both sides of the Atlantic for almost 20 years. Now principal of Media&Marketing, a Los Angeles-based consulting service for the professional audio industry, he can be reached at [mediapr@aol.com](mailto:mediapr@aol.com), or 818-753-9510.

dynamics and the impact of percussion.

The bass is neither boomy nor thin, and bass transients are very tight. You can hear the deep bass-drum roll at the beginning of Stravinsky's *Firebird*. The deepest notes are low in level, but they are audible.

Measured anechoic response is 3 dB from 65 Hz to 20 kHz, or about 50 Hz-20 kHz near a console. A broad 3 dB rise around 10 kHz contributes to the speaker's bright, airy sound. The energy time curve is sharp and coherent, which shows that transients should be tight and clear.

The Dynaudio Acoustics BM5 at \$699 a pair is a very clear monitor. It is easy to live with in daily operations because the distortion is so low, and you don't have to strain to hear things. In all, this is a clean, refined speaker.

### MANUFACTURER'S SPECS

Max. SPL 102 dB at 1.25 meters  
THD <0.1% at 88 dB SPL,  
100 Hz-20 kHz.  
Recommended power: 50-150 Watts  
per channel  
Impedance: 4 ohms  
Frequency response: 50 Hz to  
20 kHz, 3 dB.

□ □ □

Bruce Bartlett is a microphone engineer and technical writer, and the author of *Practical Recording Techniques* published by Howard Sams. Jenny Bartlett is a technical writer. Bruce can be reached at 219-294-8388.

### Product Capsule: Dynaudio Acoustic's BM5

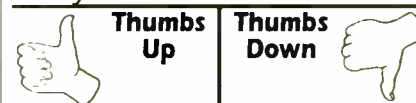

**Thumbs Up**

- ✓ Clean and clear
- ✓ smooth and uncolored
- ✓ Fairly deep bass for the size
- ✓ Easy access connectors

**Thumbs Down**

- ✓ May be a little too bright

For more information contact Audio Exchange at 617-982-2626; fax: 617-982-2610; or circle Reader Service 97

It's Sleek.  
It's Reliable.  
It's Ergonomic.  
It's Dead.



Presenting Foundation 2000RE. The ultimate recording/editing platform and a darn good mousetrap for just \$10,000. Foundation is the fastest, most intuitive non-linear audio platform on Earth. No cursor. No mouse. Just an amazing array of delightfully direct controls, including a solid brass jog wheel and touch-sensitive screen. Designed for the veteran engineer — yet easily learned by those new to digital —



Foundation's joys are revealed the moment you begin using it. For starters, the superb 16-channel

  
FOUNDATION



## PRODUCT EVALUATION

# Popless Passes Wolfman Test

by John Bisset

**WASHINGTON** Some of the newest state-of-the-art mic processors boast adjustable sibilance controls. The Popless Voice Screen company has achieved that same type of control, incorporating it into a passive pop filter that does not require a line cord.

The VAC-series provides an ingenious way of adjusting the amount of pop and sibilance control. The level of control is achieved using the trademarked Variable Acoustic Compression concept. Simply put, Popless provides two pop screens that can be spaced far apart for maximum filtering, or placed close together for minimum filtering.

The distance between the screens is adjusted by choosing one of three slots in the screen holder. The further apart, the more compression of pops and sibilance.

## Tested by Wolfman

Because the placement of the screens is variable, maximum transparency and minimal filtering can be obtained by using only one screen. This was the choice in trying the filter for Liberty Broadcasting's "Wolfman Jack Live from Planet Hollywood": a weekly Oldies request show featuring the late Wolfman Jack, which Multiphase engineered.

An Electro Voice RE-20 was used to capture the unmistakable rasp that was the Wolfman. The Popless Voice Screen offered an extra measure of protection, because Wolf cuddled up close to the mic, especially during phone bits.

We had previously used a foam pop filter for the Wolfman. Foam filters work on pops and sibilance, but also filter out vocal transparency. For higher-quality mics, the effect between the two types of filters was noticeable, with the Popless filter appearing acoustically transparent.

Because the craziness of live satellite

radio is not a place to test various settings of the filter screens, additional evaluation was done in the Liberty studios by Production Director Michael Wolfgang. Mike is called on to provide voice talent for a variety of formats and situations. The ability to quickly change screen position, or eliminate a screen altogether, was a positive point.

Another feature Mike appreciated was the low profile of the assembly. Some screens are big enough to block copy stands. The Popless models measure only 3.5 inches in diameter, so they do their job while staying out of the way.

You might ask why use a pop screen

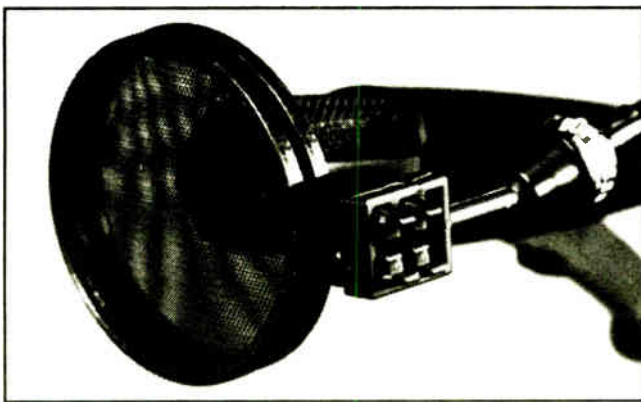

Popless VAC Voice Screen

at all. Besides filtering out the pops and sibilance, the Popless Voice Screen helps protect the mic against moisture, while providing a safe distance between the announcer and the mic. The filter screens are washable and easily replaceable.

Because the filter assembly is mounted on an 8-inch flexible gooseneck, it is long enough to permit proper placement for a variety of microphones. The pop screens "pop" in place, further simplifying operation.

Not only did the filter perform well, but the mounting assembly is a real work of art. It is always nice when a manufacturer

doesn't cut corners. Popless not only spent the research and development money to build a versatile filter, but they went the extra mile to invest in an above-average mounting system.

## Hold on tight

In the past we have used other filters with simple clamps. The result was talent knocking the filter off, or watching it slip as the clamp spring aged. Such will not occur with Popless. A spring-loaded clamp affixes the gooseneck to the mic stand or boom, and a securing wingnut keeps the device in place. The clamp can be opened wide enough to accommodate a 3/8-inch to 1-1/2-inch diameter.

The securing wingnut has an additional feature — it thwarts theft, because you must spend time unscrewing the wingnut before you can remove the assembly.

A second wingnut secures the clamp to the gooseneck. This pivotal point allows for a variety of mics, booms, and stands. It also means the gooseneck position can be varied, then locked down (do these guys know jocks or what!).

The business end of the gooseneck where the screen is attached terminates in a ball socket. This flexible socket allows the filter assembly to be quickly pushed to one side, or moved closer or farther away from the microphone.

Although the screen is mostly used for voice work, some interesting effects can be obtained in miking acoustic instruments. The effect of the double screen placed at the maximum spacing is to reduce transients from a miked guitar.

The Popless Voice Screen VAC-re is made in the USA, is patented, and costs less than \$50.

□ □ □

For more information on the VAC-re, contact Popless Voice Screens at 800-252-1503; or circle Reader Service 120.

audio quality is perfect for broadcast promos, spot productions and shows of any length. Rugged Fostex hardware coupled with the most bulletproof software in the industry ensure each job gets done simply, quickly, and reliably. At \$10,000 it completely trans-

forms the price/performance equation for

digital audio workstations. Manufactured

in the U.S.A., the 2000RE is

backed by a worldwide

service and support

network. Why not build

your next project on a solid

Foundation? Call 1-800-7-FOSTEX for a demo or free video tape.

Discover for yourself what makes the Foundation 2000RE such a

killer system.

**Fostex**



### One wheel everyone can get behind.

Grab hold of the solid brass jog wheel and feel the track. Foundation's unsurpassed audio scrubbing resolution sounds and feels like magnetic analog, so you'll park at exactly the right point—without circling the block.



### The ultimate screen test.

Simply use your finger to select a waveform, edit envelopes, library information, and much more while you're recording or playing back. Foundation even lets you output your display to any video monitor.



### The keys to your success.

Don't wait, do it now. Ergonomic controls unlock your creative power. Lighted transport and track ready buttons are right there. Dedicated editing buttons give you fast single stroke cut, paste, fade and trim functions.



### Our Removable Project Environment puts everything in the palm of your hand.

Foundation's removable disk system stores all audio, edit, mix and project data. In a matter of seconds your work is loaded with total recall and you're on-line, ready to go.

Fostex Corporation of America 15431 Blackburn Avenue, Norwalk, California 90650, U.S.A. Telephone: (310) 921-1112 Fax: (310) 802-1964

Circle (175) On Reader Service Card

World Radio History

## FM Book Is Worthy of Attention

by Rich Rarey

**WASHINGTON** As we endure the dog days of summer, I'd like to recommend a book for your summer reading pleasure that should be required reading for everyone in broadcasting. The book, "Man of High Fidelity: Edwin Howard Armstrong" by Lawrence Lessing, has been out of print for several decades, but a cache of paperback copies has recently become available through the Museum of Radio and Technology in Huntington, W.Va.

Written in 1956 (two years after Armstrong's death), and revised and re-issued in 1969 with a new foreword, author Lessing presents an interesting, insightful study of the great American inventor's life and the forces that seemed to conspire to destroy him. It seems difficult now to think about frequency modulation as a subject of intense patent litigation, to think that anyone else but Armstrong invented regeneration, superregeneration and the superheterodyne receiver, or was the father of FM.

But then, as now, expansion into new electronic territories meant a great deal of money was at stake—and with that lure, came the deeds of contentious almost-rans, the large corporations, and even the United States government.

## Visionaries

In 1919, as General Electric and American Marconi were forming the Radio Corporation of America, no one, save the inventors, amateurs and David Sarnoff, had the idea of using the wireless for anything resembling broadcasting. As Lessing writes "...amateurs of all ranks had never ceased to press on in pursuit of this goal. But these inventors and amateurs were obviously visionaries and not the solid, practical men of affairs who now forgathered about the big mahogany conference tables to agree among themselves how the new wireless industry, as they saw it, was to be constituted and divided."

It was the amateurs—Major Armstrong among them, not the corporations, that sent the first shortwave signals across the Atlantic. The amateurs had been relegated by government order (from military and commercial pressure) to the "commercially useless" shortwave frequencies above 1.5 MHz.

Some passages in "Man of High Fidelity" may make you angry. Lessing detailed accounts of Armstrong's long patent fights with Lee de Forest, inventor of the two-tetrode vacuum tube or audion, who believed that he had stumbled upon regeneration before Armstrong—although de Forest could not describe how regeneration worked.

In one instance, de Forest embedded Armstrong's latest findings on regeneration and circuit diagrams into his own

continued on page 43 ►



## PRODUCERS FILE

# Active Studio with Passive Hybrid

by Ty Ford

**BALTIMORE** With all of the high-tech stuff making the rounds these days, it is sometimes nice to find simple solutions for everyday problems.

I was in several studios doing voice work this past month. On both occasions, the client was on the other end of the phone listening to the session. The first studio was using a hybrid box to link the console to the phone line: an elegant, if not somewhat pricey and over-engineered way to do the job, considering that voice nulling was not an issue.

The second studio used the "hold the receiver up to the speaker" method: not elegant, and not very nice sounding, but functional. While experimenting with really cheap technology, like the Radio Shack phone patch box, I learned there is a difference between commercial and residential phone lines. On my residential phone lines in the Bell Atlantic area, I got a rather nasty hum along with the audio, even when using isolation transformers.

### In the loop

A call to Harris Allied's Gary Hardwick proved very helpful.

According to him, most residential service is POTS (plain old telephone service) and will normally be loop start. Business service is normally PBX or KSU (key system) and will usually be ground start. Hardwick also noted that a business line can be a loop start and that it depends on which system exists at the closest central office (CO) and how it is terminated.

With a loop start system, when you take the handset off the cradle, a switch puts a 600 ohm load on the line and creates a current flow from the CO. The CO senses the current and starts the dial tone. That current flow results in the hum. In a ground start system, the PBX or KSU (key system) sends a ground flash to summon the dial tone.

Because my service is loop start, my next step up was to order a simple little \$95 box that Elgin makes called the EC-30A.

It is smaller than a box of kitchen matches, has an RJ11 on one end, a 1/4-inch TS jack on the other and does a very nice job of putting audio down the phone line without hum. It is a passive device that doesn't require power and doesn't seize the line. That means, if you forget to disconnect the RJ11 after your session, the line still works.

The only problem I ran into was with my fax modem. It didn't like the loading, and wouldn't pick up as long as the EC-30A was connected to the phone line. Since then I've added a separate fax/data line. End of problem.

### "Direct" dial

Not long after that, I got a call from a client that wanted to direct me as I did my takes. I thought it would be great if I could route her comments into my headphones and my audio down the line to her so I wouldn't have to keep picking up the phone in between takes to get her direction and comments. I grabbed a mono Y-connector off the wall and plugged it into 1/4-inch TS jack on the Elgin.

In order to combine both her voice and my voice in my headphone mix, I needed a headphone amp with two inputs and the ability to mix them.

That is where my Revox PR99 reel came in handy. The switchable front-end monitoring provided by the PR99 provides Stereo, Reverse Stereo, Left Only, Right Only and Mono.

Switching the PR99 input monitoring to Mono, I connected one leg of the Y-connector from the Elgin EC-30A to the left channel input of the PR99, I fed the other branch of the Y-connector with an output from my DSE-7000 workstation. Monitoring with the

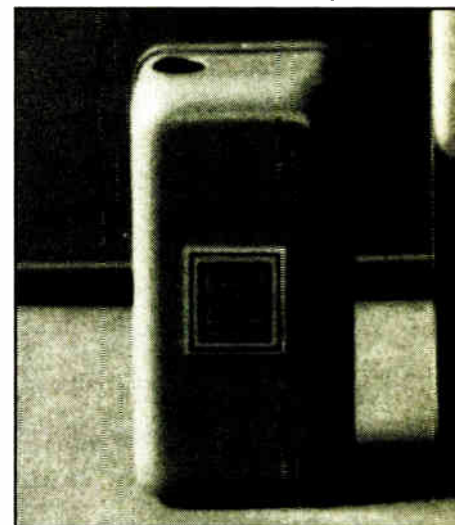

Elgin EC-30A passive phone interface

PR99 in mono allowed me to mix the levels of both the phone and mic levels with the PR99's input level controls.

Because my mic was routed through my Mackie 1604 mixer to the DSE-7000, the client could hear the "live" throughput of my voice from the microphone, plus the playback of any recorded takes. The really neat thing was being able to converse "hands-free" using my studio mic and headphones instead of using the telephone handset.

Although you might want to dress up the system by installing a switch on the phone line before the EC-30A, I mounted the EC-30A within easy reach of my main console seat, allowing me to unplug the line from the box when it is not in use.

This solution is not digital, doesn't require a hard drive or a monitor and doesn't use any power. It is simple, and it works.

□ □ □

For more information contact Harris Allied at 317-962-8596.

Want to share some of your best simple solutions? Contact Ty via e-mail at: [tford1010@aol.com](mailto:tford1010@aol.com) or at 410-889-6201.

## I COULD HAVE BOUGHT A DIGILINK!

Are you thinking about replacing your old cart machines with 'Digital Carts' such as floppies, flopticals, Bernoullis, or Opticals??? Well, think about it a little more! Add up the list price for a digital cartridge recorder, just a single player, AND the floppy disks--- and you will find that you could have bought a Digilink workstation for \$7,995 that gave you 'Live' -AND- 'Automation' capabilities!!!

A Digilink workstation stores audio on an internal hard disk and comes out of the box with a capacity of 547 one minute, stereo carts for only \$7,995. Even better, the Digilink hard disk has an average 15 year life. Imagine how many floppies you will break, wear out, lose, and replace over 15 years. That doesn't count all of the floppy disk mechanisms that will jam, break, and simply fail...

Also with a Digilink, you get much more! You can stack up hundreds of 'carts' in the play list and just walk away. You get satellite automation in the Digilink workstation and can optionally add CD players. A digital audio cut and splice editor even comes standard with Digilink. Because Digilink will play and record at the same time, you can play a spot to air while it starts a scheduled network autorecord. You can even network delay with Digilink.

With all of these features, it is easy to see why there are more than 500 Digilink workstations around the world from Paris to Moscow to Taiwan to Jamaica and in your own backyard. Don't suddenly come to the realization that you could have bought a Digilink!

Call Arrakis now...

(303) 224-2248

## ARRAKIS

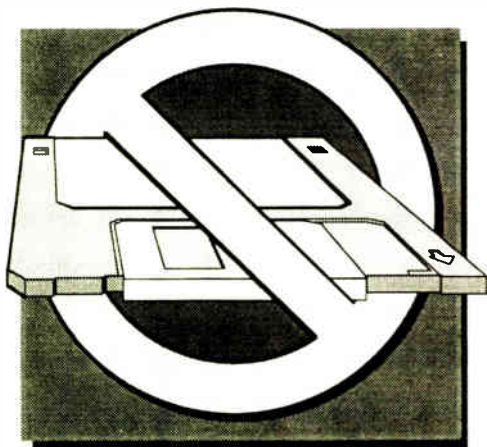

© 1993 Arrakis Systems Inc. 2619 Midpoint Drive, Fort Collins, CO. 80525

Circle (83) On Reader Service Card

## PRODUCT GUIDE

Companies with new product announcements for Studio Sessions Product Guide should send them to Radio World, c/o Studio Sessions Editor, 5827 Columbia Pike, 3rd floor, Falls Church, Va. 22041

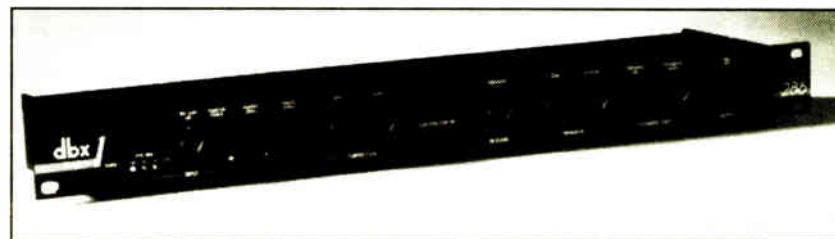

### dbx Microphone Processor

dbx Professional Products manufactures the 286 Microphone Processor for recording studio vocals and providing studio-quality processing for live sound. Features include dbx compression, HF and LF enhancement, de-essing, an expander/gate circuit, phantom power and Balanced Mic and Line Level inputs. An insert jack is included for patching in EQs and reverbs. For more information, contact dbx at 801-568-7660, or circle **Reader Service 165**.



# Products & Services Showcase

For more information on the products shown below, circle the appropriate Reader Service No.(s) on the enclosed Subscription/Reader Service card or contact the advertiser directly.

**NEW Receiver!**

## UNIVERSAL SCPC XE-1000



**SCPC BROADCAST AUDIO RECEIVER**

New, affordable, frequency-agile receiver. direct channel entry by keyboard. selectable companding 1:1, 2:1, 3:1, wide/narrow bandwidth, de-emphasis selectable, 950-1450 MHz, line output 600 ohms, muting, transponder agile, LNB power supply, 50-channel memory, full baseband output, high-quality audio. Every needed feature at a sensible price (lowest in the industry). Write or call for full information on this quality receiver—the answer for your station. Networks call for prices.

**UNIVERSAL ELECTRONICS, INC.** 4555 Groves Road, Suite 12 Columbus, OH 43232  
 Communications Specialists Phone: (614) 866-4605 Fax: (614) 866-1201

READER SERVICE NO. 41



- CUSTOM ANTENNA PHASING SYSTEMS
- ANTENNA CONTROL SYSTEMS
- AM/MF ANTENNA TUNING UNITS
- DIPLEXERS & MULTIPLEXERS
- TRANSMITTER COMBINERS
- DUMMYLOADS (WITH MATCHING NETWORK)
- ASSOCIATED RF COMPONENTS
- CALL OR FAX FOR MORE INFORMATION

**PHASETEK INC.**

550 CALIFORNIA RD. UNIT 11  
 QUAKERTOWN, PA 18951  
 PHONE: 215-536-6648  
 FAX: 215-536-7180

READER SERVICE NO. 135

### The Headphone Amp that Can ...



- Please your talent with plenty of power
- Mount easily at talent station
- Drive high or low impedance phones

The low distortion HSA-100 Headphone Amplifier mounts easily with four mounting holes in its heavy-duty steel front panel. It runs on a ±15 to 18 volt power supply. Its discrete transistor output can drive impedances as low as 16 ohms! Input level is jumper selectable from -10 to +8 dBm. Ideal for custom applications — call or fax for details.

Power pack included not pictured.

**bdi Broadcast Devices, Inc.**  
 5 Crestview Avenue  
 Peekskill, NY 10565

Tel: (914) 737-5032 Fax: (914) 736-6916

READER SERVICE NO. 151

**Cellcast**  
 REMOTE BROADCAST STUDIO

**THE CELLULAR DIFFERENCE**

- Easy to Use
- Reliable
- Cost Efficient
- Portable
- Flexible



Technology & convenience combine to bring you on-the-spot remote broadcast capabilities with excellent sound quality. Cellular transceiver, frequency extender, and mixer all in one! Powered by Ni-cad rechargeable batteries or AC power supply — utilizes cellular technology or land lines.

For more information call  
**1-800-852-1333**

READER SERVICE NO. 174

### Quality\* Power Tubes

3CX15000H3	4CX5000A/81704	4X350A/8321
3CX15,000A7	CX3500A	4CX250R/7580W
3CX15,000A3	4CX1600B	4CX250BT
3CX15,000H3	4CX1500A	4CX250BC/8957
3CX10,000H3	4CX800A	4CX250B/7203
3CX10,000A7	4CX400A	4X150A/7034
3CX3000F7/8162	4CX350AC	5CX1500B
3CX3000A7		5CX1500A
3CX2500H3		YC130/9019
3CX2500F3/8251		8560AS
3CX2500A3/8161		811A
4CX15,000A/8281		833A
4CX10,000D/8171		833C

**Svetlana**  
 ELECTRON DEVICES

- Watch this list grow.
- Manufactured in Russia's largest power tube factory.
- Generous\* warranty based on high quality.
- Honest prices based on quality at low cost.

• Shipment from USA stock.

<b>Broadcasters</b>	<b>OEMs, Distributors</b>
Phone: 205-882-1344	Phone US: 800-578-3852
FAX: 205-880-8077	Int'l & US: 415-233-0429
800-239-6900	FAX: 415-233-0439

READER SERVICE NO. 199

## Attention Advertisers:

# RadiWorld

Combine Direct Mail With Advertising in a Total Marketing Package!

**RADIO WORLD** reaches 18,000+ equipment buying prospects. The list can be customized for your specific needs. Select by geographic region, firm type, occupational breakdown or other sub-divisions.

Call Christopher Rucas at  
**800-336-3045**  
 for more information!

READER SERVICE NO. 151

## AXS (Ax'-sess)... Jocks Love It!

AXS is an entirely new approach to digital audio controllers. It starts with superb audio using the premium quality apt-X™ system. AXS is easy to learn, easy to use, and powerful beyond words.

AXS is a modular design that begins as a simple cart replacement and grows to any combination of CD, hard disk, satellite or specialty programming with ease.

AXS has all the sophisticated feature options including device independent multi-channel background audio record and replay. Macro programming makes tough to run event sequences easy. Software drives a powerful programmable real time IOMAP.

**Jocks love AXS:** A fast 99 page, 28 button Jock F/X panel that can be time linked and remote wired is standard.

Use a software driven four-channel stereo audio switcher with on-screen control or the powerful eight-channel dual-buss routing switcher, or include both if you wish. AXS is controlled through a trackball, touchscreen, keyboard, buttonbox, telco or remote modem.

**AXS Systems...**

From \$6000.00 using your 486 computers and hard disks.

READER SERVICE NO. 18

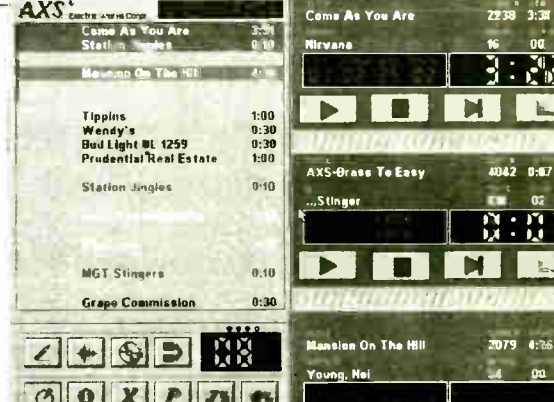

## AXS

### The Management

800-334-7823 • 817-625-9761  
 FAX 817-624-9741  
 P.O. Box 1-36457 Fort Worth, TX 76135  
**1700+ Stations • Our 14th Year**  
 SEE US AT WME BOOTH #1119

SEE US AT WME BOOTH 1119



# The Right Tool(s) For The Job



**R-60**



**MR-40**



**R-16**

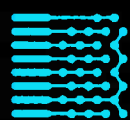

**AUDIOARTS ENGINEERING**

Everyone knows how frustrating it is to try to get work done with tools that aren't designed for the task at hand. Audioarts understands this frustration and has designed consoles that make your work a breeze.

The **R-60 Console**, for example, offers all the right features for on-air use such as high quality illuminated switches for instant identification; A and B inputs on each channel that can be assigned to any combination of program, audition and mono output busses and modular construction that lets you configure layout and replace components quickly and easily. User friendly control logic and Audioart's exclusive Simple Phone™ make controlling source machines and handling phone calls on the air second nature. This all adds up to an on-air console that works for you, not against you.

The **MR-40** is just the tool you need for multi-track production. With the look and feel of a familiar on-air board, the MR-40 provides 4 bus channel output assign that makes routing to, and monitoring from multi-track recorders a snap. 3-band EQ and stereo effect sends give you all the processing flexibility required for great productions.

For cramped quarters such as remote vans or news rooms, the **R-16** offers high quality mixing in a compact package. It offers all the necessary features of a full-sized on-air board such as modular construction; program, audition and cue busses; machine start/stop switches; built-in cue speaker; studio talkback and more.

Isn't it about time you got the right tools for the job? Get Audioarts from BSW!

**Call Today For More Information Or To Place Your Order**

Phone: 800 . 426 . 8434

*Equipment Solutions To Keep You Number One*

**BSW**

BROADCAST SUPPLY WORLDWIDE

Fax: 800 . 231 . 7055



# PRODUCT GUIDE

Companies with new product announcements for Studio Sessions Product Guide should send them to Radio World, c/o Studio Sessions Editor, 5827 Columbia Pike, 3rd floor, Falls Church, Va. 22041

## Power Chords Pro

Power Chords Pro from Howling Dog Systems of Ontario, Canada is MIDI music software for Windows that uses the image of a guitar fingerboard instead of a piano-style keyboard to input music information. Production people with no keyboard experience can create MIDI commercial jingles with a mouse on a virtual guitar neck. Works with most sound cards and popular interfaces. *For more information, contact Howling Dog at 613-599-7927 or circle Reader Service 67.*

## Peavey Spectrum Analog Filter

Peavey Electronics of Meridian, MS makes the Spectrum Analog Filter, a

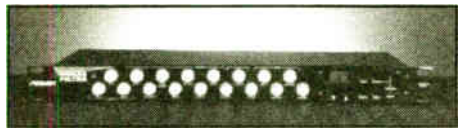

programmable low-pass analog filter that can process any audio sound source. The Peavey Spectrum gives audio the "wah" filtered quality of vintage synthesized sound. Features include a 3-channel line/low-level input mixer, classic voltage-controlled 4-pole filter, MIDI control, 100 programmable memory locations and is made in the United States. *For more information, contact Peavey Electronics at 601-483-5365 or circle Reader Service 162.*

## Zoom 1202 Processor

Samson Technologies is marketing the Zoom 1202: a 1 RU reverb/multi-effects processor offering a total of 512 parameter-adjustable programs. The 1202 samples audio at 44.1 kHz for CD-quality sound and features true stereo operation. Inputs can be configured as stereo or two mono signals for simultaneous processing with different effects. Front panel controls include two-band EQ and a 16-position rotary switch to select variations on basic programs. List price is \$250. *For more information, contact Samson at 516-364-2244 or circle Reader Service 30. (Watch for a review of the Zoom 1202 in a future Studio Sessions.)*

## Marantz Professional Cassette Deck

Marantz Professional Products offers the PMD502 analog cassette deck for broadcast, sound reinforcement and DJ services. The PMD502 has two heads, two motors, Dolby B noise reduction



as it is equipped with a 12 percent pitch control, a defeatable AGC circuit, linear time counter and optional XLR Ins/Outs for +4 dB signals. The PMD502 also has front panel mic inputs for recording audio without a mixer. Suggested price is \$479. *For more information, contact Marantz at 708-820-4800 or circle Reader Service 163.*

## Spirit Pro Tracker

DOD Electronics distributes the Soundcraft Spirit Pro Tracker mixer, an 8x2 rack-mountable mixer ideal for small production projects and direct-to-tape multitrack recording. The Pro Tracker features phantom-powered mic inputs on all eight channels, built-in limiting, a return bus for stereo effects and internal power supply. Frequency response is 5 Hz to 150 kHz, with less than 0.003 percent THD. The mixer chassis is three RU high and weighs under 14 pounds.

*For more information, contact DOD Electronics at 801-566-9135; or circle Reader Service 27.*

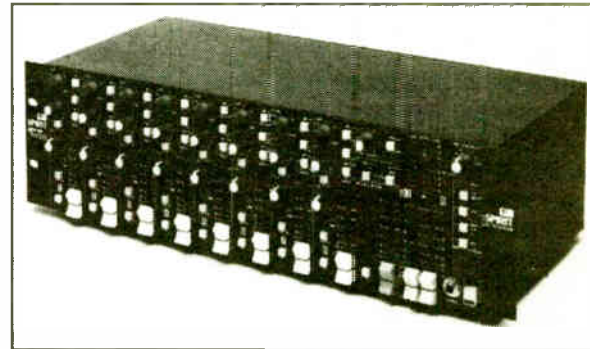

**Sharing  
programming**

**doesn't take a  
rocket scientist.**

**Or does it?**

Radio and rocket science. If you never exactly thought the two belonged in the same sentence, consider this: our satellite services help you share programming coast to coast at a **lower cost** than ever before. Genius? Well, you can create your own satellite network, increase programming quality at local levels, utilize **state-of-the-art digital technology**, and keep overhead low. Plus, it's all brought to you by people who understand your needs -- the **radio only experts** at NPR Satellite Services. You don't have to be a rocket scientist to see the benefits. Call us today at (202) 414-2626.

 **NPR Satellite Services®**  
**Link up with us**

635 Massachusetts Ave., NW., Washington, DC 20001-3753 • (202) 414-2626

Circle (133) On Reader Service Card

World Radio History



# Products & Services Showcase

For more information on the products shown below, circle the appropriate Reader Service No.(s) on the enclosed Subscription/Reader Service card or contact the advertiser directly.

**COST-EFFECTIVE PROGRAMMABLE PATCHING**

## REPLACE 16 PATCHCORDS IN A SINGLE KEYSTROKE

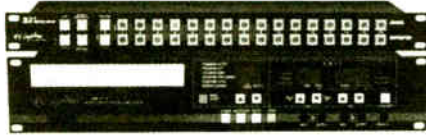

**AM-16 SERIES PROGRAMMABLE AUDIO SWITCHER**

- 16x16 switching matrix, balanced inputs & outputs
- Non-volatile storage of 100 programs
- Serial interface □ Expandable to 5 levels deep
- Multi-station remote control □ Level adjustment for each input □ Exceptional audio performance

Routing multi-channel audio and time code signals electronically outperforms patch bays for speed and reliability. The AM-16 allows for a variety of system configurations in small to medium size applications and is priced far less than any other alternative — a complete 16 x 16 matrix for only \$1,495.

*3E Systems*  
PROFESSIONAL DIGITAL AUDIO  
5321 STERLING CENTER DRIVE, WESTLAKE VILLAGE, CA 91361  
PHONE (818) 991-0360 FAX (818) 991-1360

**READER SERVICE NO. 200**

See Us At  
The BSW  
Booth 1338

## Byte it with



**PhoneBYTE**  
Digital Phone-Bit Recorder

A Digital Recorder specifically designed to record phone calls and play them back quickly and easily.

Fast nondestructive editing.  
Easy access and fast stacking of bits.  
The most powerful way to record and air phone-bits.

**NOW INTERNET READY**

**The Blue Group**  
1001 Ridge Avenue  
Clearwater FL 34615  
TEL 813.442.1665

**READER SERVICE NO. 111**

A Broadcast Industry

# BEST BUY

Cartridge Reproducer

Mono Play	Stereo Play
<b>\$1050</b>	<b>\$1150</b>

(F.O.B. Factory - U.S. \$)

**RELIABLE / RUGGED  
PROFESSIONAL DESIGN**



**DL Series**

**AUDI-CORD CORPORATION**  
1845 West Hovey Avenue  
Normal, Illinois 61761 USA  
Phone 309-452-9461  
Fax 309-452-0893

Available Through Your Regular Distributor

**READER SERVICE NO. 36**

## WEATHER RADIO

Model CRW



Price \$540.00

Sensitivity .28 microvolts for 12 dB quieting. All 3 frequencies. Alert tone demutes receiver, closes relay and gates audio to 600 ohm rear terminals. Another set of rear terminals has continuous 600 ohm audio output. Double conversion crystal controlled, crystal filter in first I.F., ceramic filter in second I.F. Dual gate MOS FET front end. 50 ohm coaxial input. Adjacent channel (j25 kHz) down to 70 dB. 19" rack mount, 3 1/2" H, all metal enclosure. In stock—available for immediate delivery.

**GORMAN REDLICH MFG. CO**  
257 W. Union St. • Athens, Ohio 45701  
Phone 614-593-3150 • FAX 614-592-3898

**READER SERVICE NO. 88**

## The CircuitWerkes AC-2 Autocoupler



More Features. Better Price.

- Auto-connect and disconnect.
- FCC Pt.68 registered.
- Two-Year limited warranty.
- LED Indicators for audio clipping, incoming rings and line status.
- Answers on user selectable number of rings.
- Momentary or latching dry contacts at pickup.
- Momentary open collector output at pickup.
- Defeatable pickup inhibit function for cart decks, etc.

- Can be combined with CircuitWerkes DTMF decoder board to form an inexpensive dial-up DTMF remote control.
- Optional ComboLok provides for secured access.
- Suggested list only \$199.

**CircuitWerkes**  
6212 SW 8th Place  
Gainesville, Florida 32607  
(904) 331-5999  
fax (904) 331-6999

**READER SERVICE NO. 197**

# MATCHBOX II IS BEST FOR DIGITAL

with its HI-GAIN mode for Power-Mac\* and other digital editor sound cards

**NEW!!**



Get MATCHBOX II to convert your Power-Mac\* audio to *balanced* professional levels!

Only MATCHBOX II has *programmable gain* that's optimized for digital editor sound cards.

15,000 units in use worldwide!

- ◆ HI-GAIN mode for digital editors
- ◆ All four outputs adjustable
- ◆ Pro-grade gold-plated RCA jacks
- ◆ Over 110 dB dynamic range
- ◆ Self-contained power supply

**HE HENRY ENGINEERING**  
TEL (818) 355-3656  
FAX (818) 355-0077  
FAX-on-Demand Doc #120 (818) 355-4210

\* Power-Mac is a trademark of Apple Computer

**READER SERVICE NO. 21**

# Radio World

Vol. 19, No 18 Radio's Best Read Newspaper September 6, 1995

## Attention Advertisers!

Product Showcase ads always get impressive results!

Reach 18,000+ broadcast professionals! Radio World's Product Showcase provides a perfect medium for test marketing your products and services. It's an efficient, effective and affordable advertising option.

**Advertise in the Product Showcase Directory!**

"It Works! It's Great!"

**Advertising is good for business!**

For more information, including rates and deadlines, fax your sales representative at

**1-703-998-2966**  
or call  
**1-800-336-3045**



# Use Mini-Mackie for Production

by Alan R. Peterson

**WASHINGTON** There is always a need for one more production room: A clean, simple voice-with-music booth to take some load off the main room.

Components "retired" to the shop (reel, CD player, cassette deck) could be resurrected for the project, but the price of a new console could be intimidating.

It may surprise you to know the highly acclaimed Mackie 1202 "baby" mixer can be used as such a production console, holding its own against much bigger boards.

For the purpose of this article, reference will be made only to the Mackie 1202 mixer. Clones made by Soundcraft, Peavey, Yamaha, Samson and others are also available. The 1202 has excellent RFI immunity and, with proper cabling and grounding, will perform well in studios located at antenna sites.

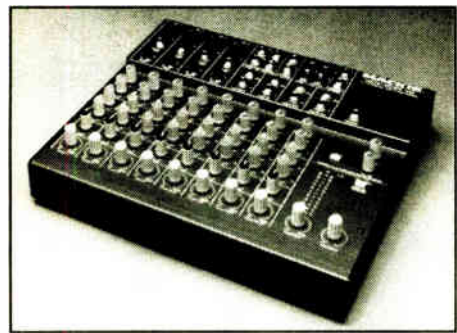

The Mackie 1202 mixer: a production console?

Lacking cue and reverb busses and mute relay circuitry, the 1202 seems to be out of its league as a production mixer. Don't believe it. The 1202 takes four Low-Z mics or mono line inputs and four stereo inputs. It has two-band EQ and two auxiliary sends. Some applied ingenuity and external circuitry can create a fine tabletop production suite.

Figure 1 is one way to configure the 1202 (shown differently from the actual panel layout to aid in visualizing signal flow). Two mics are used, one with compression on that channel's insert jack (the Radio Design Labs ST-CL1, for example).

The stereo inputs accommodate a CD player, cassette deck, phono preamp and return line from the reel-to-reel (or soundcard output if using a software-based PC multitrack instead of reels).

Auxiliary Out line 1 feeds a budget reverb while line 2 becomes the console's Cue bus. Adjust effect levels with the Aux 1 pots, and cue sources with the respective channels' Aux 2 pots. Cue output (Aux Out 2) feeds a powered speaker.

A button on the mixer switches the Aux 2 return to "Tape In" position, used here as a cart machine or hard disk playback return. Again, reconfigure this for your facility's particular needs.

Both balanced and unbalanced outputs are available from the 1202. As drawn, all recording components are fed a compressed stereo signal from the balanced connectors, with the

monitor feed coming off the unbalanced RCA jacks. Should this load down the signal, add some isolation

resistors or drop a "Henry box" distribution amp on the output to provide isolated feeds to each machine.

Monitor levels must be adjusted at the amplifier, since the 1202's Master pot controls overall level to both TRS and RCA jacks simultaneously.

Speaker mute and tally light circuitry can be built inside a black box and attached to the mixer with double-stick tape. Talent must turn this circuit on manually. Refer back to *Bottomline Broadcaster* in the June 14, 1995 *RW* for relay circuits.

Stations will find this set-up to be a flexible adjunct to the big-money room. Very small facilities can actually use this as their main production center.

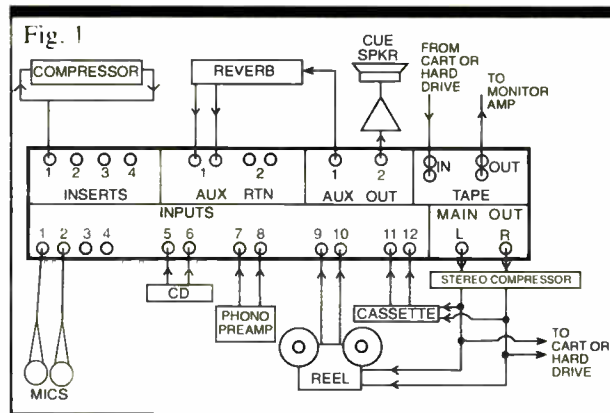

## *Translator!* The FM Transmitter of Choice

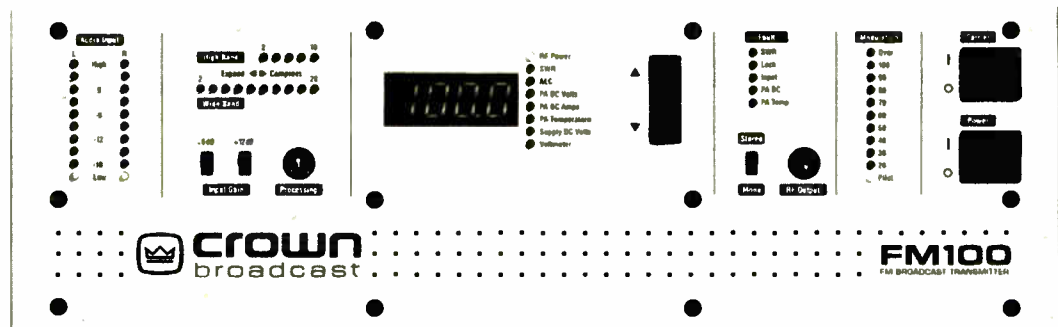

### Integrated Transmitter Systems by CROWN®

#### Applications

- ┌ Suited for FM translator service
- ┌ Ideal for satellite or terrestrial-fed systems
- ┌ Use it as a stand-alone transmitter
- ┌ Use it as a stand-alone exciter with composite input
- ┌ Use it as an FM exciter with built-in IPA
- ┌ Great for community and campus radio
- ┌ A perfect backup transmitter system

#### Models

- ┌ FM30, adjustable from 3 to 33 watts output
- ┌ FM100, adjustable from 20 to 110 watts output
- ┌ FM250, adjustable from 20 to 250 watts output
- ┌ FM500, 50 to 500 watts (available third quarter '95)

#### Integrated System Components

- ┌ FM exciter (digitally tunable, frequency-agile)
- ┌ Audio processor (with compressor/limiter)
- ┌ Stereo Generator
- ┌ RF Amplifier
- ┌ Lowpass Filter
- ┌ New, optional FM Receiver Module
- ┌ New, optional FSK IDer

#### Features

- ┌ Excellent signal quality and reliable performance
- ┌ Lightweight, compact, easily shipped worldwide
- ┌ 110/120 VAC, 220/240 VAC or DC powered
- ┌ Built-in digital metering and diagnostics
- ┌ User tunable from 88 to 108 MHz
- ┌ Optional tuning for 65-73 MHz in 10 kHz steps
- ┌ Modular, flexible design
- ┌ Fully illustrated and detailed user information
- ┌ Type notified for FCC part 73 & 74; meets FCC, DOC, and CCIR requirements
- ┌ Quick setup; designed for easy installation even by non-technical people

For more information, contact Crown Broadcast Sales at (219) 294-8050 or fax (219) 294-8302.



A Division of Crown International, Inc.  
1718 West Mishawaka Road  
Elkhart, Indiana 46515-1000  
Phone: (219) 294-8050; FAX: (219) 294-8302

## BUYERS GUIDE

October 4

STL, Telco, Remote & ISDN

November 1

FM Transmission & RDS

November 29

Studio Source Equipment

December 27

Delivery & Broadcast Services



## SHORT TAKE

# Wireless 'Phones from Sennheiser

by Ty Ford

**BALTIMORE** Each person has his or her own story about the time the headphone cable got wrapped around the chair leg or the coffee cup. In the heat of the moment, headphone cables are an accident waiting to happen. The only good thing that can be said about headphone cables is that, if you can't remember where you put the 'phones, you can follow the cable from the console to them.

With the Sennheiser IS 550 infrared headphones (\$359), you can kiss those cables goodbye. This is an FM system

operating in the 2.3 MHz to 2.8 MHz range. Frequency response is quoted as 18 Hz to 24 kHz, distortion is .8%, S/N is 64 dB. The headset weighs just over five ounces and is powered by rechargeable, easily replaceable batteries.

The transmitter has a socket that accepts the battery pack for recharging, so when the headset starts to fade or distort as the juice runs out, you can exchange batteries and keep going. Of course, this means you need to have an extra battery pack and that you place the transmitter somewhere where it can be reached. In my tests, a freshly charged set of batteries lasted between three and

four hours of continuous use at a moderately loud level. You could expect a longer use cycle by turning the headset off when not in use or by listening at lower levels.

Setup is easy: plug the transmitter into an unbalanced stereo TRS or mini jack, adjust the modulation level on the transmitter and position it so that it covers the area in which the phones will be worn. The headset is comfortable, easily adjustable and has volume, balance and stereo/mono controls and a power switch.

The receiving sensors are mounted on the right ear cup assembly. The only problem with this design is that reception

breaks up the more you turn the right side of your head out of a direct line with the transmitter. Although breakup is slight at a distance of up to four feet from the transmitter, anything over that results in a lot of white noise if your head is turned the wrong way. Sennheiser would do well to consider mounting the receive elements on top of the headband to allow 360 degree reception.

Inside, the reception worked well as long as I faced the unit to a distance of at least 40 feet. Outside, the transmitter made the trip through my front window and storm window to a distance of 20 feet in the shade; however, when I got the headset out into open sunlight, the infrared from direct sunlight completely destroyed reception.

Freedom always comes with a price. If you can live with the limitations of the IS 550 headset, you'll never have to worry about tripping over the cord again. Of course, then there's the problem of remembering where you put the headset ... maybe Sennheiser could install a beeper?



## RE audio codecs— full compliance with the industry standard

Buy an audio codec from just about anybody other than RE and you may get more than you bargained for—hopeless operational procedures, non-standard compression protocols and limited connectivity.

Then again, you may get less. Less bandwidth. Fewer compression options. No service.

Let's face it. There are a lot of products out there that promise you the world, yet corrupt your signal and complicate your life. You simply cannot afford non-standard audio codecs. That's why when the time comes to look at your audio transmission needs, you'll want to take a closer look at RE.

RE offers ISO/MPEG Layer II audio compression, which is the most widely used high-fidelity audio compression algorithm in the industry. We're the only company in the world that can offer you half sampling frequencies for a choice of six different sampling rates, and bandwidths up to a full 20kHz. We're also the company to provide

CRC scale factors to protect your audio from transmission errors. And when it comes to compression and compatibility, our implementation of ISO/MPEG Layer II has been thoroughly checked and tested by the IRT in Munich—part of the very team that invented the standard in the first place.

With several outstanding RE *Easy ISDN* packages to choose from, why not give us a call? For further information, contact RE at (216) 871-7617

- Full 20 kHz bandwidth
- Choice of six sampling frequencies
- Outstanding audio quality even at low bit rates
- Simple encoder operation
- Auto-configuring decoder for easy set-up
- IRT-tested ISO/MPEG Layer II compression
- G.722 for full bi-directional communication and cue channels
- Optional AES/EBU digital audio

re

RE AMERICA, INC. • Telephone: (+1) (216) 871-7617 • Telex: (+1) (216) 871-1303 • RE JAPAN CO., LTD. • Telephone: (+81) 03-3320-0460 • Telex: (+81) 03-3320-0197 • RE DEUTSCHLAND GMBH • Telephone: (+49) 02461-6803-0 • Telex: (+49) 02461-56831 • RE UK LTD. • Telephone: (+44) (0)1734 731119 • Telex: (+44) (0)1734 731190 • RE INTERNATIONAL, AS • Telephone: (+45) 39 17 00 00 • Telex: (+45) 39 17 00 10 • Plus 30+ authorized distributors worldwide

## Changes in 1995 EEOC

**WASHINGTON** September will offer large broadcasters slight relief from both the scorching heat and the paperwork involved in meeting Equal Employment Opportunity Commission (EEOC) requirements.

At the request of the National Association of Broadcasters (NAB), the EEOC agreed for this year only to allow broadcasters to submit their EEO-1 form based on first quarter payroll data.

Until four years ago, both the EEOC and the Federal Communications Commission (FCC) required broadcasters to use data from the first quarter to fill out their forms. Then, in 1991, the EEOC mandated that all employers use data from the third calendar quarter for reporting.

Both the FCC and EEOC reports require the employer to submit counts of employees broken down by sex, job category, and ethnic group. In March, the NAB asked for relief from duplicate reporting efforts. "Instead of conducting two staff surveys within five months of one another (which result in nearly identical data), these licensees would need to conduct only one."

The NAB missed its chance to comment originally. Sources at the EEOC said despite publishing the change in the Federal Register in 1989 and 1991, "we did not receive a comment from them on the change in the filing deadline or the payroll period."

Only broadcasters and group owners with more than 100 employees will be affected by this change. The EEO-1 form is due September 30. A source at the EEOC stressed the change was effective only for 1995 and said the commission is negotiating with the FCC to determine what quarter the data should come from next year. "We will let them know," the source said.



# Touch & Go!

## AudioVAULT

AudioVAULT is the world's most successful Digital Studio System, because AudioVAULT provides everything you need from digital technology. Customized to your operation, AudioVAULT gives your program director and on-air talent the freedom to do what they do best. And AudioVAULT is uniquely flexible to support your station's growth for years to come.

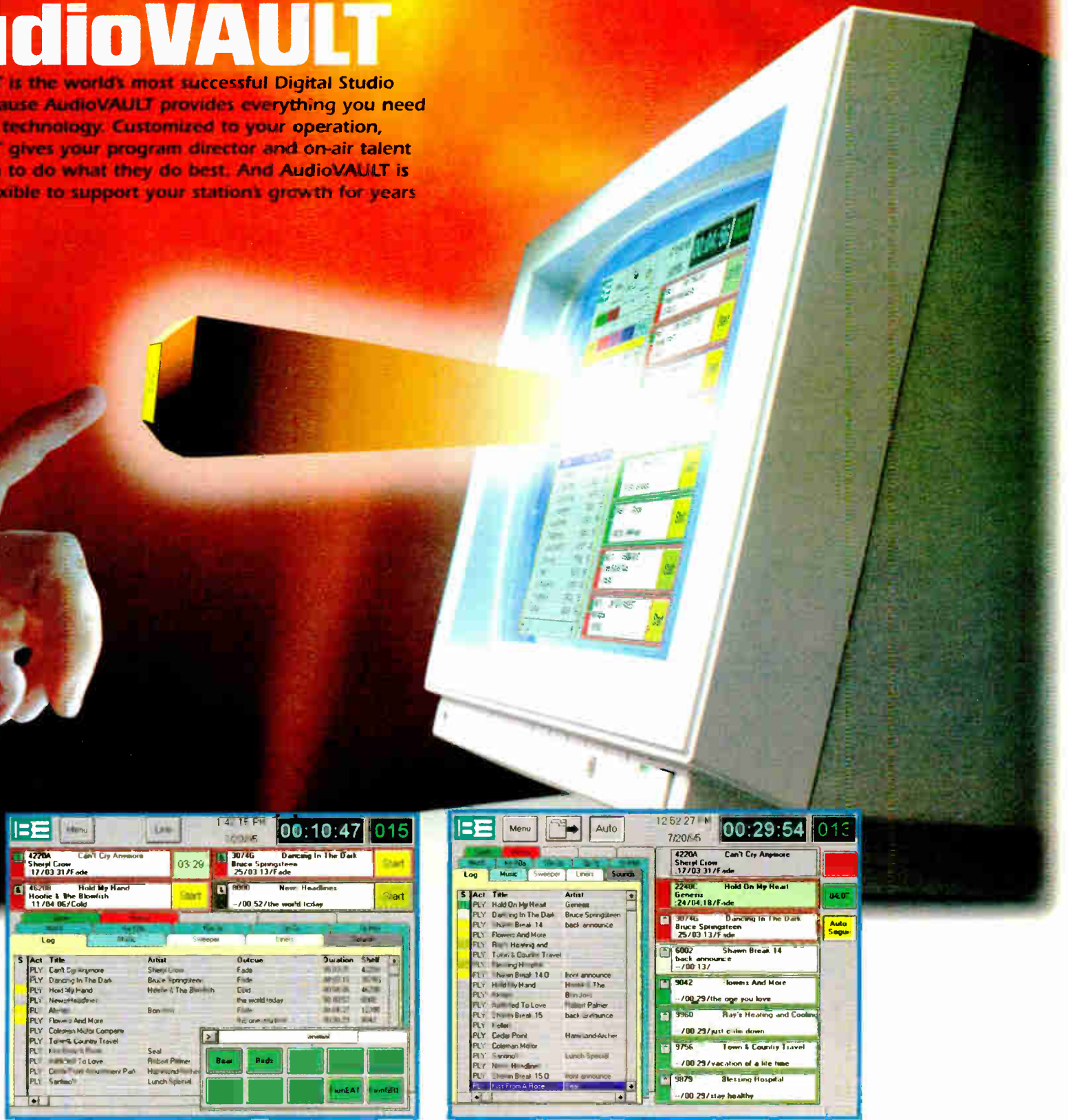

### GO AVAIR! This is AudioVAULT AVAIR

...the most powerful, jock friendliest live radio tool in the digital radio world. Designed with maximum input from radio's top pros, for maximum live creativity and spontaneity. Customize and save AVAIR screens for every jock's individual needs. Run the wildest morning show. AVAIR gives your people the power to do everything you want them to do.

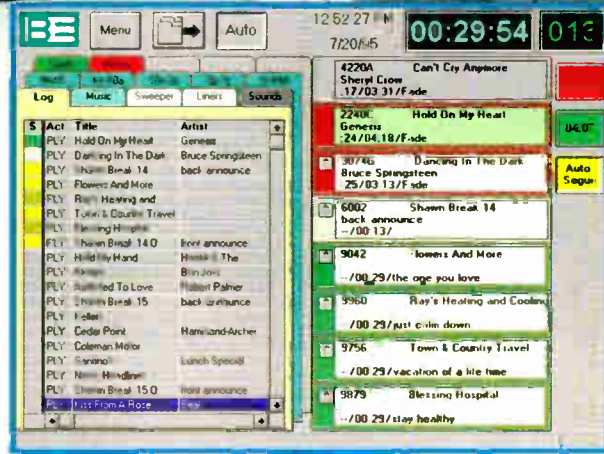

### GO AWAY!

The other side of AVAIR...running automatically, sounding live. Music-on-hard-drive, net delay and playback...whatever you need to do, AudioVAULT handles it. And BE backs you up with 24-hour support, every day. You work better, sleep better.

**GET GOING!** AudioVAULT Digital Studio Systems start below \$9000.

Call your BE Digital Representative at 217-224-9600 (or fax 217-224-9607) and get the AudioVAULT 1995 Video and Demo Diskette.

**BE BROADCAST ELECTRONICS, INC.**

WORLD LEADER IN RADIO BROADCAST TECHNOLOGY

4100 N. 24th Street/F.C. Box 3606/Quincy, IL 62305-3606/(217)224-9600/Fax: (217)224-9607

Go see AudioVAULT at Booth 319, Radio-Audio Hall, WME New Orleans 1995.

Circle (164) On Reader Service Card

©1995 BROADCAST ELECTRONICS, INC.

World Radio History



# IMPOSSIBLE?



**B**ut have you ever thought about professional digital audio editing? Too slow? Too expensive? Difficult to understand? SADiE™ Disk Editors have changed all that. For a start SADiE™ runs on a PC, so you get much more computer for far less money. It has a fully functional Windows user interface, non-destructive sample accurate editing, real time cross fades with real time automated digital mixing, bounce down, overdub, EQ and dynamics control. And real time-saving.

SADiE™ Disk Editors have sold worldwide into broadcast, post-production, studios and mastering organisations. They have already been really put to the test out in the field and our existing customers will be pleased to see some of their suggestions in SADiE™ Version 2.2. The SADiE™ Disk Editor is just \$9,995\* for a complete turnkey system, to include a 486/66DX PC, 2.0 Gbyte SCSI drive, 2 in: 4 out SADiE™ (digital/analog/SMPTE timecode support) and breakout box. Software updates are free for the lifetime of the product and there are *no hidden software extras*. It's all included in an honest straightforward price.

So next time, you might phone or fax for some information - we know that anything's possible with SADiE™.

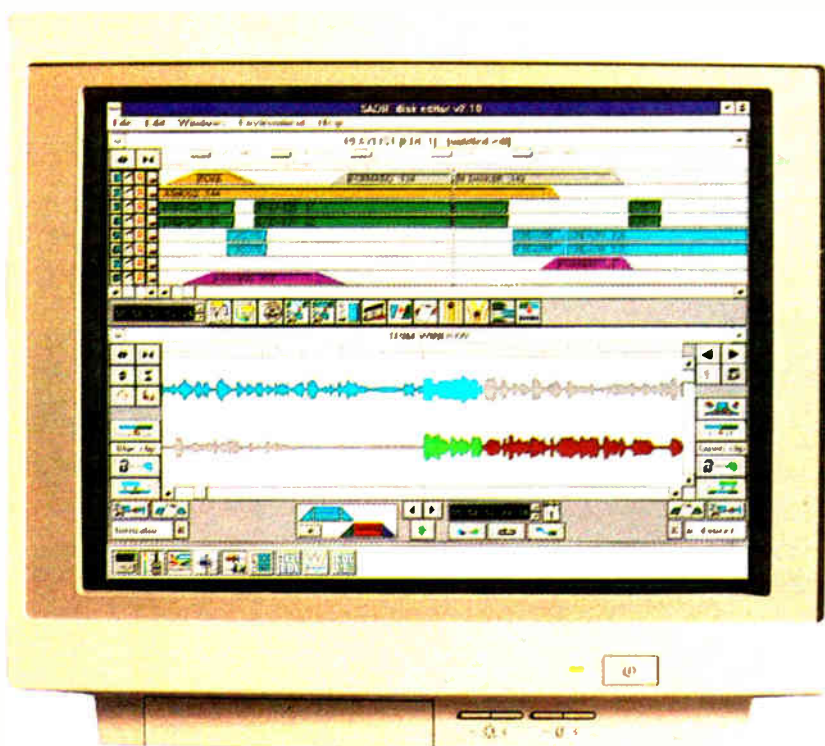

Windows 3.1\* on 486/66 host computer

Rapid graphical editing

Clear user interface

Fully non-destructive, sample accurate editing

Creates edits while recording

All crossfades calculated in real-time

Jog and shuttle scrub modes

Unique Trim Window allowing real-time adjustment of audio

Real-time automated mixdown..

.. Bounce down

.. Dynamics control

.. EQ

.. Digital resampling

.. Time scrunch

.. Noise reduction

.. Overdub

.. Reverse playback

AES/EBU, SPDIF and balanced analog I/O

All standard sample rates

Full SMPTE timecode support with chase and trigger lock



Studio Audio Digital Equipment Inc  
1808 West End Avenue  
Suite 1119  
Nashville, TN 37203  
USA  
TEL: 615 327 1140  
FAX: 615 327 1699

#### SADiE™ DISTRIBUTORS WORLDWIDE

Argentina Kappa T 081 31 0818 F 081 31 1493 • Asia Pacific VW Marketing T +44 372 728481 F +44 372 724009 • Australia TVC T 09 249 6688 F 09 249 6858 • Canada JSGS Ltd. T 416 751 7907 F 416 751 7975 • Denmark SC Sound T 43 99 88 77 F 43 99 80 77 • Finland Oy HedCom AB T 90 682 866 F 90 682 8489 • France Coach Audio T 87 77 00 00 F 87 77 01 21 • Germany Stefan Mayer Audio Engineering T 0 6851 6519 F 0 6851 6519 • Hong Kong/China Digital Professions Ltd T 852 318 0588 F 852 305 1455 • India Sound Team T 22 801 3275 F 22 861 9677 • Israel Sontronics Electronic Equipment T 03 5705223 F 03 6199297 • Japan Otartec T 03 3332 3211 F 03 3332 3217 • Korea Avix Trading Co. Ltd. T 02 565 3565 F 02 565 3561 • Netherlands JTM T 035 233 448 F 035 247 649 • New Zealand Videx T 09 444 6085 F 09 444 3837 • Philippines Tracks T 2 631 3277 F 2 631 3267 • Poland Unico T +44 223 63025 F +44 223 301488 • Russia Triarios T 095 909 5773 F 095 909 0501 • Singapore/Malaysia/Indonesia Edit Point T +65 338 1826 F +65 337 7156 • South Africa Tru-Fi Electronics SA (Pty) Ltd T 011 462 4256 F 011 462 3303 • Spain Lexion T 93 203 48 04 F 93 280 40 29 • Sweden Tranzicom T 08 730 3710 F 08 730 5125 • Switzerland Media Solutions T 064 41 57 22 F 064 41 00 35 • Thailand KDM Trading T 2 318 2724 F 2 318 6186 • UK Studio Audio & Video Ltd T 01353 648888 F 01353 648867 •

\* Windows is a registered trademark of Microsoft Inc. † Plus local taxes, duty and delivery where applicable. Studio Audio & Video Ltd reserve the right to change specifications without prior notice.

Circle (183) On Reader Service Card  
World Radio History



# Design Transmitter Site the Correct Way

► continued from page 20

around your equipment, adding doors and the like where they are needed. You can do it by hand (after all, we did it that way since the stone age), but take my word for it, CAD is so much easier.

While we are on the subject of doors, keep in mind that the equipment has to get into the building through the doors (unless you plan to set the equipment on the slab and build the walls around it!). Not only door size but also door placement is important here.

While you are planning on getting the equipment in, remember that someday, some poor soul will have to get that equipment out as well. Do him a favor by placing and sizing doors so that any piece of equipment can be removed from the building without having to remove another piece of equipment.

## Troughs, etc.

In days of yore, floor troughs were a common feature of transmitter buildings. Floor troughs were a convenient means of running cables, power, ground strap and the like between equipment. I still like floor troughs and install them whenever possible. In my experience, foot-for-foot, floor troughs are less expensive and infinitely more convenient than EMT or PVC conduit for getting wiring around inside the plant.

The builder will have to construct some forms when installing the foundation, and a source of steel plate covers will have to be located. 3/8-inch boiler plate is an inexpensive material for trough covers and can be obtained in prefabricated widths to which the troughs can be poured, further reducing the cost.

An alternative to floor troughs is a basement with wire raceways. This is more trouble and expense than floor troughs, but it also provides some storage space in which you can store old equipment, vinyl records, carts and useless and outdated promotion materials until they rot. A basement of this type need not be a full basement, nor need it be a subterranean basement.

The transmitter building can be elevated four or so feet to make room for a short basement. Some stations use such basements for the coils of excess sample line. This is not a bad idea, but if you do this, be sure to use stabilized sample line since all the line will not be in a "similar environment."

The temperature of the line buried or suspended outside will be different from that of the line in the basement, causing the phase-shift of the lines to differ. Stabilized line will suffer this problem to a degree, but not nearly so much as non-stabilized line.

## Mechanical

The heating, ventilation and air-conditioning (HVAC) requirements of a transmitter site will vary widely with the geographical location, climate, transmitter power and transmitter type. A 50 kW tube-type transmitter in the deep south will require you to move a lot of air to keep it happy, while a 1 kW solid-state transmitter in Michigan may not need any outside ventilation at all. Usually the requirements are somewhere in between.

The environment outside the transmitter

building will determine, to a great degree, what type of HVAC system is needed. Dirty environments generally need a closed system, where no outside air is routed through the transmitter equipment. Some filtered outside air will be needed in such installations to create a positive

**Floor troughs were a convenient means of running cables, power, ground strap and the like between equipment.**

pressure inside the building to keep dirt and dust out. This is usually done by mixing a small amount (usually 5 - 10 percent) filtered outside air with the inside return air for the HVAC system.

In a closed system, the amount of the cooling that will be needed is equal to the heat produced by the transmitter (including the PA exhaust) in BTUs plus the building heat load plus whatever reserve you desire. The transmitter manufacturer can provide you with the transmitter heat load at different power levels, but you will need to enlist an HVAC planner to determine the building heat load. This is determined by building size, construction and insulation. Plan to install an air conditioner that is a size bigger than the calculated cooling requirement.

In my experience, such a unit will run less and be more efficient than one that just barely carries the load and runs all

the time.

If the outside environment is relatively clean and the climate not too severe, it will be much more economical to supply the transmitter intake with filtered outside air and vent the transmitter exhaust back outside. Most transmitters are quite happy with intake air temperatures in normal summertime climatic ranges as long as plenty of air is circulated. The cooling load for the HVAC system then will be the building's heat load plus the radiation heat load from the transmitter (heat radiated by the transmitter cabinet). If you are creative, you can use the transmitter intake air to provide a bit of positive pressure to the building. Many transmitters pull in more air than is exhausted through the PA chimney, with the excess

continued on page 46 ►

## FM Book Required Summer Reading

► continued from page 33

patent claim. Lessing writes that these findings were the very same de Forest was publicly attacking as erroneous. Yet, these actions held up Armstrong's patent to regeneration for years.

In a cruel twist of fate, the United States Supreme Court upheld the de Forest claim to regeneration. The opinion, written by Justice Benjamin N. Cardozo, stated "On August 6, 1912, a diagram showing a feed-back hookup showing the... circuits is recorded... with a note that by the use of the coupling 'a beautiful clear tone' (feedback) had been developed... There is also a note that the pitch, i.e. frequency, was varied by altering the plate voltage, which means, or was understood, we are told by de Forest, to mean that by other simple adjustments the frequency of the oscillations could be varied at will." An extremely neat trick of the court to control the natural sciences through man-made law.

### Useless?

During this litigious period, Major Armstrong had created a practical method of frequency modulation. Instead of confining the transmitted waves into a small space, he built equipment that allowed the waves to swing over a very wide band of frequencies. Lessing writes that "the great irony of the situation was that most of the early unsuccessful work on frequency modulation had been done in the laboratories at AT&T and RCA, which had concluded that it was useless for radio purposes... it was AT&T's John Carson... who in 1922 administered what was thought to be the coup de grace to frequency modulation in a paper before the I.R.E. (Institute of Radio Engineers). Carson was so injudicious as to draw the sweeping conclusion: 'This type of modulation inherently distorts without any compensating advantages whatever.'"

Lessing adds that following Carson, mathematicians here and abroad wove even more intricate proofs that frequency modulation was useless; these proofs had the effect of veiling frequency modulation's real worth from investigators.

Armstrong, above all things, is portrayed as a tireless worker, almost obsessive, whose inventions were stimulated by

experts around him who said that "it couldn't be done." I frankly found it refreshing to read about such honest genius.

It is remarkable that Lessing, in 1956, writing about the radio boom of the 1920s, captured the flavor of an era that is strikingly similar to our own "boom" of the 1990s; "amateurs" playing with computing devices discover novel uses for computer networks, and large commercial concerns discover that fortunes can be made from it. Perhaps the rise of Information Providers is similar to the rise of the radio manufacturers... perhaps.

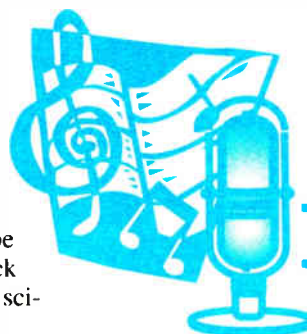

## PUBLIC DOMAIN

"Man of High Fidelity" is worthy of your attention this summer. The book would make a perfect gift for the youngster who hungers for knowledge and inspiration.

### Dis 'n' Data

The *Public Domain* summer book report would not be complete without an accounting of how "Man of High Fidelity" became available after being out of print for many years. Lloyd McIntyre, one of the founding members of the Radio and Technology Museum, said that Harry Houck, Major Armstrong's right-hand man in France since WWI, had a cache of about one thousand paperback books stored in a warehouse, along with "tons" of his own electronic equipment.

Houck, who by all accounts was a superb craftsman and electronics engineer and a loyal friend of Armstrong throughout his life, bought the remaining paperback copies of "Man of High Fidelity" from the publisher.

According to Lloyd McIntyre, Houck was generous to radio clubs with both his time and resources, and Houck's nephew, Gilbert, continued to visit the clubs in his uncle's behalf when Harry became elderly.

After Harry Houck's death, Gilbert dis-

covered the cartons of paperbacks in the warehouse. Although hundreds of copies were water-damaged and unsalvageable, about 175 paperbacks were intact and were donated to the museum. According to the museum's curator, Mr. Zane Parsons, only 40 paperbacks remain in stock.

Founded in 1991, the museum holds many different hardware exhibits of the bygone days of radio. One of the favorite exhibits is the Frank Lynch radio shop, a re-creation of Mr. Lynch's Dunbar, W.Va., radio shop of the 1930s. The exhibit is replete with tube stores, workbench, composition horn speakers, meters, and 45 V "B" batteries that Zane Parsons says still have 15 volts left.

The museum curators are proud of their archives too; Mr. Parsons says they have mint-condition Radio Craft magazines from the 1930s, along with schematics and manuals for many old model radios. Interested visitors may copy schematics and manuals for their own radios, but Mr. Parsons says "You'll have to do it by hand, we're saving to buy a photocopier." Interestingly, if you need a 01A vacuum tube (or similar tube from those days), the Museum sells these items to pay for its upkeep. It is nice to know that after 60 years, my old Zenith can still be re-tubed.

The Museum of Radio and Technology is a non-profit organization, staffed by volunteers, and can be reached in Huntington, West Virginia at 304-525-8890.

□ □ □

Rich Rarey is the technical director of National Public Radio's "All Things Considered." He can be reached at e-mail: [rrarey@npr.org](mailto:rrarey@npr.org).

*EDITOR'S NOTE: Armstrong's widow, Marion, would carry on the court battles over the invention of FM that drove her husband to suicide in 1954. Eleven years after the publication of Lessing's book, 13 years after Edwin Armstrong's death, and countless court battles later, on Oct. 9, 1967, the Supreme Court upheld two lower court rulings affirming Armstrong's patents and decisively establishing him as the great inventor he truly was.*



# Products & Services Showcase

For more information on the products shown below, circle the appropriate Reader Service No.(s) on the enclosed Subscription/Reader Service card or contact the advertiser directly.



**Econco**  
**REBUILT POWER TUBES**



*Approximately One Half  
the Cost of New*

3,000 Hour Unconditional Guarantee

*Call for Our Price List*

Econco 1318 Commerce Ave. Woodland, CA 95695  
Phone: 916-662-7553 Fax: 916-666-7760 Telex: 176756  
Toll Free: 800-532-6626 From Canada: 800-848-8841

**READER SERVICE NO. 196**



**STATI-CAT**  
makes  
Lightning Prevention  
**Easy!**

**Cortana**  
Corporation

*Write to us today for a FREE brochure!*

P.O. Box 2548, Farmington, NM 87499  
**Call (505) 325-5336**  
FAX (505) 326-2337

**READER SERVICE NO. 173**

**ONLY COOL-AMP  
SILVERPLATES  
ON THE JOB.**

Cool-Amp assures cool conductivity for copper, brass, bronze contacts. Prevents power loss from oxidation. *Applies easily on-the-job.* Even outperforms electroplating in recent tests. Time proven since 1944.



**CONDUCTO-LUBE. THE SILVER-BASED CONDUCTIVE LUBRICANT.**

The upstart, since 1952. Developed for switches. Uses continue to expand to all applications needing a conductive lubricant.

**ORDER FACTORY DIRECT:**  
**503-624-6426 or FAX 503-624-6436**

*Conducto-Lube* **COOL-AMP**

**READER SERVICE NO. 127**

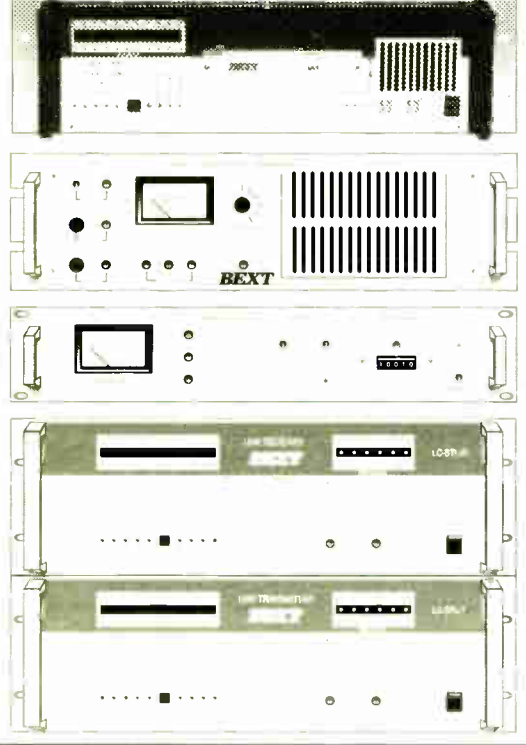

**BEXT**  
*High performance RF*

**Exciters  
Amplifiers  
Translators  
Transmitters  
STL's**

Backed by our two-year warranty and the BEXT 24-hour engineering hotline.

619-239-8462 1045 10th Ave.  
FAX: 239-8474 San Diego, CA 92101

**READER SERVICE NO. 128**

**TWO NEW ADDITIONS TO THE COAXIAL DYNAMICS WATTCHMAN® TRANSMITTER PROTECTION SYSTEMS**

Models 81081 and 81082 with 15/30/60 kw Meter Scales

**NEW!**  
4-1/16 and 6-1/8 series line sections and elements to add to our exciting line-up



**WATTCHMAN**—protects your transmitter and transmission line system. A permanent 19 inch rack installation used with any dual socket line section 7/8", 1-5/8", 3-1/8" and elements (additional) to monitor CW, TV, and FM power. Model 81070 features two easily read meters to monitor both forward and reflected power. The reflected meter provides a front panel adjustable set point which controls the trip level for fast transmitter shut down and alarm. Abnormal load conditions quickly cause transmitter shut down in less than 15 milliseconds including control relay. Both visual and audible alarms indicate system malfunction. Contacts provided for remote alarm and reset switching. Contact us for your nearest authorized Coaxial Dynamics Representative or Distributor in our World Wide Sales Network.

**COAXIAL DYNAMICS, INC.**  
15210 Industrial Parkway • Cleveland, Ohio 44135  
(216) 267-2233 or 1-800-COAXIAL • Fax: (216) 267-3142  
*Service and Dependability A Part of Every Product*

**READER SERVICE NO. 39**

**ARE YOU LOOKING FOR A COST EFFECTIVE ALTERNATIVE TO MANUFACTURER SERVICE?**

**SERVICE, REPAIR & CALIBRATION**

- STL's • RPU's • TSL's
- Exciters • AM/FM Broadcast Monitors • Remote Control Systems

**SPECIALIZING IN EQUIPMENT BY**

- Belar • Marti • Moseley • McMartin • TFT • And others...

*An authorized TFT service center*

**IN CASE OF EMERGENCY**

We can help get you back on the air with our STL Loaner Program. We have STL's available that will be set to your frequency prior to shipping. We also provide over-the-phone technical assistance.



2198 Hubbard Lane, Grants Pass, OR 97527  
**(503) 471-2262**

**READER SERVICE NO. 44**

**Get rid of your %\$#@& patch bays and try this for a switch**

**Zercom CORPORATION**

Do your audio routing through a Zercom Patch Switch system. Easy to install and use, a Patch Switch system provides you with front panel access to an unlimited number of input sources (by bussing units), Stereo or Mono selection, Phase reversal, signal summing, and a PCB that's set up for easy installation of audio pads. The enclosed audio switches have been tested to over 1,000,000 cycles for dependable performance. And best of all... it's a Zercom product with a two year warranty.



**The Zercom 'PS-2' Patch Switch \$379.00**

P.O. Box 84, Zercom Drive  
Merrifield, Minnesota 56465-0084  
218/765-3151-Fax 218/765-3900

*Available through all major dealers*

**READER SERVICE NO. 110**



STATION SERVICES

# Neural Nets Aid Audio Processing

by Tom Vernon

**HARRISBURG, Pa.** What does predicting soybean futures have in common with processing broadcast audio?

The answer is that they are mathematically similar problems which have solutions in the same emerging technology. This month *Station Sketches* examines neural nets, a paradigm shift in audio processing technology.

**Hardware and software**

Neural nets can be implemented in both hardware and software, and emulate groups of biological neurons, the supreme example being the human brain. They can be designed to make decisions in situations where many parameters are known, but there is no established hierarchy of rules. They are the latest development in the branch of computer science known as artificial intelligence. Neural nets evolved out of the largely unsuccessful attempts to mimic the brain with rule-based systems.

Artificial intelligence and neural nets opened up to computers a realm of problems which had previously been inaccessible. Whereas the operation of traditional Boolean-state machines is strictly an On/Off, Yes/No affair, neural nets can

Outputs of neurons are connected to the inputs in the next layer, with the output layer connected to the environment.

Groups of layers are then configured into a network. Layers sandwiched between the input and output are known as hidden layers. Figure 2 shows a simple neural net.

and how fast to recover to unity gain. The circuitry that performs this feat has undergone a continuous evolution

In the beginning, limiters had a simple RC circuit to determine trajectory. It was better than nothing. Later developments included RMS detectors, which gave a

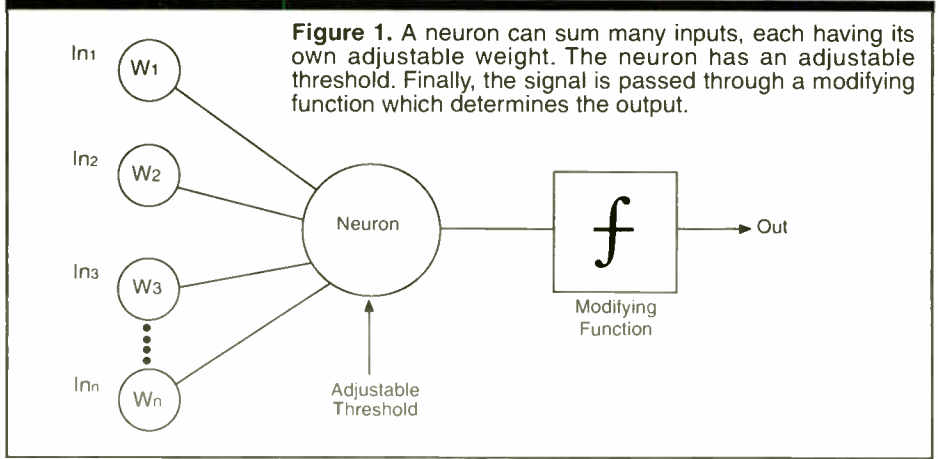

**Figure 1.** A neuron can sum many inputs, each having its own adjustable weight. The neuron has an adjustable threshold. Finally, the signal is passed through a modifying function which determines the output.

Before our net can be useful it must be trained for the task at hand. As the neural net is being initiated, target outputs, or goals are established for each set of input conditions. The first several times the net produces an output, it will be nothing like the goals. But during each repetition, a

better representation of audio power, and compound decay circuits, which better matched processing to program material. These were improvements in the state of the art, but the fundamental problem remained: different program material still produced very similar gain trajectories.

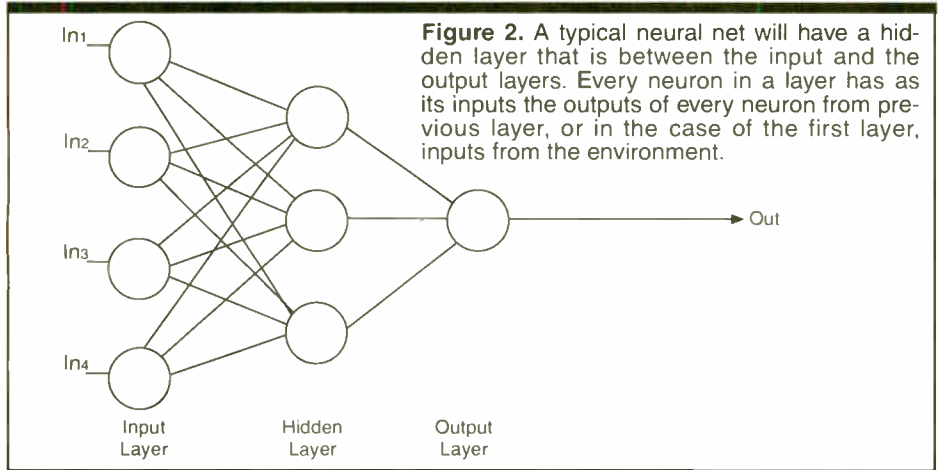

**Figure 2.** A typical neural net will have a hidden layer that is between the input and the output layers. Every neuron in a layer has as its inputs the outputs of every neuron from previous layer, or in the case of the first layer, inputs from the environment.

process Yes/No along with all the gray area in between: hardly ever, perhaps, sometimes, or almost always.

In addition to stock market analysis, neural nets are used by the military for friend/foe recognition, and by banks to determine credit-worthiness of mortgage applicants.

Another important similarity between neural nets and the brain is that they are both capable of learning from experience. Neural nets can observe subtle relationships between inputs and adapt to changing circumstances. In a sense, they use an intuitive approach to problem solving.

**Back propagation network**

One of the most common types of neural nets is the back-propagation network. The basic element of a neural net is a neuron, as shown in Figure 1. Each neuron can sum numerous inputs, each one modifiable by programmable weight. Inputs come either from the outside world or from other neurons. The summation of these weights is added to an adjustable threshold for that neuron. From there it goes to a modifying function that determines the final output.

The first step in building a neural net is to arrange a group of neurons in a layer. Here inputs to neurons in a layer are the outputs of neurons in the previous layer, or in the case of the first layer, from the environment.

proportion of the errors will be propagated backwards through the net to the individual neurons. The weights are then adjusted so that the next time the outputs will be closer to the goals. Several repetitions are necessary because only a small proportion of the errors are fed back.

Finally, the neural net will be able to distinguish between each input set, and come close to producing the desired out-

**Fickle thing**

Gain trajectory is a very fickle thing, and there is no one "universal" trajectory, even for a given format. Different source material simply has different trajectories.

In audio processors, a neural net can substitute for the conventional decay circuits that determine the gain trajectory. What makes this type of circuitry unique is that it has the ability to synthesize many trajectories, and pick the one best suited to the program material at the moment. This eliminates the need for using one trajectory as the best overall compromise.

The neural net must be trained for its function of picking the best gain trajectory. To do this, the prototype is exposed to a wide variety of musical selections. It is then optimized for the best possible performance with each one.

**Only Clark**

At the present time, the only broadcast product using this technology is a retrofit board manufactured by Clark

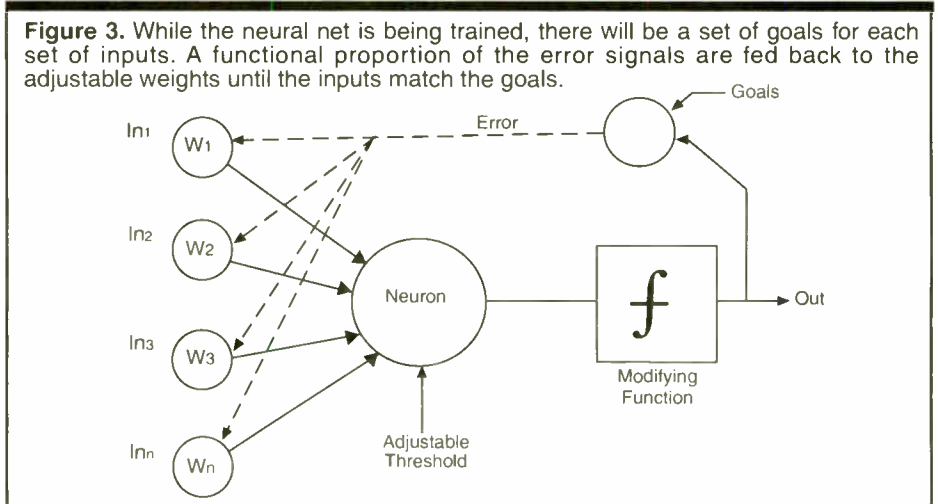

**Figure 3.** While the neural net is being trained, there will be a set of goals for each set of inputs. A functional proportion of the error signals are fed back to the adjustable weights until the inputs match the goals.

puts. Figure 3 shows a back-propagation network in the training mode.

At the heart of any broadcast ... processor is the circuitry that determines gain trajectory: when to reduce gain, how much and how quickly to reduce gain, and when

Communications for card No. 5 in the Urban Optimod 8100A. More products can be expected to come to market in the near future, as the competitive advantage that is realized by this technology is too compelling to ignore.

Neural net processors will themselves be in a state of continuous refinement and evolution, due to competitive pressures for increased loudness, as well as the influence of the music industry. Groups like U2, using synthesizers and electronic drums, are leading the way, as the recording industry continues to create musical waveforms unlike those in prior releases.

Very special thanks to Glen Clark, of Clark Communications Systems Inc. for sharing information used in the preparation of this article.

□ □ □

*Tom Vernon wishes there was a neural net that would write the thesis for his Ph.D. His radio home is the University of Pennsylvania's public station, WXPN-FM. You can e-mail Tom at TLVernon@AOL.com, or telephone 717-367-5595.*

**LMA/DUOPOLY CONTOUR MAPS**

The **DATAWORLD** LMA/DUOPOLY Market Survey Contour maps present a precise electronic verification of overlapping and intersecting contours.

AM 5 mV/m and FM 3.16 mV/m City Grade contours are shown in full color, including transmitter site indicator. The map is supported with a printout showing all of the stations which appear on the map.

Daily updating of **DATAWORLD'S** AM and FM databases protects against errors and omissions.

**OTHER MAP OPTIONS**

- SHADOWING (TERRAIN SHIELDING)
- CONTOUR COVERAGE
- POPULATION DENSITY
- ZIP CODE BOUNDARIES
- RECEIVED SIGNAL LEVEL
- SPECIAL REQUIREMENTS

**1990 CENSUS WHO ARE YOUR LISTENERS?**

**1990 BUREAU OF CENSUS POPULATION COUNTING**

- Comprehensive Ethnic and Demographic Data
- Ethnic/Demographic Data Available for Each Zip Code Within Coverage Area
- Age Analysis Reflected in Ethnic Breakout
- Resolution Increased to Block Level
- Percent of County Coverage Shown

**ETHNIC PIE-CHART DISPLAY**

- Projects Ethnic Population in Multi-Color Pie Chart Form

**dataworld®**

800-368-5754 FAX: 301-656-5341

Circle (206) On Reader Service Card



# Healthy Outlook for Shortwave

► continued from page 7

receiver could include a small thermal printer to print out data received by the ID Logic system. If a receiver is used on a regular basis, then the ID Logic system will keep the data file of the receiver up to date at all times.

The Hong Kong-based PRS Corp., which developed ID Logic technology, first approached the BBC WS with the idea of incorporating ID Logic into its broadcasts. After a close look, the BBC joined with the Voice of America (VOA) to examine the technicalities of what PRS was suggesting. A small consortium of interested SW stations and companies then formed to pursue the ID Logic idea.

## Consortium meeting

These discussions culminated in a meeting of the consortium in Hong Kong, hosted by PRS and the BBC WS. Taking part in the meeting were BBC WS, VOA, Deutsche Welle (DW), Radio Canada International (RCI), TDF, and three SW receiver manufacturers—Phillips, Sony and Sangean. More recent additions to the consortium are Radio Austria International and Radio Australia International.

"We see (ID Logic) as a possible movement forward into a new dimension in SW broadcasting. We have always felt that we needed to help the listener in this crowded SW spectrum."

said Ian Davey, the engineer in charge of ID Logic-related activities at the BBC WS.

Robert Kamosa, chief engineer at the VOA, also feels that despite the current momentum toward satellite DAB in the international area, ID Logic remains a reasonable system to implement.

"We would still like to keep all the options open," Kamosa said. According to Kamosa, the VOA feels,

**Despite any future move to satellite broadcasting, there will still be many more people in the world listening to DW on SW.**

as do many other international broadcasters, that SW broadcasting, especially to certain areas of the world, will continue for the foreseeable future.

"If ID Logic can be implemented in a very cost-effective manner," Kamosa said, "I think it is a very user-friendly type of system that can only enhance SW reception while we await the final developments in direct satellite broadcasting."

Even once satellite broadcasting arrives, Kamosa added, it may be a long time before listeners in some underdeveloped areas of the world can afford satellite equipment; however,

they might more easily afford an ID Logic-equipped SW receiver.

## AMDS signal

DW is ahead of its fellow ID Logic consortium members, having broadcast an AMDS signal on one of its SW transmitters for two years now. Norbert Schall, head of the DW Planning and Project Section, said that DW will not be the first to implement

ID Logic on all of its operations; but it certainly will do so if other broadcasters do.

Schall added that despite any future move to satellite broadcasting, there will still be many more people in different parts of the world listening to DW on SW. "It is necessary," he said, "to make things easier for those listeners—

not simply abandon them because they do not have a satellite dish."

ID Logic creates another all-too-familiar "the chicken or the egg" situation. Receiver manufacturers are hesitant to redesign receivers unless data transmissions for the radios to pick up exist. But broadcasters do not want to transmit a data signal unless receivers are on the market.

RCI Chief Engineer Jacques Bouliane said that as soon as an encoder appears on the market, he will use it to make ID Logic transmissions available. His hope is that this will help prove there is a need for ID Logic receivers in the marketplace.

Hopefully the majority of SW broadcasters feel this way, and standards will be agreed upon in the near future. Then international SW broadcasting can enjoy the new lease on life that it most certainly deserves.

□ □ □

*Information on ID Logic is available via the World Wide Web at <http://www.hk.net/~prs/>.*

*Ian McFarland was a producer and host of many feature programs at Radio Canada International for 24 years. Following two years as an invited English specialist at Radio Japan, he is now a free-lance broadcaster and writer, promoting the field of international broadcasting.*

## Design Factors to Consider for New Sites

► continued from page 43

air venting out around power supply components and the like.

Solid-state transmitters generally need a fairly controlled environment. A closed system is about the only option with these transmitters, mostly because of the non-centralized intake and exhaust schemes made necessary by modular construction.

In systems where transmitter exhaust is vented outside, be sure the back-pressure does not exceed the manufacturer's recommended maximum. Figures I have seen for this are in the half-inch Hg range. If you exceed this you may considerably shorten PA tube life. Another consideration is the prevailing wind. Do not place the intake downwind of the exhaust; you will create a more-or-less permanent low pressure on the intake and back-pressure on the exhaust. The best route to take is to place intakes and exhausts on the building roof so that both operate in about the same ambient pressure.

### Heat not needed

Usually we don't think too much about needing heat at transmitter sites. Most sites I have been around vent some of the transmitter exhaust into the building during cold weather, and this is a fine use of otherwise wasted energy. This can be done manually with a butterfly damper in the exhaust duct, or if you are dead set on spending money, with a motorized, thermostatically-controlled damper.

The problem with this comes when the transmitter is broken. Creature comforts are usually not too important at a transmitter site, but when the transmitter is dead and it is 16 degrees

inside the transmitter building, you may have trouble holding onto your tools! Not only that, wide variations in operating temperature are hard on sensitive equipment.

It is a good idea to install at least 10 kW of electric heat strips in the HVAC system. These need only be activated when heat cannot be provided by the transmitter. Take my word for it, you will be glad they are there when you need them.

Finally, plan for emergencies in your HVAC system. This is particularly important in closed systems where all the transmitter's heat is dumped back into the building. If the cooling fails on a warm day, the temperature inside the building could build to dangerous levels. Install an emergency ventilator fan and intake that is thermostatically controlled.

Such a system should come on at about 85 degrees Fahrenheit, pulling in outside air low and exhausting hot building air high. I usually place such ventilators on the roof, with the intake on an upwind wall. Should the cooling system fail, this will hold inside temperatures to a few degrees above outside ambient temperature.

In next month's column, I will look at the all-important electrical requirements plus grounding, basic lightning protection and transmission line egress methods. I will also look at getting your layout and specifications into architectural drawings that will be used for building permit application and construction drawings.

□ □ □

*Cris Alexander is director of engineering for Crawford Broadcasting in Dallas. He can be reached at 214-445-1713.*

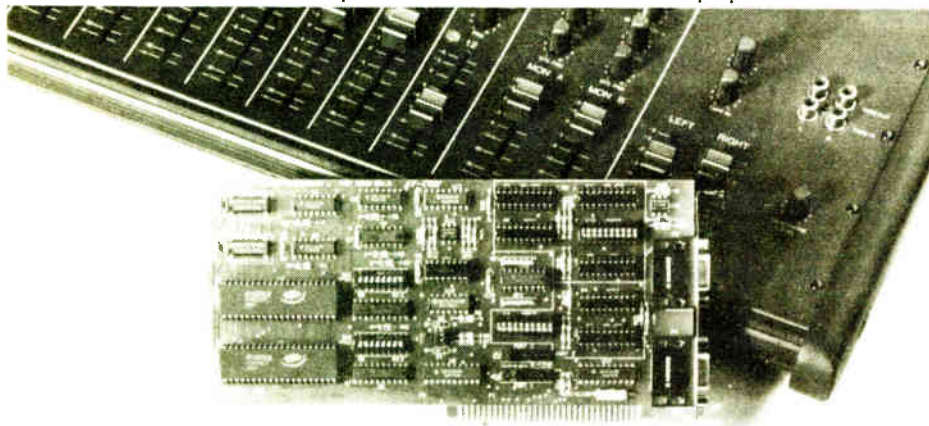

## PC-Based Automation and Control

### DAT / VTR Control

Synchronize intelligent DAT players and VTRs using SMPTE 207M machine control from your PC. The AV-COM provides two ports with Sony™ 9-pin connectors selectable as SMPTE 207M, PA-422, RS-232, or MIDI digital control.

### Cart Deck Automation

Automate the playing of prescheduled ads and commercials from multiple cart decks. Your automation project will require more than 2 PC COM: ports. Our COMM+ products provide 2, 4, or 8 high quality ports to make your automation task simple and reliable.

### Satellite Control

Control your Satellite system or video teleconferencing equipment. Use a PC to monitor and control dish positioning, frequency monitoring, and alarms. Our Digital I/O cards provide optically isolated inputs and reed/latching relay outputs to suit your task.



PO BOX 830  
LIBERTY, SC 29657  
(803) 843-4343

Other  
Products  
Available!



**re·li·a·ble** (ri lī'ə bəl), *adj.*

1. that may be relied on; trustworthy.
2. dependable in achievement, accuracy.
3. the PR&E BMX III.

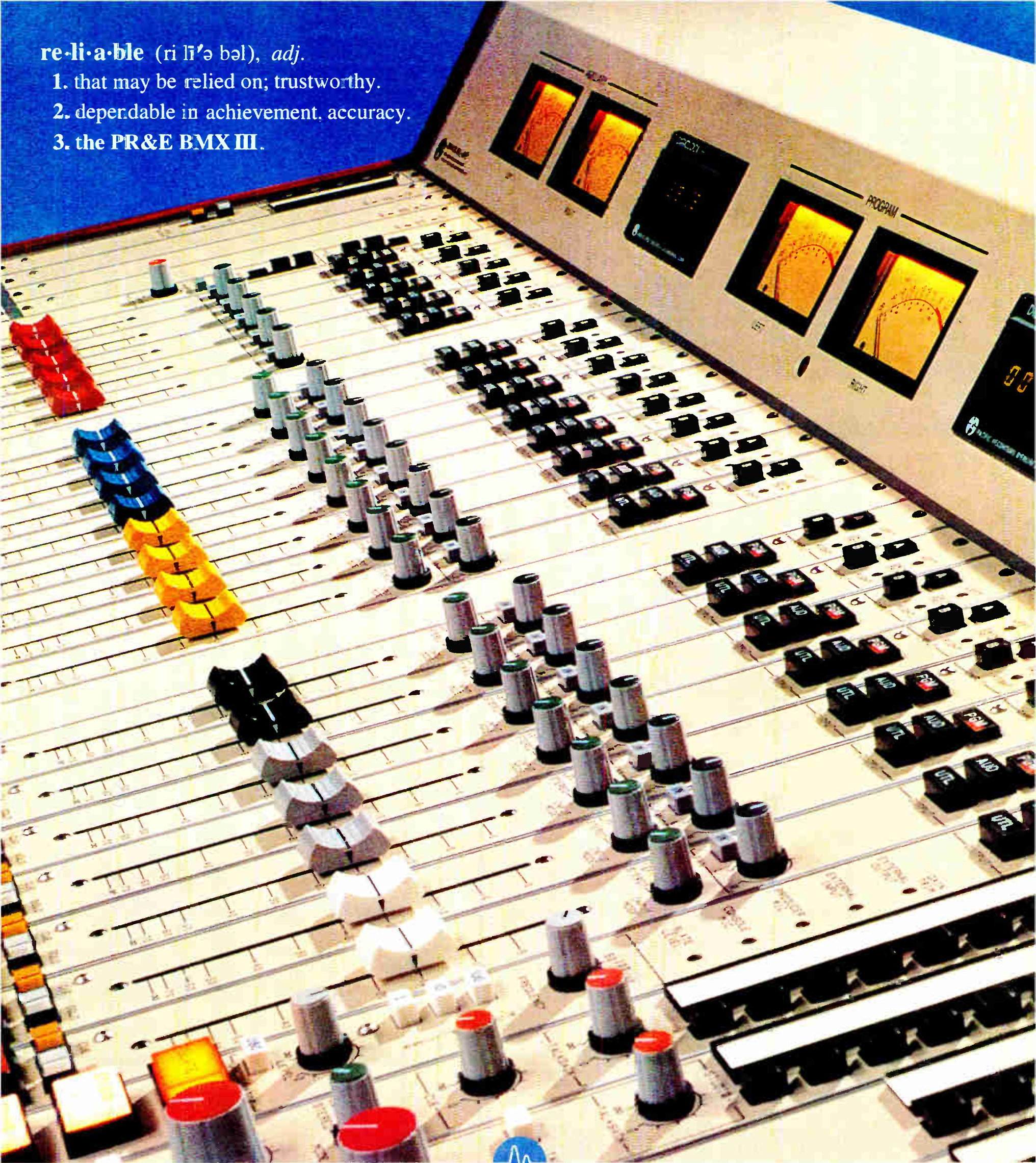

**PACIFIC RECORDERS & ENGINEERING**  
**DESIGNS THAT MAKE THE DIFFERENCE**

2070 Las Palmas Drive, Carlsbad, CA USA 92009

GSA Contract: GS-03F-4064B

Tel: 619-438-3911

Fax: 619-438-9277

E-Mail: [sales@pre.com](mailto:sales@pre.com)

Circle 195 On Reader Service Card

World Radio History





# LOG FOR LESS

Everyone loves Eventide digital audio-loggers. They've thoroughly obsoleted old-fashioned reel-to-reel logging recorders. But for some stations, our 24-channel model VR240 is more than the budget can handle. And many stations will never need to record up to 24 channels.

## 500 hours, half the price

The Eventide VR204 4-channel digital logger is the perfect answer. It costs less than half the price of a fully optioned Eventide VR240! The high density DDS2 drive of the VR204 can actually record more than 500 hours, divided among up to 4-channels, on a single DAT tape. That's twice the record time of our original models.

## Built-in hard disk

The VR204 is a single drive machine, yet it can play and record simultaneously. That's because it features an ingenious built-in hard disk memory module that keeps recording even if the tape is playing back an

earlier segment (or if the tape runs out). When the tape resumes recording, the content of the hard disk is transferred to tape, maintaining the completeness of the taped log.

## Two-way compatibility

There's also a play-only model, the VP204, which is ideal for the GM's or PD's desk or for the group's main office. And both the VR204 and VP204 can playback any of the 24 channels recorded on an Eventide VR240.

Keep an accurate audio record of everything that goes out on your air. Keep track of the competition as well. Contact your broadcast dealer or Eventide for the full story on the economical VR204. Because without an Eventide digital logger, you really don't know what you're missing.



**Now record  
500+ hours on  
one tiny DAT tape**



Circle (172) On Reader Service Card

World Radio History

**Eventide**  
the next step

One Alsan Way, Little Ferry, NJ 07643  
Tel 201-641-1200 Fax 201-641-1640



PRODUCT EVALUATION

## JBL PA System Looks and Sounds Good

by John Bisset

**SPRINGFIELD, Va.** With remote season in high gear, JBL's new EON portable performance series mixer/speaker system arrived in time for some heavy-duty field testing. The EON has been designed for simplicity. Given the non-technical nature of many of the interns that set up remotes, this feature is a real plus.

The system also looks good. It has been designed to match perfectly, from two microphones to a logical, easy-to-use mixer and self-powered speakers.

### Complete package

The EON system is a complete sound reinforcement package. It's nice when the manufacturer gives you all the cables and connectors you need to make the system work.

Hookup is a breeze, thanks to the oversized, tabloid-type instruction manual. This manual is about the size of *RW*, and contains several "quickstart" sections to permit fast interconnection. Large, easy-to-understand drawings accompany the written instructions, so there's no doubt where interconnecting cables go.

JBL designers really thought out this system. The self-powered speakers have built-in handles for ease of transport. Each speaker has a power switch, a front panel power indicator lamp and delayed turn-on to prevent unwanted noise when the system is plugged in.

Both male and female IEC AC sockets are mounted on the rear of the speaker, making it easy to daisy-chain several speakers together (only two are supplied in the basic EON package).

### Audio like AC

Speaker audio is routed just like the AC—there are male and female XLR jacks. Here's where the JBL folks really got creative: the self-powered speakers are switch-selectable for either mic or line level inputs. A small indicator light illuminates when the mic position is chosen. Because a mic can be plugged

the maximum volume setting at any of our remote evaluation locations, which included indoor club settings, as well as outdoors at car dealerships. Two sizes of speakers can be purchased.

The speakers are equipped with mount-



JBL portable EON performance series

ing features for pole-mounts or suspension mounting. They are shaped in such a manner that they can be set upright for speaker use, or slanted on the side for stage monitor use.

As mentioned earlier, the EON system includes a 10-channel stereo mixer, built for the road. Like the speakers, the MUSICMIX-10 combines ergonomics and simplicity in a state-of-the-art mixer, with high-performance features.

Each channel accepts XLR mic or TRS line level inputs. A trim control adjusts the level of the input signal. You can monitor the signal level using the overload LED.

Each channel is clearly numbered, and an LED beneath the plastic overlay glows when signal is present. The combination of the overload LED and the signal present LED simplifies setup.

High/mid/low EQ is provided for channels one through six. The tape or aux stereo inputs have high and low EQ adjustments.

The MUSICMIX-10 has a separate effects bus, with level adjustments for each channel. A separate monitor bus provides an individual monitor feed.

Each mono channel also has a Pan pot, for adjusting the amount of signal being sent to the left or right channel.

### Full-featured mixer

The output is monitored using 12-segment LED VU meters. I mentioned earlier that this is a full-featured mixer. Other attributes are an effects return to monitor control, as well as to the main; a mono/stereo output switch; built-in headphones amp and control; and tape output jacks for recording.

JBL also includes some features that you know came from years of research. For example, the mixer has a built-in handle on the side, to facilitate transport.

Cable strain relief notches have been molded into the top of the mixer, near the input and output connectors. If someone trips over a wire, he won't yank the cable from the connector. There is also a built-in phantom power source. Starting at \$2,177, the system is a good investment. (Components are individually priced.)

The conservative design should account for long life, and the durable construction

of both the mixer and the self-powered speakers ensures that the equipment won't die after its first ride in the back of the remote Jeep.

□ □ □

*John Bisset is a principal with Multiphase, a contract engineering and special projects company based in Washington. He can be reached at 703-323-7180.*

## Quantum FM

Solid State

Solid Reliability

from

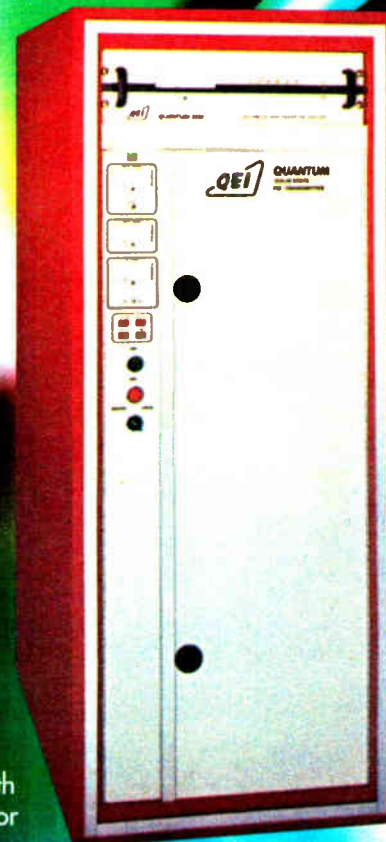

- Proven reliability
- Maintenance-free FET technology
- Self-contained modules with own power supply regulator
- Compact size reduces shipping costs, allows affordable air shipment
- Power levels between 300 Watts and 6 kW
- Modular design offers buy-only-what-you-need affordability and convenience

For the same price you pay for a tube transmitter, you can now have a superior solid state FM transmitter with high-power, advanced technology exciter and cableless combiner. The modular design of QEI's QUANTUM-Series FM transmitters offers the advantage of buying only the amount of power you need...and means that you can upgrade to higher power levels whenever you're ready.

QUANTUM from QEI—the people who have been designing and building solid state transmitters longer than anyone else in the industry.

You need to know more! Call Jeff Detweiler today toll free (800) 334-9154.

QEI Corporation  
One Airport Drive • P.O. Box 805  
Williamstown, NJ 08094

Tel (800) 334-9154  
Fax (609) 629-1751

24-Hour Service Hotline  
(609) 728-2020

### Product Capsule: EON portable performance series

Thumbs Up	Thumbs Down
<ul style="list-style-type: none"> <li>✓ thorough tech manual, excellent troubleshooting tips</li> <li>✓ simple, non-confusing, color-coded layout</li> <li>✓ built-in transport handles</li> <li>✓ plenty of power</li> </ul>	<ul style="list-style-type: none"> <li>✓ pocket-size version of tech manual</li> <li>✓ offer a combined AC/signal cable to be used when daisy-chaining units</li> </ul>

For more information, circle Reader Service 155, or contact JBL at 818-894-8850.

directly into the speaker, you can take a mic and one speaker and easily cover events such as small-scale personal appearances.

The back panel also houses a volume control, an overload light and a signal present light. The signal present light is great for troubleshooting, since it is ahead of the volume control.

The EON self-powered speakers are efficient—and loud. We never reached



## USER REPORT

# Futuristic KRK 'K-Rok' Monitors

by Matthew Hexter  
Chief Audio Engineer  
Horizons Video & Film

**COLUMBUS, Ohio** I walked into my favorite audio store, and the familiar face behind the counter told me that he had found the "perfect" reference monitor for the "perfect" price. I shrugged off his comment because I had heard it before.

I even reminded him of the other "perfect" pieces of gear that he had sold me that were now obsolete. I continued on my way, lusting after all the gear on display until a funny-looking shape

caught my eye. I walked over for a closer look. My initial impression was that I was looking at a speaker, but were my eyes deceiving me? The guy behind the counter chuckled and said, "Those are the perfect monitors I was referring to."

The K-Roks from KRK are futuristic-looking reference monitors that pack a lot of bang for the buck. Priced aggressively at \$449.95 a pair, they offer solid frequency response, great stereo imaging and superb extended low-end response. For me, the selling point was that I can listen to the K-Roks for hours and not feel fatigued.

I have to admit that initially I was

turned off by the design of the K-Roks. But after having the design philosophy explained to me, it made sense. The odd pyramid shape is intended to enhance the low end.

For many years, monitor manufacturers made the speaker cabinet look like a shoe box,

resulting in parallel "walls." They also put the port hole in the back. The outcome? If you put the speakers too close to a wall, your bass disappears!

But hats off to Keith Klawitter, founder of KRK, and his crew. Not only did they put the port holes in the front, ensuring low-end accuracy, but they also claim that the non-parallel surfaces optimize the frequency response linearity.

## Hearing is believing

I put the K-Roks up against some of the best and most well-known monitors, specifically, the

Yamaha NS-10s, Tannoy System 8 NFM IIs, Genelec 1030As and the Alesis Monitor Ones. Using some of my favorite music, Spyro Gyra's Three Wishes, Bonnie Raitt's Longing in Their Hearts and Green Day's Dookie, I began the test.

I started with the Yamahas and Tannoys, because I am most familiar with these. Then I put on the Genelecs. The Genelecs are incredible speakers, but at \$995 per speaker, they're out of my price range.

Then I switched to the K-Roks. Wow! The audio salesman was right. The stereo imaging was great, the bass was tight and punchy, and I can get used to the unusual design. I felt that the K-Roks were the clear choice, based on the fact that I can buy a pair of these for less than \$400 and still have money in my pocket.

## Real-world concerns

As you probably guessed, I took the jump and purchased a pair. Do I have any regrets? None whatsoever.

Here at Horizons we not only do audio sweetening for video, but we also record spots and mix sound for picture. So I have to make sure my monitors give me a true representation of my work. The K-Roks do a great job with both music and vocals. I am also finding that they help me get a handle on locating that great radio mic proximity effect. (You know, that low bottom that makes you sound like James Earl Jones.)

Currently we are working on a book-to-tape project in which we are using Sonic Solutions to record the audio. Although the need of critical monitoring is not necessary, it is important that the voice talents' nuances carry from the mic to the end listeners' ears. I am finding that the K-Roks are doing a great job of translating these subtleties.

## Conclusion

Although my time using the K-Roks has been short, they are soon becoming my favorite near field monitor. I even went so far as to post an article on the Internet claiming my love of and loyalty to them. So if you're in search of a great reference monitor that packs accurate frequency response with a funky Aztec design, then you've come to the right place.

Don't forget the other benefits of these new bad boys on the block: they do not give you a headache after 10 minutes of listening to them, the tight and punchy bass is a welcome addition to a small speaker and best of all, the price is right.

For information, contact the company in California at 714-841-1600; fax: 714-375-6496; or circle Reader Service 161.



TRYING TO MAKE SENSE OUT OF DIGITAL AUDIO SYSTEMS?

# There is a better way!

It's not easy trying to understand the conflicting claims made by different manufacturers when you're buying a Digital Audio On-Air & Production System, whether a single, multipurpose Workstation or an integrated, multiple studio setup. At one end of the spectrum, you're faced with a wide variety of simple "Cart Machine Replacements," and on the other, products whose complexity confounds even the most seasoned broadcast engineer.

The ENCO DAD486x Digital Audio Delivery System solves the problem! DAD is simply the most powerful On-Air & Production system available, yet its uncomplicated approach and inherent ease of operation makes immediate sense to any user.

- Intuitive On-Screen displays that are immediately familiar to operators. Optional Touchscreen makes operation quick and easy.
- Complete On-Air flexibility with various "Virtual Machines" for Live Assist, Automation, or Satellite Programmed operations. Interface to other equipment plus scheduling and billing packages. Seamless segue and voiceover transitions sound "Live" in all modes. Script capabilities can be included.

- Full production capabilities, including Graphic Cut & Paste Assembly Editing. Includes analog and digital inputs/outputs. Interfaces with most multichannel editing packages.

- Runs on DOS for proven speed, reliability, and compatibility with other equipment; not an operating system originally intended for multimedia applications. This is a professional tool meant to produce efficiency and profits, not entertain the staff!

- Operates on common off the shelf computers and network architecture. You won't be locked into proprietary hardware that may not be available whenever you need service.

- No monthly licensing fees. DAD is an outright purchase. Software upgrades are free for the first year.

- DAD is proving itself everyday in radio and TV facilities worldwide.

Call Your DAD486x Dealer or ENCO  
For Complete Information

**ENCO**  
SYSTEMS, INC.

24403 Halsted Road, Farmington Hills, MI 48335 USA  
TEL: 800-362-6797 or 810-476-5711 FAX: 810-476-5712

Circle (115) On Reader Service Card

World Radio History



See us at  
**NAB**  
 New Orleans  
 Booth 355

# NEW Math for Going DIGITAL

 + 
  + 
  = 
 **Cart Replacement**  
 MSRP \$1299      MSRP \$795

 + 
  + 
 **BROADCAST tools inc.** 1616 CONTROLLER = 
 **AUTOMATION**  
 MSRP \$1495      MSRP \$399

 + 
  = 
 **satellite switching**  
 MSRP \$299      MSRP \$299  
 Satellite Channel Controller      Satellite Transponder Controller

 **or**  = 
 **AUDIO switching**  
 MSRP \$399      MSRP \$629  
 Passive Stereo Switcher / Router      Active Dual Stereo Switcher

Go **completely** DIGITAL the *easy* way  
 with software from **WireReady® NSI!**

Off-the shelf **HARDWARE** works *with* your **own** computers!

Novell *and* Lantastic **LAN compatible** Backed *with* 24-hour 800 support & **FREE** Upgrades

**GROUP** Software Licenses **Available**

*Call for package pricing and a complete catalog.*

**Southeastern Sales Office**

200 Fairway Drive, Suite 2  
 Smithfield, North Carolina 27577  
 Phone: 800-369-7623  
 Fax: 919-934-8120

**Main Sales Office**

2342 S. Division Ave.  
 Grand Rapids, Michigan 49507  
 Phone: 800-999-9281  
 Fax: 616-452-652

**Western Sales Office**

P.O. Box 1638  
 Palmdale, California 93550  
 Phone: 800-858-9008  
 Fax: 805-273-3321

Please visit us  
 on the  
 World Wide Web:  
[www.abg.com](http://www.abg.com)

*in 35 years*

You may also reach us anytime via electronic mail  
 cServe: **75371,144** internet: **support@abg.com**



Circle (214) On Reader Service Card

World Radio History



# Products & Services Showcase

For more information on the products shown below, circle the appropriate Reader Service No.(s) on the enclosed Subscription/Reader Service card or contact the advertiser directly.

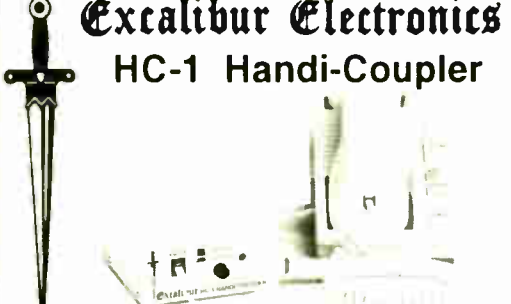

**Excalibur Electronics**  
**HC-1 Handy-Coupler**

Here is the simplest, quickest, most convenient way to connect audio to a telephone. The HC-1 connects in series with the handset of any phone using modular connectors. No connection to the phone line is needed. Press the front panel button and external audio is available on separate send and receive 1/4" TRS jacks on the rear panel. Release the button and the handset is once more connected for normal use of the phone. Nothing could be simpler!

You can find many uses for the HC-1 around your station: on-air studio, production room, newsroom, sales office, field news kits, sports remotes, etc.

EXCALIBUR ELECTRONICS, INC., CHANTILLY, VIRGINIA  
*Please circle our bingo number for a data sheet and a dealer list*

**READER SERVICE NO. 216**

See it in New Orleans, call us to buy it, install it, erect it, or license it—

**Technet<sup>®</sup> Systems Group**  
A Division of Steve Varr Associates, Inc.

**Broadcast Equipment  
Turn-keyed Systems  
Tower Erection & Service  
Technical Consulting**

**Your Single Source for  
All Your Technical Needs**

Fax Inquiries to:  
**1-800-FAX-4-SOS**  
(1-800-329-4767)

P.O. Box 422 Auburn, NH 03032  
Tel: 603-483-5365 Fax: 603-483-0512

**READER SERVICE NO. 22**

**PUMP UP THE VOLUME!**  
**Now You Can Be Dominant and Sound Great at the Same Time**



We have re-written the book on FM composite processing. Move up to the crystal-clear sound of the FM FlexiMod and control your market with a dominant, dynamic new sound.

The FM FlexiMod is the culmination of ten years of research into aggressive composite processing. Its new approach to loudness control without distortion will revolutionize the sound of your station.

The FlexiMod will add sparkle and body to overprocessed, multi-generation audio and enhance all program material for a consistent, dominant on-air sound.

The secret behind the breakthrough performance of the FM FlexiMod is our proprietary c-limiter circuit. This hybrid limiter-clipper will give you brick wall modulation control with extremely low second-harmonic distortion products.

**Loudness without grunge!**  
The FM FlexiMod is the only processor you will need to guarantee dynamic presence on the dial. It will clean up your sound and increase your loudness by at least 3db!

FlexiMod. Already overachieving in major markets nationwide.  
Only \$1395.  
Available direct from MicroCon Systems or from selected dealers.  
30-day no-risk on-air trial.

For further information contact:  
Jim Somich at MicroCon Systems Ltd. (216) 546-0967

**READER SERVICE NO. 8**

**WIRELESS IFB SYSTEM**

Used by hundreds of TV stations for van-to-field cueing in ENG & SNG applications. Transmitter provides mix of program and instructions to rugged, pocket receivers.

- 100% duty cycle
- Wideband audio
- Excellent operating range



**COMREX<sup>®</sup>**

Comrex Corp., 65 Nonset Path, Acton, MA 01720  
Tel: 1-800-237-1776 Fax: 508 635-0401

**READER SERVICE NO. 15**

**THE FINEST STUDIO SYSTEMS IN THE BROADCAST BUSINESS**



**Audio Broadcast Group Inc.**  
**Studio Furniture & Prewired Systems**

Your studio environment specialists for the last 35 years.

We Are The Industry Standard.

For additional information on how we can serve you, please call today.

**SOUTHEASTERN SALES OFFICE** 200 Fareway Drive, Suite 2 Smithfield, North Carolina 27577  
Phone: 800-369-7623 Fax: 919-934-8120

**MAIN SALES OFFICE** 2342 S. Division Avenue Grand Rapids, Michigan 49507  
Phone: 800-999-9281 Fax: 616-452-1652

**WESTERN SALES OFFICE** P.O. Box 1638 Palmdale, California 93550  
Phone: 800-858-9008 Fax: 805-273-3321

YOU MAY ALSO REACH US ANYTIME VIA ELECTRONIC MAIL  
cServe: 75371,144  
internet: support@abg.com

For 35 years

**ABG**  
Audio Broadcast Group, Inc.

**READER SERVICE NO. 59**

**The MicMan<sup>™</sup> Jr. - A 2 Channel Preamp**



**The MicMan<sup>™</sup> Jr. Portable Mic Preamp**

- 1 dB noise figure
- Gain range +26 to +82 dB
- 0.001% THD @ 1 kHz. @ A=40 dB
- 160 kHz bandwidth for transparent sound
- Fixed. (external PS-1), or portable use
- Uses standard alkaline batteries
- +12 or +48 V phantom microphone power
- Great value-\$425 with external power supply!

**BENCHMARK MEDIA SYSTEMS, INC.**  
Phone 800-262-4675, FAX 315-437-8119

**READER SERVICE NO. 105**

**PTTEK**  
*Your RF Power Amplifier Source*

**Compact FM Broadcast Power Amplifiers**  
**150W 300W & 500W**



Power Outputs  
FM150.....50-175W  
FM300.....150-350W  
FM500.....250-500W

Drive  
10W will drive all 3 models to full power

**INTRODUCTORY PRICES**

500W.....	\$3,330
300W.....	\$2,500
150W.....	\$1,650

1814 Schooldale Dr, San Jose, CA 95124

CALL 408 448 3342 OR FAX 800 416 7934  
For data sheet

**READER SERVICE NO. 220**



## USER REPORT

# 'See' Signal with Wohler Monitors

by Jeff Zigler  
Chief Engineer  
WTSO(AM)-WZEE(FM)

**MADISON, Wis.** As radio moves into completely digital audio systems, it is important to step back and examine the audio chain as a whole. The computers we entrust our music and commercials to perform an indisputably accurate job of storage and retrieval, not to mention their seemingly infinite advantages over razor blades and old one-trick-pony analog effect boxes collecting dust in the engineering shop closet.

Accurate audio manipulation still requires two important pieces of analog equipment. Unless you are completely synthesizing the source material, the first is an accurate transducer to convert sound waves into electronic messages. Second, in all conditions, you need accurate monitoring.

## Accurate monitoring

Without accurate monitoring at the input stages, the likelihood of getting a precise conversion from analog to digital is poor, and the accuracy of the monitoring system limits analysis of the stored

material. I use the word "system" because, while we must listen to audio fidelity and detail, we must be conscious of headroom, noise and signal relationships in the material we are working with.

These criteria are very difficult for any one monitor system to meet, but I have found that Wohler Technologies has made extraordinary accomplishments in this area with its AMP series of audio monitoring systems.

## Incredible monitoring

The AMP series monitors not only provide incredibly accurate audio monitor-

ing for the ear, but also combine audio level (Vu or PPM), phase and overload monitoring for the eyes. Without a doubt, it is the visual monitoring that sold me on the AMP 2. The level metering is fast and accurate, starting from -40 dB below zero reference. It is amazing how many things will show up with that much resolution; poor bulk erasures and ground loop buzzes, for example. Even more amazing is that the jocks operating the AMP 2 now notice these imperfections because of the impressive visual monitoring.

**Wohler's design reminds me of those rare pieces that are almost overdesigned to prevent obsolescence.**

The phase indicator is simple to use. It is set up like a traffic light—green is good, yellow requires some concern and red indicates a problem. While this display is not as hypnotic as an X-Y phase scope, it is far more practical for the average jock to use. I would like to stress that the AMP 2 also sounds great, but when Wohler combined this with accurate visual monitoring, the AMP 2 became the only choice for my monitoring needs.

The phase indicator is simple to use. It is set up like a traffic light—green is good, yellow requires some concern and red indicates a problem. While this display is not as hypnotic as an X-Y phase scope, it is far more practical for the average jock to use. I would like to stress that the AMP 2 also sounds great, but when Wohler combined this with accurate visual monitoring, the AMP 2 became the only choice for my monitoring needs.

## Big sound, little space

The AMP 2 takes up only two units of rack space and is merely 10 inches deep. This is important to me because my racks are full and, as is true of most of today's control and production rooms, space is a premium.

Unlike many other "rackable" monitors, the AMP series is not simply a pair of powered near-field monitors with rack ears. The AMP series comes in a solid all-metal chassis, providing complete magnetic shielding (which I will touch on later).

Wohler has introduced a mono sub-woofer into the AMP series that greatly improves the low end response of the system: in the AMP 2 the specs stay down to 80 Hz. The AMP 2 operates in a bi-amped configuration, with a low frequency limiter in the subchain to keep the bass tight and to protect the sub from overdrive in high SPL operation. The AMP 2 can provide up to 104 dB SPL. However, I would hate to imagine running it that loud while it is mounted in a rack with other physically coupled equipment. I recall burning in our AMP 2 on the shop bench and rattling tools off the bench back-board. People stopped by the shop to see what was making all this sound.

Our general manager came up with the

I think my application took Wohler somewhat by surprise because it previously offered muting on one channel or the other (it must be a TV thing). Anyway, Wohler was quick to come up with a modification for our unit to mute both channels simultaneously.

## Details and options

Wohler's design reminds me of those rare pieces that are almost overdesigned to prevent obsolescence. You remember: a chassis large enough to keep capacitors from drying out from excessive heat, a case strong enough to survive moderate falls, and my favorite, bridging jacks—extra jacks to bridge in a piece of equipment without a "Y" cord.

The AMP series also provides excellent magnetic protection for nearby video monitors. I did not concern myself with this initially because this is radio and we don't use video monitors. But as I prepare to install our new hard disk audio system, I am glad our AMP 2 won't distort the three computer monitors I have to squeeze into the control room.

Little details seem to be important to Wohler and it really shows in the options sheet. I won't list them all, but a few options that caught my eye include AES/EBU inputs, peak hold on meters, multiple input selector and DC operation.

The AMP series is somewhat vast, so take your time, look it over carefully and you'll find exactly what you want.

□□□

For information, contact Carl Dempsey in California at 415-589-5676; fax: 415-589-1355; or circle Reader Service 72.

## SHORT TAKE

## AKG K240M Headphones Consistent

**SAN LEANDRO, Calif.** In broadcasting, headphones come and go, but the AKG K240M remains the standard for reference-quality studio monitoring. They also withstand the daily abuse of the studio.

I specify the K240M for my facilities because it contributes greatly to the overall consistency of our air-sound. The K240s deliver reference quality when driven by any of the various equipment in the studio.

Unlike other popular headphones which offer very low impedance, the K240M has a true 600 ohm impedance easily driven by simple op-amp outputs or current boosted outputs without damage. Low impedance headphones are frequently burned-out by current boosted headphone outputs. Large voltage swings can be applied without element heating or damage.

The K240M frequency response is consistent from room to room and jack to jack.

The K240M architecture is a combination of open and closed ear technology. By using six damped passive membranes, cup resonance is minimized. While this decreases efficiency, it provides for a smooth frequency response.

— Philip Moore  
Consulting Engineer  
PKM Associates

For more information, contact the company at 818-894-8850; or circle Reader Service 79.

**” AEV CELEBRATES AN UNPRECEDENT OUTSTANDING WORLDWIDE SUCCESS!**

**Radio Stations from all continents enthusiastically praise EXCLUSIVE FM as an extraordinary and absolutely exclusive event!**



**AEV Exclusive FM AUDIO PROCESSOR**

**ASK FOR IT, the whole world is asking for it.**

**AEV**

**ELECTRONIC BROADCAST EQUIPMENT**

AEV  
ITALY  
Phone  
39 + 51  
950249  
950350  
Fax  
950201

Circle (167) On Reader Service Card



## USER REPORT

# CBC Winnipeg Winner with Tannoy

*Monitors Used in Studio and Remote Applications Are Flexible, Clean with Strong Stereo Imaging*

by Christopher McPherson, CET  
Systems Technologist  
CBC Radio Winnipeg

**WINNIPEG, Manitoba** With so many good studio monitor products available, choosing a speaker can be difficult. CBC Radio Winnipeg's choice of Tannoy monitors was based on their past performance in our plant and on expectations of improved performance with the new design. In one case, the flexibility of the built-in power amplifier was an important factor.

## Various applications

We are currently using PBM 6.5LM II, System 8 NFM II and System 10 DMT II for various applications around the station. CKSB, the French production studio, required a near-field monitor to act as an alternate monitor and to improve the consistency of the mixes of a children's production. Tannoy PBM 6.5LM II speakers were chosen for their size and compatibility with the Limpet power amplifiers. This was important as there was no additional power amplification available. Line-level switching allows easy selection of either the main or alternate monitors, giving operators and producers the means to compare different programs.

The same speakers have proven useful in remote applications. Again, the built-in amps and small size have proven to be assets, increasing portability and providing a simple interface to portable mixing consoles. The rear audio multi-connector reduces the need for adapters, allowing both quarter-inch and XLR connectors.

The only obstacle was matching the output level with the main monitors. There is a switch, but the actual required sensitivity required a pad. Perhaps a level control would add more flexibility.

Producers and operators report that these monitors have good detail and definition and provide them with a stable reference for their productions. There is some thought that the 6.5 might be a bit

too bright, but this has not been a problem to date.

## Radio Mobile

Slightly larger speakers were required for the Radio Mobile. This fully equipped, 24-track production control room is used to record various types of music, from classical to rock, for local and network stereo and mono programs. Tannoy System 8 NFM II speakers were the choice for the alternate near-field monitors. There was available power amplification, and because there was no outboard crossover, interface was simple. The coaxial point source design provides a strong stereo image even when the monitors are spaced farther apart.

Several operators have noticed this effect and have commented on the sensitivity at high frequencies. Detail is enhanced by the brilliance of these speakers. As with the 6.5s, there was concern that having an overly bright response would make it possible to produce a mix that had less top end than expected; however, this has not become a problem in production. Earlier versions of the Tannoys had adjustments to set the high frequency response, but this adjustment is only available now on the 12-inch and larger models.

The main multitrack radio recording studio is equipped with a Sony MXP 3000 console and a Studer D820-48 MCH DASH recorder. Main monitoring is handled by Sota CF 2000. This quad-amped speaker system provides a full-range reference. However, aside from the Yamaha NS-10s and the console PFL speaker, there was no permanent alternate monitor. Power amplification and switching was already installed and functional, so speakers with internal crossovers would be the best choice.

## Stronger stereo image

Various brands of mid-sized speakers were begged or borrowed and put into place for a while. The mixes produced with each monitor were acceptable, but we wanted a stronger stereo image and a

**The newest series of Tannoy monitors has gotten a positive response in their application at our studios.**



**AS-101 Audio Switcher**

- Illuminated and legendable control buttons
- Instant or overlap switching
- Front panel accessible level controls
- Options include: RS-232 interface, remote control, relay-follow-switch outputs
- Network proven quality and reliability

10 Stereo In - 1 Stereo Out

P.O. Box 1342 Bellingham, WA 98227  
1-800-645-1061 FAX (206) 676-4822

**Conex Electro-Systems, Inc.**

Circle (201) On Reader Service Card

speaker with a newer and more modern design. Tannoy System 10 DMT is a good match for the available power, provides a coaxial source (all previous speakers had been based on separate drivers) and has built-in crossovers.

The monitors have interfaced easily into the existing studio setup, and even when the monitors initially were placed far apart, there was a strong stereo image with good definition. Various locations and spacings are being tried to fine-tune the point of optimum balance for fidelity

and imaging. The balance engineers who use the studio have grown to trust the monitors' performance. The low frequency response has been generally considered adequate for the speaker size. Also, strong top end was one of the characteristics noted of the 10 DMT.

The newest series of Tannoy monitors has gotten a positive response in their applications at our studios. The most striking difference between the older models and the newer ones appears in the higher frequencies, where the clarity and detail in the newer design outshines previous speakers.

For information, contact Mark Bertrand in Canada at 519-745-1158; fax: 519-745-2364; or circle Reader Service 77.

## USER REPORT

# Mixing and Mastering With Digital Designs

by Glenn Barratt  
Studio Owner/Chief Engineer  
Morning Star  
Communications

**SPRING HOUSE, Pa.** In the past, I have been skeptical of product endorsements the same way that I am skeptical of infomercials. Every word I say here is sincere and based on the 20-odd years that I have been working in audio.

I am a self-taught, seat-of-the-pants engineer/producer out of the '70s. I was earning a music teaching degree when the world of music recording steered me along its path. Since then I have received Gold and Platinum records for work with Gladys Knight, Redina Delle, Kriss Kross, BB&Q and Kool & The Gang. I have been nominated for a Grammy Award for Grover Washington Jr.'s "Summer Chill," a jazz instrumental piece, and had the opportunity to write and produce on the last two Pieces of a Dream albums.

Other artists that I have worked with include: Kenny G, Marvin Gaye, Dionne Warwick, The Spinners, Loose Ends, Pretty Poison, Teddy Pendergrass, The Gap Band, Edwin Hawkins, Steven Ford, Kae Williams, Jr. of Breakwater, Hezekiah Walker, Kirk Franklin, BeBe & CeCe Winans, Ron Winans, Dionne Harper and New Jersey Mass Choir.

My experience with Digital Design monitors goes back at least 10 years. I had heard the HD1s at AES in New York and knew that I had to have a pair. After discovering the price, I had difficulty justifying that much money for monitors (and a power amp). I began to investigate alternatives. That is when I spoke to the designer of Digital Designs and ordered a pair for evaluation.

I was amazed at the clarity of imaging from the 161s, which were a fraction of the price of the HD1s. I immediately bought two pairs and replaced the other speakers I was using in two control rooms. My confidence and exuberance for the new speakers spread to many of my clients, who in turn ordered speakers.

Over the years the speaker has con-

tinued to improve in its durability and widened its window of superb imaging without sacrificing any part of its sonic quality. Today's product seems almost bulletproof. Working with rap clients or classical artists, no one is disappointed with sonic decisions they make based on the Digital Designs speaker or with what they take home when the session is over.

Since my initial love affair with the HD1s, I have found that they can sound drastically different from control room to control room and that they are not suitable for more demanding types of music like rap or heavy R&B. My experience with Digital Designs in multiple control rooms has been much more pleasing, even considering all the different power amps involved.

Also, the speakers have treble and midrange attention to help tune the speakers to the room. Many other studio owners complain about always having to replace tweeters due to client or engineer abuse. I have never had that problem with Digital Designs, and those speakers are pumping every day.

During the last year or so I have been mastering projects that I mix whenever possible. I have mastered the latest from Pieces of a Dream, as well as half a dozen new gospel releases. I use the 161s with a sub-woofer and the Digital Designs crossover as my primary mixing speaker system. In mastering I use a pair of 181s only. The midrange clarity and overall transparency is amazing. This combination has yielded positive comments from clients and masters.

I am just a guy who appreciates really good recordings. I am always listening and trying to emulate those recordings with my own work. I believe my association with Digital Designs products has not only allowed me to hear the detail in great recordings better, but also to create that detail in my own work, which has given me a reputation for excellence in mixing.

For information, contact the company in Oklahoma at 405-239-2800; fax: 405-946-4544; or circle Reader Service 58.



## USER REPORT

# Connecting Studios with Digital Tools

by **Dwight Small**  
**Chief Engineer**  
**KNDD(FM)**  
**Viacom Broadcasting**

**SEATTLE** A few years ago, our station ran an AC format that featured a four-person morning show. The show originated from two studios, with the news person in a third. It quickly became evident that an efficient means of communication between studios was necessary.

Fortunately, the **Broadcast Tools SMI-5** studio intercom system had just been introduced. After reviewing several different intercom systems, the SMI-5 appeared to be the most cost-effective, flexible system.

## Separate control

The unit includes intercom, monitor interface and headphone control. The air talent appreciates the last feature because it provides separate bass and treble controls for the host's headphones. The intercom has four buttons with LED tally to call the other stations in the system. This allows a total of five dedicated stations. There is an All Call function if all stations need to be paged.

**You can have more than five units and set the system up so that all units do not appear in all studios.**

When a station is called, the monitor audio dims and the intercom audio is routed to the called studio's monitor speakers. Dim level is adjustable via a front panel control. If the monitors are muted, the intercom is routed to the host headphones. In this case, the program audio is fed to one ear and the intercom audio to the other. For a jock or talent who finds this distracting, there is a privacy control on the front panel that cancels this function. An LED indicates the privacy function is active.

In addition, there is a separate guest headphone feed with independent level control that does not have the intercom function. The monitor portion of the unit provides a master level control plus a mono sum function. The mono sum feature is especially useful to check phase. Additionally, there is a control that activates the dim function so that the dimmed monitor and headphone levels can be set.

The SMI-5 also provides a mic or line input to facilitate the talk-back function. In our system, we used an external line output from the talent's mic to feed into the system. It made the operation easier for the jocks and provided better quality audio.

## Straightforward wiring

The wiring for this system is straightforward and is done with standard 25-pair telephone cable. The back of the SMI-5 has a standard 25-pair AMP connector for the station cable. All of our intercom cables terminate in the engineering frame

area on telephone punch blocks, with a block dedicated for each studio. Broadcast Tools provides an interface to facilitate the interconnecting of each SMI-5, but we elected to use punch blocks. The intercom is like wiring a 1A2 telephone system, with the units being cross-connected in this area. You can have more than five units and set the system up so that all units do not appear in all studios. In our case, the studios, news booth and engineering shop are connected. We plan on using the shop's intercom to feed our remote IFB. This will allow each studio to communicate with the talent at a remote.

The connections with the consoles and

monitors were fairly easy and made through quarter-inch TRS jacks on the rear of the SMI-5. In all of our studios, the monitor amplifiers are external to the console, so interruption of the feed to insert the SMI-5 was easy. Our Pacific Recorders BMX provided a post monitor input selector feed for both the monitor and headphones. In our Autogram consoles, we took the monitor feed from the monitor amp socket in the console. This is after the input select switch and volume control, so those console functions remain intact.

For headphones, we interrupted the headphone feed after the input select

switch and returned the output of the SMI-5 to the headphone amplifiers to provide intercom directly to the headphone jacks on the console. For remote control, there is a DB-25 connector on the unit's rear panel that brings out tally and control functions.

Reliability is always a concern in broadcast facilities. Our units have been in service for over three years with no major failures and almost no maintenance problems. I can recall only one switch and a headphone jack that had to be replaced in that time. Our old format has been long since replaced by modern rock, but the Broadcast Tools SMI-5s are still serving us well.

For information, contact Don Winget in Washington state at 206-938-4089 (phone and fax), or circle Reader Service 14.

## Bradley & Telos Didn't Just Ride The Talk Show Wave...



## We Helped Create It!

### Phones For Every Kind Of Talk Show

More than a decade ago, Bradley Broadcast Sales and Telos Systems introduced the Telos 10, the first broadcast product to use digital signal processing. Since then, Telos products have put the power of great phones into the hands of broadcasters around the world. No one has more experience with Telos technology than Bradley Broadcast Sales.

### The 100 Delta Digital Hybrid

For the very best broadcast phone quality, choose the 100 Delta. It provides natural, two-way conversation even on the toughest lines and includes a remarkable digital dynamic equalizer that automatically corrects spectral degradation on every call.

### The ONE Digital Hybrid

Fast, automatic digital nulling allows smooth conversation without speaker-phone effects, level problems, and distortion. The ONE can be ordered in a rack chassis or compact modem-style case. Or choose the ONE plus ONE, a dual hybrid with built-in mix-minus matrix.

### The ONE-x-Six Talk Show System

This affordable system includes all of the telephone interface and control equipment needed for talk show programming. A single rack-mount unit houses a Telos ONE digital hybrid and a six-line, broadcast phone system. For system control, use the desktop Switch Console, also included.

### Bradley Knows Telos

No one knows Telos better than Bradley does. Call us. We'll help you connect to your callers with great phones.



Where Service  
 And Engineering  
 Make The  
 Difference

CALL TOLL FREE: 1-800-732-7665

Bradley Broadcast Sales • 12401 Twinbrook Parkway • Rockville, MD 20852 • 800-732-7665 • FAX: 301-230-6526

Circle (119) On Reader Service Card



## DYNAUDIO

### Radical Advances for Dynaudio Acoustics BM5 Nearfield Monitors

**ROCKLAND, Mass.** Dynaudio Acoustics introduces the newest member of its BM series, the BM5 two-way nearfield monitor. Radical advances in design, materials technology and production techniques have produced a high-performance product. The BM5's designers have preserved many of the characteristics found in larger and more expensive models from Dynaudio Acoustics (e.g., M1 console-top monitor) but at an attainable price (\$699 a pair).

The BM5 uses a newly developed 170 mm (6.7-inch) magnesium-silicate impregnated polypropylene bass driver with an extra-large 75 mm aluminum

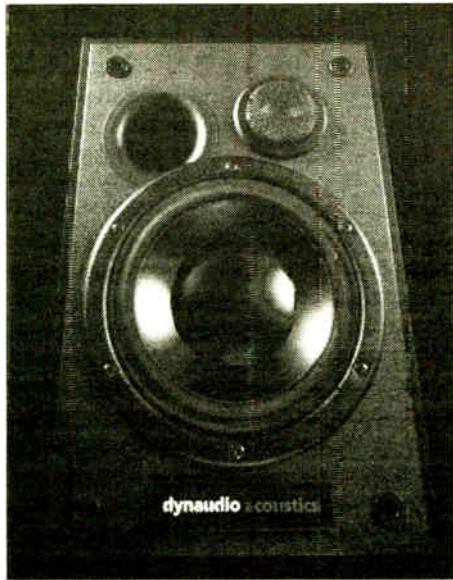

voice coil, allowing higher power handling capability with lower distortion.

The new thermally protected 28 mm (1.1-inch) soft dome high-frequency driver uses a neodymium magnet and aluminum voice coil, with a crossover frequency of 2.5 kHz. Frequency response is rated at 50 Hz to 20 kHz ( $\pm 3$  dB); THD is  $< 0.1$  percent at 88 dB any frequency from 100 Hz to 20 kHz; impedance is 4 ohms nominal and typical maximum output is 102 dB (at 1.25 m). Recommended power is 150 W per channel for best results.

The cabinet of the BM5 is heavily braced and front ported, which is tunable with the use of included foam plug inserts. Other features include system output matching to within 1.5 dB SPL, gold-plated connectors and magnetic shielding, due inherently to center-

magnet structure in driver design. Rear channel wall mounting in a surround monitoring system, the BM5 offers a cost-effective, high-performance monitor option not available on the market today.

Imaging and detail are outstanding, with a smooth and extended high frequency response and tight bass response. In a tracking or mixing environment, the BM5 provides an accurate reference with extended dynamics and low distortion allowing extended listening without fatigue, a Dynaudio hallmark.

As a playback monitor, the BM5's exceptional imaging and detail bring out nuances in recordings usually heard only in large and expensive high-end home systems. When powered by a good amplifier, the sense of the speakers disappearing and the live musical event remaining is distinctly evident with the BM5s. The front port design offers an additional "kick" when the BM5s are used in the nearfield context, and allow more versatility in placement without concern for rear wall reflections.

The BM5 is equally at home in the project studio, pro mixing room or broadcast facility. Read the review of the BM5 monitor in Studio Sessions.

For information, contact Bruce Bartone at U.S. distributor AXI, Audio Exchange International, in Massachusetts at 617-982-2626; fax: 617-982-2610; or circle Reader Service 124.

## BEYERDYNAMIC

### Rugged Beyer DT200 Series Are Solid Performers

**FARMINGDALE, N.Y.** beyerdynamic offers the latest additions to its headset range. The company's DT 108/109 headset combinations are known for their rugged construction, field serviceability and sonic performance.

The introduction of the DT 200 series products hails the beginning of a new industry standard for the broadcast market.

The DT 200 series is comprised of a range of models, with and without boom microphones. These headsets are available with a choice of microphone capsules. The main design criteria for the DT 200 series was a low-profile, lightweight headset for sports commentators, with ergonomics that optimize sonic performance and visual appeal, without compromising long-term comfort.

The following products are part of the DT 200 series: DT 250 stereo headphone; DT 280 single-sided headset with dynamic microphone; DT 290 double-sided headset with dynamic microphone; DT 281 single-sided headset with omnidirectional, electret condenser; DT 291 double-sided headset with omnidirectional, electret condenser; DT 282 single-sided headset with cardioid, electret condenser; DT 292 double-sided headset with cardioid, electret condenser.

The electret condenser versions come supplied as standard with an external pre-amplifier. Some versions are available with a built-in pre-amplifier for use with cameras requiring high input levels.

For information, contact the company in New York at 516-293-3200; fax: 516-293-3288; or circle Reader Service 7.



Looking for the ultimate affordable digital STL solution?

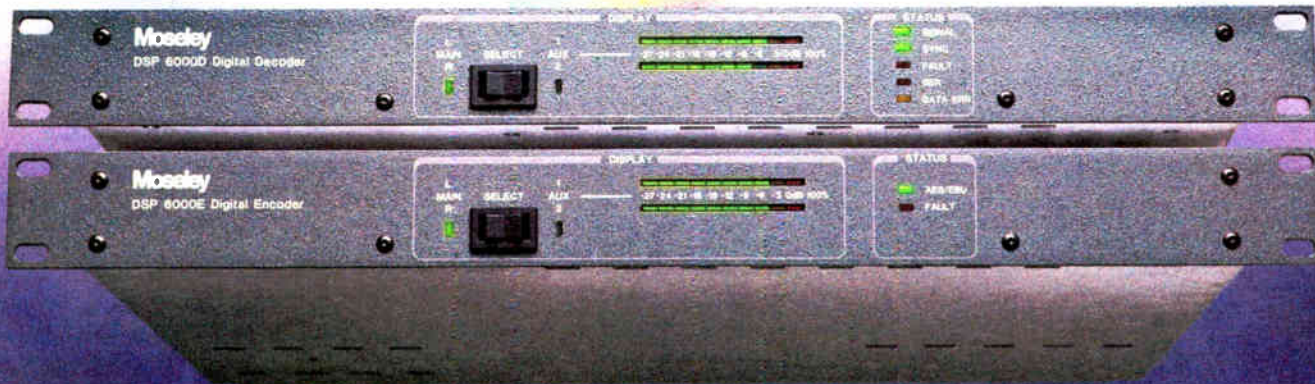

# Look No Further!

## Moseley

Moseley Associates Inc.  
111 Castilian Drive  
Santa Barbara, CA 93117  
Voice (805) 968-9621  
Fax (805) 685-9638

**W**HEN Moseley introduced the DSP 6000 in 1992 it was immediately acclaimed by the broadcast industry as THE digital STL solution. Here's why. The DSP 6000 virtually eliminates the problems associated with conventional analog transmission such as noise due to signal fades, birdies from intermod interference, and lack of spectrum for multiple audio feeds to LMA and Duopoly transmitter sites. Almost three years later, the DSP 6000 is the de-facto industry standard for sonic clarity and reliability with sales approaching 2,000 installations worldwide. But you probably already knew all of that stuff, right?

What you may not have known, is that the DSP 6000 also works in conjunction with your existing Moseley analog composite STLs! If you've invested in a Moseley PCL 505/C, 600, 606, 606/C or 6000, a few simple modifications convert your entire system to digital! And it won't cost a pot of gold (just under \$6,000). Call us for modification instructions, or better yet, ship us your STL and for a mere hundred bucks, we'll make the modifications and do the setup for you.

Isn't it time you stopped chasing rainbows and started enjoying the sonic clarity of digital? "Digitally clear. Clearly digital. Just the way we planned it." ▼



NOW  
SHIPPING



# We Made Talk Radio Easy...

## The Way It Should Be.

Talk radio can be difficult. Your telephone system shouldn't be. Gentner designed the TS612 to make it easy. The way it should be.

The TS612 is a six-line (expandable to 12) Telephone System. It features Gentner's Direct Connect Technology™, which allows you to hook it into a regular telephone line.

Plus, its built-in handset and keypad eliminate the need for another screening telephone.

With the TS612 you can talk to callers off-air while other callers are on-air.

The TS612 features built-in mix-minus to compliment Gentner's digital audio enhancement. It has two DCT Superhybrids, automatic level control, dual air control surfaces, optional screener control surface, and dual audio bus operation.

You also have DCT connection to your hard disk or studio PC for screening and controlling calls.

The TS612 was designed specifically for talk shows.

### **Gentner**

Contact the broadcast professionals at Harris Allied for complete details. Find out just how easy talk radio can be for you.

**1-800-622-0022**

**Fax 317-966-0623**

 **HARRIS  
ALLIED**

Circle (154) On Reader Service Card  
See Us At WME Booth 1109  
World Radio History

©1994 Harris Corp.



## AUDIX

**Response from Audix 1A Monitors Called Clear, Transparent, Full-Bodied**

**LAKE FOREST, Calif.** The Studio 1A from Audix is a compact two-way monitor (13 inches x 9 inches x 10 inches) comprised of a single 6.5-inch polycarbonate woofer and a one-inch cloth dome tweeter.

The use of an advanced, space-age composite material in the woofer frame means there is no metallic interference with the woofer's own magnet. The monitor is front ported so that placement to rear walls is not sonically critical. This is especially beneficial in a studio environment where space is at a premium.

With a frequency response of 50 Hz to 18 kHz ( $\pm 3$  dB) and a sensitivity of 87 dB, the 1A has an impressive power

handling of up to 250 W. The enclosures are made of a specially formulated wood composition designed to absorb vibration with minimal resonance for a tighter, more accurate sound. For additional dampening, the cabinets utilize acoustic fiberglass inner-lining.

The 1As deliver a clear, transparent, full-bodied sound, breaking away from the traditional "mid-range only" sound that typifies most nearfield monitors. Relationships between the bass, midrange and treble are very well balanced and distinguished. The 1A is designed to offer excellent impulse response and time alignment. They reproduce a burst of energy in the same order it was received,



thereby replicating the special quality of the original sound.

For tracking and mixing, the 1As provide startlingly accurate results for hours on end without ear fatigue.

For information, contact the company in California at 800-966-8261; fax: 714-588-8173; or circle Reader Service 123.

## SENNHEISER

**Sennheiser IR Headphones All-Digital Performers**

**OLD LYME, Conn.** A new level of quality in infrared (IR) sound transmission systems is made possible with the IS 850, a digital IR headphone system by Sennheiser. The ISO 850 guarantees CD quality sound reproduction without wires.

The ISO 850 consists of a high-quality digital transmitter with digital and analog inputs, plus specially developed headphones incorporating a digital-to-analog converter.

Digital sources of all standard sampling frequencies are connected to the IR-transmitter via optical (TOS) or coaxial inputs. Analog signals are routed via

Since 1991, BE has introduced more new AM and FM transmitters, with more advanced ideas and useful technology, than any other company in the world. At the same time we were bringing prices down. No other company can touch Broadcast Electronics for value.

**BROADCAST ELECTRONICS IS THE ONLY MAJOR MANUFACTURER DEVOTED EXCLUSIVELY TO ENGINEERING BETTER RADIO. CALL 217-224-9600 NOW.**

**GET MORE THAN YOU PAY FOR.**

**MORE**

- Exciters that deliver CD-quality sound for under \$5400. Broadcast Electronics FX-50 exciter technology is unsurpassed.
- Transmitters with redundant PAs and power supplies that plug in from the front panel.
- AM transmitters with switching power supplies; they sound great at .1% or 100% output power.
- Transmitters with no plate blocking capacitors or sliding contacts to fail.
- Transmitters you can buy for under \$6000.
- All with 24-hour support.



**BE BROADCAST ELECTRONICS, INC.**

WORLD LEADER IN RADIO BROADCAST TECHNOLOGY

4100 N. 24th Street/P.O. Box 3606/Quincy, IL 62305-3606/(217)224-9600/Fax: (217)224-9607

**SEE MORE AT BOOTH 319, RADIO-AUDIO HALL, WME NEW ORLEANS, 1995**

©1995 BROADCAST ELECTRONICS, INC.



gold-plated input jacks to a high-resolution delta-sigma analog to 16- (18-) bit digital converter with 64-times oversampling. Anti-aliasing filters substantially reduce possible interference and distortion, and analog inputs are automatically sampled at 48 kHz.

At the headphone, the digital IR-data stream is picked up by multiple photodiodes and transferred to a BCC (bistream, continuous calibration) digital-to-analog converter with automatic sampling rate detection. Push-pull bridge amplifiers provide optimum matching of the CD-quality audio signals to the specially developed transducers.

For the acoustic system of the digital IR-headphone/receiver, a diaphragm "DuoFol" was developed that consists of two extremely thin foils. The two layers combine to prevent any partial membrane movements and diaphragm breakup, particularly at high frequencies.

Soft oval cushions enclose the outer ear and provide a natural sound perception. The headband can be adjusted and rests on soft cushions. The transducers are ergonomically slanted.

Attached to the underside of the headband are several compartments. Two of them hold a single AA battery to power the receiver. The others contain the receiver electronics with the D/A converter and amplifiers, plus the operator volume and balance controls.

A dome atop the center of the headband contains the IR-photodiodes facing in all four directions of the compass, so that the IR-signal can be picked up no matter which way the receiver is facing.

For information, contact Joe Ciaudelli in Connecticut at 203-434-9190; fax: 203-434-1759; or circle Reader Service 73.



**SONY**

**Sony MDR-7506 Emphasizes Transparent Sound**

**MONTVALE, N.J.** With the increasing fidelity of consumer audio systems and the looming digitalization of radio, audio production and post production are demanding more objective monitoring. That's why dynamic/closed professional headphones are enjoying such a rise in popularity.

Fitting snugly over the ear to close out noise and reflections, these headphones set the stage for direct-radiator input to the ear to minimize coloration. Sony Electronics has long backed this design philosophy. Sony's MDR series headphones have enjoyed steadily increased popularity among broadcast and recording professionals alike.

Sony's top professional headphone, the MDR-7506, has a rugged design proven to be reliable in the most demanding situations, such as field recording and concert monitor mixing. It features folding construction for compact storage, but the design goes much deeper. Each earpiece contains a 40 mm direct driver unit for clear high-quality sound reproduction beneath a closed housing with ample padding to protect the head and that enable the cup to fit snugly over the ear to help seal out external noise.

The MDR-7506 provides a broad and flat frequency response from 10 Hz to 20 kHz with a handling of up to 1 W dB SPL and 63 ohm impedance. It features both quarter- and eighth-inch gold connectors that easily screw into position on the OFC cord based on the application.

The great audio quest has been to deliver sound with an absolute minimum of



coloration. Now, in an era of digital transparency, the onus is on the professionals to monitor quality ever more closely. That quest starts with the right tools.

For information, contact the company in New Jersey at 800-635-SONY(7669), or circle Reader Service 205.

**AUDIO-TECHNICA**

**High SPL, Clarity from Audio Technica Headphones**

**STOW, Ohio** The audio-technica ATH-M40 and ATH-D40, two models of closed-back dynamic Precision Studiophones, recently became available to the pro audio and music industry markets.

The ATH-M40 is designed specifically for professional studio monitoring. The ATH-D40 provides a bass-enhanced frequency response that makes it ideal for low-frequency sound sources.

Superior components provide very high SPL capabilities while maintaining exceptional clarity of sound. Exterior design features include sturdy, strain-relief cable and comfortable circumaural earpieces that can permit one-ear monitoring.

Both models of Studiophones utilize 40-millimeter drivers with neodymium magnets and copper-clad aluminum wire voice coils for lowest mass. Each pair is equipped with an 11-foot cable terminated in a standard quarter-inch connector.

The ATH-M40 features a frequency response of 5 Hz to 28 kHz, a sensitivity of 100 dB and an impedance of 60 ohms. The ATH-D40 offers a frequency response of 20 Hz to 28 kHz, a sensitivity of 102 dB and an impedance of 66 ohms. Both models feature a maximum input power of 1,600 MW at 1 kHz.

For information, contact Peter T. Sabin in Ohio at 216-686-2600; fax: 216-688-3752; or circle Reader Service 17.

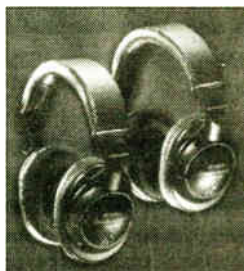

**GENELEC**

**Flat Response, Accuracy From Genelec's New Line of Active Studio Monitors**

**IISALMI, Finland** Genelec offers a full line of Active Studio Monitors, from small two-way systems to massive, full-range designs incorporating dual 15-inch woofers and 3.6 kW of amplification. All of these models are well-suited for broadcast use and include a unique variety of user controls and performance features.

First, Genelec provides a discrete, dedicated amplifier for each drive unit in every speaker it builds. The amplifiers are precisely designed for optimal performance to match the requirements of the specific drive unit to which it will be coupled.

Signal is fed to the amplifiers via active crossover networks, which operate at line level (before the amplifier). This approach provides a significant improvement in sonic performance over passive designs. It avoids the deleterious sonic effects that are caused to passive crossover components when heat produced by high current amplified signals pass through on their way to the drive unit. Further, since the crossovers are put at line level, the amplifiers can be direct-coupled to the drive unit, providing greater



damping and more accurate response.

Full system equalization is incorporated in all systems as well, allowing Genelec Active Monitors to provide flat frequency response at the listening position in real-world conditions. These monitors also feature Genelec's proprietary Directivity Control Waveguide for precise, stable stereo imaging, and full system protection from clipping.

For information, contact U.S. distributor QMI in Massachusetts at 508-435-3666; fax: 508-435-4243; or circle Reader Service 38.

**ROLAND**

**Roland AFP-700 Analyzes and Tames Feedback**

**LOS ANGELES** The Roland AFP-700 anti-feedback processor is designed to minimize feedback from speakers in all types of PA applications. From concert halls to conference rooms, the AFP-700 is an ideal product for removing unwanted feedback and increasing the overall system gain.

An Auto function gives the AFP-700 the ability to automatically find the feedback point at its source. The automatic narrow band filter adjusts the frequency at the feedback point, eliminating loss of quality of the original signal source. A Dynamic function included with the processor counters feedback that may occur when sudden movements near or around a microphone are encountered while in the Auto mode.

In addition to the auto anti-feedback function of the AFP-700, a parametric equalizer is included in the Manual mode. A built-in spectrum analyzer allows incoming sound to be analyzed in real time.

The AFP-700 can also function as a 91-band high-quality graphic equalizer when the unit is put into the GEQ mode.

For information, contact the company in California at 213-685-5141; fax: 213-722-0911; or circle Reader Service 74.



**JOIN THE HUNDREDS WHO HAVE USED DIGILINK TO ACHIEVE ECONOMIC RECOVERY**

- ☐ 10 hours of stereo digital audio storage for \$7,995\* complete
- ☐ Satellite, CD, Tape, and Hard Disk Automation
- ☐ Simultaneous Play, Record, & Network transfer
- ☐ Digital Editor with Waveform Editing for tight production
- ☐ Crossfade CD's, sources, and hard disk audio
- ☐ Music Scheduling system built in for basic CD automation
- ☐ Digital Networking for transfer of audio and schedules

Digilink is the #1 selling digital audio hard disk system in radio today. You can replace your cart machines for live On Air and have an automation system for walk away at the same time! Link over 15 workstations & scheduling computers on our digital network and transfer audio and schedules between your studios.

For more information, call or write  
ARRAKIS,

(303) 224-2248

the premier broadcast manufacturer of  
consoles, furniture, Digilink and Trak\*Star digital audio products.

Consoles  
Modulux  
Trak\*Star  
Digilink  
Modulink

**ARRAKIS**

\* Suggested retail price. Complete system

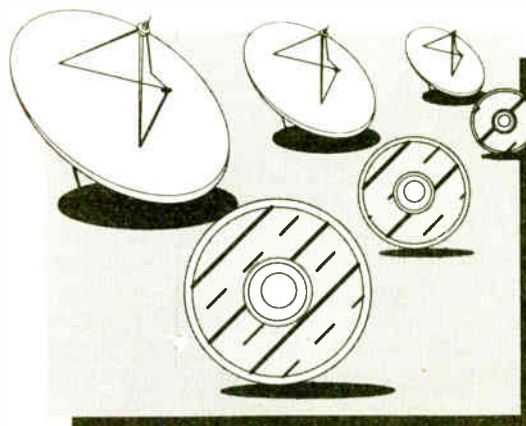

© 1993 Arrakis Systems inc. 2619 Midpoint Drive, Fort Collins, CO. 80525

Circle (113) On Reader Service Card



# Products & Services Showcase

For more information on the products shown below, circle the appropriate Reader Service No.(s) on the enclosed Subscription/Reader Service card or contact the advertiser directly.



**Pristine SYSTEMS INCORPORATED** DIGITAL ON-AIR SOLUTIONS

- Feature Rich Live Assist and Walk Away
- On-Line Redundancy... No Black Box
- The Best Integrated Play List Scheduler (Music & Breaks) & On-Air Playback
- Dolby AC2 Overlapping Hard Disk Audio
- Music on Hard Disk and/or CD Jukeboxes
- Provide Computers/Players & Save \$\$\$ or Buy/Lease From Us

**SEE US IN NEW ORLEANS AT BOOTH 849**

WEST/INT'L <b>310/670-7500</b> FAX 310/670-0133	EAST <b>803/370-2400</b> FAX 803/370-2314
---	---

READER SERVICE NO. 158



## Why gamble on a lower-priced rebuilt?

Have your Eimac tube **REMANUFACTURED** by the trusted original manufacturer.

- Original Specifications
- Original Warranty
- 30 Day Turnaround

Call us: **VARIAN - EIMAC**  
301 Industrial Way.  
San Carlos, CA 94070  
(800) 414-8823 or  
fax (415) 592-9988



**varian**®  
power grid tube products

READER SERVICE NO. 62



MADE IN U.S.A.

## HOW CAN I FIND TIME TO DRIVE TO THE TRANSMITTER???

Why drive when you can call? Using Monroe's 6000 Series Remote Controls and your telephone, two-way radio, microwave link or other audio path you can have complete control over a remote. For over 15 years, Monroe Electronics has supplied the broadcast industry with reliable and affordable DTMF remote control systems.

Let us help reduce your driving time, call Monroe Electronics today at (800) 821-6001.

Distributor and Representative inquiries invited.

**ME MONROE ELECTRONICS** 800 821 6001  
LYNDONVILLE, NY 14098 716 765 2254  
FAX 716 765 9330

READER SERVICE NO. 169

# Unique!

Shively FM Antennas offer standard features often unique in the industry: Our unique fine-matching transformer, included as standard equipment on Shively commercial antennas, can correct VSWR mismatches of up to 1.5:1 to compensate for tower effects. Unlike most others, it is tunable both under power and pressure, so it requires no disassembly of the system, and no adjusting of taped slugs for tuning. This means a better match, with less rigging time and costs. Watch future issues of **Radio World** for other unique Shively features.

## Shively Labs

A Division of Howell Laboratories, Inc.  
19 Harrison Road, Bridgton, ME 04009  
207-647-3327 FAX 207-647-8273

READER SERVICE NO. 181

## Freeland Products, Inc.

Power Tube Rebuilders Since 1940

**AVERAGE SAVINGS OF 50% OFF NEW TUBE COSTS**

RADIO • TV • INDUSTRIAL APPLICATION  
UHF • KLYSTRONS



CALL OR WRITE FOR YOUR FREE PRODUCT INFORMATION PACKET

75412 HIGHWAY 25  
COVINGTON, LOUISIANA 70435  
(504) 893-1243 • FAX (504) 892-7323  
1 (800) 624-7626

READER SERVICE NO. 19

## STAY ON THE AIR ...AND MORE!



Service & Affordable Quality for Over 23 Years

## AUTOGRAM CORPORATION

1500 Capital Avenue (214) 424-8585  
Plano Texas 75074-8118 1-800-327-6901  
FAX (214) 423-6334

READER SERVICE NO. 82

## Call For Rigid Line MYAT & Components

Facing a "right now" emergency? Planning a new installation? Upgrading your facility? Whatever the need, MYAT is the solution. MYAT products are quality-built for maximum performance and long life. And we take delivery commitments seriously.

Call your favorite RF distributor or MYAT direct at 201-767-5380, or fax 201-767-4147 for our complete catalog and reference guide.



380 Chestnut St.  
P.O. Box 425  
Norwood, NJ  
07648

READER SERVICE NO. 192

## B-SERIES FM BROADCAST POWER AMPLIFIERS



Reliability through design is the key to the B-series power amplifiers



## Silicon Valley POWER AMPLIFIERS

The RF People

Silicon Valley Power Amplifiers, a quality supplier of OEM modules is now producing a range of compact power amplifiers. All units are complete with rack slide ready to install in a 19" rack system.

Power outputs 150W, 300W, 600W, & 1250W

For prices and delivery CALL 1-800-986-9700

READER SERVICE NO. 204



# MARKETPLACE

## Recently Introduced Products for the Radio Broadcast Professional

### 5-Lobe Clamping Knobs

Rogan Corp. offers a new series of soft-to-the-touch Pure Touch 5-Lobe clamping knobs. Ideal for a broad range of applications, the 5-lobe styling of the knobs makes them ideal for a broad range of clamping applications such as industrial machinery and office furniture.

Rogan Pure Touch Knobs are molded of a soft thermoplastic outer surface and a tough plastic body. The knobs can be

ordered in three sizes and a variety of colors. They are supplied with threaded brass inserts and plated steel studs in standard or custom sizes and configurations, including metric.

To obtain a free Rogan catalog and/or product sample contact the company at 800-423-1543; or circle Reader Service 6.

### MX-5000 Amplifiers

MCL Inc. unveiled the MX-5000 amplifiers as part of its new Maxxim series. The MX-5000 is a compact single drawer TWT amplifier that offers performance typically associated with much larger amplifiers. The 10.25 drawer incorporates a resonant mode switching power supply, which minimizes space requirements and provides higher efficiencies and superior performance.

The MX-5000 design is available in several models including 400 W and 700 W C-band, 600 W and 700 W Ku-Band and 400 W Ku-DBS configurations. Ease of operation is maximized through the use of a backlit LCD and pushbutton controls, while an internal microcon-



troller monitors and controls all aspects of the amplifiers performance.

For information, contact Ron Adamson at 708-759-9500; or circle Reader Service 141.

### Faster DSP from Motorola

Motorola's digital signal processor division is making available a faster version of its 24-bit DSP56004 digital signal processor (DSP). Previously available at 50 MHz, the division's Symphony DSP56004 is now available at 66 MHz and is optimized to provide home theater and ambient effects for consumer audio applications. The 66 MHz DSP56004 delivers 33 million instructions per second and a 15 nanosecond instruction cycle.

With support for standard interfaces, the

DSP56004 provides customers with a single-chip audio effects engine. The chip features a low-cost serial host interface for communication with microcontrollers, an external memory interface for glueless connection to SRAMs and DRAMs for data storage and a serial audio interface, simplifying the interface with analog-to-digital and digital-to-analog converters.

For information, contact Motorola at 512-891-2030; or circle Reader Service 218.

### PYRAMID! Acoustical Panels

Minneapolis-based Netwell Noise Control released all-new acoustical foam panels, PYRAMID!

This 2-foot by 2-foot acoustical panel absorbs up to 95 percent of the reverberation in any studio, rehearsal or broadcast setting. Available in several colors and thicknesses, this open cell polyurethane foam material is designed to treat

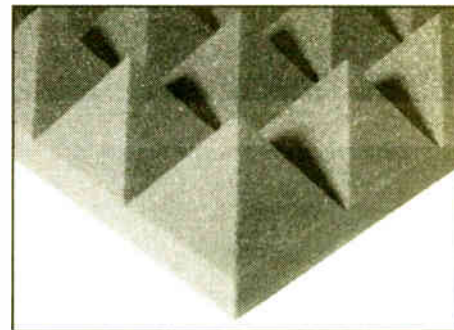

unwanted sound and enhance room acoustics in a variety of settings.

The company offers free catalogs and free samples are available.

For information contact Netwell Noise Control at 800-638-9355; or circle Reader Service 149.

### Cable Testing Kit

RF Industries introduced the RFA-4017 coaxial cable testing kit. This convenient, low-cost assemble testing kit allows bench and field technicians to test cables quickly and easily with the most popular ends. The kit includes adapters that cover the following connector types: SMA, N, UHF, TNC and mini-UHF.

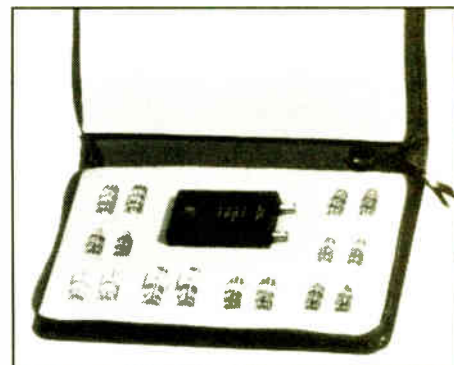

Powered by a 9 V battery, the cable tester is lightweight, small and completely portable. The LED front panel on the front of the tester indicates pass or fail. If the result is fail, the panel saves you valuable diagnostic time by indicating whether failure is due to a short, open conductor or open shield. Installed cable can be easily tested by using two testers.

For information contact RF Industries Les Perlman at 800-233-1728; or circle Reader Service 125.

## TECHNOLOGY UPDATES

### CROWN

#### Crown D-45, D-75A Amplifiers Have New Look, Clean Sound and Short-Circuit Protection

**ELKHART, Ind.** Crown recently introduced a new, improved version of its D-75 power amplifier, called the D-75A, and at the same time debuted a lower power version, the D-45. The difference between the D-75A and its predecessor is immediately obvious—the front panel has been attractively restyled. This look was also utilized with the D-45, and both models are housed in a compact one-rack-unit, rack-mountable package.

Another new feature is detented front panel controls that provide precise repeatability. Barrier block outputs have been added for solid, failsafe connection. North American 120 VAC, 60 Hz units have a standard three-wire grounded AC plug, and international units can be ordered in a variety of power options.

The front panel includes four indicators (two for each channel). Each channel has a signal indicator as well as Crown's exclusive IOC (Input/Output Comparator), which work like sensitive distortion meters. Each channel has a red LED that flashes when distortion of any kind exceeds 0.05 percent.

Solid-state circuitry is enhanced by another Crown exclusive, patented AB + B circuitry, which assures efficient operation and protects against shorted, open, mismatched or low-impedance loads. This multimode topology also virtually eliminates the possibility of any switching distortion.

Power output of the D-75A has been increased to 40 W per channel at 8 ohms; 110 W at 8 ohms, bridged. The D-45 delivers 25 W at 8 ohms; 70 W at 8 ohms, bridged. Both are rated for 16, 8 and 4 ohm use and are impervious to even the most reactive load.

The D-75A and D-45 are covered by Crown's 3-year No-Fault Warranty, and for a small fee, the warranty can be extended another 3 years. This extensive guarantee covers failure for any reason.

For further information, contact Crown International in Indiana at 219-294-8000; fax: 219-294-8329; or circle Reader Service 121.

### SPEAKERKITS

#### Speakerkits Inc. Offers Monitors You Can Design

**FLORAL PARK, N.Y.** Speakerkits Inc., has been manufacturing speaker systems for 18 years. Its offers 24 models of speaker systems in all shapes and sizes, and can design and/or manufacture a system for any need.

Speakerkits offers The Soundcubes which are 5x5x5-inch enclosures with a 4-inch coaxial speaker. These are used in a stereo pair with a subwoofer featuring two 6-1/2-inch woofers in a bandpass type enclosure, reproducing frequencies below 125 Hz (cabinet measures 16Hx7.5Wx15D). A system like this is designed for smaller rooms or lower listening levels than its larger relatives. This sub can also be used with the large model 4.2, (8Hx5Wx4.5D), which features a separate 4-inch woofer and half-inch polymer tweeter for greater accuracy and detail.

A step up in sound pressure level, deep bass response and overall sound quality is the model 6200 subwoofer (slightly larger cabinet 9Hx17Wx13D) with the model 5.2 satellites. The sub features two 6-1/2-inch woofers in a ported enclosure and the satellites (11Hx7Wx5.5D) have a 5-1/4-inch

polypropylene woofer and half-inch dome tweeter. The model 5.2 can also be used without the sub although there is a sacrifice of frequencies below 65 Hz.

The larger model 6.2 CD (15Hx9Wx7D) is the most common

studio monitor size. Down sizing is a compromise but it is with approximately this size bass driver and enclosure that the system can compete on its own with floor standing speakers. This system features a 6-1/2-inch polypropylene woofer and one inch polymer dome tweeter in a ported enclosure. This can also be used with under 100 Hz.

Even in DJ and PA applications downsizing may be desirable. Speakerkits has introduced model 1505 which is actually no smaller than its earlier relative but has been split in two. The base bottom consists of a 15-inch driver with a 3-inch voice coil and 108-ounce magnet in a ported enclosure covered in gray carpet. The top cabinet holds an eight inch mid-range and dual element piezo horn. This can sit on top of the bass bottom or be raised on a 36-inch pole (there is a socket in each cabinet). This allows for midrange and high frequencies to project over a crowd without the need for separate stands. It is also easier to maneuver four smaller, lighter cabinets than two heavy, bulky units.

For information contact Speakerkits at 516-354-7006; or circle Reader Service 116.

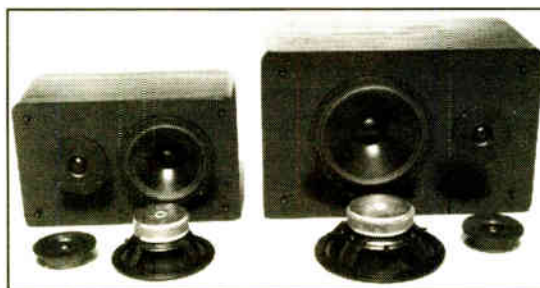



# MARKETPLACE

Recently Introduced Products for the Radio Broadcast Professional

## Automatic CW Station Identifier

RACOM introduced the Automatic CW Station Identifier Model 700B. It provides automatic identification of repeaters and base stations in Morse Code. Call letters (up to 50 characters) and all operating parameters may be programmed with a PC. Features include pulsed tone or pulsed carrier output, three-timers, two-system monitors, test switch and status LED.



The unit lists for \$74 and is made in the United States.

For information contact Charles Legree at Racom at 800-722-6664; or circle Reader Service 80.

## Digital Audio Cables

Gotham Switzerland launched a new range of multipair AES/EBU 110-ohm digital audio cables. Four different multipair types are available; GAC-4, 8, 10 and 12. The basis for the cables is the GAC-2/1 AES/EBU cable that guarantees a constant impedance of 110 ohms over the entire run of cable.

Screening comprises Gotham's exclusive double Reussen shield, featuring two opposing, spiral-wound, bare copper shields, helping the cable achieve good flexibility with tight electrical performance tolerances. Constant impedance is achieved by means of two nonconducting strands in the core, which maintain the correct geometrical position of the two conductors even when the cable is bent or twisted.

For information contact DGS Pro Audio at 800-292-2834; or circle Reader Service 91.

## Low-Cost Vertical Racks

Winsted Corporation launched a new series of economy vertical racks designed for use as either starter units or add-ons. The new racks are available in both 35-inch and 70-inch sizes and are finished in black textured baked-on enamel and shipped flat to reduce freight cost.

Modular, "knocked down" concept also allows assembly in side-by-side configuration which requires fewer side panels. All models are built to strict 19-inch EIA specifications and constructed of heavy gauge steel to provide maximum support for heavy electronics. Panels include side vents for air flow and large access opening for cables is provided in the pedestal.

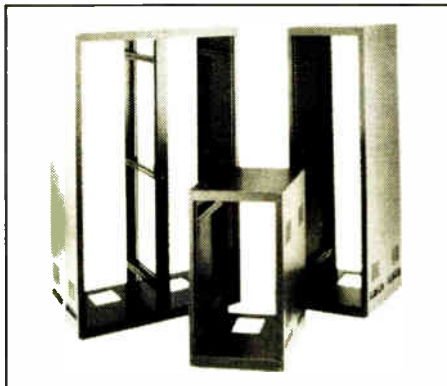

For information contact Randy Smith or Kent Lilja at Winsted at 612-944-9050; or circle Reader Service 99.

## Product Line Expands

HBB added the DDS90M 4mm DAT data cartridge to its Advanced Media Products line. Developed to deliver increased reliability and security in a variety of bulk data backup applications, the DDS90M incorporates many of the HBB's proven design innovations.

The recording surface of the tape is made with high-density, evenly distributed, non-corroding metal particles which results in an exceptionally smooth surface. Immediately beneath the recording surface, the density of the particles is reduced, allowing for an increased con-

centration of binding polymers. These two processes, combined with a system that precisely controls the migration rate of a special lubricant, result in high output, low block error rates and reduced head wear.

For information contact Frasier Jones at 207-773-2424; or circle Reader Service 213.

## New DAT Recorder

Sony Electronics unveiled new DAT recorder that incorporates high-end features such as Sony's Super Bit Mapping (SBM) process in the A-D circuitry and a four-motor direct-drive transport.

The DTC-A8 DAT incorporates high-resolution digital conversion with switchable SBM processing. SBM processing more effectively preserves the quality of the 20-bit resolution signal during conversion to 16-bit storage. SBM had previously only been applied to rock, country and classical masters to improve the quality of CD releases.

For information contact Beverly Randolph Meaux at 201-930-6981; e-mail: meauxb@cmail.nhq.sony.com; or circle Reader Service 143.

## Three-Channel Imaging System

Miles Technology introduced the MTI-3 TriSonic Imager, a highly effective device that takes two-channel sound and enhances it through the use of three loudspeakers or loudspeaker clusters. Incorporating Miles Technology's patent-pending electro-acoustic imaging process, the MTI-3 takes center-panned sound sources in the mix, such as lead vocals or kick drum, and reproduces them in the center channel. Conversely, side-panned sounds radiate unmasked from the side loudspeakers.



The unit also features two surround outputs providing high-fidelity ambience extraction. These outputs can also easily be converted mono sends for added flexibility in professional installations.

For information, contact Keith Clark at 616-683-4400; or circle Reader Service 178.

## Universal VOX Switch

A new unique voice operated (VOX) switch model PTT-02 was unveiled by the communications division of Azden Corp., a manufacturer, distributor and dealer of Azden brand amateur and commercial radios and cassettes.

The PTT-02 can give any radio the advantages of remote manual or voice-triggered transmission. Variable microphone gain, adjustable frequency equalization and VOX gain are included. It is usable with all types of microphones including dynamic and electret. A removable belt clip, Velcro tape and a soft desk pad permit universal mounting.

An Off-PTT-VOX switch permits either normal push-to-talk or VOX operation. An adjustable (from 0) to +8 dB) 2 kHz



gain control coupled with an overall gain control (0 to +10 dB) provides matching of most microphones to most radios as well as shaping the frequency response for improved DX operation.

For information contact Sid Wolin at 516-328-7500; or circle Reader Service 182.

## Universal Crimp Tool

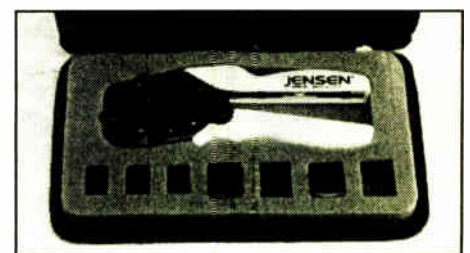

Jensen Tools is offering its Universal Crimp Tool in kit form. The tool designed to make any crimp connection with a single tool frame and interchangeable dies, comes in a compact zipper-style nylon case with protective die-cut foam interior designed to hold the tool frame and up to seven dies.

Jensen Crimp Kits come with two dies included and are available in two models. A telco kit (model 23B231) contains dies for RJ11 (4-6 position) and RJ-45 (8 position) cable. The coax kit (model 23B233) contains dies for RG-58/59/62, PVC and plenum. Buyers may select from a complete assortment of other dies, including fiber optic, to complete a kit.

For information contact Jensen at 800-426-1194; or circle Reader Service 202.

## Power Station Mixer

Spirit unveiled the Power Station, a rack-mountable, 10-channel powered mixer with features and a performance previously unavailable in an integrated mixer product.

The mixer section features eight mic/line balanced inputs and two stereo inputs with two stereo outs. A two-track return and send is also available for recording applications. A switchable pre/post aux bus with FX direct internal Lexicon assign is incorporated on each of the Power Station's 10 inputs. The channel equalization features a highpass filter (18 dB/octave at 100 Hz) plus high- and low-fixed and sweepable mid-band. A dual seven-band graphic equalizer on the output also provides patching to aux for monitor EQ.

The unit's power amplifier is capable of delivering 300 W per channel with a THD specification of less than 0.01 percent.

For information contact 616-695-5948; or circle Reader Service 217.

## SUBSCRIPTION/READER SERVICE FORM

# RadioWorld

### FREE Subscription/Renewal Card

I would like to receive or continue receiving Radio World

FREE each month.  Yes  No

Signature \_\_\_\_\_ Date \_\_\_\_\_

Please print and include all information:

Name \_\_\_\_\_ Title \_\_\_\_\_

Company/Station \_\_\_\_\_

Address \_\_\_\_\_

City \_\_\_\_\_ State \_\_\_\_\_ ZIP \_\_\_\_\_

Business Telephone ( ) \_\_\_\_\_

Please check only one entry for each category:

#### I. Type of Firm

- |   |  |
|---|--|
| <input type="checkbox"/> D. Combination AM/FM station | <input type="checkbox"/> F. Recording Studio             |
| <input type="checkbox"/> A. Commercial AM station     | <input type="checkbox"/> K. Radio Station Services       |
| <input type="checkbox"/> B. Commercial FM station     | <input type="checkbox"/> G. TV station/teleprod facility |
| <input type="checkbox"/> C. Educational FM station    | <input type="checkbox"/> H. Consultant/ind engineer      |
| <input type="checkbox"/> E. Network/group owner       | <input type="checkbox"/> I. Mfg, distributor or dealer   |
| <input type="checkbox"/> J. Other _____               |  |

#### II. Job Function

- |  |   |
|--|---|
| <input type="checkbox"/> A. Ownership              | <input type="checkbox"/> G. Sales                 |
| <input type="checkbox"/> B. General management     | <input type="checkbox"/> E. News operations       |
| <input type="checkbox"/> C. Engineering            | <input type="checkbox"/> F. Other (specify) _____ |
| <input type="checkbox"/> D. Programming/production |   |

### Reader Service

Sept. 6, 1995 Use until Dec. 6, 1995

Please first fill out contact information at left. Then check each advertisement for corresponding number and circle below.

#### Purchasing Authority

1. Recommend 2. Specify 3. Approve

001	023	045	067	089	111	133	155	177	199
002	024	046	068	090	112	134	156	178	200
003	025	047	069	091	113	135	157	179	201
004	026	048	070	092	114	136	158	180	202
005	027	049	071	093	115	137	159	181	203
006	028	050	072	094	116	138	160	182	204
007	029	051	073	095	117	139	161	183	205
008	030	052	074	096	118	140	162	184	206
009	031	053	075	097	119	141	163	185	207
010	032	054	076	098	120	142	164	186	208
011	033	055	077	099	121	143	165	187	209
012	034	056	078	100	122	144	166	188	210
013	035	057	079	101	123	145	167	189	211
014	036	058	080	102	124	146	168	190	212
015	037	059	081	103	125	147	169	191	213
016	038	060	082	104	126	148	170	192	214
017	039	061	083	105	127	149	171	193	215
018	040	062	084	106	128	150	172	194	216
019	041	063	085	107	129	151	173	195	217
020	042	064	086	108	130	152	174	196	218
021	043	065	087	109	131	153	175	197	219
022	044	066	088	110	132	154	176	198	220

Copy & Mail to: Radio World, PO Box 1214, Falls Church, VA 22041, or FAX to: 703-998-2966



# RDS ~~OR~~ AND SCA?

STATE OF THE ART SUBCARRIER PRODUCTS FROM THE WORLDWIDE LEADER IN SUBCARRIER TECHNOLOGY.

## RDS-1 Generator

The RDS-1 is a PC expansion card supplied with software to turn any PC ('286 or better) into a powerful cost effective RDS encoder/subcarrier generator. Store up to 255 radiotext messages of unlimited length, and run full RDS automation locally or by remote control. Buy the PC card and software, or buy the broadcast quality rack mounted PC system preloaded with your messages to go on the air. The RDS-1 is the only fully software definable RDS generator available.

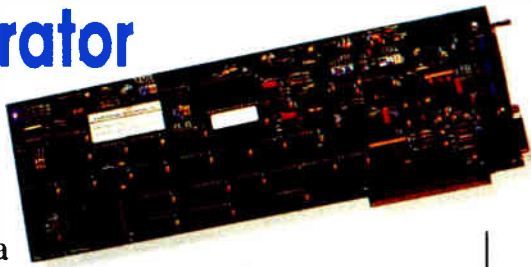

## SCA-186 SIDEKICK® SCA Audio Generator

The worldwide standard for professional and reliable performance. Quartz controlled stability. Built-in modulation monitor. Integrated audio processor provides best possible audio quality. Built-in noise generator and incidental noise meter for optimum transmitter adjustment and lowest possible cross-talk. Composite loop-through to simplify installation.



## RDS-MA & PRD-3000 Monitor-Analyzer Test System



The RDS-MA is a complete RDS receiver, monitor and analyzer test system (with or without the PC) enabling you to test your RDS system performance off the air, off your transmitter or in the studio; and to check out your competition!

Or choose the PRD-3000 Monitor/ Analyzer unit only, supplied with the software to turn your laptop PC into an RDS subcarrier test facility (using the serial port). The only fully software definable RDS test equipment available.

## RDS-X Professional Data Receivers

The only professional user configurable RDS data receiver available. Unlimited addressability, full auto tuning, with antenna diversity for reliable mobile operation. Use it for EAS, GPS, signs, billboards. You name it, we can control it. RS-232 and five switched control outputs. Fully boxed and powered. Assembled and tested PC board available in OEM quantities.



## DSCA-188 DATA SIDEKICK® SCA Data Generator

Highest data rate throughput with async or sync operation. Quartz controlled subcarrier synthesizer. Built-in error test generator. Controlled baseband spectrum for minimum bandwidth. Built-in peak deviation meter. Standard RS-232/422 data input. The workhorse of the radio industry for stock quotation and radio data transmission.

## SCA Receivers

Data and audio SCA receivers quoted in many configurations; fully packaged and as OEM assembled circuit boards. Customization to suit specific needs available.

## Regain Modulation Lost To SCA

Get Eric Small's technical paper describing how to prevent power loss in your main program when running SCA or RDS. The secret is out.

**Call or fax for our RDS/SCA Info Package. In the US, call toll free (800) 826-2603**



**MODULATION SCIENCES INC.**

12A WORLD'S FAIR DRIVE SOMERSET NJ 08873  
TEL (908) 302-3090 FAX (908) 302-0206

Circle (70) On Reader Service Card

World Radio History



# Planning Ahead Can Save the Day

by Barry Mishkind

**TUCSON, Ariz.** Good planning and preventive maintenance can protect you and your station from parts failures, unpredictable outages and many other such problems. And always, there are all sorts of little surprises dropped upon us by management that can be filled with trap doors.

For example, with all the recent activity in creating duopolies and LMAs, many stations find themselves relocating or consolidating studios. If it is to the transmitter site, the licensee is usually in total control. However, when leasing space,

control becomes highly relative. While there are many issues involved, here are a few that need to be considered when moving to a new studio site:

## Clear sight

Is there clear line of site for the STL path? This includes not only existing buildings, but if you are moving to a new industrial park, what about future buildings? A guarantee in the lease of continued access to the signal path would protect you from a three-story building going up 50 feet from your STL dish.

What about the adjacent tenants? A good lease will give you some control

over the construction of the walls, for proper sound control.

A good lease will also provide for notice to you of any prospective tenants who could affect your operation.

Here is an actual experience: one radio studio that was the first tenant of a building suddenly developed strange hums and buzzes in the audio. It turned out that a new company had moved into the building and put in several huge walk-in freezers. The result was both an audible low frequency sound generated by the compressors as well as spikes on the power line causing occasional "pops."

In this case, the only thing the station

could do was move the studio as far away as possible in the building, and deal with what artifacts were left via filters, etc. A clause in the lease would have saved a lot of hassle.

## Phone capacity

Is there enough phone capacity and reliability? Some of the newer sections don't yet have enough lines installed, and worse ... construction crews seem to be attracted to those 900-pair cables like tornados are attracted to mobile home parks. If you feed or control your transmitter via phone line, a cut cable could put you off the air for hours.

What about power service reliability? Similarly, whether a newer or older area, check out the power grid and ask some of the local businesses what happens during a storm.

Modern studios use much less power than in previous years, but with so much micro-processor controlled equipment, a stable, reliable power feed is highly desirable. Additionally, not only is loss of power inconvenient and of concern, but how bad are the spikes when the power drops and returns? Whether or not you are at the end of a feed, you might decide to add some power line filters and surge suppressors to ensure a clean micro-processor power feed.

Of course, a backup generator can be very helpful, but remember, it has to be placed somewhere where it will not interfere with on-air operations. Also, you will be off the air until you get it up and running. And how often do you want to do that, anyway?

Another item worth considering is a UPS (uninterruptible power supply) capable of carrying the control room until the generator is able to take over. This prevents consoles and CD players from resetting, for example.

What about parking? Few office buildings, etc. are designed with sufficient parking for businesses like radio stations, where a sales staff as well as the various air staffers come and go all the time. Furthermore, if you do find space for employees, what about visitors and listeners coming in to pick up prizes? Will they have to hike in from the next town?

Planning a few extra spaces will prevent such hassles, especially around the back door.

## Format tastes

Are you protected from the effects of your loud control room speakers? No, I do not mean OSHA problems. I mean the folk next door who decide they do not like your format. Many stations have become locked into a sort of "sound war" with their neighbors due to no protection being placed in the lease.

Clearly, this is just a starter list of what to check on before committing to a new lease. You will likely think of others of importance to your station, such as time of mail and UPS delivery or matters pertaining to special laws in one town or another which might affect your operation. The point is to try to anticipate as much as possible. The general manager might be upset at the additional costs involved in being prepared, but he will thank you later when everything is running smoothly.

□□□

Barry Mishkind can be reached at 520-296-3797, or [barry@AzStarNet.com](mailto:barry@AzStarNet.com) via the Internet. His home page is at <http://www.AzStarNet.com/~barry/>.

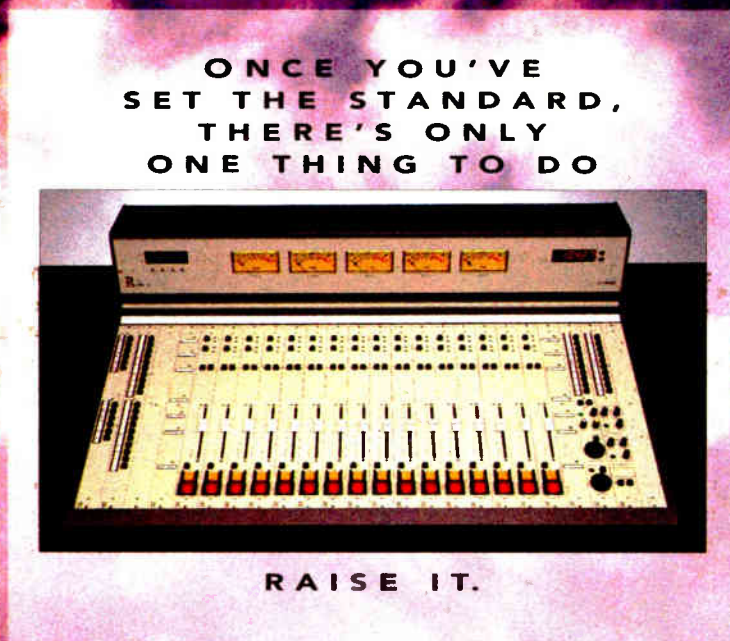

ONCE YOU'VE  
SET THE STANDARD,  
THERE'S ONLY  
ONE THING TO DO

RAISE IT.

Ward-Beck **RENAISSANCE** Series consoles once again set the standard for today's desktop radio environment. • They offer easy integration with automation systems; modular units to make expansion and service easier; 4 telco send outlets; 8 to 24 input channels; live, live assist and walk-away operating modes, and more. • Once you've seen the quality of Ward-Beck, you'll understand why Renaissance is the first choice of discerning radio engineers the world over. • Call toll-free 1-800-771-2556 or write, Ward-Beck Systems Ltd., 841 Progress Avenue, Scarborough, Ontario, Canada M1H 2X4. In Toronto call (416) 438-6550 or fax us at (416) 438-3865.

W A R D — B E C K S Y S T E M S L T D .





# CASH REBATES

up to \$500  
at NAB Show

Bring this page to Fidelipac's Booth #119 for rebates on new purchases of MX Series Consoles, Broadcast Audio Consoles, DCR1000 Series digital cartridge recorders or CTR10 Series analog cartridge machine equipment.

If you did not attend the show, FAX a copy of the \$500 bill to Fidelipac for more information.



**DYNAMAX**<sup>®</sup>  
BROADCAST PRODUCTS BY FIDELIPAC<sup>®</sup>

Fidelipac Corporation □ P.O. Box 808 □ Moorestown, NJ 08057 U.S.A. □ TEL 609-235-3900 □ FAX 609-235-7779

Circle (103) On Reader Service Card  
World Radio History



# Broadcast Equipment Exchange

"Broadcast Equipment Exchange" accepts no responsibility for the condition of the equipment listed or for the specifics of transactions made between buyers and sellers.

## BROADCAST ENGINEERING CONSULTING SOFTWARE

Professional software packages for preparing FCC applications and plotting coverage. For Windows and DOS.

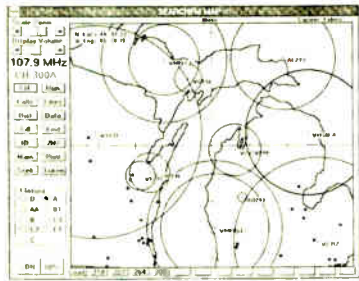

- Prepare concise FCC coverage maps and allocation studies from USGS digital line graph databases
- Search for AM, FM and TV channels with our professional graphics oriented programs and FCC databases
- Determine population with US Census databases
- Plot S.T.L. paths using NGDC terrain databases
- Tower and airport databases & more!

**V** CALL 1-800-743-DOUG  
DOUG VERNIER  
Telecommunication  
Consultants

**PROFESSIONAL SOFTWARE**

## RADIO RESOURCES

Over the last 2 years we have purchased \$1 million of quality pre-owned equipment from broadcasters. Fax or call us with a list of your excess equipment and we will let you know how we can increase your cash flow.

Looking to save dollars by purchasing a piece of quality pre-owned equipment? We have a variety of items available from transmitters to receivers. A particular piece of equipment can be obtained via fax by calling our toll free 1-800-54-RADIO. We also have a variety of other broadcast equipment.

Most popular equipment are coming in! Call today to reserve your copy of the Electronic Spectrum Analyzer. We also have Potomac held transmitters, AM & FM, and a Delta broadcast bridge plus receiver products for sale.

For complete prices on new equipment, please give us a call for a price quote.

Call Steve or Chuck  
**1-800-54 RADIO**  
1-800-891-2963 (FAX)

Circle (12) On Reader Service Card

## AMPLIFIERS

### Want To Sell

Newcomb HLP-14 tube amp w/phono variable EQ. \$25+UPS. E Davison. 217-793-0400.

RTS-405 stereo TT preamp. 6 mos use. \$140+shpg. B Lord. 206-932-4839.

### Want To Buy

Tube Hi-Fi, speakers, tubes, Altec, Marantz, McIntosh, Western Electric, coax/triax and corner speakers, tubes-VT-4C, 845's, etc. 405-737-3312 FAX: 405-737-3355.

## 3" HELIAX STANDARD COAXIAL CABLE

50-ohm, unused, cut to length. Priced below market. Shipped instantly. Call Basic Wire & Cable (NANCY) 800-227-4292 FAX: 312-539-3500

Jampro 3-bay antenna, 100.9 MHz w/radomes. \$1800. R Mason, 703-962-1133.

Andrews HJ7-50A 1 5/8" Helix coaxial, 100', new, on shpg reel w/connectors & hanging accessories, \$1300. S Hill, 503-857-1063.

### Want To Buy

High pwr FM antenna on or near 107.1 FM, prefer 8, 10 or 12 bay. B Michaels, 409-244-4170.

1 kW class mod reactor choke. Bill, 914-356-6553.

200' Helix xmsn line, 1 5/8" or 3". J Powley, 910-342-1843.

6-bay medium pwr CP on or tunable to 100.1 MHz. D Michaels, 916-926-1332.

6-bay on or near 92.1. J Hansen, 612-632-2992.

## AUDIO PRODUCTION

### Want To Sell

Rcdg/prod studio setup, board monitors, dist amp, FX, carts, R-Rs, TT, mic, etc. bulk eraser, 200-300 music length carts, open reels, cassettes, BO. M Mattson, 414-783-5551.

Roland SRV 2000, \$490; dbx 503 expander/comp. \$350; Orban 414-A stereo compressor. \$425/BO; UA 565-filter, BO; Orban 245-E stereo synth, BO; Ross 15 band stereo EQ, BO; Urei 546 stereo parametric EQ, BO. T Coffman, 619-571-5031.

Urei 530 stereo EQ, BO. Orban 111B reverb, BO. Urei 533 mono EQ, BO. K Stokes, 504-383-5271 x229

Pro Announcer 500 mic processor as new w/manual. \$600. G Barnett, 619-328-1104.

Tascam ES-50 & 51 combo sync. 2 slaves. \$2500. D Michaels, 916-926-1332

ADC 1/4" patchbays and cords. NEW. UNDER HALF PRICE ADC TT patchbays. \$129 up NEW cords. \$9.95 W Gunn, POB 2902. Palm Springs CA 92263. 619-320-0728

Bulk eraser, \$49; Stewart 4 ch D-box, \$95; Cue command decoder, \$125; NEW Tascam midiizer MTS1000, \$450; Infonics 7" reel copier 1-3 copies, 2 @ \$125 ea; Furman elec crossovers, \$95; Peavey M2600 pwr amp, \$375; Crest FA800 PWR AMP, \$475. W Gunn, POB 2902, Palm Springs CA 92263. 619-320-0728.

## ADC PATCH CORDS NEW T.T. sale-\$6.95 NEW 1/4" sale-\$8.95

patchbays and used equipment too! audio village 619/320-0728

Good used studio tape 1/2" \$15, 1" \$30, 2" \$55. W Gunn, POB 2902. Palm Springs CA 92263. 619-320-0728.

### Want To Buy

MXR-Neve-API EQs, mic-pres, delays, etc. T Coffman, 619-571-5031

Ampex tube mixers, plug-in mic pre-amp modules for PR10's, Altec or other tube compressors, Mackie mixers. W Gunn, POB 2902 Palm Springs CA 92263. 619-320-0728

## AUTOMATION EQUIPMENT

### Want To Sell

Gorman Redlick EBS decoder. \$225/Best Offer. Steve. 402-438-4989.

Sentry Systems Format Sentry FS12C automation, including PC & 2 IGM 48-tray Instacarts, original including 3 ITC 750 reels, Best Offer. Schafer automation system with 2 multi-tray cart machines, Best Offer: ITC 750 PB reels (3), Best Offer. K Stokes, 504-383-5271 x229

SMC Carousels (4), mono, Best Offer GM, KWED-AM, 210-379-2234.

SMC Carousels (2) various mem cards, expansion card, audio & sensor cards, terminal, etc. BO: Extel printer for automation system, BO. C Tracy, WKNE, 603-352-9230.

### Want To Buy

Audio Prophet computer system with Sat box & ribbon cables. 3 needed. Don. WSHN, 616-924-4700

## CART MACHINES

### Want To Sell

Dynamax ESD10 cart eraser/splice finder, new, \$600; Harris Criterion 90-2 R/P cart deck, stereo, \$500; Harris Criterion 90-2 R/P cart deck, mono, \$400; Harris Criterion 90-1 ply cart decks (2), mono, \$200/ea; Harris Criterion 80 ply cart deck, mono, \$150; Audicord Series 100 "S" ply cart decks (2), mono, \$200/ea; Audicord Series 100 "S" double deck cart, mono, \$300; Spotmaster cart winder. \$200. J Franks. 614-522-8171

No matter how you stack it...



Nobody reconditions tape heads like JRF.

- Heads restored to new performance spec at a fraction of new cost
- Cart machines and all open reel formats
- Full line of replacement heads for all manufacturers

Experience the difference experience makes. Ask around. Nobody treats you or your heads better than JRF.



249 Kennedy Rd., Greendell, NJ 07839  
(201) 579-5773 Fax (201) 579-6021

Tapecaster X-700-R/P new cond w/aux tone option, secondary cue tone gen/detector. \$500. R Franklin, 215-646-7788

BE 3000A stereo R/P w/tones, very good cond \$850 BE 3000A mono PB/delay rcd, rack mount, new. \$500 BE 3000 mono R/PB w/tones, good cond \$650 BE 3000 (3) mono PB w/tones. \$450/ea D Kelly, 402-372-5423

Mono Tapecaster 700RP & 700P (1 ea), good for parts or refurb work. BO C Tracy, WKNE, 603-352-9230

Great Prices on original equipment tape heads for ITC, BE, Fidelipac, Otari, Tascam & others!  
**(804) 984-4255**  
**HE HALL Electronics**

### Want To Buy

ITC, BE, Fidelipac cart machines: single, triple, mono, stereo, play & record/play. Call M O'Drobinak @ 619-758-0888

## CONSOLES

### Want To Sell

INC CM-1056 150 hrs, excellent condition, keypad & LCD display, will trade for Adtran #1SU128, \$800/BO B Holms, Timeless Voyager Radio, POB 6678, Santa Barbara CA 93160 805-964-3301.

McMartin B-502 stereo console. 5-pot, 10-input stereo. \$500. J Franks. 614-522-8171

Otari MX-70 16-chnl, never used, BO G Prietragallo, KPSL, 303 N Indian Canyon, Palm Springs CA 92262 619-323-5775.

McMartin B502 stereo console \$300 Gary, 919-790-6315

UREI Mod One stereo consoles (2), BO R Stafford, 501-933-0403 FAX

Ramsa 820 20x8x16 w/meter bridge, \$1795, Quantum 23x16x24 as used by LA Philharmonic, \$3750. W Gunn, POB 2902, Palm Springs CA 92263. 619-320-0728

### Want To Buy

API/Neve whole or parts, working or not T Coffman, 619-571-5031

## DISCO-PRO SOUND EQUIPMENT

### Want To Sell

ATI MatchMaker, IHF to 300 ohm, dbx snl chnl noise gate, BO. Steve, 402-438-4989

Sony DTC-750 DAT R/P, great shape, low hrs with remote & 10 used tapes \$400 or trade for 386 or better computer with color monitor E Scott 603-366-2013



706 Rose Hill Drive Charlottesville VA 22901

# MARTI

- 40 watts VSWR protected power output
- Peak-Hold baseband modulation LED display
- State-of-the-Art composite stereo performance
- Meets FCC and CCIR requirements
- Full remote capability
- Test multimeter with Forward and Reverse power ranges
- Call for your HE Price!



## ME-40 FM Broadcast Exciter

Call us for the Best New & Completely Rebuilt Equipment! (804) 984-HALL (4255) Fax: (804) 984-FAXX (3299)

Circle (208) On Reader Service Card



## FINANCIAL SERVICES

**EQUIPMENT FINANCING**  
ON ALL RADIO EQUIPMENT

- Easy to qualify
- Fixed-rate, long-term leases
- Any new or used equipment
- 100% financing, no down payment
- No financials required under \$50,000
- Refinancing existing equipment

**ENF** EXCHANGE NATIONAL FUNDING

Call Mark Wilson  
(800) 275-0185

## FINANCING

**LOANS BY PHONE (800) 699-FLEX**

- We finance all types of Broadcasting Equipment
- Flexible Credit Criteria
- Flexible Payment Plans
- No Down Payment, No Payments For 90-Days Available

To apply or request additional information call Jeff Wetter.

**FLEX LEASE, Inc.**

**LIMITERS**

**Want To Sell**

Audimax 4440-A, BO: Volumax 4000-A. BO. T Coffman, 619-571-5031.

CRL PMC 300A, \$500; CRL SMP 400A, \$500; CRL SMP 400B, \$500; CRL NRSC pre-emphasis/filter, \$300; CRL NTSC de-emphasis/filters (2), \$300/ea. GM, KWED-AM, 210-379-2234.

Orban Optimod 8100, \$2900. Gary, 919-790-6315.

CBS Volumax 410, \$150/BO. Steve, 402-438-4989.

Orban Optimod FM 8100A, xint cond, incl spare Aphex #4 & #5 cards, orig box & manual, \$3500. G Barnett, 619-328-1104.

### Want To Buy

Gates, Inovonics, Fairchild, RCA, Urei, Teletronics, all types, solid state & tube. T Coffman, 619-571-5031.

## MICROPHONES

### Want To Sell

AKG 460-EB, BO: EV RE-27, BO: Sennheiser 421, mint, BO. T Coffman, 619-571-5031.

Sony ECM377 large dia. cond mic. \$495; RCA 77DX w/new ribbon. Crown GLM200 lavalier like new, \$125. W Gunn, POB 2902, Palm Springs CA 92263. 619-320-0728.

EV RE 38 ND mic, \$275/BO. 206-839-9414.

### Want To Buy

77-DX's, 44-BX's, WE KU-3A's On-Air lights, recording lights & audition lights. Top price paid. Fast response. Bill Bryant Mgmt, 2601 Hillsboro Rd. G12, Nashville TN 37212. 615-269-6131. FAX: 615-292-3434.

RCA ribbons, AKG 451's. Neumann KM84's. U87's AKG 414's. W Gunn, POB 2902, Palm Springs CA 92263. 619-320-0728.

## MISCELLANEOUS

### Want To Sell

Alertlite 3-V vertical on-air light, disappearing lettering on 3 sides, same model sold by Collins Allied, etc. texan globe, steel base, ceramic socket, new, \$35. R Franklin, 215-646-7788.

Paradyne 4951-03 equip rack, black, has full set of blank covers, \$175; Soundolier equip rack, \$120+shpg. B Lord, 206-932-4839.

Assorted radio/TV tubes, at least 80, old-fashioned carrying case, \$75+shpg. E Scott, 603-366-2013.

Duncan 442s (6) & 441s (17) timer faders, full throw 10,000 ohms w/P&G style knobs, new, never used, \$20/ea 441 monos, \$30/ea 442 stereos; Beyer BV372 015 006 mic input xformers, 200 ohm primary, 100,000 ohm secondary, \$18/ea. B Wilson, 407-682-2346.

**Rotron Blowers** for Elcom, Harris, CCA, CSI, McMartin, rebuilt & new. Goodrich Enterprises Inc. 11435 Manderson St. Omaha, NE 68164 402 493 1886 FAX 402 493 6821

EMU Proteus 1 MIDI sound mod. \$425/BO. 206-839-9414.

Symetrix TI-101 phone interfaces (5). BO. K Stokes, 504-383-5271 x229.

Muffin fans 6" & 9", mint cond, \$5/ea+UPS; Western Elect 111C repeat coil, 23A EQ, \$20/ea; 52 type headset w/153 amp. \$25+UPS. E Davison, 217-793-0400.

### Want To Buy

Teac 3300SX head bridge, good; Optimod updated 9100A. D Schroeder, WSWL, 904-433-1141.

10 kW gen & xfer switch. J Hansen, 612-632-2992.

Phonograph records from 1950 to 1970, all types of music, 45s, 33s, 78s & xscriptions, top prices paid, will travel. B Berry, 800-321-2920.

Jazz record collections, 10" LP/12" LP be-bop, swing, dixie, highest prices paid. B Rose, Program Recdgs, 228 East 10th, NINY 10003. 212-674-3060.

## MONITORS

### Want To Sell

Belar RF-1 FM RF amp, \$250. Craig, KSIW, 612 S 14th Ave, Yakima WA 98902-4327. 509-453-5492.

Pacific Rcdrs LSM-10 line selectors/monitors (2), BO. K Stokes, 504-383-5271 x229.

UHER 4400 Report Monitor, current model in excellent condition, \$650; UHER 4400IC stereo, as is, \$125. S & G Electronic, 215-474-7663.

## RECEIVERS & TRANSCEIVERS

### Want To Sell

Gorman Redlick EBS decoder, \$225/BO. Steve, 402-438-4989.

Johnson AT-4A modified multiplex tuner, used for data xmission on weather network, (150). BO D Leinen, 405-728-2525.

**GE Superadio III** custom modified w/noise free SCA w/improved selectivity & sensitivity, \$95. Other modifications avail. Performance guaranteed. **800-944-0630**

Yaesu FTC-1123 5 W. 150-160 MHz front programmable handhelds w PL tone & chgr. 10-chnl (10). \$150/ea. P Russell, Bowdoin College, 207-725-3066.

Johnson Ultracom 513 UHF 2-way radio base unit, singl chnl, \$50. E Lightman, 412-266-2802.

## SCA RECEIVERS—ALL TYPES

Reading Service / Ethnic / Data Professional / Table Will work to meet your receiver needs

**DAYTON INDUSTRIAL CORP.** (Manufacturer) 2237 Industrial Boulevard Sarasota, FL 34234 Tel: 813 351 4454 FAX: 6081

McMartin TR-E7 SCA receiver, working w/rechable batts, \$50; TR55 & 66B, \$20/ea+UPS. E Davison, 217-793-0400.

### Want To Buy

Any EBS encoder/decoder in good cond. JP Ambrutis, 207-443-6671.

## RECORDERS

### Want To Sell

Ampex 351 decks (2) w/Inovonics electronics, mono, BO: Ampex 351 deck w/orig tube electronics, mono, BO. GM, KWED-AM, 210-379-2234.

# SERVICES

**REMOTE EQUIPMENT RENTALS**

**COMREX and GENTNER**  
1, 2 & 3-Line Extender Systems  
Now With The New TELOS ZEPHYR  
MARTI VHF/UHF RPU Systems  
ISDN & Switched-56 Systems  
Call or FAX Dwight Weller

**WELLER AUDIO-VISUAL ENGINEERING**  
Baltimore, Maryland  
Phone: (410 or 800) 252-8351 FAX: (410) 252-4261

**G.K. PAINTING CORP.**

Industrial/Commercial Painting  
Sandblasting/Waterblasting  
Special Coating (specialize in radio towers)

5141 Bradfield Drive  
Annandale, VA 22003  
**703-978-1824**  
FAX: 703-978-1824

**HARRIS ALLIED PARTS AND TECHNICAL SUPPORT**

Now we can be reached online via e-mail.  
**TSUPPORT@HARRIS.COM**  
For your parts needs or with any technical problems you're having.

**Tower Sales & Erection**  
Turnkey Site Development  
Installation & Maintenance  
AM/FM Broadcast TV  
Microwave Systems  
Antennas & Towers

**TOWERCOMM**  
Communications Specialists

Ben Wall President  
6017 Triangle Dr  
Raleigh, NC 27613  
(919)781-3496  
Gen. Contractor #25891 Fax (919)781-6454

**FM TRANSMITTER HELPLINE**  
24 Hour Emergency Phone Consultation

Specializing in:

- CCA/CSI
- Arcing Problems
- AEL FM Transmitters

**MBE Enterprises**  
Phone: 818-772-8017  
Pager 818-604-7925

**REMOTE BROADCASTS IN THE U.K. AND EUROPE**

Planning renotes from the U.K. or Europe? we offer a one stop service

- we organize venues for your shows
- we provide temporary equipment
- live links via ISDN/Switched 56
- experienced radio engineers
- we help you line up guests

Contact London (44) 181 442 8900  
Wired for Sound Ltd., London UK

**Where In The World Are You?**

Reach radio professionals worldwide by advertising in Radio World's international edition.

Call Simone for more information.  
**1-800-336-3045**

**DISTRIBUTOR DIRECTORY**

The following distributors serving the broadcast industry would be glad to help you with any of your requirements.

...country, top 40, news, urban, talk, jazz, the classics, mixed bag...

**RADIO! The beat goes on!**

**CROUSE-KIMZEY OF ANNAPOLIS**  
tops in broadcast equipment  
**1-800-955-6800**  
ask for Kathleen

**CORNELL-DUBILIER MICA CAPACITORS**  
FROM STOCK

**JENNINGS VACUUM CAPACITORS**  
FROM STOCK

**JENNINGS VACUUM RELAYS**

**SURCOM ASSOCIATES, INC.**  
2215 Faraday Ave., Suite A  
Carlsbad, California 92008  
(619) 438-4420 Fax: (619) 438-4759

# Accuracy... Time and Time Again.

## Real World Propagation™ Studies Deliver Accurate, Field-Tested Results.

Don't compromise when you need critical propagation studies for your network. We'll create accurate propagation maps based on real world statistics.

- Real World Propagation™ studies are accurate and field-tested
- Professional customer service and support
- Cost-efficient alternative to purchasing a software package

For more details call  
**1-800-441-0034**

**Communications Data Services**  
Incorporated  
Leaders in wireless products and services since 1983



## RECORDERS...WTS

Revox A77 1/4" 1/2-trk stereos (2). \$300/ea. J Franks, 614-522-8171.

Revox A77 3 3/4-7 1/2. B77 3 3/4-7 1/2. B77 7 1/2-15. very used, work needed on tape path. decent electronics. \$400/BO. J Ravenscraft, WTAL, 1820 E Park Ave. Tallahassee FL 32301-2824. 904-671-1450.

Scully 280B reel. BO: Revox B710 casset rcd. BO: Otari MX5050 2-trk reel. BO: Otari MX5050 4-trk reel. BO: ITC 750 w/rcdg amp & roll-around cabinet. BO: Revox A-77 reel. BO. K Stokes, 504-383-5271 x229.

## HEAD RELAPPING/REPLACEMENT

All tape and film formats  
30 years experience

**iem**

350 N. Eric Drive  
Palatine, IL 60067  
708-358-4622

Technic 85 MK 2 for parts, as is. \$75+shpg. H Sewell, Oakridge Music, 2001 Elton Rd. Haltom City TX 76117. 817-838-8001.

Astocom-Marlux 407 RR rcd 7" 1/4-trk. works, 3 3/4-7.5, 3 motor, 4 head. \$30. E Lightman, 412-266-2802.

Otari ARS-1000 (4) R-R decks w/25 Hz detectors, xint cond. \$595 or \$2000/all. J Hansen, 612-632-2992.

## DO YOU NEED PARTS FOR AMPRO CONSOLES &amp; CART RECORDER

**SEQUOIA ELECTRONICS**  
1-(408) 363-1648  
FAX 1-(408) 363-0957

Otari ARS-1000 R-R PBs (4) w/tone sensors, good cond. \$300/ea. Randy, 815-942-2839.

Scully 4-trk 1/2" 280B in roll-around console. \$600; ITC 750 PB decks (3). \$500/all. Gary, 919-790-6315.

Tascam 388 8-trk R-R w/console. 7.5 ips/dbx-NR. xint cond. \$850. G Parmelee, 802-247-4208.

## ITC Reel-to-Reel Specialists. Complete stock of spare parts. Motor rebuilding and heads for both reel-to-reel and cart machines.

**VIF INTERNATIONAL**  
PO Box 1555  
Mtn View CA  
94042 U.S.A.

Inside USA: 1-800-848-4428  
Outside USA: 1-408-739-9740  
FAX: 1-408-739-0809

Ampex ATR100 taperecorders for parts. Circuit cards, heads, motors, machine parts, or electronic parts. Call 818-907-5161.

Otari 5050-SHD 8 trk 1/2" newly rebuilt, heads have full life left. \$1800. W Gunn 619-320-0728.

Scully '100' recorders, record/play amplifiers. 8, 16, 24 track heads. Sequoia Electronics, 4646 Hounds-haven Way, San Jose CA 95111. 408-363-1646.

Tascam ATR 60 8 trk w/stand, remote. \$2250; Otari 5050-8 new heads, rebuilt. \$1595; Ampex 440B-8. \$1950; Tascam 25-2. \$495; Ampex ATR700. \$495; Scully 16 trk 2". \$2950; Tascam 52 top of line. \$650; M79-24 fully rebuilt. \$9,500; Tascam locator for 85-16. \$375; Fostex E22 1/2" timecode deck. \$950; Fostex A80 8 trk w/450 mixer. \$995. W Gunn, POB 2902, Palm Springs, CA 92263. 619-320-0728.

## REVOX PARTS/SERVICE

Cassette-CD-Open reel  
NOS PR99 repros.  
Capstan resurfacing. ALL BRANDS  
**JM TECHNICAL ARTS**  
30 Music Sq. W. #156  
Nashville, TN 37203 (615) 244-6892

## Want To Buy

Revox 2-trk head assy for 1/4-trk head assy. W Gunn, Box 2902. Palm Springs Ca 92262. 619-320-0728.

Reel-Reel Recorders: 10", better 7". Nagra and other professional portables. S & G Electronic. 215-474-7663.

## REMOTE &amp; MICROWAVE EQUIPMENT

## Want To Sell

Moseley TSK-3A temp sensor LVK-3 line voltage sampler. \$30/ea; Kahn 58-A Symetra Peak. \$100. R Humphrey, WVA, 1015 Main St. Wheeling WV 26003. 304-234-0057.

AT LAST EASY REMOTES: INTRODUCING new podium/19" rack combo on wheels! SAVES TIME, unit slides into vans! Prewired AC & XLRs, speakers, much more. CALL SPACEWISE 1-800-775-3660

Harris System 90 brains & audio switching equip. BO: McMartin TBM 1000A FM relay receiver. BO. T Stafford, 501-933-0403 FAX.

Moseley DRS-1 30-chnl digital/analog remote cntrl, 2 compl systs w/status & limit alarms. \$650/ea. Gary, 919-790-6315.

Moseley MRC 1600 16-chnl. \$1000; TFT 7601 10-chnl. \$500. B Spitzer, KKLS/KKMK, 605-343-6161.

## RENT IT HERE! Call Steve Kirsch for Details

**COMREX**  
1, 2, & 3-Line Extenders  
Switched 56/ISDN Systems

**TELOS**  
Zephyr  
Digital Phone Hybrids

**CCS "PRIMA" CODECS**

**SHURE**  
FP-410 Automatic Mixers

**REMOTE AUDIO PACKAGES**

**SILVER LAKE AUDIO • 516-623-6114 • FAX: 516-377-4423**

Zercom Maxitel Z-82 phone remote syst. \$400. J Franks, 614-522-8171.

2-line encoder, perfect cond. less than 1 yr old. works 200%. \$2500/BO. S Swartz, 407-686-2133.

## WE RENT

**TELOS ZEPHYR**  
CCS "Prima" Codecs  
Stereo RFL, NO LICENSE

**COMREX**  
3-Line Extenders

Frank Grundstein  
Audio/Video Consultants  
610-642-0978

Gentner EFT-3100 3-line frequency extenders, like new. \$5000/pair. Steve Kirsch, Silver Lake Audio, 2590 Hillside Ct. Baldwin NY 11510 516-623-6114.

## Want To Buy

Marti STL-8, 10 or similar STL, mono OK. D Jackson, WADQ-FM, 203-762-9425.

Moseley RPL-3 RX receiver VHF in 161 MHz band; Marti H Pol VHF co-linear antenna. array 161 MHz horizontal POL. 4-bay 9-10 dB gain. 2 needed. T McGinley, WPGC, 6301 Ivy Ln #800, Greenbelt MD 20770. 301-441-3411.

## REPAIR SERVICES

## DENON CD CART PLAYER REPAIR



- Same Day Service
- Reasonable Rates
- We honor Denon Warranty

**AUDIO VIDEO SERVICE LABS, INC.**  
800-765-4434

Quality Denon Service Since 1991  
"The Best Kept Secret in Broadcasting"

## SATELLITE EQUIPMENT

## BUY

Satellite Systems pays cash for Westwood One Radio Networks satellite receivers!

## REPAIR

Satellite Systems repairs all major brands of satellite equipment, including the Fairchild Dart 384 and Scientific Atlanta. Our turn-around time averages 24-hours. Plus, we provide pre-and post-service support along with a 90-day warranty.

## SELL

The Ariel Digital Satellite Receiver

- 5 card slots
- 1 year warranty
- Compatible with Fairchild Dart 384
- Excellent technical support

## SATELLITE SYSTEMS

Satellite Equipment for Radio

615 East Brookside  
Colorado Springs, CO 80906  
(719)634-6319 Fax: (719)635-8151

## Want To Sell

3.2M SA satellite syst. water heater type mount, heavy duty black bracing. 9630 rcvr. \$3500/BO. Steve, 402-438-4989.

Mod Assoc 10 W solid-state HPA/Upcon. dual thread, no mods, for SPCP uplinking. \$7500/BO; Wegener 1806-24 satellite rcvr for FM squared format. \$500; Zephyrus Model 304/392 satellite rcvr. Moody, Jones, SMN formats. \$400. Gary, 919-790-6315.

Prodelin 10" diameter 8 section fiber-glass dish & equip. high quality dish, good cond. \$950/Best Offer. C Rich, 317-268-2251

## Want To Buy

S/A 7300 wideband receiver, good condition & reasonable please. C Tracy, WKNE, 603-352-9230

## SOFTWARE/DATABASES

## Want To Sell

**Affordable TRAFFIC & BILLING**  
PC SOFTWARE for DIGILINK & other popular digital systems. Excellent for non-automated stations, too. Try it for 60 days. No obligation. For demo, call ABA Software (813) 643-3689

Available this FALL,  
Ron Balonis' Broadcast Engineer's  
COMPUTER TOOLBOX for WINDOWS.  
For information, write to  
**COMPUTER TOOLBOXES**  
118 Rice St., Trucksville, PA 18708

## STATIONS

## Want To Sell

3kW FM CP in small North Central Illinois community. Tom, 815-584-5186.

S.C. 1000 watt AM established, profitable, includes bldg., land, equipment. 803-537-3442 for more info.

## Want To Buy

Retired couple seeks small AM/FM combo w/real estate, cash. A Toriello, 718-893-4328.

Small or medium market FM station in NM, TX or OK. R Mickle, Christian Music Svcs, 131 Fairview Ave. Ponca City OK 74601. 405-762-7515.

Cash for CP or distressed FM in CA or NV, must have potential to be viable, principals or brokers OK. Phone or FAX, 818-831-6787.

Bdctr, not broker wants station(s), AM or FM, in S AL, W FL, E GA areas, prefer high pwr, but will consider all. Bdctr, 906 Northwood Cir. Nacogdoches TX 75961.

Small radio station in NE Mid-Atlantic region, CP considered. \$60K or less. C Davis, 6802 Fox Meadow Rd, Baltimore MD 21207. 410-298-5958.

## EMPLOYMENT

To place ads in this section, use the ActionGram form. To respond to box numbers, write Radio World, PO Box 1214, Falls Church, VA 22041. Attn: \_\_\_\_\_

## POSITIONS WANTED

Announcer/music director w/6 yrs on-air exper in Gospel, Urban formats lkg for a station to take to the top, sports & news exper as well. John, 910-632-9826.

Country/Oldies morning AT, promotions, remotes, adult, topical, humorous, no Gump, no puke, no liners! Mike, 510-432-6300.

Dedicated individual looking to expand horizons, any format, will move, enjoy prod. lft on-air. Brian, 313-374-1041.

Small market talent needs next step, prod/prog exper, creative & cheap. Luke, 815-244-8062.

Small market news director seeks opportunity to move back to mid-CA, extensive announcing, prod & Spanish exper, xint board skills! J. 415-431-1543.

Subcarrier svcs market development, expand the reach of your station's investment, enter new markets, stake a claim in new info delivery capabilities. Tom, 206-361-9287.

Freelance Mix show/club DJ avail for digitally rcded, custom music mixes, 6 yrs club & radio exper, mix show programming, on-air & pro, set your station apart from the rest. Dave, 313-483-5882.

Good PR skills, great motivator, very interested in sales, good team plyr w/lots of talent, eager & ready to work, you be the judge. Rick, 405-386-6524.

Looking for a different voice for your commercials, VOs, liners & open & closes, give me a call, the first one is on me, incl standard ground delivery, will write &/or produce, when you call ask about our royalty-free buyout, customized jingles, rock bottom prices. Paul, 208-324-2593.

My girlfriend found out about my love affair w/radio & left me, bring "The Slug Bodean Show" to your station. Russ, 307-362-7211

## HELP WANTED

## POSITIONS WANTED

Chief engineer, AM &/or FM, former CE Houston, Miami, Boston, Ft Lauderdale, FCC general, ham, non-drinker. M Gottesman, 758 St Michael St #1005, Mobile AL 36602-1326.

Program directors; have you been interested in a very knowledgeable DJ specializing in vintage Soul music w/a great personality that can enhance your bottom line by doing a 4-hour (morning, afternoon, evening) show? Free one hour audio tape to see if I can do something for your radio station, The Greg Foster R&B Radio Show, audio entertainment at it's very best! 800-770-7878.

Young, energetic sports guy w/over 6 yrs exper & strong prod skills looking to move up, self-motivated & willing to relocate. Derek, 505-392-5367.

## HELP WANTED

Group of 6 stations in Hudson Valley, NY want to move up to full time chief from present contract engineer. Knowledge of RF, studio maint, computers, digital audio a must. Good pay & benefits. Fax resume to: Eric Straus, 518-828-9424.

## CHIEF ENGINEER

K92 Radio in Roanoke Lynchburg is seeking an FM broadcast engineer with several years experience. Requirements: Technical school graduate, SBE certified, proficient at troubleshooting audio quality, radio station RF and studio systems, strong PC & digital system knowledge. Send resume & salary requirements to EEO Coordinator (#03), K92 Radio, P O Box 92, Roanoke, VA 24022. Minorities & women are encouraged to apply. EOE/M-F

## HELP WANTED

Well-established successful AM/FM radio seeks 2 FT talent, news & sports depts, we require team plyrs, hard work, self-starters, we offer competitive salary, 401k, 75% comp pay ins & supportive work environment, send resumes, air checks. J Kling, KWLM/Q102, POB 838, Willmar MN 56201. 612-235-1340.

Assistant Chief Engineer for multiple site Southwest duopoly. Applicant should have minimum of five years experience in maintenance of directional AM, Class C FM, and major market studios. Digital audio, satellite Uplink experience, and computer literacy a plus. E.O.E. Send resume and salary requirements to Radio World, POB 1214, Falls Church VA 22041. Attn: Box # 95-9-6-1RW.

Eden, NC: Looking for radio salespersons with the vision to become partners with our clients as their marketers. Must be aggressive with positive attitude. Honesty is a must to our advertisers and community. Contact John Messina, WCLW Radio. 1-800-761-8066.

## ENGINEERING ASSISTANT KHKS-FM

Dallas radio station has immediate opening for an assistant engineer. Must have minimum of 5 years experience in AM/FM transmitters, directional antenna systems, studio design and construction, mechanical and electrical maintenance skills, strong computer skills (including LAN), knowledge of digital audio systems, prior experience with satellite systems and remote broadcasts. FCC General Class license or SBE Certification (or equivalent) required. Associate or Bachelor's degree in Electronics or Electrical Engineering preferred. Send resume to Human Resources, KHKS-FM, 8235 Douglas, Suite 300, Dallas, TX 75225. Equal Opportunity Employer.

## SINE SYSTEMS

The Nashville-based company known for "Innovative Solutions" has an opening in its engineering department for a "utility infielder." This is a job for an energetic and talented individual who can wear many hats. Duties would include:

- Taking customer-service telephone calls
- Performing factory repair of Sine Systems equipment
- Creating production documentation and procedures for assembly, test and quality control
- Assist in defining and developing new products
- Assist in writing software and firmware
- Assist in writing product documentation
- Assist in sales/marketing
- Assist in purchasing

Experience and education is valuable, but energy, enthusiasm and willingness to learn are even more important. For complete information about this job opening, call our Fax-On-Demand line from your fax machine (615-227-2393). Listen to the voice instructions and request document 198.



**STATIONS..WTS**

FM operating, dark or CP, exper bdctr, will consider joint venture, prefer purchase or lease. J Powley, 910-342-1843.

**STEREO GENERATORS**

**Want To Sell**

Optimod 8000A FM stereo gen & processor, re-chipped, BO; TM Century auto segue unit, handles up to 3 CD plyrs, contains faders that respond to TM Century cue tones, BO. T Stafford, 501-933-0403 FAX.

**TAPES/CARTS/REELS & CD's**

**Want To Sell**

300 cart holder metal swinging floor model Lazy Susan, \$125; 200 cart holder, wood tabletop Lazy Susan, \$50; 100 cart holder, wood wall mount to tabletop, \$20. J Franks, 614-522-8171.

Compl formats on 10 1/2" reels, w/ques, AC Gold, Big Band, Country, also Beautiful Music background instrumental, many on metal reels, \$15/reel, sets only. Rt 2 Box 399, Harpers Ferry WV 25425. 304-725-9425.

## MARATHON PRODUCTS COMPANY

### Audio Cartridge Rebuilding Division

Rebuilding/reloading, like new, all brands, any length up to & including 3.5 minutes, \$1.95 for Standard Tape, \$2.15 ea. for HOLN Tape. FOB out plant, 48 hrs delivery. (New rate effective 3/1/95)

**New NAB Marathon cartridges prices on request.**

35 Years professional experience!  
Lifetime member AES R.D. MYERS Sr.  
Manufacturers of Audio Devices,  
Continuous Tape Mag.

69 Sandersdale Rd. Charlton, MA 01507  
1-508-248-3157 or 1-508-853-0988

Circle (104) On Reader Service Card

Audiopak A-4s thousands of music length 2:30-5:30, also per OBD for LDT, \$1.50/ea. P Kreigler, KMYZ, 5810 E Skelly Dr #801, Tulsa OK 74137. 918-665-3131.

Gray Fidelipacs, Red Fidelipacs, AA-3s, AA-4s, many different lengths, several hundred avail, 25 cents/ea+shpg. GM, KWED-AM, 210-379-2234.

Music library from syndicator's rdg studio, thousands of 45s, 33s, CDs, cassettes, R-Rs, incl contemporary, singles, country, Big Band, 50s/60s on vinyl, dance singles, ethnic, polka/old time, BO; will build country oldies library, all will come off orig CDs, only 10.5" reels, no tones, 50 to 3000 titles, reasonable price; 200 to 300 music length carts, 7" reels, 300+ cassettes, BO. M Mattson, 414-783-5551.

418 carts, Scotch carts, mostly music length, good to very good cond w/AC music, \$500/all. Randy, 815-942-2839.

Aristocart A W 20 (110) cart racks, holds 20 carts ea, \$550; Dynamac ESD 10 eraser splice finder, good cond, \$400. D Kelly, 402-372-5423.

Black Scotchcart IIs, 300 3.5 min. almost new cond, \$1.90/ea+shpg. B Lord, 206-932-4839.

**Want To Buy**

Beatles radio programs on CD, DAT or R-R, also interviews, cash or will trade from my extensive collection. Rich, 800-680-1144.

Potomac Instruments FIM-21 & Nems Clark 120E field strength meters, trade only-both for 1 FIM-41; Bird 8745-677 20 kW port dummy load, requires external water sply, \$750. Gary, 919-790-6315.

Tektronix 7613 storage mainframe, 7L12 spectrum analyzer, 7L5 spectrum analyzer w/option 25, 7K11 CATV preamp & carrying case for xtra plug in units, \$7500/BO. S Lockwood, 206-783-9151.

DB meters, original Ampex and RCA styles. Unused in box, \$100 each. S & G Electronic, 215-474-7663.

Leader FM Signal Generator Model 3215; McMartin FM/SCA Generator Model BFM-2001; SMC Int'l Model FSM-5 FM/SCA field strength meter; Variable Power Supply, Best Offer. Contact Jay McMartin, 402-896-1262 or P.O. Box 37620, Omaha NE 68137.

**Want To Buy**

Tektronix 520 vectorscope or similar. J Powley, 910-342-1843.

**TRANSMITTERS**

**Want To Sell**

CCA AM 5000D 5 kW AM on 1500 w/500 W cut-back, would trade for 1 kW AM, \$5000. B Campbell, KRIG Radio, POB 877, Bartlesville OK 74005-0877.

BE-FM30 30 kW FM xmtr+FX30 exciter, only 40K hrs, in storage. BO: Gates FM-5C 5 kW FM xmtr, needs rebuild, PCB capacitors removed, no exciter, \$2000, you haul. Gary, 919-790-6315.

Cetec-Sparta 602A 2.5 kW FM xmtr, tuned to 100.9 MHz w/exciter manuals, new, \$6500. R Mason, 703-962-1133.

**BESCO** World Leader in AM - FM Transmitters

"Now in our 30th year"

**91 AM & FM Pre-Owned Units in Stock**

- ✓ ALL - Powers
- ✓ ALL - Manufacturers
- ✓ ALL - Instruction Books
- ✓ ALL - Complete
- ✓ ALL - Spares

Call and take advantage of our liberal trade-in plan. Tune and test on your frequency, available on site. Complete inventory on request.

Phone: 214-630-3600  
Fax: 214-226-9416

Collins 831 D-1 FM xmtr. operated @ 1700 W on 104.9 MHz from 1971 to 1994, good cond. BO: Collins 310Z-1B FM exciter, operated on 104.9 MHz from 1971 to 1989, after 1989 used as back-up. BO. T Stafford, 501-933-0403 FAX.

Continental 315A-1 1984 5 kW on 1430 kHz, very good cond, \$17,500. T Love, WOBW/WMGR, 912-439-9704.

**CONTACTORS BY GELECO**

Ph: (416) 421-5631  
Fax: (416) 421-3880

Harris 1987 FM 3.5K xmtr, type accepted TPO 4.0 kW @ 92.1 MHz w/MX-15 exciter, currently on air, avail 9/15/95, \$16,500. M Harris, KDOK, Tyler TX, 903-593-2519.

## CONSULTANTS

**Consulting Communications Engineers**

- Station improvement and modernization
- FCC Applications and Field Engineering
- Frequency Searches and Coordination
- AM-FM-CATV-ITFS-LPTV

**OWL ENGINEERING, INC.**  
1-800-797-1338

1306 W. County Road, F, St. Paul, MN 55112 (612)631-1338 Member AFCEE

**EVANS ASSOCIATES**

Consulting Communications Engineers

TV • FM • AM • ITFS • Satellite  
FCC Applications, Design  
and Field Engineering

Video/Data/Voice • Light Fiber &  
Microwave • Wide-Area Networks & STL's

210 S. Main Street  
Thiensville, WI 53092  
(414) 242-6000 • FAX (414) 242-6045  
Member AFCEE

**TEST EQUIPMENT**

**Want To Sell**

CBS Labs FM Volumax automatic peak cntrlr, works, good shape, \$100/BO. A Wasilewski, 509-248-1460.

Inovonics 500 1/3 octave audio analyzer w/reverb time measurement, also incl XY plotter adapter, \$900. B Wilson, 407-682-2346.

Tektronix 541A scope w/53/54 plug in & probes, inj/svc manual, \$350+shpg. R Thayer, WLLG/WBRU, Main St, Boonville NY 13309. 315-942-5517.

Heath AG-8 audio oscillator, \$20/BO: Running time meter, 1 hr divisions, 115V, \$20+UPS. E Davison, 217-793-0400.

## BEXT

Great new or demoed FM transmitters, exciters, amps and STL's, some at discount prices  
**USA 619-239-8462**  
**FAX: 619-239-8474**

Continental 315A-1 1984 5 kW on 1430 kHz, very good cond, \$17,500. T Love, WOBW/WMGR, 809 S Westover, Albany GA 31707-4953. 912-439-9704.

Harris/Gates BC5H 5000 W xmtr, freq 1080 AM, BO. Jack, 304-765-7373.

Modulation Sciences DSCA-108 data Sidekick used for xmission of data on SCA network, BO. D Leinen, 405-728-2525.

TTC 100 W LPTV UHF xmtr, rebuilt upconvert & mod, tube final, \$10,000/BO. Steve, 402-438-4989.

**PC - SOFTWARE**

AM FM TV Search Programs  
Contour Mapping-STL Paths  
RF HAZ-1990 POP Count  
FAA Tower-Draw Tower

**Doug Vernier**  
Broadcast Consultant  
1600 Picturesque Dr  
Cedar Falls, IA 50613

**800-743-DOUG**

North America RF & Audio

**Mirkwood Engineering Services**

Broadcast and Telecommunications Consultants

Multidiscipline Engineering and Planning Firm including • Application & Allocation Services  
• Project, Engineering & Construction Management • Site Acquisition  
• Rural & Remote Site Installations  
• Field Service • Studio Design & Installation

50 Park Ave. Claremont, NH 03743  
(603) 542-6784

**MLJ**

Moffet, Larson & Johnson, Inc.  
Consulting Telecommunications Engineers

1110 North Glebe Rd. #800  
Arlington, VA 22201

(703) 741-3500  
FAX: (703) 741-0312

Member AFCEE

**MULLANEY ENGINEERING, INC.**  
Consulting Engineers

•Design & Optimization of AM Directional Arrays  
•Analysis for New Allocation, Site Relocation, And Upgrades  
AM-FM TV LPTV  
Wireless Cable  
(MDS/MMS/ITFS/OFS)  
•Environmental Radiation Analysis  
•Field Work  
•Expert Testimony

9049 Shady Grove Court  
Gaithersburg, MD 20877  
Phone: (301) 921-0115  
Fax: (301) 590-9757

**E. HAROLD MUNN, JR. & ASSOCIATES, INC.**

Broadcast Engineering Consultants

AM - FM - TV

**WAYNE S. REESE**  
PRESIDENT

Box 220, 100 Airport Rd.  
Coldwater, MI 49036

**517-278-7339**

**W. LEE SIMMONS & ASSOC., INC.**

BROADCAST TELECOMMUNICATIONS CONSULTANTS

5 Gracefield Road  
Hilton Head Is., SC 29928

1-800-277-5417  
803-785-4445  
FAX: 803-842-3371

**T. Z. Sawyer Technical Consultants**  
AM-FM-TV-LPTV

- FCC Applications & Exhibits
- Experimental Authorizations
- AM Directional Antennas
- High Power Antenna Arrays
- Frequency Studies
- Class Upgrades
- STL Applications
- Station Inspections

**1-800-255-2632**

**Teletech, Inc.**

BROADCAST CONSULTANTS AND ENGINEERS

- FCC Applications & Field Engineering
- Frequency Searches & Coordination
- Tower Erection & Maintenance
- Facility Design & Construction

CONTACT:  
**Kenneth W. Hoehn**  
23400 Michigan Ave  
Dearborn, MI 48124  
(313) 562-6873

**Don't Gamble with your Advertising Dollars!**

Advertise in Radio World and reach 18,000+ subscribers.

Call Simone at 800-336-3045 today!

**GRAHAM BROCK, INC.**  
BROADCAST TECHNICAL CONSULTANTS

Full Service From Allocation to Operation  
AM/FM/TV/AUX Services:  
Field Work; Antenna and Facilities Design

Over 35 years engineering and consulting experience

912-638-8028  
202-393-5133

**"HEY!"**

"Have you heard?"

**The STL-1 and STL-2** are the hottest selling Composite STL's around!

- Excellent Specs
- Excellent Quality
- Excellent Price

Complete STL-1 10 watt System \$4,495

**CHECK IT OUT FOR YOURSELF!**  
**SEE US AT WME BOOTH 260**



"The Transmitter People"

**Energy-Onix**

518-828-1690

FAX: 518-828-8476

752 Warren Street, Hudson NY 12534

Circle (24) On Reader Service Card



### TRANSMITTERS...WTS

RCA BTA-10U 10 kW AM xmtr, needs repairs, \$3500. B Barry, WAMB, 615-889-1960.

Wilkinson AM-1K 1 kW AM @ 840 kHz, 23 yrs old, \$1500; Harris FM 3.5 k 107.9 MHz 9-bay antenna & 300' of xmsn line, \$17,000. D Kelly, 402-372-5423.

Solid State MW1 transmitter. Clean, rebuilt, surplus from cancelled LMA. Call Bob at 304-684-3400.

### FM-Transmitters

Translators & Amplifiers  
Solid State 15 watt to 6 Kw.  
Jimmie Joynt  
Factory Direct Sales  
800/279-3326

Xformers, chokes & other parts for Gates BC1-J & later series xmtrs, incl new, Peter Dahl mod reactor, all tested, BO. Mike, 615-741-2277.

QEI amplifiers, exciters and stereo generators. All are reconditioned and are tuned and tested on your frequency. 6 month warranty is included. If you want quality used equipment, call or fax 609-232-1625 and ask for Bob Brown.

New McMartin 20 W, BEM-8000 FM exciters, New McMartin IBM10050 FM relay rebroadcast xmtr; also some used McMartin B910 exciters 15W. Goodrich Enter., 11435 Manderson St., Omaha, NE 68164. 402-493-1886 fax 402-493-6821



**NEW  
McMARTIN  
BF-5K**  
Lowest priced  
tube replacements

5500 W FM, broadband grounded grid output circuit, VSWR protection, excellent efficiency 75-80% automatic recycling & overload status. Fully remote controlled. FCC approved to 5500 watts.

**Goodrich Enterprises, Inc.**  
11435 Manderson Street  
Omaha, NE 68164  
402-493-1886  
FAX: 402-493-6821

Used equipment for sale: Belar SCM-1, Belar RFA-1, Belar FMS-1, Belar FMM-1, Moseley MRC 1600 system, TFT EBS receiver/generator, Gentner patch panel, and Harris racks. Call Transcom Corp. 800-441-8454 or 215-884-0888.

McMartin AM/FM xmtr, any model, exciter or stereo modules. Goodrich Ent., 11435 Manderson, Omaha NE 68164. 402-493-1886.

### TURNTABLES

#### Want To Buy

1.5 to 2.5 kW FM pwr amp. D Jackson, WADQ-FM, 203-762-9425.

200' Helix xmsn line, 1 5/8" or 3". J Powley, 910-342-1843.

Used 2 to 5 kW FM xmtr, ant. studio equip, etc. xint working cond. all or part, for export. S Lazarian, 818-795-8641.

Harris SX-1A 2.5 kW, good shape & reasonable. T Yarbrough, 615-967-2201.

RCA 5 kW AM, type BTA-5U & 10 kW AM, BTA-10U, any cond for parts. B Barry, WAMB, 615-889-1960.

#### Want To Sell

Technics SP-15 (2) with Gray arms, car-trid-ges. BO. GM, KWED-AM, 210-379-2234.

Technics SP-25 33 1/3 & 45 rpm direct drive, quartz locked with pitch adj, good condition, \$250. R Franklin, 215-646-7788.

Technics SP25 TTs (2), \$200/ea; Audiometrics S-220 tonearms (2), \$100/ea; Radio Systems PA-1 preamps (2), \$100/ea. J Franks, 614-522-8171.

Sparta 2-sp2 (2) TTs w/"bag" of spare parts, tired but operational, BO. C Tracy, WKNE, 603-352-9230.

## TRANSCOM CORP.

Serving the Broadcast Industry Since 1978

Fine Used AM & FM Transmitters  
and Also New Equipment

For the best deals on Celwave products,  
Andrew cable and Shively antennas.

1 kW FM 1978	Collins 831C-2	1 kW AM 1974	RCA BTA-1R3
1.5 kW FM 1975	Wilkinson 1500E	5 kW AM 1987	Continental 315R1
2.5 kW FM 1978	Harris FM2.5K	5 kW AM 1978	Harris MW5A/B
2.5 kW FM 1983	Harris FM2.5K	5 kW AM 1981	Harris MW5B
3 kW FM 1974	Harris FM3H	5 kW AM 1977	RCA BTA 5L
5 kW FM 1967	Gates FM5B	10 kW AM 1974	CSI T-10-A
10 kW FM 1971	Collins 830F1-B	10 kW AM 1981	Continental 316-F
10 kW FM 1968	RCA BTF 10D		
20 kW FM 1974	Collins/Cont 816R-2		
20 kW FM 1976	Harris FM20H/K		
20 kW FM 1968	RCA BTF 20E1		
25 kW FM 1975	Sparta 625-A		

1077 Rydal Road #101  
Rydal PA 19046

800-441-8454 • 215-884-0888 • FAX No. 215-884-0738

Circle (1) On Reader Service Card

### TUBES

#### Want To Sell

4X150A, 4CX250B, 4-400, 4-1000, 807, 833, 8874, 8877, RCA, Amperex, EIMAC, etc. Westgate 800-213-4563.

**FOR THE BEST PRICE**  
& 24 Hr service on transmitting tubes  
call Goodrich Ent Inc at 402-493-1886  
day or night, FAX 402-493-6821.



#### Quality\* Power Tubes

3CX15000H3	4CX400A
3CX15.000A7	4CX350AC
3CX15.000A3	4X350A/8321
3CX15.000H3	4CX250R/7580W
3CX10.000H3	4CX250BT
3CX10.000A7	4CX250BT
3CX3000F7/8162	4CX250BC/8957
3CX3000A7	4CX250B/7203
3CX2500H3	4X150A/7034
3CX2500F3/8251	5CX1500B
3CX2500A3/8161	5CX1500A
4CX15.000A/8281	5CX1500A
4CX10.000D/8171	YC130/9019
4CX5000A/8170	8560AS
4CX3500A	811A
4CX1600B	833A
4CX1500A	833C
4CX800A	

- Watch this list grow.
- Shipment from USA stock.
- Manufactured in Russia's largest power tube factory.
- Generous\* warranty based on high quality.
- Honest prices based on quality at low cost.

#### Broadcasters

Phone: 800-239-6900  
205-882-1344

FAX: 205-880-8077

#### OEMs, Distributors

Phone US: 800-578-3852  
Int'l & US: 415-233-0429  
FAX: 415-233-0439

Circle (139) On Reader Service Card

#### Buy Factory Fresh New Tubes

- ✓ EIMAC, BURLE, SIEMENS, AMPEREX, NATIONAL, and more
- ✓ Off-the-shelf delivery
- ✓ 24-hour emergency service



1-800-348-5580  
FAX: (708) 208-2550

### ECONCO

Quality  
Rebuilt Tubes

Approximately 1/2 the  
Cost of New

Call for Our Price List

800-532-6626

916-662-7553

FAX 916-666-7760

Circle (93) On Reader Service Card

### Advertise!

Call your advertising representative

1-800-336-3045

for details & deadlines

### THE

## Purple Processor™

Finally! A loud, clear and DYNAMIC FM  
processor without the grunge! We can prove it!

Call 1.800.732.7665 for a DEMO.

This listing is provided for the convenience of our readers.  
Radio World assumes no liability for inaccuracy.

Page No.	Advertiser	Reader Service No.	Page No.	Advertiser	Reader Service No.
8	360 Systems	35	66	Hall Electronics	208
38	360 Systems	200	15	Harris Allied	112
53	AEV SNC	167	31	Harris Allied	180
7	ATI	160	57	Harris Allied	154
7	Altronic Research	47	38	Henry Engineering	21
6	Arrakis	130	16	ITC	100
19	Arrakis	210	14	Inovonics	118
34	Arrakis	83	44	J Squared Technical Service	44
59	Arrakis	113	24	Korg	33
38	Audi-Cord Corporation	36	16	Listen Up Software	54
52	Audio Broadcast Group	59	69	Marathon Products	104
71	Auditronics	31	27	Micro Technology Unlimited	76
60	Autogram	82	52	MicroCon Systems, Inc.	8
36	BSW	177	63	Modulation Sciences	70
20	Belar	101	60	Monroe Electronics	169
52	Benchmark Media Systems	105	56	Moseley	146
29	Bext	26	18	Musicam USA	49
44	Bext	128	60	Myat Inc.	192
55	Bradley Broadcast	119	37	National Public Radio	133
35	Broadcast Devices, Inc.	151	26	Neumann USA/Sennheiser	16
58	Broadcast Electronics	87	10	Orban	114
41	Broadcast Electronics	164	52	PTEK	220
4	Burk Technology	42	47	Pacific Recorders	95
1	CCA Electronics	9	35	Phasetek	135
26	CRL	65	60	Pristine Systems	158
35	Celcast Communications	174	49	QEI	203
38	Circuit Werkes	197	40	RE America	122
13	Clark Communications	71	66	Radio Resources	12
44	Coaxial Dynamics	39	2	Register Data Systems	81
11	Communications Data Services	10	46	Sealevel Systems	157
52	Comrex	15	60	Shively Laboratories	181
54	Conex Electro-Systems	201	60	Silicon Valley Power	204
3	Continental Electronics	126	42	Studio Audio & Video Ltd	183
44	Cool-Amp	127	70	Svetlana Electron Devices	139
44	Cortana	173	35	Svetlana Electron Devices	199
39	Crown Broadcast	170	21	Tascam/Teac	85
23	Cutting Edge	56	52	Technet	22
45	Dataworld	206	38	The Blue Group	111
70	Econco	93	35	The Management	18
44	Econco	196	70	Transcom Corp.	1
50	Enco Systems	115	28	UPI	90
69	Energy-Onix	24	35	Universal Electronics	41
48	Eventide	172	70	Varian	185
52	Excalibur	216	60	Varian	62
65	Fidelipac	103	64	Ward Beck	78
32,33	Fostex Corp.	175	72	Wheatstone	150
60	Freeland Products, Inc.	19	22	Whirlwind	40
30	Ghostwriters	37	51	Wireready Newswire Systems	214
38	Gorman Redlich	88	44	Zercom	110

Publisher	Stevan B. Dana	Ad Traffic Coordinator	Kathy Jackson
Associate Publisher	Carmel King	Ad Production Coordinator	Lisa Lyons
Marketing Consultant	Al Leon	Production Assistant	Cristina Strigel, James Cornett
Marketing Assistant	Regan Deatherage	Ad Coordination Manager	Simone Mullins
Production Director	Lisa Stafford	Circulation Director	Eleya Finch
Publication/Desktop Systems Mgr	Julianne Shannon Stone	Circulation Manager	Steven Bowman
Classified/Showcase Production Coordinator	Vicky Baron	Accounts Receivable	Steve Berto

#### Advertising Sales Representatives

U.S. East: Skip Tash	703-998-7600	Fax: 703-998-2966
U.S. West: Dale Tucker	916-721-3410	Fax: 916-729-0810
International: Stevan B. Dana	+1-703-998-7600	Fax: +1-998-2966
Europe: Dario Calabrese	+39-2-753-0274	Fax: +39-2-753-2697
Japan: Eiji Yoshikawa	+81-3-3327-2688	Fax: +81-3-3327-3010

Free Subscriptions are available upon request to professional broadcasting and audiovisual equipment users. For address changes, send current and new address to RW a month in advance at P.O. Box 1214, Falls Church, VA 22041. Unsolicited manuscripts are welcomed for review; send to the attention of the appropriate editor.



# Why Auditronics' 210 console remains radio's virtual standard

The contemporary 210 console contains exactly those features and qualities your on-air people tell us they need to do their best work. Nothing more, nothing less.

The Auditronics 210 has the best record for up-time of any radio console. It just plain works, elegantly, all day, every day, all year, every year.

And, most important in this age of cost concern, we've made our production more efficient, so we can deliver today's 210 console at a price less than that of over a decade ago.

It's no wonder the 210 console continues to be the on-air mixer of choice among quality-conscious broadcasters. Choose the Auditronics 210 for your next console replacement or upgrade. Call 901-362-1350 today for complete information.

*This Auditronics 210-18 in KPFA-Berkeley's on-air studio is one of four 210s in use at the Pacifica Foundation station.*



**auditronics, inc.** 3750 Old Getwell Road, Memphis, Tennessee 38118 • 901-362-1350 FAX 901-365-8629

Circle (31) On Reader Service Card

World Radio History



*We've taken all we know, all you've asked for,  
and the very best of today's technology to  
bring you our **FINEST AUDIO CONSOLE***



THE A-6000's open architecture frame lets you change module locations with NO restrictions, giving layout top priority and allowing easy reconfiguration as format needs change. And while Wheatstone is well known for superior technical performance, the A-6000 surpasses even our own previous consoles in virtually every measurement category! The WHEATSTONE A-6000 has the appearance, features and power to satisfy the most demanding program and production staff. Its engineering, performance and thoughtful design will help your personnel achieve *broadcasting excellence*.

## A - 6 0 0 0    B R O A D C A S T    C O N S O L E

7305 Performance Drive, Syracuse, NY, 13212  
(tel 315-452-5000 / fax 315-452-0160)

 Wheatstone Corporation