

\*\*\*\*\*3-DIGIT 605  
S1037230 D080 9602  
THOMAS E BRAXTON 341  
MTS  
LUCENT BELL LABS/RM 2B-217  
2000 N NAPERVILLE RD  
NAPERVILLE IL 60563 1443



**Production Stories  
from NPR in Public  
Domain, page 22.  
For Studio Sessions,  
see pp.17-32.**

# Radio World

Vol 20, No 7 Radio's Best Read Newspaper April 3, 1996

## Via Subcarrier: It's Digital Audio Radio

by Lynn Meadows

**BOSTON** A new digital audio broadcasting concept may steal the show this year — the NAB '96 spring show that is. Last fall, WCRB(FM) and Sanders, a Lockheed Martin Company, introduced the idea of digital broadcasting on a subcarrier at the Radio Show. On April 14, during the "DAB: U.S. and Worldwide Planning" conference, they will present actual data gathered while lab and field testing their on-carrier digital system, FMdigital (FMd).

David Maxson, vice president, director of engineering for Charles River Broadcasting Co., and Dr. David Murotake, project manager at Sanders will present the paper. They will also have a booth in the Special

Technologies Exhibit hall. "We don't want to jump ahead and make claims that we haven't proven yet," said Maxson. "What we've done so far is a development testing program." Sanders and WCRB developed and are testing what Maxson calls an "extra high speed subcarrier" that operates reliably at about 200 kilobits per second (kbps). That is 10 times faster than the systems the National Radio Systems Committee is considering for a high speed data standard.

### How it works

The idea is straightforward: Scratch the traditional 57 kHz, 67 kHz, and 92 kHz subcarriers and use that 40 kHz to send a digital signal. Sanders developed a modem that transmits approximately five bits/second/hertz. With 40 kHz of bandwidth, the modem can pass 200 kbps — enough to carry a compressed, digitally coded, stereo audio signal. So far only raw data has been passed through the FMd system. Sanders and WCRB put a repeating random pattern of bits through a series of hoops — multipath, low signal level, interference — to check for errors. Maxson will bring that data to the spring show. Once they see how the modem behaves with raw data, Maxson

said they plan to talk to companies with perceptual audio coders and decide on variables like error correction. "Obviously, there is a little more development to go on here," he said. He added that a couple things are working in their favor. The same inexpensive chips and technologies that have taken 300 baud modems to 28.8 kbps and beyond in just 10 years are similar for this FM digital signal. Another plus for the subcarrier system,

said Maxson, is that receivers could be made inexpensively. **Subsystem design** "Instead of designing a whole new receiver from the antenna to the speaker, all we need to do is just design this subsystem that would go in a receiver that would attach to the FM front end that is already there," he said. continued on page 9 ►

## WME Draws Fire; NAB Splits Hall

by Bob Rusk

**WASHINGTON** The National Association of Broadcasters (NAB) needs to make some dramatic changes if it wants continued support from audio exhibitors at the combined Fall Radio Show/World Media Expo. That is what many exhibitors, who have a long list of complaints, are saying. The convention brings delegates of the NAB Radio Show together with those from the Society of Broadcast Engineers, Radio Television and News Directors Association, and Society of Motion Picture and Television Engineers. The NAB is aware that the mix of audio and video interests at the



### Father of ENDEC EAS!

Gerald M. Le Bow

Jerry knows more about ENDEC EAS than anybody else on the planet, because he created it. Meet Jerry and enjoy his presentation as he walks you through a step by step introduction to the ENDEC, and how easy it is to comply with the FCC's mandate, at **NAB in Booth 3517** in Radio Land Monday through Friday.

Beginner's Lecture on the hour 10a.m.-1p.m.  
Advanced Lecture on the hour 2p.m.-4p.m.  
Master's Lecture on the hour at 5 p.m.

1-800-622-0022 **HARRIS**



**Tower and antenna calamities are easier to solve than you think. Check out Buyers Guide, pp. 59-73**

## Prestholdt To Receive Radio Award

by Bob Rusk

**WASHINGTON** The National Association of Broadcasters (NAB) selected Ogden Prestholdt as the 1996 recipient of the NAB Radio Engineering Achievement Award. That award and two others will be presented April 17 at the engineering luncheon during NAB '96. Prestholdt, 79, began his career in 1937, working in local radio, before joining the CBS network. He later became a partner at the Washington-based engineering firm A.D. Ring & Associates from 1969 until his retirement in 1984. "I am surprised and pleased to receive this award," said Prestholdt from his home in Sarasota, Fla., where he has been based as a consulting engineer since retiring. His projects include the development of two

# NEWSWATCH

## KXBT Moves To Expanded Band

**SAN FRANCISCO** On March 19, KXBT(AM) started broadcasting in the expanded band. The Federal Communications Commission granted the station a special temporary authority to begin broadcasting at 1640 kHz.

KXBT joins WJDM(AM) 1660 kHz in the much-coveted expanded band. General Manager Andy Santamaria said the station will simulcast its soul oldies format at 1190 kHz.

The station returned its Continental Transmitter to 1640 and is using a unipole antenna to broadcast both stations.

Santamaria said that during the testing time, he heard from DXers in Arizona and Oregon.

## Radio Hall of Fame Nominees

**CHICAGO** The Museum of Broadcast Communications announced the nominees for the Radio Hall of Fame. The winners in four categories will be inducted into the hall on Sunday, Oct. 27. Casey Kasem will host the event.

The nominees for the "Network or Syndicated - Active" category are Rick Dees, host of ABC's "Rick Dees Weekly Top Forty"; Karl Haas, classical music commentator and host of "Adventures in

Good Music"; Eddie Hubbard, veteran disc jockey on ABC Radio's Stardust format; Tom Joyner, morning host on ABC's Urban Contemporary Network; and Susan Stamberg, reporter and anchor for National Public Radio's "All Things Considered."

"Local/Regional - Active" nominees are Paul Berlin, who has been "Mr. Music" in Houston for over 40 years, first at KNUZ(AM) and later at KQUE(FM); Gordon Hinkley, talk show host at WTMJ(AM) in Milwaukee; Hy Lit, disc jockey at WOGL-FM in Philadelphia; Larry Morrow, who wakes up Cleveland on WQAL(FM); and Jerry Williams, talk show host for WRKO(AM) in Boston.

The five nominees in the "Network or Syndicated Pioneer" category are Eddie Cantor, deceased, known as the "King of the Clowns"; William Conrad, deceased, the actor who played Matt Dillon on radio's "Gunsmoke"; Bing Crosby, deceased, whose radio career lasted over three decades; Wolfman Jack, deceased, the quintessential rock 'n' roll disc jockey; and Kate Smith, also deceased, the singer who introduced the song "God Bless America."

In the "Local and Regional Pioneer" category, the five nominees are Jack Brickhouse, voice of the Chicago Cubs and Chicago Bears on WGN; John Gambling Sr., host of "Rambling with Gambling" from 1959 to 1991 on WOR(AM) in New York; Harden & Weaver, the most popular radio team in

continued on page 3 ►

## Take a LOOK at THIS:



## Then look at our competition.

**OF COURSE** many stations are cost-conscious these days—just remember why you wanted a new console in the first place: to **UPGRADE**.

**The R-60** has what's needed, with all the right features: our **SIMPLE PHONE®** module for easy error-free talk segments; twin six bank preselectors, so you won't run out of input capacity; onboard machine control panel, clock, timer, a well-designed cue system, and a truly effective control room and studio monitor interface. And because it's totally modular, service is easy—even while you're on-the-air! Documentation: this can determine whether you have an installation day or an installation week. We've done it right to guide you through. And **PERFORMANCE?** Of course we've handled that; simply compare our specs.

**DON'T MISS your opportunity to upgrade.** Choose the R-60 radio console from **AUDIOARTS**.

### FREQUENCY RESPONSE

Line (10Hz-20KHz) ±1/10dB

Mic (20Hz-20KHz) ±1/10dB

### THD+N (20Hz-20KHz)

Line, +4dBu .005%

Mic & Line, +16dBu .005%

### IMD (SMPTE)

Mic & Line, +4dBu .004%

### DIM

Mic & Line, +16dBu .005%

### DYNAMIC RANGE

Line 114dB

Mic 98dB

### HEADROOM

ref +4dBu 24dB

### OFF & ASSIGN ISOLATION

1 KHz -110dB

20 KHz -105dB

### BUS CROSSTALK

1 KHz -100dB

20 KHz -75dB

7305 Performance Drive, Syracuse, NY 13212  
tel 315-452-5000 / fax 315-452-0160  
E-mail: Wheatstone@aol.com



**AUDIOARTS ENGINEERING**

## Index

### STUDIO SESSIONS

- IQS SAW Plus Adds New Features**  
by Bruce Bartlett with Jenny Bartlett 17
- Demeter VTCL Has Vintage Sound**  
by John Diamantis 49
- In-house Jingle Production at NPR**  
by Rich Rarey 22
- Avoid Those Cheap Imitation Radio Voices**  
by Alan R. Peterson 27
- Desktop CD Authoring is Reality**  
by Bruce Bartlett with Jenny Bartlett 29

### FEATURES

- Silly Survey Tests Your Airchain**  
by Chip Diggers, C.E. 30
- Secrets of Saving and Storing Tapes**  
by Frank Beacham 32
- Use CAD Software for Engineering**  
by Andrew Ellis and David Wigfield 33
- High Fidelity SSB Is Not at All an Oxymoron**  
by Al Parker 33
- Famous Team of Toner and Sniffer**  
by Frederick M. Baumgartner 35
- CU-SeeMe Software for the Internet**  
by Tom Vernon 37
- Digital Audio Needs an 'Eye' Test**  
by Jim Somich 43
- Factoring Filters for AM Diplex**  
by Jerry Westberg 46

### RUNNING RADIO

- U.S. Border Stations Cash In on Canada**  
by James Careless 49
- Illinois Broadcaster Works 106-hour Work Week**  
by Lee Harris 51
- Learn from Disastrous Promotions**  
by Mark Lapidus 52
- Language Can Work to Your Advantage**  
by Ty Ford 53
- Free Help to Enhance Your Web Site**  
by Alan Haber 55

### BUYERS GUIDE

- WNWC Profits from Cellular One Deal**  
by Gordon Govier 59
- Shively Labs Exceeds Expectations**  
by Martin D. Hadfield 62
- WCIL Benefits from LBA**  
by Joey Helleny 62
- ERI Softens Blow of Hurricane Opal**  
by Charles Harrell 64
- Crawford Couples with Kintronics**  
by W.C. Alexander 65
- Antenna Concepts Is Eager to Please**  
by Greg S. Carpenter 66

**NEWSWATCH**

**NEWSWATCH**

**NEWSWATCH**

**NEWSWATCH**

▶ continued from page 2

the history of the nation's capital on WMAL(AM); Ernie Harwell, long-time voice of the Detroit Tigers on WJR(AM); and William B. Williams, deceased, WNEW(AM) disc jockey who brought music to life in the "Make Believe Ballroom."  
Ballots have been mailed to over 5,000

radio executives, broadcast historians and members of the Radio Hall of Fame. The voting deadline is August 1.

**Run off Results Announced**

**WASHINGTON** The National Association of Broadcasters (NAB) run off elections are over.

William Poole, general manager of WFLS-AM FM in Fredericksburg, Va., will represent district four — Delaware, Washington, D.C., Maryland and Virginia. Stephen C. Davenport, president of WKXG(AM) and WYMX(FM) in Jackson, Miss., won the district eight seat and will represent Louisiana and Mississippi.

Mark Hedberg, vice president, general manager of KRIB(AM) and KLSS-FM in Mason City, Iowa, won the runoff in district 14 and will represent Iowa and Wisconsin.

**Multi-Market Radio Works Wall Street**

**NEW YORK** Multi-Market Radio (MMR) recently filed a registration statement with the Securities and Exchange Commission (SEC) for a public offering of five million shares of Class A Common Stock.

The company will file another registration statement with the SEC for a public offering of \$110 million of Senior Subordinated Notes due in 2006.

MMR will use the money to consolidate and pay down indebtedness. The group operates radio stations in medium-sized markets and has a purchasing agreement with SFX Broadcasting to acquire 11 of the Liberty Broadcasting stations that SFX is buying.

**IRT Issues Invitation**

**MUNICH, GERMANY** The IRT (Institut für Rundfunktechnik) has invited all manufacturers interested in enhancing compatibility and interoperability of products using the ISO/MPEG Audio Layer II standard to a meeting at 1 p.m. April 14 in the Kyoto Room of

the Imperial Palace Hotel in Las Vegas.

The meeting will address seven key areas: sampling frequencies of the PCM audio input/output signal; basic I/O interfaces; minimum common structure of optional ancillary data field; definition of transport layer; file formats and conversion between them; multichannel protocols and extra error protection.

IRT hopes to promote a common vocabulary and refine guidelines to ensure interoperability and compatibility of MPEG Layer II products at various levels.

Along with increasing customer awareness and understanding of Layer II technology, the Institut hopes to encourage broader implementation of MPEG Layer II.

**REGULATORY UPDATE**

**WASHINGTON** Uncle Sam wants you to register your antenna structure. New owners or those planning to alter their existing structures must register them before any alteration or construction begins according to the Federal Communications Commission (FCC). However, owners of existing antenna structures with no alteration plans should use the FCC timetable published below. Owners with a large number of structures in multiple states can make arrangements with the FCC to register them all at once. Call (202) 418-0680 for information. Stations should file FCC Form 854 to register. The form is brand new and is expected to be available on the FCC's fax on demand service starting in June. Here are the dates for registering existing antenna structures that will not be altered anytime soon.

STATE	WINDOW		
Michigan	July 1-31, 1996	Alabama	
Montana		Washington, D.C.	Dec. 1-31, 1997
		Maryland	
Arizona		Arkansas	
Hawaii	August 1-31, 1996	North Dakota	Jan. 1-31, 1998
North Carolina		Utah	
Alaska		Idaho	
New Mexico	Sept. 1-30, 1996	Mississippi	Feb. 1-28, 1998
New York		South Dakota	
		Vermont	
Massachusetts	Oct. 1-31, 1996	Kentucky	March 1-31, 1998
Missouri		Tennessee	
Illinois	Nov. 1-30, 1996	Connecticut	
Wyoming		New Jersey	Apr. 1-30, 1998
		South Carolina	
Nevada		Texas	May 1-June 30, 1998
Oklahoma	Dec. 1-31, 1996		
Puerto Rico			
California	Jan. 1-Feb 28, 1997		
Ohio			
Iowa	March 1-31, 1997		
Virginia			
American Samoa			
Georgia			
Guam	April 1-30, 1997		
Gulf of Mexico			
Mariana Islands			
U.S. Virgin Islands			
Louisiana/Maine	May 1-31, 1997		
Rhode Island			
Colorado	June 1-30, 1997		
Minnesota			
Nebraska	July 1-31, 1997		
Pennsylvania			
Florida	Aug. 1-Sept. 30, 1997		
Indiana			
Delaware			
Kansas	Oct. 1-31, 1997		
Washington			
New Hampshire			
Oregon	Nov. 1-30, 1997		
Wisconsin			
West Virginia			

**The Wizard™ has gone STEREO!**

The new **DIGITAL** FMSA-1 gives The Wizard System unmatched stereo monitoring capabilities.



Superlative stereo performance. Linear-phase filters that reveal the true performance of your audio processing. The stability of digital stereo demodulation. The sophisticated graphical presentation of The Wizard. And—with the RS-232 port—operation on site or off.

**Contact Belar today for more details on what should be your next modulation monitor**

**BELAR ELECTRONICS LABORATORY, INC.**  
119 LANCASTER AVENUE • P.O. BOX 76 • DEVON, PA 19333-0076 USA  
(610) 687-5550 • FAX (610) 687-2686  
Call, write or FAX for more information on Belar AM, FM, Stereo, SCA, and TV monitors.

**Question:**  
Ever wonder why transmitter manufacturers operate Altronic dummy loads at NAB and other trade shows?

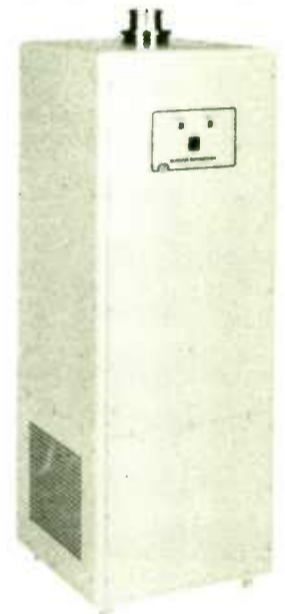

**Answer:**  
The best performance and the most dependable dummy loads built.



**ALTRONIC RESEARCH INC.**

WATER AND AIR COOLED MODELS FROM 1000 WATTS TO 1,500,000 WATTS

P.O. Box 249  
Yellville, AR 72687  
(501) 449-4093

# SBE Publishes Emergency Alert System Primer

**WASHINGTON** The Society of Broadcast Engineers seized the lead early at a local level in the push to help broadcast stations comply with the new Emergency Alert System (EAS) mandated by the Federal Communications Commission in its new Part 11 rules. As early as February 1995, the Houston chapter of the SBE exemplified grassroots broadcast teamwork at its best when it put its money where its goals were and voluntarily modified EBS decoders to receive an eight-second emergency warning tone instead of a 22-second warning tone for 67 Southeast Texas radio and television stations.

Each station saved about \$120 in fulfilling the FCC July 1, 1995, tone conversion deadline. The Houston chapter, in one helpful day, elevated the stature of engineers to radio and television management by proving them (the engineers) to be clear and bottom-line thinkers. That in turn helped reaffirm the idea that engineers should always be part of the strategic-planning team at a station.

Fellowship among engineers, demonstrated by chapter member Dave Biondi allowing the SBE to use his business, the Broadcast Service Co., as the conversion site, is overwhelming evidence of the technical and financial benefits that can be brought to the management of a station — if only the engineers are allowed to participate in the decision-making process.

Houston's efforts were seconded by Washington's SBE Chapter when it, too, had an EAS day. With the support of Bud Aiello and the National Public

Radio facility in D.C., Washington's SBE voluntarily modified stations gear

AM-FM. Seattle; Richard Rudman, KFWB(AM) Los Angeles and Gary Timm, of WTMJ(AM)-WKTI(FM) Milwaukee, it is available from the society's headquarters for \$25 (for SBE members) and \$35 (for non-members).

The primer is exhaustive. Topics covered include: EAS basics, system requirements, operational options, operational procedures, technical specifications, diagrams, developing a local plan, guide for SECC chairs, questions and answers, summary, EAN network chain, part II information and EAS-related releases.

NAB '96 is the ideal place to shop for

Among the players at the show with EAS gear is TFT Inc. It offers the EAS 911 encoder/decoder, the EAS 930 multimodule receiver; the EAS 940 program/transmitter interrupt unit; and the EAS 941 remote control/status module for EAS 911

Gorman-Redlich is planning to showcase its brand-new EAS encoder/decoder and its line of NOAA weather radios on hand —

a good companion for EAS. Many of you familiar with the FCC text on EAS know that the commission encouraged the use of RBDS with the new EAS. If you are interested, look for Sage Alerting's ENDEC — fully compatible with RBDS and scheduled to be on display at the Harris booth.

Of course, if you own a Class D FM you are not required to have an EAS encoder.

Also, any FM station used as a translator or booster entirely dedicated to rebroadcasting programming of another local broadcast station is not required to have any EAS gear and neither is it required to comply with the EAS.

The SBE EAS Committee has put together a terrific publication. Its intent, according to SBE, is to "offer this publication as a guide to building that EAS."

"That EAS" is a reference to an alerting system that is flexible in the transmission of emergency messages yet not vulnerable like the old EBS serial-relay system.

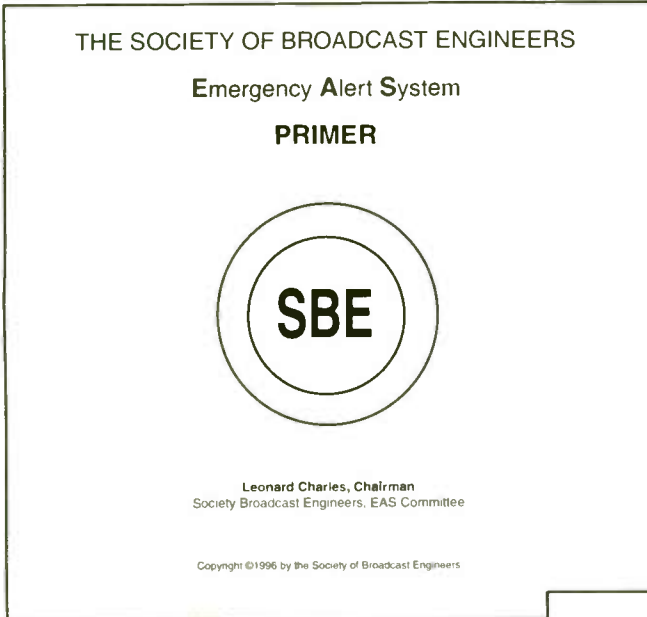

### Broadcast stations

Required	7/1/95	1/1/97	1/1/98
two-tone encoder timing	8-25 seconds	8-25 seconds	8-25 seconds*
two-tone decoder timing	3-4 seconds	3-4 seconds	no de-mute tone required
digital decoder and encoder	not required	use is required	use is required

\* two-tone signal used only to provide audio alert to audience, before EAS emergency messages, and during the required monthly test

Source: SBE EAS Primer

from the tri-state area to help bring them into compliance.

The national SBE applauded both chapters' proactive approach at the time. It also started a new committee to help with conversion to the new EAS system. The charter is and was ideated to help managers, engineers and owners make the best choice for their stations when selecting an EAS system.

The SBE EAS Committee (in cooperation with the Ennes Foundation) just delivered "The Emergency Alert System Primer." A product of the joint effort of Leonard Charles, chairman, WISC-TV Madison, Wis.; Fred Baumgartner, TCI National Digital Television Center, Denver; Dane Ericksen PE, Hammet & Edison Inc., San Francisco; Paul Montoya, Broadcast Services, Lakewood, Colo.; John Price, KMTT-

the gear you need to bring your station into compliance. As a quick reminder, radio broadcast stations' timetable for EAS was decided as in the chart:

As you can see, the Jan. 1, 1997, only is eight months away. Time to go shopping. Recently certified EAS equipment will be on display in Las Vegas April 14-18. Be sure to add it to your shopping list as well as your station budget.

**ARC-16: the logical choice for LMA and duopoly transmitter control.**

The ARC-16 is available through:

*Equipment Solutions To Keep You Number One*

**BSW**  
BROADCAST SUPPLY WORLDWIDE

**Phone: 800-426-8434**  
**Fax: 800-231-7055**

**Put us in your sites.**

BURK TECHNOLOGY • 7 Beaver Brook Rd., Littleton, MA 01460 • Phone (508) 486-0086 • Fax # (508) 486-0081 • email control@burk.com

Circle (8) On Reader Service Card

READERS FORUM

If you have comments for Radio World, call us at 800-336-3045 or send a letter to Readers Forum (Radio World, Box 1214, Falls Church, VA 22041 or e-mail at 74103.2435@compuserve.com). All letters received become the property of Radio World, to be used at our discretion and as space permits.

DOS Platform Simpler, Faster, More Dedicated

by Larry Lamoray

**FARMINGTON HILLS, Mich.** I read with great interest Kevin Lockhart's recent *Guest Commentary* and staunch support of Windows as a stable operating platform for digital audio. He makes several valid points, but in my opinion, a few need further examination.

The DOS vs. Windows issue has many hidden facets.

To reiterate a statement of mine as quoted by **RW** in an earlier issue, "Windows is one of the best software packages available for typical desktop applications." Windows was developed specifically to manage the launching and operation of literally thousands, if not tens or hundreds of thousands of unrelated software programs for various home, office, and proprietary applications.

By the very nature of that fact, it is optimized for one, and in fact does not even permit the programmer of application software access to critical areas for optimization of memory and other resources. While this is of minor concern for typical desktop applications, it is a major issue if you are attempting to run an entire broadcast facility, where even minute delays in network transfer or file access are unacceptable, and support of multiple workstations performing a wide variety of tasks is mandatory.

Any engineer who runs the numbers on the required amount of memory caching and network overhead to properly manage such operations in a large scale system quickly realizes that to do so efficiently requires absolute control of the optimization parameters.

I note that several digital audio system manufacturers get around this by spreading

critical management duties over several PCs. But with DOS, the optimization control is available to permit integration of more dedicated functions into a single PC. That is not only inherently more economical, but leaves fewer points of potential failure as well. Granted, you lose the ability to play games or write letters home on your on-air workstation, but that is not the reason that you bought it. (I wonder how many systems were knocked off the air for just that cause — and nobody can verify it?)

One of the major concerns in choice of an operating system is ease of support. Of course, given a perfect world, all of the many digital audio products utilizing various computer platforms and operating systems would work well right out of the box — everytime — all the time. Unfortunately, such is not the case, and when a broadcaster's audio system goes down he or she cannot wait for assistance.

Faced with an existing user base that is often not as computer literate as it would like to think, this presents many unique challenges to manufacturers attempting to provide a cost-effective and user-friendly product, plus support the substantial level of customer assistance required.

While Windows setup configurations can be complex for the uninitiated, and support from Microsoft is never immediate, DOS configurations are far more straightforward and easier to support via telephone or fax.

The operating system is the primary contributing factor as to how easy it is to create a truly intuitive GUI (Graphic User Interface). Windows is infamously frustrating for novice users, with the required "double clicks," overlays, and delays. Windows is easier to program for, but DOS permits a simplified and faster reacting dedicated GUI that strips away all but the functions actually required for the task at hand, and provides programmers far greater flexibility in designing the GUIs that they envision.

I am amused by Mr. Lockhart's reference to Windows being today's technology. As Windows is merely a protected mode environment that rides on DOS, isn't DOS in the same category? I might refer your readers to a similar *Guest Commentary* in the May 1995 issue of *Upside Magazine*, a monthly publication widely read by computer professionals, titled "Praise of DOS." The author refers to Windows as "a 500 pound gorilla ... that you can't hide," and expounds on how "It's a memory hog that turns a large, fast computer into a small, slow computer." The unusual number of ensuing letters to the editor in support of those statements can only indicate that there is wide agreement among those most knowledgeable concerning such matters.

But ultimately, it is of course, each individual customer who must decide on what is best for his or her specific application. I submit that there is adequate market acceptance reflecting both schools of thought, those who buy into the Windows phenome-

Protect Radio's Interests

The upcoming NAB Conference and Exhibition underscores the health of the different electronic media, and the rapid pace of revenue growth for all of them.

If you look at radio, television, cable, and multimedia, just about each and every segment can boast a successful yearly "show" where leading professionals gather to disseminate the latest information, and leading manufacturers gather to exhibit the latest wares.

Not so for the oldest medium: radio.

Two years ago, the fall radio-exclusive show, a remnant of the old NRBA (National Radio Broadcasters Association) became one of four conferences held together by a combined exhibit floor, World Media Expo. Equipment manufacturers were initially pleased. Where they once had to attend four different conferences (or at least three for those that were radio-only), they could now handle all four with one trip.

But the reality of the event has left many radio/audio companies and attendees unhappy. The largest NAB Radio Show, with its record-breaking radio/audio pavilion exhibit, was dwarfed in its very first WME by the television exhibits.

While the spring NAB show boasts incredible exhibits for radio/audio interests, the agenda for attendees is diminishing year by year. For radio/audio exhibitors, costs-per-qualified-lead are making the fall gathering uneconomical, thus creating a catch-22 — which show do you attend if you are in radio?

In the spring show, more and more "audio" companies are opting to locate their booths on the video side of the convention center. In 1995, the industry's largest radio equipment supplier, Harris, followed that route. These companies are drawn by the bustling traffic in the video hall compared to the audio hall.

Now the NAB tells us that it will be splitting the World Media Expo floor into audio and video sections. Could spring's trends repeat themselves in the fall?

NAB needs to watch this situation carefully, and make sure that radio/audio is well represented. Radio is a distinct and separate medium. Its business, programming and technical interests and needs should be well-served and protected by the association that represents it.

-RW

non and are comfortable with its peccadillos, and those who realize that the true measure of a system is performance, reliability, and support.

□ □ □

Larry Lamoray is vice president, sales and marketing of Enco America in Farmington Hills, Mich.

Require community service

Dear RW,

I have been following the story of WJDM(AM), Elizabeth, N.J., and can hear the station's 1660 kHz broadcasts quite well during the day and night 85 miles from the station. As a native of Elizabeth, I am very disappointed to see that WJDM has abandoned its promise of full-time local service in favor of Radio AAHS, a national, satellite-delivered children's format service.

Some background information is in order here. Several years ago, the owner of WJDM, then a daytimer on 1530 kHz, lobbied Congress with the promise of providing Elizabeth with its first and only full-time radio service. The city of 125,000 people is the county seat of Union County, one of the nation's most densely populated counties.

Union County is also a black hole when it comes to news coverage. It has no local daily newspaper. The county's only daily newspaper, the Elizabeth Daily Journal, folded in 1992 after a run of 212 years. The county's only other radio station, WERA(AM) in Plainfield, has a directional pattern that puts a null over much of Union County, including Elizabeth.

Although Elizabeth is practically in sight of the New York City skyline, the stations in New York have neither the time nor the desire to cover news in Union County. Moreover, most businesses in Union County cannot afford to advertise on New York stations. So, WJDM's lobbying efforts have

worked. WJDM got its expansion band frequency, higher power and permission to operate 24 hours on the new frequency. But Elizabeth and Union County remain woefully unserved.

It is time to smash the deregulation idol to which altars have been erected all over Washington and require broadcast stations to serve their communities of license. It seems hypocritical indeed to hear broadcasters complain about the advances being made in direct broadcast satellite technology while they are using their stations to provide the same thing: homogenized, national satellite programming without a shred of localism.

Philip E. Galasso  
West Creek, NJ

Stay local

Dear RW,

I can understand why radio station owners, especially FM radio station owners, are afraid of what satellite digital audio radio services (DARS) would do to their radio listeners.

Why would I listen to a radio station that plays seven, 10, 12 or more songs in a row, separated only by a slug of commercials — no news, no weather, no information — when I could listen to digital, maybe even without commercials? When I get nothing local from my local FM station, I might as well listen to digital radio.

T.S. Storck  
Penn Valley, CA



Vol. 20, No. 7 April 3, 1996

Editor in Chief.....Lucia Cobo  
Managing Editor.....Whitney Pinion  
Technical Editor.....Alan Peterson  
Associate Editor.....Angela Novak  
Staff Writer.....Lynn Meadows  
Assistant Editor.....Christopher Nicholson  
Technical Advisors.....John Bisset, Tom McGinley  
Editorial Director.....Marlene Lane  
Assistant Editorial Director/Audio.....Alan Carter

Radio World (ISSN: 0274-8541) is published bi-weekly by Industrial Marketing Advisory Services, Inc., 5827 Columbia Pike, Suite 310, Falls Church, VA 22041. Phone: 703-998-7600, Fax: 703-998-2966. Second-class postage rates are paid at Falls Church VA 22046 and additional mailing offices. POSTMASTER: Send address changes to Radio World, P.O. Box 1214, Falls Church VA 22041. REPRINTS: Reprints of all articles in this issue are available. Call or write Giselle Hirtenfeld, P.O. Box 1214, Falls Church, VA 22041; (703) 998-7600; Fax: (703) 998-2966 Copyright 1996 by Industrial Marketing Advisory Services, Inc. All rights reserved.

—PRINTED IN THE USA—

Next Issue of  
Radio World  
April 17, 1996

## Separate WME Audio Floor

► continued from page 1

show has upset some long-time audio exhibitors. Haidee Calore, NAB senior vice-president, conventions and exhibitions, admitted that the NAB is "concerned about losing exhibitors," and added that "we have spent a lot of time with people trying to learn how to improve the event."

At the top of the list of complaints is the disappointing business some companies say they do at this convention.

"It is the most over-sold show on earth," one exhibitor said. "The NAB sells it like it's a major event, and it isn't."

Industry heavyweight Harris Broadcast

is scaling back its participation in the show to match the lukewarm response the company has received in recent years.

"The fall show is a nice, small show. It merits a nice, small appearance," said Dave Burns, Harris studio product manager. He added that "the spring show merits as much money as you can possibly budget."

The high cost of attending both shows is too much for some companies.

Ernie Belanger, marketing vice-president at Energy-Onix, said, "I can understand and appreciate the need for the NAB to serve the many facets of the broadcasting industry. However, I truly

believe that it is not fair financially that there are two separate venues for radio people to attend."

Belanger suggested that there be just one show for radio.

Many industry insiders who made scathing comments about the fall show spoke only on the condition of anonymity. As one person confided, "It's very difficult for an exhibitor to be open and honest without the fear of retribution. The biggest dilemma that any exhibitor has in offering constructive criticism is that the NAB owns the ballpark."

One company that decided not to participate in the fall show this year cited disappointing attendance and sales in the past — even when there were four separate shows.

"It should have been successful (with

SBE, RTNDA, and SMPTE participating), but we felt like it was four shows that were lame to begin with," a representative said. "You ended up with one big show which was disappointing."

"I walked booth-to-booth last year and asked exhibitors if they were happy with what they paid and what they got. They said no."

That opinion was shared by Tim Schwiager, vice-president, marketing at Broadcast Supply Worldwide which will be at the show this year.

"We have been an exhibitor for over 10 years," he said, "and there has been a noticeable decline in (the number) of customers coming to our booth" since the fall show became a combined event.

"We first noticed this in Los Angeles in 1994. We thought people were nervous about going to California because of the recent earthquakes," he continued. "Last year in New Orleans we assumed there would be more customers. We were shocked to see that the attendance was very light."

"Although the reported attendance figures were healthy, we did not see those people at our booth. We don't know where they were. We know that the NAB is working on getting more of the attendance into the exhibit hall. We applaud them for that."

One change is a splitting of the halls this year. There will be a television/video/film hall and a radio/audio hall.

"Our goal is to create a show-within-a-show," explained Calore.

"This allows us to put the appropriate conferences near the appropriate exhibit hall. It allows us to create a focused environment for each of the two communities, while still having it under the umbrella of a larger event. All of our promotional campaigns for 1996 will highlight that. We'll have a special message for people in the radio industry."

Additionally, there will be exclusive exhibit hours from 3-6 p.m. on Thursday and Friday, with no conferences to compete with the exhibits.

Calore used last year's attendance figures, which included 4,450 qualified radio buyers, as evidence that the combined show is growing. She compared that to 1993 when it was just the radio show and there were 3,400 buyers.

Calore is aware, that many exhibitors would prefer to return to the radio-only format, eliminating video from the fall show.

"There are people from the television/video side that aren't real thrilled about being connected with a bunch of radio/audio exhibits," she remarked. She went on to say that some audio companies like being part of the combined show. However, the head of one of the firms that she said gave the NAB positive feedback on the show questioned Calore's statement.

"I find it surprising. I never told them anything like that," the executive insisted. "It's not a very worthwhile show. Unfortunately, if you don't go, people say 'What's the matter with that company? Why didn't they go?' We'll probably end up attending this year, but haven't made a commitment yet."

Attempting to reassure the audio attendees, Calore stressed, "We want this to work for everybody, especially the folks who have been involved in our fall event for quite some time which are all of our radio people. The radio industry is very important to NAB."

# It's a Free Tape Explosion!



What studio couldn't use more professional tape — and a TASCAM DA-88? So to celebrate the DA-88's numerous technical achievements and awards (including the coveted Emmy), and introduction of the new TDK PRO line of precision recording media, TASCAM and TDK are rewarding DA-88 buyers with what they need most — FREE tape. Act now and for each DA-88 you buy, you'll get the explosive 60-piece TDK Studio Tape Package. That's 20 each of TDK's hottest and highest quality professional Hi8 (MP120), DAT (DA-R60), and Cassette (SM60) tapes — tape you'll use every day. For tracking, mastering and cutting demos. You'll get 80 hours of record time on 60 free tapes — over a \$500 value. So if you've been waiting to buy your DA-88, or want to add tracks to your current setup, don't hesitate any longer. Get to your dealer and make a deal today. Because this explosion won't last forever.



**TDK PRO**



**TASCAM**  
Take advantage of our experience

To qualify for the free TDK tape offer, you must purchase a TASCAM DA-88 between April 1, 1996 and June 30, 1996 from any authorized USA or Canadian TASCAM Dealer. After you take delivery of your DA-88, mail a copy of your fully paid dealer receipt, complete with serial #'s, directly to TASCAM USA, Dept. FREE TAPE, 7733 Telegraph Rd., Montebello, CA 90640. In Canada, mail to TEAC CANADA LTD, Dept. FREE TAPE, 340 Brunel Road, Mississauga, Ontario L4Z 2C2, Canada. For your protection, we suggest mailing by certified mail. TASCAM will ship prepaid direct to you the TDK 60 Piece Studio Tape Package. Offer good for each and every new DA-88 purchased during the duration of the promotion (sixty tapes as described for each DA-88 purchased). All requests must be received by mail, no later than July 15, 1996; no FAX requests will be accepted. Please allow 6-8 weeks for processing and delivery.

Circle (57) On Reader Service Card

World Radio History

# Infinity, Stern Create New Network

by Alan Haber

**NEW YORK** Howard Stern — radio and television mogul, best-selling scribe, and soon-to-be shining star of the silver screen — has re-upped with Infinity Broadcasting for five years.

Sweetening the deal is an agreement between Infinity and Stern to create the Howard Stern Radio Network. There has already been a lot of interest in the network from stations. According to Stern's agent, Don Buchwald, there has been interest from stations in small markets "which heretofore we were not making deals in for the Howard Stern morning radio show."

Stern, announcing the re-signing and agreement to his listeners on the air on Tuesday, March 5, told sidekick and perpetual voice of reason Robin Quivers that he "signed for another couple of years." "Another couple?" asked Quivers. "Yeah," Stern answered, slowly, "another." He hesitated. "—technically five." Quivers laughed hysterically.

Stern noted during the March 5 broadcast that he'd "been talking to a bunch of companies that wanted to hire us. As a matter of fact, I'd even had the financing put together to start our own radio network, where we wouldn't have to work for anybody."

"And?" Quivers asked.

"I had it in place," Stern answered.

"And?" Quivers repeated.

"But it was like so much hassle," Stern suggested, "and I just said, eh, 'Forget it.'" The King of All Media laughed. He said he was going to stay where he was. "It was like, I could see this one blowing up in my face," he said.

There don't look to be many explosions taking place, however — at least not any of the destructive kind. Stern is not likely to look for a way out of what arguably is the best radio deal in town — any town. Stern is currently carried in 24 markets, on big stations like home base WXRK in New York, WYSP in Philadelphia, and KLSX in Los Angeles.

Big stations, big markets. And now, other size markets.

"We've started to make some deals," said Buchwald. "We've made three deals in the last week, and we have a number of other conversations going on. These same stations, and other stations as well, who are in our affiliation at the moment, are interested in other product that would come through on the Howard Stern Radio Network."

Buchwald said the programming for the network will not be developed "in any quick fashion."

"We're going to take as much time as necessary until it reaches Howard's standards, which for radio are high."

It is not yet known whether any of the 24 stations currently affiliated with Stern will be part of the new network.

Buchwald said that, in the past, he had not been looking at stations in other than the top 50 markets to carry Stern's show.

Although Buchwald didn't name any of the interested stations, he did say that one station in York, Pa., had been signed slightly before the new deal with Infinity was announced.

Buchwald noted that there is "a whole bunch of other things (going on) that we're not even talking about yet." Stern is talking on the air about the celluloid

version of his first book, "Private Parts," which is about to go into production.

Stern, who has been in New York radio for about 15 years, is "generally pleased with things," Buchwald said. "I think

**Stern is currently carried in 24 markets, on big stations.**

he's turned on — he's turned on by the radio business. And he is vitalized by the idea of the network and is vitalized by the last rating book. The fall rating book was probably the best rating book he's ever had in 20 years of broadcasting. That's pretty amazing."

Buchwald ran down some of the New York numbers. Persons 18-34, number one with a 16.3. Men, 18-34, number one with a 23.5 — the next highest ranking being at 9.9. Men 25-54, number one with a 16.9. Stern keeps on keeping on. "Not only is this guy able to ride it out," said Buchwald, "but, as you see, he's at the top of his game. And he is very enthusiastic about his radio show and his radio future."

Stern's listeners, tuned into his March 5 broadcast, might be excused for thinking otherwise. "I didn't even tell my wife I signed a new contract," Stern said. "I was just moaning and, like, 'Oh, no, I signed another contract.' And she was like, 'Why? What did you do? I don't understand. Weren't you going to discuss this?'"

"I even remember you saying you had this discussion with her and she said, 'Well, why don't you sign for another year?'" said Quivers.

"Yeah," Stern said, "but you can't. Not with this company." Quivers and Stern laughed. "It's like the army," he said. "'Cause we make a lot of money for the company and now they know they've got us for five years, and they'll make a lot of money with their stock."

Stern, putting the brakes on his humor train in order to be momentarily serious, had nothing but praise for Infinity. "I'll tell you," he said, "if you're going to stay in radio, this is the company to be with. They're real good guys. I'm glad for their success. They deserve it. They took some balls-out chances, especially on us. Yeah.

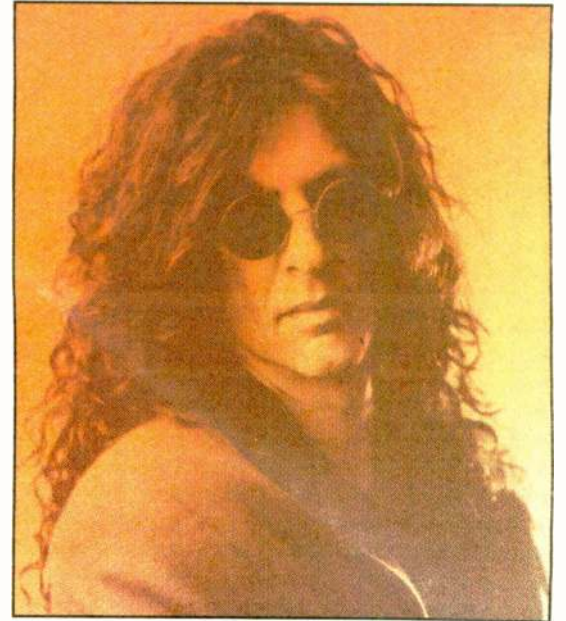

Howard Stern

They definitely took chances on me."

Five days a week of alarm clocks going off at unholy hours for five more years? The news wasn't all bad. "I did get us 51 weeks vacation, though, a year," Stern told his on-air compatriots.

"Well," said Quivers, "we only have to work a week, then."

"Yeah," Stern announced. "This week, and then we're off. We're off 'till this week next year." 

## PCS No Threat to Radio for Now

by Angela Novak

**WASHINGTON** Most of the buzz about PCS (Personal Communications Service) licensing revolves around the billions of dollars the PCS auctions have brought in and the potential for cheaper wireless phone services.

What few people are talking about is the impact PCS will have on radio broadcasting.

The FCC has issued 141 PCS licenses since July 1994. PCS auctions have brought in over \$7 billion. That money, according to the FCC, "is deposited with the U.S. Treasury to reduce the national deficit."

PCS operates in a digital rather than analog format, which is used with cellular systems. It is a wireless medium that can be used to send audio to multiple receivers in any location.

Broadband PCS providers can provide digital audio channels through subscription-based or other for-pay services, and the services could be coupled with PCS two-way communications capability.

Rick Ducey, senior vice president of the Research and Information Group at the National Association of Broadcasters (NAB), said that while PCS is certainly a potential competitor for radio broadcasters, "the emphasis is on potential."

"PCS is not a head-on competitor in the short run," he said.

Ducey pointed out that because of the amount of money being spent on licenses, PCS operators initially will target

the markets that will bring the biggest and fastest returns.

"The telephone market is clearly their bull's eye," he said.

Ducey said that PCS is not likely to take away advertising revenue in the short or medium term because PCS cannot deliver the large audiences that radio advertisers demand.

PCS licenses range from broadband to narrowband, regional to national and licensees are free to offer any of a wide variety of services. The Federal Communications Commission (FCC) implemented rules intended to "ensure that competition and market forces drive business and consumer decisions."

The commission allocated 120 MHz of spectrum for broadband PCS, which the FCC expects will offer "primarily mobile telephone services." The 3 MHz of spectrum allocated for narrowband PCS will be used for "advanced messaging and paging" and the 20 MHz of spectrum allocated for unlicensed PCS will be used for "short range communications, such as local area networks in offices."

Believing that the industry itself will be quick to adopt PCS standards, the FCC has not adopted technical standards for PCS.

The FCC included a build-out regulation that requires licensees to make their service available to one-third of the population in their service area within five years and two-thirds in 10 years.

New licensees can start building their systems immediately. Rules governing PCS can be found in the Code of Federal Regulations, Vol. 47, Part 20-39. 

### Mixer and Expander

**MX100** Three Input Mic/Line Mixer  
**XP100** Four Input Companion Expanders

- Low noise Mic/Line switchable inputs • Phantom power
- Independent headphone and balanced line outputs
- Bright 3 color LED meter • XLR connectors
- Quiet external power • Rack and desk mounting

**AUDIO TECHNOLOGIES INCORPORATED**



328 W. Maple Avenue  
Horsham, PA 19044  
TEL: (215) 443-0330 • (800) 959-0307  
FAX: (215) 443-0394

Call or write  
for free  
detailed  
brochure



# NAB to Honor Robinson for Achievements

by Bob Rusk

**WASHINGTON** Each year the National Association of Broadcasters (NAB) presents an Engineering Achievement Award to a radio engineer who has made contributions in the following categories: inventions, development of new techniques, dissemination of technical knowledge and literature, leadership in broadcast engineering affairs or an outstanding contribution that warrants recognition.

This year's Achievement Award will be presented to Gerald R. Robinson, 65. Robinson was vice president, director of engineering for Hearst Broadcasting until

his retirement last year.

While based in Milwaukee, Wisc., Robinson directed and managed the technical operations of six Hearst radio stations and six television stations. In addition, he started the Hearst Washington News Bureau and Hearst Broadcasting Productions.

He championed stereo and digital compatibility for all Hearst stations and has been an active participant in recent industry efforts to develop data broadcasting standards.

Robinson, who now lives in Fort Myers

Beach, Fla., said receiving the special Achievement Award was "the last thing I thought would happen. It comes as a complete surprise. I'm extremely happy."

Robinson started in engineering while in the Air Force during the Korean War, where he worked on radio and radar equipment.

When asked to recall his proudest achievement during the many years he worked in radio, he said he took great pride in overseeing the Hearst stations.

"We made sure that each of our facili-

ties was up to date with technology and in compliance with FCC regulation," said Robinson. "We trained our people to read the meters and made sure they always followed the rules."

Now, as a consultant to the Hearst properties, Robinson is passing his vast knowledge on to the younger generation of engineers.

"I enjoy that and look forward to their phone calls," he said.

**He championed stereo and digital compatibility for all Hearst stations.**

## En Banc Hearing on Spectrum

by Christopher Nicholson

**WASHINGTON** Broadcasters should be aware that spectrum use is on everyone's mind in this town.

On March 5, the FCC conducted a day-long en banc hearing on spectrum policy to gather information and spur debate from panelists representing various perspectives related to spectrum.

Congress is planning its own hearings on spectrum use. Senator Larry Pressler (R-S.D.), chairman of the Senate Committee on Commerce, Science and Transportation, scheduled two hearings on spectrum policy in March and two more in April.

The FCC hearings studied spectrum use from a regulatory standpoint. Panelists answered questions from each of the commissioners and then participated in an open discussion where they debated topics suggested by the commission.

The hearings were divided into four panels with different panelists discussing various aspects of spectrum policy. The panels focused on future spectrum demand, technology trends, spectrum allocation and spectrum assignment.

Congress will take an informational and policy perspective on spectrum while gathering information to determine its policies on spectrum. The FCC will be invited to testify at congressional hearings.

According to Pressler, the hearings will "involve all aspects of the spectrum including civilian services, scientific and medical use, maritime emergency and navigation systems, cellular phone services and data communications systems, as well as radio and television broadcasting."

Pressler said the hearings are necessary because, "we must do everything we can to make sure the interests of the American taxpayer are protected while preserving our nation's security and technological leadership."

# Save Lives! Save Money! Switch to EAS - Today!



### Practice/Help

These keys allow training and practice without interrupting the broadcast in progress.

### "User-definable 'Event' and 'Location' keys"

These keys guide the operator through the encoding process and allow fast and easy required weekly tests.

### User-friendly programmable front panel

Large, easy-to-use lighted keys are as easy to use as your familiar bank ATM.

### Digital Voice Recorder

Allows unattended operation that plays back the audio portion of messages received for either manual or automatic forwarding.

### 24-column printer

Logs every EAS and SAME message received and transmitted and prints comprehensive Help Menus and instructions.

### FREE EAS Handbook

- Amended FCC Rules
- Installation Guide
- Products & Pricing



## TFT INC

Sound Quality for Over 25 Years!

3090 Oakmead Village Drive  
Santa Clara, CA 95051-0862  
Phone: (408) 727-7272 Fax: (408) 727-5942  
E-Mail: eas911@aol.com

### TFT EAS 911 EAS Encoder/Decoder Now FCC Type Certified

After 4 years of development & testing, TFT leads again with a new EAS Encoder/Decoder that will save lives and protect property by speeding emergency messages to the public at risk in seconds. At the same time TFT could save the industry over \$60-million annually in EBS operating costs and reduce EBS test tune-out by more than 88%.

All the details are in a new comprehensive EAS Handbook, the only complete reference. **Yours FREE for the asking.** In it we show you the low cost, easy solution to EAS.

For your **FREE new TFT EAS Handbook (A \$29 value)**  
**Call: 1-800-347-3383**



# BSW

# EQUIPMENT SOLUTIONS

BROADCAST SUPPLY WORLDWIDE

YOUR BROADCAST EQUIPMENT SOURCE FOR OVER 23 YEARS

MARCH / APRIL 96

SEE BSW  
AT NAB BOOTH

1400



New Roland Workstation  
PAGE 2

Record Your Own CD's  
PAGE 5

Preview Of Events  
BSW's NAB Booth  
PAGES 8-9

The  
New Mackies Are  
Here And BSW Has  
Them SEE PAGE 3 FOR ALL THE DETAILS

HUGE SAVINGS

EXCEPTIONAL SERVICE

EXPERT ADVICE

OUTSTANDING SELECTION

ORDER TOLL FREE

**1-800-426-8434**

EXTENDED HOURS: 6AM TO 6PM PACIFIC 9AM TO 9PM EASTERN

*Tremendous  
Values Inside*

## STUDIO MINIDISC



### Denon DN980R/DN980F Studio MD Machines

Stations all over the country are using MiniDisc for audio playback in on-air and production applications. Convenience of removable carts (discs) and the quality of digital.

- Cue to music/instant start
- Advanced editing features
- Digital & balanced analog I/O
- Comprehensive remote interface

#### DN990R recorder/player

**\$2888.00**

#### DN980F player

**\$1988.00**

## MINIDISC FOR THE ROAD



### Sony MZ-R3

#### Portable MD Recorder

- Ultra compact design and superior audio quality makes the MZ-R3 a natural for recording in the field.
- 10 sec. shock resistant memory
- Handy editing features
- 7 hours recording on 2"AA" batteries
- Supplied remote control and headphones

**\$539.00**

**CALL BSW NOW FOR  
MORE SAVINGS!**

**1 • 800 • 426 • 8434**

# BSW Makes Digital Affordable!



**NEW**  
Complete Workstation  
For Under \$3000.00

## INTRODUCING THE ROLAND VS-880 YOUR COMPLETE DIGITAL STUDIO IN A BOX

- 14 channel - 8 buss digital mixer
- 8 channel hard-disk recorder • Non-destructive recording and limited editing capabilities • 999 levels of undo
- Optional on-board digital effects
- SCSI port for additional hard drives

**Mfr. List \$2495.00 Call For BSW Sale Price**

### Roland DM-800

#### 8 Track Digital Audio Workstation

- 8 track system
- Dedicated mixer w/EQ & pan
- Dynamic mixer automation
- Extensive editing features
- Pro level interface
- Internal dual hard drives

**Complete Systems Starting  
Under \$7000.00**



**Powerful Production  
Work Station**

**Fastest Access To  
1000 Audio Cuts**



### 360 Systems Instant Replay Hard Disk Recorder

- Instant audio playback with 50 Hot-Keys
- 1,000 cut library
- No learning curve
- CD quality audio

**Now available with up  
to 16 hours storage for  
under \$3995.00**

# We've Got All The New Mackies!

BSW'S EXTENDED HOURS  
6AM to 6PM PACIFIC  
9AM to 9PM EASTERN  
1-800-426-8434

Discover the amazing value and performance of the worlds hottest audio mixers. 3 brand new models to choose from.

## Mackie MS1202VLZ

- 4 mono mic/line & 4 stereo inputs
- 3-band EQ
- AFL/PFL solo
- Channel mute/alt routing
- Control room/phones matrix
- 11.2" x 11.8"

Mfr List \$429.00

**Call For BSW Sale Price**



MS-1202VLZ



## Mackie MS1402VLZ

- 6 mono mic/line & 4 stereo inputs
- 60mm faders
- 3-band EQ
- Channel mute/alt routing
- Control room/phones matrix
- 13" x 14"

Mfr List \$599.00

**Call For BSW Sale Price**



## Make Your Mackie Broadcast Ready!

When you plug in the Broadcast Tools CCII into your Mackie console, you now have the ability to turn on your mic channels and mute the studio monitors. Additionally, the CCII provides a relay contact to activate on-air warning lights. A must for every Mackie console being used in broadcast facilities.

**BSW Price \$279.00**



## Mackie CR1604VLZ

- 16 studio-grade mic preamps
- Four submaster busses
- Channel mute/alt routing
- 3-band EQ with mid sweep
- AFL/PFL solo
- Control room/phones matrix
- 17.9" x 17.4"

Mfr List \$1199.00

**Call For BSW Sale Price**



## DYNAMAX MXR SERIES

### Truly Modular - Truly Affordable

A durable series of on-air consoles with the flexibility of modular design. 6 to 18 channel models available.

- Versatile dual channel inputs
- VCA level controls
- Input expansion switches
- 4 assignable outputs
- Excellent RF immunity

**Starting Under \$3,300.00**



## RANE SM82 STEREO MIXER

### 8 Stereo Inputs

The Rane SM82 is the perfect solution when you need many inputs in a limited rack enclosure. Perfect for use with digital workstations, small production centers or dubbing stations.

- 8 Stereo inputs
- Stereo balance controls
- Stereo AUX send and return
- Extremely low noise performance

Mfr List \$599.00

**Call For BSW Sale Price**



## DBX 166A Audio Compressor/Limiter

Need to smooth-out and tighten your audio levels? The dbx 166A provides two independently programmable channels of compression, peak-limiting, and noise-gating all in a single rack package.

- PeakStop® limiting controls overloading
- Switchable attack and release times
- Balanced XLR and 1/4" in/outputs

**BSW Price \$349.00**

Mfr. List \$549.00

**Save \$200.00**



## Symetrix 421/422 Audio Level Controllers

Like having a magic set of hands to ride audio levels, the 421 and 422 provide smooth, automatic gain riding.

- Perfect for STLs and pre-processing
- Maintains constant modulation level
- Very low noise performance
- Stereo or mono units

**421 mono \$399.00**

**422 stereo \$419.00**



## Symetrix 528E Voice Processor

Broadcasting's most popular voice processor makes your vocals jump out on the dial. Audio levels remain consistent with reduced noise and added punch.

- De-esser circuit to reduce sibilance distortion
- Compressor/limiter/downward expander
- Versatile Parametric EQ

**BSW Price \$499.00**

Mfr. List \$699.00

**Save \$200.00**



## Alex Digital Effects Processor

The Alex offers classic Lexicon sound with over 4000 effects combinations including reverbs, chorus, flanging, echoes & delays at a very attractive price.

**BSW Price \$299.00**

Mfr. List \$399.00

**Save \$100.00**

## Vocal Virtuoso

### Audio Technica AT4033/SM Studio Condenser Mic

Don't be fooled by the low price. The AT4033 offers incredible voice reproduction, perfect for on-air and production work. Vocals will have more sparkle and low-end punch.

- Excellent sensitivity and dynamic range
- Switchable hi-pass filter
- Internal windscreen and shockmount included.
- Requires phantom power

**BSW Price \$525.00**

Mfr. List \$725.00

**Save \$200.00**



## Supercharged Handheld

### Shure BETA58A Dynamic Cardioid Mic

World's most popular microphone for all-around applications.

Beta Technology gives you condenser specs in a dynamic package. In use by thousands of vocal artists around the world.

**BSW Price \$169.95**

**BSW HAS A HUGE  
INVENTORY OF MICROPHONES  
AND ACCESSORIES**

**1 - 800 - 426 - 8434**

# BSW & Superscope/Marantz Your CD Experts

**Powerful, professional features  
at very affordable prices!**



## PMD320 CD Player

Rack mountable -  $\pm 10\%$  pitch control -  
fader start - digital output - 10 key  
direct track access

**BSW Price \$329.00**



## PMD321 CD Player

Cue to music - +4 balanced XLR outs -  
Rack mountable -  $\pm 10\%$  pitch control -  
fader start - digital output - 10 key  
direct track access

**BSW Price \$399.00**

## CDR620 CD Recorder

At Last, the wait is over. Record your own  
CD's with the Marantz Recorder. Now you  
can take the SCSI output of your digital  
workstation and archive on CD's instead of  
costly hard drive space. Only the CDR620  
allows SCSI interface, balanced analog  
inputs and outputs, AES/EBU & IEC-958-II  
digital I/O. Also includes sample rate  
converter and DAT start ID/CD track  
converter. Powerful remote control option.

Mfr. List \$5000.00

**Call For BSW Price**



## CD Turntable For Production

### Pioneer CDJ500II CD Player

From the oversized cue wheel and  
start button to the large pitch/speed  
slider, the CDJ500II gives you the  
feel of those great old turntables  
with the quality and quick access of  
CD. A super production machine!

**BSW Price \$799.00**

Mfr. List \$999.00

**Save \$200.00**



## Portable DAT

### Sony TCDD8 DAT Recorder

- Anti-shock mechanism for stable recording and playback
- 3 sample rates
- Up to 4 hours recording on 4"AA" batteries
- Analog and digital I/O

**BSW Price \$699.00**

Mfr. List \$799.00

**Save \$100.00**

**ORDER TOLL FREE**

**1 - 800 - 426 - 8434**

World Radio History

Broadcast With Digital  
Quality, Speed and  
Accuracy for Less

## Let BSW and ARRAKIS Show You How

Arrakis Digilink, the top selling digital workstation in radio today, is the foundation for a completely integrated, and flexible system that lets you create, store, automate and play back CD quality audio. Live or automated, Digilink is the most popular selling system in broadcast.

### Translator, Booster or Back-up Transmitter



CROWN FM SERIES

#### Low Power FM Transmitting Systems

These economical and flexible transmitters are ideal for translator and booster applications or for use as reliable stand-by or stand alone transmitters. Three models with power output from 3 to 215 watts.

- User selectable frequency
- Built-in stereo generator & audio processing
- Built-in metering & diagnostics
- 120/240VAC or DC operation
- In use throughout the world in harsh environments

**Call For BSW Pricing**

## Arrakis Digilink III

Multi-purpose Digital Workstation

- Powerful new version of the #1 selling workstation in radio
- Triple play & record
- Dual stereo play output
- Perfect for Live on-air, production or automation
- Low investment cost - High productivity return

**10 Hour Systems  
Starting Under \$8,000**

**Live On-Air, Production  
or Automation For  
Under \$8,000**



### Easy, Push-button Control For Digilink III

ARRAKIS GEM-6/DL-GEM

#### 99 Button Control Surface & Software

- Operate up to 6 DLII or DLIII workstations
- One-button record with autotrim
- Push-button playback of hundreds of audio files

**Mfr. List \$1195.00  
Call For BSW Price**



### Are You Ready For EAS ?



The New EAS (Emergency Alert System) will soon be required by all broadcast stations. Plan ahead to avoid the last minute crunch and take advantage of great BSW pricing on TFT's new systems.

**Order Your EAS System From BSW Now!**

**VISIT US ON THE WEB  
[www.bswusa.com](http://www.bswusa.com)**

# The Perfect Match

The ultimate speaker with it's ultimate amplifier - together in one package.  
Talk about the perfect match, that's the JBL 6208



Now you can have an extremely accurate monitoring system incorporating JBL's acclaimed Multi-Radial™ baffle that aligns the acoustic centers of the high and low frequency transducers so that all frequencies reach you at precisely the same time. And best of

all you'll have the convenience of a perfectly matched, built-in amplifier with electronically balanced inputs that accept -10 dBv and +4dBu signals (XLR and 1/4"). An amplifier and speaker system designed to make beautiful music together. It doesn't get any better.

To get your ears matched up with a set of these great new speakers just call BSW toll free!

1 . 800 . 426 . 8434

*Equipment Solutions To Keep You Number One*

**BSW**  
BROADCAST SUPPLY WORLDWIDE

# NAB PREVIEW OF SPECIAL EVE BOOTH 1400

**Live Broadcasts**

**BSW and Telos Team-up to make  
this an NAB you'll never forget !**

## Back By Popular Demand

Hong Kong's hottest morning team.....Steve James and Harry Wong from Metro Broadcasting's 104FM Select return to broadcast their morning drive show live from the BSW booth. The only English-Cantonese music station in Hong Kong, 104FM Select reaches a huge, cosmopolitan listening audience with its adult contemporary format. A Telos Zephyr at FM Select Hong Kong Studios linked via Sprint ISDN lines to another Zephyr in the BSW booth will let Steve and Harry conduct their show just like back home.

Last year, Steve and Harry were the hit of the show with their zany observations about America, interviews with local people...and who knows....maybe Elvis will show up to sing again. Don't miss this extraordinary event.



*FM104 Select's Steve James and Harry Wong*

## THE GARY BURBANK SHOW!

Talk about entertaining. **The Gary Burbank show** can be best described as a unique blend of Monty Python and David Letterman....rolled into one big party. You'll experience satire, song parodies, political cartoons, com-

mercial spoofs, and a cast of caricatures giving their outrageous observations on life's simpler problems. Originating from WLW in Cincinnati, the Burbank show is syndicated and broadcast live to stations throughout America.



*Two time Marconi award winner Gary Burbank*

## The Telos Zephyr™ The Best Way To Hear From There



All this excitement from the BSW booth is made possible thanks to the Zephyr Digital Network Audio Transceiver. The Zephyr is capable of transmitting and receiving 20kHz duplex audio on a single dial-up ISDN (Integrated Services Digital Network) phone line. Now, for the price of a phone call, you can take your show on the road and still have studio quality duplex audio. See and hear for yourself why the

Zephyr is the inexpensive and ideal solution for remote broadcasts, ad hoc networks, back-up satellite and many other applications.



# EVENTS AT BSW'S



**Free Jingles**

**TONY GRIFFIN**  
PRODUCTIONS

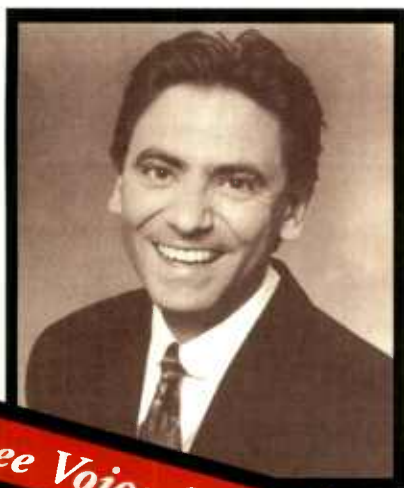

**Free Voice Overs**

*Top voice over artist, Joe Cipriano*

We've had so many requests to have him back....we just couldn't refuse.....For one day....and one day only....The Voice of Fox Television....Joe Cipriano, will announce your stations ID absolutely free. You've heard Cip announce upcoming episodes of Married With Children and The Simpsons....now he'll provide his signature voice to your station. ID provided at no charge on DAT.

Thanks to the Telos Zephyr, Joe will be doing the read live from his studio in Los Angeles.

**Please note:** Jingles and voice overs available to licensed stations on a first-come, first served basis. One ID per station. Due to the popularity of this promotion, ID's limited to the time allowed, so come early. Be sure to check at the BSW booth to verify last minute schedule changes.

What would you have to pay to get the nations top jingle house to sing a custom jingle for your station...Hundreds? Thousands? How about Free? Tony Griffin Productions and pioneers in cutting edge technologies, Telos Systems, Sprint and BSW

*Tony Griffin Productions has provided distinctive audio signatures for clients from WCBS to the BBC, from ESPN to Honda, from IBM to Dr. Pepper....and now your station!*

will merge talent and technology in creating a live digital recording session of station IDs from the show floor. A Telos Zephyr in BSW's booth will be

linked via Sprint ISDN lines to another Zephyr at Griffin's Dallas recording studio. Listen-in as the singers adapt the lyrics and sing your ID. You'll walk away with an air quality, customized jingle on DAT...recorded live from the show floor! See and hear history in the making....**only at the BSW booth.**

## BSW Booth 1400 Event Schedule\*

### Mon: 4/15

12-3pm The Gary Burbank Show  
3-7pm 104FM Select

### Tue: 4/16

9:30-11:30am Tony Griffin Productions  
12-3pm The Gary Burbank Show  
3-7pm 104FM Select

### Wed: 4/17

12:30-2:30pm Tony Griffin Productions  
3-7pm 104FM Select

### Thr: 4/18

10-12 noon Joe Cipriano Promos

Daily equipment giveaway drawings 15 minutes before show close

\*Schedule subject to change. Stop by booth 1400 for updates

### Special Show Pricing

*BSW will make it worthwhile to purchase your equipment during the show with Special NAB Pricing.*

### Daily Prize Drawings

*Stop by each day and register to win free gear such as Symetrix Mic Processors and Mackie Mixers....to name a few.*

# DESIGN YOUR OWN STUDIO LAYOUT AND Save HUNDREDS!

BSW Introduces Configurable Studio Furniture  
From Middle Atlantic **Call BSW For Complete Details.**

Multi-bridge, available in 4 or 6 space versions comes with complete hardware to configure with one or two rack bays or with open workspace.

Multi-rack wedge shaped tops can reverse to create multiple system configurations.

48" x 30" multi-desk with gentle-curving top.

Thirteen space rolling multi-rack can be used with slant or straight front.



**Complete 4-piece Configurable Studio System Under \$1,000\***  
(\*includes 2 side racks, center desk and 4 space multi-bridge)

# A BETTER

BETTER DE-ESSER  
with ratio control.



BETTER input section with both mic and line (wireless) inputs that can be summed together

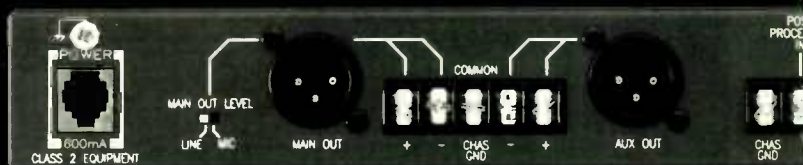

BETTER Signal-To-Noise Ratio : 97dB.

BETTER mic preamp  
utilizing the SSM 2017 chip

VOICE PROCESSOR

**Knock Down Racks Ship UPS - Assemble In Minutes**

**Soundolier 900 Series Knock down equipment racks**

Perfect utility rack ideal for use at the transmitter or in areas not requiring side panels.

- Easy to assemble
- All hardware included
- UPS shippable to save on freight charges
- Available in two sizes

**900-19 19" high \$113.95**  
**900-28 28" high \$124.95**



**Tough, Lightweight Cases Made For The Road**

**SKB Rack Cases**

- Ultra tough polyethylene shell keeps your equipment safe.
- Easy access front and rear
- 1/2 the weight of plywood cases
- Air Transport Association (ATA) approved
- 14" deep in 2 to 12 space sizes

**All Models Sale Priced Under \$200**

**Light & Power For Your Rack**

**ETA PD8L Lighted Power Strip**



Protect all your studio equipment from power surges, spikes and noise.

- 8 protected outlets on back
- Pull-out light modules illuminates rack
- Overload protection breaker

**BSW Price \$79.00**

# MOU T H T R A P

**BETTER** EQ section with each band covering 20-20K with filters in series.

**BETTER** output section with main and aux to feed 2 devices or a stereo input.



**BETTER** THD+Noise spec : 0.009%.

**BETTER** Equivalent Input Noise spec: -130 dBu.

**BETTER** Price (Really!)

**BETTER** contact your local RANE dealer and check one out!



# RANDOM ACCESS CONVENIENCE FOR ON-AIR or PRODUCTION

## MD801R

Now you can get an MD recorder/player with the familiar look, feel and durability of Tascam. The MD801R MiniDisc Recorder is really a versatile, self contained editing station with a number of useful features that make it ideal for radio.



### Features:

- Move, insert, divide and combine editing
- Instant locate and repeat playback
- Defeatable SCMS encoding
- AES/EBU & S/PDIF digital I/O
- RS-232C and parallel interfaces
- Enter data via any standard PC keyboard

Mfr. List \$2499.00

**Call For BSW Sale Price**

### DAP-1 Portable DAT Recorder

Features: top rated transport • XLR and RCA inputs • phantom power • mic limiter • 20 dB pad • 3 sample rates • S/PDIF digital I/O • rechargeable battery included  
Mfr. List \$1899.00

**Call For BSW Sale Price**



### CD401MKII Professional CD Player

Features: balanced output, pitch control, fader start, auto-cue with selectable sensitivity • single/repeat play modes • digital output  
Mfr. List \$1049.00 **Call For BSW Sale Price**

### 122MKIII 3-Head Cassette Deck

Features: balanced & unbalanced I/O • bias & level calibration • pitch control • 2 auto-locator points plus RTZ • Dolby B, C and HXPro • built-in 400Hz/10kHz oscillator • external or fader start capability • gear & clutch-coupled input level control  
Mfr. List \$1349.00 **Call For BSW Sale Price**



# TASCAM

# NOBODY

Does Remote Gear Like BSW

1 - 800 - 426 - 8434



## Complete ISDN Audio System in a Compact, Portable Package

**Comrex Nexus™**  
ISDN Codec

The Nexus is a cost effective, easy-to-use system for sending 15 kHz or 7.5 kHz bidirectional mono audio over the standard ISDN network. Setup is a snap since Nexus includes a dial keypad, LCD display and memory dial. Includes built-in terminal adaptor and NT1 for direct ISDN interface. Works with any outboard mixer.

**Mfr. List \$2300.00**  
**Call For BSW Price**



## Your Field Companion

**Comrex Codec Buddy™** Remote Mixer

Travel light to your next remote. The Codec Buddy is a high-quality remote mixer that will become your favorite companion in the field.

- 4 Channels, (2 Mic/Line switchable)
- 4 Headphone outputs with split feeds
- Separate PA feed
- Built-in telephone interface and frequency extender

**Mfr. List \$1900.00**  
**Call For BSW Price**

**VISIT US ON THE WEB**  
[www.bswusa.com](http://www.bswusa.com)

## RUGGED REMOTE MIC

**Shure VP64**  
Interview Mic



- Long reach handle
- Omni pick up pattern without proximity effect
- Neodymium element assures exceptional frequency response
- Hand (pictured) not included

**BSW Price \$77.00**  
Mfr. List \$ 135.00 **Save 43%**

## SPECTACULAR HEADSET

**Beyer DT290**  
Broadcast Headset



- Low profile & lightweight
- Excellent headphone isolation
- Dynamic mic element, cardioid pattern
- Durable and great sounding

**BSW Price \$189.00**  
Mfr. List \$299.00 **Save 37%**

## EASY CELLULAR REMOTES!



**Conex CellJack**  
Cellular Phone Interface

Turn your cell phone into a remote broadcast center

- XLR mic/line input
- Tape/Aux & tuner inputs
- Send & receive level controls
- Powered from cell phone
- Works only with Motorola bag phones

**BSW Price \$229.00**

# Budget Solutions

**Headphone Amp** - 5 separate amplifiers for individual level control of 5 headphones. One input signal can feed all 5 outputs or two signals can be split between outputs.



**Fostex PH-5**  
**ONLY \$159.00**

## Portable Cassette -

Great for note taking or recording actualities. Includes built-in condenser mic and jack for external mic. Operates on two "AA" batteries.



**Panasonic RQL340**  
**ONLY \$49.95**

## Signal Converter

2-channel or 8-channel rack mount units convert back and forth between -10dBv and +4dBu, eliminate ground loop hum and convert between balanced and unbalanced signals at either end.



**LLS 2-Channel ONLY \$77.00**  
**LLS8 8-Channel ONLY \$239.00**

## Studio Timer -

Counts up or down in hours, minutes and seconds. 1/2" red LED digits, remote start, stop and reset. Will also count up or down from memory presets.



**Radix ST500**  
**ONLY \$179.00**

**Line Amp** - Dual channel line buffer/amp is ideal for use as a gain block, attenuator, level and impedance converter, signal splitter or stereo summing amplifier. **Requires WA100-3 Power Supply \$10.00**



**ATI L200-XLR**  
**ONLY \$198.00**



## Mic Boom Stand -

An economical yet rugged tripod mic stand with boom. Stand height is adjustable from 35" to 60". Boom extends to 25 1/2". Ebony black.



**Atlas TE16BE**  
**ONLY \$38.95**

## Studio Cassettes -

The Teac V375 (single) and W416 (dual) are the least expensive rack mount cassette decks available. Both units feature Dolby B NR, 2 color LED meters, 3-position tape selector and BSW custom RK2 rack kit.

**V375/RK2 ONLY \$119.95**  
**W416/RK2 ONLY \$134.00**



**ORDER TOLL FREE**

**1 - 800 - 426 - 8434**

## CD Player Packages -

Inexpensive CD players feature excellent sonic quality, cue to music, peak level search and the BSW custom RK1 rack kit. The SLPG450 adds instant track select, a wireless remote and a front panel headphone jack.

**SLPG350/RK1 ONLY \$159.95**

**SLPG450/RK1 ONLY \$169.95**



## Cassette Storage -

Great looking, heavy gauge steel cassette storage unit can be wall mounted, left free standing or joined to other units to expand storage capacity. Holds 19 cassettes.

**Model 1217**

**ONLY \$19.95**

## Circuit Identifier -

Provides continuous identification for all your remote circuits with your pre-recorded message. No station should be without one.

**Broadcast Tools Talking Duck**

**ONLY \$124.95**



**Carrying Bags -** Protective padded cases great for hauling all kinds of equipment from remote mixers, portable recorders to microphones, cables etc.

**KEB20 fits small recorders**  
**7.5" X 9.5"**

**ONLY \$22.95**

**KEB22 fits compact mixers**  
**9.5" X 12.5"**

**ONLY \$23.95**



## Laser Lens Cleaner -

Provides gentle brushing action to clean your CD laser lens to diminish or eliminate CD skipping. Also has audio test tones for system setup.

**Audiosource LLC3**

**ONLY \$22.95**



**Mic Processor -** Includes a mic preamp, compressor/limiter, notch filter, and 10-band graphic EQ. Compact, easy to use with surprisingly good specs considering its low cost. 9 1/2" inch size. **Rolls HR11C**

**ONLY \$169.00**

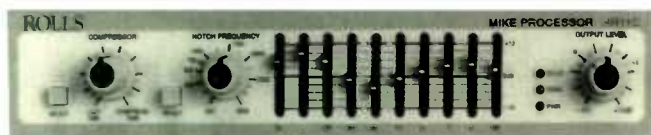

## Cart Rack -

The standard for studio cart storage. Great looking, sturdy mahogany construction. Holds 100 Carts, walnut finish.

**Prorax W100**

**ONLY \$99.95**



**ORDER TOLL FREE**

**1 - 800 - 426 - 8434**

## BACK PAGE SPECIALS!

1 - 800 - 426 - 8434

### Low Cost Rack-Mount Tuner



**Technics STK550R** - This quality tuner is shipped with BSW's custom rack mount kit and features 30 presets for FM and AM frequencies. Non-destructive memory allows presets to stay intact even when power is off.

**ONLY \$159.95**



**Great Headphones -  
Great Price!**

**AKG K240M** - Broadcasters favorite now at a reduced price. Comfortable, sealed ear phones with excellent audio quality. You'll be a hero when you buy these for the airstaff.

**ONLY \$79.95**

### Control Your Audio Level



**dbx 163X** - Probably the easiest compressor/limiter ever to use. Just set the gain and adjust the slider for the amount of compression you need. Single channel.

**ONLY \$119.95**

**See BSW At NAB Booth 1400  
Las Vegas Convention Center  
April 15-18th**

*Equipment Solutions To Keep You Number One*

**BSW**  
BROADCAST SUPPLY WORLDWIDE

*Address:*  
7012 27th Street West  
Tacoma, WA 98466 USA

*Worldwide Phone:* 206 . 565 . 2301  
*Worldwide Fax:* 206 . 565 . 8114  
*Worldwide Web:* [www.bswusa.com](http://www.bswusa.com)

**Sale Prices Expire 5/15/96  
Call Us Today For Best Selection!**

**BSW offers thousands of products from over 200  
Manufacturers. Call for our 158 Page Catalog.**

**Extended Hours  
6AM to 6PM Pacific  
9AM to 9PM Eastern**

**Prices and specifications subject to change.  
Some items limited to stock on hand.**



# NFCB Discusses Funding, Future

by Stan Barr  
and Patricia Lawrence

**SAN FRANCISCO** Federal funding cuts and preparing for the future were hot topics during the National Federation of Community Broadcasters (NFCB) Annual Conference this winter.

In addition to workshops on production techniques, FCC rules and regulations, internet, and converting from an analog to a digital system, there was much talk about federal funds and the upcoming start of satellite digital audio radio services (DARS).

Community broadcasters face some changes in regards to federal funding. There are more program choices especially on the satellite delivered services such as DARS and this service is in its infancy," said NFCB President CEO Lynn Chadwick in one of the workshops.

At this NFCB conference reaffirmed community radio's commitment to local service. "No satellite service can serve the community like the community station," Chadwick said.

Chadwick also said Congress needs to find that not all of the money from spectrum auctions should go towards reduction.

"We have to give some back to the telecommunications infrastructure," she said.

## Content providers

Keynote speaker Gigi Sohn, deputy director of the Media Access Project in Washington, startled the nearly 400 delegates in attendance during her opening remarks at the conference.

"I'm going to propose a radical idea for some of you. You are no longer just broadcasters," she said.

"Close your eyes. What you are for the 21st century is a 'content provider' (laughter from the audience). And, as a content provider, you want to reach as many people as possible. That's critical when you're fighting for funding. If it appears you're just on your little transmission, I can assure you that you'll be in trouble."

Sohn spoke about telecommunications issues facing community radio with wit and humor. She explored ways community broadcasters can gain access to new listeners.

For one, Sohn suggested going beyond the transmitter to advanced telecommunications networking including the information superhighway and the development of broadband fiber optics.

And ... there is another option: Ask the government in this era of mega mergers to mandate some sort of access on new technology. The first and probably most important of these new technologies is satellite digital audio radio services (DARS)."

DARS is the multichannel digital satellite based radio service that will permit one entity to send 40 channels or more of CD quality sound nationwide. Unlike cable radio, DARS technology can be received in the car.

## Free access

Sohn said the NFCB has asked the FCC to set aside a portion of a channel on the DARS system for free access by non-commercial entities.

According to Sohn, someone in the

general council's office at the FCC said the commission was 'very interested' in adopting such a provision.

Digital television spectrum, Sohn suggested, could also provide low cost access for community broadcasters. She pointed out that television broadcasters will be able to broadcast four, to six different programs or other services in the same space as one program is now delivered.

"I suggest in exchange for that privilege television broadcasters should set aside twelve hours a day of their capacity for low cost public access. Just like the cable systems, multichannel providers should have public access.

## Bits are bits

"I'm not talking only about television. Bits are bits.

When we're talking about digitizing it doesn't matter. Television programming isn't the only medium that can be transmitted over that spectrum. Radio can. World Wide Web pages can. Information, paging, cellular telephone services can. So in fact NFCB's participation in this proceeding is very appropriate and very right."

Sohn highlighted what she said was one of the most important aspects of the

telecommunications bill that the media did not discuss.

"Nobody, but nobody talked about the digital spectrum giveaway to the broadcasters



The Red Thunder Band is presented by American Indian Radio on Satellite (AIROS).

that was in this bill and what this could mean to funding social programming or funding public broadcasting."

Sohn said that the way the spectrum is set aside for digital television is a major issue facing community broadcasters.

The Media Access Project position is that broadcasters should not get digital television spectrum for free but should pay for it with extra public services like free time for candidates, noncommercial speech and more and better educational programming for children.

"If they don't pay for it with public

service," said Sohn, "they should have to pay for it with money."

Delegates from the United States, Canada, Puerto Rico and the African countries of Senegal and South Africa attended this year's conference.

Stan Barr and Patricia Lawrence produce *Innocents Abroad*, a weekly travel-related show heard on public radio.



Keynote Speaker, Gigi Sohn, deputy director, Media Access Project Washington, and Lynn Chadwick, president and CEO of NFCB

## Digital Audio Via Subcarrier

► continued from page 1

Jeff Andrew, project manager at USA Digital Radio (USADR), agreed that implementation of a subcarrier system would be simple. USADR's in-band, on-channel DAB systems are being tested in San Francisco as part of the Electronic Industries Association's efforts to find a DAB standard.

"The way they are proposing it, you wouldn't need to get any additional license and there probably wouldn't be a standard because there is no standard really now for the way you use your subcarrier," he said. "I would assume they could just present it. If the broadcasters wanted to use it, they could go ahead and do so."

The big question is whether or not broadcasters would use a system that replaces existing subcarriers. Subcarrier uses are unlimited and often profitable — reading services for the blind, intelligent vehicle applications, global positioning services, RBDS.

Andrew said that subcarrier compatibility was important to USADR when they developed their DAB system because many stations have long-standing contracts for their subcarriers.

"The FM broadcasters have always looked at the subcarrier portions of our bandwidth as being a secondary service — something that's opportunistic," said Maxson. "While it's a way to make a little extra money, it's not really the primary business."

Michael Rau, co-chair of the NRSC's high speed subcarrier committee, said that there must be a business reason for a broadcast station to use its subcarrier.

"If the technology could not show how stations could make additional money with it, then it would likely not be very well received," said Rau. He estimated that half the stations in the top-25 markets use their subcarriers — some leasing them for upwards of four or five thousand dollars a month.

Sanders may build a flexible data protocol into the new system, however; a flag on the data channel could tell the receiver how to interpret the data. That way, Maxson said,

the new system might eventually be used to broadcast stereo digital, send images or data or even reallocate the data channel to have several narrow band mono channels.

## Working group

Sanders and WCRB have been working on this project for over a year. It began when Murotake and Dr. David Herrick who listen to WCRB's classical music format gave Maxson a call.

"We put their peanut butter and our chocolate together and came up with an idea," said Maxson.

The DAB proponents are interested in the technology but uncertain what its future is.

"It'd be good to find out how the new technologies (such as the one from Boston) can join the mainstream effort in a useful manner without creating a new 'proponent' all over again," e-mailed Nikil Jayant, director, multimedia communications research laboratories, Lucent Technologies, sponsor of two DAB systems.

Jayant added "anything that impedes the current DAR process is not conducive to the overall effort."

Andrew said USADR has swapped notes with Sanders and he is very interested to hear their paper at the show. WCRB and Sanders have started what Maxson called a "fledgling" working group to put together ideas on how to make the best use of their technology.

"What we'd like to do at the show is to get people who are interested to volunteer to give their two cents worth," he said. He invited people to stop by their booth in the lobby of the Las Vegas Convention Center.

Aside from details on flexible protocol for the data packet, the working group will also look at how to tune the digital signal.

"Do you have a 102.5-D for digital?" Maxson pondered. "Or would you have a second FM dial that is the digital FM?"

DAB proponents have been anticipating that question for a long time. Now, a newcomer may answer it before they do.

On Air  
Screen

**Navigator (KDLT)**

Track A: 00:04:14 intro: 09

Track B: 00:00:00 intro: 00

All Around The World

11:00:00 -> 11:49:10 00:49'02

04'23 All Around The World - Lisa Stansfield 19"

04'10 I Wish - Stevie Wonder T 18"

04'29 Set Them Free - Sting 35"

C START DAT2

01'19 [Bottom of the Hour]

00'03 R-r-r-r-Radio -

00'45 Casual Furniture -

00'30 Harley Davidson -

00'35 News Call 1 -

00'34 Cancer

00'34 Japan

"Hot Keys"

**Carts**

ON

1

Applause

2

Window Crash

3

Roar!!

4

Plane & Car Crash

**Inflight**

10 s 5 s 0

All Around The World I Wish

fade out...▶ 00:04:108 fade in...▶

xfade.....▶ 00:03:459 begin off...▶

end off....▶ 04:23:280 att. (dB): 1

Programming Segues  
and Voice-Overs

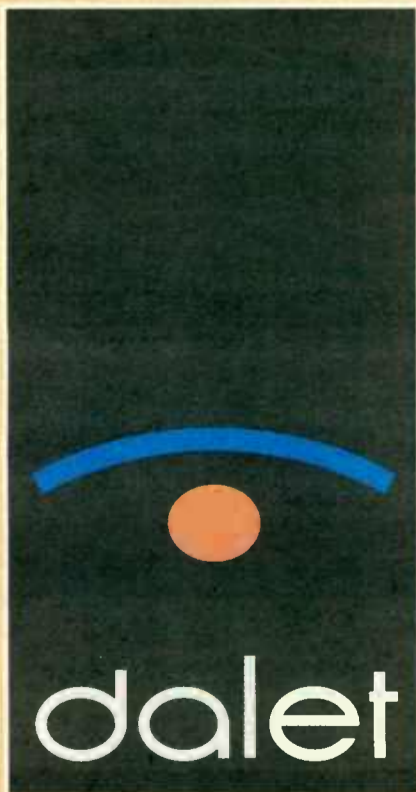

# The Elegant Solution

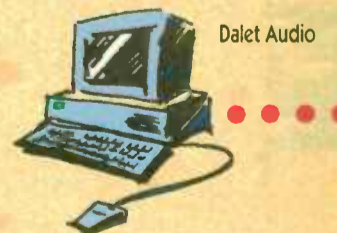

Satellite  
Automation

See Us at NAB Booth 4007

World Radio History

## Broadcasting Solutions For:

- Cart Replacement
- Live Assist
- Satellite Automation
- Multitrack Editing
- Music Automation
- Text and Audio for News

## Elegant Architecture:

- Windows™ Multitasking
- Unlimited Storage / Users
- Standard PC Networks
- Expandable
- Central Storage
- User-Configurable

## More Than 1000 Users Worldwide!



**KKND**  
Tucson, Arizona

**Kerry Fink, GM, Mix 106**  
Gainesville (Atlanta), Georgia

"We have been using the Dalet System since June 1993. We have been so pleased with its performance and development that we are implementing the system in our network studios for the "Music Of Your Life" satellite network that we are currently developing."

Kerry Fink

**Dalet Digital Media Systems**  
285 West Broadway, Suite 605 - New York, NY 10013  
Phone: 1 (212) 370 0665

**Dalet Express Fax Line:**

**1 (800) 257 1223**

Circle (113) On Reader Service Card

World Radio History

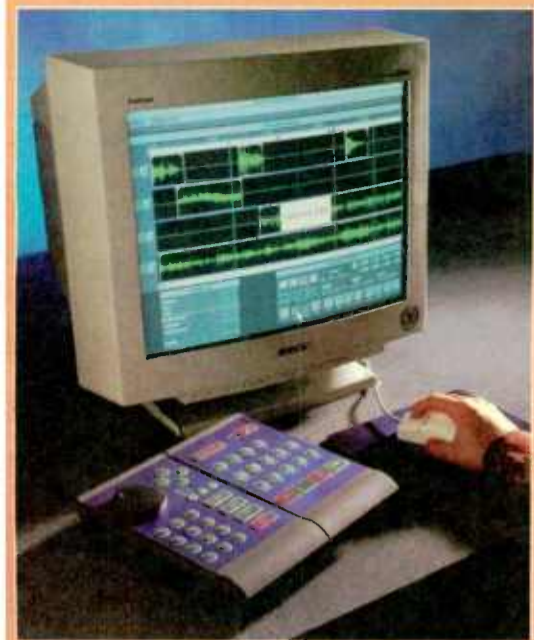

**Production**

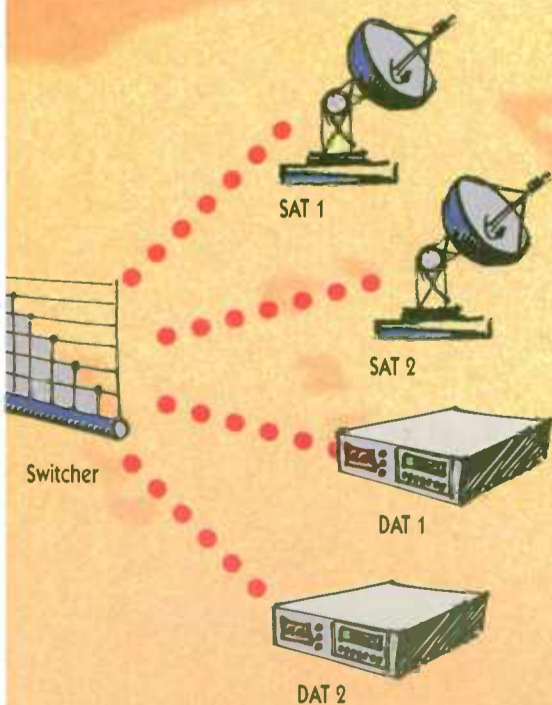

# RBDS STATIONS

The following is Radio World's quarterly listing of RBDS stations, equipment and receiver manufacturers, and service providers. If you would like to be included in the next listings, contact Lynn Meadows at 703-998-7600.

## RBDS Equipment Manufacturers/Distributors

AEV (Encoder)  
Via Saviolo Budrie  
Di S. Perisceto  
Bologna  
Italy

**Belar Electronics Labs Inc.**  
**PO Box 76**  
**Devon PA 19333**  
**Contact: David Hirsch**  
**610-687-5550**  
**Reader Service 56**



Broadcast Supply Worldwide (Encoder)  
7012 27th St. West  
Tacoma, WA 98406

Circuit Research Labs (Encoder)  
2522 W. Geneva  
Tempe, AZ 85282

Harris Allied (Encoder)  
3712 National Road West  
Richmond, IN 47374

**Inovonics (Encoder/Decoder)**  
**1305 Fair Ave**  
**Santa Cruz CA 95060**  
**Contact: Anne Chaney**  
**408-458-0552**  
**Reader Service 50**



Modulation Sciences (Encoder/Monitor)  
12A World's Fair Drive  
Somerset, NJ 08873

RDS Diagnostix (Test/Decoder)  
74 Hanover Road  
Mountain Lakes, NJ 07046

Audio Broadcast Group (Encoder)  
2342 S Division Ave  
Grand Rapids, MI 49507

AZTEC S.A. (Encoder)  
31 Rue Du Chemin de Fer  
67200 Strasbourg  
France

**RE America, Inc. (Encoder)**  
**31029 Center Ridge Road**  
**Westlake, OH 44145**  
**Contact: Soren Pihlman**  
**216-871-7617**  
**Reader Service 118**



Rohde and Schwarz (Encoder)  
4425 Nicole Drive  
Lanham, MD 20706

SCA Data Systems (Encoder)  
2912 Colorado Ave.  
Suite 200  
Santa Monica, CA 92404

Teli AB (Encoder)  
14980 Nunashamn  
Sweden

Tectan (Encoder)  
Box 27157  
Concord, CA 94527

VG Electronics (Encoder)  
Theaklen Drive  
Hastings East Sussex TN34 1YQ  
England

## RBDS Receiver Manufacturers (with current U.S. models)

**Advanced Digital Systems**  
**(PC RDS Receiver)**  
**13909 Bettencourt Street**  
**Cerritos, CA 90701**  
**Contact: Mike McCoy**  
**800-888-5244**  
**Reader Service 167**



Axxess (Paging)  
6620 Riverside Drive, Ste 200  
Metairie, LA 70003

AZTEC S.A. (Mobile Data Receiver)  
31 Rue Du Chemin de Fer  
67200 Strasbourg  
France

Delco Electronics (Car)  
1 Corporate Center MS CT-16A  
Kokomo, IN 46904

Denon (Car/Home)  
222 New Road  
Parsippany, NJ 07054

Grundig (Portable)  
3520 Haven Ave., Unit L  
Redwood City, CA 94063

Indy Automotive Electronics  
2420 E 55th Place  
Indianapolis IN 46220

Modulation Sciences (Data)  
12A World's Fair Drive  
Somerset, NJ 08873

Nokia Paging, Inc  
12345 Starkey Rd, Ste K  
Largo FL 34643

Onkyo (Home)  
200 Williams Drive  
Ramsey, NJ 07446

Philips Car Stereo (Car)  
9600 54th Avenue  
N. Minneapolis, MN 55442

Pioneer (Car)  
2265 East 220th St.  
Long Beach, CA 90810

## RBDS Service Providers

Axxess/Spartan (Paging)  
6620 Riverside Drive, Ste 200  
Metairie, LA 70003

**DCI (Global Positioning)**  
**10121 Miller Ave,**  
**Cupertino, CA 95014**  
**Contact: Jim Bradley**  
**408-446-8350**  
**Reader Service 94**



Coupon Radio  
(Information Services)  
10 Rockefeller Plaza  
New York, NY 10020

Sage Alerting (EBS)  
700 Canal Street  
Stamford, CT 06902

SATX (Data Broadcast Software)  
Milestone Technologies  
2221 Mariner Circle  
Raleigh, NC 27603

**Specialized Comm.**  
**(Music Information)**  
**1638 153rd St. SE**  
**Bellevue, WA 98007**  
**Contact: Allen Hartle**  
**206-641-9043**  
**Reader**  
**Service**  
**92**



Terrapin (IVHS Services/Diff-GPS)  
11958 Monarch Street  
Garden Grove, CA 92641

To feature your  
company's logo and  
information on the  
RBDS Roll Call page,  
contact

Christopher Rucas at  
**800-336-3045**



# Riding the Tide at MAB Conference

by Sharon Rae

**LANSING, Mich.** Convergence in the telecommunications industry took center stage at the 1996 Great Lakes Broadcasting Conference and Expo where the theme was "The Changing Tides of Broadcasting."

Consolidation was on everyone's mind. In panels like "Merger Mania," "Mergers: The Artful Deal," and Surfing Your Future: Tips from Winners & Wipeouts," industry leaders gave their predictions on what to expect.

For engineers, Terry Baun, president of the Society of Broadcast Engineers (SBE), said that the bottom line in radio is that technical support is being outsourced.

Baun predicted mergers would cause some outfalls of people in the industry. He stressed that engineers should focus on how they fit into the mission of their station and how they can contribute to the station's bottom line.

## Survival of the fittest

Mergers may produce a survival of the fittest, Baun suggested. The "fittest" engineers will be those with extra skills who know how to read a balance sheet and how to be a positive element at their station, he said.

David Bartlett, president of the Radio Television New Director's Association (RTNDA) said that despite rumors to the contrary, more news organizations and news jobs are being created rather than eliminated.

Bartlett said that whatever consolidation is taking place was inevitable. He said the new telecommunications bill is not deregulatory or regulatory but a "reorganization" of regulation.

According to Bartlett, anything that enables or contributes to the possibility of more voices or more niches is good from the standpoint of the public. In the end, he said the public will be better served by the new bill as long as deregulation

is really "deregulatory" and not just a "reshuffling of the same tattered old deck of government control on content."

It is tough for any one program to survive simply because it has a monopoly franchise, said Bartlett. He pointed out that it is important to look at broadcasting in the context of everything else that is happening in telecommunications.



The Great Lakes Broadcasters Conference and Expo featured a busy exhibit floor.

Michael Walenta, general manager of West Michigan Public Broadcasting, said he believes mergers will strengthen the industry overall. Like Bartlett, he stressed that merger mania and the Telecommunications Act go beyond broadcasting.

Broadcasting is moving rapidly away from being a passive activity for listening or watching to an interactive activity, said Walenta. He said people seek out interactivity citing the high hit rates for the X-Files on the Internet happen when the show is on.

## Act now or else

Larry Patrick of Patrick Communications said his brokerage firm has a basic message for radio and TV stations thinking about selling: buy, sell or find an unassailable niche, said Patrick.

Those who do not, "are going to be

killed and killed relatively quickly," he continued.

He warned that the markets are consolidating and if a station is competing by itself against eight radio stations, it is hard to imagine how it will survive without a unique niche. But there is some good news.

"The good news is if you don't have the resources to play at that level, you probably will become a very wealthy person quickly, because your stations are worth a lot to somebody else to gain market share," said Patrick.

Patrick said what he sees are clients who want to acquire at least 60 percent of market revenues. He encouraged broadcasters to go for strategic buys that would generate a good chunk of revenue.

During his luncheon address, John Parikh, CEO of Joint Communications, used a surfing metaphor to talk about keeping some balance while riding the "giant wave of change."

"There's nothing we can do to stop (the wave) — it's coming," he said. "What surfers can do is get up on the wave and get a good ride."

He gave some predictions of how things might change starting with changing demographics. "The baby boom is aging and that creates new niche opportunities. This, however, also creates a large group of people who feel there's nothing out there for them," Parikh said.

Parikh encouraged attendees to be willing to change themselves. "The days where you could learn something and never get any better at it or any different are over."

He told his audience to define what their skills are, look at what expertise are

est from both broadcasters and data services providers. NTL is working on an agreement with a Japan-based company that is interested in joining the multiplex with a data service.

NTL also is considering becoming a multiplex provider on its own, which will probably involve a new license separate from those for radio stations or transmission providers.

"DAB is an important advancement in technology for radio. Where we are able, we will continue to provide opportunities for industry to carry out these experiments," said Tony Stoller, chief executive of the Radio Authority.

To that end, the U.K. government just announced an amendment to the Broadcasting Bill that extends licenses for existing FM radio stations that provide programming via DAB multiplexes.

Stoller said he could not see an end to FM licenses for radio stations presently simulcasting on FM and DAB. According to NTL, national DAB coverage is expected to cost a radio station about 2 million British pounds (approximately \$3 million) per year for transmission facilities. In the short term, that kind of money will be hard to rationalize without an audience to advertise to.

*Bev Marks is a broadcast consultant based in England who contributes regularly to Radio World.*

necessary for success in the future, and develop those skills.

"Keep an eye more on where you want to go and less on what's happening around you," he said. "It's a good world. It's a safe world. The only thing we do know is that things are going to change — some people will get bigger. However, some of the smaller ones are actually going to be more successful."

*Sharon Rae heads up Rover News Services out of Lansing, Michigan — she can be reached at SCohon@aol.com or at 517-339-3253.*

## Radio Engineer Honored

► continued from page 1

directional antenna systems in Australia.

Prestholdt's many other achievements include a U.S. patent for a method of detuning guy cables on TV structures that are near AM directional antennas. He also has a patent pending for a medium wave antenna.

Prestholdt, the author of numerous articles on broadcast antennas, graduated from the University of Minnesota in 1938 where he taught for two years as a graduate student.

"During the latter part of that time, I met someone who was building a radio station — WLOL(AM) — in the Twin Cities," Prestholdt said. "They needed someone to help guide construction of the station and be in charge of technical operations."

"We went on the air on June 14, 1940, which was my first wedding anniversary," he happily recalled.

Prestholdt joined the engineering department at CBS Radio in New York in 1943 and served as director of engineering from 1960 to 1969.

After a career that has spanned nearly 60 years, Prestholdt said that his proudest achievement has not yet been fully realized.

"It is a rather novel scheme that I believe has many uses for radio stations, would not be an expensive thing to do, and would improve the interference-free nighttime coverage of high-powered stations," he explained.

Without giving away all the details, Prestholdt said that "this is an idea I have exposed to the engineering community only briefly."

Not one to put down his soldering gun, he added that "if a project came along that interested me, yes, I would take it on."

Prestholdt's counterpart receiving the Television Engineering Achievement award is Charles W. Rhodes. Rhodes recently completed his tenure as chief scientist of the Advanced Television Test Center.

# England Begins DAB Multiplex Experiment

by Bev Marks

**CAMBRIDGE, England** Last month, NTL (National Transcommunications Ltd.), the U.K. private-radio transmission services provider started a year-long Eureka-147 digital broadcasting trial from a single DAB transmitter at its Croydon site in South London.

The trial comes after a DAB test transmission of commercial radio stations last November at the Sound Broadcasting Equipment Show (SBES) in Birmingham, England.

The U.K. Radio Authority, the British equivalent of the FCC, granted NTL a license to provide a longer term "marketing test-bed for commercial services."

NTL already provides transmission services for eight analog FM radio stations from the Croydon site. Now, some of these stations are being used in the DAB trial.

The radio stations currently on DAB are Classic FM, Heart 106.2, Kiss 100 FM, Melody FM, Sunrise Radio, Talk Radio UK and Virgin 105.8. Two of the participants

have AM-only licenses.

Participants are granted monthly licenses for the multiplex experiment, leaving open the possibility that more stations could be allowed into the multiplex later this year. The trial is expensive for participating radio stations, however, and other willing participants may be hard to find.

"We want to help independent radio explore the great opportunities presented by DAB while saving them the worry of the technicalities," said Jon Trowsdale, NTL DAB product manager.

The trial is the result of close collaboration between NTL, the Radio Authority, radio stations and Harris Corporation.

Harris provided a DAB 2000 transmitter that is running at about 400 W and gives an ERP of 1 kW via a two-panel Kathrein-Werke antenna. NTL chose 192 kbps for stereo services and 92 kbps for mono services, which they said will provide adequate audio performance.

NTL is uncertain about the final multiplex configuration, which will depend upon inter-

# Candidates Enjoy Talk Radio Time

by Lee Harris

**MANCHESTER, N.H.** Primary election battles have traditionally been fought at rallies, pancake breakfasts, and visits to senior citizens' centers.

This year talk radio has been the battleground of choice for most of the Republican candidates. On much of talk radio these days, the primary fight isn't just the major topic, it's the only topic.

In the early primary states, talk radio listeners couldn't escape politics even during the commercial breaks. At New Hampshire's leading talk operation, WGIR(AM), Manchester, Program Director Dan Pierce noted that the candidates were on the air with interviews and paid advertising earlier and heavier than ever before.

"This was outside the window for the FCC's lowest unit charge rule, so they were paying full freight," Pierce said. "When Steve Forbes came in, he was buying up everything he could and that was definitely different from previous primaries. These are testaments to the perception that talk radio speaks to the people the candidates want — the people who are likely to go to the polls on election day, especially for a primary."

Ed Walsh, director of programming and news at KFYI(AM) Phoenix fears that even die-hard political junkies were burned out by the relentless parade of negative political advertising.

"With the political spots, we were running up to 19 minutes an hour in AM drive and 16 minutes the rest of the day, and many of those hours contained two or more Forbes ads."

The candidates were on KFYI with amazing regularity. Walsh estimates that Pat Buchanan was interviewed no fewer than 36 times with Forbes putting in nearly as many appearances. At WGIR, the experience was similar.

"Buchanan was here early and often and he was able to recruit the kind of people that gave him the grass roots support and organization that enabled him to win in New Hampshire," said Pierce.

Programming consultant Valerie Geller who specializes in news/talk sees these appearances as a key tactic of Buchanan's highly effective but low budget campaign.

"It's easy and cheap. A candidate doesn't even have to leave his hotel room. He can sit in his bathrobe and slippers and be on the phone with the host, taking calls from listeners."

Buchanan, of course, brought a wealth of media experience to the campaign including an intimate knowledge of talk radio gathered both as a guest and as host of his own syndicated show.

Candidates Alan Keyes and Bob Dornan also know their way around talk radio. For a time, Dornan was a frequent guest host on the Limbaugh show. Keyes lists "radio talk show host" as his profession.

Even Forbes did commentaries on his magazine's now-defunct syndicated radio program, "The Forbes Report." The one candidate who seemed to shun talk radio in the early primaries was Bob Dole. Walsh said Dole turned down frequent requests for interviews in Arizona. And according to WGIR's Pierce, the only radio interview Dole did in New Hampshire was on the syndicated Don Imus show which originated from Manchester on the morning of the primary.

As powerful as local radio proved to be for Buchanan in New Hampshire, it presented problems as the multistate primary days came along. On 'Junior Tuesday,' March 5, eight states held primaries and two more conducted caucuses.

Pierce theorized that there was simply no way the tireless Buchanan could cover all that ground with one-on-one local radio interviews. Buchanan also created the most heat for the stations.

Walsh said the switchboard at KFYI was busy with callers split down the middle — half complained the station was too pro-Buchanan while the other half complained they were being too hard on the candidate.

The primaries were definitely hard on talk radio personnel. In addition to taking care of his own product, Pierce helped lots of out-of-towners.

"We had Mike Siegel from KVI(AM) Seattle broadcasting from our conference room. We had Westwood One's Tom Leykis and Jim Bohannon in there plus I don't know how many television news crews. I can't even count the number of TV interviews I did. These reporters were looking for every possible angle and lots of them came up with, 'Hey, maybe Dan Pierce knows what he's talking about.'"

Pierce doubts that President Clinton and his GOP challenger will make as much use

of local talk radio, but he expects politics to continue to energize the format.

"The format enables the audience to get a more direct access to a discussion of the issues, and that makes them feel more involved in the process."

Valerie Geller wouldn't be surprised if Mr. or Mrs. Clinton popped up on a leading local show from time to time.

"The talk shows were effective last time around. While then-president Bush was perceived as being out of touch, the Clintons seemed happy to be on-the-air talking to and with the people."

Although some see this fractious primary process as the worst thing to hit the GOP since Lincoln's assassination, Walsh disagrees. "It's a wide open party and this sort of give and take is probably good for the Republican party and certainly great for talk radio." 

## Wait till you see what Continental's got at NAB!



om and dad thought that I was a pretty

neat addition to their lineup, but that was before they saw the exciting new members of Continental's complete line of AM and FM transmitters. The guys in engineering have been busy putting the latest technological improvements into our reliable RF products, and the sales and marketing guys have made sure that all the right power levels are available. It's probably the most exciting thing I've ever seen! Well, that and the first time daddy changed my diaper.

I'm a little new to this broadcasting game, so don't take my word for it... make sure the Continental booth is on your NAB itinerary and see for yourself! And when you stop by, remember to ask them about the other recent additions to the Continental family: Continental Lensa S.A. and Continental TELEFUNKEN Sendertechnik GmbH. These new members of the family help make Continental your single source for the finest and most advanced transmission products available.

Booth 2605 

**1946-1996. For 50 years, Continental Electronics has provided excellence in broadcast transmission products worldwide. Refuse to compromise... call Continental first!**



**Continental Electronics Corporation**

P.O. BOX 270879 • DALLAS, TEXAS 75227-0879 • 214-381-7161 • FAX 214-381-4949

1.96.105

Circle (16) On Reader Service Card

# Billion Dollar Trust Fund for CPB

by Lynn Meadows

**WASHINGTON** Congress is ready to push Big Bird out of his federal nest — with a one billion dollar golden parachute. The Public Broadcasting Self-Sufficiency Act of 1996 as introduced by Congressman Jack Fields (R-Texas) would create a one billion dollar trust fund for public broadcasters with money earned by auctioning 351 vacant noncommercial channels.

The licenses would be given a 'commercial' status and be moved to enhance their value. Bidders would be assured that they would have ATV spectrum assigned to

them whenever that decision is made. Fields proposed a three-year transition period to self sufficiency ending Sept. 30, 2000. The bill earmarks appropriations of \$250 million for the Corporation for Public Broadcasting (CPB) for 1998, 1999 and 2000.

## CPB oversight

If the bill passes, the CPB would be the administrators of the trust fund once the annual appropriations cease. Public broadcasters who spoke at a hearing last month repeatedly asked Congress to continue federal oversight of the CPB once appropriations stop.

"To leave the governance of the Trust solely up to the bylaws of the Corporation for Public Broadcasting is a risk," said Lynn Chadwick, president of the National Federation of Community Broadcasters (NFCB).

Delano Lewis, president and CEO of National Public Radio (NPR), said,

"Our concerns with the bill are that it reverses 25 years of vesting financial control and decision-making at the local level, by moving both to a Washington institution.

Speaking on behalf of the National Minority Public Broadcasting Consortia, Deann Borshay asked that federal legislation mandate that the

CPB board be accountable to the public and that there be a mechanism for annual oversight and review.

## Transition period

Lewis called the three-year transition period too short and the one billion dollar trust fund inadequate. He calculated that with today's rates, the interest generated by the trust would provide less than 30 percent of current appropriated levels.

"My first response is that in these lean economic times, 'when' and 'for what' has Congress created a trust fund of any size — little yet for a billion dollars?" Fields had said in his opening statement. Fields told the panelists that the President would appoint the CPB board filling it with people who "should be capable of investing wisely."

Reviews were mixed on the expanded underwriting opportunities authorized in the bill. If it passes, stations could broadcast "well-established" corporate logos or slogans even if they include a call to action by the viewer or listener. Stations could also broadcast "strictly quantifiable comparative descriptions of products, services, or providers of products or services."

"The NFCB believes that this support will help many stations to develop increased financial support from their local communities," said Chadwick.

Lewis, however, said that the bill would fundamentally change the nature of public broadcasting by commercializing it.

Borshay said the Consortia was concerned that unserved and underserved communities "will become buried in a drive towards commercialization and privatization."

## Overlapping stations

The bill allows licensees in markets with two overlapping television stations to operate one as a public broadcasting station and the other as a commercial station with the profits from the commercial station funding the public broadcasting station.

The licensee could also sell one of the overlapping stations if the proceeds from the sale went to the retained public broadcasting station. In either of the two examples, the station would no longer be eligible for grants from the CPB.

The bill would allow noncommercial, educational broadcast stations to accept compensation for broadcasting programs produced by somebody else. In Fields' example, stations could form partnerships with commercial entities like The Discovery Channel.

Under the proposed bill, the CPB could produce programming. Lewis said that would mean the CPB could compete with local public radio and television stations and independent producers.

The bill would also eliminate many of the mandates on CPB imposed by Congress including set-asides and unnecessary reporting requirements. Richard Carlson, president and CEO of the Corporation for Public Broadcasting, praised that idea.

"Like everyone else, we're doing more with less. Our appropriation has dropped almost 20 percent over two years. We simply must have the flexibility to respond to those changes in a creative and intelligent way."

"If we don't act now, with dispatch," warned Fields, "I believe that we will lose the 'golden opportunity' of the vacant, noncommercial licenses. This spectrum will be taken and auctioned by the Budgeteers — and, with the cold reality of our country's budget deficit, funding for CPB will get more problematic each year."

## We've Strengthened Our Cast

### Sonic Foundry's Sound Forge™ 3.0

Whether you're a musician, sound designer or multimedia developer, full-featured sound editing for the Windows® platform has never been easier. Sound Forge offers editing, application of audio-processing effects, creation of loops and regions, and generation of playlists. An expandable plug-in architecture tailors Sound Forge to any application. Both a 16 Bit (Windows 3.1 or Windows for Workgroups™ 3.11) version and a 32 Bit (Windows® 95 or Windows NT™) version are included.

### Noise Reduction Plug-In

Now there's no need to slave away filtering noisy recordings. Sonic Foundry's Noise Reduction Plug-In is designed to automatically remove background noise such as tape hiss and electrical hum. Click Removal is also included, allowing you to eliminate clicks and pops automatically.

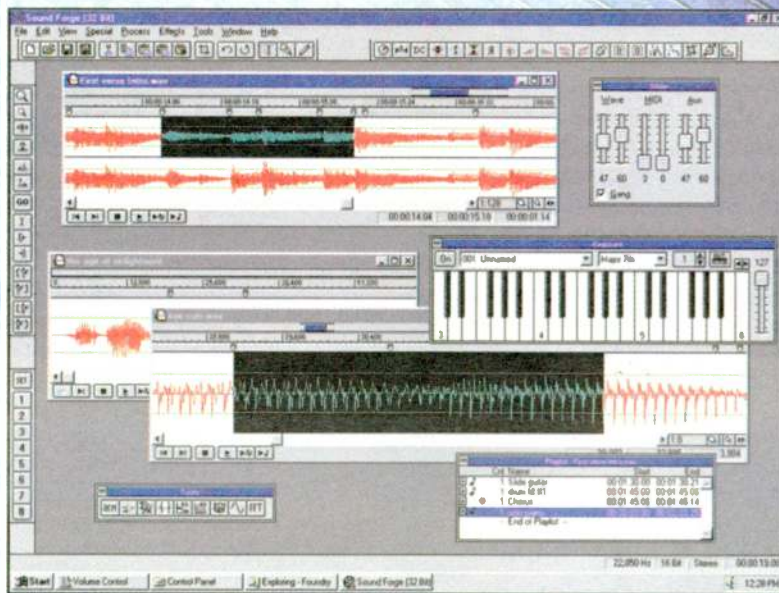

### Spectrum Analysis Plug-In

And if you need to identify that particular frequency component, you'll find the Spectrum Analysis Plug-In a great addition.

Spectrum Analysis includes Spectrum Graph and Sonogram display for easy frequency (or pitch) identification.

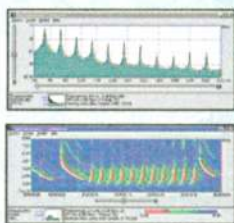

### Batch Converter Plug-In

The Sonic Foundry Batch Converter Plug-In is a time saving utility for those needing to convert tens, hundreds, or even thousands of sound files to a different format automatically. All Sonic Foundry plug-ins require Sound Forge 3.0.

### Sound Forge XP

Sound Forge XP, a general purpose sound editor provides the same easy to use interface found in the professional edition. Sound Forge XP is intended for sound designers, multimedia developers, and hobbyists requiring a powerful yet affordable sound editor.

For more information  
call Sonic Foundry at  
1 800 57 SONIC (577 6642)



100 South Baldwin, Suite 204, Madison, WI 53703  
Tel: (608) 256 3133, Fax: (608) 256 7300  
CompuServe: 74774,1340 or GO SONIC  
Internet: sales@sfoundry.com, Sonic Foundry and Sound Forge are trademarks of Sonic Foundry Inc. Other products mentioned are trademarks of their respective manufacturers.

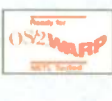



# Studio Sessions

Go Inside an **NPR**  
Jingle Session  
See page 22.

Equipment and Applications for Radio Production and Recording

## PRODUCT EVALUATION

# QS SAW Plus Adds New Features

**Bruce Bartlett  
and Jenny Bartlett**

**KHART, Ind.** Many people already use the Software Audio Workshop (SAW) from IQS. Now meet SAW Plus V.2.0; it's just as powerful for its price of \$999. It is full of convenient features. What does SAW Plus do that SAW didn't? Some amazing things. Depending on the speed of your computer and hard drive, you can mix up to 16 mono or stereo tracks in real time with level changes, solo, and panning. By the way, 16 stereo tracks is equivalent to 32 tracks. The program can convert sample rates between different soundfile formats in real time. SAW Plus also has realtime graphic effects: echo, noise gate, compressor, reverb, polarity invert, reverse, looping,

and pitch-shifting. It does all this with any Windows-compatible soundcard.

I was knocked out by the colorful, futuristic screens. Each screen is uncluttered and the faders and buttons are artfully shaded. Most buttons are text rather than icons, so you do not forget what they do.

SAW Plus has several windows:

- The Recording Control Panel is where you set the sampling rate and levels and initiate recording. You can change the level of a digital input signal in realtime. The 120-step level meters have realistic action.
- The Remote Transport Window has stop, play, markers, looping, and much more.
- The Full View Window shows the entire soundfile at a glance. You can skip instantly to any part by clicking on it.
- The Soundfile View shows the waveform of the sound you recorded. In this

2,200 kilobits per second (kbps) drive. As IQS predicted, SAW Plus could not reach its full potential with my system.

You can use up to four sound cards for multiple I/O. Windows 95 will work but Windows 3.1 is preferred.

Thanks to assembly language coding, SAW Plus is incredibly fast. Zooms, signal processing and waveform redraws are nearly instant. All operations are intuitive and well thought out.

I could mix up to seven stereo tracks without glitches on my 486, but when I added realtime fades and graphic EQ, not even two stereo tracks would mix in real time without errors. Still, I could listen to



Main screen of SAW Plus

the EQ to check it, then have the computer calculate a new soundfile with this EQ. It then played with no problems.

I used SAW Plus with a Digital-Only CardD card by Digital Audio Labs. Sound quality was excellent. Playback is a clone of the original signal.

I liked many convenient features of SAW Plus. For example, you simply double-click a region in a track to expand it into a large waveform for editing. Function keys can be programmed so that each one brings up a different view of your choice. Changing from a soundfile view to a multitrack view is a keystroke away.

Editing and region-defining are well done. You accomplish most work with mouse clicks and keyboard shortcuts. The manual is first-rate. It is well organized, easy to read and thorough.

Although it lacks an index, the manual offers a tutorial along with helpful tips on applications, optimizing performance, and help resources. You have all the tech support you need, such as free software updates from the IQS BBS.

SAW Plus is really better suited for multitrack production than for album assembly. Someday I would like to see IQS do a

screen, you mark regions — sections of sound that you want to keep. You can also delete unwanted sounds, cut and paste, and undo edits.

The Region View is a list of the regions you defined.

The Multitrack View shows the tracks and what is on them. You can place regions from a list into tracks, or record directly to the multitrack screen. When you click on the fader icon for each track, a pan pot and fader pop up. You can set the level at any point in a track, and fade from one level to another. It is easy to do and works well.

The Sequence View shows the ordered list of regions in any one track, along with their times and lengths. Displays keep you updated on timing information. Level and pan changes show up as curved lines within each track.

As for minimum requirements, a Pentium 90 is recommended. Slower machines will result in fewer tracks or less realtime DSP. Other requirements are 16MB RAM, SVGA monitor with a resolution of 800 x 600 and 256 colors, at least 7,200 rpm SCSI hard drive and a Windows-compatible 16-bit sound card.

My computer and hard drive are on the slow side: a 486-66 with 20MB RAM and

continued on page 20 ▶

## SHORT TAKE

# Create CDs with Corel

Stations interested in creating CDs as multimedia sales tools, jock "greatest hit" collections or historical retrospectives should know about Corel CD Creator 2.

This audio editor/graphics program builds upon the original 1994 version of Corel CD Creator by bringing it up to Windows 95 compatibility. CD Creator 2 lets users develop compact discs for audio, data, video or photo images and allows custom creation of jewel case artwork. All elements of CD creation including "jacket art" can be handled in-house on a single machine.

Enhancements and new applications include a 32-bit audio editor which performs click and pop removal, fades, equalization and format conversions.

Drag-and-drop arrangement of track order is possible and audio tracks can be merged.

Jewel-case art can be created on the same computer generating the CD. A default insert is automatically built, based on the layout. Users can drag-and-drop in clip art and graphics from other applications to customize the insert. Fonts and character sizes can be scaled and modified to fit the insert.

Because CD Creator 2 can also write video to a CD, radio stations can use it for numerous marketing applications.

A multimedia sales presentation CD-ROM with video and graphics can be created in-house by the marketing and promotions staff. Video and sound clips of the jocks' best moments can go to disc as an annual "video aircheck." Heritage stations can make a CD showing the timeline of the station's long history, complete with pictures and sound bites of an earlier time.

Corel CD Creator 2 is compatible with CD recorders from Kodak, Philips, Ricoh, Yamaha and a number of other manufacturers. A Macintosh version of the original CD Creator is also available (see photo).

Minimum system requirements for CD Creator 2 are Windows 95 running on a 486/33 PC with 8MB RAM (16MB recommended) or Windows NT 3.51 on a 486/66 with 20 to 24MB RAM. Macintosh system requirements are System 7.1, a Mac 68030 or better or Power Mac. A built-in system analyzer checks for compatibility and validates the the system requirements for users.

The suggested price of Corel CD Creator 2 is \$495. Original CD Creator users can upgrade for \$95. For more information, contact Corel Corporation at 613-728-8200 or circle Reader Service 200.



Corel CD Creator 2



**RW**  
**exclusive!**

New Digital Workstation Uses Eight Million Tubes

See page 21

# The First Name In Digital, The Final Choice In MiniDisc



**MD Cart Series  
Recorders/Players** *The DN-995R/  
990R recorders and DN-981F player offer  
all the advantages of MD without the con-  
ventional tape cart problems of wow and  
flutter or annoyances of drop-outs and  
tape stretching. These full-function units  
provide audio and computer interface as  
well as a multitude of options, including  
synchronization. Optional "Hot Start"  
switchbox adds instant playback of any 10  
tracks (DN-981F).*

**T**he first name in digital, Denon has also become the premier manufacturer of MiniDisc products for broadcast and post production applications. Denon not only offers the most comprehensive line of MiniDisc products on the market, they are the only ones totally committed to MD technology.

The MiniDisc format has proved to be the most convenient and reliable medium available. MD can literally be used millions of times without any signal degradation. The sonic quality is equal to Compact Disc and immensely superior to celluloid, while offering unsurpassed portability. More and more digital audio users are turning to MD for archival purposes due to drop-outs caused by DAT over the years.

From recording and replication to MD Carts and ENG MD recorders, Denon has a full family of products to integrate MD technology quickly and economically. Contact your favorite distributor and find out why Denon is the "final choice in MiniDisc".



**DN-1100R MD Recorder** *The DN-1100R MD recorder offers 74 minutes of stereo recording time with a 44.1 kHz sampling rate, 16-bit linear (A/D converter) quantization and ATRAC compression. The unit also features 10 independent "Hot Start" buttons to which any 10 tracks from a total of 255 can be assigned. This feature is ideal for sound effects libraries, sound bytes and announcements.*

**DN-80R Portable MD Recorder** *The DN-80R is the most advanced ENG recorder on the market, allowing up to 148 minutes recording time in mono and 74 minutes in stereo, per disc. The portable unit provides news gathering personnel and reporters who are on-the-move with shock-proof recording and playback capabilities from a 40 second memory buffer. Further time-saving production features include field editing on a single disc. A standard 23dx video camera battery provides maximum power for a full 148 minutes.*



**DN-045R MD Replicator** *The DN-045R MD replicator performs exact digital-to-digital dubs, up to 3.5 times faster than realtime without the cascade of ATRAC compression. The included Windows™ software also allows fool-proof editing during replication.*

**DENON**  
The First Name In Digital Audio

Denon Electronics Division of Denon Corporation (USA), 222 New Rd. Parsippany, NJ 07054 (201) 575-7810

NAB Booth #1020

Circle (37) On Reader Service Card

World Radio History

# Demeter VTCL Has Vintage Sounds

by John Diamantis

**FREDERICKSBURG, Va.** Tubes have certainly become the hot audio ticket — pun intended — of the '90s.

Some manufacturers these days seem to be shoving a tube or two into a box in place of op-amps just so they can jump on the Golden Glow bandwagon. Most of it is the same stuff we have seen all along, except now it has tubes.

Luckily, there are manufacturers utilizing tubes because they appreciate their audio characteristics, and they design their circuits to perform with state-of-the-art specs and unique and desirable operating characteristics, thereby creating a useful, brand new product.

## Squeeze the tube

The Demeter Vacuum Tube Compressor Limiter (VTCL 2A) is such an item. If you're looking for a box that will give you effects from clean limiting to crunchy compression, and every point in between, then look no further. This baby does it all.

The audio path is completely tube, with no transistors and no ICs. Jensen transformers are an option if you desire balanced ins and outs. This circuit is

channel, as well as an input sensitivity control to optimally match your source output level to the VTCL 2A. A lighted VU meter for each channel can display input level, output level, or compression level. A switch allows a 10 dB increase in meter drive sensitivity to better view low levels.

Connections can be made via XLR connector (pin 2 or 3 hot, switch selectable), tip and ring connector, or mini-plug. The power cord is a detachable IEC type.

Although I did not receive an operator's manual, there was an instruction sheet that described basic operation of the unit. Also included was a chart showing typical attack/release settings to make the VTCL 2A mimic the characteristics of Teletronics LA-2A or the notorious Fairchild 660 series.

## Plug-in test

I set up a pair of vintage LA-2As for a quick A/B comparison. The Demeter's dynamics could be made to sound close to the LA-2A, but its overall character was cleaner and had more deep low end; always a nice thing. Would I sell my LA-2As? I don't think so. But, I admit the Demeter is one flexible piece of gear.

Not having a Fairchild 660 on hand — much less 15 grand to purchase one — I was unable to make a direct comparison to the VTCL-2A. Fortunately, I have used a 670, and I was able to closely replicate the overall flavor and feeling that box imparted to a performance.

The big difference with the Demeter is you do not need to balance variable- $\mu$  tubes for minimum thump feedthrough or even try to find some matched 6386s to do the job. There are no matching or adjustment requirements, and the VTCL-2A's audio path is definitely cleaner.

By the way, if you actually *remember* minimum thump feedthrough, you really must get out more.

I ran a variety of audio through the VTCL-2A and was struck with how easy it was to get the sound I wanted.

Voice tracks could be cleanly leveled, or run hard and fast without sounding bad. In my testing, at least two announcers liked the resultant mic sound with the VTCL-2A running with moderate

attack and fast release. It gave them what they felt was a real punchy and upbeat sound.

In the airchain as a mic processor, I was able to get any type of effect I wanted out of this unit, but it sounded best adjusted for that elusive warm intimate mic sound.

## Going to tape

In the production room, full mixes were run through Demeter with great results. Just a bit of gain reduction gave some needed leveling without smashing the dynamics to bits, a syndrome common to lesser devices.

A couple of car dealer spots

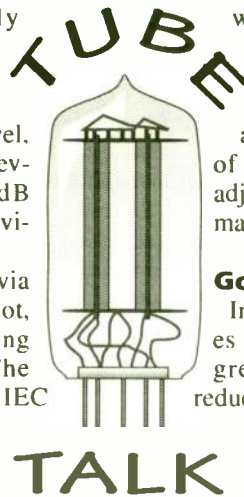

dilemma even when running the attack and release controls at full tilt fast.

A small complaint is that the controls feel touchy and very sensitive. The attack control, for instance is scaled reverse log.

This means a whole lot of change occurs from full fast (completely clockwise) to a relatively slow 25ms (less than one-quarter turn). It takes practice to line up both channels in this range if you want to process stereo without linking the channels.

The Demeter VTCL-2A acquitted itself very well on the test bench, with no more than 0.05 percent THD under normal operating conditions.

As you increase the input level, the front panel green light activates and distortion increases to a still-imperceptible 0.1 percent. Max input level is greater than +20 dBm, and maximum output level was +32 dBm.

**I ran a variety of audio through the VTCL-2A and was struck with how easy it was to get the sound I wanted.**

produced in-house really benefited from being run 15 dB into gain reduction with the release set fast. It made them loud and obnoxious ... *just the way we love 'em.*

The "soft knee" or gradual increase in compression ratio with increasing input allows the use of more gain reduction than usual in some cases, and no matter what the setting of the controls, the VTCL-2A's dynamics were clean and controlled.

Unlike most other units, the VTCL-2A's attack control feels more like an audio zoom lens, allowing you to get close by slowing the attack and adding punch to the audio, or zoom back by speeding the attack and shrinking the audio peaks.

Despite the wide range of control, it was very difficult to get into a dynamic

Frequency response was 7 Hz to 22 kHz and the -3 dB points were 3 Hz and 41 kHz. The extended low-frequency response — especially for a tube unit — added to the great sound of this unit. Square wave response at 5 kHz was excellent, with no ringing and square corners. Noise was better than 85 dB below +4 dBm, which is outstanding for a tube unit.

The Demeter VTCL-2A impressed me with its audio and dynamic performance, and I would recommend it to anyone looking for a great sounding, high-quality, and extremely flexible compressor/limiter.

□ □ □

*John Diamantis is chief engineer for WBQB-FM and WFVA(AM), Fredericksburg, Va. He can be reached at 540-373-7721.*

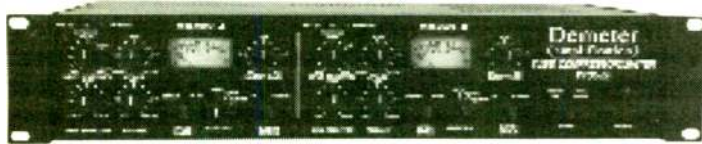

Demeter VTCL 2A

comprised of five dual triodes: one 12AX7 and one 12BH7 per channel with one shared 12AU7. It appears to be fairly conventional — no schematic was provided, but my curiosity drove me to tracing out the circuit by hand.

The side chain is entirely solid state, and gain reduction is accomplished via a photocell opto-isolator, similarly to the infamous Teletronix LA-2A. The DC supplies for filaments and high voltage are regulated.

Parts quality is good, with a lot of point-to-point wiring between the three circuit boards and front and rear panels. Construction is mostly very good, but during shipping, my unit had a bent rear panel where the power transformer mounts.

While it did not affect the operation of the box, it could be a source of future problems.

The VTCL 2A is a dual-channel compressor/limiter with the usual attack/release/threshold front panel controls. There are bypass switches for each

New

\$245.00



**Cellular Telephone Interface**

Microphone, tape and tuner inputs • Headphone Jack • Send and receive level controls

Works with most Motorola bag phones

CONEX ELECTRO SYSTEMS

1-800-645-1061 (360) 734-4323 FAX (360) 676-4822

Circle (14) On Reader Service Card

## FM BROADCAST POWER AMPS

... the low-cost way to increase power



HENRY FM Broadcast Power Amplifiers is the low-cost way to upgrade to "Class A" service or new construction or backup service at high power stations. Eimac ceramic triodes are used in grounded grid ... a design that is conservative, reliable, stable and very economical. Type accepted for use with any type-accepted 10 watt exciter. Input and output low-pass filters are built in for service as a primary or backup transmitter.

TOLL-FREE (800) 877-7979

## HENRY RADIO

2050 South Bundy Drive  
Los Angeles, CA 90025

Phone (310) 820-1234  
FAX 310-826-7790

Circle (63) On Reader Service Card



# All-tube DAW Astonishes Industry

*Ollafi Pro's New Digital Workstation Redefines the Role of Tubes in Production*

by Lord Euphell Forrit

**EXCUSEME, Miss.** Ollafi Pro (Audio) caught the broadcast industry completely by surprise on April 1 with its inaugural product: the 04-01 all-tube digital audio workstation (DAW).

This is the very first DAW to completely replace conventional digital silicon circuitry with vacuum tubes. The 04-01's A/D-D/A conversion, RAM buffering and processing is performed entirely by eight million 12AX7 dual-triode tubes split-configured as 16 million logic gate circuits. Another 28 tubes are used in the audio circuitry along with eight green "magic eye" VU tubes.

The only silicon found in the 04-01 is in the IDE hard disk controller, one rectifier bridge in the power supply and one LED. Everything else is a tube.

The company secretly collaborated on

**'It's obvious if one tube sounds good, 14 will sound better. The 04-01 sounds warm. Real warm.'**

the development of the 04-01 with reclusive computer innovator Heywood U. Nockitoff.

Nockitoff said, "It's the natural evolutionary route. The tube revival is at a fever pitch in the audio community. The only area left to improve with tubes was in the roots of logic circuits."

**Circuitry**

Tubes imported from the tiny Baltic nation of Kräkur-Zinnbed provide the 04-01's brainpower. The entire one-year factory output and existing inventory of the Kutcher-Noezov company was purchased for the inaugural 04-01.

The design draws on Univac and Eniac computer circuits of the 1940s, combined with popular starved-plate audio circuit concepts of the present. Nockitoff increased the cycling speed of 12AX7 tubes to a degree unheard of five decades ago.

"Tubes are easy to fool," said Nockitoff. "Optimize the symmetry of both plate outputs, stagger the phase so one signal arrives at the next stage before the other and they'll believe anything."

There are 14 tubes per channel in the audio chain. "Lots of people love the soft distortion characteristics," commented Nockitoff. "It's obvious if one tube sounds good, 14 will sound better. The 04-01 sounds warm. Real warm."

The first 04-01 was beta-tested at a project studio in Watering, Kan. "We had to build another 11,000 square feet to the existing physical plant to accommodate the 04-01 in our multitrack machine

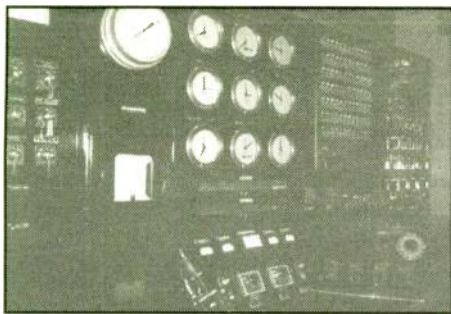

The 04-01's front panel

room," said studio manager Howie Doohan. "Do you have any idea the footprint eight million tubes takes up?"

Power consumption and heat output are

not as big a problem as in tubes' glory days. Starved-plate tubes require 40 V instead of several hundred. Still, the thermal output of eight million 12AX7 tubes makes the studio warm. Real warm.

**Tube distortion**

The sound of the 04-01 was judged superb by the studio engineers. Soft-clip distortion as high as 50 percent can be dialed in as desired by the operator. According to Doohan, "That's warm. Real warm."

Unfortunately, analog-to-digital conversion was less than spectacular. In spite of the improved speed of the 12AX7s, processor speed was considered inferior

to even the old Zilog Z80 microprocessor. A one-minute, 44.1 kHz stereo soundfile took over two hours to transform and render. The screen redraw took 1.1 seconds.

The original 04-01 will remain at the studio for recording long-form shows for a station in CurlyLarry, Mo. The heat output of the 04-01 will be recovered to run a water desalinization plant.

Cost of the Ollafi Pro 04-01 DAW should be \$21 million, including wall-wart power supply. Plans are now being made for a broadcast laptop model to be released in time for next April Fool's Day.

□□□

*Happy April Fool's Day, folks. "Ollafi Pro" is an anagram for "April Fool." All names and places speak for themselves, including the author's.*

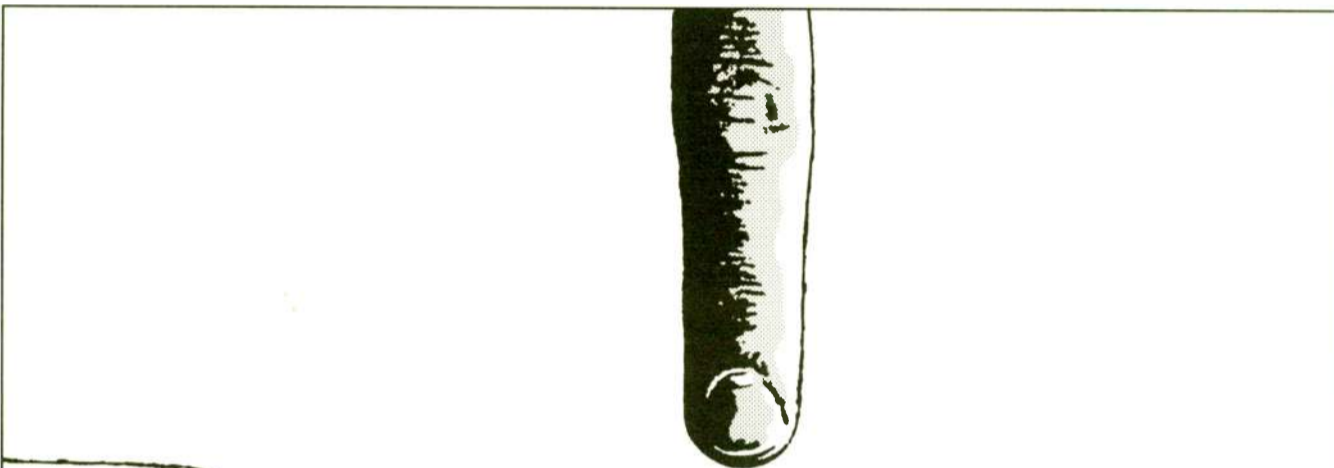

**We put the finger on 3 more stations.**

TALK RADIO 1070  
LITE 98.3 FM  
Z-104 FM

When the V.P. and GM of Midcontinent Media in Madison, Wisconsin, wanted to increase efficiencies and profits and decrease overhead... he gave all three of his stations the finger!

Now each one has MediaTouch, the original digital automation system. With its patented touch screen control and network audio, it creates economies of time and staff, driving profitability sky high.

With MediaTouch, digital automation is neither expensive nor risky. And now, thanks to a solutions-driven team of experts, both our software and service mandates are solid.



*"We carefully reviewed all available digital systems before picking MediaTouch. We've now lowered our operating and capital expenditures while improving the sound of all three stations. MediaTouch integrated our three diverse broadcast formats, giving operational efficiencies at the cost savings we were looking for."*

*David Graupner, V.P. and GM, Midcontinent Media*

So use your finger to call us for info or a demo, then give your station the MediaTouch finger.

call: 1 800 665 0501 <http://www.rubicon.net/~omt>  
fax: 1 204 783 5805 E-mail: [omt@summit.rubicon.net](mailto:omt@summit.rubicon.net)



# In-house Jingle Production at NPR

Wynton Marsalis' Studio Band and a World-Class Facility Team Up to Create New NPR Theme Music

## Part I of II

by Rich Rarey

**WASHINGTON** Every afternoon at 4 p.m., EST, NPR listeners hear a familiar melody, arranged in an unusual style: "Dah-de-dah-dah (rest) dah-de-dah-dah da."

This may be a poor text translation of the "All Things Considered" (ATC) opening theme, but the melody has been the program's signature for decades. Don Voegeli composed the original melody in the 1970s. It recently got a facelift in a recording and mixdown session that involved world-class musicians and NPR's large multitrack performance studio, Studio 4A.

## Once from the top

This is the story of that session, a product that originally did not meet expectations, and the time and effort it took to

Sunday)" and "Talk of the Nation." ATC would also begin an hour earlier at 4 p.m.

As the format clock was developed, we noticed there was not enough



# PUBLIC DOMAIN

music in the existing ATC theme package to fill the spaces. Worse, NPR did not have full usage rights to the music: RealAudio and worldwide distribution outlets had to have the ATC themes excised from the transmission.

Plans for a new theme arrangement were made, and a 4 p.m. start date in September 1995 was established. The

Details were made so part of the group would remain an extra day. Trombonist Wycliffe Gordon would lead and arrange the ATC music for the nine-piece jazz group.

This project marked the first time that NPR had the ability to record and mix down themes — in house — for one of its own news programs.

## Calling the shots

NPR engineer Mark Greenhouse was chosen to direct the session on Aug. 26, 1995. Prior to joining NPR, Mark owned and worked in recording studios for two

decades. His production philosophy is KISS (Keep It Simple, Stupid): short mic lines without the use of snakes, as few patches as possible and good preamps.

Using Studio 4A's SSL G+ series console, Mark and NPR engineer John Carrillo routed signals like this:

Drums on tracks 1 through 8, acoustic bass on tracks 9 and 10, piano on 11 and 12, brass on 13 through 16, reeds on 19 through 21 and a stereo overhead pair on 23 and 24. The recording deck was a Sony 24 track digital.

Greenhouse and Carrillo like "bright" recordings, but do not like achieving it through EQ. Sennheiser and Neumann mics were used throughout to achieve that desired crispness. An EV RE-20 went on the kick drum and a spaced overhead pair of B&K 4006 omnis rounded out the mic plot.

## Musical chairs

Positioning musicians is a critical step for a quality recording. Greenhouse said, "We had risers in the room and put the brass section one level up from the floor-level reeds. The piano and drums were kept in the same room with the band mainly for the groove."

The physically closer together you put the musicians, the better they play. That's "groove." Acoustic leakage between performers is less apparent because there is minimal time-delay.

Marsalis' 1923 Steinway "B" Grand had the lid opened wide, facing away from the band. Greenhouse said large dense foam blocks snuggled against the piano side facing the band minimized leakage through the soundboard.

A pair of Sennheiser MKH40 mics in an ORTF arrangement was positioned just above the opened side of the piano. One mic faced the tuning pins and the other mic faced the piano's belly. The drums and bass had foam blocks placed in a V shape around them, with enough room to maintain sightlines to conductor/player Wycliffe Gordon.

The most stunningly beautiful acoustic bass sound was captured by careful mic placement. Says Carrillo, "One MKH40 mic aimed at strings on the neck captures a lot of the definition and slap. Another MKH40 mic on the bottom near the bridge or off to one side on the body adds 'phatness' to the sound. I seldom point a mic at the hole, because it makes the sound too boomy."

The result was a deep, rich acoustic bass texture that oozed from the speakers like a rich sugary molasses. Heady stuff that greatly impressed me.

With the mics set up and the band in place, it was time to roll the Sony and lay down the new ATC theme ... which is entirely another story. One I will save for the next *Public Domain*.

□ □ □

Rich Rarey is the technical director for National Public Radio's "All Things Considered." He can be reached at [rrarey@npr.org](mailto:rrarey@npr.org)

## So What Is an ORTF?

The ORTF placement technique we used to record the piano was the result of experiments done by the French National Broadcasting Organization (*Office de Radio-diffusion-Télévision Française*). Like many things in French culture, the ORTF technique is simple and elegant.

Two cardioid microphones are placed 6.7 inches (170mm) apart, with the microphone backs at a 110-degree angle. Because low frequencies have long wavelengths, both mics essentially inhabit the same space inside a wave under 500 Hz. Above this point, the mics' placement in space detects time delays in sound arriving from different points in the stereo spread.

The ORTF technique yields a natural stereo sound with good mono compatibility and a pleasing openness superior to conventional X-Y placement. In conversations with NPR recording engineers, I found they regard mic spacing and angle values as guides only. They will move the mics and alter the



Warming up in studio 4A at NPR headquarters

rehabilitate that product.

The story begins in September 1994 at a public radio program directors' meeting, where a newly-expanded two-hour ATC program was announced.

NPR member stations and news management felt the time was right to make the change; making it consistent with "Morning Edition," "Performance Today," "Weekend Edition (Saturday and

two-hour format would be implemented earlier in June 1995, to give the staff a chance to iron out any format bugs.

While director Bob Boilen arranged music in spring and early summer of 1995, he discovered a band Wynton Marsalis put together to record "Harlem Suite" for NPR's "Making the Music" would be working in studio 4A the last week of August 1995.

## Walkaway:

Turn off the lights; lock the doors; go home. A few short years ago this level of automation at radio stations was impossible. But thanks to rapid advances in technology it's now an everyday occurrence. Anyone can go home, but to go home legally it takes specialized equipment. If you're contemplating a walkaway, you need to call about our RFC-1 Dial-Up Remote Control and our DAI-1 Dial-Up Audio Interface. For instant information 24-hours-a-day call our "Fax-On-Demand" from your fax machine and request documents 101 and 110.



SINE SYSTEMS

Voice: (615) 228-3500

Fax: (615) 227-2367

Fax-On-Demand: (615) 227-2393

24 Hour FAX-ON-DEMAND

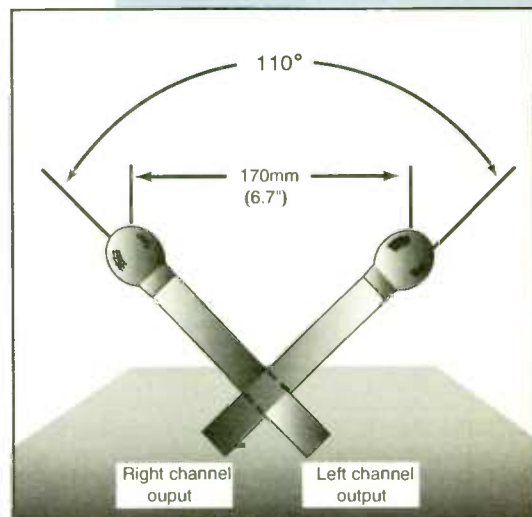

angle to achieve the best sound for the situation.

Refer to "*Stereo Microphone Techniques*" (Bruce Bartlett, Focal Press, Stoneham, Mass., 1991) or "*The Microphone Handbook*" (John Eargle, Elar Publishing Co., Plainview, N.Y., 1981) for details on ORTF and many other mic techniques you should know about.

-Rich Rarey

# The Future—Today.

Your on-air system isn't cutting it. You want something that was "made just for you." Look no further. The system of the future is here today from Gentner and Harris—your complete source for audio conferencing.



Simplify the process of bringing callers together with fingertip control from **Gentner's TS612 DCT**. The TS612's dual superhybrid technology provides crisp, clean caller audio with much more flexibility.

Callers will be less likely to switch since you'll get that smoother on-air sound you've been looking for.

The control surface is easy to use. It seems like an ordinary business telephone. But, ordinary it's NOT!

On-air talent can screen a call; transfer it from the handset to on-air conference with as many as four callers together; and lock in a VIP guest.

Thanks to line status indicators that are multi-colored, the user can instantly tell who's on the air, on hold, screened or talking to the producer.

With Gentner's SCREENWAIR software and a PC, the screener uses a keyboard and headset instead of the control surface and preselects calls for on-air and adding names, comments, etc. An additional monitor is placed in the studio

where the talent can see who is on screened hold.

With NETWORK INTERFACE you can expand the TS612 system into multiple studio configurations. Add a Network Interface for each mainframe and the communications link between studios for proper management of 12 phone lines is provided.

Telephone calls for broadcast teleconferencing and pro audio applications are made easy with **Gentner's TeleHybrid**. Simply connect it to your existing telephone to deliver full duplex audio to your console or conference system without the fear of echo or feedback.

The TeleHybrid "installs" between your telephone and its handset. Audio connections to your equipment are made with XLRs.

With the TeleHybrid, the hassle and expense of dedicated phone lines are a thing of the past. Your regular telephone system becomes your "on-air" system. Anyone in your facility can screen a call or transfer it to the studio or boardroom. Best of all, the TeleHybrid is very affordable.



The TeleHybrid is the key to simple, great sounding telephone calls on your professional audio system.

Your telephone can be single or multi-line, analog or digital—the TeleHybrid doesn't care. The only requirement is that your telephone have a detachable handset with a modular connector.

1-800-622-0022

FAX 317-966-0623

<http://www.broadcast.harris.com>



**HARRIS**

© 1996 HARRIS CORP.

# [solutions]

can your codec do this?

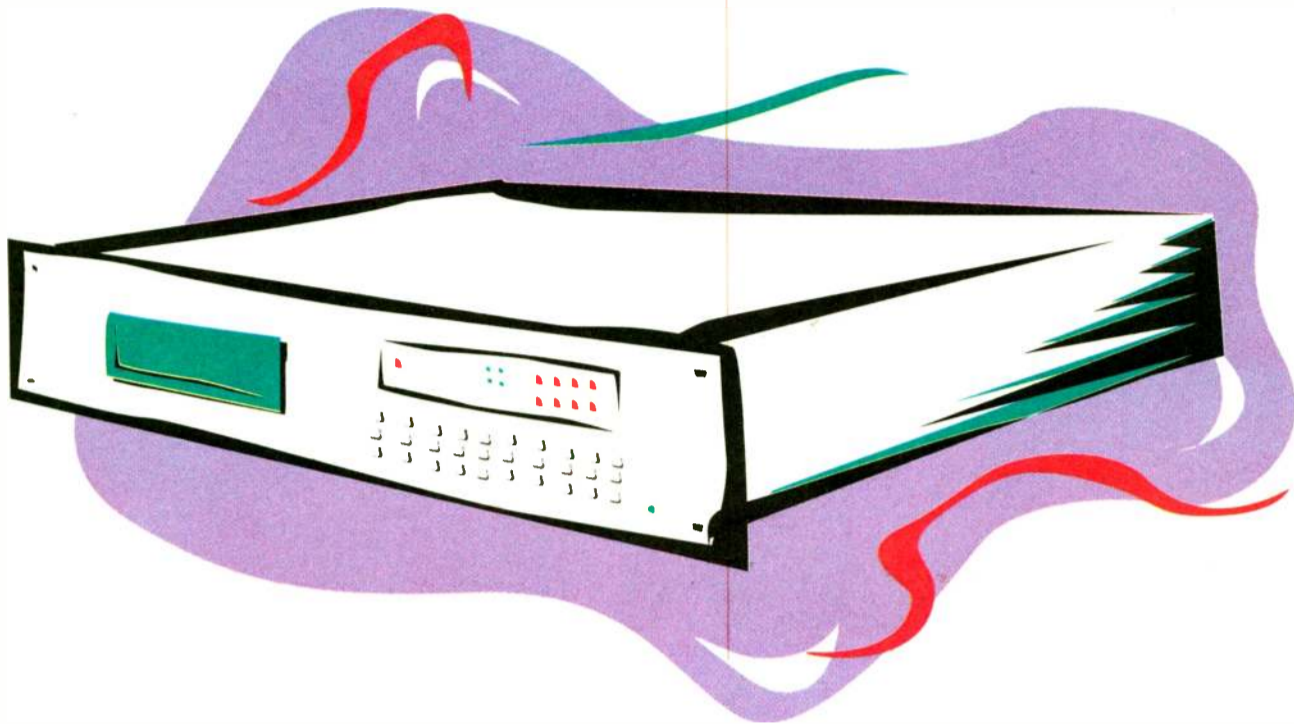

## “CDQPrima™ can!”



**Beatles in 1968:** From a studio in Liverpool, John, Paul, George and Ringo could have cut all the music for the feature film *Yellow Submarine* while it was being edited in Los Angeles at the same time! They could have sent SMPTE time code, text and CD-quality audio over a single ISDN line to Producer Al Brodat!



**Elvis In 1959:** From West Germany, Sgt. E. Presley could have remotely cut a hit without leaving the base and sent it to an empty studio in Nashville. At 0900 hours in West Germany, Elvis could have automatically started a tape recorder at the closed RCA Victor Studio B and had it ready for final mixing the next morning.



**Walt Disney in 1937:** From three different remote locations, Snow White's Director David Hand could have received voice-overs in stereo from Roy Atwell, Adriana Caselotti and Lucille LaVerne using a CDQPrima™. David Hand's Prima would have received each talent's voice-over, even though each incoming call came from a codec of a different configuration.

### Your Station Can Send & Receive CD-quality Sound Over [1] ISDN Line!

- Best CD-quality stereo sound for radio broadcasters, recording studios, film, voice-overs & satellite operators
- 20 kHz CD-quality stereo sound with better than 89 dB dynamic range and .01% total harmonic distortion
- Exclusive MUSICAM® enhanced encoder algorithm is compatible with all standard ISO/MPEG Layer II decoders
  - Psychoacoustic tuning with results in real time
  - CD-quality sound over 2 ISDN B channels
- Cascade-proof mastering quality with up to 6 ISDN B channels at 384 kb/s
- AND MUCH MORE!

CDQPrima™

For information and your nearest dealer call:  
Tel: 908-739-5600 Fax: 908-739-1818 Fax On Demand: 908-935-2777  
Internet: <http://www.musicamwest.com>  
MUSICAM USA™ 670 N. Beers St., Building 4, Holmdel, NJ 07733 USA



Circle (89) On Reader Service Card

World Radio History



# PRODUCT GUIDE

Companies with new product announcements for Studio Sessions Product Guide should send them to:  
Radio World, c/o Studio Sessions Editor, 5827 Columbia Pike, 3rd floor, Falls Church, Va. 22041

## Soundelux Microphone

Group One Ltd. is distributing the U.S.-made Soundelux U95 tube microphone.

The U95 is made in Hollywood, Calif. to the standards of the tube mics of the 1950s, with a one-inch-diameter capsule and 6072A vacuum tube electronics. The two-pound microphone body is made from brass, chrome and nickel and mic patterns are switchable between omni, cardioid and figure-eight with six intermediate steps.

Suggested price for the Soundelux is \$2,900 and includes power supply, shock mount and wooden case.

For more information, contact Group One Ltd., at 516-249-1399 or circle Reader Service 108.



## Sound Forge Plug-ins

Sonic Foundry announced new QSound plug-in modules for the Sound Forge 3.0 audio software package. The collection is called QTools and are used to add the QSound 3D audio localization effect to

ordinary stereo speakers.

Sonic Foundry is also preparing to release Waves L1-Ultramaximizer, allowing users to maximize the final digital signal on the way to mastering. It offers look-ahead limiting and three noise-shaping curves. The product is designed for any application requiring limiting or requantization of the digital signal.

For more information, contact Sonic Foundry at 608-256-3133 or circle Reader Service 146.

## Korg Music Module

Korg U.S.A. introduces the compact i5M Interactive Music Module. This is a MIDI music module appropriate for radio jingle production and creation of professional-sounding music for other broadcast production.

An interactive composition mode allows auto-arranging of 192 musical



styles such as Reggae, House, Latin, Pop and more. The 6MB waveform memory of the i5M contains 384 sounds and 16 drum programs. An internal digital effects processor provides 47 types of effects, including reverb and chorus.

For more information, contact Korg U.S.A. at 516-333-9100 or circle Reader Service 160.

## New Killer Tracks CDs

New music CDs from Killer Tracks include the NJJ Production Music Library and Chronic Trax vol. 1.

NJJ is "Not Just Jingles" and has an upbeat street sound from New York City. The library consists of 25 CDs in 15 different musical

styles. Updates are shipped periodically.

Chronic Trax was produced by Chronic Music — producers of the L.A. Riot sample CD series — and is available as a three-CD collection of acid jazz, hiphop and deep house cuts. Chronic Trax vol.1 is available as a buyout.

For more information and a demo CD, contact Killer Tracks at 800-877-0078 or circle Reader Service 135.

## Fostex Hard Disk Recorder

Fostex announced the availability of the D-80 eight-track hard disk recorder/editor.

The unit occupies three rack-spaces and

contains an 850MB hard drive for approximately 18 minutes of uncompressed recording time. The D-80 features eight-track simultaneous recording, Copy/Move pasting across different tracks, MIDI and digital I/O connections.

The D-80's front panel is removable and serves as a full-function remote control; a feature shared with Fostex' popular R8 analog tape recorder. The D-80 can be cascaded with other D-80s or the Fostex DMT-8 for up to 24 tracks. Suggested retail price of the D-80 will be \$2,195.

For more information, contact Fostex at 310-921-1112 or circle Reader Service 139.

## Quantum FM

Solid  
State

Solid  
Reliability

from

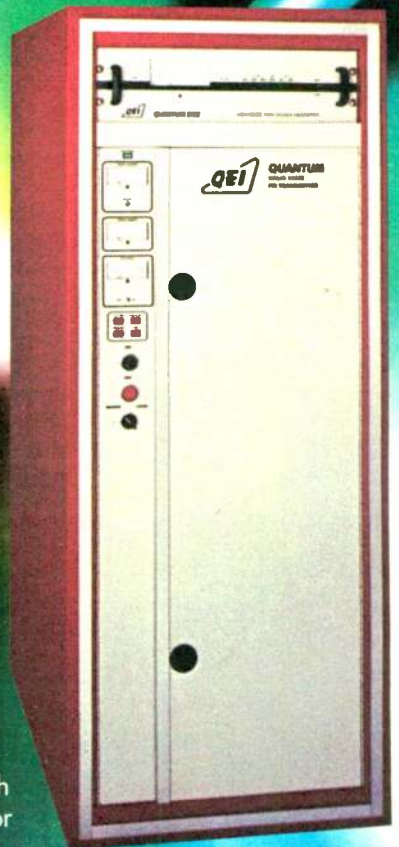

- Proven reliability
- Maintenance-free FET technology
- Self-contained modules with own power supply regulator
- Compact size reduces shipping costs, allows affordable air shipment
- Power levels between 300 Watts and 6 kW
- Modular design offers buy-only-what-you-need affordability and convenience

For the same price you pay for a tube transmitter, you can now have a superior solid state FM transmitter with high-power, advanced technology exciter and cableless combiner. The modular design of QEI's QUANTUM-Series FM transmitters offers the advantage of buying only the amount of power you need...and means that you can upgrade to higher power levels whenever you're ready.

QUANTUM from QEI—the people who have been designing and building solid state transmitters longer than anyone else in the industry.

You need to know more! Call Jeff Detweiler today toll free (800) 334-9154.

QEI Corporation  
One Airport Drive • P.O. Box 805  
Williamstown, NJ 08094

Tel (800) 334-9154  
Fax (609) 629-1751

24-Hour Service Hotline  
(609) 728-2020

## The "Doctor" is in!

Gerald M. Le Bow

Jerry knows more about ENDEC EAS than anybody else on the planet, because he created it. The "Doctor" will see you at **NAB in Booth 3517** in Radio Land Monday through Friday and let you examine the first EAS system to be certified by the FCC, ENDEC.

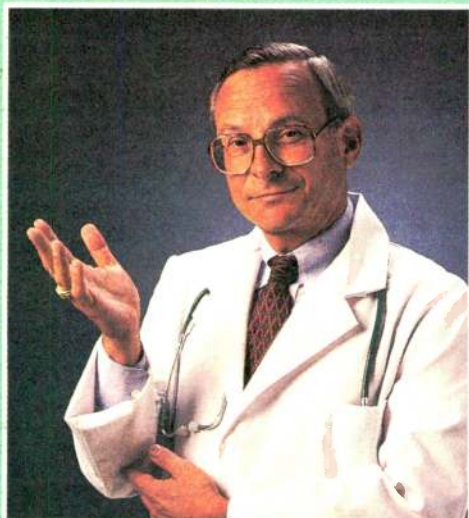

Beginner's Appointments on the hour 10a.m.-1p.m.  
Advanced Appointments on the hour 2p.m.-4p.m.  
Master's Appointments on the hour at 5 p.m.

1-800-622-0022



**HARRIS**



O P T I M O D - F M 2 2 0 0 D I G I T A L P R O C E S S O R

# We downsized everything except the OPTIMOD sound.

DIGITAL SOUND THAT ANY FM STATION CAN AFFORD.

As you can see, we've cut the cost of digital processing by two-thirds. But what you can't see, and really should hear firsthand, is what isn't downsized. The new 2200 is a direct descendant of the best selling digital processor in the world. So you not only get the same loud, clear OPTIMOD sound, the 2200 gives you key features you'll only find in high end processors, including 8 factory audio presets, the flexibility to program 8 user settings, and the choice of either protection limiting or two-band processing. A lot more than you'd expect in a downsized box. But then, it's not just any box. It's an OPTIMOD.

2200: \$3,850 US USER PRICE; 2200-D WITH DIGITAL I/O: \$4,450

**orban**<sup>®</sup>

H A Harman International Company

© 1996 Orban, Inc. Orban and OPTIMOD are registered trademarks. 1525 Alvarado St., San Leandro, CA 94577 USA  
Phone 1•510•351•3500 Fax 1•510•351•0500 E-mail custserv@orban.com

# Avoid Those Cheap Imitation Radio Voices

*Oh Nooo, Mr. Bill! Avoid Another Fine Mess When Creating Radio Characters So You Won't Have to "Play It Again, Shweetheart."*

by Alan R. Peterson

**WASHINGTON** "Hey, you know, I can do lots of impersonations ... how can I get into radio commercials?"

I get this question a lot. People feel the bug bite them hard after a couple of radio commercials for their uncle's car dealership, after cracking up their buddies with impersonations or just the idea that "I can do that too" after watching MTV.

I enjoy meeting these folks. They have real desire and a raw ability that can be honed into a marketable product. But impersonations? How do I put this delicately?

How about: If you know someone asking this, clip this column and give it to them.

**Well excuuse me**

A fellow back in my high school and college days claimed he could impersonate several hundred celebrity voices. He did okay on each one's most famous

Nicholson, Jimmy Stewart, Arnold Schwarzenegger, William Shatner and Sly Stallone round out a good mimic's bag of tricks.

Women performers can take a lead from Nancy Cartwright (Bart Simpson) and develop a little boy's voice. After that, tack on Roseanne, Princess Diana, a Gabor sister, Barbra Streisand, Tyne Daly's *Mary Beth Lacey*, Joan Rivers, Julia Child, Mary Tyler Moore's "ohhh, Mister Gra-a-aant," Olive Oyl and Wilma Flintstone for one dynamite demo package.

The biggest headaches regarding impersonations are these. One, you risk sounding really lame if your character is only a few degrees off. Dead celebrities are easy, but living legends take a sharp ear.

Two, they could lead to a lawsuit from the actual person or his or her estate, so be careful.

Of course, what is wrong with inventing *original* characters?

My two favorite voice talents are Billy West (Nickelodeon's Ren and Stimpy) and Mike O'Meara of the syndicated Don and Mike

show. West's Stimpy is basically a brain-impaired version of Larry Fine of the Three Stooges. O'Meara's double-jointed voicebox recreates Fine, Harry "M\*A\*S\*H" Morgan, Werner

Klemperer and a number of original voices.

These guys know how to listen and experiment and are not mentally locked on the American Movie Classics channel. Both are constantly evolving and creating new variations.

"Saturday Night Live" alumni Martin Short created Ed Grimley ("oh, I must say!") by blending the vocal quirks of two former classmates.

Dan Castellaneta came up with Homer Simpson the same way.

This is what anybody who wants to experiment with voices should be doing.

Merge Maxwell Smart with John Houseman. Combine Larry Linville's "Frank Burns" character with Ringo Starr's Liverpool accent. Graft the Sally Struthers squeak onto Carol Channing's big smiley voice. Remember, anything original always has its roots in something previously established; all that is needed is to add onto it.

Finally, a voice talent has to be ready *at any time* to show he/she can pull it

off. Take the scenario that happens when fresh talent calls a radio station:

"Hi Mr. Manager. I'm Sammy Somebody. I want to do commercials for your station; I do lots of voices."

"Really? Let me hear you do your three best."

"What, right now?"

"Sure. Pretend the tape is rolling. Go!"

"...Uh, well, I do W.C. Fields, Stan Laurel, Edward G. Robinson..."

"Fine. Do one now."

"Uh, well, I need to have some copy..."

"Do you have a tape you can send me?"

"Uh, no... I just figured I could come in when you needed me."

"Tell you what: I have a client who wants a Jerry Seinfeld voice. Can you do Seinfeld?"

"Who's he? ... (click) ... hello?"

**Well isn't that special?**

This is not an uncommon occurrence. If you know someone who really wants to use his or her voice creatively and does not know where to begin, better let him see this column.

It may help him or her avoid a few mistakes on the way to his or her dream. Radio always needs talented, disciplined players ready to move when the call goes out.

And — in my best Baretta voice — dat's da name a' dat tune.

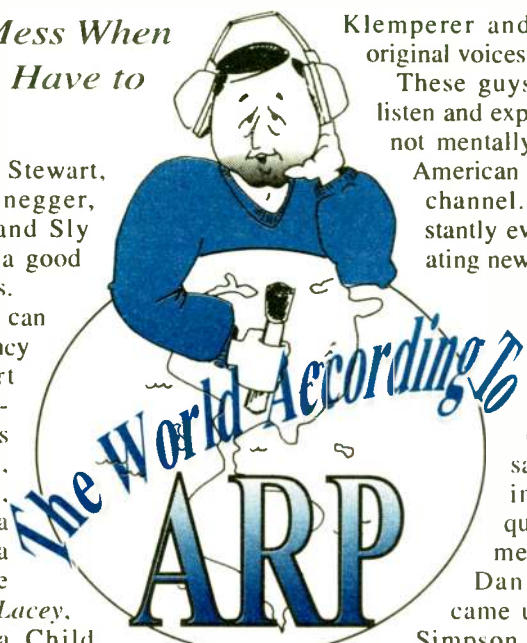

**Folks who do celebrity voices need to get contemporary and concentrate on hot voices.**

phrases; Kermit the Frog's "Hi-ho," Moe Howard's "Spread out" and John Wayne's "Awww, listen up, pilgrim" were plausible. But he could not sustain a character beyond that one magic phrase.

Attempting the Gettysburg Address as Ed Sullivan was impossible. His imitation of Arte Johnson's German soldier from the old "Laugh-In" show never made it past "verrrry interesting." Result: his list dropped way down very fast. Humbling, but it made him work harder. I hope he is doing well today.

What is the point? Most vocal impressionists I meet today only do the buzzphrases of classic (dead) performers. We overlook variations and imperfections because our hazy memories accept the blemishes.

But is there a market for these voices? Take a look at radio's demographics. Why put a Jack Benny or Walter Brennan on a radio spot? Howard Cosell and Richard Nixon were enormously popular voices, but are not in demand now.

**You dirty rat**

Folks who do celebrity voices need to get contemporary and concentrate on hot voices. Male voice talents should be doing Jerry Seinfeld, Homer Simpson, John Madden, Dick Vitale, Bob Uecker, Jay Leno, Beavis and/or Butthead, Robin Leach and Howard Stern.

It helps to take on "contemporary classics" too. Johnny Carson, Ted Kennedy, Yosemite Sam, Gary Owens, Jack

**RF ENGINEERING SOFTWARE**

**dataworld®**

authorized distributor of **EDX Engineering Software**

- ◆ SIGNAL™ MSITE™ and TPATH™ package
- ◆ MSITE™ Wide area coverage prediction
- ◆ TPATH™/RPATH™ Point-to-Point Link Studies
- ◆ International Terrain Data
- ◆ **New Release:** 30 Meter US Terrain Data



Established 1971

800-368-5754 FAX: 301-656-5341  
e-mail: info@dataworld.com  
http://dataworld.com/

**1750 TLM TOWER LIGHT MONITOR**



- ◆ DESIGNED FOR BROADCAST TOWER APPLICATIONS
- ◆ FAA/FCC COMPLIANCE ASSIST
- ◆ FOUR SEPARATE INPUTS
- ◆ POWER LINE TRACKING
- ◆ PHOTOCCELL INHIBIT
- ◆ "AND"/"OR" LOGIC ELECTION
- ◆ DETECTS SINGLE-LAMP FAILURES
- ◆ "DAISY CHAIN" CAPABILITY FOR MULTI-TOWER APPLICATIONS
- ◆ MONITORS BEACONS AND/OR OBSTRUCTION LIGHTS
- ◆ BINARY LOGIC STATUS OUTPUTS FOR REMOTE CONTROL INTERFACE

PLEASE CONTACT US FOR COMPLETE DETAILS  
<http://www.PI-usa.com>



**Potomac Instruments, inc.**

932 Philadelphia Ave., Silver Spring, MD 20910  
Phone 1-301-589-2662 • Fax 1-301-589-2665

# Products & Services Showcase

For more information on the products shown below, circle the appropriate Reader Service No.(s) on the enclosed Subscription/Reader Service card or contact the advertiser directly.

## S.C.M.S., Inc. Charlotte, N.C.

Low Prices - Experienced Staff  
New and Re-built R.F. and Audio

**THIS MONTH'S SPECIAL**  
**NEW KOSS LOW COST**  
**SPORTS HEADSET WITH**  
**BOOM MIKE**  
**#SB-30**  
**ONLY \$45.00**

You Know We Know Radio —  
Toll-Free 800-438-6040  
FAX 704-889-4540

READER SERVICE NO. 34

## Digital Audio, Analog Audio, Communications and Computers ... It's Easy as ...



Please visit us  
on the  
World Wide Web:  
[www.abg.com](http://www.abg.com)

Since 1960, production and broadcast professionals have turned to ABG for solutions. As the world has changed, so have our products, and so have we. From cutting edge digital production gear to the latest designs in custom studio furniture to ISDN telecommunications gear, ABG stays ahead of the game so you can concentrate on what you do best. You create the messages ...you move the world...we'll give you the tools to make it possible.

Please call today! ABG ... your single source solution.

**SOUTHEASTERN SALES OFFICE**  
200 Fareway Drive, Suite 2  
Smithfield, North Carolina 27577  
Phone: 800-369-7623  
Fax: 919-934-8120

**MAIN SALES OFFICE**  
2342 S. Division Avenue  
Grand Rapids, Michigan 49507  
Phone: 800-999-9281  
Fax: 616-452-1652

**WESTERN SALES OFFICE**  
P.O. Box 1638  
Palmdale, California 93550  
Phone: 800-858-9008  
Fax: 805-273-3321

YOU MAY ALSO REACH US ANYTIME VIA ELECTRONIC MAIL  
cServe: 75371,144  
internet: support@abg.com



For 36 years  
**ABG**  
Audio Broadcast Group Inc.

READER SERVICE NO. 9

## Composite Audio DA and Switcher!



The CDS-200 Composite DA/Switcher

### APPLICATIONS

- Switching Between Composite STL's
- Main/Alternate Processing Switching
- Feed Two Transmitters and an RDBS Encoder
- Feed one SCA Generator to Two Transmitters
- Distribute Composite with the Ease of Audio

### FEATURES

- 2 Input Switcher
- 3 Isolated Outputs
- Individual Level Control for Each Output
- Front Panel and Remote Control with Full Status
- Power Fail Memory with Bypass Mode
- Inputs Selectable for Balanced or Unbalanced Operation
- Front Panel Test Jack

**bdi** Broadcast Devices, Inc.  
5 Crestview Avenue  
Peekskill, NY 10566

Tel: (914) 737-5032 Fax: (914) 736-6916

READER SERVICE NO. 15

## VACUUM & GAS CAPACITORS



Over 800  
Capacitor Models

Voltage Ratings to 100 kV  
Variable & Fixed  
Vacuum & Gas  
Unlimited Capabilities

Applications: Communica-  
tions, Power, Electronic, Semi-  
conductor Fab, Dielectric  
Heating Equipment, & Medi-  
cal MRI & Heart Defibrillators.  
Ask about our vacuum relays  
& other components.

**JENNINGS**

Jennings Technology Corp.  
970 McLaughlin Ave., San Jose, CA, 95122 USA  
Call (408) 292-4025 for a free catalog

READER SERVICE NO. 84

## TRANSFORMERS & TRANSDUCERS



**FLEX-CORE**  
features a  
complete line of  
current &  
potential  
transformers,  
transducers, and  
instrumentation.

◆ Transformers

◆ Transducers

◆ Recording Systems

◆ Energy Management

◆ Harmonic Analyzers

◆ Demand recording and  
Control Systems

**FLEX-CORE**  
div. Morlan & Associates, Inc.  
(614) 889-6152 FAX: (614) 876-8538  
TECH. ASSISTANCE: (614) 876-8308

READER SERVICE NO. 59

# New! StereoMixer!

*StereoMixer* is an 8-input 'mini-console' that can mix 4 stereo or 8 mono line sources. Both stereo and mono outputs. Ideal as an input expander or source combiner. Balanced inputs and outputs, with superb specs. *Dozens of uses...keep one on hand!*



**HENRY ENGINEERING**  
503 Key Vista Drive  
Sierra Madre, CA 91024 USA  
TEL (818) 355-3656 FAX (818) 355-0077  
FAX-on-Demand Doc #122 (818) 355-4210  
<http://www.broadcast.harris.com/henryeng/>

**HE HENRY  
ENGINEERING**

We Build Solutions.

READER SERVICE NO. 109



**Pristine  
SYSTEMS**  
INCORPORATED

**DIGITAL  
ON-AIR  
SOLUTIONS**

- Feature Rich Live Assist and Walk Away
- On-Line Redundancy... No Black Box
- The Best Integrated Play List Scheduler (Music & Breaks) & On-Air Playback
- Dolby AC2 Overlapping Hard Disk Audio
- Music on Hard Disk and/or CD Jukeboxes
- Provide Computers/Players & Save \$\$\$ or Buy/Lease From Us

**WEST/INT'L**  
310/670-7500  
FAX 310/670-0133

**EAST**  
864/370-2400  
FAX 864/370-2314

READER SERVICE NO. 193

## LINE OUT

# Desktop CD Authoring Is Reality

## Part I of II

by Bruce Bartlett  
with Jenny Bartlett

**ELKHART, Ind.** At last, cutting compact discs on a desktop is affordable.

You "burn" each disc one at a time, using a CD-R recorder and blank discs. On these discs, you can archive IDs, themes, jingles, commercials, sound effects, and so on — all with digital clarity.

Compared to DAT, the CD-R format is more robust and gives you random access to any track on the disc. Once recorded, a CD-R is not erasable, but your audio program is safe from magnetic fields and accidental erasure. CD-R (Compact Disc Recordable) is a write-once optical medium that will play on any audio CD player or CD-ROM drive.

CD-R discs should last about 70 years. Their sound quality can be excellent; every bit as good as a standard compact disc. There are many other uses for the CD-R format:

- Record custom sound libraries of samples, sound effects, and production music.

- Make digital-quality demos to send to A&R people.

- Record a CD-R premaster to send to a CD replicator. Most CD replicators can take CD-R premasters. CD-R is more robust than DAT.

- Create a reference disc of your finished stereo mixes. This is also called a *test copy* or *one-off copy*.

- Archive existing recordings in the rugged optical format.

## What you need

To get started making CD-Rs, you need either a self-contained consumer CD-R recorder or an add-on CD-ROM recorder which you add to an existing computer system.

Discs from both types of recorders sound the same, and both play on any consumer CD player, but a disc from one type of recorder will not play on the other. A self-contained CD recorder is a complete system in one box. It includes a CD transport, laser, microprocessor, analog and digital audio I/O, display, keypad, volume control and level meters.

Because it needs no computer, the recorder is easy to use. Just start with an edited program on DAT or analog tape. Plug in your audio source, play your edited program, set levels, and start recording.

Self-contained recorders write audio only. They use blank discs in the "CD for Consumer" format, which cost about \$20 and last 63 minutes. The recorder costs about \$1,700 and more.

In contrast, an add-on CD recorder costs upwards of \$800 and connects to a SCSI connector or to a spare expansion port in your computer. The unit can write computer data or audio, and uses discs in the "CD for Professionals" format. The discs cost \$7 to \$10 and come in lengths of 18, 21, 63, and 74 minutes up to 650MB.

Maximum program length is 71.5 minutes.

With the add-on unit you need a CD recording program, which is usually supplied with the recorder. If you do not like that program, you may find a better one that is compatible.

Your hard drive should be a fast A/V type of at least 1GB capacity. Usual minimum requirements for the computer are a 486DX2-66 with 16MB RAM. Another necessity is a quality 44.1 kHz, 16-bit soundcard and recording software. You can daisy-chain recorders to write more than one CD at a time.

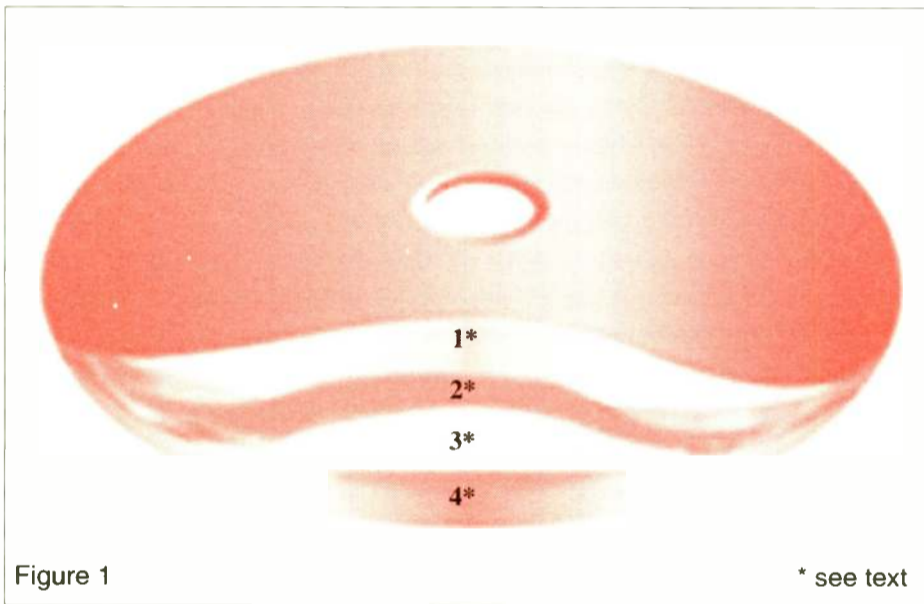

CD-Rs follow the Sony-Philips Orange Book part II standard, which defines the recordable CD format. Audio CD-R discs can play on conventional CD players, which conform to the Red Book standard.

A recordable CD looks like a standard compact disc, but has a gold layer on the top and a blue dye recording layer on the bottom. The blue layer looks green because of the gold layer behind it. High-speed CD-R discs use a yellow dye.

From top to bottom, the layers of the disc are: 1. Clear plastic protective layer with a printed label. 2. Gold reflective layer. 3. Dye recording layer. 4. Clear plastic substrate layer. See Figure 1.

A spiral groove is etched in the substrate to guide the laser. The dye fills the spiral groove. During recording, the laser melts holes in the dye. The plastic substrate flows into the holes and makes pits. During playback, the same laser reads the disc. Laser light reflects off the gold layer behind the pits, and the optical reader detects the varying reflectance at each pit.

## More data area

A CD-R disc has two more data areas than a regular CD. The Program Calibration Area (PCA) is used by the CD recorder to make a test recording. This determines the optimum laser power for the disc; typically 4 to 8 milliwatts.

There is the Program Memory Area (PMA), which stores a temporary table of contents (TOC) until the recorder writes the final TOC. The TOC is a list of the tracks, their start times, and the total program time.

Before we go over the differences among CD-R recorders, we need to explain the term "session." A session on

disc contains a lead-in, program area, and lead-out.

Each session has its own TOC. Some CD-R recorders allow "single-session" or "Disc-at-Once" recording. The entire disc must be recorded nonstop. Once you write to the disc, you cannot add more later. Disc-at-Once lets you control the layout of each track on the disc, and the length of the silence between tracks.

On the other hand, most CD-R recorders permit "Track-at-Once" recording. You can record one track, or a few tracks, at a time — up to 99 tracks. A partly-recorded disc will play on a CD-R

the other sessions, you need to play the disc on a CD-R writer.

When buying a CD-R writer, look for a buffer of 1MB or larger. Some CD-R writers are unreliable, and some write SCMS copy code, so be careful before you buy.

## Standalone writer

Suppose you have a DAT filled with promos and want to transfer them to CD using a standalone CD-R writer. First, edit your promos into a finished program. You will need a sound card and two-track digital editing software.

Now, here is the procedure. Plug the DAT into the sound card. Copy your promos from DAT to hard disk. Define each promo as a *region*, or a selected section of audio. Trim the start and stop points of each region to remove noise between promos.

Put the promos in a playlist — an edit decision list (EDL) or cue sheet — in the order you want them to appear on the CD. Make sure the total playing time is less than the CD-R length of 60 minutes.

Put silent spaces or crossfades between promos and adjust the level of each promo as needed. Now set your DAT in record mode, and play the playlist off the hard disk.

Once the program is transferred back to DAT, write a start ID one half-second before each cut. Renumber the program numbers. Now your edited DAT is ready to play into the CD-R writer.

Plug your audio signal into the CD-R writer's input, set levels, and start recording. Your program will transfer in real-time. Many CD-R writers will convert the DAT's start-IDs to track numbers. If not, add track numbers manually while recording.

Next time: Computer CD-R procedures and vendors of hardware and software.

□ □ □

*Bruce Bartlett is a mic engineer, writer and recording engineer, and the author of "Practical Recording Techniques" published by Howard Sams. Jenny Bartlett is a technical writer. Bruce can be reached at 219-294-8388.*

## ABG is Studio Furniture

Our furniture systems offer you the industry's most extensive list of standard features, including:

- Complete delivery, set-up and installation
- PC/Video monitor arms
- Pull out keyboard drawers
- Durable Pionite® laminate
- AC wiring and cable runs
- Cooling fans and ventilation ducts
- Solid oak trim
- Uncompromised construction
- Leveling feet at each corner
- Heavy duty EIA standard rack rails drilled and tapped
- Smoked plexiglass panels for unused spaces
- Choice of colors

If you're thinking of upgrading your facility, you can't afford not to call us!

Please call today for full color brochure.

**SOUTHEASTERN SALES OFFICE**  
200 Fareway Drive, Suite 2  
Smithfield, North Carolina 27577  
Phone: 800-369-7623  
Fax: 919-934-8120

**MAIN SALES OFFICE**  
2342 S. Division Avenue  
Grand Rapids, Michigan 49507  
Phone: 800-999-9281  
Fax: 616-452-1652

**WESTERN SALES OFFICE**  
P.O. Box 1638  
Palmdale, California 93550  
Phone: 800-858-9008  
Fax: 805-273-3321

YOU MAY ALSO REACH US ANYTIME VIA ELECTRONIC MAIL

eServe: 75371,144  
internet: support@abg.com  
web site: www.abg.com

For 36 years  
**ABG**  
Audio Broadcast Group Inc.

Circle (60) On Reader Service Card

# Silly Survey Tests Your Airchain

by Chip Diggers, C.E.

**EDITOR'S NOTE:** This humorous "survey" has been circulating among radio engineers in an unnamed market in the Carolinas and was sent to us.

Any engineer who has ever had to mutilate a station's audio quality based on inaccurate research or the whims of a new program director will recognize and appreciate the following questions.

To all area radio station program directors and managers:

Radio engineers are conducting an Audio Processing Satisfaction Survey in your market.

Engineers need your help in determining who among you are most satisfied with the overall sound of your radio stations. For your participation, your station will receive a Golden Greenie screwdriver, suitable for display in your lobby or reception area.

Please answer the following questions with a number from 0 to 9, with 0 meaning "least satisfied" and 9 meaning "most satisfied."

Please begin.

- My station's high end is boosted enough.
- My station's high end is reduced enough.

My station's high end is limited, clipped and smeared enough.

My station's bottom end is just muddy enough.

My station's bottom end is so compressed it sounds like a jet engine.

My station's modulation monitor meter never deviates more than two percent and may as well be superglued to the scale.

At last, I have enough separate bands of compression.

All external parameters of our audio processing chain are at the maximum grunge position.

Processing is set so high you can hear our jocks' nose hairs brush against the mic screen. Research shows listeners like that.

All air talent — men and women — have the USDA recommended allowance of testosterone.

My station is definitely bright enough.

My station is definitely "thumpy" enough.

We have achieved the "louder than everyone else in the market and I don't care how we do it" plateau.

Our spatial enhancer artificially replaces lost separation stripped away during previous processing to our satisfaction.

The engineer tells me our sound is fatiguing to women, which means our airchain is adjusted exactly right.

I can still hear the station when I turn the radio all the way down, which means our airchain is adjusted exactly right.

Every instrument and voice in every song has that wonderful "wall-of-sound" texture which means our airchain is adjusted exactly right.

Our listeners — both of them — have ears that bleed often and they purchase lots of replacement speakers.

The jock's sealed headphones adequately feed back through the mic during pauses and breathing.

Our processing makes CDs sound better than when they were recorded.

I know what dynamic range is and also know that nobody likes it.

Please add up your totals and place them on the bottom of the page. A total of 189 means your Golden Greenie (an old chewed-up Greenie screwdriver and can of Testor's model spray-paint) will be sent immediately.

A total of 10 or less means you probably have a decent-sounding radio station. Who'da thunk it?

□ □ □

*Chip Diggers is a pseudonym for a chief engineer working several stations in the Carolinas. His true identity has been withheld so he still has a job.*

**FM AIR-CHAIN PRODUCTS**

*An all star cast...*

250, 260, 630, 255, 708, 716

Combining stellar performance with down-to-earth value for more than 20 years.

#### 250 Programmable 5-band Processor

Gated AGC, 5-band Compression and EQ, split-spectrum Limiting—all with colorless gain control. Manually pre-program 4 processing presets or place entirely under RS-232 remote control.

#### 255 "Spectral Loading" Processor

Triband-PWM Stereo Processor for contemporary music formats. Includes gated AGC and 3-band Compressor/Limiter. Our unique "Spectral Loading" feature gives a very aggressive sound.

#### 260 Multifunction "Utility" Processor

This simple stereo AGC/Compressor/Limiter is ideal for budget-FMs, uplinks, TV-aural and many other station chores. Split-spectrum processing utilizes PWM dynamic control.

#### 708 Digital-Synthesis FM Stereo Generator

A basic Stereo-Gen with outstanding specifications. Built-in, adjustable Composite Processing, RDS/SCA combining, and accurate front-panel metering for easy setup.

#### 716 "DAVID-II" FM Processor/Stereo-Gen

A gated-AGC/Compressor/Limiter, plus clean digital synthesis of the multiplex baseband signal. This second-generation design features PWM gain control, an adjustable Composite Processor and RDS/SCA combining. A fantastic performer!

#### 630 FM "Relay" Receiver

A tunable, single-channel re-broadcast receiver for FM translator service and similar, critical off-air pickups. Features both composite multiplex and left/right audio outputs. IF bandwidth, auto-mute and auto-blend functions may be remotely selected; alarm outputs for loss of carrier and loss of program audio.

**NAB Booth 1300**  
Radio/Audio Hall

Call today for complete technical information on these items, plus our line of AM, Radio-Data and Measurement products.

# Inovonics, Inc.

1305 Fair Avenue  
Santa Cruz, CA 95060 U.S.A.

TEL: (408) 458-0552 FAX: (408) 458-0554  
E-Mail: inovonics@aol.com



Watch for the following in upcoming Studio Sessions:

■ Roland SRV Space

Reverb

■ Tascam DA-20 DAT Recorder

■ Earthworks OM1 Microphone

■ Monitors From Mars

Only in Radio World

ABOUT THE ONLY THING  
IT CAN'T DO FOR  
YOUR TALK SHOW HOST IS  
MAKE EVERY  
CALLER SOUND  
INTELLIGENT.

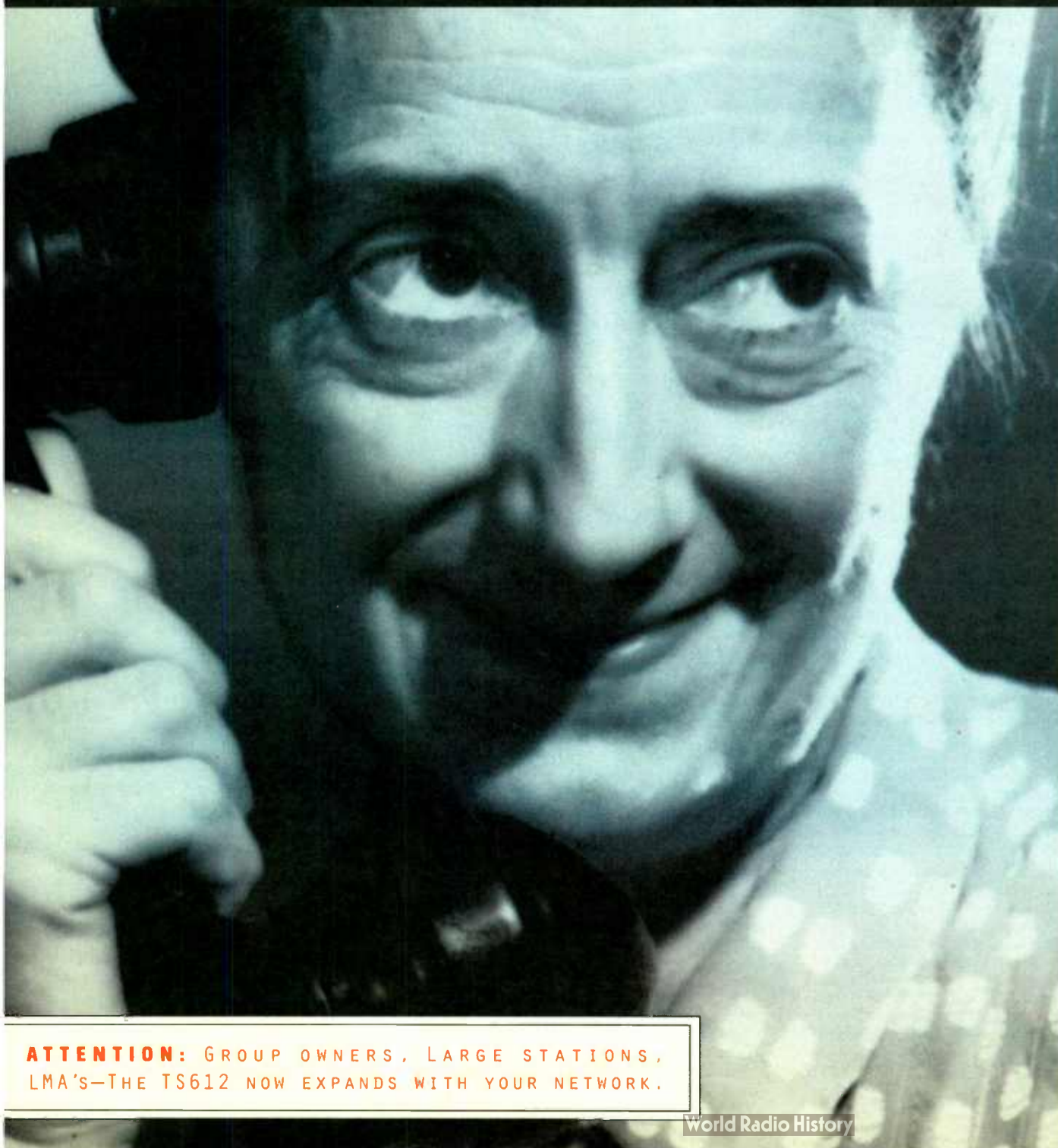

**ATTENTION:** GROUP OWNERS, LARGE STATIONS,  
LMA'S—THE TS612 NOW EXPANDS WITH YOUR NETWORK.

World Radio History

Occasionally, every talk show has to deal with an out of touch caller. But that's probably not the worst of your talk show host's problems. Chances are, your host is also trying to screen calls, conference multiple lines and make smooth transitions to commercial breaks — all while trying to come up with a snappy comeback for the space cadet on line 3. That's why we've updated the old talk show phone with the TS612. All the important functions are clearly marked and the phone lines color coded to make on-air decisions hassle free. Want to screen calls? Press **SCRN**. Want to conference up to

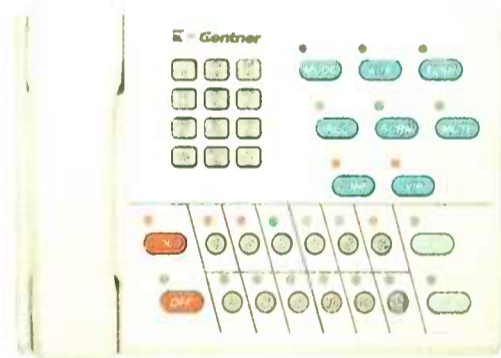

THE TS612 CAN NOW HANDLE YOUR MULTI-STATION, MULTI-STUDIO APPLICATIONS.

four lines? Press **CONF**. Don't want to lose a very important caller? Press **VIP**. Your host can even call for pastrami on rye while on-air some caller explains the finer points of cloud-watching. The point is, the TS612 is simple, versatile and lets your host concentrate on the show rather than the phone system.

To find out more, call us.

Circle (41) On Reader Service Card

See Us at NAB Booth 2016

 **Gentner**

1 - 800 - 945 - 7730

OR 1 - 801 - 975 - 7200

## SIGNAL-TO-NOISE

# Secrets of Saving and Storing Tapes

by Frank Beacham

**NEW YORK** At Tom's bake shop, the sensual pleasure that comes from the sweet aroma of rising dough is missing. This is a place more prone to nervous energy. One crisis follows another. Things are so tense that Tom rarely even fires up the oven without having a nail-biting, distressed customer waiting anxiously in the wings.

Tom Neuman's peculiar brand of baking goes on in a high-tech industrial oven at the Ampex Recording Technology Group (now Quantegy, after the recent company sale) in Redwood City, Calif. As senior

staff engineer, one of Tom's roles is to save valuable information on damaged magnetic recording media.

Through his doors have passed nervous representatives of the Grateful Dead and the FBI, the "Ed Sullivan Show" and tabloid TV's "Hard Copy." All had one thing in common. Their audio and video tapes had a problem.

## A gummy mess

In many cases it was sticky tape syndrome, a phenomenon where magnetic recording tapes — mostly from the '70s and '80s — become sticky and resist moving through a tape recorder without

squeaking and gumming up the works. A result of faulty binders on some tape stocks, Tom solves this problem nicely with a patented process where tapes are "baked" in an oven for 24 to 48 hours at a temperature of about 121 degrees Fahrenheit.

Because Tom claims a success rate of "about 100 percent" in baking sticky tapes and then transferring the recordings to new media, we asked his advice for today's recordists who want to preserve their work for the future with the latest generation of recording tape.

First of all, Tom recommends archiving on the old standby: analog reel-to-reel tape.

"No, I don't recommend archiving on DAT," he said. "I can't say that's the official company position. We do sell DAT and a lot of people archive on it, but if it were me, I wouldn't. As a matter of fact, DAT scares the hell out of me."

In real-world usage, Tom said, he is amazed how few problems we have with DAT cassettes, because "the tracks are so tiny and the tape so thin that it doesn't take much to cause damage."

A recordist using DAT is squeezing information onto a tape surface 1/200 smaller than that allowed by quarter-inch analog tape, said Tom.

"A little piece of dust on an R-DAT could cause you to lose half a second, where on the analog tape you wouldn't even notice it. So it's prone to damage because it's so tiny."

When using analog tape for archiving, Tom recommends storing the tape tails out.

"There are two reasons for that," he said. "One is when your tape recorder is in regular mode, the tape is wound on the reel at the best possible tension conditions. The tape is laid down uniformly so you don't have edges sticking up damaged and you don't have very high tensions."

"If you were to rewind the tape first, the rewinding puts an enormous amount of strain on the tape and all those built-in stresses are going to sit there for the next five or ten years and it could distort the tape," he said.

## Did you hear that?

"Another reason is, if over long storage, print-through occurs, you'll have a post-echo rather than a pre-echo. A pre-echo would be like I say (a quick) 'hello.' And just before I say hello you'll hear it. 'Hello. Hello.' But because every sound has a decay if the echo comes after the word, you'll never hear it because the real word itself is still decaying and it gets hidden. Post-echo print-through is never noticeable."

It's also better to record archival tapes at the highest possible recording speeds, Tom said. A voice recording would be sonically OK at either 7-1/2 or 3-3/4 IPS, he said.

"But if you record at 7-1/2, the wavelengths on the tape — the dimensions of the frequencies — are going to be twice as big."

By stretching the audio information over a greater tape surface area, Tom said, it's easier to recover it.

"Archival, the higher the speed, the better off you'll be," he said. "The downside is every time you double the speed, you spend twice as much money on tape."

As for sticky tape syndrome on the latest generation of recording stocks, Tom is hopeful the problem is licked, but cannot guarantee it's a thing of the past.

"The new formulations have been out three or four years and we've had no trouble," he said.

Ironically, with 3M's announcement that they are leaving the recording tape business, only two manufacturers of professional-grade analog reel-to-reel tape remain. They are Ampex and BASF. Ampex's most archival advanced formulations are 456 and 499 Grand Master. At BASF, it's 911 Studio Mastering Tape.

□ □ □

Frank Beacham's address is 163 Amsterdam Ave. #361, New York, NY 10023. E-mail: beacham@radiomail.net. Visit his Internet web site at: <http://www.beacham.com>

## If our marketing department had been as talented as our engineers, you'd probably be using a Prisma™ workstation right now.

### The alternative workstation.

Okay, granted, there are already a lot of digital audio workstations out there. Some are so expensive that you can only afford one for six editors. Some are little more than PC sound cards that can't lock to picture without timecode drift. Some are so complicated that after you've bought a Mac™, 5 add-in boards, a bus expansion box and 12 pieces of software, it almost nearly works most of the time.

That's why you should explore our radically different approach. Admittedly, we're guilty of spending far more time perfecting our products than advertising them. But today, a growing number of major post production facilities and recording studios are reaping the benefits of our meticulous engineering. They also rave about our great service and quick support — available worldwide via internet, fax, or phone without having to wait on hold for hours.

### One hardware platform; three software solutions.

**Prisma™** is our one-card hardware platform that frees up your CPU by handling all processing and signal flow on board. Its DSP capabilities are so massive that plug-ins aren't even an issue. Invest in Prisma hardware and then choose the Windows®-based software package that fits your applications and budget. Each has an elegant, hands-on interface that's free from frustrating drop-down menus, and floating window clutter.



### EXPRESS™ for PRISMA™

Express™ presents a simple, 2-panel interface with all the tools you need on-screen — instead of hidden in a mass of annoying pulldown menus. Perfect for broadcast, commercial production, multimedia and small home studios.

8 tracks • Over 250 markers & 99 Auto Locate points • 10-level Undo/Redo • Fader automation • Directly-draggable fades & cross-fades • Easy head & tail trim • Fast bi-polar waveform views • Snap anything to markers, current position or other sounds • Compatible with & upgradable to Producer™ • Networkable

**Express™** is a creative tool for broadcast and commercial production with a no-frills interface so simple to use that even a program director could learn it. It uses Producer's hot-key shortcuts to reduce the learning curve if you upgrade.

**Producer™**† takes the software recording studio paradigm to a new level. Its studio-friendly look and feel removes the impediments to creativity found in many current workstations.

**StudioTracks™ XP** has the tools you need for serious, heavyweight film and video post production, sound design, dialog editing and Foley work. XP stands for Cross Platform: StudioTracks runs on both Prisma and Spectral's even-more-powerful AudioEngine™ hardware, too.



Above: Producer Edit panel; below: Mixer panel



### PRODUCER™ for PRISMA™

Radically different from any other workstation software, Producer™ is a "virtual studio" with direct access to familiar audio tracking and mix-down tools including an automated mixer. Free from drop-down menus and nested windows, Producer's direct interface boosts productivity & creativity.

99 virtual tracks, each w/4 layers • 8/16\*/24\* or more tracks • 4 sends & returns + 2 mixer tracks • Rich DSP features • 10 Undo levels • Automated fades, pans, mutes, aux sends • 2 EQs per mixer channel • Default cross-fades & butt-splices or custom via built-in editor • Markers • Snap anything to anything • 3 waveform views incl. fast bi-polar waveform display • Grid can be set to bars/beats, frames etc. • Direct VITC lock • Can add timecode burn-in to video • Networkable  
\*via linked CPUs

### Get the whole, hitherto untold Spectral workstation story.

Prisma™, Express™, Producer™ and StudioTracks™ are just part of our product line. They all come from an established company that specializes in digital audio workstation and connectivity solutions. Call, fax or e-mail for complete, detailed information on our practical approach to enhanced productivity.

We've been keeping it a secret for far too long.

†The software program Formerly Known As Prisma Music. Our previous Marketing Department did it.



Above: StudioTracks edit screen; below: segment editor; inset: dynamic DSP

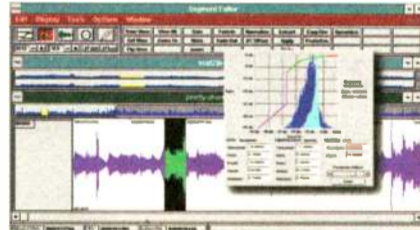

### STUDIOTRACKS™ XP

Spectral's advanced, cross-platform™ solution for film & video dialog editing, sound design and other edit intensive workstation applications.

256 virtual tracks • 12 tracks w/2 sends & returns

• Internal track bouncing • Auto-Conform™

• Direct VITC lock • Drag & drop SFX & dialog snips from library to project • Spectrum analysis • Flexible dynamics processing • Silence-stripping

• Envelope editing • 2 EQs per channel • Digital patchbay • Textual play list for mix-to-pix or mastering • Machine control • Networkable

\*Runs on Spectral's Prisma™ & AudioEngine™ hardware

\*\*Optional



**SPECTRAL**  
A Euphonix Company

18800 142nd Ave NE, Woodinville, WA 98072

<http://www.spectralinc.com> info@spectralinc.com  
Tel: 206.487.2931 • Fax: 206.487.3431 • Sales: 800.407.5832



# Use CAD Software for Engineering

by Andrew Ellis and David Wigfield

**SAN FRANCISCO** No one would consider sending a business letter with erasures and typographical errors. Word-processing and Spellcheck software have raised the quality standard for business mail.

Yet, the engineering documents at many stations are still hand-drawn on notebook paper. Worse, many of them are seriously out of date. Some stations have no meaningful documentation of their systems at all.

## Write it down

This was once regarded as a crude form of job security by some engineers. If you wrote nothing down, the manager had no choice but to depend on you. The design of many stations existed only in the heads of the people who built them.

The reason this unprofessional approach worked for a time is that few chief engineers had managers who understood engineering. Today, though, many formerly independent stations are parts of groups and most groups have knowledgeable engineering managers. Up-to-date local station managers often know the technical side of radio, too.

Radio stations have been growing far more complex as new technologies add equipment to once-simple layouts. There is a greater need than ever for clear documentation and a huge pent-up demand

functions to draw circles, arcs and polygons, as well as lines, but the handy features of CAD software are stored symbol libraries and grids.

A symbol library stores frequently used symbols and images. A schematic library, for example, would have drawings of resistors, capacitors, op-amps and so forth stored for instant insertion in drawings. A mechanical library would include pictures of XLR connectors, knobs, buttons and other physical parts.

## Easy revisions

Schematic libraries are not useful if the connections between parts do not line up. Grids and "snaps" make sure that they do. A grid is represented by a matrix of dots on the screen. When you insert a library part into the drawing, the software "snaps" it to the nearest grid point. This ensures that adjacent parts line up perfectly and eliminates the tiny location adjustments that plague paint-type drawing programs.

Just as word processors let you fix mistakes you might have ignored in the old days, CAD software lets you redo drawings until they are perfect. Later, the drawing can easily be called up and revised when new gear is added or changes are made to equipment already in use.

Finally, CAD software makes it easy to create labels for distribution amplifiers, patch fields and so forth. Arrays of switches usually are not spaced at intervals convenient for word processing programs. But printing a label for a row of buttons using CAD software is, well, a "snap."

Figure 1 is the schematic diagram of a dual-headphone amplifier drawn using CAD and our schematic parts library. One secret to a useful parts library is to have each object stored in the proper scale. Mechanical parts are

easy — just store them life-sized. For schematic libraries, we drew parts proportional to one another and sized for 1/4-inch grid spacing.

Many CAD programs allow plotting "unscaled" drawings. You can begin drawing immediately, then have CAD fit the finished drawing to the page. Of course, the drawing may end up so squeezed that you cannot read the labels. If that happens, break the drawing into two or more pages.

## Swapping parts

We keep drawings of our parts libraries on the wall next to the computer. When you insert a part, you need to know where the insert point is on the part and its orientation. For example, our diode symbols insert at the left-hand end of the diode symbol and at the cathode side. If you need to insert the diode the other way, you can rotate it by 180 degrees before inserting it.

Figure 2 is the same headphone amplifier drawn with our mechanical parts library. Most of our mechanical parts are stored with insert points at their centers.

Because all parts are stored actual size, you can quickly tell whether that front panel is big enough for what you want to put on it. We also store blank 19-inch

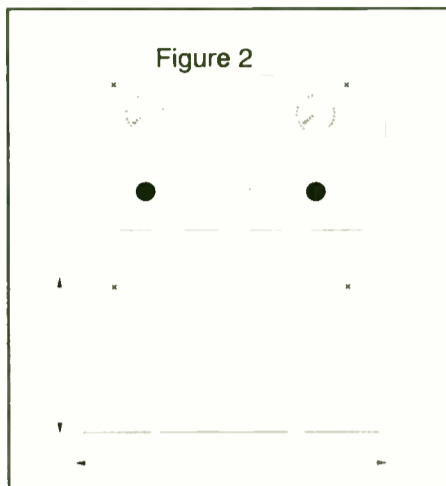

rack panels of various heights for bigger projects. You can also store studio rooms and furniture to help shoehorn new equipment into tight spaces.

While unscaled drawings are handy for schematics, mechanical drawings are often most useful when plotted actual size. Your front-panel drawing can do double duty as a drilling template — just tape the drawing to the panel and drill through it. A life-sized drawing also helps you judge ergonomic issues, such as control spacing, before you build.

Industry-leasing Autodesk by Autodesk in Sausalito, Calif., still costs around \$3,000. More limited programs, including Autodesk's own AutoCAD LT, cost only a few hundred dollars. The program we use, EasyCAD by Evolution

Computing based in Tempe, Ariz., costs less than \$200 in its Windows 3.1 version. (EasyCAD is available at larger software stores or factory direct from Evolution Computing.)

If you decide to upgrade later, most of the low-end CAD programs can export files to AutoCAD or other top-line programs by using drawing exchange (.DXF) files. The DOS version of EasyCAD will run well even on old slow computers.

## CAD packages

CAD packages provide the raw materials for drawing. You can draw lines and simple shapes. Parts libraries, however, are the most valuable aspect of CAD programs. After all, no one would want to draw the squiggly lines for a schematic resistor more than once. Having stored resistor symbols means inserting one is just a matter of a mouse click or two.

CAD packages support many output devices. Windows-based programs allow for the use of any output device with a Windows driver. CAD drawings for architecture are usually made on large-format pen and raster plotters, which can crank out blueprint-sized drawings. But small-sized drawings of acceptable quality, 300 or so dot-per-inch, can be made on standard office laser or inkjet printers. If you need a large-format, color or high-resolution print, many desktop publishing programs will read .DXF files. That means your local print shop can easily turn out 2,400, or more, dot-per-inch drawings for your disk files.

□ □ □

Andrew Ellis is assistant technical supervisor of CBS Radio's KCBS and KRQR in San Francisco. David Wigfield is an engineer at KCBS and KRQR. Both can be reached at 415-765-4055.

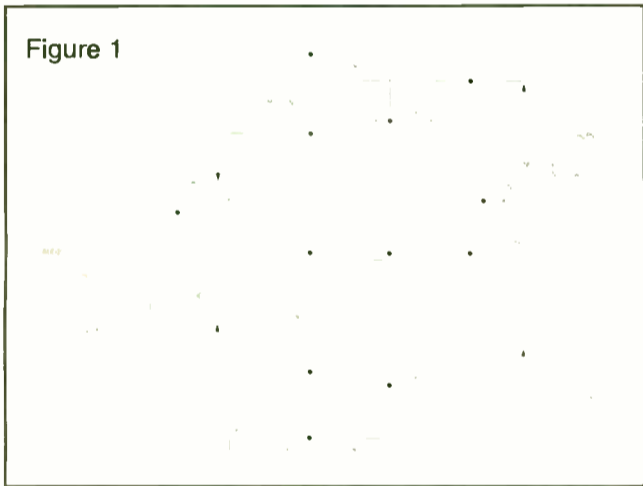

for updating drawings not revised in many years.

Fortunately, the same desktop computer that cleaned up business letters can help produce quality engineering drawings of your station. With inexpensive computer-aided design (CAD) software and some practice, you can turn out better drawings than those many equipment manufacturers provide with their products.

CAD software can let you make accurate scale drawings of things that you are only considering. It is a tremendous timesaver to show someone a drawing of what you have in mind before you build it. It demonstrates your concern for users' needs and may help you, too.

Perhaps that box you are about to build for remotes needs another input or indicator light. No problem, but you find that out only if the sports director looks over your design. Revising the drawing is simple. Changing the equipment after building it is much harder.

CAD software is similar to computer "paint" programs, but has some special features that make it easier and faster to use. Most CAD software has built-in

# High Fidelity SSB Is Not at All an Oxymoron

by Al Parker

**HICKSVILLE, N.Y.** While my primary interest in amateur radio is amplitude modulation, I have come to appreciate the need for SSB.

As much as we all love the dulcet tones produced by a well tempered plate-modulated rig, only single-sideband will cut the mustard when the HF bands aren't propagating. At this ignominious juncture in the 11-year sunspot cycle, we often find ourselves running the legal limit just to be heard.

AM would be up to the challenge if not for the dirty trick played on the AM community many years back. In a thinly veiled effort to crush AM, the Feds imposed an arbitrarily low ceiling on maximum AM input power. I'll be talking more about that in the future. Suffice it to say, as things stand, many of us are forced to revert to SSB when conditions are bad. I've discovered that this is not the end of the world.

## Tight budget

After obtaining my amateur ticket, the first thing I did was make a beeline to the nearest hamfest. I was on a tight

budget, but I was hopeful nevertheless that I could latch onto an old AM rig for a song. Living in New York may have some advantages culturally, but in terms of finding cheap, classic ham gear, it's a black hole. The vendors and buyers are just too savvy about the market.

That fateful Saturday it looked like the greenbacks were going to stay in my pocket. At my lowest point of despair, on my way out in fact, I spied a hapless-looking hairy chap with two enormous, gray boxes.

The two identical transmitters were incomplete, but impressive nevertheless. I looked closer and noticed, under the grime, the "Hallicrafters" name. I didn't know what that meant. Then something even more important caught my eye, three letters: DSB — double-sideband. Wow, AM!

I tried to look cool, not wanting the guy to know I was interested. I had 50 bucks. I cut to the chase. "Would you take 50?" I braced for a harsh rebuff. Much to my surprise he smiled, "Pull your car around." I wondered which one of the impressive looking rigs I'd

continued on page 45 ▶

# We let Rick Dees use one and now he won't give it back!



**"Nope. No way. Forget it. This Instant Replay is mine."**

Hey, we understand. After all, Instant Replay puts 1,000 of his favorite noises right in front of him — ready for instant playback. No other audio player makes it so easy to be spontaneous and creative. It's fast, it's easy and it's fun.

Check it out. One Instant Replay can store up to 16 hours of stereo sound. That's 16 hours of sound effects, spots, promos, even entire songs — anything — and you can play any of them back instantly just by pressing one of 50 Hot-Keys! There's no need for a computer and no need for training. It's self-contained and it works right out of the box — just push the buttons and go!

**Try Instant Replay Free!  
Call 818-991-0360**

To prove how Instant Replay can make your station better, you can Test Drive one with no obligation! Call us now for free overnight delivery of your Test Drive unit. And like Rick Dees, once you get your hands on Instant Replay you won't want to give it back either.



Transfer one cut or one thousand between machines using the D-NET high-speed digital audio network.



Print hard copy lists of all stored cuts so you always know what's where!



Store up to 16 hours of CD-quality digital audio on Instant Replay's internal hard disk.

**360 Systems**

PROFESSIONAL DIGITAL AUDIO

5321 Sterling Center Drive • Westlake Village, CA 91361 • (818) 991-0360 • fax (818) 991-1360

If you're a call-letter station, you can try Instant Replay for 10 days with no obligation. If you decide to buy Instant Replay, we'll make arrangements through one of our authorized dealers. Offer good in the continental US only. Offer expires July 1, 1996.

\*Suggested retail prices: \$2995 for 4 hours of storage; \$3495 for 8 hours of storage and \$3995 for 16 hours of storage. 360 Systems Instant Replay is a registered trademark of 360 Systems. ©1996 360 Systems.



Circle 186 on Reader Service Card

World Radio History

See Us at NAB Booth 1605

# Famous Team of Toner and Sniffer

by Frederick M. Baumgartner

**DENVER** The other day, while checking out some L-band feeds on RG-11 from several roof-mounted dish antennas, I pronounced one bad connector on the ground, one bad LNB and one open connector on the roof. The folks upon whom I laid this pronouncement were understandably skeptical, considering I spent only a few minutes and used only a toner and a sniffer and never went up on the roof.

Most of us who work in the technical side of broadcasting find puzzle-solving enjoyable and useful. I delight in trying to glean all of the information a situation has to offer. Given that, you might not be aware of all the information a toner can give, and maybe you know a trick or two that I've missed and you can share.

reach the shield of a mult or coax. Figure 2 shows the use of a ground (or any large area of mostly conductive material) as a counter poise.

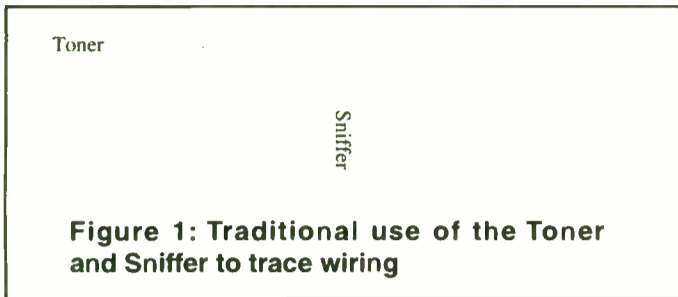

Figure 1: Traditional use of the Toner and Sniffer to trace wiring

In this way, the sniffer will pick up the toned wire's signal even though there is only one conductor. Bleed from one wire to another is much more pronounced with this method.

The real art of toning comes when you understand your body's role as part of the circuit. The sniffer already is capacitively coupling itself to you. You are the return path for the sniffer. This is all high impedance stuff (inductive coupling if you will). To the sniffer, you are a convenient path to ground or, at the very least, a capacitive path that is coupled to one end of the toner.

This relationship is the basis for most serious testing. If you need to increase the coupling, wrap one wire of the toner around your wrist (or the sniffer for really tough situations). Keep in mind that there must always be a complete circuit. The least obvious part is the coupling between the wire and ground (even if not grounded), and the sniffer's connection through your body (and other things) back to the toner. Figure 3 illustrates this. You can be creative establishing this path. Take advantage of capaci-



Figure 3

**What is it**

If you stretch wires for fun or profit, you either have or need a toner and sniffer. The toner is the easy part. It is a simple audio oscillator and continuity checker built into a small plastic box. The sniffer is a larger "inductive" pickup device with a high-gain amplifier and speaker. The pair are often available for under \$100 at most electronic tool and communications supply distributors and catalogs.

In the most simple application, the toner is connected to a pair of wires as in Figure 1. Bringing the sniffer close to the pair of wires anywhere along their path allows you to hear the toner signal. Touching the sniffer to the exposed wire produces a much louder signal. If the pair is shorted, the continuity checker built into the toner will light. You will have to switch from the toner mode to the continuity check mode for this. If the pair is shorted, the signal received will be so weak as to be useless. This is the classic use of these tools: toning a pair of wires and sniffing it out along its path. It makes finding a pair of wires among other pairs easy, especially if the wires are undocumented. It also works on coax cable.

This does take a little practice, largely because wires running among the toned wire will inductively pick up some of the tone. For example, if you tone a single pair of a 500-pair telephone cable, after a few feet, every pair will have some signal on it. The directly toned pair will still be considerably louder and experience counts. A thousand feet down the line, the difference in levels may not be so pronounced.

On occasion, there is only a single wire, a wire is shorted or you can only

tive coupling.

You can use the sniffer to find things other than the blessed toner.

The sniffer is great at finding AC wires behind walls and under floors; simply pass the sniffer near the AC wire and listen for the hum.

It can also be used as a signal tracer on PC boards and even fairly high voltage (be cautious!) circuits without harm, given its insulated nature.

Looking for interstate audio and, to a degree, IF signals takes a bit of practice. Still, there is no single tool that can help you divide the working part from the nonworking part more quickly.

Toners make a distinct audio sound. They also make distinct video on a mon-

I suspect that anything this elegantly simple might have other uses. I have found many that I can't list here.

Now about the low noise block (LNB). I knew that the connector that was open in the building was such, because I inserted my body in the circuit and touched the center pin.

Hearing no increase in sound, I knew that there was no wire beyond the connector. Of the lines that toned out (indicating lots of wire downstream of the sniffer), the one without continuity had to have an open connector on the roof.

Then, reversing the continuity checker, I could see from the brightness of the light-emitting diode (LED) that a good LNB conducted better in one direction than the other.

The LNB that did not exhibit that trait was, of course, bad.

The expensive LNB spectrum analyzer said the same thing after a few trips to the roof and removing and reconnecting connectors a few times. But of course, the sniffer wasn't worth much

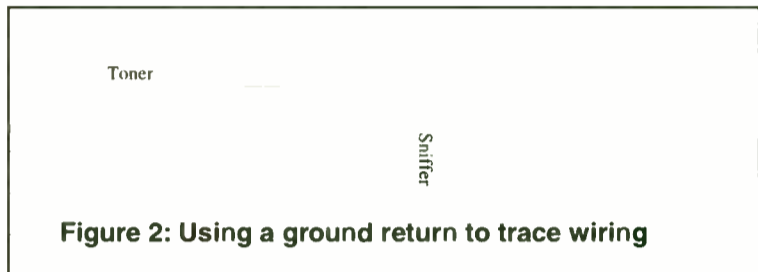

Figure 2: Using a ground return to trace wiring

itor, which is useful when tracing video display lines. There is also a certain amount of harmonics from the toner reaching well into the IF and RF regions. Sometimes these can be useful signals to have around. No RF generator? Try the toner.

when it came to aligning the dish.

*Fred Baumgartner is a special projects engineer with TCI's National Digital Television Center in Denver, Colo. He has served as chief engineer at KDVR/KFCT and WTTV/WTTK.*

**MOVING?...**

Don't leave us behind!

Mail or fax your current label and new address (with effective date) to:

Circulation, RW,  
PO Box 1214  
Falls Church, VA  
22041  
or  
FAX 703-998-2966.

Address changes will be processed within four weeks of receipt.

Thanks!

**IF YOU DON'T YET OWN ONE AND YOUR COMPETITION DOES, WORRY.**

Review in *Line Up - The Journal of the Institute of Broadcast Sound*  
February/March 1996

**unity**

the world's best-sounding FM & AM processors

**CUTTINGEDGE**

TEL: (216) 241-3343 • FAX: (216) 241-4103 • E-MAIL: INFO@CUTTINGEDGE.ZEPHYR.COM

Circle (67) On Reader Service Card

# Products & Services Showcase

For more information on the products shown below, circle the appropriate Reader Service No.(s) on the enclosed Subscription/Reader Service card or contact the advertiser directly.

## WATTCHMAN® TRANSMITTER PROTECTION SYSTEMS



**WATTCHMAN®** protects your transmitter and transmission line system. A permanent 19" rack installation used with any dual socket line section 7/8" through 6 1/8" and elements (additional) to monitor CW, TV, and FM power. Model 81070 features two easily read meters to monitor both forward and reflected power. Abnormal conditions quickly cause transmitter shut down.

**TERMINATING LIQUID/AIR LOADS** (84000/85000 series) available to cover CW power ranges of up to 10,000 Watts over a frequency range of DC to 2.4 Ghz. All models are available with optional thermal overload switches to interface with the user's interlock or warning circuit.

SEE US AT NAB BOOTH #3908/3909



**COAXIAL DYNAMICS, INC.**  
15210 Industrial Parkway  
Cleveland, Ohio 44135 (216) 267-2233  
Toll Free 1-800-COAXIAL (262-9425)  
FAX: (216) 267-3142  
Web Site <http://www.coaxial.com>  
Email: [coaxial@apk.net](mailto:coaxial@apk.net)

READER SERVICE NO. 40

**NEW  
Receiver!**

## UNIVERSAL SCPC XE-1000



### SCPC BROADCAST AUDIO RECEIVER

New, affordable, frequency-agile receiver, direct channel entry by keyboard, selectable companding 1:1, 2:1, 3:1, wide/narrow bandwidth, de-emphasis selectable, 950-1450 MHz, line output 600 ohms, muting, transponder agile, LNB power supply, 50-channel memory, full baseband output, high-quality audio. Every needed feature at a sensible price (lowest in the industry). Write or call for full information on this quality receiver—the answer for your station. Networks call for prices.

**UNIVERSAL ELECTRONICS, INC.** 4555 Groves Road, Suite 12 Columbus, OH 43232  
Communications Specialists Phone: (614) 866-4605 Fax: (614) 866-1201

READER SERVICE NO. 184

## CREATE A MASTER CLOCK SYSTEM

ECONOMY MASTER CLOCK CAPABLE OF DRIVING 100 SLAVES FOR \$260.00  
5 DIGITAL SLAVES FOR UNDER \$1000.00

### MASTER CLOCK

- ESE TIME CODE OUTPUT
- EXTERNAL SYNC INPUT
- 1PPS OUTPUT
- 3 TYPES OF ENCLOSURES
- DRIVE 100 DIGITAL SLAVES
- NEW "LX" ENCLOSURE
- SYSTEMS UPGRADABLE TO CRYSTAL, WWW, MODEM AND GPS

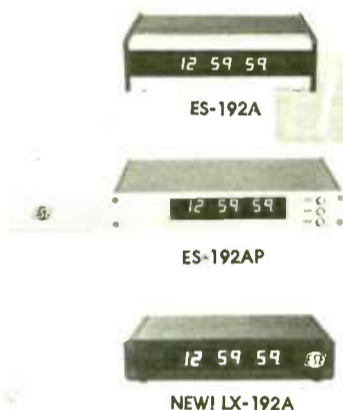

### DIGITAL SLAVES

- 5 TYPES OF ENCLOSURES
- 4 SIZES OF L.E.D.'s
- DISPLAY TIME OR DATE
- OPTIONAL TIME ZONE OFFSET
- VIDEO INSERTER
- COMPUTER INTERFACE
- MANY OPTIONS AVAILABLE



**3 YEAR WARRANTY**  
PRACTICAL SOLUTIONS SINCE 1971

142 Sierra St., El Segundo, CA 90245 • (310) 322-2136 / FAX: (310) 322-8127

READER SERVICE NO. 157

**NOW  
INTERNET  
READY**

**Byte  
it  
with**



A Digital Recorder specifically designed to record phone calls and play them back quickly and easily.

Fast nondestructive editing.

Easy access and fast stacking of bits.

The most powerful way to record and air phone-bits.

**The Blue Group**

1001 Ridge Avenue  
Clearwater, FL 34615  
TEL 813.442.1665

READER SERVICE NO. 90

**HURRY  
UP**

**TELESCOPING MAST**  
for fast and easy deployment  
of lightweight antennas

- Manually deployed with quick lock/release collars in one minute or less
- 25' extended height
- 6' retracted height
- 20 lb. top load capacity
- Rigid azimuth locking
- Over 50 mph wind speed capacity
- Free standing
- Universal vehicle mounting stand included
- Portable - 20 lbs.
- High strength anodized aluminum construction
- Ideal for lightweight antennas
- Designed and built by the leading manufacturer of pneumatic telescoping masts.



P.O. Box 900  
Orville, Ohio 44667-0900  
Phone 216-682-7015  
FAX 216-684-1190

READER SERVICE NO. 115

## Suddenly... Everything's Changed!



Introducing the AD2004, a quad, 20-bit A-to-D converter. Designed for applications that require no-compromise performance and space efficiency, the converter is ideal for broadcast environments. The 1/3 wide chassis allows 12 channels to rack mount in only 1 RU.

The THD and noise is -102.5 dB (0.0008%) broadband at 1 dB below FSD, much better than other products. A reference port allows multiple converters to be precisely phase locked. An ultra low jitter (11 ps) VCXO produces a clean 64X sample clock that may be free-run or phase-locked to an incoming AES/EBU reference. Jitter reduction is outstanding (-50 dB) with idle tones below -135 dB

when either free running or phase-locked to an AES/EBU reference signal.

The converter runs at a fixed sample rate of 48 or 44.1 kHz. Optional dual sample rates are available. 75 Ω BNC outputs are standard and conform to AES3-id. Optional 110 Ω AES3, with a word clock output is available. Metering has both coarse and fine scales for monitoring near FSD. A selectable hold function can retain the highest peak until manually reset. FSD detection is exact.

Twice the number of channels, absolutely the highest performance, and about half the price of some two channel converters, at \$1800 it's about to start a revolution!

**Benchmark**  
...the measure of excellence!

SEE US  
AT NAB  
BOOTH  
#2320

**BENCHMARK MEDIA SYSTEMS, INC.**  
Phone 800-262-4675, FAX 315-437-8119

READER SERVICE NO. 134

STATION SKETCHES

# Cu-SeeMe Software for the Internet

by Tom Vernon

**HARRISBURG, Pa.** The World Wide Web is having an increasing impact on broadcasters, as it is on business in general. A growing number of stations are putting up Web pages, many complete with real-time audio. In fact, broadcasting a station's audio over the Internet is becoming commonplace.

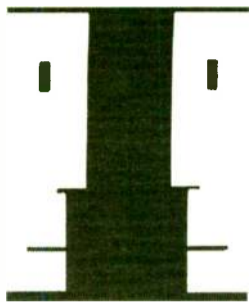

However, a lesser-known technology exists to broadcast both audio and video on the Internet, and a few pioneering broadcasters are putting it to good use.

CU-SeeMe can be used over the Internet to make connections to any other desktop using the same software. It works in the same manner as e-mail, except that with CU-SeeMe you have a real-time meeting with audio, video and written messages.

**Commercial version**

Originally developed at Cornell University and available as freeware, a more robust commercial version has recently been made available through White Pine Software in Nashua, N.H.

This enhanced version of the software features color capability over higher bandwidth connections, improved audio and video algorithms and a whiteboard for collaboration during conferences. It is available on both Windows and Macintosh platforms with equivalent feature sets.

CU-SeeMe works through low bandwidth Internet connections that are facilitated via software-only video algorithms that reduce data transmission. The protocol was designed specifically for TCP/IP networks and the Internet. It can also run over ISDN networks that provide TCP/IP network support. Modem connections using SLIP or PPP are also supported, although you must have at least a 28.8 k baud connection.

While person-to-person conferencing is possible with this simple setup, broadcasting audio and video to large numbers of viewers requires a bit more. Figure 1 shows a typical setup.

Reflector technology is at the core of reaching the masses. Reflectors are really just high-end servers running the CU-SeeMe reflector software. They receive the transmission and rebroadcast (reflect) the packets to a number of connected clients.

**Event viewing**

Promoters of noncommercial events often get others to volunteer the use of their reflectors to maximize the number of people who can view an event. Currently, reflectors for numerous platforms are available for free distribution and may be downloaded from White Pine's Web site.

Teleconferencing technology has existed for years; it was first demonstrated at the 1964 World's Fair. At that time, there was no infrastructure to support global or even national transmission of video. Satellite technology made video-teleconferencing feasible, although it was an

expensive proposition. It wasn't until 1993 that researchers at Cornell University unveiled CU-SeeMe as a means to economically deliver what was first shown almost 30 years before.

A few innovative stations have been using this technology to broadcast live concerts on the Internet. KVR-9 at the University of Texas at Austin

the Internet. Following the concert, the band interacted with fans via the Internet, making it a truly interactive event.

In addition to entertainment uses such as techno-rock concerts and comedy club acts, individuals and organizations are using CU-SeeMe for a variety of innovative applications. NASA-TV uses it to broadcast transmissions from the space

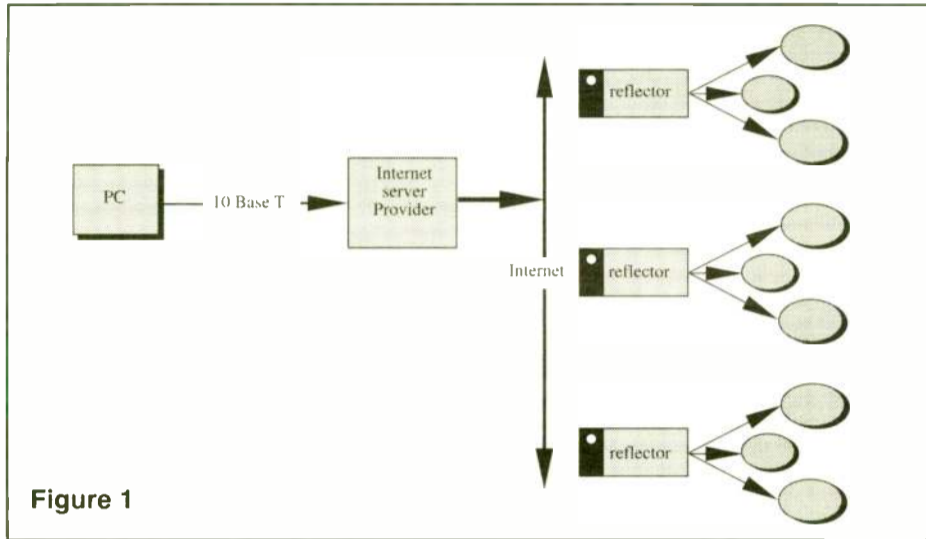

Figure 1

collaborated with MuchMusic, the all-music television network, to launch the first CU-SeeMe rock concert.

Toad the Wet Sprocket performed live at a club in Austin; the event was videotaped and broadcast later that evening on

shuttle. Students from grade school through college are connecting globally with this technology.

In New York City, Mayor Rudolph Giuliani used it for his first interview on the World Wide Web.

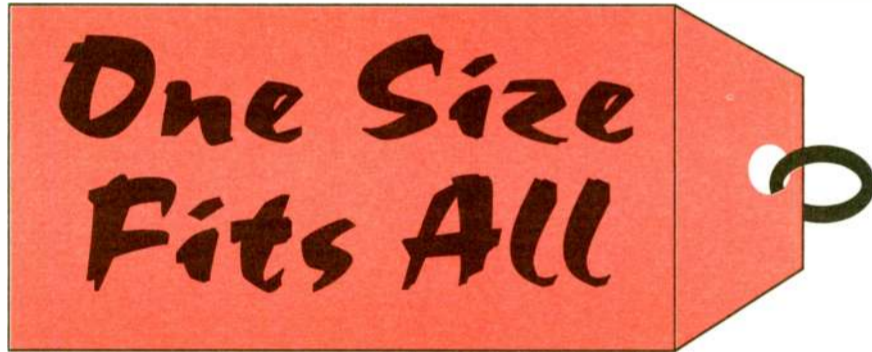

**All types of stations, from a single Class C Local stations, to LMAs and Duopolies in multiple markets, to transmitters, to studios and transmission facilities...**

**All remote control configurations, from 16 to 256 channels per site, up to 256 sites...**

**It's all in the NEW GSC-3000 Site Control system from Gentner...the people who originated dial-up remote control.**

*Check it out at NAB '96 — Booth 2016.*



**Gentner Communications Corporation**  
1825 Research Way  
Salt Lake City, UT 84119  
1-800-945-7730  
(801) 975-7200

**Call for a free demo disk!**

Circle (82) On Reader Service Card  
World Radio History

These are exciting times for the media business. Standards are currently being developed for interactive multi-user data sharing, application sharing, conference management and other video conferencing technologies.

Although a ground-breaking technology today, video conferencing and real-time multimedia will soon be as commonplace as Web browsers and e-mail.

For more information about CU-SeeMe, call White Pine Software at 603-886-9050, or check out their Web site: <http://www.wpine.com>.

□ □ □

*Tom Vernon divides his time between consulting and completion of a doctoral degree. He works for the award-winning WXPN in Philadelphia. You can e-mail Tom at [tlvernon@aol.com](mailto:tlvernon@aol.com) or call 717-367-5595.*



**WARD-BECK SYSTEMS**

*See us at NAB '96  
Booth 10300*

*Check us out on the  
Internet*

<http://www.wbsltd.com>

**RADIO CONSOLES**

**RENAISSANCE**

- MK I** - 8 Input Channels
- MK II** - 16 Input Channels
- MKIII** - 24 Input Channels

**AUDIO DISTRIBUTION**

**M8200 SERIES**

**AMPLIFIERS INCLUDING:**

- Mic Preamps
- Remote Sensitivity DAs
- Stereo DAs
- Remote Gain DAs
- Remote Switching
- Compressor/Limiter
- 600 Ohm or Low Z DAs
- Test Oscillators

**METERING**

- M445 Extended Range Meter/Monitor **\*\*NEW\*\***
- M405P Portable Extended Range Meter
- MP Meter Panel Series

**\* NOW AVAILABLE FROM \*  
WARD-BECK**

**"PODS"**

**low cost audio problem solvers**

**WARD-BECK SYSTEMS LTD.**

841 Progress Avenue  
Scarborough, Ontario  
Canada M1H 2X4

Phone: (416) 438-6550

Fax: (416) 438-3865

**TOLL FREE 1-800-771-2556**

Circle (72) On Reader Service Card

KEYBOARD CONNECTION

# Inoculate Your PC against Viruses

by Barry Mishkind

**TUCSON, Ariz.** Perhaps you remember four years ago in March when there was a worldwide scare over the potential effects of the Michelangelo virus. Some people shut down their computers or changed the system date.

**Be prepared**

Others ran anti-virus programs and kept working. A few did nothing, and of that group there were a few reports of lost data. Overall, it was proclaimed to be an example of media hype valuable only in alerting people to the

potential disaster they faced if they did not pay attention to computer security. Cynics called it a good sales job by the anti-virus software writers.

While there is no reason to panic, it is necessary to consider the effect on your station if one or more of your computers was suddenly wiped clean. Hopefully you are backing up your critical data on a regular basis.

Yet, even with a backup, it can take hours to restore normal operation after a virus attack, and you could still lose valuable data.

A good virus detection and cleaning program is very important for every facility.

**New factors**

This is truer today than ever before. While many companies felt they could keep their computers clean by staying with commercial software and not allowing diskettes to come in from outside, there are three new factors that should not be overlooked.

The first threat comes from a new breed of viruses that attack from what might appear to be a different direction, from inside your applications.

They are known as macro viruses because they are usually written using the scripting language found in programs like Microsoft Word or Excel.

These macros can be hidden inside

data files and passed along via LANs and the Internet.

An unsuspecting user can be infected while reading e-mail. Some of the macros have already been identified and can be fixed with up-to-date versions of programs like Dr. Solomon's Anti-Virus Toolkit or the Norton AntiVirus.

These macros range from the inconvenient "Colors," which randomly changes in Word documents, to "Concept," which attaches itself to the template that sets the standards for every file produced on the computer.

**Gift horses**

A worrisome variant is the macro Trojan horse. While they do not replicate, they can be set to delete key files or reformat a hard drive while appear-

continued on next page ►

## Products & Services Showcase

For more information on the products shown below, circle the appropriate Reader Service No.(s) on the enclosed Subscription/Reader Service card or contact the advertiser directly.

**PHARTRONICS PRESSURE SENSOR INTERFACE**  
FOR FM, AM, TV AND MICROWAVE

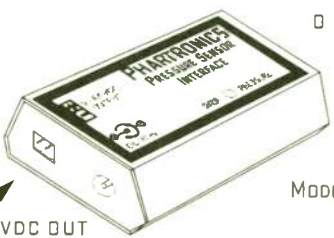

MODEL: PSI-V3  
D • 15 PSI IN  
D • 4.5 VDC OUT

WHAT'S YOUR LINE PRESSURE RIGHT NOW?  
COMPATIBLE WITH ANY REMOTE CONTROL

**HARRIS**  
1-800-622-0022

READER SERVICE NO. 1

**B-1000 POWER AMPLIFIER**

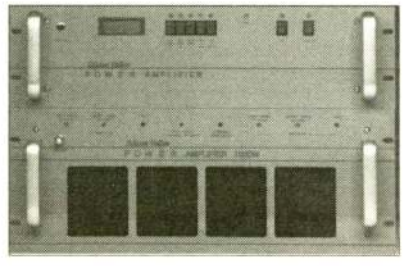

**READY TO GO**  
Reliable, all solid state, output power to 1250 watts. Never needs tuning. Steady output power tolerates wide a.c. voltage swings. Self starts after outage. Efficient. Economic. Transportable.

**Silicon Valley POWER**  
AMPLIFIERS  
The RF People  
1-800-986-9700

READER SERVICE NO. 149

**REMEMBER THE CORTANA FOLDED UNIPOLE ANTENNA? WE STILL MAKE IT WITH THE SAME HIGH QUALITY MATERIALS AND WORKMANSHIP. IT FEATURES...**

- **BROAD BANDWIDTH** for better sound,
- **GROUNDING ANTENNA** for lightning and static electricity,
- **ELIMINATES ISOCOUPPLERS** in VHF and UHF antenna lines,
- **BEST ANTENNA FOR DIRECTIONAL ARRAYS.**

**ALSO**  
DETUNING SYSTEMS FOR ANYTHING THAT DISTORTS YOUR AM COVERAGE PATTERN: TOWERS, POWER LINES, TANKS OR ANY METAL STRUCTURE.  
FOR INFORMATION CALL, FAX OR WRITE:

**nott ltd.**  
4001 La Plata Hwy  
Farmington, NM 87401  
Phone 505-327-5646 Fax 505-325-1142

READER SERVICE NO. 51

**THE COST EFFECTIVE ALTERNATIVE TO MANUFACTURER SERVICE**

**SERVICE, REPAIR & CALIBRATION**

**SPECIALIZING IN EQUIPMENT BY**

- STL's • RPU's • TSL's
- Exciters • Optimods
- AM/FM Monitors
- Remote Control Systems
- Belar • Marti
- Moseley
- McMartin
- TFT
- And others...

**WE ALSO PROVIDE**  
Free, over-the-phone technical assistance  
STL loaner/rentals  
PCL 505 Certification



2198 Hubbard Lane, Grants Pass, OR 97527  
**(541) 471-2262**

READER SERVICE NO. 76

**ACCEPT NO SUBSTITUTES**

- Eliminate flanging (hollow room) effect
- Eliminate bad room acoustics
- Hold absolute levels
- Correct voice symmetry
- Front panel input level select +4 to -50 dB
- Three section variable boost and cut equalization
- Compander/Expander cross coupled for maximum punch
- Built-in earphone jack

**AIRcorp 500PH Microphone Processor**



- DE-ESSER designed to protect pre-emphasis curves
- Simultaneous mic level and line level outputs
- Internal 48 Vdc Phantom Supply

**AIR corp**  
Call your dealer  
or call **214-304-0455** or fax: **214-304-0550**

READER SERVICE NO. 101

ing to do the expected task.

The second sort of problem worth attention is the potential for viruses that are written to attack 32-bit operating systems like Windows 95. These would not be detected by older 16-bit virus scanners.

Both Dr. Solomon's and Norton's programs have been updated to detect and fix these new hazards, and upgrades are available from the manufacturers.

Finally, hackers have been reported to hide viruses and Trojan horses in some applications using the Internet. Instructions can be embedded in Web pages to automatically download files and programs to your computer, either for immediate activation or for future infection.

If you do a lot of surfing on strange World Wide Web sites, you may consider isolating the computer from any local network in your building. That way, if you do get hit, no virus or Trojan horse will be able to migrate through your entire facility.

Similarly, watch your incoming e-mail, especially any unfamiliar files in your download directory. Before running them, it is a good idea to scan them with a virus scanner.

\*\*\*

Most people really do not care how the computer does what it does. All they want is to be able to turn it on and have the necessary programs come up so they can get on with the job at hand.

File management is not a real problem; when problems do come up, such as a missing file, they just ask someone for help.

Others want to know as much as possible about what goes on inside the computer, especially in regard to the files that accumulate (under Windows, a directory can contain 400 or more files).

Within the limits of the hard drive's capacity, power users often save most of the files and e-mail that finds its way onto the system. Locating a specific file can be a job.

Personally, I am pretty picky about the file manager I use. I have tried a number of them over the years, and once I find one I like, it is hard to get me to move on.

Magellan was great. It was fast, and could rapidly scan through files — even .ZIP files — searching for any word pattern. However, it is no longer supported, and some newer file formats stump Magellan.

XtreeGold was also nice and fast, especially the DOS version. But it too is no longer being developed, and chokes on long file names generated by the latest programs.

**Flexible options**

The Norton Navigator (NN) seems to be one of the best file managers now available. Complete with utilities, including one to add long file names to older applications, the Navigator has several features that really speed up maintenance chores.

For example, you can archive files simply and quickly by dragging them to a viseclamp icon to "squeeze" the files into a zip file. Want to make them a self-extracting .EXE file so you can give a copy to someone who might not have PKUNZIP?

Just change the extension from .ZIP to

**A good virus detection and cleaning program is very important for every facility.**

.EXE and Navigator instantly makes the file changes for you.

To get a zipped file is just as easy; NN displays the files in any zip file. All you do is drag the file you seek to the Decompress icon.

\*\*\*

If you have been to your local bookshop, you may have noticed the tremendous increase in computer books. Part of this is due to the trend

away from unlimited free technical support. However, there are also efforts to produce clear, understandable books, so that the reader can find the needed help and get back to work.

Osborne/McGraw-Hill is one of the publishers bringing out new books aimed at getting you to the key information quickly.

First, the "Certified Tech Support" series offers answers to the most frequently asked questions with short steps and pictures. "Windows 95

Answers" is one such book.

Other titles cover Excel, 123, Word, Netware, OS/2 and more. For those with no time at all for hunting answers, the "For Busy People" series really boils down the essentials of such topics as the Internet, Windows 95, Word and others.

Full color screenshots make sure you can duplicate what you see in the book and get the most of your computer time. □ □ □

For information from S&S, makers of Dr. Solomon's, call 617-273-7400. For Norton users, call Symantec at 800-441-7234. Barry Mishkind can be reached at 520-296-3797, or [barry@broadcast.net](mailto:barry@broadcast.net) via the Internet. Check out his home page at <http://www.broadcast.net/~barry/>



**Set It And Forget It.**

MEET THE SHURE FP410, THE "HANDS OFF" MIXER THAT DELIVERS PERFECT SOUND AUTOMATICALLY. The Shure FP410 is not just another pretty face.

It's a hard working portable mixer that forever solves the nagging problems of multiple open microphones. By automatically keeping unused microphones turned down, the FP410 dramatically improves your audio quality.

The secret: Shure IntelliMix® — the patented operational concept behind the revolutionary FP410. It thoroughly shatters existing standards for portable mixer performance and ease of operation.

Just set your levels and flip the switch to "Automatic." Shure IntelliMix does the rest. ♦ Its Noise Adaptive Threshold activates microphones for speech but not for constant room noise, such as air conditioning.

♦ Its MaxBus keeps the number of activated

microphones equal to the number of talkers. ♦ And its Last Mic Lock-On keeps the most recently activated microphone open until a newly activated microphone takes its place.

With Shure IntelliMix, you'll get a "seamless" mix that's as close to perfect as you'll find. Providing the cleanest, clearest sound you've ever heard from a portable mixer. And freeing you from the tedious task of turning microphones on and off.

For a closer look at the world's most efficient portable automatic mixer, call for more information, including the article

"Why Use An Automatic Mixer?"

We think you'll agree: The Shure FP410 is automatically a classic.

Call 1-800-25-SHURE. The Sound Of Professionals...Worldwide.™



**NEW !!!**

# Trak\*Star III-

**4 x the power  
& On Sale !!!!**



- **The #1 selling Trak\*Star II has a NEW big brother !!!**
- **Trak\*Star III has 4 times the power of Trak\*Star II with...**
  - **Real time fade**
  - **Effects bus**
  - **New screen design**
  - **Edit & assemble files up to 6 hours long**
  - **many other powerful new features.**
- **Complete backup capability for your On Air Digilink**
- **Trak\*Star III now comes with a 1.2GB drive standard**

Trak\*Star III is a *NEW* multipurpose digital audio workstation for multitrack mixing and editing. Fully compatible with the #1 selling and industry standard Digilink & Trak\*Star II, the Trak\*Star III has four times the raw processing power of the Trak\*Star II with many new features that utilize this remarkable new power... *real time fade, effects loop, 4 autolocator points, edit files up to 6 hours long, punch in-out, a 1.2GB drive standard, Digilink backup software, & 100's of others.*

Trak\*Star, by Arrakis Systems, is the first cost effective multitrack digital audio recorder, mixer, and editor designed specifically for the radio broadcast professional. Also, Trak\*Star is the only multitrack editor that is a complete backup to your Digilink on air workstation in every way right down to the audio routing switcher and control logic. More than just a digital editor, a Trak\*Star digital workstation is a completely integrated digital solution that interfaces throughout your station to On Air, News, Editing, Traffic, etc. for transfer of digital audio, schedules, text, E-mail, and News wires.

With Trak\*Star, creating spots, jingles, and liners has never been easier. Record and store on disk all of your standard music beds and sound effects. Select any combination of up to 4 stereo or mono sound files for editing and mixing. Once selected, you can easily scrub, cut, splice, copy, move, delete, fade, and mix any combination of these files to create your new spot or jingle. Record or overdub new voice tracks into the system while simultaneously playing back your preassembled mix. No matter how much you cut, splice, or throw away pieces of files... non-destructive digital editing leaves your original files unchanged. With Trak\*Star you have unprecedented levels of control when you cut and splice by expanding tracks and actually working with the waveform itself. Trak\*Star completely revolutionizes multitrack audio production for radio.



*The 22,000 series console can add even more functionality to Trak\*Star by providing video & audio monitoring, plus audio input & output feeds*

Trak\*Star is literally a complete multitrack studio in a compact box. As a radio specific product by Arrakis Systems, the Trak\*Star works the way you do with the features and price that you need.

*Call now to find out how this amazing new workstation can be made to work for you.*

**for more information call... (303) 224-2248**

*in some areas, call (970) 224-2248*

**Sale !!!**

TS3-600

**\$5,995**

*(a \$7,995 value)*

#1 IN  
STUDIO  
FURNITURE

#1 IN  
AUDIO  
CONSOLES

#1 IN  
DIGITAL  
AUDIO

**arrakis**  
SYSTEMS INC.

2619 Midpoint Drive, Fort Collins, CO. 80525  
Voice- 303-224-2248, Fax- 303-493-1076



## Audio Consoles

The standout #1 leader in reliable, high performance, digital ready consoles for radio, Arrakis has several console lines to meet your every application. The 1200 series is ideal for compact installations. The modular 12,000 series is available in 8, 18, & 28 channel mainframes. The 22000 Gemini series features optional video monitors and switchers for digital workstation control.

### 1200 Series Consoles



1200-5	Five ch	\$1,795
1200-10	Ten ch	\$3,495
1200-15	Fifteen ch	\$4,995

### 12000 Series Consoles from \$3,995



### 22000 Series Consoles from \$6,995



## Digital Workstations

#1 in digital workstation sales, Arrakis has over 1,600 workstations in use around the world.

As a multipurpose digital audio record-play workstation for radio, it replaces cart machines, reel machines, cassette recorders, & often even consoles. Digilink has proven to be ideal for live on air, production, news, and automation applications. Place a workstation in each studio and then interconnect them with a digital network for transferring audio, text, & schedules between studios. Arrakis is the #1 choice of broadcasters.

### Satellite Automation



### CD Automation



Use for Live On Air, Automation, Production, News & Scheduling



### Digilink & Trak\*Star Workstations

## Studio Furniture

With over 1,000 studios in the field, Arrakis is #1 in studio furniture sales for radio.

Using only the finest materials, balanced laminated panels, and solid oak trim, Arrakis furniture systems are rugged and attractive for years of hard use.

Available in two basic product families with literally thousands of variations, an Arrakis studio furniture package can easily be configured to meet your specific requirement, whether it is simply off the shelf or fully custom.

Call Arrakis to find out how easy it is to design and build your next studio.

### Desk\*Star studio furniture systems



### Modulux studio furniture systems

## Complete systems...

As illustrated in the Sony Worldwide Networks master control studio on the right (one of seven Arrakis studios in the Manhattan, New York complex), Arrakis can provide complete major market studios with Arrakis consoles, digital workstations, video-audio switchers, furniture, and system prewiring.

With a choice of several console lines; digital workstations for live air, production, news, and automation; and two major studio furniture product lines, Arrakis can meet broadcasters needs from the compact news studio to the major market network origination center. Complete Arrakis equipped studios can be found around the world from Tokyo, to Moscow, to Japan, to Tahiti. Call Arrakis today for your equipment or studio needs,

**Sony Worldwide Networks**  
Manhattan, New York



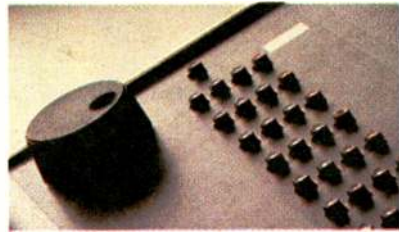
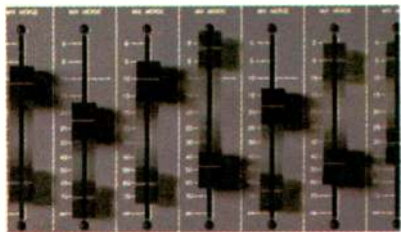

## YOU'VE GOT TO HAVE THE RIGHT TOOLS



**THE ADX**  
**ENSEMBLE.**  
**REAL MOVING**  
**FADERS.**  
**REAL**  
**PUSHBUTTONS.**  
**REAL**  
**INTUITIVE**  
**SOFTWARE.**  
**THE DIGITAL**  
**WORKSTATION**  
**FOR**  
**REAL**  
**SERIOUS**  
**PRODUCTION**

### YOU DID IT.

YOUR STATION MANAGED TO HIRE THE **HOTTEST** PRODUCTION GUY IN THE MARKET FROM YOUR CROSS-TOWN COMPETITOR. HE'S GOT THE CHOPS. HE'S GOT THE PIPES. YOU CAN'T WAIT 'TIL YOUR CLIENTS HEAR THE HOT NEW IMAGE LINERS AND SPOTS HE'S GONNA CUT. OF COURSE, YOU HAD TO PROMISE HIM **ANYTHING** HE WANTED IN HIS NEW STUDIO. IT TURNS OUT THAT WHAT HE WANTS IS A REAL WORKSTATION BECAUSE HE OUTGREW THE TOYS AT HIS LAST GIG. HE NEEDS ONE THAT MAKES HIS COMPLEX PRODUCTION WORK EFFORTLESS. YOU COULDN'T AGREE MORE. AFTER ALL, THE HOTTEST TALENT SHOULD HAVE THE HOTTEST TOOLS, **RIGHT?** YOU BOTH DECIDE ON AN ADX. THE ADX WORKSTATION WAS SPECIFICALLY DESIGNED FOR POWERHOUSE ARTISTS WHO CAN'T AFFORD TO WASTE VALUABLE PRODUCTION TIME WITH CREATIVITY-LIMITING TOOLS. GIVE US A CALL AND WE'LL SHOW YOU HOW THE ADX WORKSTATION MAKES ANYTHING ELSE SEEM LIKE A TOY.



### DESIGNS THAT MAKE THE DIFFERENCE

PACIFIC RECORDERS & ENGINEERING  
 2070 LAS PALMAS DRIVE  
 CARLSBAD, CA 92009 USA  
 619-438-3911  
 FAX: 619-438-9277  
 E-MAIL: SALES@PRE.COM  
 GSA CONTRACT: GS-03F-4064B

# Digital Audio Needs an 'Eye' Test

by Jim Somich

**BROADVIEW HEIGHTS, Ohio** As we move into the digital era, it is important that we develop a solid technical foundation. The testing and troubleshooting of digital audio is no more difficult than that of analog audio, once its basics are understood.

The Audio Engineering Society/European Broadcast Union (AES/EBU) format is the most popular digital-audio format used today. To test and troubleshoot audio equipment that uses the AES/EBU format, you need special test equipment. Conventional analog test equipment will not work because it is not designed to work with digital signals. Digital-audio test sets are becoming more common and are available from companies such as Tektronix. Unfortunately, prices are still quite high, but that will change as digital totally replaces analog in our systems.

The AES/EBU format supports two channels of multiplexed digital audio with embedded clock and data in a serial data-stream. The location of rising and falling edges of the signal determines the logic state of the bits. Resolution can be as high as 24 bits, although most systems use only 16 bits (consumer version) or 20 bits (professional version). Sample rates can range from 32 kHz to 48 kHz, and the maximum data rate is 3.072 Mbps.

In analog systems, we are used to dealing with audio signals that are continuous. AES/EBU digital-audio equipment sends and receives digital audio in individual 64-bit packets called frames. Each frame contains two sub-frames, A and B, each having 32-bit intervals. The first 4-bit intervals are synchronization characters. The next 24-bit intervals are the digital-audio data arranged from Least Significant Bit (LSB) to Most Significant Bit, (MSB) in 2's complement format. In applications that use less than 24 bits, unused bits are 0s. The final 4-bit intervals contain control information.

Timing problems are common in digital-audio systems and can result in ugly digital distortions. Signal transitions must occur within a small interval or else the signal may become corrupted. Short-term deviations cause jitter, which propagates throughout the digital-audio system, getting worse at each link. Long-term deviations affect sample-rate accuracy, making system clocks unstable and inaccurate.

Noise and interference can also cause problems with the high-bandwidth signal. This is especially true for the consumer AES/EBU systems, which use an unbalanced signal with amplitudes ranging from 200 mV to 1 V. Noise degrades the signal amplitude, and systems may not be able to lock onto a signal and recognize data transitions. Interference, such as reflections and ringing, can also degrade amplitude and affect performance.

To prevent noise and interference from obscuring signals, you must use cables designed for digital systems and be sure they are properly terminated. Industry standard connectors for digital systems

are the common XLR microphone connector for professional (balanced) systems and the RCA phono connector for consumer (unbalanced) systems.

Consumer systems are based on the SDIF (Sony Digital Interface Format) or SPDIF (Sony-Philips Digital Interface Format). These consumer formats are almost identical to the AES/EBU professional format for the actual digital program data, but are quite different in the details. What this means is that you can usually establish compatibility between AES/EBU and SDIF or SPDIF, but you will lose some of the peripheral data in the process,

such as indexing information.

A third type of problem is equipment incompatibility. Incompatibility may occur if transmitting and receiving devices operate at different sample rates. For example, if you try to use a digital tape recorder with a 48 kHz sample rate to record audio from a CD player with a 44.1 kHz sample rate, the recording may contain "clicks," other periodic artifacts or no audio at all. This can happen even though the inputs and outputs are electrically compatible. Transmitters and receivers using different data formats cause similar incompatibilities.

continued on page 50 ▶

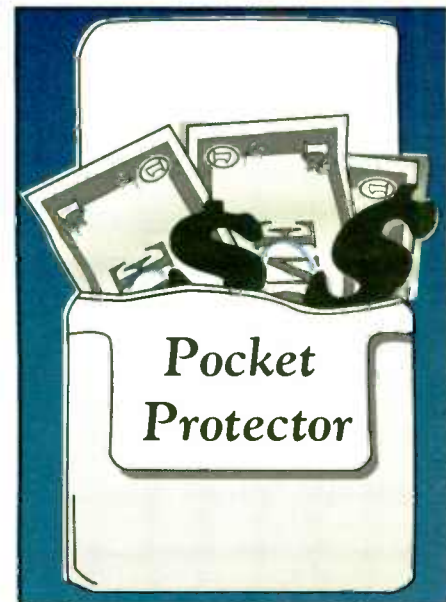

**FULL COMPASS**  
Audio • Video • Lights

**Low Discount Prices**  
Ask about our Demo, Closeout & Clearance Products

**DENON**



**Denon DN1100R**  
A MD Recorder equipped with 10 independent Hot Start buttons to which any 10 tracks can be assigned. When a Hot Start button is pressed, the track assigned to it will be instantly played back. Designed originally for theaters and public announcements where instant playback is required, Hot Start can be used as a sampler function for DJ's and for generating sound effects in live broadcasts or post-production. LIST \$2,600.00 **Call For Price**

**Electro-Voice RE20 Dynamic Cardioid**



The legendary RE20 is designed for critical recording and broadcast. Peak free response even up close, it is ideal for the studio as well as voice overs, announce booths. Features include a bass roll-off switch and Variable-D cardioid pattern which has no proximity effect for the same response at any distance. LIST \$746.00 **Call For Price**

**Electro-Voice SENTRY 100A**



The classic flat response monitor for studio or rack mounting. Outstanding dynamics and constant directivity make this the value in home monitors. 8", 2 way, 6 ohms, 17.25" x 12" x 11.125", 28 pounds. LIST \$344.00 **Call For Price**

**intelix**



**Intelix 8002-MCB 8x2 Mixer**  
A 1-rack-space 8-channel mixer with dual bus output, limiter and headphone output. Each of the 8 main inputs features a high quality variable gain microphone preamplifier with balanced mic/line switchable input, phantom power, low-cut filter switch and two switches to select the main and/or aux bus. A ninth line level input is available from the rear and can be jumpered to either bus. The main output features a RMS limiter and has front panel variable threshold and ratio. The balanced output can be switched between mic and line level. The auxiliary bus is routed to both the headphone jack and rear balanced output. The multi-colored LED bargraph meter may be internally jumpered for peak or RMS reading and may indicate the level of either the main or aux output. The external low voltage power supply is UL rated. **Call For Price**

**JVC XD-P1-PRO Miniature DAT Recorder with Digital Mic**

- World's smallest DAT
- Completely modular
- Docking digital stereo/shotgun mic
- 32/44 1/48K analog/digital record/playback
- No SCMS: one bit 64x ADC
- Twin 18 bit 8x DAC
- Full ID editing capability
- Absolute time
- 3 hour play battery life
- 2.5 hour record battery life
- Separate AC power supply charger
- Snap-on A to D converter
- Thumb-sized remote control.

LIST \$1849.00 **SPECIAL \$994.50**

**400+ PRODUCT LINES**

**marantz**

**Marantz PMD222 Portable 3-head Mono Cassette Recorder**



Features include: Ultra compact, 3 heads, metal tape capability, memory rewind, peak indicator, half speed playback, built-in condenser mic, AC adaptor jack, ambient noise control, modular telephone and external speaker jacks all in a 3 pound unit. LIST \$479.00 **Call For Price**

**SENNHEISER**

**Sennheiser HD 414 Classic Limited Edition Collector's Headphone**



The HD 414 Classic is a 50th Anniversary reissue of the world's first Open-Aire headphone that represented a milestone in the history of sound reproduction. Features the famous look of the original with black headband and yellow ear cushions. This supraural design is featherlight at 2.8 oz. It comes with a 10ft. oxygen-free copper signal cable that terminates in a 1/8" to 1/4" gold-plated stereo phone plug. **Call For Price**

**Sennheiser MD 421-U Dynamic Cardioid**



One of the most versatile and popular of Sennheiser's dynamic microphones. Designed over 20 years ago yet still quite renowned for its sonic quality, ability to handle high sound pressure levels and durability. A favorite of musicians, broadcasters, recording studios and sound contractors. Five position bass roll-off switch provides equalization control up to 1000Hz. Humbucking coil employed to reduce interference from equipment and power. LIST \$469.00 **Call For Price**

**SHURE**

**Shure M267**



The most popular field production mixer ever. Features include switchable limiter, phantom power, LED peak indicator, 1/4 headphone jack, battery check function, tone oscillator, mic/line switches on all 4 inputs and outputs, low-cut switches, mix bus jack and much more. Battery or 120/240 Vac power. Option: Rack mountable with A268R. LIST \$625.00 **Call For Price**

**Shure SM7 Cardioid Dynamic**



A fixture around the world, the "smooth and silky" unidirectional SM7 is famous for making voices and other sources sound their best. Extremely popular for radio and television, especially voiceovers. Unique graphic EQ tailoring switches permit the choice of four different response curves. Yoke assembly allows exact positioning. LIST \$566.00 **Call For Price**

**Technics**

**Technics SL1200 MK2**



Disco-type turntable w/ direct drive motor. 33-1/3 and 45 rpm speeds, each variable by +/-8% Aluminum diecast and heavy rubber base plus double-damped platter provide excellent isolation against feedback. High torque brings platter to 33-1/3 rpm in 0.7 second. LIST \$499.00 **Call For Price**

GET YOUR FULL COMPASS CREDIT CARD TODAY!

**1-800-356-5844**

(608) 831-7330 • Fax (608) 831-6330  
8001 Terrace Ave., Middleton, WI 53562

- No annual fee
- Quick credit approval
- Apply by mail or fax
- Will not deplete other lines of credit



Circle (21) On Reader Service Card

World Radio History

# Products & Services Showcase

For more information on the products shown below, circle the appropriate Reader Service No.(s) on the enclosed Subscription/Reader Service card or contact the advertiser directly.

## Is Your Digital Audio System Internet Ready ?

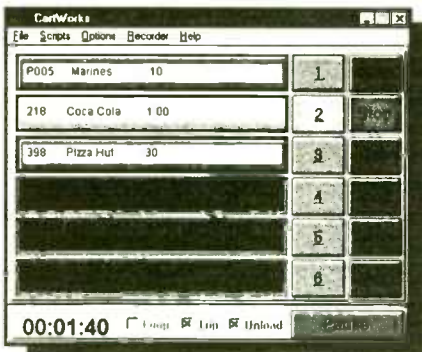

## CartWorks

Must See At NAB96  
Booths 2826 & 1617

<http://www.cartworks.com>  
1-800-795-RADIO Fax (601) 853-9976

READER SERVICE NO. 165

## Eimac Factory Rebuilds

Have your Eimac tube **REMANUFACTURED** by the trusted original manufacturer.

- Eimac Quality
- Original Specifications
- Factory Testing
- New-Tube Warranty

Call us: **CPI**  
Eimac Division  
San Carlos, CA., USA  
(800) 414-8823 or  
fax (415) 592-9988



Available through  
Richardson Electronics  
(708) 208-2200



READER SERVICE NO. 140

A Broadcast Industry

# BEST BUY

Cartridge Recorder / Reproducer  
Mono R/P Stereo R/P  
**\$1550 \$1800**  
(F.O.B. Factory - U.S. \$)

RELIABLE / RUGGED  
PROFESSIONAL DESIGN

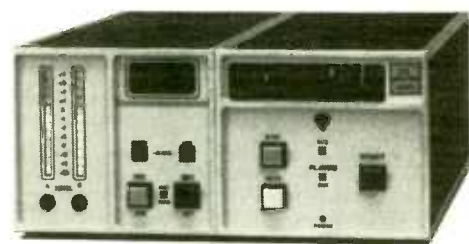

DL Series

## AUDI-CORD CORPORATION

1845 West Hovey Avenue  
Normal, Illinois 61761 USA  
Phone 309-452-9461  
Fax 309-452-0893

Available Through Your Regular Distributor

READER SERVICE NO. 173

## Factory Direct Sales

### 20 watt FM Translator



- Frequency Agile both input & output
- High quality performance
- One year limited warranty
- Station ID available

**\$2,990.00**

### Solid State FM Transmitters

100 Watt .....\$2,790.00  
250 Watt .....\$3,490.00  
500 Watt .....\$5,990.00

### FM Amplifiers

100 Watt .....\$1,290.00  
250 Watt .....\$1,790.00

### 2,500 & 5000 watt FM Transmitter

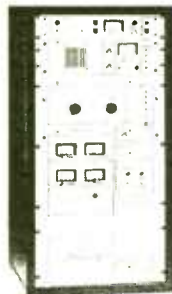

Complete with Solid State exciter and IPA  
2,500 watt .....\$12,990.00  
5,000 watt .....\$22,990.00

Jimmie Joynt Factory Direct Sales  
17194 Preston Rd #123-297 Dallas TX, 75248  
Ph 214/335-3425 800/279-3326 Fax 214/377-4625

READER SERVICE NO. 65

## DIGITAL ANTENNA MONITORS

In-Stock-Available for Immediate Delivery

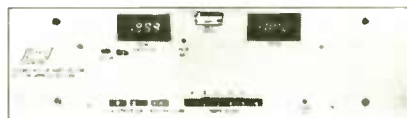

Price US\$2400.00 2 Towers  
Will operate with any remote control equipment.



Price US\$1780.00 2 Towers

For AM directionals with studio located at transmitter site.

These monitors are state-of-the-art instruments of unequalled accuracy (.5% or better on ratio and .5° or better on phase) and stability. With typical modulation the true ratio readout of these monitors is a factor of 10 more stable than instruments that measure normalized amplitude, and their phase readouts are rock solid. Phase sign is automatic, no extra operation. In addition to the analog DC outputs for remote control the Model CMR has a multiplexed BCD digital output which can be used to drive the Remote Indicator Model CMR-1. RF inputs have dual protection. Gas discharge tubes across the sample line terminations plus relay protection.

GORMAN REDLICH MFG. CO.  
257 W. Union St. Athens, Ohio 45701  
Phone 614-593-3150 • FAX 614-592-3898

READER SERVICE NO. 190

## Cellcast

REMOTE BROADCAST STUDIO

THE CELLULAR DIFFERENCE

- Easy to Use
- Reliable
- Cost Efficient
- Portable
- Flexible



Technology & convenience combine to bring you on-the-spot remote broadcast capabilities with excellent sound quality. Cellular transceiver, frequency extender, and mixer all in one! Powered by Ni-cad rechargeable batteries or AC power supply — utilizes cellular technology or land lines.

For more information call

**1-800-852-1333**

READER SERVICE NO. 66

## CD CONTROL Satellite LIVE Time Shifting NEWS AUTOMATION

## DigiCenter™

Digital Audio Management Systems  
Custom Designed to YOUR needs.

INTELLIGENT INTERFACES: In management of Traffic, Music, Accounting, Production, and Editing.

YOUR TOTAL SERVICE SUPPLIER: Consulting, Engineering, Manufacturing, Installation and Technical Assistance.

SEE US AT THE NAB SHOW - BOOTH 2005

Discover the benefits of a system tailored to YOUR needs. •Phone: (309)828-1381  
•Fax: (309)828-1386 •Internet: <http://www.itc-net.com> •E-Mail: [itc@itc-net.com](mailto:itc@itc-net.com)

International Tapetronics Corporation 2425 South Main Street, Bloomington, IL 61702

READER SERVICE NO. 215

# High-Fidelity Single Side Band

► continued from page 33

bought. I got my answer when the Grizzly Adams lookalike overburdened my car's rear suspension with both monsters. I didn't realize it at the time, but that old duffer had launched me on an odyssey.

## Little power

When I got home I took a closer look at what my 50 bucks had bought. I grimaced. Two weeks and three cans of tuner cleaner later, I had one working unit hobbled together out of the two. It was a

**The old rig was only capable of producing about 20 W of "screen-modulated" AM. So big and so little power.**

Hallicrafters HT-37. I was ready to go on AM. About the time I had the unit all wired-in and teamed-up with a disreputable National NC-109 receiver, I received a copy of the HT-37 instructional manual. I discovered, much to my horror, that the old rig was only capable of producing about 20 W of "screen-modulated" AM. So big and so little power.

It was really just an SSB rig with a provision for low-level AM. Now I really felt cheated. After a few frustrating attempts to be heard at that puny power level, I turned my efforts toward finding a real AM transmitter. I eventually found a Johnson Ranger. The HT-37 languished.

I had hi-fi, plate-modulated audio and all was well — for a while. As the number of sunspots waned, I started having more and more trouble communicating with my friends on 50 W of AM. I thought about upping the ante: maybe I could homebrew a bigger plate-modulated rig. I had lots of big ideas, but no modulation transformer.

I also wondered about the advisability of running a high-power AM rig in my congested suburban neighborhood. One of my buddies remembered that I had the HT-37. Sideband would be better than nothing at all, at least until I could get more AM power.

## Slop-bucket

I fired up the 37 and decided to do something a little unconventional. After experiencing the impeccable audio of the Ranger, I couldn't just go cold-turkey on "slop-bucket" (the AMers' nickname for SSB). I moved the electret mic and miniature equalizer I'd been using with the Ranger over the HT-37 position. If I couldn't have AM audio, at least I could play DJ with a boom mic.

After customizing the EQ to suit the characteristics of the rig's audio chain, I checked in with my regular group, apologizing profusely for being on SSB. Much to my amazement, I didn't receive any cat calls. To the contrary, I got raves. Imagine raves from dedicated, prejudiced AMers.

I'd stumbled into something called "phasing sideband generation." A friend and avid Hallicrafters collector, Scott Richards (WB8 RAV), explained that the HT-37, and a few other rigs manufactured in the 1950s and '60s, featured a system of sideband generation based on the phase relationships between the carrier and sidebands in a modulated signal.

The audio is split into two components, 90 degrees out of phase. The carrier is suppressed in the balanced modulators. Because the sidebands are out of phase, one is canceled out and the other enhanced. This system can produce better audio than crystal filter systems. Filters depend on a kind of brute force, slice-and-dice approach. Even the best crystal filters knock off lows and highs, imparting the usual restricted SSB sound.

Some might wonder why all manufacturers eventually opted for "inferior" crys-

tal SSB generators? The answer is simple. Phasing systems produced better audio but were more likely to go out of adjustment. Every time I change a tube or even move the HT-37, I have to make some minor tweaks on the phasing unit to keep the opposite sideband properly suppressed.

Even on its best day, I can only achieve about 35 to 40 dB suppression of the opposite sideband. Even a slight misalignment can result in the unwanted sideband zooming up in signal strength. Hallicrafters rigs of the same vintage featuring crystal filters could achieve better than 50 dB suppression, even after being dropped off a cliff.

Having been weaned on AM, I am more than willing to make an occasional adjustment to achieve SSB audio reproduction approaching the quality of amplitude modulation. Because most of my communications are with members of the AM community, a little unsuppressed opposite sideband isn't a big deal. It's about as noticeable as a leper colony.

The Hallicrafters HT-37, Central Electronics 20A and other such phasing rigs are gaining in popularity, stimulated by the new emphasis on hi-fi audio. Vintage SSB equipment is slowly gaining in popularity as AMers set higher standards of audio for everyone.

It's important to remember that early SSB rigs were competing in an AM market. The manufacturers had to soften the shock of transition by making their sideband rigs sound full-bodied. Only after AM went into its temporary period of darkness or "suspended animation" in the '70s did manufacturers get away with building sideband rigs with dreadful, almost telephonic, audio. Fortunately, we're coming full circle, back into the light.

## Name that transmitter

One afternoon, a few months back, I was in for another one of those ham radio learning experiences. I was in my usual scheduled QSO, on AM due to the improved afternoon 75-meter propagation common to December. A sideband station broke in. I was feeling particularly self-satisfied that day. On hearing the distinctive, crystal-clear audio, featuring extended highs and lows, I boasted of my ability to identify the breaker's rig by ESP. The dignified gentleman played along. "Sir, I'll bet you're transmitting on a Hallicrafter HT-37." I was undaunted. "OK, then it's a Central 20A." He laughed again and I was stumped.

When he revealed that he was running a Kenwood 950 DSP, I practically fell off my chair. The darn thing sounded like a vintage phasing rig. Of course, the Neumann mic didn't hurt either.

Puzzled, I did some investigating. It turns out that those clever folks at Kenwood were smart enough to leap forward by looking back. Incredibly, that 950 DSP is a phasing rig. Using modern solid-state digital electronics, they have produced an amazing, albeit pricey, machine that generates SSB the

same way a classic HT-37 does, sans the fussy adjustments.

Thanks to advanced technology, the superior audio comes at no cost in reliability or opposite sideband suppression. In fact the 60 dB suppression beats most modern crystal filter rigs. Other bonuses include digital readout, built-in receiver and all the automation most of us vintage users put down in public but secretly admire.

In an imperfect world there are times when one must compromise. The important thing is to compromise in a way that preserves one's dignity. Thanks to a wonderful old idea married to new technology, single sideband can be a very dignified way to compromise.

□□□

*Al Parker writes about amateur radio and photography. He can be reached at 516-681-6733.*

## LMA/DUOPOLY CONTOUR MAPS

The **dataworld** LMA/DUOPOLY Contour Analysis is a precise electronic verification of overlapping and intersecting contours.

AM and FM City Grade contours are shown in full color, including transmitter site indicator. The map is supported with a printout showing all of the stations which appear on the map.

Daily updating of **dataworld's** AM and FM databases ensures the latest information.

### OTHER MAPPING OPTIONS

- Shadowing (Terrain Shielding)
- Contour Coverage
- Population Density
- Zip Code Boundaries
- Received Signal Level
- Custom Displays

### WHO ARE YOUR LISTENERS ?

Others give you 1990 Census Data. Only **dataworld** gives you CURRENT year data and FIVE year projections!

- Comprehensive Ethnic and Demographic Data
- Ethnic/Demographic Data Available for Each Zip Code Within Coverage Area
- Age Analysis by Ethnic Groups
- Resolution Increased to Block Level
- Percent of County Coverage Shown
- Projections into the next century

**ETHNIC/DEMOGRAPHIC INFORMATION DISPLAYED USING MULTI-COLOR SHADING**



800-368-5754 FAX: 301-656-5341  
e-mail: info@dataworld.com  
WWW: http://dataworld.com

## FM Value Leaders ...at NAB '96

**"DAVID-II"  
Processor / Generator  
\$1985**



The "DAVID" tradition continues. A hot new *feedforward-PWM* processing section is coupled with flawless Digital Synthesis of the multiplex signal. Add the built-in, adjustable Composite Processor, and "DAVID-II" delivers the *density* you demand, and a sound that *keeps listeners tuned-in*.

**FM Mod-Monitor  
Off-Air / Tunable  
\$2200**

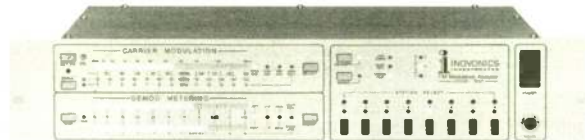

Accurate and affordable. Fully featured monitor displays total modulation, demodulated program audio, pilot and subcarrier injections. Remotable Peak Flasher, plus alarms for loss of carrier and loss of program audio. Carrier level and multipath readouts.

**FM "Relay" Receiver  
Single Channel / Tunable  
\$1100**



A professional receiver for translator service. Composite and stereo audio outputs. Selectable IF bandwidth, carrier-loss and program-loss alarms. Front-panel metering and unique auto-mute and auto-blend functions.

**Inovonics, Inc.**

1305 Fair Ave. • Santa Cruz, CA 95060 U.S.A.  
TEL: (408) 458-0552 • FAX: (408) 458-0554

**BOOTH 1300  
RADIO/AUDIO HALL**



Circle (42) On Reader Service Card

World Radio History

Circle (85) On Reader Service Card  
See us at NAB Booth 1608/LN2

**BOTTOMLINE BROADCASTER**

# Bare Bones Telephone Box

by Jim Murphy

**MORGANTOWN, W.Va.** With all the remotes and sporting events nowadays, the modern broadcast engineer may spend more time on location than in the office or at the workbench. At these sites, challenges abound as the engineer pokes about, trying to find power — hopefully properly grounded — and places to set up mixers and hang wireless antennas, and, well, you know how it is. You've been there, right?

**Lots of needs**

Even though electronic boxes are getting smaller, for some reason the equipment needs are greater; now we have headphone mixers and amps, foldback equipment, wireless mics, tiny tape recorders, referees' mics, crowd mics, floor mics, links to locker rooms and talkback circuits. All this is in addition to the main remote console. Then, there are the codecs and the ISDN modems ... and Switched 56 ... whew!

So we set up this backbreaking array of equipment, connect all the wires, establish the link to the studio and patiently await the kickoff, or tipoff or the beginning of the remote.

As the broadcast gets under way, you settle back at your mixer to cruise through the first segment. Suddenly all this wonderful, modern equipment goes dead. Plop. Nothing. ISDN and SW56 are dead. Mixer is dead.

Now, there may be hundreds, even thousands, of people around you, but not a single one of them can help. You try to find someone to go find someone, somewhere, and fetch them to help you get power back. Maybe even to tell you what is wrong, when it will be fixed — anything to give you answers for the announcers. And even though these malfunctions are clearly out of your control,

and even though you had absolutely nothing to do with their demise, and even though you are miles away from a friendly body to help you, the program people

during commercial breaks. Although I have used the AMI S2559 chip, any DTMF encoder could be used. These are even sold as a keypad unit, but

741 family and move into the later generations. Working with a 741 is analogous to operating an 8-bit computer or using a green screen monitor. Nine-volt batteries provide the differential voltage for the operational amplifiers, and four AA cells can power the dial circuitry. Battery life is excellent if you place a dual SPST switch in the +9 and -9 lines.

This project can be built in a 5-inch by 7-inch box of normal depth, unless you want to get fancy and use VU meters, a microphone switch, large knobs or extra headphone jacks. If you desire all these features, choose a larger box, but be aware of your battery life. Of course, you could substitute larger batteries, which would require a larger box to house them, and on and on. Soon you will be housing the unit in a circus trunk.

Point-to-point wiring works fine. You might want to protect the input to the OP-275 by placing diodes in both directions from the input terminal to ground. This will keep spikes from destroying the chips.

Note that the 50 mf caps in series with each leg of the telephone line must be nonpolarized types. If you can't get them, you can simulate them as shown in the inset. Just make sure they can handle at least 100 volts. Making your own does use up valuable space, so try to get the NP types.

Remember that this is a bare bones unit with no fancy frills and is intended to act as an emergency set, or maybe as a news stringer's interface on occasion, like every other presidential election. The box should be as small and rugged as possible, with easy access to the battery packs.

When everything goes dead, haul out your box, plug in a plain old telephone (POT) line, press and dial. When the studio answers, flip the hold switch, pass the mic to the announcer, and resume your broadcast. Never again will you get "the look" or hear those words, "can't you do something?!"

Because now you can!  
□ □ □  
*James Murphy is the director of engineering for West Virginia Radio Corp. Reach him care of RW.*

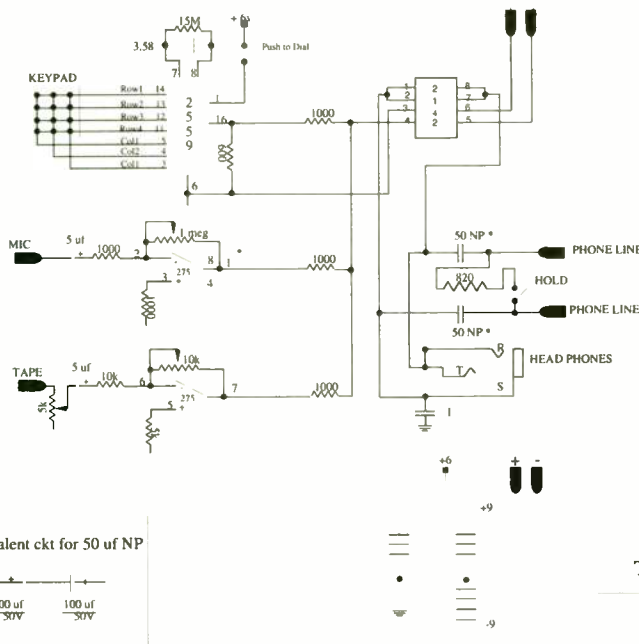

FIG 1

Telephone Box  
File: phonebox.SLB  
1/25/95

always toss you a look that asks, "can't you do something?!"

Our Bare Bones Telephone Box might just help out, and could get you out of a jam by keeping the broadcast going, albeit telephone quality. The box is small enough to fit in any corner of your travel case and the setup is quick and easy; just find an old analog line, such as a fax or modem, plug in a mic and headphone, and you are back in business.

Figure 1 shows the circuit, which, you will agree, is simple and unsophisticated. The design criteria were minimum components, maximum battery life and straightforward circuitry.

The unit has its own dialer, so you don't even need a telephone. There are two inputs, one microphone and one high lev-

el, and a single headphone output that can monitor both transmit and receive. If your studio has the capability, you can receive talkback down the line

the cost is usually above \$65. You can build it cheaper. The S2559 chip utilizes a readily available TV colorburst crystal. Others use a 1 MHz crystal and work just as well, although they may be a bit harder to find. Also, make sure your keypad is a matrix type; i.e., one that connects rows to columns. There are others on the market, so be aware of the configurations. Pressing the Push-to-Dial switch only during the dial time extends battery life. Output circuitry utilizes an SSM-2142 line driver made by Analog Devices. This chip is designed to work into a low impedance load and has no trouble driving a telephone line. The mic and tape amplifiers are OP-275s, but an ordinary op-amp could be used. I would highly recommend that you graduate from the

## Online Engineering Services

Convenient modem dial-up for commonly needed studies and FCC database information

- FM Studies
- Contour Studies
- Population Studies
- Coverage Maps
- Terrain Analysis
- Within Studies
- LPTV Studies
- LMA/Duopoly
- RF Propagation Analysis

Call 800-441-0034 for details or  
Visit our Home Page at:  
<http://www.comm-data.com>



Communications  
Data Services  
incorporated

tel: 703-534-0034  
fax: 703-532-5497  
email: [info@comm-data.com](mailto:info@comm-data.com)

Come see us at NAB Booth 3307/ Radio Hall

**New**  
**RF INDUCED CURRENT METER**

**Covers ANSI C95.1 RF Induced Current Requirements**

**Cushioned Clamp-on Sensor For Walking or Climbing**

**Fiber-optically Isolated Digital Readout / Control**

**Also, A Complete Line of EMF Meters and Monitors From DC to Microwave**

For further information, call or write:

**Holiday Industries, Inc.**  
14825 Martin Drive  
Eden Prairie, MN 55344  
612 934-4920 fax: 612 934-3604

AM EMISSIONS

# Examining Your AM Emissions

by Thomas G. Osenkowsky

**BROOKFIELD, Conn.** The annual ritual of performing AM emissions measurements has recently passed. Some owners groan about spending money to make annual emissions measurements; however, it must be realized that some laws do have their merits.

While installing new transmitters on a south Caribbean island, I noticed considerable interference on our 1270 kHz frequency. I located a station on 1320 kHz splattering over 100 kHz either side of carrier. A government telecommunications officer The offi-

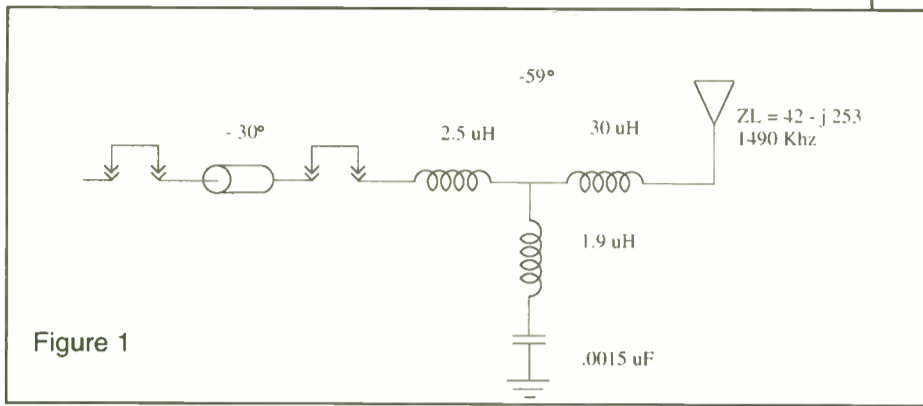

Figure 1

Equation 2

$$C_{uf} = \frac{F_c}{2 * \pi * X_s * F_t^2} - \frac{1}{2 * \pi * X_s * F_c}$$

$$L_{uh} = \frac{1}{4 * \pi^2 * F_t^2 * C_{uf}}$$

$F_c$  = Carrier Frequency, Mhz  
 $F_t$  = Trap Frequency, Mhz  
 $X_s$  = Required Shunt Reactance, ohms

problems noted in the field can be due either to a faulty antenna/coupling system or an external influence at the measuring location.  
 Tom Osenkowsky is a Connecticut-based engineer. Reach him care of RW.

Equation 1

$$F \text{ (Mhz) Reject} = \frac{1}{2 * \pi * C_{uf} * L_{uh}}$$

cial told me he was aware of the splattering, but that the government had no emissions regulation in place that he could enforce.

Why do we measure emissions in the field instead of at the transmitter site? Let's consider an actual station. The antenna tuning unit (ATU) is shown in Figure 1. Given the component values, what is the expected amount of second harmonic signal at the antenna terminals given 1000 W of transmitter power and a second harmonic power of 100 W (assume the harmonic filter in the transmitter failed) being fed into a 180-degree radiator at 1490 kHz. The answer: theoretically zero at 2980 kHz.

Examining the ATU design, I specifically chose the shunt-leg capacitor and inductor to series-resonate at 2980 kHz, thereby shunting all second harmonic energy to ground while providing the correct capacitive reactance at 1490 kHz for a -59 degree Tee network. Equation 1 is used to calculate the series-resonant frequency, Equation 2 is used to design the shunt branch to resonate at a higher frequency than  $F_c$  for a lagging Tee or a lower frequency than  $F_c$  for a leading Tee.

Failed or misadjusted transmitter output network components, loose ATU or antenna hardware, and a host of other anomalies can cause out-of-band emissions. In one station, I found roasting mice that had been laid upon an ATU coil and were causing intermittent second and third harmonics in excess of 30 dB above FCC limits. These problems would show up in the field and be evidenced on a radio receiver.

Harmonic measurements can yield different results depending on the measuring instrument. If we measure harmonics at 1 kilometer using a spectrum analyzer or communications receiver and a calibrated field intensity meter, the data may not correlate. The spectrum analyzer or receiver is typically fed from an untuned antenna that has different characteristics at different frequencies given a fixed length.

Different monitoring locations can produce drastically different results as well. External influences such as underground pipes, power lines and fences can have widely different propagation characteristics at different frequencies, i.e., fifth harmonic.

A good starting place for harmonic and spurious emissions is at the transmitter while playing into a dummy load. Any

## Give us your application, we'll give you the Stars.

If you're considering satellite communications for audio, data, telephone, or Internet connections, call us. As leading satellite systems integrators—with over 100 networks operational worldwide—we can help you select the right technology for your needs from our multiple lines of equipment. NSN features a stellar line-up of products from ComStream, ViaSat, Gilat, Channel Master, NorSat and other leading manufacturers, and satellite capacity on the GE Americom and PanAmSat fleets, Orion Atlantic, and other major carriers.



**That's great. (ho hum) But what about service?** On average, NSN installs a network a week. And we support them all, large and small, 24-hours a day, everyday. We'll help you implement the network you need and keep it up and running.

**What about Internet?** NSN's InSat™ system is the world's first interactive satellite Internet server, providing Internet connectivity anywhere on the globe, regardless of telephone line availability. NSN can also deliver turnkey Internet domain hardware and software (with or without satellite access) for

your company, ready to "plug and play" with any existing Internet service provider, so that you can put the 'Net's global connectivity to work immediately.

**It's not Rocket Science...** just good old-fashioned attention to detail and the best customer service in the business.

Call us now with your application... we'll give you connectivity, from the stars of the VSAT industry.

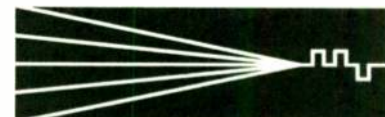

**NSN NETWORK SERVICES**

PO Box 7510  
 Avon, Colorado 81620

http://nsn.net  
 e-mail sales@nsn.net

970 ♦ 949 ♦ 7774

Fax 970 ♦ 949 ♦ 9620

800 ♦ 345 ♦ VSAT  
 8 7 2 8

See us at NAB - Booth 1513 - where we'll introduce **SpotBoxx**.

Circle (119) On Reader Service Card



# BANDWIDTH...

Never looked  
so good...



**DRFL 700**  
The microwave link that  
gives you 3 times more  
available bandwidth than your  
current channel.

JNS Electronics setting a new  
benchmark in spectrum efficiency, quality and reliability.

JNS Electronics is proud to announce a major breakthrough in Spectrum Efficient Digital Microwave Communications. With the release of the DRFL700, JNS Electronics brings from the future a product for today. The transmitted data has a high degree of spectral efficiency due to advanced digital signal processing. This revolutionary method requires less than half the bandwidth, over a large proportion of the transmitted spectrum, compared to typical competitors.

**FOR MORE TECHNICAL INFORMATION CONTACT:**

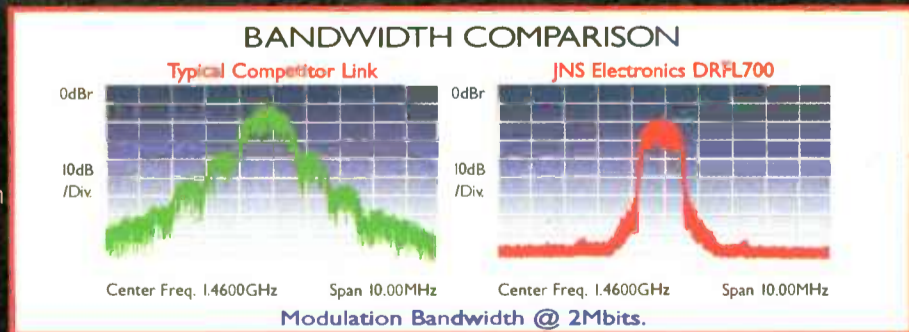

## JNS ELECTRONICS

**J.N.S. ELECTRONICS PTY. LTD.**

P.O. Box 85 Rosanna, Melbourne, Victoria, 3084, Australia  
Telephone: (613) 9852 2100 Fax: (613) 9852 0977 Email: info@jns.com.au

**J.N.S. ELECTRONICS INC.**

P.O. Box 32550 San Jose, CA 95152, U.S.A.  
Telephone: 408 729 3838 Fax: 408 926 1003



Your Resource for Business, Programming & Sales

## U.S. Border Stations Cash In on Canada

*Radio Stations Along the U.S.-Canada Border Are Taking Advantage of Their Listeners to the North*

by James Careless

**OTTAWA** There are a lot of stations clustered along the U.S.-Canada border. And the smart ones are taking advantage of that fact, by formatting themselves not just to serve domestic tastes, but those across the border as well.

Ironically, it is the Canadian broadcast regulator that has given these stations a competitive edge.

The Canadian Radio-television and Telecommunications Commission (CRTC) has done this in two ways. First, it requires all radio stations to play Canadian songs at least 30 percent of the time. Second, the commission forces FMs to play "non-hits" at least 50 percent of the time, in order to preserve AM as a music medium.

### Much in common

In order to get a handle on cross-border broadcasting, *RW* contacted four stations along the U.S.-Canada border. Although they are located in different locations, all four have much in common.

KISM-FM is located in Bellingham, Wash., right across the border from British Columbia. Its 50,000 watts allows KISM to cover much of Seattle and Vancouver.

Sixty percent of the station's audience is Canadian, according to general manager Rick Staeb.

"Our main listening area is all along the

rock-style format. Hence, when it comes to programming, Kingston is "as important a market to us as is the Watertown area."

WQHR-FM (AC) and WBPW-FM (Country) are both 100,000 W powerhouses located in Presque Isle, Maine, across the border from the Canadian province of New Brunswick. Their audiences are split roughly 50/50 between the two countries.

Both stations are run by General Manager Keith Mede. He's an expatriate Canadian, as is the primary owner of WQHR and WBPW.

### Know the rules

Mede himself is "very familiar with the limitations (imposed on stations) by the CRTC." That's why he moved to Maine, where it's easier to do business, "yet have an impact on the Canadian market."

As mentioned earlier, all of these stations use similar tactics to attract Canadian listeners and advertising revenues.

The first thing they do is to "de-Americanize" their call sign, to make it sound more domestic to Canadian listeners.

For instance, KISM is identified on-air as "The Independent Rock Station." WQHR is simply "Q-86," and WBPW is "Hot Country 97."

"We really play down our positioning," says Mede. "We never say the 'W' except

presentation, so that the Canadian listeners really don't know which country they're listening to.

"We're very generic about the times and our location," said Keith Mede, "even how we program ourselves from a news and sports standpoint.

"We try to ride the fence. We don't carry

airplay to Canadians like Bryan Adams, Alanis Morissette and Shania Twain.

"It's Canadian content, but it's recognizable to our American audience as well," says Mede.

The fourth tactic these stations employ is to aggressively pursue Canadian sales. In fact, all four have sales teams in both countries, reporting differing degrees of success in closing deals in Canada.

### Great percentage

For instance, Bilodeau said that "we get a great percentage of revenue and ratings from Kingston, for the most part ... you just go out and sell."

Mede also reports success, helped by the fact that his stations aren't unionized, while his competitors across the border are. Because of this, "our rate structure is lower

than our Canadian counterparts, who have less audience."

However, Rick Staeb said that covering two countries, plus fighting the interference problems caused by the Rocky Mountains, can make sales difficult. "The geography is such that it is challenging to get McDonald's of Canada and McDonald's of the United States to look at our total coverage."

The fifth thing these stations do is to promote themselves in Canada, not just with PSAs, but appearances, concert sponsorships, and community good works.

"We've had the chance to present

continued on page 50 ▶



local high school basketball because when you are in Presque Isle, what does that mean to someone in Edmundston, New Brunswick?"

Staeb added, "We do our temperature in both Fahrenheit and Celsius. We will also do regional news stories, both Vancouver and Washington."

Next, the stations take advantage of their freedom from Canadian content and hit-to-nonhit ratios to play the music Canadians want to hear. Interestingly, this doesn't mean that they ignore Canadian artists, just the ones that are obscure.

For instance, WQHR and WBPW give



border," said Staeb, "all the way from Victoria on Vancouver Island, all the way east into Abbotsford, Chilliwack and up the Fraser River Valley."

WCIZ-FM is located in Watertown, N.Y., across Lake Ontario from Kingston, Ont., and a host of other smaller towns in Canada's most populous province.

### Cross-border action

Established in 1988, "CIZ" was created with the cross-border audience in mind, according to program director Ted Bilodeau. That's because CIZ reaches 250,000 Canadians with its 100,000 W transmitter, said Bilodeau, as opposed to 200,000 Americans.

As well, Kingston is a university town, which is a natural target for CIZ's classic

the once per hour that we have to."

Meanwhile WCIZ is simply known as "CIZ Watertown-Kingston," a trick that plays on the fact that Canadian callsigns all start with "C."

This tactic was chosen when the station first decided on its call sign, recalled Bilodeau. Station management knew that they had to start their U.S. callsign with a "W," so they decided to "make it 'W-C-something' and use 'C-da-da-da' on the air, just to help our Canadian audience relate a little better to the station." (Ironically, CIZ's use of the letter "Z" is a dead giveaway. That's because station announcers pronounce this letter "Zee," while Canadians pronounce it "Zed.")

The second tactic is to extend this generic approach to all aspects of on-air

## Tour The World Of EAS!

with expert, Gerald M. Le Bow

Jerry knows more about ENDEC EAS than anybody else on the planet, because he created it. Meet Jerry and enjoy his presentation as he easily guides you through the FCC's mandate at **NAB in Booth 3517** in Radio Land Monday through Friday. Don't forget your passport!

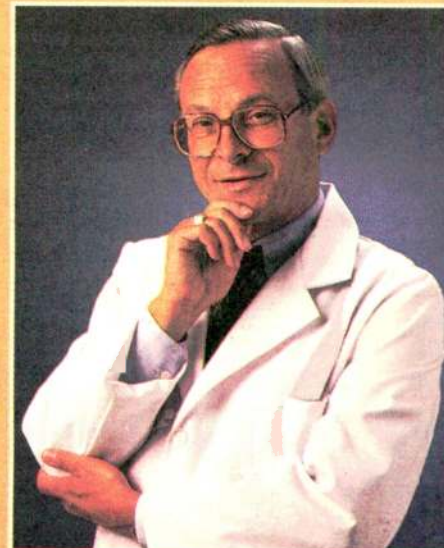

Beginner's Tour on the hour 10a.m.-1p.m.  
Advanced Tour on the hour 2p.m.-4p.m.  
Master's Tour on the hour at 5 p.m.

1-800-622-0022



**HARRIS**

# Border Stations Cash In

(Canadian) people like Tom Cochrane, Jeff Healey, Kim Mitchell — people like that — at shows even in Kingston,” says Bilodeau. “We also try to do a lot for the community ... we employ Canadians and we pay Canadian taxes. We do everything we can to help the community and, as they say, ‘give back,’ a strategy that includes collecting 4 tons of food for a Kingston charity.

## On remote in Canada

“We go on location,” said Mede. “We’ll do contesting, we’ll stop in malls. We’ll take station vehicles to different trade shows and events, and broadcast from them.” In order to satis-

fy Canadian law, Mede does this with Canadian talent.

And the final tactic these station use? They keep their noses clean with the



Canadian government, especially Customs. “It’s a challenge,” said Bilodeau. We’ve had to learn the requirements for crossing the border, but it’s easy, y’know: follow the

rules and it’s great.”

As noted off the top of this article, all four of these U.S. border stations have a substantial Canadian following; in fact, it makes up 50 percent or more of their total audience.

Sometimes the impact of this market penetration can be astounding.

For instance, Canadian ratings show that “Hot Country 97” is “the number one station in the Canadian market, with the exception of Fredericton (the provincial capital and only major city in the region), of course,” said Mede. Meanwhile, “on my AC station (Q-96) I have a 1-800 line, and I take anywhere from 9-12,000 Canadian request calls per month.”

The bottom line: chasing listeners in Canada pays off for U.S. border stations, thanks in no small part to the CRTC.

## Eye Testing Your Audio

► continued from page 43

To troubleshoot digital-audio problems, you need equipment designed specifically for digital-audio testing. Confidence monitors, for example, verify that signals are making their way through patch panels and cable harnesses. You also use them to monitor and modify the control bits. Digital-audio monitors are the modern equivalent of VU meters, which measure signal levels. In addition, digital audio monitors measure data-stream activity, including data format, sample rate and channel status.

### Eye diagrams

For detailed testing and analysis, you need an instrument that can generate eye diagrams. Eye diagrams (Figure 1) show bit transition activity and the shape of the waveforms. With eye diagrams, you can detect jitter, interference and frequency response problems. Jitter shows up as a smearing of the normally crisp edges of the eye diagram. Attenuation in long cable runs shows up as a reduction in overall eye height.

Because eye diagrams measure only peak-to-peak jitter, you may also want to analyze the frequency content of the jitter. By measuring the jitter spectrum with a digital-audio measurement set, you may be able to find the source of the jitter. Fluorescent lights, for example, often cause jitter with a 120 Hz frequency component.

Digital-audio sets can also let you monitor individual bits in the data-stream. You can monitor the amount of time a bit interval is logical 0 or logical 1. Because AES/EBU digital-audio systems use the 2’s complement format, each data bit should be a “1” 50 percent of the time and a “0” 50 percent of the time. If your measurement varies significantly from 50 percent, you have a problem with one of your system’s components. You can also monitor the status of the control bits with the digital-audio set. The use of these bits is not standard. For example, some units set the validity control bit when they use error correction. Other units may not use this bit in the same way and refuse to reproduce the audio when this bit is set. The only way to diagnose this type of equipment incompatibility is to monitor the control bits.

Understanding the basics of how AES/EBU datastreams work and how digital-audio devices communicate is important when dealing with digital-audio products. This understanding, and the knowledge that the right test equipment is available, will help unravel the mysteries of AES/EBU equipment and make troubleshooting considerably easier.

Jim Somich is a radio broadcast engineering consultant and president of MicroCon Systems Ltd., a manufacturer of broadcast equipment. He can be reached at 216-546-0967.



Despite buzzards, RF interference, and abandoned coal mines, the crew at K-LAKE 97.7 FM broadcast 24 hours per day, 7 days per week in Mount Pleasant, Texas. Clockwise from left, Bobby D. Moore, morning DJ and Program Director; Mary O’Connell, Traffic Coordinator and Office Manager; Donna Hill, Sales Manager and Co-Owner; Bob Hill, Co-Owner and General Manager.

## The Buzzard Damaged Everything, But We Still Kept Broadcasting

“...One time, a buzzard landed on a power line and snapped it. That line fell into another line and voltage just shot through this end of town. We had \$10,000 worth of damage to the transmitter and almost every piece of equipment we owned was damaged. We had the SMARTCASTER plugged into a wall, not even through a surge protector, and it worked great. It survived ‘The Buzzard Incident’ and kept us on air.

“But not only are they reliable, SMARTS products are intelligent as well. A friend of mine who’s in the business was visiting from out of town. He was listening to us while driving in from the Dallas-Fort Worth airport. The first thing he said when he saw me was, ‘Man, I thought you guys were live.’ He just couldn’t tell. The SMARTCASTER handles the satellite feeds, logging, and local hard drive programming seamlessly. And because we have our sound card broadcasting at 16 MHz, we have rich digital sound without any digital hiss or popping.

“SMARTS is a class company with dependable, reliable products. And it’s all because they’re all former broadcasters themselves, so they already know the challenges we face.

“Hey, I’ve got plenty of stories about John and Jan at SMARTS. Call me at (903) 577-9770, and I’ll tell you how SMARTS has been instrumental to our success.”

—Bob Hill

Circle (58) On Reader Service Card

## Cost-Efficient Broadcasting Starts With Some SMARTS...

### SMARTCASTER

- ◆ Operate unattended, but broadcast around the clock.
- ◆ Reduce costs on all operations, including production, engineering, talent.
- ◆ Increase the time you have to sell.

### SMARTS TRAFFIC

- ◆ Automates the business end of your station.
- ◆ Produces daily logs.
- ◆ Prints bills and affidavits of performance.
- ◆ Provides daily sales reports and financial information.

### SMARTTOUCH

- ◆ Automates your broadcast remotes, including sporting events.
- ◆ No operator required at the studio.
- ◆ Control and program are fed over a single dial-up phone line.

Call or write for a free SMARTS demo disk.  
1-800-747-6278

We’re Changing The World Of Broadcasting



P.O. Box 284  
2102 Main Street  
Emmetsburg, IA 50536  
Phone: 1-800-747-6278  
Fax: 1-800-498-0618  
E-mail: smart@ncn.net

OFFBEAT RADIO

# Illinois Broadcaster Works 106-hour Week

by Lee Harris

**NEW YORK** Who is the favorite air personality at WDUK(FM) in Havana, Ill.? You'd have to say it's Win Stimson.

While his voice is a little on the creaky side, Win gets a lot of airtime on WDUK. He pulls the 6 to 10 shift at the station. That's 6 a.m. to 10 p.m., Monday through Saturday. He also works a little on Sundays, 7 a.m. to 5 p.m.

**Five days a week**

You see, Win is really the only air personality at the 3 kW class A station. He's also the general manager, sales manager, program director, traffic manager and every other job title you can think of, including owner.

You're probably thinking WDUK is automated, and Win cuts voice tracks or takes a satellite service. Wrong. Win is actually on his little five-channel Sparta board 16 hours a day (10 on Sunday)

tisers, does the logs, writes the copy, handles the sales orders, puts the bills in the mail and tries to grab a bite to eat now and then.

It may sound like radio hell, but Win is not an unhappy man. All the usual questions (like, how can you stand it?) bring rather unusual answers.

The heyday of Havana, Ill., was back in the 1920s, when the small city was a major port of operation for bootleggers running their booze up and down the Illinois River. The big money left town with the repeal of prohibition, and the years haven't been kind to Havana. When Win joined WDUK in 1970, the then new station had a small but reasonable complement of employees. Win bought out the owners in 1973, and continued doing business as usual. Then really hard times hit Havana and surrounding Mason County. Major employers shut down and the county suffered one of the highest unemploy-

ment rates in the nation. The local economy suffered enormously and as employees left, Win couldn't afford to replace them. By 1989, it was down to Win and his wife, Mary.

I visited Win about that time, and found him in downtown Havana, hunched over that little Sparta in his tiny but sunny studio. At the time WDUK was located in a semi-dilapidated brick building that had once been home to the local newspaper, the Havana Democrat.

Not much has changed in the past seven years. WDUK did relocate to a new house-like building at the transmitter site, but the studio equipment is the same. The Sparta board, a couple of old Tapecester cart-machines, a pair of rumble-bucket turntables, a consumer grade cassette deck, and Win's sole concession to changing times ... a CD player, also consumer grade, all going out over the air in glorious mono. There's a little production studio too, with an even smaller Sparta board and a Tapecester cart record unit.

**Done by hand**

For Win, far removed from the multi-track glamour and union regulated hours of major market radio, it's enough. The AP wire service became too expensive, so it's gone. There's no computer. All traffic and billing is done by hand. Mary used to help with the paperwork, but she developed a hereditary retina disease and she's now legally blind.

Daughter Jennifer, however, is now 18, and having grown up in the radio station, can fill in for her father in virtually any capacity. She even pulls all of Dad's hours when Win and Mary try to get away for a day or two every few years.

Most operators faced with Win's challenges would opt for the obvious solution — some sort of automation or satellite service. Win's not interested. He said WDUK is primarily a local information station.

"I never want to give up control over the music," Win said. As for the impossible hours he imposes upon himself, he said, "I really don't mind. I like listening to the music we play, and the information we broadcast. I don't even mind the paperwork. Before I got into the business I used to listen to the radio, and that's what I do now."

WDUK is about 30 miles southwest of Peoria. Surely in the age of duopolies, Win has had decent offers for the station?

"Oh yes, we've been approached. But I don't know what else I'd do. I have no ambition to operate another station. I don't think I'd be a good manager. I'm real happy with what we're doing right now."

Well, there's one you don't hear every day in this business, all the more amazing considering the source. While economic pressures and competing technologies continue to hammer the radio business, Win Stimson sits serenely at the helm of WDUK, holding the wheel steady, hardly noticing the storm of change crashing all around him.

□ □ □

Lee Harris, former station owner/manager, is currently morning anchor at all-news WINS(AM) in New York.

**Win is actually on his little five-channel Sparta board 16 hours a day (10 on Sunday) unless his wife or teenage daughter steps in to relieve him.**

unless his wife or teenage daughter steps in to relieve him for awhile.

He does the news, he spins Country and Pop hits, keeps an eye on some syndicated shows, plays the spots (mostly voiced by him), answers the phone, calls adver-

ment rates in the nation. The local economy suffered enormously and as employees left, Win couldn't afford to replace them. By 1989, it was down to Win and his wife, Mary.

I visited Win about that time, and found

## Running Radio Marketplace

**A Supermarket of Radio Station Services**

For information on the services shown below, circle the Reader Service number on the enclosed card or contact the advertiser directly.



Direct From Music City, USA  
The **Nashville Record Review**, hosted by Katie Haas and Bill Cody, counts down Country's Top 40 with a four-hour weekly syndicated radio program produced on compact disc.

For more information contact:

East: Ken Mullane  
(203) 965-6423

West: Lynn Wells  
(303) 771-9800

Reader Service No. 195

## STATION/STUDIO SERVICES

**427 SOUND EFFECTS \$89.00**

For a 5-CD set with a 30-day money-back guarantee.

*Take an extra \$10 off if you mention this ad!*

Send \$79 to Ghostwriters  
2412 Unity Ave. N., Dept. RW  
Minneapolis, MN 55422

For credit card orders call  
**(612) 522-6256**

READER SERVICE 102

**BUY-OUT MUSIC — \$77**

82 :30 & :60 music beds for . . . . \$77  
328 :30 & :60 music beds for . . . \$198  
120 production effects "Zings, Zaps and Zoodads" for . . . . . \$99  
122 New Lasers & Sweepers for . . \$99

For FREE DETAILS on production music, sound effects, call

**Ghostwriters (612) 522-6256**

READER SERVICE 102

**Doing business without advertising is like winking in the dark... You know what your are doing but no one else**

**765 Hit Songs Of the 80's On 50 Compact Discs Only \$599**

The "A" List with the most-requested Pop, AC, and Rock hits! With index codes for automatic sequencers. For a free demo and complete track listings, phone or FAX Ghostwriters:

**(612) 522-6256**

For sale to Radio Stations only. For track listings only, circle Reader Service number 210

READER SERVICE 210

**ATTENTION PROVIDERS!**

Promote your services to **Radio World's** 18,000+ readers. Reach Radio Station and Recording Studio owners/managers and engineers with your message. For information on affordable advertising call **Simone** at **1-800-336-3045**.

## PROMO POWER

# Learn from Disastrous Promotions

by Mark Lapidus

**FAIRFAX, Va.** Fun! Isn't that why you got into radio to begin with? If you're not having fun doing radio, then your attitude and approach deserve a little modification.

A friend of mine and I were recently swapping stories about unusual promotions we've done and the funny (and sometimes not so funny) things that have gone wrong with them. We concluded that there are lessons to be learned.

Hey, this sounds like a great excuse for telling tales and having a few laughs. If after reading some of these you remember something you'd like to share, drop me an e-mail or a fax. When I get enough stories, I'll write a follow-up column. Meanwhile, check out this array of promotions gone awry and hopefully they'll spark an occasional grin.

**Pizza Speed Eating Contest:** The concept was to draw attention to a new restaurant and its delicious pizza. The on-air promotion part worked: every booth was filled with picture-perfect families. The contestant who ate the most pizza in 20 minutes would win the grand prize: a big \$105 in cash!

Stacks of pizza were brought out and the stop-watch was started ... ready, set ... eat! Ten minutes later the first contestant threw up. He was discreet, vomiting into his napkin behind the table. Okay ... that's reasonable ... maybe he wasn't feeling too

well before he started eating. Two minutes later, things got a little out of hand when contestant number two lost his cookies in his lap. Less than a minute after that, contestant number three puked directly into the pizzas laid out on the table. Contestants four, five and six promptly added their freshly chewed morsels to the fray. And that's when I noticed the pretty families leaving in mass numbers.

**You win \$5,000 dollars:** The day this happened the group president was visiting. The timing was great! He was going to hear us give away a huge prize live on the air to a very happy listener. We only did this once a week. The contest was easy. Listen for the Song of the Day, be the 10th caller after the song ends and win \$5,000.

The song ended. The DJ went on the air live and counted up the callers: You're caller one ... thanks for calling! You're caller two, three, four, five, six, seven, eight, thanks for calling ... you're caller number 10! YOU WIN \$5,000 IN CASH! WHAT'S YOUR NAME? You may have noticed he skipped number nine. He went from eight to 10. I heard it. The general manager heard it. The group president heard it. I rushed into the control room — while the DJ was still live on the air — and told him that not only did that caller win \$5,000, because he just told her she did, but to go back to the phone and award the next caller \$5,000 as well, because that guy was the real caller number 10.

**The car's yours!:** Ten keys were given away for a brand new four-wheel-drive vehicle. Only one key worked. The winners were in position at intermission each to try their key on the car. Over 5,000 people were watching this beautifully staged event at the raceway. The DJ built the excitement with the crowd as each key failed to start the car. The crowd went wild when the ninth key didn't work, because everyone knew that the 10th person had to have the winning key.

Just as a formality, that contestant got in the car, put the key in the ignition — the crowd noise died down to hear the engine start — and nothing happened! The DJ lost his cool when the crowd started throwing trash. He couldn't help himself; he started cussing out the audience. Meanwhile, the contestants were all trying the keys again, but nothing worked. Nobody told the contestants that with this particular model, they had to push in the clutch or the car wouldn't start.

**Fill up the food truck:** It's the old fill a truck with food for the homeless promotion for Thanksgiving. A DJ camps out in a moving truck, all set to live there until it's filled from top to bottom with food for the homeless. The listening audience to this particular station either didn't understand the concept or just didn't care. The station begged and begged, but only piddling amounts of food showed up. After a week, the jock missed having a life and the station was tired of being publicly humiliated. In the middle of the night, they pretended

to have met their goal and moved out.

**Free Food:** I was doing a remote from a car dealership. The owner made it clear to the radio station that he felt having free food to attract customers was extremely important. We arranged for a sub shop to deliver a bunch of foot-long subs.

While I was still meeting with the owner, the car dealership's sales staff spotted the food. They ate every last morsel in 10 minutes. The owner was so mad, he had to leave his own dealership. I never saw him again even though four cars sold during the broadcast.

**Live from ?:** On "The Best of Don & Mike" syndicated show, I recently heard them tell an outrageously funny story about going to Ireland to do a live broadcast back to the United States, sponsored by a major beer. They described getting ready for the show before departure, the plane ride over, renting the car and finally heading for the broadcast site.

They only had one problem. Nobody knew where they were going and after spending hours driving around the Irish countryside, they gave up. The broadcast never happened. Is this a true story? It sounds too much like real radio to be made up. Can't you picture someone on your air staff doing this?

Send me your stories! As Les Nessman once said on WKRP in Cincinnati: As God is my witness ... I thought turkeys could fly.

□ □ □

Mark Lapidus is the vice president of marketing at Liberty Broadcasting. Send him your stories at fax: 301-899-6218; or e-mail [libertyhq@aol.com](mailto:libertyhq@aol.com)

Third-generation RBDS technology



Compliant with all



US/EBU standards

100% • No exceptions • Future-proofed • Easy to implement



new features via PC • Five serial ports



for different uses • By different people • Global positioning capability



No wonder we're the industry leader

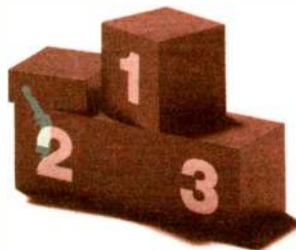

It's the RE 532 full-featured RBDS encoder



Call!



(216) 871-7617



RE AMERICA, INC. • Telephone: (+1) (216) 871-7617 • Telefax: (+1) (216) 871-4303 • RE UK LTD. • Telephone: (+44) (01734) 731119 • Telefax: (+44) (01734) 731190  
 • RE JAPAN CO., LTD. • Telephone: (+81) 03-3320-0460 • Telefax: (+81) 03-3320-0497 • RE DEUTSCHLAND GMBH • Telephone: (+49) 02461-6803-0 •  
 Telefax: (+49) 02461-56831 • RE INTERNATIONAL AS • Telephone: (+45) 39 17 00 00 • Telefax: (+45) 39 17 00 10 • Plus 30 authorized distributors worldwide.



Circle (87) On Reader Service Card

World Radio History

# Language Can Work to Your Advantage

Part IX

by Ty Ford

**BALTIMORE** As I round the final turn with this series of articles about copywriting for radio, it's time to dig deeper into the bowels of language.

From the creative side, the more you know about the language, the better you can fine-tune the client's message. From the defensive side, the more you know, the better prepared you are to steer the client away from language that obscures the message, makes them sound unprofessional and leads to tune-out. Even if you are not a copywriter or production person, getting a better handle on language can help identify a piece of problem copy.

Radio is a spoken-word medium. Copy that isn't written for the spoken word usually sounds stiff. The best copy sounds as if it was written effortlessly, because of the natural flow of ideas and the cadence of the speech. With single voice copy, what you end up doing is writing copy that talks to the listener rather than at the listener.

**Good copy has a rhythm, and the different ways you combine words and phrases create different impressions.**

There are several other conventions. Have something to say. Say it clearly. Say it more than once. Tell them what you're about to tell them, tell them, and tell them what you just told them. Put the client's name in as many as seven times in a 60, especially if they don't have name awareness. The most creative production is useless if the listeners don't remember the client's name and what the basic offer is.

Good copy has a rhythm, and the different ways you combine words and phrases create different impressions. A series of short words or phrases works better than long ones for creating a quick dynamic impression. Longer phrases indicate luxury or relaxation. Long complex sentences force the listener to pay too much attention to your train of thought.

Make a point of using strong verbs. Verbs of being — is, am and are — do not contain the same energy component that more active verbs like buy, drive, feel, smell, own and taste do.

In general, words beginning with the hard, plosive consonants, B, C, D, F, K, P, Q or T, are more powerful than those beginning with A, E, I, L, M, N, O, U and W. This doesn't mean you should go for overly aggressive words for every piece of copy, especially if the image you are trying to create is one of luxury or splendor. That "Big, Bad, Barbados Vacation," for example, might be better expressed as a "Wonderful, Warming, Tropical Tour."

After a while, you'll run into situations where these rules don't seem to apply. The word "great" has more power than the word "large," but neither are as powerful as the word "massive," which starts

with an "M." When you run into these contradictions and recognize them, you're no longer an apprentice copywriter.

The most frequently abused concept in radio copy is the screaming, fast, repetitious spot. Listeners will probably remember the first three seconds of the spot: just enough for them to tune out. The only time this kind of spot works well is if it is a parody, and the parody better be strong enough to overcome the presentation.

The next most irritating spot is one that runs too many times within the same period or in the same spot break day after day, week after week. Comedy spots also have a much shorter shelf life.

**Slogans**

Good slogans are very important. They give the listener a "handle" that will help them retain the client's name. If you don't finish the line "Just for the Taste of It" with "Diet Coke," you've been on another planet.

The following list from the NAB's Copywriting book offers 10 different kinds of word play, which should give you a great starting place.

*Alliteration:* Syllables and words sound alike: Sell Simpson and be Sure.

*Metaphor:* Words suggest a resemblance:

A rainbow of flavors, or a cloud-filled mattress.

*Simile:* A resemblance using "like" or "as": Fresh as a daisy.

*Pun:* A play on words: Johnson Radiator Repair. There's no better place to take a leak.

*Condition Terms:* Using "if" ... then ...": If you like chocolate, you'll love Chunky.

*Allusion:* A literary reference: The muf-

fler with the Midas Touch.

*Hyperbole:* An exaggeration: A Million Dollar Smile

*Transferred epithet:* Unusual adjective/noun use: Fly the Friendly Skies

*Analogy:* Creating similarities in dissimilar things: Our Homes Are Your Castles.

*Chiasmus:* from the Greek mean placing crosswise: We plan our work, and work our plan.

**Performance**

When I started doing free-lance voice work for advertising agencies, one of the first pieces of direction I got was not to sound so much like a radio announcer. I thought I had dropped most of the pushed inflections that I used on the air, but they were still hearing it.

Talent that doesn't sound "announcery" is one of the many strengths of a good agency-produced spot. To make this work at your station, you need to work with your on-air staff to encourage it to develop different performance abilities. I'm not talking about character voices; I'm talking about developing different attitudes and real sounding reads.



As broadcasters, you can close your eyes and see the picture. There's a stack of copy that has to be cut before the talent can get out of the station. You record the spot, dump it to cart or to the hard drive system and split.

The worst abuse of the announcer style read is "The Puker" delivery. I'd like to get my hands on the person who set the tone for many of our on-air talent today. What they were after was more excitement. What they got was something very unnatural and unconvincing. "The Puker" delivery, by itself, sends a strong negative message to the listener. Would you be interested in listening anything that someone who spoke this way had to say?

That's not to say that talent with more narrow abilities should be discounted. If that's the case, you write to their performance strengths. If your production director is the only one with any voice versatility, you will burn that voice out. Even if he or she does have a broad range of delivery styles, the styles will lose impact when they are played together in a spot break.

You really need the versatility of different good voices to keep the breaks from bogging down. If you're hiring airstaff because they have a great street sound but no production chops, you are taking away from the depth needed to produce high-quality commercial breaks. You end up contributing to the tune-out.

These people don't have to be production wizards, but they do need to have versatile voices and the ability to maintain a character throughout a spot. My final installment in this series will deal with the production and technical aspects of how to reinvent your radio station's commercial sound.

Ty Ford's "Advanced Audio Production Techniques" can be found on the Web at [http://www.bh.com/bh/jp/2408\\_0082.htm](http://www.bh.com/bh/jp/2408_0082.htm). You can download his AIFF voice demo via FTP at <ftp:jagunet.com> from the <pub/users/ford> directory.

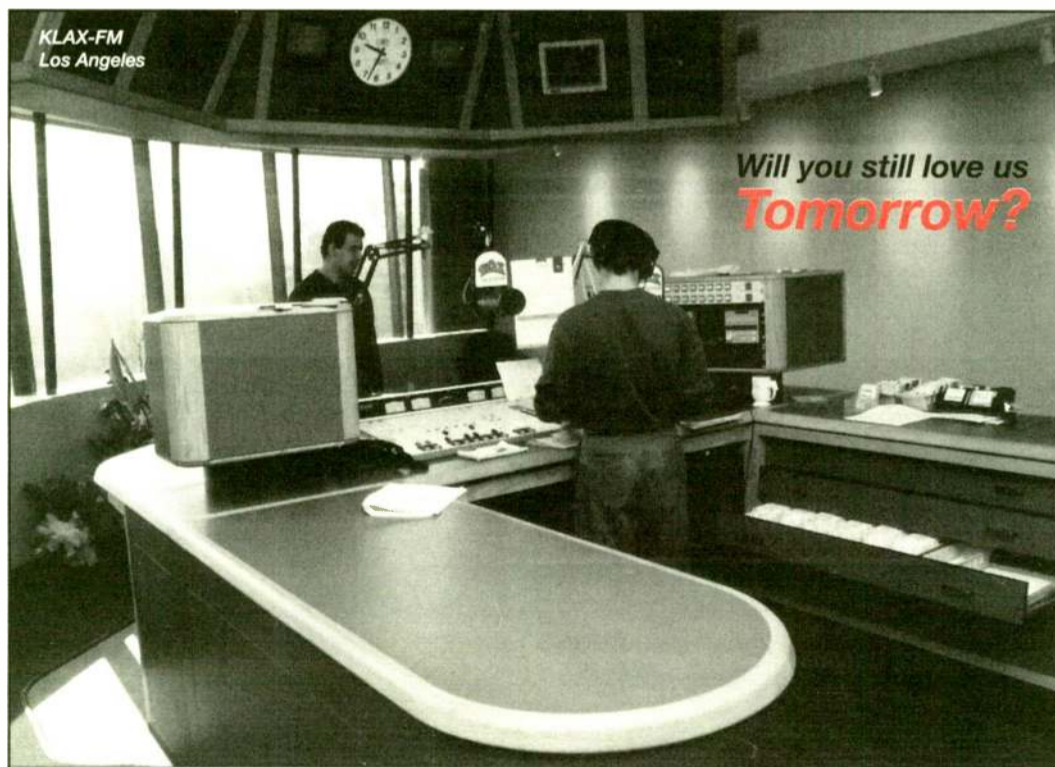

**Studio furniture is one decision you'll be living with for a long time. If you make it Murphy, you can count on a relationship that will last for years. Durability, deliverability and thoughtful design—all part of the enduring elegance of Murphy Studio Furniture.**

**MURPHY**  
STUDIO FURNITURE

▲ 4153 N. BONITA STREET ▲ SPRING VALLEY, CA 91977 ▲ TEL (619) 698-4658 ▲ FAX (619) 698-1268 ▲  
▼ (800) 307-1060 ▼ Email [dwmurphy@electriciti.com](mailto:dwmurphy@electriciti.com) ▼ URL <http://www.electriciti.com/dwmurphy> ▼

Our service goes beyond design and fabrication, to total management of your concept's execution.

Circle (81) On Reader Service Card

HARRY S. HEADPHONE  
stars as ACE RADIOMAN in

# TRIUMPH ON THE AIRWAVES

He flew far above the competition!  
Ace RadioMan knew he  
had to have the best... *OTARI*

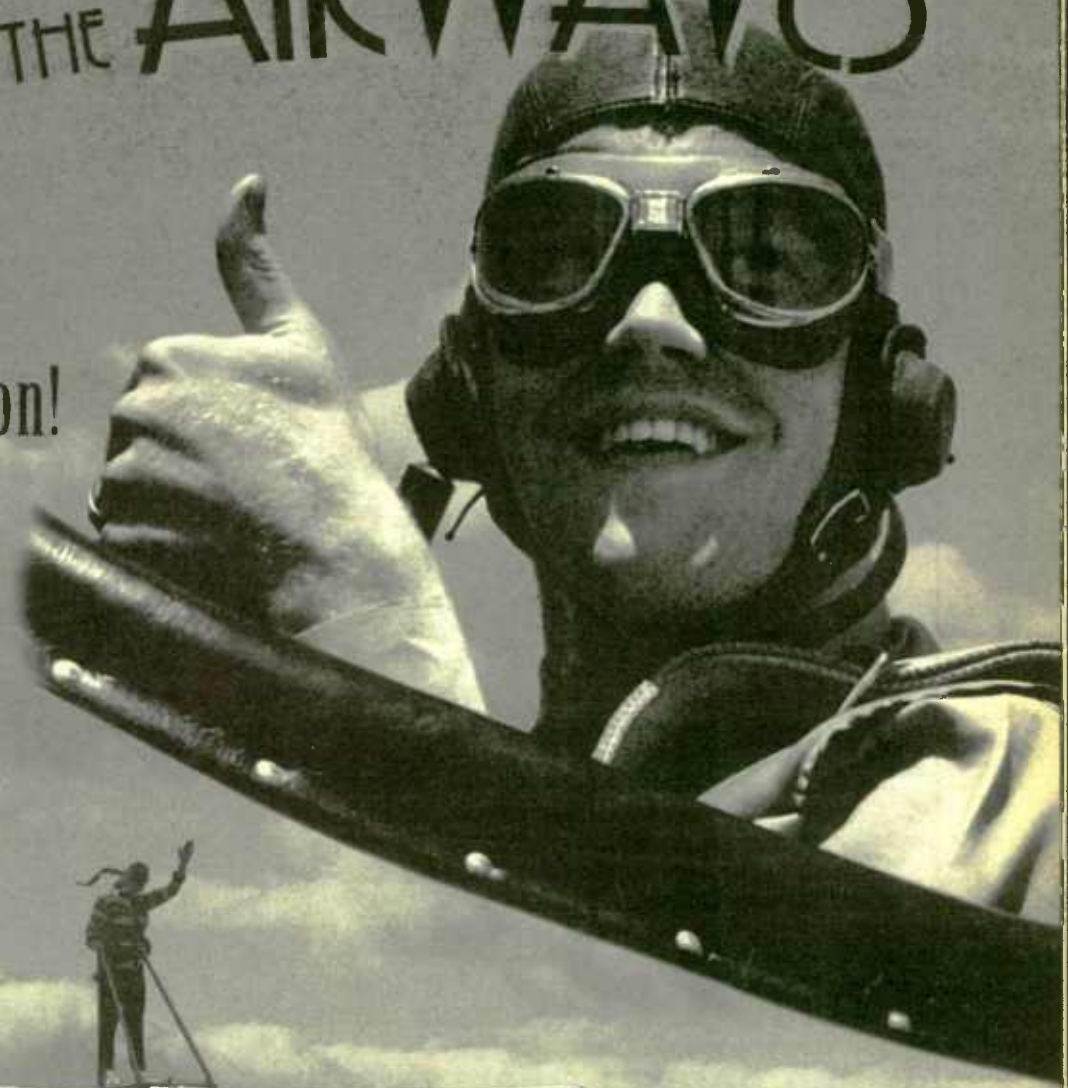

## FEATURING

- ★ Random Access Disk Recorders
- ★ DAT Recorders ★ Tape Recorders
- ★ CD Changers ★ Mixing Consoles
- ★ MiniDisc Recorders

team  
**OTARI** ★



AN  
**OTARI**  
PRODUCTION

Otari's ★FULL LINE of audio ★STORAGE,  
★MANIPULATION and ★DELIVERY SYSTEMS  
gives you the ★TOOLS TO SOLVE your station's  
audio problems at reasonable cost. And Otari's legendary  
★RELIABILITY means these problems stay solved!  
Call your Otari dealer or 415-341-5900 for information.  
And don't forget to ask for a large poster of this ad!

Otari Corporation U.S.A.  
Phone: (415) 341-5900, Fax: (415) 341-7200  
L.A. Sales: (818) 972-3887, G.E. Sales: (615) 255-6080

Otari Inc. Japan  
Phone: (81) 4-2401-8626, Fax: (81) 4-2401-8633

Otari Deutschland GmbH Germany  
Phone: (49) 2159-50961, Fax: (49) 2159-1776

Otari Singapore Pte., Ltd.  
Phone: (65) 284-7211, Fax: (65) 284-4727



B-10 Broadcast  
Console



RADAR Disc  
Recorder



MX-50II Tape  
Recorder



DTR-8 DAT Recorder



MR-10 Mini-Disc  
Recorder/ Player



CDC-600  
CD Changer

# Free Help to Enhance Your Web Site

by Alan Haber

**ALEXANDRIA, Va.** Yup, there's nothing like parking yourself in front of your PC and listening to your favorite radio stations while you work, collect your e-mail, et cetera, et cetera, et cetera. In fact, there's nothing I like better.

Oh ... hi there, loyal Haberspacers! Didn't see you comin' in the cyber-door! I was listening to some cyber-radio and chatting to my fellow Web watchers here in the global Haberspace headquarters about loving the "live broadcasting on the Web" thing! The revolution — and make no mistake about it, it *is* a revolution — is here, and it's coming to your town, or, more accurately, to your station.

Yeah, you'll be there on the Web with

Musictown's Web servers linked to the station's current Web site"; and "Global Stage live chat room access on Musictown's Web servers," among other goodies.

## Web advertising

What else will Musictown do? Gold said the 'Town'll "create Web-based advertisements to expand the array of products that can be sold by a radio station's sales department." Also, he said, "Musictown may be able to secure advertisers for a station's Web site." Sounds like a potential winner for stations looking to maybe bump up their bottom lines with their cyber-activity! And that's not

all: Musictown will put together and do the upkeep for a new site for your station for one year at no charge — if you don't already have a site, that is.

## There's nothing like listening to your favorite cyber-stations while you work.

Check out Musictown, but watch out for stray cyber-beams and slippery floors. You can buzz Gold at 1-800-800-2786.

There's nothing I like better than bumping into something completely unexpect-

ed and wonderful on the Web. Linking from here to there, as I'm often wont to do, brought me to "Gerard's Radio Collection" at <http://www.es.ruu.nl:80/people/gerard/radios/#radios>. Gerard's got himself a tres neat-o overseas site that serves up eye-poppin' pix and detailed descriptions of 24 radios of varying styles.

You'll find all sorts of great vintage radios here. Seen a cigarette box-style radio recently? Gerard's got one — could be from around 1970, he said. You'll be

able to check out a radio built this year in the Netherlands. You'll see what Gerard says "was probably the cheapest radio that could be bought in 1961" — the

continued on page 68 ►



your station's signal. Maybe not next week, but sometime in the future — hopefully sooner than later. And, when you do take the live broadcasting plunge, you'll be searching out sites that offer links to your station's site so people from around the globe can easily find you and hear what you're cooking up in your studios.

## A town called Musictown

Yup, yup, it's real handy to be listed on a site that provides a link to your bag of tricks. I've come across a real promising one that isn't open for business as of this writing, but soon will be — Jeff Gold, the owner, told me the doors would be swinging wide for the general public on May 15th. Oh, yeah — the site's called Musictown, and I was able to take a tour of it in its pardon-our-dust state (the URL: <http://www.musictown.com>).

Really cool graphics, folks, and lots of radio stuff on the way, such as links to stations broadcasting live on the Web. And, at FM.NET (<http://fm.net>), a part of Musictown that is billed as "The New Standard for Finding Radio Stations on the World Wide Web," it looks like there's going to be a whole lot of radio goin' on.

As part of the FM.NET enterprise, Musictown is giving radio stations "free World Wide Web site enhancements," said Gold, so they can enhance their Web sites. Like what, you ask? Well, Gold said that Musictown will work with a station's Internet service provider to serve up, for the best price of all — free — a link to a station's URL: "StreamWorks real-time audio and video delivery from

Getting your network up and running with us will put you on top



of the world.

When you're dealing with the *radio-only* experts, why wouldn't you be on top of the world? We can take the most complex ideas and make them easy. Our simple and affordable solutions to your satellite needs include C-band satellite space for your network and uplink to get you up and running. Our transportable uplink can even be delivered right to your location. Or, if you're in a major market, you can utilize one of our fixed uplinks. And that gets your network going quickly! Call us today for more information at (202) 414-2626.



NPR Satellite Services<sup>®</sup>  
Link up with us<sup>®</sup>

635 Massachusetts Ave., NW., Washington, DC 20001-3753 • (202) 414-2626

Circle (125) On Reader Service Card

World Radio History

# Prophet Systems Inc. announces

PAGE #1	Record	Autoroll	Cuts List	Swap		Option Menu
POT 1 (A/S)	POT 2 (A/S)	POT 3 (A/S)	POT 3 (LOCAL)	POT 4 (LOCAL)	POT 4 (LOCAL)	
A APRIL BLOSSOM 00:15 <b>1</b>	B WAGON WHEEL 00:19	C KARLS APPLIA 00:59	D BAKERY CAFE 00:19	E CINNAMON 00:02	F JACKS PLACE 00:08	
G LARRYS RV 00:31	H HDA 00:03 <b>2</b>	I VoiceTRAC fo 00:15 <b>3</b>	J DUDDENS 00:45	K EBS 00:50	L HIRSHFELDS 00:03	
M RADIO SONG 04:08	N DAYBREAK 03:41	O NOTHING'S NE 02:59	P MANDY 03:14	Q WALKIN' AWAY 02:47	R NOBODY'S HOM 03:26	
S LINER A	T LINER B	U LINER C	V LINER D	W LINER E	X LEGAL ID	
1 2 3 4 5 6 7 8						
Sat Mar 2, 1996		POT	Insert	Delete	Mark	
55° High: 58° Low: 32°			17:48:00	ReSyno		
<b>06:36:32 PM</b>		1		(0:02) NOTHING'S NEWS CLINT BLACK	02001-01	Adjusted 00:02:59
23:28				Spot Block		00:03:25
KOGA FM # 2		2		TOWN AND COUNTRY (GEORG)	07600-01	00:00:21
SHIFT #04 BILL SMITH	MANUAL MODE	3		KARLS APPLIANCE 1 (John M.)	52060-02	00:00:59
Block Fill ON	Default Source 01	1		B AND J HITCHING POST (E. LEMOYNE)	52015-02	00:00:13
Run UDE	Special Menu			Variety center Update Sale (Georg)	40050-01	LiveCopy
?	Station Data	2		JACKS PLACE	52010-04	00:00:08
EXIT	Reports	End F11	Skip F12	Clipboard-0	Last Delete-0	Hold Bin-27
						-02:31
						Play - Pause

## Version 5

### Live Show Interface (LSI)

The centerpiece of Version 5 is the new Live Show Interface (LSI). This new interface allows the D-J to run even the most high energy shows smoothly. Fully utilizing the power of Windows, the Live Show Interface features:

- ◆ **Drag and Drop Commercials and Songs**  
Audio events can be easily moved around in the log using the mouse or touch screen. They can also be moved to the button bar and the holding bin.
- ◆ **Audio Source Management**  
Version 5 allows the D-J to specify which audio card a commercial or song will play out of ahead of time. It is easy to pre-position sliders and to crossfade items. Plus, Version 5 actually allows six stereo audio events to play simultaneously for each control room!
- ◆ **Fully Touch Screen Compatible**  
The Live Show Interface was designed from the ground up to be totally touch screen compatible.
- ◆ **Expanded Button Bar**  
Forty-two pages of buttons for immediate access to 1008 liner, jingles, laugh-tracks, etc.—PER SHIFT! And you can have up to 99 shifts!
- ◆ **Auto Roll of Buttons**  
Auto roll allows the D-J to mark buttons that will playback one after the other automatically. Mark up to 24 buttons which will all playback in order.
- ◆ **Quick Record**  
Take phone calls, edit them with our wave form editor, and place the event on log...all in just seconds.
- ◆ **Holding Bin**  
The holding bin is temporary storage for items that the D-J can't get to immediately. He can move them to the holding bin for easy retrieval later in the shift.
- ◆ **Macro Buttons**  
Accomplish complex tasks in one click of the mouse with macro buttons. Tasks such as changing from manual to satellite or auto control, changing the active station, turning on and off sources or relays, etc. become effortless with Version 5.
- ◆ **Pause/Reposition**  
Pause a spot or song, fast forward or rewind to a new point, begin play from a designated point using the pause/reposition button.

**FULLY  
TOUCH SCREEN  
INTEGRATED**

**Audio Wizard™ for Windows™**  
The *Flexible* Digital Automation System featuring Windows and Novell Technology

Windows is a Registered Trademark of Microsoft Corporation. Novell is a Registered Trademark of Novell, Inc. Intel is a Registered Trademark of Intel Corporation.

World Radio History





# You asked us to design a

Markets of all sizes are taking advantage of the new FCC ruling that allows multiple station ownership within a market. This means groupings of stations—2, 3, 4, 6, 8 even up to 14 or more— can share all of their audio and data out of ONE system that was **built** to handle multiple stations. Plus, with our new Version 5 with the Live Show Interface even the biggest, high-dollar market will sound better and run smoother than ever! Prophet Systems has Windows-based systems ranging from a single workstation system to a 100 workstation Goliath running 14 radio stations all out of a one system. There is absolutely no system better suited to running multiple stations than Audio Wizard CFS for Windows.

# control room interface for

- ◆ Pentiums on every workstation!
- ◆ New, high quality computers with three year factory warranty!
- ◆ Exclusive time and temperature announce!
- ◆ Backtime system, fills out each hour!

INTEL  
PENTIUM  
INSIDE !!

# high energy, live shows.

- ◆ Automatically record and play network feeds!
- ◆ The leading hard drive music automation system in the industry!
- ◆ Unsurpassed flexibility, runs any program or music log!
- ◆ On-line copy system, integrate your stations!

HOT STANDBY  
BACKUP FILE  
SERVER!

# So we did! The new Version 5

“ We had another DOS digital system that didn't fit our needs. It was clunky and couldn't handle even basic functions well. Now we have purchased four systems from Prophet. We have not found any limitations of the Audio Wizard for Windows system. The Audio Wizard for Windows is the most live sounding system I have ever heard. ”

- Jeff Hutton, KITI/KWMQ, Southwest City, MO, KTLQ/KEOK, Tahlequah, OK

# Live Show Interface.

“ We're proud to show people our system. Everyone who has seen the system is impressed. Audio Wizard for Windows is extremely easy to use. It's unlike any other system that is out there. It will handle any format, even news. The Windows platform is easy to operate. It has been extremely stable which is important for a walk-away station. We're very pleased with the system and would definitely buy it again if we had to do it all over. This is the only system I've heard that sounds live. ”

- Norm Laramee, KKPT/KSYG/SRN, Little Rock Arkansas

# Fear no competition!

Find out why Audio Wizard™ for Windows is the fastest growing digital audio automation system in the world. Call for information or a free demonstration. **Let us help you slay your dragon.**

Prophet Systems, Inc.  
1-800-658-4403

West Coast Office: (800) 886-4808

Mid West Office: (800) 658-4403

East Coast Office: (800) 699-7039



Circle (163) On Reader Service Card

World Radio History

Istelco 1961-1996

**35** years of experience

- **Modular design**
- **Reduced dimensions**
- **Perfect signal**
- **Fully reprogrammable\***

\* under patent

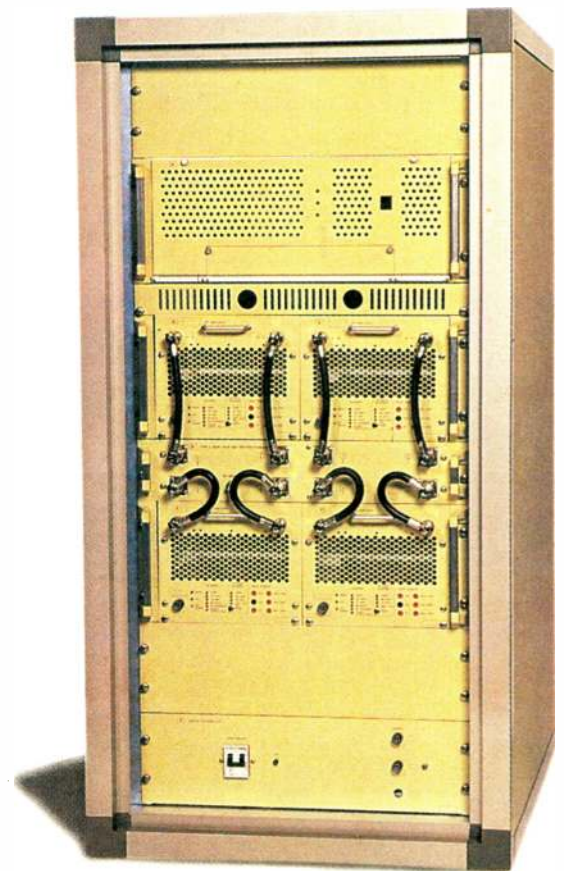

200W L band DAB Transmitter

To get an optimized **DAB** transmitter we have simply followed the ingenuity of our design rules

## **Istelco for Digital Broadcasting**



*For further details please contact:*

**Central and South America  
North America and Canada  
International**

**Istelco USA Inc.** 8280 N.W. 27<sup>th</sup> street, Suite 501, Miami FL • phone 305 7159410, fax 305 7159414  
**Istelco USA Inc.** 9035 Wadsworth Pkwy, Suite 4450, Westminster CO • phone 303 431 1699, fax 303 431 2868  
**Istelco S.p.A.** via dei merciarì, s.n.c. - P.O. Box 16 - zona industriale, Sferracavallo - Orvieto (TR) Italy  
phone +39 763 316231 • Fax +39 763 316236 Telex 661013 Istelco

USER REPORT

## WNWC Profits from Cellular One Deal

by Gordon Govier  
News Director  
WNWC(FM)

**MADISON, Wis.** The digital radio connections that allow cellular phone users to call from virtually anywhere to anywhere across the United States are based upon a network of 10,000 radio towers. But that is just the start.

Next on the horizon is personal communication services with which you will be able to fax, phone or e-mail from anywhere to anywhere. Over 100,000 antenna sites will be needed for the PCS revolution, says Jim Crooks, the CEO of Broadcast Communications in New Glarus, Wis.

Standing in the way of all those towers sprouting up across the landscape are the FCC, FAA, state and federal environmental agencies, local zoning codes and antisocial NIMBYs (Not In My Back Yard).

### Boost bottom line

Radio broadcasters who already own and operate towers can boost their bottom line by expanding the use of their largest asset.

Broadcast Communications specializes in tower siting and construction. When Cellular One came to Madison, the company contracted with Broadcast Communications to establish its cellular network. It soon became apparent a tower was needed to cover the rapidly growing west side of Madison.

Finding a site for a new tower would have been nearly impossible. Almost all of the existing towers were already fully utilized. A 350-foot tower belonging to WNWC(AM) presented the best opportunity for Cellular One.

There were two options: tear down the old tower and build a new one or modify the existing tower to handle the additional

load. Space considerations prevented the former choice. Next, it had to be determined if the existing tower was up to the challenge.

"Cellular One agreed to handle the engineering study," says Crooks. The study determined heavier guy wires were needed and the mast would have to be replaced with a tower section to handle the new WNWC antenna.

### Respective needs

Negotiations between Cellular One and WNWC identified the respective needs of the new joint operation. The former needed a tower that was tall enough and strong enough to cover the west side of the city; the latter wanted to upgrade its antenna and transmission line to improve coverage.

It was determined that Cellular One would front the cost of strengthening the tower and the transmission line at no expense to WNWC. WNWC would permit the tower rental for 10 years, pro-rated to reflect the upfront improvements.

Cellular One engineers determined they needed four antennas at the 250-foot level on the tower and a microwave dish at the 125-foot level. The engineering study determined that some guy wires needed to be replaced, but the guy anchors were adequate.

WNWC was able to decrease the antenna size from an old eight-bay horizontally polarized ERI antenna, which decreased the windload on the top of the tower.

Cellular One also needed space for its

radio and telephone equipment and would normally have brought in a pre-fab building. However, WNWC had its old, unused studio at the base of the tower. Cellular One remodeled the concrete block building and installed its equip-



WNWC and Cellular One happily share a tower.

the security needed for its operation.

Cellular One and WNWC are both happy with the arrangement and have discovered that cellular and broadcast can make good partners. WNWC Station Manager Greg Walters is pleased with the arrangement.

"The timing on this project was perfect," he says. "Each company achieved mutually satisfying goals. The Cellular One people have been very cooperative and helpful." It was also through the negotiations for this project that WNWC news department obtained its first cellular phone. Cell phones at that time cost hundreds of dollars more than they do now.

In recent years a new candelabra antenna has been raised on another old antenna site on Madison's west side, providing space for three TV antennas, three FM antennas and one-hundred two-way radio antennas. But such cooperative projects are very sensitive and rare.

Crooks himself attempted to site an 1100-foot tower in the Madison area several years ago. He negotiated agreements that would have brought in \$14,000 per month from renters but could not find land for it.

Clients typically will pay from between 75 cents to \$1.50 per foot of tower height per month.

"A lot of income can be generated from this one source of revenue, if they can work it out," said Crooks.

As the current lease expires in 1997, WNWC and Cellular One are discussing their working relationship on a joint project to further improve the WNWC tower.

For more information from Broadcast Communications, contact the company in Wisconsin at 608-527-5670; or circle Reader Service 128.

ment. Cellular One's section of the building is now completely separate from the WNWC transmitter building and permits

## I DARE YOU!

I dare you to try my FM FlexiMod on your station. I introduced the FM FlexiMod to broadcasters in April and the response has been fantastic! Over 97% of those who tried the FlexiMod added it to their processing chain. They discovered what high-tech composite processing can do for a station's sound.

I will be glad to send you a brochure and white paper that tries to use words to describe what improvements are possible over conventional composite processing, but a demo is the only sure-fire way to make a believer out of you. Join the 97% who sound cleaner and louder than they did with their old processor.

The FM FlexiMod is the best investment you can make in the sound of your station. It is not a re-hash of old processing ideas. It's distortion-cancelling, signal-enhancing circuitry is unique and unavailable in any other processor.



CIRCLE THE BINGO NUMBER  
OR CALL ME TODAY FOR MORE INFORMATION.  
You have nothing to lose but flat sound, grunge, and distortion.  
**BECOME A BELIEVER!**

Sincerely,  
**Jim Somich**  
Inventor of the FM FlexiMod  
(216) 546-0967

Manufactured by MicroCon Systems Ltd. and sold by leading equipment dealers.

### SUBSCRIPTION/READER SERVICE FORM

**Radio World**

FREE Subscription/Renewal Card

I would like to receive or continue receiving Radio World FREE each month.  Yes  No

Signature \_\_\_\_\_ Date \_\_\_\_\_

Please print and include all information:

Name \_\_\_\_\_ Title \_\_\_\_\_

Company/Station \_\_\_\_\_

Address \_\_\_\_\_

City \_\_\_\_\_ State \_\_\_\_\_ ZIP \_\_\_\_\_

Business Telephone ( ) \_\_\_\_\_

Please check only one entry for each category:

- I. Type of Firm**
- D. Combination AM/FM station
  - A. Commercial AM station
  - B. Commercial FM station
  - C. Educational FM station
  - E. Network/group owner
  - F. Recording Studio
  - K. Radio Station Services
  - G. TV station/teleprod facility
  - H. Consultant/ind engineer
  - I. Mfg, distributor or dealer
  - J. Other \_\_\_\_\_

- II. Job Function**
- A. Ownership
  - B. General management
  - C. Engineering
  - D. Programming/production
  - G. Sales
  - E. News operations
  - F. Other (specify) \_\_\_\_\_

### Reader Service

April 3, 1996 Use until July 3, 1996

Please first fill out contact information at left. Then check each advertisement for corresponding number and circle below.

#### Purchasing Authority

1. Recommend 2. Specify 3. Approve

001	023	045	068	089	111	133	155	177	199
002	024	046	069	090	112	134	156	178	200
003	025	047	070	091	113	135	157	179	201
004	026	048	071	092	114	136	158	180	202
005	027	049	072	093	115	137	159	181	203
006	028	050	073	094	116	138	160	182	204
007	029	051	074	095	117	139	161	183	205
008	030	052	075	096	118	140	162	184	206
009	031	053	076	097	119	141	163	185	207
010	032	054	077	098	120	142	164	186	208
011	033	055	078	099	121	143	165	187	209
012	034	056	079	100	122	144	166	188	210
013	035	057	080	101	123	145	167	189	211
014	036	058	081	102	124	146	168	190	212
015	037	059	082	103	125	147	169	191	213
016	038	060	083	104	126	148	170	192	214
017	039	061	084	105	127	149	171	193	215
018	040	062	085	106	128	150	172	194	216
019	041	063	086	107	129	151	173	195	217
020	042	064	087	108	130	152	174	196	218
021	043	065	088	109	131	153	175	197	219
022	044	066	089	110	132	154	176	198	220

Copy & Mail to: Radio World, PO Box 1214, Falls Church, VA 22041, or FAX to: 703-998-2966

# Products & Services Showcase

For more information on the products shown below, circle the appropriate Reader Service No.(s) on the enclosed Subscription/Reader Service card or contact the advertiser directly.

## Coverage!

Great format, great studio sound...but unless your **antenna** sends that sound where your target audience is, your bottom line will suffer.

Shively Labs has thirty years experience in providing pattern **solutions** for predictable and profitable **coverage**.

*...it pays to be heard.*

SEE US AT NAB BOOTH #5304

## Shively Labs

A Division of Howell Laboratories, Inc.  
An Employee-Owned Company

19 Harrison Road, Bridgton, ME 04009

207-647-3327 FAX 207-647-8273

e-mail: sales@shively.com

READER SERVICE NO 45

## New: R-505 Field Strength Meter



Handheld RF Signal Measuring System  
Freq Range: 3 to 1000 MHz  
Accuracy: +/-2 dB  
Data Logging & PC Control via RS-232  
Battery & Line operation  
Calibrated Antenna Systems are also available

### Z TECHNOLOGY, INC.

P.O. Box 6806

Beaverton, OR 97007 USA

Tel: 503/591-5051 Fax: 503/591-0241

READER SERVICE NO. 70

## Auto Answer Telephone Coupler



Ideal for unattended situations such as listen lines, IFB feeds, dial-up networks, remote transmitter sites & satellite links. This could make life simple again.

- ✓ Clean connection to phone line
- ✓ Easy to install
- ✓ Send or receive program
- ✓ F.C.C. registered

### COMREX

Comrex Corp, USA Tel: 508-263-1800 Fax: 508-635-0401  
Fax-on-Demand: 508-264-9973 (Doc. #110)

READER SERVICE NO. 95

## The CircuitWerkes AC-12 Telephone Autocoupler Bay

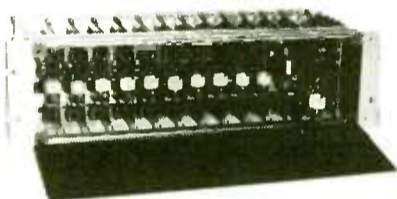

Get up to 12 couplers in a neat, compact chassis

- ✓ Auto-answer & disconnect.
- ✓ 2 audio busses for mass feeds.
- ✓ Individually card selectable buss or auxiliary audio I/O.
- ✓ LED indicators for ring, clipping, power & online.
- ✓ Ring counter answers on user seatable ring number.
- ✓ Momentary or latching dry contact outputs at pickup.
- ✓ Remove & install cards without affecting the rest.
- ✓ A special, non-bussed, balanced audio card for IFB feeds, etc. is available.

The AC-12 rack-mounted coupler bay is the best way to eliminate a wall or cabinet full of yesterday's couplers. Our unique dual audio busses eliminate the tedious and messy wiring associated with networks and other mass feeds. Each card can also individually either send or receive telco audio. Best of all, a fully loaded AC-12 lists for under \$185 per coupler.

### CircuitWerkes

6212 SW 8th Place  
Gainesville, Florida 32607  
(352) 335-6555 / fax 331-6999

READER SERVICE NO 120

## New Products at ERI!



- ▶ Your single source for antennas, filters,  $\lambda$  mounting, towers, lightning protection, grounding systems, engineering and installation services.

ERI ELECTRONICS RESEARCH, INC. 812-925-6000

### NAB Booth 3000

- ▶ Low Power FM antenna CP-II Series  
2000 W input  
Circular Polarization  
\$1,175.00 for 2 bays  
Ideal for Translator or Booster
- ▶ Lightning Spur Protection System  
Top and Side mount dissipators  
Measured dissipation values  
Low impedance ground interface  
Anode and Cathode grounding systems  
Spur's unit price is \$300.00

READER SERVICE NO. 55

## Hollywood's Newest Star

"...I'll only use a MAX-Z for my remotes. It does the job every time.

*It sounds great, sets-up in seconds, and is so simple to operate even a Hollywood Reporter can figure it out!"*

James St. James' Hollywood is on nearly 200 North American Markets daily

Zercom CORPORATION  
800-950-4260

**James St. James**



READER SERVICE NO. 209



## Econco REBUILT POWER TUBES



Approximately One Half  
the Cost of New

3,000 Hour Unconditional Guarantee

Call for Our Price List

Econco 1318 Commerce Ave. Woodland, CA 95695  
Phone: 916-662-7553 Fax: 916-666-7760 Telex: 176756  
Toll Free: 800-532-6626 From Canada: 800-848-8841

READER SERVICE NO 20

# Products & Services Showcase

For more information on the products shown below, circle the appropriate Reader Service No.(s) on the enclosed Subscription/Reader Service card or contact the advertiser directly.

## Why Drive When You Can Call?

Reduce your driving time.  
Have complete control over a remote site.  
Use a Monroe 6002 Remote Control with:

- telephone or RF/link
- momentary or latching action
- 6 or 12 1 Amp contact closure
- audio response to remote commands
- selectable security code

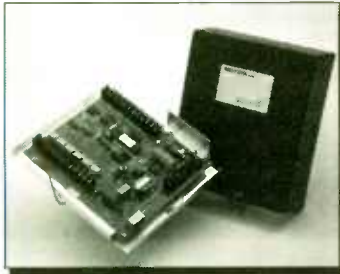

For over 15 years Monroe Electronics has supplied the broadcast industry with reliable and affordable DTMF remote control systems.

**ME MONROE ELECTRONICS**  
LYNDONVILLE, NY 14098

800-821-6001  
716-765-2254  
Fax 716-765-9330

READER SERVICE NO. 123

**PTTEK**  
Your RF Power Amplifier Source

## Compact FM Broadcast Power Amplifiers 150W 300W & 500W

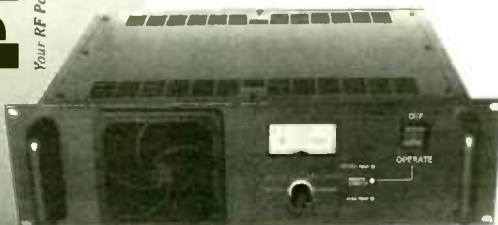

Power Outputs  
FM150.....50-175W  
FM300.....150-350W  
FM500.....250-500W

Drive  
10W will drive all 3 models to full power

1814 Schooldale Dr,  
San Jose, CA 95124

### INTRODUCTORY PRICES

500W.....\$3,330  
300W.....\$2,500  
150W.....\$1,650

CALL 408 448 3342 OR  
FAX 800 416 7934  
For data sheet

READER SERVICE NO. 148

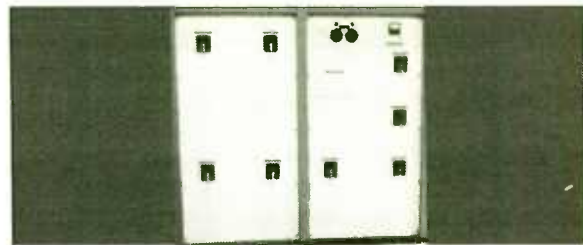

- CUSTOM ANTENNA PHASING SYSTEMS
- ANTENNA CONTROL SYSTEMS
- AM/MF ANTENNA TUNING UNITS
- DIPLEXERS & MULTIPLEXERS
- TRANSMITTER COMBINERS
- DUMMYLOADS (WITH MATCHING NETWORK)
- ASSOCIATED RF COMPONENTS
- CALL OR FAX FOR MORE INFORMATION

## PHASETEK INC.

550 CALIFORNIA RD. UNIT 11  
QUAKERTOWN, PA 18951

SEE US  
AT NAB  
BOOTH #4102

PHONE: 215-536-6648  
FAX: 215-536-7180

READER SERVICE NO. 98

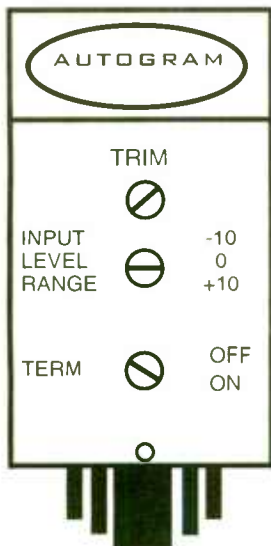

## Are you "stuck" with external amps for your unbalanced cassettes and CD's?

The Autogram IA-1 is a direct replacement for the MT-1 transformers used in all Autogram and Collins IC and AC series consoles.

Transformerless balanced input too!

Only \$65.00 list. Call your dealer or...

**AUTOGRAM CORPORATION**

Plano, Texas (800)327-6901

Other improved modules available also!

READER SERVICE NO. 30

## PLC

Priority Leasing Corporation

800-999-9546 FAX 512-345-8650

## LEASING ADVANTAGES

- 100% Financing
- Fixed payments
- Avoid obsolescence
- Tax advantages
- Conserve Capital
- Up to 5 year terms

READER SERVICE NO. 73

## Excalibur Electronics HC-1 Handi-Coupler



Here is the simplest, quickest, most convenient way to connect audio to a telephone. The HC-1 connects in series with the handset of any phone using modular connectors. No connection to the phone line is needed. Press the front panel button and external audio is available on separate send and receive 1/4" TRS jacks on the rear panel. Release the button and the handset is once more connected for normal use of the phone. Nothing could be simpler!

You can find many uses for the HC-1 around your station: on-air studio, production room, newsroom, sales office, field news kits, sports remotes, etc.

EXCALIBUR ELECTRONICS, INC., CHANTILLY, VIRGINIA  
Please circle our bingo number for a data sheet and a dealer list

READER SERVICE NO. 194

## DIELECTRIC

### FOR ALL YOUR RF NEEDS!

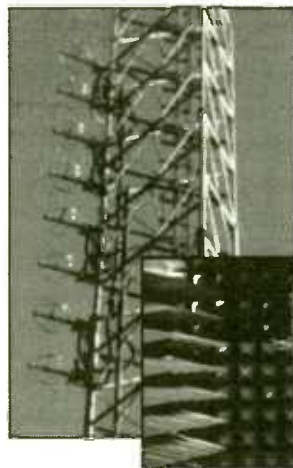

- \*ANTENNAS
- \*SWITCHES
- \*COMBINERS
- \*FILTERS
- \*TRANSMISSION LINE
- \*LOADS

Dielectric's unique anechoic chamber antenna measurement system translates directional pattern requirements into specific solutions for YOUR station.

CALL TODAY!

DIELECTRIC COMMUNICATIONS

P.O. Box 949 Raymond, ME USA  
(207) 655-4555 Fax (207) 655-7120

READER SERVICE NO. 198

## USER REPORT

# Shively Labs Exceeds Expectations

by **Martin D. Hadfield**  
Vice President - Engineering  
Entercom

**SEATTLE** It started with a phone call from Portland, Ore. Larry Holtz, chief engineer at KNRK-FM (then, KMUZ-FM), one of the Entercom stations that serves the Portland area, gave me the bad news: our directional FM antenna was failing. A choice had to be made between repairing the old antenna or replacing it with a new one. Considering the long-term implications, we decided to replace the antenna.

Recognizing that it can take months to

finally replace a directional FM antenna, we selected a vendor known to us for high quality and quick response. We chose **Shively Labs**, located near Portland, Maine. They outdid our expectations and our new antenna was on the air in under a remarkable two weeks.

### We can do it

When we first inquired about turnaround time, Bob Surette, manager of RF engineering at Shively said, "Fax me copy of the (construction permit) pattern that's on file (at the FCC), and I'll let you know in a couple of hours if we can match it or improve it." I faxed him a copy of the original pattern, and then came the news: "We can do it."

Within a day of giving Shively the order, Dennis Butterfield, Shively's mechanical designer, ordered construction to begin on a new two-bay directional FM antenna that met the directional characteristics that were on file with the FCC. Shively keeps pre-manufactured scale models of its antenna line in stock that can simply be tuned to your frequency

for range-testing purposes, so I was able to fly back to observe the tests and fine-tune the order within nine days of our first phone calls.

Range testing not only confirmed that the pattern met the FCC requirements, but further experimentation allowed us to actually improve the pattern envelope over the previous antenna by manipulating the directional elements of this pole-mounted antenna.

Six days after testing and certification, the antenna was fully fabricated and shipped from Portland to Portland. But before we could install it, we needed FCC permission. Surette express-mailed the test results so that Shively's fast manufacturing turnaround would not be undermined by documentation delays.

### Notable improvements

Three days after submission to the FCC, we received permission to proceed. The antenna was installed the day after the FCC's thumbs-up. Supplemental documentation followed. Immediately after the new operation began, both station

personnel and listeners noticed the improvement and let us know about it.

It should be noted here that not only were certain anticipated delays overcome by a fast manufacturing process by Shively Labs, but the FCC approved the request quickly because the replacement antenna matched or met the original pattern requirements and necessary protection to other FM stations. Because workloads at the FCC vary, any planning should allow adequate time for commission response.

Subsequent to this installation project, the station has had snow and icing conditions on this radome enclosed antenna. Our old antenna also had radomes, however it was an internally fed, helical style with several parasitic elements per bay. It had exhibited high VSWR under such conditions, but the new Shively antenna showed almost no change in operating constants. This demonstrates that not only did Shively get us our antenna quickly, but it is a good performer.

I understand that Shively Labs uses "It pays to be heard" as a slogan. I think what they accomplished in our situation shows that they know what those words mean.

For more information from Shively Labs, contact the company in Maine at 207-647-3327; or circle Reader Service 100.

## MW ANTENNA SYSTEMS



50 KW MW TUNING UNIT

Antenna Tuning Units  
Transmitter Combiners  
Folded Unipole Antennas  
Diplexers, <sup>NAB</sup> <sup>7</sup> <sup>25</sup>  
RF Com Booth #1525

Call LBA Technology for RF systems and excellent technical service. Products for MW, FM, Shortwave and TV are designed and built to international standards. LBA antenna systems will improve your efficiency, performance and reliability.

LBA is the world leader in single and multiple station folded unipole antenna systems for high efficiency, wide-band MW transmissions at all power levels. LBA systems are found from Alaska to Argentina, Kuwait to Saipan.

Our capabilities include the design and fabrication of RF equipment, complete system integration with products of other leading suppliers, project management, on-site installation, and commissioning. Consult LBA for fast response to your RF needs.

919-757-0279

919-752-9155 FAX

or Contact Our Representatives  
Worldwide



**LBA TECHNOLOGY, INC.**

P.O. Box 8026 Greenville, NC 27835 USA

30 YEARS OF

WORLDWIDE ENGINEERING  
SERVICES

COMPLETE LINE OF RF  
PRODUCTS

An LBA Group Company

©1993

Circle (25) On Reader Service Card

## USER REPORT

# WCIL Benefits from LBA

by **Joey Helleny**  
Director of Operations  
and Engineering  
WCIL-AM-FM

**CARBONDALE, III.** At WCIL-AM-FM, we decided to investigate the installation of a folded unipole AM antenna for two reasons. First, we were having continuing problems with lightning damage to our solid-state main AM transmitter. Second, we had been approached by a local paging company about leasing space on our tower.

It seemed like a win-win situation and

the timing was right, so we contacted the folks at LBA Technology about their Tunipole line of products.

Our situation was fairly straightforward without any complicating factors, so LBA was able to recommend one of its basic, low-cost designs in the UP-310 model. LBA was able to fabricate and ship the antenna in about six weeks. Try to arrange for the antenna to be delivered directly to your tower site. The boxes are fairly heavy so you should avoid having to lug them from your studio location.

Physical installation of the Tunipole only took about half a day with a two-man tower

crew. All the hardware was well-fabricated and easy to assemble.

The UP-310 installs as three foldwires, one each along the corners of the triangular tower. Brackets at the top and bottom of each wire hold them in place with a spring tensioner at the bottom. Fiberglass standoffs on each side keep the wires from flapping in the wind.

Because we did not have the proper equipment to measure antenna resistance on the day the tower crew was there, we just moved the shorting jumper up and down the tower a couple of times looking for the best SWR to match. We then returned to series-fed transmission at reduced power for a couple of days until our consultant could arrive with an impedance bridge.

Our Harris ATU was easily adjusted to accommodate the new antenna. We only replaced one capacitor and removed the static drain choke. Eventually we plan to double-check the position of our shorting jumper for best bandwidth, but we have no complaints about how the signal sounds so far.

The contours do not seem to have been affected much. Our ground system and antenna were in good shape though, so there were not any real deficiencies for the Tunipole to overcome in those areas.

The best improvement for us has been in protection for our AM transmitter. We went through the entire 1995 storm season without any damage. The previous season we had replaced several RF power transistors. Plus, we now have additional monthly income from the paging company.

The only side effect we have noticed from the change is an occasional occurrence of static snapping on one guy wire. We also plan to install a PVC conduit for the feed wire that runs from our ATU to the unipole. The wire tends to move in the breeze, sometimes causing minor VSWR.

The LBA Tunipole has proven an easy and cost-effective solution for WCIL.

For more information from LBA Technology, contact Jim Bradshaw in North Carolina at 800-522-4464; or circle Reader Service 77.

**dynaudio acoustics®**

At less than  
\$700/pr.  
there are no  
excuses not  
to own  
the best!



BM5

2-way  
nearfield  
monitor

Welcome the next standard in monitors from the world leader in serious monitoring, Dynaudio Acoustics. Introducing the new BM5 2-way nearfield monitors. The BM5 breaks new ground for low cost/high performance reference monitoring. By utilizing new materials, production methods, and driver designs - in short, all new technology - Dynaudio has created a new standard, again. Crafted in Denmark by people so devoted to advancing loudspeaker design, some call it fanatical. Compare the BM5s to other popular nearfield monitors, and you'll be a Dyn fanatic, too! And at under \$700/pr.\*, there's no reason not to use the best anymore!

The BM5 is...remarkably transparent... neither boomy nor thin...a very clear monitor...is easy to live with in daily operations...a clean, refined speaker.  
- Radio World

Available through selected dealers, music stores and pro audio and broadcast specialists. \*based on mfr's suggested retail price of \$699/pr.

**dynaudio acoustics®**  
U.S. Dist.: **AXI** - Audio Exchange International  
T 617 982-2626 • F 617 982-2610

Circle (31) On Reader Service Card

**re·li·a·ble** (ri lī'ə bəl), *adj.*

1. that may be relied on; trustworthy.
2. dependable in achievement, accuracy.
3. the PR&E BMX III.

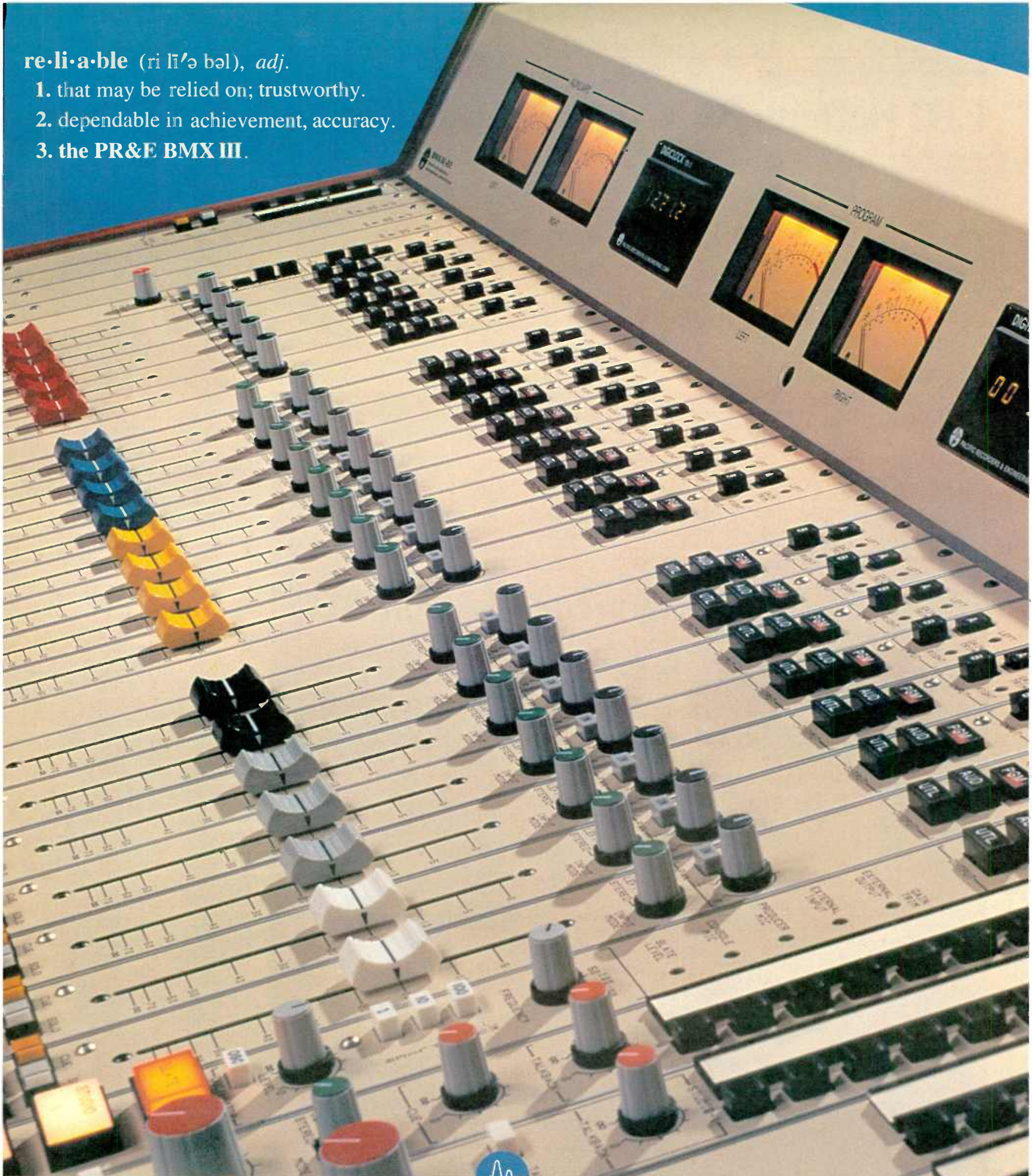

**PACIFIC RECORDERS & ENGINEERING**  
**DESIGNS THAT MAKE THE DIFFERENCE**

2070 Las Palmas Drive, Carlsbad, CA USA 92009      GSA Contract: GS-03F-4064B

Tel: 619-438-3911      Fax: 619-438-9277      E-Mail: [sales@pre.com](mailto:sales@pre.com)

## USER REPORT

# ERI Softens Blow of Hurricane Opal

by Charles Harrell  
Vice President and  
Technical Director  
McClure Broadcasting Group

**COLUMBUS, Ga.** The optimum situation for the use of a directional antenna system for FM is when the station you must protect lies somewhere near 90 degrees away from the direction you want to move. Our case was a very good example. We have a C2 facility that was operating non-directional 25 miles from the main area we wanted to serve. By using a LP-6E-DA-HW-SP directional antenna made by **Electronics Research**

(ERI), we were able to move more than eight miles closer.

I met with ERI in Las Vegas at the NAB and was shown some examples of what its antenna systems could do. Although directional antenna systems are complicated to design, build and install, education is the key to effectively using them. The first thing I noticed about ERI was the willingness of everyone to help with the educational process.

The decision was made to use half-wave spacing instead of the standard full-wave spacing. The directional pattern is much more controllable because

the vertical and horizontal patterns match very closely. Another advantage of this system is a 9 MHz impedance bandwidth. This is important for stereo separation and even more important for subcarrier use. This also minimizes the adverse effects of radial ice or fog.

#### Major factor

Another major factor affecting my decision to purchase from ERI was that it manufactures its own towers, including the now famous "lambda" sections. These are used behind the antenna systems to keep the effects of the tower on the antenna pattern close to zero. ERI

also has its own installation crews.

I inked the deal with ERI and acquired the land for the new transmitter site. Everything was going great. Then came along hurricane Opal. I had a 570-foot tower on the ground, no antenna, no coax, no building, no transmitter and not much hope. Imagine driving through heavy rain and high winds at 4 a.m. and seeing this. When the sun came up, I discovered that the tower had fallen across the building no less than four times on its way down.

I have another FM station in the market, so my thoughts turned to using its backup transmitter if it could be retuned. I would need a backup anten-



Opal's power had devastating effects on radio towers in Columbus, Ga.

na and a piece of coax line. What happened next explains why ERI is such a successful company.

I called ERI and explained my situation. I was asked what frequency the station was on and how long the coax needed to be. After being on hold for about three minutes, I was told an antenna and a piece of coax could be loaded and a crew would be on the way within the hour. Service just does not get any better than that. I was back on the air in 35 hours. That is four hours before the competition made it back on the air with nothing more than a power failure.

#### Great signal

Now that we were back on the air with a great-sounding temporary signal, it was time to pursue the new transmitter site. I called ERI again and found that it had already stepped up delivery of the tower and antenna systems. The anchor crew showed up first. That is all this crew does and they have made an art of it.

In a few days, the tower and antenna arrived. Part of the installation crew met the truck to unload the steel. The rest of the crew arrived the next day. The erection of the tower went smoothly. The antenna system was handled with great care as I realized another advantage of hiring the people who manufacture the antenna to install it.

When the antenna system installation was complete, the tower crew broke out the RF bridge, network analyzer and such to tune the antenna system to perfection. When is the last time you saw a tower crew do this? The antenna system met specs, but the crew felt that they could improve it, so they did that for the next three hours.

We now have a signal and programming that allows us to take most of the advertising revenue that the competition use to get. If I could think of anything critical to say about this company, I would. The fact is that ERI is perhaps the most professional company I have ever dealt with. When a company performs this well, it deserves respect.

For more information from ERI, contact Max Brown in Indiana at 812-925-6000; or circle Reader Service 132.

Your listeners don't use this anymore.



So why are you still using that old transmitter?

Call your dealer today for a fully integrated and state-of-the-art FM transmitter from Crown.

 **CROWN**  
broadcast

1718 W. Mishawaka Road, PO Box 1000, Elkhart, IN 46515-1000  
Phone: 800-294-8050; Fax: 219-294-8222

See us at NAB  
(Booth #2523)



## USER REPORT

# Crawford Couples with Kintronics

by **W.C. Alexander**  
**Director of Engineering**  
**Crawford Broadcasting**  
**Company**

**DALLAS** Back in 1989, Crawford Broadcasting Company purchased an unbuilt construction permit for a 10 kW-D/1 kW-N five-tower DA-2 AM station in Dallas. We would have to build the station from the ground up. All we had was a piece of paper giving us authority to construct, so we had a real challenge ahead.

When the phasing and coupling system design was completed, I sent it to several manufacturers for bid. When I received the proposals back from the manufacturers, I compared them carefully and consulted with several trusted colleagues. Based upon merits, features, reputation and recommendations of others, I chose Kintronic Laboratories to provide the phasing and coupling system for the project.

## Nothing left to chance

As the project moved forward, the equipment arrived from the Kintronic plant in Bluff City, Tenn. by dedicated truck. The first indication I saw of the care with which Kintronics equipment is manufactured was the way it was crated. Nothing was left to chance. As I recall, there was no shipping damage — it looked like our equipment had been rigged for an air-drop.

The phasor, antenna tuning units and control system went together flawlessly. Everything worked right the first time, and the RF components and plumbing were exactly as I had specified them. Tuneup and proof went like clockwork. When all was completed, we had a site that we were — and still are — very proud of.

The next year, the time came to upgrade and rebuild our Southern California AM station's transmitter plant and directional antenna system. A new transmitter, remote control system, phasing and coupling system were planned. This time I did not even solicit proposals from other manufacturers. Kintronic Laboratories got the order.

The equipment arrived on time and we somehow managed to install it while remaining on the air. We did this by shifting non-directional operation from tower to tower while we swapped out the antenna tuning units (ATUs) at the individual towers. The phasor itself was connected at night while the station was off the air.

Like in the Dallas project, tuneup was a snap. The RF components and plumbing were all as I had specified, and there was no problem getting everything to work. We set the operating parameters on the antenna monitor, checked the monitor points and went home.

Last spring, a capacitor failed in an ATU at our duplexed AM site in Portland, Ore. This caused a fire that, fed by a 50 kW

transmitter, destroyed the center tower tuning house, our ATU and the other stations phasor. (This was not a Kintronics phasor/ATU.)

All those involved in the situation — the engineers from both stations, corporate chiefs and consulting engineers — put our heads together to decide which direction to proceed. It was not surprising that there was no argument over who the manufacturer of the replacement equipment would be. We called Kintronics.

## Looks, sounds great

In a short time, Kintronics built a new phasor, ATU and duplex filters for the other station and a new ATU and duplex filters for our station. I recently visited the site. It looks and sounds great.

Last spring, Crawford Broadcasting Company purchased another unbuilt CP, this one for a 50 kW-D/1.4 kW-N four-tower DA-2 in Denver. Again, I did not even solicit bids from other manufacturers. This project was a little different from the others that I had done in that I used moment-method techniques to design the phasing and coupling system. As the project progressed, I found that Kintronics also has the capability of utilizing the same moment-method nodal analysis circuit design techniques.

After the towers were built, measured data was used to refine the design of the system. All the ATU and phasor networks

were preset at the factory to the values predicted by the nodal analysis routine. The result was that when the system was fired up, the parameters were quite close to the desired values. We saved days of tuning time by using nodal analysis techniques.

As with the other projects, the Denver project turned out great. Final tuneup was a snap. All the phasing and coupling equipment is well-constructed, looks and works great. The site is a real showplace. Our chief engineer there plans to invite the local SBE chapter out this spring to hold its meeting there. He is as proud of the site as I am.

When the next AM project comes along,

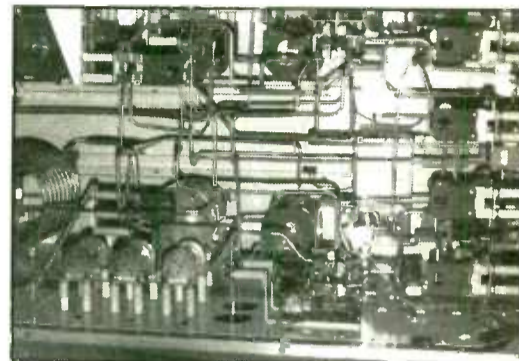

The interior of the Kintronics phasor

there is no question that I will call on Kintronic Laboratories to manufacture the phasing and coupling equipment. I can do so with the assurance that the equipment I receive will be built exactly to my specifications with care and quality.

For more information from Kintronic Laboratories, contact the company in Tennessee at 423-878-3141; or circle Reader Service 153.

## AEQ Digital Hybrids show the way to be followed

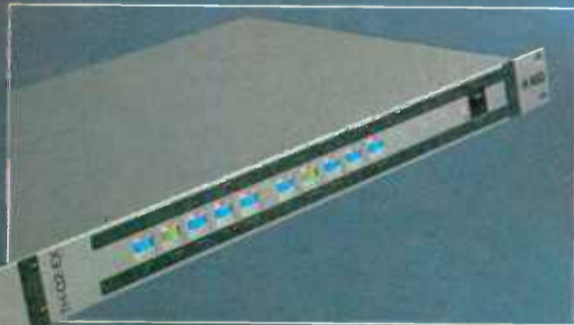

### Digital Hybrid TH-02EX Mk-II

- ▶ Frequency Extensor included as standard.
- ▶ Works with one or two telephone lines.
- ▶ Second line provides true multiconference. Simultaneous speech between operator and two listeners.
- ▶ 60 dBs hybrid null.
- ▶ No previous re-alignment required.
- ▶ Ideal companion for remote connections with the Portable Mixer-Extensor TLE-02.



### Frequency Extensor TLE-02

- ▶ On Air phone call with audio presence, depth and clarity of voice. No "telephone sound".
- ▶ Designed for non-technical users. Ideal for field reporters.
- ▶ Light weight (3.3. Lb) and great autonomy, using 8 AA batteries.
- ▶ Dialing pad in front panel (pulse/tone selectable).
- ▶ Independent level control of Mic/Line input, auxiliary input and headphones.



### Portable Mixer PME-02

- ▶ Three independent Mic/Line switchable inputs (XLR connector) electronically balanced and one unbalanced input (mini-jack) for line level portable stereo tape recorder.
- ▶ Independent input level control.
- ▶ Electronically balanced output (XLR connector) and follow up output (mini-jack).
- ▶ Connectable to other PME-02 or to the TLE-02 (optional accessory for mechanical coupling).
- ▶ Great autonomy, using 8 AA batteries, external transformer or car battery adaptor (12 V).
- ▶ Low level battery indicator.



AEQ AMERICA: 2211 South 48th Street, Suite H - Tempe, AZ USA 85282

Phone: (1 602) 431 0334 - Fax: (1 602) 431 0497

## USER REPORT

# Antenna Concepts Is Eager to Please

*KKJT(FM) Looked to Antenna Concepts to Provide a High-quality Antenna that Was Reasonably Priced*

by **Greg S. Carpenter**  
**Owner/Operations Director**  
**KKJT(FM)**

**JOSHUA TREE, Calif.** April, 1994 found my partner Gene Headley and me at the NAB Convention looking for equipment to use with our construction permit to build a new 6 kW FM station serving Joshua Tree, Calif., a small community about 30 miles north of Palm Springs.

We were talking to all the antenna manufacturers present, as I was looking for someone who was nearby, willing to make any modifications that I might need without hassle and could supply a high quality product at reasonable price. We found **Antenna Concepts** in Placerville, Calif., could do just that.

#### Cost considerations

We needed a four-bay antenna and decided to purchase the FM Tracker

ACT4L. This is a four-bay, circular polarization, cable-fed antenna capable of 6 kW ERP. This antenna is available in either line-fed or cable-fed versions. We chose the cable-fed model simply for cost considerations, however, I think it is better to spend a little extra on the line-fed model.

Later that year when I contacted the company, I spoke to Jeryl Schooler who is acquainted with the product and intensely helpful when it came time to pick up the completed antenna. Throughout the project, Mark Cunningham, the owner of Antenna Concepts, kept in touch with me as we

made changes to our plans.

We found out that we were not going to be able to use an existing tower at the site and decided to install a 70-foot telephone pole as the antenna support. Mr. Cunningham designed a method of supporting the antenna even though about six feet of antenna structure extended above the pole.

In January, the antenna was ready to be shipped. Gene and I decided to take a little time off and drive up to Placerville to pick it up. I told Jeryl Schooler that we would be arriving in our pick-up truck and she made sure that everything was packed to fit. After a few nervous moments, the Antenna Concepts crew had the antenna loaded and we drove south to Joshua Tree with a very heavy truck.

When the time came to install the antenna on the pole, I contacted John Hignite, owner of Hignite Construction, a rigging company in Bellflower, Calif., John and a partner arrived early one morning and we began to install the antenna. I had previously checked all the

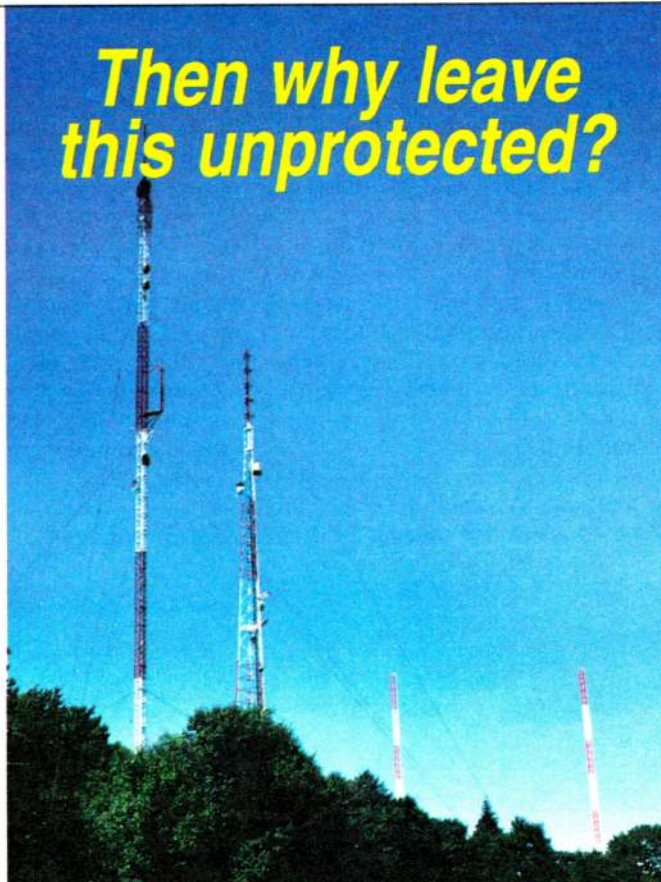
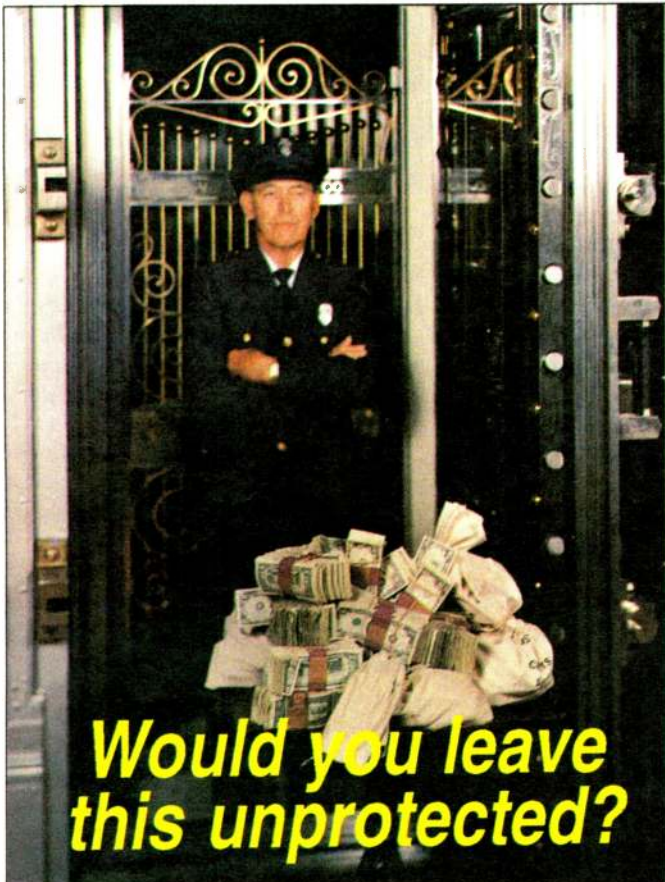

**Overall, I found Antenna Concepts makes a good product at a fair price.**

parts against the parts list provided with the antenna, but was still worried that something would be missing or would not fit or something would prevent us from finishing the job. However, everything went fine and by the end of the day we had the antenna up on the pole and ready to test.

**WHR Series STABILINE® Voltage Regulators**  
 for radio and television broadcasting installations.

**Superior power conditioning to safeguard your business investment.**

All delicate electronic devices, including your station transmitters, are designed to perform within a certain voltage range.

More often than not, however, the voltage that reaches your critical operating equipment is highly inconsistent or "dirty" because of power line disturbances like sags, surges, spikes and brownouts. And dirty power can wreak havoc with your broadcast system, mobile production vehicles or remote transmitter sites causing equipment malfunction, hardware/software damage or reduced power tube life.

#### Don't become a victim of polluted power lines!

Cost-effective WHR Series STABILINE® Voltage Regulators prevent power quality problems from attacking your vulnerable electronics. The preferred choice of broadcasters worldwide for use with transmitters, receiving stations, studios and mobile production units, these high power regulators automatically feed voltage sensitive equipment a constant voltage level – even when the power line input voltage and system load vary widely. STABILINE® – the preferred choice of broadcasters worldwide.



3-phase, 500 kVA model.

#### The industry's most extensive list of standard options and features:

- Output voltage maintained to  $\pm 1\%$
- Power ratings from 2 to 1680 kVA
- 99% typical efficiency
- High overload capacity
- No waveform distortion
- Maintenance bypass switch
- High energy transient suppression
- Zig-zag neutral generation
- Input voltage range alarm contacts
- Frequency trip meter and ammeters
- Analog or digital control
- Single or individual phase control
- Single or three-phase models
- 19-inch rack mount versions
- All voltages up to 660 V
- Tropicalization treatment

For catalog or more information, call, write or fax Ted Gladis.

**SUPERIOR ELECTRIC**  
 WARNER ELECTRIC

383 Middle Street  
 Bristol, CT 06010 USA  
 Telephone: 860-585-4500  
 Fax: 860-582-3784

1-800-787-3532 in USA & Canada



# Harris DIGIT<sup>®</sup> Digital Exciter

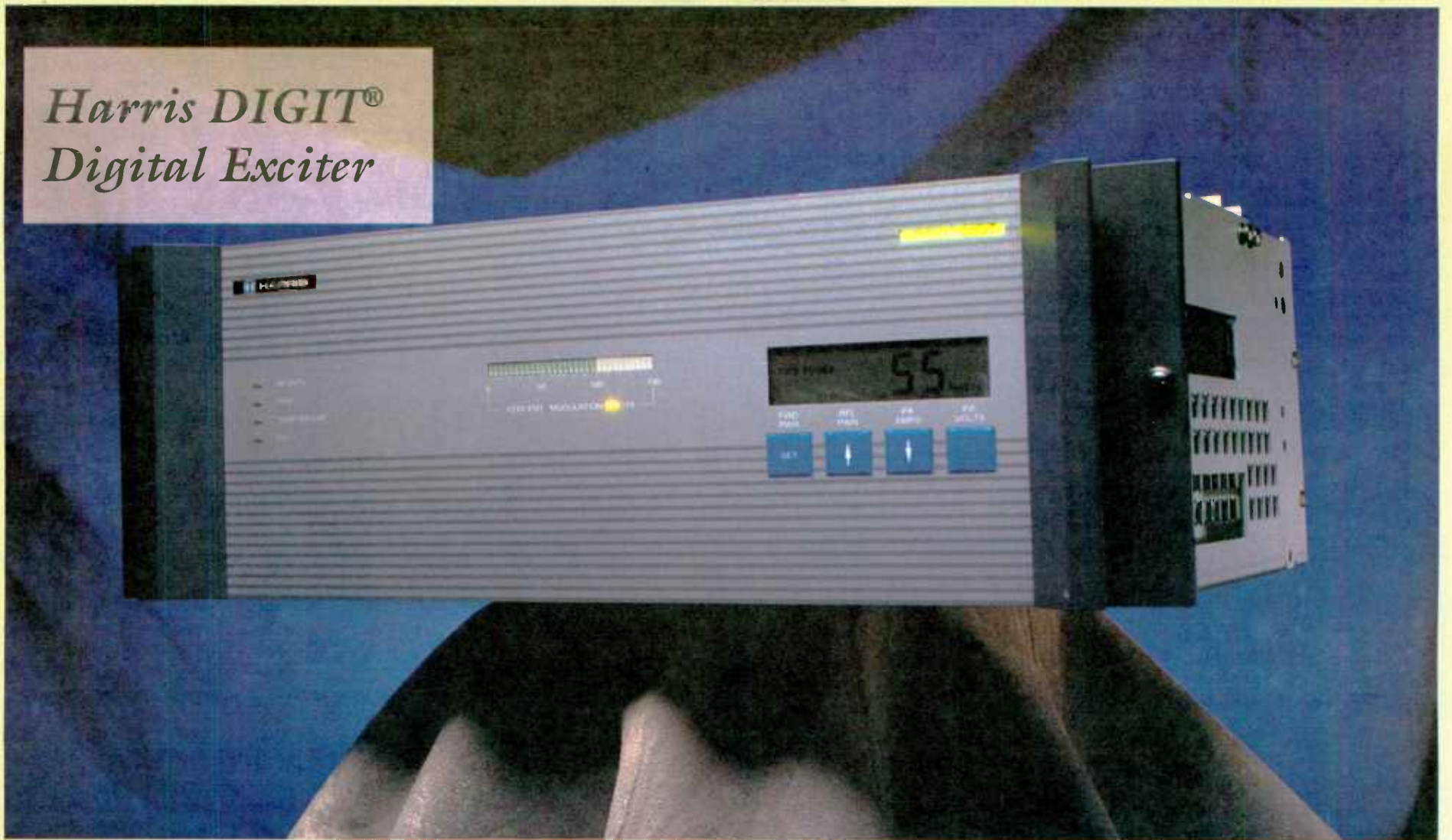

## World Standard Digital FM Exciter

**W**hen we introduced the DIGIT<sup>™</sup> we knew it was going to be a world class FM exciter. In a little over a year the DIGIT<sup>™</sup> has proven to be the world standard with over 500 DIGIT exciters shipped.

The DIGIT<sup>™</sup> FM exciter can convert studio standard digital audio (AES/EBU) directly to FM stereo with no analog steps. Additionally, an analog input module is available to accept analog composite stereo for those who have not yet upgraded to digital.

Direct Digital Synthesis is accomplished with a numerically controlled oscillator. This digital implementation of FM assures you of the highest quality sound that your station is capable of producing.

Included with the DIGIT<sup>™</sup>'s digital input module is a DSP based digital stereo generator which provides lower distortion and

greater separation than any competing exciter. Also, included is a digital composite limiter (DCL) which is an implementation of the WAVES L1 Ultramaximizer<sup>™</sup>, used by digital recording studios. Harris exclusive DCL allows DIGIT<sup>™</sup> to sound louder than competing FM exciters without over-modulation. The DCL uses "look ahead" circuitry to predict and correct overmodulation peaks before they can occur.

The DIGIT<sup>™</sup> FM exciter is capable of N+1 operation and is completely frequency agile with modulation level and linearity independent of carrier frequency.

Besides the DIGIT<sup>™</sup>, Harris has a wide range of "Clearly Digital<sup>™</sup>" products for all your broadcast needs whether AM, FM, or TV. For more information, contact Harris.

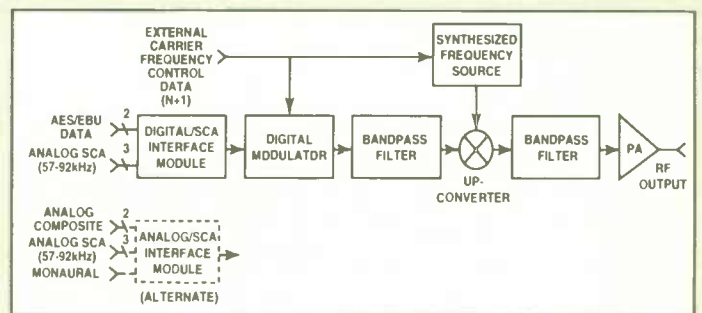

**Harris DIGIT<sup>™</sup> Signal Blocks shows that although DIGIT<sup>™</sup> is revolutionary, its technology is easy to understand.**

### Harris Corporation Broadcast Division

U.S. and Canada:  
TEL: 217-222-8200  
FAX: 217-224-1439

Elsewhere:  
TEL: 217-222-8290  
FAX: 217-224-2764

<http://www.broadcast.harris.com>



©1996 HARRIS CORP.

See Us at NAB Booth 3517 & 5809

### FEATURES:

- Proven Reliability backed by a 3 Year Warranty
- Digital FM Generation for 16 Bit Sound Quality
- Drift Free Digital Circuits
- Immunity to Subsonic Transients
- Compatible with all RDS/SCA requirements
- Full N+1 capability
- Manufactured under ISO 9001 Quality System



# Enhance Your Web Site

► continued from page 55

Philips BOX15U/01E. And so on.

Gerard is apparently connected in some way with the Department of Computer Science at the Utrecht University in the Netherlands; he's done a heckuva job with this neat-o site. So neat-o, in fact, that it's my Neat-O Site of the Month. Well done and bravo, Gerard!

Time to dip into the Haberspace Cyber-Mail Bag. Let's see what the postal folks have brought our way, shall we?

Over at "DJ Domicile, The Hub of the Internet Radio World," which James Cholke, who e-mailed the global Haberspace headquarters, hopes will eventually become "a great place for

radio stations and DJs like myself to share ideas, news, audio, etc." there's a lot happening. Don't worry about a thing, James. The site looks pretty good already.

What's here? Lots of links to stations, links to the RealAudio and Xing sites, and plenty of room for expansion. Check it out at <http://www.webcom.com/jada/prod/dj.html>

From time to time, I've mentioned sites that offer links to regional broadcasters. Scott Roberts, a broadcast technician at Butte College in Northern California, did the e-mail thing to let me know about his site. Here you'll find, among other stuff, a list of broadcaster links in the Chico

area of California.

Nice job, Scott. By the way, Scott bears a rather striking resemblance to the main guy at Microsoft (check out the side-by-side pictorial comparison and be amazed, be truly amazed). URL away at <http://www.cin.butte.cc.ca.us/~scott/>.

I heard from Richard Kenadek, chief engineer at two AMers in the great state of Massachusetts — WSRO in Marlboro and WGAW in Gardner. The stations carry a LOT of sports, said Richard, "especially local high school sports."

The stations' site offers schedules for NCAA basketball and Boston Red Sox baseball games carried on WSRO (the Sox are also carried on WGAW), a coverage map for both stations and handy-dandy links to the very latest stats on the current populations of the United States and the World (handy, I'm thinking,

especially if you're looking for people to invite to your birthday party, or you just want to know the potential audiences for your station's live Web broadcasts — hint, hint).

## Vegas prep

As I write this, I'm about five weeks away from placing my cyber-bags in the peculiarly spacious (and nicely carpeted, I might add) trunk of my hovercraft, ever-so-aptly dubbed the HaberHover. I'll be reporting on the generous cyber-related goings-on at NAB '96 in future *Haberspace* articles.

One nice thing about traveling in the HaberHover is I can make a beeline for somewhere else if I'm double-parked and a guy in blue bearing a ticket with my name on it should be heading my way!

Anyhoo, keep the e-mail comin'. I love to hear from you folks at [zoogang@ix.netcom.com](mailto:zoogang@ix.netcom.com). I've gotta go and park myself back in front of my PC. Y'all come back next month, y'heah?

# Leave The Rest Behind

## Travel light to your next remote.

The Codec Buddy is a high-quality remote mixer that will work with any delivery system from POTS to RPU to ISDN. The Buddy handles program mix, headphone feeds, communications, codec return, and PA feed...with a built-in one-line frequency extender as a bonus.

All of this in a rugged 8 lb. package for only \$1900!

**COMREX**  
We make great connections

COMREX Corporation, 65 Nonset Path, Acton, MA 01720 USA Tel: 508-263-1800 Fax: 508-635-0401  
Email: [info@comrex.com](mailto:info@comrex.com) Fax-on-Demand: 508-264-9973 Toll-free: 800-237-1776 in N.A. or 0-800-96-2093 in the U.K.

Circle (27) On Reader Service Card

## 64 Years Ago

Reprinted from Radio World  
April 16, 1932.

Editor's note: The RW of old, printed for a time in the 1920s and 1930s and today's RW are unrelated except in name.

## BRITISH TRY DUAL SYSTEM

Washington.

A British company has worked out a type of wire radio system by which radio programs can be received with loudspeakers over a line from a central radio receiver of high power, according to a report from Trade Commissioner Floyd E. Sullivan, London, to the Department of Commerce. The company engaging in this business is Standard Radio Relay Service.

Selective radio receivers with high power amplifiers are located at central points in each district and the programs are picked up and sent out over wire lines which are tapped at intervals to serve subscribers. Dealers as well as individuals are taking advantage of the service.

The subscribers are required to purchase the usual post office license, which is compulsory in England, and a charge of 1 shilling six pence per week is made for the service. Loudspeaker may be either purchaser outright or rented.

Freedom from interference and the annoyance of maintenance are the inducements held out to prospective subscribers. Only programs of English origin are picked up and sent out over the system, and those who prefer to listen to distant stations in Europe and elsewhere cannot take advantage of the service.

## J. L. Baird Is Nearly Ready with New Set

London.

A new type of television receiver will soon be placed on the market by the Baird Television, Ltd., according to reports.

This new receiver is said to operate on the mirror drum principle and to be capable of throwing a large picture on a screen. The device is still in the experimental stage. It has been in the laboratory stage for some time, for when Mr. John L. Baird, the inventor, was in New York last Fall he told newspaper representatives that he was then working on such a system. It is also recalled that he did not consider it necessary to have a wide frequency band necessitating going into the higher frequencies to get quality pictures. It is not known at this time whether the new system will utilize broadcast frequencies or higher frequencies.

Call us for details  
**800-237-1776**  
<http://www.comrex.com>

# TECHNOLOGY UPDATES

## CORTANA CORP.

### Lightning Strike Protection System

**FARMINGTON, N.M.** A Thailand consultant reported that stations with the

Stati-Cat system from Cortana Corporation received no lightning damage during monsoon season. This was in an area described as having "heavy and frequent strikes."

How does the Stati-Cat system prevent a strike? During a storm, a high DC volt-

age charge develops between the bottom of the storm cloud and the earth. Research shows that the region of greatest negative charge determines the lightning path. The many sharp points provided by the Stati-Cat function as resistors by ionizing the air around each sharp point, thereby providing an electric current path between the tower and the cloud. By reducing the negative charges in the cloud above the tower with a small continuous current, the potential for a sudden, massive discharge is greatly reduced.

In manufacturing the Stati-Cat line,

Cortana has chosen to use materials approved for corrosive atmospheres — 6061-T6 aluminum and stainless steel 304. Stati-Cat system's sharpened points are constructed of 1/8-inch stainless steel rods which have proven their ruggedness in the most severe climates.

The cost of a Stati-Cat is usually recovered during the first lightning season and a design and quote are available without obligation.

For more information from Cortana Corporation, contact the company in New Mexico at 505-325-5336; fax: 505-326-2337; or circle Reader Service 161.

## Antennaco

### Heavyduty Yagi Antennas

**MILFORD, N.H.** Antennaco is now delivering extremely rugged RPU antennas that can survive the challenges of multiple field deployments. Antennaco's full line of Heavy Duty Yagi antennas were designed to make the installation process quick and painless and the transportability of the antennas a non-issue.

The antennas have a broad bandwidth (typically 5 - 10 percent of Fc) and are individually factory-tuned, obviating the need for field tuning with each use. Gamma match feeds have been eliminated with the use of a fully-balanced, center-fed driven element. Additionally, the fed element is epoxy sealed, eliminating any incursion of moisture and the degradation of signal associated with exposed feeds.

Mechanically, the Heavy Duty antennas are ruggedly constructed using thick-walled square aluminum tube

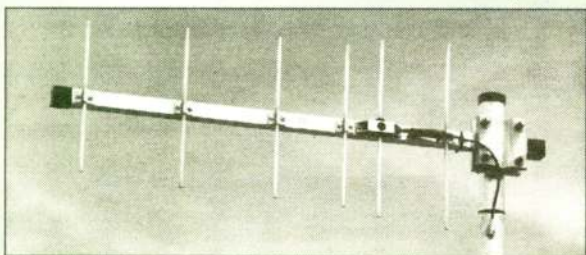

as the core of the boom structure. The individual elements are each solid aluminum rods that can be rapidly broken down and reassembled if required. Stainless steel hardware is used throughout. These antennas should easily survive repeated installations, cross-country tours in the back of the truck or a permanent home in some remote location.

The antennas are available in various configurations from VHF through 1000 MHz.

For more information from Antennaco, contact Dennis McGivern in New Hampshire at 603-673-3153; or circle Reader Service 186.

## SSAC INC.

### Solid-state Beacon Flasher

**BALDWINVILLE, N.Y.** The FA155-2 from SSAC Inc. is a totally solid-state beacon flasher auxiliary module. The module provides a method of synchronously flashing additional beacons on structures such as radio, TV, cellular telephone and mobile radio towers among others.

The FA155-2 is designed for long life in a rugged outdoor environment. The module is enclosed in a small molded plastic package to protect against shock, vibration and humidity. The package includes a molded in-heat transfer plate to facilitate heat transfer to the mounting panel.

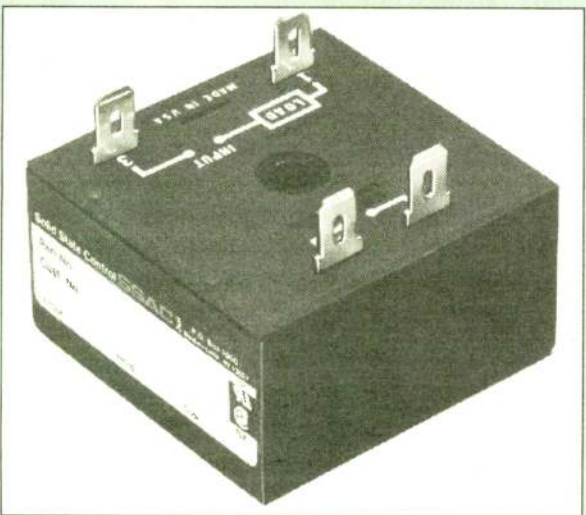

A Quick Mount packaging approach simplifies installation by only requiring one screw while screw terminals are replaced by quarter-inch male quick connect terminals.

Also included in the FA155-2 is a 2500 W rated triac output device capable of handling high inrush currents drawn by incandescent beacon lamps. Electronic zero voltage switching circuitry triggers the output device on each half-cycle of the AC voltage to reduce the stress on the filament, thereby increasing the lamp life by 10 times. Zero voltage switching also eliminates RF interference energy emitted from mechanical type flashers.

The FA155-2 is designed to meet or exceed FAA or FCC requirements for fail safe design. If the unit fails, the lamps remain on continuously.

For more information from SSAC, contact the company in New York at 800-377-SSAC (7722); or circle Reader Service 178.

## Put Some Sizzle In Your Spanish!

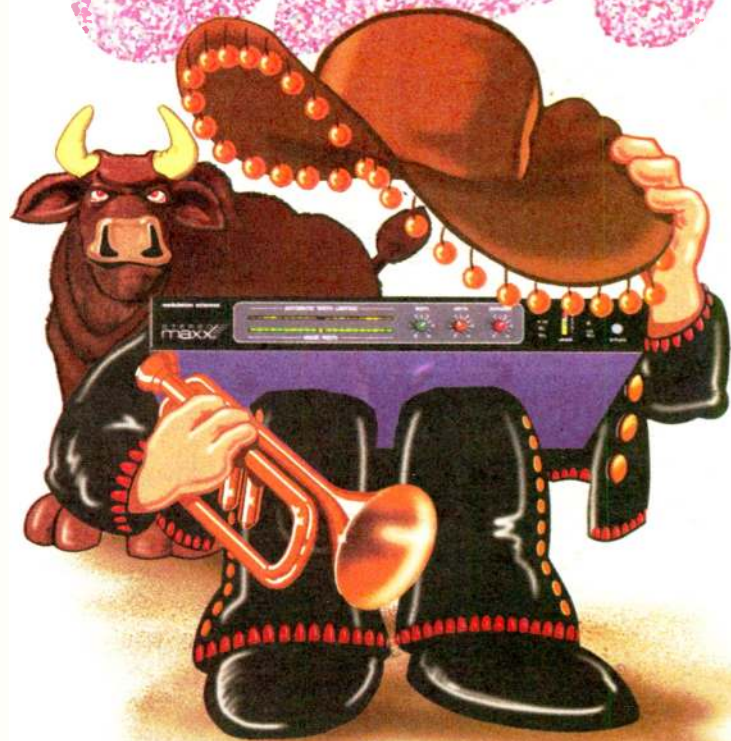

The sweetest sounds in today's Spanish music, soft ballads to hot dance, spell success for your station. Now make your signature sound - and your ratings - soar with StereoMaxx from MSI.

StereoMaxx sets you apart from your competition by making your stereo sound fuller, bolder. It'll make the other stations sound flimsy - "mono" not *macho*.

With StereoMaxx, your listeners will swear you've improved the audio gear. The engineer won't mind the easy set up. The PD will be all smiles. And the GM won't complain about the cost. StereoMaxx is "simpatico"; it won't give you the headaches you get with other processors. Mariachi, Tejano or whatever comes next, your music—and listeners—rate the best.

Call MSI, the stereo authority at (800) 826-2603 and fire up your sound.

**ms modulation sciences inc.**

12A World's Fair Drive Somerset, New Jersey 08873  
Voice (908) 302-3090 • Fax (908) 302-0206

# MARKETPLACE

Recently Introduced Products for the Radio Broadcast Professional

## ISDN Audio Codec

Comrex has introduced the Nexus to its family of ISDN Audio Codecs. A built-in terminal adapter and NT1 make the unit easy to set up and use for remote applications. The Nexus can send 15 kHz bidirectional audio on BRI ISDN and is also compatible with all standard G.722 codecs. Setup is accomplished with an LCD and memory dialing is featured on the Nexus for frequent connections. The input is switchable between microphone and line levels and the output is a vari-



able mix of local program and codec return. Nexus also provides ancillary data capability for linking a laptop with the station. The small, rugged unit weighs less than three pounds and can easily fit into a briefcase.

For more information from Comrex, contact the company in Massachusetts at 508-263-1800; fax-on-demand: 508-264-9973; e-mail: [info@comrex.com](mailto:info@comrex.com); or circle Reader Service 181.

Information from Comrex is also available via the World Wide Web at <http://www.comrex.com>

## Telecommunications Products Catalog

Trompeter Electronics is introducing its new 40-page "Telecommunications Products Catalog." The catalog serves as a complete product selection guide

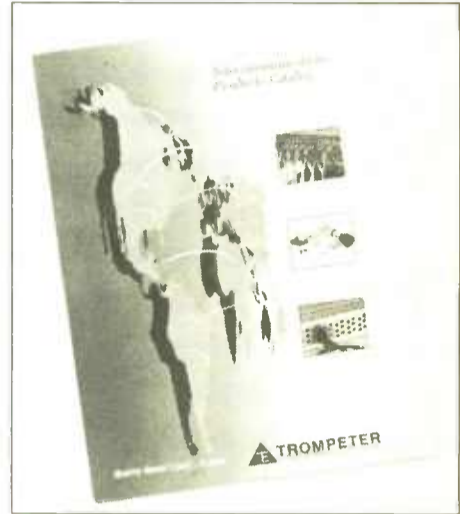

for Trompeter's telecom, broadcast and broadband products. Included are coax connectors, assemblies, patch cords, tools and DSX products.

For more information from Trompeter, contact the company in California at 818-707-2020; fax: 818-706-1040; or circle Reader Service 202.

## WHY SETTLE FOR A FEW TOOLS WHEN YOU CAN HAVE THEM ALL?

Most digital audio systems provide the basic tools to accomplish specific functions, but only DAD486x gives you all of the tools you'll ever need to perform virtually any task imaginable: On-Air, Production, Library Management, Interface with Scheduling & Billing - and for any format; Live Assist or Automated - small or major market. It offers the ultimate in flexibility without stifling creativity.

Any digital audio system is expected to provide immediate operating efficiencies and improve the bottom line. But systems are often selected without giving proper credit to the role as a platform for future capabilities and expansion.

Can the system adapt when you decide to change formats or automate overnights via satellite... or accept and delay more external feeds? What if you do your own in-house automation? Can it handle an LMA or duopoly, integrate a new station, maybe even simulcast with the present one? How flexible will it be for the new PD, or that hot morning jock... both of whom will likely have strong opinions on how to best utilize the system? Most digital audio products just don't adapt very easily, and you will most certainly be faced with additional software and/or hardware expenses for any changes... not with DAD.

DAD486x is the ultimate Master Toolchest for broadcast professionals. Your staff may not use all of the tools at first, but as proficiency is achieved, they'll come to apply them in more and better ways to improve your entire product. DAD doesn't dictate an operational structure.

For any given task there are multiple tools and solutions. It runs on standard, non-proprietary computer hardware, easily interfaces with other professional equipment and systems, and can implement various levels of redundancy and fault tolerance. Featuring a completely open architecture, it maximizes future adaptability, is easily maintained, and can readily be configured as anything from a stand-alone workstation to any number of networked workstations, each optimized for specific tasks.

Best of all, DAD486x costs about the same as systems with far less features.

Software upgrades and improvements are free for the first year, plus there are no hidden monthly fees. Call ENCO and

find out why so many stations and groups throughout the world have standardized on DAD486x, the Ultimate Broadcast Audio Toolchest!



**ENCO**  
SYSTEMS, INC.

## Technology Update

### Flash Technology Offers Paint Alternative

**BRENTWOOD, Tenn.** A popular misconception is that only painting a tower and using red incandescent light will fulfill the FAA requirements for marking an aviation obstruction. The truth is that if a strobe lighting system is used, painting a tower is not necessary.

Since the late 1960s, strobe lighting systems have been a FAA-approved method for marking aviation obstructions such as towers. Until recently, if a tower proponent filing with the FAA did not specifically indicate the intent to use a strobe lighting system, the FAA automatically assigned that the tower be marked with red lights and alternating bands of aviation orange and white paint.

The cost savings of using a strobe lighting system varies slightly by the tower height, utility rate and frequency of painting. However, a typical savings of over 60 percent is accomplished after five years following the purchase and installation of a strobe lighting system.

Incidentally, even the FAA has recently started converting its existing red light and painted towers to strobe lighting systems.

For more information from Flash Technology, contact either Ron Brown or Sean Clare in Tennessee at 615-377-0600; or circle Reader Service 177.

24403 Halsted Road, Farmington Hills, MI 48335 USA • Tel: 800-ENCOSYS (800-362-6797); 810-476-5711; Fax: 810-476-5712

# THE ONLY TALK SHOW DELAY THAT CAN MAKE THESE STATEMENTS.

Bad words, **#@\$^&\*%!** like bad news, often come in threes. The new Eventide BD500 is the only obscenity delay in the world that can eliminate them. Now, when you hit the Dump button, you don't lose the whole delay and the obscenity **%#^!@\*\$!** protection that goes with it. You can divide the total available delay time into not one, or even two, but several discrete segments. You still have protection even after dumping two consecutive **&\*%\$#@#!** no-no's.

You also get the cleanest, quickest delay catch-up you can buy. Because there's only one way to maximize audio quality and still catch-up rapidly after a delay dump... and Eventide owns the patent. Over the years, several other brands of delay have come and gone. But the simple fact is that the catch-up methods others use must be painfully S-L-O-W to avoid serious audio problems.

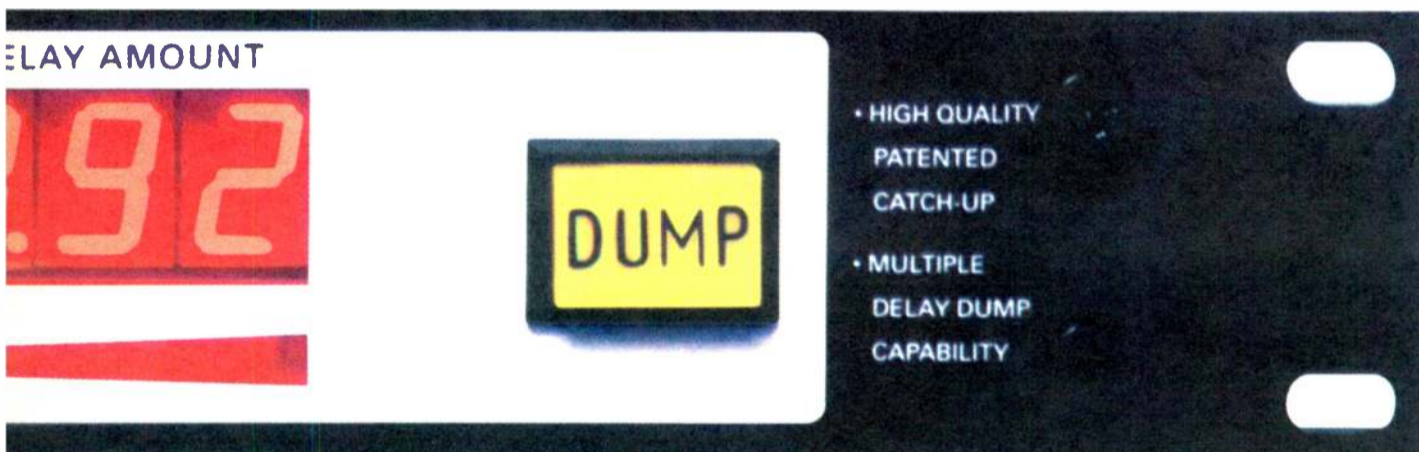

And, because you may not be using that analog console forever, the BD500 is also the only broadcast delay that's digital-

ready with optional AES/EBU digital audio inputs and outputs. It's stereo, of course. A convenient new "sneeze" button allows the talent to sneeze, cough, etc. without being heard on air, and without dead air. All front panel switches (except configure) and all status indicators can be remoted (both RS-232 and dry contacts are provided.) Plus, only the BD500 gives talent both a digital readout of delay time and a "quick read" LED bar graph that shows "you're safe" at a glance.

For all these features and quality, you'd expect top-of-the-line pricing. But surprise! The BD500 costs thousands less. It's the best value ever in a broadcast talk show delay. Exactly what you'd expect from the people who invented digital broadcast delays in the first place. Call your distributor, Eventide direct, or check it out on the Web at <http://www.eventide.com>

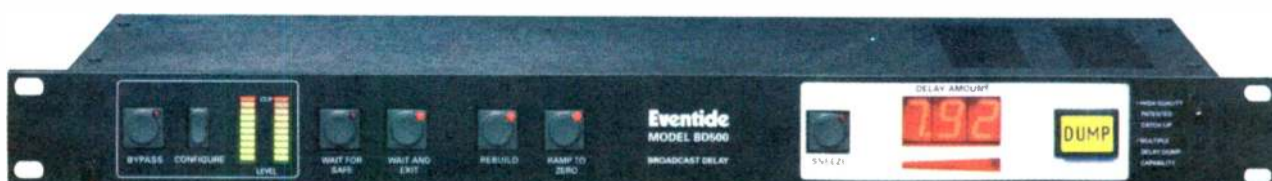

**BD500**  
**Eventide**  
the next step

Eventide Inc. 1 Alsan Way, Little Ferry, NJ 07643 • Tel (201) 641-1200 • Fax (201) 641-1640 • <http://www.eventide.com>

Circle (79) On Reader Service Card

World Radio History

# CABLE REFERENCE GUIDE

The following is a list of companies that produce transmission line, cables, line connectors, RF line filters and cable management devices. It is not an exhaustive list, and other companies listed elsewhere in Buyers Guide may also manufacture cable products.

## Company

Andrew Corp., Orland Park, IL  
contact: Robert Leonard  
phone: 708-873-2859 fax: 708-349-5915

Belden Wire & Cable, Richmond, IN  
contact: Kip Coates  
phone: 317-983-5200 fax: 317-983-5257

Cablewave Systems, North Haven, CT  
contact: Mary Ann Dixon  
phone: 203-239-3311 fax: 203-234-7718

Canare Cable Inc., San Fernando, CA  
contact: Barry Brenner  
phone: 818-365-2246 fax: 818-365-0479

Clark Wire & Cable, Mundelein, IL  
contact: Carlyn Buchanan  
phone: 800-222-5348 fax: 847-949-9595

TL	CB	CN	FL	WM
✓	✓	✓		
	✓			
✓				
	✓	✓		
	✓	✓		

## Company

Cole Wire & Cable, Lincolnwood, IL  
contact: Lee Abramson  
phone: 800-323-1403 fax: 708-673-2243

Communications and Energy Corp.  
East Syracuse, NY  
contact: Steve Shafer  
phone: 800-882-1587 fax: 315-452-0732

Gepco International Inc., Chicago, IL  
contact: Larry Smith  
phone: 312-733-9555 fax: 312-733-6416

Lemo USA Inc., Santa Rosa, CA  
phone: 800-444-5366 fax: 707-578-0869

Microwave Filter Co., East Syracuse, NY  
contact: Terry Owens  
phone: 800-448-1666 fax: 315-463-1467

Myat Inc., Norwood, NJ  
contact: Philip Cindrich  
phone: 201-767-5380 fax: 201-767-4147

Nemal Electronics International  
North Miami, FL  
contact: Benjamin Nemser  
phone: 305-899-0900 fax: 305-895-8178

Panduit Corp., Tinley Park, IL  
phone: 800-777-3300 fax: 708-532-1811

RF Industries Ltd., San Diego, CA  
contact: Les Perlman  
phone: 800-233-1728 fax: 619-549-6345

Rip-Tie, San Francisco, CA  
contact: Michael Paul Fennell  
phone: 415-543-0170 fax: 415-777-9868

Times Microwave Systems, Wallingford, CT  
contact: Robert Perelman  
phone: 800-TMSCOAX (867-2629)  
fax: 203-949-8423

Trompeter Electronics, Westlake Village, CA  
contact: Cameron Selogie  
phone: 800-217-2020 fax: 818-706-1040

TL	CB	CN	FL	WM
✓	✓			
			✓	
	✓			
		✓		
		✓		
✓		✓		
✓	✓	✓		
		✓		
		✓		✓
		✓		✓
	✓	✓		
	✓			

## This Year, We're Way Ahead of the Competition



**NAB 1996—The Big One.**

**Hold onto your LMA. . .**

**Fasten your seatbelt. . .**

**The only industry supplier resourceful enough to equip and staff two booths at NAB is Harris Corp. Broadcast Division. We will feature the most extensive line of Clearly Digital™ products to be found under the Las Vegas sun!**

**See us in TV Hall #5809 (Out in front, of course)**

**See us in Radio Hall #3517**

**TEL: 800-622-0022**

**FAX: 317-966-0623**

<http://www.broadcast.harris.com>

TL=transmission line CB=cables CN=connectors FL=RF line filters WM=wire management

## EIGHT IS GREAT!



**Come to the Harris Booths and find out how to win this Mackie 16-8 Mixing Console plus these 8 Oktava Recording mics!**



© 1996 Harris Corp.

Circle (17) On Reader Service Card

**"ITC's AUDIO SWITCHERS HAVE BEEN KEPT a secret TOO LONG!"**

**I found the best Audio switcher on the market at ITC. Designed for complex radio applications, it's what I've been looking for all along... ITC's Switcher is the choice...hands down! P. S.**

**SEE US AT NAB BOOTH 2005**

**Paul Strickland**  
Director of Engineering  
Service Broadcasting

**ITC's Audio Switcher... Call for yours today: (309) 828-1381**

Internet: <http://www.itc-net.com>  
Email: [itc@itc-net.com](mailto:itc@itc-net.com)  
Fax: (309)828-1386

**Another ITC Audio Management Tool.**

**International Tapetronics Corporation**  
2425 South Main Street, Bloomington, IL 61702

Circle (3) On Reader Service Card



# MARKETPLACE

Recently Introduced Products for the Radio Broadcast Professional

## Ergonomic Crimping Tools

Panduit now offers a new series of ergonomically engineered crimping tools that are designed to fit comfortably in the contour of the human hand and reduce the force necessary to properly crimp terminals by up to 50 percent.



Panduit's Contour Crimp tools are available in three different styles so that operators may select the tool with the optimal die configuration. As an added feature, the crimping tools automatically emboss inspection dots into the crimped product.

For more information from Panduit, contact the company's terminals product manager in Illinois at 800-777-3300 x2241; fax: 815-485-5839; or circle Reader Service 75.

## Digital Audio Master Cassettes

Sony has introduced its DARS-MP Series Metal Particle Tape that features a coating technology wherein the metal particles in the magnetic layer are aligned diagonally, allowing the tape to record smaller wavelengths. Additionally, a newly developed binder system improves tape durability and lowers dropouts, especially during overdubs, when tape is frequently shuttled.

Available in 30-, 60- and 113-minute lengths, the Sony DARS-MP cassette will be on shelves early this spring.

For more information, contact Sue Faber or Jen Revis at Technology Solutions in New Jersey at 212-696-2000; e-mail: jrevis@tsipr.com; or circle Reader Service 138.

## Nearfield Performance Monitor

Available from Klipsch Professional is the KP-110-B compact performance mon-



itor designed to accommodate a variety of nearfield applications including keyboard, stage monitoring and recording. The monitor features a Tractrix Wave horn that provides a controlled beamwidth of 110 degrees in both the vertical and horizontal plane. The low frequency component is a high performance longstroke woofer for tight low end response.

The KP-110-B can be mounted with the optional SB-101 bracket on a microphone stand permanently installed to the wall either vertically or horizontally.

For more information about Klipsch,

contact Jesse Walsh Public Relations in Michigan at 616-695-5948; or circle Reader Service 104.

## Digital Audio Processor

New from Orban is the Optimod-FM 2200 digital audio processor. The 2200 is intended to bring quality sound and features to smaller broadcast radio stations at an affordable price.

Features on the 2200 include eight programmable presets, two-band processing with HF enhancement, all digital stereo



encoder/generator and a digital AES/EBU input/output option. Also included on Orban's Optimod-FM 2200 are LED input/output gain reduction meters, alignment tone generator, remote control and nonvolatile memory.

For more information from Orban, contact Amy Huson in California at 510-351-3500; fax: 510-351-0500; or circle Reader Service 183.

## FAMOUS LAST WORDS:

"I don't need a backup transmitter."



## Crown's FM500

500 watts of fully integrated RF output.

There when you need it.

Available at new lower pricing through your broadcast dealer today.



1718 W. Mishawaka Road, PO Box 1000, Elkhart, IN 46515-1000  
Phone: 800-294-8050; Fax: 219-294-8222

See us at NAB  
(Booth #2523)

Circle (78) On Reader Service Card

World Radio History

# Broadcast Equipment Exchange

"Broadcast Equipment Exchange" accepts no responsibility for the condition of the equipment listed or for the specifics of transactions made between buyers and sellers.

## AMPLIFIERS

### Want To Sell

**Bogen DB-10** mono hi-fi tube amp, vgc, \$35; Bogen J-50 tube public address amp, vgc, \$50; Eico HF-61 mono pre amp, tube, vgc, \$25; Scott 121-C mono hi-fi preamp, exc cond, no cabinet, \$50; Scott 330-B hi-fi tuner, AM & FM, vgc, cabinet, \$50, all items +shpg. B Leslie, Pro Rcdg Srv, 13709 Mapleleaf Dr, Cleveland OH 44125. 216-662-1435.

**RTS-405** stereo TT preamps (2), \$140 ea +shpg. B Lord, Lord Bdcig, 3824 SW Myrtle St, Seattle WA 98126. 206-932-4839.

**Crown D 150-A** stereo pwr amp, \$250. D Lundy, 606-546-6650.

## ANTENNAS/TOWERS/CABLES

### Want To Sell

**290' Utility towers**, 2-1/4" iron, 18" face, 20' sections, all lights working, must be dismantled, \$2000 ea/\$3000 both. JJ, WVKV Radio, 304-765-7373.

**Celwave CFM-LP-3** 3 bay on 100.9, \$1000 +shpg or pick up. J Crawley, Group Radio, POB 185, Campbellsville KY 42719. 502-465-8884.

**Celwave CFMHP-4** 4 bay FM w/deicers & matching transformer, removed for site change, stored indoor, on 93.9 MHz, 3-1/8 input w/1-5/8 reducer, excel cond, BO. B Shotwell, WPVO, POB 939, S Deerfield MA 01373. 413-665-0939.

**Price Reduced!** (2) 3 tower phasers 5 kW, \$2000/ea, you pick up. 805-237-6111 or 818-446-3468.

### 3" HELIAX STANDARD COAXIAL CABLE

50-Ohm, unused, cut to length. Priced below market. Shipped instantly. Call Basic Wire & Cable (NANCY) 800-227-4292 FAX: 312-539-3500

**325' Utility tower**, 36" face, on ground in Minneapolis, ready to ship, with all lights, junction boxes, base insulator, guy insulators, turnbuckles & hardware, exc cond, \$10,000. J Thibodeau, Childrens Bdcig Corp, 612-925-8896.

**Bird 43** wattmeter with 1-5-10-25-100-500 W elements, (2) 25 W loads & case; Texscan reflection coefficient bridge with elements; (2) 1/2" coax to N-female connectors, new; (2) Andrew flange waveguide assy, new; (3) Andrew 2' flex/twist waveguide section, new; Andrew 2' flex/twist waveguide #wftp137-24, new; Mitec 3' flex/twist mini waveguide section, new; Macom video low pass filter, new. Ron, 540-896-9256.

**Harris ERI FML-2E** 2 bay at 99.3, \$1500. R Warwick, KLLY/KKBB, 3651 Pegasus Dr #107, Bakersfield CA 93308. 805-393-1900.

**ANDREW 7/8" AIR HELIAX (HJS-50)** 3.25' FT. NEW! ANDREW 1 1/2" RIGID, 20 FT LENGTHS 3/8, 1/2, & 7/8 FOAM IN STOCK. REBUILT DIELECTRIC 5-BAY ON 97.1 W/RADOMES, 40KW INPUT, 2.7 GAIN.

**JIM MUSSELL BROADCAST ENG. 805-922-7775**

**Phelps Dodge CPM HP 6 BX** 6-bay FM antenna. S King, KMML, 1703 Avondale St, Amarillo TX 79116. 806-355-9777.

**Tower phasers 5 kW** (2), you pick up, \$1200 ea. 805-237-6111.

**Scala 450** (2) STL antennas + 200' 7/8" foam feedline, will separate, \$800/BO. D Emewein, KCHK, 25821 Langford Ave, New Prague MN 56071. 612-758-2571.

**NEW & USED:** 1-5/8 & 7/8" coax cable, on spools, will cut to length, guaranteed. Goodrich Enterprises, 11435 Manderson St, Omaha NE 68164. 402-493-1886.

**RF ANTENNA SYSTEM COMPONENTS** - Coils, Capacitors, Contactors, Switches, Jacks, Cable, etc. Refurbished, Reconditioned. Guar-anteed. For FREE catalog and price list contact: UNITED SYSTEMS @ (303) 980-6813.

### Want To Buy

**Rohn 45** 10' sections. K Diebel, KTJC, 1707 Louise St, Rogville LA 71269. 318-738-5852.

## AUDIO PRODUCTION

### Want To Sell

**Pultec EQH-2** tube EQ; RCA BA-11 vintage mic pres; UREI 535 stereo EQ, \$350; White 4400 EQ; Orban 245-E stereo synthesizer; Altec 352-A mixer amp, \$150; Gates M-5576 vintage tube program amp; Allison Labs variable filters. T Coffman, 619-571-5031.

**dbx 224** type II simu. encode/decoder, \$193; dbx 21 type II disc/tape decoder, \$39; Burwen DNF-1201A dynamic noise filter, \$147; Burwen TNE-7000A transient noise elim, \$271; Aphex aural Exciter type B, \$139; ADC Sound-shaper graphic EQ (3), \$46 ea. D Peck, House of Music, 5050 Laguna Blvd #112, Elk Grove CA 95758. 916-684-8000.

## CASSETTES • CARTS • REELS

### J & I AUDIO/VIDEO

A wholesaler in the Radio and Television market. Now running SPECIALS on audio and video: **BASF CASSETTES-AMPEX R-Rs AUDIOPAK, FIDELIPAC & ITC CARTS DAT & THE NEW R-CD** For more information call **Kris Elliot** at **1-800-942-1711** or write to: **J&I Audio/Video** 20899 Kelvin Pl. Woodland Hills, CA 91367

### Circle (105) On Reader Service Card

**Rane PE-15** parametric EQ, new cond, \$150; DOD Digitech R-831-C 31 band EQ, new cond, \$125; DOD Digitech R-855 4 channel mixer, exc cond, \$125; Shure SR-107 10 band EQ, vgc, \$125, all items +shpg. B Leslie, Pro Recording Services, 13709 Mapleleaf Dr, Cleveland OH 44125. 216-662-1435.

**Revox B225** CD player, \$300. B Pace, KMXX, POB 30570, Albuquerque NM 87190. 505-881-7002.

**ADC PATCH CORDS**  
**NEW T.T. sale-\$6.95**  
**NEW 1/4" sale-\$8.95**  
patchbays and used equipment too!  
**audio village 619/320-0728**

**Tangent 1202A** mixing console, 12 chnl in, stereo mono out, EQ on ea input chnl, echo send/return, all inputs mic/line level, solo & foldback outs, \$600 +shpg. S Lawson, KAK Prod, 928 Hyland Dr, Santa Rosa CA 95404. 707-528-4055.

**Technica 16 Hz to 25K** stereo graphic EQ, \$150 +shipping; Lexicon PCM-60 reverb, mono in stereo out, \$100 +shpg. Skip, 614-890-9977.

**Roland DEP-5's** (5) digital delay lines, \$225 each. 1-616-782-9258.

**Ursa Major 8x32** reverb was \$6000 new/now \$650. W Gunn, 619-320-0728.

### Want To Buy

**Neve, API, MXR, mic pres/EQs, delays, compressors, harmonizers, reverbs.** T Coffman, 619-571-5031.

## AUTOMATION EQUIPMENT

### Want To Sell

**Audio Systems Net-Com AP-1** tone decoder for AP news, rack mount, \$75; Control Design CDC-60T time announce controller with manuals, controller only, \$50. J Meloon, WDBA, DuBois PA 15801. 814-371-1330, e-mail: WDBA@key-net.net.

**IGM EC w/2-24** Go-Carts, complete unit, working, BO. K Smith, KYCN, 450 East Cole, Wheatland WY 82201. 307-322-5926.

**ITC 750 R-R's** (8), \$100 ea; SMC stereo Carousels (4), \$100 ea; IGM 24 tray Carousels (5), \$200 ea; IGM 78 tray Go-Cart, \$100. T Beschta, WAQE, POB 703, Rice Lake WI 54868. 715-234-9059.

**STOP**  
CLOCK DRIFT IN  
PCs  
SERVERS

- AFFORDABLE ATOMIC CLOCK STABILITY
- SMPT MASTER CLOCK GEN μSEC ACCURACY

CALL FOR BROCHURE OR FAX-BACK **\$995**

TEL: 800-940-2248 • FAX: 309-833-5175  
W CLARK & ASSOCIATES, MACOMB IL

**SMC DP-2** with (4) Carousels, (5) R-R's; (2) SMC ESP-1 with (4) Carousels, (4) R-R's; SMC MSP with (3) Carousels, all units worked when removed, \$4250. SBC, 600 N Ki-wanis, Sioux Falls SD 57104. 605-334-1117.

**SMC MSP automation system**, works great, SMC racks (3), 452 bi-directional Carousel, (2) ARS 1000 reels, (3) single cart PB, (2) 25/1000 Hz tone generator, battery backup, silence sense, manuals, very clean, \$2000 you pick up in VA. H Espravnik, magnum Comm. 615-230-3618 or 615-452-3983.

**Kenwood DP 2010** CD player w/remote, will trade for 10.5" R-R recorder, \$100 +shpg. E Lightman, WEDL, 550 Merchant St, Brighton PA 15003. 412-266-2802.

### Want To Buy

**Looking for parts** for SMC Mini-Pro 1 automation programmer/controller. Glen or John, KIXC, POB 29, QuanaH TX 79252. 817-663-6363.

## BROKERS

Appraisals • Brokerage • Consulting

**T.A. BRANSON**  
media broker

1-800-453-3169

"Member NAB"  
Confidential  
Small/Medium Market Specialist

## CART MACHINES

### Want To Sell

**Harris Criterion 90-3** triple PB w/tones (2), \$250 ea; ITC triple R/P w/tones, \$1500; Audicord 132R w/network delay w/tones, \$250. T Beschta, WAQE, POB 703, Rice Lake WI 54868. 715-234-9059.

**ITC 3D mono**, \$400; Harris RP mono, \$250; ITC RP mono, \$350; Audicord RP stereo cart (2), \$300. B Pace, KMXX, POB 30570, Albuquerque NM 87190. 505-881-7002.

**ITC Delta - new pinch rollers: Mono playback (2), record/play (2), stereo record/play (1).** MOTIVATED! Spotmaster series 2000 record (1). **Wes, 818-798-9128.**

**Spotmaster Ten-70** mono, fast forward, motor recently rebuilt, seasonal use, few hours/day, stored summers, service manual incl, we pay shpg. \$300; Tapeaster 700P mono, seasonal use, few hours/day, stored summers, old style with latching handle for carts, incl manual, \$400. A Slauch, 315-696-6550.

**ITC 3 deck** (6) w/WRA recording amp; BE 6000 (6). J Phillips, 414 Washington Ave, Defiance OH 43512. 419-782-8591.

**ITC 3D triple deck** (2), BO. S King, KMML, 1703 Avondale St, Amarillo TX 79116. 806-355-9777.

Great Prices on original equipment tape heads for ITC, BE, Fidelipac, Otari, Tascam & others!

**(804) 984-4255**

**HE HALL Electronics**

**Spotmaster stereo cart machine**, as is make over; Harris Criterion Compact II, BO. D Lundy, 606-546-6650.

**Tapeaster 700P, X700 R & RP**, rebuilt & ready to go on the air; BE 2000 RP, \$195, Encores P & RP, \$100-\$450. AD Ishkanian, Focus on Truth, 1802 Hilliard Rd, Richmond VA 23228. 804-262-4330.

**ITC record amps**, 3 tone, stereo \$350 or mono \$250. W Gunn, 619-320-0728.

### Want To Buy

**ITC, BE, Fidelipac cart machines:** single, triple, mono, stereo, play & record/play. Call M O'Drobinak @ 619-758-0888.

## CD PLAYERS

### Want To Sell

**Pioneer PD-M502** single 6-pack CD players (12), like new, \$150 ea. D Leutz, KKBN, POB 708, Twain Harte CA 95303. 209-586-1988.

**Studer A727** (2), \$125 ea +shpg. Skip, 614-890-9977.

## COMPUTERS

### Want To Sell

**Atari 1040 ST** with color monitor, printer & tons of software including MIDI software, \$300. W Whitney, 2232 Wengler, Overland MO 63114. 314-428-8430.

**APT ACE 100 Pro**, pro audio card with balanced in and out 4:1 compression, \$900. S King, KMML, 1703 Avondale St, Amarillo TX 79116. 806-355-9777.

### Want To Buy

**Tandy 6000 HD** with at least one floppy drive. Mel Crosby, 408-363-1646.

## CONSOLES

### Want To Sell

**Harris/Gates M-6616** Yard II, working when removed, \$1000. JJ, WVKV Radio, 304-765-7373.

**Ramsa WR-T820** 20 chnl recording console, exc cond with meter bridge & stand, \$2200/BO. J Mueller, Family Stations, 290 Hegenberger Rd, Oakland CA 94621. 501-568-6200 X240.

**JBL 7510** automatic 24 channel mixer, \$250; (2) Altec 1567-A tube mixers, \$300 ea. D Lundy, 606-546-6650.

**Carvin 18** channel console, \$250. 1-616-782-9258.

**SpecMix 8 trk**, 16x8x2 with power supply, manual, \$500. S Bogart, Bogart Productions, 817-467-0158.

**SQN 4S Series 2** 4 input 2 out ENG mixer/Portabrace case, exc cond, \$2500. Don, Scales Film Sound, 3142 Market Pl, Bloomington IN 47403. 812-339-4446.

**Allen & Heath SYNCON 28x24** great sounding discrete board-like API was \$36k new/now \$8000; Ramsa 820 mixer, \$2200. W Gunn, 619-320-0728.

**LPB Signature II** model S-20 console, \$1300/BO. Arlie or Bill, 802-860-2440.

### Want To Buy

**10 chnl mono** or stereo broadcast board with program & audition in excellent condition. JJ, WVKV Radio, 304-765-7373.

**RCA BC-7** in gd cond. P Gray, KJDY, Box 399, John Day OR 97845. 541-575-1185.

## DISCO-PRO SOUND EQUIPMENT

### Want To Sell

**Furman TX-4** tunable 3 way/5 way electronic crossover & bandpass filter, fair cond, \$100/BO. M Saady, First City Recdg, 213-05 75th Ave #2L, Bayside NY 11364.

**Hollywood edge cartoon** trax sound effects with manual, exc cond, \$225. K Thomas, Rebel Recording, 457 Snapping Turtle Ct, Atlantic Beach FL 32233. 904-388-7711.

## FINANCIAL SERVICES

# FINANCING

**LOANS BY PHONE (800) 699-FLEX**

- We finance all types of Broadcasting Equipment
- Flexible Credit Criteria
- Flexible Payment Plans
- No Down Payment, No Payments For 90-Days Available

To apply or request additional information call Jeff Wetter.

# FLEXLEASE, Inc.

## LIMITERS

### Want To Sell

**CRL PMC300A** hardly used, mint condition, BO. M Ward, 38G Productions, 18 Wilson Dr, Framingham MA 01701. 508-875-6109.

**Gates tube Sta-Level limiter** M5167, very clean, \$450; Altec 1612-A limiter compressor, \$275. D Lundy, 606-546-6650.

**HE HALL Electronics**

The ONLY Source You Need for: Digital, Pro - Audio, & RF

706 Rose Hill Drive Charlottesville VA 22901

**486 PC System**

Open-ended architecture, always upgradeable

Simultaneous Record and Play of audio

Stereo and Mono audio

User-controlled variable audio overlap for live-sounding segues

Accepts downloads from all standard traffic and music scheduling systems

Provides a 31-Day historical log of everything that aired and when

System support available 24 hours a day, 365 days a year

**\$ 8,995 LIST**

**- CALL FOR YOUR HE PRICE!**

User Programmable Database Search and Store Parameters

Live Assist Screen Pictured

**When your Station is Important: Trust Experience and Simplicity**

Please visit our Internet site at [www.halls.com](http://www.halls.com)

**LPB®** (804) 984-HALL (4255) Fax: (804) 984-FAXX (3299)

Call us for the Best New & Completely Rebuilt Equipment!

Circle (80) On Reader Service Card

### LIMITER...WTS

Symetrix CL-150 fast RMS compressor/limiter, \$175. D Kelly, KWPN, Box 84, West Point NE 68788. 402-372-5423.

Texar Audio Prizm (2) with manual, in good condition, \$1300/pair. J Davies, WMT, 600 Old Marion Rd NE, Cedar Rapids IA 52402. 319-395-0530.

Orban 9000AM, 8000, 8100, ST, xfm, DAP, Modulimiter. J Phillips, 414 Washington Ave, Defiance OH 43512. 419-782-8591.

Clark Communications Cobalt Blue processor #5 replacement card for Optimod 8100, \$600/BO. D Nadon, WNNH, 501 South St, Concord NH 03304. 603-225-1160.

Modulation Sciences CP-803 composite processor. J Mulhern, KSCB, POB 3125, Liberal KS 67905. 316-624-3891.

Orban 8000A, \$1000. D Sports, WCLA, POB 427, Claxton GA 30417. 912-739-3035.

### Want To Buy

UREI LA2A, LA3A, LA4A, 1176, Gates, RCA, Collins, Altec, dbx 160/165. T Coffman, 619-571-5031.

Teletronix LA-2A's, UREI LA-3A's & LA-4's, Fairchild 660's & 670's, any Pultec EQ's & any other old tube compressor/limiters, call after 3PM CST, 214-271-7625.

### MICROPHONES

### Want To Sell

AKG 414B TLII w/C-12 capsule, new, \$950. D Miller, Airborne Audio, 12209 W 88th, Lenexa KS 60215. 913-492-8822.

Beyer MC-740 large diaphragm condenser, \$850; Sennheiser 441. T Coffman, 619-571-5031.

Electro Voice 644 sound spot mic (2), \$125 ea; Altec 525-A power supplies (2) for Altec condenser mics, \$75 ea. D Lundy, 606-546-6650.

### Want To Buy

Neumann U-48 or U-67 for studio, must be reasonable, will consider partial trade. B Leslie, Pro Recdg Srv, 13709 Mapleleaf Dr, Cleveland OH 44125. 216-662-1435.

RCA 77-DX's, 44-BX's, WE KU-3A's On-Air lights, recdg lights. Top price paid. Fast response. Bill Bryant Mgmt, 2601 Hillsboro Rd, G12, Nashville TN 37212. 615-269-6131, FAX: 615-292-3434.

Neumann, RCA, AKG, UREI, Pultec, Fairchild, etc. J Phillips, 414 Washington Ave, Defiance OH 43512. 419-782-8591.

Western Electric teardrop 24-A mic stand to trade for RCA desk mic stand. S Horner, KPRZ, 9255 Towne Centre Dr, San Diego CA 92121. 619-535-1210.

Neumann KM 84 mics. D Miller, Airborne Audio, 12209 W 88th, Lenexa KS 60215. 913-492-8822.

RCA 77-DX's & 44-BX's, any other RCA ribbon mics, on-air lights, call after 3PM CST, 214-271-7625.

### MISCELLANEOUS

### Want To Sell

1964 Rock-O-La stereo juke box, good cond, \$1500. D Leutz, KKBN, POB 708, Twain Harte CA 95303. 209-586-1988.

**AUDIO TRANSFORMER MAGIC**



Circle (130) On Reader Service Card

**audisar**  
P.O. Box 1561 Bellevue, WA 98009  
206-454-2040

### Circle (130) On Reader Service Card

Paradyne 4951-03 equip rack, blk, full set of blank covers, \$175. Sound-olier equip rack, \$120 +shpg. B Lord, Lord Broadcasting, 3824 SW Myrtle St, Seattle WA 98126. 206-932-4839.

Tapco 2202 graphic EQ, \$100; Harris phono preamps (2), \$75/pr; Harris automation racks (6), \$200 ea. T Beschta, WAQE, POB 703, Rice Lake WI 54868. 715-234-9059.

E.V. HR-60-40 horns (2) with adapters, \$75. 1-616-782-9258.

TT's, preamps, cart machines, cart racks, old Gates remote control, old Gates remote broadcast equip, etc. BO. JJ, WVKV Radio, 304-765-7373.

Tubes: (2) 6DX8, (4) 6SU7, (10) 6SL7, (2) 6J5, (10) 6AL5, (4) 6C4, (2) 12AT7, (4) 12BY7; Cart Decks: (2) ITC PDII mono PB; Processing: CRL APP 400, CRL PMC 450, CRL SEP 400A, CRL PMC 300A; large knife blade switch; Tru-Fidelity reactor transformer; EF Johnson RF scissor switch; PBX system with 6 phones. Will, 704-648-3588.

King 650 & 600 cass loaders (2), pre-recorded or blank loading, \$1250 ea; Columbia C6046 27 pair audio cable 2 line & shield, \$4/ft. D Lundy, 606-546-6650.

Noble 3" slide pots, high qual 10K ohm audio taper, substantial quantity, \$3 ea; Switchcraft D3F mic connectors, rectangular panel mount 3 pin female mic, receptical, first quality, substantial quantity, \$3 ea; Stancor-Triad TA-17, A-3845, Triad M-42 all mod transformers, orig boxes, never used, tube & transistor types. F Holovnia, Northeast Rdg, 17 Canna Dr, Shrewsbury MA 01545. 508-753-1335.

### Want To Buy

Acrosound TO-350 audio output transformer, or Peerless (Altec) S-268-Q, need only one or the other, must be reasonable. B Leslie, Pro Recording Srv, 13709 Mapleleaf Dr, Cleveland OH 44125. 216-662-1435.

Jazz record collections, 10" LP/12" LP be-bop, swing, dixie, highest prices paid. B Rose, Program Recordings, 228 East 10th, NNY 10003. 212-674-3060.

CCA Citadel cart machine replacement motor(s), 115V/60 Hz, 460 rpm hysteresis/synchronous type with or without mount & capacitor. D Bailey, KXGQ, 2005 Pleasant Valley Ave #301, Oakland CA 94611. 510-658-9899.

### MONITORS

### Want To Sell

Gates 2639 mod monitor (2) AM, working, \$50 ea; General Radio 731-B, works, \$40; RCA retubed w/ocial tubes, \$40. J Crawley, Group Radio, POB 185, Campbellsville KY 42719. 502-465-8884.

McMartin TBM-2200A stereo monitor, bought reconditioned 7 yrs ago, never used. JJ, WVKV Radio, 304-765-7373.

McMartin TBM2000A & TBM2000B, \$150 ea or \$250/both; Belar FMS-1, \$500; Belar SCA, \$250. B Pace, KMXQ, POB 30570, Albuquerque NM 87190. 505-881-7002.

## EDX—The Best RF Planning Software

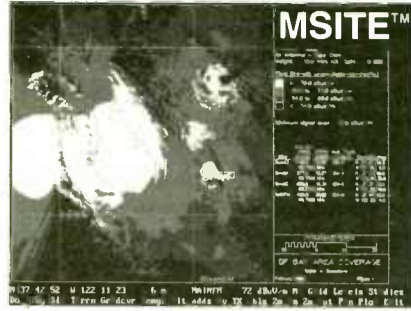

Coverage Area Prediction

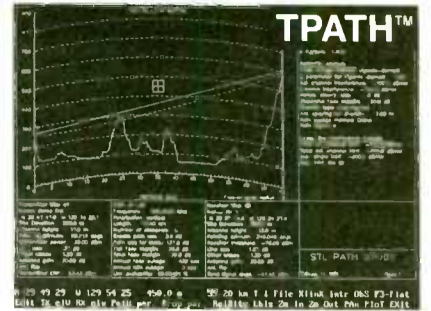

Point to Point Link Studies

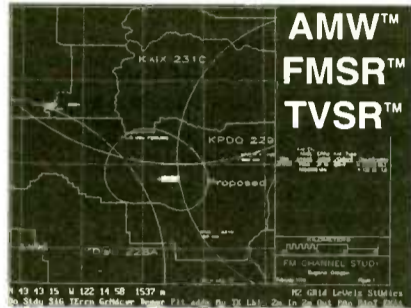

AM, FM, and TV Channel Studies

See us on the Internet!

- Web: <http://www.edx.com/>
- e-mail: [info@edx.com](mailto:info@edx.com)

Belar RFA-1 FM RF amp, \$200. C Siegenthaler, KSIW, 612 S 14th Ave, Yakima WA 98902. 509-453-5492.

### RECORDERS

### Want To Sell

45's from 50's thru 80's, approximately 5-6000 in good cond, sold as collection only, \$4500. D Leutz, KKBN, POB 708, Twain Harte CA 95303. 209-586-1988.

Ampex 350-2, tube, vgc, \$150/both, power sply, \$25; Magnecord PT-63-J electronic only, tube, vgc, \$35, all items +shpg. B Leslie, Pro Recdg Services, 13709 Mapleleaf Dr, Cleveland OH 44125. 216-662-1435.

Ampex parts, transport & electronic parts, from 350 units to MM1200 recorders, some new, most used in exc cond, motors, headstacs, guides, etc; Scully 280 electronic complete, \$100 ea. M Gore, 415-469-0136, noon-5PM PST.

Revox A77 2 track 7.5-3.75 stereo, speed problem. BO; Ampex AG-350-2 w/orig Ampex tube-type preamp, UPS shippable, BO +shipping; Shaffer stereo tape PB electronic, rack mount, solid state, \$50 +shpg. J Meloon, WDBA, DuBois PA 15801. 814-371-1330. e-mail: [WDBA@key-net.net](mailto:WDBA@key-net.net).

### REVOX PARTS/SERVICE

Cassette CD Open reel NOS PR99 repros. Capstan resurfacing. ALL BRANDS. **JM TECHNICAL ARTS** 30 Music Sq. W. #156 Nashville, TN 37203 (615) 244-6892

Sony TC-M5D prof field cassette R/P, exc cond, with case & manual, \$250. J Swartz, FACE Co., 237 Frost Ave, Rochester NY 14608. 716-235-4928.

## CONSULTANTS

### Consulting Communications Engineers

- Station improvement and modernization
- FCC Applications and Field Engineering
- Frequency Searches and Coordination
- AM-FM-CATV-ITFS-LPTV

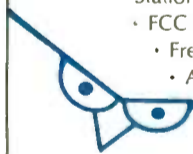

### OWL ENGINEERING, INC.

E-mail: [Owleng19@skypoint.com](mailto:Owleng19@skypoint.com) 1-800-797-1338  
1306 W. County Road. F, St. Paul, MN 55112 (612)631-1338 Member AFCEE

### EVANS ASSOCIATES

Consulting Communications Engineers

TV • FM • AM • ITFS • Satellite  
FCC Applications, Design  
and Field Engineering

Video/Data/Voice • Light Fiber &  
Microwave • Wide-Area Networks & STL's

210 S. Main Street  
Thiensville, WI 53092  
(414) 242-6000 • FAX (414) 242-6045  
Member AFCEE

### North America RF & Audio

### Mirkwood Engineering Services

Broadcast and Telecommunications Consultants  
Multidiscipline Engineering and Planning Firm  
including • Application & Allocation Services  
• Project, Engineering & Construction  
Management • Site Acquisition  
• Rural & Remote Site Installations  
• Field Service • Studio Design & Installation  
50 Park Ave. Claremont, NH 03743  
(603) 542-6784

### GRAHAM BROCK, INC.

Business and Technical Consultants

Full Service From  
Allocation to Operation  
AM-FM-TV-AUX Services,  
Field Work, Antenna and  
Facilities Design

Over 35 years engineering  
and consulting experience  
912-638-8028  
202-393-5133

### PC - SOFTWARE

AM FM TV Search Programs  
Signal Mapping—STL Paths  
RFHAZ—US Census PopCount  
FAA Tower—Draw Tower

Doug Vernier  
Engineering Consultant  
1600 Picturesque Drive  
Cedar Falls IA 50613  
800-743-DOUG

### W. LEE SIMMONS & ASSOC., INC.

TELECOMMUNICATIONS CONSULTANTS

Allocation Studies • AM, FM,  
TV, LPTV • Applications •  
Appraisals • Inspections • Local  
& Wide Area Computer Network  
Microwave Design • Specialized  
Computer System Designs  
44 Bow Circle #B, Hilton Head Is, SC 29928  
803-785-4445 fax 803-842-3371  
e-mail: [wlsimm@IBM.net](mailto:wlsimm@IBM.net)

### MULLANEY ENGINEERING, INC.

Consulting Engineers  
• Design & Optimization of  
AM Directional Arrays  
• Analysis for New Allocation,  
Site Relocation, And Upgrades  
AM-FM TV LPTV  
Wireless Cable  
(MDS/MMDS/ITFS/OFS)  
• Environmental Radiation Analysis  
• Field Work  
• Expert Testimony  
9049 Shady Grove Court  
Gaithersburg, MD 20877  
Phone: (301) 921-0115  
Fax: (301) 590-9757  
email: [mullengr@aol.com](mailto:mullengr@aol.com)

### MLJ

Moffet, Larson & Johnson, Inc.  
Consulting Telecommunications  
Engineers

1110 North Glebe Rd. #800  
Arlington, VA 22201  
(703) 741-3500  
FAX: (703) 741-0312  
Member AFCEE

### T. Z Sawyer Technical Consultants

AM-FM-TV-LPTV

- FCC Applications & Exhibits
- Experimental Authorizations
- AM Directional Antennas
- High Power Antenna Arrays
- Frequency Studies
- Class Upgrades
- STL Applications
- Station Inspections

1-800-255-2632  
FAX: (301) 913-5799 • 6204 Highland Dr. • Chevy Chase, MD 20815

### E. HAROLD MUNN, JR. & ASSOCIATES, INC.

Broadcast Engineering  
Consultants  
AM - FM - TV  
WAYNE S. REESE  
PRESIDENT  
Box 220, 100 Airport Rd.  
Coldwater, MI 49036  
517-278-7339

## DISTRIBUTOR DIRECTORY

The following distributors serving the broadcast industry would be glad to help you with any of your requirements.

...Republicans say that's the way it was... Democrats say that's the way it is... the people say this is the way it's going to be... and some things never change...

RADIO! The beat goes on!

**CROUSE-KIMZEY OF ANNAPOLIS**  
tops in broadcast equipment  
1-800-955-6800  
ask for Kathleen

CORNELL-DUBILIER MICA CAPACITORS

FROM STOCK

JENNINGS VACUUM CAPACITORS

FROM STOCK

JENNINGS VACUUM RELAYS

**SURCOM ASSOCIATES**  
2215 Faraday Ave., Suite A  
Carlsbad, California 92008  
(619) 438-4420 Fax: (619) 438-4759

### RECORDERS...WTS

Sony TC 765-2 1/4" 2 track, 7.5 & 15 ips, 10.5" reels, exc cond, \$694 +shipping; Ampex AG-440 1/4" 2 track, 7.5-15 ips, in 3' Bud rack, \$195 +shipping. D Peck, House of Music, 5050 Laguna Blvd #112, Elk Grove CA 95758. 916-684-8000.

Scully 280 R-R, \$200; Magnecond PT 6 tube R-R, \$250; Revox A77 R-R, \$250. D Lundy. 606-546-6650.

Tascam 32 mastering R-R deck, 7.5-15 ips, exc cond, manuals, box, etc, free shipping in US, \$1350. Globe Music, 540-344-3283.

BE 3000 (2) mono PB with tones, good condition. \$450 ea; BE 3000A mono PB/delay, rack mount, new, \$500. D Kelly, KWPN, Box 84, West Point NE 68788. 402-372-5423.

**DO YOU NEED PARTS FOR AMPRO CONSOLES & CART RECORDER**  
**SEQUOIA ELECTRONICS**  
1-(408) 363-1646  
FAX 1-(408) 363-0957

ITC SP stereo play 3 tones. \$450; Tapeaster 701P mono play. \$250 both \$550, both guaranteed in exc cond with manuals, etc. Ken Lamson, 510-447-7405.

Otari MTR-10-4TR overbridge model, has CB-109 auto locator, \$3500. T Devine, WVVK, POB 1559, Lexington KY 40592. 606-253-5900.

Tascam 38 1/2" 8 track R-R, Best Offer/trade. S King, KMML, 1703 Avondale St, Amarillo TX 79116. 806-355-9777.

Teac 33-4 in good condition, \$125; Styli (4) 5107A, 5107AL, \$8 ea; Elgin recorder connector ERC-19645, \$20; Otari 50-50 in poor condition, good for parts or refurbishment, \$100, +shpg on all items. Dr Rogosky, WTSR, 609-771-2450.

**CLEAN PATCH BAYS**  
**NO DOWN TIME**



**VERTIGO BURNISHERS AND INJECTORS RESTORE ORIGINAL PERFORMANCE TO YOUR PATCH BAYS**  
\$34.95 Ea.  
**VERTIGO RECORDING SERVICES**  
12115 Magnolia Blvd #116 818-907-5161  
North Hollywood, CA 91607 fax 818-784-3763

Nagra III sync recorder with SLO resolver, \$995 for both; NEW MRL Short Test Tapes only, \$195 for 2", save \$400! Save on all other formats too. W Gunn 619-320-0728.

Scully '100' recorders, record/play amplifiers, 8, 16, 24 track heads. Sequoia Electronics, 4646 Hounds-haven Way, San Jose CA 95111. 408-363-1646.

Tascam 32 2-track, \$950; ATR60 8-track, mint, \$2950; Teac AQ-85 locator for 85-16, \$395; Custom Locator for ANY deck, \$495; Tascam DX-8 dbx for 80-8, \$295; Fostex A80 1/4" 8-track, like new, \$595. W Gunn 619-320-0728.

ITC 750 series R-R PB only deck, fair condition, \$200. D Leutz, KKBN, POB 708, Twain Harte CA 95383. 209-586-1988.

TASCAM 34B four channel reel-to-reel recorder/reproducer. exc cond with technical manual. \$675.00. D. Harris, 703-319-1431.

**Want To Buy**

Second-hand SONY PCM2000 portable DAT recorder. Fax: offers, service record, total head-wear to Fernando @ IBIS PRODUCTIONS, 508-486-9652.

Ampex ATR100 taperecorders for parts. Circuit cards, heads, motors, machine parts, or electronic parts. Call 818-907-5161.

### REMOTE & MICROWAVE EQUIPMENT

**Want To Sell**

**RENT IT HERE!** Call Steve Kirsch for Details

COMREX 2- & 3-Line Extenders Digital Codecs	TELOS Zephyr Digital Phone Hybrids	CCS "PRIMA" CODECS	SHURE Automatic Mixers	REMOTE AUDIO PACKAGES
---	--	-----------------------	---------------------------	--------------------------

**SILVER LAKE AUDIO • 516-763-1776 • FAX: 516-763-1750**

Moseley TRC15, \$300; Moseley MRC1600, \$500; Harris 9100, \$500; Marti STL-8 (2) transmitter only, \$500; Dolby DSTL, \$8000. B Pace, KMXQ, POB 30570, Albuquerque NM 87190. 505-881-7002.

Moseley MRC-1600 in exc cond, \$2150; Gentner VRC-1000 with VRC-2000 software upgrade, like new, \$2350. D Leutz, KKBN, POB 708, Twain Harte CA 95383. 209-586-1988.

TFT 7601-C & 7601-R send receive units, price for set, \$300 + UPS. J Crawley, Group Radio, POB 185, Campbellsville KY 42719. 502-465-8884.

Moseley WRG-10T wire control remote control, working when removed. JJ, WVVK Radio, 304-765-7373.

Moseley MRC-1600 remote control. J Mulhern, KSCB, POB 3125, Liberal KS 67905. 316-624-3891.

**WE RENT**  
**TELOS ZEPHYR**  
CCS "Prima" Codecs  
**COMREX**  
3-line extender  
Frank Grundstein  
Audio/Video  
Consultants  
**610-642-0978**

Comrex DXR 7.5 kHz codec boxes (2) with cables & modems for 56KB digital telephone lines, \$2000; Moseley TRC 15-AW remote control with Hallikainen TEL 171 digital telemetry installed, \$400. R Cowell, KNTR, POB 5009, Ferndale WA 98248. 360-384-5117.

### REPAIR SERVICES

**PIKE'S PEAK SATCOM**  
→ Dart 384  
→ SA7300 (Dat32)  
→ SCPC Receivers  
Repair Specialist  
Low Rates  
Fast Reliable Service  
Buy, Sell, Trade  
**Pike's Peak Satcom**  
Tel 719-390-6606  
Fax 719-390-6616

Circle (24) On Reader Service Card

### SATELLITE EQUIPMENT

**Want To Sell**

Uniden CAT100R, CAT-30, never used, \$150; CATV frequency agile modulator, chnl 2-36, never used, \$100. D Bailey, KKGQ, 2005 Pleasant Valley Ave #301, Oakland CA 94611. 510-658-9899.

**UNIVERSAL SCPC XE-1000**  
NEW!  
**SCPC BROADCAST AUDIO RECEIVER**  
New, affordable, frequency-agile receiver, direct channel entry by keyboard, selectable companding 1:1, 2:1, 3:1, wide/narrow bandwidth, de-emphasis selectable, 950-1450 MHz, line output 600 ohms, muting, transponder agile, LNB power supply, 50-channel memory, full baseband output, high-quality audio. Every needed feature at a sensible price (lowest in the industry). Write or call for full information on this quality receiver—the answer for your station. Networks call for prices.  
Phone: (614) 866-4605 Fax: (614) 866-1201  
**UNIVERSAL ELECTRONICS, INC.** 4555 Groves Road, Suite 12 Columbus, OH 43232  
Phone: (614) 866-4605 Fax: (614) 866-1201

Drake Satellite Systems ESR2220 rack mount receiver with downconverter, LNA available separately, manuals, \$150 +shipping. J Meloon, WDBA, DuBois PA 15801. 814-371-1330, e-mail: WDBA@key-net.net.

Wegener DR 55 digital audio receiver toned for Reach Satellite Network, \$800. R Cowell, KNTR, POB 5009, Ferndale WA 98248. 360-384-5117.

## Is it is time to upgrade?

### Rely on... SATELLITE SYSTEMS

Upgrade your Fairchild Dart 384 and Scientific Atlanta 7300/7325 to LNB receivers—use existing equipment as trade-in.

Satellite Systems has 5-years of experience and is respected industry-wide for prompt, accurate service to radio stations and networks.

Plus, contact us for Ariel and Zephyrus 700 SCPC receivers.

Pre-and post-service technical support along with a 6-month warranty.

Turn to the leader in repair, upgrades, new equipment, used equipment and accessories. We can answer all of your questions.

### SATELLITE SYSTEMS

Satellite Equipment for Radio

### STATIONS

**Want To Sell**

Class A FM in Northern CA, excel studio w/equip in downtown location. 1-800-397-4146.

TOP 200 MARKET New England 5kW Full Time AM, \$269K. 617-444-2587.

Beautiful gulf coast of Texas, C-1, 100,000 W FM priced right, \$495,000. J Saunders, 713-350-4499.

Northern Cal Class A FM CP, excel studios, w/lots of equip. 1-800-397-4146.

**Want To Buy**

Looking for small AM/FM, dark OK. J Laino, 718-893-4328.

### TAPES/CARTS/REELS & CD's

#### A&D

**Cart Rebuilding**  
Do Bad Carts Have Your Temperature Rising?

Let A&D clean, load & pack your carts. They'll be serviced within 10 working days! **Guaranteed!**  
3706 Vold Ct. Eau Claire WI 54701 Fax: 715-835-1151

**Want To Sell**

300 carts, exc cond, various lengths, \$1.50 each. Dave, 308-995-4020.

Fidelipac Hot-Tape carts (200), \$150 +shipping. Skip, 614-890-9977.

100's of 40-sec to 5.5 min tape cartridges, mostly Audiopak A-2 w/fer ScotchCarts, BO. J Meloon, WDBA, DuBois PA 15801 814-371-1330, e-mail: WDBA@key-net.net.

45 rpm records, approx 10,000, hits from 50's-90's, most exc cond, all or part. D Peck, House of Music, 5050 Laguna Blvd #112, Elk Grove CA 95758. 916-684-8000.

10.5 NAB metal reels 1/4" (48), \$200. T Devine, WVVK, POB 1559, Lexington KY 40592. 606-253-5900.

Audiopak A-2 brand new carts, approximately 1200, 2.5 to 5.5 minute lengths, Best Offer. J Mueller, Family Stations, 290 Hegenberger Rd, Oakland CA 94621. 501-568-6200 X240.

Oldies format on blk Scotchcarts II's with over 3200 hit songs from the 50's-80's, \$7500; black Scotchcart II's, 300 3.5 min, \$1.75 each, all carts in almost new condition +shipping. B Lord, Lord Broadcasting, 3824 SW Myrtle St, Seattle WA 98126. 206-932-4839.

Pams Jingles reference tapes from the years of 1951-1976, available from every radio market in the US, Canada & Europe, call after 3PM CST, 214-271-7625.

## MARATHON PRODUCTS COMPANY

### Audio Cartridge Rebuilding Division

Rebuilding/reloading, like new, all brands, any length up to & including 3.5 minutes, \$2.05 for Standard Tape, \$2.25 ea. for HOLN Tape. FOB out plant, 48 hrs delivery. (New rate effective 3/1/96)

New NAB Marathon cartridges prices on request.

35 Years professional experience! Lifetime member AES R.D. MYERS Sr. Manufacturers of Audio Devices, Continuous Tape Mag.

69 Sandersdale Rd. Charlton, MA 01507  
1-508-248-3157 or 1-508-853-0988

Circle (155) On Reader Service Card

## SERVICES

- **Terrain Analysis**
- **FM Studies**
- **Population Studies**
- **FCC/FAA Databases**
- **Contours**

Communications Data Services, Inc.  
**800-441-0034**  
fax 703-532-5497  
http://www.comm-data.com  
6105-E Arlington Blvd.  
Falls Church, VA 22044

**HARRIS**  
**PARTS AND TECHNICAL SUPPORT**  
Now we can be reached online via e-mail.  
**TSUPPORT@HARRIS.COM**  
For your parts needs or with any technical problems you're having.

**FM TRANSMITTER HELPLINE**  
24 Hour Emergency Phone Consultation  
**Specializing in:**  
• CCA CSI  
• Arcing Problems  
• ALL FM Transmitters  
**MBE Enterprises**  
Phone: 818-772-8017  
Pager 818-604-7925

**Tower Sales & Erection**  
Turnkey Site Development  
Installation & Maintenance  
AM/FM Broadcast TV  
Microwave Systems  
Antennas & Towers  
**TOWERCOMM**  
Communications Specialists  
Ben Wall President  
6017 Triangle Dr  
Raleigh, NC 27613  
919-781-3400  
Fax: 919-781-5094

**REMOTE BROADCASTS IN THE U.K. AND EUROPE**  
Planning remotes from the U.K. or Europe  
we offer a one-stop service  
• we organize venues for your shows  
• we provide temporary equipment  
• live links via ISDN/Switched 56  
• experienced radio engineers  
• we help you line-up guests  
Contact London (44) 181 442 8900  
Wired for Sound Ltd., London U.K.

**REMOTE EQUIPMENT RENTALS**  
COMREX and GENTNER 1, 2 & 3-Line Extender Systems  
Now With The New TELOS ZEPHYR MARTI VHF/UHF RPU Systems  
ISDN & Switched-56 Systems  
Call or FAX Dwight Weller  
**WELLER AUDIO-VISUAL ENGINEERING**  
Baltimore, Maryland  
Phone: (410 or 800) 252-8351  
FAX: (410) 252-4261

**G.K. PAINTING CORP.**  
Industrial & Commercial Painting  
Sandblasting & Waterblasting  
Special Coating (specialize in radio towers)  
**703-978-1824**  
Fax: 703-978-1824  
5141 Bradford Drive, Annandale, VA 22003

**Don't Gamble with your advertising dollars!**  
**Advertise in Radio World and reach 18,000+ subscribers.**  
Call Simone at  
**1-800-336-3045 today!**

**TAPES/CARTS/REELS...WTS**

Scotch 206 & Ampex Grand Master on 7" reels, \$2 ea in groups of 40. Globe Music, 540-344-3283.

**TAX DEDUCTIBLE**

Non-profit organization seeks STL/TSL, audio production & satellite interface computer equipment, donations only, we pay shipping. R Walterscheid, KAMO, Carlsbad NM, 505-887-6323.

**TEST EQUIPMENT**

**Want To Sell**

Dumont 514-AD, 5" oscilloscope, dual trace built in calibrator, \$150 + shpg. J Crawley, Group Radio, POB 185, Campbellsville KY 42719. 502-465-8884.

Tektronix 2445A oscilloscope; Tektronix 1740 waveform monitor/vec-toroscope, exc cond; Telecom Research time code gen/reader. Ron, 540-896-9256.

Potomac Instruments FIM-21 field strength meter, exc cond, \$2500; Potomac Instruments AM-19 phase monitor, 2 tower system, working when removed, \$1000. JJ, WVKV Radio, 304-765-7373.

Harris/Gates 2 tower system phasor cabinet, working when removed, \$2000. JJ, WVKV Radio, 304-765-7373.

**The #1 Choice of Professionals Nationwide**

- Superior Noise Rejection
- NIST Traceable Calibration
- 20-40 DB Null at 90 Degrees

**The Proven System for Accurate AM Bandwidth & Harmonic Measurements**

Chris Scott & Associates  
Bowling Green, KY  
PH: 502 781-5301  
FAX: 502-781-1232

Sound Technology 1000A, \$750; Sound Technology 1700A, \$1000. B Pace, KMXQ, POB 30570, Albuquerque NM 87190. 505-881-7002.

Tektronix 466, mint condition with cables, manuals & cover, \$450. R Stankus, Mid-Lo Broadcasting, 11037 Jacqueline Ave, Englewood FL 34224. 941-473-2256.

Bell & Howell 100-4540 oscilloscope 4" solid state, \$50 +shipping. E Lightman, WEDL, 550 Merchant St, Ambridge PA 15003. 412-266-2802.

Phasemaster T-10,000 rotary phase converter, \$3500, working when removed. JJ, WVKV Radio, 304-765-7373.

Fluke 1920A frequency counter, perfect cond, calibrated, manual, \$300/BO. R Branske, Southwest Comm, POB 952, New Lenox IL 60451. 708-399-5444.

**Want To Buy**

Manual for Hickok 605-A tube tester, copy OK. B Leslie, Pro Recdg Srv, 13709 Mapleleaf Dr, Cleveland OH 44125. 216-662-1435.

**TRANSMITTERS**

**Want To Sell**

CCA AM-250D 8 tube now on 1550, 250W, \$1000 + u haul it. J Crawley, Group Radio, POB 185, Campbellsville KY 42719. 502-465-8884.

Harris/Gates FM 20B with Bext RVR PTX 20 exciter, \$10,000 with exciter, \$8000 without, working when removed. JJ, WVKV Radio, 304-765-7373.

Cetec-Sparta (Bauer) 602-A 2.5 kW FM, 100.9 MHz, has new final w/manu-als & exciter, \$5800. R Mason, WKY, 508 W Oak St, Covington VA 24426. 540-962-1133.

Gates BC5P2 5000 W, 960 AM, \$3000. Roy, KCGS, 501-448-5567.

Gates 500 W AM xmtr, operational or for parts, cheap or free to gd home, you ship. 502-845-6000.

RCA BTA-50H ampliphase transmitter parts; RCA BTA-50J ampliphase 50 kW AM transmitter in good cond. S Porter, WWL Radio, 1450 Poydrasi #440, New Orleans LA 70112. 504-593-2106.

TTC 2500 FM w/exciter & harmonic fil-ter, easy to retune, \$5000 & u haul it. J Crawley, Group Radio, POB 185, Campbellsville KY 42719. 502-465-8884.

Continental 814R-2 1 kW, presently on air, exciter, spare controller cards with semi-conductor kit, verty good condition, \$9750. C Dreibelbis, WJUN, POB 209, Mexico PA 17056. 717-436-2135.

**BESCO** World Leader in AM - FM Transmitters  
"Now in our 30th year"

**91 AM & FM Pre-Owned Units in Stock**

- ✓ ALL - Powers
- ✓ ALL - Manufacturers
- ✓ ALL - Instruction Books
- ✓ ALL - Complete
- ✓ ALL - Spares

Call and take advantage of our liberal trade-in plan. Tune and test on your frequency, available on site. Complete inventory on request.

Phone: 214-630-3600  
Fax: 214-226-9416

QEI amplifiers, exciters and stereo generators. All are reconditioned and are tuned and tested on your frequency. 6 month warranty is included. If you want quality used equipment, call or fax 609-232-1625 and ask for Bob Brown.

McMartin BF1K 1.5 kW FM, used, completely refurbished, tuned & tested on your frequency & guaranteed. Goodrich Ent, 402-493-1886.

COLLINS 5 KW FM transmitter. Twenty years old, with Continental exciter. Was operating at 93.9 MHz when removed from service. Reasonably clean, \$5000. Contact Energy-Onix, 518-828-1690 FAX: 518-828-8476.

Harris 1978 2500 W FM, 2.5 H3, good cond, fairly new driver & final Svellana tubes, \$6500. WDKD, POB 1125, Kingstree SC 29556. 803-382-2361.

QEI FM exciter, used one week, must sell quickly. 714-744-7915.

McMartin BF5K 5 kW FM, com-pletely refurbished, tuned & tested on your frequency & guaranteed. Goodrich Ent, 402-493-1886.

Used equipment for sale: Belar SCM-1, Belar RFA-1, Belar FMS-1, Belar FMM-1, Moseley MRC 1600 system, TFT EBS rcvr/generator, Gentner patch panel, and Harris racks. Call Transcom Corp 800-441-8454 or 215-884-0888.

Gates BC500T 230 V single phase SR-69441, 1010 kHz on-air, BO; RCA BTA50G Ampliphase SR-BCD922058, 101 kHz on-air, BO. B Kaufman, KXEN, Box 8085, Mitchell IL 62040. 618-797-2299.

**Want To Buy**

Harris/Continental FM 1 kW to 10 kW seriously ill xmtrs or amps. 714-282-7500.

AM transmitter, 20-25 kW in good operating condition, prefer newer but will consider all. D Miller, WNAM, POB 707, Neenah WI 54957. 414-727-2055.

McMartin AM/FM xmtr, any model, exciter or stereo modules. Goodrich Ent., 11435 Manderson, Omaha NE 68164. 402-493-1886.

Harris MW1. K Thompson, WWIC, 815 W Willow St, Scottsberg AL 35768. 205-259-1050.

**TUBES**

**Want To Sell**

Radio/TV recvg tubes, approx 500, some rare, rectifier, pwr, audio types, send for list; precision tube tester, many extras, BO. F Grassi, Demo-Vox Sound, 1038 Bay Ridge Ave, Brooklyn NY 11219. 718-680-7234.

**REBUILT ELECTRON TUBES**

Partial List: **6623, 23791, TH150, 6425F, 6427, 8550, 6804, 6696, 6697, 5681, 5682, 5671, 7804, 3CX10,000H3, 3CX20,000H3, 4CX5000A, 4CX35,000C**

Worn out power tubes purchased

**Vacuum Tube Industries, Inc.**

1-800-528-5014  
508-584-4500 X75

**INCREDIBLE TRANSMITTERS**

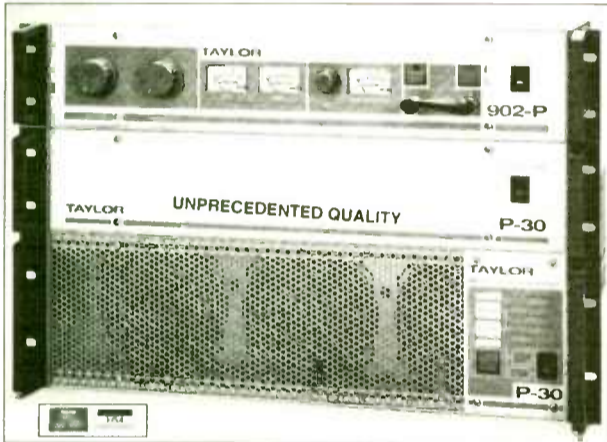

**TV TRANSMITTERS**

1Watt	\$1,114
2Watt	\$1,664
4 Watt	\$2,138
20 Watt	\$3,880
40 Watt	\$5,046
100 Watt	\$6,206
200 Watt	\$9,874
400 Watt	\$13,171
800 Watt	\$18,295
1KWatt	\$22,900

**FM RADIO TRANSMITTERS Including Stereo Encoder**

1Watt	\$1 138
30Watt	\$1 499
300 Watt	\$3 174
600 Watt	\$5,960
1K Watt	\$8,716
2K Watt	\$11,905
4K Watt	\$20,741

**TAYLOR**  
The Transmitter People

Taylor Bros. (Oldham) Limited, 116 St Oldham, England. Tel: 0161 652 3221 Fax: 0161 626 1736

**TRANSCOM CORP.**

Serving the Broadcast Industry Since 1978

Fine Used AM & FM Transmitters and Also New Equipment  
For the best deals on Celwave products, Andrew cable and Shively antennas.

1 kW FM 1978	Collins 831C-2	1 kW AM 1982	Harris SX1
2.5 kW FM 1983	Harris FM2.5K	1 kW AM 1981	Harris MW1A
2.5 kW FM 1978	Harris FM2.5K	5 kW AM 1977	RCA BTA 5L
5 kW FM 1969	RCA BTF 5D	5 kW AM 1979	Continental 315-F
10 kW FM 1968	RCA BTF 10D	10 kW AM 1971	CCA AM 10,000D
10 kW FM 1971	Collins 830F-1B	10 kW AM 1974	CSI T-10-A
20 kW FM 1968	RCA BTF 20E	10 kW AM 1992	Nautel ND-10
50 kW AM Harris MW50C3 (1100 KHZ)		25 kW AM 1982	CSI T-25-A

1077 Rydal Road #101  
Rydal PA 19046

800-441-8454 • 215-884-0888 • FAX No. 215-884-0738

Circle (23) On Reader Service Card

**This is One Crate Opening You Can't Afford to Miss!**



If a new **High Power transmitter** is in your future plans...

Plan now to see the 'Next Generation' of **High Power FM transmitters**

We'll uncrate the **High Power Transmitters of the Future** at NAB Booth #4100

**Building FM's Future... Today!**



752 Warren Street  
Hudson NY 12534

518-828-1690  
FAX: 518-828-8476

Circle (48) On Reader Service Card



**Power You Can Trust**

**Worldwide Power Tube Leadership**

- Largest Selection
- Applications Support
- Committed to Quality

Made in U.S.A.

Call 800-414-8823  
Int'l. (415) 592-1221  
or Fax 415-592-9988



Circle (169) On Reader Service Card



**Quality Power Tubes**

3CX2500A3	4CX15,000A
3CX2500F3	4CX15,000J
3CX2500H3	4X150A
3CX3000A7	5CX1500A
3CX3000F7	5CX1500B
3CX10,000A3	572B
3CX10,000A7	5U4G
3CX10,000H3	6550B
3CX15,000A3	6550C
3CX15,000A7	6A57G
3CX15,000H3	6BM8
4CX250B	811A
4CX250BC	833A
4CX250BM	833C
4CX250R	EL34
4CX350A	SV811-3
4CX350AC	SV811-10
4CX400A	TH5-4
4CX800A	TH5-6
4CPX800A	TH6-3
4CX1500A	TH6-3A
4CX1600B	YC130 9019
4CX1600U	8560AS
4CX3500A	SK300A
4CX5000A	SK1300
4CX10,000D	SK1320

- Watch this list grow.
- Shipment from USA stock.
- Manufactured in Russia's largest power tube factory.
- Generous\* warranty based on high quality.
- Honest prices based on quality at low cost.

**Broadcasters**  
Phone: 800-239-6900  
205-882-1344  
FAX: 205-880-8077

**OEMs, Distributors**  
Phone US: 800-578-3852  
Int'l & US: 415-233-0429  
FAX: 415-233-0439

Circle (145) On Reader Service Card

**FOR THE BEST PRICE**  
& 24 Hr service on transmitting tubes  
call Goodrich Ent Inc at 402-493-1886  
day or night, FAX 402-493-6821.

EIMAC, AMPEREX, RCA 4CX250B, 4-400, 4-1000, 4CX300, 4CX350A, 807, 833, 3CX400A7. Westgate 800-213-4563.

**D and C Electronics Co.**

**Lowest Price on Tubes including:**

4-1000A/3-1000Z/  
8877/4CX250B/833A  
4-500/5-500/4-400/  
4CX 3500/5CX1500

and much more!  
Factory Warranty!

**1-800-881-2374  
(352) 688-2374**

Se habla Español  
FAX: (352) 683-9595

**ECONCO**

**Quality Rebuilt Tubes**  
Approximately 1/2 the Cost of New

Call for Our Price List

**800-532-6626  
916 662 7553**

**FAX 916-666-7760**

Circle (170) On Reader Service Card

**Buy Factory Fresh New Tubes**

- ✓ EIMAC, BURLE, SIEMENS, AMPEREX, NATIONAL, and more
- ✓ Off-the-shelf delivery
- ✓ 24-hour emergency service

**Richardson Electronics, Ltd.**

**1-800-348-5580**  
FAX: (708) 208-2550

Eimac/Varian 3CX1500A7/8877, brand new, current code date, full warranty, \$500. R Stankus, Mid-Lo Bdctg, 11037 Jacqueline Ave, Englewood FL 34224. 941-473-2256.

**Want To Buy**

Socket for 5CX1500A tube, will mount in FM Collins 831D-2. J Mulhern, KSCB, POB 3125, Liberal KS 67905. 316-624-3891.

Thompson TH328 or TH338 pullouts. Mark, 315-635-9310.

**TURNTABLES**

**Want To Sell**

Technics SL1200 MK 2-A TT's (2), \$350. K Diebel, KTJC, 1707 Louise St. Rogville LA 71269. 318-728-5852.

Technics bdcT TTs (3) w/power supply, tone-arm, \$150 ea +shpg. Skip, 614-890-9977.

Rek-o-Kut 12" recd TT, no lathe, cabinet or tone arm, induction type motor, 78/33 speed, vgc, \$75; Channel Master 6653 variable speed TT, 12" platter, 16-78 rpm, built-in pre amp, magnetic cartridge & stylus for 33/45 & 78, excellent condition, \$75; Gray 103 series 16" TT, wired for stereo, no cartridge, vgc, \$35. All items +shipping. B Leslie, Pro Recording Services, 13709 Mapleleaf Dr, Cleveland OH 44125. 216-662-1435.

**BOOST YOUR SALES**

**Advertise in Radio World's Classified Section**

**You'll be impressed with the results!**

# ADVERTISER INDEX

This listing is provided for the convenience of our readers. Radio World assumes no liability for inaccuracy.

Page No.	Advertiser	Reader Service No.	Page No.	Advertiser	Reader Service No.
34	360 Systems	86	28	Henry Engineering	109
65	AEO	44	19	Henry Radio	63
7	ATI	33	46	Holiday Industries	111
38	AirCorp.	101	72	ITC	3
3	Altronic Research	6	44	ITC	215
20	Antique Electronic Supply	176	30	Inovonics	36
40, 41	Arrakis	91	45	Inovonics	42
44	Audi-Cord Corporation	173	58	Itelco	47
29	Audio Broadcast Group	60	38	J-Squared Technical Service	76
28	Audio Broadcast Group	9	74	J&I Audio/Video	105
75	Audisar	130	48	JNS Electronics	166
79	Audiotronics	49	28	Jennings Technology Corp.	84
61	Autogram	30	62	LBA Technology	25
76	BBH Software, Inc.	180	76	Marathon Products	155
3	Belar	13	21	Media Touch	52
36	Benchmark Media Systems	134	59	Microcon Systems	96
28	Broadcast Devices, Inc.	15	69	Modulation Sciences	64
4	Burk Technology	8	61	Monroe Electronics	123
78	CPI	169	53	Murphy Studio Furniture	81
44	CPI	140	24	Muscam USA	89
44	CartWorks	165	47	NSN	119
44	Cellcast/Artran	66	55	National Public Radio	125
60	Circuit Werkes	120	38	Nott Ltd.	51
36	Coaxial Dynamics	40	26	Orban	19
46	Communications Data Services	62	54	Otari	114
68	Comrex	27	42	PR&E	69
60	Comrex	95	63	PR&E	22
19	Conex Electro-Systems	14	61	PTEK	148
15	Continental Electronics	16	77	Peter Dahl Co.	205
64	Crown Broadcast	7	38	Phartronic	1
73	Crown Broadcast	78	61	Phasetek	98
35	Cutting Edge	67	76	Pikes Peak Satcom	24
10, 11	Dalet	113	27	Potomac Instruments	43
27	Dataworld	39	61	Priority Leasing Corporation	73
45	Dataworld	85	28	Pristine Systems	193
18	Denon Electronics	37	56, 57	Prophet Systems	163
61	Dielectric Communications	198	25	QEI	38
62	Dynaudio Acoustics/AXI	31	52	RE America	87
36	ESE	157	28	S.C.M.S.	34
78	Econco	170	20	Sascom Marketing Group	151
60	Econco	20	60	Shively Laboratories	45
60	Electronic Research Inc.	55	39	Shure Brothers	106
70	Enco Systems	107	38	Silicon Valley Power	149
77	Energy-Onix	48	22	Sine Systems	35
71	Eventide	79	50	Smarts Broadcast Systems	58
61	Excalibur	194	16	Sonic Foundry	29
44	Factory Direct Sales	65	32	Spectral Inc.	110
28	Flexcore	59	66	Superior Electric	54
20	Freeland Products, Inc.	201	78	Svetlana Electron Devices	145
43	Full Compass Sound	21	20	Svetlana Electron Devices	126
31	Gentner	41	8	TFT	12
37	Gentner	82	6	Tascam	57
51	Ghostwriters	102, 210	36	The Blue Group	90
44	Gorman Redlich	190	20	The Parts Connection	5
51	Group W Satellite	195	77	Transcom Corp.	23
74	Hall Electronics	80	36	Universal Electronics	184
1	Harris	2	37	Ward Beck	72
23	Harris	61	2	Wheatstone	18
25	Harris	83	80	Wheatstone	112
49	Harris	11	36	Will-Burt	115
67	Harris	46	60	Z Technology, Inc.	70
72	Harris	17	60	Zercom	209

Publisher	Stevan B. Dana	Production Assistant	Tinna Masters
Associate Publisher	Carmel King	Production Assistant	James Cornett
Production Director	Lisa Stafford	Ad Coordination Manager	Simone Mullins
Publication Manager	Heather K. Heebner	Circulation Director	Eleya Finch
Classified/Showcase Production Coordinator	Vicky Baron	Circulation Manager	Steven Bowman
Ad Traffic Coordinator	Kathy Jackson	Accounts Receivable	Steve Berto

**Advertising Sales Representatives**

U.S. East: Skip Tash	703-998-7600 Fax: 703-998-2966
U.S. West: Dale Tucker	916-721-3410 Fax: 916-729-0810
U.S. Midwest: Sandra Harvey-Coleman	317-966-0669 Fax: 317-966-3289
International: Stevan B. Dana	+1-703-998-7600 Fax: +1-703-998-2966
Europe: Dario Calabrese	+39-2-7030-0310 Fax: +39-2-7030-0211
Japan: Eiji Yoshikawa	+81-3-3327-2688 Fax: +81-3-3327-3010

Free Subscriptions are available upon request to professional broadcasting and audiovisual equipment users. For address changes, send current and new address to RW a month in advance at P.O. Box 1214, Falls Church, VA 22041. Unsolicited manuscripts are welcomed for review. send to the attention of the appropriate editor.

# EMPLOYMENT

To place ads in this section, use the ActionGram form. To respond to box numbers write Radio World, PO Box 1214, Falls Church, VA 22041. Attn: \_\_\_\_\_

**POSITIONS WANTED**

Computer-literate engineer seeks long-term prof relationship in major market, 18 years of AM directional, high power FM, RPU, satellite & DCS programming exper. S Boucher, 616-722-9606.

Experienced PD, GM, jock, prod dir looking for any FT position in Alaska, any format, have worked several formats. Ron, Box 87, Dillingham, Alaska 99576.

Recent graduate from bdcT school seeks long term position. Hardworking, dependable & willing to relocate. Mike, 402-756-3327.

Graduate of broadcasting school, very energetic, hardworking & willing to relocate. Derek, 405-732-7615.

National voice avail for station promos, liners, etc, for demo & info write: Voice, POB 94, Novelty OH 44072. 1-800-774-6940.

Recent hardworking/dedicated graduate of bdcT school seeking to start his career in on-air, production, and/or sales in Missouri. Dale, 405-672-6205.

Seeking on-air position, 5 yrs exper, sports preferable, will do news, high school basketball, football PBP exper + new work, Syracuse grad. Kevin, 607-467-6069.

Southeastern radio stations: benefit from my 30+ years of announcing, production & engineering experience, last 7 years with VOA. Alex, 513-777-8423.

Veteran programmer looking for my next challenge, let me take your station to the next level. Roger, 423-235-6889.

Young new talent trained in production, on-air, copywriting & sales seeks exciting job at your station, willing to relocate. Robert, 405-794-5071.

ND with solid work ethic seeks on-air position with aggressive station, will relocate. Mark 216-455-5174.

Will write promos, liners, PSAs, spots for ultra cheap prices. Mike, 716-673-2402.

**HELP WANTED**

**CHIEF ENGINEER:** three station stable company seeks CE with studio & PC experience. Flagship station for UVA sports. Send resume and salary requirements to: Dann Miller, WINA, PO Box 498, Charlottesville VA 22902. EOE.

**CHIEF ENGINEER** for multiple AM/AM-DA/FM/LPTV clients on Central California Coast. 2 years broadcast experience and tech. degree minimum. People skills important. Resume to: Interstellar Communications, P.O. Box 13057, San Luis Obispo CA 93406.

**CHANCELLOR BROADCASTING COMPANY**

Due to our unprecedented growth and market duopolies, CBC has several immediate openings for Radio Chief Engineer positions in large and major markets around the country. Individuals must have at least 5 years hands on experience with AM DA and FM operations from studio to transmitter, and strong computer hardware knowledge. SBE certification and/or General FCC license preferred. Send letter and resume in confidence to:

Engineering Department  
**CHANCELLOR BROADCASTING COMPANY**  
625 Eden Park Drive  
Suite 1050  
Cincinnati, OH 45202  
E.O.E./E.E.O.  
No phone calls please.

**Broadcast Engineering Technician - Jacor Broadcasting of Colorado, Inc.** Applicant will be responsible for installation, maintenance, troubleshooting, repair, and modification of a wide variety of broadcast equipment including FM transmitters, production and air studios, remote broadcast equipment, and IBM compatibles. Candidate must be willing to handle after hour emergencies, work a flexible schedule, and accept direction from Chief Engineer. Please send resume to Laura Kronberg, 1380 Lawrence St, #1300, Denver CO 80204. Jacor Broadcasting of Colorado, Inc. is an equal opportunity employer. No phone calls.

**CHIEF ENGINEER** for top 10 market FM stations. Strong RF & studio construction skills required. Minimum 5 years experience in Mid to Major markets EOE. Resume salary requirements to: Radio World, POB 1214, Falls Church, VA 22041. Attn Box #96-3-6-1RW.

**CARTWORKS**, a division of dbm Systems, Inc., is experiencing rapid growth with our digital-based audio systems which requires immediate expansion of our sales team. Rep positions available throughout the U.S. Interested parties should visit NAB '96 booth # 2826 or call Bob Buie @ 1-800-795-7234.

**News Anchor/Editor/Reporter**

New York and Pennsylvania Christian network looking for an experienced radio news person. Five years in radio news gathering and production a minimum. Our news department is "ISSUES DRIVEN" and production intensive. Contact: Glenn H. Lambert, News Director Family Life Network P.O. Box 506, Bath, NY 14810 607-776-4161



“SOMETHING  
WONDERFUL

is about to happen!”

 **AUDITRONICS**

3750 Old Getwell Road, Memphis, TN USA (901) 362-1350 FAX (901) 365-8629

NAB Booth 3005

Circle (49) On Reader Service Card

See Us at NAB Booth 3005

World Radio History

*We've taken all we know, all you've asked for,  
and the very best of today's technology to  
bring you our **FINEST AUDIO CONSOLE***

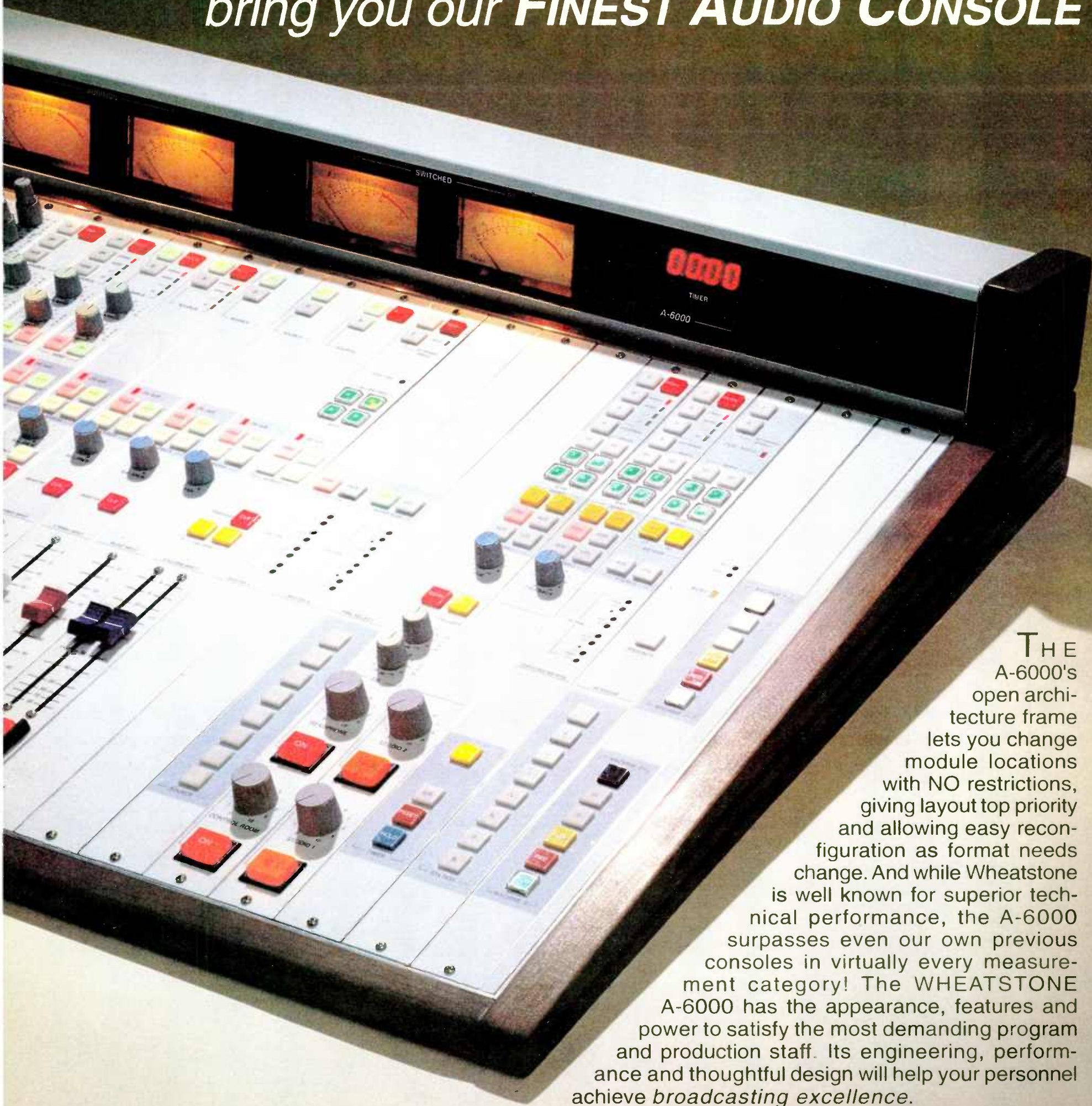

**T**HE A-6000's open architecture frame lets you change module locations with NO restrictions, giving layout top priority and allowing easy reconfiguration as format needs change. And while Wheatstone is well known for superior technical performance, the A-6000 surpasses even our own previous consoles in virtually every measurement category! The WHEATSTONE A-6000 has the appearance, features and power to satisfy the most demanding program and production staff. Its engineering, performance and thoughtful design will help your personnel achieve *broadcasting excellence*.

## **A - 6 0 0 0    B R O A D C A S T    C O N S O L E**

7305 Performance Drive, Syracuse, NY, 13212  
(tel 315-452-5000 / fax 315-452-0160)

 Wheatstone Corporation

Circle (112) On Reader Service Card

World Radio History