

*****3-DIGIT 857
 S101903 D08 0103 682
 BARRY MISHKIND
 2033 S AUGUSTA PL
 TUCSON AZ 85710 7905

Site Scramble

With new FM licenses likely, tower space is becoming even more valuable.

Page 29

ABCs of Radio

Johnny Donovan approaches 30 years of success in New York.

Page 49



Radio World

The Newspaper for Radio Managers and Engineers

November 7, 2001

INSIDE

ENGINEERING



▼ Masked engineer Guy Wire has strong feelings about EAS; AM engineers pass the torch; and a recipe for making your next project a miserable experience.

In This Issue

GM JOURNAL

▼ Take a teen to lunch and find out why he thinks 'radio stinks.'

Page 29



INTERNET RADIO

▼ For a station in St. Louis, streaming was the answer to a prayer.

Page 42



▼ When ComedyWorld went belly-up, its \$3.5 million of new gear sold for about \$550,000.

Page 45

AT THE NEXUS

▼ Jack Allen wins a Comrex Nexus codec.



Page 4

NEWS ANALYSIS

What Next For Sirius?

Sat Launch Delayed; CEO Out. Now What?

by Leslie Stimson

NEW YORK Is satellite radio going to succeed with a slow product launch? Will there still be two companies selling the subscription services a year from now?

Wall Street analysts and radio observers asked those questions after Sirius Satellite Radio's David Margolese stepped down as chief executive officer in October, and company officials confirmed the satcaster will not begin offering subscription digital radio by the end of this year as planned.

Launch plans

Sirius intended to make its launch plans public on Nov. 14.

Margolese co-founded the company formerly called CD Radio in 1990. He will remain as non-executive chairman of the board. Sirius officials said the move had been planned for a while, saying the company is making the

See SIRIUS, page 8 ►

Manufacturers Slow To Embrace EFD

Proponents Believe Documentation Software Will Make Facility Design Faster, Gear Shopping Cheaper; Manufacturers Say 'Show Me'

by Steve Jess

INDIANAPOLIS The Society of Broadcast Engineers is trying to convince equipment manufacturers to adopt a standard for "Engineer-Friendly Documentation."

While engineers drafting the standard are enthusiastic about its poten-

tial to streamline facility design, manufacturers have been slow to respond.

David Baden, chief technical officer at Radio Free Asia, heads an SBE task force of engineers and manufacturers drafting the EFD specification.

"We're slapping the baby, but it's not crying yet," he said to describe EFD.

See EFD, page 6 ►

The Struggle For Tower Space

Page 3



Space on the Empire State Building is in demand after events of Sept. 11.

Photo: Eric Wandel, ERI

Why pay extra for analog?

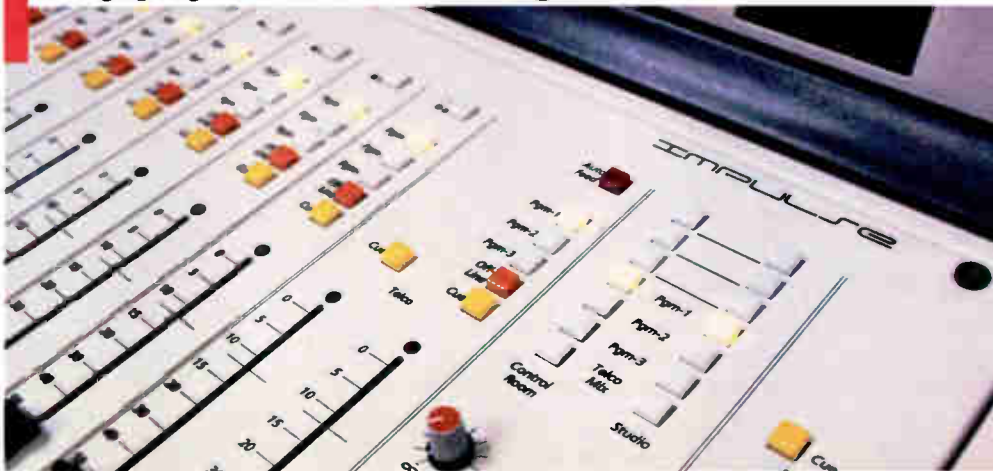

Transition to digital on your timetable with the new Harris Impulse Digital Console by Pacific Research & Engineering. It can accept either analog or digital inputs and reconfigure from analog to digital easily — right in your studio. You can get the benefits of a digital console for less than the cost of most analog consoles. To find out more, call us today. Or, feel free to act on Impulse

next level solutions
HARRIS

1-800-622-0022 • www.harris.com

NewsBytes Now
 Every Business Day
 at www.rwonline.com



◆ NEWSWATCH ◆

FCC Modifies Mail Policy

WASHINGTON As a security measure, the FCC stopped accepting delivery of paper filings to its Washington headquarters as of Oct. 18. It will no longer accept hand-delivered or messenger-delivered documents to its 12th St. address.

Instead, those are to be diverted to its Capitol Heights, Md., facility at 9300 East Hampton Dr. The deadline for accepting deliveries to that address has been extended to 9 p.m. each weeknight.

The commission encouraged the public

to e-mail all documents instead.

"The commission finds it necessary at this time to make these changes to its procedures to protect the health and safety of its employees and therefore finds good cause to make them as expeditiously as possible," officials stated in a public notice.

Filings and other documents sent to the FCC by U.S. Postal Service or overnight delivery services should continue to be addressed to 445 12th St., Washington, DC 20554. The FCC will divert those deliveries to the Maryland.

At press time, the FCC was looking for an alternative Washington site to accept messenger or hand-delivered filings.

ARMA Cancels Fall Event

The American Radio Manufacturers Association won't hold a regional show in New England after all.

Organizer Vince Fiola said he cancelled the November show when it became clear it would lose about \$10,000. He blamed several factors, including the economy, terrorism and the resulting decision by other conventions to move their dates closer to ARMA's.

Several exhibitors had promised to take part, then backed out after Sept. 11. Fiola, who owns cabinetry supplier

Studio Technology, will still lose money on the event because he had signed a contract with a hotel in Burlington, Mass.

"I really still believe that (ARMA) is a viable organization but obviously I can't continue to pay all the money and take losses if there's no support from the industry," Fiola said. "I can't have the same nine or 10 companies show up and having it cost Studio Technology money."

Fiola still plans to hold an ARMA event in the middle Atlantic states next year, and said a winter show in Atlanta is being considered.

"It may just be the state of the world right now, and the industry as well," Fiola said.

Index

FEATURES

Digital Dawn for Srpski Radio Banja Luka
by Blažo Guzina 14

Passing the AM Torch in San Antonio
by Gary Keener 15

Who's Buying What? 16

How Not to Design a Facility
by Richard Schrag 18

Workbench: You Can Find Old Xmitter Parts
by John Bisset 21

How One State's OEM Reacted
by Robert Schroeder 24

EAS: Not Even a Glass Half-Empty
by Guy Wire 25

Where the NEC Came From
by Charles S. Fitch 26

LPFM Stations Are Rolling Out
by Ken R. 28

GM JOURNAL

Tower Siting: Relief Ahead?
by Barry D. Umansky 29

Take a Teen to Lunch
by Scott Fybush 29

Radio Legends: Reinvention Is Key
by Scott Fybush 30

Putnam's Career Dates to 1934
by Laura Dely 34

INTERNET RADIO

Web Watch: High Demand Challenges Net Radio
by Sandy Wells 41

KFNS Will Never Stop Streaming
by Michael C. Phares 42

Ad Insertion Helps Terra Stations, Niche Music Channels Thrive 42

At Auction, Tears of a Clown
by Sandy Wells 45

STUDIO SESSIONS

Donovan: Making WABC Sound Great
by Ken R. 49

Iasys Sound System Optimizes Acoustics
by Sam Wise 49

Surround-Sound Mic Techniques
by Bruce Bartlett 50

Pioneer DVR-A03: Storage Galore
by Carl Lindemann 51

Product Guide 55

OPINION

62

BIG EASY

TECHLINE STUDIO FURNITURE

Easy to INSTALL – Easy to AFFORD!

- machine-tapped rack rails
- built-in top and bottom ventilation
- removable doors
- punchblock enclosure available
- compatible with Wheatstone Wiremax System
- available with type 66 or Krone™ blocks
- modular design for variety of configurations
- both standup and sitdown heights
- above counter turret accessories
- fast installation
- generous wireways
- built-in levellers



STARTS at \$2900

Available options include
prewired punchblocks

OUR HIGH-STYLE TECHLINE STUDIO FURNITURE

boasts uncompromising **QUALITY** tailored to the **TIGHTEST BUDGETS**, with all the features a well-designed studio calls for.
A TRULY COST-EFFICIENT SOLUTION FOR YOUR NEXT STUDIO PROJECT!

 **Wheatstone Corporation**
tel 252-638-7000 / fax 252-635-4857 / sales@wheatstone.com / www.wheatstone.com

copyright © 2001 by Wheatstone Corporation

N.Y. Stations Scout Tower Options

by Randy J. Stine

NEW YORK New York City radio broadcasters are studying the feasibility of expanding the transmission facility at the Empire State Building and reexamining the importance of maintaining auxiliary sites since the collapse of the World Trade Center in September.

FM stations WKTU, WNYC, WPAT and WKCR continue their search for main transmission sites and face months of planning to find long-term permanency. The broadcasters hope to have new full-power transmitters in place by the end of 2002. WQCD(FM) lost its auxiliary transmitter at World Trade Center site.

The World Trade Center's 360-foot antenna mast also served most New York City television stations. Six television technicians lost their lives in the commercial jet terrorism attacks.

With the exception of WKTU, the affected radio stations have operated on low power from auxiliary locations following emergency installations. WKTU

immediately switched to its full-power backup on the Conde Nast building at 4 Times Square. Both WPAT and WNYC relocated to temporary low-power transmission facilities on the Empire State Building.

Experts said with the loss of the World Trade Center's master FM antenna, the availability of tower space in New York City is limited and will likely become more expensive.

Empire almost full

The Empire State transmission facility is considered nearly full and the only other options — 4 Times Square, the Alpine tower in Alpine, N.J., and the American Tower Corp.'s Alpine location — are considered less attractive, they said.

"There is an absolute shortage now of space that will give you the best coverage over the tri-state area," said Lou Libin, a 17-year broadcast engineering consultant. "There is not one spot that has a lot of space left."

The Empire State Building does not

have the infrastructure to handle much more, Libin said. If the majority of the affected TV stations relocate there as predicted, radio stations may be forced to operate on reduced power while the overhaul is being done.

"The antenna proper can handle additional stations; the limitation is really on the hardware (combiner) and master

patch panel," said Tom Silliman, president of Electronics Research Inc., the company that designed the Empire master FM antenna.

"The power handling capability of the filters is the question. As you add more stations, it increases the probability of a failure."

The consortium of broadcasters on the master FM antenna has commissioned a study to determine the best options for adding more stations, said Silliman.

See TOWER, page 10 ▶

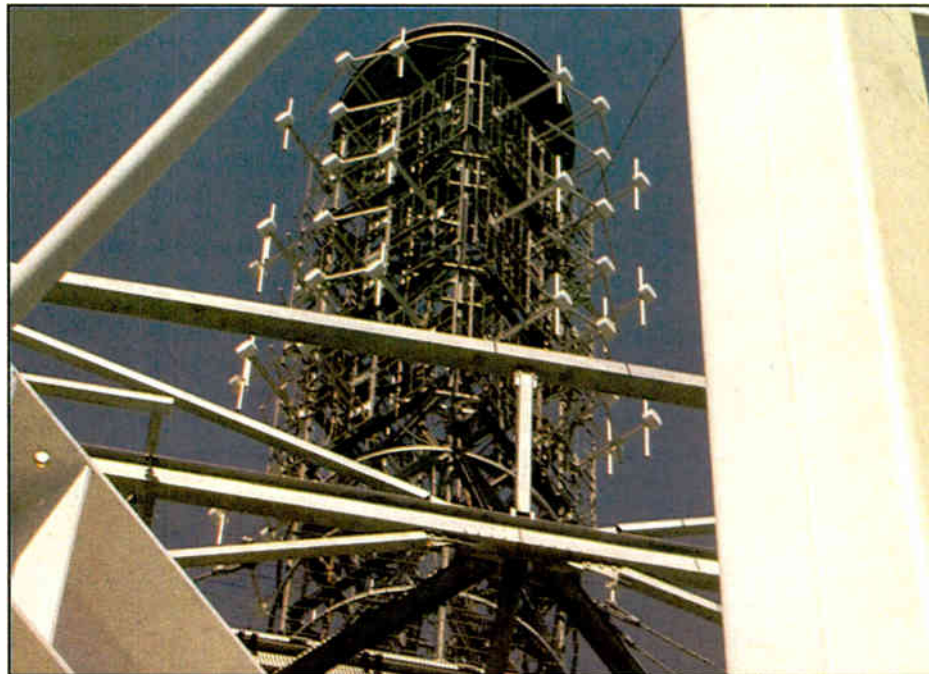

In addition to relocating its main transmitter site to the Empire State building, WNYC will add a backup at this Shively master FM antenna system on the Conde Nast building.

Radio Stations Stretch To Cover War Events

by Naina N. Chernoff

WASHINGTON As events unfolded in the months after the September terrorist attacks, radio networks were modifying their schedules and budgets to satisfy the public's interest in news.

While networks such as ABC, CBS and National Public Radio were taking a wait-and-see approach to permanent

Radio's vice president of news, said of the war on terrorism. "Considering that, it will be covered by the news media like any other."

Berry said his news staff was prepared ready to cover whatever military action would happen next. With a reporter in Afghanistan and an existing supply of satellite phones that will be used by reporters overseas, he



Something rarely seen in live radio — VU meters down during a moment of silence.

changes in their programming schedules, their news teams were providing extended coverage and incorporating more news updates into their schedules.

Even as these programming decisions were being made, many radio organizations were also facing the implications of the anthrax scare, asking themselves about mailroom security and employee safety and realizing that media can be targets, too.

"This is a war unlike any that have been fought," said Chris Berry, ABC

said the staff was ready.

The network decided to produce four short news reports each hour for its affiliates and an hour-long special report on the continuing story each night for an indefinite period of time. The reports began airing for a short time after the Sept. 11 attacks and introduced again after the U.S. response in early October, Berry said.

In September, the network created a new radio show around the topic hosted See PROGRAMMING, page 12 ▶



STOP
PULLING YOUR HAIR OUT OVER VOICEMAIL!!

CALL S.C.M.S., INC.

- ✓ 25 Years of Personal Service (1976-2001)
- ✓ Experienced Staff
- ✓ Competitive Prices for over 600 Quality Manufacturers of New Equipment
- ✓ Huge Stock of Rebuilt RF and Audio Gear
- ✓ Extensive Rental Fleet (RF, Coders, Test Equipment, Audio, and More)
- ✓ Trade-Ins Welcomed
- ✓ Turnkey RF and Studio Installations Planning and Design.
- ✓ Custom Studio Furniture

YOU-KNOW-WE-KNOW-RADIO

800-438-6040 - www.scmsinc.com - Pineville, N.C.
FAX: 704-889-4540 e-mail: sales@scmsinc.com

FROM THE EDITOR

Paul's Bookcase Is Groaning

by Paul J. McLane

Let's reach up to the ol' bookshelf and see if any interesting tomes have arrived in time for holiday shopping.

What do you want to know about loudspeakers and headphones? Here's a hefty resource book from Focal Press with all the answers.

"Loudspeaker and Headphone Handbook, Third Edition" is edited by John Borwick, with contributions from 13 experts. It starts with principles of sound radiation and delves deeply into transducer drives, types of loudspeakers — electrostatic, distributed mode, multiple-driver systems — as well as amplifier interfaces, enclosures, room environments, studio monitoring, subjective evaluation and standards.

This is a highly technical book for professionals or audio libraries. Neither the content nor the price are for casual readers. It's a 736-page hardback with a retail price of \$120. For that money, it had better give a satisfying thud when it lands on your desk (it does).

If you need a reference source on this topic, ranging from theory to construction to measurements, it's excellent.

Call (800) 366-2665 and ask for ISBN # 0-240-51578-1.

★ ★ ★

Handy for the newsroom is the updated "Associated Press Broadcast News Handbook" by Brad Kalbfeld, deputy director and managing editor of the AP Broadcast Division. It's divided into two parts, and the second is the best reason to buy it: an alphabetical guide to specifics of broadcast style.

This is where radio newsmen can learn whether to write "Canada goose" or "Canadian goose"; how to handle profanities in news copy; the differences in "palate," "palette" and "pallet"; or how to spell "fusillade." The handy A-to-Z format is an outgrowth of the familiar AP Stylebook that print journalists keep on their desks.

The first part of Kalbfeld's book explains the basics of broadcast writing and is useful for students and others unfamiliar with the newsroom environment, although it's only a brief overview. (I like the ambitious headline on page 69: "What's News?") That question can occupy a graduate-level course, not just a couple of pages. But then again, broadcast

news is about the headlines, isn't it?)

Published by McGraw-Hill, the book retails for \$24.95.

Visit www.books.mcgraw-hill.com or ask a retailer for ISBN #0-07-136388-2.

★ ★ ★

Many radio people are interested in music. If you have an appreciation for the science of sound as used in music, the second edition of "Acoustics and Psychoacoustics" will please you.

David M. Howard and James Angus have written a textbook covering topics such as the basics of waves; how humans hear; notes and harmony; how acoustics apply to musical instruments; how environments affect how we hear music; and electronic processing of sound. Math-heavy sections are interweaved with more general discussions.

On the surface, this has little to do with radio; yet I couldn't keep from flipping through it, taken in by the concise text and the excellent illustrations. Maybe I need to get a life. This softcover is pub-

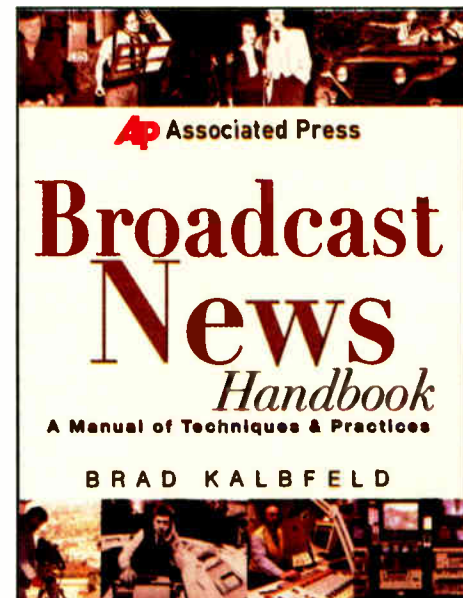

lished by Focal Press and retails for \$44.95. Call (800) 366-2665 and ask for ISBN #0-240-51609-5.

★ ★ ★

"Queer Airwaves" is about gay and lesbian broadcasting. Phylis A. Johnson and Michael C. Keith gathered interviews with activists, broadcasters and scholars

See BOOKS, page 12 ▶

Jack Allen, a host at Cox station WPLR(FM) in Milford, Conn., wins a Comrex Nexus codec in our Silver Sweepstakes this issue. The Nexus has everything you need for direct connection to ISDN, including a terminal adapter, for remote broadcasts. It provides studio-quality, 15-

kHz two-way audio in a package that weighs less than 3 pounds. Delay of 6 milliseconds makes interactive broad-

casts seamless.

This box is great for sports, interviews and remote talk shows. The prize includes a travel case with room for headphones, mics and cables. Retail value: \$2,410.

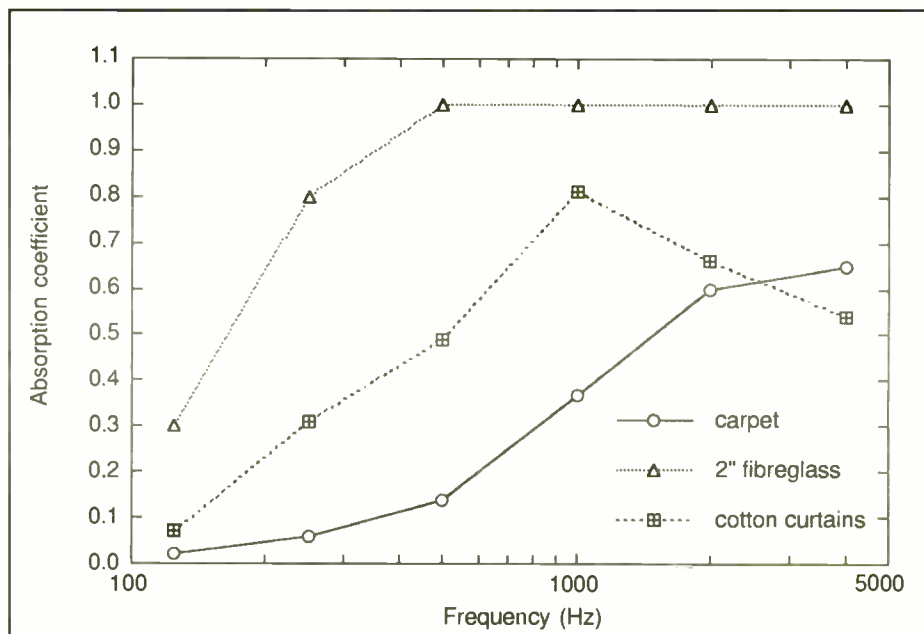

Shown are typical absorption curves for porous absorbers, from 'Acoustics and Psychoacoustics.'

Which Transmitter Control System is Right for You?

- Front Panel Display
- Site-to-Site Control
- 16 - 64 Channels
- Studio Control with Flexible Communications

- 85 Sites
- 8 - 256 Channels / Site
- Built-in Macros

- Single Site Solution
- 16 Channels
- Built-in Macros

ARC-16



GSC3000



VRC2500



Burk is proud to add the GSC3000 & VRC2500 to our product line, giving you more choices with our continued high level of support.

BURK

TECHNOLOGY

Phone: 1-800-255-8090
Email: sales@burk.com
www.burk.com

VOA Interview Questions Linger

by James Careless

Did Voice of America cave in to the U.S. State Department and yank an interview with Taliban leader Mullah Omar in September? Was VOA's decision to air the interview after a newsroom revolt coincidental?

Did this incident, which received play in the media including The Washington Post, foil an attempt by the State Department to pressure VOA? Or did VOA's journalists stage an unnecessary storm simply because they believed what they read in the newspaper?

In the world of Washington politics, this incident reveals how difficult it can be to nail down exactly what took place in such circumstances.

Print report

On Sunday, Sept. 23, the Washington Post printed a story by Ellen Nakashima. Under the headline "Broadcast With Afghan Leader Halted," she reported that, two days earlier, VOA had "decided not to air parts of a story that included parts of a rare interview with the leader of Afghanistan's ruling Taliban, Mullah Mohammed Omar, officials said yesterday."

The reason for the decision, Nakashima wrote, was the intervention of Deputy State Secretary Richard Armitage and senior National Security Council members. According to the Post, this group contacted the VOA's Board of Broadcast Governors, who are political appointees, and demanded that the interview be pulled.

The board passed this order to VOA staff, and the mullah piece was put into the archives.

"We told the members of the Board of Broadcast Governors that we didn't think it was appropriate for the Voice of

America to be broadcasting the voice of the Taliban into Afghanistan," Nakashima quoted State Department spokesman Richard A. Boucher as saying. "We didn't think it was consistent with their charter."

As it turned out, many VOA journalists read the Sunday edition of the Washington Post. When they saw Nakashima's column, they were incensed.

In response, the journalists drew up a petition to senior management. It stated that the mullah's comments were only

Many of us here believe this was the most important fight for VOA's credibility in many years.

— Jim Malone

meant to be part of a four-minute piece on President's Bush speech to Congress.

"By any standard, the mullah's comments qualified as news," said VOA national correspondent Jim Malone. "We said that, thanks to the State Department's pressure, the integrity of the VOA was at stake."

Minor revisions

The result? According to a story in the Post three days later, "there was a rethinking, and the VOA yesterday transmitted the piece with minor revisions. But the episode revealed an impulse to squelch facts that is never far beneath the surface in time of war or quasi-war."

Was the VOA's integrity under attack by State? Or was the initial Nakashima story, relying on unnamed sources, off the mark?

Pull or not?

VOA spokeswoman Tish King said that the State Department contacted VOA's governors on Friday, Sept. 21, the same day that VOA conducted the Omar interview.

King confirmed that State wanted the

interview pulled. However, she said the reason it didn't air on Sept. 21 was that VOA journalists also were trying to arrange an interview with the exiled king of Afghanistan in Rome. Together, both interviews were to have been used in the Bush speech reaction piece.

"They dispatched a correspondent to Rome," King said. "As of Monday (Sept. 24), they had not succeeded in getting the interview. But they succeeded in getting another interview with the Northern Alliance. So they combined those pieces to do the background story, which was broadcast on Tuesday the 25th."

In short, State may have protested but VOA's board and management did not give in.

"Was there a gag order?" concluded King. "No."

VOA journalist Jim Malone said he wasn't questioning whether King was telling the truth. But he believes the petition "may have had a role in paving the way for the mullah's comments to be broadcast. By going on record with 206 signatures, I believe the board became aware of how the journalists at VOA felt about any attempt to suppress the mullah's comments in the report."

"It was the News Division leadership that in the end showed courage by running the piece despite pressure from State," Malone said. "I believe the petition let them know that the staff was fully supportive of their efforts and presented the correct impression that journalists at VOA are a united front when it comes to resisting censorship pressures from the government."

"Many of us here believe this was the most important fight for VOA's credibility in many years, a defining moment in the history of an organization that sees its primary mission as broadcasting the truth in the form of balanced, fair and comprehensive news." 

NEWSWATCH

Ackerley-Clear Channel to Close Q1 '02

SAN ANTONIO The Ackerley Group's sale to Clear Channel Worldwide is expected to close during the first quarter of next year, assuming the deal passes antitrust review and Ackerley stockholders approve.

The companies peg the value of the all-stock deal at approximately \$497 million. Ackerley shareholders will get 0.35 shares of Clear Channel stock for every Ackerley share they hold. Clear Channel also is assuming \$294 million of Ackerley's debt, bringing the deal's overall value to nearly \$800 million.

When finalized, Clear Channel will get Ackerley's radio, TV, outdoor and interactive media assets.

Lowry Mays, chairman and chief executive officer of Clear Channel Worldwide, stated, "This transaction allows Clear Channel to enter Boston, Seattle and Portland, Ore., three of the top-25 U.S. outdoor advertising markets. Seattle is also a top-25 U.S. radio

market where we currently have no presence. In addition, this acquisition enables us to offer our advertising customers more cross-platform advertising opportunities."

In Seattle, Clear Channel assumes Ackerley stations KHHO(AM), KJR(AM), KBTB(FM), KFNN(FM) and KUBE(FM).

Other assets include:

Outdoor advertising — Boston (2,507 displays), Seattle (2,233) and Portland, Ore. (1,355).

Television — In Alaska: Fairbanks (KTVF). In British Columbia: Vancouver (KVOS). In California: Bakersfield (KGET), Eureka (KVIQ), Fresno-Visalia (KGPE), Monterey-Salinas (KCBA, KION), Santa Barbara-Santa Maria-San Luis Obispo (KCOY, KKFX), Santa Rosa (KFTY). In New York: Binghamton (WIVT, WBGH), Elmira (WETM), Rochester (WOKR), Syracuse (WIXT), Utica (WUTR), Watertown (WWT1). In Oregon: Eugene (KMTR).

Interactive Media — Bakersfield, Calif. (iKnowBakersfield.com), Rochester, N.Y. (iKnowRochester.com) and Monterey-Salinas, Calif. (iKnowCentralCoast.com).

radio SYSTEMS • MILLENIUM CONSOLES

601 Heron Drive, Bridgeport, New Jersey 08014
(856) 467-8000 voice (856) 467-3044 fax www.radiosystems.com



SMART CHOICE

-  **EXCELLENT VALUE**
The bottom line is that Millennium consoles work because their performance, look and sound present the best console value around.
-  **PROVEN**
Over 500 broadcasters use more than 3000 Millennium and RS series consoles to stay on the air every day. Most users who have bought one of our consoles bought another.
-  **FULL FEATURED**
You can buy options for a Radio Systems console — but you don't have to! From full remote control to complete monitoring, Millennium consoles work right out of the box!
-  **GREAT LOOKS**
Millennium consoles are beautifully styled with glowing soft-touch keypads and rich mahogany side-panels. And, owners can even inexpensively update their older consoles to a Millennium model.
-  **GUARANTEED**
Our consoles come with the best warranty in the business with 2-year no charge overnight parts delivery to keep you on the air.
-  **EASY INSTALLATION**
Make an afternoon out of installing your next console — not a career! These boards almost seem to wire and install themselves.
-  **SUPERB ENGINEERING**
These boards have the low noise and distortion specs that you need to compete with digital alternatives. And full DC control and modular construction keeps the performance clean and repairs a snap for the life of the console.

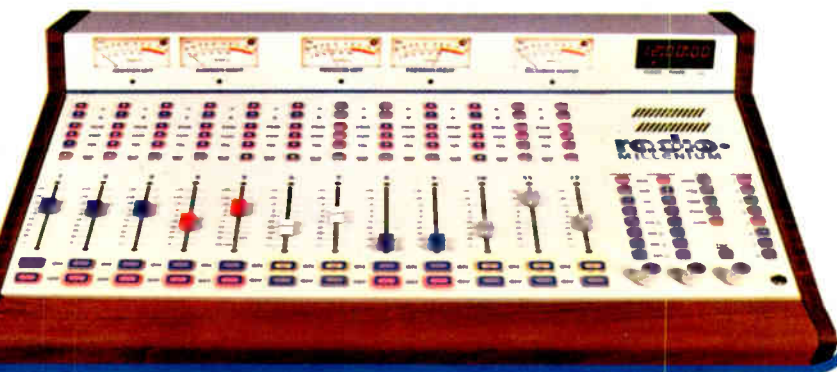

GUEST COMMENTARY

Passing the AM Torch in San Antonio

Gary Keener

For some time now, Paradigm Associates, headed up by John Furr, has been offering a seminar on what consulting engineers do. We meet for three or four days, from early in the morning to late in the evening, listen to lectures from experts in our field, and work out problems.

The symposium was intended as a training vehicle for our own folks at Paradigm, but quickly was expanded to include a

group of other consultants, directors of engineering, contract engineers and owner-engineers with whom we work.

Topics at the most recent symposium, held last winter in San Antonio, included math for antenna work, AM allocations, AM diplexing, top loading or sectionalizing of AM towers, AM directional antennas and field work.

We heard presentations from W.C. Alexander of Crawford Broadcasting, who is a Radio World columnist; Charles Crane

of Paradigm Associates; Tim Cutforth of Vir James; John Furr of Paradigm; and Charlie Gallagher, whom we lured out of his retirement from Gallagher and Associates.

With kibitzing from the audience led by Frank McCoy of American Media Services, it was a fascinating and informative four days. And except for one section about FM allocations, the discussion was all about AM.

Why was that? Who needs AM these days? In our experience, lots of people have important questions about AM systems. And with IBOC DAB just around the corner, we expect to get more calls to solve AM problems.

What kind of problems? Cell tower issues, collocations, directional antenna adjustments, station moves and upgrades, disappearing ground systems and just plain mistakes.

A lot of older systems, designed in the days before we all had computers on our desks, need to be revisited for broadbanding and other issues. Soil conductivity has changed dramatically in many places, and stations need to document that and

amend their patterns to reclaim their coverage areas.

Many stations are collocating AM facilities on tall towers holding up FM antennas. This requires either physical or electronic sectionalizing, the latter utilizing skirt wires.

AM-to-AM collocations are also becoming more common. Virtually any new or moved AM facility will now require a directional antenna. Meanwhile, the land on which to build arrays isn't even available in many places, or is prohibitively expensive.

AM experience

The knowledge pool needed to cope with all these problems has shrunk in the past few years, as AM lost economic importance in our industry. Station personnel frequently have little experience with AM issues — so little that sometimes they don't even realize they have problems, or opportunities.

Within the consulting business itself, the "old guard," the folks who gave us nine-tower arrays, are mostly gone or going, but their creations are still very much with us, and will be for the foreseeable future.

It's up to another generation to gather up the knowledge required and bring

See AM TORCH, page 22 ▶

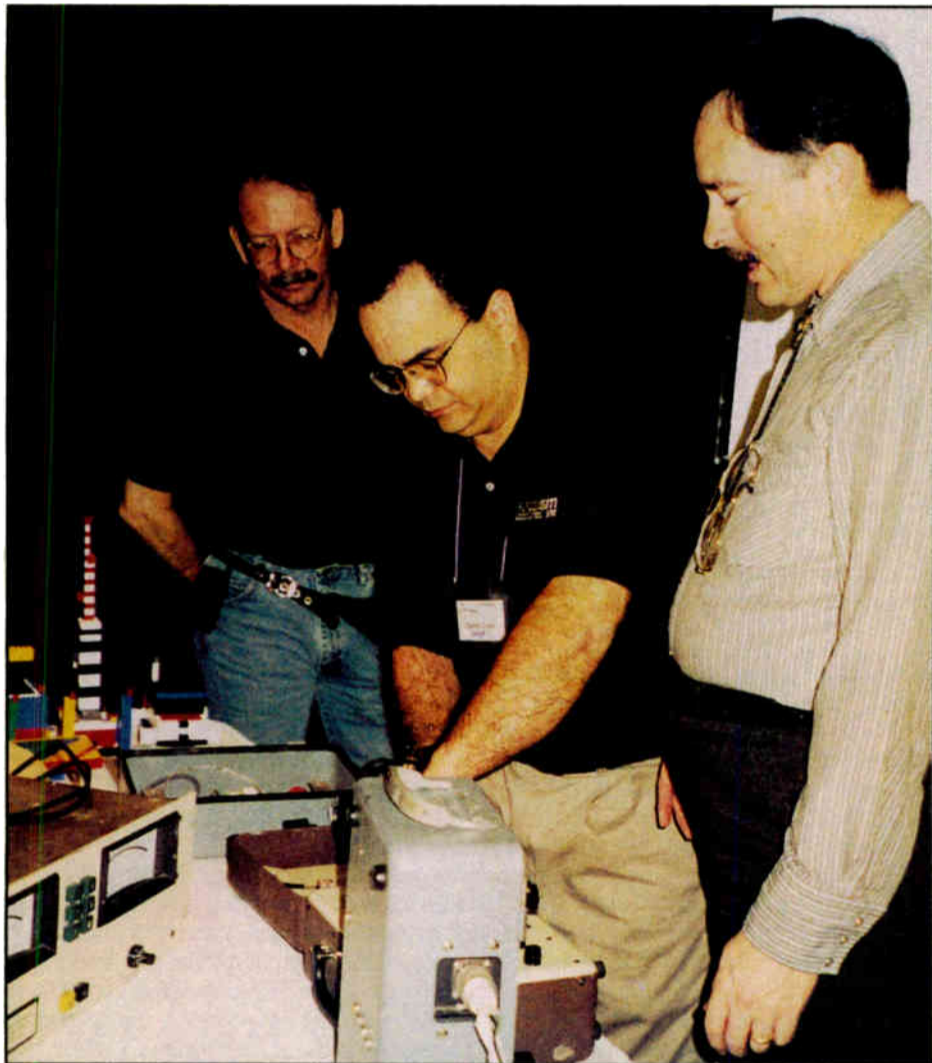

Charles Crane, center, and Tim Cutforth, right, set up a network tuning demonstration while Mike Vanhooser looks on.

MARKET PLACE

Henry Solves 'DJ Echo'

One unpleasant side effect of using the latest digital on-air processors is the delay they introduce into your off-air monitoring system.

Henry Engineering offers MoniSwitch, a specialized audio switcher that automatically switches the jock's headphones from "air" to "local" when the microphone is on, so the jock doesn't hear delay artifacts caused by the processor. At all other times, the air signal is monitored as usual.

Individual gain adjustments allow you to match the levels of air and local audio. Price: \$195.

For information contact your broadcast equipment dealer or Henry Engineering in California at (626) 355-3656 or visit the Web site at www.henryeng.com.



Digitally Different

Omega_FM - \$5880

NEW!

OUR GOAL WAS TO DEVELOP A DIGITAL PROCESSING SYSTEM FOR FM THAT WOULD RIVAL ANYTHING ON THE MARKET. WE MET THAT GOAL...AND THEN SOME.

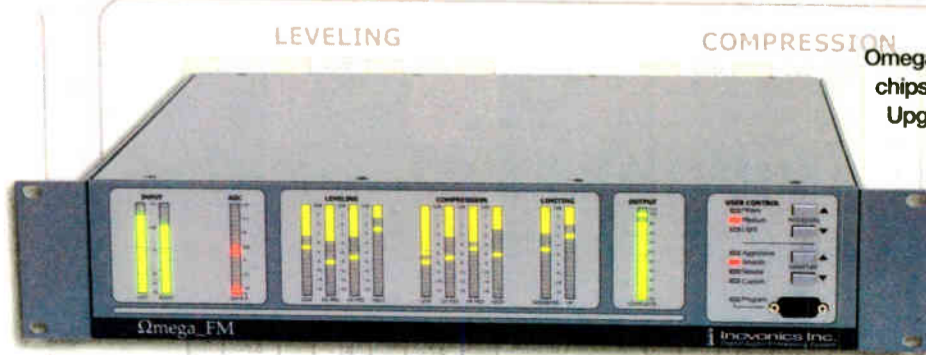

Omega_FM is a 100%-digital, software-based design. It doesn't use DSP chips or other application-specific parts that rapidly become obsolete. Upgrades don't plug into 'expansion slots,' they're simply uploaded.

Omega_FM is straightforward and uncomplicated. Hardware simplicity keeps the signal path short and your audio clean. Low latency lets you monitor off-air.

Omega_FM is loud, clean and versatile. We don't expect you to take our word for this, and you shouldn't. Schedule a demo at your station through an equipment supplier of your choice.

Inovonics
1305 Fair Ave. • Santa Cruz, CA 95060
TEL: (831) 458-0552 • FAX: (831) 458-0554
www.inovon.com • e-mail: info@inovon.com

Hear It... Processing doesn't get any better than this.

EFD

► Continued from page 1

EFD is intended to make it easier for an engineer to design a facility and choose the right equipment for it. Richard Farquhar, former chairman of the 19-member EFD Task Force, said, "Our entire goal is that a staff engineer, radio, TV, post-production, whatever, can go to an EFD-friendly server and pull down data so that he can do his daily job."

Digital conversion

Farquhar is president of RAF Consulting Inc. He said the current wave of digital TV construction and the potential for thousands of digital transmitter projects at radio stations make the EFD initiative timely.

Yet the digital transition for radio and TV comes as engineering staffs have been reduced due to station consolidation.

tained by SBE or another neutral party.

An engineer designing a facility could import the file into a variety of devices, from a personal digital assistant such as a Palm Pilot to a computer running a computer-assisted design application such as AutoCAD.

Baden said the engineer would begin using EFD by querying a database on the SBE Web site.

"If you're looking for, say, a digital distribution amplifier for video, you click on the manufacturers (and) compare the prices. When you find the one you want, you just do an XML stream right into the your (CAD) drawing."

The engineer's CAD program would immediately flag any incompatibilities, such as mismatched connectors, input/output impedances or signal levels.

How are manufacturers responding to the SBE's initiative? That is a question of perspective.

On one hand, EFD committee member Steve Lampen said SBE distributed about



David Baden

"Our staffs tend to be smaller," said former SBE President Andy Butler. "We're having to outsource more of our design work, and we're having to do more design work with fewer people in shorter periods of time. More and more we're using electronic tools in our design process. All of this simply means that we need to be able to get information quickly and easily," Butler said.

The data at the core of EFD would reside on a database maintained by SBE, but it would come from the manufacturers. Using an SBE-designed template, the manufacturer creates a file in Extensible Markup Language, or XML, containing the complete electrical and physical specifications of each piece of equipment the company builds. The file would be uploaded to an online database main-

1,000 CD-ROMs containing the EFD specification and a simple program to generate EFD files during NAB2001.

On the other hand, Baden said only one manufacturer, Broadcast Electronics Inc., has submitted EFD-compliant files to the SBE database.

"Everybody's interested in it," Baden said "(But) the response is less than enthusiastic."

Baden believes some manufacturers may be reluctant to produce information in a format that streamlines comparisons between their products and a competitor's. "You get a large manufacturer, they're selling such a wide product line with so many products in competition with themselves, why would they want to move to a format that would make it easier to compare?"

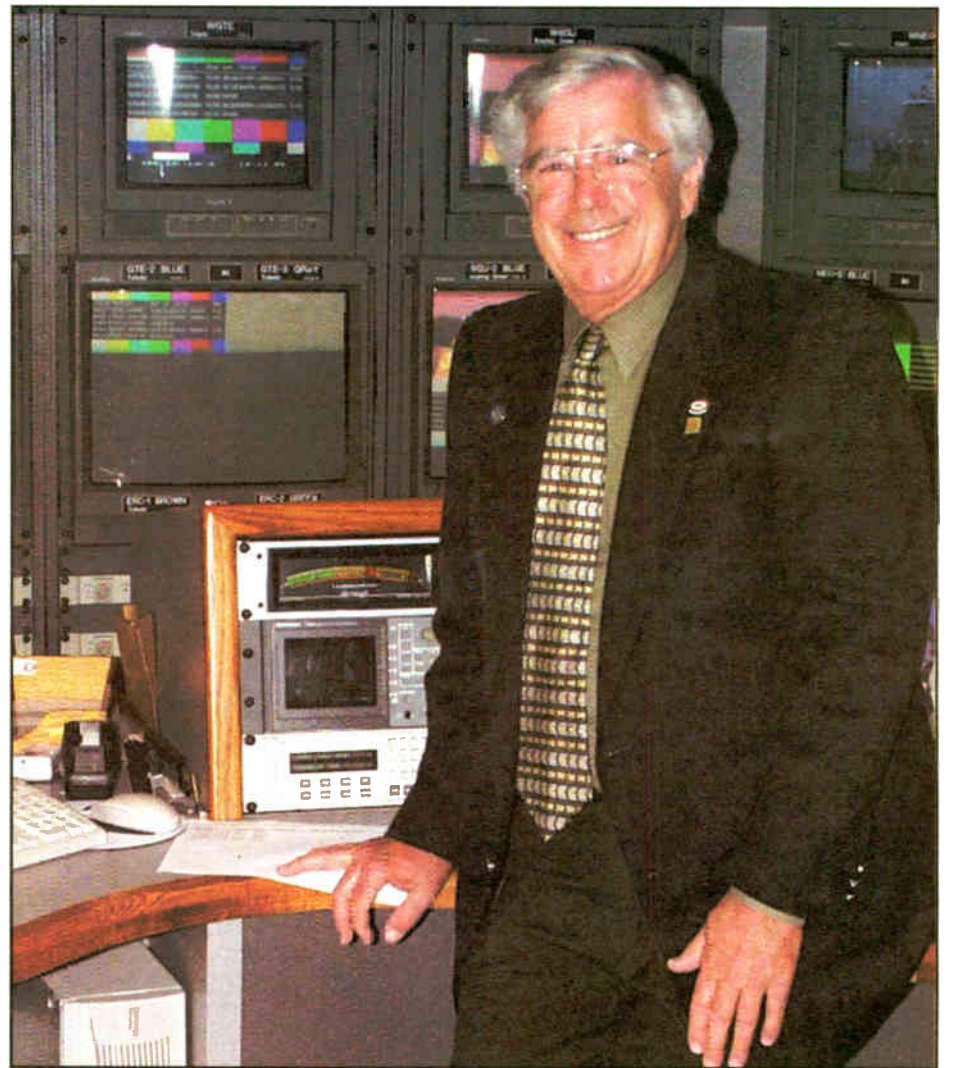

Richard Farquhar

Such reluctance may be short-sighted, said Lampen, a technology specialist with Belden Wire and Cable Co. and a columnist for Radio World.

EFD is really "a great deal for manufacturers," he said. "This will differentiate a firm that does have EFD from one that doesn't, simply because they'll be able to bid and do quality work at a considerable savings because they don't have to do all this research, or in some cases guesswork."

Concept?

Part of the reason for the potential cost savings is that EFD will include detailed specifications not normally found in conventional catalogs or specification sheets, Lampen said.

"For instance, in the wire and cable side of things, it might load up something like bend radius, something that's not listed in the catalog. And if they bent a wire tighter than the bend radius (during the design phase), there would be a little flag that would come up saying you've exceeded the bend radius of this cable."

The presence of engineer-friendly documentation might even become a competitive advantage for an equipment manufacturer, said Farquhar.

"When you start doing diagrams and designs, you are actually not partial to particular brands of equipment. You want to put in what is best for the customer," he said. "(But) the more information is available to us, the more likely that piece of equipment is included in the design."

Farquhar and Lampen said about a dozen companies have expressed interest in participating in EFD.

Lampen said his employer, Belden, is "about 85- to 90-percent committed" to participating. However, the company is unlikely to create an EFD file for each of its 4,500 products.

"It's fairly impossible for us to put them all in the database for EFD to use,

so we're probably going to do this in stages, and start with maybe the top 100 broadcast products. Once that's in line, then every few weeks we'll add another 50 products or that kind of thing," he said.

A spokesman for console and digital router manufacturer Wheatstone Corp. was concerned that the EFD standard might become a moving target for manufacturers.

"We believe the concept is a good one, but question the need to create a new protocol just to share information on a common template," said Michael Shane.

"Once this new 'system' was up, running and debugged — after how many revisions? — you would then be tasked with a continual updating process in order to keep pace with constantly developing new software packages."

SBE planned to release another piece of software at its national convention, originally scheduled for September. The convention and the software release were delayed by the terrorist attacks of Sept. 11.

The software tentatively is set for release Nov. 1. That's before the SBE national convention that was re-scheduled after the terrorist attacks, and is now slated for Nov. 27-28 at the Turning Stone Casino Resort in Verona, N.Y.

The software would simplify the process of entering data and producing an EFD-compatible XML file, said Farquhar. He said the goal is to have a comprehensive data entry system, because the EFD standard is meant to include virtually every relevant specification about a given model.

"The spec list is miles long because we wanted every possible detail to be included, so that when this is loaded up in back of the (CAD) program, anything you do that affects these specs would automatically show up," Lampen said. 🌐

Complex problems...

WE SPECIALIZE IN RELIABLE,
COST EFFECTIVE PRODUCTS FOR
YOUR BROADCAST RELATED NEEDS.

AFS-2 AUDIO FAILSAFE
CAS-1 CON/AIR SWITCHER
ACU-1 AUDIO CONTROL UNIT
DAI-2 DIAL-UP AUDIO INTERFACE
TTI-2 TIME-TEMP-ID DELIVERY SYSTEM
MBC-1 MESSAGE BOARD CONTROLLER
RFC-1/B REMOTE FACILITIES CONTROLLER
TAS-1 TELEPHONE ANNOUNCEMENT SYSTEM

Innovative solutions!

 Sine Systems, Inc.

615 • 228 • 3500 (VOX)
615 • 227 • 2367 (FAX)
WWW.SINESYSTEMS.COM

IBOC Q&A: Sample Rates

Among the most important questions radio managers and engineers soon may face is how to implement IBOC DAB technology.

Radio World has asked Ibiqity Digital Radio to answer common IBOC questions in this space. The first is answered by Broadcast Technology Manager Jeff Detweiler.

Q: I am planning a new studio build-out and want it to be ready for IBOC. What digital audio sample rate and what synchronization considerations should I base my design around?

A: Ibiqity's in-band, on-channel technology integrates digital audio in the IBOC exciter at a sample rate of 44.1 kHz. This sample frequency was selected because of its availability in CD-equipped automotive receivers and meets the desired audio bandwidth requirements.

Sampling frequency determines the limit of audio frequencies that can be reproduced digitally. One of the most important rules of sampling, the "Nyquist Theorem," states that the highest frequency that can be accurately represented is equal to one-half of the sampling rate.

So if the desired bandwidth is 20 kHz, it must be sampled at least twice as frequently (i.e., over 40 kHz). If the resolution bandwidth is less than twice the

audio sampling frequency, spurious artifacts may be produced.

In the case of IBOC FM, which has an equivalent audio bandwidth of 20 kHz, it is desirable to use a sample frequency at or above the standard 44.1 kHz. IBOC AM has an equivalent audio bandwidth of 15 kHz and requires at least the standard 32 kHz sample rate.

For the sake of compatibility of AM and FM program material, it is suggested that you standardize on a sample frequency at or above 44.1 kHz. If you are not able to standardize on 44.1 kHz at the studio and over the STL path, you can always convert the rate prior to the AES input of the IBOC exciter.

In addition to sample frequency, you

should also carefully consider methods of synchronization. Professional digital systems not only offer AES3 digital audio output, but also have provisions for external AES3 synchronization.

The synchronization input should be fed with a highly stable AES3 reference signal, which normally originates from a sync generator. Digital audio tape (DAT), MD, hard-drive-based mass storage systems and editors may have external sync inputs that should be fed an AES reference or 44.1 kHz square-wave word clock.

Selection of this timing reference is one of the most critical choices made in a digital facility. Instability of the digital master clock, better known as "jitter," is more

critical than bit-rate resolution. Some timing references use crystals with 50- or even 100-ppm tolerance, which provide a less-than-desirable master clock.

It is also possible to use an AES sample rate converter (SRC) with a GPS input as the system clock. If a converter of this type is used at both studio and transmitter, the two locations may be effectively locked together.

While it is not mandatory to adopt these recommended sampling rates and synchronization methods to broadcast an IBOC signal, following these recommendations will help you maximize the increase in quality and performance that IBOC offers.

Please send us your own IBOC questions for a reply in this space. E-mail to radioworld@imaspub.com. Radio World welcomes other points of view.



ISDN Simplicity.



Broadcasting on ISDN doesn't have to be complicated or expensive.

The Nexus has everything you need for full-fidelity, low delay, mono audio on ISDN. And it is extremely easy to use. With a list price of only \$2,300, there's no need to wait any longer to sound great.

(800) 237-1776

Comrex Corporation, 65 Nonset Path, Acton, MA 01720
Fax: (978) 635-0401 Fax-on-demand: (978) 264-9973
Email: info@comrex.com

COMREX
www.comrex.com

NEWS WATCH

Rice Ponders Appeal for License Revocation

WASHINGTON Michael S. Rice was considering an appeal in October of the FCC's order that he shut down his five stations.

The case goes back to 1994, when Rice was convicted of sex offenses with five minors for which he served five years in prison. Rice and the FCC do not agree on whether he was still involved in station operations after his arrest and during his time in prison. He said he was not, but the FCC eventually decided to revoke his authority to operate the stations, saying he lacked the character qualifications to be a licensee.

Rice has another appeal related to the case still pending, saying the FCC's actions were arbitrary and capricious. Because of the pending appeal, the FCC had granted a special temporary authorization to operate his stations earlier this year, believing it was possible for the former licensees of Rice's stations to operate them in the interim.

In October, the FCC denied Rice's request to extend the STA, saying it served the public interest to let the STA expire, as Rice had been untruthful with the commission.

Rice cited several reasons why the public would benefit if the stations remained on the air, including providing "critical information to the public" in light of the terrorist attacks.

The five stations that went dark were WBOW(AM), WBUZ(AM) and WZZQ(FM), all in Terre Haute, Ind.; KFMZ(FM), Columbia, Mo.; and KBMX(FM), Eldon, Mo.

Sirius

► Continued from page 1
transition between developing a technology and launching a new product category.

Few sources that spoke with Radio World believed the move had been long-planned. They noted that no new CEO had been hired when Margolese stepped down and two Sirius executives, Senior Vice President and Chief Financial Officer John Scelfo and Senior Vice President and General Counsel Patrick Donnelly, would share the CEO duties in the interim.

World-class

"Over the years we have worked diligently to establish a foundation that would allow Sirius to become a world-class company," said Margolese in a statement. "Sirius is now strong enough to achieve this and the time has come for me to pass the baton."

Wall Street analysts and other radio observers were not surprised at the

change in command, noting the company had been missing deadline targets for the last year.

"Sirius had a lead over XM and they squandered it. Margolese lost credibility because he's been pushing his dates," said one source whose comments were echoed by several observers.

"For the last two quarters, we kept hearing they were 99-percent there," said another analyst, who added it was "strange" for Margolese to step down before the product launch.

However, most sources also charac-

learn at the end of October when receiver chipsets would ship to manufacturers. Accounting for production time, that would place Sirius aftermarket receivers in consumer hands this spring.

Given those factors, observers predicted a launch no earlier than late in the first quarter of 2002.

Before Margolese stepped down, Sirius downplayed a lawsuit filed against it in a federal court in Vermont that claimed Sirius misled investors about the timing of the service launch.

The law firm Johnson & Perkinson

approximately \$250 million cash infusion to operate next year. XM and Boeing Capital Services Corp. signed an agreement on the basic terms of a \$66 million funding package, including \$35 million in new debt financing with Boeing and \$31 million in restructured obligations with Boeing Satellite Systems International Inc. The deals were expected to close by the end of October.

In light of financial market conditions and the aftershock of national events, XM is paring down operating expenses and, with \$125 million in funds, said it has enough money to operate "deep" into the second quarter of next year.

XM's launch

While XM is the sole satcaster with receivers on retail shelves, early reports from some purchasers report good signal robustness. One consumer electronics consultant said that of several stores he visited in San Diego in September, some did not have XM product to show or live units for consumers to try.

XM launched in a dismal retail market given the poor economy and consumer fears of continuing military action.

Sirius said it only expected to sell about 20,000 units anyway in Q4, which it said was not a significant amount.

But for all the discussion about which company is ahead or behind in what area, one company developing this new product category is not enough, several analysts said. According to this argument, Sirius and XM need each other to create consumer awareness. That, in turn, would generate revenues, something both companies need to meet their business plan targets in 2002.

One analyst dismissed the glitches in the rollout of satellite radio so far as a "sputter" and said he believes that in the long term, satellite radio will be successful.

"Look at Iridium," he said, referring to the failed global mobile telecommunications service that used low-earth orbit satellites. "You launch before you're ready and you're dead. In order to spec out chips, you need satellites out there. You never know how the satellites will work until they're up there." 🌐

You launch before you're ready and you're dead ... You never know how the satellites will work until they're up there.

NEWS WATCH

VOA Ups Hours to Middle East, Asia

WASHINGTON To offer more coverage of events resulting from September's terrorist attacks, Voice Of America increased the number of hours it broadcasts to the Middle East and Central Asia. It added time to its daily programs in five languages.

News broadcasts in Pashto and Dari, aimed at Afghanistan and Pakistan, expanded by 30 minutes to 105 minutes each. Urdu broadcasts to Pakistan and India added a half-hour program for a total of two hours. Farsi broadcasts to Iran increased by two 30-minute programs for a total of four and a half hours. Arabic broadcasts for the Middle East and North Africa grew from four half-hour programs to nine hours.

VOA's additional programming is broadcast via shortwave and on the AM band and streamed on the Internet at www.voanews.com.

terized the 43-year-old Margolese, a Canadian cell phone entrepreneur, as a visionary who helped create the product category of satellite radio.

Sirius Vice President of Marketing Doug Wilsterman credited Margolese with raising nearly \$2 billion, enough that Sirius said it had enough cash on hand, around \$392 million, to fund operations well into the fourth quarter of next year.

Several observers said it was time for someone with a different set of skills to lead the company, someone with operations expertise. But, said one analyst, if just replacing the CEO would solve everything, management would be easier. He and others predicted a new CEO would demand a hand in shaping a new executive roster.

A new CEO must keep the company focused on its launch, specifically getting receivers into stores, experts say. While Sirius was out in front of XM a year ago in terms of launching satellites and building studios, it stalled on getting receivers into the market.

Sirius reportedly is facing a chipset delivery problem from its supplier Agere. The company was expected to

stated in the document that by saying it intended to launch by late 2000 or early 2001, Sirius' stock price became artificially inflated and subsequently hurt investors, including Johnson & Perkinson.

Sirius said the lawsuit was "an entertaining piece of fiction," and it would defend itself.

Performance tests

In October, Sirius expanded its in-vehicle testing to additional markets including Houston, Seattle, the New York metropolitan area, Indianapolis and Columbia, S.C.

"We've been doing a number of markets since January, and we're pleased with the performance results," said Wilsterman. The tests help Sirius evaluate the company's product and transmission, distribution and system capabilities, including retail sales support, installation, subscriber management and billing, customer service and communications.

XM, meanwhile, expanded its product rollout begun in September to the rest of the southeast and southwest. It also made progress on obtaining

PORTABLE ONE

DUAL DOMAIN

True Dual Domain Audio Testing at an Attractive Price Point

- Comprehensive analog audio analyzer
- True digital domain analyzer with -140 dB residual noise
- Independent analog & digital audio generators and analyzers
- Generate and measure interface jitter
- Digital interface analyzer
- View AES/EBU status bits
- Loudspeaker monitor for digital & analog signals
- Internal save and recall of 30 test setups



Audio Precision
Audio Precision
PO Box 2209
Beaverton, Oregon 97075-2209
Tel: (503) 627-0832; Fax: (503) 641-8906; US Toll Free: 1-800-231-7350
Email: techsupport@audioprecision.com; Web: www.audioprecision.com



MILLION DOLLAR SOUND FOR UNDER \$4,000*

Introducing Omnia-3, the all-digital audio processor that offers all the clarity, punch and raw power of the original Omnia. At an amazingly affordable price.

Omnia-3 includes standard features not found anywhere else—like 48kHz sampling, three-band processing, digital audio inputs and outputs, integrated composite clipper, and a removable PC card that simplifies software changes.

Impressive features aside, it's the sound that will blow you away. No other audio processor sounds as good as Omnia. That's why leading broadcasters the world over choose Omnia to boost ratings and crush the competition.

For this much power—on the dial and in the marketplace—you'd expect to pay twice the price. But now, you don't have to.

With Omnia, you lead. And others follow.



www.omniaaudio.com

North America: + 1.216.241.7225

Europe: + 49.81.611.42.467

Omnia is used in 4 of 5 leading stations in New York, 2 of the 3 top stations in Los Angeles and 5 of 6 of the most listened to stations in the US. It's on the leading stations in Paris, all of the BBC's FM stations in the UK, and the number one stations in Canada, Ireland, Germany, Finland, Australia, India, China, Denmark, and Sweden.

*\$3,880 (US) MSRP for Omnia-3fm model. Prices may be slightly higher outside the U.S. due to duties, freight and other costs.

Stations Take Financial Hit

Rebuilding Radio Facilities Will Be Expensive

by Randy J. Stine

NEW YORK It will likely cost New York City radio broadcasters millions of dollars to rebuild transmission facilities lost in the World Trade Center collapse, even after insurance settlements.

The cost of securing new leases at existing sites around the city will be the major expense, experts said.

A month after the attacks, FM stations WPAT, WNYC, WKCR and WKTU were in the process of negotiating with the owners of the Empire State Building and the Conde Nast building at 4 Times Square for permanent homes.

"When you lose an entire transmission site, there are a lot of additional expenses that come along," said Mike Tocco, chief engineer for Spanish Broadcasting's WPAT. The station lost its transmitter, STL receiver and dish, processing equipment and related gear.

"It will be close to a million-dollar project to replace what we lost and to buy into the system at Empire, plus another \$400,000 to build an auxiliary site," Tocco said in October. "We've already spent over \$100,000 just to get back on the air from Empire at low power."

Big price tags

Prior to the Trade Center collapse, WPAT was without an auxiliary transmission site. Tocco said the station's ownership is considering locating a back-up site on the rooftop structure at the Conde Nast building in the heart of Times Square.

"The final price tag will be big. Insurance will probably cover replacement of the equipment, but I'm not sure what they'll do for compensation since we have to move to a whole new site," Tocco said.

Joining the existing ERI combiner facility at Empire State Building includes a "buy-in" of \$500,000 to \$600,000, according to one engineer familiar with the system.

He said new stations pay for their share of the original construction costs, plus interest from date of installation. The monies, minus costs related to their combiner and transmission line, are divided equally among the 13 existing stations in the consortium.

Broadcast groups represented include Clear Channel Communications, Emmis Communications, Infinity Broadcasting, Spanish Broadcasting System, Inner City Broadcasting Corp. and the New York Times. The ERI antenna went into service in 1994.

Joe Maguire, senior engineer for Clear Channel's WKTU, said his group found it hard to put a dollar figure on the equipment loss.

"We lost the transmitter, transmission lines, spare parts, processing equipment, STL receiver, test equipment, T-1 lines, UPS boxes. The list goes on and on," Maguire said.

Maguire said replacing everything and relocating a main transmission facility would cost the station substantially.

"A new solid-state transmitter is \$60,000. Filters for the combiner at Empire run \$80,000 apiece installed, plus the initial cost of getting in there," he said.

WKTU had been planning to relocate its main transmitter site to the Empire State Building even prior to the events of Sept. 11. A move to Empire is still "a few months off"

if everything goes as planned, Maguire said.

That includes FCC approval for the move and having the facility come together as hoped, he said.

Another affected station, WNYC(FM), licensed to the WNYC Broadcasting

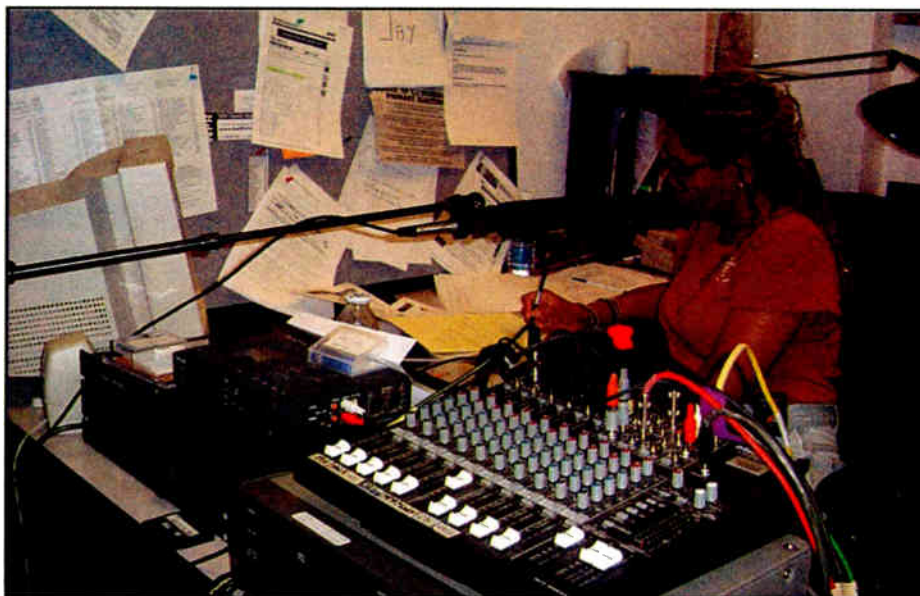

Jo Ann Allen, WNYC's local host of NPR's 'All Things Considered,' is shown broadcasting from the borrowed New York desk of NPR Program Chief Jay Kernis, located at Columbia University's WKCR(FM).

Tower

► Continued from page 3

"It will determine whether they expand or build a second system. The demand certainly appears to be there," Silliman said.

Experts said the Empire State transmission facility remains the clear favorite to land a majority of the stations looking for new homes. With an antenna height of nearly 1,500 feet, the ERI combiner facility on Empire is already home to 13 FM stations.

Three more FM stations are on the Empire mast but are considered independent because they are not on the ERI combiner system.

Electrical supply

"There are a lot of issues at Empire right now. It's very crowded. There are very serious electrical supply questions to be addressed first," Libin said.

If the Empire State Building transmission facility cannot accommodate additional stations immediately, the rooftop broadcast center atop the 52-story Conde Nast building in Times Square is another alternative. It was completed by Shively Labs in 2000 and is the auxiliary site for Clear Channel's five-station group.

Gary Savoie, senior engineer for Riser Management systems, a collaborator on the Time Square project, said the Conde Nast facility likely will fill quickly, with television and radio broadcasters scrambling to find space for both main and auxiliary transmission sites.

The 4 Times Square master FM antenna is capable of handling 130 kW and has room for an additional seven FMs, Savoie said.

"They're limited a bit by the amount of floor space they have for transmitters on the designated floor where the combiner is

Foundation, expects to take a financial hit of close to \$4 million because of the attacks. That includes equipment, securing new transmission sites, programming costs and lost revenue from fundraising.

"Insurance will cover the equipment loss, but that isn't the highest cost. That will be the cost of joining the Empire ERI combiner system," said Dean Cappello, vice presi-

dent of programming for WNYC.

Cappello said the station lost three transmitters in the WTC collapse — two 10 kW Harris FMs and a 1 kW Quest, Omnia processors, a Moseley STL repeater site and other equipment.

The NPR affiliate hopes to be broadcasting at full power from Empire in six to nine months if the station finds room on the existing system. "It could be a year to 18 months if they build a new system there," he said.

Recovery a year?

WNYC employees evacuated their studios and offices in the Municipal Building, located near the WTC. Employees were back in their offices by the second week of October.

WNYC was broadcasting its signal from an emergency satellite dish on the roof of the Municipal Building via satellite to National Public Radio in Washington. NPR sends the signal back to New York via ISDN to WNYC's low-power emergency antenna on Empire. The signal is just 12 percent, 850 W, with a substantial drop in audio quality, said a radio station spokeswoman.

WNYC will also join the Shively system at the 52-story Conde Nast building at 4 Times Square and use it as an auxiliary transmission site, Cappello said.

Officials with Columbia University's WKCR could not be reached for comment. Richard Koziol, CE for WKCR, previously said the station planned to locate its main transmitter at the Conde Nast building. ●

located. I think things will settle down a few months from now, but right now there is a lot of talk about who is going where and whether anything new will be built for television," Savoie said.

Bob Surette, manager of RF engineering for Shively Labs, said the Maine-based company is delivering three combiner modules for its master antenna in the Conde Nast building.

Aux sites

"In addition to the Conde Nast stations, we also have been involved with the planning and implementation for a number of aux facilities throughout New York and New Jersey. Many broadcasters are rethinking their aux sites and giving them a higher priority," Surette said.

With the limited number of available transmission site options in New York, some experts predict an eventual replacement will be needed for the World Trade Center site.

"I think the real long-term option will be a new site someplace," Libin said.

Those options could include rooftop installations at the Chrysler and CitiCorp buildings in Manhattan or a new tower in the Meadowlands area in New Jersey, Libin said.

Finding an adequate facility to handle a rooftop antenna is not simple, Savoie said.

"You have quite a few tall buildings that are surrounded by other tall buildings, and you have a finite amount of buildings with the height and roof structure to handle a master antenna," Savoie said.

"The problem is no one wants a 1,500-foot tower in their backyard," said Mike Tocco, CE for WPAT(FM), one of the affected stations. "I don't expect to see a new transmission facility built any time soon."

Another possible replacement site, the Alpine tower site, has an antenna height of nearly 1,200 feet and sits north of

Manhattan and across the Hudson River. Engineers believe Alpine is an inferior alternative to Empire, Tocco said.

"It wouldn't give us the type of coverage pattern we need," Tocco said.

For radio, Alpine serves only as the back-up transmitter site for WPLJ(FM), he said.

Libin said New York City's FM band is so crowded that radio stations must seek options to give them the best possible signal for optimum coverage.

"It's also very crowded in nearby markets, so you really have a daisy-chain effect. So if you find a decent transmission spot, but not perfect, then you have co-channel or adjacent-channel issues to deal with," Libin said.

David Groth, president of Radio Engineering Services, said antenna location is the most important decision broadcasters must make when building a transmitter site in the one of the country's most congested radio market.

Tall enough?

"What you are dealing with is geography. In this case it's tall buildings. In Manhattan, you have severe multipath distortion because of it. You have to get your signal out over the skyline to have good coverage and to reach the suburbs," Groth said.

He said all of New York City's top-rated stations are on Empire or were on the World Trade Center.

"Reception is king. People receive something on every notch of their radio dial. The more you jump out at someone, the more likely it is they'll hear you," he said.

The Helmsley-Spear and the Durst Organization, the owners of the Empire State and Conde Nast buildings respectively, have frozen their rates for rooftop space at levels set prior to the Sept. 11 World Trade Center catastrophe, Savoie said. ●



Hooked on Radio Systems line of analog audio consoles

by: Mark W. Persons, President
M. W. Persons & Associates

BRainerd, MN: A few years ago two of my radio station customers became "hooked" on the Radio Systems line of analog audio consoles. I found that I enjoyed the same excitement when I installed the consoles for them.

It all started when I was asked to recommend a console to a broadcaster who still believes in programming live 18 hours a day. The console had to be rugged, reasonably priced and the audio had to be clean. That ruled out all consoles with audio transformers. Over my 30 years of radio broadcast engineering, I have installed and reinstalled more than 100 audio consoles, but at this time I noticed that Radio Systems was gaining a good name in the industry with the RS-12 series 12-channel audio consoles. After installing the first one at WJYY FM Radio in Brainerd, Minnesota, there was no turning back. The client was so impressed that he would then accept nothing else for his main studios. To date he has purchased one for each of his seven stations and ordered two more for stations scheduled to be built soon. Three of them are in his new \$800,000 studio facility in Brainerd.

What brought on this attitude? The Radio Systems RS-12, and later the RS-12a Millennium Audio Consoles, are designed to be rugged and easy to use while keeping audio quality high. The operators love them.

Personally, I like the red peak lights on each analog VU meter. Console output commands to start and stop CD players and digital audio storage equipment are easily programmable with computer-type plug-in jumpers. The commands can be continuous or momentary. Audio stays on the audio cards in the bottom of the console and is adjusted by audio voltage-controlled amplifiers, which are clean as a whistle and

have left-to-right stereo gain matched to fractions of a dB. Front-panel buttons turn the VCAs on and off. Front-panel slide pots are DC controls for the VCAs.

The Radio Systems RS-12a 12-channel Millennium console was introduced two years ago. It was a good upgrade to the RS-12. It kept the wonderfully clean audio boards in the bottom of the console frame and replaced the black colored top with a beige/blue panel of the same size.

The most interesting changes were soft rubber pushbuttons with LED lamps instead of the original hardware switches with incandescent lamps. The new buttons have a really nice feel as well as being completely silent in their operation. The factory people tell me the meters have been improved to be more accurate. Either way, they work just fine.

For stations with the original RS-12 console there is an upgrade kit, which will replace the black top with the new beige/blue Millennium top. They throw in new mahogany sides to make it look like a new console. The kit costs \$2,000. For \$2,500 you can send a console to the factory for a reworking, including bringing it up to factory-new specifications. A new RS-12a 12-channel audio console is \$5,495. Six-channel, 18-channel, and 24-channel models are available too. High-quality P&G faders are available as an option.

Digital may be a current buzzword, but for the client's money and mine, these analog consoles are as good as it gets. Until we have a real digital standard, I am staying with analog consoles.



Disaster Relief

From now until the end of the year,
Radio Systems will donate \$100
for every console sold
to the American Liberty
Partnership.

radio
SYSTEMS

601 Heron Drive, Bridgeport, New Jersey 08014
(856) 467-8000 voice (856) 467-3044 fax www.radiosystems.com

Programming

► Continued from page 3

by veteran anchor Sam Donaldson called "Live in America," which features interviews with high-profile guests and listener calls around the country. Berry said several stations around the country have begun to carry the program, which will also be aired indefinitely.

But at a time when many advertisers are still shocked by the events of Sept. 11 and unsure of their own budgets due to the declining economy, the networks are incurring much of the cost of the increased news coverage.

Eliminating commercials for a few days after the attacks and producing increased programming and overseas coverage have had a negative effect on the bottom line for many. Though he declined to give firm figures, Berry said the network was evaluating its budget in October. The one thing that has helped free up some funds, he said, was the low number of other breaking news events the media had to cover this year.

Nonetheless, he is confident ABC Radio will provide the necessary coverage. "We will do whatever is necessary," he said.

Networks agree

Other representatives from broadcast outlets share ABC's attitude.

"It's a new set of rules and you do what you need to do," said Dana McClintock, Infinity Radio's vice president of communications. "You serve the community."

Infinity, which owns CBS Radio, also made an open-ended decision to feed its more than 180 stations frequent updates on the war and related news. CBS news stations in New York, WINS(AM) and WCBS(AM), as well as radio stations in Washington and throughout the world have been providing stations with updates.

No programming changes had been made by early October, but McClintock said the network would determine its needs on a day-to-day basis.

NPR also was assessing the situation daily. The network has refocused much of its broadcasts on the attacks and aftermath, said Bruce Drake, vice president of news and information. At daily meetings

in the early fall, the news staff focused its efforts on six or so core angles of the story, he said, adding that NPR also extended its daily afternoon program "Talk of the Nation" for two hours for a total of four after Sept. 11.

At press time, Drake said NPR would continue to examine the story to see whether expanded coverage or additional programming changes were necessary.

Network, station war plans

Drake said NPR also is exploring avenues of additional funds to cover the expenses of reporting on the war but declined to name specific figures or funding sources. "All the other priorities within the company are taking a back seat."

Like ABC, Drake believes NPR is in position to cover the war and provide listeners with the necessary reports thanks to its work in Kosovo. Drake said 34 reporters reported on that story with satellite phones, which will now be used by NPR press in the Middle East.

Meanwhile, at home, NPR's staff is continually fine-tuning its "war plan," which lays out the different levels of coverage and five levels of programming NPR would carry in the event of another terrorist attack, said Margaret Low Smith, vice president of programming.

The levels range from constant rolling coverage to fewer hours of news programming, depending on the amount of information available.

"We know that we have to do at every level," Low Smith said. "We want to be careful to provide meaningful news."

Throughout the country, the public's need to keep up with the latest news has grown since the September attacks.

In Houston, for example, Clear Channel stations had to fill two distinct needs of the public this fall. According to Ken Charles, director of AM programming for Clear Channel Houston, the city's two AM stations, KPRC, a news-talk station, and KTRH, an all-news station, have provided coverage that complements one another, with KPRC serving as a "local town hall," inviting listeners to call in to talk about their thoughts, opinions and feelings, while KTRH provides constant news.

KTRH also chose to add the "Live in America" show with Sam Donaldson to

its lineup in September and KPRC picked up a show that Clear Channel began syndicating from its Tampa, Fla., station, WFLA(AM), the "Glenn Beck Program," a public affairs call-in talk show.

In addition, Clear Channel's five FM stations in that market have found a new way to meet the demand of listeners craving news by carrying one-minute newscasts during the morning drive time and covering breaking news when necessary, Charles said. Like other broadcasters, the stations will carry the short newscasts indefinitely, he said.

According to Associated Press Broadcast, about 500 radio and television stations have been using its news services to provide war coverage. With

15 bureaus in Central Asia and the Middle East and more than 50 reporters in the region, the AP reported a rise in group owners and news and music stations signing up for the AP's services in early October.

Besides the modifications in programming, Charles said broadcasters at the Houston Clear Channel stations are dealing with another issue: finding the appropriate levels of humor and providing the right amount of coverage.

"We're going to write this book as we go along," Charles said. "If we're going to make a mistake, it's going to be that we're making the mistake of being too sensitive or we're going to provide too much information." ●

Sam Donaldson Gets Personal on the Radio

NEW YORK Like many people in the television business, ABC's Sam Donaldson started his broadcast career in radio.

It was the early 1960s when the 40-year broadcast news veteran started reporting for WTOP(AM) in Washington. He eventually made the jump to television, covering the White House for close to 15 years and later anchoring shows such as "20/20" and "PrimeTime Live."

Now, the co-anchor of the Sunday-morning roundtable program, "This Week With Sam Donaldson & Cokie Roberts," Donaldson has made a name for himself as one of the most recognizable public affairs reporters and commentators.

He actually was considering a comeback to radio, which he calls "his first love," when the attacks on Sept. 11 occurred. Soon after, he and ABC's news staff decided the time was right to launch a new show focusing on the attacks and their impact on the nation.



ABC News Correspondent Sam Donaldson, shown with Producer Vanessa Boyer in the foreground, is hosting a two-hour daily radio talk show.

In mid-September, Donaldson went on the air with his new two-hour radio show, "Live in America," in which he interviews high-profile guests and accepts calls from listeners around the country. The two-way communication, Donaldson said, is what he enjoys the most.

"Radio is the most intimate of all public means of communication," he said. "There's an intimacy and a connection that television doesn't allow."

Donaldson said he also likes radio because he is able to express a different persona on the radio, where he can share anecdotes and jokes.

Currently, Donaldson said "Live in America" is focusing on the war and will be aired indefinitely by some 20 or more ABC stations across the country.

At a time when news consumption is high, Donaldson said radio news is receiving a needed boost. But the attacks aren't just impacting news stations, he said.

"I think that local programming in some cities, where shock jocks have played on certain themes, has changed," he said. "People are taking life much more seriously."

After the current conflicts no longer dominate the news, Donaldson hopes to keep the show on the air and expand its subject area, discussing topics as mundane as listeners' pet peeves or serious topics such as tax reform.

"Radio provides the kind of connection you can't get otherwise," he said. "It's a wonderful way to have an interesting discussion."

—Naina N. Chernoff

Books

► Continued from page 4
of the gay community.

Their interesting stories are presented in the form of brief excerpts. Reading this book is like sitting around a table having a wide-ranging discussion with people from all walks of broadcast. (On the other hand, for those few readers who object to any story in these pages about gay issues, you'd better steer clear.)

Just as interesting are the book's appendices. They include an interview with the late Allen Ginsberg; a timeline of notable events in the gay community through early 2000; a segment on the Gay and Lesbian American Music Awards; and numerous broadcast clippings and transcripts.

The book is 300 pages in hardcover and retails for \$44.95. Published by M.E. Sharpe (www.mesharpe.com). Ask for ISBN #0-7656-0400-0.

If you've read a good book lately and think it would interest Radio World readers, tell us about it via e-mail to radioworld@imaspub.com.

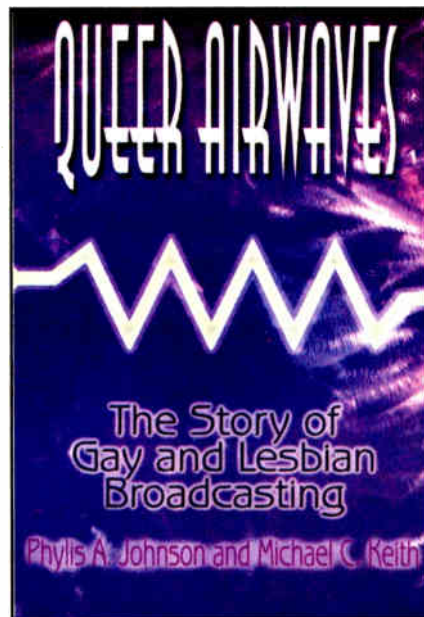

Encore!

The Telos Zephyr is one tough act to follow. It revolutionized point-to-point audio by combining ISDN with MPEG coding, and quickly became the #1 selling codec worldwide — perhaps the most successful digital broadcast product ever. So what will we do for an encore?

Presenting Zephyr Xstream, with innovations like AAC (Advanced Audio Coding) for superior fidelity, a special low-delay mode, and an Ethernet port for IP audio streaming, remote control and easy software updates. There's also a rugged portable version with full-featured digital mixing.

And of course Zephyr Xstream includes everything else you'd expect from a Zephyr, like Layer-II and Layer-III coding, ISDN connectivity, a simple, friendly user interface, and bulletproof reliability.

Zephyr Xstream. Sometimes the sequel is even better than the original.

Telos
www.zephyr.com



Digital Dawn for Srpski Radio Banja Luka

Blažo Guzina

Srpski Radio Banja Luka, located in Bosnia and Hercegovina, recently built the first fully digital radio studio in the Serbian-speaking region of Southcentral Europe. The classical FM station now is prepared for a possible DAB future.

Srpski Radio Banja Luka was founded in 1993 by the newly established authorities of Republika Srpska, the Serbian portion of Bosnia and Hercegovina, as part of the RTRS public broadcasting service.

Regional

The station aims to offer comprehensive programming to Serbian-speakers in Bosnia and Hercegovina from Banja Luka and five other regional radio centers, including hourly news breaks, music, educational and entertainment programming.

The station broadcasts 24 hours a day over a network of stereo FM transmitters across Republika Srpska. In the Banja Luka region itself, it has two transmitters broadcasting at 95.9 MHz and 93.5 MHz.

Having managed to survive the turmoil of the past seven years, Srpski Radio Banja Luka decided to prepare itself technologically for the new millennium.

RTRS Technical Director Boško Budiša offered a contract to upgrade the station to Lola Audio, a Yugoslav manufacturer and supplier of audio and video equipment.

The station wanted to replace existing audio and signal distribution equip-



The new production room, above, and on-air suite, below, make full use of computerization.



ment in the studio and control room of its first program with digital equipment. The plan was to build a studio suitable for both production and broadcasting of high-quality FM stereo programs.

The new studio was built around an Amptec Stone-D001 digital mixing console and a Scott Studios Spot-Box 1 touchscreen-based playback system.

According to Lola Audio Chief Executive Zoran Kecojević and Dejan Ljubisavljević, development manager for the company, the installation took into account the station need to continue using analog tape recordings alongside new digital audio material.

Tech checks

For example, the Amptec Stone-D001 features one hybrid analog/digital input, in addition to its five digital inputs.

Lola Audio staff, under the direction of Ljubisavljević, prepared and performed technical checks and adjustments on the equipment at the Lola production plant in Belgrade.

Afterwards, they completed installation, alignment and measurements in Banja Luka in one week.

For high-end stereo signal level control, Lola added external RTW bar-graph peak program meters to the setup.

The equipment installed in Banja Luka includes two Denon CD players, two Denon MD recorders, 360 Systems Short/cut hard-disk recorder/editor and Instant Replay playback system, an R-DAT digital cassette deck and Tannoy 800 A monitors.

Lola Audio customized equipment — designed and manufactured at its Belgrade facility — included LA 2800 distribution amplifiers and LA 2812 power amplifiers for parallel connection of announcer and guest headphones, an LA 4811 speaker TB box, racks and equipment furniture.

According to Bora Ilkić, technical director of the RTRS radio division, the sta-

tion in Banja Luka now has a fully digital, perfectly designed, comfortable and reliable system.

In addition to the modernization of its studios, the radio station intends to gradually enlarge its network of transmitters in order to cover more of Republika Srpska with a high-quality FM signal.

Blažo Guzina is a senior engineer in the technical development department of Radiotelevizija Srbije in Belgrade and reports on the industry from Yugoslavia.

He can be reached via e-mail at blazo_guzina@yahoo.com.



Construction in the Air Studio

MARKET PLACE

RFS Produces Massive Cable

Radio Frequency Systems recently produced what it called the world's largest aluminum air dielectric coaxial cable.

The 9-inch-diameter transmission line was made at an RFS plant in Germany earlier this year as part of two HF radio projects.

RFS made approximately 3,300 feet of the cable in two lots. The longest cut length measured about 750 feet. It was rolled onto a drum measuring 15 feet in diameter. The cable and drum weighed several tons. The cable has peak power and RF voltage ratings of 5,800 kW and 24 kV respectively.

The cable is part of the RFS Heliflex line.

For information contact the company in Connecticut at (203) 630-3311 or visit the company Web site at www.rfsamericas.com.

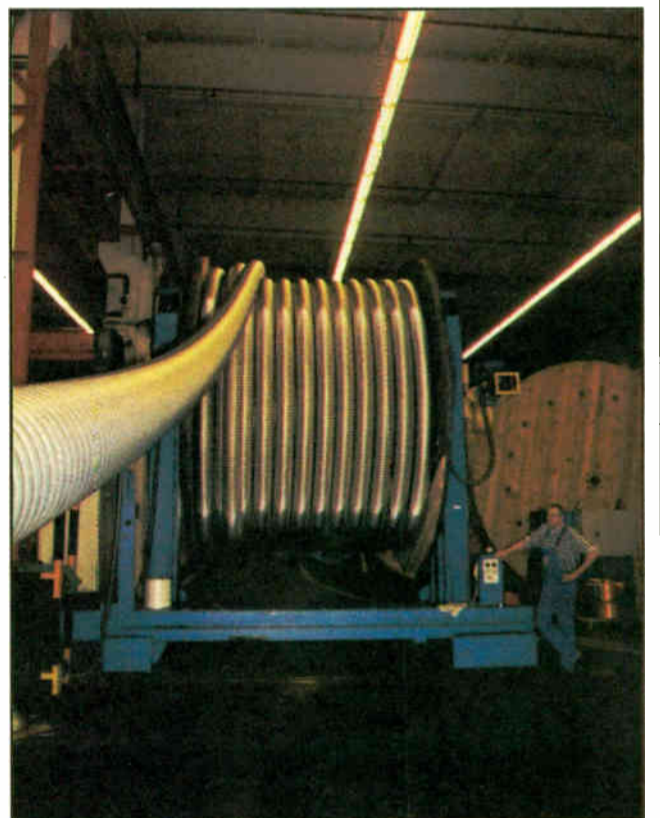

Part of the cable is wound onto a drum. Scale is indicated by the worker at right.



The 9-inch line is shown during construction.



Broadcast Electronics signed a contract with the **Federal Radio Corp. of Nigeria** to supply RF transmitters and studio equipment for a massive FM radio project.

BE will supply and install equipment for 32 FM stations to be built across Nigeria. The project is to be completed by early 2003.

tal production system at the London headquarters of the British foreign broadcasting service.

The IBM solution, based on RadioMan broadcast content management software from Finnish company **Jutel**, will be implemented over the next two years. It will improve broadcast quality and transform production processes for the 42 lan-

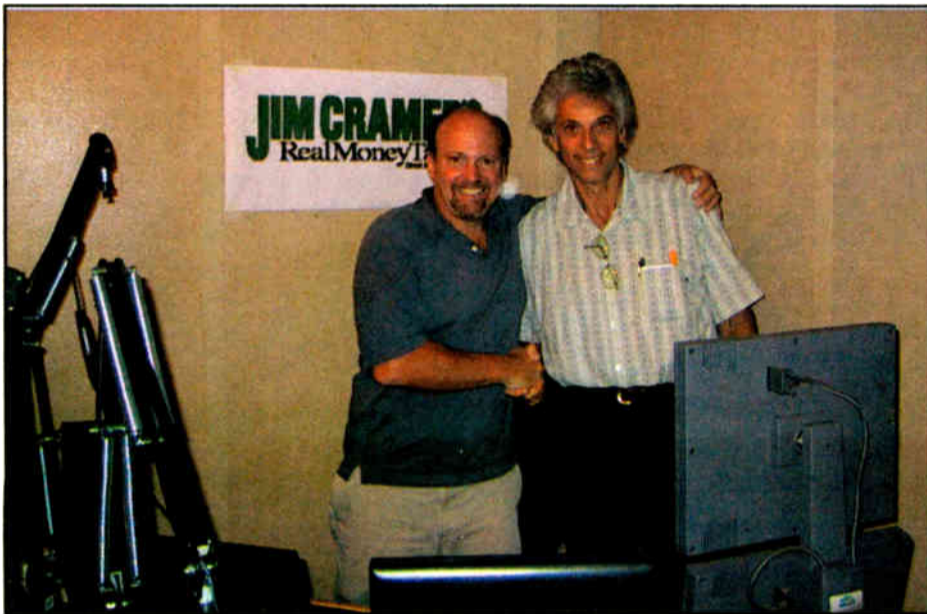

Pictured in his new isolation booth are Jim Cramer, left, and Walters-Storyk Design Group Principal Architect John Storyk.

Each installation will include BE FM-20S solid-state transmitters in a main/alternate configuration. Production and on-air studios will use AudioVault digital automation systems.

Northgate Ltd. of Lagos, Nigeria, will assist BE. **RDA Systems** signed an agreement with BE to provide systems pre-wire services, including wiring studios to **Audioarts D-70** consoles and fabricating between-room wiring.

RDA and BE agreed on the use of XLR-type connectors in lieu of punch-blocks. The wiring system can be inserted into the StudioVantage furniture being provided by **Drieselman Manufacturing**. RDA is providing special power strips for the 220V, single-phase electrical environment in Nigeria. ...

Sierra Automated Systems was recognized by Clear Channel radio station **WNDE(AM)** in Indianapolis for getting it back on the air after an electrical fire in June that destroyed its engineering facility.

The fire happened on a Friday. **WNDE** was back on the air and operational in less than 48 hours after the fire destroyed its almost-new **SAS 64000** Audio Routing Switcher.

Dan Mettler, regional engineering manager for Clear Channel Radio, said, "(SAS) immediately had a replacement 64000 on its way and by early Sunday morning, it was in my hands." ...

BBC World Service this year selected **IBM** to design and implement a new digi-

guage sections of the **BBC World Service**.

Digigram will supply more than 1,000 PCX sound cards for the project, which is creating the largest digital radio production and broadcast system in the world. It will call for 908 PCX924 sound cards, 174 PCX822np cards and 82 PCX440np cards.

This is the second time in a year the BBC has chosen the Jutel-IBM-Digigram combo. The previous project is installing RadioMan software in 26 BBC English Region local radio stations. Some 950 Digigram sound cards are part of that, bringing Digigram's involvement in the BBC projects to more than 2,100 sound cards. ...

Cumulus Media purchased **Wheatstone D-5000** consoles and a **Bridge 2001** audio network router for a new facility in Houston.

Wheatstone is customizing the consoles to communicate with the station automation system, with faders displaying the names of upcoming songs. Gary Kline is special projects corporate engineer for Cumulus. ...

Antex Electronics said its sound card the **LX-24M** is being deployed by South American radio broadcast provider **Hardata** in its radio automation system.

The companies said **Hardata's** automation services are the most widely used in South America, with approximately 3,000 workstations in 20 countries. ...

Entravision station **KCCL(FM)** in

Sacramento installed a new **Jampro JHPC-4** antenna, which the companies said has improved the station's coverage significantly.

Station Chief Engineer Paul Waegele said, "The original signal for Sacramento's 101.9 frequency was designed to create a null towards the west of our transmitter facility on Mt. Ararat, located in Shingle Springs." He said the system had produced multipath problems.

The new antenna is a four-element omnidirectional antenna, capable of a power output of 47,000 watts. ...

The **Walters-Storyk Design Group** designed a two-room radio production studio for **TheStreet.com's** financial journalist and co-founder Jim Cramer.

Broadcast from Wall Street and syndicated by **Premiere Radio Networks**, "Jim Cramer's **RealMoney**" is airing in markets including Los Angeles, Washington and Seattle. ...

Audemat said it has recently sold **Goldeneagle FM** monitoring systems to prominent U.S. broadcasters including **Hispanic Broadcasting Corp.**, **Clear Channel**, **Entercom** and **Maine Public Broadcasting**.

Goldeneagle allows remote monitoring via the Internet of up to 40 FM stations in

a market. Signal-strength and audio quality measurement is via a TCP/IP interface that can be accessed from anywhere in the world. ...

DG Systems' StarGuide Digital Networks division delivered 68 T1/E1 Audio Multiplexing Systems to **OTE**, the Hellenic Telecommunications Organization in Greece.

The **TEAM** systems will be used to enhance **OTE's** audio capabilities on the Greek mainland and surrounding islands. ...

As part of an overhaul of its country-wide contribution network, the **South African Broadcast Corp.** placed a big order with **Audio Processing Technology** for audio data compression codecs, including (25) **NXL384As** and (21) **NXL384Ds**. They are used in a network linking nine regional studios to Johannesburg.

APT also took its first major order for its **WorldNet Rio** codec. Finnish broadcaster **Digita** placed an order for 15 units ...

WorldSpace Corp. signed European radio broadcaster **Europe 1** to its lineup of content providers found on the **WorldSpace** satellite radio system.

See WHO'S BUYING WHAT, page 23 ▶

MARKET PLACE

Narda Downloads RF Data to PCs

Narda Safety Test Solutions calls it a first: a system for downloading, saving and analyzing data collected in personal RF safety monitors worn by engineers, field technicians and others who work in proximity to sources of RF radiation.

The **Nardalert XT** Interface Kit is a hardware and software solution for retrieving data logs stored in **Nardalert XT** monitors, saving the records on PC, and viewing graphed data to determine RF exposure levels with respect to the monitor's alarm settings and a specific industry or government standard.

"This is an important new tool for helping people avoid unhealthy exposure to RF radiation in the course of their work," said Richard Strickland, director of business development. "It's valuable to workers and management for improving job safety, in the short term and over the long haul. There's never been anything like this before."

The kit comes in a plastic case and includes an interface module and two cables. One connects the module to the **Nardalert XT** personal RF monitor; the second, a conventional computer serial cable with nine-pin connector, links the module to the PC. Self-installing software for Windows is provided on a CD-ROM.

For information contact Robert Johnson at Narda in New York at (631) 231-1700 or send e-mail to NardaSTS@L-3COM.com.



"Feature-rich and flexible"

Steve Runck of the Northwestern Radio Group has a lot to say about BSI's digital automation

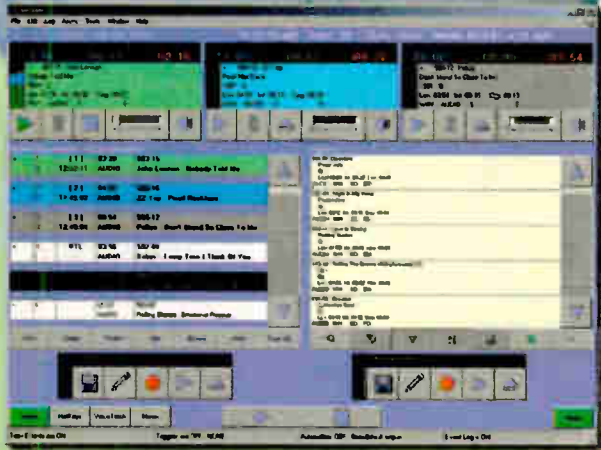

Only \$1499
including technical
support and upgrades

August 22, 2001

When we started down the road with BSI's digital automation in 1996, our immediate need was for a good satellite controller. We also had been fighting to keep an old analog automation system on the air on our AM station. Today we use BSI's automation not only as a satellite controller, but also as our FM automation system.

We also use BSI's software to automate our AM schedule, including music on hard drive. We use a third system for satellite store-and-forward duties. The import routines make it a snap to integrate music and spots from your scheduling software with your BSI logs, and the voice-track editor's drag-and-drop capabilities make having a great hosted sound so easy that any jock will be able to quickly learn it.

The really great part about BSI's digital automation is that you can design as simple or complex of a system as you need in an economical, non-proprietary software and hardware environment. BSI's automation is so feature-rich and flexible that we will never run out of new possibilities for implementing our broadcasting mission. And if you really need a feature that's not already there, chances are good the BSI team will respond to that need in a future release. Where we started with a single PC running BSI's digital automation, the Northwestern Radio Group now employs approximately 17 automation programs at our stations in the Upper Midwest and Florida. KFNW is now down to 12-hour days for manned operation, and our staff is finding more time to be creative, both in the production room and out in the community.

We always like to think we will never need tech support, but I've always been thankful for BSI's 24/7 commitment to us when we DO have a problem. I've even gotten some of those poor guys out of bed in the middle of the night, and they've always gotten us back up and running within a reasonable amount of time. They've even helped us when the problem was hardware-related, and not software.

Yes, we like BSI's digital automation too!

Steve Runck
Staff Engineer
KFNW AM-FM, Fargo, ND

Price, Power and Performance

More than 5000 broadcasters use our software in more than 50 nations around the world. Our \$1499 Simian includes one year of 365/24/7 tech support and software upgrades. Simian has amazing features, such as streaming spot substitution, automated online requests and touchscreen compatibility. Runs on Windows 98, NT, 2000, ME and XP.



Test and try before you buy.

www.bsiusa.com

888-bsiusa1

**Broadcast
Software
International**

GUEST COMMENTARY

How *Not* to Design a Facility

Richard Schrag

The author is with Russ Berger Design Group.

Whether you're upgrading existing studios or building a new radio facility from the ground up, facility design and construction can be a daunting task.

The best way to turn a project into a lengthy and costly nightmare is to ignore some of the common pitfalls. In case you haven't experienced them firsthand, here are a few of the most reliable ways to make your next construction project a miserable experience.

Don't plan ahead — If you can avoid setting goals for the project, you can keep everyone, from the design professionals to your own staff, completely in the dark. That way, they'll have no way of knowing if the project is on track, lending an aura of mystery to your expectations for technical performance, budget, schedule and facility operations.

Not only will the lack of direction be a source of constant irritation throughout the project, it will leave plenty of room for second-guessing later on.

Start with an unrealistic schedule — If you allow enough time for each step along the way, you won't fully experience the chaos that ensues when entire systems are overlooked until construction has begun, or when lead time for one component holds up a half-dozen other trades.

Don't forget, if you order all your equipment first, then you can get a jump on obsolescence by having it sit in a warehouse somewhere while it takes twice as long as you expected for the station to get built.

Pick a site first — Don't bother to figure out what you're going to build before you shop for a building or make an offer on some property for new construction. It would spoil your fun if you knew ahead of time that the place at the end of the runway with the eight-foot ceilings doesn't have enough restrooms to meet code.

When you buy first and ask questions later, you get to spend all your time, effort and money overcoming the building's inherent shortcomings rather than getting what you really need.

Establish your budget before you have all the facts — Here you have several options. One way is to come up with a number yourself out of thin air. You can base it on, "How can it possibly cost more than that?!?" or "I thought that's what I heard the station across town spent on their studios."

A more entertaining approach is to pass it off to the most technically minded

throughout the project.

A third alternative is to entrust budgeting to someone outside your organization who has absolutely no experience in how a radio station works. Maybe your real estate agent has a number in mind.

However you come up with a budget, the important thing is to make sure you haven't thought of everything. Constant surprises keep a project interesting.

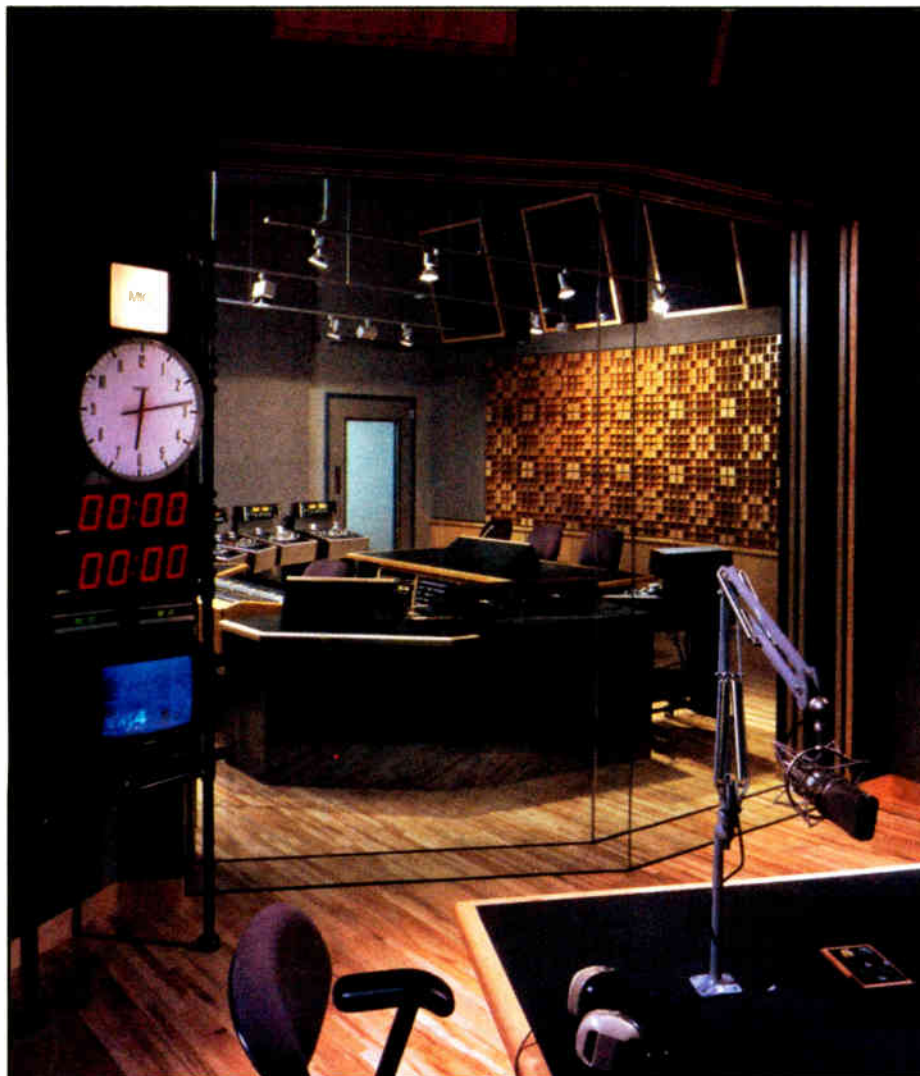

If you don't relegate consoles and equipment to 'afterthought' status, you might give the impression that they are part of the design, as in this studio at National Public Radio in Washington.

people on your staff, but give them 24 or 36 hours to come up with a comprehensive budget. Have them commit their half-baked guesses to writing in a report for the next board meeting, so it can continue to be a source of embarrassment

Assemble the wrong team — Picking design professionals and contractors who are not team players is a good way to ensure that intramural squabbling and personality conflicts will compromise the quality of your project.

One type of firm that's perfect for this is the one that takes a "cookie-cutter" approach to the project — someone who knows exactly what you need before you even say a word, and won't let your unique requirements get in the way.

Another choice might be someone particularly unqualified for the task at hand, such as an architect who thinks "living room furniture" every time you say "console."

Once you do select a team to put your project together, you can add to the confusion by poorly defining the roles that each member will play. If there's enough ambiguity in their responsibilities, you can almost guarantee that some important aspect of the job will be overlooked.

Leave communication to chance — Verbal direction allows everyone to selectively remember what they wanted to hear in the first place.

Sure, you could have consistent and clear documentation, but just think of all the paperwork that would entail. Besides, once everyone knows that a decision has been made, you lose the opportunity to cover the same ground a second or third time.

Get caught up in the details — Focus on items that have little impact on the success of the facility.

For example, if you worry enough about the cost of the light fixtures, you won't have any time left to make sure that the other 98 percent of the project cost makes sense. This is a great way to feel like you're intimately involved in managing the project without really helping at all.

Don't get caught up in the details — If you account for everything you'll need, it will make your budget look worse. Allowing your vision to become cluttered with the realities of what it actually takes to construct a station is much harder than just letting each new issue hit you square in the face.

Anyway, when you run out of money at the end of the job, the chair you're sitting in right now and your 20-year-old copier will both look great in your new facility.

Ignore local rules and regulations — Building a station in this town is just like building one anywhere else, right?

Letting the building inspector point out code violations a week before everything's

See FACILITY, page 20 ►

For all your audio & audio-for-video needs:

BROADCAST
 www.BRADLEYBROADCAST.com
 PRO AUDIO

800-732-7665

Local Phone: 301-682-8700 • Fax: 301-682-8377 • Address: 7313-G Grove Road, Frederick, MD 21704

"You just have to speak to the right people."

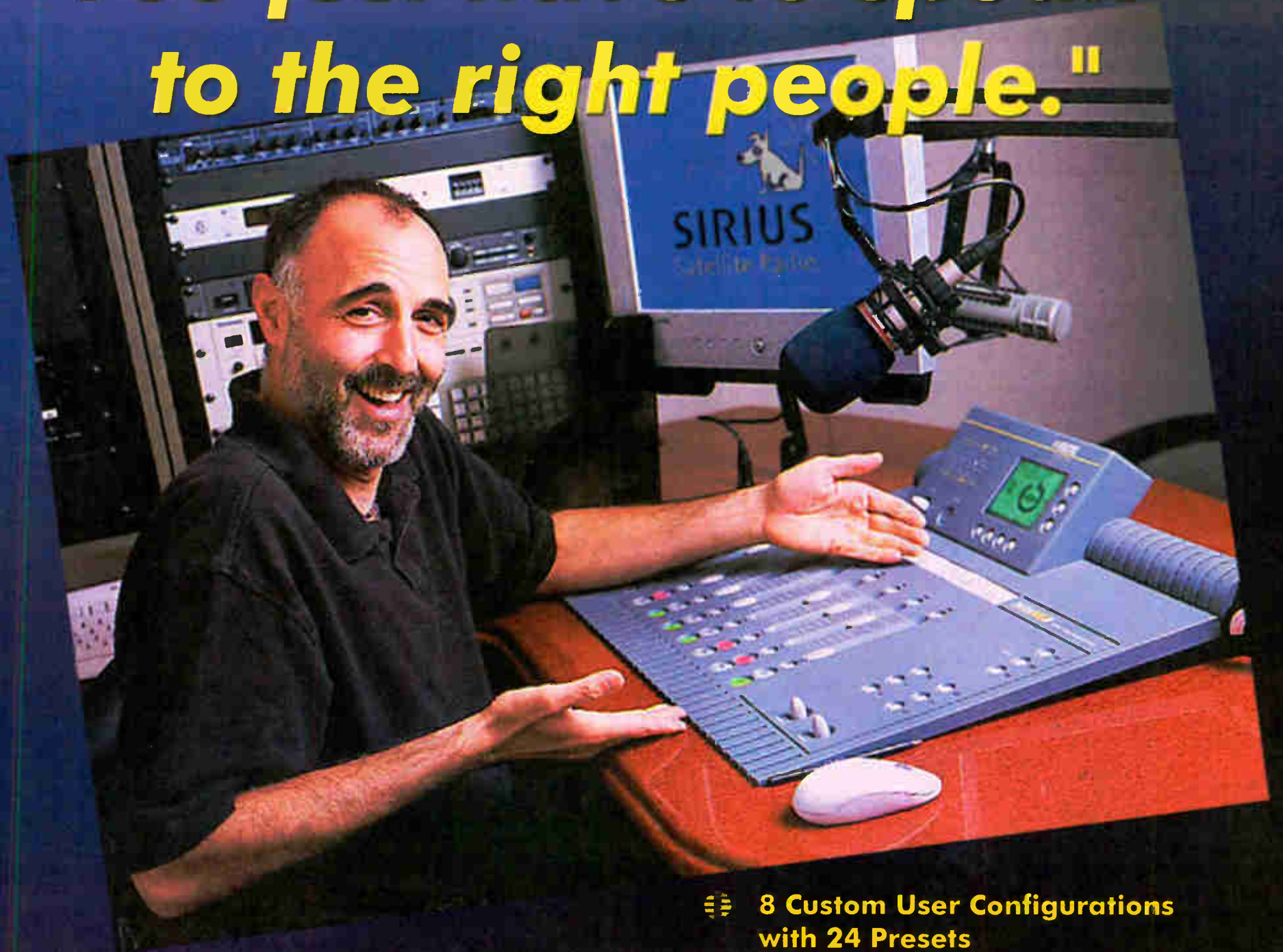

☰ Instant "Production to Air" Change-Over

☰ Custom Voice Processing, Dynamics, and EQ

☰ 8 Custom User Configurations with 24 Presets

☰ Protected, Intuitive Menu Structure

☰ Intercom Auto-Sense I/O and Signal Loss Notification

"This board is an 11! Even though the faders only go to 10..." *Lenny Bloch, Program Manager, Sirius Satellite Radio*

KLOTZ DIGITAL's Paradigm sets the new digital audio standard for radio on-air consoles. Easily integrated into your existing control room/facility, this compact and durable 24 input console boasts more features than any other in its price range! Expandable to 48 inputs, the Paradigm digital console provides operators with a standard and intuitive control surface and offers the ultimate in flexibility and digital audio quality. That's why the most sophisticated and technologically advanced facilities throughout the world choose KLOTZ DIGITAL.



DIGITAL

5875 Peachtree Industrial Blvd.

Bldg. 340

Norcross, GA 30092

Phone: 678-966-9900

Fax: 678-966-9903

www.klotzdigital.com



Facility

► Continued from page 18

finished might mean making a few last-minute changes, but that won't hold up anything except your certificate of occupancy. Accessibility requirements, permits, insurance coverage — these are just annoying little details, aren't they?

Leave the wiring until last — There's a lot of construction that has to be completed before you can bring in the equipment and hook it up, so don't concern yourself with that part of the design early on.

Surely you'll be able to find some way to get cables between the studio and the equipment room once the place is nearly finished. When you do get around to it,

deal with each system independently, so the installers can knock one set of holes in the walls for audio wiring, a different set for telephone/data, a different set for security and so on.

Forget about contingency plans — Once you've set your budget, make sure you have no way of dealing with any cost overruns. Arrange to have your existing lease expire the same day your new place is supposed to be ready. That way, even minor setbacks can become ulcer-inducing crises.

Don't think about equipment and architecture at the same time — These are two different areas of the design, and trying to mix them might just confuse things.

If that means your equipment racks have to be 18 inches wide to fit into the opening that's been left in the wall, well,



The wire management systems incorporated into the architectural design at Nashville Public Radio (WPLN) eliminate some time-honored traditions: exposed cable trays and wires strung across the floor.

TWIN STREAMS OF SPARKLING DIGITAL AUDIO BOTTLED AT THE SOURCE DELIVERED CRYSTAL CLEAR



Moseley

You went all-digital and spent \$10K on a processor for a signature air sound, right? So the last thing you want to do is pollute the air chain with compression.

Demand the pristine 16-bit linear audio of the SL9003Q. It's configurable with up to two pairs of uncompressed stereo audio. You choose the sampling rate: 32, 44.1 or 48 kHz. Even add a cost effective T1 backup option with redundant audio modules, for still more versatility.

Dual, uncompressed AES streams — one STL — and the reliability and quality of Moseley.

The choice is clear.



phone (805) 968 9621 • 111 Castilian Drive • Santa Barbara, CA 93117-3093 • www.moseleysb.com

certainly someone will have a creative solution. You've probably always admired your technical staff's ability to modify something that's already built to allow maintenance access that wasn't considered in the design, or to provide "emergency" ventilation for some piece of gear that was starting to burn up.

Think of your station as an office (with some equipment) — After all, what's so special about this radio stuff? If a building's mechanical and electrical systems had enough capacity for the previous tenant (what was it again, an insurance company?) they should be good enough for you.

Surely the landlord won't object to a few satellite dishes in the front yard or an emergency generator in the parking lot, so there's no point in bringing up those issues until construction is well underway.

Put all your eggs in one basket — Paying disproportionate attention to one aspect of the job can help you miss the forest for the trees.

If you spend all your time thinking about equipment issues, for example, you are less likely to be distracted by the major shortcomings of the office layout or the complete lack of storage in the floor plan. What's more, a myopic fascination with one problem can monopolize project meetings so that other important issues are never even discussed.

Save your best ideas until the last minute — A few "oh, by the way" changes late in the project will help keep everyone on their toes. That eleventh-hour inspiration may be just the thing to render the entire design completely unworkable.

Count on "hidden" cost savings — If you've got a brother-in-law who can provide some of the labor, or if you've got a "connection" with a supplier, assume that will trump whatever budget your contractor has given you. If you try hard, you might be able to overlook the very real possibility that your brother-in-law will take five times as long to complete the job, or that your supplier friend didn't include installation like the other bidder did.

Expect miracles — You'll need them. Of course, if you choose instead to carefully plan your construction project with an appropriate budget and schedule, involving a capable team of designers and contractors, you might find that miracles aren't required. But where would be the fun in that?

For information about Russ Berger Design Group, visit www.rbdg.com.

RW welcomes other points of view. 

Workbench

Radio World, November 7, 2001

Past columns are archived at www.rwonline.com/reference-room

You Can Find Old Xmitter Parts

John Bisset

We've all worked for owners who thought transmitters last forever, but the truth is that as a transmitter ages, the availability of parts becomes a real problem.

Because many failures involve the power supply, a reliable source of such components is good insurance, especially as a manufacturer's supplies dwindle.

Dave Biondi, who hosts the *radio-tech@broadcast.net* listserv, offers up the site www.rectifiers.com as a good source of high-power rectifiers. The phone number is (800) 556-3618.

Another source, offered by Tony

mica and vacuum capacitors.

Finally, Bill Bowin of Columbus, Ohio, suggests contacting Larry Cagle of Electronics Manufacturing Inc. at (800) 556-3618 or e-mail lcagle@zebra.net.

This company manufactures the OEM stacks for some of the Continental, Harris, BE and CCA rigs.

Harlan Biele, M.D. — medical doctor, not music director — commented on our suggestion for the need for periodic generator engine oil analysis, instead of simply changing the oil.

While we're on the topic of generators, cold weather (snow and ice specifically) may require dependence on generators soon. A visual inspection, at the very least, is warranted.

Fig. 1 shows the stack of a generator. Check the little flapper to make sure it moves freely. If it is missing, replace it before ice and snow arrive.

Inside, check fluid levels, belts and the battery terminals. Look for leaking fluids and correct the problem.

Your generator will be your back-up this winter. It must be reliable when called to serve. A thorough maintenance plan by a reputable generator service company is money well spent.

Have you had fun with some of our "wiring nightmare" pictures?

It's always rewarding to hear from readers of this column, especially when they are committed to educating their management about engineering, as our recent pictures did.

Stephen Blodgett, director of technical operations for KNX(AM) and KCBS(AM-FM) in L.A., writes, "As a group, engineers have failed to effectively communicate the need and nature of our work to upper management. Without education, the electronic world that we live with remains evasive and troublesome to management and ownership."

The result, he says, is that engineering essentials often are undervalued and misunderstood.

"I have found that most corporate management appreciates the CE who

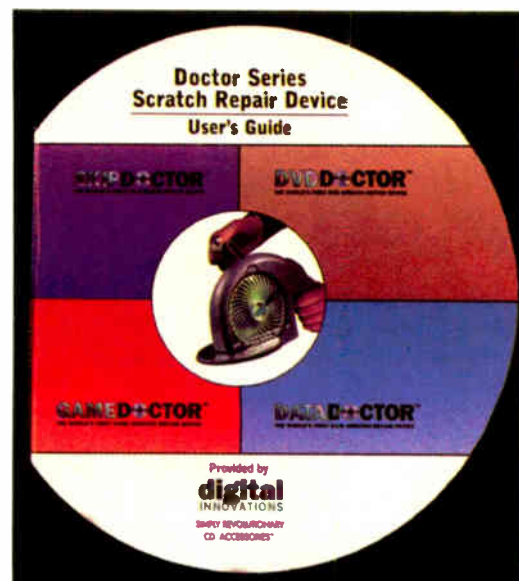

Fig. 2: The Doctor Series Scratch Repair Device resurfaces your CDs.

can effectively communicate the need."

Photos certainly can be worth a thousand words, and can be useful in getting your point across.

Include faulty parts in the mix. Show your manager the parts damaged by lightning or a blown power supply capacitor. It's like getting the parts back when the mechanic repairs your car. You know the job was done.

Gary Leonard of KWWR(FM) and XKEO(AM), Mexico, Mo., was reading a B-Net thread about cleaning vinyl records and just for fun punched in www.discwasher.com. The company still exists.

George Kelly of Kelly Engineering Services adds that Discwasher sells an excellent touchless CD washer that uses a high-speed motor. It spins CDs in a surfactant bath to remove oils, dust and dirt

See WORKBENCH, page 22 ►



Fig. 1: Make sure the flapper on the generator stack moves freely.

Mulligan of Mulligan Technical Services in Montana, is Surplus Sales of Nebraska at (402) 346-4750 or on the Web at www.surplussales.com.

Surplus Sales has the IR stacks used in some Continental transmitters as well as the Unitrode "puck"-style diodes found in the Harris MW-10. In addition, it stocks

Dr. Biele writes to tell *Workbench* that Jiffy Lube has an engine oil analysis program, with on-site analysis machines from Global Technovations. They call it a "blood test for your car."

Oil analysis for any engine can spot problems before they become catastrophic.

NEW

Is "Processor Delay" driving your DJ

Use **MoniSwitch** to eliminate it!

MoniSwitch is a special audio switcher that automatically switches the DJ's headphones from "air" to "local" when the mic is on. Those weird echoes and flanging effects are gone!

Quick and easy installation...

works with any console's Mic Tally output.

MoniSwitch is IN STOCK at all Henry Engineering dealers.



For detailed info, visit www.henryeng.com Tel: 626.355.3656 Fax: 626.355.0077

We Build Solutions

AM Torch

► Continued from page 15
these facilities into the new millennium. If, as some experts are now predicting, AM IBOC takes off, we're liable to suddenly have our hands full.

We go mining wherever we can for the information we need to "do" AM engineering, from the past and the present. We've learned in putting on the seminars that we really need to consult two or three generations of engineers to gather the knowledge and experience it takes to make AM work.

Some of these can only speak to us now through faded books and technical journals, but their information is just as useful today as it was 50 years ago. In many cases, though, the human resources are still there, and we've taken advantage of those resources wherever possible.

Hands-on

Modern AM is a combination of very old technology and very new, so you need both worlds. In my office are a Nems-Clarke field intensity meter from 1961 and a Pentium III computer we use to analyze the data it puts out. Both meter and computer are working fine, thank you. We use computer modeling to confirm computations and predictions from 50 and 60-year-old textbooks.

We also run mini-NEC to come up with our own models. AM antenna engineering is much more "hands-on" than FM. The details become important, and they're on your desk, not some design engineer's.

We're trying to round up as many of those details, old and new, as we can. My text tells us the optimum "antifading" height for an AM tower was discovered to be 190 degrees back in the 1930s. Taller towers have high-angle radiation characteristics that reduce the effective coverage area.

The FCC told us they don't want us feeding AM towers with slant wires anymore. They want us to use unipoles of at least three equally-spaced wires. Our software has a program which uses a coaxial transmission line model to help us design and tune unipoles.

The best way to tune "T" networks in AM feeder systems is with the RF bridge and the station antenna monitor. This allows you to check both element reactance and phase shift. The two don't always follow the cook-book formulae of

the software in the real world.

Shorting unused turns on a coil can cause high circulating currents which can burn it up. Leaving the turns unshorted can cause high voltage to appear at the end. Sampling loops should be mounted directly on the tower, not on stand-offs.

It goes on and on. We collect it in notebooks and in our heads.

The torch is being passed, albeit slowly. We need the information, and we go looking to find it.

People tell us we can't do something from time to time. We usually go out and do it anyway. Will there be a "new crop" of AM technicians and consultants? Probably not anytime soon.

What will happen is that some of the same people who are already involved in other aspects of broadcast engineering will see economic opportunity when it appears, and join us. In the meantime, the least we can do is try to collect and preserve the knowledge that already exists about how to engineer AM broadcasting, so we'll all have that in the future.

To that end, we're having another

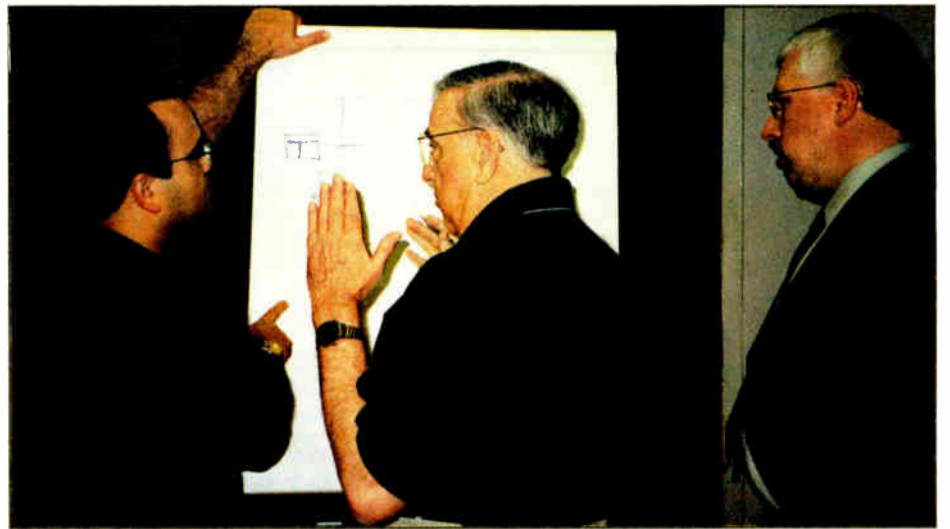

Charles Crane and Charlie Gallagher discuss a diagram while Cris Alexander listens.

symposium in February, here in San Antonio. We'll cover the basics of FM allocations, but the rest of four days will be about AM issues. You're welcome to join our group!

For more information on the upcoming

Symposium 2002, visit www.RFTrainingCo.com/current_events.shtml.

Gary Keener is a consultant with Paradigm Associates in San Antonio and a former CE. Reach him at (210) 828-4555 or via e-mail to gkeener@pdigm-inc.com.

Workbench

► Continued from page 21
without touching the surface of the CD. The product costs about \$60.

What do you do when the CD is scratched? Wendell Hall of WJFK(AM-FM) in Washington showed me a slick

device manufactured by Digital Innovations, shown in Fig. 2.

The Doctor Series Scratch Repair Device is a manually operated product that radially resurfaces CDs. This action repairs the primary causes of skipping and distortion, and will repair abrasions, light to medium scratches and surface imperfections.

With its "reversibility" feature, it can

repair deeper, more stubborn scratches.

The company offers tips on caring for CDs that can be found at www.digitalinnovations.com. Select "About CDs."

Have you sealed your buildings for the winter? Fig. 3 shows the inside of a phasor with three openings at the lower left, ideal doorways for mice (first arrow).

The RF lines that lead to the outside are sealed with the white Teflon-brand bushings seen at the base (second arrow).

Check for little things like this, and at the least, plug the holes inside the building with steel-wool plugs.

Mice can chew through wires, and not until you've had to replace chewed control wiring will you appreciate the importance of these seemingly "minor" maintenance checks.

John Bisset has worked as a chief engineer and contract engineer for more than 30 years. He is a district sales manager for Harris Corp. Reach him at (703) 323-8011.

Submissions for this column are encouraged, and qualify for SBE recertification credit. Fax your submission to (703) 323-8044, or send e-mail to jbisset@harris.com.

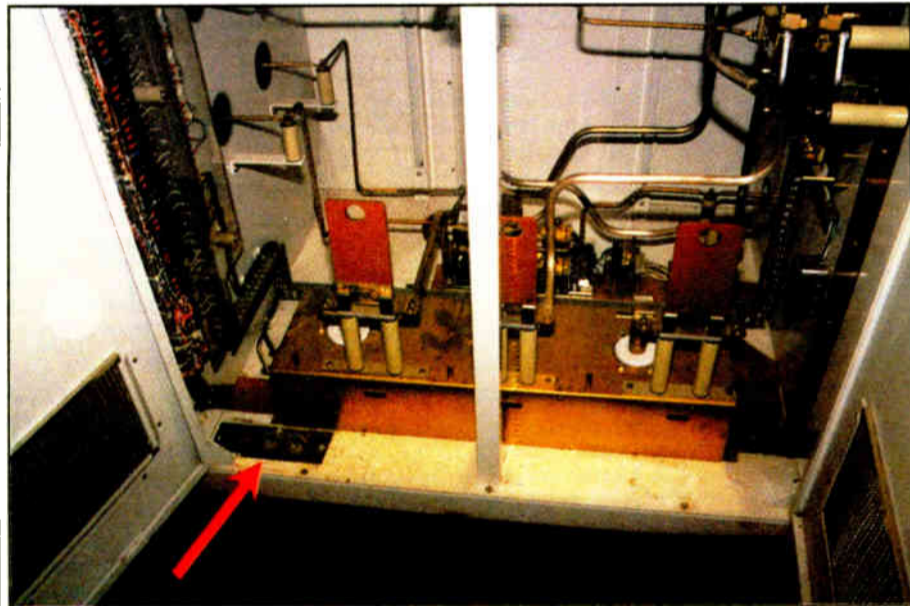

Fig. 3: Seal your buildings and equipment for winter. Rodents will look for escape from the cold.

RDL® RAISES THE BAR FOR DIGITAL PERFORMANCE



RU-UDC1



SOURCE SELECTION (2 models to choose from)

- AES/EBU
- SPDIF

DISTRIBUTION (2 models to choose from)

- AES/EBU
- SPDIF

CONVERSION (4 models to choose from)

- 2-digital to analog
- 2-format

SURE-LOK™ Auto-Recovery Sentinel means the BEST choice for production, the ONLY choice for broadcast. There is never a need to manually restart RDL digital products to resynchronize: IT'S ALL AUTOMATIC!

And SURE-LOK is exclusive to digital products from Radio Design Labs®.

All models: up to 24 bit, 96 kHz capable. In professional applications, anything less is unacceptable.

For a complete listing of our products, call or write: (800) 281-2683 • (805) 884-5415 • email: sales@rdlnet.com • website: www.rdlnet.com



RDL®
Radio Design Labs



► Continued from page 16

Europe 1 commenced 24-hour broadcasts in French of breaking news, sports and information via the West beam of the WorldSpace AfriStar satellite throughout Francophone West Africa and the Mediterranean Basin. ...

Entertainment Networks India Ltd. bought Telos ISDN talkshow products, TWOx12 Talkshow Systems with Desktop Directors and Assistant Producer call screening software to serve its four Metro networks.

Recent buyers of the Omnia-6 processor include Nashville station WSM(FM) and its Chief Engineer Watt Hairston, and Bayerische Rundfunk in Munich, Germany, which chose the Omnia-6fm processor for its Bayern 1 and Bayern 3 formats. ...

Radio Frequency Systems helped complete the installation of a 13-channel FM combining system for the **Macau Tower**. The tower hosts FM and UHF broadcasting equipment, as well as a revolving restaurant and plaza area. ...

Radiodiffusion-Télévision Marocaine in Morocco chose **Dalet** music and newsroom systems.

The installation is helping RTM broadcast its programs in three dialects and four languages from Rabat and nine regional stations. RTM is equipping 60 workstations with the Dalet digital music system. ...

Each week, 189 radio stations air **"The WoodSongs Old-Time Radio Hour"** with a mix of grassroots acoustic music performed in front of a live audience.

The show takes place in the 400-seat Kentucky Theater in Lexington, Ky.

Front-of-house sound reinforcement consists of six **Mackie SRM450** Active loudspeakers. The performance is mixed down to two ADAT recorders from a Mackie 32*8 Bus console. ...

At the NAB's IBOC listening tests during the Radio Show in New Orleans, **Lucid Audio's** DA 9624 D-to-A converter was used.

The test was the second part of a two-tiered evaluation. The first involved testing of Ibiqity Digital IBOC systems on consumers. **DynaStat** conducted those tests using the Lucid converters. NAB duplicated the DynaStat setup for The Radio Show, focusing on radio professionals. ...

RDA Systems installed a **Sierra Automated Systems & Engineering** system for **Hispanic Broadcasting Corp.** in Los Angeles.

The staff of RDA Systems recently was factory-certified by SAS to install its audio routing systems.

"The Dave Koz Radio Show" recently added its 100th affiliate market with the addition of **WQCD(FM)** in New York. **WJZZ(FM)** in Atlanta had signed on as well.

NBG Radio Network Station Sales Director Fred Jordan said the smooth-jazz show is on in every top-five market and in 20 of the top 25.

Koz is heard weekdays from 6 to 9 a.m. on **KTWV(FM)** in Los Angeles. ...

LPB Communications shipped of the first of 25 of its Blue 5c Audio Consoles to **The Bible Broadcasting Network**. BBN plans to install the Blue 5c in 25 radio stations.

LPB said BBN assisted in beta-testing the Blue 5c in high RF environments and is replacing traditional on-air boards as a move to simplify service and operations and significantly reduce costs.

Ron Muffley is network engineering manager for BBN. ...

KUPL(AM) incorporated **Sennheiser** microphones into radio coverage of Portland Beavers minor-league baseball and Portland Timbers soccer.

The teams play in Civic Stadium, recently renovated and renamed PGE Park. Engineer Tim Denny chose the Sennheiser evolution 100-series, which offer plug-ons for wireless use.

KUPL ties the microphone inputs together with a **Mackie 1602** that sends into its **Comrex Matrix** codec. ...

ENCO Systems signed a deal with **SADiE** to sell the latter's PC-based digital audio workstation to U.S. buyers.

Gene Novacek, president of ENCO, cited SADiE support of CartChunk and its DSP platform. RADiA will be offered as an integrated option to ENCO's DADpro32.

ENCO also announced an agreement with **Desktop Technologies** allowing ENCO to sell the NewsBoss newsroom management system. ...

Sonifex has won a contract to supply **BBC** local radio stations with its Courier portable hard-disk recorders. The order is the largest single order for Couriers that Sonifex has received, part of the BBC's program to redevelop regional broadcasting sites, including London, Kent and Sheffield.

The order was for approximately 100 Couriers; every BBC local radio station in England will be issued units. ...

AP Radio will provide Web content to **LMiV**, the media company created as an industry approach to help local radio stations compete in the Internet world.

The LMiV network consists of about 200 radio stations with a combined audience of 37 million people in the United States and Canada. ...

VRT is the national radio and television for the Flemish-speaking part of Belgium. The eight VRT stations are streaming with 12 **Maxxstream M 200** units.

Meanwhile, Finnish Broadcasting **YLE** purchased five Maxxstream units to enable high-end audio conditioning for its streams, which can be heard at www.yle.fi/radiomafia/maxxmafia.asx

SRI Swiss Radio International is using four M 200 units with four cards each to stream to various Win and Real encoders.

"Who's Buying What" is printed as a service to our readers who are interested in how their peers choose equipment and services. Information is provided by suppliers.

Companies with news of unusual or prominent sales should e-mail information and photos to radioworld@imaspub.com.

Construction Starts on Northwestern Media Center

Construction is underway on a proposed \$5.5 million media center for Northwestern College Radio.

The interim president of Northwestern College and Radio, Dr. David Erickson, said growth in the school's media ministry requires a new facility to house KTIS(AM-FM), Northwestern's 14-station radio network headquarters, the Sky-Light satellite network and online music station LifeNet.FM.

A two-story building with 41,000 square feet of space is being built south of the campus entrance.

The media center is named in honor of Mel Johnson, a longtime Northwestern radio broadcaster and former chairman of its board, who died this year.

"This is God's ground and this is God's ministry," said KTIS manager Jon Engen. "The purpose of this ministry and this media center is to effectively get the good news of Jesus Christ out to the next generation."

The Northwestern College radio ministry is a network comprising eight AM and FM stations in the Upper Midwest. Its audience is approximately half a million listeners every day.

The Sky Light Satellite Network and Sky2 provide Christian programming to 300 station affiliates.



"We're On-Air in Five Minutes."



When you've got audio to cut and no time to spare...

Trust Short/cut 2000™ to get a move on. How fast is it? You'll be editing tracks as fast as you can push the buttons. And when you're working on-air, Short/cut's ten Hot Keys keep your best clips cued-up and ready to go.

We've also tripled audio storage to a whopping 12 hours – and with a hard drive so quiet you can work right next to an open mike.

Whether it's breaking news, phone-ins, sports, interviews, or live events, the new Short/cut 2000 is radio's #1 choice for stand-alone digital audio editing.



360 Systems, 5321 Sterling Center Drive, Westlake Village, CA 91361 • Phone (818) 991-0360 • Fax (818) 991-1360

FIRST PERSON

How One State's OEM Reacted

Robert Schroeder, BSEE

The author is communications officer of the New Jersey Office of Emergency Management.

I was pleased to read Radio World's coverage of the events of Sept. 11 events. Things here at the N.J. Office of Emergency Management were no less busy. I thought you might be interested in what we were doing.

We were alerted to the first plane crash by one of our cellular 911 operators. After putting on CNN, we all stood aghast as we watched the second,

third and fourth attacks take place. Immediately we activated the State Emergency Operations Committee and began calling in all our state, federal and Volunteer Organizations Active in Disaster representatives. I activated my communications center and began scheduling some RACES operators to come in to handle the amateur radio traffic that ensued.

EAS

As for the Emergency Alert System, before I could pick up the phone to call him, Tony Gervasi from Nassau Holdings called me to say that

WPST(FM) at 97.5 MHz, our primary EAS outlet station, was going off automation and would be manned with live operators. Tony gave me a private fax number so that we could send any EAS messages to him for broadcast.

As a backup, we have a secure 800 MHz trunking system in place that can override the program audio of any of our five LP stations and put ourselves on the air without any intervention from the radio stations. This system became necessary due to the fact that

other than weather-related.

In addition to their Philadelphia and Atlantic City transmitters, the Mt. Holly forecast office now has a new 300-watt transmitter in Monmouth County as of Sept. 25. A 1 kW transmitter is being installed in Sussex County and should be on the air by November.

Cellular proposal

A project that I've been working on since 1999 is a cellular EAS system for New Jersey. In short, an emergency message originating from the state EOC can be transmitted to all cellular subscribers and displayed on their handset.

I believe that a proposed cellular EAS system could have saved some lives.

— Robert Schroeder

MARKET PLACE

Bird Updates Products

Bird Component Products Inc. released a new attenuator kit and upgraded the frequency range of its 10-T series 10 Watt Terminations.

The 3-A-MFB-K1 Attenuator Kit has four attenuators, each rated at 3 W. The four have 3, 6, 10 and 20 dB values. All attenuators have BNC male and female connectors. The case protects the gear with internal pre-cut foam used for mounting. The kit can be used to determine dB values for transmit, receive or measurement systems as an alternative to variable attenuators.

The 10-T series of 10 Watt Terminations is now rated at 10 GHz. The operating temperature runs from - 40 to +40 degrees Celsius with a VSWR of 1.1:1 maximum from DC to 2.4 GHz; a 1.15:1 max from 2.4 to 6 GHz; and a 1.25:1 max from 6 to 10 GHz. Connectors are male and female. BNC and TNC connectors are also available for applications with a maximum frequency range of 4 GHz or lower.

For more information contact Bird at (727) 547-8826 or visit the company Web site at www.birdfla.com.

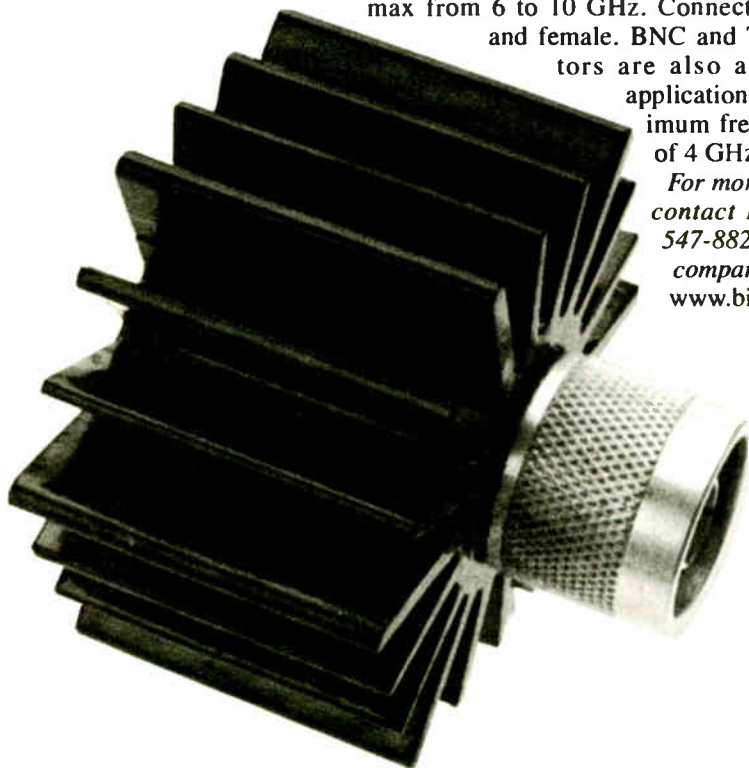

so many stations have become automated either full- or part-time. On Sept. 11, however, this takeover system wasn't necessary.

As it turned out, NJOEM did not issue any EAS messages.

There is nothing we could have said that wasn't already on radio and television. Also, with the radio-controlled warning signs operated by the N.J. Department of Transportation, all New Jersey motorists were notified that access to New York City was closed.

Ready to go

Make no mistake, EAS was mission-capable that day. It's just that neither the governor nor the state director felt it necessary to use it.

I do commend Tony for his quick thinking. I am pleased to say that this office has an excellent rapport with all participating EAS broadcasters and cable operators. Our SECC is chaired by Rich Archut, chief at WKDN.

Joe Miketta from Mount Holly NWS called to say that his office was prepared to simultaneously air any of our EAS messages over their NOAA weather radio network. He points out that the network is an all-hazard system and can be used for emergencies

I believe had this feature been available on 9/11, it could have saved some lives. Unfortunately there are many political hurdles to jump before this plan gets implemented. More info is available at www.ceasa.net.

As for your editorial in the Oct. 10 issue, I too wonder why Washington didn't issue any kind of presidential EAS message. It wouldn't have been a warning, but perhaps more of a declaration. It also would have served to test if the PEP system actually worked.

I did some "Wednesday-morning quarterbacking" with Bonnie Gay of the FCC. We both agree that all states need to think outside the box and revise their EAS Plan and Warning Plan accordingly.

I breathed a sigh of relief knowing that my state plan is done and obtained final approval by the FCC just a few months ago. In light of last month's events, I now have to revise it again.

These are my personal observations and not an official statement from Office of Emergency Management.

H. Robert Schroeder, N2HX, can be reached via e-mail to LPPSCHRR@gw.njsp.org.

RW welcomes other points of view.

Custom AM Directional Antenna Phasing And Matching Systems



Four-Tower 50 kW DA-2 Open-Panel And Shelf Phasor

CFRB Radio - Toronto, Ontario

Your No. 1 Source For AM Antenna Systems And Accessories In The USA And Worldwide

Online Shopping Now Available At kintronic.com

Click On LOGIN, Then SHOPPING**

** Prior Approval Required



We Design And Build For DRM Or IBOC Digital Audio Broadcasting

Kintronic Labs, Inc



Phone: (423) 878-3141

Fax: (423) 878-4224

Product Brochures Available At www.kintronic.com

Broadband, Low Cost STL Isocoupler

NEW PRODUCT



Model KTL FMC-0.2P STL Isocoupler

GUEST COMMENTARY

EAS: Not Even a Glass Half-Empty

RW's Masked Engineer Is Fed Up With the Failings of the Emergency Alert System

Guy Wire

The Emergency Alert System has done little to assist the public in times of real emergencies except maybe for tornado and hurricane warnings in some areas. It has done even less for broadcasters except burden us with government-mandated weekly tests, threats of FCC fines for non-compliance and multiple layers of confusing codes and procedures.

Huh?

Ask any jock what they'd have to do in the case of a real EAS activation and they probably don't have a clue.

Ask any average citizen what EAS is supposed to do and you will get mostly blank stares or a baffled "EA what?"

But when actual emergencies happen, we rarely if ever hear a real activation. Witness the tragic events of Sept. 11 in New York and Washington or the earthquakes in Northridge, San Francisco and Seattle. Nada from EAS.

They got scooped by local broadcasters acting on their own for all the vital information. The public is left with a general perception that EAS is not ready for prime time.

Our EAS officials tell us their wonderful system is only for early warning of emergencies they can predict. Mostly tornadoes and hurricanes. Forget anything with a "short fuse" like earthquakes and terrorist attacks. Apparently once those hit, there is no further need for the public to be alerted to other related threats. EAS doesn't even have event codes for civil emergencies like widespread riots, bombings or terrorist attacks.

Why could we not have required EAS alert decoding built into every new radio and television sold?

Then there is the National emergency alert. The president takes over all electronic media to tell us on the "PEP" stations of something major that would have widespread impact, like maybe incoming nukes.

The National alert has never been activated. If it were, only stations with properly trained operators paying attention or with decoders wired directly

into the air chain would get it. The only people who would hear or see it would have to have radios or TVs already turned on to those stations.

Sept. 11, 2001, was probably the one day since EAS and its predecessors were invented that such activation would have been justified. We were under direct attack on multiple fronts by insidious terrorists right on our home soil. Many thousands of people were killed or missing.

If nothing else, we needed some calming reassurance that our government and military were in control and executing an appropriate defensive response.

Beyond major weather events, EAS only gives lip service to its intended mission. All those other codes from blizzards to tsunamis go virtually unused.

What we have in EAS today is a redundant and marginally effective system at best for alerting the public of an impending weather emergency. It prefers to ignore emergencies of other kinds whether local, state or national.

Beyond major weather events, EAS only gives lip service to its intended mission. All those other event codes from blizzards to tsunamis go virtually unused.

Several of my engineering comrades have spent tireless hours in meetings with state and local civil defense and other government officials setting up elaborate EAS plans, complete

with thick three-ring binders of complicated procedures and rules. Unfortunately, they are the only ones who even know they exist. Many layers of dust entomb these masterpieces in every station.

When real emergencies strike, stations mostly ad-lib their own response, relying on cable and local TV plus satellite news feeds and all-news radio

stations for their information. Civil authorities sitting in a county courthouse entrusted to oversee and authorize EAS activation for many local plans are almost always too late to the party to even matter. They invariably sit on their hands and never activate.

Looking back, Conelrad and EBS were created primarily for early warning of a nuclear strike. Few stations used EBS for severe weather events until the Cold War was winding down.

Black holes

EAS was a step in the right direction but too many black holes still remain. If we can't decide to make it a *real* system, we may as well scrap it and just use NWS and the other

resources we already depend on.

What to do?

EAS still entrusts receipt and delivery of its alerts to mostly low-paid and untrained jox or board ops at the local station level. Few unattended automated stations trust automatic forwarding and do not run it for fear of being "burned." Once and for all, we have got to get the weakest link out of this equation.

Second, it's only half a system. We do have most broadcast and civil agencies equipped with an encoder. But nobody else has a receiver that automatically responds to an alert.

Putting EAS decoding in the hands of the public at large is the missing half. An entirely

new and universal level of alerting would be directed to those who need it most, free of delayed middleman filtering by broadcasters.

Streamline

Third, the authority chain needs to be streamlined to make activation more effective and quickly executed from designated officials who are the closest to any given emergency situation.

Why could we not have required EAS alert decoding built into every new radio and TV sold? The public could receive the alerts directly with automatic activation of all sets, whether on or off. Millions of folks may not have a radio or TV turned on, but *are* within earshot of one.



this subcarrier that would turn on all sets and pre-empt any other selected channel.

Such activation could come from the weather service, the president, the governor, local police or fire officials, the FAA, a nearby military base commander or even the local all-news station — whichever designated source or authority is closest to a given serious emergency condition. This is just a starting point. There no doubt are many others that should be considered and refined by those involved in EAS planning.

EAS needs to grow up and become more efficient and more proactive in protecting the public when Mother Nature or our fellow man threatens us. The technology to support this effort certainly has grown up and stands ready. It's time to start rethinking how to deliver the emergency mail. It's time to start re-filling the glass.

Guy Wire is the pseudonym for a veteran radio engineer whose comments appear regularly at the Radio World Web site at www.rwonline.com. RW welcomes other points of view.

MARKET PLACE

Classic Air Light Price Reduced

CBT Systems has lowered the cost of its new Classic "On-Air" Light to \$295.

The unit features traditional sand casting, buffed aluminum housing and Plexiglas lens. It installs easily on a standard two-gang j-box; optional legends and flasher module are available.

CBTS also offers a studio and control room "On-Air" lighting control system that interfaces to console status and tally indicators.

For more information contact CBT Systems in California at (858) 536-2927 or send e-mail to cbt-net.com.



Where the NEC Came From

Charles S. Fitch

On a recent trip to the Radio World Web site at www.rwonline.com to find a link to a manufacturer's site, my unfettered ego caused me to look into the NEC section, where back articles in this continuing series reside.

To make me feel old, our Webmeister has listed the run date of each of the back columns posted. Although this column has been addressing the National Electrical Code and its impact on broadcast installations and operations for more than three years, it's not quite as old as the NEC itself, which first appeared in 1898.

The NEC, the most widely used electrical standard in the world, is one of approximately 300 "codes" published by the National Fire Protection Association.

Peer group

The NFPA is a peer group comprising people and organizations in a private, not-for-profit corporation. It has 75,000 members from areas of interest such as manufacturers, trade unions, insurance and fire safety, that labor in a particular industry where some sort of uniform standards are needed to enhance safety.

MARKET PLACE

Switchcraft Releases BNC Connectors

Switchcraft's new HP75BNC line of 75-ohm BNC cable mount connectors was developed for the broadcast industry and other areas where impedance BNCs are used.

The connectors are made of machined brass and nickel plating and use 50MI gold-plated center pins. The series has seven configurations for most cable sizes and types. They work with standard BNC crimping tools.

The connectors have a voltage rating of 500 V RMS and a return loss of less than -25 db at 3 GHz.

For information contact Switchcraft in Illinois at (773) 792-2700 or visit www.switchcraft.com.

As issued by the NFPA, these codes are advisory but are backed by a process of review and consensus. The NEC gets its teeth when made part of the building code in your community.

Historically, the main driving force and a major beneficiary of these codes has been the insurance industry. In the past, before the "90-day bottom line" mantra became the guiding force, most insurance organizations were far more proactive in attempting to limit accidents and hence claims against their policies.

Ben Franklin is considered the father of insurance in America. He encouraged the creation of insurance funds and established the American College of Life Underwriting as well as the first fire brigade in Philadelphia. His goal was to attenuate injury, loss of life and damage to property.

(Ben's fire brigade is interesting. You paid in advance, periodically, to have your home or business protected by the brigadiers — in a way, an insurance policy.)

America was an agrarian nation through most of the 18th and 19th centuries. Transportation limitations and the needs of the land kept most folks within a few miles of their birthplaces.

Franklin, one busy guy, also implemented the federal postal system. This, and the subsequent invention of the telegraph and telephone, helped coalesce our nation.

By 1900, a national feeling was coming into vogue, bringing interest in national standardization.

This was a watershed for national safety awareness.

Health and fire safety

Among the events precipitating uniform safety standards were the great epidemics of this period, including cholera and influenza outbreaks. These launched a serious march toward public health standards in water supply and sanitation.

Another was the Great Baltimore Fire of Feb. 7, 1904, a blazing example of the need for standardization.

The fire quickly went out of control, fanned by the wind and the close, wood-frame construction of the old city. Special express trains on the B&O railroad were created to bring fire companies and apparatus from as far away as New York City and

Wilmington, Del.

These units arrived only to discover that their hose connections did not fit Baltimore hydrants, which used bastard fittings. The out-of-towners were forced to put their input hoses in the Jones Falls Creek to make their stand, and they pumped the creek dry.

The lessons of the fire resonated. Resistance to standardization and safety principles was overcome. Codes that had been voluntary or advisory were given the force of law, taken into building codes and regulations nationwide.

An updated version of the NEC is published every three years. The next version is due in 2002.

The NFPA and its safety standardization effort were ready to supply the need for thoughtful standards. Our nation and other countries have benefited greatly from the expertise contained in its publications. The NFPA has prospered since that time. It is based in Quincy, Mass. Information about the association and the NEC can be found at www.nfpa.org.

In addition to the NEC, the association promulgates codes and standards covering plumbing, range hood exhaust systems and life safety devices, to mention just a few.

Under its current schedule, an updated version of the NEC is published by the NFPA every three years, with the next updated version due out in 2002. This series of articles focuses on the current version, dated 1999, which is the edition with which you usually must comply.

Concerning the NEC and many of the other codes from the NFPA, always keep in mind that the NEC is



not a design manual. It is only an annotation of specification minimums, which, if met, will create a minimally safe, hence insurable installation.

As long as these minimums are met or exceeded, the quest for efficiency, capacity, low noise, enhanced regulation, expansion capability and other considerations are left to the design engineer.

We'll return to the details of the NEC next time.

Charles S. Fitch, W2IPI, is a registered professional consultant engineer, a member of the AFCCE, a senior member of the SBE, lifetime CPBE, licensed electrical contractor, station owner and former director of engineering of two New England television stations.

He can be reached via e-mail to FitchPE@home.com

National Electrical Code® and NEC® are registered trademarks of the National Fire Protection Association Inc. Material from the NEC used in this series of articles is reprinted with permission from NFPA 70-1999, the National Electrical Code®, Copyright© 1998, National Fire Protection Association, Quincy, MA 02269.

This reprinted material is not the complete and official position of the NFPA on the referenced subject, which is represented only by the standard in its entirety.

Radio World encourages our readers to obtain a full copy of the code as a complement to this series and as a future reference.

Make switching from analog to digital as easy as this.

Analog or digital, Antex has you covered. When you add the best 20-bit digital sound quality, highly stable Windows 95/98/NT software, and up to 4 inputs and 8 outputs, we think you'll agree that the Broadcaster Series is the one for you. To find out more, visit www.antex.com today or call 1-800-338-4231.

If You Feel Like This



You Need This

Looks like you've got your hands full again. Except you're running out of hands. And because you have many facilities you could use a few more legs, too.

Let Harris' Intraplex STL PLUS™ give you a hand getting your new station up and running quickly and profitably or upgrading your station to the best quality digital on-air sound available today.

STL PLUS™ gives you bi-directional program audio transport over a T1 line, fiber or microwave link. So you can interconnect your studios, offices and transmitter sites. And because it's a digital system, you're delivering pure, crystal clear sound – regardless of the distance. Even if you're surrounded by the highest mountains or tallest buildings.

Now for the PLUS in STL PLUS™: You can also transmit LAN/WAN data, telephone, intercom, and remote control over the same digital line. All of which can rack up some pretty impressive cost savings for your inter-facility communications.

Best of all, STL PLUS™ grows with you as no one else can. It has the industry's largest assortment of plug-in modules. So you can design the perfect system for today and quickly, easily, and affordably upgrade it for tomorrow.

So, contact your Harris representative about STL PLUS™ today. You'll be a leg up on the rest.



next level solutions

SERVICE

SYSTEMS

AUTOMATION

TRANSMISSION

LPFM Stations Are Rolling Out

Ken R.

Very few initiatives of the FCC have caused as much controversy as low-power FM. The battle lines were drawn with the NAB, many large broadcast groups and a lot of engineers on one side and a small but diverse group of schools, churches and equipment manufacturers on the other. But having written, the hand moved on.

LPFM is a reality. The initial wave of construction permits was granted and early operations are hitting the airwaves.

Radio World contacted several LPFM license-holders to find out about their facilities, their broadcast agendas and their views on the new service.

Church chat

The largest number of licensees is in the category of churches.

First Baptist Church of Mansfield, La., will be on the air with KEPT(LP) in December. Dave Vise, program operations manager and youth minister, will air a mostly automated, music-intensive format provided by American Family Radio based in Tupelo, Miss.

"We're going to go with some country-gospel and adult contemporary music in our retirement community here near Shreveport," Vise said. "We have a radio/TV committee with about



Kim Law

seven or eight people and they asked me to handle it because of my 22 years of broadcast experience."

The station will run some local news, information and weather, which will be inserted into the format using a Smarts Broadcast system. Vise will gradually add local sports and other community events.

"Our signal will probably reach about a 10- to 15-mile radius and our tower is already up," said Vise. "The studio is under construction right now."

Vise believes his operation will pose no threat to local commercial broadcasters. "We will totally depend on local underwriting," he said. "There is no other signal in our market to interfere with and we won't affect signals from Shreveport."

Vise believes that he will be filling a void in his radio market.

"We want to reach out to the community and our desire is to have a first-rate product, not just a room full of wires throwing out a signal," Vise



Joe Steinberger, Right, With Pier Paolo Santorelli

said. "I'm looking forward to it and my congregation and community are excited, too."

WRFR(LP) was licensed to Penobscot School in Rockland, Maine. The school's co-founder is Joe Steinberger, who plans to use his station as the voice of his community. The call letters stand for "Radio from Rockland."

Steinberger plans a special emphasis on live, local music.

"We also hope to feature literature readings from local authors, stories for children and definitely some news and call-in type radio programs," Steinberger said.

"Our school is a center for language learning and people from various countries teach German, French, Italian and other languages to adults here. We may offer news in those languages on our station."

The target air date is Jan. 1, 2002. The studio will be a simple one based on an I-Mac with software from Logram International of Paris, France.

"They made us a gift of their software, which we are translating into English," Steinberger said. "We will be using a small Behringer board that was designed as a mixer for musicians, but it suits our purposes."

Volunteer effort

WRFR will use an all-volunteer staff, including Steinberger, although he may need to hire a scheduling secretary. The station budget for its first year of operation is \$10,000.

"Obviously it's not about the money here," Steinberger said. "Commercial stations will do anything to keep other people from competing with them and the government's interest is to make sure they don't get away with that. The airwaves should belong to everybody and anything else takes something away from the American people."

Steinberger believes his goal is not to compete with other local broadcast operators such as Clear Channel.

"If there were a technology to increase tenfold the number of FMs without interfering with existing stations, the NAB would still be

opposed," Steinberger said. "But I have no sympathy for them. They should not be allowed to control that."

The station is being consulted by Pier Paolo Santorelli of Radio Popolare in Milan, Italy, which is also a community radio station.

"He flew across the Atlantic to help us for three weeks," Steinberger said, "at no charge."

Governmental glitch

LPFM has been a complicated matter for the Georgia Department of Transportation. Kim Law is senior public information specialist for the department, which was granted several LPFM licenses.

Many LPFM licensees have ambitious ideas. But in Georgia, transportation officials have hit potholes in their LPFM plan.

"We were mainly looking to use these stations for hurricane evacuation and extreme weather information," said Law. "We could also have used them for traffic control with our Intelligent Transportation System which is headquartered in Atlanta. However, we've decided not to do anything with the licenses."

With many LPFM applicants across the country coming up empty-handed, this may sound strange.

"The licenses granted turned out to not be in the areas that would be of much use to us," Law said. "We also determined that we were not ready to meet the rules requiring 24-hour operation. We are currently trying to find another governmental agency here in Georgia to take over for us."

But it gets more complicated. The



Mansfield Baptist Church

DOT applied for 10 licenses. It was granted three and was turned down for two. However, to find locations for the remaining five, additional expensive and time-consuming studies would have to be completed.

"There is also a Technology Authority in Georgia and they wanted to get involved, which was another layer of government," said Law. "And FEMA owns the AM frequencies that would actually be better for us for our emergency information anyway."

On hold

Law said her department was forced to put the whole idea on hold and let the licenses expire in 12 months if a solution can't be found.

"The DOT in Illinois is going forward like crazy, but here everyone is fighting for control," Law said. "It's been a fascinating process, however."

Fred R. Morton, CBRE of Sugarland, Texas, is a commercial broadcast owner and contract engineer. He also owns the Web site www.lpfm.com.

"The reason I started the site is that I fear that if people put radio stations on the air wherever they want and with whatever power they want, chaos will result," Morton said. "I do not condone pirates because of the damage they cause and I just try to provide the

best information I can."

Morton said major broadcast groups are needlessly scared of LPFM operators. "I fail to see the harm in a non-commercial 100-watt signal."

He believes that if the big broadcast groups hadn't gone "consolidation crazy," there may never have been a need for LPFM.

"The whole movement may have been a backlash to rampant consolidation because many out there had the perception that one or two guys owned everything."

Morton said these smaller groups just wanted to have their own voice on the radio band.

"There are some Web sites out there that are militantly against commercial broadcasters, but I am not one of those," Morton said. 



BROADCAST LAW REVIEW

Tower Siting: Relief Ahead?

Barry D. Umansky

Ever since the advent of wireless telegraphy and AM radio broadcasting — the first modes of electronic communications — people have cast a wary eye on communications towers and antennas.

The public's first concern centered on aesthetics and potential decreases in property values.

In recent years, much local opposition to communications facilities has shifted to the communications signals themselves and to negative health effects claims from these signals.

Some public concern about the emissions from communications towers has been over the interference potentially caused to other electronic systems.

FCC regulations address broadcast signal "blanketing" and oblige broadcasters to remedy interference caused to nearby TV and radio reception and to certain other electronic devices.

Overrides

Moreover, insofar as the regulation of these electronic-interference effects is concerned, the FCC has adopted a firm policy of federal preemption.

Interference effects, along with more traditional concerns about aesthetics and property values, still are often at the foundation of much local opposition — as displayed in zoning board hearings, city council meetings and general public protests.

But the developing area of local concern centers on the biological effects of human exposure to electromagnetic energy. In some cases, this RF radiation focus has been the surrogate for the real motivating factor — allegedly diminished property values caused by existing or proposed towers and antennas.

Until recently, a now relatively mature broadcasting industry has not needed to site significant numbers of new antennas — and thereby obtain the assent of local officials. But with the advent of digital television, which

requires every TV station to begin to employ a new antenna (but not necessarily a new tower) over the next several years, television broadcasters now have to work with their local officials.

Moreover, digital TV rollout is forcing many FM stations operating on TV towers to relocate to other sites. These TV towers must accommodate one or more new digital TV antennas and often do not have the structural capacity to continue to support FM antennas as well.

New towers

Also, the facility modification efforts of existing FM and AM stations often require new tower sites or changes to tower configurations and antenna loading.

Finally, after a long hiatus, the FCC is expected to license hundreds of new FM stations by sometime next year, so the scramble for new tower sites is in full swing.

Unlike the FCC's local regulation preemption of the interference effects, the commission has failed to afford any other meaningful preemption to aid broadcasters.

There has been an FCC preemption policy, the so-called "PRB-1" policy, that limits local restrictions on amateur radio antennas sit-

ings. And the terms of the Telecommunications Act of 1996 provide a limited form of preemption for "personal wireless facilities" where the tower siting restriction is based on RF radiation exposure standards more restrictive than the FCC's own RFR guidelines.

Though petitioned to do so by the National Association of Broadcasters in 1986 and the former Electromagnetic Energy Association in 1994, the commission has declined to adopt a policy of federally preempting state and local broadcast siting regulations that impose duplicative, let alone more restrictive RF radiation exposure standards.

On several occasions, the FCC has stated that it "will not hesitate to consider" preemption if states and

See LAW REVIEW, page 36 ▶

With the FCC expected to issue hundreds of new FM station licenses sometime next year, the scramble for new tower sites is in full swing.

Take a Teen To Lunch

And Learn Why Youths Don't Like Radio and What You Can Do to Win Them Back

Scott Fybus

Want to fill a radio station program director's heart with abject fear? Offer up a quote like this, from a 14-year-old girl interviewed a few months ago in suburban Detroit:

"The music that I download is more important to me than the music on the radio."

Frightened yet? How about this quote, from a 14-year-old boy:

"Every time I turn to the radio, the chances are that it's on a commercial."

It's not a horror film, exactly — but what video consultant Fred Jacobs of Jacobs Media screened for a room full of program directors and other station management at The NAB Radio Show in New Orleans was meant as a wake-up call for the industry.

Jacobs held a focus group with 16 teens and he said the message to radio is clear: If you want younger listeners, cut down on the advertising clutter, back-announce and give them more reasons to listen.

Still think it's safe to ignore those younger listeners? Dave Beasing, Jacobs Media's alternative format consultant, said he's heard too many radio managers say, "We'll get the listeners when they turn 25."

See RADIO, page 38 ▶

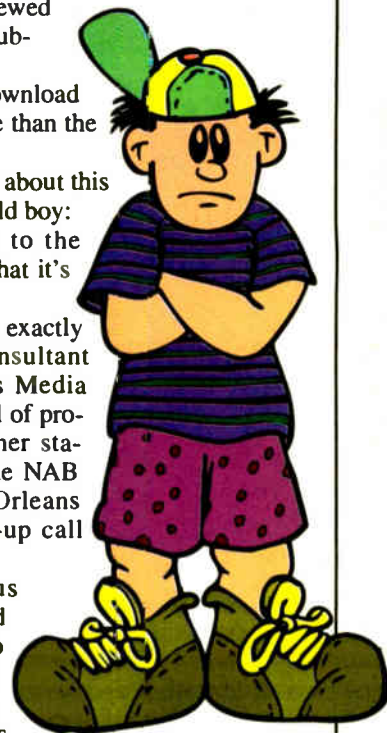

Questions to ask before you buy a transmitter

1. How much power do I need?
2. What's Bext's telephone number?



619-239-8462

www.bext.com
sales@bext.com

Radio Legends: Reinvention Is Key

Scott Fybush

In this world of voicetracking, eight-station clusters and 1,200-station groups, is there room for radio legends like Gordon McLendon, the Texas station owner wh credited with the invention of top 40 radio?

"I've really only known one genius in my life and that was McLendon," said Ken Dowe, who programmed McLendon's flagship station KLIF(AM), Dallas, decades ago.

But if Dowe balked at being labeled "Radio Legend" himself at The NAB Radio Show, he was at least willing to

acknowledge his longevity in the business. "I like the title 'wily veteran,'" Dowe said.

Fellow panelist Bobby Rich, now the program director and morning jock at KMXZ(FM) in Tucson, said a recent event reminded him how long he's been in the business.

Generations

"They introduced a guy named Lew Dickey," Rich said, "but that wasn't Lew Dickey!"

Rich remembers today's Lew Dickey Jr., the head of Cumulus, as a 10-year-old boy waiting in the car out-

side WOHO(AM), Toledo, for his father, station owner Lew Dickey Sr.

As for reminiscing, Michael O'Shea, who now heads New Northwest Broadcasting, said the good old days might not have been all that good, at least to judge from a tape he found of the nighttime show he and Rich had on WOHO 40 years ago.

"We thought we had the greatest two-man radio show of all time," O'Shea said, "but I put on the tape and we got 8 seconds in and said, 'We never want to hear this again!'"

So what's to be learned from this group of legends — ahh, err, "wily

veterans"?

"The radio business is all about reinvention," said Gary Stevens. "You have to be flexible and you have to move with the times."

That's a lesson Stevens has learned many times in his career.

Though best-remembered by many for his long-ago days as a "good guy" DJ on WMCA(AM) in New York, Stevens found his way out from behind the mic to become the head of Doubleday Broadcasting, then entered the mergers and acquisitions business through his own firm, Gary Stevens and Associates.

Boxed in

Chuck Blore knows that lesson, too. After leading Los Angeles' KFWB(AM) and later KIIS(AM) to top-40 ratings success in the 1960s and '70s, he focuses most of his energy on producing TV commercials for radio stations.

He said too many radio people today allow themselves to be boxed in by their musical formats.

"I ask too many PDs to tell me about their radio stations and they describe the music, not what actually makes their station outstanding."

To Blore, the real key to radio success is attitude.

"To stand out, you have to be outstanding and open different doors," he said. "And if there are no doors, open the damn walls!"

Rich said that task might actually be easier for today's radio people than it was in his day.

"We didn't have the tools then that we have today," he said.

But tools can be a dangerous thing, Stevens said, cautioning would-be legends about the risks of too much reliance on research when programming a radio station.

"The best radio people don't need research," he said. "They instinctively know what to do and they stand out."

Dowe said standing out could be a challenge in today's radio environment. He recalled a recent visit to a large station group's clustered studios in a market he declined to name.

Good spin

"I was reminded of a food court," he said of the rows of identical studios, each bearing a different station's banner.

So is consolidation a bad thing? Not in O'Shea's view; his New Northwest group has grown to 43 stations in eight markets over three years.

O'Shea said clustering has been a good thing for some of those cities: In Astoria Beach, Ore., for instance, New Northwest bought six adult contemporary stations from different owners and brought a variety of formats to the market in the process.

"This is consolidation, I believe, on the good spin," he said.

Some things in radio never change, of course. Stevens said the people who work in radio have always been a breed apart.

"Don't try to understand us," he said. "We are different people. We do radio. Real people work in banks and sell cars."

And if the equipment is ancient, the pay is lousy and the hours are worse?

"The real radio guy says to himself, 'You know, I would have done it for free,'" Stevens said. ●

The Net Effect

Connections to make, places to go: for your sports, music, news, crop reports, any kind of networking you want--through your network to the nation. NPR Satellite Services gives you the down to earth experience and years of engineering savvy to send out your message while keeping your original quality and content in.

We work with you providing the tools and 24/7 operational support at any time, anywhere in the *universe*. We can use your existing gear or we can build your network from scratch. And our space segment, C-band, and Ku-band receiver options are priced affordably at under \$1,600!

Link up with us and let us know what in the world we can do for you!

NPR
Satellite
Services

Link Up With Us!

See us at www.nprss.org
or call 202-513-2626

can run my radio station for \$995.

MP3 on any card!

Multiple Streams
No Skipping! No Kidding!

- ✓ Satellite
- ✓ Voice Track
- ✓ Live Assist
- ✓ Automation
- ✓ Internet



iMediaTouch

Record and Play MP3, MP2, PCM, ADPCM, and Windows Media Audio on ordinary sound cards. iMediaTouch does more for less!

(888) 665-0501 www.imediatouch.com

World Radio History



6-Channel Headphone Amp — Exclusively at BSW for Only \$299!

BSW bought a truckload of these so we could save you a load of money. This is without a doubt the best headphone amp you can buy for the price. **Features:** 6 direct inputs and 6 direct outputs; crystal clear, low distortion for reduced listening fatigue and enough power to please even the most discriminating DJ. Don't miss this opportunity. Once these are gone, the price goes back up.

506E List \$529.00 **ONLY \$299.00**

ONLY \$299.00
Save 43%



Save on the Symetrix 528E

Broadcasting's most popular voice processor! The 528E is a complete unit that performs 6 separate functions: microphone preamplification, de-essing, compression/limiting with downward expander and 3-band parametric equalization. Buy one for every microphone in your facility.

528E List \$749.00 **ONLY \$479.00**

ONLY \$479.00
Save 36%



SALE
\$499⁰⁰

SALE! Sony CD Recorder with FREE CDRs

The exciting Sony CDR-W33 CD recorder features high-quality, 24-bit AD/D/A converters, DSP functions available on the analog inputs and CD-TEXT support. It's an excellent choice for your project studio or radio production facility.

Features: Super Bit Mapping™ recording (records 24-bit quality into 16-bit format); selectable DSP functions available on the analog inputs including: 3-band mid-parametric EQ and limiter; 32 kHz-48 kHz sampling rate converter; Control-S for supplied remote and PS-2 (for PC keyboard) allowing basic control and text entry; CD-TEXT support; 2X finalize; wireless/wired remote control; digital and analog record level control; coaxial digital, optical digital and unbalanced analog phono rack out. Now with 50 FREE CDRs.

CDRW33 List \$715.00
ONLY \$499.00

FREE
50-Pack
CDR74zsb



Hafler P1000

The P1000 is the perfect marriage of amplifier technology and efficiency, with a MOSFET output stage producing over 100 watts of pure Hafler power from a single rack space (50 watts/channel into 8 ohms). You'll find Hafler's patented trans-impedance circuitry in the P1000. Whether you require broadcast monitoring, critical studio monitoring or surround sound amplification, the Hafler P1000 delivers the results you demand.

P1000 List \$569.00 **ONLY \$349.00**

Hafler Reliability
Only \$349.00



NEW
SALE
\$199⁰⁰

Great Power... Low Price.

Hafler's new super-affordable TA1100 is a two-channel, two rack height, convection-cooled (no fans), MOSFET (metal oxide semiconductor field effect transistor) power amp. The circuitry used in the TA1100 has been very successful in bringing new levels of clarity and intelligibility to broadcast facilities and headphone monitoring installations. **Features:** soft start circuit protects speakers; thermal sensing network amplifier monitors the heatsink and transformer temperature; LED indicators of operating status and fault type; 40 watts per channel into 8 ohms.

Hafler TA1600 offers 60 watts per channel into 8 ohms.

TA1100 List \$299.00 **ONLY \$199.00** TA1600 List \$399.00 **ONLY \$299.00**

The World's Best



BROADCAST SUPPLY

FREE
distribution amplifier
with
purchase of an R-5
(a \$449.00 value)

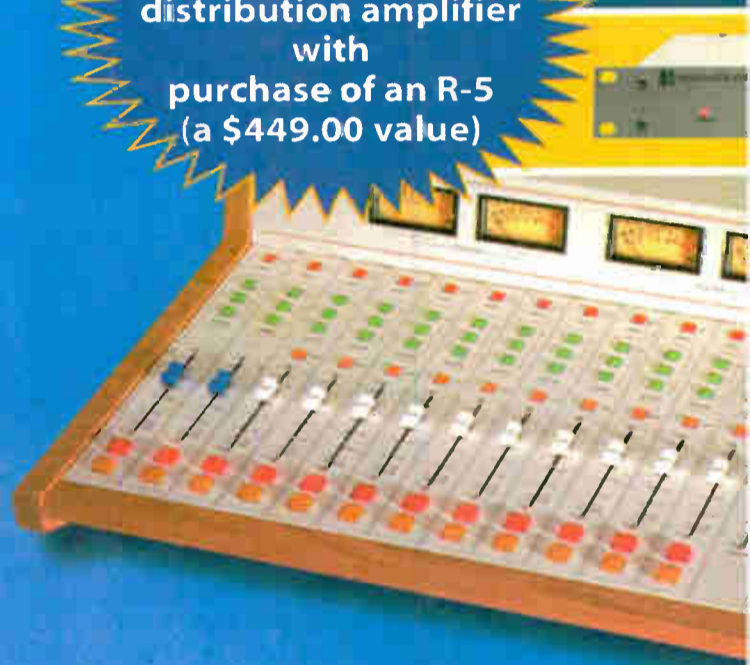

Get a Great Deal on this Rock-Solid Audioarts Console

The R-5 is a quality Audioarts console in a cost-effective package. **Features:** 12 channels (2 mic, 10 stereo line, 1 telephone); 4 high-quality switches throughout; Simple Phone™ telephone channel; Program and Audition; channel on/off switches with full monitor muting, remote control of channel on/off; six-segment talkback; 5-source control room monitor selector (PGM, start/stop, reset and hold controls. Now, through December, get a free distribution amp with your R-5 purchase. Exclusively at BSW.

R-5 List \$5,095.00 **ONLY \$4,395.00**



The Audioarts SDA-8400 is a 1x8 channel stereo, rack-mounted distribution amplifier. **Features:** LED status lights for all input and output channels, extremely flat frequency response, separate 3-conductor connectors for each input and output.

BSW Price \$449.00 or FREE with R-5 purchase

Our Fall Catalog Available Now

Order Today 1.800.426.8

Source for Professional Audio Products.



le
fixed-position configuration. Features: 13
mic preamps; 2 inputs per channel; illuminated
and mix-minus out; 5-fm stereo VU meters for
machine control logic and programmable
ce stereo line selector studio control with
D, TEL, EXT1, EXT2); built-in digital timer with
y 31st, 2001, receive a FREE Audibits SDA8400
M

\$99.00 and Below

Incredible Products at Incredible BSW Sale Prices



SALE
\$99⁰⁰ ea.

NEW

Hafler M5 Monitor Speaker

This is absolutely the best speaker buy of the year! The Hafler M5 is a passive reference monitor utilizing an elaborate crossover network and tweeter overload protection. The result is a compact package offering high power handling and unmatched sound quality for the price. Magnetically shielded. Power handling 20-200W. Dimensions: 6.75"W x 12.25"H x 7"D 10 lbs..

M5 ONLY \$99.00 ea.

NEW Behringer Audio Tester

This durable tester accepts XLR, mono and TRS phone (1/4", 1/8", TT), RCA and MIDI. The LED display shows which input pin is connected to which output pin. Separate shield and phantom power LEDs indicate proper shield connection and phantom power presence. The CT100 requires insertion of only one plug and indicates shorts and opens, as well a continuity check. A test tone generator (1 kHz and 440 Hz) is also included. Don't just buy one...at this price buy several!

CT100 ONLY \$35.00



SALE
\$99⁰⁰

Behringer 8-Channel Mixer

Before you dismiss this mixer as a \$99.00 toy...wait up. We've never been more impressed with a quality mixer that at \$300.00 or \$400.00 would be a bargain. This 8-channel mixer (4 mono and 2 stereo) is ideal for applications that demand quick mixing in a limited space. Features: 4 mic preamps with phantom power; 3-band EQ; 2 AUX sends; 2 stereo AUX returns; durable steel casing.

MX802 ONLY \$99.00



**Cable Tester
ONLY \$35.00**

INCREDIBLE Deals on 5 Packs!



SALE
5 for \$89⁰⁰

ROSS

Great low cost headset used for studios or remotes. Lightweight with a full enclosure design. Hard-wired 1/4" connector.

TD81140G (pack of 5)
ONLY \$89.00



SALE
5 for \$49⁰⁰

PROCO

Quality low-cost 25' mic cables at a great price. Complete your new mic package with this 5 pack.

M25PH05 (pack of 5)
ONLY \$49.00



SALE
5 for \$99⁰⁰

BEHRINGER

You'll be pleasantly surprised at the first rate sound from these very well built, very inexpensive mics! Each includes a hard case for each, and an on/off switch. An incredible deal!

You can also purchase multi-colored windscreens 5-packs for only \$24.00!

XM2000SPK0 (pack of 5)
ONLY \$99.00
WS912PK0 (pack of 5)
ONLY \$24.00



STATION SERVICES

How to Lobby the FCC

To say that the FCC's structure, organizational dynamics and decision-making procedures are difficult to understand may be an understatement. A new reference, "FCC Lobbying: A Handbook of Insider Tips and Practical Advice," may help to simplify the agency's procedures for radio managers.

The handbook, published by Telecommunications Reports International, allows readers to use chapters as stand-alone resources, target special topics of interest and formulate plans to address specific circumstances.

"We created the handbook to arm you with time-tested strategies to advance your position, respond to queries, avoid procedural mishaps and best your competition," said Erwin G. Krasnow, co-author and member of the communications practice of Verner, Liipfert, Bernhard, McPherson and Hand.

Krasnow and his Verner Liipfert partners and co-authors,

David R. Siddall and Michael D. Berg, are former FCC and NAB insiders with decades of experience among them in lobbying the commission as well as understanding how it operates.

The handbook is \$199 in print or \$179 for a downloadable copy from the Internet.

For more information or to order the handbook, call TRI in Washington toll-free at (800) 822-6388 or visit www.tri.com.

FCC Lobbying

A Handbook of Insider Tips and Practical Advice

Erwin G. Krasnow • David R. Siddall • Michael D. Berg

TRI

Putnam Retires After 67 Years

Broadcaster George Putnam, who recently celebrated his 87th birthday and 26th anniversary on KRLA(AM), ended his record run on Los Angeles radio when he broadcast his last installment of "Talk Back" on Sept. 28.

"We're sorry to see George leave," stated Dave Armstrong, vice president/general manager of the Salem Communications' Los Angeles cluster, which includes KRLA, KKLA(FM) and KFSH(FM).

"We offered him another time slot, but he chose not to accept it. He's an amazing personality and everyone at Salem Broadcasting wishes him all the best in his future endeavors."

The voice

Putnam's career began on his 20th birthday in 1934 at WDGY in Minneapolis. He worked as a newsman, reporter and commentator for most of the major broadcasting organizations in the country, including NBC, ABC, Mutual, Dumont and Metromedia. He shared the role of the voice of Fox Movietone News newsreel service with Lowell Thomas.

While George achieved early

success in New York — where Walter Winchell described his voice as "the greatest in radio and television" — Putnam has been a fixture in Los Angeles broadcasting since 1951.

Putnam broadcast "Talk Back" on KIEV(AM) for 25 years, and for the past year since the transformation of "AM 870" to the new KRLA(AM).

The recipient of four Emmys, six California Associated Press Television & Radio Association awards, eight annual Radio & Television News Club awards, the Los Angeles Area Governor's Award from the Academy of Television Arts & Sciences and more than 300 other honors and citations for service to his country and community, Putnam has been called the "west's most honored newsman."

KLRA shifted its schedule in the wake of Putnam's departure. "The Mike Gallagher Show," Salem's syndicated talk



George Putnam

show, began to air on KRLA in the morning drive time, 6 to 9 a.m. With Gallagher joining KRLA, Hugh Hewitt moved from morning drive into Putnam's former afternoon drive time, 3 to 6 p.m.

Putnam also is a noted breeder of thoroughbred horses and has ridden his Palominos in more than 40 consecutive Tournament of Roses Parades on New Year's Day.

— Laura Dely

Frequency Agile STL Systems

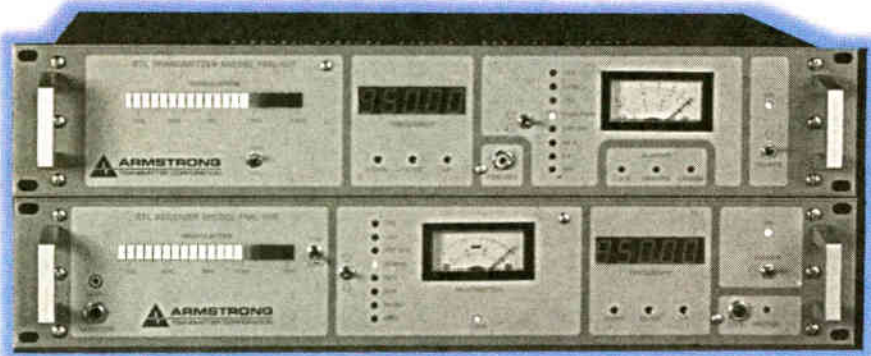

▲ If you are looking to deliver clean, crisp audio to your transmitter via microwave, Armstrong FML-10 STL system offers unsurpassed audio purity in a rock-solid, feature-packed package.

▲ Built to tough manufacturing standards throughout, FML-10 system features microprocessor controllers, advanced PLL circuitry, ultra linear VCO and front panel frequency programmability with digital frequency readout.

▲ Currently in service at over 300 stations in 21 countries, this field proven design is a "rock-solid" STL choice for any station.

Complete System Under \$5500.00
Same Day Shipping
30 Day Money Back Guarantee



ARMSTRONG
TRANSMITTER CORPORATION

4835 N. Street • Marcellus, NY 13108 • PH: 315/673-1269 • Fax: 315/673-9972
E-mail: info@armstrongtx.com • www.armstrongtx.com

STATION/STUDIO SERVICES

BUSINESS BOOSTERS FROM GRACE BROADCAST SALES • ORDER TOLL-FREE! 1-888-GRACE-88

Selling ads is good. Selling *more* ads is **better.**

How Many of Your Local Merchants
Are Losing Customers to "Out-of-Town" Stores??

— Be a Hometown Champion! RESERVE NOW for your market!! —
(Find out how it feels to have merchants calling YOU to get on the air.)

THE NEW GBS "SHOP YOUR HOMETOWN
MERCHANTS" CAMPAIGNS - NOW SHIPPING!
• Holiday Series - \$299 • Year-round Series - \$299 • Special! Both Series - \$499



Sound Ideas for Building Business™

For DEMOS visit www.gracebroadcast.com

BALSYS

TECHNOLOGY GROUP, INC.

PROFESSIONAL BROADCAST
ENGINEERING SERVICES

Analysis - Installation - Support

7141 Tallotree Lane
Orlando, FL 32835
Tel: 407-822-7055
Fax: 407-296-2587
www.balsys.com
sales@balsys.com

HOLIDAY FEATURES FROM GRACE BROADCAST SALES

This Christmas,
Share the Real Story of God's Love!

"Christmas Treasures"
Forty (40) 30-second Features

— Commemorating —
the Birth of Jesus Christ
\$135 complete

Fully-Produced Music Bed for Sponsor Adjs. Incl.



Sound Ideas for Building Business™

HEAR DEMOS ONLINE AT
www.gracebroadcast.com

ORDER TOLL-FREE 888-GRACE-88

ATTENTION PROVIDERS!

Promote your services to **Radio World's** readers. Reach Radio Station and Recording Studio owners/managers and engineers with your message.

For information on affordable advertising
call **Simone** at 1-703-998-7600, ext. 154.

Rhapsody in Blue.

.....
**Digital Core
Routing System**
.....

.....
**Scalable Up to
4,096 Channels**
.....

.....
**Digital & Analog
24 Bit I/O**
.....

.....
**Mix Multiple
Inputs to
Any Output**
.....

.....
**IFB-Talk to
Remotes**
.....

.....
**Integrated
Intercom
Functions**
.....

Introducing the new 32KD Digital Audio Network from Sierra Automated Systems.

This modular, digital-core routing system processes more audio, routes more signals, and provides more user control than any other system in its class.

Routing, mixing, signal processing, IFB, mix-minus, and more, run simultaneously without conflict. All this functionality is readily accessible via PC, mixing boards, or dedicated control panels. And the performance? Like music to your ears.

For more details about the impressive capabilities of the 32KD, give us a call or visit our web site.

SAS. Doing more for radio. Again.

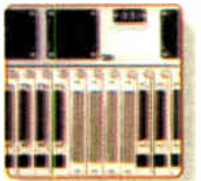

32KD

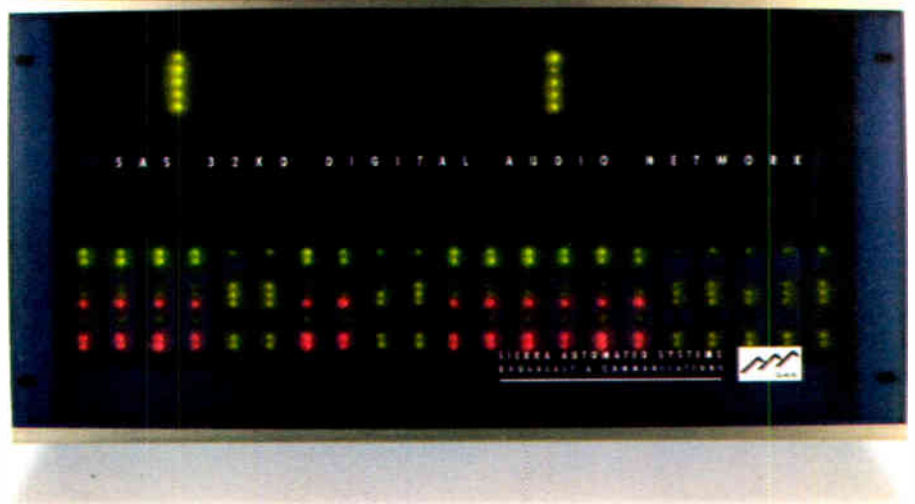

**SIERRA
AUTOMATED
SYSTEMS**

818-840-6749
sasaudio.com

Law Review

► Continued from page 29

localities adopt RF standards that adversely affect its licensees' ability to provide authorized services.

However, even when confronted with clear evidence of the adoption of such regulations by non-federal authorities, the commission generally still fails to act.

Empowered

For some time the broadcasting industry has been urging the FCC to use its general regulatory powers to prod local authorities to expedite zoning and other land use approval for new and modified broadcast facilities.

Based on some of the same concepts

advanced in the 1986 NAB petition, the NAB and the Association for Maximum Service Television filed a

joint petition in 1997, asking the commission to adopt a policy to preempt state and local government restrictions on the placement, construction and modification of broadcast transmission facilities.

Clearly, this country has no cohesive and uniform policy to weigh the rights of duly licensed terrestrial spectrum users.

— Barry Umansky

joint petition in 1997, asking the commission to adopt a policy to preempt state and local government restrictions

The focus of the petition was on the rollout of digital television; however, the petition sought relief for all broad-

cast communications towers/antennas.

The NAB/MSTV petition generated much support among broadcasters and broadcast-related organizations. It also was the subject of widespread opposition by municipalities, associations representing municipalities and certain members of the U.S. Congress.

Instead of acting upon the NAB/MSTV petition, the commission created a DTV Tower Strike Force. However, there have been few examples where this entity has played a meaningful role in resolving disputes among television broadcasters and local officials.

Indeed, the transition to digital television has been delayed or even halted in many markets where local opposition is prevalent.

Clearly, this country has no cohesive and uniform policy to weigh the rights of duly licensed terrestrial spectrum users.

For example, occasionally the FCC licenses a broadcaster and a local zoning board effectively "unlicenses" the station. The web of state, county, local and residential regulations and practices now in place results in a confusing and litigious atmosphere that adversely affects all of us.

Battles

Tower-siting battles often are needlessly long, expensive and contentious. Nearly identical dramas play out in communities and neighborhoods across the country with results that too often depend on personal and business relationships, random prejudices, perceptions and unfounded fears often exploited for political purposes.

Moreover, local and state governments are provided with little in the way of guidelines, expertise or limits to their authority to regulate antennas. With nothing to balance the hysteria of a vocal minority and nothing to balance fairly technical requirements against unfounded but tightly held fears, unreasonable, unfair and unproductive results will continue.

Based on these existing and growing difficulties, there is a drive to create a national antenna policy that would provide a framework of reason and fairness. Efforts are underway to create a Tower Consortium, composed of spectrum users and allied organizations.

The consortium will seek input from concerned parties and individuals, draft a comprehensive "Tower and Antenna Policy" for local land use officials, promote that policy nationwide and sponsor state and federal legislation and regulation to create a more rational and just tower/antenna siting policy in this country.

I am serving as counsel to the new Tower Consortium. If you are interested in the consortium, would like to join or just want to know what it's doing for the communications industry, please feel free to contact me. It is a worthy effort of broadcasters and other communications companies — acting together — to eliminate needless obstacles to our provision of service to the public.

Barry D. Umansky, the former deputy general counsel of NAB, is with the communications practice group at the law firm Thompson Hine LLP in Washington. Contact him at (202) 263-4128 or via e-mail to barry.umansky@thompsonhine.com.

Radio World welcomes other points of view. 🌐

YOUR WORLD STARTS HERE

Radio World

The Newspaper for Radio Managers and Engineers

Dear Radio World,

You are up to something and I can't figure out exactly what it is.

I used to think Radio World was some kind of engineers-only deal, all about wires and tubes and RF and other stuff I don't get. Meanwhile, here I am, an on-air talent and program director for 30 years, who will read any and all trade publications back-to-front to learn something about programming, marketing, production, motivation, etc. And, here comes the part that doesn't make sense, I LOVE RADIO WORLD!

Now understand, I'm already paging through my R&R, Gavin, FMQB, Network40, Hitmakers, Billboard Monitor, Radio Ink and whatever else I can get my hands on. Do I need another trade publication? I don't think so.

But about six months ago, I pick up your newspaper. And I find it pretty darn interesting. And I fall in love with the regular columns by Alan Peterson. ALL of them. I immediately begin looking forward to each new issue just so I can read "The World According to ARP."

Then a guy named Ken R. starts contributing articles. And I am reading and ripping them out for my files or to share with somebody else at the radio station.

In a recent issue, I read three of the best articles I've seen anywhere in months. Thomas Ray's "WOR Survives Black Wednesday," Scott Fybus's "Z100 Settles Into New Home," and most of all, Mark Lapidus' totally on target and important "Don't Be Clustered In You Cluster."

But wait, there's more.

I also have a home studio I'm piecing together with spit, duct tape and bailing wire so the equipment reviews and advertisements also jump out at me.

Paul, this is a LOVE letter. Please keep publishing this valuable thing you call Radio World. RADIO is a big WORLD that contains many, many, facets ... and you're doing a great job covering them.

Thank you.

Bobby Rich
PD/Morning Show Host
KMXZ, Tucson, AZ



Since 1993 Bobby has anchored the Bobby & Brad "Good Clean Fun" morning show on KMXZ Tucson (Journal Broadcast Group's 94.9 MiXfm). He is also the program director. His 30+ year radio career includes on-air and programming assignments that have taken him from Spokane, Wash., and Davenport, Iowa to Los Angeles, Philadelphia, San Diego and New York to name just a few. He was also vice president/general manager of two stations in Seattle, while co-hosting their morning program.

Billboard Magazine and the Gavin Report have each named him Adult Contemporary Program Director of the Year and Air Personality of the Year, a total of five times. He is a three-time nominee for a Radio & Records Industry Achievement Award and he's listed in the 1998-2002 Who's Who In America. Most recently, he appeared on the Legends panel at the 2001 NAB Radio Show, New Orleans.

For almost 25 years, Radio World has delivered the information that helps our readers remain competitive in the dynamic world of radio. Thank you for reading Radio World!

Tell us why YOU read Radio World!

Send your professional credentials and anything else you'd like to share to: agutowski@imaspub.com, or fax 703-820-3310 attn: A. Gutowski. Include your contact information, and we'll get back to you.

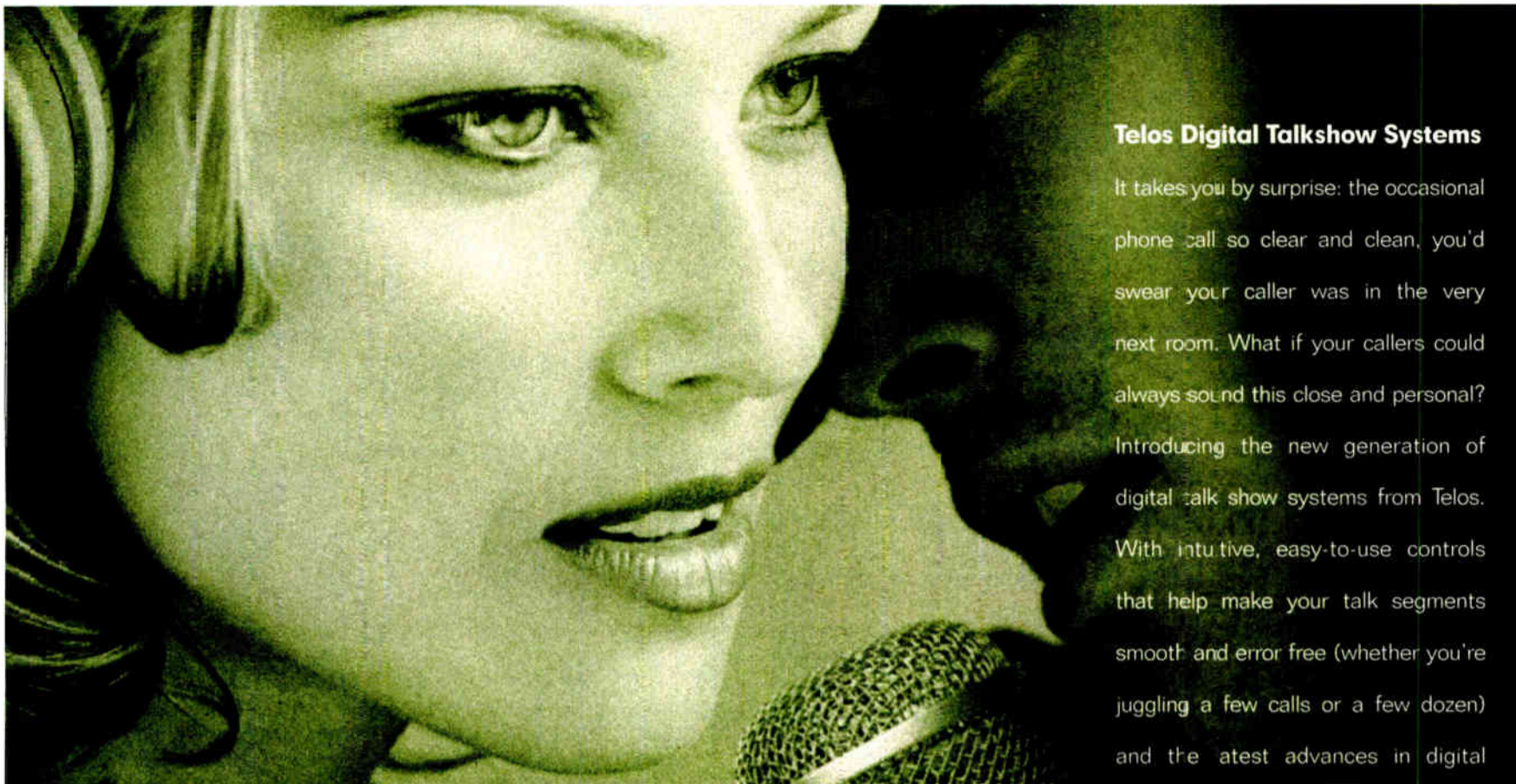

Telos Digital Talkshow Systems

It takes you by surprise: the occasional phone call so clear and clean, you'd swear your caller was in the very next room. What if your callers could always sound this close and personal? Introducing the new generation of digital talk show systems from Telos. With intuitive, easy-to-use controls that help make your talk segments smooth and error free (whether you're juggling a few calls or a few dozen) and the latest advances in digital

phone hybrids from the company that invented them. Never have your callers sounded so consistently loud and crystal clear - it's the next best thing to having them there. Don't just talk to your audience... get intimate.

Talk radio is suddenly intimate

Telos Systems. Connected.



Telos TWOx12™ Integrated Talkshow System

Using POTS or ISDN lines, the TWOx12 handles up to 12 callers on two built-in digital hybrids. The intuitive phone controller tames even the wildest talk shows.

Telos
S Y S T E M S
www.telos-systems.com

TELOS SYSTEMS NORTH AMERICA: +1.216.241.7225 • TELOS SYSTEMS EUROPE: +49.81.61.42.467

Radio

► Continued from page 29

"As if someday they will just magically wake up and decide radio is for them," Beasing said.

Beasing said a study by research firm Look-Look.com found teens will spend \$136 billion this year. The market is too big for stations to ignore, he said, despite conventional wisdom that older-targeted formats like AC and oldies can produce higher revenue even if the ratings are lower than "young" formats like CHR and hip-hop.

"This is a huge opportunity for radio," said analyst Jayne Charneski of Edison Media Research. Listeners 16 to 40 were the subject of market surveys her company conducted this year. Edison's results

reinforced the findings of a 2000 study of listeners 12-24.

On the surface, the numbers look

population almost as much as the original baby boom, which peaked in 1957 when 4.3 million babies were born.

Every time I turn to the radio, the chances are that it's on a commercial.

— A 14-Year-Old Focus Group Participant

promising: In 1990 alone, 4.16 million people were born in this country, the peak of an "echo boom" that swelled the

Overall, Charneski said, there are 52 million potential listeners aged 12-24 — "that is the period when music loy-

alties are formed."

So what's the bad news? Edison found radio listening among teenagers is down 15 percent over the last 7 years. Among those 18-24, radio listening has declined 16 percent, threatening the bonds that have long brought young listeners and the radio industry together.

Her research echoes Jacobs Media's focus groups when it comes to the reasons teens aren't listening. Fully 75 percent of the teens Edison surveyed thought there were too many commercials on radio. Nearly as many — 74 percent — liked CDs better. And 63 percent think there's too much talk on the radio.



Jayne Charneski

Is there a solution? Charneski said radio could learn a few lessons from MTV, which posted its highest ratings ever in 2000 by playing a variety of popular music.

A radio station that learns from MTV, Charneski said, would offer its listeners "an urban, alternative and boy-band mix with a strong rhythmic lean," along with aggressive promotions that target high schools with heavy listener involvement.

"There are no stations that currently sound like this," Charneski said.

Building such a station might require a change of attitude in the sales department, said Brad Hefler of the Peter A. Mayer advertising agency.



Fred Jacobs

Many CHR stations, he said, have to skew their presentations to advertisers to focus on older listeners or risk losing important accounts completely.

Other media

Hefler said that attitude leaves radio at a disadvantage against other media, including newspapers, teen magazines and TV networks like UPN and WB that have built their entire business model around attracting younger viewers.

"We were in this space at one time," Hefler said of the days when 1960s hit radio stations built huge advertising sales on largely teen-aged audiences.

He offered an action plan that would make pursuing 12-24 year old listeners an industry initiative, including aggressive cross-promotions with other media, additional research on the best ways to target younger listeners and a renewed emphasis on young-skewing formats in big groups' market-cluster strategies.

"On the wheel of formats," Hefler said, "a young, teen-targeted radio station is never a possibility" when cluster owners begin tweaking formats in markets where they own multiple signals.

Hefler said the glory days of the '60s aren't coming back, so radio needs to learn how to coexist with all the other media that compete for teens' attention.

"The Internet is there," he said. "It's not going anywhere."

A final word of advice?

"Take a 14 year old out to lunch," Hefler said. "You'll be surprised."

Scott Fybush, a regular contributor to RW, has been listening to radio since long before the age of 14. Contact him via e-mail to scott@fybush.com.

When you require the ultimate in accurate timing

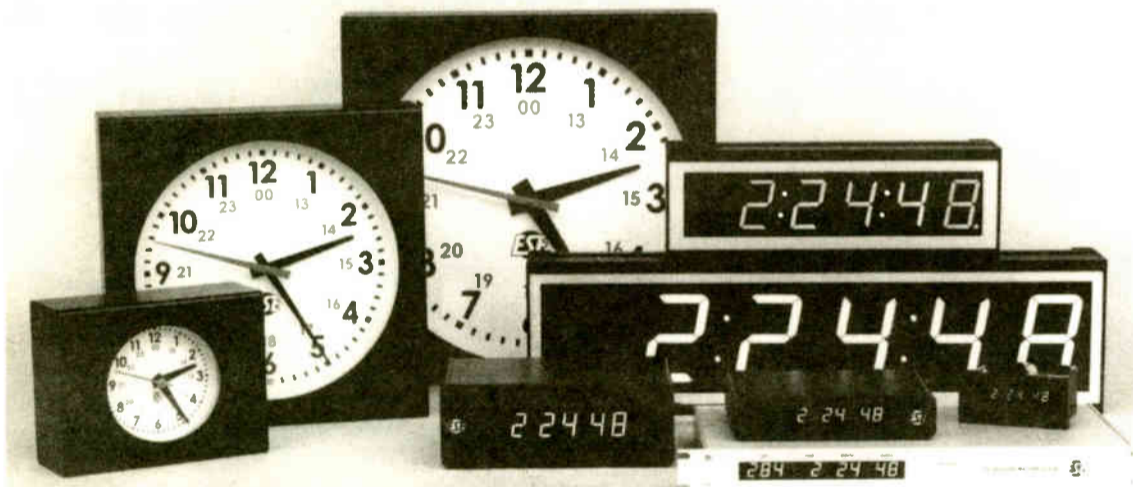

WHEN you require the best, most accurate in precision timing look only to ESE. Designed for "Precision Timing", ESE Master Clocks & Accessories have been the industry standard for over three decades.

Whether using GPS, WWV, Modem, Crystal or line frequency accuracy — all ESE Master Clocks can drive digital or analog slave clocks, as well as interface with video and/or computer based systems. Call or visit our web site for more details.



142 Sierra Street • El Segundo, CA 90245 USA
Phone: (310) 322-2136 • Fax: 310.322.8127

www.ese-web.com

Process This!

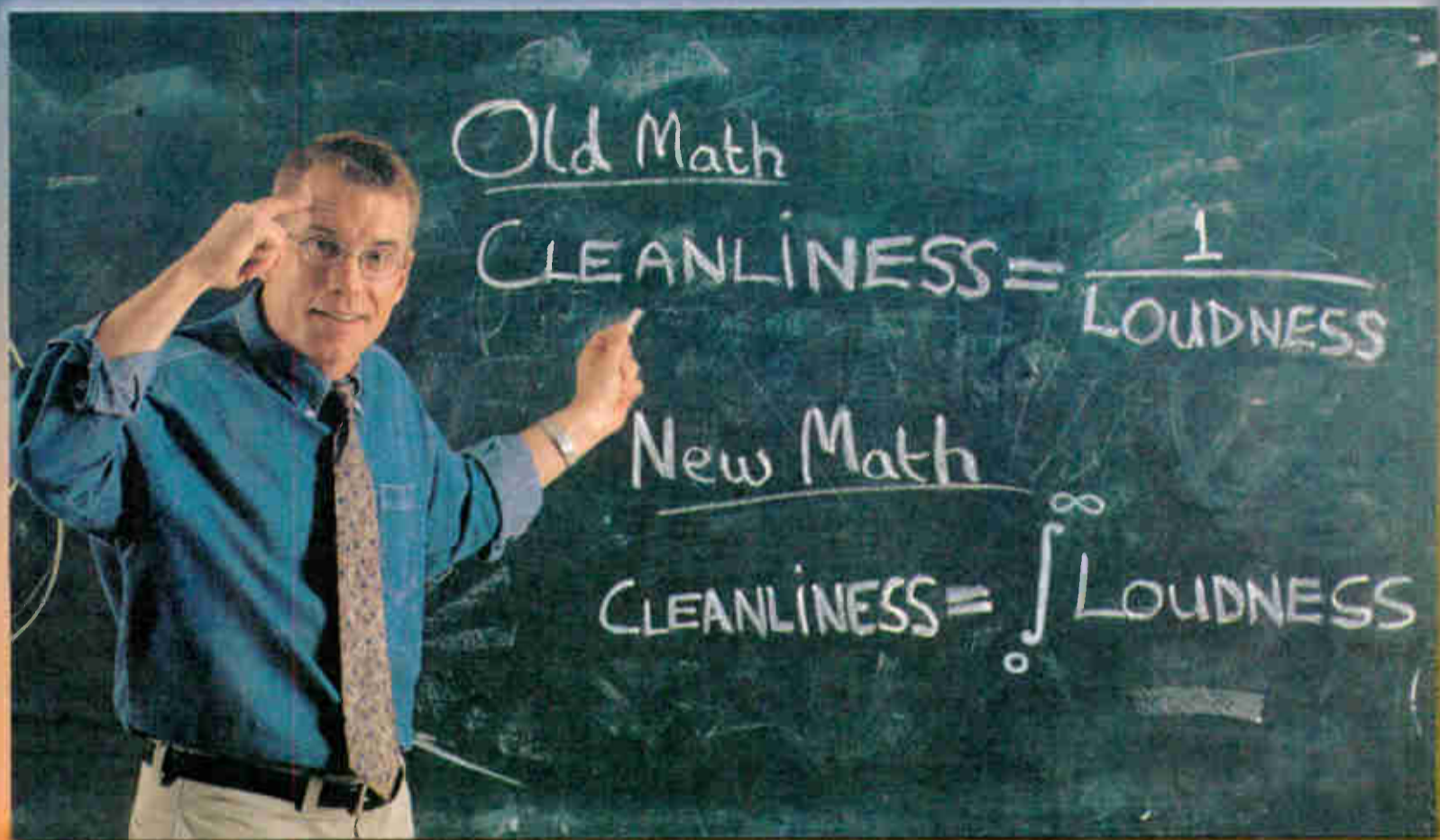

Introducing

The NEW Aphex 2020MkII



The original Aphex Model 2020 audio processor set the standard for audio quality, loudness and extended coverage. Not content to sit on its laurels Aphex continued to research ways to improve performance even further. The result is the 2020MkII.

New processing algorithms and circuit designs, in addition to the fifteen proprietary circuits* from the original, allow even greater loudness without sacrificing a clean, natural sound. The MkII's increased flexibility also gives a station the ability to create its own unique sonic signature. New features include a split band optical high frequency limiter, a low distortion overshoot compensated low pass filter* (with no spurs), improved remote control interface, RDS, and dual composite outputs.

Audition the new 2020 MkII on your station and you'll find that Aphex has really done its homework—creating a processor with performance and features unmatched at any price. The 2020MkII—in a class by itself.

APHEX
SYSTEMS

Improving the way the world soundsSM

11068 Randall Street, Sun Valley, CA 91352 U.S.A
818-767-2929 Fax: 818-767-2641 www.aphex.com

*(patented or patent pending)



DIGITAL AUDIO NETWORK ROUTER

- *BI-DIRECTIONAL FIBEROPTIC OR CAT-5 INTERLOCATION CONNECTIVITY*
- *ALL DIGITAL DOMAIN AES SWITCHING*
- *ANALOG OR DIGITAL (AES SAMPLE RATE) INPUTS*
- *BOTH ANALOG AND AES DIGITAL OUTPUTS*
- *SERIAL CONTROL AND DISPLAY WITH WHEATSTONE CONSOLES*

THE 2001 MAKES AUDIO NETWORKING PRACTICAL. It's simple to install, easy to learn, and certain to reduce system costs. Compact enough for small applications, yet stackable for tremendous growth potential, it's design consists of 7" rackmount digital routing cages, each capable of handling 512 simultaneous audio channels on its backplane.

Units can be stacked to suit particular card complements (analog or digital input and output cards or optical network cards) but more significantly cages can be separated by great distances and network their audio through either bidirectional fiberoptic links or a single CAT-5 wire. **ONE INTERCONNECT DOES IT ALL:** 64 channels of simultaneous bidirectional digital audio, intercage communication, X-Y controller commands plus auxiliary RS-232 data streams. This single interconnect between your studio and central rackroom can save you tens if not hundreds of thousands of feet of wire in a typical installation.

The 2001's graphic based setup software is intuitive and easy to use, with all the authorization and security levels you could want. And of course we have a full

complement of control panels and PC applications to choose from—all designed for straightforward operation and a rapid learning curve.

With 25 years of experience, Wheatstone has the infrastructure in place to help you build your OWN infrastructure. Contact us for answers.

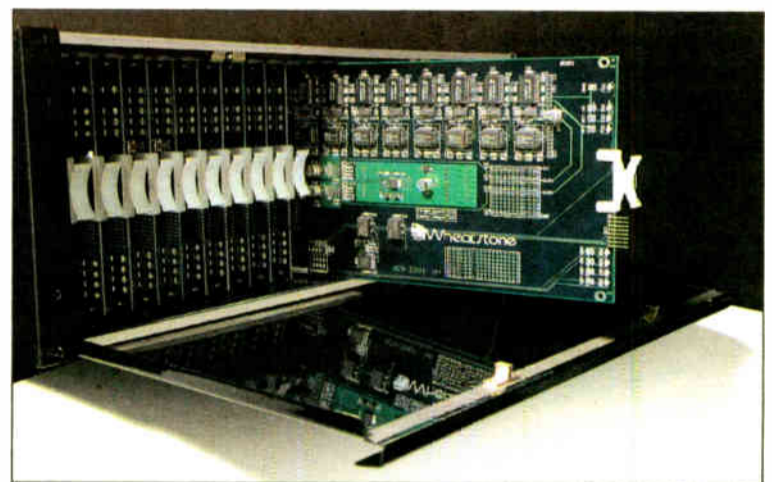

MIXED SIGNAL SWITCHING is easily accomplished with a choice of AES digital or ANALOG 24-bit A>D input cards, and of course 24-bit digital or 24-bit D>A ANALOG output cards, all of which can be serviced from the front of the cage. All signals are routed entirely in the digital domain.

Internet Radio

COMEDY
WORLD

The Auction
Page 45

Radio World

How to Succeed in the Dot-Com World

November 7, 2001

WEB WATCH

High Demand Challenges Net Radio

Sandy Wells

Contrary to many reports that the Internet didn't heed its call during the high demand of that terrible day, Sept. 11, MeasureCast Inc. reported that streaming news/talk stations it measures saw dramatic increases in total time spent listening in the days following the attacks.

On Sept. 11, some stations saw TTSL jump 8,900 percent from the previous Tuesday, according to MeasureCast.



Bill Piwonka

"We had five AM news/talk stations make the top five for the first time," said MeasureCast's VP of Marketing Bill Piwonka.

The five AM's included WSB in Atlanta, Chicago's WLS, KRLA in Glendale/Los Angeles, WTMJ in

Milwaukee and CFRB in Toronto.

WLS, ABC Radio's guinea pig for its new ad insertion software, streamed 3,064 hours to an audience of 2,069, according to MeasureCast.

Los Angeles-area KCRW(FM), NPR's West Coast flagship station, which dropped most of its cultural and music programming to cover the Sept. 11 events, reached No. 8 on the list, the highest ranking the station has achieved.

"Because major news organizations' Web sites were overwhelmed and operating slowly last Tuesday and because many people don't have TVs or radios in their offices, thousands of office workers tuned to the Internet to get the latest information of the terrible attacks," said MeasureCast CEO Ed Hardy.

Shiny

The Associated Press reports that it attracted a record number of listeners to its "All News Radio" programming.

The AP said America Online, an ANR subscriber, experienced more than 35,000 simultaneous streams of the service. In the nation's capital, WTOP(AM-FM)'s FederalNewsRadio.com, a news service "side channel" targeted to serve the large number of federal workers there, attracted more than 22,000 users, a record number.

Radiostorm.com, an Internet radio network, was overwhelmed with demand for ANR streams and had to widen its bandwidth to accommodate an aggregate total of half a million listeners during the crisis week.

MeasureCast said Internet radio listening had doubled as measured by total time spent listening between

January and September. That's despite a dip over the Labor Day weekend, which suggests that office workers still drive the listening numbers.

It's baaack ... sort of

With new ad insertion partner Hiwire, radio behemoth Clear Channel slipped back to streaming in September, starting with KIIS(FM) and following soon with eight others. Kevin Mayer, Clear Channel Internet Group's chairman and CEO, said the company plans to have 100 stations streaming by year's end.

Visitors to a Clear Channel streaming station site these days face a Hiwire pop-up screen when they click on a "listen" icon. Users must agree to a long, small-text legal document and register before they may hear a single streamed note.



turnkey solution for their streaming issues might want to look at what Steve Dinetz, Davis Juris, Bill Moyes, Terry Robinson, Eric Neumann and David Kantor have cooked up.

The new, improved version of XACT Radio Player features a one-click installation for the XACT "custom radio player," along with Windows NT compatibility, player customization for radio stations and online reporting for stations.

The service also features a rating system that managers can access in real

Radiostorm.com had to widen its bandwidth to accommodate an aggregate total of half a million listeners during the crisis week.

Until someone figures out a better way to glean target-useful info from our listeners, this probably is how all terra broadcasters will have to initiate streaming.

Radio broadcasters looking for a

time as listeners use the player.

"As listeners rate each artist, it remembers what you like to listen to," said Rachael Lee, an XACT spokesman. "Stations can do song testing through

See WEB WATCH, page 44

Go MaxxStream

Wideband audio from narrowband streams
for radio broadcast and internet streaming

If your encoding/broadcasting setup is a mess
AND your sound leaves much to be desired....
Go MaxxStream! The industry's most integrated solution supporting multiple encoders/bit rates simultaneously, audio capture, archiving and processing.

Utilizes Waves award-winning audio processors, the quality standard used for Gold/Platinum CDs and blockbuster movies. Be warned, the difference is not subtle!

Contact information:
Email: maxxstreaminfo@waves.com
(North & South America)
Tel: 1-866-546-6115
(Headquarters)
Tel: 972-54-360-470



Go MaxxStream: www.maxxstream.com



GUEST COMMENTARY

KFNS Will Never Stop Streaming

Michael C. Phares

I read the article by Thomas R. Ray III regarding Internet streaming in Radio World's Aug. 1 issue with great interest.

As opposed to ceasing our streaming, we at FanSports KFNS(AM-FM) here in St. Louis came to a different conclusion. Because we are the only all-sports radio station in St. Louis, we broadcast to a somewhat smaller (nothing like WOR's!) but extremely rabid audience.

Damn the torpedoes

Most of our audience works inside during the day, so the Internet stream of our audio was the answer to a prayer for those who couldn't receive our 1,000-watt AM signal inside their office walls. Consequently, our fans have become extremely reliant on the Internet stream.

When the American Federation of Television and Radio Artists commercial ban was announced, there was no way we were going to dump our audio stream.

We also have the problem of spot breaks of different durations and floating occurrence depending on programming. Our solution was Neanderthal-simple — as we agreed wholeheartedly with the absurdity of Thomas Ray's assertion that "spot replacement ... would require another operator and essentially the operation of separate radio station strictly for the Internet."

I had my studio engineer install a

whole issue right on the streaming page, keeping "i-listeners" up-to-date on why we're replacing commercials and inviting their suggestions for what we ought to play — basically having fun with it.

I'd like to do past play-by-play of sports events but I'm sure I'll run into AFTRA problems again, so we're probably going to use our own recorded interviews or straight music CDs —



Mike Phares

maybe college fight songs? — since we already paid for an Internet music license after the first go-round of Internet streaming madness.

Minor problems

Yes, it sounds a little rough sometimes when we switch over. But our listeners don't seem to notice — and really don't care what we put on as long as they get their sports. And it's less confusing than silence.

The Internet stream of our audio was the answer to a prayer for those who couldn't receive our 1,000-watt AM signal inside their office walls.

— Michael C. Phares

simple toggle switch that our control room technician actuates simultaneously with the click of the mouse on our ENCO DADpro32 audio delivery box.

This switches the feed from our on-air signal to a CD player in our rack room that runs continuously. In this way, we cover all breaks, regardless of what's broadcast, AFTRA spots or not.

The Internet audience gets whatever we put in the CD player. As long as you have an operator 24 hours a day, this will work.

We've burned CDs with station promos and locally produced PSAs (we're not an AFTRA station) and, yes, the audience tires of it, generating some terrific e-mails.

So I have taken to responding to the

Thomas Ray is quite right when he points out that the proposed Internet talent fee is ridiculously out of proportion for the number of actual listeners it generates, but operationally, it's a moot point.

Supplying an alternate feed that works is still the issue. We are in the process of working with Yahoo! Broadcast, our media streamer, on an ad-insertion project that will work with the DADpro32, but aren't quite there yet.

That would make the need for the toggle switch unnecessary. Regardless, it's not elegant — but we're still streaming.

Michael C. Phares is vice president of broadcast and technical operations at KFNS in St. Louis. Visit the KFNS Web site at www.kfns.com.

AD INSERTION HELPS TERRA STATIONS, NICHE MUSIC CHANNELS THRIVE

Terrestrial Webcasters regained some of their standing online in September, MeasureCast said, with six of the top 10 spots compared to only two in August.

The Internet radio world was inverted in April following the American Federation of Television and Radio Artists' move to begin collecting triple rates for terrestrial commercials featuring their talent that were also streamed online.

While Internet-only Webcasters were unaffected by the AFTRA move, many terrestrial stations silenced their streams until the end of summer, when more broadcasters began to deploy ad-insertion technology that allowed them to strip out AFTRA commercials from their Webcast content.

British invasion

Britain-based Webcasters JazzFM and Virgin Radio ranked first and second in the MeasureCast September ratings, which measures total time spent listening. Classical KING(FM) placed third in the monthly list; Net-only Webcasters MEDIAmazing.com and ESPNRadio.com rounded out the top five.

The events of Sept. 11 pushed news/talk stations up in the ratings. Five news/talk format stations make the MeasureCast Top 50. Only one such station — Salem Communications' KRLA(AM) in Los Angeles — made the list in August.

KRLA jumped from No. 31 in the August standings to 16 in September by streaming 26,936 more hours. Cox' news/talk WSB(AM) appeared for the first time at No. 8.

The September ranking includes 16 newcomers, 14 of which are terrestrial stations. AM- and FM-streamed stations also secured 12 of the top 25 slots, three more than they did in August. Internet-only stations claimed 20 of the top 50 spots, down from 29 in August.

Arbitron also reports that Virgin Radio placed high in its September ratings, taking the No. 1 spot. But unlike the patterns that MeasureCast reports, Arbitron found that Internet-only music Webcasters dominated the September numbers.

Motorola, Intel, FBR Technologies, Susquehanna Radio and Warburg Pincus share ownership of RadioWave, an Internet radio aggregator that took four of Arbitron's top 10 places in September with niche music channels.

Two public radio stations, Seattle's KPLU(FM) and Boston's WBUR(FM), took the No. 3 and No. 4 spots in the Arbitron ratings, but only WBUR streamed all-news following the Sept. 11 attacks.

KPLU's assistant station manager, Kerry Swanson, said people wanted relief from the news and talk and tapped into KPLU's jazz stream much more than its news stream. The station has a third stream of blues music, but it's the smallest of its streams, according to Swanson.

Arbitron said some of the channels and stations that previously reported in its ratings reports did not "meet the new service policies of providing Arbitron with data in a timely and consistent manner and therefore, are not included in this month."

"In the past, we worked to include all stations and channels in the Webcast Ratings, even if that meant delaying the results while we waited for data," said Bill Rose, vice president and general manager, Arbitron Webcast Services. "Customers told us that they need the ratings soon after the end of the month."

The company introduced a new service, "Webcast Audience Profile," in June, which gathers streaming media channels' audience demographics. The company said the WAPs will complement its Webcast ratings charts.

— Laura Dely

The MeasureCast Top 10 — September 2001

Stations are rated by TTSL — Total Time Spent Listening — the number of hours streamed by the broadcaster in the reported time period (September 2001).

Channel/Format	Owner	URL	TTSL
1. JazzFM/Jazz	JazzFm.com/eJazz.fm	www.jazzfm.com	672,995
2. Virgin Radio/Adult Alt.	Virgin Radio New Media	www.virginradio.co.uk	426,716
3. KING(FM)/Classical	Classic Radio Inc.	www.king.org	388,176
4. MEDIAmazing/Listener-Formatted	MEDIAmazing	www.mediamazing.com	358,091
5. ESPN Radio/Sports Talk	The Walt Disney Internet Group	www.espnradio.com	306,718
6. Radio Margaritaville/Classic Rock	Radio Margaritaville	www.radiomargaritaville.com	236,496
7. WFYZ(FM)/Classic Rock	Sea-Comm Media	www.937thebone.com	187,042
8. WSB(AM)/News/Talk	Cox Radio Inc.	www.wsbradio.com	137,250
9. 3WK Undergroundradio/Alt. Rock	3WK	www.3wk.com	133,405
10. KCRW(FM)/College	Santa Monica College	www.kcrw.org	130,354

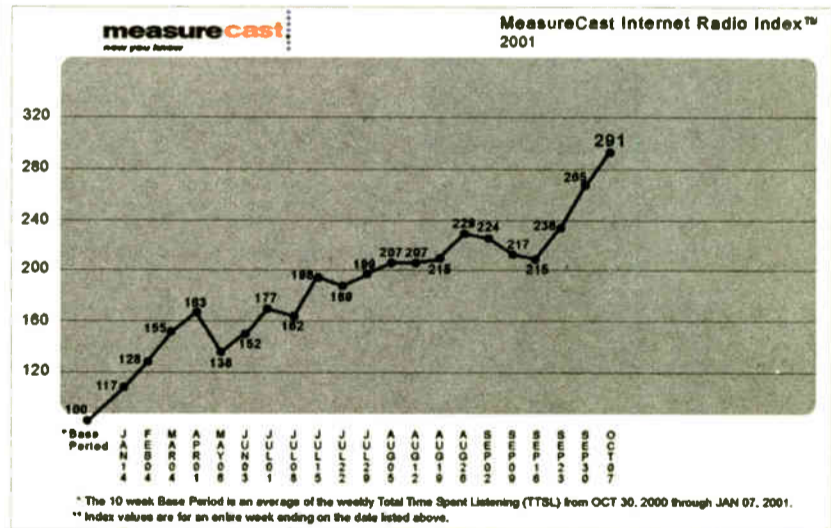

Arbitron Webcast Ratings Top-10 Report — September 2001

Webcast networks (either radio group owners who stream their content online or aggregators of online content) are rated by ATH — the sum total of all hours that listeners tune to an Internet station.

Channel/Format	Owner	URL	ATH
1. Virgin Radio/Hot AC	Virgin Radio New Media	www.virginradio.co.uk	342,600
2. RadioWave - Hits Happen/CHR	Motorola et al*	www.radiowave.com	247,700
3. KPLU(FM)/Jazz/Blues/News	Pacific Lutheran University	www.kplu.org	212,500
4. WBUR(FM)/News/Talk	Boston University	www.wbur.org	187,400
5. Tom Joyner Morning Show/Talk	ABC Radio Networks	www.tomjoyner.com	149,700
6. WQXR(FM)/Classical	New York Times	www.wqxr.com	126,300
7. RadioWave - Flava2k/Urban Contemporary	RadioWave	www.radiowave.com	111,900
8. Cablemusic - Smooth Jazz	Cablemusic Networks Inc.	www.cablemusic.com	88,500
9. RadioWave - Classic Rock	Radio Wave	www.radiowave.com	76,900
10. RadioWave - Sweet Nothings/Soft AC	RadioWave	www.radiowave.com	73,300

* In addition to Motorola, RadioWave investors include Intel, FBR Technologies, Susquehanna Radio and Warburg Pincus.



In the Spotlight!

The Broadcast Richardson name may be new to you, but its ideology is not...servicing the customer.

Broadcast Richardson has combined the technical, integration and consulting expertise of the recently acquired Broadcast Richmond with the wide product offering and unsurpassed service of Richardson Electronics.

Complementing its specialized, value-added services, Broadcast Richardson draws from its 200+ product lines to offer you true inter-product integration.

Broadcast Richardson is prepared to lead the way in the broadcast industry. Turn to us for your next component, equipment or system need!

- **Transmitter Components**
- **AM, FM, TV, HF Transmitters**
- **Studio Equipment**
- **Broadcast Systems**
- **Antennas**
- **Cable TV**
- **Microwave**
- **Satellite**
- **Webcasting**

Call Today!
800-348-5580

*More than 60 locations
worldwide to serve you.*

E-mail: broadcast@rell.com

Internet:
www.broadcast-richardson.com

630-208-2200
Fax: 630-208-2550

© 2001 Richardson Electronics, Ltd. MK2189

***A Featured Presentation...
From one of our 200 product lines!***

RFCAST

AM Transmitters

Features Include:

- Identical and on-line hot plug-in amplifiers, fully protected
- Built in modulation monitor and audio processor (optional)
- Digital and AM stereo compatible
- Covers AM and extended AM band
- High accuracy synthesized oscillator
- Built-in remote control interface
- 24 month warranty



AT1K5 – 1 kW AM Solid State



AT7K5 – 5 kW AM Solid State

***Competitively Priced For You!
In Stock. Call Today!***

BROADCAST 
 ***RICHARDSON***

Integrated Solutions

Web Watch

► Continued from page 41

XACT with song-by-song feedback to find out what's being clicked through. Managers find that valuable information for improving the quality of broadcasts."

XACT Radio pays all costs including licensing, bandwidth, royalties and equipment. XACT employs a team of salespeople that sell the service to advertisers and shares a cut of revenues from those sales with stations.

with simple voice commands, speaker enhancement designed to boost the richness and clarity of ordinary PC speakers and a CD label maker.

Microsoft Plus! for Windows XP retails at a suggested price of \$39.95.

About the same time that Microsoft introduced its enhancements to its player, RealNetworks launched its RealOne platform, which it boasts will transform the creation and consumption of digital media. (Take that, Microsoft!)

"RealOne Platform is groundbreaking and will introduce ABCNEWS.com's



The XACT Radio allows users to customize their Net radio players. Shown is 'David's' XACT Radio player.

realONE PLAYER

play | more | explore

INTRODUCING REALONE PLAYER!

RealONE is a revolutionary service that combines exclusive brand name programming and cutting edge player software, providing consumers a single source for enjoying digital media on their PC. At the heart of RealONE is the all-new RealONE Player, which fuses the rich technology of RealPlayer® and RealJukebox® with an integrated media browser and deep content discovery services, and enables you to:

- Discover the richness of audio and video on the Internet.
- Play anything you want—from CDs to radio stations to MP3s to sports highlights.
- Organize and build your personal digital music and video collection.
- Go anywhere you want with your tunes by creating a custom CD or transferring to an MP3 player.



The new, fully-integrated media browser lets you access and enjoy media, no matter what—or where—it is. Surf the Web; browse your PC; transfer MP3s; and enjoy CDs and radio stations.

- RealONE topic centers, including Music, Sports, News and Entertainment offer exclusive content, broadband media and more, all in one clearly organized and easy to access location.
- With media search you can easily find and play music videos, news clips, sports highlights, music downloads, movie trailers, interviews, radio stations, TV stations and more.
- Get artist information such as discographies, biographies and concert dates; get recommendations about similar artists or genres; and even purchase CDs directly within RealONE Player.
- The new RealONE Player home page makes it easy to access great programming and get help and how-tos, skins, visualizations, plug-ins and more.



Play. More. Explore. Play a clip and get more info and links related to it, which you can explore in the media browser—all while the clip is playing!

The RealONE Player is available for free, but to supercharge your RealONE Player with advanced features and premium programming, belong to RealONE, RealNetworks' media subscription service. For a detailed description of RealONE, please see the "RealONE Member Benefits" fact sheet.

DISCOVER

Whether you're searching for a song to download, trying to find your hometown radio station or looking for a movie trailer, RealONE Player is the easiest way to discover and enjoy your favorite media.



Get rich information and links related to the clip you're playing in the related info window.

- New radio search makes it easy to find your favorite music, sports, news and talk stations and discover new ones around the globe.
- The new message service keeps you informed about the latest programming and special offers of interest to you.

XACT said there is no cost to broadcasters for the service. (They pay the bandwidth costs! And share revenue from ads they sell!)

Microsoft unveiled Microsoft Plus! for its new operating system, Windows XP, in September. The product is

audience to a true multimedia experience," said Bernard Gershon, senior vice president and general manager, ABCNEWS.com. "ABC has had a great relationship with RealNetworks since the launch of RealAudio in 1995," Gershon said.

Media Player is growing rapidly in at-home and at-work use while RealNetwork's RealPlayer has been in decline in the same categories.

Taking advantage of the current market conditions, busy-busy Loudeye acquired Activate Inc. in September for \$4 million in cash and stocks.

With the Activate acquisition, Loudeye, a provider of services and infrastructure for the authorized delivery of digital content, Loudeye's has made five such transactions in the past six months.

The company said it will move much of its technical operations into Activate's "Grand Central" production facilities in Seattle. Activate provides streaming media services.

Loudeye has music-licensing agreements with the five major record companies and more than 800 independent labels.

Loudeye Sample Services provides song samples for customers including CDNOW, Tower Records, BMG Direct, AOL, Amazon.com and MSN.

In other notable transactions, file-sharing service Yaga Inc. acquired online payments capability when it bought MagnaCash Inc. for an undisclosed sum.

Online ratings champ KPIG(FM) is under new ownership. Mapleton Communications purchased the New Wave Broadcasting outlet located in the Monterey, Calif. market.

KPIG's adult album alternative mix has won a nationwide following, placing in the top 20 of Arbitron's Webcast Ratings last year.



MTVi Radio has struck audience gold, according to figures released by Arbitron Webcast Audience Profiles. It finds that a majority of the Internet radio network listeners are well-educated, affluent and active online.

The July/August survey found that 69 percent of MTVi users are college grads and more than half have household incomes exceeding \$50,000 per year.

"The Arbitron data show that MTVi's stations appeal to a highly desirable consumer target for advertisers," said MTVi VP Brad Porteus.

Solid gold

The survey also uncovered the fact that more than 50 percent of the listeners are 18 to 34, with nearly a third in the 25-34 group.

Arbitron said the audience is 52 percent male and 48 percent female.

While services such as MTVi feast on the young, The Media Audit finds the 50+ crowd to be the fastest-growing segment of the Internet audience, rising from 19 percent to 25 percent of the total audience from 1997 to 2000.

TMA also points out that more than 47 percent own cell phones and 21 percent made five or more e-commerce purchases during the past year. And they still like Buicks, Lincolns and Cadillacs.



On Sept. 11, some stations saw TTSL jump 8,900 percent from the previous Tuesday, according to MeasureCast.

designed to improve the PC experience for digital audio and video users, games, customized desktops and screensavers.

Among the key features is Plus! Voice Command, which allows users to control Windows Media Player

The improvements will bring a "reinvented" RealPlayer to the market just as the pioneering software is beginning to lag in battle for dominance with the Windows Media Player.

Jupiter Media Matrix Softusage data from July shows the Windows

"They didn't grow up with the personal computer," said TMA Co-Chairman Bob Jordan. "They are the readers of the printed word. They are the backbone of the newspaper and magazine readership. To attract them to the Internet is a remarkable achievement for the new medium."

Send Web news and releases to Internet Radio Editor Laura Dely at LD@imaspub.com. Pictures of events, stations and studios are welcome.

Sandy Wells is a frequent contributor to Radio World.

Contact him at (323) 469-6864 or send e-mail to SandyWells@Prodigy.net.

At Auction, Tears of a Clown

ComedyWorld Internet Radio Venture Ended With Sell-Off of Equipment to Make Its Final Payroll

Sandy Wells

By some accounts, the auction held in the spacious Los Angeles facilities of the moribund Internet radio venture known as ComedyWorld.com exceeded expectations.

When the business, now in Chapter 7 bankruptcy proceedings, closed down last spring, managers locked the doors behind them. Employees found themselves waiting for weeks to retrieve personal belongings and, in some cases, a final paycheck, while every last bit of equipment was accounted for.

"We wanted to secure our assets that were there so we wouldn't be plundered and that there would be a maximum amount of cash to pay the employees," said former Comedyworld.com Director of Engineering Barry Thomas. Thomas is currently Chief Technology Officer at StratosAudio, Inc., a company that provides interactive technology company for conventional radio broadcasters.

There were never any lackluster periods and the crowd remained throughout the sale."

By the end of the day, everything had been sold off.

"The turnout was pretty hot," said Thomas. "We did better than the low-end estimate and a little less than the high-end."

The Pro Tools 001 systems, originally \$7,500, went for roughly \$3,000. Infinity picked up most of a \$200,000 automation system for \$45,000. The

system included a confidence monitor that mimicked a local affiliate, allowing Comedyworld.com engineers to verify whether a programming element had played, making troubleshooting a breeze.

A \$10,000 reception console reportedly went for \$50. Such was the ignominious end for an idea that six months before had appeared to have tremendous potential.

Poised for growth, 20 audio and video studios had been placed inside trailers housed within a 50,000-square-foot warehouse in the Marina Del Rey area of Los Angeles.

The long-term plan, according to



Shown is one of three CW broadcast studios auctioned in August.

Thomas, was to move everyone into an adjoining building, remove the trailers and convert the remaining space into a parking garage for the 70-plus Los Angeles employees (another 40 worked on the Web site in San Francisco).

See AUCTION, page 47 ▶

The roughly \$3.5 million worth of relatively new equipment sold for an estimated total \$550,000.

While most bankruptcy auctions can only expect to get a modest percentage of the original value of the equipment being sold off, the Aug. 20 event was rather successful.

Over the 10-and-a-half-hour period, more than 250 registered bidders from Citadel, Premiere Radio Networks, Infinity, Trinity, the Victor Group, individuals, reps from smaller companies and dealers bid on items from 1,850 lots.

They bid on rows of file cabinets, scores of microphones, 150 PCs, 10 MACs, server equipment, seven Digidesign Pro Tools systems, four audio edit studios, three multitrack audio production studios, a radio network distribution center, at least 40 sets of headphones, video equipment, a box of Comedyworld.com posters, even a baby's crib.

The roughly \$3.5 million worth of relatively new equipment sold for an estimated \$550,000.

"Bidding was competitive," said auctioneer Ray Bleu. "At times it was frenzied. The broadcast and video equipment had heavy participation.



Insert Tab A



How to Monitor in a Tight Situation

The new RM-1 is the ideal solution for monitoring needs in tight industrial environments. It's the perfect speaker for machine rooms, VTR monitoring, surveillance, mobile and stationary control rooms, theme park applications or any other situation where monitoring is needed and space is tight.

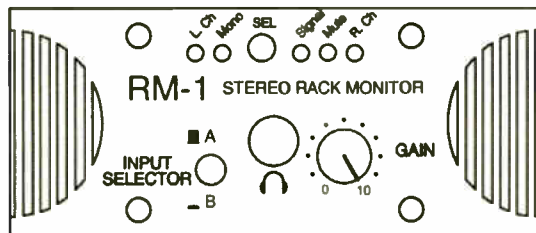

Features include:

- Dual Stereo Inputs with independent volume controls.
- Switchable Matrix (L/R/Mono/Stereo) with high intensity multi colored LED's which tally the mode selected.
- Signal Presence/Amplitude Indicator.
- Balanced and Unbalanced I/Os.
- Universal Stereo Headphone jack with ample volume for noisy machine room environments.
- Fully shielded to prevent interference with video monitors or VTR tape machines.

The RM-1 employs a unique new driver technology that results in outstanding frequency response, considering the limited space enclosure. This revolutionary transducer was developed by Foster Electric, the parent company of Fostex America.



Fostex

www.fostex.com

15431 Blackburn Ave. Norwalk, CA 90650 • 562.921.1112

Products & Services SHOWCASE

SIX MILLION THUNDERSTORMS HIT PLANET EARTH EVERY YEAR! IT TAKES ONLY ONE TO PUT YOU OFF THE AIR!



The STATI-CAT LIGHTNING PREVENTION SYSTEM provides a continuous, low-resistance discharge path for the static electric charge on tall structures. Dissipation points are 1/8" stainless steel rods.

This affordable and rugged system has proven itself in the field for over 15 years.

Cortana
Corporation Inc.

Write or call for a free brochure and design
P.O. Box 2548, Farmington, N.M. 87499-2548
Toll Free Ph: 888-325-5336 • Fax: 505-326-2337

POWERFUL DIAL-UP CONTROLLER



THE DR-10

Perfect for Studio & Automation Control Interfaces with most studio automation systems. Control it from either a dial-up line or external audio path. The DR-10's active, balanced, telco audio output lets you do live remotes, remote announcement recording and...much, much more!

Outstanding Features: Exceptional Value

- >10 dry relay contacts out.
- >Auto-answers on user settable ring # and auto-disconnects.
- >Relays can be assigned to any tone & can be momentary, latching with distinct on/off codes, or interlock latched with others.
- >Up to 8 digit, user set, password.
- >Momentary relays can close after tone.
- >Relays can beep when activated. Closures are after the beep!
- >Proprietary two-tone & detection delay modes eliminate false trips.
- >4 Status inputs beep when queried, alarm dial and control relays.
- >Control equipment & monitor local audio with the internal audio hybrid.
- >All settings retained after power failure.
- >Silencer option removes DTMF tones from the audio output.
- >New LOWER list price only \$399.00.
- >Best features vs. price in the industry.

Visit our web site or call your favorite dealer for more info.

CircuitWerkes - 352-335-8555 Fax 380-0230

http://www.circuitwerkes.com / 3716 SW 3rd Place, Gainesville, FL 32607

ERI Towers Above the Rest

Monopoles
Guyed Towers
Self-Supporting Towers
Structural Analysis
Tower Reinforcing

Electronics Research, Inc.
7777 Gardner Road • Chandler, IN 47610
(812) 925-6000 • www.ERInc.com

Buy simplicity, reliability and service

EAS

Price \$1750.00

Equipment is in stock for immediate delivery!

GORMAN-REDLICH MFG. CO.
257 W. Union St. Athens, Ohio 45701

Phone 740-593-3150
FAX 740-592-3898

Now available with optional DTMF control via a phone line.

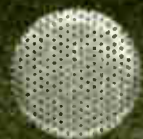

- 5 two-way RS-232 inputs/outputs for computer, remote signboard & character generator
- 6 audio inputs on standard models. All audio inputs & outputs are transformer isolated from encoder-decoder board
- Automatic interruption of program audio for unattended operation
- 1 line 40 character LCD display with LED backlighting
- 20 key keypad to program unit, set modulation level, set input levels
- Will handshake with automation equipment jimg@gorman-redlich.com Web Site: www.gorman-redlich.com
- 2 year warranty
- 2 minutes of digital audio storage
- 25 pin parallel printer port for external printer
- 52 terminals on the rear to interface with other equipment by removable plugs
- BNC fitting with 600ohm balanced audio out for second transmitter

◆ Also available: weather radars, antennas for weather radios, crystal controlled synthesized FM digitally tuned radios, remote signboards, cables for interconnection, character generators.

Designed for Broadcasting! MINI-MIX 8A



\$2499 List

12 Stereo Inputs 2 Stereo Outputs
2 Dedicated Mikes 1 Mono Output

Service & Affordable Quality for Over 28 Years

AUTOGRAM CORPORATION

1500 Capital Avenue (972) 424-8585
Plano Texas 75074-8118 1-800-327-6901
FAX (972) 423-6334
info@autogramcorp.com

THE RAMSEY PX1 35W FM STEREO EXCITER/TRANSMITTER



- Frequency Agile - 87.5 to 108.0 MHz
- Digitally Synthesized PLL
- Temperature and VSWR Protected
- 120/240/12 VDC Power with Auto Battery Back-up

ONLY \$1795⁹⁵

The PX1 was designed to fill the needs of the low power or community broadcaster. Set-up and use is fast and simple with just 5 buttons to access all parameters - power, frequency, modulation, and more. The 2-line vacuum fluorescent display gives you "at-a-glance" verification of all important functions. The micro-controller continuously monitors frequency, temperature, deviation, etc. and makes subtle adjustments on the fly like a "virtual" station engineer.

Two balanced inputs (XLR) are provided, as are inputs for SCA and RDS (BNC) RF Output connection is type "N", output power is adjustable from 1 to 35 Watts.

If you're setting up a new station, we also supply consoles, microphones, antennas, feedline, and more.

AVCOM-RAMSEY TECHNOLOGIES

793 Canning Parkway • Victor, NY 14564

Order Toll-Free: 800-446-2295

www.highpowerfm.com • sales@ramseyelectronics.com



WOODLINE FURNITURE

serving the broadcast industry with quality furnishings

www.woodlinefurniture.com

Phone: (616) 261-9600

Design

Manufacture

Install

intelligent ergonomic designs
elegant and durable
full array of finishes
flush mounted consoles
computer accommodations
standard EIA rackrail included
rear access to equipment
convection or assisted cooling
all cabling fully concealed
cabling fully accessible

4 week leadtime

visit our website soon



Auction

► Continued from page 45

While Internet venture money made Comedyworld.com possible to begin with, it also created problems later. Initially flush with cash to build up the infrastructure, the company also spent like a broadcast station.

Its business model, however, appeared to be a hybrid: part Internet portal and part fledgling radio network.

"The idea was to build the value of the Web site using the radio shows and the talent connected to them," said Thomas.

Jay Clark, now program director for WRKO(AM) in Boston, joined the venture somewhat reluctantly.

"I laughed at the idea at first," said Clark. "But then I met with the backers in New York. They were comfortable with the Internet, but hadn't done a lot of broadcasting."

Clark's success with FM talk stations in Orlando, Fla., and L.A. — stations that had a strong comedic component — led to his role at Comedy World.

Initially he was hired to develop the content for a terrestrial radio network that was intended to coexist with an Internet portal containing a strong video component.

Moved to Net

"The project started early on as a radio project," Clark said. "The original investors wanted to start a radio network, but they found that the money was more easily obtained for an Internet venture."

"The backers expected us to be run like an Internet company. We had this Internet division spending like an Internet company," said Clark.

The lineup in its final stages included hosts Ahmet Zappa, Allen Harvey, the Boone Brothers and 'Wrestling 101' with 'Big Schwag.'

Clark estimates that the company was spending at the rate of \$8 million a year.

"It was a lot of money. We spent like a major-market radio station, but we put out a terrific product."

Through a partnership with Citadel, Comedyworld.com was able to work with 19 affiliates, four taking the network feed full-time.

Clark went to work training comedians to do radio shows, complete with writers, board ops, producers and screeners. The Internet identity associated with the network bestowed upon the venture a certain cachet not only with investors, but also with its fiercely loyal employees who were just as enamored of Comedy World's cutting-edge image.

Thomas, who has extensive experience as a radio engineer, said the perception that Comedy World was an Internet-only entity became a problem for the company.

"The Internet had a nebulous revenue

stream. When the economy slowed, we scaled back to our core business — the radio network. The Internet identity, instead of being an asset, became a liability in terms of funding and getting PDs to consider us a programming source. It made our sales guys' jobs a lot harder."

Nevertheless, Thomas said streaming audio and video content on the Internet was a wonderful tool for testing product.

"We had six months to refine a show before going on the air."

The lineup in its final stages included hosts Ahmet Zappa, son of rock icon Frank Zappa, Allen Harvey, the Boone Brothers and "Wrestling 101" with "Big Schwag."

"It would have taken us (another) year and a half to get to a break-even point in a normal economy. It would have been a normal radio play at that point," Thomas said.

However by March of this year, the investors were getting nervous, although it was not evident to the enthusiastic employees.

"We were within six weeks of good Arbitrons coming in," said Thomas, referring to affiliates in Syracuse, N.Y., Spokane, Wash., and Charleston, S.C. "And once you show traction with a radio network, it's a whole lot easier to build an affiliate base."

When the bottom fell out in April, after one of the investors yanked a bridge loan, the end was sudden. Clark said the board operators volunteered to stay an extra week to keep the content flowing to the affiliates until new programming could be arranged.

"These people cared," said Clark. "As a manager, that's all you can ask for. There was magic in those studios where



Almost-new CW computer monitors are shown on preview at the auction site.

people gave 110 percent. It came to be a family that would grow and we'd make money, at least that was the idea."

For those employees, the success of the auction meant that final paycheck plus severance pay would finally arrive in the mail. 🌐

25th Anniversary Silver Sweepstakes

Enter to win one of 25 great prizes in Radio World's reader appreciation contest giveaway!

IMAS Publishing is celebrating 25 years of serving you and the radio broadcast industry. To mark this significant milestone, 25 of radio's leading equipment suppliers have teamed up with Radio World to express their appreciation.

Throughout 2001, Radio World will conduct 25 random drawings. Prizes and winners will be announced in every issue of Radio World all year long.

To become eligible to win, you need to complete these three easy steps:

- 1) Register online at our Web site www.rwonline.com
- 2) Click the Silver Sweepstakes icon on our homepage
- 3) Fill out the electronic entry form — that's it, you're done!

It's your chance to celebrate our Silver Anniversary with these fine Radio World supporters ...

Contest Rules: To enter the drawing, simply register online at www.rwonline.com/sweeps. 25 drawings will be held throughout the year. Contest ends December 19, 2001. One prize per winner. All contestants MUST reside in the United States and have a valid mailing address. Winners should receive prizes within 30 days of notification, however, actual delivery time may vary and is not guaranteed by IMAS Publishing. Federal, state and local tax laws may apply to prizes and are the sole responsibility of the winner.

Power Can Be Beautiful

BMX*digital*

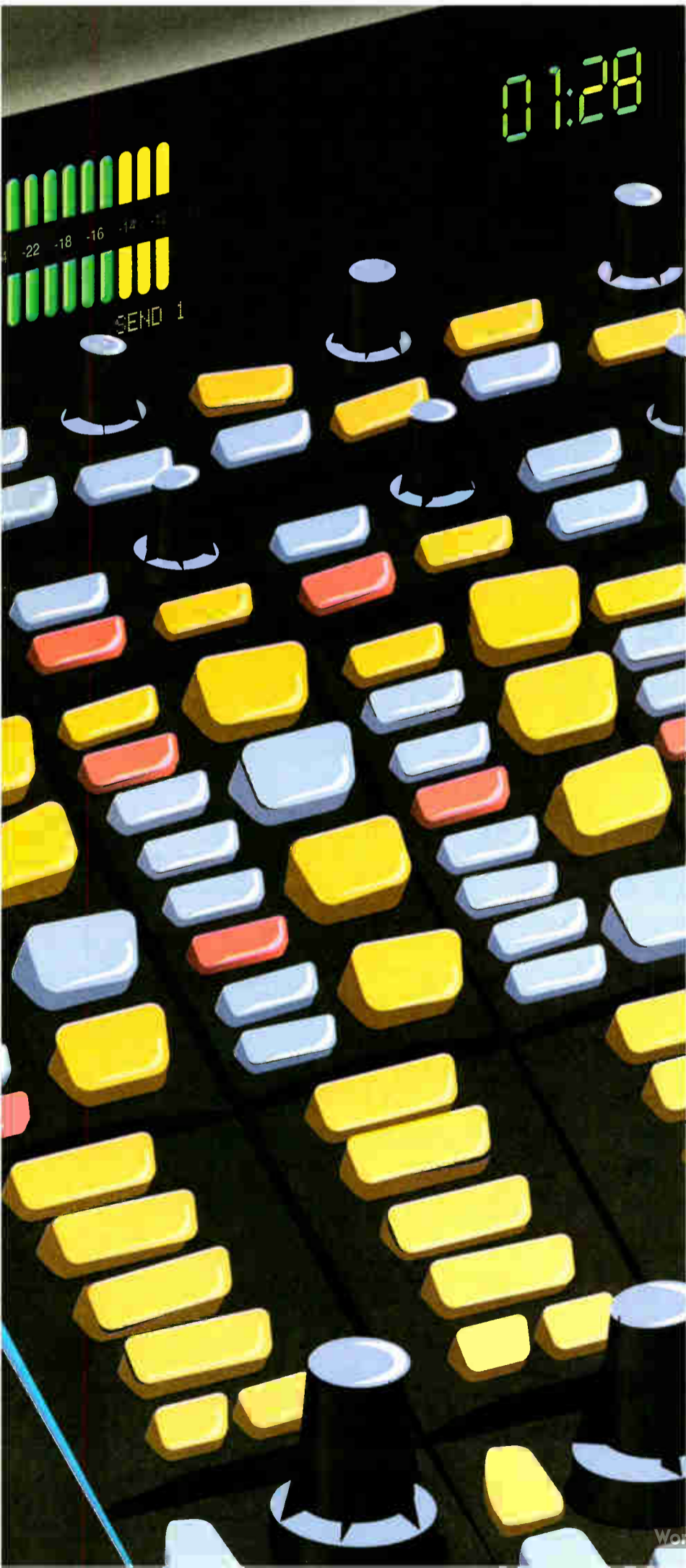

Sure, it's the best looking broadcast console you've ever seen. But, beneath the sleek, elegant exterior beats the heart of a true warrior!

Pacific BMX*digital* has everything you need to win the digital revolution. Whether it's the number of output buses, mix-minuses, off-line mixes, stereo sends, direct IFB's, monitor inputs and outputs, inter-communication paths or logic interface, BMX*digital* offers more.



Incredible Flexibility including all input modules accommodate analog and digital signals without reconfiguring, swapping, or even removal from the mainframe.

Amazing Adaptability with easy storage, recall and reconfiguration of set-ups for various day parts, and built in connectivity to routing switchers, digital storage systems and other networked sources.

Low Cost of Ownership by design, Pacific BMX*digital*'s true cost of installation, operation and maintenance is markedly lower than other consoles.



Legendary BMX Reliability

is what you expect in a Pacific BMX from Harris. The table pounding of your resident shock jock won't faze this beauty.

Pacific BMX*digital*. Beauty that's a lot more than skin deep.

next level solutions

SERVICE

SYSTEMS

AUTOMATION

TRANSMISSION

www.broadcast.harris.com

HARRIS

Studio Sessions

Tips & Tricks for
Surround-
Sound
Miking
Page 50



Radio World

Resource for Radio On-Air, Production and Recording

November 7, 2001

PRODUCER PROFILE

Donovan: Making WABC Sound Great

Ken R.

People who endure three years at a radio station in today's climate are considered survivors. People who last 10 years are celebrated.

Anyone who can manage to last almost 30 years at what is arguably the most listened-to radio station in the world would have to be called a legend. That's Johnny Donovan.

Donovan came to WABC(AM) in

New York in 1972. At that time, the late Rick Sklar, program director, decimated WOR(FM), one of his main competitors, by grabbing the best jocks, paying them more and letting them be creative on the air.

Donovan enjoyed the next 10 years playing music until May 10, 1982.

"The station suddenly went 'talk' and I was out of a job," Donovan said. "I told them I could do production. The voice was there, but I had no experience."

Donovan must have done something right because now he is not only the production director for WABC, he is

See WABC, page 52 ▶



Johnny Donovan and Peter Kanze



PR&E ABX-34 Console at WABC

PRODUCT EVALUATION

Iasys Sound System Optimizes Acoustics

Sam Wise

AudioControl Industrial has been making one-third-octave real-time analyzers since the late 1970s.

Real-time analyzers are limited, however, in that they show only the total soundfield and do not provide any time or phase information about the signals.

The results depend considerably on the acoustics of the space in which the measurements are taken, and do not necessarily allow the direct sound from the loudspeakers to be optimized or the effects of reflections to be considered separately.

In real life, optimizing a sound system may require knowledge of the interactions between a loudspeaker and the room it operates in.

With experience, the human ear can become a fine instrument for adjusting sound. But sometimes ears fail to reveal the cause of audible problems clearly enough to tweak a solution.

During the 1970s, Dick Heyser put forth the theory of time delay spec-

trometry. This allows engineers to analyze not only the steady-state results of loudspeaker/room interaction, but also to see the time history of this interaction.

By this means, it is possible to separate out the direct sound from the individual reflections or measure the overall final long-term result.

Dedicated users

TEF was a revelation to dedicated users, providing a great deal of insight into sound-system operation.

However, the original Goldline TEF test instrument implementing these ideas was difficult and slow to operate, providing a lot of detail that could be difficult to interpret.

Since then, instruments have been developed that are more refined and easier to use, ultimately leading to PC-based measurement systems.

Even these require considerable theoretical understanding. What the majority of users would really like is a test instrument that is dead simple to use, while still providing insight

See IASYS, page 57 ▶

Is running your production studio like controlling a nuclear reactor?

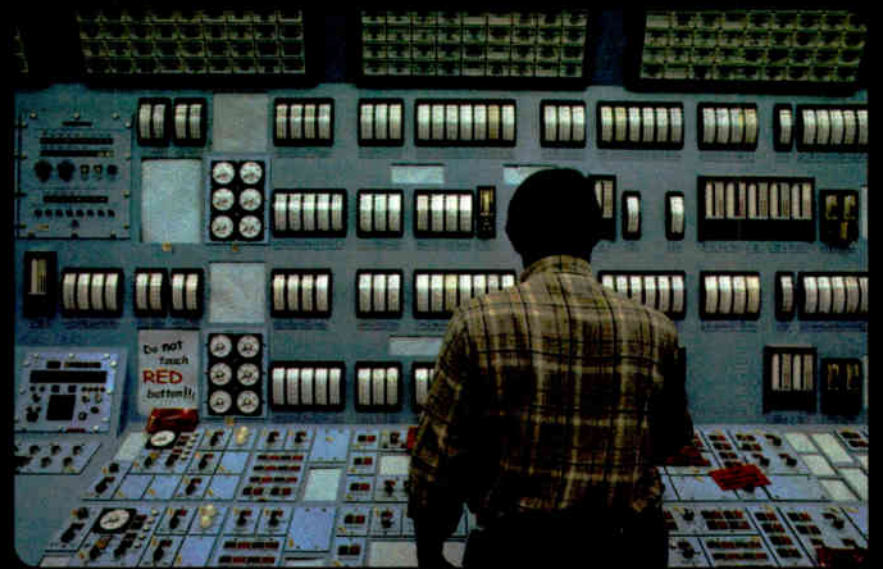

Simplify. Cool Edit Pro | The complete multitrack recording studio for Windows™



Up to 64 tracks • More than 40 DSP effects
DirectX™ Support • Crash recovery • Tons of
file formats • Optional MP3 encoder/decoder

Download a demonstration version from
www.cooledit.com
or call and we'll send a free demo/tutorial CD.

Syntrillium
Software

P.O. Box 62255
Phoenix, AZ 85082 USA
www.syntrillium.com
cepro@syntrillium.com

1-888-941-7100
(toll-free sales, USA and Canada)
tel: +1-480-941-4327
fax: +1-480-941-8170

TIPS AND TRICKS

Surround-Sound Mic Techniques

Bruce Bartlett

Last month, I checked out some microphone techniques for recording in surround. With these methods you can capture an orchestra with hall reverb, a live concert with audience reaction or a documentary with ambience.

Here are several more techniques that may be used for surround-sound miking.

DMP Method — DMP engineer Tom Jung has recorded in surround using a Decca Tree stereo array for the band and a rear-aiming stereo pair for the surround ambience (Fig. 1). Spot microphones in the band complete the miking.

The Decca Tree uses three microphones spaced a few feet apart, with the center mic placed slightly closer to the performers. The center mic feeds the center channel in the 5.1 system.

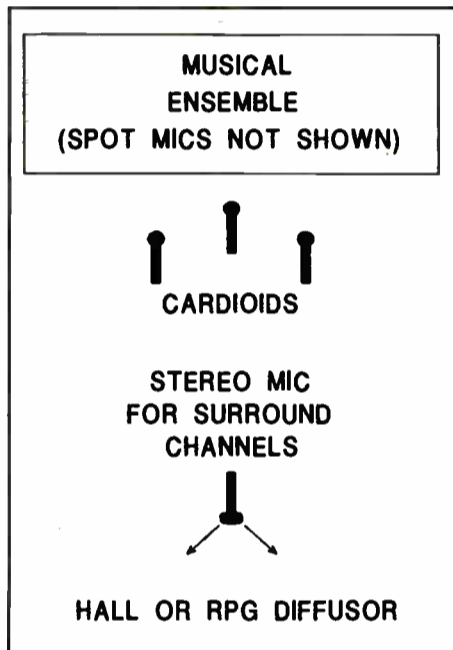

Fig. 1: DMP Surround Miking Method

The rear-aiming microphone pair is either a coincident stereo microphone or a spaced pair whose spacing matches that of the Decca tree outer pair. Jung tries to aim the rear mics at irregular surfaces to pick up diffuse sound reflections.

Woszyk Technique — A recording instructor at McGill University, Wieslaw Woszyk developed an effective method for recording in surround that also works well in stereo. The orchestra is picked up by a PZMR wedge made of two 18-inch by 29-inch hard baffle boards angled at 45 degrees.

A mini omni mic is mounted on, or is flush, with each board. At least 20 feet behind the wedge are the surround microphones: two coincident cardioids angled 180 degrees apart, aiming left and right and in opposite polarity (Fig. 2).

According to Woszyk, his method has several advantages:

- Imaging is sharp and accurate, and spaciousness is excellent due to strong pickup of lateral reflections.
- The out-of-phase impression of the surround pair disappears when a center coherent signal is added.
- The system is compatible in surround, stereo and mono. In other words, the surround signals do not phase-interfere with the front-pair signals. That is because the surround signals are delayed more than 20 msec; the two mic pairs operate in sep-

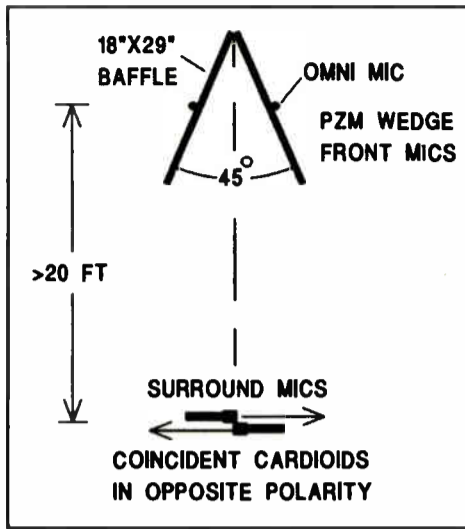

Fig. 2: Woszyk Surround Miking Method

arate sound fields and the surround mics form a bidirectional pattern in mono, with its null aiming at the sound source.

If a PZM wedge is not acceptable because of its size and weight, other arrays with wide stereo separation may be substituted.

Williams Five Cardioid Mic Array — Michael Williams, an independent audio consultant, worked out the math to determine the best cardioid microphone arrangement for realistic reproduction of surround-sound fields. His method is shown in Fig. 3.

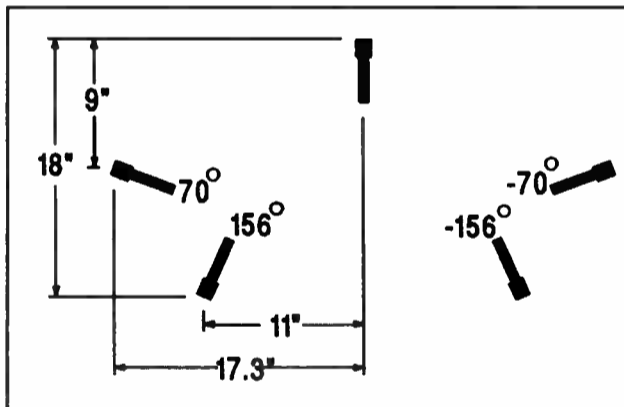

Fig. 3: Williams Five Cardioid Mic Array (MMA or Multichannel Mic Array)

Double MS Technique — Developed by Curt Wittig and Neil Muncy, the double MS technique uses a front-facing mid-side microphone pair for direct sound pickup and a rear MS pair facing away from the front (Fig. 4).

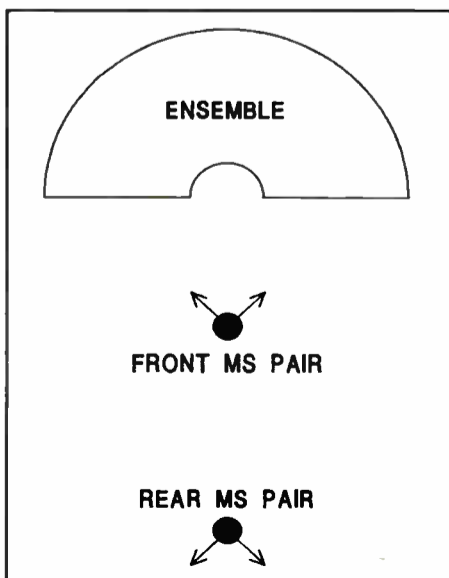

Fig. 4: Double MS Technique

The rear pair is placed at or just beyond the critical distance of the room — where the reverberant sound level equals the direct sound level. The matrixed outputs feed front left, front right, rear left and rear right speakers.

No center-channel microphone is specified, but you could use the front-facing cardioid mic of the front MS pair for this purpose.

Surround Ambience Mic (SAM) Array — This array was developed by Gunther Theile of the Institute fur Rundfunktechnik (IRT). Four cardioid mics are placed 90 degrees to each other and 21 to 25 cm apart. No center channel is described.

SPL Atmos 5.1/ASM 5 Surround Recording System — This system uses a special microphone mount with five arms that radiate out from the center point, like a star. At the end of each arm is a Brauner condenser microphone aiming outward from the center.

The five mics feed a five-channel mixing console, which adjusts the mic polar patterns and offers panning, bass management and surround monitoring.

SPL's Web site can be accessed at www.spl-electronics.com.

The SPL system uses the Ideal Cardioid Arrangement (ICA 5, Fig. 5) developed by Volker Henkels and Ulf Herrmann.

The Holophone — This is a surround microphone using several omni microphone capsules flush-mounted in a football-shaped surface.

Web site: www.theholophone.com.

Stereo Pair Plus Surround Pair — In this method, the center-channel mic is omitted. You use a standard stereo pair of your choice to pick up the musical ensemble, plus another stereo pair of your choice to pick up the hall ambience.

The hall mics feed the left-surround and right-surround channels. For

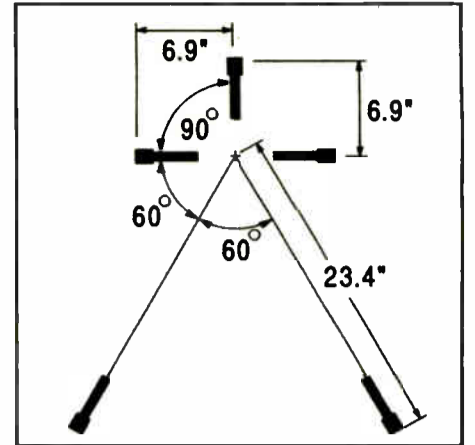

Fig. 5: Ideal Cardioid Arrangement

example, two Crown SASS-P MKII microphones can be placed back-to-back, separated by several feet.

Mike Sokol Method — When recording concerts, surround-sound guru Mike Sokol often uses a Crown SASSR-P MKII stereo microphone aiming toward the audience, feeding the surround channels. The front soundstage is a multitrack mix of several close-up mics (Fig. 6).

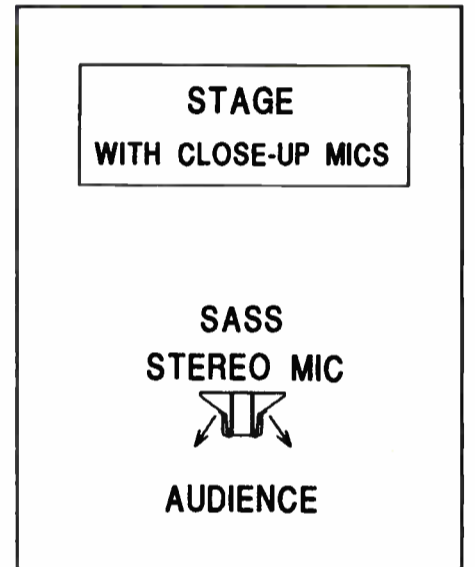

Fig. 6: A Surround Method by Mike Sokol

There you have several microphone techniques for recording in surround. New methods are being developed each year. Whatever technique you choose, you can expect a quantum leap in sonic realism over stereo.

Bruce Bartlett is the author of *On-Location Recording Techniques* published by Focal Press. Reach him in c/o Radio World.

PRODUCT GUIDE

ENCO NewsBoss Agreement

ENCO Systems, provider of Digital Audio Delivery Systems, and Desktop Technologies, publisher of NewsBoss, a newsroom management system, entered into an agreement to establish ENCO as a dealer and support facility for NewsBoss.

NewsBoss will now be an integral part of the DADpro32 digital audio delivery system.

For more information contact Enco in Michigan at (800) 362-6797, (248) 827-4440 or visit the company Web site at www.enco.com.

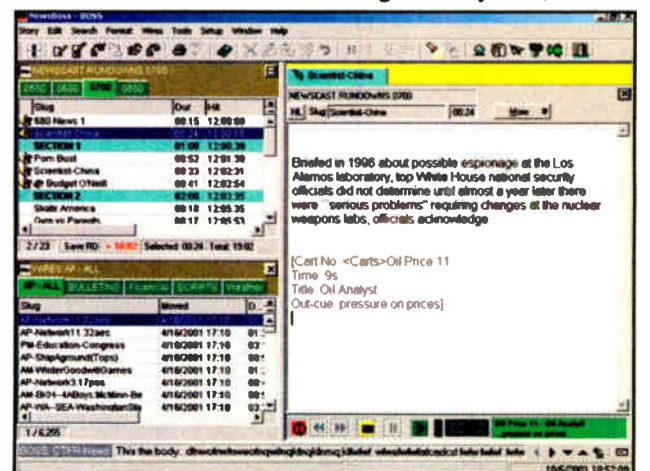

PRODUCT EVALUATION

Pioneer DVR-A03: Storage Galore

Carl Lindemann

The Pioneer DVR-A03 disc burner is an evolutionary leap in mass storage. With the ability to store up to 4.7 GB of data on a single disk, the A03 is a near-ideal solution for archiving massive amounts of audio production.

The DVR-A03 is the first CD/DVD recorder aimed at a mainstream audience. While the prior generation of DVD-Rs cost more than \$5,000, this one comes in just under the \$1,000 mark. Blank disc prices have fallen as well. Clocking in at about \$30 last year, they can now be had for less than \$10.

Although that is not quite as cheap as the CD-R in terms of dollars per megabyte of storage, the convenience of not having to hassle with using numerous CDs to store large projects may be worth the price.

Features

Basically, the DVR-A03 is an ATAPI CD-R/RW with the added capability of reading/recording/rewriting the higher capacity DVD data format. As a CD burner, it is an 8x/4x/24x drive with a 2 MB data storage buffer and lossless linking (burn proof) to prevent underruns.

The unit records at up to 8x real time, records rewritables at up to 4x real time and reads at up to 24x real time. Given the market glut of up to 16x real-time CD recording speeds, that is nothing special.

The CD performance is not the main reason to buy this unit, however. As a DVD, it writes at twice real time (or, more precisely, 2.8 MB/sec), rewrites at real time (1.4 MB/sec), and reads at up to 4x real times (5.9 MB/sec).

to reset the BIOS to activate the IDE compatibility. Once in place, Windows 2000 identified it properly.

The next step was installing the DVR software bundle. Most of the included software was intended to help consumers in burning video DVDs. For data purposes, the Prassi Primo DVD software is the familiar CD-R recording package included with many CD-Rs, but with DVD enhancements.



The simple, menu-driven system was so intuitive that no manual was needed to navigate basic operation. I was ready to burn a test disc in minutes.

The first experiment was with DVD-RW. Because DVD-R blanks are still relatively expensive (\$10), the rewritable seemed a safe bet. The first session went flawlessly. The system recorded 4 GB of data and the disc was ready to read.

Both the reading (and erasing) of the disc took just under an hour. (Incidentally, the stated 4.7 GB is

ers appeared.

The format wars raged over whether the DVD discs should be naked, like the CD, or enclosed in a protective case, like the MiniDisc.

Avoid scratches

The attraction of enclosed discs is durability. Anyone who has suffered trying to recover audio or data from a badly scratched CD knows that naked

discs are vulnerable. With CD-Rs it is even worse. Not only can scratches on the bottom degrade readability, but tearing the thin recording layer on top will destroy a disc.

With DVDs, the vulnerability issue is magnified because the data density — the amount of information in a given area on the disc — is nearly 10 times as great as it is on a CD. What seems a small scratch on a CD can be far more destructive on a DVD.

Despite the increased risk, it appears that the DVD recording format is destined to go the way of the CD and not the MiniDisc. The burgeoning home DVD market has decid-

Product Capsule: Pioneer DVR-A03

Thumbs Up

- ✓ Microphone amplification available
- ✓ Rugged, all-metal construction
- ✓ Versatile input and output gain adjustment controls
- ✓ Good noise and frequency response specifications
- ✓ Excellent manual and tutorial

Thumbs Down

- ✓ Still relatively high cost per MB

For more information contact Pioneer New Media Technologies in California at (310) 952-2111 or visit the Web site at www.pioneerprodj.com.

ed this. Recordable discs must be compatible with the players that are quickly replacing VCRs.

That being said, I did not find these discs to be particularly fragile. But it is worth remembering that scratches on a DVD could be costly.

Lots of room

With a little care to keep discs in the included jewel box for safekeeping, the discs should be just fine. Leaving them lying around the studio is not a good idea. But the same could be said for CD-Rs.

After my experiments with the DVR-A03, I can see how this could quickly obsolete the CD-R only market.

If past trends hold — and prices for both media and recorders drop — DVD-Rs will be ubiquitous within three years. The smaller CD discs will likely remain available for a long time; they are very cheap and will do for many smaller tasks.

The ability to store far larger archives, however, is attractive and will become nearly irresistible as demands for storage increases much as prices drop. ●

After my experiments with the DVR-A03, I can see how this could quickly obsolete the CD-R-only market.

The 2x DVD write speed is fast even by CD-R standards. A 16x CD-R is only recording at 2.4 MB/sec. Given the far greater data capacity, the need for such high speeds becomes obvious.

Installing the DVR-A03 was as easy and popping in any ATAPI CD-R. I tested it in an all-SCSI system so I had

actually about 4.4 GB.)

When I started working with DVD-R discs I was able to write at twice the speed. I experienced one failure that was later determined to be a problem with the operating system. After a fresh installation of Windows 2000, the drive performed flawlessly.

Given the fast burn speeds needed to save all that data, the lossless linking is crucial to avoid buffer underruns. Without this, the high data demands would undoubtedly challenge hard drives to keep up.

A few notes about the DVD format itself are worth mentioning.

The DVD recorder has been a long time in coming. For the past few years, there has been some confusion over the DVD format. Several competing standards offered by manufactur-

Get Focused.

24-bit Analog I/O • 24/96 Digital I/O
Balanced XLR Connections



"Sonically, the LynxONE is top quality. Easy install and crash free operation... offers I/O and sync options professionals expect. One could use this card for a big-buck master session or block-buster movie without any reservations."

- Pro Audio Review
April 2000

"It's extremely clean, very clear, and amazingly accurate. Rock solid with a wide range of programs."

-Recording Magazine
February 2000

"The LynxONE is an excellent mastering card in terms of sound quality and flexibility. Suitable for today's professional studio."

AUDIO QUALITY: 5 [out of 5]
-Electronic Musician
August 1995

◆ READER'S FORUM ◆

What Do You Think?

No one speaks their minds like Radio World readers.

Reader's Forum appears on the inside back page of every issue.

**RW NEWS
BYTES**

**Did you see
these
breaking
stories?**

**ARMA Cancels
Fall Event**

**Telos Upgrades
Zephyr Xstream
Software**

**Clear Channel
Exceeds Sales
Hiring Goal**

**Netia Browser
Gains New
Database**

**RAB Teaches
Wartime Selling**

**Get your daily
diet of**

NEWS BYTES

**by visiting
us on the
web every
business day.**

www.rwonline.com

**RW NEWS
BYTES**

from the editors of
Radio World

WABC

► Continued from page 49

also the voice of the Rush Limbaugh Show, which emanates from ABC's studios in New York.

In his spare time, Donovan is the voice of the Yankees, the Jets, ESPN's commercials and Radio Disney.

"The secret to longevity is to find something you can do to make yourself indispensable," Donovan said. "Don't wait for the official appointment. Just start doing things."

The copy he reads often comes from the word processors of others, but Donovan has the freedom to jazz it up. WABC no longer has professional copywriters on staff. "Now whoever has the advertising account writes the copy," Donovan said.

Radio sales is the one area in which Donovan never wanted to toil.

Spot choices

"Don't ever do anything once ... that you don't want to do forever," said Donovan. "But I handle the production for a lot of car dealers and other retail accounts."

Donovan believes the controversial nature of talk radio brings in a higher percentage of regional and local commercials. But would he ever voice a spot he did not believe in?

"It's my job to read the stuff the hosts don't want to read," Donovan said. "Once in a great while there is something so controversial that management doesn't want their station voice (me) to do it so they find some guy over at 'PLJ,'" he said, referring to sister station WPLJ(FM).

"It's my job to read everything they give me."

"Once someone here wrote a spot for a funeral home which began, 'If you or a loved one has recently died ...,'" laughed Donovan. "I used to save a reel of all the really dumb ones."

Donovan writes some humorous material on his own for Limbaugh.

"The spots are just put-ons, but we have fun with them," Donovan said. "We also work with a guy in Tennessee named Paul Shanklyn who is a great voice impersonator. We like to throw ideas around with him."

Donovan is paid by WABC and is additionally compensated for the work



Production Equipment at WABC

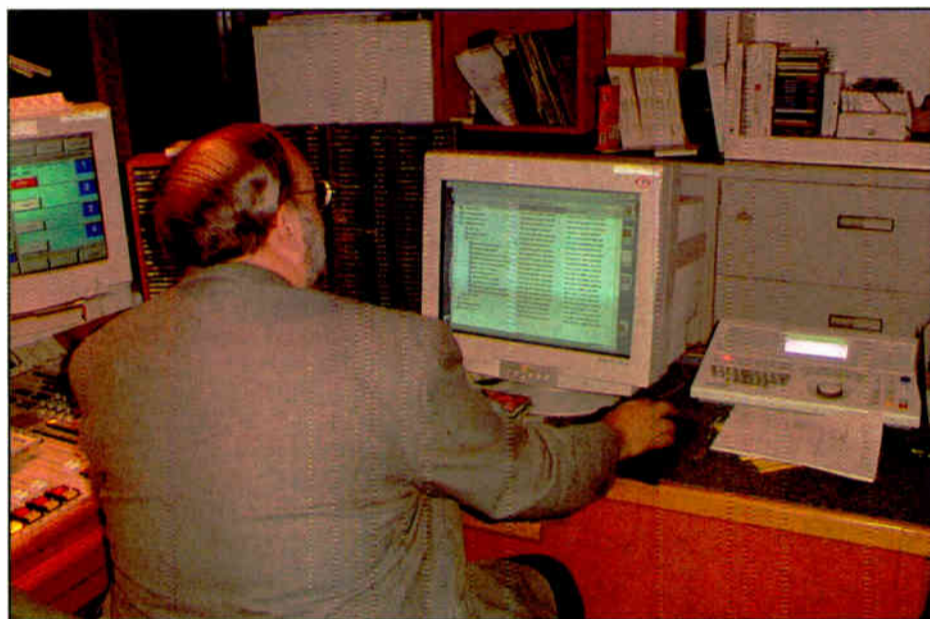

Johnny Donovan on Digidesign Pro Tools

he does for Limbaugh.

Another pearl of wisdom from the production director who has the job everyone wants:

"Don't ever do anything for free," said Donovan. "If you do, you are no longer a professional; you are an amateur."

On Sept. 11, 2001, music stations in New York scrambled to change their programming to accommodate the serious nature of the terrorist attacks.

But at WABC, it was not necessary to alter the format.

"We didn't dig out any patriotic tunes or anything that was clichéd," Donovan said. "We are a talk station and we didn't have to change one bit to cover this. Why should we take a break?"

Business as usual

Donovan said he just had to stay current, create some new sweepers and intros to reflect the events as they happened, but otherwise made no changes.

"We grabbed the best sound bites of the hosts talking about the events and built promos around them," Donovan said. "Why play a three-minute song when 60 seconds of our normal programming is better?"

Johnny Donovan is a hands-on sort of guy. He has been a member of NABET, the National Association of Broadcast Employees and Technicians union, since the late 1960s.

WABC uses a combination of digital and analog equipment to get their production on the air.

"I edit everything on Digidesign Pro Tools, which I love," Donovan said. "Once it's done, I dub it to a reel and walk it over to an engineer in another studio who loads it into the ENCO digital server."

WABC saves the analog tapes just in case something is lost in the computer.

See WABC, page 53 ►



The production room looks into the WABC talk studio.

WABC

► Continued from page 52

"After all, it's just AM," Donovan said.

Donovan has some definite ideas about how to construct promos for talk hosts.

"The one big mistake I see is that some production people write a promo, then try

to find sound bites to fill in the predetermined holes," Donovan said. "It's impossible. You should start with any (audio) content that has power to it, then write bridging material around it."

Donovan said most of the hosts on WABC are "walking sound-bite machines."

"In any 10 minutes they are on the air, you should be able to grab six to eight great bites with beginnings and endings," said Donovan. "The callers are pretty interesting, too."

For more information on the time when WABC was a top-40 station, go to <http://musicradio.computer.net>.

The current WABC site is www.wabcradio.com.

Ken R. is a former broadcaster who has a voice like Johnny Donovan. But only in his dreams. 🎧



The WABC Talk Studio

PRODUCT GUIDE

SeaPort USB I/O Cards Offer Many Uses

The SeaPort PIO 48 and SeaPort PIO 96 from Sealevel Systems provide 48 or 96 channels of buffered drive digital I/O for a variety of applications, including audio studio automation and satellite antenna control systems.

SeaPort is plug-and-play, so installation is simple, permitting users to add digital I/O applications to any USB-equipped PC.

The SeaPorts can be ordered with IDC or edge connector ribbon cables for direct connection to standard relay racks. Optional cable lengths are available.

Each port's mode is user selectable as inputs or outputs allowing the user to customize I/O combinations as needed.

Prices: SeaPort PIO 48 retails for \$319; SeaPort PIO 96 is \$359; optional cables are \$9.95 each.

For more information contact Sealevel Systems in South Carolina at (864) 843-4343; fax to (864) 843-3067; or visit www.sealevel.com.

Fostex Slim Power Monitor Fits in Rack

The Fostex RM-1 is a 1 RU stereo monitor panel designed for use in mobile and stationary control rooms or any application where monitoring space is tight.

The RM-1 is rugged, making it suitable for round-the-clock operation. The front panel's options allow audio output to be configured for the user's particular application. Dual concentric volume control adjusts the left or right inputs independently.

The front portion of the control adjusts the left channel and the rear portion adjusts the right channel input volume.

On the rear panel, two stereo left and right inputs, designated as input A and B, permit the user to monitor two stereo sources within the RM-1. The input combo connectors can take either balance XLR connectors or 1/4-inch TRS phone connectors. When using an unbalanced TRS-type connector, the RM-1 will sense this and adjust the input sensitivity accordingly.

The RM-1 is shielded to prevent interference. Frequency response is specified at 150 Hz to 20 kHz; sensitivity for the XLR input is rated at 82 dB SPL at 1 m (maximum volume). Price: \$599.

For more information, contact Fostex in California at (562) 921-1112; fax to (562) 802-1964; or visit www.fostex.com.

radio world

*** Sneak Preview ***

January 2002: For the first time in history, Radio World readers have the opportunity to weigh in with their collective opinions about the products that affect their daily lives.

Introducing

The 2002 Radio World Readers' Choice Awards & Sweepstakes



Look for your copy of **Radio World's 2002 Industry Source Book & Directory** during the first week of January. Inside you'll find a ballot that lists new radio broadcast products in 12 categories. Vote for your favorite product in each category.

After you cast your vote, your name is automatically entered in the Readers' Choice Sweepstakes and a chance to win one of 26 great products from our sponsors.

Watch for your copy of the **2002 Sourcebook & Directory** coming in January. Get ready to vote for your favorite products and win!

Products & Services SHOWCASE

Remote tools

Designed by broadcast engineers for broadcasters, our flexible line of remote access and control equipment gives you elegantly functional solutions to your control requirements without the need for "custom boxes".



DC-8A Dial-Up Remote Control

Controls and monitors 8 external devices from any touch-tone telephone with extremely flexible programmable features.



PSC Programmable Schedule Controller

Stores and controls up to 160 events with Hour/Minutes/Seconds, Day/Month/Year, or Day of Week with Daylight Savings Time correction. 20 SPST relays and/or 32 serial custom commands provided.



MSO-8 Control Panel

Provides a convenient way to add front panel control to our smaller profile products with eight LED-indicator-equipped switches.



SRC-1616L Serial Remote Control

Equipped with 16 opto-isolated and CMOS/TTL compatible inputs and 16-Relay (Form C) outputs that may be controlled from a host computer, or a pair of units can be used in a stand-alone configuration (relay extension cord).



MC-16 Telephone Hybrid/Coupler

Full featured telephone line coupler/hybrid provides 32 programs; 32 ASCII strings (DTMF to ASCII); 64 macros; 16 relays; auto answer; 4-digit access codes and much more.



BOS, ROS & PBB-24 Switch Panels

The BOS offers 12 N.O. dry contact switches with status LEDs in a desktop panel. The ROS is similar, but in a single-space rack unit. The PBB-24 provides 24 momentary buttons that can be programmed to output ASCII character strings.



SRC-8 Serial Remote Control

The SRC-8 provides a means of adding 8 channels of remote control to RF, wireline and fiber type STL systems and may also be used with dedicated modems (full & half duplex models).



SSM Smart Silence Monitor

Monitors any stereo or two independent monaural sources and generates alarms indicating loss of carrier when white noise and/or silence is detected.



UI-4II Universal Interface

Perfect for adding logic functions to mechanical switches/relays, adding remote functions to transmitter control/logic, detecting phone line "ring", etc.

Check out our web site for product information, list pricing and a list of distributors!

Internet: www.broadcasttools.com E-mail: bt@broadcasttools.com

Voice: 360 . 854 . 9559
Fax: 360 . 854 . 9479

**BROADCAST
tools inc.**
Innovative Problem Solving Tool For Broadcast

THE MOST COMPLETE FM TEST SET AVAILABLE AND IT'S A GREAT MOD MONITOR TOO!

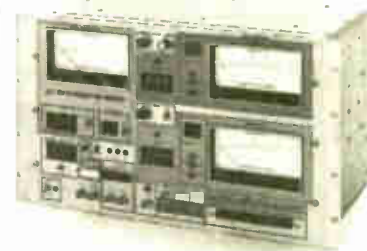

- Complete proof of performance instrument
- Frequency agile
- Converts standard X-Y scope into a spectrum analyzer

The QEI Model 691 Modulation Monitor and Test Package is a high technology precision instrument that set a new standard for FM performance measurement tools. We also manufacture a very comprehensive FM transmitter line. Contact QEI today and let us put our innovations to work for your station. Contact our sales department at 800-334-9154 (International 856-728-2020) or by e-mail at qeisales@qei-broadcast.com.

<http://www.qei-broadcast.com>



QEI CORPORATION
PO Box 805
Williamstown NJ 08094 USA
800-334-9154/856-728-2020
856-629-1751 Fax

THE COST EFFECTIVE ALTERNATIVE TO MANUFACTURER SERVICE

SERVICE, REPAIR & CALIBRATION

- STL's • RPU's • TSL's
- Exciters • Optimods
- AM/FM Monitors
- Remote Control Systems

SPECIALIZING IN EQUIPMENT BY

- Belar • Marti
- Moseley
- McMartin
- TFT
- And others...

WE ALSO PROVIDE

Free, over-the-phone technical assistance
STL loaner/rentals
PCL 505 Certification



2198 Hubbard Lane, Grants Pass, OR 97527

(541) 471-2262

ENCORE SERIES™ HDA400 and HDA600 Stereo Headphone Amplifiers

Complete monitoring solutions for Interview Studios, Broadcast Remotes, Production Rooms, Learning Centers, Live Sound and Recording Studios.

HDA400 Basic 1X4 with front and rear headphone program outputs.

HDA600 Full featured 1X6 includes program, cue and direct channel inputs.

FEATURES:

- Drives most 32 to 600 ohm phones over 120dB SPL
- Master Program inputs
Balanced TRS and XLR*
- Master Mono/Stereo switch and Level control
- Cue* Mic or Line Balanced TRS and XLR input
- Cue Send* Left/Right/Both channel selector
- Direct* inputs, unbalanced stereo or balanced mono
- Signal Present* and Input Overdrive indicators
- Internal 115/230VAC power supply
- * HDA600 only



<http://www.atiguys.com>
Call or write for detailed brochure

328 W. Maple Ave. • Horsham, PA 19044
(800) 959-0307 • (215) 443-0330 • FAX (215) 443-0394

AT AUDIO
TECHNOLOGIES
INCORPORATED

CUSTOM CABINETRY & PREWIRED SYSTEMS

BUILDING STUDIOS FOR OVER 34 YEARS



Q101
CHICAGO



RAM BROADCAST SYSTEMS, INC.

www.ramsyscom.com PHONE: 800-779-7575 FAX: 847-487-2440

◆ PRODUCT GUIDE ◆

Products for Radio Air & Production Studios

Mail info and photos to: RW Product Guide, P.O. Box 1214, Falls Church, VA 22041

Harris Digital Console Line Grows

The Harris Pacific Legacy console is a modular console available in three sizes: 14-, 22- or 30-input modules.

The Legacy's A and B inputs accommodate analog and digital sources without switching cards or reconfiguring the system. It features hot-swappable panel modules for easy console configuration and maintenance.

The console also has digital and analog outputs for four program buses, a stereo send and a telco record mix bus; off-line and mix-minus outputs for up to four telco/codec input modules and a stereo cue with automatic metering.

A suite of opto-isolated control logic is also standard. The Legacy has a low-profile, countertop drop-through design.

Price: \$13,000 to \$35,000.

For more information, contact Harris in Ohio at (858) 569-7178 or visit the Web site at www.harris.com.



Harris Pacific Legacy Demo at The NAB Radio Show

SonicCase Pro, Compact But Roomy

The three-shelf design of the Sonic Sense SonicCase Pro lets it accommodate a full-size portable DAT recorder, batteries and accessories.

The case has a weather-resistant enclosure and its double layers of 1000 denier Cordura, lined with 1/4-inch padding, stands up to field use.

Like Sonic Sense's larger cases, the SonicCase Pro has easy-access openings to facilitate charging, changing connectors and other adjustments without unpacking.

A plastic window allows components to remain visible, yet protected from the elements.

Price: \$159.

Sonic Sense cases are distributed by CTC Audio.

For more information on the Sonic Sense Sonic Case Pro, contact the company in Colorado at (877) 324-4463, (303) 753-0201, or visit the company Web site at www.sonic-sense.com.



Pulsar Music Production Family Grows

Creamware released an addition to the Pulsar family of music production systems for PC and Mac.

The PowerPulsar 15 SHARC DSP can be used in music creation for radio production. With 15 32-bit SHARC DSP chips, PowerPulsar is touted as a powerful audio board with significant processing speed.

The unit is available in four I/O versions, offering from 20 to 28 audio inputs and outputs in combinations of analog, S/PDIF, AES/EBU, ADAT and Z-link formats.

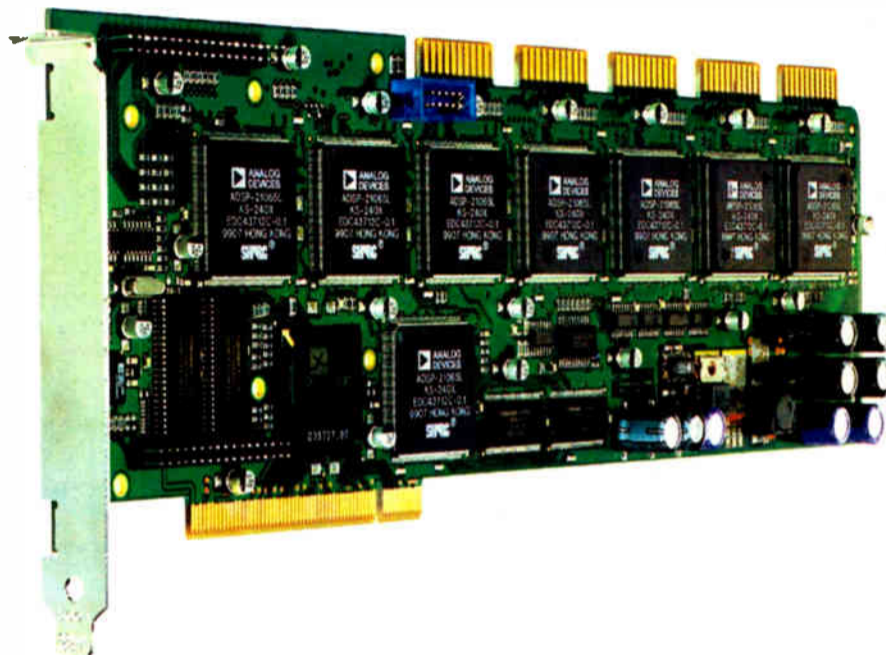

With Version 3 software, the unit features a professional 24/48 channel mixing console for internal and external sound sources, more than 60 high-quality DSP effects (including MasterVerb reverb), the STS-3000 studio sampler and a collection of new synths based on virtual analog, FM, wavetable and vector synthesis.

Price: \$2,255 to \$2,345.

For more information visit www.creamware.de or call the North American office in Barnaby, B.C. Canada at (604) 435-0540 or fax: (604) 435-9937.

The Wizard™ has gone STEREO!

The new DIGITAL FMSA-1 gives The Wizard System unmatched stereo monitoring capabilities. . .



Superlative stereo performance. Linear-phase filters that reveal the true performance of your audio processing. The stability of digital stereo demodulation. The sophisticated graphical presentation of The Wizard. And—with the RS-232 port—operation on site or off.

Contact Belar today for more details on what should be your next modulation monitor



BELAR ELECTRONICS LABORATORY, INC.
119 LANCASTER AVENUE • P.O. BOX 76 • DEVON, PA 18333-0076 USA
(610) 687-5550 • FAX (610) 687-2686

Call, write or FAX for more information on Belar AM, FM, Stereo, SCA, and TV monitors.

www.belar.com

Products & Services SHOWCASE

Eliminate Lightning

15 Years
of Success



The **Gila-Stat** is designed to reduce lightning damage by lowering the likelihood of a direct lightning strike to:

- Buildings
- Communication Towers
- Electric Utility Substations
- Industrial Facilities

nott ltd.

3801 La Plata Hwy
Farmington, NM 87401
phone 505-327-5646 fax 505-325-1142
800-443-0966

Import/Export .wav Anywhere On Your Network.

VoxPro™



**World's Quickest,
Easiest Phone Editor**

206.842.5202 www.audionlabs.com

TERACOM COMPONENTS

The Employees of Teracom Components would like to express our condolences to all of the American People who suffered as a result of the attacks of September 11th and its aftermath. We were stunned and devastated by the acts of terror in New York, Washington DC, and Pennsylvania.

While these actions were committed within the United States, we consider them crimes against all of Humanity.

All of us at Teracom Components share your pain and anguish and stand united with you.

For Further Information, Please Contact
Tel: 1-207-627-7474 Fax: 1-207-727-7473
E-mail: larry.boone@teracom-c.com
Web: www.teracom-c.com

Filters, Combiners, RF Components, Antenna Systems

AM ANTENNA SYSTEMS

**Antenna Tuning Units
Transmitter Combiners
Folded Unipole Antennas
Diplexers, Triplexers
RF Components**

LBA antenna systems will improve your efficiency, performance and reliability. Our products are designed and built to international standards. Call LBA Technology for RF systems and excellent technical service.

800-522-4464 / 252-757-0279
Fax 252-752-9715
Email: lbatech@lbagroup.com
or Contact Our Representatives Worldwide

LBA Technology, Inc.
P.O. Box 8026, Greenville, NC 27835 USA
35 YEARS OF WORLDWIDE
ENGINEERING SERVICES
An LBA Group Company



The RF People

Silicon Valley POWER AMPLIFIERS

Our growing product line
SATISFACTION GUARANTEED !!

B-150A
up to 185w
B-300A
up to 330w

B-450
up to 500w
B-600
up to 630w

10/1000
10 watts in, 1000w out

B-850
up to 930w
B-1000
up to 1200w

B-1500
up to 1750w
B-2000
up to 2.2kw

10/3000
10 watts in, 3kw out



Phone:- (408) 986 9700

e-mail:- sales@svpa.com

Fax:- (408) 986 1438

Website:- www.svpa.com

THE #1 CHOICE!

- Eliminate flanging (hollow room) effect
- Eliminate bad room acoustics
- Hold absolute levels
- Correct voice symmetry

AIRcorp 500PH Microphone Processor



- Front panel input level select +4 to -50 dB
- Three section variable boost and cut equalization
- Compressor/Expander cross coupled for maximum punch
- Built-in earphone jack

- DE-ESSER designed to protect pre-emphasis curves
- Simultaneous mic level and line level outputs
- Internal 48 Vdc Phantom Supply

AIR corp

Call your dealer

or call 972-304-0455 or fax: 972-304-0550



American Radio Manufacturers Association

**The ARMA Expo which
was to be held on
November 15th & 16th at
the Boston Marriott-
Burlington, MA has been**

CANCELLED

Iasys

► Continued from page 49

into the things that affect sound, rather than things that have historically been easy to measure.

This is what the AudioControl Industrial Iasys — pronounced “I assist,” without the T — sets out to achieve: insightful measurement leading to sound system improvements that do not require a degree in signal processing to comprehend.

The question is, does Iasys succeed at this?

The first use of Iasys is to aid with adjustment of crossover frequencies and relative levels between devices. The process involves mounting the loudspeaker system into its installation position in the building, then starting the “crossover” test.

A few simple rules

As with all procedures employing Iasys, the instrument follows an automatic process of data collection with the operator bound by a few simple rules. Iasys analysis begins with the measurement of background noise and the setting of test levels in order to achieve a minimum 18 dB signal-to-noise ratio, ensuring accuracy of other measured results.

The next step is measurement of the useful bandwidth of each device, along with its “energy center” — a frequency near the middle of the pass-band. The user is prompted to store each result.

Once Iasys has measured more than one device in a multiway system, it offers a recommended crossover frequency and instructs the user to start a further test to adjust the levels.

It is possible to intervene here and manually alter the recommended crossover frequency before proceeding.

In this review, a home audio system consisting of JBL Control 5 Plus full-range monitors and a JBL Control SB-5 subwoofer was evaluated, receiving a recommended crossover of 236 Hz, almost exactly matching the JBL crossover setting.

For the next stage, Iasys indicates the various passbands and their relative amplitudes, allowing adjustment of crossover band levels.

Crossover setup makes no recommendations about filter shape or slope

rate, only frequency and amplitude. The user can, however, select alternative filters and note the overall results each introduces.

The next suggested step is delay/polarity adjustment to aid in ensuring that loudspeaker system elements are mounted and delayed correctly prior to equalization.

Iasys initially measures the rough delay between the loudspeaker and microphone using a short pulse, and then fine-tunes this with proprietary measurements of the noise signal.

If the delay measurement follows previous measurements of the same device, then, within about one minute, delay time, estimated distance and absolute polarity at the “energy center” frequency of the device are indicated.

acoustic absorber near the microphone can be used to see what changes occur when some possible reflection paths are blocked.

So, in short, coherence can be of help in tuning sound systems, but users interpreting impulse response-based measurements will probably continue to find those measurements more useful.

Combining results

The next step is usually the Iasys “equalizable spectra” test, which combines the results of the frequency response and coherence measurements to indicate approximate recommended band amplitude adjustments and to show frequencies that can and cannot be safely improved with an equalizer.



The AudioControl Industrial Iasys

The instrument then suggests a “coherence” test, used to indicate acoustic cancellations in the loudspeaker system and its interaction with the room.

The coherence test repeats continuously, taking approximately 30 seconds per sweep. This allows adjustments to be made to levels, delays and/or physical device relationships to optimize the overall result.

Unlike the acoustical measurement systems TEF, DRA Labs’ MLSSA or JBL Smaart, however, it is impossible to distinguish between effects caused by device alignment and those caused by reflections, as there is no visible time response.

The familiar method of waving an

example, if a signal null is likely to have been caused by interference effects between devices or between a device and an acoustic reflection, then trying to equalize this will have little effect other than stressing the loudspeaker and amplifier.

Iasys attempts to single these effects out and warns to leave them alone.

Another useful test is called simply “limiter.”

Limiters are often placed just before the power amplifier to protect the loudspeaker drivers and/or amplifiers from overdrive conditions, often with haphazard settings.

Iasys tries to overcome this by detecting power compression by track-

Product Capsule:
AudioControl Industrial Iasys

Thumbs Up

- ✓ Extensive menu of useful audio measurement tools
- ✓ ‘Dead simple’ to use
- ✓ Automated collection of all data

Thumbs Down

- ✓ External power conversion needed for 230 V operation
- ✓ Parallel one-third octave real-time display not possible

For more information from AudioControl Industrial, contact the company in Washington state at (425) 775-8461, fax (425) 778-3166 or visit www.audiocontrolindustrial.com

ing the relationship between the output drive level and the change in measured sound pressure, simultaneously monitoring the amplifier output to detect possible clipping conditions.

A limiter can then be inserted and the test repeated to confirm a suitable setting. Having by now built-up confidence in Iasys, the home audio system was used to confirm the successful safe operation of this function.

Simplifies speaker setup

Finally, Iasys provides a useful indication of RT60 reverberation time and the overall sound pressure level, but not a conventional parallel one-third-octave real-time display.

For those who work in both 115 V and 230 V environments, two Iasys units (or a power transform) will be needed, because external voltage selection is not provided.

Iasys is designed to simplify the setup and equalization of loudspeaker systems. It recommended the same settings for a simple three-way home music system as those provided the manufacturer.

For installers who find the use of TEF, MLSSA or Smaart a little bit daunting, Iasys can help optimize sound system settings. It also has the advantage of coming as a rugged self-contained instrument including measurement microphone and soft carrying case.

Sam Wise is a venue technology consultant with Arup Acoustics, based on Isle of Wight, England.



AEQ eagle
ISDN AUDIO CODEC

THE AFFORDABLE POWER

ONLY!
\$ 2,795
manufacturer's price



Dual channel audiocodec.
Analogue and Digital Inputs / Outputs.
Unique multiplexing capabilities.
The E@sy control Bus features IP Remote Control capability.
Offers easy to use monitoring capability on the front panel.

AEQ Broadcast International Inc. 2660 S.W. 87 Avenue Davie. Fort Lauderdale. Florida 33328
Phone: (954) 424-0203 Fax: (954) 424-0902 email: aeqamerica@aol.com
VISIT US AT: www.aeqbroadcast.com

World Radio History

BROADCAST

Equipment Exchange

"Broadcast Equipment Exchange" accepts no responsibility for the condition of the equipment listed or for the specifics of transactions made between buyers and sellers.

ACOUSTICS

Want to Sell



Full product line for sound control & noise elimination.
www.acousticsfirst.com

AMPLIFIERS

Want to Buy

RCA, Altec tube amplifiers & mixers in any condition, working or not. Larry Drago, WELI, POB 85, New Haven CT 06501. 203-230-5255.

ANTENNAS/ TOWERS/CABLES

Want to Sell

Dielectric 3-5/8" motorized four port coaxial switch. Continental Communications, 314-664-4497. Email: contcomm@fiast.net.

Andrew 1-5/8" air dielectric transmission cable, 200', \$400. K Diebel, KHMB, 1707 Louisa St, Rayville LA 71269. 318-728-2370.

**GUNION'S
TOWER
PAINTING**
320-764-2572

Cablewave 3 bay FM medium power, 92.1 mHz, \$1500. K Diebel, KHMB, 1707 Louisa St, Rayville LA 71269. 318-728-2370.

CCA 10 bay antenna. Worked when removed from service in 301. Currently on ground, tuned to 99.1 mHz, \$10,000/BO. Tommy Jenkins, Encore Broadcasting, 3303 N Midkiff, #115, Midland TX 79706. 915-520-9912.



ICE KRACKERS, INC.
Inexpensive permanent protection of guy wire anchor hardware from guy wire ice slides. Average cost \$400 for 400' foot tower. ICE KRACKERS sized by guy wire diameter. All sizes available.
273 Circle Drive, Springfield, IL 62703
(800) 747-8921
Ask for Jim Newbanks

ERI 6 bay FM antenna, 92.1 mHz, medium power, \$1000. K Diebel, KHMB, 1707 Louisa St, Rayville LA 71269. 318-728-2370.

Rohn CC 24" face tower. (17) twenty foot sections (340'), includes beacon, sidelights, guy pull-offs, other hardware. Carlton Veirs, WTBG, POB 198, Brownsville TN 38012. 731-772-3700, 8AM to 5PM Central.

AM Ground Systems

Reliable, On-time Installation
Quality Workmanship
Ground System Evaluation
and Repair
www.amgroundsystems.com
1-877-766-2999

LPFM ANTENNAS

\$95!

3db gain single bay
fmbroadcasters.com

AUDIO PRODUCTION

Want to Sell

Digigram cards: (2) PCX80 1 rec/4 play; (2) PCX9 PB only; (5) PCX5 R/P; (4) PCX5 PB only; (1) PCX5 R/P (need repair); (3) PCX5 PB only (need repair). Price includes all audio cards, cable with XLR connectors, lightning arrestors, instructions & pin out sheets for both digital & analog set-up, \$5000/all. David Leeds, New Media Bdctrs, PO Box 7000, Havre MT 59501. 406-265-7841 or email: leeds@imine.net.

Gentner 10, 10 chnl stereo switcher for analog audio, \$300 +shpg. Joe Barker, Trans World Radio, 14411 Commerce Way #250, Miami Lakes FL 33016. 305-828-4237.

AUDIO RESTORATION

We bake squeaky tapes, remove hiss, hum and background noise and remaster old airchecks, jingles or production onto CD. Visit www.kenr.com for a demo. Bring old tapes back to life!

KenR

AUTOMATION EQUIPMENT

Want to Sell

Prophet XP5, Antex cards, Wizard editor, D.R.R., excellent unit for satellite interface. Mitchell Johnson, Johnson Comm, 501-756-9933.

Enco DAD 32 system w/server, production workstation & on-air workstation which is touchscreen. Tommy Jenkins, Encore Broadcasting, 3303 N Midkiff, #115, Midland TX 79706. 915-520-9912.

CART MACHINES

Want to Sell

AudioCord DL players (3) in excellent condition, \$250 each. Richard Plessinger, Oyster Radio, 35 Island Dr, #16, Eastpoint FL 32328-3264. 850-670-8450.

Audiocord DLPM single play cart player, \$450. Mark Larsen, KBQR, Box 20335, Piedmont CA 94620. 510-465-6035.

Fidelipac CTR 123, like new stereo record & play, top of the line, has only 100 hours use, \$490/BO. Jeff Ostler, TRAX/KTKK Radio, 2470 North Fairfield Rd, Layton UT 84041. 801-771-1820.

CD PLAYERS

Want to Sell

Audiometrics CD-10 professional CD players (2), one needs repairs, \$800. George Arroyo, WQNO, 1033 Semoran Blvd #253, Casselberry FL 32707. 407-830-0800 ext 110.

COMPLETE FACILITIES

NEW OR USED
COMPLETE PACKAGES

STUDIO/STL/TRANSMITTER/ANTENNA OR ANY COMBINATION OF ABOVE.
-LEASE OPTIONS-
-EMERGENCY RENTALS-
-REMOTE BROADCAST RENTALS-

SCMS, Inc. (800) 438-6040
"You Know We Know Radio"

CONSOLES

Want to Sell

Harris Stereo 80 8 mixer stereo console, \$850 +shpg. Joseph Bahr, Islands FM, Box 6556, San Juan PR 00914. 787-728-0364.

Autogram IC-10, stereo, good condition, \$1000. Andrew, KRKO, 425-304-1381 ext 102 or Andrew.skotdal@krko.com.

Electro-Voice EVT-5212 Tapco mixer, stereo 12 channel, like new, \$350 +shpg. Gene Whittenberger, Whittenberger Studio, POB 396, Mexico IN 46958. 765-985-2224.

Harris Medalist-8, removed from service 10/01. Power supply & manual. Will deliver within 150 miles, \$500/BO. Chuck Crouse, WLMI, 27 Fraley St, Kane PA 16735-0868. 814-837-9711.

Shure M267, 4 channel mixer, \$325. Mark Larsen, KBQR, Box 20335, Piedmont CA 94620. 510-465-6035.

TOA RX-5-16, 16 channel stereo mixer, like new, \$375 +shpg. Gene Whittenberger, Whittenberger Studio, POB 396, Mexico IN 46958. 765-985-2224.

Want to Buy

Looking for good, used stereo console. 10-18 channels, 20+ inputs. Prefer sliders. Call Randy Norris, WXTQ-FM, 300 Columbus Rd, Athens OH 45701. 740-593-6651 or email: randy@wxtq.com.

Western Electric 25A. Paying up to \$7500 for this console & always buying WE mics, tubes, catalogs & turntables. Larry Drago, WELI, POB 85, New Haven CT 06501. 203-230-5255.

LIMITERS/ AUDIO PROCESSING

Want to Sell

Orban 8000-A audio processor, \$1500 +shpg. Joseph Bahr, Islands FM, Box 6556, San Juan PR 00914. 787-728-0364.

Orban XT-2. Joseph Bahr, Islands FM, Box 6556, San Juan PR 00914. 787-728-0364.

Alesis MEQ-230, 30 band EQ, like new, \$175 +shpg. Gene Whittenberger, Whittenberger Studio, POB 396, Mexico IN 46958. 765-985-2224.

Want to Buy

Teletronix LA-2A's, UREI LA-3A's & LA-4's, Fairchild 660's & 670's, any Pultec EQ's & any other old tube compressor/limiters, call after 3PM CST, 972-271-7625.

**Broadcast
Equipment
Exchange**

For more information, call Simone at 703-998-7600, ext. 154.

Radio World

MICROPHONES

Want to Sell

Audio Technica AT9400 uni/stereo condenser mic, \$175. Mark Larsen, KBQR, Box 20335, Piedmont CA 94620. 510-465-6035.

Sennheizer 441 in box with papers, \$300. Will Dougherty, WLD, Music Valley, Rt 1, Box 1548, Mill Spring MO 63952. 573-998-2681.

Shure headset mic condenser with case, cables, \$120. Mark Larsen, KBQR, Box 20335, Piedmont CA 94620. 510-465-6035.

Want to Buy

RCA 77-DX, 44-BX, KU-3A's, WE-639's, On-Air & recording lights wanted, top dollar paid! 615-352-3456, FAX: 615-352-1922. E-mail: billbryantmgmt@yahoo.com.

RCA 77-DX's & 44-BX's, any other RCA ribbon mics, on-air lights, call after 3PM CST, 972-271-7625.

Altec 639B, cage beat up, but sounds great. Would like to swap for RCA Junior Velocity in good condition. Rudy Paolangel, RP Media, 324 South Geneva St, Ithaca NY 14850. 607-273-5773.

RCA 77DX/44BX. Will pay \$1000 for these mics. Call anytime. Larry Drago, WELI, POB 85, New Haven CT 06501. 203-230-5255.

MISCELLANEOUS

Want to Sell

ROTRON BLOWERS AND PLATE BLOWERS, new & rebuilt for Elcom, Harris, CCA, CSI, McMartin. Goodrich Ent. 11435 Manderson St. Omaha, NE 68164 402 493 1886 FAX 402 493 6821

SCA RADIOS for sale. Any Quantity. Call: 212-244-1140.

Comrex Hot Line, good condition and Comrex Hot Rack, like new, \$2600/both. Andrew, KRKO, 425-304-1381 ext 102 or Andrew.skotdal@krko.com.

BAY COUNTRY BROADCAST EQUIPMENT

BUY - SELL - TRADE
Your #1 Source For
Quality Used Radio
Broadcast Equipment

View The Latest List On Line At:
<http://www.baycountry.com> Or
Call And We Will Fax It To You.

7117 Olivia Rd., Baltimore MD 21220
Toll Free: 877-722-1031
FAX 786-513-0812
E-mail: info@baycountry.com
Member of BBB

Comrex Nexus Units (2), scratched cases, perfect operation, \$1175 each. Andrew, KRKO, 425-304-1381 ext 102 or Andrew.skotdal@krko.com.

Two boxes (19 total) or new motors. Oriental motor, Japan S-301 motors, 7.5W 115V 1500/1800 rpm, \$30/all. Will Dougherty, WLD, Music Valley, Rt 1, Box 1548, Mill Spring MO 63952. 573-998-2681.

RF CONTACTORS MICA CAPACITORS

(IN CANADA ONLY)

USED AM XMTRS

FROM

GELECO

416-421-5631

FAX: 416-421-3880

Want to Buy

Gates catalogs, any old radio catalogs, older than number 96. Leave phone number. Jeff Glass, 815-784-5219.

RCA on-air lights in any condition, working or not, will pay best prices for them. Larry Drago, WELI, POB 85, New Haven CT 06501. 203-230-5255.

Old Audio Engineering magazines prior to 1953. Mike Stosich, Esoteric Sound, 4813 Wallbank Ave, Downers Grove IL 60515. 630-960-9137.

MONITORS

Want to Sell

Used Mod Monitors, McMartin & Belar. Many to choose from, tuned & calibrated on your frequency, full guaranteed. Goodrich Ent. 402-493-1886.

RECEIVERS/ TRANSCIVERS

Want to Sell

EAS receiver, brand new condition, \$1000. K Diebel, KHMB, 1707 Louisa St, Rayville LA 71269. 318-728-2370.

Fairchild Dart 384 with DATS & SE DATS with cards & down converter (2), like new, \$800 each. Richard Plessinger, Oyster Radio, 35 Island Dr, #16, Eastpoint FL 32328-3264. 850-670-8450.

Broadcast Tools DSC-20 channel changers for Starguide, never unwrapped, \$125 ea. Andrew, KRKO, 425-304-1381 ext 102 or Andrew.skotdal@krko.com.

Broadcast Tools PSC/B to change DSC-20 for Starguide, never unwrapped, \$195 ea. Andrew, KRKO, 425-304-1381 ext 102 or Andrew.skotdal@krko.com.

Broadcast Tools UI-4II adds logic or remote functions to equipment, never unwrapped, \$65 ea. Andrew, KRKO, 425-304-1381 ext 102 or Andrew.skotdal@krko.com.

ATTENTION MANUFACTURERS & DISTRIBUTORS

HURRY! Don't get left out!
Of our "2002 Directory Sourcebook" of course!

IT'S FREE!

If you haven't already submitted your
FREE LISTING FORM yet then
you better hurry!

You can do it easily online! Just go to:
www.imaspub.com/rwsourcebook.html

Various advertising opportunities are also
available in the Sourcebook. For more
information on advertising call Simone at
703-998-7600 ext 154 or
email your requests

to: smullins@imaspub.com
But hurry! Time is running out!
The deadline is quickly approaching!

Broadcast Tools USC-16 universal satellite channel controller, never unwrapped, \$150. Andrew, KRKO, 425-304-1381 ext 102 or Andrew.skotdal@krko.com

Vertex FTH-7008 (4), 16 channel, 5 watt radio with IVC 29 charger, can program UHF, \$75 each. Peter Russell, Bowdoin College, Sills Hall, Brunswick ME 04011. 207-725-3066.

Vertex VX-200, 6 channel UHF 450-470 chargers (2), 5 watt handheld, can program, \$75 each. Peter Russell, Bowdoin College, Sills Hall, Brunswick ME 04011. 207-725-3066.

RECORDERS

Want to Sell

Revox PR 99 2 track (1/2 track) low hours. \$695; Tascam 34B 4 track (1/4 track) w/remote, low hours, \$995. Rack mount ears on both, neither used in broadcast service. Bill Borrelli, Costa-Eagle Radio, 462 Merrimack St, Methuen MA 01844. 978-686-9966 x 41.

Otari MX5050 BII, very good condition, \$850; MX5050 BII, good condition, \$650. Andrew, KRKO, 425-304-1381 ext 102 or Andrew.skotdal@krko.com

Tanberg 15-21 Series 15 reels (2), uses 7" reels, like new, but needs belt, \$50/both. Will Dougherty, WLD, Music Valley, Rt 1, Box 1548, Mill Spring MO 63952. 573-998-2681.

Tascam ATR60-2T, top of the line 2 track with center track time code, like new, only 200 hours use, \$1990. Jeff Ostler, TRAX/KTKK Radio, 2470 North Fairfield Rd, Layton UT 84041. 801-771-1820.

Buying or selling used Equipment?
You're in the right place!
To advertise call
703-998-7600, ext. 154.

REMOTE & MICROWAVE
Want to Sell

REMOTE EQUIPMENT RENTAL
Silver Lake Audio
(516) 763-1776
silverlakeaudio.com

Burk TC-8, 8 channel remote control, no relay panel, \$1000 +shpg. Joseph Bahr, Islands FM, Box 6556, San Juan PR 00914. 787-728-0364.

Moseley PCL/505/C STL XTR on 950.00 MHz, BO. Joseph Bahr, Islands FM, Box 6556, San Juan PR 00914. 787-728-0364.

OFF THE AIR?
Emergency Back-up Rentals
FM Exciters - STLs -
FM Pwr Amps - Antennas -
Studio & Test Equipment
SCMS Inc (800) 438-6040
"You Know We Know Radio"

Comrex LX-7 frequency extender/encoder, \$200. Mark Larsen, KBQR, Box 20335, Piedmont CA 94620. 510-465-6035.

Symetrix TI-104 telephone interface, 4 lines, 2 consoles, \$500. George Arroyo, WQNO, 1033 Semoran Blvd #253, Casselberry FL 32707. 407-830-0800 ext 110.

SATELLITE EQUIPMENT
Want to Sell

Comstream CM701 satellite modems (2), \$3500 +shpg each. Joe Barker, Trans World Radio, 14411 Commerce Way #250, Miami Lakes FL 33016. 305-828-4237.

Comstream CX801 modem protection switch includes support for automatic failure of modems & codec's, \$3000 +shpg. Joe Barker, Trans World Radio, 14411 Commerce Way #250, Miami Lakes FL 33016. 305-828-4237.

Comstream Uplink rack, sturdy equip rack with power dist & wiring for codec's, ABR's, modems, etc., \$2000 +shpg. Joe Barker, Trans World Radio, 14411 Commerce Way #250, Miami Lakes FL 33016. 305-828-4237.

PCSI CS8000 satellite voice/data multiplexer, \$3000 + shpg. Joe Barker, Trans World Radio, 14411 Commerce Way #250, Miami Lakes FL 33016. 305-828-4237.

SSE transceiver, 10 watt, C-Band transceivers (2), \$2500 each +shpg. Joe Barker, Trans World Radio, 14411 Commerce Way #250, Miami Lakes FL 33016. 305-828-4237.

Wegener DR-96 satellite receivers (2), very little use, \$1000/both. K Diebel, KHMB, 1707 Louisa St, Rayville LA 71269. 318-728-2370.

STATIONS
Want to Sell

DUE TO DEATH OF OUR FATHER, TWO GREAT RADIO STATIONS FOR SALE: North East California, great hunting and fishing, 5000 watt AM 570, Class C FM 100,000 watt, \$250,000 or Best Offer, highly motivated! Phone 530-233-3570.

AM, FULLTIME, FAMOUS FLORIDA RESORT. CHEAP! JOINT VENTURE. (478) 741-1710. wrecktech@yahoo.com.

SELLING OR BUYING....visit: www.broadcaststations4sale.com. We are now accepting new listings. We make it easy to sell your radio station.



TAPES/CARTS/ REELS/CD's

Want to Buy

10.5" music reels, Drake Chenault, Con Tempo 300, Library reels, 1979-1990, also seasonal reels & cue sheets. Chuck Raub, 570-434-2782.

Marantz PMD-221 that are non-working, physically complete preferred, but basket cases will be considered. Leave message. Jeff Glass, 815-784-5219.

TEST EQUIPMENT

Want to Sell

Ampex 300E vacuum tube voltmeter, \$30; Beta Scope non destructive thickness gauge, \$30; (4) HP 400D vacuum tube voltmeters, \$40/all; NRI 12 vacuum tube voltmeter, \$25; HP 400L vacuum tube voltmeter, \$20; Sierra Electronics scope in metal box, \$20; Standard electrical products Type LR-5 Adjust-A-Volt variable transformer, cable cut, \$20; Supreme 574 electronic set tester in case w/manual, \$40; Motorola TA-42 input & output terminals, T&R 2-25 amp fuses, 1-15 amp fuse, \$30. Will Dougherty, WLD, Music Valley, Rt 1, Box 1548, Mill Spring MO 63952. 573-998-2681.

Want to Buy

Field intensity meters, any make, any model, any condition. Gary Keener, KBNU/KBLT, 5150 Broadway, #601, San Antonio TX 78209. 210-828-4555.

Midwest Digital Services Inc. Professional Audio/Video Service

Authorized Service: Sony, Panasonic, Tascam
Repairs for Denon
Sales: Sony, Tascam, Nagra

Specialists in DAT, DTRS, CD, Betacam, DVCpro & Dvcam

12859 S. Harlem Ave., Palos Heights, IL 60463
800-809-3309; 708-448-7539; Fax 708-448-7678
midwestdigital@compuserve.com
midwestdigitalservices.com

CONSULTANTS

EVANS ASSOCIATES Consulting Communications Engineers
FCC Applications • Design • Field Engineering • Tower Detuning Upgrade & Relocation Studies - AM Directional Array Tuning & Proof
EXPERTS IN:
TV • DTV Transition • FM • Directional Antennas • RF Exposure
210 S. Main St., Thiensville, WI 53092, (262) 242-6000, FAX (262) 242-6045
<http://www.evansassoc.com> Member AFCCE

Consulting Communications Engineers EMC Test Lab
• FCC Applications and Field Engineering
• Frequency Searches and Coordination
• AM-FM-CATV-ITFS-LPTV
• EMC Test Lab-FCC and European (IEC)
OWL ENGINEERING, INC.
1-800-797-1338 Fax (763) 785-4631
E-mail: info@owleng.com
8899 Hastings St NE, Minneapolis, MN 55449 (763) 785-4115 Member AFCEE

T. Z. Sawyer Technical Consultants
www.sawyer.com
AM-FM-TV-LPTV
• FCC Applications & Exhibits
• Experimental Authorizations
• AM Directional Antennas
• High Power Antenna Arrays
• Frequency Studies
• Class Upgrades
• STL Applications
• Station Inspections
1-301-913-9287
FAX: (301) 913-5799
5272 River Rd, #460, Bethesda, MD 20816

GRAHAM BROCK, INC.
BROADCAST TECHNICAL CONSULTANTS
Full Service From Allocation to Operation AM/FM/TV/AUX Services;
Field Work: Antenna and Facilities Design
Over 35 years engineering and consulting experience
912-638-8028
202-393-5133
www.grahambrock.com

Doug Vernier Telecommunication Consultants
Broadcast Engineering Consulting
AM/FM/TV/LPTV/DTV
Custom mapping service
Frequency searches
Propagation prediction
FCC application preparation
V-Soft
SOFTWARE FOR YOUR PC
(800) 743-3684
www.v-soft.com

System One Communications
Broadcast Constructors & Consultants
Houston, Texas
888-625-5649
➤ AM-FM Site Construction Specialists
➤ Complete Tower Service
➤ Antenna & Transmission Line Diagnostics
➤ Custom Studio Designs & Furniture

R. MORGAN BURROW, P.E. & ASSOCIATES, P.C.
ALLOCATION STUDIES
(AM, FM, TV, LPTV) New facilities, site relocation, FM upgrade, duplex
FIELD WORK A SPECIALTY
• AM Directional antenna adjustment, measurement & proof
• RADHAZ measurements - RADiation HAZard evaluation
• FM & TV field intensity & other measurements for purchase/insurance purposes
• CATV Leakage Testing
ELECTROACOUSTICS
OSHA measurements
301-948-3844 • Fax 301-330-9565

M Celenza Communications Consultants
TV-\$550; LPTV-\$550; FM-\$250;
AM Freq Searches-Call for quote
Applications, Amendments & Upgrades
Antenna Structure Registration,
Field Work Avail
631-928-0077
Fax: 631-928-1905

MULLANEY ENGINEERING, INC.
Consulting Engineers
• Design & Optimization of AM Directional Arrays
• Analysis for New Allocation, Site Relocation, And Upgrades
• AM-FM TV LPTV
• Wireless Cable (MDS/MMDS/ITFS/OFS)
• Environmental Radiation Analysis
• Field Work
• Expert Testimony
9049 Shady Grove Court
Gaithersburg, MD 20877
Phone: (301) 921-0115
Fax: (301) 590-9757
email: mullengr@aol.com

FASTER... MORE ACCURATE RADIO COVERAGE
• Real Time 3-D Displays
• Interference calculations
• Cost effective mapping
• Fully integrated databases
• Used by the FCC
• Latest standards built-in
RADIO SOFT
Visit us on the the web at www.radiosoft.com
109 West Knapp Ave. Edgewater, FL • (386) 426-2521

dataworld
Market Analysis
Engineering Software
Ethnic/Demographic Data
Custom Full-color Mapping
Sales Marketing Packages
www.dataworld.com
800-368-5754
info@dataworld.com
fax: 301-656-5341

Communications Technologies, Inc.
Broadcast Engineering Consultants
AM FM TV LPTV
Cellular/PCS Site Analysis
P.O. Box 1130, Marlton, NJ 08053
Phone: (856) 985-0077
Fax: (856) 985-8124
Internet: commtechrf.com
Clarence M. Beverage
Laura M. Mizrahi

PROMOTE YOUR BUSINESS!
Call Simone to advertise.
703-998-7600 ext. 154

DISTRIBUTOR DIRECTORY

The following distributors serving the broadcast industry would be glad to help you with any of your requirements.

CORNELL-DUBILIER MICA CAPACITORS

FROM STOCK

JENNINGS VACUUM CAPACITORS

FROM STOCK

JENNINGS VACUUM RELAYS

SURCOM ASSOCIATES
2215 Faraday Ave., Suite A
Carlsbad, California 92008
(760) 438-4420 Fax: (760) 438-4759
e-mail: link@surcom.com web: www.surcom.com

hang tough----stay healthy
----above all----tell it
like it is----

RADIO! The beat goes on!
CROUSE-KIMZEY OF ANNAPOLIS
tops in broadcast equipment
1-800-955-6800
ask for Kathleen
kkannapolis@worldnet.att.net

STUDIO FURNITURE?
STURDY CUSTOMIZED SYSTEMS FOR EVERY NEED AND BUDGET!
WHY PAY ANY MORE?
SPACEWISE
800-775-3660
info@spacewise.com

TRANSMITTERS WTS (cont.)



POWER TUBES
REBUILT

1/2 THE COST
OF NEW!

ECONCO

TEL: 800-532-6626
INTL: +1-530-662-7553
FAX: +1-530-666-7760
www.econco.com
SE HABLA ESPAÑOL



TRANSMITTERS
Want to Sell

BE FM-30, 30KW FM. Continental Communications. 314-664-4497. Email: contcomm@fiastl.net

Harris-Gates BC-10H 10KW AM transmitter. Continental Communications. 314-664-4497. Email: contcomm@fiastl.net

RCA BTF-20-E1. Continental Communications. 314-664-4497. Email: contcomm@fiastl.net

RCA BTF-5-E1 5KW FM transmitter, single phase. Continental Communications. 314-664-4497. Email: contcomm@fiastl.net

WE RENT FOR LESS

Hotlines FM Exciters
Zephyrs STL's
Nexus FM Pwr Amps
Audio Test Equipment

If we don't have it, we will get it!
SCMS, INC. (800) 438-6040
"You Know We Know Radio"

Continental 317B parts. (2) plate transformers 480V input, various tubes, inductors & caps. Contact WEVD Engineering Department, 201-939-4266.

Ramsey FM-100 hobby transmitter, stereo FM, 25 MW to 1 watt, like new, \$375. Gene Whittenberger, Whittenberger Studio, POB 396, Mexico IN 46958. 765-985-2224.

CCA 1000-D 1.0 KW FM, w/out exciter, \$3500 +shpg. Joseph Bahr, Islands FM, Box 6556, San Juan PR 00914. 787-728-0364.

Harris 10-H, 10KW w/out exciter, \$8000 +shpg. Joseph Bahr, Islands FM, Box 6556, San Juan PR 00914. 787-728-0364.

McPherson Radio Corporation
Specializing in pre-owned QEI FM transmitter products. All tuned and tested on your frequency, 6 month warranty included!

MRC has a facility to meet your broadcast needs for repair and complete overhaul of QEI exciters and low power transmitters. Other broadcast manufacturer products are also welcome.

Bob Brown
Voice/Fax: 856-232-1625
Email: rjbeme@aol.com

Harris MX-15 FM exciter, good condition, \$1500 +shpg/BO. Joseph Bahr, Islands FM, Box 6556, San Juan PR 00914. 787-728-0364.

Continental 314R-1 AM xmtr, 1 kilowatt, tuned to 1600 kHz, located in Chicago IL, \$5000. George Arroyo, WQNQ, 1033 Semoran Blvd #253, Casselberry FL 32707. 407-830-0800 ext 110.

Cunningham CM 30-50 rack mount presunrise transmitter. Adjusts 0-50 watts, measures 19" wide x 12" deep x 8.75" high. 15 lbs, FCC approved, 3 tubes, 1 transistor, new/complete with instruction book, \$750. James Cunningham, KTG5, RT 2 Box 113B, Stonewall OK 74871. 580-285-4496.

Harris MW-5 AM 5 kilowatts xmtr tuned to 1140 kHz, presently on the air in Orlando FL, \$10,000. George Arroyo, WQNQ, 1033 Semoran Blvd #253, Casselberry FL 32707. 407-830-0800 ext 110.

Harris MW-5A, missing plate transformer, good for parts, tuned to 1290 kHz, located in West Palm Beach FL, \$1000. George Arroyo, WQNQ, 1033 Semoran Blvd #253, Casselberry FL 32707. 407-830-0800 ext 110.

Harris SX-1 AM xmtr, 1 kilowatt, solid state, tuned to 1190 kHz, located in West Palm Beach FL, \$6000. George Arroyo, WQNQ, 1033 Semoran Blvd #253, Casselberry FL 32707. 407-830-0800 ext 110.

Want to Buy
BE, Harris, any exciter, physically complete but in poor electrical condition. Leave message. Jeff Glass, 815-784-5219.

TRANSCOM CORP.

Serving the Broadcast Industry Since 1978

Fine Used AM & FM Transmitters and Also New Equipment

300W FM 1988 Harris FM 300K Solid State Single Phase	5KW AM 1996/8 Harris "Gatee" 5 Solid State
1 KW FM 1981 Harris FM 1K Single Phase	5KW AM 1980 Harris MW5A
1 KW FM 1968 Harris FM 1H	10KW AM 1989 Nautel AMPFET 10, Solid State
2.4KW FM 1995 QEI Quantum Solid State upgradeable to 6 KW	10KW AM 1986 Harris MW10B
2.5KW FM 1984 Harris FM 2.5K Single Phase	50KW AM 1978 Continental 317C-1
2.5KW FM 1980 Harris FM 2.5K Single Phase	50KW AM 1982 Harris MW-50B
2.5KW FM 1979 Harris FM 2.5K	
2.5KW FM 1976 Collins 831D Single Phase	
3.8KW FM 1994 Continental 814J Solid State Single Phase	
5 KW FM 1985 BE FM 5A	
5 KW FM 1991 BE FM 5B Single Phase	
6 KW FM 1994 Henry 6000D Single Phase	
10KW FM 1974 Harris FM10H/K	
25KW FM 1980 CSI T-25-F	
30KW FM 1983 BE FM 30	
50KW FM 1982 Harris Combiner w/auto exciter-transmitter switcher	

Continental 802B Harris MX-15 BE FX 50 BE FX 30

EXCITERS

Potomac Ins. AA51 Audio AnyL (new)
Belar SCM-1, SCA Monitor
Moseley TRC-15 Remote w/ Hallikainen
Moseley TRC-15-A Remote Control System
Delta 4 Port SW 1 5/8 mol. #6730E
SCA Generator (Mx-15 Module)
ATI Line Amplifier
Optimod 8100A (cards 3 thru 9)
Dummy Load, 5 KW water cooled
Dummy Load 2.5 KW air cooled

Miscellaneous Equipment:

Potomac Ins. AA51 Audio AnyL (new)
Belar SCM-1, SCA Monitor
Moseley TRC-15 Remote w/ Hallikainen
Moseley TRC-15-A Remote Control System
Delta 4 Port SW 1 5/8 mol. #6730E
SCA Generator (Mx-15 Module)
ATI Line Amplifier
Optimod 8100A (cards 3 thru 9)
Dummy Load, 5 KW water cooled
Dummy Load 2.5 KW air cooled

2655 Philmont Ave #200, Huntingdon Valley, PA 19006
800-441-8454 • 215-938-7304 • FAX No. 215-938-7361
VISIT OUR NEW INTERNET SITE: www.fmamtv.com
SEND YOUR E-MAIL REQUESTS TO: transcom@fmamtv.com

TUBES

Want to Sell

EIMAC, AMPEREX, ED-COM, 3CX2500F3, 3CX3000A7, 4CX250B, 4CX300A, 4CX1000A, 4CX1500B, 4CX5000A, 4-400C, 811, 833C, ETC. WESTGATE 800-213-4563.

FOR THE BEST PRICE & 24 Hr service on transmitting tubes & sockets/ports, new & rebuilt call Goodrich Ent. at 402-493-1886 day or night, FAX 402-493-6821.

TUBES, Eimac, Svetlana
Phone: 905-844-5772
Fax: 905-844-6263
www.hard-to-find.net
ams@hard-to-find.net



ISO 9001 Certified

The Answer for a
Reliable Clean Signal

NEW POWER TUBES

Triodes
Tetrodes
Pentodes

NEW SOCKETS &
REPLACEMENT PARTS

Worldwide Availability

Made in U.S.A.

CALL 800-414-8823
Int'l (650) 592-1221
Fax (650) 592-9988

Visit our Web Site at
www.eimac.com



D & C Electronics Co.
NEW TUBES
We have the alternatives for all your needs, at the lowest prices, direct from OUR STOCK!!!
EIMAC, SVETLANA, PRO-TEK®, EEV and many others.
(352) 688-2374
PH: (800) 881-2374
FAX: (352) 683-9595
SE HABLA ESPAÑOL WE EXPORT
VISA/MASTERCARD ACCEPTED

TURNABLES

Want to Sell

Technics SP-15 studio grade turntable, good condition, \$275. Andrew, KRKO, 425-304-1381 ext 102 or Andrew.skotdal@krko.com

Buying Or Selling Used Equipment? YOU'RE IN THE RIGHT PLACE!

For more information, call 703-998-7600, ext. 154.
E-mail: smullins@imaspub.com

EMPLOYMENT

HELP WANTED

ENTERCOM ROCHESTER, NY has an immediate opening for a staff engineer. Ideal candidates will have knowledge in transmitter and studio repair and installation. Computer and AudioVault experience helpful. We offer excellent benefits and growth potential. Resume to Joseph Fleming, 500 B. Forman Bldg/Midtown Plaza, Rochester, NY 14604 or fax: (716) 423-9552.

ADVERTISE YOUR EMPLOYMENT AD ON OUR WEB SITE FOR ONLY \$2 PER WORD!

ADS GET POSTED THE NEXT BUSINESS DAY AND WILL RUN FOR A FULL TWO WEEKS!

COMBINE THIS WITH AN AD IN OUR RADIO WORLD NEWSPAPER EMPLOYMENT SECTION AND REALLY COVER THE BROADCAST INDUSTRY AND THEN SOME!

www.RWOnline.com

Call Simone Fowell for all the details at
703-998-7600
Ext. 154
between 9-5 EST

POSITIONS WANTED

Broadcasting school graduate looking for work as an announcer or in sales. Willing to relocate. Call Robbie, 918-652-7853.

Fresh out of school. Rookie DJ looking for a job. Excellent music DJ & announcer for commercials & PSA's. Kevyn, 918-496-0419 or capanellah14@aol.com.

Brilliant personality, great voice & tight board! Will relocate. Rhianna, 405-440-0595.

Rookie seeks on-air, production, and/or producer position. Willing to relocate. Experience with OKC's #1 news/talk radio station. Jen, 405-773-6169.

Jason M. here! Rookie radio disc jockey trained & ready to rock. On-air, production, copywriting. Oklahoma area. Jason, 405-703-0150.

Serious, funny, smart, dumb, cool & a geek. Specializing in copy writing. Interested in production, sports, interviews & on-air. Willing to travel, Lequane, 405-773-9747 or 405-706-8306.

Friendly, industrious, FCC commercial-1st Class w/radar/amateur-extra radio licensed, CE, asst CE, seeking FT, PT, contract work, AM/FM, cable, TV, within 75 miles radius of metro NYC area. 718-969-5224 or write: Mitchell Rakoff, 81-12 Roosevelt Ave #702, Jackson Heights NY 11372-6746 or email: mitchellrakoff@yahoo.com.

Looking for radio opportunity. Joe, a shooting star, the name for fame in this game called life. Joe, 918-622-8103.

Radio World
Space is available!
To advertise, call 703-998-7600, Ext. 154.

Radio World

5827 Columbia Pike, 1st Floor • Falls Church, VA 22041
PHONE: 703-998-7600 • FAX: 703-671-7409

Classified Advertising Rates
Effective January 1, 2001

	1x	6x	13x	26x
1-9 col inch (per inch)	\$95	90	85	80
10-19 col inch (per inch)	\$80	70	60	50
Distributor Directory	\$120	115	110	105
Professional Card	\$90	85	80	75
Station/Studio Services	\$175	150	125	100
Classified Line Ad	\$2/word			
Blind Box Ad	\$15 additional			

Call Simone, Ext. 154, Classified Ad Manager, to reserve space in the next issue.
Use your credit card to pay, we now accept VISA, MASTERCARD and American Express.

Grab some of the spotlight!
Advertise in Radio World's Broadcast Equipment Exchange
Call, 703-998-7600, ext. 154.

ACTION-GRAM

EQUIPMENT LISTINGS

Radio World's Broadcast Equipment Exchange provides a FREE listing service for radio stations only. All other end users will be charged. This FREE service does not apply to Employment Help Wanted ads or Stations For Sale ads. These are published on a paid basis only. Send your listings to us by filling out the form below. Please be aware that it takes one month for listings to appear. The listings run for two consecutive issues and must be resubmitted in order to run again. Thank you.

Please print and include all information:

Are you currently a subscriber to Radio World?
 Yes No

Signature _____ Date _____

Contact Name _____
 Title _____
 Company/Station _____
 Address _____
 City/State _____
 Zip Code _____
 Telephone _____

Brokers, dealers, manufacturers and other organizations who are not legitimate end users can participate in the Broadcast Equipment Exchange on a paid basis. Line ad listings & display advertising are available on a per word or per inch basis.

WTS WTB Category: _____
 Make: _____ Model: _____
 Brief Description: _____
 Price: _____

WTS WTB Category: _____
 Make: _____ Model: _____
 Brief Description: _____
 Price: _____

*Closing for listings is every other Friday for the next month's issue. All listings are run for 2 issues unless pressed for space or otherwise notified by listee.
Broadcast Equipment Exchange
 PO BOX 1214, Falls Church, VA 22041 • Tel: 703-998-7600 • Fax: 703-998-2966

ADVERTISER INDEX

This listing is provided for the convenience of our readers. Radio World assumes no liability for inaccuracy.

PAGE	ADVERTISER	WEBSITE URL
23	360 Systems	www.360systems.com
56	A.R.M.A.	www.armagroup.org
57	AEQ	www.aeqbroadcast.com
56	Air Corp	See ad for contact information
39	Aphex Systems	www.aphex.com
34	Armstrong Transmitters	www.armstrongtx.com
54	ATI	www.atiguys.com
8	Audio Precision	www.audioprecision.com
64	Audioarts/Wheatstone	www.wheatstone.com
56	Audion Labs	www.voxpro.net
63	Auditronics/Wheatstone	www.auditronics.com
46	Autogram Corporation	www.autogramcorp.com
46	Avcom-Ramsey Technologies	www.highpowerfm.com
34	BALSYS	www.balsys.com
55	Belar	www.belar.com
29	Bext	www.bext.com
18	Bradley Broadcast	www.bradleybroadcast.com
43	Broadcast Richardson	www.broadcast-richardson.com
17	Broadcast Software Int'l (BSI)	www.bsiusa.com
54	Broadcast Tools	www.broadcasttools.com
32, 33	BSW	www.bswusa.com
4	Burk Technology	www.burk.com
46	Circuit Werkes	www.circuitwerkes.com
7	Comrex	www.comrex.com
46	Cortana	cortana@cyberport.com
46	Electronic Research Inc.	www.eriinc.com
38	ESE	www.eseweb.com
45	Fostex Corporation	www.fostex.com
46	Gorman-Redlich Mfg. Co.	www.gorman-redlich.com
34	Grace Broadcast Sales	www.gracebroadcast.com
1	Harris	www.harris.com
27	Harris	www.harris.com
48	Harris	www.broadcast.harris.com
21	Henry Engineering	www.henryeng.com
15	Inovonics	www.inovon.com
54	J Squared Technical Service	jsquared@cdsnet.net
24	Kintronic Labs	www.kintronic.com
19	Klotz Digital AG	www.klotzdigital.com
56	LBA Technology	www.lbagroup.com
51	Lynx Studio Technology	www.lynxstudio.com/rw
31	MediaTouch	www.imediatouch.com
20	Moseley Associates	www.moseleysb.com
56	Nott Ltd.	www.nottltd.com
30	NPR Satellite Services	www.nprss.org
9	Omnia, a Telos Company	www.omniaaudio.com
54	QEI	www.qei-broadcast.com
22	Radio Design Labs (RDL)	www.rdl.net
5	Radio Systems	www.radiosystems.com
11	Radio Systems	www.radiosystems.com
54	RAM Broadcast Systems, Inc.	www.ramsyscom.com
3	S.C.M.S.	www.scmsinc.com
35	Sierra Automated Systems	www.sasaudio.com
56	Silicon Valley Power	www.svpa.com
6	Sine Systems	www.sinesystems.com
49	Syntrillium Software	www.syntrillium.com
13	Telos Systems	www.zephyr.com
37	Telos Systems	www.telos-systems.com
56	Teracom Components	www.teracom-c.com
41	Waves, Inc.	www.maxxstream.com
2	Wheatstone	www.wheatstone.com
40	Wheatstone	www.wheatstone.com
46	Woodline Furniture	www.woodlinefurniture.com

Radio World

THE NEWSPAPER FOR RADIO MANAGERS & ENGINEERS



Radio World celebrates 25 Years by giving you \$25.00 off the regular subscription price. Take advantage of this Silver Anniversary offer and enjoy the newspaper for Radio Managers & Engineers at this lowest rate ever.

Don't miss our Silver Sweepstakes in which 25 lucky winners will win valuable prizes! Look for contest details in this issue.

Special Introductory Rates • For New Subscribers Only

1 Year for \$34.00 (usually \$59.00) **N95**
 2 Years for \$59.00 3 Years for \$85.00

Payment Options: Check or money order payable to IMAS Publishing
 Visa M/C Am Ex

Card # _____ Exp _____
 Signature _____ Date _____
 Please Print:
 Name _____
 Title _____
 Company _____
 Address _____
 City _____ State _____ Zip _____
 E-Mail _____
 Phone () _____ Fax () _____

Your subscription begins upon receipt of payment. IMAS Publishing appears on all financial transactions.

◆ READER'S FORUM ◆

SBE fund

I noticed that Paul McLane nicely had a mention of the Ennes Foundation fund (Oct. 10, "Radio: There When It Counted") set up by the national Society of Broadcast Engineers and its New York City Chapter for the families of the six engineers who died in the Sept. 11 attack.

I would like to urge and challenge every SBE chapter to contribute to this fund. I also would like to ask that each engineer go to their manager and ask for a reasonable gift from each station to be made in the memory of these men.

As engineers, try to imagine their final moments. Dedicated to the job, watching their building on fire by looking at the monitors in the racks. Alarms of all kind going off. Phones ringing.

Then imagine the floor dropping out from beneath your feet. Makes your daily problems look rather pleasant, doesn't it?

How much to give? Not all stations have a large budget, but I can see that \$100 per station is realistic in most markets. These six men represent us. I call on equipment producers and vendors to join in, and on the larger regional and national broadcast groups to make an additional donation.

We have the children of those six to take care of. This is not about bragging rights as to who gave the most. It's about doing the right thing.

*Tom Bosscher
Chairman, SBE Chapter 102
Grand Rapids & West Michigan
Director of Broadcast Engineering
Services and Technology
Cornerstone University
Grand Rapids, Mich.*

Donation information: The SBE has established a trust fund to assist families of broadcast engineers affected by the tragedy of Sept. 11. Make your check payable to "Ennes Educational Foundation Trust Fund" and mail it to

SBE, Attn: Broadcast Engineer Relief Fund, 9247 North Meridian Street, Suite 305, Indianapolis, IN 46260.

XM receivers

Just went out and had an XM receiver installed in my S-70 Volvo. It is truly amazing. I have not had a chance to try it out in the canyons of Ft. Worth or Dallas yet, but will do so in the next couple of days and let you know what I hear. So far, the audio is outstanding. Or should I say WOW! WOW! WOW!

I am utilizing my standard Volvo FM receiver with the audio being FM modulated from an XM receiver. A small head unit I have on my dash just below my radio.

I think the radio industry should give this some concern. So far — I have called 10 dealers locally — about 500 receivers have been sold and installed. I hope that broadcasters will not take the "this is of no concern to us" motto. That's what happened to AM when FM came on the scene.

*John Lackness
Technical Sales Manager
Marti Electronics
Ft. Worth, Texas*

ENCO

Just saw the article by Tom Ray in Radio World (Sept. 12, "ENCO and WOR, Perfect Together"). Nice job and nice placement. We appreciate your running it very much.

One small note, our new phone number is (248) 827-4440 since our move in July.

*Don Backus
Vice President, Sales & Marketing
ENCO Systems
Southfield, Mich.*

Wiring nightmares

I was just catching up on the last two issues of Radio World and was looking over John Bisset's *Workbench* photos of that rack of haphazard wiring (Aug. 15, "What to Do When You Inherit a Dump"). I was happy to see your instruction to grab photos of these kinds of events.

As a group, engineers have failed to effectively communicate the need and nature of our work to upper management. Without education, the electronic world we live with remains evasive and trouble-

Radio, Thinking Twice

Many things have changed since Sept. 11, including journalistic and management decisions about what kind of programming to air and the balancing of free speech and America's need to be informed vs. putting troops and other lives at risk.

Broadcasters are on the front lines in this debate because of our ability instantly to reach the public — and maybe terrorists too, should they choose to tune in.

The White House persuaded U.S. TV network executives to limit the use of videotapes issued by Osama bin Laden and his aides. The administration said the statements could include coded messages to followers that could incite more attacks. According to published reports, network officials characterized the government request as unprecedented but reasonable, and agreed to review all such material before airing it.

But there was little agreement beyond that, including how or whether to present such tapes, how long to wait before airing them or how many times to repeat them.

These tough decisions are happening not just at the national level, nor only to TV executives, nor only involving cases of terrorism. In an environment in which Americans tolerate more restrictions on civil liberties in the name of safety, we can reasonably predict that law enforcement and other government agencies will make more requests of broadcast outlets in future cases.

Perhaps next time it will be a hostage situation in which the person holding the gun calls your radio station promising to release captives if you air his voice. Perhaps your news department will come into possession of tapes that incriminate a politician but put another person heard on the tape into harm's way. Perhaps the authorities will plead with you not to blow the cover on their chase of a murder suspect before he or she can kill again.

The decisions are not easy ones, and cases like these have happened. When a reporter learns the name of a government source or plays a tape of a criminal conversation, lives literally may be at stake. And now managers find themselves asking whether their station broadcasts could somehow help a terrorist attack our nation.

RW is not immune to such decisions. Recently we were asked not to reveal certain arrangements for FCC personnel regarding the upcoming Olympics for security reasons. We complied. But next time the situation might be different, the decision may not be so easy to make; the public's need to know may be stronger or the case against publication less clear.

In the months and years to come, radio managers likely will be faced with more decisions of this kind. Don't wait until the FBI is on the other end of the phone to think about this. Conduct a dialogue now among the decision-makers at your broadcast organization. Develop a plan so that when your news director or general manager is faced with a request by authorities to withhold information for the public good, you have some idea how to respond.

No one can anticipate every eventuality; and only you can decide what is right for your radio station and your community. But by developing a plan, you and your staff will have guidelines on which to rely when that phone call comes.

—RW

some to management and ownership.

The result is that engineering essentials are often undervalued and misunderstood. I have found that most corporate management appreciates the engineer who can effectively communicate the need. So photos certainly can be, as John said, "worth a thousand words."

*Stephen H. Blodgett
Director, Technical Operations
KNX(AM)-KCBS(FM),
Los Angeles*

Tums moments

Just stopped laughing after reading Alan Peterson's column on "off the air" moments in the Sept. 12 issue.

I don't know if this qualifies, but back in the Drake top 40 days of 93/KHJ(FM) in Los Angeles, it seems that one morning precisely at 6 a.m. the top-of-the-hour ID played, and exactly at that moment an earthquake hit the area.

As the intro to the next song was playing, the legendary Robert W. Morgan waited for the shaking to stop and supposedly said, "Six o'clock in Boss Angeles, and if you don't get up, I'll do it again."

It may not have been a Tums moment, but it was another great moment in the career of one of the all-time greats.

*Hal Widsten
General Manager
KWED(AM)
Seguin, Texas*

Write to Us

RADIO WORLD
READER'S FORUM

P.O. Box 1214
Falls Church, VA 22041

radioworld@imaspub.com

—EDITORIAL STAFF—

Paul J. McLane	ext. 117	Editor
Sharon Rae Pettigrew	ext. 126	Managing Editor
Leslie Stimson	ext. 129	News Editor/Wash. Bureau Chief
Laura Dely	ext. 198	GM Journal/Internet Radio Editor
Michele Kramer Peterson	ext. 149	Studio Sessions Editor
Michael Hedrick	ext. 146	Buyer's Guide Editor
Thomas R. McGinley	—	Technical Adviser
Alan Peterson	—	Technical Adviser
T. Carter Ross	ext. 120	Editor-in-Chief (International)
Marguerite Clark	—	Editor (International), Milan
Rogelio Ocampo	ext. 121	Latin America Editor in Chief
Karina Gerardi	ext. 137	Latin America Editor
Renata Beck	ext. 196	Latin America Assistant Editor
Terry Hanley	ext. 130	Administrative Assistant
Peter Finch	—	Editorial Assistant, Milan

—EDITORIAL CONTRIBUTORS—

W.C. Alexander, Bruce Bartlett, Frank Beacham, John Bisset, Read Burgan, Naina N. Chernoff, Harry Cole, Troy Conner, Vince Ditingo, Mark Durenberger, Ty Ford, Scott Fybus, Harold Hallikainen, Paul Kaminski, Peter King, Mel Lambert, Mark Lapidus, Carl Lindemann, Ted Nahil, Tom Osenkowsky, Ken R., Rich Rarey, Bruce Rogow, Randy Stine, Steve Sullivan, Travis the VIO Guy, Barry Umansky, Tom Vernon.

Radio World
Vol. 25, No. 23 November 7, 2001

Telephone: (703) 998-7600 • Business Fax: (703) 998-2966 • Editorial Fax: (703) 820-3245
E-mail: radioworld@imaspub.com • Web site: www.rwonline.com

—ADVERTISING SALES REPRESENTATIVES—

US Southeast & Mid-Atlantic: John Casey	330-342-8361	Fax: 330-342-8362	e-mail: jdcasey@imaspub.com
US Northeast & Central: Sandra Marcum	765-966-0669	Fax: 765-966-3289	e-mail: adsales@aol.com
US West: Dale Tucker	916-721-3410	Fax: 815-352-1698	e-mail: dtucker@imaspub.com
Classified Ads: Simone Mullins	703-998-7600 x154	Fax: 703-671-7409	e-mail: smullins@imaspub.com
Germany, Austria: Dagmar Hänle	+39-02-7030-0310	Fax: +39-02-7030-0211	e-mail: dhänle@imaspub.com
France: Silvia Di Stefano	+39-02-7030-0310	Fax: +39-02-7030-0211	e-mail: sdistefano@imaspub.com
European Sales Mgr., Africa, Middle East: Raffaella Calabrese	+39-02-7030-0310	Fax: +39-02-7030-0211	e-mail: rcalabrese@imaspub.com
Japan: Eiji Yoshikawa	+81-3-3327-2688	Fax: +81-3-3327-3010	e-mail: callmsn.com
Asia/Pacific: Wengong Wang	+86-755-5785161	Fax: +86-755-5785160	e-mail: wwg@imaschina.com
Latin America: J.O. Lima e Castro	+55-11-3873-1211	Fax: +55-11-3673-1499	e-mail: limcas@uol.com.br

NEXT ISSUE OF RADIO WORLD NOVEMBER 21, 2001

For address changes, send current and new address to RW a month in advance at P.O. Box 1214, Falls Church, VA 22041. Unsolicited manuscripts are welcomed for review: send to the attention of the appropriate editor.

World Radio History

—ADMINISTRATION & PRODUCTION—

Stevan B. Dana	President/CEO
Carmel King	VPI/Group Publisher
Marlene Lane	Editorial Director/COO
Chuck Inderrieden	Production Director
Eric Trabb	Sales & Marketing Director
John Casey	Associate Publisher
Lisa McIntosh	Production Director
Annette Linn	Production Department Manager
Kathy Jackson	Ad Traffic Manager
Sheryl Unangst	Circulation Director
Robert Green	Circulation Manager
Amy Gutowski	Marketing Manager
Alexander Sisson	Accounts Receivable

Radio World (ISSN: 0274-8541) is published bi-weekly by IMAS Publishing (USA), Inc., P.O. Box 1214, Falls Church, VA 22041. Phone: (703) 998-7600, Fax: (703) 998-2966. Periodicals postage rates are paid at Falls Church VA 22046 and additional mailing offices. POSTMASTER: Send address changes to Radio World, P.O. Box 1214, Falls Church VA 22041. REPRINTS: Reprints of all articles in this issue are available. Call or write Joanne Munroe, P.O. Box 1214, Falls Church, VA 22041; (703) 998-7600; Fax: (703) 998-2966. Copyright 2001 by IMAS Publishing (USA), Inc. All rights reserved.

—Printed in the USA—

AUDITRONICS SERIES 2600

IT'S NEW — IT'S A BARGAIN — AND IT'S MODULAR, giving you any combination of mic, line or accessory modules. It's also INSTALLER FRIENDLY, with a hinged meterbridge that opens wide for direct access to connectors, trimmers and logic switches. Onboard cue and headphone amps keep you in budget. BEST OF ALL, you can have this AUDITRONICS tough-as-steel quality for **\$3995!**

- FULLY modular
- All electronic switching
- Separate mic & line inputs
- Eight or twelve input channels
- Two stereo Program busses
- Two Mono/Mix-minus busses
- Full-featured monitoring
- Twin VU meter pairs (PGM & switched)
- Opto-isolated control logic
- Built-in cue and headphone amps

AUDITRONICS

tel: 252-638-7000 / fax: 252-635-4857 / sales@auditronics.com

www.auditronics.com

copyright © 2001 by
Wheatstone Corporation

AUDIOARTS DIGITAL D-70



The D-70 digital console from AUDIOARTS not only utilizes the latest in digital technology and chip sets, it can be ordered with a serial interface that lets it integrate with most popular automation systems and station routers; it even has WHEATSTONE's exclusive VDIP™ software system.

Plug-in modules let you have any combination of mic, analog or digital line inputs, and the 4 stereo buses give you plenty of flexibility (each has both digital and analog outputs). With sample rate conversion on all digital inputs plus selectable console clock rates of 32, 44.1 or 48KHz (and an optional external house sync) the D-70 can fit right in with all your facility's present equipment.



WHEATSTONE'S VDIP™ Virtual Dipswitch Software lets you configure D-70 input channels with a laptop computer. Once configured console runs stand-alone.

With a compact, tabletop-mount footprint and a modular rear connector system that utilizes plug-in submodules for easy analog-to-digital field switches, the D-70 can be configured onsite quickly and easily. On the functional side, fullscale digital peak plus simultaneous VU metering, LED illumination everywhere, built-in machine interface, automatic timer and clock (stand-alone or ESE slave) all come standard, along with separate source selection for control room and studio plus built in talkback. You can even order the D-70 console with a SUPERPHONE module to support two callers with automatic digitally generated mix-minus. Both digital and analog line selector panels are also available.



THE D-70 DIGITAL AUDIO CONSOLE —benefit from WHEATSTONE's experience— at an AUDIOARTS price!