

\*\*\*\*\*AUTO\*\*3-DIGIT 857  
S101903 D31 0306  
BARRY MISHKIND  
2033 S AUGUSTA PL  
TUCSON AZ 85710 7905

599

TiVo or Not TiVo

Skip Pizzi weighs the outlook for personal audio recorders.

Page 30

Ramping Up

With the codec issue settled, will HD Radio finally take off?

Page 12

# Radio World



The Newspaper for Radio Managers and Engineers

November 5, 2003

## INSIDE

### NEWS & ENGINEERING

▼ Eddie Fritts keeps satellite radio in his crosshairs.

Page 3

▼ Jim Hawkins peeks under your capacity hat.

Page 27



### STUDIO SESSIONS

▼ Canadian performance theaters: a high-performance card from AudioScience; and ARP on the wisdom of turning your morning show into a TV program.



In This Issue

## NRSC Regears For HD-R, RBDS

by Leslie Stimson

**PHILADELPHIA** The pushing and pulling continues between members of the standards-setting National Radio Systems Committee and Ibiqity Digital Corp. over disclosure.

While it's not unusual for tensions to arise over what information should be shared and what should remain proprietary, sources said, the standards-setting process for IBOC is complicated by the fact that the technology already has been

introduced into the marketplace.

Before the NAB Radio Show here, the NRSC identified areas in which it needs more information from Ibiqity for its standards-setting process, including patents, data transport and the new codec. The goal is to compile enough information for "someone skilled in the art" to build compliant devices, sources said.

Ibiqity turned over a list of approximately 70 granted patents relating to its IBOC transmission system. The technology See NRSC, page 16 ▶

## Pirates Look to City Hall

*Some Enlist Local Governments in Battle With FCC*

by Naina Narayana Chernoff

**WASHINGTON** Some pirate broadcasters resisting FCC efforts to shut them down are enlisting support of local elected leaders to keep their unlicensed stations on the air.

Radio activists say resolutions passed by local governing boards are unlikely to change national policy but highlight a growing feeling of powerlessness that they feel communities have over the inability to hear local voices on the radio.

"It's logical that people in local communities don't understand why the (federal) government won't give them licenses for stations," said Michael Bracy, executive director of the Low Power Radio Coalition.

Although such resolutions do not seem to constitute a trend, pirate broadcasters have, in some cases, succeeded in winning the backing of local leaders, said

See PIRATES, page 8 ▶

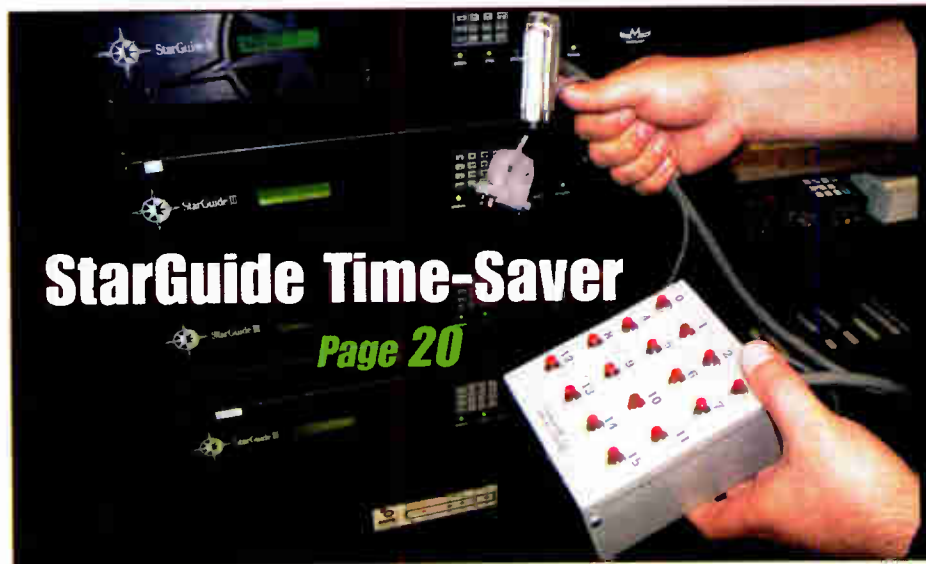

### StarGuide Time-Saver

Page 20

### SMART METER

▼ An engineer in New Mexico snags a sophisticated signal meter from DK-Audio.

Page 4



Sign Up For NewsBytes Weekly Digest at [www.rwonline.com](http://www.rwonline.com)

### Reliable Program Audio Over The Internet?

#### IntraLink-IP™ Streaming Multiplexer

Create a program audio circuit wherever an Ethernet jack exists with the IntraLink-IP streaming multiplexer. The QoS of packet switched networks has improved dramatically signaling the beginning of a new low-cost means of professional audio transport. IntraLink-IP has a Harris exclusive forward correction scheme which takes advantage of these networks. It delivers robust streaming for critical STL/TSL and general purpose broadcast audio transport. Contact your Harris sales representative today.

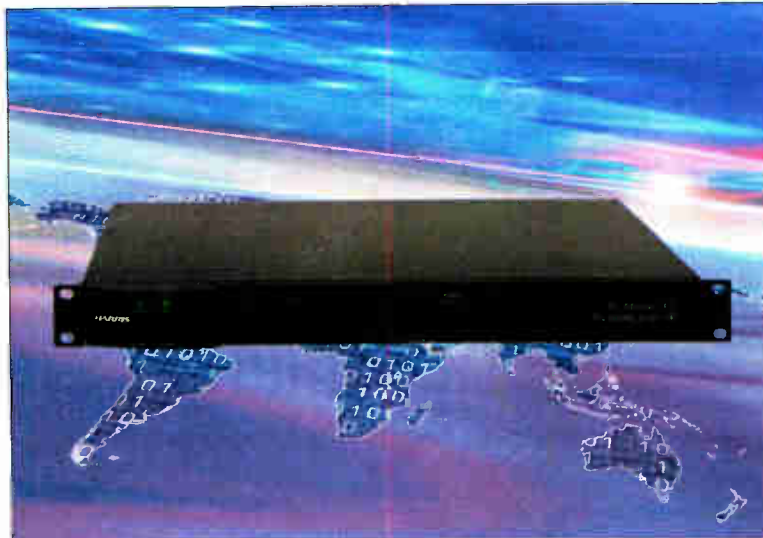

[www.broadcast.harris.com/network-access](http://www.broadcast.harris.com/network-access)



# ◆ NEWSWATCH ◆

## NAB, NPR Part Ways on LPFM Report

by Leslie Stimson

**WASHINGTON** NAB and NPR, once on the same side regarding low-power FM, now have very different takes on whether LPFMs should be allowed on third-adjacent channels.

NAB engineers have torn apart the report on LPFM done by Mitre Corp. for the FCC. The association says in no way should the agency conclude

from the report that third-adjacent-channel protections can be eliminated in order to squeeze more low-power stations on the band. The study should be "rejected out of hand," the association says, citing technical flaws including "site selection, frequency selection, receiver selection and receiver characterization."

NPR, however, supports a trial implementation of LPFM stations on third-adjacent channels subject to certain application processing and interference remediation safeguards.

"We believe that the best way for policy makers to implement LPFM is to begin with a measured trial period

of interim LPFM service introduction," states NPR. "We believe such a trial period would be important in documenting the successful strategies of interference remediation and avoidance where it counts — in the real world."

### 'Harmful'

Congress imposed the third-adjacent-channel restrictions on LPFM in 2000, citing conflicting data about whether the channel protections for full-power stations needed to be maintained. But it required the FCC to conduct a study in several markets.

"The report actually demonstrates

... that listeners within a full-power FM station's protected contour will experience harmful interference from LPFM stations located on third-adjacent channels," states the association in comments filed with the commission.

"Existing broadcasters have a legitimate expectation that they can and will reach their audiences. The same is true for consumers who have purchased hundreds of millions of FM radios," NAB stated.

Restrictions barring LPFM stations from operating on third-adjacent channels (a two-channel separation) from full-power stations are not necessary, concluded the Mitre Corp. report submitted to the FCC June 30. The report found that LPFM stations could be operated on third-adjacent channels if "relatively modest" geographic separation — from tens of meters to slightly more than one kilometer — is maintained.

NAB said the report had so much wrong with its testing methodology that the resultant test data could not support this recommendation.

"Consequently, Mitre's distance separation will not eliminate third-adjacent channel interference," the association states. "Moreover, Mitre's spacing formulas are premised on a static population assumption. But population shifts will inevitably occur; the commission must ensure that all persons within a station's protected contour, including those who have relocated near a LPFM station, are not subjected to harmful interference when listening to their desired full-power FM station."

NPR, too, believes some of the testing methodology in the report is flawed, specifically tests using the receivers for radio reading services. Because of those impairments, NPR states, there can be no conclusion that 100-watt LPFMs could be authorized on third-adjacent channels to stations

See NEWSWATCH, page 6 ▶

# Audioarts R-90

## The Perfect Console for Multi-Studio Buildouts!



### OUR NEW R-90 HAS THE FEATURES ENGINEERS WANT:

Two stereo program busses and two mono busses—one pre and one post-fader (perfect for backfeeds or on-the-fly mix-minus); dual phone caller support using Wheatstone's exclusive Bus-Minus<sup>®</sup> circuitry, which generates mix-minus caller feeds with the simple push of the module's MXM bus assignment switch. Both control room and studio monitoring with talkback are provided, including both pre and post studio and headphone level pot monitor feeds. You can even choose a second monitor module for studio two/headphone two output feeds, giving you plenty of monitoring flexibility. And while the frame is compact, it can accommodate up to 23 input or accessory modules in any combination. Because all switching is electronic (and all switches are LED illuminated) you can count on the ultimate in reliability. THIS IS A TRULY VERSATILE AND COMPACT AUDIOARTS CONSOLE!



Made in USA

tel 252-638-7000/fax 252-635-4857  
sales@wheatstone.com  
copyright © 2003 by Wheatstone Corporation



AUDIOARTS ENGINEERING  
www.audioarts.net

### NEWS

NRSC Regears For HD-R, RBDS	1
Pirates Look to City Hall	1
NAB, NPR Part Ways on LPFM Report	2
Ad Sales, Rush Dominate Radio Show	3
From the Editor	4
NAB Radio Show Snapshots	5, 6, 32
NewsWatch	10

### HD RADIO NEWS

Ibiquity Sees Finish Line in Sight	12
Beasley Converts First	
HD-R Station in Philadelphia	14
Tomorrow Radio Research Advances	16
Philips Releases HD	
Radio Single-Chip Processor	17
DRM: New Digital Kid on the Block	18

### FEATURES

Workbench: A StarGuide/ Hard-Drive Interface	20
I Love Your Hat	27
At Marconis, the 'Suits' Loosen Up	28
PAR for the Course	30
Is There an Ideal Impedance?	31
NAB Marconi Winners	33

### STUDIO SESSIONS

Performance Theaters Buck Trends	34
High Performance From AudioScience	36
Coincident-Pair Stereo Mic Technique	37
Radio on TV Not Always a Good Idea	38

### OPINION

Radio's Real Founding Father	45
Reader's Forum	46

# Ad Sales, Rush Dominate Radio Show

by Leslie Stimson

**PHILADELPHIA** The NAB intends to remain vocal on the topic of satellite radio's alleged attempts to go local. That's one of the clear messages that emerged

acknowledged that authorities were conducting an investigation. Limbaugh said the accounts contained inaccuracies and he had been advised to limit public comment on the matter until the investigation was complete. He said he would clarify the stories when he could.)



Clear Channel's John Hogan, Hubbard Radio's Ginny Morris, Susquehanna Radio's David Kennedy, NewRadio Group's Mary Quass and Infinity's Joel Hollander delve into the hot topics of the industry.

from the NAB Radio Show.

The economy, radio's recovery and what Rush Limbaugh would say next also dominated conversations.

The exhibit hall was smaller than in years past, with 98 booths compared to 112 in Seattle last year and 160 the previous year.

Some vendors said a smaller show floor was better, allowing salespeople to spend more quality time with clients and potential customers. Other vendors disagreed, believing a larger hall with more attendees allows more product exposure. Most concurred that having the show in Philadelphia helped generate attendance from the Northeast and Mid-Atlantic states.

Attendance held steady; roughly 3,900 attendees were in Philadelphia, on par with Seattle attendance, according to NAB. Sessions were well attended.

For a time, the Limbaugh controversy overshadowed discussions of media ownership, satellite radio and LPFM.

## Rush talk

Comments made earlier on ESPN by the convention keynote speaker sparked criticism from city officials and the local media here. Radio host Limbaugh said on television that Philadelphia Eagles quarterback Donovan McNabb received undeserved credit for his team's success because the media wanted "a black quarterback to do well."

Limbaugh then quit his ESPN role the night before he addressed the NAB, saying he didn't want to make other ESPN employees on the show "Sunday NFL Countdown" uncomfortable.

Limbaugh's daily show is syndicated by Premiere Radio Networks to 600 radio stations.

The story went national, and extra police were called in for Limbaugh's keynote address.

During that speech, Limbaugh spent most of his time discussing how he loves radio. He said he didn't mean to hurt McNabb with his comment; that he was giving his opinion about the media.

"We live in a country where there is supposedly a First Amendment and you can offer an opinion," Limbaugh told attendees. "But in certain places and certain times, you can't."

Limbaugh did not address drug use allegations that appeared in some print media during the show. Premiere issued a statement attributed to Limbaugh that said he was unaware of any investigation, but would cooperate if his assistance were required.

(About a week later, Limbaugh would admit on his radio program that he was indeed addicted to painkillers. He said he would take a month-long break from his show to check into a drug rehabilitation center. As for a report about alleged purchases of black-market painkillers, he

Commenting on the Limbaugh/ESPN controversy during a session, several radio group executives said Limbaugh had been expressing his opinion and they admired his decision to quit the TV program. If he had expressed the opinion on his own show, it wouldn't have become national news, they agreed.

## 'More than our share'

NAB President/CEO Eddie Fritts sought to focus attendees on terrestrial radio's battles regarding media ownership, satellite radio and LPFM. He said this year, radio has had "more than our share" of major issues on its plate.

NAB opposed the FCC's new radio market definitions, which are based on Arbitron Radio Metros. The new media ownership rules have been stayed by a federal appeals court, as NAB and other groups challenged them.

The broadcasters association wants the commission to retain the contour overlap method of defining a market for the purposes of attributing ownership. A modified version of the rule remains in effect.

Comments were due in early October to the FCC in its proceeding to develop a new way to define radio markets for those areas not rated by Arbitron. NAB believes retaining the contour overlap rules works best.

"Changing the definition for small-market radio could be disastrous for companies that built their businesses under the old rules," said Fritts.

The commission announced under its new localism initiative it would hold public hearings in states where radio licenses are coming up for renewal. Such increased scrutiny, said Fritts, is

coming at a time when some stations have been praised for their public service.

He cited radio's role in covering the Northeast power blackout and Hurricane Isabel and took a jab at satellite radio.

"I can assure you, there weren't many people in Isabel's path who tuned to satellite radio for storm-tracking information," Fritts said.

NAB has been aggressively pushing the FCC to mandate the satellite services as national, rather than local, services. He said satellite radio seems "hell-bent" on going local if their business plans fail.

XM, which announced in October that it has more than 929,000 paying customers, has patented a way to insert and air local programming using its terrestrial repeaters. The satcaster says it doesn't intend to actually broadcast local material.

But NAB wants the final rules governing satellite radio's terrestrial repeaters to specify those as national-only services.

"We're not against competition. But satellite radio was authorized as a national programming service only," Fritts said.

The rules are pending. When questioned about how the FCC views satellite radio during her appearance at the show, commissioner Kathleen Abernathy replied, "Satellite radio is a national service. The issue is still pending. I thought it would have been done by now and it's still in play."

## 'Proud'

Abernathy agreed with radio broadcast attendees who believe the agency's new radio market definition, as part of its now-stayed media ownership rules, does not work for small markets. That's why, she said, the commission sought industry expertise.

"This is not over. I agree with you about small markets.

See NAB, page 5 ►

## SCMS, INC.

YOU-KNOW-WE-KNOW-RADIO!

### SPREAD TOO THIN AND FEELING DRAINED?

- Experienced Staff
- 26 Years of Personal Service
- Competitive Prices for over 600 Quality Manufacturers of New Equipment
- Huge Stock of Rebuilt RF and Audio Gear
- Extensive Rental Fleet (Audio, RF, Codecs, Test Equipment, and more!)
- Trade-Ins Welcomed

TRY SCMS ON FOR SIZE - WE CAN FILL YOUR NEEDS

<p><b>WEST COAST</b>  <b>Doug Tharp</b>          Voice 866.673.9267          Cell 818.398.7314          Email dtharp@san.rr.com</p>	<p><b>CENTRAL</b>  <b>Bernie O'Brien</b>          Cell 731.695.1714          Email bernieob@earthlink.net</p> <p><b>MID-WEST</b>  <b>Mary Schnelle</b>          Voice 1.800.245.4307          Fax 513.583.1343          Email mschnelle@maryschnelle.com</p>	<p><b>NORTH-EAST</b>  <b>Dan Lohse</b>          Voice 908.722.6015          Fax 908.722.4359          Pager 877.792.8024          Email scmsnorth@aol.com</p>
<p><b>SOUTH-WEST</b>  <b>Tyler Callis</b>          Cell 817.312.6338          Email tylercallis@integrity.com</p>	<p><b>MID-SOUTH</b>  <b>Bob Mayben</b>          Voice 877.391.2650          Fax 256.543.0595          Email bobmayben@usa.net</p>	

CORPORATE SALES OFFICE - PINEVILLE, N.C.

Toll FREE 800.438.6040 Fax 704.889.4540

Email sales@scmsinc.com

www.scmsinc.com

FROM THE EDITOR

# Superstars of Audio Processing

by Paul McLane

Kudos to engineering consultant Dave Bialik for pulling off three spectacular panels at the recent AES show in New York.

group of processing manufacturers has been gathered in one room.

Bialik also coordinated a panel about the reconstruction of New York broadcast facilities in the wake of 9/11 and

AES show is a draw for us radio folks.

★ ★ ★

Remarkable to me are the reactions we



Dave Bialik coordinated this awesome processing panel. Standing, from left: Marvin Caesar of Aphex Systems, David Reaves of Translantech Sound, Frank Foti of Omnia, Emil Torick, formerly of CBS Labs, Leonard Kahn of Kahn Communications, Rocky Graham of Dolby Labs, Thomas Lund of TC Electronics, Robert Reams of Neural Audio and Jay Brentlinger of CRL/Orban. Seated: Mike Dorrrough of Dorrrough Electronics, Moderator Glynn Walden and Dave Bialik.

Bialik does a great job at this sort of thing; as proof, I offer this photograph of his panel on audio processing for broadcast. I don't know when, if ever, such an influential

another on digital broadcasting. Well done, Dave. Your special events are a big reason that the East Coast



Nathan Miller, engineer for Family Life Radio in Albuquerque, N.M., takes home a sweet prize in our New Technology Sweepstakes. He wins an MSD100T audio meter from DK-Audio, which retails for \$1,395.

This is a center zero-type correlation meter with a range from -1 to +1 for indication of the phase relationship in the stereo signal. It offers an oscilloscope indication or goniometer, which gives an engineer details about the content of the signal, something often found only on expensive mixing consoles.

Functions include selectable scales and reference levels as well as a spectrum analyzer with FFT and 1/3-octave function. The MSD100T has several metering scales: Nordic scale, BBC-style PPM and its equivalent EBU version, DIN, classic VU and two digital meters derived from the Sony 1630 standard, one covering a 60 dB window, the other just the top 6 dB with correspondingly increased resolution.

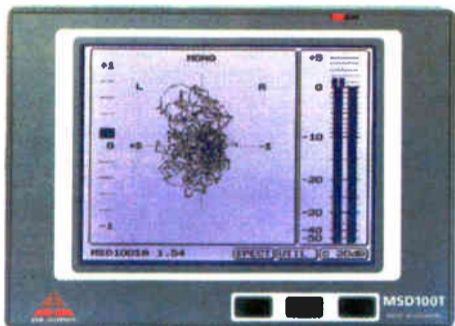

receive whenever Radio World publishes a story about stations operating on the fringe of our world of radio.

The Aug. 13 story about Stephen Provizer is but one example. No doubt we'll hear more about our story in this issue about radio pirates seeking support from local governments.

Some readers gripe that a publication like Radio World has no business reporting on such things. I could not disagree more.

I take pride that RW is one of the few radio publications, if not the only one, that devotes regular coverage to the legal stations operating via LPFM or Part 15, and further delves into the arguments, pro and con, of illegal "pirates" and other unpopular — but very real — occupants of our spectrum. To do so in a balanced way is the mark of a professional journalistic enterprise.

At the heart of the complaints, I suspect, is the mistaken impression that *coverage* equals *support*.

First, note that I differentiate between LPFMs and other low-power operations from pirates. It's ridiculous to equate organi-

zations that operate within the law, trying to serve small but important communities, with rebels trying to flaunt the law. But that's just what many opponents have done, going right back to the NAB's earliest opposition to the entire concept of legal LPFMs. (NAB continues to obstruct, through its unyielding position on LPFMs on third-adjacent channels.)

Further, if a station, licensed or otherwise, is having an impact on radio, that's worthy of discussion. Should we *not* report on the activities of pirate organizations, if we know they are going on and if they are affecting broadcasters in their areas? Should we *not* report that a pirate in your backyard is asking your city councilman to support them?

Not talking about such operations will not make them go away. These folks are part of the world of radio, whether we like their approach or not, whether they reach two blocks or two continents. I will never let RW be only a newspaper that writes about big and established organizations, excluding smaller or fringe elements.

I reiterate our editorial position:

We support the maximum legal, efficient use of the radio spectrum and the FCC's role in enforcing it. We think more stations can fit into our spectrum legally.

We do not support unlicensed use of the spectrum or defiance of the law.

We will report on, and comment on, organizations involved in these debates, including organizations that choose to defy the law, so that readers can develop their own informed decisions.

★ ★ ★

"He's the most wired and connected person we know."

It's Kerry for president — not *that* Kerry, but Kerry Richards, chief engineer of WOR(AM).

Leave it to Tom Ray, corporate director of engineering for Buckley Broadcasting, to come up with this idea. See [www.kerryforprez.us](http://www.kerryforprez.us).

A radio engineer as president of the United States? Why not?

And it turns out Kerry Richards has a platform. The site even includes a picture of it.

"This platform is behind one row of equipment racks at WOR. While the primary purpose of this platform is to cover and protect the wiring, Kerry has been known to stand on this platform and pontificate." 🌐

## Get online with the new solution for IP control and monitoring.

Access your remote site over the Internet.

Simultaneous operators and multiple access levels.

Installs at the studio or transmitter site.

Alarm notifications by email and SMS.

Customizable HTML-based interface.

You need an IP solution for remote facility control that's adaptable and easy to manage. One that will work whether your transmitter site has T1 or no network connection at all. And you need something that's easy to implement.

The Web Interface from Burk Technology adds IP control to the GSC3000 and VRC2500 transmitter remote control systems, allowing access from any Internet connection and a standard web browser. SNMP-enabled, with multi-operator support, the Web Interface installs at the studio or transmitter site — wherever an Ethernet connection is available. Enjoy the benefits of a totally integrated solution that offers the flexibility needed by today's broadcasters.



BURK TECHNOLOGY 800-255-8090 (Main Office) | 800-736-9165 (Kansas City) | WWW.BURK.COM



Jeff Littlejohn of Clear Channel, hand to chin, visits the ERI booth.

Photo by Jeff Littlejohn

# THE NAB RADIO SHOW



FCC Commissioner Kathleen Abernathy defended the FCC's new ownership rules, despite 'all the abuse we took.'

Photo by Lisa McIntosh



Attendees walked through the exhibit floor to reach most sessions.

Photo by Lisa McIntosh



Ed McMahon, Little Peggy March and Pat Clark broadcast from the Comrex booth.

Photo courtesy Comrex

## NAB

► Continued from page 3  
We don't know."

However, she said, "figuring out localism will be hard for the FCC to decide."

Abernathy said the commission pondered the rules for nearly two years before the June 2 vote, and felt the current definition didn't accurately reflect the economic realities of each market, specifically "who's competing for ad share in that market."

Abernathy, putting in her third appearance at an NAB Radio Show, said she was proud of the job the commission did with the media ownership rules, despite "all the abuse we took."

Indecency was another hot topic among attendees.

Punishments for violators range from fines to license revocation. Abernathy says when reviewing such cases, she relies on the facts and the rules, rather than what she finds personally offensive.

"I want to send this message loud and clear — there is a cost to violating our rules."

On the same day, the commission released decisions on two indecency cases, including a proposed fine of \$357,500 against Infinity Broadcasting in the Opie & Anthony episode involving an alleged sex stunt in St. Patrick's Cathedral.

Also during the convention came news

reports that the male suspect in the case, Brian Florence, had died of a heart attack. Florence had been facing a minor charge in the indecency case. He was 39.

The issue of licensing low-power FMs sparked heated responses from attendees. Several feared that FCC field office employees wouldn't keep LPFMs from interfering with existing full-power FMs.

Abernathy said that under Powell, the commission has allocated more resources to field offices because it recognizes that devoting more uses for the broadcast spectrum could produce more interference.

### Turnaround?

On the business front, radio is holding its own compared to other media, said David Kennedy, president and chief operating officer of Susquehanna Radio Corp., during a session with radio group executives.

Rep. Greg Walden, R-Ore, echoed his belief during a different panel. Walden believes the economy "is beginning to turn" while fellow House member Rep. Eliot Engel, D-N.Y., disagreed. The latter said he's worried about the economy and described the worst job loss in the nation since the days of President Herbert Hoover.

Prometheus Radio Project staged a small protest outside the convention center just before the show closed. The LPFM supporters said advocates of localism and diversity in radio were protesting big media.

Next year the NAB Radio Show is to be held in San Diego, Oct. 6-8.



Buy one of our  
DA's, Phone Hybrids or Silence Sensors  
any time this year  
and get a  
**CT-2002 Clock - up/down Timer FREE!**  
(a \$135.00 value)

radio SYSTEMS

601 Heron Drive, Logan Township, NJ 08085  
(856) 467-8000 • (856) 467-3044 FAX  
www.radiosystems.com

CALL ONE OF THESE PARTICIPATING DEALERS

BROADCASTERS GENERAL STORE

BSW

Crouse-Kimzey

SCMS INC

Tech Systems Group

(352) 622-7700 (800) 426-8434 (800) 433-2105 (800) 438-6040 (888) 832-4638

# THE NAB RADIO SHOW



'Cadillac' on WXTU(FM), Philadelphia. The station has converted to HD-R.

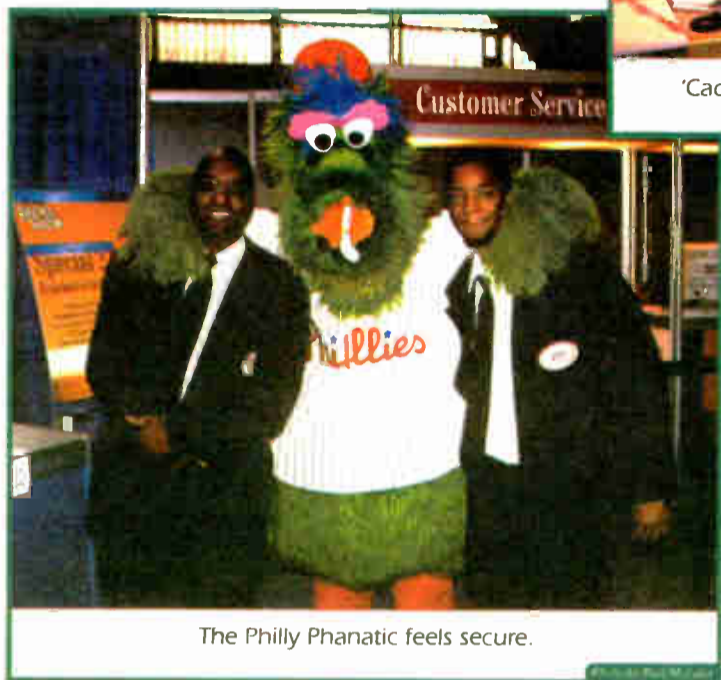

The Philly Phanatic feels secure.



National and local media turned out in force for the Limbaugh keynote.



David Stewart and Andy Laird chat in the Broadcast Electronics exhibit.

## CONDIRON BROADCAST ENGINEERING

### The Call Screener for Windows

Discover what it can do  
for your talk shows!

- ➔ Control your studio Telos® or Gentner® phone system from anywhere in the world!\*
- ➔ Receive screening/phone status from anywhere in the world!\*
- ➔ Clear, easy to read screens
- ➔ Reliable & easy to use!
- ➔ Talk Show Host friendly!



\* With a TCP/IP connection

One-time charge...no yearly fees!

Site licenses available.

Group & Network pricing! Affordable!

The Call Screener for Windows  
For more info, pricing and a free demo,  
log on to [www.cbsoftware.cc](http://www.cbsoftware.cc)

## Newswatch

► Continued from page 2  
carrying radio reading services "without materially impairing the reading service."

NPR encourages Congress to retain the current protections for radio stations providing reading services.

Congress mandated two other components to the LPFM tests: an economic analysis to determine the impact on full-power FMs if third-adjacent-channel protections were eliminated, and independent audience listening tests to establish exactly what interference is objectionable to the average radio listener.

Mitre reported that the proposed costs of the listening tests exceeded its project budget. Because costs were driven by sample size, Mitre chose to use a single listener to judge whether harmful interference was present in the audio during the van tests.

NAB said this is inadequate, that a single listener "is no substitute for a properly designed and executed subjective evaluation." Congress' intent was clear, NAB said, and funding issues do not excuse lack of compliance with the testing procedures dictated by lawmakers.

As for the economic analysis, Mitre stated it assumed a showing of interference was a prerequisite for that test. NAB argues that assumption is wrong. 🌐

# The Best Just Got Better!

With new rock solid, fully digital modem technology, the Matrix is the most reliable, best sounding codec available. And now the Matrix offers another tool for your remote kit: **The GSM Wireless Module.**

- New** Built-in GSM Phone
- New** Aggressive Algorithm delivers 7 kHz on GSM.
- New** Error Handling Technique.
- New** External Antenna.
- New** Increased Power for More Reliable Connections.
- New** Remarkably Stable Modem Technology.

All this adds up to better stability, improved audio, and greater flexibility. Already own a Matrix? **Call us and we'll upgrade you to the newest modem technology for FREE!** Plus we'll be happy to set up a demo of the new GSM module.



## Here is what some of our numerous Beta Testers had to say:

Clear Channel Director of Engineering for St. Louis Dary! McQuinn said: "Sounds much better than a bad [RPU], almost as good as a good [RPU], and way better than you should ever expect from a cell phone remote!" but all KLOU's Program Director Al Brock could say was, "Wow!"

Shaun Kassity from Salem Communications' 104.7 The Fish in Atlanta: "Thanks to Matrix GSM we had the best sounding remotes ever on our station!"

Steve Kirsch of Silver Lake Audio: "The feed was rock solid. I'm very impressed—it sounds much better than I thought it would."

Collin Mutambo, Radio Simba, Kampala, Uganda: "We are indeed quite impressed."

But our personal favorite, from Jerry Dowd of Jefferson Pilot's WBT in Charlotte, NC: "We hope to keep the betas until you get nasty with threatening letters." Thanks Jerry. We'll take that as a compliment!

Testing has been successful in 25 US states and on 6 continents with more results coming in every day. The Matrix with the optional GSM Module delivers 7 kHz on GSM wireless. Now accepting orders.

**Call us today at 800-237-1776 to learn more about the Matrix!**

**COMREX**

19 Pine Road, Devens, MA 01432 USA

Tel: 978-784-1776 • Fax: 978-784-1717 • Email: [info@comrex.com](mailto:info@comrex.com) • [www.comrex.com](http://www.comrex.com)

World Radio History

# Pirates

► Continued from page 1

Pete triDish, a community radio activist, former Philadelphia pirate and a staffer of the pro-LPFM Prometheus Radio Project.

Licensed radio broadcasters say pirates are breaking the law and interfering with licensed stations. They argue that the FCC needs to continue efforts to crack down on the scofflaws.

## Support

This summer, local government bodies in two California cities, San Francisco and Santa Cruz, passed resolutions stating their support of pirate radio stations. The unanimous votes came on the heels of visits to the stations by FCC Enforcement Bureau field staff.

A third station in Vermont, days after the FCC attempted to confiscate its broadcasting equipment, was trying to get back on the air and obtain support from local government leaders for the station.

A source in the FCC Enforcement Bureau declined to comment on the pending investigations and could not offer details about the steps the FCC will take to shut down the stations. The cases, the source said, would follow normal procedures for dealing with unlicensed broadcasters.

The agency follows a process that begins with a warning to the unlicensed operators, asking them to cease broadcasting within 10 days. If stations do not comply, ensuing steps include fines, another visit from FCC field staff accompanied by U.S. marshals to confiscate equipment, and, finally, criminal prosecution.

In 2001, the FCC Enforcement Bureau shut down 184 unlicensed FM operations; it closed 158 in 2002. During the first quarter of 2003, bureau staff closed 85 operations, a noticeable rise in the enforcement rate. The agency has not yet determined a cause for the apparent

increase, said the source.

## San Francisco Liberation Radio

According to so-called "free radio" broadcasters, if more unlicensed, volunteer-run stations gain the support of communities, and if the debate on the new media ownership rules continues in Congress and the nation, FCC policies stand to be challenged by citizens seeking a voice in their towns and cities.

Community support for free radio stations, supporters say, gives strength to their argument for diversity and localism, which they allege are lacking in the mainstream radio industry, a charge NAB

tion of FCC rules. The agency issued the notice after attempting to seize the station's equipment without success. Olson said the DJ working at the station at the time would not let the field staff enter the station. In mid-October, the FCC raided the station and shut it down. The FCC would not discuss whether those running the station would be fined.

Earlier, the city's Board of Supervisors had passed a resolution asking the FCC and the city and county of San Francisco to not interfere with the functioning of the station. The resolution included language that urged federal, state and local officials to support policies and practices

pirates from LPFM is in the courts, and a decision about whether third-adjacent-channel protections truly are needed for LPFM is in limbo, she said, it is not fair for the FCC "to hold up broadcasting until those issues are settled. As long as it is not settled entirely, it prohibits people like us from applying for a license."

## 'Rhetoric'

Many broadcasters do not agree.

"A lot of these people hide behind rhetoric," said Mark Powers, vice president of the California Broadcasters Association. "It's really about anti-authority. Even if you told them to stop now and they could become legitimate, it would ruin the foundation they were in business for in the first place."

The California Broadcasters Association does not view local government support of pirate broadcasters as problematic, because those jurisdictions have no authority in the area of broadcast regulation.

Fewer communities, Powers said, support pirates now thanks to the presence of the new authorized low-power FM service, which, he said, has met the need for community radio and eliminated many unlicensed operations. After the creation of LPFM, the association stopped keeping track of the number of interference complaints California broadcasters lodged against unlicensed broadcasters.

Powers discounts the view that licensed broadcasters are not meeting the needs of communities. If listeners were really interested in pirate radio, he said, the audience would have grown beyond "the couple people listening."

"In the end, the audience drives broadcasting. Broadcasting does not drive the audience," said Powers.

The FCC has yet to approve any LPFM applications filed by former pirates while the licensing issue continues to be debated in the courts. In 2002, a federal appeals court in Washington ruled that the ban on former pirates as LPFM operators is unconstitutional but decided that the FCC may reject pirates on a case-by-case basis. In May 2002, the same circuit court agreed to rehear the case following a request by the FCC.

In July of this year, the FCC released the results of a study by the Mitre Corp., which concludes that many LPFM stations could be operated on third-adjacent channels with respect to full-power FM stations. Broadcasters were preparing comments opposing the methodology of the study in October.

Olson said San Francisco Liberation Radio filed applications for licenses twice in the past, once in the mid-1990s and again during the LPFM license window. Both applications were rejected. Olson did not know why; the rejections predated her association with the station.

She said the station has been broadcasting in the San Francisco area since 1993 without any interference complaints. Operating with 100 watts, SFLR airs music and programming, including commentary opposing the continuing war in Iraq.

San Francisco Supervisor Matt Gonzalez, president of the board of supervisors, developed the city's resolution supporting SFLR and believes that taking a stand will be beneficial.

"For us, it just seems very natural to not be frightened of speech, and in this case the alternative press that's trying to

See PIRATES, page 10 ►



A DJ from Freak Radio spins a tune.

says is untrue.

For many unlicensed operators, the community support is symbolic.

"(The city's resolution) will not compel the FCC to do anything," said Sarah Olson, a DJ at San Francisco Liberation Radio, which airs on 93.7 MHz and online. More important, she said, "It galvanized the community."

Enforcement Bureau field staff delivered a notice to SFLR in July stating it was operating without a license in viola-

that encourage diverse local noncommercial media and calling for the FCC to roll back the relaxation of its media ownership rules.

The San Francisco resolution, Olson said, was based on a similar measure passed in Seattle last March that supported diversity in media ownership. The resolution also addressed the issue of whether former pirates would be eligible to license LPFMs.

Because the decision to forbid former

## Kintronic Labs, Inc

**OFFERING COMPLETE CONCEPT - TO - ON AIR SERVICES FOR DIGITAL AM RADIO**

**WIDEBAND ANTENNA TUNING UNITS, PHASING AND MATCHING SYSTEMS TO MEET CUSTOM REQUIREMENTS**



**THREE TOWER AM 50kW NDA-D / DA-N DIRECTIONAL ANTENNA SYSTEM ST PAUL, MN.**

**NEW "DLTU" SERIES SUPER WIDEBAND ANTENNA TUNING UNITS**



**DIRECTIONAL ARRAY ANTENNA TUNING UNIT GAITHERSBURG, MD**

Phone: (423) 878-3141 Fax: (423) 878-4224 Email: [ktl@kintronic.com](mailto:ktl@kintronic.com) Web Site: [www.kintronic.com](http://www.kintronic.com)



# Wish you had more

up top?

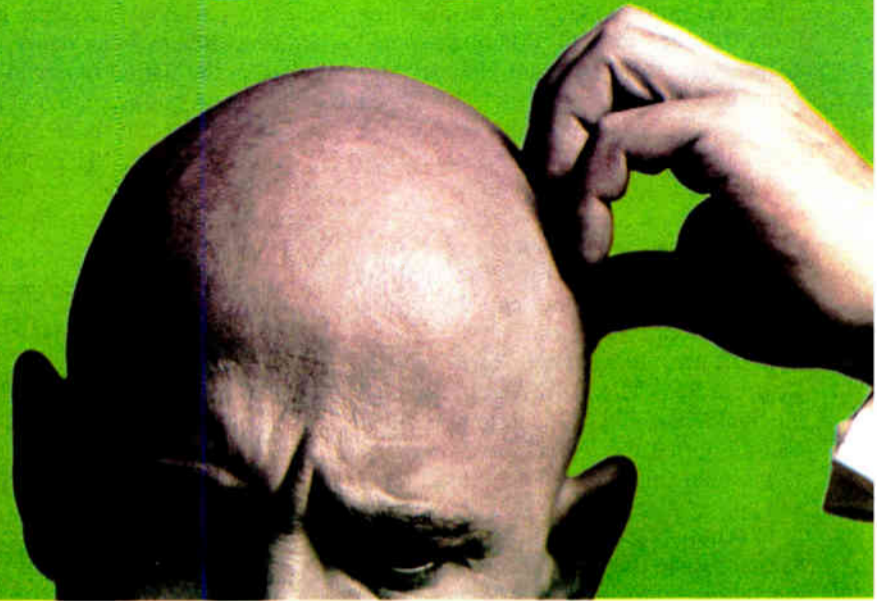

## Announcing Omnia-6EX.

There's a lot of buzz about the new HD Radio codec. We've heard it and agree with the many others who like it and say it's now time to get on with radio's transition to digital.

Because HD Radio can transmit audio frequencies up to 20kHz, listeners will finally be allowed to hear the full CD spectrum – if their radio stations choose the right on-air processor. On this point, you should know something important: Some “HD” processors simply hack off everything above 15kHz... robbing listeners of the full HD Radio experience and keeping our industry in a fidelity backwater.

The new Omnia-6EX won't short-change your listeners. We've built Omnias with sampling rates of 48kHz and higher from the start. All along, we've needed the sampling headroom to keep analog FM audio grunge-free. Now it's essential for HD Radio. Even if some listeners wouldn't notice the missing high frequencies, there's a fair chance they would hear a sharp 15kHz low-pass filter operating within HD Radio's codec range.

Omnia-6EX is also full of processing enhancements that result in yet more bass punch, yet more voice clarity, than the original Omnia-6. A sound so powerful and free of artificial constraints, you'll crave it for your station the first time you hear it.

More than 50% of the US' Top 100 FM stations have already upgraded to Omnia. Maybe you're next?



*The new Omnia-6EX has enhanced processing for analog FM, and is ready for HD Radio with a second limiter section and digital output. Both FM and HD limiters and outputs are included as standard.*

**Omnia**  
A Telos Company  
omniaaudio.com

# Pirates

► Continued from page 8

get a message out to folks," he said.

Olson said SFLR is waiting for a response from the FCC to a letter it sent citing the unresolved issues of allowing former pirates to apply for licenses and keeping the third-adjacent channel protections. Meanwhile, she said, SFLR will continue to seek community support for the station and is considering whether to take the issue to the state level.

## Free Radio Santa Cruz

SFLR's campaign for state support may be aided by another city that issued its support for pirate radio.

In September, "Free Radio Santa Cruz" at 96.3 MHz successfully lobbied the Santa Cruz City Council to pass a resolution urging the federal government to stop threatening to close the music, news and public affairs station.

In August, FCC field agents tried to gain access to the radio and Web streaming station but could not. The agents left a notice that the station was broadcasting without a license, stating that transmissions from the location were interfering with broadcast television, said a DJ who calls himself Skidmark Bob.

Also known as Freak Radio, the station has a Web site on which it boasts it is "proving FCC incompetence 24 hours a day, 7 days a week," and has been on the air "eight years without a license."

According to Skidmark Bob, it is the second time Freak Radio has received the support of the city council. Like San Francisco, the Santa Cruz resolution also urges federal, state and local officials to support policies and practices that encourage diverse local noncommercial media. In 1999, the council approved a statement supporting the station.

Duran said the station has received numerous visits by the FCC and has always evaded an equipment seizure by the agency. "It would be really bad to raid us," he said. "We have so much com-

munity support. We get donations."

In September, 25 people turned out at an emergency session called by the city council about the station, he said, adding that the members passed the measure unanimously and in it, recognized Freak Radio broadcasters for going "to great lengths to ensure that their equipment operators without causing harmful interference with any other radio signal."

Once, the station switched frequencies after a local public station complained to the FCC about interference.

Santa Cruz Vice Mayor Scott Kennedy said it is critical that communities take a stand for independent media.

Johnson, was unfair because the five-day filing window was too short and that the entire process has proceeded slowly. The station airs at 87.9 MHz.

The Peace and Justice Center, a Burlington-based nonprofit group, filed for an LPFM application two-and-a-half years ago. According to Johnson, the Center has not received a response from the FCC because the application conflicted with another from the Vermont Department of Transportation, which filed three-quarters of the 20 applications filed by Burlington groups.

Over two years ago, Free Radio Burlington launched a community-based

Although they found no transmitting equipment at the site, field agents gave a warning for the station to get off the air within 10 days. Prepared for such a visit, Johnson said other collective members took away the computer equipment used to stream the station's broadcasts to its transmitter a half-mile away from the station to avoid confiscation.

Now the station is working to get back on the air and streaming on its Web site. Johnson said he and fellow collective members are working on gaining community support.

Free Radio Burlington expects to get the support of its city leaders within the next six months. Johnson is assured the station will get a favorable response. "We're trying to be a community asset, not an eyesore," he said. "(The station) is something that the council members can use at election time."

The collective members say they also are considering how to address their grievances before the FCC. "We've talked about the possibility of filing a lawsuit for not representing the people they're serving," Johnson said. "We don't have enough money for it, but we'll build up community support and do it. Until then, we'll keep broadcasting."

One of Free Radio Burlington's other goals is to start up classes for Vermont residents interested in launching pirate radio stations. "We think pirate radio is on the rise," he said. "If a community desires a station run by the public for the public ... (we want) to help." ●

**F**or us, it just seems very natural to not be frightened of speech, and in this case the alternative press that's trying to get a message out to folks.

— Matt Gonzalez, San Francisco Board of Supervisors President

"Radio and television outlets are increasingly controlled by a very large corporations," he said. Though Free Radio Santa Cruz programmers have criticized the council during broadcasts, "it makes it more important to support the resolution. Free speech isn't predicated on agreement."

Duran said the station's whole premise is "having our own free speech." He said the 30 volunteers who run the station have never applied for a low-power FM license and will never do so. "We never wanted to be licensed," Duran said. "We don't want any censorship, inspections or the FCC telling us how to run things."

## Free Radio Burlington

Other pirate radio broadcasters say that the commission is not supporting the public's wishes by encouraging a diversity of media. The LPFM process, said Free Radio Burlington collective member Patrick

radio station, similar to the type that was going to be provided by Peace and Justice Center, he said. For the first time, in September, FCC field agents tried to inspect the station's location.

## NEWS WATCH

### Stations Fined on Public Files

**WASHINGTON** The FCC is cracking down on public file violations.

The Media Bureau issued 28 Notices of Apparent Liability to radio stations that the agency said did not adequately comply with the commission's public file requirements. They were ordered to pay fines of \$3,000 each. The bureau determined that \$4,000 fines were warranted, but reduced the fines because the stations voluntarily disclosed the violations.

Stations in Maryland, Virginia, West Virginia and Washington, D.C., were fined. Radio's three-year nationwide license renewal period began in October.

The FCC said the actions "mark a change in policy from the last renewal cycle (1995-98) and reflect the Media Bureau's effort to enforce public file rules in a meaningful way as part of the renewal process."

"Our decision to fine these stations reflects the seriousness of the violations, and it is consistent with FCC Chairman Michael Powell's initiative to promote and protect localism in broadcasting," said Media Bureau Chief Ken Ferree. "The public file provides citizens with important information about broadcasters' service to their communities. Make no mistake about it — the FCC will not tolerate less-than-diligent efforts to ensure the accuracy and timeliness of that information."

### Localism Hearings Set

**WASHINGTON** The FCC may be coming to a community near you. The commission has announced when and

where it intends to hold public hearings on localism.

An initiative of Chairman Michael Powell, the localism task force will seek input from consumers, industry, civic organizations and others about broadcast ownership.

Each hearing will be chaired by at least one commissioner. A meeting is set for San Antonio in December; the first was slated for Charlotte, N.C., in October.

Other cities scheduled for hearings in 2004 include Santa Cruz/Salinas, Calif., Rapid City, N.D., Portland, Maine and Washington.

### KUPD Fined for Kile Call

**WASHINGTON** The FCC fined Tempe Radio, licensee of KUPD(FM) in Tempe, Ariz., for airing a phone call with the widow of a baseball player without first notifying her the call could be broadcast. The fine was \$4,000.

The case stemmed from October of last year, when the commission received a complaint that the station had aired a telephone conversation between host Beau Duran and Flynn Kile, the then-recently widowed wife of St. Louis Cardinals baseball pitcher Darryl Kile. Duran called Ms. Kile, who was visiting Arizona, and asked whether she was "hot" and whether she had a date for the St. Louis Cardinals-Arizona Diamondbacks playoff game.

The station admitted it aired the brief exchange and that Duran did not tell Ms. Kile the call "would be or was being aired."

Tempe fired Duran. The station issued a memo to employees warning them that airing phone calls without first informing parties their calls may be aired would result in termination.

## The Wizard™ has gone STEREO!

The new **DIGITAL FMSA-1** gives The Wizard System unmatched stereo monitoring capabilities. . .



Superlative stereo performance. Linear-phase filters that reveal the true performance of your audio processing. The stability of digital stereo demodulation. The sophisticated graphical presentation of The Wizard. And—with the RS-232 port—operation on site or off.

Contact Belar today for more details on what should be your next modulation monitor



**BELAR ELECTRONICS LABORATORY, INC.**  
119 LANCASTER AVENUE • P.O. BOX 76 • DEVON, PA 19333-0076 USA  
(610) 687-5550 • FAX (610) 687-2686

Call, write or FAX for more information on Belar AM, FM, Stereo, SCA, and TV monitors.

[www.belar.com](http://www.belar.com)

# Experience. Stability. Vision. *And Erick Steinberg.*

Susquehanna People

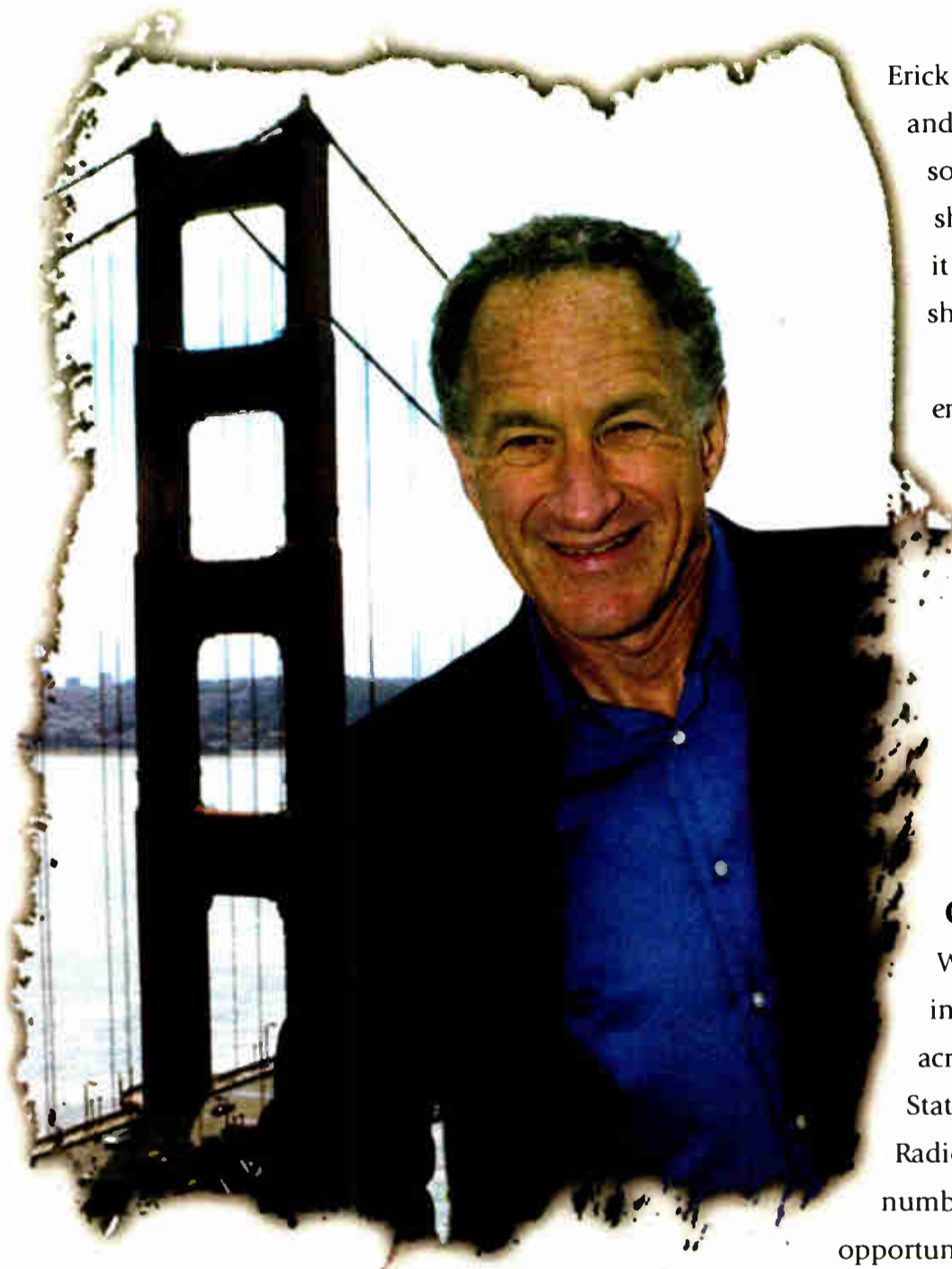

## *Erick Steinberg*

Director of Technical Operations  
Susquehanna, San Francisco

Erick Steinberg's job is challenging, demanding, and requires a very hectic work pace. It's something he describes as "hard fun." "Radio is show biz," he says. "It should be fun!" Of course, it also helps that he's surrounded by people who share his passion for the industry.

"We're all career broadcasters around here, and I enjoy working for a company that is run by broadcasters," Erick says. "Their commitment to technical excellence and training at all levels is unbelievable!"

When he first arrived at Susquehanna Radio, Erick says, "I felt right at home." Now, six years later he adds, "Susquehanna is just the right size. My work friends are here, my work family is here. I intend to make this my last stop in radio."

### **Make a Sound Career Choice!**

With operations in major markets across the United States, Susquehanna Radio Corp. offers a number of radio career opportunities. For more information, visit our website or call our Human Resources Department at (717) 852-2132.

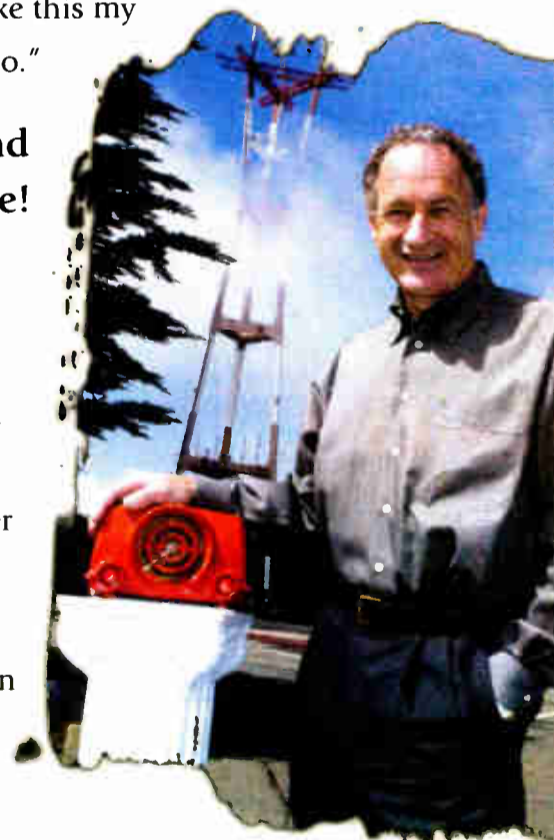

**SUSQUEHANNA**  
RADIO CORP.

*A subsidiary of Susquehanna Pfaltzgraff Co.*

Susquehanna Commerce Center West  
221 W. Philadelphia St. ■ York, PA 17404  
(717) 852-2132 ■ Fax (717) 771-1436  
[www.susquehannaradio.com](http://www.susquehannaradio.com)

*Susquehanna Radio Corp. is an Equal Employment Opportunity Employer, an ESOP Company, and maintains a Drug-Free Work Environment.*

## Ibiquity Sees Finish Line in Sight

by Leslie Stimson

**PHILADELPHIA** Ibiquity Digital Corp. is focused on getting HD Radios to market and regaining momentum for digital conversion at stations.

At the same time, a leader of the body that develops standards for IBOC says that if stations should fail to transition, he fears terrestrial radio eventually may migrate to a new band — one in which all frequency allocations would be auctioned.

Ibiquity executives say approximately 280 radio stations encompassing more than 100 markets have licensed the company's technology. Roughly 55 are on the air with an HD Radio signal, said Ibiquity President and Chief Executive Officer Robert Struble. He made the comments during the NAB Radio Show in Philadelphia.

The company believes it's well on its way to licensing 300 stations by the end of the year.

Ibiquity has identified six cities as launch markets for the consumer rollout — New York, Los Angeles, Chicago, San Francisco, Miami and Seattle. In each, 10 to 18 stations have licensed the technology.

Stations in 35 states as well as the District of Columbia and Puerto Rico have committed to HD Radio.

Struble said the company started taking receiver orders before the NAB Radio Show for stations on the air with a digital signal that want one of the first 1,000 Kenwood HD Radio receivers. He said Ibiquity has those receivers, which incorporate the new HDC codec software.

### Aftermarket units first

Ibiquity is selling the receivers to broadcasters for \$399 each. Broadcasters need a compatible Kenwood head unit to hear the digital programming.

Looking towards 2004, JVC and

Panasonic have early launch plans for aftermarket HD Radios, said Struble. Kenwood plans a limited launch in the fourth quarter of this year and will be ready to ship to retailers in January.

Delphi plans to have in-dash HD

interested in HD Radio believe the technology virtually eliminates reception problems due to such issues as multipath interference and ignition noise.

Kenwood, Yamaha and JVC are developing home radios.



From left: Delphi's Robert Schumacher, Lang Sturgeon of WPOC(FM) in Baltimore, Ibiquity's Scott Stull and Susquehanna Radio's Charlie Morgan are bright and chipper before their session.

Radios next year in 2005 model-year cars. The company plans to begin production of HD Radios in the first quarter of 2004.

There is consumer demand now for digital radio, said Robert Schumacher, business line executive for Delphi's Wireless Division, who also spoke during the NAB convention. He said satellite radio is creating that interest. "Delphi has shipped over 1.1 million digital radios" to retailers, he said.

Poor reception is the most common complaint in vehicle audio systems, he said, adding that radio manufacturers

"It's all about the speed of the receiver uptake now," said Struble, regarding Ibiquity's plans.

But while it's trying to go forward, company executives are still answering questions from the industry about its new codec, the layoffs this summer and its financial needs.

Of the codec switch, Struble said, "It's a strange example of how the process is supposed to work. We took feedback from the industry about what they wanted. Sometimes the process is loud and

messy, but it works," he said of Ibiquity's decision to drop PAC and adopt a new, proprietary codec, HDC.

Sirius, meanwhile, intends to continue using Ibiquity's PAC codec; in fact, some members of Ibiquity's former PAC team of about eight people now work for Sirius. The satcaster says it has "enhanced the engineering staff to incorporate coder development" in its abilities, giving the satellite radio company "more flexibility and more control" over the direction of that coder development.

Ibiquity lost critical time to market and expense trying to integrate PAC into its system after it merged with Lucent Digital Radio, broadcast sources said.

Layoffs this summer reflected the rollout delay caused by the codec switch, Struble said. There are no plans for more layoffs, he said.

The reductions also reflected the changing nature of the company's needs. Struble said development of the technology is largely complete and that Ibiquity now needs to focus on working with its 18 receiver manufacturing partners to get radios to store shelves. The technical expertise the company needs now is more in technology transfer than design, he said.

Earlier reports that the company had spent roughly \$30 million last year were inflated, Struble said. He and other broadcast sources said the figure was lower. Ibiquity is a private company and declines to release spending figures.

The company has sufficient cash on hand to last another year, said Struble. Other broadcast sources said the layoffs stretched the funds on hand to ensure this, and that Ibiquity is still looking to broadcasters as well as its current financial backers for more investment.

### Kudos for codec fix

Key to getting that funding is proving to investors that the new codec works. After recent demos, key National Radio Systems Committee members believe Ibiquity has resolved the issue. The

See IBIQUNITY, page 14 ▶



**Finally, an RDS/RBDS solution built for the US radio market, offering consumer-rich programming and revenue generating interactive services. And also at the best price, Free!**

**dMarc Networks™ is the market leader in data services.**

To start generating revenue today, call (949) 791-1200 ext. 13

**dMarc Networks™ is HD Radio Ready™!**



**dMarc Networks**

**Turning Data Into Profits™**

[www.dMarcNetworks.com](http://www.dMarcNetworks.com)  
[www.RadioGreetings.com](http://www.RadioGreetings.com)



**More reliable** Xport doesn't rely on the off-the-shelf modems found in other POTS codecs. Instead, we developed a custom DSP modem optimized for live audio.

**Easier and lower cost** Xport's ISDN option lets you use it as a universal field codec.

**Better sounding** Xport's aacPlus is the finest low-bitrate codec on Earth – and Xport is the only POTS codec to have it. You'll be stunned at how good an analog line can sound.

## Now, your POTS and ISDN remotes are more reliable, better sounding, easier, and cost less.

**Zephyr Xstream owners, hear the clarity of aacPlus for yourself!**  
To get an instant demonstration of Zephyr Xport, visit [telos-systems.com/xport/](http://telos-systems.com/xport/)

**More reliable** Zephyr Xstream's pure-digital ISDN connection on the studio side eliminates a lot of the analog line problems that can make a modem unstable. An Xport call is converted to digital by the nearest Telco central office, and continues through the network to your studio in digital form. Working as a tightly integrated system, Xport and Xstream extract maximum performance and reliability from real-world Telco lines.

**Easier and lower cost** Your studio Zephyr Xstream is now universal, linking with both POTS and ISDN codecs in the field. You need only one box and one line for everything, so you save money, your operators have only one interface to learn, and you conserve console inputs and outputs.

Today, Zephyr Xport and Xstream are *The Best Way to Hear from Anywhere.*

*Telos*  
AUDIO | NETWORKS



[telos-systems.com](http://telos-systems.com)

Telos, the Telos logo, Zephyr, Zephyr Xstream, Zephyr Xport, The Best Way To Hear From Anywhere are all registered trademarks of TLS Corporation. © 2003, TLS Corporation. All rights reserved. aacPlus (TM) Coding Technologies

World Radio History

# Ibiquity

► Continued from page 12

group had suspended standard-setting efforts for IBOC this spring due to a problem with the audio quality of PAC on AM at low bit rates, an issue for stations that want to include data services with their digital programming.

Ibiquity recently resolved the problem, and standard-setting for digital radio has resumed. NRSC Chairman Charlie Morgan gave the technology developer kudos for handling the codec issue quickly.

He urged major-market broadcasters to convert their stations to digital and not wait until receivers are widely available.

digital signal might affect its neighbor; that's why, he said, the FCC has only allowed AMs to use IBOC during the day in its interim authorization.

While protection ratios for analog or digital won't change with nighttime operation, the amount of interference increases due to skywave propagation. The phenomenon occurs after sunset in the AM band when signals bounce off layers of Earth's atmosphere, traveling hundreds or thousands of miles.

Skywave reception of so-called clear-channel stations will probably go away if digital radio becomes widely used by stations at night, Morgan said.

Ibiquity has conducted additional tests to help define the extent of this additional interference and plans to submit those soon to NAB committees working on the AM issue, said Morgan and Struble.

transmitting both the analog and digital FM signals without requiring a high-loss hybrid combiner or the use of a circulator to attain the required isolation between the digital and analog transmitters.

The company says the design meets the current FCC requirement for informal notification of IBOC implementation. Stations must use a single antenna for IBOC implementation and include verifying information in their notification to the commission that they've converted. The company says the product is a true dual-input antenna that excites all the radiating elements with both analog and digital signals.

ERI says the design allows the use of a single antenna while eliminating

the combining loss present with the 10-dB hybrid combining method.

A beta test is in the works for a Greater Media facility. ERI expects production models of the antenna to be available by the second quarter of 2004.

Greater Media Vice President for Radio Engineering Milford Smith called the development "the killer app" in terms of being able to implement HD Radio in a cost-effective way.

Precise implementation details were not available at press time. ERI said it has patents pending on the antenna.

Vendors with HD Radio equipment on the show floor reported heavy interest in the practical nuts and bolts of digital radio implementation. 

## DIGITAL NEWS

### Beasley Converts First HD-R Station In Philadelphia

**PHILADELPHIA** Beasley Broadcast Group plans to convert 10 stations to HD Radio by the end of January. The process is complete for seven stations, including the first to go on the air with an HD Radio signal in the Philadelphia market.

In an on-air demonstration on the eve of last month's NAB Radio Show, the broadcaster and Ibiquity Digital Corp. showcased the digital audio that incorporates Ibiquity's new codec on WWDB(AM) and WXTU(FM).

"The people who listen to radio will embrace this new technology," said Chairman/CEO George Beasley.

For the first seven stations, the company

speaking to a new generation of digital kids."

Beasley said of the AM quality, "AM digital sounds like FM."

The company has converted five of six stations in southeast Florida. They are Miami stations WKIS(FM), WQAM(AM) and Boca Raton AM stations WWNN, WSBR and WHSR.

Those still to be converted in Beasley's initial batch are WPOW(FM) in Miami and WPTP(FM) and WTMR(AM), both in Philadelphia.

Beasley is an Ibiquity investor. The group, founded in 1961, owns or operates 26 FMs and 15 AMs in large and mid-size markets.

## Consumer demand for digital radio exists now.

— Delphi's Robert Schumacher

"Without broadcasters taking the lead and investing in IBOC installations, I fear that IBOC may become stalled or simply die a slow death," said Morgan. If that happens, he cautioned, "I believe we will see some form of new-band terrestrial radio. Possibly these new facilities will be sold at auction. Existing broadcasters will have no assurances that they will have the same role in this new service that they have today."

AM performance of IBOC at night remains an issue. Morgan said the NRSC didn't have enough information to know how a station transmitting a

Shortly after the show, NAB Director of Advanced Engineering David Layer, who serves as the NAB staff person on the NRSC, said the committee thinks the FCC would issue a second notice about IBOC in 2004, with details about how stations may implement the service.

#### Dual inputs

Also at the NAB radio convention, Electronics Research announced it has completed a working prototype of a dual-input, side-mounted FM antenna designed for FM IBOC applications.

ERI says the antenna is capable of



**Audemat-Aztec**

## RDS FM Datacasting

Use your FM RDS sub carrier to boost your audience and distinguish yourself from your competition. Display your station's call letters or slogan, song titles, artist names, and many other services....

>>Prices start at \$ 1,350



Affordable static RDS generator: **FMB10**

Dynamic RDS generator with embedded web server: **FMB80**

Digital stereo generator, RDS and DARC generator, sound processor and composite clipper: **FMX410/FMX480**

www.audemat-aztec.com • Aventura, FL USA tel: +1 (305) 692 7555  
Fax: +1 (305) 682 2233 - ussales@audemat-aztec.com



From left: Dave Donahue, VP/GM of Beasley's Philadelphia cluster, shakes hands with George Beasley; Ibiquity's Bob Struble is at right. WXTU(FM) was the first station in Philadelphia to go HD Radio.

spent roughly \$75,000 converting each station for a total of approximately \$400,000, said VP/Chief Technology Officer Robert Demuth. The group also was able to take advantage of Ibiquity license fee waivers.

For all 10, the conversion figure is close to half a million dollars, Demuth said.

Don Melnyk, director of engineering for the Philadelphia cluster, said the conversions were turnkey. The FMs are using Broadcast Electronics transmission equipment; the six AMs use Harris and BE HD Radio gear.

Ibiquity Digital President/CEO Robert Struble said, "We have good reason to be excited about the future of radio. We're

Beasley began acquiring stations while still a high-school principal. He had relatives in the business who helped him apply to the FCC for a license to build a 500-watt daytimer, WPYB(AM) in Benson, N.C. He worked in radio and education for several years, but eventually was able to concentrate on radio. He eventually sold the station for a profit and purchased one with a 1,000-watt signal in a slightly larger market, Goldsboro, N.C.

Four of his five children work with Beasley; his daughter Caroline is chief financial officer of the organization.

— Leslie Stimson

# Drive Your Business.

Introducing  
Expressfinancing  
on Harris  
digital broadcast equipment.



Now you can get 0% Financing\*  
from  
American Express Business Finance  
on select Harris digital  
broadcast equipment.

0%  
financing.

## 0% Financing for 36 months

American Express Business Finance and Harris Broadcast Communications Division announce a new limited-time offer for your digital upgrade path.

- Get your digital solution up and running as quickly as possible with the leading broadcast supplier—Harris.
- Preserve your cash with a 36-month, no-interest financing plan on any equipment purchases of \$20,000.00 or more. Use your working capital to grow your business and earn higher profits.

- Move into the new generation of television with digital solutions specifically designed for your industry. Don't settle for limited systems—integrate your business with anything from automation to encoding to transmission.

For more information on 0% financing of Digital Transmitters or other Harris equipment with American Express, please call your local District Sales Manager or Sandy Lam at 513-459-3719.

\*Terms & Conditions Apply. Financing available through American Express Business Finance Corporation to qualified customers in the U.S. Financing is subject to credit approval and execution of standard American Express Business Finance documentation. 0% Financing available on 36 month term with \$1.00 purchase option. Offer ends December 31, 2003.



[www.broadcast.harris.com](http://www.broadcast.harris.com)



World Radio History



From left: Shoichi Suzuki (Kenwood), Ron Thompson (KKJZ), Tom Walker (Ibiquity Digital), Mike Bergman (Kenwood) with a Tomorrow Radio Van.

## Tomorrow Radio Research Advances

Also at the NRSC meeting in Philadelphia, Harris, NPR and Kenwood presented an initial test progress report from its Tomorrow Radio field tests to the standards body.

As previously reported, testing was successfully completed at public radio FM stations KALW in San Francisco, KKJZ in Los Angeles, WETA in Washington and WNYC in New York in September. The project aims to determine whether splitting the channel of a station transmitting in HD Radio to create supplemental audio/data channels is feasible and whether such a system could withstand a mobile environment.

The companies had hoped to have a final report ready for the radio show, but representatives called the project "a work in progress." The group needs to do follow-up testing with Ibiquity's new HDC codec.

Participants drove about 5,000 miles during testing.

Mike Starling, NPR's vice president for engineering and operations, said he's confident results would show it's at least possible to have the secondary channel coverage out to city-grade contour of 70 dBu. He said consulting engineering firm Hammett and Edison was still evaluating the results. An analysis and final report are expected in time for the NRSC's meeting at the CES convention in January.

NRSC sources said they don't think commercial radio broadcasters have fully thought about the implications should secondary and tertiary channels become possible for pubcasters using HD Radio.

—Leslie Stimson

## NRSC

► Continued from page 1

developer and the NRSC continue to discuss what further information is needed as the sides try to reach agreement.

Several sources stressed that neither wants the process to stop again, referring to the several-month hiatus while Ibiquity resolved its codec problem for AM by switching codecs.

NRSC members say they also want to make sure their standards for different technologies are current.

### RBDS re-ignited

At the NRSC meeting in Philadelphia, members also re-established the Radio Broadcast Data System Subcommittee. Entercom Vice President of Engineering Marty Hadfield said the group would review the U.S. standards and make sure they are up to date.

"We know we have some elements that don't fit in from the original design," said Hadfield. For example, there were 20 formats when RBDS appeared in radios in this country about 10 years ago; now there are roughly 40.

Entercom uses RBDS on all of its FM stations. Hadfield cites several reasons for renewed interest in the technology, which allows stations to incorporate inaudible signals into broadcasts on the 57 kHz FM subcarriers to control what users see on radios enabled with the technology.

More car radios are equipped with RBDS capability than 10 years ago; and now, more stations have hard-drive computer systems that they can use to configure their Web-based networks to edit or schedule the text messages that RBDS-enabled radios receive.

The first meeting for this new subcommittee is slated for Nov. 6.

The NRSC also is re-focusing on AM standards. It's been five years since the NRSC has reviewed the RBDS standard for this country and 10 since it has reviewed some of the AM broadcasting standards. The NRSC created an AM subcommittee to review standards for AM pre-emphasis/de-emphasis and two other standards for occupied bandwidth. No chairman had been selected by presstime. 🌐

# Tieline is the "Clear" choice for POTS, ISDN and Wireless Codecs



## Clark Dixon, Chief Engineer Clear Channel Tulsa.

*"We do numerous remotes and have had great success using Tieline codecs. Tielines codecs give us a lot of control we previously didn't have. They are versatile and they perform very well."*

### The Essential Codec Checklist

- ☑ Compatible with other 15kHz POTS codecs
- ☑ Unrivalled link stability over POTS (Used for STL's)
- ☑ Connects to other ISDN codecs via G.722 (ISDN option)
- ☑ 15kHz audio bi-directional over POTS
- ☑ 15kHz audio bi-directional over ISDN (optional)
- ☑ GSM Wireless Connectivity for mobile phones
- ☑ Automatic Intelligent Gain Control
- ☑ Low 100ms POTS latency
- ☑ Music/Voice + up to 9600bps data simultaneously
- ☑ Remote relay, RS232 control and remote audio level control
- ☑ Auto Reconnection on power or line loss
- ☑ Upgrade over the Internet.
- ☑ Rugged Metal Construction

### A small selection of network users

- |                              |                                |   |
|------------------------------|--------------------------------|---|
| ■ Clear Channel              | ■ Jefferson-Pilot Broadcasting | ■ University of N. Alabama Sports Network |
| ■ Entercom                   | ■ Tribune Broadcasting         | ■ Tennessee Titans Radio Network          |
| ■ Talk America Radio Network | ■ Simmons Media                |   |
| ■ Sandusky                   |                                |   |



**Ask your favorite dealer  
for a FREE demo today!**

**Tieline**   
TECHNOLOGY

www.tieline.com

Tieline Technology - 7202 East 87th Street, Suite 116, Indianapolis, IN 46256. Toll Free (888) 211-6989  
email: sales@tieline.com



DIGITAL NEWS

## Philips Releases HD Radio Single-Chip Processor

**SAN JOSE, Calif.** Royal Philips Electronics has its first HD Radio receiver chipset ready for automotive radio manufacturers.

Philips says the SAF3550 is a highly integrated digital integrated circuit that uses fewer components to demodulate and process HD Radio signals in automotive applications when compared to competitors.

Philips said it waited to come out with its first HD Radio chip so it could load more capabilities onto the IC.

The chip is designed to complement Philips' automotive AM/FM receiver chipset, the Philips' SAF7730 IF-CarDSP and the TEF6721 companion tuner. The tuner has been designed to handle wide-band or narrow-band HD Radio signals in a single integrated circuit.

and intermediate frequency functions in its HD Radios.

Samples of the SAF3550 are available. The electronics manufacturer will ship in volume in early 2004. The cost is \$25 in 1,000 unit quantities, a slightly lower price than competitor Texas Instruments.

Morgan said Ibiqity Digital's change of codecs did not entail design changes for the Philips chip; the product had enough memory space and computing power overhead to accommodate a new software load.

— Leslie Stimson

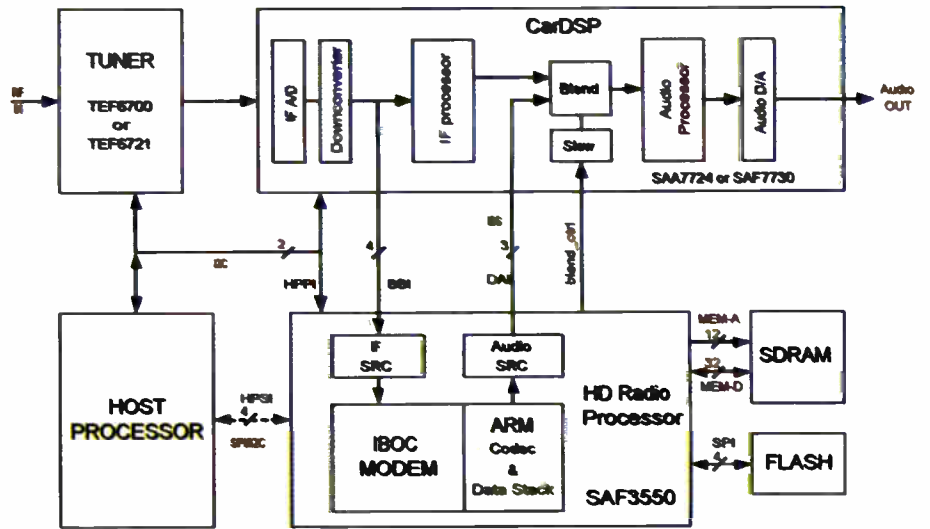

This block diagram contains three integrated circuits from Philips: the tuner, CarDSP and HD Radio processor.

# Great Software from BSI

If you're a high-volume manufacturer, you want to be able to build the radio with or without HD.

— Jack Morgan

Jack Morgan, automotive director of Philips' semiconductors division, said his company uses fewer circuits to perform the processing functions, so it's cheaper to build the chip.

Philips also claims flexibility in its chip design works for receiver manufacturers.

"If you're a high-volume manufacturer, you want to be able to build the radio with or without HD," said Morgan. Receiver makers want the HD Radio portion of the radio to be a plug-in component for flexibility in manufacturing, he said.

He said the Philips chip can decode compressed DVD, CD or MP3 in addition to HD Radio so the same automotive radio can handle front and rear-seat audio processing.

The chips have been designed to support the wireless data functions of HD Radio such as song title, artist and album name. The SAF3550 can also support future functions such as a second audio program channel, several minutes of replay and increased data services such as customized station and program content.

Morgan said Kenwood is using Philips integrated circuits for its tuner

BSI produces Simian digital automation, but did you know that we have a whole family of products for Radio?

WaveCart, Stinger, Speedy, Skimmer and WebConnect can all work together to make your station function professionally and sound amazing. In addition to the software that we have created, we offer partner products like AudioScience sound cards, Natural Broadcast Systems traffic and billing software and various other hardware accessories.

Any and all of our programs are available on our website for download. So install our software and play with it for as long as you want. Once you've decided that it's the software for your station, give us a call or order online.



**Broadcast Software International**  
 1925 Bailey Hill Road, Suite A  
 Eugene, OR 97405  
[www.bsiusa.com](http://www.bsiusa.com)  
 888-BSI-USA1 (888-274-8721)  
[info@bsiusa.com](mailto:info@bsiusa.com)

Para el español, llamada Felipe Chavez,  
 Distribuidor de los E.E.U.U.  
 (916) 368-6332  
[fchavez@ommedianet.com](mailto:fchavez@ommedianet.com)



**Simian**  
 digital automation  
**\$1499**

**WaveCart**  
 digital cart machine  
**\$299**



**Stinger**  
 instant audio player  
**\$199**

**WebConnect Pro**  
 email remote control  
**\$299**

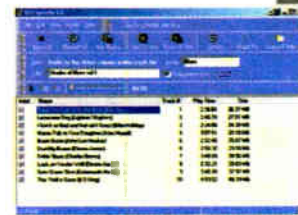

**Speedy 4.0**  
 CD-to-PC recorder  
**\$199**

**Skimmer**  
 easy audio logging  
**\$299**



Thousands of users have discovered how easy and versatile BSI software really is.  
**Test and try before you buy.**

# DRM: New Digital Kid on the Block

by Lawrie Hallett

This is the second in a two-part series on the development of the Digital Radio Mondiale technology. Part 1, in the Oct. 22 issue, explored DRM's history and

have been almost exclusively on separate frequencies from any analog outputs of the same program material.

Thus, the DRM approach is similar to that of Eureka-147, an all-digital signal. The reasoning is that because the available band-

on separate channels from those used for any existing AM analog version of the same service. It is possible to operate all-digital DRM transmissions on other frequencies below 30 MHz, where space and regulations allow.

Current planning rules simply require

sions it is essential to maintain phase accuracy and to avoid incidental phase products being created.

The DRM system can operate within current AM broadcast band plans, which are predominantly based on signals having channel spacing of 9 or 10 kHz. Stations transmitting using DRM also may use narrower bandwidths (4.5 or 5 kHz), inevitably

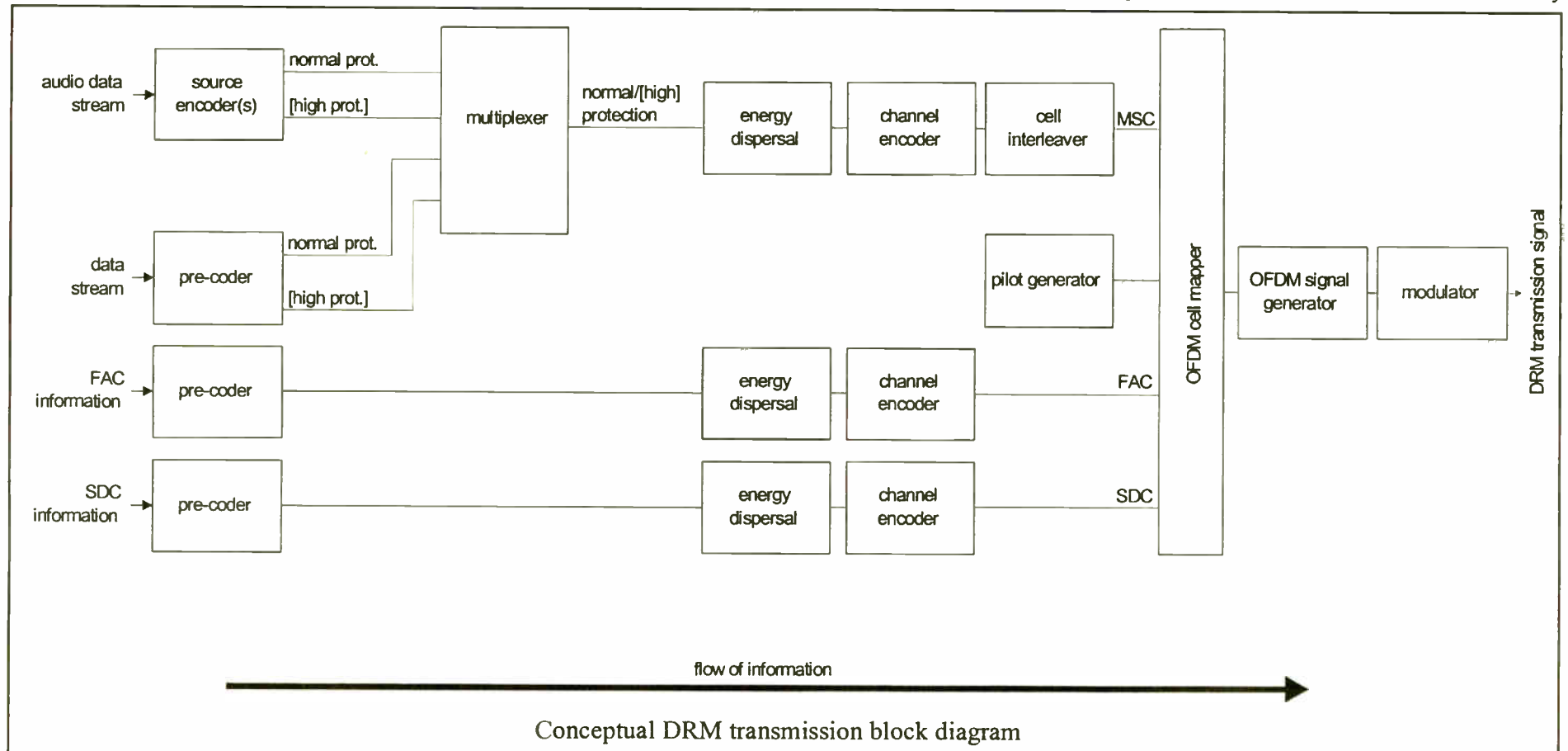

The DRM signal path. DRM's Peter Jackson states: 'While this does not show a transmitter, there would usually be an exciter after the modulator, providing two options for driving the transmitter: linear and non-linear. For a linear transmitter the DRM COFDM composite signal from the exciter is applied to the transmitter input, amplified and then applied to the antenna. In the case of a non-linear transmitter the exciter provides a DRM signal phase component, which replaces the usual transmitter input from the carrier frequency synthesizer, and a DRM signal amplitude component, which goes into the transmitter modulator where the normal audio would go in. An amount of delay is applied to the amplitude component to ensure that it is time co-incident with the phase signal at the modulator and the resultant DRM COFDM signal is then produced at the transmitter output, which is coupled to the antenna.'

began to look at how the technology compares to Eureka-147 and HD Radio.

For DRM, the situation is slightly more complex, as a reduced-quality simulcast mode is available within the system specification. However the DRM consortium prioritizes stand-alone operations, which means the DRM all-digital transmissions to date

width is so limited in ITU Regions 1 and 3, the DRM simulcast mode cannot offer full audio quality and interference may still be caused to existing AM services.

For Eureka-147, there is no simulcast mode, as the system is operated on entirely separate frequencies.

DRM allocations therefore can be made within the existing AM broadcast bands, but

that, to avoid interference to nearby analog services, the effective radiated power level of any DRM service be 7 dB down from the maximum that would be allowed for an analog service transmitting from the same location and on the same frequency.

From an engineering perspective, the only other area of concern is antenna systems. Just as with HD Radio, for DRM transmis-

with lower data carrying capacity.

The system specification also includes the ability to use multiple channel implementations (for example, dual-channel allocations within bandwidths of 18 or 20 kHz). Such wider-bandwidth modes have a greater data carrying capacity and could be used to carry high-quality stereo audio and

See DRM, page 19 ▶

**ALTRONIC RESEARCH INC.**  
Performance By Design

**MANUFACTURER  
OF RF COAXIAL LOAD RESISTORS.**

**DUMMY LOADS FROM 1 KW TO 1500KW,  
AVAILABLE IN AIR, WATER OR SELF  
CONTAINED HEAT EXCHANGERS.**

**HIGH POWER NON-REACTIVE CERMET  
RESISTORS FROM 1 OHM TO 20 MEGOHMS.**

Radio World

**ALTRONIC RESEARCH INC.**

P.O. Box 249 • Yellville, Arkansas 72687 870-449-4093 • Fax: 870-449-6000  
E-mail: altronic@mtnhome.com Web Site: <http://www.altronic.com>

# DRM

► Continued from page 18 enhanced data features.

In a channel of 9 or 10 kHz, approximately 200 carriers constitute the DRM OFDM signal. However, within the DRM specification, the precise modulation scheme used can be varied to suit the particular type of transmission being undertaken (local broadcasting, international long-distance or multi-hop sky-wave etc.) and the type of programming being broadcast.

The mode used defines the amount of error correction employed in the transmissions and hence the amount of carrying capacity left for program material. The worse the transmission path, the greater the amount of error correction used and the smaller the remaining available program-carrying capacity.

A DRM signal contains an internal multiplex comprising three distinct parts: the Main Service Channel, Fast Access Channel and the Service Description Channel. The function and characteristics of these parts of a DRM signal are described in the accompanying chart on page xx.

The best available program audio quality is achieved using MPEG-4 Advanced Audio Coding with Spectral Band Replication, otherwise known as MPEG-4 aacPlus. After the recent changes in the coding system used by the Ibiqity HD Radio system, the two systems are now even more similar to each other.

Coding Technologies says SBR, which both DRM and HD Radio use, is an efficient method for recreating high-frequency audio components from a Musical Instrument Digital Interface file-like low-bit-rate data stream (~2 kbps).

At low bit rates, most transform coding systems (such as MPEG-4 aacPlus) perform better if the bandwidth of the program material being transmitted is reduced. The principle is that, by reducing the audio bandwidth, data bits can be more efficiently used because the number of frequency analysis bands needed is reduced.

By using SBR to digitize and subsequently recreate audio frequencies above around 7 kHz, the performance of the AAC coding can be made more efficient, as it only needs to handle frequencies below this point. The resultant audio has good subjective performance in the most critical part of the audio spectrum (500 Hz to 6 kHz) while retaining an audio bandwidth that extends up to 15 kHz (all in a data rate of around 20 to 25 kbps).

## Euro digital radio

In essence, therefore, mainstream implementations of DRM are similar to AM HD Radio with the analog system component removed. After the recent change of codecs by HD Radio, although some differences remain, the similarities extend to the coding algorithm used as well.

While this development may have reduced the unique intellectual property rights associated with the HD Radio system, it should make dual-standard HD Radio and DRM receivers easier and, because of potential economies of scale, cheaper to produce. Despite greater technical differences between them, the World DAB Forum and the DRM consortium recently announced an alliance to jointly promote the DRM and Eureka-147 systems.

Several receiver manufacturers support the move. Fenno de Boer, group marketing manager business develop-

ments for Sony Personal Audio Europe, stated in September, "We are actively supporting the spread of digital radio broadcasting in Europe and through our partnership with members of DAB and DRM we believe we can expand the use of digital radio in Europe."

Although DRM is the younger standard, some broadcasters are investing heavily. Peter Gordon of transmission firm VT Merlin, speaking at the launch of new DRM facilities in the United Kingdom, said the company has invested approximately \$828,000 in its new 200 kW MF DRM facilities. He said these facilities will "be used to encourage broadcasters to begin DRM pilots," adding that since the official launch of the standard in June, "there had already been a surge of interest from other broadcasters." 🌐

## Digital Radio Mondiale's Component Channel

Term	Acronym	Explanation
Main Service Channel (MSC)	64-Quadrature Amplitude Modulation or 16-QAM (latter employed when enhanced signal robustness is required)	This contains the data for all the program services in the DRM signal (audio, text data, etc.). The gross bit rate of the MSC is defined by the DRM channel bandwidth in use and by the transmission mode (error correction level used, etc.).
Fast Access Channel (FAC)	Always 4-QAM for fast resolution	This contains service selection information and 'housekeeping' data to allow a receiver to correctly decode the signals carried in the MSC (details of transmission mode audio coding, etc.) A receiver resolves this channel before it tackles the MSC or SIDC.
Service Description Channel (SIDC)	16-QAM or 4-QAM (latter employed when enhanced signal robustness is required)	This contains service information such as details of alternative frequencies, frequency schedules and audio metadata information.

## Logitek Brings Large Console Flexibility to small workspaces



Remora-10 console at Cache Valley Broadcasting, Logan, UT



### Possible Remora Configurations

**Remora-4:** four faders with controls for input assignment, monitors, and console functions

**Remora-10 (shown):** addition of six-fader module brings additional mixing capability with another stereo LED meter

**Remora-16:** incorporates Remora-4 base unit with two 6-fader modules

**Remora-22:** incorporates Remora-4 base unit with three 6-fader modules

## You don't need to settle for less when designing small on-air or production rooms.

Logitek's Remora Digital Console brings you all the flexibility of larger consoles in a very small footprint. As a control surface for our Audio Engine digital router, the Remora offers you access to all inputs and outputs on the Audio Engine, multiple mix-minus busses, dedicated talkbacks, and more. Remora consoles give you fast, convenient tabletop installation—no need for cutouts or custom furniture designs. And, its attractive full color displays plus stereo LED meters give you all the information you need at a glance.

Try the Remora as a companion to our popular Numix console or on its own. You'll soon see why Logitek's Console Router Systems make sense for your facility.

Logitek Electronic Systems, Inc.

5622 Edgemoor, Houston, TX 77081 USA 713.664.4470 800.231.5870 www.logitekaudio.com

©2003 Logitek Electronic Systems, Inc.

**Logitek**  
Console Router Systems

## A StarGuide/Hard-Drive Interface

by John Bisset

Multiple sites or cluster stations usually mean multiple satellite feeds and their associated multiple StarGuide receivers.

When interfacing these receivers to automation equipment, half the fun is in ensuring that the proper command relay triggers the appropriate event in the automation. In the past, we'd wait

the receiver, in the automation or within the wiring connecting the two.

I visited recently with Chris Kelley, market engineer for the Salisbury, Md., Clear Channel cluster. I spied a box with pushbutton switches hanging on a peg in his shop and asked about it. Fig. 1 shows a relay simulator switch box that Chris put together. Talk about a time-saver.

If there is a question about relays fir-

ing, press button 1, and the command for relay 1 should be sensed by the automation. If not, you know where to start looking for your problem.

Not only is the box good for troubleshooting; but when your PD adds a new show, the relay simulator ensures the program will properly trip each automation break.

You'll note in Fig. 3 on page 22 that Chris wired two cable connectors to the

interfacing is quick and accurate.

I remember in the early days of satellite programming, crouching behind a rack with the probes of a Simpson 260 mashed into the tiny relay screw holes, endlessly waiting for those darned tones to be sent! Hey, welcome to the 21st century! I told Chris he ought to build these and sell them — as if he or any other engineer has the time.

Nonetheless, this is one of those projects that can be built in an afternoon, with a handful of Radio Shack pushbutton switches, a Bud box, some cable and

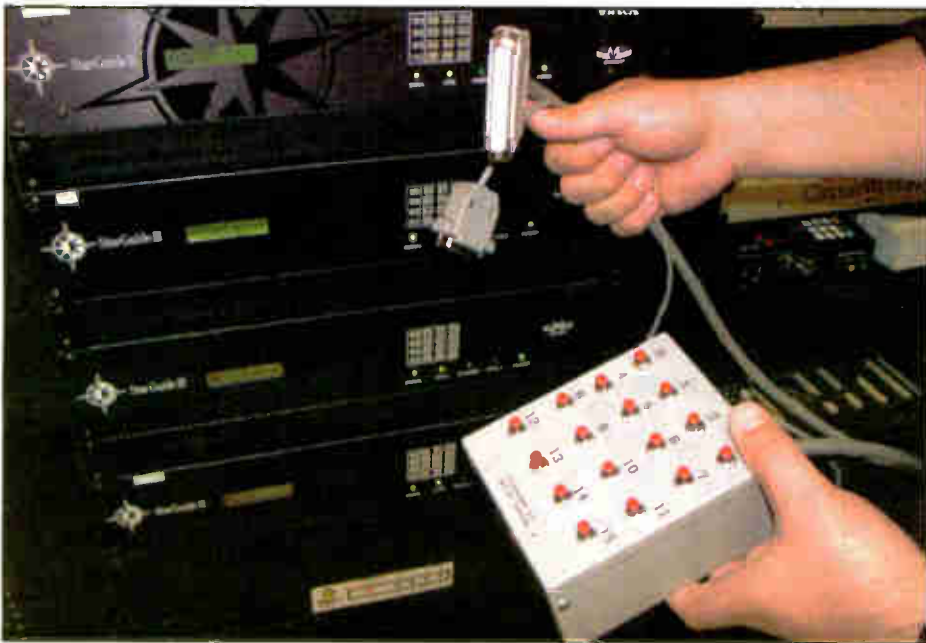

Fig. 1: Chris Kelley created this time-saving relay simulator switch box.



Fig. 2: Remove the multi-pin relay plug on the back of the StarGuide and plug it into the appropriate connector on the relay simulator.

through each break, ensuring that the right relay contacts closed. It was a time-consuming problem. When a break was missed, you'd have to schedule your day around the times the relays closed, in an effort to determine if the problem was in

ing on command, you remove the multi-pin relay plug on the back of the StarGuide (see Fig. 2) and plug it into the connector on Chris' relay simulator. Now the relay simulator switches are connected directly to the automation.

relay simulator. The first cable is for StarGuides that use the big 16-relay card. The smaller connector mates with the smaller four-relay port mounted on the audio card. Regardless of the receiver, the

a couple of connectors.

Thanks, Chris, for sharing such a simple, yet useful idea! Chris Kelley can be reached at (410) 742-1923.

See WORKBENCH, page 22 ▶

## It's a format converter for digital audio! It's a D.A. for digital audio! It's DigiMatch 2X6!

DigiMatch 2X6 converts between AES/EBU and SPDIF formats, and gives you 6 digital outputs! Use DigiMatch 2X6 to feed both AES/EBU and SPDIF gear! 1/3 rack width, built-in AC power supply.

In stock at all Henry Engineering dealers.

**We Build Solutions**



Blueboxes, Inc.

[www.henryeng.com](http://www.henryeng.com) 626.355.3656



"We've identified our needs and we're absolutely convinced the solution is NexGen."

**Gordon Carter**  
WFMT-Chicago

"A beginner to the industry, I found NexGen easy to learn. The flexibility really makes the system work for you."

**Amy Flaherty**  
KNOM-Nome Alaska

"NexGen is doing exactly what we expected. We're extremely pleased."

**Clint Barrick**  
KOHM  
Texas Tech University

NexGen "increases operation efficiency" and "allows our staff to be more productive."

**Jim Clark**  
KBYY  
Brigham Young  
University-Idaho

## NexGen 2 Studio Suite, the revolutionary "all in one" radio system designed with you in mind.

Prophet Systems has integrated all our software packages into one ultra powerful software suite, NexGen 2 Studio Suite. NexGen 2 is the product of our many years of experience, and our well deserved reputation for thinking outside of the box. NexGen 2 utilizes the same classic Prophet feature-rich software, but it's packaged into hardware that maximizes your investment of money and time like never before!

## MusicGen

*Finally a professional music scheduler at a great price-FREE!  
Download MusicGen from our website, and keep it as our contribution to great radio!*

Choose from four affordable Studio solutions, each designed to handle your specific needs.

### **Studio 11 ~ \$4,500**

Cost-effective solutions for the standalone AM, FM or LPFM. Ideal for remote or home-based voice tracking and music scheduling.

### **Studio 22 ~ \$7,000**

Designed for mostly automated, satellite or voice tracked stations.

### **Studio 41 ~ \$7,500**

Perfect for active control rooms and production studios.

### **Studio 44 ~ \$9,700**

The best of both worlds! This powerful workstation can handle live or automated operations.

With any Studio solution, we include all the software you need to run your station.

### **NexGen Digital**

### **WANcasting™**

### **VoiceTRAC**

### **MusicGen**

### **CDX/AFC**

### **Digital Reel-to-Reel**

### **PhoneTRAC**

Research and order directly from our website.  
[www.prophetsys.com](http://www.prophetsys.com)



1-877-774-1010  
[www.prophetsys.com](http://www.prophetsys.com)  
[sales@prophetsys.com](mailto:sales@prophetsys.com)

# Workbench

▶ Continued from page 20

★★★

Remote transmitter sites come with their own set of obstacles. In addition to AC power issues, getting reliable telco service to that mountaintop site may be an impossibility.

Rick Fulkerson of Com-Serv in Lake Havasu, Ariz., uses Motorola bag phones with a modem interface to Sine Systems remote controls at nearly a dozen transmitter sites in the state. Because the phone company cannot get lines to the sites, it's the only choice, and a reliable one. Rick says

other remote-control systems can be made to work as well. The only issue is the ring sensitivity adjustment. Cell phones "ring" with a square wave.

Rick says the Sine Systems instruction book more than adequately covers this issue. The modem interface gives you a straight analog phone line to connect to the remote control system. It's simple and inexpensive, and you cheat lightning; there's no hard-wire phone line into your shack.

AC to the site can be just a big an issue. Rick says the quote to get power to one of the sites was more than \$1 million. He said they'll be keeping the generator.

★★★

For the eighth year, NAB asked me

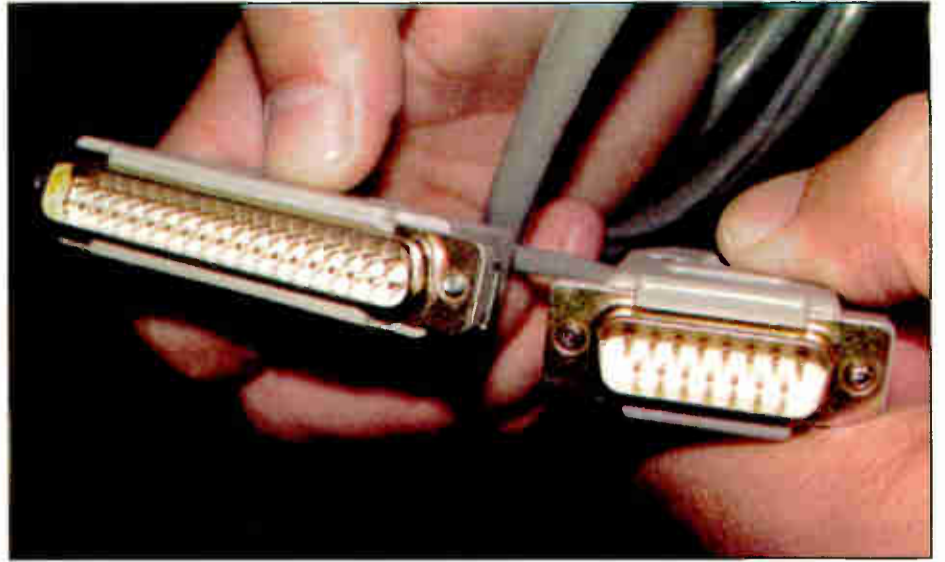

Fig. 3: Interfacing is quick and accurate.



Providing a unified voice for tower erection, service and maintenance companies.

The **National Association of Tower Erectors (NATE)** is leading the way in safety and education for the tower construction industry. Active in all facets of the trade, NATE has become recognized as the leader in telecommunications and broadcast construction procedures and practices.



The **Annual NATE Conference & Exposition** is widely regarded as the most comprehensive and up-to-date educational event in the tower industry.



NATE 2004... where small companies make a **BIG** impact!

## Contact NATE Today!

National Association of Tower Erectors

8 Second Street SE • Watertown, South Dakota 57201-3624  
Tel: 605-882-5865 or 888-882-5865 • Fax: 605-886-5184  
Website: [www.natehome.com](http://www.natehome.com) • Email: [nate@natehome.com](mailto:nate@natehome.com)

to present the NAB Radio Show's Transmitter Workshop. We had over 60 engineers in attendance, on the last day of the show — a great turnout. For those who missed this year's show, I understand the NAB will be back on the east coast in two years.



Fig. 4: Here's how to reach Stymielock.

Dielectric Communications provided the workbooks for the attendees, as well as Mag lights that were given out during the troubleshooting session for correct answers to troubleshooting problems. Thanks to all who spent the day with us.

During the workshop, a lockout bar that we featured in a previous *Workbench* column was discussed. Stymielock is a patented bar that permits multiple locks to be fastened to a gate or fence. Each tenant's lock can be unlocked and reattached without disturbing the other tenants' locks. Stymielock prevents being locked out by a tenant inadvertently looping his lock through your hasp. Fig. 4 gives the pertinent information for the company. When you call for information, tell them you heard about their product from the pages of Radio World.

John Bisset has worked as a chief engineer and contract engineer for more than 30 years. He is the northeast regional sales manager for Dielectric Communications. Reach him at (571) 217-9386, or [john.bisset@dielectric.spx.com](mailto:john.bisset@dielectric.spx.com).

Submissions for this column are encouraged, and qualify for SBE recertification credit. 

# Another late night at the station?

# You need iMediaTouch.



## Is your digital audio delivery system keeping you up at night?

Since 1984, over 500 radio stations around the world have trusted iMediaTouch broadcast automation software. With a host of award winning features designed to save both time and resources without breaking the bank, the iMediaTouch digital audio delivery system is easy to use and dependable time after time.

iMediaTouch broadcast automation software.  
Connecting radio groups through superior technology.



To find out more call us  
Toll Free 888 665 0501 or visit [www.omt.net](http://www.omt.net)

# Behind the scenes, Gary Beebe, chief engineer

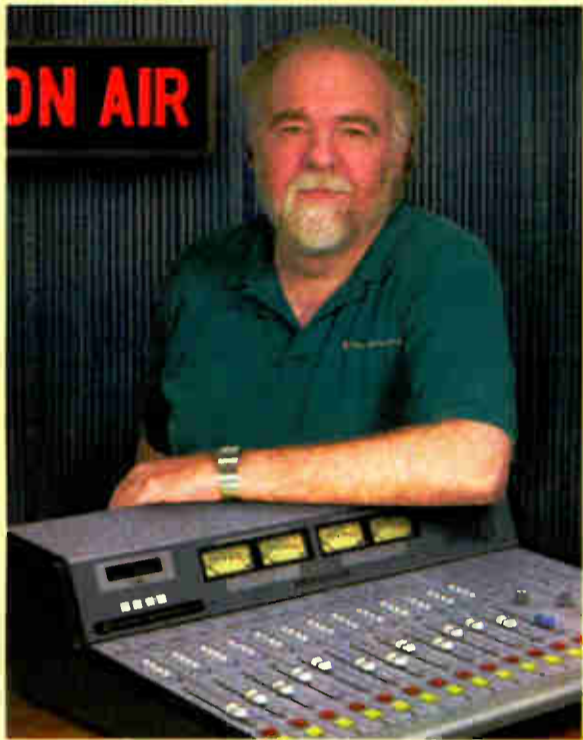

Gary Beebe and consoles: a time-tested team. For expert, friendly assistance with any broadcast audio need, call BSW today at 800-426-8434.

**G**ary knows broadcast equipment. As our in-house sales engineer, Gary Beebe knows how to operate virtually everything at your station. And install it. He may even know how to rebuild it when it breaks down.

Before joining BSW in 1996, Gary worked for 20 years as a broadcast engineer in Salt Lake City and Northern California. He's built numerous studios,

rigged remote trucks, and like you, has seen our industry change from giant knobs to PC interfaces.

We're honored to have someone with Gary's level of expertise as part of our team. Gary lends his experience to every salesperson at BSW. So when you call with a difficult equipment question, or need to custom-order RF equipment, there's a good chance Gary is working for you behind the scenes. Yet exceptional as he is, he's typical of the helpful, friendly folks you find when you call BSW. Let our staff offer you expert service with your next purchase. Call us today.



## 12-Channel Console Packed with Performance

A truly no-nonsense unit with plenty of usability, the new Audio 12 channels and 4 busses and offers a monitor module with talkback program, audition, pre- and post-mono fader outputs, plus independent more. **Features:** built-in cue speaker/amp and headphone jack/amp busses plus two mono output busses. Right now, we are offering you Plus, we are adding a FREE phone module with your purchase. You

R55 List 5,795<sup>00</sup> **CALL FOR PRICE**



## Pro MiniDisc Deck with XLR In/Out

Take advantage of MiniDisc's flexible editing, durable media and outstanding sound with this professional deck from Sony. Sporting a high design, the MDS-E12 MiniDisc recorder includes RS-232C and 9 interfaces for broadcast remote control capability, plus record/play control I/O and balanced analog XLR I/O. Check out the other pro features: 24-bit converters; Wide Bit Stream technology, using advanced digital filtering for yielding 20-bit precision onto 16-bit media; long play/rec mode; 10 multi-access "Hot Start" memories; variable-speed function: ±12.5%; PS/2 keyboard input, which allows easier access to remote disc titling functions; 6-second pre-record buffer; balanced XLR/unbalanced RCA analog I/O, coaxial and optical digital I/O.

MDSE12 List 945<sup>00</sup> **699<sup>00</sup>** **SO**



BSW's new Traffic Helicopter makes sure the sales staff gets to the Steak Hut for lunch and back to take your sales calls as quickly as possible. We calculated that it'll take 7,589 years to pay for itself, but it's just one of those extras management couldn't do without.



Only \$75<sup>00</sup>

## Affordable Cable Tester

With a connection set that includes XLR, 1/4", RCA, 1/8", TT and MIDI connectors, the Swizz Army by Ebtech can be used to tell the exact wiring of any cable or adaptor. The device clearly shows continuity, opens and shorts, even intermittent shorts! It also has test tone generation, phantom power detect and grounded XLR shield detect. Runs on two "AA" batteries.

SWIZZARMY List 179<sup>95</sup> **75<sup>00</sup>**

## Classic Style, Modern Acoustics

Class up your studio with this retro-styled dynamic mic from Shure. The Model 55SH Series II provides the Shure classic UNIDYNE II design coupled with modern acoustic components. This cardioid mic is excellent for voice reproduction, with its characteristic Shure tailored response and presence peak.

**Features:** low-impedance output rated at 75-300 ohms; 50 Hz-15 kHz frequency response; cartridge shock mount, on/off switch, 5/8"-27 thread swivel mount.

55SH List 284<sup>00</sup> **189<sup>00</sup>**

**SHURE**



## High-End Clarity with Low-End Punch

The Mackie HR624 is the ideal choice for smaller studios needing a quality nearfield monitor. Its 100W LF and 40W HF bi-amplification offers smooth, detailed mid-range with high-end clarity. Low-end punch is provided through a robust 6-inch woofer. Response is ruler-flat from 52 Hz to 20 kHz, providing accurate monitoring true to the sound source. The die-cast wave guide provides a wider "sweet spot" listening area. Mackie is so confident in the HR624's frequency response that each speaker comes with a certificate of calibration. Priced as each.

HR624 List 599<sup>00</sup> **449<sup>00</sup>/ea.**

**MACKIE**



# doubles as our in-house



**FREE**  
Phone Module  
with Purchase  
(a \$614 value)!

## nance

The R55 modular console has an output module with meter selection, and much stereo program and audition. The R55 at a very low price. Can't beat that. Call us today.

UDIOARTS ENGINEERING



**New Lower Price!  
Plus \$20 Rebate!**

## Quality, Affordable Wireless System

What a great time to add Sennheiser wireless to your arsenal! The price has just been lowered by \$50<sup>00</sup>, AND if you buy before December 31, Sennheiser is offering a \$20 manufacturer rebate!

Evolution wireless systems utilize Sennheiser's proprietary noise-suppressing HDX compander technology for crystal clear sound that rivals wired microphones. The EW101 is a plug-on transmitter and a diversity 1/2-rack receiver (rack kit sold separately). **Features:** switchable UHF frequency technology; four frequency presets; long transmission range (30 mW RF power) and rugged construction.

EW101	List 835 <sup>99</sup>	<b>449<sup>99</sup></b>	
EWRAK	List 76 <sup>99</sup>	<b>59<sup>00</sup></b>	<b>SENNHEISER</b>



## 24-Bit Profanity Delay with Automation

The AirTools 6000AT is a 24-bit digital delay unit for live broadcast that prevents unwanted profanity or comments from reaching the airwaves. Engineered by Symetrix, the 6000AT offers advanced delay technology with up to 20 seconds of user-definable delay at a full 20 kHz range of stereo bandwidth, digitally stretching the broadcast audio so that when unwanted comments are dumped from the air, the programming continues on, uninterrupted and without a gap, with no unwanted pitch shifting. The 6000's Automation Control Interface offers the ability to trigger automation changes or control a router with 'delayed' contact closures. Four TTL logic inputs on the 6000 digitally tag the audio on input and close the corresponding relay when the tagged delayed audio reaches the 6000's output. It takes all of the mathematical guesswork out of local breaks. Call for our low sale price today!

6000AT List 2,299<sup>90</sup> **CALL FOR PRICE**

**airTools**



IRU-  
DB-  
relay  
tures:  
noise  
ording

nd track/  
lanced

NY.



**Only  
\$189<sup>00</sup>**

## AM/FM Tuner with Memory Backup

The Tascam TU690 is an affordable, quality AM/FM rackmount tuner. **Features:** quartz PLL synthesized tuning system; manual/auto/preset tuning; 30 FM and 30 AM station presets; multi-function florescent display; preset memory back-up; timer on/off and clock function; remote control. BSW has it at the great low price of \$189<sup>00</sup>.

TU690	List 235 <sup>00</sup>	<b>189<sup>00</sup></b>	<b>TASCAM</b>
-------	------------------------	-------------------------	---------------



## Rackmount CD/MP3 Player with RS-232

The PMD325 by Marantz is a professional CD player with plenty of flexibility. With MP3 compatibility and the ability to play any CD, CD-R or CD-RW (including unfinalized discs!), it offers plenty of versatility. **Features:** single-track, random or timer play modes; external control via RS-232 serial port or RC5 port; GPI contact closure control port; pitch control; A-B loop; auto-cue; ID3 and MP3 CD Text capability; balanced XLR outputs with adjustable trim; XLR, coax and optical digital outputs; 10-key pad and rotary knob for direct track access; and AMS play. It includes custom rackmount kit and remote control.

PMD325	List 499 <sup>90</sup>	<b>449<sup>00</sup></b>	<b>marantz</b>
--------	------------------------	-------------------------	----------------



## News Console in 2 RU Space

The Dixon Systems NM-250 newsmixer is designed for busy newsrooms and contains almost all the features of a full broadcast console in a two-rack-space unit. **Features:** 2 mic inputs with on/off switch and 48-volt phantom power; mono line input for telephone hybrid; input for computer sound card; front panel input for DAT/cassette recorders; built-in mix-minus bus for telephone hybrid; built-in talkback system with 2 sends and receives; relay closures for computer/telephone/mic channel on; LED VU meter display; built-in headphone amp; balanced XLR line, mic and phone inputs via pluggable terminal connectors; unbalanced RCA I/O.

This mini-console is one of the best values in the radio industry. Don't pay for a full-size tabletop board if you don't need it. Call for our low price today!

Dixon also makes self-contained, rack-mountable stereo amplifier and speaker monitor system designed to compliment the NM250 Newsroom Mixer. The RM-35 employs a quality stereo amplifier driving two 3x5" shielded speakers, each in its own acoustically treated enclosure.

NM250	List 1,195 <sup>00</sup>	<b>989<sup>00</sup></b>
RM-35		<b>299<sup>00</sup></b>

**Dixon**



## Active Matrix Switching of 8 Stereo Inputs

The Broadcast Tools ACS 8.2 provides active matrix switching of eight stereo inputs to two stereo and monaural outputs. Any of the eight inputs assigned to output one have fading capabilities. **Features:** headphone monitoring; 16-input GPI; audio activity monitoring; serial port and contact closure remote control and removable screw terminals for all connections. 1RU rack space unit.

ACS8.2	List 759 <sup>00</sup>	<b>639<sup>00</sup></b>
--------	------------------------	-------------------------

**BROADCAST  
tools** .INC.

BSW offers package pricing • Let us save you money on your next quote

**800 • 426 • 8434 or online @ [www.bswusa.com](http://www.bswusa.com)**

Broadcast Supply  
Worldwide.  
Your Best Source  
for Professional  
Audio Products.

**BSW**

# SHOWCASE

## Telephone Solutions by CircuitWerkes



### The HC-3 hybrid telephone autocooupler

The HC-3 is ideal for many tasks like listen & concert lines, remote broadcasting, IFB interfaces, & More.



### The New Telco-6, six line, incoming, ring detector

Is someone calling? Find out with the new Telco-6! The telco-6 detects telephone ring signals from one to six lines and provides a dry relay output for each line.

More Features.  
Better Price!



### CP-1 & CP-2 call progress decoders

Did you ever connect a telephone coupler to a phone line or PBX only to discover that it won't hang up? CircuitWerkes' call progress decoders can save the day on most systems. They listen for dial-tone or busy signals and, when present, force your couplers offline.



### The AC-12 telco autocooupler bank

Get up to a dozen, full featured, telephone autocoouplers in just 5.25" of rack space. The coupler bay features a common power supply and two audio busses for easy mass feeds. Individual couplers can be used for sending or receiving separately from the rest - perfect for IFBs. Newly updated design improves audio performance and overall reliability to a new standard of excellence!

CircuitWerkes - 352-335-6555 Fax 360-9230 http: www.circuitwerkes.com 2805 NW 6th Street, Gainesville, FL 32609

## VoxPro PC

# \$999

### Fast, Simple, Voice-phone Editing, Network Included

Instantly share files room to room, user to user and more!



## MP3

Import-Edit  
WAV WMA AIF TOO

206.842.5202 x204  
www.audionlabs.com

## Mini Mix 8A

Proven...Affordable...

Reliable



Autogram

800.327.6901

www.autogramcorp.com

## AM Antenna Solutions



LBA Tunipole™  
Folded Unipole Systems



RF Components



Vacuum Capacitors



Diplexer, Triplexer and  
Phasor Systems

COMET  
Sold Here!

LBA Technology, Inc. is your proven supplier of innovative, digital-ready AM antenna systems. Our products include tuning units, phasing systems, multiplexers, AM/ wireless isolation systems and components for every power level. We help hundreds of broadcasters in the USA and worldwide to --

Reach further –  
sound better!

LBA Technology, Inc.



3400 Tupper Drive, Greenville, NC 27834

800-522-4464 / 252-757-0279 / Fax 252-752-9155 / Email lbatech@lbagroup.com / www.lbagroup.com

LBA  
Since 1963

It's New!



### FlipJack FJ-500

3 channel cell phone interface

- Two headphone jacks
- Two Mic inputs And a Line Input
- Connect To A Standard Telephone Line.
- Operates on "AA" batteries or external power
- Balanced Line Level Output
- Small Size: 1.5"H x 4.8"W x 4.5"D
- Tuner input for off-air monitoring
- LED level indicator

www.conex-electro.com

CONEX ELECTRO SYSTEMS

1602 Carolina St. P.O. Box 67 Bellingham, WA 98227  
360-734-4323 FAX 360-676-4822  
EMAIL conex@conex-electro.com

800-645-1061

## Broadcasting to the World

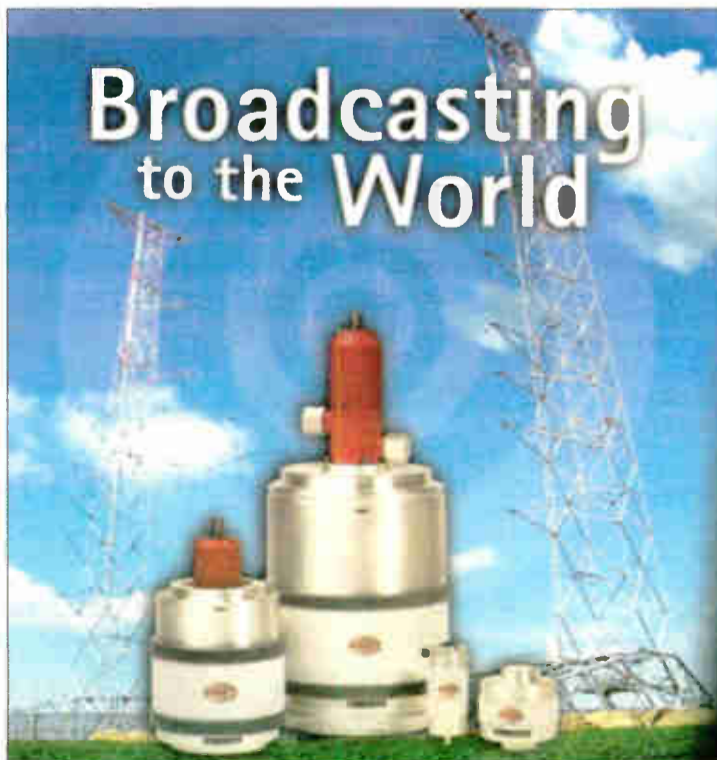

COMET NORTH AMERICA

421 Wanda Corner Road  
Cincinnati, Ohio 45140  
Ph: (513) 851-5000  
Fx: (513) 851-7085  
www.cometna.com

- 25 years of experience in the industry
- Broadcasters
- Professional Test Equipment
- Trained in North America with Kirtropic Labs to provide engineering expertise to broadcasters



Kirtropic Labs, Inc.  
144 Pine and Grove Road  
Bull Run, VA 22918  
Ph: 421-818-2141  
Fx: 421-818-4234  
www.kirtropic.com



PHOTO FEATURE

## I Love Your Hat

by Jim Hawkins

*This is one in a Radio World series of photographs of radio broadcast facilities and radio history from the collection of Jim Hawkins.*

Capacity hats always add to the pizzazz of a tower, but they are more than just for good looks. An antenna should be tuned so that it presents as close to a purely resistive load to the transmitter as possible. To accomplish this, vertical antennas are constructed to a length of 1/4 wavelength of the RF signal.

In certain cases it is desirable to physically shorten the antenna, while maintaining the electrical length (such as the lowering of the angle of radiation). This decreases the capacitance from the antenna to ground, causing an increase of the component of the capacitive reactance. This means that part of the energy from the transmitter will be reflected back to the transmitter rather than radiated.

You may have noticed that a cell phone or ham antenna on an automobile often has a short "spiral" in the center. This acts as an inductor to increase the inductive reactance. In the complex impedance equation  $Z = R + jX$ , X is the reactive component (capacitive or inductive) that we would like to be minimized.

Commonly it is said that we want  $j0$ , the imaginary part of the equation, to appear at the transmitter. Adding the right amount of inductive (positive) reactance in the case of the mobile antenna cancels out the capacitive (negative) reactance, resulting in a more tuned antenna or one in which the impedance  $Z = R$ . Attaching a "hat" to the antenna adds capacitance to the shortened vertical antenna and makes it electrically longer. The increased capacitance results in a lowered capacitive reactance, which means a smaller inductor may be used in the base tuning circuit.

An additional side effect is to shift the maximum current point upward, increasing

the radiation resistance, lowering ground losses and, therefore, increasing the efficiency of the antenna.

A "hatted" antenna is said to be top-loaded. Some hats are implemented in a more stealthy manner by simply placing the top insulators of the top guy wires further from the top of the tower, making the guy wires form a top hat up to the point of the first set of insulators away from the tower.

Because I am touching only briefly on the subject, please refer to other sources for details, such as "Antennas with Wireless Applications" by Leo Setian, Prentice Hall.

Visit Hawkins' Radio and Broadcast Technology Page online at [www.jphawkins.com/radio.html](http://www.jphawkins.com/radio.html).



From left: WNEW in 1966 (razed), WPAT in 1998, WIP in 2002



You Read It Here...

15 Years Ago



"While the logistical ramifications of the late August buyout of Allied Broadcast Equipment Corp. by Harris Corp. have been spelled out by the companies, what remains to be seen is how the partnership might affect other broadcast manufacturers and distributors. ...

"Some claim the currently potent Allied will weaken under the wings of Harris, a well-known supplier of broadcast equipment, opening up competition more evenly among smaller companies.

"The sentiment of a lot of manufacturers is that Allied was getting much too strong," said one industry official who did not want to be identified. ...

"Others say the buyout of the Allied operations will give Harris products an unfair advantage in the marketplace, leaving companies hesitant to use Allied as a distributor. One manufacturer even questioned the legality of the acquisition."

"After the Allied Sale" by Chuck Taylor Oct. 1, 1988

Swishing and swirling audio is the sad result of bit rate reduction combined with the wrong processing. Unless all sources, storage media and transmission systems are linear the audio will be bit rate reduced at least once, probably several times. Each pass generates more artifacts. Lower quality processing, multiband compression, limiting and clipping can make those artifacts even more apparent. But level control is still essential.

**Introducing the new Compellor® 320D** - the world standard AGC is now available with both digital and analog i/o. For almost two decades the Compellor has sustained its unrivaled reputation for 'invisible' operation. The same cleanliness of circuitry and intelligence of processing algorithms that make it 'invisible' also make it perfect for processing in the digital domain. The Compellor will not 'unmask' the masking from upstream reductions and it will feed a signal that will sail through downstream reductions.

The 320D fits any plant from all digital to all analog and anywhere in between. Perfect for all HD applications, the Compellor 320D will help keep your great audio great at a price that won't wipe you out.



The NEW ApheX Model 320D Compellor - 2 Channel Compressor/Leveler with Digital and Analog I/O

**APHEX SYSTEMS** Improving the way the world sounds<sup>sm</sup>  
11068 Randall Street, Sun Valley, CA 91352 U.S.A  
818-767-2929 Fax: 818-767-2641 [www.aphex.com](http://www.aphex.com)

Compellor and ApheX are registered trademarks of ApheX Systems

FIRST PERSON

# At Marconis, the 'Suits' Loosen Up

by Paul Kaminski

A gathering that NAB President/CEO Eddie Fritts called the largest in recent years came to honor excellence in radio at the 2003 Marconi Radio Awards dinner during the NAB Radio Show in Philadelphia. It was my first time at the Marconis. Radio World asked me to share my impressions as a first-time attendee.

The event was emceed by standup comedian and WB television network personality Steve Harvey, who hosts the morning show at Radio One's KKBT(FM) in Los Angeles. Harvey fired more than a few zingers at the audience; by his own admission, he toned down his usual act, not unlike a NASCAR restrictor plate.

Jeff Smulyan of Emmis Communications seemed to warm to Harvey's repartee, trading good-natured barbs with him as he strode to the lectern. Smulyan would have a good night. His Indianapolis newstalk WIBC would pick up two Marconis, one for Medium-Market Station of the Year (shared with WIVK in Knoxville, Tenn.) and one for Medium-Market Personality of the Year, for Greg Garrison. WIBC GM Tom Severino gave his staff, especially Operations Manager John Quick, credit for the station's performance and Garrison's development into an air personality of great "class and style." Garrison was the prosecutor in the Mike Tyson rape trial.

executives assembled by Jefferson Pilot Radio President Clarke Browne and led by former "Saturday Night Live" band-leader G.E. Smith. The image of

handled the vocals. ABC Radio's Mitch Dolan was among the guitarists; he would have even more reasons to smile later in the evening.

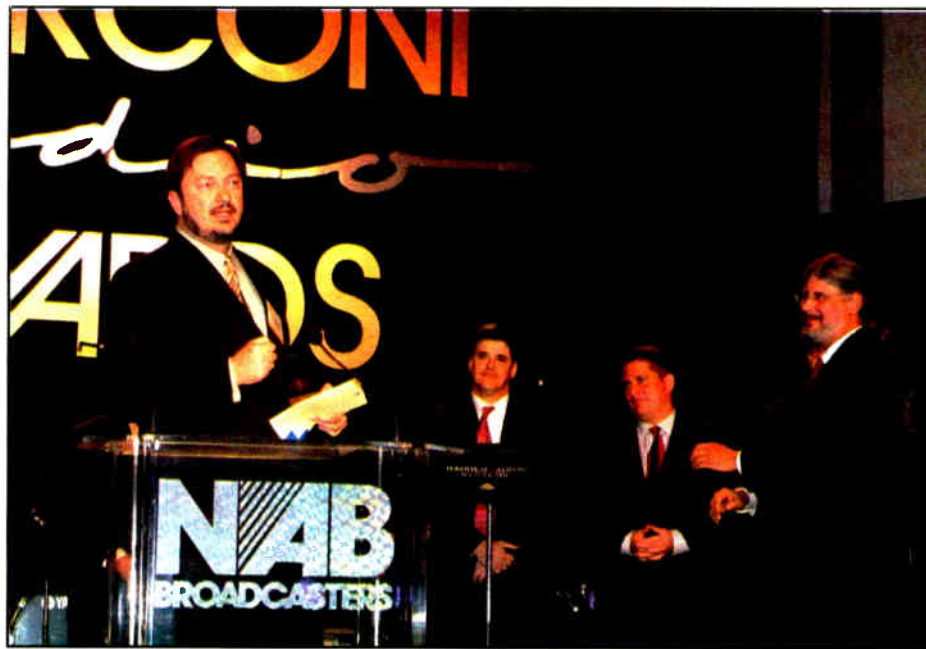

WABC in New York was honored as Legendary Station of the Year. Program Director Phil Boyce accepts.

Bonneville CEO Bruce Reese — button-down shirt, tie and all — singing Mick Jagger ("Start Me Up", "Miss You") and Cream ("Sunshine of your Love") was a "you had to be there" moment.

When people get up and dance, bands know that they made some good music. And people did.

Ronn Owens of ABC station KGO in San Francisco won Major-Market Personality of the Year, and KGO also would win as Major-Market Station of the Year — a good night for the staff at Radio 810 in the City by the Bay. But

ABC wasn't done yet.

Earlier that day, keynote speaker Rush Limbaugh from Premiere Radio Networks, a past Marconi winner, had briefly addressed the controversies surrounding him. Harvey and some presenters would take more than a few shots at the talk legend during their time at the podium. After one such remark by a presenter, Network/Syndicated Personality of the Year Sean Hannity of ABC Radio, voice about to break, stepped to the podium to accept his award and delivered a spirited defense of Limbaugh.

The final award of the evening went to the Legendary Station of the Year, WABC in New York. The ABC O&O talk powerhouse also saw its morning team of Curtis (Sliwa) and (Ron) Kuby nominated for Major-Market Personality of the Year. So the station that brought us music radio legends like Harry Harrison, Ron Lundy, Dan Ingram, Cousin Brucie, Chuck Leonard and Johnny Donovan — still there as production director — took two out of three nominations for their talk programming. On that night, it was good to be Mitch Dolan.

For some reason I can't explain, the whole ambience of the evening seemed to be the right tone for the time. It was nice to see people, some of whom might call the "suits," loosen up and kick out the jams. I hope the "Formats" might make another appearance in another venue. Are you listening, Clarke Browne and G. E. Smith??

One final aside: There is hazard in wearing a tux, white shirt and black bowtie to these events. One of our tablemates was so dressed and was asked to bring wine to another table. In all good humor, he did.

Winners are listed on page 33. Paul Kaminski is news director for the Motor Sports Radio Network and a contributor for CBS Radio News.

The ambience of the evening felt like the right tone for the time.

The entertainment was provided by a "pick-up band," but not just any pick-up band. "The Formats" comprised radio

Reese, along with R&R's Erica Farber, Dan Hotchkiss of Hotchkiss Marketing Solutions and Fred Murr from Regent

## HIGH VOLTAGE RECTIFIERS

Nobody Knows Them Better Than We Do

Once again, HV Components/CKE brings you a reliable retrofit rectifier package for your transmitter that saves you money and delivers the performance and reliability you've come to expect from us. Our Model 51016 shown here is a three-phase full wave bridge designed to easily drop into your AM, FM or television transmitter. Conservatively rated for power supplies of up to 12 KV and 9 amps output, this retrofit package fills the bill for most any application.

Quick, Cost-Effective & Expert Solutions

WE HAVE CCA RECTIFIERS

www.rectifiers.com

800-649-6370

## STATION/STUDIO SERVICES

SHOP HOMETOWN MERCHANTS THANKSGIVING CHRISTMAS NEW YEARS DON'T DRINK & DRIVE

WE PROVIDE THE MESSAGES.

YOU PRESENT THEM TO CLIENTS....

...AND BUSINESS GETS BETTER!

GBS SALES BOOSTERS - FULLY PRODUCED :30- AND :60-SECOND FEATURES

\*Just want you to know how successful our "SHOP AT HOME" Campaign is. So far, we have sold 20 packages at \$500 each....\* - FL

\*With your holiday series we sold about \$11,000 worth of greetings in this, our first holiday season on the air....\* - TX

GRACE BROADCAST SALES  
Toll-free 1-888-472-2388  
Sound Ideas for Building Business™

FREE DEMOS & SALES TIPS!

www.gracebroadcast.com

WISHFUL THINKING WON'T INCREASE YOUR BILLING....

...but market-exclusive

GBS SALES BOOSTERS WILL!

Don't Drink & Drive Shop Hometown Merchants  
Thanksgiving Christmas New Years More!  
CALL TOLL-FREE 1-888-472-2388

FREE DEMOS & INFO www.gracebroadcast.com

SPACE AVAILABLE

Call Simone For Details

1-703-998-7600 ext. 154

ATTENTION PROVIDERS!

Promote your services to **Radio World's** readers. Reach Radio Station and Recording Studio owners/managers and engineers with your message.

For information on affordable advertising call **Simone** at **1-703-998-7600, ext. 154.**

World Radio History

# MUSICAM USA

# 500 gives you more reasons

# to own a new

# NETSTAR™

# Codec



The new NetStar IP & ISDN Codec gives you all these benefits:

- AAC, AAC-LD, MPEG 2, MPEG 3, G.722 and G.711 algorithms for the best audio and full compatibility
- Bi-directional audio over IP and ISDN
- Linear, uncompressed bi-directional audio over IP
- Ancillary Data and 8 Contact Closures over IP & ISDN
- Simultaneous connections on IP and ISDN
- Automatic backup of IP with ISDN, and vice-versa
- Full remote control and status monitoring from any Web Browser
- ...and lots more

Now, through December 31, 2003, we'll give you \$500 for every NetStar you purchase. Owning the world's best Codec has never made more cents!



Model 500 shown



**MUSICAM USA**

MUSICAM USA  
670 North Beers Street, Bldg #4  
Holmdel, NJ 07733 USA  
732-739-5600  
732-739-1818 fax  
sales@musicamusa.com  
www.musicamusa.com

MUSICAM USA is the d/b/a of Corporate Computer Systems, Inc

\$500 MUSICAM USA Rebate valid with proof of purchase from any authorized U.S. based MUSICAM USA Distributor. Contact factory for details.

# PAR for the Radio Course

*With TiVo Winning Some Converts, How Likely Is The Success of the 'Personal Audio Recorder'?*

by Skip Pizzi

It's unlikely that any reader of this column doesn't have at least a little awareness of the Personal Video Recorder or PVR, an important new consumer product that has emerged in the last three years or so.

Alternately known as Digital Video Recorder or Personal Digital Recorder, the device is known to most of us by its best-known brand name, "TiVo."

While other PVR brands such as ReplayTV, Ultimate TV and Dishplayer have been marketed, TiVo has captured the generic labeling prize, like Kleenex and Xerox before it. And like Xerox, the name has even become a verb, as in, "Let's TiVo '60 Minutes' so we can watch the end of the football game."

I Tivo, you TiVo, he/she/it TiVos.

The PVR has incited strong opinion on both sides. Most PVR owners are vehement in their support of the device's usage, with some assigning it life-changing status. Meanwhile, many TV broadcasters and advertisers consider it a threat to the existence of the television industry as we know it. (Is that such a

bad thing?)

Nevertheless, despite all the hoopla, the PVR has not enjoyed particularly successful early penetration, at least when compared to other devices with equivalent notoriety in their early days, like CD or DVD. For example, in the first four years of the DVD's availability, more than 14 million players were sold. Contrast this to the PVR's first four years, during which only about 1.5 million units have been sold.

---

**Initial attempts at a Personal Audio Recorder have been introduced, but these are not yet true counterparts to the Personal Video Recorder. This may change.**

---

This is largely attributed to the need to both purchase PVR hardware and pay a subscription fee to enable the device, often in addition to what the user is

already paying for TV service from a cable or satellite provider. (Without a live connection to a particular service provider, the PVR is at best a dumb recorder, essentially a non-linear VCR. With a subscription to its metadata service, the PVR becomes a smart device that runs circles around a VCR's functionality.)

Only a small minority of enthusiast-class consumers has seemed willing to do this so far, but this obstacle to adoption is about to fall.

The U.S. digital cable TV industry is launching on a massive campaign to

include PVR capability in its new digital set-top boxes, hoping to thereby improve uptake of digital cable, and reduce churn among new users. This subsidy of PVRs in cable set-top boxes is expected to double the penetration of the devices over the next year or so.

It's worth the investment by cable companies because it is expected to accelerate digital cable conversion by consumers, and thereby allow cable operators to shut down their less spectrally efficient — and thereby less profitable — analog services sooner. Moreover, PVR capability may allow cable operators to improve customer satisfaction and increase purchase rates for premium services such as pay-per-view and video-on-demand.

#### Radio equivalent

Another important ingredient is the food chain for that program scheduling data used by PVRs. Today, the PVR metadata that service providers like TiVo use to populate their PVRs' electronic program guides (EPGs) is obtained from schedule-data aggregators like Tribune Media Services and Gemstar-TV Guide. (The term "interactive program guide" or IPG also is used on occasion.)

These companies collect schedule data from all TV networks, stations and cable channels, and deliver it to customers for publication. Originally those customers were all print-media publishers, but increasingly such data is used by companies like TiVo or cable/satellite MSOs to feed their subscribers' EPGs.

(Note that the industry is still struggling to convert to a more dynamic model. In the print environment, lead times were weeks ahead of air dates, and last-minute changes were never accommodated. The EPG world demands far more frequent updates, a distribution mechanism for which has not yet been broadly instituted. This will remain a significant issue as the PVR/EPG environment matures.)

So what about a radio equivalent to the PVR? Some initial attempts at a Personal Audio Recorder have recently been introduced — see Radio World Oct. 8,

## The Big Picture



Photo: Gary Hayes, BBC

by Skip Pizzi

page 1 — but these are not yet true PVR counterparts. Numerous obstacles stand in the way of such equivalence.

First, the consumer incentive to adopt a PAR is less compelling than that of the PVR, because most radio services are format-driven rather than program or schedule-oriented. Therefore the concept of time-shifting generally holds less appeal; most programming is essentially similar at all times. The exceptions to this are sports and some talk-oriented programming, and a substantial amount of public radio (which is still largely program/schedule-driven, as detailed in recent columns), but these uses may not create the critical mass required to drive the commercial success of a PAR. It is largely for this reason that an "ACR," an audio-only equivalent of the VCR, never emerged, despite numerous attempts to launch such a product.

Next, consider that there is no existing universal aggregator of schedule data for U.S. radio.

Besides the fact that a traditional market or demand for such service does not exist, the number of stations that such a provider would have to manage is an order of magnitude greater for radio than it is for TV in the United States. Thus it would seem challenging to make comprehensive radio schedule-data aggregation into a viable business today.

So today's PAR vendors have no third-party source for fully featured EPG data, leaving most PARs as essentially manual devices, like VCRs, when it comes to time-shifting. (As non-linear devices, however, some PARs add "live-pause" functionality, which certainly beats the VCR. Also, at least one PAR vendor has developed its own online database to provide some level of EPG-like functionality for Internet radio, but some user assembly is still required, and it does not contain full national, broadcast-radio schedules.)

Finally, remember that the radio business is advertiser-driven, and commercial radio broadcasters, like their TV brethren before them, are in no hurry to witness the success of any ad-zapping device — which is how the traditional TV industry views the PVR above all else. So most broadcasters will likely do what they can to slow or stop the emergence of a PAR.

Nevertheless, there may indeed be a robust market ahead for some type of non-linear audio recorder with radio tuning capability. To succeed, however, it may require a different approach than the PVR. More on this next time.

Skip Pizzi is contributing editor of *Radio World*. 

**Over  
946,080,000 seconds  
of precision timing**



**W**HEN you require the best, most accurate in precision timing look only to ESE. Designed for "Precision Timing", ESE Master Clocks & Accessories have been the industry standard for over three decades.

Whether using GPS, WWV, Modem, Crystal or line frequency accuracy — all ESE Master Clocks can drive digital or analog slave clocks, as well as interface with video and/or computer based systems. Call or visit our web site for more details.

• 3-Year Warranty •



142 Sierra Street • El Segundo, CA 90245 USA  
Phone: (310) 322-2136 • Fax: 310.322.8127

[www.e-se-web.com](http://www.e-se-web.com)

WIRED FOR SOUND

# Is There an Ideal Impedance?

by Steve Lampen

We left our story about the history of wire and cable (RW, Sept. 1) with Bell Labs testing thousands of cables of different impedances.

They wanted to know, "Is there an ideal impedance for attenuation? Is there an ideal impedance for power handling? Is there an ideal impedance for high voltage?"

To their surprise, as you can see in Fig. 1, the results for each requirement were quite different.

You will note, for instance, that attenuation gets lowest around 77 ohms and rises on either side of that value. Because this value dictates the relationship of the dimensions of the cable, this calls out the ratio of sizes. That is, if you choose a center conductor, and the material (dielectric) around it (their original dielectric was air), then the distance to the outer conductor (shield) and the overall diameter of the cable are pre-determined.

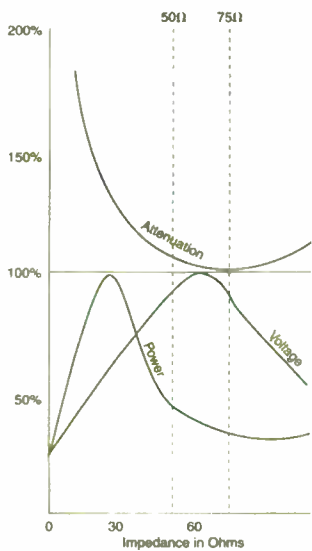

Fig. 1

Likewise, if you want to build a cable of a specific impedance, you already know the diameter and you have chosen the dielectric inside, the size of the center conductor is pre-determined.

But that's not all they found.

You will note that, while 77 ohms was the best number for attenuation, this is an odd ratio. If you change it slightly to 75 ohms (with a very small increase in attenuation), you can use standard-gage wires. Thus 75-ohm coax was born.

This is why all those coaxes intended to carry signals, not power, not high voltage, are 75 ohms. Cables like baseband video cable, CATV/broadband cable, are all 75 ohms. But for coaxial cables meant to carry high power, as you can see, an impedance of 30 ohms was required.

And therein lies a story.

### Inefficiencies in scale

Once upon a time, when I was a young (read: ignorant) wire salesman, I had a customer at Lawrence Berkeley Laboratories. This is part of the University of California Berkeley, where they do pure research. My customer was building an atom smasher which, he told me, would allow him to look back almost to the moment of the Big Bang!

This machine was huge, probably a hundred feet long. Now, you know me, the Star Trek fan. I was entranced.

All he needed was 30-ohm coax. So I talked to our factory people. "Make some 30-ohm coax!" I said.

"Well," said our grizzled factory engi-

neer, "That's all well and fine, but we'd have to throw most of it away."

"Why?" I demanded. I was told that the ratio of sizes called out by this impedance is extremely difficult to make.

"We could make it," said the engineer. "But we would probably throw 90 percent of it away."

I reluctantly told the customer. His response? "Fine. Make 10 times as much as I need. Throw away the 90 percent that's bad and send me the rest. And I'll pay for it all."

(Turns out he had painted himself into a corner and didn't have an alternative. All the other cable manufacturers had turned him down flat.)

So we did! An interesting side note: we recently made some 30-ohm coax for another customer. This time, we only threw away 10 percent. Wow. We're getting better!

Our previous column mentioned that research by Lloyd Espenschied and Herman Affel at Bell Labs in 1929 showed that 75 ohms was the ideal impedance for low-loss (low attenuation) coaxial cable, and 30 ohms was the ideal impedance for high-power coax. They also determined that, for high voltage, you will need 60-ohm coax.

Here is the dilemma for broadcasters. You want a cable that can handle high voltage *and* high power. This is where 50-ohm coax comes from. It is a compro-

mise between voltage and power.

In fact, the first transmission-line coaxial cables were made by taking small copper pipe and putting it inside large copper pipe. If you do this with standard sizes of copper pipe, you will get impedances like 51.5 ohms or 52 ohms. That was close enough for government work. All you had to do was tune your transmitter and antennas to match. In fact, RCA standard transmission line was 51.5-ohm coax for almost four decades.

Speaking of transmitters: Our solid-state IC transmitters of today no longer require a compromise for high voltage. What you really need is 30-ohm cable, good for high power but not high voltage. Of course, your transmitter would have to be tuned to 30 ohms, and your antenna had better be 30 ohms. But you could probably increase efficiency. Too bad 30-ohm cable is so hard to make.

See LAMPEN, page 33



# Maxlink

Wireless 5 GHz UNII • ISM Band Data Link

Maxlink is a leading-edge, wireless data network product designed to provide a cost-effective alternative to T1/E1, DSL and cable modems.

For broadcasters faced with costly phone bills, the Maxlink provides twin full-duplex, high-speed T1/E1 data performance. Best of all, the Maxlink doesn't tether you to a T1 line or constrain you with FCC licensing applications.

With a low profile radio/antenna combination, it's cost-effective, fast and easy to deploy whenever and wherever you need it.



Moseley

whenever

wherever



111 Castilian Drive • Santa Barbara, CA 93117-3093 • www.moseleysb.com



Bob Mercer, left, of Delmarva Broadcasting chats with a visitor to the Career Fair.



RCS Founder Dr. Andrew M. Economos cuts the cake to kick off the company's 25th anniversary year.



High Into the Blue: Ricky Recruiter, right, and Michael Edwards promote the U.S. Air Force.

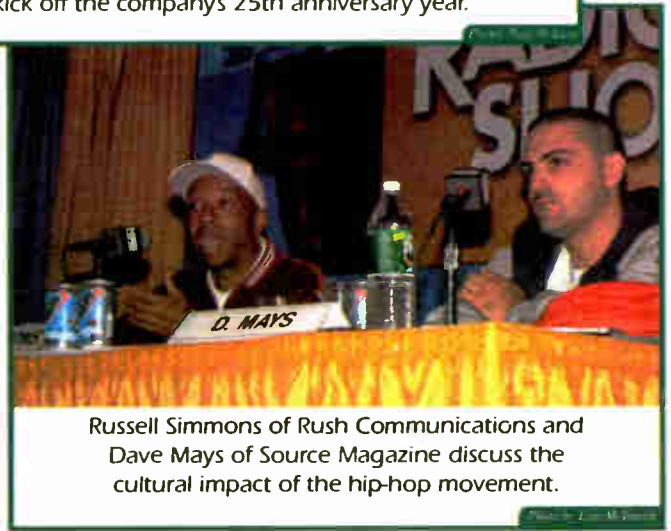

Russell Simmons of Rush Communications and Dave Mays of Source Magazine discuss the cultural impact of the hip-hop movement.

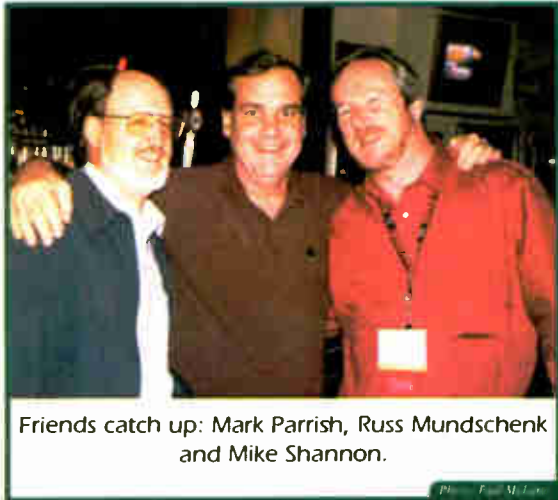

Friends catch up: Mark Parrish, Russ Mundschenk and Mike Shannon.

# THE NAB RADIO SHOW



Keynote speaker Rush Limbaugh spoke about the power of radio and commented briefly on the Donovan McNabb controversy. The following week he would reveal an addiction to painkillers.



Chubby Checker and NAB's Dennis Wharton



Art Constantine of Musicam USA shows off the NetStar IP & ISDN Codec.

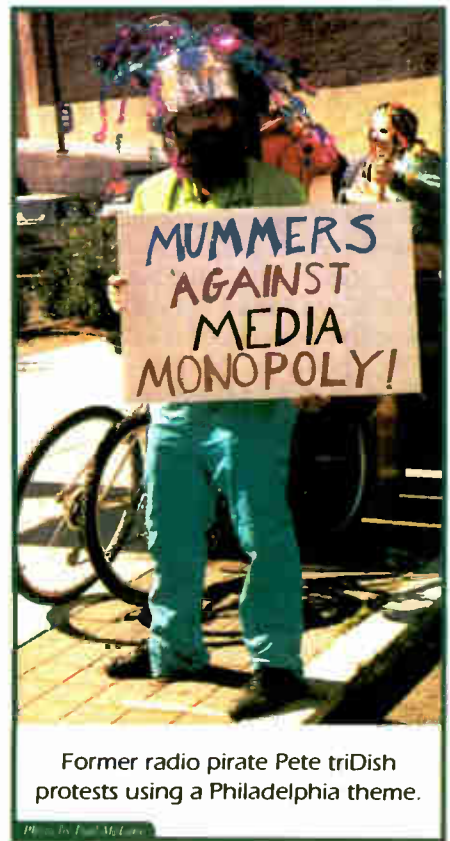

Former radio pirate Pete triDish protests using a Philadelphia theme.



## NAB Marconi Radio Award Winners

**Legendary Station:**  
WABC, New York

**Network/Syndicated Personality:** Sean Hannity



**Major-Market Station:**  
KGO, San Francisco

**Large-Market Station:**  
WMJI, Cleveland

**Medium-Market Station:**  
Tie: WIBC, Indianapolis;  
WIVK, Knoxville, Tenn.

**Small-Market Station:** Tie:  
KLVI, Beaumont, Texas;  
WCRZ, Flint, Mich.



**Major-Market Personality:**  
Ronn Owens, KGO,  
San Francisco

**Large-Market Personality:**  
Preston Westmoreland,  
KTAR, Phoenix

**Medium-Market Personality:** Greg Garrison, WIBC, Indianapolis

**Small-Market Personality:**  
Jim Kerr, KNCO(AM),  
Grass Valley, Calif.



**AC:** KOIT, San Francisco

**CHR:** WSTR, Atlanta

**Classical:** KDFC, San Francisco

**Country:** KPLX, Dallas

**News/Talk/Sports:** WTMJ, Milwaukee

**Oldies:** KCMO(FM), Kansas City

**Religious:** KNOM, Nome, Alaska

**Rock:** KQRS, Minneapolis

**Urban:** WVAZ, Chicago

# Lampen

► Continued from page 31

The 1920s were full of major research and breakthroughs. Much of the early work on television was done in those years. And, in wire and cable, some new insulations began to become available.

You may recall in a previous column the scare that occurred during World War I when someone figured out that the Germans could have cut off our entire supply of rubber by simply blockading Central and South America.

Luckily, this never happened, or almost all the insulated wire, and all the tires, would have been impossible to make. It is no wonder, then, that there was a major push in the 1920s to invent "artificial" rubber, to reduce

our dependency on tree rubber. All the rubber companies were given this project. One of them was B.F. Goodrich.

Working for Goodrich was a recent University of Washington graduate, Waldo Semon. He had done papers and other research on the petroleum industry. So he went to them and said, in effect, "What do you throw away? After you make all the kerosene, gasoline and other useful stuff, you throw away a bunch of things. What are they?"

Realizing that they could make money off the byproducts they threw away, petroleum companies were only too happy to send Waldo a sample of everything they discarded. Among them were gases ethylene and propylene.

Waldo knew that, to mimic rubber, he had to create long molecules called "monomers." In experimenting with these

gases, he eventually produced "ethylene-propylene-diene-monomer," more commonly known by its initials, EPDM. This was the first artificial rubber.

When World War II rolled around, we were no longer dependent on natural rubber. EPDM is still put on wires. It is still "cured" like natural rubber. It is still "thermoset" so it can't be recycled like plastics. But it has many of the ruggedness and wear properties of natural rubber.

Is inventing EPDM, which saved his country, good enough for Waldo Semon? Of course not. The next thing he made was even more amazing. We used over 90 billion pounds of it last year. Know what it was? Tune in next time!

Steve Lampen's latest book, "The Audio-Video Cable Installers Pocket Guide" is published by McGraw-Hill. Reach him via e-mail to [shlampen@aol.com](mailto:shlampen@aol.com).

## Hearing Is Believing

### Zephyr Xport with aacPlus® will convince you!

Remember the first time you heard a Telos Zephyr using MP3 coding? You were probably stunned at how good it sounded. That's the same way we felt when we heard the new Telos Zephyr Xport with aacPlus®. Xport sends 15kHz audio over POTS lines - extra bandwidth for sparkling, crystal-clear sound that's superior to traditional POTS codecs.

Zephyr Xport lets you plug into any available POTS line and connect to your ISDN Zephyr Xstream at the studio. That's right... with Xport you dial POTS and it comes out ISDN! You save money because your Zephyr Xstream can now be used to receive ISDN or POTS remotes. There's also an ISDN option that lets Xport use ISDN as well as POTS for use on virtually any remote with any available analog or digital phone line.

Telos introduced the world to MP3 with the original Zephyr. Now they've introduced aacPlus®, the new MP4 standard, in the Zephyr Xport. aacPlus® sounds so good that XM Satellite Radio, Digital Radio Mondiale and many others are using it to deliver their critical audio. When Xport connects to a Zephyr Xstream, only a small portion of the connection is analog. Once the phone call gets to the nearest Telco central office it stays digital all the way to the studio, resulting in better data rates, more reliable connections and superb audio.

In fact we think Zephyr Xport is so good that we're offering you the opportunity to try one, risk-free, for 10 days. Put Zephyr Xport to work on your station and find out just how spectacular POTS remotes can sound! After 10 days you can send it back... but we think you'll be so impressed you'll want to keep it instead. Call us and request your free trial today.

Check send/receive levels and line conditions at a glance. Use the Select and Navigate keys to access fast on-screen setup menus.

Convenient 2-channel mixer with separate mic and line inputs makes Xport a self contained remote kit.

Headphone controls let talent monitor a customized mixture of send and receive audio.

Internal fanless power supply means silent operation with no "wall warts"

Optional ISDN upgrade lets Xport use analog or pure-digital phone connections.

Light but rugged extruded aluminum chassis and energy-absorbing bumpers help tame road thumps.

Storage for 100 Auto-Dial numbers and 30 frequently used location settings make remote setup fast and easy.

Interface connector provides use of 2 bidirectional contact closures.

Mic input features switchable built-in 12-volt Phantom power.

Aux interface lets you connect to a cell phone handset.

Output section includes direct output of far-end audio and an adjustable mix of local and receivable audio.

Ethernet port isn't just for one remote control; load the Xport driver software on your computer and send PCM audio directly into the codec for transmission.

*Telos*

Try the Zephyr Xport for 10 days\*

\*Please Call For Details

Your Number One Source For Broadcast Equipment!



**Broadcasters General Store**

FOUR OFFICES TO BETTER SERVE YOU!

Cindy Edwards 828-698-2893 cindy@bgs.cc  
Cecile Gibson 937-783-2995 cecile@bgs.cc  
Mark Goins 352-362-3704 mark@bgs.cc  
Gary Tibbot 765-935-6707 gary@bgs.cc

Florida Home Office

1-352-622-7700

[www.bgs.cc](http://www.bgs.cc)

## Performance Theaters Buck Trends

by James Careless

**TORONTO** Some might view them as throwbacks to the Golden Age of radio: performance theaters where radio broadcasters can strut their stuff in front of actual audiences.

But the two radio performance theaters in Toronto — one operated by the Canadian Broadcasting Corp., the other by Rogers Broadcasting — are anything but dated. Both spaces are leading-edge broadcast studios, with room for a few hundred avid spectators or more.

### Quest for audio perfection

Named for the legendary Canadian pianist, the 337-seat Glenn Gould Studio is housed in the CBC Broadcasting Centre in downtown Toronto.

In keeping with Gould's own obsessive quest for audio perfection, the studio, called the GGS, is a recording engineer's dream. Despite its downtown location a few blocks from SkyDome, home of the Toronto Blue Jays, the GGS is a whisper-quiet space when empty, yet acoustically rich and alive when in use.

To keep outdoor traffic and subway noises at bay, the floor of the studio floats on about 7,500 double-sized rubber pucks. Its air conditioning ducts are four times normal size to eliminate resistance that can cause whooshing sounds. Interior wood and plaster fittings have minimal connection to the rest of the Broadcasting Centre.

These features result in an acoustically pure, sonically isolated space. Optimized for live classical and jazz presentations, Glenn Gould Studio is an audio oasis in the middle of a noisy city.

### Equipment options

"We are constantly vigilant in our search for extraneous noise," said GGS General Manager Tom Shipton. "We are accustomed to this task. One time we heard a strange noise, and by careful listening, we figured out that it came from a bearing that had gone bad in a water circulation pump eight floors away. We are always on the case."

The production control room is located

just right of the stage area. Inside is an AMS Neve VR Legend analog console, 60 microphone/line inputs and a flying faders automation system. The control room



The Glenn Gould Studio

contains a range of digital and analog recording systems, both disk- and tape-based.

Meanwhile, the studio has 96 microphone inputs scattered strategically throughout the room. Depending on the performance, engineers can choose from a treasure house of AKG, beyerdynamic, Neumann, Sennheiser, Shure, Sony and vintage microphones.

So how did the cash-strapped CBC manage to build this multimillion-dollar space in the 1990s, when the multistorey Broadcasting Centre was built?

"We developed a business case that justified building Glenn Gould Studio, because this was new rather than a replacement to existing facilities," said Shipton. "The case detailed the CBC's use of other people's theaters and concert halls for recording radio programs before live audiences. Our research showed that by building Glenn Gould Studio, we would break even on these costs in five years."

In fact, the broadcaster recouped its costs in three.

"Today, GGS actually contributes money to the CBC through CBC Radio concert presentations, and making GGS available to independent performers,

Convinced that his people could do the job cheaper, Rogers turned the project over to the Rogers Broadcasting engineering department.

Rogers had gambled before. He personally manufactured and sold FM radios in the 1960s, convinced that Torontonians would flock to this medium once they heard how good it was. Now the decision to let in-house staff build the VRGT paid off.

Today, the Rogers Toronto radio stations — FM stations CISS ("Jack 92.5") and CHFI, AM stations CFTR and CJCL — can connect from their control rooms directly to the VRGT seven floors below with a few clicks of a mouse.

The signals travel between the two via a 256-x-256 audio router located in the fifth-floor engineering rack room, explained Rogers broadcast technician Anthony Guerra. The router is a Sierra Automated Systems SAS64000.

### Integration of audio

"We use it to ease the integration of audio from any master control radio studio on the fifth floor to the theater control room in the subbasement," he said. The theater control room is equipped with a Mackie digital audio console, power amplifiers and video processing equipment.

recording artists and business groups on a rental basis for the 40 percent of time we are not using it ourselves," he said.

**O**ne time we heard a strange noise, and by careful listening, we figured out that it came from a bearing that had gone bad in a water circulation pump eight floors away.

— GGS General Manager Tom Shipton

To date, artists such as Mariah Carey, Shania Twain, Diana Krall, Oscar Peterson and Elvis Costello have recorded in the GGS, as have many Canadian classical performers.

### Performance space

A few miles uptown from the GGS is the Velma Rogers Graham Theatre. Named for the wife of Rogers Broadcasting owner Ted Rogers Jr., the VRGT is located in the Rogers Toronto office tower/broadcast complex at 777 Jarvis Street.

Unlike the Glenn Gould Studio, the VRGT did not start life as a performance space. In fact, the 360-seat auditorium originally was an HVAC machine room. When its plant was upgraded to smaller, more efficient equipment, the space became available.

Needing a space for board meetings and other gatherings, Ted Rogers commissioned an outside firm to price renovating the space into a theater.

The theater itself features a 30-foot screen for movies/television projection (from either a Christie DLP or Sanyo LCD projector), a full 5.1 audio system and lots of microphone inputs for radio events. Add its versatile seating layout — seats can be removed easily to reveal a dance floor — and the VRGT stacks up as an impressive performance space.

Not surprisingly, "We have had a number of big artists appear at the Velma Rogers Graham Theatre, including Janet Jackson and Alanis Morissette," said Guerra. "We can interview them on the stage proper, or have an operator upstairs patch between the VRGT and the station's master control room."

That the CBC and Rogers both operate radio performance theaters a few miles apart is unusual, by modern radio standards. That both facilities are state-of-the-art and in demand is even more unlikely in an age when many stations exist only within computer hard drives.











### Product Showcase



























#### Model AFS-3 Audio Failsafe

- silence sensor—balanced or unbalanced audio
- provides contact closure on loss of audio
- adjustable from 30 seconds to 5 minutes
- dry relay contacts or logic level voltage
- front panel alarm indicator and audible alert
- optional audio detect mode

# Chapter One

Once upon a time, a radio engineer  and talk show host named Steve  grew frustrated with the awful sound of his telephone  system. So, he read lots of books  about Digital Signal Processing and invented the  Telos 10. After that, Steve's phones sounded great, and he was happy. Lots of other radio stations that used it were  happy, too, and Steve's company grew large and hired more  smart engineers. They partnered with the MPEG folks  and introduced MP3 to the world with  Zephyr. And Zephyr sounded so good, it made *lots* of people  *very* happy.

About the same time, another radio engineer named Frank  was figuring out how to make audio sound both loud  and clean . Frank began building processors for lots of important  big-market radio stations. Soon, Frank teamed his audio chops  with Telos' DSP gurus , and built the first digital audio processor  that gave stations the loud, clean, punchy sound they wanted without the digital "grunge" – which made lots of Program Directors and engineers at even more radio stations happy . And Frank's processors became the choice of top stations like , , , ,  and many more.

Now, Steve and Frank's companies have the biggest R&D team  in the industry, with respected broadcast engineers like Jeff Keith , scientists like Greg Shay , and studio-audio experts like Mike "The Catfish" Dosch . These guys think up  lots of innovative gear together; cool stuff like the Zephyr Xstream  ISDN Transceivers with leading-edge MPEG AAC , and Omnia-6 , the broadcast audio processor preferred by major radio stations around the world, and the world's first broadcast phone system, TWOx12 , that takes advantage of the digital clarity of ISDN, and the truly amazing little Zephyr Xport  POTS+ISDN codec which features aacPlus® , and is winning lots of awards.

...and that's just the *beginning* of the story! 

**Omnia**  
A Telos Company

**Telos**  
AUDIO | NETWORKS

telos-systems.com  
omniaaudio.com

The Telos logo, Zephyr, Omnia, TWOx12, Zephyr Xstream and Zephyr Xport are all registered trademarks of TLS Corp. ©2003, TLS Corp. All other trademarks property of their respective holders. All rights reserved.

## PRODUCT EVALUATION

# High Performance From AudioScience

by Alan R. Peterson

The last thing you want your station's digital audio coursing through is the on-board audio interface found on many motherboards.

When the sound card is actually an integrated element of the entire PC system, you are never guaranteed decent sound or any simple means of "ungluing" the interface from operation.

it through a fairly capable Texas Instruments DSP chip, applying compression and limiting, followed up by five-band EQ. There is even +48V phantom power available at the mic jack.

As the jack takes a phone-style plug, an XLR-to-TRS adapter must be used.

Unlike those computer store sound cards with their noisy and inefficient Mic In jacks, the ASI5111 is one audio interface you can confidently plug a decent

Edit 2.0 to first observe how the interface behaved without any actual audio applied to it.

My own evaluation of any audio interface begins with a look at its own quietest noise.

Cheap cards generate lots of it. The cheaper the card, the higher the noise — detected as a high flickering VU meter when recording and as background hiss during playback.

## No noise = good news

The ASI5111 stayed quieter than any other audio interface I have tried. The waveform line stayed quite flat at zero, while the Cool Edit VU bar danced slightly at -87 dB — much quieter than I would have expected.

Zooming in on the waveform, my first sign of any noise occurred between -0.006 percent and +0.002 percent of Adobe Audition's (formerly Cool Edit) entire dynamic range (see Fig. 1). Very respectable.

Again, this is as unscientific an examination as one would want, but it sure tells a compelling story.

Is this degree of noise immunity that important for broadcast production? Think about it. Take several tracks, all containing a level of hiss, and make a mixdown. Those little slices of noise add up quickly and affect the end product.

Before recording any analog audio via the XLRs, the interface had to be zeroed first in the AudioScience mixer window to avoid clipping. The capture was clean, with wide highs and no distortion at 44.1 kHz sample rate — just the way a high end card should behave.

The audio specs on the ASI5111 are impeccable and the balanced XLR cables

microphone into and expect it to sound good. The compressor has a hard break-away (knee), and extreme amounts will squash things pretty well.

While it remains best to send mic signals through your console and feed the line-level inputs to the ASI5111, a direct microphone can take advantage of the onboard processing to shape the dynamics and keep things bright.

And unlike cheapie sound cards, the ASI5111 comes with breakout cables with D connectors at one end and balanced XLRs at the other. Connect the ASI5111 directly into your existing rig without experiencing that uneasy feeling associated with mini-plugs or phonostyle S/PDIF jacks.

Spec-wise, the ASI5111 boasts published figures of -100 dB SNR and an ear-pleasing 0.0025 percent THD+Noise, with its 24-bit A/D and D/A converters.

I am unable to verify these figures in my home studio. But my own fairly non-scientific test, to be described in a moment, certainly revealed superior performance.

## In use

The ASI5111 was installed in a Compaq PIII-500 PC running Windows 98SE, still a viable operating system for audio playback (AudioScience supports Win 98 through XP and Linux, too).

A CD-ROM is bundled with the interface; but to play it safe, I downloaded the latest Windows drivers at the AudioScience Web site, along with ASIMixer, the software mixer that sets all parameters and DSP settings for the card.

ASIMixer lets you alter input and output response from -10 to +20 dBu in 1 dBu steps. The mic can be set for 20, 40 or 60 dB gain. You may also dial in your compression and EQ settings here.

Once in and running, I launched Cool



You may defeat it in BIOS, but let's face it: you should start out with a really good audio interface from the get-go.

So once you have turned off the on-board interface and begun your search for a dedicated sound card, remember that your entire station is going to hinge on the audio quality and stability of the device you choose.

Skip the musician's card and the home Blaster bundle and go right for the AudioScience ASI5111, a PCI audio adapter intended for high performance, up to 96 kHz sample rate and extremely low noise.

## A lot, a little

A superb sounding card, the ASI5111 has a feature set that is surprisingly austere. It excels at recording and playing back 8-, 16- and 32-bit PCM audio at numerous sample rates.

It does not handle MPEG or Dolby AC2 files, however, and it has only one physical set each of balanced analog inputs and outputs and switchable S/PDIF or AES/EBU digital ins and outs.

Should your tasks require handling these file types through multiple I/Os, such as running outputs to three pots on the console, you may want to consider the higher-priced AudioScience ASI6118 interface instead.

The ASI5111 is a compact PCI card with D-sub connectors and a 1/4-inch TRS jack on the backplane. Its signature appearance, an orange metal shield, covers critical circuitry that no doubt contributes to outstanding SNR figures.

The nine-pin D-sub connectors basically behave like boy-girl seating: the female connector carries analog audio, the male connector handles the digital stream.

The 1/4-inch phone jack takes microphone-level input, amplifies it and routes

## Product Capsule:

**AudioScience ASI5111**  
Audio Interface Card

### Thumbs Up

- ✓ Superb specs and low self-noise
- ✓ Plug-and-play installation
- ✓ Linux support
- ✓ Internal DSP on mic input

### Thumbs Down

- ✓ Single combined output
- ✓ Does not handle onboard MPEG or Dolby digital audio.

Price: \$545

For information, contact Audio Science in Delaware at (302) 324-5333 or go to [www.audioscience.com](http://www.audioscience.com).

ASI5111 handles PCM WAV files superbly, on-board MPEG and Dolby encoding/decoding is not a feature of this card.

By the way, do not go looking for an internal audio connection for your CD-ROM drive. Unlike Blaster-compatible sound cards, the ASI5111 is dedicated solely to moving audio in and out of the backplane ports.

The individual microphone input on the backplane actually is useful. I can bypass the console and plug directly into the PC with the mic, and still take advantage of low noise and processing similar to what I might dial up on a dbx 286 or Symetrix 528 mic processor.

## Summary

The ASI5111 is a natural in PC-based radio broadcast and production systems, its primary design consideration. Numerous manufacturers, such as BSI, have adopted AudioScience interfaces for use with digital on-air storage and playback software.

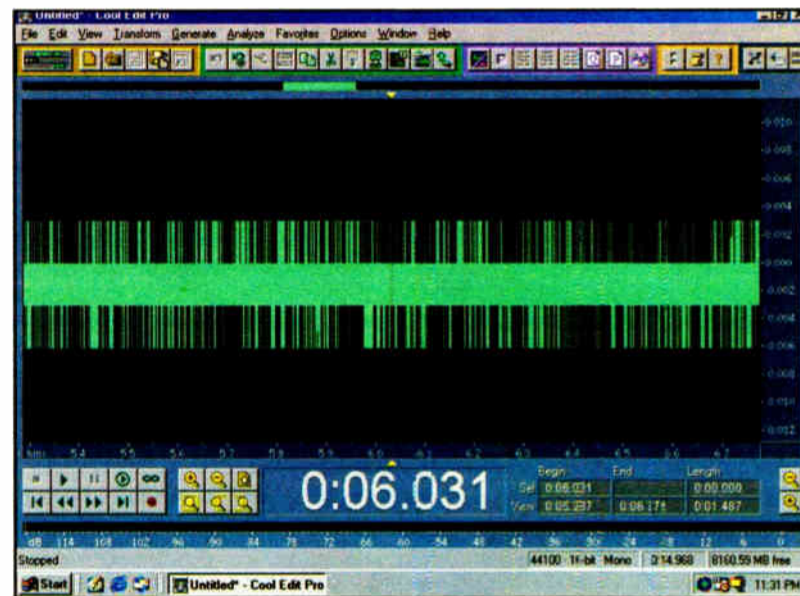

Fig. 1: Self-noise and DC offset generated by the AudioScience ASI5111 audio interface add up to very little.

mean the interface can jack directly into your console with no intermediate IHF-to-Pro matching device.

Again, the only concern you should have is that the ASI5111 is a one-in, one-out card. This is not an interface for simultaneous multitrack recording (say, like the 001 interface for Pro Tools). The intent is to input one element at a time, then mix down all elements in software to a single output.

You want multiple outputs? Step up to the AudioScience ASI6118 card, with its eight stereo outputs.

Also, it must be repeated that, while the

For production, the ASI5111 becomes an outstanding performer when built into a PC outfitted as a multitrack workstation, as long as you are okay with loading in one audio element at a time.

In all, the ASI5111 is a high-caliber performer. One of its beefier brothers may turn out to be a better choice if you wish to go the multiple I/O route.

Long-time RW columnist Alan Peterson handles imaging and production for WMET(AM) in Washington and is the chief engineer for the Washington campus of the Connecticut School of Broadcasting. 

## TIPS AND TRICKS

# Coincident-Pair Stereo Mic Technique

by Bruce Bartlett

You may be called upon to do a remote broadcast or recording of an orchestra, string quartet or pipe organ. If your station is stereo, you will need to understand stereo microphone techniques to produce such a broadcast.

These techniques capture the sound of a musical ensemble as a whole, using only two or three microphones, and frequently are used to record classical-music ensembles and soloists. During playback of a stereo recording, phantom images of the instruments are heard in various locations between the stereo speakers. These image locations — left to right, front to back — correspond to the instrument locations during the recording session.

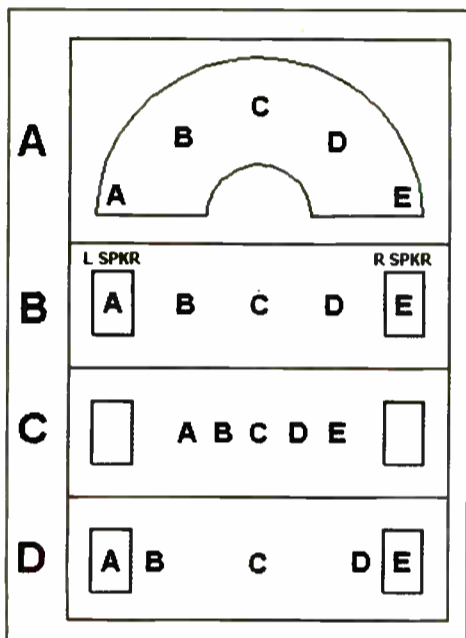

Fig. 1: Stereo Localization Effects. A) Instrument Positions; B) Accurate Localization; C) Narrow Stage Width; D) Exaggerated Separation

There are four microphone techniques commonly used for stereo recording: the coincident-pair, the spaced-pair, the near-coincident-pair and the baffled-omni pair techniques. This article concentrates on the coincident-pair method.

## Goals of stereo miking

In stereo miking a large musical ensemble, one objective is accurate localization. When this is achieved, instruments in the center of the ensemble are reproduced accurately midway between the two playback speakers. Instruments at the sides of the ensemble are reproduced from the left or right speaker. Instruments located halfway to one side are reproduced halfway to one side, and so on.

Fig. 1 shows three stereo localization effects. In Fig. 1-A, various instrument positions in an orchestra are shown: left, left-center, center, right-center, right. In Fig. 1-B, the reproduced images of these instruments are accurately localized between the stereo pair of speakers. The stereo spread or stage width extends from speaker to speaker.

If the microphones are placed improperly, the effect is either the narrow stage width shown in Fig. 1-C, or the exaggerated separation shown in Fig. 1-D. (Note that a large ensemble should spread from speaker to speaker, while a quartet can have a narrower spread.)

To judge these stereo localization effects, it is important to position yourself properly with respect to the monitor speakers. Sit as far from the speakers as they are spaced apart. Then the speakers will appear to be 60 degrees apart, which is about the same angle an orchestra fills when viewed from the typical ideal seat in the audience (say, 10th row center). Sit exactly between the speakers (equidistant from them); otherwise the images will shift toward the side on which you are sitting and will become less sharp.

## Coincident-pair technique

With the coincident-pair (or X-Y) method, two directional microphones are mounted with their grilles touching and their diaphragms placed one above the other, angled apart to aim approximately toward the left and right sides of the ensemble (as in Fig. 2).

For example, two cardioid microphones can be mounted with their grilles touching and angled apart. Other directional patterns can also be used. The greater the angle between microphones, and the tighter the polar pattern, the wider the stereo spread.

This is how the coincident-pair technique produces localizable images: A directional microphone is most sensitive to sounds in front of the microphone (on-axis) and progressively less sensitive to sounds arriving off-axis. That is, a directional mic produces a relatively high-level signal from the sound source it is aimed at, and produces a relatively low-level signal for all other sound sources.

The coincident-pair method uses two directional microphones symmetrically angled from the center line, as in Fig. 2. Instruments in the center of the ensemble produce an identical signal from each microphone.

During playback, a phantom image of the center instruments is heard midway between the stereo pair of loudspeakers. That is because identical signals in each channel produce a centrally located image.

If an instrument is off-center to the right, it is more on-axis to the right-aiming mic than to the left-aiming mic. So the right microphone will produce a higher-level signal than the left mic. During playback of this recording, the right speaker will play at a higher level than the left speaker; this reproduces the image off-center to the right — where the instrument was during recording.

The coincident array codes instrument positions into level differences between channels. During playback, the brain decodes these level differences back into corresponding image locations. A pan pot in a mixing console works on the same principle.

If one channel is 15 to 20 dB louder than the other, the image shifts all the way to the louder speaker. So, if we want the right side of the orchestra to be reproduced at the right speaker, the right side of the orchestra must produce a signal level 20 dB higher from the right mic than from the left mic. This occurs when the mics are angled apart sufficiently. The correct angle depends on the polar pattern.

Instruments partway off center produce interchannel level differences less than 20 dB, so they are reproduced part-

way off center.

Listening tests have shown that coincident cardioid microphones tend to reproduce the musical ensemble with a narrow stereo spread. That is, the reproduced ensemble does not spread all the way between speakers.

A coincident-pair method with excel-

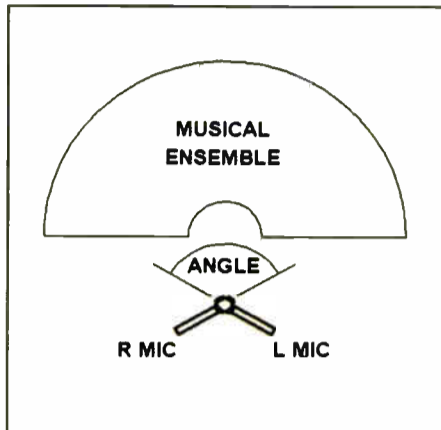

Fig. 2: Coincident-Pair Method (Top View)

lent localization is the Blumlein array, which uses two bidirectional mics angled 90 degrees apart and facing the left and right sides of the ensemble.

A special form of the coincident-pair technique is the Mid-Side (MS) recording method illustrated in Fig. 3. A cardioid or omnidirectional microphone fac-

ing the middle of the orchestra is summed and differenced with a bidirectional microphone aiming to the sides. This produces left- and right-channel signals.

With this technique, the stereo spread can be remote-controlled by varying the ratio of the mid signal to the side signal. This remote control is useful at live concerts, where you cannot physically adjust the microphones during the concert. MS localization accuracy can be excellent.

Researcher David Griesinger has suggested coincident recordings can be made to sound more spacious by boosting the bass 4 dB (+2 dB at 600 Hz) in the L-R or side signal.

Stereo microphones (X/Y or MS) include two coincident microphone capsules mounted in a single housing for convenience.

A recording made with coincident techniques is mono-compatible; i.e., the frequency response is the same in mono or stereo. This characteristic is important for radio broadcasts because many people will be listening to your signal in mono.

Because of the coincident placement, there is no time or phase difference between channels to degrade the frequency response if both channels are combined to mono. If you expect your recordings to be heard in mono, consider coincident methods.

## Hardware

A coincident pair of microphones should be mounted rigidly with respect to

See MIC TECHNIQUES, page 38 ▶



## Swing

Portable ISDN Audio Codec:

- Compact, light weight and easy to operate with a worldwide ready ISDN connection.
- Works anywhere and is compatible with all codecs on the market.
- It has a built-in digital phone hybrid for POTS connection and it works simultaneously with the ISDN connection.



Now with MP3 !!!

## Eagle

ISDN Audio Codec

- Stereo and Mono.
- Digital and Analog I/O.
- Capable of establishing an On Air conversation with two callers.



## TH-02 Ex

Digital Telephone Hybrid

- Known worldwide for its high performance.

AEQ  
Phone: 954 - 581 7999 Fax: 954 - 581 7733  
sales@aeqbroadcast.com www.aeqbroadcast.com

# Radio on TV Not Always a Good Idea

by Alan R. Peterson

"You know what would be cool? If we could Webcast live video of the morning show."

Good heavens, my blood runs icy cold when I hear that.

A good idea at first, it often balloons to entail unexpected expense, more staff, a new wrinkle with the station's streaming service and a whole new set of conditions thrust upon the talent.

I mention this because I was asked recently about the feasibility of Web camera placement in a talk studio for the benefit of a computer-bound audience that absolutely must see how ugly hosts can be.

I have dealt with this before. If it is done right, it can be somewhat interesting. If done wrong, it is *very* wrong.

## You're on the air!

I am all for any weapon that gives a station a superior position in any market. Live pictures from the studio can be compelling, especially if there are famous guests or wacky stunts to be enjoyed.

But when the stunts dry up and there are no guests booked for the week, that video feed gets mighty dull.

The trouble is, we have been spoiled by the shots seen on Howard Stern's show on the E! Channel and by the MSNBC feed of "Imus in the Morning" every weekday.

Good studio design and graphics, fast switching and an expensive set of robotic overhead cameras on a track make these shows effective.

In our minds, we want our own video productions to look just as slick. But a locked-down camera under crummy lighting will not do it. And our own denial of these shortcomings only serves to embarrass us when we try to pass it off as a professional product.

Not counting the production of "video airchecks" in which a jock's performance is captured on tape, the first time I had to sweat a video feed from a radio studio was when I was tied in with Fairfax Public Access Corp. in 1999.

A foreign-language channel produced there and carried by the local Cox Cable franchise runs music and a scrolling Powerpoint presentation when there are no TV programs scheduled. Once in a while, a live radio-type show in the Farsi language would be carried on the channel, also accompanied by Powerpoint.

To begin with, what sort of agreement do the hosts have? Are they represented by AFTRA? If so, it's time to negotiate a new work agreement that includes video time on the Web. That may cost a penny or two.

Will Sluggo the Drunken Stunt Intern *really* want to be on camera? It means he

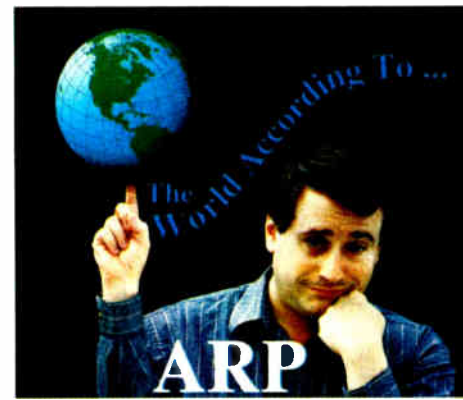

so figure on a salaried staff.

Paid about the same as a junior show producer on his or her second job, that is about \$20,000 to \$23,000 per person. Now your morning show staff expenses have jumped up an additional \$60,000 to \$70,000.

By the way, we are not talking about skilled video operators, but most likely a youthful crew that will exploit every last "cool" effect on the switcher and shoot the morning show in extreme "Caffeine Cam" mode. You thought the freehand Shaky Cam technique on "NYPD Blue" was extreme? Wait 'til you see what passes for Net video with such a ragtag crew.

Need I mention that your engineer — whether in-house or a contract dude who shows up once a week — is now required to service and maintain a video rig? In addition to trips to the transmitter, testing the emergency generators and putting out microwave popcorn fires, this poor soul is now a video engineer as well.

How much more salary will be demanded for maintaining TV lighting and making sure cameras are shaded properly?

## But I wantit! I wantit!

All right. So, flying in the face of reason and sensibilities, your morning act still wants to stream a video feed of the studio on the Web.

What would be a reasonable way to pull it off without breaking the bank or going nuts stringing an overhead robotic camera track?

One idea I have had in my head for about a year has yet to be developed as actual software or hardware. According to my research, no one has yet introduced a product that does what I am about to suggest, but when they do, they just might have something. I only wish I had the computer chops to pull it off myself.

Most Webcams are USB affairs these days, and many PCs now have multiple USB ports. Imagine being able to connect three or four simple little \$80 Webcams to the back of a PC, driven by software that emulates a video switcher.

This software would allow an operator to switch, dissolve and fade between Webcams, as well as generate titles and lower-third graphics, all within a garden variety PC, much in the same way professional rigs costing several hundred grand do.

All the Webcams would be glued down unobtrusively where the action in the studio is happening. All are genlocked by the PC hardware so there is no flicker or loss of sync when a camera is switched.

The PC would then output a video signal to your streaming gear or squirt it out the door to your streaming provider.

As the Webcast video would most likely be low-res anyway, there would be no need for \$1,000+ Mini-DV cameras

See RADIO ON TV, page 40 ▶

## Watching a DJ doing nothing on TV is duller than watching toothpaste harden in your sink.

One week, the host requested — nay, *demand*ed — a live camera in place of the graphics, hoping to draw a more receptive audience who might have been channel surfing.

After lots of discussion, he got his wish. A 500-watt fresnel light was hung in the studio, a camera cable was run out to Master Control and his radio show now had pictures.

Very dull pictures.

The single camera was placed so the host had one continuous shot. You could not see his guests. When he played songs, he sat back and read the paper. When he got up for coffee or a bathroom break, the camera showed a blank white wall and the lower edge of the console.

Watching a DJ doing nothing on TV is duller than watching toothpaste harden in your sink, if not by much.

## You ought to be in pictures

I have found that morning hosts are the ones most interested in streaming a video feed of the live show, or else are chosen by management to represent the station. It is felt the additional exposure of pictures on the Web will bolster the recognition and familiarity of the show.

In reality, a lot of issues must be addressed beyond "how do we take good pictures?"

It mounts two microphones on a single stand. Microphone angling and spacing are adjustable.

To pick up the full spectrum of an orchestra, the microphones should have uniform response from 40 Hz to 20 kHz. Self-noise should be low (less than 20 dB A-weighted) to avoid hiss in the recording. A stereo pair of mics should be the same model number, and well-matched in frequency response and sensitivity.

You may need to roll off frequencies below 80 Hz to eliminate rumble from trucks and air conditioning, unless you want to record organ or bass-drum fundamentals.

Sound from an orchestra or band approaches each microphone from a broad range of angles. To reproduce all the instruments' timbres equally well, the microphone should have a broad, flat response at all angles of incidence within at least +/- 90 degrees. Stated another way, the polar pattern should be uniform with frequency.

Bruce Bartlett is a technical writer/microphone engineer, recording engineer and audio journalist. 🎧

actually has to shower, shave and dress for a video Webcast every Monday morning. The time to get slovenliness out of your system is when you are an intern.

And just what do you take a picture of? The Stern and Imus TV shows are successful in part because they use proven television techniques, showing stills of phone guests when appropriate and using artistic bumpers going into breaks.

Do you show a picture of Mr. Morning scratching his nostrils when the traffic reporter is on the phone giving a report? What is on the Web when a song is playing? Can you even play songs over the Web without having to worry about RIAA, ASCAP and BMI fees? Not likely.

When are you going to tell that musical guest or famous actor that they are going to be on a video camera during the interview? They typically are prepared only for a radio broadcast and may even have a rider in their agreements about how and when they may appear on camera. An ambush like this might mean no interview for you today.

There also is the danger of becoming so enamored with the video cameras that it is easy to forget *you are doing a radio show!*

You start to play to the cameras and forget that your entire performance must come from carefully chosen words to describe a situation or an action. Holding up a coffee cup to show viewers cheats your listeners of the experience.

Again referring to Stern and Imus, they know they are on camera. But they will still verbally describe the vibrant color of a New Mexico sunset or what a studio guest is (not) wearing for the benefit of the primary radio audience.

## Money money money

How about the cost of Web video? You want shots like Stern or Imus get? Get ready to part with a lot of money. Overhead robotic tracks, proper video lighting, electrical installation that is up to code, a vectorscope and waveform monitor and reconfiguring the studio to look good on camera all cost a bundle.

On top of everything else, there is the need for a camera joystick operator, a technical director to work a camera switcher and lower-third graphics, and someone who has a fundamental idea of proper video lighting. Remember, the last thing you want this to look like is a convenience-store surveillance image.

I cannot see interns doing this for free,

## Mic Techniques

▶ Continued from page 37

each other so that they can be moved as a

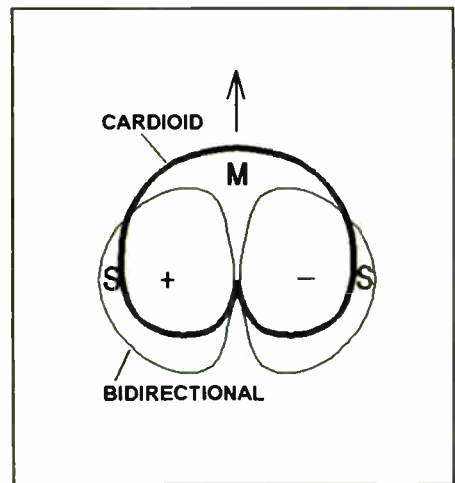

Fig. 3: Mid-Side Stereo Miking Method (Top View)

unit without disturbing their arrangement. A device for this purpose is called a stereo microphone adapter or stereo bar.

# Products & Services SHOWCASE

## ERI Towers Above the Rest

Monopoles  
Guyed Towers  
Self-Supporting Towers  
Structural Analysis  
Tower Reinforcing

Electronics Research, Inc.  
7777 Gardner Road • Chandler, IN 47610  
(812) 925-6000 • www.ERInc.com

## POWERFUL DIAL-UP CONTROLLER



THE DR-10

Perfect for Studio & Automation Control  
Interfaces with most studio automation systems.  
Control it from either a dial-up line or external audio path. The DR-10's active, balanced, telco audio output lets you do live remotes, remote announcement recording and...much, much more!

### Outstanding Features: Exceptional Value

- >10 dry relay contacts out.
- >Auto-answers on user settable ring # and auto-disconnects.
- >Relays can be assigned to any tone & can be momentary, latching with distinct on/off codes, or interlock latched with others.
- >Up to 8 digit, user set, password.
- >Momentary relays can close after tone.
- >Relays can beep when activated. Closures are after the beep!
- >Proprietary two-tone & detection delay modes eliminate false trips.
- >4 Status inputs beep when queried, alarm dial and control relays.
- >Control equipment & monitor local audio with the internal audio hybrid.
- >All settings retained after power failure.
- >Silencer option removes DTMF tones from the audio output.
- >New LOWER list price only \$399.00.
- >Best features vs. price in the industry.

Visit our web site or call your favorite dealer for more info.

**CircuitWerkes** - (352) 335-6555 Fax 380-0230

http://www.circuitwerkes.com / 3716 SW 3<sup>rd</sup> Place, Gainesville, FL 32607

## Superior Broadcast Products

### FM TRANSLATORS

Frequency Agile Transmit & Receive  
In a Wide Range of Power Choices  
**CALL FOR SPECIAL PRICING**

### SOLID STATE TELEVISION TRANSMITTERS

From 5 watts to 120 Kw  
Starting at \$4990

### ANTENNAS

UHF-VHF Panel Antennas  
UHF Slot Antennas  
Low Power Medium Power High Power  
Custom Antenna Patterns

### TELEVISION STL's & MICROWAVE

**CALL FOR PRICING!!**

### FM TRANSMITTERS & EXCITERS

from 20 watts to 30,000 watts  
30 watt exciters starting at \$995  
250 watt Solid State Transmitter \$2750  
1000 watt Solid State Transmitter \$6500  
3500 watt FM Transmitter \$14,990

### \*\*\* Special Pricing \*\*\*

10,000w FM Transmitter \$18,990  
20,000w FM Transmitter \$35,990

### FM ANTENNAS

Low Power Starting at \$495  
Custom Designed Patterns  
All Power Ranges  
Full Wave Length or Half Wave Length

### FM AMPLIFIERS

100 watt \$1195  
250 watt \$1750

### STLs

Complete Transmitters & Receiver

\*\*\* Special Pricing \*\*\*  
**\$3500**

## Superior Broadcast Products

WHERE WE BELIEVE IT IS AS IMPORTANT  
WHO YOU BUY FROM AS WHAT YOU BUY!

### CONTACTS

Jimmie Joynt Voice (800) 279-3326

Benny Springer

Voice (800) 695-7919  
Fax (903) 297-4651  
email bennySBP@aol.com  
web: www.superiorbroadcast.com

17194 Preston Rd Suite 123-297 Dallas, Tx 75248

## SOUND CHOICE FURNITURE

High quality stock studio furniture from the manufacturers of  
The Best Custom Studio Furniture

Call Today  
before \$5,995\*  
Introductory Price  
Expires!

Starting as low as  
**\$3,295**

Introducing "Sound Choice Furniture," new from Mager Systems, Inc. the manufacturer of The Best in Sound Furniture. Sound Choice Furniture is high quality stock studio furniture, featuring the same high quality construction methods and materials found in Mager Systems, Inc. custom furniture. All "Sound Choice Furniture" includes solid surface countertops. The standard color is stormy gray for the solid surface top and a medium speckled gray on the cabinets (see photos). Call today to see how Sound Choice Furniture will benefit your studio.



Radio World  
The Best in Sound Furniture

\*As shown,  
excluding Console &  
Guest Top

Sound Choice Furniture  
offer these Fine  
Standard Features:

- Solid Surface Tops
- 1-1/2" thick 19-ply plywood cabinet construction
- 13-ply Finland Birch access panels
- No Particle Board or melamine
- 10-year Limited Warranty
- Reversible Punch Block cabinet
- Modular - Many Configurations, add-ons and colors available
- Built in ventilation
- Fast Installation - No cabinet assembly

TEL: 623-780-0045 • FAX: 623-780-9860

www.magersystems.com • mager@magersystems.com

Visit our website for more information

Buy simplicity,  
reliability and service

## EAS

Price \$1750.00

Equipment is in stock for  
immediate delivery!

GORMAN-REDLICH MFG. CO.  
257 W. Union St. Athens, Ohio 45701

Phone 740-593-3150  
FAX 740-592-3898

Now available  
with optional DTMF  
control via a phone line.

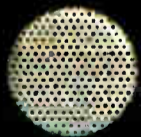

- 5 two-way RS-232 inputs/outputs for computer, remote signboard & character generator
- 6 audio inputs on standard models. All audio inputs & outputs are transformer isolated from encoder-decoder board
- Automatic interruption of program audio for unattended operation
- 4 line 40 character LCD display with LED backlighting
- 20 key keypad to program unit, set modulation level, set input levels
- Will handshake with automation equipment
- 2 year warranty
- 2 minutes of digital audio storage
- 25 pin parallel printer port for external printer
- 52 terminals on the rear to interface with other equipment by removable plugs
- BNC fitting with 600ohm balanced audio out for second transmitter

jimg@gorman-redlich.com Web Site: www.gorman-redlich.com

◆ Also available: weather radios, antennas for weather radios, crystal controlled synthesized FM digitally tuned radios, remote signboards, cables for interconnection, character generators.

# ◆ PRODUCT GUIDE ◆

## Products for Radio Air & Production Studios

Mail info and photos to: RW Product Guide, P.O. Box 1214, Falls Church, VA 22041

### Low-Cost EAS Decoder for LPFM

TFT Inc. has made a low-cost EAS decoder available, aimed at the low-power FM market.

The EAS 911D/S is based on the company's 911D EASE Decoder but lacks a printer and four-port COM expander board. At \$1,595, it is targeted toward the budget LPFM market.

LPFM stations do not tend to need an



interface to a character generator or LED message sign, features of the higher-priced EAS 911D. Features of the unit include two digitally tuned receivers, a 51-key front panel with LCD, a practice key, balanced audio output, speaker and two relay outputs.

Stations wishing to add the printer or four-port COM expander later can do so; both items are pluggable

For more information from TFT Inc. contact the company in California at (408) 943-9323 or visit [www.tftinc.com](http://www.tftinc.com).

### Pop-Up Canopies Setup Fast

KD Kanopy says it continues to improve upon the concept of the pop-up

canopy. For remotes, KD Kanopy lets two people set up in less than 30 seconds without extra parts required.

A KD Kanopy can be used indoors or outdoors. Frame construction is aluminum; joint fittings are reinforced fiberglass. Fabric tops are 250-denier Oxford polyester, which is strong and lightweight, water-resistant and fire-resistant. UV protectors prevent fading. The canopies can be customized with station logos; full-coverage graphic printing is now available. They help a station to stand out in the crowd at fairs, openings and other remote opportunities. Side panels and rail curtains are available. The canopies come in a variety of shapes and sizes.

For more information, including pricing, contact KD Kanopy in Colorado at (303) 650-1310, or go to [www.kdkanopy.com](http://www.kdkanopy.com).

## Radio on TV

Continued from page 38  
 mounted around the room. Most of their superior imaging capabilities would be thrown away anyway during encoding.

Fifteen or so years ago, a company called Newtek did something similar called the Video Toaster, which converted an Amiga computer into a full video production suite for use with actual video cameras. The idea is the same, but now the hardware is simpler, and presumably anyone could do it.

The first company to cook up the USB video interface and software to make this happen will be praised by morning shows and "pirate" Webcasters everywhere.

That will be the easy part. You have to make sure that everybody really wants to be part of a TV Webcast and know how to play to it and the radio as well. That could be a tougher sell.

### Tascam FireWire Interface Controls DAWs

Tascam is shipping its FW-1884 DAW control surface and audio/MIDI interface. The professional-quality interface uses FireWire high-speed data transfer protocol. It has an 18-channel audio interface, eight mic preamps, 4x4 MIDI interface and editing and mixing controls.

According to Tascam, the FW-1884 takes command of the entire studio and replaces much of the gear needed to record into a DAW. With more bandwidth than USB, FireWire delivers 18-channel audio input and output — eight analog, eight ADAT digital and two S/PDIF coaxial or optical. The FW-1884 has nine 100-mm motorized touch-sensitive faders and dedicated controls for pan, solo, mute and select per channel and tactile control over four bands of EQ.

For more information, contact Tascam in California at (323) 726-0303 or go to [www.tascam.com](http://www.tascam.com).



# SH SHOWCASE SE

Products & Services

## MIX'N MATCH

### System 10,000 Modular Amplifiers

Over 40 interchangeable Microphone, Line and Audio DA Modules for you to mix 'n match to your requirements.

- Transformer or Active Balanced Outputs • VCA Option Available
- Backup, Alarmed Power Supplies • RF Protected
- Clean & Quiet Performance • Attractive & Safe Design
- Cool Operation

AUDIO TECHNOLOGIES, INC.  
 328 W. Maple Avenue, Horsham, PA 19044, USA  
 800-959-0307 • (215) 443-0330 • Fax: (215) 443-0394



Free Brochure Available Upon Request  
<http://www.atiguys.com>

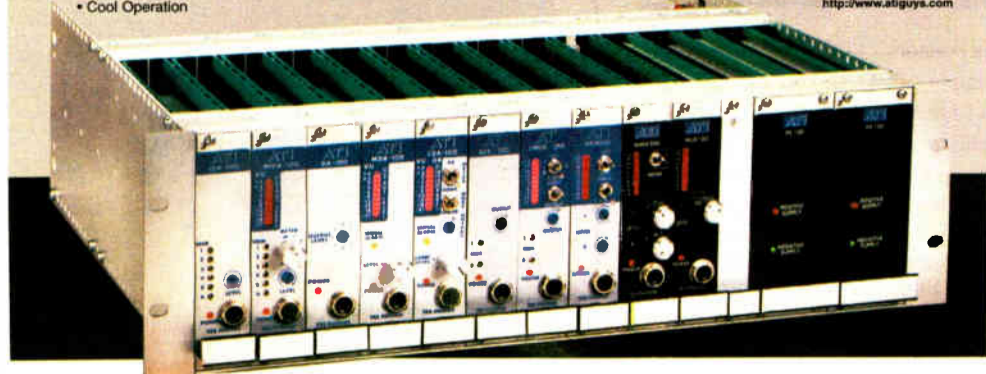

May we present...  
**YOUR AD**

RADIO WORLD'S  
 Products and Services Showcase  
 provides a perfect medium  
 for marketing your  
 products and services.

For more information, call Simone at  
 703-998-7600, ext. 154  
 to request a media kit.



# BROADCAST EQUIPMENT EXCHANGE

"Broadcast Equipment Exchange" accepts no responsibility for the condition of the equipment listed or for the specifics of transactions made between buyers and sellers.

## ACOUSTICS

### Want to Sell



Full product line for sound control & noise elimination.

www.acousticsfirst.com

## AMPLIFIERS

### Want to Sell

AudioClassics.com Buys-Sells-Trades-Repairs Vintage and High-End Audio Equipment. 800-321-2834 or steve@audioclassics.com.

## ANTENNAS/TOWERS/CABLES

### Want to Sell

Superior Broadcast Products FM Antennas All Power Levels. Contact Benny Springer Phone 800/695-7919

263' guyed Rohn AM tower, lighting package included, well maintained, buyer arranges take-down, shipping. Phil Mueller, KCYN, 2573 N Radio Hill Rd, Blanding UT 84511. 435-259-1035 or 435-260-8033 (cell) or email: exnews@frontiernet.net.

## AM Ground Systems

Reliable, On-time Installation Quality Workmanship Ground System Evaluation and Repair  
www.amgroundsystems.com  
1-877-766-2999

ERI 3-bay FM antenna tuned to 102.1 FM, 5 years old, great condition, \$1950. Rod Chambers, 3015 Johnsonville Rd, Susanville CA 96130. 1-800-366-9162.

Andrew 340' or 3" heliast, recently removed from service for an upgrade, \$1500. Bruce Campbell, Dove Media, 598 Westwood Dr, #201, Abilene TX 79603. 325-677-3900.

## S.W.R FM & Television Antennas

Contact Benny Springer Phone 800/695-7919

ERI FMH 10-AC circ polarized 10-bay FM tuned to 104.9 MHz, recently removed from service, \$7500. Bruce Campbell, Dove Media, 598 Westwood Dr, #201, Abilene TX 79603. 325-677-3900.

Refrigerated truck bed for transmitter shack, 8x24x8' tall w/AC in wall, \$2000. Bruce Campbell, Dove Media, 598 Westwood Dr, #201, Abilene TX 79603. 325-677-3900.

RFS Cablewave SPD-10 dry air pump, like new, \$500. Bruce Campbell, Dove Media, 598 Westwood Dr, #201, Abilene TX 79603. 325-677-3900.

## AUDIO PRODUCTION

### Want to Sell

Eventide H3000B ultra harmonizer, like new, stereo, manual included, \$950 +shpg. Gerry Turro, WJUX, 75 Second St, Dumont NJ 07628. 800-585-1031.

## AUTOMATION EQUIPMENT

### Want to Sell

QE1 7775 ATS-FM system complete with manual, working when removed from service, \$100. Duane Ashbaucher, WPOS, 7112 Angola Rd, Holland OH 43528. 419-865-5551.

Smartcaster Jock in the Box live assist CD automation system with 8 Pioneer 18-disc players, computer, hardware, rack. runs 24/7, \$3250 +shpg. John Wilsbach, WMSS, 214 Race St., Middletown PA 17057. 717-948-9136.

## CART MACHINES

### Want to Sell

Audi-Cord Series 100, stereo mod-quad-1 stereo R/P in working cond, mod-quad sequencer needs repair, also included are service manuals, \$150 +shpg. Duane Ashbaucher, WPOS, 7112 Angola Rd, Holland OH 43528. 419-865-5551.

## COMPLETE FACILITIES

NEW OR USED COMPLETE PACKAGES  
STUDIO/STL/TRANSMITTER/ANTENNA OR ANY COMBINATION OF ABOVE.  
-LEASE OPTIONS-  
-EMERGENCY RENTALS-  
-REMOTE BROADCAST RENTALS-  
SCMS, Inc. (800) 438-6040  
"You Know We Know Radio"

## CONSOLES

### Want to Sell

Two ATI Vanguard Series boards in working order. Will sell "as is" for \$250.00 each plus shipping and handling. For a picture of what one looks like e-mail michael@rb.org or call Mike Raley @ (704) 523-5555.

## DISCO-PRO SOUND EQUIP

### Want to Sell

ATI Audio Distribution Amplifier 2016-1. We have about 10 of these as a result of studio renovations. They cost over \$1,100.00 new but will let these go for \$300.00 each plus S&H. Contact Michael Raley at (704) 523-5555 for more information or e-mail Mraley@rb.org for a picture.

Audio Arts 8400 Distribution Amplifier. We have about 15 of these as a result of studio renovation. They cost over \$1,100.00 new but will sell "as is" for \$300.00 each plus S&H. Contact Michael Raley at (704) 523-5555 or e-mail Mraley@rb.org for a picture.

Audio Cord Cart machines. We have about Several "E" series playbacks at \$20.00 each, 10 "DL" series playbacks and two "A" series playbacks at \$20.00 each. Most of them have been refurbished. We also have one "A" series P/R mono, two "E" series p/r mono, two "DL" series p/r mono and two "DL" series stereo p/r at \$100.00 each. Call Michael Raley @ (704) 523-5555 or e-mail Mraley@rb.org for more information. No connectors are available. Will sell "as is". Shipping and handling charges apply. Call Michael Raley @ (704) 523-5555 or e-mail Mraley@rb.org for some pictures.

Denon 650 F CD player. Will sell "as is" for \$225.00 plus s/h. Email Mraley@rb.org for picture or call (704) 523-5555 for more information.

Enberg BA - 6 Annunciator. Four of them in great condition with no more than eight years of use in them. Original cost was \$359.00 each but we will sell them for \$225.00 each "as is" plus s/h. Call Mike Raley at (704) 523-5555 or e-mail Mraley@rb.org for more information.

Otari MX 50, and two MX 5050 all in good shape. Will sell "as is" for \$50.00 each plus s/h. Call Mike Raley at (704) 523-5555 or e-mail Mraley@rb.org for pictures. They work I'm just trying to get rid of them!

Revox Reel to Reel Recorders. Good for parts but might be repairable. We've got seven of them and can let them go for \$20.00 each plus s/h. Call Michael Raley @ (704) 523-5555 or e-mail Mraley@rb.org for pictures.

Tascam CD 301 (Have two working units) will sell as is for \$225.00 each plus s/h. Email Mraley@rb.org for a picture or call (704) 523-5555.

Tascam Ministudio Porta One Cassette. Four mic lines for remotes This cost \$600.00 new but will sell "as is" for \$125.00 plus s/h. Call Mike Raley at (704) 523-5555 or e-mail Mraley@rb.org for a picture.

Technics SL-D2 record player can let go "as is" for \$125.00 plus s/h. E-mail Mraley@rb.org for a picture or call Mike at (704) 523-5555 for more information.

Ten Nidec motors for Audio-cord "E" series. 117v 6H 3.1w 0.2amp 12p and 600rpm. Will sell "as is" for \$5.00 each. Working condition just somewhat noisy. Call Michael Raley (704) 523-5555 or e-mail Mraley@rb.org for pictures.

TFT 713 AM Frequency and Modulation Monitor. Cost \$3,400.00 new but will sell for \$1500.00 plus S&H. Needs re-calibration. Call Michael Raley at (704) 523-5555 or e-mail Mraley@rb.org for a picture.

Two B.E. Record Playback cart machines Two Stereo units "as is" for \$65.00 each and two mono units "as is" for \$50.00 each. Call Michael Raley @ (704) 523-5555 or e-mail Mraley@rb.org for pictures.

Two RTS 416 Distribution Amplifiers. Has slight problem pushing +4. Cost \$1,173.00 new but will take \$325.00 for each unit plus S&H. Call Michael Raley at (704) 523-5555 or e-mail Mraley@rb.org for a picture.



## LIMITERS/AUDIO PROCESSING

### Want to Sell

Optimod 8000A in good condition, \$600/BO. Patrick Lopeman, Bay View Bldg, 4359 South Howell Ave, Milwaukee WI 53207. 414-482-1959.

Orban Audicy, cherry condition, private owner, latest software, 52 min RAM, digital I/O, SCSI drive support, SMPTE card, 25' extender cables for keyboard, screen and console, \$8.5K. 410-296-2868 or tford@jagunet.com.

Orban Optimod 8100 with XT/2 chassis, excellent condition complete with key, removed for an upgrade, \$3400. Chris Dusterhoff, Bryan Bldg, Box 3248, Bryan TX 77805. 979-846-1150.

### Want to Buy

Teletronix LA-2A's, UREI LA-3A's & LA-4's, Fairchild 660's & 670's, any Pultec EQ's & any other old tube compressor/limiters, call after 3PM CST, 972-271-7625.

Orban 8100 XT2 (2) with or without zero card. Matt Connor, Martz Comm Group, 1592 Union St, #304, San Francisco CA 94125. 518-483-1100.

## MICROPHONES

### Want to Sell

Shure SM-7 high quality, studio dynamic microphones in excellent condition, \$250 each or \$950 for all. Mike Friend, WNAN, 2250 Old Ivy Rd, Charlottesville VA 22903. 434-971-4096 or email: wnrnmike@hotmail.com.

### Want to Buy

RCA 77-DX's & 44-BX's, any other RCA ribbon mics, on-air lights, call after 3PM CST, 972-271-7625.

## MISCELLANEOUS

For mike flags  
It's  
www.mikeflags.com

### Want to Sell

K-Y Filter Company  
3010 Grinnel Place  
Davis, CA 95616



## ELIMINATE BROADCAST BAND RFI

Plug-in telephone/modem RFI FILTERS

(530)757-6873

www.ky-filters.com/rw.htm

Arrakis 100RS, 16 stereo inputs, 4 stereo outputs, audio routing/switcher with manual, in good working condition, \$75 +shpg. Duane Ashbaucher, WPOS, 7112 Angola Rd, Holland OH 43528. 419-865-5551.

Proteck 20 MHz Spec. analyzer (A-3502). Make a decent offer. Call Michael Raley @ (704) 523-5555 or e-mail Mraley@rb.org.

www.rwanline.com

# ACTION-GRAM

## EQUIPMENT LISTINGS

Radio World's Broadcast Equipment Exchange provides a FREE listing service for radio stations only. All other end users will be charged. This FREE service does not apply to Employment Help Wanted ads or Stations For Sale ads. These are published on a paid basis only. Send your listings to us by filling out the form below. Please be aware that it takes one month for listings to appear. The listings run for two consecutive issues and must be resubmitted in order to run again. Thank you.

Please print and include all information:

Are you currently a subscriber to Radio World?

Yes  No

Signature \_\_\_\_\_

Date \_\_\_\_\_

Contact Name \_\_\_\_\_

Title \_\_\_\_\_

Company/Station \_\_\_\_\_

Address \_\_\_\_\_

City/State \_\_\_\_\_

Zip Code \_\_\_\_\_

Telephone \_\_\_\_\_

Brokers, dealers, manufacturers and other organizations who are not legitimate end users can participate in the Broadcast Equipment Exchange on a paid basis. Line ad listings & display advertising are available on a per word or per inch basis.

WTS  WTB  Category: \_\_\_\_\_

Make: \_\_\_\_\_

Model: \_\_\_\_\_

Brief Description: \_\_\_\_\_

Price: \_\_\_\_\_

\*Closing for listings is every other Friday for the next month's issue.

All listings are run for 2 issues unless pressed for space or otherwise notified by listee.

Broadcast Equipment Exchange

PO BOX 1214, Falls Church, VA 22041 • Tel: 703-998-7600 • Fax: 703-998-2966

**MISCELLANEOUS (WTS) Cont.**

**BAY COUNTRY BROADCAST EQUIPMENT**  
 BUY - SELL - TRADE  
 Your #1 Source For Quality Used Radio Broadcast Equipment  
 View The Latest List On Line At: <http://www.baycountry.com>  
 Or Call And We Will Fax It To You  
 7117 Oliva Rd., Baltimore MD 21220  
 Toll Free: 877-722-1031 • FAX: 786-513-0812 • E-mail: [info@baycountry.com](mailto:info@baycountry.com)  
 Member of BBB

**GEI Model ARC - 27** Automatic Remote Control - \$50.00 "as is" plus shipping and handling - Call Michael Raley @ (704) 523-5555 for more information or e-mail [Mraley@rb.org](mailto:Mraley@rb.org) for a picture.

**TFT 886 AM EBS** receiver for obsolete system, now useful as frequency agile AM receiver, excellent condition, \$50/BO + shpg. Bob Rivkin, KPLM/KJJZ, 441 S Calle Encilia, #8, Palm Springs CA 92262. 760-320-4550.

**RECEIVERS/ TRANSCEIVERS**

**Want to Sell**

**GE BLS** mobile UHF 40 watt, 16 channel, no scan or 8 channel with scan, \$50. Set to your frequency. Peter Russell, Bowdoin College, Brunswick ME 04011. 207-725-3066.

**GE MVP** mobile one channel on 147.81/21 elements for 147.7350/135 and 147.27/87, new microphone, speaker & power cable, \$20. Peter Russell, Bowdoin College, Brunswick ME 04011. 207-725-3066.

**Kenwood TR-7950** 2 meter transceiver, 50 watt, PL encode, \$30. Peter Russell, Bowdoin College, Brunswick ME 04011. 207-725-3066.

**Yaesu FT-2500M** 2 meter transceiver, 50 watt, 31 memories, PL encode, \$75. Peter Russell, Bowdoin College, Brunswick ME 04011. 207-725-3066.

**RECORDERS**

**Want to Sell**

**Revox A-77 R/P r-r** in good condition, \$60 each +shpg. John Wilsbach, WMSS, 214 Race St., Middletown PA 17057. 717-948-9136.

**Revox A77**, 2 wood cases, \$60 + shpg, 2 rackmounts, \$150 +shpg, in good working condition, 10" reels, owner manual. Duane Ashbaucher, WPOS, 7112 Angola Rd, Holland OH 43528. 419-865-5551.

**VoxPro Control Surface**, (12) Mac based, ADB Bus control surfaces, \$500 each, shpg included to lower 48 states. John Arndt, Greater Media-Philadelphia, One Bala Plaza, #429, Bala Cynwyd PA 19004. 610-771-9698.

**REMOTE & MICROWAVE**

**Want to Sell**

**Superior Broadcast Products**  
 FM STL Transmitter & Receivers 3,500 for both  
 Contact **Benny Springer**  
 Phone 800/695-7919

**Moseley 1600** microprocessor remote control, w/manual, in good condition, \$400/BO +shpg. Bob Rivkin, KPLM/KJJZ, 441 S Calle Encilia, #8, Palm Springs CA 92262. 760-320-4550.

**WE RENT FOR LESS**  
 Hotlines Zephyrs Nexus Audio  
 FM Exciters STLs FM Pwr Amps Test Equipment  
 If we don't have it, we will get it!  
 SCMS, INC. (800) 438-6040  
 "You Know We Know Radio"

**Moseley 1620** microprocessor remote control, w/manual, good condition, \$400/BO +shpg. Bob Rivkin, KPLM/KJJZ, 441 S Calle Encilia, #8, Palm Springs CA 92262. 760-320-4550.

**Moseley Taskmaster 20** remote access program version 2.3.9 w/manual, \$100/BO +shpg. Bob Rivkin, KPLM/KJJZ, 441 S Calle Encilia, #8, Palm Springs CA 92262. 760-320-4550.

**Symetrix T101** telephone interface, works great, \$200 +shpg. Gerry Turro, WJUX, 75 Second St, Dumont NJ 07628. 800-585-1031.

**Telos Zephyr 9101** mono unit, excellent condition, V.35 ready, ISDN ready, \$1950 +shpg. Gerry Turro, WJUX, 75 Second St, Dumont NJ 07628. 800-585-1031.

**Telos Zephyr 9200** stereo unit, excellent condition, V.35 ready and ISDN ready, \$2250 +shpg. Gerry Turro, WJUX, 75 Second St, Dumont NJ 07628. 800-585-1031.

**Marti RPT-15** 450.45 MHz and R-50 receiver, \$750. Patrick Lopeman, Bay View Bldg, 4359 South Howell Ave, Milwaukee WI 53207. 414-482-1959.

[www.rworld.com](http://www.rworld.com)

**SATELLITE EQUIPMENT**

**Want to Sell**

**Three Zephyrus** Analog Sat Receivers \$20.00 each "as is" and one Digital Zephyrus sat receiver for \$100.00 "as is" plus shipping and handling - Call Michael Raley @ (704) 523-5555 for more information or e-mail [Mraley@rb.org](mailto:Mraley@rb.org) for a picture.

**Wegner ON 86** Digital Audio Receiver 3944.1 MHZ - \$200.00 "as is" plus shipping and handling - Call Michael Raley @ (704) 523-5555 for more information or e-mail [Mraley@rb.org](mailto:Mraley@rb.org) for a picture.

**STATIONS**

**Want to Sell**

**WXBH AM-1190**, Upstate NY, excellent condition, must sell immediately. [www.wxbh.com](http://www.wxbh.com), 518-234-3400.

**Want to Buy**

Looking for AM's, FM's, non-commercials, translators, or CP's in western US. Please email: [Dougs@ihradio.org](mailto:Dougs@ihradio.org).

**TAX DEDUCTIBLE EQUIP**

**Want to Sell**

A non-profit 501(c)(3) Christian Ministry, seeks tax deductible donations of working professional grade live/post radio production equipment of studio automation systems, modulation monitors, DAT, CD players, mikes, turntables, mixing boards, and other radio production equipment. Also, need transmitters, translators, transmission lines, and antennas to be used in our Youth Radio Ministry Training Program. All donations will receive a tax deductible receipt and God's blessings for their donations. Minister Dr. R. Hodges, 916-721-3285 or [info@lwcr.org](mailto:info@lwcr.org).

## CONSULTANTS

**EVANS ASSOCIATES**  
 Consulting Communications Engineers  
 FCC Applications • Design • Field Engineering • Tower Detuning Upgrade & Relocation Studies • AM Directional Array Tuning & Proof  
 EXPERTS IN:  
 TV • DTV Transition • FM • Directional Antennas • RF Exposure  
 210 S. Main St., Thiensville, WI 53092. (262) 242-6000, FAX (262) 242-6045  
<http://www.evansassoc.com>  
 Member AFCCE

**Consulting Communications Engineers EMC Test Lab**  
 • FCC Applications and Field Engineering  
 • Frequency Searches and Coordination  
 • AM-FM-CATV-ITFS-LPTV  
 • EMC Test Lab-FCC and European (IEC)  
**OWL ENGINEERING, INC.**  
 E-mail: [info@owleng.com](mailto:info@owleng.com) **651-784-7445** Fax (651) 784-7541  
 5844 Hamline Ave. N., Shoreview, MN 55128 \*Member AFCCE\*

**FASTER... MORE ACCURATE RADIO COVERAGE**  
 • Real Time 3-D Displays  
 • Interference calculations  
 • Cost effective mapping  
 • Fully integrated databases  
 • Used by the FCC  
 • Latest standards built-in  
**RADIO SOFT**  
 Visit us on the web at [www.radiosoft.com](http://www.radiosoft.com)  
 109 West Knapp Ave. • Edgewater • FL • (386) 428-2521

**System One Communications**  
 Broadcast Constructors & Consultants  
 Houston, Texas  
**888-625-5649**  
 ➤ AM-FM Site Construction Specialists  
 ➤ Complete Tower Service  
 ➤ Antenna & Transmission Line Diagnostics

**GRAHAM BROCK, INC.**  
 BROADCAST TECHNICAL CONSULTANTS  
 Full Service From Allocation to Operation AM/FM/TV/AM Services  
 Field Work Antenna and Facilities Design  
 Over 35 years engineering and consulting experience  
**912-638-8028**  
**202-393-5133**  
[www.grahambrock.com](http://www.grahambrock.com)

**M Celenza**  
 Communications Consultants  
 FM-AM-TV-LPTV-LPFM Applications, Amendments, Upgrades, Frequency Searches, Directional Antennas  
 Field Work (Station Inspections)  
**631-928-0077**  
**Fax: 631-928-1905**  
 41 Kathleen Crescent, Coram N.Y. 11727

**MULLANEY ENGINEERING, INC.**  
 Consulting Engineers  
 • Design & Optimization of AM Directional Arrays  
 • Analysis for New Allocation, Site Relocation, And Upgrades  
 AM-FM TV LPTV Wireless Cable (MDS/MMDS/ITFS/OFS)  
 • Environmental Radiation Analysis  
 • Field Work  
 • Expert Testimony  
 9049 Shady Grove Court  
 Gaithersburg, MD 20877  
 Phone: (301) 921-0115  
 Fax: (301) 590-9757  
 email: [mullengr@aol.com](mailto:mullengr@aol.com)

**Communications Technologies, Inc.**  
 Radio Frequency / Broadcast Engineering Consultants  
 AM FM TV LPTV Cellular/PCS Site Analysis  
 P.O. Box 1130 • Marlton, NJ 08053  
 Tel: 856/985-0077  
 Fax: 856/985-8124  
[www.commtechrf.com](http://www.commtechrf.com)  
 Clarence M. Beverage  
 Laura M. Mizrahi

**Doug Vernier**  
 Telecommunication Consultants  
 Broadcast Engineering Consulting  
 AM/FM/TV/LPTV/DTV  
 Custom mapping service  
 Frequency searches  
 Propagation prediction  
 FCC application preparation  
**vsoft**  
 Software for your PC  
**(800) 743-3684**  
[www.v-soft.com](http://www.v-soft.com)

**David C. Schaberg**  
 Allocation Specialist  
 FM & AM Frequency Searches  
 Move-ins, upgrades, allocations  
 Maximization of signals  
 "If someone else says it can't be done, then we want the opportunity to prove them wrong!"  
 Since 1989  
 3105 S. Martin Luther King Jr., Blvd.  
 Lansing, MI 48910-2939  
[www.starradio.net](http://www.starradio.net)  
**800-393-1037**

**dataworld**  
 Market Analysis  
 Engineering Software  
 Ethnic/Demographic Data  
 Custom Full-color Mapping  
 Sales Marketing Packages  
[www.dataworld.com](http://www.dataworld.com) **800-368-5754**  
[info@dataworld.com](mailto:info@dataworld.com)  
 fax: 301-656-5341

**Structural Analysis**  
**ERI**  
 Electronics Research, Inc.  
 7777 Gardner Road  
 Chandler, IN 47610  
 (812) 925-6000  
[www.ERInc.com](http://www.ERInc.com)  
 REGISTERED PROFESSIONAL ENGINEERS  
 STRUCTURAL ANALYSIS  
 ERI Incorporated 1943  
 TOWER REINFORCING

**R. MORGAN BURROW, P.E. & ASSOCIATES, P.C.**  
 ALLOCATION STUDIES  
 AM, FM, TV, LPTV, New facilities, site relocation, FM upgrades, digital  
 FIELD WORK A SPECIALTY  
 • AM Directional antenna adjustment, measurement & proof  
 • RADHAZ measurements, RADJUL, HAZ and evaluation  
 • FM & TV field intensity & other measurements  
 • Facility inspections for purchase/insurance purposes  
 • CATV Leakage Testing  
 ELECTROACOUSTICS  
 OSHA measurements  
**304-258-7921 • Fax 304-258-7927**

**Planck Technical Services, Inc.**  
 Broadcast Construction/Service  
**909-370-4515**  
[www.plancktech.com](http://www.plancktech.com)  
 • AM-FM-LPTV-SW Station construction  
 • Tower Construction  
 • Transmitter/Antenna Service

**AW Online**  
 To advertise in Radio World e-mail: [stewell@imaspub.com](mailto:stewell@imaspub.com)  
 Visit our web site: [www.rworld.com](http://www.rworld.com)

**DISTRIBUTOR DIRECTORY**  
 The following distributors serving the broadcast industry would be glad to help you with any of your requirements.

**CORNELL-DUBILIER MICA CAPACITORS**  
 FROM STOCK

**JENNINGS VACUUM CAPACITORS**  
 FROM STOCK

**JENNINGS VACUUM RELAYS**

**SURCOM ASSOCIATES**  
 2215 Faraday Ave., Suite A  
 Carlsbad, California 92008  
 (760) 438-4420 Fax: (760) 438-4759  
 e-mail: [link@surcom.com](mailto:link@surcom.com) web: [www.surcom.com](http://www.surcom.com)

...Some people get hooked on broadcast equipment big time...they think about it...dream about it...talk about it all the time...for example...us...  
**RADIO! The beat goes on!**  
**CROUSE-KIMZEY OF ANNAPOLIS**  
 tops in broadcast equipment  
 1-800-955-6800  
 ask for Kathleen  
[kkannapolis@worldnet.att.net](mailto:kkannapolis@worldnet.att.net)

**Are You a Distributor?**  
**ADVERTISE HERE!**  
 Space is available.  
 Call 703-998-7600, ext. 154.



**POWER TUBES**  
**REBUILT**  
-----  
**1/2 THE COST**  
**OF NEW!**

# ECONCO

TEL: 800-532-6626  
NLT: +1-530-662-7553  
FAX: +1-530-666-7760  
www.econco.com  
SE HABLE ESPAÑOL



**TRANSMITTERS**

**Want to Sell**

**RANGEMASTER AM:** Legal FCC Part 15 type accepted transmitter, 1-2 miles range possible! 919-367-0607 or go to [www.am1000rangemaster.com](http://www.am1000rangemaster.com).

(5) **Five KW FM's.** Continental Communications., 314-664-4497, [ContComm@sbcglobal.net](mailto:ContComm@sbcglobal.net).

**10 KW AM's** (5). Continental Comm., 314-664-4497, [contcomm@sbcglobal.net](mailto:contcomm@sbcglobal.net).

**CSI T-25-F 25 KW (GG) FM.** Continental Comm., 314-664-4497, [contcomm@sbcglobal.net](mailto:contcomm@sbcglobal.net).

**Superior Broadcast Products**  
**FM Transmitters**  
20 watts to 30 Kw  
Contact **Benny Springer**  
Phone 800/695-7919

**Harris MW-5-B, 5 KW AM** (5). Continental Comm., 314-664-4497, [ContComm@sbcglobal.net](mailto:ContComm@sbcglobal.net).

**McMartin BF-5K, 5kW FM.** Factory rebuilt in perfect, like new condition, includes new tubes, tested & tuned on your frequency. Guaranteed, fully adjustable from 0 to 5.5 kW. Goodrich Enterprises Inc, 402-493-1886.

**AnaCom ANASAT - C Series C-Band Transceiver** 10 watt just reconditioned \$6,000.00. For Technical Information e-mail [Rmuffley@bbradio.org](mailto:Rmuffley@bbradio.org) for purchase call Michael Raley at (704) 523-5555 or e-mail at [Mraley@rb.org](mailto:Mraley@rb.org) for pictures.

**CCA 8000G FM transmitter,** excellent condition with a spare PA tube, still in the box. Cale Tharp, WASE, 519 North Miles St, Elizabethtown KY 42701. 270-766-1035.

**CCA HELP**  
▪ Rotron Blowers ▪ Rebuilt Plate Blockers ▪ Tubes  
▪ Tube sockets/parts ▪ most all transmitter parts  
▪ rebuilt tuning line assemblies  
**Goodrich Ent. Inc**  
402-493-1886  
[www.goodrichenterprises.com](http://www.goodrichenterprises.com) [cgoodrich@tconl.com](mailto:cgoodrich@tconl.com)

**Classic Collins 20v2 transmitter.** Operating when removed from service, tuned to 790, buyer arranges shipping or pickup. Phil Mueller, KCYN, 2573 N Radio Hill Rd, Blanding UT 84511. 435-259-1035 or 435-260-8033 (cell) or email: [exnews@frontiernet.net](mailto:exnews@frontiernet.net).

**OFF THE AIR?**  
**Emergency Back-up Rentals**  
FM Exciters - STLs -  
FM Pwr Amps - Antennas -  
Studio & Test Equipment  
**SCMS Inc (800) 438-6040**  
"You Know We Know Radio"

**Peter Dahl single phase converter kit** for 25-30 KW transmitter, \$3000. Carl Haynes, Dominant Comm Corp, POB 9734, Jackson MS 39286. 601-981-9080.

**QEI FMQ 10000 transmitter** tuned to 100.1 in good working condition and can be retuned on the field. This was installed in March of 1994 but will be replaced by another xmitter sometime at the end of the summer of 2003. This xmitter cost \$30,000.00 new but will let go for \$18,000.00. Call Mike Raley @ (704) 523-5555 or e-mail [Mraley@rb.org](mailto:Mraley@rb.org).

[www.RWOnline.com](http://www.RWOnline.com)  
Call Simone Fewell for all the details at  
703-998-7600 ext. 154

**QEI FMQ series 6.0 to 9.6FM.** This xmitter did a tour of duty in Argentina but some goofy laws in this country made it impossible to permit the station to operate at this power. To make a long story short it was only in operation no more than four months. Will let this go for \$22k firm. Call Mike Raley at (704) 523-5555 or E-mail [Mraley@rb.org](mailto:Mraley@rb.org) for pictures.

**SINGER (remake of CCA) model FM 20,000 E** tuned to 89.5FM. Currently in "fairly good" operating condition, with a TPO of 17.1 KW. This can be retuned on the field and parts are available through Goodrich Enterprises (402)-493-1886. Call Michael Raley @ (704) 523-5555 or e-mail [Mraley@rb.org](mailto:Mraley@rb.org) for pictures. \$7,250.00 and buyer arranges shipping.

**BEXT**  
From the tall to the small  
[WWW.BEXT.COM](http://WWW.BEXT.COM)  
**888 239 8462**  
Transmitters & Antennas

**Harris MW1A,** purchased new in 1986, clean & gd condition. 250 watts tuned to 1570. Technical manuals, spare parts and factory rebuilt modules included, \$4000/BO. Jerry Tye, WTYE, Robinson IL 62454. 618-544-2191.

**Peter Dahl single phase converter kit** for 25-30 KW transmitter, \$3000. Carl Haynes, Dominant Comm Corp, POB 9734, Jackson MS 39286. 601-981-9080.

**TUBES**

**Want to Sell**

**FOR THE BEST PRICE**  
& 24 Hr service on transmitting tubes & sockets/parts, new & rebuilt call Goodrich Ent. at 402-493-1886 day or night, [www.goodrichenterprises.com](http://www.goodrichenterprises.com).

**Want to Buy**

Pair of Eimac 3-500Z with little use or new at reasonable cost. Ed Davison, 1129 Willowbrook Dr, Springfield IL 62707-8130. 217-793-0400 or [weqd@arrl.net](mailto:weqd@arrl.net).

**EMPLOYMENT**

**WANT TO FILL A POSITION?**  
SOCIETY OF BROADCAST ENGINEERS  
**Jobs ONLINE & RESUME Service**  
[www.sbc.org](http://www.sbc.org) • (317) 846-9000

**WANT TO FIND A NEW JOB?**

**HELP WANTED**

**NETWORK ONE** is seeking experienced and talented radio show hosts and producers for worldwide commercial distribution to our network of radio, television, home entertainment and new media outlets. All submissions are considered. Send your resume along with a demo on CD or cassette to: Network One Entertainment, Inc., Attn: Submissions, 3319 Greenfield Rd #423, Dearborn MI 48120-1212.

**RF PARTS COMPANY** • Broadcast • Industrial Communications  
• EIMAC • TAYLOR • ECONCO • SVETLANA  
Also  
Motorola • Toshiba • SGS-Thomson & Mitsubishi Semiconductors  
Catalog: [www.rfparts.com](http://www.rfparts.com)  
Se Habla Español • We Export  
760-744-0700 • 800-737-2787  
Fax: 760-744-1943 E-mail: [rpf@rfparts.com](mailto:rpf@rfparts.com)

**D And C Electronics**  
An International Distributor of RF Components  
**Tubes**  
NEW & REBUILT  
TRANSMITTERS, STUDIO EQUIPMENT, STLs, ANTENNAS.  
RADIO DATA SYSTEM (FOR CAR RADIO DISPLAY)  
EXCITERS-TRANSMITTERS, TRANSLATORS, MIXERS-CONSOLES, RADIO LINK  
RPU, MOSFETS, VACUUM CAPACITORS, SOCKETS  
**Eimac** **Pro-Tek**  
SVETLANA **OMB** **EEV**  
BROADCASTING USA DISTRIBUTOR  
BEST PRICES To Order: 1-800-881-2374 FROM OUR STOCK  
Outside U.S. (352) 688-2374  
Se Habla Español  
3089 Deltona Blvd. 352-688-2374  
Spring Hill, FL 34609 BEST SERVICE Fax 352-683-9595  
Website: [www.dandcelectronics.com](http://www.dandcelectronics.com)

There's one person who can really help develop your career.  
And we want to talk to you.  
National Sales - TV News Content Management Systems; US USD 75 - 90k  
International Sales - Digital Audio Post Systems; Australia AUD 120 - 150k  
Field Application Engineer - Digital Audio Filters; US - East USD 40 - 60k  
Interested? Visit the website and contact us to find out more about these and other vacancies  
Experienced industry professionals helping to develop careers and finding the right faces for the job.  
web : [www.interfacio.com](http://www.interfacio.com)  
email : [needingmoregain@interfacio.com](mailto:needingmoregain@interfacio.com)  
telephone : USA 516 705 8374 Intl. +44 (0) 20 8986 5002

**Rookie with ambition** and drive looking for a job on-air or behind the scenes. Willing to relocate anywhere. Sharon, 405-607-0856, or 405-323-9117 or [ladyslay@cox.net](mailto:ladyslay@cox.net).

**Smooth-voiced DJ,** trained in digital production & copywriting. Ready to get the job done at any cost! Nadia Staton, 817-467-4946 or [NADIA\\_UNIQUE22@yahoo.com](mailto:NADIA_UNIQUE22@yahoo.com).

**Sports freak** can't wait to make an immediate impact at your station. Fully trained on-air, production, news, copywriting. Will relocate. Lance, 817-266-2928 or [Dodgerblue730@aol.com](mailto:Dodgerblue730@aol.com).

**Energetic, hard-working graduate** of American Broadcasting School in DFW area! Love sports, willing to do news, need to stay local. Aaron, 817-465-9460.

**SERVICES**

**Got Services?**  
Spotlight them here!  
For more details, call Simone Fewell at 703-998-7600, ext. 154 or e-mail: [stfewell@imaspub.com](mailto:stfewell@imaspub.com)

**TRANSCOM CORP.**  
Serving the Broadcast Industry Since 1978  
Fine Used AM & FM Transmitters and Also New Equipment

USED FM TRANSMITTERS				NEW TV - VHF		NEW TV - UHF	
2.5kw	1978	Collins 831D2	10 watt	500 watt	10 watt	500 watt	
5kw	1983	Harris FM5K	100 watt	1,000 watt	100 watt	1,000 watt	
10kw	1988	BE FM 10A	250 watt		250 watt		
10kw	1980	Harris FM10K					
10kw	1999	Harris Z10 CD (solid state)					
20kw	1982	Harris FM20K					
20kw	1978	Collins 831G2					
20kw	1989	QEI FMQ20.000B					
25kw	1997	CCA 25.000G (single phase)					
25kw	1980	CSI T-25-FA (Amplifier Only)					
25kw	1982	Harris FM25K					
30kw	1984	BE FM30					
40kw	1978	2-PCA BTF 20E1 (combined)					
50kw	1982	Harris Combiner w/auto exciter-transmitter switcher					
USED AM TRANSMITTERS				USED MISC. EQUIPMENT			
400wrt	1988	Nautei P400 (solid state)	BE FX30 Exciter				
5kw	1982	Harris MW5A	Continental 802B Exciter				
5/10kw	1982	Continental 316F	Nicom NT20, 20 watt Exciter				
50kw	1985	Continental 317C2	Belar AMM3 Mod. Monitor				
50kw	1986	Nautei AMPFET 50	Denon 720R Cassette Recorder				
			Harris AMS-G1 AM Stereo				
			Inovonics AM Stereo Processor, Model 250-01				
			Kintronics 50kw AM RF Switch, Model RFC8-1				
			Potomac Phase Monitor AM1901, Digital, 2 Tower				
			Potomac Phase Monitor AM19, 2 Tower				
			Potomac TU-16 Remote Control				

2655 Philmont Ave #200, Huntingdon Valley, PA 19006  
800-441-8454 • 215-938-7304 • FAX No. 215-938-7361  
VISIT OUR NEW INTERNET SITE: [www.fmamtv.com](http://www.fmamtv.com)  
SEND YOUR E-MAIL REQUESTS TO: [transcom@fmamtv.com](mailto:transcom@fmamtv.com)

**CHIEF ENGINEER** for 4 station cluster in Southeast. Knowledge of all facets of radio broadcast engineering is required, as well as a minimum of four years experience with digital audio (Audio Vault), Novell computer networks, and broadcast transmitter systems. SBE certification is a plus. Must possess organizational skills and the ability to execute General Manager's policies, procedures, and directives with minimum supervision. Must be available to work weekends or holidays when necessary. Interested candidates should e-mail a resume and a cover letter outlining your qualifications to: [donnacl@g1063.com](mailto:donnacl@g1063.com) or fax to: 732-751-1726. EEO.

**POSITIONS WANTED**

Friendly, yet authoritative sound, morning man, news, production, copy, loves M.O.R./Easy Listening formats, available immediately. 2.5+ years experience. Larry Kay, 203 Harvestview North, Mount Joy PA 17552. 717-653-2500 anytime.

I'm **Ebonie AKA Vanity Knight!** DJ, commercial producer, copywriter. ABS graduate very enthusiastic and energetic. Willing to work hard for the best ratings. 214-293-8226.

**Rookie broadcaster** who loves music wants to work for you! On-air, production, and board op experience. Will travel. Chris, 405-455-1742 or [austinontheair@yahoo.com](mailto:austinontheair@yahoo.com).

Check out the web site!  
[www.rwonline.com](http://www.rwonline.com)

# ENTER TO WIN

Here's your chance to unpack **FREE GEAR** in 2003. Enter to win one of 26 New Technology prizes.

Over the past two years, **Radio World** and dozens of industry suppliers have joined forces to award more than \$115,000 worth of radio and pro audio gear — from microphones, master clocks and sound cards, to audio processors, routers, CD mastering machines and shopping sprees.

In 2003 you can expect a similar range of cool New Technology products from our great sponsors. It takes only seconds to sign up online. And best of all, there are 26 chances to win in 26 drawings - - one for every issue of **Radio World**. This is our way of saying "thank you" for allowing us to bring you New Technology for the past 27 years.



To enter the sweepstakes you must complete these 3 easy steps:

- 1 Go to our website [www.rwonline.com](http://www.rwonline.com)
- 2 Click on the New Technology Sweepstakes icon
- 3 Follow the instructions and fill out the electronic entry form — that's it, you're done!

So what are you waiting for? Don't miss out in '03. Enter to win New Technology products from these fine **Radio World** supporters:

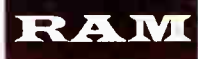

**Contest Rules:** To enter the drawing, simply register online at [www.rwonline.com/sweeps](http://www.rwonline.com/sweeps). 26 drawings will be held throughout the year. Contest registration expires Dec. 3, 2003. Final contest prize announcement on Jan. 1, 2004. One prize per winner. All contestants MUST reside in the United States and have a valid mailing address. Winners should receive prizes within 30 days of notification; however, actual delivery time may vary and is not guaranteed by IMAS publishing. Federal, state and local tax/tariffs may apply to prizes and are the sole responsibility of the winner. Employees and affiliates of IMAS Publishing are not eligible.

# ADVERTISER INDEX

This listing is provided for the convenience of our readers. Radio World assumes no liability for inaccuracy.

PAGE	ADVERTISER	WEB SITE URL
37	AEQ	<a href="http://www.aeqbroadcast.com">www.aeqbroadcast.com</a>
18	Altronic Research	<a href="http://www.altronic.com">www.altronic.com</a>
27	Aphex Systems	<a href="http://www.aphex.com">www.aphex.com</a>
40	ATI	<a href="http://www.atiguys.com">www.atiguys.com</a>
14	Audemat-Aztec Inc.	<a href="http://www.audemat-aztec.com">www.audemat-aztec.com</a>
26	Audion Labs	<a href="http://www.voxpro.net">www.voxpro.net</a>
26	Autogram Corporation	<a href="http://www.autogramcorp.com">www.autogramcorp.com</a>
10	Belar	<a href="http://www.belar.com">www.belar.com</a>
17	Broadcast Software Int'l (BSI)	<a href="http://www.bsiusa.com">www.bsiusa.com</a>
33	Broadcasters General Store/Telos Systems	<a href="http://www.bgs.cc">www.bgs.cc</a>
24, 25	BSW	<a href="http://www.bswusa.com">www.bswusa.com</a>
4	Burk Technology	<a href="http://www.burk.com">www.burk.com</a>
26	Circuit Werkes	<a href="http://www.circuitwerkes.com">www.circuitwerkes.com</a>
39	Circuit Werkes	<a href="http://www.circuitwerkes.com">www.circuitwerkes.com</a>
28	CKE/HVCA	<a href="http://www.rectifiers.com">www.rectifiers.com</a>
26	Comet North America	<a href="http://www.cometna.com">www.cometna.com</a>
7	Comrex	<a href="http://www.comrex.com">www.comrex.com</a>
6	Condron Broadcast Engineering	<a href="http://www.cbsoftware.cc">www.cbsoftware.cc</a>
26	Conex Electric Systems	<a href="http://www.conex-electro.com">www.conex-electro.com</a>
12	dMarc Networks	<a href="http://www.dmarcnetworks.com">www.dmarcnetworks.com</a>
39	Electronics Research Inc.	<a href="http://www.eriinc.com">www.eriinc.com</a>
30	ESE	<a href="http://www.es-web.com">www.es-web.com</a>
39	Gorman-Redlich Mfg. Co.	<a href="http://www.gorman-redlich.com">www.gorman-redlich.com</a>
1	Harris	<a href="http://www.broadcast.harris.com/network-access">www.broadcast.harris.com/network-access</a>
15	Harris	<a href="http://www.broadcast.harris.com">www.broadcast.harris.com</a>
20	Henry Engineering	<a href="http://www.henryeng.com">www.henryeng.com</a>
8	Kintronics Labs	<a href="http://www.kintronic.com">www.kintronic.com</a>
26	LBA Technology	<a href="http://www.lbagroup.com">www.lbagroup.com</a>
19	Logitek	<a href="http://www.logitekaudio.com">www.logitekaudio.com</a>
39	Mager Systems	<a href="http://www.magersystems.com">www.magersystems.com</a>
31	Moseley Associates	<a href="http://www.moseleysb.com">www.moseleysb.com</a>
29	Musicam USA	<a href="http://www.musicamusa.com">www.musicamusa.com</a>
22	National Assn. Of Tower Erectors	<a href="http://www.natehome.com">www.natehome.com</a>
9	Omnia, a Telos Company	<a href="http://www.omniaaudio.com">www.omniaaudio.com</a>
23	OMT Technologies	<a href="http://www.omt.net">www.omt.net</a>
21	Prophet Systems Innovations	<a href="http://www.prophetsys.com">www.prophetsys.com</a>
5	Radio Systems	<a href="http://www.radiosystems.com">www.radiosystems.com</a>
3	S.C.M.S.	<a href="http://www.scmsinc.com">www.scmsinc.com</a>
34	Sine Systems	<a href="http://www.sinesystems.com">www.sinesystems.com</a>
39	Superior Broadcast Products	<a href="http://www.superiorbroadcast.com">www.superiorbroadcast.com</a>
11	Susquehanna Radio Corp	<a href="http://www.susquehannaradio.com">www.susquehannaradio.com</a>
13	Telos Systems	<a href="http://www.telos-systems.com">www.telos-systems.com</a>
35	Telos Systems	<a href="http://www.telos-systems.com">www.telos-systems.com</a>
16	Tieline America	<a href="http://www.tieline.com">www.tieline.com</a>
2	Wheatstone	<a href="http://www.audioarts.net">www.audioarts.net</a>
47	Wheatstone	<a href="http://www.wheatstone.com">www.wheatstone.com</a>
48	Wheatstone	<a href="http://www.wheatstone.com">www.wheatstone.com</a>

## Radio World

5827 Columbia Pike, 3rd Floor Falls Church, VA 22041  
PHONE: 703-998-7600 • FAX: 703-671-7409

### Classified Advertising Rates Effective January 1, 2003

	1x	6x	13x	26x
1-9 col inch (per inch)	\$105	100	95	90
10-19 col inch (per inch)	\$90	80	70	60
Distributor Directory	\$130	125	120	115
Professional Card	\$100	95	90	85
Station/Studio Services	\$195	165	140	119
Classified Line Ad	\$2/word			
Blind Box Ad	\$15 additional			

Call Simone Fewell, Ext. 154, Classified Ad Manager, to reserve space in the next issue. Use your credit card to pay, we now accept VISA, MASTERCARD and American Express.

[www.rwonline.com](http://www.rwonline.com)

## ◆ READER'S FORUM ◆

# Radio's Real Founding Father

*Two University Professors Argue That Charles Herrold Invented the Radio Station*

by Mike Adams

*The author is professor and chair of the Department of Television, Radio, Film and Theatre at San Jose State University in California.*

The question, "Who was the first radio broadcaster, and where and when did broadcasting as we understand it first take place?" has been asked since 1920.

For almost 80 years, the answer appearing in the history books was, "Frank Conrad of KDKA(AM) in Pittsburgh in 1920." And when I was a DJ on legendary top-40 powerhouse WCOL(AM) in Columbus in the 1960s, I believed it, too.

But while I was spinning the hits in Ohio, a story was slowly unfolding thousands of miles away in San Jose, California — a story that would forever change the way I looked at broadcasting.

## Early show

A young university professor, Gordon Greb, had uncovered evidence showing that a local wireless experimenter named Charles Herrold was really the first individual to broadcast entertainment programming to an audience, as early as 1910 — 10 years before Conrad and KDKA.

Herrold had a technical school in downtown San Jose called Herrold College of Wireless and Engineering. His students served as its DJs and newsreaders, broadcasting music and news via a phonograph and microphone.

Greb further learned that Herrold received a license in 1921 using the call letters KQW, and that KQW was bought by CBS in 1949 and moved to San Francisco to become KCBS. This was truly a find, for KCBS management was unaware of its historical significance as the first station. In my small world of radio, it was earth-shattering news.

Years later, as fellow university professors at San Jose State, Gordon told me of his 1950s discovery. I got excited, and he and I agreed to collaborate in retelling the story. Our book, "Charles Herrold, Inventor of Radio Broadcasting," was recently published by McFarland and Co. It finally tells the complete Herrold story, 45 years after the initial discovery. What took so long?

As Greb continued to compile information in the form of letters, press clippings and other documents with dates and program information, he began to see a solid confirmation that the broadcasting of entertainment programming as early as 1909 did take place.

He also found early technology used in the broadcasts, and most important, he found living witnesses from the Herrold broadcast days. One such individual was Herrold's wife Sybil, who had a weekly show beginning in 1912. She called it the "Little Hams" program, for the audience members were primarily young people

interested in radio.

After a year-long research effort, Professor Greb detailed the Herrold story in an article he wrote for the Winter 1958 issue of the Broadcast Education Association's Journal of Broadcasting (JOB). It was the first time a national academic audience had heard about Charles Herrold.

Greb also organized a major promotion with KCBS in San Francisco to make the announcement public in the Bay Area of Northern California, using the station's 50,000-watt signal to make the point that they were *first*.

Because of this article, important post-1960 broadcast history books included Herrold, such as Barnouw's "Tower in Babel" and Sterling's "Stay Tuned." More scholarly articles followed that further discussed the "first station" theme, and compared Herrold with Lee de Forest and KDKA, among others.

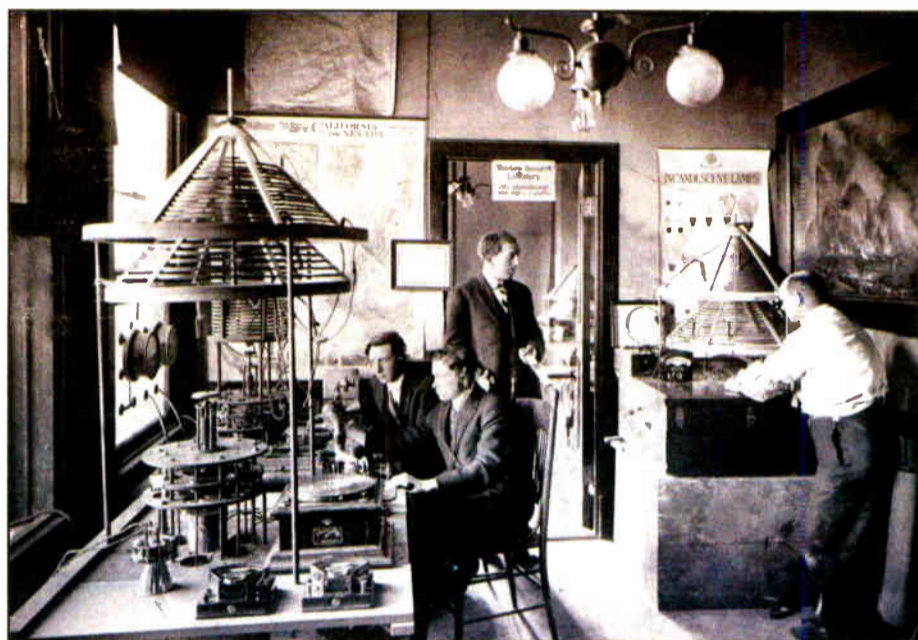

Herrold stands in the center of his studio during a 1912 broadcast, as students Emile Portal and Ken Sanders play records from a windup phonograph. Engineer Frank Schmidt operates the arc transmitter, at right.

The answer to the question of "Who was the first broadcaster?" gradually was becoming more complex. In fact, the discovery and promotion of the Herrold story lead to a decades-long feud between the two major contenders, KDKA and KCBS, both of which claimed in their promotional advertising to be "the first station."

However, once the original 1958 story grew stale, nothing new appeared. By the 1980s, the academic community had lost interest. Awareness of the Herrold story outside of Northern California waned.

I joined Gordon in 1988 in an effort to revive the story. Our initial research resulted in the PBS video, "Broadcasting's Forgotten Father: The Charles Herrold Story." But more important, we became friends and colleagues in historical research with a common goal.

We agreed that the only way for the Herrold story to gain national credibility

was through the publication of a well-researched, clearly documented book. We made trips east, to the Smithsonian History Center in Washington, the New York Public Library and Antique Wireless Association archives in Rochester. Our goal was to find other examples, if any, of pre-1920 broadcasting, similar to that of Herrold in San Jose.

Important documents surfaced describing Herrold's broadcasting of entertainment programming to an audience pre-1912. This evidence was not in the original Herrold papers, and not available during the production of the video. After reviewing and processing this new information, several major articles and our book were written.

## Burden of proof

First, there is what I call the "smoking gun" of broadcasting: an ad in the 1910 catalogue of Electro-Importing, a New York mail-order company that sold radio parts to experimenters.

It included a printed notarized endorsement from Herrold: "We have



Charles Herrold in 1904

teners and facilitating phone-request radio in 1912.

I ask readers to look at the context in which the question of the first broadcaster has been asked since 1920. All previous claims to being the "first station" used RCA in-house historian George Clark's 1920 criteria. It had to (1) include entertainment programming, (2) include regularly scheduled broadcast times, (3) be pre-announced/advertised ahead of time in the press and (4) be intended for a known "citizen" audience. Clark defined "citizen" as a non-amateur, non-hobbyist listener, as opposed to someone with technical skills.

It was this distinction that caused Clark to say, and early historians to write, that all pre-KDKA, 1920 broadcasts were invalid because their audiences were largely amateurs, which is simply not true. Professor Greb and I have determined through our research that many pre-1920 "citizen" listeners heard the de Forest and Herrold broadcasts at "public" listening posts in record stores, at the 1915 Panama Pacific International Exhibition and on crude homemade crystal sets.

The Herrold experiments came to an abrupt halt when the entry of the United States into the World War caused all radio transmitters and receivers to be shut down and sealed until 1919. In 1920, when the Commerce Department began issuing commercial licenses, KDKA was first. Six months later, Herrold received his license for KQW. As mentioned, that station would go through a series of owners, ultimately ending up with CBS in 1949.

Today there is no real agreement as to a single "first station." Most historians credit KDKA for the first "commercial" license in 1920, de Forest for his 1916 broadcast of the Hughes-Wilson presidential election and Herrold for broadcasting pre-announced entertainment to an audience on a regularly scheduled basis from 1909-1917.

We, the authors, have found evidence in the form of primary documents — some by Herrold, others by print journalists — indicating that Herrold was the first to do so.

Charles Herrold invented the radio station.

For more information on Charles Herrold, visit the author's Web site, [www.charlesherrold.org](http://www.charlesherrold.org).

## ◆ READER'S FORUM ◆

**Big Fish Gobbles  
Little Fish**

Yet another chapter has been written in the destruction of the "service" we used to call radio. I am seeing more and more the national trend about which I will speak, and it is changing the nature of the medium.

reduce power. They have not come to any agreement yet.

If anyone doubts that the FCC has sold out their role as custodians of the public trust for the RF spectrum and is catering to big money interests, it's time to wake up and smell the proverbial cup o' joe. When stations can freely trade power and coverage to meet business advantages, and leave small communi-

**When stations can freely trade power and coverage to meet business advantages, and leave small communities without local service, what is the point of the FCC at all?**

— Michael Baldauf

The group owners of stations are now manipulating licensed power levels, so that stations they own in bigger markets on adjacent channels of their smaller market stations can boost power, leaving less service in the smaller markets. Examples follow regarding Denver, the biggest city in Colorado. Fifty miles south is the next biggest city, Colorado Springs; 50 miles south of that is Pueblo.

A Denver FM station with very low power is owned by a big group that purchased a Class C station in Colorado Springs, as well. The Class C is going to be reduced in power or turned off, despite a solid audience and positive cash flow, in order to push a newly galvanized Denver station. The smaller market suffers.

A Clear Channel FM station located 45 miles south of Pueblo with a 200-mile separation from the station north of Denver, will be moving 85 miles north to Colorado Springs and reducing power to a fraction 100 kW license to serve a bigger audience. The change will no longer allow the licensee to serve their original city of license with a strong signal. Again, the smaller market suffers.

Here is an AM example. A 5,000-watt station in Lamar, Colo., that provides a vital service to southeast Colorado and southwest Kansas is approached by a station on the same frequency in Houston, Texas, to see if they can pay the station to

ties without local service, what is the point of the FCC at all?

Why don't they give the regulatory authority to the FTC? After all, regulating radio is no longer any different than regulating Wal-Mart or Conoco.

*Michael Baldauf  
Co-Owner/Engineer  
The Technology Department  
Pueblo, Colo.*

**Provizer, Part 15  
Legitimized**

In his letter "Bigger Fish To Fry?" (Oct. 8), Paul Shinn makes some statements that are in dire need of adjustment.

Mr. Shinn questions why Radio World would "care to devote precious print to pity some pirate, Part 15 broadcaster." That's an oxymoron if I've ever heard one.

"Part 15" means Part 15 of FCC rules and regulations. A facility that operates within the parameters of FCC rules — any and all FCC rules — is a legal operation. Stations operating outside of the confines of the rules cannot be considered Part 15 operations, and are, therefore, the "pirates" to whom he was referring.

Mr. Shinn asks, "Aren't the pages of Radio World more valuable than some station that struggles to cover two city

blocks?" The truth is that Part 15 AM stations, properly constructed, can reach a radius of 2 to 4 miles. There is even a report of one Part 15 station covering 10 miles. It is amazing what you can do with a tenth of a watt when you do it right.

Personally, I think that RW should devote more time and space to Part 15. This is a story to keep an eye on. The truth is that Stephen Provizer, the subject of Mr. Shinn's barbs, is one of the most prominent and hardest-working people in the fight for the survival of local, community-oriented (real) radio.

That's the opinion of a "real" broadcaster with 16 years in the "trenches" and a construction permit for a brand-new FM station in his hand.

My advice to Mr. Shinn is to not be so quick to knock these guys. Stephen Provizer, William C. Walker, Chris DiPaola — these are names that are, even at this moment, rising to prominence in the wonderful world of radio. Don't underestimate them.

*Scott Clem  
WPKC(FM)  
West Frankfort, Ill.*

**Interference Is  
Not an Iffy Thing**

The FCC created the low-power FM service in 2000, but the issue of when and how these stations might interfere with full-service licensees remains needlessly murky.

This is unacceptable. Although we differ with NAB on whether the spectrum can accommodate more LPFMs, we agree with the association when it says broadcasters have a right to expect that their signals will reach their audiences. For the commission to be clueless about interference questions this long after the creation of the service is not right.

It's the FCC's job to ensure spectrum integrity when it selects station allocations and to help stations sort out a solution when an interference issue does arise. When lawmakers first began holding hearings on LPFM, the four tests conducted by proponents and opponents regarding potential interference never really established at what point interference becomes so objectionable that a listener tunes out. Shouldn't this be done before making a decision on whether to allow LPFMs on third-adjacent channels?

Lawmakers decided it was okay to create the LPFM service. But what the general public doesn't realize is that lawmakers handed off the hard part, that pesky interference issue, to the FCC to decide.

The commission also delegated this seemingly complicated task to Mitre Corp., which in turn subcontracted much of the testing to Comsearch. According to at least one broadcast consultant, this firm is known more for its telecommunications engineering work than for broadcast engineering.

NAB and NPR were once allies on this issue but now have parted ways. NPR favors at least a trial expansion of LPFM. But both agree that portions of the Mitre report are flawed to the point where we cannot believe its conclusions. Messy work indeed.

The FCC began the LPFM endeavor under a pro-LPFM chairman and is proceeding with it under a chairman whose politics are much different, a man whose support of LPFM has been inconsistent at best. That's part of political reality in Washington. But what we need now is clean research. The NAB's objections are not entirely without cause.

We have no doubt that several broadcast engineering firms would love to lend the commission their expertise on this issue, for a fair price, and really get to the bottom of the interference question.

We welcome lawful new entrants to radio without damaging the spectral integrity of existing stations. We wish the FCC and Mitre had put together a better plan to make the case. They still could do so.

— RW

## —EDITORIAL STAFF—

Paul J. McLane	ext. 117	Editor
Leslie Stimson	ext. 129	News Editor/Wash. Bureau Chief
Michele Kramer Peterson	ext. 149	Studio Sessions Editor
Kelly Brooks	ext. 136	Buyer's Guide Editor
Thomas R. McGinley	—	Technical Adviser
Alan Peterson	—	Technical Adviser
John Bisset	—	Contributing Editor
Skip Pizzi	—	Contributing Editor
T. Carter Ross	ext. 120	Editor-In-Chief (International)
Marguerite Clark	—	Editor (International), Milan
Rogelio Ocampo	ext. 121	Latin America Editor in Chief
Karina Gerardi	ext. 137	Latin America Editor
Terry Hanley	ext. 130	Editorial Assistant & Listings Coordinator
Peter Finch	—	Editorial Assistant, Milan

## —EDITORIAL CONTRIBUTORS—

W.C. Alexander, Bruce Bartlett, Frank Beacham, Naina N. Chernoff, Harry Cole, Troy Conner, Vince Ditingo, Mark Durenberger, Charles Fitch, Ty Ford, Scott Fybush, Harold Hallikainen, Jeff Johnson, Craig Johnston, Paul Kaminski, Peter King, Mark Lapidus, Mark Persons, Sharon Rae Pettigrew, Michael LeClair, Carl Lindemann, Frank R. Montero, Ted Nahil, Tom Osenkowsky, Ken R., Rich Rarey, Randy Stine, Travis the V/O Guy, Barry Umansky, Tom Vernon.

**Radio World**

Vol. 27, No. 23 November 5, 2003

Telephone: (703) 998-7600 • Business Fax: (703) 998-2966 • Editorial Fax: (703) 820-3245  
E-mail: radioworld@imaspub.com • Web site: www.rwonline.com

## —ADVERTISING SALES REPRESENTATIVES—

US East: John Casey	330-342-8361	Fax: 330-342-8362	e-mail: jcasey@imaspub.com
US West: Dale Tucker	916-721-3410	Fax: 815-352-1698	e-mail: dtucker@imaspub.com
Product Showcase & Classified Ads: Simone Fewell	703-998-7600 x154	Fax: 703-671-7409	e-mail: sfewell@imaspub.com
European Sales Mgr., Africa, Middle East: Raffaella Calabrese	+39-02-7030-0310	Fax: +39-02-7030-0211	e-mail: rcalabrese@imaspub.com
Japan: Eiji Yoshikawa	+81-3-3327-2688	Fax: +81-3-3327-3010	e-mail: callems@msn.com
Asia/Pacific: Wengong Wang	+86-755-5785161	Fax: +86-755-5785160	e-mail: wwg@imaschina.com
Latin America: Alan Carter	703-998-7600 x111	Fax: 703-671-7409	e-mail: acarter@imaspub.com

**NEXT ISSUE OF RADIO WORLD NOVEMBER 19, 2003**

For address changes, send current and new address to RW a month in advance at P.O. Box 1214, Falls Church, VA 22041. Unsolicited manuscripts are welcomed for review; send to the attention of the appropriate editor.

## —ADMINISTRATION &amp; PRODUCTION—

Stevan B. Dana	President/CEO
Carmel King	VPI/Group Publisher
Marlene Lane	Editorial Director/COO
Chuck Inderrieden	CFO
Eric Trabb	Sales & Marketing Director
John Casey	Associate Publisher
Annette Linn	Production Director
Melissa SE Robertson	Production Publication Coordinator
Kathy Jackson	Ad Traffic Manager
Milagros Castañeda	Classified/Product Showcase Layout
Robert Green	Circulation Manager



Radio World (ISSN: 0274-8541) is published bi-weekly by IMAS Publishing (USA), Inc., P.O. Box 1214, Falls Church, VA 22041. Phone: (703) 998-7600, Fax: (703) 998-2966. Periodicals postage rates are paid at Falls Church VA 22046 and additional mailing offices. POSTMASTER: Send address changes to Radio World, P.O. Box 1214, Falls Church VA 22041. REPRINTS: Reprints of all articles in this issue are available. Call or write Joanne Munroe, P.O. Box 1214, Falls Church, VA 22041; (703) 998-7600; Fax: (703) 998-2966. Copyright 2003 by IMAS Publishing (USA), Inc. All rights reserved.

—Printed in the USA—

# WHEATSTONE D-4000

## DIGITAL AUDIO CONSOLE



*Based on the technical architecture of our popular D-5000, this new D-Series console is totally modular, offering features to satisfy the most demanding engineers — but at a lower price point than its predecessors.*

- Hot-swap design
- Four stereo mix buses
- Six pointer-style true VU meters
- Any mix of digital and analog inputs
- AES and balanced analog outputs
- Choice of master clock rates
- Up to 4 mix-minus outputs using SPD-4000 phone remote modules
- 24 bit A-to-D conversion on analog inputs,
- A/B source switching with fully independent logic and machine control
- Mode selection on stereo inputs
- Low profile drop-through counter design
- Multiple studio outputs with talkback interrupt

*Wheatstone has more digital audio experience than most of our competition combined. The D-4000 is a truly high performance, reliable console that will make your transition to digital a pleasure. Benefit from our expertise — **CHOOSE WHEATSTONE** — the Digital Audio Leaders!*

 *Wheatstone*



## **GENERATION 9 DIGITAL CONTROL SURFACE**

Designed to integrate flawlessly with the Wheatstone BRIDGE digital audio network router, the Generation 9 control surface allows you to easily create large or small platform-based systems that are exceptionally user-friendly and flexible. Wheatstone BRIDGE network cages house all I/O ports and engine cards, and may be wired in tandems within a single equipment room or interconnected to separate remote locations by means of fiberoptic or CAT-5 cables to provide single wire studio integration schemes.

Once configured, the system operates entirely independently of external computers. Configuration itself is intuitive and carried out onsite by means of user-friendly graphic interfaces provided by Wheatstone desktop software. We have gone to great lengths to make these setups easy for your field engineers, allowing expansions and changes to be achieved painlessly. Naturally, the Generation 9 system also takes full advantage of Wheatstone's exclusive VDIP® configuration

software as well, so that studio functions (like mutes, fader and timer starts, tallies, etc.) are easily accomplished right at your desktop. Once set-up is completed the desktop is disconnected; all settings are retained in nonvolatile storage and the entire system runs standalone. Ethernet protocol is built in, providing interface with automation, scheduling, and hardware controllers as you require.

Whether you're planning a small, centrally located studio network or a large, multiple format build-out, the Generation 9 Digital Control Surface can form the basis for a fully integrated, reliable and user-friendly broadcast system that will handle your most demanding requirements *and* be able to change with your varying needs as they arise.

At Wheatstone we have more combined digital design expertise than anyone. **Benefit from our hard work!** Choose **WHEATSTONE—the Digital Audio Leader.**

 **Wheatstone Corporation**

600 Industrial Drive, New Bern, North Carolina, USA 28562  
[www.wheatstone.com](http://www.wheatstone.com) / [sales@wheatstone.com](mailto:sales@wheatstone.com)

copyright © 2003 by Wheatstone Corporation  
tel 252-638-7000 / fax 252-635-4857