

No Noise

Tips for using mic windshields and pop filters.

Page 26

The Bauer 707

After 45 years, Paul Gregg keeps the Bauer legacy alive.

Page 26

Radio World



\$2.50

The Newspaper for Radio Managers and Engineers

October 6, 2004

INSIDE

NEWS

▼ NPR takes a modular approach at the Republican National Convention.

Page 3



▼ Peter Burk thinks RDS spells success.

Page 4

ENGINEERING

▼ The ABCs of broadcast and audio standards.

Page 12

▼ Bruce Elving on the proliferation of FM translators.

Page 20

▼ At Radio Free Asia, a new automated system for DXers.

Page 31

STUDIO SESSIONS

▼ Jingle questions for Ken R.; JRN walks the POTS line in Branson; and the rundown on AES.

In This Issue



OPINION

▼ Radio should fight mandatory airchecks.

Page 46



Sign Up For
NewsBytes
Weekly Digest at
www.rwonline.com

Radio Groups Plan Spending For IBOC

by Leslie Stimson

As radio groups plan their capital expenditures for the next year, those planning to invest more heavily in HD Radio are mapping out expense strategies — for 2005 and beyond.

Industry observers believe early-adopter commercial group owners will spend approximately \$115 million total over the next few years on IBOC gear.

Although engineering executives of major groups contacted for this story declined to share exact budget information, they were willing to discuss the thought processes guiding financial planning for their digital conversions: how they are choosing markets to be transitioned first, and their equipment needs.

A number of broadcasters have already invested in IBOC. Greater Media was the first group to announce it was converting all of its 19 stations and the conversion was funded for \$2 million in 2003, according to Milford Smith, vice president of engineering. Ten are on-air with three yet to go this year and the rest in early 2005. But of three major companies that recently announced they will transition the majority of their stations to HD

See IBOC, page 8 ▶

NEWS ANALYSIS

Klotz Digital America Restructures, Sheds GP

by Randy J. Stine

GRASS VALLEY, Calif. Klotz Digital America Inc. is shedding its Graham-Patten division and losing its president in a restructuring.

Company executives planned to time the announcement for September.

Klotz said it would either sell or close its Graham-Patten products division, which sells edit suite audio mixers for the television post-production segment, in Grass Valley, Calif., by mid-October.

Klotz Digital America President John Carey will leave the company when the

See KLOTZ, page 7 ▶

Rocky Mountain Digital

KUVO turns on IBOC in Colorado. Page 14



Shown: KUVO Senior Engineer John Mkiiv

Together We Have The Power To Move Radio Forward.

At Harris, we're taking our leadership in the radio industry to an even higher level. Shaped by the feedback of customers and audiences across the market spectrum, the newly-formed Harris Radio Team is rich with the industry's most comprehensive products, services and expert resources. All with a focused team solely dedicated to moving our industry, and your business, forward. It's a spirit of innovation built on decades of pioneering solutions for radio. So get your business heading in the right direction, turn to the new leadership of Team Harris Radio.

To learn more about the new Harris Radio Team, call us at 800-622-0022 or visit us at www.broadcast.harris.com.

THE NEW HARRIS RADIO TEAM IS ON THE AIR



www.broadcast.harris.com



See us at the NAB Radio Show Booth #902

FCC Seeks Input on EAS Changes

WASHINGTON EAS alerts on the Internet or cell phones? It could happen.

Fear that the Emergency Alert System is ineffective and outdated is prompting the FCC to seek input from broadcasters and others on ways to incorporate new warning mechanisms to reach more people during times of emergency.

Expanding EAS to include digital radio and television along with wireless communications is one of many possibilities raised in the commission's Notice of Proposed Rulemaking released in early August (RW, Sept. 1, page 3).

Critics have claimed that EAS is a patchwork of alert systems that lacks focus because of protocol that varies from state to state and that the voluntary nature of EAS

makes it more difficult to coordinate emergency plans effectively.

The FCC's action stems in part from recommendations from the Media Security and Reliability Council and the Partnership for Public Warning, a nonprofit private-public partnership. Both groups have recommended that a national, uniform, all-hazard risk communication warning process be implemented with a single federal entity in charge.

The Department of Homeland Security, the Federal Emergency Management Agency, the FCC and the National Oceanic and Atmospheric Administration's National Weather Service now have a role in the implementation of EAS.

In the NPRM, the FCC raises the possibility of federal legislation being required to

accomplish the objective of funding the process to fix EAS.

"I think the FCC did an excellent job of posing the questions that should be asked of EAS. Broadcasters will need to look carefully at the NPRM as the answers may have significant impact on them," said Ken Allen, executive director of the Partnership for Public Warning.

Allen believes that EAS is a vital warning system, but it must be part of a national warning capability using multiple channels of distribution and multiple technologies.

The Emergency Alert System is a mechanism for warning the American public of an emergency and provides a means for the president to address the country. EAS is voluntary for broadcasters, except for carrying

mandatory presidential alerts — which has never occurred — and running monthly tests to ensure their EAS equipment works.

The agency asks in the NPRM if requiring broadcasters to carry all local and state emergency information might make EAS a more robust and reliable notification tool. Broadcasters have been encouraged to carry such warnings.

"Some parties assert that voluntary (as opposed to mandatory) participation in state and local EAS alerts impairs the credibility of the entire EAS," states the commission in the document.

The FCC seeks comments on mandatory monitoring of NWS where signals are available. The mandatory relay of NWS emergency information worries some broadcasters for various reasons.

"NWS has the propensity to send many duplicative warnings and sometimes the automated audio is almost unintelligible," said Tom Taggart, part-owner of WRRR(FM) in St. Mary's and WXCR(FM) in New Martinsville, both in West Virginia.

Richard Rudman, vice chair of the California state emergency communications committee, said EAS can work if it finds reliable funding.

"It can be done correctly with proper support and funding. (We can) have an emergency partnership that is ready to go at any time to warn people at risk to take proactive action. The integration of technological enhancements into EAS will be critical," Rudman said.

Paragraph 32 of the NPRM includes mention of alternative public alert and warning systems. The Internet, cellular telephone capabilities, television, cable boxes, clock radios, fax and computerized calling systems (reverse 911) are just a few of the options mentioned, some of which are already available from companies in the private sector.

The filing deadline for comments in EB Docket No. 04-296 is Oct. 30.

— Randy J. Stine

ANY SOURCE TO ANY FADER!



THE AUDIOARTS ENGINEERING D-16

IT LOOKS EXPENSIVE — BUT IT'S NOT!

THIS NEW RADIO CONSOLE from Audioarts combines the benefits of a ROUTER and an AUDIO CONSOLE into one COST-EFFECTIVE digital package, letting you route any input to any fader or to any monitor feed, with all sources clearly shown in bright LED dot matrix displays right above the faders and monitor level controls.

A COMPACT TABLETOP DESIGN, the D-16 has the features you need: both analog and digital PROGRAM and AUDITION stereo outputs, 2 MONO analog outputs, 14 input faders plus 2 caller faders, 4 mic preamps, control room and studio monitoring, built-in cue and headphone amps (with concealed headphone jack) — even four internally generated mix-minus outputs!

WITH 24-BIT A>D and D>A inputs and outputs and sample rate converters on every AES digital input, the D-16 will work with virtually any digital source gear you have. It can run your source machines too (up to eight of them) — all opto-isolated. Its DSP DIGITAL METERING simultaneously displays VU columns and peak hold fullscale digital so you can be assured of pristine performance. Its powerful caller tools generate mix-minuses automatically, and you can program any of its four MXM outputs to be pre or post fader.

And with Wheatstone's extensive digital background and reputation you can be assured that the D-16 is a great console!



AUDIOARTS ENGINEERING

252-638-7000 / www.audioarts.net / sales@wheatstone.com

See us at the NAB Radio Show Booth #500

World Radio History

Index

NEWS

| | |
|-------------------------------------|---|
| Radio Groups Plan Spending for IBOC | 1 |
| Klotz Digital America Restructures | 1 |
| FCC Seeks Input on EAS Changes | 2 |
| NPR Tries Modular Approach at RNC | 3 |
| Burk Thinks RDS Spells Success | 4 |
| Radio Hits the RNC | 5 |
| Newswatch | 6 |

HD RADIO NEWS

| | |
|--------------------------------|----|
| KUVO Turns on IBOC in Colorado | 14 |
| New HD Radio Scorecard | 15 |
| 5.1 Surround Implemented How? | 18 |

FEATURES

| | |
|---|----|
| Workbench: Put the 'Squeeze' on Dawn or Joy | 10 |
| ABCs of Broadcast & Audio Standards | 12 |
| On the Proliferation of FM Translators | 20 |
| Sample Course of Study Unveiled by SBE | 22 |
| Paul Gregg and 45 Years of Bauer | 26 |
| SBE Conference Preview | 28 |
| RFA Implements Automated System for DXers | 31 |

STUDIO SESSIONS

| | |
|-------------------------------------|----|
| AES Promises a San Francisco Treat | 32 |
| JRN Walks the POTS Line in Branson | 36 |
| Mic Accessories Help Decrease Noise | 39 |
| Got a Jingle Question? Ask Ken R. | 39 |

OPINION

| | |
|---|-------|
| Reader's Forum | 44-46 |
| Into 'The Free-Love Digital Domain' | 45 |
| Say No to Retention of Program Recordings | 46 |

NPR Tries Modular Approach at RNC

by Leslie Stimson

NEW YORK This election season, the two major political conventions each attracted some 15,000 members of the media.

For the Democratic National Convention, Radio World focused on equipment used by Associated Press Radio to report the event. An earlier article looked at how ABC Radio Networks is using specially equipped busses to cover the campaigns and conventions.

Smiley Show." There were also two technical employees devoted to IT, another two devoted to telecom issues and a shop person to build anything that was needed.

Reporters used Sony MiniDisc recorders and shotgun mics, the Audio Technica 835, according to Andrea Jackson-Gewirtz, technical director for elections 2004. To file stories from the protests preceding the convention and during the nearly week-long event, NPR

Madison Square Garden. At each area, NPR personnel could write, edit, go online, file stories and conduct interviews.

Reporters had Cool Edit Pro on their laptops. "They could have it in their hotel room. They could edit, be online and then come to the workspace and file with T1s," said Jackson-Gewirtz.

Simultaneous filing

Two T1s in the hotel workspace transmitted data and audio with a throughput rate of 192 kilobits per second.

Additionally, NPR also had two free-standing "road runner" stations set up as filing points. Personnel also could conduct quick two-ways at these stations if the T1s were busy, Jackson-Gewirtz said.

From these workspaces, three people could file stories at the same time.

In Madison Square Garden, the network had two sites, one on the convention floor and another elsewhere in the arena. The site in the hall was called the "seat" to make it clear "it was the seat of where we came from" every night for the network's 8 to 11 p.m. special election coverage, she said. The special was carried to affiliates on its own satellite channel.

The "seat" was located in office space under the stage. The GOP had the stage built up 10 feet in order to accommodate

the media, she said.

This was the area NPR considered the primary entry point into Studio 3A in Washington.

From the seat, audio from four sources was sent to Washington: wireless mic 1 and wireless mic 2 for the roving reports on the floor, audio from "seat" guests and podium audio.

Two T1s were available in this area. Audio from wireless mic 1 and 2 were on one T1 line, while the second T1 carried the seat program audio and podium audio.

Lots of RF

NPR had additional workspace in the Garden. This 10-by-20-foot space accommodated overflow guests. Audio from three mics was sent back to Washington over an ISDN line. The T1 in this area was for data transport.

The area was used occasionally, mainly as a place from which engineers could feed host material, she said. NPR hosts travel with engineers who record their audio. All the audio is split-tracked, because two people are miked for stereo recording.

"That audio, (along) with a USB interface, was loaded into Cool Edit Pro on location to be edited, or to send raw elements back with an engineer, who would sum it for them," said Jackson-Gewirtz.

NPR transmitted audio for several shows, including "Morning Edition."

See NPR, page 5 ▶



Margot Adler, host of 'Justice Talking' and New York correspondent, covers protests on the eve of the RNC.

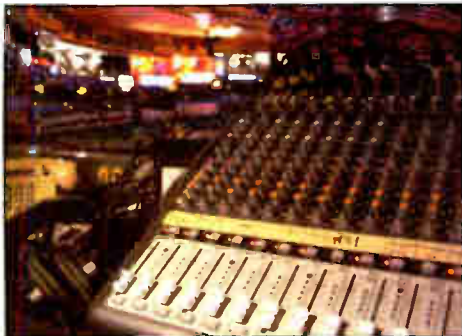

NPR used this new Mackie Onyx 1620 in the Garden workspace.



Umbrellas confiscated by the U.S. Secret Service

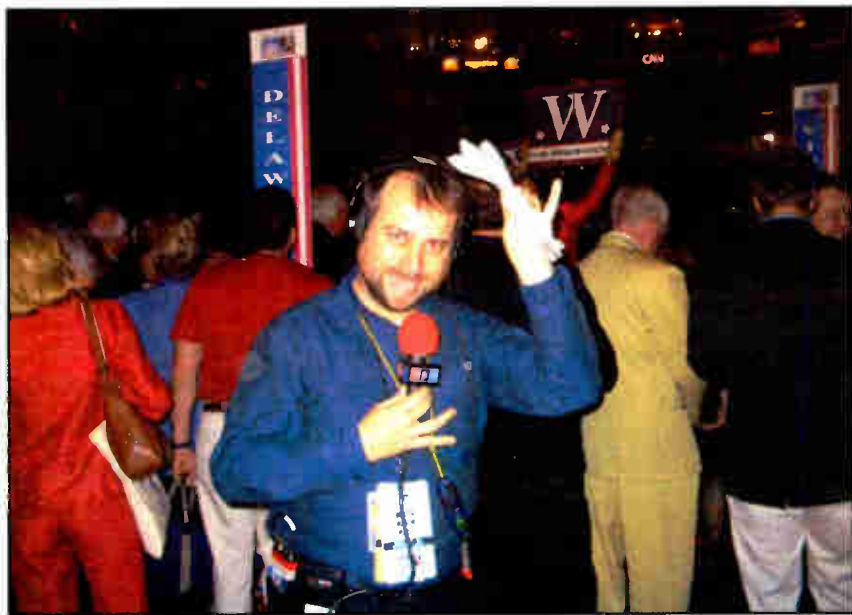

Robert Smith, New York correspondent

This story details how National Public Radio approached the Republican National Convention.

NPR sent approximately 40 editorial personnel and 12 technical employees to the Republican National Convention.

Of the seven engineers, six worked on several of the NPR shows and one worked exclusively on "The Tavis

sent Mitch Eaton, an engineer, and Anne Hawke, a producer, along with host Margot Adler to file using a Nera World Communicator Mini M4 satphone packaged with a GlenSound ISDN Mixer.

Instead of creating one huge workspace, NPR this year tried an approach based on several, smaller, work areas.

The network set up a work area in a nearby hotel and a couple of areas in



Reduce Your Work Load Save Time and Money With SCMS!

- ❖ 28 Years of Personal Service
- ❖ Extensive Rental Fleet
- ❖ Experienced Technical Staff
- ❖ Rep for 600+ Companies
- ❖ New & Rebuilt Audio & RF
- ❖ Trade-ins Welcomed

Mid-South Sales:
Bob Mayben
Voice: 877-391-2650

Central Sales:
Bernie O'Brien
Cell: 731-695-1714

West Coast Sales:
Doug Sharp
Sales: 866-673-9267

Mid-West Sales:
Mary Schnelle
Sales: 1-800-245-4307

South-Atlantic Sales:
Art White
Sales: 770-632-1295

North-East Sales:
Jim Peck
Sales: 315-623-7655

CORPORATE SALES OFFICE
Pineville, N.C.

Call: **BOB, MIKE,**
ERNIE or MATT

Toll FREE 1-800-438-6040
1-704-889-4508

Fax 1-704-889-4540
e-mail sales@scmsinc.com
www.scmsinc.com



Burk Thinks RDS Spells Success

RDS, secondary audio, PAD — radio is getting more powerful.

In a series of interviews, I am touching base with various industry people — to learn the perspectives of suppliers, where a great deal of the engineering expertise resides, as well as broadcasters — asking about the technologies that many think will remake the “face” of radio.

In a recent column I discussed datacasting with an executive of Broadcast Electronics. Today I chatted with Peter Burk, president and founder of Burk Technology, whose ad has appeared at the bottom of this page for 18 years (!) and who was a frequent contributor to Radio World in his days as a chief engineer.

His company is known for its transmitter remote control products, like the GSC3000, VRC2500 and ARC-16, so I was interested to find out why Burk recently began promoting an RDS product.

McLane: Where do you see RDS fitting in?

Burk: We have a different set of needs in the United States than in Europe. Although Europe has successfully been using RDS for 10 years, it hasn't been used extensively in the United States because of how networks are organized and so forth.

It's fairly obvious that the emphasis that brought RDS back to life is the scrolling of song title and artist. The disappointment was that receivers, many of them, don't have the Radio Text field. You only have the little PS field that is commonly displayed.

When it became possible to scroll song title and artist in the PS field, it became a very competitive point. It's no longer just call letters and format.

McLane: What is Burk doing?

Burk: We knew we wanted to do RDS, we saw it was a perfect fit for what we were already doing.

We identified Audemat-Aztec as the leading encoder in the world, with 10 years of experience marketing to Europe and a lot of collateral development on top of that.

We use their core engineering talent on the RDS and add to that a user interface that is designed for the United States, to add easy adaptation for automation systems, to feed the information to the RDS unit — also to provide our standard same-day repair and U.S.-based tech support.

The product is the RDS Master, an encoder based on the FMB-80 encoder. The price to the U.S. user is \$2,795. The product is available through most U.S. dealers.

There are a substantial number in the field; we started shipping in the summer.

McLane: You're thought of as a remote control company. Why is RDS a good fit for Burk?

Burk: The market is one that we are well entrenched in. Our infrastructure is in place for that.

We have a lot of experience with embedded microprocessors and real-time data, and 20 years of subcarrier experience, doing remote control over subcarrier.

McLane: But what about HD Radio?

Burk: It's hand in glove; they go together very well. HD Radio will use the same datastream and need to provide the same data; as the applications for datacasting continue to grow, if the RDS is capable of handling the extensions that come along and as long as there is still analog FM broadcasting, there will still be RDS.

The RDS Master uses an extensive Ethernet-driven core module that allows for extensible adaptation. The IP2 that is inherent in the RDS Master has a long pedigree.

McLane: A broader question: You told me you've been out visiting clients recently. What are they concerned about these days?

Burk: The biggest challenges facing engineers today are organization and education.

Having to try to learn new things is difficult as new technology comes out. It's very tempting to say, “No, I know this old technology, I've invested a lot of time in it, I don't have time to learn this new thing.”

From the Editor

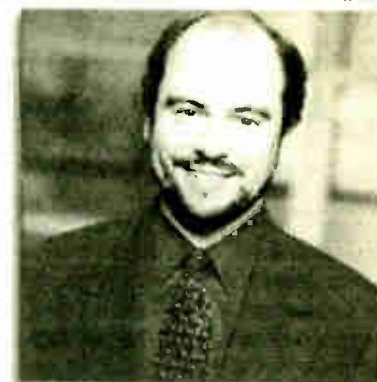

Paul J. McLane

In HD Radio, you can't possibly use yesterday's skills.

McLane: On the remote control side, you recently introduced new software, the Lynx 5, for the GSC/VRC series ...

Burk: ... with real-time updates, the fastest GSC ever. We've shipped over 500 copies.

McLane: Isn't the remote control marketplace a mature one?

Burk: There is growth. You'd think of it as a replacement market, but that doesn't account for the level of business there is.

It's interesting that it's been “keeping up with technology” as opposed to people wearing out remote controls. The remote controls they are replacing are technically functional but not as technically advanced.

We see a lot more interest in Ethernet and some of the additional capabilities to manage more sites effectively. What we allow people to do is take advantage of the technology advances without having to throw everything out and start over.

Our Web Interface product is a way to hook up the existing remote control to the Internet, plus other features. Also, getting on the Web is really nice; but if you don't have good Net access at the transmitter, it's a problem. If you've got a connection back to the studio for your remote control, you can put the Web Interface at the studio and tie it to the remote control and put it on the Web — so you can get on the Web without Web access at the transmitter.

Things like that make it a growth market. 

FAQ: Engineering Extra

This month we'll deliver to readers our first issues of the new Radio World Engineering Extra, an extra edition of your familiar Radio World newspaper, published six times a year. In this space I'll be telling you more it over several columns.

How is Radio World's Engineering Extra different from the Radio World I know?

It's a “deep tech” version, written by engineers for engineers. It will make more use of charts, graphs and schematics. It allows our editorial staff the space to publish white papers, detailed technical discussions and in-depth designer interviews without cramping the news, features and industry analysis of technical news that make Radio World successful.

Further, this edition is available to readers both in and outside of the United States. Thus our clients now can take further advantage of IMAS Publishing's powerful brand reach and expertise in foreign markets as well as RW's position in the U.S.

Who subscribes to it?

Radio World's Engineering Extra is available free to radio engineers and qualified technical personnel. You must sign up separately to receive it. You can do so at www.rwonline.com/eng-extra.

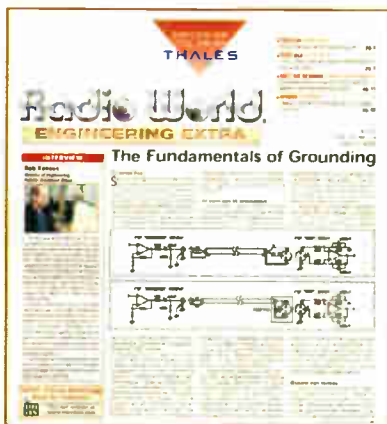

...SCROLL WITH IT...



RDS Master™

RDS ENCODER

The RDS Master sets the standard for RDS datacasting. It delivers powerful user features, like Web-based setup menus and TCP/IP access for changing your settings on the fly. Scrolling RDS displays artists and song titles, and you can update messages as often as you want. You can even integrate the RDS Master with your remote control.

Visit www.burk.com/rds and learn more about the easiest to use and most versatile RDS encoder available today.

Scroll with it. You'll see the difference.



BURK TECHNOLOGY

800-255-8090 (Main Office)
800-736-9165 (Kansas City)
www.burk.com

See us at the NAB Radio Show Booth #1505
World Radio History

NPR

► Continued from page 3
 "Day to Day," "Talk of the Nation," "All Things Considered," "The Tavis Smiley Show" plus news spots, in addition to its nightly election special.

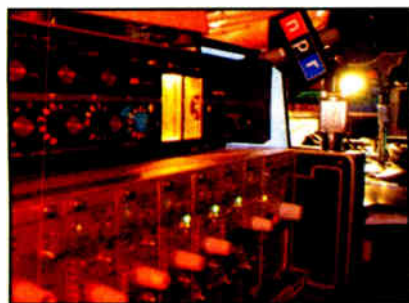

Charlie Meyer

NPR used this Prospect Electronics CL-61 and its multi-function 6-channel talkback unit for IFB.

Asked what worked well, Jackson-Gewirtz said, "In terms of what we provided to NPR, we did a good job in that we had the ability to do many things simultaneously."

What didn't? The heavily-saturated RF environment in the area complicated

things, she said. NPR brought three wireless mics to the RNC, but only two worked consistently without dropouts.

However, the wireless mics gave reporters the ability to be on several shows and remain in the same place, she said.

NPR had similar setups at the DNC earlier in the summer. All in all, she said



Charlie Meyer

One of three wireless mics NPR took to the RNC.

this year's DNC and RNC involved better working environments than in the previous conventions, in which NPR personnel worked from cramped, hot trailers that leaked.

NPR budgeted about \$150,000 for coverage of each of the political conventions, a spokeswoman said.

FIRST PERSON

Radio Hits the RNC

NEW YORK With a recent degree in radio communications from Hofstra University, I was fortunate enough to have been selected to assist in the radio communications division as a professional volunteer at the Republican National Convention in Madison Square Garden.

Throughout the week of Aug. 29, my group collected sound bites that were recorded from celebrity guests, state delegates and the many government officials taking part in the event. The sound bites were subsequently placed on the convention Web site, www.gopconvention.com.

Being a professional volunteer on Radio Row during a national convention was a once-in-a-lifetime opportunity.

My role was to interview guests such as Pat Boone, Don King and various politicians as they visited Radio Row, where the live radio broadcasts took place. To perform the recordings we used two methods: a Sony MZ-NHF800 portable MiniDisc recorder with a Peavey PV-12 XLR microphone attached, and a Sony handheld M450 microcassette-corder with built-in microphone.

Once the recordings were taped we downloaded the material to our desktop computers and began the required editing — deleting the pauses and recorded misspeaks. Our editing was done by using a program called Audacity, a free program we downloaded from the Internet, which is much like Pro Tools and Sound Forge.

Once the editing was complete, the WAV sound files were made into MP3 files using Smart FTP programming and sent off to the company that controls the Web site for their posting. On Thursday evening at the end of the convention I believe we ended up with a collection of more than 120 sound clips.

Being a professional volunteer on Radio Row during a national convention was a once-in-a-lifetime opportunity. From the first interviews early on Monday morning, to being present as President Bush gave his acceptance speech, I was in awe of the entire convention.

It was hard work and long hours, but it was worth it to have the chance to interview political leaders like Marc Racicot, former governor of Montana and Bush-Cheney '04 campaign chairman, Sen. Zell Miller, D-Ga., and Gov. Rick Perry of Texas. Everyone on Radio Row did a great job and I felt privileged to work with such professionals.

To replay speeches or hear selections of what delegates said during their time in New York, visit www.gopconvention.com.

— Paul Cleary

The author is seeking a job in radio and may be reached at paulbcleary23@yahoo.com.

NEWSWATCH

Stations Oppose Mandatory Recording, Retention

WASHINGTON Commercial and noncommercial stations are uniting against the FCC's proposed rules for mandatory content recording and retention. The Station Resource Group and National Federation of Community Broadcasters have told the FCC the proposed mandatory recording rule "would not substantially enhance the indecency complaint process, and would, in fact, merely multiply the number of complaints filed against the same small number of programs."

In comments filed with the agency, the SRG and NFCB state the proposed rule would impose burdens on noncommercial stations.

Seventeen commercial licensees representing 43 stations told the agency the requirement would have "an unconstitutional chilling effect" on speech. The cost of equipment and overseeing program recording would be burdensome on small stations, and the duplication

and distribution of copies would violate the Copyright Act and require stations to breach program agreements with third-party suppliers, the licensees stated.

"Stations should be able to avoid the program retention rule by certifying they do not air a format likely to include indecent programming, or by certifying that particular program segments are supplied by third parties." It makes no sense to have hundreds of stations recording the same programming, they said.

Nearly 500 comments were filed on the issue by the Aug. 27 deadline, according to John Garziglia of Womble Carlyle, representing the Small Market Operators Caucus. Of those, about 257 comments were filed through the caucus Web site (www.smallmarket.org) and about 90 broadcaster comments were filed through NAB's Web site, he said in a memo to caucus members.

— Leslie Stinson

The industry standard reaches new heights

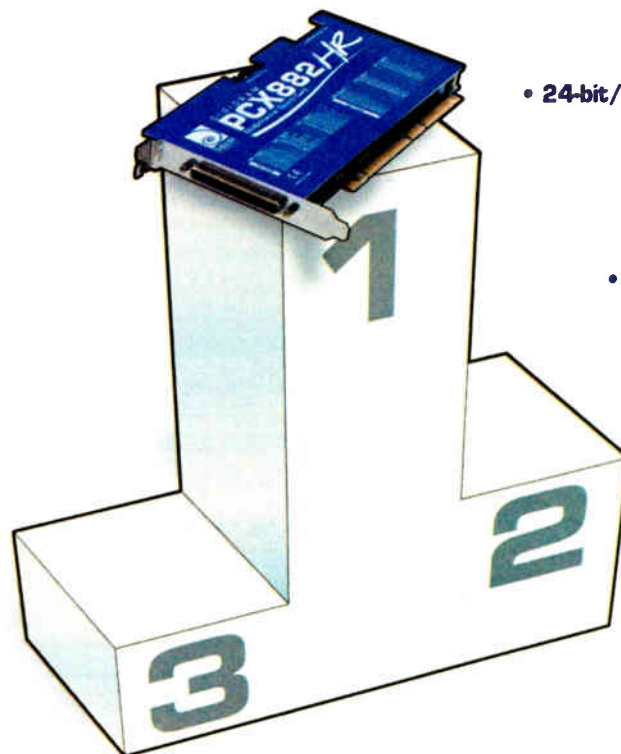

- 24-bit/192 kHz converters
- Hardware sample rate converters
- 66 MHz/64-bit PCI interface
- More powerful DSP
- Comprehensive set of drivers: Digigram np, WDM DirectSound, Wave, ASIO
- Short-length PCI format
- Maximum input and output level: +24 dBu

Presenting the new HR series of PCX sound cards

Digigram's PCX range of sound cards has become the de facto standard in the broadcast industry since its launch in 1989. The new HR series sets new benchmarks for the industry and underlines Digigram's commitment to superior audio quality, reliability, and innovation.



www.digigram.com - Tel: (703) 875 9100 - input@digigram.com

◆ NEWSWATCH ◆

FCC Cracks Down On Debtors

WASHINGTON They're calling it the "red light rule." Beginning Oct. 1, any individual or company that owes money to the FCC won't be getting a license — or any other service — from the agency until the debt is paid. The rule is being implemented under the Debt Collection Improvement Act of 1996.

When an application or request for benefit is filed, the agency will check the FCC Registration Number to see if the entity or person owes money to the commission.

"Multiple FRNs associated with a Tax Payer Identification Number will be included in the red-light check; and if the TIN is found to have delinquent debt — your application will receive a red-light," states the commission in its notice.

Delinquent debtors will be notified and given 30 days to pay the debt or make other arrangements. Those who don't will see their applications dismissed.

The commission also is leaning hard on those who don't pay application fees in a timely way. Such fees must now be paid in full before an application will be granted. In the past, if an application fee was underpaid, the application

was processed anyway and the applicant billed for the difference. Beginning Oct. 1, the commission will bill for the additional fees due but will complete processing of the application until full payment is received.

Freeze Imposed On Major Filings

WASHINGTON The FCC has frozen major filings; the forms you'd need to build or sell a station are no longer valid.

When a federal appeals court in

ruled in September that the commission could go ahead with some of its ownership changes for radio, including a new market definition, the agency decided to replace its Forms 301, 314 and 315 and issue new ones for commercial stations. Until those are available, the FCC won't accept the old forms.

The Media Bureau will issue a notice providing more information regarding the filing of new applications as well as guidance on the processing of Form 301, 314 and 315 applications that are pending. Applications proposing pro forma assignments and transfers of control (FCC Form 316) of commercial radio stations will continue to be processed.

ENCO Opens West Coast Support Office

SOUTHFIELD, Mich. Digital audio systems provider ENCO Systems has opened a technical support office in California. Heading the branch will be Dean Tiernan, returning to a technical support role after most recently working as a radio news journalist.

Tiernan had served as product manager of Audicy, Orban's digital audio workstation, and worked for that company in a product management and technical support role for seven years. He will be based in San Luis Obispo and will join Enco Systems' support staff for radio, television and fixed sound markets.

"As ENCO has grown over the years, we've always tried to put our resources where it will do our customers the most good," said President Eugene Novacek. The company also has a facility in the United Kingdom and a support facility in Singapore.

Got a Good Technical Idea? Tell NAB

WASHINGTON The NAB has put out a call for papers for its Broadcast Engineering Conference next spring in Las Vegas, during the NAB show.

It encourages ideas on digital audio, digital radio, new receiver technologies, security, automation and a long list of other potential topics. The organizers say they also are "very interested" in case studies, practical experience that would be of help to fellow engineers.

Presenters deliver technical papers on various topics; presentations are limited to 30 minutes including questions.

If you have an idea, you can submit a proposal of up to 200 words. It should "explain precisely what conference attendees could be expected to learn from your paper. Papers promoting company products or services will not be accepted. However, papers explaining the underlying technologies used in broadcast products or services will be acceptable."

The proposal deadline is Oct. 15. If accepted, the paper is due in late January.

To submit a proposal, go to www.nab-show.com/becpapers.asp; if you have questions, call John Marino at (202) 429-5346.

model AFS-3 audio failsafe

FUNCTION: dual channel, adjustable length silence sensor

FEATURES: two audio inputs • relay output • optional status voltage output for signaling external devices • silence detection delay from 30 seconds to five minutes in 30 second increments • positive adjustment via rear panel rotary switch • front panel LED status indicators • front panel defeat switch • internal audible alert—continuous or pulsing • audio detect mode • silence alarm output is compatible with RFC-1/B telemetry input and requires only two wires

model DAI-2 dialup audio interface

FUNCTION: remote broadcast or emergency interrupt via telephone

FEATURES: telephone line autocoupler and tone decoder • momentary or latched relays for control and audio switching • programmable relay output • front panel relay status indicators • telephone audio output • audio monitor input • AGC on audio feeds • balanced audio I/O • four logic level input triggers • seven DPDT and one 4PDT relays

OPTIONS: CI-1 composite insertion module • DB-1 50ms delay board

model RFC-1/B remote facilities controller

FUNCTION: transmitter remote control via telephone

FEATURES: expandable from 8 to 64 channels of telemetry and control • programmable control activity by date and time • programmable telemetry alarms

OPTIONS: MA-2 modem adapter • PA-2 parallel printer adapter • TS-1 temperature sensor • ACM-2 AC current monitor (tower light monitor) • RS-232 serial data adapter • SP-8 telemetry and telephone line surge suppressor

model RAK-1 intelligent rack adapter for RFC-1/B

FUNCTION: modem, printer output and battery backup for RFC-1/B

FEATURES: parallel printer adapter • modem adapter • backup battery • telephone line surge suppression • front panel status indicators • sleek 1U chassis • available for new installation or as an add on accessory package for existing RFC-1/B installations (use of the RAK-1 does not eliminate the need for the RP-8 relay panel)

OPTIONS: SP-8/TO telemetry input surge suppressor

model MBC-1 message board controller

FUNCTION: studio devices trigger custom messages on LED display

FEATURES: fifteen logic level inputs • selectable input priority • text and graphics can be combined in a single display • communications output can drive multiple displays • displays can have different messages on same input trigger • factory default messages for easy initial setup • works with inexpensive, attractive LED display

OPTIONS: OC-2 Optocoupler senses ringing telephone line

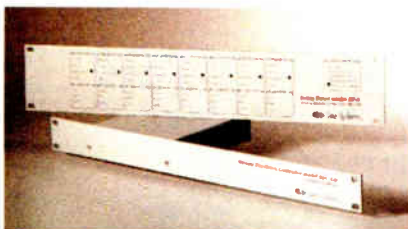

Sine Systems, Inc. • 972 Main Street • Nashville, TN 37206 • (615) 228-3500 • www.sinesystems.com

innovative solutions

Sine Systems, Inc.

Klotz

► Continued from page 1

restructuring is complete. The shakeup also results in Klotz moving its digital broadcast division management office from Campbell, Calif., to an existing Klotz regional office in Norcross, Ga., just north of Atlanta.

Graham-Patten was founded in 1980 and manufactures digital audio products and systems for video editing. It is best known for its SoundPals product line. Klotz purchased Graham-Patten Systems Inc. in 2001 for an undisclosed price. Efforts to sell the division continue, Carey said.

Networking system demand

"We will continue to pursue opportunities in the radio broadcast business. The demand for our networking systems and digital consoles remains very strong. The restructuring allows our U.S. operations to better suit the anticipated needs of our customers," Carey said.

Klotz Digital America Inc. is a wholly owned subsidiary of Klotz Digital AG, based in Munich, Germany. Carey described Klotz Digital America as a sales, distribution, service and installation subsidiary of the parent company, which does all of its manufacturing in Germany. The parent company announced a restructuring itself in the spring of 2003.

We will continue to pursue opportunities in the radio broadcast business.

— Outgoing President John Carey

Klotz Digital AG Chief Executive Officer Thomas Klotz said, "We have gained substantial market share in the United States since we founded Klotz Digital America in 1999. It's by far the most important and largest market for us.

"When we purchased Graham-Patten we had intentions to further expand into the television market. However, the downturn in the economy since 2001 and the growing cost to market and develop new products for television were factors in us getting out" of TV.

Seven Graham-Patten employees will be laid off or working for new ownership at the Grass Valley facility by mid-October. Only two management employees, Carey and a financial administration person, worked out of the Campbell, Calif., office.

As part of the restructuring, Klotz Digital will use Atlas Sound to distribute its VariZone digital public address system in the United States, Carey said.

Thomas Klotz said better-than-expected sales in the PA market softened the financial impact Klotz will experience for closing or selling the Graham-Patten division.

Carey said Klotz Digital America was

expected to begin shipping the new AEON digital radio broadcast console in October. The companion to the company's DC II console will sell at a slightly lower price point. "It's less modular and more of a cookie-cutter approach to the control surface market for us. Still, the AEON uses the same hardware and architecture that the high-end DC II does," he said.

Howard Mullinack, president and CEO of Graham-Patten when Klotz purchased the company in 2001, said of the recent developments, "I regret Klotz was not successful with the Graham-Patten patent line. When you look at mergers and acquisitions, a lot of times things do not work out for a lot of different reasons and this was one of them."

Mullinack, currently director of strategic development and marketing for Sierra Automated Systems, a competitor of Klotz

in the networked audio distribution/router marketplace, said Graham-Patten sold to Klotz in part because the company needed additional capital to fully reach its potential. "We were looking for Klotz to inject large amounts of capital into GP and rev up our R&D and that never happened," he said.

As part of the sales agreement, Mullinack stayed on with Graham-Patten for one year as vice president of Graham-Patten operations for Klotz.

"Klotz was looking to use the GP plant as a US-based manufacturing facility for the Klotz product line, too. That never happened either," Mullinack said.

Post 9/11 economy

Several other industry observers interviewed by Radio World say they were not surprised by Klotz' restructuring announcement, considering it another

indication that the post-9/11 economy continues to test the mettle of radio equipment manufacturers.

Harris Corp., for instance, announced in June that it had reduced its U.S. broadcast workforce by 5 percent; and observers say some other radio equipment manufacturers continue to face a soft broadcast supplier marketplace.

Klotz in particular was viewed as being in a healthy financial position just a few years ago, the sources said.

"Here's a company that had a lot of momentum a little over three years ago with the XM deal. Many had drawn the conclusion they had some of the best routing systems out there at the time, but others have passed them now. Competition has increased but the economy hasn't improved," one observer said.

See KLOTZ, page 8 ►



**GET IN ON THE ACTION...
ON OR OFF THE FIELD.**

Matrix Portable:

Delivering the sound of the coin toss to listeners around the world is as simple as pressing a button. Only the advanced Comrex Matrix POTS codec delivers the highest quality audio and superior connection reliability over both standard wired and GSM wireless phone connections. Our road-proven design and construction, plus ease of operation and real-world features, make Matrix your best choice for all your POTS and ISDN remotes. The results? Your listeners hear the collision, the grunting, the exhale... and the sound of victory.



Matrix Rack:

Sure all the action is in the field, but a great remote needs a great home base. And there's nothing better than the Matrix Rack. It's compatible via POTS and ISDN with ALL Comrex codecs as well as those from nearly everyone else. Perfect for receiving those calls from the field. Make the Matrix Rack the center of communications for ALL your remotes.

Grab your audience by the ears and give them the full experience—not just a story.

Doing a remote? Put Comrex on the line.

COMREX

Toll Free: 800-237-1776 • www.comrex.com • e-mail: info@comrex.com
19 Pine Road, Devens, MA 01434 USA • Tel: 978-784-1776 • Fax: 978-784-1717

See us at the NAB Radio Show Booth #1005
World Radio History

IBOC

► Continued from page 1

Radio — Clear Channel, Entercom and Cox — common themes emerged.

Groups plan to focus on the top markets, convert more FMs than AMs at the start, and spend the majority of their conversions funds on the RF side: new transmitters, exciters and STLs.

Studio upgrades to digital equipment, in many cases, have already been performed in preparation for final IBOC conversion, executives for the companies said.

Ibiquity Chief Operating Officer Jeff Jury also hears these themes from the groups and others that plan to convert but have not made their plans public. He said the average conversion cost for an FM station is around \$100,000.

It's a strategy

"Each of these companies have 'capex' strategies," he said. "I think they're making a strategic decision that now is the time to take advantage of HD Radio and also now is the time to take advantage of the transition to start thinking of it going forward."

Clear Channel, for example, is trying to transition facilities quickly.

In order to accomplish this, Jeff Littlejohn, vice president of engineering for Clear Channel Radio, said the company is beginning with the easy stations, "but we are also starting to work now on the stations that will be more difficult so that their conversion is not delayed more than necessary."

Through its many acquisitions after passage of the Telecom Act, the company inherited plants with various brands and models of equipment, depending on the preferences of the previous owner. Over the past three to four years, as the company has bought both transmitters and related systems, it has done so with the idea that the stations would eventually convert to digital, Littlejohn said.

"That fact is making some of our conversions easier to implement," he said.

The company is finding it needs to replace 40 to 50 percent of its STLs to be able to "get full advantage of HD Radio."

He declined to provide detail about the company's data plans; he said Clear Channel is investigating the use of surround sound with HD Radio but has made no decisions.

Clear Channel is estimating conversion costs at between \$50,000 to \$110,000 with

an average of \$100,000 per station. Using this figure, the company would spend roughly more than \$100 million. The company announced earlier it would convert 1,000 of its 1,200 stations to HD Radio. It hopes to convert at a pace of 100 stations per year initially, then at a faster pace as it gains experience; and has also said it hopes to convert a majority of the 1,000 stations in three years.

sees conversion spending for TV and radio, said there really is no round conversion figure for FM stations because numerous variables affect the cost, such as the location of the tower and transmitter and the amount of power needed. Stations for which the company has purchased a transmitter in the past three years, he said, have built-in IBOC capability; and antenna costs vary considerably.

Groups plan to focus on top markets, convert more FMs than AMs at first, and spend the majority of conversions funds on transmitters, exciters and STLs.

Entercom Communications also is trying to convert stations before making decisions about IBOC's data capabilities; it plans to transition 80 percent of its 104 stations over the next four years.

"We're thinking of data applications down the road," said Jack Donlevie, executive vice president and general counsel. "Now, we're strictly repeating our over the air signal. Almost all of the money is going to the transmission chain," he said.

In time, he said, the company may find it needs to replace STLs for IBOC because many of Entercom's STLs carry feeds for multiple stations.

Entercom is estimating conversion costs at \$100,000 to \$150,000 per station and plans to upgrade FMs first. The costs can vary quite a bit depending on transmitter or antenna needs.

Donlevie also said studio projects the company might undertake in the next year are not related to HD Radio.

The expenditure of about \$10 million is spread out over four years.

Asked whether the expense would prevent the company from doing something else with its money, he said no. "It's not significant. It's not chump change, but it's not going to cause us not to do other things," Donlevie said.

Spread out the costs

Cox plans to convert 80 percent of its 78 stations within four years. Using Ibiquity's per-station average of \$100,000, that works out to roughly \$6.2 million.

Cox plans to convert 100 percent of its stations eventually, he said.

But Sterling Davis, Cox Broadcasting's vice president of engineering, who over-

"We're partners on antennas in several markets, so we need to do it with other tenants on the combiner system."

In general, "We're focusing on stations that make the most money to convert first in the pecking order." As an example, he said, in the case of a station that gener-

ates \$100,000 a year, it doesn't make sense to spend half a million dollars on an IBOC upgrade right away.

Cox has mapped out its conversions through 2007. It has completed stations in Atlanta and Miami. It was finishing up in Houston, Birmingham, Ala., and Orlando, Fla. in September.

He also said the company was not sacrificing other projects in order to convert its radio stations to digital.

"The answer, generally, is no. We're not *not* doing something because of conversions. We may not build a new building (somewhere) ... but I don't want to send the message to the community that we're upgrading regardless of cost."

The company will replace some STLs. Some stations are running their studio-to-transmitter signals on T1s instead. It has replaced some STLs with an eye towards future IBOC conversions.

That goes for transmitters too, he said. Cox has taken into account future digital conversions when it made transmitter purchases for the past three years.

Klotz

► Continued from page 7

Klotz Digital announced in April 2000 it would provide XM Satellite Radio with 200 Vadis audio platform mainframes and nearly 50 DC II digital audio mixing consoles.

Another notable Klotz client is NPR; the company supplied its Vadis II audio network for the NPR West production facility in California.

XM and NPR officials declined comment for this story.

"Klotz may simply want to erase the liability of aftercare and customer service with Graham-Patten and the best way to do it is selling or closing the company," speculated another industry observer.

Thomas Klotz said, "I can say that after three years with Graham-Patten, the products are all very stable and robust and require very little aftercare. We will assure that in cooperation with our partners we will maintain service and support for those products as long as warranties are in effect."

Another source close to Klotz said it was likely a number of "precipitating factors" that led to the restructuring.

"I think you have the slow economy coupled with the fact that the (Graham-Patten) division wasn't meeting expecta-

tions. (Klotz) also suffered a bit on equipment delivery and that has alienated some customers," the source said.

Thomas Klotz agreed there have been delivery problems the past 24 months and blamed them on the rollout of new products.

"We have developed a complete set of new products the past two years, including new interface cards for Vadis and new consoles. During that time we did experience some delays. We are very grateful to our customers who stood by us."

Carey described his departure from Klotz Digital America as a normal business restructuring decision that was "mutually agreed to be in the best interests of the company and myself."

Carey joined Klotz in 2000 as vice president of business development and was promoted to president in 2001.

"When I was brought in, it was to run three divisions (radio broadcast, television post-production and public address) and since we are selling or closing one of them and distributing our PA systems through Atlas Sound, I would have been down to running just one division now," Carey said.

Carey said he has several consulting engagements pending once he leaves Klotz.

Thomas Klotz said he expects to name a new president for Klotz Digital America at a future date. He will continue to serve as director for KDA.



DL1 Digilyzer
Handheld digital audio analyzer and monitor

NTI Americas Inc.
PO Box 231027
Tigard, Oregon 97281 USA
503-639-3737
www.nti-instruments.com
americas@nti-instruments.com

The Digilyzer puts both digital audio measurements and self-contained monitoring with you anywhere. The ideal audio troubleshooting tool for HD Radio conversions and digital audio production.

DL1 functions and features:

- ◆ Measures and monitors digital audio
- ◆ AES, SPDIF, ADAT signals
- ◆ Balanced and unbalanced inputs
- ◆ 32k - 96k sample rates
- ◆ Digital carrier level and frequency
- ◆ Digital domain audio - level, frequency and THD+N
- ◆ Status and user bits
- ◆ Built-in audio monitor with speaker and headphone jack
- ◆ Digital error logging

Concise and complete digital audio measurements in a palmtop handheld.

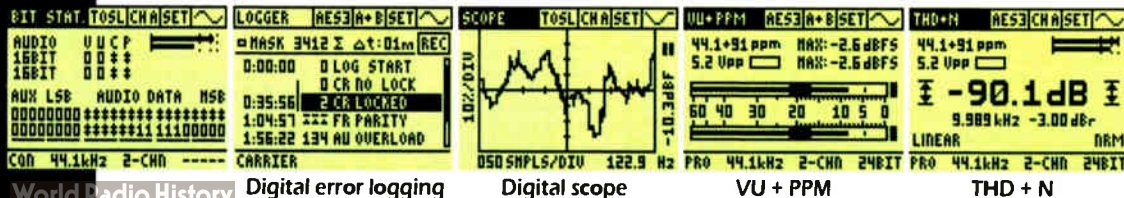

The routing switcher gets a new twist.

(About five twists per inch, actually.)

Everybody needs to share audio. Sometimes just a few signals — sometimes a few hundred. Across the hall, between floors, now and then across campus. Routing switchers are a convenient way to manage and share your audio, but will your GM really let you buy a router that costs more than his dream car? Unlikely.

If you need a routing switcher but aren't made of money, consider Axia, the Ethernet-based audio network. Yes, Ethernet. Axia is a *true network*. Place our audio adapter nodes next to your sources and destinations, then connect using standard Ethernet switches and Cat-6. Imagine the simplicity and power of Ethernet connecting any studio device to any other, any room to any other, any building to any other... you get the idea.



Routers are OK... but a network is so much more modern. With Axia, your ins and outs are next to the audio, where they belong. No frame, no cards, no sweat.

Scalable, flexible, reliable... pick any three.

An expensive proprietary router isn't practical for smaller facilities. In fact, it doesn't scale all that well for larger ones. Here's where an expandable network really shines.

Connect eight Axia 8x8 Audio Nodes using Cat-6 cable and an Ethernet switch, and you've got a 64x64 routing switcher. And you can easily add more I/O whenever and wherever you need it. Build a 128x128 system... or 1024x1024... use a Gigabit fiber backbone and the sky's the limit.



Are you still using PC sound cards?

Even the best sound cards are compromised by PC noise, inconvenient output connectors, poor headroom, and other gremlins. Instead, load the

Axia IP-Audio Driver for

Windows® on your workstations and connect *directly* to the Axia audio network using their Ethernet ports. Not only will your PC productions sound fantastic, you'll eliminate sound cards and the hardware they usually feed (like router or console input modules). Just think of all the cash you'll save.



There's a better way to get audio out of your PC. No more consumer grade "k" connectors — with Axia your digital audio stays clean and pristine.



Put an Axia Microphone Node next to your mics and send preamplified audio anywhere you need it, over Ethernet — with no line loss or signal degradation.

Put your preamps where your mics are.

Most mainframe routers have no mic inputs, so you need to buy preamps. With Axia you get ultra-low-noise preamps with Phantom power. Put a node in each studio, right next to the mics, to keep mic cables nice and tight, then send multiple mic channels to the network on a single Cat-6 cable. And did we mention that each Mic Node has eight stereo line outputs for headphones? Nice bonus.



Put your snake on a diet.

Nobody loves cable snakes. Besides soldering a jillion connectors, just try finding the pair you want when there's a change to make. Axia Audio Nodes come in AES/EBU and balanced stereo analog flavors. Put a batch of Nodes on each end of a Cat-6 run, and BAM! a bi-directional multi-channel snake. Use media converters and a fiber link for extra-long runs between studios — or between buildings.



An Axia digital audio snake can carry hundreds of channels of digital audio on one skinny CAT-6 cable. We know you're not going to miss soldering all that multi-pair...



Scott Studios



Axia is already working with some great companies. Like Enco Systems, Prophet Systems, Scott Studios, Radio Systems, Balsys Technology Group, and of course Telos and Omnia. Check AxiaAudio.com/partners/ to find out who's next.

With a little help from our friends.

A networked audio system doesn't just replace a traditional router — it *improves* upon it. Already, companies in our industry are realizing the advantages of tightly integrated systems, and are making new products that reap those benefits. Working with our partners, Axia Audio is bringing new thinking and ideas to audio distribution, machine control, Program Associated Data (PAD), and even wiring convenience.



Would you like some control with that?

There are plenty of ways to control your Axia network. For instance, you'll find built-in web servers on all Axia equipment for easy configuration via browser. PathfinderPC® software for Windows gives you central control of every audio path in your plant. Router Selector nodes allow quick local source selection, and intelligent studio control surfaces let talent easily access and mix any source in your networked facility.

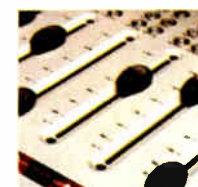

Control freaks of the world, rejoice: intelligent Axia mixing surfaces give talent complete control of their working environment. Reconfigure studios instantly and assign often-used sources just where they're most useful.



"This sounds expensive." Just the opposite, really. Axia saves money by eliminating distribution amps, line selectors, sound cards, patch bays, multi-pair cables, and tons of discrete wiring — not to mention the installation and maintenance time you'll recover. And those are just side benefits: our hardware is about half the cost of those big mainframe routers. That's right... *half*. Once you experience the benefits of networked audio, you will never want to go back. AxiaAudio.com for details.



Axia products are available in the USA from Broadcasters General Store and Broadcast Supply Worldwide. See www.AxiaAudio.com/buy/ for more information. © 2004 IIS Corp. All rights reserved. Axia is a trademark of IIS Corp. All other trademarks and likenesses are property of their respective owners.

Workbench

Radio World, October 6, 2004

Past columns are archived at www.rwonline.com/reference-room

Put the 'Squeeze' on Dawn or Joy

by John Bisset

John Allan is vice president of marketing for CPI-Eimac Division; he read our series of comments about rebuilt tubes. John points out that the CCA transmitter

reports on those.

Proper alignment of both grids seems to be the critical element; it seems to vary from one rebuilder to the next — sometimes from one rebuilt tube to the next. It is Eimac's position that when you need

by going to Richardson's Web site: www.rell.com/litrequest.asp.

John Allan can be reached at john.allan@cpil.com.

buy a rebuilt tetrode tube from Econco. Triodes aren't so much an issue. Econco tests each tube after rebuilding, and these tests define the operating characteristics, which can then be graded for certain transmitters. Econco knows the best characteristics for a Collins 819, for example, and will select one of those tubes from its rebuilt stock.

George further explained that the fila-

★★★



Doug Hall and the first of seven edit suites at The College of New Jersey.



Avoid the fine; repair damaged tower fencing quickly.

uses a grounded grid triode, most likely the 3CX15000A7. For some reason, Eimac receives the most feedback about rebuilds of that particular type not working well for broadcasters.

By comparison, the industrial folks using low-mu triode oscillators seem to have the most success with rebuilds. Broadcast tetrodes seem to be more forgiving than the high-mu triodes, and Eimac gets both good and bad

the lowest distortion and best match, a new tube is the way to go.

Obtaining the longest life from a high-power tube — whether a triode or tetrode — can only be achieved when you have a full understanding of the tube's operation. With that in mind, Eimac publishes "The Care and Feeding of Power Grid Tubes," now in its fifth edition. Single copies are available through Richardson Electronics. You can request a free copy

George Badger is a consultant with Econco after spending a career at Eimac. By far, the 4CX15000A is the most popular rebuild for broadcasters. George says Econco has developed several characteristic grades for this tube, and certain grades work better with one transmitter than another. All of these "grades" fall within the specs for the tube.

George's point is that you should specify the transmitter you're using when you

ments used in these tetrodes are thoriated tungsten, not steel. A part of the rebuilding process is to inspect the filament and re-carborize it if needed. This process adds a layer of carbon to the filament. The depth of penetration of the process will determine how long the tube will last. If the carborization is not deep enough, the tube life will be shortened.

Why not just load on a thick layer? An

See TUBES, page 12 ▶

ONE product, TWO solutions!

It's **AUTOSWITCH**, an automatic audio switcher!

AutoSwitch eliminates that annoying "digital echo" in DJ headphones by switching the headphones from Air to Local audio when the mic is on.

It's also an automatic silence sensor, and can switch your audio to a backup source if the main source fails.

Now in stock at all Henry dealers.



We Build Solutions....(two in one box!)



NEW!

www.henryeng.com 626.355.3656

Commander G3

Modular Stereo POTS • ISDN • GSM Codec

Introducing the new Tieline Commander G3

At Tieline, we've taken a fresh approach to audio codec design. Now you can customize your audio codec to suit your exact needs for remote broadcasts and STLs. You only pay for what you need and we're the first to be compatible with most major ISDN and POTS codecs in your rack.

Think of the new Commander G3 as a codec foundation with two expansion slots which accept your choice of POTS, ISDN and GSM modules. You simply buy what you need.

For example, if you need a mono 15kHz POTS codec, simply buy the Commander G3 with a POTS module for one low price. Need 15kHz Stereo or dual mono over POTS? Just add another POTS module.

If you're looking for a mono/stereo ISDN codec without POTS, you can buy a Commander G3 with an ISDN module only. It comes with G.711, G.722, and Mpeg Layer 2. Tieline's "Music" algorithm also delivers an astounding 15kHz stereo over a single ISDN B channel! You can always add a POTS or wireless GSM module later if you need.

Need a stereo ISDN STL with automatic failover to 15kHz mono POTS? Buy the Commander G3 with POTS and ISDN modules plus Tieline's new Freedom Failover software kit.

Plug in the GSM module and deliver up to 7.5 kHz over GSM networks and up to 15 kHz over HSCSD wireless networks.

Control your remote talent's mic input gain from the studio and send simultaneous audio, serial data and relay activation in either direction.

We've even created digital matrix router software which enables you to cue audio off air, create a local audio intercom, and talkback to the studio all without interrupting your broadcast.

The new Tieline Commander G3 is simply the world's most powerful, flexible and customizable codec. It's even compatible with your Comrex** Vector, Matrix, Blue and Musicam Liberty POTS codecs.

Every Tieline codec comes with a two year warranty plus the support of an experienced engineering team with more than 25 years in the broadcast industry right here in Indianapolis. That's why hundreds of stations, major radio groups and networks across America use Tieline to deliver audio every single day.

Hurry, free demonstration Commander G3's are limited. Call your favorite broadcast dealer or call us at 800-750-7950 to book your free demo.



Tieline TECHNOLOGY

** Comrex and Musicam are registered trademarks of each respective corporation

800-750-7950

www.tieline.com/rw

World Radio History

ABCs of Broadcast & Audio Standards

by Tom Vernon

If you're a regular reader of Radio World and even marginally involved in broadcasting, you probably know the major equipment companies and the names of the movers and shakers in our industry.

Less well publicized, but equally important, are the groups that establish our technical standards, and the people who toil behind the scenes to make it happen.

NRSC, MPEG, IEEE — what do all those initials stand for?

Alphabet soup

NRSC, the National Radio Systems Committee, is jointly sponsored by the National Association of Broadcasters and the Consumer Electronics Association. It provides a forum where broadcasters and receiver manufacturers can work to develop standards and solutions for broadcast systems. Most members are engineers, technicians or scientists with a detailed knowledge of the subjects under study. Currently there are four subcommittees under NRSC.

The Digital Audio Broadcasting Subcommittee of the NRSC is responsible for a 10-year effort in the development and testing of in-band/on-channel (IBOC) digital radio systems for both AM and FM. At present, the DAB Subcommittee is developing voluntary standards for IBOC, based on the Ibiquity HD Radio technology.

The AM Broadcasting (AMB) subcommittee functions to maintain the NRSC standards for analog AM broadcasting. Digital data broadcasting is the focus of NRSC's DDB Subcommittee, and the recently-reactivated RBDS Subcommittee maintains the NRSC's RBDS standard.

The NRSC has developed four sets of standards for radio broadcasters:

NRSC-1 specifies AM preemphasis/deemphasis and broadcast audio transmission bandwidth specifications;

NRSC-2 describes emission limitations for AM broadcast transmission;

NRSC-3 details audio bandwidth and distortion recommendations for AM broadcast receivers;

NRSC-4 is the standard for United States RBDS signals.

Dave Wilson, director of engineering for CES, says, "Broadcasters and receiver manufacturers must depend on each other to make things work, and our organization is a forum for making that happen." He said a hot topic that the RDS group is grappling with is dynamic PS code, which provides a fast update of text but is not compliant with the NRSC-4 standard.

"Our ultimate goal," Wilson said, "is to have RDS on par with the text services available through satellite radio."

Moving pictures and more

Established in 1988, MPEG, short for Moving Picture Experts Group, is a working group in a subcommittee of the International Organization for Standardization/International Electrotechnical Commission (ISO/IEC), in charge of developing standards for coding movies, video and music in digital compressed formats.

MPEG standards owe much of their popularity to the fact that MPEG files are usually much smaller for the same quality. The MPEG standards describe bit stream syntax and decoder specifications, and include ISO/MPEG-2, optimized for 128 kbps per channel, as well as ISO/MPEG Layer 3 (also known as MP3), which is optimized for 56 and 64 kbps per channel transmissions.

Less well known are MPEG-4, a standard that describes coding of natural and synthetic audio objects, and MPEG-7, an audio description of meta information on sound.

Dolby Laboratories developed standards for noise reduction and signal processing. The original Dolby standard for noise reduction in professional-grade analog tape equipment, Dolby A, was developed in 1965. Dolby SR, for "Spectral Recording," was developed in 1986.

Dolby AAC, or Advanced Audio Coding, is a standard for digital compression of audio files that competes with MP3. Dolby claims that it delivers audio quality comparable or better than MP3, with significantly lower bit rates.

New advances in technology may make the adoption of a single technical standard for broadcast transmission and reception less important than it has been in the past, and lead to more rapid transitions to new technologies.

In recent years, for example, the adoption of a standard for AM stereo was delayed for a number of years as four competing standards dwindled to two, and finally one.

Do it in software

Software radio may make these types of delays a thing of the past.

Vanu Bose, president and CEO of software radio developer Vanu Inc. and keynote speaker at the IEEE Broadcast Technology Society Awards Luncheon this month in Washington, said, "A software radio is a wireless communications device in which all of the signal processing is implemented in software. By simply downloading a new program, a software radio is able to interoperate different protocols, incorporate new services and upgrade to new standards."

Software radios also have the potential

Save yourself the fine *and* expense of fixing the problem. Some fencing contractors will barter with radio stations. But barter or not, don't ignore this kind of problem.

★ ★ ★

We're beyond most of the FM ducting problems by this time of year; but Dielectric's Radio Product Line Manager Matt Leland passed on a Web site that you should bookmark for next year.

Ducting can drive an engineer crazy. Not only for FM reception, but RPU shots, too. Too many PDs and GMs attribute this phenomenon to "something" we engineers are doing wrong or not doing. "I can't hear the station! It's got to be the engineer's fault!"

(I do remember one chief who used the phenomenon to get a spare set of new tubes. When you can't hear the station, I guess management will do almost anything. I never sold a new transmitter as a result of ducting, but I guess it's possible.)

This site will be helpful next year when Mother Nature starts tormenting us: <http://home.cogeco.ca/~dxinfo/tropo.html>

Matt Leland can be reached at matt.leland@dielectric.spx.com.

John Bisset has worked as a chief engineer and contract engineer for more than 30 years. He is the northeast regional sales manager for Dielectric Communications. Reach him at (571) 217-9386, or john.bisset@dielectric.spx.com.

Submissions for this column are encouraged, and qualify for SBE recertification credit. 🌐



for mass customization, by downloading different standards into each receiver.

As one observer who works in the halls of Radio World commented, software radio may bring benefits for broadcasters as well as consumers.

"Now the broadcaster can truly have a secret weapon in his tool bag by varying the codec best suited for the program material (any time, any day, any song). This is where thing will start to get interesting from a competitive standpoint."

Tell Radio World your thoughts on current and future standards. Write to radioworld@imaspub.com.

Tom Vernon is a technical training specialist working in Philadelphia. Reach him at (717) 367-5595. 🌐

For More Information

There are many resources on the Web where you can find up-to-date information about standards and the activities of standards committees.

www.nrscstandards.org: Information about NRSC's subcommittees and standards, including RBDS and DAB.

www.dolby.com: Most of the broadcast information is about TV audio, but the knowledge base has a wealth of information on Dolby AAC vs. MP3 and Dolby 5:1 Surround Sound.

www.worlddab.org: An international, non-governmental organization, World DAB coordinates implementation of digital radio based on the Eureka-147 standard. The site has lists of standards, FAQs and links to organizations promoting digital radio on a country-by-country basis.

www.ce.org/standards: Most information of interest to broadcasters is on the NRSC site, but the Consumer Electronics Association's site has additional standards and information about receivers and other consumer gear.

www.mpeg.org: This site has information and resources for MP3, tutorials about AAC vs. MP3, links to MP3 players and a wealth of links to other sites.

www.chiariglione.org/MPEG: This is the official MPEG Web site. See 'From MPEG1 to MPEG21' for a complete description of MPEG's development activities for the past 15 years.

www.aes.org/standards: Information on upcoming standards meetings, working group reports, standards in print and a database of connectors and coding tables.

Tubes

► Continued from page 10

overly thick layer of carbon will make the filament so fragile that transporting it by surface or airfreight will ensure its destruction. The tube will fail before it's even used.

★ ★ ★

Doug Hall works with General Manager Kevin Potucek at the Communications Studies Department of the College of New Jersey. Fig. 1 shows Doug at the first of seven edit suites he and Kevin are installing.

The suites use Pro Tools, Final Cut and a Digi-002 console. An Avid package is to be added to the cassette, DAT and MD machines in each suite to provide state-of-the-art audio and video editing.

I often hear engineers lament, "Where will the next generation of engineers come from?" Schools like the College of New Jersey are stepping up with the answer. This is no "hand-me-down" studio; graduates will be trained on what's current in the industry.

★ ★ ★

Joe Stack at Modulation Sciences writes, "I've discovered that sometimes a small burst of dry air is needed and there's no can of 'commercial' dry air available. Using an empty plastic dish-

washing soap bottle like Dawn or Joy, with the nozzle still on, will give a nice, forceful burst of air every time the bottle is squeezed, and all without batteries."

Using this air bottle along with a small clean paintbrush can help push dirt from hard-to-reach places inside a transmitter or computer.

Have you wondered what to do with those little silica gel packs packed with products to absorb moisture? If you are worried about the air inside the bottle collecting moisture, Joe says, unscrew the cap of the plastic bottle and insert a little gel pack to "soak" up any moisture that might get in.

Sometimes, simple tips are the best.

Joe Stack can be reached at jstack@ieee.org

★ ★ ★

If you've monitored the trades, you've seen a number of stations fined for missing, inadequate or damaged tower fencing. Fencing seems to be a hot button for inspectors these days (along with EAS).

The best course of action when this kind of problem is discovered is to show prompt diligence in getting it corrected, as the engineer did for the site in Fig. 2 on page 10.

In another case, a station recently was fined for not fencing its tower, which was in a swamp. The station staff had figured that no one could get to the tower because of the swamp, so it didn't need a fence. The FCC didn't buy that.

Streaming audio sound a bit muddy?

Clean it up with Omnia A/X.

The biggest problem with streaming audio is, quite frankly, its sound: swirling, gritty and muddy. This is no way to treat your carefully crafted programming.

Omnia A/X helps wash streaming audio clean with the power of Omnia audio processing – captured on your PC. Modeled after the highly successful Omnia-3net (our hardware-based three-band processor), Omnia A/X gives you full control over the dynamics of your web-casting, audio production, recording, mastering... just imagine all you can do!

Forget about dedicated PC cards and other gimmicks; Omnia A/X is **software-based** — all DSP calculations are performed natively, within the PC processor, saving the cost and hassle of specialized cards or external devices. Just load the software onto your Windows PC and Omnia A/X is ready to work, integrating seamlessly with Windows Media, Real, MP3 streaming encoders and audio production software.

Omnia A/X is so intuitive and simple to use, you'll be processing audio in just minutes. All the familiar tools you need are just a mouse click away: three bands of Automatic Gain Control plus wideband AGC, distortion-free final limiter, bass enhancement, and factory presets to simplify setup.

Don't settle for streaming audio that's buried in the mud. Let it sparkle instead with Omnia A/X.



Omnia A/X the pure-software audio processor for your Windows PC. Streaming and bit-reduced audio are dramatically improved by the power, punch and purity of Omnia.

Omnia
A Telos Company
omniaaudio.com

Radio World

Covering Radio's Digital Transition

October 6, 2004

FIRST PERSON

KUVO Turns on IBOC in Colorado

First FM in the State to Go Digital Also Is First to Test Nautel HD Radio Transmitter

by Mike Pappas

DENVER KUVO is the first FM broadcaster in Colorado to broadcast HD Radio. We turned on the digital signal Aug. 1. As a stand-alone public radio station with a full-time classic jazz format, KUVO 89.3 FM has always tried to be on the forefront of technology.

In 1999 KUVO was the first radio station in the Denver market with a fully digital plant; so it was a natural for us to be interested in HD Radio. When HD Radio seed market money became available for Denver from the Corporation for Public Broadcasting last year, its parent, Denver Educational Broadcasting Inc., applied for the grant.

The \$75,000 CPB grant was approved late last year. As chief engineer, I was

charged with the conversion.

At the time of our CPB application,

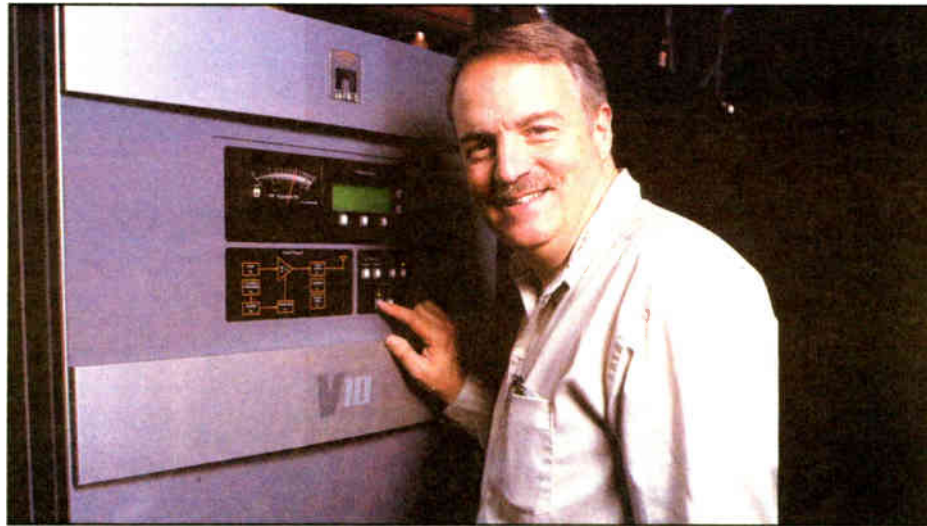

KUVO Chief Mike Pappas checks out the Nautel V-10 HD Radio transmitter

high-level or low-level combining. Adding to the potential issues of high-level combining, we are diplexed into an eight-bay Shively 6810 BR with a Kathrein combiner only 800 kHz away from KVOD's 90.1 MHz signal.

Best implementation scenario

I attended the National Public Radio Public Radio Engineering Conference preceding the NAB this year and there was a fair amount of discussion regarding the problems of both antenna and high-level combining, including spectral regrowth problems and transmitter isolation issues.

Spectral regrowth can happen when HD Radio "sidebands" mix with the primary carrier frequency and create spurious signals on second, third and fourth adjacent channels. The transmitter isolation issue involves the need to keep the analog FM signal out of the HD Radio transmitter where it can create spectral re-growth problems.

Isolators can be used to increase the isolation to the HD Radio transmitter, but the initial estimates on the amount of isolation required to prevent spectral regrowth appeared to be off by an order of 10 dB or so. Additionally, finding an isolator with sufficient power handling and isolation in the time frame we needed was questionable.

GUEST COMMENTARY

5.1 Surround Implemented How?

Frank Foti Says Radio Needs the Real Thing, Not Synthesized, Matrixed or Compromised

by Frank Foti

The Aug. 11 issue of Radio World contains the article, "5.1 Implementation in the Real World," by Robert Reams of Neural Audio. Mr. Reams is to be complemented for his insight and efforts in the exciting area of surround audio.

We, at Telos, Omnia and Axia share in this enthusiasm. We expect that the ability to broadcast surround may well be significant for FM radio's future. And we thank Radio World for providing a forum to discuss this important topic.

Mr. Ream's article proposes that a matrix surround system should be good enough for FM broadcast. But matrix systems are yesterday's technology and have critical limitations, as most who have seriously studied the topic agree. This is why we support an advanced multichannel method for 5.1 HD Radio FM transmission that has performance very close to discrete.

Not your Dad's surround

Radio needs the real thing, not synthesized, not matrixed, not compromised. For surround on radio to be respected and to successfully compete with other media, we need state-of-the-art performance, and the matrix methods just don't cut it.

The multichannel system invented by

Fraunhofer Institute (FhG) and Agere Systems is superior in every way. It should be — it comes from people who know their stuff.

FhG are the folks who created MP3 and MPEG AAC. FhG is also getting a lot of attention for its new Isoono system that uses as many as 304 loudspeakers to create an amazingly enveloping sound space for applications like high-end movie theaters.

The Agere people are former Lucent and Bell Labs audio coding researchers. As Telos' Steve Church explained in a recent Radio World Guest Commentary (June 16), the system Agere has developed is a powerful spatial audio coding technology that takes advantage of the latest knowledge in aural perception.

From psychoacoustics, we know that the level difference, time difference and coherence between channels are what create the perception of spatial image. FhG's encoder estimates these values in multiple frequency sub-bands and transmits them to the decoder in an ancillary stream that accompanies the usual stereo audio stream.

A very compact representation lets the surround information be transmitted in HD Radio's FM ancillary data channel. The stereo signal is unaffected and the system is compatible with current HD

See SURROUND, page 18 ▶

my initial plan was to use antenna combining of the analog and digital signals with our new antenna at our new tower site. KUVO, along with KRMA Rocky Mountain Public television and KVOD(FM) Colorado Public Radio, have been working on building a new



Engineers Justin Peacock (left) and Joey Kloss check the Omnia processor.

transmission site for the last five years on Mt. Morrison. Our existing site, built in the early 1950s on Lookout Mountain, is a "non-conforming user"; the zoning prevents us from making any modifications to the tower or antenna.

Additionally, construction delays at the Mt. Morrison site of more than 18 months caused us to consider high-level combining with our current antenna/tower site to get us on the air with HD Radio before the CPB grant ran out.

As a result, I needed to look at either

As a result of the PREC information, I tossed out our initial plan for antenna combining and rethought how best to implement HD Radio. At the NAB, I met with vendors and discussed our options and looked at equipment.

I decided that our best approach was to go with low-level combining. I was concerned about the issue of spectral regrowth and low-level looked like it might offer the best solution to this problem. The Denver FM market is

See KUVO, page 16 ▶

More Reasons Stations are Choosing BE HD Radio Solutions



Reason #8 — On-the-Fly Mode Change

Only Broadcast Electronics offers you the flexibility and system efficiency of on-the-fly mode change. BE HD Radio™ Transmitters can be switched among HD Radio-plus-analog FM, HD Radio-only, and analog FM modes without transmitter modifications. On-the-fly mode change gives you more options as you make your transition to HD Radio, as well as enhances ongoing system operation and backup capabilities.



Broadcast Electronics, Inc. • Tel: (217) 224-9600 • Fax: (217) 224-9607 • Web: www.bdcast.com • E-Mail: bdcast@bdcast.com

HD Radio in the Top 10 Markets

| Market | Licensed | On-Air | Market | Licensed | On-Air |
|--------------------|----------|--------|---------------------|----------|--------|
| 1-New York | 10 | 6 | 6-Philadelphia | 10 | 5 |
| 2-Los Angeles | 18 | 9 | 7-Houston/Galveston | 1 | 0 |
| 3-Chicago | 10 | 10 | 8-Washington | 4 | 4 |
| 4-San Francisco | 13 | 9 | 9-Boston | 13 | 8 |
| 5-Dallas/Ft. Worth | 5 | 1 | 10-Detroit | 16 | 12 |

HD Radio in: Florida

The following stations in Florida are licensed by Iiquity for HD Radio.

| Rank | Market | Call Sign | AM/FM | Freq. | Format | On Air? | Owner |
|------|-------------------------------------|-----------|-------|-------|-------------|---------|--------------------------------|
| 12 | Miami-Ft. Lauderdale-Hollywood, FL | WFLC | FM | 97.3 | AC | | Cox Radio, Inc. |
| 12 | Miami-Ft. Lauderdale-Hollywood, FL | WQAT | FM | 105.1 | Urban AC | | Cox Radio, Inc. |
| 12 | Miami-Ft. Lauderdale-Hollywood, FL | WKAT | AM | 1360 | Classical | | Spanish Media Broadcasting |
| 12 | Miami-Ft. Lauderdale-Hollywood, FL | WLRN | FM | 91.3 | Nws/Tlk/Inf | | Miami/Dade County School Board |
| 12 | Miami-Ft. Lauderdale-Hollywood, FL | WPOW | FM | 96.5 | Rhync/CHR | | Beasley Broadcast Group |
| 12 | Miami-Ft. Lauderdale-Hollywood, FL | WPYM | FM | 93.1 | Rym/CHR/Dnc | | Cox Radio, Inc. |
| 12 | Miami-Ft. Lauderdale-Hollywood, FL | WQBA | AM | 1140 | Spn/Nws/Tlk | | Univision Radio |
| 12 | Miami-Ft. Lauderdale-Hollywood, FL | WRHB | AM | 1020 | Ethnic | | New World Broadcasting |
| 12 | Miami-Ft. Lauderdale-Hollywood, FL | WRHC | AM | 1560 | Spn/Nws/Tlk | | WRHC Management Corp. |
| 12 | Miami-Ft. Lauderdale-Hollywood, FL | WRTD | FM | 98.3 | Span/Trpcl | | Univision Radio |
| 12 | Miami-Ft. Lauderdale-Hollywood, FL | WUFE | AM | 670 | Spn/Spt/Nws | | Fenix Broadcasting Corp. |
| 12 | Miami-Ft. Lauderdale-Hollywood, FL | WDNA | FM | 88.9 | Jazz | X | Bascomb Memorial Brcdst. |
| 12 | Miami-Ft. Lauderdale-Hollywood, FL | WEDR | FM | 99.1 | Urban | X | Cox Radio, Inc. |
| 12 | Miami-Ft. Lauderdale-Hollywood, FL | WHSR | AM | 980 | Internat l | X | Beasley Broadcast Group |
| 12 | Miami-Ft. Lauderdale-Hollywood, FL | WKIS | FM | 99.9 | Country | X | Beasley Broadcast Group |
| 12 | Miami-Ft. Lauderdale-Hollywood, FL | WQAM | AM | 560 | Sports | X | Beasley Broadcast Group |
| 12 | Miami-Ft. Lauderdale-Hollywood, FL | WRMA | FM | 106.7 | Span/Btfs | X | Spanish Broadcasting System |
| 12 | Miami-Ft. Lauderdale-Hollywood, FL | WUNN | AM | 1470 | Motivatiol | X | Beasley Broadcast Group |
| 21 | Tampa-St. Petersburg-Clearwater, FL | WUSF | FM | 89.7 | Educational | X | University of South Florida |
| 47 | West Palm Beach-Boca Raton, FL | WJNA | AM | 640 | Nostalgia | | Crystal Boynton Beach, Inc. |
| 47 | West Palm Beach-Boca Raton, FL | WXEL | FM | 90.7 | Clsc1/NPR | | Barry Telecommunications |
| 47 | West Palm Beach-Boca Raton, FL | WSBR | AM | 740 | Bus News | X | Beasley Broadcast Group |
| 50 | Jacksonville, FL | WJCT | FM | 89.9 | News/Info | | WJCT, Inc. |
| 124 | Pensacola, FL | WYCT | FM | 98.7 | cp - NOA | X | ADX Communications |

The HD Radio Scoreboard is compiled by Radio World using information supplied by Iiquity Digital Corp. This page is sponsored by Broadcast Electronics. The data shown here reflect best information as of Sept. 17, 2004. HD Radio is a trademark of Iiquity Digital Corporation.

The Bottom Line

Licensed



On the Air



Market Penetration



Licensed by Iiquity and on the air

Licensed by Iiquity and not on the air

HD
RADIO
SCOREBOARD

KUVO

► Continued from page 14

congested, and the last thing I wanted to worry about was interference to other broadcasters.

We are on the air with a Nautel FM-10 analog transmitter and it has logged more than 40,000 hours of run time since we purchased it. In that time, we have had only 3 hours of unscheduled downtime.

With that kind of reliability it only made sense for us to take a look at the Nautel HD Radio solution. At the NAB, Nautel was showing its new M-50 HD Radio-capable adaptive pre-distortion exciter along with the Nautel V-10 HD Radio-compatible transmitter. Looking at the spectrum analyzer plots from the M-50/V-10 combination showed that spectral re-growth was virtually eliminated with Nautel's DSP adaptive pre-distortion system.

As a result of seeing the Nautel demo

We also needed Ethernet to the site for program-associated data. Based upon these requirements I ordered two sets (four frames) of Harris Intraplex, which were configured with two sets of 44.1/16 uncompressed AES/EBU digital audio — the second audio channel is for a Tomorrow Radio secondary audio channel which we will implement as soon as it becomes available — four RS-232 lines, two POTS telephone circuits and 512 kilobits per second of Ethernet capability.

Listening tests used

The Intraplex frames output E-1 (32 time slices at 64 kbps, eight more than T-1), which goes into our E-1 x 2 microwave radios for transmission to our site on Lookout Mountain. We used our Terra Sonde Digital Audio Toolbox watchdog feature to monitor the STL system long-term and check for errors on the AES/EBU digital audio channels.

We needed a 20 kHz processor and

needed to supply the 208 three-phase power to the V-10. As part of the electrical work we ordered 100 foot of 4-inch wide copper strap to provide grounding and lightning protection. By the time we got all of the grounding installed we had only a foot of it left over.

All of our planning paid off, as it only took 16 hours from the time the transmitter was moved into the building to initial power up. On July 28 the engineering crew from Nautel arrived to commission the V-10. Mike Woods, FM project leader, and Chris Mahaney, research technologist, arrived and started the final commissioning.

While Mike and Chris worked on the V-10, the KUVO engineering staff of Justin Peacock, Joey Kloss and John Micky finished assembling and wiring the support rack which included installing the Harris Intraplex frames, microwave radios, the Omnia, Ethernet hub, MGE UPS, Nautel coax switch

The other interesting result besides occupied bandwidth was the frequency measurement. The M-50 exciters receive a 10 MHz reference clock from the GPS receiver and the FM carrier frequency error was less than 0.5 Hz!

We did several sets of A-B listening tests switching between our Nautel FM-10 with its old STL, a Moseley PCL-606, and processing and the V-10 with the new STL and air chain. The analog FM side of the V-10 made the best FM audio I have ever heard.

The Omnia 6 EX HD has an open and clean sound that makes us really stand out on the dial and yet it sounds unprocessed. Additionally, it has more apparent high-end than our old chain (which was no slouch, either).

Once we commenced with full-time Nautel M-50/V-10 HD Radio operation on July 30, I have received numerous calls from our listeners commenting on how much better KUVO's analog FM signal sounded after the change.

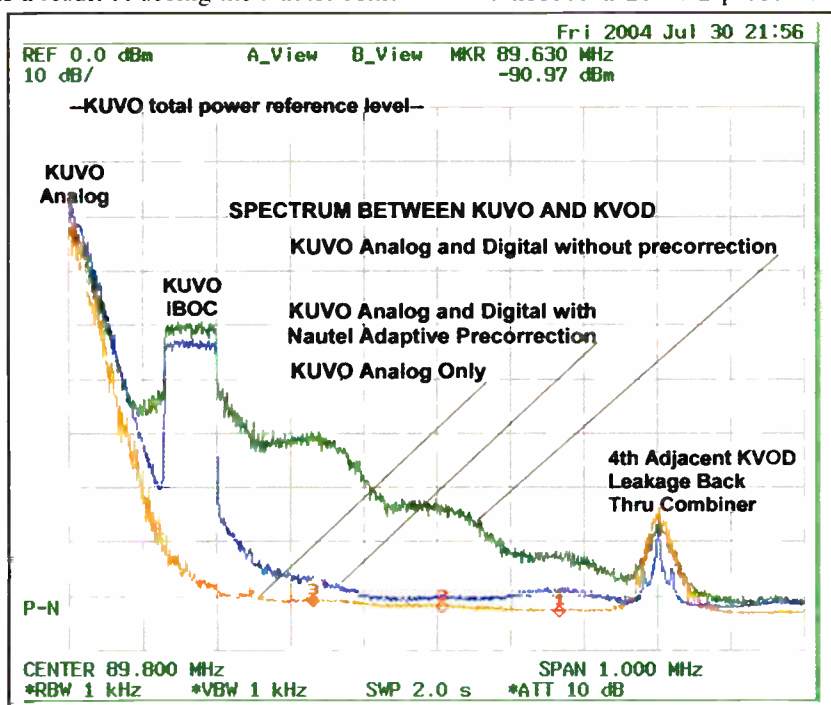

Nautel hired David Maxson of Broadcast Signal Labs to document the performance of the V-10/M-50 combination. The results show KUVO's signals are within the FCC's RF mask.

at the NAB Show I ordered the Nautel V-10 hybrid transmitter with the Nautel M-50 adaptive preconditioning exciters. Our 6.2 kW TXPO needed to generate our 22,500 ERP was within the 7.7 kW HD Radio capability of the V-10 and we agreed to be a beta site for the first unit shipped.

Nautel committed to delivering the V-10 on July 23 and we scheduled installation to start on the 24th.

During the wait for the Nautel we went ahead and prepped the site for the transmitter. Our existing STL was composite-based and we needed to have an AES/EBU 44.1 kHz/16 bit/20 kHz-capable STL.

we auditioned both of the major HD Radio processors. As a result of our listening tests we purchased an Omnia 6 EX HD.

Prior to its installation we had dialed in the processing and created the day-parts for all of our specialty shows. The Omnia 6 is a powerful processor and it has a huge number of adjustments. To speed up my learning curve, I made several calls to Omnia support to help me tweak the 6 EX HD and the results were most satisfying.

We also installed a Dielectric 3 1/8-inch coax switch to let us rapidly switch between our FM-10 and the V-10 and we purchased all of the electrical parts

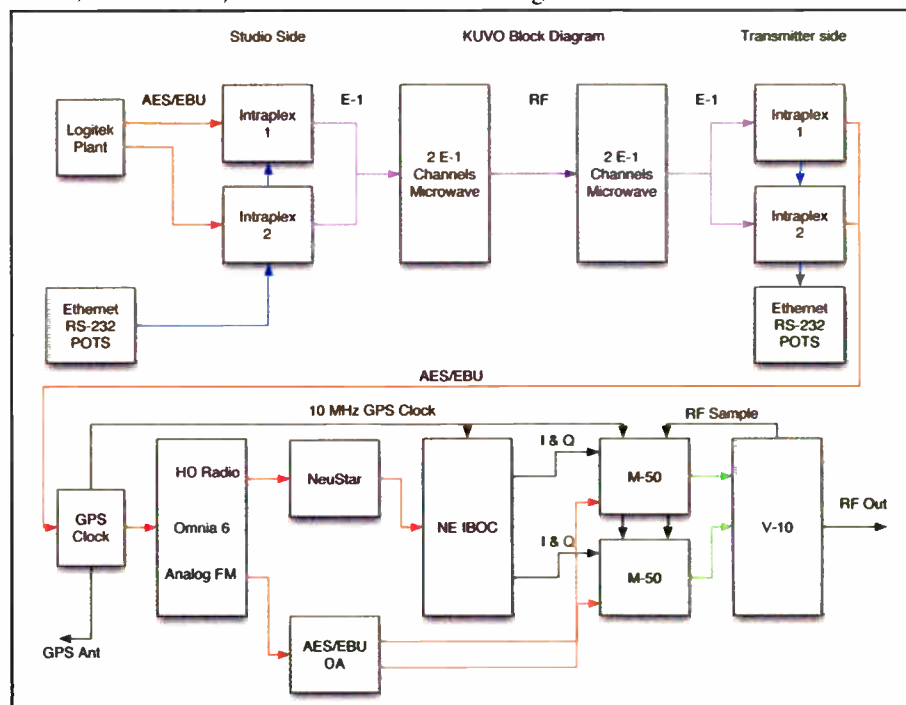

Block Diagram of KUVO's Air Chain

controller and the Sine Systems RFC remote control.

We started on-air testing late on the 29th and found that using our old modulation monitor to set the modulation levels on the FM side was problematic when the HD Radio carriers were on. With no modulation present, no sub carriers, the stereo pilot on and the HD Radio carriers on, our analog FM modulation monitor was indicating 20 percent to 25 percent modulation.

It would appear that in this day and age of HD Radio, our old analog FM modulation monitor's time has passed. We ended up setting the analog FM modulation level on the M-50 exciters by turning off the HD Radio carriers.

Nautel arranged to have David Maxson of Broadcast Signal Labs in Boston arrive on the 29th to document the performance of the Nautel adaptive pre-distortion system on the M-50 exciter. He was able to confirm that the V-10/M-50 combination met all FCC occupied bandwidth requirements with margin to spare and was not creating any spectral re-growth problems.

Performance documentation

We also had our regular measurement engineer, Howard Eldridge of Frequency Measurement Co., perform a full set of measurements from our air signal. His results confirmed Maxson's measurements.

Additionally, the V-10 has been rock solid and we haven't had a single glitch with it since it went on the air.

The total cost of the HD Radio conversion was in the range of \$130,000, with the CPB grant covering \$75,000 of it. This was more than I initially budgeted; the cost increase resulted from the change from antenna combining to low-level combining.

We did a fair amount of listening to the HD Radio signal using the Ibiqity HD Radio reference receiver to set the levels between the analog FM side and HD Radio. We also used it to set the delay time on the M-50 exciter of the AES/EBU digital input for the analog FM signal.

We found we needed eight seconds of delay on the analog side to match the HD Radio digital signal. This delay didn't present any issues for our on-air staff, as we haven't monitored off-air since the installation of our digital plant in 1999.

A pair of Broadcast Tools Silence Monitors (one at the studio and one at the transmitter site) alert engineering via the Sine Systems remote and the studio using BetaBrite electronic text displays in the plant. We put both Nautel M-50 exciters on the MGE UPS as we get frequent power hits at the site and keeping the exciters up saves having to wait eight additional seconds for the delay to fill to restore audio.

See KUVO, page 19 ►

Product Showcase



Model DAI-2 Dialup Audio Interface

- perform unattended remote broadcasts
- DTMF operated controller with relay outputs
- fully programmable output on any key press
- momentary and/or maintained relay outputs
- four logic inputs with programmable output
- balanced audio input and output with ALC

Sine Systems, Inc.

615.228.3500
more information: www.sinesystems.com

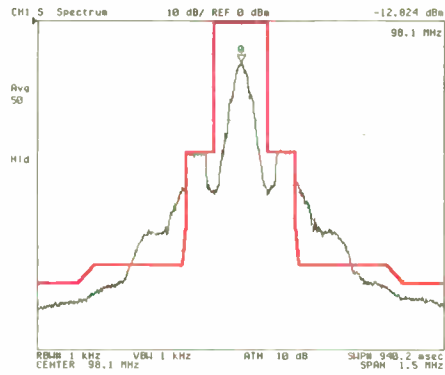

Going...

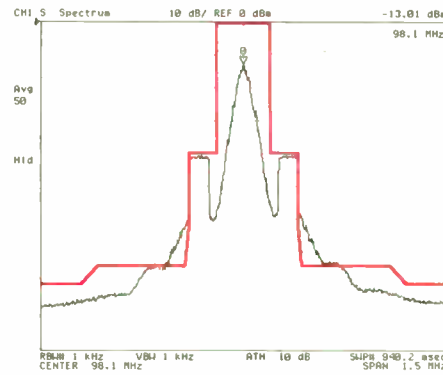

Going...

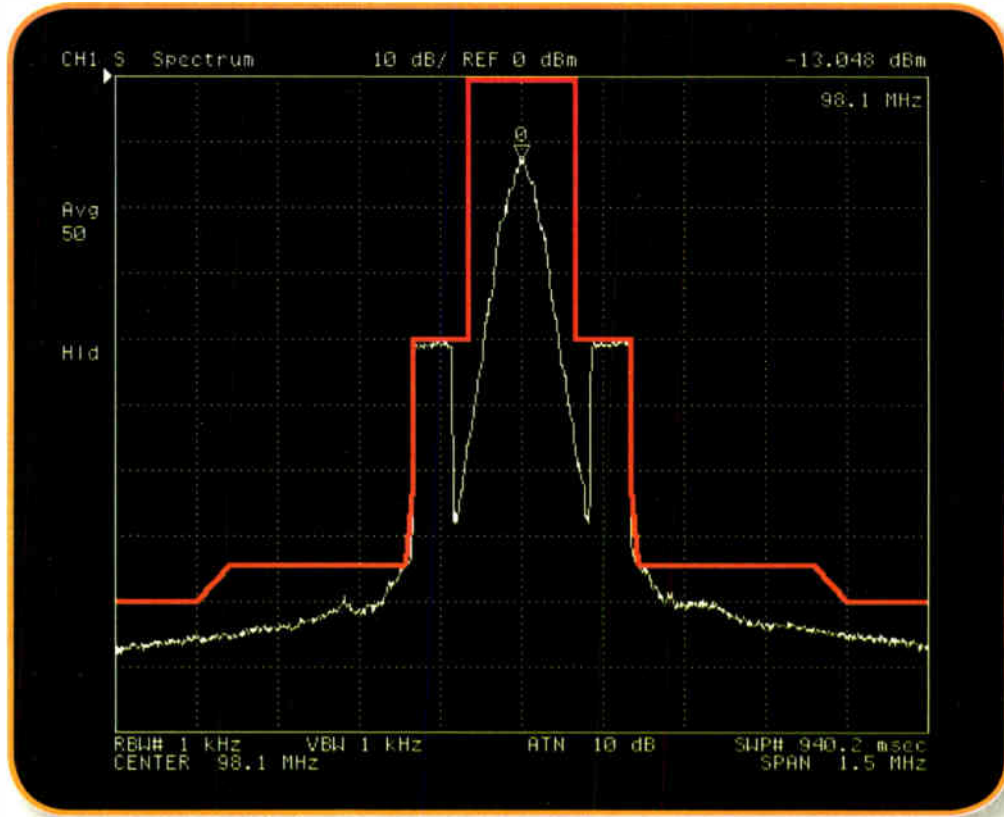

Gone.

See us at the
NAB Radio Show
 Booth # 1410
 •••••
 Visit www.nautel.com
 For late-breaking
 updates on
 Nautel's NAB Radio
 Show Events

Introducing Nautel's Newest Cutting Edge FM Technology – **Digital Adaptive Pre-Correction**



V10

Worried about not meeting the HD Radio™ mask requirements? After all, you wouldn't want to interfere with someone else's signal. Nautel's new M50 Direct-to-Channel digital FM exciter samples the all-digital or hybrid HD Radio™ output of the V10, 10 kW FM transmitter and dynamically applies digital adaptive pre-correction. This means no expensive external bandpass filter and no additional tuning. Even better, because the M50 continuously monitors and adjusts the RF output, your performance is optimized regardless of environmental changes and your signal will always be within spectral limits.

To learn more about how we can perfect your HD Radio™ signal, visit our website www.nautel.com.



M50



Surround

► Continued from page 14

Radio FM transmitters and receivers. (Details on this technology can be found at www.omniaaudio.com.)

All of the matrix-based schemes contain a dual drawback: They compromise the 5.1 separation and they degrade the stereo mix.

The word *matrix* as applied to surround comes from the fact that the surround channels are mixed (matrixed) into the stereo channel with altered phase. You suppose you can't hear that when you are listening in stereo? With matrix, you get unacceptable spatial distortion in both the stereo and surround signals.

The analog FM-stereo system in place today offers discrete two-channel audio with



Ask Dad about this backwater tech!

separation that reaches 70 dB. The broadcast industry would not have accepted a method for FM stereo that used synthesized, fake duophonic sound, and passed that off as stereo. This is akin to what the matrix proponents wish to do.

Matrix methods such as Neural's which use a steering channel to vary the decoder's

phase/amplitude coefficients — theirs is apparently in a "watermark" buried within the analog FM signal — can improve the perception of surround separation on some types of programs compared to a classic matrix approach, but all the channels are still mixed to two in the usual matrix fashion and the problems from doing that are still there.

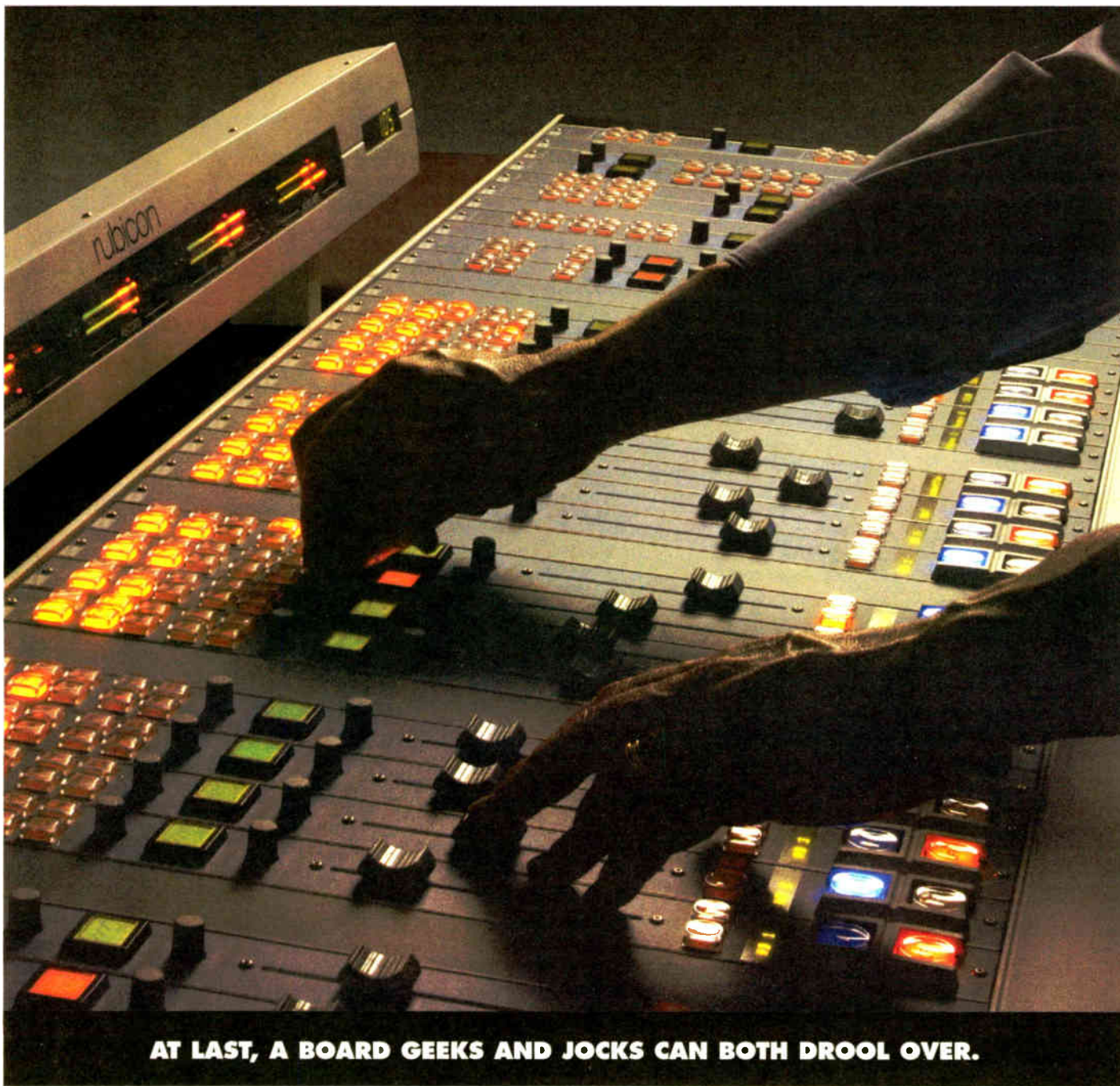

AT LAST, A BOARD GEEKS AND JOCKS CAN BOTH DROOL OVER.

Fact is, SAS packs so much sophistication and capability into the depths of the new **Rubicon™** control surface that even the most intensive major market



SAS Connected Digital Network™
Rubicon Control Surface
32KD Digital Audio Router
RIOLink™ Remote I/O

programmer or board operator will swoon. Yet Rubicon is so intuitive, so comfortable, so easy to use, the weekend intern is sure to sound like a pro. Here's why:



Frequently used controls are always right at the operator's fingertips. And for the power-user, the multi-function "dynamic control matrix" provides quick access to deeper capabilities. In other words, Rubicon has a bucket load of features for the simplest or most complex of broadcast-related tasks.



And should you think form to precede function, you'll find Rubicon's clean, easy-to-understand interface wrapped up

within a custom-configured, drop-dead gorgeous frame.

Best of all, Rubicon is engineered by the brand synonymous with the finest in digital audio routing and network design. When it comes to quality and reliability, our name is all over it.

Come see for yourself Rubicon's brains and beauty, power and performance.

It'll be love at first sight.



Engineering great radio.
**SIERRA
AUTOMATED
SYSTEMS**

For more information call 1.818.840.6749,
email sales@sosaudio.com or visit www.sosaudio.com.

Now let me address each of Mr. Reams "real world" issues.

Scarcity of 5.1 music. If radio were to be broadcast in a 5.1 format, there is no question record companies would respond by making 5.1 versions of their releases available. They have a strong motive for doing so, since they have the opportunity to sell surround music to consumers in the DVD-audio and Super Audio CD formats and radio would provide potent promotion.

TM Century has told us that it is excited about the possibility to provide broadcasters with surround mixes of both oldies and currents, and that it has the capability to do this. Mr. Reams approach is to "render 2.0 channel material on 5.1 speakers" — another way of saying that a synthetic, "re-channeled for surround" approach is good enough.

Lack of 5.1 infrastructure. A 5.1 studio infrastructure is just too much trouble for our industry to deal with? What does he think, that we can't count past two? That we can't figure out an audio editor that goes past stereo?

Just as broadcast engineers in a previous generation successfully managed the transition from mono to stereo, we will certainly be able to handle today's demand for a channel increase. As regards to studio routing, cabling, etc., by the way, one way of going to multi-channel is as easy as CAT-5.

Look around — the world today is migrating to network-based audio distribution via high-speed networks. Adding more channels to a network-based router and cabling installation is done mostly by changing the software of the system, at very little incremental cost compared to stereo.

It's the same for delivery systems. Modern consoles use the surface+engine configuration, so existing surfaces might well be connected to upgraded engines. Yes, since matrix systems mix everything to two channels, they offer the advantage that stereo studio wiring, etc. can be used. But is that reason to clamp our industry forever to a '70s quad-like approach?

Lossy codecs are incompatible with traditional surround. Absolutely correct. You don't want to run audio from a traditional matrix system like Dolby ProLogic over a compressed channel like HD Radio FM. The result is not at all pretty and we are not proposing to do this.

Automotive playback. The article seems to say also that the automotive world can't deal with discrete. But there are already full-discrete systems in a few high-end cars using DVD-audio players, and more are coming soon in most models.

Why would broadcast discrete be a special problem case? Both stereo and surround are fully supported by the FhG system, as it delivers both the original stereo mix and the discrete surround mix as they were created in the recording studio to each class of receiver.

With regard to handing stereo from non-5.1 stations, this could be done just as it is today with the rear speakers simply duplicating the front, or a local spatial processor — such as Dolby, SRS or even Neural's — could be used to synthesize some different effect, should a listener prefer that.

With the current expansion of digital audio delivery technologies — satellite, Internet, DVD and SACD — now is hardly the time to dilute or dumb down broadcast radio tech. We're going to need the best we can get.

Foti is president of Omnia Audio. Radio World welcomes other points of view. 🗣️

KUVO

► Continued from page 16

We did a demo of HD Radio for the KUVO staff on Aug. 3 using the Ibiqity-supplied HD Radio reference receiver. We purposely set the antenna in an area with known multipath issues in our performance studio.

We started the demo in the analog mode and the multipath artifacts were quite audible. These artifacts included the typical "tearing" sound and noise modulation that one has with multipath. We then switched to digital HD Radio and the improvement was immediately noticeable to everyone there.

The quality of the HD Radio audio is quite good. We do notice some artifacts on source material that has been previously MPEG encoded, such as NPR news feeds and the ATRAC-encoded audio from our MiniDisc machines, being passed through the HD Radio system. With locally generated, non-MPEG encoded source material this isn't an issue.

We have installed a Neural Audio/Harris NeuStar codec pre-conditioner to pre-condition the HD Radio signal after the Omnia, and our listening tests indicate that it reduces the HD Radio codec artifacts significantly. Normally, the NeuStar operates with a direct connection to the Harris Dexstar HD Radio exciter and the units become interactive.

Specially-modified NeuStar

KUVO received a beta experimental NeuStar with some modifications so that it could operate without the Dexstar exciter. This was a special unit, sent to us for some audio listening tests and experiments because the normal "commercial" settings, which the units employ for the bulk of the broadcast community, are not typically suitable for public radio. As a result of these tests, new presets designed for the needs of public radio are being developed and we like the results.

I looked at how we were going to implement program-associated data support for HD Radio and RDS for our conventional FM analog service. I selected The Radio Experience to format and generate our PAD and RDS data using a PC at the studio and shipping it via the Ethernet capability of the Intraplex to the Nautel NE IBOC exciter and the M-50 exciter.

Our next issue was the most challenging to solve. As the first FM broadcaster on the air with HD Radio in Colorado we needed to educate our listeners, inform the public in general and develop a relationship with a local retailer who could supply HD Radios for purchase. Since at this time the bulk of HD Radios available at walk-in stores are car units we needed to find a retailer that had a major presence in the auto sound marketplace and carried HD Radios. We did some homework on local retailers and contacted Ibiqity who gave us a referral at Ultimate Electronics SoundTrack.

We set up a meeting with the promotions staff and car audio sales manager at Ultimate and proposed a program of underwriting announcements, in-store remotes and a live broadcast of the Colorado Symphony with three-time Grammy winner Dianne Reeves. We also proposed a joint press release event with them including HD Radio demos and live drive sessions to show the elimination of multipath.

The folks at Ultimate Electronics had been waiting for an FM broadcaster to go on the air with HD Radio and were primed to help us launch the service. As a result of our proposals they will be participating in our

press launch, Dianne Reeves-Colorado Symphony Broadcast and in store remotes. This rollout was slated to begin in late September and we expect that this plan will significantly increase the exposure of HD Radio to the public and drive demand for HD Radio.

On Aug. 16 we started promoting HD

during one of the three mini-breaks per hour. The breaks also occur in our programming from PRI, MPR and the Jazz Satellite Network. The 40-second announcements give a brief overview of HD Radio and direct listeners to the KUVO Web site, where there is additional information on HD Radio.

Being at the forefront of HD Radio takes

Ramos have supported our HD Radio conversion program from day one.

KUVO's HD Radio conversion has been a major learning process for me. At the start of the project, I read everything that I could get my hands on and talked to vendors and other CEs who had put HD Radio on the air.

I found the PREC to be invaluable and the information that was disseminated prevented me from making a bad choice. Our vendors provided outstanding pre-sales consultation, after-sale technical support; most important, they delivered on schedule.

I have been in the broadcasting business for a long time. HD Radio is the most exciting advancement in FM since the advent of stereo. With Tomorrow Radio and 5.1 surround, the future looks very promising for HD Radio and those broadcasters who fully embrace it. 🌐

I have received numerous calls from our listeners commenting on how much better KUVO's analog FM signal sounded after the change.

Radio on the air using tag lines coming out of the top-of-the-hour news from NPR. The tag line is "Colorado's first FM HD Radio station." There is a 40-second announcement

a major commitment from management. My boss, KUVO Program Director Carlos Lando, and our General Manager and Chief Executive Officer Florence Hernandez-

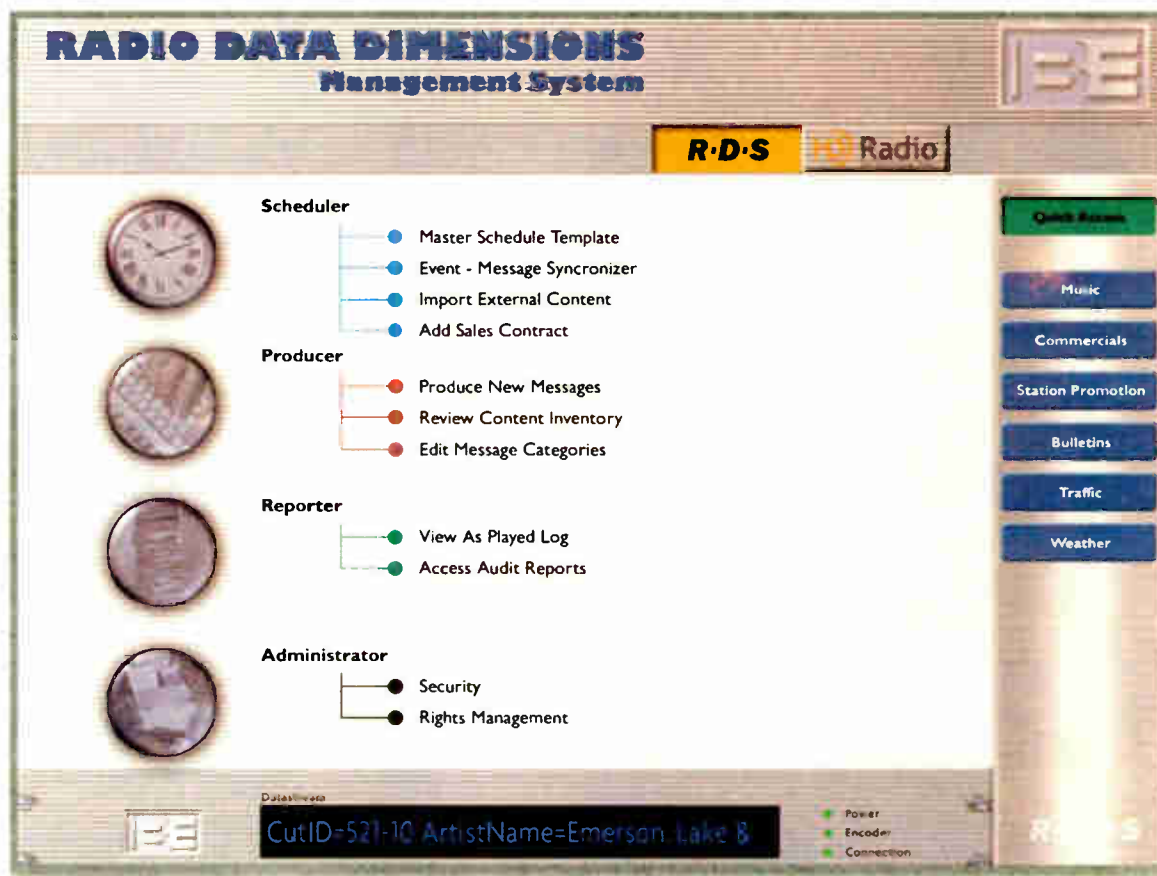

Radio Data Dimensions: Making radio read and write.

If you're not taking advantage of RDS on your analog FM service, you may be losing listeners and revenue. BE's Radio Data Dimension simplifies feeding your station's branding, title and artist information, sponsorship and promotional messages, Amber Alerts, and more. Increase income and listener loyalty using text messages with traffic, weather, or even gas prices from third-party providers. Part of BE's Total Radio Program and Data Integration, Radio Data Dimensions puts you in control of today's RDS and tomorrow's HD Radio opportunities in one integrated management site. Contact BE to put your data to work for you.



Broadcast Electronics, Inc. • 4100 North 24th Street, P.O. Box 3606, Quincy, Illinois 62305-3606 U.S.A.
Telephone: (217) 224-9600 • Fax: (217) 224-9607 • E-Mail: bdcast@bdcast.com

©2004 Broadcast Electronics, Inc. All rights reserved. BE and the BE logo are registered trademarks of Broadcast Electronics, Inc. HD Radio is a registered trademark of Sony Digital Corporation.

See us at the NAB Radio Show Booth #702
World Radio History

GUEST COMMENTARY

On the Proliferation of FM Translators

by Bruce F. Elving

The author is publisher of *FMedia!* and the *FM Atlas* book.

Almost totally ignored by the trade and consumer press is a massive invasion of translators taking place on the FM band, thanks to a recent filing window by the U.S. Federal Communications Commission.

Those applications have begun to work their way through the FCC bureaucracy, and are thrilling the construction permit holders with new authorizations that will blossom into relayers, some ostensibly serving a real purpose in conquering coverage and terrain difficulties; others apparently redundant clutterers of the dial, and precluding more meaningful activity by other possible licensees on the channels in question.

A handful of religious broadcasters was largely responsible for many of the applications, as well as some public entities and a few commercial broadcasters.

Radio World got things right a few issues ago when it suggested reform is needed when it comes to the FCC's next filing window for FM translators. Such reform could, hopefully, result in more filings by independent groups, rather than by national groups seeking relayers of stations that might already have a presence in an area.

FMedia! newsletter has been publishing lists of FM translator grants, as received straight from the FCC. Analyzing those grants has been both fun and excessively time-consuming.

By the numbers

This article will, hopefully, shed some light on all that translator activity. The National Association of Broadcasters, the FCC and advocates for public and religious media should all be interested.

The flock of new translator grants pub-

lished during a six-week period ending July 27 would occupy three full pages of this newspaper at the text size you are reading now. Just a sample, those for California, appears in the sidebar box.

As I write, there have been about 550 more translators granted through early September. Earlier in the year, the translator figures come to about 450 in August, 250 in July, 420 in June, 270 in May, 210 in April and 70 in March (a more typical month).

On one day during the FCC's translator-granting frenzy, it announced 115 new translator grants; days of 40 to 50 grants were common.

The FCC has been so efficient in granting translators that, in some places, more than one frequency has the same primary station. Thus, Grand Junction, Colo., has three stations all purported to be relaying KTMH 89.9 Colona. They are K224CS 92.7, K229AH 93.7 and K284AP 104.7.

Because translators are allowed up to 250 watts, it is conceivable the translator frequencies will be more visited by listeners than the main station frequencies, which are limited to 100 watts at 30 meters above average terrain.

Too, translators provide a service in improving the coverage of nearby stations, both commercial and noncommercial. That aids the public interest, and is fully in keeping with the mandate of the FCC to grant stations that will better serve the population and land area of the United States.

All the recently granted translators are to relay terrestrially-received signals, be they the primary station directly or the primary station as received by another translator's signal.

The loophole here is that many of the new translator grants are to national organizations or their sympathizers, and not truly local. Don't listen to one of those translators, expecting to receive weather

all possible available frequencies.

One of the national groups, Radio Assist Ministry, based in Twin Falls, Idaho, has filed hundreds of applications, along with another Twin Falls group, Edgewater Broadcasting. They are identified with stations KAWZ 89.9 and KEFX 88.9 of the Calvary Satellite Network.

Radio Assist Ministry is supposedly just that, a ministry to assist local stations spread their signals. Almost all the stations they say they will relay are non-commercial.

If the stations get on the air, and prove valuable to the primary stations so "assisted," the primary station would presumably be able to buy the equipment plus pay a \$500 finders-type fee to aid the Twin Falls group with its engineering expertise in getting the frequency. For noncommercial users, there is no FCC application fee.

Thus the commercial broadcaster is faced with a significant whammy — increased competition for audience and perhaps increased interference from stations not having to pay FCC fees, unlike what the commercial broadcaster is saddled with.

30 a day

The FCC received some 10,000 applications for new translators in the latest filing window. Some have been thrown out for technical reasons, while others face petitions to deny, and still others are mutually exclusive to other applications.

While there was a recent slow-down in the rate of new translator grants, in the days preceding the writing of this article the pace has lately been up to 30 a day, and it promises to continue.

I have e-mailed the NAB lists of translator grants, asking them to urge the FCC to go slow, and to analyze the material for potential interference to their member stations. The NAB did not respond to that request, but, as noted below, an official with that organization did comment on the differences in interference potentials he perceives from translators and low power FM.

Some of the most flagrant misuses of frequencies — where more than one frequency in a city is listed as having the same primary — are expected to shake down to different primaries being named, or some redundant translators never being built. In certain cities, dif-

See TRANSLATORS, page 21 ▶

One day the FCC announced 115 new translator grants; other days with 40 to 50 were fairly common.

Commenting on the granting of more than one translator in the same city to the same primary station is the FCC's Dale Bickel: "It may appear excessive, but it does not violate any FCC rule. If the translator application meets the FCC's requirements, we grant it."

Some, such as Don Schellhardt, of the Amherst Alliance, as reported in the Sept. 1 Radio World, correctly point out the disparity in rules and laws that unfairly pit translators against low-power FM.

However, sometimes translators benefit LPFM. Translators around Melbourne, Fla., Ocean Shores, Wash., and in north-eastern Wisconsin will relay LPFM sta-

warnings or forecasts, Amber alerts, local news or public service announcements!

Unlike LPFM, translators do not have to do EAS tests, have local public records files or have any semblance of local studios.

A concern to the Amherst Alliance and others is that the many translator grants will prevent any meaningful growth in low-power FM. It will little matter if Sen. John McCain, R-Ariz., succeeds in getting the Mitre Report's recommendation adopted into legislation allowing for more LPFM at reduced channel spacings to full-power stations and to FM translators. The damage will have been done.

A cursory look at the FCC's FM Query www.fcc.gov/mb/audio/fmq.html for Honolulu, for example, shows how Radio Assist Ministry, Edgewood Broadcasting and the Educational Media Foundation have apparently spoken for

MEASURING THE DIFFERENCE in Digital Audio Cable Performance...

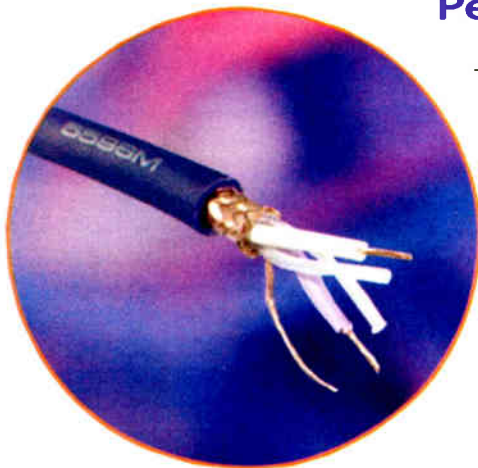

The critical link in digital audio interfacing, Gepco 110Ω twisted-pair and 75Ω coax feature exacting impedance, bandwidth, and attenuation specifications to deliver low-jitter, minimal pulse rounding, and exceptional performance in high-resolution, digital audio systems.

- Precision 110Ω or 75Ω Impedance
- 25MHz Bandwidth for 192kHz Sampling Rates
- Low-Jitter
- Minimizes Pulse-Rounding
- Multi-pair Designs up to 24 Pairs

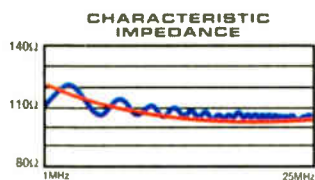

www.gepco.com email: gepco@gepco.com 800.966.0069

GEPCO
INTERNATIONAL, INC.

TRANSMITTING CLARITY

MARKET PLACE

Burk Releases Lynx 5 Software

Burk Technology is shipping new Lynx 5 software for the GSC3000 and VRC2500 transmitter remote control systems.

The company said the software introduces new features for the remote management of broadcast facilities, networks and groups — most notably, the addition of real-time data updates.

"The remote control hardware now sends condition changes to the PC immediately upon detection instead of waiting for the software to periodically poll for updates," according to Burk. This is the first time the GSC3000 and VRC2500 systems have offered this feature, it said.

Also new are a charting tool, which provides an on-screen historical view of multiple analog channels; a set of U.S. maps now included in the Custom Views utility, and other options for creating customized screens with detailed data depiction; and a retooled Data Browser function for access to logged site data without requiring the user to set up a new report.

President Peter Burk said current users could still download Lynx 4 free from the company Web site, or buy the upgrade and use the new features in version 5.

Lynx 5 becomes the standard GSC3000 and VRC2500 software; current users buying new units can integrate the new version at no extra cost. Lynx 5 also is available from dealers as a software-only upgrade.

For information contact the company in Massachusetts at (978) 486-0086 or visit www.burk.com.

Translator

► Continued from page 20

ferent locations or different transmitting patterns might be employed so the primaries of those stations might not be all that redundant.

In a telephone chat, Jeffrey Yorke, spokesman in the NAB's office of communications, said that one of his fears of low-power FM, as opposed to translators, is that most station operators are not experienced broadcasters, and might use poor, non-FCC type-accepted equipment. That equipment could create interference outside the authorized channel of the LPFM station. Ads in various radio publications seem to bear this out, although it's not the purpose of this article to point an accusatory finger.

Hobbyists who are interested in FM

DX, the listening to long-distance FM radio signals, might also be concerned about translator proliferation. They provide interesting targets for the listener with specialized equipment to try for.

Conversely, the existence of a nearby translator might make impossible the reception of a non-local FM station with unique programming, or close the dial to frequencies that were relatively vacant, and upon which interesting tropospheric or skip reception had previously been possible.

Of course, this is no reason for the FCC not to grant a station — that it might clutter the receiving landscape for out-of-market stations. That might be like telling a neighbor he can't plant a tree because your view across his property would be diminished.

An inconsistency with the NAB's approach is that several years ago it

urged, quite successfully, that translator "abuse" be stopped. That included stopping third parties who operated FM translators from receiving rental income if the translator was outside the primary coverage area of the main station. It also ensured that primary stations couldn't extend their coverage outside their main service areas and thereby reach into another station's market.

The fallacy of that approach is that there has been abuse — mainly by non-commercial stations invading the 92 to 108 MHz part of the dial, and extending their signals far away from their primary market, and as pointed out above, not having to pay a filing fee to the FCC.

The Calvary Satellite Network, in fact, has asked the FCC to enable satellite-received translator signals in the commercial part of the dial, not just 87.9 to 91.9

MHz, where they are confined today.

Looking at it from that standpoint, the multitude of applications filed by the two Twin Falls outfits begins to make sense. Applications filed on behalf of reluctant primary stations for satellite stations might suddenly become affiliates of KAWZ or KEFX, not the nearby station mentioned in the FCC application.

Since March, at least 2,000 FM translators have been granted by the FCC. They deserve scrutiny by broadcasters and anybody else concerned with the integrity of the FM band.

The author is publisher of *FMedia!* and the *FM Atlas* book. The list of translators granted is available by subscribing to the *FMedia!* newsletter.

Visit <http://members.aol.com/fmatlas/home.html> for more information.

RW welcomes other points of view. ☺

Lots of Translation

The following is a list of new FM stations, translators and low-power FMs granted by the FCC in a six-week period this summer within the state of California; most are translators. (The full list for the United States for just that six-week period would occupy three full pages of *Radio World*.)

Translators have less than 100 watts unless shown otherwise; technical parameters for most LPFM stations are not announced, but can be up to 100 watts at 30 meters above average terrain (horizontal, vertical or both h & v). Asterisks are noncomms.

- CA Atwater K256AV *99.1 (KLVN 88.3 Livingston)
- CA Banning K250AL *97.9 (KXRD 89.5 Victorville), h,v
- CA Cambria K239AR *95.7 (KGZO 90.9 Shafter), h,v
- K243AX *96.5 (KDKL 88.3 Coalinga), h,v
- CA Concord K216FV *91.1 (KCSM 91.1 San Mateo), v. The FCC granted this translator after determining it was not a booster.
- CA El Paso de Robles (Paso Robles) K244DX *96.7 (KFYE 106.3 Kingsburg), h,v
- K293AW *106.5 (KDKL 88.3 Coalinga), h,v
- CA Homewood K232DN 94.3 (KYM 96.1 Sacramento), h,v
- CA Huron K269FA 101.7 (KHRN 98.3 Huron), 250 h,v
- CA King City K243AW *96.5 (KQKL 88.5 Selma), h,v
- CA La Grange *107.5 La Grange Historical Association, LPFM
- CA Mendocino K270AV *101.9 (KNHT 107.3 Rio Dell), v
- CA Modesto K292FN *106.3 (KAMB 101.5 Merced), 170 h
- CA Nevada City K225AU *92.9 (KLVS 99.3 Grass Valley), h,v
- CA North Highlands K227AU *93.3 (KARA 99.1 Williams CA), h,v
- CA Santa Maria K269EW *101.7 (KGZO), h,v
- CA Stockton K299AQ *107.7 (KLVR 91.9 Santa Rosa), h,v
- CA Tehachapi K240DH *95.9 (KGBM 89.7 Randsburg), h,v
- CA Truckee K227AW 93.3 (KNCO-FM 94.1 Grass Valley), h,v
- CA Yucaipa K231BD *94.1 (KXRD 89.5 Victorville), h,v



AudioVAULT: Because you wouldn't drink from the other guy's mug.

Just because you sit in the same chair, it doesn't mean you have to work on the same computer. The other talent. Whether you're left- or right-handed, left- or right-brained, the latest AudioVAULT lets you create a custom interface that matches your workstyle. AudioVAULT enhances automatic ad and content management with a second-generation CD ripping, true IP network rig, enhanced cue list capabilities, and other new benefits including RDS and HD Radio data service integration. Now it's time to get serious about stepping up to the reliability of AudioVAULT. Already own AudioVAULT? Contact BE for upgrade details.

Total Unleashed Radio

- Program Generation & Audio Management
- Data Generation & Management
- Transport
- Transmission



Broadcast Electronics, Inc. • 4100 North 24th Street, P.O. Box 3606, Quincy, Illinois 62305-3606 U.S.A.
 Telephone: (217) 224-9600 • Fax: (217) 224-9607 • E-Mail: bdcast@bdcast.com

See us at the NAB Radio Show Booth #702
 World Radio History

Sample Course of Study Unveiled by SBE

by Ken R.

What training will future broadcast engineers need? What kind of job descriptions, work conditions and salaries can they expect to find in the field?

After years of development and much input from two and four-year colleges, the Society of Broadcast Engineers Certification Committee released its approved sample curriculum.

"This took three years of research and coordination," said Linda Baun, SBE certification director. "It's a guideline for the schools, but a very complete one, and is available at no charge to anyone."

Defining the curriculum was a project of the SBE National Certification Committee. Ralph Hogan, CPBE, was the curriculum subcommittee chairman and primary author of this 18-page document, which covers suggested requirements for a Broadcast Technology Associate of Applied Science Degree, a Broadcast Technology Bachelor of Applied Science Degree and a Broadcast Technology Associate of Technology Degree. Chriss Scherer is SBE National Certification Committee Chair.

"Until this point we haven't had anything specific to offer the schools," said Hogan. "This document was a three-year project and covers traditional technologies, but also newer fields such as HD

television and HD Radio. We've added more IT components because more of our people find themselves working in those areas."

Hogan collaborated with Michael Scott of Bates Technical College in Tacoma and Dr. James Paluzzi, who was head of the broadcasting program at Boise State University.

Appended to the sample curriculum are other sections that would be of use to schools, engineering candidates and equipment manufacturers. These include material on the nature of broadcast engineering, some of the job classifications, working conditions, likelihood of employment in various categories, training and advancement

opportunities, earnings and related fields of study.

Baun said SBE has no way of knowing which schools will be implementing this sample curriculum at this early date.

"But I can tell you that 13 schools, four broadcasting groups, four manufacturers and five media and technical

See CURRICULUM, page 23 ▶

Broadcast Training

The following is a selected list of technical schools and factory training courses offering broadcast and broadcast-related training. These have been identified by the SBE National Certification Committee from information gathered from chapters.

AFRTS Technical Training Program

Ft. Meade, Md.
www.dinfos.osd.mil

Bates Technical College

Tacoma, Wash.
www.bates.ctc.edu

Boise State University – Selland College of Applied Technology

Boise, Idaho
www.boisestate.edu

Cayuga Community College

Auburn, N.Y.
www.cayuga-cc.edu

Cleveland Institute of Electronics

Cleveland
www.cie-wc.edu

Cuyahoga Community College

Cleveland
www.tri-c.cc.oh.us/Metro

Hocking College

Nelsonville, Ohio
www.hocking.edu

Milwaukee Area Technical College

Milwaukee
http://oncampus.matc.edu/catalog/electronic/electronic_technology.htm

Mitchell Technical Institute

Mitchell, S.D.
www.mti.tec.sd.us

Napa Valley College

Napa, Calif.
www.nvc.cc.ca.us

Pasadena City College

Pasadena, Calif.
www.paccd.cc.ca.us

Southern Alberta Institute of Technology

Calgary, Alberta Canada
www.sait.ca

Spartan School of Aeronautics

Tulsa, Okla.
www.spartanaero.com

Spokane Community College

Spokane, Wash.
www.scc.spokane.edu

St. Louis Community College at Florissant Valley

St. Louis
www.stlcc.mo.us/fv

FREE VOICE TRACKER SOFTWARE FOR FREE-LANCE JOCKS ONE DIGITAL SYSTEM STANDS OUT



The same way the red apple stands out from a group of green ones, savvy broadcasters know Scott Studios' stands out from other digital systems.

Free-lance announcers can now get Scott's outstanding VTX Voice Tracker® software free! They can record great voice tracks (even in pajamas) from any home studio with an Internet connection. The magic's in Scott's VTX (Voice Track eXchanger) and VoiceTracker.com site.

GET FREE VOICE TRACKER SOFTWARE AT NAB BOOTH 704

This is like getting a free phone when one signs up for wireless, except VoiceTracker.com has no contract, no minimum, and the data transfer bill goes to the station airing the show (not the announcer).

1-888-GET-SCOTT

VTX works just like Scott Studios' popular VT32 in-house Voice Tracker. It's fast and easy. Voice Tracker already enhances music flow and smooths shows at thousands of stations. Announcers hear-it-like-it-is, with song ends and intros in their headphones while recording Voice Tracks.

VTX is automatic, reliable and runs totally unattended.

Scott even helps VTX stations and free-lancers hook up with each other through free listings on VoiceTracker.com.

Try VTX free for yourself in Booth 704 at the NAB Radio Show, VoiceTracker.com, or call 1-888-GET-SCOTT today.

Scott Studios
13375 Stemmons Freeway, Suite 400
Dallas, Texas 75234 USA

Voice Tracker and Scott Studios are trademarks of Scott Studios IP



Curriculum

► Continued from page 22
venues have requested a copy since we made it available," she said. "Our National Certification Committee has a list of SBE Certified Schools. These schools have curriculums which were reviewed by our committee and their programs were granted certified status by SBE."

Word from campus

Jim Heidenreich is head of the Electronic Engineering Technology school at Cuyahoga Community College in Cleveland, an SBE-certified school.



Ralph Hogan

"When I started this program we didn't have the guidance of SBE," he said. "But when I met station representatives at a seminar here in Cleveland, they told me that when they hire engineers, they aren't just looking for a general license. They want SBE certification. That's

when I called SBE and submitted our curriculum for approval." And Heidenreich had another suggestion for bringing young people into this industry.

in connection with a remote vehicle or some other non-critical area, they could offer something just above minimum wage and it would give people a chance to work in a radio environment."

decreased, Heidenreich is upbeat about the future.

"Will there be a problem in getting people interested in broadcast? No, not if the jobs are there." 🌐

This document was a three-year project and covers traditional technologies, but also newer fields such as HD television and HD Radio (and) more IT components.

— Ralph Hogan

"I would like to see more stations offer an apprenticeship during summer vacation," he said. "If they need gopher work

Even though the requirements for broadcast engineers have expanded and the value of RF training alone has

How to Submit Letters

Radio World welcomes your point of view on any topic related to the U.S. radio broadcast industry.

Send letters via e-mail to radioworld@imaspub.com, with "Letter to the Editor" in the subject field; fax to (703) 820-3245; or mail to Reader's Forum, Radio World, P.O. Box 1214, Falls Church, VA 22041.

"Logitek gives me the capabilities I want."



First Broadcasting Corporation
Sacramento, CA

First Broadcasting Console Configurations

- 2 Logitek Audio Engines, networked
- 6 analog I/O cards
72 inputs & outputs
- 4 digital I/O cards
32 stereo inputs & outputs
- 2 SharcAttack multi-DSP processing cards for EQ, dynamics processing and more
- 2 Numix-12 consoles

Sample Sampler

Here is a sample two-year course list for a Broadcast Technology Associate of Applied Science Degree, with approximately 15 credits per semester. Courses are by topic, not necessarily in time sequence.

- Broadcast Operations & Broadcast Operations Lab
- Electronic Field Production & Lab
- Broadcast Facilities Maintenance & Lab
- RF for Broadcasting & Lab
- Broadcast Technology Internship

- Introduction to Operating Systems
- Basic Computer Systems & Lab
- Lab Networking Technologies
- Network Service and Support

- DC Electronics Laboratory
- AC Electronic Laboratory
- DC Electronics Theory
- AC Electronics Theory
- Digital Systems & Lab
- Solid State Devices/Circuits & Lab

- Applied Communication
- Technical Math
- Occupational Relations
- Intro to Microcomputers

"For audio consoles, I always choose the Logitek Audio Engine with the Numix control surface."

I believe it's a product that gives a lot of bang for the buck. Its mix-minus capabilities and ease of use make it a real winner, and it looks great. We have used this board in both on-air and production rooms in many radio, TV and Webcasting facilities in two states, and I have never had any off-air time, EVER!"

— Jay Rose, CE
JRBE Inc.

Logitek Electronic Systems, Inc.
5622 Edgemoor
Houston, TX 77081 USA 713.664.4470 800.231.5870 www.logitekaudio.com

Logitek
Console Router Systems

©2004 Logitek Electronic Systems, Inc



**The Official Comrex STAC
Instant Gratification Kit:**

1. Call your favorite Comrex reseller and order STAC
2. Cut out photo of STAC
3. Practice using STAC by pressing buttons on picture
4. Be completely ready to go when your real STAC arrives

INSTANT GRATIFICATION

What are YOU talking about? A call-in on local politics? An interview with the winning quarterback from his hotel? An eyewitness with late-breaking news? A dedication to the one someone loves? Congratulating the ninth caller on winning concert tickets?

Introducing STAC (Studio Telephone Access Center) from Comrex. STAC puts you in quick control of your talk-shows, call-ins and phoners with great sound, ease of operation and scalable configuration. Incorporating a pair of Comrex high-performance digital hybrids with automatic level control, STAC provides the most natural sounding telephone audio – even when conferencing multiple callers.

Consisting of an incredibly intuitive console and a compact rack-mounting mainframe (which houses the hybrids, multiline controller and all telephone/audio connections), STAC is truly a turnkey solution. The expandable STAC system is available in six (STAC 6) and twelve (STAC 12) line versions. Call screening and control are available from any networked computer — using a standard web browser with the included STAC IP, your talent can host their shows from anywhere there is an Internet connection.

STAC the deck in your favor — order STAC today.

STAC
STUDIO TELEPHONE ACCESS CENTER

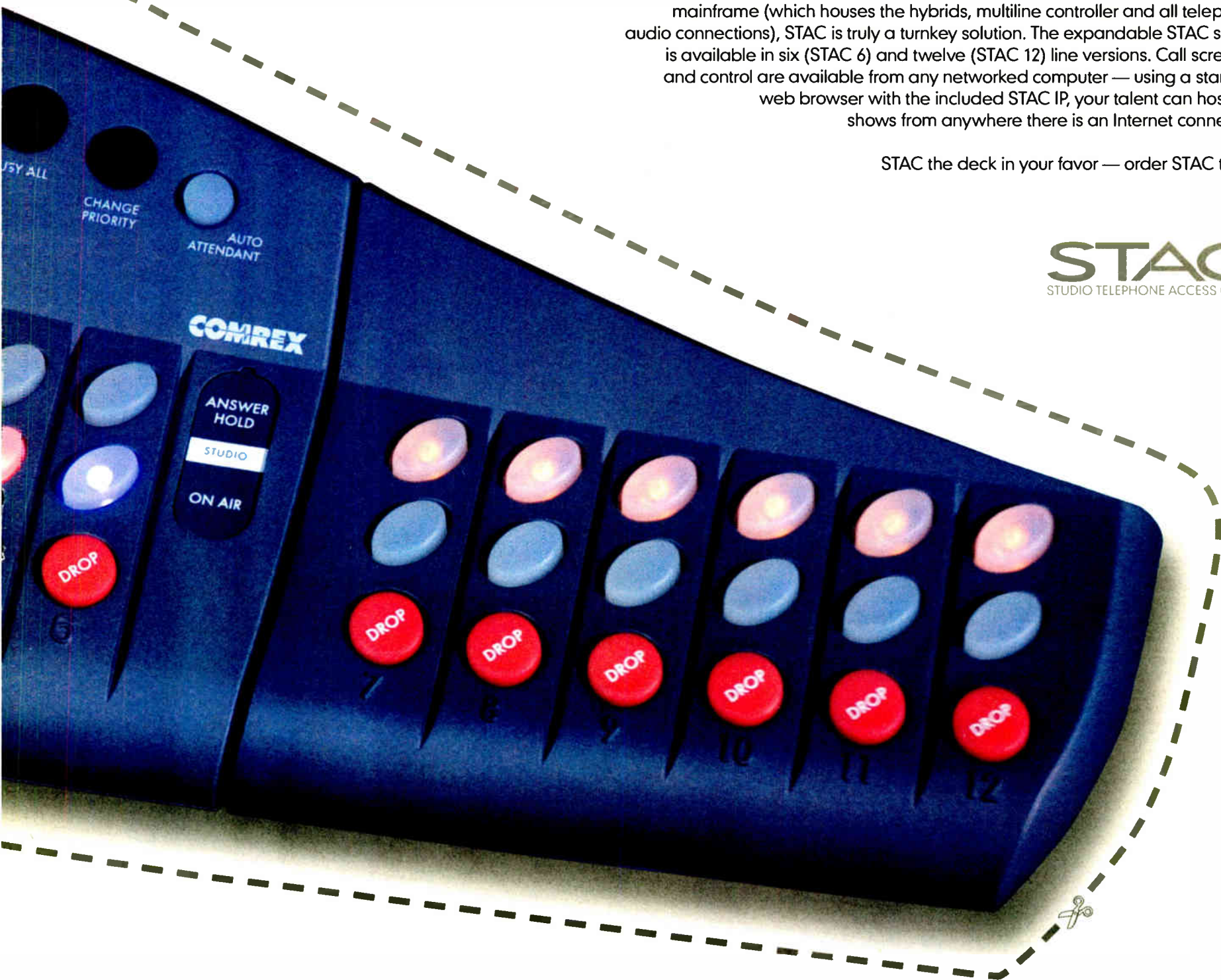

STAC shown actual size

Got Calls? Put Comrex On The Line.

COMREX

Paul Gregg and 45 Years of Bauer

*A Unique Broadcast Opportunity in 1960
Prompted the Creation of Bauer and the 707*

by Charles S. Fitch, P.E.

In 1960, a unique broadcast opportunity appeared: an across-the-board daytime power increase for Class IV AM stations to increase power from 250 to 1,000 watts. One byproduct was the creation of a transmitter company to focus on the anticipated demand for a cost-effective 1,000/250-watt transmitter to power hundreds of eligible stations.

That company was named the Bauer Electronics Corp. Its descendant, Bauer Transmitters Inc., continues to operate in El Paso, Texas, as a refurbishing, repair and support facility. Besides remanufacturing classic Bauer transmitters, the firm also designs and builds AM antenna diplexing networks.

Business opportunity

Class IV AM stations prior to 1960 were 250 watts day and night. Today called Class C, these were local stations that served metro and town centers. In rural locations, they served as newspapers of the air, network outlets and community bulletin boards.

Theoretically, an increase to 1,000 watts would double daytime coverage, and possibly listeners — an increase not to be ignored.

Based on a suggestion from consulting engineer Bob Hammett, a new company was formed using the design talents of Fritz Bauer to “mass produce” a transmit-

ter for this market. Bauer had been making innovative and reliable transmitters literally in his garage since the late 1940s (see sidebar).

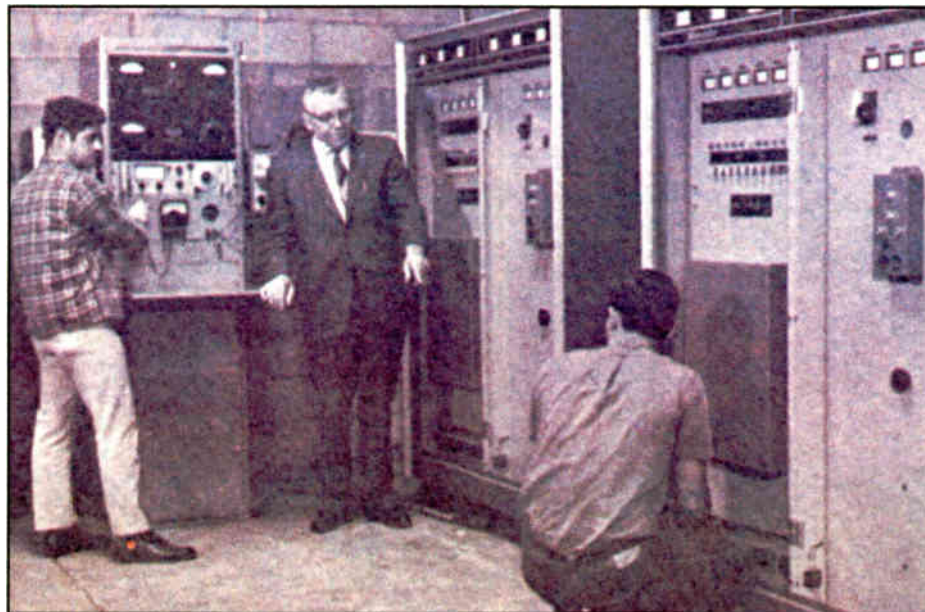

Fritz Bauer, center, is shown in a Granger Associates brochure from 1968.

The original company principles were Fritz Bauer as president, Ed Edison and Paul Gregg as vice-presidents and Hammett as secretary/treasurer.

Bauer wanted a product with several qualities: simplicity in circuitry with a minimum count of common tubes, ease of maintenance, high value and good per-

formance.

This “ideal” transmitter was introduced at the 1960 NAB convention as the Bauer 707. The tubes up to the final could be bought at a local TV/radio shop; all the power tubes were 4-400s.

Under any definition this unit was a quality product; hundreds are still run-

according to the company.

To answer another opportunity — the burgeoning FM dial — Bauer added FM transmitters, primarily of the then-novel grounded grid design, to its list of broadcast products.

Changing hands

In the latter part of the 1960s, several companies attempted to mimic the full service/supply posture of RCA.

See BAUER, page 27 ▶

Fritz Bauer

Born in 1905, Bauer got his technical training mainly from service in the Signal Corps in the 1920s.

After World War II when he began modifying old Collins police transmitters that had been working on 160 meters for broadcast use. During the 1950s he started building low-power AM transmitters and sold quite a few in Latin America.

He moved to California in the mid-1950s and was building a 1 kW transmitter (the FB-1000J, progenitor of the 707), his first commercial product.

Eventually moving into nearby San Mateo, Bauer continued to build transmitters in his garage. It was in this garage where Bauer and Paul Gregg worked on the prototype 707. Simultaneously Fritz Bauer was busy building the FB-5000J, the first broadcast transmitter to use a high-power tetrode (the 4CX5000A).

A leg up for Bauer was the proximity of the Eimac tube plant and other vendors including transformer maker Electro Engineering Works.

The first two Bauer FB-5000J transmitters were sold to Golden West Broadcasters of Gene Autrey fame, and went to KSFO in San Francisco and KVI in Seattle. The chief engineer of Golden West was Loyd Sigmon, known in the Los Angeles area as the developer of the Sigalert.

Although Bauer was president of Bauer Electronics Corp., which built and sold the 707, he continued to maintain his own company, Bauer Electronic Manufacturing Co., which made higher-powered transmitters like the FB-5000J. Bauer's own company supplied these transmitters, first to BEC and then to Granger BEC, which handled sales.

In 1970, when Cetec-Sparta bought BEC and the 707 line from Granger Associates, Cetec also bought the product and manufacturing facilities of Fritz Bauer's own company, moving all transmitter manufacturing into Cetec's plant in Sacramento.

Fritz Bauer died in 1970 of a heart attack at age 65.

Paul Gregg's analysis is that, “There was a craftsmanship in Fritz Bauer transmitters not found in any others. It was not unusual to have a factory engineer from Gates or RCA or Collins, on a busman's holiday at a NAB convention, stop by and marvel at the simplicity of a Fritz Bauer-built transmitter. The beautiful wiring harness and the unique way power components were mounted set his product apart from all the others, even including those of the Bauer Electronic Corp.

“The corporation could copy his ideas but never his talent.”

ting. However the most interesting innovation was that the transmitter could be bought in kit form for \$3,495.

U-built-it

This was the era of the transmitter watch operator. One thing you had plenty of at the transmitter was time.

The 707 went together easily, much as a Heathkit might; on average the job took about two weeks when done carefully. The benefits were the cost — nearly 20 percent less than “factory built” — and that the station staff knew their transmitter inside out. When the project was completed, a Bauer representative came to the station to perform a proof; if it met published specifications, a nameplate was affixed carrying the required information.

Although the first few 707s were made in Fritz Bauer's garage, by 1962, the company was making a dozen 707s a month in a new plant in San Carlos, Calif. Overall it made 500 or so, nearly two-thirds of which are still running in various services,

STATION/STUDIO SERVICES

MAKE COMMERCIAL BREAKS MORE APPEALING TO LISTENERS - AND MORE VALUABLE TO ADVERTISERS!

WE PROVIDE *Ready-to-Air* Business BOOSTERS. YOU PRESENT THEM TO CLIENTS....



...AND BUSINESS GETS BETTER!

Something New to Sell Every Month!
HOLIDAYS • SEASONAL EVENTS • FRESH IDEAS!
RETAIL SALES BOOSTERS • SAFETY CAMPAIGNS

:30- and :60-second features

GRACE BROADCAST SALES
Toll-free 1-888-472-2388
Sound Ideas for Building Business™

FREE DEMOS & SALES TIPS!
www.gracebroadcast.com

VETERANS DAY NOVEMBER 11
HONORING AMERICA'S VETERANS

21 :30-SEC. FEATURES
available for local sponsorship

FREE DEMOS
available now
www.gracebroadcast.com

729 Sound Effects
on 5 CDs- \$100

Take \$10 off if you
mention Radio World.

www.radiomall.com
Or call 800-759-4561

2412 Unity Ave N, Minneapolis, MN 55422

ATTENTION PROVIDERS!

Promote your services to **Radio World's** readers. Reach Radio Station and Recording Studio owners/managers and engineers with your message.

For information on affordable advertising
call **Simone** at 1-703-998-7600, ext. 154.

Bauer Timeline

1959: Bauer founded in December in Burlingame, Calif.

1967: Company is bought by Granger Associates

1970: Bauer/Granger is bought by Cetec/Sparta

1980: The Bauer transmitter activity is bought by Elcom (Paul Gregg) and Radiorama, a large Mexican broadcaster, from Cetec.

Late 1980s: Nearly the total output of the company is in orders from Radiorama

1992/3: Bauer closes its California plant and moves to El Paso, Texas

Bauer

► Continued from page 26

Ampex attempted this gambit in the TV arena. On the radio side, Sparta/Cetec bought Bauer from its new owner, Granger Associates, so as to be able to supply transmitters along with its audio gear.

During the Granger and Cetec operation, Paul Gregg served as transmitter product manager and later as a consultant to Cetec when the entire Sparta operation was moved to Carpinteria, Calif., and combined with Schaffer under the name of the Cetec Broadcast Group.

When, in 1980, Cetec decided to exit

the broadcast equipment business, Gregg, along with the principles of the Mexican broadcast group, Radiorama, purchased the transmitter line and moved it back to Sacramento, where it became Elcom Bauer.

Transmitter manufacturing is a tough market; between severe domestic competition and evolving technology, Bauer essentially became an export firm. The reliability and simplicity of its designs were strong advantages in far-flung places.

Bauer eventually stopped making new transmitters in 1993. The firm now functions mainly as a repair and support com-



Paul Gregg

pany run hands on by Gregg in a modest storefront facility in El Paso.

However, some 300 original Bauer 707s live on in transmitter facilities, most of

them abroad but many are in use at U.S. radio stations, and a handful are running strong on the 160 meters amateur band.

Even today, Bauer transmitters and most other Bauer products are supported for parts and service.

Looking back at its history, among the firsts listed by the company on its Web site are:

- ✓ The first AM transmitter kit
- ✓ The first transmitter with solid-state rectifiers
- ✓ The first solid-state FM transmitter
- ✓ The first all-tetrode 5 kW AM transmitter
- ✓ The first to remanufacture its own AM and FM transmitters

The company can be reached via the Web at www.bauertx.com.

Paul Gregg

In an industry populated by exceptional and accomplished people, Paul Gregg is a standout.

An octogenarian, Gregg, now president of Bauer Transmitters, Inc., has spent almost all his adult life in broadcasting, primarily in equipment manufacturing. Still active, he can look back on a career that has spanned 60 years of broadcast.

Graduating from high school in 1941, and with World War II on the horizon, Gregg was in a hurry to get into radio. He attended Northwestern Radio Television Institute in Minneapolis and had his First Class Radio Telephone License and his first radio job, at KWLM in Wilmar, Minn., at age 17.

Further stops were KFBB in Great Falls, Mont., and then KLS in Oakland, Calif., before joining the Army Air Corps on Dec. 7, 1942. Most of his Air Corps service was as a radar instructor in Boca Raton, Fla. After the war he returned to KLS (now KWBR) and built KWBR(FM) in San Francisco in 1947.

Gregg also built the first of those infamous three-tower self-supporting AM directional antennas near the end of the Oakland bridge. Low tide allowed him to walk out the ground radials in hip boots.

In the late 1950s, with a young family, he went to work for Gates Radio selling and installing products on the West Coast. The Class IV power increase in 1960 allowed him to become a principle in the start of the Bauer Electronics Corp.

Over the years that company went through many changes and owners, which caused Gregg to break out on his own, forming Elcom, a company focusing on audio processing.

Eventually an opportunity to buy back Bauer appeared and he added that product line to the Elcom offerings in 1980.

The robust tube design of Bauer transmitters worked well in challenging power and climate locations; many Bauers were shipped to Mexico and countries south. That circumstance lead Bauer to become primarily an exporter. Eventually, to support Mexican and Latin American customers better, the company moved from California to El Paso in 1992.

Paul Gregg, a stalwart of the industry, still pilots his modest company every day from his workbench.



DIGITAL RADIO IS IN OUR FUTURE. WE'RE CHOOSING MOSELEY T1 STL.

Introducing the Starlink SL9003T1

Whether you're rolling out HD Radio™ or planning a studio move, look to the name you've trusted for over forty years to now provide the smart choice in T1 STLs.

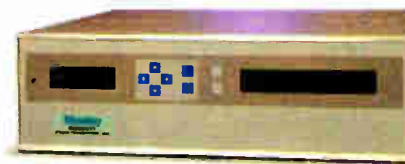

The new Moseley Starlink SL9003T1 has all the payload advantages of digital—including, bi-directional program audio; Ethernet LAN/WAN extension; transmitter remote control; plus, telephone voice channels—delivered over a single T1 link or license-free Spread Spectrum radio.

And consider this, *the Starlink is priced nearly a third less than the competition.*

How can a Moseley Starlink SL9003T1 possess so much capability and still save you money? Just ask our industry-recognized experts Dave Chancey or Bill Gould for the details.

Starlink SL9003T1 Digital STL.

Good choice.

Dave Chancey 805 968 9621
Bill Gould 978 373 6303

Moseley

www.moseleysb.com

BOS-CON Hosts SBE National Meeting

by Craig Johnston

IBOC implementation and problems finding STL frequencies within the 950 MHz radio bands will be the two principal issues taken on by the Society of Broadcast Engineers at its annual meeting in Boston, Oct. 26-27, according to SBE President Ray Benedict.

"We will be talking about and looking at a radio conversion to IBOC," he said, "discussing what engineers need to know and if there's anything our education committee (needs) to be doing to educate engineers on what's happening with IBOC, so they can keep up with the field."

SBE's annual meeting will be held in concert with the BOS-CON Regional Convention in Marlborough, Mass.

The BOS-CON convention will feature several sessions on IBOC, including "IBOC - The Real World," offering offer first-hand experiences with IBOC installations from John Kennedy, director of engineering for Entercom-Boston; Paul Shulins, CBRE, director of technical operations for Greater Media Boston; and Robert Yankowitz, RF Systems manager for Viacom Boston.

Coordination

On the subject of the 950 band, Benedict said "We're hearing more and more problems about the new Part 101 coordination procedures instituted by the commission a year ago October. (There are) a lot of complaints that people are having difficulty finding frequencies available when they actually know there are frequencies available."

The FCC's proposal to require stations to retain, for up to three months, recordings of their on-air programming is on SBE's radar.

"We'll be working with engineers on



Guest speaker for the SBE National Awards Dinner will be John Lyons, who designed and manages the broadcast tower and facilities of 4 Times Square.



John Lyons, CPBE, manager of communications and broadcast operations for the Durst Organization. Lyons designed and manages the broadcast tower and facilities atop the 4 Times Square building in New York City.

Other radio sessions at the BOS-CON SBE Convention include "Internet-Based Control and Observation of Broadcast Transmitting Facilities," sessions on accurate tower logging and tower zoning, "Adaptive Correction of AM Transmitter Load Impedance Variations" and "What HD Radio Needs to Wow Today's Radio Listeners."

The BOS-CON event and various SBE meetings are free. Registration for the Ennes Workshop and SBE Awards Dinner are \$25 and \$12, respectively.

We'll be working with engineers on logistics of how to implement that new (mandatory recording) rule, if it comes about, from an engineering point of view.

— Ray Benedict

logistics of how to implement that new rule, if it comes about, from an engineering point of view," he said.

"The SBE feels that just the engineering of doing the recording is going to be a burden on many radio stations."

Benedict noted SBE's focus on the engineering aspects of issues like compliance recording.

"The SBE tries to stay with pure engineering issues that affect the industry and engineers, and hopefully people will see that with our filings with the FCC.

"We feel that ownership issues and issues involving the owners are best handled by the NAB and trade organizations, the state organizations that work directly with the owners."

SBE's National Meeting includes the fall Board of Directors Meeting, the invitation-only annual Fellows Breakfast, Annual Membership Meeting open to all SBE members and the National Awards Reception and Dinner.

The special guest speaker for the SBE National Awards Dinner will be

BUSINESS DIGEST

RCS Invests in TV Automation Firm

Seeking to broaden its software offerings, Radio Computing Services Inc. said it is making a "major" investment in Florical Systems Inc.



Florical President Jim Moneyhun and RCS Chairman/Founder Andrew Economos

RCS makes software for the radio industry. It said Florida-based FS1 is "known for its advanced enterprise-level digital asset management systems and television automation software innovations known as CentralCasting and ShareCasting."

RCS President Philippe Generali and Florical President Jim Moneyhun made the announcement.

Ennes Workshop Radio Highlights

10 a.m.: "Linearity Performance Measurements in Modern AM Transmitters," Geoffrey N. Mendenhall, Harris

10:45 a.m.: "Implementation Methods for FM Simulcast Analog and IBOC Digital Operations," Bill Harland, Electronics Research Inc. (ERI)

11:30 a.m.: "IBOC - The Real World," with John Kennedy of Entercom-Boston; Paul Shulins, Greater Media Boston; and Robert Yankowitz, Viacom Boston

1 p.m.: "Keeping an Accurate Tower Log," John Bisset, Dielectric and Radio World

1:45: "Adaptive Correction of AM Transmitter Load Impedance Variations," Geoffrey N. Mendenhall, Harris

2:30 p.m.: "What HD Radio Needs to Wow Today's Radio Listeners," Frank Foti, Omnia Audio/Telos Systems

3:30 p.m.: "Internet-Based Control and Observation Broadcast Transmitting Facilities," Geoffrey N. Mendenhall, Harris

4:15 p.m., "Playing Both Sides of the Street," Dane Ericksen, Hammett & Edison, on 2 GHz TV BAS, 950 MHz Aural BAS and FCC issues.

5 p.m., "Adventures in Antenna Zoning," Fred Hopengarten, antenna lawyer

Info

What: SBE National Meeting & BOS-CON Regional Convention

Where: Best Western Royal Plaza Hotel & Trade Center in Marlborough, Mass.

Host: Chapter 11, Boston

When: Oct. 26-27

Exhibits: Oct. 26, 6-8 p.m.; Oct. 27, 9 a.m. to 4 p.m. (free)

How: www.sbe.org and www.bos-con.com.

Schedule

Tuesday Oct. 26

Ennes Workshop (registration req'd): 9 a.m. to 5:45 p.m.
National Certification Committee: 1 to 4 p.m.
National Frequency Coordination Committee: 1 to 4 p.m.
National Membership Committee: 2 to 4 p.m.
Bos-Con Trade Show: 6 to 8 p.m.
National Board of Directors: 6 to 10 p.m.

Wednesday Oct. 27

SBE Fellows Breakfast (Invitation): 8 to 9 a.m.
Bos-Con Trade Show: 9 a.m. to 4 p.m.
Annual Membership Meeting: 4 to 5 p.m.
National Awards Reception: 5 to 6 p.m.
National Awards Dinner (Ticket Req'd): 6 to 8:30 p.m.

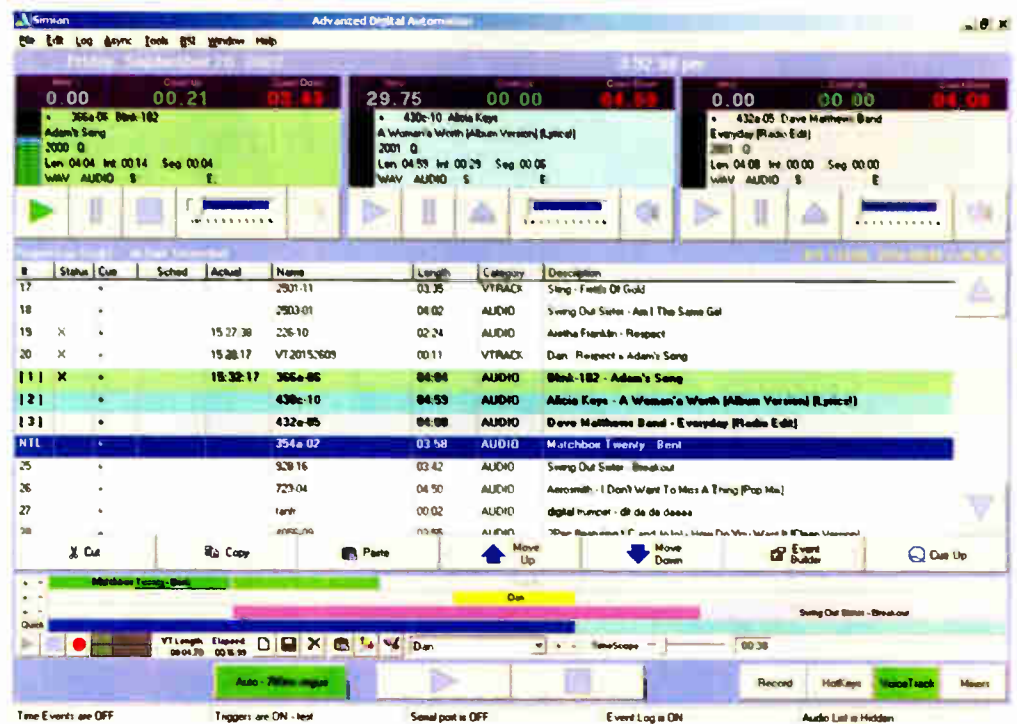
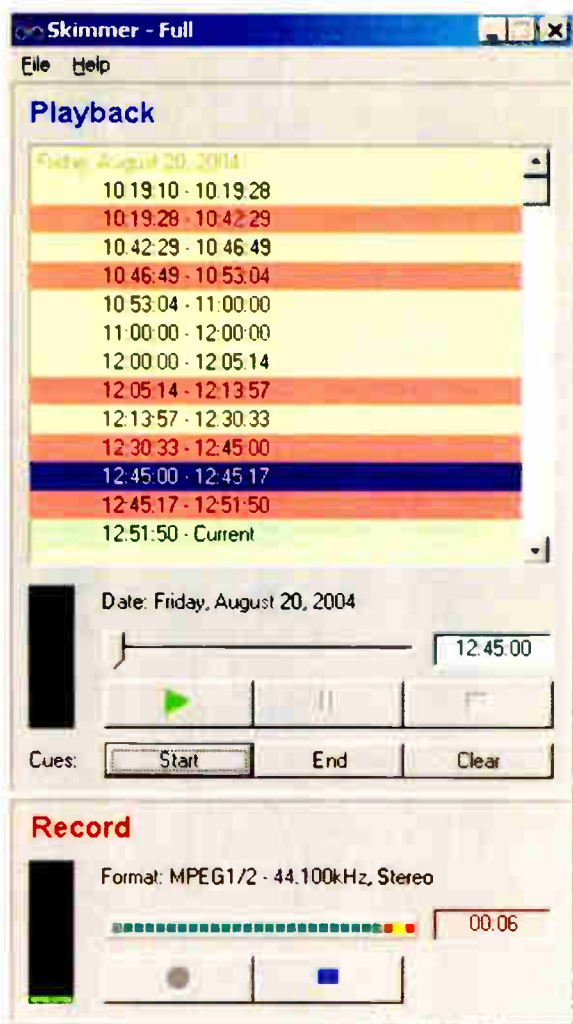

Get Skimmer FREE this month when you buy Simian

Purchase a copy of Simian digital automation this month and receive a free copy of Skimmer, BSI's audio logger.

Simian is a powerful, reliable, and affordable automation system, with the most complete feature set in the industry. The \$1499 Simian is touch-screen compatible, has easy voice-tracking, and runs on a standard Windows PC, using standard Windows (linear or compressed) audio files.

Skimmer is a fast, customizable audio logging application. We've sold hundreds at \$299. Some of the features include:

- Automated or manual operation
- Set your own output folder
- Customizable automated file naming
- Compression (MP3 CODEC included)

Save \$299 when you buy Simian now!



www.bsiusa.com sales@bsiusa.com 1-888-BSI-USA1
Broadcast Software International

Products & Services SHOWCASE

The Simple Cell Phone Interface Solution FJ-500 FlipJack

CELL PHONE INTERFACE



Connect To Standard Telephone In Event Of Poor Cell Phone Connection



CONEX
ELECTRO-SYSTEMS

Call For More Info
800-645-1061
www.conex-electro.com

SHOCK & AWE!

Avoid any unnecessary shock to your equipment. The next time you ship your rack mountable equipment insist on a shock absorbing and secure environment. Our shock-protected shipping cases have an inner rack shell, surrounded with shock absorbing foam for superb shock-isolation while in transit.

SHOCK PROTECTED

8 RU 24" Deep - only \$ 629
12 RU 24" Deep - only \$ 699

For other sizes, configurations and options

Shop Star Case Online
www.starcase.com
info@starcase.com

Toll Free 800-822-STAR (7827)
Toll Free 800-782-CASE (2273)



8 Rack Unit (14") High, 24" Deep
2" Foam-Isolated Inner Rack Shell
Front & Rear Lids & Tapped Rails
3 1/2" Swivel & Locking Casters

Superior Broadcast Products TV - FM - AM Transmitters & Antennas

FM Transmitters



Grounded Grid Models Feature

- Solid State High Performance Exciter
- Solid State Driver
- Ease of Installation
- Fast Delivery
- Motor Driven Tuning
- Complete Front Panel Metering
- Low Pass Filter
- Soft Start Up
- Cost Effective Pricing
- Financing Available
- LED Read out on front panel shows operating parameters

AM Transmitters

Solid State AM Transmitter

Power Levels to 50,000 watts

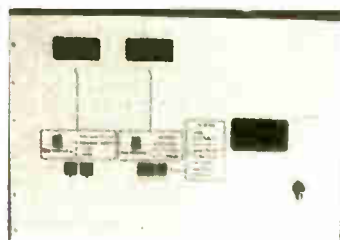

Wide band Amplifiers. Up to 150% modulation
Compatible with AM IBOC. Remote control interface.
Fast Delivery Shipped from Dallas, TX

1,000 watt Priced as low as \$7,900.00

Broadband FM Antennas

Ideal for Digital or multi station operation

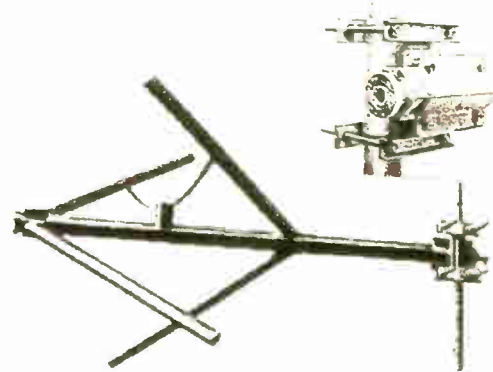

Circular polarization - DC ground for lightning protection - mounts directly to tower leg - Power input 4,000 watts per bay

Contact Benny Springer 800/695-7919 or Jimmie Joynt 800/279-3326 17194 Preston Rd. Suite 123-297 Dallas TX 75248

CircuitWerkes Control Solutions

DR-10 Dial Up Controller & Remote Broadcast Interface

- ▶ The DR-10 is a Dial-Up remote control with telephone audio input and output for remote broadcasting.
- ▶ If your automation works with satellite networks, you can use the DR-10's relay outputs to fire commercials, liners, etc.
- ▶ Use the DPDT relays to insert the phone audio directly into the program path when necessary, especially for emergencies.
- ▶ When used with our Silencer Option, the DR-10 is the **ONLY** product available that will completely remove DTMF control tones from the audio path for extra clean remotes.

pREX Programmable Relay Multiplier & Converter

- ▶ 12 optocoupled inputs and 16 CPU-controlled relay outputs.
- ▶ Control any output or a group of outputs from a single contact or from a group of GPIs using logic modes like AND, OR, XOR, NOR, NAND, NXOR, Interlocked, etc.
- ▶ Output modes include: Momentary, Toggled, Leading or Trailing Edge, Pulse Stretching up to 45 hours, Input Debounce, Maximum Ontime, Minimum Ontime and more.
- ▶ Program or control the relays by serial port using terminal or GUI.

GENr8 Programmable DTMF Tone Encoder

- ▶ The GENr8 is a powerful, yet inexpensive DTMF Generator that can produce either single DTMF tones or can record and play DTMF sequences up to 20 digits.
- ▶ Active, balanced, audio input and output lets you mix DTMF and program material without an external mixer.
- ▶ Program or control the GENr8 by serial port using terminal or our free GUI.
- ▶ Optically isolated inputs work with external contact closures to send tones or program the GENr8.

Learn how you can take control at www.circuitwerkes.com



CircuitWerkes, Inc. - 2805 NW 6th Street, Gainesville, Florida 32609, USA 352-335-6555

Mini Mix 8A

Proven...Affordable...

Reliable

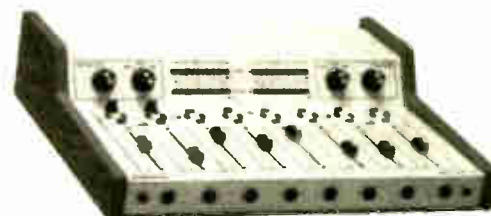

AUTOGRAM

800.327.6901

www.autogramcorp.com

Radio Free Asia Implements Automated System for DXers

Radio Free Asia is using a new automated reception report system that will be of interest to those who like to collect proof of distance listening. It was launched at the beginning of August at the Mexican DXing Conference in Veracruz.

The system is at www.techweb.rfa.org. According to the National Association of Shortwave Broadcasters, visitors can click on the "QSL Reports" link to get there.

"This advanced new service combines the power of the Mambo open-source content management system and a database," NASB stated.

Until now, RFA, like many shortwave broadcasters, has processed reception reports through postal services with a QSL card. Radio Free Asia, which notes its eighth anniversary this year, started issuing QSL cards to confirm reception reports two years ago. This year, it also started accepting e-mail submission.

It will still accept those formats; but NASB credits RFA's Chief Technology Officer David Baden with "spearheading a new trend in how DXers submit reception reports and how radio stations receive feedback."

Baden provided more details to Radio World: "Reports are verified for accuracy by the Automated Reception Report System. Data such as the broadcast language, broadcast date/time and the broadcast frequency are confirmed.

"If the reception report is determined to be an accurate and correct RFA broadcast, it is marked in the database as a 'valid report,' and a visual representation 'dot' of the report is placed on the 'Listeners Grid.'"

He said the grid is a "zoomable" world map that shows the location of reception reports received into the system. The grid is regenerated with each viewing.

"In most cases, when checking the

Listeners Grid after completing a report, you will find that your 'dot' is already on the map," Baden said, adding that suggestions for improvements are invited.

Meanwhile, for confirmed reception reports of programs monitored in August, RFA issued a special QSL card with a copy of the original artwork used to produce RFA's pins for the 2004 Summer Games in Athens.

The cards are designed by A.J. Janitschek, manager of RFA's production support department.



Sabre Towers



MARKET PLACE

Delco Wire and Cable Goes for Clarity

Aiming for purity of signal and ease of installation, Delco Wire and Cable introduced the Clarity line of digital audio cables this year.

Clarity cables are flexible snake cables that contain from two to 12 individually jacketed 110 ohm AES/EBU digital audio pairs. Each pair is color-coded for easy recognition at terminal points, and is capable of carrying conventional analog audio signals as well as digital audio data.

Delco also introduced a five-leg serial digital video snake cable and coaxial digital video cable as well under the Clarity label.

Contact the company in Ontario at (905) 669-2476 or visit www.delcowire.com.

Sabre offers a complete line of towers, monopoles and tower components. In the tower industry for more than 25 years, Sabre towers are engineered with experience. Offering everything in guyed towers from a 12" face tubular lightweight tower

to an 84" face solid leg knock down tower, Sabre has a tower for nearly all broadcast applications. Committed to customer service, Sabre offers quality products at competitive prices with the shortest lead times.



800-369-6690 • www.sabrecom.com
2101 Murray Street • PO Box 658 • Sioux City, IA 51104

Studio Sessions

Ken R. Takes
Your Jingle
Questions



Inside

Radio World

Resource for Radio On-Air, Production and Recording

October 6, 2004

AES Promises a San Francisco Treat

This Year's Convention Is the First West Coast AES to Feature Special Broadcasting Events

by Ty Ford

The 117th Audio Engineering Society Convention takes place at the Moscone Convention Center in San Francisco, Calif. from Thursday, Oct. 28 until Sunday, Oct. 31.

Vendor displays notwithstanding, the show's special events, workshops, tutorials and technical tours comprise a formidable wealth of information at many levels. Read on for a cherry-picked list of highlights for Radio World readers.

Special Events

David Bialik is a systems engineering consultant in New York and broadcast events coordinator for the show. He emphasizes that this AES show is the first West Coast AES that features special events for broadcasters.

"The message is clear — AES is not just for recording engineers and designers. The AES is recognizing broadcast engineers and bringing them into the fold."

Bialik said that, unlike some sessions that have admission fees, the special events are open to everyone.

"Opportunities for the Engineer in the Digital Broadcast World" runs Thursday from 1:30 to 3 p.m., and is moderated by Radio World Associate Publisher John Casey.

"Today's broadcast engineer needs an

expanded set of credentials in his toolbox, and often is required to have additional knowledge as an IT expert and network systems troubleshooter," said Casey. "One



With last summer's completion of Moscone West, San Francisco's Moscone Center covers more than 20 acres on three adjacent blocks.

need only look at the path new technology has carved for the distribution of program content via IP or fiber to get a glimpse of what the future holds."

Bialik says this panel is made up of professionals running top facilities and hiring today's audio people.

"Advertisers, the audience and, right now, sports programming are raising the bar for audio quality for radio and TV. This session will help engineers get a handle on how to utilize their skills in

this new marketplace."

"If you want to stay employed as a broadcast engineer," adds Casey, "you won't want to miss this session."

The "Digital Broadcast Radio Forum," Friday from 10 a.m. to 1 p.m., has been a convention event for the last 14 years. According to Bialik, who serves as moderator, "Digital radio has now gone from theory to reality. There's Eureka, IBOC (HD Radio), Satellite Radio and Tomorrow Radio. Representatives from NAB, NPR-Tomorrow Radio, Ibiquity, XM, Consumer Electronics, the Electronic Frontier Foundation and other organizations will be talking about digital radio broadcasting, different listening environments and the progress digital radio broadcasting has made."

"Surround Sound for Digital Radio" will be moderated by Emil Torick, the long-time head of CBS Laboratories. Bialik says participants from Orban, Dolby, Telos, Neural Audio, SRS and XM will be talking about the introduction of surround sound for digital radio.

"They're going to do it right this time, which means not like Quad."

The session is on Saturday, from 9 a.m. to noon.

Workshops

Workshops comprise another large part of any AES convention. Christopher Struck, director of engineering for Dolby Labs, is in charge.

"The workshops are two hours in length and audience participation is encouraged," said Struck. "The first workshop of interest to radio station engineers might be 'Firewire in Studios: Benefits and Challenges,'" on Friday, 11:30 a.m. to 1:30 p.m.

"In addition to what the panel brings to the table, we expect a lively debate. We're interested in discussing how this relatively new technology fits in and what positive disruption it may make. Does it replace a lot of cable clutter? Why do I want to convert? What about mLAN, Yamaha's version of 1394? What, if any, are the compatibility issues? Am I going to have to sign up to one company's flavor? Why have a second network at all?"

On Saturday from 9 a.m. to 11 a.m., the "Architectural Acoustics for Film and Broadcast Studios" workshop panelists will address the "black art" of acoustics. According to Struck, "You'll learn what works and a theoretical command of why. We know, for example, that what works in a big room doesn't work in a small room. This session will be very valuable to radio engineers who are forced to build smaller studios."

As audio is more often stored digitally, decisions about the storage medium become increasingly important. Struck says the workshop, "Which Audio Recording and Storage Medium for What Purpose?" will address the efficacy of digital tape, optical disk, hard disk, online, nearline and offline storage and distributed network/local storage.

"The decision to pursue this topic came right from the AES Technical Committee for audio recording and storage systems. It's about how to protect your data in the short and long terms," he

See AES PREVIEW, page 34 ▶

Audio Distribution Done Right

How many channels do You need?



From a small 2 Channel Summing Box up to 60 Channels in 3RU - ATI has your solution.

MIC or Line Audio Digital Audio - AES/SPDIF Master Clock/Sync

Celebrating 25 Years
of Innovation

Hear for yourself why more Engineers and Sound Professionals are specifying Audio Technologies Inc.
For your nearest Dealer call +1-215-443-0330 or visit our new webpage at www.ATIaudio.com

VIDEO LIGHTING STANDS CASES CABLES SOFTWARE AND MUCH, MUCH MORE
800-356-5844

FULL COMPASS

CALL TODAY, TALK TO A PRO.

GET GEAR HERE

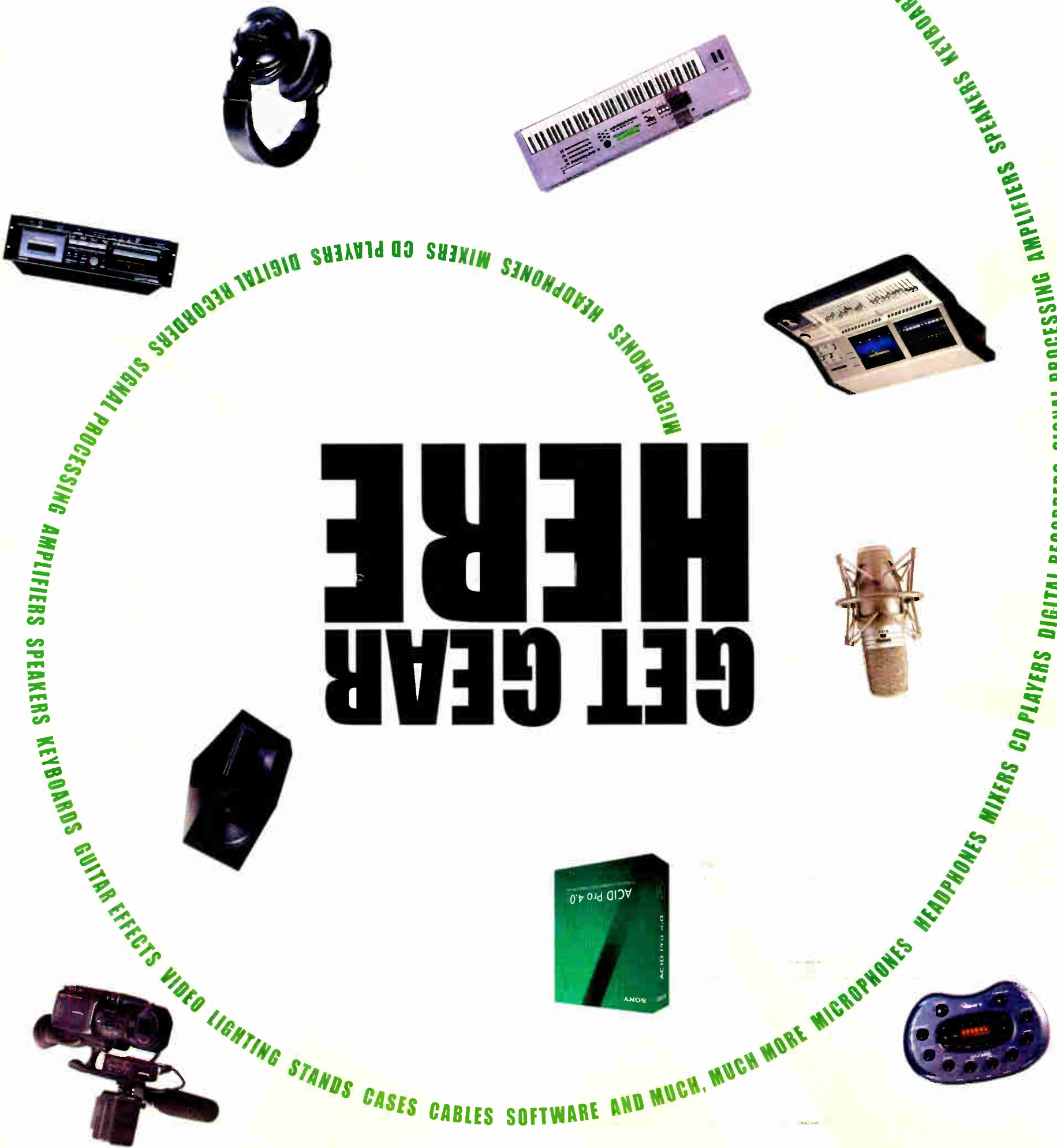

MICROPHONES HEADPHONES MIXERS CD PLAYERS DIGITAL RECORDERS SIGNAL PROCESSING AMPLIFIERS SPEAKERS KEYBOARDS GUITAR EFFECTS VIDEO LIGHTING STANDS CASES CABLES SOFTWARE AND MUCH, MUCH MORE

MICROPHONES HEADPHONES MIXERS CD PLAYERS DIGITAL RECORDERS SIGNAL PROCESSING AMPLIFIERS SPEAKERS KEYBOARDS GUITAR EFFECTS VIDEO LIGHTING STANDS CASES CABLES SOFTWARE AND MUCH, MUCH MORE

AES Preview

► Continued from page 32

said. This workshop is scheduled for Saturday at 11:30 a.m. to 1:30 p.m.

For engineers who wish to dive even deeper into the technology, AES also presents a series of tutorials, typically two hours in length.

Vice President and Director of Engineering for Wavefront Semiconductor Bob Moses serves as the Tutorials chairman.

"We find experts in various target fields and get them to (conduct) a class on a topic. Tutorials are more about training than research or academic presentations. We ask that the lectures not exceed 90 minutes to allow for a healthy Q&A," he said. Tutorial notes will be made available free, online to AES members.

Moses says Sennheiser's Jurgen Wahl will lead with "Subjective Microphone Comparisons" on Thursday, from 9 to 11 a.m. "Jurgen will address and show how different mics interact with different spaces. He'll drill down into the details as to why different mics should be used in different situations and why seemingly similar microphones sound so different."

Moses has lined up former THX engineer Tony Grimani to present a two-part tutorial on acoustics, "Acoustics — Part 1" on Thursday from 1:30 to 3:30 p.m. "Part 2" is from 4 to 6 p.m.

"Tony is the acoustics expert in this field," Moses said. "I'll personally sit through both of his sessions. We're trying to demystify the art. Tony will cover small room acoustics for studios, home theater and listening rooms, wave theory, sound isolation and damping."

Stanley Lipshtiz and John Vanderkooy of the audio research group at Canada's University of Waterloo will encoore a classic presentation, "The Basics of Digital Audio," on Friday from 9 to 11 a.m. to illustrate the issues involved with sampling and quantization noise. During this practicum, attendees will be able to hear quantization noise and the effect of dithered quantization.

"These guys are pretty fun to watch and listen to," Moses said. "This 'living"

textbook on digital audio works very well even if you don't understand the big words, because they let you hear what they are talking about."

Digidesign's Michael Poinboeuf takes

shield, balanced vs. unbalanced. It's entertaining and also incredibly informative. Bill's also been known to expose bad designs from manufacturers that cause problems."



The tour of George Lucas' Skywalker Sound production studio 'is a rare event that has sold out quickly in the past,' said the technical tours chair.

the "Digital Plumbing for Studio, Broadcast and Live Audio" tutorial, Friday from 2 to 4 p.m. According to Moses, "Michael's been active in the implementation of standards. I begged Michael to do this session. CAT-5, Ethernet, Firewire, ATM, busses, networks, interfaces — there's a lot going on. Find out how best to use the emerging technology."

Also on Friday, at 2 p.m., John LaGrou from Millennia Media talks about the importance of high-quality microphone preamps in "Design and Use of Microphone Preamps." He will discuss discrete vs. integrated amps and other design secrets that can make your voice talent stand out on the air.

The "Grounding and Shielding" tutorial on Saturday from 11:30 a.m. to 1:30 p.m. features Jensen's Bill Whitlock. Moses says this session is a favorite and has been on tour around the country.

"Bill's on a mission to eradicate bad grounding," Moses said. "There is some simple science behind where to tie your

On Sunday from 11:30 a.m. to 1:30 p.m., acoustic designer John Storyk will give his own take on "Acoustic Issues Concerning Small Studio Environments." This tutorial will investigate small-studio issues and includes real-world experiences, tips and tricks. Storyk's perspective will balance acoustics with aesthetics.

Technical tours

Larry the O, the communications manager for Meyer Sound — and who declines to disclose a last name — is the Technical Tours Chair. Among the many tours, the following four seem destined to attract broadcasters, among others.

On Thursday from 9 a.m. to 1 p.m. there will be a tour of KQED Public Broadcasting Radio and TV. According to Mr. O, "Since its inception, KQED has been a pioneer in educational TV. They were also the first to commit to digital broadcasting and a Web site. The result of the complete overhaul of both TV and

FM facilities several years ago is something to be seen."

The tour of Meyer Sound Laboratories on Friday from 9 a.m. to 1 p.m. will be special because 2004 is Meyer Sound's 25th anniversary. Mr. O says this tour will give broadcasters a unique look into the detail Meyer uses in its manufacturing.

"Getting to 70 percent isn't hard. Going the whole nine yards to full detail is gloriously insane. That's what we do. I have a 100 percent success rate of flooring people with the tour. The words 'I had no idea' are very typical. We start by researching paper for 16 months before choosing the paper we use to make our own speaker cones."

Film buffs and musicologists will enjoy the tour of Fantasy Studios/Saul Zaentz Film Center on Friday at 1 to 5 p.m. Mr. O explains, "Built in the late 1960s, the Fantasy Studios/Saul Zaentz Film Center is one of the most historic places in the Bay Area. Fantasy, in addition to being a major jazz label in the '60s, was built to record Creedence Clearwater Revival. There are currently five music studios, Foley, mix and editing rooms."

The opportunity to walk the hallways and studios built for George Lucas in the late 1970s while "The Empire Strikes Back" was in production makes the tour of Skywalker Sound on Saturday from 1 to 5 p.m. a must-see. No expense was spared in the construction of the studio, which features the Scoring Stage recording room.

Says O, "The ranch itself is amazingly beautiful and at the same time it's right at the cutting edge of technology. This is a rare event that has sold out quickly in the past."

There are many other events in each category, and the AES Show promises enough technical papers to reach from Bangor, Maine to the front door of the FCC in Washington. Bring comfortable shoes and remember, calories don't count in San Francisco.

For a complete listing of the 117th AES Convention events visit www.aes.org.

Ty Ford is a frequent contributor to Radio World and can be reached at tyreeford@comcast.net.

PRODUCT GUIDES

Audiophonic's Archives Arm Restores Old Recordings

Woodland Park, Colo.-based **Audiophonic Corp.** released information on its Cook Recording Division and Archives arm and customized sound restoration service.

Historic recordings can be sent to the company for denoising and sweetening using peripheral and main system equipment such as turntables, tape recorders and 8- and 16-channel Ampex and Studer machines.

The service removes the background hash from wire recordings, cassettes and tapes. Additionally, the service covers 16- and 12-inch transcription discs, 78s, LPs and 16 mm film soundtracks, optical and magnetic.

The Cedar system is used, consisting of three special-purpose computers tied together to eliminate noise, a declicker, decrackler and dehisser. As a backup plan for recordings with major flaws, such as cracked or warped vinyl records, a special program is installed in a computer from the company's sound library that removes the hum and "deep pops" that the Cedar system cannot.

For more information, contact Audiophonic Corp. at (719) 687-6357.



VoxProPC 3.3 Offers Sound Card Compatibility

Audion Labs released version 3.3 of its VoxProPC voice editing software. The upgrade allows for gain increase for selected audio for one or both tracks; compatibility with most sound cards; MP3 import and export of multiple files using an LAME encoder/decoder; streamlined administrative features and faster access to file-containing folders.

Users also will notice master recordings displayed in the current user's account, regardless of where associated edits reside. Gain control volume adjustments are featured in 1 dB increments for a maximum of +/-24 dB on either or both channels. This version also deletes cancelled recordings, and stores the most recent 25 deleted files in the deleted file folder, with older files automatically deleted as newer ones move in.

VoxProPC 3.2 software upgrades are available at no charge within one year of registration.

For more information, contact Audion Labs at (206) 842-5202 or visit www.audion-labs.com.



Chapter Two

One balmy Cleveland evening, the Telos and Omnia gang were relaxing when someone asked a blue-sky question: "What do you think the radio station of the future will be like?"

The ideas flew. "Computers will send digital audio right to the mixing bus," said one engineer. "Information, too." "No more sound cards, distribution amps or cable bundles," said another. "No more expensive routing switchers, either. Everything will be simply networked," said a third, "and all the audio devices will talk to each other using low-cost stuff from the computer world." "They'll probably be broadcasting in surround sound by then," piped one. "Consoles will be fully integrated with phone and codec gear, and will be much more flexible!" offered another.

Waitjustaminutehere!" came a voice from the corner. "We could do all of that today! We could use Ethernet, and it would be quick to set up and easy to use. You could network dozens of studios, or whole buildings with it. And it would cost a lot less than any other all-digital system. I'll bet broadcasters would love it!"

The engineers got very excited and decided to turn their ideas into reality. Tirelessly, they toiled. Immense quantities of pizza, Chee-tos and magical elixirs were consumed. Finally, they were ready... but how would the world react?

Good news! The system they brought to NAB was a success! Broadcasters swooned. The press were impressed. Early adopters adopted it.

Meet Axia, the newest division of Telos. Axia is all about making radio studios better. Another happy ending! Or is it just the beginning?

Stay tuned for more...



JRN Walks the POTS Line in Branson

Remote Broadcast of Country Music Festival Uses Comrex Blue Boxes After ISDN Plan Fails

by Lew Jones

BRANSON, Mo. When I started planning the broadcast of BransonFest 2004 from Branson, Mo., I thought it would be simple. All I needed was an ISDN line.

I already had promises from celebrities like the Oak Ridge Boys, Mickey Gilley and Pam Tillis to appear on the program; the Branson-Lakes Area Chamber of Commerce had agreed to assist with details; and the Welk Resort Theatre, the site of BransonFest for the last few years, had guaranteed full backstage access and a place to set up my equipment.

I had, of course, done this sort of work before. As operations manager of Jones Radio Networks' Classic Hit Country format, I have been involved in a number of remote broadcasts, always focusing on keeping the listeners in touch with the classic country artists whose music they hear daily.

For instance, during Fan Fair 2002, I did one of the first broadcasts from the newly installed radio studio in Nashville's Ryman auditorium, taking advantage of the simultaneous Grand Ole Opry performance for ambience and extra celebrity involvement. Classic Hit Country personalities also have conducted interviews and broadcasts at many of the past years' Country Radio Seminars from the Nashville Convention Center.

Enter Murphy's Law

BransonFest, which is under the general sponsorship of the Branson Lakes Area Chamber of Commerce and Convention & Visitors Bureau, serves as the official kick-off of the Branson tourist season. Occupying the better part of a week in early April, various artists from the area's competing theatres converge at one venue for short "teaser" versions of their acts. Huge circus-style tents are set up on the grounds, with food-tasting areas, booths promoting the shows and attractions and a number of events staged free to the public.

The broadcast should have been a piece of cake. After installing the ISDN line, all the other parts of the puzzle should fall into place. Welk Resort Theatre Operations Manager Mike Hughes had agreed to work on this detail. Meanwhile, my guest list was growing.

In addition to The Oaks, Gilley and Pam Tillis, Ronnie McDowell agreed to stop by, and I was told I could catch the Gatlin

Brothers, who were flying in for a few hours. Also to be featured on the broadcast was a sound tour of the Roy Rogers and Dale Evans Museum and Theater, which had been moved from California during the previous year. Roy Rogers Jr. would be our host for that excursion. "Dusty," as he had been nicknamed by his dad, performs with his group, The High Riders, doing Western songs reminiscent of Roy and Dale.



The author poses with country music artist Pam Tillis during BransonFest 2004.

Enter Murphy's Law, arriving in the form of a phone call from my main contact, Vicky Hall of the tourism department of the Chamber of Commerce. She had received word on the installation of the ISDN line, and it wasn't good. For previous broadcasts at the Ryman and Nashville Convention Center, the necessary line had already been in place. But this time, it would have to be installed from scratch.

The telephone company serving Branson is not one of the major ones, and their estimate on the high-quality line was for thousands of dollars. It was clearly a budget-busting item, and threatened the entire project. The situation obviously needed to be reexamined.

I could cancel, but going back to Branson for a broadcast was something I had wanted to do at JRN for some time. In the mid-1990s, I was program director of the old Branson Music Network, and thus knew the town well. I returned on several occasions to do tape-recorded backstage

interviews, but never for any daily broadcasts. Call it a personal whim, but I really wanted to do it.

So, with ISDN out of the question, the search for alternative technology began. The interviews could be taped and brought back, of course, but this would destroy the immediacy of the broadcast. Coordinating with the actual BransonFest event was desirable, as Classic Hit Country has a number of affiliates in the area, and local remotes help to entice listeners to attend the events.

Unlike a local remote, where it's desirable to attract walk-by or drive-by traffic, this was strictly for the radio audience.

The Blue Box was mated with a Shure FP-42 four-channel mixer, and I carried three Shure SM58 mics, which were mounted on desktop mic stands. It worked out that only two of the mics were used at a time, with one kept back for a spare. When there was more than one guest, as with the Oak Ridge Boys, they simply handed the mic back and forth.

Our setup was simple. One Blue Box was placed in our Classic Hit Country control room in Denver, hooked into our console, and its companion unit was with me in Branson. With AC power applied, and the connection made to the non-PBX line at the theatre, I just had my Blue Box dial up the other one back in Denver, and communication was established.

While it worked out fine in the end, when first testing the unit from Branson, there were serious misgivings. I wanted to be on location a full day early so I could try everything out and run down any problems that might come up. Nothing is more nerve-racking than having a celebrity guest waiting while equipment has to be fiddled with or someone from the venue searched out because of a missing detail, such as nearby AC power. During this pre-test, Marty and members of our engineering staff pronounced the sound somewhat poor. However, we kept working, setting levels and establishing procedures and hoped for the best for the actual broadcast.

When the dialup connection was made the following day, the sound was much better. The first day's long-distance connection was probably just a bad line. As we all know, it happens with other phone calls.

There was no need to monitor the broadcast on speakers, as there was plenty going on in the backstage location. Unlike a local remote, where it's desirable to attract walk-by or drive-by traffic, this was strictly for the radio audience.

As a longtime reader of Radio World, I had seen ads for the types of codecs that used POTS lines — plain old telephone service. I wondered, could a pair of these devices rescue our project? I knew they had filled the bill for local remotes at stations across the country for quite some time, and many news operations had used them to good effect. Maybe this was the way to go.

Simple setup

After checking what might be available on a rental basis, the JRN engineering staff and I settled on a pair of Comrex Blue Boxes from Silver Lake Audio in New York state. They were portable, appeared to have the right connections for our use and were said to be reliable.

Upon arrival in Branson, we saw that the Welk Resort Theatre had gotten the local phone company to install an outside line for the Blue Box, bypassing their PBX, and had also provided a regular extension for me to use in keeping in contact with the studio. For simplicity, I received verbal cues from Marty Montell, who directed the broadcast from JRN in Denver, rather than attempt to employ any mix-minus circuitry.

There was no need to be monitoring the broadcast on any speakers, as there was plenty going on in the backstage location.

The decision was made to re-dial quickly if quality was poor, but the problem did not repeat itself.

The "remote studio" was actually a corner of the backstage hospitality area of the Welk Theatre, and consequently was a bit noisy, with musicians coming and going and a lot of conversation. Thankfully, the Shure mics picked up just enough of this background to provide backstage ambience, but not enough to be distracting.

It was a great broadcast experience. The aforementioned scheduled guests were able to make it on time, and there were unscheduled drop-ins from veteran country music manager Jim Halsey, instrumental in the careers of such artists as Roy Clark, Merle Haggard, the Judds and the Oak Ridge Boys; and the Jordanaires' Ray Walker, who sang background for Hank Snow, Red Foley and most notably, Elvis Presley.

And while strolling around the exhibit hall tent, I serendipitously encountered "The Ragin' Cajun," musician Doug Kershaw, who granted me an interview and personally delivered tickets for me and the family to his show for our last night in town.

The author is the operations manager for Jones Radio Networks' Classic Hit Country. 📞

WE GIVE YOU STIMSON

Name: Leslie Paula Stimson

Title: News Editor/Washington Bureau Chief

Experience: 26 years of industry experience, including more articles on IBOC DAB than any journalist in the world. Former reporter for radio stations, VOA, Maryland News Network, MPR, McGraw-Hill, NAB's Radio Week, NAB Daily News and Radio Business Report.

Speaker/Panel Moderator: Consumer Electronics Association, Federal Communications Bar Association and regional equipment shows

Heroes: My husband, and my late parents Catherine and Burt Stimson



Radio World's pages are home to the finest writers and columnists in the industry. Like Leslie Stimson. Just one more reason we're the newspaper for radio managers and engineers.



WANNA TRADE?

\$500 TRADE-IN CREDIT on ANY CONSOLE
TOWARDS an AUDIOARTS R-90*

* Larger \$\$\$ Trade Credit on Select Models - Call SCMS for Details

Audioarts R-90 - The Streamlined Audioarts Console

FEATURE LIST:

- dual phone caller support
- Wheatstone's reliable SimplePhone® circuitry
- true modular construction
- electronic switching throughout
- LED illuminated switches throughout
- extensive control room monitoring
- dual studio support
- dual headphone support
- external power supply
- failsafe power option
- 23 input/accessory positions
- one master module position
- two monitor module positions
- digital timer (manual and auto restart)



- digital clock (reads ESE time code)
- cue speaker with built-in amplifier
- conductive plastic faders and monitor pots
- connectorized faders and channel ON/OFF switches
- steel construction
- concealed headphone jacks
- countertop installation

**CORPORATE
SALES OFFICE
Pineville, N.C.**

**Call: BOB, MIKE
ERNIE or MATT**

**Toll FREE 1-800-438-6040
Fax 1-704-889-4540**

**e-mail sales@scmsinc.com
www.scmsinc.com**

Mid-South Sales:
Bob Mayben
Voice: 877-391-2650

Central Sales:
Bernie O'Brien
Cell: 731-695-1714

West Coast Sales:
Doug Tharp
Sales: 866-673-9267

Mid-West Sales:
Mary Schnelle
Sales: 1-800-245-4307

South-Atlantic Sales:
Art White
Sales: 770-632-1295

North-East Sales:
Jim Peck
Sales: 315-623-7655



SHOwCASE

Products & Services



**ACM-3 AM NOISE MONITOR...
new technology for positive control.**

- Complete Kits Available for New Installations
- Economical Upgrades Available for Existing ACM Users
- Maximized Performance From Your FM Transmitter
- Assured Signal Coverage Consistency
- Positive Control of Multipath Artifacts
- Reduced Subcarrier Crosstalk
- Maximized Stereo Separation
- Switch Selectable High-Pass and 75 μ s Filters
- Portability and Compact Versatility of RACK-UP® Series

NEW 2004

READ ABOUT IT! <http://r9.rackups.com>

RDL International Sales: (928) 443-9391
United States Sales: (800) 281-2683
European Sales: (31) 20-6238-983

Broadcasting to the World

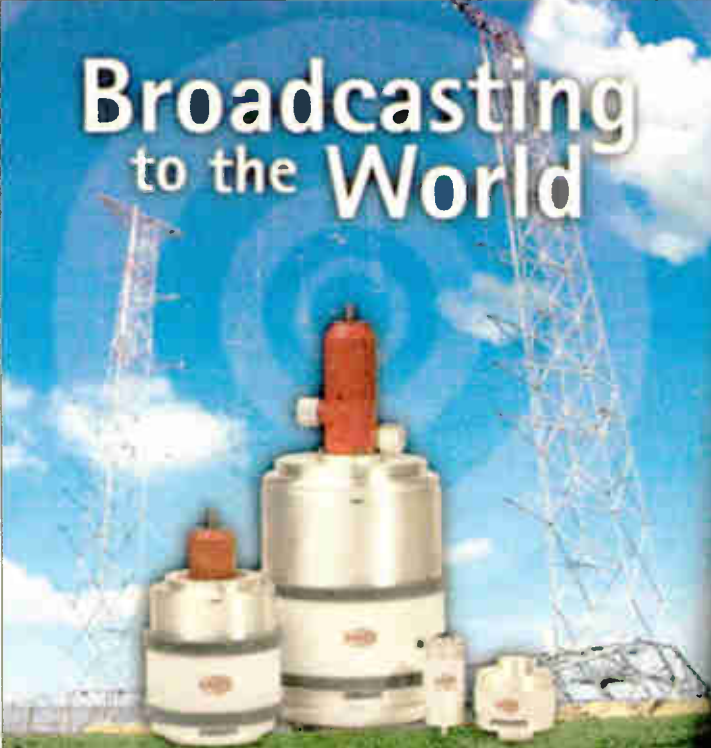

COMET NORTH AMERICA
421 Wanda Comet Road
Cincinnati, Ohio 45140
Ph: (513) 831-5000
Fk: (513) 831-7889
www.cometna.com

- World's largest manufacturer of broadcast towers
- Broadcast towers for AM, FM, TV, and Satellite
- Broadcast towers for AM, FM, TV, and Satellite
- Broadcast towers for AM, FM, TV, and Satellite
- Broadcast towers for AM, FM, TV, and Satellite
- Broadcast towers for AM, FM, TV, and Satellite

KTL
Kintronic Labs, Inc.
188 Pleasant Grove Road
Burlingame, CA 94010
Ph: (415) 879-2141
Fk: (415) 879-4224
www.kintronic.com



DIGITAL ANTENNA MONITORS

In-Stock-Available for Immediate Delivery



Price US\$2700.00 2 Towers
Will operate with any remote control equipment.



Price US\$2100.00 2 Towers
For AM directionals with studio located at transmitter site.

These monitors are state-of-the-art instruments of unequalled accuracy (.5% or better on ratio and .5° or better on phase) and stability. With typical modulation the true ratio readout of these monitors is a factor of 10 more stable than instruments that measure normalized amplitude, and their phase readouts are rock solid. Phase sign is automatic, no extra operation. In addition to the analog DC outputs for remote control the Model CMR has a multiplexed BCD digital output which can be used to drive the Remote Indicator Model CMR-1. RF inputs have dual protection. Gas discharge tubes across the sample line terminations plus relay protection.

GORMAN REDLICH MFG. CO.
257 W. Union St. Athens, Ohio 45701
Phone 740-593-3150 • FAX 740-592-3898
www.gorman-redlich.com/jimg@gorman-redlich.com

You're Here!



...and so are the potential buyers for your products and services.

Radio World's Product & Services Showcase pages are a great place to promote your business.



To advertise, call 703-998-7600, ext. 154
or e-mail: stewell@imaspub.com.

AM Antenna Solutions



LBA Tunipole™
Folded Unipole Systems



RF Components



Vacuum Capacitors



Diplexer, Triplexer and Phasor Systems

COMET Sold Here!

Reach further – sound better!

LBA Technology, Inc.

3400 Tupper Drive, Greenville, NC 27834
800-522-4464 / 252-757-0279 / Fax 252-752-9155 / Email Lbatech@Lbagroup.com / www.Lbagroup.com

LBA Since 1963

Problem Solvers For You!

CircuitWerkes makes control and interface solutions including: telephone couplers, powerful DTMF operated controls and encoders, subaudible decoders & encoders, sophisticated and simplified relay expanders, and more. Our product line is growing monthly and we keep stuff in-stock for instant delivery. Call us or visit our website to see how we can help you at a surprisingly affordable price!

NEW From CircuitWerkes:

The GENr8 DTMF Tone Generator / Encoder



- Generates all 14 DTMF tones & eight, user defined, DTMF sequences.
- Balanced audio input for mixing & balanced output at up to +17dBm.
- Generate tones or sequences with contact closures.
- Program or control via serial port with our free software.

See our MANY new problem solvers online at www.circuitwerkes.com

Mic Accessories Help Decrease Noise

Accoutrements Like Windshields and Pop Filters Curb Effects From Breath, Wind

by Blazo Guzina

In everyday recording and broadcasting practice, engineers use myriad devices to facilitate work with microphones.

Windshields, pop filters, stands and booms, shockmounts, cables and connectors influence the quality of recorded sound.

Wind is one of the most negative influences on sound recorded outdoors, and causes unwanted vibration of the microphone membrane. The extent of the vibration is proportional to wind velocity.

Windshields are made to fit many microphones and are practically indispensable for outdoor recording or live broadcast.

Breath effects

The purpose of a shield is to curb noise due to wind turbulence at microphone edges and corners, especially if they are sharply curved.

Noise can be more or less efficiently reduced depending on the type of microphone, its construction, the mechanical properties of the membrane and the shape of the housing.

Pressure microphones, especially those with an aerodynamic housing, generally, are less sensitive to wind and draft disturbance than other types.

Sometimes, windshields may be useful indoors, when it is necessary to reduce the breath effects of ultraclose microphone placement. Moreover, in drama recording studios, windshields permit rapid and abrupt boom movements.

Masks are more or less effective, depending on type and material. The screen is made of rubber or polyurethane foam, a wire or plastic acoustically transparent mesh, fiberglass-reinforced polyester, fabric, silk and even faux fur.

Masks are most effective in reducing the unwanted rushing sounds produced by wind or draft in a range of 4 kHz to 5 kHz, in amounts ranging from 12 dB to 30 dB. Finding which sort of mask best suits a particular microphone and application is a simple matter of trial and error.

Pop quiz

When recording with a microphone close to the mouth, the membrane is hit by a little explosion of air known as "pop."

Gradient and ribbon-type microphones are sensitive to wind and plosive sounds (*p*, *t* and *k*, for example), and are not suitable for outdoor recording and broadcasting. Even when used in a studio, a pop filter in front of a microphone is mandatory. Some microphones have built-in pop filters or ball-shaped grilles.

External pop filters are either in the form of a nylon "stocking-type" screen stretched in a hoop placed a few inches from the microphone, or a foam sleeve or "sock" put over the microphone.

Even ordinary windshields can help reduce the intensity of sound pops. A good pop filter does not affect microphone level and creates only minimal change in directivity and response.

A natural way of reducing pop sounds is placing the microphone to the side or

above the mouth. Microphones with omnidirectional polar characteristics generally are better than directional ones when employing this solution.

No restrictions

Because microphone cables carry the electrical output signal to the recorder or mixing console, it also is important to consider microphone impedance and cable length.

With low-impedance microphones, there are no practical restrictions regarding cable length in a studio or on stage during a live broadcast. Low-impedance microphones (150 to 600 ohms) generally pick up less hum than high-impedance ones.

For equipment with high-impedance inputs, low-impedance microphones with step-up transformers are recommended. The engineer then is free to use any desired length of microphone cable.

If a microphone, connectors and cable are checked properly, and mechanically and electrically accurate, there should be no hum pickup or high-frequency loss.

Microphones with balanced outputs — three-pin XLR or DIN connector, wired to a two-conductor shielded cable — generally pick up less hum than unbalanced ones.

The purpose of shockmounts is to hold the microphone body in a resilient soft suspension that isolates it from unwanted mechanical vibrations. Most common vibrations are the result of impact, bumps to the microphone stand, handling, footfalls and floor thumps.

Some microphones have a built-in internal shockmount, designed to isolate the microphone capsule from its housing. This design reduces both stand thumps and handling or cable noise.

Inexperienced speakers

In a situation where the user is still not satisfied with measures taken to reduce vibration noise, the last recommended solution is to use a bass roll-off filter to cut off the low-frequency portion of microphone response.

In addition to the above equipment, there are also many ways of mounting microphones. Suspension by adjustable wires, stands and booms is advisable if there is a risk of table tapping by inexpe-

rienced speakers.

Stands and booms hold the microphone and enable the user to position a membrane toward a sound source. A stand is better if it has as weighty a base as possible in order to assure the balance and stability of the upright pole.

The legs of a stand usually are detachable or may fold together for storage and transport. A heavy-duty studio floor stand comes with antivibration mounts concealed in the legs or with rubber tips.

Floor and desk stands differ in dimensions and purpose. Stands may also have a flexible shaft, known as a gooseneck or swan neck. Shafts and adapters allow the adjusting and positioning of a microphone as desired.

Booms differ from stands in that they have a long horizontal arm attached to the vertical pole. This arm may be telescopic, with one end weighted to balance the front end, together with a stand adapter, which holds the microphone.

The arm is fully adjustable for length and angle. Arms usually are designed to enable panning of the microphone through a full circle by turning the pole.

For stereo recordings, a twin microphone adapter bar may be used. The bar must match common types of stands with threads, making it possible to fit two microphones on one stand. 🌐

Got a Jingle Question? Ask Ken R.

Author and Connoisseur of Classic Radio ID Jingles From the '60s and '70s Takes Questions

by Ken R.

This article is an excerpt from "The Second Jingle Book," PAMS Productions Inc. of Dallas, referred to below, was one of the leading producers of radio ID jingles.

Q: *What happened to the full jingle sound we used to hear? Are producers even using all-male groups as the dominant sound anymore? Frankly I think the synthetic music sounds cheap.*

A: *More than the vocal blend, it's the instruments, or lack thereof.*

To someone whose ears are accustomed to real brass and strings, synthetic music does sound cheap and thin. To people raised on hip-hop, rappers, Britney and that whole hee-haw gang, contemporary jingles sound natural, and anything with brass and strings sounds old-fashioned.

People listening to contemporary hit radio today were probably born in the 1980s — after disco, for heaven's sake. These youngsters were eight years old when the Gulf War was going on, which seems like last week to me. They have a different frame of reference.

With respect to vocals, group singing in general is almost non-existent in pop music. With the exception of a few girl groups and boy groups, who mostly wail and improvise, actual harmony is extinct.

Certainly the type of chords used in earlier vocal groups is gone because it sounds "old." I'm referring specifically to diminished, augmented sixth chords and major seventh chords, for you musical folks. In fact I once asked Jackie Dickson (now Jackie Merriman), one of the best Dallas singers, how she was doing, and she replied, "Oh, you know, thirds and sixths."

Another casualty is that swingin' style. In rap, not only is harmony gone; melody is MIA.

Q: *I'm a jingle writer. How do I find the names of some of the production companies and advertising agencies in Chicago and other places?*

A: *When I was soliciting jingle business, I went to the library and got the "Advertising Red Books," properly called "The Standard Directory of Advertising Agencies" and "The Standard Directory of Advertisers." That was many years ago; they sell them online now, as well.*

You can search and find all the agencies that specialize in broadcast, and then pick up the name of the broadcast producer at that agency. A demo CD to that person can sometimes be a start, especially if you follow with a phone call.

Usually the skills that make a great musical talent are not found in the same person with great self-promotional talents. But you need a little of both to succeed.

Q: *What are your favorite PAMS packages that don't get much recognition? (Note: PAMS Productions Inc. of Dallas was one of the leading producers of radio ID jingles.)*

A: *Here's my list of favorite, non-series overlooked packages.*

"WLS 70-71" — Probably the tightest, coolest package ever. Great vocals; in fact it was the peak of the PAMS sound. Most of these cuts would still work today.

"Super Country" — I'm not a big country fan, but this thing was smokin'.

"LOVE FM" — The 1969 package that ran on the ABC O&O stations. Very different, and it experimented with new rock sounds. Cool vocals, and it was recorded in stereo.

"Smart Set" — Magnificent orchestral arrangements. Probably the biggest group

of musicians PAMS assembled. It also had a nice logo, although that was probably originally written by Tom Merriman for WIFE(AM)'s "Starbright" package at CRC. Very cool for the "better music" stations.

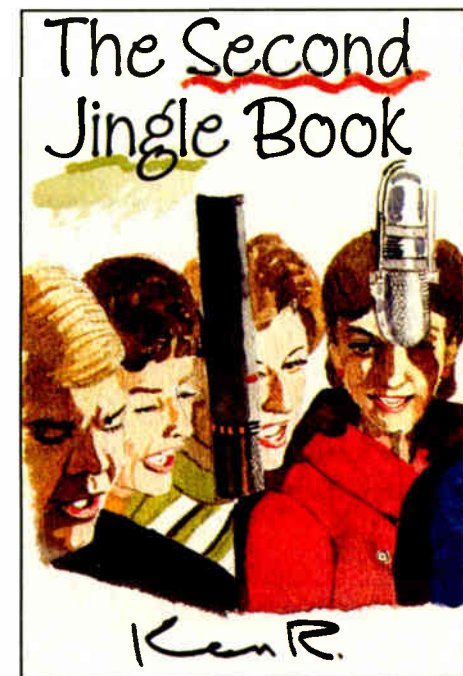

Q: *Did you know the "Sonowaltz" cut from Series 18 was based on a recording called "Blue Brass Groove"? The original recording is from the big band of Julian "Cannonball" Adderley. It's a composition by his brother Nate and can be found on the CD "African Waltz" (Riverside Records CD OJCCD-258-2, available from ZYX-Music). What's the story behind this?*

A: *I was not aware of that, but based on the MP3 clip you sent me, it certainly seems to be taken from that song.*

The main writer on Series 18 was Euel Box, the guy responsible for many PAMS jingle packages in the 1950s through about 1973. Several of the other cuts in Series 18 are borrowed from songs, too. Henry

See JINGLE BOOK, page 40 ▶

Jingle Book

► Continued from page 39

Mancini influenced a lot of PAMS jingles. Si Zentner, another handleleader, had a few "tribute cuts" in PAMS' early series.

In an effort to sound contemporary, jingle writers took ideas from whatever hits were popular at the time. This was true right through the 1970s, when the influences included Sergio Mendez, Chicago, The Carpenters, Crosby Stills & Nash and others.

Sometimes PAMS even named cuts after the composers on the package lyric sheets. Examples that come to mind are "Mr. Lucky" (Mancini) in Series 18 and "Lalo Says" in Series 40, named after Lalo Schiffrin, who wrote the music for the "Mission: Impossible" TV series.

Q: What are the copyright considerations when designing a package that includes an existing song? Does it involve getting permission from the publisher and paying ongoing licensing fees?

A: There are two answers: Yes, there are copyright and licensing issues involved; and no, almost no one in Dallas or Memphis, another jingle hub, paid any attention to them.

I could point out literally hundreds of instrumental and lyrical rip-offs perpetrated by the jingle companies, created and sold. Perhaps because only a bar or two would be stolen, claimants didn't bother prosecuting.

One example of a station that paid for the rights is WABC(AM), New York, which licensed "I'll Take Manhattan" for an annual fee.

Q: I heard a great jingle that JAM Creative Productions did for you some time ago. It was a phone message jingle sung to the tune of "In the Mood." What's the story?

A: That jingle appears on the marvelous JAM 1979 promotional album, which is where you probably heard it. (Visit JAM at

www.jingles.com.)

"On the Phone" was created when we had a little time left at the end of a session for one of our retail clients, which Jon Wolfert, president of JAM, was producing. The drums on the phone jingle were actually a very primitive

New York were not sung in Dallas?

A: It is true. An early assortment of cuts from Series 16, 17, 18, 22 and 23 was sung with New York singers. A second session, with cuts from Series 26, was also sung by that same group.

In an effort to sound contemporary, jingle writers took ideas from hits that were popular at the time. This was true through the 1970s, when the influences included Sergio Mendez, Chicago, The Carpenters, Crosby Stills & Nash and others.

machine. I played piano, and singer/arranger/musician Chris Kershaw played bass. It took only a short time to complete, but I've gotten more comments on that over the years than most of the other stuff we did.

I must credit Mr. Wolfert for bringing that together. He took my silly lyrics and turned it into a polished production.

Q: What is it about the key of F that make jingle producers want to use it repeatedly?

A: Many jingles are in F because this often puts the highest part, soprano, on C above middle C, a nice high spot yet not too high. It also allows Mr. Bass Man to end up on an F at the bottom of the bass clef. In other words, it's a good range for the singers of a traditional vocal group.

All-guy jingles are more likely in C or D because of where that puts the lead guy.

And here is more information than you wanted: If it's a really mellow jingle, the writer will place it a little lower on the staff so that the group can sing softer, with more air, and create a breathier sound. You need a lot of energy to hit those high notes.

Q: Is it true that some of the 1960s PAMS jingles we heard on WABC(AM),

Jon Wolfert, president of PAMS Productions Inc., tells me that the first session was done at Olmstead Sound Studios,

One E. 54th St., New York 22, N.Y. Their phone was PLaza 1-0890.

WABC historian Peter Kanze has the mono reel of the second session. Reading the label, he learned that it was held Aug. 24, 1963, at A&R Recording, 112 W. 48th Street in New York. The phone number at that studio was JUDson 2-1070. The instrumental tracks were supplied by PAMS, 18 of them in all, and the singers recorded a total of 149 takes.

The reason these weren't sung in Dallas? WABC was an American Federation of Television and Radio Artists (AFTRA) signatory, and all on-air talent belonged to the union, according to Wolfert.

"ABC management was afraid there would be a problem if word got out that the station was using jingles performed by non-union talent. Thus PAMS sang the cuts with N.Y. union singers to keep the peace."

"The Second Jingle Book" is available through www.ken@kenr.com.

Blue Sky MediaDesk Offers Desktop Monitoring

Blue Sky International describes its MediaDesk as a compact 2.1 full-range monitoring solution suitable for critical mixing and monitoring on the desktop. It enables computer-driven audio recording and production in a close-field environment of less than one meter, and incorporates two Blue Sky amplified satellite speakers and a powered subwoofer that features a cast aluminum frame and 8-inch forward firing driver with 1.5-inch voice coil.

The company says a pair of MediaDesk two-way satellite speakers is at the heart of the system. Each one is powered by a low-distortion 60-Watt amplifier located in the subwoofer, and features a four-inch Neodymium hemispherical driver and a one-inch soft dome Neodymium tweeter.

MediaDesk employs the company's computer-optimized crossover and 2.1 bass management network, delivering audio from the subwoofer to the main monitors with on- and off-axis frequency response. It can be upgraded to a 5.1 multi-speaker system with a kit that includes three additional satellite speakers, a three-channel amplifier, 5.1 bass management and a wired remote volume control with channel level trims.

Additionally, the system features analog RCA (-10 dBv) and balanced XLR inputs, switchable from +12 dBu to +24 dBu maximum input level, allowing MediaDesk to be interfaced to consoles, digital audio workstations and soundcards.

For more information, contact Blue Sky International at (516) 249-1399 or visit www.abluesky.com.

SH SHOWCASE SE

Visit Us at the
NAB Radio Show
in Booth 700

**The Industry Experts in
Antenna, Structural,
and Transmission Line
Systems**

Now the broadcast industry's source for
Andrew HELIAX® Coaxial Cable

**The Original
ROTOTILLER® FM Antenna**

ERI ELECTRONICS RESEARCH, INC. www.eriinc.com

**Looking for a MANUFACTURER,
a DISTRIBUTOR, a CONSULTANT?**

Look no further...

The 2004
Radio World
Directory Source Book
is available for purchase!

**ONLY
\$14.95**
(INCLUDES SHIPPING/HANDLING)

To order
copies contact:
Simone Fewell at
sfewell@maspub.com
or fax your request to:
703-671-7409

There will be no billing, all orders must be pre-paid.
We accept VISA, MasterCard, and American Express.

BROADCAST

Equipment Exchange

"Broadcast Equipment Exchange" accepts no responsibility for the condition of the equipment listed or for the specifics of transactions made between buyers and sellers.

ACOUSTICS

Want to Sell

AcousticsFirst™
Toll-Free 888-765-2900
Full product line for sound control & noise elimination.
www.acousticsfirst.com

ANTENNAS/TOWERS/CABLES

Want to Sell

AM Ground Systems

Reliable, On-time Installation
Quality Workmanship
Ground System Evaluation and Repair
www.amgroundsystems.com
1-877-766-2999

Andrews Coax HCC-300. 90' already on the spool waiting to be picked up by buyer. This line was installed in 1982 and removed from service back in November. Just like the antenna I listed it is located in Alert, NC awaiting it's new owner. Asking \$2500. Email Mraley@bbradio.org for pictures.

Shively Labs 6810-6R-DA antenna. This antenna is tuned to 92.5FM with a gain of 6.09 and db of 7.85. This was originally installed in 1986 and removed from service back in November. System also included raycooms for ice protection and is 20 dbk max. Pictures are available so e-mail Mraley@bbradio.org for the full scoop. Asking \$20,000. buyer responsible for pick-up and delivery. This system is located in Alert, NC.

Cablewave CP-1000-2, 2 bay FM transmit antenna with Radomes. 2000W power capacity, brand new, still in factory sealed cartons, complete antenna, tuned to 92.3 MHz, \$1250/BO. Ray Knudson, KNXR, 1229 Park Ave, La Crosse WI 54601. Voice pager: 608-789-1894 (16 sec to record message).

Want to Buy

WPAY/WPFB, Inc. is in need of a used 6-8 bay FM broadcast antenna, circular polarity. Must be in upper band with 3-1/8 input. Also need 3-1/8 helix, 300'. Mark Evar, WPAY, 1009 Gallia St., Portsmouth OH 45662. 513-422-3625.

You're in the right place!
Radio World
Broadcast Equipment Exchange

AUDIO PRODUCTION

Want to Sell

Shure M67 & M675 set. Together they provide 8-channel mono mixer with cue (on 4 channels) and monitor outputs. Switchable for 3 or 4 mics, 2 to 5 line, up to 2 phono inputs, 110v or battery power, \$200 includes S&H. Curt Bramblett, Nick Curtiss Studio, 6 Columbus Ct, Palm Coast FL 32137-8332/ 386-986-0229.

AUTOMATION EQUIPMENT

Want to Buy

Arrakis Digilink digital audio workstation, prefer Digilink 3 but will consider older units. Stan Smith, Cumulus Broadcasting, 601 Second Ave N., Columbus MS 39701. 662-327-1183.

SCSI audio drives for Arrakis Digilink automation system. Stan Smith, Cumulus Broadcasting, 601 Second Ave N., Columbus MS 39701. 662-327-1183.

CART MACHINES

Want to Sell

ITC 99-B stereo R/P cart machine in excellent condition, \$500. Tom Toenjes, KJTY, 6120 Riley Creek, St Marys KS 66536. 785-640-6047.

ITC cart machines, \$25 per playback +shpg. Patrick Lopeman, WMOM, 206 E Ludington Ave, Ludington MI 49431. 231-845-9666.

ITC stereo cart machine, record/playback, \$350 +shpg. Donald De Rosa, WAMF, 315-374-1300 or email: WAMF1300@alltel.net

Spotmaster cart machine, record/playback, \$350 +shpg. Donald De Rosa, WAMF, 315-374-1300 or email: WAMF1300@alltel.net

Tapemaster cart machine, record/playback, \$250 shpg. Donald De Rosa, WAMF, 315-374-1300 or email: WAMF1300@alltel.net

COMPLETE FACILITIES

NEW OR USED COMPLETE PACKAGES
STUDIO/STL/TRANSMITTER/ANTENNA OR ANY COMBINATION OF ABOVE.
-LEASE OPTIONS-
-EMERGENCY RENTALS-
-REMOTE BROADCAST RENTALS-
SCMS, Inc. (800) 438-6040
"You Know We Know Radio"

CONSOLES

Want to Sell

Harris Medalist, 10 channel, stereo in excellent condition, \$950. Tom Toenjes, KJTY, 6120 Riley Creek, St Marys KS 66536. 785-640-6047.

Mackie 1604VLZ Pro Mixer 16x4x2, new, never used, in pristine condition, \$800 +shpg. Donald Lockett, 202-365-2368 or email: CDDJDoc@netscape.net

LIMITERS/AUDIO PROCESSING

Want to Sell

Orban 8100 A/1, like new, taken out of service 6/1/04. Manual included, \$2000 +shpg. Jerry Evans, KGVM, 1504 Highway 395, Gardnerville NV 89411. 775-782-2211.

Orban 9000 AM audio processor w/manual, good condition, currently in service, \$2000. Jerry Evans, KGVM, 1504 Highway 395, Gardnerville NV 89411. 775-782-2211.

CRL PMC 300A AM audio processing peak modulation controller; spectral energy processor SEP 400A, \$1000/BO. Jerry Evans, KPTL, 1960 Idaho St, Carson City NV 89701. 775-884-8000.

Want to Buy

Teletronix LA-2A's, UREI LA-3A's & LA-4's, Fairchild 660's & 670's, any Pultec EQ's & any other old tube compressor/limiters, call after 3PM CST, 972-271-7625.

MICROPHONES

Want to Buy

RCA 77-DX's & 44-BX's, any other RCA ribbon mics, on-air lights, call after 3PM CST, 972-271-7625.

MISCELLANEOUS

Want to Sell

ROTRON BLOWERS AND PLATE BLOCKERS, new & rebuilt for Elcom, Harris, CCA, CSI, McMartin, Goodrich Ent. 11435 Manderson St. Omaha, NE 68164 402 493 1886 FAX 402 493 6821

Audiomax, Volumax, Microwave transmitter & receiver w/antenna. Not type accepted. Lots more, will trade too. Ron Moore, WLMA, 207 Wingert Rd, Greenwood SC 29649. 864-943-1350.

Cleaning out our storage rooms! 100's of carts, Gates President board, Schafer automation, etc. Call Ron for inventory and pricing. Ron Moore, WLMA, 207 Wingert Rd, Greenwood SC 29649. 864-943-1350.

Proteck 20 MHZ Spec. analyzer (A-3502). Make a decent offer. Call Michael Raley (704) 523-5555 or e-mail Mraley@rb.org.

MONITORS

Want to Sell

RCA AMN-1 frequency & modulation monitor with instruction book. \$350 +shpg. Donald De Rosa, WAMF, 315-374-1300 or email: WAMF1300@alltel.net

RECEIVERS/TRANSCIEVERS

Want to Sell

Inovonics 630 professional FM bct receiver, frequency agile, brand new, 750/BO. Ray Knudson, KNXR, 1229 Park Ave, La Crosse WI 54601. Voice pager: 608-789-1894 (16 sec to record message).

RECORDERS

Want to Sell

Tascam 42B r-r, 2 track tape recorder/player. Good condition, comes with rolling rack/stand & some paperwork. Serial #90009-863. \$550/BO. buyer pays shipping. Bob Rivkin, KPLM, 441 S Calle Encilla #8, Palm Springs CA 92262. 760-320-4550.

Revox stereo r-r tape recorders (2), \$1000 or \$475 each +shpg. Donald De Rosa, WAMF, 315-374-1300 or email: WAMF1300@alltel.net

Sony DAT PCM 7030, just factory serviced, excellent condition, u-pay shipping or pick up, BO. Richard Miller, Latitude 21 Bldg, 590 Ulumalu Rd, Haiku, Maui, HI 96708. 808-572-5534.

Tascam 122B cassette recorder, deluxe model, 2 speeds, excellent condition, u-pay shipping or pick up, make offer above \$375. Richard Miller, Latitude 21 Bldg, 590 Ulumalu Rd, Haiku, Maui, HI 96708. 808-572-5534.

REMOTE & MICROWAVE

Want to Sell

WE RENT FOR LESS
Blueboxes FM Exciters
Zephyrs FM Power Amps
POTS Codecs STL's
RF/Audio Gear Test Equipment
If we don't have it, we will get it!
SCMS, INC. (800) 438-6040
"You Know We Know Radio!"

davicom
New Monitoring Systems by Linkbit
MAC+ & MiniMAC+
THE MOST FLEXIBLE SECURE-IP
REMOTE MONITORING SYSTEMS
ON THE MARKET
COMLAB INC.
2300, Leon-Harmel, Suite 220
Quebec, QC, G1H 4L2
Tel: 418.682.3380 Fax: 418.682.8996
E-mail: sales@comlab.com Web: www.davicom.com

BAY COUNTRY BROADCAST EQUIPMENT

BUY - SELL - TRADE
Your #1 Source For Quality Used Radio Broadcast Equipment
View The Latest List On Line At: <http://www.baycountry.com>
Or Call And We Will Fax It To You
7117 Olivia Rd., Baltimore MD 21220
Toll Free: 877-722-1031 • FAX 443-596-0212 • E-mail: info@baycountry.com
Member of BBB

Want to Buy

Conex Celljacks. Kent Smith, WMJZ, POB 1766, Gaylord MI 49734. 989-732-2341.

SATELLITE EQUIPMENT

Want to Sell

MPEG-2 Satellite Receivers, LNBS, C & Ku Band Equipment. www.daveswebshop.com, 479-997-2230.

Wegner DN 86 Digital Audio Receiver 3944.1 MHZ - \$100.00 "as is" plus shipping and handling - Call Michael Raley @ (704) 523-5555 for more information or e-mail Mraley@rb.org for a picture.

STATIONS

Want to Sell

MUST SELL due to owners health. Just reduced by \$15,000. Station located in N.E. Tennessee. Call Jennings at 423-968-5221 or 276-466-2893.

STEREO GENERATORS

Want to Sell

Inovonics 716/David II FM stereo generator/processor, brand new, \$1250/BO. Ray Knudson, KNXR, 1229 Park Ave, La Crosse WI 54601. Voice pager: 608-789-1894 (16 sec to record message).

STUDIO EQUIPMENT

Want to Sell

ATI Audio Distribution Amplifier 2016-1. We have several of these as a result of studio renovations. They cost over \$1,100.00 new but will let these go for \$160.00 each plus S&H. Contact Michael Raley at (704) 523-5555 for more information or e-mail Mraley@rb.org for a picture.

Audio Cord Cart machines. We have about Several "E" series playbacks at \$20.00 each, 10 "DL" series playbacks and two "A" series playbacks at \$20.00 each. Most of them have been refurbished. We also have one "A" series P/R mono, two "E" series p/r mono and two "DL" series p/r mono. Call Michael Raley @ (704) 523-5555 or e-mail Mraley@bbradio.org for more information & pictures. No connectors are available. Will sell "as is". Shipping and handling charges apply.

Enberg BA - 6 Annunciator. Have several of them in great condition with no more than eight years of use in them. Original cost was \$359.00 each but we will sell them for \$150.00 each "as is" plus s/h. Call Mike R at (704) 523-5555 or e-mail Mraley@rb.org for more information.

Ten Nidec motors for Audio-cord "E" series. 117v 6H 3.1w 0.2amp 12p and 600rpm. Will sell "as is" for \$5.00 each. Working condition just somewhat noisy. Call Michael Raley (704) 523-5555 or e-mail Mraley@rb.org for pictures.

www.rworld.com

TFT 713 AM Frequency and Modulation Monitor. Cost \$3,400.00 new but will sell for \$1000.00 plus S&H. Needs re-calibration. Call Michael Raley at (704) 523-5555 or e-mail Mraley@rb.org for a picture.

Two RTS 416 Distribution Amplifiers. Has slight problem pushing +4. Cost \$1,173.00 new but will take \$300.00 for each unit plus S&H. Call Michael Raley at (704) 523-5555 or e-mail Mraley@rb.org for a picture.

TAPES/CARTS/REELS/CDs

Want to Sell

172 carts in Lazy Suzan, \$300 +shpg. Donald De Rosa, WAMF, 315-374-1300 or email: WAMF1300@alltel.net

2000 tape carts, full light A/C library, 25cents each +shpg. Patrick Lopeman, WMOM, 206 E Ludington Ave, Ludington MI 49431. 231-845-9666.

TRANSMITTERS

Want to Sell

McMartin BF-5K, 5kW FM. Factory rebuilt in perfect, like new condition, includes new tubes, tested & tuned on your frequency. Guaranteed, fully adjustable from 0 to 5.5 kW. Goodrich Enterprises Inc, 402-493-1886.

CSI T-25-FA FM Transmitter. Recently removed from service in Savannah, GA after 18 yrs of solid operation. Includes Relay interface for remote control and Low Pass filter but not the exciter. This is a three-phase box tuned to 89.5 FM. TPO is 25k with an efficiency of .73. This also includes a CSI T-3 which drives the final. We have the manuals for both. Asking \$13,000 plus buyer arranges shipping. Give me a call at 704-523-5555 or e-mail Mraley@bbradio.org.

BEXT
From the tall to the small
WWW.BEXT.COM
888 239 8462
Transmitters & Antennas

Harris BC-10H, 10KW AM in excellent condition, \$7500. Tom Toenjes, KJTY, 6120 Riley Creek, St Marys KS 66536. 785-640-6047.

Buying used equipment?
Selling used equipment?
YOU'RE IN THE RIGHT PLACE!
Radio World
Broadcast Equipment Exchange
For more information, call Simone Fewell at 703-998-7600, ext. 154

QEI FMQ series 6.0 to 9.6FM. This xmitter did a tour of duty in Argentina but some goofy laws in this country made it impossible to permit the station to operate at this power. To make a long story short it was only in operation no more than four months. Will let this go for \$18,000.00. Call Mike Raley at (704) 523-5555 or E-mail Mraley@rb.org for pictures.

OFF THE AIR?
Emergency Back-up Rentals
FM Exciters - STLs -
FM Pwr Amps - Antennas -
Studio & Test Equipment
SCMS Inc (800) 438-6040
"You Know We Know Radio!"

Radio World
Equipment Exchange



**POWER TUBES
REBUILT

1/2 THE COST
OF NEW!**

ECONCO

TEL: 800-532-6626
INTL: +1-530-662-7553
FAX: +1-530-666-7760
www.econco.com
SE HABLA ESPAÑOL



TRANSMITTERS Cont.
Harris Gates One, 1 KW AM transmitter on 1090 Khz. Two year old, in excellent condition, \$8500. Pick up only near Raleigh NC. Brian Mishkin, WTSB, 3305 Durham Dr, Ste 111, Raleigh NC 27603. 919-329-9810.

RCA BTA1S 1000/500 watt broadcast transmitter with new matched pair of 400-C power tubes in transmitter with manuals, \$3000 +shpg. Donald De Rosa, WAMF, 315-374-1300 or email: WAMF1300@alltel.net.

CCA HELP
▪ Rotron Blowers ▪ Rebuilt Plate Blockers ▪ Tubes
▪ Tube sockets/parts ▪ most all transmitter parts
▪ rebuilt tuning line assemblies
Goodrich Ent. Inc
402-493-1886
www.goodrichenterprises.com cgoodrich@tconl.com

Check out the web site!
www.rwonline.com

TUBES & COMPONENTS
Want to Sell
FOR THE BEST PRICE
& 24 Hr service on transmitting tubes & sockets/parts, new & rebuilt call Goodrich Ent. at 402-493-1886 day or night, www.goodrichenterprises.com

RF PARTS™ CO.
From Milliwatts to Kilowatts™
EIMAC • TAYLOR • ECONCO • SVETLANA
Motorola • Toshiba • SGS • Thomson & Mitsubishi Semiconductors
Se Habla Español **800-737-2787** We Export
760-744-0700 Email: rfp@rfparts.com Web: www.rfparts.com

RW Online

TRANSCOM CORP.

Serving the Broadcast Industry Since 1978

Fine Used AM & FM Transmitters and Also New Equipment

| USED FM TRANSMITTERS | | | |
|----------------------|------|--|--|
| 1KW | 1998 | Harris Quest Solid State | |
| 1.5KW | 1987 | BE FM1 5A | |
| 3.5KW | 1988 | BE FM3 5A | |
| 3.5KW | 1992 | Harris HT3 5 | |
| 10-12KW | 1980 | CCA 12 000E | |
| 20KW | 1978 | Collins 831G2 | |
| 25KW | 1980 | CSI T25-FA (Amplifier Only) | |
| 25KW | 1982 | Harris FM25K | |
| 30KW | 1986 | BE FM30A | |
| 30KW | 1994 | Continental 816R-6C | |
| 50KW | 1982 | Harris Combner w/auto exciter-transmitter switcher | |

| NEW TV TRANSMITTERS ANALOG AND DIGITAL | | | |
|--|--|-------------|--|
| VHF AND UHF | | TV Antennas | |
| (*0 W to 10KW) | | TV STL | |

| USED TV TRANSMITTERS | | | |
|----------------------|-----|------|---------------------------------------|
| 1KW | UHF | 1992 | Acrocyne |
| 10KW | UHF | 1999 | Iteco T614C (Like new-60 hrs. of use) |

| NEW MISC. EQUIPMENT | | | |
|---------------------|-----------------|-------------------|--------------|
| Denon 720R | Cassette Player | Belar AMM3 | (@ 1300 KHz) |
| Moseley | remote controls | Crown D75, BGW 85 | |

| USED MISC. EQUIPMENT | | | |
|----------------------|-------------------------------------|------------|--|
| Audio Amplifiers | | BGW 85 | |
| | | Crown D-75 | |
| Audiometrics | Stereo Distribution Amplifier | | |
| Belar | AMM3 Modulation Monitor | | |
| Moseley | remote controls | | |
| Polomac | Phase Monitor AM19 w/sampler | | |
| Polomac | Phase Monitor 1901 Digital 2Twr | | |
| Sola | Voltage Regulator 60hz 1KVA s-phase | | |

Harris DIGIT. 2002 BE FX 30
Continental 802B *New* 20 watt-synthesized

2655 Philmont Ave #200, Huntingdon Valley, PA 19006
800-441-8454 • 215-938-7304 • FAX No. 215-938-7361
VISIT OUR NEW INTERNET SITE: www.fmamtv.com
SEND YOUR E-MAIL REQUESTS TO: transcom@fmamtv.com

D And C Electronics

An International Distributor of RF Components
Tubes
NEW & REBUILT

TRANSMITTERS, STUDIO EQUIPMENT, STLS, ANTENNAS,
RADIO DATA SYSTEM (FOR CAR RADIO DISPLAY)
EXCITERS-TRANSMITTERS, TRANSLATORS, MIXERS-CONSOLES, RADIO LINK
RPU, MOSFETS, VACUUM CAPACITORS, SOCKETS

Eimac Pro-Tek®
SVETLANA OMB EEV
USA DISTRIBUTOR

BEST PRICES To Order: 1-800-881-2374
Outside U.S. (352) 688-2374
Se Habla Español

3089 Deltona Blvd. Spring Hill, FL 34609
BEST SERVICE 352-688-2374 Fax 352-683-9595
Website: www.dandcelectronics.com

PROMOTE YOUR BUSINESS!

Your Company

To advertise, call 703-998-7600, ext. 154 or e-mail: sfewell@imaspub.com.

"BEE" in the habit of selling your used equipment here!
Call Simone for details at (703) 880-7500, Ext. 154.

ACTION-GRAM

EQUIPMENT LISTINGS
Radio World's Broadcast Equipment Exchange provides a FREE listing service for radio stations only. All other end users will be charged. This FREE service does not apply to Employment Help Wanted ads or Stations For Sale ads. These are published on a paid basis only. Send your listings to us by filling out the form below. Please be aware that it takes one month for listings to appear. The listings run for two consecutive issues and must be resubmitted in order to run again. Thank you.

| | | |
|---|--|--|
| <p>Please print and include all information:</p> <p>Contact Name _____</p> <p>Title _____</p> <p>Company/Station _____</p> <p>Address _____</p> <p>City/State _____</p> <p>Zip Code _____</p> <p>Telephone _____</p> <p>Brokers, dealers, manufacturers and other organizations who are not legitimate end users can participate in the Broadcast Equipment Exchange on a paid basis. Line ad listings & display advertising are available on a per word or per inch basis.</p> | <p>Are you currently a subscriber to Radio World? <input type="checkbox"/> Yes <input type="checkbox"/> No</p> <p>Signature _____ Date _____</p> | <p>WTS <input type="checkbox"/> WTB <input type="checkbox"/> Category: _____</p> <p>Make: _____ Model: _____</p> <p>Brief Description: _____</p> <p>Price: _____</p> |
| | | <p>WTS <input type="checkbox"/> WTB <input type="checkbox"/> Category: _____</p> <p>Make: _____ Model: _____</p> <p>Brief Description: _____</p> <p>Price: _____</p> |

*Closing for listings is every other Friday for the next month's issue. All listings are run for 2 issues unless pressed for space or otherwise notified by listee.
Broadcast Equipment Exchange
PO BOX 1214, Falls Church, VA 22041 • Tel: 703-998-7600 • Fax: 703-998-2966

EMPLOYMENT

HELP WANTED

POSITIONS WANTED

Staff Engineer, Susquehanna Radio Corp.

Susquehanna Radio Corp. has an immediate opening for a staff engineer in our York, PA market. The successful candidate will perform maintenance on all types of equipment ranging from high power transmitters to professional audio equipment. Additional responsibilities will include working on installations and special projects. If you have 2 years of broadcast electronics experience, strong computer and networking skills and an Associates Degree in electronics this opportunity may be for you. FCC general class license or SBE certification and construction trade experience desirable. Valid drivers' license required. On-call 24-7 rotation schedule one week per month. We offer a flexible benefits program that includes a 401(k) plan with a match; medical/dental insurance; vacation, holiday, and personal days; adoption assistance, and a fitness center. We are an ESOP Company. Send resume including salary history to: Max Turner, Regional Engineering Manager, Mturner@indyradio.com. Fax: 317-558-7153. Susquehanna Radio Corp. is an Equal Opportunity Employer.

Renda Broadcasting

Seeks a full time Radio Broadcast Assistant Engineer reporting to the Chief Engineer at its 4-station cluster located in S.W. Florida. Duties will include repair and maintenance of electronic broadcasting equipment including high power transmitters, computerized automation systems, satellite delivery systems and RPU's. The successful applicant will also be responsible to assist the C.E. in the build out of a new studio complex. Applicant must be willing to travel to remote transmitter sites, be willing to wear a pager, be on call, and have own vehicle. Great benefits included with salary package. Applicant should send resume with experience and salary requirements to: Jerry L. Heckerman, C.E., c/o Renda Broadcasting, 4210 Metro Parkway, Ste 210, Fort Myers, FL 33916. or Email to: Jheckerman@rendabroadcasting.com. No phone calls please. Renda Broadcasting is an E.O.E. Minorities are encouraged to apply.

972-523-0078 your first step to hiring Shane Williams, hardest working up-n-comer in the business. Producing, promotions he does it all! Call 972-523-0078 before someone else does.

Fresh out of school! Attended American Broadcasting School and Dallas Sound Lab. Experience: analog/digital recording, Protocols, FCC rules/regulations, programming, and production etc. Will travel. Phillip Magallon, 972-709-3895.

ABS graduate needs on-air News/DJ position in N California/Nevada. Excellent voice, production and old style work integrity. A great investment to your station! Bob, 409-733-2380.

Fresh approach, innovative ideas by this graduate of American Broadcasting catapult your station to the top. For production and on-air contact Kiev Adair, kiever@bellsouth.net or 601-924-9114.

New to the radio business, have lots of spunk and enthusiasm. Experienced in on-air announcing, production, copy-writing and sales. Will travel. Deana, 405-706-4884.

Spirited personality, and optimistic outlook. Highly motivated, multi-tasker. Ready to tackle on-air, newscasting, traffic, and voice productions. Proficient in CE2K. Call Tamia, 972-352-8454 or tammyhugger@abglobal.net.

Talented, hard working team player seeks a FT gig. Resume, aircheck, letter of recommendation available upon request. Anthony, 765-349-1291.

To advertise,

call 703-998-7600,

ext. 154

or e-mail:

sfewell@imaspub.com.



Consultants

Consulting Communications Engineers EMC Test Lab

- FCC Applications and Field Engineering
- Frequency Searches and Coordination
- AM-FM-CATV-ITFS-LPTV
- EMC Test Lab-FCC and European (IEC)

OWL ENGINEERING, INC.
E-mail: info@owleng.com **651-784-7445** Fax (651) 784-7541
5844 Hamline Ave. N., Shoreview, MN 55126 Member AFCEC



FCC Applications • Design • Field Engineering • Tower Detuning Upgrade & Relocation Studies • AM Directional Array Tuning & Proof

EXPERTS IN:

- TV • DTV Transition • FM • Directional Antennas • RF Exposure

210 S. Main St., Thiensville, WI 53092. (262) 242-6000, FAX (262) 242-6045
http://www.evansassoc.com Member AFCEC

Communications Technologies, Inc.
Radio Frequency / Broadcast Engineering Consultants
AM FM TV LPTV Cellular/PCS Site Analysis
P.O. Box 1130 / Marlton, NJ 08053
Tel: 856/985-0077
Fax: 856/985-8124
web: commtechrf.com
Clarence M. Beverage
Laura M. Mizrahi

GRAHAM BROCK, INC.
BROADCAST TECHNICAL CONSULTANTS
Full Service From Allocation to Operation AM/FM/TV/ATX Services:
Field Work Antenna and Facilities Design
Over 35 years engineering and consulting experience
912-638-8028
202-393-5133
www.grahambrock.com

FASTER... MORE ACCURATE RADIO COVERAGE

- Real Time 3-D Displays
- Interference calculations
- Cost effective mapping
- Fully integrated databases
- Used by the FCC
- Latest standards built-in

RADIO SOFT
Visit us on the web at www.radiosoftware.com
101 Demorest Sq., #E, Demorest GA - 706-778-6811

System One Communications
Broadcast Constructors & Consultants
Houston, Texas
888-625-5649
► AM-FM Site Construction Specialists
► Complete Tower Service
► Antenna & Transmission Line Diagnostics

Structural Analysis



Electronics Research, Inc.
7777 Gardner Road
Chandler, IN 47610
(812) 925-6000
www.ERInc.com



David C. Schaberg

Allocation Specialist
FM & AM Frequency Searches
Move-ins, upgrades, allocations
Maximization of signals
"I do the tough ones!"
Contract engineering in the Midwest, build-outs across the country and equipment repairs.
517-393-1037
dcs1037@yahoo.com

Doug Vernier
Telecommunication Consultants
Broadcast Engineering Consulting
AM/FM/TV/LPTV/DTV
Custom mapping service
Frequency searches
Propagation prediction
FCC application preparation
VSoft
Software for your PC
(800) 743-3684
www.v-soft.com



Market Analysis
Engineering Software
Ethnic/Demographic Data
Custom Full-color Mapping
Sales Marketing Packages

www.dataworld.com
800-368-5754

info@dataworld.com
fax: 301-656-5341

Herb Kravitz
Broadcast Engineering Consultants

AM~FM
Professional Technical Support
Comprehensive Field Service
phone 609-347-4821
fax 609-347-6397
hkradio@msn.com

Mullaney Engineering, Inc.
Serving Broadcasters Since 1948
9049 Shady Grove Court
Gaithersburg, MD 20877
(301) 921-0115
Fax (301) 590-9757
mullaney@mullengr.com
Member AFCEC

Check out the web site!
www.rwonline.com

M Celenza
Communications Consultants
FM-AM-TV-LPTV-LPFM
Applications, Amendments, Upgrades, Frequency Searches, Directional Antennas
Field Work (Station Inspections)
631-965-0816 or 516-429-8340
celenza@prodigy.net
41 Kathleen Crescent, Coram N.Y. 11727

DISTRIBUTOR DIRECTORY

The following distributors serving the broadcast industry would be glad to help you with any of your requirements.

CORNELL-DUBILIER MICA CAPACITORS

FROM STOCK

JENNINGS VACUUM CAPACITORS

FROM STOCK

JENNINGS VACUUM RELAYS

SURCOM ASSOCIATES

2215 Faraday Ave., Suite A
Carlsbad, California 92008
(760) 438-4420 Fax: (760) 438-4759
e-mail: link@surcom.com web: www.surcom.com



Are You a Distributor?

ADVERTISE HERE!

Space is available.
Call 703-998-7600, ext. 154.

ADVERTISER INDEX

This listing is provided for the convenience of our readers. Radio World assumes no liability for inaccuracy.

| PAGE | ADVERTISER | WEB SITE URL |
|--------|--------------------------------|---------------------------|
| 32 | ATI | www.atiaudio.com |
| 30 | Autogram Corporation | www.autogramcorp.com |
| 9 | Axia, A Telos Company | www.axiaaudio.com |
| 19 | Broadcast Electronics | www.bdcast.com |
| 21 | Broadcast Electronics | www.bdcast.com |
| 29 | Broadcast Software Int'l (BSI) | www.bsiusa.com |
| 4 | Burk Technology | www.burk.com |
| 30 | Circuit Werkes | www.circuitwerkes.com |
| 38 | Circuit Werkes | www.circuitwerkes.com |
| 38 | Comet North America | www.cometna.com |
| 7 | Comrex | www.comrex.com |
| 24, 25 | Comrex | www.comrex.com |
| 30 | Conex Electric Systems | www.conex-electro.com |
| 5 | Digigram | www.digigram.com |
| 40 | Electronics Research Inc. | www.eriinc.com |
| 33 | Full Compass | www.fullcompass.com |
| 20 | Gepco International | www.gepco.com |
| 38 | Gorman-Redlich Mfg. Co. | www.gorman-redlich.com |
| 26 | Grace Broadcast Sales | www.gracebroadcast.com |
| 1 | Harris | www.broadcast.harris.com |
| 10 | Henry Engineering | www.henryeng.com |
| 38 | LBA Technology | www.lbagroup.com |
| 23 | Logitek | www.logitekaudio.com |
| 27 | Moseley Associates | www.moseleysb.com |
| 17 | Nautel | www.nautel.com |
| 8 | NTI Americas, Inc. | www.nti-instruments.com |
| 38 | Radio Design Labs | www.rdlnet.com |
| 3 | S.C.M.S. | www.scmsinc.com |
| 37 | S.C.M.S. | www.scmsinc.com |
| 31 | Sabre Communications | www.sabrecom.com |
| 22 | Scott Studios | www.scottstudios.com |
| 18 | Sierra Automated Systems | www.sasaudio.com |
| 6 | Sine Systems | www.sinesystems.com |
| 16 | Sine Systems | www.sinesystems.com |
| 30 | Star Case Mfg. Co., Inc. | www.starcasemfg.com |
| 30 | Superior Broadcast Products | www.superiorbroadcast.com |
| 13 | Telos Systems | www.telos-systems.com |
| 35 | Telos Systems | www.telosystems.com |
| 11 | Tieline America | www.tieline.com/rw |
| 2 | Wheatstone | www.audioarts.net |
| 47 | Wheatstone | www.wheatstone.com |
| 48 | Wheatstone | www.wheatstone.com |
| 26 | www.radio-mall.com | www.radio-mall.com |

◆ READER'S FORUM ◆

Radio World, October 6, 2004

Feels Like Home

In response to the piece on skywave listening (*Reader's Forum*, July 1), here are my two cents.

I was bitten by the DXing bug when we had to build a five-tube radio for shop class in high school.

The purpose was to teach schematic reading and chassis design, and as each stage of the radio was built and tested — starting with the power supply, then the audio section, IF cans, etc. — it was tweaked for maximum efficiency.

I took that butt-ugly aluminum chassis radio through 48 states and Canada on my school vacations. There were six of us in an 18-foot camper, and space was tight, but I always managed to pack that radio, a long piece of antenna wire and a tuning stick in my allotted space.

At night, I would sit outside of whatever campground we had visited, and try to get WBZ(AM) 1030 in Boston for hometown news. Then I would try for New York City. After that it was just a matter of running the range of that dual-ganged air dielectric capacitor to find a faraway signal and an occasional adjustment of the antenna coil with the adjustment tool.

That radio still sits on a bookcase at my parents' house. And when I am away from home and in a car, I still try every night to find WBZ at the top of an hour for news. I could just as easily plug in the laptop and go to Boston.Com for the news, but it doesn't have the warmth of the familiar broadcaster's voice, or evoke the memories of my summer nights in the dark with a tuning tool and my headphones.

John Sullivan
Wakefield, Mass.

Tape Everything' Rule

Assuming the FCC passes the "tape everything aired from 6 a.m.-10 p.m." rule, what is the best way to do this?

With VCRs, two tapes per day (an 8-hour and an 6-hour) would do the job, and if we are required to keep them for 90 days (seems to be a tossup right now between 60 and 90 days), that means finding storage for 180 videotapes.

My chief engineer thinks it would be infinitely easier to run everything into a single hard drive.

Can anyone guesstimate the size of hard drive it would take to hold 1,260 hours of audio?

Check my math: I know that with old-time radio shows, I can reduce them to MP3 and get about 100 half-hour shows on one 700 MB CD.

Fifty hours per CD, divided into 1260 hours (90 days at 14 hours per day), equals about 25 CDs. 700 MB times 25 equals 17.5 gigs of hard drive space — so we could get the whole kit and kaboodle on a 20-gig hard drive.

Am I close?

Dan Hughes
WPCD(FM)
Champaign, Ill.

RW Technical Advisor Tom McGinley

replies: I agree with your CE. Using VCR tapes sounds inviting because the media and hardware are widely used and dirt-cheap. But the single most important problem is finding a good, user-friendly method of cataloging and quick retrieval. Scanning back and forth to find the exact spot or break can become very time consuming; storage is unwieldy; and as tapes are used, dropouts and errors get significant.

Archiving using a PC and MP3 compression offers the most reliable and easy-to-use method. iMediaTouch and Telos offer good software systems that do this. There are other systems, some using Linux, that are very reliable.

A number of logging approaches were discussed in the Sept. 8 issue in the story, "CEs Explore Audio Logging Options," from companies such as Sonifex, Eventide, LakeSoft and MediaGuide. Do a Google search for audio logging.

In Support of Kahn

I was offended at the dismissive tone toward the Kahn CAM-D system in the Ray "commentary" article ("AM IBOC — The Wrath of Kahn," July 14).

The interference problems associated with the Ibiqity system are monumental, and were not even referenced. This attack piece under the guise of an objective comparison left much to be desired. The use of innuendo against the genius of Leonard Kahn is not worthy of your fine publication. It makes me wonder if this writer is vested in Ibiqity, in a way that clouded his objectivity?

When you look at the interference that will be caused by this so-called superior system, it will truly cause existing AM operators to operate under an unacceptable burden, and destroy the existing band for conventional AM reception long before the technology would be readily available to the public in the transition to the new system.

Kahn is acting to save the AM band, by producing the best system possible within the existing FCC spectrum allotted. Take the speculative "Ibiqity noise floor" to another band, but don't take up my additional bandwidth that the public depends on, or that will disrupt the businesses of existing operators that struggle with interference already.

I am not a TV operator, but I do operate AM stations. Of all the broadcast entities capable of implementing changes such as required to go digital, television broadcasters are most able. AM broadcasters, operating what has become for the most part a predominantly news/talk medium, are well served to *not* have their spectrum trashed by those who would provide "just one more music station."

My message to broadcasters and the FCC: Proceed with caution. Public interest is best served by preserving AM as you *refine the service* — not destroy it — especially in this time of national threat.

Ralph H. McBride
General Manager
News Radio FOX
KOLE(AM)/KRCM(AM)
Beaumont, Texas

Our readers have something to say

"I read the magazine nearly cover to cover before leaving the post office."

Gary Kline
Corporate Director of Engineering
Cumulus Media Inc.

Radio World
The Newspaper for Radio Managers and Engineers

Radio World, October 6, 2004

GUEST COMMENTARY

Into 'The Free-Love Digital Domain'

The Author Dismisses Tom Ray's Article in Defense of IBOC, Insisting Hope Lies in Cam-D

by Jerry Smith

Thanks for changing over the years, Radio World. You really screwed AM with your Motorola hype. Now at 20 years later, I see much more balance.

This is my response to Tom Ray's nar-

some music. Sadly, most FM product is similar to satellite radio already — not fit for long-term listening in the face of new audio cards in home computers that leave our 44.1 and less audio files in the dust.

As for the technical explanation that Tom offers:

The noise that Tom refers to will soon be multiplied by the addition of IBOC to AM. New chip technology greatly reduces the noise floor for old analog radio without degrading the audio like heavily compressed digital processing.

row-minded article, "AM IBOC — the Wrath of Kahn" (July 14). I promise you this: IBOC might work on some FM stations looking for extraordinary income sources, but AM is a spurious, noise-generating skywave bomb that will hit this land like tolerance and sensitivity training — hiding the real societal needs of truth and justice behind false religion.

Tom Ray is the perfect spokesperson for IBOC-I, and could have done the same skit for Motorola AM stereo 20 years ago. I read with disinterest his misinformation campaign on Leonard Kahn's Cam-D system proposal for another answer to the AM need to insert digital in our name. Fortunately, there is a total disregard for the real-world problems associated with this "condom" approach for bringing AM into the free-love digital domain, while FM receives its complimentary "pill."

To my good ears, that is precisely what IBOC has offered to date and why Kahn's Cam-D is the hope to those of us without the Buckley Foundation to support our radio habits.

'Good analog is not that costly'

Right now, with the exception of the GM product line and most Japanese model car radios, basic analog AM is capable of outperforming the IBOC AM product without tying up two adjacent channels in the process. That is a fact. We have no idea the brands of test radios the IBOC tests have employed in their subjective testing for comparison between IBOC and analog to evaluate the listening differences.

Granted, 90 percent of the AM stations in this nation lack source material, technical budgets and audio processing capable of producing good analog audio. I have the measurements and the airchecks to prove the real-world activity — good analog is not that costly. There are radios that can receive and process decent AM audio for voice, and with a little work

some music. Sadly, most FM product is similar to satellite radio already — not fit for long-term listening in the face of new audio cards in home computers that leave our 44.1 and less audio files in the dust.

As for the technical explanation that Tom offers:

Kahn AM Stereo was cut off at the docks by Motorola's legal team as the first 250,000 multimode chips were about to arrive in the country in 1985. Those of us who read the publications back then observed that NTIA endorsed the multimode chip as the best method of introducing all formats into the marketplace for the sake of allowing the marketplace to have the opportunity to decide.

Sadly, due to the politics of spin, we were choked on the NAB endorsement of Motorola in 1990, the flooding of the market with free C-QUAM encoders and the plundering of the Harris Stereo system by the lawyers forcing Big H to adopt the Big M package — the sterilization of AM, as some called it.

And the noise that Tom refers to as "crap" will soon be multiplied by the addition of IBOC to AM. New chip technology has arrived that greatly reduces the noise floor for old analog radio without degrading the audio in the manner of heavily compressed digital processing. As for separation, there is very little separation above 3 kHz on anything recorded in history. A pulse or tone burst test with IM tones utilizing digital compression has distortion far greater than the resultant 8-bit sample rate above 10 kHz, as described in Tom's analysis of the "wrath of Kahn."

I accept that the majority of our broadcast technical types are more adept at quoting trade publications and partial truths than actually performing worthwhile field analysis that would include the highly saturated analog receiver world. But sooner or later, much as the Iranian desert military action during the Carter administration exposed our weakness, so shall Mother Nature and the laws of physics again halt the dreams of a false science as we move toward the de facto standardization of a non-functioning AM IBOC algorithm.

Tom, you seem to forget that IBOC wants a nice chunk of money for royalty

to insert this RF buzz into your transmitter. That's even more reason the Cam-D system is a good investment right now. Given that it will take years to rid our world of those horrible analog boxes, I submit that \$50,000 utilized over the next 20 years to get an immediate improvement in analog audio and offer stereo with the "digital" buzzword minus the awful flutter and hash, is about the same as a tube budget for those stations running older transmitters.

Analog vs. sideband buzz

Many of us who survived the Vietnam Era, the erosion of our society by the politically correct, the smashing of AM stereo by Big M and its battery of lawyers and the Clinton years were hopeful that IBOC would just leave AM alone and go after the folks who lost on the Internet stocks most likely to support the theory of another digital idea initially described as "almost CD quality" or "FM-like" audio.

As the hurdles were cleared, the open boldness of this system in the face of physical laws and multipath on FM — not to mention atmospheric inversions that cripple the data stream far greater than the effect on the analog path — seemed to have no limits. Add NPR and its bid to add channels for added revenue base and there you have it: Radio cannot survive without government help — much like NPR.

Tom, you did mention the NTSC, did-

n't you? Bad move. NTSC and HDTV...Let's see, 20 years ago we saw some fabulous HDTV signals via Japan. That is L Band equivalent and if I were you or IBOC, I would not use the example. NTSC is here and DTV-HDTV is an out-of-band concept and it will work eventually. The HDTV we see is about 25 percent of the quality of the original proposed system because our friends at NPR and others want to downgrade picture quality for the sake of multicasting, as if we really need more channels of "crap" on our sets.

Its analog vs. the IBOC sideband buzz, and a system that cannot work with any degree of skywave propagation, which we know begins well before sunset and continues after sunrise — critical hours that were perhaps prophetically named long ago for the times in which stations such as WOR can already create high noise fields, or "crap," hundreds of miles outside the useful service area.

The entire packaging of this experiment, regardless of the number of happy endorsements, will not survive. We could give IBOC some expanded L Band space and without a doubt broadcasters could reap the rewards of the new channel placement. I submit that not only is AM digital with the present system a failure, but not far behind is FM digital — likened unto a laden brother-in-arms burdened by his medals and hype, having only 4 months of experience and talking about a cure for something we did not think needed fixin' until someone mentioned the D word.

Jerry Smith is a broadcast consultant and engineer, and can be reached at jerry@jerrysmith.net.

The Elephant in AM's Room

The publication of your op-ed piece about IBOC AM (*Reader's Forum*, July 1) is a watershed moment for Radio World, which I have read and enjoyed for many years as an independent AM owner and operator.

I would suggest that RW decide once and for all whether it is a reasonably objective periodical devoted to informing radio station management, or a thinly disguised promotional piece touting "new technology at all costs" on behalf of its advertisers.

The suggestion that any form of listening to any commercially viable radio service is "archaic" — be it AM, FM or satellite — is nothing short of outrageous, particularly in a periodical like RW, which declares its commitment to the radio industry.

The distinction between groundwave listening and skywave listening to AM is irrelevant. If people are listening, the service is valuable, regardless of the method of propagation. Those who listen regularly to a skywave AM signal are not necessarily fringe-hobbyist DXers or walking antiques. Any loss of listenership from the status quo is simply unacceptable, and certainly not "progress."

It is time to talk about the elephant that Ibiqity's flawed IBOC system has placed squarely in AM's room.

As noted by the FCC, the system will cause objectionable adjacent-channel interference at night, and no amount of hype from rapturous experimental users or Bob Struble will negate this. It is up to us as an industry to stand up and demand a digital AM system that will improve the band, as opposed to one that will benefit large-market high-powered AMs at the expense of local signals on adjacent channels.

The statement that "skywave listening is not as important ... as it was when far fewer stations existed" is a tacit admission of the obvious: *more* stations require *more* interference protection — not less. Let's stop torturing common sense in the rush to implement something that could be hugely destructive to AM service as we know it.

AM broadcasters will rue the day we permitted a single manufacturer — not an objective industry consortium — to impose (with nods from the hapless commission and the big group-captive NAB) an IBOC standard on the band that only benefits certain AM broadcasters, to the detriment of others.

*Robert C. Savage
President
WYSL(AM) News 1040
Avon, N.Y.*

◆ READER'S FORUM ◆

Impeding Progress

There are but a few things in this world that get my Irish up, and ignorance is high on that list.

Reading Mr. De La Hunt's letter in the July 1 issue ("Interference Is Unacceptable"), I was disgusted with the complete lack of common sense I perceived.

ence to other broadcasters. Do you realize that your signal is prohibiting some poor person in the far reaches of Minnesota from hearing a broadcast that originates in Texas? In order to play by the rules that you have created for yourself, the only logical choice is for you to go dark and send your license back to the FCC.

At least then it might be acquired by

Progress is the only thing that makes sense. The only way a nation can develop is by moving forward.

— Edward C. Dulaney

It made me wonder what Mr. De La Hunt would have said to our radio pioneers, men like DeForest, Armstrong, Marconi, Tesla and others. I can see it now: "Trying to send messages over anything other than wire is absurd. All you will do is add to the interference that is already experienced by people sending long-distance telegraph messages. Besides, there are already ways to send signals without using wires. The native people in this land have been using smoke signals for many years, and the technology is already available!"

In the history of our country — and of the entire world, for that matter — there have always been people on the fringe who have attempted to stand in the way of progress. I'm sure Henry Ford got quite tired of the naysayers when he proposed the first automobile. But he persevered, and today we have some highly advanced forms of transportation thanks to his persistence. Progress is the only thing that makes sense. The only way a nation can develop is by moving forward.

So, while my broadcasting experience has spanned only 25 years, as opposed to Mr. De La Hunt's 50 years, I feel that his views most certainly will not benefit broadcasting. Even his off-handed comment about C-QUAM destroying the AM spectrum shows a level of absurdity that is laughable.

I have just one suggestion to Mr. De La Hunt: Turn off your transmitter right now, and stop causing so much interfer-

ence to other broadcasters. Do you realize that your signal is prohibiting some poor person in the far reaches of Minnesota from hearing a broadcast that originates in Texas? In order to play by the rules that you have created for yourself, the only logical choice is for you to go dark and send your license back to the FCC.

someone with a passion for radio, and a desire to watch the industry grow instead of stagnate.

Edward C. Dulaney
Chief Engineer
Crawford Broadcasting
Denver

Mutual Respect

I enjoyed the article about the Mutual "network" ("The World's Largest Radio Network," July 1). It was concise and well written.

It is always a pleasure to read about the history of radio. You should have more articles about radio history. Things never really change — they just get re-invented.

Keep up the good work.

Randall F. Miller Jr., CBNT
Harrisburg, Pa.

Inovonics Assists Ham

I would like to share a positive experience I had with Inovonics Corp. I have been an amateur radio operator since age 13. I grew up in the heyday of AM radio, not only on the "Broadcast Band," but on the Amateur Radio frequencies, as well.

In recent years, there has been a substantial increase in AM activity within the hobby. Many of us just enjoy the

The FCC recently proposed, and seems to be fast-tracking, a requirement that broadcasters to record all material broadcast during the indecency "safe harbor" hours (6 a.m. to 10 p.m.) and retain such recordings for a period of up to 90 days. The stated purpose of the proposal is to "improve the complaint process" and allow the commission to better enforce existing indecency standards.

The problem with this proposal is that it doesn't reflect any reasonable need or justification. Broadcast stations, by and large, comply with the indecency rules. With more than 15,000 full-power broadcast stations on the air, the majority of which offer programming 24 hours per day, millions of hours of programming are available to the populace each year. And yet in the period between 2000 and 2002, the FCC received only a little over 14,000 indecency complaints pertaining to just 598 programs. During this period, the FCC dismissed only a tiny fraction of the complaints — 1.2 percent — for the lack of a tape, transcript or significant excerpt.

In the year 2000, the FCC issued or proposed indecency-related fines against only 10 broadcast stations. Between 2002 and 2003, the number of indecency complaints increased, but the number of programs that triggered these complaints declined to just 375.

These figures clearly illustrate that the vast majority of broadcasters understand and follow the FCC's prohibitions on indecent programming. But rather than commending the industry on its track record of compliance, the FCC seeks to punish all for the acts of a few. Our industry has a long history of self-policing. The record clearly reflects that we generally do a good job, especially in the area of indecency.

While broadcaster comments filed in response to this proposal are overwhelmingly in opposition, it seems that the Eighth Floor has its mind made up. We encourage the FCC to listen up before enacting this overbroad and burdensome proposal. Such a global knee-jerk reaction is by no means the best way to deal with indecency on the airwaves.

— RW

sound of AM, compared to the traditional sound of single side band reduced carrier mode of operation. AM equipment tends to lend itself to experimentation, as the equipment itself can be fairly simplistic in design.

Within the broadcasting industry, many stations are replacing those old tube "boat anchor" transmitters. Some of these transmitters are finding a new home, primarily on the 160- and 75-meter amateur band. I currently am restoring — from the ground up — a beautiful 1946 Gates 250C1 transmitter.

During the restoration process, an opportunity presented itself to purchase a used Inovonics 231 Map-II processor. Unfortunately when I purchased it, no documentation was available from the seller, but I attempted to hook it up and dial it in. I was having difficulty getting it to do what I expected it to do.

I sent an e-mail to Inovonics asking if a manual was available. I received an immediate reply from Inovonics President Jim Wood, who informed me a manual was available and provided all the ordering details.

Upon receiving the manual, I soon discovered why I had trouble dialing it in. My unit had the FM limiter pre-emphasis board installed instead of the AM limiter

board. That explained why it was not behaving as expected on AM.

I then sent another e-mail to Jim, to which he promptly replied they no longer had any AM cards for my unit, but he would check to see if any bare AM limiter printed circuit cards were still at the factory. Sure enough, a board was still available. He asked if I was willing to build one up, and said he would promptly ship it free of charge. Not only did he send one out, he sent all the critical components that he felt I might have a hard time getting.

When someone treats you that well, it proves how great people can be. I am building the AM card up in my basement lab and looking forwards to hitting the 160-meter airwaves with my Inovonics 231 processor.

Joe Fell, W3GMS
East Fallowfield, Pa.

Correction

A story in the Sept. 8 issue misstated that WWV moved to Ft. Collins, Colo., in 1996. The year was 1966.

—EDITORIAL STAFF—

| | | |
|--------------------|----------|--|
| Paul J. McLane | ext. 117 | Editor |
| Leslie Stinson | ext. 129 | News Editor/Wash. Bureau Chief |
| Kelly Brooks | ext. 136 | Associate Editor |
| Thomas R. McGinley | — | Technical Adviser |
| Alan Peterson | — | Technical Adviser |
| John Bisset | — | Contributing Editor |
| Skip Pizzi | — | Contributing Editor |
| T. Carter Ross | ext. 120 | Editorial Director |
| Marguerite Clark | — | Editor (International), Milan |
| Rogelio Ocampo | ext. 121 | Latin America Editor in Chief |
| Karina Gerardi | ext. 137 | Latin America Editor |
| Teresa Geary | ext. 126 | Assistant Editor (International) |
| Terry Hanley | ext. 130 | Editorial Assistant & Listings Coordinator |
| Peter Finch | — | Editorial Assistant, Milan |

—EDITORIAL CONTRIBUTORS—

W.C. Alexander, Bruce Bartlett, Frank Beacham, Naina N. Chernoff, Harry Cole, Troy Conner, Vince Dittingo, Mark Durenberger, Charles Fitch, Ty Ford, Scott Fybus, Harold Hallikainen, Jeff Johnson, Craig Johnston, Paul Kaminski, Peter King, Mark Lapidus, Mark Persons, Sharon Rae Pettigrew, Michael LeClair, Carl Lindemann, Frank R. Montero, Ted Nahil, Tom Osenkowsky, Ken R., Rich Rarey, Randy Stine, Travis the W/O Guy, Barry Umanzky, Tom Vernon.

Radio World

Vol. 28, No. 21 October 6, 2004

Telephone: (703) 998-7600 • Business Fax: (703) 998-2966 • Editorial Fax: (703) 820-3245
E-mail: radioworld@imaspub.com • Web site: www.rwonline.com

—ADVERTISING SALES REPRESENTATIVES—

| | | | |
|---|-------------------|-----------------------|-----------------------------------|
| US East: John Casey | 330-342-8361 | Fax: 330-342-8362 | e-mail: jcasey@imaspub.com |
| US West: Dale Tucker | 916-721-3410 | Fax: 916-729-0810 | e-mail: dtucker@imaspub.com |
| Product Showcase & Classified Ads: Simone Fewell | 703-998-7600 x154 | Fax: 703-671-7409 | e-mail: sfewell@imaspub.com |
| European Sales Mgr., Africa, Middle East: Raffaella Calabrese | +39-02-7030-0310 | Fax: +39-02-7030-0211 | e-mail: rcalabrese@imaspub@tin.it |
| Japan: Eiji Yoshikawa | +81-3-3327-2688 | Fax: +81-3-3327-3010 | e-mail: callems@msn.com |
| Asia/Pacific: Wengong Wang | +86-755-5785161 | Fax: +86-755-5785160 | e-mail: ww@imaschina.com |
| Latin America: Alan Carter | 703-998-7600 x111 | Fax: 703-671-7409 | e-mail: acarter@imaspub.com |

NEXT ISSUE OF RADIO WORLD OCTOBER 20, 2004

For address changes, send current and new address to RW a month in advance at P.O. Box 1214, Falls Church, VA 22041. Unsolicited manuscripts are welcomed for review; send to the attention of the appropriate editor.

—ADMINISTRATION & PRODUCTION—

| | |
|----------------------|------------------------------------|
| Steven B. Dana | President/CEO |
| Carmel King | VPI/Group Publisher |
| Marlene Lane | COO |
| Chuck Inderrieden | CFO |
| Eric Trabb | Sales & Marketing Director |
| John Casey | Associate Publisher |
| Annette Linn | Production Director |
| Melissa SE Robertson | Production Publication Coordinator |
| Kathy Jackson | Ad Traffic Manager |
| Linda Sultan | Classified/Product Showcase Layout |
| Robert Green | Circulation Manager |

Radio World (ISSN: 0274-8541) is published bi-weekly by IMAS Publishing (USA), Inc., P.O. Box 1214, Falls Church, VA 22041. Phone: (703) 998-7600, Fax: (703) 998-2966. Periodicals postage rates are paid at Falls Church VA 22046 and additional mailing offices. POSTMASTER: Send address changes to Radio World, P.O. Box 1214, Falls Church VA 22041. REPRINTS: Reprints of all articles in this issue are available. Call or write Emily Wilson, P.O. Box 1214, Falls Church, VA 22041; (703) 998-7600 ext 148; Fax: (703) 998-2966. Copyright 2004 by IMAS Publishing (USA), Inc. All rights reserved.

—Printed in the USA—



More.

*The Wheatstone GENERATION-5
has the POWER and FEATURES
Stations Demand the MOST*

LOTS More!

Our Generation-5 provides your operators with a straightforward traditional control surface coupled with all the benefits of digital technology. It gives you the flexibility of system-wide source, mix and destination control (any signal *anywhere*), a powerful mix-minus section and a complete event store, name and recall system. One wire from this surface can control THOUSANDS of wires in your technical operations center.

And while the G-5 *feels* like an analog console, its DSP-based mixing engine keeps your digital sources digital while converting analog sources to switched digital, eliminating crosstalk and noise. It can furnish remote and telcom functionality on any input fader without fear of feedback—a real plus in back-to-back

daily operations. Its built-in graphic displays keep operators on top of things with just a glance. And since the entire system is software based, you can accommodate any format with a press of a button.

Like all our **Generation Series** consoles, the G-5 has complete failsafe options available, such as automatic fail-over DSP and CPU cards and redundant power supplies. We can even provide scheduling software and studio mounted satellite cages that can be configured to mix independently from your main routing system.

At **WHEATSTONE** we've built and sold over a thousand digital audio consoles. The G-5 is a culmination of all that experience. Benefit from our expertise — choose **WHEATSTONE!**

See us at the NAB Radio Show Booth # 500



Wheatstone

600 Industrial Drive, New Bern, North Carolina 28562
252-638-7000 / www.wheatstone.com / sales@wheatstone.com

copyright © 2004 by Wheatstone Corporation

World Radio History



Behind Every GOOD CONSOLE

There's an EVEN BETTER ROUTER

GENERATION 4

A Straightforward, Easy-to-Use Control Surface

There's no long learning curve required to immediately start using this traditional layout specifically envisioned for operators of all skill levels.

BRIDGE TECHNOLOGY enables the GEN-4 surface to operate far beyond the limits of its studio main-frame. Integration with the Bridge digital audio network router provides systemwide access to all station on-air and off-air audio resources via inter-linked CAT-5 or fiberoptic cable. And of course, we all know **EXPERIENCE COUNTS!** With over eighty Wheatstone Generation control surfaces already operating in the field, you can be assured your installation will proceed smoothly and on time.

the digital audio leaders

www.wheatstone.com



Wheatstone

See us at the NAB Radio Show Booth # 500

World Radio History

Copyright © 2004 by Wheatstone Corporation