

*****AUTO***3-DIGIT 604
 R101497 D08 0511
 THOMAS E BRAXTON
 PRESIDENT
 BRAXTON EMC CONSULTING LTD
 201 BULI LN
 BOLINGBROOK IL 60490 1520

62

see page 11 inside



- **FROM THE TECH EDITOR**
 Michael LeClair responds to readers' comments on digital AM Page 3
- **KEEP CRACKERS FROM THE NETWORK**
 Protect your system from exploitation. Page 18
- **DO YOU HAVE A SICK BUILDING?**
 Manage your clean air for a healthy bottom line. Page 22
- **IP & HD: THE NAB ALPHABET**
 Guy Wire says vendors found the spring show one of the most productive in years. Page 27

Radio World

ENGINEERING EXTRA

June 14, 2006

ENGINEER INTERVIEW

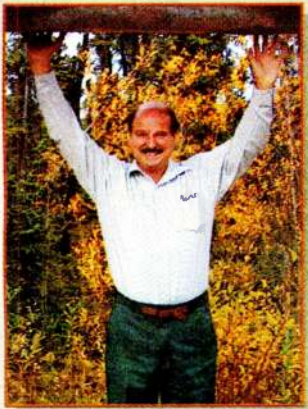

Larry Arnold

Arnold Drawn To CAD Circuit Design

Kintronic Engineer Finds Project Layout, Testing, Installation Rewarding

by Michael LeClair

Back in the early days of radio engineering it was a standard part of the job description to encounter unusual conditions and challenging requirements. In those early days, most transmission projects

SEE ARNOLD, PAGE 14

Do Diode Meters Measure Up to Calorimetry?

An Overview of Conventional and New Transmitter Output Power Measurements in Digital Broadcast Systems

by Tim Holt

The author is director of applications and systems engineering for Bird Technologies Group.

The measurement of transmitter output power has always been an important consideration in the operation of broadcast transmission systems. As broadcast network systems are planned and integrated, coverage predictions, as well as the prediction of the possibility of co-channel interference, are based upon several factors, including geographical terrain, antenna gain and directionality, and transmitter output power.

The introduction of new digital modulation formats into broadcast settings has necessitated a re-thinking of the methods that are used for the measurement of transmitter power. The accuracy and reliability in which these measurements may be made is related to our understanding of the limitations of conventional power measurement methods, as well as our understanding of the proven techniques that have been developed for use with digital broadcast systems.

In this paper, we will review some of the characteristics of conventional measurement methodologies, as well as develop a foundation of understanding of newer techniques. We also will discuss "first-principle" power measurement methods, and present data as to how various measurement methodologies compare with measurements developed using first-principle techniques.

CONVENTIONAL POWER MEASUREMENT TECHNIQUES

Instruments used through the years for

the measurement of transmitter output power may be categorized as follows: In-line or Thru-line Instruments; Terminating Power Meter/Directional; Coupler-Based Instruments; and Radio Frequency Calorimeters.

the advantage of providing measurements that truly represent heating power, as their definition would imply. These devices also provide the advantage of responding to the aggregate power presented to their input, as they are typically broadband devices.

One might argue that terminating-type laboratory power meters also would provide this advantage, in that these instruments also are typically broadband in nature, but they

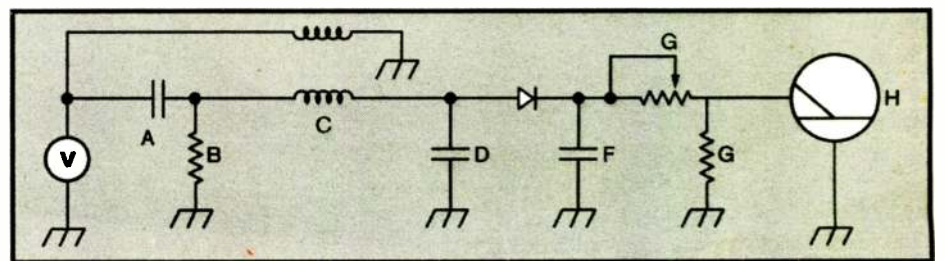

Conventional Power Meter Schematic

Of the above categories, in-line power meters have been the most popular instruments, owing to their simplicity, ease of use and their ability to measure both forward and reflected power. First-generation instruments of this class were developed in the 1950s, using simple point contact diode detectors. Within the past five years, versions of these instruments have been developed using up-to-date diode devices and low-noise amplifiers, more appropriate for the measurement of signals incorporating complex modulation.

Terminating power meters and their associated directional couplers also have been used extensively. Power measurement techniques developed around instruments of this class are adaptations of power meters that were designed for laboratory use, but can provide high-quality measurements in broadcast applications when paired with the appropriate directional coupler.

Radio frequency calorimeters provide

are limited to measuring very low-power levels, and must be used with a directional coupler. These couplers are useful only over a relatively narrow band. Following are some additional details regarding these power measurement instruments:

FIRST-GENERATION IN-LINE POWER METERS

These power meters comprise a short length of precision transmission line fitted with either a single or a dual directional coupler. The output of the directional coupler is typically in the range of 40–60 dB below the main transmission line level. The coupler output is connected to a simple diode detector and then scaled and displayed on a meter movement.

Most of these power meters actually measure the peak power of the signal, while the meter scale is actually calibrated in average power. While this approach has

SEE POWER METERS, PAGE 4

RW-EE: A Deep Technology Read for Engineers



Visit our website at www.rwonline.com

Stand alone reliability or networked flexibility. Why should you have to choose?

With the Harris **PR&E RMXdigital™** console and **Vistamax™** networked audio management system you don't have to give up reliability to get the flexibility of networked audio, you can have **both!** Whether you have a large consolidation, or just want to update one studio, we've got you covered. Our unique distributed approach reduces wiring, installation time and expense. Harris' scalable digital audio solution can be tailored to fit the most demanding needs and strictest budget.

The touch and feel your talent loves with the adaptability every engineer needs—all at a price the boss will like.

Call 800-622-0022 today and put the power of Harris to work for you.

HARRIS assuredcommunications™
 Broadcast • Microwave • RF • Government Systems www.harris.com



THIS IS THE NEXT BIG THING:



WHEATNET™ — FUTURE PROOF!

WHEATNET LETS YOU ROUTE THOUSANDS of bi-directional signals at ONCE in just 60 microseconds — all secure, virus-proof and in just 2 rackspaces! **WHEATNET** leaps way ahead of conventional stacked router or IP-based designs, interconnecting up to 48 studios (each with its own independent mix engines and I/O resources) using just one CAT-5 wire per studio, plus providing systemwide X-Y control from one central location. You can even meter and monitor (in stereo) any signal systemwide.

REDUNDANCY? We've got that covered too: just add a second WHEATNET and CAT-5 link from each studio and have an AUTOMATIC standby interconnect for the ENTIRE system!

WHEATSTONE has a proven track record for digital networking; benefit from our experience!



48 CAT-5 PORTS with 128 audio channels
(plus embedded control data) per port.
**THAT'S 6144 TRAFFIC CHANNELS IN JUST
TWO RACK SPACES!**



 **Wheatstone**

GET THE POWER!

tel 252-638-7000 / sales@wheatstone.com

copyright © 2005 by Wheatstone Corporation

■ Telephone: (703) 998-7600
 ■ Business Fax: (703) 998-2966
 ■ Editorial Fax: (703) 820-3245
 ■ E-mail: rwee@imaspub.com
 ■ Online: www.rwonline.com

—EDITORIAL STAFF—

Editor in Chief/U.S. Paul J. McLane
ext. 117
 Technical Editor: Michael LeClair
 Production Editor: Kelly Brooks
ext. 136
 Technical Adviser: Thomas R. McGinley
 Technical Adviser: John Bisset

—ADMINISTRATION & PRODUCTION—

President: Stevan B. Dana
 Chief Executive Officer: Carmel King
ext. 157
 Publisher: John Casey
(330) 342-8361
 Chief Operating Officer: Marlene Lane
ext. 128
 Chief Financial Officer: Chuck Inderrieden
ext. 165
 Sales Director: Eric Trabb
(732) 845-0004
 Editorial Director: T. Carter Ross
ext. 120
 Production Director: Davis White
ext. 132
 Publication Coordinator: Karen Lee
ext. 106
 Ad Traffic Manager: Lori Behr
ext. 134
 Classified/Product Showcase: Linda Sultan
ext. 141
 Classified Ads: Claudia Van Veen
ext. 154
 Circulation Manager: Robert Green
ext. 161

Next Issue

Radio World: June 21
Engineering Extra: August 23

imas Radio World (ISSN: 0274-8541) is published bi-weekly with additional issues in February, April, June, August, October and December by IMAS Publishing (USA), Inc., P.O. Box 1214, Falls Church, VA 22041. Phone: (703) 998-7600, Fax: (703) 998-2966. Periodicals postage rates are paid at Falls Church, VA 22046 and additional mailing offices. POSTMASTER: Send address changes to Radio World, P.O. Box 1214, Falls Church, VA 22041. REPRINTS: For reprints call or write Emily Wilson, P.O. Box 1214, Falls Church, VA 22041; (703) 998-7600; Fax: (703) 998-2966. Copyright 2006 by IMAS Publishing (USA), Inc. All rights reserved.

—Printed in the USA—

FROM THE TECH EDITOR

by Michael LeClair



Responding to Readers' Comments on Digital AM

In the last couple of issues I have related my experiences with the conversion of a 1 kW AM station to digital operation. A number of you have responded with well-thought-out comments, and I want to talk about these a little this month.

One reader pointed out to me that the measurements we took as an initial test of digital coverage did not follow a scientifically rigorous and repeatable process. I agree with that observation completely. These "coverage" tests were anecdotal at best. But I'm not too concerned about that for this initial testing of what we can expect with digital AM in the real world, and I would like to explain why.

FOR GOOD MEASURE

The familiar proof-of-performance measurements for AM stations require the collection of literally hundreds of data points. Once all of this data has been brought together it is possible to develop values for the signal strength on an average basis. These averages are then interpolated to create the familiar contour maps we all use to talk about the reach of a particular radio station.

If the measurements are conducted carefully, and within similar seasonal conditions, they should be repeatable over time within a reasonable error margin. This repeatability is the basis of the scientific process.

The key concept here is that to achieve repeatability it requires a statistical average of a lot of measurements. The more measurements we have the more accurate it is, statistically anyway. But as anyone who has done measurements for a proof knows, it takes some skill and care to get valid measurements due to the effects of man-made structures.

Measurement points are selected to avoid such effects. Often in the final calculations, some measurement points have to be "thrown out" because they don't correspond to an expected mean value — a good reason to collect more measurements than the minimum required.

But listeners don't really care all that much about the statistical accuracy of our measurement studies — they are really just concerned about whether they can listen to a radio station or not. It doesn't take scientific rigor to drive around, as you expect your listener to do, and see where the signal has problems.

In measuring the analog field strength with our meter, we did make sure we chose a spot that would not suffer from local interference effects, but the observations were taken in locations suggested by the dropout rate of the digital signal on a consumer radio.

The fact is that signal quality varies greatly within areas that a contour map shows as having adequate signal level for reception. Secondary roads represent one of the worst-case reception conditions for AM due to the ubiquitous overhead power lines. Signal strengths can vary up to 6 dB due to the effects of these lines, and more if there is a noisy electrical transformer generating enough interference to cause the radio to desensitize. That amount of signal change can and does cause an analog AM signal to

degrade audibly when the average signal strength is below a certain threshold.

This leads me to another reader's comment, which questioned my choice of 2 mV signal strength as a reliable coverage limit for analog AM. This responder noted that my experience in the densely populated New England area, with poor soil conductivity to boot, may not reflect conditions in other, more rural parts of the country. This point is well taken. Another example of extended coverage is the case of clear channel AMs where the lack of interference allows reception at remarkable distances.

Analog AM can get very good quality coverage out past 2 mV, in places where man-made noise and interference are not prevalent. In New England, if you drive on an interstate highway it will always make your station seem to go further. The high-speed road noise helps mask the rising noise floor on the AM receiver too.

The only problem is that once you get off the highway the signal fades out at the end of the exit ramp. Interstate highway coverage is good to have, but probably doesn't make up the majority of your listeners.

A LISTENABLE SIGNAL

As someone who has worked in AM for many years I have a fondness for this medium. I grew up listening to AM stations. As such I have a tendency to want to take an "optimistic" view of the coverage area of our AM stations.

However, as someone with a responsibility to my employer that includes providing objective evaluation of coverage area, sometimes I have to keep these impulses in check. The question I ask myself is, "Would I be willing to drive with my sales manager in the car with me to prove that reception is good in this area?" At least in our region, I am not comfortable doing this with less than 2 mV of signal. But I'm willing to accept that in other parts of the country this works just fine.

One reader wondered about my assertion that I could get reliable digital coverage in areas that suffered noise or fade on the analog. He pointed out that digital carriers suffer from the same statistical fadeouts and problems due to man-made noise.

In contrast to analog, however, the digital signal does not degrade in a steady fashion as the interference rises. Up until the interference or fade reaches that last tenth of a decibel below the digital crash point, it will sound the same as a more powerful signal. Once that threshold is exceeded the digital radio will, of course, lose the ability to decode the signal completely, and substitute the analog signal as a backup source.

This explains why it is possible to have a listenable digital signal in places where the analog signal is badly impaired. There is a significant region of coverage where the analog gets noisy and the digital just sails on through.

The fact that we get as much coverage as we do encourages me to plan for a future upgrade of this transmitter; with the latest equipment we should improve the digital coverage area even more. A new transmitter

is actually less expensive than the digital signal generation equipment. But for now this compromise is acceptable to get us off the ground with digital.

One heartfelt comment from a reader concerned the experience of so many AM radio stations that invested in the technology of AM stereo. The painful nature of that technology's failure still informs the fears of so many of us in the radio business. If improving the quality of AM didn't work the last time, why should we invest in this new technology that promises improvements, but may not deliver?

On this question I would point out that there is a hopeful difference this time through. Everything I see and hear suggests to me that on the FM band, HD Radio is rapidly growing and will drive demand for new radios. Unlike the previous experience with AM stereo, new digital-ready radios will bring support for both FM and AM reception. This will generate a market ready for the audible improvements of AM digital.

The receiver piece of the puzzle is a strong reason to support a compatible digital receiver to FM HD, rather than one of the alternative systems that have been floated as possibilities. Receiver manufacturers lost money on the failure of AM stereo too, and they are not eager to repeat it.

While I'm sympathetic to the concerns of those who dislike being dependent on a proprietary system, compatibility can be a powerful market force that develops potential listeners.

That's all I have room for in this issue but please keep those comments and e-mails coming to rwee@imaspub.com. I enjoy reading them and want to keep the engineering dialog open to all points of view. ■

IN THIS ISSUE

- 1 Do Diode Meters Measure Up to Calorimetry?
By Tim Holt
- 1 Arnold Drawn to CAD Circuit Design
By Michael LeClair
- 3 From the Tech Editor
By Michael LeClair
- 18 Keep Crackers Away From Network
By Stephen M. Poole
- 22 Ventilation and Dangers Of Sick Buildings
By Charles S. "Buc" Fitch
- 27 NAB2006 Abuzz Over IP, HD Rollout
By Guy Wire
- 30 Ignoring Logical Reasoning Is Logical
By Barry Blesser

Power Meters

CONTINUED FROM PAGE 1

served the broadcast industry for many years, the use of simple in-line power meters in complex modulated signal systems has been questioned due to the inability of simple diode detectors to respond to signals with very high peak to average power characteristics common to digital modulation formats.

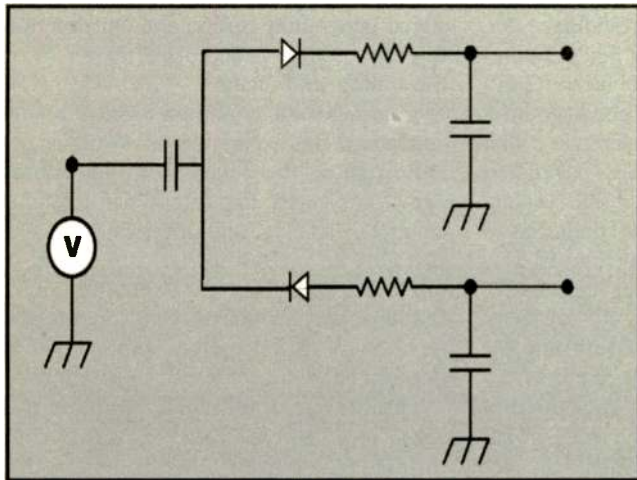

Next-Generation Diode Detector Schematic

Diode detectors in conventional in-line power meters are operated largely over the non-linear portion of their dynamic range with their accompanying meter scales calibrated to read average power, even with the

diode operating in a nonlinear fashion. This approach works fine, so long as the power meter is used to measure a single defined waveform or a closely related signal, such as CW or FM modulation.

IN-LINE POWER METERS WITH SQUARE-LAW DETECTORS

This latest generation of in-line power meters is configured in much the same manner as the first-generation instruments, with the important difference in the detector technology. An alternative approach using diodes that works well in systems carrying complex modulation is to operate the detector diodes below approximately -20 dBm in an area known as the "square law" region of the diode's dynamic range.

In this region, diode detectors behave in much the same manner as thermal detection devices, where at low signal levels, the diode's rectified output is a function of the square of the RMS input voltage. The transfer function for a full-wave square-law diode detector is approximated as follows:

$$V_{out} = (V_{in} / 5.77)^2$$



THE EXPRESS LANE IS NOW OPEN.

PCI EXPRESS

AudioScience introduces the world's first PCI Express sound cards: the ASI6600 series.

Not only do you get the advantage of speedy PCI Express data transfer, but our ASI6600 series sound cards are loaded with Built for Broadcast™ features. With PCI Express slots fast becoming the standard in new PCs, now is the time to get in the fast lane. Get ahead, and stay ahead, with AudioScience. Learn more by calling +1-302-324-5333 or visit www.audioscience.com.

ASI6600 SERIES FEATURES

- +24dB analog levels
- 96kHz sample rates
- SSX multi-channel support
- MRX multi-rate mixing
- MPEG Layer 2 and 3 encoding and decoding
- TSX time scaling
- SoundGuard transient voltage protection
- Short 6.6" PCI card format
- Up to 4 cards in one system
- Windows 2000, XP and Linux software drivers

BUILT FOR BROADCAST

AUDIOSCIENCE
Sound Engineering
Sonic Excellence

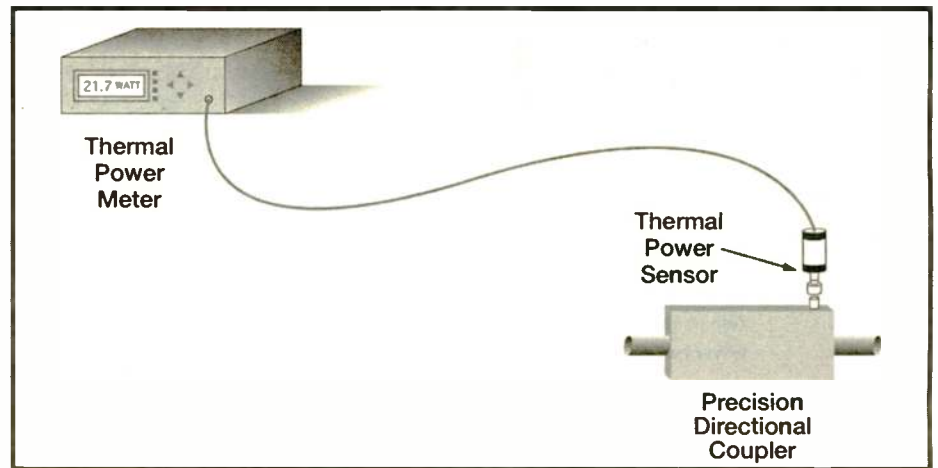

Fig. 1: Terminating Power Meter

Where: all voltages are in millivolts

This relationship holds as long as the total excursion of the signal is contained within the diode's square law region. The theoretical bounds for this range are from approximately -20 dBm on the high side to the noise floor as determined by the bandwidth of the measurement at the lower end. Measurement ranges of 50 dB are possible in most systems.

TERMINATING POWER METER/DIRECTIONAL COUPLER POWER METERS

These instruments, generally used for laboratory applications, are wide in frequency and dynamic range, and may be used in conjunction with high-power directional couplers for making high-power measurements (see Fig. 1).

They may use either thermal converter technology or diode detector measurement

which is the accuracy of the instrument's internal reference. Also, the internal reference operates at a single frequency and power level.

Second, operation of the power meter at frequencies other than the internal reference frequency requires the use of calibration offsets. These offsets carry their own uncertainties.

Third, the effects of mismatch uncertainty between the input to the power sensor and the output of the directional coupler are significant. Since the VSWR characteristics of the sensor input and the coupler output change with frequency, the magnitude of the mismatch uncertainty also will change with frequency.

RADIO FREQUENCY CALORIMETERS

Radio frequency calorimeters have formed the foundation for high-power measurements for many years. This power measurement method remains in use as the

	Error Component	Error Value	
1	Instrumentation Uncertainty and Noise	±1.5%	
2	Power Reference Uncertainty	±1.2%	Thermal power meters require the use of a reference oscillator. This is typically a 50 MHz, 1 mW source.
3	Calibration Factor Uncertainty	±3%	The accuracy to which specified sensor calibrations are known.
4	Mismatch Uncertainty (Based upon a source VSWR of 1.5 and a load VSWR of 1.2)	±4%	Based upon a source VSWR (directional coupler side arm) of 1.5, and a sensor VSWR of 1.2.
5	Attenuation Factor Uncertainty	±1%	Using a 50 dB directional coupler and an HP8753D network analyzer, the best possible attenuation measurement is +/- 0.5 dB.
6	Linearity	±1%	
7	Temperature Drift	±1.6%	Assuming a 7°C total spread in ambient temperature at measurement point.
Worst-Case Error		±13.3%	
Probable Error		±5.8%	

Table A: Error Analysis Showing Worst-Case Error Percentage

approaches to power detection. They are generally more difficult to use, as they require frequent calibration and are more expensive than the above choices.

Another issue with these instruments is that the measurement of transmission system VSWR is more difficult, as this measurement requires the use of a dual-channel coupler, and a second measurement channel on the power meter. Like the square-law-based instruments described above, they work well in cases of complex modulation, as they respond to the heating power of the signal.

The error analysis of a typical implementation for this power measurement approach appears in Table A. While the analysis is fairly self-explanatory, there are a few comments worth making.

First, the accuracy of power meters in this class is dependent upon many factors, one of

means by which NIST establishes primary RF measurement standards.

As mentioned above, calorimetric systems measure the true heating power of a signal, including the fundamental frequency, all harmonics and sidebands and other modulation related contributions. The calorimeter will measure the total aggregate power contained in the signal.

The calorimeter is a device that responds to heat and will measure the heating power of a low frequency (50 or 60 Hz), or DC

SEE POWER METERS, PAGE 6

got gear? cables & connectors
racks
tools
problem solvers
test gear
& much more
www.systemsstore.com

GET EVERYTHING UNDER CONTROL



- RS-232 Control of all RDL Switching Modules
Examples include computer controlled switching of 4x1 and 2x1 audio, video and digital audio signals.
- RS-232 Control of Many OEM Products
- Eight 0 to 10V (or 0 to 5V) Outputs
Examples include computer control of audio levels using RDL VCA modules or computer control of lighting.
- Status Inputs from Eight Sources
Examples include sensing contact closures from satellite receivers or from RDL audio or video detection modules.
- Rack mountable using RDL RU-RA3HD

RS-232

- RS-232 Control of 8x4 Audio Routing
Direct interface with RDL System 84 allows switching, mixing & routing 8 mono or stereo sources to 4 outputs.
- Eight 0 to 10V (or 0 to 5V) Outputs
Examples include computer control of audio levels using RDL VCA modules or computer control of lighting.
- Status Inputs from Eight Sources
Examples include sensing contact closures from satellite receivers or from RDL audio or video detection modules.
- Rack mountable using RDL RU-RA3HD

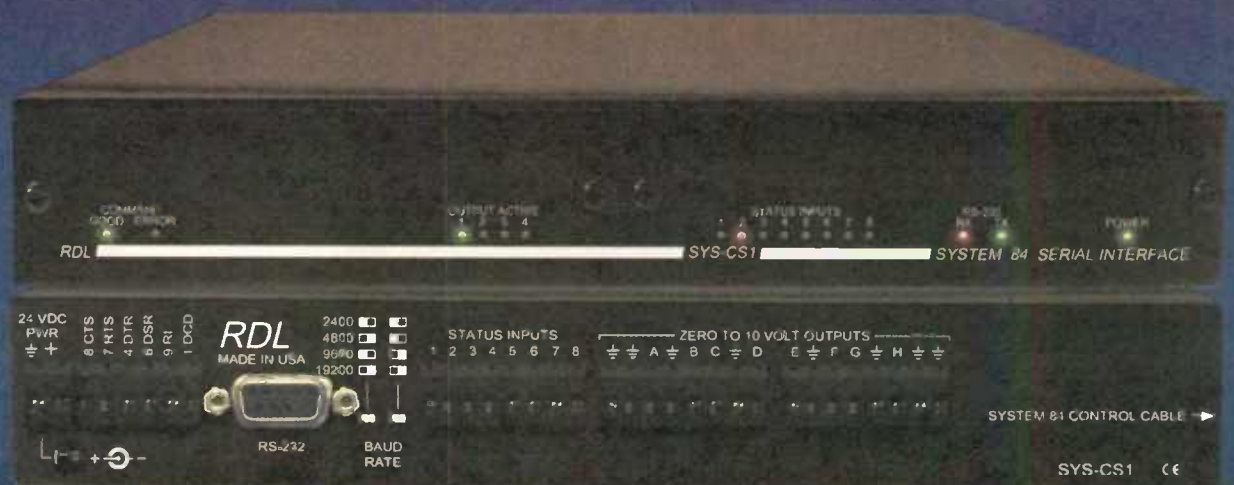

www.rdl.net.com

RDL • 659 N. 6th Street • Prescott, AZ • 86301



RDL®

Radio Design Labs

(800)-281-2683

Power Meters

CONTINUED FROM PAGE 4

energy in exactly the same manner in which the calorimeter will respond to RF signals. This characteristic enables the calorimetric system to be highly accurate,

accuracies of +/- 1 percent are possible using the substitution calibration methodology outlined above.

Although calorimetric power measurement methods yield results with unparalleled accuracy, calorimetric systems have their limitations, such as: 1) calorimeters are generally difficult to use; this is especially

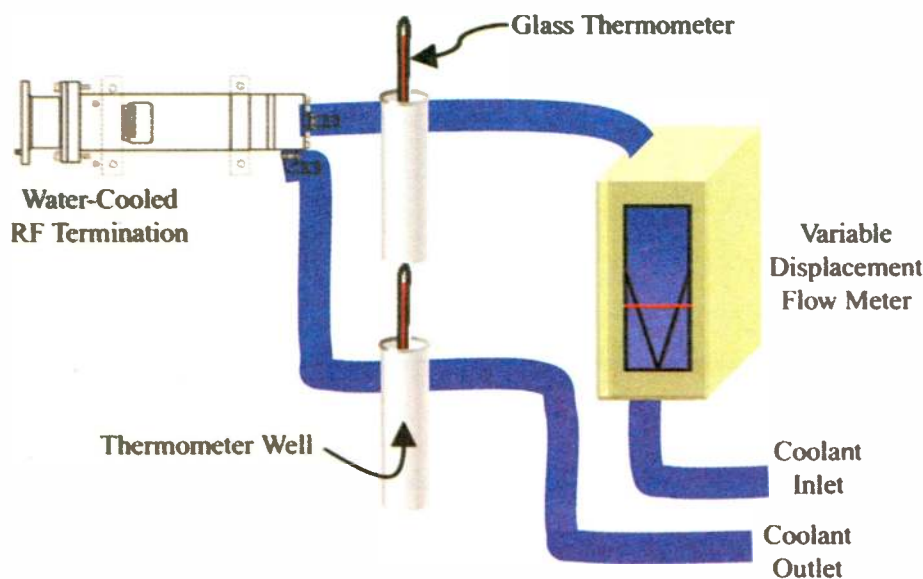

Fig. 2: Calorimeter

as the low frequency AC, or DC energy used to calibrate the calorimeter may be known very precisely.

This calibrating energy also is useful in the establishment of a path back to NIST primary standards. Typical field calorimetric system accuracy is +/- 4 percent, but

true in field settings, with typically uncontrolled environments; 2) best results with calorimetric methods are obtained with highly trained operators; and 3) calorimeters are terminating devices, and are not suitable for directional power measurements, leading to antenna match measurements.

Livewire On Board!

Now Radio Systems' Millennium digital consoles are available with six channels of Livewire connectivity.

Use your Millennium console as a standalone work surface AND network it throughout your facility to any Livewire-ready digital delivery system, Windows® Media Player or Axia analog or digital audio node.

It's the best of both worlds with standalone functionality and network flexibility using the Livewire IP audio standard.



radio
SYSTEMS

Radio Systems, Inc.
601 Heron Drive, Logan Township, NJ 08085
phone: 856 467-8000 Fax: 856 467-3044 www.radiosystems.com

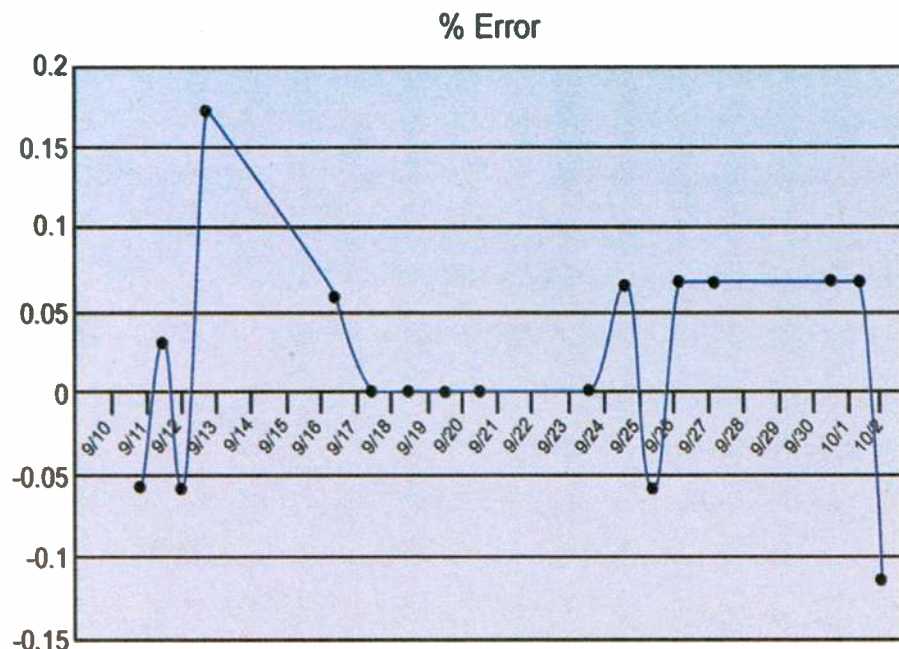

Fig. 3: Calorimeter Accuracy

A pictorial diagram of a typical calorimetric system is described in Fig. 2. In this system, a water-cooled, high-power RF termination is used as a means to convert radio frequency energy into heat, with the constraint that this must be done in a highly efficient manner, so as to capture the majority of the energy dissipated in the load.

Load efficiency is also important from the perspective of calibration, as the heat flux from the load in areas other than the coolant path cannot be easily captured, and also will behave as a function of the ambient temperature.

In other words, if the calorimeter is calibrated at 25° C, and the ambient temperature changes to 15° C, this additional gradient will result in more heat escaping from the load in areas other than the coolant path. This will have the effect of shifting the calibration point of the calorimeter.

Also contained in this system is a means of determining the mass flow rate, in this case a volumetric flow measurement instrument (Rotameter). While flow meters of this type have been used in field calorimeter instrument through the years, more precise turbine-type instruments are available.

Finally, the system contains two temperature-sensing elements, one placed at the input to the RF load, and the other placed at the output. While the picture shows glass thermometers, most modern systems use thermocouples or thermistors for these components, for their improved accuracy and repeatability.

Calorimetric systems will measure power in accordance with the following equation:

$$\text{Power(kW)} = 0.263 \times \Delta T \times \text{Flow}$$

Where: temperature measurements are in degrees centigrade, and flow rate is in gallons per minute

While this formula will provide an indication of the power dissipated in the load, it is necessary in most cases to compensate for physical changes to the coolant used in the system — temperature variations, say, or an operator's change in practice to using a different coolant mixture, such as ethylene glycol and water.

For example, the specific heat of pure water has a value of 1.0 at a temperature of 15-1/4° C, but this value drops to 0.998 at a temperature of 35-1/4° C. Modern calorimetric instruments automatically compensate for these changes.

As mentioned above, one important attribute of the calorimetric system is that

the system will respond essentially the same for DC or low-frequency AC energy as for RF energy. This "substitution" calibration procedure may be characterized as follows:

Low Frequency Power Reference — This reference will be used to measure the actual power used for calibration. Since low-frequency energy will be used for calibration, inexpensive, highly accurate instruments are available. Inexpensive digital multimeters, are typically accurate to within +/- 1 percent for low-frequency voltage and current measurements. The best choices are AC power meters such as those made by Yokogawa, which measure voltage and current, as well as the phase angle between these parameters. It is possible to measure the delivered power to the load using instruments of this type.

Low-Frequency Source — In many cases, 60 Hz energy may be used. A primary consideration is the stability of the energy source.

Perform Calibration — The calibration should be performed at or near the power level where the RF measurement will be made, in order to avoid linearity errors. Connect the low-frequency source to the calorimeter, along with the reference standard.

Perform Substitution — Connect the RF source to be measured to the calorimeter in place of the low-frequency source, and perform the measurement. Typical medium-term measurement accuracy for the system as calibrated above is quite good, as shown in Fig. 3.

TRACEABILITY TO NATIONAL STANDARDS

As mentioned above, there are two widely used traceability paths from high-power RF measurements performed "in the field" back to the low-power primary standards maintained by NIST. These two paths are outlined in Figs. 4 and 5.

The first (Fig. 4) incorporates the concept of DC or low-frequency substitution, as we explained above. The path begins with the calorimeter that is used as the "working standard," and may be used as a reference standard for other power meters. As described above, the calorimeter is calibrated using voltage and current meters, or a low-frequency AC power meter. These instruments are easily traceable to primary standards.

The second path (Fig. 5) is intended for

SEE POWER METERS, PAGE 8



**This is how you feel when you find out
the remote is this afternoon.**

ACCESS IP Codec is how you cope.

ACCESS uses BRIC technology on the **public Internet** to deliver wideband mono or stereo audio on an IP network. Use it on DSL, cable, WiFi, satellite, 3G cellular, or pretty much whatever you've got. It can even operate as a POTS codec, delivering wideband mono or stereo audio over a single POTS line.

Read all about BRIC technology in the IP Audio Coding brochure. Want a copy? Contact us at 800-237-1776 or check our website at www.comrex.com/ip



Your Pass to Amazing Audio From Anywhere

Put Comrex On The Line.

COMREX

Toll Free: 800-237-1776 • www.comrex.com • e-mail: info@comrex.com
19 Pine Road, Devens, MA 01434 USA • Tel: +1-978-784-1776 • Fax: +1-978-784-1717

World Radio History

Power Meters

CONTINUED FROM PAGE 6

working standards that are comprised of terminating power meters and directional couplers as described earlier. Traceability for measurement systems of this type requires the use of a dual path, one for the calibration of the directional coupler using precision attenuation standards, and the other for the calibration of the power meter using calibrated thermistor mounts (bolometer).

THE CHALLENGE OF DIGITAL MODULATION

The measurement of radio frequency power in digitally modulated signals presents a challenge due to high peak to average power ratios (crest factor) found in 8-VSB, COFDM and similar signal types. In general, the average power of signals using complex modulation is constant, whereas the peak power is data dependent. (See Fig. 6)

In practice, crest factor values of 7 dB are typical for these systems, with crest factor values as high as 12 dB possible, especially in multiple carrier settings. Conventional diode detector power meters, being peak reading instruments, tend to follow the envelope established by the peak power value of the signal.

POWER METER COMPARATIVE TESTING

So far, we have established that calorimeter power meters are able to provide the best accuracy, and provide read-

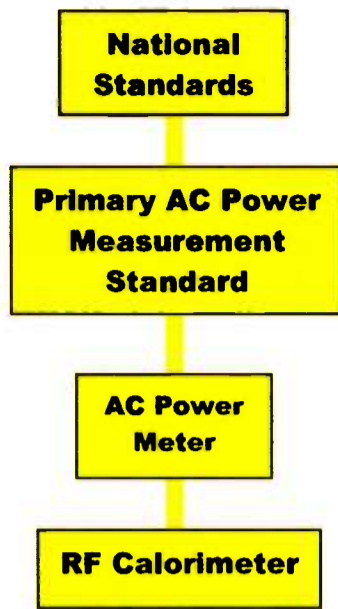

Fig. 4: Traceability Path to NIST for High-Power RF Measurements

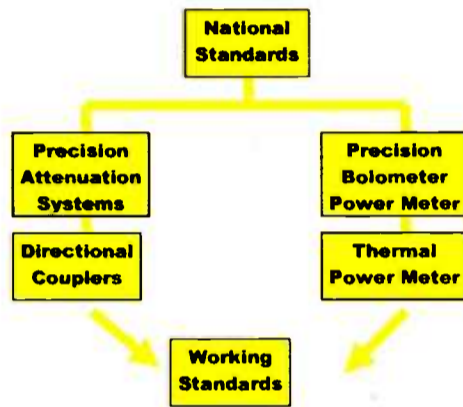

Fig. 5: Traceability Path for Directional Couplers

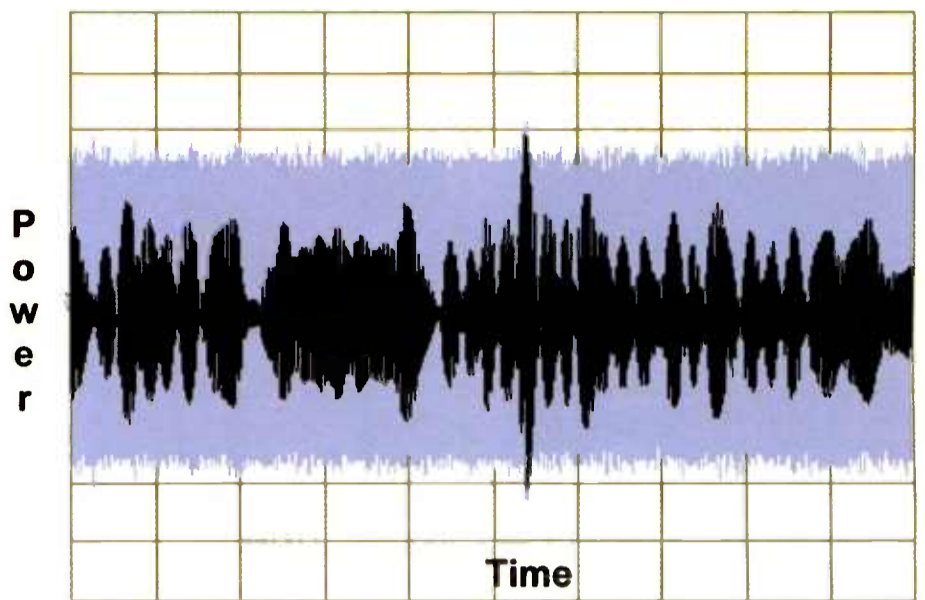

Fig. 6: Variation in Digital Power with Modulation

ings that truly represent heating power values. As it is not generally practical to use calorimetric methods on a daily basis, it is important to understand how transmitter power measurements made with alternative techniques compare with those obtained with calorimeters.

To make this comparison, we chose three different power meter types, along the lines of those described above. These power meters were then used to make transmitter power measurements, while using a high-power calorimeter as a reference.

In addition, the power measurements were made using signals with no modulation (CW), with COFDM modulation, and

with 8-VSB modulation. Each of these formats has different crest factor characteristics. Specifically, power meter types chosen for the testing were: conventional in-line directional power meter with single diode detector; thermal terminating power meter with directional coupler; and in-line power meter with square-law detector.

TESTING PROTOCOL

Each power meter type was tested independently, using the calorimeter as a reference. The testing was performed at power levels from 2 kW to 12 kW, in order to expose issues with dynamic linearity. Test

SEE POWER METERS, PAGE 10

AM Multiplexed Directional Antenna Systems For The Digital Revolution



Directional Antenna Phasing Systems

The way they ought to be...

**WFLF - AM 970
50/46 KW DA-2**

**WQTM - AM 740
50 KW DA-2**

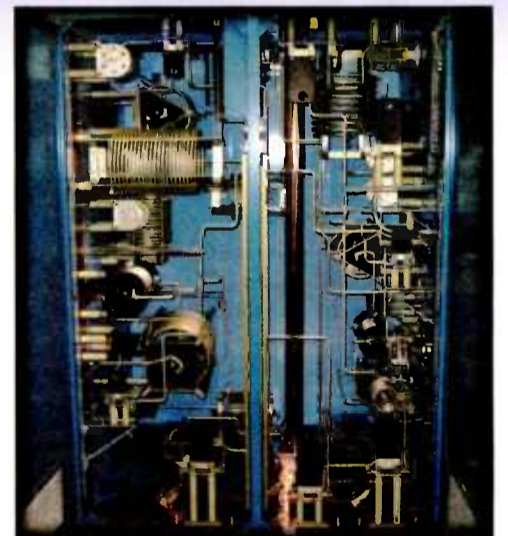

Interior Craftsmanship
Synonymous With Kintronic Labs

Built by Kintronic Labs for Clear Channel Communications, Tampa, Florida



Nobody Does It Better!

423.878.3141 fax 423.878.4224 Email: ktl@kintronic.com www.kintronic.com

"We were building brand-new studios. Why use the same old tech?"

"Our company bought a station in San Diego, and we had to move the studios. Since the station would be a part of our Southern California network, we needed equipment



that could quickly re-route multiple audio signals – from satellite, T-1, ISDN and remote vehicles – to different destinations.

"With Axia, setting up new routing configurations is easy; you just save new routes in software and recall them when you need them. SmartSurface makes controlling our many different audio sources and destinations very straightforward and uncomplicated; our air staff loves it!



"I knew how expensive routing equipment was. I also knew we'd regret buying a system with fewer capabilities just to save money.



"More than anything, we wanted to avoid limiting our operations with the use of conventional routers. Most of those systems force you to plan, during installation, for every signal routing configuration you might ever possibly need. If your needs change, you either have

"And expanding the network couldn't be simpler. Just plug in more audio nodes and boom! you've got more inputs.



"I've worked with lots of equipment in the past 30 years, and Axia is by far the easiest system to install and get up to speed with. There are just a few cables instead of hundreds; the entire installation – with testing – took just *one week*.



to re-wire or settle for operational compromises. Not very user-friendly! Making sure that the system was easy for non-technical air talent to understand and operate was critical, too.

"Here's the kicker: Axia cost about half what we would have paid for a conventional router. We're very pleased, and plan to expand the network to our second control room. My advice? Get Axia. You won't be disappointed."



"Axia addressed all these concerns.

— Rudy Agus, Chief Engineer, Hi-Favor Broadcasting
Los Angeles, California



www.AxiaAudio.com

Power Meters

CONTINUED FROM PAGE 8

results were as follows:

CW comparison — The test began by applying power to the systems with no modulation applied into a 50-ohm load. Under this signal condition, the power meters in the system, including the calorimeter, should produce very similar readings.

These readings were used as a baseline for the remainder of the tests. Power readings were recorded for various power levels between 2 and 12 kW.

Test results for CW test — In CW testing, with no modulation applied, the performance of the power meters was within published specifications, +/- 5 percent, as seen in Graph A.

8-VSB comparison — The second phase of the testing required connecting the calorimeter and the in-line power meters to a source of 8-VSB-modulated RF power to demonstrate the performance of the various meter types under 8-VSB modulation. The procedure used for the previous CW testing was repeated using the same power levels.

Test Results for 8-VSB test — The results of the 8-VSB test are shown in Graph B. The test data illustrates that the thermal and square-law-based diode power meters track the calorimetric system to within 3 percent across the power ranges tested.

COFDM Comparison — In the third phase of testing, the calorimeter and the three in-line power meters were connected to a source of COFDM-modulated RF power in order to demonstrate the performance of the various power meter types under COFDM modulation. The test procedure as outlined in the previous steps was followed, again using the same power levels as used during the CW and 8-VSB testing.

COFDM Test Results — The COFDM test results are indicated in Graph C. In this phase, the accuracy differences between the thermal and square-law diode power meters were even more pronounced than in the previous testing. The results show that the BPM and the thermal power meters were consistently within 2 percent of the calorimeter.

CONCLUSION

In this paper, information as to various methods for the measurement of transmitter output power was provided, and these methods were compared with the "first principle" methodology of radio frequency calorimetry. This information may be used to ensure that good choices are made with regard to the measurement of transmitter output power.

Finally, test data was presented illustrating the performance of three types of power meter systems when used with common digital modulation schemes, as well as under conditions where no modulation is present.

Based upon the data collected during testing, it is clear that the square-law-based

diode power meter and the thermal power meter/directional coupler combination are capable of the measurement of signals using complex modulation with accuracy

approaching a calorimetric power measurement system.

Comment on this or any article. Write to rwee@imaspub.com. ■

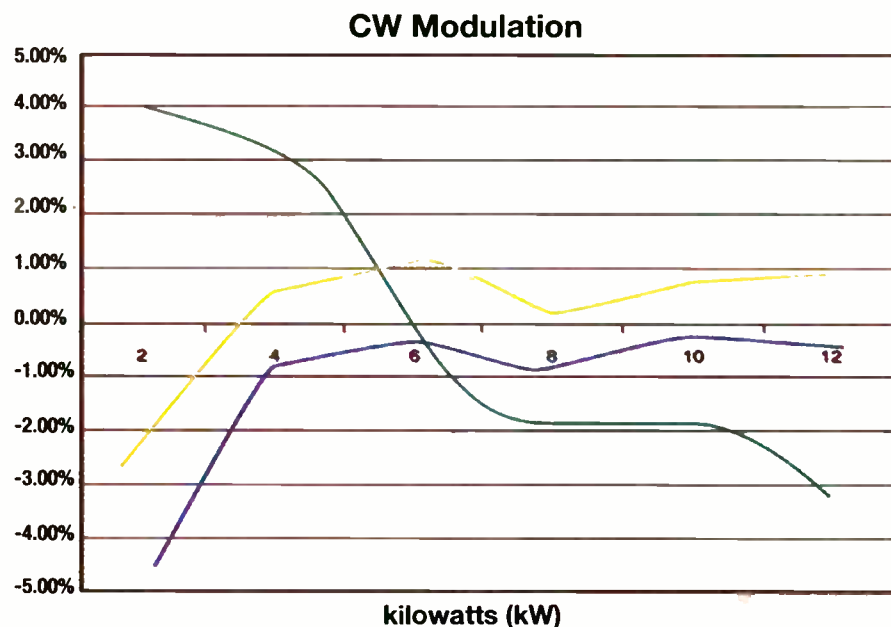

Graph A: Comparison of Measurement Accuracy for Continuous Wave Modulation Systems

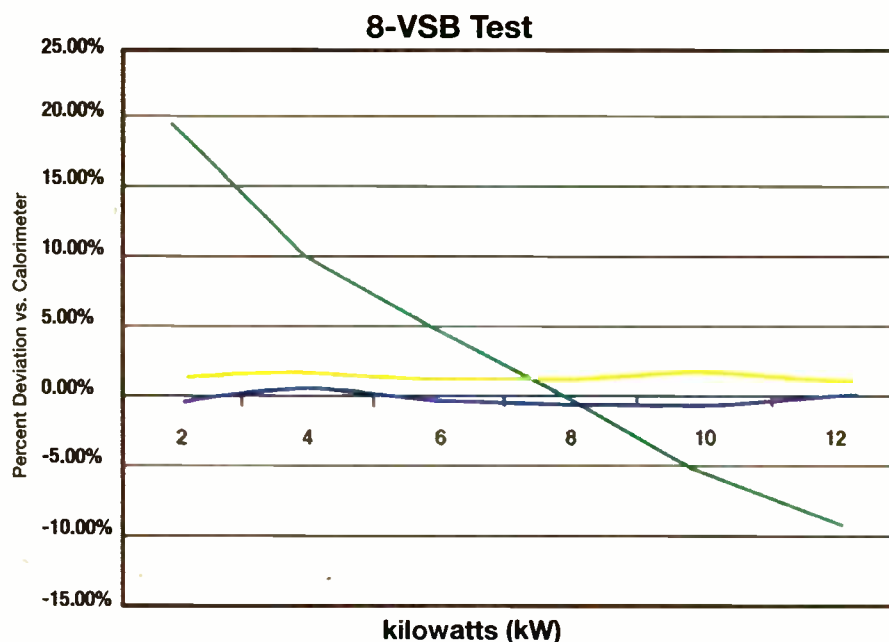

Graph B: Comparison of Measurement Accuracy on 8-VSB Digital Modulation

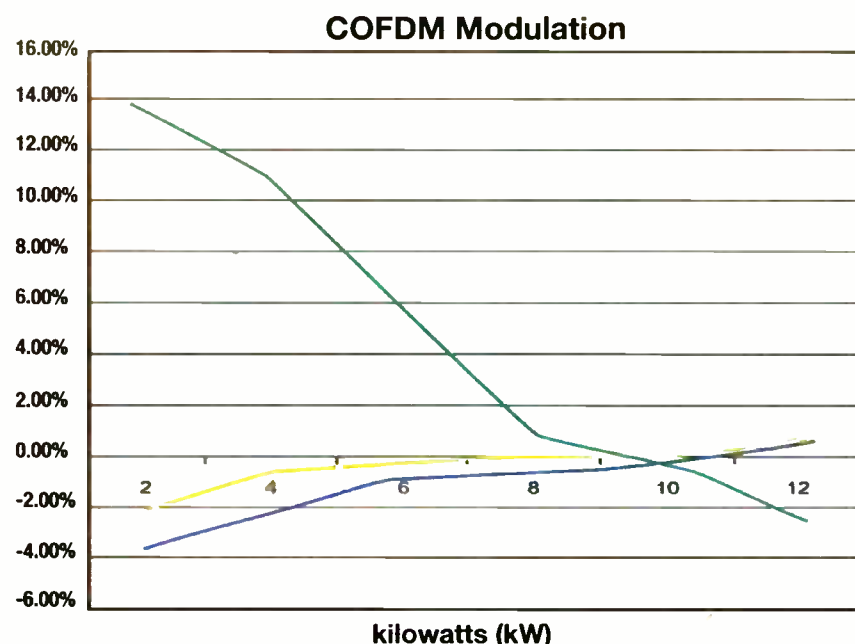

Graph C: Comparison of Measurement Accuracy on COFDM Signal

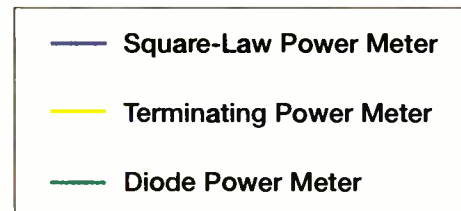

Introducing Big Pipe LT. The single box solution, perfect for the rest of us.

Easier on the real estate and easier on the checkbook, Big Pipe LT is not just another studio-transmitter link. Big Pipe LT takes the proven performance of our now-industry-standard Big Pipe, and packs it in a single-rack space.

With bidirectional capabilities up to a whopping 45 Mb/s, you can interchange analog and digital audio, HD Radio data, Ethernet, and serial data via a wireless or wireline path.

Flexible and reliable, Big Pipe LT works just as well for studio facility interconnects as it does for any other media transport needs. And because it comes from BE, you know that Big Pipe is designed for the realities of radio, including tight budgets and rock solid performance. Contact BE for details.



Broadcast Electronics, Inc. • 4100 North 24th Street, Quincy, Illinois 62305-3606
Telephone: (217) 224-9600 • www.bdcast.com • E-Mail: bdcast@bdcast.com

Broadcast Electronics and the BE logo are registered trademarks of Broadcast Electronics Inc

ANYWHERE, EVERYWHERE, ON THE AIR.

INTRODUCING THE EXPANDING FAMILY OF THE SAS CONNECTED DIGITAL NETWORK.™



New Rubicon-SL Console Control Surface

A "junior" Rubicon™ for less demanding studio applications. Offering full router source select, four mix buses, an unlimited number of mix-minus, mode, pan/balance, talkback, and more, SL is an ideal replacement for a dated analog console. Rubicon-SL fully integrates into an SAS 32KD Mixer/Router System.

New Rubi-T Mini Console Control Surface — Ideal for voice tracking rooms, news booths, edit booths, announce booths, effects mixing, and more. Just 6" high, Rubi-T's input module features a full-length 100mm P&G fader, channel ON/OFF, and four programmable source select or bus assignment buttons. Input, monitor, talkback, meter, remote control, and other modules are easily configured.



New RIOGrande Stand-Alone Mixer/Router — RIOLink, the SAS Remote I/O chassis for the 32KD, has grown into a full-featured stand-alone mixer/router, a junior version of the 32KD. Use it with Rubicons, SLs, Rubi-Ts, or simply as a powerful 32x32 analog and digital router. Connect two RIOGrandes with CAT5 or fiber for a great 64x64 mixer/router system.

With Rubicon, Rubicon-SL, Rubi-T, 32KD, and RIOGrande, the SAS Connected Digital Network has evolved to meet a wide range of budgets and requirements. In fact, it is now the "go-to" solution for hundreds of stations across the country moving into router-based networked control systems—providing the industry's most versatile and flexible user-friendly consoles, powerful routing of thousands of channels, integrated IFB/talkback/intercom, serial/ GPI/IP control, and so much more.

Whether you're building a Top-10 multi-station facility or a simple single air studio, SAS has the perfect system for any market, any where.

For more information, call 1.818.840.6749, or email radio@sasaudio.com.



**SIERRA
AUTOMATED
SYSTEMS**

www.sasaudio.com

APT, Pulsecom HD-PCAU Card Has AES/EBU Interface

APT and Pulsecom say they have enhanced their Program Channel Access Unit to support telco-based STL, remote-to-studio and studio-to-studio HD services. The companies began jointly developing the original PCAU broadband audio channel card in 2001; it was designed to deliver AM (7.5 kHz mono) and FM (15 kHz stereo) program content with analog interfaces, rather than the AES/EBU interfaces more appropriate for digital radio.

The HD-PCAU assists broadcasters with their migration from analog to digital by offering an AES/EBU interface, the 20 Hz-20 kHz bandwidth needed to transport HD content and auxiliary data input/output allowing RBDS to be embedded in the audio stream.

The incorporation of the apt-X data compression algorithm lets broadcasters maintain audio quality up to the point of final stage HD Radio emission.

"The original PCAU card ... freed operating companies from the 'manual workarounds' and 'special assemblies' that previously prevented them from selling broadband audio alongside broadband data," said Dave Corp, Pulsecom director of marketing. "With the introduction of a new HD-PCAU designed to be compatible with the original PCAU at rates up to 15 kHz, broadcasters have a cost-effective means to sequentially migrate to HD Radio links without sacrificing the coverage and support offered by the telcos."

For more information, including pricing, contact APT in New Jersey at (800) 955-APTIX (2789) or visit www.aptx.com.



Charlie Wooten, Clear Channel director of engineering, Panama City, Fla., holds the HD-PCAU alongside Stan Bailey of Pulsecom and APT Commercial Director Jon McClintock at APT's booth at NAB2006.

Genelec Debuts 8200 Series Monitors, 7200 Series Subwoofers

Genelec says its 8200 Series bi-amplified active monitors and 7200 Series active subwoofers are suitable for users who want a network speaker system that can be set up, measured, analyzed and calibrated.

The 8240A uses a 6.5-inch woofer and 3/4-inch tweeter set into Genelec's Advanced Directivity Controlled Waveguide. The free-field frequency response is 48 Hz to 20 kHz. Peak SPL per pair is 115 dB driven by a pair of 90 watt amplifiers for each driver.

The 8250A has an eight-inch woofer and one-inch tweeter set into the DCW with a free-field frequency response of 38 Hz to 20 kHz. Peak SPL per pair is 120 dB driven by 150 watt LF and 120 watt HF amplifiers. Both models are compatible with Genelec Loudspeaker Manager software and the company's loudspeaker control network, as well as the 7260A, 7270A and 7271A active subwoofers; and also can be used independently of the network. Drivers are magnetically shielded.

The 7260A features a 10-inch driver with a 120 watt power amplifier, frequency response of 19 Hz-85 Hz and ability to deliver SPLs of 108 dB at one meter. The 7270A incorporates a 12-inch driver with a 250 watt power amplifier, frequency response of 19 Hz-85 Hz and ability to deliver SPLs of 112 dB at one meter. The 7271A has a 500 watt power amp and ability to deliver SPLs of 118 dB at one meter.

Genelec says the 8200 and 7200 DSP Series monitors are built on the foundation of its 8000 MDE and 7000 LSE Series. The 8240A retails for \$1595, and the 8250A retails for \$2550. The 7260A retails for \$2950, the 7270A for \$3650 and the 7271A for \$5495.

For more information, contact Genelec in Massachusetts at (508) 652-0900 or visit www.genelecusa.com.



Genelec 8250A

Tascam Replaces CD-RW750 With CD-RW900

Tascam's CD-RW900 CD recorder/player expands upon the company's CD-RW750, adding MP3 playback, pitch and key control and a keyboard input for naming tracks.

The CD-RW900 features PS/2 keyboard input, trim function, sample rate converter and coax and optical S/PDIF digital inputs and outputs with level control. Wireless remote control is included.



Tascam CD-RW900

The CD-RW900's PS/2 keyboard input lets users name tracks using CD Text, but also gives the user one-key access to frequently accessed menu functions.

Front-panel features include a multi-jog dial, which is used to select tracks for playback or to set parameters.

Highlights include CD Text and MP3 ID3 tag display; unbalanced RCA inputs and outputs with dedicated input level controls; +/-16 percent pitch control in 0.1 percent steps (CD audio discs only); key control (CD audio discs only) and fade in/fade out recording.

The CD-RW900 also offers a list of MP3 playback modes, including reading ID3 tags and directories of MP3 files. Pitch and key are adjustable, so CDs can be played at a faster tempo without the "chipmunk" effect of changing the pitch.

The 2 RU CD-RW900 retails for \$679.

For more information, contact Tascam in California at (323) 726-0303 or visit www.tascam.com.



www.dielectric.com

At Dielectric, you'll find the same spirit of innovation that inspired "Doc" Brown to build a better radio antenna in 1942 alive and well in our full range of broadcast solutions:
TV & FM Broadcast Systems • Tower Lighting
Mobile Media • M2M Solutions

Convergence is poised to change our industry more in the next five years than the previous sixty years combined. Working together — the possibilities are boundless.

Dielectric
 COMMUNICATIONS
 Innovative Engineering
 for a Digital World™

got gear?
 cables & connectors
 racks
 tools
 problem solvers
 test gear
 & much more
www.systemsstore.com

VADIS THE COMPLETE AUDIO/MEDIA PLATFORM AND SOLUTION

Decentralized Audio/Media Network

OEM-Products

VARIZONE
Public Address

Xenon
'All-In-One'
Digital Audio Console

acorn
Digital Audio Network Console

D.Cennium
Customizable Digital Radio Console

VADIS D.C. II
Fully Customizable
Digital Audio Console
for Radio and TV

MORE THAN JUST A DIGITAL AUDIO NETWORK

VADIS is the state of the art Audio/Media Platform for the professional audio industry with the versatility to provide solutions for numerous applications.

VADIS, the premier audio solution, integrates audio and control across multiple audio disciplines converging on-air, production, post production, live sound, and sound reinforcement onto one platform.

OUR TECHNOLOGY IS YOUR SUCCESS

- Integrated platform concept
- Fiber optic networking
- Any audio source – anywhere

For more information
visit www.klotzdigital.com
or call 678-966-9900

KLOTZ
DIGITAL

Arnold

CONTINUED FROM PAGE 1

were one-of-a-kind; custom installations with many of the components assembled and built on site. Radio engineers are still known for their ability to get the job done, no matter what the circumstances.

In this month's interview we talk with Larry Arnold, an engineer who works in research and development with Kintronic Laboratories.

Arnold's work has taken him around the world to work on a variety of large medium-wave transmitter facilities during their construction. As in the days of early radio engineering, these large facilities tend to be custom-built and require engineers to use a range of skills to complete them. Outside of knowledge of RF, it can take mechanical, construction, electrical and electronics experience to achieve a successful installation.

As many of these installations are international, it also requires being comfortable with traveling in foreign countries and working with support staff who may speak a different language. Arnold admits to being drawn to this kind of work and enjoying the adventures.

Tell me about your educational background and training.

It's interesting because my career began with communication and radio training in the United States Marine Corps. After radio I continued with cryptography, electronics, radar and IFF systems. I graduated top in

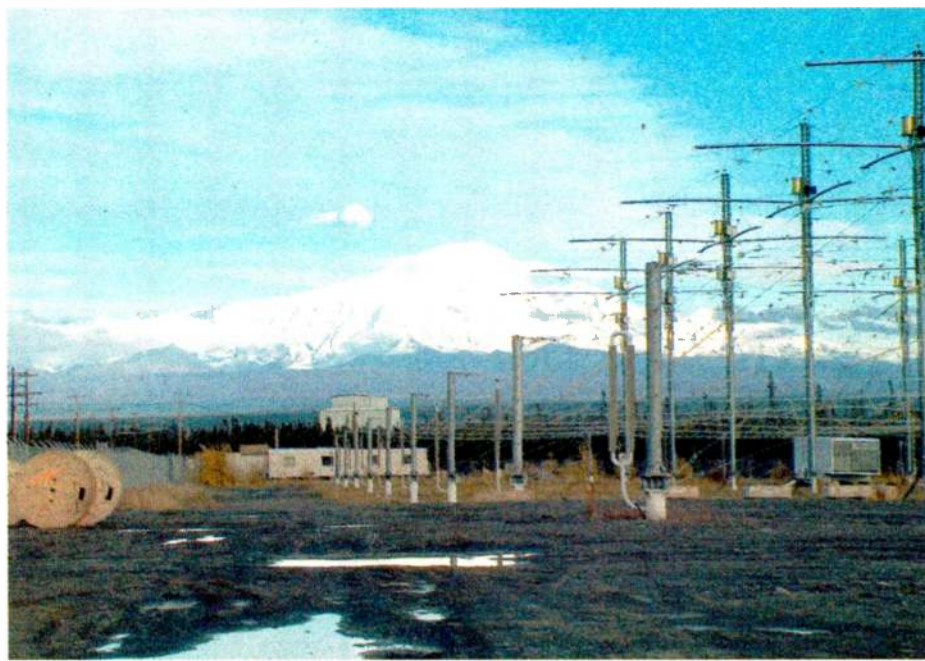

Individual Antenna Elements in HAARP

my classes, and then spent the remainder of my military career as a senior instructor at communications and electronics schools in California.

Upon completion of my six-year term in the Marine Corps and graduation from DeVry University in 1979, I went on to become a test engineer for Raytheon Missile Systems Division. I ultimately left the company after 19 years as a senior engineer, having done several stints such as international military projects and contract teaching for Northeast State University.

After leaving Raytheon, I became a sen-

ior project engineer for BF Goodrich Aerospace in Kansas City, Kan., where I focused on radio and navigation electronics and test programming. While at BF Goodrich, I was invited by Tom King of Kintronic Laboratories to join his staff in order to take on the largest high-powered medium-wave international system [the company] had ever done.

I didn't know it at the time, but my military and government manufacturing experience garnered me the skills and clearance level that would aid in future projects with Kintronic Laboratories, such as the HAARP Alaskan short-wave research system.

What is the HAARP Project?

HAARP is the High Frequency Active Aurora Research Project. This site has 3 to 4 megawatts of RF Power operating from 2 to 12 MHz with a multitude of individual phased transmitters. They use a 40-acre antenna array consisting of 360 dipoles. They beam the power into the upper atmosphere with enough power to ionize it.

Kintronic Labs built 720 RF terminations to dissipate HF dipole common mode currents that appear under certain antenna array operating conditions, as a result of multiple transmitters feeding the array. The loads had to be precisely made to meet a challenging specification of keeping emissions 150 dB below the carrier power levels.

Special construction techniques were used on each termination load that consisted of a network of bifilar non-inductive resistors with consistent unit-to-unit characteristics. The wire was bifilar-wound to cancel out the inductance of the resistive coils. Every metal-to-metal connection was made with similar materials in order to avoid any galvanic action that could cause unwanted emissions.

The automatic test system was configured using a software-based data collection system that included an oscilloscope, DMM, network analyzer, arbitrary function generator, frequency counter and control circuits. It would do Direct Current Resistance measurements, Power Pulse testing, VSWR and Smith Chart characteristic plotting automatically, and then print the required data and test results on three separate printers.

What is it that first drew you to broadcasting?

I've always liked radio. When I was young my older brother was in the Eagle Scouts and they worked on a radio transmitter they told me would "transmit and receive around the world." The scout leader



High-Power Linear Actuated Contactor In Prototype

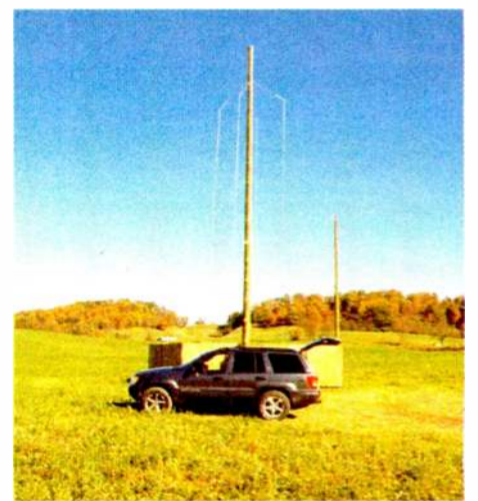

Kinstar Antenna

was an ex-Marine, worked for Raytheon at that time, and was the one who had the idea to build the project radio system.

I remember seeing all the components for the transmitter before it was built, with boxes of tubes and keys, a microphone and other stuff. This started my interest in electronics. I don't remember if that transmitter was ever completed or if it worked, but the idea of being able to communicate around the world just drew me in.

In high school I remember working in the audio-visual department. We had a closed-circuit television system that broadcast the sports events through the school. I remember running a 75-ohm video cable all the way across the high school roof to the gymnasium so we wouldn't have to move the heavy and delicate Ampex video tape recorders on site to record a game. The holes drilled into the dome roof caused a little concern, but it all worked out fine.

Describe your current work at Kintronic Laboratories.

I primarily conduct research and development, and perform a variety of disciplines ranging from custom-printed circuit board designs; fiber optics control system design; generating production tests and calibration; performing production pre-tuning; RF high voltage; current and frequency testing of new RF products; generating manufacturing process sheets; and system troubleshooting.

I also have enjoyed working on high-powered medium-wave projects, such as the Sri Lanka AM system, where I was involved in the design, installation, integra-

SEE ARNOLD, PAGE 16



Rack and Roll with **STABILINE®** Rack Mount UPS & AVR for ENG & Mobile Production

Ruggedized STABILINE SEG Series - True On-Line UPS Systems

- 2 and 3 kVA sizes
- 19-Inch, 2U Rack Mount Form Factor

Are the ideal solution for mobile broadcast applications where shock and vibration are normal conditions.

Battery module construction, front panel mounting ears and side mounting slides prevent battery movement and damage. Each UPS consists of a 2U Inverter and a 2U Battery Module (VRLA maintenance free batteries). These ruggedized Battery Modules may be interconnected (daisy chained) to provide for additional run-times of up to several hours. Optional battery charger modules, heavy duty mounting slides and high temperature batteries are also available.

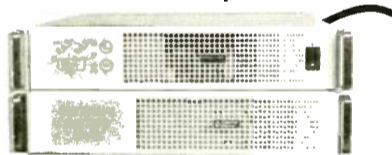

STABILINE WHR Series Automatic Voltage Regulators



- 19-Inch Rugged Rack Mount Style
- Single Phase, 2-30 kVA power sizes
 - 120, 120/240, 208, 240, 380, 480 and 600 VAC models
- Hold output voltage within $\pm 1\%$
 - Two input voltage ranges (NARROW or WIDE)
 - 99% typical efficiency

Units automatically and continuously feed voltage sensitive equipment a constant voltage level even when power line input voltage and system loads vary - with no waveform distortion, high overload capacity and the lowest added source impedance available. For severe applications, WHR Series units can be connected for all buck and boost operation. Many standard options available.

Visit www.superiorelectric.com/WHRworksheets.htm for Configuration/Quote Request. Superior Electric is a NAB Associate Member and SBE Sustaining Member



383 Middle Street • Suite 105
Bristol, CT 06010 USA
info@superiorelectric.com



Telephone and Fax Numbers • Telephone: 860-585-4500 • Fax: 860-582-3784
Toll-Free (in USA and Canada only) • 1-800-787-3532 • 1-800-821-1369

We're all talk.

And all action, too.

All talk and no action? That certainly doesn't describe any radio station we've ever seen. With guest interviews, news and traffic feeds, live reports and listener calls to juggle, a talk studio is one of the most active places on the planet. Seconds count, and there's no room for mistakes.

That's why we created Status Symbols[®] for the Telos TWOx12 Talkshow System. Instead of flashing lights to decipher, there's easy-to-understand picture icons that give talk pros the information they need with just a glance. What caller's next? Who's screened, and who's just holding? With Status Symbols, you'll know instantly. And only Telos has them.

TWOx12 has lots more benefits. Like Digital Dynamic EQ, for uniform caller audio despite less-than-perfect lines. Twin DSP-powered hybrids for quick, no-hassle conferencing. A unique Dual Studio Mode that lets you use your 12-line phone system like dual six-line systems for extra flexibility. And TWOx12 is the world's only talk show system that can work with either POTS or ISDN lines to deliver exceptional caller clarity. Impressive? You'd expect no less from the company that *invented* the digital broadcast hybrid.

Is TWOx12 the perfect union of word and deed? Thousands of broadcasters worldwide think so. Why not see for yourself?

Telos
AUDIO | NETWORKS



12 lines, two digital hybrids, and superior audio performance. Desktop Director controller features handset, speakerphone and headset jack. Drop-in controls available for popular consoles.



New Call Controller has Status Symbols, DTMF pad and recorder controls (like Desktop Director), but lets talent use their favorite wireless phone or any standard handset for call screening.



Status Symbols show exactly what's what. Intuitive icons show calls locked on-the-air, which hybrid they're on, who's next in queue and more. So much better than a panel of blinking LEDs.



Assistant Producer enables talk show production via LAN or WAN. Status Symbols, Caller ID support, instant messaging and caller database are just a few benefits. Supports touchscreens, too.

Arnold

CONTINUED FROM PAGE 14

tion and testing of the control, monitoring and RF systems. I do field engineering on an as-needed basis and we are continually working on large medium-wave systems.

Describe what it's like to work on one of these projects.

On the Sri Lanka project, the components had to be shipped from the United States to the site via boat. To start out, you have to go through everything and make sure it survived the journey. You have to check all the assemblies before you start to put the system together to make sure nothing has come loose.

While we were working on this project the local laborers discovered a cobra. There was a pond between the transmitter building and the towers that was spanned by a 900-foot section of open-wire transmission line, which was the main feeder to the antenna central tuning house.

The cobra was on the transmitter building side of the line. We ended up using 12-foot lengths of tamping steel to punch down into a pile of rocks, and eventually killed the cobra. The cobra occasionally growled with a loud, unusual and unnerving sound.

The open-wire transmission line on this project was designed to accommodate 400



Sri Lanka Open-Wire Transmission Line

ranging from 118 to 121 ohms, using a vector impedance meter and also with a bridge.

What is the most rewarding thing to you about working in broadcasting?

I guess I really like the variety, and the opportunity to do everything on a project. I like to design a project, draw it up in CAD, and then I can prototype it myself. Once it

tion. I also do performance testing of the completed systems. It turns out you can always use a range of skills when you are working in the field.

I recently worked on a new design of a linear drive contactor for high-power RF switching. These contactors can pass 400 amperes of current and switch 96 kV at 60 Hz. I used a high-current source to test the current capacity of the contactor and melted the wires running to it, but the contactor showed no sign of damage.

As you can imagine, these contactors have to be physically large to handle this much power and the challenge was to make them switch quickly and reliably. I designed a control board for the actuator that uses electric braking to eliminate mechanical overshoots. These contactors can handle large amounts of power but don't generate the large mechanical shocks of traditional solenoid-driven contactors.

[Ed. note — Kintronic Laboratories won a "Cool Stuff" Award from Radio World for these contactors at NAB2006.]

How are digital modulation systems for HD Radio or DRM changing the way that we build medium-wave transmission facilities?

That is something we have to consider now on every related project because the bandwidth requirements are much higher for digital systems. Input impedance bandwidth, phase linearity, pattern bandwidth and match to the signal from the transmitter and RF final load characteristics are important in the design of an HD compatible antenna system.

What about projects in the United States?

Kintronic Laboratories is involved in numerous AM HD radio projects in the US. I have worked on projects as simple as installing a new antenna tuning unit, as well as the development of our new AM KinStar low-profile antenna design.

A few years back when we were developing the Kinstar antenna, I helped to construct the test site where we compared the performance to a conventional quarter-wave design. The prototype we built was less than 50 feet tall, but it basically had the same efficiency as a 150-foot antenna.

As part of the study that Ron Rackley, PE, prepared for the FCC, I helped come up with a way to measure the current distribution on the antenna while it was under operation to show that it worked as predicted. Just recently the FCC ruled that the Kinstar is acceptable for use on non-directional full-time stations without a proof-of-performance. ■

MARKET PLACE

Gemini CDT-05 Turntable Plays CDs, Vinyl

Gemini says its CDT-05 hybrid turntable combines the feel of the turntable with the ability to play both CDs and vinyl. Additionally, the company says it plays CDs with the hands-on control of a full-size direct drive platter.

The CDT-05 features a skip-resistant straight tone-arm system and a CPU-controlled high-torque direct drive motor, which drives the unit's aluminum platter. A Mix mode allows users to simultaneously play CDs and vinyl records.



In both analog and digital modes, DJs have variable pitch control, with selectable ranges of 4, 8, 16 or 50 percent, along with pitch bend and master tempo functionality. Three DSP effects — Filter, Zoom and Echo — with variable parameter and a forward/reverse switch can be accessed in either mode.

The company says that during CD playback, the CDT-05 affords three hot starts, frame accurate cue and seamless loop for digital flexibility. The motor also can be disengaged for DJs who prefer CD decks with a passive, non-motor driven platter.

The CDT-05 also provides MP3 CD support and features independent outputs for the CD and turntable.

It retails for \$1,179.

For more information, contact Gemini in New Jersey at (732) 738-9003 or visit www.geminidj.com.

How to ...

Submit a letter to the editor: E-mail us at rwee@imaspub.com with "Letter to the Editor" in the title field.

I remember seeing the components for the transmitter before it was built, with boxes of tubes and keys, a microphone and other stuff. I don't remember if that transmitter was ever completed or if it worked, but the idea of being able to communicate around the world drew me in.

kW of medium-wave power at around 800 kHz. The characteristic impedance of the transmission line was 120 ohms. Separate transmission lines were installed between the central tuning house and the two end towers. They were measured following the installation of the lines by Sri Lankan laborers, and yielded a characteristic impedance

is ready I turn it over to manufacturing. My specialty is electronics and testing but I like doing a wide range of work, including mechanical and optical work.

I can go in the field and use CAD to draw and design circuits during the integration of a project. I also can do assembly, welding and soldering work during installa-

DIGITAL AUDIO SWITCHING

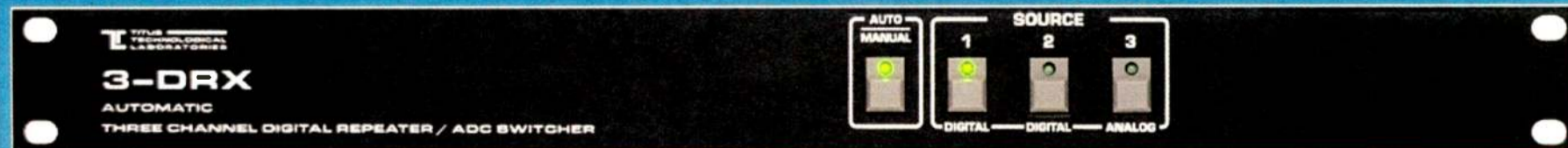

THE LOGICAL WAY 3-DRX

Automatically switches between two AES digital audio signals or a stereo analog signal. Analyzes digital signal errors (CRC, bit, framing, etc.) and checks for loss of audio on the digital signal. User programmable.

TITUS TECHNOLOGICAL LABORATORIES

800.806.8851

WWW.TITUSLABS.COM

JUST ENOUGH TEST



Is your bulky bench analyzer more test than you use and more weight than you want?

Sophisticated Minstruments from NTI give you just enough test capability, plus functions not even available on their larger siblings... and these flexible instruments fit in the palm of your hand

ML1 Minglyzer Analog Audio Analyzer

The ML1 is a full function high performance audio analyzer and signal monitor that fits in the palm of your hand. The comprehensive feature set includes standard measurements of level, frequency and THD+N, but also VU+PPM meter mode, scope mode, a 1/3 octave analyzer and the ability to acquire, measure and display external sweeps of frequency response generated by the MR1 or other external generator.

With the addition of the optional MiniSPL measurement microphone, the ML1 also functions as a Sound Pressure Level Meter and 1/3 octave room and system analyzer. Add the optional MiniLINK USB computer interface and Windows-based software and you may store measurements, including sweeps, on the instrument for download to your PC, as well as send commands and display real time results to and from the analyzer.

- ▶ Measure Level, Frequency, Polarity
- ▶ THD+N and individual harmonic measurements k2→k5
- ▶ VU + PPM meter/monitor
- ▶ 1/3 octave spectrum analyzer
- ▶ Frequency/time sweeps
- ▶ Scope mode
- ▶ Measure signal balance error
- ▶ Selectable units for level measurements

DL1 Digilyzer Digital Audio Analyzer

With all the power and digital audio measurement functions of more expensive instruments, the DL1 analyzes and measures both the digital carrier signal (AES/EBU, SPDIF or ADAT) as well as the embedded audio. In addition, the DL1 functions as a smart monitor and meter for tracking down signals around the studio. Plugged into either an analog or digital signal line, it automatically detects and measures digital signals or informs if you are on an analog line. In addition to customary audio, carrier and status bit measurements, the DL1 also includes a sophisticated event logging capability.

- ▶ AES/EBU, SPDIF, ADAT signals
- ▶ 32k to 96k digital sample rates
- ▶ Measure digital carrier level, frequency
- ▶ Status/User bits
- ▶ Event logging
- ▶ Bit statistics
- ▶ VU + PPM level meter for the embedded audio
- ▶ Monitor DA converter and headphone/speaker amp

NEW! AL1 Acoustilyzer Acoustics & Intelligibility analyzer

The AL1 Acoustilyzer is the newest member of the Minstruments family, featuring extensive acoustical measurement capabilities as well as core analog audio electrical measurements such as level, frequency and THD+N. With both true RTA and high resolution FFT capability, the AL1 also measures delay and reverberation times. With the optional STI-PA Speech Intelligibility function, rapid and convenient standardized "one-number" intelligibility measurements may be made on all types of sound systems, from venue sound reinforcement to regulated "life and safety" audio systems.

- ▶ Real Time Analyzer
- ▶ Reverb Time (RT60)
- ▶ High resolution FFT with zoom
- ▶ Optional STI-PA Speech Intelligibility function
- ▶ THD+N, RMS Level, Polarity

MR1 Minirator Analog Audio Generator

The MR1 Minirator is the popular behind-the-scenes star of hundreds of live performances, remotes and broadcast feeds. The pocket-sized analog generator includes a comprehensive set of audio test signals, including sweep and polarity signals which work in conjunction with the ML1 Minglyzer.

- ▶ Sine and square waves
- ▶ Pink & white noise
- ▶ Polarity test signal
- ▶ Stepped sweep for response plots
- ▶ Balanced and unbalanced outputs

MiniSPL Measurement Microphone

The precision MiniSPL measurement microphone (required for the AL1 Acoustilyzer and optional for the ML1 Minglyzer) is a precision reference mic for acoustics measurements, allowing dB SPL, spectrum and other acoustical measurements to be made directly.

- ▶ 1/2" precision measurement microphone
- ▶ Self powered with automatic on/off
- ▶ Omni-directional reference microphone for acoustical measurements
- ▶ Required for the Acoustilyzer; optional for the Minglyzer

MiniLINK USB interface and PC software

Add the MiniLINK USB interface and Windows software to any ML1 or DL1 analyzer to add both display and storage of measurement results to the PC and control from the PC. Individual measurements and sweeps are captured and stored on the instrument and may be uploaded to the PC. When connected to the PC the analyzer is powered via the USB interface to conserve battery power. Another feature of MiniLINK is instant online firmware updates and feature additions from the NTI web site via the USB interface and your internet-connected PC.

- ▶ USB interface fits any ML1 or DL1
- ▶ Powers analyzer via USB when connected
- ▶ Enables data storage in analyzer for later upload to PC
- ▶ Display real time measurements and plots on the PC
- ▶ Control the analyzer from the PC
- ▶ Firmware updates via PC
- ▶ MiniLINK USB interface is standard



NTI
NTI Americas Inc

PO Box 231027
Tigard, Oregon 97281 USA
503-639-3737
www.nti-instruments.com
americas@nti-instruments.com

Keep Crackers Away From Network

Protect Your System From Exploitation: Select Server Carefully, Create Tough Passwords, Watch Staff

Stephen M. Poole holds CBRE and CBNT certifications and is chief engineer for Crawford Broadcasting Corp. in Birmingham, Ala.

In previous articles, we looked at ways to avoid exposing critical network services to the world at large. I want to show you exactly who you're up against. Understanding what motivates the typical "dark hat" hacker, also called a "cracker," will help you anticipate attacks and guard against them.

Have a look at a typical cracker: Kevin Poulsen, aka "Dark Dante" to his peers back in the late '80s and early '90s. After he allegedly cracked into some government computers, the FBI began looking for Poulsen and he became a fugitive — not like Harrison Ford's character in "The Fugitive," but more in the sense of Leonardo DiCaprio's character in "Catch Me If You Can."

Poulsen continued hacking and cracking even while on the run. In 1990, in one of his most famous stunts, he took over the phone lines going into KIIS(FM) in Los Angeles to ensure that he'd be the 102nd caller for a contest, winning a Porsche. He actually taunted the authorities, finally becoming so notorious that he was featured on "Unsolved Mysteries."

When viewers tried to call the 800-number on the screen, it had mysteriously gone dead.

Shortly after that program aired, Poulsen was finally captured and spent several years in jail. After his release, he changed from a "black hat" hacker to a "white hat," working first for Security

Focus (www.securityfocus.com), and most recently for Wired magazine.

He's a good guy now, but I use him as an example because he fit the stereotype to a tee. The typical "dark hat" is a single male, young and intelligent, with a fascination for computers, networking and electronics in general. He's a loner who craves the acceptance of others like him. He's most likely into pornography and spends hours, if not days, on the Web. He hacks, downloads and runs unlicensed software, and cracks computer systems just to see if he can do it — then brags about it to his friends.

Do you have anyone like this working at your station? Keep an eye on them.

NEXT-GENERATION HACKING

In the mid '90s, most successful (from the hacker's point of view) computer viruses actually didn't do anything harmful, at least not deliberately. The guys who wrote them were simply trying to get their malware to spread as widely as possible before it was discovered. Writing a virus that formatted a hard drive was actually a negative, when seen in that light.

That's changing. Nowadays, the motiva-

tion may indeed be money, at least for a few. Viruses are "passé" to the cracking community. Spamware, worms and so-called "phishing" — attempts to get you to enter your personal information at a fake Web site, for example — are much bigger threats.

You may not realize it, but the spam e-mail you receive daily, advertising everything from cheap Viagra to beautiful Russian wives, was probably sent to your e-mail account from a computer that had been taken over by cracking software. Some



Hackers Adrian Lamo, Kevin Mitnick and Kevin Poulsen circa 2001

unsuspecting user downloaded what he or she thought was a free game, or clicked on an executable attachment in their e-mail. Next thing you know, their computer is infected with a "spambot" program that contacts the cracker's "home base" on the Web for information and then floods the Internet with e-mail.

More malicious worms scan your computer for personal information and send it to overseas crooks.

Regardless of the actual motivation of the guy who is trying to crack into your computer network, that's what broadcasters are up against. On the one hand, our systems offer a rich target for the "pay for play" spammers and "phishers" because we're likely to have high-speed Internet access and many computers available for exploit.

On the other hand, the guys who simply want to impress their friends might think it desperately cool to hack into your HD PAD data, or to slip hardcore porn onto your station's Web site, or to change all the Celine Dion and Natalie Grant in the playlist to headbangers like Metallica and Korn.

The above is especially true if you have a popular, high-profile radio station. There's some cross-pollination here: many of the same guys who might try to hack your Web page might also run their own Web radio stations, or even pirate broadcast stations. Even if you're not a target now, you could be in the future.

What makes us vulnerable is the explosive growth of networking in our business; and we're still playing catch-up. Even large, profitable operations are unlikely to have an employee dedicated to ensuring computer security. It's a task that normally falls to engineering, when and if we have time.

When I first took the job here in Birmingham several years ago, we had a handful of computers on dial-up accounts for e-mail. Now we have several audio networks, remote access to our systems over the Internet, over a dozen static IP addresses, several different DSL lines and a host of servers that are exposed to the public.

If you don't read anything else I say here, please believe this: Even if you haven't been attacked yet, trust me, you will be. It may be tomorrow, it may not be for another year. But it will happen. I've been trying to address that issue in this series of articles.

In two earlier stories, I explained network servers and firewalls. I've also shown you a great free tool called Nmap (www.insecure.org) that will help you determine what network ports may be opened on your systems. I want to wrap things up with a look at protecting your computers from crackers and dangerous software, and especially from the weakest link in the chain: the employees who use them.

CHOOSE YOUR SERVER CAREFULLY

The safest thing to do is to not expose any servers to the Internet. Isolate computers that require special services into discrete, firewalled subnets, and then use another overall firewall on your Internet access to block all incoming requests.

But maybe you want to expose, say, a Web server. It's possible to download one of these for Windows that's quite easy to set up and get running. It's tempting, too, because you can be a hero. You can rig one of these up in an hour or less, open port 80 (the standard "http" port) in your firewall, register your IP address under a domain name and then proudly announce to the staff that the station now has a Web site. And hey,

SEE CRACKERS, PAGE 20

The Fabric of Time



Broadcasters have woven ESE precision master clocks and timing-related products into their facilities for over 35 years. ESE products accurately synchronize broadcast operations using a choice of GPS, WWV, Modem, Crystal or line frequency for affordable, reliable, perfect time.

Spend a few seconds on www.eseweb.com to discover a vast universe of timing systems that are designed for easy installation, set-up and operation.

Precisely
measured
and
delivered
by

ESE

142 Sierra Street
El Segundo, CA 90245 USA
Tel: (310) 322-2136
Fax: (310) 322-8127
www.eseweb.com

got gear?
cables & connectors
racks
tools
problem solvers
test gear
& much more
www.systemsstore.com

Breathtaking Clarity

Telco Digital Program Audio

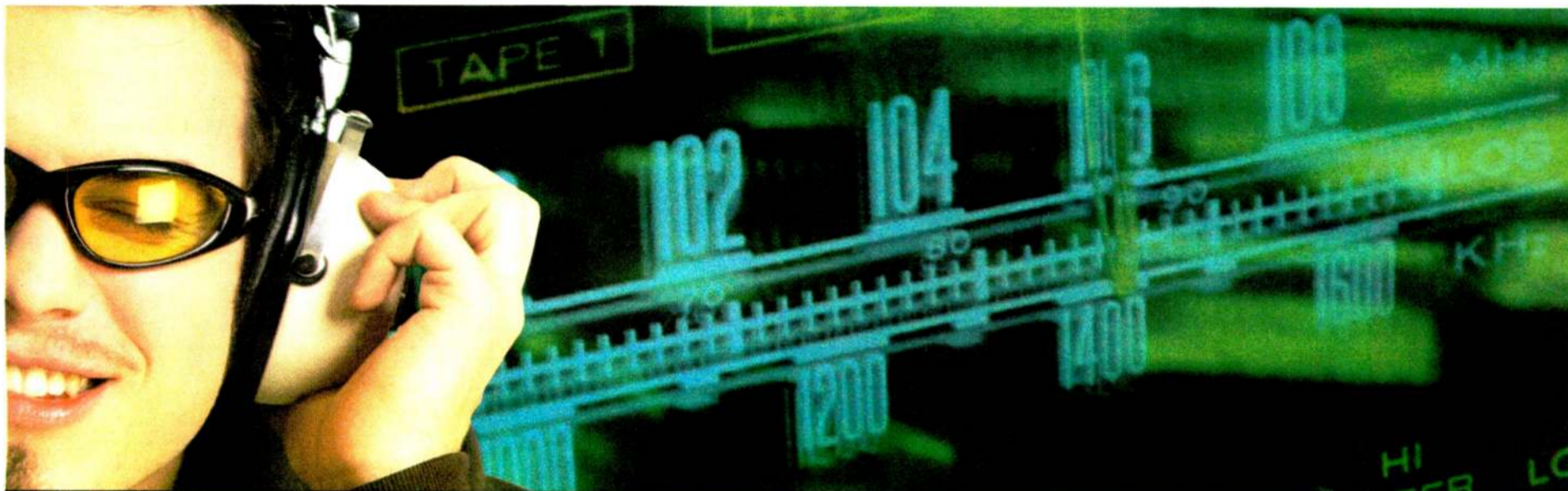

Next Generation Audio for Your Listeners

PCAU Program Channel Access Unit

*A New Standard for Telco STL, Remote-to-Studio
and Studio-to-Studio Links*

40 Years of Pulsecom innovations.
Here's another — The PCAU: Telco Digital Program Audio

Acclaimed apt-X™ Audio Quality:

- ✓ Transparent Digital Coding delivers outstanding fidelity
- ✓ Low Latency — ideal for monitoring applications
- ✓ Free of “Cascading CODEC” and “Listener Fatigue” issues
- ✓ Multiple tandem connection support
- ✓ Automatic alignment, zero loss Broadband Audio

Universal Telco Connectivity:

- ✓ Compatible with Telco Digital Loop Carrier and NGDLC systems
- ✓ Best-in-class reach to serve remote locations
- ✓ Campus mode delivers service over 3 miles of twisted pair
- ✓ High performance alternative to Western Electric™ KS20159L3, Tellabs™ 4008 and D4 PCUs
- ✓ E-mail: dave.corp@pulse.com to learn more about the PCAU Trial Program



PULSECOM®

Pulsecom is an ISO9001:2000 Company

www.pulse.com
800-381-1997

Pulsecom is a registered trademark of Hubbell, Incorporated. apt-X is a trademark of Audio Processing Technologies, Ltd.
Western Electric is a trademark of Lucent Technologies, Inc., Tellabs is a trademark of Tellabs, Inc., and HD Radio is a trademark of Ibtiquity Digital Corporation.
©2005 Pulse Communications, Inc. All rights reserved.

Crackers

CONTINUED FROM PAGE 18

you did it all yourself. The Web server is sitting right there in your office.

The truth is you may just have bought yourself a world of hurt. Never forget that ease-of-use and security are almost always direct opposites when you're talking about software. As a general rule, the "safer" a server package is, the more difficult it will be to set up properly. Don't be fooled.

The Apache Web server (www.apache.org) is the most popular Web server as of this writing. It has been carefully tweaked by a worldwide community of programmers in real, live production environments for years. Many major corporations, such as Google, use it. It's rugged, reliable and difficult to crack. You can download it for free. But it has zillions of options and can bewilder a newbie. Unless you know what you're doing, it can be set up improperly, exposing that Web server to attack or outside control.

A good e-mail server is even more difficult to configure properly. If you're not careful, you'll simply expose a free spam-forwarding service to the Internet at large. Unless you're able to administer a publicly exposed server properly, you're really better off with a hosting company. Let them handle the headaches of firewalling and keeping things patched. You can get plenty of Web space, with e-mail, for \$30-\$100 a month from companies such as Go Daddy and APlus. I think it's worth it.

If you insist on doing it yourself, use a reliable server such as Apache, and regularly check for patches and updates. Frequently examine the access logs to get an idea of how you're being attacked. The bottom line is that unless you're willing and able to devote several hours a week to each server that you expose to the Internet, you're better off letting someone else do it for you.

USE CLEVER PASSWORDS

We recently set up an FTP server on one of our static IP addresses. It's not registered under a domain name and we don't publish the IP address to anyone but our employees. Within a couple of days of exposing that FTP server to the Internet, we were already getting attacked. My access logs had line after line of attempts using common names and passwords, one after another.

A simple "read only" Web server that just returns pages is one thing. But the rule here is simple: If anyone outside of the building can change anything on that server, it

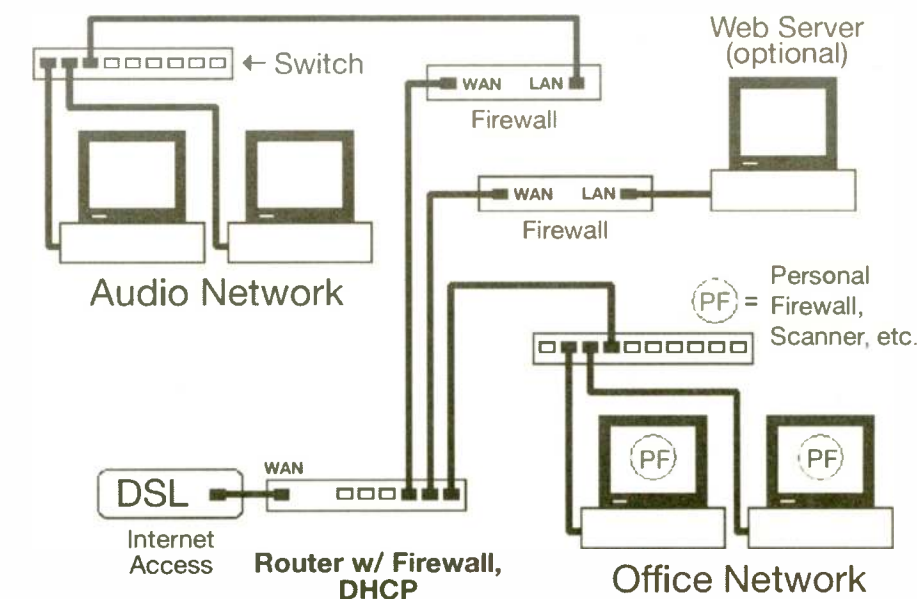

A Complete Network with Web Server

should be protected with a strong password.

I realize passwords are a pain. If password choice is left up to the employees, they'll invariably choose things that are easy to remember, like "myname," "letmein" and my personal favorite, "password." And yet, as our editor at RWE sagely pointed out to me earlier, you also can make passwords so difficult to remember that employees write them onto slips of paper and tape them to the computer monitors. That's not good, either. What to do?

The best password is a mix of numbers and letters, something that's not easily guessed or easily found by an automated attack. The latter is a program run by the cracker that tries a bunch of common passwords and user names, based on "dictionary" collections that are updated and shared by the cracking community.

These programs are smart enough now to try common variants, too, so be careful; simple substitutions like "p4ssw0rd" instead of "password" aren't secure enough. If you examine your server logs as I recommend above, you'll invariably see line after line of attempts from foreign IP addresses.

The best idea I've seen thus far is to tell your employees to come up with a simple, easy-to-remember rhyme or phrase, for example, "Mom lives at 120 Doodat Street in Taneytown." Take the first character of each word: "Mla1DSiT." A password like this is difficult to crack with a brute force dictionary attack, but is relatively easy for an employee to reconstruct, should he or she forget it later.

You're not going to stop a determined

attack, but most crackers are lazy in real life. Unless you have a server that really lures and fascinates them, they're only going to try for a few minutes, then move on. Use strong passwords and you'll go a long way toward frustrating them.

Here's a hacker's tip. Another way to discourage lazy crackers is to simply change the port numbers used by your servers. It's beyond the scope of this article for me to go into detail, but if you can run your own server, you should be able to figure this out.

Forgive me for stating the obvious, but don't forget to change those passwords whenever an employee is terminated, especially if it's the Station Hacker, and most especially if he's being terminated for tampering with the computer systems.

TRAIN (AND WATCH) YOUR EMPLOYEES

You can have the most carefully isolated and firewalled system in broadcasting, with separate subnets for audio, station control and offices; and all it takes is for one employee to click on an attachment that installs some malware and your office network is compromised. At best, your Internet access will slow to a crawl, meaning that you may not be able to get in from home to remotely administer things; at worst, if there's a "crack" in your firewall, that worm could jump onto the audio network and cause chaos.

What about internal virus/malware protection on each computer? I'm of mixed opinion on this. For the office machines, it's not a bad idea. But be careful before

installing it on audio automation and remote control computers. First, it may void your warranty and/or support contract. Second, my experience with this software has been less than stellar; most of it slows the system noticeably and causes other problems to boot.

For the record, I don't run any type of scanner or malware detection on either my personal equipment or the audio and HD computers at my stations. I use the "isolate-and-firewall" method described in previous articles, but the choice is yours. Just be aware that this type of protection isn't a panacea, and can often cause more problems than it solves.

Anytime a new hire is made, you should take that person aside and explain basic safe computing procedures. Explain the password rules mentioned above. Tell them not to open any attachments, not even if they appear to come from a known-to-be-good source; many malware programs read the address book on the infected computer to spread themselves. If you have no choice but to accept attachments, it's safest to have the person sending the attachment send a separate e-mail warning that an attachment is on the way.

You also should have a strict policy in place that prevents employees from installing software on company machines. Just don't let them do it. At best, they'll be slowing down your systems; at worst, they could compromise your hard work. You should especially keep an eye on the Station Hacker here.

Any time you receive new software from an approved vendor, install it on an isolated test machine. "Nmap" that machine, and/or use something like Zone Alarm (www.zonelabs.com) to see if that software does anything you don't approve of, as discussed in previous articles. If you see anything you don't like, call the vendor and discuss it.

Finally, don't ever compromise what you know you're supposed to do. Many vendors, to be blunt, are lazy (and stingy, as support costs money) and will tell you to do something like "disable your Windows' firewall" just because that's easier than trying to walk you through the detailed settings to permit their software to work without compromising everything else on that computer. Don't let them do it. Tell them that it is unacceptable. If they still won't help you, consider changing vendors.

Be vigilant, be hardheaded ... and stay safe.

Tell us about your successes or headaches in radio station IT management. Comment on this or any article to rwee@imaspub.com. ■



Pristine Systems
www.pristinesys.com
www.summittraffic.com
 1•800•795•7234

BLACKBOX
Audio Logger

- Record up to 16 Channels
- Off Air & Dead Air Alerts
- Compliance & Verification
- Web Browser Access
- Talent & Market Monitor
- PodCast Recorder
- Available in Spanish
- Extended Support for AM/FM/TV Tuner Boards
- Mic & Time Skimming

CDS³²
Radio Automation

- Music on Hard Drive
- Satellite Operations
- AutoPromo Builder
- "Wet" Voice-Tracking
- WEB/RDS Radio Text
- HD Radio Ready
- CobraNet & LiveWire
- LAN/WAN Operations
- Content Depot Ready
- Easy to Use!

SUMMIT TRAFFIC

- Optimized Scheduling
- Real Time Avails (\$\$\$)
- User Defined Reports & Logs
- Multi-User/Multi-Station
- Open Item A/R
- Fast & Accurate Billings
- 20 Years: Radio, TV & Cable
- Windows, Linux & Novell
- Compatible With all Major Automation Systems



HD RADIO™ ? I'M GOING WITH MOSELEY.

My challenge is to make the right STL choice for today, as well as for tomorrow.

With Moseley, it's no problem.

Check out their **Starlink SL9003Q-2SLAN**, the first STL to provide AES digital audio and Ethernet data over the traditional 950 MHz band.

Or add a bi-directional Ethernet LAN extension and serial data link to a new or existing STL with the license-free 900 MHz **Lanlink 900D**.

For T1 lines or license-free 5.8 GHz links, the **Starlink SL9003T1** STL/TSL transports bi-directional AES digital audio, Ethernet LAN extension, remote control, and telephones.

Your best connection to the future is a smart STL choice today. Take it from me, Moseley will insure that your station is ready for HD Radio™ and the new digital services of tomorrow.

Give the digital STL experts at Moseley a call for more details.

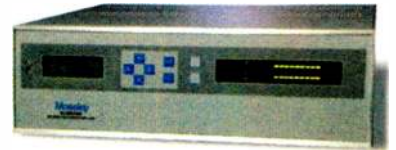

Moseley

Dave Chancey 805 968 9621

Bill Gould 978 373 6303

www.moseleysb.com

Ventilation and Dangers of Sick Buildings

Proper Management of Clean Air Makes for A Healthy Work Environment and Bottom Line

Charles S. "Buc" Fitch, P.E., is a frequent contributor to Radio World.

Efforts to control our environment for comfort's sake have been with us from time immemorial, but in modern context many engineers feel that Leonardo DaVinci was the premier progenitor. The apocryphal tale is that around the year 1500, DaVinci was having an affair with the Lady Beatrice, duchess of Milan. After a rather athletic session, she commented how hot it was and that maybe he should spend a little less research time on the helicopter and parachute, and possibly invent an air conditioning system for her bedroom.

She was his main squeeze, so this great Italian artist, scientist and engineer designed and built the first mechanical fan to provide ventilation, on which work began the next morning.

We engineers are just suckers for love.

AIR SUPPLY

"Comfort" is a wonderful word, and as we age it gets even more appealing. Few of us like to suffer. Over the intervening 500 years our techniques have gotten more sophisticated than DaVinci's water-powered fan, but even at this late date ventilation is still just moving air — and the calories in it — around and through the space.

The American Society of Heating, Refrigerating and Air-Conditioning Engineers, a peer organization, publishes the industry standards for HVAC, which include ventilation (standard 62; see footnote [1] at the end of this article for more information). The ASHRAE code does for HVAC what the National Electrical Code,

published by the National Fire Protection Association, does for electrical codes.

The most critical component of those standards is "make-up air," the percentage of fresh air mixed in with inside recirculated air. That percentage varies with the use of the space — a house is less than a laboratory, for example — but should never be less than 10 percent of the total volume.

Again, as with the NEC, these are minimums; the percentage can be higher, if for instance your main studio is also used as a live performance venue and is viewed more like an auditorium. You might even automate daypart percents if your morning-show studio is packed with people in the morning but a ghost town for the rest of the day while the automation runs. A simple time clock could open the outside air control (the damper) more just during this high-use period.

The percent of outside air has a direct effect on the bottom line because you have to treat this air with additional heat in winter and cooling in the summer to bring it to desired comfort levels — all of which costs money.

The middle ground is where outside air can be used for cooling. Many components of the workspace, including your own caloric output, generate heat. Simply by bringing in the cooler spring or fall outside air, you can make the space comfortable. This "economizer" action prevents that expensive compressor from running in the cooling system.

Drafts and fan short-cycling are avoided by mixing the warmer, recirculated inside air and sufficient outside air to keep the vent temperature around 55° to 65° F.



A pad-mounted HVAC system is shown. Note make-up air ducts on left.

You can maintain the final temperature at a comfortable level by factoring both heat gain from heat sources in the space and heat loss from the incoming cooler air with proper design and control. The cooling you need is accomplished with a fan and a motorized damper.

Economizers normally are available on all packaged units — my feeling is you should never buy a cooling system without one — and are easily implemented in most split systems. Perceptions are important, however, and the best HVAC systems are high in volume and low in velocity because air movement across our skin liberates the heat.

are the easiest to maintain on a cost basis. Most come out of the equipment quickly and can be kept clear and clean with a bath in the janitor's sink.

Replacement types should be changed often, at least every quarter. If you cannot afford to do so, at least replace them at the beginning of heating and cooling seasons.

If many people work in close quarters or eat and drink at their work positions, High-Efficiency Particulate Air (HEPA) filters, changed often, are the best options. HEPA filters have nearly supplanted electronic-type air filters, which had the downside of producing some ozone.

Economizers normally are available on all packaged units — my feeling is you should never buy a cooling system without one — and are easily implemented in most split systems.

The draft/chill effect inside is akin to wind chill outside. You feel cold; most often, your skin actually is colder. If your staff is wearing sweaters, it's time to investigate.

Another quality of ventilated air to consider is purity. Just because you're inside doesn't mean you are safe. The HVAC depends first on filters that become less effective with use. The timing for maintenance is really a function of what is happening in the space.

Be especially aware that high-volume office paper duplication, cooking, smoking and literally anything that increases the particulate matter, dust or vapor waste in the space will precipitate a need for more frequent service work on the filters. Carpentry and painting or any sort of construction in your station mandates that the filters be maintained immediately after project completion.

The renewable/washable types of filters

However, offensive and even dangerous air from outside can sometimes be brought in, and the filter may be insufficient. Potentially dangerous air can be created in the space by a chemical spill or inappropriate work. You may have a sick building surrounding your station; we'll take up that unique case in a moment.

MY BIGGEST FAN

Air cannot move if the fans don't run, so be certain that belts in air handlers are working and at specification tightness. If in doubt, replace at least once a year. Check oil motors every time you go into the equipment.

Also be aware of balance and distribution problems. While troubleshooting a complaint of no AC in a small office, I once discovered the vent grill removed from the upstream adjacent office and a

SEE CLEAN AIR, PAGE 24



Tuning Stations World-Wide

- Committed to superior technical support
- Best available product delivery

(408) 282-0363
sales@jenningstech.com
www.jenningstech.com



Multicast Ready

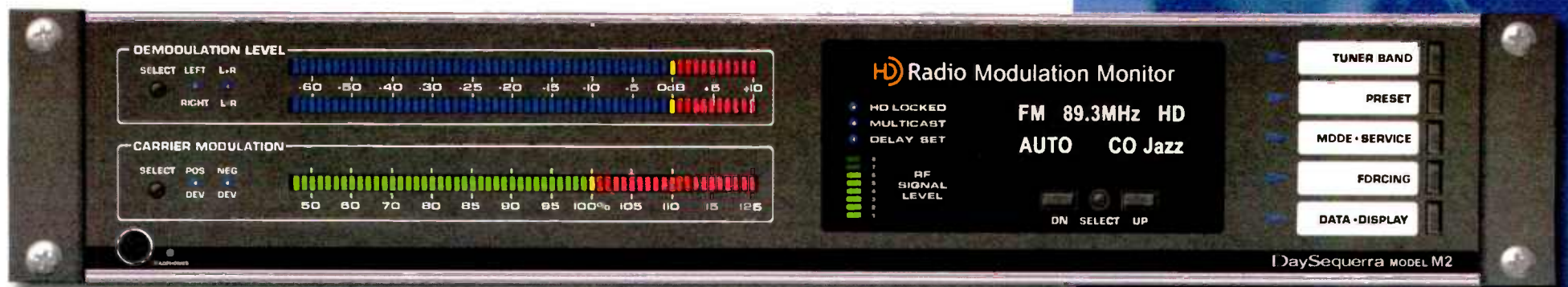
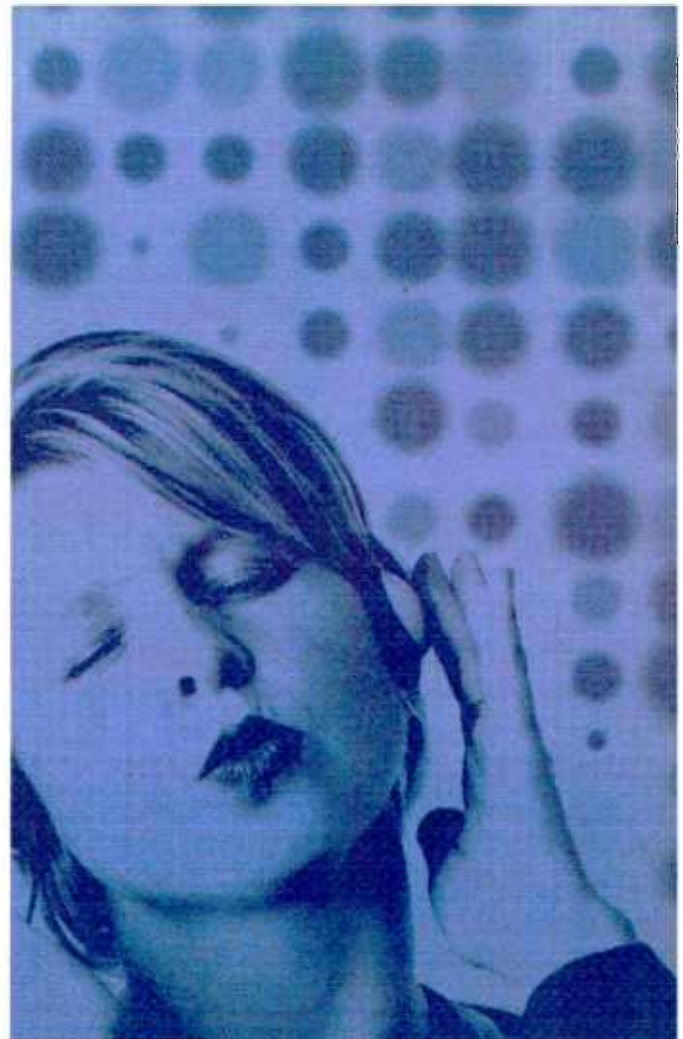

- BRIGHT, PEAK-READING LED BARGRAPH METERS
- ANALOG AND DIGITAL DEMODULATION LEVELS
- ACCURATE ANALOG CARRIER MODULATION LEVEL

M2 HD Radio™ Modulation Monitor



- PUSHBUTTON AND PRESET TUNING FOR AM AND FM BANDS
- RECEIVE ALL MULTICAST BROADCASTS INCLUDING HD-2
- BALANCED ANALOG AND DIGITAL AUDIO OUTPUTS - 5.1 SURROUND CAPABLE
- DIGITAL TO ANALOG AUDIO TIME ALIGNMENT MONITOR
- DISPLAY ALL MPS AND MULTICAST PROGRAM SPECIFIC DATA (PSD)
- NETWORK OPTION M2.2 BUNDLE FOR REMOTE HD RADIO™ MONITORING

M4 HD Radio™ Tuner

**BOTH MODELS
NOW SHIPPING**

HD Radio
Pure Digital. Clear Radio.



World Radio History

DaySequerra

154 Cooper Rd. S902
W. Berlin, NJ 08091
856-719-9900
www.daysequerra.com

Clean Air

CONTINUED FROM PAGE 22

rag stuffed into the duct to stop flow next door. Some people want more than their fair share; check periodically for closed vent louvers and see that no one has modified the system, such as taping over a vent with cardboard or placing a file cabinet over a return vent.

Fans for the washrooms have separate ventilation requirements. As a minimum these should run whenever the washroom is occupied, if not continuously. For public health — not to mention general olfactory survival — they should exchange the air completely every few minutes and vent outdoors.

When I was a younger and more approachable consulting engineer than the threatening ancient ogre I am now, I was asked delicately to investigate an “odor” problem on a client visit. In short order, I discovered that both washroom doors were gasketed, solid types so no input air was being provided; apparently this an extreme case of soundproofing. Also the exhaust duct had been disconnected by someone in the attic to make way for a conduit and never reconnected. Noxious aromas would build up in the room; when the door was opened and the vacuum released, they would be fan-catapulted out into the attic to descend on the room below.

That was the GM’s office. Many were unhappy when the problem was fixed.

The most overlooked comfort factor is humidity, usually expressed in relative humidity (RH) or the percent of the possible water that can evaporate at a specific temperature. RH comfort is a personal preference, but in general, for people, maintenance between 40 and 60 percent is considered appropriate. In an office environment, water usually needs to be added to the air to maintain these levels.

In heating systems, humidifiers are flow-through or boiler-types. In simple terms, a flow-through passes system air through a permeable material that has been soaked with water. A boiler-type creates water vapor, or steam, and allows it to migrate into the system airflow. The former is expensive to maintain. The latter is expensive to operate, as the water is boiled electrically.

SICK BUILDINGS

One sleepy Sunday night in 1976 at KYW(AM) in Philadelphia, I passed reporter Malcolm Poindexter leaving the building. A simple, “Hello, where you off to?” brought the response that he was headed up to the Bellevue Stratford Hotel based on a tip from a staff member there that something strange was going on with the guests.

The story he broke was Legionnaires’ Disease. Conventioneers in the hotel were contracting a bacterial illness, primarily air-borne, that was spawning in the cooling water tanks of the hotel. The water spray injection was propagating the virus through the convention via the HVAC system of the building. Because of the seniority of many of these folks, their older immune systems were challenged to cope and a notable death rate appeared. [2]

This outbreak was a tragedy for those

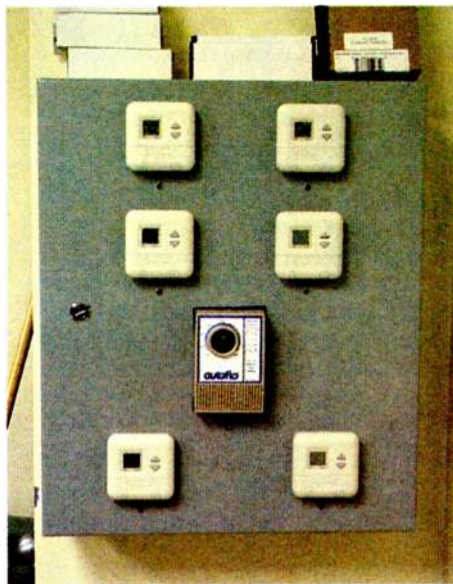

Custom Control Panel with Timer

who suffered, and the hotel was a first-class example of a “sick building.” It was later shown that, while the outbreak was essentially due to a hygiene problem, a simple chemical washing of the tanks could have prevented or at least ameliorated the situation.

Your office may not be a massive four-star hotel, but it can be just as sick. Health problems in a sick building can range from depressed employees to ambulances cued up at the front door to take the staff to the hospital.

Hygiene factors are involved and cover the gamut, including climate-control — temperature, drafts, air quality, etc. — lighting levels and color temperature, aromas, cleanliness, noise levels and the overall sound environment.

Although we’re focusing on climate control issues, a sick building also can present a plethora of other concerns. On your watch, make certain that at least:

- ✓ Really hot water (at least 125° F) is available in the washrooms, kitchen and slop sinks
- ✓ Washrooms are cleaned thoroughly and serviced regularly on a timed basis that reflects the level of use
- ✓ Trashcans are emptied daily, especially if perishable materials, such as food waste, are contained
- ✓ Lighting is adequate and uniform in level and color temperature, and that there are no flashing fluorescent tubes
- ✓ Climate-control provides clean, draft free, even-temperature air with better-than-the-minimum fresh air exchanges
- ✓ Filters in air handling equipment are serviced regularly
- ✓ Noxious aromas are not present, and materials or processes that produce these aromas, such as chemical solvents and detergents and paper duplication chemicals, are not present in the employee space
- ✓ Refrigerator temperatures are correct for food (~38° F) and freezer sections are at least 20° F or below to prevent spoilage
- ✓ Dust, dirt and any other soiling are removed regularly from floors, rugs, drapes, curtains, ceiling tiles, vent grills and ledges, in an effort to avoid contributing to airborne particulate matter

EVENT PLANNING

Most managers fear the “big disaster,” such as a tower falling down. But few disasters carry negative ramifications as great as that of a major sick-building event caused by an airborne agent.

If you are unlucky enough to experience a sick building event, whatever it is — people fainting, foaming at the mouth or

smarting eyes — clear the building immediately and gather everyone at a safe spot, such as the foyer of another nearby office building, or in their cars in the parking lot if it is isolated. As soon as possible, call 911, tell them what you know and ask for help. [Ed. Note — For information on creating a station Disaster Recovery Plan see RW May 24, page 24.]

What next? Be proactive and start helping. The more you interact with your people and get a handle on what has happened, the better you will be able to take action. Start triaging and begin a list of who was in the building and what happened to them. Make sure not to leave anyone behind, and see that those who really need help get it first.

Occasionally by head counting, you’ll find the event — smoke bomb in the bathroom, possibly — was staged to cover another action, such as a low-life ducking out on his bookie.

As things calm down, make certain everyone talks to you before they leave. Interview everyone and ask them where they were and when their “symptoms”

brew gathered on the surface in the staging trap. This conglomerate of aromas rose up the waste pipe. Our office had filled with this potent vapor because we had one waste trap not filled with water — the overflow drain under the hot water heater in the utility room off the mailroom.

The fix was a couple of coffeepots of water poured into that trap. I turned on the air-handlers and manually forced them into economizer mode. Although we were in deep winter, the maximum fresh air exchange was created, as was the maximum heating bill; however the offices, minus the pungent aromas, were ready for use the next morning.

The second instance was a high-emotion call from a client who had his entire staff run out of the building one fall day because of “poison gas.” The poor fellow didn’t have a very loyal staff and they used it as an excuse to go home mid-day because they thought it would take that long to air out.

These folks were sort of correct, as the aroma was being taken in by the roof-mounted AC unit and circulated into the

The best HVAC systems are high-volume and low-velocity because air movement across our skin liberates the heat. The draft/chill effect inside is akin to wind chill outside. You feel cold; most often, your skin actually is colder. If your staff is wearing sweaters, it's time to investigate.

appeared. Find out whom they were with as well. Write all of this down, but draw no conclusions at this time. If the medicos release them from care, send them home in a cab with instructions to call your cell phone for rescheduling. People may not be calm enough to drive carefully, and you don’t want to worry about getting them home safely.

The fire department will usually inspect the building with breathing apparatus, and most often will identify whatever agent was present that caused the event. Follow their guidance on what actions you should take to ameliorate the situation.

Once you’ve documented and eliminated whatever that culprit was, start venting if it was airborne, or clearing out the material if it was substance-related. Then air out the building as much as possible and for as long as possible.

The only exception to this venting rule is if the agent is a bioterrorism agent. Leave these to the professionals for elimination.

OOH, THAT SMELL

Two examples of sick-building events I’ve experienced: Several decades ago I was CE at a station with a top-floor office. One late afternoon, a potent chemical smell suddenly took over the space, making everyone lightheaded. Nearly the whole staff was driven out — except for yours truly, who was responsible for finding the source.

The station had been the first tenant in this new building. When all the floors filled up, the contractors left the site. The painters’ parting gift was to pour their leftover solvents and thinners down the slop sink drain. Possibly tens of gallons of this

office space. The smell was a solvent-based roof treatment material being applied that morning. The intensity of this wafting scourge was exacerbated by the wind, which drove a concentration of it right into the economizer input vent.

Sometimes it’s your fault and sometimes it’s not.

In the end when it’s time for conclusions, it doesn’t matter what the fundamental cause was. Make changes so it cannot happen again.

Next time, we’ll look at the sunset schedule for Freon, along with a discussion of the new, replacement refrigerant gasses. We’ll also put together two HVAC case studies: a large studio/office and a transmitter building. ■

FOOTNOTES

[1] ASHRAE’s current ventilation standards are ANSI/ASHRAE Standard 62-2001, “Ventilation for Acceptable Indoor Air Quality,” plus ASHRAE BOD approved for publication Addenda and ASHRAE Standard 62.2-2003, “Ventilation and Acceptable Indoor Air Quality in Low-Rise Residential Buildings.”

Since the original publication, several ASHRAE BOD approved addenda to the Standard have been published. These addenda are available for free download from the ASHRAE Web site, www.ashrae.org.

[2] The first known outbreak of Legionnaires’ Disease was at a convention for ex-service personnel in Philadelphia in 1976. A total of 221 people contracted the disease and 34 died. Most of those who died were Legionnaires, which is how the disease got its name.

got gear?
cables & connectors
racks
tools
problem solvers
test gear
& much more
www.systemsstore.com

Independent Talkback

A Headphone System with Selectable Talkback for Each User

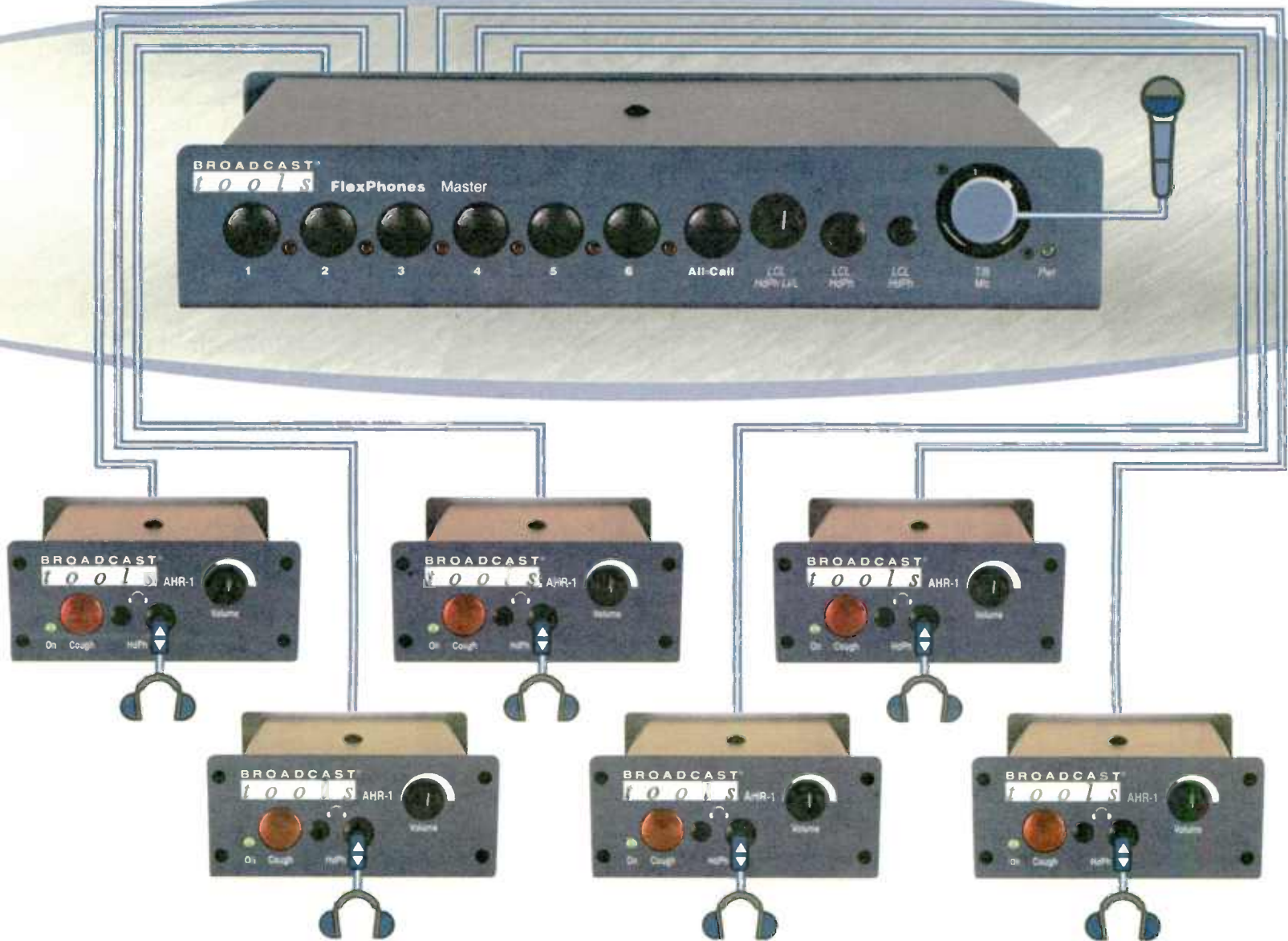

FlexPhones Master

The FlexPhones Master is a professional Broadcast/Studio six channel distributed headphone system with independent talkback capabilities. Each of the six channels provides stereo program monitoring and selective talkback with interconnection via CAT5 cable to multiple Active Headphone Remotes (AHR-1) and/or Monitor Selector Interface (MSI). Multiple masters may be cascaded to form larger systems.

The FlexPhones Master is equipped with inputs for stereo program and talkback audio. Rear panel program and talkback trimmers are provided to pre-set maximum input levels. The microphone/line level talkback input is available via a rear panel plug-in euroblock connector, while the front panel XLR connector facilitates the use of a user-provided gooseneck microphone or headset. The front panel is equipped with a level control for local headphones with both 1/4" and 1/8" stereo headphone jacks. The six front panel talkback switches allow the user to independently communicate with each AHR-1 listener and can be configured to insert talkback audio into only the left or both ears and dim either or both program channels. Any combination of switches may be pressed, while the "All-Call" interrupts all listeners. The Talkback function can be remotely controlled. Six RJ45 jacks are provided to distribute audio and power via CAT5 cable to the AHR-1's, which conform to the Studio Hub format. Low-Z balanced audio distribution is used to preclude audio degradation with long cable runs.

AHR-1 Active Headphone Remote

The Active Headphone Remote (AHR-1) contains a stereo amplifier designed to work with any combination of high-efficiency headphones with impedances between 24 and 600 ohms. The AHR-1 is equipped with 1/8" and 1/4" headphone jacks, level control, user-configured utility momentary pushbutton and LED indicator. Two rear panel RJ45 jacks are provided for connection via CAT5 cable to the FlexPhones Master. The AHR-1 may be desktop mounted, under counter or with the optional HR-1/MP or HR-1/MP-XLR mounting plates, which may be turret or counter-top mounted.



Manufactured with
Pride in the USA

BROADCAST
t o o l s

support@broadcasttools.com
www.broadcasttools.com

INNOVATIVE PROBLEM SOLVING TOOLS FOR BROADCAST

SH **SHOWCASE** SE

Products & Services

Talking. Dial-Up Remote Control

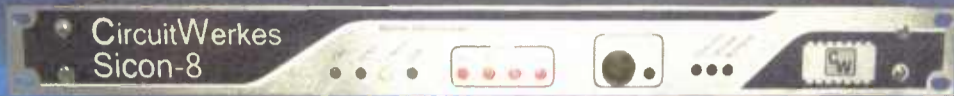

Introducing the First Totally New Talking Remote Control Design in Over a Decade!!

- Voice recordable technology
- Internet capable
- 8 channels metering, status, & control
- Expandable up to 16 channels
- 2 heavy-duty SPDT relays per channel
- Self-calibrating, auto-ranging meters
- Up to 5 alarms per channel
- Cell-phone interface
- Audio pass-through
- Free GUI software to monitor your site & program the Sicon-8
- X-10 capability for additional control

Learn how the Sicon-8 can help you take control at www.circuitwerkes.com



CircuitWerkes, Inc. • 2805 NW 6th Street, Gainesville, Florida 32609, USA 352-335-6555

WEATHER RADIO Model CRW-S



Price \$540.00

Sensitivity .28 microvolts for 12 dB quieting. All 3 frequencies. Alert tone demutes receiver, closes relay and gates audio to 600 ohm rear terminals. Another set of rear terminals has continuous 600 ohm audio output. Double conversion crystal controlled, crystal filter in first I.F., ceramic filter in second I.F. Dual gate MOS FET front end. 50 ohm coaxial input. Adjacent channel (± 25 kHz) down to 70 dB. 19" rack mount, 3.5" H, all metal enclosure. In stock—available for immediate delivery.

GORMAN REDLICH MFG. CO

257 W. Union St. • Athens, Ohio 45701
Phone 740-593-3150 • FAX 740-592-3898

www.gorman-redlich.com/jimg@gormanredlich.com

AM RF Systems...



without the surprises.



LBA Technology is your proven, worldwide supplier of HD radio ready AM antenna systems. Our array of RF products includes directional antenna systems, diplexers and triplexers, ATU's, and components for every power level. LBA systems are designed and custom fabricated to your distinct requirements.

We put our 40 years of AM RF experience into helping you reach farther and sound better! See what we can do for you at www.LBAGroup.com or call us at 252-757-0279



LBA Technology, Inc.

Reach Farther, Sound Better.™

252.757.0279 • www.LBAGroup.com • 3400 Tupper Drive • Greenville, NC 27835

OPTILATOR™

T1-OPELATOR NOW AVAILABLE!



Fiber Optic Modem Protection

Lightning Protection that keeps on working!

Fiber optic protection impervious to Lightning.

It is now a recognized name brand in the RF Industry.

For more technical information call toll free 888-471-1038, Ph: 727-823-6100, Fax: 727-823-6044. For pricing and sales call: Harris, Broadcast General Store, Broadcastworks, Broadcast Richardson, RF Specialists, Crouse-Kimzey, EuroExchange Brokers Inc., S.C.M.S., or your local distributor.

See our web page: www.opticsshield.com It is for real!

The Ultimate Lightning Protection!

OMNIRAX The Engineer's Choice!

BROADCAST FURNITURE

Omnirax from Design to Production

- At Omnirax we work together with you from initial design concept all the way through finished product, ensuring that your furniture will provide you with years of satisfied use.
- Our strength is forging partnership relations where we can use our expertise to turn your ideas into reality. We are able to work to your exacting specifications or provide comprehensive design services that remove the guesswork from your investment.
- Our CAD/CAM process ensures precision fit and finish, repeatability, and ease of modification. All of our designs are rendered in the computer prior to manufacturing. We are able to make alterations and adjust to your equipment, guaranteeing you not only get what you want, but exactly what you need.
- We are small enough to give every job the personal touch, large enough to outfit a complete facility.
- The measure of our success is the achievement of a synthesis of form, function and ergonomic comfort.

CAD drawing

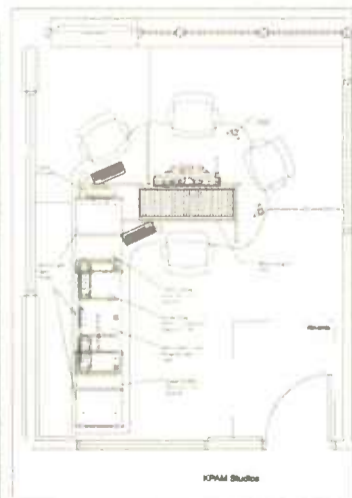

CAD rendering



Installed



"I'm blown away" - Dave Williams, Director of Engineering, Clear Channel San Francisco

P. O. Box 1792 Sausalito, CA 94966 800.332.3393 415.332.3392 FAX 415.332.2607
www.omnirax.com info@omnirax.com

NAB2006 Abuzz Over IP, HD Rollout

Vendors Tout Audio Over IP, IP-Based Remote Control for Transmitters, Emergence of HD Radios

Guy Wire is the pseudonym for a veteran radio broadcast engineer.

NAB2006 is in the books as a resounding success for vendors and attendees alike. Every vendor I talked to said this was their most productive NAB in many years. Not enough working engineers get to attend this annual rite of passage, so your intrepid masked confidante will share some insights gleaned from traveling through April's proceedings in Sin City.

This was the year of IP connectivity for broadcast products of all flavors. Few radio stations nowadays operate without a LAN, storage servers and workstations producing and moving the product. IP has really mushroomed in recent years as most new product introductions feature Ethernet ports for joining both wired and wireless LANs.

Remote control for transmitter sites via IP also is catching on quickly. This will become very important for stations adding HD and HD2 operations going forward. Why put up with the pager pestering you to drive up a mountain road just to reset something when all you literally need to do is lift a finger to complete the task? Do it in your easy chair at home via computer or from your wireless laptop in Starbucks, or via your Web-enabled cell phone.

A few brave folks are even using wireless LAN links to do this directly where wired ISP services to transmitter sites are

again showed its Access "BRIC" system with first deliveries of the cell phone and cradle kit later this summer.

The demonstration of Peter Greenberg's "Travel Today" broadcast during the NAB2006, live from 37,000 feet on a Lufthansa jet trip from Frankfurt, Germany to New York proved this technology has a bright future. Using the Access in combination with the Boeing Connexion satellite air-phone system and an Internet backhaul to the Los Angeles studios, the show sounded superb with no drops or stutters — even when one of the show's callers called from another jet flight crossing the Atlantic in the other direction.

Comrex, Tieline, Telos, APT and other companies showed new IP-based remote broadcast products that may very well sunset the venerable Marti RPU and eventually even the popular POTS codecs. The first question you may want to ask a store hosting your next broadcast remote is, "Do you have broadband cable or DSL in the house and can we use it for our broadcast?" If those resources do not allow full-speed duplex, you may still need cell phones or some other RF link for real-time IFB if needed; but this new choice is rapidly muscling its way into the remote broadcast limelight.

AXIA ON THE MOVE

Axia Audio introduced its audio-over-IP studio control and routing system several years ago, but it was clear this year the concept has jelled into the next major paradigm

over LANs or letting hard drives stream it to the air chain. As technology and hardware advances prove themselves worthy, old fears wash away quickly.

Another innovation in console design was shown at the Harrison booth. A longtime supplier of live performance and recording studio consoles, Harrison added the free and powerful Audacity audio editor to its Trion console. It's an open-source product built on their Ikis platform. Software control is based on Linux, and talks USB and Ethernet. For those who don't want to pay hefty licensing fees for mainstream options, this could be just the ticket.

SURROUND SOUND SLOWS

5.1 surround sound was on the NAB2006 radar screen this year, but it did not command the sense that it was a contending "killer-app" for digital radio. Telos demonstrated its Fraunhofer discrete system with an impressive A-B comparison against a captive Harris/Neural matrix system.

Meanwhile across the hall, Harris/Neural showed their latest SW 4.0 codec and 5.1 surround signal processing product. It features an intuitive GUI that allows the user to visualize 5.1 balancing and mixing effects as adjustments and corresponding sonic evaluations are made. That innovation garnered a Cool Stuff award.

Telos is teaming up with WZLX(FM) in



Boston to launch the first over-the-air full-time 5.1 surround sound encoded FM transmission this summer. I still think the industry has a long way to go before a significant market of available standardized 5.1 content and OEM 5.1 sound systems in new cars drives any demand for this technology.

IBIQUITY MIA

The industry's acceptance and full endorsement of HD Radio as its digital standard going forward came through loud and clear this year. Almost every booth showing a broadcast product of significance touted it as HD-ready.

SEE GUY WIRE, PAGE 29

Now Available from the leading name in Radio Monitoring Equipment



The absence of a large Ibiqity display booth seems to send a signal that Bob Struble believes his marketing job is mostly done. The heavy lifting of promoting HD is now in the hands of broadcasters and receiver-makers.

not available. Chuck Lakaytis at Alaska Public Broadcasting is controlling five sites via wireless IP and designing a system to add 26 more. Using SSL encryption should provide adequate security against hackers.

Several new budget-priced remote control devices attracted considerable attention. Among those are Broadcast Tools' WVRC-8 and the WIT easi-8, both of which won RW Cool Stuff awards.

IP AUDIO GROWS

Audio over IP for both remote broadcast applications and entire studio facilities really came into its own this year. Using Laptops and Flash recorders along with access to wireless LANs has revolutionized the way field news reporters do their jobs. But now they also can do much of the same work via the "high-fidelity" cell phone with G3 connectivity. Comrex

for studio design. Axia has signed up a bevy of well known broadcast manufacturing and software partners to expand its universe; no longer do we have to worry about it being a proprietary system using proprietary software from a sole supplier.

While some engineers are concerned about lack of standards for audio over IP, Axia's Michael "Catfish" Dosch keeps reminding everyone that TCP/IP is the only real standard needed for its technology, and it is entirely open. Axia has written a software driver, available for free, that lets Windows-enabled devices play any audio routed over IP.

Others are still wary about sending packetized, mission-critical real-time audio over LANs with the potential vulnerabilities of latency and lost data. Axia says that with the proper routers and setup this is nothing to fret about. It reminds me of when we first worried about transmitting digital audio



- Frequency Agile High and Low level inputs
- High Resolution Graphical Color Display
- HD Status, Station Info, and Program Info
- Analog to HD Audio Delay Measurement
- HD and Analog Program Audio Metering
- RJ 45 Ethernet Interface
- FFT Spectrum Analysis
- 8 Assignable Analog Audio Outputs (L/R Analog, L/R HD, L/R Tomorrow Radio, 5.1 Surround, etc)

Here are some sneak preview screen shots!

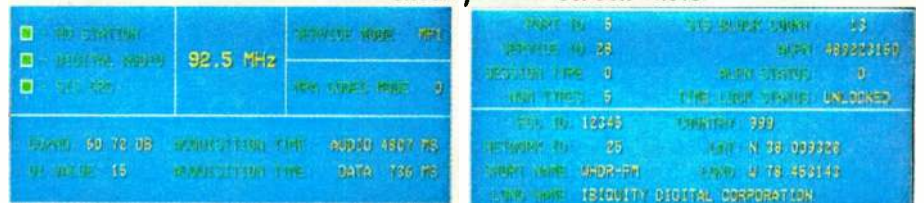

For updates and more information on the BELAR FMHD-1 and AMHD-1 go to www.belar.com/hdradio.htm

Belar Electronics Laboratory, Inc.
119 Lancaster Avenue
P.O. Box 76
Devon, Pennsylvania 19333 USA

Telephone: (610) 687-5550
FAX: (610) 687-2686
E-mail: sales@belar.com
Website www.belar.com

TECH-Mart

One Stop Shopping for all your Technical Broadcast Engineering Needs!



Rebuilt Power Tubes 1/2 the cost of New!

ECONCO

Se Habla Español

Se Habla Español



Tel: 800-532-6626 Web: www.econco.com
Intl +1-530-662-7553 Fax: +1-530-666-7760

RF PARTS COMPANY
From Milliwatts to Kilowatts™

Eimac • Amperex • Svetlana • M/A-Com
Motorola • Toshiba • Philips • Mitsubishi
Se Habla Español • We Export

800-737-2787
760-744-0700 Email: rfp@rfparts.com
www.rfparts.com

AM Ground Systems Co.

Ground System Construction,
Evaluation & Repair

1-877-766-2999
www.amgroundsystems.com

Who you know can make
all the difference...

SBE

100+ Local SBE Chapters
5,400+ Members
Nationally-Recognized
Certification Program
JobsOnline & ResumeBank

www.sbe.org • (317) 846-9000

**FASTER...
MORE ACCURATE RADIO COVERAGE**

- Real Time 3-D Displays
- Interference calculations
- Cost effective mapping
- Fully integrated databases
- Used by the FCC
- Latest standards built-in

RADIO SOFT

Visit us on the web at www.radiosoft.com
101 Demorest Sq., #E, Demorest GA - 706-778-6811

COMMUNICATIONS TECHNOLOGIES, INC.
RADIO FREQUENCY/BROADCAST ENGINEERING CONSULTANTS

- AM, FM and TV coverage prediction studies
- Upgrade studies for existing stations
- Broadcast transmission facility design
- FCC applications preparation -
construction permit and license engineering

P.O. Box 1130 Tel: (856)985-0077
Marlton, NJ 08053 Fax: (856)985-8124
www.commtechrf.com

GRAHAM BROCK, INC.
BROADCAST TECHNICAL CONSULTANTS
Full Service From Allocation to
Operation AM/FM/TV/AUX Services;
Field Work; Antenna and
Facilities Design

Over 45 years engineering
and consulting experience

912-638-8028
202-393-5133
www.grahambrock.com

TECH-Mart GRAM

Next issue space
deadline: August 23

GET YOUR MESSAGE OUT THERE!

To receive more information about advertising in the Radio World Engineering Extra's TECH-Mart Section, fill out the form below and fax it to Claudia at 703-671-7409.

___Yes, I'm interested in advertising in the TECH-Mart Section of Radio World Engineering Extra. Send more information to:

Name: _____

Company: _____

Address: _____

Via Fax: _____

Or via e-mail: _____

Or if you'd like to get started quickly,
just contact Claudia Van Veen at
703-998-7600 or Cvanveen@imaspub.com

Guy Wire

CONTINUED FROM PAGE 27

Many vendors said until this year, most customers had just been kicking tires and were quite tentative about HD, making few commitments. But the number of naysayers and antagonists seems to be dwindling by the day.

Since the days of USADR, the various IBOC systems proponents have all had booths at the NAB show. But not this year. Most attendees found it curious that Ibiqity would be MIA without a booth to tout its system and show off new receiver designs. It did have a nice hospitality suite and Ibiqity managers were seen milling around the company's manufacturing partners' booths.

But the absence of a large Ibiqity display booth seems to send a signal that Bob Struble believes his marketing job is mostly done. The heavy lifting of promoting HD and making it stick is now in the hands of broadcasters and receiver-makers.

BUT WHAT ABOUT AM?

Even as FM HD's adoption accelerates nicely across all markets and companies of decent size, the future of AM HD remains in doubt as the cloud of uncertainty about night interference and lost coverage lingers. This had been perhaps the most hotly debated question of the HD rollout, and it has yet to be adequately answered with any independent real-world studies or tests.

I was disappointed to see that virtually none of the sessions or papers even attempted to shed light on what's going to happen when the FCC authorizes full-time AM HD operations. There are about 120 AM HD stations on the air operating daytime with plenty of critical hours experience. It seems only reasonable that before the commission authorizes full-time AM HD, it would grant a number of Special Temporary Authorizations allowing key, existing AM HD stations to stay on at night in order to evaluate skywave behavior and the critical issues of interference and lost coverage.

Unfortunately that would have been too sensible and logical for the FCC to pursue, and it is not equipped to tackle too much hard work. At least it could have farmed out the project to capable consulting firms. Instead, we are now hearing that as soon as it gets a fifth commissioner in the next few months, the proposal to allow full-time AM HD will be adopted and the floodgates will open.

CPB is pursuing a new study this sum-

mer on how well HD will cover and what the interference impact will be as the rollout continues. But this appears to be for FM only. Another loud signal: AM HD isn't all that important anymore.

Ibiqity, along with its major broadcast partners, has apparently made the strategic decision to essentially turn its back on the

With almost 800 U.S. stations having added HD operations and HD2 formats appearing almost daily, receiver manufacturers are offering more products in support of the rollout. Even RadioShack has announced it will carry HD radios. Best Buy and Circuit City can't be far behind.

probable interference fallout that full-time AM HD will spawn, and instead concentrate on the more lucrative potential that FM HD, multichannel and data initiatives will provide.

Overall, it seems obvious that effective AM coverage and de facto protected contours will shrink. Secondary contour and fringe coverage will be lost to many stations. Mostly large-market, high-power signals with low night limits will have the best chance to retain respectable coverage, both inside their protected and secondary contours.

Local channel, marginal regional channel and rim-shot facilities may find that they indeed will lose much of their target area coverage, and fighting this reality will prove to be difficult if not futile. Some may decide to place those formats on a sister FM HD2 channel or, perish the thought, lease time on a competitor's facility or just become an Internet station.

TOO LITTLE, TOO LATE

DRM and DRE did show some presence at NAB2006, but not in a way that would suggest either is ever going to be a viable U.S. alternative to Ibiqity and HD Radio. While DRE is a clever concept and makes better use of the FM composite spectrum, DRE reminds me a little bit of Noise-Free Radio: A novel but flawed idea in its day and clearly not the long-term answer the industry needs going forward in the 21st century.

changed how to structure questions and where to look for their answers.

In fact, my Last Word column embodies this same duality. I let my mind wander to random ideas, patterns and fantasies in order to find topics. I then filter them using my logical mind. While writing, I again let my intuitive mind take control in order to discover analogies and examples. And finally, I apply my knowledge of good writing to create a structured, linear article, followed by extensive editing.

It was with great effort that I learned the oldest wisdom about writing: just write anything and then edit and filter. In writing my first book, some 300,000 words ended in the trash can. The key to creative productivity is learning to be comfortable with dumb ideas, which should then be easily discarded. ■

DRM is still concentrating mostly on shortwave applications but has introduced a VHF mode that could be useful in the FM band. Yet they have done nothing to further refine or advocate the use of its little-known hybrid mode for AM applications in the U.S. Many of us still believe the single-sideband AM mode of DRM has

significant potential to help AM get through the messy HD hybrid phase.

Ibiqity might consider any part of DRM as a possible remedy to improve AM HD if the full-time rollout becomes a legal quagmire of interference litigation. Only then will it become motivated to look for a more viable hybrid solution if enough important AM stations press their case.

FULL SPEED AHEAD

FM HD is now gaining international traction, as the U.S. rollout looks more and more promising. Other countries, primarily Asia, are looking at it as a potential compatible digital mode with existing analog services.

With almost 800 U.S. stations having added HD operations and HD2 formats appearing almost daily, receiver manufacturers are bringing more products to market every week in support of the rollout. Even RadioShack has just announced it will carry HD radios. Best Buy and Circuit City can't be far behind.

The Boston Acoustics Receptor was seen in many booths and has quickly become the reference HD monitor receiver of choice for many. And I finally got to see the long-overdue Radiosphy portable boom-box combo. Three demonstration units were all working nicely on the floor, although I found them rather toasty to the touch.

Minimizing power consumption still seems to be a challenge, suggesting there is still a fair amount of work to do to get the HD receiver chipset squeezed into a smaller, more power-efficient package for portables.

The industry is experiencing warp-speed changes as HD charts a new course for broadcasters, equipment manufacturers and listeners alike. For those who focus on creating and delivering quality and compelling content on the new delivery platforms, while super-serving their local audiences, success will come more easily. ■

—Advertiser Index—

Page	Advertiser	Web Site
23	ATI (U.S.A.)	www.atiaudio.com
32	Audioarts Engineering	www.audioarts.net
4	AudioScience, Inc.	www.audioscience.com
9	Axia - A Telos Company	www.axiaaudio.com
27	Belar Electronics Laboratory, Inc.	www.belar.com
10	Broadcast Electronics	www.bdcast.com
25	Broadcast Tools, Inc	www.broadcasttools.com
26	Circuit Werkes	www.circuitwerkes.com
7	Comrex Corporation	www.comrex.com
12	Dielectric Communications	www.dielectric.com
18	ESE	www.es-web.com
30	Global Security Systems	www.gssnet.us
26	Gorman Redlich Mfg	www.gorman-redlich.com
1	Harris Corporation	www.broadcast.harris.com
22	Jennings Technology	www.jenningstech.com
8	Kintronic Labs Inc	www.kintronic.com
13	Klotz Digital Audio Systems Inc	www.klotzdigital.com
26	LBA Technology, Inc.	www.lbagroup.com
21	Moseley Associates	www.moseleysb.com
17	NTI Americas, Inc.	www.nt-instruments.com
26	Omnirax	www.omnirax.com
20	Pristine Systems	www.pristinesys.com
19	Pulsecom	www.pulse.com
5	Radio Design Labs (RDL)	www.rdlnet.com
6	Radio Systems Inc	www.radiosystems.com
1	Sierra Automated Systems	www.sasaudio.com
11	Sierra Automated Systems	www.sasaudio.com
26	Stormin Protection Products	www.opticsshield.com
14	Superior Electric	www.superiorelectric.com
15	Telos Systems - TLS Corp.	www.telos-systems.com
16	Titus Labs	www.tituslabs.com
31	Vorsis	www.vorsis.com
2	Wheatstone Corporation	www.wheatstone.com

—Advertising Sales Representatives—

US East & Latin America: John Casey e-mail: jcasey@imaspub.com	Phone: 330-342-8361 Fax: 330-342-8362
US West & Canada: Dale Tucker e-mail: dtucker@imaspub.com	Phone: 916-721-3410 Fax: 916-729-0810
Classified Ads: Claudia Van Veen e-mail: cvanveen@imaspub.com	Phone: 703-998-7600 x154 Fax: 703-671-7409
European Sales Mgr., Africa, Middle East: Raffaella Calabrese e-mail: rcalabrese@imaspub.com	Phone: +39-005-259-2010 Fax: +39-02-700-436-999
Japan: Eiji Yoshikawa e-mail: callems@world.odn.ne.jp	Phone: +81-3-3327-2688 Fax: +81-3-3327-3010
Asia/Pacific: Wengong Wang e-mail: ww@imaschina.com	Phone: +86-755-5785161 Fax: +86-755-5785160

—Next Issue of Radio World: June 21, 2006
Radio World Engineering Extra: August 23, 2005—

For address changes, send current and new address to Radio World a month in advance at P.O. Box 1214, Falls Church, VA 22041. Unsolicited manuscripts are welcomed for review: send to the attention of the appropriate editor.

Blesser

CONTINUED FROM PAGE 30

As a second example, we were preparing a software release for the Audicy workstation. At the last minute we discovered a serious but intermittent bug. Our software engineers performed dozens of experiments, collecting massive quantities of data. Weeks of analysis and design reviews failed to find the bug. The data remained inconsistent, incomplete and contradictory.

And then in a flash of intuition, someone suggested we had ignored the possibility that there were actually two bugs! By sorting the data into two bins, we found both problems in a few hours.

In both examples, intuition redirected engineering techniques, which then



Ignoring Logical Reasoning Is Logical

How Intuition, Dual Thinking Can Influence Engineering Techniques and Decision-Making

Dr. Barry Blesser is director of engineering for 25-Seven Systems.

The radio engineer has a gut feeling that the intermittent noise arises from a corroded splice where the coaxial cable first went underground. The program director has the intuition that reducing the number of spots would actually increase the station's revenue. The engineering manager has the hunch that an intern would make a great technician once trained.

These assertions by well-trained individuals are not based on the kind of formal logic and reasoning that we value in professional, technical and scientific activities.

To be socially acceptable, logical reasoning often is used to rationalize and justify a conclusion that simply appeared spontaneously. Or, when being honest, we add such qualifiers as hunch, intuition, gut-feel or best guess to signal that we cannot defend the assertion, even though it has a high probability of being correct.

ANALYSIS PARALYSIS

Recent research has shown that in many situations logical reasoning actually is counterproductive. The likelihood of making a wise decision is actually reduced by spending too much time debating the pros and cons of a decision. It can in fact be logical to ignore logical reasoning.

Scientists now explain this apparent paradox with the discovery that we have two independent and perhaps unrelated thinking systems: explicit logic (conscious) and intuitive hunches (unconscious).

Consciousness is like the display on the dashboard in an automobile, providing only limited data about the state of the engine. Of the thousands of neurological substrates in our brain, most have no connection to consciousness awareness, but they make valuable contributions to our ability to handle complex situations with massive quantities of data.

We are simply not aware of how the brain sorts possibilities, which is called "deliberation without attention." We say of a

complex problem "I will sleep on it," which means we are providing time for unconscious deliberations to process the mess. At 3 a.m., the answer just pops out — in the flash of lightning that wakes us up.

Thinking without awareness produces results when there are more than a few factors to consider. Logical reasoning works best with only a small amount of reliable data. It takes the form of "if A, then B; if C then D; if A and B then D," and so on. But when we are faced with perhaps hundreds of unreliable data fragments, unconscious thinking can harness a lifetime of buried

experiences, quickly seeing patterns that are consistent with the data, while readily ignoring noise and missing information.

A typical example of massive data without a readily apparent explanation is troubleshooting an unexplained defect in a large system. In such cases, an engineer would be wise to intuit multiple explanations quickly and then to test them logically by running experiments.

Theories, explanations and hypotheses are not created rationally even though they can be tested with formal logic. Because these two abilities are unrelated, some people are better at generating theories than at testing them, and vice versa. They are different skills that use different mental activities. A team composed of individuals with different skills is ideal.

Malcolm Gladwell, in his best-selling and easy-to-read book "Blink," provides a collection of simple case studies to illustrate the power, and danger, of using intuitive

thinking. He also collected numerous scientific studies to explain how intuition has evolved to be a major contributor to our survival as a species.

Furthermore, he observes that we broadcast our emotional attitudes even if we are unconscious of how we are feeling. Gladwell calls quick responses "thin slicing." When you hear the screeching tires of a fast-approaching truck, you react without thinking through your logical options and simply jump out of the way. Logic is too slow and too vulnerable to confounding noise, such as an unrelated horn and a ringing cell phone.

Timothy Wilson, psychologist and author of "Strangers to Ourselves," summarizes this dual mentality: "The mind oper-

Some of the debates raging in radio publications, such as multicasting and HD Radio, are perfect candidates for dual thinking. These topics are too complex to evaluate solely on logic.

ates most efficiently by relegating a good deal of high-level, sophisticated thinking to the unconscious, just as a modern jetliner is able to fly on autopilot with little or no input from the human 'conscious' pilot," he said. "The adaptive unconscious does an excellent job of sizing up the world, warning people of danger, setting goals and initiating action in a sophisticated and efficient manner."

DUAL THINKING

We are most productive when the two modes of thinking work together. Unfortunately, engineers and scientists are taught subtly to distrust intuition, and artists are taught to avoid logic: two polar extremes. While some individuals have a natural gift for combining the two modes, most of us learn the skill with great effort. In fact the best art and technology often result when the two modes are fused into a holistic unity.

Consider a meeting called by the engineering manager to address a technical problem. Using the rules of brainstorming, the group can be initially encouraged to free-associate, articulating apparently unrelated ideas. Then the mode switches to analyzing the choices and the implications. The mode can be switched back to articulating wild ideas full of fantasy.

Intuition is the engine, and logic is the filter. In this way, both types of thinking are harnessed and fused into a single optimum strategy.

Some of the debates raging in radio publications, such as multicasting and HD Radio, are perfect candidates for dual thinking. These topics are too complex to evaluate solely on logic. On the one hand, the danger of intuitive thinking is that personal biases and hidden agendas strongly influence the results. On the other hand, these questions are simply too complex to produce a clean, neat conclusion. I strongly recommend combining the two approaches rather than treating them as incompatible binary choices.

As a demonstration of dual thinking, I would like to share two personal experiences that illustrate how a flash of intuition solved an otherwise intractable engineering problem.

When I was developing the first electronic reverberation system at EMT in 1975, we were struggling with how to handle the massive heat from some 400 ICs without using fans, which would have produced too much noise for a recording studio. We evaluated dozens of designs in terms of heat-transfer mechanisms, thermodynamics and thermal resistance. We failed to solve the problem.

However, while daydreaming one morning, our marketing director found the perfect solution: construct a floor-standing case out of extruded heat-sink stock. At first nobody recognized that this aesthetic design, which looked like a rocket ship and a modern art sculpture, was actually a solution to an engineering problem. Abandoning the requirement of hiding the solution was an intuitive shift in thinking.

SEE BLESSER, PAGE 29

Homeland Security & All-Hazard Alert Systems



Connect to ANY DEVICE, ANYWHERE

- Smoke Detectors
- CellPhones
- Mobile Devices

real FM radio™

GLOBAL SECURITY SYSTEMS

228.255.7220 • www.gssnet.us • info@gssnet.us

ANY DEVICE ANYWHERE™

This Little Unit



Can Do BIG Things!

Our new AP-3 is the perfect HD Processor:

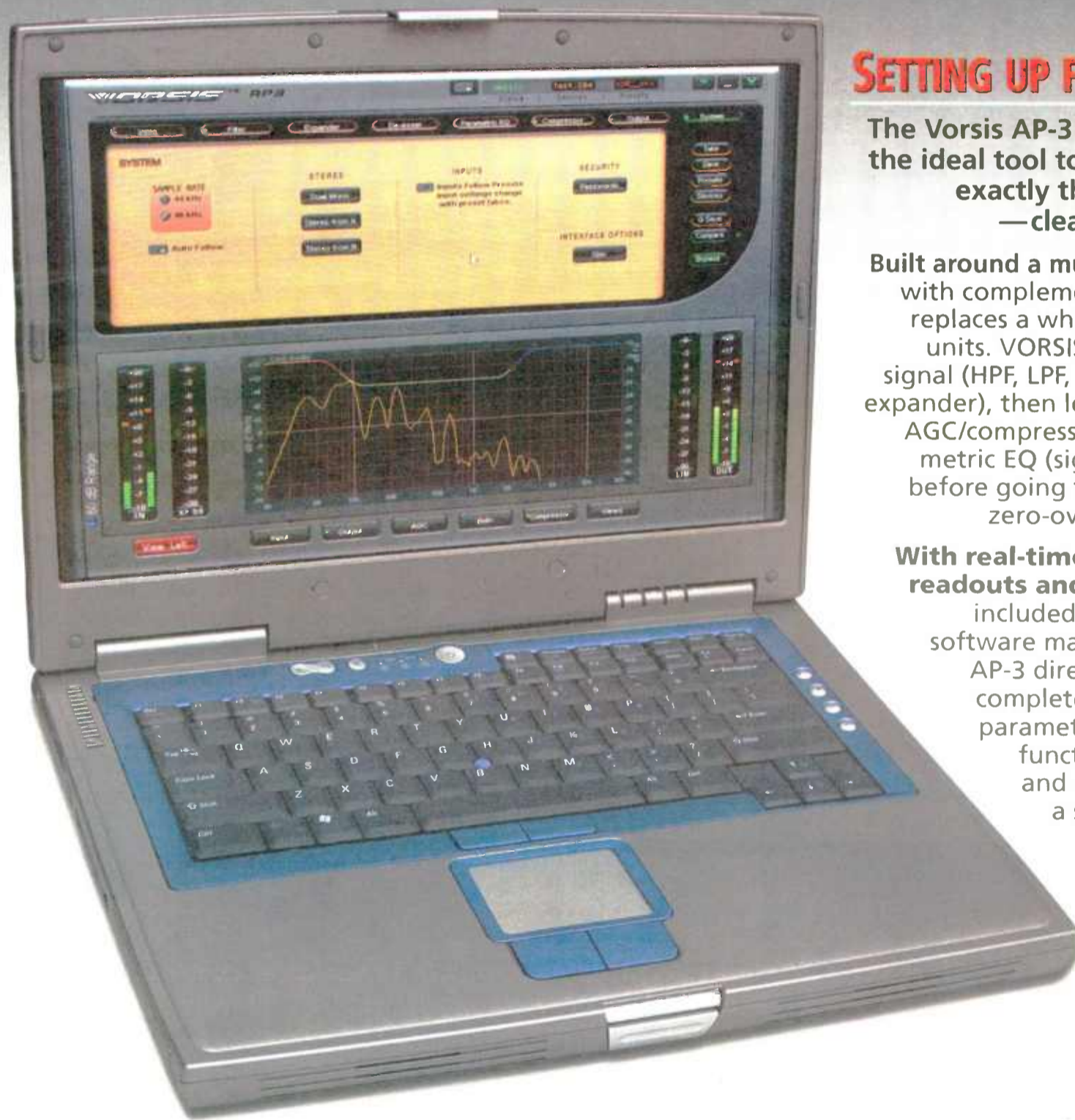

SETTING UP FOR HD RADIO?

The VORSIS AP-3 digital processor is the ideal tool to shape your sound exactly the way you want it — cleanly and efficiently.

Built around a multi-band compressor with complementary AGC, the AP-3 replaces a whole rack of dedicated units. VORSIS pre-conditions your signal (HPF, LPF, notch filter, de-esser, expander), then let's you apply 3-band AGC/compression and 4-band parametric EQ (signal chain reversible) before going through a final stage zero-overshoot peak limiter.

With real-time spectrum density readouts and full metering, our included PC graphic interface software makes operation of the AP-3 direct and easy, offering complete control of all audio parameters, presets, monitor functions, system settings and security—all through a single RJ-45 ethernet connection that lets you control one or many AP-3 units.

TAILOR THAT SOUND

VORSIS™

tel 252-638-7000 / sales@vorsis.com / www.vorsis.com

Copyright © 2005 by Wheatstone Corporation

World Radio History

It's a Whole New WORLD!



AUDIOARTS ENGINEERING

NET-8 DIGITAL AUDIO NETWORK

AUDIOARTS NET is the **EASY** way to interface your **D-75N digital consoles!** And because **D-75Ns** are also standalone designs each studio can operate **INDEPENDENTLY**, relying on the network only to share resources. And by **EASY** interface we **MEAN** it—you don't have to be a software guru or IT professional to get up and running—and **STAY** running! And because it's **AUDIOARTS**, you can rest assured it'll be reliable and preserve your budget. **TAKE ADVANTAGE** of **WHEATSTONE'S** extensive expertise in **DIGITAL TECHNOLOGY!**

 **AUDIOARTS ENGINEERING**

sales@wheatstone.com / tel 252-638-7000 / www.audioarts.net

Copyright © 2006 by Wheatstone Corporation