

\*\*\*\*\*AUTO\*\*SCH 3-DIGIT 856  
 S117298 D08 0610  
 TOM MILLER 232  
 ASST CHIEF ENGINEER  
 KTZR  
 2033 S AUGUSTA PL  
 TUCSON AZ 85710 7905

**The Law and You**

A special issue focusing on the FCC, legal matters and your station.

Page 58

**Go-Ye Radio**

Galcom International operates by the dictate "Go ye therefore, and teach all nations."

Page 56



# Radio World

\$2.50

The Newspaper for Radio Managers and Engineers

September 12, 2007

NEWS ANALYSIS

## For AM IBOC, The 'Real Test' Comes Now

*But No Mad Dash Is Foreseen*

by Leslie Stimson

"The real tests come now."

That's how one engineering group head characterized what will happen now that digital AMs are allowed to leave their digital transmitters on at night.

The FCC rules authorizing IBOC become effective Sept. 14. The rules give certainty to many aspects of the technology; and for AM owners — many of whom hope the promise of better audio quality gives them parity with their FM counterparts — it's been a long wait.

"As more people turn it on at night, it will be interesting to see who gets inter-who's wiped out and who's not," group engineering executive, not to be identified.

National Radio Systems tested reviewed test results conductivity Digital several years ago to possible AM nighttime interference its leadership said at the time is no practical, consistent way to the effect of IBOC operation on reception because propagation change each night due to varying weather conditions.

Engineers said then that the only real test AM nighttime IBOC was to happen when several stations in the area are on at night.

**Quickly?**

That presumably will happen. But quickly?

The question is the pace of the rollout. Several radio group engineers contacted for this article don't expect a mad rush for AMs to go on at night. They expect a large-market, big-wattage clear-

See AM IBOC, page 14 ▶

## NAB and the ABCs of RF

In Charlotte, While Managers Look to Reignite Radio, Engineers Learn How Not to Get Burned

THE NAB RADIO SHOW

Shown: Atop the Park Tower building in Tampa, Fla., where two broadcasters were fined by the FCC in a precedent-setting RFR case. The convention features a two-part RF safety course by Richard Strickland.

Photo by Richard Strickland

## WHEATSTONE adds features and saves money

This G-7 is NEW and LOADED with FEATURES: event recall, automation interface, bright source displays, and EQ/Dynamics and panning, all recallable on EVERY input channel for production or mic processing—the list goes on.

With the Wheatnet™ network design you'll get a simple, reliable, low latency system with high-speed digital audio, meters and logic commands—all in Real Time. PLUS we'll assemble, test and configure the entire system right in our plant, assuring you a smooth on-time installation.

**WHEATSTONE—WE MAKE THE GOOD STUFF.**

[www.wheatstone.com](http://www.wheatstone.com)  
© 2006 by Wheatstone Corporation

Thousands of tech tips! Visit the Workbench archive at [radioworld.com](http://radioworld.com)

NewBay Media

# NEWSWATCH

## Allow AMs on FM Translators?

**WASHINGTON** Some AM stations could gain access to a new, potentially revitalizing outlet while FM translators could face new competition on their part of the radio dial.

The commission is inviting comments on a proposal to allow AMs to broadcast on FM translators as a fill-in service.

NAB petitioned the commission for the change in 2006 and now the FCC tentatively has decided to approve it. The association proposed that AM stations be

allowed to use FM translator stations to rebroadcast the AM signal, provided that no portion of the 60 dBu contour of any such FM translator station extends beyond the smaller of a 25-mile radius from the AM transmitter site or the 2 mV/m daytime contour of the AM station.

The commission said it received more than 500 comments on the petition, with most of them supporting the proposal. Opponents said such a change could hurt LPFMs or believe the change would not fix the noise problems on the AM band and would actually clutter the FM band.

Now the issue has advanced to a Notice of Proposed Rule Making and the FCC invites comments on that, including

the issue of program origination at night over FM translators by AM daytime-only stations.

Comments to MB Docket 07-172 are due 60 days after Federal Register publication.

## Germany Is Testing HD Radio

**COLUMBIA, Md.** We may know results of a German field test for HD Radio by the end of this month.

Network operator Media & Broadcast of T-System and a private station planned

to begin HD Radio field tests, including two multicast channels, at the end of August and give results to the local communications regulator in Stuttgart on Sept. 27.

Radio Regenbogen is in the Rhine-Neckar area of Germany.

Helping to support the tests are Ibiqity Digital, audio expert Georg Neumann, Orban/CRL Systems, Broadcast Electronics and Ruoss AG, which is also assisting with HD-R tests in Switzerland.

## News Roundup

**HARRIS BROADCAST** showcased its technology at the Digital Radio Forum in the Dominican Republic. Harris worked with its Dominican Republic dealer, Repuestos de Radio & TV, to provide presentations for regional broadcasters interested in HD Radio, Digital Radio Mondiale and Eureka-147. The forum, planned by regulators there, showcased radio transmission technology and implementation strategies. Harris said some Dominican Republic broadcasters are asking the government to issue licenses to experiment with digital radio transmission, especially HD Radio.

# THE TOOLS HAVE CHANGED...



## BUT THE *MISSION* REMAINS THE SAME

Today's audio control surface has evolved to a very high degree. Yesterday's wish list is today's feature set: total router integration, routable audio and logic, total show recall, and a complete set of DSP audio processing are under the hood of this G7...

All in a package of stainless steel and aluminum designed for years of 24/7 service, with a familiar look and feel that will *help your talent make years of great radio*.

Networked audio requires a higher level of expertise, experience and resources. Benefit from all three with **WHEATSTONE!**

**WE MAKE THE GOOD STUFF**

**Wheatstone**

Copyright © 2007 by Wheatstone Corporation

tel 252-638-7000 / www.wheatstone.com / sales@wheatstone.com

## Index

### NEWS

For AM IBOC, The 'Real Test' Comes Now	1
NewsWatch	2
Primosphere Wants Back in Satellite Game	3
Just Don't Forget to Hit 'Save'	4
NAB vs. Sirius/XM: Debate Sizzles	5
Merger Technical Arguments Disputed	8
The Customer Should Always Be Right	12
Mexico Steps Toward Digital Standard	18
Mexico Wants FCC 'Do-Over' on IBOC	18

### RADIO SHOW PREVIEW

Tech Sessions Delve Into Digital	22
Avoid RF Safety Mistakes	26
Digital Radio: OK, Now What?	28
They Are the Best of the Best	32
Convention Highlights	33
How Less Is More Became Anything Goes	34
NAB Signs Freeman for Spring Show	34
Managers Learn What PPM Means for Them	36
Exhibitor List	38

### FEATURES

Workbench: Keep Racks Organized, Toolboxes Dry	42
We Map the Mobile Multimedia Maze	44
What to Do Before All Is Lost	46
CCRadio SW: A Classic AM/FM/SW Receiver	48
The FCC: Is It Your Friend or Foe?	50
FCC Inspectors Crashed My Farewell	51
FCC Inspection FAQ	53
In the Field? Been There Since Age 7	54
A Radio You Can Drop in Via Parachute	56

### GM JOURNAL

OK, Some ABCs About the FCC's CDBS	58
'Four Years? I've Got Plenty of Time!'	62
Show Me the Public File	64
People News	65
Study: HD Radio's Tepid Growth Story	66
Auctions for the Greater Good	68
The Rise and Fall of GreenStone Media	70
Remotes That Are All About the Sponsor	72

### OPINION

Amendments Leave No Room for Error	76
Article Skips Another Coding Family	77
Reader's Forum	77-78
Try Something	78

# Primosphere Wants Back in Satellite Game

## Impact on XM/Sirius Merger Debate Is Unclear

by Leslie Stimson

**WASHINGTON** Primosphere says it could be operational with a new U.S. satellite digital radio service in five years — and on the air much sooner if it were allowed to use the existing infrastructure of XM and Sirius.

Sirius officials scoffed at the proposal and said Primosphere's application has been long dead.

Primosphere was an original applicant for S-DARS spectrum but lost in the auction for satellite licenses. Now as the industry debates the proposed merger of XM and Sirius, Primosphere wants to recast that debate and asked the FCC to review its ruling from a decade ago.

Observers believe what happens on this issue will be interesting regardless of whether the merger of Sirius and XM is approved.

Back in 1992, six companies applied for S-DARS spectrum licenses. By the time of the 1997 FCC auction, four remained: Satellite CD Radio, which became Sirius; American Mobile Satellite Radio Corp., which became XM; Primosphere Limited Partnership; and Digital Satellite broadcasting Corp. The latter two lost out to the bids of approximately \$83.3 million from Satellite CD

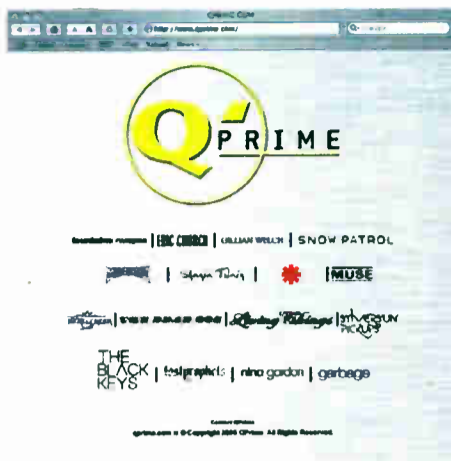

Primosphere principals Clifford Burnstein and Peter Mensch own entertainment company Q-Prime.

that decision to be reviewed. The FCC's International Bureau did so; it ruled that the companies which would become XM and Sirius qualified as licensees and it dismissed Primosphere's application. The company then asked the bureau to reconsider and also asked the full commission to review the license grant decision, according to FCC filings.

In 2001, the agency denied Primosphere's applications for review and

application is still pending, it remains an "existing applicant for authorization to launch and operate" a satellite digital radio service.

If it receives the S-band spectrum, the company says it will build and launch "its own satellites and market its own service." The company notes that in 1996, along with its original bid, it also paid \$140 million in launch fees for the two satellites it proposed in its original application — funds the FCC still has, Lieberman said.

The company estimates it would take five years to be operational. However, it would like to be up and running sooner. It proposes that the commission allow it to use a portion of the S-DARS spectrum now used by XM and Sirius and require the merged satcasters to allow Primosphere to use their satellite systems to deliver Primosphere programming to its subscribers.

Primosphere cited a similar agreement the agency approved in 1999 for a satellite TV provider to lease to another provider transponder capacity on an existing satellite.

NPR, without specific reference to Primosphere, has argued in its own comments to the FCC that if regulators do approve a merger, they should also require that a "sufficient" amount of the S-band spectrum licenses occupied by the satellite companies be vacated to make room for another competitor.

Sirius, meanwhile, in a July response,



# BSW

Lowest Prices and Largest Inventory on EVERYTHING For Broadcast

BSWusa.com      800-426-8434

Radio and \$90 million for AMRC. Now Primosphere is telling the FCC that its bid for an S-DARS license remains viable.

The organization is a holding company for New York resident Clifford Burnstein and his partner Peter Mensch in the entertainment industry company Q-Prime; the latter is a music management group for such artists as Shania Twain, Nickel Creek, Red Hot Chili Peppers and Metallica. Their attorney, Howard Lieberman of Drinker Biddle & Reath, told Radio World the men own Primosphere, each holding half of the company.

### Years of requests, denials

In 1996 Burnstein and Mensch bid about \$67.5 million for an SDARS license through Primosphere with the intention of restoring music genres they said were no longer available in major radio markets. According to their FCC filing from late 1992, Primosphere originally was proposing a free service; the owners are not commenting on what kind of service they would introduce now if they win their case, Lieberman said.

After the commission dismissed Primosphere's application as an unsuccessful bidder in 1997, the company asked

affirmed the licenses granted to Sirius and XM. At the same time the International Bureau denied Primosphere's request to reconsider its dismissal.

Primosphere next asked a federal appeals court to review the XM and Sirius license grants and also asked the full commission to review the bureau's dismissal of its S-DARS application.

In 2003 the appeals court rejected Primosphere's challenges and affirmed the licenses for Sirius and XM. In 2004, Primosphere told the FCC it wanted to withdraw its 2001 "review" request.

Now, Primosphere tells the commission that because the FCC failed to act on its request, the application for an S-DARS license is still pending and it wants its application to be considered at the same time the commission is reviewing the merger application from XM and Sirius.

The company also wants the commission to authorize a portion of the S-DARS spectrum to Primosphere if the agency approves the XM/Sirius merger, pointing out the FCC originally stated in 1997, "[I]f the winning bidder fails to submit the balance of the winning bid or the license is otherwise denied, we will assess a default payment ... and re-auction the license among the other existing applicants."

Primosphere says because its review

called Primosphere's motion the "latest gambit in an attempt to breathe new life into its long-dead application for satellite radio service and profit from the proposed XM/Sirius merger."

### Re-auction

Sirius argues that Primosphere's application to hold an S-DARS license became moot when it lost the auction bidding. When Primosphere "voluntarily" withdrew its application, that retraction became effective without any action from the FCC, according to Sirius.

Primosphere's application was only "pending" as long as challenges to the XM and Sirius licenses were unresolved; those challenges were resolved long ago, Sirius stated in its recent FCC filing. "There is now way for Primosphere to un-ring this bell" now, it stated.

It was difficult in August to foresee the likely outcome of the case. No other filings on this topic had been filed with the commission at press time, and attorneys contacted by RW for comment said they were unfamiliar with the case.

Lieberman said typically the FCC addresses many unresolved issues related to a topic when the agency releases a rule-making or an order, and his clients hope

See PRIMOSPHERE, page 20 ▶

32,837 products in stock at press time!

## Harris Intraplex Now at BSW



### Intraplex STL HD System

BSW is your source for the industry's leading HD STL. These digital Intraplex Studio-to-Transmitter Link systems are specifically designed for IBOC conversion for HD Radio. They're the ideal choice for a single studio-to-transmitter link or multi-location wide area audio, telephone and data network. BSW has the lowest package pricing! Call your sales rep with your quote today.

Call BSW For Lowest Price: 800-426-8434



### Omnia 1 FM Now Shipping!

- The processor we've been waiting for — BIG-MARKET FM SOUND in a downsized box
- Powerful new hardware, firmware and algorithms
- Ethernet, RS-232 modem and GPIO remote ports
- Call for low sale price now through 10/31.

OMNIA1FM List \$2,995.00

Call BSW For Lowest Price: 800-426-8434

## Stereo Pocket Rocket



### Zoom H2 Recorder Now Shipping!

- The only portable with 4 (!) mic capsules in a W-X/Y configuration for 360° recording, it delivers unbeatable stereo imaging
- 24-bit/96kHz resolution for high sound quality

HD202PKG List \$334.99

Lowest Price only \$199!

AUDIOARTS ENGINEERING



## FREE Phone Module with Audioarts D75

Phone module a \$709 value Offer good thru 10/31

- Industry's Top Radio Digital Consoles—with modular plug-in design for easy customization
- Four stereo output busses (PGM, AUD, AUX, UTL)
- Both digital and analog outputs
- On Sale Now at BSW! — plus get a FREE SP75 Superphone module through 10/31. Call today!

Call BSW For Lowest Price: 800-426-8434



### Same Day Shipping

BSW stocks a huge warehouse of products. Stock items shipped the same day. Just order by 7:00 PM Eastern Time.

Free Shipping on Most Web orders over \$99

FREE ground service delivery to the continuous 48 states. Excludes heavy or oversized items.

# Just Don't Forget to Hit 'Save'

If you use the FCC's CDBS system, I can save you thousands of dollars.

I was sifting through reports on commission fines recently and was astonished at how easy it appeared to be for a manager to make a mistake while using the online database tool to stumble into an expensive error.

In one such case, the FCC ruled: "Significantly, [the station] provides no copy of the on-screen notice confirming that the Form 301 was successfully received for processing. In fact, a search of the CDBS filing database indicates that, while [the station] initiated the filing process for its Form 301 application, and completed validation checks, it did not complete the filing process."

The licensee in fact thought it *had* uploaded the form almost 24 hours before the deadline. And even though the FCC could tell after the fact that the station had tried to file, it rejected its plea.

Misuse of CDBS, it appears, can cost you a lot of money, if not your application. So I asked our legal eagle Harry Cole to explore this topic. You might save thousands of dollars by reading his article on page 58.

Also in this issue, I've gathered several more articles about the FCC and legal questions. In our *Features* section, Jim Withers and Big Jim Williams reflect about what it's like when the FCC shows up; and we print excerpts of a FAQ from the commission addressing misperceptions about site visits.

In *GM Journal* are more articles to help you, including David Solomon on the 2011 renewal cycle and two Missouri educators on what happened when they asked stations to produce the required Issues-Programs Lists. Would *your* station be ready if they knocked on your door?

★ ★ ★

I have RW "people business" to catch you up on.

Richard Strickland, whose expertise about RF safety has appeared in our pages, will be found here more regularly.

In this issue we launch "Spotlight on

RF Safety," which will appear frequently. In each article, Strickland will address a question or common misperception on this vital topic of concern.

Strickland has taught more than 80 public and private seminars on RF radiation safety and has been hired by groups including NAB, NPR, Sony, Motorola, NYNEX Mobile, ABC, ESPN, the U.S. Army, Bell Atlantic Mobile and many others to help employees understand this topic.

You'll find the column within the NAB Radio Show preview section of this issue because Strickland is also a prominent speaker at the upcoming convention.

★ ★ ★

I'm sorry to note the passing of contributor Gary Palamara, who was 56.

A resident of Howell, N.J., he died suddenly on July 4. Born in Brooklyn, Gary began his career with Armed Forces Radio and spent three decades in audio and video, working as a studio and field engineer on events including the Olympics, U.S. Open Tennis, the NCAA and NBA Finals, and the Miss America Pageant. He was a U.S. Air Force veteran who served during the Vietnam War in Thailand.

For decades Gary owned and operated Morningstar Sound, a sound installation and recording company. He wrote for me in 2002 about the excitement of listening in on military broadcasts, a story archived on our Web site; more recently he offered tips about audio recording at press conferences, which he called his "view from the back of the room."

A week before his heart attack, Gary



Gary Palamara

e-mailed me; he was in the midst of press conferences and radio interviews surrounding the release of Michael Moore's recent movie "Sicko." "Hope you're keeping cool down there. Just wanted to thank you for the nice work as always on the article. It's always a pleasure working with you folks. I guess now it's on to the next thing."

Bonnie, his wife of 36 years, tells me Gary was a gifted photographer and spent hours taking pix of nature, family and friends, as well as work-related subjects. You can see Gary's photos and thoughts at [www.garypalamara.com](http://www.garypalamara.com).

He is also survived by a daughter and son-in-law, Gretchen and Scott Cook, a son and daughter-in-law, Jason and Lori Palamara, and a son, Zachary Palamara.

★ ★ ★

When I told you our company would be acquired by NewBay Media, I discussed the benefits but also mentioned that we'd likely experience some pain.

One instance is the departure of Marlene Lane. She leaves as IMAS chief operating officer; but she is familiar to many readers and advertisers for other hats she wore over 21 years.

Marlene started with IMAS when it had only about 10 employees and when "Industrial Marketing Advisory Services" consisted of just RW and TV Technology. She was the first official *Buyer's Guide* editor for both publications and soon was named TV Tech editor and, later, associate publisher. She also helped launch the international version of TVT.

Marlene worked on the launch of RW Online when that was a relatively new concept in our market; and she was the one who cooked up the name "Guy Wire" for our featured anonymous columnist.

Eventually Marlene was named to run the entire editorial department, a job in which she had the good sense to hire me in 1996.

For nine years she also managed our Daily operations, which produces convention publications for NAB and other organizations. "That first NAB Daily, that

## From the Editor

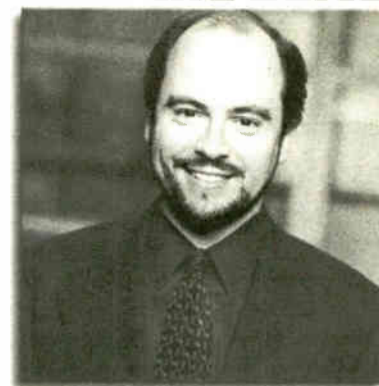

### Paul J. McLane

was the toughest," she recalled. "I was making it up as I went, on half-a-shoe-string budget. Thank goodness my staff took mercy on me and helped as much as they could."

Marlene later moved into marketing, HR and circulation. But for me she'll always be an IMAS editorial chief. "I'm sure going to miss my IMAS family," she said in her last week.

It's hard to imagine our office without her.

★ ★ ★

Meanwhile congratulations are due to our news editor and Washington bureau chief, Leslie Stimson, on her 10th anniversary with Radio World.

If you see Les at the NAB Radio Show in Charlotte, congratulate her, and be sure to compliment her on the spiffy logo for her new bimonthly e-mail newsletter "The Leslie Report." She also welcomes your news tips; write her at [lstimson@imaspub.com](mailto:lstimson@imaspub.com).

★ ★ ★

And Michael LeClair reminds me that RW Engineering Extra has turned three years old. Hard to believe!

RW's publication team had been exploring how to grow its business. Meantime I was chafing because I sensed a great deal of good technical information in the industry and was seeking a forum where it didn't need to be squeezed — industry white papers from innovative

See MCLANE, page 19 ►

## Your Single Source for Broadcast Solutions



ERI is your single source for the broadcast industry's best antennas, filter and combining systems, transmission line and RF components, and towers and structural products. Our professional team of engineers, designers, fabricators, project managers, and installers take pride in contributing to your success by delivering products and services to meet all of your RF and structural needs.

ELECTRONICS RESEARCH, INC. **ERI**

Call Toll-free at 877-ERI-LINE • Visit Online at [www.eriinc.com](http://www.eriinc.com)

Visit us in Booth #310 at the NAB Radio Show

# NAB vs. Sirius/XM: Debate Sizzles

Broadcasters Ask the FCC to Deny the Merger and the Satcasters Respond

Do the satellite radio companies compete with terrestrial radio?

Regulators are looking into this question and more as they determine whether the merger of Sirius and XM is in the public interest. Key to their decisions will be the relevant competitive product and geographic market for the satcasters and their competitors, post-merger.

The following are excerpts from NAB's petition to deny the proposed satellite radio merger as well as the combined opposition response from Sirius and XM. Technical arguments for and against the union begin on page 8.

## THE NAB ARGUMENTS

### S-DARS Is Distinct Market:

From the perspective of a consumer looking for an alternative source for a multi-channel, mobile audio service that is available as the consumer travels anywhere in the country, there is simply no one to turn to other than XM and Sirius.

No other audio product or service provides more than a hundred pre-programmed audio channels — including out-of-town sports, numerous specialized channels, and material that would be subject to commission forfeiture if aired on terrestrial radio — at the flip of a switch. And no one else provides such programming on a nationwide, seamless, mobile basis, or will do so for the foreseeable future (and certainly not within the two years required under the merger guidelines).

*Terrestrial Radio* — ... As a preliminary matter, it is important to recognize that terrestrial radio is not a single entity in the local markets in which each radio broadcaster competes. Rather, each local market consists of multiple terrestrial radio licensees competing vigorously with each other. ...

[I]t is significant that terrestrial radio is a free, rather than subscription, service. If satellite DARS and terrestrial radio were substitutable products, it would defy common sense for anyone to pay \$12.95 or any other price if they could get an essentially equivalent product for free. ... In other words, terrestrial radio and satellite DARS are complementary rather than substitutable services. ...

*HD Radio* — HD Radio is an emerging radio service that offers improved audio quality and more programming variety than analog terrestrial radio. Nevertheless, even with digital capabilities, local radio stations will not be able to offer the hundreds of channels satellite radio can, nor will they offer the nationwide scope of satellite radio.

### Advanced Technology Claim:

The applicants claim that, through efficiencies, the combined company "will be able to" offer consumers access to advanced technology sooner than otherwise because the merger efficiencies, "including the marriage of two engineering organizations, will ensure better results from each dollar invested in research and development." ...

Here, too, the claims are speculative and non-verifiable. While the applicants speculate

about what they *might* do, there are no

details about what they *will* do, or *when*, or *how*.

### Claim of Operational Efficiencies:

*Duplicative Programming Expenses.* The applicants say they will "eventually" be able to reduce duplicative programming expenses. ... [T]he claim of "eventual" savings is speculative. ... [A]ny

savings here would involve fixed, not variable, costs. Nor can the merged entity eliminate much of their most expensive programming because of their existing long-term contracts.

*Operational Expenses for Infrastructure.* The applicants say they "will be able" to reduce operational expenses by no longer having to "maintain distinct broadcast operations infrastructure to facilitate the scheduling, storage, compression, transmission and uplink of programming and content to the applicants' satellites and terrestrial repeater networks." ... [A]ny benefit here is highly speculative, particularly in light of the fact that the companies will admittedly have to use separate platforms for another decade or so.

### Violated Receiver Interoperability Rule:

... [T]he commission did not mandate a specific receiver standard, but did require the licensees to develop such a common standard. The commission also made clear that receiver interoperability was to occur prior to the initiation of satellite DARS service. XM and Sirius both made the required certifications.

Whatever XM's and Sirius's intentions were when they made these certifications in 1997, the fact is that they did not comply with the receiver interoperability rule prior to "final" system design and introduction of service in late 2001 and apparently have not done so six years later either.

This matter came to the commission's attention again in 2005 when XM failed to include a receiver interoperability certification in an application for replacement satellites. In light of the missing certification, the International Bureau indicated that it would send letters to XM and Sirius requesting that "they provide the current status of their efforts to develop an interoperable receiver and that they *provide a clear timeframe for making such an interoperable receiver available to the public.*"

### Violations of Part 15 Equipment Rules:

[B]oth XM and Sirius have engaged in apparently widespread violations of commission equipment rules designed to

ensure that their modulators/receivers do not interfere with broadcast radio stations.

As a result, as has been widely reported, listeners to religious and other non-commercial radio stations may not only receive interference, but may receive "signal bleed" that results in their unintentionally hearing on their car broadcast radios such programming as "The Howard Stern Show." ...

In addition, with respect to both Sirius and XM, the Enforcement Bureau has indicated that the "employees who were

**In constructing its network of repeaters, XM has engaged in what is perhaps the most widespread violation of commission technical rules by a major licensee in the history of the commission.**

— NAB

involved in the decision to make such modifications or were aware of potential non-compliance" were "executive and senior-level employees."

### Violations of Repeater Rules:

In constructing its network of repeaters, XM has engaged in what is

perhaps the most widespread violation of commission technical rules by a major licensee in the history of the commission.

XM's own submissions to the commission indicate that *more than 40 percent* of its nearly 800 repeaters were operating illegally. ... Significantly, when these violations came to XM's attention, it did not promptly remedy the situation. Rather, it continued to operate unlawfully while it worked to fix the problems and, even after bringing the matter to the commission's attention, continued to operate four of the unauthorized repeaters and two repeaters at unauthorized power levels.

## XM AND SIRIUS REPLY

*These excerpts are from the public redacted version of the Sirius-XM Joint Opposition filing.*

Overwhelmingly, the opponents of this merger are terrestrial radio broadcasters and surrogates funded by them. This is hardly surprising.

Terrestrial broadcasters have the most to lose from increased competition, since they compete with satellite radio and other audio entertainment services for the same listeners. In fact, scorched-earth opposition to the merger by the National Association of Broadcasters — not to mention the association's longstanding reflexive opposition to the very existence of satellite radio — is itself powerful evidence of the competition that so obviously exists. ...

All available evidence shows that consumers have a variety of reasonable

See MERGER, page 6 ▶

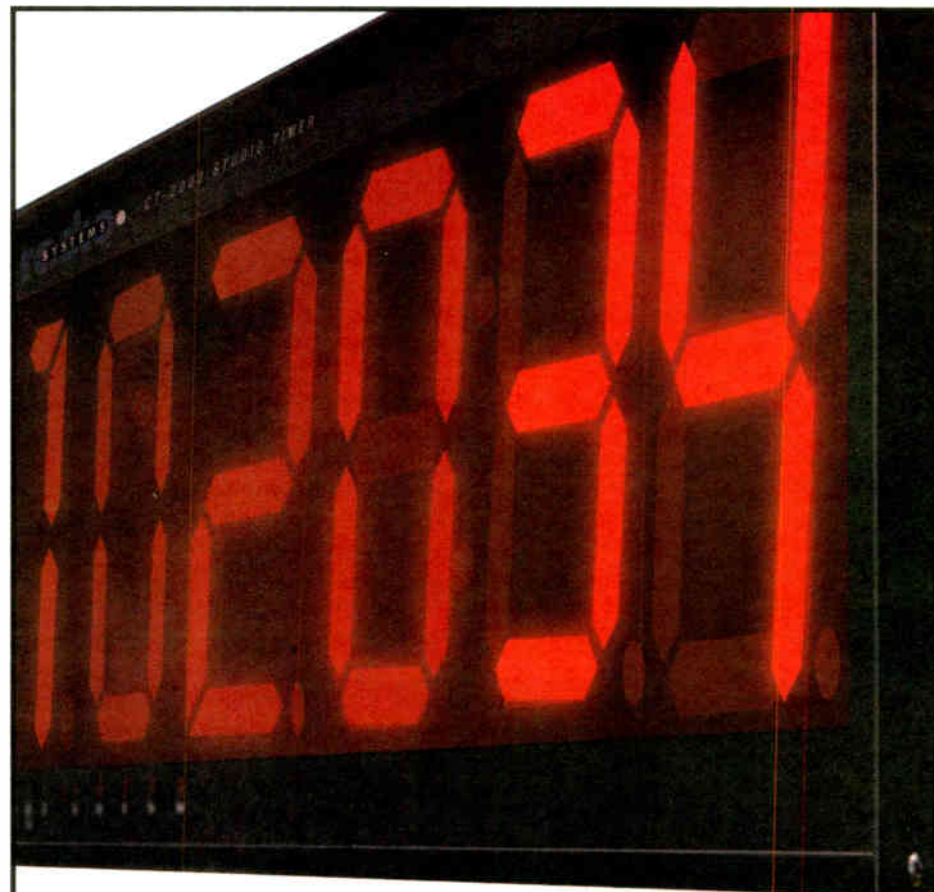

## Shown Actual Size

Radio Systems' Clock/Timer line grows with the addition of our super larger 4" digital display. Like all Radio Systems' CT-2002 Clock/Timers, the CT-2002 4" is a time of day clock, master/slave display and up/down timer all in one. Log on, call or contact one of our dealers today for more information about our growing line of clock/timers.



radio  
SYSTEMS

Radio Systems, Inc.  
601 Heron Drive, Logan Township, NJ 08085  
phone: 856 467-8000 Fax: 856 467-3044 www.radiosystems.com

# Merger

► Continued from page 5  
substitutes for satellite radio, including, of course, terrestrial radio, but also HD Radio, wireless phones, iPods and other MP3 players — and new technologies are appearing by the day.

With all of these alternatives, it is abundantly clear that a combined Sirius and XM would lose subscribers if it attempted to raise prices without providing greater content or quality of service.

## Facilitate Interoperable Radios:

Sirius and XM have spent much effort and resources in designing an interoperable radio. However, due to current size and cost restraints of an interoperable radio, manufacturers have expressed little interest in producing or distributing such a product; nor has any automobile company opted to include one in its vehicles. And neither company has chosen to subsidize the cost of producing an interoperable radio because of uncertainty that such an expense could be recouped in the marketplace.

As the [economist Charles River Associates] Competitive Effects Analysis shows, the merger will remedy these barriers by providing a commercial incentive to produce and distribute interoperable radios. Increased subscribership will likely encourage radio manufacturers to produce, consistent with customer demand, radios that tune to all channels of the combined company's service.

## 'Significant Efficiencies':

... The combination of Sirius and XM will produce considerable merger-specific efficiencies, leading to more innovative services for consumers, higher quality services, and lower prices — to the benefit of consumers. Without the merger, consumers will not realize these benefits. ... Significant merger-specific savings are likely to result in the following areas:

**Satellite operations** — In the near term, the combined entity will be able to eliminate significant redundancy in satellite uplink, control and transmission facilities, including reducing costs necessary to communicate with satellites, as well as the costs of duplicative back-up control facilities. Over the long term, capital expenditure savings in satellite network replacement will be substantial.

**Broadcast operations** — The combined company can eliminate duplicative studio operating costs, including person-

nel, facilities, content storage and retrieval, and content delivery costs.

**Terrestrial networks** — Duplicative costs to operate and maintain terrestrial repeaters could be eliminated or reduced through the co-location of terrestrial repeater sites.

**Programming and content** — The merged entity will generate significant merger-specific efficiencies by eliminating duplication in the overhead and production of similarly formatted channels and by improving scale economies in program acquisition. ...

## Sirius, XM Compete With Audio Services:

... The evidence shows exactly what the anecdotal comments of actual satellite radio subscribers suggest: Satellite radio competes with and is substitutable for numerous other audio entertainment services and devices.

This is particularly true for terrestrial

radio, but it is clear that satellite radio also competes with Internet radio, iPods, MP3 players, wireless phones and HD Radio. Commenters' allegations and arguments to the contrary are inaccurate, internally inconsistent and ignore market reality. ...

## Entry Into Audio Entertainment Market:

... [N]ew product and services are regularly introduced as a response to evolutions in the audio entertainment marketplace.

For example, Slacker expects to introduce satellite car kits that will permit users to receive ... high-quality music through the Ku-band. And there is sure to be intense and growing competition from an array of wireless Internet services that offer many, if not all, the same features as satellite radio. ...

QUALCOMM, a communications technology firm that also offers some wireless services to end-users, is using a technology known as MediaFLO to provide service

in the lower 700 MHz band. The transmission capacity and high power limits permitted in connection with this and similar services (such as Crown Castle's Modeo and Aloha Networks' Hiwire) permit enhanced coverage and can be used to provide audio, video and data services. ...

There is abundant evidence that mobile satellite service (MSS) systems can be used to provide audio entertainment services. ... In particular, New ICO Satellite Services G.P. (ICO) — which has access to 2 GHz spectrum with properties similar to that used by XM and Sirius — is scheduled to launch a hybrid MSS satellite system later this year and reiterated in this proceeding its plan to offer multimedia subscription services, including audio entertainment, over that system.

## No Character Issues:

... XM and Sirius take their obligations and responsibilities as FCC

See MERGER, page 16 ►

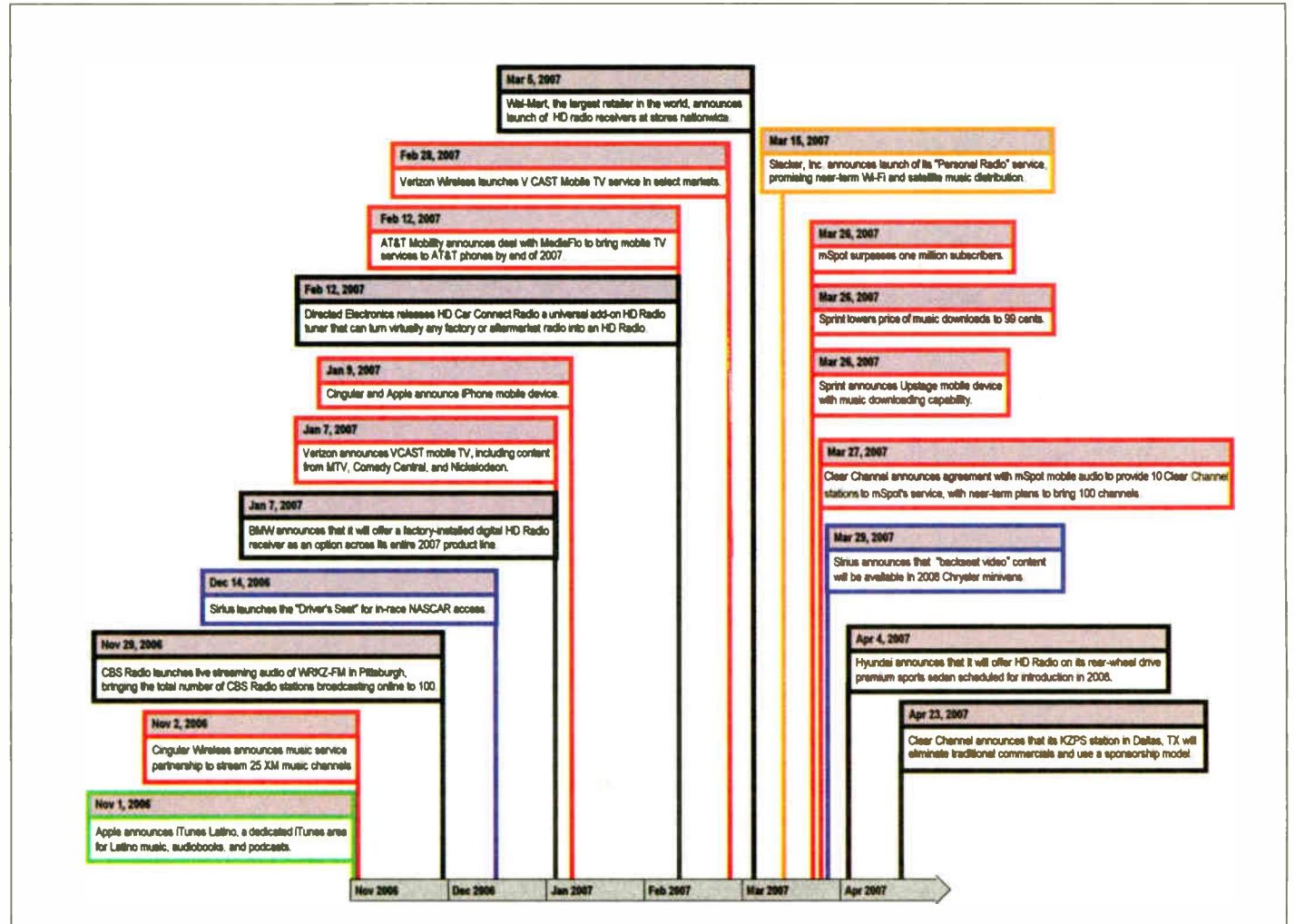

The satellite companies depicted their rollout vs. competing media introductions in a timeline. This part depicts Nov. 2006 to April 2007.

**Finally.... a great rack-mountable HD-Radio tuner that doesn't bust the budget!**

### Sangean HDT-1X HD Radio tuner

- Analog and S/PDIF digital optical outputs
- Full HD Radio capability plus C-Quam AM Stereo
- Split Mode: Digital in left channel, Analog in the right
- AM adaptive bandwidth and synchronous detector
- FM RDS capability
- Good sensitivity and selectivity

### Customized for your own needs:

- 2RU rack ears.....\$19.95
- AES/EBU digital output adapter.....\$49.95
- 600 ohm balanced output adapter.....\$39.95



**Sangean HDT-1X HD Tuner**  
\$249.95 (manufacturer's list)  
Please call for current price



**Please call 800-732-7665**

**www.bradleybroadcast.com**



## Impossible Remote? Nah, You've Got ACCESS.

### Meet Another Real-World Super Hero...

Broadcasting a live Phoenix radio program from out to sea would be challenging for even the most seasoned veterans. Not for Attorney and Certified Financial Planner® (and world traveler) Keith DeGreen. Keith is shown here using the Comrex ACCESS Portable as he and his ship, The Global Adventure, approach Koror Harbor In The Republic of Palau—450 miles east of the Philippines and 7,200 miles from Phoenix!

ACCESS delivers mono or stereo over DSL, Cable, Wi-Fi, 3G cellular, satellite, POTS (yep, ACCESS is a full featured POTS codec and works seamlessly with Matrix, Vector and Bluebox)—plus some services you may not have even heard of. Given the challenges of the public Internet, it's no small boast to say that ACCESS will perform in real time over most available IP connections.

Contact Comrex today and find out how ACCESS can make you become a Real-World Super Hero—wherever you are!

*Keith has been broadcasting his radio program, a unique mix of personal finance, economics, politics, and real-life "extreme broadcasting" adventure for 19 years. Listen live 8–11 AM Sunday mornings AZ time on NewsTalk 550, KFYI, or catch Keith's archived shows, and enjoy the amazing videos, photos and blogs of his open-ended round-the-world journey at his website, [www.theglobaladventure.com](http://www.theglobaladventure.com).*

See Us at NAB Radio Show Booth #300

Put Comrex On The Line.

**COMREX**



*Keith DeGreen says:  
"Whether I'm a thousand miles out to sea, visiting unusual ports of call, or exploring remote inland places, my Comrex ACCESS Portable empowers me to project a broadcast-quality signal back home at anytime from virtually anywhere."*



«ACCESS»

Toll Free: 800-237-1776 • [www.comrex.com](http://www.comrex.com) • e-mail: [info@comrex.com](mailto:info@comrex.com)  
19 Pine Road Devens, MA 01434 USA • Tel: 978-784-1776 • Fax: 978-784-1717

# Merger Technical Arguments Disputed

On page 5 we summarize general arguments about the satellite merger made by NAB and Sirius/XM. Here we excerpt selected technical positions submitted by the parties to regulators for their review.

## NAB ENGINEERING STATEMENT CITES TECHNICAL LIMITATIONS

The following are excerpts from an engineering statement prepared on behalf of NAB by Dennis Wallace of Meintel, Sgrignoli & Wallace.

The systems as currently deployed are not interoperable. That is to say, an XM receiver cannot receive the Sirius signal and vice versa. Thus, as is true today, if the proposed merger of XM and Sirius were consummated, consumers would still need to purchase a new interoperable receiver in order to receive the signals of both providers. ...

The data capacities of both the XM and Sirius systems are filled with programming and significant spare capacity is not available. Expanding the number of program offerings on the XM or Sirius platforms through more aggressive digital compression is possible but would result in unacceptable degradation of audio quality.

**SDARS Technical Overview** — As shown, the two SDARS providers have deployed significantly different system implementations. These differences contrast sharply, from the highly inclined

receivers, the introduction of a new interoperable radio that will work with both systems, or by obsolescing the satellite receivers of one provider and adopting the technical parameters of the other. In

Parameter	Sirius	XM
Headquarters	New York, NY	Washington, DC
Number of studios	75	82
# of satellites in operation	3	2
Orbital configuration	Highly-inclined elliptical (HEO)	Geostationary (GEO)
Satellite elevation angle (typ.)	60 degrees	30 degrees
# of terrestrial repeaters	105 (46 markets)	1,700 (70 markets)
Repeater modulation	OFDM	OFDM
Frequency band (MHz)	2320-2332.5 MHz	2332.5-2345 MHz
Audio coding	PAC	MPEG-AAC
Satellite modulation	TDM QPSK	TDM QPSK
Satellite FEC (uplink)	R-S (128,120)	R-S (255, 223)
Downlink carriers per satellite	1	2
Satellite signal BW (per carrier)	4.2 MHz	1.8 MHz
Satellite signal bit rate (per carrier)	4.4 Mbps	2.048 Mbps
Satellite signal bit rate (total)	4.4 Mbps	4.096 Mbps
Repeater signal bandwidth	4.1 MHz	5.2 MHz

Source: MSW

Technical Parameter Comparison

elliptical orbit of the Sirius satellites to the geostationary approach of the XM satellites, to different frequency allocations of the satellite and terrestrial repeater frequencies and bandwidths, and to the different audio codecs employed by each provider. These differences cannot be easily harmonized without significant disruption to current consumer

**These differences cannot be easily harmonized without significant disruption to current consumer receivers, the introduction of a new interoperable radio ... or by obsolescing the satellite receivers of one provider and adopting the technical parameters of the other.'**

— Meintel, Sgrignoli & Wallace

the latter case, it is not likely that the satellites currently in use by the providers would be capable of changing bandwidths and bit rates so as to function with the system of the other provider.

**New Interoperable Receiver** — FCC rules actually require that both SDARS providers design interoperable receivers, although to date neither SDARS provider has provided such a receiver. In its March 1997 Report and Order on SDARS, the FCC declined to set a specific receiver design but did require the SDARS providers to design receivers that would receive all DARS providers. ...

In January 2005, the FCC's International Bureau's Satellite Division asked both XM and Sirius to provide an update regarding the progress on making the interoperable receiver available. On March 14, 2005, both companies replied to the FCC with a joint letter stating that, at that time, the receiver was not yet completed.

The complexity of the design task to produce an interoperable radio is significant. It would need to have wider bandwidth in order to receive both SDARS signals. It would need to have separate TDM-QPSK demodulators with various bandwidths, as well as OFDM demodulators of various bandwidths, as well as various FEC decoders. In addition it would need to have separate transport stream de-multiplexers for both services and two separate audio decoders. Also, there would be some need for software to allow the consumer to navigate the services of both providers. This is indeed a complex design task, and the fact that the joint venture has not produced any com-

in degradation to the audio quality of the service. ...

It is important to note that XM and Sirius use completely different audio codecs. The Sirius system utilizes a compression algorithm called PAC while the XM system uses an MPEG-AAC codec. These two audio codecs are not interchangeable. Thus, an interoperable satellite receiver would need to have the circuitry to decode both types of audio codecs, thus increasing the complexity and cost of production.

## ATC CHALLENGES MSW/NAB CONCLUSIONS

*Dr. Deepen Sinha, president of ATC Labs, prepared comments on behalf of Sirius and XM.*

Independently, Sirius and XM have committed substantial resources in attempting to develop [higher coding efficiency]. However, the efforts have progressed along separate tracks. While Sirius has focused on improving coding efficiency through improved psychoacoustic modeling and joined encoding (i.e., *statistical multiplexing*), XM has focused more on optimizing the pre-processor configuration, particularly in optimizing the overall interaction between the pre-processor and the audio encoder.

Combining these efforts likely would yield improved efficiency on both the systems. The three available tools for realizing improved efficiency through transmit

See TECHNICAL, page 10 ►



COMET, the world leader for high voltage vacuum capacitors, leads the next wave of technological innovation with the Integrated Drive for the broadcast industry.

The ideal solution for today's transmitters, antenna tuning, phasing and coupling units; the Integrated Drive is a multi-functional product for the accurate alignment of motors, couplers and capacitors eliminating the need to source and integrate components from multiple suppliers.

In addition to ensuring 100% accuracy, the Integrated Drive dramatically reduces R&D, procurement and assembly lead times. The once tedious and error-prone assembly of components is now replaced with a standardized, easy-to-install subsystem.

Our single source solution is easily integrated into new and existing applications.

Contact us today for more information!

The X-perts for security, inspection, electronics and communication

COMET North America, Inc., 76 Progress Drive, Stamford, CT 06902  
T +1 203 969 2161, F +1 203 969 2162, usa@comet.ch, www.comet.ch



# WORLD LEADER IN TALKSHOW SYSTEMS

## ONE-X-SIX



The perfect multi-line talkshow system for use with up to six phone lines.



## TWOx12

Make fast-paced production and high quality conferencing a snap with this 12 line on-air phone system.

## SERIES 2101

The world's only talkshow system especially designed to meet the challenges of integrating large connected broadcast plants.

## Introducing Nx12!

Our most flexible standalone talkshow system.. ever. This self-contained 12 line system includes 4 hybrids and is offered with Livewire Audio-over-IP and either analog or AES inputs/outputs. Call for availability.

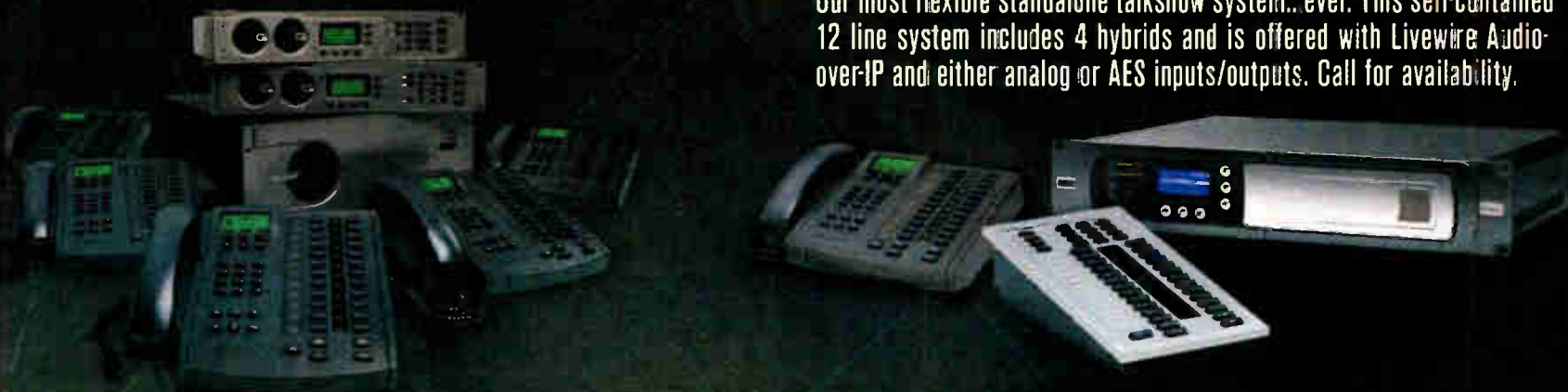

# CONTROL AS YOU LIKE IT

## DESKTOP DIRECTOR

Sophisticated, yet easy-to-use, control stations that make fast-paced production a snap.

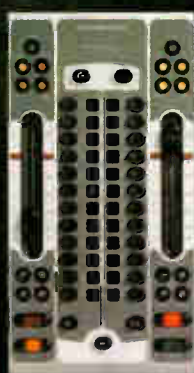

## CONSOLE DIRECTOR

Console + turret mounted accessory controllers put control right at the talent's fingertips. Axia Element users get even tighter integration.

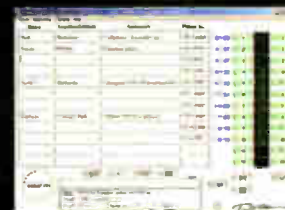

## CALL CONTROLLER

Simplified and cost effective option for call screening and on-air control.



## ASSISTANT PRODUCER

This talkshow management system completes your Telos multi-line talkshow system with easy-to-use client/server call screener software that provides vital real-time link between producers and talent.

*Telos*

AUDIO | NETWORKS

[www.Telos-Systems.com](http://www.Telos-Systems.com)

© 2007 TLS Corp. Telos, Axia, One-x-Six, TWOx-2, Series 2101, Nx12, Call Controller, Desktop Director, Assistant Producer, Console Director, Livewire and Element TM TLS Corp. All rights reserved.

World Radio History

# Technical

► Continued from page 8

side upgrades are therefore: improved psychoacoustic modeling statistical multiplexing, and, optimized pre-processing. ...

In sum the [Meintel, Sgrignoli & Wallace] report simply fails to take into account the substantial improvements in system performance that have been — and can still be — achieved through upgrades in the encoding of audio programming without changes to the current generation of receivers. As noted herein, these improvements can result in additional channels of programming being made available on existing satellite systems without diminishing the audio quality enjoyed by listeners and without eliminating current channels.

## NEURAL: NAB GOT IT WRONG

Neural Audio Corp. also commented on behalf of Sirius/XM.

The NAB Engineering Statement concludes ... that XM and Sirius “are limited in their ability to add new program channels to their services without removing an equivalent number of existing program channels,” and that “[a]ttempts to achieve more program capacity through more aggressive digital compression and fewer bits per program would result in significant audio quality degradations likely to be unacceptable to consumers.”

[T]hese conclusions are at odds with well-established technological trends in the broadcasting industry. Continuous advancements in audio compression technologies have allowed many audio entertainment providers—including broadcasters as well as both of the satellite radio providers — to provide more programming over the same amount of bandwidth without any corresponding degradation in

audio quality, even with reductions in bit rates. Neural Audio has contributed to that progress by developing and improving solutions that XM has employed successfully to substantially increase the number of channels it offers. ...

[T]he conclusion that the satellite radio providers could only add new channels by subtracting others overlooks the various methods available today — including the solution developed by Neural Audio — that allow providers of audio entertainment to use their existing bandwidth more efficiently without any negative impact on audio quality. There is no evidence that either satellite radio provider has reached its “capacity” and can no longer avail itself of these technologies. ...

Second, the nature of certain program-

ming allows the companies to conserve bandwidth, even without resorting to the available technological techniques. For example, the existing systems offer seasonal sports such as the National Football League (on Sirius) and Major League Baseball (on XM). While such programming requires a large bandwidth in order to support the many games being played simultaneously, this bandwidth allocation

channels that each company can provide. In fact, these figures significantly *understate* the number of channels provided by each company: XM now offers 178 channels while Sirius offers 134.

Thus, XM and Sirius already offer many channels above the limit at which the NAB Engineering Statement asserts audio degradation will occur. This fact alone undermines the validity of the bit-rate analysis contained in the NAB Engineering Statement.

Finally, the claim ... that “the total capacity of the two systems will not change even if the companies merge” is incorrect. We understand that XM and Sirius are in stages of expanding system bandwidth by up to 25 percent of their total system capacity through the introduction of hierarchical modulation technology.

In hierarchical modulation, two separate data streams are modulated on a single carrier. The hierarchical modulation consists of a basic constellation (modulation scheme), which is the same as in the original system, and a secondary constellation (overlaid on top of the original), which carries the additional data for the upgraded system.

The upgraded system with the hierarchical modulation is backward compatible in the sense that receivers that have been deployed in the original system can continue receiving data in the basic constellation. New receivers can be designed to receive data carried in the secondary constellation, as well as those in the basic constellation. As a merged company, this new bandwidth could be pooled to support expanded programming for subscribers. 🌐

**There is no evidence that either satellite radio provider has reached its ‘capacity.’**

— Neural Audio

is largely unused much of the time. Since the minimum overlap exists between the NFL and MLB seasons, both sports packages could be offered to current XM and Sirius subscribers without regard to bandwidth constraints. ...

[T]he NAB Engineering Statement incorrectly identifies XM’s codec as MPEG-AAC. In fact, XM’s audio codec utilizes a proprietary version of the aacplus (MPEG 4 HE AAC) open standard, which uses Spectral Band Replication to further enhance compression efficiency. ...

Fourth, the NAB Engineering Statement misstates the alleged channel capacity of both companies... [specifically] that XM and Sirius offer 148 and 123 channels, respectively, which it then claims represent the maximum number of





# AM / MW DUMMY LOADS



**KINTRONIC LABS, INC.** **KINTRONIC LABS, INC.**

## EXTREMELY ROBUST AND RELIABLE!

CONVECTION COOLED			FORCED AIR COOLED		
					
WITHOUT INPUT METER MODEL DL-5-78EIA INDOOR	WITH INPUT METER MODEL DL-5-78EIA INDOOR	MODEL DL-5-78EIA OUTDOOR	MODEL DL-50-318EIA INDOOR	MODEL DL-50WP-318EIA OUTDOOR	

## KINTRONIC

PHONE: 1-(423)-878-3141  
FAX: 1-(423)-878-4224



## LABS, INC.

Email: [ktl@kintronic.com](mailto:ktl@kintronic.com)  
[www.kintronic.com](http://www.kintronic.com)

# Wireless Broadband Internet Remotes



*"The first time out with the Tieline was a brilliantly simple experience for everyone involved. For lack of a better phrase, the codec just worked."*

- Christian Vang  
Chief Engineer  
Clear Channel St. Louis



*"The codecs sounded great. My management was very, very impressed with the demos"*

- Grady Jeffreys,  
Technical Manager,  
Mackay Communications



*"The remote was a spectacular success, in no small part thanks to the flawless sound which the Tieline G3 provided over the public Internet"*

- Mike Rabey  
Chief Engineer  
Entercom Indianapolis

**100%**  
\*COMREX  
POTS  
Compatible



**Get Free demo codes delivered to your door Now!!**

**Tieline**   
www.tieline.com

**800-750-7950**

\*Compatible with Comrex Matrix, Blue, Vector POTS Codecs Comrex is a registered trademark of Comrex corporation

GUEST COMMENTARY

# The Customer Should Always Be Right

*Equipment Manufacturers and Others Must Address Lack of Customer Service*

by Thomas R. Ray III

I don't know. Maybe it's the fact that I'm getting older and becoming a curmudgeon in my old age. But is it me or does it seem like manufacturers' and vendors' Customer Service Departments are more like *lack* of Service Departments these days?

Used to be a piece of equipment came with a relatively detailed technical manual that included a theory of operation and could answer 95 percent of any questions

you may have, including repairing said equipment. Today, if you get a manual at all, it often is incomplete and does absolutely nothing to advance your knowledge of the gear.

So when there is a problem, you are forced to pick up the phone and call Customer Service. Here is where the trouble begins.

I can count on one hand the manufacturers or vendors in



which I have confidence and from whom I can expect a very useful answer. That's sad.

Some recent examples:

- We recently had an ISDN line failure at the WOR studios. The tech they sent out discovered a broken wire on the main-frame in the basement of the building.

He scored points for actually looking at the frame, as he said the break wasn't obvious and he had to move the wiring around to find it. But when he came back up to our Master Control room, he had zero clue as to how to tell if the ISDN circuit were functioning.

He had no ISDN test set with him. He was a DSL technician, and said flat out he knew nothing about ISDN. (It amazes me that I, a lowly broadcast engineer, can tell the difference and troubleshoot dial tone, T1, ISDN and DSL, but the tech from the phone company knows *only* DSL!)

The phone company had no business sending him out on the job in the first place having no knowledge of ISDN (as I said, he gets points for fixing the problem). Unfortunately, this is typical.

- I had a question regarding something I was attempting to do with an IP router and called the manufacturer, as their online knowledge base was useless. The person on the other end of the phone, whom I could barely understand, had no knowledge of the product with the exception of what she was reading from the script.

**Don't tell me something isn't a priority.**

I had to explain to her at least five times that I had no access to the product at the time of my call, as I was in traffic on the West Side Highway in Manhattan, and was looking for a simple "yes" or "no" to my question. This was a concept she couldn't grasp, as she repeatedly asked me to log into the device, shuffling pages in the background each time I explained that I couldn't log in because I was nowhere near the product and was in a moving vehicle. I finally thanked her and hung up.

- I had occasion to call a manufacturer of a device regarding an IP aspect of their product. I have two of them and was inquiring as to how I could change the port numbers for the application I was attempting to access so I did not have to set up a VPN at the location of these devices, as it would be extreme overkill. I was told this was impossible and that the application I was attempting to access was "undocumented."

So I did some research. I talked to the software developer their device uses, who promised to call me back shortly. I then researched the application I was trying to run. Turns out it is fully adjustable.

But there was no information in the manual as to how to access this application, so I turned to their competition's Web site and downloaded the manual on the competing product.

There, in glorious black and white, was a complete section on the application. Not documented, my butt. So I followed the competition's instructions and

See SERVICE, page 20 ►



Mike O'Shea, Chief Engineer  
WUSF, Tampa Florida

"When we started shopping for new consoles at WUSF, my first step was to ask my peers what they thought. I posted a question on Pubtech saying I was thinking about switching to a routing system console, and asked for recommendations. The majority of responses led us to Logitek.

We have purchased several Logitek consoles over the past few years, and are amazed at how much console we get for the price. I recently bought two consoles plus a router for less than I paid in 1989 for two analog consoles. When you consider what the 1989 costs represent in today's dollars, the cost savings are incredible and there's no comparison for the flexibility we have today.

Even better is the support we get from Logitek. When I call them with a question, the answer comes back right away. It's obvious to me that Logitek has a philosophy that the sale can never be complete without on-going responsive tech support.

When upgrading your studios, do your homework and ask your peers for their recommendations. My research led to Logitek, and I've been completely satisfied."

**Logitek**  
Console Router Systems

Logitek Electronic Systems, Inc.  
5622 Edgemoor • Houston, TX 77081  
Toll Free: 800-231-5870 • Tel: (713) 664-4470  
info@logitekaudio.com

Learn how you can save time and money at  
[www.logitekaudio.com](http://www.logitekaudio.com).



*Oh Brother!  
Go tell it to an engineer.*

*Hey Babe.  
I'm big where it counts.*

**OMNIA ONE: Small Box. Big Attitude.**

**Omnia**  
A Telos Company  
OmniaAudio.com

Omnia, ONE are registered trademarks of TLS Corp. ©2007. All Rights Reserved.

World Radio History

# AM IBOC

► Continued from page 1  
channel stations that have already made their nighttime transmission equipment preparations will transmit digitally at night first.

One of those 50 kW high-powered stations is Buckley Broadcasting's WOR(AM) in New York. Director of Engineering Tom Ray, a vocal IBOC advocate, said he's ready to go digital at night.

"We have been ready for a long time. We have a bunch of listeners in HD. We can't wait to have it on at night and light up our audience."

Ray, who lives in the null of his station's antenna pattern, plans to listen to his stations and others on the night of Sept. 14. "It will be interesting to drive around and see what happens."

He's curious about the HD reception in his area of other high-powered AM clear-channel stations like WLW in Cincinnati and WGN in Chicago.

Clear Channel Radio was still formulating its nighttime digital plan when contacted in August. Steve Davis, senior vice president for engineering and capital management, said, "Our plan will be to begin nighttime operation on all those AMs under our control which can do so within the prescribed mask in a manner reasonably conforming to our analog patterns. It will be an exciting time to truly

evaluate this technology." Throughout the IBOC conversion process, he said, "We have been measuring our arrays, calculating pattern bandwidth and making other engineering assessments with respect to the feasibility

**Instances in which a station has a single, non-directional tower with a currently compliant daytime HD-R operation are poised to go nighttime digital.**

— Steve Davis, Clear Channel Radio

of in-mask compliant nighttime operation on our AM stations, along with assessing the feasibility and practicality of daytime operation. For some AM stations this simply won't be possible, due to physical factors such as the geometry of the array or tower heights.

"Likewise we have AM stations that we haven't converted to IBOC, even during daytime hours, for the same types of reasons," Davis continued.

"For other stations it will be possible, but only with extensive rework such as a new phasor, which may not happen for some time."

Instances in which a station has a sin-

gle, non-directional tower with a currently compliant daytime HD-R operation are poised to go nighttime digital, according to Davis.

Crawford Broadcasting Director of Engineering Cris Alexander, who like

adjustments you did for daytime have to be redone for night," he said.

Of its 15 AMs, Crawford has converted 12 to IBOC. Out of those, four are ready to go nighttime HD-R.

### Waiting

Cox Radio Orlando Director of Engineering Steve Fluker said, "Personally I don't think the adoption of AM IBOC at night will create a flurry of station upgrades.

"I do think though that most of the stations already operating during the day will welcome the chance to leave it on 24 hours a day. I think we have such a division out there where stations are either totally committed and excited about AM HD and are already in the process of converting, or they aren't behind it yet and are taking a wait and see approach before making the investment."

Several engineers, including Fluker and Glen Clark of Glen Clark & Associates, an AM engineering consultancy, said many smaller AMs that are holding back on converting to IBOC at all, much less at night, are doing so due

Tom Ray contributes to RW, agrees with Davis that stations that have disparate day/night antenna patterns with different power levels have some work to do before they can turn on their digital at night.

"A different nighttime pattern means a different set of parameters, so all the

## How AM Nighttime Interference Or Be Mitigated

Glen Clark's office prepared these interference-prediction maps for Clark's 2002 filing to the FCC about AM nighttime IBOC (story, page 1).

The illustrations show the skywave situation between WJR(AM) in Detroit and WABC(AM) in New York City. These are sister stations to WMAL(AM). All three were recently sold to Citadel from ABC.

Blue contours are from WJR. Red contours are from WABC. There are groundwave and skywave contours, thus a total of four contours in the two maps.

Fig. 1 shows the impact of the WABC Skywave contour on the WJR Groundwave contour. The predicted WABC skywave contour reaches the Detroit River,

although it falls about two miles short of the WJR tower, according to Clark.

In Fig. 2, the contours are reversed. Fig. 2 shows the impact of the WJR skywave contour on the WABC groundwave contour. The predicted WJR skywave contour encompasses 100 percent of Manhattan.

This is just one example of an AM situation where the computer model predicts that the listeners in one market may become aware of nighttime HD transmissions in another market. Clark pointed out that in Fig. 2, WJR's skywave contour also comes within a few miles of Atlanta. Cox' WSB(AM) is on 750 kHz in Atlanta, one channel removed from WJR's 760 kHz.

Clark said it will also be interesting to

### THE BEST OF BOTH WORLDS!



The new AS16585 gives you the best combination of IP connectivity and DSP-based processing:

**ONBOARD AUDIO ACCELERATOR.** We rev up your sound two ways: The powerful integrated DSP gives you realtime processing, without bogging down your PC. And our powerful **Built for Broadcast** technologies like MRX multi-rate mixing, TSX time-shifting, and MP3 compression speed up your workflow.

**LIVEWIRE AUDIO-OVER-IP.** Route 16 channels of 24bit digital audio over your Ethernet network with unprecedented control and flexibility.

**PICK YOUR DRIVER.** Whatever driver you need, we've got you covered. Windows WAVE, WDM or ASIO. XP and Vista. Even Linux ALSA!

**SURROUND SOUND BUILT IN.** Enjoy tomorrow's sound today. Record, play and mix up to 8 channel streams.

To learn more, ask your automation VAR, or call +1-302-324-5333.

**Figure 1 - Map Showing Impact of WABC(AM) Night Skywave on WJR(AM) Night Groundwave**

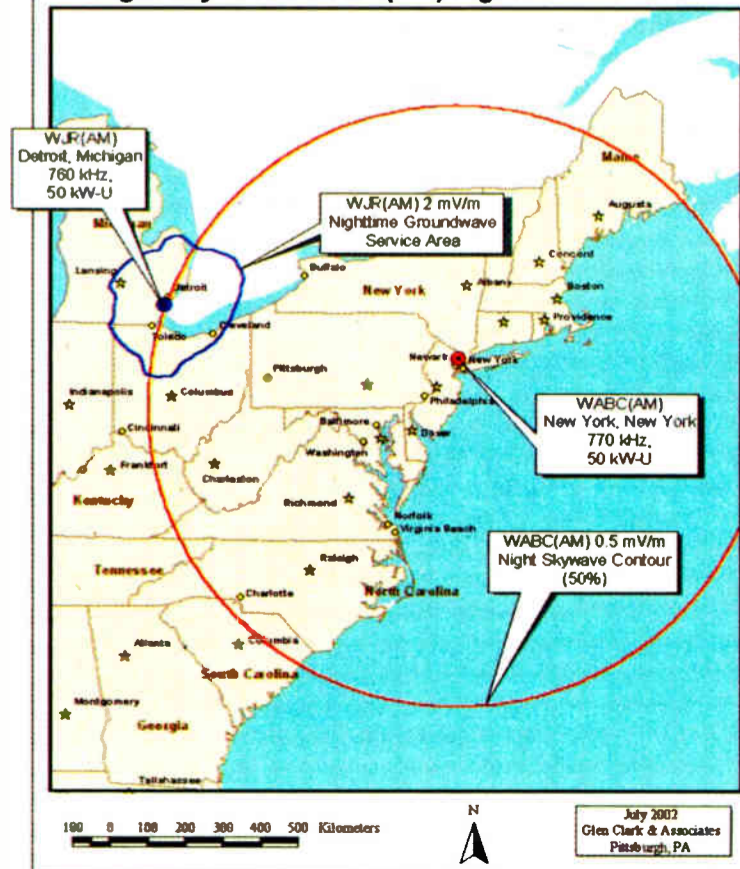

**Figure 2 - Night Skywave**



www.audioscience.com



See us at NAB Radio Show Booth #619

to cost reasons.

Owners should be taking better care of their directional arrays, said Clark. "Ibiquity has a graph that says ideally your VSWR should be less than what's shown in this graph if you want to have good HD performance. Few stations today meet that spec."

Clark has seen some stations that have narrowband antennas "clean those up," but he believes when people realize the correlation between antenna bandwidth and service area, "that's when serious money will be spent on broadbanding."

Fluker agrees that, with AM IBOC antenna systems and especially directional arrays, "It's not advisable to just install the digital exciter and turn it on. The antenna tuning system must be checked first and properly tuned for the digital signal. This goes for both ND and DA systems. Also tuning does not just mean adjusting the match to 50 ohms JO. There is a critical phase match between the antenna and transmitter that must be checked and corrected if necessary."

An improper match, Fluker said, "can cause the digital sidebands to become

less symmetrical across the carrier which will make them more noticeable on AM analog radios. This can be heard as a low hiss, buzz or sort of a 'bacon frying' sound. Properly tuned, these artifacts can virtually go away."

This noise can also be aggravated on wide-band AM radios, he said, such as some that had been carried earlier, but are no longer, by Chrysler and Mercedes.

Opinions are all over the map when it comes to predicting interference on AMs at night to adjacent analog channels from stations broadcasting in IBOC. Several engineers said much of the interference will occur outside a station's FCC-protected contour, and therefore, its listening area.

Ray said Internet discussions came alive after the IBOC rule effective date was published in the Federal Register, and many of those who object to AM

IBOC at night do so because of the technology's assumed diminishment on sky-wave listening.

"They're talking about DX listening. I don't serve the DXer. I serve the local community."

**Null areas tricky**

Here's the rub interference-wise. AM directional antennas present more of a challenge than do non-DAs, observers said. Most directional arrays are adjusted and tuned at the carrier frequency and as the bandwidth is increased, the characteristics of the antenna system can change.

"You may even see some slight changes in the null areas in the different areas of the bandwidth," said Fluker.

"These changes with only the analog audio were not too objectionable, but you might hear the quality of the audio

change as you drive through a deep null. Since the digital sidebands are even further removed, their characteristics in a null will behave differently from the main audio and therefore could create interference to their host channel in these nulls."

Such host channel interference, said Fluker, could be more of a problem than interference to other adjacent stations due to skywave. After all, the HD signal still fits within the legal bandwidth of the AM station.

The engineer who wished to remain unnamed said if he were the owner of a small AM that already has marginal coverage, he'd be asking, "How far does the AM digital signal carry and what problems related to interference will crop up? How far do I get; is it usable or choppy?"

What happens if the FCC receives  
See AM IBOC, page 16 ▶

**Might Occur**

see if the station in Nashville on 1510 kHz has any impact on WTOP(AM) listenership in Washington on 1500 kHz, and what effect the station in Cincinnati on 1530 kHz may have on listenership to the station in Buffalo on 1520 kHz. What impact, if any, will WLW in Cincinnati have on WOR in New York? WLW is on 700 kHz, WOR is at 710 kHz.

Using the maps to illustrate the concept of two stations agreeing to go directional at night and "face" their signals away from each other, Clark said WABC might for example go directional at night, sending more signal east toward Manhattan and less signal west toward Detroit. In return, WJR might go directional at night, sending more signal northward toward Detroit and less signal eastward toward New York City.

**Map Showing Impact of WJR(AM) on WABC(AM) Night Groundwave**

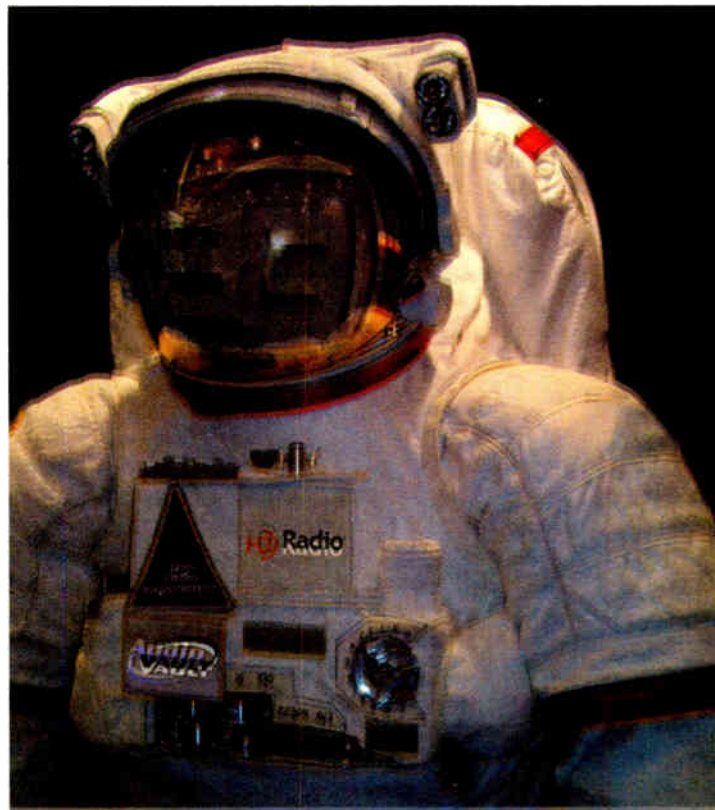

Total Radio. Guaranteed.

**Today & Tomorrow  
BE goes the distance with you**

Our mission-critical solutions for analog and digital radio go the distance for you with unparalleled innovation and product reliability.

BE products— AudioVAULT, The Radio Experience, Big Pipe, FXi FM+HD Radio exciter, analog and HD Radio FM and AM transmitters and more—offer stations a competitive edge for the greatest flexibility in programming, distribution and transmission for increasing listenership and revenue.

But that's only part of the story. BE's customer service is the best in our industry. We combine the traditional values of a company founded in 1959 with the energy and creativity of a start-up.

BE goes where no one has gone before to earn and keep your confidence. That's Total Radio. Guaranteed.



Broadcast Electronics, Inc. • 4100 North 24th Street, Quincy, Illinois 62305  
(217) 224-9600 • brcast@bhdcast.com • www.bhdcast.com

Broadcast Electronics, the BE logo, The Radio Experience and AudioVAULT are registered trademarks, and Total Radio and Big Pipe are trademarks of Broadcast Electronics, Inc. HD Radio is a trademark, and the HD Radio logo is a registered trademark of Intellectual Property Digital Corporation.

# AM IBOC

► Continued from page 15  
interference complaints? Could it change or rescind authority for some AMs to go IBOC at night?

The agency would do so only if large numbers of broadcasters begin to complain about interference, or they believe their livelihood is threatened "and they blame stuff on IBOC wrongly," said one group engineering official.

Ray said the publication of the rules

Clark had an additional solution: Stations might agree between themselves to go directional at night and to face their signals away from each other.

Several engineers agreed the interference issue would eventually resolve itself as new IBOC receivers penetrate the market. But the question is what to do about today's analog receivers.

Clark said many clients are angry it took so long to get approval for AM nighttime IBOC, and some have moved on to what they perceive as other revenue-producing ventures.

Time will reveal whether IBOC will

It takes the shroud off.

— Tom Ray

gives the IBOC technology certainty. "It takes the shroud off." As for the FCC's potential to change its nighttime IBOC rules, he said, "Could they come back and change some things? Of course they could; they're the FCC."

But he and most engineers contacted for this article said drastic interference would have to occur for the commission to rescind nighttime permission. The agency said its rules it would consider interference complaints on a case-by-case basis.

Several engineers believe that in cases of proven AM nighttime IBOC interference, FCC-imposed resolutions might involve requiring a station to reduce its HD-R injection level or requiring a station to reduce power in one digital sideband. The agency could also forbid certain stations from using IBOC at night.

help struggling AMs, he said. Getting in-dash, factory-installed HD Radios is vital because "hardcore early adopters," such as those who buy aftermarket radios, "don't make the Arbitron book," he said.

"Radio today is run by accountants. The comptroller will ask, 'What's the payback?' He doesn't want to know the signal is going out farther. He wants to know how [IBOC] will translate into sales revenues and higher Arbitron ratings," said Clark. He predicts that when a station manager perceives that the competition is beating his station, only then "will the purse strings open up for broadbanding."

"You've got to have receivers in the dashboard for that to be a commercial force," said Clark. Automakers are installing iPod adapters in the dash faster than they are HD Radios, he observed. 🌐

## BROADCASTERS' #1 CHOICE FOR HD MONITORING!



- MODULATION MONITORING
- NRSC MASK COMPLIANCE
- TIME ALIGNMENT MONITORING
- SILENCE SENSING/ANALOG, HD1, HD2 ...
- PSD & RDS DATA MONITORING
- MONITORING OF MULTIPLE STATIONS
- EMBEDDED WEB SERVER & ALARM NOTIFICATION VIA EMAIL, VOICE INTERFACE



## GOLDENEAGLE HD

WITH SPECTRUM ANALYZER AND DIGITAL DEMODULATOR

**Audemat-Aztec**  
Broadcasting Innovation

<http://www.goldeneagle-hd.com>  
Miami, FL USA -  
Tel: 305 249 3110  
ussales@audemat-aztec.com

See us at NAB Radio Show Booth #226

World Radio History

## NEWSWATCH

**NAB** mailed a mock invoice to some 13,000 stations to demonstrate the potential impact of a so-called performance "tax" and get stations involved in its efforts to oppose RIAA. The call-to-action mailer mockingly billed the recipient station for "the privilege of promoting the record labels music free of charge and lining recording industry executives' pockets."

**RADIO ONE** named Barry Mayo president of its radio division. Mayo reports to Al Liggins, who remains CEO. Liggins said Mayo had been a consultant to the company for the past year. Mayo stated: "We are no longer in the radio business, we are in the 'audio entertainment business' and we need to leverage our products well beyond the terrestrial signals we are licensed to operate." Mayo is former president of Broadcast Partners, VP/GM of WRKS(FM) New York and SVP/Market Manager for Emmis Radio in New York. The company also said CFO Scott Royster would leave.

**AUSTIN NEXT:** The NAB will hold its fall Radio Show next year in Austin, Texas. Dates are Sept. 17 to 19, 2008.

**PAUL GREGG**, president of Bauer Transmitters in El Paso, Texas, reported that 11 bays from two used FM antennas were stolen. He believes the items, which were uninsured, were taken for their copper/brass value.

**NEWBAY MEDIA** has formed a new Video/Broadcast Group, which will be run by the former CEO of IMAS Publishing. The company, owner of Radio World and other former IMAS publications since its recent acquisition of IMAS, said this move combines strengths of NewBay titles like Television Broadcast, Government Video and Videography with IMAS

broadcast titles TV Technology and Radio World. The group is headed by Executive Vice President Carmel King, former CEO of IMAS Publishing.

**NON-COM WFUV(FM)** in New York will use a \$500,000 grant from The New York State Music Fund to support development of an HD2 channel featuring alternative music. The fund is from money that labels and some radio groups paid out to settle so-called "payola" allegations by former New York State Attorney General Eliot Spitzer, who is now governor. The Fordham University licensee's main format is Triple A; the second stream targets listeners in their 20s and 30s.

**ALERT FM:** Global Security Systems and 3n are collaborating on integrating the latter's "mass notification" technology with Alert FM.

**FAME:** The National Radio Hall of Fame announced its Class of 2007: Jerry Coleman, Jimmy Durante, Richard Durham, Dan Ingram and Marian McPartland.

**SBE:** Barry Thomas ran unopposed to become president, replacing two-term president Chriss Scherer.

**WORLDSPACE** reported operating expenses that continue to far outweigh its revenue, in a quarterly summary filed with the SEC. "The company has incurred an accumulated deficit of approximately \$2.4 billion through June 30, 2007 and expects to continue incurring losses for the foreseeable future," it stated.

**GEORGE MOORE**, longtime engineer with the government's international broadcasting organizations, died in August, according to the Broadcasting Board of Governors. He was 54.

## Merger

► Continued from page 6  
licensees seriously. But, claims by the NAB and others that the companies cannot be relied upon to comply with merger conditions due to alleged rule violations are little more than a rhetorical sideshow.

**Interoperability** — Opponents continue to suggest that XM and Sirius have violated a commission mandate to develop, manufacture or market an interoperable receiver, but that is incorrect. In implementing its rules for the satellite radio service, the FCC required all satellite radio licensees to develop designs for an interoperable radio and to certify that they have done so. ... As the companies explained in the application, they have fully complied with the commission's requirement by certifying to the agency that they completed a design for an interoperable radio.

**FM Modulators** — Last year, the FCC's Enforcement Bureau issued inquiries to both companies concerning the possibility that some of their receivers were non-compliant with commission regulations. Sirius and XM each timely responded to these inquiries, and both have cooperated fully with the

Enforcement Bureau in its investigation of this matter. All newly produced receivers are fully consistent with applicable regulations. ...

**Terrestrial Repeaters** — Sirius and XM voluntarily brought their terrestrial repeater variances to the FCC's attention after taking unilateral actions to bring many of those variances into compliance. In October 2006, Sirius informed the commission that 11 of its terrestrial repeaters had been operating at variance from their approved specifications. Sirius has turned off each of the repeaters and filed requests with the agency to reauthorize them. ...

Similarly, XM voluntarily notified the FCC in October 2006 that its terrestrial repeater network "as built" varied from the authorizations that originally were granted for the construction of the network. At that time, XM took steps to eliminate the largest variances by turning down the power levels of numerous repeaters and turning off the transmitters for others. As XM explained to the commission in its request to reauthorize its repeaters, the network as built is far smaller and less powerful than what the commission initially authorized and thus should be far less troubling to licensees of adjacent spectrum. 🌐



# ONE

Harris — The ONE choice for end-to-end radio solutions.



## ZX™ Series

FM tri-mode transmitters featuring multiple PA modules and power supplies for maximum redundancy. When used with the FlexStar™ HDx Exciter, the ZX™ Series can operate in either digital only or FM/FM-HD. ZX transmitters are available from 500 W to 3500 W.

## FlexStar™

HDx Exciter brings HD Radio™ and analog audio to a new level. Featuring real-time adaptive correction for increased power and efficiency and the latest iBiquity platform in HD Radio™ —Exgine—HDx Exciter unlocks new revenue streams.

## Destiny™ 3DX-50

Highly efficient, medium-wave transmitter, and the latest in the DX™ family of world-class digital AM transmitters. Fully compatible with HD Radio and DRM. Harris AM transmitters are available from 1 kW to 2 MW.

## PR&E NetWave™

Modular, network-enabled, high-performance radio broadcast console packed with features that are perfect for small to medium studios. Share all your studio resources throughout the facility with the Harris® VistaMax™ audio management system.

HD Radio is a trademark of iBiquity Digital Corporation.

From AM/FM and HD Radio™ and DRM transmission to program audio transport to consoles to broadcast studios — Harris offers you the best products and systems in the business backed by outstanding customer service.

For more information visit [www.broadcast.harris.com/radio](http://www.broadcast.harris.com/radio), call +1 800 622 0022 or [broadcastsales@harris.com](mailto:broadcastsales@harris.com).

Harris is the ONE company delivering interoperable workflow solutions across the entire broadcast delivery chain with a single, integrated approach.

Business Operations • Media Management • Newsrooms & Editing • Core Processing • Channel Release • Media Transport • **TRANSMISSION**

**HARRIS**®

assuredcommunications®

Broadcast • Government Systems • RF Comm • Microwave

[www.harris.com](http://www.harris.com)

World Radio History

# Mexico Steps Toward Digital Standard

*IBOC for the Northern Border; Probable Adoption of Eureka-147 for All of Mexico*

by Gabriel Sosa Plata

**MEXICO CITY** Mexican stations along the U.S. border can transmit AM or FM IBOC on an experimental basis.

The Mexican government also is on the verge of formally approving IBOC for radio broadcasters along the U.S. border. For the rest of the country, the choice of a digital standard remains pending.

The Mexican communications regulator, Comisión Federal de Telecomunicaciones, or Cofetel, recently prepared a document titled "Digital Terrestrial Radio



Secretary of Communication and Transport Luis Téllez Kuenzler during the 71st convention of the National Chamber of the Mexican Radio-Television Industry

Transition Policy for Radio Broadcasting Stations Located Within the Coordination Zone of Mexico's Northern Border" for consideration.

Cofetel is a decentralized unit of the Secretary of Communication and Transport. Cofetel was granted that body's former role in overseeing and regulating radio and television in 2006.

#### The document

According to the document, as a first stage in the digital transition process, commercial and non-profit broadcasters in the coordination zone of the northern Mexican border may voluntarily transmit using the IBOC system.

The coordination zone stretches about

200 miles south from the U.S.-Mexico border. Mexican and U.S. authorities are obliged by international agreements to coordinate frequency use in the zone. Indeed, Mexico has recently protested to the FCC that the regulator approved AM nighttime IBOC in the United States without reference to those international agreements. See story, page X.

Earlier Cofetel documents also state that Mexican stations have reported reception quality problems due to the U.S. adoption of IBOC. Mexico has

See MEXICO, page 19 ▶

## Mexico Wants FCC 'Do-Over' On IBOC

This development has some AM stations, in particular, worried. Mexican officials say they are not happy the FCC issued IBOC rules governing broadcast transmissions without coordinating those through international treaties.

In a letter to Chairman Martin filed in the IBOC docket, the Mexican Federal Telecommunications Commission states that "until technical criteria" have been established between the agencies to allow "optimal and efficient development of analog and digital radio broadcasting along our common border," the commission should hold off.

Sources told Radio World they believe Mexico filed so it would have standing in any proceeding on IBOC and to have a way to adjudicate interference claims for the border area.

Indeed, the Mexican regulator also refers to possible interference from U.S. IBOC stations to Mexican stations as a reason to have the coordination completed according to treaties first.

Engineers contacted by RW also believe that if the FCC receives interference complaints from Mexico once U.S. AMs go IBOC at night, it may either ask the interfering stations to drop the injection level of one digital sideband, ask a non-directional station to go directional or cease IBOC operations at night.

Before the FCC's IBOC rules were published in the Federal Register, producing an effective date of Sept. 14 for the changes to take effect, some IBOC proponents speculated the Mexican situation might have accounted for the delay in publication. Other IBOC proponents said the delay was "procedural" at the commission and not related to the international treaty issue.

Glen Clark, principal of Glen Clark & Associates, characterized the Mexican letter as "unsettling," making some stations wonder if the FCC would be put in a position where it may have to repeal nighttime AM IBOC authorizations. "It may be 'trading bait' and have nothing to do with HD or AM," he said. "But the fact that they went on the record tells me this isn't just grousing."

The FCC was expected to answer Mexico's letter, sources said in August.

— Leslie Stimson

## HOW does the Next Generation *SAGE ENDEC*

Help you meet your upcoming EAS requirements?

With the FCC's recent Report and Order mandating that all broadcast facilities have Common Alert Protocol (CAP) capabilities, *Sage ENDEC* brings the solution to you at the NAB Radio Show in **Booth 229.**

Visit with Harold Price and Jerry LeBow, developers of the *Sage ENDEC*, and find out what you need to do to satisfy your new FCC EAS requirements. See demos of CAP and all the other new *Sage ENDEC* features at the booth.

**SAGE**  
ALERTING SYSTEMS, INC.

800 Westchester Avenue, Suite 641 North  
Rye Brook, NY 10573  
Phone 914 872 4069  
info@sagealertingsystems.com

# Mexico

► Continued from page 18 raised the issue with the FCC so that it can "take the necessary measures to avoid such problems."

At press time, the document was still in a consultative phase. Once opinions and suggestions have been received from the public, government agencies and stakeholders, Cofetel will send the document to the Federal Commission on Regulatory Improvements for a secondary hearing.

The final version of the new rules would go into effect once they are published in the Official Daily of the Federation. The document had not been finalized, nor published, as of August.

Once the rules are published, Cofetel said, commercial and non-profit broadcasters who seek to use IBOC would receive authorization quickly.

## Speedy adoption

Secretary of Communication and Transport Luis Téllez Kuenzler told the recent convention of the industry group National Chamber of the Mexican Radio-Television Industry (CIRT) that the government hopes IBOC transmissions will start as soon as possible in the northern frontier "to keep the industry competitive."

Téllez said that Mexico must acceler-

ate its studying of the available standards and the spectrum each requires in order to determine how the various digital radio technologies might be used to the public's advantage. Cofetel is analyzing three standards: HD Radio, Eureka-147 DAB and Digital Radio Mondiale.

The president of the CIRT Consultative Council, Eduardo Laris Rodríguez, said a digital radio standard should be a priority for Mexican authorities "because the technology already exists, and should be used to serve the Mexican people."

With regard to a standard that will be developed for the whole of Mexico, the CIRT has voiced its support on various occasions for a mixed system: using Eureka-147 DAB as a national standard, but allowing HD Radio along the U.S.-Mexico border.

Non-profit stations have not put forth a united front regarding a digital standard for Mexico.

The future of digital terrestrial radio appears on the verge of definition in Mexico, but questions remain.

For several years, the Consulting Committee on Digital Radio Broadcasting Technologies (CCTDR), made up of representatives from both industry and government, has conducted transmission tests of FM IBOC, Eureka-147 and, more recently, AM IBOC in Mexico City. In addition, the station Radio Educación has tested DRM transmissions.

CIRT, working with the private radio group Grupo Radio Centro, continues to operate a Eureka-147 transmitter for testing purposes.

The results of the different digital terrestrial radio transmission tests have not

been disclosed publicly.

Raúl Trejo Delarbe, a researcher at the Universidad Nacional Autónoma de México, said that, seven years after its creation, the work of the CCTDR remains a mystery.

"Who knows what technical trials its members have performed; but in any case, they certainly haven't yet found an obvious answer to the question of digital radio," Trejo said. This parallels the position of the community radio association and the communications research association for Mexico.

"An issue that could and should be discussed in the widest possible manner, putting options, costs and projections on the table, has been kept behind the scenes out of fear of technological convergence and exchange of ideas on the topic," Trejo said. 🌐

# McLane

► Continued from page 4 suppliers, as well as long-form interviews and profiles by our contributors. It was frustrating to have such content or conceive those ideas, yet not be able to give them the space they deserved.

The solution seems obvious in hindsight but was not so at the time. With RW Engineering Extra we found a way to solve both problems; it has been an unqualified success. Congrats to all who had a hand in making it work.

If you're an engineer and not already getting RWEE, be sure to sign up using the Subscribe button at [radioworld.com](http://radioworld.com).

★ ★ ★

What are the world's seven "wireless wonders"?

Recently broadcast veteran Gary Allyn posted an interesting item on his Web site. Reading news of yet another list of the "New Seven Wonders of the World," Allyn came up with his own as they would apply to the broadcast industry.

"They are just some that come to mind, and are in no particular order," he wrote, and listed several batches. Among them are the following, his "seven wonders that have had great impact."

1. The gramophone (and all phonograph records)
2. Guglielmo Marconi
3. Computers
4. Audio tape and compact discs
5. Heinrich Hertz (discoverer of radio waves)
6. Lee De Forest
7. David Sarnoff

How did Gary do? What would you list as radio's "seven wonders of the wireless world"? Tell me at [radioworld@imaspub.com](mailto:radioworld@imaspub.com). 🌐

the professional broadcaster's choice for

# IP STLs

WorldCast Eclipse



**At last! An IP audio codec that offers a reliable, DSP-based platform and automatic back-up for 24/7 reliability.**

APT's WorldCast Eclipse is the ultimate in flexibility and choice offering IP, X.21/V.35 and ISDN interfaces and a selection of popular coding algorithms including Enhanced apt-X, MPEG Layer 2/3, MPEG 4 AAC, G.711 and G.722

All the features you expect from a professional broadcast codec are supplied as standard: analog and AES/EBU I/Os, adjustable silence detection, alarm ports, contact closures, speed dials, embedded auxiliary data and many more...

Configuration and control of the WorldCast Eclipse is straight-forward and simple thanks to APT's powerful and intuitive Codec Management System (CMS). Offering extensive real-time management of multiple codec units, the CMS enables alarm monitoring, logging and performance monitoring as well as configurable user and audio profiles.



To see the full functionality of CMS, download a trial version from [www.aptx.com](http://www.aptx.com).

Also Available:



**WorldCast Horizon**  
Bidirectional stereo audio codec offering Enhanced apt-X over IP



**WorldCast Meridian**  
Multi-algorithm audio codec with both IP & X.21/V.35 interfaces



**WorldNet Oslo**  
Professional, Modular Audio Multiplexing Platform offering up to 14 stereo channels over T1/E1 or IP links with Enhanced apt-X or linear audio. Built-in redundancy, automatic back-up and hot-swappable cards ensure round the clock reliability for multi-channel STLs.



APT Headquarters  
Tel: +44 (0)28 9037 1110  
Email: [info@aptx.com](mailto:info@aptx.com)

APT North America  
Toll Free: 800 955 APTX  
Boston Tel: 781 810 2260  
Email: [sales@aptx.com](mailto:sales@aptx.com)



[www.aptx.com](http://www.aptx.com)

# Service

► Continued from page 12  
accessed the application.

I also figured a temporary away around my port dilemma. Then the software developer contacted me with information on where the port information was located. I'm waiting for this manufacturer to read through the "undocumented" documentation I sent to them and get me instructions to log into the device to change the ports. Why did I have to do the legwork?

• Same manufacturer. A feature that was previously working stopped working. So I called Customer Service and said, "Well, I must be doing something wrong."

They responded with, "You mean, you had it working?" Turns out there is a software bug. I asked if it were being addressed. The response was that they would get to it, but it wasn't a priority.

So I listed the four 50 kW stations in New York, mine included, that need this feature — we all have the same device — then asked, "How many more 50 kW stations in New York would need to use this feature before it becomes a priority?" Funny how that question gets things fast-tracked.

• I ordered a new snow blower after my 16-year-old one at home went to that big junkyard in the sky. I was told I would be contacted within 10 days for delivery. On the 12th day, I called Customer Service.

I called every day until the 20th day, when I threatened to cancel the order right then and there, thereby sticking

them with freight charges, as, I discovered, the blower had been shipped to and was in a warehouse not a 50-minute drive from my home. It's amazing how fast delivery was scheduled for the next day.

**Today, if you get a manual at all, it is often incomplete and does absolutely nothing to advance your knowledge of the gear.**

• The only positive experience I've had relatively recently was with an X-Box 360 I bought my son for Christmas.

The hard drive unit was DOA out of the box, as verified by the error code that came up and by following the directions on Microsoft's knowledge base, which also recommended calling Microsoft. I did. On Christmas Day. Kudos to Microsoft for having a fully staffed Customer Service Center with knowledgeable people, who verified my diagnosis and advised me to return it to the place of purchase, and provided me with a "case number" in the event of any trouble with the store.

I had purchased this online at *bestbuy.com*, so I called the local BestBuy on the 26th, explained the situation, and they said, "Come on in!" I don't think I was in the store 10 minutes. The only caveat is that, when returning something purchased online, they can't exchange it. You need to return it, and then purchase a new one. Mine came with a fresh purchase date and a \$20 gift card! It was absolutely pleasant.

### What needs to be done?

Manufacturers should provide complete and accurate information either in printed form or on their Web sites. If the software changes, make the information changes with the release of the new version.

Hire people who are interested in and train them to be knowledgeable in their products.

Stop reading from scripts! Not every problem falls conveniently into a template!

Don't lie. Don't tell me something is "undocumented" when you simply don't know the answer. Tell me you don't know and will research it.

Don't tell me something isn't a priority. I'm calling about it. It's a priority to me.

L-I-S-T-E-N to what the customer calling is saying. You may learn the customer's actual needs.

I think it would be interesting to hear from a few manufacturers to get their perspective. I tend to do business with companies that treat me like a valued customer, listen to what I have to say and help me in every aspect so I can get the job done. Customer Service is severely lacking in all areas, not only in broadcast.

I hope that manufacturers start taking their Customer Service commitment seriously and start remedying this situation. Then maybe the customer, like me, won't be a grump when they call.

*RW welcomes other points of view to radioworld@imaspub.com.*

*Tom Ray, CPBE, is vice president/corporate director of engineering, Buckley Broadcasting/WOR Radio, New York. E-mail him at tomray@wor710.com.*

## Primosphere

► Continued from page 3

the Primosphere request would be answered when the satellite radio merger review is completed.

Asked for comment, NAB spokesman Dennis Wharton said, "NAB takes no position on the merits of the Primosphere claims, but their interest once again shows that it would be bad public policy to have a monopoly entity control all the spectrum allocated to satellite radio service."

XM did not respond to a query for comment.

## Ethernet path...

IP-based equipment control

Remote mirrored servers

Transmitter remote control

RBDS

Surveillance and security

Backup audio path

## to the transmitter site.



Innovative IP-based applications save money, save time and protect valuable station assets. But how to get IP connections at remote transmitter sites?

**LanLink HS-900** provides IP Ethernet and RS-232 data where no wires or cables exist. And without licenses, leases or new antennas.

Ask the digital STL experts today.

**Moseley**

Dave Chancey 805.968.9621 Bill Gould 978.373.6303 [www.moseleysb.com](http://www.moseleysb.com)

See us at NAB Radio Show Booth #308

World Radio History

# SCMS

## Service and Pricing you can Count On!



### Orban CRL

**1967**

First Orban product sold to customer: a stereo synthesizer sold to WOR-FM, New York.

**1972**

Bob Orban's first of 24 patents issues (U.S. #3,370,106, "Stereo Synthesizer").

**June 2007\***

SCMS acquires assets of Major Broadcast Equipment Supplier

**2005**

Orban Optimod 8500 Third Generation of Digital Processing is released and takes audio processing to a new level of industry setting standard.

**2003**

OPTIMOD-FM 8300 is introduced at NAB in Las Vegas. OPTIMOD-PC ships. World's first audio PCI Sound Card with Optimod-class DSP for broadcast signal processing.

**2000**

Orban Optimod 8400 Second Generation of Digital Processing is released to immediate great reviews and becomes the new industry standard.

Orban Inc. is purchased by CRL from Harman International.

**1996**

First low-priced, all digital processor for FM introduced. OPTIMOD-FM 2200. The DSE 7000FX introduced with new DSP engine offering on-board effects like reverb, equalization and compression.

**1991**

Orban leads the transition to digital with the first successful DSP-based FM audio processor, OPTIMOD-FM 8200. Thousands on air around the world.

**1987**

Orban's first product using micro-processor technology is introduced. The 787A Programmable Mic Processor incorporates equalization, compression, and de-essing in a digitally-controlled analog signal path.

**1975**

OPTIMOD 8000 audio processor introduced for the new FM format. Bob Orban and partner, John Delantoni, set up Orban Associates as a privately held company.

**1976**

SCMS founded by Bob Cauthen

**1978**

OPTIMOD-AM 9000A offers AM stations a more "FM-like" sound quality and reduced interference. In modified form, the receiver equalizer and low-pass filter ideas form the basis for the NRSC-1 standard issued in 1987.

**1983**

OPTIMOD-TV Model 8182A introduced. Adds Hilbert Transform clippers and a CBS Loudness Controller to the original 8180A.

**2007\***

Orban begins shipping the new Optimod 6300 high-quality, multipurpose stereo audio processor for digital radio, digital television, netcasts, STL protection, satellite uplink protection, and digital mastering. Orban also introduces the all-digital 9300 Optimod-AM audio processor for monophonic AM shortwave, medium wave and long wave broadcasts.



**Orban Optimod 6300**

Three Processors in One:

1. A no-compromise processing chain for digital transmission and media
2. A studio AGC (with peak limiting for STL protection)
3. A talent headphone processor

Here  
for the  
Long Haul!

\* Go to <http://www.orban.com/about/timeline/> for a full look at Orban's timeline.

Mid-South: 1-877-391-2650 Bob Mayben  
 Central: 1-731-695-1714 Bernie O'Brien  
 West Coast: 1-866-673-9267 Doug Tharp  
 Mid-West: 1-513-899-3036 Mary Schnelle  
 South-Atlantic: 1-770-632-1295 Art White  
 North-East: 1-315-623-7655 Jim Peck  
 South-West: 1-210-775-2725 John Lackness  
 North Central: 1-513-376-8600 Pam Lefler  
 Pro Audio: 1-877-640-8205 Ric Goldstein  
 Latin America: 1-760-650-1427 Lily Massari

**Contact SCMS**  
 at any of its offices  
 to discuss your needs  
**1-800-438-6040**  
 Bob, Ernie, Matt, Mike or Andy  
 HQ in Pineville, NC



**www.SCMSinc.com**

Go to <http://www.scmsinc.com/07022007.htm>



# Tech Sessions Delve Into Digital

*Topics Include Leasing Bits, HD Measurements, Transmitter Tips and a New SBE Certification*

by Scott Fybus

The NAB Radio Show is a place to see the latest processors, transmitters, console and other gear on the exhibit floor. It's a good place to socialize with others in the industry, too.

But for the engineering community, Charlotte also will be a spot for an intensive education in the latest broadcast technology, in three days' worth of technical workshops.

The workshops begin Wednesday, Sept. 26, with the Society of Broadcast Engineers' Radio Engineering Forum. As larger broadcasters refine their HD Radio implementations and smaller stations prepare to make the jump into the digital world, this year's forum has a strong focus on HD Radio and other digital technologies.

## EPG and more

The morning begins with an "HD Radio Technology Update" from Raymond Miklius, vice president at Broadcast Electronics.

With the impending transition of HD Radio from experimental to full commercial status, Miklius says broadcasters will soon have new uses that go beyond just audio on their data stream.

"Leasing bits in the HD stream for anyone who wants to transport data will be an important use," Miklius said.

Those customers can include billboard companies and other advertisers who need to do occasional "large object transfer" of data to displays in remote locations, as well as electronic program guide

data and perhaps premium programming that makes use of the "conditional access" technology now being developed.

Before the data stream can get to customers, it has to successfully make its way from transmitter to antenna, and then out to receivers. Measuring those digital signals isn't always as easy as using an old-fashioned field-strength meter or modulation monitor, though.

Tim Holt of Bird Electronic Corp. will discuss some of the new challenges of VSWR measurements in broadcast systems, followed by Ben Brinitzer, Clear

Channel regional vice president of engineering, who will speak on "The Pitfalls and Procedures of HD Radio Measurements."

## Are you a DRB?

In a world where broadcast engineers need to know as much about codecs and network analyzers as they do about microphones and cart machines (and yes, there are still some of those out there), the SBE is unveiling a new certification program.

Ralph Hogan, chairman of the SBE's DRB Specialist Certification Committee, and SBE President Chriss Scherer will discuss details of the Digital Radio

See TECH, page 24 ►

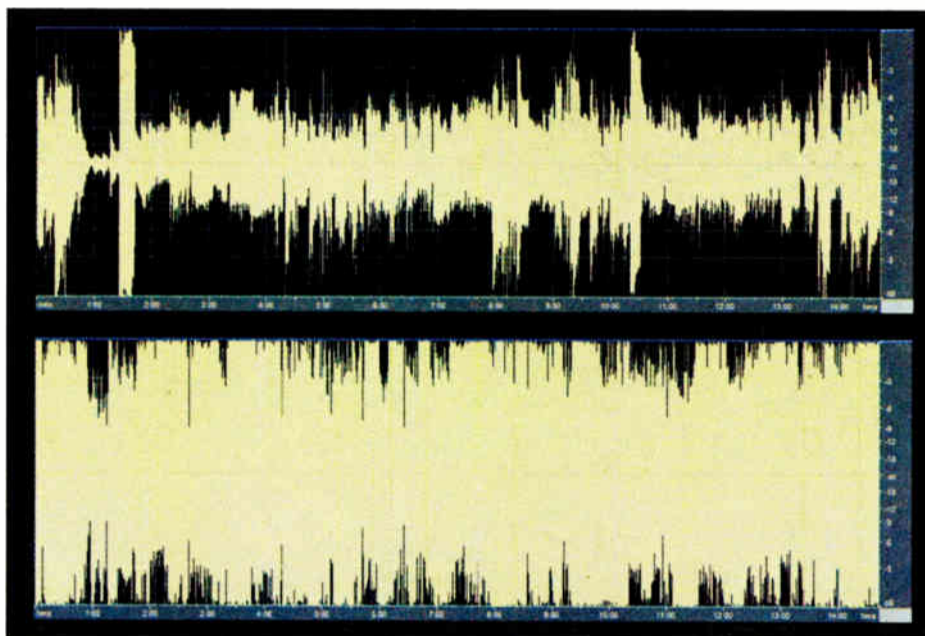

Greg Ogonowski will present in the session 'Processing for HD Radio.' This comparison shows the difference in density and consistency between unprocessed audio, top, and processed audio.



## How to Go

**What:** NAB Radio Show

**Where:** Charlotte Convention Center, Charlotte, N.C.

**When:** Sept. 26-28

**Who:** Dallas '06: 3,099 attendees. Philadelphia '05: 3,789.

**How:** [www.nabradioshow.com](http://www.nabradioshow.com). On-site registration opens Tuesday at 3 p.m.

**Housing:** call (703) 205-9114 or e-mail [nab07housing@expovision.com](mailto:nab07housing@expovision.com)

**How Much:** NAB members \$495 until Sept. 21, \$595 after. Non-members: \$795/\$895. Spouses \$100. Marconi tickets separate, \$100.



## BURLI. COMPLETE NEWS PRODUCTION FOR RADIO.

**BURLI.** A newsroom system for modern radio newsrooms. All the news management tools you expect... plus support for the latest technologies, formats and standards. All in a proven, stable, easy-to-use package used by newsrooms of all sizes across America and around the world.

TO FIND OUT HOW BURLI CAN WORK FOR YOU...

[www.burli.com](http://www.burli.com) | [info@burli.com](mailto:info@burli.com) | +1.604.684.3140

**Booth 610  
NAB Radio  
Show.**

**BURLI**





# SANITIZED FOR YOUR PROTECTION

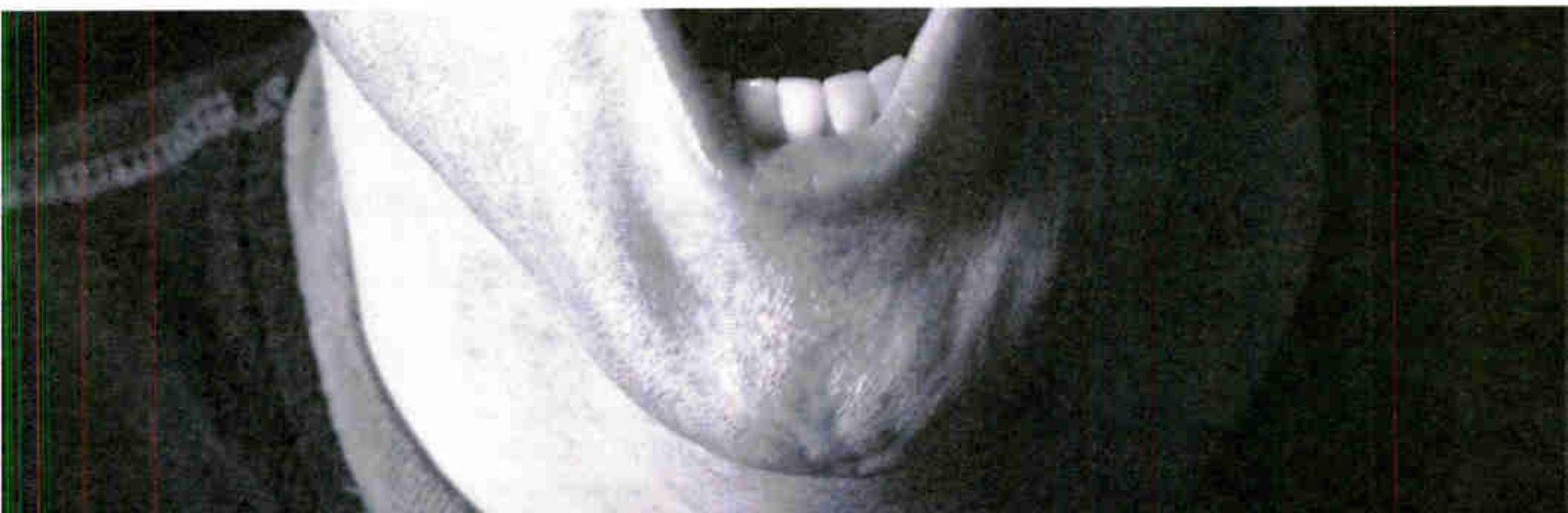

# SOME WORDS SHOULD BE OBSCENE AND NOT HEARD



Eventide Broadcast Delays are designed to keep profanity off your air, and angry listeners, embarrassed advertisers, and the FCC off your back. We invented the obscenity delay and have a solution for stations large and small that provides up to 80 seconds of the highest quality revenue and license-protecting delay.

Our new HD compatible BD600, 24-bit delay, comes standard with AES/EBU, and provides up to 80 seconds of memory — twice as much as other delays. There are fully adjustable Delay and Dump functions, and a Sneeze function which “excites” audio entering the delay, allowing the host to sneeze, cough, or make a short comment without being heard on air.

The BD600 offers two different methods of delay buildup and

reduction. Eventide’s catch-up and catch-down system, and an exclusive fast-entry-and-exit feature which allows starting a broadcast with the delay already built up to a safe amount and ending it with a rapid reduction of delay.

For HD, the BD600 offers MicroPrecision Delay™ mode which allows up to 10 seconds of delay to be adjusted in real time in 100 nanosecond increments. This is useful for synchronizing analog and digital signals while on-air, without audible artifacts, to maintain a seamless user experience.

Whatever your size, whatever your format, you can’t expect to protect the integrity of your air and the foundation of your business without an Eventide Broadcast Delay in your rack.

# Eventide®

HD COMPATIBLE

One Alsan Way, Little Ferry, NJ 07643 tel.201.641.1200 [www.eventide.com](http://www.eventide.com)  
Eventide is a registered trademark and MicroPrecision Delay is a trademark of Eventide Inc. ©2005 Eventide Inc.

World Radio History

# Tech

► Continued from page 22

Broadcast Specialist program to be formally unveiled later this fall at the SBE's national meeting in Pittsburgh.

Later in the morning, two giants of the audio processing world will share the stage to discuss one of the stickiest issues of the digital transition: the need to change completely the way most engineers have thought about processing for decades. The session is "Audio Processing for HD Radio."

"You now have two entirely different signal paths at most stations," says Greg Ogonowski, vice president of new product development at Orban/CRL. "There's one for analog processing with pre-emphasis, and one for digital without pre-emphasis."

Ogonowski says the latter path can — and often does — feed multiple transmission sources, from HD Radio to Webcasts to satellite transmission.

He and co-presenter Frank Foti, president of Omnia Audio, agree that the HDC codec being used for HD Radio presents challenges. "It's not the best codec, and not the worst," Ogonowski said.

Foti says the increased emphasis on multicasting at lower bit rates on HD FM stations is making processors work harder.

"Dynamics processing needs to have some added functioning to condition audio to sound good at lower bit rates," Foti said.

At any bit rate, though, Ogonowski

said the move away from the pre-emphasis that's been used in most forms of analog recording and transmission, from LPs to tape to FM broadcasting, opens up the opportunity for much cleaner high-frequency audio.

"To me it's a big selling point," he said.

That, in turn, means rethinking some aspects of studio design to make sure digital and analog transmission chains both get what they need for quality signals.

Ogonowski says avoiding digital audio compression at the studio end is a good place to start, in order to avoid creating artifacts further down the chain when the audio is compressed again for transmission.

thing out on the edge of town that breaks right at the worst possible moment."

John Bisset, Broadcast Electronics' Northeast regional sales manager and writer of RW's popular *Workbench* column, says that in these days of staffing cutbacks, it's important for even non-technical types to have some understanding of what really goes on out there below the blinking lights.

His "AM/FM Transmitter Workshop & Breakfast" was a fixture for several years at the NAB Radio Show.

"This workshop started a number of years ago with a discussion of engineering for non-engineers," Bisset said.

It returns this year by popular demand, "focused for people who want a good refresher course, or for studio engineers who are, frankly, scared of the transmitter site," Bisset said.

With contract RF engineers increasingly stretched thin and in-house engineers focused on IT issues at the core of much of today's technology, Bisset says it's important for several people at any given station to have at least a basic understanding of some of the troubleshooting techniques that can help them get a station back on the air in a crisis.

"We'll tell them what not to touch so they don't kill themselves," Bisset said. "It's wise of NAB to not leave these guys hanging."

"There'll be a little on HD Radio as well," Bisset says, for stations contemplating the digital future. The focus, however, will be on the good old analog sites that still represent the majority of broadcast facilities in small and medium markets.

One tip Bisset offers, even for those who can't make it to Charlotte: Don't be afraid to use transmitter manufacturers' field-service hotlines. He says transmitter makers build the price of that service into their products' cost, so there's no reason to be hesitant to call for help when there's a crisis.

Attendees will receive a take-home workbook and breakfast, both sponsored by BE, but Bisset says representatives from most of the big transmitter manufacturers will be on hand to round out the session with a roundtable discussion of their products and some time to answer questions from the audience.

Also during the show, the National Radio Systems Committee will meet on Wednesday afternoon. 

## MEASUREMENT EQUIPMENT SETUP - SEPARATE ANALOG AND DIGITAL ANTENNA INPUTS

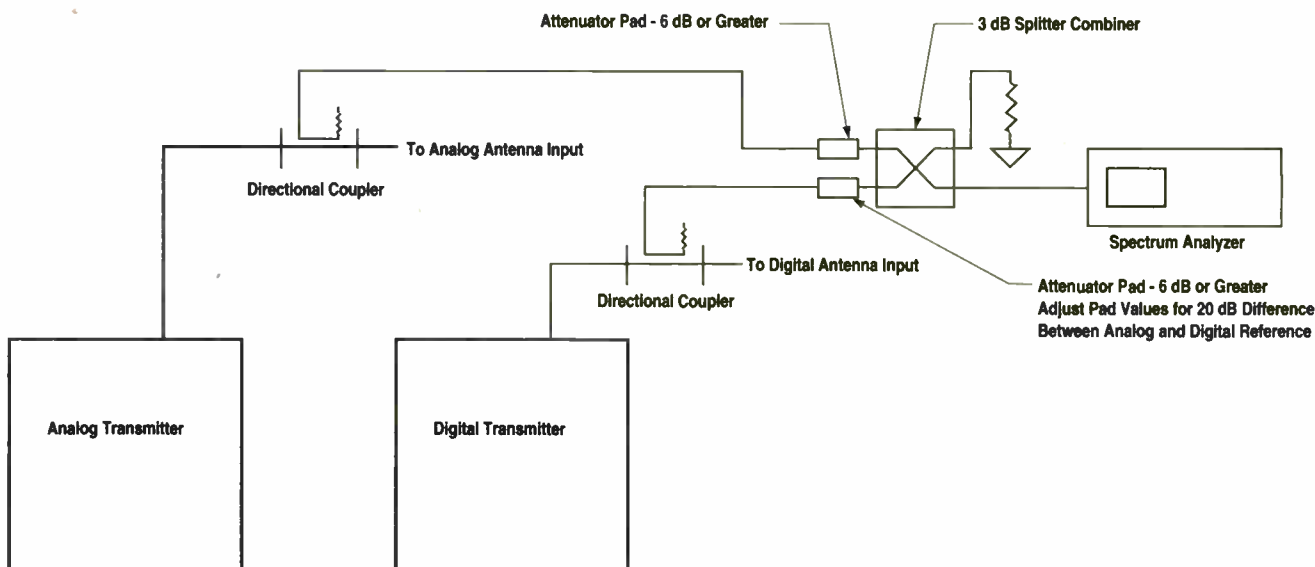

Graphic from Ben Brintzer's discussion of HD Radio measurements. Drawing is by Randy Mullinax of Clear Channel.

### Leasing bits in the HD stream for anyone who wants to transport data will be an important use.

— Ray Miklius

The Wednesday sessions conclude with another aspect of the signal chain that can make or break the quality equation, as Kevin Campbell of APT discusses "STL Considerations for HD Radio."

#### Keep safe from RF

On Thursday, Sept. 27, the engineering sessions turn to an issue that affects both digital and analog broadcasters of all types: RF safety.

As transmitter sites and neighborhoods grow ever closer, RF issues are cropping up in an increasing number of "NIMBY complaints," while at the same time broadcasters are dealing with new RF concerns from digital transmitters at shared sites and ever-stricter federal regulations.

Richard Strickland, the founder of RF Safety Solutions and an RW contributor, will conduct an all-day "NAB RF Safety Course" in two sessions, covering the latest OSHA and FCC regulations, workplace hazards, the special considerations of AM stations and the most recent FCC enforcement activities.

#### Meet your transmitter!

While the Wednesday and Thursday sessions are intended primarily for engineers with at least some experience, the engineering session on Friday, Sept. 28 is designed in part for radio people who may only know the transmitter as "that

**EXPECT MORE FROM YOUR AM TRANSMITTER**



Made in USA

---

**Armstrong Transmitter X-1000B**  
**1KW HD Radio ready AM Transmitter for under \$10K**

Built with dual hot-swappable 600 Watt RF modules capable of 150% modulation, X-1000B can bring that major market sound to your radio station. Engineered with the latest technological innovations, X-1000B offers high reliability, built-in redundancy and it is HD Radio ready.

Best of all, our customers tell us that the money they save running the X-1000B pays for itself with savings in electricity and

maintenance costs over an older transmitter...and as a bonus they get exceptional reliability and that major market sound for free.

But, don't take our word for it. Talk to our customers already on-the-air with the X-1000B. Call or email for a users list and decide for yourself why owning this transmitter is a no-brainer.



Tel 315-673-1269 / sales@armstrongtx.com / www.armstrongtx.com

® HD Radio is a registered trade mark of iBiquity Digital Corporation.



To meet with one of  
our representatives at the  
NAB Radio Show, please  
call 202.513.2626

wherever. whenever.

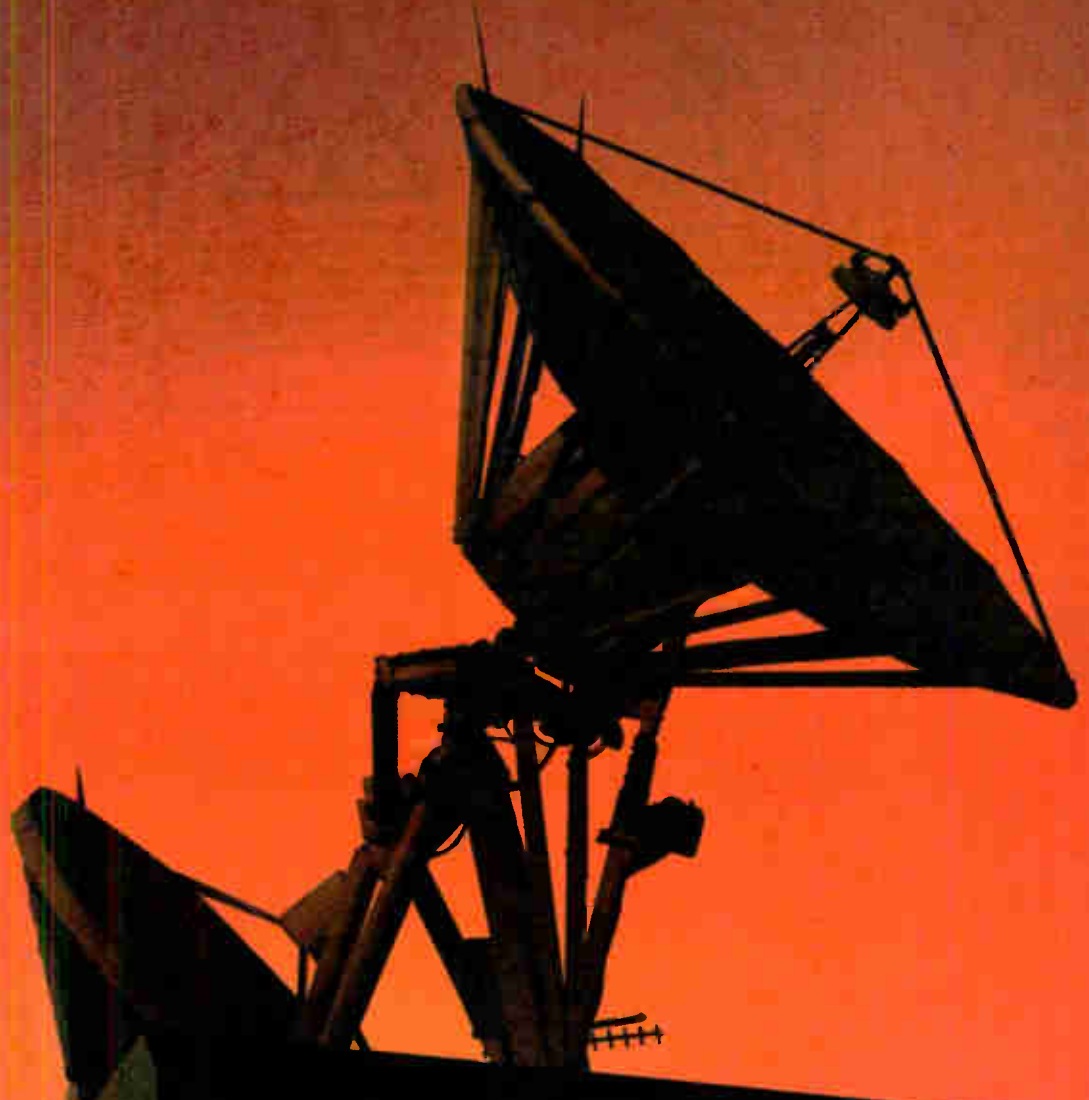

Prime C-band satellite capacity, digital system design, and expert field engineers to assist you. To cover the U.S., Mexico, and the Caribbean. Faraway affiliates, distant stations, hard-to-reach areas are all within easy reach. With reliable, low-cost solutions, maximum flexibility, and engineering support 24/7. Wherever you want us, whenever you need us: Call NPR Satellite Services at 202.513.2626, or visit [www.nprss.org/rworld](http://www.nprss.org/rworld).



space segment | equipment | uplink services | system design | engineering support | 24x7 customer service



# Avoid RF Safety Mistakes

Radio stations tend to use incorrect level signage, and AM stations rarely consider the RF burn hazard. Engineers can use the following guidelines:

RF hazard signs are supposed to communicate information. The three basic field level signs have the action words NOTICE, CAUTION and WARNING at the top. These signs represent an escalating threat or hazard level. All of the signs begin the message panel with "Beyond this point ..."

NOTICE signs indicate that the RF field levels may exceed public limits. This is the right choice for the gates into the transmitter facility, assuming that there are no areas that exceed the occupational limits other than on the tower or inside smaller fenced areas, such as around AM towers.

CAUTION signs indicate that the RF field levels may exceed the human limits (Occupational/Controlled FCC limits).

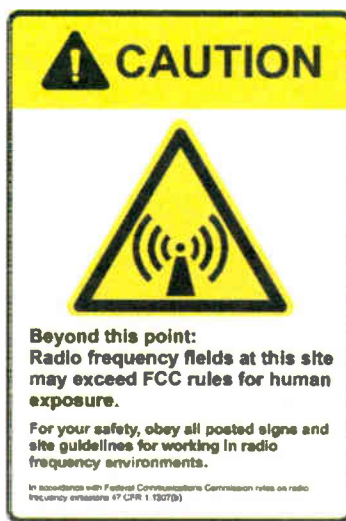

A prominent feature of the NAB Radio Show's technical sessions is a two-part course on RF safety by Richard Strickland of RF Safety Solutions on Thursday, Sept. 27.

Strickland has presented more than 150 public and private seminars on RF radiation safety and has written numerous articles, in Radio World and elsewhere, on this topic.

To help readers understand this important topic, Radio World here begins a recurring series of Q&As with Strickland about RF safety.

Question: What is the most common mistake radio stations make in their RF safety signage and what should engineers do about it?

This sign should be used on the fences around AM towers. The minimum is one on the gate, but one on each side of the fence is better.

WARNING signs indicate that the field levels exceed the human limits. It is rare to need or want this sign. With this sign in place, nobody should go beyond the point indicated unless power is reduced.

Every gate to the enclosure around an AM tower should have a "DANGER: Burns" sign. Note that the word danger is a higher threat level than the word warning and indicates the high threat level from contacting a tower or feed line. RF burns

have become a hot button with the FCC.

FM stations, unless top-mounted on an AM tower, should have a "Tower CAUTION" sign at the base of the tower. This sign warns of RF hazards on the tower near the antennas rather than "beyond this point." I recommend that the sign be mounted at eye level just behind the ladder so that it is the last thing that a climber sees before ascending. If there is an elevator on the tower, add a second sign near the entrance to the elevator.

Spotlight on RF Safety will appear regularly in Radio World. E-mail questions or suggestions to the author at rfsafety@optonline.net.

Get the Best Prices on all the Popular Brands!



...and much more!

Contact Chuck Maines at Broadcast Depot to get your next quote.



E-mail: [cmaines@7bd.com](mailto:cmaines@7bd.com) | [www.7bd.com](http://www.7bd.com)  
Toll-Free: 877-90-BDNow (23669) | Fax: 765-983-3817

**SURE BETS**

## Start Your Engines!

Itching for something exciting to do during your convention visit? We tell you about the Lowe's Moter Speedway on page 28. But you can also jump right into the seat of an authentic Nextel Cup car and get a feel of the racetrack yourself.

The Richard Petty Driving Experience offers NASCAR fans a chance to get beside or behind the wheel with its Driver Experiences and Ride-Along programs. For instance, in one package, each participant receives three laps in a NASCAR Nextel Cup-style stock car at speeds approaching 160 mph. Prices range from a \$99 ride-along to a \$2,499 "racing experience."

Packages sell out in advance, so for times and reservations call 1-800-BE-PETTY or visit [www.1800bepetty.com/home.aspx](http://www.1800bepetty.com/home.aspx).



# Faster, Better, More Powerful

GSelector is the future of music scheduling. Hundreds of PDs have already migrated to GSelector because they needed a faster way to program more stations. They needed a better scheduler that leaves virtually no unscheduled positions. They needed a more powerful program that gives them the cross-station protection they must have in today's HD world. **Migrate with the best. [www.gselector.com](http://www.gselector.com)**

# GSelector<sup>®</sup>

music scheduling  
**reinvented<sup>™</sup>**



**NAB Radio Show Booth #217**

© Copyright 2007 RCS, Inc. All Rights Reserved. RCS, RCS Sound Software, GSelector and their logos are registered trademarks, and Music Scheduling Reinvented is a trademark, of RCS, Inc. GSelector's demand-based, goal-driven scheduling system is protected by US Patent 6,910,220.

**World Radio History**

# Digital Radio: OK, Now What?

*Charlotte Convention Features Sessions on HD Radio Aimed at GMs and Money Managers*

by James G. Withers

HD Radio is no longer a technical experiment. It is here and being implemented on numerous stations in markets of various size.

Now comes the hard part. How are broadcasters to capitalize on the anticipated benefits of this new method of broadcasting?

From multicasting on FM stations, to near-FM fidelity on the AM band, what steps can managers take to justify the expense of converting to digital radio?

Several sessions at the NAB Radio Show are targeted toward general managers and financial managers.

**'Have some fun'**

On Thursday Sept. 27, the session "HD Programming: The New Frontier" deals with the multicasting possibilities offered to FM stations as part of the IBOC stream. This session focuses on deriving revenue from two, three or even four additional programming channels.



Cynthia Morgan



Andy Mussaw



Dan Mettler

Panel moderator Charlie Cook, vice president of country for Cumulus Broadcasting, hopes the session will be an eye-opener for non-technical station managers.

"We hope to show managers that there are programming opportunities out there for stations that do have HD signals on the air. Stations can experiment, have some fun, even re-invent formats since there isn't a lot of tune-in yet."

Once HD Radio is more established, Cook believes, it will be more difficult to push the edges of the programming envelope; but right now, he says, "Stations

of excitement from broadcasters. We are hearing about some very interesting ideas, such as creating sponsor-branded channels, as stations attempt to monetize their investments in HD Radio technology."

Kelly believes the benefits to AM, though different from those on FM, will be just as important.

"Niche music formats that simply cannot be supported on a full Class C FM will definitely migrate back to AM stations. That will help diversify AM programming, which will, in turn, help the bottom lines of those stations."

**Guerilla marketing**

Andy Mussaw, managing partner for Graffiti Radio, has real-world experience running an HD channel. Graffiti Radio is Delmarva Broadcasting's full-time HD channel attached to WSTW, its powerhouse Contemporary AC FM station in Wilmington, Del.

"From a format standpoint, we

**We are hearing about some very interesting ideas, such as creating sponsor-branded channels, as stations attempt to monetize their investments in HD Radio technology.**

— Don Kelly

can take chances — even stumble a bit — as they ease into some ideas that will have long-term prospects to attract listeners and advertisers."

Session participant Don Kelly, director of broadcast marketing for Ibiqity Digital, agrees that now is the time to experiment.

"The ability of FM stations to multicast is generating a tremendous amount

chose alternative rock, since that was a format hole in Wilmington," he said.

"We've tightened the format way down, though, and are going for a much younger audience than a traditional alternative station. Since there aren't all that many radios out there yet, we're doing some experimenting and so far, the feedback we are getting is very positive."

See HD RADIO, page 30 ▶

**PREVENT BROADCAST DOWNTIME WITH**

# STABILINE®

**POWER QUALITY SOLUTIONS**

**Transient Voltage Surge Suppressors**



**PT1 Series / Branch Panel Protection**

- Parallel Connected
- 25 to 100kA Surge Current Capacity
- Single & Three Phase Models
- All Mode Protection
- UL 1449 Second Edition
- LED Visual Protection Status

**Uninterruptible Power Supplies**



**SEG Series / Exciter & Signal Generator**

- True Regenerative On-Line Technology
- Single Phase, 120 & 230 VAC Models
- 1 to 6 kVA Capacities
- 19-Inch, 2U Rack Mount Models
- Optional Extended Battery Modules
- Input Power Factor Correction



## Superior Electric

28 Spring Lane, Suite 3, Farmington, CT 06032  
 Phone 860-507-2025 • Fax 860-582-3784  
 www.superiorelectric.com

**SURE BETS**

## Life in the Fast Lane

North Carolina has always been in the thick of things when it comes to fast cars and racing, dating to the days of Wilkes County moonshiners souping up their cars to outrun local police and federal agents; NASCAR legend Junior Johnson got his start in the moonshine business.

Today, the Charlotte area is home base to 90 percent of NASCAR racing teams and it is the future home of the NASCAR Hall of Fame.

The Lowe's Motor Speedway (the former Charlotte Motor Speedway) is in nearby Concord. It is on the site of the first NASCAR race and is host to the Coca-Cola 600, one of the top five Nextel Cup Series races.

Tours are available of the track daily. Visitors can get an up-close look at areas that are off-limits on race days including a Nextel Cup garage and the victory circle; you can take a van ride on the steeply banked track. Tours are available on non-event days Monday through Saturday 9:30 a.m., 10:30 a.m., 11:30 a.m., 1:30 p.m., 2:30 p.m. and 3:30 p.m., and Sundays 1:30 p.m. to 3:30 p.m. Admission is \$5 per person. Group tours are available by reservation.

Call (704) 455-3204 or visit [www.lowesmotorspeedway.com](http://www.lowesmotorspeedway.com). The track is open 9 a.m. to 5 p.m. daily and 1-5 p.m. Sundays.

# MUSICAM USA

**The World Leader in IP Codecs**

## Introducing our next generation of IP Audio Codecs

*featuring*

### *Suprima* IP DUAL AUDIO CODEC



- Includes LAN, ISDN U & S/T, and X.21 interfaces standard
- Auto backup to ISDN from IP or X.21
- Built-in Web server for control and monitor from remote locations
- Includes SIP protocol over IP, MPEG2, MPEG3, MP2/4 AAC, apt-X, G.722, G.711 & PCM
- Portable and Decoder Only versions also available

### *SupriMAX*

**MULTIPLE IP CODEC**

- Up to 14 full-featured IP codecs housed in one unit
- Each module is hot-swappable
- Ideal for multicast applications
- Redundant Power Supplies
- Comes fully loaded with every available algorithm included
- Monitor large systems with SNMP management

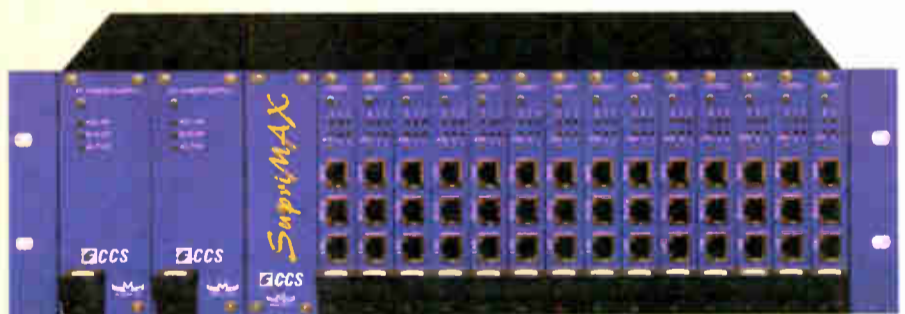

*Visit our website to view the MUSICAM USA Product Portfolio and contact MUSICAM USA, the IP technology leader, for more information about how easily our products can help you master the "audio over IP" direction for your station(s). We are already shipping products to major groups and small stations alike. Check our references and let's go!*



670 North Beers Street, Bldg. #4  
Holmdel, NJ 07733 USA  
phone: 732-739-5600 - fax: 732-739-1818  
email: [sales@musicamusa.com](mailto:sales@musicamusa.com)  
web: [www.musicamusa.com](http://www.musicamusa.com)

# HD Radio

► Continued from page 28

As for promotional efforts, Mussaw says it's been tough.

"We have put some money into it, but mostly, it's been guerilla marketing so far. We did do a cross-promotional campaign with the local minor league team, where we promoted the team on the station and got in-stadium mentions on the Jumbotron, and, of course, we promote the station on the Graffiti Radio home page and stream."

## Riffing on digital

A second example from the real-world of HD Radio will be offered in the session "RIFF2's Road to Success," which details the experiences of Greater Media's HD2 station in Detroit.

RIFF2, which was covered early on in the pages of Radio World, has now been on the air for two years, an amazing feat in itself. Program Director Mark Pennington says things are only getting better.

"We're programming RIFF2 on the HD2 channel of

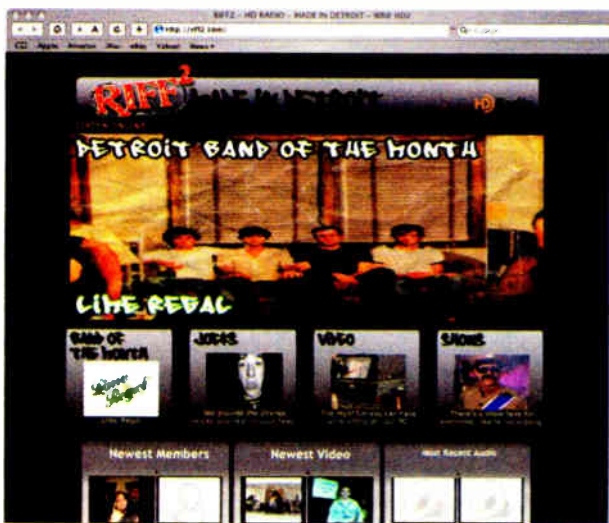

Multicast Pioneer: RIFF2's Web Site

WRIF, Greater Media's mainstream rock FM station, but we are not a brand extension of that station at all. Instead, we're targeting 18- to 24-year-old males; much younger than WRIF, and our marching orders are to get young people interested in radio again, as opposed to iPods and the Internet."

He says his main message to station managers getting ready to program their HD channels is to try new things.

"We're using new talent, right out of broadcasting schools. We're very broadly formatted; doing things that would never fly on traditional radio. We experiment every day on ways to make the station compelling enough to make people go out and buy the radios."

Pennington went on to explain that, in terms of programming options, HD Radio is like the Wild West.

"Pretty much anything goes on RIFF2. We segue from hip-hop to rock to alternative and back again. Our

## HD for Managers

*HD Radio for non-technical managers is the theme of several sessions at the NAB Radio Show.*

"HD Radio for Managers: Stages of Implementation"  
Thursday, 10:30–11:45 a.m.  
Jeff Detweiler, Geoff Mendenhall, Dan Mettler, Jim Watkins

"HD Programming: The New Frontier"  
Thursday, 3–4:15 p.m.  
Michael Abl, Charlie Cook, Don Kelly, Cynthia Morgan, Andy Mussaw

"HD Radio: RIFF2's Road to Success"  
Friday, 10:30–11:45 a.m.  
Bob Bloom, John Long, Mark Pennington, Milford Smith

**Pretty much anything goes on RIFF2. We segue from hip-hop to rock to alternative and back again. Our only absolute rule is to play no less than 25 percent local artists.**

— Mark Pennington

only absolute rule is to play no less than 25 percent local artists. Detroit has such a wonderful history of creating music that we want to showcase lesser-known, local artists that someday have a chance of breaking out to the big time."

The RIFF2 session, Pennington says, will go beyond the actual construction and operation of the channel, although those aspects of the station are covered, as well.

More to the point for non-technical managers are details about creating programming, driving listeners to the channel (even when that means requiring them to purchase new radios), and finally, how to get new advertisers to spend incremental dollars on this new medium.

### Benefits now

Also on the agenda is the session "HD Radio for Managers: Stages of Implementation" on Thursday morning. Discussion includes technical representatives from Ibiqity, Harris Corp., Clear Channel and WHUR(FM) in Washington.



SURE BETS

## Charlotte Shout!

The NAB Radio Show coincides with Charlotte Shout, a month-long celebration of the arts, entertainment and food in the city. See [www.charlotteshout.org](http://www.charlotteshout.org). Some of the featured events:

*The Rat Pack Is Back* — "Dino, Sammy, Frank and Joey" will entertain in a cabaret atmosphere (food and drink), \$50–\$65 per person, Wednesday, Sept. 26 at 8 p.m., North Carolina Blumenthal Performing Arts Center, 130 North Tryon Street, [www.blumenthalcenter.org](http://www.blumenthalcenter.org) or (704) 372-1000.

*Culinary Arts Experience* — A two-day celebration of food, wine, music and the culinary arts. Celebrity chefs such as Bravo Channel's Sam Talbot will demonstrate their skills on a high-tech stage at Charlotte's Gateway Village Promenade. Local upscale restaurants will provide food and wine. Friday and Saturday, Sept. 28–29, Fri. 5–10 p.m., Sat. 10 a.m.–10 p.m., 800 W. Trade Street. The Friday Night Preview Gala is a \$75 all-inclusive ticketed event; Saturday is free and open to the public. E-mail [info@charlotteshout.com](mailto:info@charlotteshout.com) or call (704) 332-2227.

*Happy Birthday Igor* — The Charlotte Symphony will celebrate Igor Stravinsky's 125th birthday with a presentation by Russian pianist Olga Kern, Friday, Sept. 28 and Saturday, Sept. 29, 8 p.m., Belk Theater, 130 North Tryon Street, (704) 972-2000, [www.charlottesymphony.org](http://www.charlottesymphony.org), tickets \$16–74.

Dennis Wharton, executive vice president for media relations with the NAB, says both sessions are a natural "next step" as broadcasters consider adding HD channels to their stations.

"The NAB is a strong advocate of HD Radio, and has supported the [HD Digital Radio] Alliance all along," he says.

"Sessions like these at the Radio Show are our attempt to help broadcasters understand the benefits as well as the costs of digital broadcasting. We know most broadcasters will make the transition over time, but we want them to know there are definite benefits, even today." 🌐

**When quality level control matters, you do have a choice!**

**Ariane...**



**Or these.**



**The Ariane Sequel ...There Is NO Equal!**

High-quality, multi-purpose digital AGC... For pre-processing level and ambience control • low-artifact streaming and digital broadcast • program distribution • television audio loudness optimization

**TRANSLANTECH SOUND, LLC**

Sound Processors and Broadcast Sound Consultation

[HTTP://www.translantech.com](http://www.translantech.com) • email: [Sales@translantech.com](mailto:Sales@translantech.com) • New York: (212) 222-0330 • Europe: +49 2361 9049 649

©Copyright 2007 TransLanTech Sound, LLC

See us at BGS NAB Radio Show Booth #304

# Broadcast Software

1-888-274-8721

www.bsiusa.com

## Radio Automation

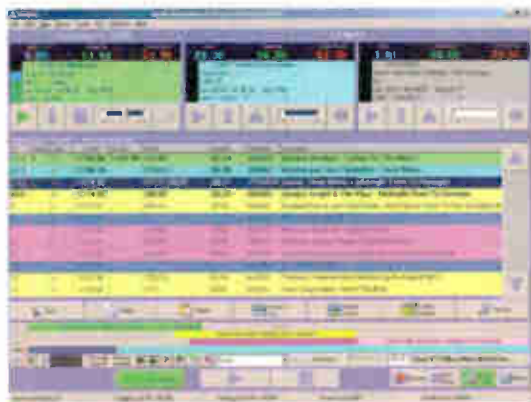

**Simian** - radio automation and digital playout system.

## Instant Audio



**Stinger** - Instant Access to 288 'rapid-fire' audio files.

## Digital Cart Player

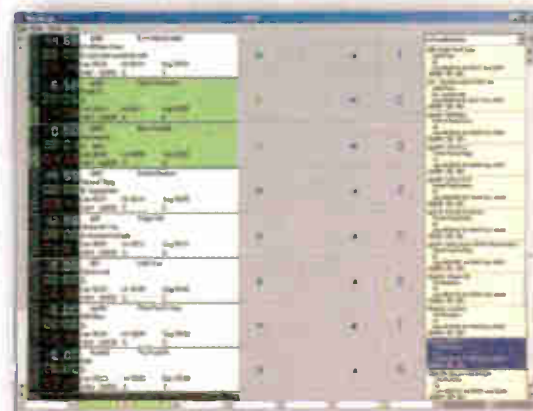

**WaveCart** - the original on-screen cart machine replacement.

## Audio Logging

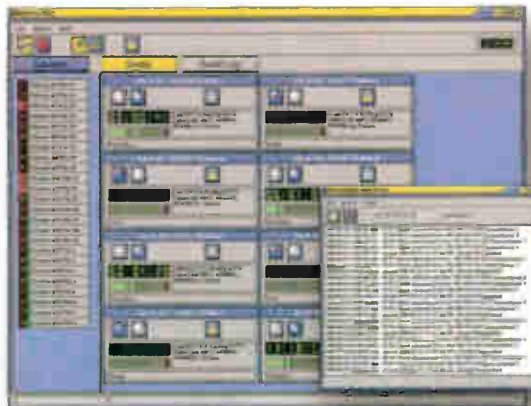

**SkimmerPlus** - skimming and audio logging with web playback.

## Complete Systems



**Systems** - fully configured with hardware, software and music.

## Music Library



**MusicStore** - select from over 48,000 ready-to-play songs.

## CD Ripping

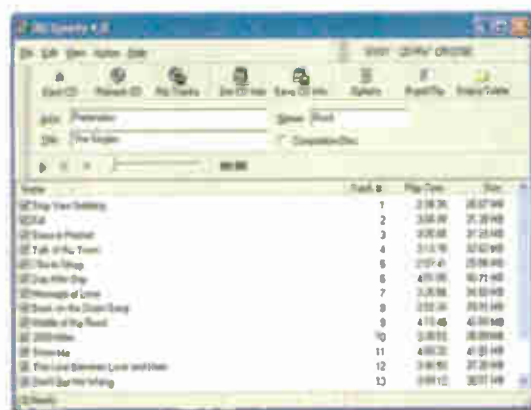

**Speedy** - fast CD ripping with automatic file tagging.

## Sound Cards



**AudioScience** - professional sound cards built for broadcast.

## Remote Control



**Trigger & Relay Kits** - for GPI/O and satellite operation.

**Broadcast Software International**

503 E. 11th Avenue

Eugene, Oregon 97401 USA

Direct: 541-338-8588

Fax: 541-338-8656

www.bsiusa.com sales@bsiusa.com

See Us at NAB Radio Show Booth #121

World Radio History



## They Are the Best of the Best



*What earns a station a Marconi nomination? Established in 1989 and named after inventor and Nobel Prize winner Guglielmo Marconi, the NAB Marconi Radio Awards are given to stations and outstanding on-air personalities to recognize excellence in radio. Winners will be announced in Charlotte. Here's how finalists in one award category, "Medium-Market Station of the Year," described themselves to NAB:*

### **KGSR(FM), Austin, Texas**

What makes 107.1 KGSR so special? Simply put it IS Austin, Texas. From the music to the storytellers it creates an atmosphere in which listeners can experience the sounds of Austin's music scene and beyond. In 2006 KGSR won the R&R Award for Triple A Station of the Year and continued to be a difference maker in the community. In 2006 KGSR continued its support of groups such as The Capital Area Food Bank, Shoes for Austin, Family Eldercare and The Christmas Bureau (to name a few) focus on helping the city's less fortunate. KGSR realizes that local musicians are what make Austin the Live Music Capital of the World, so through support of the SIMS Foundation (contributions have exceeded \$1.5 million) and The Health Alliance for Austin Musicians, KGSR helps provide adequate and low-cost health care to local artists. "107.1 KGSR, Where Music and Community Come First."

### **KTTS(FM), Springfield, Mo.**

KTTS: Fall 2006 ratings period: 13.8 rating (25-54)/13.6 share (12+)/#1 in the market. 2007 "Humanitarian of the Year" by the Country Radio Broadcasters. Nominated for "Station of the Year" by The Academy of Country Music in 2002, 2004, 2005 and 2006 and by The Country Music Association 2002-2006. Raised \$158,258

in 2006 and \$152,475 in 2007 during Radiothons for St. Jude Children's Research Hospital. Promoted the St. Jude Dream Home in 2006; \$412,500 was raised. Provided gifts and food to over 400 households via "The 2006 KTTS Christmas Crusade." Provided news coverage and organized humanitarian efforts during the March 2006 tornadoes and the ice storm of January 2007. Features a 24-hour news team, which was awarded "Best Radio News" 2004-2007 by 417 Magazine, "2006 Story of the Year" by the Missouri Associated Press Broadcasters and numerous other awards by the MAPB and the Missouri Broadcaster's Association.

### **WWL(AM), New Orleans, La.**

WWL Radio has an 85-year history of delivering breaking news, compelling talk and sports to New Orleans, the Gulf Coast and the central U.S. During the Hurricane Katrina disaster and its aftermath, WWL was the ONLY means of mass communication in the New Orleans region as water poured into the city. Already the market's news and talk leader, WWL(AM/FM)'s ratings delivery exploded 75% in July 2006 with the first Arbitron book after the storm — as the station became the "medium of record" for the city. During 2006, WWL's hosts and newscasters were featured in all major media covering the ongoing Katrina recovery. WWL's Web site — [www.wvl.com](http://www.wvl.com) — is permanently installed in the Library of Congress as an important document of Katrina-devastated New Orleans and its recovery. As New Orleans recovery continues, WWL remains the soundtrack for a city on the mend.

### **WDEL(AM), Wilmington, Del.**

If you were building your dream radio station, would it be voice tracked? Syndicated? We

believe you can't pipe in great radio. WDEL(AM) has its own news, traffic and sports reporters, news anchors and talk hosts producing great LIVE and LOCAL content not available from satellites. Under the same family ownership since 1931, WDEL delivers award-winning live and local programming for air, online and mobile devices. Streaming since 1996, we long ago replaced our reporters' cassettes with camcorders. Audio is broadcast on 1150 AM. Video and audio podcasts, plus daily video newscasts, appear on [wdel.com](http://wdel.com). The #1 Arbitron-ranked AM station in the market and top 10 overall, in 2006-07 WDEL earned 11 AP awards, 24 Delaware Press Association awards, four RTNDA Murrow awards and national recognition for [wdel.com](http://wdel.com). A 2005 NAB Crystal winner, WDEL's highly respected [SmartDrive.com](http://SmartDrive.com) program promotes responsible driving to students in 37 high schools.

### **WFMS(FM), Indianapolis, Ind.**

WFMS has been the #1 12+ station in the Indianapolis market for the past 32 ratings periods, that's eight years at #1. For eight years running, WFMS has had the highest-rated 12+ share of any country station in a top 50 market, often the highest share of any station in the top 50. In the past 18 months, the WFMS Riley Radiothon raised over \$1 million for Riley Hospital for Children in Indianapolis. The WFMS Friends & Neighbors Program has helped local charities raise over \$2 million since its inception 11 years ago. In 2002 WFMS personality JD Cannon was inducted into the Country Music DJ Hall Of Fame. The Country Music Association named WFMS the Large-Market Station of the Year in 1997, 2000, 2001, 2004 & 2006. WFMS was named the 2006 Major-Market Station of the Year by the Academy Of Country Music. ●

# SERVING THE BROADCAST BUSINESS FOR 30 YEARS

## Unparalleled Service and Selection

### FULL COMPASS

PRO AUDIO / VIDEO

Choose from brands like:

360 Systems Air Tools AKG Allen & Heath Aphex ATI Atlas Sound Audio Technica Auralex Beldin Beyer Coles Crown DBX Denon Digidesign Dorrough Edirol Electro Voice	Eventide Fostex Gemini Genelec Gepco Heil Henry Engineering HHB JBL JK Audio Klark Teknik	Rane Raxxess RDL Rode Roland	Sennheiser Shure Sony Sound Devices Stanton Tascam TC Electronics Technics
--	---	--	---

CALL OR CLICK FOR OUR FREE 400 PAGE CATALOG

FULLCOMPASS.COM | 800.356.5844

World Radio History



## Convention Highlights

In addition to the technical sessions and selected management presentations discussed in this special section of RW, the NAB Radio Show will include several other highlights and sessions of note. For a full list visit [www.nabradioshow.com](http://www.nabradioshow.com).

### TUESDAY

Reception  
4-5:30 p.m.

### WEDNESDAY

Dickstein Shapiro's "Broadcast Financing 2007: Radio's Changing Landscape"

8-11 a.m.  
Features Ed Christian, Lew Dickey, Joe Schwartz, Jeff Smulyan, Peter Smyth and Vic Miller

### Career Fair

9 a.m.-1 p.m.  
NABEF, BEA and RTNDA host.

### "My Research Budget's Been Cut"

1-2 p.m.  
"Is online music testing ready for prime time?"

### "Podcasting: Download Content, Upload Dollars"

2:15-3:30 p.m.

### "The Bedroom Project: How Young Americans Use, Consume and Interact with Technology and Media"

3:45-5 p.m.  
Fred Jacobs of Jacobs Media talks about a research project done with Arbitron.

### Opening Reception on Exhibit Floor

5-7 p.m.  
John Boy & Billy Show Presents:  
Brews 'N BBQ  
8-10 p.m.

### THURSDAY

FCC Breakfast  
7:30-8:45 a.m.

### State of the Industry & Keynote Address

9-10:30 a.m.  
State of the radio industry with NAB President/CEO David K. Rehr, keynote by Republican pollster and research expert Dr. Frank Luntz. Rehr also will present the first NAB HD Radio Multicast Award.



Frank Luntz

### "Repositioning Radio: Finding the Right Words and Messages to Communicate Radio's Value"

10:30-11:45 a.m.



Convention Center Green

"Technology: What's Next"  
10:30-11:45 a.m.  
Exhibit Hall Lunch  
11:45 a.m.-1:45 p.m.

### "What America's Most Influential Marketers Say About Radio"

1:30-2:45 p.m.  
Marketing execs from Anheuser-Busch, Dunkin' Donuts, Pepsi-Cola and Carat discuss their expectations for radio.

### "Breaking the Language Barrier — Gringos in Spanish Radio"

3-4:15 p.m.

### NAB Marconi Radio Awards Dinner & Show

7-9:30 p.m.  
Musical entertainment by Collective Soul.  
Hosted by Glenn Beck of Premiere Radio



Collective Soul

Networks. Separate ticket required, \$100/person.

### FRIDAY

Breakfast on the Exhibit Floor  
8-9:30 a.m.

### "Integrating Digital Media Into the Radio Mix"

9-10:15 a.m.

"Threats or Opportunities: Google...eBay...The Internet Gets Into Radio Commerce"  
9-10:15 a.m.

### "Green-Tuning Your Facility"

10:30-11:45 a.m.

### Radio Luncheon: National Radio Award Presentation and Speaker

Noon-1:30 p.m.  
Legendary independent owner Jerry Lee of WBEB(FM) receives the National Radio Award. Also, Bill Press, talk show commentator, will speak.



Jerry Lee

What's  
**Google**™  
doing with  
radio automation?

Google has been redeveloping SS32 and Maestro from the ground up. Our new system can be summed up in just three words...

**Progressive. Flexible. Sound.**

We're breaking new ground with automation technology.  
**Don't get left behind.**

**800-726-8877**

Visit [www.google.com/radioautomation](http://www.google.com/radioautomation) to find out more.

Come see us at the NAB Radio Show.  
September 26 - 28th in Charlotte, NC. Booth # 517.

© Copyright 2007. All rights reserved. Google and Google logos are registered trademarks of Google Inc.

# How Less Is More Became Anything Goes

Strategy Finds Adherents Beyond Clear Channel, But Skeptics Remain

by Craig Johnston

It is coming up on nearly three years since radio mega-owner Clear Channel Radio introduced its "Less Is More" initiative, substituting 30-second commercials for :60s in its stations' inventory with the overall aim of reducing clutter and increasing the portion of each hour devoted to programming instead of ads.

When Clear Channel's proposal kicked off, Radio World observed that the rest of the industry would "go to school" on this campaign, watching and learning.

An NAB Radio Show session, "How 'Less Is More' Became 'Anything Goes,'" will delve into the lessons learned since then. Panelists in the Friday session say there's no universal agreement on the move to :30s.

As moderator, Mike Cortese, director of sales for Emmis Indianapolis, promises to remain balanced. But he noted that his group in March began executing the Less Is More strategy. "It's working for us."

## Too much

An early question from advertisers that Cortese's sales staff had to answer was whether a 30-second spot could contain enough information to be as effective as a :60. He had his Indianapolis creative staff rewrite existing 60-second commercials into :30s, then played them side by side.

"What we found was the 30-second spot is more effective," he said. "Frankly, if you have too much information, the listener is not going to retain it all anyway." Cortese also noted that for the same amount of dollars spent, an advertiser can



Photo by Tauria M. Connell

afford more frequency with :30s.

For anyone who thinks there is unanimity of agreement on the strategy, though, Steve Sklenar, director of sales for Lincoln Financial Group of Charlotte, will disabuse them of that notion. He thinks 30-second spots have upset the market supply and demand curve.

"They've saturated it, they've got too many of them, they can't get rid of them," said Sklenar. "And they've changed their commission structure to pay less for :60s and more for :30s. Why do you think they did that?"

Sklenar believes Clear Channel made a mistake selling the concept to Wall Street first, "then took it to 13 hundred stations." He noted that :30s have become popular with discounters, national and network buyers. "They can't get rid of them where the premium is, which is on the streets."

He said that countering the Less Is More strategy with his Charlotte stations

has led them to Nos. 1 and 3 revenue rankings in the market, outperforming their audience shares.

If he suddenly became convinced moving to :30s was the correct path, it would only take one buying cycle to get there. "But I'm not going to do it until it makes sense for me. And right now there are too many restaurants serving that food."

Clear Channel

**They've saturated it,  
they've got too many  
of them, they can't  
get rid of them.**

— Steve Sklenar

will be represented on the panel by J.D. Freeman, regional vice president and market manager for Clear Channel in Dallas. Freeman has applied the company's Lonestar development model to the company's KZPS(FM). It's a test of whether no spots are better than some spots.

"What we do is we drive revenue by giving clients sponsorships, and those

sponsorships include giving hourly on-air mentions, as well as 30-second live integrated messages throughout the sponsored time period," said Freeman. "They also get online narration into the radio station's Web site at [lonestar925.com](http://lonestar925.com)."

Clear Channel in Dallas originally premiered the Lonestar format on its HD2 digital signal. Freeman describes the musical genre as indigenous to the state of Texas. "It is Texas-centric: outlaw country, with some southern rock and alternative country."

"Everybody knows the spot model of :60s and :30s and :15s and :10s, but what we're trying to do here is see if there is a way, integrated way that when a client is associated with this content, this product, they're really inextricably tied together. The benefit of being part of our brand, is a benefit of their brand as well."

While those panelists will be concentrating on what works for the broadcasters and advertisers, the third leg of the equation, the listeners, will be represented by Warren Kurtzman, vice president of Coleman, the North Carolina-based radio audience research company.

At the 2006 NAB Radio Show, Coleman introduced a study, "What Happens When The Spots Come On: The Impact of Commercials on the Radio Audience." That analysis of PPM audience data from Coleman, Arbitron and Media Monitors countered a belief among advertisers, agencies and radio executives that radio loses a considerable portion of its audience during commercial breaks.

During the Less Is More session, Kurtzman will apply PPM data toward the question of the audience's acceptance and perceptions of the shorter spots and fewer overall minutes devoted to advertising on the stations.

Michael Weiss, president of CBS Sales for Interep, also will appear on the panel. 

## SURE BETS

### Lip-Smackin' Good!

When it comes to pig pickin', every Tar Heel considers him- or herself an expert.

In North Carolina, barbecue is not so much about the sauce, although that is important. It's about cooking the meat, and that means roast pork, or whole pig, cooked over a hickory or oak fire in a drum. The slow-cooked meat often is chopped by hand into a fine pulp for serving.

Speaking of sauce, people might quibble about ingredients and amounts (Western Carolinians add ketchup), but it is always a heavily seasoned vinegar-based mixture. If you are pig pickin', the "must-have" accompaniments include coleslaw, boiled potatoes, hush puppies and gallons and gallons of fresh-brewed, sweet iced tea.

Armed with this information, your quest for the perfect barbecue may take you to the following popular pig purveyors: *Bill Spoon's Barbecue*, 5524 South Boulevard, (704) 944-3605, 10:30 a.m. to 3 p.m., Mon.-Fri.; cash or check; *Bubba's Barbecue*, [www.bubbasbarbecue.com](http://www.bubbasbarbecue.com), 4400 Sunset Road, (704) 393-2000, 11 a.m. to 8 p.m., seven days a week; and *Carolina Country Barbecue*, 838 Tyvola Road, (704) 525-0337, 11 a.m.-9 p.m. Mon.-Sat. and 11 a.m.-8 p.m. on Sunday.

## NAB Signs Freeman For Spring Show

After 21 years with the same contractor, NAB will try a different one for its big spring convention in Las Vegas.

The organization also will put the job out for bid on a regular basis in the future. Association officials have awarded a contract to Freeman after taking bids from four companies. (Freeman also is the contractor for the 2007 fall Radio Show.) NAB has used GES Exposition Services for 21 years, according to NAB convention exec Chris Brown.

"It will be a two-year contract with an option to extend one additional year," Brown told Radio World. "Our intent is to put the business out for competitive bid every three or four years."

Brown said exhibitors had expressed general concerns with "the rising cost of services, union work rules, confusing surcharges and service levels."

"To their credit, GES had made real improvement in a number of these areas, but again, we felt we needed to make absolutely certain we were offering our exhibitors the best in pricing and service," Brown said. "While admittedly the approach had been different in the past, we are now fully committed to a regular process of competitive bids for this and other key vendor relationships."

A general contractor manages setup and move-out of a show, handling booth material and products in and out of the convention center, and managing much of the labor involved in the booths. It also works with the NAB to create show décor, signage and structures.

Brown says the change is a matter of being responsive to its customers, in this case NAB exhibitors.

"Over the last several years, with swings in the economy and industry, our exhibitors have been more and more focused on maximizing the return from their investments in events like ours. And no other vendor relationship we maintain has more significance in determining an exhibitor's overall satisfaction and return on investment at our show than the relationship we have with the general contractor."

Brown said it was "long past time" to put the job out to bid. Freeman, he said, "will save our exhibitors money and, we feel, will deliver best-in-class service."

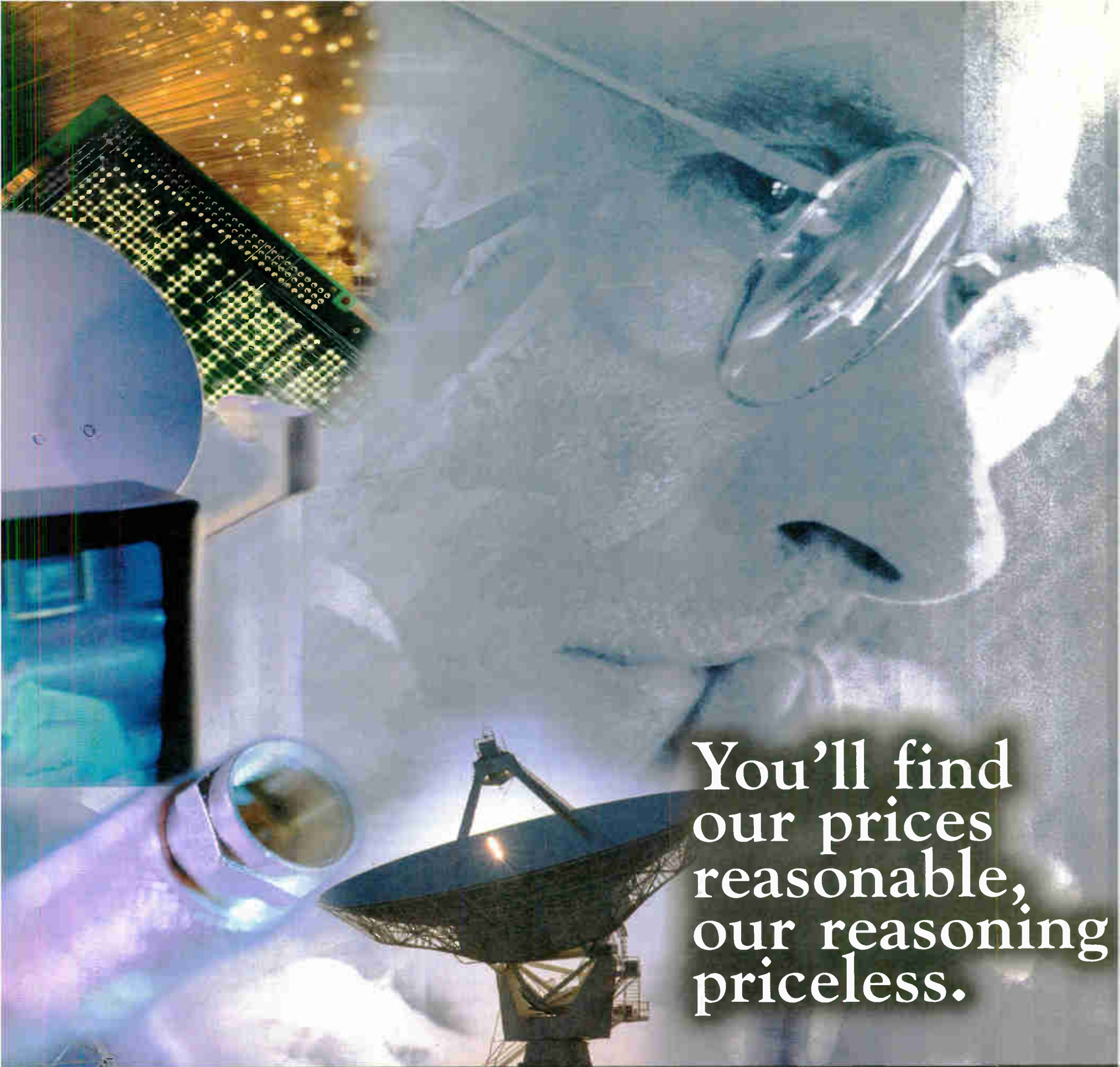

You'll find  
our prices  
reasonable,  
our reasoning  
priceless.

Keeping track of all the satellite and fiber optic communications products out there is a full time job.

That's why so many people come to **DAWN**CO. They count on us for everything from satellite antennas, receivers, LNBS, and position controllers to fiber optic broadband links, satellite links and data links.

We offer the broadcast TV, cable TV, radio and educational fields high quality equipment at down-to-earth prices.

**DAWN**CO formerly known as Dawn Satellite.

But more than equipment, we offer expertise. We can examine your situation and your budget, and recommend exactly what you need. You save both time and money by making the best possible buying decision.

Call a **DAWN**CO expert with your questions by simply dialing **800.866.6969**. Use the same number for our free catalog, or find it all on the web at [www.DAWNCO.com](http://www.DAWNCO.com).



**DAWN**CO

Reasonable prices, priceless reasoning.

# Managers Learn What PPM Means to Them

## Radio Begins to Assess Whether and How PPM Will Change Perceptions About Audience

by Timothy Kimble

The rollout of Arbitron's new PPM method of measuring listening is advancing, and the results have begun to challenge perceptions of how people listen to their favorite stations.

Philadelphia this year became the first market to launch the Portable People Meter, which uses a device similar to a cell phone to monitor stations to which a listener is exposed. That approach is very different from the classic diary system, which dates to 1965.

PPM advocates say the old method captures what listeners *think* they are listening to or what they think they remember listening to.

The new system collects encoded data broadcast by participating stations. The audio may be playing on a participant's radio, in a cubicle next to them or in the store where they shop for groceries.

### Sinking in

This change in monitoring has attacked what researchers call "phantom cume."

"There's this phantom cume that we suspected was there, and now we know it," said Tripp Eldredge. "These are people who listen to stations that didn't sink in at diary time for one reason or another."

Eldredge, president and COO of Direct Marketing Results, says DMR research done in conjunction with the A.C. Nielsen Center for Market Research at the University of Wisconsin has shown that stations may need to rethink how they attract loyal listeners and turn phantom cume into more valuable listeners.

"This changes how people in the industry have thought about their PI listeners. The research shows they may not necessarily be a PI for one station most of the time. They may be a PI at one station, then drift over to another station

a few weeks later."

Eldredge says this data is available because of the continuous measurement nature of PPM, compared with a diary that measures habits for a more limited time.

The data, he said, "also tells us that listeners tend to listen to four or five sta-

know that by your cume, you'll do well." He will present a Wednesday session at the NAB Radio Show, "The New PI: How Consumers Drive Ratings in a PPM World."

### Adult Contemporary

Among those benefiting from phantom cume appear to be stations oriented towards adult listening.

For example, consultant Mike McVay of McVay Media says adult contempo-



An Arbitron marketing photo demonstrates the PPM clipped to a shirt (soldering iron and Detrola radio not included).



Mike McVay



Tripp Eldredge

tions on a regular basis instead of two or three."

Eldredge says programmers must consider new ideas about how to program for stronger time spent listening. "TSL will be key, and we'll look at how we keep those listeners who may be a P5 or P6 listening longer."

He also says stations performing at the top of their markets will likely not have to worry about major adjustments and will not likely see ratings loss.

"If your brand is well known, and you

rare station WBEB(FM), always a strong finisher in the Philadelphia ratings, saw its cume increase from 300,000 with diaries to 1 million with PPM. He also says listeners apparently tune in from two and a half to four and half more times a week than previously thought.

With this extra cume and tune-in, sales people should be rejoicing, right? The final verdict is not yet in on that.

Cox Radio President/CEO Robert Neil has been a vocal skeptic and refused to add his Houston stations to PPM methodology until it was accredited by the Media Rating Council, which happened in January. Arbitron rolled out

the system there in the spring. Neil also has cited disappointment with Arbitron's efforts to educate advertisers on how the system works.

Some owners in Philadelphia reportedly are upset because they feel WBEB's strong showing in the 18-34 age range is a distortion of active listening. Radio One CEO Alfred Liggins, a competitor, likened WBEB's format to elevator music in making his claim.

Radio One is the largest radio compa-

See PPM, page 37 ▶

## Control Solutions

### Model RFC-1/B Remote Facilities Controller

- control transmitter from any telephone
- 8-64 channels of telemetry and control
- programmable control by date and time
- optional printer and modem adapters
- programmable telemetry alarms
- integrated rack panel



### Model RAK-1 Intelligent Rack Adapter

- parallel printer interface
- internal modem for data transfer
- front panel status indicators
- battery backed power supply
- rack mountable chassis
- accessory package for RFC-1/B



## SURE BETS

## Mint Collection

The Mint Museum of Art is located in one of the first branches of the United States Mint at 2730 Randolph Road, Charlotte.

It offers rich and impressive collections of American and European paintings; furniture and decorative arts; African, pre-Columbian and Spanish colonial art; porcelain and pottery; and regional crafts and historic costumes.

Your ticket stub also gets you admission to downtown's Mint Museum of Craft + Design, which features objects in ceramics, glass, fiber, metal and wood (shown).

Tickets \$6, Tues. 10 a.m.-10 p.m., Wed. through Sat. 10 a.m.-5 p.m., Sun. Noon-5, (704) 337-2000. Visit [www.themintmuseums.org](http://www.themintmuseums.org).



# PPM

► Continued from page 36

ny that primarily targets African-American and urban listeners; it and fellow urban broadcasters have complained that their formats are not adequately represented because of the makeup of PPM panels.

Consultants too are continuing to eye PPM results. McVay says he would like to see a shorter time period for listeners to participate; the current term is a year. He'd prefer something more like the traditional ratings period of three months, to avoid drop-off.

## 50 to come

Arbitron Senior Vice President Thom Mocarsky has heard the criticisms and says that while some PPM participants do drop off, it's about 5 to 10 percent, and those are replaced immediately.

While cume increase has been "across the board," he said, the ratings company is working on improving the involvement of younger demographics.

With an abundance of data, he said, some will always be open to misinterpretation, but Mocarsky said early PPM results have produced many more positives and show strong growth in a medium thought by some to be in decline.

Eldredge too noted the exciting amount of data coming out of the PPM. "Now, figure out how to make that phantom cume listen to your station longer," he tells stations. "They may move from P5 to P2 or P1."

McVay also is upbeat but warns against stations becoming jukeboxes.

"Music sweeps will help, but don't be just a music machine. I can listen to my iPod for that." He also noted that PPM data has shown that listeners will stay tuned through commercial breaks at a

surprisingly high rate of about 90 percent. "Not talking isn't the key to increasing audience. Personality is a big part."

audiences: Hispanics and African-Americans spend more time listening to radio than other consumer segments of the Houston radio metro; and a larger

Houston about the listening habits of children, because listeners as young as six are eligible to participate in PPM-based ratings.

It seems likely that many ramifications of the PPM measurement system will become more clear in the coming year.

The first "currency" radio ratings from the Houston PPM were released in July, making it the second PPM market, following Philadelphia. Over the next three years, the system is scheduled to be deployed in the top 50 markets. No. 1 New York, along with the embedded Nassau-Suffolk and Middlesex-Somerset-Union markets, are scheduled to roll out PPM this fall.

Timothy Kimble is a news anchor/reporter for Media Atlantic Network. 

## Several sessions will deal with the wealth of new data beginning to emerge from PPM implementation and the questions raised by the technology.

Other trends in the early PPM results, according to Arbitron: Data in Houston show that radio delivers consistently high levels of weekly and daily cume

percentage of the radio audience is employed full-time than the general market population.

Data is also flowing from Philly and

1.818.840.6749

www.sasaudio.com



## It's not just what's in the box, but who delivers the package.

As a broadcaster, you make a serious investment to get (and keep!) your programming on air. But often the real value of the broadcasting components and software in your station are measured by more than price and features alone.

Sometimes the true benefits are found in the quality, integrity and experience of the people who bring them to you.

SAS has been serving, supporting and supplying innovation to broadcasting for 20 years. And in that time our evolving technologies have consistently led the industry.

Why? Simple. We listen to our customers. Solve problems. Invent new ideas.

From digital routers to console control surfaces, from intercommunications to systems integration, SAS provides comprehensive and competitive broadcast engineering solutions that are intelligent, reliable and expandable for broadcasters large and small.

How can we help you?

Call us. We'll deliver the goods.



20 years of listening. 20 years of innovation.

### Look who's talking now.

ABC Air America Bonneville ClearChannel CBS Disney ESPN Moody NPR Palomares Radio One Spanish Broadcasting System Westwood One And more than 1000 major market and smaller radio stations and broadcasters across the country and abroad depend on the expertise of SAS. Shouldn't you?

See us at NAB Radio Show Booth #506

## PPM at NAB

*Several sessions will deal with the wealth of new data beginning to emerge from PPM implementation and the questions raised by the technology.*

"The Portable People Meter, Listener Loyalty Programs, Listening Appointments and Web Traffic"

Wednesday, 10-11 a.m.

Info session hosted by service provider ResponseBase

"The New P1: How Consumers Drive Ratings in a PPM World"

Wednesday, 1-2 p.m.

Tripp Eldredge

"Seducing PPM: The 7 Habits of Highly Successful Ratings"

Friday, 9-10:15 a.m.

Mark Ramsey

"PPM - The PDs"

Friday, 10:30-11:45 a.m.

Buzz Knight, Gary Marince, Bill Weston

"PPM: From Real World to Currency"

Friday, 2-3:15 p.m.

Mary Barnas, Pierre Bouvard, Kathy Crawford, Janice Finkel-Greene, Blaise Howard, John Snyder



Ask us about our turn-key studio engineering solutions, including furniture and installation.

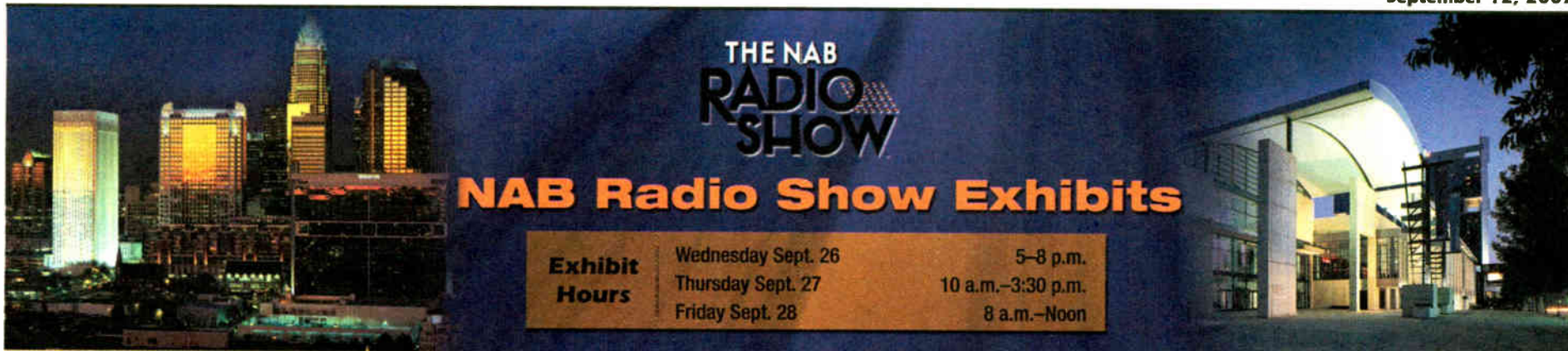

THE NAB  
RADIO  
SHOW

NAB Radio Show Exhibits

<b>Exhibit Hours</b>	Wednesday Sept. 26	5-8 p.m.
	Thursday Sept. 27	10 a.m.-3:30 p.m.
	Friday Sept. 28	8 a.m.-Noon

The following are exhibit booth numbers for the NAB Radio Show in Charlotte. The list was provided by show organizers and was current at press time. Late registrants may not be listed. Check on-site program for changes.

Company	Booth	Company	Booth	Company	Booth
25-Seven Systems	603	Inovonics Inc.	504	Radian Communication Services	626
AEQ	227	Jampro Antennas Inc.	409	Radio Advertising Bureau	526
Airshift Media Ltd.	105	Jetcast Inc.	204	Radio Systems	201
AmWins	531	Kintronic Labs Inc.	110	Radio Traffic.com	205
APT- Audio Processing Technology	615	KLZ Innovations LTD	210	Radio World/NewBay Media LLC	621
Arbitron	301	Larcan USA	505	RCS	217
Armstrong Transmitter	513	LBA Technology Inc.	528	Reliable Broadcast Inc.	532
Army National Guard	211	LEA International	200	Rohde & Schwarz	529
Audemat-Aztec	226	Liquid Compass Streaming Media	428	Sabre Towers & Poles	111
AudioScience	619	Logitek Electronic Systems	611	Sage Alerting Systems	229
Barix Technology Inc.	113	Mackay Communications	202	SafeAssured ID	209
Belar Electronics Lab Inc.	433	Mainesource	527	Shively Labs	401
BIAfn Financial Network Inc.	405	Marketron Broadcast Solutions	530	Sierra Automated Systems & Eng. Corp.	506
Bid4Spots.com	429	Media Monitors LLC	606	Sitepro.com	331
BMI	507	Media Professional Insurance	511	Snapstream Media	411
Broadcast Electronics Inc	417	MediaSpan Group Inc.	629	Stainless LLC	613
Broadcast Software International	121	Micro Communications Inc. (MCI)	631	Stream on Fiber	101
Broadcasters General Store	304	Moseley Associates Inc.	308	Superior Electric	212
Burk Technology	403	Myat Inc.	328	Thales Components Corp.	127
Burli Software Inc.	610	Nautel	221	The Media Audit	319
Business TalkRadio Network	608	NDS	122	Tieline Technology	206
Clear Channel Satellite	533	OMT Technologies	501	Univision Radio	207
Coaxial Dynamics	637	Orban/CRL	230	Valcom Manufacturing Group Inc.	612
Communication Graphics Inc.	601	OTLighting Inc.	532	Viero	602
Comrex	300	PlanetJam Media Group	124	V-Soft Communications	605
Continental Electronics Corp.	500	Play MPE	627	Westar Music	336
D.A.V.I.D. Systems Inc.	203	Power-Link/ProofOfPlay.com	103	Wheatstone Corp.	510
Dalet Digital Media Systems USA Inc.	107	Propagation Systems Inc. (PSI)	213	WhiteBlox	329
DAVICOM, a div of Comlab	632			WideOrbit	521
DaySequerra-ATI	112				
Dielectric Communications	117				
Dolby Laboratories	330				
Double Radius Inc.	228				
Eastlan	617				
ENCO Systems Inc.	508				
Energy-Onix	427				
ERI-Electronics Research	310				
Federal Communications Commission	326				
FirstCom Music	600				
Global Security Systems LLC	421				
Google	517				
Harris Corp.	311				
HIBN {Home Talk}	109				
Impact PBS	628				

**SURE BETS**

## Fore!

With their moderate climate and sunny skies, the Carolinas are noted for first-class golf, including the legendary Pinehurst Golf Resort.

Pinehurst, 92 miles due east of Charlotte, is a national landmark and a premiere golf resort that has hosted "more championships than any other golf course in the country," most recently the 2005 U.S. Open. The facility features *eight* 18-hole championship golf courses, 24 tennis courts and a 31,000-square-foot spa.

Charlotte also hosts the PGA Wachovia Championship at the Quail Hollow Club, a redesigned Tom Fazio course. The city area has more than 80 golf courses, public and private. The Ballantyne Resort Golf Club, shown, recently was named among the "Top 38 Great Golf Resorts in the World" by PGA Magazine. Visit [www.ballantynesort.com/golf/index.cfm](http://www.ballantynesort.com/golf/index.cfm). Pro shop: (704) 248-4383.

Check out [www.golfnorthcarolina.com](http://www.golfnorthcarolina.com) and [www.ncgolf.com](http://www.ncgolf.com) for information on courses.

— Charlotte "sure bet" tips were compiled by Jackie Broo.

Photo courtesy of Visit Charlotte

# The Landscape has Changed.

**GROW YOUR REVENUE  
WITH MYSIMBOOK**

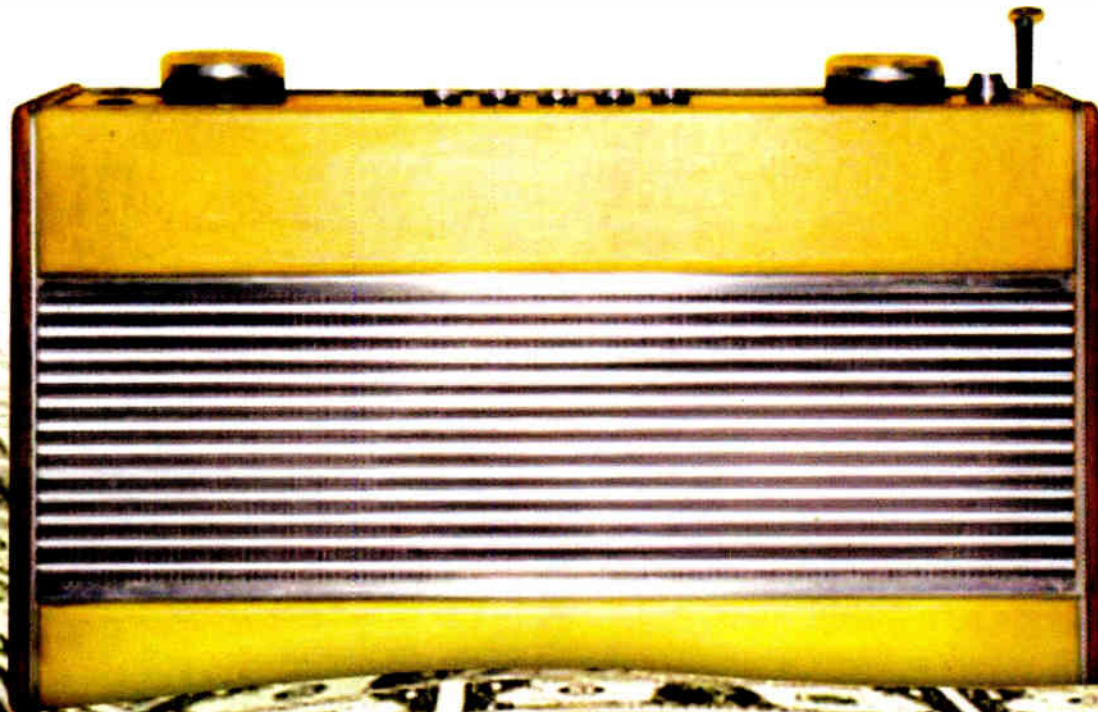

MySimBook's radio partner program gives broadcasters the power to resell mobile marketing packages and provides a rich information channel to dramatically enhance the FM broadcast experience.

- **Text Message Marketing** delivers advertising and promotional messages instantly to mobile phones through SMS (Short Messaging Service).
- **Shortcode Marketing** allows listeners to easily text in keywords to your designated shortcode and in a matter of seconds they'll receive content, promotions, deals or even ringtones. For example, text "mobile" to 69746 (MYSIM).
- **FM/RDS Marketing** allows radio content blasts to be synchronized with existing FM broadcasts and sent to multiple receiving devices equipped with an FM chip, such as cell phones, iPods, or other PDAs.

[www.alertfm.com](http://www.alertfm.com)

See us at the NAB Radio Show Booth # 421



**MySimBook.com**

*Providing new revenue streams for FM broadcasters*

For more information, call 337.291.7570

or toll free at 888.311.3350



# You're looking at a complete audio-over-IP routing system.

(Just add Cisco.™)

**Administer this** • The beauty of the Web is that you can get information anywhere. Same thing with Axia: you can set up and **administer an entire building full of Axia equipment** – audio nodes, consoles, virtual routers, whatever – from your own comfy office chair. All you need is a standard Web browser (PC or Mac, we like 'em both). Put an Internet gateway in your Axia network and you can even tweak stuff remotely, from home or anywhere there's a Net connection. Mochachino, anyone?

**A node for every need** • Someday, all broadcast gear will speak Livewire (so says our Magic 8-Ball). Until then, there are Axia Audio Nodes that turn analog and AES sources into routable 48 kHz / 24-bit audio streams.

**Automation station** • Wouldn't it be cool to have a **self-monitoring air chain with silence-sense** that can fix problems, then e-mail a status report? To be able to switch your program feed from Studio "A" to Studio "B" with one button? Or build custom switching apps and scheduled scene changes based on Boolean logic and stacking events? PathfinderPC software does all these things and more. But unlike HAL 9000, it doesn't talk back to you.

**It's not rude to point** • Little kids tell mommy what they want by pointing — a pretty intuitive way of doing things. PathfinderPC software gives talent the same convenience. You can **build custom "button panels"** to execute complex operations with just one click. You can map these panels to controller modules on Element consoles or to turret-mounted controls, place mini-applications on studio computer screens, even run them on touchscreen monitors.

**Ether Net** • Hardly a month goes by without a story concerning someone getting knocked off the air by STL frequency interference or bandwidth reductions. There's also the headache of trying to add HD Radio™ program streams to already maxed-out transmission links. Luckily, Axia clients have a way around this particular roadblock: they've been using Ethernet radios from well-known manufacturers like Orthogon, Dragonwave and BE to construct a link between the studios and the transmitter that operates *above* the crowded 950 MHz band. Put an Axia AES/EBU Audio Node on both ends of that link and before you can say "Look! Up in the sky!" you've got an Ethernet STL, with room for multiple channels of program audio plus backhaul. And that's **uncompressed 48 kHz, 24-bit audio** — without nasty compression artifacts that degrade your lovingly-tweaked audio chain. Add a couple of Axia GPIO nodes to the mix, and your new STL link can carry remote control commands for transmitter and processing gear, too.

**AES yes** • You like your audio to stay digital as much as possible, right? We get that. That's why we have AES/EBU Audio Nodes that let you plug AES3 sources right into the network. Studio-grade sample-rate converters are inside: anything from **32 kHz to 96 kHz** will work. Oh, and there's 8 AES ins + 8 AES outs in each node. Digital distribution amp, anyone?

**Brains in the box** • The typical radio jock cares for studio equipment about the same as a five-year-old cares for a puppy: haphazardly, if at all. That's why we **took the CPU out** of our Element modular console and put it in here, with the power supply and GPIO ports. That means a greatly reduced chance of being taken off the air by a Coke spilled into the board. C'mon, don't you have better things to do than trying to dehumidify circuit boards with a hair dryer?

**That's cool** • Noisy fans in studio equipment? That's a major *faux pas*. You won't find a fan in any Axia Audio Nodes — they're designed to run **cool and silent** (unlike your morning show talent).

**Let it grow** • Growing your business computing network is easy: just add more PCs and hook them to the Ethernet switch. But with broadcast routers, adding more capacity usually means buying another frame, installing more I/O cards, pulling more discrete cable through conduit that's already full to the brim. Hope you've got stock in Green Formula! But since IP-Audio networks use standard Ethernet, **adding more capacity to an Axia system is as simple as plugging in an Audio Node** wherever you need inputs. And should you need to move to new digs, you can just unplug your Axia system and take it with you. Try doing *that* with a big iron router.

**0rc slayer** • Hooking up an Axia Audio Node may be the simplest thing you've ever done. All our I/O is presented on RJ-45 and adheres to the StudioHub+ standard, so connecting audio devices is as simple as plugging in an Ethernet patch cable. All of which gives you more time to play World of Warcraft with those guys from IT.

**Level headed** • These green, bouncing dots built into every Axia Audio Node are confidence meters. One glance and you know whether an audio source is really active — or just playing possum.

**Push to play** • Axia Router Selector Nodes are pretty cool. Think of them as **really advanced selector and monitor panels**; put one anyplace you need access to audio streams from the IP-Audio Network. Like newsrooms, where a reporter might need access to a satellite feed or a Zephyr connection. Or dubbing stations, where audio is captured and stored for later use. Or in the station's TOC, so you can monitor any of the hundreds — or thousands — of audio streams on your network at a moment's notice. Use the LCD screen to scroll through a list of available streams, or use the eight Fast Access keys on the front panel to store and recall the streams you use most. And Router Selector nodes have something standard XY panels don't: an input for fast connection of an analog or AES device. Sweet.







« Thinking about Axia but waiting 'til we're "more established?" You might not know that there are over 400 Axia studios on-air around the world — and counting.



« An Axia system can expand or shrink as much as you want it to — the Ethernet backbone lets it scale easily, on-demand. Portable too: just take it with you if you move.



« Axia systems install in as little as half the time of hardwired routers — and without expensive, bulky multi-pair cable. Whatever will you do with all the time you save?



« Is IP reliable enough for 24/7 audio transport? Millions of VOIP business phone users with systems based on Cisco routers certainly think so. Coincidence?

**Nothin' but Net** ■ Did you know you can plug a PC directly into an IP-Audio network and use it to send and receive audio? Can't do that with a mainframe router. Well, you *could* add more input cards to the mainframe, and then buy high-end audio cards for your PCs, and then run more wiring all over the place... but with Axia, you just install the **IP-Audio Driver** on any Windows \* PC to send and receive pure digital audio right through the PC's Ethernet port — no sound card required or additional router inputs needed. You get better, cleaner PC audio that's sharable right to the network. The single-stream version is great for audio workstations; the multi-stream version lets you send and record **16 stereo channels simultaneously** — perfect for digital automation systems.

**CYA** ■ Sooner or later, someone's going to ask for a hard copy of a specific broadcast. Whether it's a client looking for proof of play, a Group PD that wants airchecks, or a listener claiming your morning show did something naughty, you're going to need a way to prove what was said. Axia makes it easy to keep archives of your programming with iProFiler networked audio logging software. Just install iProFiler on a Windows PC with a NIC and connect it to your Axia network; tell it what audio streams you want to record and it goes to work, sucking audio out of your network like pimientos from

Martini olives. iProFiler can record **up to 16 channels of stereo audio simultaneously**, storing them as time-stamped MP3 files you can save to a network drive or FTP server for listening or re-broadcast. And since logic always follows audio in an Axia network, you can tell iProFiler to record only when the jock's mic is open (or vice versa). And of course, you can listen to saved audio from any PC connected to the Axia network.

**Put that in your pipe** ■ How many discrete wires can a CAT-6 cable replace?

Well, a T-3 data link is pretty speedy with 44.7 Mbps of throughput. But Axia networks use Gigabit

Ethernet links, with 1000 Mbps, between studios. That's more than 22 times the capacity of a T-3; enough throughput for 250 stereo channels per link — the equivalent of a **500-pair bundle on one skinny piece of CAT-6**. You can even use media converters and optical fiber for higher signal density if you want. Think that might save a little coin in a multi-studio build-out?

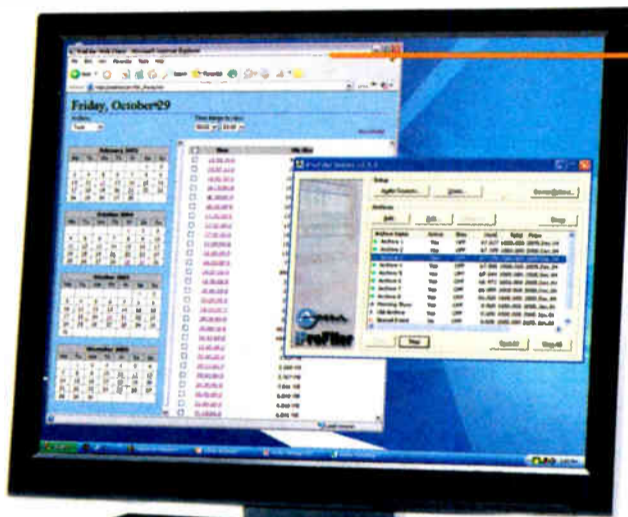

**Heavyweight champion** ■ This is an Axia StudioEngine. It works with our Element Modular Consoles (the fastest-growing console brand in the world by the way) to direct multiple simultaneous inputs and outputs, mix audio, apply EQ, process voice dynamics, and generate multiple mix-minuses and monitor feeds on the fly. To make sure it delivers the reliability and ultra-low latency broadcast audio demands, we powered the StudioEngine with a fast, robust version of Linux — so fast that **total input to output latency is just a few hundred microseconds**. How can one little box do so much? There's a blazingly-fast Intel processor inside, with enough CPU muscle to lift a small building. Strong *and* fast: Ali would approve.

**Hakuna matata** ■ Axia networks are self-monitoring and self-healing. Spanning Tree Protocol in the Cisco Ethernet switches we use combines nicely with PathfinderPC's automated program stream monitoring to help ensure that your studio network is **on the air 24/7**. And all Axia gear (like this StudioEngine, that mixes control room audio streams) runs real-time Linux for operation that's as bulletproof as Superman's boxers. Which means "no worries, mate."

**You got to have friends** ■ Sure we think IP Audio is cool. But it's even cooler that so many *other* folks think so too. Delivery system providers like ENCO, Prophet,

BSI, BE, iMediaTouch, DAVID Systems and more all have products that **work directly** with Axia networks. So do hardware makers like AudioScience, International Datacasting Radio Systems, Telos and Omnia. Check out the whole list at [AxiaAudio.com/partners/](http://AxiaAudio.com/partners/).

**Jammin' on the mic** ■ Radio studios and microphones go together like Homer Simpson and donuts. Unfortunately, so do preamps, mic compressors, EQ boxes, de-essers — let's face it: most studios house more flying saucers than Area 51. Axia helps clean up the clutter by including mic preamps with our Microphone Nodes; not bargain-basement units either, but **studio grade preamps** with headroom enough to handle Chaka Kahn. Phantom power, too. And if you choose to use Axia Element consoles in your studios, you'll find world-class mic processing built right in: vocal dynamics (compression and de-essing) from the audio processing gurus at Omnia, plus three-band parametric EQ with SmartQ, available on every mic input. Rap on, Grandmaster

**Very logical, Captain** ■

Routing logic along with audio used to be almost as hard as performing the Vulcan Mind Meld. But Axia makes it simple, because machine logic can easily be converted to data and paired with Livewire audio streams. So **logic follows audio throughout the facility** on Axia's switched Ethernet backbone. Eight assignable GPI/GPO logic ports, each with five opto-isolated inputs and five opto-isolated outputs, are built into every Element power supply, so you can control on-air lights, monitor mutes, CD players, DAT decks, profanity delays, etc. If you've got more than eight audio devices (and who doesn't), just add a standalone GPIO node like this one wherever you've got gear.



[AxiaAudio.com](http://AxiaAudio.com)

# Workbench

Radio World, September 12, 2007

Past columns are archived at [radioworld.com](http://radioworld.com)

## Keep Racks Organized, Toolboxes Dry

by John Bisset

Last issue Mark Ward offered a warning to broadcasters to check the phone number of the nearest FAA Flight Service Station.

You'll recall he needed to report a tower light outage but the number had been changed. Chris Tracy, market chief for Clear Channel's Springfield, Mass., cluster adds more on this, found on an Internet list.

Chris writes that when calling in a NOTAM (Notice to Airmen) of a tower light failure, be persistent to make sure that the notice is posted. Make sure you get the NOTAM number, the date and time issues, and the initials of the person taking the NOTAM.

If your jock staff calls in the failure, make sure your step-by-step instructions include obtaining this information and notifying you as the CE. Be sure to check that the NOTAM was actually issued by heading to <https://www.notams.jcs.mil/>.

It's interesting to note that the site is hosted by the Joint Chiefs of Staff of the Department of Defense.

Enter the three-letter abbreviation for the nearest airfield, preceded with the letter "K." So for Manchester (MHT), you would enter KMHT. Click the radio button labeled "View NOTAMs" and you should get back all NOTAMs related to that airfield. About halfway down the list should be the tower light NOTAMs.

If your NOTAM is listed, confirm that everything is correct as was reported to the FAA.

Another note: Check the expiration date of the NOTAM. If you don't see your NOTAM listed, and a reasonable amount of time has passed — say 60 minutes — call the FAA back. Use the

NOTAM number you were given earlier and get the issue resolved.

As Mark Ward noted, there have also been significant changes as to how tower lighting failures are reported. This has evolved as a part of the privatization of the whole flight service system. The telephone numbers to the local FFS (Flight Service System) are either no longer in use or will be terminated soon. Some FFS locations have already been shut down.

In its place is a new national number for all tower light and obstruction system malfunctions and outages, toll free (877) 487-6867. But there is a twist. If the assigned FFS for your area is busy, the call is automatically routed to the next available Flight Specialist throughout the country. So if you're calling from Maine, you could be connected to a flight

specialist in Anchorage.

Because the specialist may be outside your area, it's important to check the NOTAM on the above mentioned Web site. Do the legwork now, and don't wait until the lights fail.

Thanks to Chris Tracy for the added information. Chris can be reached at [ctracy@clearchannel.com](mailto:ctracy@clearchannel.com).

★★★

We typically see D-rings in the phone closet, along with a butt-in set, as seen in Fig. 1. But there's no reason the D-rings can't be used inside equipment racks, as shown by Cox Richmond Market Chief Jon Bennett.

One of the biggest advantages of using these rings in racks, Jon says, is that they keep the wiring neat without taking up a

lot of room like plastic duct would. Seen in Fig. 2, the D-rings are easily bolted to the rack support to keep wiring neatly routed.

Jon Bennett can be reached at [jon.bennett@coxradiocom](mailto:jon.bennett@coxradiocom).

★★★

Larry Lamoray of The Systems Store ([www.systemsstore.com](http://www.systemsstore.com)) sends a note with a neat device pictured in Fig. 3.

The Thread Checker belongs in every shop and gives you an efficient way to check the size of both metric and standard nuts and bolts.

It's easily mounted on a wall, where it's out of the way, but ready to identify. With the Thread Checker, there are no more crossed threads.

See THREAD, page 45 ▶

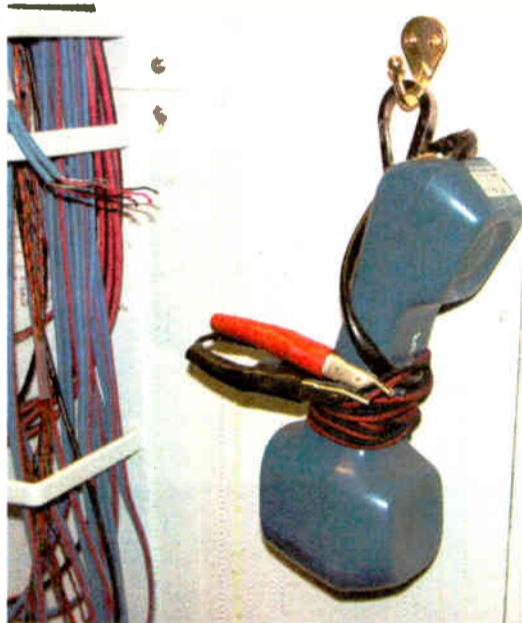

Fig. 1: Have a butt set handy in your phone closet.

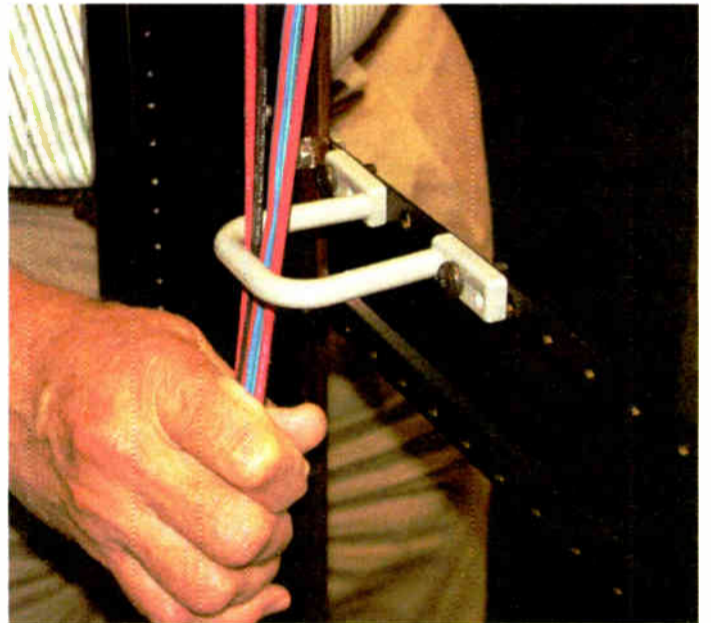

Fig. 2: D-rings can also be used in equipment racks.

## The Best FM-Translator Receiver, Hands Down!

Your obvious choice for all critical off-air pickup applications!

Composite/MPX and L/R audio outputs.

Passes RDS and SCA subcarriers.

Wide/narrow IF bandwidth selection.

Accurate front-panel metering of total-mod, L/R program audio, signal strength and multipath.

Carrier-loss muting and built-in overdeviation protection.

'Tally' outputs for remote alarms of carrier loss and program audio channel loss.

Model 631  
\$1390

IN STOCK NOW!

For full technical details, visit

[www.inovon.com](http://www.inovon.com)

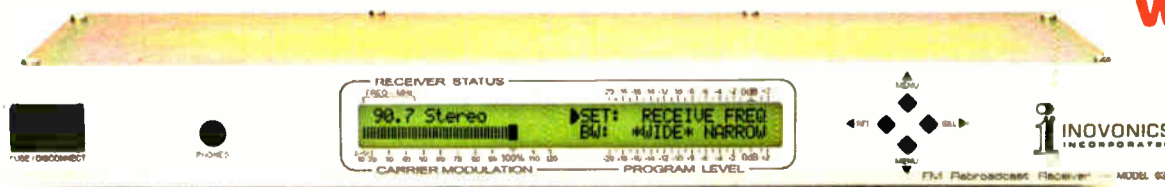

**Inovonics**  
1305 Fair Ave. • Santa Cruz, CA 95060  
TEL: (831) 458-0552 • FAX: (831) 458-0554  
[www.inovon.com](http://www.inovon.com) • e-mail: [info@inovon.com](mailto:info@inovon.com)

See us at NAB Radio Show Booth #504



**specify:**

## Millenium **ANALOG**

### For Analog Dependability

Millenium Analog Consoles still offer thousands of broadcasters great sounding audio performance.

With solid-state switching, rugged LED-lit keypads and total DC audio control, Millenium Analog Consoles are known for 24/7 reliability. When analog fits the bill — the best value is Radio Systems Millenium Consoles.

Analog, Digital or Livewire — only Millenium lets you choose.



**specify:**

## Millenium **DIGITAL**

### For Digital Connectivity

When digital is the requirement— Millenium Digital Consoles are built to provide full digital quality and performance.

With 10 mix-minus outputs, simultaneous analog and digital stereo buses and **FREE** factory digital channel upgrades, Millenium digital consoles are engineered for your digital future.

Analog, Digital or Livewire — only Millenium lets you choose.



**specify:**

## Millenium **LIVEWIRE**<sup>®</sup>

### For Network Connectivity

Millenium Livewire consoles feature IP audio connectivity **AND** local studio mixing.

Connect your local studio sources to 12 channels of studio mixing and select facility-wide sources on LCD displays. Radio Systems combines the power of Livewire networking with the functionality of a studio stand-alone console package.

Analog, Digital or Livewire — only Millenium lets you choose.

Livewire is a registered trademark of TLS Corp.

**Analog, Digital or Livewire...**  
**only Radio Systems lets you choose.**

Radio Systems, Inc. • 601 Heron Drive • Logan Township, NJ 08085  
Phone: 856-467-8000 • Fax: 856-467-3044 • [www.radiosystems.com](http://www.radiosystems.com)

See us at NAB Radio Show Booth # 201

World Radio History

**radio**  
**SYSTEMS**

Analog and Digital Broadcast Equipment

# We Map the Mobile Multimedia Maze

*If the Camel Is a Horse Designed by a Committee, Its Next Project Must've Been Wireless Multimedia*

by Skip Pizzi

Time was, all it took to provide a broadcast service was a transmitter and a receiver. While technically that's still true, there's a lot more to it nowadays.

Some recent failures point out just how difficult it is to put all the pieces in place, and how high the stakes are in attempting to do so.

Consider all the current hype over Mobile Multimedia services — often called simply “Mobile TV,” but for this newspaper's audience in particular, it's important to note that the services typically include radio services or other radio-styled, audio-only services as well.

Given such buzz, you'd think that players who were early to market would do quite well. Unfortunately this is not the only parameter of success, as two pioneers of Mobile TV recently learned.

In the U.S., Crown Castle's planned *Modeo* service has curtailed its efforts without ever fully launching, and is now moving to sell off the service's spectrum assets (it had a national license for 1670–1675 MHz). Meanwhile, in the U.K., British Telecom's *Movio* service, which launched there in October 2006 (with a Mobile TV subscription service over DAB), has announced it will cease operations early next year.

What happened to both services is an object lesson on how the world of wireless media-content delivery has changed, and it bears observation by broadcasters as they appraise their future prospects.

## A moving target — literally

First, let's step back a bit to clarify some basic assumptions and the motivations they engender.

Wireless broadband is seen as the obvious next step in the evolution of the connected citizen. As consumers have become accustomed to broadband connectivity in *fixed* locations, the services thereby obtained have become an increasingly common, expected and relied-upon part of their daily lives.

So it stands to reason that portable versions of the same will become quite popular. Thus the primary target of wireless broadband is the handheld consumer device.

The ideal makeup of this device is a complex calculation, and one that is also still evolving, of course, but it is without doubt a highly multifunctional device.

Clearly, voice and simple data communication (such as Instant Messaging) will be primary functions, but the “pocket convergence” of other functionalities

mitter. In this case the handheld device is a multi-purpose receiver that includes a cellular phone transceiver, plus a digital broadcast receiver.

Mobile multimedia services are acquired, discovered, navigated, authenticated and if necessary, ordered (for on-demand services) via the “phone side” of the device, but the media content itself is delivered to the device via its digital broadcast “receiver side.”



Nokia's N77 'multimedia computer' promises 'an optimized mobile TV experience in a compelling and compact form factor.'

makes these devices even more appealing. This includes push e-mail, Internet browsing and search, contacts and calendar synchronization, lightweight productivity applications, games, camera and/or photo display, media storage/playback (music and videos/TV shows/movies) and — the apparent Holy Grail du jour — live or on-demand access to rich media content.

There are two schools of thought on how to provide the latter.

One approach employs the broadband cellular network that is used for all other connectivity, but this can provide a less than optimal user experience due to congestion on these networks, especially given the requirement for a fairly constant and relatively wide bandwidth to play a real-time audio/video signal. (And when a large number of users all want to watch the same signal at once, this becomes a much more serious problem.)

So an alternate approach has emerged, in which the A/V signals are delivered to the device via a digital broadcast trans-

mission. This method keeps the high-bandwidth traffic off of the cellular network, and allows an unlimited number of simultaneous users to receive the same content without clogging the network.

## It takes a corporate village

The path between media content creation and delivery to consumers has become much more crowded in the digital world, particularly where wireless distribution is involved.

Yes, *wired* broadband is still a growth business, but most players have already planted their stakes in that arena, and the ongoing Net Neutrality debate notwithstanding, it is a fairly open, stable and regulated marketplace, with only incremental growth foreseen.

Wireless multimedia, on the other hand, remains the Wild West, with lots of open space on the horizon, no dominant players as yet, and regulations still to be drawn. Thus it looks to be the next telecom gold rush, so many players are flocking to become engaged.

## The Big Picture



by Skip Pizzi

There are also more players involved due to the sheer number of segments in the chain. As the digital media business has evolved, different players have concentrated (either by choice or by rule) on an increasingly specialized piece of the overall distribution channel.

This is quite different from the traditional world of wireless delivery, where there were really only two businesses involved: 1) broadcasters, who created, distributed and delivered content through the air to consumers, and 2) manufacturers, who built receivers that consumers simply bought, turned on and tuned to broadcast channels to receive content.

Today the chain includes content providers, their hosting services, distribution networks (the Internet backbone), last-mile connectivity (wireless service providers) and compatible devices.

And that's not the end of the complexity: In the United States, the device design typically is controlled by the wireless service provider, so consumers' choice of receiver and features is constrained by their network. This means the long and growing list of styles and features included on these devices are not always available to every consumer at all times, or at the price point they'd prefer.

Importantly, this control of features typically includes the non-inclusion of an FM radio receiver on most U.S. handsets — even though in many cases the required circuitry may actually be loaded on the device, but wireless network operators simply choose not to enable it.

Some have argued that this becomes a matter of public safety, because during disasters the cell network may be temporarily inaccessible due to overload, but the radio could be providing a user with valuable or even life-saving information throughout.

See MOBILE, page 46 ►

## DIGITAL AUDIO SWITCHING



## THE LOGICAL WAY 3-DRX

Automatically switches between two AES digital audio signals or a stereo analog signal. Analyzes digital signal errors (CRC, bit, framing, etc.) and checks for loss of audio on the digital signal. User programmable.

**TITUS**  
TECHNOLOGICAL  
LABORATORIES

800.806.8851

WWW.TITUSLABS.COM

# Thread

► Continued from page 42



If you haven't been to the Systems Store Web site, visit. You'll be amazed at the variety of problem-solvers the Systems Store sells.

★★★

Randy Howard and I must buy our vitamins from the same company.

Randy writes about the perforated plastic or paper containers that hold silica crystals. These packets can be used to deter moisture in toolboxes. The only problem is that if the wrapper gets torn, the little silica beads are now rolling around in the toolbox.

Enter the vitamins.

Randy found a small perforated plastic container in his last bottle of mail order vitamins. The cylinder is about 1 inch long and 3/4-inch in diameter. Because

the ends are perforated but the wall of the cylinder is solid, there's less chance of the container being torn open. The solid wall also provides a means of attachment with either glue or tape to the inside of whatever it's protecting.

The device is called a "SORB-IT CAN" and is manufactured by S-CPP in Belen, N.M. The humidity absorber protects products from moisture damage during shipping or storage. The company's site is [www.s-cpp.com](http://www.s-cpp.com).

John Bisset has worked as a chief engineer and contract engineer for 38 years. He is the northeast regional sales manager for Broadcast Electronics. Reach him at (571) 217-9386, or [jbisset@bdcast.com](mailto:jbisset@bdcast.com). Faxed submissions can be sent to (603) 472-4944. Submissions for this column are encouraged, and qualify for SBE recertification credit.

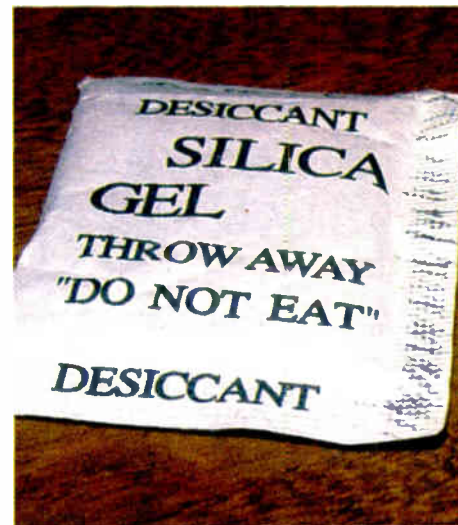
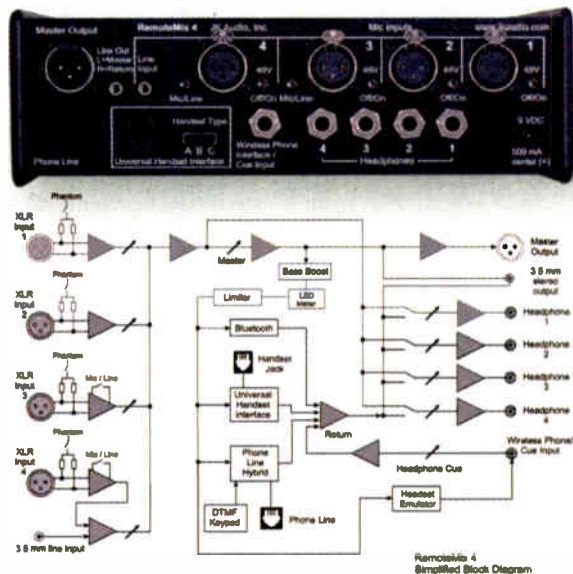

Fig. 4: Silica gel packs are great — until they rip in your toolbox.



## RemoteMix 4

Introducing A Field Mixer That's Outstanding In Its...um...Field



Combining a four-channel field mixer with a four-channel headphone amplifier, a phone-line hybrid, a universal PBX handset interface, a wireless phone interface and Bluetooth® Wireless Technology to connect to cell phones and portables, the RemoteMix 4 is ready to work just about anywhere you are.

Use it as a phone-line hybrid, calling into your studio talk show hybrid. Use it as a front end mixer for your POTS, ISDN or IP codec. Or use it as a combination broadcast/IFB mixer. No matter how you use it, you'll find that it's an incredibly versatile mixer.

Plus... IT SOUNDS GREAT! A soft limiter prevents overdriving the phone line interfaces, while the mixer XLR output is pre-limiter (full range), meaning you have a feed for every need. Bass boost adds a bit of low end before sending the signal down the phone line to provide that "how'd you get it to sound THAT good over POTS lines" nudge. There are convenient 3.5 mm send and receive jacks for recording the show or mixing in your MP3 player.

The RemoteMix 4 can be powered by batteries or the included AC adapter, so you'll never lose a connection — even during a loss in power!

We think we've done our homework with RemoteMix 4. And it'll be in your hands in plenty of time for the fall sports season.

**JK Audio**  
TOOLS FOR SUCCESSFUL RADIO

JK Audio, Inc. Sandwich, IL 60548 USA • Toll Free: 800-552-8346 • Tel: 815-786-2929 • Fax: 815-786-8502 • [www.jkaudio.com](http://www.jkaudio.com) • [info@jkaudio.com](mailto:info@jkaudio.com)

Fig. 3: Quickly determine bolt and nut threads with the Thread Checker.

## RADIO IT MANAGEMENT

# What to Do Before All Is Lost

*Develop a Content Archive for Your Station.  
You Never Know When a Failure Could Occur*

by Chris Prewitt

Your station likely is spending a lot of time and money putting audio segments together every day. Often these pieces are aired for their lifecycle and then forgotten. The issue becomes what to do with these segments later.

This article poses many important questions and lots of possible solutions. It also deals with the questions you must answer when setting up an archive or backup of your audio pieces.

We will discuss the keys to a good backup, some of the potential solutions that exist and some recommended steps to take in backing up your audio files.

## First questions

The first decision you need to consider before developing your backup plan is how much of your audio you want to store.

Depending on the needs of your station, the budget and content, you may have very different archive needs, from every piece of audio you generate to small segments done occasionally.

You will also need to think about how long you want the archived files avail-

lossy compression, in my opinion.

Formats like MP3 and AAC do have the benefits of taking up much less storage space, but not without a cost.

media you will use to store the files.

Many types of storage media exist and are used by different companies. Without reviewing them all, the most common used for backups are CD (compact disc), DVD (digital versatile disc), hard-disk drive, Flash drive and DLT (Digital Linear Tape).

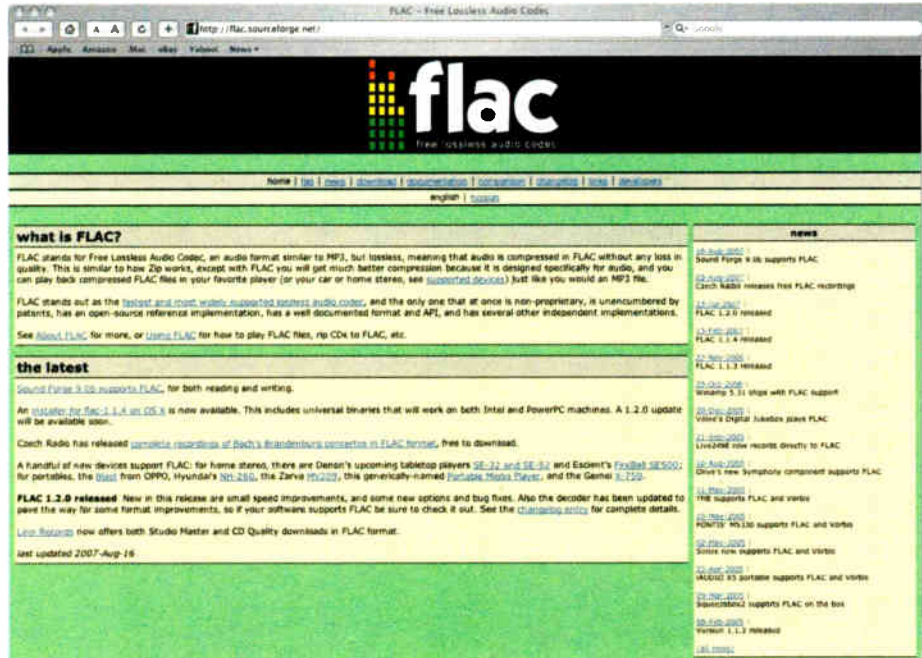

Free Lossless Audio Codec Web Page



Hard-disk drives come in various formats and numerous sizes.

able. Sometimes audio gets dated very fast and is not really useful anymore, so it's important to know what needs to be kept for 1 month vs. 50 years.

The audio stored could range from something "nice to have" to something you absolutely must keep. So consider how secure to make the archives.

Typically radio station archives will continuously grow as more material is generated and it is a good idea to estimate the growth. Once you have the answers to these four major questions you can begin to develop a backup plan.

- How much past material will be archived?
- How long do you want it available?
- How secure does it need to be?
- How much it will grow each month or year?

## What are you willing to lose?

There are three keys to maintaining a valuable archive: high quality in the backups, a universal format and redundancy.

When starting to determine how much you will store, the idea of compressing the audio probably will arise. Many consumers use compressed formats for their audio like MP3 or AAC, but for professional broadcast use, quality is too important for a

Unfortunately, they permanently delete some of the audio.

If you do want to compress the audio in your backups it is important to look into a lossless compression. A good example of this is FLAC, a Free Lossless Audio Codec that can compress up to 24-bit audio files. There are several lossless compressions that exist, but FLAC seems to be one of the best right now.

This brings up another key with regards to backups: The format you save in is important.

When deciding what format to save in, consider the future and find a format that will still be around when you need to access your archives. The WAV format seems to be the most common and universally accepted format. This format is normally uncompressed and often used by experts. Two benefits of WAV files are that it can be very high-quality audio, and many software programs can edit the files. The major drawback is the large size of files.

Again, selecting a format that will still be in use when you need it is an important factor to consider and you must find one that meets your needs.

## Medium

When considering the format of the audio you also need to decide on what

Each media format has its own advantages and disadvantages and can be useful or not depending on your backup situation.

The compact disc originally was developed for digital audio and is still the standard for physically storing media. The CD has two major drawbacks for archive use. A CD typically only holds 650 to 700 MB of data or around 80 minutes and is reported to have a lifecycle of anywhere from 18 months to 100 years. But three years seems to be the most

common estimate for the life of a CD and this is just not enough space or time for most archives. I would only recommend a CD as a short-term backup media.

A DVD is a little better than a CD; its lifecycle should be a little longer and it can store more than eight times more data. Certain DVDs can be burned on both sides and sometimes in dual layers for increased storage space. DVD-Audio has advantages over the CD in that more audio can be stored and the quality of the audio can be set higher. DVD is a good format for personal use when the content needs to be high quality and does not need to last more than five years.

The medium you probably use on a daily basis and more than any others is the hard-disk drive. These come in several formats and numerous sizes.

The lifespan of a single hard drive can vary from 18 months or less to 15 years or more. Typically drives come with a warranty of three to five years. Hard drives are unique in that regular use is good for the drive. You will find that a disk will last longer spinning in a system than sitting on a shelf; the startup and shutdown process is hard on disks.

Hard-disk drives can be set up in many ways and used internally in a computer, externally in an enclosure of some sort, combined with several drives, or even in several systems over a SAN (storage area network) to reach the storage needs you have. The maximum size on a single hard drive on the market seems to grow every day; now it is right around 1000 GB or 1 terabyte per disk.

Hard drives are also relatively cheap considering the amount of storage they provide and many ways they have of protecting the data on them. More on that in a moment.

Flash drives and tape drives are also common for backup uses. The lifecycle of a Flash drive is tough to determine and appears to be based more on how much it is used than how long it has been used. Flash drives range in size from 32 MB to

See ARCHIVE, page 48 ▶

## Mobile

▶ Continued from page 44

Note also that this differs significantly from the non-U.S. experience, where all devices generally run on all networks. There, consumers typically buy their devices first, based on the features they want (often including FM radio, by the way), then they shop for a service plan from a provider, knowing that the device is certain to work as expected when they connect.

Thus the U.S. consumer's experience is the result of an intricate dance with content providers, service providers (sometimes several) and device manufacturers. Even among the device manufacturers, a little ballet of their own may take place between OEMs (original equipment manufacturers) and what are called ODMs (original device manufacturers) — lesser-known subcontractors who actually fabricate the devices for the brand-name companies whose logos are on the shell.

The process of device design has itself become a complex matrix that starts with choices of spectrum and radios (most devices now include multiband transceivers covering WiFi, Bluetooth,

CDMA or GSM for voice, GPRS or EDGE for 2.5G data, HSDPA or EV-DO RevA for 3G broadband service, etc., with future devices also likely including some sort of digital multimedia broadcast receiver), then moves to decisions on processor chips, operating system and other included software, user interface (buttons, touchscreen and/or QWERTY), screen size/aspect ratio/resolution, physical interfaces/connectors, and battery life/size.

Actual implementation flows from the specs (and delivery schedule) set by the net operators to the OEMs to the ODMs and back. Along the way substitutions or compromises may need to be made, sometimes resulting in a non-optimal product, but one which the net op is already committed to deploy.

All this just reflects some of the technical complexity of digital wireless delivery, but there is a similarly byzantine business architecture involved, as well.

We'll consider the latter next time, with a closer look at the two recent failures mentioned earlier, and some rules of the road for broadcasters if they want to be successful players in this complicated space.

Skip Pizzi is contributing editor of Radio World. 📺

# JUST ENOUGH TEST



Is your bulky bench analyzer more test than you use and more weight than you want?

Sophisticated Minstruments from NTI give you just enough test capability, plus functions not even available on their larger siblings... and these flexible instruments fit in the palm of your hand

## ML1 Milyzer Analog Audio Analyzer

The ML1 is a full function high performance audio analyzer and signal monitor that fits in the palm of your hand. The comprehensive feature set includes standard measurements of level, frequency and THD+N, but also VU+PPM meter mode, scope mode, a 1/3 octave analyzer and the ability to acquire, measure and display external sweeps of frequency response generated by the MR1 or other external generator.

With the addition of the optional MiniSPL measurement microphone, the ML1 also functions as a Sound Pressure Level Meter and 1/3 octave room and system analyzer. Add the optional MiniLINK USB computer interface and Windows-based software and you may store measurements, including sweeps, on the instrument for download to your PC, as well as send commands and display real time results to and from the analyzer.

- ▶ Measure Level, Frequency, Polarity
- ▶ THD+N and individual harmonic measurements k2→k5
- ▶ VU + PPM meter/monitor
- ▶ 1/3 octave spectrum analyzer
- ▶ Frequency/time sweeps
- ▶ Scope mode
- ▶ Measure signal balance error
- ▶ Selectable units for level measurements

## DL1 Digilyzer Digital Audio Analyzer

With all the power and digital audio measurement functions of more expensive instruments, the DL1 analyzes and measures both the digital carrier signal (AES/EBU, SPDIF or ADAT) as well as the embedded audio. In addition, the DL1 functions as a smart monitor and meter for tracking down signals around the studio. Plugged into either an analog or digital signal line, it automatically detects and measures digital signals or informs if you are on an analog line. In addition to customary audio, carrier and status bit measurements, the DL1 also includes a sophisticated event logging capability.

- ▶ AES/EBU, SPDIF, ADAT signals
- ▶ 32k to 96k digital sample rates
- ▶ Measure digital carrier level, frequency
- ▶ Status/User bits
- ▶ Event logging
- ▶ Bit statistics
- ▶ VU + PPM level meter for the embedded audio
- ▶ Monitor DA converter and headphone/speaker amp

## AL1 Acoustilyzer Acoustics & Intelligibility analyzer

The AL1 Acoustilyzer is the newest member of the Minstruments family, featuring extensive acoustical measurement capabilities as well as core analog audio electrical measurements such as level, frequency and THD+N. With both true RTA and high resolution FFT capability, the AL1 also measures delay and reverberation times. With the optional STI-PA Speech Intelligibility function, rapid and convenient standardized "one-number" intelligibility measurements may be made on all types of sound systems, from venue sound reinforcement to regulated "life and safety" audio systems.

- ▶ Real Time Analyzer
- ▶ Reverb Time (RT60)
- ▶ High resolution FFT with zoom
- ▶ Optional STI-PA Speech Intelligibility function
- ▶ THD+N, RMS Level, Polarity

## MR2 & MR-PRO Minirators Analog Audio Generator

The MR2 & MR-PRO are the new standards for portable audio generators - the behind-the-scenes stars of thousands of live performances, recordings and remote feeds. Both pocket-sized analog generators include a new ergonomic instrument package & operation, balanced and unbalanced outputs, and a full set of output signals.

- ▶ Sine waves - Swept (chirp) and Stepped sweeps
- ▶ Pink & white noise
- ▶ Polarity & delay test signals
- Plus the MR-PRO adds:
  - ▶ User-stored custom signals & generator setups
  - ▶ Phantom power measurement
  - ▶ Impedance, balance measurement & cable tester
  - ▶ Protective jacket

## MiniSPL Measurement Microphone

The precision MiniSPL measurement microphone (required for the AL1 Acoustilyzer and optional for the ML1 Milyzer) is a precision reference mic for acoustics measurements, allowing dB SPL, spectrum and other acoustical measurements to be made directly.

- ▶ 1/2" precision measurement microphone
- ▶ Self powered with automatic on/off
- ▶ Omni-directional reference microphone for acoustical measurements
- ▶ Required for the Acoustilyzer; optional for the Milyzer

## MiniLink USB interface and PC software

Add the MiniLINK USB interface and Windows software to any ML1 or DL1 analyzer to add both display and storage of measurement results to the PC and control from the PC. Individual measurements and sweeps are captured and stored on the instrument and may be uploaded to the PC. When connected to the PC the analyzer is powered via the USB interface to conserve battery power. Another feature of MiniLINK is instant online firmware updates and feature additions from the NTI web site via the USB interface and your internet-connected PC.

- ▶ USB interface fits any ML1 or DL1
- ▶ Powers analyzer via USB when connected
- ▶ Enables data storage in analyzer for later upload to PC
- ▶ Display real time measurements and plots on the PC
- ▶ Control the analyzer from the PC
- ▶ Firmware updates via PC
- ▶ MiniLINK USB interface is standard on AL1 Acoustilyzer



**NTI**  
NTI Americas Inc

PO Box 231027  
Tigard, Oregon 97281 USA  
503-684-7050  
www.minstruments.com  
info@ntiam.com

## PRODUCT EVALUATION

## CCRadio SW: A Classic AM/FM/SW Receiver

by James Careless

A silky-smooth tuning dial, complete tuning through the entire AM, FM and shortwave bands, and audio that sounds like it comes from a speaker, not a tin can: That's the new C. Crane CCRadio SW.

This comes in a package that is HD-free; the CCRadio SW is bereft of either HD-FM or HD-AM.

"C. Crane specializes in AM reception, and, in our opinion, HD-AM is just not ready," says President Bob Crane. "Meanwhile, when you go to the trouble of building a quality AM receiver like the CCRadio SW, the sound quality is really quite good."

## Talk fan

Located in northern California and found online at [www.ccrane.com](http://www.ccrane.com), C. Crane has long been a source for top-flight radio receivers, especially in the AM band.

The reason is simple: Bob Crane is a big talk radio fan, which means he listens to AM a lot. The trouble is that northern California isn't blessed with a lot of local talk radio stations. Hence Bob Crane's quest to find highly sensitive AM receivers like the legendary GE Superradio III (found on his site). To pick up the distant stations he enjoys, he needs high-end receivers.

In the same vein, Bob Crane's interest

in offering high-performance radios motivated him to design his own, such as the AM/FM CCRadio, manufactured under license by Sangean.

Crane's customers are also big radio fans, but their tastes are more eclectic than his.



"Many have been asking me for years to bring out an SW receiver with great sound, adjustable RF gain, bandwidth filters and a really smooth tuning system," Crane said.

## Up close

The CC Radio SW is about the size and shape of a small-sized cereal box, turned on its size. It is encased in black plastic with brushed metal trim, comes

with a detailed LCD display, and weighs 4.5 lbs. The CC Radio SW has a single 5 watt, 8 ohm speaker.

The receiver's frequency range covers 87–108 MHz FM; 520–1710 kHz AM North America/522–1620 kHz Europe (the tuning increments can be switched from 10 to 9 kHz steps, to work in either market); and three shortwave

bands. The first (SW1) picks up where AM leaves off, going from 1711 kHz to 10010 kHz continuously. SW2 covers 9990–20010 kHz, and the SW3 band covers 19990–29999 kHz. The overlap between SW bands makes tuning stations in this spectrum much easier.

The radio has a jack for external speakers and antennas, plus a switch that allows you to choose between local and distant signals.

Besides the usual assortment of onboard clocks (local and world time), alarms and

50 memory presets, the CCRadio SW comes with twin battery compartments; one for four AA cells and a second for four D cells. This means that listeners have a backup power source onboard.

Now for the good stuff. In terms of features, the CCRadio SW is reminiscent of the much-loved Panasonic RF2200 AM/FM/SW receiver, which I am fortunate to own. This means that there's lots of truly useful gear on board for fine-tuning.

Without a doubt, the CCRadio SW's finest feature is its 2-inch-diameter tuning dial. Indented with an old-fashioned

**C. Crane specializes in AM reception, and, in our opinion, HD-AM is just not ready.**

— Bob Crane

thumb/finger "well" for one-digit tuning, this dial floats as you turn it, making band scanning a breeze. (The CCRadio SW also comes with push-button scanning and Up/Down tuning, but the dial is much more fun.)

Add the ability to adjust the Dial Speed (slow = 1 kHz steps in AM/SW; 10 kHz in FM; fast = 9/10 kHz AM, 5 kHz SW, and 100 kHz FM), and the CCRadio SW offers a degree of tuning precision not seen in most modern receivers. For band-scanning through

See CRANE, page 49 ▶

Coverage  
Reliability  
**HD Radio™ Experience**

When Vermont Public Radio installed HD Radio™ at some of the worst weather sites in North America, they chose

**Shively Labs®**  
...again!

WVPR/Mt Ascutney;  
WNCH/Burke Mtn; WVPS/Mt Mansfield - Bringing the first HD Radio™ signals to the Green Mountain State!

P. O. Box 389, 188 Harrison Rd.  
Bridgton, Maine USA 04009  
(207) 647-3327 (888) SHIVELY  
FAX (207) 647-8273  
sales@shively.com www.shively.com  
- An Employee-Owned Company -  
ISO-9001:2000 Certified

**THE NAB  
RADIO  
SHOW**

September 26-28, Charlotte  
See us at Booth 401

Mt. Mansfield  
Vermont  
October 2006

## Archive

▶ Continued from page 46

over 64 GB and claim to allow around 10,000 write/erase operations in a lifetime. Flash drives are useful for personal backups and can often hold more than a CD or DVD and are also more durable.

Tape drives such as DLT are common in massive archives such as *archive.com*. The DLT tape should last around 30 years and can range in size from less than 1 GB to over 800 GB. The drawbacks of tape: it is slow to record on; tapes are more expensive to buy; and they take up more physical space.

## More than one

Redundancy in backups is another key and can help in your choice of formats and media.

Having all your station backups on one hard drive in one format is a start; but it would be better to have at least two copies of everything. Perhaps your station could start with one copy of all your archives in the WAV format and a smaller backup in FLAC or another compressed format.

When dealing with redundancy you are ensuring your audio will survive in the face of failure. On the smallest scale your backup could be two copies of your files in two separate folders on the same hard drive. However, better to have two copies on two separate hard drives. Better still, the hard drives should be in different computers.

Redundancy allows you to plan for a failure, whether it is a hard drive developing bad sectors or a building catching fire.

If your audio is important enough you may want to look into off-site storage redundancy. This can be as simple as ask-

ing the staff to backup all their data to a DVD and take it home with them, or as secure as hiring a company like Evault to store your audio files and guarantee they will be available when you need them. There are many companies like Evault ([www.evault.com](http://www.evault.com)) that offer "a complete solution that keeps your data secure, compliant, and easy to manage."

If you don't have the resources available to spread your backup out, you may want to consider setting up a RAID configuration on your archive system. There are two RAID configurations that are valuable for redundancy in a backup: mirrored or striped set.

Mirrored drives require at least two disks and are called a RAID 1. In this setup the exact same data is on both disks and if one fails the other has an exact copy of your archive. RAID 5 is the most common striped set configuration and requires at least three disks in the computer.

Striped set configurations spread the data over all the disks and they each work as a backup for the others. In this system if you experience a hard-drive failure, as long as one disk is still working you can replace the bad disks and the data will be rebuilt.

Developing a proper archive for your station involves answering important questions and then taking necessary steps to backup what is needed. You never know when a failure could occur, so the sooner you start the better.

Share your ideas about archiving and backup methods. Write to [radioworld@imaspub.com](mailto:radioworld@imaspub.com).

Chris Prewitt is a systems administrator for UMKC Information Services at the University of Missouri, licensee of *KCUR(FM)*. He had assistance from Chuck Haddix and Scott Middleton of the *Marr Sound Archives*. E-mail him at [radio@theprewitt.com](mailto:radio@theprewitt.com).



# Crane

► Continued from page 48  
AM or SW, it is a delight.

The next useful tuning feature is the CC Radio SS's bandwidth filters. In AM/SW, these are set as "wide" and "narrow." The wide filter allows you to maximize audio quality, by allowing in signals 3 kHz on both sides of the frequency you are tuning. For instance, if you are tuning 560 AM, the radio will tune in 557–562 kHz.

The narrow filter focuses on the tuned frequency and cuts off the sides, helping to block out interference from adjacent channels. In FM, the filters choose between "mono" and "stereo," allowing you to enjoy FM stations too faint to deliver stereo reliably.

The third tuning feature is the CCRadio SW's adjustable AM RF Gain. Located on the far left of the front pane, this feature allows you to desensitize the receiver in either AM or SW modes, reducing distortion when listening to powerful stations.

On SW, I used the RF Gain repeatedly to maximize a station's signal input (indicated by an onscreen Signal Strength Meter), while nulling out interference from other sources. When used in tandem with the wide/narrow filters and the slow tuning speed (wide to find the station; narrow to isolate it), the RF Gain made tuning precise and intuitive.

## Performance

I took the CCRadio SW out to the woods to test its overall performance. Although it is capable of using an external antenna, I used the long onboard whip.

Tuning the AM, SW and FM bands was a sheer joy. The main tuning dial allowed for extreme precision, while the bandwidth filters and RF gain allowed me to lock onto the weakest of stations. The best part: using all this equipment and the CCRadio SW's excellent speaker, I was able to tune by ear. All the bells and whistles simply aided my tuning, but never got in the way of it.

Downsides? I would like to eliminate the electronic clicking caused as the radio tunes between kHz steps. Although it is faint, the clicking does interfere with careful listening during band-scanning.

As well, the CCRadio SW's shape and relative thinness make it top-heavy and prone to tip over. It could benefit from a deeper case (which would allow the speaker to provide more bass), or a built-in fold-out back stand.

The CCRadio SW would also benefit from including SSB and direct 0–9 push button tuning, features that Bob Crane will include in a newer high-end model now in the works. Finally, the power consumption seems to be rather heavy, but that may be unavoidable given the CCRadio SW's size and features.

## Conclusion

All told, the C. Crane CCRadio SW is a great listening receiver for AM, FM and SW. It hearkens to a time when audio quality was taken seriously by makers of portable radios. For those wanting a radio that sounds good and performs well, it is a welcome choice.

This said, some day Bob Crane will have to add HD-FM and HD-AM to this set.

The CCRadio SW is available for \$149.95 at [www.ccrane.com](http://www.ccrane.com).

## MARKET PLACE

### Rohde & Schwarz Offers Compact FM Transmitters

Rohde & Schwarz has introduced a line of compact FM transmitters featuring a range of capabilities.

The transmitters, the R&S SR8000 and R&S NR8200 series, "help to ensure the high quality of analog networks with the reliability of advanced digital transmitters."

R&S NR8200 FM transmitters are available for transmit powers of 2.5 kW to 40 kW. Two single transmitters with up to 5 kW each can be accommodated in a 19-inch rack.

Exciter standby, (n+1) standby, passive standby and active dual-output stage with manual or automatic switchover can be implemented for the R&S NR8200 line. Transmitters already in the network can be integrated in a (n+1) redundancy system.

The FM transmitters of the R&S SR8000 series are rated for output power between 100 W and 2.5 kW. All functions are integrated in a single transmitter and occupy a maximum of 8 RU. Single-frequency network operation is possible. Passive standby and (n+1) standby systems containing up to eight main transmitters are available as a standby system.

The transmitters are air-cooled. Transmitter and amplifier parameters required for diagnostics can be retrieved locally or remotely via standard (IP) protocol and standard software (Web browser, SNMP).

For information contact the company's Maryland office at (410) 910-7836 or e-mail [chris.petrole@rsa.rohde-schwarz.com](mailto:chris.petrole@rsa.rohde-schwarz.com). The Web site is [www.rohde-schwarz.com](http://www.rohde-schwarz.com).



# The USB-to-AES Digital Audio Solution!



## NEW!

The new USB-AES Matchbox connects AES/EBU digital audio to any PC.

Just plug-and-play, no software or drivers are needed.

Use sample rates of 48.0, 44.1, or 32.0 kHz.

Digital input and output on XLRs, plus audiophile-grade analog outputs for critical monitoring.

- Output Confirm LEDs indicate play audio
- Transformer balanced digital I/O
- Simultaneous Play and Record
- SPDIF I/O also provided
- Monitor jack with Mute
- USB powered – no wall wart!

For complete specs, please visit [www.henryeng.com](http://www.henryeng.com)  
In stock at all Henry Engineering dealers.



**We Build Solutions**



626-355-3656

# The FCC: Is It Your Friend or Foe?

by Jim Withers

What do you do when the FCC shows up at your door?

Here and on the following several pages, RW presents three perspectives on that question.

Here's a dream (or nightmare) for you.

You're in the studio enjoying the morning's first cup of coffee. The sales staff is all out selling, the morning host is cruising the Web looking for stuff to talk about and in general, life as a radio guy is pretty good.

But then the front door opens and in walks a stranger. He's carrying a small notebook covered in imitation leather and holds out a business card.

Turns out it's not your lucky day, this is not Ed McMahon and you have not just won a million dollars from Publishers Clearinghouse. It's John Doe, FCC field engineer. Yikes! The Feds!

In something like 1.5 milliseconds, your coffee cascades down from your stomach to your large intestine; and after an emergency trip to the restroom, you prepare to walk the plank of an FCC field inspection.

This is, no doubt, the first vision that many of us get whenever someone mentions "FCC." But why, I wonder?

I've worked in broadcasting, both radio and TV, for more than 35 years and have been visited by an inspector now and then. These were not the bamboo-shoots-under-the-fingernails episodes we all fear.

(Note to the commission: Even though I have found the EB folks friendly enough,

FCC is rather new on the scene, and, considering the scope of what it does, surprisingly small.

The FCC is structured into several bureaus, each dealing with a specialized area of communications, and with associated administrative functions attached.

**Without them, there wouldn't be much to keep your 100 kW competitor down the street from suddenly taking a liking to your little 6 kW frequency.**

I also like my dentist. I don't, though, go out of my way to schedule extra office visits with him, if you know what I mean.)

In any event, even though inspections are what most of us worry about, the Enforcement Bureau is a small piece of a much larger agency. But if the primary focus is not handing out Notices of Apparent Liability to us poor broadcasters, what exactly is the mission of the FCC?

## Pipsqueak

It turns out to be more supportive than you might think.

First, as government agencies go, the

Most of the staff of roughly 2,000 works from the headquarters building in Washington, but there are other satellite locations (like those pesky field offices) scattered around the country. The whole deal runs on a budget of just \$304 million a year.

A mighty big organization compared to my 1,000-watt peashooter AM, bustling with the activity of five (!) dedicated radio folks; but as a part of the federal government and its annual budget of \$2.5 trillion (that's 2.5 followed by 11 zeros), the commission is a pipsqueak.

Yet pipsqueak or not, it's still the FCC and a major factor in the life of any broadcaster.

So what do we get from these guys, other than heartburn when we open the station door and in walks a friendly field engineer?

Mostly, order. That's the big thing: Order. In fact, it is highly likely that without the FCC, there wouldn't even be a meaningful commercial broadcasting business.

Consider the chaotic world of broadcasting before the Communications Act of 1934, the one under which we all still operate, was enacted.

The FCC's predecessor agency, the Federal Radio Commission, oversaw the Radio Act of 1927. Like most of the rest of the country during the Roaring Twenties, broadcasting was a bit of a free-for-all. Erstwhile broadcasters built up a transmitter, listened around a little bit until they found a fairly quiet spot on the dial, tuned up and let 'er rip. Fifty watts, one hundred, whatever. Guys (and a few women) built up homemade rigs and went on the air.

Until 1927, even "real" stations — that is to say, those few that operated under the aegis of the Interstate Commerce Commission and the Radio Act of 1912 — ran a bit loosey-goosey.

In the early, early days, no big deal. Stations came and went like traveling circuses so I suppose a little "frequency drift" now and again was not too terrible.

But as it turned out, radio was going to be big business. Bill Paley (CBS) discovered it beat the heck out of selling cigars; David Sarnoff (NBC) figured out that good program-

ming would sell a lot of RCA radios; and the business side of radio was off and running. And once that happened, regulation was not only inevitable, it was imperative.

So the Communications Act was created to supersede the old Radio Acts and the FCC was born.

## Standards

The original "Great Communicator," Franklin Roosevelt, was president when the FCC was created in 1934 to oversee the burgeoning business of broadcasting.

Television was on the way, and it was apparent that it would be as big as (some day, even bigger than) radio. Thus the Radio Commission of 1927 became the Federal Communications Commission in deference to the broadened scope of its work.

The "Communications" part encompasses regulation of all sorts of businesses: cable TV, satellites of all varieties, telephone companies, international broadcasting and shortwave, amateur or "ham" radio and, of course, traditional broadcasting. The commission even has the power to fine companies whose only communications act is to send all of us those unwanted "\$99 Trip for 4 to Orlando!" junk faxes.

From the beginning, then, the FCC has promulgated standards (even though they didn't always get it right the first time; the CBS/RCA color TV battle of the early 1950s is a prime example), and instituted rules of operating that stand even today. All to advance the goal of imposing order on the chaos that had been 1920s radio.

Power limits were established and then strictly enforced. Frequencies were assigned. Modulation levels and characteristics were defined.

Rules allowing directional antenna operation were put into place so more local/regional stations could sign on to serve smaller communities without interference. Daytime operation was allowed and the historic clear-channel frequencies were locked down.

See FCC, page 52 ▶

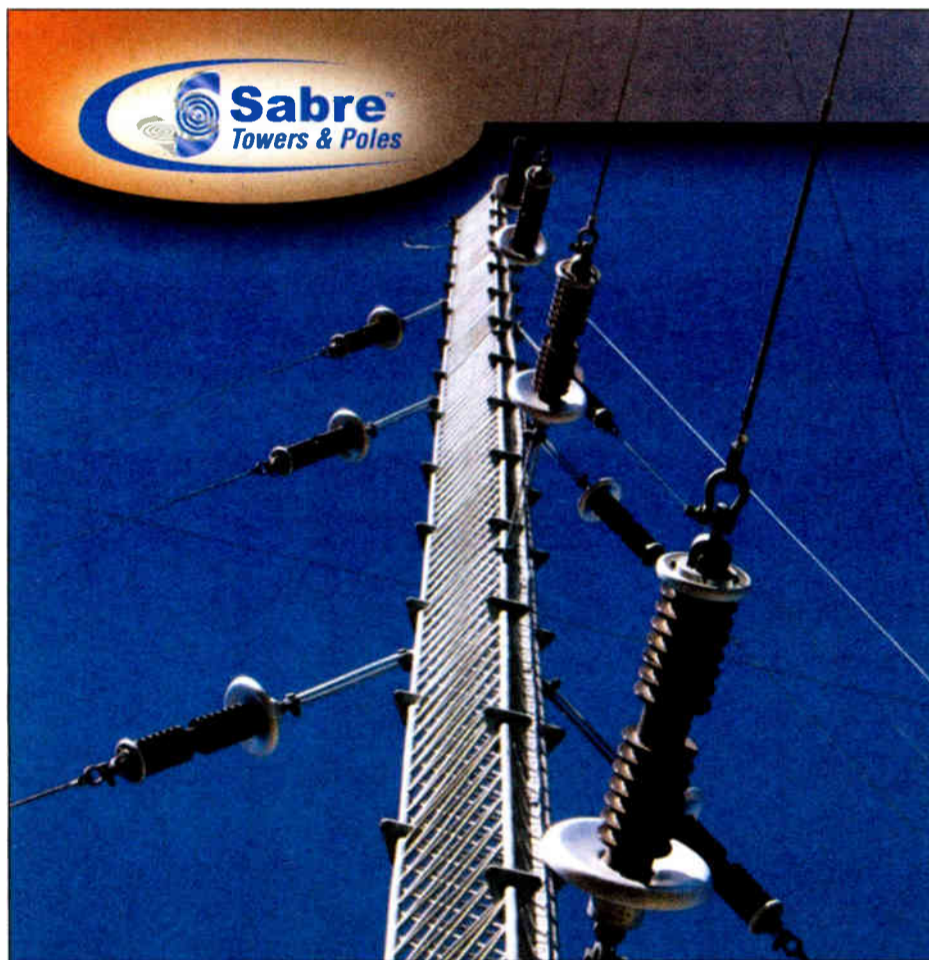

Sabre designs, manufactures and installs towers to meet your broadcast specifications. We offer everything from custom FM support sections to turnkey AM installations. Committed to customer service, we deliver quality products at competitive prices with the shortest lead times.

Call Sabre today for all your tower needs.

**1-800-369-6690**

[www.sabrecom.com](http://www.sabrecom.com) • [broadcastsales@sabrecom.com](mailto:broadcastsales@sabrecom.com)

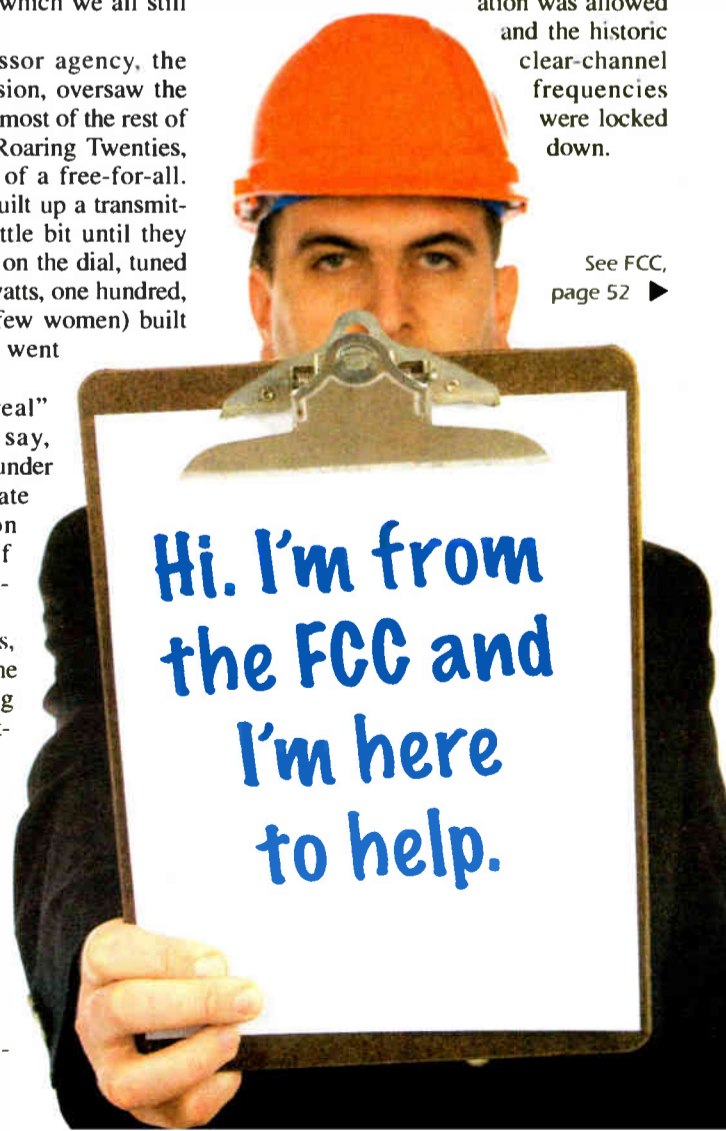

FIRST PERSON

# FCC Inspectors Crashed My Farewell

by Big Jim Williams

I had never been visited by the Federal Communications Commission until that morning. The timing was as perfect as a Hollywood movie scene, because, just minutes before, I had terminated my employment at the radio station.

But I'm getting ahead of my story.

## Kaput

I had had it with the station's new owner. I'd been on the staff for almost eight years and had survived endless battles. Although in my late 20s, I was senior when it came to longevity at the station. I had worked under constantly changing formats, two ownerships and 12 managers who turned over faster than hamburger patties on a McDonald's grill.

Our new out-of-town owner came with a gruff exterior, dictatorial style and a barrage of contradictory phone calls. He also refused to believe our small-market station wasn't like the major-market blowtorch he'd sold in the Pacific Northwest for millions. We were a "dollar-a-holler," rip-and-read outlet and glad to get it in our market back in the '50s.

I had given my two-week notice after being offered an announcing job in the next county at a "whopping" \$40 more a month.

I was leaving for greener pastures that, I hoped, used less fertilizer.

I signed our station on and usually worked the board until noon. However, on my last day, I said goodbye at 10 a.m. and introduced my replacement, who slipped into our wobbly control room chair (every station had one) and began reading news and playing 78-rpm records.

As my final duties as a "combo" man, I signed off on the program log. Then I entered the adjacent transmitter room and made the required readings, signed off on

On my last morning, she called early: "Jim, whatever you do, don't leave the station when you get off the air, because I have a surprise for you."

We were in a small block building containing offices, studio and transmitters in a bean field on the edge of town. Shortly before 10 a.m. a taxi pulled up to the station.

The driver brought in boxes and platters of food, all from Lola: barbecued

We were eating, wearing our shirts and hats and having one heck of a farewell when a black car pulled into our dusty parking lot. Two unsmiling men in dark suits and carrying attaché cases walked into the building.

They were FCC inspectors. How's that for timing?

**I was through. Kaput. Finished. Gone. History. No longer a station employee.**

the transmitter log and took my First Class "ticket" off the wall.

I was through. Kaput. Finished. Gone. History. No longer a station employee.

## Lola luau

Over years at the station I'd received the usual phone requests for songs. My morning listeners had been great.

One was an elderly lady named Lola, someone I had never met, whose music requests I usually honored. She was lonely. When time permitted, we often chatted on the phone, even sent gifts to my family and me.

When I announced I was leaving, I received calls, including one from Lola.

chickens, pineapples, various salads, vegetables, punch, rolls and eating utensils. There was more than enough food to feed our small gluttonous staff. Lola had also sent six Hawaiian shirts and wild-looking straw hats like those seen in "Hawaiian Punch" television commercials.

It was a completely catered luau! The only things missing were ukuleles, Hawaiian dancers, singer Don Ho and Lola.

Every employee joined in for the free food and fun as the party spilled into the cramped front office and Studio "B" in a New Year's Eve atmosphere. I called my wife, Joan, who, with our four-year-old son, Doug, joined in.

## Oops

I was no longer a station employee, wasn't fond of the station owner, and, at that point, didn't care what happened. I felt God did answer prayers.

It was hard not to laugh.

They wanted to talk to the manager. He wasn't there. They wanted to talk to the chief engineer. He wasn't there. They wanted to talk to the program director.

The station didn't have one because I had just quit.

Then they wanted to talk to "the person in charge of the transmitter."

It wasn't me, either, who had been minutes before.

See LUAU, page 52 ▶

# BUY SHURE GEAR GET FREE STUFF\*

**FULL COMPASS**  
HONEST PEOPLE. LOW PRICES.

## BUY SHURE GEAR, GET FREE STUFF

- PURCHASE \$50 = FREE MAG-LITE™ KEY CHAIN FLASHLIGHT
- PURCHASE \$250 = FREE BACK PACK
- PURCHASE \$500 = FREE SWISS USB MEMORY KNIFE
- PURCHASE \$1000 = FREE SUPER BATTERY
- PURCHASE \$1500 = FREE VINTAGE LEATHER COMPUTER BRIEFCASE
- PURCHASE \$2000 = FREE SWISS ARMY WATCH

QUANTITIES ARE LIMITED, CALL TODAY!

VISIT [FULLCOMPASS.COM](http://FULLCOMPASS.COM) FOR MORE DETAILS OR CALL THE PROS AT 800-356-5844

CALL TODAY FOR THE LOWEST PRICES ON AUDIO, VIDEO AND LIGHTING GEAR  
SHOP BY PHONE 800.356.5844 | BROWSE [FULLCOMPASS.COM](http://FULLCOMPASS.COM) | REQUEST YOUR FREE 400 PAGE CATALOG TODAY!

\*Shure related microphones, wireless microphones, electronics, and most replacement parts.

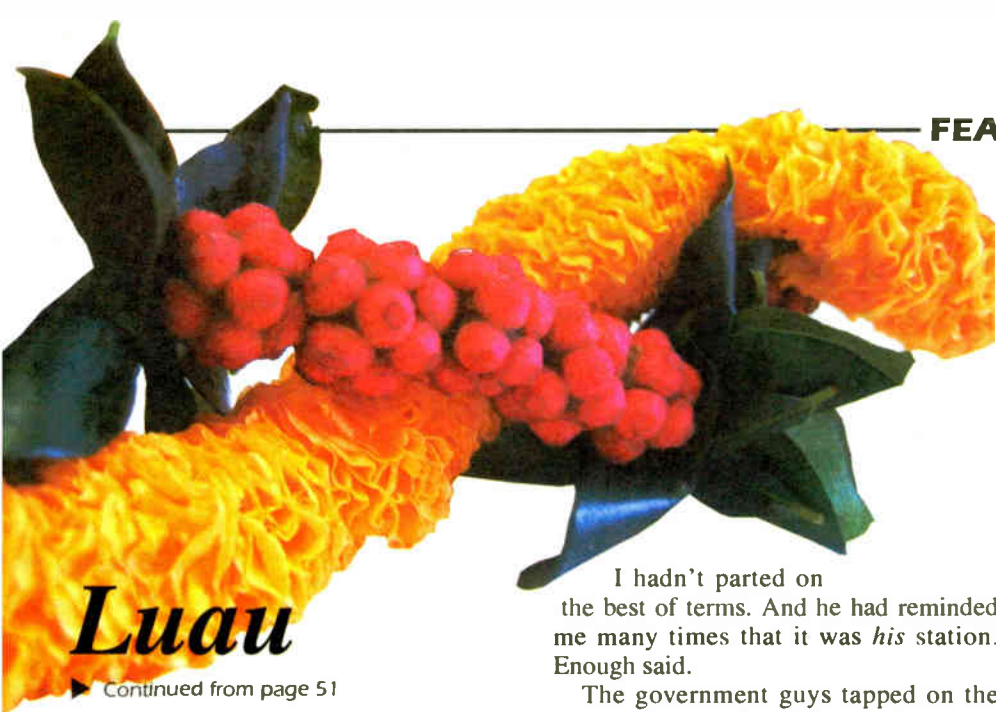

## Luau

► Continued from page 51

The wild, noisy party of porking-out personnel in floppy straw hats and bright Hawaiian shirts continued non-stop around the FCC duo.

I led the inspectors into the transmitter room and pointed into the control room. Bob, my replacement, only minutes on his new job, was behind the glass reading, spinning records, and trying to master the control board.

"He's in charge of the transmitter," I said. Then repeated: "I no longer work here." My framed "FCC ticket" was under my arm. "I signed off both logs minutes ago," I said. (And was glad I had, because I was usually behind on my transmitter readings, too busy on-air to log them every 30 minutes as then required.) I stood back, watched, grinned and savored every moment.

I could have helped, but the owner and

I hadn't parted on the best of terms. And he had reminded me many times that it was *his* station. Enough said.

The government guys tapped on the glass and flashed their credentials. Bob started another record before nervously stepping into the transmitter room. He didn't need another distraction but he had a *big* one.

The inspectors were there to check the station's compliance with FCC's rules and regulations, they said. Our RCA 1 kW transmitter, which filled one side of the cluttered room, was about the size of a walk-in refrigerator. It bristled with dials, meters, knobs and big switches.

I felt sympathy for Bob but not for the station's owner, who lived miles away but within listening range. This wasn't my problem.

One of the inspectors turned to Bob and indicated the transmitter. "Can you show me where you read the plate voltage?"

Bob hesitated, looked at the multiple meters and dials and said: "I ... I don't

know."

The inspectors looked perplexed. "Can you show me where you read the plate current?"

More hesitation: "I don't know."

"How about the phasing meters?" (We had two 300-foot towers.)

"I don't know." Bob was sweating and pale.

The FCC questioner sighed. "We need to read the meters at the towers. Where's the key to the *doghouse*?", the small wooden structure at the base of the fenced first tower.

"I don't know."

The two hadn't smiled since entering the building. They rolled eyes and appeared ready to give up in disgust. Then one fidgeted — maybe too much morning coffee — and asked: "Where's the men's room?"

Bob sheepishly repeated words I shall never forget.

"I ... I don't know," he said.

Unable to contain themselves, the stone-faced inspectors broke into laughter.

### New career

Bob returned to the control room seconds before his record ended.

## FCC

► Continued from page 50

Unlicensed operators were shut down. Operator requirements were put into place (most of them long since made obsolete by reliable technology).

All of this was necessary to get the business of broadcasting up and running. None of it would have happened without an FCC.

When Edwin Armstrong proved that wideband FM was viable as a complement to AM, the FCC set aside a band of frequencies for use by FM broadcasters. (Oops — another goof; the first FM band, in what we know as the VHF TV spectrum, was changed to accommodate that service. FM got booted up to 88 MHz, where it still lives.)

Over and over, the commission pressed for standardized operations and frequencies, because radios had to be built to those standards. No standards, no radios. No radios, no radio broadcasting.

Because it's tough to make money with radio if there are no listeners, the FCC scores big for setting up rules to foster standardization.

### Responsive

But isn't this all ancient history? What do they do now other than rail on about Wardrobe Malfunctions?

Turns out, quite a lot. Only 320 of the 2,000 people work in the Enforcement Bureau, the heartburn part of the agency. A lot of effort is expended in other areas.

For example, the National Do-Not-Call Directory? That's one of my personal favorites; the FCC did that. How about phone number portability? And making frequencies available for WiFi hotspots?

Coordinating available orbit space for satellite communications; reserving "silent spaces" for radio astronomy; even making sure Mr. Microphone doesn't step on your neighbor's TV audio — all of this is the work of the FCC.

As for taking care of us broadcasters, consider some examples of how the FCC has benefited us in the more recent past.

In the 1960s, AM stations were king; FM's mostly were money-losers. The

The inspector found the closet-sized men's room six feet away in a corner.

I finished my party, said my goodbyes to everyone, and left. Days later I went to work at a station 30 miles north.

I called Lola and thanked her for a wonderful, unforgettable party and for helping create one of my most memorable experiences in broadcasting. I'm still sorry we never met.

I thought about calling the FCC and thanking them for making my farewell party such a success, but didn't.

My replacement was Bob Eubanks, who went on to a successful career as host of television's "The Newlywed Game."

The station was in Ventura, Calif. The year was 1959. I never found out if the station was cited, fined or passed FCC inspection. I didn't call the owner and didn't see Bob again for several years.

Some people still don't believe it when I say it was just a coincidence FCC inspectors arrived minutes after my job ended. I call it fate.

It was the first and last time I ever had anything to do with the FCC. Actually both inspectors were very nice.

Maybe I should have invited them to the luau. 🌺

commission recognized that and allowed broadcasters to simulcast the AM programming onto a sister FM until it became apparent that FM had matured to the point of profitability.

The FCC is deep into digital radio now. Without getting into the pros and cons of IBOC here (particularly on AM), we can agree that we do have a standard, broadcasters are pushing bits into the ether and companies are building radios to pick them up.

There are plenty of other examples.

In my mind, the commission single-handedly saved UHF TV broadcasting when it mandated in the 1960s that all TV sets manufactured after a certain date contain a built-in UHF tuner. Prior to that, if you wanted to receive a UHF station on your all-VHF set, you had to buy a tuner box that sat attractively on top of your set, like a misplaced shoebox, and downconverted UHF to an unused VHF channel. Needless to say, UHF stations were long the stepchildren of TV.

Although some may consider it "too little, too late," the expanded AM band was a respectable and creative way of addressing interference in the legacy AM spectrum.

The relatively new rule establishing Class C0 FM stations is another example of commission reaction to the changing broadcasting environment. By inserting an intermediate class of station between C1 and full Class C, it opened up a slew of possibilities for expanded coverage by smaller stations. And even more recently, the rules now consider community of license changes to be a minor modification of your license. In the end, that is the whole idea behind the FCC: to promote the effective and efficient use of the public's spectrum.

The next time a person shows up at your door and you immediately think "Uh, oh, it's a Fed," just remember: Without them, there wouldn't be much to keep your 100 kW competitor down the street from suddenly taking a liking to your little 6 kW frequency.

Jim Withers is owner and operator of KSIX(AM) in Corpus Christi, Texas. E-mail him at jim@koplar.com.

Comment on this or any article. Write to radioworld@imaspub.com. 🌺

**m!ka MICROPHONE AND MONITOR ARMS**

Outstanding design - Yellowtec's new product line for positioning microphones and monitors. m!ka integrates simple and elegant appearance with heavy duty performance. Combining mic and monitor mounts into one modular system, m!ka helps you restore order to your desk-top area.

**YELLOWTEC**  
Heinrich-Hertz-Strasse 1-3  
40789 Monheim, Germany  
Phone +49-2173-967 315  
e-mail: info@yellowtec.com

[www.yellowtec.com](http://www.yellowtec.com)

## FCC Inspection FAQ

Responding to a Freedom of Information request from Radio World for an earlier story, an FCC info packet came with a set of "frequently asked questions" from the Enforcement Bureau about inspections. We found it interesting as an insight into the kinds of questions asked of the bureau. Excerpts are below; the full document is found at [www.fcc.gov/eb/otherinfo/inspect.html](http://www.fcc.gov/eb/otherinfo/inspect.html).

### Residential Inspection of Radio Equipment

**Q: What happens if I do not allow the FCC agent to inspect my equipment?**

A: Failure to allow inspection forecloses the opportunity to resolve the problem. Thus, refusal to allow inspection is a serious challenge to the Commission's authority to inspect radio stations and is a violation of the Rules. Such a refusal may lead to revocation of a license, maximum monetary forfeiture, or other Commission sanctions.

**Q: The FCC Agent standing at my door does not have a search warrant, so I don't have to let him in, right?**

A: Wrong. Search warrants are needed for entry involving criminal matters. One of the requirements as a licensee, or non-licensee subject to the Commission's Rules, is to allow inspection of your radio equipment by FCC personnel. Whether you operate an amateur station or any other radio device, your authorization from the Commission comes with the obligation to allow inspec-

tion. Even radio stations licensed under a "blanket" rule or approval, such as Citizen's Band (CB) Radio, are subject to the Commission's inspection requirement.

**Q: Well then, if I am a low-power broadcaster and don't have an FCC license, they need a search warrant, right?**

A: Wrong again. The FCC agents have the authority to inspect all radio equipment; even if you do not have a license, the FCC can still inspect your equipment. Section 303(n) of the Act gives the FCC the right to inspect all "stations required to be licensed." This language covers your low-power radio station. The FCC agents are inspecting the equipment, not searching your house.

**Q: ... [H]ow do I know what the Agent will do next?**

A: Once you open the door, the agents should show their FCC identification card and badge, identify themselves by name and agency, and should state the purpose of the visit. They then should request permission to inspect the radio station. The agents may also ask to see records such as licenses for the station or operator. Agents, however, should never open private cabinets, drawers or other private items in the search for license documents.

**Q: Can the agents come to my residence at any hour of the day or night to conduct an inspection?**

A: FCC Agents inspect during the hours of operation. If you are operating your station during late or unusual hours you cannot use the time element as justification for refusing to permit an inspection at that time. You can-

not avoid an inspection by electing to operate only during late or unusual hours.

**Q: What can happen to me if the agent determines that I am using illegal or unauthorized equipment?**

A: There are several different ways that this situation can be handled. You may volunteer to surrender the equipment to the agent who will then destroy it under FCC procedure. If you choose not to surrender the equipment, the FCC can bring a proceeding against you to take the equipment. This is known as an in rem (i.e., property) forfeiture proceeding. Additionally, if you choose not to surrender the equipment, you can be issued a civil monetary forfeiture penalty. See 1997 Forfeiture Policy Statement 12 FCC Rcd 17087 (1997).

**Q: Am I required to surrender any illegal or unauthorized equipment to the agent?**

A: No, surrender is voluntary. However, it is the best way to avoid a large monetary forfeiture.

### FAQ for the Business Environment

**Q: FCC Agents arrived to inspect the radio at my office. My boss isn't here. Should I call my boss to be present for the inspection?**

A: You may call your boss if you wish. If the company is open for business, however, the inspection should be permitted regardless of whether your boss is present. This is not an acceptable reason to delay an inspection.

**Q: My boss didn't tell me anyone would come by to inspect our radio so I don't have to let the FCC inspectors in, right?**

A: Wrong. The licensee is responsible for knowing the rules and those include the FCC's right to inspect. Because the employer is responsible for the acts of the employee, it is up to the licensee-employer to inform its staff as to its responsibilities concerning the operation of the radio station.

**Q: How do I know that these are really agents from the FCC?**

A: FCC Agents have a badge and credentials with their names and the FCC seal which they will present to you when requesting your permission to inspect. If you would like to further confirm their identity, you may call the FCC's Communications and Crisis Management Center in Washington, D.C., at (202) 418-1122. It is open 24 hours a day, 365 days a year.

**Q: If an agent is testing my FCC authorized equipment and the equipment breaks or malfunctions during the tests, is the FCC liable?**

A: If the agent was negligent, you may have a claim under the Federal Tort Claims Act (FTCA) to recover damages for your property. The FCC will make the initial determination whether the agent was negligent.

**Q: Can I have my attorney present during the inspection? Can I make the agent wait to start the inspection until my attorney is present?**

A: You may have your attorney present during the inspection; however, there is no constitutional right to have your attorney present. Therefore, you may not make the agent wait until your attorney arrives. Making the agent wait for your attorney conflicts with the "unnecessary delay" requirement discussed earlier.

▶▶▶ NAB/R&R CONVENTION 2007, SEPTEMBER 26-28

VISIT US ON LEVEL 2

CHARLOTTE CONVENTION CENTER

See what the excitement is about.



**MusicMaster** is the next generation of music software. It is powerful, easy to use, intuitive, multi-tasking, and best of all, it produces great logs with less editing time. I especially like the optimum goal rules that automatically work your library for proper balance as well as the wizard that analyzes not only rules but also schedules and suggests improvements. The "instant analysis" feature lets you see at a glance what percentage comprises each hour of any attribute you define (e.g., sound codes, tempo codes, etc.). MusicMaster gets the job done—the right music product is essential to ratings success.

MARK ST. JOHN Senior Vice President/Zapoleon Media Strategies

Let us show you the innovations that have powered MusicMaster's growth to more than 2,500 users worldwide.

GO TO [www.mmwin.com](http://www.mmwin.com)

or call 1.800.326.2609

Music Master  
Scheduling™

# In the Field? Been There Since Age 7

For Amanda Alexander of Crawford,  
Radio Engineering Is a Family Affair

by Ken R. Deutsch

One in a series of occasional articles on the changing face of engineering.

At age 21, Amanda Alexander of Crawford Broadcasting in Denver officially has been an engineer for five years. But she had her first taste of the business when she helped her father Cris, the company's director of engineering, build a station in St. Louis.

"I didn't do any dangerous work, but my dad gave me a punch tool and I got to have fun with that," she said. "I helped clean the place up since there was dust and trash from all the work we were doing."

That was in 1993, which would have made Amanda Alexander 7 years old at the time.

chief engineer at the four-station Denver cluster under Cris Alexander. "She has an excellent grasp of basic engineering principles and learns new concepts very quickly." Cris Alexander is also an RW contributor.

Robert Payne is an engineer who met the younger Alexander while doing contract work for the Crawford stations. "She is a sweet lady," he said. "Since she is agile and small, she was the one we asked to crawl down behind the furniture to do the wiring."

Alexander started at Crawford as a board op and moved into production, then engineering; but she was involved with converting one of the stations to HD Radio even before she became an engineer. Alexander in August graduated from the Cleveland Institute of Electronics. She

with the optimism of youth.

"I don't consider any day a bad day," she said. "Some days are hectic and there

Alexander embraces the challenges.

"The whole HD situation has been interesting; trying to get the Program Associated Data display to work right. It's all timing," she said. "You also have to get your analog and digital signals to sound the same, and that takes good ears



Like daughter, like father: the two radio engineers in the family, Amanda and Cris.

**'Sometimes schools do a test and it basically tells you what your career should be. I never saw "radio engineer" on that list.'**

She greatly admires her father, a man who has worked in the field for 20 years and is Amanda's "grand-boss."

"That's like my boss's boss," she said. "It wouldn't be right for me to report directly to my father."

## Grasp

Crawford Broadcasting owns four AM stations in Denver: sports outlet KLZ and Christian talk and music stations KLDC, KLTT and KLVZ.

"During the past year I've watched her mature as an engineer," said Ed Dulaney,

understands that her job requires many different skills.

"One of the projects I enjoyed the most was changing out our old Audioarts R-60 boards for new Wheatstone Generation 6 control surfaces and Bridge routers at our four stations," said Alexander. "But I also like riding around on the John Deere doing our spring cleanup."

## Sunny side of the street

We asked if she can recall her worst day on the job. Her answer was infused

have been too many of those to count. We've had problems with two or more stations at the same time, but when you work with Ed Dulaney, who has a great sense of humor, there is never a bad day. Engineering is a blast."

While HD Radio is still new ground,

to tell if one channel is too high. You don't want to go from a loud analog signal to a softer digital signal and that is what I hear on a lot of other stations. Timing problems make you want to turn off the station if you hear them, and that

See ALEXANDER, page 55 ►

## More Time With Amanda Alexander

*What might help the radio technical industry attract and keep other people of your age?*

"I think the main thing that really got me into radio was the fact that my father is an engineer. I grew up around it. I became friends with his co-workers and was surrounded with it.

"Unfortunately for the radio technical industry, awareness of our industry just isn't out there. I only heard about it through my dad. Schools have career days; and I never saw or heard of anyone from a radio station coming in and talking about it. Sometimes schools do

a test and it basically tells you what your career should be; I never saw 'radio engineer' on that list. I think that if information on our trade were to be put out there, into schools, and was just talked about more, kids would be attracted to it.

"It's radio! This is an amazing industry, a fun one. I think the idea of being able to help put something out there on the radio is astounding, why not be a part of it?"

*This still appears to be a male-dominated field. What's your perception?*

Radio World  
The Newspaper for Radio Managers and Engineers

**Our readers have something to say**

"Thanks to John Bisset for all the info over the years. I have learned a ton and also discovered where I needed to concentrate more study."

George R. Seifert  
Radio Engineer  
Journal Broadcast Group - Tucson

HEIL SOUND  
www.heilsound.com

Shown: The Heil PR 20 Professional Dynamic Cardioid Studio Microphone



Alexander sets up a spectrum analyzer during an AM IBOC adjustment.

# Alexander

► Continued from page 54

could happen in Denver where the signal drops out a lot.”

Amanda Alexander has lived at home with her parents while completing her degree. She enjoys fishing with her father in Grand Lake, where the family has a cabin.

“Naturally I am very pleased and proud to have my daughter following in my footsteps in the broadcast engineering field,” Cris said. “It has been fun re-learning a lot of the things I first learned when I entered the field. It has also been fun observing Amanda’s enthusiasm on the job as well as watching her become more proficient. Amanda is destined for great things. I’m certain I’m not the only one glad to have her around.”

Amanda said she loves the job and sees engineering as her career. “As hard as it may be at times, I love it. It stretches me so much more than any other job I’ve tried to do.

“I would like to move up the corporate ladder; and if that happens it would be great. But I love working hands-on. I don’t want to end up sitting at a desk telling other people what to do, at least for another five or 10 years. And even then I would still want to work with my hands.”

*Ken Deutsch is a frequent contributor to Radio World as well as a student at the University of Toledo.*

“I think engineering is still a male-dominated field. I am one of only two only female engineers at Crawford Broadcasting Co. Although I don’t feel I necessarily have to prove myself, I still try. I want people to respect me and my abilities.

“I think one of the main reasons radio engineering is male-dominated is because of the types of things engineers are required to do. There are jobs that need to be done that require lots of strength. Most women do not have that strength naturally and have to really work hard to get their strength to match that of a typical male engineer.

“I have found one of the good things about being a female engineer is the fact that I have small hands. Men have big hands and fingers; and there are times when we have to put our hands in these small spaces to work on something. My hands usually fit much better than a man’s hands and I don’t have the same problems as men.”

*What’s the hardest part of the job, or the worst part?*

“I think the hardest part of the job for me is the heavy work. There are times when we have to lift very heavy objects and I can’t really lift it; I usually have to get Ed Dulaney or someone else around the station to help me out.

“One other hard thing, or maybe what I consider to be the worst part, is when I get sick from work. Every year we have to mow at three of our four sites.

“There are usually hundreds of weeds to go through. As much as I love mowing and being outside, I usually pay for it for a week or two afterwards with .ny allergies.”

**MARKET PLACE**

## Audio Precision Updates Analyzers To Help Laptop Users

Audio Precision announced features of software upgrades for its 2700 Series and ATS-2 audio analyzers.

The AP2700 v3.30 and ATS v1.60 control software includes USB connectivity, native support for Windows Vista and improved user profile management. The company considers the 2700 its “flagship.”

It said the updates in functionality and connectivity of its audio test gear would be helpful as more engineers and product line testers move to laptops rather than tower computers for instrument control. “In addition, the AP Test Signals and Resource Disc reference CDs have been revamped for the release with new tones and sample tests to make hundreds of audio tests faster and easier.”

USB will be the standard interface for new 2700 Series and

ATS-2 analyzers. Current customers can buy a USB adapter kit separately; the APIB interface will remain available as an option.

Analyzers in the APx family of analyzers are already USB-enabled and Vista-compliant.

AP2700 v3.30 and ATS v1.60 control software update are available as a free download from the ap.com Web site. The USB adapter will be available in September and will ship with new 2700 Series and ATS-2 audio analyzers. Customers can also purchase the USB adapter separately in an upgrade kit for \$650 list.

For details on features, including support for multiple user profiles, download the What’s New document for each product at [www.ap.com/products](http://www.ap.com/products).

# AM Antenna Solutions

**Reach Farther, Sound Better!**

LBA is your trusted supplier for IBOC-ready AM antenna systems. For over 40 years we have been designing and manufacturing reliable *Directional Antenna Systems, ATU’s, Multiplexers, Combiners, Cellular/PCS Colocation Isolators, and RF Components* for all power levels. Choose an LBA system and join thousands of satisfied broadcasters in the US and worldwide!

LBA can also design, manage, install, and finance your complete RF project. Please call us today for a free technical consultation!

Visit us in booth #528 at the NAB Radio Show in Charlotte, NC!

[www.LBAGroup.com](http://www.LBAGroup.com)



**Directional Antenna Systems**



**Diplexer/Triplexer Systems**



**High-Power Antenna Tuning Units**



**RF Components**

Your Source For:



## LBA TECHNOLOGY, INC.

3400 Tupper Drive, Greenville, NC 27834  
800-522-4464 / 252-757-0279 Fax: 252-752-9155  
Contact Jerry Brown at [jbrown@lbagroup.com](mailto:jbrown@lbagroup.com)



SINCE 1963

# A Radio You Can Drop in Via Parachute

*Some 550,000 Free Receivers Later, Christian Radio Charity Soldiers On*

by James Careless

Five hundred and fifty thousand solar-powered, fixed-tuned radios distributed to 125 countries worldwide. That's what Galcom International, a Christian ministry based in Hamilton, Ontario, west of Toronto on Lake Ontario, has accomplished since its founding in 1989.

But that's not all; Galcom has also devised suitcased-sized radio station kits containing everything one might need to set up a functioning low-power AM, FM or shortwave radio station quickly.

"It contains a 300-500 watt transmitter, simple mixer, MP3 player, cassette player/recorder and two microphones," says Rev. Allan McGuirl, Galcom's international director.

"The local people construct a tower, then set up the equipment and go on air.



With this equipment, they can reach up to 50 miles away."

### The power of coincidence?

The divine inspiration to build and distribute free radios fix-tuned to Christian

broadcasts occurred separately to Tampa businessman Harold Kent and Israeli tent builder Ken Crowell. It was only when the two met through a mutual friend that they got onto the subject, and discovered their shared goal.

They then contacted McGuirl, who sensed that God wanted him to build a solar-powered, fix-tuned radio to reach remote areas lacking power and the money to buy batteries.

Collectively, the three formed Galcom International and began producing "Go-Ye" radios in Israel, named in reference to Matthew 28:19: "Go ye therefore, and teach all nations."

Funded by donations, 40,000 of these radios were built and tuned to Voice of Hope, AM 945 broadcasting from Lebanon. They were then sent into Syria, Lebanon and Jordan.

Unfortunately, pressure from Israel's ultra-Orthodox community made it hard for Galcom to keep working there, McGuirl said. So he and his wife moved their office from their Hamilton home and looked for manufacturing space locally.

Today, Galcom International has a small plant in southern Ontario, where many of the radios are assembled by volunteers.



A shipment drops in Colombia.

"We have all the components, and they snap them together," McGuirl said. "It's a pleasant time of fellowship for them, and a big help to us." The plant also makes Galcom's suitcased-size transmitter units, which local broadcasters use to set up their own Christian radio stations.

### The Go-Ye Radio

Available in AM, FM or shortwave versions, the tough, durable Go-Ye looks like three cassette tape cases stacked together and put on end, and topped with a flip-up solar power panel. (The Go-Ye has a built-in rechargeable battery, but it can also run directly off sunlight.) Besides a sliding on/off switch that also offers two volume levels, there's no knobs of dials to fiddle with on the Go-Ye.

The only exception is a new two-frequency shortwave model, which Rev. McGuirl's son invented for remote areas of Colombia. In some cases the only way to get these radios to people is to fly into the jungle and "drop the radios in with parachutes," according to the newsletter of the National Association of Shortwave Broadcasters.

"Volunteers make the little parachutes," says McGuirl. "We've probably delivered 20,000 radios this way."

The Go-Ye radio looks simple but it is a solid, well-engineered piece of radio hardware. A specific model used by RW was fix-tuned to 91.5 FM, a local mono voice/music service that allowed for through comparisons with conventional radios. The verdict: The Go-Ye provides solid reception and good, clear audio. Meanwhile, its solar panel works in even low light.

Fixed tuning offers a few advantages for the local Christian stations that distribute these radios.

"First, a lot of the people we are dealing with are unfamiliar with technology, so a simple receiver is the smartest thing to give them," said McGuirl. Second, hard-wiring the Go-Ye to a specific frequency, by using a crystal and pre-cut internal or external antenna, discourages thieves from stealing the radios and reselling them on the black market as general-purpose receivers.

### Moving ahead

Galcom International is as much a radio engineering firm as it is a Christian ministry. This explains why the company is always working on new technological ways to spread the word of God.

For instance, the company has developed a new low-powered transmitter with a front-mounted touchscreen audio mixer. Just plug in mics and CD players, add the antenna and you are ready to go on air. Due to go into production, this transmitter will be available for FM and sell for approximately \$500.

For the future? Galcom wants to build a newer, thinner radio with the Audio Bible on board.

"Our goal is to spread the word of God, and to be on the cutting edge of radio engineering," McGuirl says. "Most of all, we want our radios to be so reliable, that they can keep our listeners connected to the Gospel day in and day out. Fortunately, the Go-Ye design is very solid. For instance, when I was in Colombia distributing some radios recently, I met a man who had a Go-Ye receiver that he had received 13 years ago, and it was still operating."

Comment on this or any article. E-mail radioworld@imaspub.com.

## Time is Infinite



Measure  
and  
Display  
it with

**ESE**

142 Sierra Street  
El Segundo, CA 90245 USA  
Tel: (310) 322-2136  
Fax: (310) 322-8127  
www.eseweb.com

Broadcasters have counted on ESE precision master clocks and timing-related products for over 35 years. ESE products accurately synchronize broadcast operations using a choice of GPS, WWV, Modem, Crystal or line frequency for affordable, reliable, perfect time.

Spend a few seconds on [www.eseweb.com](http://www.eseweb.com) to discover a vast universe of timing systems that are designed for easy installation, set-up and operation.



DSPXtreme  
AUDIO PROCESSOR

# Extreme PROCESSING

The DSPXtreme is the newest addition to BW Broadcast's DSPX range of audio processors and we've included a few new features you wouldn't normally expect in an audio processor.



The first thing you will notice is the 2RU form factor which now includes two colour screens - one of which is touch sensitive. As well as looking great, the touch screen removes the need for jogwheels, joysticks and buttons allowing you to navigate, setup and control the DSPXtreme with a touch of your finger.

Behind the stylish front panel you'll find we've included more of the features that have made the DSPX range of processors among the best in the world. If you don't need all the features, no problem, the DSPXtreme is available in four different versions with tailored hardware and programming features: FM, AM, CD, HD.

For quality FM stereo broadcasting, the DSPXtreme-FM includes the world class stereo encoder found in the DSPX and DSPXtra. As well as the standard processing features you'd expect in a top-line processor, the DSPXtreme-FM has dual

output paths allowing HD and FM services to be processed simultaneously without compromise. Simulcasting of FM and HD service is not a problem using the diversity delay feature.

With 6-Bands of audio limiting, distortion controlled clipping and look-ahead limiting you will have everything you need at your fingertips to create your own distinct sound for broadcasting or audio production.

Remote configuration and monitoring is simple with numerous connectiv-

ity options. These include an Ethernet port for LAN or WAN access, an RS232 serial port and an 802.11 (WIFI) Wireless interface. If you don't require a full user interface a remote trigger port is available that allows preset selection through contact closures.

You want more? No problem. The DSPXtreme has a flexible 'flash' upgradeable architecture which means that as we continue to make enhancements and add features, you can continue to reap the rewards. You can simply download the upgrades from our website.

[www.bwbroadcast.com](http://www.bwbroadcast.com)





COLE'S LAW

## OK, Some ABCs About the FCC's CDBS

*It's Easy to Misuse This Online Tool — As Some Stations Have Found to Their Dismay*



thought that it had then filed the necessary follow-up long-form application through CDBS and was doubtless disappointed to get word from the commission a year or so later that its short-form application had been dismissed because no long-form had been filed.

The licensee sought reconsideration but that was

sympathy for those that fail to negotiate it correctly). So we here at Team Cole's Law thought it might be a good idea to provide a brief introduction to CDBS.

Before we get started, let's get one thing straight.

While the electronic filing of applications is not exactly rocket science or brain surgery, it is a complex process which requires *not only* understanding of certain basic mechanical steps, *but also* a full grasp of the substantive regulatory underpinnings of the various FCC forms *as well as* a detailed and accurate familiarity with the facts on which you are basing your answers to the questions on those forms.

This kind of activity is not for the faint of heart. It is generally best left to folks who know what they're doing — especially if the consequences of messing up include the dismissal of an important application and/or the imposition of a considerable fine.

(To read about a prominent licensee who was fined \$20,000 for the way it answered a question on an application, go to <http://commlawblog.com> and click on Aug. 2.)

Nevertheless, far be it from us to tell you that you can't do your own filing if you want to. As Oliver Wendell Holmes said, "If my fellow citizens want to go to hell, I will help them. It's my job."

### Tips

So, for those who decide to cross the CDBS minefield on their own, here are a few tips about some common CDBS traps. We'll assume that you know how to get into CDBS in the first place and also that you have a solid grasp of the FCC's rules that apply to your particular filing (for more, see [www.fcc.gov/mb/cdb.html](http://www.fcc.gov/mb/cdb.html)).

Instead, we'll limit our intro course to some important CDBS mechanics.

*Read the questions and the instructions* — Most FCC application forms and reports are now set up in a series of checkbox or fill-in-the blank yes/no questions. Simple, right? Not so fast.

See CDBS, page 60 ▶

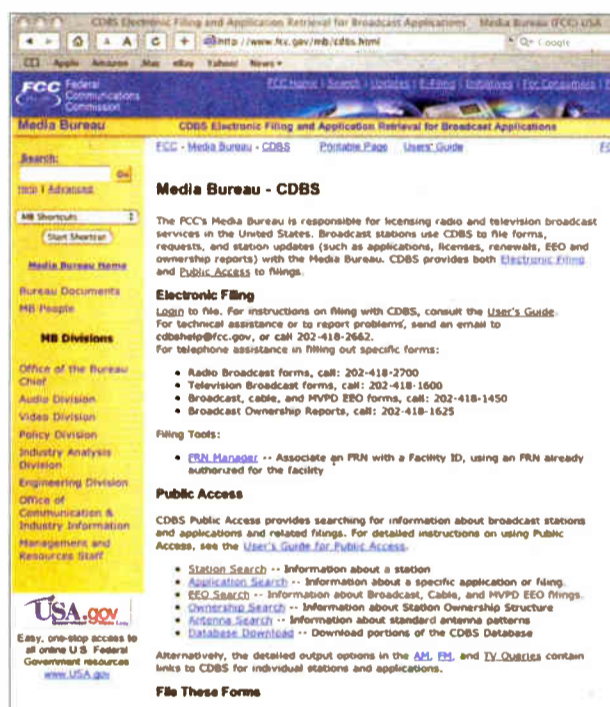

denied in early August of this year.

In another case, an FM licensee, WLVO, thought that it had filed its license renewal application in 2003, also through CDBS, only to be told by the commission in 2004 that, because no such application had been filed, the station's license had expired and its call sign had been deleted.

Both licensees' problems arose from simple failure to negotiate CDBS-land correctly (and the FCC's lack of

by Harry F. Cole and Jeffrey J. Gee

Any sensible person, after reviewing the basic literature (you know, classics like "Tron," "2001 — A Space Odyssey," "I, Robot" or "WarGames") must realize a basic truth about modern society: Computers are evil.

That's a feeling likely shared by many who have gone *mano a mano* (or would that be "*mano a disco*") with the FCC's computerized electronic filing system.

Dubbed CDBS for "Consolidated Database System," it is the only way to file the vast majority of broadcast applications and routine filings such as construction permit applications, ownership reports and the like. So anything you might have to file with the commission is probably going to have to go in through CDBS.

CDBS, however, can be a tricky thing, as a couple of broadcasters recently were reminded.

### Oops

In one case, an AM licensee, WBCU, had filed a short-form modification application. The licensee

## Our focus is always on our #1 product: Radio Automation for Terrestrial & Internet Delivery

- Dynamic On-Air screen layout - simple transition from your old system to software that is truly-state of the art
- 5th Generation Radio Automation with the latest advances in Audio-over-IP, RDS and Internet streaming
- Simple, Revolutionary, Steadfast with unparalleled support for our products



TOLL FREE 888-665-0501  
Web. [www.imediatouch.com](http://www.imediatouch.com)  
Email. [sales@imediatouch.com](mailto:sales@imediatouch.com)



See us at  
NAB Radio  
#N501

# What will you plug into?

"The PR40 is THE BEST mike I have ever used."  
-Art Bell, Coast to Coast

"I suddenly realized that my old studio mics had just become overpriced hammers. These Heil mics blew my mind, but left my budget in great shape."  
-Dave Hines, KXUS, Clear Channel

"Nobody ever said anything nice about my voice until I started using this (PR 40)."  
-Leo Laporte, KFI, The Tech Guy

I just put in some of the Heil PR 40's replacing Neumann's and I have to tell you man, that's the best sounding microphone I have ever heard for broadcast. Sure made a believer out of me.

Jay Rose KVEG, Las Vegas

"The Heil PR 30 presents the smoothest and most articulate speech audio from any dynamic microphone I have ever used. Congratulations to the Heil team for bringing large diaphragm dynamics to the marketplace."

-Mike Dorrugh, company founder and President,  
Dorrugh Electronics



[www.heilsound.com](http://www.heilsound.com)

# CDBS

► Continued from page 58

You should *not* start filling in the answers until you have thoroughly read the questions *and* all of the instructions and worksheets associated with the question.

Unfortunately, most of these instructions do not appear in the CDBS versions of the forms — you have to access them separately, which you can do by clicking on the link to “instructions,” which is stuck unobtrusively at the top of the first portion of the form to be completed.

Keep in mind that you (or your boss) will be certifying, under penalty of perjury, that you have read and are complying with all instructions and worksheets associated with each question.

**Save early, save often** — At the bottom of each section of each form you will find a button marked “Save.” Any changes you make to your answers to the form go away unless you hit the “Save” button before exiting out of the application.

**Validation: It may not mean what you think** — Once you are satisfied that a section has been fully and accurately completed (and saved), it must be validated.

Next to the “Save” button is a “Validate” button. Hitting that button validates the portion of the application you’re working on as long as all necessary answers have been provided.

A couple of caveats about validation: The validation process does *not* assure that your answers are correct; rather, it merely checks to see that all the necessary holes in the application have been filled with some information. Successful validation does *not* necessarily mean that the application as you have completed it is grantable.

Also, validation is *not* the same thing as filing. Just because you have successfully validated your application, don’t think that you are finished with CDBS.

When you have completed, saved and validated all necessary portions of the application, work your way back to the main menu by hitting the “Menu” button (which is next to the “Save” and “Validate” buttons at the end of each separate section of the application).

Before you get to the main menu, you will pass through a screen that lists all the sections of the application you’re working on. If you have correctly validated

everything, the status for each section should be marked “valid” — otherwise, the application won’t be accepted by CDBS.

**File the application** — Okay, so the application’s been completed and validated and you’re back at the main menu.

Scroll through the listing of blank forms and down to the “work in progress” portion of the page, and find the form that you have been working on. Click in the small button in the far left column to select that form, then continue scrolling to the very bottom of the page.

There you will find a row of buttons. If you want to try a dry run, hit “Test File.” CDBS will then review the application and let you know whether it is ready to be filed. If it finds problems, it will list them — although it may not tell you how to fix those problems.

If you want to file the application you have selected, hit the “File Form” button. Be sure that you have your FCC Registration Number (FRN) and associated password handy when you hit the button, because CDBS will ask you for them before proceeding, and it will not do anything with your application until you provide that information.

Once you have hit the “File Form” button, you are almost finished — and we stress “almost.”

**Confirmation** — Once CDBS has completed its initial processing of the application and determined that it is complete, you will see a screen that includes language expressly confirming that the application was “Successfully filed.” It will provide the time and date of the filing, and will specify the CDBS “Application Reference Number” for the filing.

Before you do anything else you should print a copy of that screen for your records, because that screen provides confirmation that you have in fact filed the application. This screen is the equivalent of the “stamped in” copy you would have received back in the day when applications were filed on paper. Without it, it

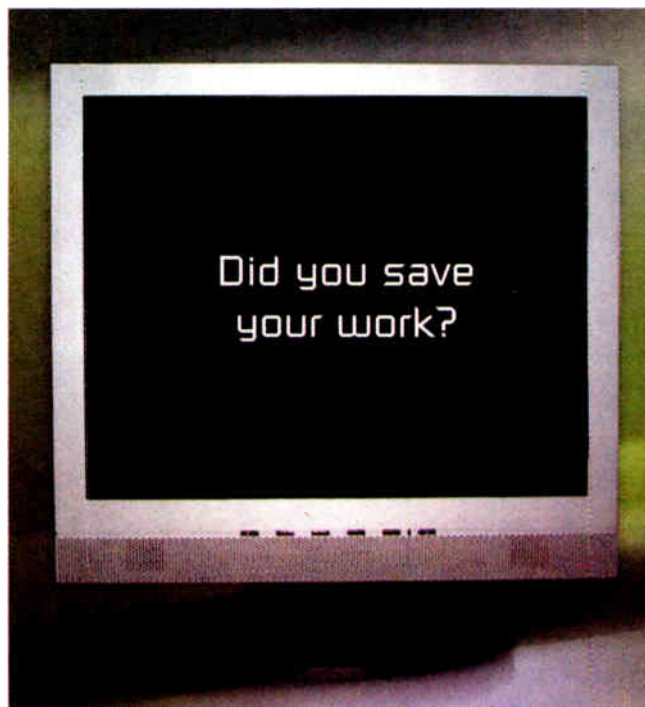

could be very difficult to establish that you really did file the application.

As a general rule, if you don’t get a confirmation screen from CDBS, it’s probably safe to assume that your application has *not* been filed.

You can check on this by returning to the main menu, scrolling down to the application in question (in the “work in progress” portion), and looking at the far right-hand column.

If that column includes a reference number (consisting of the year/month/date of filing followed by three letters, e.g., 20070912ABC for an application filed on Sept. 12, 2007), then it’s been filed — but be sure to make a note of the file number, and it would also be a good idea to print a copy of that screen for possible future reference.

**Pay the fee** — If the application you are filing is subject to a fee, the confirmation screen will let you know what the fee is and will give you the option of paying it online right then and there.

You can take advantage of that opportunity by hitting the “Electronic Form 159” button. If you go that route, you will need your credit card information — including the security code for the card and the FRN (and FRN password) of the payor if the payor is different from the applicant.

You don’t have to pay online. As an alternative, you can send in a check to the commission’s fee filing office. But that has to be accompanied by a properly completed Form 159 (Fee Remittance

Advice) *and* it *MUST* be received by the FCC within 14 (count ’em, fourteen) calendar days of the filing of the application. If the fee is not received by then, the application is subject to dismissal and may not be processed at all.

(The WLVO licensee mentioned messed up with this payment requirement. He apparently did send in a check in connection with his 2003 renewal, but it got to the commission too late, which resulted in his 2003 renewal being treated as not having been filed. Fortunately for the licensee, his lawyer found a rule that forced the commission to go back and accept the 2003 application; but you should not count on the FCC leaving that particular loophole open again.)

If you do pay the fee online, the good news is that the processing of your application will start immediately. Snail-mail fee payment means that processing won’t start until the FCC has received and cashed the check.

CDBS provides a confirmation screen showing that online payment has been made. If you go that route, be sure to print a copy of that screen.

**Keep a copy** — And while you’re at it, you will want to go back to the main menu, scroll down to the application you just filed, select it by hitting the small button in the far left column, then scroll down to the bottom of the page and hit the “Print Form” button.

CDBS will then put up on your screen a printable copy of the application, as filed. Note that, if you attached any exhibits, you may have to manually access each of the exhibits in order to print them. Keep in mind that the FCC’s public file rules require stations to place a copy of any application tendered for filing with the FCC in their public inspection files.

By being careful to work the mechanics properly, you should be able to get your applications on file.

Again, though, that is no guarantee that they will be grantable, or that you won’t be subject to a fine because of the way you answer the questions in the form. But you should at least be able to get it in the door.

Harry Cole is a member and Jeffrey Gee is senior counsel in the law firm of Fletcher, Heald & Hildreth PLC. They can be reached at cole@fhhlaw.com or gee@fhhlaw.com. Read their blog postings on regulatory developments at www.commlawblog.com.

Converters . MADE by RME

## ADI-8 QS

8-Channel high-end AD/DA Converter

24 Bit/192 kHz . Analog to/from AES/EBU, ADAT or MADI

Reference quality . Fully remote controlled . Low latency converter design

www.rme-audio.com/qs  
Engineered and Made in Germany

North America distribution  
Synthax USA  
www.synthax.com



8 x Analog I/O (up to +24 dBu) . 4 x AES/EBU I/O (8 channels, up to 192 kHz)

2 x ADAT I/O (8 channels, up to 96 kHz) . MIDI I/O . Word Clock I/O

optional: MADI I/O (ADI-8 QS-M)

RME  
The Art of Interfacing

# OMNIRAX

## BROADCAST FURNITURE

What differentiates Omnirax from other furniture manufacturers is our uniquely balanced blend of style, functionality and ergonomics, our excellent collaborative custom design ability and our fanatical attention to detail.

Omnirax has been making bold statements in Broadcast Furniture for the past several years. We have experienced a meteoric rise from a virtual unknown in the Radio industry to the "Engineer's Choice" in just a few short years with the introduction of the Innova Line. A heartfelt thanks to all our customers!



The essence of the Innova Line lies in combining modular components with custom tailored shapes to fit particular requirements of On-Air, Production and Imaging Studios.

Cable raceways are integrated into the structural design to facilitate wiring and create logical access points throughout. Conventional casework and cabinetry is produced so that an entire facility has a unified look and feel.

Omnirax works directly with Chief Engineers, Program Directors, Architects and Station Owners to provide intuitive and custom solutions at near-production prices.

When you begin planning your next project please call us and let us help you get the furniture you want. We can make this part of the project go smoothly, and the sooner we are involved the easier this becomes.



*"The Omnirax design makes these studios incredible for talent and operators on both sides of the console."*

*"Our furniture from you not only fit into our budget and timeline, it was very well constructed and looked beautiful. I expect to be outfitting many more facilities with Omnirax."*



*"I was impressed with the exceptional care given packaging for shipment. A few very large and potentially fragile components made it cross-country completely unscathed."*

*"I'm blown away!"*

*~ Dave Williams, Director of Engineering  
Clear Channel San Francisco*



*"I wholeheartedly recommend Omnirax to everyone."*

*~ John Buckham, Project Engineer, Entravision Communications*

**Omnirax P O Box 1792 Sausalito, CA 94966**  
**800.332.3393 www.omnirax.com**

## STATION/STUDIO SERVICES

Be compliant with the new **BAS Prior Coordination Notification Procedures!**

# Point. Click. Done.

Hundreds of people have told us they need a service that will:

- ★ Perform a Path and Interference study for each application.
- ★ Send all the Prior Coordination Notices to others in the spectrum.
- ★ File the FCC Form 601.
- ★ Make it easy to start the process.
- ★ And do it for less than other services charge.

So we've created your inexpensive, one-stop solution for RPU and STL licensing needs!

# Point. Click. Done.

visit [www.terrestrialrf.com](http://www.terrestrialrf.com)  
or call 888-373-4832

# YOU!

...like promotions that are *easy* to sell, a pleasure to air, and make you *lots* of money? We're all about that. Please take a moment to visit [GRACEBROADCAST.COM](http://GRACEBROADCAST.COM) and check out our :30- and :60-second "Sales Boosters." FREE demos, money-making sales helps, and *ridiculously healthy returns* await.

Neat Ideas. Free Demos.

**GRACE BROADCAST SALES**  
Sound Ideas for Building Business<sup>SM</sup>

Questions? Call us toll-free (888) 472-2388.  
[www.gracebroadcast.com](http://www.gracebroadcast.com)

**Market Exclusive! Ideas You Can Sell Now!**

- Safe Driving Tips - 10 :30's \$89
- Fall Car Care - 15 :30's \$129
- Farm Safety - 20 :30's \$159
- Salute/Amer. Farmer - 20 :30's \$159

plus...Halloween Safety, 4-H Week,  
Don't Drink & Drive & Much More!

FREE Demos at [GraceBroadcast.com](http://GraceBroadcast.com)  
Call Toll-Free! (888) 472-2388

**Reserve for Your Market Today!**

**GRACE BROADCAST SALES**  
Sound Ideas for Building Business<sup>SM</sup>

"Just want you to know how successful our "SHOP AT HOME" Campaign is. So far, we have sold 29 packages at \$500 each...." - FL

**"SHOP YOUR HOMETOWN MERCHANTS"**  
Keep Local Dollars Working at Home!

Fully Produced • Market Exclusive  
Ready to Sell & Air Right Now!  
:30-second features - \$399

**FREE DEMOS & INFO**  
[www.gracebroadcast.com](http://www.gracebroadcast.com)

## ADVERTISE

### Your Services Here

**Providers:** Promote your services to Radio World's readers.

Reach Radio Station owners/managers and engineers with your message.

For information on affordable advertising call **CLAUDIA** at 1-703-998-7600, ext. 154 or e-mail [cvanveen@imaspub.com](mailto:cvanveen@imaspub.com)

## BROADCAST LAW REVIEW

# 'Four Years? I've Got Plenty of Time!'



*Actually, The Time to Start Preparing For the 2011 Renewal Cycle Is Now*

are not automatically renewed as part of their full-service station renewal applications.

Stations should also keep in mind that FM translator stations located in different states than the underlying full-service station may be on a different renewal cycle.

by David H. Solomon

The next radio license renewal cycle doesn't begin until 2011. So there's plenty of time for stations to get their compliance act together to avoid renewal delays or penalties, right? Wrong.

During the most recent renewal cycle, the FCC has been fining stations for violations left and right. During the last two years alone, more than 300 radio and television stations have been subject to a combined total of about \$2 million in penalties. In addition, numerous renewals

*Avoid Delay in Renewal Processing* — While ultimately the commission controls how quickly to process renewal applications, licensees can increase their odds of prompt renewal by paying particular attention to compliance in "hot" areas being given special attention by the FCC.

During the current renewal cycle, indecency and sponsorship identification issues (including payola for radio stations and video news releases for television stations) have resulted in many license renewals being delayed.

**Many stations start checking right before they file their renewal applications, discover mistakes and report them as required, which often leads to fines — generally ranging from \$4,000 to \$10,000 per station.**

have been held due to commission consideration of indecency and sponsorship identification issues.

The time for stations to take action to prevent such problems in the next renewal cycle is now. By taking some fairly simple and inexpensive steps, stations can avoid more costly penalties or delays at the time of their next renewal.

By 2011, when stations begin filing renewal applications, it will be too late.

Based on FCC actions during the most recent renewal round, here are some key areas on which stations should focus their compliance attention.

*File Renewal Applications on Time* — This seems straightforward but a number of stations filed their renewal applications late and got fines as a result.

The fines were generally \$1,500 if the stations filed before the license term ended and \$7,000 if they filed after the license term ended, in which case the commission found they engaged in unauthorized operation as well.

This can be avoided by putting an effective tickler system in place for license renewal applications, which must be filed four months prior to expiration of the station license.

Also, stations should not forget to renew any FM translator stations, which

The reason for this is that the commission moves extremely slowly in deciding cases in these sensitive areas and wants to keep the applications pending in order to stay within the statute of limitations for any fines it may issue. (The problems from delay can often be addressed through a statute of limitations tolling agreement.)

Given that indecency and sponsorship identification issues have caused renewal delays, and have also resulted in large enforcement actions, licensees should pay particular attention to avoiding violations in these areas. Compliance plans, combined with training and management oversight, can play a big role in this regard.

The more difficult issue in avoiding such renewal delays is to identify in advance what the "hot" issues might be during the 2011 renewal cycle.

There's no magic to this, but, as 2011 draws nearer, paying close attention to what enforcement actions the commission is taking, and what the chairman and commissioners (and members of Congress) are saying about their enforcement priorities, is a good start.

*Keep Public Inspection Files in Order* — Renewal applicants must certify that  
See 2011, page 63 ▶

# 2011

► Continued from page 62  
they placed all documents in their public inspection files at the appropriate times.

Many stations start checking right before they file their renewal applications, discover mistakes and report them as required, which often leads to fines (generally ranging from \$4,000 to \$10,000 per station). Late-filed or missing quarterly issues-programs are particularly common.

## Taking some simple steps now can avoid bigger problems later.

To avoid these problems, stations should make sure they have a system in place to ensure compliance — identify who is responsible (and who is the back-up), what they are supposed to do and when they are supposed to do it.

Stations should also have someone checking to make sure these procedures are being followed and that the required materials are in fact being placed in the public inspection file in a timely fashion so problems don't pile up. The commission will not excuse a licensee based on employee turnover or lack of knowledge of the violations.

*Following the EEO Rules.* Licensees must file a Broadcast EEO Program Report, along with their last two EEO public file reports, with their renewal applications.

These reports give the FCC staff an easy opportunity to identify any problems in design and implementation of a station's EEO program. Fines of up to \$20,000 have been issued in the current renewal round.

Stations should thus focus on their EEO efforts in advance. They should make sure they have clear procedures in place to comply with the outreach, recruitment and record-keeping rules.

*TV Stations: Complying With Children's TV Rules.* Numerous television stations have received fines (of up to \$20,000) at renewal for various children's television-related violations that must be reported on the renewal form.

These have most commonly involved violations of the children's television commercial limits and failure to publicize the existence and location of children's programming records. Here, too, developing and implementing compliance procedures in advance can help avoid problems at renewal time.

In sum, now is the time for broadcasters to be thinking about what they can do to protect themselves against fines and delays when the next renewal cycle begins in 2011. Taking some simple steps now can avoid bigger problems later.

*The author is a partner in the Washington law firm of Wilkinson Barker Knauer LLP and a regular contributor to Radio World. From 1999 to 2005, he was chief of the FCC Enforcement Bureau.*

### PEOPLE NEWS

The inaugural Kellar Radio Farm System Institute, held at Appalachian State University in Boone, N.C., was held in July. The program is a "farm system" for future radio broadcasters, designed to attract, train and create talented students, who are taught by professionals volunteering their time over the 10-day event. It is named for former broadcaster Art Kellar, who donated \$500,000 to get the program underway.

Seventeen students qualified for the first program, which covered programming, copy writing, promotions and marketing. They also completed the 17 modules of the RAB sales training certification course. Dan Vallie of Vallie Richards Donovan Consulting, pictured with the students, serves as director of the institute.

Students who completed the program now have the opportunity, anytime in the next 10 years, to apply to Appalachian and the Kellar Radio Farm System Institute for \$50,000 in seed money for investment in radio broadcast ownership.

*For more information about the Kellar Radio Farm System Institute, contact Dan Vallie at (828) 262-3919.*



# COMPLETE MICROPHONE TO ANTENNA TECHNICAL SERVICES



**Complete Systems Integration**  
Studio and RF Systems Installation, Test, & Documentation

**HD Radio Transmission**  
Factory Authorized By Several Manufacturers For HD Installation & Certification

**Plug & Play Transmitter Buildings**  
Solid Reinforced Concrete Shelters With All Equipment Installed, Tested, & Documented - Ready For Simplified Site Build



**Custom Broadcast Studio Furniture**  
High Quality, Distinctive, & Rugged Studio Furnishings - Designed & Fabricated For The Specific Studio & Application

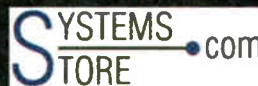

**SystemsStore**  
Your Online Source for Cable, Connectors, Punchblocks, Racks, Wire Management, Test Equipment, Tools, & Problem Solvers To Complete Any Technical Installation.



**BALSYS COMPANIES • 930 Carter Road #228-234, Winter Garden, FL 34787 USA  
T: 407.656.3719 • F: 407-656-5474 • www.Balsys.com • www.SystemsStore.com**

# Show Me the Public File

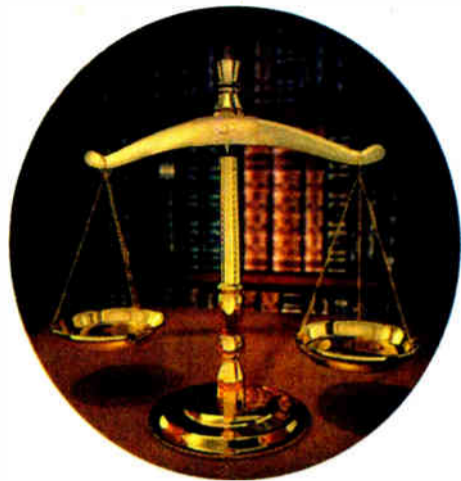

by **Mark Smith and Elizabeth Clark**  
Truman State University

Although a majority of Missouri radio stations complied with Public Inspection File requests in a recent study, one in five licensees failed to produce Issues-Programs Lists upon demand during station visits.

Large-market operators in the statewide study had the highest rate of noncompliance, followed by small- and medium-market stations.

Two factors encouraged our study of Issues-Programs List compliance.

First, the FCC has consistently promoted Lists as gauges of community service. The government requires non-commercial and commercial stations to maintain Public Inspection Files. In each File, Title 47 requires stations to prepare Lists that are available upon demand by the public and FCC.

Second, as part of the government's localism debate, the FCC has encouraged the public to inspect station Files firsthand to assess the community service efforts of broadcasters. Based on the FCC's continued emphasis of producing Lists to document local public service, we devised a study to visit Missouri Stations and report our encounters.

## 'At any time'

Four times each year a licensee must have prepared a new List, which is stored in the Public Inspection File at the main studio location or at a designated location if the station has been granted a studio waiver. Stations may opt for a paper version or an on-site electronic database.

Each quarterly List must provide the station's significant treatment of community issues and incorporate brief descriptions of issues as well as the days, times, titles and durations of programs deemed to have addressed community issues.

The Missouri Broadcasters Association, through timely e-newsletters, has consistently encouraged its membership to prepare and file complete quarterly information.

Researchers visited 19 noncommercial and 79 commercial broadcast outlets generated from a list of more than 300 stations licensed to serve Missouri communities in small, medium and large markets. Small-market stations, the largest percentage of radio operators in Missouri, accounted for 67 licensees. Medium markets, such as St. Joseph and Springfield, represented 14 stations. Seventeen stations in St. Louis and Kansas City, the state's two largest met-

## Missouri Study Finds 20% of Stations Fail to Produce Issues-Programs Lists Upon Demand

ropolitan areas, were included in the sample.

We recruited several students from a Truman State University mass communication course to assist us with station visits statewide in 2006. Twenty minutes was established as a reasonable threshold for station personnel to produce Lists after individual requests. Federal law requires the Public File to be available for inspection "at any time" during regular business hours.

Researchers recorded field observations immediately following each visit.

### One in five stations fail

While a majority of radio stations provided access to Lists, the radio industry in Missouri struggles with full compliance of federal requirements.

The noncompliance rate for all markets approaches 20 percent. Large-market radio stations in St. Louis and

and Lists (verbal refusals and locked studio doors) and incomplete Files.

The researchers visited dozens of stations with personnel who were prepared for List requests; however, unfamiliarity with the Public File, its contents and lack of timely access were encountered among station management and frontline employees (receptionists and front-counter personnel).

A researcher who entered a small-market station in mid-Missouri before noon waited several minutes for a station employee to acknowledge his presence at the front counter. "You'll have to come back at 1:30. Our operations manager knows about the Public File," the employee stated. When asked again if station personnel could offer immediate assistance, the reply was "no."

A sales manager at another station cluster in the same community struggled to locate a Public File only to discover

**If stations take pride in community service, generating, maintaining and actively promoting Lists would seem to favor rather than punish broadcasters.**

Kansas City had the highest rate of non-compliance: Four licensees (24 percent) were unable to produce access to required documentation within the research parameters. Thirteen radio licensees (19 percent) who operate small-market stations failed to comply with researchers' requests.

The lowest rate of noncompliance, 14 percent, occurred among medium-market stations with a single licensee operating two stations in a Springfield radio cluster who failed to fulfill timely requests for List documentation. Of the 19 noncompliant broadcasters in all markets, 15 commercial and four noncommercial licensees had not met List availability.

Among group owners in Missouri, small operators had the highest rate of noncompliance (58 percent) followed by large-market (25 percent) and medium-market licensees (17 percent). Likewise, small-market locally owned stations (86 percent) had a higher failure rate than large markets (14 percent). Noncompliance among local owners in medium-markets was not a factor because the noncompliant stations operated under group ownership.

### Encounters with stations

It was not uncommon for station personnel to claim that no one, except for the FCC, had requested File information for many years, if at all.

"This is the first time in my 21 years of broadcasting anyone has asked for this," said one program director.

Not only did the inability to access Public Files within 20 minutes of station visits account for noncompliance but also personnel with limited or no knowledge of Files, denial of access to Files

that the requested List had not been filed. "We had personnel turnover in 2005 — they did not prepare reports for that year — we need to take care of that," the manager claimed.

Student-operated radio stations, which experience regular turnovers of personnel, face a continuous challenge of familiarizing station operators with File regulations. Contacts with two college broadcasters failed to produce access to Lists.

A researcher encountered the chief operator in a southeast Missouri station who was ill prepared for a File request. When asked for a copy of the List, the CO claimed to have no knowledge of a File or Lists.

The CO pointed to stacks of yellowed documents on a shelf. "That's all we've got, if that's what you're looking for. If the FCC was to come, I'd just have to throw all that up there [on the shelf] down on the floor here and say, 'There you go, see if you can find what you want,'" the CO said.

It was apparent that the documents did not include current Lists and it's unlikely the FCC would agree with this station's the filing system.

Another southeast Missouri broadcaster, who did not respond to knocks on a locked station door during business hours, had posted a sign informing the public of limited studio accessibility. The station was obviously broadcasting because its transmission was being received on the researcher's car radio and could be heard from speakers inside the building.

A sign posted on the window claimed the station was open for business twelve hours per week, Tuesdays and Thurs-

days. Federal law requires access to Lists eight hours a day, Monday through Friday.

The presence of larger staffs, which would presumably handle frequent requests for File information in metropolitan areas, did not significantly increase the chances of compliance.

Despite requests to access the studio File, a Kansas City station steered our field researcher to List documentation supposedly posted on the broadcaster's Web site; no link was apparent.

A St. Louis broadcaster denied access to its File claiming that only the human resources director, absent from the studio, had been authorized to service requests.

### Suggestions for greater compliance

The rate at which Missouri broadcasters failed to produce List requests is likely a concern to licensees beyond the Show-Me state.

In the 1980s, researchers visited stations nationwide to ascertain access to the Annual List of Problems and Needs, the precursor to today's Issues-Programs List. A noncompliance finding of 20 percent matches the Missouri study rate more than two decades later. It is not unreasonable to conclude that a nationwide sample of station visits in 2007 would yield similar results.

Our findings serve as reminders that station employees charged with preparing or fulfilling public information requests must abide by relatively modest federal laws.

One station manager, who complied with our request for File access, suggested that List documentation is useless if no one asks for it (the government claims that stations should use the documents internally to determine levels of community service as well as for public scrutiny).

The public undoubtedly has little knowledge of Lists or the right to inspect Files because stations are not required to publicize access to prescribed records, nor has the FCC consistently promoted the existence of File information.

If stations take pride in community service, generating, maintaining and actively promoting Lists would seem to favor rather than punish broadcasters. Many stations regularly provide public service documentation to the National Association of Broadcasters as demonstrations of community involvement. Why not expand this information to a wider audience?

If licensees promote community service documented on Lists through a variety of communications devices, including the Internet, we foresee public awareness of both the existence of the Lists and the extent to which stations take pride in serving their communities.

As we write, the FCC is considering the viability of Public File postings on station Web sites. We suggest that broadcasters take a proactive attitude. List compilations posted on station Web sites, combined with invitations to comment on public service, would seem to respond, in part, the localism debate initiated by the FCC. Many stations ask the public to provide news tips. Why not invite listeners to examine Web site Lists and suggest community issues that licensees can address with station programming?

The authors teach broadcast journalism at Truman State in Kirksville, Mo.





Tell us about your job change or new hire. We're particularly interested in hearing news about radio engineers and other managers. Send news and photos via e-mail to radioworld@imaspub.com or mail to Radio World People News, P.O. Box 1214, Falls Church, VA 22041.

Mike Tosch accepted a position with KSPN(AM) 710 ESPN Radio and KDIS(AM) 1110 Radio Disney in Los Angeles as chief engineer. Both are owned by the Walt Disney Co. in Burbank.



Mike Tosch

Tosch left his job at Sporting News Radio and KMPC-1540 as director of engineering. He will be in charge of new facilities design and buildout for a new transmitter site for KSPN, and new studio facilities for KSPN Radio in downtown Los Angeles in a new redevelopment project called "LA-Live."

He reports to GM Bob Koontz and VP of Engineering Clay Steely in Dallas.

D.A.V.I.D. Systems hired Dane Roose as project engineer. He designs network topologies, conducts quality control testing and assists with large-scale project planning as well as lends his IT background to the support team. Roose, a former specialist (E-4) in the U.S. Army who served during the Persian Gulf War, joins the company after having spent more than three years running an independent IT consulting business, with which he developed customized software solutions for the construction and remodeling industry. Prior to that, he spent four years as a team leader at the Computer Sciences Corp.

James H. Kemman passed away at the age of 70 after a battle with prostate cancer.



James H. Kemman

The longtime engineer for Electronics Research Inc. was still working for the company when he died. Kemman had previously worked for Silliman, Moffet and Kowolski, and later Silliman and Silliman, in Washington and Silver Spring, Md.,

for 23 years. His career began as chief engineer of WLAN(FM) in Lancaster, Pa. Kemman is survived by his wife Ruth, a son and daughter and several grandchildren.

Netia added three technical hires to its staff: Sebastian Torres, Frederick Monge and Yoann Keiflin. The company says Torres, a Microsoft Certified Professional, is working with Netia project managers on the specification, installation and maintenance/support of Netia products. Prior to joining Netia, Torres was responsible for testing P Series server systems at IBM's facility in France. ... Monge has been appointed to the role of developer in charge of Netia's MultiTrack XT editing tool. He had been a

developer at Faith Technologies, responsible for its mXMFTool, a real-time application that allows for the creation of Mobile DLS and Mobile XMF content. ... After working as an intern at Netia for the last three years, Keiflin assumed the role of developer in charge of the company's Nodal Master and Media Logging solutions.

Symetrix appointed Dallas Dougherty to the new position of product and training specialist/field engineer. He works with all Symetrix brands but with a main focus on training and support for SymNet. Dougherty most recently served as product specialist at Mackie (Loud Technologies).



Dallas Dougherty

Logitek appointed Bill Hacke as a senior electrical engineer. He returned to his native Houston after 20 years working in Silicon Valley. Hacke's most recent position was in the design of multi-channel audio processing equipment for the cell phone industry.

Inovonics promoted Ben Barber to chief operating officer. He has been with the company for 20 years, active in new product development and marketing, production engineering and customer support.

LOUD Technologies promoted Christopher Mael to business director of its Mackie and Tapco brand group. Prior to his promotion, he held both business management and account management positions at LOUD.

Al Jason joined Harris Corp.'s radio sales team as district sales manager for the northwestern U.S. region. He had previously served as western regional sales manager of



Al Jason

radio products for Dielectric Communications, western regional sales manager for ERI and domestic sales manager for Jampro Antennas.

Renee Roland Crittendon joined FCC Commissioner Jonathan Adelstein's staff as legal advisor for spectrum and international issues. She has worked at the FCC since 2001, and most recently served as deputy bureau chief in the Wireline Competition Bureau. ... Amy Blankenship joined Commissioner Deborah Taylor Tate's staff as a legal advisor on family, children and media issues. She most recently served as counsel to Sen. Sam Brownback on the Senate Judiciary Committee.



JACOB K. JAVITS  
CONVENTION CENTER  
NEW YORK, NY, USA

# 123<sup>rd</sup> AES Convention

October 5th-8th, 2007

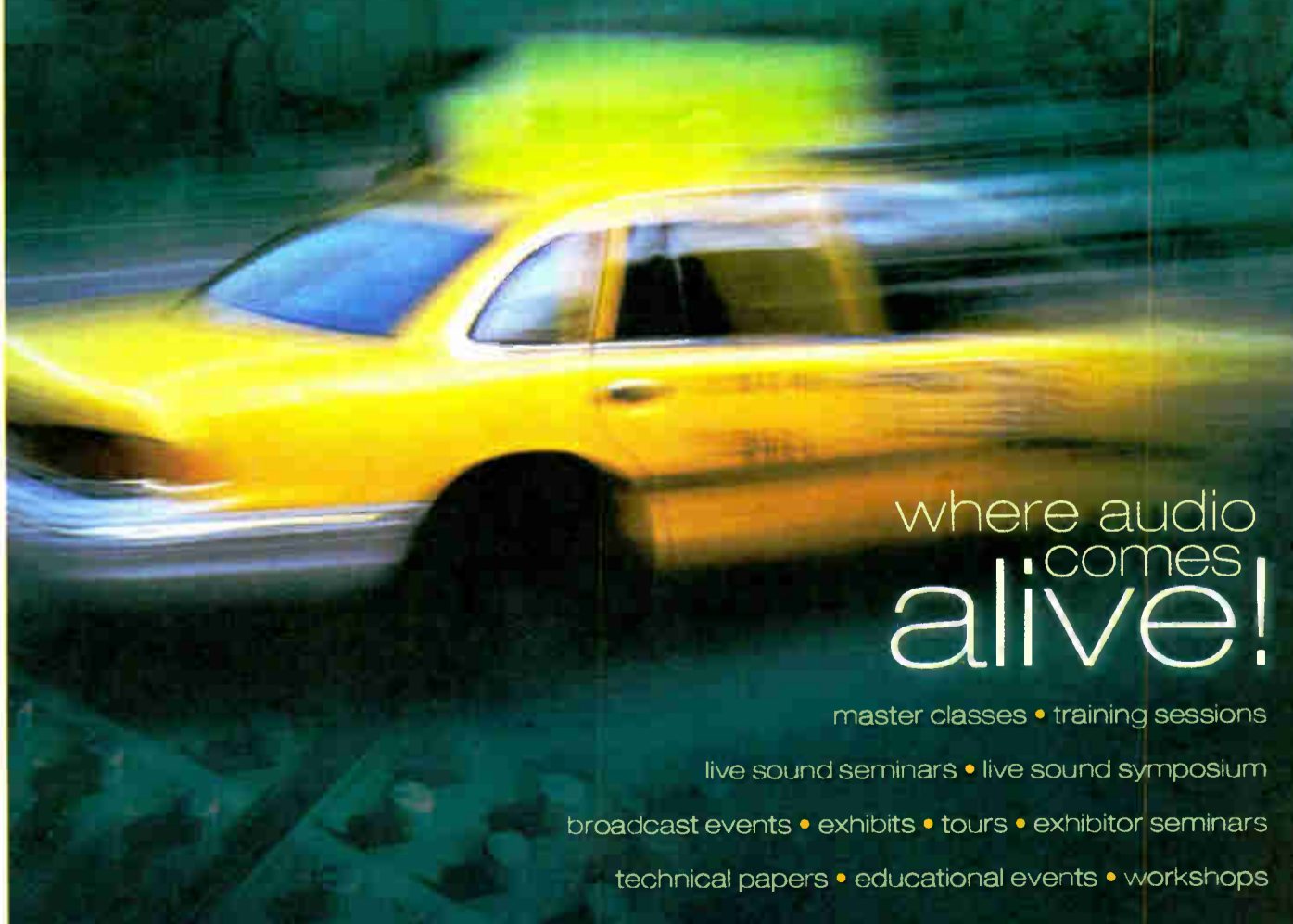

where audio  
comes  
alive!

master classes • training sessions  
live sound seminars • live sound symposium  
broadcast events • exhibits • tours • exhibitor seminars  
technical papers • educational events • workshops

# Study: HD Radio's 'Tepid Growth Story'

by Paul McLane

Is HD Radio up to the task of helping traditional radio compete with other new media?

One study suggests the answer is no.

Internet radio will boom. Cell phone audio listening is gaining momentum. But HD Radio growth is disappointing. These are among findings of Bridge Ratings, which published this chart as part of a report on "Digital Media Growth Projections" in August. It shows booming expected growth for Internet radio (purple) and wireless Internet (teal) in the coming decade, with terrestrial radio (red) essentially flat, then eroding toward 2020, and HD Radio use bubbling along only near the bottom.

To read the lower grid, choose a media format at left, then read across. For example, "Bridge Ratings estimates that by the start of 2008, HD Radio sales will reach 0.5 million." HD Radio is in light blue in the chart.

"The entire spectrum of digital audio alternatives, and especially Internet radio and its wireless distribution, continue to represent the biggest challenge to traditional radio," Bridge concluded.

"Confirming an earlier trend, a rising component of trouble is cell phone activity among all age groups up to 65 years of age. New cell phone capabilities which will turn the mobile phone into a more dynamic part of daily life will potentially surpass Internet radio as the most significant challenger to traditional radio's time spent listening.

"Based on what we know now," Bridge stated, "we do not see HD Radio as a significant contributor to boosting listening to terrestrial radio."

## 'Disappointing'

"Projections for HD Radio's growth is disappointing, as our just-released study on HD vs. Internet radio suggests at this point in time a slower growth curve for the new technology unless the industry can overcome significant consumer resistance due to issues related to the benefits of HD Radio," it found.

"We have lowered our previous estimate of HD units sold through the end of 2007 to approximately 400,000 and only 2.4 million by 2010 unless marketing, pricing and distribution efforts improve."

Why isn't HD Radio catching on?

"The number one response from those who have 'little or no interest at this time' continues to be 'Don't see a need' followed by 'Not aware of its benefits,'" Bridge found. Consumer awareness of HD Radio continues to "grow impressively," it said, "but consumer interest in owning or listening to HD Radio continues to decline as a function of the general population; 75 percent of the sample now has heard of HD Radio at some time in the past. Only 7 percent expressed that they are very interested in owning HD Radio, down from 9 percent in January of 2007."

The company concluded that "a solid case of product differentiation or product benefit has not been made by the broadcast community and therefore, those early adopters and innovators who potentially were interested in HD six months ago have, for the time being, moved on to something else."

Bridge did find that "the combined effect of HD

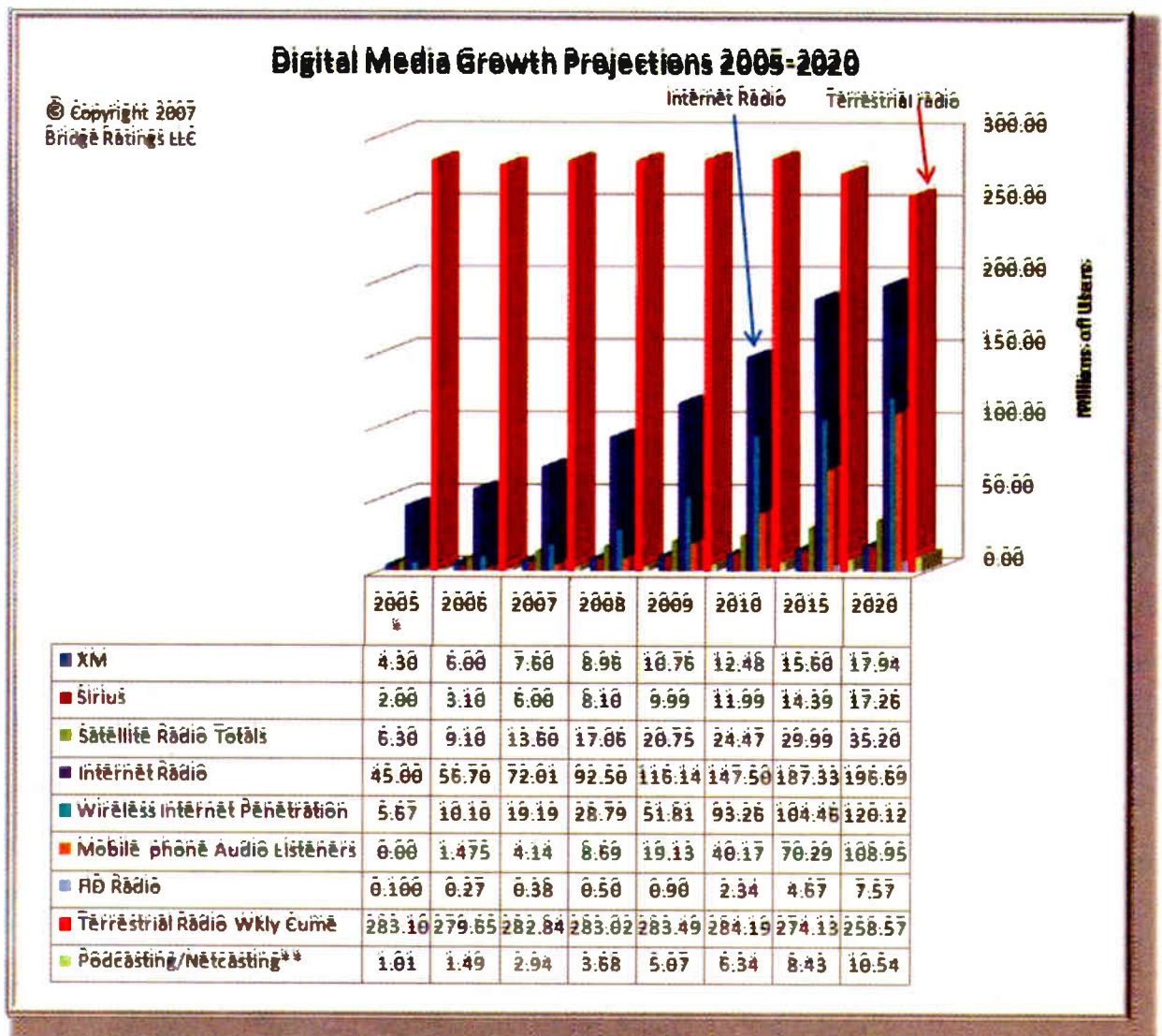

Radio's roll-up and increasing growth of Internet radio together with a general market malaise are slowing original growth projections for satellite radio."

## Encouraging youth trend?

"Because our predictive polling cannot foresee changes in technological and sociological change, the figures shown do not take these into consideration," Bridge also noted in regards to its overall numbers. "Traditional analog radio, even with advances such as HD technology, may sustain popular use, especially among older listeners. The maintaining of mass usage numbers, of course, relies on quality of the programming."

The company's data indicates that subscribers to satellite radio should reach 23 million by 2010, or 6.7 percent of Americans, and 35 million by 2020. But these projections are down from the company's earlier estimates of 50 million subscribers and don't take into consideration a possible merger.

It also found that despite accelerated new car purchase activity, a high percentage of consumers either do not convert free trial subscriptions or do not renew paid subscriptions. The latter percentage is now approaching 55 percent of consumers not renewing or converting.

Traditional radio, meanwhile, is sharing in the Internet radio boom. The percentage of Internet radio listeners who consume simulcasts of terrestrial radio stations is climbing; a quarter of Internet listeners heard at least one terrestrial radio simulcast online in the month prior to the survey; that's 18 million listeners.

"Assuming technology status quo, we anticipate that by the beginning of 2008 this number will rise to 32 percent and by 2010, 38 percent of Internet radio listeners will spend time with a terrestrial radio simulcast," though developments in the contentious licensing fight may affect these trends.

The study also relates encouraging news about younger consumers; some in the 12-21 age bracket are rediscovering traditional radio through contemporary music formats such as top 40 and alternative rock.

"What is attracting this young group back is the increasing dedication to new music by some of these stations and a change in the manner the music is being presented on these stations. We are seeing contemporary music stations with a better appreciation of the fact that their most active listeners are very much into 'music discovery' and use these radio stations to help filter out uninteresting new music."

Its earlier research also indicated that radio was benefiting in its pursuit of younger listeners from Internet simulcasting and an "iPod fatigue" effect.

Other findings: Investment and development in WiMax systems will continue in 2007, accelerating out-of-home use of Internet radio. "The negative potential of the new copyright royalty fees on the growth of Internet radio is difficult to project at this time."

Automotive companies are seeing demand for Internet-capable in-car systems and are moving forward with plans to install Internet-capable boxes in 2007 and '08 models, Bridge reported.

"Though initial exposure to this technology will be focused on new cars coming out of Detroit and Japan, plans are unfolding rapidly for after-market installations. This out-of-home and office use coupled with already significant user numbers at home and office are exerting upward pressure on growth for Internet radio listening," which includes both Internet-only audio as well as radio simulcasts.

## PEOPLE NEWS

Burk Technology awarded certificates to nine more broadcast engineers at its factory training sessions held June 21 and June 22.

Training covered the company's line of broadcast facility remote control systems, software and accessories. Highlights included tips and tricks and best practices for implementing Burk Technology hardware and software, including the ARC Plus, Arc and Flame Detector and Watchband Remote Receiver.

(L-R): Brian Edgerton, WHDH(TV), Boston; Louis Muise, Entercom, Boston; Jorge Luis Dieguez, RVR Electronics, Miami; Dave Goldstein, WBZ(AM), Boston; Louis Toepel, KOMO(TV), Seattle; and Frank Kelley, Salem Radio, Boston.



# Enjoy the Experience



**ACS 8.2 Plus** Audio Control Switcher



**WVRC-8** Web & Voice Remote Control System



**Pro-Mix 12**



**WVRC-4** Web & Voice Remote Control System

**SRC-16** Serial Remote Control

## ACS 8.2 Plus Audio Control Switcher

The ACS 8.2 Plus provides matrix audio switching of 8 stereo inputs to 2 stereo plus 2 mono outputs. Any input assigned to output one has fading capabilities. Matrix switching allows any/or all inputs to be assigned to any/or all outputs. The ACS 8.2 Plus may be controlled via front panel switches, contact closures, 5-volt TTL/CMOS logic and/or the multi-drop RS-232 serial port (control via USB or Ethernet with optional devices). Installation is simplified with plug-in euroblock screw terminals.

## WVRC-8 Web & Voice Remote Control System

The WVRC-8 provides a cost-effective, eight channel solution for web based and/or recordable voice response dial-up transmitter site control. Each analog, status, silence sensor, temperature sensor and power failure input can be configured to email up to four individual email addresses, allowing different input alarms to be routed to different email recipients.

## WVRC-4 Web & Voice Remote Control System

The WVRC-4 is a four-channel version of the WVRC-8 in a half-rack profile.

## SRC-16 Serial Remote Control

The Broadcast Tools® SRC-16 is a computer interface to the real world. Connection through an RS-232, RS-422 or RS-485 serial port with baud rates up to 38400, the SRC-16 can notify your PC software program that any of 16 optically isolated inputs has been opened or closed and allows your software to control sixteen SPDT, 1-amp relays. Two units can be operated in a standalone mode (master/slave mode) to form a "Relay extension cord," with sixteen channels of control in each direction.

## Pro-Mix 12

The ProMix 12 is a feature-packed broadcast audio mixing console that is ideal for broadcast and audio production facilities needing an affordable compact solution. The ProMix 12 comes in a small package, but is loaded with useful features including a mix-minus output, an announce booth output with full duplex talkback, a monoaural output, selectable metering, and remote starts on all line level stereo input channels. Whether you need a compact console for your on-air applications, or a mixer for post-production or fieldwork, the ProMix 12 is the right console at the right price. We're confident that the ProMix 12 will provide many years of trouble-free operation.



## ACT-2 Audio and/or Composite Transformer 2

The ACT-2 transforms balanced or unbalanced monaural, stereo or composite audio into two independent telemetry outputs, which may be displayed on Internet, dial-up or serial remote control systems. The user attaches either balanced or unbalanced audio to either of the high-Z balanced inputs or the BNC input. Consumer or professional levels may be used, which are converted to proportional zero to five-volt DC outputs. Left and right level controls along with audio activity LEDs are provided. The ACT-2 is powered by a surge protected internal power supply and may be rack mounted on the optional RA-1 mounting shelf.



USA Proud

**BROADCAST  
tools**

support@broadcasttools.com  
www.broadcasttools.com

**INNOVATIVE PROBLEM SOLVING TOOLS FOR BROADCAST**  
*These products can be seen at the Broadcasters General Store Booth # 304 at the Radio Show In Charlotte.*

## Promo Power



by Mark Lapidus

# Auctions for the Greater Good

*When You Help Clients Create Powerful Spots, They Will Be Successful, Happy — And on Your Station*

The quantity of items auctioned on a daily basis online is astounding, unprecedented.

Because of the general public's familiarity and participation with these online auctions, media outlets may now raise even larger sums of money for worthy non-profit causes.

That's the good news. The bad news is that few radio stations are participating in what could be a windfall in terms of helping the communities that we serve.

Auctions do take time, effort and a bit of money, but the payoff in terms of real dollars and in goodwill can be enormous. There are many ways to conduct successful auctions on-air, online or using a combination.

Let's explore how to exploit auctions for the greater good.

### Pick it

A large part of your success depends on the items you select to auction.

It's no secret that the more rare the item — or the more unique the experience — the greater the likelihood of raising significant dollars. In order to acquire these irreplaceable items, planning is key.

Unless you are wired to celebrities on a daily basis, it's going to take some time to gather enough autographed items for an auction. This process typically begins with purchasing or trading for matching paraphernalia to the celebrity whose autograph you're chasing.

**Few radio stations are participating in what could be a windfall in terms of helping the communities that we serve.**

If you're doing a sports auction and you want the quarterback of your local NFL team to sign an item, your best shot is a football or a helmet. If you're after a bunch of sports celebrities and you know they visit your station regularly for interviews, you'll need a closet full of easily accessed items for those impromptu moments.

Country stations with a lot of guests coming through should have a stockpile of guitars, hats and tambourines that could be signed.

One nice item that works in any music format is an item that is often called "words." You have the artist simply write the lyrics to a hit song a piece of paper and sign it. Take the paper, get the CD on which the song appeared and have them mounted together in a nice frame.

This may cost you \$150 for framing, but if it's a hot artist, the item could very well garner \$500 to \$1,000. If you can't float the bill for purchasing items and you can't cut a trade, discuss the financial obligation with the charity for which you're raising the money. After they witness the return on investment one time, they'll be hooked.

If you'd like to mix up the auction a bit, try adding experiences that can't be bought.

If you think creatively you'll be able to come up with a bunch of things that you may take for granted, but that would blow a listener's mind. If you know you've got a hot artist coming in for an interview, save five slots of two for "breakfast" and a meet and greet with the artist.



You've got a friend in eBay.

No artists? How about a guest slot on your morning show as the traffic reporter? Great seats and backstage visits at concerts and sporting events consistently raise big dough.

### Pitch it

Okay, so now that you've got a bunch of items to auction, what's the best medium?

Personally, I like online auctions that are promoted on-air because you can reach a much larger audience over time with very short messages. If you have no auction tool on your own Web site, don't sweat it; you can put up all the information and pictures on your site with links to what you've posted on eBay.

The advantage to utilizing eBay is that it's a brand that people trust and know how to use. There's also a chance you'll get bidders that aren't even in your broadcast area who just happen to really want the item being auctioned.

If I'm a Beyoncé fan and you're auctioning a signed lyric sheet, I won't care that you happen to be doing so from another city.

With eBay you may also select the number of days you want to hold the auction. When you do so, work backward, assuring that you have the auction ending in a drive time when the greatest possible audience is available.

When doing live promos throughout the auction, the jocks may also want to mention how much an item is actually going for at that moment.

When you opt to forego the Web component and solely do an on-air auction, it generally takes a lot of yak time and may be of little interest to a portion of the audience who can be turned off and tune out. However, if you're going that route, make sure you've got someone to answer your phone who knows how to jack up bidders while they're on the line. Two people work even better because they can shoot bids back and forth between callers, raising the price.

If possible, fulfillment should be handled by the non-profit for whom you've conducted the auction. It's much better that they collect the money directly (via credit card or check). Buyers are likely to be more forgiving with a non-profit than with a media outlet if an item doesn't turn out to be quite what they expected.

Plus, if a high bidder decides to renege on their bid, it's better that they deal with the non-profit directly — that way, the non-profit will at least have a chance to explain why they really need the donation.

Hey! I just located a singing fish signed by Brad Paisley in my shed! Any bidders?

Mark Lapidus is president of Lapidus Media. Reach him at [mlapidus@cox.net](mailto:mlapidus@cox.net).

## GrahamStudios

Broadcast Furniture...System Integration...Automation

- Twenty three years serving broadcasters worldwide.
- Studio layout, furniture design, installation, and turnkey systems.
- Modular design featuring metal posts & wood panels offer flexibility, quality and beauty. Panels can be interchanged, the system easily reconfigured, or expanded.

Service, Quality and Price make Graham Studios the number one broadcast studio furniture manufacturer in the world.



Toll Free (866) 481-6696

or (970) 225-1956

email: [rod@graham-studios.com](mailto:rod@graham-studios.com)

<http://www.graham-studios.com>

# Products & Services SHOWCASE

## Internet & Talking Remote Control



Introducing the First Totally New Talking Remote Control Design in Over a Decade!!

- Voice recordable technology
- Onboard Web Server
- 8 channels metering, status, & control
- Expandable up to 32 channels
- 2 heavy-duty SPDT relays per channel
- Self-calibrating, auto-ranging meters
- Up to 5 alarms per channel
- Cell-phone interface
- Audio pass-through
- Free GUI software to monitor your site & program the Sicon-8
- X-10 capability for additional control

Learn more & test-drive the Sicon-8 web server at [www.circuitwerkes.com](http://www.circuitwerkes.com)



CircuitWerkes, Inc. - 2805 NW 6th Street, Gainesville, Florida 32609, USA 352-335-6555

## OPTILATOR™

T1-OPELATOR NOW AVAILABLE!



### Fiber Optic Modem Protection

Lightning Protection that keeps on working!  
Fiber optic protection impervious to Lightning.  
It is now a recognized name brand in the RF Industry.  
For more technical information call toll free 888-471-1038,  
Ph: 727-823-6100, Fax: 727-823-6044. For pricing and sales call:  
Harris, Broadcast General Store, Broadcastworks Broadcast  
Richardson, RF Specialists, Crouse-Kimzey, EuroExchange  
Brokers Inc., S.C.M.S., or your local distributor.  
See our web page: [www.opticsshield.com](http://www.opticsshield.com) It is for real!  
**The Ultimate Lightning Protection!**

The Exstreamer 1000: Balanced inputs and outputs, eight contact closures, significantly better quality signal converter and a pro AES/EBU interface, all delivered by the Barix low cost, low power, PC-free philosophy.

## natural selection

For further information visit:  
[www.barix.com](http://www.barix.com)



**A**  
audessence

[www.audessence.com](http://www.audessence.com)

Solving Audio Level problems completely.....

**THE HUB**  
**RADIO SHOW**  
Broadcast Depot #527  
[www.broadcastdepot.com](http://www.broadcastdepot.com)  
Sept 26-28 2007 Charlotte, NC

**The Short/cut Replacement**

**NOW USE MULTIPLE CONTROL PANELS.**  
Two hosts record and edit on same screen using their own dedicated control panel.

Remove Talk-Over  
Auto Network  
MP3 - WAV - WMA  
AGC - Search By Title  
Advanced Effects and Fast!

Available at all  
broadcast distributors  
[audionlabs.com](http://audionlabs.com)  
206 842 5202 x203

**VoxPro<sup>PC</sup>**

## THE BEST RF EQUIPMENT GUARANTEED!

- ▶ FM-VHF-UHF-L Band
- ▶ RF Line Components
- ▶ Cables and Connectors
- ▶ Antenna Panels and Systems
- ▶ Loads
- ▶ Filters
- ▶ Combiners
- ▶ Patch Panels
- ▶ Splitters & Couplers
- ▶ Digital Power Meters

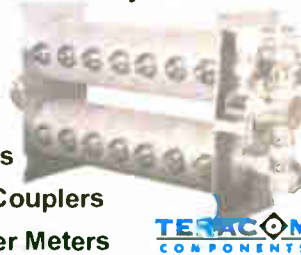

**TESACOM**  
COMPONENTS

Tel: +1 207 627 7474  
Fax: +1 207 627 7473  
[sales@acornrf.com](mailto:sales@acornrf.com)

**Acorn**

# The Rise and Fall of GreenStone Media

*'While We Created Great Programming, Tragically, We Did Not Have the Capital to Press On'*

by Ken R. Deutsch

It was only last winter that we reported on a start-up radio network, Seattle-based GreenStone Media ("GreenStone Keeps Women in Mind," December 6, 2006).

Run by women and devoted exclusively to the needs and interests of females, this network was backed by some powerful feminists including Gloria Steinem and Jane Fonda, as well as former FCC commissioner Susan Ness.

In August, citing a lack of capital and traction in the market, GreenStone ceased to exist in a flurry of headlines, and even a few recriminations.

"Former staffers ... are grumbling that its founders aren't living up to their feminist creds," the New York Post Page Six gossip column reported. "Women's libbers Gloria Steinem and Jane Fonda are 'putting their own reputations above their female employees' finances,' one source told Page Six. The recently shuttered (network) is 'refusing to pay severance, and the founders won't file for bankruptcy protection because it would publicly embarrass Jane and Gloria.'" Page Six also quoted a Fonda spokesperson denying those accusations.

## Counter-programming

Why did GreenStone fail?

Keating Willcox, owner of WNSH (AM), Beverly, Mass., was one of the handful of affiliates that picked up GreenStone's programming.

"I think it failed because it didn't have enough money, and it spent the money it

had too quickly," he said. "GreenStone had fancy offices and a fancy Web site. They were running shows out of New York and Los Angeles. Syndication

shouldn't be that expensive. I run our station with just one employee: me! I cut the lawn and just have a contract engineer. I also think GreenStone could have done more with marketing.

"But I enjoyed the format, because for AM it was great counter-programming. Here in the shadow of Boston we have a

just another talk format about politics. It was about shopping, kids and that kind of stuff. They never really got too political on the air and that's why we thought it might catch on.

"But they were strapped for cash, doing shows out of two different cities. I think it was a great concept but it should have been 24 hours of original material instead of just 12 hours a day with a repeat at night."

WEEV, part of the five-station Regent Communications cluster, will simulcast the ESPN programming heard on one of its FM stations until another on-air lineup can be put together.

GreenStone corporate officials did not return numerous calls or e-mails from Radio World.

## Five-year process

Industry experts still believe there is a market for such content.

Sean Ross is vice president of music and programming for Edison Media Research. "There is already successful female lifestyle talk programming," he said. "It's just not always within the framework of a dedicated 'female talk' station, and not all of it features female hosts."

Ross mentioned successful syndicated shows like The Link Radio Networks' "Bob & Sheri" and Premiere Radio Network's "Delilah" and "Wake Up with Whoopi." There are also local stations like KRSK(FM), Portland, Ore., and KSTP(FM) in Minneapolis that offer high-profile female personalities.

"New talk stations are hard to build, unless you're able to launch with instant franchises that were running on a competitor," said Ross. "It's usually a five-year process and a lot of owners don't have the patience. It's that much harder when you're launching an entire network with the meter running.

"It's been difficult for Air America, even with some decent success stories in local markets. GreenStone shouldn't be a referendum on the potential of female talk any more than Air America should be the only acid test of whether there is a market for progressive talk."

Daniel Anstandig is vice president/consultant for McVay Media; he also believes there is a market for programming aimed at women.

"I've seen several research studies and  
See GREENSTONE, page 72 ►



Maureen Langan wrote in her blog on the network's last day in August, "Yesterday, when we took your calls and e-mails ... I realized you got what were about — just giving you some information and some fun every morning. No agenda. No screaming. No forcing our points of view on you. Just our take on current events. And laughs. Lots of laughs."

## Ness: Final Words

GreenStone Media President/CEO Susan Ness wrote a goodbye on the network's Web site on Aug. 17. Excerpts:

GreenStone was formed two years ago to address the absence of female-friendly talk programming on commercial radio today. Examining the landscape, rarely did we find women who were hosts of their own shows, and hardly any of the program directors responsible for programming the 11,000 commercial radio stations operating in the U.S. today were women.

We saw that as an opportunity. Advertisers love reaching women — and what better than an audience that is hanging on every word? Women buy 83 percent of all products and services, make 53 percent of all investment decisions, and start over 70 percent of new businesses.

We also knew that women were leaving commercial radio at a faster clip than their male counterparts. Our research showed that most women — and many men too — did not like the hard political talk or sports talk or acid-male talk that is permeates radio today. You wanted to be informed on what was happening in the world, but you also wanted to relax and have a good laugh with friends. And you were weary of shouting matches that pass as discourse. ...

At our peak, GreenStone produced 63 hours per week of live, female-targeted talk programming to radio station affiliates. ... Right out of the box, "The Lisa Birnbach Show" won not one, but two GRACIE awards ... We developed fabulous shows, but we were not successful getting station carriage. Perhaps it was because we were ignorantly perceived as being too "feminist" or too "political." (It is odd that radio executives consider Rush Limbaugh entertainment and not political, but women — well, that's another story.) All they had to do was listen!

Or perhaps stations didn't want to invest the time and resources to enable a new talk format to succeed. It takes between 18 months and two years to build an audience — especially for a new type of talk. ...

The radio industry is also highly concentrated, and we could not get carriage on stations owned by most of the major radio groups. Our station affiliates were mostly in small markets, making it almost impossible to prove that the concept works.

While we created great programming, tragically, we did not have the capital to press on. It was a longer and more expensive process than a small, independent programming company could shoulder in today's turbulent marketplace. ...

We believed (and still believe) that women need a voice on commercial radio, and that radio needs women's voices.

lot of male-type political talk shows."

An employee for GreenStone affiliate WTWK(AM), Plattsburgh, N.Y., declined to comment on the station's reaction or plans.

A third affiliate, WEEV(AM), was known in Albany, N.Y., as "1300 Eve" during its short stint with GreenStone.

"I thought they had enough steam when they started out, but apparently it's the old 'running out of money' problem," said General Manager Bob Ausfeld.

"The concept was there and it wasn't

## It's a Dog's Life

More than 425 homeless animals found homes during WCSX(FM)'s Sixth Annual "Pet-A-Palooza" this summer.

The Greater Media station in Detroit organizes the event with a variety of family and pet-oriented activities. Attendees are encouraged to bring pets and to consider taking an animal home from Adoption Alley as well. Thirty-three humane organizations brought cats, dogs, rabbits and ferrets for possible adoption to qualified people. Dogs could also enter Milt Wilcox's Ultimate Air Dogs distance-jumping competition.

Proceeds were donated to Guardians for Animals, a local non-profit animal-rights organization.

A local dog expert answered canine questions and The Rock-N-Roll K-9s — 35 dogs demonstrating speed and agility skills set to music — performed.

A similar station event earlier this year found homes for another 170 or so animals.

Send photos of your remote or promotional event. E-mail radioworld@imaspub.com.



A contestant for Best Dressed Pet

# SHOwCASE

Products & Services

See us at  
**THE NAB  
RADIO SHOW**  
Booth 632

The **NEW**  
**MiniMAC Remote Control**



Smaller than the **MAC**,  
but just as **smart!**

SCMS  
davicom

1-800-418-4040 | 1-704-881-4545  
www.scmsinc.com

1-410-632-3389 | 1-410-632-8996  
www.davicom.com

USE THE COUPON BELOW AND  
**SAVE 10% ON YOUR NEXT ORDER!**

**Freeland Products, Inc.**  
Rebuilder of Quality Tubes Since 1940

www.freelandproducts.com  
75412 Highway 29, Covington, LA 70435  
800-624-7626 905-898-1248 Fax 905-852-7328

E-mail [freeland-inc.com@freeland-inc.com](mailto:freeland-inc.com@freeland-inc.com)

Are you looking for ways to cut your engineering budget, while maintaining the highest quality for your station?

We offer a great warranty, quick service and technical support for our customers 24/7. We can bank your rebuilt tube too, until you need it, just ask.

We have a **LARGE** stock of commonly used tubes ready to ship. If you're in a hurry we can ship from stock.

Call 800-624-7626 for more information!

**Take 10% off the cost of your next Rebuilt Transmitter Tube.**

-coupon copies are not VALID-  
This original coupon **MUST** accompany the used tube when sending for rebuild.

Radio World

See us at  
**NAB Radio Show**  
Booth #637



**LCD  
DISPLAY  
WATTMETER**

Model 81030

[www.coaxial.com](http://www.coaxial.com)

**Coaxial  
Dynamics**

800-262-9425

Buy simplicity,  
reliability and service

**EAS**  
Price \$1750.00

Equipment is in stock for  
immediate delivery!

**GORMAN-REDLICH MFG. CO.**  
257 W. Union St. Athens, Ohio 45701

Phone 740-593-3150  
FAX 740-593-3698

New available  
with optional DMP  
control via a phone line



- 5 two-way RS-232 inputs/outputs for computer, remote signboard & character generator
- 6 audio inputs on standard models. All audio inputs & outputs are transformer isolated from encoder/decoder board
- Automatic interruption of program audio for unattended operation
- 4 line 40 character LCD display with LED backlighting
- 30 key keypad to program unit, set modulation level, set input levels
- Will handshake with automation equipment
- 2 year warranty
- 2 minutes of digital audio storage
- 25 pin parallel printer port for external printer
- 52 terminals on the rear to interface with other equipment by removable plugs
- BNC fitting with 600ohm balanced audio out for second transmitter

Jim@[gorman-redlich.com](mailto:gorman-redlich.com) Web Site: [www.gorman-redlich.com](http://www.gorman-redlich.com)

Also available: weather radios, antennas for weather radios, crystal controlled synthesized FM digitally tuned radios, remote signboards, cables for interconnection, character generators

**SONIFEX**  
Manufacturers of Audio Broadcast Equipment

**SONIFEX  
Redbox**

**SUPERIOR SAMPLE RATE CONVERSION**

**Redbox RB-SC2  
Dual Sample Rate Converter**

Produces AES/EBU, S/PDIF and Toslink optical level digital audio outputs from balanced AES/EBU, S/PDIF & Toslink optical level digital audio inputs.

- Supports sample frequencies up to 176.4kHz & 192kHz
- Output sample rate set by internal switch or external remote
- Has 2 independent sample rate converters & can function as a full bidirectional sample rate converter
- Has 2 optional 192kHz/24bit floating point converters to allow an analog/digital or digital/digital path
- Remote control via RS-232 with free control software

Visit our website for details:  
[www.sonifex.co.uk](http://www.sonifex.co.uk)

CALL FOR  
NEW  
CATALOGUE

**INDEPENDENT AUDIO**

T: 207 773 2424  
E: [info@independentaudio.com](mailto:info@independentaudio.com)  
[www.independentaudio.com](http://www.independentaudio.com)

**RECEIVERS**

**OUTSTANDING** specifications and pricing on professional quality receivers for **EAS**, monitoring and translators.

The **AFC3** is a three receiver rack mount that is configured to your **EAS** or monitoring specific application. Each receiver has internal frequency selection (PLL) switches, front panel controls and indicators, and rear panel connections.



Price: **Approximately \$1300** (depending on receiver choice)

Select three receivers from our FM or FM/SCA, NOAA Weather, Public Service and/or AM Monitor/Receivers. All receivers are PLL (synthesized) designs using the latest state of the art components and are available as stand alone receivers as well as in AFC3 combinations.

**DAYTON INDUSTRIAL CORPORATION**

2237 Industrial Blvd., Sarasota, FL 34234 Tel. (941) 351-4454  
Email: [SCARadio@aol.com](mailto:SCARadio@aol.com) WebSite: [www.DaytonIndustrial.com](http://www.DaytonIndustrial.com)  
Quality Receivers Designed and Manufactured in the USA since 1980

# Remotes That Are All About the Sponsor

Radio Sales Experts Experiment in Ways To Put an End to Boring, Ineffective Remotes

by James Careless

Somewhere on this planet right now, a bored DJ is sitting inside a car dealership or retail store, doing a radio remote.

He doesn't know much about the products he's hawking, or maybe even care. He's being paid to do this remote, promoting his station's call sign and offering free coffee mugs/T-shirts/whatever in the process.

So he's doing it.

"The problem is that radio remotes have always been viewed as the 'icing on the cake,' to push advertisers over the top when it comes to buying airtime," says M. Bruce Abbott.

He is creative director/partner at Radio Lounge, a Houston advertising consultancy that has as its motto "saving radio advertising from itself."

"Unfortunately, radio remotes tend to be done half-heartedly by the promotions department," Abbott tells RW.

It is for this reason that Radio Lounge, Emmis Communications' four Indianapolis stations and Fouts & Son Advertising are advocating innovative alternatives to traditional radio remotes.

Although their strategies vary, these separate organizations happen to be working toward the same goal: to make radio remotes actually work for the people paying for them.

## NoMoreRemotes.com

When it comes to radio remotes, the site *NoMoreRemotes.com* doesn't pull punches.

"Long ago in 1957, Americans enjoyed root beer floats, drive-ins, vinyl records, smoking on airplanes, and they definitely enjoyed their radio station remotes," intones an announcer as his printed words float back into a star-studded galactic background a la "Star Wars," with the familiar theme playing underneath.

"But sadly, 1957 is long since past. Root beer floats, though tasty, are not on the diet plan, drive-ins have been replaced by home theater systems, vinyl has been replaced by MP3s, smoking on airplanes is just plain stupid, and radio



Mike Cortese

station remotes just don't work."

Emmis sales execs, the site promises, "can take you from uncool to custom."

"Radio remotes don't work because they have use the same pull-the-kit-off-the-shelf, cookie-cutter approach to onsite promotion," says Emmis Indianapolis sales exec Mike Cortese in explaining why his cluster established the Web site with the unusual name.

"What does work, however, are events that are tailored specifically to the client's product and image, and that give listeners a valid reason to stop by."

A case in point: Rather than do a standard radio remote at Myer's, which Cortese describes as a "big Wal-Mart style store in Indianapolis," Emmis came up with a promotion that tied into Myer's sponsorship of the Indianapolis Colts football team.

"What we did was bring in a Colts player to sign autographs at the store for two hours on a Saturday," Cortese tells RW. "This gave listeners a reason to come in while working with the store's existing advertising. Most importantly, it was a custom solution that was tailor-made for this client."

Despite its name, *NoMoreRemotes.com* doesn't forbid the use of radio remote entirely. However, any remotes that are

scheduled must make sense from an advertising perspective in terms of the client and not the radio station.

"Our goal is to bring more traffic to our client," says Cortese. "Cookie-cutter radio remotes just don't do this anymore."

## Driving traffic

Radio Lounge's Abbott still sees a place for radio remotes, specifically in selling value at the broadcast location.

"Let's say you are broadcasting from a car dealership," he said. "To motivate interested buyers to drop by, you need to talk about value-added deals exclusively related to this event. For instance, 'If you come in during this remote, we will knock \$1,000 off the price of a new car, or throw in a free maintenance package, but only if you come here now.' That's the kind of sponsor-related message that has sufficient value to attract qualified traffic."

**The problem is that radio remotes have always been viewed as the 'icing on the cake,' to push advertisers over the top when it comes to buying airtime.**

— M. Bruce Abbott

"Qualified traffic" is also a mantra for John Fouts, owner of Fouts & Son Advertising in Mechanicsville, Va.

"It is useless to bring in 100 people as traffic, if the only reason they are coming in is to see Charlie the DJ," Fouts said. "It makes far more sense to attract qualified traffic of 25 people, 'qualified' meaning that they are coming in to buy the products being sold at the store; not to gawk at the DJ or get free T-shirts."

To make this happen while reducing costs for his advertisers, Fouts doesn't buy regular radio remotes, "which can cost \$4,000 to \$8,000 per station," he said. "Instead, what I do is buy 60-second spots at four or more stations during 3-6 p.m. on a Friday. At \$100 a live spot, you can get 30 spots for \$3,000, less than you'd pay for one remote."

"Next, I give each of the stations a dedicated phone number to call me at, because I'm the one who does the remote," Fouts said. "When I come on, I don't identify myself or the station; all I do is talk about the advertiser. If I'm at a car dealership, for instance, I'll talk to customers who just got a deal on a car, or a salesman who can say what's hot right then and there. In this way, I focus solely on the sponsor, and on attracting the kind of qualified traffic that wants to buy his products."

"Regular radio remotes chew up a lot of time, with stations promoting themselves on the sponsor's dime," he concludes. "I don't do that. My remotes are all about the sponsor."

It's not the radio remote, but the one-size-fits-all approach to radio advertising that is dead, says Jeff Haley, president and CEO of the Radio Advertising Bureau.

"Advertisers will not buy cookie-cutter programs. Smart radio stations will propose a remote if it makes sense for the client, the brand, the station and, most important, the listeners." ●

## GreenStone

► Continued from page 70

sat in on audience focus groups where female radio listeners complain about the aggressive and testosterone-pumped nature of their local talk radio station," he said.

"It seems intuitive that female audiences would have an appetite for talk radio that speaks to them in a friendly, thought-provoking way. Theoretical research is one thing, but when you consider the success of female-targeted personalities such as Oprah Winfrey, Ellen DeGeneres and the women of 'The View,' the concept seems even more natural."

But according to Anstandig, GreenStone may have faced an image problem.

"Unfortunately their potential became limited by the labels that were placed on the network," he said. "Names like Gloria Steinem and Jane Fonda on the marquee may have unfairly branded the network as one with a political agenda, which couldn't be further from the truth of what was on the air."

In her goodbye blog entry, President/CEO Susan Ness made reference to that argument.

"We developed fabulous shows, but we were not successful getting station carriage. Perhaps it was because we were ignorantly perceived as being too 'feminist' or too 'political.' (It is odd that radio executives consider Rush Limbaugh entertainment and not political, but women — well, that's another story.) All they had to do was listen!"

It takes a lot of effort and a lot of luck to launch any radio network and reach viability, but time and the fates conspired against GreenStone Media, which ceased operation Aug. 17.

Ken R. Deutsch is a former broadcaster and recording studio owner. He can be reached at ken@kenddeutsch.com. ●

## Faces of Radio News

Like the classic masks of theater comedy and drama, radio news work can vary from the light-hearted to the devastating.

ABC Radio contributors are shown on two recent assignments: ABC Entertainment Correspondent David Blaustein interviews Homer at the premiere of "The Simpsons" movie in Springfield, Vt., and ABC News Radio Correspondent Aaron Katersky flew to the tragic Minneapolis bridge collapse in time to report from location for morning drive.





# BROADCAST

## Equipment Exchange

"Broadcast Equipment Exchange" accepts no responsibility for the condition of the equipment listed or for the specifics of transactions made between buyers and sellers.

**ACOUSTICS**  
**WANT TO SELL**

**AcousticsFirst™**  
Toll-Free 888-765-2900  
Member: 888-765-2900

Full product line for sound control & noise elimination.  
[www.acousticsfirst.com](http://www.acousticsfirst.com)

**AMPLIFIERS**

AudioClassics.com Buy - Sells - Trades - Repairs New, Used & Vintage - McIntosh, Marantz, Klipsch, Tannoy, JBL and other US made audio equipment. 800-321-2834

**ANTENNAS/TOWERS /CABLES**

**WANT TO SELL**

**AM Ground Systems**  
Reliable, On-time Installation  
Quality Workmanship  
Ground System Evaluation  
and Repair  
[www.amgroundsystems.com](http://www.amgroundsystems.com)  
1-877-766-2999

**ERI 30 KW RATED SINGLE BAY.**  
New! Never removed from shipping box. 3 hanging brackets-tuned to 94.3 FM - \$5000 - call GC KINCER - KY - 606-832-2271 OR [gkincerc@gmail.com](mailto:gkincerc@gmail.com)

**AUDIO PROCESSING (INCLUDES ON-AIR)**

**WANT TO SELL**  
Orban Digital Optimod 8200 With Digital Audio Card - Excellent condition. Priced \$4700.00 Contact Gene Huff - 606-877-1326 or [wyrgeradio@yahoo.com](mailto:wyrgeradio@yahoo.com)

**WANT TO BUY**  
ORBAN Optimod 8100/FM or 8200 in perfect condition. Will pay for shipping to Miami, FL. Contact Daniel Bitencourt, [judam@bol.com.br](mailto:judam@bol.com.br)

**AUTOMATION EQUIPMENT**

**WANT TO SELL**  
Now available, radio automation for the Linux operating system. Schedule music, voice track, create shells, auto or announcer assist mode, set intro and ending cues, hit the vocal every time with your voice tracks, execute exact time events, join networks, and more. The software is free, there is a small duplication fee. For more info call 406.665.1832.

[www.radioworld.com](http://www.radioworld.com)

**WANT TO BUY**  
Vintage BE Audio Vault 100 digital record/play computer (1993 version). [kentverbeck@yahoo.com](mailto:kentverbeck@yahoo.com)

**CHAPTERS**

Who you know can make all the difference

**SBE**  
Get connected to an SBE Chapter  
[www.sbc.org](http://www.sbc.org)  
(317) 846-9000

**COMPLETE FACILITIES**

**WANT TO SELL**

NEW OR USED COMPLETE PACKAGES

STUDIO/STL/TRANSMITTER /ANTENNA OR ANY COMBINATION OF ABOVE.  
-LEASE OPTIONS-  
-EMERGENCY RENTALS-  
-REMOTE BROADCAST RENTALS-

SCMS, Inc. (800) 438-6040  
"You Know We Know Radio"

**CONSOLES/MIXERS**

**WANT TO SELL**  
Autogram, Model IC-10, stereo, 10 channel broadcast console, in very clean, good operating condition with service/operating manual. Asking Price: \$1,500.00 or best offer. Shipping not included. Call: 1-423-543-5849. E-Mail: [billment@usit.net](mailto:billment@usit.net).

Gatesway 80, mono, 8 channel broadcast console with power supply manual. Excellent, clean condition with manual, Asking Price: \$300. Shipping not included. Gatesway, Stereo 80, 8 channel broadcast console. Excellent, clean condition with power supply and manual. Asking Price: \$500.00 Shipping not included. Call: 1-423-543-5849. E-Mail: [billment@usit.net](mailto:billment@usit.net).

[www.radioworld.com](http://www.radioworld.com)  
Call Claudia Van Veen for all the details at  
**703-998-7600 ext. 154**

Harris "Procast" stereo, 12 channel, full-featured broadcast console, factory new in the unopened box, manufactured by Henry Engineering (Henry Matchbox) for Harris Corporation. This is the same console as the Broadcast Tools "ProMix 12", 12 channel stereo console that is currently listed in the BSW catalog for \$1,299.00. The only difference is the cabinet is painted "white" with the Harris "Procast" logo. Asking Price: \$995.00 with shipping included. Call 1-423-543-5849. E-mail: [billment@usit.net](mailto:billment@usit.net).

Schafer, Model 2007, stereo, 8 channel rotary pot broadcast console with Shalco "Davenport" stereo step attenuators. Exceptionally clean and in good working condition with manual. Asking Price: \$695.00. Shipping Included. Call: 1-423-543-5849. E-Mail: [billment@usit.net](mailto:billment@usit.net).

**LIMITERS/AUDIO PROCESSING**

**WANT TO BUY**  
Teletronix LA-2A's, UREI LA-3A's & LA-4's, Fairchild 660's & 670's, any Pultec EQ's & any other old tube compressor/limiters, call after 3PM CST - 214 738-7873 or [sixtiesradio@yahoo.com](mailto:sixtiesradio@yahoo.com)

**MICROPHONES**

**WANT TO SELL**  
RCA 44 BX The famous big square favorite of the networks in the 40s. \$3000 or Best offer. [heritageradio@msn.com](mailto:heritageradio@msn.com)

RCA 77 DX - Just like Larry Kings'! \$2000 or Best offer. [heritageradio@msn.com](mailto:heritageradio@msn.com)

**WANT TO BUY**  
RCA 77-DX's & 44-BX's, any other RCA ribbon mics, on-air lights, call after 3PM CST, 214 738-7873 or [sixtiesradio@yahoo.com](mailto:sixtiesradio@yahoo.com)

**MISCELLANEOUS**

**WANT TO SELL**  
BLOWN BLOWERS AND FLARE BLOWERS, new & rebuilt for Elcom, Harris, CCA, CSI, McMartin, Goodrich, Ent. 11435 Manderson St. Omaha, NE 68164 402 493 1886 FAX 402 493 6821

Transmitter Bandpass filter - Power Rating at 5 KW or more - Freq 101.9 FM - Call John at 928-425-7180 or email [bill@gila1019.com](mailto:bill@gila1019.com) but must place "for John" in the subj line.

**ADVERTISE!**  
For more information, call Claudia Van Veen at 703.998.7600, ext. 154.

**WANT TO BUY**  
Collector want to buy: old vintage pro gears, compressor/limiter, microphone, mixing consoles, amplifiers, mic preamps, speakers, turntables, EQ working or not, working transformers (UTC Western Electric), Fairchild, Western Electric, Langevin, RCA, Gates, Urei, Altec, Pultec, Collins. Cash - pick up 773-339-9035

Equipment Wanted: old, obsolete, or unused signal processing, recording, and playback equipment. Limiters, preamps, EQ, mixing desks, microphones, tape machines (cassette and reel), etc. Donations gladly accepted; asking prices considered. 443-854-0725 or [ajkivi@gmail.com](mailto:ajkivi@gmail.com).

I'm looking for San Francisco radio recordings from the 1920's through the 1980's. For example newscast, talk shows, music shows, live band remotes, etc. Stations like KGO, KFRC, KSFO, KTAB, KDIA, KWBR, KSFX, KOBY, KCBS, KQW, KRE, KTIM, KYA, etc... Feel free to call me at 415-383-6216 or you can email me at [ronwtamm@yahoo.com](mailto:ronwtamm@yahoo.com).

**DONATIONS NEEDED**  
All Volunteer, Non-profit Low Power community radios stations need Equipment. Will offer tax deduction letter, You determine donation value, We will pay shipping. Equipment shared between three Wisconsin stations. Looking for Mics, Mixers, field equipment, etc. You name it. Email: [Dan@WIECradio.org](mailto:Dan@WIECradio.org)

**PROGRAMMING**

**BARTER**  
Country Oldies Show, Steve Warren hosts classic country hits from 1960's to 1980's. Two hours every week, mp3 download, 100% barter. Info/demo 800-827-1722 [www.countryoldies.com](http://www.countryoldies.com).

**WANT TO SELL**

**Audio Journeys**  
"Explorations into Destinations around the World"  
Available in 30 or 5 minute segments  
[www.travelradio.com](http://www.travelradio.com)  
1 877-662-8747  
[AudioJourneys@TravelRadio.com](mailto:AudioJourneys@TravelRadio.com)  
Travel Radio International™

1600+ sixteen-inch Radio Transcriptions: 190 Sesac, 80 Capitol, 460 World, 880 Standard. \$1.50 each + shipping. Don Kennedy 800-377-0022 [bigbandjump@mindspring.com](mailto:bigbandjump@mindspring.com)

**REMOTE & MICROWAVE**

**WANT TO SELL**

**WE RENT FOR LESS**

Blueboxes FM Exciters  
Zephyrs FM Power Amps  
POTS Codecs STL's  
RF/Audio Gear Test Equipment

If we don't have it, we will get it!  
SCMS, INC. (800) 438-6040  
"You Know We Know Radio"

**WANT TO BUY**  
College radio Station looking for older tube-type Marti RPU equipment. 26MHz gen preferred but high band VHF okay. Contact Scott at 757-229-1547

**PROMOTE YOUR BUSINESS!**

**ADVERTISE!**  
For more information, call Claudia Van Veen at 703.998.7600, ext. 154. or [cvanveen@imaspub.com](mailto:cvanveen@imaspub.com)

**SPEAKERS**

**WANT TO BUY**  
Collector wants to buy old vintage speaker & amplifier, McIntosh, Marantz, Electro Voice, Jensen, Altec, Tannoy, Fisher, Dynaco, Cash- pick up 773-339-9035

**BAY COUNTRY BROADCAST EQUIPMENT**

**BUY - SELL - TRADE**  
Your #1 Source  
For Quality Used Radio Broadcast Equipment

View The Latest List Online at: <http://www.baycountry.com>  
Or call and we will fax it to you.

7117 Olivia Rd., Baltimore MD 21220  
Toll Free: 877-722-1031 • FAX 443-596-0212 • E-mail: [sales@baycountry.com](mailto:sales@baycountry.com)

**STATIONS**

**WANT TO SELL**  
[www.radiostationsforsale.net](http://www.radiostationsforsale.net)  
FM Translator in ME ... @ 35K  
FM Class A CP in PA @ 250K  
AMwFM Translator NH @ 500K  
FM Class C-3 in ME... @ 595K  
AM CP in Providence RI @ 1M  
AM-FM-Weekly PA @ 1.75M  
Inquiries 781-848-4201 anytime or e-mail [salesgroup@beld.net](mailto:salesgroup@beld.net)

NEW FM CP's for Western college towns. Class C1 KRKV covers Lamar to La Junta, Colorado. Class C3 KVAR reaches from Chadron to Gordon, Nebraska, includes tower site. Asking \$250K each or \$450K for both. Contact Richard at 256-497-4502 or [rdwabney@yahoo.com](mailto:rdwabney@yahoo.com).

**ADVERTISE YOUR EMPLOYMENT AD ON OUR WEB SITE FOR ONLY \$2 PER WORD!**

ADS GET POSTED THE NEXT BUSINESS DAY AND WILL RUN FOR A FULL TWO WEEKS!

COMBINE THIS WITH AN AD IN OUR RADIO WORLD NEWSPAPER EMPLOYMENT SECTION AND REALLY COVER THE BROADCAST INDUSTRY AND THEN SOME!

[www.radioworld.com](http://www.radioworld.com)  
Call Claudia Van Veen for all the details at  
**703-998-7600 ext. 154**  
between 9-5 EST

**STEREO GENERATORS**

**WANT TO SELL**  
Digital STL Xmtr CD Link, Digital STL Receiver 950T - Excellent condition Priced \$5500.00 - Contact Gene Huff - 606-877-1326 or [wyrgeradio@yahoo.com](mailto:wyrgeradio@yahoo.com)

**STUDIO-TRANSMITTER LINKS (STL) AND RPU**

**WANT TO SELL**  
Moseley Starlink T1 STL system for sale. (Barely) used 10 months. Save \$1500 over new. Call Jerry at 775.884.8000 or [jerry@991fntalk.com](mailto:jerry@991fntalk.com)

**TAPES/CARTS/ REELS/CDs**

**WANT TO SELL**  
Syndicated/Network - various - 16 inch, original radio transcriptions \$10 each. List available [heritageradio@msn.com](mailto:heritageradio@msn.com)

**WANT TO BUY**  
Large or small collections of 16" transcriptions or 12" transcriptions, not commercial LPs. Bill Cook, 719-687-6357.

V-DISCs - 12 in. 78 RPM discs. Bill Cook, 719-687-6357

**TEST-METERING-MONITORING**

**WANT TO SELL**  
Test Equipment: 1. Spectrum analyzer 2. FM Field Strength Meter 3. Analog Bird Thru-line wattmeter w/ slugs - Call John at 928-425-7180 or email [bill@gila1019.com](mailto:bill@gila1019.com) but must place "for John" in the subj line.

**TRANSMITTERS/ EXCITERS/ TRANSLATORS**

**WANT TO SELL**

**OFF THE AIR?**  
Emergency Back-up Rentals

FM Exciters - STL's - FM Pwr Amps - Antennas - Studio & Test Equipment

SCMS Inc (800) 438-6040  
"You Know We Know Radio"

Collins 830D-1 1.5 kilowatt FM transmitter. Late 1960's vintage. With exciter. Price \$1,000. Contact Mike by email at [peacock@wrfem.com](mailto:peacock@wrfem.com)

FREE to a good or bad home Gates BC-1J 1000 Watt AM transmitter tuned to 1270. Located in Winnfield, LA - in working order with Manuals-must be picked up. Call Tedd Dumas 313-256-5924 or email [twdumas@bellsouth.net](mailto:twdumas@bellsouth.net)

**SPACE IS AVAILABLE!**

## Consultants

**Consulting Communications Engineers  
EMC Test Lab**

- FCC Applications and Field Engineering
- Frequency Searches and Coordination
- AM-FM-CATV-ITFS-LPTV
- EMC Test Lab-FCC and European (IEC)

**OWL ENGINEERING, INC.**  
651-784-7445 Fax (651) 784-7541

E-mail: info@owleng.com  
5844 Hamline Ave. N., Shoreview, MN 55126 \*Member AFCEE\*

**R. MORGAN BURROW, P.E. & ASSOCIATES, P.C.**

**ALLOCATION STUDIES**  
(AM, FM, TV, LPTV) New facilities, site relocation, FM upgrade, duplex

**FIELD WORK A SPECIALTY**

- AM Directional antenna adjustment, measurement & proof
- RADHAZ measurements - RADation HAZard evaluation
- FM & TV field intensity & other measurements
- Facility inspections for purchase/insurance purposes
- CATV Leakage Testing

**ELECTROACOUSTICS**  
OSHA measurements

rburrows@comcast.net  
304-258-7921 • Cell 301-938-0985

**PROMOTE  
YOUR  
BUSINESS!  
ADVERTISE!  
ADVERTISE!  
ADVERTISE!**

For more information, call  
**Claudia Van Veen**  
at 703.998.7600,  
ext. 154.  
cvanveen@  
imaspub.com

### DISTRIBUTOR DIRECTORY

The following distributors serving the broadcast industry would be glad to help you with any of your requirements.

**CORNELL-DUBILIER  
MICA CAPACITORS**

FROM STOCK

**JENNINGS VACUUM  
CAPACITORS**

FROM STOCK

**JENNINGS VACUUM  
RELAYS**

**SURCOM ASSOCIATES**  
2215 Faraday Ave., Suite A  
Carlsbad, California 92008  
(760) 438-4420 Fax: (760) 438-4759  
e-mail: link@surcom.com web: www.surcom.com

**SCMS INC.**  
YOU KNOW WE KNOW RADIO!

John Lackness  
Sales

210-775-2725  
P.O. Box 932 • Cibola, TX 78108

johnl@scmsinc.com  
BROADCAST EQUIPMENT SALES AND RENTALS



"Call me for your next transmitter or antenna"

**EVANS ASSOCIATES** Consulting Communications Engineers

**FOR YOUR ENGINEERING NEEDS FOR THE NCE-FM  
FALL 2007 FILING WINDOW, CALL US!**

- Field Services & Construction
- FCC Licensing & CP Applications
- Upgrade Studies & Technical Negotiations

210 S. Main St., Thiensville, WI 53092 (262) 242-6000  
ben@evansassoc.com Member AFCEE

**COMMUNICATIONS TECHNOLOGIES, INC.**  
RADIO FREQUENCY/BROADCAST ENGINEERING CONSULTANTS

- AM, FM, TV coverage & Upgrades
- Broadcast transmission facility design
- FCC applications preparation - construction permit and license engineering

Clarence M. Beverage • Laura M. Mizrahi  
P.O. Box 1130 Tel: (856)985-0077  
Marlton, NJ 08053 Fax: (856)985-8124  
www.commtchr.com

**Doug Vernier**  
Telecommunication Consultants

Broadcast Engineering Consulting  
AM/FM/TV/LPTV/DTV  
Custom mapping service  
Frequency searches  
Propagation prediction  
FCC application preparation

**V-Soft**  
Software for your PC

(800) 743-3684  
www.v-soft.com

**Mullany Engineering, Inc.**  
Member AFCEE

Serving Broadcasters Since 1948

9049 Shady Grove Court  
Gaithersburg, MD 20877  
(301) 921-0115  
Fax (301) 590-9757  
mullaney@mullengr.com

**FASTER...  
MORE ACCURATE RADIO COVERAGE**

- Real Time 3-D Displays
- Interference calculations
- Cost effective mapping
- Fully integrated databases
- Used by the FCC
- Latest standards built-in

**RADIO SOFT**

Visit us on the web at www.radiosoft.com  
101 Demorest Sq., #E, Demorest GA 30535-2725

**MEDIA TECH INC.** 704-799-2245  
jpierce@mediatechusa.com

High-quality Internet Streaming  
For Broadcasters!  
Give us a call to "hear" the difference!  
Streaming Equipment available

**GRAHAM BROCK, INC.**  
BROADCAST TECHNICAL CONSULTANTS

Full Service From Allocation to Operation AM/FM/TV/AUX Services; Field Work; Antenna and Facilities Design

Over 45 years engineering and consulting experience

912-638-8028  
202-393-5133  
www.grahambrock.com

**BESCO** World Leader in AM - FM Transmitters

"Now in our 34th year"

**AM & FM Pre-Owned Units In Stock**

All Powers • Manufactures • Instruction Books • Spares & All Complete

Visit our Website:  
www.besco-int.com

Or Call Rob Malany, National/Int'l Sales at 321-960-4001

**BEXT**  
FROM THE TALL TO THE SMALL

www.bext.com  
619-239-8462

Transmitters and Antennas



Rest Assured! **FCC Certified**  
FM Stereo Transmitter

- 50W RF output, continuous duty!
- Auto protect with auto soft fail & auto restore!
- Automatic battery backup!
- Digital display of all parameters
- Perfect for LPFM, Translators, as well as stand-alone exciters

www.ramseyelectronics.com  
800-446-2295  
In Our 33rd Year!

### TRANSMITTERS/EXCITERS/TRANSLATORS (cont.)

**TRANSKOM CORPORATION**  
Serving the Broadcast Industry Since 1978  
Transmitters and Broadcast Equipment for Radio & Television

Used FM Transmitters		Exciters	
1 KW	2007	Crown FM1000A(new)	Used 2004 Harris DIGIT 2nd Generation
1 KW	2007	Crown FM1000E(new)	"New" 20w & 30W Synthesized exciters
1 KW	1999	Crown Fm2000A	
7+ KW Digital	2005	Harris Z16 HDS IBOC	New TV Transmitters- Analog and Digital
7+ KW Digital	2002	Harris Z16 IBOC	OMB & Technalogix
10 KW	2001	Henry 10,000D-95	VHF and UHF TV Antennas
20 KW	1985	Harris FM20K	(10 W to 10 KW) TV STL
20 KW	1989	QEI FMQ 20,000B	
25 KW	1980	Harris FM25K	
25 KW	1989	Continental 816R-3B	
25 KW	1990	Continental 816R-3B	
35 KW	1987	Harris FM35K	
50 KW	1982	Harris Combiner w/auto exciter transmitter switcher	
Used AM Transmitters		Used TV Transmitters	
2.5 KW	1986	Harris SX2.5A-single phase	1 KW UHF Axcerra 832A, CH 28
5 KW	1982	Harris MW5A	
5 KW	1987	Harris MW5B	
5 KW	1988	Harris SX5A-single phase	
10 KW	1985	Continental 316F	
50 KW	1985	Continental 317C2	
Used Misc. Equipment			
20 KW		Altronics 20KW Air Cooled Load	
		Denon 720R cassette NEW	
		Sola Voltage Reg. 60hz 1 KVA s-phase	

Please visit our website, [fmamtv.com](http://fmamtv.com), for the most current listings.

Harris HT 20CD 20 Kilowatt FM transmitter. New in March 2000. Excellent Condition. Price \$25,000. Contact Mike by email at [peacock@wifem.com](mailto:peacock@wifem.com)

CSI T-5-A 5kw transmitter currently in service as backup. Tuned to 1060. Includes manual, schematics and spares. \$5000.00 or best offer. Call Steve @ 770-328-6182 or Bill @ 770-328-6388.

Elcom-Bauer 602 FM 2.5kw Transmitter for sale with new, BEXT frequency agile exciter. \$3500. Call Jerry at 775.884.8000 or [jerry@991fntalk.com](mailto:jerry@991fntalk.com)

Nautel FM-5 - Less than three years in service (solid state) - used as a booster for KSIR FM (like new) - \$15000 or will trade for 5kw AM (solid state) call GC KINCER 606-832-2271 or E-MAIL [gckincer@gmail.com](mailto:gckincer@gmail.com)

Kinfronic Laboratories Power cutback unit with controller. \$1000. [rswaffer@nctc.com](mailto:rswaffer@nctc.com)

FM Translator at 104.5 - Manchester, KY Call Joey Kesler 606-843-9999

Buying used equipment?  
Selling used equipment?  
**YOU'RE IN THE RIGHT PLACE!**

For more information, call  
Claudia Van Veen  
at 703.998.7600, ext. 154,  
or [cvanveen@imaspub.com](mailto:cvanveen@imaspub.com)

**WANT TO BUY**  
67 kHz (SCA Channel 1) Used or repairable (with manuals if available) - call John 517-316-5307

AM Phasors, Phasor Parts, Phase Monitors, Rf Switches, AM Transmitters. Continental Communications 314-664-4497, [Contcomm@Sbcglobal.net](mailto:Contcomm@Sbcglobal.net)

Elcom-Bauer 602 FM 2.5kw Transmitter for sale with new, BEXT frequency agile exciter. \$3500. Call Jerry at 775.884.8000 or [jerry@991fntalk.com](mailto:jerry@991fntalk.com)

**DBS**  
Diversified Broadcast Systems

AM Transmitters  
500 to 50,000 watts

FM Transmitters  
20 to 30,000 watts

STL Transmitters/Receivers

Television VHF UHF  
Analog and Digital

FM and Television Antennas

Transmission  
Line and Connectors

**Benny Springer**  
1-800-210-1737  
[BennySB@aol.com](mailto:BennySB@aol.com)

Two AM MW-10 Transmitters

- One On 1030, In WV
- One On 1040, In NC Assemble From One Keep Remainder For Spare Parts. Make Offer.

Continental 10 KW

3-phase transmitter-FM 90.5 type 816R-1A  
Taken out of service Feb 1, 2007. Extra tubes and some spare parts. Exciter not included. Call for price.

Contact Vernon H. Baker  
WPAR FM 540-961-2377 or [vbaker@vtacs.com](mailto:vbaker@vtacs.com)

800-441-8454 • 215-938-7304 • FAX: +1-215-938-7361  
www.fmamtv.com • E-mail: [transcom@fmamtv.com](mailto:transcom@fmamtv.com)  
RETUNING & TESTING AVAILABLE • CALL US FOR A QUOTE!



**POWER TUBES  
REBUILT  
-----  
1/2 THE COST  
OF NEW!**

# ECONCO

TEL: 800-532-6626  
INTL: +1-530-662-7553  
FAX: +1-530-666-7760  
www.econco.com  
SE HABLA ESPAÑOL



## Reach Broadcast Professionals!

For more information, including rates & deadlines, call Claudia Van Veen at 1-703-998-7600 ext. 154.

Advertise today!



# EMPLOYMENT

### HELP WANTED

**TIRED OF BEING A TINY COG** in a huge corporate machine? Come work for a respected, rapidly growing group that is still run by broadcasters! If you are a detail oriented, results-driven, radio broadcast engineer with knowledge of RF, studio, and IT systems, we want to hear from you! Send resume and references to: Galaxy Communications Engineering Position 235 Walton St. Syracuse, NY 13202 EngineerPosition@GalaxyCommunications.Com No phone calls please. Galaxy Communications is an Equal Opportunity Employer.

To advertise, call Claudia at 703-998-7600, ext. 154.

**FOREVER BROADCASTING** with over 30 radio stations in the Central and Western Pennsylvania markets of Altoona, State College, Johnstown, Meadville-Franklin, and New Castle is expanding its engineering team. Self-motivated individuals at all levels please apply. EOE. Please submit resume to LDeppen@aol.com.



**ENGINEER WANTED**  
CLEAR CHANNEL RADIO - NEW YORK CITY  
is looking for a Broadcast/Studio Systems Supervisor

**If you:**  
Have excellent RF maintenance, repair, and troubleshooting skills;  
Are familiar with AES, analog and composite audio testing and troubleshooting methods; Understand T1's, DS3's, and know where to look when you see CRC errors; Know how to troubleshoot equipment;  
Work well in a diverse team; Like to help out and learn in areas outside those of your current expertise...

**Then we:**  
Have a great job for you with excellent benefits in a cutting edge new multi-station facility (that you will help construct!). Salary commensurate with experience. Some heavy lifting required, 24/7 on call, occasional overnight maintenance too. All resumes held in strict confidence!

Email resume to:  
joshhadden@clearchannel.com

### POSITIONS WANTED

**Christian professional eager to work/learn!** Exceptional listener, great show prep, and boards! Follows direction well, very methodical, and a team player. Sharon Tyson 214-527-7177; bleslynn1966@yahoo.com

**Creative, energetic, outgoing female with a sultry voice** who has a passion for on-air, copywriting, delivering news and traffic! Tasha Brown 817 689-2192 Foxibrown99@yahoo.com

**Energetic, enthusiastic, happy, outgoing, personable female.** Strong on-air, promotions, traffic, news/sports and copy ability. A real go-getter with leadership strength! Wendy Lewis 469-443-2271; wooppeleew@yahoo.com

**Good on-air presence, creative copywriter, very humorous,** highly responsible, quick thinker, who gets along well with others, and is industrious! Jeff Mitchell 972-276-0389, forkenspooner@yahoo.com

**C.E. position wanted:** Experienced with computers, transmitters, H.D. transmitters, automations, digital studios. Robert King, Call: (915) 581-2979.

**Innovative, tenacious, enthusiastic, reliable starlet** with an unbelievable radio broadcast passion. Very versatile news, sports, talk, on-air personality or copywriting. Marcy "W" 972-983-6211, or speckledbird7@aol.com

**Persistent, musical knowledge, enthusiastic, with great personality** and works extremely well with others, as well as under pressure. Willing to travel. Phillip Jones 214-405-6315, or BigPhill\_06@yahoo.com

**Bilingual, impressive creative writing, ambitious go-getter.** Good news, boards and digital ability. Organized, and goal oriented, with some film/video experience too! Leslie Rodriguez 214-486-0502, leslej\_ro82@yahoo.com

### TUBES & COMPONENTS



ISO 9001 Certified  
The Choice of Successful Broadcasters Since 1934

### NEW POWER TUBES

Triodes  
Tetrodes  
Pentodes

### NEW SOCKETS & REPLACEMENT PARTS

Worldwide Availability

Made in U.S.A.

CALL 800-414-8823  
Int'l (650) 592-1221  
Fax (650) 592-9988

Visit our Web Site at  
www.eimac.com



**FOR THE BEST PRICE**  
& 24 Hr service on transmitting tubes & sockets/parts, new & rebuilt call Goodrich Ent. at 402-493-1886 day or night, www.goodrichenterprises.com

## D & C Electronics

An International Distributor of RF Components  
**Tubes**

NEW & REBUILT

TRANSMITTERS, STUDIO EQUIPMENT, STLS, ANTENNAS,  
RADIO DATA SYSTEM (FOR CAR RADIO DISPLAY)  
EXCITERS-TRANSMITTERS, TRANSLATORS, MIXERS-CONSOLES, RADIO LINK  
RPU, MOSFETS, VACUUM CAPACITORS, SOCKETS



Pro-Tek®



EEV

BEST PRICES

To Order:  
1-800-881-2374  
Outside U.S. (352) 688-2374  
Se Habla Español

FROM OUR STOCK

3089 Deltona Blvd.  
Spring Hill, FL 34609



BEST SERVICE

352-688-2374  
Fax 352-683-9595

Website: www.dandcelectronics.com



EIMAC • TAYLOR • SVETLANA  
New & Rebuilt Tubes - Same Day Shipping  
Motorola • Toshiba • SGS • Thomson & Mitsubishi Semiconductors  
800-737-2787 760-744-0700  
rfp@rfparts.com www.rfparts.com

Highly qualified, multi-talented female, dedicated to work for the best interest of company. Not afraid of challenges, and exceeding them! Leslie (972) 840-8052, or twinturbo\_girl2003@yahoo.com

www.radioworld.com

Extremely knowledgeable and articulate racing writer/talk show host Adam Amick is available for shows, correspondent, features, etc. Check out www.bleacherreport.com or www.rubbinsracingshow.com for samples. Call 214-384-5812 or email: adam@rubbinsracingshow.com

Are you a small market station needing a good nuts & bolts engineer in the LA area? I will make your station shine! CET, fully FCC Licensed. Available for Full/Part-time/Contract work. Available immediately. Mitchell Rakoff, 917-324-8466 mitchellrakoff@yahoo.com

TO DO:



# ADVERTISER INDEX

This listing is provided for the convenience of our readers.  
Radio World assumes no liability for inaccuracy.

PAGE	ADVERTISER	WEB SITE URL
69	Acorn	www.acornrf.com
19	APT	www.aptx.com
24	Armstrong Transmitter Co.	www.armstrongtx.com
16	Audemat-Aztec Inc	www.audemat-aztec.com
69	AudEssence	www.audessence.com
69	Audion Labs	www.audionlabs.com
14	AudioScience Inc.	www.audioscience.com
40-41	Axia - A Telos Company	www.axiaaudio.com
63	Balsys Technology Group	www.balsys.com
69	Barix AG	www.barix.com
6	Bradley Broadcast	www.bradleybroadcast.com
26	Broadcast Depot	www.broadcastdepot.com
15	Broadcast Electronics	www.bdcast.com
67	Broadcast Tools, Inc	www.broadcasttools.com
31	BSI	www.bsiusa.com
3	BSW	www.bswusa.com
22	Burli Software	www.burli.com
57	BWBroadcast	www.bwbroadcast.com
69	Circuit Werkes	www.circuitwerkes.com
71	Coaxial Dynamics	www.coaxial.com
8	Comet North America	www.cometna.com
7	Comrex Corporation	www.comrex.com
71	Davicom, a Div. of Comlab	www.davicom.com
35	DAWNco	www.dawnco.com
71	Dayton Industrial Corp	www.daytonindustrial.com
4	Electronics Research, Inc.	www.eriinc.com
56	ESE	www.ese-web.com
23	Eventide	www.eventide.com
32	FDW-W	www.fdw-w.com
71	Freeland Products, Inc.	www.freelandproducts.com
51	Full Compass	www.fullcompass.com
39	Global Security Systems	www.alertfm.com
33	Google Inc.	www.google.com/ads/asaudio
71	Gorman Redlich Mfg	www.gorman-redlich.com
62	Grace Broadcast Sales	www.gracebroadcast.com
68	Graham Studios	www.graham-studios.com
17	Harris Corporation	www.broadcast.harris.com
59	Heil Sound, Ltd.	www.heilsound.com
49	Henry Engineering	www.henryeng.com
42	Inovonics Inc	www.inovon.com
45	JK Audio	www.jkaudio.com
10	Kintronic Labs Inc	www.kintronic.com
55	LBA Technology, Inc.	www.lbagroup.com
12	Logitek	www.logitekaudio.com
20	Moseley Associates	www.moseleysb.com
29	Musicam - USA	www.musicamusa.com
53	MusicMaster/A-Ware	www.mmmwin.com
25	NPR Satellite Services	www.nprss.org/rworld
47	NTI Americas, Inc.	www.nt-instruments.com
13	Omnia - A Telos Company	www.omniaaudio.com
61	Omnirax	www.omnirax.com
58	OMT Technologies/Media Touch	www.omt.net
21	Orban	www.orban.com
5	Radio Systems Inc	www.radiosystems.com
43	Radio Systems Inc	www.radiosystems.com
27	RCS	www.rcsworks.com
62	RF Licensing	www.terrestrialrf.com
60	RME c/o Synthax USA	www.rme-audio.com/qs
50	Sabre Communications	www.sabrecom.com
21	SCMS	www.scmsinc.com
71	SCMS	www.scmsinc.com
48	Shively Labs	www.shively.com
37	Sierra Automated Systems	www.sasaudio.com
36	Sine Systems	www.sinesystems.com
71	Sonifex Ltd.	www.sonifex.co.uk
69	Stormin Protection Products	www.opticsshield.com
28	Superior Electric	www.superiorelectric.com
9	Telos Systems - TLS Corp.	www.telos-systems.com
52	Thum & Mahr GmbH	www.yellowtec.com
11	Tieline Technology	www.tieline.com
44	Titus Labs	www.tituslabs.com
18	TMC	www.sagealertingsystems.com
30	TransLanTech Sound, LLC	www.translantech.com
79	Vorsis	www.vorsis.com
80	Vorsis	www.vorsis.com
1	Wheatstone Corporation	www.wheatstone.com
2	Wheatstone Corporation	www.wheatstone.com

# Amendments Leave No Room for Error

## Broadcaster Opposes Senator's Support of Extended FCC Authority Over Unintentional Profanity Slips

by W.C. "Cris" Alexander

The following was sent to Sen. Sam Brownback, R-Kan., on behalf of Crawford Broadcasting Co., and copied to RW:

Dear Sen. Brownback:

We read recently that you plan to attach to a finance bill amendments that would extend FCC indecency authority over inadvertent broadcast of fleeting expletives. You were quoted in one article: "Broadcasters should not be allowed to use the public airways to disseminate violent or obscene material."

As responsible broadcasters, we agree and go to great lengths to steer clear of anything even approaching obscene material. However, we know from experience how fleeting expletives can appear in otherwise "clean" program material without warning. This is very difficult to protect against. As such, we wish to make you

who are perhaps not quite so responsible, that like to "push the envelope" in an effort to pander to, titillate or shock the audience. Such broadcasters are a small minority. The rest of us are conscientious and assiduous in our efforts to maintain family-friendly programming that goes nowhere near anything approaching the definition of indecency or obscenity.

### Real-world limitations

As such, we would encourage you to rethink your efforts to empower the FCC to impose penalties for fleeting expletives. A reasonable response would be to enable such enforcement only in cases of intentional, repeated or careless transmission of expletives. Perhaps another good mechanism would be to build in an affirmative defense for broadcasters that employ, maintain and regularly test profanity delay equipment.

The statutory maximum forfeiture in the amount of \$325,000 per utterance is

**The statutory maximum forfeiture  
of \$325,000 per utterance is excessive ...  
It could well exceed the value of  
the entire radio station.**

aware of the real-world situation, the mechanisms that responsible broadcasters use to protect against the airing of fleeting expletives and the shortcomings thereof.

### Accidents will happen

Our stations that air talk programming employ a 40-second profanity delay for the purpose of screening out caller expletives and other profanity that tends to come up from time to time. If a caller says a bad word, the engineer pushes the "dump" button and the last 12 seconds or so is cut from the program. Our company policy requires that the call then be immediately terminated (a "once-bitten" policy).

However, malfunctions can and do occasionally occur. We test our profanity delays once a week to make sure they and their controls are working, but again, despite our best efforts, things do occasionally go wrong.

We also have found that fleeting expletives do occasionally make it into even the most innocuous programming. We recently experienced a case wherein a caller to a national Christian call-in program uttered an expletive that the producers inadvertently failed to cut from the recorded rebroadcast version of that program. This was from a trusted source, one who would never be expected to produce a fleeting expletive utterance, and yet it happened.

Fortunately, in this instance it happened during the overnight "safe harbor" period, but that it happened at all is a good lesson in how easily it can happen.

We fully realize there are broadcasters

excessive. It takes little stretch of the imagination to conceive of a case where through no fault of our own and despite our best efforts to prevent it, a fleeting expletive from a caller might make it onto the air, a complaint would be filed and a forfeiture in this amount levied. Many small broadcasters would be financially ruined by such a levy. It could well exceed the value of the entire radio station.

While we understand the intent of the forfeiture amount, certainly penalizing broadcasters for such inadvertent utterances must be an unintended consequence. We strongly urge you to revisit this issue.

Senator, just as in normal everyday conversation, fleeting expletives can crop up suddenly and without warning. It takes a screener with quick reflexes and a sharp ear keenly attuned to the program material to catch and cut out such material on the fly. Despite our very best efforts, occasionally such material can and does make it to air.

The FCC has not until recently brought enforcement action in such cases. We would encourage you to take a reasoned approach in your efforts to address the problem of objectionable material on the airwaves. We would support you in any such reasoned approach that makes allowances for real-world limitations.

If you or your staff would like more information or wish to discuss the matter further, please call or write.

Cris Alexander, a contributor to Radio World, writes here in his role as director of engineering for Crawford Broadcasting Co., Denver. ●

GUEST COMMENTARY

# Article Skips Another Coding Family

Pizzi Story on 'Digital Audio 3.0' Left Out Important Information, Forsaking ADPCM Principles

by Jon McClintock

Having taken some time to carefully read through Skip Pizzi's article "Moving On Up to Digital Audio 3.0" (July 4), I'd like to reply and challenge some statements made in the piece. It made for interesting reading but I believe there were some fundamental omissions in the article, which meant that it stopped considerably short of reflecting the true history of digital audio.

The uninitiated or those new to the industry who read this article would have drawn two possible conclusions: first, that there is only one type of compression algorithm available, i.e. those based on perceptual coding principles; and second, that every new release of algorithm surpassed the previous generation and made the life of the broadcaster better, easier and cheaper.

### Coding techniques

With regards to the nature of digital audio data compression algorithms, there are fundamentally two coding principles. As Skip pointed out, one of these principles is the perceptual coding technique, which works on the basis of psycho-acoustic masking. This means that if one signal is higher in amplitude and close enough to another signal in the time axis, then the second signal is considered irrelevant and removed.

This technique is based largely on the subjective nature of what a computer-generated ear considers to be irrelevant. This technique also is highly processor-intensive and adds considerable latency to an encode/decode process.

However, Skip's article fails to mention the second family of coding techniques, i.e. those based on Adaptive Differential Pulse Code Modulation principles, which work in the time domain. The apt-X algorithms, which are used extensively throughout the broadcast industry, are key amongst this family.

These algorithms use Predictive Analysis and Backward Adaption to reconstitute an audio signal. Simply put, the technology predicts what will happen based on previous knowledge, subtracts the actual from the predicted and sends only the differential. It is simple, retains audio integrity and offers a low latency.

The apt-X algorithm was launched in 1988 and productized in 1990 in DSP format and then in a PC sound card, so it would be true to say this algorithm was fundamental to Digital Audio 1.0 and 2.0. The suppliers of

hard-disk recorders for radio automation and playout systems enjoyed great success with apt-X in the early and mid-90s. Scott Studios, The Management, Computer Concepts, Barcode, IMD and various other manufacturers installed more than 15,000 systems throughout North America, Europe and Asia.

At the same time, suppliers of real-time transport solutions also realized the merits of apt-X as they migrated from analog to digital. Broadcasters could purchase apt-X-based solutions for ISDN, X.21, V.35, T1, E1, RF and satellite delivery from a myriad of manufacturers. These include Harris Intraplex, Moseley, TFT, IDC, RVR, DB Electronica, Comrex, GlenSound, Systembase, KW and recently Mayah, Pulsecom and Prodys (Musicam USA).

### apt-X on the scene

The first application in which apt-X was deployed was a satellite network in the early '90s for reporting on NBA games. This point is important, as apt-X has a high tolerance to bit errors and, in the event of a small dropout or partial breakdown in a circuit, can reestablish the connection quickly.

In the same way that perceptual coders did not stand still, amazingly neither did apt-X. Enhanced apt-X was launched in 1999 with even lower latency, increased word depth and greater tolerance to transient content; and apt-X Live in 2006 with increased bandwidth efficiency (8:1) for wireless applications.

Roll on to the mid-2000s and the two fundamental issues challenging broadcasters are alternative transport mediums and increasing the number of audio channels (surround sound).

Most broadcast engineers today are either interested in or currently using IP networks for their audio delivery. Audio-over-IP networking is cost-effective and highly efficient but using perceptual codecs in this application can cause several problems.

The latency introduced by the coding techniques combined with the natural latency of IP networks makes the solution unworkable for any real-time application. Second, perceptual codecs are largely frame-bound and therefore, when using them across a packet-based

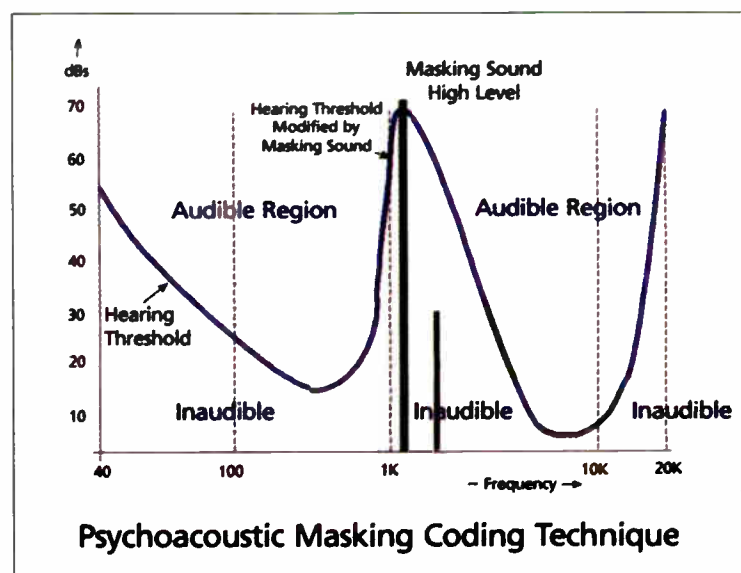

Psychoacoustic Masking Coding Technique

Principles Adopted By MPEG Codecs

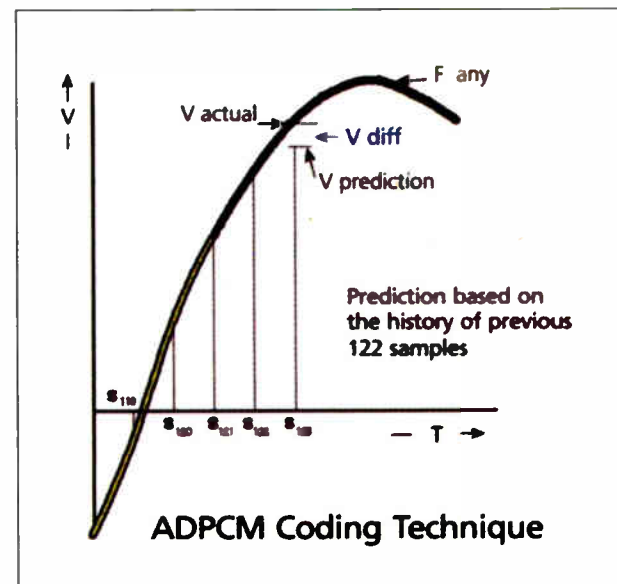

ADPCM Coding Technique

Principles Adopted By apt-X Codecs

network, any lost packets will cause an inevitable drop in audio and re-synchronization latency.

Additional algorithms can be layered in for Forward Error Correction, which will go some way to addressing these problems, but they also will introduce even more latency and bring the total delay to more than one second — certainly not a desirable outcome for real-time talkback applications.

Now this takes me to my final point. As Skip outlines in his article, the new stuff is better than the old stuff. However, the new stuff is still struggling to overcome the weaknesses inherent in perceptual coding techniques.

On the other hand, the same fundamental principles that enabled the early versions of apt-X coding to overcome frailties in satellite links now ensure that the new apt-X-based codecs perform magnificently in packet-based IP networks. As apt-X is not frame-bound, packets can be shaped to ensure dropped or lost packets do not adversely affect the audio. Also, in the event of a particularly stressed network, the data stream can reconnect in less than 3 milliseconds using apt-X's Auto Sync feature.

Skip's article was a good piece but I felt that in omitting the role that apt-X codecs are currently playing in the new age of Digital Audio 3.0, he presented an imperfect overview of the current situation. I do hope that this commentary will go some way to correcting this oversight.

The apt-X algorithms were there at the beginning of digital audio; have been fundamental to storage and transport throughout recent times and today in the so-called era of Digital Audio 3.0; and they still offer audio quality and performance unparalleled over both synchronous and packetized networks.

Jon McClintock is the commercial director for APT.

## ◆ READER'S FORUM ◆

### Down With The Ship

As we mark the launch of fulltime HD-AM in the United States, it's amusing to note the Canadians' adoption of a "wait-and-see" attitude about interference problems the Ibiqity system "might" generate before they approve it for use in the Provinces ("Canada Allows IBOC," Aug. 1).

In this case, "wait-and-see" likely means waiting to observe at arm's length the Titanic maiden voyage of a technical scheme unwanted by anyone other than Ibiqity, its captive big-group engineering executives, equipment sales engineers and receiver geeks blogging on radio industry Web sites from their moms' basements. After four years of halting and much-debated tests, IBOC AM still has all the consumer appeal of a \$200 electric fork.

And it has destructive potential capable of wiping out what remains of entrepreneurial radio in the United States. Nothing here is at stake but the owner-operator system, which made possible the careers of Rush Limbaugh, Randy Michaels and countless oth-

ers who started out on small-market AMs.

Of course this all means nothing to today's blundering FCC, populated as it is by aloof amateur political hacks stamped by muscular Ibiqity lobbying into adoption of the junk-engineering "standard" called IBOC AM.

In an eerie parallel to the idiot King Canute, who stood on the seashore commanding the waves to stop, the equally dim-bulb commission has preemptively "eliminated" HD-AM interference by proclamation, declaring that the technical wonders of IBOC will "outweigh the slight potential of increased interference."

Well, I don't know about you guys, but I certainly feel better now. Dismissing the everyday use of a billion perfectly serviceable existing analog AM radios to favor an estimated 357 HD-AM listeners makes perfect sense. Now isn't that just what stumbling AM needs?

If the FCC were only around in April 1912, maybe we could have outlawed icebergs.

Bob Savage  
President/CEO  
WYSL(AM) NewsPower 1040  
Rochester, N.Y.

# Radio World

Vol. 31, No. 23 September 12, 2007

Telephone: (703) 998-7600

Business Fax: (703) 998-2966

Editorial Fax: (703) 820-3245

E-mail: radioworld@imaspub.com

Web site: www.radioworld.com

Next Issue of Radio World September 26, 2007

Next issue of Engineering Extra October 17, 2007

For address changes and subscription renewal, please visit www.radioworld.com and click on "Subscribe to RW." To submit letters or story proposals, to request writer's guidelines, or for other editorial matters, e-mail the editor at radioworld@imaspub.com.

## —EDITORIAL STAFF—

Paul J. McLane	ext. 117	Editor in Chief, U.S.
Leslie Stimson	ext. 129	News Editor/Wash. Bureau Chief
Kelly Brooks	ext. 136	Associate Editor, RW & Production Editor, RWEE
Thomas R. McGinley	—	Technical Adviser
Michael LeClair	—	Technical Editor, RWEE
John Bisset	—	Contributing Editor
Skip Pizzi	—	Contributing Editor
Marguerite Clark	—	Editor (International), Milan
Rogelio Ocampo	ext. 121	Latin America Editor in Chief
Karina Gerardi	ext. 137	Latin America Editor
Brett Moss	ext. 143	Managing Editor (International)
Brian Smith	ext. 140	Managing Editor, Web
Peter Finch	—	Editorial Assistant, Milan

## —EDITORIAL CONTRIBUTORS—

W.C. Alexander, Steve Callahan, James Careless, Harry Cole, Mark Durenberger, Charles Fitch, Ty Ford, Scott Fybush, Frank Grundstein, Harold Hallikainen, Craig Johnston, Paul Kaminski, Peter King, Mark Lapidus, Daniel Mansergh, Sharon Rae Pettigrew, Carl Lindemann, Ted Nahil, Tom Osenkowsky, Ken R., Rich Rarey, Tom Ray, Randy Stine, James G. Withers, Travis the VIO Guy, Barry Umansky, Tom Vernon.

## —ADMINISTRATION &amp; PRODUCTION—

John Casey	.....	Publisher
T. Carter Ross	.....	Editorial Director
Davis White	.....	Production Director
Karen Lee	.....	Production Publication Coordinator
Lori Behr	.....	Ad Traffic Manager
Robert Green	.....	Circulation Manager

—CORPORATE—  
NewBay Media LLC

Steve Palm	.....	President and CEO
Paul Mastronardi	.....	Chief Financial Officer
Michael Ruber	.....	Controller
Nancy Gregson	.....	Marketing Director
Denise Robbins	.....	Group Circulation Director
Joe Ferrick	.....	Vice President of Web Development

## Market Groups

Carmel King	.....	Executive Vice President, Video/Broadcast Group
Eric Trabb	.....	Vice President / Sales Director, Video/Broadcast Group
Adam Goldstein	.....	Vice President, Group Publishing Director Pro Audio & Systems Division
John Pledger	.....	Vice President, Group Publishing Director Music Player Network
Jo-Ann McDevitt	.....	Publisher, Technology & Learning

## —ADVERTISING SALES REPRESENTATIVES—

US East & Latin America: John Casey	330-342-8361
Fax: 330-342-8362	e-mail: jcasey@imaspub.com
US West & Canada: Dale Tucker	916-721-3410
Fax: 916-729-0810	e-mail: dtucker@imaspub.com
Classified & Product Showcase: Claudia Van Veen	703-998-7600 x154
Fax: 703-671-7409	e-mail: cvanveen@imaspub.com
Europe, Africa, Middle East: Raffaella Calabrese	+39-02-7030-0310
Fax: +39-02-7030-0211	e-mail: rcalabrese@imaspub.com
Japan: Eiji Yoshikawa	+81-3-3327-5759
Fax: +81-3-3322-7933	e-mail: callens@world.odn.ne.jp
Asia-Pacific: Wengong Wang	+86-755-5785161
Fax: +86-755-5785160	e-mail: wwg@imaschina.com

Radio World Founded by Stevan B. Dana

Radio World (ISSN: 0274-8541) is published bi-weekly with additional issues in February, April, June, August, October and December by NewBay Media LLC, P.O. Box 1214, Falls Church, VA 22041. Phone: (703) 998-7600, Fax: (703) 998-2966. Periodicals postage rates are paid at Falls Church, VA 22046 and additional mailing offices. POSTMASTER: Send address changes to Radio World, P.O. Box 1214, Falls Church, VA 22041. REPRINTS: For reprints call or write Emmilly Wilson, P.O. Box 1214, Falls Church, VA 22041; (703) 998-7600; Fax: (703) 998-2966. Copyright 2007 by NewBay Media, LLC. All rights reserved.

—Printed in the USA—



## Try Something

### The Words of FDR Offer a Lesson for Embryonic Multicasters

Franklin Roosevelt's administration was only weeks old when a newspaper reporter asked him how he intended to deal with the Depression, then in its third, devastating year.

When dealing with extraordinary circumstances, Roosevelt said, "It is common sense to take a method and try it. If it fails, admit it frankly and try another. But above all, try something!" He communicated this action plan to the nation over the radio, via the periodic broadcasts later famously known as his Fireside Chats. The nation listened, and although the Depression ground on for another six years, the relatively new medium provided an unparalleled conduit for reassuring the public throughout the crisis.

Now, more than 70 years later, radio remains a primary method for informing and entertaining the public. Broadcasters today, though, face their own extraordinary circumstances. Alternative delivery systems such as iPods, XM/Sirius and cellphones with MP3 players all add up to a competitive environment previously unknown to radio broadcasters.

HD Radio represents a viable response to that competition, but only if our industry exploits its advantages, even if only through the sometimes painful process of trial and error. In the end, how each broadcaster reacts to and harnesses this new technology for the benefit of its audience may well determine whether or not it is in business 10 years down the road.

Roosevelt intuitively knew that the best way to tackle his set of "extraordinary circumstances" was through experimentation. RW believes the same action plan must be adopted by broadcasters, as each tries to assess risk-vs.-reward in the emerging world of HD Radio.

The successful broadcaster will "try something," as he or

she attempts to convert IBOC from a technological capital expense to an audience aggregator and revenue source. Many of these attempts will no doubt fail outright, some will limp along in search of audience acceptance and a few will flourish, making their stations financially successful into the next decades. Success will breed imitators, and in the cases of failure, the successful operator will "admit it frankly" and try something else.

In the end, the only real failure will be for the industry to squander this opportunity, by waiting for consumers to adopt the technology before it provides them with a demonstrable benefit.

FM stations can create that benefit by multicasting additional *unique* programming or totally new data services. We emphasize "unique" because simply adding "more of the same" will not be seen by the public as a compelling reason to adopt this new technology. The experience of digital broadcasters in the United Kingdom, where unique content is credited with helping the DAB format thrive, supports this conclusion.

AM stations will at long last find themselves on a nearly equal footing, fidelity-wise, with FM, opening up programming options that AM operators thought gone forever.

The programming and ancillary revenue streams are, or soon will be, there to be mined. It only remains for the creative operator to identify and exploit them. RW urges broadcasters to explore the opportunities of HD Radio, even those that might seem outlandish. And more important, if those initial assumptions turn out to be false, then heed the "common sense" words of FDR, who was, after all, one of the first to really understand the power of radio to reach and inform the public.

—RW

## ◆ READER'S FORUM ◆

### LeSEA Corrections

Thank you for running the story on LeSEA Broadcasting and its shortwave facilities ("LeSEA Broadcasts to the World," July 18). Having visited the Big Island of Hawaii recently, I noted there were two errors in your story.

First, the second transmitter at Na'alehu is a Harris-brand transmitter. They have one Continental and one Harris. The place is a great, clean facility and extremely well maintained.



The other comment, about the stations being manned 24/7, might be true at South Carolina and Maine, but the Hawaii operation is staffed from 4 p.m. to 8 a.m. local time only. Propagation over the Pacific is poor during the daytime.

My family considered this part of Hawaii the perfect place for Elvis, Amelia Earhart and Jimmy Hoffa to share an apartment, but it was absolutely perfect for a couple of 12 million watt shortwave stations.

Mark Heller  
President  
WGBW(AM) Radio  
Two Rivers, Wis.

### Wasted Space

Why are you allowing valuable space in a periodical devoted to broadcasting to serve as a pulpit for Burt Fisher to spew his verbal venom on the hobby of amateur radio (*Reader's Forum*, July 18)?

If there is any merit to his comments — and from what I have seen that's doubtful — they should be aired in a ham magazine, not in *Radio World*, a tabloid whose front page proclaims itself to be a "Newspaper for Radio Managers and Engineers." The broadcast engineering community would be far better served if the 13 column inches on page 46 of the July 18 issue had been used for airing an intelligent discussion of one of the many problems facing our industry.

If Mr. Fisher is so disenchanted with ham radio I suggest he go to the town square in the village in which he lives, set a trash container on fire and toss his ham license into it, just as the protesters of a few decades ago did with their draft cards.

Jack Layton  
McMurray, Pa.

thing; one of them my father, who left the farm to learn radio repair at a tender age and then to serve aboard the Yorktown with the VF-5 fighter squadron.

College is, in my opinion overrated, although I am a product of high education and hold several MA degrees. With [Barton's] work and that of General Electric, Westinghouse and a few others, our basic understanding of transmission systems was pretty much nailed down until the time of Armstrong with his FM system, again a young man who was not a college graduate when the regenerative detector came about in 1912.

A willing mind, strong hands and a formidable attitude overcome a good many things but also prepare those who really need to go on for advanced-level schooling to become the tremendous workers among those things of the high altitudes. Thank Mr. O'Neal for his fine article.

Stanley Adams  
Memphis

### Stay in the Closet

Your article recognizing homosexual radio ("Gay Radio Gets a Coming Out," July 18) is morally inappropriate.

William E. Bauer, Ph.D.  
Program Director  
KRNG(FM), Renegade Radio  
Wadsworth, Nev.

### Arkansas Farm Boy Makes Good

I just noticed the excellent article by our generational radio expert James E. O'Neal ("Loy Barton, A Forgotten Radio Pioneer," July 18).

Loy is certainly not well known among general conversational circles but those of us who enjoy the reading, research and writing of communications history readily recognize the name — a farm boy from Arkansas who made good. A lot of boys of that same generation could say the same

### Correction

The article about AM IBOC on page 1 in the Aug. 15 issue misspelled the last name of Ibiquity Digital spokeswoman Vicki Stearn.

# QUESTION:



*Would you process all these different voices the exact same way? Of COURSE Not!*

The new **VORSIS M-1 Digital Microphone Processor** is individually designed for ALL of your on-air talent at truly affordable prices. Only with the VORSIS M-1 do you get individual presets, fully adjustable compression and expansion, multi-band EQ (either pre or post dynamics), high and low pass filters, de-esser, and built-in phantom power. And all of it available via our easy-access graphic interface. **The M-1 Digital Mic Processor** — a new level in voice management.

*REDEFINING Digital  
Audio Processing*

**VORSIS**®

copyright © 2007 by Wheatstone Corporation

tel 252-638-7000 / [www.vorsis.com](http://www.vorsis.com)

World Radio History

# Condition your Signal

with the New Vorsis® HD-P3

## What Is It?

A four-band parametric equalizer feeding a three-band limiter with adjustable crossover points, AGC and selectable filters for FM, AM or streaming audio formats. The HD-P3 includes a variable de-esser, an expander and dual digital outputs (one with user selectable HD latency FM delay), plus high pass, low pass and notch filters, and a signal de-correlator to optimize bass content. All this controlled by an ethernet protocol computer interface that lets you run one or many HD-P3s from your office or internet based locations.

## What It's For:

Processing for your new HD signal, improving your existing FM or AM signal chain, preprocessing streaming audio-over-internet, a standalone HD processor or a realtime DJ monitor feed—and finally—a KILLER studio production tool.

## What's It Like?

“PERFORMANCE WITH OVERDRIVE”



# VORSIS®

It's What's Next in Processing

a division of Wheatstone

Copyright © 2007 by Wheatstone Corporation

World Radio History