

1967 In Review: Best Artists, Records & Songs In
Pop, Country & Rhythm & Blues ••• List Of Top Disk
Producers ••

December 23, 1967

Gold Disk LPs,
Singles • Top

Cash Box

Hits Of The Past 19 Years ••• Bios Of Lead-
ing Artists ••• Survey Of Global Record Scene

Cash Box



Choir of Kings Colleg

DOCTOR DOLITTLE: HE WALKS & TALKS WITH THE ANIMALS

Int'l Section: Part 2



On the Town

Donovan's Songs Of Beauty, Love

Ralph J. Gleason

THEY CAME from all over, in buses and in cars. They hitch-hiked and they walked and by 2:30 in the afternoon on Friday they were camped outside Winterland waiting to be first in line for the concert by Donovan that night.

Thus the return to San Francisco of the British singer who first appeared here in September at the Cow Palace was a real triumph.

"When Donovan comes here, it's not a dance, it's not a concert, it's not an event. It's a religious experience," one long-haired youth said at Winterland.

And the followers treated it that way.

Thursday night at the Fillmore, the audience sat packed against each other on the floor while Donovan, from a stage covered with flowers, with incense burning and candles instead of light bulbs illuminating the music stands, sang his songs of love and beauty.

"I understand my congregation is made up of the finer sex," he sang out and the girls on the floor in the audience breathed in ecstasy. All night long they sang along with him, softly swaying, their hair slowly floating from side to side, as they mouthed the words to "Celeste," "Retired Writer," "Young Girl Blues," "Sunny Goodge Street," and moved in joy to "First There is a Mountain," "Fat Angel," and "Mellow Yellow."

★ ★ ★



DONOVAN
Mysterious quality

AT WINTERLAND it was the same thing except that there were more people, more than I have ever seen packed into that huge hall, sitting on the dance floor, crowding the stage and piled on top of one another in the aisles.

"Happiness goes in a circular motion." Donovan instructed the neophytes in a new song he featured ("I haven't a name for it yet," he said later). And even though they had not heard it before, they seemed to know the lyrics. It is a mysterious quality that Donovan possesses. Somehow he verbalizes the dreams of youth. Now is the time for myths, apparently, and Donovan's fairy tales, descriptions of the scene and delineations of a mystical philosophy of love fit perfectly. "I tell you his name is love" Donovan sings: "Life is love and love is life." And in his new song he says "everybody is a part of everything, anyway."

Donovan stands today at the top with The Beatles and the Rolling Stones and few others. He is the most imaginative of all the contemporary singers, using his voice (which is an excellent instrument to begin with) in the manner jazz singers do. In fact, a good deal of what Donovan does is jazz. He is it who finally has made the amalgam of jazz and poetry work. He sings his in-tempo songs with a jazz beat and an edge to his voice and a sound and phrasing that is reminiscent only of Billie Holiday. Not only this observer but other jazz fans in the audience were struck by this. The accompaniment (bass, drums, celeste, conga, drums, flute) is a jazz oriented backing. Harold McNear, who doubles on flute and tenor, is a fine soloist and backs Donovan like James Moody backs Dizzy Gillespie.

★ ★ ★

DONOVAN, OF COURSE, both in his lyrics and his music and, too, in the way in which he sings, is supremely lyrical. "My songs exist in the essence of silence" he told the Winterland audience as he waited for them to become quiet. And they became quiet, almost holding their breath in reverent attention as he sang.

He is an extraordinary performer. The pageantry, the flowers (he throws them to the audience at the end, after a joyous "Mellow Yellow"), the incense, the long robes, are all effective but the musicianship is underneath and solid as a rock. He knows exactly what he is doing, he is show-wise to the nth degree. The songs themselves are artfully constructed with echoes of familiarity, "songs of the realm" in the Tolkienian expression and articulating the "beginning of a new world."

"I wish only to enhance and beautify the days of youth" he says and adds "I sing my poems of the beauty I see that all may see and know the reassurance I know, that God is love."

"Wear Your Love Like Heaven"... a fabulous new album evolves from a best-selling single.



LN 24349/BN 26349 Stereo

"For Little Ones"... an album of irresistible appeal for children of all ages.



LN 24350/BN 26350 Stereo

"A Gift From A Flower To A Garden"... Donovan's music, his art, his poetry... all in a magnificently designed volume that includes the two LP's, a beautiful art portfolio, complete lyrics, and full color photographs.

L2N 6071/B2N 171 Stereo

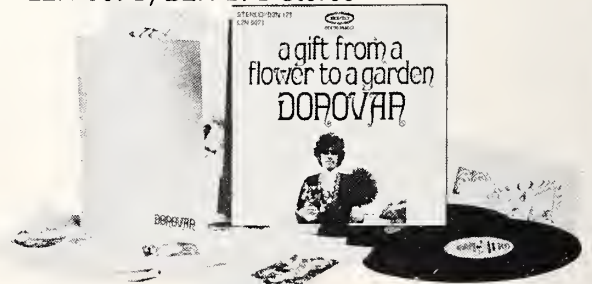

Produced by Mickie Most

A TOTALLY UNIQUE CONCEPT.

DONOVAN'S OWN!



Publication Office / 1780 Broadway, New York, New York 10019 / Telephone: JUdson 6-2640 / Cable Address: Cash Box, N. Y.

GEORGE ALBERT
President and Publisher
MARTY OSTROW
Vice President
LEON SCHUSTER
Treasurer

IRV LIGHTMAN
Editor in Chief

EDITORIAL
TOM McENTEE Assoc. Editor
ALLAN DALE
DANIEL BOTTSTEIN
JOHN KLEIN
MARV GOODMAN
EDITORIAL ASSISTANTS
MIKE MARTUCCI
ANTHONY LANZETTA
HEDDY ALBERT

ADVERTISING
BERNIE BLAKE
Director of Advertising

ACCOUNT EXECUTIVES
STAN SOIFER New York
BILL STUPER New York
HARVEY GELLER Hollywood
WOODY HARDING
Art Director

COIN MACHINES & VENDING
ED ADLUM
General Manager

BEN JONES Asst.
CAMILLE COMPASIO Chicago
LISSA MORROW Hollywood

CIRCULATION
THERESA TORTOSA Mgr.

CHICAGO
CAMILLE COMPASIO
29 E. Madison St.
Chicago 2, Ill.
(Phone: (312) FI 6-7272)

HOLLYWOOD
HARVEY GELLER
6290 Sunset Blvd.
Hollywood, Calif. 90028
(Phone: (213) 465-2129)

EUROPEAN DIRECTOR
NEVILLE MARTEN

ENGLAND
NEVILLE MARTEN
Dorris Land
9a New Bond St.
London, W1, England
Tel: 01-493-2868

ITALY
MARIO PANVINI ROSATI
Galleria Passarella 2
Milan (Italy)
Tel: 790990

GERMANY
MAL SONDOCK
Josef Raps Strasse 1
Munich, Germany
Tel: 326410

HOLLAND
PAUL ACKET
Thereslastraat 59-63
The Hague
Tel: 837703

FRANCE
CHRISTOPHE IZARD
24, Rue Octave Feuillet
Paris XVI Tel: 870-9358

SCANDINAVIA
SVEN G. WINQUIST
Kagehalmsvagen 48,
Stockholm-Enskede,
Sweden, Tel: 59-46 85

AUSTRALIA
RON TUDOR
8 Francis St.,
Heathmont, Victoria
Tel: 870-5677

CANADA
LORI BRUNER
1560 Bayview Ave.
Suite 107
Toronto 17, Canada

SUBSCRIPTION RATES \$20 per year anywhere in the U.S.A.
Published weekly. Second class postage paid at New York,
N. Y. 10001 U.S.A.

Copyright © 1967 by The Cash Box Publishing Co., Inc.
All right reserved. Copyright under Universal Copyright Con-
vention.



MERRY CHRISTMAS

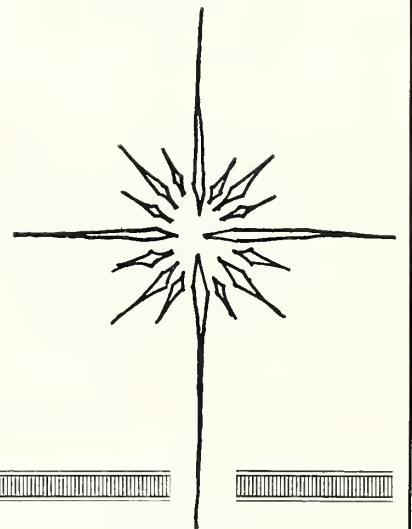

AND BEST WISHES FOR THE NEW YEAR

SPAIN
FEDERICO HALPERN
Sagasta 23,
Apartado 4025,
Madrid
Tel: 257 0907—224 8600

ARGENTINA
MIGUEL SMIRNOFF
Rafaela 3978,
Buenos Aires,
Tel: 69-1538

BRAZIL
LUIS DE C. GUEDES
Rua Rego Freitas,
289—3°, andar
Saa Paula, SP

MEXICO
ENRIQUE ORTIZ
Insurgentes Sur 1870
Mexico 20, D. F.,
Tel: 24-65-57

JAPAN
Adv. Mgr.:
SHOICHI KUSANO

Editorial Mgr.:
MORIHIRO NAGATA
466 Higfashi-Olzumi
Neirimaku,
Tokyo





CashBox TOP 100

DECEMBER 23, 1967

1	DAYDREAM BELIEVER Monkees-Colgems-1012	12/16-1	33	THE OTHER MAN'S GRASS IS ALWAYS GREENER Petula Clark-Warner Bros.-7097	43 52	66	LOVE POWER Sandpebbles-Columbia 141	75 81
2	HELLO GOODBYE Beatles-Capitol 2056	2 7	34	SUSAN Buckingham-Columbia-44378	46 57	67	BACK UP TRAIN Al Green-Hot Line 15000	72 82
3	I SECOND THAT EMOTION Smokey Robinson & Miracles-Tamla-54159	5 8	35	BEAUTIFUL PEOPLE Kenny O'Dell-Vegas-718	39 47	68	IN ANOTHER LAND Bill Wyman-London 907	71 83
4	I HEARD IT THRU THE GRAPEVINE Gladys Knight & The Pips-Soul 35039	3 3	36	SINCE YOU SHOWED ME HOW TO BE HAPPY Jackie Wilson-Brunswick-55354	38 40	69	LITTLE BECKY'S CHRISTMAS WISH Becky Lamb-Warner Bros.-7154	— —
5	THE RAIN, THE PARK, AND OTHER THINGS Cowsills-MGM-13810	4 2	37	YESTERDAY Ray Charles-ABC-11009	28 29	70	COVER ME Percy Sledge-Atlantic-2453	74 77
6	CHAIN OF FOOLS Aretha Franklin-Atlantic-2164	13 42	38	I CAN SEE FOR MILES Who-Decca-32206	31 15	71	DANCING OUT MY HEART Ronnie Dove-Diamond 233	81 90
7	WOMAN, WOMAN Union Gap-Columbia-44297	12 24	39	PLEASE LOVE ME FOREVER Bobby Vinton-Epic-10228	30 14	72	NOBODY BUT ME Human Beinz-Capitol 5990	83 93
8	YOU BETTER SIT DOWN KIDS Cher-Imperial-66261	9 9	40	AN OPEN LETTER TO MY TEENAGE SON Victor Lundberg-Liberty-55996	6 6	73	CHATTANOOGA CHOO CHOO Harpers Bizarre-Warner Bros.-7093	59 49
9	BEND ME, SHAPE ME American Breed-Atco-811	19 58	41	DANCING BEAR Mamas & Papas-Dunhill-4113	51 70	74	EXPLOSION IN MY SOUL Soul Survivors-Crimson-1012	— —
10	BOOGALOO DOWN BROADWAY Fantastic Johnny C-Phil-L.A. of Soul-305	15 19	42	WATCH HER RIDE Jefferson Airplane-RCA Victor-9389	53 67	75	TWO LITTLE KIDS Peaches & Herb-Date 1586	88
11	SKINNY LEGS AND ALL Joe Tex-Dial-4063	14 17	43	PATA PATA Miriam Makeba-Reprise-0606	32 13	76	GOOD COMBINATION Sonny & Cher-Atco 6541	84 —
12	IN AND OUT OF LOVE Diana Ross & Supremes-Motown-1116	10 11	44	PEACE OF MIND Paul Revere & Raiders-Columbia-44335	35 38	77	IN MY MISTY MOONLIGHT Dean Martin-Reprise 0640	62 66
13	SNOOPY'S CHRISTMAS Royal Guardsmen-Laurie-3416	34 56	45	I CAN'T STAND MYSELF (WHEN YOU TOUCH ME) James Brown-King-6144	54 63	78	THE LESSON Vikki Carr-Liberty-56012	— —
14	MASSACHUSETTS Bee Gees-Atco-6532	17 21	46	OKOLONA RIVER BOTTOM BAND Bobbie Gentry-Capitol-2044	41 41	79	BABY, NOW THAT I'VE FOUND YOU Foundations-UNI 55038	98 —
15	SHE'S MY GIRL Turtles-White Whale-260	16 20	47	MONTEREY Eric Burden & The Animals-MGM 13868	76 —	80	DARLIN' Beach Boys-Capitol-2068	— —
16	SUMMER RAIN Johnny Rivers-Imperial-66267	21 27	48	I AM THE WALRUS Beatles-Capitol-2056	56 61	81	ITCHYCOO PARK Smal Faces-Immediate-501	80 85
17	JUDY IN DISGUISE John Fred & Playboys Band-Paula-282	22 53	49	BEST OF BOTH WORLDS Lulu-Epic-10260	60 72	82	INSANITY COMES QUIETLY TO THE STRUCTURED MIND Janis Ian-Verve Forecast 5072	82 88
18	HONEY CHILE Martha Reeves & Vandellas-Gordy-7067	23 32	50	O-O, I LOVE YOU Dells-Cadet-5574	52 50	83	LOST Jerry Butler-Mercury-72764	— —
19	INCENSE & PEPPERMINTS Strawberry Alarm Clock-UNI-55018	7 4	51	I'LL BE SWEETER TOMORROW O'Jays-Bell-691	55 60	84	A VOICE IN THE CHOIR Al Martino-Capitol 2053	87 94
20	IT'S WONDERFUL Young Rascals-Atlantic-2463	27 55	52	EVERYBODY KNOWS Dave Clark Five-Epic-10265	69 78	85	TO GIVE (THE REASON I LIVE) Frankie Valli-Philips-40510	— —
21	A DIFFERENT DRUM Stone Poneys-Capitol-2004	33 39	53	GOIN' OUT OF MY HEAD/CAN'T TAKE MY EYES OFF YOU Lettermen-Capitol 2054	68 —	86	STORYBOOK CHILDREN Billy Vera & Judy Clay-Atlantic 2445	67 73
22	I SAY A LITTLE PRAYER Dionne Warwick-Scepter-12203	8 5	54	WHO WILL ANSWER? Ed Ames-RCA 9400	79 —	87	SKIP A ROPE Henson Cargill-Monument-1041	— —
23	NEXT PLANE TO LONDON Rose-Garden-Atco-6510	25 28	55	COME SEE ABOUT ME Jr. Walker & The All Stars-Soul-35041	58 64	88	PIECE OF MY HEART Erma Franklin-Shout-221	61 65
24	LAZY DAY Spanky & Our Gang-Mercury-72732	18 18	56	I'M IN LOVE Wilson Pickett-Atlantic 2448	66 76	89	PICK UP THE PIECES Carla Thomas-Stax-239	— —
25	KEEP THE BALL ROLLING Jay & The Techniques-Smash-2124	11 11	57	WHAT'S IT GONNA BE Dusty Springfield-Philips-40498	57 62	90	LITTLE RAIN MUST FALL Epic Splendor-Hit Biscuit 1450	92 100
26	IF I COULD BUILD MY WORLD AROUND YOU Marvin Gaye & Tammi Terrell-Tamla 54161	36 48	58	TELL MAMA Etta James-Cadet 5578	64 74	91	SOCKIN' 1-2-3-4 John Roberts-Duke-425	94 87
27	BEAUTIFUL PEOPLE Bobby Vee-Liberty-56009	29 31	59	TO SIR WITH LOVE Lulu-Epic-10187	20 16	92	SPOOKY Classics Iv-Imperial 66259	96 99
28	NEON RAINBOW Box Tops-Ma'a-580	24 26	60	BABY YOU GOT IT Brenton Wood-Double Shot-121	65 68	93	LITTLE DRUMMER BOY Lou Rawls-Capitol-2026	— —
29	BY THE TIME I GET TO PHOENIX Glen Campbell-Capitol-2015	26 30	61	TOO MUCH OF NOTHING Peter Paul & Mary-Warner Bros. 7092	63 69	94	WE'RE A WINNER Impressions-ABC-11022	— —
30	LOVE ME TWO TIMES Doors-Elektra-45624	42 51	62	GREEN TAMBOURINE Lemon Pipers-Buddah 23	85 89	95	SOMETHING'S MISSING 5 Stairsteps-Buddah 20	97 98
31	AND GET AWAY Esquires-Bunky-7752	40 45	63	AM I THAT EASY TO FORGET Engelbert Humperdinck Parrot 40023	89 —	96	THIS THING CALLED LOVE The Webs-Pop Side 4593	93 95
32	WEAR YOUR LOVE LIKE HEAVEN Donovan-Epic-10253	37 46	64	DEAR ELOISE Hollies-Epic 10251	70 80	97	UNITED PAR I Music Makers-Gamble-210	— —
			65	MY BABY MUST BE A MAGICIAN Marvelettes-Tamla 54158	77 —	98	COUNT THE DAYS Inez & Charlie Foxx-Dynamo 112	100 —
						99	EXPECTING TO FLY Buffalo Springfield-Atco-6545	— —
						100	I WONDER WHAT SHE'S DOING TONIGHT Tommy Boyce & Bobby Hart-A&M-893	— —

ALPHABETIZED TOP 100 (INCLUDING PUBLISHERS AND LICENSEES)

A Different Drum (Screen Gems, Columbia, BMI)	21	Goin' Out of My Head (Saturday, Seasons Four, Vogue, BMI)	53	Judy In Disguise (Su Ma, BMI)	17	Happy (Jalynne, BRC, BMI)	36
A Little Rain Must Fall (Chardon, BMI)	90	Good Combination (Tripartite, Pam-Bar, D&K, BMI)	76	Keep The Ball Rollin' (Screen Gems, BMI)	25	Skip A Rope (Tree, BMI)	87
A Voice In The Choir (Case, ASCAP)	84	Green Tambourine (Kama Sutra, BMI)	62	Lazy Day (Screen Gems, Columbia, BMI)	24	Snoopy's Christmas (S&J, Next Day, Kaiser, ASCAP)	13
Am I That Easy To Forget (4 Star, BMI)	63	Hello, Goodbye (Macien, BMI)	2	Little Becky's Christmas Wish (Carlman, BMI)	69	Sockin' 1-2-3-4 (Don, BMI)	91
And Get Away (Hi-Mi, Flomar, BMI)	31	Honey Chile (Jobete, BMI)	18	Little Drummer Boy (Int'l Korwin, Mills, ASCAP)	93	Something's Missing (Kama Sutra, BMI)	95
An Open Letter to My Teenage Son (Asa, ASCAP)	79	I Can See You For Miles (Essex, ASCAP)	38	Lost (Double Diamond, Downstairs, Parabut, BMI)	7	Spooky (Bill Lowery, BMI)	92
Baby Now That I've Found You (Saturday BMI)	49	I Can't Stand Myself (Taccoa, Soil, BMI)	45	Love Me Two Times (Wippen, BMI)	30	Summer Rain (Johnny Rivers, BMI)	16
Baby You Got It (Big Shot, BMI)	60	If I Could Build My Whole World Around You (Jobete, BMI)	26	Love Power (Unbelievable, BMI)	65	Storybook Children (Blackwood, BMI)	86
Back Up Train (Tosted, BMI)	67	I Heard It Thru The Grapevine (Jobete, BMI)	4	Massachusetts (Nempor, BMI)	14	Susan (Bag-O-Tunes, Diogens, BMI)	34
Beautiful People (Mirwood, BMI)	27-35	I Am The Walrus (Comet, ASCAP)	48	Monterey (Slamina, Sea Lark, BMI)	47	The Rain, The Park, And Other Things (Akbestal & Luvlin, BMI)	5
Bend Me Shape Me (Helios, BMI)	9	I'm In Love (Pronto, Tracebob, BMI)	56	My Baby Must Be A Magician (Jobete, BMI)	65	The Lesson (Alta, ASCAP)	78
Best of Both Worlds (Dick James, BMI)	49	In Another Land (Gideon, BMI)	68	Neon Rainbow (Earl Barton, BMI)	28	This Thing Called Love (Emaou, BMI)	96
Bookaloo Down Broadway (Dandelion, BMI)	10	I Say A Little Prayer (Blue Seas, ASCAP)	22	Next Plane To London (Myrwood, Anthers, BMI)	23	Tell Mama (Flame, BMI)	58
By The Time I Get To Phoenix (Johnny Rivers, BMI)	29	I Second That Emotion (Jobete, BMI)	3	Nobody But Me (Weman, BMI)	72	To Give (Saturday, Seasons Four, BMI)	85
Chain of Fools (14th Hour, Pronto, BMI)	6	I Wonder What She's Doing Tonight (Screen Gems/Columbia, BMI)	100	Oko'ona River Bottom Band (Larry Shayne, ASCAP)	45	To Sir With Love (Screen Gems, BMI)	59
Chattanooga Choo Choo (Lee Feist, ASCAP)	73	Itchycoo Park (Nice Songs, BMI)	81	O-O I Love You (Chevis, BMI)	50	Too Much of Nothing (Dwarf, BMI)	61
Come See About Me (Jobete, BMI)	55	I'll Be Sweeter Tomorrow (Zira, Floteca, BMI, Mia, ASCAP)	51	Other Man's Grass Is Always Greener (Nothorn, ASCAP)	33	Two Little Kids (Jalynne, BMI)	88
Count the Days (Catalogue, C&I, BMI)	98	In And Out Of Love (Jobete, BMI)	12	Pata Pata (Xina, ASCAP)	43	United Part I (Razor Sharp Blockbuster, BMI)	97
Cover Me (Pronto, BMI)	70	In The Misty Moonlight (4 Star BMI)	77	Peace Of Mind (Daywin, BMI)	44	Watch Her Ride (Jefferson Airplane, BMI)	42
Dancing Bear (Wingate, ASCAP)	41	Incense & Peppermints (Calridge, ASCAP)	19	Peace Of My Heart (Web IV, BMI)	88	Wear Your Love Like Heaven (Peer Int'l, BMI)	32
Dancing Out of My Heart (Richard Irwin, ASCAP)	71	It's Wonderful (Shacsar, BMI)	20	Pick Up The Pieces (East, Groovesville, BMI)	19	We're A Winner (Chi Sound, BMI)	94
Darlin' (Sea of Tunes, BMI)	80	Insanity Comes Quietly To The Structured Mind (Dialogue, BMI)	82	Please Love Me Forever (Selma, BMI)	39	What's It Gonna Be (Rumbalero, BMI)	57
Dear Eloise (Maribus, BMI)	64			She's My Girl (Chardon, BMI)	15	Who Will Answer (Sunbury, ASCAP)	54
Everybody Knows (Francis, Day, Hunter, ASCAP)	52			Skinny Legs And All (Tree, BMI)	11	Woman Woman (Glaser, BMI)	7
Expecting to Fly (Ten East, Springalo, Cotillion, BMI)	99			Since You Showed Me How To Be	—	Yesterday (Mac Len, BMI)	37
Explosion In My Soul (Double Diamond, BMI)	74					You Better Sit Down Kids (Christmarc, BMI)	8

DON'T GET INVOLVED



IF you want your daughter living in a world where she's not safe on Main Street at high noon.

IF you want your son believing that violence and kicks go hand-in-hand.

BUT if you're concerned with the terror that is spreading through our cities... if you care about the world the next generation will live in—the world you're helping to make—then you'd better get involved. Now. And you can start with

SOUTH END INCIDENT K-13865 by **THE BEACON STREET UNION**

They ask the questions people all over America are asking today. And they give the answers on

The Sound of
The Now Generation
is on



MGM
RECORDS

A Coral Rock Production
Produced by Wes Farrell

MGM Records is a division of
Metro-Goldwyn-Mayer Inc.

SALE! DAY-OLD CHRISTMAS GIFTS*



Catch the post-Christmas crowd and Make It Big during the Biggest Week of the Season! Capitol's "Day-Old Gift Sale" designed to help you corral the Christmas money running around loose during the post-Christmas week... and there's a big merchandising program to help you bag the big spenders! A dealer could get rich!



*Capitol's "Day-Old Christmas Gifts" merchandising aids:

- ★ Colorful 100-Album Floor Merchandisers
- ★ Eye-Catching Window Banners
- ★ "Sale" Album Stickers
- ★ Hard-Sell B&W Newspaper Ad Mats
- ★ E-Z-Browse Divider Cards

See your Capitol
Records rep.
NOW!



CBS & Sony Forming Label In Japan

NEW YORK — The Columbia Broadcasting System and Sony Corporation plan to form CBS/Sony Records in Japan, it was announced last week.

The CBS/Sony tie will dissolve CBS Records' licensing agreement with Nippon Columbia, which, despite its name, has no corporate association with CBS.

The venture, a 50/50 partnership, will produce, manufacture and distribute records, pre-recorded tapes and music publications. The wide range of repertoire of CBS Records and CBS International will flow through the new company, which will

be established as soon as approval from the Japanese Government is received. The new company will also record Japanese music and musicians, both classical and pop, and market these recordings throughout the world.

The deal is being negotiated in Japan by Goddard Lieberman, president of the CBS/Columbia Group, Harvey Schein, president of CBS Int'l, and Akio Morita, executive vice president of Sony, and Nurio Ohga, director and general manager of Sony. Both Lieberman and Schein were still in Japan at week's end.

'I. M. Flowers Show' Blossoms Over FM Into Major Disk Act Exposure

NEW YORK—"The I.M. Flowers Show," a rock program over FM radio whose format is as far-out as many of its record acts, is luring a nationwide audience as well as major sponsor label sponsorship.

A program that eschews the conventional Top 40 deejay style, it is aired "live" over WCBS-FM in New York on Fridays and Saturdays from 11 pm to 1 AM, and taped versions are syndicated over the same time period to six CBS-affiliated FM outlets.

According to John C. DeWitt, producer of CBS/FM and responsible for program development, the show is a "world unto itself." It is an outgrowth, DeWitt explains, of the evolution of a rock sound whose content, music and lyrics, is "saying something."

Reading from a prepared script,

FRONT COVER:



Professor Henry Higgins is Doctor Dolittle now. Rex Harrison, the star of the classic "My Fair Lady," adds another major musical role to his career, as the lead in the new 20th Century Fox film, "Doctor Dolittle," which premieres this week (19) in New York. The 20th Century Fox Records' soundtrack, distributed by ABC Records, is already a chart-seller, and should really get going as the film saturates the nation's as well as the world's movie houses. The Leslie Bricusse score has received some of the most extensive disk coverage of any musical, film or stage vehicle, in years. (See separate story Pg. 105)

FOR INDEX

SEE PGS. 10-12

Transcontinental Investing's purchase of the Tip Top rack operation of San Francisco, indicated in last week's issue was confirmed at press time. More details next week.

I.M. Flowers, a "mystique" pseudonym for a former New York record promotion man, sets a tone right out of psychedelia, leaning heavily on sensual prose and rhyme schemes. This mood is further enhanced by the use of an echo chamber and filtering.

The program was first conceived last April. A pilot program was aired in July in Oklahoma City, which DeWitt feels contains a good-cross section of various markets, including the 17 to 23 age bracket that the show zeros-in-on. The regular schedule began on Oct. 6.

Label Sponsorship

A number of labels with acts that fit the show's programming concept have become sponsors. This consists of 1 hour sponsorship by two companies each night. So far, Mercury Records, Elektra Records, Tower Records have bought time, with commercials consisting of 60-second opening and closing spots and 5 1-minute spots throughout the show. DeWitt said that

(Continued on page 102)

Larry Newton Renews Pact With ABC

NEW YORK—Larry Newton, president of ABC Records, has signed a new long-term contract with the American Broadcasting Companies, the parent company. Sam Clark, former ABC president and now group vp in charge of non-broadcasting operations for ABC, said that the new pact had been granted in recognition of "outstanding achievement during the three years he has headed the ABC record division."

Headed Label Expansion

Clark noted that Newton had expanded and improved the distribution of ABC Records and had attracted to the label an "additional number of top recording stars." Newton has also ne-



Larry Newton

Gavin Radio Conference Historic First; As Two Nearly \$2 Bill Industries Meet

LAS VEGAS—Two near-billion dollar-per-year industries, radio and records, converged here at the Riviera Hotel on Dec. 8-10 to pay tribute to their own as well as exchange ideas. Billed as the "Bill Gavin Radio Program Conference," it was a significant first for both burgeoning businesses, attended by approximately 600 execs, reps, jocks, promomen, producers and music librarians. A tribute as well to Gavin who conceived the seminar.

Saturday was devoted to a seven-

hour discussion of "Trends and Problems in Radio Programming" (a total of 19 speakers from both radio and records) with an awards banquet (see complete awards list on pg. 66) and special stage show featuring Ed Ames, Ray Price and the Baja Marimba Band. Sunday produced some heated panel discussions on pop, non-rock, rhythm and blues and country/western programming.

Pat O'Day Keynoter

Program director for KJR, Pat O'Day, in his keynote address, noted that the last meet in Chicago some 20 months ago was relegated to radio personnel only. "There is one great misconception," he said, "that the music business is constantly indebted to the radio industry. . . I'm afraid that we need you more than you need us." (Yet Atlantic's Jerry Wexler, later in the day, said, "The truth is, on a personal level we mingle very well with radio people . . . but in the

Whitney Young: Respond To Needs Of The Negro

LAS VEGAS — Whitney M. Young, Jr., executive director of the National Urban League, was the final speaker at the Bill Gavin seminar, and drew a standing ovation as he closed with an appeal to both industries that they respond to the Negro's needs. Equal opportunity, he said, is only a theory in America. "But in reality there's still a gap as great as it was 20 or 30 years ago."

"Stop generalizing," was his suggestion to radio and other media. "Negroes did not riot in Newark — some Negroes did . . . add positives . . . if all we feed the Negro is a daily dose of negatives then we're playing with fire — the next fire may consume all of us . . . intergrate yourself with Negroes in policy making positions, carry Urban League radio shows, training opportunity programs . . . respond to the Negro who has given so much to America." Or else—"we're going to be hurt — as people. We will never be able to explain to a generation yet unborn why we, who had so much, were unwilling to give it to others."

Gavin Awards List Pg. 66

business relationship we're on sufferance. We mustn't transgress and the relationship, really, is a set of rules . . . 'don't come 'til Friday. They're too long, shorten them. They're too dirty, clean 'em up.'")

"Twenty months ago," O'Day recalled, "the middle of the road radio people listened with interest to stories of how KLAC had just blitzed L.A. with an all-talk format . . . the top 40 delegates were concerned over diminishing numbers with an eye over their shoulder on Drake and Shenault. . . In the past 20 months we have improved . . . are giving the public better and better radio. Yet there is an area where we have lost ground . . . one glaring failure . . . we are failing to inspire, groom and nurture the men that must develop if we ourselves are to advance . . . if our group present this morning pledges to return home and give the time, effort and interest to those for whom we are responsible, pledge to unselfishly share our knowledge, our experience and failures. If we do this one thing the expense and effort of delegates, the cost of flying them over a million miles to gather here, will be more than justified. . . Let's return and become teachers . . . let's let our people join our industry and become part of what we're doing."

Improving Communications

Joe Smith, v.p. and general manager Warner Bros.-7 Arts Records, (Continued on page 198)

Sholes' NARAS Luncheon: Nostalgia & Good-Humor

NEW YORK—Nostalgia and good-humor were in good supply at a luncheon here last week in honor of Steve Sholes, RCA Victor Records pop A&R vp.

Affair, held last Tuesday (12) at the Americana Hotel, was sponsored by the New York chapter of NARAS, the disk awards society. Father Norman J. O'Connor, president of the chapter, said the luncheon had inaugurated a series of similar fetes in tribute to major industry figures.

A light-hearted touch figured in both verbal and pictorial thumb-nail bios of the exec, who has been associated with RCA since 1929, when he joined the company while still attending high school. In addition, as the guests ate, Sholes' industry years were measured by 44 taped selections of hits he has produced over the last 20 years, including classic sides by Eddy Arnold, Elvis Presley, Jim Reeves, Louis Armstrong, Coleman Hawkins, Hank Snow, Henry Mancini, Elton Britt, Earl Hines-Billy Eckstine and many others. This gesture offered the broad nature of Sholes' musical

(Continued on page 102)

Otis Redding, Bar-Kays Deaths Add Sad Note To Holiday Season

NEW YORK—Otis Redding, one of the top R&B performers, was killed last week (10) when his twin engined Beechcraft jet enroute from Cleveland undershot the runway at Madison, Wis., and plunged into the icy waters of Lake Monona. The plane, Redding's for only two months, was piloted by 28-year-old Richard Fraser, who also perished in the crash. Ben Cauley (20), a member of the Bar-Kays, was the only survivor; four members of the group (Phalon Jones, Jimmie King, Carl Cunnig-

ham, and Ronald Caldwell) were killed as was Redding's valet, Matthew Kelly. James Alexander, the only other surviving Bar-Kay, was traveling by a commercial airline at the time.

Redding was buried in Macon, Ga. last Fri., Dec. 15. Jerry Wexler, executive vice president of Atlantic Records, eulogized the nationally famed chanter at the ceremony.

The 26-year-old Redding, who lived in Macon, Ga., was an enthu-

(Continued on page 102)

THE STRAWBERRY ALARMS



WITH THEIR NEW

TOMORROW

B/W **"BIRDS IN**

UNI 55046

CLOCK STRIKES AGAIN!!!

MASH SINGLE

R R O W

MY TREE"

UNIVERSAL CITY RECORDS • A DIVISION OF MCA INC.



INDEX OF FEATURES

YEAR-END SUMMARY

Best Albums Of 1967.....	24
Best Albums Of 1967 (Country).....	111
Best Artists Of 1967 On Albums.....	26
Best Artists Of 1967 On Singles.....	20
Best Artists Of 1967 On Singles (Country).....	111
Best Artists Of 1967 On Singles (R&B).....	70
Bios Of Leading Artists Of 1967.....	52, 54, 56, 58, 60, 62, 64
Golden Albums.....	30, 42
Million Sellers (Singles).....	28, 30, 32, 34
NARAS Poll Winners.....	42
Necrology 1967.....	80
Producers Of Top 100 Hits.....	74, 76
Top 100 Chart Hits Of 1967 (With Publishers And Writers).....	16, 18
Top Country Chart Hits Of 1967.....	111
Top R&B Chart Hits Of 1967.....	68
Top Songs Of Each Month In 1967.....	36
Top Albums For Past 7 Years.....	72
Top R&B Hits For Past 7 Years.....	72, 74
Top Singles Hits Of The Past 19 Years.....	44, 46, 48
Year In Review—1967.....	48, 50

WEEKLY FEATURES

Album Reviews.....	107, 108
Basic Album Inventory.....	104
Bios For DJ's.....	106
Christmas Activity List.....	102
Country Music Section.....	110-114
Looking Ahead (Singles).....	84
Platter Spinner Patter.....	106
Radio Active Chart.....	82
R & B Top 50.....	99
Record Ramblings.....	94
Single Reviews.....	90, 92
Sure Shots.....	98
Top 100 Albums.....	103
Top 100 Labels.....	100

INTERNATIONAL SECTION

Argentina.....	49
Australia.....	56
Denmark.....	54
Finland.....	55
France.....	44
Germany.....	46
Great Britain.....	2
Holland.....	57
Italy.....	26
Japan.....	53
Norway.....	53
Spain.....	40
Sweden.....	53

#1 FEMALE NEWCOMER (R&B) IN '67

*Thank You Cash Box
and Everyone!*

Bettye Swann



**RECENTLY CLOSED AT BIMBO'S IN S.F., CURRENTLY TOURING SUPPER CLUBS
AND CAMPUSES. NEWEST LP "MAKE ME YOURS" ON MONEY RECORDS.**

**PERSONAL MANAGER
GEORGE BARTON
LOS ANGELES, CALIF.
933-7853**

**MUS-ART CORP. OF AMERICA
HOLLYWOOD—LAS VEGAS—
LONDON**

Peace

**THE MAMAS
& THE PAPAS**



JULY 30

LOU,
I THINK WE SHOULD
RECORD SCOTT MCKENZIE.
John

Twin Pines Hospital
And Rest Home

Dear Lou & John,
Thanks for the worry-free life
of leisure.

Scott

Aug 2

John
You're right.
He's great —
Will he record?
Lou

AUGUST 5

LOU,
SCOTT WILL RECORD.
I PROMISED HIM A WORRY-
FREE LIFE OF LEISURE.
John



ON OFE

PRODUCED BY JOHN PHILLIPS & LOU ADLER

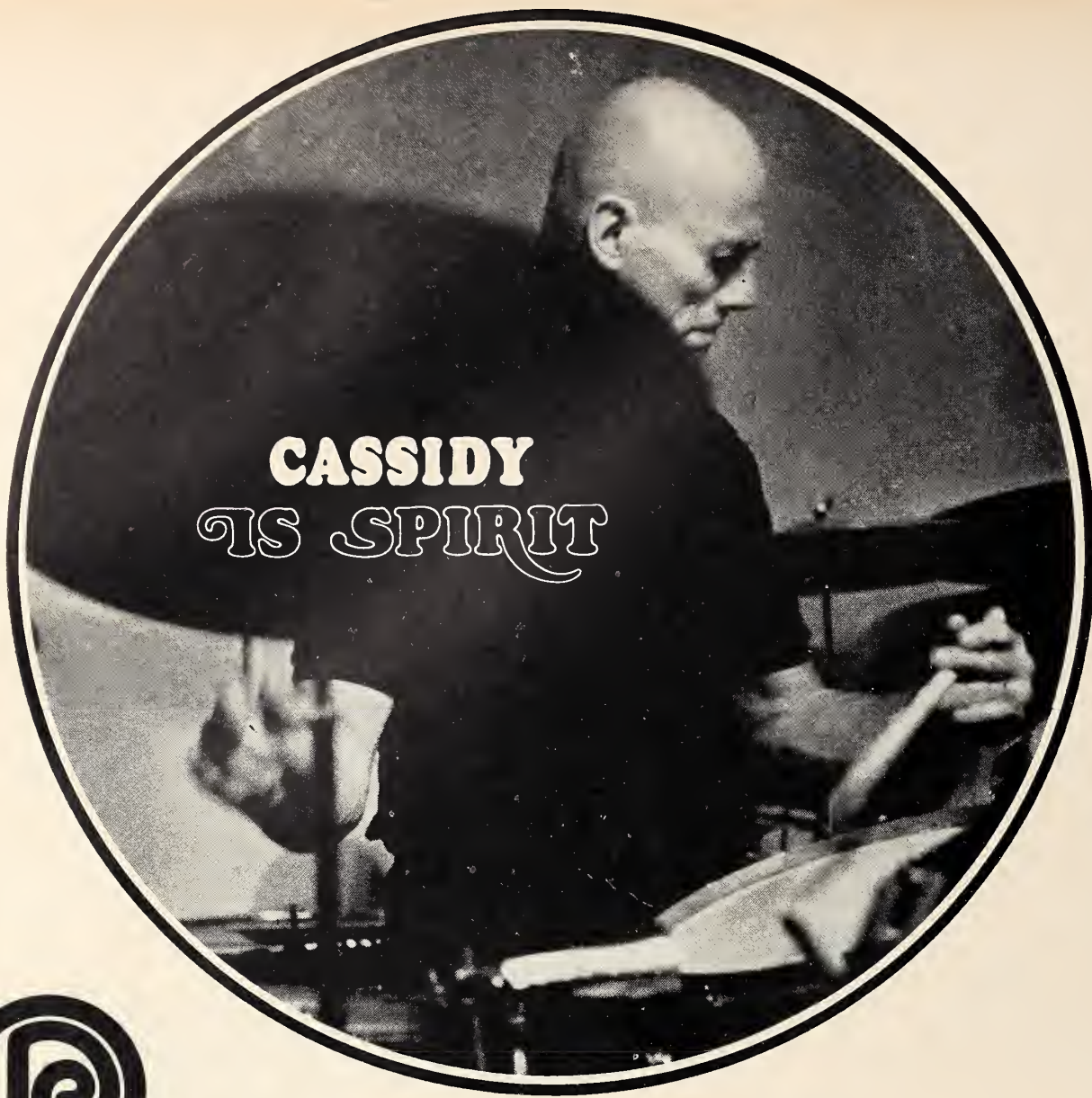

CASSIDY
AS SPIRIT



ON ODE



RANDY CALIFORNIA
AS SPIRIT

MARK ANDES
AS SPIRIT

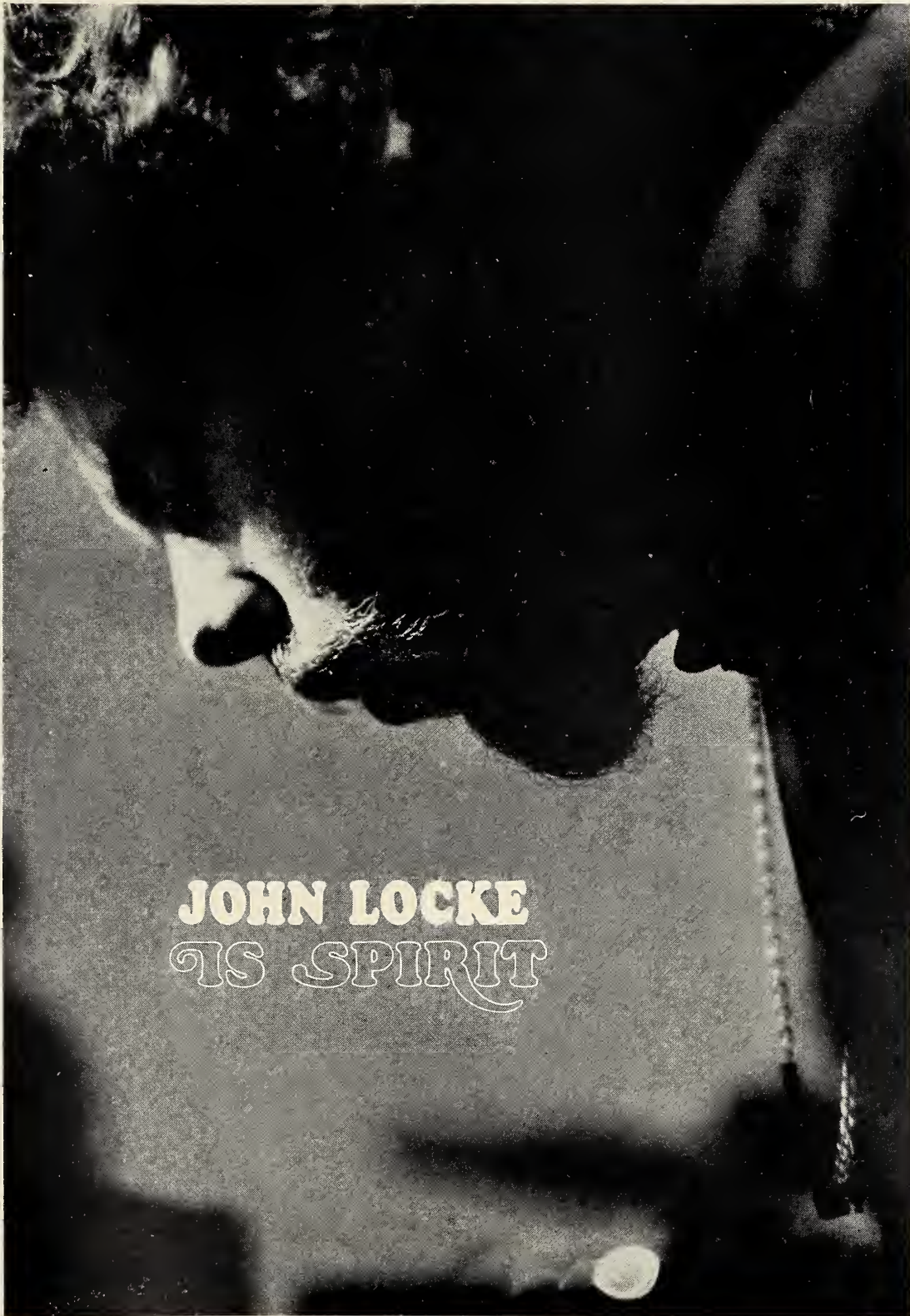

JOHN LOCKE
AS SPIRIT

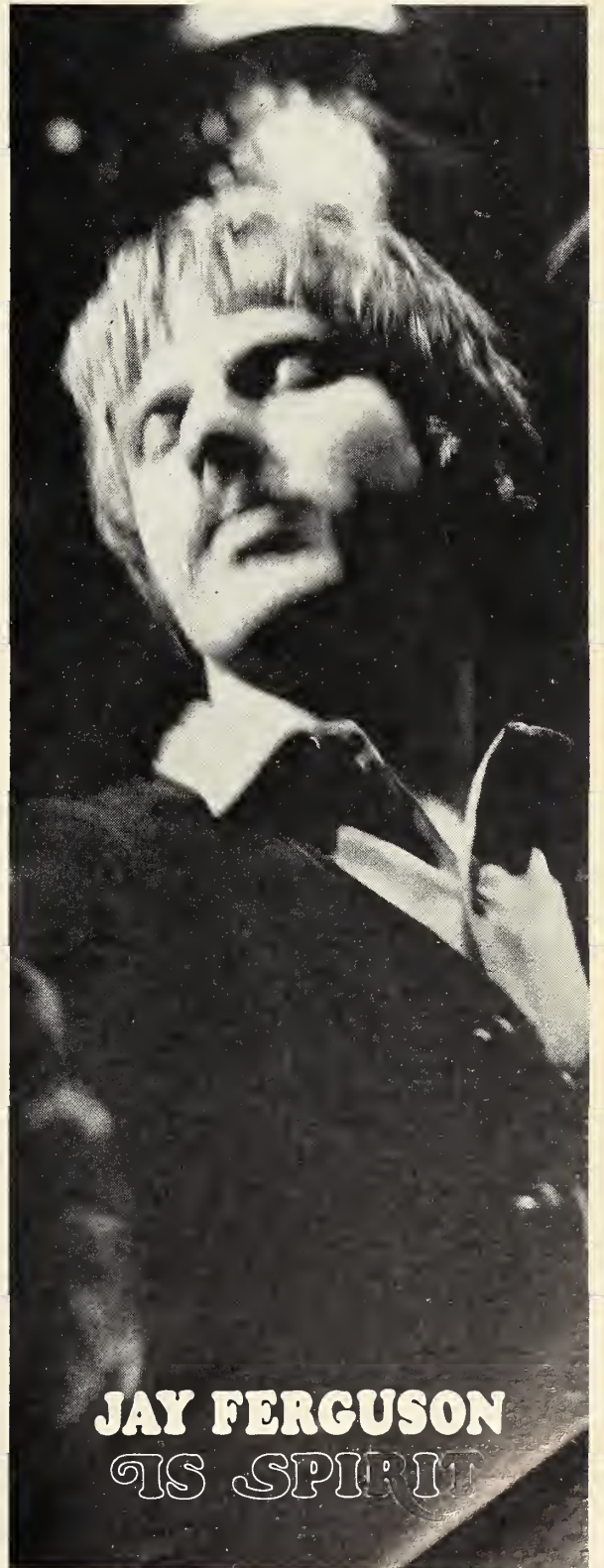

JAY FERGUSON
AS SPIRIT

Top 100 Chart Hits of 1967

A COMPILATION OF THE YEAR'S BIGGEST HITS COMPILED FROM THE WEEKLY CASH BOX TOP 100 LIST. LIST IS COMPILED AS FOLLOWS: FOR EACH WEEK A SONG IS #1 IT RECEIVES 135 POINTS. EACH #2 SONG IS AWARDED 124 POINTS. #3 GETS 123 #4 GETS 122 #5 GETS 121. #6 THRU #10 GETS 115 TO 111. #11 SONG GETS 90 POINTS AND SO ON DOWN THE LINE TILL #50 SONG WHICH GETS 51 POINTS. ONLY THE TOP FIFTY TITLES OF ANY GIVEN WEEK ARE INCLUDED IN THE SURVEY. SURVEY BEGINS WITH THE FIRST ISSUE IN JANUARY.

	Total Points
1. Letter—Box Tops—Mala Barton—BMI—Carson	1502
2. Light My Fire—Doors—Elektra 45615—Nipper ASCAP—Doors	1460
3. Can't Take My Eyes Off You—Frankie Valli—Philips 40446—Saturday & Seasons Four—BMI—Crewe, Gaudio	1458
4. Ode To Billie Joe—Bobbie Gentry—Capitol 5950—Shayne—ASCAP—Gentry	1443
5. To Sir With Love—Lulu—Epic 40187—Screen Gems—Columbia—BMI—Black, London	1428
6. Happy Together—Turtles—White Whale 244—Chardon—BMI—Banner, Gordon	1409
7. Windy—Association—Warner Bros. 7041—Irving—BMI—Friedman	1375
8. I'm A Believer—Monkees—Colgems 1002—Screen Gems—Columbia—BMI—Diamond	1373
9. Groovin—Young Rascals—Atlantic 2401—Slacar—BMI—Cavaliere, Brigati	1353
10. Respect—Aretha Franklin—Atlantic 2403—East, Time—BMI—Redding	1277
11. Georgy Girl—Seekers—Capitol 5756—Chappell—ASCAP—Springfield, Daele	1259
12. I Think We're Alone Now—Tommy James & Shondells—Roulette 4720—Kama Sutra, Patricia—BMI—Cordell	1257
13. Something Stupid—Frank & Nancy Sinatra—Reprise 0561—Green Wood—BMI—Parks	1252
14. Soul Man—Sam & Dave—Stax 231—East, Pronto—BMI—Haynes, Porter	1250
15. Come Back When You Grow Up—Bobby Vee—Liberty 55964—Painted Desert—BMI	1246
16. Sweet Soul Music—Arthur Conley—Atco 6463—Redwal—BMI—Redding, Conley	1232
17. Ruby Tuesday—Rolling Stones—London 904—Gideon—BMI—Jagger, Richards	1224
18. Kind Of A Drag—Buckingham—USA 896—Maryon—BMI	1220
19. A Little Bit Of Soul—Music Explosion—Laurie 3380—Southern—ASCAP—Carter, Lewis	1190
20. I Got Rhythm—Happenings—B. T. Puppy 527—New World—ASCAP—George & Ira Gershwin	1183
21. Reflections—Supremes—Motown 1111—Jobete—BMI—Holland, Dozier, Holland	1153
22. Somebody To Love—Jefferson Airplane—RCA 9140—Copper, Penny—BMI—Slick	1148
23. The Happening—Supremes—Motown 1107—Jobete—BMI—Holland, Dozier, Holland, Devol	1138
24. She Rather Be With Me—Turtles—White Whale 249—Chardon—BMI—Banner, Gordon	1108
25. Come On Down To My Boat—Every Mother's Son—MGM 13733—Picture Tone, Goldstein—BMI—Ferrell, Goldstein	1099
26. I Was Made To Love Her—Stevie Wonder—Tamla 54151—Jobete—BMI—Cosby, Hardaway, May, Wonder	1097
27. Incense & Peppermints—Strawberry Alarm Clock—UNI 55018—Claridge—ASCAP—Carter Gilbert	1093
28. Then You Can Tell My Goodbye—Casinos—Fraternity 977—Acuff—Rose—BMI—Laudermilk	1087
29. Apples, Peaches & Pumpkin Pie—Jay & Techniques—Smash 2086—Leaps & Bounds, Act III—Irby	1083
30. A Little Bit Me, A Little Bit You—Monkees—Colgems 1004—Screen Gems, Columbia—BMI—Diamond	1083
31. The Rain, The Park & Other Things—Cowsills—MGM 13810—Akbestal, Luvlin—BMI—Kornfield, Duboff	1081
32. Mercy, Mercy, Mercy—Buckingham—Columbia 44182—Zawinul—BMI—Zawinul	1080
33. Never My Love—Association—Warner Bros. 7074—Tamerlane—BMI—Don & Dick Addriss	1070
33. It Must Be Him—Vikki Carr—Liberty 55986—Asa—ASCAP—Becaude, Davie	1070
35. There's A Kind Of A Hush—Herman's Hermits—MGM 13681—Leo Feist—BMI—Stevens, Reed	1062
36. We Ain't Got Nothing Yet—Blues Magoos—Mercury—72622—Amanga, Ranga—BMI—Scala & Esposito	1059
37. Dedicated To The One I Love—Mamas & Papas—Dunhill 4077—Trousedale—BMI—Pauling, Bass	1059
38. Don't You Care—Buckingham—Columbia 91624—Beechwood, Macbeth—BMI—Holvay, Bisbier, Guercio	1056
39. This Is My Song—Petula Clark—Warner Bros. 7002—Shamley—ASCAP—Chaplin	1041
40. Love Is Here & Now You're Gone—Supremes—Motown 1103—Jobete—BMI—Holland, Dozier, Holland	1038
40. Sock It To Me—Mitch Ryder & Detroit Wheels—New Voice 820—Saturday—BMI—Crewe, Brown	1038
42. Release Me—Englebert Humperdinck—Parrot 40011—Four Star—BMI—Miller, California	1032
43. All You Need Is Love—Beatles—Capitol 5964—Maclen—BMI—Lennon, McCartney	1025
44. Expressway To Your Heart—Soul Survivors—Crimson 1010—Double Diamond, Downstairs—BMI—Gamble, Huff	1013
45. Penny Lane—Beatles—Capitol 5810—Maclen—BMI—Lennon, McCartney	995
46. Please Love Me Forever—Bobby Vinton—Epic 10228—Selma—BMI—Malone—O, Blanchard	988
47. A Whiter Shade Of Pale—Procol Harum—Deram 7507—Essex—ASCAP—Reed, Booker	987
48. Jimmy Mack—Martha Reeves & Vandellas—Gordy 7058—Jobete—BMI—Holland, Dozier, Holland	982
49. Baby I Love You—Aretha Franklin—Atlantic 2427—14th Hour & Pronto—BMI—Shannon	975
50. Snoopy Vs The Red Baron—Royal Guardsmen—Laurie 3366—Fuller, Sanphil, Windsong—BMI—Gernhard, Holler	972
51. How Can I Be Sure—Young Rascals—Atlantic 2438—Slacar—BMI—Cavaliere—Brigati	969
52. For What It's Worth—Buffalo Springfield—Atco 6459—Ten, East, Springalo, Cotillion—BMI—Stills	966
53. Tell It Like It Is—Aaron Neville—Parlow—101—Orlap—BMI	960
54. My Cup Runneth Over—Ed Ames—RCA 9002—Chappell—ASCAP—Jones, Schmidt	954
55. Let's Live For Today—Grass Roots—Dunhill 4084—Dick James—BMI—Mogul, Shapiro, Julien	944
56. Silence Is Golden—Tremeloes—Epic 10184—Saturday—BMI—Gaudio, Crewe	912
57. Up, Up And Away—Fifth Dimension—Soul City 756—Johnny Rivers—BMI—Webb	898
58. Carrie Anne—Hollies—Epic 10180—Maribus—BMI—Hicks, Clarke, Nash	890
59. Your Precious Love—Marvin Gaye & Tammi Terrell—Tamla 54156—Jobete—BMI—Simpton, & Ashford	889
60. White Rabbit—Jefferson Airplane—RCA 9248—Copper Penny—BMI—Slick	881
61. Brown Eyed Girl—Van Morrison—Bang 545—Web IV—BMI—Van Morrison	880
62. Pleasant Valley Sunday—Monkees—Colgems 1007—Screen Gems, Columbia—BMI—Goffin, King	873
63. Gimme Little Sign—Brenton Wood—Double Shot 116—Big Shot—ASCAP—Smith, Hoover, Winn	870
64. Green Green Grass Of Home—Tom Jones—Parrot 40009—Tree—BMI—Putnam	862
65. Cold Sweat—James Brown—King 6110—Dynatone—BMI—Brown, Ellis	861

(Continued on page 18)

Thanks To All... For Our Happiest Year!

**WATCH
FOR LOTS
OF NEW THINGS
IN THE NEW YEAR**

EVERY MOTHERS' SON

MANAGEMENT: PETER LEEDS

PUBLIC RELATIONS: DOMINIC SICILIA



TOP 100 CHART HITS OF 1967

(Continued from page 16)

	Total Points
66. The Beat Goes On—Sonny & Sher—Atco 6461—Marc, Cotillion—BMI—Bono	858
67. Higher & Higher—Jackie Wilson—Brunswick 55336—Jalynne, BRC—BMI—Jackson, Smith	856
68. 98.6—Keith—Mercury 72639—Screen Gems, Columbia—BMI—Gischoff, Powers	856
69. Funky Broadway—Wilson Pickett—Atlantic 2430—Routeen, Drive In—BMI—Christian	846
70. Society's Child—Janis Ian—Verve/Folkways 5027—Dialogue—BMI—Ian	841
71. San Francisco Flowers In Your Hair—Scott McKenzie—Ode 103—Trousdale—BMI—Philips	840
72. I Never Loved A Man The Way I Love You—Aretha Franklin—Atlantic 2386—14th Hour—BMI—Shannon	837
73. Baby I Need Your Loving—Johnny Rivers—Imperial 66227—Jobete—BMI—Holland, Dozier, Holland	831
74. Alfie—Dionne Warwick—Scepter 12187—Famous—ASCAP—Bacharach, David	811
75. You're My Everything—Temptations—Gordy 7063—Jobete—BMI—Whitfield, Penzabene	810
76. Close Your Eyes—Peaches & Herb—Date 302—Tideland—BMI—Berry	802
77. San Francisco Nights—Eric Burdon & Animals—MGM 66231—Sealark, Slamina BMI—Burdon, Briggs, Weider, Jenkins, McCulloch	800
78. Girl You'll Be A Woman Soon—Neil Diamond—Bang 542—Tallyrand—BMI—Diamond	797
79. All I Need—Temptations—Gordy 7061—Jobete—BMI—Holland, Dozier, Holland	796
79. On A Carousel—Hollies—Imperial 166231—Maribus—BMI—Clarke, Hicks, Nash	796
81. Soul Finger—The Bar—Keys—Volt 148—East—BMI—Jones, Cunningham, Cauley	793
82. Western Union—Five Americans—Abnak 118—Jet Star—BMI	789
83. Testify—Parliaments—Revilot 207—Groovesville—BMI—Taylor, Clinton	786
84. With A Girl Like You—Young Rascals—Atlantic 2424—Slacsar—BMI—Brigati & Cavaliere	784
85. I Can See For Miles—The Who—Decca 32206—Essex—ASCAP—Townshend	782
86. C'mon Marianne—Four Seasons—Philips 40460—Saturday, Seasons Four—BMI—Brown, Bloodworth	778
87. Bernadette—Four Tops—Motown 1104—Jobete—BMI—Holland, Dozier, Holland	777
88. Creeque Alley—Mamas & Papas—Dunhill 4083—Trousdale—BMI—Philips, Gilliam	772
89. More Love—Smokey Robinson & Miracles—Tamla 54152—Jobete—BMI—Robinson	767
90. Don't Sleep In The Subway—Petula Clark—Warner Bros. 7049—Duchess—BMI—Trent, Hatch	766
91. You Know What I Mean—Turtles—White Whale 254—Chardon—BMI—Gordon, Banner	765
92. I've Been Lonely Too Long—Young Rascals—Atlantic 2377—Slacsar—BMI—Cavaliere, Brigatii	760
93. Let It Out—Hombres—Verve/Forecast 5058—Crazy Cajun—BMI—Cunningham	756
94. California Nights—Lesley Gore—Mercury 72649—Genius, Enchanted—BMI—Hamlisch, Liebling	756
95. Him Or Me What's It Gonna Be—Paul Revere & Raiders—Columbia 44094—Daywin—BMI—Lindsey & Melcher	756
96. There Is A Mountain—Donovan—Epic 10202—Peer Int'l, Hi Count—BMI—Leitch	750
97. Ding Dong The Witch Is Dead—5th Estate—Jubilee 5573—Leo Feist—Arlen, Harburg	749
98. Good Thing—Paul Revere & Raiders—Columbia 43907—Daywin—BMI—Lindsay, Melcher	749
99. Dandelion—Rolling Stones—London 905—Gideon—BMI—Jagger, Richards	747
100. Sunday Will Never Be The Same—Spanky & Our Gang—Mercury 72679—Pamco—BMI—Wisner	741

#3 MALE VOCALIST (ALBUMS) FOR '67

**THE GREATEST
NEWS SINCE
BLACK PEPPER!**

LOU RAWLS

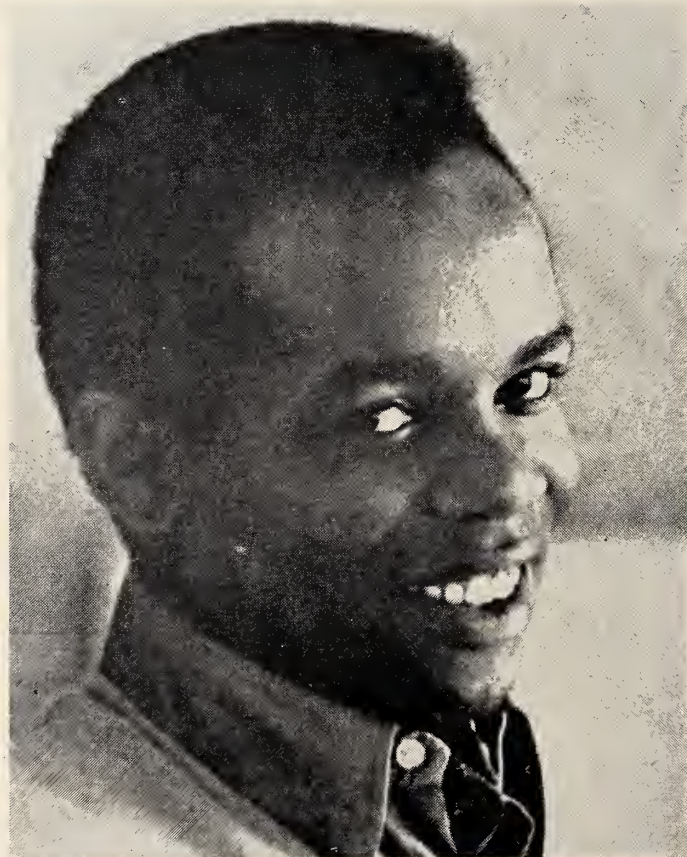

Exclusive Booking

Associated Booking Corp.

Joe Glaser



Personal Management

J. W. Alexander

*It was a wonderful year—
My deepest thanks to all
who made it possible.
Warmest wishes,
Bobbie Gentry*

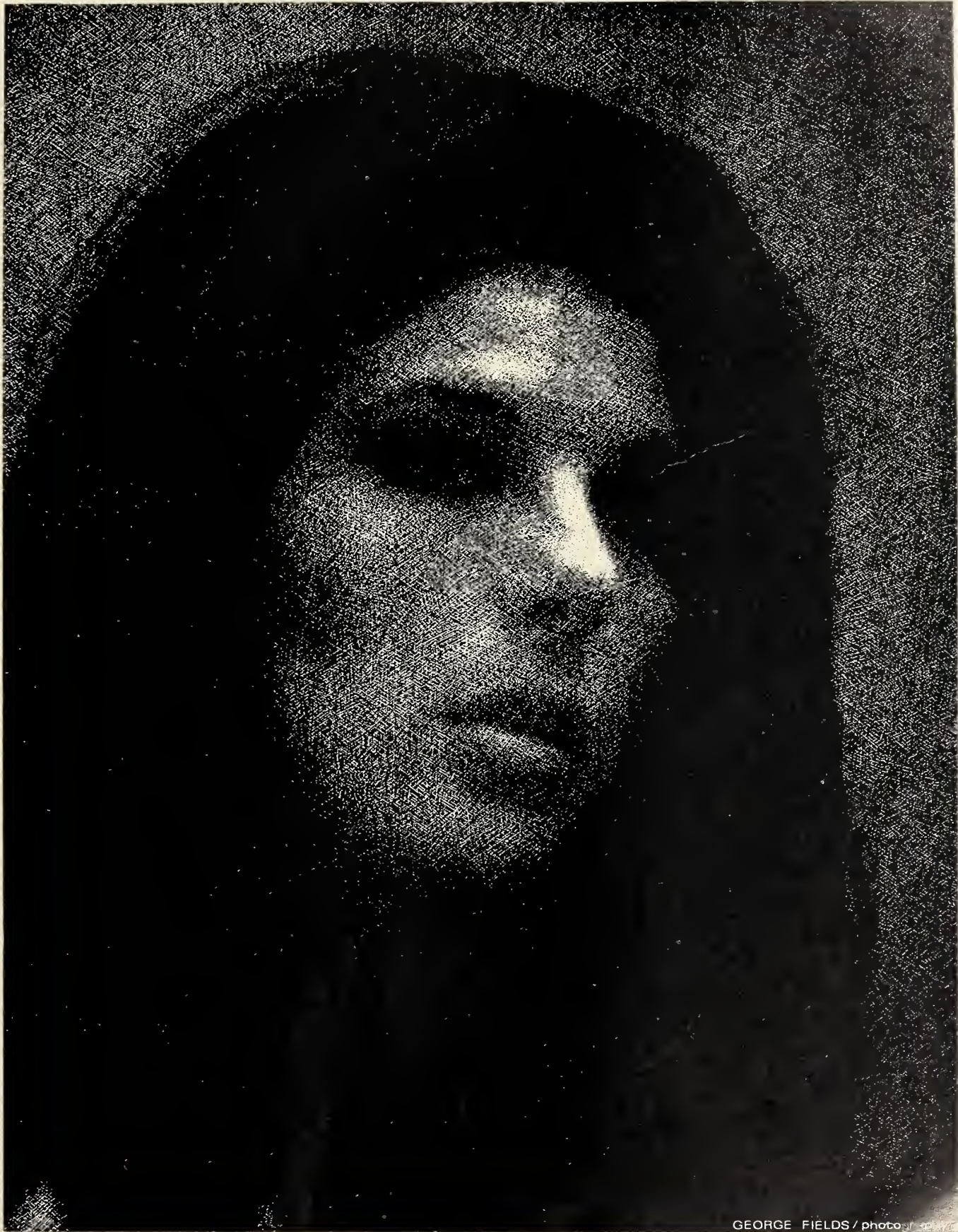

GEORGE FIELDS / photo



PERSONAL MANAGEMENT:
JESS RAND ASSOCIATES
BEVERLY HILLS, CALIF.

Best Artists of 1967 on Singles

A TABULATION OF ARTISTS WHO ACHIEVED GREATEST SUCCESS IN THE FIELD OF SINGLE RECORDS ACCORDING TO THE WEEKLY CASH BOX TOP 100 BEST SELLER LIST. NAMES LISTED BELOW ARE IN ORDER OF STRENGTH IN THEIR VARIOUS CATEGORIES BASED ON A WEIGHTED POINT SYSTEM WHICH GIVES CREDIT FOR LONGEVITY ON TOP 100 AS WELL AS HEIGHT ATTAINED ON CHART. ALL TITLES WHICH APPEARED ON THE TOP 100 WERE USED FOR AN ARTIST'S TOTAL. THE SUM TOTAL OF ALL OF AN ARTIST'S HITS RESULTED IN THE POSITIONING OF A NAME.

TOP MALE VOCALISTS

- tie { 1. FRANK SINATRA
1. NEIL DIAMOND
2. STEVIE WONDER
 3. FRANKIE VALLI
 4. Donovan
 5. Wilson Pickett
 6. Tom Jones
 7. James Brown
 8. Johnny Rivers
 9. Arthur Conley
 10. Otis Redding
 11. Bobby Vee
 12. Keith
 13. Elvis Presley
 14. Bobby Vinton
 15. Ed Ames
 16. Jackie Wilson
 17. Sonny Bono
 18. Ray Charles
 19. Joe Tex
 20. Al Martino
 21. Ronnie Dove
 22. Jimmy Ruffin
 23. Dean Martin
 24. Lou Rawls
 25. Frankie Laine
 26. P. J. Proby
 27. Jack Jones
 28. Toussaint McCall
 29. Tommy Roe
 30. Jimmie Rodgers
 31. Marvin Gaye
 32. James Darren
 33. Bobby Goldsboro
 34. Bobby Darin
 35. Roger Miller
 36. Percy Sledge
 37. Roy Orbison
 38. Al Kent
 39. Gene Chandler

TOP FEMALE VOCALISTS

1. ARETHA FRANKLIN
2. NANCY SINATRA
3. PETULA CLARK
4. Dusty Springfield
5. Dionne Warwick
6. Sandy Posey
7. Vikki Carr
8. Lesley Gore
9. Carla Thomas
10. Miriam Makeba

TOP DUOS

1. PEACHES & HERB
2. MARVIN GAYE & TAMMI TERRELL
3. NANCY SINATRA & LEE HAZELWOOD
4. Frank Sinatra & Nancy Sinatra
5. James & Bobby Purify
6. Simon & Garfunkel
7. Sam & Dave
8. Peter & Gordon
9. Jon & Robin
10. Otis Redding & Carla Thomas
11. Tommy Boyce & Bobby Hart

TOP INSTRUMENTALISTS

1. HERB ALPERT
2. BOOKER T & THE MG'S
3. BOB CREWE GENERATION
4. Cannonball Adderley
5. New Vaudeville Band
6. King Curtis
7. David Allen & Arrows
8. Roger Williams
9. Nitty Gritty Dirt Band
10. Yardbirds

TOP VOCAL GROUPS

1. MONKEES
2. DIANA ROSS & THE SUPREMES
3. YOUNG RASCALS
4. Mamas & Papas
5. Beatles
6. Four Tops
7. Paul Revere & The Raiders
8. Herman's Hermits
9. Rolling Stones
10. Association
11. Temptations
12. Four Seasons
13. Mitch Ryder & The Detroit Wheels
14. Hollies
15. Lovin' Spoonful
16. Tremeloes
17. Animals
18. Seekers
19. Martha Reeves & The Vandellas
20. Gary Lewis & The Playboys
21. Marvelettes
22. Smokey Robinson & The Miracles
23. Beach Boys
24. Dave Clark Five
25. Byrds
26. Bar-Kays
27. Left Banke
28. Platters
29. Peter, Paul & Mary
30. Jr. Walker & The All Stars
31. Tokens
32. Sam The Sham & The Pharoahs
33. Innocence
34. Seeds
35. Critters
36. Pozo Seco Singers

TOP NEW MALE VOCALISTS

1. ENGLEBERT HUMPERDINCK
2. SCOTT MCKENZIE
3. BRENTON WOOD
4. Aaron Neville
5. Van Morrison
6. Bill Cosby
7. Robert Knight
8. Spyder Turner
9. Bunny Sigler
10. Freddie Scott
11. Oscar Toney Jr.
12. Chris Bartley
13. Jimmy Castor
14. Mickey Murray
15. Prince Buster

TOP NEW VOCAL GROUPS

1. BUCKINGHAMS
2. TURTLES
3. TOMMY JAMES & THE SHONDELLS
4. Jefferson Airplane
5. Doors
6. Happenings
7. Bee-Gees
8. Royal Guardsmen
9. Spencer Davis Group
10. Spanky & Our Gang
11. Every Mother's Son
12. Box Tops
13. Fifth Dimension
14. Jay & The Techniques
15. Grass Roots
16. Music Explosion
17. Procol Harum
18. The Who
19. Blues Magoos
20. Five Americans
21. Casinos
22. Electric Prunes
23. Parliaments
24. Fifth Estate
25. Strawberry Alarm Clock
26. Cowsills
27. Easybeats
28. Soul Survivors
29. Harper's Bizarre
30. Brenda & The Tabulations
31. Sopwith Camel
32. Esquires
33. Parade
34. Hombres
35. Music Machine
36. ? & The Mysterians
37. Ohio Express
38. Mojo Men
39. Yellow Balloon
40. Terry Knight & The Pack
41. Forum
42. Youngbloods
43. Emperors

TOP NEW FEMALE VOCALISTS

1. BOBBIE GENTRY
2. LULU
3. JANIS IAN
4. Bettye Swann
5. Linda Jones

SINCEREST SEASON'S GREETINGS

FROM

ALL THE STAFF AT

UNITED RECORD DISTRIBUTORS, INC.

1827 South Michigan Ave., Chicago 16, Illinois
(All Phones: CAlumet 5-6605)

PROMOTION STAFFERS

BILL LEANER—MIKE ALLEN

LEROY PHILLIPS—COREY WADE

"JACK OF ALL TRADES"—ERNIE LEANER

best
newcomer
male
vocalist
[SINGLES] #6
in 1967



#1 comedy artist of 1967

PRODUCER / ROY SILVER



I wish to thank the
for making 1967 another
Beach Boys and Sea of

I especially want to
broadcasters who have
“The Plumber’s Tune,”
40-year-old plumber
(You’ve really made
Christmas for him.)

Sea of Tunes Publishing Co.
9042 La Alba Drive
Whittier, California 90603
(213) 697-4655

21
22
21
3

entire music industry
great year for The
Tunes Publishing Company.

thank all the wonderful
embraced Capitol Records'
written by Eck Kynor, a
from Whittier, California
this an unforgettable

Sincerely,
Murry (Dad) Wilson

Public Relations:
Fred Stuart Associates
9126 Sunset Blvd.
Los Angeles, California 90069
(213) 274-0674

BEST ALBUMS OF 1967

A TABULATION OF ALBUMS WHICH ACHIEVED GREATEST SUCCESS ON THE CHARTS ACCORDING TO THE WEEKLY CASH BOX TOP 100 LP BEST SELLER LIST. TITLES LISTED BELOW ARE IN ORDER OF STRENGTH BASED ON A WEIGHTED POINT SYSTEM WHICH GIVES CREDIT FOR LONGEVITY ON TOP 100 AS WELL AS HEIGHT ATTAINED ON CHART. ALL TITLES WHICH APPEARED ON THE TOP 100 WERE USED FOR THIS SURVEY. THE SUM TOTAL OF EACH TITLE RESULTED IN THE POSITIONING OF THE ALBUM.

	Total Points		Total Points
1. Dr. Zhivago—Soundtrack—MGM	5641	32. Groovin—Young Rascals—Atlantic	1617
2. Sound of Music—Soundtrack—RCA	4840	33. 4-Tops-Live—Motown	1585
3. A Man & A Woman—Soundtrack—United Artists	3776	34. Diana Ross & Supremes Greatest Hits—Motown	1562
4. More of the Monkees—Colgems	3634	35. Aretha Arrives—Aretha Franklin—Atlantic	1496
5. Sgt. Pepper's Lonely Hearts Club Band—Beatles—Capitol	3321	36. The Byrds' Greatest Hits	1449
6. Surrealistic Pillow—Jefferson Airplane—RCA	3301	37. Here Where There Is Love—Dionne Warwick—Scepter	1445
7. S.R.O.—Herb Alpert & Tijuana Brass—A&M	3262	38. Ode To Billie Joe—Bobbie Gentry—Capitol	1433
8. The Monkees—Colgems	3012	39. Album 1700—Peter Paul & Mary—Warner Bros.	1426
9. Monkees Headquarters—Colgems	2829	40. Claudine—Claudine Longet—A&M	1424
10. Doors—Elektra	2820	41. Are You Experienced—Jimi Hendrix Experience—Warner Bros.	1391
11. Sounds Like—Herb Alpert & Tijuana Brass—A&M	2776	42. Temptations-Live—Gordy	1330
12. Revenge—Bill Cosby—Warner Bros.	2773	43. Mamas & Papas—Dunhill	1322
13. I Never Loved A Man—Aretha Franklin—Atlantic	2724	44. Georgy Girl—Seekers—Capitol	1311
14. Mamas & Papas Deliver—Dunhill	2524	45. Reach Out—4 Tops—Motown	1298
15. The Best of Lovin' Spoonful—Kama Sutra	2274	46. In the Arms of Love—Andy Williams—Columbia	1279
16. Born Free—Andy Williams—Columbia	2253	47. Bee Gees 1st—ATCO	1248
17. Collections—Young Rascals—Atlantic	2251	48. There's a Kind of a Hush All Over the World—Herman's Hermits—MGM	1246
18. Whipped Cream & Other Delights—Herb Alpert & Tijuana Brass—A&M	2230	49. 4 Tops Greatest Hits—Motown	1244
19. Wonderfulness—Bill Cosby—Warner Bros.	2196	50. Vanilla Fudge—ATCO	1229
20. Release Me—Engelbert Humperdinck—Parrot	2149	51. Francis Albert Sinatra & Antonio Carlos Jobin—Reprise	1215
21. That's Life—Frank Sinatra—Reprise	2025	52. Thoroughly Modern Millie—Soundtrack—Decca	1210
22. Flowers—Rolling Stones—London	2018	53. Carryin' On—Lou Rawls—Capitol	1181
23. Insight Out—Association—Warner Bros.	2012	54. Winchester Cathedral—New Vaudeville Band—Fontana	1174
24. Born Free—Roger Williams—Kapp	1994	55. With A Lot O'Soul—Temptations—Gordy	1152
25. Paul Revere & The Raiders Greatest Hits—Columbia	1944	56. Got Live If You Want It—Rolling Stones—London	1147
26. Between the Buttons—Rolling Stones—London	1906	57. Temptations Greatest Hits—Gordy	1129
27. Spirit of '67—Paul Revere & The Raiders—Columbia	1791	58. Hollies Greatest Hits—Imperial	1124
28. My Cup Runneth Over—Ed Ames—RCA	1744	59. Hums of Lovin' Spoonful—Kama Sutra	1090
29. Bob Dylan's Greatest Hits—Columbia	1692	60. Up, Up, and Away—5th Dimension—Soul City	1074
30. Supremes Sing Holland, Dozier, Holland—Motown	1675	60. Super Hits—Various Artists—Atlantic	1074
31. Cabaret—Original Cast—Columbia	1655	62. Too Much—Lou Rawls—Capitol	1014
		63. Sugar—Nancy Sinatra—Reprise	993
		64. To Sir With Love—Soundtrack—Fontana	982
		65. Tiny Bubbles—Don Ho—Reprise	959
		66. Equinox—Sergio Mendes & Brasil 66—A&M	952
		67. 2nd Gold Vault of Hits—4 Seasons—Philips	950
		68. Somewhere My Love—Ray Conniff—Columbia	948
		69. The Yardbirds' Greatest Hits—Epic	941
		70. Happy Together—Turtles—White Whale	930
		71. Winchester Cathedral—Lawrence Welk—Dot	924
		72. Nancy, Naturally—Nancy Wilson—Capitol	884
		73. Younger Than Yesterday—Byrds—Columbia	881
		74. Man Of La Mancha—Original Cast—Kapp	877
		75. Silver Throat—Bill Cosby Sings—Warner Bros.	858
		76. How Great Thou Art—Elvis Presley—RCA	852
		77. Rewind—Johnny Rivers—Imperial	851
		78. Smiley-Smile—Beach Boys—Brother	842
		79. Psychedelic Lollipop—Blues Magoos—Mercury	842
		80. Boots With Strings—Boots Randolph—Monument	840
		81. Windows of the World—Dionne Warwick—Scepter	839
		82. Strange Days—Doors—Elektra	840
		83. Mercy, Mercy, Mercy—Cannonball Adderly—Capitol	838
		84. Happiness Is—Dean Martin—Reprise	834
		85. Best of Sonny & Cher—ATCO	824
		85. I'll Take Care Of Your Cares—Frankie Laine—ABC	824
		87. Casino Royale—Original Soundtrack—Colgems	822
		88. What Now My Love—Herb Alpert & Tijuana Brass—A&M	805
		89. New Gold Hits—4 Seasons—Philips	803
		90. Revolution—Paul Revere & The Raiders—Columbia	802
		91. Supremes A Go-Go—Motown	798
		92. Janis Ian—Verve/Forecast	794
		93. Lady—Jack Jones—Kapp	791
		94. Guitar Freakout—Ventures—Dolton	791
		95. Best of Herman's Hermits Vol. II—MGM	782
		96. Renaissance—Association—Valiant	774
		97. Going Places—Herb Alpert & Tijuana Brass—A&M	773
		97. Parsley, Sage, Rosemary & Thyme—Simon & Garfunkel—Columbia	774
		99. Mellow Yellow—Donovan—Epic	731
		100. A Day In The Life—Wes Montgomery—A&M	728

SEASON'S GREETINGS AND
BEST WISHES TO EVERYONE

FROM NASHBORO
THE HOME OF GOSPEL MUSIC

ON
NASHBORO AND CRESCENT

AND
GREAT POP AND R & B

ON
A-BET AND EXCELLO

NASHBORO RECORDS

1011 WOODLAND STREET
NASHVILLE, TENN.
(615) 227-5081

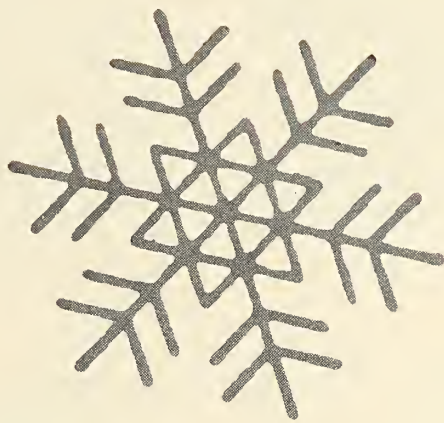

BEST WISHES



PERRY COMO



20



BEST ARTISTS of 1967 on ALBUMS

TOP MALE VOCALISTS

1. FRANK SINATRA
2. ANDY WILLIAMS
3. LOU RAWLS
4. Johnny Rivers
5. Dean Martin
6. Ed Ames
7. Bob Dylan
8. Elvis Presley
9. Jack Jones
10. Sonny Bono
11. Don Ho
12. Gary Lewis
13. Frankie Laine
14. Wilson Pickett
15. Donovan
16. Ray Charles
17. Eddy Arnold
18. James Brown
19. Al Martino
20. Stevie Wonder
21. Tom Jones
22. Gene Pitney
23. Tony Bennett
24. Bobby Vee

TOP FEMALE VOCALISTS

1. ARETHA FRANKLIN
2. DIONNE WARWICK
3. NANCY WILSON
4. Petula Clark
5. Nancy Sinatra
6. Cher
7. Barbra Streisand
8. Joan Baez
9. Judy Collins

TOP ORCHESTRAS & BANDS

1. HERB ALPERT & THE TIJUANA BRASS
2. RAY CONNIFF
3. LAWRENCE WELK
4. Mantovani
5. Baja Marimba Band
6. Henry Mancini
7. Bert Kaempfert
8. Billy Vaughn

TOP COMEDY ARTIST

1. BILL COSBY

TOP VOCAL GROUPS

1. MONKEES
2. ROLLING STONES
3. SUPREMES
4. Mamas & Papas
5. Paul Revere & The Raiders
6. Four Tops
7. Temptations
8. Young Rascals
9. Lovin' Spoonful
10. Beatles
11. Association
12. Herman's Hermits
13. Byrds
14. Four Seasons
15. Hollies
16. Seekers
17. New Vaudeville Band
18. Peter Paul & Mary
19. Sonny & Cher
20. Mitch Ryder & The Detroit Wheels
21. Yardbirds
22. Sergio Mendes & Brasil '66
23. Lettermen
24. Beach Boys
25. Animals
26. Simon & Garfunkel
27. Peaches & Herb
28. Peter & Gordon
29. The Who
30. Sam The Sham & The Pharoahs
31. Smokey Robinson & The Miracles
32. Sandpipers
33. Buckingham
34. ? & The Mysterians

TOP NEW INSTRUMENTALIST

1. MIDNIGHT STRING QUARTET

TOP NEW FEMALE VOCALISTS

1. CLAUDINE LONGET
2. BOBBIE GENTRY
3. JANIS IAN

TOP NEW MALE VOCALISTS

1. ENGELBERT HUMPERDINCK
2. FRANKIE VALLI
3. JIM NABORS

TOP NEW VOCAL GROUPS

- Tie {
1. DOORS
 1. JEFFERSON AIRPLANE
 2. BLUES MAGOOS
 3. 5TH DIMENSION
 4. Jimi Hendrix Experience
 5. Bee Gees
 6. Vanilla Fudge
 7. Mothers of Invention
 8. Turtles
 9. Strawberry Alarm Clock
 10. Royal Guardsmen
 11. Tommy James & The Shondells
 12. Procol Harum
 13. Big Brother & The Holding Co.
 14. Cowsills
 15. Country Joe & The Fish
 16. Every Mother's Son

TOP INSTRUMENTALISTS & COMBOS

1. ROGER WILLIAMS
2. VENTURES
3. BOOTS RANDOLPH
4. Cannonball Adderley
5. Booker T & The M.G.'s
6. Spencer Davis Group
7. Wes Montgomery

TOP SOUNDTRACKS (FILMS & TV)

1. DR. ZHIVAGO
2. SOUND OF MUSIC
3. A MAN & A WOMAN
4. Thoroughly Modern Millie
5. Casino Royale
6. You Only Live Twice
7. Wild Angels
8. Double Trouble
9. To Sir With Love
10. Born Free

TOP ORIGINAL CAST LP's

1. CABARET
2. MAN OF LaMANCHA
3. FIDDLER ON THE ROOF
4. Mame
5. I Do I Do

*Season's Greetings
and
Thanks to
ALL*

**BILLY
VAUGHN**

CURRENT SINGLE:
"THE LAST SAFARI"
DOT 17054

CURRENT ALBUM:
"ODE TO BILLY JOE"
DOT DLP-M 3828/DLP-S 25828

FORTHCOMING ALBUM:
"PRETTY COUNTRY"



"The Nation's Best Selling Records"

SINCEREST CHRISTMAS

&

NEW YEAR GREETINGS TO ALL

LEONARD GARMISA

BOB GARMISA



GARMISA DISTRIBUTING CO., INC.

1700 So. MICHIGAN AVE., CHICAGO 5, ILL.
ALL PHONES: 922-7455



REPARATA & THE DELRONS

Steve & Bill Jerome Management



THE FIFTH ESTATE

Steve & Bill Jerome Management



BLADES OF GRASS

San Donna Management



RENEE ST. CLAIR

Joe & Mello Normandie Mgt.



SAN FRANCISCO EARTHQUAKES

Kenny Young Management



MARIE APPLEBEE

Joan Capp Management



SOCIETY'S CHILDREN

Steve Wax Management



ALDORA BRITTON



BENJAMIN FRANKLIN

Fern Management Corp.



THE FRONT END

Steve & Bill Jerome Management



CHRISTOPHER

Steve & Bill Jerome Management



SUE, BILL & STEVE JEROME & FRED MUNAO

A REAL GOOD FAMILY

**THANKS
TO ALL OUR FRIENDS**

REAL GOOD PRODUCTIONS INC.; 1697 B'WAY, N.Y.C.; 765-3561

Ames Brothers	Sentimental Me (Rag Mop) You You You	Carol 1950 Victor 1953	Love Letters In The Sand Don't Forbid Me	Dot 1957 Dot 1957
Anderson, Leroy	Blue Tango	Decca 1951	Why, Baby, Why	Dot 1957
Andrews Sisters	Rum And Coca-Cola I Can Dream, Can't I	Decca 1944 Decca 1949	April Love	Dot 1958
Anka, Paul	Diana	ABC Par 1957	*The Letter	Mala 1967
Association	Lonely Boy *Cherish *Never My Love *Windy	ABC Par 1960 Valiant 1966 Warner Bros 1967 Warner Bros 1967	I Saw Mommy Kissing Santa Claus Till I Waltz Again With You	Columbia 1952 Coral 1952 Coral 1953
Austin, Gene	Ramona	Victor 1928	Ricochet	
Autry, Gene	Silver Haired Daddy Rudolph The Red-Nosed Reindeer	Columbia 1939 Columbia 1950	There's A Star-Spangled Banner Waving Somewhere	Victor 1942 Columbia 1945
Avalon, Frankie	Venus	Chancellor 1958	Sentimental Journey	Victor 1959
Baker, LaVern	I Cried A Tear	Atlantic 1959	Three Bells	Luniverse 1956 Warner Bros. 1959
Barber, Chris	Petite Fleur	Laurie 1959	Flying Saucer	
Barron, Blue	Cruising Down The River	MGM 1949	Kookie Lend Me Your Comb	
Barton, Eileen	If I Knew You Were Comin' I'd Of Baked A Cake	National 1950	Jumpin' Jive	Columbia 1939
Baxter, Les	Poor People Of Paris	Capitol 1956	Hey Baby	Smash 1962
Beatles	*I Want To Hold Your Hand *Can't Buy Me Love She Loves You *A Hard Day's Night *I Feel Fine *Help! *Eight Days a Week *Yesterday *We Can Work It Out *No Where Man *Paperback Writer *Yellow Submarine *Penny Laine *All You Need Is Love	Capitol 1964 Capitol 1964 Swan 1964 Capitol 1964 Capitol 1964 Capitol 1965 Capitol 1965 Capitol 1965 Capitol 1966 Capitol 1966 Capitol 1966 Capitol 1966 Capitol 1966 Capitol 1967 Capitol 1967	Way Down Yonder In New Orleans Polonaise (by Chopin) Tequila *I Can't Stop Loving You The Twist Let's Twist Again Limbo Rock/Popeye Mr. Sandman *Lightnin' Strikes *Downtown Come On-A My House Hey There Saerchin' Yakety Yak Charlie Brown Poison Ivy Topsy (Part II) Nature Boy Mona Lisa Too Young Ramblin' Rose Temptation Hubba Hubba Till The End Of Time Prisoner Of Love When You Were Sweet Sixteen Because Don't Let The Stars Get In Your Eyes Wanted Hot Diggity Papa Loves Mambo Round And Round *Catch A Falling Star	Challenge 1958 ABC Par 1962 Parkway 1960 Parkway 1961 Parkway 1962 Cadence 1954 MGM 1966 Warner Bros. 1965 Columbia 1951 Columbia 1954 Atco 1957 Atco 1958 Atco 1959 Atco 1959 Love 1958 Capitol 1948 Capitol 1949 Capitol 1951 Capitol 1962 Victor 1945 Victor 1945 Victor 1945 Victor 1946 Victor 1947 Victor 1948 Victor 1952 Victor 1954 Victor 1956 Victor 1956 Victor 1957 Victor 1958
Bennett, Tony	Because Of You Cold Cold Heart Rags To Riches Stranger In Paradise It's Just A Matter Of Time Stranger On The Shore Smokie White Silver Sands Josephine He'll Have To Stay Quarter To Three Green Onions Ain't That A Shame I'll Be Home Friendly Persuasion Remember Your'e Mine I Almost Lost My Mind	Columbia 1952 Columbia 1952 Columbia 1953 Columbia 1954 Mercury 1959 Atco 1962 Hi 1959 Hi 1960 Hi 1960 Capitol 1960 Legrand 1962 Stax 1962 Dot 1955 Dot Dot Dot Dot 1956	Checker, Chubby	
Benton, Brook			Chordettes	
Bilk, Mr. Acker			Christie, Lou	
Black's Combo, Bill			Clark, Petula	
Black, Jeanne			Clooney, Rosemary	
Bonds, Gary U. S.			Coasters	
Booker T & MG's			Cole, Cozy	
Boone, Pat			Cole, Nat "King"	
			Como, Perry	

(Continued on page 30)

SEASONS GREETINGS and WARMEST THANKS

*To all those who helped make 1967
a Beautiful Year for me.*

Jimmy Wisner

888 8th Avenue

New York, N. Y.

765-4680

SEASON'S GREETINGS

FROM HERB ALPERT & THE TIJUANA

BRASS & BURT BACHARACH & THE BAJA

MARIMBA BAND & TOMMY BOYCE & BOBBY

HART & PAUL DESMOND & RUTHANN FRIEDMAN

ANTONIO CARLOS JOBIM & PETE JOLLY & CLAUDINE

LONGET & JOHNNY MANDEL & HERBIE MANN & THE

MERRY-GO-ROUND & LIZA MINNELLI & CHRIS MONTEZ

WES MONTGOMERY & THE MOVE & PHIL OCHS & THE

PARADE & PROCOL HARUM & JIMMIE RODGERS & THE

SANDPIPERS & SERGIO MENDES & BRASIL '66

SHIPLEY AND BREWER & SMALL CIRCLE OF

FRIENDS

TAMBA 4 & WE FIVE

LEE MICHAELS



Million-Sellers

SINGLES THAT HAVE SOLD A MILLION OR MORE COPIES
*SIGNIFIES RIAA-CERTIFIED MILLION SELLER

Fontane Sisters	Hearts of Stone	Dot	Herman's Hermits	Mrs. Brown You've Got A Lovely Daughter	MGM 1965
Ford, Tennessee Ernie	Sixteen Tons	Capitol 1955		*I'm Henry VIII, I am	MGM 1965
Four Aces	Tell Me Why	Decca 1951		*There's A Kind Of A Hush	MGM 1967
Four Lads	Love Is A Many-Splendored Thing	Decca 1955	Highwaymen	Michael	United Artists 1961
Four Seasons	Moments To Remember	Columbia 1955	Hilltoppers	P.S. I Love You	Dot
	No Not Much	Columbia 1956	Holly, Buddy	Paggy Sue	Coral 1958
	Sherry	VeeJay 1962	Hollywood Argyles	Alley-Oop	Lute 1960
	Big Girls Don't Cry	VeeJay 1962	Horton, Johnny	Battle Of New Orleans	Columbia 1959
Francis, Connie	*Rag Doll	Philips 1964	Howard, Eddy	To Each His Own	Mercury 1946
	Who's Sorry Now	MGM 1958	Hunt, Pee Wee	12th Street Rag	Capitol 1951
	My Happiness	MGM 1959		Oh	Capitol 1953
	Among My Souvenirs	MGM 1959	Hunter, Tab	Young Love	Dot 1957
	Mama/ Teddy	MGM 1960	Hyland, Brian	Itsy Bitsy Teenie Bikini	Kapp 1960
	Everybody's Somebody's Fool/ Jealous Of You	MGM 1960			
	Together	MGM 1961	Impalas	Sorry (I Ran All The Way Home)	Cub 1959
	Many Tears Ago	MGM 1961	Ink Spots	To Each His Own	Decca 1946
	Where The Boys Are	MGM 1961		The Gypsy	Decca 1946
Franklin, Aretha	*Respect	Atlantic 1967	James, Harry	Ciribiribin	Columbia 1939
	*I Never Loved A Man	Atlantic 1967		One O'Clock Jump	Columbia 1941
	*Baby I Love You	Atlantic 1967	James, Joni	You Made Me Love You	Columbia 1946
Freberg, Stan	St. George And The Dragonet	Capitol 1958		Why Don't You Believe Me	MGM 1953
				Your Cheating Heart	MGM 1953
Gentry, Bobbi	*Ode To Billie Joe	Capitol 1967		Have You Heard	MGM 1954
Gibbs, Georgia	Kiss Of Fire	Mercury 1952	James, Sonny	Young Love	Capitol 1957
	Tweedle Dee	Mercury 1955	James, Tommy & the Shondells	*Hanky Panky	Roulette 1966
	Dance With Me Henry	Mercury 1955	Jenkins, Gordon with The Weavers	Maybe You'll Be There	Decca 1947
	*Sugar Shack	Dot 1963	Jolson, Al	Goodnight, Irene	Decca 1950
Gilmer, Jimmy & Fireballs				April Showers b/w Swanee	Decca 1945
Glahe, Will	Beer Barrel Polka	Victor 1938		California Here I Come b/w Rockabye Your Baby	Decca 1946
Gleason, Jackie	Melancholy Serenade	Capitol 1953		You Made Me Love You b/w Ma Blushin' Rose	Decca 1946
Godfrey, Arthur	Too Fat Polka	Columbia 1947		Sonny Boy b/w My Mammy	Decca 1946
Grant, Gogi	Suddenly There's A Valley Wayward Wind	Era 1955	Jones, Jimmy	Anniversary Song	Decca 1946
		Era 1956		Handy Man	Cub 1960
Haley, Bill	Shake, Rattle And Roll	Decca 1955	Jones, Spike	Good Timin'	Cub 1960
	Rock Around The Clock	Decca 1955		Cocktails For Two	Victor 1944
Hamilton IV, George	A Rose And A Baby Ruth	ABC-Par 1958	Jordan, Louis	All I Want For Christmas	Victor 1948
Harris, Phil	The Thing	Victor 1950	Justis, Bill	Choo Cho Ch'Boogie	Decca 1946
Harrison, Wilbert	Kansas City	Fury 1959	Kaempfert, Bert	Raunchy	Phillips Int 1958
Hayes, Bill	Davy Crockett	Cadence 1955	Kalin Twins	Wonderland By Night	Decca 1961
Haymes, Dick	You'll Never Know	Decca 1943	Kallen, Kitty	When	Decca 1958
	Little White Lies	Decca 1948	King, Claude	Little Things Mean A Lot	Decca 1954
Hebb, Bobby	*Sunny	Philips 1966	King, Pee Wee	Wolverton Mountain	Columbia 1962
Heidt, Horace	Deep In The Heart Of Texas	Columbia 1941		Slow Poke	Victor 1951
Helms, Bobby	My Special Angel	Decca 1957			
Herman, Woody	Laura	Columbia 1945			
	Woodchopper's Ball	Decca 1947			

(Continued on page 32)

AGAIN THIS YEAR —

Thanks

To

You!

ROGER WILLIAMS



REPRESENTATION:
AGENCY FOR THE
PERFORMING ARTS

PRODUCTION:
R-J PRODUCTIONS, INC.



EXCLUSIVE:





**HERB ALPERT & THE TIJUANA BRASS / #1 ORCHESTRA
(ALBUMS & SINGLES) / 1967 CASHBOX POLL / HERB ALPERT
#1 INSTRUMENTALIST (SINGLES) / 1967 CASHBOX POLL**





CLAUDINE LONGET 🌿 **#1 NEWCOMER FEMALE VOCALIST**
(ALBUMS) 🌿 **1967 CASHBOX POLL** 🌿 🌿 🌿 🌿 🌿 🌿 🌿 🌿 🌿



#1 MALE VOCALIST
R & B
(Cash Box Best of 1967 Poll)

*Thanks to Everyone
who helped make
this a Great Year*

James Brown



Personal Mgt. Bookings

BEN BART **UNIVERSAL**

ATTRACTIONS



MONTH-BY-MONTH—1967's TOP TEN

A special feature designed to aid disk jockeys interested in flash back ("A year ago at this time") programming. Compilation for these results comes from weekly Cash Box Top Ten Best Seller Lists during given month.

JANUARY

1. I'm A Believer—Monkees—Colgems
2. Snoopy vs. The Red Baron—Royal Guardsmen—Laurie Parlow
3. Tell It Like It Is—Aaron Neville—Columbia
4. Sugar Town—Nancy Sinatra—Reprise
5. Words Of Love—Mamas & Papas—Dunhill
6. Good Thing—Paul Revere & Raiders—Four Tops—Motown
7. Standing In The Shadows Of Love—Georgy Girl—Seekers—Capitol
8. Coming Home Soldier—Bobby Vinton—Epic
9. That's Life—Frank Sinatra—Reprise

FEBRUARY

1. Georgy Girl—Seekers—Capitol
2. I'm A Believer—Monkees—Colgems
3. Kind Of A Frog—Buckingham—USA
4. Ruby Tuesday—Rolling Stones—London
5. Tell It Like It Is—Aaron Neville—Parlow
6. Lave Is Here & Now You're Gone—Supremes—Motown
7. We Ain't Got Nothin' Yet—Blues Magoos—Mercury
8. 98.6—Keith—Mercury
9. Words Of Love—Mamas & Papas—Dunhill
10. Good Thing—Paul Revere & Raiders—Columbia

MARCH

1. Ruby Tuesday—Rolling Stones—London
2. Love Is Here And Now You're Gone—Supremes—Motown
3. Sock It To Me, Baby—Mitch Ryder & Detroit Wheels—Cosinos—Froternity
4. Then You Can Tell Me Goodbye—Hoppy Together—Turtles—White Whole
5. Baby I Need Your Lovin'—Johnny Rivers—Imperial
6. There's A Kind Of A Hush—Herman's Hermits—MGM
7. Kind Of A Frog—Buckingham—USA
8. For What It's Worth—Buffalo Springfield—Atco
9. Dedicated To The One I Love—Mamas & Papas—Dunhill
10. Georgy Girl—Seekers—Capitol

APRIL

1. Hoppy Together—Turtles—White Whole
2. A Little Bit Me, A Little Bit You—Monkees—Colgems
3. Somethin' Stupid—Nancy & Frank Sinatra—Reprise

3. I Think We're Alone Now—Tommy James & Shondells—Roulette
4. Dedicated To The One I Love—Mamas & Papas—Dunhill
5. This Is My Song—Petula Clark—Warner Bros.
6. There's A Kind Of A Hush—Herman's Hermits—MGM
7. Jimmy Mack—Martha & The Vandellas—Gordy
8. Western Union—Five Americans—Abnack
9. Bernadette—4 Tops—Motown
10. Penny Lane—Beatles—Capitol
11. The Happening—Supremes—Motown
12. For What It's Worth—Buffalo Springfield—Atco

MAY

1. The Happening—Supremes—Motown
2. Groovin'—Young Rascals—Atlantic
3. Sweet Soul Music—Arthur Conley—Atco
4. Somethin' Stupid—Nancy & Frank Sinatra—Reprise
5. I Got Rhythm—Hoppings—B. T. Puppy
6. Don't You Core—Buckingham—Capitol
7. You Got What It Takes—Dave Clark Five—Epic
8. On A Carousel—Hollies—Imperial
9. A Little Bit Me, A Little Bit You—Monkees—Colgems
10. Hoppy Together—Turtles—White Whole
11. I Think We're Alone Now—Tommy James & Shondells—Roulette
12. Release Me—Engelbert Humperdinck—Parrot

JUNE

1. Respect—Aretha Franklin—Atlantic
2. Groovin' Young Rascals—Atlantic
3. Release Me—Engelbert Humperdinck—Parrot
4. I Got Rhythm—Hoppings—B. T. Puppy
5. Somebody To Love—Jefferson Airplane—RCA
6. She'd Rather Be With Me—The Turtles—White Whole
7. Creeque Alley—Mamas & Papas—Dunhill
8. Windy—The Association—Worner Bros.
9. A Little Bit Of Soul—Music Explosion—Lourie
10. All I Need—Temptations—Gordy
11. The Hoppings—Supremes—Motown
12. Sweet Soul Music—Arthur Conley—Atco
13. Sunday Will Never Be The Same—Spunky & Our Gang—Mercury

JULY

1. Windy—The Association—Worner Bros.
2. Can't Take My Eyes Off You—Frankie Valli—Philips

3. A Little Bit Of Soul—Music Explosion—Laurie
4. San Francisco—Flowers In Your Hair—Scott McKenzie—Ode
5. Come On Down To My Boat—Every Mother's Son—MGM
6. Up-Up And Away—The Fifth Dimension—Soul City
7. Groovin'—Young Rascals—Atlantic
8. Let's Live For Today—Grass Roots—Dunhill
9. She'd Rather Be With Me—The Turtles—White Whale
10. Don't Sleep In The Subway—Petula Clark—Warner Bros.
11. Light My Fire—The Doors—Elektra
12. Respect—Aretha Franklin—Atlantic
13. C'mon Marianne—The Four Seasons—Philips
14. I Was Made To Love Her—Stevie Wonder—Tomlo

AUGUST

1. All You Need Is Love—The Beatles—Capitol
2. Light My Fire—The Doors—Elektra
3. Pleasant Volley Sunday—The Monkees—Colgems
4. I Was Made To Love Her—Stevie Wonder—Tomlo
5. Ode To Billie Joe—Bobbi Gentry—Capitol
6. Mercy, Mercy, Mercy—The Buckinghoms—Columbio
7. Baby I Love You—Aretha Franklin—Atlantic
8. A Whiter Shade Of Pale—Procul Horum—Derom
9. White Rabbit—Jefferson Airplane—RCA
10. Words—The Monkees—Colgems
11. Can't Take My Eyes Off You—Frankie Valli—Philips
12. A Girl Like You—Young Rascals—Atlantic
13. Windy—The Association—Warner Bros.

SEPTEMBER

1. Ode To Billie Joe—Bobbi Gentry—Capitol
2. The Letter—The Box Tops—Malo
3. Reflections—Diono Ross & Supremes—Motown
4. Come Back When You Grow Up—Bobby Vee—Liberty
5. Apples Peaches And Pumpkin Pie—Joy & The Techniques—Smosh
6. Baby I Love You—Aretha Franklin—Atlantic
7. All You Need Is Love—The Beatles—Capitol
8. Never My Love—The Association—Worner Bros.
9. You're My Everything—The Temptations—Gordy

10. Light My Fire—The Doors—Elektra
11. The Letter—Box Tops—Malo
12. Never My Love—Association—Warner Bros.
13. To Sir, With Love—Lulu—Epic
14. How Can I Be Sure—Young Rascals—Atlantic
15. Gimme Little Sign—Brenton Wood—Double Shot
16. Ode To Billie Joe—Bobbi Gentry—Capitol
17. Dandelion—Rolling Stones—London
18. Soul Man—Sam & Dave—Stax
19. Hey Baby—Buckingham—Columbia
20. Little Ole Man—Bill Cosby—Warner Bros.
21. Come Back When You Grow Up—Bobby Vee—Liberty
22. Apples, Peaches And Pumpkin Pie—Joy & The Techniques—Smosh
23. Higher & Higher—Jockie Wilson—Brunswick
24. Brown Eyed Girl—Von Morrison—Bang

NOVEMBER

1. Incense & Peppermints—Strowberry—Alorm Clock—UNI
2. (tie) To Sir With Love—Lulu—Epic
3. Soul Man—Son & Dove—Stax
4. The Rain, The Park and Other Things—Cowsills—MGM
5. It Must Be Him—Vikki Carr—Liberty
6. Please Love Me Forever—Bobby Vinton—Epic
7. Your Precious Love—Morvin Goye & Tammi Terrell—Tomlo
8. How Can I Be Sure—Young Rascals—Atlantic
9. Let It Out—Hombres—Verve/Forcast
10. (tie) The Letter—Box Tops—Malo
11. Expressway To Your Heart—Soul Survivors—Crimson
12. I Can See For Miles—The Who—Decco

DECEMBER

1. Doydream Believer—Monkees—Colgems
2. The Rain, The Park & Other Things—Cowsills—MGM
3. Hello Goodbye—Beatles—Capitol
4. Incense & Peppermints—Strowberry—Alorm Clock—UNI
5. I Soy A Little Prayer—Dionne Warwick—Scepter
6. I Heard It Thru The Grapevine—Glady Knight & Pips—Soul
7. I Second That Emotion—Miracles—Tomlo
8. An Open Letter To My Teenage Son—Victor Lundberg—Liberty
9. You Better Sit Down Kids—Cher—Imperial
10. Keep The Boll Rolling—Joy & Techniques—Smosh

*Season's Greetings
and
Best Wishes To All
for
A Merry Christmas
and
A New Year
Full of Happiness
Good Health and Prosperity
from all at*

ESSEX RECORD DISTRIBUTORS

10 FENWICK ST. (201) 243-7700 NEWARK, N. J.

"New Jersey's Leading Independent Distributor"

Million-Sellers

- | | | |
|-----------------------------------|----------------------------------|------------------|
| Storm, Gale | Moonglow & Picnic Theme | Decca 1956 |
| | I Hear You Knockin' | Dot |
| | To Know Him Is To Love Him | Dore 1958 |
| Todd, Art & Dotty | Chason D'Amour | Era 1957 |
| Tokens | *The Lion Sleeps Tonight | Victor 1961 |
| Toys | *A Lover's Concerto | Dynavoice 1965 |
| Tucker, Orrin | Oh, Johnny | Columbia 1939 |
| Turtles | *Happy Together | White Whale 1967 |
| Twitty, Conway | It's Only Make Believe | MGM 1958 |
| | Lonely Blue Boy | MGM 1960 |
| | Donna | Del-Fi 1958 |
| Valens, Ritchie | *Can't Take My Eyes Off You | Philips 1967 |
| Valli, Frankie | Melody Of Love | Dot 1956 |
| Vaughn, Billy | Sail Along Silv'ry Moon | Dot 1957 |
| | Broken Hearted Melody | Mercury 1959 |
| Vaughan, Sarah | Take Good Care Of My Baby | Liberty 1961 |
| Vee, Bobby | *Come Back When You Grow Up | Liberty 1967 |
| | *Roses Are Red | Epic 1962 |
| Vinton, Bobby | Primrose Lane | Challenge 1960 |
| Wallace, Jerry | Stardust | Liberty 1957 |
| Ward, Billy | 'Twas The Night Before Christmas | Decca 1942 |
| Wairing, Fred | Baby (You Got What It Takes) | Mercury 1960 |
| Washington, Dinah & Benton, Brook | | |
| Weavers, The | On Top Of Old Smoky | Decca 1951 |
| Weber, Joan | Let Me Go Lover | Columbia 1954 |
| Weems, Ted | Heartaches | Decca 1950 |
| Welk, Lawrence | *Calcutta | Dot 1961 |
| Whiteman, Paul | Whispering | Victor 1920 |
| | Three O'Clock In The Morning | Victor 1922 |
| Whitfield, David | Cara Mia | London 1956 |
| Whiting, Maggie | The Tree In The Meadow | Capitol 1948 |
| with Jimmy Wakely | Slipping Around | Capitol 1949 |
| Whitman, Slim | Indian Love Call | Imperial 1951 |
| | Secret Love | Imperial 1953 |
| | Rose Marie | Imperial 1954 |
| Williams, Billy | I'm Gonna Sit Right Down | Coral 1957 |
| Williams, Roger | Autumn Leaves | Kapp 1955 |
| Williams, Tex | Smoke, Smoke, Smoke | Capitol |
| Willis, Chuck | What Am I Living For | Atlantic 1958 |
| Wilson, Jackie | Night/Dogging Around | Brunswick 1960 |
| Winterhalter, Hugo | Canadian Sunset | Victor 1956 |
| Woolley, Sheb | Purple People Eater | MGM 1958 |
| Young Rascals | *Groovin | Atlantic 1967 |

jerry ross productions, inc.

would like to thank

jay & the techniques
keith
spanky & our gang
bobby "sunny" hebb
jerry butler
dee dee warwick
les mc cann
joe renzetti
jimmy wisner
and
the mercury record corporation
for

a colossal year

Golden Albums

THE LIST OF ALBUMS BELOW REPRESENTS THOSE RELEASES THAT THE RECORD INDUSTRY ASSOCIATION OF AMERICA (RIAA) HAS CERTIFIED AND AUDITED AS HAVING EACH SOLD AN AMOUNT WORTH AT LEAST \$1 MILLION AT FACTORY PRICES. THEY CONSTITUTE, NEEDLESS TO SAY, THE EVERGREEN CATALOG OF LP MERCHANDISE—IN ALL PHASES OF MUSIC—CURRENTLY AVAILABLE. THERE IS ALWAYS CONSUMER INTEREST IN THEM, AND WISE IS THE DEALER WHO CAN IMMEDIATELY FULFILL THE REQUEST FOR MOST, IF NOT ALL OF THE GOLD-DISK ALBUMS. DISPLAY OF THIS SHEET ALONG SIDE A BROWSER CALLED "GOLDEN ALBUMS" COULD INCREASE SALES.

1967

I NEVER LOVED A MAN—Aretha Franklin—Atlantic 8139/SD 8139
 SGT. PEPPER'S LONELY HEARTS CLUB BAND—Beatles—Capitol T/ST 2653
 JUST LIKE US—Paul Revere & The Raiders—Columbia CL 2451/CS 9251
 MORE OF THE MONKEES—Colgems—COM/COS 102
 S.R.O.—Herb Alpert & The Tijuana Brass—A&M LP 119/SP 4119
 GOT LIVE IF YOU WANT IT—Rolling Stones—London LL 3493/PS 493
 TILL—Roger Williams—Kapp KL/KS 1081
 SONGS OF THE FABULOUS FIFTIES, PART 1—Kapp KL 1209/KS 3209
 SONGS OF THE FABULOUS FIFTIES, Part 2—Kapp KL 1210/KS 3210
 ROGER WILLIAMS GREATEST HITS—Kapp KL 1260/3260
 YAKETY SAX—Boats Randolph—Monument
 THAT'S LIFE—Frank Sinatra—Reprise F/FS 1020
 LOU RAWLS LIVE—Capitol T/TS 2459
 THE TWO SIDES OF THE SMOTHERS BROS.—Mercury MG 20675/SR 60675
 BETWEEN THE BUTTONS—Rolling Stones—London LL 3499/PS 499
 MIDNIGHT RIDE—Paul Revere & The Raiders—Columbia CL 2508/CS 930B
 THOROUGHLY MODERN MILLIE—Original Soundtrack—Decca DL 1500/71500
 THE BEST OF MANCINI—Henry Mancini—RCA Victor LPM/LPS 2693
 AN EVENING WITH BELAFONTE—Harry Belafonte—RCA Victor LPM/LSP 3415
 BEST OF THE BEACH BOYS—Capitol T/DT 2545
 WINCHESTER CATHEDRAL—Lawrence Welk—Dot DLP 3774/DLP 25774
 SPIRIT OF '67—Paul Revere & The Raiders—Columbia CL 2595/CS 9395
 MAMAS & PAPAS DELIVER—Dunhill D/S 50014
 BORN FREE—Roger Williams—Kapp KL 1501/KS 3501
 MAME—Original Cast—Columbia KOL 6600/KOS 3000
 HEADQUARTERS—Monkees—Colgems COM/COS 103
 MY CUP RUNNETH OVER—Ed Ames—RCA Victor LPM/LPS 3774
 STRANGERS ON THE SHORE—Mr. Acker Bilk—Atco
 REVENGE—Bill Cosby—Warner Bros. W/WS 1691
 PARSLEY, SAGE, ROSEMARY & THYME—Simon & Garfunkel—Columbia CL 2463/CS 9363
 BORN FREE—Andy Williams—Columbia CL 2680/CS 9480
 THE BEST OF THE LOVIN' SPOONFUL—Kama Sutra KLP/KLPS 8056
 THEMES FOR YOUNG LOVERS—Percy Faith & Orch.—Columbia CL 2704/CS 9504
 I WALK THE LINE—Johnny Cash—Columbia CL 2190/CS 8990
 SURREALISTIC PILLOW—Jefferson Airplane—RCA Victor LPM/LSP 3766
 FLOWERS—Rolling Stones—London LL 3509/PS 509
 A MAN AND A WOMAN—Soundtrack—United Artists UAL 4147/UAS 5174
 EBB TIDE—Earl Grant—Decca DL/DL 7 4165
 BLUE MIDNIGHT—Bert Kaempfert—Decca DL/DL 4569
 SOUNDS LIKE—Herb Alpert & Tijuana Brass—A&M LP 124/SP 4124
 SERGIO MENDES & BRASIL '66—A&M LP 116/SP 4116
 SOUNDS OF SILENCE—Simon & Garfunkel—Columbia CL 2469/CS 9269
 PAUL REVERE & THE RAIDERS GREATEST HITS—Columbia KCL 2662/KCS 9462
 BLONDE ON BLONDE—Bob Dylan—Columbia C2L 41/C2S 841
 HIGHWAY 61—Bob Dylan—Columbia CL 2389/CS 9189
 BRINGING IT ALL BACK HOME—Bob Dylan—Columbia CL 2328/CS 9128
 THE DOORS—Elektra EK 4007/EKS 74007
 2ND VAULT OF GOLDEN HITS—Four Seasons—Philips PHM 200-221/PHS 600-221
 ODE TO BILLIE JOE—Bobbie Gentry—Capitol T/ST 2830
 TONY BENNETT'S GREATEST HITS VOLUME III—Columbia CL 2373/CS 9173
 PISCES, AQUARIUS, CAPRICORN AND JONES LTD.—Monkees—Colgems COM/COS 104
 SINATRA AT THE SANDS—Frank Sinatra—Reprise 2F/2FS 1019
 THEN ALONG CAME THE ASSOCIATION—Warner Bros. 1702
 THEIR SATANIC MAJESTY'S REQUEST—Rolling Stones—London NP/NPS 2
 RELEASE ME—Engelbert Humperdinck—Parrot PA 61012/PAS 71012

1966

SUMMER DAYS—Beach Boys—Capitol T/ST-2354
 GOLDEN HITS—Roger Miller—Smash 27073/67073
 8ALLADS OF THE GREEN BERETS—S/Sgt Barry Sadler—RCA Victor LPM-3547/LSP-3547
 ROY ORBISON'S GREATEST HITS—Monument—8000/18000
 LIVING LANGUAGE SPANISH—Young People's—
 LIVING LANGUAGE FRENCH—Young People's—
 COLOR ME BARBRA—Barbra Streisand—Columbia CL-2478/CS-9278
 I'M THE ONE WHO LOVES YOU—Dean Martin—Reprise—6170/S-6170
 BIG HITS (HIGH TIDE & GREEN GRASS)—The Rolling Stones—London LP-1
 OLIVER—Original Cast—RCA Victor LOCD/LSOD-2004
 SOUTH OF THE BORDER—Herb Alpert's Tijuana Brass—A&M LP/SP-108
 THE LONELY BULL—Herb Alpert's Tijuana Brass—A&M LP/SP-101
 WHAT NOW MY LOVE—Herb Alpert's Tijuana Brass—A&M LP-114/SP-4114
 HERB ALPERT'S TIJUANA BRASS, VOL. 2—A&M LP/SP-103
 MY WORLD—Eddy Arnold—RCA Victor LPM/LSP-3466
 SOUTH PACIFIC—Original Cast—Columbia OL-4180/OS-2040
 IF YOU CAN BELIEVE YOUR EYES AND EARS—Mamas & Papas—Dunhill D/DS 50006
 YESTERDAY & TODAY—Beatles—Capitol T/ST 2553
 THE BEST OF JIM REEVES—RCA Victor LPM/LSP 2890
 THE BEST OF THE ANIMALS—MGM E/SE 4324
 DANG ME—Roger Miller—Smash MPS 27049/FRS 67049
 GOLD VAULT OF HITS—Four Seasons—Philips PHM 200-196/PHS 600-196
 AFTERMATH—Rolling Stones—London LL 3476/PS 4776
 DR. ZHIVAGO—Soundtrack—MGM E/SE 6 ST
 THINK ETHNIC—Smothers Bros.—Mercury MG 20777/SR 60777
 STRANGERS IN THE NIGHT—Frank Sinatra—Reprise F/FS 1017
 REVOLVER—Beatles—Capitol T/TS 2576
 THE DAVE CLARK FIVE'S GREATEST HITS—Epic LN 24185/BN 26185
 SOMEWHERE MY LOVE—Ray Conniff Singers—Columbia CL 2519/CS 9319
 THE SHADOW OF YOUR SMILE—Andy Williams—Columbia CL 2499/CS 9299
 THE BEST OF AL HIRT—RCA Victor LPM/LSP 3309
 I STARTED OUT AS A CHILD—Bill Cosby—Warner Bros. W/WS 1567
 WONDERFULNESS—Bill Cosby—Warner Bros. W/WS 1634
 WHY IS THERE AIR—Bill Cosby—Warner Bros. W/WS 1606
 BILL COSBY IS A VERY FUNNY FELLOW, RIGHT!—Warner Bros. W/WS 151B
 JEANNETTE MAC DONALD & NELSON EDDY FAVORITES—RCA Victor LPM/LSP 1738
 PERRY COMO SINGS MERRY CHRISTMAS MUSIC—Camden CAL/CAS 600
 THE MONKEES—Colgems COM/SOC 101
 ELVIS PRESLEY—RCA Victor LPM/LSP 1254
 ELVIS' GOLD RECORDS, VOL. 2—RCA Victor—LPM/LSP 2075
 ELVIS' GOLD RECORDS, VOL. 3—RCA Victor—LPM/LSP 2765
 JOAN BAEZ, VOL. 2—Vanguard—VRS 9094/VSD 2097
 JOAN BAEZ—Vanguard—VRS 9078/USD 2077

JOAN BAEZ IN CONCERT—Vanguard—VRS 9112/VSD 2122
 SOUL AND INSPIRATION—Righteous Brothers—Verve V/V-6 5001
 MAMAS AND PAPAS—Dunhill D/S 50010
 THE MONKEES—Colgems—Com/Cos 101
 MY NAME IS BARBRA, TWO—Barbra Streisand—Columbia CL-2409/CS-9209
 THE BEST OF HERMAN'S HERMITS—MGM 4315/S-4315
 DECEMBER'S CHILDREN—The Rolling Stones—London 3451/451
 SEPTEMBER OF MY YEARS—Frank Sinatra—Reprise 1014/S-1016
 A MAN & HIS MUSIC—Frank Sinatra—Reprise 1016/S-1016

1965

GLAD ALL OVER—Dave Clark Five—Epic LN-24093/BN-26093
 PETER, PAUL & MARY IN CONCERT—Warner Bros. 1555/S-1555
 EVERYBODY LOVES SOMEBODY—Dean Martin—Reprise R-6130/RS-6130
 WONDERLAND OF GOLDEN HITS—Andre Kostelanetz—Columbia CL-2039/CS-BB39
 BARBRA STREISAND/THE THIRD ALBUM—Columbia CL-2154/CS-8954
 RING OF FIRE—Johnny Cash—Columbia CL-2053/CS-B853
 BEACH BOYS IN CONCERT—Capitol TAO-2198/STAO-2198
 ALL SUMMER LONG—Beach Boys—Capitol T-2110/ST-2110
 SUGAR LIPS—Al Hirt—RCA Victor LPM-2965/LSP-2965
 PEOPLE—Barbra Streisand—Columbia CL-2215/CS-9015
 THE SOUND OF MUSIC—Soundtrack—RCA Victor LOCD-2005/LSOD-2005
 TRINI LOPEZ AT P.J.'S—Reprise R-6093/RS-6093
 GETZ/GILBERTO—Stan Getz—MGM/Verve 8545/68545
 BEATLES VI—Capitol T-2358/ST-2358
 DEAR HEART—Andy Williams—Columbia CL 2338/CS 9138
 HELP!—The Beatles—Capitol MAS-2386/SMHS-2386
 INTRODUCING HERMAN'S HERMITS—MGM 42B2/S-4282
 HERMAN'S HERMITS ON TOUR—MGM 4295/S-4295
 MORE ENCORE OF GOLDEN HITS—The Platters—Mercury 20591/60252
 RETURN OF ROGER MILLER—Smash 27061/67061
 GREAT SONGS FROM MY FAIR LADY—Andy Williams—Columbia CL-2205/CS-9005
 GUNFIRE BALLADS & TRAIL SONGS—Marty Robbins—Columbia CL-1349/CS-8158
 LOOK AT US—Sonny & Cher—Atco 177
 THE BEACH BOYS TODAY—Capitol T-2269/ST-2269
 THE PINK PANTHER—Henry Mancini—RCA Victor LPM-2795/LSP-2795
 OUT OF OUR HEADS—The Rolling Stones—London 3429/429
 FIDDLER ON THE ROOF—Original Cast—RCA Victor LOC-1093/LSO-1093
 SURFER GIRL—The Beach Boys—Capitol 1981/ST-1981
 SURFIN' USA—The Beach Boys—Capitol T-1890/ST-1890
 SINATRA'S SINATRA—Frank Sinatra—Reprise 1010/9-1010
 WELCOME TO THE LBJ RANCH—Capitol W-2423/WS-2423
 MY NAME IS BARBRA—Barbra Streisand—Columbia CL-2336/CS-9136
 THE DOOR IS STILL OPEN TO MY HEART—Dean Martin—Reprise 6140/S-6140
 GOING PLACES—Herb Alpert's Tijuana Brass—A&M LP-112/SP-4112
 WHIPPED CREAM AND OTHER DELIGHTS—Herb Alpert's Tijuana Brass—A&M LP/SP-110
 RUBBER SOUL—The Beatles—Capitol T-2442/ST-2442

1964

MY FAIR LADY—Original Cast—Columbia OL 5090/OS 2015
 JOHN FITZGERALD KENNEDY—A MEMORIAL ALBUM—Premier CFX 402099
 CAROUSEL—Film Soundtrack—Capitol—W 694/ SW 694
 THE KING AND I—Film Soundtrack—Capitol—W 74/SW 740
 RAMBLIN' ROSE—Nat "King" Cole—Capitol T 1793/ST 1793
 MEET THE BEATLES—The Beatles—Capitol T 2047/ST 2047
 HONEY IN THE HORN—Al Hirt—RCA Victor LPM 2733/LSD 2733
 THE BEATLES' SECOND ALBUM—The Beatles—Capitol T 2080/ST 2080
 THE SECOND BARBRA STREISAND ALBUM—Barbra Streisand—Columbia CL 2045/CS 8854
 HELLO, DOLLY!—Original Cast—RCA Victor LCO 1087/LSO 1087
 HELLO, DOLLY!—Louis Armstrong—Kapp 1364/3364
 THE WONDERFUL WORLD OF ANDY WILLIAMS—Columbia CL-2137/CS-8937
 CHRISTMAS HYMNS & CAROLS—Robert Shaw—RCA Victor LM-2139/LSC-2139
 VICTORY AT SEA, Vol. 1—Robert Russell Bennett—RCA Victor LM-2335/LSC-2335
 SOMETHING NEW—The Beatles—Capitol T-2108/ST-2108
 THE BEST OF THE KINGSTON TRIO—Capitol T-1705, 2280/ST-1705, 2280
 UNFORGETTABLE—Nat King Cole—Capitol T-357/DT-357
 RAMBLIN'—New Christy Minstrels—Columbia CL-2055/CS-8855
 THE BARBRA STREISAND ALBUM—Columbia CL-2007/CS-8807
 FUNNY GIRL—Original Cast—Capitol VAS-2059/SVAS-2059
 JOHNNY HORTON'S GREATEST HITS—Columbia CL-1596/CS-8396
 COTTON CANDY—Al Hirt—RCA Victor LPM-2917/LSP-2917
 THE ANDY WILLIAMS CHRISTMAS ALBUM—Columbia CL-2087/CS-8887
 CALL ME IRRESPONSIBLE—Andy Williams—Columbia CL-2171/CS-8971
 MY FAIR LADY—Soundtrack—Columbia KOL-B000/KOS-2600
 BEATLES '65—Capitol T-222B/ST-2228
 THE BEATLES STORY—Capitol TBO-2222/STBO-2222
 MARY POPPINS—Soundtrack—Vista 4026/S-4026

1963

WEST SIDE STORY—Original Soundtrack—Columbia OL-5670/OS-2070
 GLORIOUS SOUND OF CHRISTMAS—Eugene Ormandy—Philadelphia Orchestra—Columbia
 ML-5769/MS-6369
 1812 OVERTURE-TSCHAIKOVSKY—Antal Dorati and The Minneapolis Symphony—Mercury MG-
 50054/SR-90054
 EXODUS—Original Soundtrack—RCA Victor LOL-1058/LSO-1058
 CALYPSO—Harry Belafonte—RCA Victor LPM-1248/LSP-1248
 G. I. BLUES—Elvis Presley—RCA Victor LPM-2256/LSP-2256
 SEASON'S GREETINGS FROM PERRY COMO—Perry Como—RCA Victor LPM-2066/LSP-2066
 VIVA—Percy Faith—Columbia CL-1075/CS-8038
 THE MUSIC MAN—Soundtrack—Warner Bros. B-1459/8S-1459
 TIME OUT—Dove Brubeck Quartet—Columbia CL-1397/CS-8192
 I LEFT MY HEART IN SAN FRANCISCO—Tony Bennett—Columbia CL-1B69/CS-8669
 ELVIS' CHRISTMAS ALBUM—Elvis Presley—RCA Victor LOC-1035/LPH-1951
 GIRLS, GIRLS, GIRLS—Elvis Presley—RCA Victor LPM-2621/LSP-2621
 BELAFONTE RETURNS TO CARNEGIE HALL—Harry Belafonte—RCA Victor LOC-6007/LSO-6007
 BELAFONTE—Harry Belafonte—RCA Victor LPM-1150
 JUMP-UP-CALYPSO—Harry Belafonte—RCA Victor LPM-2388/LSP-2388
 MOVIN'—Peter, Paul & Mary—Warner W/WS 1473
 EXODUS—Mantovani—London LL-3231/PS-224
 DAYS OF WINE AND ROSES—Andy Williams—Columbia CL-2015/CS-8815

(Continued on page 42)

#2 BLUES MAGOOS

NEWCOMER VOCAL GROUP-ALBUMS

(WE TRY HARDER) CASH BOX BEST OF 1967 POLL



PRODUCED AND DIRECTED BY
BOB WYLD AND ART POLHEMUS
FOR LONG HAIR PRODUCTIONS



AWARD
To

NEIL DIAMOND
NO. 1 MALE VOCALIST

In The Annual Cash Box Poll

My thanks
and appreciation for these
last two unbelievable years
Neil Diamond



Recordings

- SOLITARY MAN
- CHERRY, CHERRY
- I GOT THE FELLIN'
- YOU GOT TO ME
- GIRL, YOU'LL BE A WOMEN SOON
- THANK THE LORD FOR THE NIGHT TIME
- KENTUCKY WOMAN

Writing

- SUNDAY & ME
- SOLITARY MAN
- CHERRY, CHERRY
- I GOT THE FELLIN'
- I'M A BELIEVER
- YOU GOT TO ME
- LITTLE BIT ME, LITTLE BIT YOU
- MY BABE
- GIRL, YOU'LL BE A WOMAN SOON
- THE BOAT THAT I ROW
- I'LL COME RUNNIN'
- THANK THE LORD FOR THE NIGHT TIME
- IF I WALK A CROOKED STREET
- KENTUCKY WOMAN
- SHILO

Performing

- CASH BOX #1 MALE VOCALIST
- RECORD WORLD MOST POPULAR MALE VOCALIST
- TEEN SCREEN AWARD-FAVORITE MALE VOCALIST
- HEADLINING OVER 125 COLLEGE CONCERTS '67-'68

*They all agree...

NEIL IS NOW!

Golden Albums

(Continued from page 38)

MOON RIVER & OTHER GREAT MOVIE THEMES—Andy Williams—Columbia CL 1809/CS 8609
 HANDEL'S MESSIAH—Eugene Ormandy & Philadelphia Orch.—Columbia M2L 263/M2S 607
 CHRISTMAS WITH CONNIF—Roy Canniff—Columbia CL 1390/CS 8185
 THE LORD'S PRAYER—Mormon Tabernacle Choir—Columbia ML 5386/MS 6068
 PORGY AND BESS—Original Sound Track—Columbia OL 5410/OS 2016
 FOLK SONG SING ALONG—Mitch Miller—Columbia CL 1316/CS 8118
 IN THE WIND—Peter, Paul & Mary—Worner Bros. W8 1507/WS 1507
 SINGING NUN—Soeur Sourire—Philips PCC 203/PCC 603

1962

PARTY SING ALONG WITH MITCH—Mitch Miller—Columbia CL-1331/LS-8138
 MORE JOHNNY'S GREATEST HITS—Johnny Mothis—Columbia CL-1344/LS-8150
 WEST SIDE STORY—Original Cast—Columbia OL-5230/OS-2001
 CAMELOT—Original Cast—Columbia KOL-5620/KOS-2031
 FLOWER DRUM SONG—Original Cast—Columbia—OL-5350/OS-2009
 THEME FROM A SUMMER PLACE—Billy Vaughn—Dot 3276/25276
 BLUE HAWAII—Billy Vaughn—Dot 3165/25165
 SAIL ALONG SILVERY MOON—Billy Vaughn—Dot 3100/25100
 808 NEWHART BUTTON DOWN MIND—808 Newhart—Warner Bros. W-1379/WS-1379
 SATURDAY NIGHT SING ALONG WITH MITCH—Mitch Miller—Columbia CL-1414/CS-8211
 MEMORIES SING ALONG WITH MITCH—Mitch Miller—Columbia CL-1542/LS-8342
 SENTIMENTAL SING ALONG WITH MITCH—Mitch Miller—Columbia CL-1457/LS-8251
 STAR CAROL—Ernie Fard—Capitol T-1071/ST-1071
 NEARER THE CROSS—Ernie Fard—Capitol T-1005/ST-1005
 FRANK SINATRA SINGS FOR ONLY THE LONELY—Frank Sinatra—Capitol W-1053
 NICE 'N' EASY—Frank Sinatra—Capitol W-1417
 SONGS FOR SWINGIN' LOVERS—Frank Sinatra—Capitol W-653
 STRING ALONG—Kingston Trio—Capitol T-1407
 MUSIC, MARTINIS AND MEMORIES—Jackie Gleason—Capitol W-509
 MUSIC FOR LOVERS ONLY—Jackie Gleason—Capitol W-352
 JUDY AT CARNEGIE HALL—Judy Garland—Capitol WBO-1568
 HAPPY TIMES SING ALONG—Mitch Miller—Columbia CL-1568/CS-8368
 MEMORIES ARE MADE OF THIS—Ray Conniff—Columbia CL-1574/CS-8374
 CONCERT IN RHYTHM—Roy Conniff—Columbia CL-1163/CS-8022
 'S MARVELOUS—Roy Conniff—Columbia CL-1074/CS-8037
 MODERN SOUNDS IN COUNTRY & WESTERN MUSIC—Roy Charles—ABC Paramount ABC-410/
 ABCS-410
 BREAKFAST AT TIFFANY'S—Henry Mancini—RCA Victor LPM-2362/LSP-2362
 THIS IS SINATRA—Frank Sinatra—Capitol T-768
 BOUQUET—Percy Faith Strings—Columbia CL-1322/CS-8124
 SO MUCH IN LOVE—Roy Conniff—Columbia CL-1720/CS-8520
 FAITHFULLY—Johnny Mathis—Columbia CL-1422/CS-8219
 SWING SOFTLY—Johnny Mothis—Columbia CL-1165/CS-8023
 OPEN FIRE, TWO GUITARS—Johnny Mathis—Columbia CL-1270/CS-8056
 PETER, PAUL AND MARY—Peter, Paul and Mary—Warner Bros. W-1449/WS-1449
 MY SON THE FOLK SINGER—Allan Sherman—Warner Bros. W-1475/WS-1475
 THE FIRST FAMILY—Voughn Meader—Cordence CLP-3060

1961

CALCUTTA—Lawrence Welk—Dot DLP-3359/ST-25359
 COME DANCE WITH ME—Frank Sinatra—Capitol W-1069/WS-1069
 SOLD OUT—Kingston Trio—Capitol T-1352/T-6352
 GLENN MILLER STORY—Glenn Miller Orchestra—RCA Victor LPM-1192
 CHRISTMAS CAROLS—Mantovani—London LL-913/PS-142
 THEATRE LAND—Montovani—London LL-1219/PS-125
 FILM ENCORES VOL. 1—Mantovani—London LL-1700/PS-124
 GEMS FOREVER—Montovani—London LL-3032/PS-106
 STRAUSS WALTZES—Montovani—London LL-685/PS-118
 SPIRITUALS—Ernie Fard—Capitol T-818
 ELVIS' GOLDEN RECORDS—Elvis Presley—RCA Victor LPM-1707
 BELAFONTE AT CARNEGIE HALL—Horry Belofante—RCA Victor LOC-6006/LSO-6006
 TCHAIKOVSKY CONCERTO—Von Cliburn—RCA Victor LM-2252/LSC-2252
 ENCORE-GOLDEN HITS—The Plotters—Mercury MG-20472/SR-60243
 BLUE HAWAII—Elvis Presley—RCA Victor LPM-2426/LSP-2426
 HOLIDAY SING ALONG WITH MITCH—Mitch Miller—Columbia CL-1701/LS-8501

1960

STUDENT PRINCE—Maria Lanza—RCA Victor LM-1837
 60 YEARS OF MUSIC—Honoring 30 Great Artists—RCA Victor LM-6074
 ELVIS—Elvis Presley—RCA Victor LPM-1382
 PAT'S GREAT HITS—Pat Boone—Dot 3071/25071
 KINGSTON TRIO AT LARGE—Kingston Trio—Capitol T-1199
 KINGSTON TRIO—Kingston Trio—Capitol T-996
 MORE SING ALONG WITH MITCH—Mitch Miller—Columbia CL-1243/CS-8043
 HEAVENLY—Johnny Mothis—Columbia CL-1351/CS-8152
 WARM—Johnny Mothis—Columbia CL-1078/CS-8039
 LOVE IS THE THING—Nat King Cole—Capitol W-824
 HERE WE GO AGAIN—Kingston Trio—Capitol T-1258
 FROM THE HUNGRY I—Kingston Trio—Capitol T-1107
 SOUND OF MUSIC—Original Cast—Columbia KOL-5450/KOS-2020
 MERRY CHRISTMAS—Johnny Mathis—Columbia CL-1195/CS-8021
 CHRISTMAS SING ALONG—Mitch Miller—Columbia CL-1205/CS-8027
 STILL MORE SING ALONG—Mitch Miller—Columbia CL-1283/CS-8099

1959

HYMNS—Ernie Ford—Capitol T-256
 JOHNNY'S GREATEST HITS—Johnny Mathis—Columbia CL-1133
 MUSIC MAN—Original Cast—Capitol WAO/SWAO-990
 SING ALONG WITH MITCH—Mitch Miller—Columbia CL-1160/CS-8004
 SOUTH PACIFIC—Rodgers & Hammerstein—RCA Victor LOC/LSO-1032
 PETER GUNN—Henry Mancini—RCA Victor LPM/LSP-1956

1958

OKLAHOMA—Gordon MacRae—Capitol WAO-595

NARAS Grammy Awards Presented In 1967

- 1 RECORD OF THE YEAR (Award to the Artist and A & R Producer) STRANGERS IN THE NIGHT—Frank Sinatra—A & R Producer: Jimmy Bowen (REPRISE)
- 2 ALBUM OF THE YEAR (Awards to the Artist and A & R Producer) SINATRA: A MAN & HIS MUSIC—Frank Sinatra—A & R Producer: Sonny Burke (REPRISE)
- 3 SONG OF THE YEAR (This is a Songwriters' Award) MICHELLE—Songwriters: John Lennon, Paul McCartney (CAPITOL)
- 4 BEST INSTRUMENTAL THEME (This is a Composer's Award) BATMAN THEME—Composer: Neal Hefti (RCA)
- 5 BEST VOCAL PERFORMANCE—MALE—STRANGERS IN THE NIGHT (Single)—Frank Sinatra (REPRISE)
- 7 BEST INSTRUMENTAL PERFORMANCE (OTHER THAN JAZZ)—WHAT NOW MY LOVE—Herb Albert & the Tijuana Brass (A & M)
- 8 BEST PERFORMANCE BY A VOCAL GROUP—A MAN AND A WOMAN—Anita Kerr Singers (WB)
- 9 BEST PERFORMANCE BY A CHORUS—SOMEWHERE MY LOVE (Lara's Theme from "Dr. Zhivago")—Ray Conniff & Singers (COL)
- 10 BEST ORIGINAL SCORE WRITTEN FOR A MOTION PICTURE OR TELEVISION SHOW (This is a Composer's Award) DR. ZHIVAGO—Composer: Maurice Jarre (MGM)
- 11 BEST SCORE FROM AN ORIGINAL CAST SHOW ALBUM (This is a Composer's Award; plaque to the A & R producer; MAME (Original Cast)—Composer: Jerry Herman—A & R Producer: Goddard Lieberson (COL)
- 12 BEST COMEDY PERFORMANCE — WONDERFULNESS — Bill Cosby (WB)
- 13 BEST SPOKEN WORD, DOCUMENTARY OR DRAMA RECORDING—EDWARD R. MURROW—A REPORTER REMEMBERS—VOL. 1 THE WAR YEARS—Edward R. Murrow (COL)
- 14 BEST RECORDING FOR CHILDREN—DR. SEUSS PRESENTS: "IF I RAN THE ZOO" AND "SLEEP BOOK"—Marvin Miller (RCA-CAMDEN)
- 15 BEST ALBUM NOTES (This is an Annotator's Award) SINATRA AT THE SANDS—Frank Sinatra—Annotator: Stan Cornyn (REPRISE)
- 16 BEST INSTRUMENTAL JAZZ PERFORMANCE—GROUP OR SOLOIST WITH GROUP—GOIN OUT OF MY HEAD—Wes Montgomery (VERVE)
- 17 BEST ORIGINAL JAZZ COMPOSITION (This is a Composer's Award) IN THE BEGINNING GOD—Composer: Duke Ellington (RCA)
- 18 BEST CONTEMPORARY (R & R) RECORDING (Award to the artist, plaque to the A & R Producer) WINCHESTER CATHEDRAL—New Vaudeville Band—A & R Producer: Geoff Stephens (FONTANA)
- 19 BEST CONTEMPORARY (R & R) SOLO VOCAL PERFORMANCE—MALE OR FEMALE (This category is for single records) ELEANOR RIGBY—Paul McCartney (The Beatles) (CAP)
- 20 BEST CONTEMPORARY (R & R) GROUP PERFORMANCE—VOCAL OR INSTRUMENTAL (This category is for single records) MONDAY, MONDAY—The Mamas & The Papas (DUNHILL)
- 21 BEST RHYTHM & BLUES RECORDING (Award to the Artist, plaque to the A & R Producer) CRYING TIME—Ray Charles—A & R Producer: Tangerine Records (ABC-PARAMOUNT)
- 22 BEST RHYTHM & BLUES SOLO PERFORMANCE—MALE OR FEMALE (This category is for single records) HOLD IT RIGHT THERE—Ramsey Lewis (CADET)
- 24 BEST FOLK RECORDING (Award to the Artist, plaque to the A & R Producer) BLUES IN THE STREET—Cortelia Clark—A & R Producer: Felton Jarvis (RCA)
- 25 BEST SACRED RECORDING (MUSICAL) (Non-Classical) (Award to the Artist, plaque to the A & R Producer) GRAND OLD GOSPEL—Porter Wagoner & the Blackwood Bros.—A & R Producer: Chet Atkins (RCA)
- 26 BEST COUNTRY & WESTERN RECORDING (Award to the Artist, plaque to the A & R Producer) ALMOST PERSUADED—David Houston—A & R Producer: Billy Sherrill (EPIC)
- 27 BEST COUNTRY & WESTERN VOCAL PERFORMANCE—FEMALE—DON'T TOUCH ME (Single)—Jeannie Seely (MONUMENT)
- 28 BEST COUNTRY & WESTERN VOCAL PERFORMANCE — MALE — ALMOST PERSUADED (Single)—David Houston (EPIC)
- 29 BEST COUNTRY & WESTERN SONG (This is a Songwriter's Award) ALMOST PERSUADED — Songwriters: Billy Sherrill, Glenn Sutton (EPIC)
- 30 BEST INSTRUMENTAL ARRANGEMENT (This is an Arranger's Award) WHAT NOW MY LOVE (Herb Alpert & the Tijuana Brass)—Arranger: Herb Alpert (A & M)
- 31 BEST ARRANGEMENT ACCOMPANYING A VOCALIST OR INSTRUMENTALIST (This is an Arranger's Award) STRANGERS IN THE NIGHT (Frank Sinatra)—Arranger: Ernie Freeman (REPRISE)
- 32 BEST ENGINEERED RECORDING—NON-CLASSICAL (This is an Engineer's Award) STRANGERS IN THE NIGHT (Frank Sinatra)—Engineer: Eddie Brackett (REPRISE)
- 33 BEST ENGINEERED RECORDING—CLASSICAL (This is an Engineer's Award) WAGNER LOHENGRIN—Leinsdorf cond. Boston Symphony, Pro Musica Chorus & Soloists—Engineer: Anthony Salvatore (RCA)
- 34 BEST ALBUM COVER, PHOTOGRAPHY (Award to the Art Director & Photographer) CONFESSIONS OF A BROKEN MAN—Porter Wagoner—Art Director: Robert Jones—Photographer: Les Leverette (RCA)
- 35 BEST ALBUM COVER, GRAPHIC ARTS (Award to the Art Director & Graphic Artist) REVOLVER—The Beatles—Graphic Artist: Klaus Voorman (CAP)
- 36 ALBUM OF THE YEAR (Awards to Artist and A & R Producer) IVES: SYMPHONY NO. 1 IN D MINOR—Morton Gould cond. Chicago Symphony Orchestra—A & R Producer: Howard Scott (RCA)
- 37 BEST PERFORMANCE—ORCHESTRA—MAHLER: SYMPHONY NO. 6 IN A MINOR—Erich Leinsdorf cond. Boston Symphony Orchestra (RCA)
- 38 BEST CHAMBER MUSIC PERFORMANCE — INSTRUMENTAL OR VOCAL—BOSTON SYMPHONY CHAMBER PLAYERS (Selections by Mozart, Brahms, Beethoven, Fine, Copland, Carter, Piston) Boston Symphony Chamber Players (RCA)
- 39 BEST PERFORMANCE — INSTRUMENTAL SOLOIST OR SOLOISTS (WITH OR WITHOUT ORCHESTRA)—BAROQUE GUITAR (Bach, Sanz, Weiss, Etc.)—Julian Bream (RCA)
- 40 BEST OPERA RECORDING (This is a Conductor's Award; special plaques to the Principal Soloists; plaque to the A & R Producer) WAGNER: DIE WALKURE—Georg Solti cond. Vienna Philharmonic Orchestra/Principal



SCEPTER

LOVES all you out there:
dealers, disc jockeys, one-stops,
operators . . . & Burt & Hal for making

DIONNE WARWICK

No. 2 R&B
No. 2 Albums
No. 5 Singles

(Cash Box, Best of 1967 Poll)

Dionne Warwick Itinerary

Washington, D.C.	Shoreham Hotel	Dec. 19-31/67
N.Y.C.	Ed Sullivan Show	Jan 7/1-968
California, Pa.	California State U.	1/10
Charleston, W. Va.		1/12
Richmond, Va.		1/13
Los Angeles	Carol Burnett TV Show	1/16-20
Cleveland	Leos Cosino	1/25-28
Auburn, Ala.	Auburn Univ.	1/31
Athens, Ga.	Univ. of Georgia	2/1
Bethoney, W. Va.		2/2
Pittsburgh, Pa.	Univ. of Pittsburgh	2/3
West Point, N.Y.	U.S. Military Academy	2/4
San Juan, Puerto Rico	Flamboyant	2/8-14
Cookesville, Tenn.	Tenn. Tech	2/16
Greensboro, N.C.	Univ. of N.C.	2/17
Boston	Blinstrubs Village	2/19-25
Glossboro, N.J.	Glossboro St. College	2/29
Winston, Salem		3/11
New York City	Appala Theatre	3/8-14
Newark, Del.	Univ. of Delaware	3/23
N.Y.C.	St. Johns Univ.	3/24
Los Angeles	Jonathan Winters TV	3/28-4/1
Norfolk, Va.	Civic Auditorium	4/5
Lotrobe, Pa.	St. Vincent's	4/6
Hollywood, Fla.	Diplomat	4/11-20
Raleigh, N.C.	N.C. State	4/24
Providence, R.I.	Brown Univ.	4/26
Charlotte, N.C.	Queens College	4/27
Philadelphia	Academy of Music	4/28
Buffalo, N.Y.	Univ. of Buffalo	5/3
Charleston, W. Va.	Morris Harvey College	5/4
New York City	Copacabana	5/9-22
Los Angeles, Cal.	Century Plaza Hotel	6/11-26
Newport, R.I.	Newport Jazz Festival	7/6
Washington, D.C.	Carter Barron Amphitheatre	7/19-25
Philadelphia, Pa.	Quaker City Jazz Festival	10/19-20
Philadelphia, Pa.	Lotin Casino	12-23-1/4/69

Top Records of the Past 19 Years

The Top Records of 1961 thru 1967 As Compiled by Cash Box in its Annual Year-End Survey

1967

- Letter—Box Tops—Mala
- Light My Fire—Doors—Elektra
- Can't Take My Eyes Off You—Frankie Valli—Philips
- Ode to Billie Joe—Bobbie Gentry—Capitol
- To Sir With Love—Lulu—Epic
- Happy Together—Turtles—White Whale
- Windy—Association—Warner Bros.
- I'm A Believer—Monkees—Colgems
- Groovin'—Young Rascals—Atlantic
- Respect—Aretha Franklin—Atlantic
- Georgy Girl—Seekers—Capitol
- I Think We're Alone Now—Tommy James & Shondells—Roulette
- Something Stupid—Frank & Nancy Sinatra—Reprise
- Soul Man—Sam & Dave—Stax
- Come Back When You Grow Up—Bobby Vee—Liberty
- Sweet Soul Music—Arthur Conley—Atco
- Ruby Tuesday—Rolling Stones—London
- Kind Of A Drug—Buckingham—USA
- A Little Bit Of Soul—Music Explosion—Laurie
- I Got Rhythm—Happenings—B. T. Puppy
- Reflections—Supremes—Motown
- Somebody To Love—Jefferson Airplane—RCA
- The Happening—Supremes—Motown
- She Rather Be With Me—Turtles—White Whale
- Come On Down To My Boat—Every Mother's Son—MGM
- I Was Made To Love Her—Stevie Wonder—Tamla
- Incense & Peppermints—Strawberry Alarm Clock—UNI
- Then You Can Tell My Goodbye—Casinos—Fraternity
- Apples, Peaches & Pumpkin Pie—Jay & Techniques—Smash
- A Little Bit Me, A Little Bit You—Monkees—Colgems
- The Rain, The Park & Other Things—Cowsills—MGM
- Mercy, Mercy, Mercy—Buckingham—Columbia
- Never My Love—Association—Warner Bros.
- It Must Be Him—Vikki Carr—Liberty
- There's A Kind Of A Hush—Herman's Hermits—MGM
- We Ain't Got Nothing Yet—Blues Magoos—Mercury
- Dedicated To The One I Love—Mamas & Papas—Dunhill
- Don't You Care—Buckingham—Columbia
- This Is My Song—Petula Clark—Warner Bros.
- Love Is Here & Now You're Gone—Supremes—Motown
- Sock It To Me—Mitch Ryder & Detroit Wheels—New Voice
- Release Me—Englebert Humperdinck—Parrot
- All You Need Is Love—Beatles—Capitol
- Expressway To Your Heart—Soul Survivors—Crimson
- Penny Lane—Beatles—Capitol
- Please Love Me Forever—Bobby Vinton—Epic
- A Whiter Shade Of Pale—Procol Harum—Deram
- Jimmy Mack—Martha Reeves & Vandellas—Gordy
- Baby I Love You—Aretha Franklin—Atlantic
- Snoopy Vs The Red Baron—Royal Guardsmen—Laurie

1966

- The Ballad Of The Green Berets—S/Sgt. Barry Sadler (RCA)
- California Dreamin'—Mamas & Papas (Dunhill)
- Sounds of Silence—Simon & Garfunkel (Columbia)
- Sunny—Bobby Hebb (Philips)
- Strangers In The Night—Frank Sinatra (Reprise)
- You Can't Hurry Love—Supremes (Motown)
- A Groovy Kind Of Love Mindbenders—(Fontana)
- I Got You—James Brown—King
- Little Red Riding Hood—Sam The Sham & Pharaohs—MGM

- See You In September—Happenings—B. T. Puppy
- Good Lovin'—Young Rascals—Atlantic
- We Can Work It Out—Beatles—Capitol
- Up Tight—Stevie Wonder (Tamla)
- You Don't Have To Say You Love Me—Dusty Springfield (Philips)
- Kicks—Paul Revere & Raiders (Columbia)
- Lightnin' Strikes—Lou Christie (MGM)
- Cherish—Association (Valiant)
- Soul & Inspiration—Righteous Bros. (Verve)
- Hanky Panky—Tommy James & Shondells (Roulette)
- 96 Tears—? Question Mark & Mysterians (Cameo)
- Red Rubber Ball—Cyrkle (Columbia)
- Last Train To Clarksville—Monkees (Colgems)
- No Matter What Shape—T-Bones (Liberty)
- Cool Jerk—Capitols (Karen)
- Ain't Too Proud To Be—Temptations (Gordy)
- Sunshine Superman—Donovan (Epic)
- These Boots Are Made For Walking—Nancy Sinatra (Reprise) ff
- Daydream—Lovin' Spoonful—Kama Sutra
- When A Man Loves A Woman—Percy Sledge (Atlantic)
- Over & Over—Dave Clark Five (Epic)
- A Taste Of Honey—Herb Alpert & Tijuana Brass (A&M)
- Monday Monday—Mamas & Papas (Dunhill)
- Paint It Black—Rolling Stones (London)
- Turn, Turn, Turn—Byrds (Columbia)
- Bus Stop—Hollies (Imperial)
- My Love—Petula Clark—Warner Bros.
- Keep On Dancing—Gentrys (MGM)
- What Becomes Of The Broken Hearted—Jimmy Ruffin—Soul.
- 19th Nervous Breakdown—Rolling Stones—(London)
- Reach Out, I'll Be There—Four Tops (Motown)
- Summer In The City—Lovin' Spoonful—Kama Sutra
- I Am A Rock—Simon & Garfunkel (Columbia)
- Let's Hang On—Four Seasons (Philips)
- Time Won't Let Me—Outsiders (Capitol)
- Paperback Writer—Beatles (Capitol)
- Barbara Ann—Beach Boys (Capitol)
- She's Just My Style—Gary Lewis & Playboys (Liberty)
- Bang Bang—Cher—Imperial
- Crying Time—Ray Charles (ABC)
- Five O'Clock World—Vogues—Co & Co
- Somewhere My Love—Ray Conniff Singers (Columbia)

1965

- Back In My Arms Again—Supremes (Motown)
- Wooly Bully—Sam The Sham & The Pharo (MGM)
- Mr. Lonely—Bobby Vinton (Epic)
- I Can't Help Myself—Four Tops (Motown)
- Satisfaction—Rolling Stones (London)
- Downtown—Petula Clark (WB)
- You've Lost That Lovin' Feeling—Righteous Bros. (Philles)
- Come See About Me—Supremes (Motown)
- The In Crowd—Ramsey Lewis (Cadet)
- You Were On My Mind—We Five (A & M)
- Help—Beatles (Capitol)
- Crying In The Chapel—Elvis Presley (RCA)
- Love Potion #9—Searchers (Kapp)
- I Got You Babe—Sonny & Cher (Atco)
- This Diamond Ring—Gary Lewis & Playboys (Liberty)
- My Girl—Temptations (Gordy)
- King Of The Road—Roger Miller (Smash)
- Hang On Sloopy—McCoys (Bang)
- I Feel Fine—Beatles (Capitol)
- The Birds & The Bees—Jewel Akins (Era)
- The Jerks—Larks (Money)
- Can't You Hear My Heartbeat—Herman's Hermits (MGM)
- Mrs. Brown You Have A Lovely Daughter—Herman's Hermits (MGM)

- Stop In The Name Of Love—Supremes (Motown)
- Eve of Destruction—Barry McGuire (Dunhill)
- Mr. Tambourine Man—Byrds (Columbia)
- What The World Needs Now Is Love—Jackie DeShannon (Liberty)
- Shotgun—Jr. Walker & All Stars (Soul)
- She's Not There—Zombies (Parrot)
- Help Me Rhonda—Beach Boys (Capitol)
- How Sweet It Is—Marvin Gaye (Tamla)
- Unchained Melody—Righteous Bros. (Philles)
- Ringo—Lorne Green (RCA)
- Down In The Boonedocks—Billy Joe Royal (Columbia)
- The Name Game—Shirley Ellis (Congress)
- Ticket To Ride—Beatles (Capitol)
- Going Out Of My Mind—Little Anthony & Imperials (DCP)
- Like A Rolling Stone—Bob Dylan (Columbia)
- I Know A Place—Petula Clark (WB)
- Silhouettes—Herman's Hermits (MGM)
- Red Roses For A Blue Lady—Bert Kaempfert (Decca)
- I'll Never Find Another You—Seekers (Capitol)
- Cara Mia—Jay & The Americans (UA)
- Keep Searchin'—Del Shannon (Amy)
- Count Me In—Gary Lewis & The Playboys (Liberty)
- A Walk In The Black Forest—Horst Jankowski (Mercury)
- Goldfinger—Shirley Bassey (UA)
- I'm Telling You Now—Freddie & The Dreamers (Tower)
- It Ain't Me Babe—Turtles (White Whale)
- Jolly Green Giant—Kingsmen (Ward)

1964

- I Want To Hold Your Hand—Beatles (Capitol)
- She Loves You—Beatles (Swan)
- Hello, Dolly—Louis Armstrong (Kapp)
- Oh, Pretty Woman—Roy Orbison (Monument)
- I Get Around—Beach Boys (Capitol)
- Louie, Louie—Kingsmen (Ward)
- My Guy—Mary Wells (Motown)
- Blue Velvet—Bobby Vinton (Epic)
- Glad All Over—Dave Clark Five (Epic)
- Everybody Loves Somebody—Dean Martin (Reprise)
- Dominique—Singing Nun (Philips)
- There I've Said It Again—Bobby Vinton (Epic)
- Love Me Do—Beatles (Capitol)
- She's A Fool—Lesley Gore (Mercury)
- Where Did Our Love Go—Supremes (Motown)
- Java—Al Hirt (RCA)
- People—Barbra Streisand (Columbia)
- A Hard Day's Night—Beatles (Capitol)
- Since I Fell For You—Lenny Welch (Cadence)
- Forget Him—Bobby Rydell (Cameo)
- Under The Boardwalk—Drifters (Atlantic)
- It's All Right—Impressions (ABC)
- Love Me With All Of Your Heart—Ray Charles Singers (Command)
- Chapel Of Love—Dixie Cups (Red Bird)
- Little Children—Billy J. Kramer & Dakotas (Imperial)
- Bread And Butter—Newbeats (Hickory)
- I'm Leaving It Up To You—Dale & Grace (Montel)
- Dawn (Go Away)—Four Seasons (Philips)
- Rag Doll—Four Seasons (Philips)
- Suspicion—Terry Stafford (Crusader)
- Popsicles & Icicles—Murmaids (Chattahoochee)
- Washington Square—Village Stompers (Epic)
- A World Without Love—Peter & Gordon (Capitol)
- Can I Get A Witness—Marvin Gaye (Tamla)
- I Can't Stay Mad At You—Skeeter Davis—(RCA)
- Wishin' And Hopin'—Dusty Springfield (Philips)
- Please, Please Me—Beatles (Capitol)
- You Don't Have To Be A Baby To Cry—(Caravelles) (Smash)
- Sugar Shack—Jimmy Gilmer (Dot)
- Busted—Ray Charles (ABC)

- Walkin' The Dog—Rufus Thomas (Stax)
- You Don't Own Me—Lesley Gore (Mercury)
- Hey Little Cobra—Rip Chords (Columbia)
- Deep Purple—Nino Tempo & April Stevens (Atco)
- Fools Rush In—Rick Nelson (Decca)
- Don't Let The Rain Come Down—Serendipity Singers (Philips)
- Out Of Limits—Marketts (WB)
- Walk On By—Dionne Warwick (Scepter)
- Nitty Gritty—Shirley Ellis (Congress)
- Cry Baby—Garnett Mimms & Enchanters (UA)

1963

- Limbo Rock—Chubby Checker (Parkway)
- Go Away Little Girl—Steve Lawrence (Columbia)
- End Of The World—Skeeter Davis (RCA)
- Blue Velvet—Bobby Vinton (Epic)
- Telstar—Tornadoes (London)
- I Will Follow Him—Little Peggy March (RCA)
- Rhythm Of The Rain—Cascades (Valiant)
- Can't Get Used To Losing You—Andy Williams (Columbia)
- Fingertips—Little Stevie Wonder (Tamla)
- Return To Sender—Elvis Presley (RCA)
- Up On The Roof—Drifters (Atlantic)
- So Much In Love—Tymes (Parkway)
- He's So Fine—Chiffons (Laurie)
- Hey Paula—Paul & Paula (Philips)
- Big Girls Don't Cry—Four Seasons (Vee Jay)
- Surfin' U.S.A.—Beach Boys (Capitol)
- Walk Right In—Rooftop Singers (Vanguard)
- Walk Like A Man—Four Seasons (Vee Jay)
- If You Wanna Be Happy—Jimmie Soul (S.P.Q.R.)
- Easier Said Than Done—Essex (Roulette)
- My Boyfriend's Back—Angels (Smash)
- Mockingbird—Inez Foxx (Symbol)
- Our Day Will Come—Ruby & Romantics (Kapp)
- Puff The Magic Dragon—Peter, Paul & Mary (WB)
- Ruby Baby—Dion DiMucci (Columbia)
- Surf City—Jan & Dean (Liberty)
- I Love You Because—Al Martino (Capitol)
- You're The Reason I'm Living—Bobby Darin (Capitol)
- Sukiyaki—Kyu Sakamoto (Capitol)
- It's My Party—Lesley Gore (Mercury)
- The Night Has A Thousand Eyes—Bobby Vee (Liberty)
- Blame It On The Bossa Nova—Edyie Gorme (Columbia)
- Pipeline—Chantays (Dot)
- Two Faces Have I—Lou Christie (Roulette)
- You Can't Sit Down—Dovells (Parkway)
- Surfer Girl—Beach Boys (Capitol)
- Lonely Bull—Tijuana Brass (A&M)
- Hello Stranger—Barbara Lewis (Atlantic)
- Blowing In The Wind—Peter, Paul & Mary (WB)
- Wild Weekend—Rockin' Rebels (Swan)
- If I Had A Hammer—Trini Lopez (Reprise)
- Heat Wave—Martha & The Vandellas (Gordy)
- Tell Him—Exciters (UA)
- Be My Baby—Ronettes (Philles)
- Wipe Out—Surfaris (Dot)
- You Really Got A Hold On Me—Miracles (Tamla)
- From A Jack To A King—Ned Miller (Fabor)
- My Dad—Paul Petersen (Colpix)
- Bobby's Girl—Marcie Blaine (Seville)
- Candy Girl—Four Seasons (Vee Jay)

1962

- Twist—Chubby Checker (Parkway)
- Stranger On The Shore—Acker Bilk (Atco)
- Peppermint Twist—Joey Dee & Starlighters (Roulette)
- Mashed Potato Time—Deedee Sharp (Cameo)
- Moon River—Henry Mancini (RCA)
- I Can't Stop Loving You—Ray Charles (ABC)
- You'll Lose A Good Thing—Barbara Lynn (Jemie)

(Continued on Page 46)

Everybody

Loves

Somebody

Dina

Top Records of the Past 19 Years

The Top R&B Records of 1961 thru 1967 As Compiled by Cash Box in its Annual Year-End Survey

1962 (Continued from page 44)

8. The Stripper—David Rose (MGM)
9. The Wanderer—Dion (Laurie)
10. The Lion Sleeps Tonight—Tokens (RCA)
11. Johnny Angel—Shelly Fabares (Colpix)
12. The One Who Really Loves You—Mary Wells
13. Ramblin' Rose—Nat "King" Cole (Capitol)
14. Hey Baby—Bruce Channel (Smash)
15. Locomotion—Little Eva (Dimension)
16. Duke of Earl—Gene Chandler (Vee Jay)
17. Roses Are Red—Bobby Vinton (Epic)
18. Do You Love Me—Contours (Gordy)
19. Soldier Boy—Shirley (Scepter)
20. Sherry—Four Seasons (Vee Jay)
21. Walk On By—Leroy Van Dyke (Mercury)
22. I Know—Barbara George (AFO)
23. It Keeps Right On A-Hurtin'—Johnny Tillotson (Cadence)
24. Midnight In Moscow—Kenny Ball (Kapp)
25. Let Me In—Sensations (Chess)
26. Monster Mash—Bobby Pickett (Garpax)
27. Palisades Park—Freddie Cannon (Swan)
28. Can't Help Falling In Love—Elvis Presley (RCA)
29. Twist And Shout—Isley Bros. (Wand)
30. Twistin' The Night Away—Sam Cooke (RCA)
31. Surfin' Safari—Beach Boys (Capitol)
32. Breaking Up Is Hard To Do—Neil Sedaka (RCA)
33. Run To Him—Bobby Vee (Liberty)
34. Green Onions—Booker T. & MG's (Stax)
35. Wolvorton Mountain—Claude King (Columbia)
36. Love Letters—Ketty Lester (Era)
37. Town Without Pity—Gene Pitney (Musico)
38. Sheila—Tommy Roe (ABC—Paramount)
39. Please Mr. Postman—Marvelettes (Tamla)
40. Alley Cat—Bent Fabric (Atco)
41. Patches—Dickey Lee (Smash)
42. Good Luck Charm—Elvis Presley (RCA)
43. Big Bad John—Jimmy Dean (Columbia)
44. Tuff—Ace Cannon (Hi)
45. Goodbye Cruel World—James Darren (Colpix)
46. Dear Lady Twist—Gary U.S. Bonds (Lauri)
47. Paty Lights—Claudine Clark (Chancellor)
48. Sealed With A Kiss—Brian Hyland (ABC—Paramount)
49. She Cried—Jay & The Americans (UA)
50. Norman—Sue Thompson (Hickory)

1961

1. Exodus—Ferrante & Teicher (UA)
2. Calcutta—Lawrence Welk—(Dot)
3. Will You Love Me Tomorrow—Shirley (Scepter)
4. Tossin' & Turnin'—Bobby Lewis (Beltone)
5. Wonderland By Night—Bert Kaempfert—(Decca)
6. Are You Lonesome Tonight—Elvis Presley (RCA)
7. Travelin' Man—Rickey Nelson (Imperial)
8. Michael—Highwaymen (UA)
9. Runaway—Del Shannon (Bigtop)
10. Last Date—Floyd Cramer—(RCA)
11. Blue Moon—Marcel (Colpix)
12. Boll-Weevil Song—Brook Benton (Mercury)
13. North To Alaska—Johnny Horton—(Columbia)
14. Pony Time—Chubby Checker—(Parkway)
15. 100 Lbs. Of Clay—Gene McDaniels (Liberty)
16. Mother-in-Law—Ernie K-Doe (Minit)
17. Raindrops—Dee Clark (Veejay)
18. He Will Break Your Heart—Jerry Butler—(Vee Jay)
19. Quarter To Three—U.S. Bonds—(Legrand)
20. A Thousand Stars—Kathy Young (Indigo)
21. Running Scared—Roy Orbison (Monument)
22. Wooden Heat—Joe Dowell—(Smash)
23. Take Good Care Of My Baby—Bobby Vee (Liberty)
24. Wheels—Billy Vaughn (Dot)
25. Shop Around—Miracles (Tamla)
26. Last Night—Mar-Keys (Satellite)
27. Daddy's Home—Shep & Limelites (Hull)
28. Cryin'—Roy Orbison (Monument)
29. Where The Boys Are—C. Francis (MGM)
30. Apache—Jorgen Ingmann (Atco)

31. Don't Worry—Marty Robbins (Columbia)
32. Surrender—Elvis Presley—(RCA)
33. I've Told Every Little Star—Linda Scott (Canadian American)
34. Mountain's High—Dick & Deedee (Liberty)
35. Hats Off To Larry—Del Shannon—(Big Top)
36. Moody River—Pat Boone—(Dot)
37. Stay—Maurice Williams—(Herald)
38. Calendar Girl—Neil Sedaka—(RCA)
39. But I Do—Clarence Henry—(Argo)
40. Dedicated To The One I Love—Shirley (Scepter)
41. Poetry In Motion—Johnny Tillotson—(Cadence)
42. Yellow Bird—Lawrence Welk—(Dot)
43. Stand By Me—Ben E. King (Atco)
44. New Orleans—U.S. Bonds (Legrand)
45. You're Sixteen—Johnny Burnette—(Liberty)
46. Angel Baby—Rosie & The Originals (Decca)
47. Sailor—Lolita (Kapp)
48. Dum-Dum—Brenda Lee (Decca)
49. I Like It Like That—Chris Kenner—(Instant)
50. Rubber Ball—Bobby Vee—(Liberty)

1960

1. Theme From A Summer Place—Percy Faith
2. It's Now Or Never—Elvis Presley
3. Save The Last Dance For Me—Drifters
4. The Twist—Chubby Checker
5. Itsy Bitsy Teenie Bikini—Brian Hyland
6. I'm Sorry—Brenda Lee
7. Stuck On You—Elvis Presley
8. He'll Have To Go—Jim Reeves
9. Cathy's Clown—Everly Brothers
10. Running Bear—Johnny Preston
11. Walk, Don't Run—Ventures
12. Everybody's Somebody's Fool—Connie Francis
13. Handy Man—Jimmy Jones
14. My Heart Has A Mind Of Its Own—Connie Francis
15. Only The Lonely—Roy Orbison
16. Teen Angel—Mark Dinning
17. El Paso—Marty Robbins
18. Chain Gang—Sam Cooke
19. Kiddio—Brook Benton
20. Please Help Me, I'm Falling—Hank Locklin
21. Greenfields—Brothers Four
22. Night—Jackie Wilson
23. Good Timin'—Jimmy Jones
24. Baby (You Got What It Takes)—Brook Benton—Dinah Washington
25. Wild One—Bobby Rydell
26. Mr. Custer—Larry Verne
27. Sink The Bismarck—Johnny Horton
28. Sweet Nothin's—Brenda Lee
29. Puppy Love—Paul Anka
30. I Want To Be Wanted—Brenda Lee
31. Paper Roses—Anita Bryant
32. Because They're Young—Duane Eddy
33. Alley-Opp—Hollywood Argyles/Dante & Evergreens
34. Way Down Yonder In N.O.—Freddie Cannon
35. Why—Frankie Avalon
36. Burning Bridges—Jack Scott
37. Where Or When—Dion & Belmonts
38. Finger Poppin' Time—Hank Ballard & Midnighters
39. Volare—Bobby Rydell
40. Theme From The Apartment—Ferrante & Teicher
41. Devil Or Angel—Bobby Vee
42. You Talk Too Much—Joe Jones
43. Heartaches By The Number—Guy Mitchell
44. A Rockin' Good Way—Brook Benton & Dinah Washington
45. White Silver Sands—Bill Black's Combo
46. It's Time To Cry—Paul Anka
47. You Got What It Takes—Marv Johnson
48. What In The World's—Jack Scott
49. The Big Hurt—Toni Fisher
50. Harbor Lights—Platters

1959

1. Mack The Knife—Bobby Darin
2. Battle Of New Orleans—Johnny Horton
3. Venus—Frankie Avalon
4. Lonely Boy—Paul Anka
5. There Goes My Baby—Drifters
6. Personality—Lloyd Price
7. Three Bells—Browns
8. Put Your Head On My Shoulder—Paul Anka

9. Sleepwalk—Santo & Johnny
10. Come Softly To Me—Fleetwoods
11. Stagger Lee—Lloyd Price
12. Dream Lover—Bobby Darin
13. Kansas City—Wilbert Harrison
14. Smoke Gets In Your Eyes—Platters
15. Charlie Brown—Coasters
16. Mr. Blue—Fleetwoods
17. A Fool Such As I—Elvis Presley
18. Don't You Know—Della Reese
19. A Big Hunk O' Love—Elvis Presley
20. What A Difference A Day Makes—Dinah Washington
21. Quiet Village—Martin Denny
22. Pink Shoelaces—Dodie Stevens
23. Just A Matter Of Time—Brook Benton
24. Sea Of Love—Phil Phillips
25. A Teenager In Love—Dion & Belmonts
26. I'm Gonna Get Married—Lloyd Price
27. Sorry (I Ran All The Way Home)—Impalas
28. (Til) I Kissed You—Everly Brothers
29. Primrose Lane—Jerry Wallace
30. Deck Of Cards—Wink Martindale
31. Kookie Kookie (Lend Me Your Comb)—Edd Byrnes & Connie Stevens
32. Seven Little Girls (Sittin' In The Back Seat)—Paul Evans & Curls
33. Lipstick On Your Collar—Connie Francis
34. Lavender Blue—Sammy Turner
35. The Happy Organ—Dave "Baby" Cortez
36. Hawaiian Wedding Song—Andy Williams
37. Waterloo—Stonewall Jackson
38. Red River Rock—Johnny & The Hurricanes
39. Teen Beat—Sandy Nelson
40. My Heart Is An Open Book—Carl Dobkins, Jr.
41. Since I Don't Have You—Skyliners
42. Gotta Travel On—Billy Grammer
43. Frankie—Connie Francis
44. Children's Marching Song—Cyril Stapleton/Mitch Miller
45. Lonely Street—Andy Williams
46. Donna—Ritchie Valens
47. Tiger—Fabian
48. Heartaches By The Number—Guy Mitchell
49. Sixteen Candles—Crests
50. Broken Hearted Melody—Sarah Vaughan
51. Poison Ivy—Coasters
52. Petite Fleur—Chris Barber Band
53. Alvin's Harmonica—David Seville & Chipmunks
54. Only You—Frank Pourcel
55. Turn Me Loose—Fabian
56. It's Late—Ricky Nelson

1958

1. Nel Blu Di Pinto Di Blu.—Domenico Modugno
2. It's All In The Game—Tommy Edwards
3. Patricia—Perez Prado
4. All I Have To Do Is Dream—Everly Brothers
5. Bird Dog/Devoted To You—Everly Brothers
6. Little Star—Elegants
7. Witch Doctor—David Seville
8. Twilight Time—Platters
9. Tequila—Champs
10. At The Hop—Danny & The Juniors
11. Return To Me—Dean Martin
12. Catch A Falling Star—Perry Como
13. Purple People Eater—Sheb Wooley
14. Tea For Two Cha Cha—Warren Covington & T. Dorsey Orch.
15. He's Got The Whole World In His Hands—Laurie London
16. Sail Along Silvery Moon—Billy Vaughn
17. Get A Job—Silhouettes
18. Poor Little Fool—Ricky Nelson
19. Yakety Yak—Coasters
20. Tom Dooley—Kingston Trio
21. Rockin' Robin—Bobby Day
22. Topsy II—Cozy Cole
23. Secretly—Jimmie Rodgers
24. Who's Sorry Now—Connie Francis
25. Wear My Ring Around Your Neck—Elvis Presley
26. It's Only Make Believe—Conway Twitty
27. Splish Splash—Bobby Darin
28. Don't—Elvis Presley
29. Chantilly Lace—Big Bopper
30. The Stroll—Diamonds
31. When—Kalin Twins
32. Just A Dream—Jimmy Clanton
33. Susie Darlin'—Robin Luke
34. Tears On My Pillow—Little Anthony & Imperials
35. Lollipop—Chordettes

36. Everybody Loves A Lover—Doris Day
37. Hard Headed Woman—Elvis Presley
38. Big Man—Four Preps
39. Chanson D'Armour—Art & Dotty Todd
40. Oh Julie—Crescendos
41. Sweet Little Sixteen—Chuck Berry
42. To Know Him Is To Love Him—Teddy Bears
43. Fever—Peggy Lee
44. My True Love—Jack Scott
45. Twenty Six Miles—Four Preps
46. Sugartime—McGuire Sisters
47. Do You Wanna Dance—Bobby Freeman
48. The End—Earl Grant
49. Rebel Rouser—Duane Eddy
50. It's Too Soon To Know—Pat Boone
51. Looking Back—Nat "King" Cole

1957

1. Tammy—Debbie Reynolds
2. Love Letters In The Sand—Pat Boone
3. It's Not For Me To Say—Johnny Mathis
4. Young Love—Sonny James—Tab Hunter
5. Chances Are—Johnny Mathis
6. Little Darlin'—Diamonds
7. Bye Bye Love—Everly Bros.
8. All Shook Up—Elvis Presley
9. So Rare—Jimmy Dorsey
10. Round And Round—Perry Como
11. Jailhouse Rock—Elvis Presley
12. Wake Up Little Susie—Everly Bros.
13. Diana—Paul Anka
14. Honeycomb—Jimmie Rodgers
15. Teddy Bear—Elvis Presley
16. Don't Forbid Me—Pat Boone
17. I'm Gonna Sit Right Down—Billy Williams
18. Come Go With Me—Del-Vikings
19. Silhouettes—Rays
20. Party Doll—Buddy Knox
21. Butterfly—Charlie Gracie—Andy Williams
22. You Send Me—Sam Cooke
23. Day-O—Harry Belafonte
24. Fascination—Jane Morgan
25. That'll Be The Day—Crickets
26. Banana Boat Song—Tarrriers
27. A White Sport Coat—Marty Robbins
28. Too Much—Elvis Presley
29. Marianne—Easy Riders
30. I'm Walkin'—Fats Domino
31. Dark Moon—Gale Storm
32. Gone—Ferlin Husky
33. School Day (Ring Ring Goes The Bell)—Chuck Berry
34. Searchin'—Coasters
35. Whole Lot Of Shakin' Going On—Jerry Lee Lewis
36. April Love—Pat Boone
37. Be Bop Baby—Ricky Nelson
38. Rainbow—Russ Hamilton
39. My Special Angel—Bobby Helms
40. Teen Age Crush—Tommy Sands
41. Around The World—Victor Young—Man-tovani
42. Send For Me—Nat "King" Cole
43. White Silver Sands—Don Rondo
44. Melodie D'Armour—Ames Bros.
45. Raunchy—Bill Justic—Ernie Freeman
46. Mr. Lee—Bobbettes
47. Old Cape Cod—Patti Page
48. Happy Happy Birthday Baby—Tune Weavers
49. Love Is Strange—Mickey & Sylvia
50. Little Bitty Pretty One—Thurston Harris

1956

1. Don't Be Cruel—Elvis Presley
2. The Great Pretender—Platters
3. My Prayer—Platters
4. The Wayward Wind—Gogi Grant
5. Whatever Will Be, Will Be—Doris Day
6. Heartbreak Hotel—Elvis Presley
7. Lisbon Antigua—Nelson Riddle
8. Canadian Sunset—Hugo Winterhalter
9. Moonglow & Picnic—Morris Stoloff
10. Honky Tonk—Bill Doggett
11. Memories Are Made Of This—Dean Martin
12. Poor People Of Paris—Les Baxter
13. Rock And Roll Waltz—Kay Starr
14. Hot Diggity—Perry Como
15. Hound Dog—Elvis Presley
16. I Want You, I Need You, I Love You—Elvis Presley
17. Blue Suede Shoes—Carl Perkins
18. Why Do Fools Fall In Love—Teenagers
19. No Not Much—Four Lads
20. I Almost Lost My Mind—Pat Boone
21. Tonight You Belong To Me—Patience & Prudence

AMERICA'S NUMBER ONE CONCERT ATTRACTION... 6 STRAIGHT YEARS ON THE CHARTS



PERSONAL REPRESENTATION
ALAN C. BERNARD

AGENCY REPRESENTATION
PERENCHIO ARTISTS LTD.

PUBLIC RELATIONS
SHELDON A. SALTMAN

COLUMBIA RECORDS

RECORD INDUSTRY YEAR IN REVIEW

JANUARY

Disk sales for 1966 top \$700 million Record Industry Association of America (RIAA) reports, with prospects for a \$1 billion business by the 1970's. . . . MIDEM, an international music & record meeting ground in Cannes, France, takes place and immediately establishes itself as a major annual event. . . . Brian Epstein's Nems management-booking company and Robert Stigwood's similar company merge (Epstein's death later in the year leads to Stigwood's departure from Nems). . . . Capitol enters film production thru deal with Arch Obler's "Space Vision" process. . . . Columbia offers its budget-priced classics, Odyssey, one of many such lines available. . . . Wes Farrell and ABC enter label (Senate) and publishing deal. . . . RCA lowers stereo price tags on Camden (\$1.89) and Victrola (\$2.50), eliminating differential between mono & stereo. . . . Jerry Wexler, exec vp of Atlantic, is given 50th birthday party by the trade at the St. Regis Hotel in NY. . . . Warner Bros. Loma label shifts to NY under Jerry Rago-voy. . . . Lenny Mietus leaves BMI to set-up Lenny Mietus Copyright Management. . . . Jubilee Records receives wide consumer coverage on its Adam Clayton Powell LP, "Keep the Faith, Baby."

FEBRUARY

EMI signs the Beatles for nine more years. . . . 20th Century Fox buys Bregman, Vocco & Conn. . . . San Remo winner: Claudio Villa's rendition of "Non Pensare A Me". . . . Dick Sherman named head of Warner Bros. Records sales. . . . Lee Mendell named

assistant to Al Bennett, president of Liberty Records. . . . Henry Jerome leaves Decca to join UA as A&R head. . . . Henry Mancini, an ASCAP writer, and Leslie Bricusse, cleared thru BMI, will team, with songs to be alternately published thru both clearing houses. . . . Phil Skaff, Liberty vp, sets-up own label, President, out of Hollywood. . . . Dave Kapp re-elected president of Record Industry Association of America (RIAA). . . . Irv Biegel named sales manager at Amy-Mala-Bell. . . . Milt Gabler of Decca's A&R dept. is feted on his 30th year with the label at the St. Regis Hotel. . . . ABC signs deal to publish and record Bob Merrill's new musical, "Henry, Sweet, Henry". . . . Liberty opens tape duplicating plant in Omaha.

MARCH

Capitol & Columbia decide to furnish tape cartridge field with 4-track tapes; RCA says it will stay with only 8-track cartridge product, also offered by Capitol & Columbia. . . . Stereo singles being supplied for FM stereo broadcasting. . . . A National Committee for the Recording Arts is established to obtain performance fees for disk artists. . . . RCA earns 13 Grammys from NARAS (disk awards); Frank Sinatra awarded for best recording ("Strangers in the Night") and album ("Man & His Music"). . . . Beach Boys sue to terminate Capitol pact. . . . Andy Williams inks new long-term contract at Columbia. . . . 800 flock to NARM (wholesaler) convention in Hollywood. . . . Chess developing \$1.5 million recording center in Chicago. . . . Don Kirshner sues Columbia Pictures for \$35 million fol-

lowing his discharge from head of the company's label, Colgems.

APRIL

A "sound" rivalry between the east and west coasts develops, with west coast outlets sticking with their "favorite sons," the more far-out rock attractions, and limiting play on more conventional disks from the east. . . . Disk bootlegging back in full force. . . . Labels propose performance royalties for disks and performers at Copyright hearings in Washington. . . . New Copyright Bill clears House of Representatives. . . . Henry Mancini and Wesley Rose elected to ASCAP board. Harry Jenkins named RCA operations vp; Irwin Tarr promoted to marketing vp at the label. . . . RCA press tour of Indianapolis Stereo 8 cartridge facilities indicates labels faith in the system; also, label creates Stereo 8 A&R dept. under the direction of Elliot Horne. . . . Warner Bros. Records buys Valiant label and obtains the Association. . . . Monterey Pop Music Festival announced for June. . . . Dot to handle Jeff Barry's new Steed label. . . .

MAY

Indie producer ties with major labels—featuring the formation of new diskeries—continues to grow. . . . The "flower" fad spread to disks, highlighted by Scott McKenzie's "San Francisco Flowers in Your Hair," first release from Ode, the new company established by Lou Adler thru Columbia Records. . . . Terry Melcher and ABC form Equinox label. . . . Cambridge, Mass. cited as the "Haight-Ashbury of the East" for musical talent. . . . Lester Sill named to head Col-

gems Records; Emil La Voiola to help of Screen Gems-Columbia Music. . . . RCA forms publishing unit under Jerry Teifer. . . . BMI Awards: Eddie Holland as writer, Jobete Music as publisher lead BMI achievement awards. . . . Columbia to market its own 4-track cartridge tapes. . . . Atco inks Bee Gees, British group. . . .

JUNE

CBS increases price of mono albums to level of stereo; RCA follows suit. Move by the companies sets in motion similar moves by most labels. CBS cites studies by its engineers that indicate stereo recordings can be played on late model mono phonos (July sales meetings will see an overwhelming preference for stereo product). . . . A&M and Creed Taylor, formerly Verve A&R chief, make a production deal. . . . Bob McCluskey named general manager of Acuff-Rose. . . . Verve ends arrangement with Folkways label. Verve/Folkways becomes Verve/Forecast. . . . John Rosica leaves RCA to join A&M in New York. . . . Emmy Awards stir industry controversy by not naming award-winning composer for TV. . . . Columbia introduces Moby Grape via \$100,000 promo and the release of five singles from the group's debut album. . . . Atlantic earns seven RIAA-certified gold disks over 3-week period, with Aretha Franklin pacing the way. . . . Wally Schuster named to head Big 3 (Robbins-Feist-Miller) special projects. . . . Israel's 6-day war with Arab nations leads to large industry donations to the country and special LP releases of speeches and songs. (Continued on page 50)

Past Hits

(Continued from page 46)

22. I'm In Love Again—Fats Domino
23. Allegheny Moon—Patti Page
24. Just Walking In The Rain—Johnnie Ray
25. Ivory Tower—Cathy Carr
26. Green Door—Jim Lowe
27. Love Me Tender—Elvis Presley
28. Band Of Gold—Don Cherry
29. Standing On The Corner—Four Lads
30. See You Later, Alligator—Bill Haley & Comets
31. Magic Touch—Platters
32. I'll Be Home—Pat Boone
33. True Love—Crosby & Kelly
34. A Tear Fell—Teresa Brewer
35. Flying Saucer—Buchanan & Goodman
36. On The Street Where You Live—Vic Damone
37. The Fool—Sanford Clark
38. Friendly Persuasion—Pat Boone
39. Blueberry Hill—Fats Domino
40. Song For A Summer Night—Mitch Miller
41. More—Perry Como
42. Singing The Blues—Guy Mitchell
- 1955**
1. Rock Around The Clock—Bill Haley & Comets
2. Davy Crockett—Bill Hayes
3. Cherry Pink And Apple Blossom White—Perez Prado
4. Melody Of Love—Billy Vaughn
5. Yellow Rose Of Texas—Mitch Miller
6. Ain't That A Shame—Pat Boone
7. Sincerely—McGuire Sisters
8. Unchained Melody—Al Hibbler
9. Crazy Otto—Johnny Maddox
10. Mr. Sandman—Chordettes
- 1954**
1. Little Things Mean A Lot—Kitty Kallen
2. Hey There—Rosemary Clooney
3. Wanted—Perry Como
4. Young At Heart—Frank Sinatra
5. Sh-Boom—Crewcuts
6. Three Coins In The Fountain—Four Aces
7. Little Shoemaker—Gaylords
8. Oh, My Papa—Eddie Fisher
9. Secret Love—Doris Day
10. Happy Wanderer—Frank Weir
- 1953**
1. Song From Moulin Rouge—Percy Faith
2. Till I Waltz Again With You—Teresa Brewer
3. April In Portugal—Les Baxter
4. Vaya Con Dios—Les Paul & Mary Ford
5. I'm Walking Behind You—Eddie Fisher

6. I Believe—Frankie Laine
7. You, You, You—Ames Bros.
8. Doggie In The Window—Patti Page
9. Why Don't You Believe Me—Joni James
10. Pretend—Nat "King" Cole
- 1952**
1. Cry—Johnny Ray
2. Blue Tango—Leroy Anderson
3. Anytime—Edie Fisher
4. Delicado—Percy Faith
5. Kiss Of Fire—Georgia Gibbs
6. Wheel Of Fortune—Kay Starr
7. Tell Me Why—Four Aces
8. I'm Yours—Don Cornell
9. Here In My Heart—Al Martino
10. Auf Wiedersehn Sweetheart—Vera Lynn
- 1951**
1. Tennessee Waltz—Patti Page
2. How High The Moon—Les Paul & Mary Ford
3. Too Young—Nat "King" Cole
4. Be My Love—Mario Lanza
5. Because Of You—Tony Bennett
6. On Top Of Old Smokey—Weavers & Terry Gilkyson
7. If—Perry Como
8. Sin—Four Aces
9. Come On-A My House—Rosemary Clooney
10. Mockin' Bird Hill—Les Paul & Mary Ford
- 1950**
1. Goodnight Irene—Gordon Jenkins & The Weavers
2. It Isn't Fair—Sammy Kaye
3. Third Man Theme—Anton Karas
4. Mule Train—Frankie Laine
5. Mona Lisa—King Cole
6. Music, Music, Music—Teresa Brewer
7. I Wanna Be Loved—Andrew Sisters
8. I'd've Baked A Cake—Eileen Barton
9. I Can Dream Can't I—Andrews Sisters
10. That Lucky Old Sun—Frankie Laine
- 1949**
1. Forever And Ever—Russ Morgan Orch.
2. Riders In The Sky—Vaughn Monroe
3. Again—Gordon Jenkins Orch.
4. Forever And Ever—Perry Como
5. Cruising Down The River—Blue Barron Orch.
6. Cruising Down The River—Russ Morgan Orch.
7. Again—Vic Damone
8. So Tired—Russ Morgan Orch.
9. Lavender Blue—Dinah Shore
10. Buttons And Bows—Dinah Shore

JUST FOR THE RECORD!

Our Best Wishes for a Happy Holiday Season

Brenda & the Tabulations
the Kit Kats
Crispian St. Peters
Barbara Mason
The Fantastic
Johnny C
Helene Smith
Phil-L-A
SOUL

dionn
RECORDS

Jamie / Guyden 



JAMIE/GUYDEN DISTRIBUTING CO.

PHILADELPHIA, PENNSYLVANIA 19123

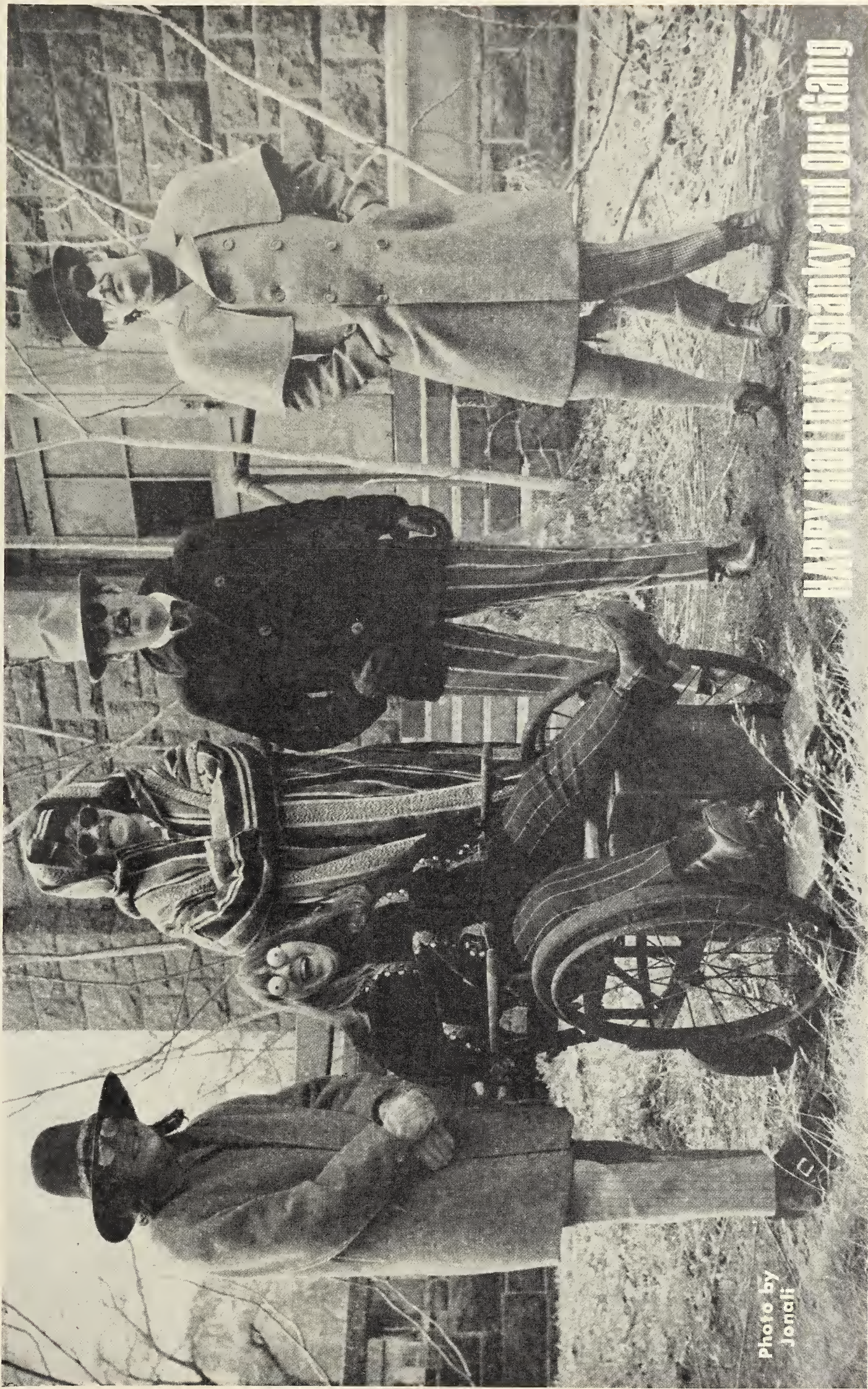

Photo by
Jonait

HAPPY HOLIDAY SPANKY and Our Gang



Public Relations **CONNIE DeNAVE**

Personnel Management **CURLEY TAIT**

Road Management **GALVIN BERNAL**

RECORD INDUSTRY YEAR IN REVIEW

(Continued from page 48)

JULY

Columbia Records, following up on its decision to eliminate the price differential between mono and stereo disks, embarks on a campaign to stress its contention that stereo disks can be played with "excellent" results on late-model mono phonos. Meanwhile, most label sales conventions report overwhelming choice of stereo product over mono. . . . ABC Records expands its interests in distrib-rack area with purchase of Seattle's Consolidated Distributors. . . . Don Kirshner forms entertainment complex. . . . MGM, Kama-Sutra & Lovin' Spoonful team

thru 1975. . . . Liberty revamps exec structure: Lee Mendell named vp of sales, Irv Kessler to vp of manufacturing. . . . Dot Records and Bob Crewe tie-in for disks and, eventually, films. . . . Newark riots put disk business there at a standstill. . . . Elektra adds \$3.50 classic line, Checkmate. . . . Capitol wins cartridge piracy case, said to be first of its kind. . . . Acuff-Rose unveils new headquarters (cost: \$500,000) in Nashville. . . . Nashville Room for country acts opens at Hotel Taft in New York. . . . Neil Anderson, formerly of BML, named to head April-Blackwood Music. . . . Monterey Pop Festival in Calif. is a big event in first try.

AUGUST

Federal Trade Commission charges Columbia Record Club with "lessening competition"; Allen Klein and Abbey Butler buy major share of Cameo/Parkway stock; charges denied by the Club. . . . Cameo/Product to be marketed by MGM thru Cameo's own line-up of distribis; Neil Bogart, others leave Cameo (to eventually tie-in with Buddah Records of Kama-Sutra). . . . RCA plans to build new headquarters in midtown Manhattan. . . . Rash of "love songs" (3 minutes and over) come along. . . . More label conventions bear-out strong stereo order pattern. . . . New Columbia pacts for Barbra Streisand, Bob Dylan; Frank Sinatra re-inks with Reprise. . . . *Cash Box* editorial notes that many "underground" artists have strong LP sales without benefit of big singles hit. . . . Vanguard adds a new \$3.50 classical line to business: Cardinal; Label ending mono classics production. . . . Outfit offers do-it-yourself tape cartridge duplication. . . . William Worrall is new president of Chappell Music. . . . Raymond Rosen buys I. J. Morgan Co., Philadelphia one-stop-rack firm. . . . "Responsibility brings new profile" Keynotes Atlanta, Ga. meet of NATRA, the deejay association.

NOVEMBER

RCA and Decca plan to go indie in England: RCA in June, 1969; Decca on Jan. 1, 1968. . . . Bill Gallagher leaves Columbia Records to join MCA in leisure time-entertainment marketing post. . . . Capitol and Audio Devices merge. . . . Bill Cosby and Coca-Cola to team on 5-minute comedy series on Top 40 radio; Elvis Presley Christmas greetings to be heard over 3,000 radio stations on Dec. 3, 10. . . . Cameo Parkway buys Allen Klein Co. . . . Singer Co. to sponsor nationwide search for teen talent, culminating in big TV show for finalists. . . . Kinney National to acquire Ashley-Famous. . . . Capitol ties with Koppelman-Rubin for Hot Biscuit label; MGM and Kev Eggers team on Poppy Records. . . . Labels start "live" showcasing of new talent. . . . RCA to build \$1 million studios in Montreal. . . . Police raid bogus record plant on Long Island; arrest three; *Cash Box* receives RIAA commendation for cooperating with association and law officials in arrests. . . . Jay Lowy named general professional manager of Famous Music. . . . Mercury sets-up \$500,000 administrative-studio complex in New York at 110 West 57th St. . . . Edward Eliscu elected new president of American Guild of Authors & Composers (AGAC), replacing Burton Lane, head of the guild for a decade. . . . McGraw-Hill to handle Argo Sight & Sound Line of London, emphasizing growing need for audio-visual product from record industry. . . . Decca opens refurbished studios in New York. . . . Cowsills, a family act with a Top 40 approach, climbs to top of Top 100 with "Rain, Park & Other Things" for MGM Records.

SEPTEMBER

Randy Wood exits Dot label, which he formed 17 years before; Arnold Burk takes over label as president, with Dick Peirce serving as general manager. . . . RCA and Don Kirshner form new label, later to be called Calendar. . . . RCA also plans pre-production outlay for new film musical, "The Man Who Could Work Miracles." . . . Aretha Franklin scores a first for a female artist: 3 RIAA-certified gold singles in a row. . . . Capitol celebrates its 25th anniversary. . . . Philco-Ford bows a series of "mini" 45rpm disks, with past singles hits kicking of the program, which also involves transistor portable phonos. . . . Ken Revercomb joins Dot Records. . . . Motown conducts first sales convention in Detroit. . . . Capitol offers 20% discount on mono product. . . . RCA inks Jack Jones. . . . Decca and Shel Talmy, American-born England-based indie producer, tie-in for various artists. . . . MGM bows Cowsills, family act, in \$200,000 promo. . . . CBS to handle Andrew Loog Oldham and Tony Calder's Immediate label; Lee Hazelwood's LHI label moves from Decca to ABC. . . . Len Sachs, LP sales head of Atlantic, cites continued strength of label's mono LP sales. . . . Dave Pell returns to Liberty A&R staff.

DECEMBER

MCA's Uni label buys Kapp Records; label to retain identity, with owner Dave Kapp staying on as consultant and producer. He'll also work with Bill Gallagher, newly-named vp of MCA, in obtaining cast LP's of musicals for MCA. . . . See marginal effects on record business in British devaluation of the pound. . . . RCA and Eugene Ormandy-Philadelphic Orchestra revive association; orchestra, with Columbia Records for 24 years, signs 5-year pact with label. . . . Elvis Presley Christmas radio show on Dec. 3 and 10th heard over more than 3000 outlets. . . . Colgems blueprints expansion into "complete" label; Lloyd Leipzig joins operation as vp. . . . Al Bennett, president of Liberty Records, sees record industry "coming of age" in view of increasing affluence and leisure-time in U.S. . . . Danny Davis, RCA A&R exec, moving to Nashville; to operate in RCA A&R there. . . . Al Massler buys Wonderland kiddie line. . . . Autolite-Ford forms tape cartridge club for Stereo 8's; RCA provides handling-mailing.

OCTOBER

Atlantic Records sold to Warner Bros.-Seven Arts in cash-stock deal that could eventually reach \$17,000,000; Atlantic management remains, with label to operate as an "independent affiliate." . . . Country Music Association elects four new Hall of Famers: Steve Sholes, Fred Foley, J. L. Frank and Jim Reeves; Hubert Long elected president of CMA. . . . Columbia/Group names four division presidents, including Clive Davis (CBS Records), Neil Keating (Columbia Record Club), CBS International (Harvey Schein) and Don Randall (CBS Musical Instruments). . . . RCA-tied Don Kirshner label, Calendar, inks Steve Lawrence & Eydie Gorme

REDD FOX NEW HIT!

"ADULTS ONLY"

REDD FOX DTL 840

DARING · SPICY · RED HOT THE LATEST AND GREATEST!

Order today for early delivery and extra profits!



DTL 212

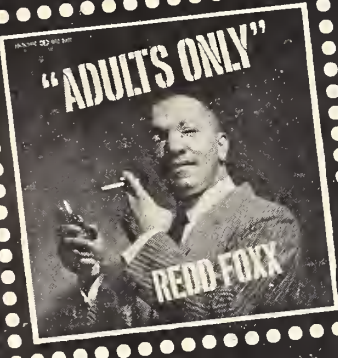

OTHER DOOTO BEST SELLERS!



DTL 838



DTL 219



DTL 829



DTL 855



DTL 820

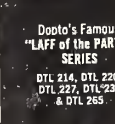

DTL 214, DTL 220, DTL 227, DTL 236 & DTL 263



DTL 809



DTL 275



DTL 295



DTL 828



DTL 266



DTL 257



DTL 804



DTL 815



DTL 274



DTL 833



DTL 290



DTL 285



DTL 801



DTL 826



DTL 836



DTL 234



DTL 294



DTL 839



DTL 808



DTL 279



DTL 249



DTL 830



DTL 232



DTL 814



DTL 825



DTL 827

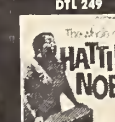

DTL 823



DTL 01



DTL 270



DTL 812

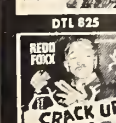

DTL 834



DTL 253



DTL 238



DTL 824



DTL 827



DTL 250

DOOTO COMEDY RECORDS \$ELL!

ORDER NOW FOR HOLIDAY SALES

5 + 1 "STOCK-UP" DEAL!

DOOTO HITS AVAILABLE ON 4 AND 8 TRACK STEREO TAPE CARTRIDGES

DOOTO RECORDS

13440 So. Central Ave., L.A., Calif. 90059 Phone 774-0743

THE
DOORS
ARE
ALWAYS
OPEN

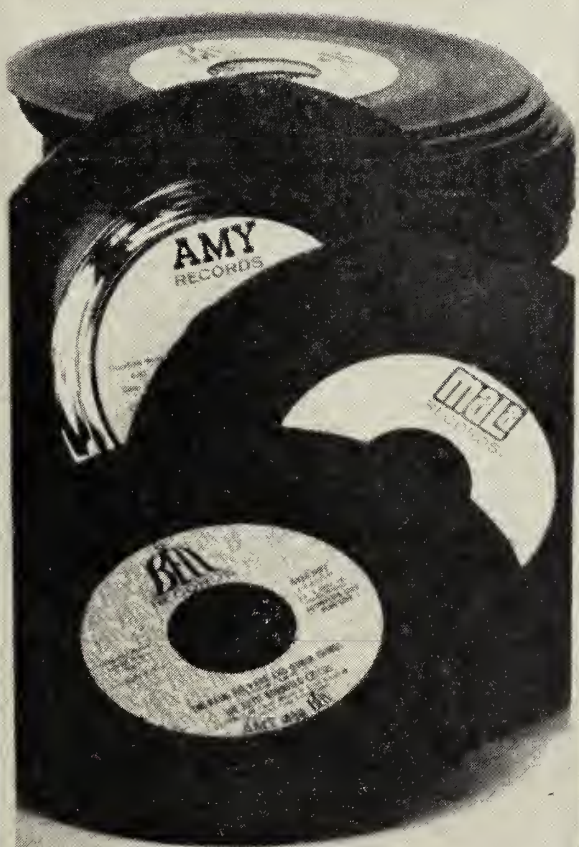
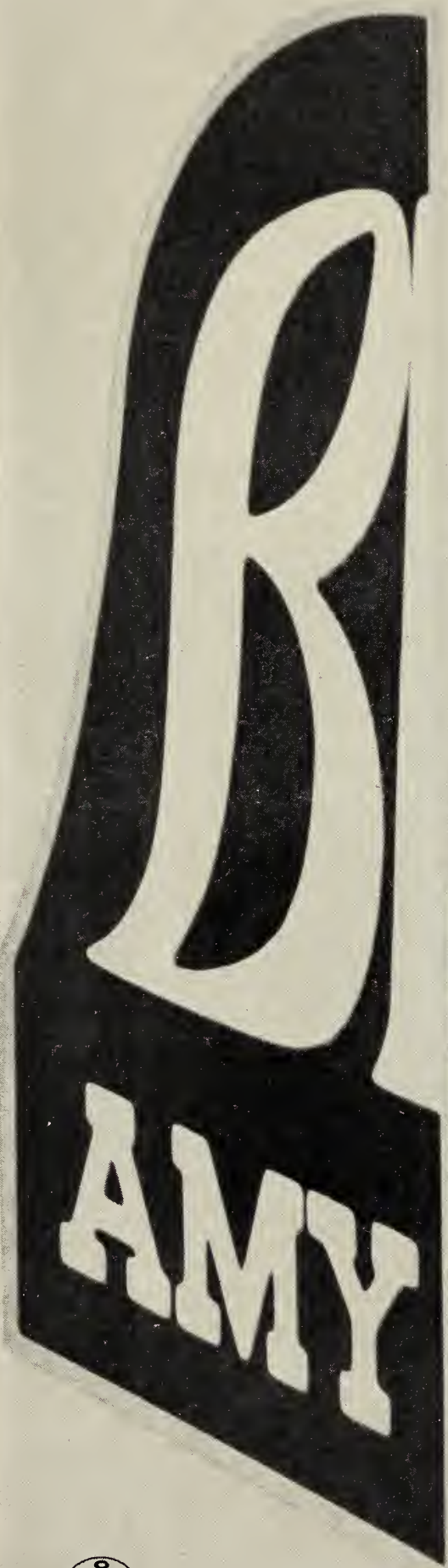

Bell Records 1776 Broadway, New York, N.Y. 10019

Bios of 1967's Leading Artists

Herb Alpert—A&M

Just a few short years ago Herb Alpert created an exciting new sound which he calls Ameriachi. The sound, a new form of jazz expression, combines American Dixieland and Mexican Mariachi. "The Lonely Bull" was the first recording by Herb Alpert and the Tijuana Brass. Since this initial waxing, Alpert and the group have gone on to score with a host of singles and LPs unlimited. They have been signed to every major TVer and have embarked on a series of night club and personal appearances.

Some hit TJB singles include: "The Work Song," "Tijuana Taxi," "Taste Of Honey," "Mame," and "Spanish Flea." Their smash LPs include: "SRO," "Going Places," "Whipped Cream & Other Delights," "South Of The Border," "Sounds Like . . ." and "What Now My Love."

Ed Ames—RCA Victor

Ed Ames, RCA recording artist, displays a performing versatility which is little short of breathtaking. In the 1960's Ames sang in night clubs, on recordings, and leading radio and TV variety shows as the lead singer and soloist with the Ames Brothers. In 1961 he acted in an off-Broadway production of Arthur Miller's "The Crucible," before entering musical comedy as the star of "The Fantastiks." He next appeared in the National Company of "Carnival," and then took on a series of dramatic roles on TV. The lead in "One Flew Over The Cuckoo's Nest" followed. When the play closed, Ames was called to co-star on NBC-TV's "Daniel Boone" series as Mingo, the Oxford-educated son of a Cherokee Indian mother and an English father, a part he continues to play. In 1964, after a recording hiatus of four years, Ames cut an LP titled, "Opening Night With Ed Ames." One of the tunes on the disk, "Try To Remember," emerged as one of the top songs of 1965. Ed Ames, who now plans to press on to a directorial debut and a venture into both opera and Shakespearean drama, broke on to the charts with "Time." He brought out a "Christmas With Ed Ames" LP. His latest single is "Who Will Answer."

Eddy Arnold—RCA Victor

The path that Eddie Arnold followed during his sensational rise from the soil to stardom is typically and thoroughly American. Its source lies at the very heartland of this country's folk music, the Tennessee hills, and from the spreads to the farthest coasts and plains. An exclusive RCA Victor recording artist for the past twenty years, Eddy's records have helped blaze this sky-rocketing path.

Richard Edward Arnold was born on a farm near Henderson, a small town in western Tennessee, the youngest of four children. With instruction from his mother and four seventy-five cent lessons from a traveling musician, Eddy learned the guitar, and when he was nineteen joined a small band performing in Jackson, Tenn. From there he went to St. Louis where he joined forces with a young fiddler player named Howard McNatt. They opened at station KWK and Eddy Arnold's phenomenal career had begun in earnest. Over the years the songster has had a number of huge hits including "Bouquet Of Roses" and "Anytime," "Somebody Like Me," was a big country outing for Eddy last year. His biggest tunes this year are: "Turn The World Around," and "Misty Blue." He is currently represented by "Here Comes Heaven."

Chet Atkins—RCA Victor

Record dealers, pop and countrywise, all across the country classify the albums of "Mr. Guitar"—Chet Atkins—as "must in inventory." The gentle, unhurried Atkins continues to be one of Victor's most consistent LP chart-makers (as well as scoring big in the singles dept.) and has once again captured top honors as the most played country instrumentalist.

As one of RCA's key A&R men, operating out of their Nashville studios, the amazing talent has turned out dozens of outstanding singles—including Jim Reeves' "He'll Have To Go," the Browns' "The Three Bells" and Floyd Cramer's "Last Date." As a guitarist his repertoire ranges from Bach to Spanish music to jazz to rock 'n' roll. Among guitar students re's a leading teacher of the instrument, a designer of guitars and author of his own "Methods" book.

Born in Luttrell, Tenn., June 20th, 1924, the son of a piano and voice teacher, Chet left high school to appear on a host of stations—including KNOX-Knoxville, WLW-Cincinnati, WPTF-Raleigh, WRVA-Richmond and in '50 became a fixture with the Opry. The axe man's big click in 1966 was "Prissy."

So far this year, Chet has found time to be feted to a night in his honor in Nashville (where he played with the Boston Pops to a packed house), produce records, work as a sideman, head up the RCA Victor Nashville A&R dept., and make a few LP's, the most recent of which are: "Class Guitar" on RCA Victor and "Chet" on PCA Camden

Joan Baez—Vanguard

Joan Baez, at one time in 1964 had all three of her albums in the Top 20 of the LP chart, calls Boston home despite the fact that her father, a professor of physics, has served in appointments in many different countries.

The youthful folk singer has had no formal musical education or training but is recognized as one of the most competent folk singers in the business. Her strong soprano voice coupled with an almost innate feeling for the folk idiom brought her favorable reviews at her first appearance with the Newport Folk Festival in 1959.

Personal appearances at colleges, concert halls and on TV brought her to the attention of Vanguard Records who signed her to an exclusive contract. Her very first LP was an immediate best-seller as have been her other Vanguard albums.

The vocalist currently lives in California near Carmel, where she maintains an Institute For The Study of Non-Violence. She scored top 100 success in 1965 with "There But For Fortune." For the past two seasons, she has gotten a piece of the Christmas sales pie with her "Noel" LP.

She has a new Christmas Song Book out. Her latest single is "Be Not Too Hard" while her latest LP is entitled, "Joan."

Chris Bartley—Vando

Chris Bartley has wasted little time in achieving success. His first effort was "Sweetest Thing This Side Of Heaven." The young artist, 18, was born in Harlem where he still lives with his parents. He worked at part-time jobs while going to school, and spent the money at the Apollo Theatre where he queued up to see his favorite singers. He was lead singer with a local group when he was discovered by his manager, Bill Downs. Downs took Bartley to song writer and producer Van McCoy, who, after hearing Bartley, signed him to an exclusive recording contract with Vando Records. Although he had never been inside a recording studio before Bartley completed cutting "Sweetest Thing This Side Of Heaven" in two takes. The artist appreciates him and he hopes to get recorded the group he sang with before he went solo. Although Bartley has already attained national popularity via his hit single, he has not run out of dreams. He has his sights set squarely on the Apollo Theatre.

Beach Boys—Brothers

Surfing is a comparatively recent phenomenon on the West Coast. Yet the sport has become so popular that the coast line where intrepid youths hitch hair-raising rides on high rolling waves is beginning to take on the look of a Los Angeles freeway during rush hour.

Soaring with these sturdy lads among the white caps was one Dennis Wilson, who decided that it was high time somebody lionized the sport in song.

Dennis took a song idea to his musically talented and versatile family. His cousin, Mike Love, wrote "Surfin'." His brother Brian got together a vocal group consisting of cousin Mike, Dennis, and a third brother Carl. Dad Murray Wilson, a long-time songwriter, ram-daddied a recording session. The song clicked immediately.

With an ear ever to the ground to detect the slightest vibration of a new musical trend, Capital Boys' first hit and snagged them for an exclusive Capital contract.

Their first Capitol disk was "Surfin' Safari," a sequel to "Surfin'" and a bona fide nationwide smash in the fall of 1962. They followed with a host of two-sided smashes that included "Surfin' U.S.A.," "Shut Down," "Little Deuce Coupe" and "Surfer Girl" and "Be True To Your School," "In My Room," "Help Me Rhonda," "California Girls" and "Good Vibrations."

In 1967 they left Capitol Records, initiating their own label, Brothers Records. Their first deck an Brothers, called "Heroes And Villains," was another smash.

They soon rejoined the Capitol ranks, however, and their most recent hit has been "Wild Honey."

The Beatles—Capitol

Beatlemania has settled down to just plain stardom for the Beatles. They're still adored, of course, but 1965 seemed to indicate that the great English foursome are far more than a quickly fading comet—they are respected by young and old, pop fans and, yes, even classical-oriented groups. A pinnacle of this well-rounded acceptance was the presentation by Queen Elizabeth of OBE's to the boys which puts them in the honored company of people in many walks of life. During their second year on the American disk scene, the crew continued to score with hit after singles and LP hit, and are currently the possessors of 13 gold record awards for singles, and about 12 for LP's. Their second summer tour of the U. S. also contained the remarkable statistic of a sell-out (some 56,000 people at Shea Stadium in New York. And their 3rd followed suit. The Beatles, in short, mean much more to the music world than Beatlemania.

Their list of hit singles is a fantastic one, featuring "She Loves You," "I Want To Hold Your Hand," "Yesterday," "Eleanor Rigby," "Hard Day's Night," "Penny Lane," "I Saw Her Standing There" and "All You Need Is Love."

Bee Gees—Atco

The precociousness of the Bee Gees, Atco recording artists, is little short of astounding. In 1960, when the average age of the group was just ten years, the Bee Gees starred in their own weekly 30-minute TV series screened from Brisbane, Australia. Previously, in 1956, the trio, Barry Gibb and his younger twin brothers, Robin and Maurice Gibb, began as an amateur group in their Manchester, England, hometown. In 1958 the Gibb family emigrated to Australia. During the following eight years, the Bee Gees became one of that country's top pop acts. The group, having won numerous honors in Australia, returned to Britain in 1967 where a fourth member was added. He was Colin Petersen, a drummer. Since the age of nine, he had made three movie appearances. After the Bee Gees became a foursome, they entered into a lengthy series of recording sessions in London. Out of these sessions came "New York Mining Disaster—1941." The Bee Gees, who write all their own materials, became a quintet in 1967. The newest member is Australian guitarist Vince Melouney. The group's first album, "The Bee Gees First" came out in July, '67. They are currently represented on LP by "Bee Gees No. 2."

Tony Bennett—Columbia

Tony Bennett was born in Astoria, New York and began his meteoric rise to stardom as a contestant on Arthur Godfrey's "Talent Scouts" TV'er.

Coming in as a runner-up to Rosemary Clooney, Tony was immediately signed to appear on Jan Murray's "Songs For Sale" show. A few months later he appeared in a Greenwich Village nitery upon the insistence of Pearl Bailey who was headlining the show. Bob Hope wandered in one night and invited the young crooner to join him the next day on the stage of the Paramount Theatre where the laughman was appearing. The young performer sang a few songs and the audience roared its approval. Four encores later, Hope announced that Tony would be joining him on a national tour. The rest is history. Mitch Miller inked the artist to a Columbia recording contract and his initial sides developed into best-sellers. The chanter has been responsible for such hits as "Boulevard Of Broken Dreams," "I Won't Cry Anymore," "Stranger In Paradise," "Because Of

You," "Rags To Riches," "I Left My Heart In San Francisco" and "Who Can I Turn To."

When he is not on tour Tony usually devotes his time to painting and high fidelity.

On the LP charts he has clicked with "I Left My Heart In San Francisco," "Tony Bennett At Carnegie Hall," "I Wanna Be Around," "This Is All I Ask," "Tony's Greatest Hits Vol. III," and "The Movie Song Album."

Blues Magoos—Mercury

The Blues Magoos are comprised of Mike Magoo, lead guitar; Ron Magoo, bass; Geoff Magoo, drums; Ralph Magoo, organ; and Peppy Magoo, rhythm guitar. The trademark of the group is its "psychedelic" sound, which is a wild, frenetic, unrestrained, emotional outpouring in musical sound that has a strong basis in traditional blues but that is played with all the variations that modern electrical instrumentation can provide. The Blues Magoos employ electrical feedback as echo box. The idea of "psychedelic music" evolved about ten months ago when the Magoos were first in its present form. Ralph, Ronnie and Peppy were the original "magoos" and were playing at the nod defunct Night Owl in Greenwich Village. Two members of the original Magoos left the group and Geoff and his friend, Mike, were added to make the present fivesome. The Blues Magoos were represented on the charts with "We Ain't Got Nothin' Yet," and "There's A Chance We Can Make It."

Booker T. & The MG's—Stax

Booker T., whose complete name is Booker T. Jones, was born in Memphis, Tennessee. He started playing the organ professionally at 14 and while in high school led the school band for four years. In 1962 Booker made "Who's Who" in high schools of America.

He polished his musicianship by playing both jazz and rock and roll gigs throughout Tennessee.

The MG's in Booker T. and MG's, stands for "The Memphis Group," meaning, of course that the musicians that play and record with Booker are all from Memphis.

Some of the boys' big decks have included "Chinese Checkers," "Green Onions," "Hip-Hug-Her" and the instrumental version of "Groovin'."

Box Tops—Mala

The Box Tops, Mala recording artists, made it the top of the charts with "The Letter." The group is comprised of Danny Smythe, 19, drums; Bill Cunningham, 18, bass guitar; Alex Chilton, 18, lead singer; Gary Talley, 19, lead guitar; and John Evans, 19, organ. The quintet has been singing and performing together for over two and a half years. The boys are all from Memphis and they attend high school and college. They have had quite a few local records that have met with some success. Evans is a music major at Memphis State where he is a few hours away from his degree. Although the Box Tops like and perform all types of music, they enjoy doing soul music most. One of their biggest idols is Otis Redding. "The Letter" was produced and arranged by Dan Penn, and the boys are managed by Roy McElwain. The quintet is booked solid for the next six months, with college dates scheduled for this fall. The group will appear at Cheetah in Chicago this month and at Cheetah in New York in Oct. The group's debut album is currently in full swing.

Browns—RCA Victor

While still in their teens, Jim Edward, Maxine and Bonnie Brown teamed up to display their musical talents by entering a talent contest in Little Rock, Ark., which they took by storm. A shot on the Louisiana Hayride followed, and later the trio became a regular feature on the "Ozark Jubilee" TV'er. Soon there were frequent invitations to appear at the Grand Ole Opry, and in 1963 the Browns became regular members of the famed C&W showcase.

The recording career of the threesome was brought home when Fabor Robinson recorded them on his label, producing their "Draggin' Main Street" and "I Was Looking Back To See" smashes. Their continued success culminated in a recording contract with RCA Victor and a line of hits that includes "Scarlet Ribbons," "The Old Lamplighter" and "Twelfth Rose." The biggest wax outing by the group, however, came in 1959 when they released "Three Bells," which took little time to rack up a million sales.

Temporarily split after Jim's induction into the Army, his two sisters drafted younger sister Norma to take his place until his return, when they picked up where they left off. Since then the trio has clicked with "You Can't Grow Peaches On A Cherry Tree," and "Coming Back To You."

Solomon Burke—Atlantic

Like so many other popular singers, Solomon Burke comes from Philadelphia where he received his principal vocal training in the church. Solomon was a soloist by the age of nine and at twelve he was known as the "Wonder-Boy Preacher" and had his own church.

He was discovered while at the temple and in 1960 he signed an exclusive long term contract with Atlantic, the results of which have been such hits as "Just Out Of Reach," "Everybody Needs Somebody to Love" and "Only Love." In addition to recording activities, the chanter has done extensive TV work and played some of the top theatres and clubs throughout the country. Latest of Burke's singles is "Detroit City."

Byrds—Columbia

The Byrds established themselves with their chart-topping Columbia deck of "Mr. Tambourine Man" and followed it up with another #1 tune, "Turn! Turn! Turn!"

Individually they have a substantial amount of experience. One was leader of a bluegrass group, another was the lead guitarist for Bobby Darin.

Before releasing them on the public, their management—previously deeply involved in folk music—trained the Byrds and prepared them for what they knew would be a highly competitive field. Since their auspicious start the Byrds have climbed both the singles and LP charts with such items as "B Miles High" and "5D (Fifth Dimension)."

Glen Campbell—Capitol

Glen Campbell got his musical start early. By the age of six he was singing and strumming the guitar on radio and at barn dances nearby his home on a farm near Delight, Arkansas. The seventh son in a family of 12 children, Campbell was surrounded by music from birth; the entire Campbell clan sang and played musical instruments. In his teens, Campbell joined a western band in Albuquerque, New Mexico, led by his uncle, Dick Bills. For five years he appeared with the band on radio and TV. Following this he had his own band for several years before he struck out for the west coast. After arriving in Hollywood in 1960, Campbell started recording for an independent label. He worked with the Champs, a singing and instrumental group and then cut "Turn Around—Look At Me," which brought him nation-wide popularity. The success of the disk led to his signing an exclusive contract with Capitol Records, Campbell, who is proficient on drums, bass, violin, mandolin, and harmonica enjoys hunting, fishing, and water skiing. Campbell saw Top "100" action in 1967 with "Gentle On My Mind" and the extremely successful "By The Time I Get To Phoenix."

Vikki Carr—Liberty

Vikki Carr was born Florencia Bisenta de Casillas Martinez Cardona in El Paso, Texas. After she was graduated from high school, she embarked upon a professional career with the Pepe Callahan Mexican-Iris Band, traveling to Reno, Las Vegas, Lake Tahoe, and Hawaii. Home again, the lark cut her first demonstration record and began a tour of recording executives' offices. Liberty Records quickly signed her to a long-term contract. Her first single for the label was so successful in Australia that she toured that continent. The songstress then had a 26-week run as featured vocalist on the Ray Anthony TV Show. She has also appeared on the Jimmy Dean and Hollywood Palace TV'ers, making her dramatic debut on the Bing Crosby Show. Her current single, "It Must Be Him," has been doing particularly well throughout the country.

Johnny Cash—Columbia

Johnny Cash has been for the past several years one of the most consistent chart-riders in both the pop and country fields. He's also a writer of more than passing note. To date, the recorded versions of his songs have reached the 10,000,000 sales mark.

He started singing with his family on their Kingsland, Ark., farm to lighten their chores. Professionally, his career began during his high school days when he received radio exposure on KLCN-Blythesville, Ark. During his hitch with the Air Force, Cash teamed with his guitarist, Luther Perkins, and bass man Marshall Grant.

They met with immediate success on the Sun label, where he scored such triumphs as "Cry," and "I Walk The Line." In 1958 Cash moved to Columbia, where he continued his phenomenal string of hits. Last he has cashed-in with "It Ain't Me Babe," "Orange Blossom Special," "The Sons of Katie Elder," "Mr. Garfield" and "Happy To Be With You." And has most recently added "The One On The Right Is On The Left" and "Boa Constrictor."

Cash presently lives in Ventura, Calif., with his wife and their four daughters. He does a good deal of traveling, though, and guests frequently through the south.

To round out his career he has done some TV shows, westerns, and even a movie. "Five Minutes To Live."

Ray Charles—ABC

Dividing his dates between AB and Impulse, Am-Par's subsid jazz label, Ray Charles enjoys a big following in the field of pop, blues and jazz, even more since his "Modern Sounds in Country and Western Music" LP's in 1962.

After a tragedy-ridden childhood (he was blinded at 6, orphaned at 15), Charles giggered around Florida, earning a big reputation as a combo sideman. At 17 he formed his own trio and toured the country, settling for a while in Seattle where he had his own sponsored TV show. His big disk break came when he was signed by Atlantic Records, for which he produced several smash hit singles and albums. Two and a half years ago he switched to Am-Par and continued his hit string with "Georgia On My Mind," "One Mint Julep" and "Outskirts Of Town." "Hit The Road Jack," "Makin' Whoopee," "Unchain My Heart," "Let's Go Get Stoned" and such LP's as "Genius+Soul-Jazz" and "Ray Charles and Betty Carter." Some of his later hit recording are: "In The Heat Of The Night" and "Yesterday."

Dave Clark Five—Epic

When the Dave Clark Five toppled the Beatles from the number one spot on the English best-selling charts with their single, "Glad All Over," the event caused such a sensation throughout England that the story was run on the front page of both the Daily Mail and the Daily Mirror. The deck, released by Epic Records in the U.S., soared all the way up the charts. It was followed by one smash (LP and single) after another, including are "Bits and Pieces," "Because," "Everybody Knows," "Any Way You Want It," "On Tour," "Catch Us If You Can," "Over And Over" and "19 Days."

Prior to Dec. 15, 1963 when Dave Clark celebrated his twenty-first birthday by signing the contract that gave him professional status, he was the leader of a group of young men whose musical activities were restricted to playing three nights a week in a Tottenham (a local London district) ballroom plus making an occasional recording.

Shortly thereafter a Dave Clark business card found it way into Buckingham Palace and Dave received an invitation to play at the annual staff ball. That was the beginning of a popularity that gradually increased until expected appearances in London produced near pandemonium among young female fans.

All this commotion is caused mainly by drummer Dave Clark heading a group consisting of Mike Smith who handles most of the vocals in addition to playing organ and piano; Ric Huxley on bass, harmonica and guitar; Lenny Davidson, guitarist and Denny Payton, saxophonist.

"Red And Blue" was a chart single for this group this year.

(Continued on page 54)

THE RESULTS ARE IN!*

SINGLES

STEVIE WONDER—#2 BEST MALE VOCALIST
MARVIN GAYE & TAMMI TERRELL—#2 BEST DUO
DIANA ROSS & THE SUPREMES—#2 BEST VOCAL GROUP
FOUR TOPS—#6 BEST VOCAL GROUP
TEMPTATIONS—#7 BEST VOCAL GROUP
MARTHA & THE VANDELLAS—#21 BEST VOCAL GROUP
SMOKEY ROBINSON & THE MIRACLES—#22 BEST VOCAL GROUP
JR. WALKER & THE ALL STARS—#30 BEST VOCAL GROUP

ALBUMS

DIANA ROSS & THE SUPREMES—#3 BEST VOCAL GROUP
FOUR TOPS—#6 BEST VOCAL GROUP
TEMPTATIONS—#7 BEST VOCAL GROUP

R & B

MARVIN GAYE—#2 BEST MALE VOCALIST
STEVIE WONDER—#4 BEST MALE VOCALIST
TAMMI TERRELL—#3 BEST FEMALE VOCALIST
FOUR TOPS—#1 BEST VOCAL GROUP } TIE
TEMPTATIONS—#1 BEST VOCAL GROUP }
MARTHA REEVES & THE VANDELLAS—#3 BEST VOCAL GROUP
MARVIN GAYE & TAMMI TERRELL—#5 BEST VOCAL GROUP
MARVELLETTES—#6 BEST VOCAL GROUP
SMOKEY ROBINSON & THE MIRACLES—#7 BEST VOCAL GROUP
DIANA ROSS & THE SUPREMES—#9 BEST VOCAL GROUP
GLADYS KNIGHT & THE PIPS—#12 BEST VOCAL GROUP

*(CASH BOX BEST OF 1967 POLL)

THE MOTOWN SOUND IS *The Sound of Young America[®]*

Bios of 1967's Leading Artists

Petula Clark—Warner Bros.

Although she has sold millions of records in Europe, Petula "Pet" Clark was practically unknown in the U.S. until Warner Bros. obtained the releasing rights of hits for America and she repeated her foreign hit pattern with the release of her first single, "Downtown."

At the beginning of World War II Pet stored on the B.B.C., singing and reciting poems to the families of British soldiers. Her first appearance gave birth to her career, and she became a regular on the network, making over 500 appearances by the time she was twelve.

While still in her teens, the lark began her wide travels as an artist, first in Holland, then farther into the continent, starting on radio, TV and making numerous p.a.'s. Despite the language barrier, she became famous throughout Europe. Following the release of her first English hit, "Gondolier," her French label, Vogue, requested that she perform the same song in French for Gallic release. Pet set marks in the record biz as the first vocalist to have a bilingual hit. She soon became a Parisian music-hall favorite.

The songstress, who is married to a French A&R director, now lives in Paris with her husband and two children.

Petula scored with "I Know a Place." Her treatment of "The Beat Goes On" has become a nationally-known theme for Plymouth motors. Other big singles for her this year include "This Is My Song," "Don't Sleep In The Subway" and "The Other Man's Grass Is Always Greener."

Bill Cosby—Warner Bros.

Bill Cosby almost never became a comedian. He was a star halfback at Temple University, but decided to give up a pro football career for comedy. The rest is history.

Cosby is currently clicking in "I Spy," a TV series in which he co-stars with Robert Culp. It is produced by Sheldon Leonard as an NBC color show.

Cosby came to fame via his many TV appearances with Jack Parr, Jimmy Dean and Andy Williams where his spoofables covered such items as karate, street football, Noah's Ark and TV commercials.

Each and every one of his first four WB LP's have earned the comic gold record.

He has made a "singing" album for Warner Bros. entitled, "Silver Throat." A single "Little Ole Man" struck big and has been followed by "Hokey For The Salvation Army Band."

Cowsills—MGM

The Cowsills' nucleus consists of Bill, Bob, Barry, and John Cowsill. Their mother Barbara Cowsill lends her voice to the boy's harmony whenever it is needed. The road managers, Dick and Paul Cowsill, who chose not to enter the performing end of the business, keep equipment straight and in order throughout their journeys. The Cowsills live in a 22-room mansion atop one of the few Newport, Rhode Island hills. Bill, born January 9, 1948, coordinates. He is the oldest member of his family. He attends Rhode Island College where his forte is English. He writes his own lyrics. Bob, born August 26, 1949, is all A's and B's in school. Barry, born September 14, 1954, plays bass guitar and sings. John, the little drummer, was born on March 2, 1956. The Cowsills' MGM single, "The Rain, The Park, And Other Things," established this group nationally.

YOU DON'T KNOW ME RCA VICTOR
ELVIS PRESLEY Brenner Music

MONTEREY
ERIC BURDON & ANIMALS MGM
Slamina Music, Inc.
Sea-Lark Ent., Inc.

AIN'T THAT SO
ERIC BURDON & ANIMALS MGM
Slamina Music, Inc.
Sea-Lark Ent., Inc.

WHAT'S IT GONNA BE
DUSTY SPRINGFIELD PHILIPS
Rumbalero Music, Inc.
Ragmar Music, Inc.

LOVEY DOVEY
BUNNY SIGLER PARKWAY
Progressive Music Pub. Co., Inc.

YOU'RE NEVER GONNA GET MY LOVIN'
ENCHANTED FOREST AMY
Pumbalero Music, Inc.
Kenny Lynch Music, Inc.

HERE COMES HEAVEN
EDDY ARNOLD RCA
Hill & Range Music, Inc.

THE IDOL
THE FORTUNES U.A.
Noma Music, Inc.
Fortitude Music, Inc.

HIS SMILE WAS A LIE
THE FORTUNES U.A.
Noma Music, Inc.
Fortitude Music, Inc.

WAITIN' FOR CHARLIE TO COME HOME
MARLENA SHAW CADET
Doiff Music, Inc.

ANY DAY NOW
PAT LUNDY COLUMBIA
Plan Two Music, Inc.

WATERLOO SUNSET
THE KINKS REPRIS
Noma Music, Inc.
Hi-Count Music, Inc.

TWO SISTERS
THE KINKS REPRIS
Noma Music, Inc.
Hi-Count Music, Inc.

SHE BELIEVES IN ME
SAMMY DAVIS, JR. REPRIS
Noma Music, Inc.
Smooth Music, Inc.

THE ABERBACH GROUP
1619 Broadway, New York, N. Y.

Critters—Project 3

The Critters, with the exception of Robert Spinella, all come from New Jersey. Spinella is from Brooklyn. The group includes Chris Darway, auto-harp; Kenny Gorka, bass guitar; Jeff Pelosi, drums; James Edmund Ryan, guitar; and Robert Spinella, organ. Darway spends much of his time painting and practicing the auto-harp. He plays numerous percussion instruments besides piano and organ. Gorka enjoys kiddie programs. He likes Judy Collins and plays the accordion in addition to the bass guitar. He would like to be a record producer someday. Pelosi sings falsetto with the Critters. Ryan is an electronics expert and is sometimes called upon to fix the Critters' instruments. Spinella sings baritone and has a predilection for soul music. The Critters scored their first big hit with "Younger Girl," their Kapp waxing of "Don't Let The Rain Fall Down On Me" made a sizeable amount of noise on the Top 100 in '67. The Critters recently switched to the Project 3 label.

Dick Curless—Tower

Born in Ft. Fairfield, Me. on Mar. 17, 1932, Dick Curless was strumming a banjo shortly after he learned to walk and talk, and by the time he was nine he was singing, accompanying himself on a guitar. In 1940 the family moved to Massachusetts, where Dick took to the airways on WARE in Ware. Dubbing himself the "Tumbleweed Kid," Dick went on to make his first recording, "The Coast Of Maine," at the age of 18.

In 1953 he went to Korea and quickly became an entertainer on the Armed Forces Korea network, making himself well-known to the rice paddy rangers with his recording of "China Nights." After the service he resumed his singing career in Bangor, Me. and in 1957 he won the Arthur Godfrey Talent Scout contest with his version of "Nine Pound Hammer."

His career came to a head when he signed a recording contract with Tower Records in Feb. of a few years back and immediately rode up the charts with his first Tower disk, "Tombstone Every Mile." Chart positions were also in store for his offerings, "Six Times A Day," "Tater Raisin' Man," "The Baron" and "House Of Memories."

Skeeter Davis—RCA Victor

Originally, best known for the RCA Victor side she recorded with her late sister, Bee Jay, "I Forgot More Than You'll Ever Know." It was a tremendous hit and firmly established the Davis Sisters, as they were then known, as record personalities. For this record the girls received the Cash Box Award in 1953 for "The Most Programmed Record of the Year." Tragedy ended their brief joint success when an automobile took Bee Jay's life.

In 1957 Steve Sholes, Victor's A&R chief, persuaded Skeeter to do a solo session, an important turning point in the young singer's career, for in 1958 she received the annual Cash Box award as "The Most Promising Female Country Vocalist."

Skeeter was born Mary Frances Penick, December 30, 1931 in Sparta, Kentucky, the oldest of six children. Neither her father, nor her mother had been professional performers, but they encouraged their talented daughter. In Dixie Heights High School, which she attended from 1945 to 1949, she sang with pop bands, but country music was her real love. She won amateur contests on radio and TV shows and became a featured singer for two years on a TV show in her area. Later, she appeared on Nashville's Grand Ole Opry.

The lark has had several dual-market hits including "The End Of The World," "I Can't Stay Mad," "Goin' Down The Road," and "What Does It Take."

Neil Diamond—Bang

Neil Diamond, born in New York, received his first "professional" experience as a musician at the age of 10 when he began playing with the Memphis Backstreet Boys (who earned their living by collecting the small change people threw out of the window as they came singing by). Several years later, at 13, Neil ran away to Kansas City and formed an essentially folk group. Called the Roadrunners, the group traveled around the midwest for a few years playing "hard-bottom-line" folk music.

Diamond left the midwestern niter circuit for New York and a crack at Tin-Pan Alley. His talent was quickly recognized and he has become one of the most sought after song writers. In addition to penning tunes for many pop vocalists, he did very well with his Bang recording of "Solitary Man." He is said to have met and developed a strong attachment to Woody Guthrie during the Roadrunner days and the Neil Diamond songs often reflect a lonesome, wandering, folk quality.

His latest big ones include "Thank The Lord For The Nighttime" and "Kentucky Woman."

Don & Goodtimes—Epic

Don & the Goodtimes are comprised of Don Gallucci, organist and leader of the group; lead singer Jeff Hawks; Ron Overman, bass guitarist; Charlie Coe, lead guitarist; and Bobby Halden, drummer. Their debut single, "I Could Be So Good To You," helped their rapid rise to popularity.

Donovan—Epic

Donovan Leitch is the full name. Born in Maryhill, Glasgow, Feb. 10, 1946—Donovan was pulled through a polio epidemic when he was three "in the hands of a white-haired professor." Donovan made his way through the educational system, but college was not for Donovan. He preferred the roaming life and set about rambling through England, taking any job that came along—digging holes and other "labourin'" things until he bought an old guitar for two pounds, figured out some chords and created a song "Why Do You Treat Me Like You Do." He and a friend, kazoo player Gypsy Dave, wandered in many directions "sing for Singin's sake and travelin' for travelin's sake." Sometimes Donovan would sing on a streetcorner with his old guitar and his fresh songs and Dave would pass the cap.

Donovan appeared on a major TV, "Ready

Steady Go," vehicle before he even had his first record released, a rarity in this era of hit record consciousness. Donovan met Geoff Stephens, a songwriter at the Denmark Street headquarters of Southern Music. Stephens later became his co-manager, along with Eden. Finally, Donovan was signed to a Pye recording contract, and almost coincidentally, interest in Donovan began showing up in the United States, where he was soon signed for U.S. and Canadian distribution by Hickory Records.

Donovan enjoyed three consecutive hits in the first six months of his professional career... "Catch The Wind," "Colours," and "Universal Soldier." He has already recorded two albums in Britain, with the first of these called "Colours."

After making the switch to Epic this year he tapped the charts with "Sunshine Superman" and repeated the smash scene with "Mellow Yellow."

Donovan continues to be highly successful both on disk and in concert, scoring now with "Wear Your Love Like Heaven."

Doors—Elektra

The Doors are comprised of Jim Morrison, vocal; Ray Manzarek, organ and piano; Robby Krieger, guitar; and John Densmore, drums. They have been influenced by jazz, blues, and rock. Manzarek describes the Doors as "a representative American group. Our influences," he says, "spring from a myriad of sources which we have amalgamated, blending divergent styles into our own thing." The Doors create their own material and envelope it with a blend of organ, guitar and percussion backing. Jim Morrison's vocals ring out over the pungent electric sound that the Doors have made their own. The quartet has performed at Hollywood's Whiskey A Go Go and Gazzarri's On The Strip; the Matrix and Avalon clubs and the Fillmore Auditorium in San Francisco; and most recently, Ondine's in New York. The Doors have come as is evinced by their first album on Elektra, "The Doors," which did very well on the LP charts and their second LP, "Strange Days," which is doing the same. Their first big single was "Break On Through."

Roy Drusky—Mercury

A man of many talents, Roy Drusky turned down a contract to play baseball for the Cleveland Indians before going ahead in the musical field and creating an enviable name for himself as one of Mercury's Records' top country artists.

While in the Navy, Roy learned to play the guitar and began composing his own songs. Out of the Navy and back in Atlanta, Ga., he began contacting musician friends and formed a band, playing many radio and TV dates. A recording contract with Decca followed and also a regular spot on the Grand Ole Opry.

Now on Mercury, he has a long string of hits behind him, including "Birmingham Jail," "My World's Losing You," "White Lightnin' Express" and his duet with Priscilla Mitchell, "Yes, Mr. Peters" and right now "If The Whole World Stopped Loving."

Married and the father of two sons, Roy and his family have an avid enthusiasm for raising French poodles, becoming quite proficient at their chosen hobby. Roy is also a racing fan and a flying enthusiast.

His latest deck is "Weakness In A Man." Just prior to this one, he had "If The Whole World Stopped Loving."

Boy Dylan—Columbia

Dylan was born in Duluth, Minnesota on May 24, 1941. After living briefly in Sioux Falls, South Dakota and Gallup, New Mexico, he graduated from high school in Hibbing, Minn. For six months, Bob attended the University of Minnesota on a scholarship. But like many of the restless, questing students of his generation, the formal confines of college couldn't hold him.

Bob started to sing and play guitar when he was 10. Five or six years later wrote his first song.

Dylan first came East in Feb. 1961. His destination: the Greystone Park Hospital, Greystone Park, New Jersey. His Purpose: to visit the ailing Woody Guthrie—singer, ballad-maker and poet. It was the beginning of a deep friendship between them.

Dylan achieved a highpoint in his career with an appearance at the Newport Folk Festival, and has since earned innumerable new followers based on his single clicks "Like A Rolling Stone," "Positively 4th Street," "Rainy Day Woman No. 12 and 35" and his controversial "Blond On Blond."

He has spent the past year recuperating from a motorcycle accident suffered in the Adirondacks.

His 1st cinema effort, "Don't Look Back" is drawing big lines at box offices throughout the world.

Every Mothers' Son—MGM

Every Mother's Son, since their inception in New York City in 1966, has quickly established itself as a solid nation-wide favorite, via their chart single, "Come On Down To My Boat." The group is composed of former folk singers Larry and Dennis Larden, Bruce Milner, organ, Schuyler Larsen, bass, and Christopher Augustine, drums. In addition to their hit single, the group has cut an album titled "Every Mother's Son."

Fifth Estate—Jubilee

The Fifth Estate was built in Springdale, Conn. The entire Fifth Estate consists of Rik Engler, Duck Ferrar, Wads Wadhams, Furvus Evans, and D. William Shute. Engler sings and plays guitar, kazoo, electric clarinet, violin, and bass guitar. He also writes songs. Ferrar sings, plays bass guitar, string bass, fuz bass, and writes songs. Wadhams sings, plays electric harpsichord, electric piano, fuz organ, and writes most of the group's material. Evans plays drums and maracas; Shute plays electric mandolin and fuz guitar. The boys constantly switch instruments during a performance, in an all-out display of versatility. The Fifth Estate, which sprang full-blown from Wa's Wadhams' cellar, made the jump to Jubilee Records and success in just one year. Their first release, "Ding Dong The Witch Is Dead," scored well on the Top 100 during the past year.

Lester Flatt & Earl Scruggs—Columbia

Having never swayed from their traditional style, Lester Flatt and Earl Scruggs are two of the best known exponents of bluegrass music in the entire country field.

The boys have never drifted towards a "pop" sound as so many other country musicians have. Their group consists of Scruggs on the five-string banjo (playing the three-finger style he invented) and Flatt on guitar, and a fiddle, a mandolin, c. bass and a dobro guitar. Their most distinctive sound comes from the fact that none of their instruments are electrified. The boys often add wild soaring vocals of old folk songs, usually dealing with unhappy love.

The first big pop-country hit came about when they scored with "Ballad Of Jed Clampett" and with "Colours" and "California Up-tight Band."

4 Seasons—Philips

The 4 Seasons, who skyrocketed to the pinnacle of the charts with "Sherry" and "Big Girls Don't Cry," were unknown just days before "Sherry" was released. Proof-positive of the show biz dream of the "overnight success" is the fact that the boys are now a household name among record buyers across the nation.

All four boys hail from New Jersey. Prior to their initial smashes, everything seemed to be going wrong for the group. However, on a chance visit to Gotham, Frankie met independent record producer Bob Crewe. Crewe decided the group could still make it if they were given the proper material and took the artists under his wing. The second record they came up with was "Sherry." Smashes that followed included "Walk Like A Man," "Candy Girl," "Ain't That A Shame" and "New Mexican Rose."

In '64 the group joined the Philips roster and smashed thru with one top-ten giant after another. Included are "Dawn," "Ronnie," "Save It For Me" and "Big Man In Town."

In 1965, they hit the charts with "Dawn G. Away," "Let's Hang On," and "Don't Think Twice." And in '66 they added "Tell It To The Rain," and "I've Got You Under My Skin."

They continue as a powerful voice in the pop musical scene with this year's hits including "C'mon, Marianne" and "Watch The Flowers Grow."

Possibly their biggest hit has been their RIAA-certified million-seller, "Rag Doll."

Four Tops—Motown

The Four Tops achieved international recognition with their smash single, "Reach Out I'll Be There" at the end of 1966. "Standing In The Shadows Of Love," "Bernadette," "7 Rooms of Gloom" and "You Keep Running Away" are their subsequent smashes. The Four Tops include, Levi Stubbs, Jr., Renaldo (Obie) Benson, Lawrence Payton, and Abdul (Duke) Fakir. All born and bred in Detroit, they have known each other since high school. Their first professional engagement was at the Ebony Lounge in Cleveland. In 1964, the group was signed by Motown, and given "the Motown treatment" of professional grooming for stage and cafe appearances. The Four Tops have starred at Basin Street East and the Apollo Theater in New York, the Howard Theater in Washington, and the Fox Theater in Brooklyn. They have guested on the Ed Sullivan Show, the Tonight Show and other network TV's.

Aretha Franklin—Atlantic

Aretha Franklin grew up with music all around her. One of five children of the Reverend C. L. Franklin of Detroit, she began singing along with her brothers and sisters in the choir of The New Bethel Baptist Church, her father's pastorate. The training she received in the field of gospel music as a youngster had a great influence on her musical style, and the roots of gospel are still present today in her singing. When she was 14, the artist joined her father on his evangelistic tours and sang in the nation's churches for four years. At 18, the singer began to give serious thought to singing blues. She was encouraged to make the move from gospel singing by Major "Mule" Holly, the bassist for pianist Teddy Wilson. Holly convinced her to audition for John Hammond, Columbia Records a&r executive. Hammond was so impressed by her singing that he signed her to a recording contract. She was on her way as a blues singer. A fine pianist as well as a gifted singer, she developed an exciting night club act. In 1966, the songstress joined Atlantic Records. Her first single for the company, "I Never Loved A Man The Way I Love You," went straight up in popularity. She has followed that one with even bigger singles and LP's. She has been awarded several gold records.

Connie Francis—MGM

Connie Francis has been one of the most successful female voices on the disk scene today.

The U.S. market is only part of her domain as a lark Queen, for she has also made most of the other parts of the world her own—and in a unique manner.

In non-English speaking countries, the performer cuts her hit recordings in the native tongue, including French, German, Spanish, Italian and Japanese. In the years she has been recording for MGM Records, Connie has sold about 25 million disks and has been awarded eight gold platters by the label.

The artist, born in Newark, N. J., (real name: Constance Franconero), first made her mark in show business at the age of 11, when she was heard, as a singer and accordionist, on the early juvenile-performer TV'er, "Startime," presented by George Sheek, now her manager. A year later she was a winner on Arthur Godfrey's "Talent Scout" show.

She was signed to MGM Records when she was 17, and in 1958 she recorded and hit with "Who's Sorry Now," which was the first link in a long chain of hits.

Apart from singles, Connie has cut a host of varied-themed LP's, and has done major niterity-TV stints all over the world. The chirp recently appeared on the charts with "Forget Domani" and "Jealous Heart."

In '64 Connie became Mrs. Richard Kanelis. And has since added "Spanish Nights And You" to her hit roster.

(Continued on Page 56)

**Remember how popular
the piano used to be?**

Roger Williams still is.



**Number One
Instrumentalist On Albums, 1967.**

Roger Williams on Kapp Records.



Bios of 1967's Leading Artists

Marvin Gaye—Tamla

Marvin Gaye began singing at the tender age of three, when he was a soloist in his father's church in Washington, D.C.

Like many of today's popular young singers, Marvin continued his religious singing until his early teens when he launched his career in the popular field, singing locally around his home town. It is interesting to note that the artist, who could belt out a rocking good gospel song in his teens, today sings in a soulful style.

The multi-talented Marvin (he sings, composes, arranges, plays the drums and piano) received his first big break a short while ago when he signed a Tamla Records recording contract. In brief period, he clicked with "Stubborn Kind Of Fellow" and "Hitch Hike." His 1963 hits included "Pride & Joy" and "Can I Get A Witness." Then it was "Try It Baby," "You're A Wonderful One," "Baby Don't You Do It," "How Sweet It Is" and "Ain't It Peculiar." All of which has been followed by "My Baby's Gone" and other big efforts.

Bobbie Gentry—Capitol

"Ode To Billy Joe," (penned and performed by Bobby Gentry, skyrocketed to the #1 spot on the Top 100 within a few weeks after its release and was soon certified by the R.I.A.A. (Record Industry Association of America) as a million-seller, giving Miss Gentry her first gold record. "Ode To Billy Joe" b/w "Mississippi Delta" was cut in Capitol's Studio C in less than an hour on an afternoon in the middle of this year. Born in Chickasaw County, Mississippi, 23 years ago, Bobbie Gentry is of Portuguese descent. She first hit the boards as a performer when she was eleven; she strummed guitar while accompanying a singer from Chickasaw County. She has since exhibited prowess on piano, banjo, vibes, and electric bass. The artist attended UCLA, where she studied philosophy, and the Los Angeles Conservatory of Music, where she pondered counterpoint and composition. She toiled in sundry San Diego and Las Vegas night spots as dancer as well as singer, and she performed as an actress in "little theater" locally and in the south starting at age 13. "Okolona River Bottom Band" was Bobby Gentry's second single hit. The album, "Ode To Billy Joe," released shortly after the single topped the charts, was also a smash.

Stan Getz—MGM/Verve

Stan Getz was born in Philadelphia on Feb. 2, 1927, and when he was 13 he became a member of his school band, playing bass, saxophone, and eventually saxophone. Two years later he joined the Jack Teagarden Band in order to raise enough money to eventually attend medical school, but soon music became such an indispensable part of his life that he abandoned his desire to become a doctor. By the time he was 18 he had played with such outstanding orchestras as Phil Harris, Stan Kenton, Jimmy Dorsey and Benny Goodman.

During the next four years he helped form the "Four Brothers" which later became incorporated in Woody Herman's "second herd." It was at this time that the saxophonist waxed "early Autumn." In 1949 he won a poll as top tenor saxophonist. Three years later Stan recorded "Moonlight In Vermont" with Jimmy Smith.

In 1958 he took his wife and three children to Elsinore, Denmark, and for three years studied, toured and experimented.

Bossa Nova chart rider "Desafinado" was waxed by Getz and Charlie Byrd in 1962. During the same year Getz won a "Grammy" for the best solo performance of the year. In March of 1963, he cut an LP with Joao Gilberto and Antonio Carlos Jobim, the Brazilian originators of the Bossa Nova. "The Girl From Ipanema," a single from the album quickly became a chart topper.

Getz continues to garner praise as a jazz innovator.

Harper's Bizarre—Warner Bros.

Harper's Bizarre is composed of Ted Templeman, who plays drums, guitar, trumpet and sings; Dicki Scoppettone, guitar; Eddie James, lead guitar; John Peterson, drums and Dick Yount, bass guitar. Scoppettone and Yount were in a folk singing group when they decided to join forces and start their own group along with Templeman and Eddie James. Scoppettone and Templeman, who aspire to be successful songwriters, pen most of the quintet's material. Harper's Bizarre have emerged from the competitive atmosphere of the San Francisco area where they have dwelled for years. The group has only been together professionally for about three years and was extremely popular only in local arenas such as the Fillmore and Avalon Ballroom. They clicked on the national level with their waxing of "59th St. Bridge Song" and followed up with LP product.

Herman's Hermits—MGM

In 1965 Herman Hermits' clicked with "I'm Into Something Good," "Mrs. Brown You've Got A Lovely Daughter," "I'm Henry the VIII," and "Just A Little Bit Better." Herman (real name Pete Noone) joined the group when they were called the Heartsbeats. The crew was playing at a Manchester youth club that Herman frequented and one night they were short of a singer. He stepped in and hasn't looked back since.

The rather unusual name of Herman comes from a cartoon character. In a cartoon TV show called "The Bullwinkle Show" was a boy called Sherman. The rest of the group was amused at the similarity of the character and their lead singer. Mistaking the name Sherman for Herman, they christened him.

The group was brought to the attention of indie producer Mickie Most—the man responsible for the hits of the Animals and the Nashville Teens. He traveled to see them at a concert in Bolton, was immediately impressed by their stage show, and signed them to a recording contract.

The initial success was not hollow as the Hermits have recently scored with "East West," "Dandy," "Leaning On A Lampost," and a host of other ditties.

Al Hirt—RCA Victor

Two years ago brought into full-blown prominence the career of Al Hirt. His single effort, "Java," was a million-seller and gained for the trumpeter a NARAS "Grammy" as the best performance by an instrumentalist. He also got his first gold disk for an album, "Honey In The Horn." His other achievements during the course of the year included an LP paring with Arthur Fiedler and his Boston Pops, a solid chart item called "Pops Goes The Trumpet." And a non-disk highlight of the year for Hirt was a dream-come-true: his own nitery on New Orleans' Bourbon Street, called simply "Al Hirt." Before striking out on his own, Hirt occupied chairs in the bands of Tommy and Jimmy Dorsey and Ray McKinley and toured with Horace Heidt. Hirt was awarded his third gold LP in 1965 for "Sugar Lips."

Hirt has a piece of the New Orleans Saints and frequently plays for halftime at their games. He continues as a consistently high album seller.

Don Ho—Reprise

Don Ho has demonstrated considerable staying power with his Reprise album, "Tiny Bubbles," which was on the charts for months. Born in Kakaako, Hawaii, Ho was raised in Kaheohe and did "just about every job" helping out at his parents' business, "Honey's Lounge," which his mother still operates. Of Hawaiian-Chinese-Portuguese-German-Dutch descent, he went to Kamehameha, became a football star, and after graduation attended Springfield College in Massachusetts, but soon became homesick. After one year at Springfield, he returned home and enrolled at the University of Hawaii, from which he graduated with a degree in sociology in 1953. After a five-year stint in the Air Force, he resigned his second lieutenant's commission and came back to Kaheohe. Ho has been a hit with audiences at Duke Kahanamoku's night club in the International Market Place.

Richard Groove' Holmes—Prestige

Richard Arnold Holmes was born about 30-years ago in Camden, N.J., the town in which he went on to attend the Witter grade school and Camden High. While in high school, Holmes excelled in many athletic endeavors including football, baseball, basketball and track. He won the New Jersey State Trophy for a high-jump of 6½ feet. Holmes developed an interest in the organ in 1952. Having had no formal music training, he taught himself not only how to play the instrument but its inner mechanical workings as well. With this technical knowledge of the organ's operation, Holmes can modify the instrument at will to produce practically any sound he is looking for. Named "Groove" by his fellow musicians, he has adopted the West Coast as his home base. "Groove" Holmes is known to jazzophiles through his 5 LPs on the Pacific Jazz logo.

His "Misty," and "What Now My Love" (both on Prestige) were big singles.

David Houston—Epic

In 1966, Epic recording artist David Houston had a C&W and pop chart hit with "Almost Persuaded." Since then he has repeated his success with "Loser's Cathedral," "With One Exception," and "You Mean The World To Me." David Houston was born in Bossier City, Louisiana, where he began to play guitar at age four, with help from his aunt, who gave him lessons on the instrument. By the time he was twelve, Houston had won a guest spot on Horace Logan's famed "Louisiana Hayride" radio show. Later, he became a regular member on the program. Encouragement and help from well-known singers Gene Austin (Houston's godfather) and Slim Whitman, both friends of Houston's father, inspired the young singer to pursue his career. Houston is an accomplished actor who has appeared in little theater plays in Shreveport and in several movies—"Horse Soldiers," "Teen-Age Kisses," and "Carnival Rock."

Englebert Humperdinck—Parrot

Englebert Humperdinck, born May 1940 in Madras, India, started out as an apprentice, engineer on leaving school, but this vocation was rather short-lived, as the urge to make music his life proved too strong. Armed with little money, which he won in a talent show, Humperdinck struck out for London to begin a show-business career in earnest. Eventually Gordon Mills, (Tom Jones' manager) arranged for Humperdinck to record "Stay," which, while it was not a big hit, resulted in a Decca Ltd. recording contract for the artist. In addition, the label chose him to represent it at the International Song Festival at Knokke-Le-Zoute, in Belgium.

He finally attained international recognition with "Release Me," on the Parrot label, which became the first in a string of world-wide hit singles and albums for the songster. His latest chart offering was "Last Waltz."

Janis Ian—Verve/Forecast

"I was born April 7, 1951. It doesn't really matter much what happened before unless you want to analyze someone." So begins Janis Ian's self-penned biography. Her pert, bright, chatty composition is permeated by this kind of unselfconscious observation. Janis Ian "lived up and down New Jersey, moved around a lot," and moved to New York in Jan. 1966. She has attended school in East Orange and she is now being educated in New York. "I write all my own songs, yes," says the young artist. "Mainly because if your head itches you scratch it, and I've found a fingernail. I'm not out to crucify anyone, nor to spare them." Miss Ian is obviously not one to throw labels around, but if she is to be classified, she would like to be known as a ballad singer. Her favorite performers are Danny Schram, Herbie Mann, and Billie Holiday. Bob Dylan, Lennon and McCartney, and her brother are her preferred writers. When she came to New York she met Rev. Garry Davis' accompanist and went down to the Gaslight Cafe in Greenwich Village. She did a set and she was on her way. The controversial "Society's Child," on Verve/Forecast, which was

cold until it was aired on a Leonard Bernstein TV'er, roared onto the top 100 as a result of the exposure. The tune dealt with an ill-fated, inter-racial love affair and, as a sensitive and beautiful work, was a big underground deck long before the public accepted it on the maestro's suggestion.

Janis has an LP out now and her latest single is entitled, "Insanity Comes Quickly To The Structured Mind."

Ian & Sylvia—MGM

Ian and Sylvia, teamed maritally as well as musically, are both Canadian. Both were successful performers in their own right before they met and sang together in a Toronto coffee house. Ian grew up on a farm in the far west province of British Columbia. As soon as he was old enough, he and his young companions travelled the surrounding ranchlands to take part in the rodeos. It was while recovering from a serious rodeo injury at the age of 19 that Ian was able to concentrate completely on his deepening interest in music. He was drawn to country music in particular and learned to play the guitar. After graduation from college, Ian took small singing jobs wherever they were available and studied with Roy Guest when that English folk singer toured Canada. He hitchhiked east to Toronto to perform country music in coffee houses. There he met Sylvia. Sylvia is a natural musician; apart from a few piano lessons from her mother in Chatham, Ontario, her home town, she learned everything she knows of music on her own. Together, Ian and Sylvia have done concert tours, dramatic roles on the Canadian TV network, and many nightclub engagements. They appeared on the Hootenanny program and The Bell Telephone Hour in the U.S. "Lovin' Sound," their current single, was recently on the charts. Before joining the MGM label complex, the duo recorded numerous LP's for Vanguard.

Impressions—ABC-Paramount

Collectively, Curtis Mayfield, Samuel Gooden and Fred Cash, constitute the Impressions. Singing together since 1958, the vocal trio is responsible for such hits as "For Your Precious Love," "Gypsy Woman," "Amen," "You've Been Cheating," and most recently "Can't Satisfy."

Gooden and Cash both from Chattanooga, began their singing in the southern city with a vocal group. Breaking away from the group, the two decided that Chicago could offer them the opportunity they needed to firmly establish a show business career, so they headed north. They hadn't been in Chicago long when they met Curtis Mayfield and the well-known, Jerry Butler. Curtis and Jerry were also singing veterans, having performed for years in their local church. The move to the Windy City took place in 1957. The following year, the group was introduced to Eddie Thomas who immediately signed them to a management contract. Thomas arranged for a recording session which resulted in "For Your Precious Love." After the record became a hit Butler left the group and Mayfield took over as lead singer.

Chuck Jackson—Wand

After he was discharged from the Navy he joined the Del-Vikings and was with them when they recorded their hit, "Come Go With Me." Jackson then went out on his own as a single and was signed by Wand Records. His first session, "I Don't Want To Cry," was a hit in both the R&B and pop fields and the artist was on his way. Jackson has headlined at most of the major clubs and theaters in the U.S. and has had solid network TV exposure. He is extremely popular in Bermuda, South America, England, and France. Effective January 1, 1968, Jackson will be recording for Motown Records. "Shame On Me," on the Wand label, was a big single for him during 1967. His "Tribute To Rhythm And Blues, Vol. II" LP, has been well received throughout the land.

Walter Jackson—Okeh

Walter Jackson did very well on the charts with "Speak Her Name," during the past year. The success of this single has prompted Okeh Records, for whom the artist records, to release an LP by the singer, also titled "Speak Her Name." The disk features such top tracks as "After You There Can Be Nothing," "A Corner In The Sun," "Sha's A Woman," and his vintage R&B hit, "It's An Uphill Climb To The Bottom." The chanter has performed at some of the country's better known showplaces: the Apollo Theater in New York; the Cow Palace in San Francisco; the Regal Theater in Chicago; the Coliseum in Baltimore; Kelly's in Detroit; and the Cincer Club in Houston. Born in Pensacola, Florida, Jackson moved with his family to Detroit when he was seven. He sang his own way, while listening to other singers on the radio and on records, studying their styles and learning from them. Among his favorites were Billy Daniels, Nat King Cole, Roy Hamilton, Dinah Washington, and Sam Cooke. Presently a resident of Chicago, Jackson's pastimes include playing chess and listening to Beethoven and Tchaikovsky.

Tommy James & Shondells

The "overnight" success of Tommy James & the Shondells brought them zooming to the top of the pop charts with their very first record . . . three years after its release. Just about the time the boys were ready to give up on "Hanky Panky" (how long can hope spring within the human breast?), lone deejay, rummaging through his old records, decided to give the tune a spin over the air. Suddenly the boys had a chart record that wouldn't quit, and were awarded a gold disk from their label, Roulette Records.

Before "Hanky Panky" had ever strated to cool down, the boys were once again moving up the charts by leaps and bounds, this time with "Say I Am," which has been followed by "I Think We're Alone Now" and "Out Of The Blue," among others.

Horst Jankowski—Mercury

Pianist Horst Jankowski, who broke onto the American disk-scene with his best-seller instrumental Mercury recording of "A Walk In The Black Forest," was born 29 years ago in Berlin.

It was the twin objective of his mother and himself that he become a prominent musician. Even as a boy of six, he recalls the piano as his favorite toy. His mother moved from Berlin when the heavy bombing began. He lost his father in 1944, when he was eight. In 1947, even though Berlin was still a bombed-out area early after the war, his mother and he moved back into the city, because she felt the finest music education facilities were there. He graduated from high school and his mother worked and sacrificed so that he could attend the Berlin Conservatory of Music. While at the conservatory, he studied tenor saxophone, trumpet and contrabass, in addition to piano. His instructors felt his talent. They obtained jobs for him playing both popular and jazz piano.

In 1960 he organized his own choir. After that his fame spread rapidly throughout Germany. In 1965 he scored his first disk success with "A Walk In The Black Forest," and since then has been an impressive album seller for Mercury.

Jankowski is almost continually traveling around to fill his busy pa and concert schedule.

Jay & Techniques—Smash

Jay and the Techniques are headed by Jay Proctor, a 26-year-old Philadelphia-born vocalist who has been in close touch with music almost all his life. His mother sang in a choir and always took her son to the group's performances. Proctor sang occasionally on WABE-Allentown, Pa., with a group he formed with several friends in the late 1950's. He then played in other groups in the Pennsylvania area until helping form the Techniques with fellow member Karl Landis. Besides Proctor, the other members of the group are Landis, 19; Chuck Crowl, 19; George Lloyd, 25; Ronnie Goosly, 18; Dante Dancho, 19; and John Walsh, 19. All of them, live in Allentown and its environs. Walsh, called "Little John" by his friends, had something a bit unusual in mind when he first decided to become a member of a group. "We all got together one night with a bunch of guitars and drums and trumpets and saxophones and tried to form a symphony orchestra," he recalls. "That didn't sound too good so we started a rock group instead." Apples, Peaches And Pumpkin Pie," Jay and the Techniques' first Smash single was a smash hit this year, as was "Keep The Ball Rollin'."

Jefferson Airplane—RCA

The Jefferson Airplane includes Marty Balin, lead singer; Paul Kantner, driving lead rhythm guitar; Grace Slick, second lead singer; Jorma Ludwik Kaukonen, solo guitar; Spencer Dryden, drummer; and Jack Casady, bass. After the Jefferson Airplane had performed at "The Matrix," a San Francisco nightspot, they signed with RCA Victor and they were on their way. Founder and leader of the group is Marty Balin, whose first show biz experience was in touring musical comedy productions as a singer and dancer. Paul Kantner had several years' experience playing guitar and 5-string banjo when he met Balin in a local club and teamed up with him. Grace Slick is a former model who had performed with another group, the Great Society. Jorma Kaukonen earned a degree in sociology from Santa Clara University and was induced to join the Airplane by his friend, Paul Kantner. Spenser Dryden was recruited for the group by Balin, and Jack Casady was sent for from Washington, D.C. when Kaukonen recommended him as a good bass player. The Jefferson Airplane's 1967 hits include "White Rabbit," "Somebody To Love" and "The Ballad Of You & Me & Pooneil."

George Jones—Musicor

Over the past several years, George Jones has earned so many laurels for his distinctive country stylings, that this songster must rank among the biggest c&w artists around today.

Jones was born on Sept. 12, 1931, in Sarasota, Texas. At the age of nine he began playing the guitar and at 12 wrote his first song. Uncle Sam gekoned in '51 and '53 after his discharge from the Marines, he returned to Beaumont, Texas. In '54 he joined the Houston Jamboree, followed this as a regular with Shreveport's Louisiana Hayride and an appearance on the trade charts with his Starday original, "Why Baby Why." He then became a favorite with Opry fans in '56, joined the Mercury roster, and smashed thru with "White Lightning" and "Who Shot Sam" among others.

George is now with Musicor where his hits have included "Things Have Gone To Pieces," "Love Bug" and "Take Me." He has also teamed up for hits with Gene Pitney ("I've Got Five Dollars And It's Saturday Night," "Louisiana Man") and with Melba Montgomery ("Multiply The Heartaches," "Blue Moon Of Kentucky").

His most recent hits include "I'm A People" and "4033," and "I Can't Get There From Here." He has done vocal duets with Melba Montgomery and Gene Pitney. His current deck is "If My Heart Had Windows."

Jack Jones—Kapp

In seven years, Jack Jones has emerged as a major singing star. His debut was in the act of his father, Allan Jones, at the Thunderbird Hotel in Las Vegas during the summer of 1957, five weeks after he was out of high school. He appeared in productions at University High School in west Los Angeles before making his professional debut. After the divorce of his parents (the Jones father and son act was built around the family premise), Jack Jones sang for scale as a single in cocktail lounges and bowling alleys around Los Angeles. He played the smaller nightclubs and Pete King, then west coast rep for Kapp Records, saw him perform at Fack's II in San Francisco and signed him to a Kapp recording contract. Jones won a Grammy Award in 1962 for "Lollipops And Roses" and another in 1964 for "Wives And Lovers." By the summer of 1964 he had moved into the major niteries, and in December of that year he opened at the Persian Room of the Plaza Hotel in New York. He had arrived. From September '63 through June '67 he had made a total of 49 network TV appearances, including his own ABC-TV Special in April '66. His single, "Our Song," was a best-seller this year.

(Continued on page 58)

BECAUSE OF YOU!

1967 WAS THE GREATEST YEAR
OF OUR LIVES

5
STRAIGHT
CHART
RECORDS
!!!



5
MILLION
RECORDS
SOLD
!!!

THE ROYAL GUARDSMEN

THANKS FOR HELPING US BECOME A PART OF
THIS EXCITING AND CHALLENGING INDUSTRY

PRODUCED BY:
GERNHARD ENT.
6747 1st AVE. SO.
ST. PETERSBURG, FLORIDA 33707
(813) 345-9180

LAURIE RECORDS
165 WEST 46th STREET
NEW YORK, N.Y. 10036
(212) JU-2-2975

MANAGEMENT:
LEONARD STOGEL
888 8th AVE.
NEW YORK, N.Y. 10019
(212) 586-6390

Bios of 1967's Leading Artists

Tom Jones—Parrot

Tom Jones, who hit with "It's Not Unusual" on the London-distributed Parrot label, was born twenty-three years ago in Pontypridd, South Wales. Tom, who went to the Treforest Secondary Modern School did the usual thing that all Welshmen traditionally do—which is singing in his chapel choir and was greatly influenced by his father and his uncle who were of course—singing miners.

After several jobs and a short period in the building industry, Tom began playing drums in and around South Wales men's clubs for several groups. It wasn't until he formed his own crew, the Playboys, that Tom got the chance to sing and from then on they started to work in ballrooms: It was from one of these appearances that he was booked for Donald Peers' BBC-TV stanza. He was so successful that he was asked a return appearance. A Decca recording contract quickly followed suit.

Tom served heavily with "Green, Green Grass Of Home." He is currently filling a big concert, TV, & pa schedule.

Jr. Walker & All Stars—Soul

Autry DeWalt, known professionally as Jr. Walker, is by no means a newcomer to the music world—he had been swinging with his present All Stars for the past six years.

Jr. hails from South Bend Ind.; and at the age of nine, learned that he had a natural talent for music. He later discovered that he could best express himself on the tenor saxophone, and as time passed, it was also learned that his style of playing was attractive to many of his buddy musicians of which there became a part of his present All Star group.

The All Stars are comprised of Vic Thomas, organist, whose hobby is fishing when not performing; Willie Woods, electric guitarist, experimenting with electronics and drag racing; and James Graves, the most recent member of the crew, is a drummer who lives in Cleveland, Ohio.

The group has hit with such giant pop-r&b smashes as "Shotgun," "Do The Boomerang," "Shake And Fingerpop," "Money" and "Come See About Me."

Bert Kaempfert—Decca

Bert Kaempfert, the German maestro known here for the big 1961 hit, "Wonderland By Night" (a salute to Manhattan), can approach the music business from almost every musical angle. He plays four instruments (piano, his first love, clarinet, saxophone and accordion), composes (e.g. "Wonderland"), arranges and is a producer for Germany's Polydor label (Decca releases his session here).

Bert was born in Hamburg, Germany, of an old Hamburg family, and is an only child. Showing musical gifts at an early age. Bert is a graduate of the Hamburg School of Music.

He, his wife and two daughters live in a roomy house in a quiet suburb of Hamburg. His favorite hobbies are fishing and boating, and he enjoys detective stories, wild west novels and a "good" film. His "pet hates" are (1) the telephone, and (2) getting up in the morning.

After a hiatus from the U.S. charts the orkster is scored again with his runaway best-seller of "Red Roses For A Blue Lady." He has since followed that up with "Three O'Clock In The Morning" and "Moon Over Naples," and a flock of best-selling LP's in 1965, 1966, and 1967.

Lainie Kazan—MGM

The first big break of Lainie Kazan's young career occurred when she was understudy to Barbra Streisand in "Funny Girl." After a year of waiting and preparation, her big moment arrived. She was called upon to go on twice in one day for Mis Streisand when she was taken ill. At that point, critics and audiences alike recognized her original and exciting talent.

When the MGM recording artist was a student at Hofstra College, she auditioned for the off-Broadway show "Leave It To Jane." She won a part, and performed nightly in the play while she continued to attend college. She next appeared in summer stock and then went on tour with "The Sound Of Music." Her first Broadway show was "Bravo Giovanni" which earned her her first critical approbation. She subsequently performed at the "Living Room" in New York City, as well as the plush "Persian Room." During her stint as Barbra Streisand's standby, she made many TV appearances, including the "Phyllis Diller Show," the "Tonight Show," and the "Today Show."

Brenda Lee—Decca

Little "Miss Dynamite" started on the road to stardom with her first network TV appearance in 1956, has been overwhelming audience with her spirited vocalizing ever since.

The explosive bundle of charm, who was born on Dec. 11, 1944 at Atlanta's Emory University Hospital (the second oldest of 4 children), was signed to a long-term Decca pact, almost immediately after her TV bow. From '56 to '60 the chirp ran up a consistent string of best-sellers but it wasn't until her waxing of "Sweet Nothing's" did she attain star disk status. Then she followed with a double-header, "I'm Sorry" and "That's All I Gotta Do," that earned her the first of many gold records. Her smash chain, after that, included "Emotions," "Dum Dum," "Eventually," "I Want To Be Wanted," "Fool No. 1" and "How About Me," "Heart In Hand," "Save All Your Lovin' For Me" and her most recent, "All Alone Am I," "Losing You," "Your Used To Be," "The Grass is Greener," "As Usual," "Rusty Bells" and "Comin' On Strong."

Brenda has now enjoyed appearances on the Perry Como, Steve Allen, Ed Sullivan and Danny Thomas network outings, among others, and has started her acting career with a role in the flick, "The Two Little Bears."

In the recent years, the talented youngster has captured the imagination and hearts of people all over the world. Accompanied by her mgr. Dub Allbritten, Brenda was greeted by an enthusiastic mob scene on her '59, '60 and '61 European and South American jaunts. The President of Brazil tagged her 'the best goodwill ambassador that America ever had' while Paris newspapers hailed her as the 'most dynamic American artist since Judy Garland.' She is in frequent demand for European tours.

Gary Lewis—Liberty

Nineteen year-old Gary Lewis made up his mind early in life that he wanted a show biz career. He was only five when he saw his father, comedian Jerry Lewis in his first film and from that time on he set his sights on the entertainment field—a course he has never altered.

Following several months of practice on the drums, Gary formed a musical combo for no other purpose in mind except to play for their own enjoyment and at fraternity parties. Unknown to his parents, Gary took the group to Disneyland to audition for a summer job. They were hired on the spot and spent most of the summer playing for teenage dancers at the famous amusement park. It wasn't until several weeks later that officials at the park were aware that they had signed the son of a famous entertainer. Gary rounded out his summer activities by appearing with the group in a flick, "Swinging Summer," for Universal Pictures.

Encouraged by his parents, friends and the reception of audiences Gary felt confident enough to ask Liberty Records for an audition. The result was the smash, "This Diamond Ring." Other big singles for Gary have been "Everybody Loves A Clown," "Count Me In," "She's Just My Style," "Green Grass" and "My Heart's Symphony," to name only a few. He has gotten married and is currently filling a gig with the U.S. Army.

Ramsey Lewis—Cadet

Once in a great while a jazz artist catches the fancy of the record-buying public in a spectacular fashion. Argo's Ramsey Lewis, who fronts his own trio, is just such an artist. The B8'er has zoomed up the top 100 chart this year with his "The In Crowd," "Hang On Sloopy" and "Wade In The Water."

Lewis was born in Chicago on May 27, 1935. He began studying the piano at the age of six, and he considers his father the major musical influence in his life during the early years. By the time he graduated from grammar school in 1948, Ramsey had won the American Legion Award for outstanding scholarship, special award for his services as official pianist at Edward Jenner Elementary School and \$150 college scholarship. After graduating from Chicago Musical College he joined a seven-piece dance band called the Clefs. With him in the rhythm section were bassist El Dee Young and drummer Isaac Holt. A few years later Ramsey switched to jazz and formed a trio with El Dee and Isaac. Since then he has been extremely active working some of the best-known jazz clubs in the country.

Trini Lopez—Reprise

Trini Lopez, who first exploded on the national scene with his best-selling Reprise single of "If I Had a Hammer" and rode the charts with a host of LP's, including "Basin Street East" and "Latin," was born twenty-seven years ago in Dallas, Texas.

Trini began playing guitar and singing Latin songs in Dallas night clubs when he was only fifteen. Stimulated by excellent audience response, the artist formed his own five-piece combo and toured the southwest. After finishing high school, he and the combo played clubs across the country for four years.

With the group polished to a fine edge, Trini took a breath and plunged into deep professional waters of Hollywood. His first two-week engagement lengthened into a full year, then he played a number of clubs, including the world-famous Ciro's.

One night while the group was performing at P.J.'s, vet music man Don Costa came into the club. Costa was so impressed with Trini that he immediately signed him to an exclusive recording contract for Reprise Records.

His list of hit singles also includes "Lemon Tree."

Lovin' Spoonful—Kama Sutra

This highly talented foursome is comprised of John Sebastian (autoharp), Steve Boone (bass), and Joe Butler (drums). After rehearsing for a time in the cavernous basement of the Albert Hotel, the (then) newly formed Lovin' Spoonful marched around the corner to audition for a Greenwich Village niterery known as the Night Owl Cafe. They were signed to records for Kama Sutra. They are represented by such singles as "Do You Believe In Magic," "Day Dream," "Summer In The City" (an RIAA-certified million seller), and "Nashville Cats." They have also scored with four charted albums: "Do You Believe In Magic," "Day Dream" the current "Hums Of The Lovin' Spoonful" and the soundtrack LP from Woody Allen's "What's Up Tiger Lilly" flick. Their latest is, "She's Still A Mystery."

Lulu—Epic

Little Marie McDonald McLaughlin Lawrie, professionally known as Lulu is currently appearing in the Columbia Pictures film "To Sir, With Love," starring Sidney Poitier. In addition to acting, Lulu sings the title song of the movie. Her Epic single, "To Sir, With Love," was a flat-out smash. Lulu was born on November 3, 1948, at Lennox Castle, Lennoxtown, Scotland. She began singing almost as soon as she could talk. She was about five when she won a competition on holiday in Blackpool. By the time she was nine she was regularly appearing with a local accordion band. She has made British and continental tours and has appeared on TV. In March, 1966, she toured Poland, reportedly the first British girl artist to play there. Lulu, who is managed by Marian Massey, began her professional career singing in Glasgow's Le Phonographe club when she was 14. Her hobbies are dancing and bowling. Ray Charles, Mel Torme, Dusty Springfield, and Stevie Wonder rare her favorite singers.

Loretta Lynn—Decca

When Loretta Lynn first came to Nashville, on a promo tour in behalf of her bow on Zero Records, she visited the offices of the Wilburn Bros. The fellas, Doyle & Teddy, liked what they heard and arranged to have her records distributed on a wider scale here and signed her to their Wil-Helm Agency.

The lark started her singing career in Custer, Wash., where she had moved from her home state of Kentucky. She started her own band there and while working a long club date was discovered by Zero execs. Her initial outings on the label, including "I'm A Honky Tonk Girl," received so much deejay acceptance that Decca officials grabbed up her contract. On Decca she immediately clicked with "I Walked Away From The Wreck."

Other credits include: "Success," "Get Set For A Heartache," "Blue Kentucky Girl," and her duet with Ernest Tubbs, "Our Hearts Are Holding Hands," as well as "You Ain't Woman Enough," "Don't Come Home A'Drink' (With Lovin' On Your Mind)," "Is You're Not Gone Too Long," and "What Kind Of A Girl (Do You Think I Am)."

Miriam Makeba—Reprise

Miriam Makeba was born in Johannesburg, South Africa, but spent most of her formative years at Pretoria, in the Transvaal. From her parents she learned the haunting rhythmic songs of her ancestral Swazi and Xosa Zulu tribes. She is completely self-taught, unable even now to read music. After barnstorming with small groups, she joined a troupe called the Black Manhattan Brothers. With them she toured throughout South Africa, Rhodesia, and the Congo. By 1957, Miss Makeba was engaged to appear as a soloist in the musical revue, "African Jazz and Variety," which toured Africa for 18 months. After an eight-month run in the leading feminine role of the controversial jazz opera musical, "King Kong," she appeared as the singing lead in a semi-documentary film titled, "Come Back, Africa," shot by American film-maker Lionel Rogosin. The film exposed and attacked South African apartheid policy. Steve Allen was so impressed by Miss Makeba's performance when he saw the movie that he introduced her to American TV audiences via his network show in November 1959. The day after her TV debut, the artist began an engagement at the Village Vanguard, a New York niterery. Since the Allen TV'er, Miss Makeba has made many other TV appearances. Her Reprise single, "Pata Pata," made the charts this year.

Mamas & Papas—Dunhill

If the combination is right it doesn't take too long to have a hit song, as proven by the Mamas and the Papas, whose first recording for Dunhill, "California Dreamin'" proved to be a million-seller, as did their follow-up, "Monday, Monday."

John, who is the leader of the group and co-penner of the hit song, has played in many spots in and around the Greenwich Village; the other "Papa" of the foursome is Canadian born Denny. Michelle, one of the "Mamas," was a model before joining the group; Cass, the other female member, traveled throughout the country in satirical revues before joining the group.

All four members are descendants of folk groups that included the Big Three, the Halifax Three and the Journeymen. They have all per-

formed throughout the U.S. and have recently returned from a trip to the Virgin Islands.

The Mamas & the Papas have proven themselves good album sellers with "The Mamas And The Papas" and "If You Can Believe Your Eyes And Ears." "Cueque Alley" was a big single for them this year. Their latest LP is "The End Of The Golden Era."

Henry Mancini—RCA Victor

Henry Mancini, composer - arranger - conductor, played a major role in bringing jazz to TV with his musical backgrounds for the "Peter Gunn" and "Mr. Lucky" series and is currently a mainstay writer of feature flick scores. Mancini was born April 16, 1924, in Cleveland, the son of a steel worker, who used to play flute in his spare time. His father sent Hank to Carnegie Tech Music School, and the Juillard Institute. He has been staff composer and arranger at Universal Pictures since 1952 and among the films to his credit is "The Glenn Miller Story." He wrote the score for the Bing Crosby film "High Time," and his score to "Breakfast At Tiffany's" which he wrote as well as recorded for RCA Victor, was a fabulous soundtrack seller. "Moon River" is the film's most famous selection, won an Academy Award as the top film song of 1961. In '62 he won the Award with "Days Of Wine And Roses" and in '63 had a nominee in "Charade." A 1964 nominee was "Dear Heart." In 1965, he had another nominee, "Sweetheart Tree." He also composed music for club acts including those of such stars as Dinah Shore, Polly Bergen, Billy Eckstine and Betty Hutton. Hank lives in Northridge, California with his wife and three children.

Mantovani—London

A comic routine ends with the line 'if everybody in the world would play a violin each day we would all be bigger and better than Mantovani.' Although it may be stretching the point a bit one would still have to go pretty far to match the sounds of Mantovani's 'cascading strings.'

The maestro is, undoubtedly, one of the most popular ork leaders in the world. Everyone of his more than 20 album releases has been a best-seller in the U.S. mart and on many occasions he has scored heavily in the singles dept. His tours have also met with fantastic success.

Born in Venice, Anunzio Paolo Mantovani, he inherited his sense of beauty and good taste from his father, who was first violinist at the famed La Scala in Milan, reigned over at that time by Arturo Toscanini.

His family then moved to England where they settled. His father tried his best to steel Monty into engineering but he stuck to his violin lessons. His love for music won out and at 20 Monty was leading his own ork at London's Hotel Metropole. London Records has been cashing in on his talent ever since.

Some of his big LP credits include "The Mantovani Sound—Big Hits from Broadway," "Mantovani Ole" and "Mr. Music."

Dean Martin—Reprise

In an era when show business personalities are usually straight-jacketed into narrow fields of expression, Dean Martin is an exception to the rule. This polished pro has a versatility that seemingly knows no bounds.

Born Dino Crocetti in Steubenville, Ohio, Martin moved with his family, when still a youth, to Long Beach, Calif. Although he recalls being "a fairly cocky kid" with no lack of self-confidence, Dean tried his hand at numerous jobs before he took up singing seriously. In 1946 he luckily found himself on the same bill with a young laughman called Jerry Lewis with whom he quickly joined up as a duo. Dean sang and played straight man to Lewis' wackiness.

Eight tremendously successful years and 16 films later, the team of Martin and Lewis was dissolved. Since then Dean has gone on as a solo to new vistas of success as a night club performer, comedian, and dramatic actor.

When he is not on the road or recording, Dean lives with his wife and three children in a formal English mansion in Beverly Hills.

"Everybody Loves Somebody" was Martin's big comeback disk in 1964 and LP & singles successes have continued, including a very popular TV variety show.

Al Martino—Capitol

In 1950, Al Martino made the disk world sit up and take notice with a potent ballad tagged, "Here I My Heart," which went on to become his first million seller. The Philadelphia chanter joined Capitol in 1952 where he immediately scored with "Take My Heart" and "Wanted." During a long dry spell in the disk biz, the warm-voiced chanter continued to play top clubs and theaters throughout Europe and the U.S. until 1963 when he returned to the charts with a giant tagged, "I Love You Because." The formula proved to be the right one, because he has scored with every single he's made since. His albums have scored equally well—each LP tagged after a hit single has won chart laurels.

Johnny Mathis—Columbia

A singer who offered straight ballad singles in 1956, when rock 'n roll had already taken over the singles market, could hardly expect more than meager sales.

However, Johnny Mathis, certainly in the crooning class, was able to buckle the teen-beat tide with an outstanding record of singles successes that carried nary a sign of rock 'n roll.

With "better" pop songs, Mathis proved a "good-music" oasis with such singles hits as "Wonderful, Wonderful," "It's Not for Me to Say," "Chances Are," "Wild is the Wind," "A Certain Smile," "Maria" and "Gina," and a host of top albums, including "Johnny's Greatest Hits," which has passed the half-million mark in sales.

One of seven children, Johnny's chief claim to fame, at first, was as an outstanding all-around athlete in George Washington High in San Francisco, his hometown, and San Francisco State College (in high school, he established a local high-jump record, 5' 5 1/2", that has been matched only four times in the history of the Olympics). An informal Sunday afternoon jam session at San Francisco's Black Hawk niterery, then co-owned by Helen Noga, his manager, Johnny sang a number with the group. Helen heard him, ending Johnny's plans to teach physical education, starting a career that now shines brightly.

THANK YOU

Voted Northeast Promotion MAN-OF-THE-YEAR

1967 Bill Gavin Radio/Record Award

Herb Rosen

888 8th Avenue N.Y.C. (212) 765-1380

the american breed

*groups may come and fads may end;
and, oh, the confusion with the change and trend;
something to last—that's the need!
and last they will...The American Breed.*

sandy duore



current single release: "bend me, shape me" (45-811)

current album release: "the american breed" (mono: a8002; stereo: a38002)

currently on nation-wide tour

acta

acta RECORDS, HOLLYWOOD 28, CALIFORNIA/A DIVISION OF DOT RECORDS, INC.

Bios of 1967's Leading Artists

Roger Miller—Smash

Roger Miller, who is currently clicking with "Ballad of Waterhole #3," on Smash, was born on a farm in Erick, Oklahoma.

Following a stint in the service, he moved to Amarillo where he began writing and working in local bands. So he decided to make the big move in Nashville and try for audition with a label. An RCA Victor contract followed in quick order and the chanter jumped into the national spotlight with a string of best-selling platters including "Hey Little Star," "You Don't Want My Love," etc. The rest is history.

He then signed with Smash and busted thru with his debut disk, "Dang Me" and followed with "Chug-A-Lug," "Do Wacka Do," "Engine, Engine #9," "One Dym" and "A-Buryin,'" "Kansas City Star," and "England Swings."

In the years of 1965 and 1966, he won a total of 11 Grammy Awards from the National Association of Recording Arts and Sciences, making him the leader in that category.

Van Morrison—Bang

Van Morrison was born in Belfast, Ireland on Aug. 31st, 1945. He attended the Orange Field Boys Secondary School, from which he dropped out at the age of 15, to become a professional musician. His first pro gig had come when he was but 5-year-old when an aunt (from Detroit) gave him \$5 for singing "Money Is The Root Of All Evil."

In 1964, Morrison opened an R&B club in Belfast and shortly thereafter formed a group called Them. Among the disks recorded by Them was "Gloria" which stirred up a bit of activity among west coast hippies. The tune, which was penned by Morrison, rose to the upper reaches of the charts in a version done by the Shadows of Knight. On his list of compositions are such tunes as "Sad Eyes," "Bring 'Em On In," "One Two," and "Mystic Eyes." Now on the Bang label, Van Morrison hit big in '67 with his "Brown-Eyed Girl" single.

Ray Orbison—MGM

Ray Orbison's dad, an oil-rig driller, has spent his life searching for black gold in the oilfields of Texas. Ray, a one-time geology student, who gave up his pick-ax for a guitar pick, has made his strike in the recording studios of Nashville.

Ray, now 27, grew up in the oil town of Wink, Texas. When his dad wasn't drilling for oil he was playing a guitar and taught Ray how to play when he was 6. He was barely in his teens when he was leading "The Wink Westerners" and conducting a talent show over the local radio station. At 16 he represented the Lone Star state at the Int'l Lions Conclave in Chicago. While a geology major at North Texas State a fellow student (and disk artist at the time) Pat Boone helped convince him to look for gold records instead of black gold.

In April of '56, he was signed to Sun Records by topper Sam Phillips and later on made chart noise with "Ooby Dooby." In '58 he signed a clef-farmer pact with Wesly Rose. Then he moved over to RCA Victor and from there on to Foster's Monument label, coming up with a Top 100 outing in "Uptown." Then came his "Only The Lonely" (a million-seller) and he's been smashing through ever since as evidenced by his "Cryin'," "Running Scared," "Candy Man," "Working For The Man" and "Leah" chart triumphs.

In '64 the artist had LP giants in his "Greatest Hits" and "More Greatest Hits" packages. His million-selling "Oh, Pretty Woman" single turned out to be one of the year's biggest decks.

Buck Owens—Capitol

Born in Sherman, Texas, on Aug. 12, 1929, Buck Owens was plinking on his mother's piano at the Pentecostal Church as soon as he could reach the keyboard. By the time he was 13 the family moved to Phoenix, Ariz., and the boy's musical ability was so apparent that his parents bought him a mandolin.

Buck had to leave school when he was still in his teens and get a job. For several years he hauled fruit and produce between Arizona and California's San Joaquin Valley. By the time he was 21 the artist played sufficient guitar to get a job with a band in a Bakersfield club. Later Owens joined Bill Wood's band in Bakersfield, played on the "Chuck Wagon" TV show there.

Buck, who writes most of his own compositions, soon came to the attention of Capitol Records which inked him to an exclusive recording contract. Over the years he has had a host of c&w sales giants including "Act Naturally," "Love's Gonna Live Here," "My Heart Skips A Beat," "Together Again," "I've Got A Tiger By The Tail," "Only You," "Buskaroo" and "Waitin' In Your Welfare Line" among many, many other hit singles and albums, including "It Takes People Like You," and "Sam's Place."

Peaches & Herb—Date

Peaches and Herb, Date recording artists, did extremely well this year with "Lets Foll In Love." Before joining forces, Herb had recorded for Date as a solo performer, and Peaches was signed to Date as a member of the female trio, the Sweet Things. Producer Dave Kapralik insisted that they try recording together after hearing them do some joint impromptu singing on a road trip. Francine Day (Peaches), 18, began singing with neighborhood groups while she attended elementary school in Washington, D.C. She was first featured as a lead singer with the Kaytones, who attained great popularity at school and community events. Peaches then sang with a succession of groups until she and two other girls formed the Darlettes. The Darlettes changed their name to the Sweet Things when they signed with Date. Herb Fame, 21, began singing in church choirs when he was 7. He also participated in every school and neighborhood group that he could find. After graduating from high school, Herb worked in a Washington record store where he met producer Kapralik and asked for an audition.

Peter, Paul & Mary—Warner Bros.

Life-long interests in folk music led Peter, Paul and Mary to Greenwich Village, where they became a trio. The group toured the country from the Blue Angel to the Hungry i developing their style and acquiring a loyal group of admirers. Their fortunes began to rise rapidly when they cut an album for Warner Brothers tagged after themselves. A single, "Lemon Tree," taken from the disk brought the trio into the national limelight.

Peter Yarrow, who was born in New York in 1927, took a psychology degree at Cornell University where he was an instructor in a folk ballad course. He was discovered at the Newport Festival in 1960 and toured the nation as a solo performer.

Paul Stookey, who was born twenty-six years ago in Birmingham, Mich., thumped an electric guitar for a high school rock n' roll group on local TV and exceeded his way through Michigan State University.

Mary Allin Travers was born in Louisville, Ky., in 1937. She has appeared with several teen-age folk groups and has made it to Carnegie Hall twice. She is the only member of the group with Broadway credits having appeared in "Mr. President" with Mort Sahl.

Besides "Lemon Tree," their hits include "If I Had A Hammer," "Puff," "Blowin' In The Wind" and "Don't Think Twice, It's All Right." Their hit LPs include "In The Wind," "Movin'," "Peter, Paul & Mary in Concert," "See What Tomorrow Brings" and "Peter, Paul & Mary Album." Their latest LP is entitled, "Album 1700."

Wilson Pickett

Wilson Pickett started his singing career in the spiritual field in the city of Detroit. He and his family had moved there when Wilson was in his teens, from Prattville, Alabama, his birthplace. For four years, Wilson Pickett was a spiritual singer, performing with groups and as a soloist in and around Detroit.

In 1959 Wilson was discovered by Willie Scorefield, as a singer with the Falcons, one of the top vocal groups in the Detroit area. The Falcons flipped over Wilson's gospel style of singing and quickly made him a member of the group. With the Falcons, Wilson became aware for the first time of the world of rhythm and blues music, an experience that was to have a profound effect upon his future career.

After being with the group for a few years, Wilson found that he had a talent for songwriting. He wrote many songs for the Falcons, including one that became a hit for the group, "I Found A Love."

In 1963, Wilbur Golden, head of Correc-Tone Records in Detroit, decided that Wilson was ready for bigger things. Golden had him audition for Lloyd Price, who then had his own record label, Double LL. Wilson was quickly signed to Double LL by Price, and his first release on the label featured Wilson singing his own composition, "If You Need Me." That record soon became a hit, and the song has since become an R&B standard, recorded by such outstanding artists as Atlantic's Solomon Burke, The Rolling Stones, Tom Jones, Bill Doggett, and many others. Another song that Wilson wrote and recorded for Double LL also became a hit, "It's Too Late."

Pickett signed with Atlantic Records in 1964, and continued his string of hits on his new label. For Atlantic he has recorded a score of hits, including his own compositions, "For Better Or Worse," "I'm Gonna Cry," and "In The Midnight Hour" and "Mustang Sally." He has become one of the hottest artists in concerts and one nighter tours, and has appeared on most of the top rock and roll TV shows in both New York and Hollywood.

Wilson Pickett's hobbies are swimming and bowling, and the collecting of spiritual albums. He has one of the largest collections of spiritual albums of any performer, and hopes one day to record a spiritual album of his own.

Webb Pierce—Decca

Webb Pierce has been for many years, one of Decca's most consistent country hit-makers. His roster of success started with "Wondering" in 1951. Country music devotees will recognize previous Pierce triumphs in "Fallen Angel," "How Do You Talk To A Baby," "Last Night," "Tupelo County Jail," "In The Jailhouse Now" and "There Stand The Glass," "Cow Town," "Sooner Or Later," "Years Gone By," "Memory #1," "Loving You Then Losing You," "That's Where My Money Goes," "Hobo And The Rose," "Sweet Memories" and his recent "Fool, Fool, Fool."

The Pierce brand of magic began at sixteen when he became proficient enough to land a job as an entertainer on a radio show on KMLB-West Monroe, Louisiana, his hometown's major station.

After a three-year stint in the Army, Pierce settled in Shreveport and played for various bands throughout the state; waiting for the audition that was soon to come from "Louisiana Hayride." At first he was used sparingly on the show, then as he received a veritable flood of mail, he was elevated to star billing. Pierce cut his first hit Decca release and his career went into high gear.

Today Webb Pierce is one of the nation's foremost country chatters. He has sold millions of recordings and popularized hundreds of folk songs, many of which he wrote himself.

Gene Pitney—Musicor

Gene Pitney began his career in music biz as a tunesmith. After supplying other performers with disk material, he stepped out on UA's Musicor label with a chart rendition of his own number, "I Wanna Love My Life Away." The chanter has pulled in plenty of loot with "Town Without Pity" and "The Man Who Shot Liberty Valence," "Only Love Can Break A Heart," "Mecca," "I'm Gonna Be Strong" and "It Hurts To Be In Love."

Some of the artists who have cut Pitney songs include June Valli, Steve Lawrence, Tommy Edwards, Billy Bland and Roy Orbison.

A native of Rockville, Conn., the 21-year-old performer has, in addition to his singing-writing background, experience as an arranger and instrumentalist.

The performer's hobbies cover three areas: taxi-drome, trapping and electronics. In 1966 Gene rode the charts with "Backstage."

Sandy Posey—MGM

"Born A Woman" on MGM, by Sandy Posey spent many weeks at various positions on the Top 100. It also established her as a major solo artist. This is her first solo disk although she has backed up many recording sessions in and around Nashville. Sandy has been involved in music on a professional level since two-year-ago when she was invited to attend a recording session and the background singers failed to show up. She has been singing ever since she can remember and her mother first noticed her harmonizing to the music of the radio when Sandy was five-years-old. The importance of Sandy Posey as a background singer is likely to fade as her solo voice is heard more and more. A partial list of the artists that Sandy has backed up includes: Tommy Roe, Joe Tex and Percy Sledge.

Sandy considers herself to be a compulsive singer, you might say, "Born A Woman . . . who has to sing."

She has been represented by "Single Girl" "What A Woman In Love Won't Do," and "I Take It Back."

Elvis Presley—RCA Victor

Every era has its national phenomena and, Elvis Presley became of those rare phenomena. His fantastic acceptance and unbelievable sales success throughout the world are unmatched by any other single recording artist popular for the same short period of time as Elvis. He is truly an artist in a class all by himself. Elvis Aaron Presley was born January 8, 1935 in Tupelo, Miss., to Vernon Presley, a paint factory employee and the late Gladys Presley. It was pure chance that brought him to a professional career and overnight fame. Elvis was going to school during the day and studying nights to be an electrician when he decided to make an amateur recording as a gift for his mother. He went to the Sun Record Company, in Memphis, and cut a record titled "That's All Right Mama." Sam Phillips, Sun's president, heard the youngster sing and saw possibilities in his unique style. He asked Elvis to leave his name for a possible audition at a later date.

Presley heard no more from Phillips for a year and a half and meantime had taken up truck driving, it being a more lucrative job (\$35.00 a week) than ushering at the theatre (\$14.00 a week). The Phillips called and before Elvis knew what had happened, he was rushed into a recording session, a contract was signed, and "That's All Right Mama" with "Blue Moon Of Kentucky" on the other side was released.

Soon RCA Victor heard the reverberations from the South, and bought Presley's contract from Sun, along with his original recordings and four additional discs. "Mystery Train," backed by "I Forgot To Remember To Forget" was one of the Sun recordings released under the RCA Victor label and was soon a runaway hit. This was followed by Victor's "Heartbreak Hotel," backed by "I Was The One."

From then on, Elvis' records were the sensation of the music world. He has 8 RIAA-certified gold records, including singles and albums and even held his leadership in his field while he was in the Army. He has an endless list of top hits, and in 1956 Elvis signed a picture deal with Hollywood producer Hal Wallis, and the deal to make him film debut for the 20th-Fox in "Love Me Tender."

Elvis followed this with "Loving You," Jailhouse Rock" and "King Creole," all of which were enormously successful. For example, 20th Century-Fox estimated that the negative cost of "Love Me Tender" was recouped in the first three days of release, an accomplishment probably without equal in the industry's history.

However, in March, 1958, Elvis was "signed" by the U.S. Army and after basic training at Fort Hood, Texas, he was shipped to Germany for duty with the famed 3rd Armored Division.

He made one television appearance on the Frank Sinatra "special" for a reported \$150,000, then reported to Hal Wallis for a film, "G.I. Blues." He then came to 20th Century-Fox for his starring role in "Flaming Star." Highlighting his 1962 efforts were the film's "Blue Hawaii," "Girls, Girls, Girls," both big soundtrack sellers for Victor, as were one of his later hits, "Fun In Acapulco," "Clambake" and "Spinout," among others.

Ray Price—Columbia

Ray Price has long been one of the big sellers on the Columbia label. More than twenty-five of his hits have appeared in the top ten national record charts in the span of over 10 years . . . many of them ("City Lights" for example) remaining in the charts for more than twenty weeks. The list of the "Grand Ole Opry" star's hits are endless but some notable ones are: "My Shoes Keep Walking Back To You," "One More Time," "Who'll Be The First," "Sort Rain" and "Burning Memories."

Price is the recipient of many industry awards for his exceptional chanting ability. He is a country artist in the grand manner and his wardrobe is without comparison in the entire field.

Price began his career studying veterinary medicine but decided that he would rather sing about animals than mend them. When he is not on the road he lives in Texas with his wife and his three-and-a-half-year-old son Clifton Ray.

His most recent biggies are: "Touch My Heart," "Danny Boy" and "I'm Still Not Over You."

Procol Harum—A&M

Procol Harum, which was formed only recently, first made the charts with "A Whiter Shade Of Pale." They have prepared a film for TV and have also appeared on a number of video shows. This swift success had its inception a year ago when British lyricist Keith Reid wrote a poem called "A Whiter Shade Of Pale" and showed it to publisher David Platz of The Richmond Organization. Enthusiastic, Platz told Reid to have it set to music. Finally, Reid found Gary Brooker, versatile vocalist and instrumentalist, to compose and sing the right melody. Then they set out this spring to organize a group, Procol Harum. The quintet, in addition to Brooker, consists of organist Matthew Charles Fisher, a classical organ student at the Royal

Guildhall School; lead guitarist Ray Royer; bassist Dave Knights; and drummer Bobby Harrison. Under the direction of producer Denny Cordell, Procol Harum recorded "A Whiter Shade Of Pale," which was released in the U.S. on the Deram label. The group's style has been described as "Surrealistic Soul" and "Bach Rock."

Otis Redding—Volt

Otis Redding was born in Dawson, Georgia on Sept. 9, 1941. While still a youth, Otis moved to Macon where he attended high school and participated in several sports and student activities. After winning a number of local amateur programs, Otis made an early decision to try his luck at a show business career. The young hopeful came to the attention of Phil Weldon, another high school student who had been booking a local band. The two joined forces and the long road to success was begun.

Otis received his first break when he became the featured vocalist with Johnny Jenkins and the Pinetoppers. While on a p. a. with the group Otis asked if he could cut a demo. The result was his initial hit—"These Arms Of Mine." The rest is history.

Jim Reeves—RCA Victor

The late Jim Reeves—one of Country (and Pop) music's most consistent hit-makers was a real westerner—having been born in Ponola County, Texas. When he was a boy, too young to learn an instrument, he talked his brother into buying a guitar to accompany him as he spent more and more time singing. In a short while he was able to play the guitar himself and at the age of nine, he was already making his first appearances before audiences. When Jim was ten, he was making \$15 per week from his talent, by singing at radio station KRMD in Shreveport, La. However, show biz wasn't really his goal; Jim wanted to be a big league ball player, and while in the University of Texas on an athletic scholarship he began to show promise on the diamond. After graduation he signed with the St. Louis Cardinals as a pitcher. Toward the end of his initial season he was injured sliding into first and the team's doctor advised against any more baseball. That was when he slid into show business as an announcer on the famous Louisiana Hayride show, finally becoming featured vocalist and record star with the release of his first hit, "Mexican Joe." From that time on it was "Bimbo," "Am I Losing You?," "Four Walls," "He'll Have To Go," "I'm Gonna Change Everything," "Is It Really Over," "Snow Flake," "Distant Drums" and many more.

In 1967 he was elected to the Country Music Hall of Fame, in Nashville.

Paul Revere & Raiders—Columbia

Paul Revere and the Raiders consist of five lads—three guitarists (lead singer Mark Lindsay doubles on sax), an electric organist and drummer. The group was formed in Portland, Ore. by Paul Revere, an ex-barber who turned restaurateur and apartment house owner by the time he was 21.

The group, which specialized in playing teen dances, conquered their own area before attempting to break into records. Their current hit is a follow-up to their previous chart rider "Steppin' Out."

The lads are managed by Roger Hart, a former KISN-Portland deejay, who spotted their potential when he was running dances in his home territory.

The group did well with "Kicks," "Hungry," and "Great Airplane Strike," and in 1967 struck RIAA gold with 3 albums, "Just Like Us," "Midnight Ride" and "Spirit Of '67."

Righteous Bros.—Verve

The Righteous Brothers, who established themselves with "You've Lost That Lovin' Feeling" on Philles, are not brothers at all. The duo actually consists of Bill Medley and Bobby Hatfield.

Bill was born in Los Angeles on September 19, 1949 and now makes his home in Santa Ana. In addition to his singing talent, he is also top-notch tunesmith (his present chart-rider is one of his own compositions). He also plays the piano and bass guitar.

Bobby was born in Beaver Dam, Wisconsin on August 10, 1940. He appeared in high school musicals, was emcee and sang in school talent shows, and because of the encouraging reaction he got, decided to enter show business.

Prior to their Philles affiliation, the lads hit with "Little Latin Lupe Lu" on the Moonglow label and since have had such smashes as "Unchained Melody" and "Ebb Tide."

Currently on the Verve label the boys have hit there with "(You're My) Soul And Inspiration," which has been certified by the RIAA as a million-seller, and with "He."

Johnny Rivers—Imperial

Johnny Rivers skyrocketed to national fame in 1964 in a seemingly-rapid-fire fashion of singles and LP hits.

As show biz paradoxes have a way of being, Johnny, despite his accelerated journey to stardom, is no "overnight success." Born in Baton Rouge 23 years ago, he studied music constantly and soon gained a large local following. Though he is now living in Hollywood, Baton Rouge is still his hometown. Johnny is the complete musician, being a songwriter, guitar player, arranger in addition to being a fine performer. He has written innumerable hits including "I'll Make Believe" which Ricky Nelson scored big in 1958.

Steeped in the classical blues tradition, Johnny got his first musical inspiration from such greats as Fats Domino, B. B. King, Ray Charles, etc.

He has had offers from every top supper club in the country including the Sands and Flamingo in Vegas and Mr. Kelly's in Chicago, as well as offers from every major TV (e.g. Ed Sullivan, Jack Paar Jimmy Dean, etc.).

Some of his hits include "Secret Agent Man," "Poor Side Of Town" and, most recently, "Summer Rain."

(Continued on page 62)

ROBBINS-FEIST-MILLER...

- Folio and Sheet Music Marketing
- Creative Copyright Promotion
- Record Production and Artist Development



Music Business

On A Global Scale!

*Through Affiliates, Agents and Representatives
In A World-Wide Music Publishing Network*

- Robbins-Feist-Miller
New York and Hollywood
- Robbins Music International (Argentina)
Buenos Aires, Argentina
- J. Albert & Son Pty. Ltd.
Sydney, Australia
- Weltmusik Edition International
Vienna, Austria
- Editions Francis-Day
Brussels, Belgium
- Robbins Music International (Brazil)
Rio de Janeiro, Brazil
- Gordon V. Thompson, Ltd.
Toronto, Canada
- Robbins Music Corporation, Ltd.
London, England
- B. Feldman & Company, Ltd.
London, England
- Francis, Day & Hunter, Ltd.
London, England
- Editions France-Melodie
Paris, France
- Sidemton Verlag
Cologne, Germany
- Trident N.V.
Amsterdam, Holland
- Edizioni Curci
Milan, Italy
- Eastern Music Publishing Co., Ltd.
Tokyo, Japan
- Grever International S.A.
Mexico, D.F.
- S. S. Suarez Music Company
Manila, Philippines
- Francis, Day S.A. (Pty.), Ltd.
Johannesburg, South Africa
- Canciones del Mundo
Madrid, Spain
- Reuter & Reuter Forlags
Stockholm, Sweden
- Editions Sidem
Geneva, Switzerland

Bios of 1967's Leading Artists

Marty Robbins—Columbia

Versatile Columbia hit-maker Marty Robbins has written hundreds of songs. He has also appeared in a number of Hollywood movies, including "The Gun And The Gavel," "The Badge Of Marshall Brennan," "The Western Musketiers," and "Buffalo Guns." His tremendous pop-country hit line-up includes "A White Sport Coat," "Singing The Blues," "Don't Worry," "Knee Deep In The Blues," "Big Iron," "Jimmy Martinez" and "El Paso," which was culled from his LP smash, "Gunfighter Ballads And Trail Songs," "Devil Woman," "Ruby Ann," "The Cowboy In The Continental Suit," "Old Red," "While You're Dancing," etc.

Born in Arizona, near the small town of Glendale, Marty moved with his family to Phoenix when he was 12 years old. At 19, he enlisted in the Navy and spent three years on a Pacific Island, where he taught himself to strum the guitar and began to compose songs. After Navy service, Marty tried many jobs and in his spare time he was writing songs.

Through a friend whose band was booked at a Phoenix nightclub, Marty made his singing debut. He sang several times as a guest, was later engaged for his first playing job as a guitarist.

In time, Marty had his own radio show and a television program called "Western Caravan." His versatile style was developed on these programs on which he ranged from gospel songs and blues to Western ballads. Besides two radio programs daily and weekly television show, Marty made frequent guest appearances on "Grand Ole Opry," becoming a regular member in 1953. He then began to make recordings, chiefly of his own works.

Some of his most recent winners include "Count Me Out," "While You're Dancing," and "The Shoe Goes On The Other Foot Tonight," "Good-night Carmen" and "Gardenias In Her Hair."

Smokey Robinson & Miracles—Tamla

Somewhere between obtaining a degree in aeronautical engineering and playing trumpet in his high school marching band, Smokey Robinson found time to form a group called The Miracles in 1953, composed of himself and three Detroit buddies named Bobby Rogers, Ronnie White and Pete Moore.

After banging around at various engagements they met Barry Gordy Jr., who heard their tune "Shop Around," and cut it for his Motown records complex. Several million copies later, Smokey and the Miracles were on their way—way up there.

A prolific songwriter, Robinson has contributed such R & B standards as "You Really Got A Hold On Me," which received the ultimate tribute by being waxed by the Beatles. Other hits for the group include, "Going To A Go-Go," "Mickey's Monkey," "I Like That" and "I'm the One You Need."

The Rolling Stones—London

Proving how to succeed in show business without really getting dressed for it are England's Rolling Stones—lead vocalist Mick Jagger—born in Dartford, Kent in '44, harmonica-guitarist & vocalist—Brian Jones, born in Gloucestershire in '44, drummer—Charlie Watts, born in Wembley in '41, guitarist Keith Richards, born in '42 and bass guitarist-vocalist Bill Wyman, born in London in '41.

Their story began in '62 when Brian and his own group were playing in an Ealing Club. Among the fans were Mick and Keith. The boys had one main interest in mind—putting R&B on the wax map and teamed up to do so. Times were hard but they carried on. In '63 they took on Watts, Wyman and Ian Stewart, who is now road mgr., as pianist. They then began to click everywhere they played—especially at the Station Hotel in Richmond, where they played every Sunday. Included in their fans were the Beatles and a live wire publicist associated with them—Andrew Oldham. Both Andy and Eric Easton were knocked out by the Stones and immediately became their co-managers. On May 10 of '63 they waxed a Chuck Berry number for Decca Ltd., "Come One," and hit with it right off the bat. It was followed by a Beatles (Paul & John) penned tune, "I Wanna Be Your Man," that soared higher on the charts. Their next deck, Buddy Holly's oldie, "Not Fade Away," proved to be their 1st big success in the U.S. Other hits that followed were "Tell Me," "It's All Over," "Time Is On My Side" and "Get Off My Cloud."

Other giants from the charts include "19th Nervous Breakdown," "Mother's Little Helper" and "Have You Seen Your Mother, Baby, Standing In The Shadows," and two RIAA-certified gold singles, "Satisfaction" and "Ruby Tuesday."

In addition, they have compiled six gold LPs, "Out Of Our Heads," "December's Children," "Aftermath," "Big Hits (High Tide & Green Grass)," "Between The Buttons" and "Got Live If You Want It."

Royal Guardsmen—Laurie

The Royal Guardsmen comprise Chris Nunley, lead singer; Tom Richards, lead guitar and harmony singer; John Burdett, drums; Bill Taylor, organ; Barry Winslow, rhythm guitar and lead singer; and Bill Balogh, bass. Their first record, "Baby Let's Wait" was released by Laurie Records. The record was not a hit. Their second and third records "Snoopy vs. The Red Baron," and the follow-up, "Return Of The Red Baron," were both on the top 100 at the same time.

Sam The Sham & The Pharaohs—MGM

Sam The Sham was born in Dallas, Texas. He spent his youth there and after graduation from high school joined the Navy for a four-year hitch.

While in service Sam decided that he wanted to devote himself to music upon his discharge. When he wound up his Navy duty he organized a combo and began to play dates throughout the South. During this period of searching for a distinctive sound and modding a cohesive crew, Sam taught himself to play the organ. In short order the Pharaohs were formed. The group became popular in various clubs in and around Memphis. (Enter Stan Kesler, an A&R producer for Penn Records, who invited Sam and the boys to drop by for an audition. It only took one listen

and a contract was issued. Almost immediately the group gave birth to "Woolly Bully" which was released under MGM's label. Other big singles for the group have been "Ju Ju Hand," "Ring Dang Do," "Li'l Red Riding Hood" and "Hair On My Chinny Chin Chin" and "Black Sheep."

"Woolly Bully" and "Li'l Red Riding Hood" were both certified as million-selling gold records R.I.A.A. (Record Industry Association of America).

Seeds—GNP

The Seeds managed to sow a place for themselves in the record business with their "Pushin' Too Hard" deck. The group is composed of Sky Saxon, lead singer, harmonica, bass, mariacas, tambourine and writer for the quartet; Jan Savage, full-blooded Cherokee, lead guitar; Daryl Hooper, piano, organ, harpsichord and sitar; and Rick Andridge, drummer. Sky Saxon founded the Seeds and wrote their songs and lyrics. He acknowledges Lightnin' Hopkins and Muddy Waters as influences. Rick Andridge's musical tastes are wide-ranging; they cover the scope from rock to Beethoven. He admires the "fantastic talent" of the Beatles and Rolling Stones. Daryl Hooper's favorite sport—ready, now?—is jousting. There's nothing strange about his musical ability, 'tho'. Jan Savage, in addition to music, loves photography. His musical interests run from jazz to rock. The Seeds record exclusively for GNP-Crescendo in Hollywood.

Ravi Shankar—World Pacific

Indian sitarist and composer Ravi Shankar was born in the Holy City of Benares in 1920. He is the brother of Uday Shankar, and it was in his companies that Ravi first began his career in music and dance as a boy. His exposure to the music of the west sent him home to India and to Indian music. He chose to start again at the beginning and sought out "the father of instrumental music," Ustad Allaudin Khan. After thoroughgoing training in the sitar and in the elaborate system of Indian classical music, he started his career again, this time as a classical soloist. He has since composed the scores of most of the prize-winning films to come out of India in recent years. And he has won most of the possible awards, too, for his film scores at the Cannes, Venice, and German film festivals. Best known in this country is the Pather Panchali trilogy. He also composed the score for "Kabulliwallah" and "Anuradha," which won the President's Prize this year, highest honor India gives in the arts and one which has come to Ravi four times. "Ravi Shankar In New York" and "Ravi Shankar At The Monterey Pop Festival" are two of the artist's LP's.

Simon & Garfunkel—Columbia

This folk-rock team came up via the typical route of Greenwich Village coffeehouses and moved on to performances at the Edinburgh Folk Festival and the Troubador and Enterprise in London. They have been seen on various television shows and are currently presenting a series of concerts on college campuses throughout the East and Midwest. They became famous when their first Columbia single, "The Sounds of Silence," went to the top of the best-selling charts and subsequently won a gold record for sales of 1,000,000 copies. Their second single, "Homeward Bound," placed among the top five, as did "I Am A Rock" and other successes include "The Dangling Conversation" and "Hazy Shade Of Winter." They have done three albums for Columbia, "Wednesday Morning, 3 A.M.," "The Sounds of Silence," and "Parsley, Sage, Rosemary and Thyme." Most of their work is music and lyrics by Simon, vocal arrangements by Garfunkel.

Their songs are in the mold of traditional folk with rock overtones, and at their center are preoccupations with loneliness, illusory existence, the pain of time passing and lack of communication.

They began singing together when they were about thirteen, spending their time after school in long, serious rehearsals, listening to each other's pronunciations and working at matching and balancing their voices. "We started doing some stuff at school and went around to a couple of record companies, but then it was time for college." The two went their separate ways, Paul to major in English literature at Queens College, and Art to Columbia University, where he is now a graduate student. During their early college years, what they now call a "dig-yourself competition" led to a breach in their friendship, but "we got over it and got back together. In the meantime, Paul had begun to do his own songwriting and, following his graduation, had gone on the first of five European jaunts to date. Periodically, Art, in between exams, term papers and other demands of student life, joined Paul, and the two became quite well known in England.

Frank Sinatra—Reprise

There are no awards in show business, but if there were, Frank Sinatra would have surely been the recipient of one.

During the early and late Forties, Frank, as the bobbysox idol, was one of the remarkable figures of the entertainment world. For the first few years of the fifties, he was one of its most neglected.

But (here's where the "comeback" award comes in), in 1963 he was well on his way back to the top, not ironically, through singing, but via his Academy Award winning role as "Mag-gio" in the film version of "From Here to Eternity." He is again one of the remarkable figures in the entertainment world.

Frank, born in Hoboken, N. J., decided to become a singer after seeing, in 1936, a Bing Crosby picture. From his own group, The Hoboken Four, Frank went on to become a vocalist with Harry James, and later with Tommy Dorsey's Pied Pipers. He started working solo in 1942.

After long disk careers with Columbia and Capitol, Frank formed his own label, Reprise.

1965 was the year of Frank's 50th anniversary, and 1966 was the year of some of his biggest singles hits, including "It Was A Very Good Year," "Strangers In The Night" and "That's Life."

Sinatra's 1967 chartmakers include "The World We Knew," "This Town" and "Somethin' Stupid" (a duet with daughter Nancy).

Nancy Sinatra—Reprise

Nancy Sinatra has been involved in show business since she was a small child, watching from the sidelines while her famed father, Frank, wowed the crowd. She was given extensive preparation for her own career—11 years of piano, 8 years of dance, 5 years of singing and 5 years of dramatic lessons.

Her first introduction to audiences came in 1959 when she sang on a TV special with her father and Elvis Presley, and later she appeared on such network shows as "The Virginian," "The Perry Como Show" and "Burke's Law."

In 1961, at the age of 21, Nancy signed an exclusive recording contract with Reprise Records and made a name for herself overseas with records like "Like I Do," "Tonight You Belong To Me" and "Think Of Me."

It wasn't until 1965 that she began to make noise Stateside as a recording artist. In the fall of that year she made a slight success with "So Long, Babe," but some months later she gained international fame with her giant "These Boots Are Made For Walking," which took almost no time to become a gold disk. She followed up immediately with "How Does That Grab You, Darling?" and was soon established as a strong record seller.

Nancy was presented with an R.I.A.A. (Record Industry Association of America) gold record award for her million-selling single, "Sugar Town" in 1966. Her 1967 hits include "Lightning's Girl" and two sessions with Lee Haylewood, "Jackson" and "Lady Bird."

Carl Smith—Columbia

A native of Franklin, Tenn., Carl Smith comes from a musical family. It was only natural for Carl's parents to encourage him to share their interests. As a boy he was quick to join in on family singalongs and by the time he reached high school taught himself to play the guitar.

Although he opted for a career during his school days, his first professional job was at deejay on WROL-Knoxville. Later, he worked similar platter spinning stints in Augusta and Ashville. Finally returning to WROL he began to perfect his singing style after working with Archie Campbell and Molly O'Day.

A regular of the Grand Ole Opry since 1950, this Columbia mainstay has cut such country decks as "Mr. Moon," "Let Old Mother Nature Have Her Way," "Don't Just Stand There," "I Almost Forgot Today," "When It's Over," "Be Good To Her," "Man With A Plan" and his most recent smash, "Deep Water."

Connie Smith—RCA Victor

It was a freak accident that brought the talent of Connie Smith out into the open. While mowing the lawn one day as a teenager, the young filly was severely cut in the leg by a piece of rock that flew up from under the mower, hospitalizing her for long, tiresome weeks. Rather than let the time pass idly by, Connie picked up an old guitar and taught herself to play, and decided right then that music was her first love.

Performances at square dances, grange meetings and picnics began to pile up after she was back on her feet, and a meeting with Grand Ole Opry star Bill Anderson led to audition tapes and a long-term recording contract with RCA Victor. Her first record, "Once A Day," roared straight up the charts to the top of the heap, and from there on in the name of Connie Smith became a household word in country circles.

Born on Aug. 14, 1941 in Elkhart, Ind., the songstress barely stretches to five feet tall, making a petite but powerful entry to the list of artists-to-be-reckoned-with.

Among her hits are "Nobody But A Fool," "Ain't Had No Lovin'" and "The Hurtin' All Over," as well as "Cincinnati, Ohio" and "Burnin' A Hole In My Mind."

Hank Snow—RCA Victor

Hank Snow, who was discovered, signed and recorded for the first time by Hugh Joseph in Canada, in 1936, was recently presented a sterling silver plaque commemorating his 25 years association with RCA Victor—one of the longest runs in popular recording history. Snow originally built his reputation in Canada, working in radio as "The Singing Ranger" and on the "Canadian Farm Hour" as well as starring at numerous exhibitions and fairs. It wasn't until 1944, eight years after singing with Victor that he appeared for the first time in the U.S. In 1948, Snow made his first American tour. In '49, Steve Sholes, then RCA's Country music A&R head, decided to release the first Snow disk in this country. The response was immediate and Hank has been hitting ever since, including some of his own compositions such as "I'm Moving On," "The Golden Rocket," "Rhumba Boogie," "I've Been Everywhere," "Ninety Days" and many more. In 1950, Snow signed with WSM in Nashville. "I Don't Hurt Anymore," which topped the million mark, was Hank's biggest seller. Hank is married and the father of Jimmy Rodgers Snow, also a Country performer.

An autobiographical album, called "This Is My Story" is another chart item for the songster.

Sonny & Cher—Atco

Sonny—Atco

Cher—Imperial

Sonny & Cher's rise to fame has been as off-beat as it has been meteoric. They first met in California in 1963, when they were both hired as background singers for a Phil Spector recording session for the Ronettes. A few months later they decided to become a duo, both as singers and as husband and wife. Two years later, as Sonny & Cher, they had become one of the hottest vocal acts in the country, with four smash singles, a best-selling album, world-wide fame and their pick of TV shows, concerts and night clubs.

A few months after they met, and were married, they made their first record, under the names of Caesar and Cleo. A few weeks later, at a recording session on which Sonny was playing and singing, he met young promoters Charlie Greene and Brian Stone. Sonny, Charlie, and Brian became fast friends. A month or so after their first meeting, Sonny called them in the middle of the night to play and sing a song for them called "Baby Don't Go." Greene and Stone liked it so much they decided to record it immediately. They did and brought it to Reprise Records. Since Sonny & Cher had a record on the

market as Caesar and Cleo, Reprise decided to put this one out under their real names.

At this point Greene and Stone decided that Sonny & Cher were a gold mine of talent. They worked out a contract to manage the duo, and to become partners in record production with Sonny. In December, 1964, Cher cut "Dream-Baby," her first record as a soloist. Since the deal with Reprise didn't work out, Greene and Stone took the disk to Imperial, who signed Cher, but agreed that Sonny & Cher could record as a team for another label.

Ahmet Ertegun, president of Atlantic Records, met Sonny & Cher while on a business visit to California in early 1965. Discovering that Sonny & Cher were free to record, he signed a contract with York Records (the Greene/Stone production firm) to distribute Sonny & Cher records on the Atco label. Their first release on Atco, "Just You" became a smash in Los Angeles in the Spring of 1965.

Their next Atco record, "I Got You Babe," broke in all markets throughout the country soon after it was released in June of that year. By the summer it had received an R.I.A.A. (Record Industry Association of America) gold record award for selling a million copies. Meanwhile Cher cut a Bob Dylan tune, "All I Really Want To Do," (for Imperial), and within a few weeks she had a hit too. Then Sonny cut a record on his own for Atco called "Laugh At Me," a record with a message for the teens, and it too became a hit. At the same time their first Atco record of "Just You" also became a big seller.

Sonny & Cher's first LP for Atco, "Look At Us," was issued in August of 1965, and later got a gold LP award from the RIAA. In three weeks it sold 600,000 copies.

"Little Man," "What Now My Love," and "Alfie" (by Cher solo) were successful singles, and in 1967, "It's the Little Things" made noise for the duo and Cher's solo waxing of "You Better Sit Down Kids" became a hit.

Spanky & Our Gang—Mercury

The spark that ignited Spanky and Our Gang into being was struck in a Florida hurricane. Spanky McFarlane had been known for some years in folk singing circles. She had sung with the New Wine Singers and had gained an excellent musical reputation, particularly in the Chicago area. In early 1966 she left the group and moved to Florida. One night, a hurricane struck the Miami area in which Spanky was living in a one-room converted chicken coop. Two young men named Nigel Pickering and Oz Bach took shelter in Spanky's quarters during a party.

While they waited for the winds to subside, the three passed the time by singing. Thus was born the idea for Spanky and Our Gang. They finally got together in Chicago and worked as a trio. Then they recruited a fourth member, Malcolm Hale, a folk singer who also had worked with the Ne Wine Singers. Pickering, before joining Spanky, had done a lot of singing, particularly C&W. Bach was at one time a well-known performer in Miami coffeehouses. Hale participated in a State Dept. tour of Viet Nam while playing with the New Wine Singers. The quartet plays what Spanky calls "good-time music . . . we want everyone around us to have fun." Spanky and Our Gang, who have succeeded admirably in their aim, first broke onto the charts with "Sunday Will Never Be The Same" for Mercury. They have since followed up with a big album and some singles.

Dusty Springfield—Philips

Dusty Springfield began her career with a tickle in the Springfield, who scored big in the early 60s with tunes like "Island Of Dreams," "Silver Threads And Golden Needles" and "Come On Home." The ensemble soon became the top vocal group in England and remained a strong group for several years. After over three years with the Springfields, Dusty broke off on her own and soon made a name as a solo artist.

Born Mary Isabel Catherine O'Brien in London, she attended St. Bernard's Convent School at High Wycombe and St. Ann's Convent School in Ealing. She formed her own vocal group while still in school but didn't turn professional until 17.

Dusty's big items for 1966 have been "You Don't Have To Say You Love Me" and "All I See Is You." Big for the lark in '67 were "The Look Of Love" and "What's It Gonna Be."

Stone Poneys—Capitol

The Stone Poneys consist of Linda Maria Ronstadt, guitar; Bob Kimmel, rhythm guitar; and Ken Edwards, lead guitar. Linda, who was born on July 15, 1946 in Tucson, Arizona, has been described as a "Peter Pan still looking for Shadow." She comes from a musical family (her father was at one time a professional singer), and her first performance was with her brother and sister, who were known locally as the Ronstads. It wasn't until after some time in the University of Arizona that Linda's preoccupation with music caught up with her. Alone with fellow Arizonian Bob Kimmel, Linda relocated to Los Angeles, where Ken Edwards joined them and the Stone Poneys were complete. The group has performed at such niteries as the Cafe Au Go Go in New York and Club 47 in Boston, breaking into the national spotlight this year as recording artists with their Capitol disk of "Different Drum."

Strawberry Alarm Clock—UNI

Strawberry Alarm Clock are exponents of jazz-rock. The group is composed of Mark Weitz (leader) on organ; Randy Seol on vocals, drums and vibes; Lee Freeman on rhythm guitar and vocals; Ed King on lead guitar; Gary Lovett; and George Bunnell on lead and special effects bass guitar, respectively. The group, as it now stands, has been together for less than a year and combines two successful Southern California bands. Randy Seol, drummer, has developed a technique whereby he performs on bongos with his hands on fire during concerts. The SAC has appeared to date on "Woody Woodbury Show," "Pat Boone," "Danny Thomas Special," "The Scene," "Groovy" and "Boss City" TV shows and has appeared in concert at The Hullabaloo, The Cheetah, Pasadena Civic and Anaheim Convention Center. Their debut album, named for their hit single, "Incense & Peppermints," composed of all originals, shows their influence of jazz and oriental music. SAC are headquartered in Los Angeles, and record for UNI Records.

(Continued on page 64)

WE'RE GRATEFUL



NEIL DIAMOND

No. 1 Male Vocalist
(1967 Cash Box Poll)

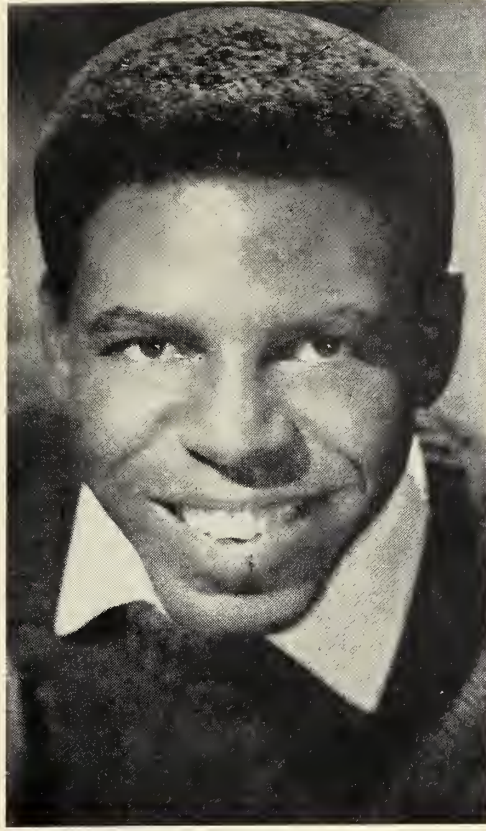

FREDDIE SCOTT

No. 1 Newcomer
Male Vocalist
(1967 Cash Box Poll-
R&B)



VAN MORRISON

One Of The Best
Newcomer
Male Vocalist
(1967 Cash Box Poll)

FOR OUR SUCCESS IN 1967



1650 Broadway; New York, N.Y.



Bios of 1967's Leading Artists

Barbra Streisand—Columbia

Barbra Streisand's route to LP stardom was a curious one. She first appeared at Columbia's studios last spring to repeat her showstopping portrayal of Miss Marmelstein for the original Broadway cast album, "I Can Get It For You Wholesale." Following this LP of Harold Rome's hit musical, came a recording that recreated "Pins and Needles," the 25-year-old revue which had made composer Rome famous, who sings one of the leads in the album, chose Barbra as his co-star.

The lark's successful recorded performances in these two show albums won her a contract with Columbia Records.

Then followed a series of remarkable LP successes, "The Barbra Streisand Album" and "The Second Barbra Streisand Album," and more. The performer triumphed in 1964-65 in Broadway's "Funny Girl," in which she played the late Fanny Brice. Her TV spectacular debut in 1965 was telecast twice. Her "Third" LP and "People" got gold LP awards in 1965.

In 1966 "My Name Is Barbra" (1 & 2), and "Color Me Barbra" were smash successes, and continued the tradition of gold which she has maintained ever since her first album.

She is currently filming "Funny Girl," in which she plays the title role.

Supremes—Motown

Sometimes three is not a crowd, but a well-organized team. That is always the case when the three are young ladies called the Supremes, close friends since their childhood days in Detroit.

The trio began to appear at local amateur shows, and church socials, after being urged to do so by their high school music instructor. The three, not yet the Supremes, won a talent contest their last year of school, and in so doing, caught the ear of a talent scout from Motown Records. Not long after they were signed to the label the girls scored with their initial hit—"I Want A Guy." "I Hear A Symphony" was a number 1 triumph in 1965.

The group have been stressing teamwork and harmony ever since, and they've steadily moved up the ladder of international popularity, including dates at the Copa and Philharmonic Hall in New York.

In 1966, they continued their winning ways with such hits as "I Hear A Symphony," "You Can't Hurry Love," and "You Keep Me Hanging On."

In 1967, the group's name was changed to Diana Ross & the Supremes (Diana is the lead singer). Later in '67, Florence Ballard left the Supremes and Cindy Birdsong replaced her.

Big among the group's outings in 1967 was "The Happening."

Temptations—Gordy

Five young fellows got together about four years ago and decided to do a little harmonizing. One night not long after, there was an opening for a vocal group in a local theatre's rock and roll show and the boys, after choosing the name that they are currently known by, got the job.

The group rose to national fame through their many hit Gordy records including "The Girl's Alright With Me," "Girl (Why You Wanna Make Me Blue)," "My Girl" and most recently "My Baby."

The Temptations also shine in person. Their extensively choreographed club routine and their rendition of "Old Man River," acappella, never fails to wake up the crowds whether they are appearing in a night club or at a rock and roll show.

In 1966 they cut three top hits: "I Know I'm Losing You," "Ain't Too Proud To Beg," and "Beauty Is Only Skin Deep."

Big for the group in '67: "It's You That I Need," and "You're My Everything."

Joe Tex—Dial

Joe Tex was born and raised in Baytown, Texas where he received musical training throughout his high school days.

His big day came in 1954, when at the age of 18 he won a two week trip to New York, where he entered an amateur show at the Apollo and won first prize. He soon returned to that theatre, this time on a paying basis and wound up staying for a full four weeks. The artist's biggest hit was "Hold What You've Got," a self penned tune.

Among his many other accomplishments Joe is a prolific songwriter with several hundred songs to his credit. His compositions have been cut by such outstanding artists as James Brown and Jerry Butler.

"S.Y.S.L.J.F.M." was one of his hit singles in 1966. "Papa Was Too" was released late in the year as was "I've Got To Do A Little Bit Better."

Big in '67 for Joe Tex were "Skinny Legs And All," and "A Woman's Hands."

Carla Thomas—Stax

Carla Thomas was singing professionally with a group called the Teen Towners over WDMA-Memphis, by the time she was 8-years old. Her father is a deejay and record artist named Rufus Thomas. When Carla was a freshman at Tennessee A&I University in Nashville, Rufus took one of her tapes to Stax Records prexy Jim Stewart. She was signed to a Stax recording contract. Her first release was a song she had written called "Gee Whiz, Look At His Eyes." This year her decks were "Let Me Be Good To You" and "B.A.-B.Y."

She has two Stax albums which are "Gee Whiz" and "Comfort Me." Carla continued her education and received her Master's degree from Howard University in 1966. With Otis Redding, she did well with "Knock On Wood," in 1967.

Hank Thompson—Warner Bros.

The versatile Hank Thompson has been up among the front runners for a number of years now, either as a vocalist, guitarist, composer or ork leader. This year, Hank and his Brazos Valley Boys have, once again, been named the most programmed band in a poll conducted among the platter spinners of country music. Also, the outfit continues to be booked solid around the country, playing many spots that are usually dominated by pop artists.

The Thompson story began back in Waco, Texas, on Sept. 3, 1925, the year Henry William was born. After mastering the harmonica Hank turned to the guitar—which so impressed officials of a flour company, when they heard him over WACO, that he was sponsored on an early morning show as "Hank The Hired Hand." A '43 to '46 hitch in the Navy followed. He then auditioned as a singer on KWTX-Waco, and won a noon-time slot. His activities broadened when he put together the Brazos Valley Boys and played dances and shows throughout Central Texas. Label-mate Tex Ritter became a fan and introduced him to Capitol officials.

This year, after his long association with Capitol, he switched to Warner Bros., where his first single and his first album, both titled "Where Is The Circus," lost no time in becoming chart items.

Tokens—Warner Bros.

The Tokens, Warner Bros. recording artists, include Jay Siegel, lead baritone; Henry Medress, first tenor; Philip Margo, bass; and Mitchell Margo, Philip's younger brother, who sings both second tenor and baritone. All of the Tokens are proficient on many instruments. The group began four years ago as rock singers and achieved quick success. They then successfully made the transition to folk singing, so that they would have wider and greater appeal. At the present time, the Tokens work out of either bag, and, in addition, do a night club act. The quartet initially wrote, performed, and recorded an outing entitled, "Tonight I Fell In Love," which was a great success. Another effort, "The Lion Sleeps Tonight," sold over a million copies. In 1964, the Tokens started their own recording company, B. T. Puppy Records. The foursome has performed at numerous college concerts throughout the U.S., and has made many TV appearances, including credits on the Dick Clark and Lloyd Thaxton shows. "Portrait Of My Love" and "It's A Happening World" were the Tokens big single success in 1967.

Tremeloes—Epic

The English foursome, the Tremeloes came into the limelight this year with their first Epic Records single, "Here Comes My Baby." The Tremeloes are comprised of Alan Blakely, rhythm guitar; Dave Munden, drums; Rick West, lead guitar; and Chip Hawkes, bass guitar. Blakely, Munden, and West have been together since the days when the group was known as Brian Poole and the Tremeloes. Chip Hawkes is the new addition. Blakely, 25, besides rhythm guitar, plays organ, drums, and piano. He also writes and arranges songs, and someday would like to be recognized as a serious composer. Munden, 21, who digs the Motown sound in pop music, hopes to play drums like Joe Morello. West, 23, has had private in classical guitar; he admires "Django Reinhardt-type jazz," plays the banjo, and has been known to play two guitars at once. Now 21, Hawkes was a solo singer before joining the Tremeloes. A self-taught musician, he likes the Beatles, the Drifters, Timi Yuro, and big bands. Besides "Here Comes My Baby," the Tremeloes hit in '67 with "Silence Is Golden" and "Even The Bad Times Are Good."

The Ventures—Dolton

The Ventures are four young men in their twenties, who have succeeded in capturing that indefinable teen age flavor that means success on singles and LP's.

Paraphrasing their first hit, it is a matter of "Run, Don't Walk" up the stairway to stardom. Beginnings for the group go back several years when Don Wilson and Bob Bogle had a local guitar act but decided to expand. They added guitarist Nokie Edwards and drummer Howie Johnson and soon after recorded "Walk, Don't Run." The disk was released first on the Blue Horizon label in their local Tacoma, Wash. area, but Liberty Records sensing a hit, picked up the master and signed the group to a wax pact. The boys now spend most of their time promoting their records with personal appearances.

The group has always had consistent success in the LP field.

"Secret Agent Man" was a chart item for the Ventures in 1966.

Bobby Vinton—Epic

Vinton organized his first band in high school playing proms and parties for students at Duquesne University which was near his hometown of Cannonsburg, Pa. Later Vinton formed a second group which was soon a favorite at teen dances in Pittsburgh. The youngster began singing a few of the numbers with the orchestra and his vocals soon became the band's most popular feature.

Bobby's career went into high gear in 1960 when Guy Lombardo discovered him at a hop outside Pittsburgh. Some TV dates followed and soon Vinton was on his way to stardom.

In November of 1960 Bobby's crew was featured as the band of the month on NBC's Saturday Prom and played with a succession of stars including Bobby Vee and the late Sam Cooke. Bobby continued his fast pace in 1961, making a nationwide tour with Tony Orlando. More club dates followed—the rest is history.

Bobby likes sports, particularly baseball, which he plays almost as expertly as he does the saxophone. The multi-talented performer is currently studying acting and reading plays.

As a vocalist, his hits include "Roses Are Red," "Is My First Smash," "Rain, Rain Go Away," "Trouble Is My Middle Name," "Blue On Blue," "Blue Velvet," "There I've Said It Again," "Mr. Blue." Biggest in 1967 is: "Please Love Me Forever."

Dionne Warwick—Scepter

Dionne Warwick, unlike many of her pop-r&b peers, has studied music since the age of six, coming from a family of gospel singers. She did a great deal of singing in choirs for different organizations. Then to school in East Orange, New Jersey and from there to the Hartt College of Music in Hartford. In time she became an accomplished singer and pianist, playing and singing in church every Sunday. Her next step forward took Dionne to the recording studios in New York where she sang in the background chorus on many recording sessions. Her unique song styling attracted two of the top tunesmiths and producers. Burt Bacharach and Hal David, who brought her to the attention of Scepter Records and what followed was "Don't Make Me Over," a tremendously successful recording.

The lark has toured all over Europe playing to turn-away audiences and establishing a significant international reputation for herself. Among her long string of hits are "Walk On By," "Anyone Who Had A Heart," "You'll Never Get To Heaven," "Are You Sure," "I Just Don't Know What To Do With Myself," "Trains And Boats And Planes," "Message To Michael," "Alfie" and "I Say A Little Prayer."

Kitty Wells—Decca

To the country music fans—and, more recently, the pop crowd, Kitty Wells ranks as one of the all-time great performers. And in a field where women are definitely not equal to men, as far as longevity of fame is concerned, this is quite an achievement. Kitty, born Aug. 30, 1919 in Nashville, began a career in radio on Nashville's WSIX in 1937, going onto various other outlets, including a long stint as a soloist on "Louisiana Hayride." She's now one of the regulars on WSM's "Grand Ole Opry." Kitty is married to Johnnie Wright, who is a successful singer in his own right.

Among her initial hits for Decca, which has been her label for many years, was "It Wasn't God Who Made Honky Tonk Angels." A host of successful singles and LP's have continued to keep her standing high in the country music community, including "It's All Over" and "A Woman Never Forgets."

She continues to be reveled by C&W fans throughout the world, with some of her more recent hits including "Love Makes The World Go Around" and "Queen Of Honky Tonk Street."

Dottie West—RCA Victor

Born on a small farm near McMinnville, Tenn., Dottie West was the oldest of 10 children and learned to accept responsibilities at an early age. She shared the many daily chores which were necessary in order to survive on the meager acreage owned by the family. Although life was hard, the family enjoyed the off hours and often had square dances at the house on week-ends when neighbors and relatives brought their fiddles and guitars for what Rotlie refers to as a good old-fashioned "hoedown."

The family moved to Cookeville, Tenn., when Dottie was seventeen and she entered college at Tennessee Tech where she majored in music. A few years later she married a fellow student, Bill West, and moved with him to Cleveland. Dottie's interest in music never dimmed and she soon managed to meet a local entertainer who arranged an audition for a country music show called "Landmark Jamboree" which was televised every Saturday night on the Ohio Network. One thing led to another and soon she was traveling around the U.S. doing p.a.'s as a full-fledged country performer.

After a false start with several other labels, Dottie signed with RCA Victor where she immediately scored with "Touch Me." Among her many other Victor triumphs are "Here Comes My Baby," "Getting Married Has Made Us Strangers," "No Sign Of Living," "Would You Hold It Against Me" and "What's Come Over My Baby."

Her later hits include: "Like A Fool" and "Paper Mansions."

Andy Williams—Columbia

Andy Williams began his singing career when he and his three brothers along with their parents organized a church choir in Wall Lake, Iowa. Later the four brothers were heard on their own radio shows from Des Moines, Chicago and Cincinnati.

After the Williams family moved to California, the brothers teamed up with comedienne Kay Thompson and formed a highly successful night club act. The group stayed together six years and then the three older brothers settled down with their families and Andy became a soloist. He achieved national prominence when he became a regular on the old "Tonight" show hosted by Steve Allen. A recording contract with Cadence Records followed and he waxed a long string of singles and LP hits.

In the fall of 1959, Andy Williams was named "Personality of the Year" by the Variety Clubs of America, an award which has been given to such stellar performers as Al Jolson, Sheve Allen and Arthur Godfrey.

In 1961 the talented singer was signed by Columbia Records for whom he has made a series of chart-riding singles and LP's. His album "Moon River" quickly went to the top of the charts in 1962 and remained there for many months.

'63 saw Andy Williams continue riding the top of the LP charts with his "Days Of Wine And Roses" LP going straight to the top and a new Christmas album moving up quickly.

In '64 Andy came thru big with "Call Me Irresponsible" and "My Fair Lady" (LP-wise) and "Can't Get Used To Losing You," "Wrong For Each Other" and "Dear Heart" (single-wise) among others. In 1965, Williams' "Dear Heart" album got a gold record award, as did his 1966 LP of "The Shadow Of Your Smile." His latest LP is entitled, "Andy."

Roger Williams—Kapp

After seeing the light of day in Omaha, Neb., Roger Williams launched his musical career with rather amazing rapidity. After picking up piano by ear at age three he penned his first composition (or more likely penciled) by age 4. And after four more years had passed he added 12 more instruments to his repertoire. After a WWI military career Williams on radio shows. He moved to New York in 1952 where he promptly signed on at Juilliard. While tinkling in a cocktail lounge Roger was discovered by Dave Kapp who signed him to Kapp Records. "Autumn Leaves" cut during another artist's excess studio time catapulted Williams to fame and the rest is history.

Nancy Wilson—Capitol

The song stylist is one of the leading lights in the sophisticated pop song field. Capitol has thought enough of her talents to pair her on LP's with such stellar instrumentalists as George Shearing and Cannonball Adderly, and it's easy to assume, that both Shearing and Adderly share the label's respect for the performer. She was born on Feb. 20, 1937 in Chillicothe, Ohio.

1963 saw Nancy Wilson become one of the strongest female disk sellers in the industry. Her Capitol albums, "Broadway My Heart" and the follow-up, "Hollywood—My Way" jumped to the top twenty shortly after release and remained there for many weeks.

1964 realized an opening of the singles market to her with "You Don't Know How Glad I Am." This year she made further gains in the singles and LP areas.

"A Touch Of Today" and "Tender Loving Care" were also big albums for the artist, who remains in widespread demand as a nightclub entertainer.

Stevie Wonder—Tamla

Stevie was born in Saginaw, Michigan, and though blind, he began playing the piano and harmonica at the age of five. The musician got his first break when he visited the home of Ronnie White, a member of the Miracles, to play with Ronnie's kid brother Gerald. When Ronnie heard Stevie sing and play the harmonica, he sent for Brian Holland, talent scout and A&R director of Tamla Records. Holland was so impressed with the youngster that he signed him to an exclusive recording contract. This resulted in the waxing of several hits including "Fingertips," and "High Heeled Sneakers."

He did very well with "A Place In The Sun" and "Blowing In The Wind," to note only two of his biggest decks.

Brenton Wood—Double Shot

Brenton Wood was born in Shreveport, Louisiana, on July 26, 1941. He came to California at the age of two, attending Dana Jr. High in San Pedro and later Compton High and Compton College. In college, he became the lead singer of a group called the Quotations. He left the Quotations to work solo and has since performed in nighteries throughout the U.S. and Canada. Double Shot Records inked Wood in early '67; he scored immediately with "The Oogum Boogum Song," which he wrote. "Baby You Got It" is his most recent hit. The artist's singing favorites are Jesse Belvin, Sam Cooke, Frank Sinatra, Diana Ross of the Supremes, and the Temptations.

Brenton Wood, who is an accomplished pianist and dancer, also studies with vocal coaches and dramatic teachers. His goal is to be a serious screen actor.

Faron Young—Mercury

Though still in his 20's, Young is approaching a decade of stardom on the "Grand Ole Opry." He exemplified the "new school" of country music singing without the twang but with the heart of a country singer. Although a consistent country hit maker, Young received pop recognition early in 1961 when "Hello Walls" skyrocketed to the top of the pop charts. Faron was born in Shreveport, La., Feb. 25, 1932. He formed his own band, playing guitar while in Shreveport Fair Park High School. He later snagged a featured spot of WKWH's "Louisiana Hayride." Between shows he toured with Webb Pierce. Joined Capitol in 1951, his first being "Tattle Tale Tears" b/w "Have I Waited Too Long," the latter now his theme. He joined the Opry in '51 and at 21, in the army, entertained for troops. Young has starred in many westerns including the title role in "Daniel Boone." The songster joined the Mercury label last year where he scored immediately with "The Yellow Bandana."

Faron's "Unmitigated Gall" and "Weakness In A Man" were among his biggest records of 1967.



the day music stopped

Imagine that all music suddenly has ceased to exist. Composers have stopped creating. Musicians are silent. The phonograph record is gone. People have stopped singing. A universal language has disappeared in the flash of a moment.

All over the world, the blow is shattering. In the United States the economic loss is beyond belief. 5,000 radio stations, deprived of the majority of their programming, are reducing their schedules or going off the air. Television producers are converting every existing program and every commercial with music to straight talk. Many sponsors are simply cancelling. The juke box is extinct. The recording industry has closed down. The music instrument manufacturing business is obsolete. 13,700,000 children who have been studying music no longer have any use for pianos or violins or woodwinds. The country's 1,385 symphony orchestras and 782 opera producing groups have disbanded. Most nightclubs,

theaters, dance halls, concert halls, ballrooms have shuttered their windows. Hundreds of thousands of people who earn their living because of music are now unemployed. The tax loss is incalculable.

A fantasy? Yes, but it makes a point. Music is vitally important in all our lives, in terms of sheer economics as well as of culture.

We are proud that BMI, together with our thousands of affiliated writers and publishers, is one of the many organizations which play a role in supporting and fostering the miracle of music.

If yesterday had been the day music stopped, you wouldn't be hearing about it from us. BMI wouldn't be in business. Nor, possibly, would you.

*All the worlds of music
for all of today's audience.*

BMI

BROADCAST MUSIC, INC.

WINNERS — Bill Gavin Record and Radio Awards for 1967

RECORDING ARTIST OF YEAR-RHYTHM AND BLUES

Winner: Aretha Franklin—Atlantic
 Runner up: Temptations—Motown

RECORD MAN OF YEAR-A&R RHYTHM AND BLUES

Winner: Jerry Wexler, Atlantic
 Runner up: Brian Holland and Lamont Dozier, Tamla-Motown

RECORDING ARTIST OF YEAR-COUNTRY MUSIC

Winner: Eddy Arnold—RCA
 Runner up: Buck Owens—Capitol
 Presenter: Bob Kingsley, KGBS

RECORD MAN OF YEAR-COUNTRY MUSIC A&R

Winner: Chet Atkins, RCA
 Runner up: Bill Sherill, Epic
 Presenter: Bob Kingsley, KGBS

RECORDING ARTIST OF YEAR-NON ROCK

Winner: Frank Sinatra—Reprise
 Runner up: Herb Alpert—A&M
 Presenter: Earl McDaniel, KGMB

RECORD MAN OF YEAR-A&R NON-ROCK

Winner: Burt Bacharach—Hal David
 Runner up: Herb Alpert—A&M
 Presenter: Earl McDaniel, KGMB

RECORDING ARTIST OF YEAR-POP-ROCK

Winner: The Association—Warner Bros.
 Runner up: Beatles—Capitol
 Presenter: Dean Tyler, WIBG

RECORD MAN OF YEAR-A&R POP ROCK

Winner: Lou Adler—Ode Records
 Runner up: Lee Hazelwood
 Presenter: Dean Tyler, WIBG

RECORD MAN OF YEAR-NATIONAL PROMOTION

Winner: Don Graham—A&M
 Runner up: Thomas Noonan, Columbia
 Presenter: Gene Creasy, WCAO

RECORD MAN OF YEAR-EXECUTIVE

Winner: Jerry Wexler—Atlantic
 Runner ups: John K. "Mike" Maitland, Warner Bros.
 Joe Smith, Warner Bros.
 Jerry Moss, A&M
 Presenter: Gene Creasy, WCAO

PROGRAM CONSULTANT OF YEAR—GROUP STATION

Winner: Bill Drake
 Runner up: Grahme Richards
 Presenter: Larry Utall, Bell Records

SECONDARY MARKET RADIO MAN OF YEAR

Winner: Dick Starr—WFUN
 Runner up: Dick Buckley, WKDA
 Presenter: Larry Utall, Bell Records

DISK JOCKEY OF YEAR-CANADIAN RADIO

Winner: Terry Mulligan—CKLG
 Runner up: Dave Boxer, CFCF
 Presenter: Reg Ayers

MUSIC DIRECTOR OF YEAR-CANADIAN RADIO

Winner: Bob Johnston
 Runner up: Ron Robinson, CKWX
 Presenter: Reg Ayers

REGIONAL PROMOTION-NORTHEAST-NEW ENGLAND

Winner: Stan Monteiro—RCA Victor
 Runner ups: Ed Penny and Ernie Campagna
 Presenter: Bertha Porter, WDRC

REGIONAL PROMOTION-EAST COAST AREA

Winner: Herb Rosen—Independent
 Runner up: Tom Kennedy—Universal
 Presenter: Bertha Porter, WDRC

REGIONAL PROMOTION-SOUTHEAST AREA

Winner: Zim Zemerl—Columbia
 Runner up: Larry King—Southland Distr.
 Buzz Bennett, WTIK

REGIONAL PROMOTION-SOUTH AREA

Winner: Fred Love—Epic Records
 Runner up: Robert Holladay—Independent
 Buzz Bennett, WTIK

REGIONAL PROMOTION-CENTRAL AREA

Winner: Howard Bednoe—All State
 Runner up: August Blume—RCA
 Presenter: Dick Weber, WKYC

REGIONAL PROMOTION-WEST CENTRAL-NORTHWEST CENTRAL

Winner: Rick Blackburn—Epic
 Runner up: Dan Desmond Jr.—Heilicher
 Presenter: Dick Weber, WKYC

REGIONAL PROMOTION-ROCKY MOUNTAIN AREA

Winner: Tie—Sandy Siler and Earl Woolf (Action)
 Runner up: Ab Atkins—Davis
 Presenter: Jack Merker, KIMN

REGIONAL PROMOTION-SOUTHWEST AREA

Winner: Wayne Shuler—Capitol
 Runner up: Joe Perry—Big State-Dallas
 Presenter: Jack Merker, KIMN

REGIONAL PROMOTION-WEST AREA

Winner: Denny Zeitler, H. R. Basford
 Runner up: Chuck Gregory—Columbia
 Presenter: Larry Mitchell

REGIONAL PROMOTION-CANADIAN AREA

Winner: Lee Armstrong
 Runner up: John Williams—Columbia
 Presenter: Larry Mitchell

RECORD MAN OF YEAR-NATIONAL PROMOTION-CANADA

Winner: Paul White—Capitol
 Presenter: Bob McAdorey, CHUM

RECORD MAN OF YEAR-EXECUTIVE-CANADA

Winner: George Harrison
 Presenter: Bob McAdorey, CHUM

PROGRAM DIRECTOR OF YEAR-CANADIAN RADIO

Winner: Gerry Bascombe—CFCF
 Runner up: Barclay Nesbitt—CKFH
 Presenter: Al Mair, APEX-COMPO

MANAGER OF YEAR-CANADIAN RADIO

Winner: Allan Waters—CHUM
 Runner up: John O. Graham—CFGM
 Presenter: Al Mair, APEX-COMPO

COUNTRY MUSIC DISC JOCKEY

Winner: John Trotter—WJJD
 Runner up: Ralph Emery—WSM
 Presenter: Ken Nelson

MUSIC DIRECTOR OF YEAR-COUNTRY MUSIC

Winner: Lee Arnold—WJRZ
 Runner up: Bob Kingsley—KGBS
 Presenter: Ken Nelson

PROGRAM DIRECTOR OF YEAR-COUNTRY RADIO

Winner: Chris Lane—WJJD
 Runner up: MacCurtis—WPLO
 Presenter: Lennie Salidor, Decca

MANAGER OF YEAR-COUNTRY RADIO

Winner: George Dubinetz—WJMD
 Runner up: Herbert Golombek—WPLO
 Presenter: Lennie Salidor, Decca

DISK JOCKEY OF YEAR-NON ROCK RADIO

Winner: William B. Williams—WNEW
 Runner up: Gary Owens—KMPC
 Presenter: John Rosica, A&M

MUSIC DIRECTOR OF YEAR-NON ROCK RADIO

Winner: Gertie Katzman—WNEW
 Runner up: Elma Greer—KSFO
 Presenter: John Rosica, A&M

PROGRAM DIRECTOR OF YEAR-NON ROCK

Winner: Dick Carr—WNEW
 Runner up: Alan Newman—KSFO
 Presenter: Ben Rosner,—RCA

MANAGER OF YEAR-NON ROCK RADIO

Winner: Harvey Glascock—WNEW
 Runner up: William Shaw—KSFO
 Presenter: Ben Rosner,—RCA

DISK JOCKEY OF YEAR-RHYTHM AND BLUES

Winner: E. Rodney Jones—WVON
 Runner up: Jim Randolph—KGfJ
 Presenter: Al Bell, Stax-Volt

MUSIC DIRECTOR OF YEAR-RHYTHM AND BLUES

Winner: John Hardy—KDIK
 Runner up: Larry Berger—WWRL
 Presenter: Al Bell, Stax-Volt

PROGRAM DIRECTOR OF YEAR-RHYTHM AND BLUES

Winner: Lucky Cordell—WVON
 Runner up: George Wilson—WHAT
 Presenter: Ed Wright

MANAGER OF YEAR-RHYTHM AND BLUES

Winner: Frank Ward—WWRL
 Runner up: Arnold Schorr—KGfJ
 Presenter: Ed Wright

DISK JOCKEY OF YEAR-POP ROCK RADIO

Winner: Don Steele—KHJ
 Runner up: Gary Stevens—WMCA
 Presenter: Bud Dain, Liberty

MUSIC DIRECTOR OF YEAR-POP FORMAT RADIO

Winner: Joe Bogart—WMCA
 Runner up: Bertha Porter—WDRC
 Presenter: Bud Dain, Liberty

PROGRAM DIRECTOR OF YEAR-POP FORMAT RADIO

Winner: Paul Drew—CKLW
 Runner up: Pat O'Day—KJR
 Presenter: Tom Noonan

MANAGER OF YEAR-POP FORMAT RADIO

Winner: Kent Burkhart—WQXI
 Runner up: Ken Draper—WCFL
 Presenter: Tom Noonan

BILL GAVIN'S PERSONAL AWARDS:

Record Company of the Year, Bell Records (Amy-Mala), New York
 Mr. Larry Utall, President

RADIO STATION OF THE YEAR

KIMN, Denver, Mr. Ken Palmer, manager

total involvement

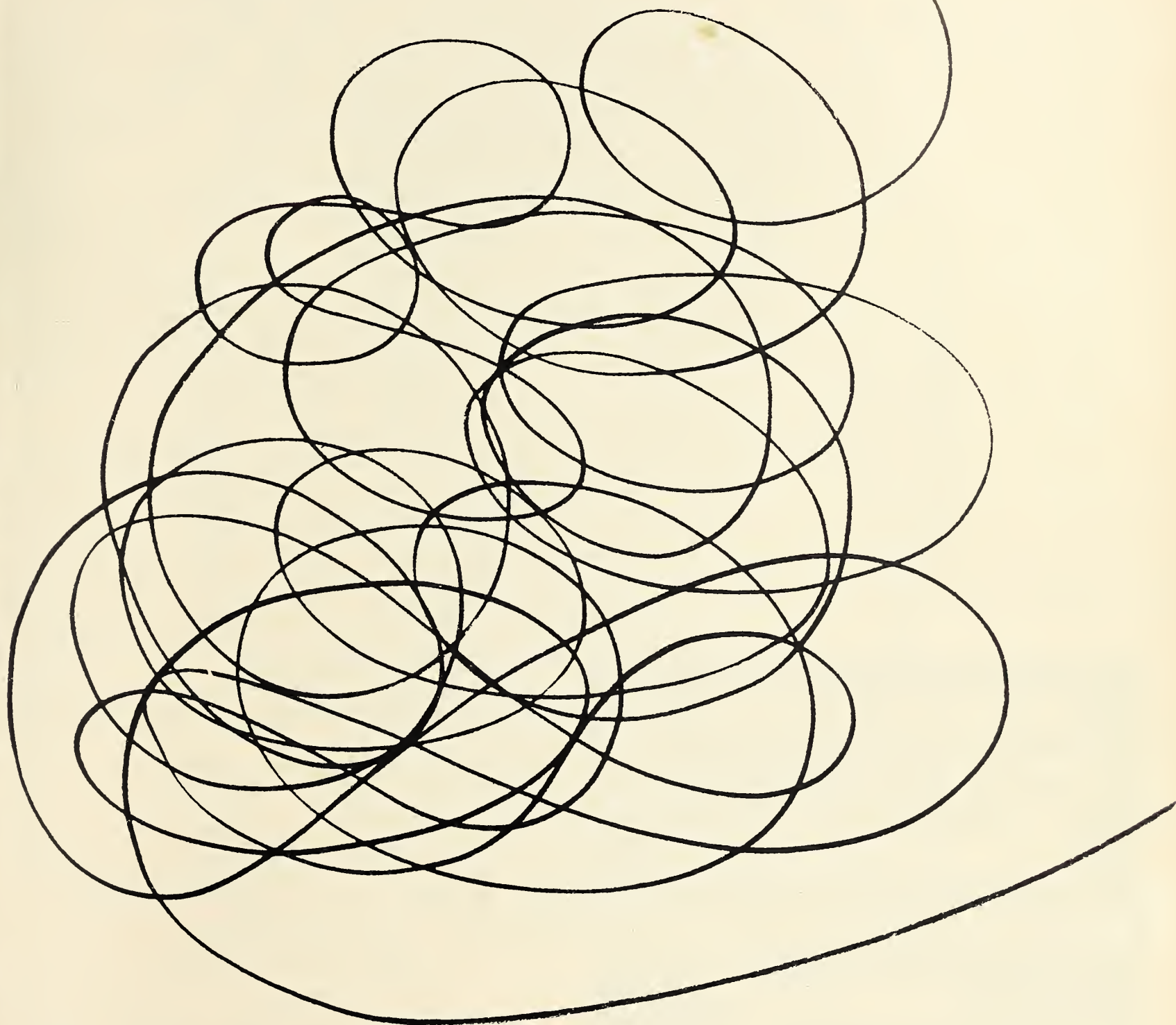

means more

to Bob Crewe and the Crewe Group of Companies than just being on top. It's not only the hit songs; not only the hit records; not only the Four Seasons and Mitch Ryder; not only motion picture production, and a TV special called "The Bob Crewe Generation," it's getting into the public's heart and staying there. The Bob Crewe Generation is more than an orchestra; it's what's happening...and you're part of it.



BEST R&B RECORDS OF 1967

A TABULATION OF RHYTHM & BLUES RECORDS WHICH ACHIEVED GREATEST SUCCESS IN THE FIELD ACCORDING TO THE WEEKLY CASH BOX TOP 50 R&B CHART. NAMES LISTED BELOW ARE IN ORDER OF STRENGTH BASED ON A WEIGHTED POINT SYSTEM WHICH GIVES CREDIT FOR LONGEVITY ON THE CHART AS WELL AS HEIGHT ATTAINED ON CHART.

	Total Points		Total Points
1. RESPECT—ARETHA FRANKLIN—Atlantic	734	31. Come On Sock It to Me—Syl Johnson—Twilight	506
2. I WAS MADE TO LOVE HER—STEVIE WONDER—Tamla	670	32. Here We Go Again—Ray Charles—ABC	486
2. SOUL FINGER—BAR-KAYS—Volt	670	33. Apples, Peaches, Pumpkin Pie—Jay & the Techniques—Smash	482
4. Soul Man—Sam & Dave—Stax	669	34. Dead End Street—Lou Rawls—Capitol	471
5. Make Me Yours—Betty Swan—Money	664	35. Dry Your Eyes—Brenda & the Tabulations	466
6. Cold Sweat—James Brown—King	656	36. Close Your Eyes—Peaches & Herb—Date	464
7. Sweet Soul Music—Arthur Conley—Atco	653	37. The Tramp—Otis Redding & Carla Thomas—Stax	461
8. Baby I Love You—Aretha Franklin—Atlantic	640	38. Love Is Here & Now You're Gone—Diana Ross & the Supremes—Motown	456
9. Mercy, Mercy, Mercy—Cannonball Adderley—Capitol	637	39. Stand By Me—Spyder Turner—MGM	453
10. Funky Broadway—Dyke & the Blazers—Original Sound	625	40. Pata Pata—Miriam Makeba—Reprise	443
11. Jimmy Mack—Martha Reeves & the Vandellas—Gordy	610	41. Pucker Up Buttercup—Jr. Walker & the All Stars—Soul	442
12. Funky Broadway—Wilson Pickett—Atlantic	600	42. Together—Intruders—Gamble	427
13. (Your Love Keeps Lifting Me) Higher & Higher—Jackie Wilson—Brunswick	586	43. The Tramp—Lowell Fulson—Kent	425
14. I Never Loved A Man—Aretha Franklin—Atlantic	586	44. For Your Precious Love—Oscar Toney, Jr.—Bell	419
15. Groovin'—Young Rascals—Atlantic	580	45. The Love I Saw In You Was Just A Mirage—Smokey Robinson & the Miracles—Tamla	418
16. Hunter Gets Captured By the Game—Marvelettes—Tamla	579	46. More Love—Smokey Robinson & the Miracles—Tamla	400
17. Nothing Takes the Place of You—Toussaint McCall—Ron	566	47. Get On Up—Esquires—Bunky	407
18. Are You Lonely For Me—Freddie Scott—Shout	564	47. Tell It Like It Is—Aaron Neville—Parlow	407
19. Ain't No Mountain High Enough—Marvin Gaye & Tammi Terrell—Tamla	560	49. With This Ring—Platters—Musicor	405
20. You're My Everything—Temptations—Gordy	558	50. Hey Leroy, Your Mama's Calling You—Jimmy Castor—Smash	396
21. Expressway to Your Heart—Soul Survivors—Crimson	546	51. In the Heat of the Night—Ray Charles—ABC	390
22. Hip-Hug-Her—Booker T. & M.G.'s—Stax	541	52. Everybody Needs Somebody—Gladys Knight & Pips—Soul	388
23. Alfie—Dionne Warwick—Scepter	537	53. I'm Wondering—Stevie Wonder—Tamla	385
24. Dirty Man—Laura Lee—Chess	533	54. Casanova—Ruby Andrews—Zodiac	380
25. Testify—Parliaments—Revilot	532	55. Bernadette—Four Tops—Motown	371
26. Your Precious Love—Marvin Gaye & Tammi Terrell—Tamla	526	56. Nine Pounds of Steel—Joe Simon—Sound Stage 7	365
27. A Natural Woman—Aretha Franklin—Atlantic	523	57. To Sir With Love—Lulu—Epic	366
28. All I Need—Temptations—Gordy	521	57. Keep a Light in the Window Until I Come Home—Solomon Burke—Atlantic	366
29. Hypnotized—Linda Jones—Loma	509	59. Feel So Bad—Little Milton—Checker	362
30. Eight Men & Four Women—O.V. Wright—BackBeat	507	60. I Don't Want to Lose You—Jackie Wilson—Brunswick	358
		61. Oh Baby—Bo Diddley—Checker	355
		62. Nearer to You—Betty Harris—Sansu	353
		63. I Say a Little Prayer—Dionne Warwick—Scepter	352
		64. Sweetest Thing This Side of Heaven—Chris Bartley—Vando	348
		65. When Something Is Wrong With My Baby—Sam & Dave—Stax	345
		66. Memphis Soul Stew—King Curtis—Atco	342
		66. Everlasting Love—Robert Knight—Rising Sun	342
		68. 7 Rooms of Gloom—Four Tops—Motown	330
		69. Boo-Ga-Loo Down Broadway—Fantastic Johnny C.—Phil-LA-of—Soul	329
		70. Standing in the Shadow of Love—Four Tops—Motown	313
		71. Reflections—Diana Ross & the Supremes—Motown	312
		72. The Dark End of the Street—James Carr—Goldwax	306
		72. I Heard It Thru the Grapevine—Gladys Knight & the Pips—Soul	306
		74. Groovin'—Booker T & M.G.'s—Stax	307
		74. Let Yourself Go—James Brown—King	301
		74. You Keep Running Away—Four Tops—Motown	300
		77. The Letter—Box Tops—Mala	299
		78. Wack Wack—Young Holt Trio—Brunswick	294
		79. When You're Young & In Love—Marvelettes—Tamla	293
		80. Whiter Shade of Pale—Procol Harum—Deram	291
		81. Knock On Wood—Otis Redding & Carla Thomas—Stax	288
		82. I've Been Lonely Too Long—Young Rascals—Atlantic	279
		83. Let Love Come Between Us—James & Bobby Purify—Bell	276
		84. Shake A Tail Feather—James & Bobby Purify—Bell	275
		85. Love Bug Leave My Heart Alone—Martha Reeves & the Vandellas—Gordy	272
		86. Stagger Lee—Wilson Pickett—Atlantic	269
		87. Your Unchanging Love—Marvin Gaye—Tamla	264
		88. 96 Tears—Big Maybell—Rojac	261
		89. The Whole World Is A Stage—Fantastic Four—Ric Tic	257
		89. You Gotta Pay the Price—Al Kent—Ric Tic	257
		91. One Hurt Deserves Another—Raelets—Tangerine	256
		91. Little Ole Man—Bill Cosby—Warner Brothers	255
		93. Bring It Up—James Brown—King	253
		94. Love Is Strange—Peaches & Herb—Date	252
		95. Let's Fall In Love—Peaches & Herb—Date	250
		96. Skinny Legs & All—Joe Tex—Atco	245
		96. Where Is the Party—Helena Ferguson—Compass	245
		98. You Gave Me Somethin'—Fantastic Four—Ric Tic	243
		99. I Dig You Baby—Jerry Butler—Mercury	240
		100. For Your Love—Peaches & Herb—Date	236
		100. Who's Loving You—Brenda & the Tabulations—Dionne	236

IF you are reading someone else's copy of
Cash Box
why not mail this coupon today!

CASH BOX
1780 BROADWAY
NEW YORK, N. Y. 10019

- Enclosed find my check.
- \$20 for a full year (52 weeks) subscription (United States, Canada, Mexico)
 - \$40 for a full year (Airmail United States, Canada Mexico)
 - \$30 for a full year (other countries)
 - \$45 for a full year (Airmail other countries)

- (Check One)
- I AM A DEALER
 - ONE STOP
 - DISTRIB
 - RACK JOBBER
 - PUBLISHER
 - RECORD CO.
 - DISK JOCKEY
 - COIN FIRM
 - OTHER

NAME

FIRM

ADDRESS

CITY STATE ZIP #

Be Sure To Check Business Classification Above!



Sincerest Thanks
Aretha Franklin



Personal Management: TED WHITE • Exclusive Representation: QUEEN BOOKING CORP.

BEST R&B ARTISTS OF 1967

A Tabulation of Rhythm & Blues Artists Who Achieved Greatest Success In Their Field According To The Weekly Cash Box Top 50 R&B Chart. Names Listed Below Are In Order Of Strength In Their Various Categories Based On A Weighted Point System Which Gives Credit For Longevity On The Chart As Well As Height Attained On Chart. All Titles Which Were In The Top 50 Were Used For An Artist's Total.

TOP MALE VOCALISTS

- tie { 1. JAMES BROWN
1. OTIS REDDING
1. WILSON PICKETT
2. MARVIN GAYE
 3. JACKIE WILSON
 4. Stevie Wonder
 5. Arthur Conley
 6. Ray Charles
 7. O. V. Wright
 8. Lou Rawls
 9. Toussaint McCall
 10. Joe Tex
 11. Soloman Burke
 12. Jimmy Ruffin
 13. Gene Chandler
 14. Lowell Fulson
 15. Joe Simon
 16. Oscar Toney Jr.
 17. Bobby Bland
 18. Little Milton
 19. Bo Diddley
 20. James Carr
 21. Chuck Jackson
 22. Percy Sledge
 23. Jerry Butler
 24. Eddie Floyd

TOP FEMALE VOCALISTS

1. ARETHA FRANKLIN
2. DIONNE WARWICK
3. TAMMI TERRELL
4. Maxine Brown
5. Shirley Ellis
6. Miriam Makeba
7. Lorraine Ellison
8. Dee Dee Warwick
9. Erma Franklin
10. Marlana Shaw
11. Kim Weston

TOP NEW FEMALE VOCALISTS

1. BETTYE SWANN
2. LINDA JONES
3. LAURA LEE
4. Ruby Andrews
5. Big Maybelle
6. Lulu
7. Bobbie Gentry
8. Helena Ferguson
9. Patti Drew

TOP VOCAL GROUPS

- tie { 1. FOUR TOPS
1. TEMPTATIONS
2. YOUNG RASCALS
 3. MARTHA REEVES & THE VANDELLAS
 4. James & Bobby Purify
 5. Marvin Gaye & Tammi Terrell
 6. Marvelettes
 7. Smokey Robinson & The Miracles
 8. Sam & Dave
 9. Diana Ross & The Supremes
 10. Fantastic Four
 11. Platters
 12. Gladys Knight & The Pips
 13. Five Stairsteps
 14. Inez & Charlie Foxx
 15. Chuck Jackson & Maxine Brown

TOP NEW VOCAL GROUPS

1. PEACHES & HERB
2. INTRUDERS
3. BRENDA & THE TABULATIONS
4. Dyke & The Blazers
5. Parliaments
6. Jay & The Techniques
7. Esquires
8. Procol Harum
9. Soul Survivors
10. Precisions

TOP NEW MALE VOCALISTS

1. FREDDIE SCOTT
2. SYL JOHNSON
3. SPYDER TURNER
4. Jimmy Castor
5. Chris Bartley
6. Brenton Wood
7. Bill Cosby
8. Tommy Hunt
9. J. J. Jackson
10. Andre Williams
11. Leon Hayward
12. J. J. Barnes
13. Robert Knight
14. Prince Buster
15. Jerry O.

TOP INSTRUMENTALISTS

1. BOOKER T & THE MG'S
2. KING CURTIS
3. CANNONBALL ADDERLEY
4. Bar-Kays
5. Bo Diddley
6. The Watts 103rd Street Band
7. Ramsey Lewis



WE'RE OVERJOYED AND VERY GRATEFUL.

THANKS AND LOVE,

PEACHES AND HERB

#1 DUO

#1 R&B NEWCOMER

Current Hit Album

JOHNNY MATHIS

UP, UP AND AWAY

CL 2726 CS 9526



Current Hit Single

AMONG THE FIRST TO KNOW

4-44357

NOW ON
COLUMBIA RECORDS

Top R&B Records of the Past 7 Years

The Top R&B Records of 1961 thru 1967 As Compiled by Cash Box in its Annual Year-End Survey

1967

1. Respect—Aretha Franklin—Atlantic
2. I Was Made To Love Her—Stevie Wonder—Tamla
2. Soul Finger—Bar-Kays—Volt
4. Soul Man—Sam & Dave—Stax
5. Made Me Yours—Betty Swans—Mottex
6. Cold Sweat—James Brown—King
7. Sweet Soul Music—Arthur Conley—Atco
8. Baby I Love You—Aretha Franklin—Atlantic
9. Mercy, Mercy, Mercy—Cannonball Adderley—Capitol
10. Funky Broadway—Dyke & the Blazers—Original Sound
11. Jimmy Mack—Martha Reeves & the Vandellas—Gordy
12. Funky Broadway—Wilson Pickett—Atlantic
13. (Your Love Keeps Lifting Me) Higher & Higher—Jackie Wilson—Brunswick
14. I Never Loved A Man—Aretha Franklin—Atlantic
15. Groovin'—Young Rascals—Atlantic
16. Hunter Gets Captured By the Game—Marvelettes—Tamla
17. Nothing Takes the Place of You—Toussaint McCall—Ron
18. Are You Lonely For Me—Freddie Scott—Shout
19. Ain't No Mountain High Enough—Marvin Gaye & Tammi Terrell—Tamla
20. You're My Everything—Temptations—Gordy
21. Expressway to Your Heart—Soul Survivors—Crimson
22. Hip-Hug-Her—Booker T. & M.G.'s—Stax
23. Alfie—Dionne Warwick—Scepter
24. Dirty Man—Laura Lee—Chess
25. Testify—Parliaments—Revilol
26. Your Precious Love—Marvin Gaye & Tammi Terrell—Tamla
27. A Natural Woman—Aretha Franklin—Atlantic
28. All I Need—Temptations—Gordy
29. Hypnotized—Linda Jones—Loma
30. Eight Men & Four Women—O.V. Wright—BackBeat
31. Come On Sock It to Me—Syl Johnson—Twilight
32. Here We Go Again—Ray Charles—ABC
33. Apples, Peaches, Pumpkin Pie—Jay & the Techniques—Smash
34. Dead End Street—Lou Rawls—Capitol
35. Dry Your Eyes—Brenda & the Tabulations
36. Close Your Eyes—Peaches & Herb—Date
37. The Tramp—Otis Redding & Carla Thomas—Stax
38. Love Is Here & Now You're Gone—Diana Ross & the Supremes—Motown
39. Stand By Me—Spyder Turner—MGM
40. Pata Pata—Miriam Makeba—Reprise
41. Pucker Up Buttercup—Jr. Walker & the All Stars—Soul
42. Together—Intruders—Gamble
43. The Tramp—Lowell Fulson—Kent
44. For Your Precious Love—Oscar Toney, Jr.—Bell
45. The Love I Saw in You Was Just A Mirage—Smokey Robinson & the Miracles—Tamla
46. More Love—Smokey Robinson & the Miracles—Tamla
47. Get On Up—Esquires—Bunky
48. Tell It Like It Is—Aaron Neville—Parlow
49. With This Ring—Platters—Musicor
50. Hey Leroy, Your Mama's Calling You—Jimmy Castor—Smash

1966

1. When A Man Loves A Woman—Percy Sledge—Atlantic
2. Uptight (Everything's Alright)—Stevie Wonder—Tamla
3. Baby Scratch My Back—Slim Harpo—Excello
4. C. C. Rider—Bobby Powell—Whit
5. The Duck—Jackie Lee—Mirwood
6. 634-5789—Wilson Pickett—Atlantic
7. Hold On I'm Coming—Sam & Dave—Stax
8. Barefootin'—Robert Parker—Nola
9. Let Me Be Good To You—Carla Thomas—Stax
10. She Blew A Good Thing—Poets—Symbol

11. Open The Door To Your Heart—Darrell Banks—Revilol
12. See Saw—Don Covay—Atlantic
13. Get Out Of My Life Woman—Lee Dorsey—Amy
14. I'm Too Far Gone To Turn Around—Bobby Bland—Duke
15. Wade In The Water—Ramsey Lewis—Cadet
16. Cool Jerk—Capitols—Karen
17. I Got You—James Brown—King
18. —Love Is A Hurting Thing—Lou Rawls—Capitol
18. Love Is A Hurting Thing—Lou Rawls Duke
20. Let's Go Get Stoned—Ray Charles—ABC Paramount
21. You Can't Hurry Love—Supremes—Motown
22. A Sweet Woman Like You—Joe Tex—Dial
23. Don't Mess With Bill—Marvelettes—Tamla
24. B-a-b-y—Carla Thomas—Stax
25. Blowin' In The Wind—Stevie Wonder—Tamla
26. Crying Time—Ray Charles—ABC Paramount
27. Going To A Go Go—Miracles—Tamla
28. What Becomes Of The Broken Hearted—Jimmy Ruffin—Soul
29. Hole In The Wall—Packers—Pure Soul
30. Knock On Wood—Eddie Floyd—Stax
31. Beauty Is Only Skin Deep—Temptations
32. Ain't Too Proud To Beg—Temptations—Gordy
33. Take This Heart Of Mine—Marvin Gaye—Tamla
34. The Love You Save May Be Your Own—Joe Tex—Dial
35. Hanky Panky—Tommy James & the Shondells—Roulette
36. My Baby Loves Me—Martha & Vandellas—Gordy
37. Misty—Richard 'Groove' Holmes—Prestige
38. It's A Man's World—James Brown—King
39. I Love You A Thousand Times—Platters—Musicor
40. Land Of A Thousand Dances—Wilson Pickett—Atlantic
41. How Sweet It is—Jr. Walker & All Stars—Soul
42. Ain't That Peculiar—Marvin Gaye—Tamla
43. You've Got My Mind Messed Up—James Carr—Goldwax
44. Rescue Me—Fontella Bass—Checker
45. Neighbor, Neighbor—Jimmy Hughes—Fame
46. Ebb Tide—Righteous Brothers—Phillies
47. Dear Lover—Mary Wells—Atco
48. Love Makes The World Go Round—Dean Jackson—Carla
49. Oh How Happy—Shades of Blue—Impact
50. I'm A Road Runner—Jr. Walker & All Stars

1965

1. I Can't Help Myself—Four Tops—Motown
2. In The Midnight Hour—Wilson Pickett—Atlantic
3. Yes, I'm Ready—Barbara Mason—Arctic
4. The In Crowd—Ramsey Lewis Trio—Argo
5. I'll Be Doggone—Marvin Gaye—Tamla
6. Shot Gun—Jr. Walker & All Stars—Soul
7. How Sweet It is—Marvin Gaye—Tamla
8. My Girl—Temptations—Gordy
9. Tonight's The Night—Solomon Burke—Atlantic
10. Gotta Get You Off My Mind—Solomon Burke—Atlantic
11. Papa's Got A Brand New Bag—James Brown—King
12. Twine Time—Alvin Cash & Crawlers—Mar-V-Lus
13. You've Lost That Lovin' Feelin'—Righteous Bros.—Phillies
14. Oh No Not My Baby—Maxine Brown—Wand
15. We're Gonna Make It—Little Milton—Chess
16. Stop In The Name of Love—Supremes—Motown
17. Ride Your Pony—Lee Dorsey (Amy)

18. Reach Out For Me—Dionne Warwick—Scepter
19. Shake—Sam Cooke—RCA Victor
20. No Pity in the Naked City—Jackie Wilson—Brunswick
21. Come See About Me—Supremes—Motown
22. Nowhere to Run—Martha & Vandellas—Gordy
23. Don't Mess Up A Good Thing—Bobby McClure & Fontella Bass—Checker
24. Mr. Pitiful—Otis Redding—Atlantic
25. It's A Man Down There—G. L. Crockett—Four Brothers
26. Back In My Arms Again—Supremes—Motown
27. Hold On To What You've Got—Joe Tex—Dial
28. I've Been Loving You Too Long—Otis Redding—Atlantic
29. The Jerk—Larks—Money
30. Treat Her Right—Roy Head—BackBeat
31. The Entertainer—Tony Clarke—Chess
32. Amen—Impressions—ABC-Paramount
33. Nothing But Heartaches—Supremes—Motown
34. It's Growing—Temptations—Gordy
35. Respect—Otis Redding—Atlantic
36. Too Many Fish in the Sea—Marvelettes—Tamla
37. Sugar Dumpling—Sam Cooke—RCA Victor
38. I Want To (Do Everything For You)—Joe Tex—Dial
39. Who's Cheating Who—Little Milton—Chess
40. Nothing Can Stop Me—Gene Chandler—Constellation
41. I Do Love You—Billy Stewart—Chess
42. Ooo Baby Baby—Miracles—Tamla
43. Right or Wrong—Ronnie Dove—Diamond
44. Name Game—Shirley Ellis—Congress
45. Baby Love—Supremes—Motown
46. Watermelon Man—Gloria Lynne—Fontana
47. Seven Letters—Ben E. King—Atco
48. Got To Find A Way—Harold Burrage—M-Pac
49. BOOT-LEG—Booker T & MG's—Stax
50. Oo Wee Baby, I Love You—Fred Hughes—Vee Jay

1964

1. My Guy—Mary Wells—Motown
2. Louie Louie—Kingsmen—Wand
3. Steal Away—Jimmy Hughes—Fame
4. Under the Boardwalk—Drifters—Atlantic
5. Walk On By—Dionne Warwick—Scepter
6. Shoop Shoop Song—Betty Everett—Vee Jay
7. The Way You Do The Things You Do—Temptations—Gordy
8. Funny—Joe Hinton—Back Beat
9. Walkin' The Dog—Rufus Thomas—Stax
10. Can I Get A Witness—Marvin Gaye—Tamla
11. Need To Belong—Jerry Butler—Vee Jay
12. I Stand Accused—Jerry Butler—Vee Jay
13. Keep On Pushin'—Impressions—ABC-Paramount
14. Nadine—Chuck Berry—Chess
15. Once Upon A Time—Marvin Gaye/Mary Wells—Motown
16. Busted—Ray Charles—ABC-Paramount
17. Little Red Rooster—Sam Cooke—RCA Victor
18. You're A Wonderful One—Marvin Gaye—Tamla
19. Loddy Lo—Chubby Checker—Parkway
20. I'm So Proud—Impressions—ABC-Paramount
21. Just Be True—Gene Chandler—Constellation
22. What Kind of A Fool Do You Think I Am—Tams—ABC-Paramount
23. I Don't Want to Be Hurt Anymore—Nat Cole—Capitol
24. High Heel Sneakers—Tommy Tucker—Checker
25. When The Lovelight Starts Shining Through Your Eyes—Supremes—Motown
26. What's The Matter With You Baby—Marvin Gaye/Mary Wells—Motown

27. Shelter of Your Arms—Sammy Davis, Jr.—Reprise
28. As Long As I Know He's Mine—Marvelettes—Tamla
29. Um, Um, Um, Um, Um—Major Lance—Okeh
30. Where Did Our Love Go—Supremes—Motown
31. Anyone Who Had A Heart—Dionne Warwick—Scepter
32. Good News—Sam Cooke—RCA Victor
33. Wish Someone Would Care—Irma Thomas—Imperial
34. Baby I Need Your Loving—Four Tops—Motown
35. You're Good For Me—Solomon Burke—Atlantic
36. Mercy, Mercy—Don Covay—Rosenhart
37. Ain't Nothin' You Can Do—Bobby Bland—Duke
38. You're No Good—Betty Everett—Vee Jay
39. Oh Baby Don't You Weep—James Brown—King
40. Good Times—Sam Cooke—RCA Victor
41. Down The Aisle—Patti LaBelle & Bluebells—Parkway
42. Rhythm—Major Lance—Okeh
43. No Particular Place To Go—Chuck Berry—Chess
44. Cry Baby—Garnett Mimms & Enchanters—United Artists
45. You Must Believe Me—Impressions—ABC-Paramount
46. I Wish You Love—Gloria Lynne—Everest
47. Let It Be Me—Betty Everett/Jerry Butler—Vee Jay
48. Tennessee Waltz—Sam Cooke—RCA Victor
49. Quicksand—Martha & Vandellas—Gordy
50. Talk To Me—Sunny & Sunglows—Tear Drop

1963

1. Pride And Joy—Marvin Gale—Tamla
2. Limbo Rock—Chubby Checker—Parkway
3. Fingertips—Little Stevie Wonder—Tamla
4. Love Of My Man—Theola Kilgore—Serock
5. Easier Said Than Done—Essex—Roulette
6. Hello Stranger—Barbara Lewis—Atlantic
7. Mockingbird—Inez Foxx—Symbol
8. The Monkey Time—Major Lance—Okeh
9. Tell Him I'm Not Home—Chcuk Jackson—Wand
10. Cry Baby—Garnet Mimms & Enchanters—UA
11. Our Day Will Come—Ruby & Romantics—Kapp
12. Candy Girl—Four Seasons—Vee Jay
13. Two Lovers—Mary Wells—Motown
14. Mickey's Monkey—Miracles—Tamla
15. Hotel Happiness—Brook Benton—Mec
16. Watermelon Man—Mongo Santamaria—Battle
17. Da Do Ron Ron—Crystals—Phillies
18. You Are My Sunshine—Ray Charles—ABC
19. Don't Make Me Over—Dionne Warwick—Scepter
20. Just One Look—Dorris Troy—Atlantic
21. Wiggle Wobble—Less Cooper—Everlast
22. He's So Fine—Chiffons—Laurie
23. Heat Wave—Martha & Vandellas—Gordy
24. Hey Girl—Freddy Scott—Colpix
25. Walk Like A Man—Four Seasons—Vee Jay
26. Release Me—Esther Phillips—Lenox
27. Zip A Dee Doo Dah—Bobby B Soxx & Blue Jeans—Phillies
28. Busted—Ray Charles—ABC
29. Another Saturday Night—Sam Cooke—RCA Victor
30. South Street—Orlons—Cameo
31. No One—Ray Charles—ABC
32. Tell Him—Exciters—UA
33. My Boyfriend's Back—Angels—Smash
34. Take These Chains From My Heart—Ray Charles—ABC
35. Frankie & Johnny—Sam Cooke—Victor
36. Mama Didn't Lie—Jan Bradley—Chess
37. Then He Kissed Me—Crystals—Phillies

(Continued on page 74)

TONY BENNETT MAKES IT HAPPEN!*

A GREAT BIG THANK YOU
TO ALL THE DEE JAYS
FOR THEIR SUPPORT
DURING THE PAST YEAR.

TONY



* S.R.O. EVERY SHOW - EVERY NIGHT *Everywhere!*

CAESAR'S PALACE — LAS VEGAS
(RETURN ENGAGEMENT JUNE 27, 1968)
EMPIRE ROOM — CHICAGO
WALDORF'S EMPIRE ROOM — N. Y.
ROOSTER TAIL — DETROIT
DIPLOMAT HOTEL — MIAMI BEACH
GREEK THEATRE — LOS ANGELES

CURRENT ALBUM:
FOR ONCE IN MY LIFE
PUBLICITY MANAGEMENT:
ROGERS, COWAN & BRENNER, INC.

COLUMBIA RECORDS
MUSIC COORDINATION:
TONY TAMBURELLO

BOOKINGS:
GAC
RECORD PROMO:
JOE PETRALIA

PRODUCERS OF THE TOP 100 HITS FOR 1967

Action Productions
401 Main
Greenwood, S.C.

Adams, Joe
2107 W. Washington Blvd.
Los Angeles, Calif.

Adler, Lou
800 Stone Canyon
Bel Air, Calif.

Alaimo, Steve
495 S. E. 10th Court
Hialeah, Fla.

Alpert, Herb
c/o A&M Records
1416 No. La Brea
Hollywood, Calif.

Atkins, Chet
c/o RCA Victor Records
800 17th Ave. So.
Nashville, Tenn.

Axelrod, David
c/o Capitol Records
1750 N. Vine St.
Hollywood, Calif.

Bacharach Burt
c/o Fred E. Ahlert, Jr.
15 East 48th St.
New York, N.Y.

Bahari, Joe
c/o Kent Records
5810 So. Normandie
Los Angeles, Calif.

Barnes, J. J.
c/o Groovesville Records
517 Pavilion, 1 Lafayette Pl.
Detroit, Mich.

Barrett, Art
c/o Original Sound Records
7120 Sunset Blvd.
Los Angeles, Calif.

Barry, Jeff
c/o Tallyrand Music
200 West 57th St.
New York, N.Y.

Barry, Steve
c/o Dunhill Records
449 So. Beverly Dr.
Beverly Hills, Calif.

Bateman, Robert
10 West 135th St.
New York, N.Y.

Beach Boys, The
c/o Nick Grillo
9000 Sunset Blvd.
Hollywood, Calif.

Bernard, Abe
236 Eugene St.
Baton Rouge, La.

Berniker, Mike
c/o Columbia Records
51 West 52nd St.
New York, N.Y.

Berns, Bert
c/o Shout Records
1650 Broadway
New York, N.Y.

Blackwell, Chris
c/o Island Records
155 Oxford St.
London, W1, England

Blake Edwards Productions
c/o Smash Records
35 E. Wacker Drive
Chicago, Ill.

Blagart, Neil
c/o Cameo/Parkway
250 West 57th St.
New York, N.Y.

Bono, Sonny
7715 Sunset Blvd.
Los Angeles, Calif.

Bowen, Jimmy
c/o Warner Bros. Records
4000 Warner Blvd.
Burbank, Calif.

Boyce, Tommy
c/o A&M Records
1416 La Brea
Hollywood, Calif.

Boylan, John
c/o Kappelman & Rubin
1650 Broadway
New York, N.Y.

Bradley, Owen
c/o Decca Records
803 16th Ave. South
Nashville, Tenn.

Bright Tunes Productions
c/o Seymour Barash
Williamsburg Savings Bank
Hanson Pl.
8klyn, N.Y.

Bristol, J.
c/o Tamla Motown Records
2648 W. Grand Blvd.
Detroit, Mich.

Brown, D.
c/o Cameo Records
250 West 57th St.
New York, N.Y.

Brown, Doug
c/o Bill Sharpley
Detroit Sound Music Co.
2120 Ewald Circle, Suite 23
Detroit, Mich.

Brown, James
200 West 57th St.
New York, N.Y.

Buie, Buddy
c/o Bill Lowery
P.O. Box 9687
Atlanta, Ga.

Byrne, Ossie
c/o N.E.M.S. Enterprises
Sutherland House
Argyle St.
London W2, England

Calello, Charlie
c/o Columbia Records
51 West 52nd St.
New York, N.Y.

Carney, Richard E.
Box 834, Greenwood Lake
New York, N.Y.

Carson, Buzz
812 17th Ave. S.
Nashville, Tenn.

Cates, George
c/o Dot Records
1507 No. Vine
Hollywood, Calif.

Charles, Ray
c/o ABC Records
1330 Ave. of Americas
New York, N.Y.

Chiprut, E.
1674 Broadway
New York, N.Y.

Clark, Dave
c/o Epic Records
51 West 52nd St.
New York, N.Y.

Clark, Sam
1330 Ave. Of The Americas
New York, N.Y.

Clinton, George
c/o Revitol Records
8832 Puritan Ave.
Detroit, Mich.

Cogbill, Tom
c/o Atco Records
1841 Broadway
New York, N.Y.

Coleman, Austin
c/o Original Sound Records
7120 Sunset Blvd.
Los Angeles, Calif.

Concert House Productions
315 W. 57th St.
New York, N.Y.

Cooper, Ted
c/o Epic Records
51 West 52nd St.
New York, N.Y.

Corday, Mitch
c/o Chartbuster Productions
1203 28th St. N.W.
Washington, D.C.

Cordell, Ritchie
c/o Roulette Records
1631 Broadway
New York, N.Y.

Cordell, Denny
c/o Decca Records
Decca House
London, England

Cosby, H.
c/o Tamla Motown Records
2648 W. Grand Blvd.
Detroit, Mich.

Courtney, Lou
10 West 54th St.
New York, N.Y.

Crew, Bob
1841 Broadway
New York, N.Y.

Critch, Yader
118 S. Weatherly
Los Angeles, Calif.

Cropper, Steve
c/o Volt Records
1841 Broadway
New York, N.Y.

Cullen, Bob
c/o RCA Records
155 East 24th St.
New York, N.Y.

Curb, Mike
1750 No. Vine
Los Angeles, Calif.

Daryll, Ted
1650 Broadway
New York, N.Y.

David, Hal
c/o Fred E. Ahlert, Jr.
15 East 48th St.
New York, N.Y.

Davis, Carl
58 E. Roosevelt Rd.
Chicago, Ill.

Davis, Don
c/o Groovesville Records
517 Pavilion, 2 Lafayette Pl.
Detroit, Mich.

Dean, J.
c/o Tamla Totown Records
2648 W. Grand Blvd.
Detroit, Mich.

Deazevedo, Alex
c/o Capitol Records
1750 N. Vine
Hollywood, Calif.

De Caro, Nick
c/o Columbia Records
51 West 52nd St.
New York, N.Y.

De Lory, Al
c/o Capitol Records
1750 N. Vine
Hollywood, Calif.

Diamond, Neil
c/o Tallyrand Music
200 W. 57th St.
New York, N.Y.

Douglas, Steve
c/o Mercury Records
110 West 57th St.
New York, N.Y.

Dowd, Tom
c/o Atco Records
1841 Broadway,
New York, N.Y.

Dozier, Lamont
c/o Tamla Motown Records
2648 W. Grand Blvd.
Detroit, Mich.

Drusky, Roy
c/o MTA Records
26 West 58th St.
New York, N.Y.

Dunwich Productions
25 W. Chestnut
Chicago, Ill.

Engemann, Carl
c/o Capitol Records
1750 N. Vine
Hollywood, Calif.

Evans, Joe
c/o Carnival Records
24 Branford Place
Newark, N.J.

Evans, Richard
c/o Cabot Records
320 East 21st St.
Chicago, Ill.

Farrell, Wes
c/o Coral Rock Productions
39 W. 55th St.
New York, N.Y.

F.G.G. Productions
1619 Broadway
New York, N.Y.

Finiz, Bob
919 N. Broad
Philadelphia, Pa.

Fogelsohn, Jim
c/o RCA Victor Records
155 E. 24th St.
New York, N.Y.

Franz, Johnny
c/o Philips Records
London, England

Fred, John
236 Eugene St.
Baton Rouge, La.

Fugua, H.
c/o Tamla Motown Records
2648 W. Grand Blvd.
Detroit, Mich.

Futterman, Lew
315 West 57th St.
New York, N.Y.

Galligan, Neil
c/o Scepter/Wand Records
254 West 54th St.
New York, N.Y.

Gamble, Kenny
c/o Gamble Records
1650 Broadway
New York, N.Y.

Garner, Bob
3830 Cosby
Houston, Texas

Garrett, Snuff
c/o Viva Productions
1800 No. Argyle
Hollywood, Calif.

Gentry, Bob
c/o Roulette Records
1631 Broadway
New York, N.Y.

Gernhard, Phil
6747 1st Ave. South
St. Petersburg, Fla.

Glasser, Dick
c/o Warner Bros. Records
4000 Warner Blvd.
Burbank, Calif.

Gold, Jack
c/o Columbia Records
6121 Sunset Blvd.
Hollywood, Calif.

Golden, Jim
MG Productions
2131 S. Michigan Ave.
Chicago, Ill.

Goldstein, Jerry
c/o U.N.I. Records
8255 Sunset Blvd.
Hollywood, Calif.

Gordon, Kelly
c/o Capitol Records
1750 N. Vine
Hollywood, Calif.

Gordon, Marc
Soul City, 1560 No. La Brea
Hollywood, Calif.

Gordy, Berry Jr.
c/o Tamla/Motown Records
2648 W. Grand Blvd.
Chicago, Ill.

Gormann, Vinny
c/o United Artists Records
729 7th Ave
New York, N.Y.

Green, Charles
York Pala Prod.
7715 Sunset Blvd.
Hollywood, Calif.

Green, Stan
c/o Scepter/Wand Records

254 West 54th St.
New York, N.Y.

Greenberg, Jerry
28 Pembroke Rd.
Hamden, Conn.

Greene, Marlin
Norala Recording Corp.
101 East 2nd St.
Sheffield, Alabama

Greenwich, Ellie
c/o Tallyrand Music
200 West 57th Street
New York, N.Y.

Grill, Hy
c/o Kapp Records
136 East 57th Street
New York, N.Y.

Grossman, Albert, B.
75 East 55th St.
New York, N.Y.

Guercio, James, W.
151 El Camino Dr.
Beverly Hills, Calif.

Guyden, Mac
812 17th Ave. S.
Nashville, Tenn.

Hall, Rick
P. O. Box 2238
603 E. Avalon
Muscle Shoals, Ala.

Handler, Ken
c/o Cantebury Records
9000 Sunset Blvd.
Hollywood, Calif.

(Continued on page 76)

PAST R&B HITS (Continued from p. 72)

38. Shake A Tail Feather—Dutones—One-Derful
39. Send Me Some Lovin'—Sam Cooke—Victor
40. You Can't Sit Down—Dovells—Cameo
41. Foolish Little Girl—Shirelles—Scepter
42. That's The Way Love Is—Bobby Bland—Duke
43. Don't Say Nottin Bad About My Baby—Cookies—Dimension
44. Desifinado—Getz & Byrd—Verve
45. Hitch Hike—Marvin Gaye—Tamla
46. Be My Baby—Rounettes—Phillies
47. I Who Have Nothing—Ben E. King—Atco
48. Pipeline—Chantays—Dot
49. Ride—Dee Dee Sharp—Cameo
50. Call On Me—Bobby Bland—Duke

1962

1. I Know You Don't Love Me No More—Barbara George—AFO
2. I Can't Stop Loving You—Ray Charles—ABC-Paramount
3. The One Who Really Loves You—Mary Wells—Motown
4. Do You Love Me—Contours—Gordy
5. The Twist—Chubby Checker—Parkway
6. Mashed Potato Time—Dee Dee Sharp—Cameo
7. Soul Twist—King Curtis—Enjoy
8. Soldier Boy—Shirelles—Scepter
9. Twistin' The Night Away—Sam Cooke—RCA Victor
10. Loco-Motion—Little Eva—Dimension
11. Letter Full Of Tears—Gladys Knight—Fury
12. Please Mr. Postman—Marvelettes—Tamla
13. Any Day Now—Chuck Jackson—Wand
14. Something's Got A Hold On Me—Etta James—Argo
15. Snap Your Fingers—Joe Henderson—Todd
16. Baby It's You—Shirelles—Scepter
17. Poor Fool—Ike & Tina Turner—Sue
18. Duke Of Earl—Gene Chandler—Vee Jay
19. Ramblin' Rose—Nat Cole—Capitol
20. Slow Twistin'—Chubby Checker—Parkway
21. Don't Play That Song—Ben E. King—Atco
22. Anne Get Your Yo Yo—Little Junior Parker—Duke
23. Turn On Your Love Light—Bobby Bland—Duke
24. Limbo Rock—Chubby Checker—Parkway
25. Peppermint Twist—Joey Dee—Roulette
26. Sherry—Four Seasons—Vee Jay
27. Rinky Dink—Dave "Baby" Cortez
28. Playboy—Marvelettes—Motown
29. He's A Rebel—Crystals—Philles
30. Party Lights—Claudine Clark—Chancellor
31. Call It Stormy Monday—Bobby Bland—Duke
32. Popeye (The Hitchhiker)—Chubby Checker—Parkway
33. Just Got To Know—Jimmy McCracklin—Art-Tune
34. You'll Lose A Good Thing—Barbara Lynn—Jamie
35. Let Me In—Sensations—Argo
36. Having A Party—Sam Cooke—RCA Victor
37. I Need Your Lovin'—Don Gardner & DeeDee Ford—Fire
38. Bring It On Home To Me—Sam Cooke—RCA Victor
39. Dear Lady Twist—Gary Bonds—Legrand
40. Lover Please—Clyde McPhatter—Mercury
41. Lost Someone—James Brown—King
42. Walk On The Wild Side—Jimmy Smith—Verve
43. Unchain My Heart—Ray Charles—ABC
44. You Beat Me To The Punch—Mary Wells—Motown
45. If You Gotta Make A Fool Of Somebody—James Ray—Caprice
46. I'm Blue—Ikettes—Atco
47. You Don't Know Me—Ray Charles—ABC
48. Beechwood 4-5789—Marvelettes—Tamla
49. Gypsy Woman—Impressions—ABC
50. Lie To Me—Brook Benton—Mercury

1961

1. Tossin' & Turnin'—Bobby Lewis—Bel-tone
2. Will You Love Me Tomorrow—Shirelles—Scepter
3. Mother-In-Law—Ernie K-Doe—Minit
4. Last Night—Mar-Keys—Satellite
5. It's Gonna Work Out Fine—Ike & Tina Turner—Sue
6. Shop Around—Miracles—Tamla
7. Don't Cry No More—Bobby Bland—Duke
8. Raindrops—Dee Clark—Vee Jay
9. I Like It Like That—Chris Kenner—Instant
10. All In My Mind—Maxine Brown—Nomar
11. Pony Time—Chubby Checker—Parkway
12. Boll Weevil Song—Brook Benton—Mercury
13. Quarter To Three—U.S. Bonds—Legrand
14. But I Do—Clarence Henry—Argo
15. Stand By Me—Ben E. King—Atco
16. Rainin' In My Heart—Slim Harpo—Excelllo
17. My True Story—Jive Five—Bel-tone
18. Daddy's Home—Shep & Limelitters—Hull
19. One Mint Julep—Ray Charles—Impulse
20. I Pity The Fool—Ike & Tina Turner—Sue
21. Blue Moon—Marcel's—Colpix
22. Angel Baby—Rosie & Original—Highland
23. Gee Whiz (Look At His Eyes)—Carla Thomas—Atco
24. You Can Have Her—Roy Hamilton—Epic
25. He Will Break Your Heart—Jerry Butler—Vee Jay
26. At Last—Etta James—Argo
27. For My Baby—Brook Benton—Mercury
28. Watusi Vibrations—Checker
29. Dedicated To The One I Love—Shirelles—Scepter
30. Let's Twist Again—Chubby Checker—Parkway
31. Hoochie Coochie Co—H. Ballard & Midnighters—King
32. 100 Lbs. Of Clay—Gene McDaniels—Liberty
33. There's A Moon Out Tonight—Capris—Old Town
34. Don't Cry Baby—Etta James—Argo
35. Mama Said—Shirelles—Scepter
36. Some Kind Of Wonderful—Drifters—Atlantic
37. Every Beat Of My Heart—G. Knight & Pips—Vee Jay/Fury
38. Ya Ya—Lee Dorsey—Fury
39. Find Another Girl—Jerry Butler—Vee Jay
40. School Is Out—U.S. Bonds—Legrand
41. Runaway—Del Shannon—Big Top
42. Let's Go, Let's Go—H. Ballard & Midnighters—King
43. Hit The Road Jack—Ray Charles—ABC Paramount
44. I Count The Tears—Drifters—Atlantic
45. Spanish Harlem—Ben E. King—Atco
46. A Little Bit Of Soap—Jarmels—Laurie
47. Cupid—Sam Cooke—RCA Victor
48. I Idolize You—Ike & Tina Turner—Sue
49. Think Twice—Brook Benton—Mercury
50. Trust In Me—Etta James—Argo

TO ALL OUR FRIENDS SEASON'S GREETINGS THE LETTERMEN

Personal Management: Jess Rand & Associates

William Morris Agency Public Relations: Freeman & Sutton



PRODUCERS OF THE TOP 100 HITS FOR 1967

Hart, Babby
c/a A&M Records
1416 La Brea
Hollywood, Calif.

Hartalid, Douglas, F.
7033 Sunset Blvd.
Hollywood, Calif.

Hatch, Tany
c/o Pye Records
A.T.U. House
G. T. Cumberland Pl.
London W2, England

Hawkins, Dale
c/a Abnack Records
825 Olive St.
Dallas, Texas

Hayes, Isaac
c/a Stax Records
1841 Broadway
New York, N.Y.

Haywood, Leon
7426 1/2 Lucerne St.
Los Angeles, Calif.

Hazlewood, Lee
4635 Ledge Ave.
No. Hollywood, Calif.

Hedafy, Najeeb
c/a Roulette Records
1631 Broadway
New York, N.Y.

Holland, Brian
c/a Tamla Motown Records
2648 W. Grand Blvd.
Detroit, Mich.

Holland, Eddy
c/o Tamla Motown Records
2648 W. Grand Blvd.
Detroit, Mich.

Holmes, Bill
6362 Hollywood Blvd.
Hollywood, Calif.

Holtzman, Marvin
c/a Capital Records
1750 No. Vine
Hollywood, Calif.

Haaven, J.
8255 Sunset Blvd.
Hollywood, Calif.

Horn, L.
c/a Tamla/Motown Records
2648 W. Grand Blvd.
Detroit, Mich.

Howe, Bones
4447 Cromwell Ave.
Los Angeles, Calif.

Huff, Leon
c/a Madara White Productions
250 S. Broad St.
Philadelphia, Pa.

Hughes, Gene
c/a Fraternity Records
Rm. 105, Sheraton Gibson Hotel
Cincinnati, Ohio

Hunter, Ivy
c/a Tamla Motown Records
2648 W. Grand Blvd.
Detroit, Mich.

In The Pocket Prod. Co.
629 W. Milwaukee
Detroit, Mich.

Ivy, Quin
Norala Recording Corp.
102 E. 2nd Street
Sheffield, Alabama

Jackson, Al
c/a Stax Records
1841 Broadway
New York, N.Y.

Jacobsen, Erik
c/a Koppelman & Rubin
1650 Broadway
New York, N.Y.

Jarrard, Rick
c/o RCA Victor Records
155 East 24th Street
New York, N.Y.

Jaye, Jerry
c/o London Records
539 West 25th Street
New York, N.Y.

Jerame, Bill
Real Good Productions
1697 Broadway
New York, N.Y.

Jerome, Henry
c/a United Artists Records
729 7th Ave.
New York, N.Y.

Jerome, Steve
Real Good Productions
1697 Broadway
New York, N.Y.

Johnston, Bob
c/a Columbia Records
51 West 52nd Street
New York, N.Y.

J.R. Enterprises Inc.
530 W. Main
Hendersonville, Tenn.

Kahl, Phil
1650 Broadway
New York, N.Y.

Kapp, Dave
Kapp Records
136 East 57th Street
New York, N.Y.

Kapralik, Dave
c/a Date Records
51 W. 52nd St.
New York, N.Y.

Kasenez, Jerry
1674 Broadway
New York, N.Y.

Katz, Jeff
1674 Broadway
New York, N.Y.

Keller, Jack
4517 Greengate Ct. W.
Lake Village, Calif.

Kent, Al
c/o Rit-Tic Records
2307 Edison
Detroit, Michigan

Kerr, George
Tra-San Productions
66 Teford St.
E. Orange, N.J.

Kesler, Stan
804 16th Ave. S.
Nashville, Tenn.

Killen, Buddy
c/o Tree Music
905 16th Ave. S.
Nashville, Tenn.

Kilpatrick, Lincoln
417 West 56th St.
New York, N. Y.

King, Windsor
315 West 57th St.
New York, N.Y.

Klein, Gary
c/o Koppelman & Rubin
7033 Sunset Blvd.
Hollywood, Calif.

Koppelman, Charles
1650 Broadway
New York, N.Y.

Kornfeld, Artie
c/o Mylin Prod.
c/o MGM Records
1350 Ave. of Americas

Lambert, Kit
6 Chesterfield Gardens
London W1, England

Lane, Ronnie
c/a Immediate Records Ltd.
63-69 New Oxford St.
London, England.

McCoy, Van
c/o Cameo/Parkway Records
1650 Broadway
New York, N.Y.

Madara, John
c/o Madara White
Productions
250 S. Broad St.
Philadelphia, Pa.

Marks, Larry
c/o A&M Records
1416 La Brea
Hollywood, Calif.

Marriott, Steve
c/o Immediate Records Co.
Ltd.
63-69 New Oxford St.
London, England.

Martin, George
c/o EMI Record Ltd.
Hayes, Middlesex, England.

Mayfield, Curtis
c/o Queens Baking
1650 Broadway
New York, N.Y.

Meaux, Huey
c/o Music Enterprises, Inc.
3111 Leeland Ave.
Houston, Texas

Melcher, Terry
c/o Columbia Records
51 West 52nd Street
New York, N.Y.

Mersey, Robert
c/o Columbia Records
51 West 52nd Street
New York, N.Y.

Michaels, Tany
c/o United Artists Records
729 7th Ave.
New York, N.Y.

Miller, Bobby
c/o Cadet Records
320 East 21st St.
Chicago, Ill.

Miller, Jimmy
c/o Island Records
155 Oxford St.
London, W1, England

M'la, Ron
c/o Centar Records
3339 N. Orlando St.
Chicago, Ill.

Mitchell, Willie
4968 William Arndt Rd.
Memphis, Tenn.

Moman, Chips
827 Thomas St.
Memphis, Tenn.

Montague
c/o Mark II
5371 West Pico Blvd.
Los Angeles, Calif.

Maore, Scotty
c/o Music City Records
821 19th Ave.
Nashville, Tenn.

Morgan, Bob
c/o MGM Records
1350 Ave of the Americas,
New York, N.Y.

Morgan, Tom
c/o Capital Records
1750 N. Vine
Hollywood, Calif.

Marris, Richard
c/o Gordy Records
2648 W. Grand Blvd.
Detroit, Mich.

Morton, Shadow
1650 Broadway
New York, N.Y.

Mass, Jerry
c/o A&M Records
1416 No. La Brea
Hollywood, Calif.

Most, Mickie
c/o RAK Music Mgt. Ltd.
The Penthouse
155 Oxford St.
London W1, England

Murray, Jerry
1729 Delaware Ave.
Detroit, Mich.

Nelson, Ken
c/o Capitol Records
1750 No. Vine
Hollywood, Calif.

Nitzsche, Jack
c/a Epic Records
51 West 52nd Street
New York, N.Y.

Nossel, Trad
10 George Street
Wallingford, Conn.

Okum, Milton
50 Central Park W.
New York, N.Y.

Oldham, Andrew, L.
Decca House
London, England

Oliver, Tommy
c/o Imperial Records
1556 N. La Brea
Hollywood, Calif.

Otis, Clyde
1697 Broadway
New York, N.Y.

Papa Don Productions, Inc.
Mabil Op. JS-4-3538
Pensacola, Fla.

Par-La Productions
728 Camp Street
New Orleans, La.

Paul, Clarence
c/o Tamla Motown Records
2648 W. Grand Blvd.
Detroit, Mich.

Penn, Don
c/o American Sound Studio
827 Thomas St.
Memphis, Tenn.

Philips, John
499 So. Beverly Dr.
Beverly Hills, Calif.

Poe, Bobby
c/o Chartbuster Productions
1203 28th St. N.W.
Washington, D.C.

Palhemus, Art
c/o Longhair Productions
200 West 57th Street
New York, N.Y.

Parter, David
c/o Stax Records
1841 Broadway
New York, N.Y.

Ragovoy, Jerry
219 West 79th St.
New York, N.Y.

Rascals, Young
c/o Atlantic Records
1841 Broadway
New York, N.Y.

Ratner, Norm
c/o Dunhill Records
449 So. Beverly Dr.
Beverly Hills, Calif.

Ray, Eddie
c/o Tower Records
1750 N. Vine
Hollywood, Calif.

Redding, Otis
c/o Phil Walden
Artists & Promotion
Macan, Ga

Reno, Bob
c/o Cameo/Parkway
250 West 57th Street
New York, N.Y.

Richards, Ron
c/o A.I.R. London Ltd.
101 Baker Street
London W2, England

Rinehart, Bill
c/o Atco Records
1841 Broadway
New York, N.Y.

Riopell, Jerry
1416 La Brea
Hollywood, Calif.

Rivers, Johnny
Soul City
1560 N. La Brea
Hollywood, Calif.

Roberts, Howard, A.
c/o Columbia Records
51 West 52nd St.
New York, N.Y.

Robinson, Smokey
c/o Tamla Motown Records
2648 W. Grand Blvd.
Detroit, Mich.

Rodgers, A.
c/o James Productions (Bell)
1776 Broadway
New York, N.Y.

Rass, Brian
2991 Ingledeale Terr.
Los Angeles, Calif.

Ross, Jerry
c/o Mercury Records
745 5th Ave.
New York, N.Y.

Rothchild, Paul A.
c/o Elektra Records
1855 Broadway
New York, N.Y.

Rowe, Dick
c/o Decca Ltd.
9 Albert Embankment
London S.E. 11, England

Rubin, D.
1650 Broadway
New York, N.Y.

Rubinson, David
c/o Columbia Records
51 West 52nd St.
New York, N.Y.

Sandusky, Vernon
c/o Chartbuster Productions
1203 28th St. N.W.
Washington, D.C.

Saraceno, Joe
c/o Imperial Records
6920 Sunset Blvd.
Hollywood, Calif.

Schmitt, Al
c/a RCA Victor Records
145 East 24th St.
New York, N.Y.

Segar, Bob
c/o Cameo Records
250 West 57th St.
New York, N.Y.

Sehorn, M. E.
1211 St. Philip
New Orleans, La.

Shal Talmy Productions.
c/o Warner Bros. Records
400 Warner Blvd.
Burbank, Calif.

Shapiro, Brad
495 S. E. 10th Court
Hialeah, Fla.

Shepherd, Bill (Bunky)
c/o Stax Records
1421 S. Michigan
Chicago, Ill.

Sherrill, Bill
c/a Epic Records
51 West 52nd St.
New York, N.Y.

Simon, John
c/o Columbia Records
51 West 52nd Street
New York, N.Y.

Slay, Frank
6362 Hollywood Blvd.
Hollywood, Calif.

Slane, P. F.
c/o Dunhill Records
449 So. Beverly Dr.
Beverly Hills, Calif.

Smith, Bobby
c/o S.S.S. International
Records
1650 Broadway
New York, N.Y.

Smith, Dallas
c/o Liberty Records
6920 Sunset Blvd.
Hollywood, Calif.

Smith, Fred
7400 Fountain Ave.
Los Angeles, Calif.

Smith, Mike
c/o Peter Walsh
6 South Hampton Pl.
London WC 2, England

South, Joe
c/o Columbia Records
51 West 52nd St.
New York, N.Y.

Springfield, Tom
c/o E.M.I. Records, Ltd.
Hayes, Middlesex, England

Stamp, Chris
6 Chesterfield Garden
London W. I. England

Stanton, Allan
c/o A&M Records
1416 La Brea
Hollywood, Calif.

Stevenson, Mickey
c/o Clarence Avant
37 West 57th Street
New York, N.Y.

Stewart, Jim
c/o Stax/Volt Records
926 E. Mclemore
Memphis, Tenn.

Stigwood, Robert
c/o N.E.M.S. Enterprises
Sutherland House
Argyle Street
London W1, England

Stills, Steven
c/o York Pala Productions
7715 Sunset Blvd.
Hollywood, Calif.

Stone, Brian
York Pala Productions
7715 Sunset Blvd.
Hollywood, Calif.

Sullivan, Peter
A.I.R. London Ltd.
101 Baker Street
London W1, England

Super K Productions
c/o Laurie Records
165 West 46th St.
New York, N.Y.

Tangerine Records
1330 Ave. of Americas
New York, N.Y.

Taylor, Baron
c/o Revilart Records
8832 Puritan Ave.
Detroit, Mich.

Taylor, Chip
1650 Broadway
New York, N.Y.

Taylor, Creed
36 East 57th St.
New York, N.Y.

Thiele, Bob
c/o ABC Records
1330 Ave. of Americas
New York, N.Y.

3 J's Production
529 East 89th Place
Chicago, Ill.

Tokens, The
1697 Broadway
New York, N.Y.

Toussaint, A.
1211 St. Philip
New Orleans, La.

Tracey, Jack
c/o Liberty Records
6920 Sunset Blvd.
Hollywood, Calif.

Traut, Bill
c/a Dunwick Productions
25 East Chestnut St.
Chicago, Ill.

Tyball, Marcus
c/o Brompton Productions
8255 Sunset Blvd.
Los Angeles, Calif.

Usher, Gary
c/o Columbia Records
51 West 52nd Street
New York, N.Y.

Van, Teddy
c/o Capitol Records
1619 Broadway
New York, N.Y.

Venet, Nick
c/o S.S.S. International
Records
1750 N. Vine
Hollywood, Calif.

Vieaneau, Jim
804 16th Ave. South
Nashville, Tenn.

Waronker, Lenny
c/o Warner Bros. Records
4000 Warner Blvd.
Burbank, Calif.

Weatherspoon, William
c/o Tamla Motown Records
2648 W. Grand Blvd.
Detroit, Mich.

Weems, Herman
c/o Ric-Tic Records
2307 Edison
Detroit, Mich.

Welk, Lawrence
c/a Dot Records
1507 N. Vine
Hollywood, Calif.

Wexler, Jerry
c/o Atlantic Records
1841 Broadway
New York, N.Y.

White, Dave
c/o Madara White Productions
250 So. Broad St.
Philadelphia, Pa.

Whitley, Ray
c/a Bill Lowery
P.O. Box 9687
Atlanta, Ga.

Whitfield, Norman
c/o Tamla/Motown Records
2648 W. Grand Blvd.
Detroit, Mich.

Williams, Ken
c/o Date Records
51 West 52nd St.
New York, N.Y.

Williams, Larry
c/o Epic Records
51 West 52nd St.
New York, N.Y.

Williams, Shannon
c/o Excella Records
1011 Woodland St.
Nashville, Tenn.

Wilson, Frank
c/o Tamla Motown Records
2648 W. Grand Blvd.
Detroit, Mich.

Wilson, Tom
c/a MGM Records
1350 Ave. of Americas
New York, N.Y.

Winfree, Jim
c/o Capital Records
1750 N. Vine
Hollywood, Calif.

Wingate, Ed
c/o Ric-Tic Records
2307 Edison
Detroit, Mich.

Winn, Hooven
8255 Sunset Blvd.
Hollywood, Calif.

Wissert, Joe
c/o Koppelman & Rubin
1650 Broadway
New York, N.Y.

Wood, Randy
c/a Dot Records
1507 No. Vine
Hollywood, Calif.

Waads, Pearl
100 West 85th Street
New York, N.Y.

Wylie, Richard "Popcorn"
3044 Taylor Ave.
Detroit, Mich.

Wyld, Bob
c/o Longhair Productions
200 West 57th Street
New York, N.Y.

Yameta Productions
635 Madison Ave.
New York, N.Y.

York Pala Productions
7715 Sunset Blvd.
Hollywood, Calif.

Young, Neil
c/o York Pala Productions
7715 Sunset Blvd.
Hollywood, Calif.

OTIS REDDING

Will Live On In Our Hearts

ATLANTIC RECORDS • 1967

TOP ALBUMS OF THE PAST 7 YEARS

1967

1. DR. ZHIVAGO—SOUNDTRACK—MGM
2. SOUND OF MUSIC—SOUNDTRACK—RCA
3. A MAN & A WOMAN—SOUNDTRACK—UNITED ARTISTS
4. More of the Monkees—Colgems
5. Sgt. Peppers Lonely Hearts Club Band—Beatles—Capitol
6. Surrealistic Pillow—Jefferson Airplane—RCA
7. S.R.O.—Herb Alpert & Tijuana Brass—A&M
8. The Monkees—Colgems
9. Monkees Headquarters—Colgems
10. Doors—Elektra
11. Sounds Like—Herb Alpert & Tijuana Brass—A&M
12. Revenge—Bill Cosby—Warner Bros.
13. I Never Loved A Man—Aretha Franklin—Atlantic
14. Mamas & Papas Deliver—Dunhill
15. The Best of Lovin' Spoonful—Kama Sutra
16. Born Free—Andy Williams—Columbia
17. Collections—Young Rascals—Atlantic
18. Whipped Cream & Other Delights—Herb Alpert & Tijuana Brass—A&M
19. Wonderfulness—Bill Cosby—Warner Bros.
20. Release Me—Englebert Humperdinck—Parrot
21. That's Life—Frank Sinatra—Reprise
22. Flowers—Rolling Stones—London
23. Insight Out—Association—Warner Bros.
24. Born Free—Roger Williams—Kapp
25. Paul Revere & The Raiders Greatest Hits—Columbia
26. Between the Buttons—Rolling Stones—London
27. Spirit of '67—Paul Revere & The Raiders—Columbia
28. My Cup Runneth Over—Ed Ames—RCA
29. Bob Dylans Greatest Hits—Columbia
30. Supremes Sing Holland Dozier Holland—Motown
31. Cabaret—Original Cast—Columbia
32. Groovin'—Young Rascals—Atlantic
33. 4-Tops—Live—Motown

34. Diana Ross & Supremes Greatest Hits—Motown
35. Aretha Arrives—Aretha Franklin—Atlantic
36. The Byrds Greatest Hits—Columbia
37. Here Where There Is Love—Dionne Warwick—Scepter
38. Ode To Billie Joe—Bobbie Gentry—Capitol
39. Album 1700—Peter Paul & Mary—Warner Bros.
40. Claudine—Claudine Longet—A&M
41. Are You Experienced—Jimi Hendrix Experience—Warner Bros.
42. Temptations—Live—Gordy
43. Mamas & Papas—Dunhill
44. Georgy Girl—Seekers—Capitol
45. Reach Out—4 Tops—Motown
46. In The Arms of Love—Andy Williams—Columbia
47. Bee Gees 1st—Atco
48. There's A Kind of Hush All Over The World—Herman's Hermits—MGM
49. 4 Tops Greatest Hits—Motown
50. Vanilla Fudge—Atco

1966

1. SOUND OF MUSIC—SOUNDTRACK—RCA VICTOR
2. WHIPPED CREAM AND OTHER DELIGHTS—HERB ALPERT & TIJUANA BRASS—A&M
3. GOING PLACES—HERB ALPERT & TIJUANA BRASS—A&M
4. Dr. Zhivago—Soundtrack—MGM
5. South of the Border—Herb Alpert & Tijuana Brass—A&M
6. The Best of Herman's Hermits—MGM
7. The Best of the Animals—MGM
8. What Now My Love—Herb Alpert & Tijuana Brass—A&M
9. Lonely Bull—Herb Alpert & Tijuana Brass—A&M
10. Why Is There Air?—Bill Cosby—Warner Bros.
11. Fiddler on the Roof—Original Cast—RCA Victor
12. If You Can Believe Your Eyes and Ears—Mamas & Papas—Dunhill
13. Big Hits (High Tide and Green Grass)—Rolling Stones—London
14. My Name is Barbra, Two—Barbra Streisand—Columbia
15. September of My Years—Frank Sinatra—Reprise
16. Rubber Soul—Beatles—Capitol
17. Wonderfulness—Bill Cosby—Warner Bros.
18. The Dave Clark Five's Greatest Hits—Epic
19. Strangers in the Night—Frank Sinatra—Reprise
20. Spanish Eyes—Al Martino—Capitol
21. Lou Rawls Live—Capitol
22. Aftermath—Rolling Stones—London
23. Golden Hits of Roger Miller—Smash
24. Somewhere My Love—Ray Coniff Singers—Columbia
25. Just Like Us—Paul Revere & the Raiders—Columbia
26. Ballad of the Green Berets—S/Sgt. Barry Sadler—RCA Victor
27. Mary Poppins—Soundtrack—Buena Vista
28. Out of Our Heads—Rolling Stones—London
29. December's Children (and Everybody's)—Rolling Stones—London
30. Boots—Nancy Sinatra—Reprise
31. Houston—Dean Martin—Reprise
32. That Was The Year That Was—Tom Lehrer—Reprise
33. Pet Sounds—Beach Boys—Capitol
34. Help—Beatles—Capitol
35. Soul and Inspiration—Righteous Bros.—Verve
36. Shadow of Your Smile—Johnny Mathis—Mercury
37. Mame—Original Cast—Columbia
38. Crying Time—Ray Charles—ABC-Paramount
39. My Fair Lady—Soundtrack—Columbia
40. Man of La Mancha—Original Cast—Kapp
41. Revolver—Beatles—Capitol
42. Midnight Ride—Paul Revere & the Raiders—Columbia
43. Beach Boys Party—Capitol
44. Sounds of Silence—Simon & Garfunkel—Columbia
45. The Young Rascals—Atlantic
46. Yesterday & Today—Beatles—Capitol
47. Thunderball—Original Motion Picture Soundtrack—United Artists
48. Turn, Turn, Turn—Byrds—Columbia
49. Daydream—Lovin' Spoonful—Kama Sutra
50. Hold On—Herman's Hermits—MGM

1965

1. MARY POPPINS — SOUNDTRACK — BUENA VISTA
2. MY FAIR LADY—SOUNDTRACK—COLUMBIA
3. FIDDLER ON THE ROOF—ORIGINAL CAST—RCA VICTOR
4. Where Did Our Love Go—Supremes—Motown
5. Goldfinger—Soundtrack—United Artists
6. People—Barbra Streisand—Columbia
7. Sound Of Music—Soundtrack—RCA Victor
8. Beatles '65—Capitol
9. Beach Boys In Concert—Capitol
10. Dear Heart—Andy Williams—Columbia
11. Beach Boys Today—Capitol
12. Bringing It All Back Home—Bob Dylan—Columbia
13. Introducing Herman's Hermits—MGM
14. Best Of Al Hirt—RCA Victor
15. Rolling Stones Now—London
16. The Return Of Rober Miller—Smash
17. A Song Will Rise—Peter, Paul & Mary—Warner Bros.
18. My Name Is Barbra Streisand—Columbia
19. Blue Midnight—Bert Kaempfert—Decca
20. Hello Dolly—Original Cast—RCA Victor
21. Whipped Cream & Other Delights—Tijuana Brass—A & M
22. Herman's Hermits On Tour—MGM
23. Louie, Louie—Kingsmen—Wand
24. Beatles VI—Capitol
25. Roustabout—Elvis Presley—RCA Victor
26. Joan Baez #5—Vanguard
27. Girl Happy—Elvis Presley—RCA Victor
28. Everybody Loves Somebody — Dean Martin—Reprise
29. Vinton's Greatest Hits—Epic
30. Dear Heart & Other Songs About Love—Henry Mancini—RCA Victor
31. Yesterday's Gone—Chad & Jeremy—World Artists
32. You've Lost That Lovin' Feelin'—Righteous Bros.—Philles
33. Just Once In My Life—Righteous Bros.—Philles
34. The Roar Of The Greasepaint—Original Cast—RCA Victor
35. The Genius Of Jankowski—Horst Jankowski—Mercury
36. 12 x 5—Rolling Stones—London
37. Ramblin' Rose—Nat King Cole—Capitol
38. L-O-V-E—Nat King Cole—Capitol
39. Hard Day's Night—Beatles—United Artists
40. Marianne Faithfull—London
41. Peter, Paul & Mary In Concert—Warner Bros.
42. Summer Days & Summer Nights—Beach Boys—Capitol
43. Sugar Lips—Al Hirt—RCA Victor
44. All Summer Long—Beach Boys—Capitol
45. Your Cheating Heart—Soundtrack—MGM
46. My Love Forgive Me—Robert Goulet—Columbia
47. Out Of Our Heads—Rolling Stones—London
48. My Fair Lady—Andy Williams—Columbia
49. Downtown—Petula Clark—Warner Bros.
50. That Honey In The Horn Sound—Al Hirt—RCA Victor

1964

1. MEET THE BEATLES—CAPITOL
2. HONEY IN THE HORN—AL HIRT—RCA VICTOR
3. WEST SIDE STORY—SOUNDTRACK—COLUMBIA
4. The Second Barbra Streisand Album—Columbia
5. In The Wind—Peter, Paul & Mary—Warner Bros.
6. Hello Dolly—Original Cast—RCA Victor
7. The Barbra Streisand Album—Columbia
8. Peter Paul And Mary—Warner Bros.
9. Louie, Louie—Kingsmen—Wand
10. Catch A Rising Star—John Gary—RCA Victor
11. Movin'—Peter, Paul, Mary—Warner Bros.
12. Pink Panther—Henry Mancini—RCA Victor
13. Charade—Henry Mancini—RCA Victor
14. Funny Girl—Original Cast—Capitol
15. Hello Dolly—Louis Armstrong—Kapp
16. Introducing The Beatles—Vee Jay
17. Days Of Wine And Roses—Andy Williams—Columbia
18. Ramblin'—New Christy Minstrels—Columbia
19. Shut Down Vol. II—Beach Boys—Capitol

20. Cotton Candy—Al Hirt—RCA Victor
21. Today—New Christy Minstrels—Columbia
22. Joan Baez In Concert—Vanguard
23. The Beatles Second Album—Capitol
24. Getz/Gilberto—Stan Getz & Joao Gilberto—Verve
25. The Singing Nun—Soeur Souire—Philips
26. Call Me Irresponsible And Other Academy Award Winners—Andy Williams—Columbia
27. Great All Over—Dave Clark Five—Epic
28. Trini Lopez At P.J.'s—Reprise
29. Wives And Lovers—Jack Jones—Kapp
30. Little Deuce Coupe—Beach Boys—Capitol
31. Roy Orbison's Greatest Hits—Monument
32. Hard Day's Night—Beatles—United Artists
33. Bye Bye Birdie—Soundtrack—RCA Victor
34. Bach's Greatest Hits—Swingle Singers—Philips
35. Something Special For Young Lovers—Ray Charles Singers—Command
36. Lawrence Of Arabia—Soundtrack—Colpix
37. How The West Was Won—Soundtrack—MGM
38. I Left My Heart In San Francisco—Tony Bennett—Columbia
39. Blue Velvet—Bobby Vinton—Epic
40. All Summer Long—Beach Boys—Capitol
41. Washington Square—Village Stompers—Epic
42. Curb Your Tongue, Knave—Smothers Bros.
43. Fun In Acapulco—Elvis Presley—RCA Victor
44. Painted Tainted Rose—Al Martino—Capitol
45. Think Ethnic—Smothers Bros.—Mercury
46. Sinatra's Sinatra—Reprise
47. Beatles' Song Book—The Hollyridge Strings—Capitol
48. Ingredients In A Recipe For Soul—Ray Charles—ABC Paramount
49. Tender Is The Night—Johnny Mathis—Mercury
50. Something New—The Beatles—Capitol

1963

1. WEST SIDE STORY—SOUNDTRACK—Columbia
2. PETER, PAUL & MARY—Warner Bros.
3. MOVIN'—PETER, PAUL & MARY—Warner Bros.
4. Joan Baez In Concert—Vanguard
5. I Left My Heart In San Francisco—Tony Bennett—Columbia
6. Moon River—Andy Williams—Columbia
7. Lawrence Of Arabia—Soundtrack—Colpix
8. Pot Luck—Elvis Presley—RCA Victor
9. Days Of Wine And Roses—Andy Williams—Columbia
10. Barbra Streisand Album—Columbia
11. Bye Bye Birdie—Soundtrack—RCA Victor
12. Jazz Samba—Stan Getz—Verve
13. How The West Was Won—Soundtrack—MGM
14. I Wanna Be Around—Tony Bennett—Columbia
15. Roy Orbison's Greatest Hits—Monument
16. Surfin' U.S.A.—Beach Boys—Capitol
17. Oliver!—Original Cast—RCA Victor
18. Kingston Trio #16—Capitol
19. Songs I Love To Sing—Frank Fontaine—ABC-Paramount
20. Think Ethnic—Smothers Bros.—Mercury
21. Our Man In Hollywood—Henry Mancini—RCA Victor
22. Richard Chamberlain Sings—MGM
23. Fly Me To The Moon—Joe Harnell—Kapp
24. Johnny's Newest Hits—Johnny Mathis—Columbia
25. James Brown At The Apollo—King
26. Broadway My Way—Nancy Wilson—Capitol
27. Surfing—Ventures—Dolton
28. Cleopatra—Soundtrack—20th Century Fox
29. Alley Cat—Bent Fabric—Atco
30. Trini Lopez At P.J.'s—Reprise
31. Sincerely Yours—Robert Goulet—Columbia
32. Themes For Young Lovers—Percy Faith—Columbia

(Continued on page 80)

SEASONS GREETINGS FROM CARNIVAL

THE MANHATTANS

"I CALL IT LOVE"

C-533

LEE WILLIAMS & THE CYMBALS

THE TOPICS

NORMA JENKINS

THE LOVETTES

CARNIVAL RECORD CORP.

24 Branford Place
Newark, N.J.
(201) 623-3328

In Memoriam

JIMMY KING
RONNIE CALDWELL

PHALON JONES
CARL CUNNINGHAM

The Bar-Kays

ATLANTIC RECORDS • 1967

Season's Greetings

and
THANKS, D.J.'s
for your
usual
fine cooperation

**BABY WHAT YOU
WANT ME TO DO**
LITTLE RICHARD

MODERN 1043

PUSH ME
LOWELL FULSOM

KENT 479

STEAL AWAY

b/w
**NOTHING CAN CHANGE
THE LOVE I HAVE FOR YOU**

Z. Z. HILL

KENT 481

**KENT &
MODERN**

TOP ALBUMS OF THE PAST 7 YEARS

33. Hail The Conquering Nero—Peter Nero—RCA Victor
 34. Shut Down—Beach Boys—Capitol
 35. Sinatra-Basie—Reprise
 36. 1962's Greatest Hits—Billy Vaughn—Dot
 37. It Happened At The World's Fair—Elvis Presley—RCA Victor
 38. I Love You Because—Al Martino—Capitol
 39. New Frontier—Kingston Trio—Capitol
 40. My Son The Celebrity—Allan Sherman (Warner Bros.)
 41. 1962's Early Hits—Lawrence Welk—Dot
 42. Tell Tall Tales—New Christy Minstrels—Columbia
 43. Music Man—Soundtrack—Warner Bros.
 44. Blue Velvet—Bobby Vinton—Epic
 45. Hobo Flats—Jimmy Smith—Verve
 46. Latin Rendezvous—Montovani—London
 47. Happy Beat—Ray Conniff—Columbia
 48. Paul & Paula Sing For Young Lovers—Phillips
 49. Ring Of Fire—Johnny Cash—Columbia
 50. Sunny Side—Kingston Trio—Capitol
- 1962**
1. WEST SIDE STORY—SOUNDTRACK—COLUMBIA
 2. CAMELOT—ORIGINAL CAST—COLUMBIA
 3. BLUE HAWAII—ELVIS PRESLEY—VICTOR
 4. Joan Baez, Vol. 2—Vanguard
 5. Modern Sounds In C&W Music—Ray Charles—ABC-Par.
 6. Peter, Paul & Mary—WB
 7. Your Twist Party—Chubby Checker—Parkway
 8. Judy At Carnegie Hall—Judy Garland—Capitol
 9. Time Out—Dave Brubeck—Columbia
 10. Doin' The Twist At The Peppermint Lounge—Joey Dee—Roulette
 11. Twist—Chubby Checker—Parkway
 12. Moon River—Andy Williams—Columbia
 13. Breakfast At Tiffany—Soundtrack—Victor
 14. Stranger On The Shore—Acker Bilk—Atco
 15. The Stripper—David Rose—MGM
 16. College Concert—Kingston Trio—Capitol
 17. A Song For Young Love—Lettermen—Capitol
 18. Music Man—Soundtrack—WB
 19. Flower Drum Song—Soundtrack—Decca
 20. Pot Luck—Elvis Presley—Victor
 21. I Left My Heart In San Francisco—Tony Bennett—Columbia
 22. Runaround Sue—Dion—Laurie
 23. Moon River—Lawrence Welk—Dot
 24. Best Of The Kingston Trio—Capitol
 25. Hatari—Soundtrack—Victor (747)
 26. Sound Of Music—Original Cast—Columbia
 27. No Strings—Original Cast—Columbia
 28. I Remember Tommy—Frank Sinatra—Reprise
 29. Let There Be Drums—Sandy Nelson—Imperial
 30. Rome Adventure—Soundtrack—WB
 31. Close Up—Kingston Trio—Capitol
 32. Portrait Of Johnny—Johnny Mathis—Columbia
 33. Sinatra & Strings—Capitol
 34. Live It Up—Johnny Mathis—Columbia
 35. Bashin' Jimmy Smith—Verve
 36. Ray Charles' Greatest Hits—ABC-Par.
 37. Something Special—Kingston Trio—Capitol
 38. Roses Are Red—Bobby Vinton—Epic
 39. State Fair—Soundtrack—Dot
 40. Behind The Button-Down Mind—Bob Newhart—WB
 41. George Maharis Sings—Epic
 42. Your Request Sing-Along—Mitch Miller—Columbia
 43. It Keeps Right On A-Hurtin'—Johnny Tillotson—Cadence
 44. Never On Sunday—Connie Francis—MGM
 45. Midnight In Moscow—Kenny Ball—Kapp
 46. Great Motion Picture Themes—UA
 47. 'S Continental—Ray Conniff—Columbia
 48. Lovers Who Wander—Dion—Laurie
 49. Tonight—Ferrante & Teicher—UA
 50. Do The Twist With Ray Charles—Atlantic
 50. Jazz Samba—Stan Getz & Charlie Byrd—Verve
- 1961**
1. CAMELOT—ORIGINAL B'WAY CAST—COLUMBIA
 1. EXODUS—FILM TRACK—RCA VICTOR
 3. GREAT MOTION PICTURE THEMES—VARIOUS ARTISTS—UNITED ARTISTS
 4. G.I. Blues—Elvis Presley—RCA Victor
 5. Sound Of Music—Original B'way Cast—Columbia
 6. Never On Sunday—Film Track—United Artists
 7. Calcutta—Lawrence Welk—Dot
 8. Knockers Up—Rusty Warren—Jubilee
 9. Button Down Mind Strikes Back—Bob Newhart—Warner Bros.
 10. Encore Of Golden Hits—Platters—Mercury
 11. Button Down Mind—Bob Newhart—Warner Bros.
 12. Nice & Easy—Frank Sinatra—Capitol
 13. Make Way—Kingston Trio—Capitol
 14. T.V. Sing Along With Mitch—Mitch Miller—Columbia
 15. All The Way—Frank Sinatra—Capitol
 16. Something For Everybody—Elvis Presley—RCA Victor
 17. Exodus—Mantovani—London
 18. String Along—Kingston Trio—Capitol
 19. Sinatra's Swingin' Session—Frank Sinatra—Capitol
 20. Goin' Places—Kingston Trio—Capitol
 21. Genius + Soul = Jazz—Ray Charles—Impulse
 22. Johnny's Moods—Johnny Mathis—Columbia
 23. Wonderland By Night—Bert Kaempfert—Decca
 24. Brenda Lee—Brenda Lee—Decca
 25. Happy Times Sing-A-Long—Mitch Miller—Columbia
 26. Ring-A-Ding-Ding—Frank Sinatra—Reprise
 27. Last Date—Lawrence Welk—Dot
 28. Judy At Carnegie Hall—Judy Garland—Capitol
 29. Tonight In Person—Limelighters—RCA Victor
 30. Carnival—Original B'way Cast—MGM
 31. Yellow Bird—Lawrence Welk—Dot
 32. Stars For A Summer Night—Various Artists—Columbia
 33. Portrait Of Johnny—Johnny Mathis—Columbia
 34. Memories Are Made Of This—Ray Conniff—Columbia
 35. Rick Is 21—Rick Nelson—Imperial
 36. Sinatra Swings—Frank Sinatra—Reprise
 37. Solid & Raunchy—Bill Black—Hi
 38. Belafonte Returns To Carnegie Hall—Harry Belafonte—RCA Victor
 39. This Is Brenda—Brenda Lee—Decca
 40. Genius Hits The Road—Ray Charles—ABC Paramount
 41. Exodus To Jazz—Eddie Harris—Vee Jay
 42. Bobby Darin Story—Bobby Darin—Atco
 43. Quarter To Three—U.S. Bonds—LeGrand
 44. 60 Years Of Music—Vol. II—Various Artists—RCA Victor
 45. Come Swing With Me—Frank Sinatra—Capitol
 46. Darin At The Copa—Bobby Darin—Atco
 47. The Astronaut—Bill Dana (Jose Jimenez)—Kapp
 48. Unsinkable Molly Brown—Orig. B'way Cast—Capitol
 49. Paul Anka's Big 15—Paul Anka—ABC Paramount
 50. I'll Buy You A Star—Johnny Mathis—Columbia
- 1960**
1. THE SOUND OF MUSIC—ORIGINAL B'WAY CAST—COLUMBIA
 2. The Button Down Mind of Bob Newhart—Warner Bros.
 3. Sold Out—The Kingston Trio—Capitol
 4. Heavenly—Johnny Mathis—Columbia
 5. 60 Years of Music America Loves Best—RCA Victor
 6. Encore of Golden Hits—The Platters—Mercury
 7. Here We Go Again—The Kingston Trio—Capitol
 8. Elvis Is Back—Elvis Presley—RCA Victor
 9. Theme From A Summer Place—Percy Faith—Columbia
 10. Nice 'N' Easy—Frank Sinatra—Capitol
 11. Belafonte At Carnegie Hall—Harry Belafonte—RCA Victor
 12. Faithfully—Johnny Mathis—Columbia
 13. String Along—The Kingston Trio—Capitol
 14. Connie Francis Sings Italian Favorites—MGM
 15. Brenda Lee—Decca
 16. That's All—Bobby Darin—Atco
 17. Paul Anka Sings His Big 15—ABC Paramount
 18. Johnny's Moods—Johnny Mathis
 19. Let's All Sing With The Chipmunks—Liberty
 20. Can Can—Original Film Soundtrack—Capitol
 21. The Lord's Prayer—The Mormon Tabernacle Choir—Columbia
 22. The Edge of Shelly Berman—Verve
 23. Gunfighter Ballads—Marty Robbins—Columbia
 24. Music From Mr. Lucky—Henry Mancini—RCA Victor
 25. Look For A Star—Billy Vaughn—Dot
 26. Sentimental Sing Along With Mitch—Mitch Miller—Columbia
 27. Outside Shelly Berman—Verve
 28. G.I. Blues—Elvis Presley—RCA Victor
 29. Darin At The Copa—Bobby Darin—Atco
 30. For The First Time—Mario Lanza—RCA Victor
 31. Kick Thy Own Self—Brother Dave Gardner—RCA Victor
 32. It's Everly Time—The Everly Bros.—Cadence
 33. This Is Darin—Bobby Darin—Atco
 34. Mario Lanza Sings Caruso Favorites—RCA Victor
 35. Ray Charles In Person—Atlantic
 36. Sing A Hymn With Me—Tennessee Ernie Ford—Capitol
 37. Genius Of Ray Charles—Atlantic
 38. My Name . . . Jose Jimenez—Bill Dana—Signature
 39. Fabulous—Fabian—Chancellor
 40. Elvis' Golden Hits—Vol. 2—Elvis Presley—RCA Victor
 41. Rejoice Dear Hearts—Brother Dave Gardner—RCA Victor
 42. Solid And Raunchy—Bill Black's Combo—Hi
 43. Fireside Sing Along With Mitch—Mitch Miller—Columbia
 44. Mack The Knife—Ella In Berlin—Ella Fitzgerald—Verve
 45. Latin Ala Lee—Peggy Lee—Capitol
 46. Young At Heart—Ray Conniff—Columbia
 47. South Pacific—Original Film Soundtrack—RCA Victor
 48. Woody Woodbury Looks At Love And Life—Stereoddities
 49. 60 Years of Music America Loves Best—Vol. 2—RCA Victor
 50. No One Cares—Frank Sinatra—Capitol

NECROLOGY / 1967

Members of the Music World
Who Died During the Year

LaVerne Andrews, singer
Harold Bakke, Columbia Records
Lady Katharine Bainbridge, comp.
Martin Block, disk jockey
Jack Bregman, publisher
James Brockman, composer
Ronald Caldwell, member Bar-Kays
Jimmy Campbell, composer
Monte Carlo, lyricist
James Cavanaugh, lyricist
Andre Cluytens, conductor
Bud Coleman, guitarist
John Coltrane, saxist
Ida Cox, blues singer
Sylvester Cross, publisher
Carl Cuning, member Bar-Kays
Sylvia Dee, lyricist
Dave Dreyer, pianist-publisher
Nelson Eddy, singer
Mischa Elman, violinist
Brian Epstein, manager
Geraldine Farrar, singer
Syd Foley, publishing
Howard Frye, mandolinist
Richard Gabbe, manager
Walter Gross, composer-arranger
Woody Guthrie, composer-performer
Robert Hall, deejay
Langston Hughes, poet-lyricist
Mississippi John Hurt, blues singer
Phalon Jones, member Bar-Kays
Al Kaplan, MGM comptroller
Oscar Keleman, distributor
Matthew Kelly, member Bar-Kays
Jimmie King, member Bar-Kays
Zoltan Kodaly, composer
Geoffrey O'Hara, composer
Bert Lahr, entertainer
Otis Redding, singer
Fabian Sevitsky, conductor
Louis Singer, composer-arranger
Asher J. Shuffer, sales manager
Eastern Co. of Cambridge, Mass.
Stuff Smith, jazz violinist
Willie Smith, saxist
Muggsy Spanier, cornetist
Rex Stewart, cornetist
Billy Strayhorn, composer-performer
Franz Waxman, composer
John Wesley Work, composer
Carl Zoehrins, pub. sales mgr.

MERRY CHRISTMAS

from

The Beach Boys

THE FIVE AMERICANS ON THE MOVE...

PROGRESSIONS
PROGRESSIONS
PROGRESSIONS
PROGRESSIONS
PROGRESSIONS



COMPATIBLE
STEREO-MONO

ABST-M-2069

ABST-M-2069

ABNAK[®]
MUSIC ENTERPRISES, INC.
DALLAS, TEXAS

COMPATIBLE STEREO-MONO ABST-M-2069

FOR BOOKINGS CONTACT:
BANKERS MANAGEMENT
AND SERVICES, INC.
825 OLIVE / RI 2-6111
DALLAS, TEXAS 75201
— CALL COLLECT —

Foreign Licensees Contact: Publisher's Licensing Corporation 40 West 55th Street, New York 10019, (212) 581-7970

EMPIRE STATE HAS A BETTER IDEA FOR "TOTAL CONCEPT" DISTRIBUTION

A DECADE
OF NEW YORK DISTRIBUTION EXPERIENCE

BERNIE BLOCK

MEL ALBERT

PLUS

A LIVE WIRE SALES & PROMOTION STAFF

EMPIRE STATE RECORD SALES CORP.

10-29 46th ROAD, LONG ISLAND CITY, N.Y. (212) EMpire 1-2700



CashBox Looking Ahead

A compilation, in order of strength, of up and coming records showing signs of breaking into The Cash Box Top 100. List is compiled from retail outlets.

- 1 **NO SAD SONGS**
(Press—BMI)
Joe Simon (Monument 2602)
- 2 **WHERE IS THE PARTY**
(Frobob Polo Al To De Corlo—BMI)
Helena Ferguson (Compass 7009)
- 3 **LITTLE DRUMMER BOY**
(International Korwin—ASCAP)
Lou Rawls (Capitol 2026)
- 4 **BREAK MY MIND**
(Windward Side—BMI)
Bobby Wood (MGM 13797)
- 5 **HEY JOYCE**
(Emallo—BMI)
Lou Courtney (Riverside 4594)
- 6 **UP TIGHT GOOD MAN**
(Fame—BMI)
Laura Lee (Chess 2030)
- 7 **OO BABY**
(Ollie McLoughlin—BMI)
Deon Jackson (Carla 2537)
- 8 **CROSS MY HEART**
(Chevis—BMI)
Billy Stewart (Chess 2002)
- 9 **I WONDER WHAT SHE'S DOING TONIGHT**
(Screen Gems—Columbia—BMI)
Boyce & Hart (A&M 893)
- 10 **MR. BUS DRIVER**
(Earl Barton—BMI)
Bruce Chenell (Mola 579)
- 11 **BIG DADDY**
(Acuff-Rose—BMI)
Booie Rondolph (Monument 1038)
- 12 **OH HOW IT HURTS**
(Brockbuster—BMI)
Barboro Moson (Arctic 137)
- 13 **MELLOW MOONLIGHT**
(Evejim—BMI)
Leon Haywood (Decco 32230)
- 14 **7:30 GUIDED TOUR**
(Sunnybrook—BMI)
Five Americans (Abnak 126)
- 15 **I CALL IT LOVE**
(Sonavan—BMI)
Monhottons (Carnival 533)
- 16 **SHOUT**
(Wemar Nom—BMI)
Lulu (London 40021)
- 17 **FOR WHAT IT'S WORTH**
(Cotillion, East—BMI)
King Curtis & King Pins (Atco 6534)
- 18 **DO ON TO OTHER**
(BOOME—BMI)
Paul Revere & Raiders (Columbia 1386)
- 19 **ON A SATURDAY NIGHT**
(East—BMI)
Eddie Floyd (Stax 233)
- 20 **SOMEBODY SLEEPING IN MY BED**
(East—BMI)
Johnny Taylor (Stax 235)
- 21 **FINDERS KEEPERS**
(Myto Music—BMI)
Al Kent (Ric Tic 133)
- 22 **FOXKEY LADY**
(Sea Lark Yamefo—BMI)
Jimi Hendrix (Reprise 0641)
- 23 **MOCKINGBIRD**
(Solurn—BMI)
Aretho Fronklin (Columbia 44381)
- 24 **HOW BEAUTIFUL OUR LOVE IS**
(Cotologue—BMI)
Plotters (Musicor 1288)
- 25 **MAGIC COLORS**
(Screen Gems Columbia—BMI)
Lesley Gore (Mercury 72759)
- 26 **TONY ROME**
(Sergeant—ASCAP)
Nancy Sinotro (Reprise 0636)
- 27 **FACE THE AUTUMN**
(Trendsetters—ASCAP)
Family (USA 886)
- 28 **YAKETY YAK**
(Tiger—BMI)
Sam The Shom (MGM K 13863)
- 29 **OH HOW MUCH I LOVE YOU**
(Miller—ASCAP)
Jack Jones (Kapp 880)
- 30 **MORE THAN A MIRACLE**
(Leo Feist—ASCAP)
Roger Williams (Kapp 843)
- 31 **PSYCHEDELIC SOUL**
(Cloman—BMI)
Chylds (Reprise 7095)
- 32 **TOMORROW**
(Alarm Clock—ASCAP)
Strowberry Alarm Clock (Uni 55046)
- 33 **DO WHAT YOU GOTTA DO**
(Johnny Rivers—BMI)
Al Wilson (Soul City 761)
- 34 **LOVE IS BLUE**
Paul Mauriat (Philips 40495)
- 35 **PLEASE BELIEVE ME**
(Ron Com—ASCAP)
Jimmy Roselli (United Artists 50234)
- 36 **I'M COMING HOME**
(Edwin H. Morris—ASCAP)
Tom Jones (Parrot 40024)
- 37 **TOO OLD TO GO WAY LITTLE GIRL**
(Diogenes—BMI)
Shome (Poppy 501)
- 38 **THAT LUCKY OLD SUN**
(Robbins—ASCAP)
Bill Medley (Verve 10569)
- 39 **ZABADAK**
(Al Gollico—BMI)
Dove Dee Dozy Beaky Mick & Tick (Imperial 66270)
- 40 **WHEN THE LIGHTS GO ON AGAIN**
(Porgie—BMI)
Koy Storr (ABC 11013)
- 41 **A MAN NEEDS A WOMAN**
(Rise—Aim—BMI)
James Carr (Goldwax 332)
- 42 **MISSION IMPOSSIBLE**
(Bruin—BMI)
Lolo Schiffrin (Dot 17059)
- 43 **A LOVE THAT'S REAL**
(Rozor Shorp—BMI)
The Intruders (Gamble 209)
- 44 **WHAT A STRANGE TOWN**
(E. B. Marks—BMI)
Jimmie Rodgers (A&M 898)
- 45 **DON'T LOSE YOUR GROOVE**
(Street Car—BMI)
Lovell Hardy (Rojoc 117)
- 46 **OLD TOY TRAINS**
(Tree—BMI)
Roger Miller (Smash 2130)
- 47 **NEVER TOO MUCH LOVE**
(Curtion—BMI)
Bards (Capitol 2041)
- 48 **HEY BOY**
(Green Light—BMI)
Eighth Day (Kapp 862)
- 49 **KEEP YOUR COOL**
(Fome—BMI)
Terry & The Chain Reaction (United Artists 50199)
- 50 **KITES ARE FUN**
(Winborn Almitra—ASCAP)
Free Design (Project 31324)

*IF you are reading
someone else's copy of*

CashBox

why not mail this coupon

today!

CASH BOX
1780 BROADWAY
NEW YORK, N. Y. 10019

Enclosed find my check.

- \$20 for a full year (52 weeks) subscription (United States, Canada, Mexico)
- \$40 for a full year (Airmail United States, Canada Mexico)
- \$30 for a full year (other countries)
- \$45 for a full year (Airmail other countries)

(Check One)

I AM A
DEALER
ONE STOP
DISTRIB
RACK JOBBER
PUBLISHER
RECORD CO.
DISK JOCKEY
COIN FIRM
OTHER

NAME

FIRM

ADDRESS

CITY STATE ZIP #

Be Sure To Check Business Classification Above!



ALL GAVIN RADIO/RECORD AWARD #1 POP-ROCK RECORDING ARTIST '67

Vital Statistics

DETAILED INFORMATION ABOUT TITLES ON THE CASH BOX TOP 100 THIS WEEK

* New To The Top 100

#1
DAYOREAM BELIEVER (2:57)-Monkees-Colgems 1012
711 5th Ave., NYC
PROD: Chip Douglas
8757 Wonderland Pk. Ave., L.A., Cal.
PUB: Screen Gems BMI-711 5th Ave., NYC
WRITER: John Stewart-FLIP: Goin' Down

#2
HELLO GOODBYE (3:24) Beatles-Capitol 2056
1750 N. Vine, Hollywood, Calif.
PROD: George Martin c/o A.I.R. London,
101 Baker St., London, W.2. Eng.
WRITERS: Lennon & McCartney
FLIP: I'm A Walrus

#3
I SECOND THAT EMOTION (2:39)
Smokey Robinson & Miracles-Tamla 54149
2648 W. Grand Blvd., Det., Mich.
PROD: Smokey Robinson & A. Cleveland (Tamla)
PUB: Jobete BMI (same address)
WRITERS: Robinson, Cleveland
FLIP: You Must Be Love

#4
I HEAR IT THRU THE GRAPEVINE (2:53)
Helios Knight & The Pips-Soul 35039
2648 W. Grand Blvd., Detroit, Mich.
PROD: N. Whitfield c/o Soul
PUB: Jobete BMI-address above
WRITERS: Whitfield-Strong
FLIP: It's Time To Go Now

#5
THE RAIN, THE PARK, AND OTHER THINGS (2:57)
The Cowbills—MGM 13810
1350 Ave. of the Americas, NYC
PROD: Artie Kornfeld c/o Mylin Prod.
PUB: Akbestal & Luvilyn BMI-888 8th Av., NYC
WRITERS: A. Kornfeld-S. Duboff
ARR: Jimmy Wisner-FLIP: River Blue

#6
CHAIN OF FOOLS (2:45)
Aretha Franklin-Atlantic 2464
1841 Broadway, NYC.
PROD: Jerry Wexler (Atlantic)
PUB: 14th Hour-BMI 1721 Field, Det., Mich.
Pronto-BMI 1841 Broadway, NYC.
WRITER: Don Covay FLIP: Prove It

LITTLE DRUMMER BOY

Lou Rawls.....(Capitol)
Harry Simeone Chorale... (20th-Fox)
Bert Kaempfert.....(Decca)
Midnight String Quartet.....(Dot)
Stevie Wonder.....(Tamla)
Joan Baez.....(Vanguard)
Ed Sullivan.....(Columbia)
Floyd Cramer.....(RCA-Victor)
Merv Griffin.....(MGM)
Do-Re-Mi Children's Chorus..(Kapp)
Ferrante & Teicher.....(U.A.)
Lennon Sisters.....(Dot)

SLEIGH RIDE

Leroy Anderson.....(Decca)
Jim Nabors.....(Columbia)
Roy Rogers.....(Capitol)
Andre Kostelanetz.....(Columbia)
Henry Mancini.....(RCA-Victor)
Andy Williams.....(Columbia)
Al Caiola.....(U.A.)
Al Hirt.....(RCA-Victor)
New Cristy Minstrels... (Columbia)
Hermanos Zavala.....(Capitol)
Jack Jones.....(Kapp)
Boston Pops Orchestra.. (RCA Victor)

CARAVAN

Bert Kaempfert.....(Decca)

KEEP ON DANCIN'

Harper & Rowe.....(White Whale)

WHO'S SORRY NOW

Bobby Vinton.....(Epic)

I CAN'T BELIEVE THAT YOU'RE IN LOVE WITH ME

Virginia Wolves.....(ABC)

THE SHEIK OF ARABY

Jim Kweskin Jug Band....(Reprise)

RED ROSES FOR A BLUE LADY

Ernie Freeman.....(Dunhill)



MILLS MUSIC, INC.
1790 Broadway
New York, N.Y. 10019

#7
WOMAN, WOMAN (3:12)-Union Gep-Columbia 44297
51 W. 52 St., NYC
PROD: Jerry Fuller c/o Columbia
6121 Sunset Blvd., L.A., Cal.
PUB: Glaser BMI-801 16 Av S., Nashville, Tenn.
WRITERS: J. Glazer, J. Payne
ARR: Al Capps-FLIP: Don't Make Promises

#8
YOU BETTER SIT DOWN KIDS (3:42)
Cher-Imperial 66261
6920 Sunset Blvd., L.A., Calif.
PROD: Sonny Bono c/o De Carlo-Kreske
8560 Sunset Blvd., L.A., Calif.
PUB: Chrismarc BMI-c/o Salvalor Bono
7715 Sunset Blvd., L.A., Calif.
Cotillion BMI-1841 B'way, NYC
WRITER: Sonny Bono
ARR: Harold R. Battiste Jr.-FLIP: Elusive Butterfly

#9
BEND ME SHAPE ME (2:05)
American Breed-Acta 811
6565 Sunset Blvd., H'wood, Calif.
PROD: Bill Traut for Dunwich Prod.
25 E. Chestnut, Chicago, Ill.
PUB: Helios BMI 1619 Bway, NYC.
WRITERS: English-Weiss
ARR: Bill Traut-E. Higgins FLIP: Mindrocker

#10
BOOGALOO OWEN BROADWAY (2:41)
Fantastic Johnny C-Phil-L.A. Of Soul #305
919 N. Broad St., Philadelphia, Pa.
PROD: Jesse James c/o Jamie-Guyden
PUB: Dandelion BMI-same address
James Boy Music BMI-Norristown, Pa.
WRITER: J. James
FLIP: Look What Love Can Make You Do

#11
SKINNY LEGS AND ALL (3:10)-Joe Tex-Oial 4063
1841 B'way, N.Y., N.Y.
PROD: Buddy Killen c/o Tree Music
PUB: Tree BMI-905 16th Ave. S., Nashville, Tenn.
WRITER: Joe Tex
FLIP: Watch The One (That Brings The Bad News)

#12
IN AND OUT OF LOVE (2:37)
Oiana Ross & Supremes-Motown 1116
2648 W. Grand Blvd., Det., Mich.
PROD: Holland, Dozier c/o Motown
PUB: Jobete BMI (same address)
WRITERS: Holland, Dozier, Holland
FLIP: I Guess I'll Always Love You

#13
SNOOPY'S CHRISTMAS (3:10)
Royal Guardsmen-Laurie 3416
165 West 46 Street, NYC
PROD: Phil Gernhard
6747 1st Ave. S., St. Petersburg, Fla.
PUB: S&J ASCAP c/o Schwartz 35 W. 45 St. NYC.
Next Day ASCAP c/o Hugo & Luigi 1619 Bway, NYC.
Kaiser ASCAP 1631 Broadway, NYC
WRITERS: Hugo & Luigi-G. Weiss
FLIP: It Kinda Looks Like Christmas

#14
MASSACHUSETTS (2:18)-Bee Gees-Atco 6532
1841 B'way, NYC
PROD: Robt Stigwood, Sutherland House,
Argyle St., London W1, England
PUB: Nemperor BMI-221 W. 57 St., NYC
WRITERS: B. Gibb, M. Gibb, R. Gibb
ARR: Bill Shepherd
FLIP: Sir Geoffrey Saved The World

#15
SHE'S MY GIRL (2:32)-Turtles-White Whale 260
8961 Sunset Blvd., L.A., Cal.
PROD: Joe Wissert for Koppelman & Rubin,
1650 B'way, NYC
PUB: Chardon-BMI 1650 B'way, NYC
ARR: Gordon Bonner-FLIP: Chicken Little Was Right

#16
SUMMER RAIN (3:30)
Johnny Rivers-Imperial 66267
6920 Sunset Blvd., L.A., Calif.
PROD: Work c/o Johnny Rivers (same address)
PUB: Johnny Rivers BMI (same address)
WRITER: Jim Hendricks
FLIP: Memory Of The Coming Good

#17
JUDY IN DISGUISE (2:47)
John Fred & His Playboy Band-Paula 282
728 Texas, Shreveport, La.
PROD: John Fred, Abe Bernard
236 Eugene St., Baton Rouge, La.
PUB: Su Ma BMI (same address as Paula)
WRITERS: J. Fred-A. Bernard
ARR: A. Bernard FLIP: When The Lights Go Out

#18
HONEY CHILE (2:56)
Martha Reeves & Vandellas-Gordy 7067
2648 W. Grand Blvd., Detroit, Mich.
PROD: R. Morris c/o Gordy
PUB: Jobete BMI (same address as Gordy)
WRITERS: Morris-Moy-FLIP: Show Me The Way

#19
INCENSE & PEPPERMINTS (2:37)
Strawberry Alarm Clock-Uni 55018
8255 Sunset Blvd., L.A., Calif.
PUB: Claridge ASCAP
6362 Hollywood Blvd., H'wood, Cal.
PROD: Frank Slay & Bill Holmes-c/o Claridge
WRITERS: J. Carter-T. Gilbert
FLIP: The Birdman Of Alkatrash

#20
IT'S WONDERFUL (2:30)
Young Rascals-Atlantic 2463
1841 Broadway, NYC.
PROD: Young Rascals c/o Slacсар
PUB: Slacсар BMI-444 Madison Ave., NYC.
WRITERS: Felix Cavaliere-Eddie Brigati
ARR: Arif Mardin FLIP: Of Course

#21
A DIFFERENT DRUM (2:38)
Stone Poneys-Capitol 2004
1750 N. Vine, H'wood, Cal.
PROD: Nick Venet (same address)
PUB: Screen Gems, Col. BMI 711 5th Av., NYC
WRITER: Mike Nesmith FLIP: I've Got To Know

#22
I SAY A LITTLE PRAYER (3:04)
Dionne Warwick-Scepter 12203
254 W. 54th St., NYC
PROD: Hal David-Burt Bacharach
c/o Fred Ahlert-15 E. 48th St., NYC
PUB: Blue Seas ASCAP-Jac ASCAP
15 E. 48th St., N.Y., N.Y.
WRITERS: Hal David-Burt Bacharach
ARR: Bacharach-FLIP: Theme from Valley of the Dolls

#23
NEXT PLANE TO LONDON (2:30)
Rose Garden-Atco 6510
1841 Bway, NY, NY
PROD: Greenstone York Pala Prod.
7715 Sunset Blvd., L.A., Calif.
PUB: Myrwood & Antiers Music BMI
c/o Kenneth G. Gist, Jr.
3696 Orcutt Rd., Santa Maria, Calif.
FLIP: Flower Town

#24
LAZY DAY (3:05)-Spanky & Our Gang-Mercury 72732
35 E. Wacker Dr., Chicago, Ill.
PROD: Jerry Ross c/o Mercury
745 5th Ave., NYC
PUB: Screen Gems BMI
711 Fifth Av., N.Y., N.Y.
WRITERS: Geo. Fischhoff-Tony Powers
ARR: Jimmy Wisner
FLIP: It Ain't Necessarily (Byrd Ave.)

#25
KEEP THE BALL ROLLIN' (3:04)
Jay & The Techniques-Smash 2124
745 5th Ave., N.Y., N.Y.
PROD: Jerry Ross (Mercury)
PUB: Screen Gems BMI-711 5th Ave., NYC
WRITERS: D. Randle-S. Linzer
ARR: Jimmy Wisner-FLIP: Here We Go Again

#26
IF I COULD BUILD MY WHOLE WORLD AROUND YOU (2:21)
Marvin Gaye & Tammi Terrell-Tamla 54161
2648 W. Grand Blvd., Detroit, Mich.
PROD: Fuqua & Bristol c/o Tamla
PUB: Jobete BMI (same address)
WRITERS: Fuqua, Bristol & Bullock
FLIP: If This World Were Mine

#27
BEAUTIFUL PEOPLE (2:10)-Bobby Vee-Liberty 56009
6920 Sunset Blvd., L.A., Calif.
PROD: Dallas Smith c/o Liberty
PUB: Mirwood BMI-221 W. 57 St. NYC
WRITER: Kenny Gist Jr.
ARR: Dallas Smith-FLIP: I May Be Gone

#28
NEON RAINBOW (2:59)-Box Tops-Mala 580
1776 B'way, NYC
PROD: Darl Penn-2870 Baskin, Memphis, Tenn.
PUB: Earl Barton BMI
1121 S. Glenstone, Springfield, Mo.
WRITER: Wayne Carson Thompson
FLIP: Everything I Am

#29
BY THE TIME I GET TO PHOENIX (2:42)
Glen Campbell-Capitol 2015
PROD: Al De Lory-c/o Capitol
PUB: Johnny Rivers Music BMI
9028 Sunset Blvd., Los Angeles 69
WRITER: Jim West-ARR: Glen Campbell
FLIP: You've Still Got A Place In My Heart

#30
LOVE ME TWO TIMES (2:37)-Ooors-Elektra 45624
1855 B'way, N. Y., N. Y.
PROD: Paul Rothchild c/o Elektra Rec.
PUB: Nipper Music ASCAP-(same address)
WRITERS: The Doors-ARR: Same
FLIP: Moonlight Drive

#31
AND GET AWAY (2:35) Esquires-Bunky 7752
c/o Scepter 254 W. 54 St., NYC.
PROD: Bill Sheppard c/o Bunky
PUB: Hi-Mi BMI 7750 S. Calumet Av., Chi., Ill.
Flomar BMI 254 W. 54 St., NYC.
WRITERS: G. Moorer-B. Sheppard
ARR: Tom Tom FLIP: Everybody's Laughing

#32
WEAR YOUR LOVE LIKE HEAVEN (2:26)
Donovan-Epic 10253
51 W. 52nd St., NYC
PROD: Mickie Most
155 Oxford St., London, England
PUB: Peer Int'l BMI-1619 Bway, NYC
Hi-Count BMI-Time & Life Bldg., NYC
WRITER: D. Leitch-FLIP: Oh Gosh

#33
THE OTHER MAN'S GRASS IS ALWAYS GREENER (3:02)-Petula Clark-Warner Bros. 7097
3701 Warner Blvd., Burbank, Calif.
PROD: Tony Hatch c/o Pye Records
A.T.U. House-Cumberland Pl., London W.1, Eng.
PUB: Northern ASCAP-445 Park Ave., NYC
WRITERS: Hatch & Trent-FLIP: At The Crossroads

#34
SUSAN (2:48) Buckinghams-Columbia 44378
51 West 52nd Street, NYC.
PROD: James William Guercio
151 El Camino Dr., Beverly Hills, Cal.
PUB: Bag O Tunes BMI c/o Richard Shelton
79 West Monroe Street, Chicago, Ill.
Diogens BMI (same address)
WRITERS: Holway-Beisbier
ARR: J. W. Guercio FLIP: Foreign Policy

#35
BEAUTIFUL PEOPLE (2:22)-Kenny O'Dell-Vegas 718
c/o White Whale-8961 Sunset Blvd., L.A., Cal.
PUB: Ishmael BMI (same address)
PROD: Porter & O'Dell
WRITER: Kenny Gist, Jr.-FLIP: Flower Girl

#36
SINCE YOU SHOWED ME HOW TO BE HAPPY (2:45)
Jackie Wilson-Brunswick 55354
445 Park Ave., New York, N. Y.
PROD: Carl Davis c/o Brunswick
PUB: Jalyne BMI 2203 Spruce St., Phila., Pa.
BRC-BMI 445 Park Ave., NYC.
WRITERS: G. Jackson-F. Smith-G. Sims
FLIP: The Who Who Song

#37
YESTERDAY (2:42)-Ray Charles-ABC 11009
1330 Av. of Americas, NYC
PROD: Joe Adams
2107 W. Washington Blvd., L.A., Cal.
PUB: MacLen BMI-1780 B'way, NYC
WRITERS: Lennon, McCartney
ARR: Sid Feller
FLIP: Never Had Enough Of Nothing Yet

#38
I CAN SEE FOR MILES (3:55)-The Who-Decca 32206
445 Park Ave., N.Y., N.Y.
PROD: Kit Lambert
EXEC. PROD: Chris Stamp (Decca, Eng.)
PUB: Essex ASCAP-10 Columbus Circle, NYC
WRITER: Peter Townshend
FLIP: Mary-Anne With The Shaky Hands

#39
PLEASE LOVE ME FOREVER (2:34)
Bobby Vinton-Epic 10228
51 W. 52 St., NYC
PROD: Billy Sherrill-c/o Epic
PUB: Selma BMI c/o M. Craft-225 E. 57, NYC
WRITERS: J. Malone-O. Blanchard-FLIP: Miss America

#40
AN OPEN LETTER TO MY TEENAGE SON (4:09)
Victor Lundberg-Liberty 55996
6920 Sunset Blvd., H'wood, Cal.
PROD: Jack Tracey c/o Liberty
PUB: Asa ASCAP c/o Liberty
WRITER: Robert R. Thompson-FLIP: My Buddy Carl

#41
DANCING BEAR (3:07) Mamas & Papas-Ounhill 4113
449 S. Beverly Dr., Bev. Hills, Cal.
PROD: Lou Adler 8428 Sunset, Hollywood, Cal.
PUB: Wingate ASCAP c/o Dunhill
WRITER: John Phillips FLIP: John's Music Box

#42
WATCH HER RIDE (3:11)
Jefferson Airplane-RCA Victor 9389
155 East 24 Street, NYC.
PROD: Al Schmitt c/o RCA Victor
6363 Sunset Blvd., Hollywood, Calif.
PUB: Jefferson Airplane c/o Wally Brady
1800 N. Argyle Ave., Hollywood, Calif.
WRITER: Kantner FLIP: Martha

#43
PATA PATA (3:10) Miriam Makeba-Reprise 0606
3701 Warner Blvd., Burbank, Calif.
PROD: Jerry Ragovoy-219 W. 79 St., N.Y., N.Y.
PUB: Xina ASCAP-c/o L. Lewis-345 W. 58 St., NYC
WRITERS: Makeba-Ragovoy
ARR: Jimmy Wisner
FLIP: The Ballad Of The Sad Young Man

#44
PEACE OF MIND (2:35)
Paul Revere & Raiders-Columbia 44335
51 West 52 St., NYC
PROD: Terry Melcher c/o ABC
449 So. Beverly Dr., Beverly Hills, Cal.
PUB: Daywin BMI 250 N. Canon Dr. Bev. Hills, Calif.
WRITERS: M. Lindsay-T. Melcher
ARR: T. Melcher-FLIP: Do Unto Others

#45
OKOLONA RIVER BOTTOM BAND (3:05)
Bobbie Gentry-Capitol 2044
1750 N. Vine, H'wood, Calif.
PROD: Kelly Gordon c/o Capitol
PUB: Larry Shayne ASCAP
6290 Sunset Blvd., H'wood, Calif.
WRITER: Bobbie Gentry
ARR: Jimmie Haskell FLIP: Penduli Pendulum

#46
I CAN'T STAND MYSELF (WHEN YOU TOUCH ME) (3:25) James Brown-King 6144
1540 Brewster Ave., Cincinnati, Ohio.
PROD: James Brown (King)
PUB: Taccoa BMI & Soil BMI c/o King
WRITER: James Brown
ARR: James Brown FLIP: There Was A Time

#47
MONTEREY (4:21)
Eric Burdon & The Animals-MGM 13868
1350 Ave. of the Americas, NYC
PROD: Tom Wilson c/o MGM
PUB: Slamina BMI 1619 Bway, NYC.
Sea Lark BMI 25 West 56th St., NYC.
WRITERS: Burdon-Briggs-Weider-
Jenkins-McCulloch
FLIP: Ain't That So.

#48
I'M A WALRUS (4:35)-Beatles-Capitol 2056
1750 N. Vine, Hollywood, Calif.
PROD: George Martin-c/o A.I.R. London
101 Baker St., London W.2, England
PUB: Mac Len-BMI-1780 B'way, NYC
WRITERS: Lennon & McCartney-FLIP: Hello Goodbye

#49
BEST OF BOTH WORLDS (2:59) Lulu-Epic 10260
52 W. 52 St., NYC.
PROD: Mickie Most
155 Oxford St
London, England
PUB: Dick James BMI 1780 Bway, NYC
WRITERS: D. Black-M. London
ARR: John Paul Jones-Peter Knight
FLIP: Love Loves To Love Love

#50
O-O, I LOVE YOU (2:58)-Oells-Cadet 5574
320 E. 21 St., Chicago, Ill.
PROD: Bobby Miller c/o Cadet
PUB: Cheviss BMI (same address)
WRITER: Bobby Miller
ARR: Chas. Stepney-FLIP: There Is

#51
I'LL BE SWEETER TOMORROW (2:45) O'Jays-Bell 691
1776 Broadway, NYC
PROD: Geo. Kerr for MIA Prod. c/o Bell
PUB: Zira BMI-P.O. Box 53, Manhattanville, N.Y.
Floteca BMI c/o Jack Pearl, 515 Mad. Av. NYC
Mia ASCAP-1776 Broadway, NYC
WRITERS: S. Poindexter-M. Thomas-J. Members-
R. Poindexter
ARR: Richard Tee FLIP: I Dig Your Act



Point of departure: the new West Coast sound
Destination: Chartsville
Estimated arrival time: Now

THE EXPRESS

out in front on track #1 with the original hit version of

LITTLE BIT OF LOVIN'

Produced by Richard Delvy for Robbins Productions

K-13851

Their first non-stop single on

MGM Records is a division of
Metro-Goldwyn-Mayer Inc.



MGM
RECORDS



Vital Statistics

DETAILED INFORMATION ABOUT TITLES ON THE CASH BOX TOP 100 THIS WEEK

* New To The Top 100

- #52
EVERYBODY KNOWS (2:15)
Dave Clark Five-Epic 10265
51 West 52nd Street, NYC.
PROD: Dave Clark c/o Epic
PUB: Francis, Day & Hunter ASCAP
745 Fifth Ave., NYC.
WRITERS: L. Reed-B. Mason
ARR: Les Reed FLIP: Inside & Out
- #53
GOIN' OUT OF MY HEAD/
CAN'T TAKE MY EYES OFF YOU (2:55)
Lettermen-Capitol 2054
1750 N. Vine, Hollywood, Calif.
PROD: Kelly Gordon c/o Capitol
PUB: Saturday BMI-1841 B'way, NYC.
& Seasons Four BMI-1501 B'way, NYC.
(Can't Take My Eyes Off You)
Vogue BMI-2449 Wilshire Blvd
Santa Monica, Calif. (Goin' Out Of My Head)
WRITERS: Ted Randazzo & Bobby Weinstein
(Goin' Out Of My Head)
Bob Crewe & Bob Gaudio (Can't Take My
Eyes Off You)
ARR: Perry Botkin Jr. FLIP: I Believe
- #54
WHO WILL ANSWER? (3:42)
Ed Ames-RCA Victor 9400
155 East 24th St., NYC.
PROD: Jim Fogelsohn c/o RCA
PUB: Sunbury ASCAP 1650 B'way, NYC.
WRITERS: Davis-Aute
ARR: Perry Botkin Jr.
FLIP: My Love Is Gone From Me
- #55
COME SEE ABOUT ME (2:57)
Jr. Walker & The All Stars-Soul 35041
2648 W. Grand Blvd., Detroit, Mich.
PROD: Holland-Dozier c/o Soul
PUB: Jobete BMI (same address)
WRITERS: Holland-Dozier-Holland
FLIP: Sweet Soul

- #56
I'M IN LOVE (2:25) Wilson Pickett-Atlantic 2448
1841 B'way, NYC
PROD: Tom Dowd-Tommy Cogbill c/o Atlantic
PUB: Pronto-BMI-1841 B'way, NYC
Tracebob-BMI-1337 Via Del Ray
S. Pasadena, Calif.
WRITER: Bobby Womack-FLIP: Stagger-Lee
- #57
WHAT'S IT GONNA BE (2:11)
Dusty Springfield-Philips 40498
35 E. Wacker Dr. Chicago, Ill.
PUB: Rumbalero BMI-1619 B'way, NYC
Ragmar BMI-219 W. 79 St., NYC
WRITERS: Ragovoy-Shuman
ARR: Gary Sherman-FLIP: Small Town Girl
- #58
TELL MAMA (2:20)-Etta James-Cadet 5578
320 E. 21st St., Chicago, Ill.
PROD: Rick Hall, c/o Fame Rec. Studio
Muscle Shoals, Ala.
PUB: Fame BMI (same address)
WRITER: Clarence Carter-ARR: Rick Hall & Staff
FLIP: I'd Rather Go Blind
- #59
TO SIR WITH LOVE (2:44) Lulu-Epic 40187
51 W. 52 St., NYC
PROD: Mickie Most
c/o Allen Klein, Warwick Hotel, NYC
PUB: Screen Gems BMI-711 5th Av., NYC
WRITERS: D. Black-M. London
FLIP: The Boat That I Row

- #60
BABY YOU GOT IT (2:00)
Brenton Wood-Double Shot 121
6515 Sunset Blvd., L.A., Calif.
PROD: Hooven-Winn, 8255 Sunset Blvd., L.A., Calif.
PUB: Big Shot BMI c/o Double Shot
WRITERS: A. Smith-J. Hooven-J. Winn
FLIP: Catch You On The Rebound
- #61
TOO MUCH OF NOTHING (2:30)
Peter Paul & Mary-Warner Bros. 7092
3701 Warner Blvd., Burbank, Calif.
PROD: Albert B. Grossman-Milton Okun
50 Central Park W., NYC.
PUB: Dwarf Music BMI, 15 E. 48 St., NYC.
WRITER: Bob Dylan
ARR: Milton Okun FLIP: House Song

- #62
GREEN TAMBOURINE (2:22) Lemon Pipers-Buddah 23
1650 B'way, NYC.
PROD: Paul Leka (c/o Buddah)
PUB: Kama Sutra BMI (same address)
WRITERS: P. Leka-S. Pinz
ARR: Paul Leka FLIP: No Help From Me
- #63
AM I THAT EASY TO FORGET (3:05)
Engelbert Humperdinck-Parrot 40023
538 West 25th Street, NYC.
PROD: Peter Sullivan
A.I.R., 101 Baker St., London W.I. Eng.
PUB: 4 Star BMI
9220 Sunset Blvd, L.A. Calif.
WRITERS: Belew-Stevenson
FLIP: Pretty Ribbons

- #64
DEAR ELOISE (2:59)-Hollies-Epic 10251
51 W. 52nd Street, NYC
PROD: Don Richards
101 Baker St., London, England
PUB: Maribus Music-BMI-1780 B'way, NYC
WRITERS: T. Hicks, A. Clarke, G. Nash
FLIP: When Your Lights Turned On

- #65
MY BABY MUST BE A MAGICIAN (2:31)
Marvelettes-Tamla 54158
2648 W. Grand Blvd, Detroit, Michigan.
PROD: Smokey Robinson c/o Tamla
PUB: Jobete BMI (same address)
WRITER: William Robinson FLIP: I Need Someone
- #66
LOVE POWER (2:10)-Sandpebbles-Calla 141
1631 B'way, New York, N. Y.
PROD: Teddy Vann, 1619 B'way, NYC
WRITERS: C. White, T. Vann
ARR: Sammy Lowe-FLIP: Because Of Love

- #67
BACK UP TRAIN (2:17)-Al Greene-Hot Line 15000
c/o Bell, 1776 B'way NYC
PROD: A. Rodgers-c/o James Production (Bell)
PUB: Tosted-BMI
1315 Cass St. S.E., Grand Rapids, Mich.
WRITERS: Palmer James-Curtis Rodgers
FLIP: Don't Leave Me

- #68
IN ANOTHER LAND (2:48) Bill Wyman-London 907
539 West 25th Street, NYC.
PROD: Rolling Stones
c/o Allen Klein Assoc., Warwick Hotel, NYC.
PUB: Gideon BMI-1271 6th Ave., NYC
WRITER: Bill Wyman
ARR: Rolling Stones FLIP: The Lantern

- #69*
LITTLE BECKY'S CHRISTMAS WISH (2:58)
Becky Lamb-Warner Bros. 7154
4000 Warner Blvd., Burbank, Calif.
PROD: Dick Glasser c/o Warner Bros.
PUB: Cariman BMI
8581 Wood Hollow Rd., Northfield, Ohio.
WRITERS: De Angelo, Casaban
ARR: Al Capps FLIP: Go To Sleep Little Lamb

- #70
COVER ME (2:56) Percy Sledge-Atlantic 2453
1841 Broadway, NYC
PROD: Quinn Ivy & Marlin Greene
c/o Norala Rec. Co., 102 E. 2 St., Sheffield, Ala.
PUB: Pronto BMI-1841 B'way, NYC
Quincy, BMI-P.O. Box 215, Sheffield, Ala.
WRITERS: M. Greene-Eddie Hinton
FLIP: Behind Every Great Man There's A Woman

- #71
DANCING OUT OF MY HEART (2:35)
Ronnie Dove-Diamond 233
1650 B'way, NYC.
PROD: Phil Kahl c/o Diamond
PUB: Richard Irwin ASCAP (same address)
WRITERS: A. Badale-C. Harma
ARR: Ray Stevens FLIP: Back From Baltimore

- #72
NOBODY BUT ME (2:11) Human Beinz-Capitol 5990
1750 N. Vine, H'wood, Cal.
PROD: Alex Deazevedo c/o Capitol
PUB: Wemar BMI, 1619 B'way, NYC
WRITER: R. Ilsey FLIP: Sueno

- #73
CHATTANOOGA CHOO CHOO (2:30)
Harpers Bizarre-Warner Bros. 7090
3701 Warner Blvd., Burbank, Calif.
PROD: Lennie Waronker c/o Warner Bros.
PUB: Leo Feist ASCAP-1540 B'way, NYC
WRITERS: Gordon, Warren
ARR: Perry Botkin, Jr. FLIP: Hey, You in the Crowd

- #74*
EXPLOSION IN MY SOUL (2:19)
Soul Survivors-Crimson 1012
1005 Chestnut St., Phila., Pa.
PROD: Gamble, Huff, 250 S. Broad St. Phila, Pa.
PUB: Double Diamond BMI,
250 S. Broad St., Phila., Pa.
Downstairs BMI, 5412 Osage Ave., Phila, Pa.
WRITERS: K. Gamble, L. Huff
FLIP: Dathon's Theme

- #75
TWO LITTLE KIDS (2:36) Date 1586
51 West 52nd Street, NYC.
PROD: David Kapralik c/o Date
Ken Williams c/o Date
PUB: Jalyne BMI
2203 Spruce St, Phila, Pa.
WRITERS: E. Record-C. Davis-B. Acklin
ARR: Burt Keyes
FLIP: We've Got To Love One Another

- #76
GOOD COMBINATION (3:03)
Sunny & Cher-Atco 6541
1841 Broadway, NYC
PROD: Sunny Bono
7715 Sunset Blvd. L.A. Calif.
PUB: Tripartite BMI 1650 B'way, NYC.
Pam-Bar BMI 400 Madison Ave., NYC.
D&K BMI c/o James Keith, Fairfax, Ala.
WRITER: Mark Barkan
ARR: Harold Battiste FLIP: You And Me

- #77
IN THE MISTY MOONLIGHT (2:44)
Dean Martin-Reprise 0640
3701 Warner Blvd., Burbank, Calif.
PROD: Jimmy Bowen-c/o Reprise
PUB: Four Star-BMI
9220 Sunset, Los Angeles, Calif.
WRITER: Cindy Walker
ARR: Ernie Freeman-FLIP: Wallpaper Roses

- #78*
THE LESSON (2:28) Vikki Carr-Liberty 56012
1200 Sunset Blvd., Hollywood, Cal.
PROD: Sammy Oliver c/o Liberty
PUB: Alto ASCAP 621 N. Alta Dr, Bev. Hills, Cal.
WRITER: Mack David
ARR: Sid Feller FLIP: One More Mountain

- #79
BABY, NOW THAT I'VE FOUND YOU (2:36)
Foundations-UNI 55038
8255 Sunset Blvd. L.A. Calif.
PROD: Tony Macaulay c/o Pye Records
Cumberland Place, W1 England.
PUB: Saturday BMI-25 W. 56 St. NYC
Weibeck BMI-139 Piccadilly
London W1, England
WRITERS: J. Macleod-T. Macaulay
FLIP: Come On Back To Me

- #80*
DARLIN' (2:11) Beach Boys-Capitol 2068
1750 N. Vine, Hollywood, Calif.
PROD: Beach Boys c/o Capitol
PUB: Sea of Tunes BMI
9042 La Alba, Whittier, Calif.
WRITERS: Brian Wilson, Mike Love
FLIP: Here Today

- #81
ITCHYCOO PARK (2:45)-Small Faces-Immediate 501
51 West 52 St., NYC
PROD: Steve Marriott, Ronnie Lane
c/o Immediate Rec. Co. Ltd.
63-69 New Oxford St., London W1, Eng.
PUB: Nice Songs BMI c/o Sterling Gilmore & Co.
15300 Ventura Blvd., Sherman Oaks, Cal.
WRITERS: Marriott, Lane-FLIP: I'm Only Dreaming

- #82
INSANITY COMES QUIETLY TO THE STRUCTURED
MIND (2:39) Janis Ian-Verve Forecast 5072
1350 Ave of the Americas, NYC.
PROD: Shadow Morton c/o Dialogue
PUB: Dialogue BMI 1650 B'way, NYC.
WRITER: Janis Ian
ARR: Janis Ian-Shadow Morton
FLIP: Sunflakes Fall, Snowrays Call

- #83*
LOST (2:35) Jerry Butler-Mercury 72764
110 West 57 Street, NYC.
PROD: Gamble, Huff 250 S. Broad St, Phila, Pa.
PUB: Double Diamond BMI c/o Gamble Huff
Downstairs BMI, 5412 Osage Ave., Phila., Pa.
Parabut BMI, 1501 Broadway, NYC.
WRITERS: Gamble, Huff, Butler
ARR: Joe Renzetti
FLIP: You Don't Know What You Got Until You
Lose It

- #84
A VOICE IN THE CHOIR (2:30)
Al Martino-Capitol 2053
1750 N. Vine, Hollywood, Calif.
PROD: Tom Morgan-Marvin Holtzman
c/o Capitol, 1270 6th Ave, NYC.
PUB: Case ASCAP 240 Central Pk S, NYC.
WRITERS: Danny DiMinno-Johnny Tucker
FLIP: The Glory Of Love

- #85*
TO GIVE (THE REASON I LIVE) (3:16)
Frankie Valli-Philips 40510
110 West 57th Street, NYC.
PROD: Bob Crewe 1841 B'way, NYC
PUB: Saturday BMI, c/o Bob Crewe
Seasons Four BMI 1501 B'way, NYC.
WRITERS: Bob Crewe, Bob Gaudio
ARR: Chas. Calello
FLIP: Watch Where You Walk

- #86
STORY BOOK CHILDREN (3:00)
Billy Vera & Judy Clay-Atlantic 2445
1841 B'way, NYC
PROD: Chip Taylor & Ted Farrow
for Blackwood Music
1650 B'way, NYC
WRITERS: Chip Taylor & Billy Vera
FLIP: Really Together

- #87*
SKIP A ROPE (2:38)
Henson Cargill-Monument 1041
530 W. Main St., Hendersonville, Tenn.
PROD: Don Law, 2016 Terrace Pa, Nashville, Tenn.
PUB: Tree BMI 905 16th Ave S., Nashville, Tenn.
WRITERS: Jack Moran, Glenn D. Tuob
FLIP: A Very Well Traveled Man

- #88
PIECE OF MY HEART (2:34)-Erma Franklin-Shout 221
1650 B'way, NYC
PROD: Bert Berns c/o Shout
PUB: Web IV BMI (same address)
Ragmar Music BMI-219 W. 79 St., NYC
WRITERS: Bert Berns, Jerry Ragavoy
ARR: Gary Sherman
FLIP: Baby What You Want Me To Do

- #89*
PICK UP THE PIECES (2:30)
Carla Thomas-Stax 239
1841 B'way, NYC.
PROD: Al Bell, Don Davis for Washday Prod.
Under supervision of Hayes & Porter c/o Stax.
PUB: East BMI, 926 E. McLemore Ave,
Memphis, Tenn.
Groovesville BMI, 2454 Calvert St, Det. Mich.
WRITERS: D. Davis, K. Barker, F. Briggs
FLIP: Separation

- #90
A LITTLE RAIN MUST FALL (2:24)
Epic Splendor-Hot Biscuit Disc Co. 1450
c/o Capitol, 1750 N. Vine, H'wood, Cal.
PROD: John Boylan c/o Koppelman & Rubin
1650 Broadway, NYC.
PUB: Chardon BMI-1650 B'way, NYC.
WRITER: Richard Fishbaugh
ARR: Trade Martin FLIP: Cowboys & Indians

- #91
SOCKIN 1-2-3-4 (2:35) John Roberts-Duke 425
2809 Erastus St. Houston, Texas.
PROD: Bob Garner 3830 Cosby, Houston, Texas.
PUB: Don Music BMI (same address as Duke)
WRITER: Roberts-Garner-FLIP: Sophisticated Funk

- #92
SPOOKY (2:59) Classics IV-Imperial 66259
6920 Sunset Blvd., Hollywood, Calif.
PROD: Buddy Buie c/o Bill Lowery
P.O. Box 9687 N Atlanta, Georgia.
PUB: Bill Lowery BMI (same address)
WRITERS: Sharpe-Middlebrook
ARR: Buie-Cobb FLIP: Poor People

- #93*
LITTLE DRUMMER BOY (2:52)
Lou Rawls-Capitol 2026
1750 N. Vine, Hollywood, Calif.
PROD: Dave Axelrod c/o Capitol
PUB: Int'l Korwin ASCAP, 44 W. 56 St. NYC.
Mills ASCAP 1790 B'way, NYC.
WRITERS: Harry Simeone, H. Onorati, K. Davis
FLIP: There's A Child With A Toy

- #94*
WE'RE A WINNER (2:15) Impressions-ABC 11022
1330 Ave of the Americas, NYC.
PROD: Johnny Pate c/o ABC
PUB: Chi Sound Corp. BMI
79 W. Monroe St. Chicago, Ill.
WRITER: C. Mayfield
ARR: Johnny Pate FLIP: It's All Over

- #95
SOMETHING'S MISSING (2:45)
5 Stairsteps-Buddah 20
1650 B'way, NYC.
PROD: Clarence Burke, Jr. c/o Kama Sutra
PUB: Kama Sutra BMI 1650 B'way, NYC.
Burke Family BMI (c/o Kama Sutra)
WRITERS: C. Burke, Jr.-C. Burke, Sr.
ARR: Clarence Burke, Jr. FLIP: Tell Me Who

- #96
THIS THING CALLED LOVE (2:49)
The Webs-Pop Side 4593
235 West 46 Street, NYC.
PROD: Robert Bateman-Lou Courtney
10 West 135 Street, NYC.
PUB: Emalou BMI 10 W. 135 St., NYC.
Andros BMI (same address)
WRITERS: W. Cooper-M. Boxley
FLIP: Tomorrow

- #97*
UNITED Part I (2:32) Music Makers-Gamble 210
1650 Broadway, NYC
PROD: Gamble-Huff, 250 S. Broad St. Phila, Pa.
PUB: Razor Sharp BMI 250 S. Broad St, Phila, Pa.
Block Buster BMI, 919 N. Broad St, Phila, Pa.
WRITERS: R. Gamble, L. Huff
FLIP: United Part II

- #98
COUNT THE DAYS (2:36)
Inez & Charlie Foxx-Dynamo 112
240 West 55th Street, NYC.
PROD: Charlie Foxx c/o Dynamo
PUB: Catalogue BMI & C&I BMI (same address)
WRITERS: Charlie Foxx-Jerry Williams-
Brooks O'Dell-Vyonne Williams
ARR: Richard Rome-Jerry Williams
FLIP: A Stranger I Don't Know

- #99*
EXPECTING TO FLY (2:36)
Buffalo Springfield-Atco 6545
1841 Broadway, NYC
PROD: York/Pala 7715 Sunset Blvd. H'wood, Cal.
PUB: Ten East BMI & Springalo BMI c/o York/Pala
Cotillion BMI c/o Atco
WRITER: Neil Young FLIP: Everyday

- #100*
I WONDER WHAT SHE'S DOING TONIGHT (2:38)
Tommy Boyce & Bobby Hart-A&M 893
1416 La Brea, Hollywood, Calif.
PROD: Boyce & Hart c/o A&M
PUB: Screen Gems Columbia BMI, 711 5th Ave, NYC.
WRITERS: Boyce & Hart
ARR: Artie Butler FLIP: Ambushers

5 NEW SPIRITUAL LP'S

**THE BEST OF
BROTHER JOE MAY**

NASHBORO 7050

**THE
EDNA GALLMAN COOKE
MEMORIAL ALBUM**

NASHBORO 7049

**THE BEST OF
THE CONSOLERS**

NASHBORO 7048

**THE BEST OF
THE ANGELIC GOSPEL
SINGERS**

NASHBORO 7047

**THE BEST OF
THE SWANEE QUINTET**

CRESCENT 3002

NASHBORO RECORDS 1011 WOODLAND ST.
Nashville, Tenn. 615-227-5081

GRAND OPENING



Two super talents. With a built-in super market. And we predict that Anders 'n' Poncia will be the supergroup of 1968. They're different from any other artists around. Because their songs are different. Spiced with their own brand of humor. And delivered with a gentle kind of self-service philosophy that lets the listener help himself to a variety of interpretations. Get on the express line now and check out

KA-240

SO IT GOES

b/w Virgin To The Nite

ANDERS 'n' PONCIA

A Kama Sutra Production/ Produced by Anders-Poncia

The Sound of
The Now Generation
is on

Kama Sutra
RECORDS
EXCLUSIVELY DISTRIBUTED BY
MGM RECORDS.
MGM Records is a division of Metro-Goldwyn-Mayer, Inc.

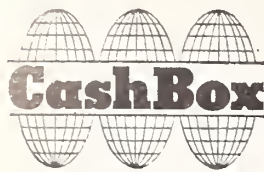

Picks of the Week

ROLLING STONES (London 906)

She's A Rainbow (2:48) [Gideon, BMI-Jagger, Richard]

Expect the unusual from the Rolling Stones and you won't be surprised! In their latest effort, the quintet steps up their blues beat with orchestrations that surround the listener in a swirling collage of offsetting tonal colors for a tremendous sounding single from the new "Satanic Majesties Request" LP. A solid item for pop programming and top sales. Flip: "2,000 Light Years From Home" (2:52) [Same credits] is an eerie venture with throbbing rhythm.

FRANKIE VALLI (Philips 40510)

To Give (The Reason I Live) (3:16) [Saturday, Four Seasons, BMI-Crewe, Gaudio]

Displaying the special flair for good music material with a pop appeal, Frankie Valli steps back into the spotlight with a tremendous side that could climb to the top of easy listening sheets and shoot for the winner's circle in pop areas. Brilliant vocal and ork arrangements bordering on classical give this side a fantastic impact. Flip: "Watch Where You Walk" (2:51) [Same credits.]

BOBBY VINTON (Epic 10266)

Just As Much As Ever (2:20) [Roosevelt, BMI-Singleton, Coleman]

The newest offering from Bobby Vinton steps up the pace just slightly giving the artist a lilting ballad amply suited to his semi-pop good music styling. Following up his strongest single in recent months, "Please Love Me Forever," Vinton should have no trouble in soaring on the teen and middle-of-the-road spots with this beauty. Flip: "Another Memory" (2:10) [Acacia, ASCAP-Vinton, Allen]

CANDYMEN (ABC 11023)

Deep in the Night (2:54) [Low-Sal, BMI-Bule, Nix, Adkins]

Exciting initial outing from the Candyman ("Georgia Pines") brought them to everyone's attention, and this strong follow-up is bound to put them higher in the top selling category than before. Hard hitting mid-speed ballad with some terrific team vocals and a fine instrumental showing. Breakout biggie. Flip: "Stone Blues Man" (2:07) [Unart, BMI-Bule, Adkins]

KING CURTIS & KINGPINS (Atco 6547)

I Was Made to Love Her (2:26) [Jobete, BMI-Cosby, Moy, Hardaway, Wonder]

Hard rhythm and a near-jazz sax workout of recent hits with appeal for the pop and blues markets has paid off for King Curtis before (i.e. "Ode to Billie Joe") and the Memphis cooker comes back with a fiery revamping of the Stevie Wonder smash for another go-round. Should see bright action. Flip: "I Never Loved A Man" (2:45) [14th Hour, Pronto, BMI-Shannon]

PHIL FLOWERS (Dot 17058)

Cry On My Shoulder (3:43) [Shifting Flowers, BMI-Flowers, McCoy]

Coming off a big noise maker that spilled from the r&b field into pop sales, Phil Flowers follows up with terrific impact via "Cry on My Shoulder," a vibrant slow ballad that showcases the vocal power of the artist. Bare blues arrangements complement the vocal showing in a manner that will have this side moving high in pop and r&b circles. Flip: "Discontented" (2:15) [Same credits.]

PAUPERS (Verve Forecast 5074)

Think I Care (2:58) [Egresser, BMI-Mitchell, Prokop]

Impressive drum shock opens this breakaway bombshell of a side in a funk-rock bag. The group's hearty handling of lyrical content, and hard hitting teen-oriented dance beat orchestrations put extra push behind this fine single, one that should spark strong action. Flip: "White Song" (2:54) [Same credits] is a slower, softer side, but also a strong one.

FALLEN ANGELS (Roulette 4785)

Hello Girl (2:20) [Big Seven, BMI-Bryant]

Good initial response to the Fallen Angels has paved the way for this very solid second effort, a side that will easily surpass the earlier side. Hard rock ork sounds give the side drive, but vocal brilliance with new power from a cute back-choral humor make it an irresistible tune for teen response. Flip: "Most Children Do" (3:10) [Big Seven, BMI-Bryant, Danchik]

LOVE GENERATION (Imperial 66275)

Maman (Mama) (3:44) [E. H. Morris, ASCAP-Charnin, Thomas]

From the score of the soon-to-open show "Mata Hari," this brilliant ballad of war and its effect on an individual soldier is an impressive performance from the orchestral and vocal standpoint. Superb arrangements and production place added dramatic emphasis on the delivery of the wording in this magnificent vignette. Exposure in the play will make this compelling single a smash. Flip: "W. C. Fields" (2:44) [Four Star, BMI-Copeland, Bahler, Bahler]

ARLO GUTHRIE (Reprise 0644)

The Motorcycle Song (2:58) [Appleseed, ASCAP-Guthrie]

Already a favorite with a best selling album to his credit, Arlo Guthrie makes a big entry in the singles field with this bluesy song of the times that packs a folk guitar and funky harmonica orking to carry extra weight with teen and folk diskophiles. Cute lyrical spoof that should be well received. Flip: "Now And Then" (2:15) [Same credits] is another track taken from the "Alice's Restaurant" LP.

PEARL BAILEY (RCA Victor 9408)

So Long Dearie (2:45) [Edwin H. Morris, ASCAP-Herman]

Sitting on top of the entertainment scene with her outstanding portrayal in the current "Hello, Dolly!" staging, Pearl Bailey is a certain winner to gain center-stage exposure for her new single from the show. Nifty bouncing track with all the mirth and zest of the songstress' talent packed into the performance. Flip: "Before the Parade Passes By" (2:15) [Same credits] is another good music pick from the Dolly score.

Picks of the Week

CONNIE FRANCIS (MGM 13876)

My World Is Slipping Away (2:47) [Screen Gems-Columbia, BMI-Sedaka, Greenfield]

Slipping back into her familiar ballad stylings, Connie Francis should make a solid showing with this lightly country-tinged side that shows her in the old form that brought her many followers. The pretty material takes on shimmering beauty from the songstress' attractive styling, and looks like a strong pop-good sales item. Flip: "Till We're Together" (2:24) [Antigony, ASCAP-Arthur]

JIMMY McCracklin (Minit 32033)

Get Together (2:45) [Metric, BMIMcCracklin]

Sharp blues beat and a terrific vocal power set Jimmy McCracklin up for a big response across the r&b and pop boards. Fine dance tempo and an excellent production job do well by the talents of the artist giving him his best shot at breakout probability in some time. Always a fine showman, this original side should put him center stage. Flip: "How You Like Your Love" (2:20) [Same credits.]

WE FIVE (A&M 894)

High Flying Bird (2:55) [Bexhill, Quartet, Sleepy Hollow, ASCAP-Wheeler]

Long looking for the comeback item, the We Five should hit paydirt with this beautiful version of the present folk-favorite which has attracted considerable attention in recent months. Splendid female vocal lead performance and a soft folk-rhythm backdrop set the pace for one of the best singles to come up for "High Flying Bird." Flip: "What Do I Do Now?" (2:25) [SFO, BMI-Stewart, Steirling]

Newcomer Picks

OHIO PLAYERS (Compass 7015)

Trespassin' (2:02) [Cudda Pane, BMI-Ohio Players]

Breaking right into an ear catching side, the Ohio Players start strong and pick up the action as the song develops. Some powerful blues workouts on the vocal end, and a top-notch beat for teen pop attractiveness give this side the solid impact needed to move high in both r&b and pop pictures. Should break open. Flip: "You Don't Mean It" (2:41) [Same credits.]

DICK CLAIR (Imperial 66272)

Hi Dad (2:40) [Asa, ASCAP-Clair, McMahon, Scott]

The first humorous reply to Victor Lundberg, this side is a cutie in terms of offhand talk, witty instrumentation (piano playing Sousa's "Stars & Stripes Forever"), and remarks that are bound to crack a smile on anyone who has heard the "Open Letter." Tremendous answer which is likely to receive smash programming action. Flip: "Tell That Joke" (2:43) [C&M, ASCAP-Clair, McMahon, Scott]

TROY KEYES (ABC 11027)

Love Explosions (2:55) [Zira/Floteca/Mia, BMI-Kerr, Harrison]

Exotic touches of harp runs give the smashing backdrop of this hard-driving rock outing a lot of plus value, and with an outpouring of vocal strength along the lines of Four Tops side this song gains enough momentum to sail high in the pop and blues listings. Tremendous punch and vigor to make it a fast teen favorite. Flip: "I'm Crying (Inside)" (3:35) [Same pubs, BMI-Harris, Kerr]

COLOURS (Dot 17060)

Brother Lou's Love Colony (2:30) [Hastings, Speed, BMI-Dalton, Montgomery]

Blossoming strains of sitar and tabla give an electrified aura to this wild west coast sound side. Unusual lyrics, beautiful group vocal work and an overall serving of beat that suits the side to dance prospects make the deck one which should develop into a sleeper due to wake with a start after the first taste of exposure. No flip info available.

FLASH & BOARD OF DIRECTORS (Mala 586)

I Pray For Rain (2:14) [Press, BMI-Penn, Oldham]

Slow rock rhythm leads through a powerful offering that should bring a big reception flocking to the new team of Flash and the Board of Directors. Extra fine lead vocal is highlighted by a string section that gives particular luster to the orchestral backdrop. A side with plenty of potential for pop action. Flip: "When the Love Light Is Shinin'" (2:00) [Same credits.]

AVENGERS (Jubilee 5609)

Everyone's Gonna Wonder (2:28) [Breck, BMI-Malcolm]

Unusual handling of instruments and a lively taste in the production makes this sampling of rock from New Zealand a side likely to be well greeted by teen pop listeners. The group has a new manner in rock that could set them high in the sales picture with "Everyone's Gonna Wonder." Fine effort. Flip: "Take My Hand" (2:15) [Sherman Devorzon, BMI-Addrissi, Addrissi]

Best Bets

TIM BUCKLEY (Elektra 45623)

Morning Glory (2:51) [Third Story, BMI-Beckett, Buckley] Attractive folk softie in the contemporary vein which includes excellent wording and imagery, splendid arrangements and the performing talent of Tim Buckley. Should catch much radio play along folk-college outlets. Flip: "Once I Was" (3:22) [Third Story, BMI-Buckley]

DRIFTERS (Atlantic 2471)

Still Burning In My Heart (2:10) [Unbelievable, BMI-McCoy, Stewart] Still around and still kicking up a storm, the Drifters deliver the most powerful side from the team in a long while. Good rhythm and tightly worked vocals put the deck up for top pop & blues showings. Flip: "I Need You Now" (2:13) [Emalou-Pronto, BMI-Bateman, Courtney]



JUST AS BIG AS EVER

BOBBY VINTON

*a fabulous new
chart-scaler*

"JUST AS MUCH AS EVER"

5-10266

STEREO / BN 26341
LN 24341



*...and it's included in
his new smash album*



LN 24341 / BN 26341 Stereo

© "EPIC", Marca Reg. T.M. PRINTED IN U.S.A.

Best Bets

ANDERS 'n' PONICA (Kama Sutra 240)
So It Goes (1:47) [Kama Sutra, BMI-Andreoli, Poncia, Jr.] Story of a born loser who's adjusted to his lot comes over very well in this slow shuffling Nashville-ish cutie. Could attract responses with minimum exposure. Flip: "Virgin to the Nite" (1:55) [Same credits]

DEREK & RAY (Mercury 72763)
Theme From "The Fox" (2:33) [Warner Sevarts, BMI-Schifrin] Lovely theme from the forthcoming movie "The Fox." The easy listening track is a side that has enough sparkle for across-the-board programming. Flip: "Thoroughly Modern Millie" (2:03) [Northern, ASCAP-Cahn, VanHeusen]

PONY EXPRESS (Reprise 0650)
(I Dream Of) Pennies (2:30) [Yuma, ASCAP-Jacobs, Meskell] Teens on the breakup route could find this outing a fine gift for its collection of put-downs. Un-love song with lots of beat. Flip: "What You Done Done" (2:38) [Same credits]

FABULOUS CHIMES (Invincible 1515)
Faithful to Me [Brazeltonis, BMI-Jones] Revived r&b interest of late in the oldie sound could turn up followers for this femme foursome who deliver the slow ballad in much the style of the Chantels. Treat with possibility. Flip info not available.

WALTER JACKSON (Okeh 7305)
Everything Under The Sun (2:20) [Saturday, BMI-Crewe, Knight] Stepping up the pace after a brilliant ballad showing last time out, Walter Jackson proves that he is capable of continuing his torrid r&b action on both levels. Flip: "Road to Ruin" (3:32) [Jillbern, BMI-Knight, Neiman, Christopher]

WEBSTERS NEW WORLD (RCA Victor 9410)
You Still Thrill Me, Babe (2:02) [Norman-Leonard, BMI-Martin] Fine rhythm of the song is up-staged by a terrific display of astounding group vocal work. The harmonies and voice-instrumentation give "You Still Thrill Me, Babe" a shine that could spark breakout reaction. Flip: "When You Grew Up" (2:49) [Remember, ASCAP-Mason, Duffy]

RAW EDGE (Sidewalk 936)
October Country (2:41) [Living Legend, ASCAP-Lloyd] Ear catching opener moves into a rapid-fire rock softie. Hard throbbing orking is covered with a blanket of soft vocal sounds for an appealing side [No flip info.]

SAMANTHA JONES (Ascot 2235)
Live for Life (Vivre Pour Vivre) (2:41) [Unart, BMI-Lai, Gimbel] Latest of a long list of recordings of this smooth film theme, this track features a lovely vocal for enjoyable middle-of-the-road spinning. Flip: "Make Me Rainbows" (2:37) [Unart, BMI-Bergman, Bergman, Williams] Soft ballad from the "Fitzwilly" soundtrack score.

BEN & SPENCE (Atlantic 2460)
I Do (2:20) [Fame, BMI-Penn, Oldham] More of the enticing blues work by Penn & Oldham, this time delivered with grand soul-charm by the team of Ben & Spence. Cute track that could climb the r&b charts. Flip: "Ooh Poo Pah Doo" (2:26) [Minit, BMI-Hill]

YELLOW PAYGES (Uni 55043)
Our Time Is Running Out (2:36) [Hanbo, BMI-Webb] Good rock workout that carries a peculiarly appealing vocal and some hefty ork push to set it on the winning road. Teen pop fans could take to it. Flip: "Sweet Sunrise" (1:57) [Trousdale, BMI-Page]

DEE ERWIN (Redd Coach 9-7)
I Only Get This Feeling (2:20) [Left Turn, Groco, BMI-Ervin] Socking Detroit styled orking gives a hard punch to this strong opening and solidly performed love song. Terrific dance item. Flip: "Wrong Direction" (2:00) [Left Turn, Wally Roker, BMI-Ervin]

ORDELLS (Dionn 505)
Sippin' A Cup of Coffee (2:35) [Lemar, BMI-Andrews, Mason, Howard] Haunting arrangements add a special tint to this slow serving of melancholia from the Ordells. Could crack the r&b charts. Flip: "Big Don" (2:20) [Bee Cool, BMI-Finiz]

DAVE "BABY" CORTEZ (Roulette 4783)
Soul Groovin' (2:15) [Patricia, BMI-Clowney] Funk backdrop and a terrific organ showcase should set up some action for vet instrumentalist "Baby" Cortez. The side carries a big beat punch for teen and blues reception. Flip: "Hot Chocolate" (2:15) [Same credits]

HOWARD TATE (Verve 10573)
Stop (2:43) [Ragmar, Rumbalero, BMI-Shuman, Ragovoy] Latiny-blues beat on this top-notch soul chant make it a likely to see plenty of exposure on both pop and r&b lines. Tremendous vocal gives the side enough energy to score. Flip: "Shoot 'Em All Down" (2:37) [Same credits]

TOM CARLISLE & CRAFTSMEN (Columbia 44372)
I Saw the Light (2:20) [Roosevelt, BMI-Carlisle] Terrific hand-clap and mariachi plus dixie background gives this happy-go-lucky side a lift which could carry it high in the pop picture. High-handed carrying on with a zestful charm. Flip: "Nightingale" (2:53) [Same credits]

BARBARA WEST (Ronn 16)
Will He Come Back (2:59) [Sims, ASCAP-Thomas] Downcast vocal showing from Barbara West and a good group orchestration makes this side a strong entry for r&b honors. Flip: "The Love Of My Man" (3:19) [Sylvia, BMI-Townsend]

ORACLE (Verve Forecast 5075)
The Night We Fell In Love (1:53) [Moo-Moo, BMI-Green] Cowsill-y teen ballad with some fine production work to give a big orchestral boost to the smooth sound of this breakout group. Hearty welcome is likely to turn up for this item. Flip: "Don't Say No" (3:05) [Sins, BMI-Friedman]

DIAMOND JOE (Sansu 475)
It Doesn't Matter Anymore (3:05) [Marsaint, BMI-Toussaint] Crack material that could have been tailor made for Diamond Joe. This side packs a terrific showcase which makes the most of the artist's voice on some powerhouse material. Could explode on r&b and pop scenes. Flip: "Gossip Gossip" (2:40) [Same credits]

NATE ADAMS (Atlantic 2466)
Why Is It Taking So Long (2:55) [Cudda Pane, Pronto, BMI-Lewis, Lewis, Farmer] Standout vocal stand by Nate Adams could attract much attention among r&b listeners for this rhythmic blueser in a slow-to-middling bag. Fine side. Flip: "I'm Gonna Be Good" (2:17) [Same credits]

ROONEY BROTHERS (Columbia 44393)
Geordie (2:00) [Roonie Tunes, BMI-Rooney, Jr.] Rock updating of the traditional folk ballad has enough flair to stir up action for the Rooney Brothers. Fine sound with plenty of teen appeal. Flip: "Just A Friend" (2:20) [Windsor, ASCAP-Rooney, Jr.]

BERT KAEMPFERT & HIS ORCH. (Decca 32241)
Caravan (2:45) [American Academy of Music, ASCAP-Ellington, Tizol, Mills] Solid reading by middle-of-the-road master Bert Kaempfert of this middle-of-the-road standard. Should see good airplay. Flip: "Melina" (3:06) This one has a memorable tune and a nice arrangement and could also do well. [Roosevelt, BMI-Kaempfert, Rehebein]

IRENE & SCOTTS (Smash 2138)
I'm Stuck On My Baby (2:06) [Sands, MRC, BMI-Monnette, Campbell, Kreinar] Spirited R&B could go places for Irene and the Scotts. Scan it. Flip: "Why Do You Treat Me Like You Do" (2:40) [Sands, MRC, BMI-Monnette, Campbell, Kreinar]

LONESOME RHODES (RCA Victor 9402)
Mister (2:42) [Crestmoor, BMI-very pretty melody. Girl invites man to take a walk with her but warns him not to think of love since she's been burned recently and doesn't want to get involved in another romance for a while. Could happen. Flip: "The Day Love Comes" (1:16) [Crestmoor, BMI-Rhodes]

LAST WORDS (Atco 6542)
I Wish I Had Time (2:45) [Sherlyn, BMI-Byrnes, Dooley] The Last Words here offer a sad but buoyant rock romancer that could bring in a healthy amount of airplay and sales action for them. Nice outing by the group. Flip: "One More Time" (2:31) [Sherlyn, BMI-Lombardo]

ATLANTIC SOUNDS (Atlantic 2468)
Pata Pata (2:10) [RHA Kumer, BMI-Makeba, Ragovoy] Catchy instrumental treatment of South African songstress Miriam Makeba's current smash. Might do something for the Atlantic Sounds. Flip: "Blast Off" (2:05) [Kilynn, Pronto, BMI-Ousley]

A HANDFUL (LHI 1201)
Does Anybody Know (2:02) [Tamerlane, BMI-Crawford] Could be a goodly number of spins on tap for this blues-toned rock ballad. Side was produced by hitmaker Lee Hazelwood. Flip: "Dying Daffodil Incident" (2:44) [Screen Gems-Columbia, BMI-London, Beam]

BARBARA MERCER (Capitol 2059)
So Real (2:30) [Macan, Sam Coplin, BMI-McGregor, Terry] Barbara Mercer could have a winner on her hands with this woes-filled love ode. Side could see action in both pop and good music markets. Flip: "Call On Me" (2:40) [Macan, Sam Coplin, BMI-McGregor, Terry, McNeil]

BROTHERS TWO (Crimson 1011)
Boogaloo (Soul) Party (2:05) [Rice Mill, BMI-Tindal, Smith, Incollingo, Matico] A contagious, danceable R&B workout, this one is filled with sales possibilities. Side contains allusions to other R&B songs, including "Soul Man" and "In The Midnight Hour." Flip: "You Got It" [Crimson, BMI-Segman, Greene, Wienstein, Bell]

DEE DEE BARNES (Aretic 138)
Do What You Wanna Do (2:20) [Blockbuster, Dan-Ray, BMI-Eskridge, Tomasso] Dee Dee Barnes could make a lot of sales noise with this rhythmic, soul-filled, love-oriented knee-slapper. Watch it. Flip: "I'm Yours And You're Mine" (2:21) [Blockbuster, Dan-Ray, BMI-Eskridge, Tomasso, Chambers]

SONNY DUBLIN (Cub 9152)
Pigmy Grind (Part I) [Bargyle, BMI-Jones] Infectious ditty about a new dance called the "pigmy grind." Could catch attention for Sonny Dublin. Flip: "Pigmy Grind" (Part II) (2:40) [Bargyle, BMI-Jones]

1910 FRUITGUM CO. (Buddah 24)
Simon Says (2:19) [Kaskat, BMI-Chiprut] Groovy, infectious rocker with lyrics based on the old children's game. Could break out for the 1910 Fruitgum Co. Flip: "Reflections From The Looking Glass" (3:04) [Kaskat, BMI-M. & T. Gutkowski, Jeckell]

EMOTIONS (Brainstorm 125)
I Can't Stand No More Heart Aches (2:36) [Ladybird, BMI - Casmil, Hutchinson] Top drawer effort from this r&b team. The side is a nicely bass-ed rhythmic lilt that could pick up a lot of blues listener reaction. Might breakout from there. Flip: "You'd Better Get Pushed to It" (2:30) [Ladybird, BMI-Hutchinson]

JIM & JEAN (Verve Forecast 5073)
People World (2:15) [Akbestal, BMI-Glover] Clever lyrical enticement and a pretty arrangement give Jim & Jean fine fare for pop-folk sales. The attractive session here is likely to gain listening fans for the duo. Flip: "Time Goes Backwards" (3:05) [Wild Indigo, BMI-Glover]

BLOCKBUSTERS (Rockin 500)
Muddy Pt. 1 (2:77) [Rockmore, BMI-Frengel, Serrano, McLaughlin, Holguin] Wild musical interlude for a change-of-pace pop spin or some heavy beat r&b play. Grand sax lines carry the throbside across very well for possible sleeper reaction. Flip: "Goodbye Squaresville" (2:45) [Rockmore, BMI-Roquemore] Rockin Records, 6365 Selma Ave., Hollywood.

HOLE IN THE WALL (Epic 10273)
Bring It On Home to Me (2:45) [Kags, BMI-Cooke] A standout version among the many recordings of this consistent favorite tune, the Hole In the Wall's rendering of Sam Cooke's oldie could stir up considerable teen interest. Slow, semi-funk side with pop and blues prospects. Flip: "Blue Turns to Grey" (2:49) [Immediate, BMI-Jagger, Richard]

OTIS LEAVILL (Smash 2141)
Charlotte (Yes I'm Gonna Miss You) (2:37) [Jalynne, BMI-Davis, Smith, Smith] Tempting taste of the Otis Leavill vocal style turns this side into a tremendous blues offering with plenty of pop impact jammed in. The mid-speed ballad is a blues powerhouse. Flip: "Nobody But You" (2:40) [Jalynne, BMI-Smith, Sims]

PEARL BAILEY (Roulette 4781)
A Man Is a Necessary Evil (2:35) [Favorite, ASCAP-Whitman, Shelley] Currently drawing rave attention with her appearance in "Hello, Dolly!" Pearl Bailey should become a much programed artist with particular emphasis on "A Man Is a Necessary Evil." Flip: "Look At That Face" (3:28) [Musical Comedy, BMI-Newley, Bricusse]

PARTNERSHIP (MGM 13854)
Baby, If I Had You (2:34) [J-Wiz, BMI-Jubilee, Matthews] The Partnership could be heard throughout the airwaves with this spirited, persuasive romancer. Eye it. Flip: "Not For Love Nor Money" (2:36) [J-Wiz, BMI-Jubilee, Matthews]

JOE STAMPLEY (Paula 289)
I'll Do Anything (2:35) [Su-Ma, BMI-Stampley, Woodfield] Could be good things in store for this mid-tempo rock romancer. Scan it. Flip: "Go On And Leave" (2:00) [Sunnybrook, BMI-Brians & Barton]

HENRY JEROME (United Artists 50233)
Henry's Trumpets (1:59) [United Artists, ASCAP-Jerome] Taken from the hornman's latest LP, this easy listening side should see a good deal of spinning activity on middle-of-the-road and good music stations. Good strong side with a smooth mid-speed drive. Flip: "Tipica Serenada" (2:46) [Mitchell, ASCAP-McMullen, Jerome, Musolino]

You are about to become involved with Van Dyke Parks!



**WARNER BROS. - SEVEN ARTS
RECORDS, INC.**

VAN DYKE PARKS IS GENERIC...THE FIRST IN A DECADE SINCE DYLAN AND THE BEATLES! ALREADY THERE IS SPECULATION AMONG RECORD CRITICS, COMMENTATORS AND COGNOSCENTI AS TO HOW AND TO WHAT EXTENT HIS EMERGENCE WILL INFLUENCE TOMORROW'S TASTES AND TRENDS. NO MATTER YOUR AGE, MUSICAL PREFERENCES OR SOCIOLOGICAL POINT-OF-VIEW, IT IS UNCOMMONLY PREDICTABLE, INEVITABLE, INESCAPABLE: **YOU ARE ABOUT TO BECOME INVOLVED WITH VAN DYKE PARKS!**



SONG CYCLE • Van Dyke Parks W/WS 1727

CashBox Record Ramblings

NEW YORK

The Gaslight Cafe is closed for good. The teenie-boppers, groupies, and weekend hippies that now inhabit the entertainment center of the Village don't really go for folk music unless it's electrified into a jug band or a folk-oriented rock package. Therefore, it stands to reason that no one can effectively hassle taxes and New York's bureaucracy with a pure folk club.

Clarence Hood's coffee house was a Macdougall St. landmark and, in addition to being the first place this columnist ever saw the then virtually

play the club until Feb. 11.

The first Dave Van Ronk and the Hudson Dusters LP is finished and is due out in Jan. or Feb. Many fans of Van Ronk will be glad to know that "Cocain Blues" is included in the package. That song in the original Van Ronk version on Prestige has recently been receiving a lot of play on the coast. Another highlight of the set might be found in "Stompin' Through The Swamp."

Crawdaddy Mag. is now in national distribution through Acme News.

Eileen Fireman and Sheila Daniel-ski are responsible for the Christmas tree in Al Altman's office at Screen-



Country Joe & Fish



Henry Jerome

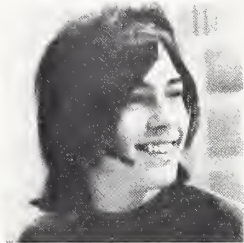

Erik

unknown Bob Dylan, was instrumental in nurturing such talents as Bill Cosby, Tom Paxton (remember the old Paxton & Robbins duo?), Phil Ochs, and Dave Van Ronk. Paxton's first LP was "The Man That Built The Bridges" on the Gaslight label; it's a collector's item now. Who can forget Malcolm, the way-back-when manager? Eric Andersen had frequently played the club as had Carolyn Hester, Ed Freeman, the Rev. Gary Davis, Richard and Mimi Farina, Billy Faier, Mary Travers, Peter Yarrow, Sandy Bull, Paul Stookey, Bob Gibson, Peter LaFarge, Snaker Ray, Buffy Sainte-Marie, and Jack Elliot. Arlo Guthrie made his latter day New York debut on the Gaslight's tiny stage and Janis Ian's first New York press gathering was held there.

Perhaps indisposed, and certainly too small, to go electric, the Gaslight (with its "World Famous For The Best Entertainment In The Village" banner) remained to the last, a symbol. A symbol of performers going upstairs to the Kettle Of Fish Bar between sets; a symbol of the Village that used to be, before the rock invasion. It's gone now, having bowed to civic, social, police, and economic pressures but, even if everything else about the Gaslight is eventually forgotten, its owner Clarence Hood will be remembered as a man who was nice to Mississippi John Hurt.

The Christmas season will be somewhat marred this year due to the untimely and tragic deaths of Otis Redding and four of the Bar-Kays.

Tiny Tim, who was signed to Reprise by Moe Austin, is on the coast now making his first LP for that label. The set is sked'ed for a Feb. release.

Bruce Scott and the Head Set are being held over from their last week's gig at the Scene with the Frantics for another week, this time with Project 3's Critters and a group called the Dickens. Steve Paul says that he will hold a Contemporary Rock Festival at the Scene during the Christmas/New Year week and that the groups involved are: an ABC group from Canada called the Influence and Blood, Sweat, & Tears. Recently seen jamming together at the Scene were parts of: Moby Grape, Vanilla Fudge, Electric Flag, Turtles, and McCoys (whose new label affiliation is soon to be announced.)

Andrew Loog Oldham's birthday on Jan. 29th, will mark the American debut of his latest group, the Nice, at the Scene. The group, which is on Immediate and will be released through Columbia in the U.S., will

Gems/Columbia. Last year, when Al was with Metric, his Christmas tree was, for some reason as inexplicable now as it was then, upside down.

Atlantic is re-releasing Bobby Darin's "Talk To The Animals" to coincide with the current showing of the "Doctor Dolittle" flick.

The Donuts, managed by Fat Frankie Scinaro, will open Jan. 1st. for a 3-week shot at Ungano's west side disco.

The Mothers will make their first mid-town New York appearance at Town Hall, Dec. 22-23. That will be one concert on each of the two nights.

Buck-Ram's Danny Fortunato has informed us that the Platters begin an 8-day gig at the Westbury Festival out on the Island. . . . TRO's Al Brackman is off to the Bahamas with his wife and daughter for a well earned holiday. He hopes to get some sailing in around Nassau.

Lanny Lee, Dot's "East Coast Man With The Tan" reports that his fastest moving singles are: "Blend Me Shake Me," "Cry On My Shoulder" by Phill Flowers, "1-2-3 And I Fell" by the Long Island Sound, and "Mission Impossible" by Lalo Shiffrin.

Jerry Ross, of Merrec, reports a good turnout for the Kenny Rankin party at the Bitter End and that Kenny's "Mind Dusters" LP is breaking in New York. Other good product for Jerry includes: "Lesley Gore's "Magic Colors," the Evergreen Blues' "Midnight Confessions," and "Saved" by the Chicago Loop.

Vanguard is pushing a bright new performer called, Erik. The label has been getting a lot of LP response on the latest Country Joe and the Fish venture.

Henry Jerome, UA's A&R director, has a new LP and single out and both are causing a lot of excitement on a national level. Title: "Henry's Trumpets."

Danny Crystal brought comic Pat Cooper up to the Cash Box offices last week for a lunch of heroes and a listen to Cooper's latest UA album, "You Don't Have To Be Italian To Like Pat Cooper."

Metro's Barry Resnick is hot on Eric Burdon's "Monterey," and the Carmel's "I Can't Shake This Feeling." He notes that the Cowsills' LP is still moving and that Betty Webb's "Tick Tock" and Connie Francis' "My World Is Slipping Away" are strong candidates for big sales.

PHILADELPHIA

Matty Humdinger Singer is getting plenty of action on "It's All Over" by the Impressions, "Deep In The Night" by the Candyman, "Love Explosion"

by Troy Keyes, and "No Bird Without Wings" by 3's A Crowd. Matty's thought for the day is: "No one can give you wiser advice than yourself."

HOLLYWOOD

This is the week we tie our Ramblings' package with mistletoe and nostalgia, delighting in several successful divinities and trying to forget the bonehead bloomers of '67.

Our percentages in forecasting the future for some bright new talents and titles? Not so bad when one considers that our industry released more than 8,000 new singles and



Bobbie Gentry



Herb Alpert

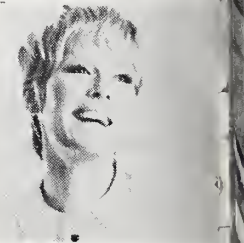

Petula Clark

about 3,600 albums in the past twelve months. And, as nearly as we can figure, its batting average for chart titles was no better than .072.

Way back on January 7th we glanced into our clouded crystal ball and chose ten probable song entries for the Oscar derby. There were 174 eligible songs, so any number above five correct guesses out of a possible ten would have made us clairvoyant. Call it beginners luck, we came up with 8 out of 10. At the same time we also added, "Our favorite continues to be 'Alfie' but our guess is, that if the final vote was taken today, 'Born Free' would be home free." . . . But in the same column we said that Liberty Records was bidding for the talents of Andy Williams, hinting that the list of labels was prodigious but that Liberty might have the inside track. Williams re-signed with Columbia. Strike one for the home team.

On Feb. 18th we noted that Frank Sinatra, Bing Crosby, Elvis Presley and Doris Day made up the fearsome foursome of artists who had successfully switched from disks to flicks. Chiding Hollywood for neglecting a demi-tasse file out of Epsen, England named Petula Clark. Less than a month after that column, Warner's announced that she had been signed to star in "Finian's Rainbow." Give us credit for at least a triple on this—and fortunate timing.

Our bases loaded home run came at the NARAS dinner in March when we found ourselves seated next to a girl named Bobbie Gentry who, at the time, was not affiliated with any label. She had co-produced a two sided disk which had been offered to a number of labels, Capitol among them. One side, we recall, was titled "Ode to Billie Joe." L.A. Times entertainment editor Charles Champlin, who was at the same table, asked Bobbie if she was involved with the music industry. "I write songs," she answered, "and I'm hoping to sign with a label as a singer." Then, just to fill the pause in the conversation, we added, "next year she'll be back here to pick up a Grammy." A million-to-one-shot statement at the time, it's a better than even money bet today. Bobbie, incidentally, was selected as a "West Coast Girl of the Week" about a month before Capitol released "Ode." The Chicasaw County Chanteuse gets our hands-down award as "West Coast Girl of the Year."

Another coast girl of the week was Marie Lawrie (alias Lulu), a 62-inch doll who made her movie debut in Sidney Poitier's "To Sir, With Love." We announced her selection on the same week that Epic released her

single. But, not having heard either side at the time, we relied on Lulu's judgment. "To Sir, With Love" is absolutely horrible," she told us. "The Boat That I Row" is the side." Chalk up our "Error of the Year" with a major assist from the cedar-haired hopeful. "The Boat That I Rowed" never sailed.

In May we went out on a limb for a record titled "San Francisco (Be Sure to Wear Flowers in Your Hair)" cut by a "former baby faced pudgy young tenor named Scott McKenzie." We added that the song itself was no "One Quick Martini" nor "Monday Monday" (two other compositions

by John Phillips who created and co-produced "San Francisco"). But acclaimed it as "the first chart bound flower song." It was, conservatively, the biggest single to come out of the short-lived hippie horti-culture.

On July 17th we tapped Tony Richard as our first "West Coast Boy of the Week," noting that he was "as curvaceous and winsomely compelling as any indie promo and pub rep guy on the coast. The "boy of the week" idea never caught on. Not one other coast based male ever requested that we consider him for the title. We'll never understand why.

One of our supreme understatements of the year—on August 5th we noted that Vikki Carr's "It Must Be Him," released by Liberty in August of '66, could, after a year, "still make it to the charts."

In September we said that seventy-nine year old Dame Edith Evans got our award as the most beautiful woman in the world. "She should also stroll away with an acting Oscar in April for her performance in "The Whisperers." We have since seen Liz Taylor in "The Comedians" and Sandy Dennis in "Up a Down Staircase." Our conviction regarding Miss Evans has been further fortified.

CHICAGO

Erroll Garner, fresh from a triumphant European tour, was in Chicago last week cutting a new MGM album at Universal Recording studios, to follow his current hit package "That's My Kick" (MGM). Garner's last session at Universal was back in the late '50s when he did a tune called "Misty"! Artist will be heading for the coast this week to do the Joey Bishop and Pat Boone TV'ers . . . The Cheetah's New Year's Eve gala will spotlight soul singer Baby Huey—all 350 lbs. of him—alternating with The Rovin' Kind . . . The Happy Medium presents "The Patchett And Tarses Show" commencing 12/21 and running through the holiday season. Club owner George Marienthal discovered the talented duo during a recent trip to New York . . . From Lee Dale Associates comes word that the 5th Dimension, who just wrapped up a most successful midwest and eastern tour, have a new album "Magic Gardens" scheduled for release late this month, featuring nine songs written by "Up Up And Away" writer Jim Webb. Group made the Playboy scene here 12/11-12 . . . Mara Lynn Brown, who has a local click in "Pablo Ya Gotta Be Puttin' Us On" (Universal), guested on the Johnny Carson TV'er last Monday

Mommy Hankes

from the

Markes

David

Mickey

Peter

Mike



COLGEMS[®]
Manufactured and
distributed by RCA

MIDEM Looks Like A Sell-Out

NEW YORK — With five weeks remaining before grande gala internationale, official opening function of MIDEM 2 in Cannes (Jan. 21-27), virtually every beach-front hotel in the Riviera resort city has reported capacity bookings for the period of the week-long second annual International Record and Music Publishing Market, according to Bernard Chevry, Commissariat Generale of MIDEM.

Chevry has completed arrangements to make use of the fifth floor of the business area of MIDEM in the waterfront Hotel Martinez.

The Martinez has been taken over completely for this year's MIDEM.

The additional fifth floor facilities will make possible the utilization of more than 300 offices by the record and publishing executives from at least 40 countries who are expected to attend MIDEM 2. Although the great influx of personnel from fully participating companies, as well as executives from other firms and individuals expected to be present in an observer-only status, has taxed hotel facilities far beyond earlier expectations, Chevry stressed that "excellent" accommodations are still available. Although some of these are somewhat removed from the immediate centers of activity, arrangements are being made by the MIDEM management for regular shuttle service to both the MIDEM office area in the Martinez

and the Palais des Festivals, scene of the evening galas.

On the subject of the galas, Chevry noted that the final schedule calls for the grand opening international gala to be held on Sunday evening (21), at which stars from numerous countries will perform.

While last year's MIDEM 1 galas were sponsored by individual record companies from various countries, this year's plan calls for several national galas. On Tuesday evening (23), for example, a Czechoslovakian and a French national gala will be presented. On Thursday evening (25), it will be the turn of the Italians and the British to present their national galas.

This year's MIDEM also incorporates the participation of a number of classical music firms. Accordingly, classical galas are expected to be presented on Monday, Wednesday, and Friday evenings.

On the closing evening of Saturday (27), the glittering festivities will reach a climax with the presentation of the annual MIDEM trophy gala, at which ceremony the top-selling artists from each country will be awarded the coveted MIDEM trophy, emblematic of sales supremacy in their respective countries during the period from 1 July 1966 to 30 June 1967.

Arrangements are now being made to have most of the trophy award winners present in Cannes to receive their awards in person.

Musicor Renews Int'l CBS Pact, Others

NEW YORK — Musicor Records renewed its foreign distribution arrangements through the worldwide CBS organization. Under the terms of the agreement, negotiated by Art Talmadge, president of Musicor, and Harvey Schein, president of CBS International, CBS will distribute Musicor product throughout the world exclusive of Great Britain and Venezuela. For the Musicor-affiliated Dynamo label, distribution will be worldwide exclusive of Venezuela.

Musicor's original CBS deal, made when the company first became a fully independent entity under Talmadge's direction in 1965, was effective for a period of two years. The contract has been re-negotiated for an additional two and one-half years, prior to the expiration of the original contract on 31 December of this year.

Musicor's earnings during the first 18 months of the original deal, it was reported, were three times more than the guarantee. Under the new agreement, the guarantee for Musicor has been doubled.

At the same time, Talmadge announced renewal of contracts with EMI for Great Britain and with El Palacio de la Musica for Venezuela. In Italy, Musicor has been associated with CGD Records, which is now 50

percent owned by CBS. The new CBS contract includes CGD, which has had steady success with Musicor star Gene Pitney. Pitney has appeared in four consecutive San Remo Festivals and has made a number of other personal and TV appearances in Italy.

Since its first overseas distribution contracts were signed two years ago, Musicor has grown steadily from its original three-artist roster to a point where today it features a host of top names in pop, country, R&B, and Latin areas. The company is also represented in the children's field with the successful LP's featuring "Birthday House" star Paul Tripp.



Talmadge & Schein

Monument In Publishing Tie With England's Keith Prowse

HOLLYWOOD — Monument Records, in partnership with Keith Prowse, Ltd., represented by Jimmy Phillips, has formed Combine Music Ltd. in England. The formation of the new firm follows a prolonged study of the British music publishing scene by Bobby Weiss, vice-president and director of the international division for Monument Records.

Combine Music, Ltd., will represent the following USA catalogues in England: Combine, Vintage, Music City Music, Longhorn, Cape Ann, Mar-Son, Songs of the World, Wide World of Music, Matamoros, House of Bryant, and Claremont House, plus specific copyrights acquired from Ahab Music.

Various foreign copyrights are being acquired by Wide World of Music and Songs of the World, for the USA and other English-speaking markets. Thus, Combine Music Ltd., will be able to exploit copyrights from France, Italy, etc., as well as those in U.S.A.

Jimmy Miller Signed To UA

NEW YORK — United Artists Records has signed as an artist an American who has become one of Britain's hottest producers. Jimmy Miller, now in the process of cutting his first LP for release on UA early next spring, first went to England several years ago at the invitation of Chris Blackwell, head of Island Music and Island Records. Working with Blackwell, Miller produced the major hits for the Spencer Davis Group, including "I'm A Man," with Stevie Winwood.

Miller is now the producer of Traffic, a new group headlining Winwood which started a few months ago following the split-up of the original Davis group. Now a fully independent producer in England, Miller hopes to line up new acts for production.

Linguistic Slip-Up

In our recent Christmas Pick of Remo Capra's "Sancta Maria" (issue of Dec. 9) we wrongly identified the languages in which the song is performed as Italian and English. The English is a translation from Latin lyrics.

Cash Box Sure Shots

The Cash Box "Sure Shots" highlight records which reports from retail dealers throughout the nation indicate are already beginning to sell quantity or else give every indication of doing so

LITTLE BECKY'S CHRISTMAS WISH

Becky Lamb.....Warner Bros. 715

EXPLOSION IN MY SOUL

Soul Survivors.....Crimson 101

THE LESSON

Vikki Carr.....Liberty 5601

BABY, NOW THAT I'VE FOUND YOU

Foundations.....Uni 5503

DARLIN'

Beach Boys.....Capitol 2068

LOST

Jerry Butler.....Mercury 72764

TO GIVE

Frankie Valli.....Phillips 40510

SKIP A ROPE

Henson Cargill.....Monument 104

Prysock Turns Actor

NEW YORK — Arthur Prysock, noted romantic singer, has turned his talents to acting.

Prysock has been signed, to a meaty role in "The Choice," a production by Dorothy and John Ashby of Detroit which will be filmed next month, mainly in Harlem.

Prysock is also under consideration by producer Monte Prosser, for a featured role in "The Man," a movie based on the book of the same name about a fictional Negro character who becomes the President of the United States.

Arthur's manager, Don Palmer, has long urged Arthur to act, without giving up his singing career, and was mainly responsible for Prysock's entering a private acting school early last October.

The deep toned singer admitted acting was somewhat difficult for him, but he had already been encouraged by numerous offers from off-Broadway shows.

Hookah Inks Freeman

HOLLYWOOD — Lennie Freeman has been signed by Hookah Publishing (publishing arm of Wednesday's Child Productions) as a contract writer, Terri Fricon, general manager of the pubbery has revealed. Freeman is a New York writer recently arrived in California and is currently working on several projects.

Freeman is the second writer to sign with the newly purchased firm, the other being Lybuk Hyd. Lybuk is a member of The Ceyleib People, a group produced by Wednesday's Child Productions for Vault Records. He is responsible for The Tanyet Suite (written with Joe Osborn) which has been recorded by the group and released on Vault records last week.

This is probably the first suite ever written for sitar.

Hookah Publishing will concentrate in new concepts of music, while Spite-N-Dival (Wednesday's Child's other BMI firm) will publish material in a middle of the road — easy listening vein.



FOR EXCELLENCE—Robert Myers (left), executive producer for Capitol's international division, accepts the Esther Award certificate attesting to the excellence of Capitol's classical labels, Angel, Melodiya/Angel, Capitol Classics, and Seraphim. Making the presentation is Henry Roth (right), music editor of the California Jewish Voice and originator of the projected annual event. In the center is the lady whose name has been lent to identify the award, Esther Roth. Esthers will be presented annually to those labels which issue the best recordings in their respective metiers during the preceding year.

A NEW
SUPERGROUP
FROM **DUNHILL**



"BIRD WITHOUT WINGS"

&

"COAT OF COLORS"

PRODUCED BY: MAMA CASS ELLIOT & STEVE BARRI

D-4120

**3's a
CROWD**

Gavin Radio Conference Historic First

(Continued from page 7)

continued this theme as he said, "If we're going to make a stab at establishing some kind of relationship, at this meeting or another meeting, I think it's got to begin with a one-word philosophy that's been embodied in the past couple of years by a couple of Jerry Wexler's people... [the late] Otis Redding and Aretha Franklin when they talk about R-E-S-P-E-C-T... And respect for each other might begin with knowing a little more about each other. I would ask a record company or distributor or promotion man—would it make sense if you contact radio stations to occasionally pick up a copy of Broadcast Magazine or Radio-TV Daily? ... Would it make some sense, that if you have an individual representing this billion dollar industry, you spend a little more time being judicious in selecting the guy who goes out there? ... It appears to me that we downgrade the position of promotion. As soon as a guy gets good at promotion we move him into a—quote—more important position. I think it makes sense to make the promotion job more important in terms of pay and responsibility. ... But the major problem lies with station management and an attitude towards the record business that borders, many times, upon contempt. I don't expect that, in a day or two, we're going to institute a crash campaign to take a record man to lunch and love him better. But I ask radio station management—are you involving yourself? Would it not make sense for a radio station manager to occasionally pick up on a CASH BOX or a Billboard or a Record World or some of the underground newspapers? To get to know more about the product that occupies thirty to forty minutes of every broadcast hour. ... I think that respect and knowledge begins with knowing more about each other."

Record Sales Vs. Research

Kent Burkhardt, vp and general manager of WQXI in Atlanta, noted his remarks were directed to those in top 40, "though not necessarily." Record sales alone, according to Burkhardt, cannot give an answer to an entertaining playlist. "We have researched heavily in Atlanta. ... I found out that about 80% of my [advance] conclusions would have been correct. But it was that unknown 20% which was a competitive key. That 20% was loaded with juicy information about our audience and the audience of our competitors. ... each market has its own peculiarities. It's up to the good radio man to find these pluses and minuses in each area. Research—not intuition—is the answer."

Marginal Records

Voyle Gilmore, vp of artists and repertoire and creative services for Capitol, recalled that many years ago "when we first started making records we used to ask 'why make a record?' We'd say—to sell it. ... Now in our discussion we say, 'Who's going to play the record?' A lot of times we go too strongly on those turntable hits—these records that get a lot of play and don't sell. ... top 40, by its very format, tends to sell records. But there are many albums that record companies release in order to try to keep a total catalog. ... we don't record these just for the prestige of having them in the catalog. ... I enjoy listening to five records in a row, particularly on FM. But I'd also like to hear the names of the artists, the titles and, if it's a new record, I'd like to know it. ... A jockey doesn't have to say 'buy it today, go down to your local store, it's now available.' ... If we don't sell records, we don't make money and we can't continue to produce the product for the radio stations to play. One of the alternatives is that record companies may stop making this product. ... But I can't believe that if radio stations can program it, make money, sell commercials and have a good rating in their area, that people will not buy it."

Personality in Radio

Harvey L. Glascock, vp and gm of WNEW in N.Y., curiously, seldom

mentioned music during his 15-minute talk. Instead he outlined WNEW's philosophy of personality and communication. "The WNEW personality teases the listeners, selling the product, the station and himself. ... painting pictures with words." The formula? "Community involvement, aggressive dependable news coverage, great personalities. And every effort is made to insure the fact that our promotion and sales take advantage of these facts."

Basic Differences

Bill Gallagher, vp of marketing, MCA, Inc., examined some of the basic differences between the two "companion" industries. "Yours is a controlled industry," he reminded the radio reps, "the FCC has allotted X amount of licenses in each market and you can pretty much judge your competition. ... If somebody out there wrote a song and I knew a chick somewhere in N.Y. who could sing and a guy who could write a chart. ... I could have you in the record business by next Monday. ... ours is not a controlled industry." He also disagreed with the concept of research in programming. "Speaking personally, I don't think that a station, through research, can determine what its consumer market wants to hear. I think that radio station sets the taste for that marketplace. ... radio has formatitis. ... you're day by day diminishing the opportunity that the creative producers in this record industry have. You're narrowing down your playlist, lessening day by day the opportunity of developing new formidable talents—people who make your listeners want to listen more to you. ... I think that radio has to examine itself in regard to this 'following' category that it has now relegated itself to—versus the leadership it had when it began to fight television and fight it successfully."

People in Radio

In a soliloquy seasoned with pungent metaphors, Ruth Meyer, WMCA's vp for programming the Strauss Group, suggested that too many format stations were turning into IBM machines, programming to a great faceless, inferior wad of semi-humanity. "Too many stations develop a successful format and then think their job is finished. That's not radio. ... no matter what you're building—no matter what market you're building it in—all you really have is people. ... the name of the game is people. ... And you have to remember that you can't turn your audience on until you know how to turn on your own people. ... Selling radio time is like running a whorehouse. You got it, you sell it, you still got it."

Big Hits From Small Towns

Charles Fach, vp and director of recorded product for Mercury Records, told how "Groovy Kind of Love" by the Mindbenders broke out of a town of about 19,000 people, Wenatchee, Wash., the apple capital of the world. Suggesting how secondary market stations could be serviced: "Become a Gavin correspondent or a correspondent with another record reporter. Or publish a playlist and circulate it to labels. ... subscribe to all the trade journals and find the people who could give me the true answers on record sales. ... As this is the day of specialization in radio, it's the day of specialization in record promotion too. We, and most other companies, maintain country and western lists, good music lists, stereo-singles lists, etc. And it's almost impractical for us, and any other record company to service every station in this country with every record. However, we would like to service all the Wenatchees with the records that will fit into their format. ... For all you radio people, I hope that your careers follow the most direct line as possible. From Hot Springs to Chicago. For all you record people, I'll see you next May at the apple blossom festival in Wenatchee, Washington."

Radio's Middle Age Spread

Charles K. Murdock, vp and general manager of WLW in Cinn., offered

"total commitment and enthusiasm" as the answer to "middle age spread" in radio. It also takes "the right music librarian, the one who's totally dedicated to, not only read the trades, but to read the people. ... There's a new brand of radio coming along. It used to be called 'middle of the road music'—I call it familiar music. The rockers? That world is coming closer together with familiar music. ... more entertainment per minute, wild community involvement, daring creativity, and overwhelming supervision. We've got to make every minute count just as you have to make every disk count. Most of all we, as radio broadcasters, have to motivate people."

Single and LP

Jerry Moss, president of A&M Records, recalled how seven or eight years ago, an artist could have a hit single with "7 or 8 hundred thousand sold and then maybe sell 15 or 20 thousand LP's. ... if we can remember back, an artist could have a #1 record and just about the only national television show that the artist could perform on would be the Dick Clark Bandstand. ... Today it's an entirely different story. The producer has really come along in such a way that I consider it a producer's business. He will make an LP that's not one hit and the rest cream cheese as it used to be. ... now a group can have a hit record and be on a nationally televised show each month if they wanted to be. Night clubs, tours, the whole situation is becoming a little more adult, a little more mature. ... As far as A&M is concerned I'd like to think that we pioneered a couple of things as far as albums were concerned. I like to think that we worked albums like singles, that we never let up. That we'd take the album back to a good music station or a middle-of-the-road station for six months if we had to, if we believed in a particular album. ... I can point to some top 40 stations that are a bit hypocritical by printing a top 40 sheet and putting down their 'album of the week' when they play none. I can also point to some sweeping regulations that are put forth by the radio industry. If we are involved in pursuing the art form how can we have a situation where a record is not supposed to be played if it's over four minutes long? ... Emile Zola said that 'art is a slice of life seen through a temperament.' What is in the temperament of a general manager who says, 'After 4 minutes, forget it, we just don't play it, Charley.' We have a responsibility. There's a little too much chaos going on outside and we can somehow affect that. ... we can somehow educate. If we're not too involved in double and triple spotting. If we're not too involved in getting our records played every second. ... I point to the people in the radio and record industries as being very responsible for what emerges from chaos."

Mystery of MOR Stations

Dick Starr, newly appointed PD at WNEW in N.Y., noted that almost twenty years after the advent of top 40 radio, almost every exec in radio today has had some experience in it. "The concepts that succeeded in top 40 are succeeding today in so called middle-of-the-road radio. The music has to be contemporary within certain quality guidelines. That, with a proper balance of good LP material and vintage records. ... constitute the lifeblood of a radio station."

U.S. and British Product

Walt Maguire, director of A&R pop singles sales for the London Record Group, traced the ascendance and influence of the British market in the U.S., terming England as "the 51st state." It's a record session center along with Hollywood, Detroit, New York, Chicago, Nashville and Memphis. "We can also see that, in the past few years, American record companies have been setting up operations in London. We know that, in 1968, five or six more are actually going into business there. Further proof that the American sound and the British sound are working together."

A&R Yesterday and Today

Steve Sholes, division vp, pop A&R for RCA Victor, noted the changes

in A&R over the years. "It seems that, today, everyone wants to get into the act. The songwriter all the way through to the elevator operator in the record company all know how the record should be made—and they're all willing to tell you too. ... This, coupled with the improvements in recording techniques which permit records to be made piece by piece on inch by inch, reduces the effectiveness of all but the most stalwart producer. I'm not saying that records shouldn't be made this way. I am saying, though, that it takes a real creative direction out of one person's hands and places it into the hands of many. ... with the creative direction spread this way, the blame should be spread too. But it doesn't always seem to work out this way. When a record is a failure, it's the producer's fault. When it's a success, he sometimes has a hellofa time getting any credit for it. ... An A&R man should be primarily interested in making a record which will sell. And which will enhance the appeal of the artist with whom he is working. There's nothing more advantageous to all concerned than developing an artist who sells records in a consistent fashion. ... An A&R shouldn't take an advantage which might bring momentary success to the label to the detriment to the career of the artist."

Responsibility to the Community

Lucky Cordell, program and music director at WVON, Chicago, noted that "it takes two men and a horse to hold our news director down." An indication of WVON's strong editorial policy. "In the last survey it was proven that we have a tremendous audience other than our Negro listeners or else we never could have become No. 1 in a city with two 50,000 watts stations and we are just a thousand." Station, Cordell said, had given 10,000 Xmas baskets to the needy last year. The school drop-out program, the runaway program, group tours to the station and tapes to Vietnam were just some of the methods of demonstrating their involvement and responsibility.

Taste and Creativity

Gavin introduced Jerry Wexler, executive vp of Atlantic Records, as a man who had brought new techniques into record productions, "a man who has brought the sounds of Memphis to the world." Wexler's incisive speech was one of the highlights of the seminar. In discussing the record industry's relationship with the radio industry, he said, "the best way to analyze the true quality of the relationship is to postulate the end situation. ... the truth is, on a personal level, we mingle very well with radio people. ... but in the business relationship we're on sufferance. We mustn't transgress. And the relationship, really, is a set of rules—spelled out—strictures, new cases, injunctions. 'Don't come 'til Friday. They're too long, shorten them. They're too dirty, clean 'em up! ... The reason is that radio is supplied with an endless wave of product to draw upon. ... and the wave cannot be dammed in any way. ... the economics of the situation dictate the tenor of the relationship."

"I've heard a lot today about research, familiarity in music, surveys, formats—I haven't heard too much about the word 'taste'—I haven't heard too much about 'creativity.' And I think at the level, maybe, of Burt Bacharach or Don Covay on one hand or William Faulkner or Ernest Hemingway—what kind of market research they did before they sat down and did their thing? Maybe they researched their hearts or some interior vision with which they were blessed. Basically I think the record business is one that has to do with the generation of product primarily and as a market industry secondarily. ... we keep having to explore the unfamiliar and the uncharted. ... an exploration into taste and into creativity."

Wexler introduced Atlantic Records' chief engineer, Tom Dowe, who commented that, in his travels over the past two years, he has been "appalled" at the sounds of his records while listening in hotel rooms and on transistors. In one town "I'd think

(Continued on page 102)

RIAA: Mailings Hike Goes Far Enough

NEW YORK — The Postal Rate Bill just enacted by Congress was met with satisfaction by the Record Industry Association of America (RIAA). The association termed the Bill, raising by 20% the rate on disk mailings, a "great improvement over the original proposal" that would have increased the record mail rate by 50%.

New Rates

Under the terms of the new rate bill, the rate on mailings of phonograph records will be 12 cents for the first pound and 6 cents for each additional pound. The current rate is 10 cents for the first pound and 5 cents for each additional pound. As originally introduced, the bill would have eliminated the minimum one-pound rate and imposed a rate of 16 cents on mailings of up to two pounds and 6 cents for each additional pound.

The original proposal had been vigorously opposed by RIAA in testimony before the Senate Post Office and Civil Service Committee in October. Jarrell McCracken, a vice president of RIAA and president of Word, Inc., of Waco, Texas, called the proposal "disastrous and extremely prejudicial against companies who sell a certain type and weight of product." The imposition of a two pound minimum," he said "would be an intolerable increase and would either put some companies out of business or require substantial increases in service charges or prices. Neither of the alternatives is reasonable."

Pop Music Is Culture

Henry Brief, the association's Executive Secretary, rebutted remarks made before the Committee to the

effect that many of the records sent through the mail today consisted of pop music that provided entertainment rather than cultural value. He pointed out that the diversity of recorded artistry and repertoire encompasses as broad a spectrum of subject matter as do books, that what is revered today as "classics" in music and books were the popular literature and music of yesterday, and that one can read a book or listen to a record for entertainment and simultaneously be enriched culturally. In asking the Committee to restore the minimum one-pound rate, Brief stressed that the record industry was not arguing against any increase in postal rates but believed that the rise should be proportionate to, and in conformity with, the increases imposed on other mail categories.



THE HAPPY COUPLE—Mr. & Mrs. Happiest Millionaire of Cleveland, winners of a contest held recently in that city, are shown at the Record Rendezvous in Richmond Mall, holding a copy of the Vista soundtrack album. The winners, Mr. & Mrs. Henry Drabeck, were chosen from entries submitted through newspapers and record outlets in the area. Prizes consisted of \$200. wardrobe, a night out with dinner and entertainment, plus an overnight stay at the Versailles Hotel, topped off with a millionaire style breakfast in bed. The contest was jointly sponsored by Giant Tiger Stores and the Helene Curtiss cosmetics firm around the Walt Disney flick and the Vista and Disneyland soundtrack LP's.

Eugene Aberbach Dies, CBS Direct Market VP

NEW YORK—Eugene Aberbach, vice president of marketing for CBS direct marketing services, died last week (11). He had been associated with CBS since 1960, and was elected to the vice presidential position in October, 1966.

A graduate of the City College of New York, with a major in History, Aberbach attended graduate schools of Columbia University and the University of Wisconsin.

He is survived by his widow, Zita; a son, Josh; daughter, Nina; and his mother, Mrs. Luba Levine.

Funeral services were held the afternoon of Dec. 13 at the Riverside Funeral Chapel in Manhattan.



BRAZILIAN GOLD—Jerry Moss (left,) president of A&M Records, and his partner, Herb Alpert (right), present a smiling Sergio Mendes with an RIAA certified gold record, symbolizing sales of over \$1 million on "Herb Alpert Presents Sergio Mendes & Brasil '66." The LP was produced by Herb Alpert and arranged by Sergio Mendes. This is the first gold record for the group.

Near Double Sales Key: Brightest Atlantic Year

NEW YORK — Seven gold singles and two Million-dollar-sales LP's combined with more than eighty charted best sellers in both fields to nearly double sales in Atlantic's biggest year yet. Capping off the label's successful '67, three Gavin Poll Awards were garnered by Jerry Wexler (Executive of the Year and R&B Producer of the Year) and Aretha Franklin (R&B Singer of the Year).

Spurring the label's sales growth were contributions from artists on the affiliated Atco, Stax-Volt, Dial, Carla and Karen firms whose distribution is handled by Atlantic. The expansion has made Atlantic one of the fastest growing companies in the industry. Among the artists leading the drive were Aretha Franklin, the Young Rascals, the Bee Gees, Cream, Wilson Pickett, Sonny & Cher, Buffalo Springfield, Vanilla Fudge, Joe Tex with the Dial label, King Curtis, Flip Wilson, Herbie Mann, Charles Lloyd, Percy Sledge, Arthur Conley, Solomon Burke, the Rose Garden and Billy

Vera & Judy Clay.

Included in the diskery's roster of more than fifty singles and thirty LP's to reach best seller proportions are seven decks by Aretha Franklin, Sam & Dave, Arthur Conley and the Mar-Keys that received RIAA certification as million-sellers, and two million-dollar albums by Aretha Franklin and Mr. Acker Bilk.

Stax and Volt Records, Jim Stewart's Memphis labels distributed by Atlantic, also experienced a sales surge that doubled the volume of '66 sales. The labels have made major gains through international handling of material featuring the late Otis Redding, the Bar-Kays, Booker T. & the M.G.'s, Carla Thomas, Sam & Dave, Johnny Taylor, the Mar-Keys, Eddie Floyd and William Bell.

Overseas representation on international charts by Atlantic has also been bolstered by a series of international appearances with many of the top stars from the various labels.

Jack Levy Joins Dot

LOS ANGELES — Jack Levy has joined Dot Records as advertising-merchandising director, according to an announcement from Dick Peirce, firm's vice-president and general manager.

The new Dot exec is a marketing specialist, credited with many innovations in the realm of all-media advertising, and in the areas of packaging as well as point-of-sale merchandising.



Jack Levy

A graduate of New York University in marketing and advertising, Levy entered the field in 1946 with Layne, Leene and Greene Advertising as an account executive and television commercial producer, supervising leading national accounts.

In 1957, he moved to the west coast, where he was tapped by Capitol Records as singles merchandising manager. A year later, he was elevated to program development manager and, subsequently promoted to national merchandising manager. Levy's versatility became even more evident in early 1960 when Capitol moved him to their publishing firm, Ardmore-Beechwood Music, as vp and general manager.

Randy Sparks Associates then retained him in a new post, that of general manager for the company. During his tenure with Sparks, he was responsible for complete supervision of the firm, including publishing, talent and record production.

Liberty beckoned in September, 1966, at which time Levy joined the organization as advertising-merchandising manager.

Jimmy Rodgers Off Critical List

NEW YORK—Singer Jimmy Rodgers, has one again been taken off the critical list at the Glendale Hospital in Glendale, Calif. as of Dec. 14. Rodgers has been hospitalized for a total of more than a week since he was attacked near the San Diego Freeway. He has undergone two brain operations during that time, the second of which was instrumental in his being removed from the critical list, for the second time.

Church Upped At Liberty

BEVERLY HILLS, CALIF.—Liberty Records has promoted Derek Church to the position of advertising and merchandising manager. He replaces Jack Levy, who has left Liberty to accept a similar post with Dot Records.

Church brings eight years of advertising and public relations experience to the position including tenures at the Nestle Company, Eastman Kodak, Autin Knight Advertising in London, England, and Smith & Hemming Advertising.

Church joined Liberty Records in August, 1967 and has been active in advertising, merchandising and promotion for the label.

He is a graduate of South East Essex Technical College in England and spent two years in the Royal Air Force as a deejay for military radio stations. In addition to his advertising, merchandising and public relations experience, he has served as director of the Irene Benton Model Agency and Training School in London and as creative advisor to the Ivy Kilgannon Theatrical Agency.

Church will report to Allen Lavinger, Liberty's manager of marketing services.

Harvey To Acquire Liberty Music Shops

WOODBURY, N. Y. — The Harvey Radio Co. has agreed to acquire, for an undisclosed amount of cash, Liberty Music Shops of New York. Liberty's sales for its latest fiscal year were approx. \$3.7 million

Harvey is a technical marketer and manufacturer of advanced components and systems for the electronics, aerospace, and communications industries. Through its retail division, the firm also sells electronic equipment and hi-fi consoles/components

Liberty operates three stores in the greater New York area, where it retails home entertainment systems and components, primarily in the hi-fi/stereo field

Harvey recently announced for the 9-months ending Oct. 31, '67, net after tax income of \$440,000. or \$.50 per share, based on 881,373 shares outstanding.

CANDY LOVE

HAS A
HIT
ON ORR RECORDS



"CHRISTMAS EVE"

b/w
"MY FAVORITE THINGS"

DEEJAYS AND DISTRIBUTORS:
WRITE TO ORR RECORDS DIVISION, TEL-FI INC.
8010 S. COTTAGE GROVE, CHICAGO, ILL.
PROMOTION-PRESSING DIRECTED BY:
BRITTE STAR PROMOTIONS
209 STAHLMAN BLDG., NASHVILLE, TENN.



Top 50 In R & B Locations

1	CHAIN OF FOOLS Aretha Franklin (Atlantic 2464)	2	UP TIGHT GOOD MAN Laura Lee (Chess 2030)	28
2	I HEARD IT THRU THE GRAPE VINE Gladys Knight & Pips (Saul 35039)	1	SINCE YOU SHOWED ME HOW TO BE HAPPY Jackie Wilson (Brunswick 55354)	27
3	I SECOND THAT EMOTION Smakey Robinsan & Miracles (Tamla 54159)	8	UNITED Part 1 United Makers (Gamble 210)	29
4	BOO-GA-LOO DOWN BROADWAY Fantastic Johnny C (Phil L.A. of Saul 305)	3	TOUCH OF BLUES Bobby Bland (Duke 426)	30
5	YESTERDAY Ray Charles (A&C 11009)	6	SOCKIN' 1-2-3-4 John Roberts (Duke 425)	36
6	SKINNY LEGS AND ALL Joe Tex (Atca 4063)	9	SOMETHING'S MISSING 5 Stairsteps (Buddah 20)	32
7	I SAY A LITTLE PRAYER Dianne Warwick (Scepter 12203)	4	MY BABY MUST ME A MAGICIAN Marveletts (Tamla 54158)	38
8	TELL MAMA Etta James (Cadet 5578)	12	COUNT THE DAYS Inez & Charlie Faux (Dynamo 112)	33
9	I'LL BE SWEETER TOMORROW OJays (Bell 691)	10	EVERLASTING LOVE Robert Knight (Rising Sun 705)	17
10	IN AND OUT OF LOVE Diana Ross & Supremes (Motown 11)	5	STORYBOOK CHILDREN Billy Vera & Judy Clay (Atlantic 2445)	45
11	HONEY CHILE Martha Reeves & Vandellas (Gordy 7067)	11	THIS THING CALLED LOVE Webbs (Pap Side 4593)	42
12	I'M IN LOVE Wilson Pickett (Atlantic 2448)	13	STAGGER LEE Wilson Pickett (Atlantic 2448)	24
13	PIECE OF MY HEART Erma Franklin (Shout 221)	14	MOCKINGBIRD Aretha Franklin (Columbia 44381)	46
14	IF I COULD BUILD MY WORLD AROUND YOU Marvin Gaye & Tammi Terrell (Tamla 54156)	16	SHAME ON ME Chuck Jackson (Wand 1166)	37
15	AND GET AWAY Esquire (Bunky 7752)	18	DETROIT CITY Salaman Burke (Atlantic 2459)	40
16	PATA PATA Miriam Makeba (Reprise 0606)	7	SPOOKY Classics IV (Imperial 66259)	43
17	LOVE POWER Sandpebbles (Calla 141)	19	HOW BEAUTIFUL OUR LOVE IS Platters (Musicar 1288)	48
18	BACK UP TRAIN Al Greene (Hat Line 15000)	23	SOMEBODY'S SLEEPING IN MY BED Johnny Taylor (Stax 235)	41
19	COME SEE ABOUT ME Jr. Walkers & The All Stars (Saul 35041)	25	HEY JOYCE Lau Courtney (Riverside 4594)	49
20	O-O I LOVE YOU Dells (Cadet 5574)	20	MORE MORE Little Milton (Checker 1189)	—
21	WHERE IS THE PARTY Helena Ferguson (Compass 7009)	22	FINDERS KEEPERS Al Kent (RIC Tic 133)	47
22	I CAN'T STAND MYSELF James Brown (King 6144)	31	PICK UP THE PIECES Carla Thomas (Stax 239)	—
23	I CALL IT LOVE Manhattan (Carnival 533)	21	A MAN NEEDS A WOMAN James Carr (Goldwax 332)	—
24	WINDY Wes Montgomery (A&M 833)	35	I RATHER GO BLIND Etta James (Cadet 5578)	—
25	SOUL MAN Sam & Dave (Stax 231)	15	I HAVE NO ONE Big John Hamilton (Minaret 129)	44

Mendes, Adler End Brasil '66 Partnership

LOS ANGELES—Sergio Mendes and Richard Adler have agreed to terminate their partnership relating to the A&M recording group Sergio Mendes and Brasil '66. Adler had acted as partner with Mendes and manager of the group for the past three years. With the partnership split-up, all Brasil '66 activity will now be handled by Mendes Enterprises, agent Jerry Perenchio and A&M. Mendes stated that "there will be no change in the Brasil '66 relationship with A&M Records and that we expect to double the 1967 output of releases during the year of 1968. Our next album on A&M is entitled 'Sergio Mendes and Brasil '66—Look Around' and is scheduled for release on January 12." The group is presently concluding another nationwide personal appearance tour and the Perenchio Agency is currently working on both a European and Latin American concert tour.

Chicago's Cheetah Gives Built-In Promo Program

CHICAGO—A series of local tie-ins is enabling Chicago's Cheetah to give record acts booked into the youth nitery the advantage of a built-in promo for their current records as well as publicity on scheduled engagements.

Eva Dolin, whose firm handles pr for the discotheque, has been working closely with local record distribution outlets and the Cheetah has started supplying giant-sized post cards, posters and album slicks imprinted with scheduled engagements of record acts at the club.

Distributors then supply local record stores and department store record sections with the material.

The recent appearance of Philips' H.P. Lovecraft was augmented by use of a hundred LP slicks supplied by the diskery, imprinted by Cheetah and distributed through Merrec.

A minimum of a hundred giant post cards &/or slicks has been requested monthly by distributors. Current waxings of acts at the nitery are also promoted on Cheetah commercials over WCFL, WLS and WVON with cuts from an LP or singles used in the spot announcements.

Feature stories have also been used in the Chicago Daily News and Chicago American's Sunday Section in conjunction with engagements by the Buckingham, Tommy James & the Shondells and others.

5th Dimension Sets Six-Month Schedule

LOS ANGELES—The 5th Dimension Soul City recording artists currently riding the charts with their new album, "The Magic Garden," are booked for the next six months, as announced by their manager Marc Gordon and their agents General Artists Corporation.

On December 22 they make their first appearance in Las Vegas as they are booked into Caesars Palace for a four week engagement. They will return to Los Angeles to headline a special Christmas Day Show at The Hollywood Palladium and then back to Vegas for their midnight show. On January 27 they will perform at "The Hollywood Stars of Tomorrow Awards" in Los Angeles and on the next day appear on The Ed Sullivan Show. On January 29 they begin a ten-day booking at The Latin Casino in Merchantville, New Jersey. From February 9 until March 1 they will be on a nationwide one-nighter concert tour and from March 22-31 they will headline a Dick Clark tour. On May 15-June 8 they make their first major New York appearance as they perform at The Americana Hotel. They will then appear at the Edgewater Beach Hotel in Chicago from June 10-16 and then The Cave in Vancouver, British Columbia from June 26-July 6.

Home For 'Homeless' Set Up On West Coast

NEW YORK—Kim Fowley, a 25-year-old west coast producer/publisher/artist, has established a sort of headquarters cum living quarters cum working quarters for 'homeless' west coast R&B and rock acts. The operation is located just off L.A.'s Sunset Strip at 6,000 Sunset Blvd., where interested groups may contact Fowley. Groups involved in the operation will receive living quarters, food, musical equipment, supervision, and guidance in rehearsals. The first group in Fowley's project is Super Band originally from Denver, Colo.

Paul Williams of Crawdaddy Magazine has for some time been attempting to interest responsible and financially solvent persons and organizations in a similar project for the New York area. Williams notes that he is willing to serve in an advisory capacity to any interested parties.

Rascals P.R. Formed

NEW YORK—Pat Cox and Billy Smith are heading up Sid Bernstein's Rascals' Public Relations Dept. at 75 E. 55th St. Smith mentioned to Cash Box that the firm will open an education dept. and a TV dept., both of which will use tapes, video tapes, and 16mm films to "bring the Rascals to places where they physically can't be." The special phone number for the P.R. dept. is 759-9898.



IN HIS HONOR—French composer and conductor Pierre Boulez is honored at a recent luncheon given by CBS Records. Shown here (from the left) with Boulez are: John McClure, Columbia Masterworks director of A&R; Thomas Shepard, Columbia Masterworks A&R producer; and Kenneth Glancy, managing director of CBS Records in England. The most recent Boulez album is "Olivier Messiaen: Et Exspecto Resurrectionem Mortuorum/Couleurs de la Cite Celeste," and is part of the label's Nov. "Music Of Our Time" release.



More Letters

Liberty Records' Victor Lundberg is shown during a recording session in L.A. for his "An Open Letter" LP, which has just been released. All of the album cuts as well as the "An Open Letter To My Teenage Son" single, which it follows, were written by Lundberg's Grand Rapids business partner, Robert Thompson.

Shadow Morton Moves HQ, Re-Names Company

NEW YORK — Beginning in Jan., '68, Shadow Morton will base his operation out of Hempstead, L.I., although the firm, which will at the same time undergo a name change to G. Shadow Morton Enterprises, will keep an office in the city.

One reason for the move is that Morton's favorite studio, Ultrasonic, is also located in Hempstead. Morton plans to cut most of his future product on the Island.

Morton has just completed one new Vanilla Fudge LP and plans to have another completed in about one month.

Stepping out of the producer's role, Morton has just cut a deck for Bob Crewe Productions on which Morton's vocal has been described as being, "sort of a psychedelic 'Nature Boy.'"

Bobby Calendar Inked By Alan Lorber Prod.'s

NEW YORK—Alan Lorber Productions has signed Bobby Calendar. Calendar will be released on MGM with his first LP scheduled for February.

Calendar will co-produce the LP with Lorber and will aim for an unusual musical quality with a social commentary lyrical content.

Dyno Voice Inks Illusion

NEW YORK—Bob Crewe has signed the Illusion, a five-man vocal/instrumental group from the New York area, for his Dyno Voice label. The group's first single, which was produced and written by Mitch Ryder, will be released after January 1. Four of the boys sing lead, and at times, the group has five-part harmony.

Impressed by their "in person" performance, Ryder invited the Illusion to tour with him this past summer as part of The Mitch Ryder Show. The group is now on their own headlining one-nighters on the East Coast and plan a cross-country promo and pa tour to coincide with the release of their first single.

The Illusion are: John Vinci (lead singer/organ); Mike Maniscalco (12 string & rhythm guitars/sax); Chuck Alder (bass guitar); Richie Cerniglia (lead guitar) and Mike Ricciardella (drums).

Peloquin Triple-Pacted

NEW YORK—Universal Television, Decca Records and MCA Music have signed Jean Peloquin to exclusive contracts, it has been announced by Sidney Sheinberg, vice president of Universal Television. Until recently, Peloquin was a backlot employee at Universal City Studios.

The three-way pact is the outcome of an audition by 27-year-old singer-composer of his original song, "Mister Painter, Paint My Dad" for Decca's west coast A & R executive Bud Dant. Impressed with Peloquin's song and talent, Dant signed him to Decca and brought him to the attention of Gil Rodin, the record company's administrative director of A & R for the west coast, who in turn brought Peloquin to Norman MacDonnell, executive producer of Universal Television's "The Virginian."

Peloquin was cast as a guitar-strumming cowboy in the "Gentle Tamers" episode of "The Virginian." On the strength of his initial performance, he has been set as a recurring character in the western adventure drama.

In addition, he has also been signed to a song writer's contract by MCA Music.

Decca's release of "Mr. Painter, Paint My Dad" is timed for early January just prior to airing of the "Gentle Tamers" segment on the NBC-TV network, in which he will perform the song.

Turtles Film Gets Wide Play

LOS ANGELES—The 16 mm film produced on the Turtles is now being shown on the following shows, according to an announcement by Johnny Musso, national sales and promotion director for White Whale Records: Big Ralph Show in Cleveland, Hi Lit Show in Philadelphia, Art Roberts Show in Chicago, Ron Chapman Show in Dallas, Clay Cole Show in New York, Robin Seymour Show in Detroit, Rick Shaw Show in Miami, Ronnie Kay Show in Oklahoma City, Larry Lane Show in Houston, Boss City in Los Angeles, and Dick Clark's syndicated show.

Variety's Act

Motown's Four Tops are shown receiving the Variety Club award from Harold Salkind, chief barker for the Variety Club of Philadelphia, during a dinner honoring Ralph Pries, international prexy of Variety Club International. From the left are: Levi Stubbs, Renaldo Benson, Salkind, Pries, Abdul Fakir, and Lawrence Payton.

Talent On Stage

JUDY COLLINS

NEW YORK—Judy Collins, long recognized as one of America's leading folk-singers, showed the other side of her talent at her Carnegie Hall concert on Dec. 9th. Most of her material was contemporary pop served up with a guitar, bass, piano, or electric organ backing to her vocals. Judy came on soft and wonderful with her agonizingly clear voice.

The performance was not without reference to the folk field, notably: the "If I Had A Golden Thread" theme from Pete Seeger's "Rainbow Quest" offering and an a cappella treatment of the traditional "Wild Mountain thyme" that served as a final encore. "Pack Up Your Sorrows," a joint clefting by Pauline Martin and the late Richard Farina, worked well as one of the brightest spots of the concert as did Bob Dylan's "Tom

Thumb's Blues."

Contemporary pop songs were represented basically by works of: Joanie Mitchell, Leonard Cohen, Jacques Brel, and Judy Collins. "Chelsea Morning" "Michael From Mountains" (both by Joanie Mitchell,) "Suzanne" and "Sisters Of Mercy" (both by Judy Collins), and Jacques Brel's "La Colombe" may be taken as representative highlights of the concert.

Judy bid farewell to what she referred to as, "my former latest album" by singing "In My Life." She was also offering greetings to a new career as a pop (as opposed to folk) singer; setting out on a path that, if this concert and her current "latest album" ("Wildflowers") are any valid indication, will eventually lead her to the top of the field.

JANIS IAN

NEW YORK—The prodigious talent of 16-year-old Janis Ian was on view to about 2500 people at Philharmonic Hall on Friday evening, December 8. The astonishing range of this young social poetess became evident as she flew through a program of songs about love, isolation, and suicide. Miss Ian has attained an awareness and a grasp of the human condition that many older heads might well envy.

Early in the program, she sang "Society's Child," the tune which first brought her to national attention after the song had been shunned for about eight months as too controversial, dealing as it does with interracial dating. The artist also romped through a whimsical rendition of "And I Did Ma," a tale of a girl who foolishly listens to her mother's admonitions

regarding the dangers of close association with the male of the species.

"Honey D'Ya Think?" deals with the pretensions of a would-be blues singer who hasn't paid his dues, and the performer gave the melody a sorrowful, ironic reading. "Younger Generation Blues" was a brittle, humorous treatment of the generation gap. Miss Ian later performed her current chart single, "Insanity Comes Quietly To The Structured Mind," which concerns the suicide of a young girl.

With a lifetime of creative effort before her, one contemplates with wonder the heights which this supremely gifted artist will attain. Miss Ian was accompanied by the New York Rock 'n' Roll Ensemble, a well-turned out organization equally at home with baroque music or hard rock.

KENNY RANKIN

NEW YORK—On Monday evening December 11, at the Bitter End Cafe in Greenwich Village, Mercury Records introduced Kenny Rankin, a singer, guitarist and writer of contemporary songs. An intimate rather than an expansive performer, Rankin delivered his material gently and without fanfare, accompanying himself softly on the guitar and depending on the audience's full attention to work his spell. He got the audience's attention without any difficulty and kept it throughout his performance.

Rankin's style shows a heavy Brazilian influence. Echoes of such composers as Antonio Carlos Jobim and Luis Bonfá permeate his songs. But he is no mere imitator. His style is his own, and he has assimilated his

influences and worked them into his own music to the extent that he is their master, not vice versa. In the end his songs must be called Brazilian-flavored, not Brazilian.

Rankin's chances of becoming a successful recording artist are extremely good, but because of the nature of his songs and his performance, he will probably sell many more albums than singles. Rock numbers, Motown soul outings and big ballads are by and large the stuff of which today's Top 100 chart is made. The intimate performer is still an important figure in the disk world, but his habitat, more or less forced on him by the public taste, is usually the LP and not the single.

Winnie's Words

Columbia's new Blood, Sweat, & Tears group formed by Al Kooper and Steve Katz (both formerly of the Blues Project), debuts at Steve Paul's west side disco, the Scene. The group uses elements of blues, rock, and jazz with heavy emphasis on a 4-piece brass section. Kooper is shown in the bottom photo while the rest of the group appears above.



Gavin Award Crowns Bell's Biggest Year

NEW YORK — With sales expected to more than double those of last year, Bell records topped off the best year in its young history with the receipt of a special award as "Outstanding Record Company of the Year" at the Bill Gavin Conference in Las Vegas earlier this month.

Awarded on the basis of constructive contributions to radio entertainment, the prize recognizes Bell's contribution in pioneering the use of independent producers and their overall representation in all phases of record product.

Highlighting the banner year was



The Bell Family: (standing, left to right) Oscar Fields, Alan Cohen, Gordon Bossin, Beverly Weinstein, Dave Carrico and Irv Biegel. Seated is Larry Uttal.

the Cash Box Annual Poll #1 record, "The Letter" by the Box Tops, which is now nearing the 2,000,000 mark in domestic sales and that many again in foreign sales. Bell has also been represented week after week with national best sellers.

The diskery's expansion moves included the hiring of sales manager Irv Biegel whose background includes many years of sales and merchandis-

I. M. Flowers Show

(Continued from page 7)

the show is in the process of lining-up several more label sponsors.

While the program's aura suggests an "underground" appeal, the records played reflect a broad outline of rock tastes. Some of the more consistently heard sounds, mostly from LP sources, are those of the Beatles, Rolling Stones, Bob Dylan, the Beach Boys, the Rascals, the late Otis Redding, the 13th Floor Elevator, Donovan, the Bee Gees, Love, the Cream, Lee Dorsey, the Hollies, among others. The Dec. 23 show will feature the Electric Prunes' LP of their "Mass in F Minor." A previous program featured a guest who was an expert in Hinduism.

Besides the New York airing, the program is taped for broadcast in Boston (WEEI), Philadelphia (WCAU), Chicago (WBBM), San Francisco (KCBS), Los Angeles (KNX) and St. Louis (KMOX).

A feature of the programming format is to disregard current chart standings, but to seek out new material with potential. The July pilot show, for instance, played "Incense & Peppermints" by the Strawberry Alarm Club, which later became a number 1 seller.

In addition to playing-it-straight, sardonic humor is also employed, although keyed to the framework of the format.

The "I.M. Flowers Show," DeWitt notes, is indicative of WCBS-FM's attempt to be continuously on top of what's happening and incorporate the mainstream of today's pop music into the backbone of the station's programming.

ing experience, the growth of the national promotion staff from a one-man operation to the present setup of three hands with Gordon Bossin and Oscar Fields joining Dave Carrico in the last eight months.

Further honor was accorded the firm when it was chosen by New York's Mayor John V. Lindsay to participate in a city-wide talent search. Among the artists previously established by Bell and its affiliated labels are: the O'Jays, Oscar Toney, Jr., Betty Harris, Clifford Curry, Al Greene and, of course, the Box Tops. On the international scene, presi-

dent Larry Uttal cited the launching of Bell in Canada through Quality Records, and E.M.I.'s handling of the Bell label in the United Kingdom to begin this coming March 8. Uttal anticipates worldwide exposure of the Bell label by the end of '68.

Sholes' Luncheon

(Continued from page 7)

activities.

Remarks In Tribute

Also in tape form was a message from Chet Atkins, Nashville A&R head of RCA. Sholes, a Nashville music figure for many years, was voted into the Country Music Association's Hall of Fame this year.

Eddy Arnold was present to offer his tribute to Sholes as "an important cog in my life as well as the lives of many other artists." The RCA artist, a 20 year veteran on the label, said he admired Sholes despite "three bad things about him: he works hard, he's honest and he loves his family." Charlie Grean, the producer-musician, who said Sholes gave him his first job in the business, got many laughs out of humorous captions for a series of slides, featuring Sholes, presented on a theatre-sized screen. Arnold and Grean were part of the dais that also included Father O'Connor, George Simon, executive director of the New York chapter, Brad McCuen, 1st vp of the chapter and RCA exec, and David Hall, a NARAS vp.

Telegram tributes were sent by Jack Stapp, Buddy Killen, Elton Britt, Don Kirshner, Joe Reisman, Joe Csida, Jack Loetz, chairman of the board of the Country Music Association, and Hank Snow.

The more than 200 guests, including Norman Racusin, vp and general manager of RCA, Sholes' family were asked to sign signature album books for presentation to the exec.

Linguistic Slip-Up

In our recent Christmas Pick of Remo Capra's "Sancta Maria" (issue of Dec. 9) we wrongly identified the languages in which the song is performed as Italian and English. The English is a translation from Latin.

Redding, Bar-Kays Deaths

(Continued from page 7)

siastic supporter of NATRA (National Association of Television and Radio Announcers) and had hosted a party at his ranch for the delegates to that organization's '67 convention in Atlanta. He was at the height of his career, having just been voted into a 3-way tie for the number one male R&B vocalist in the annual Cash Box year end poll. The Bar-Kays had just been voted into a tie for the number two spot with "Soul Finger" for best R&B record of the year in the same poll. Both Redding and the Bar-Kays were Volt recording artists. Cash Box has been informed that Volt has enough sides in the can to total at least one more Otis Redding album.

Any listing of Redding's more successful product on wax would have to include such singles as "Mr. Pitiful," "Chained And Bound," "Satisfaction," "Fa-Fa-Fa-Fa (Sad Song)" and "Try A Little Tenderness," in addition to his albums: "Pain In My Heart," "The Great Otis Redding Sings Soul Songs," "Otis Blue/Otis Redding Sings Soul," "The Soul Album," "The Dictionary of Soul," and, of course, his latest, "The History of Otis Redding," ironic in the choice of title.

He had gone into record production with a firm known appropriately as Big-O Productions. He has been credited with the composition of more than forty songs. He was equally at home as arranger, writer, producer, and performer.

Although born in Dawson, Ga. on Sept. 9th, 1941, Redding attended school in Macon. While still in high school, he won a number of local amateur contests, thus coming to the attention of his manager Phil Walden, who was also in high school at the time. "These Arms Of Mine," his first deck was cut on left over studio time while Redding was accompanying Johnny Jenkins on a date in Memphis, Tenn. An all-round performer, he was proficient on guitar, piano, bass, drums, and organ.

With Walden, Redding had recently branched out into the personal management field with Otis Redding Enterprises.

Redding had just accepted an invitation from Vice President Hubert Humphrey to head up a troupe of Stax/Colt recording artists to Vietnam this spring. He had donated his services to the 1967 Stay In School Campaign LP for the U.S. Dept. of Labor.

Notes of tragic irony may be found in the fact that Redding's untimely death follows almost 3-years to the day after the death of Sam Cooke (Dec. 11, 1964.) "Shake," written by Sam Cooke, was Redding's last single; it was also Cooke's last deck.

Otis Redding is survived by his widow, Zelma, and three children: Otis, Jr.; Dexter; and Carla.

Newton Renews ABC Pact

(Continued from page 7)

tion deal with their labels. Under Newton, 20th Century Fox Records came under ABC distribution, with the label currently sporting the major "Doctor Dolittle" soundtrack.

Newton became president of ABC on Jan. 1, 1965, succeeding Clark who was named to his present post.

A native of Philadelphia, Newton began his career in the recording industry with his first job in 1938, while still in high school. From the stock room of the Columbia Records distributor, he progressed to salesman for different record labels, including Varsity, Cosmo and Rainbow. Starting in 1940, he served for five years with the United States Army as a paratrooper. He formed his own record label, Derby Records, in 1950.

In September, 1956, Newton was appointed by Clark to the post of sales manager for ABC-Paramount Records, inc. In 1959, he was promoted to vice-president in charge of sales, and served in that capacity until he was promoted to president for ABC Records.

Katzel Named ABC VP

(Continued from page 7)



Bud Katzell

manager of Colpix Records. Katzell entered the record business in 1951 when Decca Records appointed him as its Chicago promotion representative, later promoted him to Midwestern regional promotion, and then transferred him to New York where he took over as eastern divisional promotion representative. In 1955, he was promoted to assistant to the director of promotion and publicity and was later given the additional duties of advertising and merchandising. He moved to Roulette's sales department in 1960. Katzell was appointed general sales manager in 1962.

Katzell, who organized and presented the presentation a year ago at ABC's Miami distributor convention, is currently in the process of preparing programs for ABC's three regional meetings to be held the first week in Jan.

Scotti Nominated For Golden Apple Award

BEVERLY HILLS—The Hollywood Women's Press Club has nominated Liberty Records artist Tony Scotti for a Golden Apple Award for the New-comer Of The Year.

The award will be presented at the club's Christmas party December 19th at the Beverly Wilshire Hotel.

Gavin Conference

(Continued from page 98)

that we made a bad master and in another place I'd say—"Gee, I don't remember making it in that key, it sounds sharp." . . . Why, when I went down to Miami did it sound louder? . . . All of a sudden I realized something . . . that radio engineer, that complacent pipe smoking man, gets up at 5:30 in the morning, goes out there, cranks up the transmitter, throws the oil can on the turntable, hits the console, does the opening and then goes back out to the transmitter and changes the tire on his car . . . I implore you, please, search yourselves, wake up that engineer . . . it's your radio stations, our records."

The Short List

Frank Ward, executive vp and general manager of WWRL in New York, defended format radio adding that "we are literally inundated with material. The tragedy is that there's so much good material. But we've found through trial and error, in our particular operation, that you water the whole thing down by playing too many records . . . get a record on that list and it's played and played. And you sell records if it's a good record. Yet, even though you like the saturation you get when you're on that type of station, you want us to play more records."

Marketing Sophistication

Marvin Antonowsky, vp director of media research and manager of spot buying for J. Walter Thompson, admitted that research had not yet found all the answers for radio. But that research was doing a better job each day in determining, for clients, media. "If a client decides that his how effective radio was against other best opportunity for increasing market share or market position is to concentrate on the 18 to 34 segment of his market, this generally is the outgrowth of the marketing strategy which, translated into media terms, will dictate that the advertising weight will be concentrated against this group . . . all part of an increasing marketing sophistication."



TOP 100 Albums

DECEMBER 23, 1967

1	PISCES, AQUARIUS, CAPRICORN & JONES LTD Monkees (Colgems COM/COS 104)	1	27	RELEASE ME Engelbert Humperdinck (Parrot PA 61012/PAS 71012)	27	53	CLAMBAKE Elvis Presley (RCA Victor LPM/LPS 3893)	59	77	THE VOICE OF SCOTT MCKENZIE (Ode Z12 44001/Z12 44002)	80
2	DIANA ROSS & THE SUPREMES GREATEST HITS Motown M/M3 2-663	2	28	THE BYRDS GREATEST HITS (Columbia CL 2716/CS 9516)	22	54	MONKEES HEADQUARTERS (Colgems COM/COS 103)	45	78	PLEASE LOVE ME FOREVER Bobby Vinton (Epic LN 24341/BN 26341)	82
3	STRANGE DAYS Doors (Elektra EK 4014/EKS 7414)	4	29	GROOVIN' Young Rascals (Atlantic 8148/SD 8148)	30	55	MANTOVAN/HOLLYWOOD London LL3510/PS 510	48	79	PATA PATA Miriam Makeba (Reprise R/RS 6274)	84
4	SGT. PEPPER'S LONELY HEART'S CLUB BAND Beatles (Capitol T/TS 2653)	3	30	ARETHA ARRIVES Aretha Franklin (Atlantic 8150/SD 8150)	28	56	WITH LOVE CHER (Imperial LP 9358/LPS 1235B)	57	80	COME BACK WHEN YOU GROW UP Bobby Vee (Liberty LRP 3534/LST 7534)	54
5	FAREWELL TO THE FIRST GOLDEN ERA Mamas & Papas (Dunhill D/DS 50025)	5	31	CAMELOT Soundtrack (Warner Bros. B/BS 1712)	32	57	TEMPTATIONS GREATEST HITS (Gordy GM/GS 919)	61	81	ALLIGATOR BOOGOLOO Lou Donaldson (Blue Note BLP 4263/BLPS 84264)	88
6	DR. ZHIVAGO Soundtrack (MGM E/ES 6 ST)	11	32	TO SIR, WITH LOVE Lulu (Epic LN 24339/BN 26339)	39	58	FLOWERS Rolling Stones (London LL 3509/PS 509)	52	82	RESPECT Tommy Smith (Verve V/V-6 B705)	56
7	SIMPLY STREISAND Barbra Streisand (Columbia CL 2682/CS 9482)	7	33	BUFFALO SPRINGFIELD AGAIN (Atco 226/SD 226)	36	59	WELCOME TO MY WORLD Dean Martin (Reprise R/RS 6250)	53	83	ANYTHING GOES Harpers Bizarre (Warner Bros. W/WS 1716)	89
8	INCENSE AND PEPPERMINTS Strawberry Alarm Clock (UNI 3014/73014)	8	34	AFTER BATHING AT BAXTER'S Jefferson Airplane (RCA Victor LOP/LSO 1511)	43	60	BEST OF SONNY & CHER (Atco 219/SD 219)	66	84	I FEEL LIKE I'M FIXIN' TO DIE Country Joe & The Fish (Vanguard VR3 9266/VSD 79266)	90
9	IT MUST BE HIM Vicki Carr (Liberty LRP 3533/LST 7533)	9	35	BEST OF WILSON PICKETT (Atlantic B151/SD B151)	37	61	UP, UP AND AWAY Jonny Mathis (Columbia CL 2726/CS 9526)	72	85	WILD HONEY Beach Boys (Capitol T/ST 2859)	—
10	VANILLA FUDGE (Atco 224/SD 224)	6	36	GONE WITH THE WIND Soundtrack (MGM TE-10 ST)	35	62	RAVI SHANKAR AT THE MONTEREY INT'L POP FESTIVAL World Pacific (WP 1442/WPS 21442)	69	86	COWBOYS AND COLORED PEOPLE Flip Wilson (Atlantic B149)	98
11	THEIR SATANIC MAJESTIES REQUEST Rolling Stones (London NP/NPS 2)	38	37	THE LAST WALTZ Engelbert Humperdinck (Parrot PA 61015/PAS 71015)	74	63	LOOK OF LOVE Claudine Longet (A&M 129/SP 4129)	58	87	WHEN THE SNOW IS ON THE ROSES Ed Ames (RCA Victor LPM/LSP 3913)	92
12	ARE YOU EXPERIENCED Jimi Hendrix Experience (Reprise R/RS 6261)	10	38	THE BOX TOPS (Beil 6011/S 6011)	41	64	A CHRISTMAS ALBUM Barbra Streisand (Columbia CL 2757/CS 9557)	83	88	A GIFT FROM A FLOWER TO A GARDEN Donovan (Epic L2N 6071/B2N 171)	—
13	LOVE ANDY Andy Williams (Columbia CL 2766/CS 9566)	14	39	ALL MITCH RYDER HITS (New Voice NV/NVS 2004)	44	65	PINK FLOYD (Tower T/ST 5093)	70	89	MISSION IMPOSSIBLE Lalo Schifrin (Dot DLP 25831)	93
14	SOUND OF MUSIC Soundtrack (RCA Victor LOC/D/LSO 2005)	15	40	FRESH CREAM Cream (Atco 206/SD 206)	40	66	SMOKEY ROBINSON & THE MIRACLES MAKE IT HAPPEN (Tamla T/TS 276)	60	90	THE MAGIC GARDEN The 3rd Dimension (Soul City SCM 91001/SCS 92001)	95
15	THE TURTLES GOLDEN HITS White Whale (WW 115/WWS 7115)	18	41	ALBUM 1700 Peter, Paul & Mary (Warner Bros. W/WS 1700)	29	67	FOR A FEW DOLLARS MORE Leroy Holmes (United Artists UAL 3608/UAS 6608)	71	91	RIGHTEOUS BROTHERS GREATEST HITS (Verve V/V6 5020)	67
16	DIONNE WARWICK'S GOLDEN HITS PART ONE (Scepter SRM/SRS 565)	19	42	ALICE'S RESTAURANT Arlo Guthrie (Reprise R/RS 6267)	46	68	MARY IN THE MORNING Al Martino (Capitol T/ST 2780)	75	92	REVENGE Bill Cosby (Warner Bros. W/WS 1169)	64
17	DISAELI GEARS Cream (Atco 232/SD 232)	25	43	WINDOWS OF THE WORLD Dionne Warwick (Scepter SRM/SRS 563)	24	69	EYDIE GORME'S GREATEST HITS (Columbia CL 2764/CS 9564)	73	93	DANCING IN THE STREET Ramsey Lewis (Cadet LP/LPS 794)	68
18	HERB ALPERT'S NINTH Herb Alpert & Tijuana Brass (A&M 134/SP 4134)	51	44	A MAN AND A WOMAN Soundtrack (United Artists UAL 4147/UAS 5147)	33	70	SNOOPY AND HIS FRIENDS THE ROYAL GUARDSMEN (Laurie LLP/LP 2042)	85	94	ENCORE Henry Mancini (RCA Victor LPM/LPS 3887)	97
19	4 TOPS GREATEST HITS (Motown M/M3 662)	12	45	TURN THE WORLD AROUND Eddy Arnold (RCA Victor LPM/LSP 3869)	42	71	JOHN GARY CARNEGIE HALL CONCERT (RCA Victor LOC/LSO 1139)	65	95	WITH A LOT O'SOUL Temptation (Gordy G/G3 922)	79
20	BEE GEES 1ST (Atco 233/SD 233)	13	46	ODE TO BILLIE JOE Bobby Gentry (Capitol T/ST 2830)	26	72	SOUL MEN Sam & Dave (Stax 725/SD 725)	55	96	CHRISTMAS RHAPSODIES FOR YOUNG LOVERS Midnight String Quartet (Viva V/V3 6010)	—
21	MAGICAL MYSTERY TOUR Beatles (Capitol MAL/SMAL 2835)	—	47	HAWAIIAN ALBUM Ray Conniff (Columbia CL 2747/SC 9547)	49	73	WHEN THE WHISTLE BLOWS Soul Survivors (Crimson LP 502)	76	97	MAN OF LA MANCHA Original Cast (Kapp KRL 4505/KRS 5505)	99
22	A DAY IN THE LIFE Wes Montgomery (A&M 2001/SP 3001)	23	48	DOCTOR DOLITTLE Soundtrack (20th Century-Fox DTCS 5101)	50	74	EVERYBODY NEEDS LOVE Gladys Knight & The Pips (Soul S/SS 706)	77	98	PLEASURES OF THE HARBOR Phil Ochs (A&M 133/SP 4133)	100
23	THE COWSILLS (MGM E/SE 449B)	20	49	SUPER HITS Various Artists (Atlantic 501/SD 501)	47	75	WITHOUT HER Jack Jones (RCA Victor LPM/LPS 3911)	78	99	MASS IN F MINOR Electric Prunes (Reprise R/RS 6075)	—
24	THE DOORS (Elektra EK 4007/EKS 74007)	16	50	MELLOW MOOD Temptation (Gordy G/GS 924)	63	76	FOR ALL THE SEASONS OF YOUR MIND Janis Ian (Verve Forecast FT/FTS 3024)	81	100	GOLDEN GREATS BY THE VENTURES (Liberty LRP 2053/LST B053)	62
25	TO SIR, WITH LOVE Soundtrack (Fontana MGF 27569/SRF 67569)	17	51	SMILEY SMILE Beach Boys (Brother T/ST 9001)	31						
26	INSIGHT OUT Association (Warner Bros. W/WS 1696)	21	52	SOUNDS LIKE Herb Alpert & Tijuana Brass (A&M LP 124/SP 4124)	34						

101	HISTORY OF OTIS REDDING (Volt M/S 418)	111	HERE WHERE THERE IS LOVE Dionne Warwick (Scepter M/S 555)	121	GOODBYE & HELLO Tim Buckley (Elektra EKI 318/EKS 7318)	131	LETTERMEN . . . AND LIVE (Capitol T/ST 2758)
102	CLEAR LIGHT (Elektra EKL/EKS 74011)	112	APPLES, PEACHES, PUMPKIN PIE Jay & Techniques (Smash MGS 27095/SRS 67095)	122	DOWN TO MIDDLE EARTH Hobbits (Decca DL 4920/74920)	132	TODAY'S THEMES FOR YOUNG LOVERS Percy Faith (Columbia CL 2704/CS 9504)
103	WHIPPED CREAM Herb Alpert & Tijuana Brass (A&M LP 110/SP 4110)	113	STONE PONEYS VOL. II (Capitol T/ST 2763)	123	LATIN' LOVE-IN Tony Martin (Project 3 PR 5010 SD)	133	FISTFUL OF DOLLARS Soundtrack (RCA Victor LOC/LOS 1135)
104	LOOK OF LOVE Dusty Springfield (Philips PHM 200-256/PHS 600-256)	114	A KIND OF HUSH John Davidson (Columbia CL 2734/CS 9534)	124	SURREALISTIC PILLOW Jefferson Airplane (RCA LPM/LPS 3766)	134	GET THAT FEELING Jimi Hendrix & Curtis Knight (Capitol T/ST 2856)
105	CANDYMEN ABC ABC/ABCS 616)	115	EVERLASTING LOVE Robert Knight (Monument 7000/17000)	125	GROOVIN' WITH THE SOULFUL STRINGS (Cadet LP/LPS 794)	135	LET IT OUT Hombres (Verve/Forecast FT/FTS 3036)
106	HIGHER & HIGHER Jackie Wilson (Brunswick BL 54130/BL 7-54130)	116	SILVER THROAT—BILL COSBY SINGS (Warner Bros. W/WS 1709)	126	REACH OUT Burt Bacharach (A&M 131/SP 4131)	136	FOWL PLAY Baja Marimba Band (A&M 136/SP 4136)
107	FLYING NUN Sally Field (Colgems COM/COS 106)	117	THESE ARE MY SONGS Petula Clark (Warner Bros. W/WS 1698)	127	SILK AND SOUL Nina Simone (RCA Victor LPM/LSP 3837)	137	WILDFLOWERS Judy Collins (Elektra EKS 74012)
108	COLLAGE Noel Harrison (Reprise R/RS 6263)	118	THERE MUST BE A WAY Jimmy Roselli (United Artists ULA 3611/UAS 6611)	128	SOMETHING SUPER King Richard Fluegel Knights (MTA MTA 1005/MTS 5005)	138	THAT'S MY KICK Errol Garner (MGM E/SE 4463)
109	THE WORLD WE KNEW Frank Sinatra (Reprise F/FS 1022)	119	WHAT NOW MY LOVE Mitch Ryder (Dynovoice DY 1901/31901)	129	THE KENNEDY DREAM Oliver Nelson (Impulse A/AS 9144)	139	LISTEN Ray Charles (ABC ABC/ABCS 595)
110	WINDS OF CHANGE Animals (MGM E/ES 4484)	120	PSYCLE Happenings (B. T. Puppy BTP/BTPS 1003)	130	LUSH LIFE Nancy Wilson (Capitol T/ST 2757)	140	FIDDLER ON THE ROOF Original Cast (RCA Victor LPM/LPS 3730)

Basic Album Inventory

A check list of best selling pop albums other than those appearing on the CASH BOX Top 100 Album chart. Feature is designed to call wholesalers' & retailers' attention to key catalog, top steady selling LP's, as well as recent chart hits still going strong in sales. Information is supplied by manufacturers. This is a weekly, revolving list presented in alphabetical order. It is advised that this card be kept until the list returns to this alphabetical section.

COLUMBIA

Tony Bennett	I Left My Heart In San Francisco	CL 1869/CS 8669
Tony Bennett	Tony's Greatest Hits Vol. 3	CL 2373/CS 9173
Dave Brubeck	Time Out	CL 1397/CS 8192
Byrds	Tambourine Man	CL 2372/CS 9172
Byrds	Turn! Turn Turn!	CL 2454/CS 9254
Byrds	Younger Than Yesterday	CL 2642/CS 9442
Johnny Cash	Ring Of Fire	CL 2053/CS 8853
Johnny Cash	I Walk The Line	CL 2190/CS 8990
Christy Minstrels	Ramblin'	CL 2055/CS 8855
Ray Conniff	Invisible Tears	CL 2264/CS 9064
Ray Conniff	Music from "Mary Poppins"	CL 2366/CS 9166
Ray Conniff	Ray Conniff World Of Hits	CL 2500/CS 9300
John Davidson	Somewhere My Love	CL 2519/CS 9319
Miles Davis	My Best To You	CL 2648/CS 9448
Doris Day	Sketches Of Spain	CL 1480/CS 8271
Bob Dylan	Doris Day's Greatest Hits	CL 1210/CS 8635
Bob Dylan	Subterranean Homesick Blues	CL 2328/CS 9128
Bob Dylan	Highway 61 Revisited	CL 2389/CS 9189
Bob Dylan	Blonde On Blonde	2CL 41/2CS 841
Percy Faith	Viva—The Music Of Mexico	CL 1075/CS 8038
Percy Faith	Themes For Young Lovers	CL 2023/CS 8823
Edie Gorme	Softly As I Leave You	CL 2594/CS 9394
Gorme/Los Panchos	Amor	CL 2203/CS 9003
Robert Goulet	My Love Forgive Me	CL 2296/CS 9096
Robert Goulet	On Broadway	CL 2418/CS 9218
Robert Goulet	On Broadway Vol. II	CL 2586/CS 9386
Ken Griffin	You Can't Be True	CL 907/CS 8790
	Johnny Horton's Greatest Hits	CL 1596/CS 8396
	Mahalia Jackson's Greatest Hits	CL 2004/CS 8804
Andre Kostelanetz	Shadow Of Your Smile	CL 2467/CS 9267
Mathis	Johnny's Greatest Hits	CL 1133/CS 8634
	Patti Page's Greatest Hits	CL 2526/CS 9358
Jim Nabors	Sings Love Me With All Your Heart	CL 2558/CS 9358
Peaches & Herb	Let's Fall In Love (Date)	TEM 3004/TE 4004
Pozo Seco Singers	I Can Make It With You	CL 2600/CS 9400
Revere & The Raiders	The Spirit Of '67	CL 2595/CS 9395
Marty Robbins	Gunfighter Ballads	CL 1349/CS 8158
Pete Seeger	We Shall Overcome	CL 2101/CS 8901
Simon & Garfunkel	Sounds Of Silence	CL 2469/CS 9269
Simon & Garfunkel	Parsley, Sage, Rosemary & Thyme	CL 2563/CS 9363
Frank Sinatra	Sinatra's Greatest Hits Early Years	CL 2474/CS 9274
Barbra Streisand	People	CL 2215/CS 9015
Streisand	My Name Is Barbra	CL 2336/CS 9136
Streisand	My Name Is Barbra, Two	CL 2409/CS 9209
Jerry Vale	Have You Looked Into Your Heart	CL 2313/CS 9113
Andy Williams	In The Arms Of Love	CL 2533/CS 9333
Andy Williams	Moon River	CL 1809/CS 8609
Andy Williams	Days Of Wine And Roses	CL 2015/CS 8815
Andy Williams	Dear Heart	CL 2338/CS 9138
Jerry Vale	The Impossible Dream	CL 2583/CS 9383
Tony Bennett	Tony Makes It Happen	CL 2653/CS 9453
Anita Bryant	Mine Eyes Have Seen The Glory	CL 2573/CS 9373
Buckingham	Time & Charges	CL 2669/CS 9469
Johnny Cash	Johnny Cash's Greatest Hits	CL 2678/CS 9478
Ray Conniff	This Is My Song	CL 2676/CS 9476
	World Of Hits	CL 2500/CS 9300
Bob Dylan	Bob Dylan's Greatest Hits	KCL 2663/KCS 9463
Percy Faith	Born Free	CL 2650/CS 9450
Aretha Franklin	Aretha Franklin's Greatest Hits	CL 2673/CS 9473
Moby Grape	Moby Grape	CL 2698/CS 9498
	Together On Broadway	CL 2636/CS 9436
Jim Nabors	By Request	CL 2665/CS 9465
Ray Price	Danny Boy	CL 2677/CS 9477
Paul Revere & The Raiders	Paul Revere & The Raiders' Greatest Hits	KCL 2662/KCS 9462
Marty Robbins	My Kind Of Country	CL 2645/CS 9445
Jerry Vale	More Jerry Vale's Greatest Hits	CL 2659/CS 9459
Andy Williams	Born Free	CL 2680/CS 9480
Tony Bennett	For Once In My Life	CL 2773/CS 9573
Anita Bryant	I Believe	CL 2706/CS 9506
Johnny Cash/June Carter	Carryin' On With Johnny Cash & June Carter	CL 2728/CS 9528
Ray Conniff	Ray Conniff's Hawaiian Album	CL 2741/CS 9547

COLUMBIA (Cont'd)

John Davidson	A Kind Of Hush	CL 2734/CS 9534
Miles Davis	Miles Smiles	CL 2601/CS 9401
	Sorcerer	CL 2732/CS 9532
Percy Faith	Today's Themes for Young Lovers	CL 2023/CS 8823
Edie Gorme	Greatest Hits	CL 2764/CS 9564
Robert Goulet	Hollywood Mon Amour	CL 2727/CS 9527
Ken Griffin	Greatest Hits	CL 2717/CS 9517
Johnny Mathis	Up Up And Away	CL 9526/CS 2726
Jim Nabors	The Things I Love	CL 2703/CS 9503
Peaches & Herb	For Your Love	TM 3005/TS 4005
Ray Price	Greatest Hits Vol. II	CL 2770/CS 9470
Paul Revere & Raiders	Revolution	CL 2721/CS 9521
Marty Robbins	Tonight Carmen	CL 2725/CS 9525
Pete Seeger	Greatest Hits	CL 2616/CS 9416
Frank Sinatra	The Essential Frank Sinatra	S3L42/S3S842
Barbra Streisand	Simply Streisand	CL 2682/CS 9482
Jerry Vale	Time Alone Will Tell	CL 2684/CS 9484
Andy Williams	Love Andy	CL 2766/CS 9566

COMMAND

Ray Charles Singers	At The Movies	923
Jerry Fielding & Orch.	Near East Brass West Coast Style	922
Benny Goodman & Paris	Listen To The Magic!	921
Warren Kime & Orch.	Explosive Brass Impact Vol. 2	919
Toots Thielemans & Orch.	Guitar & Strings And Things	918
Doc Severinsen & Orch.	New Sound Of Today's Big Band	917
Ray Charles Singers	A Special Something	914
Count Basie & Orch.	Hollywood-Basie's Way	912
Dick Hyman & Orch.	Brasilian Impressions	911
Warren Kime & Orch.	Brass Impact	910
Doc Severinsen & Friends	Swinging & Singing	909
Tony Mottola & Orch.	Guitar-U.S.A.	908
Count Basie & Orch.	Broadway-Basie's Way	905
Ray Charles Singers	What The World Needs Now Is Love	903
Doc Severinsen Sextet	Live!	901
Tony Mottola & Orch.	Amor Mexico/S.A.	900
Ray Charles Singers	One Of Those Songs	898
Persuasive Percussion/1966		895
Doc Severinsen & Orch.	Fever	893
Ray Charles Singers	Young Lovers On Broadway	890
Tony Mottola	Love Songs Mexico/S.A.	889
Ray Charles Singers	Songs For Latin Lovers	886
Ray Charles Singers	Songs For Lonesome Lovers	874
Ray Charles Singers	AL-DI-LA	870
Enoc Light & The Light Brigade	Dimension .3.	867
Ray Charles Singers	Something Special For Young Lovers	866
Tony Mottola & Orch.	Sentimental Guitar	864
Dick Hyman At Lowery Organ		
Doc Severinsen & Orch.	Fabulous	862
Dick Hyman At Lowrey Organ	Torch Songs For Trumpet	859
Tony Mottola & Orch.	Electrodynamics	856
Ray Charles Singers	Romantic Guitar	847
Tony Mottola & Orch.	Paradise Islands	845
Tony Mottola & Orch.	Spanish Guitar	841
Tony Mottola & Orch.	Roman Guitar Vol. 2	836
Ray Charles Singers	Something Wonderful	827
Enoc Light & Orch.	Stereo/35MM	826
Tony Mottola & Orch.	Roman Guitar	816
Los Admiradores	Bongos	809
Enoc Light & Orch.	Provocative Percussion	806
Persuasive Percussion	Persuasive Percussion	800

CONCERT DISC

Fine Arts Quartet & N.Y. Woodwind Quintet	Art Of The Fugue: Bach	MONO 1230	STEREO 230
Fine Arts Quartet & N.Y. Woodwind Quintet	Bach: Art Of The Fugue	1250	250
Fine Arts Quartet	Bela Bartok: Quartets Complete Nos. 1-6	1501/3	501/3
Fine Arts Quartet	Beethoven: Late Quartets Op. 127, 130, 131, 132, 136	1502/5	502/5
Beethoven Middle Quartets	Beethoven	1506/3	506/3

EPIC TOTAL LOCATION INVENTORY TLI

TOP ALBUM ACTION



LN 24339/BN 26339 Stereo



LN 24344/BN 26344 Stereo



LN 24341/BN 26341 Stereo

©EPIC, Marica Reg. T.M. PRINTED IN U.S.A.



CashBox Album Plans

- DIAMOND**—One free for every 5 purchased. Expires December 31.
- DUKE-PEACOCK**—Buy-7-get-one-free. No expiration date has been set.
- FORTUNE**—1 free when 6 are purchased in any combination. No time-limit.
- GATEWAY**—Two free for 10 purchased on entire catalog. No time limit.
- JEWEL-PAULA**—One free for five purchased on entire catalog. No expiration date.
- LITTLE-DARLIN'**—Special 2 on 10 deal on all product. No expiration date.
- MONMOUTH-EVERGREEN**—1 free with 10 purchased on entire catalog. No expiration date.
- NASHBORO**—Buy-7-get-one-free on entire catalog plus an additional 5% discount through January 5. 100% exchangeable.
- ORIGINAL SOUND**—15% discount on all LP's—until further notice.
- PHILIPS**—Discounts on entire catalog. SPM/SPS series are discounted 10%, all other classicals discounted 20%. No expiration date.
- PRESTIGE**—15% discount on all LP product until further notice.
- ROULETTE**—15% discount in free merchandise. Expiration date indefinite.
- SCEPTER-WAND**—2 free with every 10 purchased. No termination date.
- SIMS**—3 free with every 10 purchased on entire catalog. No expiration date.
- SMASH-FONTANA**—Special discounts available through distrib. No expiration date.
- TAMLA-MOTOWN-GORDY**—Buy-7-get-one-free. No expiration date set.
- TOWER**—10% discount on all albums. No expiration date.

RCA Radies January Album Product

NEW YORK—RCA Victor Records has announced the release of a total of 48 new albums and 1 new EP for the month of January. The EP is a Mexican disk entitled "Dueto Miseria."

Highlighting the album release are 14 popular LP's: "No Foolin'," by Peggy March; "The Love Album," by John Hartford; "Down To Earth," by Harlan Howard; "Soul of Country Music," by Connie Smith; "Newport Up roar," by Lionel Hampton and His All-Star Alumni Big Band; "The Golden Years," by Archie Campbell; "Rufus Lumley"; "The Fascinating Rhythms of Their Brazil," by Los Indios Tabajaras; "Al Hirt Plays Bert Kaempfert"; "Just Between You And Me," by Porter Wagoner and Dolly Parton; "Music From 'A Fistful Of Dollars,' 'For A Few Dollars More,' 'The Good, The Bad And The Ugly,'" by Hugo Montenegro, His Orchestra and Chorus; "John Gary On Broadway"; "The Everlovin' World of Eddy Arnold"; and "Floyd Cramer Plays Country Classics."

New Red Seal LP's

RCA's Red Seal series has 6 additions: "Pictures At an Exhibition" (Mussorgsky)/"The Young Person's Guide To The Orchestra" (Britten), Ozawa, Chicago Symphony Orchestra; "Discovery," by Larry Adler and Morton Gould and His Orchestra; "The Young Horowitz"; "Music From 'Romeo and Juliet' (Prokofiev)," Leinsdorf, Boston Symphony Orchestra; "Verdi Rarities," Caballe; Guadagno, RCA Italiana Orchestra and Chorus; and "Schumann: 'Concerto In A Minor, Op. 54'/'Novelletes, Op. 21' (Nos. 1 and 2)," Rubinstein; Giutini, Chicago Symphony Orchestra.

Foreign Albums

RCA's January release of foreign albums includes 5 special Latin-American LP's and 4 Mexican sets. The Latin-American LP's are "The Wonderful Latin-American Sound of Argentina," "The Wonderful Latin-American Sound of Chile," "The Wonderful Latin-American Sound of Guatemala," "The Wonderful Latin-American Sound of Mexico," and "The Wonderful Latin-American Sound of Venezuela." The Mexican sets are: "Que Se Acabe El Mundo," by Pablo Beltran Ruiz y Su Orq.; "Canciones Que Liegan Al Alma," by La Rondalla Tapatia; "Risas y Lagrimas Con Amalia Mendoza"; and "No Me Amenaces," by Jose Alfredo Jimenez.

Victrola Sets

6 albums have been added to RCA's Victrola series. They are: "Symphony No. 7 In D Minor, Op. 70" (Old No. 2) (Dvorak), Montoux, London Symphony Orchestra; "Schubert: 'Symphony No. 8 In B Minor, D. 759' ('Unfinished')/'Symphony No. 5 In B-Flat, D. 485,'" Toscanini, NBC Symphony Orchestra; "The New Music, Vol. 2: 'Sonatine' (Boulez)/'Interpolation' (Haubenstock-Ramati)/'Concerto For Oboe and Chamber Orchestra' (Maderna)," Gazzelloni; Maderna, Soloists of Rome Symphony Orchestra; "The New Music, Vol. 3: 'Y Su Sangre Ya Viene Cantando' (Nono)/'hi-kyo' (Fukushima)/'Serenade I' (Berio) 'Quanti' (Lehmann)," Gazzelloni; Maderna, Soloists of Rome Symphony Orchestra; "Verdi: 'Rigoletto' (Act IV)/'Luisa Miller' ('Overture'; "Quando Le Sere Al Placido")/'I Lombardi' (Trio): "Qui, Poasa Il Fianco)," Milanov, Della Chiesa, Merriman, Peerce, Warren, Moscona; Toscanini, NBC Symphony Orchestra And Chorus; and "Juditha Triumphans' (Vivaldi," Cundari, Componez, Casoni, Dominguez, Allegri); Zedda, Orchestra of The Angelicum Mailand.

RCA's January album release also includes 2 sacred LP's, 2 additions to the Vintage series and 1 original cast album. The sacred LP's are "Sing Brother Sing," by the Statesmen Quartet with Hovie Lister and "Heaven's Just A Prayer Away," by Norma Jean. The Vintage sets are "George Olsen And His Music" and "Smashing Thirds," by Fats Waller. The original cast album is "How Now, Dow Jones," by the Broadway cast.

Camden Release

RCA's economy line Camden label is offering 7 new albums for the month of January: "Mancini Plays Mancini and Other Composers," by Henry Mancini and His Orchestra; "Living Voices Sing The Music from The Broadway Musical, 'How Now, Dow Jones'"; "The World We Knew," by the Living Strings Plus Two Pianos; "Green, Green Grass of Home," by Porter Wagoner; "San Franciscan Nights," by the Living Guitars; "In The Sweet By And By," by the Blackwood Brothers Quartet; and "Cowboys And Indians," by Sonny Campbell and the Richard Wolfe Children's Chorus" (children's release).

Chart Records, which RCA dis-

All Promo Stops Culminate In "Dolittle" Opening This Week

NEW YORK—"Doctor Dolittle," the most expensive musical ever filmed by 20th Century-Fox, will open this Tues. (19) at Loew's State Theatre here in New York. The 20th Century-Fox APJAC production, which stars Rex Harrison, Samantha Eggar, Anthony Newley and Richard Attenborough, has been the subject of one of the largest and most expensive publicity and promotion campaigns ever conducted for a film.

The original soundtrack recording, which appears on the 20th Century-Fox label, with distribution by ABC Records, has received the same treatment.

In an unusual move, ABC Records released the Dolittle soundtrack almost four months in advance of the premiere; the LP moved onto the trade charts. ABC expects the premiere to boost album sales tremendously. Words and music for "Dr. Dolittle" are by Leslie Bricusse.

20th Century-Fox reports that prior to January 1, the Dolittle film will be playing in over sixty world-wide locations including New York, Los Angeles, Chicago, Canada, and overseas in England, Germany, Spain and Japan.

Soundtrack Campaign

ABC Records' vast merchandising campaign for the soundtrack LP covers many areas and includes: a four-color poster; a window display kit containing three items—a single easel window card, a four-color fold-out counter card, and a hanging

mobile display with scenes from the movie; buttons promoting "Doctor Dolittle for President of A.M.A.," a 25-count browser box and browser divider cards; 20 different 19"x19" black and white "boosters" consisting of four-color scenes from "Doctor Dolittle" for window displays; window streamers; and a four-color mail stuffer sent to rack jobbers, one-stops and key accounts. An open end interview with the film's star, Rex Harrison, promoting the soundtrack recording, is available to radio stations and disk jockeys. ABC Records has set up its biggest local co-op advertising program to date on behalf of the Dolittle LP, and national consumer advertising will reach 15 million readers with ads in *Look*, *Life*, *McCalls*, *New Yorker*, *The New York Times*, and the Sunday supplements in 15 key markets.

Special screenings have been arranged for record buyers, clerks, salesmen and store owners, who have been urged to bring their children. These screenings will be held nationwide.

Merchandising of items in connection with the film will virtually flood the nation in the form of toys, food, games, clothing and practically every conceivable merchandisable item. Exploitation, promotion and advertising by participating manufacturers will amount to over ten million dollars.

20th Century-Fox estimates well over 175 recordings from the Dolittle score at present with albums and singles released by top recording artists from various labels.

Report Radio, Phono, Tape Recorder Sales For 9 Mos. 1st Quarter

WASHINGTON—Third quarter and nine-month sales totals for sales of radios, phonos and tape recorders have been released by Electronic Industries Association. Figures include imports, with EIA arriving at total U.S. sales by combining factory sales of domestically produced items with "imports-domestic label" and "imports-foreign label."

Radios

Third-quarter total U.S. sales of radios amounted to 10,788,568 units, making a nine-month total radio market of 28,670,455. Of this total, 8,386,708, or 28 per cent, were FM radios. Of the third-quarter total, 3,357,841, or 32 per cent, were FM sets, indicating an increasing rate of FM penetration as the year progresses.

Phonos

The phono market amounted to 1,664,160 units in the third quarter, U.S.-produced machines accounting for 1,177,993, or 70 per cent, of the total. A little less than half of the remaining imports were U.S. brand. For the nine months, the phono market totaled 4,231,733 units, and again 70 per cent of those (2,988,914) were domestically produced. Over a third of phonograph imports were U.S. label.

Tape Recorders

Over a half million domestically produced home tape recorders were sold in the first nine months of 1967, out of an estimated total market of 3,060,054 units. Of the approximately 2.5 million imported units, 386,415 were U.S. brand.

tributes, has issued one new album for January: "Promises, Promises," by Lynn Anderson.

'Dolly' & 'Airplane'

About two weeks ago, RCA released two albums which were not announced in last month's release. They are "Hello, Dolly!," by the new Broadway cast starring Pearl Bailey and Cab Calloway and "After Bathing At Baxter's," by the Jefferson Airplane.

Warner-7 Arts Show Last Quarter Loss

HOLLYWOOD—Although comparative figures were not available, due to operation on different fiscal years by Warner Brothers and Seven Arts Productions, the newly merged film production outfit reported a loss of \$477,985 on revenues of \$27,370,588 for the first fiscal quarter ended Sept. 30.

A spokesman for the company attributed the loss to costs involved in consummating the merger. But Warner Bros.-Seven Arts expects to be operating profitably in the second fiscal quarter.

In its first quarter, Seven Arts earned \$2,592,971 on sales of \$16,752,979 amounting to \$1.02 per share. This quarter ended Sept. 30. Warner Brothers, in its fourth fiscal quarter, ended Aug. 31—the one corresponding most closely—showed a profit of \$3,383,000.



ADVERTISING CHEER—Shown here is Columbia's major Christmas display. The colorful stand-up unit is an alpine village, lighted by a random flasher unit and designed for use in store windows. The display features six Christmas albums by leading Columbia artists, including "Barbra Streisand/A Christmas Album," "We Wish You A Merry Christmas" with Ray Conniff and the Ray Conniff Singers, "A Christmas Present . . . And Past" by Paul Revere and the Raiders featuring Mark Lindsay, "Jim Nabors' Christmas Album," and "Christmas With Anita Bryant."

Pop Deejays Said To Flip Over Hip HP's

NEW YORK—Initial reports taken from broadcasters across the country show that 230 pop deejays have started playing and commenting on the Hip-Pocket mini-disks. The report of this reception came from Vince Novak, new products planning manager of Philco-Ford, manufacturer of the 3 7/8-inch singles.

Spinners responded to a mailing with comments such as: "wild idea," "great," "send me more," "very interested," etc. Others remarked at the high fidelity of the recordings.

The Philco-Ford catalog now comprises 24 records for an initial offering of 48 sides. Distribution is already arranged for all fifty states, and Novak states the reports show good dealer interest.

Empire Dist. Acquires Milestone, Avant Garde

NEW YORK—Empire Distributing, recently-formed distributorship in New York City, has acquired two lines for the area. They are Milestone Records, Bob Bialek's jazz line produced by Orrin Keepnews and Avant Garde Records, according to Bernie Block, president of Empire.

Marcia Hillman Forms PR-Merchandising Co.

NEW YORK—The Lansing-Hillman Agency has been formed here to specialize in music industry promotion, including merchandising. Headed by Marcia Hillman, the firm has been set to handle public relations and publicity for Super K Productions, the Jeff Katz-Jerry Kasenetz company that records such performers as the Music Explosion, Jamie Lyons, the Ohio Express and the 1910 Fruitgum Co.

Lansing-Hillman's merchandising activities will include design of buttons, posters, brochures, etc.

Marcia Hillman has been associated with such labels as Bell, Kapp and Laurie. She also wrote a weekly column out of Chicago for Cash Box, freelance liner copy for various labels and record reviews for the now defunct FM Listeners Guide.

Newton's \$1 Mil Vegas Pact

NEW YORK—MGM recording artist Wayne Newton has been signed by the Frontier Hotel in Las Vegas to a \$1,000,000 nitery pact. The deal, one of the richest in Vegas history, provides for Newton to headline at the hotel for a total of only eighteen weeks within a two-year period. The entertainer opens his first Frontier stand August 18 for four weeks.

Newton, who began rehearsals last week (13) in Miami for a "Jackie Gleason Show" guest shot, recently renegotiated his 3-year Las Vegas pact with the Flamingo Hotel to cut his association short by nine months. He headlines the Flamingo for 3 weeks bowing Dec. 22 and opens his final 3-week stand April 18.



CashBox Platter Spinner Patter

Raymond Rosen & Company has obtained exclusive distribution rights to Jerry Blavat's new album, "The Jerry Blavat TV Song Storybook." Paul Knowles, vice president and general manager of the record division of the firm, reports that the company booked sales of over 15,000 albums before the first shipment arrived. The package includes a 14-page yearbook and a 20 song album of tunes popular over the past three years.

WISM-FM-Madison, Wisconsin, Good Guy Jon Little reports an endurance-type promotion by the outlet. During remote broadcasts from Madison's Hilldale Shopping Center, WISM conducted a "Keep the Ball Rolling" contest. Entrants were invited to keep the ball rolling for as long as they could during the broadcasts. The Jay and the Techniques single was used in the contest promotion. Jay and the Techniques LP's and singles were offered as prizes along with merchandise prizes. The WISM ball rolling champ was Dave O'Connor who kept the ball rolling for nine hours and thirteen minutes.



READ ALL ABOUT IT: It was a big night recently for the First Edition at the Bitter End in New York when Warner Bros./Reprise Records hosted a party for the group. Among the merrymakers were (l. to r.): Georg Lee, president of east coast operations for Warner Bros./Reprise; Ken Kragen, co-manager of the First Edition; John Dewitt of WCBS-FM-New York; and Carl Deane, east coast promo man for Warner Bros./Reprise.

KHJ-Hollywood's "The Real Don Steele" has been set by producer Peter LaCombe to be the Canadian Broadcasting Company's "Music Man in L.A." for its "Action Set" show, aired weekly over 30 outlets in Canada. Steele will report on the top hits in L.A. plus his own "Pick of the Week."

Dick Clark Productions began the 11th Annual "American Bandstand" National Teen Dance Contest on December 2 on the ABC-TV "Bandstand" show. Selection of winner will be via write-in vote by the national TV audience. Winners will be announced on the January 13 "Bandstand" show. Prizes include 1968 automobiles for the winning couple, and Hondas for runners-up. Dick Clark hosts "American Bandstand," now in its eleventh year on ABC-TV. Ed Yates produces and directs.

This month marks WMCA-New York Good Guy Dean Anthony's third anniversary with the outlet. Known to his sizeable audience as "Dino-on-your-radio," Anthony has presided over the 1 A.M. to 6 A.M. "Night-watch" program since he first came to WMCA from WPGC-Washington. Two features, created by Anthony, have become popular favorites of his show. One is his "Actors and Actresses Game," in which listeners are asked to guess the name of an actor or actress whose initials Anthony announces throughout his program. The other is the "Off-Key Singing Club," open to any listener who sings off-key "at home, on the job, anywhere." During his stay at WMCA, Anthony, like the other WMCA Good Guys, has maintained a busy schedule hosting various musical concerts

and dances around the Tri-State area for schools. A Native of Brooklyn, he now resides in Blauvelt, New York.

Adam Ross, most recently head of Attarack's Equinox Musical operations on the coast, has joined the Metromedia syndicated TV'er starring Woody Woodbury. Ross will be in charge of all musical talent for the David Wolper shows, produced by Ralph Edwards. Prior to joining Attarack, Ross was affiliated with Capitol's publishing arm, Beechwood Music, and was a contract writer for Marty Melcher productions, having written a number of songs for such Doris Day films as "Pillow Talk," "Lover Come Back," and "It Happened To Jane."

For the sixth straight year, KNBR-San Francisco's Dave Niles led a troupe of volunteer professional and amateur entertainers on a "KNBR Christmas Special" trip to two state rehabilitation schools for boys at Stockton and Lodi. On December 9 the "KNBR Christmas Special" bus motored to a boys' school in Stockton. On December 16, the group went to a school near Lodi. Both schools are run by the California Youth Authority. The entertainment troupe is made up of KNBR listeners who have volunteered their services. There are about 35 volunteers for each trip—singers, dancers, acrobats, musicians, comedians, magicians, etc. Many have accompanied Niles in past years. Hector Gomez is the volunteer coordinator who has worked with Niles each Christmas since 1962. The Civil Air Patrol donates a bus and driver. KNBR listeners donate gasoline money and any other emergency needs.

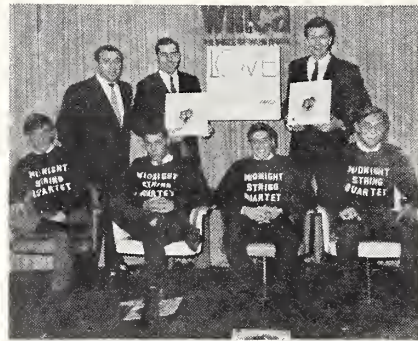

MIDNIGHTERS MEET METROPOLITAN DEEJAYS: Shown above is the Midnight String Quartet Road Company on a visit to WMCA-New York to help celebrate a recent weekend advertising campaign on the outlet. Back row (l. to r.) are: Lanny Lee, east coast promo rep for Dot Records; and Harry Harrison and Dan Daniels, WMCA Good Guys, holding copies of the Midnight String Quartet's album, "Rhapsodies For Young Lovers."

SPUTTERS: Don Sherwood of KSFO-San Francisco broadcast his show on December 1 from the La Playa Hotel, host of the first Don Sherwood Golf Tournament at the Carmel Valley Golf and Country Club benefiting the National Aid for the Visually Handicapped. . . . Dean Tyler, WIBG-Philadelphia program director and deejay hosted a two hour Hullabaloo Spectacular for the Philadelphia Naval Hospital patients on December 7.

VITAL STATISTICS: Nick Powers is now music director of WDAO-Dayton. . . . Don Ross has replaced Dave Newton as program director at KFMB-San Diego. Newton has become account executive for the outlet. Dennis Regan has assumed the post of production coordinator for KFMB. . . . Frank Ford will return as host on his own nightly conversation-interview show over WPEN-Philadelphia on January 2. . . . Stu Bowers has been appointed program director of WLW-Cincinnati.

Bios for Dee Jays

Bobby Vee



Born on April 30, 1943, Bobby Vee grew up with the sound of music. His father, Sidney Velline, was accomplished on both the violin and piano, although he was a professional chef. Bobby's uncle, Doug Velline, played sax, while Bobby's two older brothers, Sidney, Jr., and Bill, are guitarists. Bobby picked up guitar from his brother Bill while still attending Central High School in Fargo, North Dakota. Sid and Bill already were members of a five piece band and they allowed Bobby to sit in on practice sessions provided he would be silent. Then in 1959, the group filled in on a date for Buddy Holly who had been killed in a plane accident. They labeled themselves the Shadows and put Bobby on as vocalist — mostly because he knew all the lyrics to six numbers in their repertoire. As a result of the Shadows' successful performance, Bobby met Arnold Mills in Minneapolis. Mills signed Bobby to a personal management contract and Bobby was on his way. "Come Back When You Grow Up," on Liberty, made the Top 10, and Bobby's current single, "Beautiful People," is number 27 on the charts this week.

Arlo Guthrie



Arlo Guthrie was born in Coney Island, New York, on July 10, 1947. Music has always been a part of his everyday life. Arlo's mother recalls that when he was three years old, Arlo played the harmonica while jiggling around the room for the famed Leadbelly. It was common practice for the Guthrie family (Arlo and his parents and sister and brother) to make up songs while out in their car. Arlo attended college in Montana, but after six weeks, realizing he wanted to spend more time writing songs and singing them, he left school. In February 1966 he started singing professionally. In June, after his return from a one month's concert tour with Judy Collins in Japan, he cut his first album on Reprise, "Alice's Restaurant," which is number 42 on the charts this week. His singing of "Alice's Restaurant" was one of the highlights of the 1967 Newport Folk Festival.

WANTED NATIONAL PROMOTION MAN

SEEKING THE TOP SLOT AT A LEADING INDEPENDENT LABEL. DROP US A NOTE WITH YOUR BACKGROUND. SALARY TO \$20,000.00! PLUS EXPENSES!

BOX 804

CASH BOX
1780 BROADWAY
NEW YORK, N. Y.



CashBox Album Reviews

Pop Picks

MOVIN' WITH NANCY — Nancy Sinatra — Reprise R/RS 6277

This is the soundtrack LP from the lark's recent TV special, "Movin' With Nancy," and, in addition to Nancy, features such artists as Dean Martin, Lee Hazlewood, and someone billed as "A Very Close Relative." Some of the finer tracks include: "Younger Than Springtime," a very close relative; "Things," Nancy and Dean; the single "Friday's Child," Nancy; and the hit single "Jackson," Nancy and Lee. The impressive array of artists combined with the power of a TV special, should help make this one a powerhouse.

IN A MELLOW MOOD—Temptations—Gordy 924

Already beginning its climb up the charts, the Temptation's latest LP could well prove to be one of their biggest to date. Abandoning the Motown sound for this outing, the group concentrates on pop-good music and Broadway jewels such as "Hello Young Lovers," "A Taste Of Honey," "Ol' Man River" and "Try To Remember." Mellow means "rich, full, mild, made gentle by experience." That's a good description of the Temptations on this album.

A GIFT FROM A FLOWER TO A GARDEN — Donovan — Epic L2N 6071/B2N 171

Long awaited, the newest album selections from Donovan are a triple treat featuring a feast for eyes in spectacular packaging, ears in delicate and moving songs, and mind through tantalizing lyrics and melodic weavings. The two-disk set includes a pair of two new LP's "Wear Your Love Like Heaven" (BN26349/LN24349) and "For Little Ones" (BN26350/LN24350), each available separately. The first features Donovan's latest single hit; and the other is a stunning collection of original songs closer to traditional folk.

THE WHO SELL OUT—Who—Decca DL 74950

Including the Who's "I Can See For Miles" currently charted single plus 10 new selections, some of the more outstanding of which are "I Can't Reach You," "Silas Stingy," and "Mary-Anne With The Shaky Hands," this package offers four (two on each side) "commercial" (hence the title) photos of the Who in full color and should prove a powerhouse sales item. Comical "commercial" cuts include: "Odorono," "Spotted Henry," "Heinz Baked Beans," and "Radio London."

DEAR ELOISE/KING MIDAS IN REVERSE—Hollies—Epic LN 24344/BN 26344

Titled after their last single, "King Midas In Reverse," and their current one, "Dear Eloise," the Hollies may have a really big LP on their hands with this beautifully produced set. The delightful, lighthearted feeling of "Wishywash" is another highlight of the LP. A strong marketing point for the teens might be the liner notes, written by the editor of 16 Magazine.

AN OPEN LETTER—Victor Lundberg—Liberty LRP 3547/LST 7547

The opinions contained in the recitations on this album—opinions on war, sex, censorship and other perennially discussed topics—are bound to excite some disapproval, but because the recitations themselves are fairly articulate and because Victor Lundberg speaks in authoritative and well-modulated tones, the album will certainly not be ignored. Like Lundberg's recent single, "An Open Letter To My Teenage Son" (included in the LP), it will probably sell quite well.

Pop Best Bets

THE FIVE AMERICANS' PROGRESSIONS — Abnak ABST-M-2069

The Five Americans perform a package of gentle rock ditties which make for a most enjoyable listening experience. Mike Rabon, Norm Ezell, and John Durrill of the group have penned eight of the ten tunes, including the quintet's while back chart item, "Zip Code," "Stop-Light," "(But Not) Today," and "Sweet Bird Of Youth." The LP should win widespread acceptance.



FOR ONCE IN MY LIFE—Tony Bennett—Columbia CL 2773/CS 9573

Tony Bennett lends his rich baritone to a set of pop ditties. The selections include the title song, a recent chart outing for the chanter, "They Can't Take That Away From Me," "Sometimes I'm Happy," and "Baby, Dream Your Dream," from the Broadway musical "Sweet Charity." The artist is at the top of his form on the LP, and the disk should prove popular with a wide listenership.

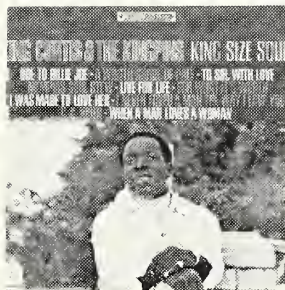

KING SIZE SOUL—King Curtis & Kingpins—Atco (SD) 33-231

Saxophonist King Curtis delivers a solid set of soul ditties. His sound is rich and full, and his solos are imaginative. Featured on the disk are the artist's recent chart singles "Ode To Billie Joe" and "Memphis Soul Stew," "When A Man Loves A Woman," and "I Was Made To Love Her." Curtis is backed by attractive band and orchestral arrangements, and the set should prove a fast-moving sales item.

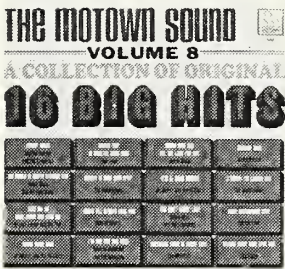

A COLLECTION OF 16 ORIGINAL BIG HITS VOL. 8—Various Artists—Motown 666

In addition to offering the record buyer five more selections than he usually gets for his money, this powerhouse set provides an excellent cross-section portrait of the Motown style. Romantic lyrics, spirited delivery and a steady but contagious beat are in evidence on most of the selections, which include hits by the Temptations, Diana Ross and the Supremes, the Four Tops and others. Should be quick chart action in store for this one.



YOU DON'T HAVE TO BE ITALIAN TO LIKE PAT COOPER—United Artists UAL 3600/UAS 6600

Though dominated by Italian-American humor, this set, as the title implies, could appeal to a wide variety of record buyers. The album makes sport of Italian-American domestic life in a manner that is good-natured enough not to offend anyone, and the jokes are not so "in" ethnically as to be incomprehensible to non-Italian-Americans. Cooper is one of the top comedy album sellers in the U.S., and his latest effort should only serve to enhance his position.



ALL YOU NEED IS LOVE—Anita Kerr Singers—Warner Bros. W/Ws 1724

Here's a light, breezy package of pop tunes rendered by the Anita Kerr Singers. Included on the LP are the title song, (You Make Me Feel Like) A Natural Woman, "No Salt On Her Tail," and "I Make A Fool Of Myself." The album should go over big with the good music, middle-of-the-road trade.



GET THAT FEELING—Jimi Hendrix—Capitol T/ST 2856.

Jimi Hendrix shows off a scintillating guitar on this powerful LP, and Curtis Knight's hard-driving, funky vocals bristle with energy. The title track is particularly rousing. Other tunes include "How Would You Feel," "Hush Now," and "Gotta Have A New Dress." The set should stir up considerable consumer reaction.

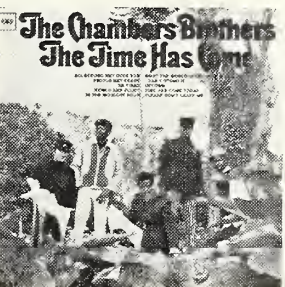

THE TIME HAS COME — Chambers Bros. — Columbia CL 2722/CS 9522

Covering a lot of musical territory, from their now classic bluey gospel offering of "People Get Ready" to an adventurous excursion into psychedelia (taking up about half of side 2) entitled "Time Has Come Today," the Chambers Brothers may have finally found the winning LP combination that will release their fame from the relative confines of the underground and folk fields to the international popularity that is stardom.

Pop Best Bets



MISTY ROSES—Sandpipers—A&M 135/SP 4135
The Sandpipers distinctive vocal treatments of "Fly Me To The Moon," "Daydream," and Tim Hardin's prize cleffing "Misty Roses" are highlights of this lovely A&M LP. Good Music and middle-of-the-road outlets should jump at the chance to spin this one and its romantic cover photo may engender strong rack and browser sales. A truly delightful album.



THE RESURRECTION OF PIGBOY CRABSHAW—Butterfield Blues Band—Elektra EKS 74015
The Butterfield Blues Band is basically a reworking of the Paul Butterfield Blues Band with brass added. The spirit is the same though, driving gutsy blues with the vocals and mouth-harp of Paul Butterfield and the guitar of Elvin Bishop standouts, as usual. "Drivin' Wheel" and "Born Under A Bad Sign" are two of the finer tracks. Based on the group's already far-reaching underground fame, this should be the biggest Butterfield LP to date.



THE DAMONE TYPE OF THING—Vic Damone—RCA Victor LPM/LSP 3916
Vic Damone renders a selection of pop melodies in a warm, smooth, and graceful manner. Included on the package are fluent readings of "Time After Time," "I Got It Bad And That Ain't Good," "Make Me Rainbows," from the film "Fitzwilly," and "The More I See You." The artist's many followers should be highly pleased with their favorite's performance.

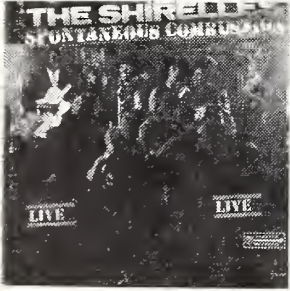

SPONTANEOUS COMBUSTION—Shirelles—Scepter SRM/SPS 562
The Shirelles are recorded live at Columbia University in New York City on this album of R&B tunes. Included on the offering are "Baby It's You," "(I Can't Get No Satisfaction)," "Tonight's The Night," and "When The Saints Go Marching In." The group generates a good deal of excitement on the set, and the LP should develop into a real winner.



H. P. LOVECRAFT—Phillips PHM 200-252/PH 3 600-252
H. P. Lovecraft, a rock act named after the late science fiction novelist and poet, has been attracting a lot of attention lately on the coast, and just recently the group was introduced on the NY scene at Steve Paul's "Scene" discotheque and received much praise. The group's LP is every bit as good as their live show; from the opening number, a swinging rock version of "Wayfaring Stranger," to the final track, a simple Gregorian chant ("Gloria Patria"), the set is a powerhouse. Watch it for action.



PAUL ANKA LIVE!—RCA Victor LPM/LSP 3875
Paul Anka is recorded live at the Royal Box in the Americana Hotel in New York City. The artist's expert song stylings result in a strong offering of pop ditties, among which are "It Only Takes A Moment," "How Insensitive (Insensatez)," "Goin' Out Of My Head," and "Memphis, Tennessee." The set shapes up as a big winner.



THE 5 STAIRSTEPS & CUBIE—Buddah BDM 1008/BDS 5008
The 5 Stairsteps, four brothers and a sister (all in their teens) have been making the Top 100 with increasing frequency of late (most recent entry is a blues-toned, soul-filled romance outing called "Something's Missing"), and their new LP is a further indication that they, along with their 2½-year old brother, Cubie, who sings and plays the drums, are on the pop music scene to stay. Young though they are, the Stairsteps put a lot of soul into their performance, and that is their charm and chief selling point.

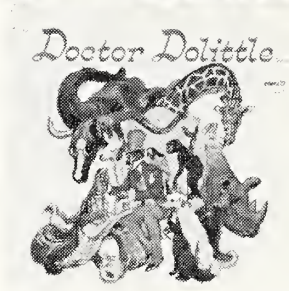

DOCTOR DOLITTLE—'Bugs' Bower Orchestra & Chorus Featuring Ron Marshall—Pickwick/33 PC/SPC 3088
The score from the 20th Century-Fox musical movie, "Doctor Dolittle," has received many disk interpretations. This one, bright and lively throughout, preserves the fanciful spirit of the flick. Ron Marshall is energetic and entertaining in the title role, and he receives spirited backing from the "Bugs" Bower Orchestra & Chorus. Could be good things in store for this set. Watch it.

Jazz Picks



GLORY OF LOVE—Herbie Mann—A&M SP 3003
Flautist Herbie Mann is one of the few jazz artists to have successfully bridged the gap between jazz and the love generation, so this set is likely to see a lot of action in both fields. Highlights of the package include; "House Of The Rising Sun," and Ray Charles' while backers "Unchain My Heart" and "No Use Crying." The album's packaging is particularly striking.



JAZZ TROPICAL!—Jonah Jones—Decca DL 4918/74918
Trumpeter Jonah Jones plays eleven Latin jazz outings in a colorful, lyrical style. Featured on the disk are "El Amor De Mi Bohio," on which Jones plays a trumpet duet with Emilio Reyes, "Lamento Borincano," "Where Is Your Laughter?" and "Now I Know The Feeling." This stylish LP should generate enthusiasm in both jazz and pop circles.



LIBRA—Gary Bartz Quintet—Milestone MSP 9006
An upbeat, fast paced offering of contemporary jazz served up by such names as Jimmy Owens, Gary Bartz, Richard Davis, Albert Dailey, and Billy Higgins, this one is a strong candidate for spins and sales aplenty. In addition to the title track, "Cabin In The Sky" and "Deep River" are outstanding cuts. Colleges might be strong marketing centers for this one, which is certainly in the mainstream of jazz.



LUNCEFORD SPECIAL—JIMMIE LUNCEFORD & Ork.—Columbia CL 2715/CS 9515
This vintage Hall Of Fame series release features the big band sound of the late Jimmie Lunceford as it stomps and swings itself through such classic jazz standards as "What's Your Story Morning Glory," "I Wanna Hear Swing Songs," "Ain't She Sweet," and "Baby Won't You Please Come Home." This set may sound like the soundtrack from one of the better musical films to come out of the '30's, but therein lies its charm.

Classical Picks



RECENT STRAVINSKY—Igor Stravinsky & Various Artists—Columbia ML 6454/MS 7054
Still alive and active in his art, Igor Stravinsky is already immortal, and thus when we hear a new work by him it is as though we were hearing Bach's latest cantata or Beethoven's latest symphony. This LP contains eight recent vocal and instrumental pieces by Stravinsky. From the spirited angularity of "Fanfare For Two Trumpets" to the unearthly beauty of "A Sermon: A Narrative And A Prayer," the album is a work of genius, and should be received as such by the classical recorded-buying public.

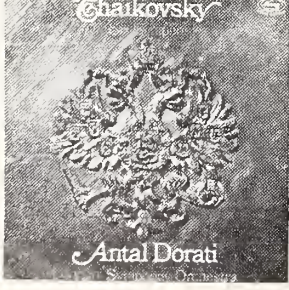

TCHAIKOVSKY: THE SIX SYMPHONIES—London Symphony Orchestra/Antal Dorati—Mercury MG6 9121/SR6 9121
The meeting of Tchaikovsky's romantic spirit with the classical form of the symphony resulted in six works which have become a standard part of many an orchestra's repertoire. On this six-record set Antal Dorati's interpretations of Tchaikovsky's symphonies are, like the symphonies themselves, a blend of the romantic and the classical. Almost invariably, the blend is a happy one. The Sixth Symphony ("Pathetique"), receives an especially effective interpretation.

Despenza Joins ABC As Late Exits For Indie Work

CHICAGO—Vet arranger, producer and A&R man Johnny Pate has left his post as head of the ABC Records Chicago office to work as an independent producer. He will remain in the Chicago area.

Filling the vacant slot for ABC is Larry Despenza.

During his four years at ABC, Pate handled sessions for the Impressions, B. King and the Trolls among others. Prior to that he had produced sides for Major Lance, Gene Chandler and several other artists.

Despenza gained experience in the record business when he co-owned with his brothers two record labels, Contact Records and Despenza Records. Both labels were Chicago-based with national distribution. In addition to producing their own disks, the brothers also sold masters to other companies.

Despenza studied sociology and psychology at Northwestern University, but decided to enter the music business four years ago. He has since independently produced records for Scepter-Wand and St. Lawrence records. He also is a songwriter and has had his compositions recorded by Willie "Soul" Williams and B. B. King, among others.

He will produce both albums and singles for ABC Records, concentrating on current contract artists in the midwestern area, and he will also scout new talent for ABC.

White Whale Issues O'Dell's 1st Album

LOS ANGELES—Kenny O'Dell's first album, "Beautiful People," the same name of his current chart single, is being released by Ted Feigin and Lee Gaseff, owners of White Whale Records. O'Dell is currently on a nationwide tour visiting certain key cities with Johnny Musso, national sales and promotion director for the White Whale label.

Reese Upped at Capitol

HOLLYWOOD—John H. Reese has been appointed to the position of procedures administration manager of Capitol Records Distributing Corp., according to an announcement by Robert L. Howe, national distribution manager of the firm.

Reese joined CRDC in November, 1966 as a part-time employee at Capitol's Bethlehem, Pa., facility, while attending Moravian College in Bethlehem. Upon receiving his Bachelor of Science degree, he was offered the position of Management Trainee, one he held until this promotion.

In his new position, Reese will act as liaison in the fields and areas of policy and procedures and will be responsible for developing and publishing operating practices and procedures for field implementation.

Reese will report directly to Howe.

Philips Signs Vignon, Debuts 'Goodbye' Deck

NEW YORK—French balladeer Jean Paul Vignon has joined the Philips Records roster, signing an exclusive long-term contract recently. First single from the singer is "Goodbye, Goodbye Colette."

This new label affiliation resulted from negotiations between indie producer Paul Vance, who recorded Vignon, and Charlie Fach, director of recorded product for Philips.

Vignon was debuted in the US more than two years ago with Columbia, and has been appearing in night club engagements across the country. One of his spots led to a film contract under which he has completed one movie and is currently doing another. He is also in a pilot tv series now being shot, "The Frenchman." Vignon has also made appearances on a number of daytime panel shows and late night tv talk programs including the Johnny Carson and Merv Griffin shows.

James Frey Named MGM Classics Head; Division Sets Artist, Product Growth

NEW YORK—James J. Frey has rejoined MGM Records as director of the classical division, which released under the DGG, Archive and Heliodor labels, reports Mort Nasatir, president.

Jerry Schoenbaum, former classical chief, has been made director of the Verve division, including the Verve/Forecast label which he has been heading since its inception more than two years ago.

Frey rejoins the MGM family after a short leave to act as manager of special services at CBS. Prior to that, he had 10 years of retail and distributor sales experience as merchandiser for E. J. Korvette in the midwest, and subsequently was MGM's first national sales manager for the Verve/Forecast label under Schoenbaum. He is a graduate of Trenton State College, where he majored in philosophy.

Working closely with Frey is Gould Cassal, operations manager. Cassal co-ordinated European production for the American market with the sales and promotion staff. Both Cassal and Frey are active in deciding what current product will be made available to the U.S. market.

Frey reports directly to Mort Nasatir.

MGM's classical division has been responsible for the American distribution of the Deutsche Grammophon and Archive labels for the last five years. It started when Deutsche Grammophon was seeking an American source of distribution for its internationally famous lines. MGM agreed to utilize its already existing wide-spread U.S. distribution network to represent DGG's famed classics in this country, thus giving the pop-oriented company a larger footing in the long-hair field.

Strong Classical Label

The sales of the imported disks have steadily increased so that DGG is now

jockeying between being the fourth and fifth largest selling classical line in the country—an unusual position for non-domestic product.

Herbert von Karajan, who recently unveiled his Salzburg production of "Die Walküre" at the Met, recorded it first for Deutsche Grammophon. Most of the cast appearing at Salzburg and at the Met are represented in the album. He noted at an MGM reception given in his honor recently at the Hotel Pierre that he was about to return to Berlin where recording for "Das Rheingold" are just beginning. Under his personal supervision, the entire "Ring" Cycle is to be completed in performance at Salzburg and the Metropolitan an on record for Deutsche Grammophon by 1970/1. With one or two exceptions, substantially the same artists will be utilized.

Catalog: Past & Future

While devoted to recordings of catalog staples with such internationally renowned artists as Karajan, Kubelik, Böhm, Jochum, Kempff, Fournier, Lear, Stewart, Fischer-Dieskau, and Haefliger, DGG's forte is the unusual. Its first stereo recording of Berg's "Wozzeck" was cheered as the record event of the year to make it an all time best-seller and winner of the NARAS award. Of considerable importance was the special packaging of Karajan's recordings of the complete Beethoven symphonies, the first set of its kind to be sold at special reduced prices; the first album released in this category, it has been widely imitated by the competition.

Among the major projects in the works at the moment is a complete Mahler symphony cycle under Rafael Kubelik. Also on the agenda is a series of recordings of Hans Werner Henze works, the first of which, "The Young Lord," is due this January. It is the first Henze opera to be recorded in its entirety; the cast is that of the Berlin premiere of the work at the Deutsche Opera.

Great prominence has been given to "live" opera recordings including Strauss' "Daphne," "Ariadne auf Naxos," and "Die Frau ohne Schatten." Most recent, and perhaps the most successful of these was Wagner's "Tristan und Isolde," recorded at the 1966 Bayreuth Festival. The astounding sales figures for this five record set, as computed by Sid Love, DGG's long-time national sales manager, have caused DGG A&R executives to look into the possibility of more "live" recordings at summer festivals throughout Europe.

Heliodor, MGM's low-price label, is also part of the Classical Division. Frey has appointed John Gula to handle editorial work, as well as new production and sales.

Discussions recently were held in Hamburg concerning the U.S. recording debuts of several new artists whose Deutsche Grammophon disks will begin to appear here shortly. These include pianist Christoph Eschenbach and Martha Argerich, both scheduled for forthcoming U.S. concert tours, and the youthful Italian, Claudio Abbado, who recently was compared to Toscanini when he guest-conducted the New York Philharmonic earlier this season.

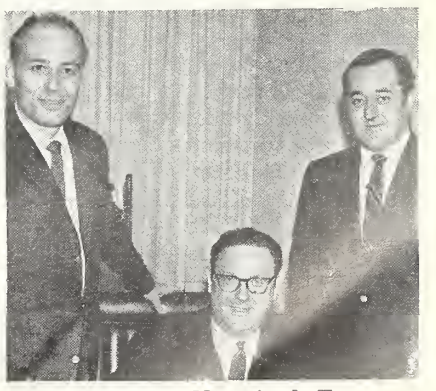

Petermann, Nasatir & Frey

All-State Plans Widest Growth In Its History

NEWARK—A program of diversification and expansion has been initiated by All-State Distributing and its affiliate, All-State Records, blueprinting the company's broadest program in 23 years of operation. Mapped out over the past two months by Sherman Koenig, president, and Irwin Fink, vp of sales, the project includes the opening of tape cartridge and record racks in several auto accessory chains in New Jersey, electronic parts stores, new car dealers, drug stores, variety and 5¢ & 10¢ stores, boat marine yards and marinas, college campuses selling both tape players and tapes.

This program will continue well into the first quarter of the year with its ultimate goal of at least 200 racking outlets.

The company has been appointed distributor and rack jobber for such lines as: Decca, I.T.C.C., Liberty, Mercury, Original Sound, Pickwick, Hill-top and is racking all lines of records and tapes for its own racking outlets.

It opens its doors to all lines of records, tapes of all configurations, not only for distribution, but for racking and ultimate sale by exposure on its racks.

The company is wholesale distributor for Atco, Volt, Kapp, Four Corners, London and the London group labels, ESP, Monument, Compass, Musicor, United Artists and its labels, Dynamo, Little Darlin', Pickwick and Ampex Tapes (all labels), United Artists Tapes, I.T.C.C. (all labels), Muntz (all labels), Modern Jazz, Decca, Mercury (all labels), Liberty (all labels), Original Sound, and accessories for Astatic, Recoton, Car Tape Caddies, and Muntz and Tenna home and auto platers, Tenna Auto Radio-FM Convertors and Multiplex and Orrtronics Auto Players.



A SWINGING SCENE—Philips' H. P. Lovecraft group was among friends at an opening night party recently held at Steve Paul's the Scene in New York. Shown in the center and second from the right of the top photo are Spanky McFarlane and Geoff Meyers, both of Spanky & Our Gang. The middle photo shows (l. to r.): Charlie Fach, Mercury director of recorded product; Lily Mercedician, of the Philips office staff; Paul Vance, writer/producer; and Bob Halley, Philips A&R producer. From the left, in the bottom photo are: Irving Fascow, music librarian of WCBS-New York; Steve Paul; and Charlie Morrison, promotion manager for Philips out of Merrec Distributors.

BEST COUNTRY ARTISTS OF 1967

A TABULATION OF COUNTRY RECORDS & ARTISTS WHO ACHIEVED GREATEST SUCCESS IN THEIR FIELD ACCORDING TO THE WEEKLY CASH BOX TOP 50 COUNTRY CHART. NAMES LISTED BELOW ARE IN ORDER OF STRENGTH IN THEIR VARIOUS CATEGORIES BASED ON A WEIGHTED POINT SYSTEM WHICH GIVES CREDIT FOR LONGEVITY ON THE CHART AS WELL AS HEIGHT ATTAINED ON CHART. ALL TITLES WHICH WERE IN THE TOP 50 WERE USED FOR AN ARTIST'S TOTAL.

TOP COUNTRY SINGLES OF 1967

1. THERE GOES MY EVERYTHING—Jack Greene—Decca
2. DON'T COME HOME A-DRINKIN'—Loretta Lynn—Decca
3. IT'S SUCH A PRETTY WORLD TODAY—Wynn Stewart—Capitol
4. Somebody Like Me—Eddy Arnold—RCA
5. Your Good Girl's Gonna Go Bad—Tammy Wynette—Epic
6. Walk Thru This World With Me—George Jones—Musicor
7. All The Time—Jack Greene—Decca
8. Branded Man—Merle Haggard—Capitol
9. With One Exception—David Houston—Epic
10. Sam's Place—Buck Owens—Capitol
11. Tender Loving Care—Buck Owens—Capitol
12. Where Does The Good Times Go—Buck Owens
13. I'll Never Find Another You—Sonny James—Capitol
14. Pop A Top—Jim Ed Brown—RCA Victor
15. Laura (What's He Got That I Ain't Got)—Leon Ashley—Ashley
16. Loser's Cathedral—David Houston—Epic
17. I Can't Get There From Here—George Jones—Musicor
18. The Hurtin's All Over—Connie Smith—RCA
19. Touch My Heart—Ray Price—Columbia
20. Lonely Again—Eddy Arnold—RCA
21. Cold Hard Facts Of Life—Porter Wagoner—RCA
22. Tonight Carmen—Marty Robbins—Columbia
23. Need You—Sonny James—Capitol
24. Jackson-Johnny Cash & June Carter—Columbia
25. Walkin' In The Sunshine—Roger Miller—Smash
26. (I'm A) Lonesome Fugitive—Merle Haggard—Capitol
27. I'm Still Not Over You—Ray Price—Capitol
28. Misty Blue—Eddy Arnold—RCA Victor
29. Danny Boy—Ray Price—Columbia
30. No One's Gonna Hurt You Anymore—Bill Anderson—Decca
31. How Long Will It Take—Warner Mack—Decca
32. If I Kiss You—Lynn Anderson—Chart
33. My Elusive Dreams—David Houston & Tammy Wynette—Epic
34. Once—Ferlin Husky—Capitol
35. I Won't Come In While He's There—Jim Reeves—RCA Victor
36. Drifting Apart—Warner Mack—Decca
37. Fool, Fool, Fool—Webb Pierce—Decca
38. I Don't Wanna Play House—Tammy Wynette—Epic
39. Misty Blue—Wilma Burgess—Decca
40. Cincinnati, Ohio—Connie Smith—RCA
41. A Woman In Love—Bonnie Guitar—Dot
42. Long-Legged Guitar Man—Johnny Cash & June Carter—Columbia
43. I Threw Away The Rose—Merle Haggard—Capitol
44. Get While The Gettin's Good—Bill Anderson—Decca
45. Hurt Her Once For Me—Wilburn Bros.—Decca
46. I Know One—Charlie Pride—RCA
47. Phantom 309—Red Sovine—Starday
48. Stand Beside Me—Jimmy Dean—RCA
49. Help Stamp Out Loneliness—Stonewall Jackson—Columbia
50. Urge For Going—George Hamilton IV—RCA

TOP COUNTRY ALBUMS OF 1967

1. THERE GOES MY EVERYTHING—Jack Greene—Decca
2. THE BEST OF EDDY ARNOLD—RCA Victor
3. THE BEST OF SONNY JAMES—Capitol
4. Touch My Heart—Ray Price—Columbia
5. Open Up Your Heart—Buck Owens—Capitol
6. Danny Boy—Ray Price—Columbia
7. You Ain't Woman Enough—Loretta Lynn—Decca
8. Don't Come Home A-Drinkin'—Loretta Lynn—Decca
9. All The Time—Jack Greene—Decca
10. Lonely Again—Eddy Arnold—RCA
11. Buck Owens & His Buckaroos In Japan—Capitol
12. Need You—Sonny James—Capitol
13. It's Such A Pretty World Today—Wynn Stewart—Capitol
14. Walk Through This World With Me—George Jones—Musicor
15. Somebody Like Me—Eddy Arnold—RCA
16. I'm A Lonesome Fugitive—Merle Haggard—Capitol
17. Yours Sincerely—Jim Reeves—RCA
18. Cold Hard Facts Of Life—Porter Wagoner—RCA
19. Nashville Rebel—Waylon Jennings—RCA
20. Singing Again—Ernest Tubb & Loretta Lynn—Decca
21. Born To Sing—Connie Smith—RCA
22. Johnny Cash's Greatest Hits, Vol. II—Columbia
23. Your Tender Loving Care—Buck Owens—Capitol
24. Happiness Is You—Johnny Cash—Columbia
25. Another Story—Ernest Tubb—Decca

TOP MALE VOCALISTS

- | | |
|------------------------|---------------------|
| 1. EDDY ARNOLD | 21. Johnny Paycheck |
| 2. BUCK OWENS | 22. Nat Stuckey |
| 3. MERLE HAGGARD | 23. Webb Pierce |
| 4. Jack Greene | 24. Billy Walker |
| 5. David Houston | 25. Mel Tillis |
| 6. Sonny James | 26. Bobby Lewis |
| 7. Ray Price | 27. Red Sovine |
| 8. Marty Robbins | 28. Hank Snow |
| 9. George Jones | 29. Roger Miller |
| 10. Bill Anderson | 30. Dave Dudley |
| 11. Warner Mack | 31. Claude Gray |
| 12. Wynn Stewart | 32. Del Reeves |
| 13. Jim Reeves | 33. Willie Nelson |
| 14. Porter Wagoner | 34. Faron Young |
| 15. George Hamilton IV | 35. Bobby Bare |
| 16. Ferlin Husky | 36. Bill Phillips |
| 17. Waylon Jennings | 37. Don Gibson |
| 18. Stonewall Jackson | 38. Robert Mitchum |
| 19. Jim Edward Brown | 39. Johnny Darrell |
| 20. Jimmy Dean | 40. Tex Ritter |

TOP FEMALE VOCALISTS

1. LORETTA LYNN
2. CONNIE SMITH
3. TAMMY WYNETTE
4. Jean Shepard
5. Jeannie Seely
6. Bobbie Gentry
7. Skeeter Davis
8. Dottie West
9. Wilma Burgess
10. Wanda Jackson

TOP NEW MALE VOCALISTS

1. JACK GREENE
2. CHARLIE PRIDE
3. LEON ASHLEY
4. Kenny Price
5. Glenn Campbell
6. Stu Phillips
7. Junior Samples
8. Jack Webb
9. Sonny Curtis
10. Jerry Reed

TOP NEW FEMALES

1. TAMMY WYNETTE
2. LYNN ANDERSON
3. LIZ ANDERSON
4. Dolly Parton
5. Bobbie Gentry

TOP LP VOCAL GROUPS

1. WILBURN BROTHERS
2. ERNEST TUBB & LORETTA LYNN
3. JIM & JESSE
4. Jean Shepard & Ray Pillow
5. David Houston & Tammy Wynette

TOP VOCAL GROUPS

1. JOHNNY CASH & JUNE CARTER
2. WILBURN BROTHERS
3. STATLER BROTHERS
4. David Houston & Tammy Wynette
5. Bobby (Bare), Norma Jean & Liz (Anderson)
6. Flatt & Scruggs
7. Willis Bros.
8. Jim & Jesse
9. Tompall & Glaser Bros.
10. Hardin Trio

TOP MALE LP VOCALISTS

1. EDDY ARNOLD
2. BUCK OWENS
3. RAY PRICE
4. Sonny James
5. George Jones
6. Merle Haggard
7. Jack Greene
8. Jim Reeves
9. Waylon Jennings
10. Johnny Cash
11. Porter Wagoner
12. Marty Robbins
13. Wynn Stewart
14. David Houston
15. Bill Anderson

TOP FEMALE LP VOCALISTS

1. LORETTA LYNN
2. CONNIE SMITH
3. WILMA BURGESS
4. Dottie West
5. Kitty Wells
6. Skeeter Davis
7. Bonnie Guitar
8. Wanda Jackson
9. Jan Howard
10. Norma Jean



CMA Honors Stations For Country Month Promo

WPAY—Portsmouth Named Top Promoter

NASHVILLE—Radio station WPAY-Portsmouth, Ohio took top honors this year in CMA's annual Country Music Month contest, it was announced last week. The contest, which honors three stations in the U.S. for their work in promoting October as National Country Music Month, saw second place go to WPLO-Atlanta and third place to WMAD-Madison, Wis.

In making the announcement, CMA executive director Jo Walker noted that there were "at least 15 stations who staged outstanding promotions on the air and in the community," a fact which made it very difficult for the

association to choose only three winners.

Each of the three winning stations is a full-time country outlet which devoted many hours of air time to salute Country Music Month and to stage various promotions, in line with the annual event, in the community. The three will all receive engraved plaques, for the lobbies of their respective headquarters, saluting them as outstanding country stations. In addition, 12 other stations received honorable mentions, with a special citation going to Chris Lane at WJJD for his promotion efforts during Country Music Month.

Buck Continues 'Toys For Tots' Tradition

BAKERSFIELD—Just as the turkey has become the traditional headliner on the Christmas menu, the annual Buck Owens Toys for Tots Show is also gaining prominence as a traditional part of the holiday festivities. This year's show, the third in as many years, was held this past weekend (16) and was filmed by NBC News as part of that medium's special documentary on Country Music.

As part of his promotion for the show, Owens wrote and recorded, at the Capitol Tower in Hollywood, special promo tapes for radio stations, informing listeners of the Toys for Tots Drive which is staged each year by

the U.S. Marine Corps. Owens' show, which is staged especially to help the Marine Corps campaign, charges an admission price of one toy, new and unwrapped to see a walloping country package. This year's lineup featured Wynn Stewart & the Tourists, Tommy Collins, Joe & Rose Lee Maphis, Rose Maddox, Freddie Hart, Kay Adams, Bob Morris and Faye Harden, Del & Sue Smart, Buddy Allen, Ronnie Sessions, Larry Daniels & the Buckshots, and, as special guest, Merle Haggard & the Strangers and Bonnie Owens. Headlining the show, of course, was Buck Owens and the Buckaroos.

Clement: 'The Cowboy' Building A Legend

NASHVILLE—Jack Clement, multi-talented musical maverick and important part of the power structure behind the Nashville music industry, has quietly become guiding force in the careers of many of today's top Country artists.

His talents as writer, publisher and excitingly creative independent producer are sought by many with ills to cure. Eighteen artists from at least 10 different labels look to Clement to create the sound that will sell.

And you can't argue with success. Some of the biggest records of the year for Clement have been: "Bob" by the Willis Brothers, "Thru The Eyes of Love", Tompall & the Glaser Bros., and some of Charley Pride's



Jack Clement

biggest: "Just Between You and Me" and "I Know One". Response to his single "Does My

Ring Hurt Your Finger", which is also published by Clement's new pub-berly Jando Music, Inc. spurred requests from enthusiastic RCA distributors for early release of his latest album "The Country Way".

Clement, who discovered Pride's recording abilities and helped land him an RCA Victor contract has worked with the label's own A&R producers on his sessions. Results: Three consecutive top 10 singles.

A major accomplishment of '67 was the creation of the Bobby Bare album "A Bird Named Yesterday". The album which is actually a collection of songs designed to blend into a totality of images and recollections of the past, was conceived by Clement and almost totally written by him.

Without Jack Clement, there would be no Stonemans, at least not the thriving musical group which recently won the CMA award for "Vocal Group of the Year". After signing a partnership with manager Bob Bean, Clement brought them to Nashville in 1965 and began producing all their records for the MGM label while furnishing them with much of their material.

Experimentation within perfection characterizes Clement's work. A plaque presented by Johnny Cash for assistance on the landmark Country session "Ring of Fire" which used trumpets with traditional guitars emphasizes his unorthodox approach. Intense concentration characterizes his sessions. "I don't get paid to entertain or make recording sessions carefree and fun," he explains. "My job is to coordinate instruments, voices, and sounds into a record that people want to hear."

"I knew everything there was to know about the music industry when I started. The average writer's knowledge of the industry decreases about 10% per year. I am now celebrating my 10th anniversary in the music industry."

Music City Jaycees Tab Denny 'Man Of Year'

NASHVILLE—Bill Denny, president of the Cedarwood publishing setup has been honored with the title of "Man Of The Year" by the Nashville Junior Chamber Commerce, it was announced at the Chamber's annual Christmas party awards banquet earlier this month.



Bill Denny

An active member of the organization's board of governors for the past 4 years, the music publisher was cited for his key participation as Coordinator for the Chamber in the recent successful campaign to legalize liquor by the drink in Davidson County. He was also singled out as being instrumental in the establishment of the highly-popular annual Music City Pro-Celebrity Golf Tournament. A past president of the Country Music Assoc., he represented both the Chamber and the CMA in the formation of the tournament.

In 1964, Denny was named "Country Music Publisher of the Year" by Music Business Magazine and he has recently concluded a term as a member of the national board of trustees of the National Academy of Recording Arts and Sciences, representing the Music City chapter.

'Spotlight' To Sovine

Coinciding with the presentation of Denny's award was the announcement that Roger W. Sovine had been selected by the Chamber board as one of five organization members to receive the annual "Spotlight Award."

Sovine, who is Professional Manager of Cedarwood, received recognition for his outstanding work in connection with this year's golf tournament, the Liquor-By-The-Drink campaign, and the Clinic Bowl charity football game.

Arnold, Atkins Head Up Gavin Award Winners

NEW YORK — Eddy Arnold was named Country Music's Recording Artist of the Year in the Second Annual Bill Gavin Radio Programming Conference, held last week in Las Vegas, while RCA's Nashville chief Chet Atkins was tabbed as Country Music's Record Man of the Year. Runners up in both categories were Capitol's Buck Owens (Recording Artist) and Epic's Billy Sherrill (Man of the Year—A&R).

In addition, several other country awards were doled out at the conference, including those for Disc Jockey

of the Year, Music Director of the Year, Program Director of the Year and Manager of the Year. The dee-jay award went to John Trotter of WJJD (Ralph Emery of WSM, runnerup), while WJZZ's Lee Arnold took the Music Director award (Bob Kingsley of KGBS, runnerup) and Chris Lane of WJJD walked off with Program Director honors (Mac Curtis of WPLO, runnerup).

George Dubinetz of WJMD was named Station Manager of the Year, with WPLO's Herbert Golombek taking the runnerup position.



SCORING A VICTORY IN GOTHAM—RCA Victor has been finding itself busy recently with a rash of country acts invading Big Town over the past few weeks to play at the Nashville Club. As part of a traditional feature with the label, a special party is held on Wed. evenings, between shows, whenever Victor artists are on the Nashville Room Bill, the above photo shows recent guests of honor. Photo shows label general manager Norm Racusin visiting and congratulating crooner Jim Ed Brown, as the songster comes off a highly successful performance at the N.Y. club.

Lynn Rodeo Scores Big In 1st Year On Trail

NASHVILLE — Under the guidance of a new rodeo director, Bruce Lehrke, the Loretta Lynn Championship Rodeo branched out of Tenn., Miss. and Ala. during 1967 and appeared across the eastern half of the nation in six markets ranging from Atlanta, Ga. to Detroit, Mich.

In its first year the company hit the national rodeo trail and it averaged 19,333 customers per stop for a total of 116,000. The average of performances in each city were four.

The company is already booked in eight cities for 1968 and Lehrke forecasts a total of 10 to 12 rodeos with attendance nearing quarter Million.

RCA Inks Jake Hess

NASHVILLE — Inspirational singer Jake Hess has been signed to a recording contract by RCA Victor Records, it was announced last week by the label's Nashville chief, Chet Atkins.

The signing makes Hess the only Nashville-based inspirational artist on the label. His sessions will be produced by Darol Rice of Victor's west coast operation, whose producing credits include dates by George Beverly Shea, pop-turned-gospel singer Tony Fontaine, the Blackwood Brothers, and the Statesmen Quartet. Hess's first Victor sessions will be held Jan. 8 & 9.



CashBox Country Roundup

'Twas the week before Christmas,
and all thru the land
The schedules were heavy for the
traveling bands.
While the folks in the city
were shopping for gifts,
Performers were bogged down
in twenty-foot drifts.

As snow-laden clouds blocked out
all the stars,
The buses unloaded their amps and
guitars.
The artists all straining in the
snow and the slush
Tried but in vain for to move that
old bus.

Under the wheels they put boards,
sticks and gravel
But that darned old vehicle
just wouldn't travel.
They raced the old engine
and stomped on the gas
But the snow was like Black-strap
and the ice was like glass.

They pushed and they heaved and they
stamped and they cursed
And finally had to give up in disgust.
They loaded equipment up over
their backs
And started to march with
their cumbersome packs.

All frozen and weary
they started to trudge
While snowflakes were
flying in thicker than fudge.
The dark clouds continued to
loom overhead,
And on each man's mind
was a warm, cozy bed.

(Meanwhile in Nashville,
away from the storm,
The homefolk were nestled in
living rooms warm,
Thinking how terribly gay
and carefree
The life of country performer
must be.)

But back on the road
with our cross-country tour
The singers and sidemen weren't
quite sure
That this was their idea of
fun and romance—
This tramping thru blizzards
to play at a dance.

All through the long march
their limbs burned with pain
And they solemnly vowed that
never again
Would they take on a tour
at this time of year,
When probably no one would so
much as care

Whether or not they lived or they died.
Or whether they froze in the
snowstorm outside.
"Who gives a damn," they thought
in dismay,
"And who is this Santa Claus cat,
anyway?"

Weary of spirit, exhausted of soul
They finally arrived at their
scheduled goal,
Completely without any
seasonal cheer—
For who could make THEIR
Christmas merry this year?

At last, with their instruments
set up to play,
And thinking of loved ones so far,
far away.
They picked out the tentative,
opening notes
While homesickness burned like a
lump in their throats.

And, singing their ballads,
they started to grieve
As lonely men often do on
Christmas Eve.
But the audience cheered when the
numbers were through
And inside the singers a new
feeling grew.

The feeling grew stronger and
flowed through their veins
And suddenly they knew it was
worth all the pains
They had gone through to get to
this desolate place.
For the cheers from the crowd and
the look on its face

Told them that while they had
looked to receive
Happiness, it was still better to give.
And here, far from home, far from
children and wives
They brought some small joy to
other folks' lives.

Because of that small gift of joy
that they brought
All of the singers were held by
one thought.
And that thought (which made all
of the artists take pause)
Was that they were the essence of a
true Santa Claus

Not a real person,
but a spirit of giving,
A spirit who made others' lives
worth the living.
And so to you artists out touring
the road
Mid snowstorms and blizzards,
'neath cumbersome loads,
We thank you for helping spread
feelings of cheer
And wish you the
merriest Christmas this year.

Speaking of Santa Claus, the old boy makes an unscheduled appearance this week at the WWVA Jamboree, joining the Wheeling Jaycees, as well as station and Jamboree personalities for the annual JC Christmas party for underprivileged children in the area. The special party is held each year after the Jaycees treat the kids to a shopping tour. . . . According to the latest Pulse survey, WTID-Newport News (and Norfolk) nearly tripled its radio audience in a one-year period, jumping from a 2 share to a 7.5 average share in Tidewater, while, on the Peninsula (Newport News, Hampton, York County) the station went from a 4 share to a 20 share during the same period. . . . Chubby Howard recently took a short leave of absence from his night-time slot at KMO-Tacoma for a ten-day series of appearances in Alaska with Capitol's Red Simpson. Chubby played steel guitar with Jack Roberts' Evergreen Drifters western swing group. . . . Frank Gilmore, program director at KGOL-Palm Desert, Calif., informs us that the outlet changed over to a country format not too long ago, serving the area from Palm Springs down through the Coachella Valley (about 100,000 people), and finds that the audience is virtually untapped. However, the station is badly in need of country disks, and asks that records be sent to P.O. Box 1603, Palm Desert, Calif., 92260. . . . We hear that John F. English's (or Johnny Sundown's, if you prefer) Celebrity Ranch radio show has become the talk of Belle Chasse, La., becoming the basis for a popular C&W club among listeners. Folks wishing to join up with the Celebrity Ranch Club can write to the Ranch at 497 11 Mile Point, Hwy 23, Belle Chasse, La.



CashBox Country Reviews

Picks of the Week

DAVID HOUSTON & TAMMY WYNETTE (Epic 10274)
It's All Over (2:30) [Al Gallico BMI-Sherrill, Sutton]

Following a decisive hit run with "My Elusive Dreams," that red-hot pair of David Houston and Tammy Wynette team up again for what should be another smash in "It's All Over." The strong ballad gets the usual first-rate treatment from the two, and can expect to be soon occupying a lofty chart berth. Flip: "Together We Stand (Divided We Fall)" (2:12) [Al Gallico BMI-Wynette, Chapel]

ERNEST TUBB (Decca 32237)
Nothing Is Better Than You (2:25) [Ernest Tubb BMI-Howell]

The venerable Hall of Famer offers his famed vocal styling to a traditional country tear-jerker called "Nothing Is Better Than You" on this side. Deck should be another in the long line of Ernest Tubb winners, especially with the juke box buyers. Flip: "Too Much Of Not Enough" (2:56) [Ernest Tubb BMI-Ripley]

CARL SMITH (Columbia 44396)
Foggy River (2:34) [Milene ASCAP-Rose]

Carl Smith crawls out of that "Deep Water," which was a healthy chart sound for him, and walks smack into a "Foggy River," which could be another winner when the mist clears. The oldie gets a swinging, low-key treatment that's bound to provide the songster with another truckload for the bank. Flip: "When Will The Rainbow Follow The Rain" (2:12) [Cedarwood BMI-Walker]

MEL TILLIS (Kapp 881)
All Right (I'll Sign The Papers) (2:26) [Cedarwood BMI-Tillis]

Another excellent, self-penned stanza in the hands of Mel Tillis, "All Right (I'll Sign The Papers)," should provide him with another long-running chart item. The medium-paced blueser should be grabbed up quickly by jocks with an ear for good programming material. Flip: "Helpless, Hopeless Fool" (2:03) [Cedarwood BMI-Westberry, Joy]

LEROY VAN DYKE (Warner Bros. 7155)
Louisville (1:58) [Moss Rose BMI-Rogers]

Away from the beaten chart path for quite some time, LeRoy Van Dyke may well make a solid re-entry into the big picture as he comes up with a topnotch piece of material called "Louisville." A rhythmic number with a contagious sound, the deck has lots of built-in potential. Flip: "There's Always Tomorrow" (2:50) [Music City ASCAP-Tubb]

BOBBY BRADDOCK (MGM 13843)
I'm A Good Girl (2:44) [Tree BMI-Braddock]

The funky sound of "I'm A Good Girl" and the ironic twist to the tragic ditty gives Bobby Braddock an excellent chance to finally break out big into the national sales scene. Should see some real good action out in the marketplace. Flip: "Old Faithful" (2:49) [Tree BMI-Braddock]

Newcomer Picks

JIMMY PAYNE (Epic 10261)
Where Has All The Love Gone (2:32) [Glaser BMI-Glasser]

A real pretty, swaying ballad offering from Jimmy Payne could prove to be worth its weight in order forms for the songster. Titled "Where Has All The Love Gone," the deck could prove salesworthy in both pop and country areas. Flip: "He Will Break Your Heart" (3:03) [Conrad BMI-Butler, Mayfield, Carter]

Best Bets

LITTLE JIMMY DEMPSEY (ABC 11020)
Bessie Was A Good Old Cow (1:50) [Dempsey, Low - Ja BMI - Dempsey]
Lots of good, free-wheeling picking makes this Little Jimmy Dempsey instrumental a good bet for heavy programming. Excellent workout. Flip: "These Boots Are Made For Walking" (2:27) [Criterion BMI-Hazelwood]

OSBORNE BROTHERS (Decca 32242)
Rocky Top (2:35) [House of Bryant BMI-B./F. Bryant]
The prolific Bryant pens provide the Osborne Bros. with a number that could well get them back on the chart road. Some fine mountain harmony on this topnotch item. Give it a try. Flip: "My Favorite Memory" (2:42) [Bronze SESAC-Statler]

MARK SCOTT & DICKY TREADWAY (T.S.M. 3332)
Long Road To Nowhere (2:07) [Ramsgate BMI-Adams]
Along with the Western Kings, Mark Scott and Dicky Treadway offer a lively blues session that could catch on and carry the crew into the big spotlight. Deck has a chance. Flip: "Pull Back The Curtain" (2:15) [Ramsgate BMI-Scott]

GRANDPA JONES (Monument 1043)
That's All This Old World Needs (2:09) [Vintage BMI-Tubert, Tapp]
Grandpa Jones has a new bag, complete with a big vocal background, and may find himself decorating many a turntable as a result. Deck is contagious, so watch it. Flip: "Don't Look Back" (2:17) [Hill & Range BMI-Jones]

RICKY SEARS (Musicor 1281)
Faded Memory (2:08) [Glad BMI-M./R. Sears]
Could be a pile of activity in store for both Ricky Sears and his walloping tear-tugger called "Faded Memory." The lively session may well help establish the songster nationally. Flip: "Change Of Heart" (2:20) [Glad BMI-M./R. Sears]

RAY LANGLEY (Great 1125)
Mesmerisement (2:12) [Yonah BMI-Gilbreath, Morrison]
Here's a comedy take-off on the world of commercials that tell us what to smoke, how to smell, etc. that makes for a good change of pace for spinners. Flip: "Ole Rover" (2:58) [Larrick, Yonah BMI-Langley, Gibson, Edwards]

A HIT SINGLE

JOHNNY WRIGHT'S

"MUSIC TO
CRY BY"

DECCA 32216





Cash Box Country Top 50

3	WHAT LOCKS THE DOOR (Acclaim—BMI) Jack Greene (Decca 32190)	29	HEAVEN HELP THE WORKING GIRL (Wilderness—BMI) Norma Jean (RCA Victor 9362)	41
1	IT'S THE LITTLE THINGS (Marson—BMI) Sonny James (Capitol 5987)	30	I DOUBT IT (Ly-Rant—BMI) Bobby Lewis (United Artists 50208)	33
4	IT TAKES PEOPLE LIKE YOU (Blue Book—BMI) Buck Owens (Capitol 2001)	31	YOU'RE THE REASON (Vogue—BMI) Johnny Tipton (MGM 12839)	32
6	FOR LOVING YOU (Painted Desert—BMI) Bill Anderson & Jan Howard (Decca 32197)	32	PROMISES, PROMISES (Yonah—BMI) Lynn Anderson (Chart 2010)	40
9	BY THE TIME I GET TO PHOENIX (Rivers—BMI) Glen Campbell (Capitol 2015)	33	SKIP A ROPE (Tree—BMI) Henson Cargill (Monument 1041)	49
8	BOTTLE BOTTLE (Window—BMI) Jim Ed Brown (RCA Victor 9329)	34	EVERYBODY OUGHT TO SING A SONG (Blue Crest—BMI) Dallas Frazier (Capitol 2011)	43
2	YOU MEAN THE WORLD TO ME (Al Gallico—BMI) David Houston (Epic 10224)	35	THE LAST THING ON MY MIND (Deep Fork—BMI) Porter Wagoner & Dolly Parton (RCA Victor 9369)	47
10	IF MY HEART HAD WINDOWS (Glad/Blue—Crest—BMI) George Jones (Musicar 1267)	19	GARDENIAS IN HER HAIR (Hill & Range/Mariposa—BMI) Marty Robbins (Columbia 44271)	37
5	WHAT KIND OF GIRL DO YOU THINK I AM (Sure Fire—BMI) Loretta Lynn (Decca 32184)	37	WEAKNESS IN A MAN (Gallico—BMI) Roy Drusky (Mercury 72742)	42
13	COUNTRY HALL OF FAME (Yellow River—ASCAP) Hank Locklin (RCA Victor 9323)	38	YOU'VE BEEN SO GOOD TO ME (Summer House, Harmony Hill—ASCAP) Van Trevor (Date 1565)	34
11	A DIME AT A TIME (Pass Key—BMI) Del Reeves (United Artists 50210)	11	MAKE A LEFT THEN A RIGHT (Central Songs—BMI) Johnny & Janie Mosby (Capitol 5980)	39
17	SING ME BACK HOME (Blue Book—BMI) Merle Haggard (Capitol 2017)	40	HANGIN' ON (Garage/Alamo—BMI) Gosdin Bros. (Bakersfield In't 1002)	46
15	BURNING A HOLE IN MY MIND (Delmore—ASCAP) Connie Smith (RCA Victor 9335)	41	I WOULDN'T TAKE HER TO A DOGFIGHT (Window—BMI) Charlie Walker (Epic 10237)	44
7	I DON'T WANNA PLAY HOUSE (Al Gallico—BMI) Tammy Wynette (Epic 10211)	42	TUPELO MISSISSIPPI FLASH (Vector—BMI) Jerry Reed (RCA Victor 9334)	48
18	I THOUGHT I HEARD A HEART BREAK LAST NIGHT (Hill & Range—BMI) Jim Reeves (RCA Victor 9343)	43	TENDER & TRUE (Acuff—Rose—BMI) Ernie Ashworth (Hickory 1484)	52
12	DOES MY RING HURT YOUR FINGER (Jando—ASCAP) Charlie Pride (RCA Victor 9281)	44	I'M A SWINGER (Barnes—BMI) Jimmy Dean (RCA Victor 9350)	52
21	JUANITA JONES (Nelson—Post—ASCAP) Stu Phillips (RCA Victor 9333)	45	WOMAN HUNGRY (Owens—BMI) Porter Wagoner (RCA Victor 9379)	—
30	LOVE'S GONNA HAPPEN TO ME (Freeway—BMI) Wynn Stewart (Capitol 2012)	46	YELLOW-HAIRED WOMAN (Hillis—BMI) Claude King (Columbia 44340)	50
26	I'LL LOVE YOU MORE (Pamper—BMI) Jeannie Seely (Monument 1029)	47	ROSANNA'S GOING WILD (Melody Lane—BMI) Johnny Cash (Columbia 4373)	—
23	WONDERFUL WORLD OF WOMEN (Cedarwood—BMI) Faron Young (Mercury 72728)	48	REPEAT AFTER ME (Tree—BMI) Jack Reno (Jab 9009)	54
31	BLUE LONELY WINTER (Newkeys—BMI) Jimmy Newman (Decca 32202)	49	A GIRL DON'T HAVE TO DRINK TO HAVE FUN (Blue Book—BMI) Wanda Jackson (Capitol 2021)	55
14	HOW FAST THEM TRUCKS CAN GO (Vanja—BMI) Claude Gray (Decca 32180)	50	LOOKING OVER MY SHOULDER (Cedarwood—BMI) Bob Willis & Mel Tillis (Kapp B42)	51
28	I'D GIVE THE WORLD (Page Boy—SESAC) Warner Mack (Decca 32211)	51	JUST FOR YOU Ferlin Husky (Capitol 2048)	—
37	HERE COMES HEAVEN (Hill & Range—BMI) Eddy Arnold (RCA Victor 9368)	52	IF YOU CAN'T BRING IT HOME Trina Love & Ott Stephens (Chart 1005)	—
25	PINEY WOOD HILLS (T.M./Gypsy Boy—BMI) Bobby Bare (RCA Victor 9314)	53	THE DAY YOU STOPPED LOVING ME Bobby Helms (Little Darlin' 0034)	—
27	BALLAD OF WATER HOLE #3 (Famous—ASCAP) Roger Miller (Smash 2121)	54	STRANGER ON THE RUN Bill Anderson (Decca 32215)	—
35	ANYTHING LEAVING TOWN TODAY (Newkeys—BMI) Dave Dudley (Mercury 70741)	55	THE ONLY WAY OUT (Is To Walk Over Me) Charlie Louvin (Capitol 2007)	—
38	ANNA (I'M TAKING YOU HOME) (Gallico—BMI) Leon Ashley (Ashley 2025)	56	FUNNY Conway Twitty (Decca 32208)	—
		57	LOVE'S DEAD END Bill Phillips (Decca 2007)	—
		58	RIVER OF REGRET June Stearns (Columbia 44321)	—
		59	BEFORE THE NEXT TEARDROP FALLS Duane Dee (Capitol 5986)	—
		60	YOU'RE EASY TO LOVE Arlene Hardin (Columbia 44310)	—

All My Thanks

“Just For You”

CAPITOL 2048

FERLIN HUSKY



TREE PUBLISHING CO., INC.
905 16TH AVE., S., NASHVILLE, TENN.

Personal Management:
HUBERT LONG TALENT AGENCY
806 16TH AVE., S., NASHVILLE, TENN. (615) 244-2424





TRAVELING SHOES—Guy Mitchell—Starday LP/SLP 412

Guy Mitchell pleased a good many country listeners with his single waxing of the title ditty of this album, and he should capture the enthusiasm of a nice-sized audience with the album itself. Among the most effective numbers on the set are "Singing The Blues" and "Heartaches By The Number," hits which span the gap between country and popular music. Watch out for this one. It could be destined for a healthy chart ride.

MICKEY GILLEY



DOWN THE LINE — Mickey Gilley — Paula LP/LPS 2195

Mickey Gilley could streak right "Down The Line" to successville with this potent LP. A rousing effort from beginning to end, the set contains a dozen exciting tracks assembled to afford the listener a varied program of tear-tuggers and finger-snappers. The title ditty is a fast-paced swinger ala Jerry Lee Lewis that almost made this reviewer get up out of his chair and twist (or whatever the appropriate dance is) when he heard it.



STEALIN' MY WORLD — Hank Karr — Akron AK/AKS 1004

Hank Karr has a rich, powerful voice, equally suited to feelingful ballads like "My House" and driving foot-stompers such as "Come On Back." The title tune is a toe-tapping, anger-filled number about unfaithfulness which could stir the hearts of thousands of country music lovers. Put this one on your list of disks to watch. It might break out.

"When It Came To Marriage... HE CHICKENED OUT ON ME!"



Dear Disc Jockey,
We think Bobbi Staff,
and her new RCA recording
are too nice for anyone
to "Chicken Out" on!
Pelton Publishing Company
Room 700
333 West 52nd Street
New York, N. Y. 10019

Allen Nelson Is WSM's New Promotion Director

NASHVILLE—Allen Nelson, formerly a member of WSM-Radio's news department, has been named to steer the station's promotional activities.

Nelson, a well-known name in Nashville broadcasting circles and a veteran announcer-newsperson, will assume the position of promotions director on January 1st, 1968. His range of activities will include the fifty thousand watter's variety of services including promotional efforts on behalf of the 42-year-old Grand Ole Opry and a planned FM outlet now pending before the FCC.

Prior to joining the WSM's news department, Nelson served Nashville's WMAK-Radio in a variety of capacities including news, music and continuity directorships. His non-broadcast activities include membership in the Nashville Symphony Chorus, Theatre Nashville and the Professional Journalistic Fraternity.

U.S. Servicemen In Germany To See Kitty Wells Show

NEW YORK — Teeing off January 4th in Heidelberg, the Kitty Wells Country Music Show will tour the U.S. Army and Air Force bases in Germany. This is the sixth consecutive year that Kitty has made this tour, which will last ten days and include U. S. military installations in Kirchgons, Kaiserlautern, Munich, Augsburg, Fulda, Wiesbaden, Bamstein, Hahn, Graferwohr and New Amsterdam.

Accompanying Kitty Wells will be key members of her troupe, including Johnny Wright, Bobby Wright, Bill Phillips and Ruby Wright.

Tickets Now On Sale For C&W Academy Awards Show

LOS ANGELES — Tex Williams, president of the Academy of the Country & Western Music, last week announced that tickets for the Academy's third annual awards show have gone on sale. The show will be held on March 4 at The Century-Plaza Hotel in L.A. Tickets are \$15.00 per person and may be obtained by writing to P. O. Box 508 in Hollywood.

- | | | | | | |
|-----------|---|-----------|-----------|--|----------|
| 1 | TURN THE WORLD AROUND | 1 | 16 | YOU MEAN THE WORLD TO ME | 2 |
| | Eddy Arnold (RCA Victor LPM/LSP) 3869 | | | Dovid Houston (Epic LN 24338/BN 26338) | |
| 2 | BRANDED MAN | 2 | 17 | SINGIN' WITH FEELING | 2 |
| | Merle Haggard (Capitol T/ST 2789) | | | Loretta Lynn (Decca DL 4930/DL7 4930) | |
| 3 | YOUR TENDER LOVING CARE | 3 | 18 | BILL ANDERSON'S GREATEST HITS | 2 |
| | Buck Owens (Capitol T/ST 2760) | | | (Decca DL 4859/74859) | |
| 4 | LOVE OF THE COMMON PEOPLE | 5 | 19 | SINGING AGAIN | 2 |
| | Woylan Jennings (RCA Victor LPM/LSP 3825) | | | Ernest Tubb & Loretta Lynn (Decca DL 4872/DL 74872) | |
| 5 | GENTLE ON MY MIND | 4 | 20 | WHAT DOES IT TAKE | 1 |
| | Glen Campbell (Capitol MT/ST 2809) | | | Skeeter Davis (RCA Victor LPM/LSP 3874) | |
| 6 | BEST OF EDDY ARNOLD | 9 | 21 | THE PARTY'S OVER | 1 |
| | (RCA Victor LPM/LSP 3565) | | | Willie Nelson (RCA Victor LPM/SLP 3858) | |
| 7 | TONIGHT CARMEN | 6 | 22 | SPANISH FIREBALL | 2 |
| | Morty Robbins (Columbia CL 2725/CS 9525) | | | Hank Snow (RCA Victor LPM/LSP 3857) | |
| 8 | LAURA (What's He Got That I Ain't Got) | 8 | 23 | COOKIN' UP HITS | 2 |
| | Leon Ashley (RCA Victor LPM/LSP 3900) | | | Liz Anderson (RCA Victor LPM/LSP 3852) | |
| 9 | ALL THE TIME | 7 | 24 | THE BUCKAROOS STRIKE AGAIN | 2 |
| | Jock Green (Decca DL 4904/DL 4904) | | | (Capitol T/ST 2828) | |
| 10 | ODE TO BILLIE JOE | 12 | 25 | I'LL HELP YOU FORGET HER | 2 |
| | Bobbie Gentry (Capitol T/ST 2830) | | | Doti West (RCA Victor LPM/LSP 3830) | |
| 11 | BEST OF CONNIE SMITH | 11 | 26 | WHAT LOCKS THE DOOR | 2 |
| | (RCA Victor LPM/LSP 3848) | | | Jock Greene (Decca DL 4939/ 7 4939) | |
| 12 | QUEEN OF HONKY TONK STREET | 17 | 27 | MY ELUSIVE DREAMS | 2 |
| | Kitty Wells (Decca DL 4929/DL 74929) | | | Dovid Houston & Tommy Wynette (Epic LN 24325/BN 26325) | |
| 13 | HELLO, I'M DOLLY | 13 | 28 | CLASS GUITAR | 2 |
| | Dolly Parton (Monument MLP 8085/SLP 18085) | | | Chet Atkins (RCA Victor LPM/LSP 3885) | |
| 14 | GEMS BY JIM | 14 | 29 | BY THE TIME I GET TO PHOENIX | 2 |
| | Jim Ed Brawn (RCA Victor LPM/SLP 3853) | | | Glen Campbell (Capitol T/ST 2851) | |
| 15 | I'LL NEVER FIND ANOTHER YOU | 10 | 30 | DON'T SQUEEZE MY SHARMON | 2 |
| | Sonny James (Capitol T/ST 2788) | | | Charlie Walker (Epic LN 24328/BN 26328) | |

Tree Grows Many Branches In 1967

NASHVILLE, Tenn. — Tree execs Jack Stapp and Buddy Killen see 1967 as a crucial year in the growth of their company. Expansion with a foreign flavor was the theme for Music City's global Tree Publishing Co., with President Jack Stapp traveling to all areas of the world establishing wholly-owned subsidiaries of the company. During the year, such offices were set up in the United Kingdom, Europe, Mexico, South America, Japan, and Australia.

Symbolically, "Green, Green Grass of Home" from the pen of Tree writer Curly Putnam, also the writer of "My Elusive Dreams," became the biggest song in England's recording history at the same time of Stapp's London junket. The Tom Jones recording of the song topped charts in a large number of countries around the world.

Another especially-active song from the Tree catalogue which aroused interest during the year was "Love of the Common People," written by John Hurley and Ronnie Wilkins. A reversal in trends was set by this tune, as it became a Pop hit and then developed in the Country field thru recordings by Waylon Jennings, Jim Ed Brown and a number of others.

In addition to Putnam, Hurley and Wilkins, other exclusive Tree penmen enjoying banner years were Roger Miller, Bobby Braddock, Red Lane, Dee Mceller, Autry Inman, and Dottie and Bill West.

On the domestic scene, Tree's internal office staff was expanded in three especially-meaningful directions with the addition of Glenn D. Tubb and Tom Hartman to the home office's Professional staff and with West Coast music man Rick Landy being tabbed to head up the company's music office in Movieland. Tubb, who is also an exclusive Tree writer, copenned with Jack Moran, Henson Car-

gill's successful end-of-the-year seller "Skip A Rope."

One aspect of the '67 expansion has been interest in other music industry business. Wilderness Music Inc. and the Bob Neal Talent Agency, both of which Stapp and Killen own 50%, have experienced stellar years. Wilderness added three BMI awards to Tree's four, and the Neal agency has had a record-breaking season for network TV appearances by Sonny James, Connie Smith, Liz and Lynn Anderson (for Country dates) also joined the agency during '67.

Acquisition of half interest with Memphis, Tenn.'s fabulous Press Music catalogue, with such key staff clefters as Chips Moman, Dan Penn and Spooner Oldham, was further evidence of the company's bold growth plan; as was the acquisition of foreign rights to Eddie Miller's Country Music Opera "The Legend of Johnny Brown."

The company's recording interest in Dial Records and newly-created JAB Records bore perennial fruit, closing out the music year with such respective chart toppers as Joe Tex's Dial recording of "Skinny Legs and All" and Jack Reno's "Repeat After Me" on JAB, both produced by Buddy Killen. Also a matter of year-end record were Tree Christmas songs "Old Toy Trains," written and recorded by Roger Miller and Joe Tex's "I'll Make Everyday Christmas for My Woman," both showing a tremendous amount of sales and air-play.

Killen's Presidency of the Nashville NARAS chapter and Stapp's Presidency of Cerebral Palsy of Tennessee and his activity in the Country Music Association, where he is a board member representing all music publishers, point up Tree's multi-faceted fields of activity which have meant continued growth.

Great Britain's Best Sellers

This Week	Last Week	Weeks On Charts	Title
1	4	2	*Hello Goodbye—The Beatles (Parlophone) Northern
2	1	5	*Let the Heartaches Begin—Long John Baldry (Pye) Schroeder
3	2	5	*Everybody Knows—Dave Clark 5 (Columbia) Donna
4	8	4	*Something's Gotten Hold of my Heart—Gene Pitney (Stateside) Maribus
5	5	6	If The Whole World Stopped Loving—Val Doonican (Pye) Immediate
6	12	3	Careless Hands—Des O'Connor (Columbia) E. H. Morris
7	14	2	*I'm Coming Home—Tom Jones (Decca) Donna
8	9	4	*All My Love—Cliff Richard (Columbia) Shapiro-Bernstein
9	15	3	*World—Bee Gees (Polydor) Abigail
10	18	2	Daydream Believer—The Monkees (RCA) Screen Gems
11	7	16	*The Last Waltz—Englebert Humperdinck (Decca) Donna
12	3	6	*Love Is All Around—The Troggs (Page One) Dick James
13	—	1	*Thank U Very Much—The Scaffold (Parlophone) Noel Gay
14	6	10	*Baby Now That I've Found You—The Foundations (Pye) Welbeck/Schroeder
15	—	1	*Magical Mystery Tour (EP)—The Beatles (Parlophone) Northern
16	16	4	I Feel Love Coming On—Felice Taylor (President) Kassner
17	11	9	*Zabadak—Dave Dee, Dozy, Beaky, Mick & Tich (Fontana) Lynn
18	—	1	Kites—Simon Dupree (Parlophone) Robbins
19	—	1	*Here We Go Round The Mulberry Bush—Traffic (Island) United Artists
20	10	6	*There Is a Mountain—Donovan (Pye) Donovan *Local copyrights

Great Britain's Top Ten LP's

1	Sound of Music—Soundtrack (RCA)	6	The Last Waltz—Englebert Humperdinck (Decca)
2	Sgt. Pepper's Lonely Hearts Club Band—The Beatles (Parlophone)	7	Axis—Jimmy Hendrix (Track)
3	Breakthrough—Studio 2 Stereo (EMI)	8	Val Doonican Rocks—Val Doonican (Pye)
4	British Chartbusters — Various (Tamla Motown)	9	Best of The Beachboys Vol: 2—The Beachboys (Capitol)
5	Disraeli Gears—The Cream (Reaction)	10	Smiley Smile—The Beach Boys (Capitol)

Argentina's Best Sellers

This Week	Last Week	Title
1	1	The World We Knew (Relay) Frank Sinatra (Music Hall); Caravelli (CBS); Paul Jourdan (RCA); Bert Kaempfert, Vincent Morocco (Philips); Nueva Generacion (Quinto)
2	2	*Quiero Llenarme De Ti (Melograf) Sandro (CBS); Lord Klave (Philips)
3	3	Aranjuez Mon Amour Richard Anthony (Odeon); Caravelli (CBS); Vincent Morocco (Philips); Lucio Milena (Disk Jockey)
4	5	I Love You, You Love Me Anthony Quinn (Odeon)
5	4	*Todo Es Mentira (Fermata) Palito Ortega (RCA)
6	6	*La Balsa (Fermata) Los Gatos, Nacho Paz (RCA)
7	8	Even Bad Times Are Good Tremeloes (CBS)
8	7	La Carcel De Sing Sing (Edami) Jose Feliciano (RCA); Pepito Perez (Disc Jockey)
9	9	*Las Manos (Melograf) Sandro (CBS)
10	15	Lenita Nilton Cesar (RCA)
11	10	No (Edami) Olga Guillot (Music Hall); Armando Manzanero, Antonio Prieto (RCA); Rosamel Araya (Disc Jockey); Carlos Lico (Odeon); Carmita Jimenez (CBS); Polo Marquez (Microfon)
12	12	Release Me Engelbert Humperdinck (Odeon)
13	14	Cuando Tu No Estas (Fermata) Raphael (Music Hall)
14	11	Esta Tarde Vi Llover (Relay) Armando Manzanero (RCA)
15	19	Vamos A La Cama (Quinto) Pibes Latinos (Quinto); Ardillitas (CBS); Victrolita (RCA)
16	16	Sock It To Me Willie Bobo (Philips)
17	13	There Is A Mountain (Edami) Donovan, Boogaloos (CBS); Fedra & Maximilian (Disc Jockey); Barbara & Dick (RCA)
18	20	Secret Love Billy Stewart (Microfon)
19	17	Summertime (Neumann) Billy Stewart (Microfon); M. J. Quartet (Philips)
20	20	Trisagio Del Soltero Napoleon Puppy (CBS); Montecristo, Chevere (RCA); Los Wawanco (Odeon) *Local

Australia's Best Sellers

1	The Last Waltz (Englebert Humperdinck—Decca) J. Albert & Son
2	Massachusetts (Bee Gees—Spin) Abigail Music
3	The Two Of Us (Jackie Trent & Tony Hatch—Astor) Leeds Music
4	To Sir With Love (Lulu—Columbia) Screen Gems/Columbia
5	Snoopy's Christmas (Royal Guardsmen—Festival)
6	Judy (Elvis Presley—RCA) Progressive Music
7	Gimme Little Sign (Brenton Wood—Festival)
8	Alternate Title (The Monkees—RCA) Tu-Con Music
9	You've Not Changed (Sandie Shaw—Astor) Chappell & Co.
10	*Sadie, The Cleaning Lady (Johnny Farnham—Columbia) Tu-Con Music Asterisk indicates locally produced record

Mexico's Best Sellers

- 1 Quinceañera—Los Vlamers (Musart) Toño Quirazco (Orfeon) Frankie y Los Matadores (Peerless)
- 2 Musita—Sonora Santanera (CBS) Carlos Campos (Musart)
- 3 Dame Una Señal (Gimmie a little sign)—Brenton Wood (Gamma) Roberto Jordán (RCA)
- 4 Tengo—Carlos Lico (Capitol) Los Cuatro Brillantes (CBS) Imelda Miller (RCA) (RCA publishing)
- 5 Noches De San Francisco (San Franciscan Nights)—Eric Bourdon and The Animals (MGM)
- 6 Cierra Los Ojos—Marco Antonio Muñiz (RSA) Carlos Lico (Capitol) Alberto Vázquez (Musart)
- 7 Yo, Tu Y Las Rosas—Los Piccolinos (CBS)
- 8 Adoro—Carlos Lico (Capitol) Armando Manzanero (RCA) Manny Bolaños (Musart) Enrique Guzmán (Acuario) Sonia (RCA) Los Kuarto (Tizoc) Carmita Jiménez (CBS) Los Dominic (Philips) Marco Antonio Vázquez (Peerless) Hermanitas Núñez (Orfeon) Los Rockin Devils (Orfeon) (Pham)
- 9 La Balada Del Vagabundo—Rosa María y Jose Guardiola (Son Art)
- 10 La Carta (The Letter)—The Box Tops (Capitol) Los Belmonts (Orfeon)

DO YOU NEED
LOW PRICED
TOP QUALITY
BRAND NEW
MODERN STEREO
CLASSICAL
EUROPEAN FOLK
REPERTOIRE
ALL RIGHTS
AVAILABLE!

CONTACT
W. G. WINKEL
POLYBAND
SONNEN STR. 20
MUNICH 15, GERMANY
TEL: 55 41 98

IN THE INTERNATIONAL LANGUAGE OF MUSIC



MERRY CHRISTMAS
and a
HAPPY NEW YEAR

To ALL our Friends . . . all over the world
THE FERMATA GROUP
DISCOS RGE, LTDA.
SOM/MAIOR
PREMIER RECORDS

ANYWHERE IN THE WORLD
THERE'S ONE PUBLISHER
YOU CAN ALWAYS BANK ON



A. SCHROEDER MUSIC CORPORATION  **ABBY SCHROEDER / WALLY GOLD**

25 WEST 56th STREET / NEW YORK, N. Y. 10019 / (212) JU 2-8810

WEST COAST OFFICE: 9000 SUNSET BLVD., LOS ANGELES, CALIF., 90046 / 274-7351 DAVID MOOK

ENGLAND

A. SCHROEDER MUSIC PUBLISHING CO. LTD.

FRANCE

EDITIONS MUSICALES A. SCHROEDER S.A.R.L.

GERMANY

A. SCHROEDER MUSIKVERLAG KG

BENELUX

A. SCHROEDER NV
(BASART)

SCANDINAVIA

A. SCHROEDER MUSIKFORLAG

ITALY

CATALOGO A. SCHROEDER
(RICORDI)

SPAIN

A. SCHROEDER MUSIC
(QUIROGA)

AUSTRALASIA

A.J.S. MUSIC OF AUSTRALASIA

JAPAN

A. SCHROEDER MUSIC (FAR EAST) LTD.

Cash Box



December 23, 1967



The choir of Kings College, Cambridge, seen above in the college chapel, are famous all over the world for their albums of Christmas carols and sacred music. Every yuletide Argo Records enjoys renewed success with such LP's as "A Festival of Lessons and Carols from Kings College, Cambridge;" "On Christmas Night;" "The Infant King;" "The Three Kings," etc. Argo is a division of the Decca group of companies.

Where has all the TALENT gone...



KATHY KIRBY



MATT MONRO



THE BEATLES



VINCE HILL



CLIFF RICHARD

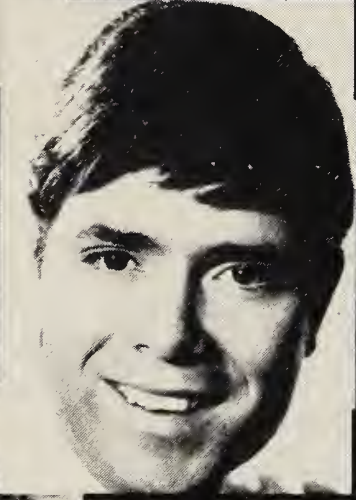

HERMAN'S HERMITS



KEITH WEST



CILLA BLACK



LULU



THE HOLLIES



DAVE CLARK FIVE

ELECTRIC & MUSICAL INDUSTRIES LTD (EMI) LONDON ENGLAND

ARGENTINE AUSTRALIA AUSTRIA BARBADOS BELGIUM BOLIVIA BRAZIL CANADA CHILE COLOMBIA CONGO DENMARK ECUADOR FINLAND
 FRANCE GERMANY GREAT BRITAIN GREECE HOLLAND HONG KONG INDIA IRELAND ISRAEL ITALY JAMAICA JAPAN KENYA LEBANON MEXICO
 NEW ZEALAND NICARAGUA NIGERIA NORWAY PAKISTAN PERU PHILIPPINES PORTUGAL RHODESIA SINGAPORE SOUTH AFRICA SPAIN SWEDEN
 SWITZERLAND THAILAND TURKEY UNITED STATES OF AMERICA URUGUAY VENEZUELA YUGOSLAVIA



BOBBIE GENTRY



THE BEACH BOYS



KEN DODD



THE SHADOWS



PAUL JONES



THE SEEKERS



FRANKIE VAUGHAN



FRANK IFIELD



PINK FLOYD



PETER & GORDON



NANCY WILSON



THE GEORGE MITCHELL MINSTRELS

to

EMI

of course!

Billboard

HOT 100

★ STAR performer—Sides registering greatest proportionate upward progress this week.

 Record Industry Association of America seal of certification as million selling single.

TOP 30

4 SEASONS PHILIPS

NEW VAUDEVILLE BAND FONTANA

BOBBY HEBB PHILIPS

DAVE DEE, DOZY, BEAKY, MICK and TICH FONTANA

WAYNE FONTANA FONTANA

FRANKIE VALLI PHILIPS

JOHNNY HALLIDAY PHILIPS

MANFRED MAN PHILIPS

SHEILA PHILIPS

H
★ STAR performer—S

Langspielplatten

HIT-PARADE

NORGES

10

PÅ TOPP



CashBox TOP 100

LE
HIT PARADE
DE SALUT LES
COPAINS

TOP TEN TALENT OF THE PHILIPS RECORDS GROUP



100

CLAUDE FRANÇOIS PHILIPS

NANA MOUSKOURI FONTANA

THE HERD FONTANA

DUSTY SPRINGFIELD PHILIPS

RAMSES SHAFFY PHILIPS

PAUL MAURIAT PHILIPS

THE SPIDERS PHILIPS

BARBARA PHILIPS

BRASSENS PHILIPS

Lang
HIT-1

TIME TOP 30

BORSA DEL DISCO

Classifica dei dischi più venduti, in base alle segnalazioni dei principali auditori di tutta Italia

A Publication of
Philips Phonographic Industries
Central Office:
Baarn, The Netherlands.

LUGLIO 1967



Great Britain — 1967 in Review

Devaluation of the pound by 14.3% in November this year, setting the new rate of \$2.40 to the pound, besides rubbing a considerable amount of gilt off the pound sterling, will also reduce the number of gold disks minted annually in recognition of a million-selling record. Gold disks and million sellers—hard to come by at the best of times—will be even more difficult to achieve as a result of the drastic austerity measures which will come in the wake of devaluation.

Faced with a straight 3/- in the pound on the basic retail price of imported goods, a rise of 15% on all imported luxury goods, and a tightening of the belt generally, the consumer may well cut down on his recording spendings.

Regretably, this gloomy prospect manifested itself at the onset Christmas "sell" and at the tail end of a year which, as will be seen by our month-by-month summary, has enjoyed a continuous rise in sales. Therefore, let us look back and re-evaluate the scene before devaluation.

Half way through the year, in our July Directory, we underlined the dramatic changes taking place within the industry at all levels. New techniques, new personalities, new processes and of course, new manufacturing forces.

A significant trend has been the emergence, with increasing chart success, of independent labels such as Chris Blackwell's Island records—"Page One" headed by Larry Page and Dick James, the Andrew Oldham and Tony Calder Immediate set-up, Robert Stigwood's Reaction label, Kit Lambert & Chris Stamp's Track label, Philip Solomon's Major-Minor, and, last but not least, Denny Cordell's New Breed Productions issued on the re-instated Regal Zonophone label.

However, 1967—particularly the second half of the year—has been notable for the entry of more and more major American manufacturers into Britain, to set up their own independent operations. The first American company to set up in Britain two years ago, CBS, has now been joined by Liberty and MGM. RCA has entered into a termination agreement with Decca, and is building its own plant in the north of England—and by 31st May 1969, will be completely independent. United Artists are in the process of finalizing plans for British independence, and American Decca is on its way in.

During the year under review, stereo sales have increased rapidly, and Britain is becoming more and more stereo-conscious. EMI, followed by other major companies, has stepped-up the pace by issuing new classical releases in stereo only. EMI was quickly rewarded for its foresight with a chart entry via their "Breakthrough" sampler LP of stereo releases.

The EP continues its decline as more and more Budget line LP's hit the counters. Singles too have taken a knock in popularity, at the expense of album sales, which week by week and month by month, like Topsy, grow and grow.

This development is applicable not only in Britain, but represents the pattern which is taking shape throughout Europe today.

In all territories singles and EPs are becoming the poor, but comparatively expensive, relation to the album. It is interesting to note that France, for years an EP market, is making the transition to singles.

Except for Radio Caroline, which manages to keep its head above water, the year has seen the sinking of the pirates—finally silenced by the Postmaster General in the early Autumn. Stepping into their waterlogged boots, and charged with the almost impossible task of pleasing everyone all of the time, the B.B.C. now rules the sound waves with round-the-clock programs on Radios 1, 2, 3 and 4. Some of these are skipped by one-time pirates who have managed to

swim ashore. However, it was not long before the B.B.C.—like the pirates before them—came "under fire" from manufacturers, publishers and protection societies on the grounds of over-exposure of the top twenty.

British artists and writers have more than maintained their chart supremacy at home, as can be seen by the lists published elsewhere in this section. Patriotism reached its peak in the second week of November when 19 out of the top 20 entries were by British artists, and 15 out of the 20 were British compositions. At the same time, this success has not been confined to Britain alone. Artists and writers have been liberally represented week by week in the American Top 100, and have lost none of their selling power on that side of the Atlantic.

As far as Europe is concerned, they have enjoyed their best year ever, and international charts have been peppered with British names and titles. During 1967 the demand for original British and American recordings all over the continent has reached unprecedented proportions. Even in Germany, where for years German language disks have dominated the charts, a complete reversal has taken place over the past twelve months. Today, British and American originals make up 95% plus of the weekly German Top Twenty.

However, as this is the British section, let us recall month by month, the main events of the year:

January

The year got off to a good start. Sales of gramophone records in January valued £2,191,000 were 6% higher than January 1966. Sales to the home market rose by 8% but sales to export, representing 14% of the total, fell by 7%. Total production of records in January, amounted to 7,685,000, was 10% lower than in the same period 1966. Output of each type of record fell and that of 78 rpm decreased by nearly 24%. British artists got off to a flying start and in the first week of the year 9 out of the Top Ten were British, led by Tom Jones at No. 1 with "Green Grass of Home" on Decca, published by Burlington. In fact, British artists accounted for 15 out of the Top Twenty, thus setting the trend for the chart pattern of 1967. However, it was an American group The Monkees, with "I'm a Believer" on RCA published by Screen Gems that held the No. 1 spot for the last three weeks of January. The American Monument label signed a 5-year deal with Decca Records to issue disks under its own label in Britain. . . . Decca welcomed executives, distributors and wives of London Records Inc. of America to Britain on the occasion of London Records' 20th Anniversary celebration. . . . EMI Manager (A&R) Norman Newell left to form his own independent production company. . . . The Charles Chaplin movie "Countess from Hong Kong" was premiered in London. The theme music from the film, "This is My Song," published by Leeds Music, gave Petula Clark an international hit and nut comedian/singer Harry Secombe back into the British charts. . . . CBS artists, The Spellbinders, Woody Herman, The Clancy Brothers, and The Brothers Four, arrived in Britain for concert tours. . . . Tom Jones' "Green Grass of Home" achieved a million sales in Britain alone for Decca Records. . . . Ken East, formerly of EMI (Australia) Ltd., appointed managing director of EMI Records in place of Mr. G. Bridge who returned to the Overseas Division at Hayes. . . . Pye Records enjoying chart success with Gene Washington's Piccadilly LP "Hand Clapping, Foot Stomping, Funkey But Live" were prompted to hold a special "Blues and Soul" Week. . . . Robert Stigwood set up a new company in Hamburg, Germany in association with Lawrence Yaskiel known as

Stigwood-Yaskiel International Limited. Function, to operate a tv, press and promotion service for their artists. . . . Peter Knight Jr. left Pye Records to join Stigwood-Yaskiel International. . . . Monkees fever hit Britain. . . . Noel Rogers of United Artists in Miami for meeting with President Mike Stewart. . . . Sound-track album of "A Man and a Woman" was issued to coincide with the opening of the film. . . . Frank Weinthrop of Walt Disney Organization visited Hollywood to discuss the forthcoming opening of "Happiest Millionaire" starring Tommy Steele. . . . John Barry and Don Black nominated for motion picture Academy Award for "Born Free." . . . Robert Stigwood joined forces with Brian Epstein's NEMS Enterprises. . . . Arthur Gorson of Arthur Gorson Associated together with Phil Ochs visited London for discussions with Transatlantic Records. . . . Bobby Darin tele-recorded 40-minute one man show for BBC television. . . . Frank Ifield made cabaret debut at London's Talk of the Town. . . . The first Monkees' album released in advance of 40,000. . . . British writers Jimmy Stewart and Gerry Langley signed contract with Mills Music. . . . The Rolling Stones returned from America where they tele-recorded an Ed Sullivan show. . . . The New Vaudeville Band followed up their "Winchester Cathedral" hit with "Peek-A-Boo." . . . George Grief, President of GoGo Records of America in London for discussions with independent producers. . . .

February

After the 6% increase in January, record sales in February failed to maintain the upward trend, and sales valued at £1,858,700 were 4½% lower than in February 1966. Sales for the home market fell by 6½% but export sales, representing 14% of the total, rose by nearly 10%. Total production of records in February amounting to 6,681,000 was 6% lower than in the same period 1966. Output of 33⅓ rpm discs and 45 rpm fell by 2% and 7½% respectively. For the first two weeks of the month American group The Monkees hung on to the No. 1 spot with "I'm a Believer" but for the last two weeks Britain's Petula Clark took over the No. 1 slot with "This Is My Song" on Pye, published by Leeds. . . . Engelbert Humperdinck entered the top three with "Release Me" on Decca published by Burlington, destined to become the biggest hit of the year. . . . Tom Jones appeared in the charts with a follow-up to "Green Grass of Home" with "Detroit City" on Decca published by Southern. . . . Newly-formed Deram label had a couple of major hits via "Mathew & Son" by Cat Stevens published by Cat Music and "Night of Fear" by The Move, published by Essex Music. . . . The Beatles shot into the charts with "Penny Lane" on Parlophone published by Northern Songs. . . . The Four Tops, on their first visit to Britain, made a successful appearance at the Royal Albert Hall. . . . Roy Berry director of Campbell Connolly, embarked on a "fact-finding" world tour. . . . The Beatles re-signed with EMI Records for a further nine years. . . . RCA had a big chart entries via Rita Pavone, The Monkees, Jim Reeves and Mamas and Papas. . . . Noel Gav Artistes and Feldman Publishers delighted with American reaction to Peter & Gordon's "Lady Godiva" with sales of over 800,000. . . . Mop-headed American Jimi Hendrix set-up residency in Britain and hit the charts for the first time with "Hey Joe"—the first time of many Hendrix Experiences. . . . The first Midem Exhibition took place in Cannes, South of France, attended by record and music men from all parts of the world. Its initial success has ensured a permanent Midem Expo. . . . Polydor Records launched Stax and Camp labels. . . . The Australian group The Seekers reached No. 1 in

America with "Georgie Girl"—a Tom Springfield/Jim Dale composition on Parlophone, published by Springfield Music. . . . EMI launched intensive sales campaign to further promote the Tamla-Motown label in Britain. . . . Top Australian singer Normie Rowe back in Britain after spending Christmas in Australia, toured Britain with the Gene Pitney and The Troggs package. . . . Pye Records held a "Dean Martin Week." . . . Vic Lewis of Nems Enterprises flew to America to arrange UK visits for Mel Tormé, Buddy Greco, Anita O'Day and Ruth Price. . . . "Green Grass of Home" continued to top the best-selling sheet music lists for Burlington Music. . . . Larry Page of "Page One" Records, who set The Troggs on the road to fame, signed new group The Loot to a management, recording and agency contract. . . . Lee Pincus of Ambassador Music signed agreement with Seven Arts Music Corp. of America to handle their screen and television scores in the U.K. . . . Sonny and Cher on European tour. . . . Kenny Barker moved from EMI to Polydor to work on the Atlantic repertoire. . . . Dick James formed a new record-production company called This Record Co. Ltd. product to be released in Britain on the Philips label. . . . Donovan followed-up his transatlantic smash "Mellow Yellow" with a 28-day tour of America and Canada. . . . CBS released Verdi's "Falstaff" with Leonard Bernstein conducting the Vienna Philharmonic Orchestra, and Dietrich Fischer-Dieskau in the title role. . . . Engelbert Humperdinck's "Release Me" sold 100,000 copies in three weeks. . . . Petula Clark's single "This Is My Song" sold a quarter of a million in two weeks. . . . The British artists enjoying American chart entries during February were The Rolling Stones with "Ruby Tuesday," Herman's Hermits with two entries, "There's a Kind of Hush" and their European smash "No Milk Today," Tom Jones with "Green Grass of Home" and Peter & Gordon with "Knight in Rusty Armour." . . . Pat Campbell, RCA's Exploitation Manager left Decca to become General Manager and co-director of the newly-formed independent Major-Minor label. . . .

March

After a discouraging drop in February, gramophone record sales rose again in March. Valued at £2,143,000 they were nearly 9% higher than in March 1966. Sales to the Home market rose by 4% and sales for export, representing 18% of the total, rose by 37%. Total production of records in March amounting to 6,861,000, was slightly lower than in the same period 1966. However, total sales for the first quarter of 1967 valued at £6,192,900, were 3% higher than for the first quarter of 1966. Sales for the home market rose by 2% and sales for export representing 15½% of the total, rose by 12%. On the other hand, production of each type of record fell and total output for the first quarter of 1967 was 6% lower than from January-March a year earlier. . . . Chartwise, the No. 1 slot for the whole of March was occupied by Engelbert Humperdinck with his Decca smash single "Release Me" published by Burlington. The tremendous success of "Release Me" prevented the Beatles making No. 1 with their double-sided "Penny Lane/Strawberry Fields Forever." Vince Hill had an unexpected hit with "Eidelweiss" on Columbia, published by Williamson from the long-running "Sound of Music." . . . Another surprise entry into the Top Ten was Harry Secombe with "This Is My Song" on Philips published by Leeds. . . . Decca's Deram label had another blockbuster with "I Was Kaiser Bill's Batman" by Whistling Jack Smith, published by Mills. . . . Sandie Shaw shot straight into the Top Ten with her Eurovision entry "Puppet On A String" on Pye published by KPM. (Continued on page 8, Part II)

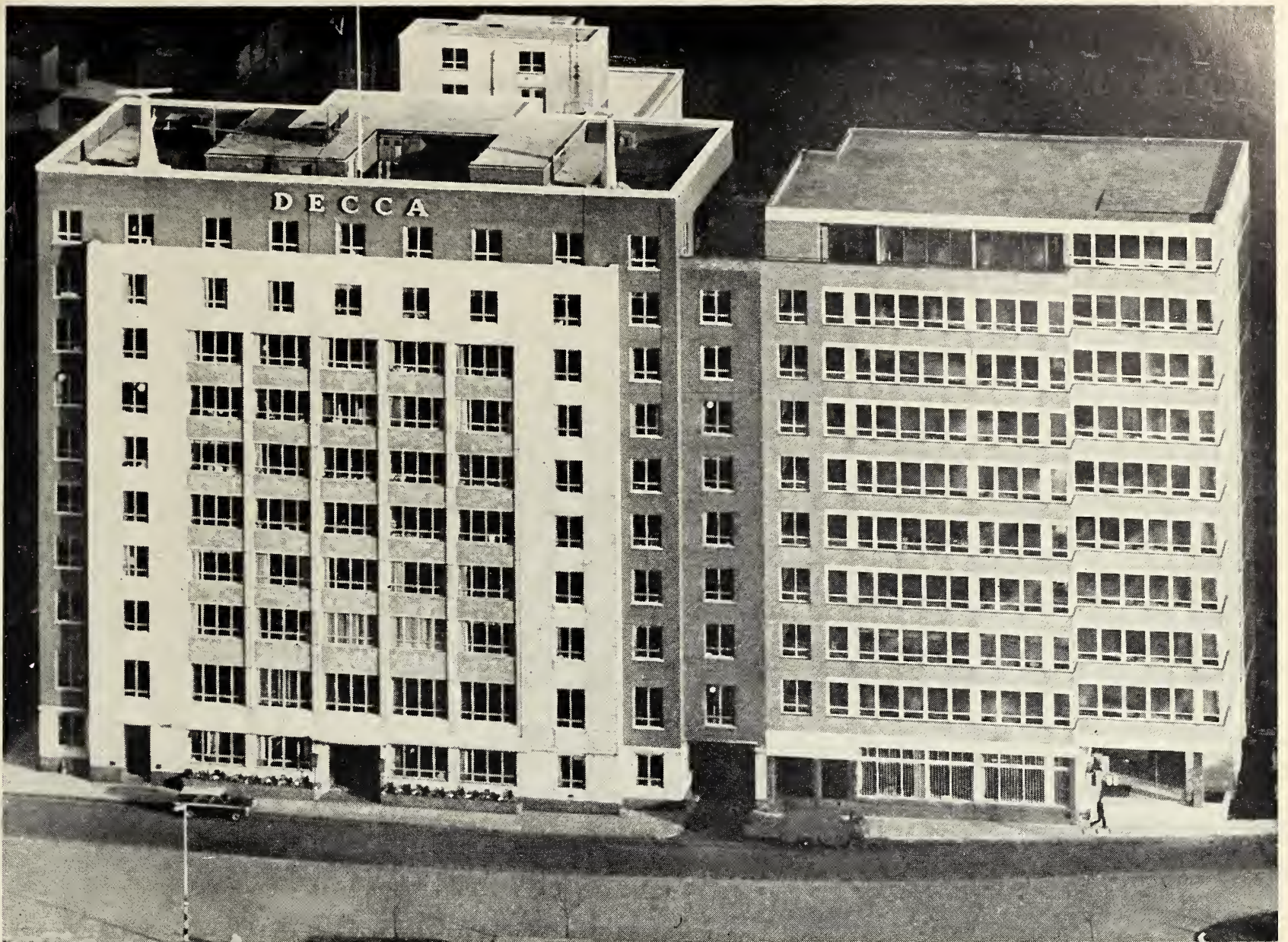

Decca offices: 9 Albert Embankment London SE1 England

The
Decca Record
Company Limited
of England
and its USA subsidiary
London Records Inc
offer American record labels a first-class
world-wide distribution service

For distribution outside of the U. S. A. — write or call Mimi Trepel, London Records Inc., 539 West 25th St., New York 1, N. Y. Oregon 5-6060

Great Britain — 1967 in Review

(Continued from page 6, Part II)
 ... "Hit the Road Stax" package tour hit Britain. . . Pickwick International launched comedian Warren Mitchell on vocal career via "Songs of World War I." . . Al Bennett of Liberty Records visited Britain for discussions with EMI. . . The American smash hit musical "Fiddler on the Roof" opened in London with Israeli actor Topol scooping all the credits. . . CBS issued a London cast album which immediately entered the LP charts where it was to stay for months and months. . . The new Chappell building in Bond Street was opened with an inaugural party for 400 guests, hosted by Mr. and Mrs. Louis Dreyfus. Alas, Louis Dreyfus, one of the greatest and best-loved publishing personalities of the century, died just a month after seeing his dream realized. . . Delyse Records delighted with their nomination for a Grammy award for their recording of Mahler's "Das Knaben Wunderhorn" sung by Janet Baker and Geraint Evans with the London Philharmonic Orchestra conducted by Wyn Morris. The album, first issued in Britain in May last year, is released in America in the Angel series. . . RCA with Bernard Nes as deputy managing director, move into new headquarters. . . Leslie Gould, managing director of Philips Records negotiated a deal with Maurice Oberstein of CBS to market the CBS repertoire on musicassettes. . . Philips became the first major British record company to issue compatible stereo albums. . . Songwriter/Arranger Les Reed opened new recording studio in London. . . Songwriters Bill Martin and Phil Coulter penned "Puppet On a String" for Sandie Shaw to sing at the Eurovision Song Contest. . . Having had enormous success with Tom Jones in

"Green Green Grass of Home" Burlington Music scooped a No. 1 with Engelbert Humperdinck's "Release Me." . . Publisher Cyril Gee of Mills Music in New York for a 3-week trip. . . Dick James well represented in the British Charts by The Beatles, The Hollies and The Troggs. . . Raphael, Spanish Singer, in London. . . The profits of the Beatles' publishing company, Northern Songs, more than doubled in the first half of last year, rising from £205,000 to £422,000. . . EMI announced Group profits for the half-year to December 31, 1966 of £2,976,000 as compared with £3,771,000 for the corresponding period in the previous year. United Kingdom profits were slightly lower than in the half year to December 31, 1965. . . Tom Jones scored a personal triumph at London's "Talk of the Town" nighterie. . . Andrew Loog Oldham of Immediate Records ended his eighteen-month agreement with Philips Records who had been marketing and distributing the Immediate product and signed a new agreement with EMI. . . Indie producer Larry Page visited the States. . . Chappells acquired the winning song from the San Remo contest, "Nom Pensare A Me." . . Francis Day & Hunter delighted with the transatlantic success of "There's A Kind of Hush" by Herman's Hermits on Columbia. . . EMI's European publishing companies held meetings in Brussels. . . Joaquin Merino of Zafiro Records of Spain, visited London and Page One Records with a view to getting British release for top Spanish group Los Brincos. . . Georgie Fame signed new recording contract with CBS Records. . . Walt Disney Productions launched the first album of their Buena Vista label "The Music of Walt Disney," and donated all proceeds from the album to the

British Spastics Society and the California Institute of Arts. . . The Rolling Stones made a 3-week tour of Europe. . . Paul Anka top of bill at London Palladium TV show. . . Publisher Fred Jackson of Fanfare Music visited Canada and America. . .

April
 Record sales for the month valued at £1,753,800 were slightly higher than in April 1966. Sales for the home market rose by 3% but export sales representing 15% of the total, took a fall of nearly 15%. On the production side 6,462,000 records were produced, representing 3% increase over the same month in 1966. This was the first time since June that output in any month had exceeded that of a year earlier. The figure for the first four months of 1967 was however, still 4% down on production for the same period of 1966. Engelbert Humperdinck continued to hold on to the No. 1 slot for the first week of April, but Frank & Nancy Sinatra took over in the middle of the month with "Somethin' Stupid" on Reprise published by Greenwood Music. By the end of the month Britain was on top again with Sandie Shaw's "Puppet On A String." Other notable chart entries during April included George Fame's first single for CBS "Because I Love You" published by Feldman, a return to the charts by Cliff Richard with "It's All Over" on Columbia, published by Aceff Rose, while Val Doonican had a chart entry with an oldie "Memories Are Made of This" on Decca published by Campbell Connelly. . . The new Track label formed by Kit Lambert and Chris Stamp had a steady chart seller via "The Purple Haze" single by Jimi Hendrix. Track is distributed through Polydor Records. . . Adrian Rudge, late of EMI, joined Larry Page's Page One Record

Company as Label Promotion Manager. . . Pye managing director Louis Benjamin and Gil Friesen, vice president of A&M Records, signed an agreement whereby A&M products would be issued on its own logo in Britain. The first single was Herb Alpert's "Casino Royale." . . Ken Glancy, managing director of CBS Records England, welcomed affiliates from Scandinavia and Central Europe to a conference centered around repertoire, marketing and sales. . . EMI acquired The Grade Organisation. . . Southern Music pro-British policy paid handsome dividends when "Winchester Cathedral" by The New Vaudeville Band was voted Best Contemporary (R & B) Recording of 1966. . . Winchester Cathedral also collected an Ivor Novello award as Britain's "International Song of the Year." . . John Barry and Don Black were nominated for a Grammy award for "Born Free." Barry's reputation in films has grown rapidly over the years, and he is now one of Britain's most sought-after film-score writers. He has been responsible for scoring all the James Bond movies and also penned the music for the award-winning film "The Knack." . . George Seymour, General Manager of Campbell Connelly, made first trip to America. . . President Records opened a London office with Roger Bolton as General Manager. . . Irish group The Dubliners gave Major-Minor an entry in the singles charts with "Seven Drunken Nights" published by Scott Solomon. . . Transatlantic Records entered the "pop" field by launching their new "Big T" label, and the company's boss Nathan Joseph reported Group turnover for 1966 was up by 28%. . . Bill Philips left the KPM Group of Publishing Companies to open his own publishing and management company. . . Philips

PYE DISTRIBUTION PAYS!

BRITAIN'S TOP 50

NOV

THIS WEEK	LAST 3 WEEKS POSITIONS	WEEKS IN CHART	TITLE	Artist	Label	Number	Publisher	(Producer)
1	9 31	3	LET THE HEARTACHES BEGIN	Long John Baldry	Pye 7N	17385	Schroeder	(T. Macaulay)
2	1 1 2	8	BABY, NOW THAT I'VE FOUND YOU	The Foundations	Pye 7N	17366	Welbeck-Schroeder	(T. Macaulay)
3	13 28 43	4	EVERYBODY KNOWS	Dave Clark Five	Columbia DB	6256	Donna	(Dave Clark)
4	2 2 1	10	MASSACHUSETTS	Dee Dee	Polydor 50-132		Abgall	(Dyma/Sligwood)
5	5 7 13	6	LOVE IS ALL AROUND	Troggs	Page One POP	343	Dick James	(Page One)
6	3 5 8	6	AUTUMN ALMANAC	The Kinks	Pye 7N	17400	Davray Carlin	(Ray Davies)
7	4 3 3	7	ZABADAKI	Dave Dee, Dozy, Beaky, Mick and Tich	Fontana TF	373	Lynn	(Steve Rowland)
8	5 4 4	14	LAST WALTZ	Engelbert Humperdinck	Decca F	18203	Donna	(Peter Sullivan)
9	11 16 20	6	IF THE WHOLE WORLD STOPPED LOVIN'	Val Doonican	Pye 7N	17396	Immediate	(Ken Woodman)
10	8 14 18	5	THERE IS A MOUNTAIN	Donovan	Pye 7N	17403	Donovan	(Mickle Most)
11	17 21 27	6	I FEEL LOVE COMING ON	Falco Taylor	President PT	145	Karsner	(Husling)
12	12 15 19	3	LET'S GET FOX GLOVES	Who	Track 304	304		

ALL
 Au
 B
 B
 C
 E
 F
 Flo
 Fog
 Hon
 I C

100%

DIRECT DISTRIBUTION THROUGHOUT THE U.K.

Record Retailer Chart 25th November 1967.

PYE RECORDS LTD., A.T.V. HOUSE, GT. CUMBERLAND PLACE, LONDON, W.1

Great Britain — 1967 in Review

Records expanded into the spoken word field with their Musicassettes, and issued a series of language courses. . . . EMI announced that from July their classical albums would be released in stereo only. . . . John Barry scooped two Oscars, one for the film score of "Born Free" and the other for the title song which he penned in collaboration with Don Black. . . . Sandie Shaw won an overwhelming victory for Britain at the Eurovision Song Contest in Vienna with "Puppet On a String" on Pye, published by KPM. . . . Frank and Nancy Sinatra's single "Somebody Stupid" sold over 200,000 within ten days of release by Pye on the Reprise label. . . . RCA launched an all-out campaign to promote their country and western artists. . . . Tom Jones had his third chart entry in a row with "Funny Familiar Forgotten Feelings" on Decca, published by Acuff Rose. . . . Guido Rigmano, President of Dischi Ricordi of Milan in London for discussions with top executives of MGM. . . . Nems Enterprises and Polydor Records hosted party for Bee Gees. . . . Frank Ifield returns from successful Australian tour to top the bill at London Palladium. . . . Val Doonican follows Tom Jones in cabaret at "Talk of the Town." . . . Scottish singer Andy Stewart made his first tour of Canada and American. . . . American rock-and-roll singer Fats Domino in Britain for a week of concerts. . . . Isaac Stern, world-famous violinist and CBS recording artist, in London for concerts at Royal Festival Hall with London Symphony Orchestra. . . . British Group The Easybeats entered American Top 100 with their United Artists single "Friday On My Mind." . . . The American musical "Fiddler on the Roof" broke all box office records in its first month at Her Majesty's Theatre, London. . . .

May
Gramophone record sales for May this year were 19% up on the same month last year. This followed the increases registered in March and April. Total sales for May were valued at £2,016,000. Home sales rose by 16% and export sales, representing nearly 19% of the total, rose by 39%. Production in May was also up on the same month last year by 7%. 6,812,000 records were produced. Output of 45 rpm records fell by 2%, but again, LP production was up by 21%. Output of 78 rpm records fell by 20%. Chartwise, British artists were at the top again throughout the month, and after four weeks at No. 1, Sandie Shaw made way for The Tremeloes' CBS single "Silence is Golden" which was destined to stay at No. 1 for three weeks. Among the month's major chart entries were "The Boat I Row" by Lulu on Columbia, published by Ardmore & Beechwood, two smash hits for RCA with "Dedicated to the One I Love" by The Mamas and Papas, published by Peter Maurice, and "A Little Bit Me, A Little Bit You" by The Monkees, published by Screen Gems. Manfred Mann had a notable entry with "Ha-Ha Said the Clown" on Fontana, published by Braun, and yet another Deram single, "I Can Hear the Grass Grow" by The Move, published by Cat Music, while Topol, star of "Fiddler on the Roof" crashed into the charts with the hit song from the show "If I Were a Rich Man" on the CBS label published by Valando. May was also a good month for the Tamla-Motown sound with chart entries from The Supremes with "The Happening," and "Bernadette" by The Four Tops, both published by Carlin Music. . . . The month also marked the rapid rise to fame of The Procol Harum with "Whiter Shade of Pale" on Deram published by Essex Music. . . . Vince Hill fol-

lowed his "Eidelweiss" hit with another oldie which quickly made its way into the charts, "Roses of Picardy" on Columbia, published by Chappell. . . . Jennings Musical Industries received the Queen's Award to Industry for their export achievements for Britain throughout the world. . . . Indie producer Norman Newell formed his own publishing company Music Associates Ltd. and completed a catalogue deal with Editions Campi of Italy. . . . Elvis Presley's Paramount film "Easy Come Easy Go" opened in London with a score published by Carlin Music. RCA issued a single, "You Gotta' Go" plus an EP sound track. . . . Other RCA soundtracks for the month included the much-publicized "Casino Royale" album featuring Dusty Springfield, Herb Alpert et al, as well as soundtracks of "Taming of the Shrew," "A Man for All Seasons" and the controversial "Ulysses." . . . CBS singing star Tony Bennett in London for series of concerts including one at the Royal Albert Hall. . . . R & B catalogues of Cotillion and Pronto Music, outlets of Atlantic Records previously handled in the U.K. by Carlin Music, were acquired by Philip Solomon's Tee Pee Music. . . . Spanish group Brincos had first British single release "Lola" on Page One label. . . . EMI acquired a majority interest in Gerry Oord's Bovema record company of Holland. Since Oord founded the company in 1947 it has been the exclusive outlet for the EMI repertoire in Holland. Bovema celebrated its 20th Anniversary in 1966. . . . With two gold discs to their credit for "Winchester Cathedral," The New Vaudeville Band launched their second Fontana single "Finchley Central" published by Meteor Music. . . . Melodisc Records had a chart success for their Blue Beat label with "Al Capone" by the king of blue beat, Prince Buster. . . . Jewel Music ac-

quired the American Suma catalogue for the U.K. . . . Engelbert Humperdinck followed his "Release Me" smash with an American country song "There Goes My Everything" on Decca published by Burlington Music. . . . Humperdinck's first album "Release Me" also issued by Decca. . . . Australian group The BeeGees now reside in Britain, signed five-year contract with Atlantic Records of America with a \$250,000 guarantee. . . . Sandie Shaw's Eurovision winner "Puppet On a String" notched up 600,000 British sales for Pye records and topped the best-selling sheet music lists for the third week running for Peter Maurice. . . . The "Doctor Zhivago" soundtrack album notched 80,000 sales for MGM. . . . EMI announced the appointment of Mr. Ken East and Mr. M. O. Hamilton as Divisional Directors of the company. . . . Elektra Records released the latest "Tom Rush" album to coincide with the American folk singers 3-week nationwide tour of Britain. . . . Geoffrey of Good Music paid routine visit to parent company World Music of Belgium for discussions with Roland Kluger. . . . Nancy Sinatra in London to record title song from the James Bond movie "You Only Live Twice" with composer John Barry. . . . Dusty Springfield opened cabaret season at London's Talk of the Town. . . . World disc sales amassed by the Beatles reached 200,000,000 singles. . . . Philips released their first EP musicassettes and announced that since they launched cassettes on the market in October 1966, 150 cassettes have been made available. . . . Transatlantic Records issued their first single by folksinger Bert Jansch "Where is Love My Dear." . . . Indonesian group Les Surfs made their debut on the Fontana label with "When I Tell." . . . EMI issued the latest Errol Garner album "That's (Continued on next page)

CBS RECORDS
CBS Records Limited
28-30 Theobald's Road
London WC1

OUT OF THE CBS HAT

a few of this years chart successes and a few of next years, too



THE TREMELOES
GEORGIE FAME
ANDY WILLIAMS
ANTITA HARRIS
BOB DYLAN
THE PEDDLERS
TOPOL
FAME
THE BYRDS
THE ZOMBIES
RAY CONNIEFF
DAVE BRUBECK
JOHNNY MATHIS
SCOTT MCKENZIE
ROSE

Great Britain — 1967 in Review

(Continued from preceding page)

My Pick" coincidental with the star's appearance on "Sunday Night at the Palladium." . . . Louis Benjamin of Pye Records concluded long-term deal with Egmont Luftner of Ariola to release Pye products in Austria as from July 1967. . . .

June

A sudden sales spurt in June, normally a dull month as far as disc sales are concerned, boosted industry hopes of a record year in over the counter sales. Leaping by 36% compared with the value of sales in June 1966 the June 1967 total was £2,054,000, an increase of £37,000 over the previous month. The high June total brought the half year sales tally to £12,018,000, over a million pounds up on the first six months of 1966, an indication that if sales continued to rise in the second half of the year, the final figure will be considerably up on 1966. Notwithstanding entry into the summer months — notoriously sluggish for disc sales, production of LPs remained remarkably consistent. Production of 2,826,000 albums in June brought the half year total to 16,184,000 LPs. The total compared with the 14,971,000 albums produced in the first six months the previous year. In contrast, production of 45 rpm records which fell in June to 3,457,000 from the previous June's total of 4,166,000, also dipped in the half year from 26,214,000 records in 1966 to 24,446,000 in the first six months of the current year. Fall-off in 45 rpm disc output is believed to be more in the area of extended-play records than singles, the former being hit by the flood of low-priced albums from the major record companies. Chartwise, June belonged to The Procol Harum whose "Whiter Shade of Pale" on the Deram label, published

by Essex, hurtled to the top where it was destined to remain for six weeks to come. . . . The Kinks with "Waterloo Sunset" on Pye published by Dovray, were also in the top three throughout June. . . . June also brought another big hit to Dave, Dee, Dozy, Beaky, Mick and Tich with "Okay" on Fontana published by Lynn, and Cilla Black returned to the Top Twenty with "What Good Am I" on Parlophone, published by Carlin. . . . The Atlantic label had a couple of chart entries via "Groovin'" by The Young Rascals, published by Sparta, and "Sweet Soul Music" by Arthur Conley published by CopCon. . . . Other American artists to figure in the charts during the month were The Beach Boys with "Then I Kissed Her" on Capitol published by Carlin, The Turtles with "She'd Rather Be With Me" on London published by Robbins, and June was the month that gave Liberty its first big independent hit with Vikki Carr's "It Must Be Him" published by Metric. . . . Isabella Wallach of Delyse Records visited New York for meetings with Bob Meyers and John Coveney of Capitol Records and Mr. Horowitz Classical Manager for American Decca. Meetings were also held with Dario Soria of RCA. . . . Harry Lewis of Ardmore & Beechwood elated with his No. 1 smash hit "Silence is Golden" by The Tremeloes. . . . Bert Corri, General Manager of Francis Day & Hunter visited America for discussions with Arnold Maxin of Robbins Music Corporation. . . . Island Records headed by Chris Blackwell, launched new label Studio One devoted to Ska Music with masters from the White label in Jamaica. . . . Harley Usill of Argo Records and director of Decca Educational Services, visited New York and Chicago. . . . A

new company Argo Sight and Sound Ltd., was formed with D. H. Toller-Bond of London Records as President, and Leo Hofberg as General Manager. . . . British activities of the company will be under the direction of Harley Usill. . . . Smash hit for the Deram (Decca) label with Procol Harum's "A Whiter Shade of Pale" published by Essex Music. . . . Ernest Fleischman, ex General Secretary of the London Symphony Orchestra joined CBS Records as Director of Masterworks (Classical Division Europe). . . . Denny Cordell (Producer) and Tony Secunda (Manager of Procol Harum and The Move) went to America promoting these artists. . . . American publisher Aaron Schoeder's London publishing outlet enjoying success via discs by Alan Price, The Walker Brothers, Gene Pitney and Jimi Hendrix. . . . In association with Roy Guest, publisher Dick James formed Gwyneth Music for the development of folk music in Britain. . . . The new Track Record Company scored hits in both singles and LP charts with Jimi Hendrix and The Who. . . . The Turtles arrived in Britain for concert dates. . . . Pye's Louis Benjamin visited Japan. . . . The Monkees in town for three concerts at London's 9,500 seater Empire Pool, Wembley. . . . Australian group The BeeGees visited America playing fourteen key cities in as many days, coincidental with their first Atlantic release "New York Mining Disaster 1941." In Britain the disc was issued on Polydor published by Abigail Music. . . . Jonathan King completed his first album for American release on Parrott titled "Jonathan King or Then Again." . . . British group The Zombies switched labels from Decca to CBS while continuing to record independently through Marquis En-

terprises. . . . Joe Smith, General Manager of Warner Bros. accompanied by singer Antia Carr in London for meetings with Louis Benjamin of Pye Records. . . . Dusty Springfield and Harry Secombe notched up international sales of 1,000,000 for "You Don't Have To Say You Love Me" and "This is My Song" respectively. Both artists record for Philips. . . . CBS injected classical repertoire into their Super Stereo series, first launched in November 1966. . . . Noel Rogers of United Artists flew to Paris to complete recording of Vanessa Redgrave's album of songs from the film "Red and Blue." . . . Two major albums from Jeff Kruger's Ember Records released in the States by American Decca, "The Best of the Irish" featuring Tommy Brennan and The Monarchs, and "The Multi-talented Miss Annie Ross." . . . Disc Imports Ltd. of Manchester announced that in order to meet the increased demand for continental records, certain foreign makes imported by them would in future be factored by the International Sales Division of EMI Records. . . . Belgian singer Adamo in London to cut tracks for indie producer Norman Newell. . . . Decca Records held party for American group The Turtles, in Britain for an 8-day tour. . . . Austrian singer/composer Udo Jurgens in London accompanied by Hans Beierlein and Dieter Weidenseld of Montana Music (Germany) for discussions with record companies concerning the release of Jurgens' discs in the U.K. . . . Coincidental with his caberet stint at Talk of the Town, CBS issued "Mel Torme Right Now" album. . . . John and Scott Walker both signed to Philips Records as solo singers. . . . Gene Pitney in London to record new (Continued on page 12, Part II)

MGM Making it in Britain



MGM Records Ltd 2DeanStreet LondonW1 REG8321

PUBLIC WARNING!



1968 WILL BE A
PAGE ONE-DERFUL YEAR

PAGE ONE RECORDS LIMITED

JAMES HOUSE 71-75 NEW OXFORD STREET LONDON WC1

Telephone: 01-836 4864 (5 lines) Cables: DEJAMUS LONDON WC1 Telex: 27135



Dynamic talent on United Artists International Labels

NEW SINGLE RELEASES

- SPENCER DAVISMr. 2nd Class
 EASY BEATS.....Music Goes Round My Head
 SHIRLEY BASSEYBig Spender
 F & T.....Live For Life
 NICOLE CROISILLE.....Now You Want To Be Loved
 (The voice from Man and A Woman)
 SAMANTHA JONES.....Why Can't I Remember To Forget

FUTURE SINGLES

- THE FORTUNES · SCOTS OF ST. JAMES
 TANGERINE PEEL · JAY AND THE AMERICANS
 BOBBY GOLDSBORO · DOMENICO MODUGNO

MOTION PICTURE ALBUMS

- HERE WE GO ROUND THE MULBERRY BUSH
 featuring Spencer Davis Group and Traffic.
 BILLION DOLLAR BRAIN
 VANESSA REDGRAVE SINGS SONGS RED AND BLUE
 from "Red, White and Zero"
 LIVE FOR LIFE (VIVRE POUR VIVRE).....music by Francis Lai
 MAN AND A WOMAN

CURRENT ALBUMS

- THE BEST OF EVERYTHING.....Frank Cordell & His Orchestra
 THE SENATE
 AND WE WERE LOVERS.....Shirley Bassey
 LOOKING AT LONG JOHN.....Long John Baldry

ANNOUNCING

Commencing February 1st, UNITED ARTISTS RECORDS will be launched as an independent company in the United Kingdom. Debut of initial releases, plans for promotion, publicity and news on exciting new signings will be announced throughout the World in the coming weeks.

Also announcement of a new office location in London.

PRESENT ADDRESS ▶ United Artists Records, Ltd., Flat 5 Albert Gate Court
 124 Knightsbridge, London S.W. 1, Telephone KNIGHTSBRIDGE 9383

Great Britain - 1967 in Review

(Continued from page 10, Part II)

tracks with Gerry Bron for future release on Stateside. . . . Judith Durham of The Seekers made solo debut with "The Olive Tree" on Columbia.

July

Despite a fall-off in disc sales for July compared with the exceptional business of the previous month, the British record industry was still on course for a record sales year. The Board of Trade statistics revealed that disc sales for July 1967 totalled £1,661,000. While this was a big drop from the June total of £2,054,000, it was nevertheless slightly up on the previous July sales figure of £1,621,000. Export figures for July were £296,000. While this total was also a dip on the previous month's sum of £324,000, in Export business, it was nonetheless a 9% increase on Export total of July 1966, i.e. £273,000. Production of records meantime continued at a pace. The total July production of 5,944,000 records of all kinds was slightly less than the production total of the preceding months, but 16% up on the comparative period the previous year. The boom in album production continued, though figures were slightly off. A total of 2,237,000 LPs were produced in July against 2,862,000 in June and 1,760,000 in the previous July. 45 rpm discs, singles and extended-play records increased production however, and made significant gains after a slowing-up period. Some 3,691,000 45 rpm discs were produced in July, against 3,457,000 in June and 3,349,000 in July 1966. Chartwise, Procul Harum with "A Whiter Shade of Pale" hung on to the No. 1 slot for the first three weeks of the month, delaying by at least a week the Beatles' takeover at the top with "All You Need is Love" on Parlophone published by Northern. The month was also remarkable for the meteoric rise to the top of the charts by Scott Mackenzie with "San Francisco" on CBS published by Dick James. . . . The Pink Floyd who had their first chart entry earlier in the year with "Arnold Laine" on Columbia published by Dunmo, came back into the charts with their follow-up "See Emily Play," again on Columbia, published by Magdalene. . . . Two female singers who came back into the charts in July were Petula Clark with "Don't Sleep In the Subway" on Pye, published by Welbeck, and Lulu with "Let's Pretend" on Columbia, published by Carlin. . . . American newcomers to the July charts were Nancy Sinatra with "You Only Live Twice" on Reprise published by United Artists; Tampla-Motown was represented by Gladys Knight with "Take Me In Your Arms" published by Jobette. . . . Dave Davies of The Kinks hurtled up the charts with his first solo disc "Death of a Clown" on Pye published by Carlin. . . . Another American entry in July was Otis Reading with "Tramp" on Stax published by Sparta. . . . Liberty Records set up their own independent operation in Britain headed by Bob Reisdorf and entered into an agreement with Philips Records for distribution. . . . Liberty got off to a fine start with The Vikki Carr single, "It Must Be Him" published by Metric which took the No. 3 slot. . . . Philips launched their Car Cassettes and named July "Musicasette Month." . . . Island Records chief Chris Blackwell visited America. . . . At home, Traffic achieved enormous sales for Island Records with "Paper Sun" single. . . . Marketing Manager Rex Oldfield left EMI to head-up MGM operation in Britain. . . . Walt Disney Productions presented European preview of "The Happiest Millionaire" starring Tommy Steele. Premier was attended by top European record executives from Britain and the continent. . . . The Troggs announced split with manager and producer Larry Page, which was to prove only temporary. . . . Top British folk singer Bert Jansch signed new 3-year agreement with Transatlantic Records, the company which set him on the road to

success. . . . Chappells opened their new recording studios within the new Chappell building. . . . Nathan Joseph of Transatlantic Records visited Sweden and U.S.A. . . . Tony Hall left Decca after many years to set up his own publicity service. . . . Polydor Records took over the manufacture, marketing and distribution of the Elektra, Nonesuch and Bounty labels in the U.K. . . . After 12½ years, Franklin Boyd left Carlin Music to set up his own pubbery. . . . Peter French and John Snell left EMI to Join Rex Oldfield at MGM. . . . Mick Jagger and Keith Richard of The Rolling Stones involved in drug offences and sentenced to terms of imprisonment which were later repealed. . . . Roland Kluger of Palette Records in London for talks with Geoffrey East of the London Office, as well as music publishers and record executives. . . . Chris Blackwell acquired British rights to three more Jamaican labels, Trojan, Coxson, and Federal. . . . The Government announced it would bring in the Bill to ban pirate radio stations as from August 15, 1967. . . . Terry Oats, late of Chappell & Co. joined RCA as Manager of their Artists Development Department. . . . British group The Troggs made 15-day tour of Scandinavia. . . . Herman's Hermits opened 2½-month 40-city tour of U.S.A. and Canada. . . . Mantovani waxed the latest James Bond theme "You Only Live Twice" for Decca. . . . American group The Toys made extensive British tour. . . . Pye Records opened their sixth and final depot in Bristol, to service S. Wales and the west country—thus giving the company blanket distribution throughout the U.K. including Northern Ireland. . . . Mrs. Monique Peer-Morris, President of the Peer-Southern Organization in England on business-cum-pleasure trip, had meetings with Tom Ward and Bob Kingston and heads of all departments of her London office. . . . Matt Monro returned to London from U.S.A. to promote his latest Parlophone single "What To Do." . . . CBS reported Scott Mackenzie's "San Francisco" selling at the rate of 10,000 per day. . . . Following the departure of Tony Hall, Selwyn Turnbull appointed Head of Promotions at Decca. . . . S. J. Marks, formerly Personal Assistant to L. G. Wood Managing Director of EMI Records, appointed Administration Manager of EMI's publisher Ardmore & Beechwood, responsible to Harry Lewis. . . . J. E. S. Lloyd took over as Assistant to L. G. Wood. . . . The Beatles' single "All You Need is Love" written specially for the live TV "Our World" BBC programme viewed by more than four hundred million people in twenty-four countries, was released worldwide by EMI. . . . The Beatles' album "Sgt. Pepper's Lonely Hearts Club Band" approached the half million mark after four weeks of release. . . . Page One Records introduced new budget line known as "4 Star" series. . . . Philips Records collected a 1967 Edison Award for their recording of Handel's "Messiah" performed by the London Symphony Orchestra & Chorus conducted by Colin Davis. . . . The London publishing house of Boosey & Hawkes and their subsidiary, Cavendish & Laffeur had a tremendous country & western hit in America with the recording of "Danny Boy" by Ray Price (Columbia), an original British Boosey & Hawkes copyright and an all-time standard. . . .

August

After a dramatic slump in July, total sales of gramophone records in August picked up and leapt to £1,985,000 against the previous month's total of £1,161,000. Sales total in August a year ago was £1,864,000 i.e. some 6½% lower than the figure for August this year. Exports however, fell from £262,000 to £237,000 when the August 1967 total is compared with the same month last year. The figure is also down when com-

(Continued on next page)

Great Britain — 1967 in Review

(Continued from preceding page)

pared with the £296,000 in exports earned in the immediately preceding month. Production of records levelled out in August and reached a total of 5,761,000 platters compared with 5,945,000 produced in the previous month and 5,787,000 produced in August 1966. Album production suffered its seasonal decline—albeit a slower one than usual—at 2,087,000 LPs compared with 2,237,000 made in the previous month and 2,270,000 in August 1966. Meanwhile, 45 rpm records (singles and extended-play) continued to pull back some of the production impetus lost over the previous year. At 3,659,000 the production total this August was only marginally down on the previous month's figures but significantly up on the 3,494,000 45 rpm's produced in August 1966. . . . For three weeks out of the month of August the No. 1 slot in the charts was occupied by Scott Mackenzie with "San Francisco" on CBS published by Dick James, which replaced the Beatles' "All You Need Is Love." . . . Tom Jones returned to the top 3 with "I'll Never Fall In Love Again" on Decca published by Tyler. . . . August also gave Anita Harris a chart entry with "Just Loving You" on CBS published by Chappells. . . . Dream enjoyed another inebriated hit with "Gin House" by Amen Corner, published by Carlin and Engelbert Humperdinck, a week after leaving the charts with "There Goes My Everything" came hurtling back with "The Last Waltz" on Decca published by Donna. . . . Another striking chart entry in August was "Excerpt from a Teenage Opera" by Keith West on Parlophone, published by Robbins. . . . Ken Glancy, managing director of CBS Records, accompanied by A & R Manager, Derek Everett, visited U.S.A. for the Columbia Records Convention in Miami. . . . Gil Friesen, Vice-President and General Manager of A&M Records, in London for talks with Louis Benjamin, managing director of Pye Records re the A&M product distributed in the U.K. by Pye. . . . Lee Magid, manager for Della Reece also in town to discuss plans for bringing the star to Britain later in the year. . . . Paul Rich appointed General Profession Manager Carlin Music, following the exit of Franklin Boyd. . . . British group The Equals contracted to President Records, the newly-formed discery of Kassner Music Publishing Group, made a four week tour of Germany and signed long-term agreement with RCA Victor to be represented in America. . . . The Paul Hamlyn-EMI Music for Theatre company, mounted a major 7-week promotion backed by national consumer competitions. . . . Since it was launched 21 months ago, M.S.D. has sold over six million records. . . . Indie producer Norman Newell took over exclusive recording of Frankie Vaughan who joined EMI's Columbia label after 11 years with Philips. . . . Chris Blackwell visited Greece seeking new artists' material. . . . Rudi Slezak took over management of Apple Music, a subsidiary of Nems Enterprises, handling compositions by The Cream and The BeeGees. . . . Indie producer/composer/arranger Charles Blackwood set up his own company Charles Blackwood Productions, and signed first group Friday's Mind. . . . Scott Mackenzie's CBS single "San Francisco" sparked off flower craze in Britain, ending up in an all-night 'Love In' at Alexandra Palace. . . . The Cream kicked off an 8-week tour of America with a 2-week stint at the Fillmore Auditorium, San Francisco. . . . Bill Randall took over post of Professional Manager of Chappell's Publishing Company in place of Terry Oates who left to join RCA Records. . . . The Tremeloes' latest CBS single "Even the Bad Times Are Good" issued to a 35,000 advance. . . . Vance Hill followed Shirley Bassey at London's Talk of the Town. . . . "A White Shade of Pale" continued to top best-selling sheet music lists for Essex Music. . . . L. G. Wood, EMI's Group

Director — Records, visited Chicago for the Distributors' Meeting Convention given by ABC Records. . . . top German star Freddie Tuinn and ace-composer Bert Kempfeart in town to cut an album for Norman Newell for international release. . . . MGM Records officially commenced their own British operation headed by Rex Oldfield and moved into new offices in Dean Street, London. They also issued first single, "Good Times" by Eric Burden. . . . British Decca suspended release of Jimi Hendrix "How Would You Feel" following American ban on artists. . . . British group The Shadows went to Yugoslavia for Splitt Song Festival. . . . Jack Baverstock of Fontana returned from 3½ week trip to U.S.A. and Canada. . . . Arthur Gorson, of New York, in London with two of his artists Tom Rush and Judy Roderick. . . . Pye Records issued the new Frank Sinatra single "The World We Know" on Reprise, published by Smooth/Carlin. . . . United Artists hosted reception at Dorchester Hotel to launch the first single on the label by British group The Fortunes (previously with Decca) entitled "The Idol" published by Fortitude Music. . . . The New Christy Minstrels in Britain for TV and radio dates. . . . Philips Records staged their 1967 Annual Sales Conference to preview future releases on Philips, Fontana and Mercury. . . . Fontana issued new low-priced Vanguard series of LPs. . . . Al Bennett, President of Liberty Records in London for opening of the label's new London office. . . . Transatlantic Records took over English rights to America's Everett Classical Catalogue. . . . Sales of Beatles' LP "Sgt. Pepper's Lonely Hearts Club Band" topped 500,000 mark. . . .

September

The first week of the month saw Scott Mackenzie still at the top of the charts with "San Francisco". . . . The second week of the month saw Engelbert Humperdinck at No. 1 with "The Last Waltz" on Decca published by Donna, thus starting his record 5-week stint at No. 1. . . . The Rolling Stones failed to get higher than No. 5 with "We Love You" single, on Decca published by Mirage. . . . The Deram label continued its fantastic run of luck with another chart entry "Let's Go To San Francisco" by The Flower Pot Men published by Carter-Lewis. . . . Cliff Richard also had another charter with "The Day I Met Marie" on Columbia published by Shadows Music. . . . British Group The Move brought the revitalized Regal Zonophone label back into the charts with "Flowers in the Rain" published by Essex. . . . Major-Minor had another hit by the Dubliners "Black Velvet Band" published by Scott-Solomon. . . . The happiest chart entry of the month came with the welcome return to the Top Ten of Frankie Vaughn with "There Must be a Way" his first single for Columbia and published by Chappells. . . . The last week of the month saw The Seekers back in the charts with "When Will The Good Apples Fall" on Columbia published by United Artists. . . . P. J. Proby's return to Britain after six months in his native America was marked by the release on Liberty of a new album "Phenomenon". . . . EMI Records and New Breed Productions Ltd. entered into a long-term contract for the UK under which all product by Denny Cordell including discs by The Move, Procul Harm and Beverley would be issued on the revitalized Regal Zonophone label. Regal Zonophone is one of Britain's oldest record labels—it was introduced in the early 1930's as a result of an amalgamation between the Regal and Zonophone labels. . . . Publisher Bill Philips moved into his new offices to activate Charms Music Ltd. and Bill Philips' Enterprises Ltd. . . . The first promotion to be handled by Tony Hall's new T.H.E.

(Continued on next page)

DELYSE

RECORDING COMPANY

The fastest growing
independent recording
company in Europe

Specializing in

Production
Package Deals
Special Projects
Customs Production
anywhere in Europe

25-27 MARYLEBONE RD.
LONDON N.W.1.

Licensing
Artiste Management
Music Publishing
Market Development

CALL LONDON HUNTER

4266

ENVOY

RECORDING COMPANY

Great Britain — 1967 in Review

(Continued from preceding page)
 company "007" by Desmond Dekker on Pyramid enjoyed chart status. . . . High in the British charts with "Even the Bad Times are Good" on CBS published by Skidmore Music, the Tremeloes returned to America for a coast tour. . . . A major tragedy of the year came in September with the sudden death of Brian Epstein at the age of 32, bringing to an end an unprecedented era of success that had started with the Beatles' debut in 1961. The Chairmanship of Nems Enterprises was taken over by Epstein's brother Clive. At the time of Epstein's death world sales of Beatle's discs amounted to over 200 million units. . . . Pye Records signed agreement to release the American B.T. Puppy label product on its own label in the U.K. . . . Mercury's British independent set-up opened in London with Lou Reizner in charge of operations. . . . George Szell and the Cleveland Orchestra in London to record for CBS. . . . American group The Turtles in British charts with "She'd Rather Be With Me" on RCA published by Robbins Music, arrived in Britain for their first concert tour of this country. . . . Wedding Bells for Island managing director Chris Blackwell who married Josephine Heinmann. . . . "San Francisco" topped the British best-selling sheet music list for third consecutive week for Dick James Music. . . . Hal Shaper, managing director of Sparta Music returned from four-week visit to South Africa setting-up a company Francis Day & Hunter publishing group in Johannesburg, to represent all Sparta material. . . . Roland Kluger of World Music, Belgium, in Britain for discussions with Geoffrey East, General Manager of his London Company, Good Music. . . . Top German duo Esther and Abbi Ofarim made British cabaret debut

at London's Savoy Hotel. . . . Francis Day & Hunter hosted party for top Spanish duo Juan and Junior to mark launching of their first British release on CBS "The Chase". . . . The BBC took over where the pirates left off by launching Radio One, transmitting 14 hours of pop per day, both recorded and live. Existing programs were also re-named Radio Two, Three and Four. The changes brought an extra 50 hours of broadcasting per week and introduced jingles and plugs for other BBC programs and features for the first time. . . . Jeff Kruger of Ember Records undertook extensive tour of Europe. . . . Philips Records announced they would no longer issue Mono classical recordings. . . . British Decca held their first ever two-day Sales Conference in London. Height of the meeting with Phase Four. . . . CBS Records held their third U.K. Sales Conference at the London Hilton. . . . Pye Records held a major international Sales Conference in association with Warner Bros. and Reprise at London's Europa Hotel which was attended by Mike Maitland President of Warner Bros. and Reprise, together with a galaxy of overseas licensees. . . . Differences between British group The Troggs and Page One Records amicably settled. . . . L. G. Wood, managing director of EMI, visited New York and Detroit. . . . Alan Bates appointed marketing manager, took on added responsibility as head of Polydor's Pop Repertoire A & R Department. . . .

October

After five weeks at the top of the charts with "The Last Waltz" Engelbert Humperdinck relinquished the position to make way for The Bee-Gees and "Massachusetts" on Polydor published by Abigail and destined for an equally long run at the top. During the month the Traffic moved up to the

No. 2 slot with "Hole in My Shoe" on Island and Procol Harum achieved their second chart entry for the Regal Zonophone label with "Homburg" published by Essex. Fontana had a couple of major hits with "Zabadak" by Dave, Dee, Mick & Tich and "From the Underworld" by a new group, The Herd, both numbers published by Lynn Music and both numbers produced by Ken Howard and Alan Blaikley. Pye started a run of fantastic chart success with "Baby Now That I've Found You" by The Foundations, published by Welbeck/Shroeder, Sandie Shaw came back into the Top Twenty with "You've Not Changed" on Pye, published by Carnaby; one of the most successful groups of the month was the Box Tops with "The Letter" on Stateside, published by Feldmans. Other American entries during the month included "Reflections" by The Supremes on Tamla-Motown published by Jobette, "Ode to Billy Joe" by Bobbie Gentry on Capitol, published by Compass. . . . John Culshaw, one of Britain's leading experts on the recording of Classical music, left Decca to take up his appointment as head of BBC TV Music programs. He was succeeded at Decca by Roy Munshull. . . . Smash American musical "Sweet Charity" opened at London's "Prince of Wales" Theatre with Juliet Prowse in the lead. Original British cast album recorded and released by CBS. . . . Top executives of American Decca in London finalising plans for the label's independent opening scheduled for January 1968. . . . Liberty Records' subsidiary Logo Minit, made debut with an album from Haphash & the Colored Coat. . . . With their "King Midas in Reverse" single hitting on both sides of the Atlantic, British group The Hollies left for dates in Singapore, Japan and the Philippines

to be followed by TV and a 12-day tour of America, where their discs are issued on the Epic label. . . . Italian publisher Gino Paoli of Senza Fine Publishing Company in London for talks with Rudi Slezak of the newly-opened Apple Publishing Co. During the month Slezak also crossed the Atlantic to visit his American outlet Nemporer Music in New York. . . . Jeff Kruger announced formation of Ember Records (International) Ltd., to embrace the company's worldwide interests in recording and publishing. . . . With their new Regal Zonophone single, "Homburg" high in the British charts, Procol Harum undertook American tour. . . . Walt Disney Productions released original cast track album from "The Happiest Millionaire" starring Tommy Steele. . . . American conductor/composer Aaron Copland in London for concert at Festival Hall, followed by recording sessions for CBS. . . . Coincidental with his appearance at London's Talk of the Town CBS released new Johnny Mathis single "Don't Talk to Me"—a Bert Kaempfert composition, published by Carlin Music. . . . Decca report fantastic dealer reaction to their newly-launched Deramic Sound system releases. . . . Ziggy Jackson, late of Melodisc Records, joined EMI to handle the new Blue Beat label specializing in the Ska sound. . . . Cliff Richard chosen to represent U.K. in next year's Eurovision Song Contest scheduled to take place at the Royal Albert Hall in April. . . . Bill Martin and Phil Coulter, writers of this year's Eurovision winner, flew to Rio de Janeiro in October with singer Georgie Fame who represented Britain in Brazil's International Song Festival with the Martin/Coulter composition, "Celebration". The song

(Continued on page 16, Part II)



THE

SOUTHERN

GROUP

OF MUSIC COMPANIES

SEND CHRISTMAS AND
NEW YEAR GREETINGS
TO ALL THEIR FRIENDS
THROUGHOUT THE WORLD

8, DENMARK STREET, LONDON, W.C.2. ENGLAND

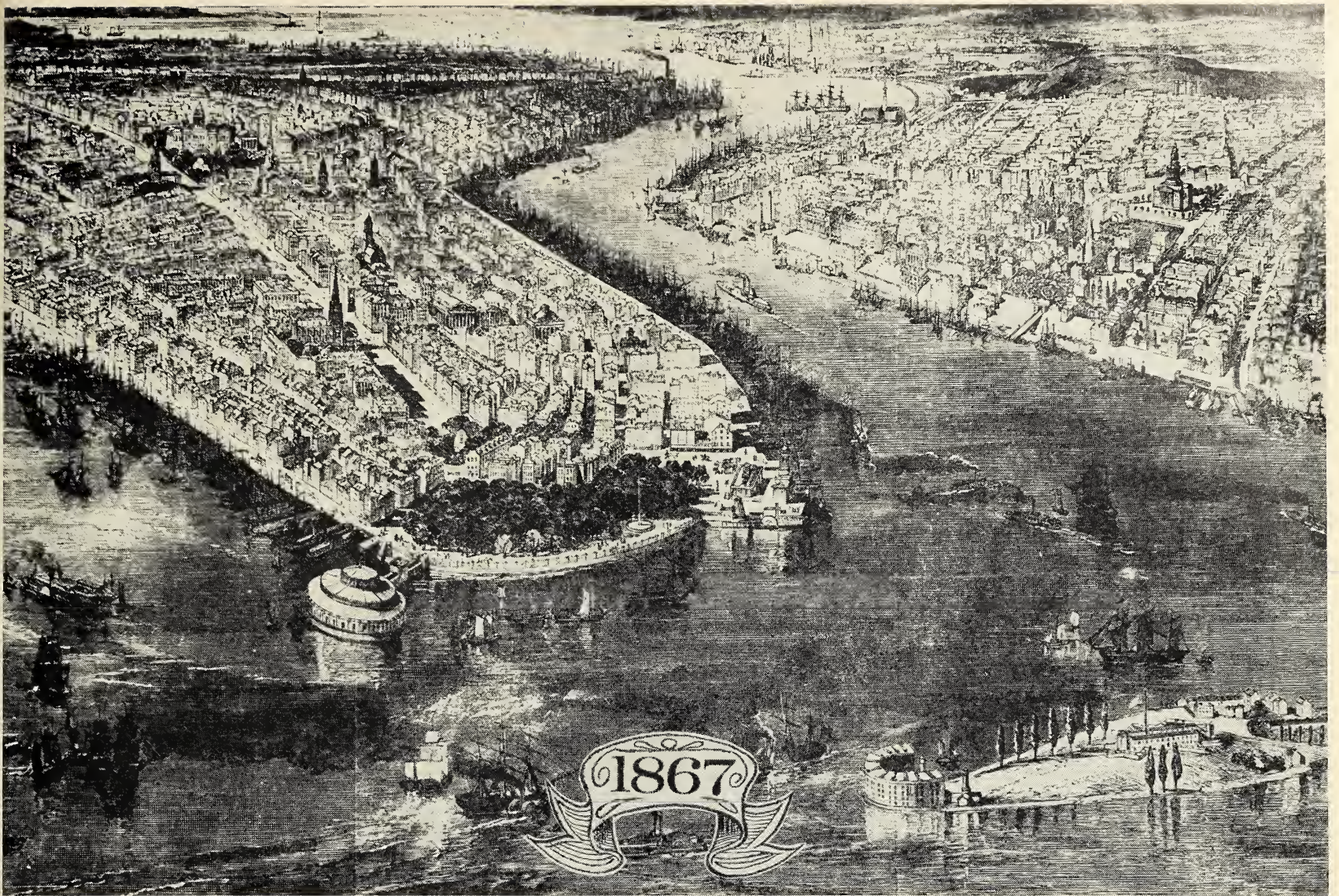

NEW YORK was growing then...

WE'RE GROWING NOW!!

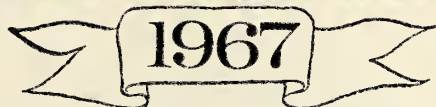

THE WORLD WIDE ORGANISATION OF

DICK JAMES MUSIC LIMITED

NORTHERN SONGS LIMITED

JAEP MUSIC LIMITED · MARIBUS MUSIC LIMITED

GRALTO MUSIC LIMITED · PACERMUSIC LIMITED

NUOVA MUSIC LIMITED · LORDS MUSIC Co. LIMITED

DICK JAMES MUSIC LIMITED · METRO MUSIC LIMITED

PAGE ONE RECORDS LIMITED · THIS RECORD Co. LIMITED

FOR USA, CANADA, MEXICO & THE PHILIPPINES

Administration Management: **WALTER HOFER**, 221, WEST 57th STREET, NEW YORK, N.Y. 10019

Music Management: **LEONARD HODES**, Suite 1200, 1780, BROADWAY, NEW YORK, N.Y. 10019

JAMES HOUSE, 71 -75, NEW OXFORD STREET, LONDON, W.C.1. ENGLAND.

Telephone:- 01-836-4864 (5 Lines) Cables; DEJAMUS, LONDON, W.C.1. Telex; 27135

Great Britain — 1967 in Review

(Continued from page 14, Part II) was placed fourth. . . . Engelbert Humperdinck awarded gold disc for 1 million British sales of "The Last Waltz" — earlier this year he was awarded gold disc for his million selling "Release Me". . . . During the month a galaxy of American stars visited Britain, including Scott MacKenzie, The Mamas and Papas, Vanilla Fudge, Lou Rawls, and Del Shannon. . . . RCA (Gt. Britain) announced plans for building British plant in North of England, to be completed within the year. . . . Scots singer Lulu topped American charts with her Epic recording of "To Sir With Love". Lulu also flew to America to appear on the Ed Sullivan show. . . . Dru Harvey, chairman of the new production company Poppy Records Inc. which licenses product to MGM Records in the U.K. announced plans to visit New York, Los Angeles and Japan. . . . Score of the Broadway smash musical "Sweet Charity" published by Campbell Connelly. . . . Under the heading "Jazz-Expo 67", the Harold Davison Agency in association with George Wein brought a host of top American jazzmen to Europe for an extensive tour. . . .

November

The first week of the month saw The BeeGees still at the top of the charts for the fourth consecutive week with "Massachusetts" on Polydor published by Abigail. By the second week of the month The Foundations had taken over the No. 1 slot with "Baby Now That I've Found You" on Pye, published by Welbeck/Shroeder. Altogether it was a remarkable week for Pye Records who had no less than six entries in the Top Twenty and all on the Pye Domestic label. Apart

from the No. 1, the other titles were "Autumn Almanac" by The Kinks published by Carlin, "There Is A Mountain" by Donovan published by his own company, "You've Not Changed" by Sandie Shaw, published by Carnaby, "If The Whole World Stopped Loving" by Val Doonican published by Immediate, and last but not least, "Let The Heartaches Begin" by Long John Baldry published by Shroeder, and destined for the No. 1 slot. . . . The month also gave President Records its first chart entry via "I Feel Love Coming On" by Felice Taylor, published by Kassner who also hosted a reception for the artist who was in town to promote the disc. . . . A more familiar American name in the British charts, Gene Pitney, returned with his latest single "Something's Gotten Hold of My Heart" on Stateside, published by Maribus. . . . but all in all, major chart honors for the month of November must go to Pye Records. . . . Decca chairman Sir Edward Lewis announced that his company had entered into a termination agreement with RCA Gt. Britain Ltd., the U.K. subsidiary of The Radio Corporation of America, which expanded into phonograph/recording operation in 1966. The agreement provided for a phase-out period ending May 31, 1969, during which time Decca will manufacture and distribute RCA label records for the account of RCA Gt. Britain. Meantime, RCA G.B. will proceed with the establishment of its own record-pressing plant and distribution organization in readiness to take over at the end of the phase-out period. . . . As a result of the deal with American Muntz Stereo Pak and Muntz International, Clive King, Managing Director of C. K. Enterprises, launched King Stereo in Britain. King will market three car model

tape machines plus two play-back units for the home and the car trade. Repertoire includes products from Capitol, Warner Bros. Reprise and Pye. . . . Decca Records hosted party for British R&B exponent John Mayall to launch his new single "Suspicions". . . . Roland Rennie, Managing Director of Polydor Records hosted celebration lunch for The BeeGees No. 1 smash "Massachusetts" with single sales in excess of 300,000. . . . Allan Stagg, formerly a director of I.B.C. Studios, appointed manager of EMI's recording studios in succession to Mr. E. Fowler who retired after 43 years' service with EMI. . . . EMI's "Music for Pleasure" company reported a 54% increase in sales for the period March to August this year as against the same period last year. . . . A joint statement by Ken Glancy, managing director of CBS and Louis Benjamin, managing director of Pye announced that as from November 1st, Pye will take over distribution of the CBS catalogue in Eire, S. Ireland. . . . The Beatles' publishing company Northern Songs run by publisher Dick James announced profits for the year to April 30th 1967 of \$2,359,000 compared with \$1,716,000 profit made in the previous twelve months. A final dividend of 32% was recommended, making a total of 56% for the year as against 40% for the previous twelve months. . . . EMI made 13 million dollar takeover bid for the Blackpool Tower Company which owns the famous tower and other important sites along the holiday resort's "Golden Mile". . . . CBS announced plans to launch the Blue Horizon label in January, as a showcase for top Blues acts in Britain and America. . . . Meantime, CBS launched another new label Direction specializing in Rhythm

& Blues, Pop and SKA. . . . MGM Records had their second chart entry from Eric Burden & The Animals with "San Franciscan Nights" published by Shroeder-Slamina. . . . Bob Reisdorf, Liberty Records' supreme in this country, announced that the label will launch a low-priced album series early in 1968. . . . Globe-trotting British publisher Cyril Shane of Shapiro-Bernstein left for an extended tour of Europe. . . . Frankie Vaughn cut first album for indie producer Norman Newell, tagged after his hit single "There Must Be a Way" for release on Columbia. . . . After breaking all records at London's Talk of the Town, Johnny Mathis was succeeded by another American singer, Wayne Newton. . . . Robert Stigwood and David Shaw resigned from the board of Nems Enterprises to form a new international entertainment organization in collaboration with The Gramophon-Philips Group. . . . Personal management artists joining the new company include The BeeGees, The Cream, and Agency clients The Foundations, etc. The new company will be called The Robert Stigwood Organization with headquarters at 67 Brook Street, London. The same HQ will house the publishing company Abigail & Dratleaf under the direction of Rudi Slezak. . . . Isabella Wallich, director of Delyse and Envoy Recording Companies, visited New York for discussions with American Decca and Capitol Records. . . . The Mechanical Copyright Protection Society for Publishers and composers in battle with record companies over claim for an increased share of the takings. . . . EMI announce plans to launch Bell Records of America in the U.K. on its own label next year. . . . Pye (Continued on page 19, Part II)

FRANCIS DAY & HUNTER LTD.—B. FELDMAN & CO. LTD. ROBBINS MUSIC CORP. LTD.

LONDON

138-140 Charing Cross Road,
London, W.C.2.

PARIS, 1er

Publications Francis-Day S.A.
5, Avenue de l'Opera

AMSTERDAM

Francis-Day
Muziekuitgevers N.V.

HAMBURG

Francis Day & Hunter
GMBH
Mittelweg 149,
2000, Hamburg 13

ZURICH

Francis-Day Produktion
Brunnweissen Strasse 26th

MADRID

Canciones Francis-Day
Carmen 20

COPENHAGEN

Francis Day & Hunter
Scandinavia A/S,
Gothersgade 9-11,
Copenhagen K
Denmark



NEW YORK

Francis Day & Hunter Inc.
745 Fifth Avenue

BRUSSELS

Editions Francis-Day S.A.
25, Place Saint-Gery

MILAN

Edizioni Musicali
Francis-Day S.R.L.
Piazza Del Liberty 2

JOHANNESBURG

Francis Day (S. Africa)
Pty Ltd.
Suite 901-4, 9th Floor
Silvern House,
139, Commissioner Street

Agents

AUSTRALIA

J. Albert & Son Pty Ltd.
137-9, King Street,
Sydney

JAPAN

Eastern Music
Publishing Company,
Kyowa Building,
34, Kotohira-cho,
Shiba,
Minato-ku,
Tokyo,
Japan

INTERNATIONAL PUBLISHERS OF WORLD HITS

GREETINGS

FROM

ARGENTINA

Editorial Musical Odeon
Av. Corrientes 485,
Buenos Aires,
Argentina.

AUSTRALIA

Castle Music Pty. Ltd.
White House,
403, George Street,
Sydney, 2000
N.S.W. Australia.

BELGIUM

S. A. Ardmore & Beechwood (Belgium)
72, Quai des Charbonnages,
Brussels,
Belgium.

BRAZIL

Sociedade Brasileira de Edicoes
Publicidade e Servicos Artisticos Ltda,
Rua Evaristo Da Veiga 20-1, Andar
Rio de Janeiro,
Brazil.

DENMARK

Imudico A/s.
Colbjornsensgade 19,
Copenhagen V,
Denmark.

FRANCE

Les Editions et Productions Musicales
Pathe Marconi,
19, Rue Lord Byron,
Paris 8e,
France.

GERMANY

Edition Accord,
Lindenstr. 19,
Cologne 5,
Germany.

GREECE

Arion Greek Music Company Ltd.
P.O. Box 287,
Athens,
Greece.

HONG KONG

Pathe Publications (Far East) Ltd.
308, The Chartered Bank Building,
P.O. Box 14694,
Hong Kong.

SINGAPORE

Pathe Publications (Far East) Ltd.
P.O. Box 182,
4th Floor,
MacDonald House,
Orchard Road,
Singapore 9.

HOLLAND

Anagon N.V.
Heemsteedse Dreef 287,
Heemstede,
Holland.

ITALY

Edizioni Musicali La Voce Del Padrone,
Piazza Cavour 1,
Milan 20121,
Italy.

JAPAN

Toshiba Music Publishing Co. Ltd.
17, Akasaka 2-2,
Minato-Ku,
Tokyo,
Japan.

MEXICO

Beechwood de Mexico S.A.
Ayuntamiento 54,
Mexico City I.D.F.,
Mexico.

NEW ZEALAND

Belcas Music Ltd.
P.O. Box 30698
408, Hutt Road,
Lower Hutt,
Wellington,
New Zealand.

SOUTH AFRICA

Ardmore & Beechwood (South Africa)
(Pty) Ltd.
P.O. Box 11254,
32, Steele Street,
Johannesburg,
Transvaal,
South Africa.

SPAIN

Ego Musical S.A.
Urgel 234,
Barcelona 11,
Spain.

SWEDEN

Editions Odeon,
Oxenstiernsgatan 37,
Stockholm,
Sweden.

U.S.A.

Beechwood Music Corp.
1750, North Vine Street,
Hollywood 90028,
California,
U.S.A.

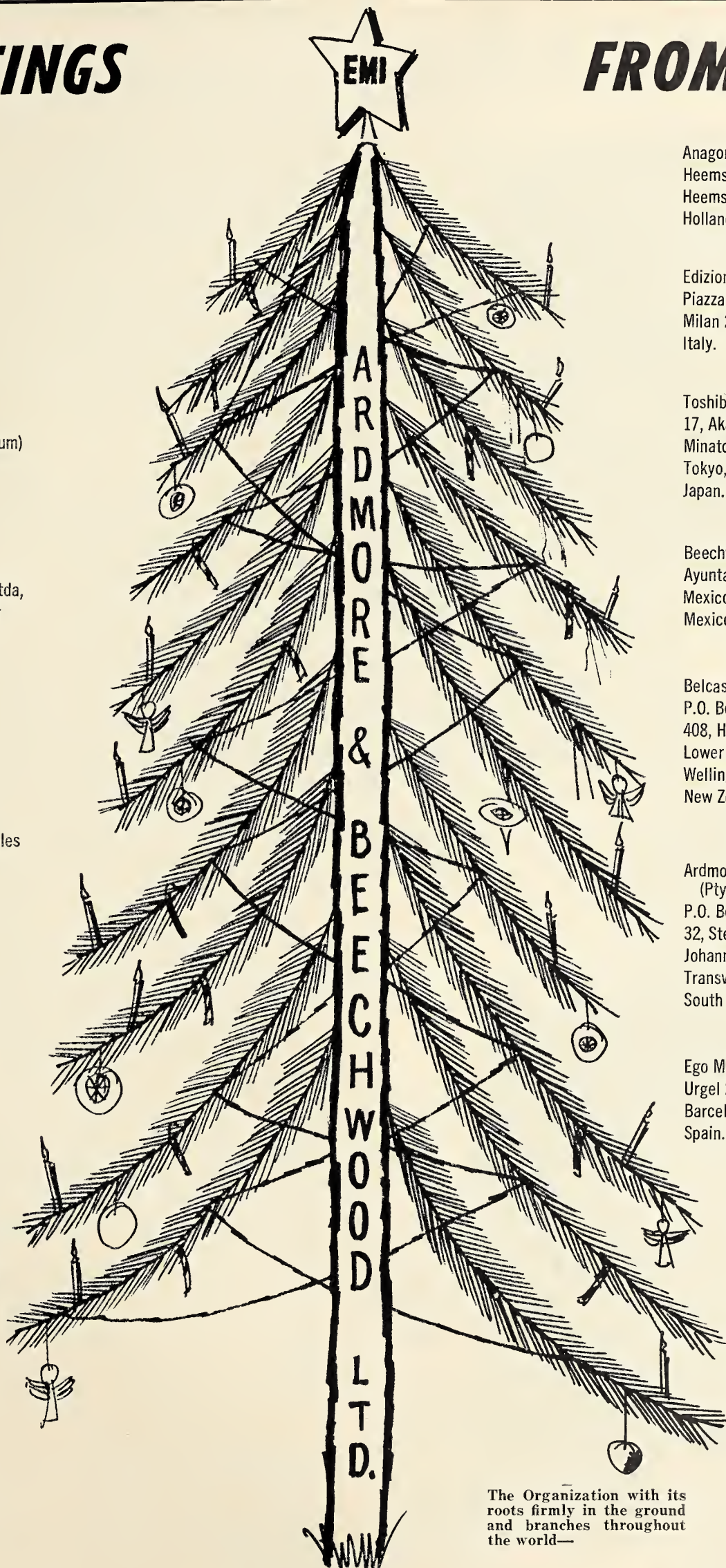

The Organization with its
roots firmly in the ground
and branches throughout
the world—

Telephone:
01-486 4531

363 OXFORD STREET
LONDON W. 1, ENGLAND

Cable:
BEECHMORE, LONDON

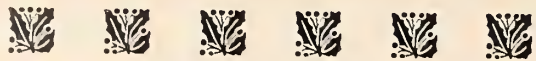

A MERRY CHRISTMAS TO YOU ALL



ENGELBERT HUMPERDINCK

Personal Manager:
GORDON MILLS
239 CHARLTON ROAD
SHEPPERTON, MIDDLESEX

Agent:
COLIN BERLIN
ACUFF-ROSE LTD.
15 ST. GEORGE ST.
LONDON, W1

1967—Indie Producers

LONDON

Of all the changes manifested in the British record business during the past half decade, none has been as profound as the emergence of the independent producer.

Incredibly quickly, the independent A&R man has effected an inter-industry explosion, and where once the vast majority of recording for the commercial market was funneled through less than a score of powerful staff recording managers, nowadays production springs from two hundred or more creative sources.

No record company dare ignore independent product; many have come to rely on it as their key to the Hit Parade. The successful freelance producer is as courted now as the hit artist. Even the mighty majors—EMI and Decca—have finally come to the conclusion . . . but it has taken a sensational run of success to bring them round.

Role of Beatles

As with much of the startling revolution that has occurred in the British music trade over the past five years, the big breakthrough of the freelance disk packagers traces to the emergence of the Beatles. That act itself is not recorded independently and it is a matter now for historians how EMI staffer George Martin plucked the group out of obscurity—but their success with their own songs, simple guitar-and-drums accompaniment, proved both easy to emulate and cheap to record.

Suddenly, while the staff producers at the big diskeries were indulging in massive orchestral backings with attendant massive recording costs, independent production became feasible. Groups could accompany themselves so the need for session musicians was minimized. Small studios (albeit with good "sound") could be booked for an hour at a time, and so a master wax could be brought in for under \$300, compared with the \$1,500 considered about par before the change.

Broken Barriers

There were, however, more barriers to be broken than just the cost. For several years a handful of non-allied British producers had been endeavoring to make inroads with the record companies without any real success. Men like Dennis Preston, who set up shop as an independent in his own studios to specialize in jazz productions, had their moments, but left the big record companies unconcerned. Even Joe Meek's colossal hit "Telstar" by The Tornados, never altered the majors' view about the value of independent product, and was dismissed by some as a mere "flash in the pan."

The major companies at the time, all had considerable A&R departments carrying four to six producers. The obvious policy so far as those companies were concerned, was to

cater first for their home-grown product which, even then, was profuse. As the Big Two, EMI and Decca, had a tight grip on distribution with Pye and Philips taking up the slack, there seemed little future for an outsider trying to get in.

But the Beatles phenomenon changed all that. When the late Brian Epstein, George Martin and EMI opened up that Liverpool vein with such explosive results, certain deeply ingrained concepts of the record business were tossed out of the window. There was a new, exciting, successful aspect . . . and everyone wanted a piece of the action. The staff producers, who for many years had prescribed the public's taste in discs, were so London-oriented that they were caught out of their stride when the provinces spawned the rocking youngsters.

Senior recording executives began frantic forays into Liverpool, Manchester, Birmingham and other large provincial cities, in search of raw materials which abounded in clubs and cellars. But in this new, teen-oriented swim, it was tough for the polished professional to sort out a click group from a bad one.

Decca Enter Indie Scene

In their eagerness not to miss out on the local talent explosion, Decca began to listen seriously to the independent tapes which began pouring in from would-be producers. Soon the company was releasing about 50% freelance product, and scoring with it. One by one the other key waxeries began to open their doors to independent repertoire.

Publishers, former singers, musicians, agents, managers et al began to get into production, leasing masters to the major companies for between 4% and 5% of the wax. But still the non-aligned producer was tolerated more than welcomed by the big guns. The big successes were still to come!

When the Beatles opened up the American market to British product, U.S. companies looked anew at the U.K. as a source of hit material. Producers such as Mickie Most, who scored first time out with the Animals' ditty "House of the Rising Sun" and Herman's Hermits' "I'm On To Something Good," secured mammoth dollar deals with American sources. Andrew Oldham crashed in with the Rolling Stones. Others followed in their wake. With American guarantees, a new faith in themselves and adequate funds, the British indie producer gained a new stature—their own labels.

In the course of the "new thinking" brought to the trade, certain elements had secured credits for their production outfits on some labels. Bunny Lewis, agent for both deejays and artists, had for instance, a production credit for his Ritz Records, which was released under the Philips banner. But, as the international success of

(Continued on next page)

A HAPPY CHRISTMAS



FRANKIE VAUGHAN

HITS OF 1967:
"THERE MUST BE A WAY"
"SO TIRED"

EMI RECORDS
LONDON

ENGLAND—BEST SELLING SHEET MUSIC—1967

TITLE	PUBLISHER
ALL YOU NEED IS LOVE	Northern Songs
CARRIE ANNE	Grolho
EDELWEISS	Williamson
FUNNY FAMILIAR FORGOTTEN FEELINGS	Acuff Rose
GEORGEY GIRL	Springfield
GREEN GREEN GRASS OF HOME	Burlington
IN THE COUNTRY	Shodm
I'M A BELIEVER	Screen Gems
IF I WERE A RICH MAN	Volondo
IT MUST BE HIM	Metric
I'LL NEVER FALL IN LOVE AGAIN	Tyler
IF THE WHOLE WCRLD STOPPED LOVING	Immediate
JUST LOVING YOU	Choppell
MORNINGTOWN RIDE	Compos
MASSACHUSETTS	Abigail
PUPPET ON A STRING	Peter Maurice
PENNY LANE	Northern Songs
RELEASE ME	Burlington
SIMON SMITH AND HIS AMAZING DANCING BEAR	Schroeder
SOMETHING STUPID	Montclare
SILENCE IS GOLDEN	Ardmore & Beechwood
SAN FRANCISCO	Dick James
THIS IS MY SONG	Leeds
THERE GOES MY EVERYTHING	Burlington
THE LAST WALTZ	Donno
THERE MUST BE A WAY	Choppell
WHAT WOULD I BE	Morvel
WATERLOO SUNSET	Belinda
WITH A LITTLE HELP FROM MY FRIENDS	Northern
WHITER SHADE OF PALE	Essex

B
A
B
B
A
A
A
A
B
A
A
B
A
B
B
B

Breakthrough Year

(Con't from facing page)

some solo producers spiralled and the flow of hit product became consistent, the British record companies broke their traditional reserve and splashed out as parent operations to independent labels.

First such operation was put into effect by Leslie Gould of Philips. He lured Andrew Oldham from his Decca environs with a deal to facilitate the Immediate label. Gould later did another deal with indie producer Shel Talmy and the Planet logo.

More Labels

Other diskeries followed. Polydor—itsself a newcomer as a British-based operation—and therefore with a burning need to establish itself, saw a way of tempting top production talent into its orbit and began its “mother-hen” operation to the Reaction (Bob Stigwood), Track (Kit Lambert-Chris Stamp), and Marmalade (Georgio Gomelsky) labels, among others.

The Pirates

Another major factor intrinsic in the rise of the indies was the advent of “pirate” radio. These offshore broadcasters for the first time, provided massive exposure for the free-lance product in a format foreign to BBC Radio at the time. The “pirates” thus broke the grip that the EMI's, the Decca's, the Pye's and the Philips had on radio exposure. Alternative sources of exposure became available to all to compete with BBC and Radio Luxembourg.

Climate became such that Decca even brought out an “independent type” label, Deram, to handle product “from out of left field.” Decca has now also agreed to act as parent to the Rolling Stones' new indie logo while EMI has moved to bring the Immediate label into its fold. EMI also tossed Denny Cordell his own label, Regal Zonophone, as part of a

deal in which EMI secured from Decca's Deram two click acts, The Move and Procul Harum.

Among the many reasons for this kind of move at the big companies is the fact that many of the best staff A&R men have been tempted into independent production. It is little wonder that with fellow producers making, by now, 10% or more on their freelanced disks that the highly proficient staffer grew dissatisfied with his relatively small monthly paycheck.

George Martin and Ron Richard quite EMI to form with Peter Sullivan, John Burgess formerly of Decca, an independent outfit, AIR (London) Ltd. Norman Newell left EMI, too, and the producer turnover at Decca has been comparatively rapid. The incoming American companies are providing even more outlets for the indie producer and are offering top dollar deals to boot. All this has made the majors face the questionable prospect of reverting to “distribution houses.” One way of averting that, they feel, is to bring the best freelancers into the fold.

If the sales power of independent producers and labels have become self-evident to the domestic trade—indies often make up 50% or more of the hit parade—it has also played a large part in perpetrating Britain's thrust into the international market. With the U.K. now an established mill for the creation of hits that will sell worldwide, the independent producer here has begun to manage his own affairs by holding on to the overseas rights to product he licenses to local companies.

By not being forced to market with one outfit throughout the world, the independent producer naturally endeavors to link with the best operation in each individual territory. Effect has been the continued success of British artists in offshore locations.

SEASON'S GREETINGS

TO ALL FRIENDS, HOME

AND ABROAD, FROM

BONNIE SCOTLAND

AND

ANDY STEWART



Great Britain—1967 in Review

(Continued from page 16, Part II)

Records launch new classical label Virtuoso. . . . EMI's HMV label to become ‘classical only’ logo. . . . Deutsche-Grammophon introduced its first classical cassettes into the U.K. . . . Jack Heath took over management of RCA's Sunbury Music. . . . “The Last Waltz” topping Best Selling Sheet Music Lists for Donna Music for 8th consecutive week. . . . Harry Secombe celebrating 21st year in show business won this year's “Radio Luxembourg Credit to Show Business Award”. . . .

December

Topping the charts at the beginning of the month was Long John Baldry with “Let The Heartaches Begin” one of five Top Ten entries for Pye Records in one week. Dave Clark was at No. 2 with “Everybody Knows” on Columbia published by Donna. Chart-wise, the last month of 1967 started off in a blaze of glory for British artists who occupied 100 per cent of the Top Ten and 18 out of the Top 20. The month also saw Frankie Vaughn's second entry for Columbia “So Tired” published by Campbell Connelly. . . . “The Last Waltz” still topping Best Selling Sheet Music Lists for Donna Music. . . . John Ilott left Chappell Publishing company after 14 years. . . . Elated with the success of The Troggs “Love Is All Around” on Page One publisher Dick James via his American company lined up strong promotional campaign for the disk's American release on Mercury. . . . Capping a year of unprecedented success indie producer Norman Newell put Des O'Connor into Top 20 with “Careless Hands” on Columbia published by E. H. Morris. . . . Nathan Joseph of Transatlantic Records announced the group's first full sales convention would take place in January 1968 attended by distributors and representatives all over the country. . . . Southern Music enjoyed another British chart entry via Donovan's

“There Is a Mountain” on Pye. . . . Bob Reisdorf of Liberty reported good sales for “Gorilla” by The Bonzo Dog Doo Dah Band. . . . New single from Tom Jones on Decca “I'm Coming Home” a chart certainty. . . . First chart entry for American singer Felice Taylor with “I Feel Love Coming On” on the President label published by Kassner. . . . Another success for President came via The Equals L.P. “Unequal Equals”. . . . Celebrated conductor and CBS artist Eugene Ormandy in Britain for concert at Royal Festival Hall. . . . Christmas season for Scottish singer Andy Stewart in native Scotland before taking off for a tour of America, Australia and New Zealand. . . . After an eight-year run the BBC took its weekly BBC disk show “Juke Box Jury” off the air. . . . Pet Clark returned to Britain for TV and recording sessions. . . . United Artists released L.P. of the Spencer Davis-Traffic score of “Here We Go Round The Mulberry Bush”. . . . Anita Harris waxed title song from United Artists picture “Danger Route”. . . . Paul Rich of Carlin Music activated new subsidiary company Amen Music representing all material from The Amen Corner. . . . The Seekers latest single “Emerald City” on Columbia published by Ardmore & Beechwood. . . . 120,000 copies of “Disraeli Gears” by L.P. by The Cream sold in U.S. in four days. . . . British sales totalled 60,000 in ten days. . . . The Cream set to open their second U.S. tour at the Fillmore Auditorium San Francisco followed by eight week coast to coast tour. . . . Lulu visited America for three TV shows. . . . The Dallas Boys on Major Minor recorded “He Won't Love You” published by Lawrence Wright. . . . The Electric Prunes in Britain to promote latest Reprise single “Long Day's Flight”. . . . Val Doonican's Pye single “If The Whole World Stopped Loving” issued in the U.S. on American Decca. . . .

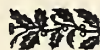

MERRY CHRISTMAS and a great '68

ROLF HARRIS



AXLE ENTERPRISES LTD

A VERY HAPPY CHRISTMAS & NEW YEAR from KEN HOWARD & ALAN BLAILEY and their artists



THE HERD

DAVE DEE DOZY BEAKY MICK & TICH



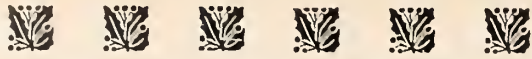

A MERRY CHRISTMAS TO YOU ALL



TOM JONES

Personal Manager:
GORDON MILLS
239 CHARLTON ROAD
SHEPPERTON, MIDDLESEX

Agent:
COLIN BERLIN
ACUFF-ROSE LTD.
15 ST. GEORGE ST.
LONDON, W1

*Wherever you may be, my very
Best Wishes go to you*

MATT MONRO



**BRITISH ARTISTS WHO HIT THE TOP 20
BRITISH SINGLES CHART DURING 1967**

ARTIST	NUMBER OF WEEKS ON CHART	TITLE	RECORD COMPANY	PUBLISHER
P. P. Arnold	(3)	The First Cut Is The Deepest	Immediate	Cat
Amen Corner	(4)	Gin House	Deram	Carlin
Long John Baldry	(3)	Let the Heartaches Begin	Pye	Schroeder
The Barron Knights	(1)	Under New Management	Columbia	West One
The Beatles	(9) (10)	Penny Lane All You Need is Love	Parlophone Parlophone	Northern Songs Northern Songs
Jeff Beck	(4)	Hi Ho Silver Lining	Columbia	Emquiry
The Bee Gees	(3) (8) (1)	New York Mining Disaster Massachusetts World	Polydor Polydor Polydor	Abigail Abigail Abigail
Cilla Black	(2)	What Good Am I	Parlophone	Carlin
Eric Burdon & The Animals	(3)	San Franciscan Nights	MGM	Schroeder/ Slamina
The Cream	(4) (3)	I Feel Free Strange Brew	Reaction Reaction	Dratleaf Dratleaf
Petula Clark	(11) (7)	This Is My Song Don't Sleep In The Subway	Pye Pye	Leeds Welbeck
Dave Clark Five	(3)	Everybody Knows	Columbia	Donna
Donovan	(5) (6) (5)	Sunshine Superman Mellow Yellow There Is a Mountain	Pye Pye Pye	Southern Donovan Donovan
Dave Dee, Dozy, Beaky, Mick and Tich	(3) (6) (7)	Save Me Okay Zabadak	Fontana Fontana Fontana	Lynn Lynn Lynn
Val Doonican	(3) (4)	What Would I Be Memories are Made of This	Decca Decca	Barrel Campbell Connelly Immediate
Spencer Davis	(3)	I'm a Man	Fontana	Island
Dave Davies	(7)	Death of a Clown	Pye	Carlin
Ken Dodd	(3)	Let Me Cry On Your Shoulder	Columbia	Dominion
The Dubliners	(9) (6)	Seven Drunken Nights Black Velvet Band	Major Minor Major Minor	Scott-Solomon Scott-Solomon
The Easybeats	(2)	Friday on My Mind	United Artists	United-Artists
Georgie Fame	(5) (4)	Sitting in the Park Because I Love You	Columbia CBS	Jewel Feldman
The Flower Pot Men	(8)	Let's Go To San Francisco	Deram	Carter-Lewis
The Foundations	(8)	Baby Now That I've Found You	Pye	Welbeck/ Schroeder
Wayne Fontana	(5)	Pamela, Pamela	Fontana	Hournew
Anita Harris	(11)	Just Loving You	CBS	Chappell
Jimi Hendrix	(6) (9) (5) (2)	Hey Joe Purple Haze The Wind Cries Mary Burning of the Midnight Lamp	Polydor Track Track Track	Yameta Yameta Yameta Schroeder
The Herd	(8)	From the Underworld	Fontana	Lynn
Englebert Humperdinck	(15) (11) (14)	Release Me There Goes My Everything The Last Waltz	Decca Decca Decca	Burlington Burlington Donna
The Hollies	(7) (2) (7)	On A Carousel King Midas in Reverse Carrie Ann	Parlophone Parlophone Parlophone	Gralto Gralto Gralto
Vince Hill	(9) (3)	Edelweiss Roses of Picardy	Columbia Columbia	Williamson Chappell
Herman's Hermits	(7)	There's a Kind of Hush	Columbia	Francis Day & Hunter
Frank Ifield	(1)	Call Her Your Sweetheart	Columbia	Acuff Rose
Tom Jones	(7) (7) (7) (12)	Green Grass of Home Detroit City Funny Familiar Forgotten Feelings I'll Never Fall In Love Again	Decca Decca Decca Decca	Burlington Southern Acuff Rose Tyler
Paul Jones	(5)	I've Been a Bad Bad Boy	HMV	Leeds
The Kinks	(9) (5) (3)	Waterloo Sunset Autumn Almanac Dead End Street	Pye Pye Pye	Davray Carlin Davray
Lulu	(7) (8)	The Boat That I Row Let's Pretend	Columbia Columbia	Ardmore & Beechwood Carlin
The Move	(6) (5) (9)	Night of Fear I Can Hear the Grass Grow Flowers in the Rain	Deram Deram Regal Zonophone	Essex Essex Essex
Manfred Mann	(7)	Ha Ha Said the Clown	Fontana	Bron
The New Vaudeville Ban	(6) (6)	Peek-a-Boo Finchley Central	Fontana Fontana	Meteor Meteor
Des O'Connor	(1)	Careless Hands	Columbia	E. H. Morris
Alan Price	(8) (7)	Simon Smith and his Amazing Dancing Bear The House That Jack Built	Decca Decca	Schroeder Alan Price
The Pink Floyd	(1) (8)	Arnold Layne See Emily Play	Columbia Columbia	Dunmo Magdalene
Procul Harum	(13) (7)	A Whiter Shade of Pale Homburg	Deram Regal Zonophone	Essex Essex
Cliff Richard	(4) (5) (1)	In the Country It's All Over I'll Come Running	Columbia Columbia Columbia	Shadam Acuff Rose Ardmore & Beechwood
The Seekers	(9) (2)	The Day I Met Marie All My Love	Columbia Columbia	Shadows Shapiro Bernstein
The Small Faces	(4) (8) (7)	Morningtown Ride Georgy Girl When Will The Good Apples Fall	Columbia Columbia Columbia	Compass Springfield United Artists
The Small Faces	(1) (5) (10)	My Mind's Eye Here Comes The Nice Itchycoo Park	Decca Immediate Immediate	Robbins Avakak Avakak
Cat Stevens	(8) (4)	Matthew and Son I'm Gonna Get Me a Gun	Deram Deram	Cat Cat
The Rolling Stones	(8) (7)	Let's Spend The Night Together We Love You/Dandelion	Decca Decca	Mirage Mirage

(Cont on Bottom of Facing Page)

BRITISH ARTISTS WHO HIT THE TOP 10 IN THE BRITISH LP CHARTS DURING 1967

ARTISTE	TITLE	LABEL	WEEKS ON CHART
The Beatles	A Collection of Beatles Oldies	Parlophone	(2)
The Bee Gees	Sgt. Pepper's Lonely Heart Club Band	Parlophone	(24)
The Cream	The Bee Gees 1st	Polydor	(1)
	Fresh Cream	Reaction	(7)
	Disraeli Gears	Reaction	(3)
Val Doonican	The Gentle Shade of Val Doonican	Decca	(4)
Donovan	Universal Soldier	Marble Arch (Pye)	(5)
The Dubliners	A Drop of the Hard Stuff	Major Minor	(6)
Georgie Fame	Hall of Fame	CBS	(1)
Jimi Hendrix	Are You Experienced	Track	(21)
The Hollies	Evolution	Parlophone	(4)
Englebert Humperdinck	Release Me	Decca	(12)
	The Last Waltz	Decca	(1)
Tom Jones	Green Green Grass of Home	Decca	(14)
	Tom Jones Live at the Talk of the Town	Decca	(12)
London Cast	Fiddler on the Roof	CBS	(23)
The Pink Floyd	Piper at the Gates of Dawn	Columbia	(11)
Cliff Richard	Finders Keepers	Columbia	(5)
	Crusade	Columbia	(1)
The Seekers	Come the Day	Columbia	(17)
The Rolling Stones	Between the Buttons	Decca	(12)
Harry Secombe	Secombe's Personal Choice	Philips	(3)
The Shadows	Jigsaw	Columbia	(5)
Cat Stevens	Matthew and Son	Deram	(3)
The Troggs	Troglodynamite	Page One	(2)
Various Artists	Breakthrough	EMI Studio 2 Stereo	(6)
Geno Washington	Hand Clapping Foot Stomping	Piccadilly	(3)
	Hipsters Flipsters		
The Who	A Quick One	Reaction	(6)
Scott Walker	Scott	Philips	(1)

BRITISH ARTISTS WHO HIT ON THE AMERICAN ALBUM CHARTS IN 1967

ARTIST	TITLE	AMERICAN LABEL	NO. OF WEEKS ON CHART
The Animals	Animalism	MGM	(8)
	Winds of Change	MGM	(12)
Eric Burdon & The Animals	Eric Is Here	MGM	(7)
	Volume 2	MGM	(9)
The Beatles	Revolver	Capitol	(5)
	Sgt. Pepper's Lonely Hearts Club Band	Capitol	(25)
Bee Gees	Bee Gees First	Atco	(14)
Dave Clark Five	More Great Hits	Epic	(5)
	5 x 5	Epic	(9)
	You Got What It Takes	Epic	(5)
Petula Clark	Colour My World	Warner Bros.	(13)
	These Are My Songs	Warner Bros.	(14)
Jeremy Clyde & Chad Stuart	Of Caggages and Kings	Columbia	(3)
The Cream	Fresh Cream	Atco	(19)
	Disraeli Gears	Atco	(1)
Donovan	Mellow Yellow	Epic	(14)
Spencer Davis	Gimme Some Loving	United Artists	(21)
	I'm a Man	United Artists	(8)
Herman's Hermits	The Best of Herman's Hermits	MGM	(14)
	Vol. 2	MGM	(22)
	There's a Kind of Hush		
	Blaze	MGM	(10)
The Hollies	Stop	Liberty	(8)
	The Hollies Greatest Hits	Imperial	(21)
	Evolution	Epic	(8)
Jimi Hendrix*	Are You Experienced	Reprise	(14)
Noel Harrison	Collage	Reprise	(1)
Englebert Humperdinck	Release Me	Parrott	(26)
Tom Jones	Green Green Grass of Home	Parrott	(15)
The Kinks	The Live Kinks	Reprise	(5)
	Face to Face	Reprise	(5)
Lulu	To Sir With Love	Epic	(3)
Mantovani	Mr. Music	London	(9)
	Golden Hits of Mantovani	London	(16)
	Mantovani in Hollywood	London	(12)
Matt Monro	Born Free	Capitol	(8)
NEW Vaudeville Band	Winchester Cathedral	Fontana	(16)
Peter and Gordon	Lady Godiva	Capitol	(11)
Procul Harum	Procul Harum	Deram	(12)
The Pink Floyd	The Pink Floyd	Tower	(4)
The Rolling Stones	Got Live If You Want It	London	(17)
	Big Hits	London	(3)
	Aftermath	London	(2)
	Between the Buttons	London	(26)
	Flowers	London	(18)
Soundtrack	Born Free	MGM	(7)
Soundtrack	To Sir With Love	Fontana	(14)
Soundtrack	You Only Live Twice	United Artists	(15)
The Seekers	Georgy Girl	Capitol	(22)
	Best of The Seekers	Capitol	(3)
The Tremeloes	Here Comes My Baby	Epic	(11)
The Who	Happy Jack	Decca	(12)
The Yardbirds	Little Games	Epic	(7)
	The Yardbirds Greatest Hits	Epic	(21)

*Anglo-American

British Artists Hitting British Top 20 Singles

(Con't from preceding page)

Dusty Springfield	(4)	I'll Try Anything	Philips	Raintree
Harry Secombe	(9)	This Is My Song	Philips	Leeds
Andie Shaw	(13)	Puppet On a String	Pye	KPM
	(5)	You've Not Changed	Pye	Carnaby
Whistling Jack Smith	(6)	I Was Kaiser Bill's Batman	Deram	Mills
The Troggs	(4)	Anyway You Want Me	Page One	Dick James
	(4)	Give It To Me	Page One	Dick James
	(4)	Love Is All Around	Page One	Dick James
The Tremeloes	(8)	Here Comes My Baby	CBS	Angusa
	(11)	Silence is Golden	CBS	Saturday
	(8)	Even The Bad Times Are Good	CBS	Skidmore
Traffic	(7)	Paper Sun	Island	Island
	(11)	Hole In My Shoe	Island	Island
Frankie Vaughan	(10)	There Must Be a Way	Columbia	Chappell
	(1)	So Tired	Columbia	Campbell
				Connelly
The Who	(5)	Happy Jack	Reaction	Fabulous
	(7)	Pictures of Lilly	Track	Fabulous
	(4)	I Can See for Miles	Track	Fabulous
Keith West	(10)	Excerpt from a Teenage Opera	Parlophone	Robbins

BURLINGTON MUSIC

and

PALACE MUSIC

of

9 ALBERT EMBANKMENT,

London, S.E.I. England

Send

CHRISTMAS GREETINGS

TO OUR FRIENDS THROUGHOUT THE WORLD

SEASONAL GREETINGS

from

ROY BERRY

and

GEORGE SEYMOUR

MIKE COLLIER

MISS L. YOUNG

RON DENTON

THE CAMPBELL CONNELLY

WORLD-WIDE GROUP OF COMPANIES

TO ALL OUR FRIENDS & ASSOCIATES

EVERYWHERE

10, DENMARK STREET, LONDON, WC2.

CARLIN MUSIC

CORPORATION

voted Britain's Top Publisher

and

Associated Companies

*Send you Seasons Greetings
and Best Wishes for 1968*

FREDDY BIENSTOCK

DEREK KNIBB

DAVE MOST

PAUL RICH

ARTHUR CRISFORD

GEOFF MORRIS

17, SAVILE ROW LONDON, W 1.

CHRISTMAS AND NEW YEAR



GREETINGS



TO ALL OUR PUBLISHING FRIENDS

from

**CAVENDISH MUSIC CO. LTD.
J. R. LAFLEUR & SON LTD.**

P.O. BOX 1. BR. LONDON, W. 1. ENGLAND

SPARTA MUSIC LTD.
Europe's youngest established Publishing House

HAL SHAPER
JANIE PALMER VIVIENNE THUMPSTON
MIKE BERRY, JR.

and our Associated Companies
Send our friends Everywhere

SEASON'S GREETINGS

155-157 OXFORD STREET
LONDON W.1. ENGLAND
Cables: HALMUSIC-LONDON

GREETINGS

To all our friends
and colleagues
throughout the world—

from

CYRIL GEE
and
TONY HILLER

MILLS MUSIC LTD.
LONDON

SEASONAL GREETINGS

from

LEN TAYLOR

of

BOURNE MUSIC LTD

34-36, MADDOX STREET
LONDON, W. 1, ENGLAND
Tel: 01-493-6412/6583
Cables: BOURNEMUSIC-LONDON

Greetings from
THE SYDNEY BRON
Group of Companies in
LONDON

BRON ARTISTES MANAGEMENT LTD.
SYDNEY BRON MUSIC CO. LTD.
YALE MUSIC CORPORATION LTD.
HIT SONGS LTD.
SHERIDAN MUSIC CO. LTD.
ANGLO CONTINENTAL MUSIC LTD.
CARRIE MUSIC LTD.
DEBMAR PUBLISHING CO. LTD.
MANN MUSIC PUBLISHERS LTD.
MARKLON MUSIC LTD.
HIT RECORD PRODUCTIONS LTD.

29-31 OXFORD STREET
LONDON, W.1. ENGLAND

BRITISH ARTISTS & COPYRIGHTS TO ENTER AMERICAN TOP 100 DURING 1967

TITLE	ARTIST	BRITISH PUBLISHER	AMERICAN PUBLISHER	BRITISH LABEL	AMERICAN LABEL
A WHITER SHADE OF PALE ALL YOU NEED IS LOVE A LITTLE BIT NOW	PROCL HARUM THE BEATLES DAVE CLARK FIVE	ESSEX NORTHERN METRIC	ESSEX MACLEN TRAVIS	DERAM PARLOPHONE COLUMBIA	DERAM CAPITOL EPIC
BEND IT	DAVE DEE, DOZY, BEAKY, MICK & TICH ROGER WILLIAMS	LYNN	SPECTORIOUS	FONTANA	FONTANA
BORN FREE BABY YOU'RE A RICH MAN COLOR MY WORLD CARRIE ANN CAT IN THE WINDOW	THE BEATLES PETULA CLARK THE HOLLIES PETULA CLARK	SCREEN GEMS NORTHERN WELBECK GRALTO ROBBINS	SCREEN GEMS MACLEN NORTHERN MARIBUS CHARDON	LONDON PARLOPHONE PYE PARLOPHONE PYE	KAPP CAPITOL WARNER BROS. EPIC REPRISE
DEAD END STREET DETROIT CITY DON'T SLEEP IN THE SUBWAY DON'T GO OUT IN THE RAIN DANDELION DEAR ELOISE	THE KINKS TOM JONES PETULA CLARK HERMAN'S HERMITS THE ROLLING STONES THE HOLLIES	DAVRAY SOUTHERN WELBECK UNITED ARTISTS MIRAGE GRALTO	MONDVIES-NOMA CEDARWOOD DUCHESS UNART GIDEON MARIBUS	PYE DECCA PYE COLUMBIA DECCA PARLOPHONE	REPRISE PARROT WARNER BROS. MGM LONDON EPIC
EAST WEST EPISTLE TO DIPPY EVEN THE BAD TIMES ARE GOOD	HERMAN'S HERMITS DONOVAN THE TREMELOES	HOUREW SOUTHERN SKIDMORE	MANKEN PEER INT. PONDEROSA	COLUMBIA PYE CBS	MGM EPIC EPIC
FRIDAY ON MY MIND FUNNY FAMILIAR FORGOTTEN FEELINGS	EASY BEATS TOM JONES	UNITED ARTISTS ACUFF ROSE	UNITED ARTISTS ACUFF ROSE	U. A. DECCA	U. A. PARROTT
GIMME SOME LOVING GREEN GREEN GRASS OF HOME GEORGY GIRL GIVE ME TIME	SPENCER DAVIS TOM JONES THE SEEKERS DUSTY SPRINGFIELD	ISLAND BURLINGTON SPRINGFIELD SHAPIRO BERNSTEIN	ESSEX TREE CHAPPELL PONDEROSA	FONTANA DECCA COLUMBIA PHILIPS	UNITED ARTISTS PARROTT CAPITOL PHILIPS
HAPPENINGS TEN YEARS AGO HELP ME GIRL HERE COMES MY BABY	THE YARDBIRDS THE ANIMALS THE TREMELOES	ROBBINS ANIM ARDMORE & BEECHWOOD	LEO FEIST HELIOS MAINSTAY	COLUMBIA DECCA CBS	EPIC MGM EPIC
HAPPY JACK HEAVEN AND HELL HA HA SAID THE CLOWN HOLIDAY HELLO GOODBYE	THE WHO EASY BEATS THE YARDBIRDS BEE GEES THE BEATLES	FABULOUS FELDMAN BRON ABIGAIL NORTHERN SONGS	ESSEX MILLER PONDEROSA MEMPEROR MACLEN	REACTION U. A. COLUMBIA POLYDOR PARLOPHONE	DECCA U. A. EPIC ATCO CAPITOL
I'VE GOT TO HAVE A REASON I'LL TRY ANYTHING I'M A MAN I WAS KAISER BILL'S BATMAN I'LL NEVER FALL IN LOVE AGAIN I CAN SEE FOR MILES ITCHYCOO PARK I'M A WALRUS	DAVE CLARK FIVE DUSTY SPRINGFIELD SPENCER DAVIS WHISTLING JACK SMITH TOM JONES THE WHO SMALL FACES THE BEATLES	— RAINTREE ISLAND MILLS TYLER FABULOUS AYAKAK NORTHERN SONGS	BRANSTON PAMBER ESSEX MILLS HOLLIS ESSEX NICE SONGS MACLEN	COLUMBIA PHILIPS FONTANA DERAM DECCA TRACK IMMEDIATE PARLOPHONE	EPIC PHILIPS U. A. DERAM PARROTT DECCA IMMEDIATE CAPITOL
JUST ONE LOOK KNIGHT IN RUSTY ARMOUR KING MIDAS IN REVERSE	THE HOLLIES PETER & GORDON THE HOLLIES	GRALTO DEAN STREET GRALTO	MARIBUS REAGENT MARIBUS	PARLOPHONE COLUMBIA PARLOPHONE	EPIC CAPITOL EPIC
LET'S SPEND THE NIGHT TOGETHER LITTLE GAMES LOOK OF LOVE	THE ROLLING STONES THE YARDBIRDS DUSTY SPRINGFIELD	MIRAGE MILLS SCREEN GEMS	GIDEON MILLS COLGEMS	COLUMBIA DECCA PHILIPS	LONDON EPIC PHILIPS
MORNINGTOWN RIDE MATTHEW & SON MUSEUM MR. PLEASANT MARTA MASSACHUSETTS	THE SEEKERS CAT STEVENS HERMAN'S HERMITS THE KINKS THE BACHELORS BEE GEES	COMPASS CAT SOUTHERN DAVRAY/CARLIN LAWRENCE WRIGHT ABIGAIL	AMAEDO DERAM PEER INT. NOMA E. B. MARKS NEMPOR	COLUMBIA DERAM COLUMBIA PYE DECCA POLYDOR	CAPITOL DERAM MGM REPRISE LONDON ATCO
NEW YORK MINING DISASTER 1941	THE BEE GEES	ABIGAIL	ABIGAIL	POLYDOR	ATCO
ON A CAROUSEL ON THE OTHER SIDE	THE HOLLIES THE SEEKERS	GRALTO SPRINGFIELD	MARIBUS CHAPPELL	PARLOPHONE COLUMBIA	IMPERIAL CAPITOL
PAPER FUN PLEASE TELL ME WHY PEEK-A-BOO PENNY LANE PORTRAIT OF MY LOVE PURPLE HAZE PAY YOU BACK WITH INTEREST PICTURES OF LILY	TRAFFIC DAVE CLARK FIVE NEW VAUDEVILLE BAND THE BEATLES THE TOKENS JIMI HENDRIX THE HOLLIES THE WHO	ISLAND SPURS METEOR NORTHERN SONGS KASSNER SCHROEDER GRALTO FABULOUS	ESSEX BRANSTON SOUTHERN MACLEN PICADILLY SEA LARK MARIBUS UNART	ISLAND COLUMBIA FONTANA PARLOPHONE — TRACK PARLOPHONE TRACK	U. A. EPIC FONTANA CAPITOL WARNER BROS. REPRISE IMPERIAL FABULOUS
RUBY TUESDAY RELEASE ME RED AND BLUE	THE ROLLING STONES ENGLBERT HUMPERDINCK DAVE CLARK FIVE	MIRAGE BURLINGTON —	GIDEON FOUR STAR BRANSTON	DECCA DECCA COLUMBIA	LONDON PARROTT EPIC
STRAWBERRY FIELDS FOREVER SUNDAY FOR TEA SIXTEEN TONS SUZANNE SOME3ODY HELP ME SILENCE IS GOLDEN SAN FRANCISCAN NIGHTS	THE BEATLES PETER & GORDON TOM JONES NOEL HARRISON SPENCER DAVIS THE TREMELOES ERIC BURDON & ANIMALS	NORTHERN SOUTHERN CAMPBELL CONNELLY — ISLAND SATURDAY SCHROEDER/SALAMINA	MACLEN SOUTHERN NOMA PROJECT 7 ESSEX SATURDAY SEALARK	PARLOPHONE COLUMBIA DECCA — ISLAND CBS MGM	CAPITOL CAPITOL PARROTT WARNER BROS. U. A. EPIC MGM
THERE'S A KIND OF HUSH THIS IS MY SONG TELL ME TO MY FACE THERE GOES MY EVERYTHING TO LOVE SOMEBODY THE OTHER MAN'S GRASS IS ALWAYS GREENER TO SIR WITH LOVE THE LAST WALTZ TIME SELLER TEN LITTLE INDIANS	HERMAN'S HERMITS PETULA CLARK KEITH ENGLBERT HUMPERDINCK THE BEE GEES PETULA CLARK	F. D & H. LEEDS GRALTO BURLINGTON ABIGAIL WELBECK	LEO FEIST SHAMLEY MARIBUS BLUE CREST POLYDOR NORTHERN	COLUMBIA PYE PHILIPS DECCA POLYDOR PYE	MGM WARNER BROS. MERCURY PARROTT ATCO WARNER BROS.
WALK WITH FAITH IN YOUR HEART WHEN I WAS YOUNG WHAT'S IT GONNA BE WEAR YOUR LOVE LIKE A DREAM	LULU ENGLBERT HUMPERDINCK SPENCER DAVIS THE YARDBIRDS	SCREEN GEMS DONNA SPENCER DAVIS —	SCREEN GEMS DONNA MARIBUS DUNBAR	COLUMBIA DECCA — COLUMBIA	EPIC PARROTT U. A. EPIC
YOU GOT WHAT IT TAKES YOU MUST HAVE BEEN A BEAUTIFUL BABY YOU WERE ON MY MIND YOU ONLY LIVE TWICE	THE BACHELORS ERIC BURDON & ANIMALS DUSTY SPRINGFIELD DONOVAN	F. D & H. YAMETA CARLIN SOUTHERN	TEEPEE YAMETA RUMBALERO PEER	DECCA DECCA PHILIPS PYE	LONDON MGM PHILIPS EPIC
	DAVE CLARK FIVE DAVE CLARK	LEEDS FELDMAN	FIDELITY REMICK	COLUMBIA COLUMBIA	EPIC EPIC
	CRISPAN ST. PETERS NANCY SINATRA	BLOSSOM UNITED ARTISTS	WHITMARK UNITED ARTISTS	DECCA U. A.	JAMIE REPRISE

SONG FESTIVALS 1968	DATE	LOCATION	EVENT
BUENOS AIRES	April 3rd to 7th		FESTIVAL OF THE LATIN SONG IN THE WORLD
	ITALY	February 1st to 3rd	SAN REMO
		June	A RECORD FOR THE SUMMER
		July	CANTIGARO
		July	VENICE FESTIVAL
		July	NEOPOLITAN SONG FESTIVAL
EUROPE	July	PESARO SONG FESTIVAL	
	October	GOLDEN CARAVELLE OF HITS	
EUROPE	April 8th (London)		EUROVISION SONG CONTEST
HOLLAND	March 11th (Amsterdam)		GRAND GALA DU DISQUE

BRITISH AGENTS & MANAGERS

ANIM LTD.
39, Gerrard Street,
London, W. 1.
Tel: 01-437-9916

AIR (LONDON) LTD.
101, Boker Street,
London, W. 1.
Tel: 01-486-3451
Ron Richards

ACUFF-ROSE MUSIC LTD.
15, St. George Street,
London, W. 1.
Tel: 01-629-7600
Colin Berlin

BERT AZA AGENCY LTD.
2, Vole Close,
London, W. 9.
Tel: 01-286-0022
Mrs. L. Azo.

AXLE ENTERPRISES LTD.
2, Holly Mount,
Hompstead,
London, N.W.3.
Tel: 01-435-4341
Ken Howard & Alon Bloikley

DEREK BOULTON MANAGEMENT
37, Sudbrooke Road,
London, S.W.12.
Tel: 01-673-2122
Derek Boulton

BRON ASSOCIATED
29/31, Oxford Street,
London, W. 1.
Tel: 01-437-4063
Gerry Bron

TITO BURNS PRODUCTIONS LTD.
Regent House,
235/241, Regent Street,
London, W. 1.
Tel: 01-734-7961
Tito Burns

BOSCOBEL PRODUCTIONS LTD.
22, Kingly Street,
London, W. 1.
Tel: 01-437-5953

CAPABLE MANAGEMENT LTD.
185, Bickenhall Mansions,
London, W. 1.
Tel: 01-935-6512

HAROLD DAVISON AGENCY
Regent House,
235/241, Regent Street,
London, W. 1.
Tel: 01-734-7961

GEORGE ELRICK
17, Polace Gate,
London, W. B.
Tel: 01-589-6472

FORRESTER-GEORGE LTD.
Suite 34,
140, Park Lane,
London, W. 1.
Tel: 01-629-6484

FOSTERS AGENCY LTD.
Piccadilly House,
Piccadilly Circus,
London, W. 1.
Tel: 01-734-5367

GALAXY ENTERTAINMENTS LTD.
7, Denmark Street,
London, W. C. 2.
Tel: 01-240-1955
Ron King & Tony Birfield

JIMMY GRAFTON
2, Strutton Ground,
Westminster S. W. 1.

NOEL GAY ARTISTS LTD.
24, Denmark Street,
London, W. C. 2.
Tel: 01-836-3941

PETER GORMLEY,
17, Savile Row,
London, W. 1.
Tel: 01-734-8605

THE GRADE ORGANISATION
235/241, Regent Street,
London, W. 1.
Tel: 01-734-5821

RIK GUNNELL AGENCY
47, Gerrard Street,
London, W. 1.
Tel: 01-736-1001

ARTHUR HOWES LTD
Eros House,
29/31, Regent Street,
London, W. 1.
Tel: 01-734-5202

INTERNATIONAL ARTISTES REPRESENTATION
Irving House,
Irving Street,
London, W. C. 2.
Tel: 01-930-3046
Phyllis Rounce

I.M.C.
Royalty House,
72, Dean Street,
London, W. 1.

BRIAN LANE & MIKE MARGOLIS
20, Drayton Mews,
Kensington, W. B.
Tel: 01-937-5204

KENNEDY STREET ARTISTES LTD.
Kennedy House,
14, Piccadilly,
Manchester 1.
Tel: Central 5423
Donny Betesch

MARQUIS ENTERPRISES LTD.
37, Soho Square,
London, W. 1.
Tel: 01-437-9405
Joe Ronocoroni

GORDON MILLS
239, Charlton Road,
Shepperton,
Middlesex
Tel: 01-smb 4002

BRIAN MORRISON AGENCY
142, Choring Cross Road,
London, W. C. 2.
Tel: 01-836-0171

NEMS ENTERPRISES LTD.
Sutherland House,
5/6, Argyll Street,
London, W. 1.
Tel: 01-734-3261

NEW MOVEMENT LTD.
4, Denmark Street,
London, W. C. 2.
Tel: 01-240-2573

KENNETH PITT MANAGEMENT
35, Curzon Street,
London, W. 1.
Tel: 01-499-7905

LESLIE SIMMONS
169, Wordour Street,
London, W. 1.
Tel: 01-437-5123

RAK RECORDS
155/157, Oxford Street
London, W. 1.
Tel: 01-437-6671
Peter Grant

SPENCER DAVIS MANAGEMENT
1, Wordour Street,
London, W. 1.
Tel: 01-734-7464

STARCAST LTD.
122/124, Regent Street,
London, W. 1.
Tel: 01-734-2813
Evelyn Taylor

STARLITE ARTISTES
6, Southampton Place,
London, W. C. 1.
Tel: 01-405-0943
Brian Walsh

DOROTHY SOLOMON AGENCY
71/75, New Oxford Street,
London, W. 1.
Tel: 01-836-1801

ROBERT STIGWOOD ORGANISATION
67, Brook Street,
London, W. 1.
Tel: 01-629-9121

TRACK RECORDS
5B, Old Crompton Street,
London, W. 1.
Tel: 01-437-9506
Chris Stamp/Kit Lambert

THE 393 MEMBERS OF CHAPPELL'S

STAFF, THROUGHOUT THE WORLD, SEND THE
SEASON'S GREETINGS TO ALL THEIR FRIENDS
IN THE MUSIC INDUSTRY.

AMSTERDAM
JOHANNESBURG
LONDON
MADRID
MILAN
MUNICH
NEW YORK
PARIS
STOCKHOLM
SYDNEY
TORONTO
WELLINGTON
ZURICH

YOUR
CONTACT

FOR THE
WORLD
OUTSIDE U.S.A.



KEITH PROWSE
MUSIC PUBLISHING CO. LTD.
THE PETER MAURICE
MUSIC COMPANY LIMITED

U. K. Companies &
Associates

Budd Music Ltd.
Clinton Music Co.
Combine Music
Ltd.
Cooper Music Ltd.
Forrest Hills
Music Ltd.
Gallico Music Ltd.
Garnett Music Ltd.
Imperia Music Co.
K.P.M. Music Ltd.
Lois Music Ltd.
Macmelodies Ltd.
Marlboro Music Ltd.
Moss-Rose Music Ltd.
Musicville Ltd.
Raintree Music Ltd.
Reynolds Music
Sam Fox Publishing Co.
(London) Ltd.
Villager Music Ltd.

Television Music Ltd.
The World Wide Music
Co. Ltd.
World Copyrights Ltd.
Foreign Companies
Edizioni Musicali
Peter Maurice (Milan)
Edition Excelsior
Hans Gerig (Cologne)
Editions Musicales
Peter Maurice (Paris)
Peter Maurice
Belgolux S.A. (Brussels)
Al Gallico Music Corp.
(New York)
Peter Maurice
Music Co. Ltd.
(New York)

21, DENMARK STREET, LONDON, W.C.2.

Telegrams & Cables: MAURITUNES, LONDON, W.C.2
Telephones: TEMPLE BAR 3856 (7 Lines)

AMERICAN ARTISTS TO ENTER TOP TEN BRITISH ALBUM CHARTS DURING 1967

ARTIST	TITLE	RECORD COMPANY	NO. OF WEEKS ON CHART
Herb Alpert	SRO	Pye	(6)
	Going Places	Pye	(4)
The Beach Boys	Pet Sounds	Copitol	(1)
	Best of the Beach Boys	Copitol	(41)
	Best of the Beach Boys Vol: 2	Copitol	(6)
	Smiley Smile	Copitol	(2)
The Four Tops	Live	Tomla Motown	(9)
Trini Lopez	Trini Lopez in London	Reprise	(2)
The Monkees	Meet the Monkees	RCA	(16)
	I'm a Believer	RCA	(1)
	The Monkees	RCA	(10)
	More of the Monkees	RCA	(18)
	Headquarters	RCA	(13)
The Mamas and Papas	Mamas and Papas Deliver	RCA	(9)
Jim Reeves	Distant Drums	RCA	(2)
Soundtrack	The Sound of Music	RCA	(47)
Soundtrack	Dr. Zhivago	MGM	(16)
Soundtrack	Thoroughly Modern Millie	BRunswick	(2)
Various Artists	British Chartbusters	Brunswick	(2)

BRITISH INDEPENDENT RECORD PRODUCERS

JOE RONCORONI

and

KEN JONES

of

**Marquis Music Ltd.
Verulam Music Ltd.
Jonjo Music Ltd.**

on behalf of their artistes

**JONATHAN KING
THE KINGSTON BYPASS
THE PAPER CLOUD
DUFFY POWER
URSULA SANDS
THE ZOMBIES**

Recorded exclusively by

**MARQUIS
ENTERPRISES LTD.**

Send Greetings to all their friends
in the Recording & Music Industries.

37, SOHO SQUARE
LONDON, W. 1, ENGLAND
Telephone: Gerrard 9405/6
Cables: MARQUIMUS

ACUFF ROSE MUSIC LTD.
15, St. George Street,
London, W. 1.
Tel: 01-629-7600
Nicholas Firth & Hubert Pattison

A.I.R. (LONDON) LTD.
101, Baker Street,
London, W. 1.
Tel: 486-3451
George Martin, John Burgess,
Ron Richards & Peter Sullivan

AXLE-SCHROEDER PRODUCTIONS
2, Holly Mount,
Hampstead, N.W.3.
Tel: 01-435-4341
Alan Blaikley & Ken Howard

BEACON SOUND LTD.
331/333, High Road,
London, N.W.10.
Milton Samuel

JOHN L. BARKER ASSOCIATES LTD.
164, Shaftesbury Avenue,
London, W.C.2.
Tel: 01-240-0572
John Barker

CHARLES BLACKWELL PRODUCTIONS
42, Glasshouse Street,
London, W. 1.
Tel: 01-734-1521
Charles Blackwell

BRON PRODUCTIONS LTD.
29-31, New Oxford Street,
London, W. 1.
Tel: 01-437-5063
Gerry Bron

CASH RECORDS
Kenneth Pitt Management
35, Curzon Street,
London, W. 1.
Tel: 01-499-7905
David Nicolson

CEECIE PRODUCTIONS
10, Denmark Street,
London, W. C. 2.
Tel: 01-493-1653
Roy Berry & Mike Collier

CHAPPELL & CO.
50, New Bond Street,
London, W. 1.
Tel: 01-629-7600
Sandy Robertson & Deke Arlon

CITY MUSIC
B, Radnor House,
93-97, Regent Street,
London, W. 1.
Tel: 01-734-5351
B. A. Palmer

CONTEMPORARY RECORD CO.
52-55, Carnaby Street,
London, W. 1.
Tel: 01-437-9602
Vic Smith

DOUBLE R PRODUCTIONS
23, Old Burlington Street,
London, W. 1.
Tel: 01-734-9942
Steve Rowland

ALAN FREEMAN ASSOCIATES
145, Oxford Street,
London, W. 1.
Tel: 01-437-5362
Alan Freeman

FXB PRODUCTIONS LTD.
100, Nightingale Lane,
London, S. W. 12.
Tel: 01-637-3189
Eddie Jarrett

HANSA PRODUCTIONS LTD.
5, Denmark Street,
London, W. C. 2.
Tel: 01-240-0674
Mark Pasquin

HILTIE RECORDS
Kenneth Pitt Management
35, Curzon Street,
London, W. 1.
Tel: 01-499-7905
Hilton Valentine & Kenneth Pitt

IVER RECORDING CO.
B, Denmark Street,
London, W.C.2.
Tel: 01-836-4524
Bob Kingston

DICK JAMES MUSIC LTD.
James House,
71-75, New Oxford Street,
London, W.C.1.
Tel: 01-836-4864
Stephen James & Denis Berger

KERROY PRODUCTIONS
42, Westburne Terrace,
London, W. 2.
Tel: 01-262-2948
Iain Kerr

LINDON RECORDS LTD.
235-241, Regent Street,
London, W. 1.
Tel: 01-734-7961
Tito Burns

MARQUIS ENTERPRISES LTD.
37, Soho Square,
London, W. 1.
Tel: 01-437-9405
Joe Roncoroni & Ken Jones

NORMAN NEWELL PRODUCTIONS LTD.
40, Montague Mansions
Baker Street,
London, W. 1.
Tel: 01-935-4133
Norman Newell

NEW BREED PRODUCTIONS LTD.
Dumbarton House,
68, Oxford Street,
London, W. C. 1.
Tel: 01-636-7906
Denny Cordell

NOEL BROWN PRODUCTIONS
26 D'Arbly Street,
London, W. 1.
Tel: 01-437-3745
Noel Brown

ORBIT MUSIC CO. LTD.
10, Albert Court,
124, Knightsbridge,
London, S.W.1.
Tel: 01-589-6293
Shel Talmy

POPPY RECORDS
73, South Audley Street,
London, W. 1.
Tel: 01-493-5912
Dru Harvey

ODDBALL RECORDS LTD.
22, Kingly Street,
London, W. 1.
Tel: 01-437-5953
Grenville Collins & Robert Wace

RAK RECORDS, LTD.
155-157, Oxford Street,
London, W. 1.
Tel: 01-437-6671
Mickie Most

RECORD SUPERVISION LTD.
Lansdowne House,
Lansdowne Road,
London, W. 11.
Tel: 01-727-0041
Denis Preston

RITZ RECORDS
Flat 6,
Albert Gate Court,
124, Knightsbridge,
London, S.W.1.
Tel: 01-589-8801
Bunny Lewis

SCOTT-SOLOMON PRODUCTIONS LTD.
73-75, New Oxford Street,
London, W.C.1.
Tel: 01-493-1801
Tommy Scott & Philip Solomon

SMASH PRODUCTIONS LTD.
26, Kingly Street,
London, W. 1.
Tel: 01-493-8512
Mike Hurst & Christopher Brough

STANLEY SCHOFIELD PRODUCTIONS LTD.
6-B, Old Bond Street,
London, W. 1.
Tel: 01-629-4642
Stanley Schofield

ROBERT STIGWOOD ORGANISATION
67, Brook Street,
London, W. 1.
Tel: 01-629-9121
Robert Stigwood

TRACK RECORDS LTD.
5B-Old Compton Street,
London, W. 1.
Tel: 01-437-9506
Chris Stamp

VOX PRODUCTIONS (GB) LTD.
11, Elgood House,
Wellington Road,
London, N.W.6.
Tel: 01-774-1208
P. Fefer

WARM RECORDS
22, Dean Street,
London, W. 1.
Tel: 01-437-8512
Mike Hurst & Christopher Brough

WITCHSEASON PRODUCTIONS LTD.
90, Westbourne Terrace,
London, W. 2.
Tel: 01-402-6894
Ioe Boyd

BRITISH ARTISTS, THEIR AGENTS & MANAGERS

ARTIST	AGENT	MANAGER
Animals	Harold Davison	Anim Ltd.
Amen Corner	Galaxy Entertainments	Ron King & Tony Birfield
Bachelors, The	Dorothy Solomon Agency	Dorothy Solomon
Berry, Dave	Kennedy Street Artists	Danny Betesch
Bennett, Cliff	Rik Gunnell Agency	Rick Gunnell
Bassey, Shirley	Leslie Simmons	Leslie Simmons
Beatles, The	Nems Enterprises Ltd.	Nems
Bee Gees, The	Robert Stigwood Organisation	Robert Stigwood
Black, Cilla	Nems Enterprises	Nems
Bilk, Acker	Harold Davison Agency	David Bilk
Beck, Jeff	Nems Enterprises Ltd.	Peter Grant
Ball, Kenny	Harold Davison Agency	Reg Tracey
Baldry, Long John	Rick Gunnell Agency	Rick Gunnell
Brown, Joe	George Cooper Agency	Harry Dawson
Beatstalkers, The	Kenneth Pitt Management	Kenneth Pitt
Bowie, David	Kenneth Pitt Management	Kenneth Pitt
Clark, Petula	The Grade Organisation	Martin Wyatt
Clark, Dave Five	Harold Davison Agency	Harold Davison
Cream, The	Robert Stigwood Organisation	Robert Stigwood
Dave Dee, Dozy, Beaky, Mick and Tich	Arthur Howes Agency	Ken Howard & Alan Blaikley
Donovan	Nems Enterprises Ltd.	I.M.C.
Doonan, Val	Starcast	Evelyn Taylor
Dodd, Ken	Forrester-George Ltd.	Dave Forrester
Dubliners, The	Dorothy Solomon	Dorothy Solomon
Dee, Kiki	Harold Davison	Dick Katz
David & Jonathan	Kennedy Street Enterprises	Danny Betesch
Fame, George	Rick Gunnell	Rick Gunnell
Faith, Adam	Starcast	Evelyn Taylor
Fontana, Wayne	Kennedy Street Artists	Danny Betesch
Foundations, The	Robert Stigwood Organisation	Robert Stigwood
The Flower Pot Men, The	Spencer Davis Management	Spencer Davis Management
Garrick, David	Arthur Howes	Boscobel Productions
Harris, Anita	Bert Aza Agency	Mike Margolis & Brian Lane
Harris, Rolf	International Artists Representation	Phyllis Rounce
Herd, The	Kennedy Street Enterprises	Ken Howard & Alan Blaikley
Herman's Hermits	Forrester-George Ltd.	Harvey Lisberg
Hill Vince	Air (London) Ltd.	Ron Richards
Hollies, The	Harold Davison Agency	Anim Ltd.
Hendrix Jimi	Acuff-Rose Agency	Gordon Mills
Humperdinck, Englebert	The Grade Organisation	
Ifield, Frank	Acuff Rose Agency	Gordon Mills
Jones, Tom	Noel Gay Artists	Robin Britten
Jones, Paul	Arthur Howes	Boscobel Productions
Kinks, The		Marion Massey
Lulu	George Elrick	Rik Gunnell
Mantovani	Rik Gunnell Agency	Gerry Bron
Mayall, John	Gerry Bron	Kennedy Street Artists
Mann, Manfred	Nems Enterprises Ltd.	Dick Katz
Mindbenders, The	Dick Katz	Galaxy Entertainments
Monro, Matt	Galaxy Entertainments	
Maughan, Susan	Noel Gay Artists	Richard Armitage
Move, The	Brian Morrison Agency	Brian Morrison
Peter and Gordon	Harold Davison	New Movement Ltd.
Pink Floyd, The	Rik Gunnell Agency	
Procul Harum	The Grade Organisation	Peter Gormley
Price, Alan	Harold Davison Agency	Tito Burns
Richard, Cliff	Fosters Agency	
Rolling Stones, The	Jimmy Grafton	Eddie Jarrett
Stewart, Andy	The Grade Organisation	Peter Gormley
Secombe, Harry	The Grade Organisation	Evelyn Taylor
Seekers, The	Starcast	Vic Billings
Shadows, The	Tito Burns	Dick Katz
Shaw, Sandie	Harold Davison	Kenneth Pitt Management
Springfield, Dusty	Kenneth Pitt Management	Derek Boulton Management
Stevens, Cat		
St. Peters Crispian	Starlite Artistes	Brian Walsh
Southern, Sheila	Starcast	Evelyn Taylor
Tremeloes, The	Harold Davison Agency	Billy Marsh
Trent, Jackie	Rik Gunnell Agency	Rik Gunnell
Vaughan, Frankie	Capable Management	Barry Clayton/Maurice King
Washington, Geno	Brian Morrison Agency	Rik Lambert/Chris Stamp
Walker Scott & John West, Keith	Robert Stigwood Organisation	Rak Records
Who, The	Harold Davison	Marquis Enterprises
Yardbirds, The	Tito Burns	
Zombies, The		

YOU CAN'T GO WRONG
WITH A WRIGHT SONG

Greetings

to

All Our Friends
In The Music Biz

**BILL WARD
SYD RICHARDSON
LAWRENCE WRIGHT**

MUSIC CO., LTD.
54 Greek Street, London W. 1.

*Christmas
Greetings
from*

**Neville Marten
&
Dorris Land**



London

WINNERS OF INTERNATIONAL SONG CONTESTS DURING 1967

ITALY

- January **SAN REMO SONG FESTIVAL**
 Winning Song: "Non Pensare A Me" published by Mascotte
 Winning Artistes: Claudio Villa (Fonit Cetra)
 Iva Zanicchi (RiFi)
- June **A RECORD FOR THE SUMMER**
 Winning Song: "La Mia Serenata" published by RCA Italiana
 Winning Artist: Jimmy Fontana (RCA Italiana)
- June **CANTAGIRO**
 Winning Songs: "Pieta Per Chi Ti Ama" published by Sugar-
 music
 "Prendi La Chitarra E Vai" published by Mills Music
 Winning Artistes: Ranieri (CGD)
 The Motowns (RCA Italiana)
- July **VENICE FESTIVAL**
 Golden Gondola "Perdono" published by Sugarmusic
 Caterina Caselli (CGD)
 Silver Gondola "Nel Sole" published by EMI Italiana
 Al Bano (EMI Italiana)
- July **PESARO SONG FESTIVAL**
 Winning Song: "Nel Sole" published by EMI Italiana
 Winning Artist: Al Bano (EMI Italiana)
- July **NEOPOLITAN SONG FESTIVAL**
 Winning Song: "O' Matusa" published by Durium
 Winning Artistes: Nino Taranto (Edibi)
 I Baldordi (Durium)
- October **FESTIVAL OF ROSES**
 Winning Song: "L'Oro Del Mondo" published by EMI Italiana
 Winning Artist: Al Bano (Emi Italiana)
- October **CASTROCARO**
 Winning Artistes: Elio Gandolfi (Cemed Carosello)
 Giusi Romeo (EMI Italiana)
- October **THE GOLDEN CARAVELLE OF HITS**
 Winning Song: "Il Silenzio" published by Durium
 Winning Artist: Daldida (Barclay)
- BELGIUM**
- July **KNOKKE SONG CONTEST**
 Winning Team: Great Britain
- FRANCE**
- June **LE ROSE DE FRANCE**
 Winning Song: "Le Vent et la Jeunesse"
 Winning Artist: Les Troubadours (AZ)
- November **CHANSONS SUR MESURE**
 Winning Song: "Les Fusils"
 Winning Artist: Anne Vanderlove (Pathe Marconi)
- YUGOSLAVIA**
- August **YUGOSLAVIAN SONG FESTIVAL**
 Winning Song: "Running Out of World"
 Winning Artistes: The Shadows (Great Britain - EMI)
 The Defini (Yugoslavia)
 Winning Song: "Pismo Cali"
 Winning Artistes: Vice Vukov (Yugoslavia)
 Heine (Germany)
- SPAIN**
- September **MEDITERRANEAN FESTIVAL**
 Winning Song: "Le Chancon du Bonheur"
 Winning Artistes: Nancy Holloway (Decca France)
 Guy Mardel (CBS France)
- EUROPE**
- April **EUROVISION SONG CONTEST (VIENNA)**
 Winning Song: "Puppet on a String" (Great Britain)
 Winning Artist: Sandie Shaw (Pye)

AMERICAN ARTISTS WHO HIT BRITISH TOP 20 SINGLES

ARTIST	TITLE	RECORD COMPANY	PUBLISHER	NUMBER OF WEEKS ON CHART
The Beach Boys	Then I Kissed Her	Capitol	Corlin	(8)
	Heroes And Villains	Capitol	Immediate	(5)
The Box Tops	The Letter	Stateside	Barton	(8)
Vikki Carr	It Must Be Him	Liberty	Metric	(9)
Arthur Conley	Sweet Soul Music	Atlantic	Cop Con	(10)
The Four Tops	Standing In			
	The Shadow Of Love	Tamla Motown	Carlin	(5)
	Bernadette	Tamla Motown	Corlin	(4)
	Seven Rooms Of Gloom	Tamla Motown	Jobette	(4)
	Knock On Wood	Atlantic	Belindo	(1)
Eddie Floyd	Respect	Atlantic	Shapiro Bernstein	(5)
Aretha Franklin	You Keep Me Hanging On	Atlantic	Carlin	(2)
Vanilla Fudge	It Takes Two	Tamla Motown	Corlin	(6)
Marvin Gaye & Kim Weston	Ode To Billie Joe	Capitol	Compass	(6)
Bobbie Gen'ry	Take Me In Your Arms	Tamla Motown	Corlin	(4)
Gladys Knight	Nashville Cats	Koma Sutro	Robbins	(1)
The Lovin'Spoonful	I'm A Believer	RCA	Screen Gems	(11)
The Monkees	A Little Bit Me			
	A Little Bit You	RCA	Screen Gems	(9)
	Alternate Title	RCA	Screen Gems	(9)
	Pleasant Valley Sunday	RCA	Screen Gems	(4)
The Mamas and Papas	Dedicated To			
	The One I Love	RCA	Peter Maurice	(11)
	Creeque Alley	RCA	Dick James	(6)
Scott McKenzie	Son Francisco	CBS	Dick James	(13)
Johnny Mann Singers	Up Up And Away	Liberty	Carlin	(6)
Gene Pitney	Something's Got Hold			
	Of My Heart	Stateside	Moribus	(2)
Prince Buster	Al Capone	Bluebeat	Melodisc	(2)
The Royal Guardsmen	Snoopy Vs The Red Dragon	Stateside	Cop Con	(8)
Jim Reeves	I Won't Come In			
	While He's There	RCA	Metric	(5)
Otis Reading	Tramp	Stax	Sporto	(2)
Nancy Sinatra	Sugar Town	Reprise	Criterion	(4)
	You Only Live Twice	Reprise	United Artists	(7)
Frank & Nancy Sinotro	Somethin' Stupid	Reprise	Greenwood	(11)
The Supremes	Love Is Here And Now			
	You're Gone	Tamla Motown	Corlin	(1)
	The Hopping	Tamla Motown	Carlin	(9)
	Reflections	Tamla Motown	Jobette	(8)
Falice Taylor	I Feel Love Coming On	President	Kossner	(2)
The Temptations	I Know I'm Losing You	Tomlo Motown	Carlin	(1)
The Turtles	Hoppy Together	London	Chardon	(6)
	She'd Rather Be With Me	London	Robbins	(11)
Stevie Wonder	I Was Made To Love Her	Tamlo Motown	Jobette	(9)
The Young Roscols	Groovin'	Atlantic	Sparta	(8)

Cash Box—December 23, 1967

THE ROBERT STIGWOOD ORGANISATION, LTD.

Incorporating

ABIGAIL MUSIC, LTD. & DRATLEAF, LTD.

67 Brook Street

London W1, England

Tel.: 01-269-9121

Cables: STIGWOOD LONDON

STIGWOOD - YASKIEL INTERNATIONAL GMBH

RUDOLF SLEZAK MUSIC GMBH

Kornerstrasse 13

2000 Hamburg 39, Germany

Tel.: 2792081/2

ABIGAIL MUSIC (AUSTRALIA) (PTY) LTD.

127 York Street

Sydney, New South Wales

Tel.: 291050

Cables: ABISONG SYDNEY

ITALY—1967 IN REVIEW

JANUARY

EMI Italiana releases a special low-priced series entitled "Invito Alla Musica" which receives strong sales success. According to the results of the sales EMI releases a package of 10 LP's devoted to the greatest classical composers: Vivaldi, Bach, Mozart, Beethoven, Brahms, Chopin, Tchaikovsky, Greig.

Starting from January 1st the repertoires of Command and Grand Award are distributed in Italy by EMI. Among the artists who will be promoted in Italy, there are: Ray Charles Singers, Fats Domino, Enoch Light, George Hamilton, Tony Motola and in the classical field, three famous orchestra conductors: Der-vaux, Var Der Nat and Steinberg.

Another step for classical music promotion on the part of EMI is the release of the series "Voci Illustri" devoted to the world greatest operatic artists. Among these singers are: Titta Ruffo, Gino Bechi, Ebe Stignani, Tancredi Pasero, Tamagni, Gli-ri, Pampanini, Pertile, Lauro Volpi.

A new English group The Motowns is introduced on the Italian scene by RCA. Under the RCA label they record their first Italian tunes: "Prendi La Chitarra e Vai" (which will soon become a hit) and "Per Quanto Io Ci Provi".

The Rolling Stones' new LP issued by Decca including the big hits of this group, starting from "Satisfaction" achieves a big success on the market.

Spotlight on a young promising Fonit Cetra talent: Gianni Pettenati, who is obtaining a strong success with the song "Bandiera Gialla" published by Curci.

Another big hit of the year may be considered "Winchester Cathedral" that is released in Italy by Phonogram under Fontana label. It is sung in the original version by the New Vaudeville Band, and has been for many weeks among the top best sellers.

Ariston pubbery obtains a strong success with the American copyright "Bang Bang" that achieves a total of 12 Italian recordings, four of them listed among the best sellers.

Giovanbattista Ansoldi, managing director of Rifi Records, purchases Renato Carosone's studios. Renato Carosone, one of the most famous Italian artists, built his own up-to-date recording studios two years ago. The reason for this sale is Renato Carosone's moving to Los Angeles, California. The complex called "Play Co" is located in Milan and includes 4 recordings studios (1 large, 1 medium, 2 small size).

Rifi artist Mina begins a series of TV shows of 1 hour and half broadcast every Saturday evening. During these performances Mina presents some of the best tunes of Italian and foreign repertoires. The show entitled "Sabato Sera" (Saturday Evening) receives a strong welcome by the Italian public and turns out to be one of the best 1967 TV shows, and one of the strongest record promotional events, not only for Mina herself, but for all the other artists who are guests of the program.

As usual the most important Italian and International event of the month is the San Remo song Festival, which took place on 26, 27 and 28 January at this well known Italian resort.

The most important events of this contest are:

First, official return of two big Italian firms on the San Remo stage: RCA Italiana and Durium which were the great absentees of last year.

Second, for the first time the number of the songs presented is raised to 30 instead of 26 (1966 edition) Of these 30 songs only 15, which were selected by 15 national juries from all over Italy, were entered in the final night. This last night was televised and broadcast, as usual, all throughout Europe with only the exception of France.

Third and very sad event of this Festival was the tragic suicide of the young singer Luigi Tenoco (RCA Italiana) composer of the tune "Ciao, Amore Ciao", which he performed together with Dalida (Barclay, RCA Italiana) only three hours before his death.

The winning song is "Non Pensare A Me" sung by the great Italian singer Claudio Villa (Fonit Cetra) with the other big talent of Iva Zanicchi (Rifi) also Italian. "Non Pensare A Me" is published by Edizioni Musicali Mascotte, the pubbery owned by Eros Sciorilli, who is the composer of the tune with the lyric writer Alberto Testa.

The other songs of the Festival we must mention, because they became best sellers in a short time are: "Cuore Matto," sung by Little Tony (Durium) and Mario Zelinotti (Durium); and "Cuore Matto," by Little Tony, which has surpassed the million mark in Italy only; "Pietre," sung by the top French singer Antoine (SAAR) with Gian Pieretti (Vedette); "Proposta," by I Giganti (Rifi) and The Bachelors (Ricordi); "L'Immensita," by Jonny Dorelli (CGD) and Don Backy (Clan); and "Quando Dico Che Ti Amo," by Annarita Spinaci (Inter-record) and Les Surfs (CGD). With regard to this latter song we must remember the RCA recording of the song waxed by Tony Renis, composer of the tune. This disk served to bring again Tony Renis on the record scene.

FEBRUARY

The Rolling Stones (Decca) release the new record "Let's Spend The Night Together" and "Ruby Tuesday". The disk obtains a strong reaction, and turns out to be one of the group's greatest hits in Italy.

Milva (Ricordi), one of the best known Italian artists, is invited for the first time to be star guest at the top U.S. club "Maisonette" of St. Regis Hotel in New York. It marks

the start of a career for this artist in the States. She will be back at the St. Regis three times during 1967. MGM is releasing her recordings in U.S.A.

Gigliola Cinquetti (Italian) and Al Korvin (Italian-Argentine living in Milan) won the television foreign artist prize "Chico Viola" awarded to them by Brazilian TV. The award is based on record sales obtained in that country.

A group of Italian journalists in co-operation with Italy's TV company organizes an interesting and original singing voyage called "Youth Cruise". The cruise will touch the ports of Genoa, Cannes, Barcelona, Tangiers, and London. The ship has on board such singing talents as Caterina Caselli (CGD), Gigliola Cinquetti (CGD) and Ricky Maiocchi (CBS).

MARCH

"Winchester Cathedral" is a preferred copyright for artists and record producers. 14 different versions of this title are released in Italy. Southern Music is conducting a strong promotional campaign on the tune which reaches the charts thanks to the original New Vaudeville Band recording issued by Phonogram.

As reported, Durium artist Little Tony reaches great success, the highest in his life, thanks to his performance of the San Remo song "Cuore Matto". The total sales of this song surpasses the 500,000 copies in the first fortnight of March, being in fact, the first best selling disk of all those presented this year on the San Remo stage.

Another song which has achieved good success is the winning tune "Non Pensare A Me". The song composed by Eros Sciorilli and Alberto Testa has been sub-licensed in all countries of the world. In France the song has been assigned to Edition Jaques Plantes in co-edition with Edition (Continued on page 28, Part II)

CAMPI editore

ESTABLISHED SINCE 1898
ROME - VIA VIRGILIO, 8
ITALY

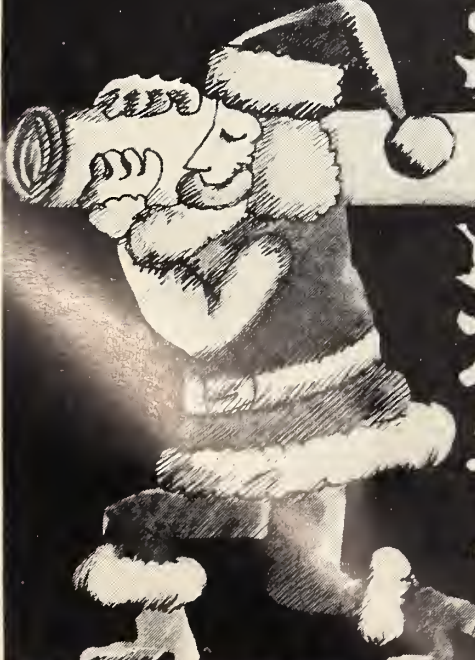

THE NEW RECORD COMPANY

THE MUSIC AND ENTERTAINMENT WEEKLY MAGAZINE

sorrisi e canzoni

TV

DE T

THE SOUND-TRACKS PRODUCTION



*** INTERNATIONAL AGENCIES**

CAM-U.S.A. INC.
370, Lexington Avenue
Suite 2208
NEW YORK - N.Y. 10017
(U.S.A.)

JAPAN-CAM
c/o TOWA Co. Ltd.
Playguide Bldg.
N° 2, 2-Chome Ginza
CHUO-KU (Tokyo)
(Japan)

CAMPANA
8, Rue de Hesse
1211 GINEVRA
(Switzerland)

C. A. M. LONDON
Ibex House Minorities
LONDON E. C. 3

S.I.M.E.P.P.
PARIS (France)

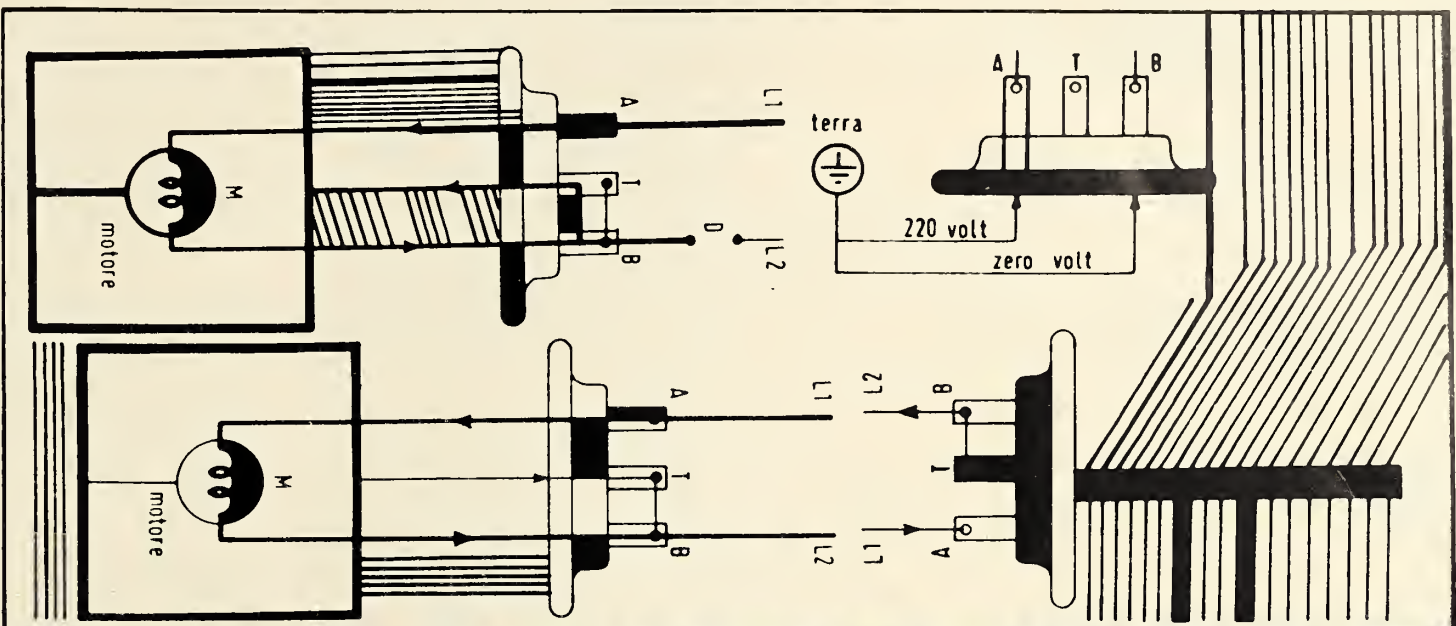

KNOW HOW

(to be successful in the record business)
TAKE THE YOUNGEST BIG INDEPENDENT COMPANY

WITH

- 1967 -

A CHI
 sung by Fausto Leali
 (30 weeks in the Top 10)

LARA'S THEME
 the Bob Mitchell orchestra
 (30 weeks in the Top 10)

LA BANDA
 sung by Mina
 (25 weeks in the Top 10)

PROPOSTA
 sung by I Giganti
 (25 weeks in the Top 10)

NON PENSARE A ME
 sung by Iva Zanicchi
 (20 weeks in the Top 10)

E ALLORA DAI
 sung by Giorgio Gaber
 (20 weeks in the Top 10)

- the most dynamic staff (160 people)
- the largest and most efficient distributing system (45 people)
- the smartest promotion
- the most modern recording studios (4)
- the quickest pressing and printing plants (20,000 records and jackets a day)
- the hottest Italian artists
- the most active international catalogues
**ATCO - ATLANTIC - B.T. PUPPY - JUBILEE
 LAURIE - MONUMENT - SUPRAPHON
 20th CENTURY FOX - VOX - WESTMINSTER**
- the greatest enthusiasm

AND YOU WILL HAVE THE FORMULA OF

RIFI
 RECORD COMPANY

MILANO - (ITALY) - corso BUENOS AIRES, 77 - tel. 273641

NEW YORK (USA) - c o Richard H. Roemer - 400, Madison Avenue
 tel. PL 2 - 0345

SAN REMO 1st PRIZE

1967 NON PENSARE A ME

CLAUDIO VILLA NA ZANICCHI

1966 I TUOI OCCHI VERDI

FRANCO TOZZI

1965 HO PERDUTO

FAUSTO LEALI

1964 L'ULTIMO TRAM

MILVA

1963 NON COSTA NIENTE

JOHNNY DORELLI

1962 I COLORI DELLA FELICITA'

WILMA DE ANGELIS

1961 MIRACOLO

LUCIANO TAJOLI

1960 VORREI SAPERE PERCHE'

MINA

1959 CERASELLA

GLORIA CHRISTIAN

1958 IL TUO BACIO E COME UN ROCK

ADRIANO CELENTANO

**hit by hit
ten years
of our time**

**EDIZIONI MUSICALI
MASCOTTE**

**GALLERIA DEL CORSO 2
MILANO (ITALY) TEL. 793601**

Italy-1967 in Review

(Continued from page 26, Part II)

Tutti and translated as "Quand Tu T'en Iras". It has been waxed by Mirelle Mathieu, one of the top French artists, under the Barclay label. It is noted that the tune became a best seller in that country.

In the States and in England the song is published by Chappell with the title "Time Alone Will Tell". It is recorded by Connie Francis under MGM label and Jerry Vale for CBS.

APRIL

The Rolling Stones (Decca) comes to Italy for the first time. They perform in Milan, Bologna, Genoa, Turin and Rome. The latest Rolling Stones' single "Let's Spend The Night Together" surpasses 150,000 copies in 15 days.

Another foreign star arrived in Italy is Sandy Posey (MGM). In our country she has recorded the Italian version of her top sellers, "Born A Woman" and "Single Girl", translated as "Nata Donna" and "Sempre Sola". This marks the start of the promotional campaign on the MGM catalogue by Dischi Ricordi.

Concerning the Ricordi firm, the top Italian group Equipe 84 wax their first English disk that includes English versions of "Auschwitz" and "29 September." The latter title is a top seller for the group with more than 350,000 copies sold.

Emi Italiana group I Nomali has obtained its first record success, selling over 150,000 copies of "Noi Non Ci Saremo". After this smash Emi Italiana releases the first LP of the group containing among the other tunes "Dio E' Morto," which will become another top seller for this group.

GTA has moved to new and bigger offices in the center of Milan, located in the Corso Europa building. GTA Records also opens a new shop for direct sales to the public. GTA releases an album entitled "12 Bacchette Per Una Chitarra" (Twelve Batons For A Guitar) waxed by Franco Cerri one of the most well known guitar players in Italy who is accompanied by twelve of the best known light music conductors and arrangers.

Mina presents some new tunes in the Saturday evening TV show. Among them are "Se C'E' Una Cosa Che Mi Fa Impazzire", "Portami Con Te", "Sabati E Domeniche" and "La Banda". The last one will result to be her biggest hit of 1967. It is an original Brazilian copyright published by Fermata Do Brasil. All tunes are released under Ri-Fi label. "La Banda" will probably sell over 400,000 copies.

Caterina Caselli (CGD) gets her first gold disk for one million sales of her record "Nessuno Mi Puo' Guidicare". The tune she presented at the San Remo Festival in 1966 and which turned out to be one of the most sold during the year 1966. Just in this period CGD releases the second LP of Caterina, which is entitled "Diamicci Del Tu". This is the same title of the TV weekly series which was presented by Caterina Caselli together with Giorgio Gaber (top Ri-Fi Artist).

On April 18th, starts the big Radio TV contest "A Disc For The Summer" the pop Festival organized by our Radio TV Monopoly in cooperation with AFI, Italian Trade Association. All Italian top artists are taking part to this manifestation, whose promotional power can be considered, on the Italian market, to that of the San Remo Festival.

MAY

Little Tony has been awarded a golden record for his million selling single of the top hit "Cuore Matto" he presented on the San Remo Stage.

Adriano Celentano (Clan) terminates his activity as an independent publisher and signs an agreement with Franz Leonardi, owner and president of Gruppo Editoriale Leonardi. As a result, Leonardi handles Clan pubbery and Clan became member of

the Leonardi publishing group.

Blue Sky pubbery also previously associated with Clan Celentano has been sold to the Sidet publishing group.

Phonogram announces big changes in its organization in Italy. Mario Corsi is appointed new general manager and Carlo Pogliani is charged with the promotional department.

The New Vaudeville Band arrives in Italy where it is enjoying a strong popularity thanks to its hit "Winchester Cathedral".

SAAR is also reorganizing its staff: in fact, Giampiero Simontacchi (formerly with Ariston) is newly appointed head of the promotional office together with Guido Ardizzone.

Marino Marini (Tiffany Records) just back from Madrid announces the conclusion of a deal for the exclusive distribution in Italy of the Spanish catalogue: Sonoplay. This deal will mark for the first time the introduction in Italy of some Spanish talents.

Brazilian music appears again on the music scene in Italy, with two songs performed by two well known songstresses, first is the Brazilian top hit "A Banda" sung by Mina (Ri-Fi) and second is "Tristeza" by Ornella Vanoni (Ariston).

Equipe 84 the top Ricordi group, is obtaining a strong success with their latest disc "29 September" reaches the top of the charts.

Curci promotion is devoted, this month, to two numbers which enter the hit parade. They are: "A Chi" Italian version of "Hurt" recorded by Fausto Leali under Ri-Fi label and "Happy Together" by the Turtles. This latter tune will be also recorded by Jimmy Fontana with the title "Per Vivere Insieme" under RCA label. But at the end of the year it is the Italian version recorded by the group Quelli, for Ricordi which may possibly be the most sold disk of this tune. Emi Italiana releases the top French hit "Inch' Allah" by Adamo. Like almost all Adamo's disks, the number is immediately listed in the charts.

Sammy Davis arrives in Italy for concerts at Palazzo dello Sport in Rome and at Palalido in Milan. Lola Falana (CGD) dancer and songstress who reached great popularity in Italy for being the star guest of the weekly TV show "Saturday Evening" is taking part to the shows with him.

Also top French talent Charles Aznavour arrives in Italy during this month and performs in Milan at Lirico Theatre and in Roma at the Sistina's.

Tom Jones presents via TV his recent hit "Green, Green Grass of Home" which has a strong reaction on the market. This song has been also translated in Italian as "Verde, Verde Erba Di Casa Mia" and released by the Ariston artist Leonardo.

Bob Mitchell, that is the pseudonym of Augusto Martelli, one of the youngest and most talented Italian arrangers, responsible for the arrangements of the top successful recordings for Mina, Iva Zanicchi, I Giganti, etc. has signed an exclusive agreement with Ariston records as orchestra conductor.

The English group the Renegades leaves Ariston to sign a new long term pact with EMI in London. From now their recordings will be distributed by Carisch in Italy.

The Beatles appear on the Italian TV screens thanks to a film showing their performance of "Penny Lane". The film is presented in one of the most popular TV shows "Settevoci" and "Penny Lane" will result to be one of the best sellers of the group in Italy in 1967. This record is distributed by Carisch.

Another guest of the month in Italy is Joan Baez, who makes series of concerts and TV appearances.

Durium American artist Rocky Roberts has a great success thanks to his tune "Stasera Mi Butto" opening theme of the weekly top Italian TV

(Continued on page 30, Part II)



JIMMY FONTANA
after his top hits
"Il Mondo"
and

"La Mia Serenata"
(winner of the Italian TV contest
"Un disco per l'estate")
now winning

the
Rio de Janeiro Popular Song Festival
with the title
"PER UNA DONNA"
(published by Edizioni Musicali RCA ITALIANA)



ITALY'S INDEPENDENT PRODUCERS

GIANDOMENICO BONCOMPAGNI
Via Nemea, 21
ROMA

ELIO BORRONI
Via Garofalo 4
MILANO, Tel. 221729

GIORGIO CALABRESE
Via Leon Battista Alberti, 12
MILANO, Tel. 343182

ICO CALLEGARI
Viale Onceimi, 55
SASSUOLO, Tel. 81096

RAIMONDO CAPUANA
Via S. Martino della Battaglia, 3
ROMA

FLAVIO CARRARESI
Via Donizetti, 11
MILANO, Tel. 705853

OSCAR CARBONI
Via Pony
FERRARA

RUGGERO CINI
Via della Cisa, 16
ROMA

ALBERIGO CROCETTA
Via Domenico Chelini, 9
ROMA

GIANCARLO DE BELLIS
Via Cassia Antica, 11
ROMA

PAOLO DOSSENA
Via Coviello, 18
ROMA

ALCEO GUATELLI
Via Fachinetti, 6
MILANO, Tel. 723271

ENRICO GENTILE
Viale Certosa, 46
MILANO, Tel. 366200

ELIO GARBIBOLDI
Via Virgilio, 9
BRUGHERIO (Milano), Tel. 79120

GIGI GALLO
Galleria del Corso, 4
MILANO, Tel. 799447

AUGUSTO MARTELLI
Via Emanuele Filiberto, 11
MILANO, Tel. 316685

ADRIANO MAZZOLETTI
Viale Palibio, 50
ROMA

FRANCO MIGLIACCI
Via Richelmy, 8
ROMA, Tel. 653818

CARLO NISTRI
Via dei Tadolini, 13
ROMA

ALDO PAGANI
Galleria del Corso, 2
MILANO, Tel. 705005

ILLER PATACCINI
CIP CANTANTI
Corso Europa, 5
MILANO, Tel. 792122

PIERO PINTUCCI
Via Cabrio Casati, 103
ROMA

ENRICO POLITO
c/o CGD
Via Carrozze, 3
ROMA, Tel. 681618

TEDDY RENO
ARICCIA

GIANFRANCO REVERBERI
Via Massimi, 101
ROMA—Tel. 3494437

NANNI RICORDI
Via Cernaia, 5
MILANO, Tel. 651207

VITTORIO SFORZI
Via Canaletto, 14
MILANO, Tel. 721066

SAURO SILI
Via Camprilli, 9
MILANO, Tel. 400563

ALBERTO TESTA
Via Settembrini, 9
MILANO, Tel. 266512

GIANFRANCO TADINI
Via Galli, 5
MILANO, Tel. 362360

AMEDEO TOMMASI
Via Capuana, 152
ROMA

VITO TOMMASO
Via Renato Fucini, 21/9
ROMA

GABRIELE VARANO
Via Schuster, 9
ROMA, Tel. 3490718

LAWRENCE WHIFFIN
Piazza Lapo Gianni, 7
ROMA, Tel. 5819309

Italy-1967 in Review

(Continued from page 28, Part II) show "Saturday Evening". Rocky is the first American artist in the record story starting in Italy his career. "Stasera Mi Butto" is published by Curci and is an original Italian copyright. The disk sales over 500,000 copies.

EMI Italiana releases the third group of singles devoted to the operatic series "Stasera All'Opera" (Tonight at the Opera). These records contain some of the best performances of Boris Christoff, Mario Del Monaco, Giacomo Lauri Volpi, Maria Callas, Renata Scotto, Beniamino Gigli.

RCA Italiana releases the first LP performed by the Monkees with their first Italian chart entry "I'm A Believer". The song is published in Italy by Sugarmusic and is recorded by Caterina Caselli who registers another record success with this cover version, which sells over 350,000 copies, entering in the charts together with the original disk.

Alberto Carisch publisher of all Donovan's compositions here has issued an album bringing together some of this artist's biggest: "Mellow Yellow", listed among the best sellers of the month, "Sunshine Superman", "Colors", "Universal Soldier" (by Buffy Ste. Marie), "Catch The Wind" and "Ballad Of A Crystal Man" all with Italian lyrics.

JUNE

The famous English group the Bachelors are guests of Italy this month, for a fifteen-day concert tour in Venice, Naples, Rome and Bari. They also appear on a personal TV show entitled "Fifteen Minutes With The Bachelors".

Ri-Fi Records has received in Milan the visit of its U.S. attorney Richard Roemer who is responsible for the negotiation of all American catalogues represented by Ri-Fi, including Atlantic, Vox, Westminster, Monument.

The most important event of the month certainly is the final night of the contest "A Disk For The Summer" held in Saint Vincent. The winning song is "La Mia Serenata" written and performed by Jimmy Fontana as a result of a final jury selection on the final night of the contest organized by Italy's Radio TV Company in cooperation with the Phonographic Trade Association AFI.

"La Mia Serenata" is so introduced on the record scene. It will result to be another top hit of RCA Italiana artist Jimmy Fontana, who repeats the big success obtained in 1966 with the other top "Disc For The Summer" hit "Il Mondo". "La Mia Serenata" sells over 600,000 copies.

Second place is taken by "La Rosa Nera" published by Sugarmusic and sung by Gigliola Cinquetti (CGD).

Third prize is taken by "Se Stasera Sono Qui" composed by Luigi Tenco and performed by Ricordi artist Wilma Goich. Both songs enter the charts and result to be among the summer top selling disks. A further confirmation of the promotional straight of "A Disk For The Summer" contest.

CGD/CBS Italiana hold their first convention at Riccione, a tourist resort on the Adriatic coast. Purpose of the meeting is the presentation of the new sales organization of CGD/CBS Italiana, the introduction of the new products and a short training course for new sales agents who recently joined the CGD/CBS Italiana. The new sales organization includes now 34 sales agents. New sales manager is Sergio Di Gennaro.

Besides the two stores located in Milan and in Rome, CGD/CBS Italiana have opened other five stores located in some important commercial centers of Italy: Naples, Catania, Turin, Genoa, and Bari; two other stores will be opened in a short time in Padova and Florence.

JULY

Three top Italian musical events were scheduled this month. First was the International Light Music Show

of Venice, which was broadcast on radio and televised. First prize, the "Golden Gondola" was awarded to Caterina Caselli (CGD) for her hit "Perdono" (280,000 copies of which had already been sold. She presented this tune in 1966 edition of the event. Second prize, the "Silver Gondola" was awarded to a new young star Al Bano over 10 newcomers. He presented "Nel Sole" which has become one of the greatest hits of the year.

This event was also a good spotlight for the youthful talent Claudio Lippi, (Bluebell), who received recognition on the final night of the contest. He presented the song "Si Maria".

Second of the month's major events was the final night of the "Cantagiorno" contest which took place at Fuggi (Roma). Massimo Ranieri (CGD) an 18 year old singer, won the singing tour, in the "B" group while in "C" category first place was taken by The Motowns (RCA). The "A" team, which includes all top artists, had no classification this year to avoid a competition between Adriano Celentano and Rita Pavone. Unfortunately, with this elimination, this event has lost a lot of its promotional power although it remains the largest Musical Show in Italy.

Third event was the Neapolitan song contest. Winning song was "O Matusa" published by Durium and performed by Nino Taranto (Edibi) and a new group I Balordi. This year's contest held for three nights in different districts of the Naples harbor was nationally broadcast and televised.

Campi Group formed a new distribution firm "Campi Distribuzione", which will distribute (in Italy) all the labels owned by Campi, including: Det, Det International, Cam, Campi Editore, and Tank. Sales manager of this firm is Aldo Tilesi.

The New Vaudeville Band arrived for a concert tour in our country. The group was then high on the carts with "Winchester Cathedral".

Don Backy, one of the leading artists of Clan Celentano, made his debut as an actor taking part in the film "L'Immensita", derived from his San Remo hit.

CDI Compagnia Discografica Italiana, is releasing a package called "Russian Musical Anthology, devoted to some of the best Russian compositions and performed by some of the most famous artists.

On the occasion of the first centennial of the birth of composer Umberto Giordano, EMI Italiana released a special LP containing some of the best interpretations of his well known operas, like: "Andrea Chenier" "Fedora", etc.

Saar's young discovery, Umberto, received a very good reaction on the market with "Gioventu" which was presented during the contest "A Disk For The Summer" and at the International Light Music Show of Venice.

AUGUST

Bobby Solo (Ricordi) visited Berlin to take part in a TV color show. Great importance is attached to this show since it is the first color program transmitted in Europe.

Adriano Celentano (Clan) negotiated with impresarios from the U.S.A., England, France, and Germany for personal performances in those countries. Adriano then topped our best seller lists with his hit "La Coppia Piu' Bella Del Mondo". His name appeared also on the German charts thanks to his recording "Una Festa Sui Prati" released by Deutsche Vogue.

CGD/CBS Italiana has scheduled promotion of its most important releases. Among the artists who were introduced were: Frank Sinatra, Antonio Carlos Jobim, Roberto Carlos, Caterina Valente, Barbra Streisand.

Another top radio program to which record firms are devoting their attention is "Batto 4" ("I Stake 4") presented by the well known Italian comic actor Gino Bramieri. On the (Continued on page 32, Part II)

don't ask us how
to make hits...
we sell them!

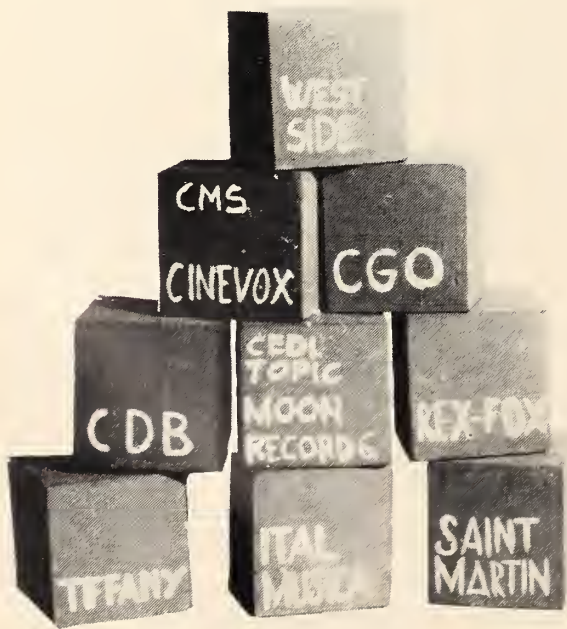

MPM
Distribuzioni Discografiche
corso Genova, 22 - 20123 MILANO - tel 8483815

STUDIO M



© Su licenza della G. RICORDI & C. S.p.A.

RITA PAVONE



DISCHI RICORDI S.p.A.

Via Berchet, 2 - Milano (Italy)

**GRUPPO RICORDI
MUSICA LEGGERA**

Galleria del Corso, 2 - Milano (Italy)

the young companies with an old tradition

*Subsidiaries of G. RICORDI & C. S.p.A. established in 1808

ITALIAN ARTISTS WHO ATTAINED BEST SELLER STATUS ON ITALY'S CHARTS

ARTISTS:	AGENT/MANAGER or RECORD COMPANY
AL BANO	FRANCO MULAZZANI, Via Principe di Piemonte, 4, MIRAMARE RIMINI
ORietta BERTI	SAURO SILI, Via Camprilli, 9, MILANO—Tel. 400563
I CAMALEONTI	PAOLO DI Ceglie, Via Larenteggia, 154, MILANO—Tel. 473926
MILENA CANTU'	ELIO BORRONI, Via Garafala, MILANO—Tel. 221729
CATERINA CASELLI	IVO CALLEGARI, Viale Puccini, 55, SASSUOLO—Tel. 81096
ADRIANO CELENTANO	CLAN CELENTANO, Carsa Eurapa, 5, MILANO—Tel. 704226
GIGLIOLA CINQUETTI	LUIGI CINQUETTI, Via Pesetti, 1, VERONA—Tel. 812008
I CORVI	LUCINO FERRARI, Piazza Santa Apollonia, 3, PARMA
LUCIO DALLA	GIANFRANCO REVERBERI, Via Massini, 101, ROMA—Tel. 3494437
RICCARDO DEL TURCO	CGD, Via Passarella, 2, MILANO—Tel. 794841
I DIK DIK	OFFICE, Galleria del Corso, 2, MILANO—Tel. 700304
DON BACKY	CLAN CELENTANO, Carsa Eurapa, 5, MILANO—Tel. 704261
JOHNNY DORELLI	CGD, Via Passarella, 2, MILANO—Tel. 794841
EQUIPE 84	DISCHI RICORDI, Via Berchet, 2, MILANO—Tel. 871313
JIMMY FONTANA	RCA ITALIANA, Via Tiburtina, Km. 12, ROMA—Tel. 416041
ISABELLA JANNETTI	ADALGISO JANNETTI, Via Imbriani, 78/G, TRANI—Tel. 42360
I GIGANTI	PINO MOSCHINI, Via Torricelli, 17, FIRENZE—Tel. 221177
WILMA GOICH	DISCHI RICORDI, Via Berchet, 2, MILANO—Tel. 871313
FAUSTO LEALI	PINO MOSCHINI, Via Tarricelli, 17, FIRENZE—Tel. 221177
LITTLE TONY	LICIO D'ALNISIO, Via Mambretti, 15, ROMA—Tel. 3272740
MICHELE	GIANFRANCO REVERBERI, Via Masini, 101, ROMA—Tel. 3494437
BOB MITCHELL	AUGUSTO MARTELLI, Via Emanuele Filiberto, 11, MILANO—Tel. 316685
MILVA	BRUNO BERRI, Carsa Vittoria Emanuele, 1, MILANO—Tel. 867367
GIANNI MORANDI	FRANCO MIGLIACCI, Via Rehelmi, 8, ROMA—Tel. 635818
MINA	ELIO GIGANTE, Via Gandina, 2, ROMA—Tel. 633876
NICO E I GABBIANI	ELIO TREINA, Via Antonia Ugo, 23, PALERMO
I NOMADI	ERPIC, Via Malmusi, 40, MODENA—Tel. 33249
GIANNI PATTENATI	LIONETTI, Via Marsala, 41, BOLOGNA—Tel. 220850
GIAN PIERETTI	DISCHI RICORDI, Via Berchet, 2, MILANO—Tel. 871313
RITA PAVONE	TEDDY RENO, ARRICCIA
TONY RENIS	MARIO ORO, Via Ombrana, 12 Bis, ROMA
ROBERTINO	ALFREDO RIZZO, Via Campo d'Africa, 23, ROMA—Tel. 7311676
ANNARITA SPINACI	GIAN CARLO DE BELLIS, Via Cassia Antica, 11, ROMA
BOBBY SOLO	DISCHI RICORDI, Via Berchet, 2, MILANO—Tel. 871313
CLAUDIO VILLA	MARIO TUGNOLO, Via Benucci, 7, ROMA—Tel. 5261683
IVA ZANICCHI	MARIO MINASI, Via Teulada, 52, ROMA—Tel. 358817

Italy—1967 in Review

(Continued from page 30, Part II)
program are Thane Russel, Marisa Del Frate, I Camaleonti, Gian Pieretti, etc.

Dischi Parade which made its debut on the Italian music scene one year ago signed a new exclusive agreement with Decca Italiana, which will distribute the Parade catalogue in Italy.

Decca Italiana presents on our market the single by the Procol Harum "A Whiter Shade of Pale". Decca planned a strong promotional campaign for this single that made it a top seller in a short time.

Ricordi issued an Italian version of the title made by the group I Dik Dik with the title "Senza Luce". Together with the original disk from the Procol Harum, it also reached the top of the charts.

Ricordi released the latest single by Milva: "Dipingi Un Mondo Per Me" b/w "Io Non So Cos'e". The first song was presented by Milva at the International Light Music of Venice and in two TV programs: "Lei Non Si Preoccupi" and "Chi Ti Ha Dato La Patente". Results were the second Milva hit of 1967: previous one was the Italian version of "Little Man" which was listed in the top positions of the charts.

Ponit Cetra enjoyed good sales reactions on the latest Sergio Endrigo single containing "Perche' Non Dormi Fratello" a folk ballad composed by Sergio introduced at the Venice International Light Music Show.

Another Adriano Celentano's hit climbed the charts, "Tre Passi Avanti".

Tiffany Records was still present on the market with a new release by "Los Bravos". The new single includes "Trapped" and "Cutting Out".

Antoine received a strong Saar promo for his San Remo hit "Pietre" which has sold more than 600,000 copies, this month he had his name listed in the best sellers thanks to the Italian version of his copyright "J Me'appelle Cannella" simply entitled "Cannella".

The summer spotlight was put on Al Bano (EMI) who hit the top position on the charts with "Nel Sole". It stayed at the top of the hit parade in Italy for 22 consecutive weeks. At present, the Al Bano song is still listed among the best sellers.

SEPTEMBER

New French discovery Philip Olivier was introduced in Italy through the "Festival Degli Sconosciuti" (The Unknown's Festival) a yearly event organized by Teddy Reno in Ariccia. This was the first time that a foreign singer took part in the contest. Olivier's records are distributed in Italy by Carisch.

Giampiero Scussell A/R Manager of Durium announced the publishing of a new record of the top Durium talent Rocky Roberts. Title of this new single is "Lasciatemi Stare" which is also the theme of the radio program "Gran Varieta". This is the second disk from the American issued by Durium, after his big hit "Stasera Mi Butto". The new disk got an immediate reaction on the market.

Phonogram has released two new disks. The first, from star Orietta Berti, is "A Piedi Nudi". The number is included in the soundtrack of the Italian motion picture "L'uomo Dai Sei Palloni". The second was recorded by Annarita Spinaci. The song is "Ciao Caro" (Goodbye Darling). This is the first disk recorded by Annarita for Phonogram.

During this period Brazilian music witnessed great success in Italy. After "La Banda", which was recorded by Mina, became the most popular number here, another Brazilian hit obtained a strong sales reaction. It was "Tristeza" sung by Ornella Vanoni (Ariston). The original version was introduced by Astrud Gilberto (MGM) who took part in an Italian TV show "Partitissima". Another strong promotion on a Brazilian copyright was announced by RCA Italiana. In fact,

two new artists from Argentina were introduced by RCA on our market: Barbara & Dik who presented the Italian version of their top hit "Funerale De Um Labrador".

CBS Italiana has signed an agreement with the popular film actor Thomas Milian, who is debuting as a singer. His first disc is "Senza Luce", another Italian version of "A Whiter Shade of Pale".

The popular young artist, Caterina Caselli (CGD), has just finished an acting role in the film, "La Ragazza Tutta D'Oro" ("The All Golden Girl") and she will shortly record her new disk for the winter season, containing on the A side, "Sole Spento", penned by Daniele Pace and published of course, by Sugarmusic. The disk will enter the charts immediately. Then Caterina will leave for a concert tour in Spain, Canada and the U.S.A.

OCTOBER

Connie Francis (MGM) arrives in Italy to take part in the TV show entitled "Roma 4", in which she will introduce to our public the Italian version of "Love Is Me Love Is You" as "Cosa C'e' Che Non Va". On this occasion Connie will meet the A/R men of Dischi Ricordi to select with them the song she will do at the next San Remo Festival.

Milva (Ricordi) has just come back from England where she was received with great interest. Milva leaves again for New York to perform at the "Maisonette" in the St. Regis Hotel.

Another Ricordi artist, Bobby Solo, has been pacted for a long singing tour in the States.

Equipe 84 has been signed to perform in France. This is the first Italian rock group pacted for concerts in France. The four boys are enjoying a good reaction on the French market with "Resta" b/w "Ho In Mente Te", released by Festival Records in its original Italian version. Festival schedules the release of the first French recording by Equipe 84. Among the four titles selected is "Auschwitz" penned and composed by the members of this group.

"Sounds of Silence" by Simon & Garfunkel" is the newly-formed CBS Italiana's biggest record to date. This new firm is associated with the music firm, CGD; it will distribute in Italy all CBS products including the U.S. catalogue of Columbia Records.

Mrs. Minatngian of Durium visits London to take part in the annual convention of Pye Records. Pye Records represents and distributes the Durium catalogue in England. Durium releases a new single by Nini Rosso: "La Ballata Dello Yankee" b/w "Serenata Maledetta". Both titles are from the sound track of the film "Yankee", the score of which was composed by Nini Rosso. This single has been released all over the world.

The Ariston group, I Corvi, thanks to the great success they obtained with the single, "Un Ragazzo Di Strada", have been called to compose and perform the sound track of the film "Che Notte Ragazzi" (published by CAM).

Adamo (EMI Italiana) is obtaining great success during his singing tour in our country. In Milan Adamo has received his 7th golden disk for his 7th million disk sold. He has also introduced his new hit, "Se Mai" (Ton Nom).

On the third, fourth and fifth of this month the Roses Festival took place in the Hilton Hotel in Rome. Unfortunately this edition of the Roses Festival was marred by disputes between the organizers and our Radio TV Company. Winner of this contest was Al Bano (EMI Italiana) who presented the tune, "L'oro Del Mondo" ("The Gold of the World"). The song is published by EMI Italiana. The second prize went to "Vivere Per Vivere", composed by Francis Lai and sub-published in Italy by Curci. The song has been presented by Memo Remigi (Cemed-Carosello), by the American guitar duo, Santo & Johnny (Continued on page 36, Part II)

WE HAVE THE SUCCESS IN OUR HAND...

**because we are a young dynamic company:
a good reason
to let's distribute here your catalogue**

PARADE RECORDS MUSIC
Viale. Bruno Buozzi 3
00197 Roma (Italy) telefono 805.109 cable: PARADE
General Manager: Vincenzo Micocci

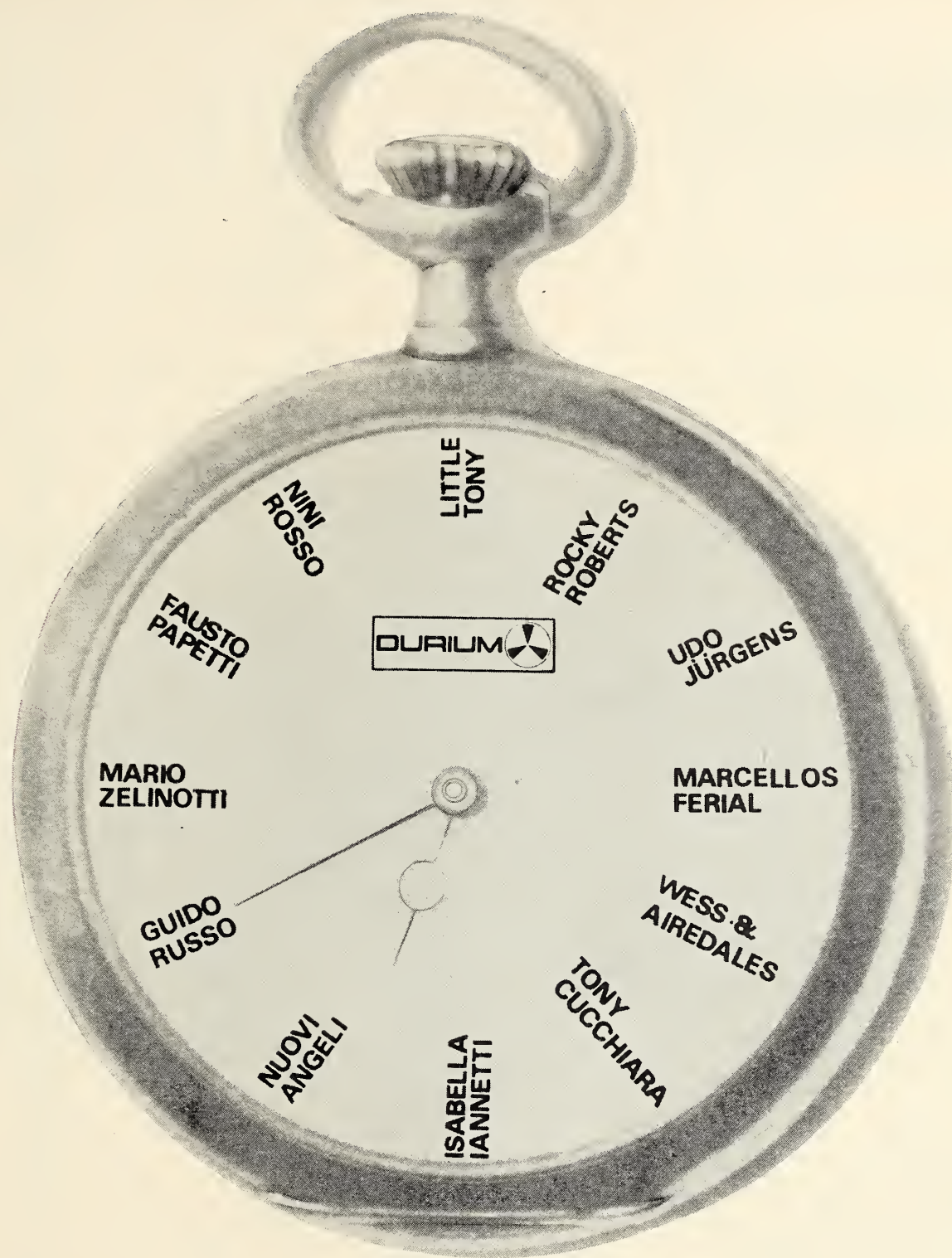

**we mark the right
time in music**

**DURIUM RECORDS
DURIUM PUBLISHING CO.**

MILANO (ITALY) VIA MANZONI 40/42 TEL. 701008

CURCI

publishing group — galleria del Corso, 4 Milano —
Tel. 79.47.46

Curci — D'Anzi — Accordo — Italcanto — Cervino —
Spanka Italiana — Music Union — Italian Yank —
Ducale — Orchestralmusic — RTV — Fast — Ariete
— Star — Dea — Izzo

is always on the **HIT PARADE** with

"STASERA MI BUTTO"

"A CHI" (Hurt)

"PER VIVERE INSIEME" (Happy together)

"DOVE, NON SO" (Somewhere, my love)
from the film "Doctor Zhivago"

"ERA LA DONNA MIA" (in the top ten of 'Un disco
per l'estate')
recorded on Carosello Records by ROBERTINO

"O VESUVIO" (II° Prize Festival of Napoli 1967)
recorded on Curci Records by DOMENICO
MODUGNO

"VIVERE PER VIVERE"

Original motion picture from "Vivre pour
vivre" United Artists Records also recorded on
Carosello Records by MEMO REMIGI (II° Prize
Festival of the Roses 1967)

"SI VIVE DUE VOLTE"

Original motion picture from "007 You Only
Live Twice"
United Artists Records

and its sister firm

CAROSELLO CEMED

s.r.l. via Beccaria, 5 — Milano
distributor in Italy of the following labels: Carosello — Curci
— Disneyland — Erato — Topolino — Buena Vista —
Triola — United Artists — Mustang — Ariete — Italian Yank

ITALIAN ARTISTS WHO HIT THE CHARTS DURING 1967; TITLE, LABELS, PUBS

ARTIST	TITLE	LABEL	PUBLISHER	Nationality
The Rokes	E' La Poggia Che Va Ricordo Quand'ero Tambino Eccola Di Nuovo Bisogna Saper Perdere Cercate Di Abbracciare Tutto Il Mondo Con Noi	RCA Italiana RCA Italiana RCA Italiana RCA Italiana RCA Italiana	RCA Italiana RCA Italiana RCA Italiana RCA Italiana	English English English English
Caterina Caselli	Cento Giorni Il Cammino Di Dgni Speranza Sono Bugiarda (I'm a Believer) Sole Spento	RCA Italiana CGD CGD CGD	RCA Italiana Sugarmusic Sugarmusic Sugarmusic	English Italian Italian Italian
Adamo	Se Mai Insieme Inch'Allah	EMI Italiana EMI Italiana EMI Italiana	EMI Italiana EMI Italiana EMI Italiana	Belgian Belgian Belgian
Adriano Celentano	Il Mondo In Mi 7 La Coppia Piu' Bella Del Mondo Tre Passi Avanti Clan	Clan Clan Clan Clan	Clan/Curci Clan Clan Clan	Italian Italian Italian Italian
Dalida	Bang Bang Ciao Amore Ciao	RCA Italiana RCA Italiana	Ariston RCA Italiana	French French
Antoine	Mama Pietre Cannella	RCA Italiana Saar Saar	RCA Italiana Sciascia MAS	French French French
Drietta Berti	Lara's Theme From Dr. Zhivago Io Tu E Le Rose	Phonogram Phonogram	Curci Nazionalmusic/ Sugarmusic	Italian Italian
I Camaleonti	Portami Tante Rose Non C'e' Niente Di Nuovo Figlio Unico	CBS Italiana CBS Italiana CGD	Sugarmusic Sugarmusic Sugarmusic	Italian Italian Italian
Riccardo Del Turco	Uno Tranquillo Il Mondo E' Con Noi Senza Luce	CGD Ricordi Ricordi	Ricordi Ricordi Sugarmusic	Italian Italian Italian
I Dik Dik	L'Immensita' Poesia	Clan Clan	Clan/Sugarmusic El & Chris	Italian Italian
Don Backy	Bang Bang 29 Settembre	Ricordi Ricordi	Ariston Ricordi	Italian Italian
Equipe 84	Quando Parlo Di Te Dite A Laura Che L'Amo Se Perdo Anche Te	RCA Italiana RCA Italiana RCA Italiana	RCA Italiana RCA Italiana RCA Italiana	Italian Italian Italian
Michele	Un Mondo D'Amore Lara's Theme From Dr. Zivago Questo Nostro Amore	RCA Italiana RCA Italiana RCA Italiana	RCA Italiana RCA Italiana Sugarmusic	Italian Italian English
Gianni Morandi	Let's Spend The Night We Love You Domani	RCA Italiana Decca Decca	EMI Italiana Sugarmusic Sugarmusic	English English English
Rita Pavone	La Danza Delle Note Strangers In The Night The World We Knew	RCA Italiana RCA Italiana CGD	Sugarmusic Sugarmusic Ricordi	USA USA USA
The Rolling Stones	Non C' E' Piu' Niente Da Fare San Francisco Ciao Amore Ciao	CGD Ricordi Ricordi	Sugarmusic RCA Italiana/ RCA Italiana	Italian Italian
Sandie Show	Guarda Se io Donevo Granada	RCA Italiana RCA Italiana	Ricordi RCA Italiana	Italian Italian
Frank Sinatra	Non Pensare A Me Nel Sole Lara's Theme From Dr. Zivago	Fonit Cetra Fonit Cetra EMI Italiana	Southern Mascotte Sidet	Italian Italian Italian
Bobby Solo	Proposta Good Vibration Penny Lane Bang Bang Bang Bang Estate Senza Te La Rosa Nera	CGA EMI Italiana Carish Clan Clan EMI Italiana Saar CGD	Curci Cicogna EMI Italiana Ricordi Ariston Ariston MAS Sugarmusic	Argentina English USA English USA USA French Italian
Luigi Tenco	Io Tu E Le Rose	CBS	Nazionalmusic/ Sugarmusic	French Italian
Claudio Villa	Bang Bang Bisogna Saper Perdere Kilimandjaro Mellow Yellow L'immensita' La Mia Serenata Lara's Theme From Dr. Zivago	Ariston RCA Italiana Saar CBS Italiana CGD RCA Italiana MGM	Ariston RCA Italiana Esedra Southern Clan/Sugarmusic RCA Italiana Curci	Italian Italian French USA Italian Italian USA
Al Bano	Proposta Se Stasera Sono Qui I Sentimenti Corriamo Un Uomo Una Donna	Ri Fi Rirordi Saar Durium	Cicogna Ricordi MAS Durium/Leonardi	Italian Italian French Italian
Al Korvin	A Chi Cuore Matto San Francisco Little Man La Banda I'm A Believer Lara's Theme From Dr. Zivago	Carosello Ri Fi Durium CBS Italiana Ricordi Ri Fi RCA Italiana Ri Fi	Curci Curci Durium Sugarmusic Ricordi Cicogna Sugarmusic Curci	USA Italian Italian USA Italian USA Italian
The Bachelors	Winchester Cathedral Parole Dio E' Morto Bandiera Gialla Pietre Quella Che Sa Piangere Yeeeh A Whiter Shade Of Pale Per Vivere Insieme Tenerezza Stasera Mi Butto Era La Donna Mia	Phonogram City Record EMI Italiana Fonit Cetra Vedette CGD RCA Italiana Decca Ricordi RCA Italiana Durium Cemed/ Carosello	Southern Ariston EMI Italiana Usignolo Sciascia Sugarmusic RCA Italiana Sugarmusic Ricordi RCA Italiana Curci	English Italian Italian Italian Italian USA Italian English Italian USA Italian
The Beach Boys	Quando Dico Che Ti Amo Quando Dico Che Ti Amo Non Pensare A Me Cuore Matto	CGD CGD Ri Fi Durium	Curci RCA Italiana RCA Italiana Durium	Italian Italian French Italian
The Beatles	Quando Dico Che Ti Amo Quando Dico Che Ti Amo Non Pensare A Me Cuore Matto	CGD CGD Ri Fi Durium	Curci RCA Italiana RCA Italiana Durium	Italian Italian French Italian
Milena Cantu	Quando Dico Che Ti Amo Quando Dico Che Ti Amo Non Pensare A Me Cuore Matto	CGD CGD Ri Fi Durium	Curci RCA Italiana RCA Italiana Durium	Italian Italian French Italian
Cher	Quando Dico Che Ti Amo Quando Dico Che Ti Amo Non Pensare A Me Cuore Matto	CGD CGD Ri Fi Durium	Curci RCA Italiana RCA Italiana Durium	Italian Italian French Italian
Christophe	Quando Dico Che Ti Amo Quando Dico Che Ti Amo Non Pensare A Me Cuore Matto	CGD CGD Ri Fi Durium	Curci RCA Italiana RCA Italiana Durium	Italian Italian French Italian
Gigliola Cinquetti	Quando Dico Che Ti Amo Quando Dico Che Ti Amo Non Pensare A Me Cuore Matto	CGD CGD Ri Fi Durium	Curci RCA Italiana RCA Italiana Durium	Italian Italian French Italian
Les Compagnons De La Chanson	Quando Dico Che Ti Amo Quando Dico Che Ti Amo Non Pensare A Me Cuore Matto	CGD CGD Ri Fi Durium	Curci RCA Italiana RCA Italiana Durium	Italian Italian French Italian
I Corvi	Quando Dico Che Ti Amo Quando Dico Che Ti Amo Non Pensare A Me Cuore Matto	CGD CGD Ri Fi Durium	Curci RCA Italiana RCA Italiana Durium	Italian Italian French Italian
Lucio Dalla	Quando Dico Che Ti Amo Quando Dico Che Ti Amo Non Pensare A Me Cuore Matto	CGD CGD Ri Fi Durium	Curci RCA Italiana RCA Italiana Durium	Italian Italian French Italian
Pascal Daniel	Quando Dico Che Ti Amo Quando Dico Che Ti Amo Non Pensare A Me Cuore Matto	CGD CGD Ri Fi Durium	Curci RCA Italiana RCA Italiana Durium	Italian Italian French Italian
Donovan	Quando Dico Che Ti Amo Quando Dico Che Ti Amo Non Pensare A Me Cuore Matto	CGD CGD Ri Fi Durium	Curci RCA Italiana RCA Italiana Durium	Italian Italian French Italian
Jonny Dorelli	Quando Dico Che Ti Amo Quando Dico Che Ti Amo Non Pensare A Me Cuore Matto	CGD CGD Ri Fi Durium	Curci RCA Italiana RCA Italiana Durium	Italian Italian French Italian
Jimmy Fontana	Quando Dico Che Ti Amo Quando Dico Che Ti Amo Non Pensare A Me Cuore Matto	CGD CGD Ri Fi Durium	Curci RCA Italiana RCA Italiana Durium	Italian Italian French Italian
Connie Francis	Quando Dico Che Ti Amo Quando Dico Che Ti Amo Non Pensare A Me Cuore Matto	CGD CGD Ri Fi Durium	Curci RCA Italiana RCA Italiana Durium	Italian Italian French Italian
I Giganti	Quando Dico Che Ti Amo Quando Dico Che Ti Amo Non Pensare A Me Cuore Matto	CGD CGD Ri Fi Durium	Curci RCA Italiana RCA Italiana Durium	Italian Italian French Italian
Wilma Goich	Quando Dico Che Ti Amo Quando Dico Che Ti Amo Non Pensare A Me Cuore Matto	CGD CGD Ri Fi Durium	Curci RCA Italiana RCA Italiana Durium	Italian Italian French Italian
Francoise Hardy	Quando Dico Che Ti Amo Quando Dico Che Ti Amo Non Pensare A Me Cuore Matto	CGD CGD Ri Fi Durium	Curci RCA Italiana RCA Italiana Durium	Italian Italian French Italian
Isabella Jannetti	Quando Dico Che Ti Amo Quando Dico Che Ti Amo Non Pensare A Me Cuore Matto	CGD CGD Ri Fi Durium	Curci RCA Italiana RCA Italiana Durium	Italian Italian French Italian
Francis Lai	Quando Dico Che Ti Amo Quando Dico Che Ti Amo Non Pensare A Me Cuore Matto	CGD CGD Ri Fi Durium	Curci RCA Italiana RCA Italiana Durium	Italian Italian French Italian
Fausto Leali	Quando Dico Che Ti Amo Quando Dico Che Ti Amo Non Pensare A Me Cuore Matto	CGD CGD Ri Fi Durium	Curci RCA Italiana RCA Italiana Durium	Italian Italian French Italian
Little Tony	Quando Dico Che Ti Amo Quando Dico Che Ti Amo Non Pensare A Me Cuore Matto	CGD CGD Ri Fi Durium	Curci RCA Italiana RCA Italiana Durium	Italian Italian French Italian
Scott McKenzie	Quando Dico Che Ti Amo Quando Dico Che Ti Amo Non Pensare A Me Cuore Matto	CGD CGD Ri Fi Durium	Curci RCA Italiana RCA Italiana Durium	Italian Italian French Italian
Milva	Quando Dico Che Ti Amo Quando Dico Che Ti Amo Non Pensare A Me Cuore Matto	CGD CGD Ri Fi Durium	Curci RCA Italiana RCA Italiana Durium	Italian Italian French Italian
Mina	Quando Dico Che Ti Amo Quando Dico Che Ti Amo Non Pensare A Me Cuore Matto	CGD CGD Ri Fi Durium	Curci RCA Italiana RCA Italiana Durium	Italian Italian French Italian
The Monkees	Quando Dico Che Ti Amo Quando Dico Che Ti Amo Non Pensare A Me Cuore Matto	CGD CGD Ri Fi Durium	Curci RCA Italiana RCA Italiana Durium	Italian Italian French Italian
Bob Mitchell	Quando Dico Che Ti Amo Quando Dico Che Ti Amo Non Pensare A Me Cuore Matto	CGD CGD Ri Fi Durium	Curci RCA Italiana RCA Italiana Durium	Italian Italian French Italian
The New Vaudeville Band	Quando Dico Che Ti Amo Quando Dico Che Ti Amo Non Pensare A Me Cuore Matto	CGD CGD Ri Fi Durium	Curci RCA Italiana RCA Italiana Durium	Italian Italian French Italian
Nico E I Gabriani	Quando Dico Che Ti Amo Quando Dico Che Ti Amo Non Pensare A Me Cuore Matto	CGD CGD Ri Fi Durium	Curci RCA Italiana RCA Italiana Durium	Italian Italian French Italian
I Nomadi	Quando Dico Che Ti Amo Quando Dico Che Ti Amo Non Pensare A Me Cuore Matto	CGD CGD Ri Fi Durium	Curci RCA Italiana RCA Italiana Durium	Italian Italian French Italian
Gianni Pettenati	Quando Dico Che Ti Amo Quando Dico Che Ti Amo Non Pensare A Me Cuore Matto	CGD CGD Ri Fi Durium	Curci RCA Italiana RCA Italiana Durium	Italian Italian French Italian
Gian Pieretti	Quando Dico Che Ti Amo Quando Dico Che Ti Amo Non Pensare A Me Cuore Matto	CGD CGD Ri Fi Durium	Curci RCA Italiana RCA Italiana Durium	Italian Italian French Italian
Gene Pitney	Quando Dico Che Ti Amo Quando Dico Che Ti Amo Non Pensare A Me Cuore Matto	CGD CGD Ri Fi Durium	Curci RCA Italiana RCA Italiana Durium	Italian Italian French Italian
The Primitives	Quando Dico Che Ti Amo Quando Dico Che Ti Amo Non Pensare A Me Cuore Matto	CGD CGD Ri Fi Durium	Curci RCA Italiana RCA Italiana Durium	Italian Italian French Italian
Procol Harum	Quando Dico Che Ti Amo Quando Dico Che Ti Amo Non Pensare A Me Cuore Matto	CGD CGD Ri Fi Durium	Curci RCA Italiana RCA Italiana Durium	Italian Italian French Italian
Quelli	Quando Dico Che Ti Amo Quando Dico Che Ti Amo Non Pensare A Me Cuore Matto	CGD CGD Ri Fi Durium	Curci RCA Italiana RCA Italiana Durium	Italian Italian French Italian
Tony Renis	Quando Dico Che Ti Amo Quando Dico Che Ti Amo Non Pensare A Me Cuore Matto	CGD CGD Ri Fi Durium	Curci RCA Italiana RCA Italiana Durium	Italian Italian French Italian
Rocky Roberts	Quando Dico Che Ti Amo Quando Dico Che Ti Amo Non Pensare A Me Cuore Matto	CGD CGD Ri Fi Durium	Curci RCA Italiana RCA Italiana Durium	Italian Italian French Italian
Robertino	Quando Dico Che Ti Amo Quando Dico Che Ti Amo Non Pensare A Me Cuore Matto	CGD CGD Ri Fi Durium	Curci RCA Italiana RCA Italiana Durium	Italian Italian French Italian
Annarita Spinaci	Quando Dico Che Ti Amo Quando Dico Che Ti Amo Non Pensare A Me Cuore Matto	CGD CGD Ri Fi Durium	Curci RCA Italiana RCA Italiana Durium	Italian Italian French Italian
Les Surfs	Quando Dico Che Ti Amo Quando Dico Che Ti Amo Non Pensare A Me Cuore Matto	CGD CGD Ri Fi Durium	Curci RCA Italiana RCA Italiana Durium	Italian Italian French Italian
Iva Zanicchi	Quando Dico Che Ti Amo Quando Dico Che Ti Amo Non Pensare A Me Cuore Matto	CGD CGD Ri Fi Durium	Curci RCA Italiana RCA Italiana Durium	Italian Italian French Italian
Mario Zelinotti	Quando Dico Che Ti Amo Quando Dico Che Ti Amo Non Pensare A Me Cuore Matto	CGD CGD Ri Fi Durium	Curci RCA Italiana RCA Italiana Durium	Italian Italian French Italian

ITALY'S BEST SELLING SHEET MUSIC

TITLE:

Lara's Theme from Doctor Zhivago
A Chi (Hurt)
* La Coppia Piu' Bella Del Mondo
* Stasera Mi Butto
* La Mia Serenata
* Nel Sole
* Senza Luce (A Whiter Shade of Pale)
* Nan Pensare A Me
* L'Immensita'
* Pietre
* Cuore Matto
* Per Vivere Insieme (Happy Together)
* Un Uomo, Una Donna
* Winchester Cathedral
* Poesia
* San Francisco

PUBLISHER:

CURCI
CURCI
CLAN (Gruppo LEONARDI)
CURCI
RCA ITALIANA
EMI ITALIANA
SUGARMUSIC
MASCOTTE
CLAN/SUGARMUSIC
SCIASCIA
DURIUM
RICORDI
CURCI
SOUTHERN
EL & CHRIS
SUGARMUSIC

* Denotes Original Italian Copyrights

focus on ariston...
to get
the right picture
of the italian music

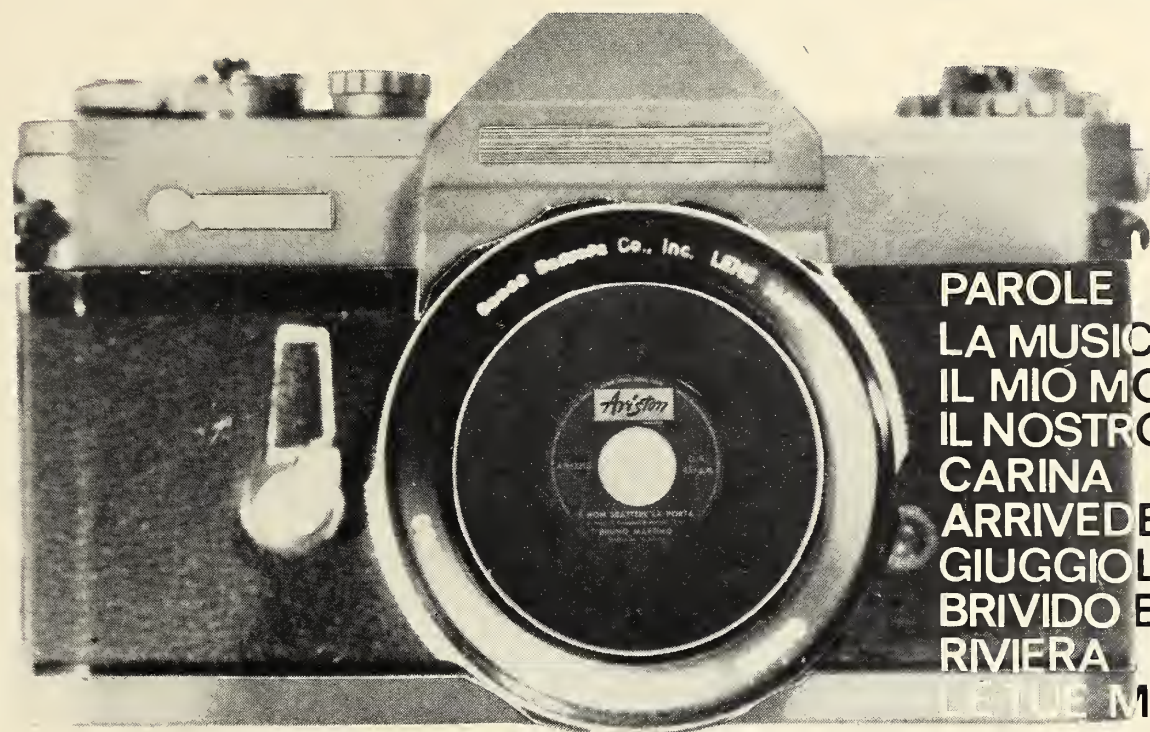

PAROLE
LA MUSICA E FINITA
IL MIO MONDO
IL NOSTRO CONCERTO
CARINA
ARRIVEDERCI
GIUGGIOLA
BRIVIDO BLU
RIVIERA
LE TUE MANI

ORNELLA VANONI
NICO E I GABBIANI
UMBERTO BINDI
ANNA IDENTICI
I CORVI
MARIO GUARNERA
BRUNO LAUZI
BRUNO MARTINO
LEONARDO
VASSO OVALE
I RAGAZZI DEL SOLE
GIANNI MASCOLO
PIER FRANCO COLONNA
I MOSCHETTIERI
THE HIPPIES
ALESSANDRA CASACCIA

STUDIO M

ARISTON RECORDS
GRUPPO EDITORIALE ARISTON
Piazzetta Pattari 1/3 phone 89 77 45
MILANO (ITALY)

Italy - 1967 in Review

(Continued from page 32, Part II)
 (Belldisc Italiana), and by the young Durium artist, Dora Ghezzi. This song comes from the sound track of the film of the same title.

Third prize went to "Il Pieno", a rock number published by Southern Music. This song has been performed by Lara St. Paul, by the group I Romans and by the vocal ensemble, The Folk Studio Singers, all CDI artists.

The prize of the international jury went to "Una Testa Dura", published by Durium in association with Edizioni Duomo. This song was excellently performed by Isabella Jannetti (Durium) and Claudio Lippi (Belldisc Italiana).

A special mention should be given to "Il Cielo", the song which received the vote of the journalists jury. This is also another Italian copyright (publisher is RCA Italiana). The performers were Lucio Dalla (RCA Italiana), Nino Cabana (Belldisc Italiana) and Tony Ben (Cinevox).

NOVEMBER

Elio Gandolfi (Cemed-Carosello) and Giusi Romeo (EMI Italiana) are the winners of the fourth "New Voice" contest which was held at Castrocaro (a little resort well known for its thermal waters). The principal interest of this contest, organized by Gianni Ravera (also organizer of the San Remo Festival), is the fact that all the winners will automatically make their debut on the San Remo stage. The final night of the contest is broadcast on the national network. All twelve finalists presented this year by Gianni Ravera were excellent. In the opinion of all specialized journalists present in the Castrocaro hall, at least eight of the finalists should have had the right to be present on the San Remo Stage.

Mina, the top Italian songstress, has formed a new label called PDU with offices at Seham in the little state of Liechtenstein. President of this new company is Giampiero Spies. Durium has signed an exclusive distribution pact with PDU for the sales

and licensing of all PDU products in Italy and all over the world. Durium will also manufacture PDU discs.

Dischi Ricordi has signed a recording contract with former RCA Italiana songstress, Rita Pavone. The contract includes all countries of the world, but all deals made by Dischi Ricordi for foreign exploitation of Rita Pavone's recordings will be subject to the approval of the lark's producer and manager, Teddy Reno.

Ri-Fi Records has obtained the distribution rights to the Supraphon catalogue of Czechoslovakia in Italy.

Southern Music is concentrating its autumn promotional campaign on four foreign copyrights. First two numbers selected are "Tatata" and "L'oiseau De Nuit", both penned and recorded by Michel Polnaroff. The other two numbers are "Finchley Central" and "Peek A Boo" recorded by the the New Vaudeville Band and released in Italy by Phonogram on the Fontana label. "Peek A Boo" has also been recorded by Ricordi artist, Bobby Solo. Also strongly promoted by Southern Music is "Detroit City", originally grooved by Tom Jones and released in Italy on the Decca label, the Italian version is released by the new Italian group, Colours, on the Ri-Fi label.

The composition, "Non Dimenticare Le Mie Parole", one of the most famous Italian standards, composed by D'Anzi, has just been recorded in a new modern version by our top singing star, Rita Pavone (Ricordi).

Another top Italian standard, also composed by D'Anzi, and published by Curci, has been recorded by another top Italian star for the Ri-Fi label. This is the Evergreen, "Tu Non Mi Lascera", recorded by Mina.

Ezio Redaelli, organizer of the top Italian summer song contest, "Cantagiuro", is preparing the second edition of the singing tour, "Cantaeuropa". As in last year's tour, 14 Italian singers will board a special train, the Cantaeuropa Express, and will perform for 21 nights in 21 of the principal towns of Europe. This year will carry singers, journalists and organizers and will exhibit an-

cient and modern paintings of Italian artists. Special care will be devoted to this art gallery, which is organized in cooperation with the State touristic office. The art gallery will be a further attraction for the "Cantaeuropa" and will also help the European promotion of Italian songs and singers. The long "Cantaeuropa" train will pass through 15 different countries: Austria, Belgium, Czechoslovakia, Denmark, France, West and East Germany, England, Norway, Holland, Poland, Monaco Sweden and Switzerland.

Among the stars of the tour are: Rita Pavone (Ricordi), Bobby Solo, (Ricordi), Gigliola Cinquetti (CGD), Nini Rosso (Durium), Dino (RCA Italiana), Wilma Goich (Ricordi), Edoardo Vianello (RCA Italiana), Giorgio Gaber (Ri-Fi) and Al Bano (EMI Italiana).

CGD holds a second 1967 sales convention. New products are presented, and a new promotional program for the Warner Bros./Reprise disks distributed by CGD in Italy is announced. This new program will emphasize LP's.

DECEMBER

Astrud Gilberto, one of the most famous Brazilian singers, arrives in Italy. On this occasion, she records the Italian version of the Brazilian tune, "Tristeza", for the Ricordi label,

which she presents on some TV shows: "Tristeza", published in Italy by Ariston, has been recorded also by the Italian talent Ornella Vanoni (Ariston).

All Italian record firms are working strongly on the next edition of the San Remo Festival. They have already presented their productions to the selection committee and now are choosing the performers, which will be coupled to perform the songs.

Some record firms report the names of artists who probably will be on the stage of San Remo for 1968 edition of the Festival.

Ariston: Umberto Bindi, Mario Guarnera, Ornella Vanoni, Leonardo Anna Identici.

Phonogram: Orietta Berti, Annrita Spinaci, Duo Farini, Disting Springfield, Armando Savini.

Curci: Elio Gandolfi (winner of the New Voice contest of Castrocaro), Domenico Modugno, Memo Remigi, Robertino.

Ricordi: Milva, Wilma Goich. Fonit Cetra: Gianni Pettenati, Carmen Villani, Sergio Endrigo, Marisa Sannia, Patrick Samson.

C.G.D.: Jonny Dorelli, Gigliola Cinquetti, Massimo Ranieri, Giuliana Valci, Nino Ferrer, I Camaleonti.

Clan: Don Bucky.

EMI Italiana: Al Bano, Pino Donaggio, Giusi Romeo (winner of the New Voice contest of Castrocaro), Bobby Gentry, Duke Ellington, Richard Anthony.

FOREIGN ARTISTS TO ENTER TOP TWENTY BRITISH SINGLES CHART DURING 1967

ARTIST	TITLE	RECORD COMPANY	PUBLISHER	WEEKS ON CHART
Desmond Dekker	007	Pyramid	Island	(5)
Rita Pavone	You Only You	RCA	Chappell	(1)
Narmie Rawe	Ooh La La	Palydor	Carter-Lewis	(1)
Topol	If I Were a Rich Man	CBS	Valanda	(7)

FOREIGN ARTISTS TO ENTER TOP TEN BRITISH ALBUM CHARTS DURING 1967

ARTIST	TITLE	RECORD COMPANY	WEEKS ON CHART
James Last	This is James Last	Palydor	(6)
Raymond Levevre	Raymond Levevre	Major Minar	(1)

FOREIGN ARTISTS TO ENTER AMERICAN TOP 100 ALBUM CHARTS DURING 1967

ARTIST	TITLE	RECORD COMPANY	WEEKS ON CHART
Bert Kaempfert	Bert Kaempfert's Greatest Hits	Decca	(4)
Bert Kaempfert	The World We Knew	Decca	(1)
Bert Kaempfert	Hold Me	Decca	(1)

RECORDS & ARTISTS WHO REACHED AUSTRALIA'S BEST SELLER LIST FROM JAN. 1-DEC. 1, 1967

ARTIST	TITLE	LABEL	PUBLISHER	NATIONALITY	ARTIST	TITLE	LABEL	PUBLISHER	NATIONALITY
Beach Boys	Good Vibrations	Capitol	J. Albert & Son	American	Masters Apprentices	Living In A Child's Dream	Astor	Apollo Music	Australian
The Beatles	Penny Lane	Parlophone	Northern Songs	British	The Monkees	I'm A Believer	RCA	Tu-Con Music	American
The Beatles	All You Need Is Love	Parlophone	Northern Songs	British	The Monkees	Theme From Monkees (E. P.)	RCA	Tu-Con Music	American
The Bee Gees	Spicks & Specks	Spin	Belinda	Australian	The Monkees	Pleasant Valley Sunday	RCA	Tu-Con Music	American
The Bee Gees	New York Mining Disaster	Spin	Abigail	Australian	The Monkees	Alternate Title	RCA	Tu-Con Music	American
The Bee Gees	To Love Somebody	Spin	Abigail	Australian	The Move	Flowers In The Rain	Festival	Essex Music	British
The Bee Gees	Massachusetts	Spin	Abigail	Australian					
The Box Tops	The Letter	Stateside	J. Albert & Son	American	Scott McKenzie	San Francisco	CBS	Associated Music	American
Eric Burdon & Animals	Help Me Girl	London		Amer. Brit.	New Vaudeville Band	Winchester Cathedral	Philips	Southern Music	British
Eric Burdon & Animals	When I Was Young	London		British					
Vikki Carr	It Must Be Him	Liberty	J. Albert & Son	American	Roy Orbison	Communication Breakdown	London	Acutt-Rose	American
The Cherokees	Oh Monah	Go!	Chappell & Co	Australian	Roy Orbison	Cry Softly Lonely One	London	Acutt-Rose	American
The Cherokees	Minnie The Moocher	Go!	J. Albert & Son	Australian					
Petula Clark	This Is My Song	Astor	Leeds Music	British	Peter & Gordon	Knight In Rusty Armour	Columbia	J. Albert & Son	British
Petula Clark	Don't Sleep In The Subway	Astor	Leeds Music	British	Peter, Paul & Mary	I Dig Rock And Roll Music	Warner Bros.	Allans	American
Ray Conniff	Somewhere My Love	CBS	J. Albert & Son	American	Sandy Posey	Single Girl	MGM		American
					Sandy Posey	I Take It Back	MGM	Castle Music	American
Dave Dee, Dozy, etc.	Bend It	Philips	Accolade	British	Procol Harum	Whiter Shade Of Pale	Deram	Essex Music	British
Sammy Davis	Don't Blame The Children	Reprise	M.C.P.D.	American	Procol Harum	Homburg	Festival	Essex Music	British
Buddy England	Movin' Man	HMV		Australian	Lynne Randall	Ciao Baby	CBS	Leeds Music	Australian
The Easybeats	Who'll Be The One	Parlophone	J. Albert & Son	Australian	Cliff Richard	The Day I Met Maria	Columbia	Belinda Music	British
The Easybeats	Friday On My Mind	Parlophone	J. Albert & Son	Australian	Rolling Stones	Ruby Tuesday	Decca	Essex Music	British
					Rolling Stones	Dandelion	Decca	Essex Music	British
Wayne Fontana	Pamela, Pamela	Philips	Connelly	British	Normie Rowe	Ooh La La	Sunshine	Southern Music	Australian
Fifth Dimension	Up-Up Ana Away	Liberty	Belinda	American	Normie Rowe	It's Not Easy	Sunshine	Tu-Con Music	Australian
Fifth Estate	Ding Dong The Witch Is Dead	Stateside	J. Albert & Son	American	Royal Guardsmen	Snoopy Versus Red Baron	Festival		American
					Royal Guardsmen	Return of Red Baron	Festival		American
Bobby Gentry	Ode To Billie Joe	Capitol	Chappell & Co	American	The Seekers	Georgy Girl	Columbia	Chappell & Co.	Australian
The Group	Woman, You're Breakin' Me	CBS	April Music	Australian	Sandie Shaw	Puppet On A String	Astor	J. Albert & Son	British
					Nancy Sinatra	Summer Wine	Reprise	Boosey & Hawkes	American
Bev Harrell	What Am I Doing Here	HMV		Australian	N. Sinatra/L. Hazelwood	Jackson	Reprise		American
Lee Hazlewood	The Girls In Paris	MGM	Boosey & Hawkes	American	Nancy & Frank Sinatra	Somethin' Stupid	Reprise	J. Albert & Son	American
Herman's Hermits	No Milk Today	Columbia	Connelly	British	Small Faces	Itchycoo Park	Stateside	Castle Music	British
Herman's Hermits	There's Kind Of Hush	Columbia	J. Albert & Son	British	Nancy Sinatra	Lightning's Girl	Reprise	Boosey & Hawkes	American
The Hollies	Carrie Anne	Parlophone	Dick James	British	Del Shannon	Runaway	Liberty	Belinda Music	American
Engelbert Humperdinck	Release Me	Decca	D. Davis & Co.	British	Spencer Davis Group	Gimme Some Lovin'	Festival	Essex Music	British
Engelbert Humperdinck	The Last Waltz	Decca	J. Albert & Son	British	Spencer Davis Group	I'm A Man	Festival	Essex Music	British
					Cat Stevens	Matthew & Son	Deram	Leeds Music	British
The Id	Big Time Operator	Spin	Cromwell	Australian	The Supremes	The Happening	Tamla/Motown	Belinda Music	American
Davy Jones	Theme For New Love	Astor	E. H. Morris & Co.	British					
Davy Jones	Dream Girl	Astor	April Music	British	The Tremeloes	Silence Is Golden	CBS		British
Paul Jones	I've Been A Bad Bad Boy	HMV	Leeds Music	British	Jackie Trent/Tony Hatch	The Two Of us	Astor	Leeds Music	British
Tom Jones	Green Green Grass Of Home	Decca	Palace Music	British	The Twilight	What's Wrong With The Way I Live	Columbia	Leeds Music	Australian
Gunter Kallman Chorus	Wish Me A Rainbow	Polydor	Chappell & Co.	German	Frankie Valli	Can't Take My Eyes Off You	Philips	Castle Music	American
The Kinks	Waterloo Sunset	Astor	Belinda	British					
					Whistling Jack Smith	I Was Kaiser Bill's Batman	Deram	Ja. Albert & Son	British
The Loved Ones	The Loved Ones (E. P.)	W & G.	Woomera Music	Australian					
Lulu	To Sir With Love	Columbia	Screen Gems-Columbia	British	The Who	I'm A Boy	Polydor	Essex Music	British
					The Who	Happy Jack	Polydor	Essex Music	British
Mamas & Papas	Dedicated To The One I Love	RCA	Associated	American	The Who	Pictures Of Lily Festival	Festival	Essex Music	British
Mamas & Papas	Creque Alley	RCA	Associated	American	Brenton Wood				American
Manfred Mann	Ha Ha Said The Clown	Philips	J. Albert & Son	British					
Dean Martin	Chapel In The Moonlight	Reprise	J. Albert & Son	American	Johnny Young	Let It Be Me (E.P.)	Clarion	Various Publishers	Australian
Dean Martin	Little Old Wine Drinker	Reprise	Essex Music	American	Johnny Young	Kiss Me Now	Clarion	Leeds Music	Australian
Masters Apprentices	Undecided	Astor	Apollo Music	Australian	Young Rascals	Groovin'	Festival	J. Albert & Son	American

ADRIANO CELENTANO

AND HIS **CLAN**
CELENTANO

DON BACKY · GINO SANTERCOLE · LEI · PILAOE · ICO CERUTTI ·
TEO · I RAGAZZI DELLA VIA GLUCK · MARIA LUIGIA ·

OPEN WINDOWS ON THE ART OF MUSIC

studio **CLAN**

CLAN
CELENTANO



CLAN
CELENTANO

ITALY'S AGENTS AND MANAGERS

ONELIO BARBATI
ERPIC
Viale Malmusi, 40
MODENA, Tel. 33249

ERMINIO BASO
Via Cappuccina, 19
MESTRE (Venezia)

FRANCO BERNABEI
Via Borelli, 31
MODENA, Tel. 32123

BRUNO BERRI
Corso Vittorio Emanuele, 1
MILANO, Tel. 867367

PIERO BONINO
Via Delle Vallazze, 91
MILANO, Tel. 299690

GIORGIO CASELLATO
Corso Lodi, 59
MILANO, Tel. 5392467

CLAUDIO CELLI
Via Plinio, 52
MILANO, Tel. 265663

LUIGI CINQUETTI
Via Pescetti, 1
VERONA, Tel. 912008

MONFREDI COTONE
Hotel Londra
NAPOLI, Tel. 312193

LICIO D'ALNISO
Via Mambretti, 15
ROMA, Tel. 3272740

PAOLO DI CEGLIE
Via Lorenteggio, 154
MILANO, Tel. 473926

LUCIANO FERRARI
Piazza S. Apollonia, 3
PARMA

GUGLIELMO GALLO
Via Fiume, 9
COMO, Tel. 273641

GIAVANNI GIACOBETTI
Via Cecilio Stazzio, 45
ROMA, Tel. 341137

ELIO GIGANTE
Via Gandino, 2
ROMA, Tel. 633876

ADALGISO JANNETTI
Via Imbriani, 78/G
TRANI, Tel. 43260

GINO LARDERA
MUSIC STAR
Galleria del Corso, 2
MILANO, Tel. 709461

STELVIO MARENGO
Via Capeelatro, 20
MILANO, Tel. 406486

ELIO MINASI
Viale Mazzini, 119
ROMA, Tel. 352156

MARIO MINASI
Via Teulada, 52
ROMA, Tel. 358817

PINO MOSCHINI
Via Torricelli, 17
FIRENZE, Tel. 221177

FRANCO MULAZZANI
Via Principe di Piemonte, 4
MIRAMARE DI RIMINI

MARIO ORO
Via Ombrona, 12 bis
ROMA

GIANNI RAVERA
Viale Mazzini, 114
ROMA, Tel. 389669

TEDDY RENO
ARICCIA
MARIO RICCI

Via Bolognesi, 98
FORLI, Tel. 24766

ALFREDO RIZZO
Via Campo d'Africa, 23
ROMA, Tel. 7311676

VITTORIO SFORZI
Via Canaletto, 14
MILANO, Tel. 721066

GIANFRANCO TADINI
Via Galli, 5
MILANO, Tel. 362360

ELIO TREINA
Via Antonio Ugo, 23
PALERMO

MARIO TUGNOLO
Via Benucci, 7
ROMA, Tel. 5261683

MARCO VISCONTI
Via Pomba, 15
TORINO, Tel. 515995

ITALIAN RECORDING STUDIOS

ACUSTICA ITALIANA
Via XX Settembre 122
ROMA—Tel. 474139

ANGELICUM
Piazza S. Angelo, 2
MILANO—Tel. 654610

AUDIO EDIZIONI PAOLINE
Via Castro Partico 21
ALBANO (Roma)

B.D.M.
Via S. Petronio Vecchio 27
BOLOGNA

CARISCH
Via Monviso, 17
MILANO—Tel. 389317

CINEVOX
Via Gregoriana, 16
ROMA—Tel. 686486

DAUNIA
Via Lecce, 31
FOGGIA—Tel. 23632

DIMAPHON
Via Pola, 15
ROMA—Tel. 8444002

DISCHI RICORDI S.p.A.
Piazza dei Cinquecento, 1
MILANO—Tel. 530394

DISCOGRAFIA ROLFILM MUSICALE
Corso Valdooppo, 11
TORINO—Tel. 511719

DURIUM S.p.A.
Via Toria, 7
MILANO—Tel. 470778

EUPHON
Via Principe Amedeo, 12
TORINO—Tel. 541441

FONIT CETRA S.p.A.
Via Bertola, 34
TORINO—Tel. 5753

Via Meda, 45
MILANO—Tel. 8432551

Via Nicola de Cesarini
ROMA—Tel. 561451

FONOLA
Via Leopardi, 25
MILANO—Tel. 872882

FONOLUX
Piazza Cinecittà
ROMA

FONORAMO DI CARLO ALBERTO ROSSI
Registrazioni e dropplaggio
Via Barletta, 11
MILANO—Tel. 5392392

FONO ROMA
Via Maria Cristina, 5
ROMA—Tel. 382051

Via Lumiere, 4
COLOGNO MONZESE (Milano)—Tel. 9123973

INTERNATIONAL RECORDING S.p.A.
Via Urbana, 172
ROMA—Tel. 480667

KRITES STUDIO
Via Biancamano, 31
ROMA—Tel. 753850

LA VOCE DEL PADRONE—COLUMBIA—
MARCOPHON S.p.A.
Via Santa Eufemia, 25
MILANO—Tel. 802622

MEAZZI s.r.l.
Via Piatti, 6
MILANO—Tel. 867361

MESSAGERIE MUSICALI
Galleria del Corso, 2
MILANO—Tel. 794841

MICROPHONE RECORD
Via Mantova 10
MILANO—Tel. 593053

PLAYCO (e. RIFI)
Via Stromboli, 18/20
MILANO—Tel. 463257

RADIO VATICANA
Città del Vaticano
ROMA

RAID
Via Giolitti, 10
TORINO—Tel. 512062

RAIFON
Viale XX Settembre 17
TRIESTE

RCA ITALIANA
Via Tiburtina, km. 12
ROMA—Tel. 416041

RECORDING CENTER
Via Ampere, 1
MILANO—Tel. 2366146

RIVEL RECORD
Via Risorgimento is.66 n. 23
MESSINA

SAAR
Via Gramsci, 20
PERO (Milano)—Tel. 3530564

SAID RECORD
Via C. Battisti, 67
PALMI (Reggio Calabria)—Tel. 209

SALAMONE
Via Frinco, 30
TORINO—Tel. 390763

SAX RECORDS
Via Pietro Borsieri, 41
MILANO—Tel. 6884423

SELESPETTACOLO
Via Rovello, 3
MILANO—Tel. 865747

SONIC
Via Gabriele Camozzi, 1
ROMA—Tel. 318519

STUDIO ARLECCHINO
Corso Vittorio Emanuele, 11
MILANO—Tel. 799690

STUDIO REGSON
Via Ludovico il Moro, 57
MILANO—Tel. 4224620

STUDIO 7
Corso Venezia, 7
MILANO—Tel. 700027

TECNIPHON
Sala Barozzi
Via Vivaldo, 7
MILANO—Tel. 794164

TITANUS
Via Sommacampagna, 28
ROMA—Tel. 471741

VIS RADIO
Via Cupa Caiafa, 36
NAPOLI—Tel. 386184

AUSTRALIA'S BEST SELLING ARTISTS—1967

Australian artists who reached our best-seller list throughout the year. (For the purposes of this list, only those Australian acts now resident in this country are shown. Talent such as the Bee Gees, the Seekers, the Easybeats, etc., will appear in the Great Britain section.)

ARTISTS	Manager/Agent	Record Company
The Cherokees	Carol West	Go!!Records
Buddy England		E.M.I.
The Groop	Peter McKennell	CBS
Bev Harrell	Ron Tremaine	E.M.I.
The Id		Spin
The Loved Ones	G.A.A. Artists Productions	W & G Records
The Masters Apprentices	Tony Dickstein	Astor
Lynn Randell	Carol West	CBS
Normie Rowe	Ivan Dayman	Sunshine
The Twilights	Garry Spry	E.M.I.
Johnny Young	Martin Clarke	Clarion

AUSTRALIAN AGENTS & MANAGERS

MARTIN CLARKE,
272 Hay Street,
East Perth,
Western Australia.

IVAN DAYMAN,
151 (a) Castlereagh Street,
Sydney,
New South Wales.

TONY DICKSTEIN,
14-22 Commercial Road,
c/- A.M.B.O.,
Melbourne,
Victoria.

G.A.A. ARTISTS PRODUCTIONS,
6 Ipydene Court,
Chadstone,
Victoria.

PETER MCKENNELL,
c/- A.M.B.O.
14-22 Commercial Road,
Melbourne,
Victoria.

GARRY SPRY,
c/- A.M.B.O.
14-22 Commercial Road,
Melbourne,
Victoria.

RON TREMAINE,
142 Second Ave.,
Royston Park,
South Australia.

CAROL WEST,
18 Glendearg Grove,
Malvern,
Victoria.

AUSTRALIA'S 10 BEST SELLERS OF 1967

AUSTRALIA'S ten best sellers of the year in sales popularity order, representing a break-down of our weekly list from January 1 to Dec. 1

1. This Is My Song (Petula Clark—Astor) Leeds Music
2. Georgy Girl (The Seekers—Columbia) Chappell & Co.
3. Snoopy versus the Red Baron (Royal Guardsmen—Festival)
4. San Francisco (Scott McKenzie—CBS) Associated Music
5. Up-Up And Away (Fifth Dimension—Liberty) Belinda Music
6. I'm A Believer (The Monkees—RCA) Tu-Con Music
7. Somethin' Stupid (Nancy & Frank Sinatra—Reprise) J. Albert & Son
8. The Last Waltz (Englebert Humperdinck—Decca) J. Albert & Son
9. A Whiter Shade of Pale (Procol Harum—Deram) Essex Music
10. Release Me (Englebert Humperdinck—Decca) D. Davis & Co.
11. Theme From The Monkees (E.P.) (The Monkees—RCA) Tu-Con Music
12. It Must Be Him (Vikki Carr—Liberty) J. Albert & Son
13. Green Grass Of Home (Tom Jones—Decca) Palace Music

INDEPENDENT AUSTRALIAN RECORD PRODUCERS

ALBERT PRODUCTIONS,
137-139 King Street,
Sydney, New South Wales.
Tel: 282141
Ted Albert, Tony Geary

KEVIN JACOBSEN ORGANISATION,
22 Alfred Street,
Milsons Point, New South Wales.
Kevin Jacobsen

SVEN LIBAEK,
290 Military Road,
Dover Heights, New South Wales.

CLARION RECORDS,
272 Hay Street,
East Perth, Western Australia.
Martin Clarke

IAN MELDRUM,
c/-2 Charnwood Court,
St. Kilda, Victoria.

REG GRUNDY ENTERPRISES,
83 Miller Street,
North Sydney, New South Wales.
Robert Iredale

SPIN RECORDS,
105 Walker Street,
North Sydney, New South Wales.
Tom Miller

GENERAL ARTISTS AUST PTY., LTD.,
321 Pitt Street,
Sydney, New South Wales.

SUNSHINE RECORDS,
151(a) Castlereagh Street,
Sydney, New South Wales.
Ivan Dayman

RECORDING STUDIOS IN AUSTRALIA

BILL ARMSTRONG PTY. LTD.,
100 Albert Road,
South Melbourne, Victoria.
Contact: Bill Armstrong

NATEC RECORDING STUDIOS,
29 Bigh Street,
Sydney, New South Wales.

E.M.I. (AUSTRALIA) LIMITED,
301 Castlereagh Street,
Sydney, New South Wales.
Contact: Cec Barlow

W & G RECORD PROCESSING CO.,
PTY., LTD.,
185-187 A'Beckett Street,
Melbourne, Victoria.
Contact: Ron Gillespie

FESTIVAL RECORDS, PTY., LTD.,
223-229 Harris Street,
Pyrmont, New South Wales

**THE INTERNATIONAL RECORD
MARKET GETS MORE EXTENSIVE
COVERAGE EACH WEEK IN CASH BOX
THAN IN ALL OTHER AMERICAN
MUSIC TRADES COMBINED.**

music is fashion phonogram makes the fashion of music



VIA BENADIR, 14 TEL. 2826241
20132 MILANO (ITALY)

SPAIN—1967 IN REVIEW

The general trend in the Spanish record industry has been toward the stabilization of sales. This is due to a general stabilization, if not deflation, in the Spanish economy. The boom of past years has been stopped by economic conditions, so we are at the same level as in 1966, which means, comparatively, a lower level. But artistically and on the business and technical levels, a lot has happened. Most Spanish companies now have completely up-to-date equipment and from the artistic point of view, a number of Spanish artists have done a considerable amount to improve our pop music scene. New talents, both in the composing and singing fields, have come up with fresh new ideas that have been well received.

Joan Manuel Serrat is a young Catalan boy, who sings his own songs in Catalan, a language spoken in the northeast region of Spain. Joan Manuel got an excellent reception from the Catalan-speaking people. During 1967 he had two big hits: "Ara que tinc vint anys" and "Canço de la

matinada," both included in one LP, which sold well in Cataluña.

The number one singer here, at least in sales, is Raphael. Twice a representative of Spain in the Eurovision song contest, he is a constant best seller and has had smash hits in South America and France as well as here. He doesn't compose, but has an almost exclusive repertoire penned by Manuel Alejandro, who writes mostly for him. Raphael's big hits in 1967 were "Hablemos del amor," "La canción del trabajo," "Cuando tú no estás," "Al ponerse el sol" y "Digan lo que digan," the last one on HMV Records, despite the fact that Hispavox, the label on which the other hits appear, made a legal claim against him for breaking a contract that the Labour Court has declared valid till February 1, 1969.

Luis Eduardo Aute is another creative singer-songwriter. He also composes for others. His biggest hit was "Aleluya No. 1."

Another composer who also sings is Manola Díaz. He is responsible for some of the hits of the well-known

Spanish group, Los Bravos. As a singer, Manolo earned a place in the charts with "Postguerra," "Bibi" and "Vino una ola." He has an LP on which Jean Bouchety provides orchestra backing. The set was produced by Alain Milhaud, also producer of Los Bravos. Manolo was Spanish representative in the Festival of Rio.

Massiel is currently the only local girl who is coming up with hits. Most of them are songs penned by Aute ("Rosas en el mar," "Aleluya").

Fonogram formed its own publishing firm in 1967. The firm also announced that its first cassettes (the Philips cartridge tapes) will be released here by December.

During the year, quite a few foreign labels changed their representatives. Liberty moved from EMI to Hispavox; Atlantic from Belter to Hispavox; Festival and CGD for Hispavox to Tempo (but Tempo went out of business shortly thereafter). Scepter is now handled by Vergara.

Three new diskeries were formed this year: CEM (in Madrid), Sayton

(in Barcelona) and Sintonia (in Madrid).

Spain is now a very important market in Europe. Despite the fact that the boom has stopped, records sell well and occasionally pass the 100,000 mark. Having in mind the number of record players working (no more than one million) this is not too bad.

In order to complete our yearly review, we shall detail the most important events of 1967 month by month.

JANUARY

Johnny Hallyday came to Spain for a performance. Joan Manuel Serrat performed four times in the Romea Theater (Barcelona). A lot of British hits came to the market (by such artists as Troggs, New Vaudeville Band, Manfred Mann, Who, Spencer Davis, Tom Jones, Dave Dee etc.). Sandie Shaw came to Madrid as did France's Mireille Mathieu.

FEBRUARY

Marc Aryan, Nino Ferrer and Sylva (Continued on Page 42)

MEXICO—1967 IN REVIEW

Sales on the record scene in Mexico during the past twelve months have been more or less the same results as in 1966. Mexican folk music (rancheras) hasn't increased very much but, nevertheless, new talents have been discovered—including names as such as Amalia Macías, José Martín, Octavio Lazareno, Las Adelitas, Jorge del Rosal, Gloria Aceves, Gerardo Reyes, Los Relámpagos, Hnas. Alegría and others, all of whom should register very good sells in 1968. In the tropical and bolero fields there are also new names, some of whom have had big hits this year, including Armando Manzanero, Los Vlamers, Mario y sus Diamantes, Trío Sensación, Chucho del Muro, Marco Antonio Vázquez, etc. . . . And in the new wave, Carlos Lico has been the Mexican revelation of the past year, with hits like "No", "Adoro", "Tengo" and others. There are also groups like Los Zorros, Los Shippys, Los Crazy Birds, Los "H", Los Zignos, etc., that have a lot of potential for 1968.

Among foreign artists, two have had their best year in México in 1967. These are the Monkees and Spanish singer Raphael, both of whom in their own categories, have become real idols. Other foreign artists with one or two hits are Los Vlamers and Mario y sus Diamantes, who also could do very well in the coming year.

Another interesting point is the fact that the Mexican bolero has been blended successfully with the ballad style, resulting in big hits like "No", "Celoso", "Adoro", "Esta tarde volveré" and others. In the writing field, México is again producing beautiful songs, led by Armando Manzanero and also by Luis Demetrio, Roberto Cantoral, Carlos Rigual, etc. Spanish composer Manuel Alejandro also collaborated in México's music success during 1967.

The American and English top hits have had a bigger acceptance than in past years, and artists like the Monkees, the Beatles, Eric Bourdon, Herman's Hermits, the Rolling Stones, the Outsiders, the Dave Clark Five and others, now have large followings.

We believe that in 1968, México will change its music policy somewhat, with a tendency toward internationalization, and its product will be welcomed in many foreign countries.

Among the Spanish groups, the most successful during this past year was Los Bravos, who reached the number two spot in the charts in England with "Black Is Black." Los Bravos are consistent sellers in Spain with English and Spanish tunes. They have had numerous hits, most notably, of late, "La moto" and "Los chicos con las chicas," from the film of the same name, which was also a hit. Los Bravos

are produced by Alain Milhaud.

Another group, very different from Los Bravos, is Los Pekenikes. Los Pekenikes created a new instrumental sound that gave them such hits as "Hilo de seda," "Frente a Palacio," "Lady Pepa," "Robin Hood," and most recently, "Embustero y bailarín." Some of their tunes (they are also composers) have been recorded by American and English artists, both in instrumental and vocal versions.

Juan & Junior used to belong to the Los Brincos group and have successfully begun their career as a duo. Also composers, they topped the charts with "La caza." Their other hits include "Nos falta fe" and "A dos niñas," produced in England by Mike Smith, the Tremeloes' producer.

Los Brincos, with their new members, record in England and are produced by Larry Page, but they have found success only in Spain with "El pasaporte," "Lola" and "Nadie te quiere ya," their most recent disks. Los Brincos write all their own material.

Other Spanish artists of note are Los Pasos, Peret (in the folk-pop field), Manolo Escobar (also folk), Bruno Lomas, Salomé, Los Salvajes, Los Sirex, Los Angeles and Los Mustang.

During the year the "Compañía Fonográfica Española Discos Barclay" (which has offices for production, management of artists and representation of Barclay records here) was formed.

JANUARY: Approximate total sales in México during 1967, with information given by recording companies during the first nine months (with an average of the last three months calculated by us):

78 rpm singles	430,506
45 rpm singles	3,908,004
45 rpm extended plays	5,047,583
33 rpm economy records	2,056,810
33 rpm standard records	3,034,233
33 rpm imported records	192,026

TOTAL: 14,669,162

Capitol records introduced Carlos Lico, singing the Armando Manzanero tune "No." Italian musical group I Musici arrived to perform on January 9 at the Palace of Fine Arts. Peerless released under the Palacio label the new instrumental La Chispita. Luis Bastón was named manager of product and artistic coordination of CBS records. Dr. Gil Beltrán, new president of RCA Spain, arrived in México. Chuck Anderson with his orchestra recorded a special album request by Columbia Records of New York. Actress Renata Seydel signed with Son Art records. Dusa released the soundtrack of "Dr. Zhivago." Eduardo L. Baptista, presi-

dent of Musart records flew to New York on a business trip. RCA bought a series of printing machines to do the covers for their recordings. Mario Friedberg, vice president of Tizoc records, returned from the United States. Gamma records offered a private exhibition of the Spanish musical, "Cuando tú no estás."

FEBRUARY: On February 2, Sarah Vaughn arrived in México City for a series of performances. Trío Los Panchos was performing in Buenos Aires. Hans Schrade named Salvador Arreguin as new A&R international rep of Dusa records. Louis Couttolenc Jr., president of RCA, and Guillermo Infantes, general sales manager of the same company, left on a business trip to Puerto Rico, Jamaica, Santo Domingo, Venezuela and Panama. Marco Antonio's LP "El Despertar" on RCA Muñiz, went over 100,000 copies. Original sound track of "A Man and A Woman" was released by Gamma. Andre Midani, general manager of Capitol records flew to Los Angeles on a business trip. Sir Joseph Lockwood, Chairman of the Board of EMI of England announced a planned visit to México on March. Mexican rock and roll group Los Moonlights are appearing in Central and South American countries.

MARCH: Errol Garner did two concerts at the Palace of Fine Arts, on March 7 and 8. Orfeon Records released a new group by the name of Los Grecos. Sergio Mendes LP was cut by Tizoc Records. On the tenth anniversary of his death, Mexican idol Pedro Infante has more than 25 records that have each sold more than 100,000 copies. Peerless Records announced that they have released 40 LPs by Infante. Nick Venet (Capitol A&R in the U.S.) finished a session of three recordings with the Mexican rock and roll group Los Yaki, singing in English. For his magnificent promotion of Mexican music in foreign countries during 1966, the Mexican Union of Theater and Music Speakers gave a diploma to Goddard Lieberson, president of CBS/Columbia Records. Los Tres con Ella, Las Hnas. Navarro and Lolita were signed by Musart Records. Eduardo L. Baptista was named president of the new board of directors of AMPRODIS (Mexican Association of Record Producers). CBS Records united all its enterprises (record production, record club, publishing and covers production), with Manuel Villareal as president. Jack Brown, president of Rainbo Records, was in México for business meetings with Mario Friedberg of Tizoc. On March 21 Sir Joseph Lockwood, Chairman of the Board of EMI (Elec-

trical and Musical Industries), came to México City and at the next day gave a press conference. With him were Mr. Lloyd Dunn, international vice president of Capitol Records and William Cavendish, personal secretary to Mr. Lockwood.

APRIL: Juan Calderón resigned as advertising and promotion manager of RCA Victor. Jorge Audiffred, sales manager and chief of promotion of Orfeon Records also resigned. Dusa Records accepted the resignation of Hugo Menniovich, sales manager of the company. Spanish idol Raphael signed to perform in México in May. José Feliciano arrived in México for a series of performances. La Rondalla Tapatia and Marco Antonio Muñiz recorded their first duet album at RCA. CBS released the "Festival of the Son of Israel." Italian singer Gianni Ales signed a contract with RLV label. Two new TV channels, 8 and 13 began operating in México City. Bolivian folk singer Zulma Yugar arrived in México. Capitol Records signed Brazilian group Bossa Tres. Orfeon Videovox moved factory and offices to México. Enrique Guzmán left CBS to go independent with his own label "Acuario." His first recordings were done by himself and his wife, actress Silvia Pinal. From Puerto Rico, Chucho Avellanet came to perform in México City.

MAY: With the assistance of Goddard Lieberson and Harvey Schein, president and vice president of Columbia Records, CBS Records celebrates the XX anniversary of its Mexican setup with a party attended by Manuel Villareal, vice president and general director of CBS Records, and Armando de Llano, Raúl Bejarano and Luis Bastón, executives of this company. Spanish idol Raphael made his debut on May 5 at the El Patié night club with the most tremendous success ever seen. Dick Jones of U.S. Capitol Records, arrived in México for a special recording session with the National Symphonic Orchestra. Armando Manzanero released on RCA, his own new composition, "Adoro." Carlos Lico followed him with the same song on Capitol Records. In México for a series of jazz performances were Dave Brubeck, Thelonious Monk and Dizzy Gillespie. Aurelio Benessini became the new sales manager of Tizoc Records. Francisco J. Quintal was named assistant manager of Fermata and Meximusic publishing. RCA began selling new stereo LPs at the price of 2.35 Dls. Brubeck, Monk and Gillespie were recorded by CBS at a jam session, accompanied by some Mexican musicians. Los Her-

(Continued on Page Q-1042)



**FOR
SUMMIT
OF
SPAIN**

LOS BRINCOOS



massiel



GUAN & JUNIOR



**EXCLUSIVE ARTISTS
OF**



CAMPOMANES 10
MADRID 13/SPAIN

SPAIN—1967 IN REVIEW

(Continued from page 40, Part II)
vie Vartan were among the February visitors to Spain. This was the month of the "Strangers In The Night" boom, and the month when "Reach Out (I'll Be There)" started to make noise. The Pop Groups contest was held in February, and Leon and Raphael were named to sing the Spanish song in the Eurovision Song Contest.

MARCH

The first disks by L. E. Aute and Angeles were released. Both were hits. "Winchester Cathedral" reached No. 1 on the charts. Visitors included Antoine and Little Tony. Only one song from the San Remo Festival reached the charts: "Cuore matto," by Little Tony. "Something Stupid" started to break out.

APRIL

Juan & Junior did it. Their song "La caza" became the first local copyright in the charts along with Eurovision's Spanish entry, "Hablemos del amor." The new Groups con-

test was held in Barcelona in the bull ring of Las Arenas. Sacha Distel, Rita Pavone, Los Surfs and Ray Charles visited Spain.

MAY

The Shadows and Palito Ortega met with considerable success in May. A song festival was held in Palma de Mallorca and won by Giorgio Gaber with "Maoorca, non ti dimentichero." Sammy Davis Jr. gave an excellent performance during his visit here. "Happy Together" and "Aleluya" hit big. The Pop Groups festival was held in Madrid.

JUNE

Los Brincos were given a big promotion in England. Their song, "El pasaporte," hit here, but nothing happened with it in England. Manolo Diaz waxed his first record as a singer. Los Angeles made the charts with their Spanish cover of "98.6." The Procol Harum's "Whiter Shade Of Pale" began to hit.

JULY

Sandie Shaw made her second visit

here while her "Puppet On A String" single was still in the limelight. The Benidorm Song Festival took place. First prize went to "Entre los dos," composed by Alfredo Domenech and by Tony Dallara and Betina. The Monkees' records began to become popular all over Spain in the discotheques. Numerous tourists visited Spain and bought folk records by the thousand.

AUGUST

Oliver Despax paid us a visit. Los Brincos' "Lola" was a hit. The Menorca Song Festival took place. First prize went to "Vuelvo a menorca," sung by Yolanda and Los Iberos song was penned by J. Gracia and L. Villanova.

SEPTEMBER

British chanter Tom Jones visited Spain this month. Joel Manuel Serrat won the Catalan Record prize. The Festival of Mediterranean Song was held in Barcelona. The winning song was "La chanson du bonheur," composed by Guy Mardel and sung by Guy Mardel and Nancy Holloway.

Second place winner was "Com el vent," sung by Salomé and Dova. Third place winner (and the only one that reached the charts) was "Mulino a vento," sung by Little Tony.

OCTOBER

"San Francisco" hit all over the country, as did the Beatles' "All You Need Is Love." Massiel presented her new song "La moza de los ojos tristes," and Los Bravos had their first film success with "Los chicos con las chicas."

NOVEMBER

This was the month of "Aranjuez mon Amour," based upon the famed Spanish piece, "Concierto de Aranjuez," and sung by Richard Anthony. Much discussion was devoted to the legal problems of Raphael and Hispavox, caused by Raphael's recording a disk on another label, HMV.

DECEMBER

Manolo Diaz made his first LP. The Christmas season caused a big boom in disk sales.

MEXICO—1967 IN REVIEW

(Continued from page 40, Part II)
manos Castro returned from their performances at the Caesar's Palace in Las Vegas.

JUNE: Orfeon Records began distributing the French label Barclay in Mexico. Musart Records signed a contract with Cuban singer Rolando La-Serie, who immediately began recording for that label. Mexico will participate in the spectacular TV show "Our World" with the appearances of folk singers Tony Aguilar and Flor Silvestre. Philips Records released the debut album of Raphael, before he signed with Hispavox. Orfeon Records announced that its international department is organized already and will be handled by Guillermo Macedo with the foreign labels Roulette, Barclay, King, Metronome, Copacabana, Music Hall, Artone Gramophone, Polar Music, Budget Sound Alshire and Westminster. Leo Porias, general manager of Peerless Records, left town for New York, Germany and Switzerland, to meet with people of Telefunken and London. Marco Antonio Muñoz and Ballet Folklórico de Mexico registered as the best sellers of RCA. Carlos Alonso García became new international A&R rep of CBS. Isela Vega signed with Peerless. CBS signed a contract with conductor Gamboa Ceballos. Jimmie Nicol, the 5th Beatle, who has settled in Mexico for a short time, left for Los Angeles with arranger Eddy Quinn to introduce a new series of recordings made by them in Mexico. "Monkees Headquarters" was released by RCA in Mexico.

JULY: All the record companies of Mexico held up production until they could get an agreement with union musicians as to the revision of a collective contract. Alejandro Siegrist, who used to be general director of Orfeon-Videovox, resigned from this company. His place has been taken by James J. Dupuis Jr. Capitol Records released "All You Need Is Love." American singer Vic Dana arrived in Mexico to do night club and TV shows. Manuel Villareal, Armando de Llano and Luis Bastón, executives of CBS Records, flew to Hollywood to take part in the annual CBS-Columbia convention. On July 8 Enrique Guzmán and Silvia Pinal married. Sergio Núñez Falcón resigned as public relations manager of Capitol Records. Enrique Levendinger, owner of Fermata publishing and record label of Brazil, arrived in Mexico to talk business with Mario Freidberg. Guillermo Buerckle was named general sales manager of Orfeon Records. On July 27 the Union of Musicians and record manufacturers reached an agreement to start to work again immediately.

Armando Manzanero cut his first album at RCA.

AUGUST: Stanley West, repertoire manager of the international RCA subsidiaries, was in Mexico for two weeks. Eduardo L. Baptista, president and owner of Discos Musart, S.A., announced the release of a new label, "REX," which will operate completely independently. Estuardo Soto was named general manager of this company. Rogerio Azcárraga, president and owner of Orfeon Records, divided his A&R department into: the a-go-go section (handled by Porfirio Reyna), the standard catalogue (by Paco de la Barrera) and the international section (directed by Guillermo Macedo). Capitol Records released a spectacular album by the name of "Música y Voz de la Patria-Himno Nacional" with a recording of the Mexican national anthem and other traditional Mexican marches and songs. Spanish composer Manuel Alejandro was in Mexico to compose the music for a new picture. Capitol Records hosted a cocktail party to introduce Mexican Priest Ramón Cue, whose LP "The Broken Christ," was probably the best seller in Mexico during 1967. Peerless Records started auto stereo cartridge production. After four months of studying in the U.S. Tomás Muñoz, general director of Gamma Records, returned to Mexico.

SEPTEMBER: Dusa Records changed address to Insurgentes Sur 1877. United Artists sold more than 50,000 copies of the first album sung by Spanish singer Raphael. Folk singer Jose Alfredo Jiménez made his debut in Mexico City at a night club. Torrebruno at the same time was working at the Tampico Club. CBS released the album made in Mexico by Dave Brubeck and his quartet, accompanied by two Mexican musicians: "Chamin" Correa and "Rabito" Agueros. The name of the album is "Bravo; Brubeck." RCA released a spectacular album called "Instrumentals for Teenagers" with Los Sonidos FM using only Mexican compositions (some of them used in the picture "Los Adolescentes"). Louis Couttolenc Jr., Guillermo Infante and Rubén Fuentes from RCA, Eduardo L. Baptista from Musart, Manuel Villareal from CBS, Heinz Klinekwort from Peerless, Hans Schrade from Dusa, Andre Midani from Capitol and Mario Freideberg from Tizoc, will attend the Latin American Convention of Record Producers in Caracas, Venezuela. Disco Club CBS made a deal to handle the international catalogues of Dusa, Peerless and Capitol Records, to complement the direct sales by each of these companies. Fritz Hentschel took charge of Disco Club CBS. César Costa signed a new ex-

SPAIN'S ARTISTS WHO HIT THE CHARTS IN '67

Juan & Junior	(Novola Records)	(Titles: "La caza", "Nada", "Nos flata fe", "Bajo el sol", "A dos niñas").
Raphael	(Hispavox Records)	(Titles: "Hablemos del amor", "Cuando tu no estás", "Al ponerse el sol").
Raphael Brincos	(HMV Records) (Novola Records)	(Title: "Digan lo que digan"). (Titles: "El pasaporte", "Lola", "Nadie te quiere ya").
Bravos	(Columbia Records)	(Titles: "La ñoto", "Los chicos con las chicas", "Uno come noi", "El loco soy yo", "Black Is Black").
Los Pekenikes	(Hispavox Records)	(Titles: "Hilo de seda", "Lady Pepa", "Frente a Palacio", "Robin Hood", "Embustero y bailarín").
Bruno Lomas	(HMV Records)	(Title: "Como ayer").
Los Salvajes	(HMV Records)	(Titles: "Todo negro", "Mi bigote").
Peret	(Discophon Records)	(Title: "Belén Belén").
Manolo Escobar	(Belter Records)	(Titles: "Un beso en el puerto", "Madrecita Maria del Carmen").
Los Pasos	(Hispavox Records)	(Title: "Ojo por ojo").
Karina	(Hispavox Records)	(Title: "El libro de magia").
Joan Manuel Serrat	(Edigsa Records)	(Titles: "Cañço de la matinada", "Ara que tinc vingt anys").
Salome	(Belter Records)	(Title: "Com el vent").
Los Sirex	(Vergara Records)	(Title: "Brindis", "Eva").
Manolo Diaz	(Sonoplay Records)	(Title: "Bibi").
Luis Eduardo Aute	(RCA Victor Records)	(Titles: "Aleluya No. 1", "Mi tierra, mi gente").
Massiel	(Novola Records)	(Titles: "Rosas en el mar", "Aleluya", "La moza de los ojos tristes").
Los Angeles	(Hispavox Records)	(Titles: "98.6", "Dentro y fuera", "Soldados de papel").

SPAIN'S INDEPENDENT RECORD PRODUCERS

Aloin Milhoud
Augusto Figueroa 39
Madrid

Melo'ix S.A.
Pedro Muguruza No. 8
Madrid

SPAIN'S RECORD STUDIOS

Fonogram
Av. América s/n
Madrid

Estudis Cimo
Vollhermoso 14
Madrid

Hispovox
Torreloguano 102
Madrid

Estudios Celodo
Av. América 22
Madrid

Compañía del Gramófono Odeón
Urgel 234
Barcelona

Belter
Gomis 1
Barcelona

Columbia
Libertad 24
Madrid

Mexico—1967 In Review

clusive contract with the American and Mexican Capitol Records companies.

OCTOBER: Musart Records got the distribution in Mexico of Velvet Records of Venezuela. Dusa Records hosted a cocktail party for the press to introduce two new budget classical labels. Those labels are Heliodor and Fontana. First recording of César Costa at Capitol: "Ciao amiccì." Spanish singer Raphael went independent although he still has a contract signed by the Hispavox label of Spain. Monkee Micky Dolenz arrived in

Mexico just to see the Grand Prix. Micky declared that the group may perform in Mexico in the summer of the next year. Female singer Grace Markay from U.S. was here. CBS held a cocktail party for Los Panchos who left town to perform in the Orient. Dusa Records announced the release of another label in Mexico under the name of "Canguro," with both on LP and EP.

NOVEMBER: Los Hermanos Carrión signed a new contract with Orfeon Records for \$4,000. Ray Anthony recorded an album in the
(Continued on page 45, Part II)



THE BEST OF SPAIN IS ON HISPAVOX RECORDS



KARINA



NURIA FELIU

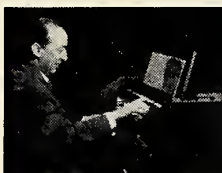

MIGUEL RAMOS



PEDRO ITURRALDE



LOS PEKENIKES



LOS PASOS



MARIA OSTIZ



GENOVEVA GALVEZ



RAPHAEL



ALICIA DE LARROCHA



PIC-NIC

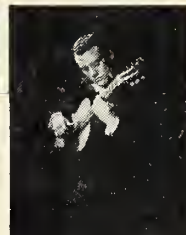

ERNESTO BITTETI



PEDRO LAVIRGEN



ALBERTO CORTEZ



MANUEL ALEJANDRO



SARITA MONTIEL



LOS ANGELES



LUCERO TENA



WALDO DE LOS RIOS

BEST SELLER ARTISTS

INTERNATIONAL PRESTIGE CATALOGUE
SPANISH SYMPHONIC MUSIC
FOLK MUSIC
THE ANTHOLOGY OF SPANISH FOLKLORE
BAND MUSIC OF THE BULLRING
ZARZUELAS
THE POP HITS OF SPAIN

HISPAVOX S.A.
 TORRELAGUNA, 102
 MADRID (17)/SPAIN
 U.S.A. REPRESENTATIVE
 COMPASS MUSIC CORP.
 250 WEST 57TH STREET
 CI 5 5390
 NEW YORK, NY 10019

PAUL BEUSCHER

*The Most Renowned Company
for the
International Music Business*

PAUL BEUSCHER — ARPEGE

Instzuments & Publishers

25-27-29 BOULEVARD BEAUMARCHAIS

PARIS

FRANCE

FRANCE —

1967 IN REVIEW

JANUARY

Decca names a new A & R man in France. He is Raymond Legrand, an excellent French composer. Through the label, Legrand begins to produce French artists. The first is Colette Renard who leaves Vogue to join husband Legrand's firm. Christian Fechner, Vogue A & R man is launching a new singer named Sullivan who will become a well known artist with his first composition, "Les Palais de l'Orient." At the beginning of the month, Jacques Dutronc is at the head of the chart with his greatest hit, "Les Playboys," Mireille Mathieu taking the first place just after with "Paris En Colère" which is the main theme of the motion picture, "Is Paris Burning?" ORTF jury chooses the song which will represent France at the Eurovision Song Contest in Vienna in April. Title is "Il Doit Faire Beau Là Bas." Lyrics are by Pierre Delanoé and music by Hubert Giraud (SEMI publishing). It will be sung at the contest by Barclay artist Noëlle Cordier. Eddy Adamis, who manages the publishing department of United Artists here, produces for the first time a

French original record through that label. His artists are twin French girls named "Les Chéries." Philips artist Juliette Greco is spending the entire month in the USSR for an extensive tour. Charles Aznavour is singing in the States, Pete Seeger makes a stage appearance in Paris.

FEBRUARY

The month begins in Cannes where MIDEM is set. All the participators are enthusiastic and Bernard Chevry is able to say at the end, "See You At MIDEM In '68." Adamo's "Inch Allah" reaches first place on the French chart. For the first time one of his songs ("Je Vous Offre") is not published by Pathé Marconi. Adamo gives it to Françoise Pourcel, Frank Pourcel's daughter, to be the first copy-right of her new publishing firm, France-Etoile. Chappell creates its own producing department. First production is an EP by new vocal group, Les Hamsters. The EP will be distributed in France, Belgium, Holland and Germany by CBS records. CBS welcomes to its French family inter-

(Continued on page 50, Part II)

ARTISTS WHO HIT FRENCH CHARTS IN 1967

NAME	TITLE	LABEL	PUBLISHER	NATIONALITY
Adamo	En Bandoulière	EMI	Pathé Marconi	Belgian
Adamo	Inch Allah	EMI	Pathé Marconi	Belgian
Adamo	Notre Roman	EMI	Pathé Marconi	Belgian
Adamo	Le Néon	EMI	Pathé Marconi	Belgian
Richard Anthony	Fille Sauvage	EMI	Essex	French
Richard Anthony	Aranjuez Mon Amour	EMI	Unpublished	French
Hugues Auffray	Blanche Caravelle	Barclay	La Compagnie	French
Hugues Auffray	C'Est Tout Bon	Barclay	La Compagnie	French
Alain Barrière	Va	Barclay	Bretagne	French
The Beatles	Penny Lane	Odeon	Northern-Tournier	G.B.
The Beatles	All You Need Is Love	Odeon	Northern-Tournier	G.B.
The Box Tops	The Letter	Stateside	Vogue International	USA
Petula Clark	C'Est Ma Chanson	Vogue	SIM	French
Petula Clark	La Dernière Danse	Vogue	Francis Day	French
Les Compagnons de la Chanson	La Chanson de Lara	CBS	France Mélodie	French
Dalida	Les Grilles de ma Maison	Barclay	Rideau Rouge	French
Pascal Danel	Les Neiges du Kilimandjaro	AZ	Rideau Rouge	French
Joe Dassin	Les Daltons	CBS	Musique 18	French
Sacha Distel	L'Incendie à Rio	EMI	Prosadis	French
Sacha Distel	Ces Mots Stupides	EMI	Chappell	French
Jacques Dutronc	Les Playboys	Vogue	Alfa	French
Jacques Dutronc	Les Cactus	Vogue	Alfa	French
Jacques Dutronc	J'Aime Les Filles	Vogue	Alfa	French
Jacques Dutronc	Le Plus Difficile	Vogue	Alfa	French
Nino Ferrer	Le Téléphone	Riviera	Beuscher	French
Nino Ferrer	Mon Copain Bismark	Riviera	Beuscher	French
Claude François	J'Attendrai	Philips	Pigalle	French
Claude François	Winchester Cathedral	Philips	SEMI	French
Claude François	Car tout le monde a besoin d'Amour	Philips	Pigalle	French
Claude François	Mais Quand Le Matin	Philips	Tournier	French
Michel Fugain	Je N'Aurais Pas Le Temps	Festival	Comtesse	French
Johnny Hallyday	Si J'étais Charpentier	Philips	France Mélodie	French
Johnny Hallyday	Hey Joe	Philips	Tulsa	French
Johnny Hallyday	Amour d'Été	Philips	Pigalle	French
Johnny Hallyday	Les Chevaliers du Ciel	Philips	Tutti	French
Johnny Hallyday	San Francisco	Philips	Tournier	French
Françoise Hardy	Voilà	Vogue	Alpha	French
Herman's Hermits	No Milk Today	EMI	Harmonia-Plante	G.B.
Laurent	Ma Reine de Sabbat	AZ	Tutti	French
Scott McKenzie	San Francisco	CBS	Francis Day	USA
Enrico Macias	J'AI Peur	EMI	Cirta	French
Enrico Macias	Les Millionnaires du Dimanche	EMI	Cirta	French
Enrico Macias	Puisque l'Amour Commande	EMI	Cirta	French
Mireille Mathieu	Viens Dans Ma Rue	Barclay	Ventura	French
Mireille Mathieu	Paris En Colère	Barclay	Salabert	French
Mireille Mathieu	Adieu A La Nuit	Barclay	Salabert	French
Mireille Mathieu	Pour Un Coeur Sans Amour	Barclay	Salabert	French
Mireille Mathieu	Ce Soir Ils Vont S'Aimer	Barclay	Beuscher	French
Eddy Mitchell	Bye Bye Precheur	Barclay	Barclay	French
Eddy Mitchell	Alice	Barclay	SEMI-Barclay	French
Mana Mouskouri	C'est Bon La Vie	Fontana	April Music	Greek
Michel Polnareff	Sous Quelle Etoile suis je né	AZ	SEMI	French
Michel Polnareff	Ta Ta Ta Ta	AZ	SEMI	French
Michel Polnareff	Le Roi Des Fourmis	AZ	SEMI	French
Michel Polnareff	Ame Caline	AZ	SEMI	French
Procol Harum	A Whiter Shade of Pale	Deram	Essex	G.B.
Anthony Quinn	I Love You, You Love Me	EMI	Chappell	USA
Sandie Shaw	Puppet On A String	Vogue	Tutti	G.B.
Sheila	L'Heure de la Sortie	Philips	Carrère	French
Sheila	La Famille	Philips	Carrère	French
Sheila	Adios Amor	Philips	Carrère	French
Sheila	Le Kilt	Philips	Carrère	French
Frank Sinatra	The World We Knew	Reprise	Barclay	USA
Nancy Sinatra	Jackson	Reprise		USA
Sonny and Cher	The Beat Goes On	ATCO		USA
The Sunlights	Ne Joue Par Au Soldat	AZ		G.B.
Anne Vanderlove	Ballade en Novembre	EMI	Eco Music	French
Sylvie Vartan	2' 35 de bonheur	RCA		French
John William	La Chanson de Lara	Polydor	France Mélodie	French

news NEWS news

FRANCE

Sandie Shaw

RCA VICTOR

distributed in France
by A.R.E.A.

FRANCE'S ARTIST AGENTS

ARNOLD 8, boulevard BONNE NEUVILLE AUDIFFRED (Yves Gardon, Georges Leraux) 48, rue de PONTHEU BEHARS (Behors Freres) 72, CHAMPS ELYSEES PELLISARIO (Roy) 33, boulevard du TEMPLE BERTIN ROLAND (Pierre Andrieu, Paul Dubos) 29, CHAMPS ELYSEES BIZOS (Louis Borrier, Eddy Morouani, Maurice Morouani, Vic Tolord) 11, rue CHATEAUBRIAND BLONDEAU (Gayna) 15, rue de TREVISE ERDAN (André Rivo, Renée Pierre, Jean Paris) 116 bis, CHAMPS ELYSEES GUERIN (Georges Botgen, Mormal) 78, CHAMPS ELYSEES SERVIEU (Roger Bernheim, Régis, Carmen Bojot, Barret, Chamolet) 33, CHAMPS ELYSEES MASI (Azoulay) 24, rue CAUMARTIN MODEL (Lilette Volant, Brawn) 11, rue des SABLONS PARIS AGENCY (Jacques Daubigny) 7, rue des FEUILLANTES PARIS 5ème. ROTEMBOURG (Jean-Louis Morquet, Roland Ribet) André Poussel, 11 rue d'ARTOIS Bernard Hilda, 33, CHAMPS ELYSEES SCRIBE-BOURBON (Jean Bourbon, Alsan Pere, Lucien Manz, Aloin Hubert, Lednermonn, Boillon) 28, rue GRANGE-BATELIERE STOLL (Renée Dorsay, Chamolet, F. Peron) 44, rue de l'ECHUIQUIER	PRO.36.35 BAL.58.80 ELY.17.74-BAL.34.40 TUR.11.96 BAL.75.50 BAL.20.23 PRO.39.40 BAL.30.26-BAL.31.47 BAL.47.85 OPE.20.25 PAS.17.40-POI.28.15 326.95.71 BAL.81.17 ELY.02.00 PRO.44.01 PRO.41.88-PRO.32.28	TAVEL (F. Marouani, Ch. Marouani, J. Milhoud, J. Marouani, Mme. R. Richard, Mme. Manette Josem) 35, rue MARBEUF TOLOMEI (Mlle. Tolamei et Jone Richard) 252, faubourg SAINT-HONORE TRIVES (Raland Lux) 78, CHAMPS ELYSEES VALERY (Louise Fauquet, Mauloudji, Evelyne Vidal) 368, rue SAINT HONORE VIGIER 78, CHAMPS ELYSEES ZHAM (Mme. Forster, François Lono, Arlette Merchez) 29, rue TRONCHET SALTANO MAURICE 42 bis, rue AMPERE, GRENOBLE (ISERE) LILLE ROMBEAU EDOUARD, Agence artistique 12, 14, rue FAIDHERBE, LILLE (NORD) LYON OFFICE ARTISTIQUE DU SUD-EST (GERMAIN GANDREL, STEPHANE BONNARD) 19, rue NOTRE DAME LYON 6ème (RHONE) MARSEILLE ORGANISATION THEATRALE INTERNATIONALE (ROBERT TREBOR) 58, cours BELSUNCE MARSEILLE 1er (BOUCHES-DU-RHONE) PRODUCTION THEATRALE MICOL 31, rue d'AUBAGNE MARSEILLE 1er (BOUCHES-LU-RHONE) STRASBOURG KICHLER 13, rue du GENERAL RAPP STRASBOURG (BAS-RHIN)	BAL.65.90 CAR.90.35 BAL.53.86 ANJ.89.11 BAL.49.30-BAL.50.31 ANJ.07.45 44.52.88 55.63.15 51.11.52-48.32.94 20.00.95-20.12.11 20.24.90 35.46.00
---	--	--	--

RECORDING STUDIOS IN PARIS

ACOUSTI STUDIOS: 54, rue de SEINE, PARIS 6ème	MED.53.30	LOUIST GASTE: 5 rue du BOIS DE BOULOGNE, PARIS 16e.	FOY.53.53
A.I.R. PRODUCTION: 134, boulevard HAUSSMANN	CAR.64.53	MARIGNAN STUDIOS: 15, rue FOREST, PARIS 18ème.	LAB.58.32
APSOME STUDIOS: 80, rue CARDINET, PARIS 17ème	WAG.89.21	PATHE MARCONI: 62, rue de SEVRES, BOULOGNE.	VAL.01.66
MARCLAY HOICHE ENREGISTRE- MENT: 9, avenue HOICHE, PARIS 5ème.	WAG.81.30	PHILIPS: 94, boulevard BLANQUI, PARIS.	KLE.07.89
CENTRE D'ENREGISTREMENT DES CHAMPS ELYSEES: 15, avenue MONTAIGNE, PARIS 5ème.	BAL.01.37	POLYDOR: 44, rue des DAMES, PARIS 17ème.	LAB.55.90
COTY ET CO.: 177, avenue de NEUILLY, NEU- ILLY-sur-SEINE.	MAI.04.74, MAI.37.75	PROGRAMMES DE FRANCE: 22, rue BAYARD, PARIS 5ème.	ELY.20.31
DAVOUT STUDIOS: 73, boulevard d'AVOUT, PARIS	PYR.53.39	PUBLI-ONDES: 28, boulevard HAUSSMANN, PARIS 9ème.	PRO.78.03
D.M.S. (diffusion magnetique sonore): 15, rue SAUSSIER-LEROY, PARIS 17ème.	WAG.91.00, WAG.40.55, WAG.77.32	PUBLI-SONOR: 1 et 3, rue du DEPART, PARIS 14ème.	DAN.28.20
EUROPA SONOR: 15, rue CHARCOT, PARIS 13ème.	JUS.33.83	S.G.P.: 28, boulevard HAUSSMANN, PARIS 9ème.	PRO.78-03
GANDIA FILMS: 4, Avenue ESTIENNE d'ORVES, NICE (ALPES MARITIMES).	88.27.86	SOCIETE INDUSTRIELLE DE SONORISATION (S.I.S.): 22, avenue de la PORTE DE CHAM- PERRET, PARIS 17ème.	GAL.96.11
GENEIX RENE: 6, rue JOUVENET, PARIS 6ème.	AUT.08.52	STUDIO ENREGISTREMENT DE MONTMARTE: 19, rue BURQ, PARIS 18ème.	CLI.27.75, ORN.09.44
JOUVE STUDIO: 99, avenue du GENERAL MICHEL BIZOT, PARIS 12ème.	DOR.60.39	TECHNISONOR: 12, rue MAGELLAN, PARIS 5ème.	BAL.96.60
INTERSONOR: 55, rue de la CROIX NIVERT, PARIS 15ème.	SUF.57.31	VONIGRAVE: 6, rue de LISBONNE, PARIS 5ème.	LAB.66.84

FRENCH ARTISTS WHO HIT FRANCE'S CHARTS

ARTIST	MANAGER/AGENT OR RECORD COMPANY
Salvatore Adamo	Charley Maruani
Richard Anthony	Charley Maruani
Hugues Aufray	Barclay
Alain Barrière	Barclay
Petula Clark	Claude Wolf
Les Compagnons de la Chanson	CBS
Dalida	Tavel et Marouani
Pascal Danel	AZ
Joe Dassin	CBS
Sacha Distel	Maurice Tézé
Jacques Dutronc	Wolfson
Nino Ferrer	Riviera
Claude François	Paul Lederman
Michel Fugain	Festival
Johnny Hallyday	Jean Pons
Françoise Hardy	Wolfson
Laurent	AZ
Enrico Macias	Vic Talar
Mireille Mathieu	Johnny Stark
Eddy Mitchell	Barclay
Nana Mouskouri	Roland Ribet
Michel Polnareff	Paul Lederman
Sheila	Claude Carrère
Anne Vanderlove	Eddy Marouani
Sylvie Vartan	Charley Maruani
John William	Polydor

Mexico—1967 In Review

(Continued from page 42, Part II)
studios of Discos Capitol de Mexico, S.A. including in his repertoire several compositions by Armando Manzanero. Enrique Noriega is the new sales manager of Dusa Records. Jose Manuel Vidal Zapater, president of Gamma-Hispavox labels, arrived in Mexico. Roulette-Tico Records has started to work in Mexico under the name of Discos Tico, S.A., having as general manager Jese Ades, as sales manager Luis Fernández García and as assistant sales and promotion manager Antonio de la Serna. Discos Rex, the new label that came to life a few months ago, already has in catalogue 80 LPs. Gamma Records sent a circu-

lar announcing that Tomás Muñoz leaves the company on January 1st to join the Spanish label Hispavox. His place will be taken by Carlos J. Camacho. From the same company we were informed that Fidel Barquet will be sales chief and that Luis Moyano will remain as production manager. Orfeon Records announced Mariano Rivera Conde as new general manager of the record division and Mariano H. Villalobos as general manager of Orfeon-Videovox. Capitol Records released the second album by Mexican revelation 1967 Carlos Lico. At the same time Musart cut the ninth album of Alberto Vázquez. Capitol released the new Beatles single, "Hello, Goodbye" and "I Am The Walrus."

ET MAINTENANT

GILBERT BECAUD — PIERRE DELANOË

(WHAT NOW MY LOVE)

SEUL SUL SON ETOILE

GILBERT BÉCAUD — MAURICE VIDALIN

(IT MUST BE HIM)

KILIMANDJARO

PASCAL DANIEL — MICHEL DELANCRAY

LE GRAND MEAULNES

ORIGINAL SOUND TRACK ON PHILIPS RECORDS

SONG BY RICHARD ANTHONY -E.M.I.-

(JEAN-PIERRE BOURTAYRE — LOUIS AMADE)

are original copyrights:



LES EDITIONS RIDEAU ROUGE

24, rue de Longchamp—Paris 16ème

DERAM

THE DAYS OF FUTURE PASSED

THE
MOODY
BLUES

recorded in
the wonderful

DERAMIC SOUND SYSTEM

WATCH OUT
IT'S TOUGH

distributed in France by SOFRASON

KURT FELTZ

MUSIK PRODUKTION

Xmas Greetings

PETER ALEXANDER-AUSTRIA

(The Last Waltz) (Talking Love)

SACHA DISTEL-FRANCE

(Irene von Avignon)

GITTE-DENMARK

(Problems)

MARTIN LAUER-GERMANY

(Rosen ohne Dornen)

RENE CAROL-PETER RUBIN
WILLY SCHNEIDER-GERMANY

Cologne, Germany

Drusus Gasse 7-11

GERMANY-RECORDS TO HIT TOP 3 ON GERMAN CHARTS DURING 1967

- *Eine handvoll Reis (A Hand Full of Rice)—Freddy Quinn—Polydor—Edition Esplanade
- Bend It—Dave Dee, Dozy, Beaky, Mick & Tich—Star Club—Minerva Music/R. von der Dovenmuehle
- Little Man—Sonny & Cher—Atlantic—Edition Intro/Meisel
- *Moderne Romanzen (Modern Romances)—Peter Alexander—Ariola—Hans Gerig Music
- *Good Night My Love—Roy Black—Polydor—August Seith Music
- Dear Mrs. Applebee—David Garrick—Pye—Rolf Budde Music
- *Frech gekuesst ist halb gewonnen—Siw Malmkvist—Metronome—Minerva Music/R. von der Dovenmuehle
- *Frag nur Dein Herz (Ask Your Heart Only)—Roy Black—Polydor—Hans Gerig Music
- *Das Glueck ist Rosarot (Luck Is Red Like Roses)—Cliff Richard—Columbia—Edition Accord
- I'm A Believer—The Monkees—RCA Victor—Hans Gerig Music
- *Es ist so schoen, dass es Dich gibt (It's Wonderful that You Exist)—Connie Francis—MGM—Francon/Schneider Music
- Memories of Heidelberg—Peggy March—RCA Victor—Melodie der Welt
- *Spanisch war die Nacht (Spanish Night)—Peter Alexander—Ariola—Hans Gerig Music
- *Lass die Sonne wieder scheinen (Let the Sun Shine Again)—Ronny—Telefunken—Edition Maxim
- Penny Lane—The Beatles—Odeon—Rolf Budde Music
- Let's Spend The Night Together—The Rolling Stones—Decca—Hans Gerig Music
- Touch Me, Touch Me!—Dave Dee, Dozy, Beaky, Mick & Tich—Star Club—Minerva Music/R. von der Dovenmuehle
- Schiwago Melodie—Maurice Jarre—MGM—Hans Gerig Music
- Puppet on a Strong—Sandie Shaw—Hit Ton—Deutsche Vogue—Hans Gerig Music
- *Morgen Beginnt die Welt (The World Begins Tomorrow)—Freddy Quinn—Polydor—Edition Doma/B. Kaempfert
- Somethin' Stupid—Nancy & Frank Sinatra—Reprise—Chappel Music/A. Seith
- Meine Liebe zu Dir (My Love For You)—Roy Black—Polydor—Riva Music/A. Seith
- Ha Ha Said The Clown—Manfred Mann—Fontana—Edition Fanfare/P. Kirsten
- Okay!—Dave Dee, Dozy, Beaky, Mick & Tich—Star Club—Minerva Music/R. von der Dovenmuehle
- All You Need is Love—The Beatles—Odeon—Northern/Rolf Budde Music
- A Whiter Shade Of Pale—Procol Harum—Deram—Hans Gerig Music
- San Francisco—Scott McKenzie—CBS—Edition Intro/Meisel
- Death of a Clown—Dave Davies—Deutsche Vogue—Aberbach Music
- Romeo und Julia (Romeo And Julia)—Peggy March—RCA Victor—Rolf Budde Music
- Jackson—Nancy Sinatra & Lee Hazlewood—Melodie der Welt/Michel
- We Love You—The Rolling Stones—Decca—Hans Gerig Music
- *Adios—Ronny—Telefunken—Maxim
- Massachusetts—The Bee Gees—Polydor—Rudolf Slezak Music/Yaskiel
- Excerpt from a Teenage Opera—Keith West—Odeon—Francis, Day & Hunter/Borneman
- Zabadak—Dave Dee, Dozy, Beaky, Mick & Tich—Star Club—Minerva Music/R. von der Dovenmuehle

BOOKING AGENTS IN GERMANY

- Gastspieldirektion Otto Hofner, 5 Cologne, Ebertplatz 2
- Gastspieldirektion Werner Laube, 75 Karlsruhe, Beierheimerallee 22
- Suedprogramm Herman Hingher, 79 Ulm/Donau, Scheffeltgasse 11
- Nordprogramme Horst Klemmer, 29 Oldenburg/OLDB, Friesenstr. 34
- Kuenstlerdienst Erich Bergau, 69 Heidelberg, Kaiserstr. 69-71
- Kuenstlerdienst Herr Walter, 3 Hannover, Landesarbeitsamt
- Kuenstlerdienst Herr Schmidt, 4 Duesseldorf, Berliner Allee
- Kuenstlerdienst Herr Huehnerberg, 2 Hamburg, Arbeitsamt
- Gastspieldirektion Hans Leo, 46 Dortmund-Hoechsten, Ginsterweg 11
- Kuenstleragentur Hermann Ahrens, 5 Cologne, Hohenzollernring 88
- Kuenstlerdienst des Arbeitsamtes, 1 Berlin—W, Haendelplatz 2
- Gastspieldirektion Schibille, 1 Berlin—Neukoeln, Ganghoferstr. 1
- Programmgestaltung Werner Veidt, 7140 Ludwigsburg, Naststr. 8
- Internationale Kuenstleragentur Hans A. Reich, 6 Frankfurt, Westendstr. 6
- Atlas—Kuenstler—Agenture Walter Apelt, 6 Frankfurt, Gleimstr. 1
- Internationale Kuenstleragentur Maria Ilona Brenk, 4 Duesseldorf, Friedrich—Ebertstr. 53
- Sueddeutsche Kapellenagentur Hans Allmendinger, 7 Stuttgart—W., Reuchlinstr. 9
- Internationale Kuenstleragentur Gisela Burghardt, 4 Dusseldorf, Gruenerstr. 39
- Internationale Kuenstleragentur Gisela Guenther, 6 Frankfurt, Humbrachtstr. 11p
- Kuenstleragentur Otto Konrad, 62 Wiesbaden, Moritzstr. 13
- Kuenstleragentur Paul Meissner, 81 Garmisch—Partenkirchen, Thoerlenstr. 5
- Agentur Edmund Osterwind, 4 Duesseldorf, Deichstr. 16
- Agentur Curt Richter-Frania, 43 Essen, Schubertstr. 3
- Agentur Heinz O. Schneider, 633 Wetzlar, Postbox 374
- Agentur Lorenz K. W. Reich, 68 Mannheim, Planken P 6, 26
- Internationale Kuenstleragentur Paul Reimann, 2 Hamburg 13, Innocentiast. 58
- Transeuropa Agency Ferry Reissel, 8 Munich, Johann-von-Werthstr. 1
- Kuenstleragentur Carla Schnitzler, 2 Hamburg 13, Isestr. 25
- Kuenstleragentur Friedrich Straub, Altenburg ueber Nuernberg, Oberasbacherstr. 30
- Kapellenagentur Josef Vogt, 62 Wiesbaden, Roederstr. 32
- Kuenstleragentur Tenno Agent, 4 Duesseldorf, Am Wehrhahn 65
- Agentur Heinz Wehler, 1 Berlin—Kladow, Waldallee 1
- Agentur Dr. Hans Weiler, 5039 Weiss, Am Hagelkreuz 12



HE FEELS SAFE WITH HIS PUBLISHER IN GERMANY

**BEST WISHES
FOR CHRISTMAS
AND
THROUGHOUT
1968**



ABERBACH (HAMBURG) GMBH.

2 HAMBURG 36 · WARBURGSTR. 22 · TEL. 44 20 02 - 04

erman Publishers
With Songs In The
Top 3 In Germany—67

OR MORE SONGS
Tuns Gerig Music—9 Songs
Minerva Music/R. von der Doven-
wehle—5 Songs

MORE THAN ONE SONG
Wulf Budde Music—4 Songs
August Seith/Riva Music—3 Songs
Edition Intro/Peter Meisel—2 Songs
Melodie der Welt/Michel—2 Songs
Maxim—2 Songs

ONE SONG
Edition Accord—1 Song
Edition Francon-Schneider—1 Song
Edition Fanfare/P. Kirsten—1 Song
Berbach Music—1 Song
Espanade—1 Song
Edition Doma/Kaempfert—1 Song
Rudolf Slezak Music—1 Song
Francis, Day & Hunter/Bornemann—
1 Song

Independent Recording Studios In Germany

(Major recording companies have
studios in key cities as well)

Media ALLACH
Munich—Salln
Lescher Strasse 16
Tel: 79 83 14

UDIO TONSTUDIO
Berlin 12
Hilmersdarker Strasse 95
Tel: 8 83 57 11

ONSTUDIO BAUER
Ludwigsburg-Eglosheim
Kirkgraeninger Strasse 46
Tel: 07264806
Tel: 3 10 98

AVARIA ATELIER GMBH
Munich-Geiselgasteig
Munich-Film-Platz 7
Tel: 05 23254
Tel: 4 76 95 11

ION PRODUKTION
Frankfurt 50
Winkelweg 13
Tel: 57 30 78

IA FILM INTERCONTI AUSSEM KG
Munich 13
Ankestrasse 2
Tel: 33 74 87

ONSTUDIO FRANKFURT GM8H & CO KG
Frankfurt
Appelallee 38
Tel: 77 53 75
Tel: 77 70 86
Tel: 04 14002

ONDIAL MUSIKSTUDIO
038 Radenkirchen/Kaln
Tel: 38 40 65
Tel: 08 881404
Tel: 08 881404 (w/vg)

ONSTUDIO DER SPECIAL RECORD
Grasshesselohe (bei München)
Matwandstrasse 16
Tel: 79 42 86/79 42 66
Tel: 5/22235

RIXI TONSTUDIO
Munich 45
Spiriansmuehlstrasse 5
Tel: 36 63 50/32 64 22

NION STUDIO
Munich 25
Schetsrieder Strasse 60
Tel: 78 98 35

ONSTUDIO DIETRICH FRHR. VI WERTHERN
Munich-Obermenzing,
Jugen-Papst Strasse 3
Tel: 88 65 81

UDIOS IN SWITZERLAND:
ONSTUDIO MAX LUSSI
asel
Simeistrasse 76
Tel: 22 06 44

UBA BEERLI & CO
4000 Basel
Laragraben 78

UDIOTECHNIK & CO, A. GYSIN & CO
uenchenstein/B1
n Steinenmueller 4



Thanks

To Bands, Orchestras,
Writers, Partners, Artists
and Everyone else
who did help to make
1967
a good and successful year.

We are proud to be
Germany's top publishers.



The Seasons Greetings

GERIG MUSIKVERLAGE
DRUSUSGASSE 7-11 · COLOGNE

A Happy and Prosperous

1968

FROM



Primavera

Music Publishers—Brussels, BELGIUM

GERMANY — ARTISTS WHO HIT GERMANY'S TOP 10 DURING 1966

ARTIST	TITLE	LABEL	PUBLISHER
Peier Alexander (Austria)	Moderne Romanzen Spanisch war die Nacht Verbatene Traeume Der letzte Walzer	Ariola Ariola Ariola Ariola	Hans Gerig Music Hans Gerig Music Hans Gerig Music Hans Gerig Music
Anna Lena (German)	Dein Herz das muss aus Gold sein	Metraname	Edition Intro/Meisel
The Beatles (British)	Penny Lane All You Need Is Love	Odeon Odeon	Ralf Budde Music Rolf Budde Music
The Bee Gees (British)	Ta Love Somebody Massachusetts	Palydor Palydor	Rudolf Slezak Music Rudolf Slezak Music
Franz Beckenbauer (German)	Du Allein	Palydor	Radia Music
Roy Black (German)	Gaad Night My Love Frag Nur Dein Herz Meine Liebe zu Dir	Palydar Palydar Palydor	Riva Music/A. Seith Riva Music/A. Seith Riva Music/A. Seith
Graham Bonney (German)	Siebenmeilenstiefel	Elektrola	AME Kassner/Kist
Gert Boettcher (German)	Sag mir noch nicht gute Nacht	Hansa	Edition Intra/Meisel
The Bar Kays (USA)	Soulfinger	Atlantic	Edition Intro/Meisel
Dave Davies (British)	Death Of A Clown	Deutsche Vogue	Aberbach Music
Dave Dee, Dozy, Beaky, Mick & Tich (British)	Zabadak—Okay! Bend It— Hard To Love You—Save Me— Touch Me, Touch Me	Star Club	Minerva Music R. von der Dovenmuehle
Donavan (British)	Sunshine Superman	Epic	Peer Music
The Equals (British)	Baby Come Back	Ariola	AME Kassner/Kist
Eve (German)	Wottalotalove	Bellaphon	Salaklang Music
Don Fardon (British)	The Letter	Deutsche Vogue	Belmont Music
Andy Fisher (German)	Der Babyspeck ist weg A Man In The Woods Mr. Cannibal	Deutsche Vogue Deutsche Vogue Deutsche Vogue	Melodie der Welt Edition Belmont Edition Intra/Meisel
Larry Finnegan (USA)	Das Schoenste Maedchen Der Welt	Deutsche Vogue	Hans Gerig Music
Nina Ferrer (France)	Le Telefone	Ariola	Ufaton
Freddy (German)	Eine Handvoll Reis Morgen beginnt die Welt	Polydor Polydor	Edition Esplanade Edition Esplanade
Connie Francis (American)	Es ist so schoen, dass es Dich gibt	MGM	Franca/Schneider
David Garrick (British)	Please Mr. Maveng Man Dear Mrs. Applebee	Deutsche Vogue Pye	Melodie der Welt Rolf Budde Music
Jan Gorissen (Denmark)	Barcarale 66	Golden 12	
Rex Gildo (German)	Augen wie 2 Sterne Sommerblau Ein Ring aus Gold	Ariola Ariola Ariola	Edition Belmont Edition Intro Edition Intro
Gitte (Denmark)	Ich Mach' Protest	Elektrola	Hans Gerig Music
Heino (German)	Wenn die bunten Fahnen wehen	Elektrola	Schott Saehne
Engelbert Humperkinck (British)	The Last Waltz Release Me	Decca Decca	Francis, Day & Hunter Paul Arends Music
Siggi Hoppe (German)	10 Kosaken, kein Gewehr	Ariola	Edition Maxim
Michael Holm (German)	SOS—Herz in Not	Hansa	Edition Intro/Meisel
The Pracol Harum (British)	A Whiter Shade Of Pale	Deram	Hans Gerig Music
The Hollies (British)	Corrie Anne	Hansa	Rolf Budde Music
Udo Juergens (Austria)	Immerwieder geht die Sonne auf Sag mir wie Geh vorbei	Ariola Deutsche Vogue Deutsche Vogue	Mantana Montana/Beierlein Montana/Beierlein
Maurice Jarre (American) USA	Schiwago-Melodie	MGM	Hans Gerig Music
Wanda Jackson (American) USA	Wenn der Abschied Kommt	Capitol	Melodie der Welt
The Kinks (British)	Dandy Deadend Street Waterloo Sunset	Deutsche Vogue Deutsche Vogue Deutsche Vogue	Aberbach Music Aberbach Music Aberbach Music
Renate Kern (German)	Lass den dummen Kummer	Polydor	Maxim
The Lords (German)	Gloryland	Columbia	Gerig Music
Scott McKenzie (American) USA	San Francisco	CBS	Edition Intro/Meisel
Manuela (German)	Monsieur Dupont Lord Leicester	Telefunken Telefunken	Edition Intra/Meisel Edition Intra/Meisel
The Music Explosion (American)	Little Bit O'Soul	Ariola	Peer Music
Siw Malmkvist (Swedish)	Ein neues Spiel, ein neues Glueck Frech gekuesst ist halb gewonnen	Metronome Metronome	Edition Intro/Meisel Edition Intro/Meisel
Peggy March (American)	Mal nicht gleich den Teufel an die Wand Romea und Julia Memories of Heidelberg	RCA Victor RCA Victor RCA Victor	Rolf Budde Music Rolf Budde Music Rolf Budde Music

ARTIST	TITLE	LABEL	PUBLISHER
Michel Mallory (France)	Annabelle	Ariola	Melodie der Welt
Manfred Mann (British)	Ha! Ha! Said The Clown	Fontcna	Edition Fonfare
The Mankees (American)	I'm A Believer A Little Bit Me, A Little Bit You	RCA Victor RCA Victor	Hans Gerig Music Hans Gerig Music
Marian (German)	Ich hab einen guten Freund gehabt	Hansa	Edition Intro/Meisel
Wencke Myhre (Norwegian)	Komm Allein Wer hat ihn gesehen	Polydor Polydor	Hanseatic Music Aberbach Music
Peter Orloff (German)	Das Schaenste Maedchen der Welt	Coronet	Hans Gerig Music
Peter, Paul & Mary (USA)	I Dig Rack 'n Roll Music	Warner Broth.	Rolf Budde Music
Vera Palm (German)	Capita	Hit Ton	Minervo Music
Ronny (German)	Lass die Sonne wieder scheinen Dunja Wenn du einsam bist Adios	Telefunken Telefunken Telefunken Telefunken	Maxim Idee Music Edition Marbot Maxim
The Rolling Stones (British)	Have You Seen Your Mother Baby Let's Spend the Night Together We Love You. Monja	Decca Decca Decca Coronet	Hans Gerig Music Mirage Music Hans Gerig Music Aberbach Music
Roland W. (German)	Stasera Mi Butto	Deutsche Vogue	Hans Gerig Music
Rocky Roberts (Italian)	Das Glueck ist Rosarot	Columbia	Accord Music
Cliff Richards (British)	La Montanara	Hansa	Bothworth Music
Nini Rosso (Italian)	Denk Ich immer nur daran	Polydor	Edition Domo
Hugo Robic (Yugoslavian)	Snoopy V!S.	Ariola	John Smith Music
The Royal Guardsmen (British)	Somethin' Stupid	Reprise	Chappel Music/ A. Seith
Nancy & Frank Sinatra (USA)	Jackson	Reprise	Melodie der Welt
Nancy Sinatra & Lee Hazlewood (USA)	Little Man	Atlantic	Edition Intro/Meisel
Sonny & Cher (USA)	Puppet an a String	Hit-Ton	Hans Gerig Music
Sandie Shaw (British)	My Friend Jack	Metranome	Edition Meteorion
The Smoke (British)	I Was Kaiser Bill's Batman	Deram	Mills Music
Whistling Jack Smith (British)	I Can't Control Myself	Hansa	Rolf Budde Music
The Traggis (British)	Silence Is Golden Even The Bad Times	CBS CBS	Edition Accord Rudolf Slezak Music
The Tremeloes (USA)	Excerpt from a Teenage Opera	Odeon	Francis, Day & Hunter
Keith West (USA)	Happy Jack Pictures Of Lily	Polydor Polydor	Hans Gerig Music Hans Gerig Music

GERMAN LANGUAGE ARTISTS WHO MADE THE CHARTS—1967

ARTISTS	LABEL
PETER ALEXANDER	ARIOLA
ANNA LENA	METRONOME
FRANZ BECKENBAUER	POLYDOR
ROY BLACK	POLYDOR
GRAHAM BONNEY	COLUMBIA
GERT BOETTCHER	HANSA
EVE	BELLAPHON
ANDY FISHER	DEUTSCHE VOGUE
FREDDY	POLYDOR
REX GILDO	ARIOLA
GITTE	ELEKTROLA
HEINO	ELEKTROLA
SIGGI HOPPE	ARIOLA
MICHAEL HOLM	HANSA
UDO JUERGENS	ARIOLA/DEUTSCHE VOGUE
RENATE KERN	POLYDOR
THE LORDS	COLUMBIA
MANUELA	TELEFUNKEN
SIW MALMKVIST	METRONOME
MARION	HANSA
WENCKE MYHRE	POLYDOR
PETER ORLOFF	CORONET
VERA PALM	HIT-TON
RONNY	TELEFUNKEN
ROLAND W.	CORONET
IVO ROBIC	POLYDOR



*Merry Christmas
and a
Happy New Year
to you all*
Michael Arends

PAUL C.R. ARENDS
MUSIC PUBLISHING GROUP
8211 Rimsting, P.O.-Box 20, Germany

AUGUST SEITH

MUSIC
MUSIC



PUBLISHERS
WHOLESALE SERVICE

FOR GERMANY'S TOP POP HITS

SEASON'S GREETINGS

MUNICH 2, GERMANY • SENDLINGER TOR PLATZ 10

ARGENTINA—1967 IN REVIEW

(Continued from page 49, Part II) smash with new film "La Muchachada de a Bordo". CBS wins "leading case" against cartridge pirate copying. Music Hall widens Durium catalog releases. Odeon revamps its A&R Dept. Music Hall's Selasco reports that sales are running 20% ahead of estimates. Famous releases Italian label FP-4. Prodisa launches ABC-Paramount, previously held by Famous.

AUGUST

Several artists arrange business trips to Chile: Juan Ramon, Yaco Monti and Los Tucu Tucu are among them. Modern folk group Los Zupay is inked by Trova, fulfils successful contract at the Payró Theater. HyR releases several German Ariola records, starting action on this catalog. New Beatles' LP show exceptional sales. Jose Feliciano returns to Buenos Aires on new and once more successful trip. First "hippie" record here, "San Francisco-Flowers on Your Hair", is successfully released by CBS.

SEPTEMBER

CBS gets top of the lists with "Trisagio del Solero", a non-musical rec-

ord; sales exceed 70,000. Brazilian chanter Eduardo Araujo visits is announced. Several diskery toppers travel to Caracas, Venezuela, to Latin American Federation meeting. Antonio Prieto visits Buenos Aires, video tapes several programs. Edmundo Rivero starts tour of Latin American countries. Leo Dan returns from short trip to Chile. Philips' manager Persichini travels to Europe. Odeon starts releasing Deram and Immediate.

OCTOBER

Microfon gets strong record with Billy Stewart's version of "Summertime". Topper Norberto Kaminsky travels to Chile, strats International promo campaign. Surco pushes strongly Atlantic/Atco records. RCA releases LP by local group Los Iracundos, recorded in Rome. Quinto forms Publishing house. A delicate situation arises by the contracting of Raphael in Spain by other label than Hispavox while his contract is seemingly still in force; the affair is widely commented here, because of success of this artist.

NOVEMBER

British group Herman's Hermits arrives in town. Melodic chanter Vicentico Valdes is also here. RCA awards Palito Ortega and Barbara & Dick with golden records; Los Gatos and Juan D'Arienzo also receive awards. Microfon arranges successful deal with Diner's Club. Famous starts releasing Brazilian Imperial records. Italian chantress Mina visits the country. Trova starts Canadian Canusa releases. Odeon pushes Special Products Division, sells records thru book-stores.

DECEMBER

Liberty's president visits Buenos Aires. Rosamel Araya receives golden record. Leo Dan starts shooting fourth. Fermata leaves association with Odeon, studies other offers. Appear new albums by Palito Ortega, Los Gatos and others in giant RCA promo campaign. Teen chanter Sandro gets strong promotion after winning Song Festival in October. Low priced records spread via one-stops, who acquire masters and press the records by themselves.

France—1967 In Review

(Continued from page 50, Part II)

been sold in one month. That song is recorded in French by Sandie herself and by Les Parisiennes (Philips), Les Compagnons de la Chanson (CBS), Luis Mariano (EMI), Frank Pourcel (EMI), Caravelli (CBS), Georges Jouvin (EMI), Yvette Horner (EMI) and Aimable (Vogue). Ray Charles is in Paris for a one night appearance at the Salle Pleyel. The triennial I.F.P.I. (International Federation of Phonographic Industry) general council meets in Paris. Over one hundred participants are present. The first order of business for the council is the election of Henri Froment as the new IFPI president. IFPI members also welcome into their association ten new countries including the USA, Argentina, Australia, Brazil, Chili, Columbia, the Congo, Peru, South Africa and Uruguay.

JUNE

The song contest, "La Rose de France 1967," takes place in Antibes from June 23rd to June 25th. There are 24 participants. Winners are "Les Troubadours" a folk group cut by AZ records. Their song, "Le Vent Et La Jeunesse," is published by La Compagnie. Tutti is enjoying great success with the sheet music sales of "Puppet On A String." 10,000 scores of the Sandie Shaw hit have been sold in two months. 20 pressing machines are working night and day at ACEM de Tourouvre to produce the Procol Harum's single, "A Whiter Shade Of Pale" for Deram. 200,000 copies have been sold in two weeks. This event will mark the start of a French market revolution: EPs giving way to

singles. "The Philips turnover for the four months of this year is exactly the same as for the same period last year," announces Louis Hazan. At the same moment Léon Cabat says that Vogue's turnover for the year 1966 showed an increase of more than 37% compared with 1965. Turnover for the first months of the current year is reported to be about 30% up from the same period last year.

JULY

Dave Brubeck and Louis Armstrong are the main performers at the 8th "Festival International du Jazz d'Antibes-Juan les Pins," organized by Jacques Hebey. Sammy Davis Jr. is the leader of an American program at

the Olympia. Lucien Adès, who manages his own firm, Adès Records, is elected to direct the SNICOP promotion campaign. Young singer Guy Mardel leaves AZ records to join CBS. Famous French soprano sax player Claude Luter is awarded the "Grand Prix du Disque 1967 du Jazz Club de France." Philips Records signs a contract with Radio Luxemburg to produce during the summer holiday a live promotional broadcast. The "Chambre Syndicate des Editeurs de Musique" council takes place in Paris on June 20th. The board of directors immediately elects the committee. President is Rolf Marbo. Vogue Records Inc. is working hard to launch the new dance called the

(Continued on page 52, Part II)



LOS GATOS

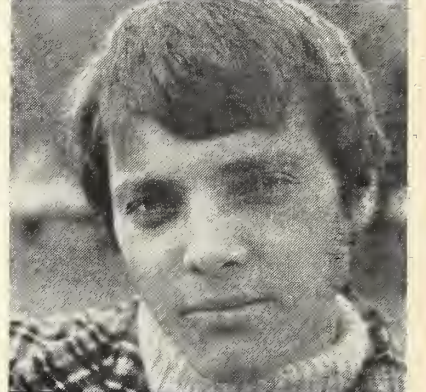

JOHNNY TEDESCO

and
FABIAN ROSS..!

PERSONAL MANAGEMENT
Fabian Ross
Terrada 259
Telephone :30-4203
Buenos Aires
ARGENTINA

THE TOP LP OF 1968!

Already Released In
ARGENTINA — URUGUAY — CHILE
BRAZIL — COLOMBIA
And Now In
SPAIN — JAPAN



"14 WITH THE TANGO"

Tapes (Vocal and Instrumental) and
Song Publishing Rights Available
For Other Markets

EDICIONES INTERNACIONALES
FERMATA (ARGENTINA) S.R.L.

PRODUCCIONES
FERMATA

SAN MARTIN 640 — BUENOS AIRES — ARGENTINA

Wire: Fermata Baires

BEST WISHES

from
SURCO

representing

Vogue
Vox
Opus
Telefunken
Atlantic

SURCO
INDUSTRIAS MUSICALES
Tucuman 439
Buenos Aires, Argentina

*the most important
classical and popular
record catalogue
in the world*



odeon "pops"



Industrias Eléctricas y Musicales
ODEON
S.A.I.C.
Corrientes 485 Buenos Aires
ARGENTINA



THESE ARE SOME OF OUR
OUTSTANDING ARTISTS:

ROSAMEL ARAYA — PEPITO PEREZ
LOS VENETO'S — ICASTO 6
BINGO REYNA — RICARDO REY

DISC JOCKEY SAIC

Pedro Goyena 72 — Buenos Aires
Argentina

1959: GROWING!

1962: GROWING!

1965: GROWING!

1968: GROWING!!

MICROFON ARGENTINA S.R.L.

Lavalle 1759 — Buenos Aires

*The experienced label
with young ideas . . . !*

ARGENTINA'S LEADING TELEVISION SHOWS

"Sabados Circulares"
Channel 13, Saturdays, 2 to 8 P.M.
Emcee and producer: Nicolas Mancera
Artists: Palito Ortega, Ramona Galarza, Yaco Montii and others

"Hotel Carrousel"
Channel 13, Mondays 9 to 10 P.M.
Emcee: Edith Boado
Artists: Palito Ortega, Violeta Rivas, Nestor Fabian and others

"El Special"
Channel 9, Mondays 9 to 10 P.M.
Producer: Miguel de Calasanz
Emcee: Silvio Soldam

Artists: Rosamel Araya, Roberto Yanes and visitors

"Comienza El Show"
Channel 11, Tuesdays 9 to 10 P.M.
Producer: Ruben Machado
Artists: Con's Combo, Ginamaria Hidalgo and others

"Telemusica"
Channel 11, Daily 1 to 2 P.M.
Producer: Manuel Iglesias
Emcee: Raul Matas
Artists: Pepito Perez, Edith Vick, The Mac Kers and others

ARGENTINA'S LEADING DISK JOCKEY PROGRAMS

"Modart En La Noche"
Radio Excelsior, Daily, 11:30 P.M. to 2 A.M.
Producer: Ricardo Kleinman

"Escalera A La Fama"
Radio Excelsior, Daily, 12:30 A.M. to 1 P.M.; 2:30 to 3 P.M.; 4:30 to 5 P.M.; Saturdays, 5 to 8 P.M.

Producer: Ruben Machado

"Servicentro Musical"
Radio Libertad, Daily, 6:30 to 7:30
Producer: Miguel Angel Merellano

"Show Brillante"
Radio Splendid, Daily 9 to 10 A.M.
Disk Jockey: Hugo Guerrero Marthineitz

ARGENTINA'S LEADING RECORDING STUDIOS

INDUSTRIAS ELECTRICAS Y MUSICALES
ODEON SA
Cordoba 669,
Buenos Aires.

DISCOS CBS SA
Paraguay 1583,
Buenos Aires.

ESTUDIOS TNT
Santa Fe 1050
Buenos Aires.

ESTUDIOS SAN MARTIN
Tueuman 451,
Buenos Aires.

SICAMERICANA SA
J. E. Uriburu 40,
Buenos Aires.

PHONOGRAM SAIC
Belgrano 1660,
Buenos Aires.

ESTUDIOS ION
Hipolito Yrigoyen 2512,
Buenos Aires.

ESTUDIOS GUEMES
Lavalle 655,
Buenos Aires.

ESTUDIOS PHONAL
Santa Fe 3117,
Buenos Aires.

ESTUDIOS NEUMANN
Maipu 235,
Buenos Aires.

ESTUDIOS AUSTRAL
Rio Bamba 1058,
Buenos Aires.

France—1967 In Review

(Continued from page 51, Part II)

"skate." "Jackson," by Nancy Sinatra is being strongly promoted. CBS, Decca, and Pathé Marconi release several singles in July. This marks a new step in the singles market development.

AUGUST

The board of directors of Sofrason (which has the Decca label) and A.R.E.A. (RCA) elect a new President: André Jeanneret. Jeanneret is no newcomer in this field, he served as sales manager for Philips for two years and then joined La Société Française Du Son (Sofrason) and remained there in charge of the electronics department for twelve years. Exiga is put in charge of the Decca N.Y. catalog and Mr. Leclanché of the Teldec catalog. Philips and Barclay begin to release singles. Price, as decided by SNICOP (Phonographic Industry Syndicate), is 650 Francs. Rolf Marbot, president of SEMI-Meridian Publishing Inc. announces that over 1,600,000 copies of Michel Polnareff's records have been sold in 14 months. For the first time, this year, Radio Monte Carlo, which has the largest audience on the Côte d'Azur during the summer, decided to charge the record companies for having their own broadcasts during August. Vogue and Barclay accepted, but Philips signed a contract with RTL, and Pathé and CBS refused the offer.

SEPTEMBER

Vogue records holds its convention, "Marché Commun," in Paris to prepare its new European policy. At this occasion, President Léon Cabat decides to release single records in France. Vogue is the last firm refusing to forsake EP's. After the end of the Convention, Cabat is visited by Mike Maitland, Warner Bros. president. During the visit, the two presidents renew the contract between Vogue and Warner Bros. Vogue will be distributed after the 1st of October in Canada by a new firm created by Warner Bros. Philips of France also holds its convention in Sept. Members verify the substantial increase in LP sales from 1966 to 1967. A few months before the "Marché Commun," Pathé Marconi lowers the prices of its classical records. Philips considers its low-

price LP policy (19 Francs 95) a complete success. A new publishing company appears in Paris; Sunny Music. Manager is Henri Marchal, who formed the firm after leaving Pathé Marconi.

OCTOBER

Just as he makes his new singles policy official, Eddie Barclay announces a new bomb: he will soon release a new type of records he calls "Mini disques" (mini records) or Disques de Poche (Pocket records). They will be 11.5 cm in diameter and play at 33 rpm. They will offer six numbers and will be sold at the price of 12 Francs, 90. Barclay says he is launching this new record because he believes that the French market is not yet ready for tape cartridges. Decca artist Nancy Holloway gets the first prize at the International Mediterranean Song Festival in Barcelona with "La chanson de bonheur" Gerard Tournier now represents the Jobete catalog in France. Chappell buys the Acuff-Rose catalog which had been represented by Editions Tropicales. In addition, Mr. Roquiere, Chappell's manager in France, announces the pending opening of a new Chappell office in Madrid under Paris control. EMI artist Dick Rivers is on tour in Canada. Les Compagnons de la Chanson are singing in Holland. In Paris, the man of the month is James Brown. Following Sheila's "Adios Amor" and Richard Anthony's "Aranjuez Mon Amour," Salvatore Adamo tops the chart with his new hit, "Le Néon."

NOVEMBER

Traditional jazz is currently undergoing a sudden explosion on the market here. In line with this trend, Antoine (Vogue) writes lyrics to a Sidney Bechet composition, "Madame Bécassine." The Vogue recording of the song marks the beginning of a concentrated attempt on the part of the label to make Béchet the star of the new season. Philips inaugurates a new LP series through the Fontana label entitled "Après Minuit" ("After Midnight"). Each LP presents love songs or sentimental mood music with nude pin-up girls on the cover. Mireille Mathieu is at the top of the chart all month long with her waxing of "La Dernière Valse." Twenty

(Continued on page 53, Part II)

SWEDEN—1967 IN REVIEW

Local artists did very well during 1967, mainly the teenage groups who were active throughout the year. Hep Stars (Olga) noted a good year, saleswise, and it is also the group who have got the biggest headlines during the year.

As 1967 started, a planned American tour gave them some headlines, but instead of crossing the Atlantic, Hep Stars left for Africa, where they made a film in Kenya. After their return, it was said that the film they had done in Africa was probably never to be publicly shown (so far it has not been), but a tune, "Malaika", which they had picked up in Africa, turned out to be a hit, but at the same time also starting something of a dispute around the copyright. Last autumn, they were back in headlines again, this time because they decided to leave their manager, Ake Gerhard-Larsson, obtaining a British manager in London, who was to help them to an international career. At this time, another copyright dispute went up around their record "Mot Okänt land", claimed to be a Swedish version of the American tune "Four Strong Winds". Early in December, tax authorities dropped into the picture, asking for around one million in Swedish currency for unpaid taxes. However, considering their popularity the amount might not be as high as it sounds.

Most frequent at the charts here has also been Sven-Ingvars (Svensk-American) Tages (Platina, later Parlophone), Ola & Janglers (Gazell), Country Four (Amigo), Osten Warnerbring (Karusell), Shanes (Columbia), Hooten Singers (Polar), Hounds (Gazell), Jan Malmström (CBS), Siv Malmkvist (Metronome), Mats Olin (Polar), Dee Jays (Hep House), Larry Finnegan (Svensk-American), Lars Lönndahl (CBS), Lill Lindfors (Polydor) and

Svante Thuresson (Metronome).

Saleswise as far as records is concerned, 1967 was a very good year, according to Swedish Association of Record Suppliers who reports that as of Oct. 1st, 1967, sales had gone up with some 30 per cent, compared with 12 months before.

Motion pictures reflected in record sales here (as in most other countries) more than usual, with movies like "The Sound Of Music", "Dr. Zhivago", "You Only Live Twice", and also local products as "Ola & Julia".

Simon Brehm, wellknown musician and head of Karusell Grammofon AB died very suddenly of a heart attack last Feb. 11th. He was later replaced as head of the company by Ivan Nordström, former EMI a & r man.

Sweden joined the Eurovision Song Contest in Vienna last April with "Som en dröm..." (As A Dream), performed by Osten Warnerbring. In end of October, Monica Zetterlund represented Sweden at the Rio de Janeiro international Song Festival, where she performed "Dej och vart barn" (You And Our Child).

One of the more remarkable changes in record biz took place July 1st, when the MGM label moved from EMI to Karusell Grammofon AB here.

Death took another wellknown personality here Aug. 16th when Gösta Rybrant, 63, died. Exactly how many songs who got Swedish lyrics from his hand is difficult to say, but it must be more than 1000.

Laxa, a smaller Swedish village with 6000 inhabitants, got plenty of fame here when the American tune "Jackson" was called "Laxa" in Swedish. Early in December, the authorities in Laxa invited the artists who done the tune in Swedish as well as the Swedish publisher to a day in their village.

NORWAY—1967 IN REVIEW

Swedish groups in general, and perhaps Hep Stars in particular, has had a most successful year in Norway during 1967. Hep Stars on Olga managed to make not less than 29 weeks at the charts with their Swedish version of "Last Night I Had A Strangest Dream", a very-hard-to-beat record. Other records with a long lifetime at the charts here includes Herman's Hermits (Columbia) with "No Milk Today" (13 weeks), Beach Boys (Capitol) with "Good Vibrations" (12 weeks), Sven-Ingvars (Svensk-American), another Swedish group with their Swedish copyright "Vid din sida" (12 weeks), Tom Jones (Decca) with "Green, Green Grass Of Home" (14 weeks), Moonkees (RCA Victor) with "I'm A Believer" (15 weeks), Rolling Stones (Decca) with "Let's Spend The Night Together" (12 weeks), Beatles (Parlophone) with "Penny Lane" (13 weeks), Swedish group Sven-Ingvars (Svensk-American) with another Swedish tune, "Du ska' tro pa mej" (16 weeks), Sandie Shaw (Pye) with her Eurovision Song Contest winner "Puppet On A String" (13 weeks), Nancy & Frank Sinatra (Reprise) with "Somethin' Stupid" (18 weeks), Sven-Ingvars (Svensk-American) for the third time with a Swedish song, "Jag ringer pa fredag" (12 weeks), Tremeloes (CBS) with "Silence Is Golden" (15 weeks), Procol Harum (Deram) with "A Whiter Shade Of Pale" (11 weeks), Beatles (Parlophone) with "All You Need Is Love" (14 weeks), Scott McKenzie (CBS) with "San Francisco" (15 weeks), Nancy Sinatra-Lee Hazelwood (Reprise) with "Jackson" ten weeks).

Local artists has not been able to reach the same good results at the charts, but the group 1-2-6 (RCA Victor) stayed at the charts for ten weeks with their "Graveyard Paradise", a local copyright.

However, saleswise, local artists are doing very good, at least to judge from the large number of local recordings being made in the country. Wenche Myhre (Polydor), Kirsti Sparboe (Trilola), Vestlandsduoen (Nor-Disc), Oslo Harmony Quartet (Polydor), are some local names who has been seen at the

local charts during the year. Rolf Wesenlund (Camp) entered the charts in December.

Swedish language and Swedish artists have a strong market in Norway—it has happened that Norwegian artists has recorded Norwegian songs in Swedish, pointing out that "they will sell better that way." Except of Hep Stars and Sven-Ingvars, mentioned above, also Larry Finnegan (originally American, now living in Sweden and recording in Swedish), Jan Malmström (CBS), Hooten Singers (Polar), Lill Lindfors (Polydor), Gunnar Wiklund (HMV) and Mats Olin (Polar) has done very well here.

Norwegian artists are also doing very well in international competition abroad. Wenche Myhre is a strong name in Germany, at the same time she's also well known movie and stage actress in Sweden. Kirsti Sparboe is about to start here international career, with a German career being the first on her schedule. A tour in Sweden is also a good credit for Norwegian artists at the home market.

France—1967 In Review

(Continued from page 52, Part II) months after the Philips decision to retail every LP at 19,95 Francs, it now appears that this price will not become standard. On the contrary, most LP albums will now be sold at 22,90 Francs. Philips releases a 5 LP set which includes all the comic monologues recorded by Fernand Raynaud for the past 10 years. Leon Cabat, Vogue prexy, is visiting U.S. and Canada.

DECEMBER

Barclay signs a three year contract with Buddah Records for the distribution of the Buddah catalog in France and the Benelux countries. Negotiations for the deal were made in New York by Eddie Barclay and Bernard de Bosson with Frank Mell from Buddah records. Because of the Christmas season, many children's records are on release. Philips decides to do a special promotion on them, since they represent 8% of the labels volume. Fontana debuts a new LP series entitled "Le Cercle des Enfants."

SWEDEN'S BEST SELLERS

Listed below are records appearing at first, second and third spot in the charts month-by-month during 1967:

- January:** 1 *Consolation (Hep Stars/Olga) Hep House AB, Sweden
2 *Vid din sida (Sven Ingvars/Svensk-American) Sven Brothers Music Inc./Edition Odeon, Sweden
3 Alex Is The Man (Ola & Janglers/Gazell) Sonet Music AB, Sweden
- February:** 1 I'm A Believer (Moonkees/RCA Victor) Screen Gems Musikförlag AB, Sweden
2 I natt jag drömde (Last Night I Had A Strangest Dream) (Hep Stars/Olga) Musikförlaget Essex AB, Sweden
3 Green, Green Grass Of Home (Tom Jones/Decca) Palace Music (Sweden) A.S. Sweden
- March:** 1 I'm A Believer (Moonkees/RCA Victor) Screen Gems Musikförlag AB, Sweden
2 I natt jag drömde (Last Night I Had A Strangest Dream) (Hep Stars/Olga) Musikförlaget Essex AB, Sweden
3 Bucket T. (Who/Polydor) Screen Germs Musikförlag AB, Sweden
- April:** 1 Penny Lane (Beatles/Parlophone) Sonora Musikförlags AB, Sweden
2 En sang en gang for langesen (Green, Green Grass Of Home) (Jan Malmström/CBS) Palace Music (Sweden) AB, Sweden
3 A Little Bit Me, A Little Bit You (Moonkees/RCA Victor) Screen Gems Musikförlag AB, Sweden
- May:** 1 A Little Bit Me, A Little Bit You (Moonkees/RCA Victor) Screen Germ Musikförlag AB, Sweden
2 En sang en gang for langesen (Green, Green Grass Of Home) (Jan Malmström/CBS) Palace Music (Sweden) AB, Sweden
3 Penny Lane (Beatles/Parlophone) Sonora Musikförlags AB, Sweden
- June:** 1 Somethin' Stupid (Nancy & Frank Sinatra/Reprise) Thore Ehrling Musik AB, Sweden
2 Ha! Ha! Said The Clown (Manfred Mann/Fontana) Sonora Musikförlags AB, Sweden
3 Puppet On A String (Sandie Shaw/Pye) Thore Ehrling Musik AB, Sweden
- July:** 1 Malaika (Hep Stars/Olga) Hep House AB, Sweden
2 Jag tror pa sommaren (Mats Olin/Polar) Polar Music AB, Sweden
3 Jag ringer pa fredag (Sven Ingvars/Svensk-American) Seven Brothers Music Inc./Edition Odeon, Sweden
- August:** 1 All You Need Is Love (Beatles/Parlophone) Sonora Musikförlags AB, Sweden
2 Maria vin vän (Larry Finnegan/Svensk-American) Seven Brothers Music Inc./Edition Odeon, Sweden
3 I'm Going Out (Tages/Parlophone) Edition Odeon, Sweden
- September:** 1 San Francisco (Scott McKenzie/CBS Sweden Music AB, Sweden)
2 All You Need Is Love (Beatles/Parlophone) Sonora Musikförlags AB, Sweden
3 Jackson (Nancy Sinatra-Lee Hazelwood/Reprise) United Artists Musikförlag AB, Sweden
- October:** 1 San Francisco (Scott McKenzie/CBS Sweden Music AB, Sweden)
2 Jackson (Nancy Sinatra-Lee Hazelwood/Reprise) United Artists Musikförlag AB, Sweden
3 All You Need Is Love (Beatles/Parlophone) Sonora Musikförlags AB, Sweden
- November:** 1 Mot okänt land (Four Strong Winds) (Hep Stars/Olga) Gehrmans, Sweden
2 *Önskebrunnen (Sven Ingvars/Svensk-American) Seven Brothers Music Inc./Edition Odeon, Sweden
3 Juliet (Ola & Janglers/Gazell) John's Music/Sonet Music AB, Sweden
- December:** 1 Massachusetts (Bee Gee/Polydor) Sonora Musikförlags AB, Sweden
2 Mot okänt land (Four Strong Winds) (Hep Stars/Olga) Gehrmans, Sweden
3 *Önskebrunnen (Sven Ingvars/Svensk-American) Seven Brothers Music Inc./Edition Odeon, Sweden

*Local copyright.

The Most
INTERNATIONALLY
SUCCESSFUL
Group on the Continent
of Europe
THE SPOTNICKS



When you read this, The Spotnicks have just started their second Japanese tour and The Moonlighters are about to finish a very successful engagement at The Alameda Hotel, Mexico City. (Ain't that international, what is?)

THE MOONLIGHTERS

Sweden's latest Group on the International Scene
Famous for Their Sound of Pop.



THESE GROUPS ARE FROM SWEDEN

THESE GROUPS HAVE INTERNATIONAL FAME CONSEQUENTLY

THEY RECORD FOR AND ARE BOOKED BY SWEDISC Islandstorget, Bromma

Personal management: Roland Ferneborg

THE Publisher In Scandinavia

REUTER & REUTER

Regeringsgatan 45

Stockholm C

Sweden

Publisher Of The Big Hits

Musikförlaget ESSEX AB

Regeringsgatan 45

Stockholm C

Sweden

DENMARK'S BEST SELLERS

Listed below are records appearing at first, second and third spot in the charts month-by-month during 1967:

- January:** 1 Oh, Oh What A Kiss (Über die Wellen) (Rocking Ghosts/Metronome) Multitone A/S, Denmark
2 En tusindfyrd i min hand (En præstkrage i min hand) (Keld & Donkeys/HMV) Imudico A/S, Denmark
3 *Jeg had aldrig faet noget (Defenders/Sonet) No publisher
- February:** 1 Oh, Oh What A Kiss (Über die Wellen) (Rocking Ghosts/Metronome) Multitone A/S, Denmark
2 *Jeg har aldrig faet noget (Defenders/Sonet) No publisher
3 *Sad'n var det ikke i halvfemsjerne (Matadorerne/Metronome) No publisher
- March:** 1 I'm A Believer (Monkees/RCA Victor) Screen Gems Musikförlag AB, Sweden
2 Oh, Oh What A Kiss (Über die Wellen) (Rocking Ghosts/Metronome) Multitone A/S, Denmark
3 Let's Spend The Night Together (Rolling Stones/Decca) Musikförlaget Essex AB, Sweden
- April:** 1 Penny Lane (Beatles/Parlophone) Multitone A/S, Denmark
2 *Sidste dans (Keld & Donkeys/HMV) Imudico A/S, Denmark
3 Let's Spend The Night Together (Rolling Stones/Decca) Musikförlaget Essex AB, Sweden
- May:** 1 Penny Lane (Beatles/Parlophone) Multitone A/S, Denmark
2 *Sidste dans (Keld & Donkeys/HMV) Imudico A/S, Denmark
3 *Du skal ikke gi' mig roser (Bjorn Tidmand/Odeon) Musikproduktion Winckler, Denmark
- June:** 1 *Du skal ikke gi' mig roser (Bjorn Tidmand/Odeon) Musikproduktion Winckler, Denmark
2 Puppert On A String (Sandie Shaw/Pye) Imudico A/S, Denmark
3 Nu tar jeg til Dublin (Off To Dublin In The Green) (Bjorn Tidmand/Odeon) Imudico A/S, Denmark
- July:** 1 Nu tar jeg Dublin (Off To Dublin In The Green) (Bjorn Tidmand/Odeon) Imudico A/S, Denmark
2 *Du skal ikke gi' mig roser (Bjorn Tidmand/Odeon) Musikproduktion Winckler, Denmark
3 Ha! Ha! Said The Clown (Manfred Mann/Fontana) Dacapo Musikforlag, Denmark
- August:** 1 All You Need Is Love (Beatles/Parlophone) Multitone A/S, Denmark
2 *Hvem har du kysset i din gadedor (Daimi/Metronome & Dirch Passer/Philips) Multitone A/S, Denmark
3 Peanuts (Wishful Thinking/Decca) No publisher
- September:** 1 *Hvem har du kysset i din gadedor (Daimi/Metronome & Dirch Passer/Philips) Multitone A/S, Denmark
2 All You Need Is Love (Beatles/Parlophone) Multitone A/S, Denmark
3 San Francisco (Scott McKenzie/CBS) Sweden Music AB, Sweden
- October:** 1 Lad mig blive noget (Let Me Be Something) (Povl Dissing/Sonet) Musikförlaget Essex AB, Sweden
2 San Francisco (Scott McKenzie/CBS) Sweden Music AB, Sweden
3 *Hvem har du kysset i din gadedor (Daimi/Metronome & Dirch Passer/Philips) Multitone A/S, Denmark
- November:** 1 Gyngerne og karusellen (Gungorna och karusellen) (Preben Uglebjerg/Polydor) Wilhelm Hansen, Musik-Forlag, Denmark
2 San Francisco (Scott McKenzie/CBS) Sweden Music AB, Sweden
3 Camp (Sir Henry & His Butlers/Columbia) Imudico A/S, Denmark
- December:** 1 *Tryllesangen (Pusle Helmut/Polydor) Multitone A/S, Denmark
2 Gyngerne og karusellen (Gungorna och karusellen) (Preben Uglebjerg/Polydor) Wilhelm Hansen, Musik-Forlag, Denmark
3 Massachusetts (Bee Gees/Polydor) Dacapo Musikforlag, Denmark

*Local copyright.

SWEDEN'S BOOKING AGENCIES

ARTISTTJANST
P.O. Box 63
STOCKHOLM-BANDHAGEN
Phone: 47 27 20
Managing director: Mr. Eddie Larsson

F.T.S. (Föreningen Turnerande Sällskap)
Palsundsgatan 7
STOCKHOLM Sv
Phone: 68 69 21

HEP HOUSE AB
Pyramidvägen 7
SOLNA
Phone: 83 44 40
President: Mr. Sten-Ake Lindström

SONET KONSERTBUREAU AB
P.O. Box 39062
STOCKHOLM 39
Phone: 67 05 40
President: Mr. Sven Lindholm

STING-PRODUCTION AB
Aspsåtravägen 48
STOCKHOLM-SKARHOLMEN
Phone: 88 04 90
President: Mr. Olof Nordström

TELSTAR PRODUCTION AB
Frösåtrabacken 24
STOCKHOLM-SATRA
Phone: 46 25 75
President: Mr. Bengt-Ake Bengtsson

NORWAY'S BEST SELLERS

Listed below are records appearing at first, second and third spot in the charts month-by-month during 1967:

- January:** 1 No Milk Today (Herman's Hermits/Columbia) Reg Connelly, Musik-Forlag. A/S Denmark
2 Green, Green Grass Of Home (Tom Jones/Decca) Palace Music (Sweden) AB, Sweden
3 Dead End Street (Kinks/Pye) Belina (Scandinavia) AB, Sweden
- February:** 1 I'm A Believer (Monkees/RCA Victor) Screen Gems Musikförlag AB, Sweden
2 Green, Green Grass Of Home (Tom Jones/Decca) Palace Music (Stockholm) AB, Sweden
3 Mellow Yellow (Donovan/Epic) Southern Music AB, Sweden
- March:** 1 Penny Lane (Beatles/Parlophone) Sonora Musikförlags AB, Sweden
2 I'm A Believer (Monkees/RCA Victor) Screen Gems Musikförlag AB, Sweden
3 Let's Spend The Night Together (Rolling Stones/Decca) Musikförlaget Essex AB, Sweden
- April:** 1 Penny Lane (Beatles/Parlophone) Sonora Musikförlags AB, Sweden
2 I'm A Believer (Monkees/RCA Victor) Screen Gems Musikförlag AB, Sweden
3 Vandra vidare (Gunnar Wiklund/HMV) Edition Odeon, Sweden
- May:** 1 Puppert On A String (Sandie Shaw/Pye) (Musikk-Huset A/S, Norway
2 Somethin' Stupid (Nancy & Frank Sinatra/Reprise) Arne Bendiksen A/S, Norway
3 A Little Bit Me, A Little Bit You (Monkees/RCA Victor) Screen Gems Musikförlag AB, Sweden
- June:** 1 Somethin' Stupid (Nancy & Frank Sinatra/Reprise) Arne Bendiksen A/S, Norway
2 Puppert On A String (Sandie Shaw/Pye) Musikk-Huset A/S, Norway
3 A Little Bit Me, A Little Bit You (Monkees/RCA Victor) Screen Gems Musikförlag AB, Sweden
- July:** 1 Somethin' Stupid (Nancy & Frank Sinatra/Reprise) Arne Bendiksen A/S, Norway
2 A Whiter Shade Of Pale (Procol Harum/Deram) Musikförlaget Essex AB, Sweden
3 Theme From 'The Monkees' (Monkees/RCA Victor) Screen Gems Musikförlag AB, Sweden
- August:** 1 All You Need Is Love (Beatles/Parlophone) Sonora Musikförlags AB, Sweden
2 Alternate Title (Monkees/RCA Victor) Screen Gems Musikförlag AB, Sweden
3 Silence Is Golden (Tremeloes/CBS) Edition Odeon, Sweden
- September:** 1 All You Need Is Love (Beatles/Parlophone) Sonora Musikförlags AB, Sweden
2 San Francisco (Scott McKenzie/CBS) Sweden Music AB, Sweden
3 Alternate Title (Monkees/RCA Victor) Screen Gems Musikförlag AB, Sweden
- October:** 1 San Francisco (Scott McKenzie/CBS) Sweden Music AB, Sweden
2 Ramona (Gunnar Wiklund/Ja) Arne Bendiksen A/S, Norway
3 Pleasant Valley Sunday (Monkees/RCA Victor) Screen Gems Musikförlag AB, Sweden
- November:** 1 The Letter (Box Tops/Stateside) Sweden Music AB, Sweden
2 Onsketrunnen (Sven Ingvars/Svensk-American) Seven Brothers Music Inc./Edition Odeon, Sweden
3 Massachusetts (Bee Gees/Polydor) Sonora Musikförlags AB, Sweden
- December:** 1 Onsketrunnen (Sven Ingvars/Svensk-American) Seven Brothers Music Inc./Edition Odeon, Sweden
2 Massachusetts (Bee Gees/Polydor) Sonora Musikförlags AB, Sweden
3 Hello Goodbye (Beatles/Parlophone) Sonora Musikförlags AB, Sweden

FINLAND'S BEST SELLERS

Listed below are records appearing at first, second and third spot in the charts month-by-month during 1967:

- January:** 1 Little Man (Sonny & Cher/Atlantic) Oy R. E. Westerlund Ab, Finland
2 No Milk Today (Herman's Hermits/Columbia) Scandia-Musiikki Oy, Finland
3 Keltainen jaansakija (Yellow Submarine) (Simo & Spede/Scandia Scandia-Musiikki Oy, Finland)
- February:** 1 Little Man (Sonny & Cher/Atlantic) Oy R. E. Westerlund Ab, Finland
2 I'm A Believer (Monkees/RCA Victor) Screen Gems Musikförlag AB, Sweden
3 No Milk Today (Herman's Hermits/Columbia) Scandia-Musiikki Oy, Finland
- March:** 1 I'm A Believer (Monkees/RCA Victor) Screen Gems Musikförlag AB, Sweden
2 Hljainin kitara (Gringo's Guitar) (Danny/Scandia) Scandia-Musiikki Oy, Finland
3 Little Man (Sonny & Cher/Atlantic) Oy R. E. Westerlund Ab, Finland
- April:** 1 *Elsa kohtalon lapsi (Martti Inanen/Safris) Erik Lindström Music, Finland
2 I'm A Believer (Monkees/RCA Victor) Screen Gems Musikförlag AB, Sweden
3 *Sua kutsun, Maarit (Danny/Scandia) Edition Coda, Finland
- May:** 1 *Elsa kohtalon lapsi (Martti Inanen/Safris) Erik Lindström Music, Finland
2 *Sua kutsun, Maarit (Danny/Scandia) Edition Coda, Finland
3 On ihmeen hyva tulla kotiin (Green, Grass Of Home) (Lasse Martensson/RCA Victor) Palace Music (Sweden) AB, Sweden
- June:** 1 *Elsa kohtalon lapsi (Martti Inanen/Safris) Erik Lindström Music, Finland
2 *Iltatulen viesti (Aikamiehet/Finlandia) Levysävel Oy, Finland
3 *Sua kutsun, Maarit (Danny/Scandia) Edition Coda, Finland
- July:** 1 *Elsa kohtalon lapsi (Martti Inanen/Safris) Erik Lindström Music, Finland
2 *Iltatulen viesti (Aikamiehet/Finlandia) Levysävel Oy, Finland
3 Erehdyn kerran (Nessuno mi può Giudicare) (Seppo Hanski/Decca) Oy Musiikki-Fazer-Musik Ab, Finland
- August:** 1 *Iltatulen viesti (Aikamiehet/Finlandia) Levysävel Oy, Finland
2 *Elsa kohtalon lapsi (Martti Inanen/Safris) Erik Lindström Music, Finland
3 Erehdyn kerran (Nessuno mi può Giudicare) (Seppo Hanski/Decca) Oy Musiikki-Fazer-Musik Ab, Finland
- September:** 1 Erehdyn kerran (Nessuno mi può Giudicare) (Seppo Hanski/Decca) Oy Musiikki
2 *Iltatulen viesti (Aikamiehet/Finlandia) Levysävel Oy, Finland
3 A Whiter Shade Of Pale (Procol Harum/Deram) Musikförlaget Essex AB, Sweden
- October:** 1 San Francisco (Scott McKenzie/CBS) Sweden Music AB, Sweden
2 *Iltatulen viesti (Aikamiehet/Finlandia) Levysävel Oy, Finland
3 Erehdyn kerran (Nessuno mi può Giudicare) (Seppo Hanski/Decca) Oy Musiikki-Fazer-Musik Ab, Finland
- November:** 1 *Ryysyranta (Irwin Goodman/Philips) Oy Musiikki-Fazer-Musik Ab, Finland
2 San Francisco (Scott McKenzie/CBS) Sweden Music AB, Sweden
3 *Iltatulen viesti (Aikamiehet/Finlandia) Levysävel Oy, Finland

*Local copyright.

SWEDEN MUSIC AB

Jungfrugatan 18
STOCKHOLM • SWEDEN
Cableaddress:
SWEDEN MUSIC • STOCKHOLM
Phone:
617530 • 602287 • 637970

STIG ANDERSON



**HIT
RECORDS**

manufacturing, sales
and distribution in
Sweden/Scandinavia,
contact

Cupol AB, Kat. Bang.,
17, Stockholm, Sweden.
Also music pub. comp.

**YOUR AMIGOS
IN SCANDINAVIA
CAN DO
SOMETHING
FOR YOU!**



RECORDS • PUBLISHING

AMIGO

MUSIKPRODUKTION AB

Atlasgatan 14 Stockholm Va
SWEDEN

Jan and Per-Anders Boquist

DENMARK—1967 IN REVIEW

The year has favored the local artists, who have managed to do very well in the competition with British and American idols. Beatles, of course, again got their share of the sales, but Monkees also got a great share of the cake here, as everywhere else.

As the year started, eight out of the top ten at the charts here were local recordings, of which four were local copyrights. Rocking Ghosts (Metronome), Keld & Donkels (HMV) and Defenders (Some) topped, with Hit-makers (Philips), Matadorene (Metronome) and Bjorn Tidmand (Odeon) following closely. Red Squares (Columbia), a British group living in Denmark where they signed an EMI contract, continued getting top sellers, so did Johnny Reimar (Philips), also a top selling artist from 1966.

Sir Henry & His Butlers (Columbia), EMI recording group also noted a success in the middle of this year. With the autumn Povl Dissing (Sonet) and Preben Uglebjerg (Polydor), Daimi (Metronome) and Dirch Passer (Philips) did very well at the charts, with Pusle Helmut (Polydor) moving up at the top in the end of the year.

Among foreign artists, Herman's Hermits (Columbia) with "No Milk Today" did nine weeks on the chart in the beginning of the year, Monkees (RCA Victor) with "I'm a Believer" noted 15 weeks, Connie Francis (MGM), also 15 weeks with "Somewhere, My Love", Beatles (Parlophone) and "Penny Lane" made 12 weeks, Bjorn Tidmand (Odeon) with the local tune "Du skal ikke gi' mig roser" left the charts after 17 weeks, and his Danish recording of "Off To Dublin In The Green" was a top seller for 11 weeks.

In the autumn Beatles returned with "All You Need Is Love" with ten weeks at the charts, with local artists

Daimi (Metronome) and Dirch Passer (Philips) at the charts for 12 weeks with the local copyright "Hvem har du kysst i din gadedor", and Scott McKenzie (CBS), with 15 weeks with "San Francisco".

This year's "Song For Europe", which took place in Vienna last April, saw no Danish artist nor song in the competition, but nevertheless, the winning song "Puppet On A String" with Sandie Shaw on Pye made nine weeks at the charts here.

Early in 1967, Danish radio stations once again took up the program "Ugens top tyve" (Top 20 of the week), at least among teenagers, probably the most appreciated radio program in the country.

CBS, handled by Nordisk Polyphon Akts. here, started with local recording last May, with Bent Sten 18, as debutant with an EP.

Artists who toured Denmark during the year included, among others, Dave Dee, Dozy, Beaky, Mick & Tich (Fontana) who came here as 1967 started, Herman's Hermits (Columbia) dropped in later in January, Yardbirds in April, Chris Farlowe & Thunderbirds, also April, Sammy Davis, Jr. noted gigantic success in May.

The wedding of the Danish Crown Princess resulted in a large number of French artists coming to Denmark, among others to appear in a big TV show.

Andrews Sisters appeared at the Copenhagen Tivoli during July Paul Jones & Hollies were here for a Danish TV show in the autumn, so did the French group Les Variations and the British Geno Washington. Dowliners Sect came here in October and Swedish group Tages in November.

On July 1st, Skandinavisk Gramophon A/S changed its name and became Electric & Musical Industries (Dansk-Engelsk) A/S.

FINLAND—1967 IN REVIEW

Finland remains one of the few countries (at least in Scandinavia) where the local language offers a very strong competition to foreign languages, as far as music life is concerned. This is something that perhaps could be worth a special investigation, but the fact is that, by tradition, if one wants a hit among teenagers in Denmark and Sweden, the best is to record it in English. In Norway, English is also very useful, but if recorded in Swedish, the result might be just as good.

In Finland, English-language records have stronger sales possibilities now than only a couple of years ago, but with few exceptions, Finnish is still the best guarantee for a hit.

The fact that foreign languages have begun to get some chances here depends upon the fact that when those teenage groups started appearing on the Finnish scene, one of the first to get real fame was a British group, Renegades, who came to Finland and made a large number of recordings here for the Scandia label. Some local talents followed up on this and began to make one or another English-language record, and the record buyers as well as audience at pop music concerts accepted it.

When 1967 started, Sonny & Cher (Atlantic) topped the charts with "Little Man," among the top ten on the charts not less than six months. Johnny (Scandia), a local talent, also made six months at the charts with his Finnish version of "Sunny Girl." Monkees (RCA Victor) made four months with their "I'm A Believer." Local talent Martti Inananen (Safir) made six months with the local copyright "Elsa, kohtalon lapsi," and at the end of the year, the choir Aikamiehet (Finlandia) has done seven months on the charts with another

local tune, "Ilkatuulen viesti," still looking ok for one or two months more at the charts. Seppo Hanski (Decca) made six months with his Finnish version of the Italian song "Nessuno mi può giudicare."

RCA Victor, however, is to be credited for the real top seller at the Finnish market, the soundtrack from "The Sound of Music," which stopped among the five most sold LP albums for 16 months.

At the end of the year, Finnish record studios were busy with the production of songs, etc. to celebrate the 50th Anniversary of Finland as an independent state (December 6, 1917).

Finland joined the Eurovision Song Contest in Vienna last April with "Varjoon-suojaan" (In the Shade of the Shadow) composed by Lasse Martensson with lyrics by Alvi Vuorinen.

Last June the CBS label here as in the other Scandinavian countries began to offer local recordings, the group First and the soloists Matti Kakkola and "Kreivi" Lindgren were the first local artists at the label.

Musichouse Westerlund received an award from Walt Disney Records for its proper handling of the Disneyland record production in Finland last spring.

Local Finnish artists usually have had comparatively small chances outside Finland, but in 1967 presented some exceptions from this rule. Finland is still their main market, but also the other Scandinavian countries have become more or less profitable for a few Finnish artists.

The EMI records, previously handled by two companies in Finland, were taken over by Musichouse Westerlund last April.

JAPANESE MUSIC PUBLISHING COMPANIES

ABERBACH TOKYO KABUSHIKI KAISHA
Zenkyoren Bldg., 409, 7-2 Hirakawa-cho, Chiyodaku, Tokyo 265-3291

AKABOSHI MUSIC PUBLISHERS
Shinjuku Daiichi Mansion, 124-1 Kashiwagi, Shinjuku, Tokyo 361-8901

BIG-HILL MUSIC PUBLISHERS
Yayoikan, 5-7 Nishi, Ginza, Chuoku, Tokyo 573-5983

CROWN MUSIC PUBLISHER, INC.
Shinwa Bldg., 8-10-2 Akasaka, Minatoku, Tokyo 582-4741

DAIICHI MUSIC PUBLISHER
Ho Bldg., 16-6-3 Kasumigaseki, Chiyodaku, Tokyo 580-0551

EASTERN MUSIC PUBLISHING CO., LTD.
Kyowa Bldg., 34 Kotohira-cho, Shiba, Minatoku, Tokyo 501-0344

FAR EAST MUSIC PUBLISHING CORP.
c/o Mr. Sadao Ochiai, 9-3-3 Kamienjyaku, Mitakashi, Tokyo (Musashino) 43-4016

FRIENDSHIP MUSIC, INC.
20-7-7 Minami Aoyama, Minatoku, Tokyo 400-9773

FUJI MUSIC INC.
3-4-2 Mukohara, Itabashiku, Tokyo 328-4781 (Kimura)

FURUKAWA MUSIC PUBLISHERS
c/o Tokyo Ongaku, 8-3 Kyobashi, Chuoku, Tokyo 281-7770

GRAMMOPHON PUBLISHING & PROMOTION K.K. 6-6-1 Shinbashi, Minatoku, Tokyo 571-6509

GEI-EI MUSIC PUBLISHERS
Nakamura Bldg. 3 Fl., 13-13-3 Akasaka, Minatoku, Tokyo 584-0901

INTERNATIONAL MUSIC PUBLISHERS CO., LTD. Mansui Bldg., 14-3 Ogawacho, Kanda, Chiyodaku, Tokyo 292-7256

ISHIHARA MUSIC PUBLISHING CORP.
40 Kotohiracho, Shiba, Minatoku, Tokyo 501-7747

JAPAN C.A.M. LIMITED
Playguide Bldg., 2-2 Ginza, Chuoku, Tokyo 562-0111

KAMINARI MUSIC PUBLISHER INC.
c/o Big Hill K.K., Yayoikan, 5-7 Nishi, Ginza 573-5983

KAWAI GAKUFU CO., LTD.
321-2 Komagome, Toshimaku, Tokyo 983-7248

KANAI MUSIC PUBLISHERS
Shin Kokusai Bldg. 8 Fl. 828-ku, 4-3 Marunouchi, Chiyodaku, Tokyo 211-7826

KOKUSAI MUSIC PUBLISHERS
Nippon Chusha Bldg., 43 Toyamacho, Shinjyuku, Tokyo 203-7672

KUSANO MUSIC INC.
Wako Bldg., 13 2-chome, Tsukasacho, Kanda, Chiyodaku, Tokyo 292-2867

MAHINA MUSIC PUBLISHING CORPORATION Daihachimori Bldg., 4-20-3 Shinbashi, Nishi, Minatoku, Tokyo 433-5321

MUSIC PUBLISHER HIT MAKER, LTD.
c/o Tokyo Gakki Shokai, Mansui Bldg., 14-3 Ogawacho, Kanda, Chiyodaku, Tokyo 291-9100

MUSICAL RIGHTS (TOKYO) K.K.
Zenkyoren Bldg., 409, 7-2 Hirakawa-cho, Chiyodaku, Tokyo 265-3291

MUSIC FRIEND PUBLISHER
Murata Bldg., 8 Fl., 27-4 Yoyogi, Shibuyaku, Tokyo 379-1431

MUSIFON, INC. OF JAPAN
c/o FM Tokai, Hatsumei Kaikan, 17 Akafuncho, Nishikubo, Shiba, Minatoku, Tokyo 502-0431

NEW ORIENT MUSIC INC.
Akasaka Mansion 201, 16-5-7 Akasaka, Minatoku, Tokyo 583-2898

NEW SOUND MUSIC PUBLISHERS CO., LTD.
Nakane Bldg., 29-62, Tansucho, Azabu, Minatoku, Tokyo

NICHION, INC. (NIHON ONGAKU SHUPPAN K.K.) Matsudaira Bldg., 3-4-1, Akasaka, Minatoku, Tokyo 584-4722

NIPO-AMERICANA MUSIC PUBLISHING CO., LTD. 2-20-4 Imakawa, Suginamiku, Tokyo 271-2170

NIPPON COLUMBIA MUSICAL ENTERPRISES LTD. 14-14-4 Akasaka, Minatoku, Tokyo 584-8111

NIPPON KAYO MUSIC PUBLISHING CO., LTD. 6-2 Yoyogi, Shibuyaku, Tokyo 379-1411

ONGAKU SHUPPAN CENTER CO., LTD., TOKYO 13-2 Hatsudai, Shibuyaku, Tokyo

ONGAKUNOTOMOSHIA CORP. 30-6 Kagurazaka, Shinjyuku, Tokyo 268-6151

ONGAKU-SHUNJUSHA LTD. 30-1 Jinbocho, Kanda, Chiyodaku, Tokyo 291-0360

ORIENTAL MUSIC CO. 13-22-2 Daisawa, Setagayaku, Tokyo 421-4123

OVERSEAS MUSIC PUBLISHERS CO., LTD. 25 Higashi Gokencho, Shinjyuku, Tokyo 260-5430

PACIFIC MUSIC PUBLISHING CO., LTD. c/o Nippon Hoso, 7-1 Yurakucho, Chiyodaku, Tokyo 281-5251

RHYTHM MUSIC PUBLISHER, INC. 18 Sarugakucho, Shibuyaku, Tokyo 461-6945

REVUE JAPAN, LTD. Hotel New Japan 881, 29-2 Nagatacho, Chiyodaku, Tokyo 581-2143

SHINKYO MUSIC PUBLISHING CO., INC. c/o Mr. Teruchiyo Miyamoto, 602-3 Nishi Sugamo, Toshimaku, Tokyo 971-3734

SHINKO MUSIC PUBLISHING CO., LTD. Wako Bldg., 2-chome, Tsukasacho, Kanda, Chiyodaku, Tokyo 292-2861

SUISEISHA 30-6 Kagurazaka, Shinjyuku, Tokyo 268-6151

SEVEN SEAS MUSIC CO., LTD. Shinmeikei Bldg., 1-3-3 Otsuka, Bunkyo, Tokyo 944-5447

TAIYO MUSIC INC. Central Apt. 335, 313-6-30-4 Jingumae, Shibuyaku, Tokyo 403-3763

TOA MUSIC CO. 30-6 Kagurazaka, Shinjyuku, Tokyo 268-6151

TONE MUSIC CO., LTD. Daisan Mori Bldg. 3 Fl., 10-4-1 Shinbashi, Nishi, Minatoku, Tokyo 502-8214

TOP MUSIC PUBLISHING CO., LTD. Kiyu Bldg., 1-9-3 Akasaka, Minatoku, Tokyo 584-7581

TOKYO MUSIC PUBLISHING CO., LTD.
Kokusai Bldg., 12-3 Marunouchi, Chiyodaku, Tokyo 213-6765

TOKYO MUSIC PUBLISHING CO.
23-7-2 Kameidocho, Kotoku, Tokyo 682-8255

TOSHIBA MUSIC PUBLISHING CO., LTD.
17-2-2 Akasaka, Minatoku, Tokyo 583-1131

TOYO-KIKAKU MUSIC PUBLISHING CO., LTD. 6-6 Nishi Ginza, Chuoku, Tokyo 572-0712

VICTOR PUBLISHING CO., LTD. OF JAPAN
12-6-3 chome Misakicho, Chiyodaku, Tokyo 262-1320

WATANABE MUSIC PUBLISHING CORP.
Matsui Bldg. 4 Fl., 4-1 Yurakucho, Chiyodaku, Tokyo 502-0037

WALT DISNEY ENTERPRISES OF JAPAN LTD. Kanesaka Bldg. 6 Fl., 4-5-2 Shinbashi, Minatoku, Tokyo 591-5886

ZEN-ON MUSIC PUBLISHERS CO., LTD.
25 Higashi Gokencho, Shinjyuku, Tokyo 269-0121

YAMADA MUSIC CORPORATION
6-8-2 Hatanodai, Shinagawaku, Tokyo 784-1033

Our best wishes for a
Merry Christmas
and
A Happy New Year.

We are looking forward to close
and successful cooperation in
the year to come.

MULTITONE A/S

Vibevej 31
Copenhagen NV
Phone 34 21 28

RECORDS SINCE 1929

strong domestic production on
BLUE MASTER - FINLANDIA - TOP VOICE

Finnish distributor of
VOGUE - ERATO - SAGA - REALITY
ELITE SPECIAL

Music Publisher: **LEVYSVEL OY**
Vuorikatu 14, Helsinki



POHJOISMAINEN SÄHKÖ-OSAKEYHTIÖ

Musical Department

Helsinki • Vuorikatu 14 • Finland

AUSTRALIA - 1967 IN REVIEW

Record production figures for the year of 1967 (when released by the statistician) will undoubtedly show the industry in a good light . . . this will be pretty much in line with most years in the past. We have a growing country, increasing almost continuously in population, productivity, and economic soundness.

The album product has emerged with flying colors this year, winning more consumer friends than ever before . . . a very good and healthy sign for the future.

Greatest lift in albums (while there is no separation available from the statistician on this matter) has been in the area of the low-priced lines. It seems that the retail price of (Aust.) \$2.50 is what has proved most acceptable to the consumer, and they are coming out in ever-increasing numbers to buy low-priced sets. Cash

Box believes that the demand for these keenly priced albums will really explode into sensational business over the next couple of years as more and more members of the public discover and accept the fact that there is nothing wrong with these records that are selling at \$2.50, alongside those selling at \$5.25 and more.

Certainly in the album field, the industry has had a good year generally, and there is no immediate reason why the present trend shouldn't continue throughout the coming years . . . especially if the retail price of \$2.50 can be held in check in the face of production costs which always seem to be creeping steadily upwards.

The consumer is proving with his many purchases that he is quite happy with the \$2.50 albums . . . he is showing a confidence in these products that should really delight the industry . . . and the industry must, in turn, make sure it retains that consumer confidence by striving to maintain a top-notch quality control over low-priced albums.

The future outlook for singles doesn't look anywhere near as bright and encouraging as the album picture . . . this is especially so in the case of locally produced singles.

It has been a tough year for local singles . . . with overall results nowhere near matching anything like the time, money, effort and energy that have gone into getting local singles to the market place.

Of the ninety-six different singles that figured in our best-seller lists over the year; only 22 were by Australian artists, and of these 22, only 13 of them were actually recorded in this country . . . and not one of those thirteen managed to rate among our ten biggest hits of the year.

There is something wrong somewhere along the line with local singles; because MANY of them are RARELY, if EVER, heard on the big top-forty stations . . . and consequently don't stand much chance of grabbing sales.

The dismal showing with so many locally produced singles has forced one prominent record company to almost completely halt single production and concentrate its efforts on albums instead, where the response has been much more substantial.

This doesn't necessarily mean that ALL local singles are bombing-out. Some of them are doing quite well, BUT the majority ARE failing to make the grade in any big way. Over the year there have been strong singles from such talent as the Groop, the Loved Ones, Masters Apprentices, the Executives, the Twilights, and so forth; but these artists are a small percentage of the total number of locally produced singles . . . most of which ultimately fail.

The singles market is a vital one to the record industry in any country, this is all the more reason why this high percentage of local failures should be closely studied in order to see just where these problems are

that are plaguing the local single product.

We would expect that 1968 will witness a further boost in the sales response to taped material . . . both in reel-to-reel and cassette form. In the past, most companies here have been marketing fully-imported lines in tape; tariffs and costs kept the retail level fairly high.

However, this picture is starting to change considerably now that locally duplicated tapes are being marketed . . . retail prices in reel-to-reel tapes have continued to tumble to the stage where they are almost comparable to the top-priced disk lines. The cassette market has been fairly small to date . . . but it is showing great promise and by this time next year we should be able to report outstanding progress with cassettes in Australia.

To sum up . . . it has been a good year in the record industry of Australia . . . and apart from a couple of dull patches on the horizon, things should continue in about the same pattern throughout 1968.

JANUARY

Decca Records of England released smash local single of "Step Back" (Composed by The Easybeats) as recorded by Johnny Young . . . not much happened with the record in England, but it did lead to a visit to London by Johnny Young . . . who is still there. Lynne Randell returned home to Australia from a visit to England and the United States, during which time she cut her chart-rating single of "Ciao Baby." . . . W & G Records reported enormous sales on their low-priced album, "The Seekers Sing Their Big Hits." . . . The Monkees had their first breakthrough here with "I'm A Believer." . . . Heading our best-sellers was Normie Rowe with "Ooh La La." Federation of Commercial Broadcasters banned air-play for "Snoopy Versus The Red Baron" due to the inclusion of the word 'Bloody,' a special version was fixed for play with a 'beep' over the offending word. . . . Demand for low-priced albums by the consumer was beginning to leap ahead.

FEBRUARY

"Green Grass Of Home" a real block-buster for Tom Jones, Decca Records and Palace Music. . . . Record production figures released at this time showed a lift of almost 50% in album production; due no doubt to the success of low-priced product. . . . "Snoopy Versus The Red Baron" by The Royal Guardsmen began its long run at the head of our sellers. . . . Local artist Buddy England out with his best release ever, "Movin' Man," it was subsequently released in America on Dot. . . .

MARCH

Plenty of rumors, but still no sign of The Monkees' television series being shown here . . . (of course it is running now). . . . The Seekers return home for all sort of work, including

a concert in Melbourne which drew more than 100,000 patrons. . . . "Snoopy" still heading the best-sellers. . . . The Seekers get Gold Record for one-million copies of "Georgy Girl." . . . EMI release "Penny Lane" by The Beatles. . . . Australian Record Company solidly into pre-recorded reel-to-reel tape. . . . Astor released "Puppet On A String" which became a biggie for Sandie Shaw. . . . "Something Stupid" starting to show big for Nancy & Frank Sinatra. . . . "Georgy Girl" heading our charts.

APRIL

Herb Alpert & Tijuana Brass touring Australia with enormous success; their albums were selling better than most singles. . . . Also touring were Eric Burdon & Animals, Dave Dee, Dozy, etc., Paul & Barry Ryan and the Loved Ones. . . . The Beatles at number one with "Penny Lane." . . . Broadcast restriction lifted from "This Is My Song," the Petula Clark record went on to become our hit-of-the-year. . . . Australia's Easybeats on their way to international hit fame with "Friday On My Mind." . . . Latest record production figures available indicate drop in 7" product, but nice lift in albums. . . . "Something Stupid" reached the top spot across the nation. . . . Local girl Cheryl Gray catching loads of air-play with "You Made Me What I am." . . . Peter, Paul & Mary booked for concert tour in May. . . . Rights in the MGM and Verve catalogues went to Phillips from Astor. . . . Liberty went from EMI to Festival. . . .

MAY

Jack Argent, head of Leeds Music group off on overseas visit. . . . Big t.v. special "The Seekers Down Under" shown nationally, with narration by Athol Guy. . . . All tracks from the "Sgt. Peppers" album under heavy broadcast restriction. . . . Fred Marks announced that Festival Records had secured the Australasian rights to the United Artists catalogue. . . . The Easybeats returned to Australia for a visit and received a Gold Record marking one-million sales globally of "Friday On My Mind." . . . EMI make first release of Musicassettes, all fully imported. . . . Phono-Vox of Australia set-up their own distribution office in Sydney. . . . "Something Stupid" still heading the charts. . . . Phillips Records officially change name to Phonogram Recordings Pty. Ltd. . . . Associated Music (Subsid of RCA here) secured Australian rights to Trousdale music catalogue of America. . . . Mr. Faecq, of World Music and Palette Records of Brussels, visiting this country. . . . Spin label releases "New York Mining Disaster, 1941" by the Bee Gees. . . . Concert tour for Peter, Paul & Mary a great success.

JUNE

Fred Marks, head of Festival Records on world tour to visit associated (Continued on page 60, Part II)

Australia's
Music
Publisher

**J. ALBERT
& SON
Pty. Ltd.**

EXTENDS
SPECIAL GREETINGS
TO ALL OUR
FRIENDS AND
ASSOCIATES
THROUGHOUT
THE WORLD

Season's Greetings To All Our Friends

YOUNG COUNTRY
YOUNG PEOPLE
YOUNG IDEAS

For the brightest young ideas on music publishing in Australia and New Zealand contact:



Phil Matthews
General Manager

Belinda Music (Australia) Pty. Ltd.,
Castle Music Pty. Ltd.
and Associate Companies
2nd Floor,
403 George Street,
SYDNEY 2000 New South Wales
Australia



De. mot moy
Professional Manager

GREETINGS FROM SYDNEY

on behalf of

ABIGAIL MUSIC (AUSTRALIA) PTY. LTD.
PENJANE MUSIC (AUSTRALIA) PTY. LTD.
DRATLEAF MUSIC (AUSTRALIA) PTY. LTD.
PAMPER MUSIC OF AUSTRALIA PTY. LTD.
PLANETARY-NOM (AUSTRALIA) PTY. LTD.

and all those other companies and catalogues daily joining the most progressive organization in Australia.

To
THE BEE GEES; ROBERT STIGWOOD; CREAM; DAVID SHAW; and many other wonderful friends throughout the world who have made 1967 a memorable year.

NORMAN WHITELEY HOLDINGS PTY. LTD.
127 YORK STREET, SYDNEY 2000
"ABISONG" SYDNEY SYDNEY 29, 1050

HOLLAND - 1967 IN REVIEW

1967 was the year of the new in BOVEMA's Gramophonehouse. Barclay, Erato, Saba, Blue Note, A.B.C. Paramount were added to the repertoire. All these labels were introduced by wonderful catalogues, special introduction albums, advertisements, eye-catching window displays, leaflets, etc., etc. And not without results: Bovema was in 1967 the company with a very big number of hits on the Dutch hitparade. Stars as Bobbie Gentry, Roger Whittaker, Lou Rawls, Al Martino, Cliff Richard, Keith West, Paul Jones, Jeff Beck, Van Morrison and others were bestsellers in Holland. And of course the top groups as the Beatles, The Beach Boys, The Move, Procol Harum, The Small Faces, The Strawberry Alarmclock, The Boxtops, Hollies and The Nice had wonderful hits. Also the Dutch groups the Cats and The Buffoons made hits in Holland. Bovema has been very successful in having its artists taking part in the various important Songfestivals which have been organized this year. Bovema-artists won prizes in the Knokke- and Splitsongfestivals and the "Coupe d'Europe" festival. Many artists of Bovema come to Holland to promote their records. We saw on television among others Roger Whittaker, Vera Lynn, Lou Rawls, Paul Jones, Adamo, The Small Faces, Keith West, Jeff Beck, The Hollies, Procol Harum, P.P. Arnold, The Nice, Twice As Much, Dave Clark Five, Pink Floyd and many, many others.

N.V. PHONOGRAM, for many years Holland's biggest record company, has increased its market-share again. This has its cause in the fact, that Phonogram released an extremely good collection of LP's during 1967. There was also a well received collection of budget-line LP's in the 1967 releases, compiled from the repertoire of the several labels represented by Phonogram, such as Philips, Decca, Fontana, London, President, American Decca and

Mercury. Phonogram also had a great number of big hitsingles in the past year. Among these were hits by Procol Harum, The Herd, Dave Dee, etc., Traffic, Rolling Stones, Tom Jones, etc. Phonogram managed also due to enthusiastic and progressive promotion, to take a total of 33% of the local single-charts during 1967. Phonogram has developed in the past years into a company which welcomes independent companies. This has resulted in contracts with successful labels such as Island, White Whale, President, Page One, R&B Records and Scepter/Wand, bringing many big hits and new artists. Among Phonogram-artists, who visited Holland for tours, TV and radio-appearances or recordings, were a.o. Dave Dee, Dozy, Beaky, Mick and Tich, Krzysto Penderecki, Them-singer Van Morrison, Eddie Boyd, The Rolling Stones, Cat Stevens, The Mindbenders, JoJhn Mayall & the Bluesbreakers, Whistling Jack Smith, Dave Berry, Manfred Mann, The Traffic, The Herd, Kiki Dee, John Walker, Tom Jones, The Moody Blues and the froggs, etc. All the records of Dave Dee (Fontana) were in the top 5. In February N.V. Phonogram announced the first eight releases in the new classical Philips LP-series, called "Boutique De Musique." These low-priced LP's received a special promotion and proved to be extremely good sellers over the year. Dutch singer Liesbeth List recorded in France for Philips. N.V. Phonogram re-released the successful "Music For The Millions" LP's, now on low-priced 12 the Decca "Phase Four Stereo" series inch LP's, in March. Growing sales for was reported in May. All the year over, Phonogram made big publicity for the already disbanded group Them. Their recording of "Gloria" finally became a hit in July. The record was released over two years ago, has been latent ever since, but came into the Top 10 this month. Album sales of

Them were jumping, especially the newly compiled LP's. Decca's long promotion made the group a legend over the years. Phonogram had a local no. 1 hit with "Melodia" by accordion-player John Woodhouse. In October the successful Royal Dutch Male Choir (150 members) "The Maas-trechter Staar" received the fifth Golden Disc. The Demaric Sound System was introduced to press, DJ's and dealers in November at a reception in Amsterdam. Sales of the LP's have been good, since this introduction. In the same month, Phonogram handed eleven Golden Discs to a great number of its local artists. Budget-line LP's of several well known British groups were the best sellers during Santa Claus time.

The year 1967 has been a year of progress for NEGRAM-DELTA in Heemstede. Although the forecast for the total extension of the Dutch record market does not exceed 5% of last year's sales, Negram-Delta will reach an extension of 30%. The main reason for this magnificent result is their expansion into the LP field. The great standard repertoire of Warner Brothers and Reprise and the marvelous operette repertoire of Eurodisc, enabled Negram-Delta to get the best possible profit of the general trend of growth in the LP field. In 1968 Negram will continue to strengthen her force in the LP field by promotion campaigns on Pye's Marble Arch Line and on the Joker label. Regarding the single-field, April 29 was quite a memorable day. At that very day Negram-Delta reigned the charts, distributing all three top-three items. One of the best selling local productions on single in the Dutch language, "Beestjes" by Ronnie and the Ronnies gave Negram-Delta another remarkable success: the record overtook the first place of the Flamish charts and stayed there for many weeks. Negram-Delta's promotion department was lent

great support by visits of many important stars as David McWilliams, David Garrick, The Kinks, Sammy Davis Jr., Long John Baldry, Miriam Makeba, The Electric Prunes, Peter Alexander and many others—last but not least Robert Stolz, Margitt Schramm and Rudolf Schock honored our country with two very, very successful tours, their "Ewig Junge Operette" will have reached enormous sales at the end of the month. For 1968 the management of Negram-Delta foresees very optimistical prospects: the relations to their foreign affiliates are better than ever and full cooperation in all fields is the result. The two youngest labels under Negram-Delta distribution: Cornet and Major Minor also predict a bright future. After discussions with the management of Elektra, with which Negram is having a direct contract now, Negram-Delta believes 1968 will even be better than 1967 for the sales of Doors, Bikel and Butterfield. On the Ariola-label the most advanced artists of 1968 will be Peter Alexander, who is growing more popular in Holland every day, and Udo Jürgens, whose tour next year will be packed by an enormous promotion campaign. For Warner Brothers and Reprise the Sinatra family and Dean Martin will remain strong sellers, while Peter, Paul & Mary will get utmost promotion.

CBS GRAMOFOPPLATEN has been tremendously successful, especially in the second half of 1967. The rise of sales compared with 1966 is expected to be approximately 10%. The most important highlight of 1967 was "San Francisco" by Scott McKenzie, which was on the local single charts for 6 consecutive weeks and is still selling very well, also due to the fact that CBS brought Scott McKenzie to Holland for a promotional TV-appearance. Ray Conniff's "Somewhere My Love" is one of the best-selling singles for 8 months now as well as his albums "Somewhere My Love" and (Continued on page 58, Part II)

for Holland * call Negram!
that speaks for itself



HOLLAND-LOCAL ARTISTS WHO HIT HOLLAND'S TOP 10 DURING 1967

ARTIST	MANAGER/AGENT	RECORD-COMPANY
After Teo	J. Pas	Phonogram
Armand	Paul Acket	Phonogram
Rudy Bennett	Cees van Leeuwen	Negram-Delto
Albert Brosens	---	Iromac
Buffoons	Poul Acket	Boyema
Golden Earrings	J. Senf	Polydor
Baudewijn de Groot	L. Nijgh	Phonogram
Heikrekels	J. Hoes	Dureco
Heintje	---	CNR
Johnny Hoes	J. Hoes	Dureco
Leen Jongewaard & André v.d. Heuvel	---	---
Karin Kent	---	Phonogram
Johnny Krooikomp & Rijk de Gooyer	---	Phonogram
Motions	---	---
Outsiders	Poul Acket	Artone
Q 65	John B. v. Setten	Negram-Delto
Rodys	J. Pas	Iromac
Ronnie & the Ronnies	W. Zomer	Phonogram
Ramses Shaffy	P. Koelewijn	Phonogram
Shoes	Thijs Chanowsky	Negram-Delto
Wally Tox	Poul Acket	Phonogram
Tee Set	John B. v. Setten	Polydor
John Woodhouse	Th. Kuppens	Phonogram
	---	Negram-Delto
	---	Phonogram



BASART IN BENELUX

number one music publishers

loidsegracht 11 — Amsterdam — Holland — Phone: 222626.
Maurice Lemonnierlaan 20 — Brussels — Belgium — Phone: 125034.



THE FASTEST GROWING RECORD COMPANY OF HOLLAND

POLYDOR NEDERLAND N.V. THE HAGUE

WE KNOW ALL THE GIRLS (and the boys) making

local recordings in our territory.

AND THEY — THE GIRLS and the boys — KNOW US.

This means that we have maximal possibilities for obtaining local covers on your material.

Please contact us: **EDITIONS ALTONA** — Vondelstraat 90
AMSTERDAM — Phones: 18.63.24 — 18.63.25
Cables: ALTONMUSIC

Same organisation: **U.A. MUSIC Nederland NV.**
PALACE MUSIC HOLLAND NV.
KASSNER — ALTONA NV.

HOLLAND — 1967 IN REVIEW

(Continued from page 57, Part II)
"This Is My Song." Further, the English group The Tremeloes made quite an impact on the local market with their singles: "Here Comes My Baby," "Silence Is Golden," "Even The Bad Times Are Good" and "Be Mine." Consistent best sellers in the popular LP field are "West Side Story," "My Fair Lady," "Porgy and Bess," and an increase of sales for all the Bob Dylan albums including his popular 2-record set "Blonde On Blonde." The Ray Conniff albums showed a rise of sales and the albums by the famous French conductor Caravelli too. Among the many CBS artists who visited our country were the Clancy Brothers, The Dave Brubeck Quartet, Miles Davis, The Ionious Monk, Anita Harris, and The Tremeloes. CBS also started a very successful local production with a very promising response for the international market with albums by The Kilima Hawaiians (Moonlight Over Hawaii), "International Melodies" played by the barrel organ "Waldkirch," Juan Pareira with "Caribbean Souvenirs" (The Sound Of The West Indies), plus very important accordion records by Antoine Momers and The Harmoniker Paraders. In the classical sector CBS introduced with great success its new medium price series: "CBS Meister Konzert," which made an enormous impact on the Dutch market, featuring such great artists as Bruno Walter, George Szell, Leonard Bernstein, Eugene Ormandy, Leon Fleischer, Robert Casadesus and Isaac Stern. One of the biggest highlights of the classical season undoubtedly was the 2-week visit to Holland of the famous conductor of the Philadelphia Orchestra, Eugene Ormandy, who made a tremendous impression on the Dutch classical music lovers, and his performances with The Amsterdam Concertgebouw Orchestra was hailed by the local critics. Verdi's opera "Falstaff," conducted by Leonard Bernstein with Dieter Fischer-Dieskau, was awarded the Dutch Edison Award in the category Opera in 1967. Among the classical artists who visited our country were: John Williams, Zino Francescatti, Pierre Boulez, Robert Casadesus, Ignor Kipnis and Eugene Istomin. Conclusion: The year 1967 was for CBS Gramofoonplaten the biggest so far and CBS continues to grow very rapidly. There was a greater demand for stereo albums. CBS successful local production and the increase of sales in the classical LP field, makes that CBS has high hopes for its future and will start 1968 with great confidence.

INELCO's Record Division did very well the past year and also the Music Tape had a promising start. The Santa Claus record sales were overwhelming and also the campaign "The Best Of Country And Western" had lots of success. The special Summer Sales Campaign was also very good, so Inelco is contented but will still fight for still more! In January Inelco started its "Local Record Production Company" with several free lance producers and the new label "Tania." Among the Dutch artists, contracted for Inelco's Dutch production are: Conny Vink, Simon Carmiggelt, Gijsbrecht, Sádor Vidák and Ad Vanderhood. In Amersfoort an Elvis Presley-day was organized. In February the Inelco-staff went to Hamburg to attend the half year meeting with the other companies and in the same month all the Dutch "Fiddler On The Roof"-artists (In Holland: "Anatevka") received a Gold Disc out of the hands of Mr. Wim Brandsteder. A big "Old Jass" press conference in March was the beginning of a number of old Jazz festivities of which RCA was the organizer; March 7 will be the "Jazzday" in future. The best RCA-LP of the year, "Mama's And Papa's Deliver," was released in April. In May Mr. Brandsteder went on a business trip to Canada and the U.S.A. where he got the "Golden Record" for the Dutch sales of "The Sound Of Music." In the same month Inelco

officials went to Helsinki for the RCA meeting in cooperation with Teldec. In June Inelco's 10th birthday was celebrated. In September Inelco started their big campaign for C&W music, entitled "The Best Of Country And Western." Inelco was present at the Teldec meeting in Hamburg to discuss collective ideas of the RCA repertoire. The Inelco Christmas campaign already started in October with the release of Elvis' big Xmas hit "If Every Day Was Like Christmas" and the Julie Andrews-André Previn record of "A Christmas Treasure." Also in October Mr. Mascini went on a business trip to RCA in America. One of the most successful Monkees hits of the year seemed to be their latest: "Daydream Believer," although "I'm A Believer" just reached the 100,000 mark. Among Inelco (RCA) artists, who visited Holland during 1967 we mention Erich Leinsdorf, Leonard Pennauro, Charles Münch, Artur Schnabel, Nina Simone, Anna Moóo, Anthony Newley and artists from the Italian "Cantouroupa '67" show and the Newport Jazz Festival concerts. Also to Holland came Messrs. Malcolm Frager, Richard Lewenthal, Friedberg (Amadeo), Waizenegger (Teldec), Detlevs (Teldec), etc.

In 1967 POLYDOR NEDERLAND N.V. has proved again to be the fastest growing company in Holland: now she is definitely one of the leading companies. Especially in the pop field Polydor Nederland developed itself so strongly, that she had regularly 8 to 10 records in the top 40 of Radio Veronica! This very successful operation was caused by artists as The Bee Gees, Jimi Hendrix, Sandy Posey, Arthur Conley, Aretha Franklin, The Who, The Golden Earrings, The Shoes, Bojoura and many others. Enormous sales were made with Atlantic, e.g. the promotion album "That's Soul" sold 25,000 copies within 3 months! Concerning the M.G.M. label a golden record will be granted for Dr. Zhivago. From the 1st of July Polydor Nederland obtained the representation of A & M Records. Sales have been very successful up till now. Together with this label Polydor Nederland has the disposal of the three famous artists of the "in" sound: Herb Alpert, Bert Kaempfert and James Last. Best sellers of the year were the Bee Gees as well as Jimi Hendrix Experience. In the local field the Golden Earrings operated successfully with Sound Of A Screaming Day, In My House and their LP Winter Harvest. Corry Brokken joined the Polydor label. A new talent with international possibilities named Bojoura was discovered by Polydor's Fred Haayen. In September Polydor introduced the Polydor Twin Series: 2 LP's in 1 album. 8000 copies were sold of the Bert Kaempfert/James Last Twin Album. In the classical field 30 new Heliodor items were successful in a nation-wide action. Roaring sales were obtained with the new middle-price D.G.G. Privilege Series. The well-known D.G.G. and Archiv subscriptions proved to be warhorses.

For CNR 1967 ended with the great news that Gert Timmerman had not only been that years most popular singer but the best selling artist as well. For the second time in succession he will receive the Midem trophy in Cannes. A big success for Gert and his producer CNR's A&R man Addy Kleyngel, who has also made the biggest vocal discovery of 1967. It's the eleven-year-old Heintje from the South of Holland, who reached in no time the Dutch top ten with his song Mama. For what concerns the classical field, 1967 was for CNR the year of the Melodia label. This contract with the Russians, clinched by CNR's manager Hans van Zeeland, was launched in January. In September a big promotion campaign followed which found her end in a tour of the Russian State Symphony Orchestra, conducted by Jewgeny Swetlanow. Results: Ovational applause and record

(Continued on page 60, Part II)

RECORDS HITTING HOLLANDS TOP 10 IN 1967

ARTIST	TITLE	LABEL	PUBLISHER NATIONALITY
After Tea	Nat Just A Flower In Your Hair	Decca	Impala-Basart Dutch
Armand	Ben Ik Te Min	Philips	Altana Dutch
Beach Boys	Then I Kissed Her	Capitol	Belinda American
Beatles	Penny Lane	Parlaphone	Leeds Holland-Basart British
Beatles	All You Need Is Love	Parlaphone	Leeds Holland-Basart British
Beatles	Hello Goodbye	Parlaphone	Leeds Holland-Basart British
Jeff Beck	Hi Ha Silverlining	Columbia	Holland Music British
Bee Gees	Spicks and Specks	Polydor	Belinda Australian
Bee Gees	New York Mining Disaster 1941	Polydor	Basart Australian
Bee Gees	Massachusetts	Polydor	Basart Australian
Bee Gees	Holiday	Polydor	Basart Australian
Rudy Bennett	How Can We Hang On To A Dream	Havac	Francis Day-Melodia Dutch
Baxtaps	The Letter	Stateside	Leeds Holland-Basart American
Albert Brozens	Jelle Zal Wel Zien	Relax	Leeds Holland-Basart Dutch
Buffoons	Tomorrow Is Another Day	Imperial	Holland Music Dutch
The Animals	When I Was Young	MGM	Schraeder-Basart British
The Animals	San Franciscan Night	MGM	Schraeder-Basart British
Ray Charles	Here We Go Again	Artane	Leeds-Basart American
Petula Clark	This Is My Song	Pye	Basart French
Arthur Conley	Sweet Soul Music	Polydor	Basart American
Dave Dee etc.	Save Me	Fontana	Impala-Basart British
Dave Dee etc.	Okay	Fontana	Impala-Basart British
Dave Dee etc.	Zabadak	Fontana	Minerva Music-Basart British
Dave Davies	Death of a Clown	Pye	Belinda British
Spencer Davis	G mmi Some Lovin'	Fontana	Essex-Basart British
Spencer Davis	I'm A Man	Fontana	Essex Holland-Basart British
Spencer Davis	Time Seller	Fontana	Essex Holland-Basart British
Golden Earrings	Saund Of A Screaming Day	Polydor	Impala-Basart Dutch
Golden Earrings	Together We Live, Together We Love	Polydor	Impala-Basart Dutch
Easybeats	Friday On My Mind	U.A.	U.A. Music-Altana Australian
Aretha Franklin	Respect	Atlantic	Atlantic American
David Garrick	A Certain Misunderstanding	Pye	Pye British
David Garrick	Dear Mrs. Applebee	Pye	Ed Bospel Music British
Bobbie Gentry	Ode To Billy Joe	Capitol	Chappell American
Boudewijn de Groot	Onder Ons	Philips	Altana Dutch
Boudewijn de Groot	Lan van Maas en Waal	Philips	Altana Dutch
Pracal Harum	A Whiter Shade Of Pale	Deram	Essex Holland-Basart English
Pracal Harum	Homburg	Stateside	Essex Holland-Basart English
Heikrekels	Waarom, Waaram	Telstar	Benelux-Music Dutch
Heikrekels	Ik Wil Alleen	Telstar	Benelux-Music Dutch
Heintje	Maar Van Je Houden	CNR	Basart Dutch
Herman's Hermits	Mama	Columbia	Connelly-Basart British
Jimi Hendrix	Na Milk Today	Polydor	Schroeder Basart American
Herd	The Wind Cries Mary	Fontana	Minerva Music-Basart British
Herd	Fram The Underworld	Fontana	Leeds Holland-Basart Dutch
Jahnyy Hoës	Jelle Zal Wel Zien	Telstar	Leeds Holland-Basart Dutch
Hollies	Carrie Anne	Parlaphone	Basart British
Engelbert Humperdinck	Release Me	Decca	Palace-Altana English
Engelbert Humperdinck	The Last Walz	Decca	Francis Day-Melodia English
Tam Jones	I'll Never Fall In Love Again	Decca	Essex Holland-Basart British
Tom Jones	Green, Green Grass Of Home	Decca	Altana British
Tom Jones	Detroit City	Decca	Holland Music British
Tom Jones	Funny, Familiar, Forgotten Feeling	Decca	Int. Muziek Co. British
Leen Jongewaard, André v.d. Heuvel	Op een mao'e pinksterdag	Philips	Philips Dutch
Scott McKenzie	San Francisco	CBS	Bospel Music American
Karin Kent	Jelle Zal Wel Zien	Decca	Leeds Holland-Basart Dutch
Kinks	Waterloo Sunset	Pye	Belinda British
Kinks	Autumn Almanac	Pye	Belinda British
Kinks	Dead End Street	Pye	Belinda British
Kinks	Mr. Pleasant	Pye	Belinda British
Jahnyy Kraai-kamp & Rijk de Goayer	De Bostella	Artane	Partengen Dutch
Manfred Mann	Ha Ha Said The Clown	Fontana	Altana British
Mankees	I'm A Believer	RCA	Int. Muziek Co. American
Mankees	A Little Bit Me, A Little Bit You	RCA	Int. Muziek Co. American
Marians	It's The Same Old Song	Havac	Belinda Dutch
Marians	Tcn:ght Will Be Stoned	Havac	Impala-Basart Dutch
Move	Flowers In The Rain	Stateside	Essex-Basart British
Outsiders	Monkey On Your Back	Relax	Impala-Basart Dutch
Outsiders	Summer Is Here	Relax	Impala-Basart Dutch
Michael Polnaref	Ta Ta Ta	Palette	Holland-Music French
Sandy Posey	I Take It Back	MGM	Int. Muziek Co. American
Q 65	Fram Above	Decca	Basart Dutch
Q 65	World Of Birds	Decca	Impala-Basart Dutch
Cliff Richard	In The Country	Columbia	Belinda British
Cliff Richard	The Day I Met Marie	Columbia	Belinda British
Rodys	Take Her Home	Philips	Impala-Basart Dutch
Rodys	Just Fancy	Philips	Impala-Basart Dutch
Ronnie & Ronnie	Beestjes	Delta	Altana Dutch
Royal Guardsmen	Snoopy Vs. The Red Baron	Stateside	American Dutch
Ramses Shaffy	Sammy	Philips	Basart Dutch
Sandie Shaw	Puppet On A String	Pye	Basart British
Shoes	Na Na Na	Polydor	Impala-Basart Dutch
Nancy & Frank Sinatra	Something Stupid	Reprise	Chappell American
Nancy Sinatra & Lee Hazlewood	Jackson	Reprise	American
Whistling Jack Smith	I Was Kaiser Bill's Batman	Deram	Basart-Mills British
Small Faces	Itchyca Park	Immediate	Holland British
Sonny & Cher	The Beat Goes On	Atlantic	Basart American
Rolling Stones	Ruby Tuesday	Decca	Essex Holland-Basart British
Rolling Stones	We Love You	Decca	Essex Holland-Basart British
Supremes	The Happening	Tamla-Motown	Impala-Basart American
Wally Tax	Let's Forget What I Said	Philips	Impala-Basart Dutch
Tee Set	Don't You Leave	Delta	Impala-Basart Dutch
Tee Set	Naw's The Time	Tee Set Records	Impala-Basart Dutch
Them	Gloria	Decca	Altana British
Traffic	A Hole In My Shoe	Island	Essex-Basart British
Tremeloes	Silence Is Golden	CBS	Anagon British
Tremeloes	Even The Bad Times Are Good	CBS	Anagon British
Turtles	Happy Together	Landon	Trident Melodia American
Vanilla Fudge	You Keep Me Hangin' On	Atlantic	Impala-Basart American
Keith West	Excerpt From A Teenage Opera	Pharaphone	Trident Melodia British
Who	Happy Jack	Polydor	Essex-Basart British
Who	Pictures Of Lily	Polydor	Essex Holland-Basart British
Roger Whittaker	Mexican Whistler	Columbia	Anagon British
Roger Whittaker	If I Were A Rich Man	Columbia	Chappell British
David McWilliams	The Days Of Pearly Spencer	Major Minar	Holland Music British
John Woodhouse	Melodia	Philips	Altana Dutch

MAKE IT A MERRY XMAS AND A FINE

1967



(from our experience with '67 we can recommend it to all of you)

Gerry Oord

Gerry Oord



Bovema-Gramophonehouse-Heemstede-Holland

HOLLAND - 1967 IN REVIEW

(Continued from page 58, Part II)
 sales. Telefunken was able to strengthen her position in the classical field with her series "Das Alte Werk." Leading artists like Frans Brüggem and Gustav Leonhardt are also responsible for this. The most loved Alt Aafje Heyhis made records again for a long time yet. CNR's classical Manager Ralph van Baaren took care of the album which is expected to be released one of these days.

During 1967 ARTONE and its subsidiary FUNCKLER RECORDS succeeded to further expand their activities in the Benelux as well as in the international markets, in spite of a rather hesitating start of the year due to decisive economic pressures. However, the second half of the year has seen a strong upward move sales-wise, so that turnover nevertheless has increased upwards of 10% as compared with 1966. This favorable

balance has been realized mainly through the company's successful switch-over of its monaural catalogues to stereo, as well as the marketing of specially compiled series and sales drives with boxed record-sets. Notably the Pete Felleman-composed Detroit Sound Series on Tamla-Motown has proved to be a grand success for such artists as The Four Tops, Marvin Gaye & Kim Weston, Martha & the Vandellas, The Marvelettes, The Supremes, The Temptations, Jr. Walker and Stevie Wonder, all of whom likewise have scored heavily in the singles field. In the jazz and blue field, further additions to the Chess Blues Series, the I Love Jazz on Chess Series and the Prestige Modern Jazz Giants Series have made this Felleman-compiled line the strongest of its kind in the Benelux. Furthermore, Artone has put itself out of the way to make special promotion efforts on behalf of its United Artists Releases. In this way, The Easy Beats' "Friday On My Mind" became a beauty of a blockbuster in Holland even before the disc had reached any status in other countries. This group, and the recently pacted Fortunes as well, were invited by Artone to do personal appearances and TV dates for record promotion purposes. Special attention has been paid also to UA's large catalogue of Motion Picture Sound Tracks and its Solid State line of double pocket sets of unique stereo quality. Activities which have resulted in additional sales. Artone's local production currently is receiving the biggest boost it has ever had through the matchless success of Johnny Kraaykamp & Rijk de Gooyer's festive reading of "De Bostella." Platter, produced by Lion J. Swaab, has already become the local hit of the year, even surpassing the tremendous success Artone scored during 1966 with Sjakie Schram's "Glaasje Op." Other local pop artists who made best sellers are Gonnies Baars, Bruno Majcherek, Conrad Orsowsky, Selma van Loggen and, of course, Sjakie Schram who continues to be very successful indeed. Artone's locally produced classical line, besides having seen an important local and international increase of sales, has been considerably extended with further releases. Highlights in these series are Albert de Klerk's Interpretations of the Haendel Organ Concertos and Haydn Organ Works, Herman Krebbers & Theo Olof performing double concertos of J. S. Bach and Vivaldi, Herman Krebbers and the Amsterdam Chamber Orchestra performing Vivaldi's "The Four Seasons" and albums presenting Italian Baroque Music played by the Amsterdam Chamber Orchestra. All in all, 1967 has been a bumper year for Artone.

1967 has become very successful for IRAMAC. The young company, one year ago only a small firm with a much awarded classical catalog and just starting in the pop business, has built itself an enormous national and international image, and has strengthened its market share from 1% to

AUSTRALIA - 1967 IN REVIEW

(Continued from page 56, Part II)
 companies. . . . Phillips here making push with Musicassettes. . . . Castle Music with the publishing rights to "Silence Is Golden" by Tremeloes. . . . "This Is My Song" heading charts for Pet Clark. . . . "Fiddler On The Roof" running in Sydney with Hayes Gordon a great success in lead. . . . RCA on enormous promo drive for Gita Rivera. . . . Festival Records acquire local rights to Project 3 label. . . . EMI getting set to release "Sgt. Pepper's album by The Beatles. . . . Astor Records appoint Don Blocker as U.S. rep. . . . A.R.C. making all-out effort with "San Francisco" by Scott McKenzie. . . . Album production was still increasing at a far greater rate than singles. . . . Drummer Snowy Fleet announced he was leaving The Easybeats. . . . "A Whiter Shade Of Pale" making heading. . . . Abigail Music with local publishing rights to songs by The Bee Gees. . . . First album release for local girl Harrell, produced by David Mackay. . . .

JULY

Record production figures for twelve months ended June 30, reach the all-time high of over 13 million units . . . with more than half the total in albums. . . . New single by Beatles, "All You Need Is Love" released. . . . American Dean Dixon resigns as conductor of Sydney Symphony Orchestra. . . . "Whiter Shade Of Pale" heading charts. . . . Dick Heming joins Astor records as national promotion head. . . . Australian artist Normie Rowe returned home after visit to London. A. W. T. (Bil) Smith, head of Australian Record Company off to the United States to visit with Columbia chiefs. . . . Festival out with soundtrack set to "Thoroughly Modern Millie." . . . Beatles album, "Sgt. Peppers," now a real sales giant. . . .

AUGUST

American artist Ray Charles on concert-tour of Australia. . . . Scott McKenzie heading our best-sellers with "San Francisco" for CBS label. . . . EMI purchase Belinda Music. . . . E.M.I. show group profit in Australia of (Aust) \$1,178,855, a strong boost over previous year. . . . Two popular teenage television shows, "Go" and "Kommotion" disappear from our screens. . . . Astor release old master by Davy Jones, "Theme For A New Love," which became a smash. . . . E.M.I. re-activate their Regal label, with a range of albums retailing at (Aust) \$2.50; their other low-priced lines are reduced from \$2.95 to \$2.50 at the same time. . . .

SEPTEMBER

Local combination, The Groop breaking-out with their "Woman, You're Breaking Me" single. . . . Disc-jockey

Tony McLaren missing as a result of boating mishap (now presumed dead). . . . "Up-Up And Away," up-up the charts for the Fifth Dimension. . . . Festival announce signing of deal which gives them future rights in discs by Procol Harum. . . . RCA reduce retail price on pre-recorded reel-to-reel tapes to \$5.95. . . . E.M.I. staff producer David Mackay off on overseas visit. . . . Matt Monro & Dusty Springfield here.

OCTOBER

Englebert Humperdinck is the chart-topper with "The Last Waltz." . . . American publisher Jack Stapp (Tree Music) is Australia and sets-up Sydney Tree with Barry Kimberley (Essex) in charge of affairs. . . . Film version of "Thoroughly Modern Millie" now running and winning fans by the score. . . . E.M.I. restrict classical releases to monthly basis. . . . RCA selling The Monkees in all shapes and sizes, singles, E.P.'s and albums. . . . Local entertainer Noel Ferrier cut an E.P. for Astor. . . . Lana Cantrell scored very well in personal appearances back home, she later returned to the States. . . . Radio station 2GB announce world-wide song-writing contest. . . .

NOVEMBER

Local girl Lynne Randell, returns to Australia from the United States following a successful concert-tour with The Monkees, to do a personal appearance tour of Australia on the same bill with Trini Lopez. . . . Astor Records issue series of Compatible E.P.'s. . . . "The Last Waltz" still at the top for Englebert Humperdinck and Decca. . . . It was hoped that the new Copyright Bill would go before the Federal House, it didn't so will now be held-over until the new year. . . . The Seekers booked to return home to Australia in December for personal appearances and a television special. . . . Newlyweds Jackie Trent & Tony Hatch have a hit on their hands here with "The Two Of Us." . . . "To Sir, With Love" finally gets away in the sales race for Lulu.

DECEMBER

Most effort has been centered on selling and promoting records as Xmas gifts; and with the nation's economy in a very buoyant position, the results have been very good all round. This is vacation time here, and many people in the trades are now away from their offices for a few weeks break. Some plants have closed down for the vacation, whilst others operate with skeleton staffs. Many top-forty radio stations are now out in their mobile studio units broadcasting from different beach and seaside resorts. MERRY XMAS TO ALL FROM AUSTRALIA.

4%. In the classical field, Iramac albums now are on sale in Benelux, France, Germany and many other countries all over the world. Daniel Wayenberg, Yi-Kwei Sze, Sidney Harth, Han de Vries among others are featured in this more and more praised series. In the Pop-business Relax, the pop label of Iramac, extended its success with the Outsiders (7 hits in 15 months) and Martine Bijl (one of Holland's leading songstresses). New successful acquisitions include the number one record star, comedian and showman Toon Hermans, soulsinger Davy Jones, pop groups Sandy Coast and Sammy Soul Set and local singers Albert Brosens and Lili Kok. In 1967 Iramac also has been very happy with the acquisition of several foreign labels. Things started off in January and February with the big country & western catalog of Don Pierce's Starday and Nashville labels featuring famous names such as Red Sovine, Flatt & Scruggs, Cowboy Copas a.o. and the Wergo contemporary music series, awarded with the Edison. In March and April, Iramac broadened its classical and religious repertoire with the distribution of Diskanto and Disco Nederland, two independent Dutch companies. Charles de Wolff of Diskanto, recently awarded an Edison, made a special album for the Europa Club of Bertelsmann. And organist Willem Talsma also received the Edi-

son, the highest Dutch musical award. In May Iramac started the Soul Sound label, devoted exclusively to rhythm & blues, blues and soul music, material licensed from Kent, Modern, United, Hollywood a.o. and also successfully featuring Davy Jones, a Canadian soul singer, currently living in Holland. During the month of August, Bellaphon was represented for the first time in Holland. Since then, Iramac has been very successful with the World Series of Bellaphon. Several popular operettas, the Boris Alexandrov Russian Choir and albums by the Hammond Brothers, Mark Evans, Albert Nicholas a.o. In addition to this, Bellaphon is scoring with the pop duo Adam & Eve. In September, Iramac introduced two other labels from Germany. Luxor Populär, the budget line of Saba, has been accepted very well in Holland thanks to the magnificent recordings and spendid covers. The Europa and Somerset labels won Dutch record market like a bomb. Never before, such great albums were offered at such a low price. Enoch Light's Project 3 has met with extremely good criticism of Dutch music press. The total sound, as recorded by the Light Brigade, Tony Mottola, Bobby Hackett, Peter Matz and The Kissin' Cousins has opened new doors in stereo. In November and December, Iramac has made new hit albums by Toon Hermans and Martine Bijl for its own Relax label.



**JUPITER
PRESTIGE**

The French Canadian labels on which all the artists have hits going for them.

DONALD LAUTREC
 MARC GELINAS
 CLAUDE SOREL
 PIERRE LETOURNEAU
 JEAN-LOUP CHAUBY
 LES SINNERS
 JEAN et STEVE
 GENE WILLIAMS
 SERGE LAPRADE
 MARCEL LEFEBVRE
 CHANTAL RENAUD
 LES MISERABLES
 LE CHOEUR D'UNE FEMME
 LES MARJENTINS
 MICHEL PAGE
 LES INTRIGANTES
 PIERRE LALONDE
 SHIRLEY HARMER
 LES MYKELS
 DOMINIQUE MICHEL

EDITIONS MUSICALES
DULAU - MONTREAL

LES EDITIONS MUSICALES CYBELE ENRG.

The publishing companies that own most of Canadian & European best selling titles.

NICOLE (Williams-Brien)
 LA MINI-JUPE (Lautrec-Jourdan)
 SI LE CHAPEAU TE FAIT
 (Lautrec-Nales-Ambou-Guéard)
 LA RONDE (Gélinas-Létourneau)
 FAIS-LA RIRE (Gérard-Bernet)
 JE SUIS ANGLAIS (Bernet-Jérôme)
 MON COEUR D'ATTACHE
 (Demary-Blanc-Macias)
 SUR TON VISAGE (Barrière-Gray)

4824 Côte des Neiges, Montréal, Canada
 733-9673 733-3636

**RCA VICTOR
 CELEBRATES IN BRAZIL
 40 YEARS OF SUCCESS IN RECORDS
 1928 • 1968**

**RCA ELETRÔNICA BRASILEIRA S. A.
 AV. IPIRANGA, 1097
 P.O. BOX 8460 • TELEX "RADIOINTER Spo 511"
 SÃO PAULO, S.P. - BRAZIL**

Part III Coin Machines and Vending



London Juke Hits; Slot Ban Urged

LONDON — London's top jukebox selections for the month of November were: "Hello, Goodbye", the Beatles latest smash that hit the Cash Box Chart December 2nd in the number 48 slot and by December 16th was gracing the #2 position; "In and Out of Love" by the Supremes and the very talented Diana Ross; "Susannah's Still Alive" recorded by Dave Davies; "I Second That Emotion" by Smokey Robinson and The Miracles and "Do You Hear What I Hear" by the Mike Sammes Singers.

Ban On Slots Urged

In the Northern Ireland House of Commons at Stormont, it was suggested that fruit machine should be prohibited.

A member described their use as a wasteful form of amusement from which people got no return for their money. "If they were suppressed it would be for the good of Northern Ireland," the member said.

The Minister of Home Affairs, William Craig said that as of June 30th 104 excise licenses had been issued for gaming machines in Northern Ireland.

Combi Restaurant/Arcade

A new restaurant costing 20,000 British pounds is soon to be built over an amusement arcade and snack bar at the Onchan Park Stadium, Isle Of Man. It is being financed by the local authority. Onchan Commissioners, who owns and operates the park, indicates the new restaurant will be open for use next summer. It will accommodate upwards of 150 people.

Toward Better Juke Earnings

CleveCoin Inaugurates Record Programming Service

CLEVELAND — Ronald Gold, chief executive at Cleveland Coin International (prominent music, games and vending distributor headquartered in this city), announced last week that his phonograph division has inaugurated a record programming service, in cooperation with Northern One-Stop, toward offering music operators higher jukebox earnings.

The service at this point essentially involves a more "careful study" of available record product to be placed on those new Wurlitzer phonos and used music machines which are sold to Ohio area operators thru CleCoin. "What we are doing here is keeping close contact with George Freeman and Don Rothenberg at Northern for a communion of thoughts and suggestions on what tunes are best for music machines in this specific area," Gold stated. "We utilize the trade charts, record company mailings, review of new product, plus keep a close eye on those artists or groups currently making a hit in this area over radio, TV and thru personal performances. Cleveland Coin has always been a must visit for artists passing through this region," Gold revealed. "If their current record product is found suitable for the jukebox audience, we can help operators and groups toward higher earnings. This service is especially important for our rural operators who do not, for obvious reasons, have the finger on the pulse of present record popularity as we do here at Cleveland and at Northern. We also take into consideration the particular type of location the music machine is destined



Columbia Records' chart-movers the Union Gap takes a moment out during CleveCoin Christmas party activities to pose with the firm's chief exec Ron Gold (right) and that music maker, the Wurlitzer Americana II. Gold believes that strong ties with the recording industry and its talent are valuable for the coin-music business.

for . . . its ethnic favorites, which artists have a good 'track record' there with past recordings . . . things of that nature," Gold further offered.

Underscoring the popularity of Cleveland Coin to the recording artist was a typical call paid on Gold

by Columbia Records' fast moving group, the Union Gap at the distrib's recent Christmas party (see photo above). At the time, the Union Gap was appearing at Otto's Grotto. Next scheduled play for the group is Los Angeles' Boss City.

Mondial Appointing 'Quiz' Distribs

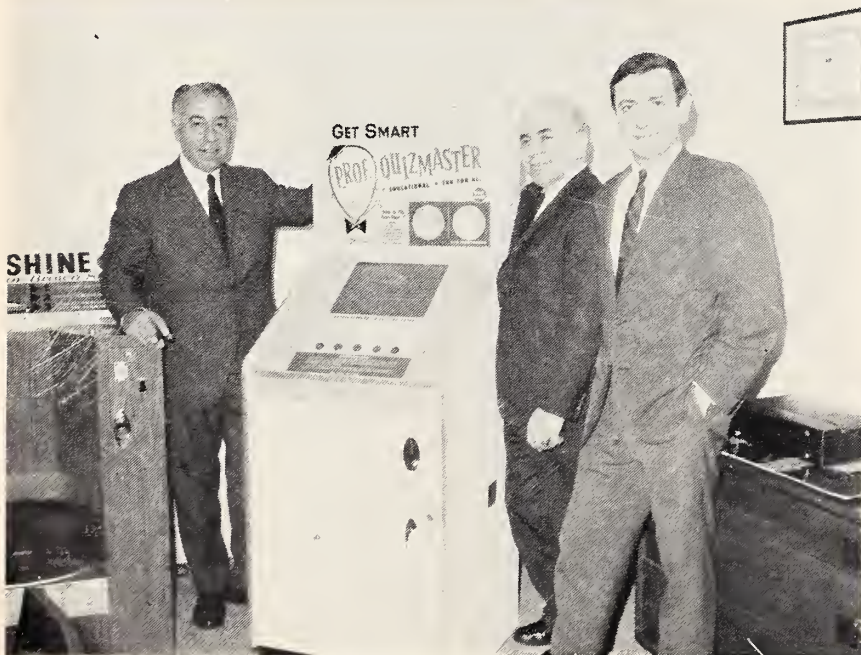

The big three at Mondial International show off their much heralded 'Prof. Quizmaster' unit. (Left to right) president Suren Fesjian, Aspet Varten and Dick Sarkisian.

NEW YORK—After what has been termed an "extremely successful" full year of location testing, Mondial International's 'Prof. Quizmaster' is now in full production and shipment to domestic and overseas operators is expected before year's end. To facilitate the United States market, Mondial is now in the process of appointing regional distributors. Their overseas network of import agents will service that market with the intriguing question and answer machine. Mondial's president Suren Fesjian (shown in the above photo at left, with Aspet Varten, center and Dick Sarkisian at right) advised that the gross collection take from several units on test passed \$100 . . . and all on nickle play. There are 500 questions offered on a single continuous

loop 35mm film reel. The player inserts his nickle and tests his knowledge on such subjects as movies, history, geography, etc. on any given five questions — each offering five multiple choice answers. Should the player select the correct answer button, a buzzer sounds and a score dial in the backglass moves up on notch (from the "Go Back to School" category for one correct answer to "Genius" for all five). Players also compete a time dial which measures the ability for "quick recall," similar to that required from students competing on the popular 'College Bowl' TV program. The questions themselves are demanding enough to pique the player's interest in coming back for a succession of plays.

Possible Game Tax Hike Seen In Fla.

TALLAHASSEE—It was reported in the recent Florida Amusement and Music Association newsletter that the Florida legislature will be called into special session in January to cope with that state's educational crisis. Among the most pressing items on its agenda will be finding several hundred million dollars to update Florida schools. The amusement industry, as always, will be eyed as a possible source of new finances. Taxes on the industry are generally not unpopular with the public in general.

Indications are strong that a legislator from the Orange County (Orlando) area will introduce a bill calling

for new and additional taxes on all amusements, as well as, cigarettes and alcoholic beverages.

The Newsletter further stated that Florida operators do not mind paying their fair share of taxes, but feel that the legislature considers them fair prey for confiscatory taxes whenever new revenues are needed for any purpose.

FAMA is already contacting members of the legislative body to point out the high level of taxes now paid by operators in that state, on both county and municipal levels, and to suggest that other sources be investigated for the needed revenues.

Formal Signing On Rowe Sale

NEWARK—Triangle Conduit & Cable Co. Inc., of Newark, and Canteen Corporation, of Chicago, signed a formal agreement December 14, for Triangle's acquisition of Canteen's Rowe Manufacturing Division, it was announced jointly by Carl S. Menger, chairman of the board and president of Triangle, and Patrick L. O'Malley, president of Canteen.

The acquisition is subject to certain conditions, including approval by Triangle's shareholders at a special meeting, which Menger said will be held probably in January.

Under the terms of the transaction, Canteen Corporation would receive \$24 million in cash and \$4 million in convertible subordinated notes from Triangle for the Rowe Division.

Rowe, with annual sales in excess of \$40 million, is one of the country's largest manufacturers of vending machine equipment and coin-operated phonographs and background music systems. Its headquarters and main production facilities are in Whippany, N.J. Rowe also has another plant in Grand Rapids, Mich.

Menger said that Triangle would operate Rowe as a wholly-owned subsidiary with Rowe's present management continuing in its current capacity.

If approved by shareholders, the acquisition of Rowe would be Triangle's first major diversification into the consumer products field. Menger said that the Rowe acquisition "reflects Triangle's concerted efforts to broaden the company's base and to enter into areas of strong growth potential."

O'Malley said that "the divestment of Rowe is in keeping with Canteen's long-range plans for concentration in the food, vending and service fields."

Triangle, listed on the New York Stock Exchange, is a major fabricator of a diversified line of copper, steel, brass, aluminum and plastic tube, pipe and wire products, and pre-insulated pipe. The company has 12 plants in 7 states and close to 2,500 employees. In the nine months ended September 30, 1967, Triangle had sales of \$85.8 million and net income of \$6 million, or \$3.01 per share of capital stock.

NAMA Council Meets

CHICAGO — Steven R. Polcyn, director of public relations of NAMA has released a list of NAMA State Council annual meeting dates for 1968.

February 2-3-4: California Automatic Vendors Council semi-annual meeting—installation at the El Mirador Hotel in Palm Springs, California.

March 22-23: Indiana Vending Council will hold their annual meeting at the Olympia Club in Ft. Wayne, Ind.

April 18-19-20: Illinois Automatic Merchandising Council will stage their Annual Meeting at the Lake Lawn Lodge in Delavan, Wisconsin.

May 17-18-19: Pennsylvania Automatic Merchandising Council stages their annual meet at Host Farms in Lancaster, Pa.

1967 In Review:

Copyright - Inflation - Convention

If you looped a rope around all those events which steered the course of the coin machine trade during 1967 and singled out those policies pursued by our industry leaders whose success or failure will profoundly affect our financial health in the months and years to come, the first and foremost item that rises to the top is the \$8.00 per phonograph assessment fee passed by the U.S. House of Representatives as payment to the performance rights societies for the use of "their music" on our jukeboxes. It was a historical move since the trade was yet to pay one thin dime in this direction under the protection of the 1909 Copyright Act. Some in the industry recoiled at the prospect of "giving in" to the societies whose "gluttony for the green stuff" was matched only by their "vague system of passing said money onto their song writing members." Others in the trade, indeed most in the upper reaches who played either a direct or indirect role in securing the \$8.00 fee as opposed to a horrifying bookkeeping nightmare of reporting individually 3¢ per side per calendar quarter (roughly \$19.20 per box) were quite elated at the compromise settlement.

Cash Box
Editorial

The Dying Dime

It took approximately ten years for the nation's operators to change over from nickel play to dime. In that decade the cost of the machines went up, transportation and labor charges went up, the number of locations began to dwindle, and more and more of the dime in circulation had been an almost exclusive nickel play.

In the last few years in New York alone, the desire to be able to play a dime on the state and city governments that a bet from Albany or City Hall might be considered, and had no effect, but simply a nickel play for more. Cigarette vendors were able to use the dime and the case now opening concerning like bus sales taxes, cables and on the other hand, the dime coin's option is to whether or not the law applies to them. Nowhere does the report or will the court attempt to consider or make judgment upon (1) the necessity for new taxes and (2) the morals behind them.

Now through all this our friend the dime, while too long to show, had in the meantime gone down the hill in value. Call it inflation or the war in Vietnam or the price of property or what you will. It is simple and worth very much today.

If all the major cities of the nation decided to tax public sales on anything over dime play, it would be negligible and in some cases destructive. But consider also that jukebox operators are not making that

much money on dime play alone. What is the outcome? The outcome is a tightrope between a rapidly devaluing dime and a rapidly rising quarter. Somewhere between the two the operator must find his late home money and his business expenses. What then is the solution, or what is the most serious competitor?

There have been calls from phonograph and record manufacturers for increasing the single play price from one dime to three cents or two plays for operators. One great manufacturer has an idea for operators with the fifteen cent coin, with an optional dime coin.

It would seem that the history of the operator to up his price and the loss between the dime and the quarter to see which becomes profitably priced and fairly priced could be considered fairly and adequately by the phonograph manufacturers. Simply issue a new "dime" model with optional fifteen cent quarter. Since the manufacturers have pointed the way in almost everything else, even merchandising this move would seem to be the most time saving.

If there are objections that such a coin change would be open territory for law-hungry governments, then consider that said governments usually tax what they feel like taxing, without law definition of who it hits. If they don't tax it, of course, it's extra money. A little extra. But it seems the only alternative to the dying dime.

Chicago Coin Unveils 'Park Lane' 6-Player Shuffle



Chicago Coin has unveiled its new "Park Lane" 6-Player Shuffle jukebox. This new model features a unique shuffle mechanism that allows for a more varied and interesting selection of music. The jukebox is designed for high-volume operation and is available in both nickel and dime play versions. It is a significant addition to the industry's lineup of jukeboxes.

Artist	Title	Label
Martha Ray	Don't Leave This Way	Capitol
Barbara Streisand	My Sweet Lord	Capitol
Wilson Pickett	Mustang Sally	Capitol
Little Richard	Rock On	Capitol

amalgamating of smaller routes into big ones as little operators were priced out of business and forced to sell. The prospect of a select few national operator combines horrified everyone in the industry except those operators heading in that direction. Indeed, many of our large companies deserve to be in prominent slots, owing to their sixth sense of where to place what equipment and their knowledge and appreciation for the extra dollar gained by milking the most from every location. This involved the common sense interest in on-location merchandising. However, there became increasing concern for the state of health of the operating trade. The prospect of salvation or "solution" through a price hike on the music machines had been boarched before the year began and made impressive inroads before the year ended. Quiet, but firm prodding at the distributor level urged many operators into converting certain of their locations onto the two-plays-for-two-bits pricing. Operators, quite naturally leary of boosting the fare and inviting the wrath of the location, needed and still need convincing that this is the necessary direction to take. Reports from those who attempted the conversion during the year sounded just fine—indeed shattered a lot of myths of screaming customers and enraged bartenders who adjusted to the two for 25¢ with a simple "Yeah... sure." One factory's official sanction of the price boost came in November with the introduction of the Seeburg Corporation's 'Spectra' phonograph. This juke, far from simply a radical departure in traditional phono design, also offered its operators an in-unit two-for-25¢ pricing option. Matter of fact, distributors were urged to promote the price increase while pointing to a special pre-selected three tune set-up which vended for the traditional three for a quarter. "A transition machine" it was labeled, offering both pricing arrangements.

questionnaire did determine, it is reported, was that music operators, without a doubt, presented the largest singles buying bloc in the country. The record companies, cognizant of the tremendous buying power of the operator but convinced almost to a man that this operator depends upon the top 100 charts for his programming material, did very little actual promotion and specialty record production for this market. The operating firms, on the other hand, have felt more and more being treated as a "stepchild" by the record manufacturers and aired their grievances many times during the year. The Record Co. MOA liaison committee set up by Bill Cannon managed to exact a bit more attention from the record execs but actually no great flow of what the trade has learned to call "jukebox material". The flow of little LP product, with the exception of the Seeburg Corp. which managed to release approximately 50 junior albums during '67, amounted to a modest dozen mostly between Atlantic and Epic Records... a lesser number than in '66 when the trade considered even that insufficient. Why such apparent disinterest in the little LP? A lower profit for the dollar invested by the one-stop and an absence of profit from the record companies who claim the LP's offer strictly promotion for their artists and nothing more. Then in October, a firm calling itself Garwin Sales secured the national distribution rights to the Seeburg little LP catalogue as well as contract agreements from several top labels including Epic, Columbia, etc. to market nationally said LP's through Seeburg distributors and one-stops. Bob Garmisa, the firm's principle, claims he sees a need for the product by the operator as well as profit in it for the record firms and naturally for Garwin Sales. Therefore, the principle production and distribution of this "jukebox material" will be in the hands and under the direction of one firm in 1968... its progress we await with considerable interest.

MOA Convention; Cannon To Top

When you speak of one-stops these days, you don't have to wait very long before the memory of the October MOA Convention comes to mind. Truly, the single disappointment in these three marvelous and fruitful

The Word is "Pile"

MOA Testifies Before the Senate

WASHINGTON, D.C.—MOA's legal wizard Nick Allen, witnesses such as Bill Cannon and Bob Nims and for the not-to-ever-be-forgotten end run play executed with Harry Witsen's preparation of that mountain of paperwork which opened the eyes of the Judiciary Committee and forced the compromise section.

But all this might end up an interesting story in the back issues of the trade press unless an identical section is carried through by the Senate in their copyright bill when they convene again in 1968. And in reality, it should pass. It's good for both parties involved.

At Senate Hearings

WASHINGTON, D.C.—The Music Operators Association (MOA) testified before the Senate Judiciary Committee on the proposed copyright bill. The hearing was held in a packed room, with many industry representatives in attendance. The testimony focused on the impact of the proposed changes on the jukebox industry and the role of operators.



CANNON'S TESTIMONY

Bill Cannon, MOA's president, testified that the industry has been severely impacted by the proposed changes. He argued that the current system is fair and that the proposed changes would be detrimental to the operators and the industry as a whole.

The earnest thanks of tradesmen went out to manufacturers' attorney Perry Patterson, MOA's legal wizard Nick Allen, witnesses such as Bill Cannon and Bob Nims and for the not-to-ever-be-forgotten end run play executed with Harry Witsen's preparation of that mountain of paperwork which opened the eyes of the Judiciary Committee and forced the compromise section.

But all this might end up an interesting story in the back issues of the trade press unless an identical section is carried through by the Senate in their copyright bill when they convene again in 1968. And in reality, it should pass. It's good for both parties involved.

Two-For-25¢ Music Pricing

Many in the industry were hard-pressed to make the income they earned in 1966. Periodic samplings of profit-pictures about the country revealed an interesting condition—the gross was up but the profit was down. The price of equipment, to everyone's chagrin, rose in many cases. The much bloated loan and bonus cancer hasn't helped matters any, except in the

Over 40% Singles Sold To Operators

An anonymous questionnaire prepared by the phonograph manufacturers and distributed through their regional representatives and by direct mail to operators to determine the exact financial condition of the trade was compiled by Price Waterhouse for presentation to Congress on behalf of the coin industry. What the

THE BEST OF HOLIDAY GREETINGS TO OPERATORS EVERYWHERE
Color-Sonics, Inc. 37 Washington St., Melrose, Mass. (617) 662-7700

Record Breaking '67 Convention Draws 2000 Tradesmen to Chi; Bill Cannon Elected President Exhibit Sellout, Banquet SRO



The annual MOA convention in Chicago was a record-breaking event, drawing over 2000 tradesmen. Bill Cannon was elected president, and the exhibit sellout and banquet were sold out. The convention featured a variety of exhibits, including the new 'Park Lane' jukebox, and a banquet with entertainment. The event was a success for the industry and provided a great opportunity for operators to network and learn about the latest in jukebox technology.

HAPPY HOLIDAY GREETINGS



from

United Billiards

to

AMUSEMENT OPERATORS EVERYWHERE.



your continued confidence in our table line is all we want for Christmas!



ART DADDIS
PRESIDENT

1967 In Review: Loans & Bonuses - Merchandising

COIN MACHINES & BILLIARDS

CashBox

Editorial

Together Again!

Beginning this Thursday afternoon, sets will come bumping onto the expressway of O'Hare International Airport, taxi up to the frantic hub of the aerial terminals and watch its passengers get swallowed up in the great metropolis called Chicago, Illinois—the Capital City of the Coin Machine Industry.

Among these tired travelers, who will have journeyed halfway across this nation and ultimately across Chicago to the Pick Congress Hotel will be great answers to the name of Laker, of Denver, of Fiddo, of France. "What's this group?" some curious bellhop will ask. "Jukebox guys, I think." "Hi, luddy will answer.

Yes, jukebox guys, games operators and the fellows who make and sell the coin-operated equipment which the public turns to every day for inexpensive entertainment and a convenient place to buy a pack of smokes, a box of candy or a can of soda pop. If you were to call them all by one name, that name would have to be the Music Operators of America.

In its 18th year, the 1967 gathering of the MOA clan should be the grandest yet. The association's position on the single, united voice of the music and games industry is recognized both within and without the trade, from the local association which looks to the national group as "high headquarters" to the very halls of the U.S. Congress which respects the name of MOA as spokesmen for the thousands of American operators.

In 1966, the Convention heard the success story of Red Wallace's month-long membership drive. Now, the 1967 Show will hear another success story—that of Jim Tolisano's tireless campaign to boost membership at the local association level in his quest for MOA support from the grass roots up.

Ford is plainly true that the legislative platform of this business is drawn in the grass roots of the country. . . in Springfield, Ill. where the ICMAA successfully turned back the anti-coin table movement. . . in Albany, N.Y. where the NYSCMA continues its attempt to clear the muddled air over games prohibition with its licensing bill. . . and in all those places where a local group quietly, patiently and effectively maintained the status quo which is always theirs under the best of conditions.

The snowballing success of MOA was aptly put by Miltie McCarthy last week when she said, "years ago it was like pulling a mule out of a machine to get operators to support MOA. . . now enthusiasm is so great it's like trying to hold back a force of wild horses." Well, it is a fine sight to see our national association held in such esteem and to hopefully see that esteem serve up the largest representation of tradesmen at the Pick Congress this weekend. We'll be on hand to meet and shake your hand—we like shaking hands with men who believe in their business—especially this business.

Cash Box—October 23, 1967

convention days was the scarcity of one-stop representatives on hand to share in the precious dialogues with operators and record company reps. But to begin any analysis of the 18th MOA Show with a sour note is almost sacrilege because the Convention proved out to be the most productive and professional gathering of this trade's more progressive members in a decade. MOA's executive vice president Fred Granger—more than any other, directly responsible for the Show's success—estimated that nearly 2,000 tradesmen from at home and abroad viewed the machines on display and enjoyed the intelligent discourse on machine operation that only another conventioning operator can provide.

Pins & Pool Tables; More For Machines

Half of the Industry Seminar, entitled "How to Make More Money with Amusement Games", provided the most unusual sight of the top sales managers of our major games manufacturing firms sitting at the same panel. The opportunity might have better been taken advantage of by the operators . . . many important

questions were never asked . . . but the thoughts of these factory representatives struck home in each instance. The loan-bonus cancer was reviewed and defiled, the "stepchild" role of the lucrative coin table was discussed, the poor habit of games collectors dropping all the take into one bag instead of keeping accurate tabs on the performance of each machine was scored as well as the tremendous upsurge in long-board shuffleboard location opportunity aired. The germ of a potentially tremendous merchandising idea, suggested at the seminar by Arizona's Ben Spaulding, brought up the possibility of staging local coin table tournaments (modeled on his highly successful association-backed contest in Phoenix), all of which might lead toward a national run-off at next MOA.

New Jersey's Bill Cannon was elected to the 1967-68 MOA presidency, succeeding Jim Tolisano. The latter's reign proved immeasurably helpful in fostering local association membership during the course of the year. Cannon's penchant for closer, more productive ties with the record manufacturers should prove his main objective during his tenure in office.

Several important developments in both music and games machine production took place during the year. Perhaps the most impressive developments were the addition of the dollar bill acceptor on the juke, the release and promotion of 100-selection units by Rock-Ola, Seeburg and AMI and the introduction of foreign-made music machines with NSM's Consul 130 and Jupiter's three new French models. Rock-Ola, a consistent supplier of 100-selection machines, provided the trade with their 'Centura' and 'Princess DeLuxe' units, Seeburg followed the 'Mustang' with their 'Phono-Jet' and Rowe bowed their 'Cadette'. AMI continued throughout the year with production of their 'Phono-Vue' film product for their popular auxiliary projector unit. On the audio-visual score, Rock-Ola revealed its plans to market a sight and sound machine in 1968. Scopitone's parent firm Tel-A-Sign entered into bankruptcy during the year, offering Jack Gordon the opportunity of securing both distribution and manufacturing rights to this line from the French factory. Gordon's surprise of the MOA Show was the preview of his Cinematic 50 machine and the announcement of a complete film and machine production program under the firm name of Cameron Audio-Visual International. Gordon's Cameron Int'l. Ltd. would continue to service present Scopitone operators with regular film releases while the other organization would market the Cinematic line. Color-Sonics' Combi 150 combination film/record machine was displayed at the MOA Show with availability promised by February. As a subsidiary of the National Company, the decision was made to move the sales offices of Color-Sonics from New York City to the home base in Melrose, Mass. about mid-year, with veteran Mickey Greenman taking over the division as chief executive officer. David Rosen continued his Cinejukebox program as

(continued)



THE SCENE—The smoke-filled, operator-packed great hall of Phoenix, Arizona's Sands Hotel. The story.

The Greater Phoenix 8-Ball Tourney

An Enthusiastic Beginning with a Morf Trade Run-Off at the End of the Rainbow

Speaking of next MOA, Granger and his staff decided immediately after this year's event to move the 1968 Show into the newly-refurbished Sherman House, or really, back into it. With NAMA moving its Show into Philadelphia for 1968, the MOA Convention will once again have a chance to stand on its own and its success will be completely dependent upon our hard-core music and games people.

From the entire staff at **EASTERN NOVELTY . . .**

... and a prosperous **NEW YEAR**

The coin industry's leading supplier of pool table supplies and accessories.

EASTERN Novelty Distributors, Inc.

HOME OFFICE: 3726 Tonnele Ave., North Bergen, N.J. (201) 864-2424
WEST COAST OFFICE: 2939 E. 11th St., Los Angeles, Cal. (213) 269-5979

Jingle Belle.

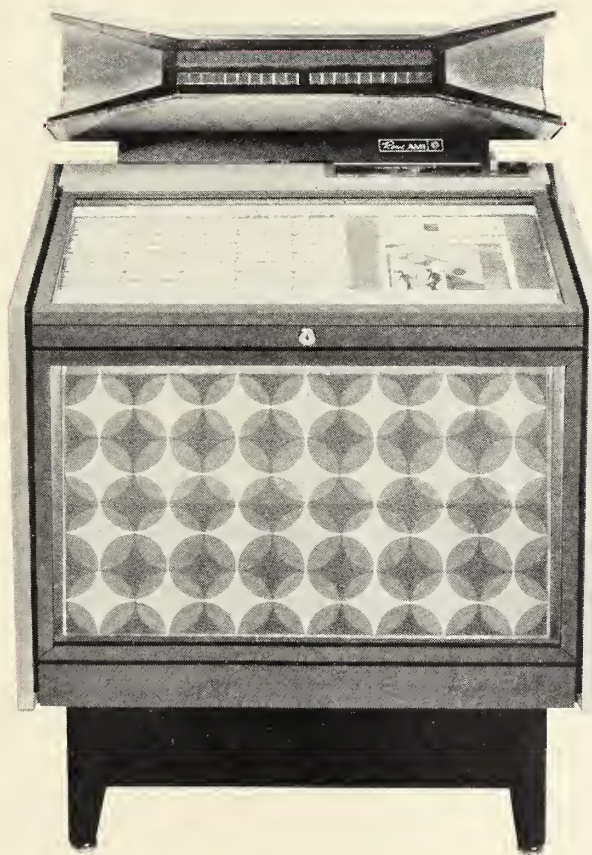

MERRY CHRISTMAS FROM THE 100-SELECTION CADETTE. JINGLE. JINGLE. JINGLE. JINGLE. JINGLE. JINGLE.

Rowe[®] MANUFACTURING
75 Troy Hills Road, Whippany, N. J. 07981

Q. What's the newest, most exciting amusement game available today that grabs more nickels than any other game in its price range? (NOTE: It's legal everywhere and perfect for every location)

A. Prof. Quizmaster

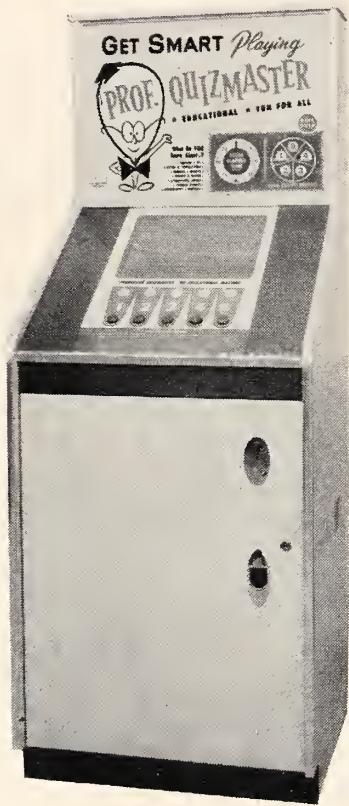

MONDIAL'S fascinating game of questions and answers. Creates location excitement and superb collections wherever placed.

**DISTRIBUTORS NOW
BEING APPOINTED**
Inquiries Invited!



**MONDIAL
INTERNATIONAL, INC.**
350 FIFTH AVE., NEW YORK, N. Y. 10001
Tel. (212) 947-5661

1967 In Review:

Counter Games - Audioviz - 100mm Cigs - Safe Filters

the first combination unit to move onto locations. Regular shipments of the Cinejuke from the Innocent plant in Milan to the Port of Philadelphia, added to Rosen's promotion program, kept the units making inroads all throughout the year.

Counter Top Units; A 5¢ Commotion

Highlighting the year for amusement machine operators was the tremendous upsurge in counter games. Interest in this type of equipment snowballed the latter part of 1967 and saw the birth of "reflex test", battery operated units from Northwestern, the Irving Kaye Co., United Billiards, and several others who found that a lot of money can be gained by the operator through nickle play on the counter.

cer Society's TV and radio campaign against smoking proved rather interesting but its effect, if any, seemed negligible on over-all cig sales. NAMA instituted Operation Alert '67 to keep kids away from the cigarette machines by the use of decals, warnings to location people, etc . . . in an attempt to keep the "house clean" and avoid unnecessary grief. As far as the equipment was concerned, the biggest story came with the enormous rise in 100mm brands and the subsequent furor over converting existing vending unit's to accept the longer size and the release of 100mm column machines by the factories. Bootlegging in high-tax areas abated to a great degree, principally through the cooperation of vendors and the local authorities as well as the institution of stiffer penalties. Finally, as the year drew to a close, Sen. Magnuson and other Congressional and Federal Agency leaders began to put pressure on the cigarette makers to study means of making cigarettes "safer" for the consumer who "just can't kick the habit". The thinking sounded good and the vending industry awaits developments on this note in 1968. One development we'll all keep our eyes on will be the progress or failure of the Strickman Filter, said by its inventor to remove up to 70% of those materials commonly referred to as "tars" while permitting most of the flavor to pass through to the smoker.

Legal Status Quo; Illinois Saves Day

Besides the copyright matter, the legislative scene was quiet for the most part across the country. The most stringent case arose in Illinois where the Chicago Crime Commission created one heck of an anti-pinball controversy, resulting in several nasty bills which would have eliminated all pingames from the State, as well as prohibited their very manufacturer out there. Through the efforts of the Illinois association and manufacturer representatives, all adverse legislation was squashed. A stink over add-a-balls came to the fore in Ohio and New York, neither of which was settled by year's end. A case in New York's Nassau County brought up the question of bonus depreciation but again a final decision was not in by year's end. The status quo was fairly well maintained throughout the country in 1967, which, if we bother to think about it, is pretty darned good.

Modern, Crisp Attitude In 1968 Would Enhance Trade's Image

That certain sophistication about the coin machine industry which, through the efforts of young, educated men entering the field and a concerted drive at the grass roots level to protect and promote the correct image of the operator, was becoming the mode and will certainly be the fashion in the months and years ahead of us. A modern, crisp and aggressive attitude, both on the route and in the showroom is becoming more evident every day. While there's a great deal of work remaining ahead, the past has been rather kind to this business and with a continued belief and a sense of pride about this unique method of making a buck, we will prevail and prosper.

COIN
MACHINES
&
VENDING

Cash Box
Editorial

MERCHANDISING—To Earn That Extra Buck

By this time, most of you have seen those colorful little STP stickers plastered on automobiles, trucks and even motor scooters zipping by on the highways. STP is a brand of motor oil, a good product to be sure, but why are they taking its particular tack all with such gusto? It's that little sticker. Why people like to stick it on their cars is a matter for the motivational research experts but the reason the company's sales department continues making them is simple—it's successful merchandising.

Merchandising—has extra effort behind the sale which might be a direct inducement, a contest, a bonus, an interesting advertising campaign, public relations or that little STP sticker. It's not something other forgotten or missed by the coin trade. Oh, to be sure, we've had our days of bullhorn, like when the pinball makers came out with coin-op discographic. All the pieces were there—big speakers, colorful wall banners, table tents, window posters, even dance demonstrations—but what was the outcome? Did John Q. Operator jump on the bandwagon? What about the auxiliary public address systems placed as an extra bonus to the location? What of the little—how many operators promote these on location? What of the promotional records issued monthly to one of our factories? These are a smattering of some really good merchandising ideas which the factories spent money on, certainly to sell more machines but also to make more money for the operator.

However, there are some very prominent operators today letting us the factories either don't know the meaning of merchandising or prefer to devote all their attention to the distributor instead of helping the operator. There are incidents from both sides.

with more than a grain of truth from each. And let's not restrict our remarks to music. There's just as much merchandising going on in the game business with operators saying they can't get a particular model because it's all going over to Europe first, then the factories issue new game ideas and wait months while the operator makes up his mind that the price is a proven money maker before he buys the first one.

It's difficult for a trade publication to appraise the efforts of a single manufacturer, distributor or operator in an editorial and equally hard to castigate anyone in particular for being remiss in their merchandising responsibilities. Our street is not so labor as apparent dispenser of merchandising techniques nor does fingers of responsible parties. Rather, we'd like to rethink an aggressive merchandising attitude on all levels of the trade through some positive suggestions—concrete useful techniques whose application could pump greater vitality into the coin machine business and a consequent increase in collections and sales.

Therefore, beginning with this issue, Cash Box will run a weekly feature entitled "Merchandising Read-Book"—a collection of promotion suggestions our readers might find useful in either long range or short term selling. We'll also, from time to time, apply the efforts of a particular machine manufacturer in good and thought-provoking merchandising. Naturally, our staff will depend in large degree upon the cooperation of the readership in supplying their suggestions on "what to say" and "how to do best" in selling this business of coin-operated entertainment. Don't be shy—let us hear from you.

Supplementing a regular supply of pins, shuffles, bowlers, guns, and base-balls from Bally, Gottlieb, Williams, Midway and Chicago Coin were a number of new notions which achieved varying degrees of success. Several knowledge test units came on the market as well as a new entry in the table soccer field and of course the above mentioned counter games. It must be concluded, though, that the traditional varieties of coin amusement machines (including tables) still provide 99% of the take, indeed from all observations, will continue to provide the staple products of the games business in the foreseeable future. To be blunt . . . that successful "new idea" failed to make its appearance in 1967.

The pool table, still from most aspects the highest money-earning, service-free piece on the market, continued to play its valuable role in the amusement business. No new factories entered the trade but several variations on the existing equipment made their appearance, including new cabinet colors and designs as well as scratch-ball return mechanisms.

Operation Alert '67; Congressional Peek

Plenty of talk but no crucial developments occurred in the cigarette vending business. The American Can-

All-Risk Insurance May Be Withdrawn Says M. Spindel

CHICAGO—Manfred S. Spindel, President of G M & V Corporation, division of Spindel Insurance Agency, Inc., states that an almost complete lack of interest on the part of operators and distributors in insurance protecting equipment on location will mean the withdrawal of the company from this market.

Spindel, who recently visited some of the principal cities where racial disturbances occurred, was amazed at the reaction of those operators who lost equipment as a result of the riots. They feel it can't happen again.

"Losses of equipment by fire, theft, vandalism, riots, and national disasters do and will occur, and any business man who does not protect himself is playing Russian roulette," Spindel said.

Spindel further reported that as the year 1967 approaches its close, the death claims paid on the lives of operators on whom distributors had placed Credit Life insurance was 203% of the total gross premiums.

Spindel feels that this is due in part to the failure of many distributors to insist that all installment contracts carry Credit Life insurance. Too many distributors feel that the only time this type of protection is necessary is if a sizable indebtedness is incurred. When this happens, adverse selection works against the insurance company.

Service fees on Credit Life for the next year have already been reduced by the Spindel Insurance Agency, Inc., because of excessive losses. It is hoped that all distributors will cooperate by seeing that all installment contracts carry this protection.

Peaches & Herb, Lettermen Head Up P/V Pairings

WHIPPANY, N. J.—Rowe AMI's director of the PhonoVue/record pairing program, George Klersey, has released data on the program for the week ending December 23rd.

PhonoVue flicks, "Rain Or Shine" (L-2908N), "Bedroom Caper" (L-2911U), "Mermaids" (L-2908E), "L'll Ol' Winemaker" (L-2909U), "Belly Dancer" (L-2907W) and "Montmartre GO-GO" (L-2906A) has been paired up with Marvin Gaye & Tammi Terrell's Tamala recording of "If I Could Build My Whole World Around You."

The fantastic Johnny C.'s latest disc of "Boogaloo Down Broadway" has been matched up with "Juke Box Patry" (L-2908H) and "Girl In Picture Frame" (L-2905B).

"Ninety Nine And A Half" on the Tower Label by The Standells goes well with P/V film cartridges "Love-In" (L-2910L) and "On The Beach" (L-2908Y).

Inez & Charlie Fox's "Count The Days" on Dynamo is compatible with flicks, "Fire Dance" (L-2907L), "Silhouette Dancers" (L-2907V) and "Living Doll" (L-2907U).

"Hermit's Heaven" (L-2910D), "Chef's Delight" (L-2908V), "Silhouette Dancers" (L-2907V), "Living Doll" (L-2907U) and "Chess Game" (L-2909V) have been matched with The Foundations' UNI cut of "Baby, Now That I've Found You."

"Going Out Of My Head/Can't Take My Eyes Off You" by The Lettermen on Capitol presents a groovy A/V mood with P/V films "Love-In" (L-2910L) and "On The Beach" (L-2908Y).

"Two Little Kids" a Date recording by Peaches & Herb swings with "Silhouette Dancers (L-2907V) and "Living Doll" (L-2907U).

What's behind the BIG DEMAND for FISCHER? SOLID QUALITY!

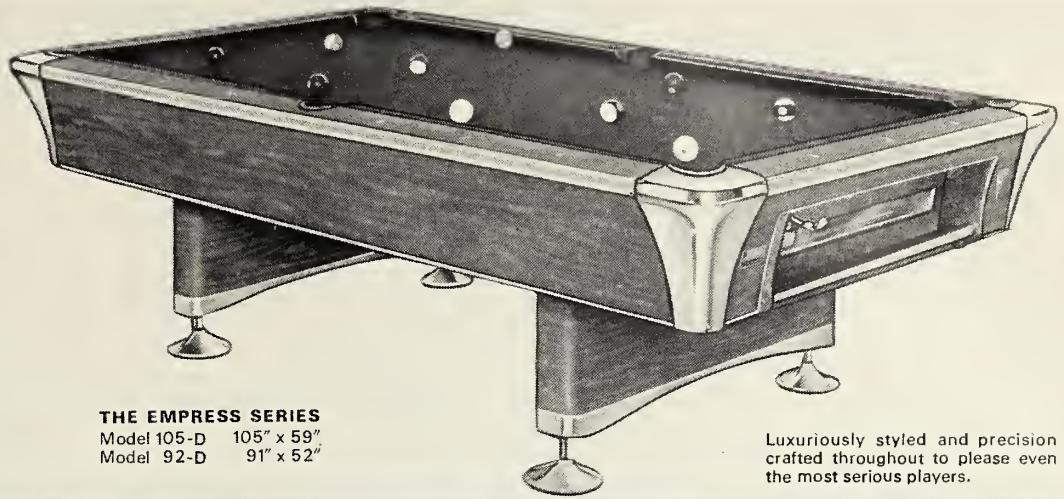

THE EMPRESS SERIES
Model 105-D 105" x 59"
Model 92-D 91" x 52"

Luxuriously styled and precision crafted throughout to please even the most serious players.

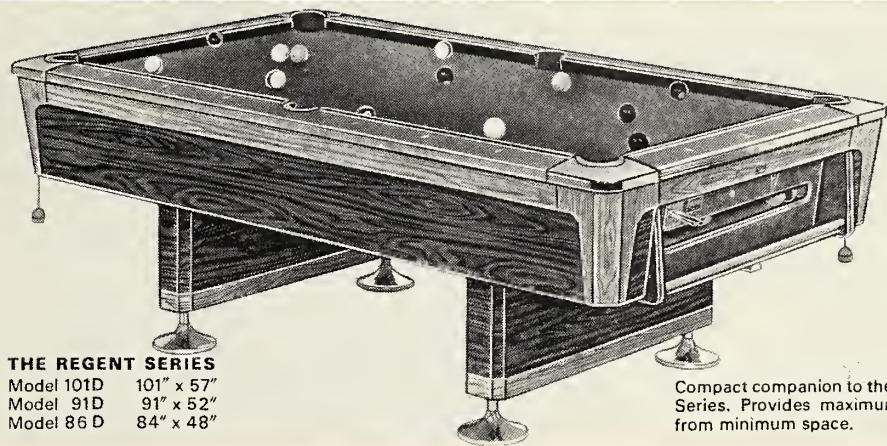

THE REGENT SERIES
Model 101D 101" x 57"
Model 91D 91" x 52"
Model 86 D 84" x 48"

Compact companion to the Empress Series. Provides maximum returns from minimum space.

More and more smart operators are installing Fischer tables in their choice locations. They find them to be the answer to more profitable operation. That's because Fischer tables are consistently solid quality throughout, embody all the fine features you expect from the ultimate in coin-op billiard equipment, and new advanced developments that make service problems practically a thing of the past. Got the message?

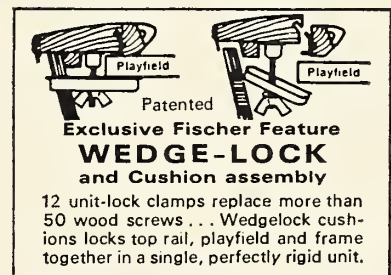

Patented
**Exclusive Fischer Feature
WEDGE-LOCK
and Cushion assembly**

12 unit-lock clamps replace more than 50 wood screws... Wedgelock cushions locks top rail, playfield and frame together in a single, perfectly rigid unit.

18 YEARS
OF PROVEN
SUPERIORITY



See your Distributor or write for further information and prices.

Fischer MANUFACTURING CO., INC., TIPTON, MO. 65081

SEASON'S GREETINGS TO ALL

Our customers and friends in
the coin machine business

from

**DENNIS RUBER
RICHARD UTTANOFF
LYN RUBER**

**DEAN ROGNESS JACK WERBANETH
CECIL RHODES**



3420 W. IRVING PARK ROAD
CHICAGO, ILLINOIS 60618
PHONE: (312) 478-2700

Proven Profit Maker!



**CHICAGO COIN'S
SKY LINE**
6-PLAYER PUCK BOWLER
with **NEW HIGH SCORE
PIN COUNT FEATURE**

Even with A Blow,
Player Gets
A Score.

Mrs.
of
PROVEN
PROFIT MAKERS
Since
1931

CHICAGO COIN MACHINE DIV.
CHICAGO DYNAMIC INDUSTRIES, INC.
1725 W. DIVERSEY BLVD., CHICAGO, ILLINOIS 60614

U. S. BILLIARDS

★ SALUTES ★

THE ARIZONA COIN MACH. ASSN.

FOR SUCCESSFUL MERCHANDISING
OF COIN-OPERATED POOL TABLES

at their

Greater Phoenix 8-Ball Tourney

(NOV. 26-30, SANDS MOTEL)

WE ARE PROUD THAT OUR 'LEADER'
TABLES PROVIDED THE LIVELY ACTION,
THE PROFESSIONAL ACCURACY AND SMOOTH
PLAY THESE BILLIARDS EXPERTS DEMAND.

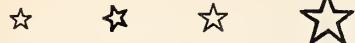

*the STARS are at
MUNVES!*

El Toro Gripper

AMF American Indi

AMF Speedway

Munves Soccer

Dale Auto Driver

Hamilton Scale

All Tech Grip Test

Souvenir Port Card Vender

Call Us Today For Details!

MIKE MUNVES CORP.

577 Tenth Ave., New York, N.Y. • BR 9-6677

New Arrangement For Vending Ops From American Tob.

The American Tobacco Co. has announced that a new vending machine arrangement will be effective Dec. 31, 1967. They are terminating their present vending machine promotional allowances and withdrawing circular number 4040 dated Aug. 31, 1966.

The new agreement applies to Tareyton 85mm brand, Pall Mall Filter 100 and Pall Mall Menthol Filter 100mm, to all direct list vending machine operators who operate and service their machines.

Pertinent points on this arrangement are as follows:

1. For the maintenance of at least one column of one or more of the following brands, in each of the vending machines covered under this arrangement, American agrees to pay the vending machine operator at the below listed rates during the period it is covered under this arrangement.

Tareyton 85mm at a rate of \$2.00 per year. Pall Mall Filter 100 and Pall Mall Menthol Filter 100 at a rate of \$2.50 per year.

They will pay for the placement of any combination of the above, for example, for the placement of one column of Tareyton 85mm and one column of Pall Mall Filter 100's and one column of Pall Mall Menthol Filter 100's, they will pay at the rate of \$7.00 per year.

2. Payment to be made in quarterly installments.

3. Forms covering the details of this arrangement are available to operators; many have been mailed.

4. All direct list vending machine operators, wishing to avail themselves of this arrangement, are asked to return the authorized forms, properly executed as soon as possible.

U.S. Billiards to Set L.I. 8-Ball Tournament

AMITYVILLE, L.I. — Len Schneller, general sales manager of U.S. Billiards, Inc. and one of the prime promoters of on-location 8-ball coin-table tournaments, has announced that the firm's president Albert Simon is currently organizing Long Island area table operators toward the staging of a Greater Long Island 8-Ball Tournament.

The L.I. contest, hopefully to begin the latter part of January or early February, will run eleven weeks at participating locations, at the end of which, a run-off will be held somewhere in the greater New York area to determine an 'A', 'B' and 'C' Class winner.

Schneller, who participated actively with Ben Spaulding in the Greater Phoenix 8-Ball Tourney several weeks back, will call a meeting of interested Long Island table operators for early January to outline the exact "how to" of staging such a contest. "The collection returns from the Phoenix tourney were considerable," Schneller revealed, "Competitors in the contest gain that something more from pool when there's a prize and the recognition of his fellow players in the offing," he added.

Simon and Schneller are currently finalizing the list of rules and regulations for the planned Long Island tourney. They urgently request all operators in that particular area to write or phone the Amityville factory to register their locations and themselves as participating operators. "This is excellent merchandising. . . . profitable merchandising and terrific public relations for this trade in the local community," Simon stated.

Triangle Elects Johnson to B. of D.

NEWARK — Bruce A. Johnson, vice president-purchasing and transportation of Triangle Conduit & Cable Co. Inc., has been elected to the company's Board of Directors, it was announced today by Carl S. Menger, chairman of the board and president.

Johnson joined Triangle in 1947 and has held a number of managerial positions. He was appointed assistant director of purchases in 1960 and director of purchases—transportation two years later. He was named a vice president in 1965.

A graduate of the University of Miami, Johnson also studied at the Graduate School of Business at Northwestern University.

He is married and has two children and lives in Spring Lake, N. J.

Season's Greetings

To All Our
New England
Friends & Customers

From
TRIMOUNT AUTO. SALES
Boston, Mass.

COMPUTER QUIZ

THE QUESTION & ANSWER GAME
DESIGNED FOR THE
COMPUTER GENERATION

FOR THE PLAYER

- * Fascinating Electronic Nixie Tube Readout
- * 2500 Different Questions Per Film
- * 5¢ - 10¢ - 25¢ Coin Acceptor

FOR THE OPERATOR

- * Door to New and Highly Profitable Markets
- * Easy-to-Service Plug-in Modular Construction
- * 12 Months of Field Testing Behind the Product

EXCELLENT TERRITORIES ARE STILL AVAILABLE!

NUTTING ASSOCIATES

556 ELLIS STREET ■ MOUNTAIN VIEW, CALIFORNIA 94040

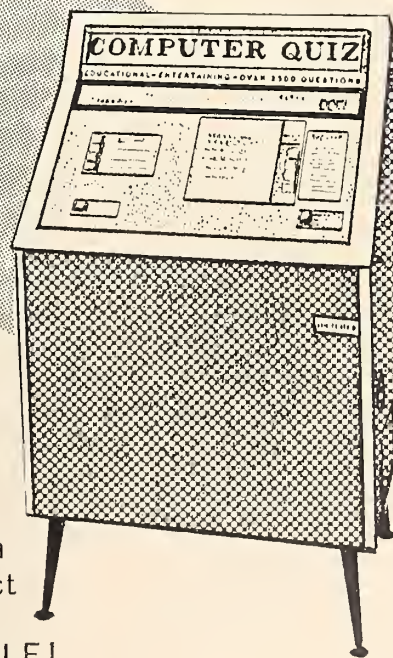

Convention Committee Named by N.A.C.

CHICAGO — Appointments of 1968 Convention and Exhibit Committee Chairmen were announced recently by Julian Lefkowitz, president of the National Association of Concessionaires.

Andrew S. Berwick, Jr., president, Wright Popcorn & Nut Co., San Francisco, California, and first vice-president of NAC, has been named General Convention Chairman.

Nat Buchman, vice president, Theatre Merchandising Corp., Boston, and executive vice president of NAC will head the association's Exhibit Committee.

Al Lapidus, president, Al Lapidus Popcorn Co. and Stanley R. Lefcourt, director of snack bar operations, Pacific Drive-in Theatres, both of Los Angeles, will serve as Co-Chairmen of the Convention Program Committee.

Berwick, prior to being elected to his present post, served two terms as NAC treasurer and in 1965 was chairman of the association's convention program committee when NAC met in Los Angeles. Buchman was general convention chairman of the recently concluded and successful convention of NAC in Florida.

Both Lapidus and Lefcourt served on the association's convention program committee with Berwick in 1965. Lapidus is a regional vice president of NAC, covering the western states.



JUKE BOX OPS' RECORD GUIDE

PICKS for PROGRAMMING

The following records, selected from the CASH BOX Top 100, represent tunes and performances which appear to be especially suitable to the juke box on location. Ops should check with their one-stops for availability.

DAYDREAM BELIEVER
Monkees (Colgems 7392)

SUMMER RAIN
Johnny Rivers (Imperial 66267)

BY THE TIME I GET TO PHOENIX
Glenn Campbell (Capitol 2015)

HELLO, GOODBYE
Beatles (Capitol 37614)

IF I COULD BUILD MY WHOLE WORLD AROUND YOU
Marvin Gaye & Tammi Terrell (Tamla 54161)

THE OTHER MAN'S GRASS IS ALWAYS GREENER
Petula Clark (W. B. 9-4612)

IN THE MISTY MOONLIGHT
Dean Martin (Reprise 4-7613)

CHAIN OF FOOLS
Aretha Franklin (Atlantic 2464)

BEST OF BOTH WORLDS
Lulu (Epic 10260)

IT'S WONDERFUL
Young Rascals (Atlantic 2463)

DANCIN' OUT OF MY HEART
Ronnie Dove (Diamond 233)

WHO WILL ANSWER
Ed Ames (RCA 9400)

* **LITTLE BECKY'S CHRISTMAS WISH**
Becky Lamb (W. B. 7154)

* **THE LESSON**
Vicki Carr (Liberty 56012)

* **TO GIVE**
Frankie Valli (Philips 40510)

* **LITTLE DRUMMER BOY**
Lou Rawls (Capitol 2026)

(* indicates first week on chart)

MARGOLD PROFILE Continued from page 12, Part III

finest service personnel. They're as good as anyone in the industry . . . we send them to every factory school available as well as the ones we conduct here. And, many of our customers send their servicemen to our schools. We plan to hold a class on cooking. That's right, cooking! We're going to show our customers how to prepare food on the new micro-wave Litton oven."

Random quotes from the pleasant speaking Margold ranged from PhonoVue record pairing service to Trimount's recent change to computer bookkeeping.

"Candy vending has proved to be one of the most profitable items to operators. The margin of profit is good and the commission structure and inventory tie-up is small."

"We offer a PhonoVue/record pairing guide to our customers to aid them in programming their Music Merchant/PhonoVue combination . . . this is just another of our 'little' services to Trimount customers."

"Cigarette vending in this area is pretty much a waiting game with operators. They will not buy cigarette machines unless they are capable of 100mm vends. When 100mm first hit the scene, operators didn't know which way to turn. We're selling them now and they're on the increase, but there was a time when operators really didn't know which way to go."

We asked Margold: What is the primary selling point of a new game or phono? Its looks; Its service; Its price; or your talent as a distributor? Irwin answered, "It's all of these to a degree, plus the fact that if it is a proven money-maker, it sells itself. Most operators buy amusement equipment on the expectation that it will increase profits and decrease service problems. If a game is trouble-free, has eye-appeal, player appeal, etc., more people will play it."

Would you say there is a noticeable lack of new game ideas from the factories? We asked. It's really not so easy as it sounds, they've all tried, but to no great degree of success. Today, everything is limited, price of equipment is higher . . . the arcade market is limited. The factories are trying. I don't think they're too complacent . . . they all want business."

The most lucrative type of locations for New England operators, according to Margold, are teenage and cafe spots

for music; bowling lanes of over 40 lanes for vending and amusement devices.

Margold views on the little LP's include, "best locations to program little LP's are the college locations. The little LP has not made an impact in the big cities. You know, the music business is mixed up and no one around is an authority on it."

Do you believe association membership for a distributor has a direct bearing on his profits? "I think so. Our problems come up at these meetings and we can discuss them . . . ideas are exchanged. We get a chance to get to know the other people in the business. Unquestionably, an exchange of information is extremely important. If we hear of a good promotion campaign some distributor out West is staging and we feel it would be valuable to our firm . . . we might give it a try. So you could say association membership has 'some' bearing on our income."

After all your years in the business Irwin, would you agree the public image of the industry could use some cleaning up? "We're getting there gradually . . . we need a little patience. We get bad publicity in the newspapers occasionally, but you keep on trying. Someday, maybe we can enjoy the respect of any other legitimate business. Until then, we must be patient."

THE ORIGINAL!!
KICKER and CATCHER
the COUNTER GAME with
BUILT-IN-PROFITS

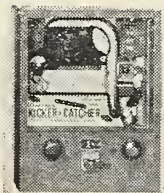

J. F. FRANTZ MFG. CO.
1940 W. Lake St., Chicago 12, Ill.
Tel: Taylor 9-2399

DAVIS Reconditioned & Refinished Equipment

SEEBURG

Seeburg LPC-480	\$845
Seeburg DS160	575
Seeburg AY160	475
Seeburg AQ160	375
Seeburg 201	325

WURLITZER

Wurlitzer	\$850
Wurlitzer 2900	595
Wurlitzer 2800	495
Wurlitzer 2600	375
Wurlitzer 2500	295
Wurlitzer 2310	225
Wurlitzer 2200	135
Wurlitzer 2150	95

ROCK-OLA

Empress 1496	\$375
--------------	-------	-------

WALLBOXES

Seeburg		
3WA . . . 160 or 200 Sel.	\$ 39
3WI . . . 100 Sel.	15



738 EAST ERIE BOULEVARD
SYRACUSE, NEW YORK 13210
PHONE GRanite 5-1631
AREA CODE 315

Seasons Greetings

To All Our Friends and
Customers in the USA
and Overseas



At This Festive Season
May We Extend Our Sincere Thanks
For All Your Patronage
Vic Haim

BELAM

Serving The Coin Machine Trade
Thruout The World

The Only American Firm
Specializing In Export

Garden State Ops Assn. Holds Christmas Fete

LAKEWOOD, N.J. — On Sunday evening, Dec. 10th, members and guests of the Garden State Amusement Operators Assn. gathered at the exclusive Fairmont Lodge here in Lakewood for their annual Christmas Dinner. Much more than a get-together at holiday time, members of this Central New Jersey music and games association used the occasion to pay tribute to their president Pat Storino and secretary-treasurer Danny Sylvester for their efforts in maintaining 15 almost trouble-free years, as well as confer

honorary membership on MOA president Bill Cannon.

An estimated 93 members and guests attended the elaborate function. In his address to the assemblage, Sylvester pointed out that the Garden State Assn. was unique in accepting operators of all varieties of coin equipment, with no distinction made between music, games and vending. "Service is our by-word here," the secretary declared, "and we manage to maintain standards of operation even stricter than the law requires."

Storino conferred an honorary certificate of Garden State membership upon Bill Cannon and saluted the MOA president's leadership abilities and personal concern for operators in his home state of New Jersey as well as across the country.

Sylvester lauded Cannon's role in organizing the Coin Machine Council of New Jersey (of which the Garden State group is an integral part). He also paid tribute to his colleague Storino for his recent election to MOA's board of directors.

"We have all benefited by being members and working together with mutual understanding," Sylvester stated. "Although we have no by-laws, we do have honor rules which we must respect as a moral obligation. This association deserves and has the loyal support of all its members . . . the support we need to survive and prosper," Sylvester further declared.

Among those attending the Christmas Dinner were: Mr. and Mrs. Irving Green of Runyan Sales, Mr. and Mrs. Iz Grabowski of Seacoast Dist., Whitey Burble of Ace Vending (vice president of the Garden State Assn.), Mr. and Mrs. Abe Lipsky of Lipsky Dist., Lou Milman of Coast Cigarette, Frank



Storino, Sylvester present MOA president Bill Cannon (right) with honorary certificate of Garden State Assn. membership.



Secretary Danny Sylvester surprises prexy Pat Storino with handsome gift of luggage — a tribute from the Garden Staters for a year well done. Pat can use it on upcoming MOA directors meet in D.C.

Mandia of Majestic Amusement, Vinnie and Pat Storino, Mr. and Mrs. Tony DeGano of Ace Automatic, Max and Phil Levine of King Amusement, Mr. and Mrs. LaBatto of J & L Vending and Joe Seminari of Top Amusement.

Before the guests retired from the dinner to the neighboring club room for entertainment, Sylvester con-

cluded his address with the following thoughts: "At this time of Christmas, let us pause to express our thanks for our many blessings. Quiet thanks for America and all she stands for; humble thanks for the sacred trust which is faith in God; happy thanks for our business association. May your Christmas be abundant."

MORE PIX ON NEXT PAGE

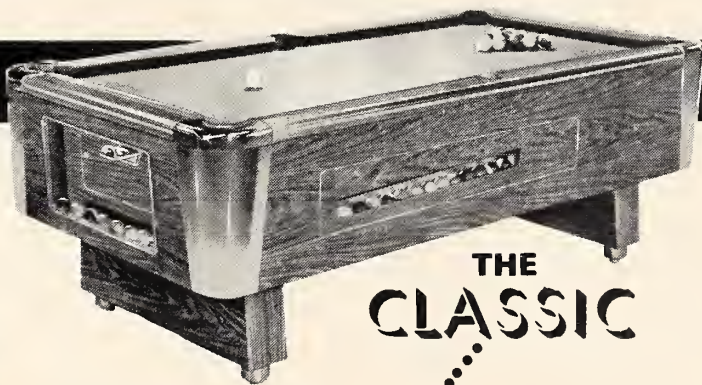

THE CLASSIC



world famous shuffleboard

Outstanding construction throughout—Cantilevered scoreboard—Built in scoreboard light—Beautiful end lamps for illumination—Horse Collar play control—Tamper proof pin gate control even when electricity is off or exclusive Magno Play Control available.

Set your sights higher ...and you'll

CHOOSE

Write for Free Color Brochure or See Them At Your Distributor

American SHUFFLEBOARD COMPANY

210 Paterson Plank Road, Union City, New Jersey (201) UNion 5-6633
1423 S. Western Avenue, Los Angeles, Calif. (213) REpublic 3-3724

The Jersey Bunch at Their Best



At the head table, the camera finds (left to right, standing) Ed Adlum, Pat Storino and Bill Cannon. (Seated, left to right) Mrs. Ed Adlum, Mrs. Pat Storino, Danny Sylvester and Mrs. Sylvester.



A really good group finds Garden State vice president Whitey Burble standing at right. Sorry, Whitey—no watch this year.



(Left to right) Jimmy Hersh, Mary Alice Sineone, and Mr. and Mrs. Tony (the photog) DeGano.

Make Sales
"jump"

Make Profits
"bounce"

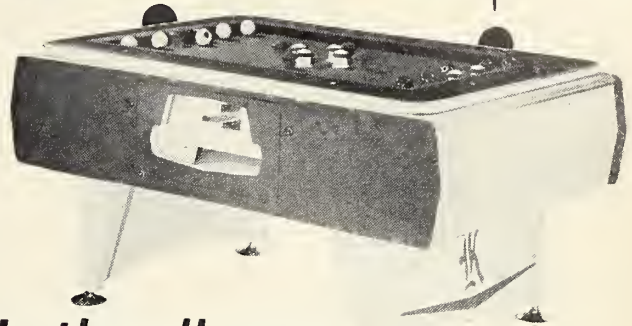

It's the all new K·L·U·B P·O·O·L T·A·B·L·E

by
Irving Kaye Co. Inc.

Check these
features
and you'll say
"Kaye?"

Completely New Design!

Features all Formica cabinet and top frame.

Colorful

Regulation size available in vibrant new colors
Red & White - Blue & White
Jumbo size available in teak

Life Time Sturdy Construction

Reinforced construction throughout, with
3/4" natural slate top. Live metal bumpers

An Operator's Dream Come True.

Completely new jam-proof and cheat-proof
coin mechanism

o.k.!"

Fits Any Location

Available in 56" X 40" regular size
or 77" X 45" jumbo size

Irving Kaye Co. Inc.

363 Prospect Place, Brooklyn N.Y. 11238

(212) STerling 3-1200

the **GENERAL**



LOOK to ★ for LEADERSHIP

One of America's oldest and largest coin machine distributors.
Established 1925—over 43 years of superior service.

Franchised Factory Distributors in
Md. — D.C. — Va. for:

**ROCK-OLA—GOTTLIEB—FISCHER—CHICAGO COIN
AMF and Other Leading Manufacturers**

We export every type of reconditioned equipment
anywhere in the World from the Port of Baltimore

General Vending Sales Corp.

237-245 W. Biddle St.

Baltimore, Md. - 21201

Phones—(Area Code 301) 837-4119

Cable Address—GENVEND

Season's Greetings!

D. Gottlieb & Co.

1140-50 N. Kostner Avenue
Chicago, Illinois 60651

Irwin Margold is one of the most dynamic and aggressive men in the coin machine and vending business. His undying energy is only one indication of the "take charge" atmosphere that constantly surrounds him. His knowledge of the industry is not questioned but respected and is backed up with 35 years of experience, both as an operator and a distributor.

After a fruitfully rewarding and successful career as an operator in the Hartford, Connecticut area, Margold was recruited in 1945 by Dave Bond of the Trimount Automatic Sales Company. His talents were known and before long played a great part in the growth and success of Trimount. Trimount's growth as a distributor and operating firm is as well respected as Margold's success as a successful sales and business manager.

Trimount services all of New England with the exception of Connecticut, offering their full line of Rowe AMI music and vending products, Gottlieb, Bally and Chicago Coin amusement

games and Irving Kaye, All-Tech and Valley pool tables. Since Margold took over the vice-presidential duties seven years ago, Trimount has divided their operation into four basic sections; Vending, which takes in mechanical feeding, soda, coffee, candy and cigarettes; Music and Games, which covers what the division name implies; Background Music, in which Trimount features the AMI background music system in all of their 600 to 700 background locations; the fourth division of Trimount is the Sound Section taking in the commercial installation of inter-communication systems, paging systems, fully equipped language labs in higher institutions using tapes and headsets with playback systems.

Trimount is also charter member of Music Operators of America, National Automatic Merchandising Association and the National Coin Machine Distributors Association.

According to Margold the state of the coin machine and vending business in the New England area has grown



Irwin Margold

considerably over the past few years. The amusement segment is status quo with a gradual growth due to the fact that more and more local governments are granting licenses to operators. "In some localities of the New England states the city and town governments have the option to grant or not to grant operating licenses, however there has never been too much trouble because the men who make up the local governments are intelligent enough to recognize growth. There are more and potential locations opening up . . . discount houses, amusement centers, fancy bowling alleys . . . this, combined with the fact that Americans have more leisure time on their hands than ever before is responsible for the good relationship and virtually trouble-free understanding between the local government structures and operators making application for licenses to operate." Margold further stated, "Industrial locations have experienced a fantastic growth rate. We have some of the finest electronics plants in the world and the wage scale is good . . . customers do not frown about buying an extra sandwich or cup of coffee. With the industrial growth of the area, hence our growth also. There has been no rapid growth of juke box locations and is directly attributed to our urban renewal programs. When a new juke location does open up . . . one is lost by the urban renewal program. The old buildings are coming down and the new ones are going up."

There seems to be no problem of legislative harassment in the New England states. "We have had attempts at unfair legislation," Margold said, "but we've been able to control it with great success."

Today's modern distributor seems to experience the same problem as the operator: obtaining qualified personnel. "Our biggest problem is the inability to obtain new people," related Margold, "this is quite similar to operator's problems, we can't seem to recruit the qualified service and sales people."

One problem that the distributor has that doesn't affect the operator in the same manner as it does us is that we have to deal with same customers over and over . . . day in and day out. It's the same people to do business with. We need new vitality . . . new blood, aggressive men to bring new ideas and better principles into the business. The men entering this business is becoming fewer and fewer . . . it's all due to the prohibitive capital needed to get started. Today, a new game can't be had for hardly under \$500 and a phonograph for no less than \$1200."

We mentioned to Margold that one of the biggest complaints of operators is that he's dictated to by distributors and factories in telling what's good for him. Do you listen, Irwin, and what do you hear? Margold answered, "Sure, we listen to the operator's gripes and complaints . . . we have to . . . it's the only way we can make an attempt to rectify them. We find it extremely important to listen and we spend a great deal of time and manpower in trying to help him. We have men that go out and do nothing but survey locations, they're considered experts in determining if a location is worth investing time and money in. This service is available to any of our customers. Recently, one of our customers told us of plans to buy three vending machines that were located in a factory. We spent a man out to check it over. The units were located on three different floors that had only 30 employees on each floor. We advised the potential buyer to forget it because it would not be profitable. I don't feel that we dictate to the operator 'tho.'"

One way distributors can keep their customers happy is to extend "efficient service." Do you feel this is true?

"The very success of any company depends upon efficient service," stated Margold, "Trimount has the very

(Continued on page 9, Part III)

Season's Greetings

from

Bally®

and its distributors

to

amusement operators

the world over!

"you can bank on a Bally game"

BALLY MANUFACTURING COMPANY

2640 BELMONT AVENUE

CHICAGO 18, ILLINOIS

Rock-Ola Factory Holds Week Long Service Seminar

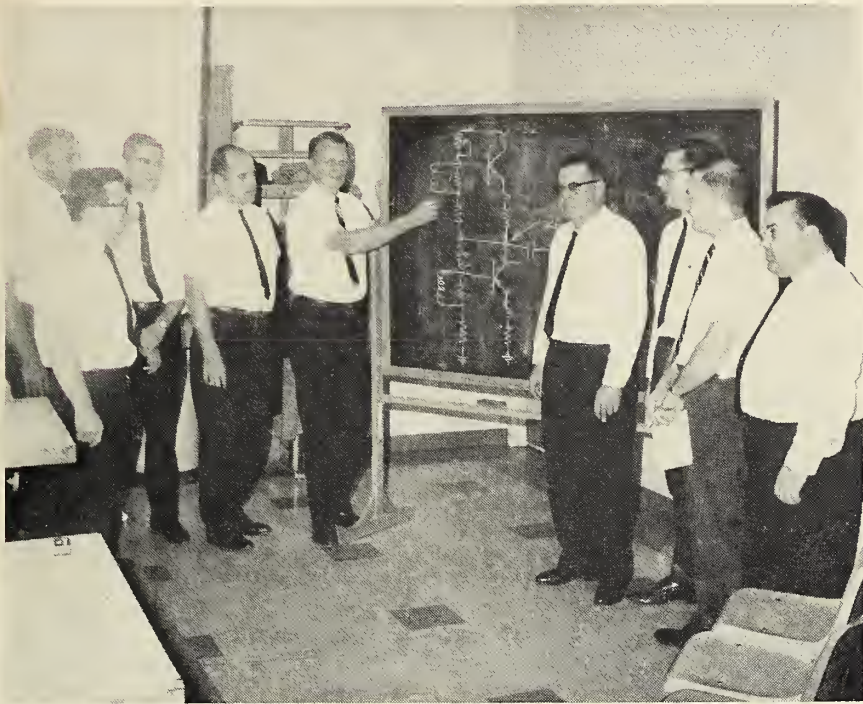

Pictured from Left to Right—Frank Schulz, Dallas Spering, William Findlay, Robert Johnson, Warren Wheatman explaining amplifier circuitry, Harry Crockett, Joseph Egner, Bernard Gregg and Roger Harvey.



Pictured from Left to Right—Front Row—Dallas Spering, Bernard Gregg, Frank Schulz explaining operation of Rock-Ola mechanism, Harry Crockett, Roger Harvey. Rear Row — Robert Johnson, William Findlay, Warren Wheatman and Joseph Egner.

CHICAGO—The Rock-Ola manufacturing Corporation in Chicago, Illinois, recently hosted a group of phonograph and vending service personnel for a week long service seminar at the Rock-Ola factory. The five day school covered all of Rock-Ola products in the vending and music equipment lines.

Under the tutelage of Messrs. William Findlay and Frank Schulz, Rock-Ola's field service engineers for phonographs, the visiting service men—Roger Harvey from Detroit, Michigan, Dallas Spering from Louisville, Kentucky, Harry Crockett from Oak Hill, West Virginia, Joe Egner, Menominee, Michigan, Robert Johnson, Grand Rapids, Michigan, and Bernard Gregg from Manhattan, Kansas—covered the mechanical end of the Rock-Ola phonographs "from the ground up" by actually assembling the phonograph from all of its component parts. Electrical and sound instruction was tutored by Warren Wheatman, Rock-Ola's sound technician. Rock-Ola's coffee machine and can vendor lines were explained by Edward Lorkowski, Rock-Ola's field service engineer for vending.

**BINGO MECHANICS
WANTED**

Legal Territory in Nevada

Must be experienced.
State age, past experience,
references.

Send photo if possible.
Write, wire or phone.

United Coin Machine Co.
2621 S. Highland, Las Vegas, Nevada
702-735-5000

Active's
THE CHOICE FOR
**the Lowest
Prices**
and
Best Equipment
ALWAYS

Exclusive Gottlieb, Rock-Ola, Fischer and Chicago Coin Distributor for Eastern Pennsylvania, South Jersey and Delaware.
ACTIVE Amusement Machines Co.
666 No. Broad Street, Phila. 30, Pa. POplar 9-4495
1101 Pittston Ave., Scranton 5, Penna.

**START THE
NEW YEAR RIGHT**
Resolve to cash in all year with
CINEJUKEBOX

Exclusive Rowe AMI Distributor
Ea. Pa. - S. Jersey - Del. - Md. - D.C.

DAVID ROSEN inc

855 N. BROAD ST., PHILA., PA. 19123
Phone: (215) CEnter 2-2900

*Wishing our friends
a Merry Christmas
and a healthy and
prosperous New Year*

*Johnny Bilotta
Bob Catlin*

Bilotta Enterprises
NEWARK, N.Y. • ALBANY, N.Y.

50 YEARS ¹⁹¹⁷/₁₉₆₇

of progress and service in
providing all your requirements in

- ★ VENDING
- ★ MUSIC
- ★ AMUSEMENT

BANNER
Specialty Company

1213-31 N. 5th St. Philadelphia, Pa. (215) 236-5000
1508 Fifth Ave. Pittsburgh, Pa. (412) 471-1373

**CLEVELAND
COIN, INT'L**

is proud
to present
The All New

★ **ATLAS**
TILT TEST

Probing for
New Profits?

**...FAST ACTION
BIG TAKE!...**

With This Most
Exciting New

★ **5c** ★

**Counter
Game**

Be 1st with this
real money-maker!

Now Available
To Distributors

WRITE ★ PHONE

CLEVELAND COIN
International
2029 PROSPECT AVE. CLEVELAND 15 OHIO
All Phones Tower 1 6715

Contact The Greatest . . . **THE GRECO BROS.**

★ For ALL Of Your ★
Domestic and Export Needs

Any Machine That Operates
With A Coin — We Got.
If We Don't — We'll Get It!

Season's Greetings from . . .

GRECO BROS. AMUSEMENT CO.

MAIN STREET, GLASCO, N.Y. CHerry 6-8700
1288 BROADWAY, ALBANY, N.Y. HO 5-0228

We Extend

Season's Greetings

TO THE ENTIRE COIN MACHINE INDUSTRY

MUSIC OPERATORS OF NEW YORK, INC.

250 WEST 57th STREET, NEW YORK CITY

To Our Members, Our Friends,

To Our Industry

SEASON'S GREETINGS

from the

WESTCHESTER OPERATORS GUILD

Carl Pavesi, Pres.

To Our Esteemed Associates
and Our Ardent Supporters
Thank you and keep the faith!

A MERRY CHRISTMAS and HAPPY NEW YEAR

NEW YORK STATE COIN MACHINE ASSN. INC.

Millie McCarthy, Pres.

Season's Greetings

To All Coin Machine Men

Thank You For Making 1967

The Biggest In Our History

HASTINGS DISTRIBUTING COMPANY, INC.

(Since 1932)

6100 W. BLUEMOUND ROAD
MILWAUKEE 13, WISCONSIN

Ets. RENE PIERRE Automatic Games Manufacturer
39 Ranchot, Jura, France

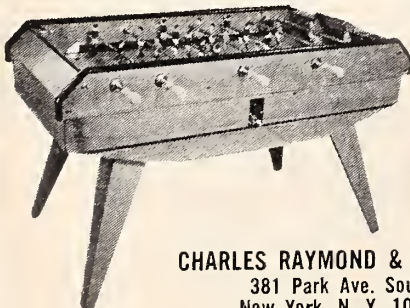

CHARLES RAYMOND & CO., INC.
381 Park Ave. South
New York, N. Y. 10016

FOOT - BALL DERBY

Competition
Lux
Standard

Tam-Tam
Billiards
American Golf



CashBox 'Round the Route

Eastern Flashes

'TIS THAT SEASON—Early Christmas parties were the order at Cleveland Coin (Nov. 22nd) and at the Garden State Amusement Operators (Dec. 10th). Ron Gold and Dave Liebling at CleCoin feted their office and show-room staff throughout the afternoon, to the tune, naturally enough, of Wurlitzer music at the Americana II. CleCoin is currently appointing regional distribs across the land to handle the new 'Atlas Tilt Test' counter game. "We've tested this unit to judge its continuity of earning performance," Gold stated. "This simply means that many of the current counter games, while terrific money-earners, seem to peak out in a relatively short span of time," he continued. "We're attempting to combine longevity and earning power in the same unit and I think we've got it in this 'Tilt Test' game," he added. . . . Meanwhile, down at the Garden State affair in Lakewood, the high spirit of the evening was something rarely seen anywhere. This is a tight-knit, organization which managed to keep the music and games and vending business operating without any legal harassment for 15 years, thanks largely to Pat Storino and Danny Sylvester.

DECK THE HALLS—The offices out at American Shuffleboard are gayly decorated in the spirit of the season. General Manager Nick Melone, checking out the year's successes, said their high volume was principally due to the introduction of new products and a tremendous upsurge in shuffleboard sales. Be looking forward to visiting with Sol and Marge Lipkin and some of that truly fine Virginia fried chicken. . . . Bert Betti's showrooms look like Santa's workshop, these days. Heard reports that Johnny Rafer is runnin' around strung with tinsel and that Jerry Gordon's dustin' off that red and white suit. Poor old Sol Mollengarden out at the Los Angeles office of Eastern Novclty will be missing that white stuff. . . . Holiday greetings go out to the trade from all the lads at Rowe factory in Whippany, including Joe Barton, Jimmy Newlander and George Klersey. . . . Morris Rood and Eddie Berg over at Runyon wishing their friends and customers a Merry. Saw Irv Green and his charming Maxine down in Lakewood over the weekend and hear the year's been good for Runyon. Oh yes—look for those James Brown photos, Max. . . .

ON THE AVE. . . . Atlantic New York's ace salesman Murray Kaye asked us to be sure and extend the very best holiday greetings to all his friends, customers and unknowns . . . says the year's biggest movers were phonos, especially the new Seeburg Spectra . . . Louie Wolberg and Runyon Sales also conveys season's greetings to their many friends and customers in the New York, New Jersey and Conn. areas. The boys down at Munve's, Joe, Mike and Dick Greenberg have been passing out greetings for the past few weeks and sends their best to those missed. The proverbial Ho! Ho! Ho! and wishes for a Merry Christmas comes from Abe Lipsky, of Lipsky Dist. Holiday Cheers come in many forms and fashions . . . Al Simon, Al D'inzillo, and Lenny Schneller wishes to thank all their good friends and customers for a prosperous year down at U.S. Billiards, Inc. and extends their best for 1968 . . . Harold Kaufman sends greetings to all of his proud Wurlitzer customers and friends from Musical Dist.

HERE AND THERE . . . Make-believe Santa, Johnny Bilotta says it was a great year for I.Q. Computer and looks forward to a good 1968 while sending his, Bob Catlin and

brother Jim's best wishes to all their faithful friends and customers. Holiday Greetings from the Cash Box Staff are in order for good friends Abe Green, Meyer Parkoff, all of the boys along New York's coinrow, tobacco jobbers, S. Goldsand, M. Bruck, S. Yolen, One Stops Eric Bernay, Sam Keenholtz, Ben Reminick, George Weiss, Bernie Boorstein and Lillian Schonberger. Merry Christmas and Happy New Year's Cheers from MONY and Ben Chicofsky, Sophie Selinger. Season's Greetings from CASH BOX also go to good friends of New York State, Millie McCarthy, The Greco Brothers, Mike & Mary Mulqueen and Gert Browne. Also to friends from Westchester, Eddie and Archie Goldberg, Carl Pavesi, Al Kress, Frank Galle, Semour Pollak, Lou Tartaglia, Dick Di Cicco and Malcolm Wein. To New York Operators, Bill Koabler, Bernard Antonoff, Hy & Ben Rubin, Max Katz, Albert Arnold, "Senator" Al Bodkin, Gil Sonin, Irv Fenichel, Al Lauro, Al Denver, Leonard Block, Sam Morrison and Steve Tarzanin, George Holtzman, Al Miniaci and Charles Bernoff. In the confusion of names, we probably missed some very good friends . . . if so, we would like to thank you and everyone else for a good year and wish Season's Greetings to all.

HO, HO, HO—The finest of the season goes out to the amusement trade from United Billiards' Art, Neatia and Gene Daddis. The United crew presently cooking like gangbusters on new 'Playmore' scratch-ball return mech for their table line . . . Old buddy Tommy Tarantelli from the Syracuse one-stop of the same name wishing all his good friends and customers a happy and healthy one. Likewise the very best from Jimmy Galuppi. Incidentally, Jimmy reports terrific upstate jukebox action on the Royal Guardsmen holiday single entitled 'Snoopy's Christmas' . . . Irving, Howard and Arnold Kaye, took time out from heavy table and counter game activity to wish their friends and customers a most happy holiday season. The Kaye plant never seems to rest, with parts manufacturer adding to the already heavy table production schedule and now counter games. Whew! . . . And, oh yes, in case you didn't get the message on our front coin page, have a merry time in the days ahead. Only comes once a year, ya know, so enjoy!

Milwaukee Mentions

Let's start by extending our wishes—and those of Milwaukee coinrow—to everyone in the industry for a Happy Holiday Season! . . . This has been one hectic week at United, Inc.! The job of moving into new quarters and the resultant packing, unpacking and what have you, always creates its share of chaos. However, Harry Jacobs, Russ Townsend and crew hope to be all settled down very shortly. New address is 5600 W. North Ave., about four blocks from the suburban area. Russ did add, though, that the past week, despite all the turmoil, was a banner one, businesswise! . . . Record City's Gordon Pelzek tells of a new Warner Bros. single that has literally taken this town by storm! Title is "Becky's Christmas Wish" by Becky Lamb, and indications are it will break some sales records! . . . All's well at Pioneer Sales Services. Joel Kleiman noted exceptional action on the new Riviera 25-selection cigarette machine, the 212 dry grounds coffee machine, and, of course, the "Phonovue!" . . . Empire's Joe Eggner was in Chicago last week attending the Rock-Ola Mfg. service seminar.



Cash Box Round The Route

Chicago Chatter

SINCEREST GOOD WISHES for the holiday season, and may the New Year bring continued good health and prosperity to everyone! . . . Rock-Ola Mfg. Corp. recently hosted a very successful weeklong service seminar, covering the firm's entire line of vending and music equipment. Sessions, held at the Rock-Ola factory, were conducted by field service engineers William Findlay and Frank Schulz (phonographs); Edward Lorkowski (vending) and sound technician Warren Wheatman. . . . We enjoyed a nice chat with ICMOA's new executive director, Frederick Gain, who's in the process of setting up the association's Springfield, Ill. headquarters in suite 716 of the Ridgely Building. Phone was installed this week and the number is 522-7552. Mr. Gain also advised that the association is planning a membership meeting for sometime in January. . . . Chicago Dynamic Industries' Mort Secore items that the firm is just starting to ship samples of their new "All American Basketball" game. Distributors should have them this week! . . . Our condolences to the family of veteran operator Priestly E. Pierce, who died recently. He was head of Pierce Music Co. in Raleigh, N. C. His son, Priestly Jr., will take over the business. . . . MOA's Fred Granger and his wife took off for Europe last week for a much deserved vacation. They'll be spending the holidays with Mrs. Granger's family in Portugal. . . . D & R Industries recently celebrated the first anniversary in the new premises at 3420 W. Irving Park Road. Under the guidance of Dennis Ruber, Dick Uttanoff and Lyn Ruber, the firm has been prospering steadily this past year! . . . Williams Electronics' Bill DeSelm took off on a biz trip last week. . . . Next meeting of the Coin Operated Industries of Nebraska (COIN) is to be held in February at the Indian Hills Motel, Omaha. An exact date has not as yet been set, however, secretary-treasurer Howard Ellis issued a mailing to all members with the suggested dates of February 10 or 17. So, hurry and send in your choice, fellas! . . . Things are busy as usual at World Wide Dist.—so much so that we had some difficulty getting through by phone! Art Wood is on the road, covering his territory. We understand Howie Freer is a bit perplexed as to what to give his missus for Christmas. Any suggestions? . . . Marvel Mfg. Co. prexy Ted Rubey was transferred to Presbyterian-St. Luke's Hospital (Chicago) for surgery and, we hear, he's coming along very nicely. In fact, Pete Green went out to visit him the other day and said he looked "too darn good" to be in the hospital! Here's hoping he's back in the office real soon. . . . Action continues at a hot and heavy pace at Atlas Music Co. These past few weeks have kept 'em hopping in all departments! Great! . . . The following singles are reportedly doing extremely well on the local juke box scene: "Am I That Easy To Forget" by Engelbert Humperdinck, "In The Misty Moonlight" by Dean Martin and "Let The Heartaches Begin" by Long John Baldry. AN EXTREMELY rapid expansion in Southern Japan and a consequent upsurge in coin machine locations in that area, the giant Sega Enterprises (manufacturers and distributors who recently signed a distribution deal for the U.S.A. with Williams Electronics) has opened a regional headquarters in Osaka. The grand opening of this Kansai showroom, shop and warehouse complex was held in the

grand style with Sega chairman David Rosen inviting in over 200 customers and friends for the party. The new \$300,000 facility will serve the region as a combined showroom, inspection and repair shop storage area and parts warehouse. An employee's dormitory and parking area have been placed adjacent to the main building. Fifteen of Sega's 38 branch offices in Japan are situated closer to Osaka than Tokyo and these offices should now be able to offer customers faster and better service. Full picture story of the new facility and open house celebration will appear next week.

Mid-West Musings

Mr. & Mrs. Tony Rateford leave next week for Clovis, New Mexico where they will spend the holiday week with their children and grand-child . . . Darlow Maxwell, Pierre in the cities for a few days on business . . . Dean and David Schroeder, Aberdeen, in the cities over the week end taking in the Viking-Green Bay game . . . Mr. & Mrs. Ernest Wojtossek in town over the week end, Ernest making the rounds and Mrs. Wojtossek getting in some shopping . . . Al Kirtz, Lake City, in town for a few hours picking up parts and records . . . Irv Linderholm and Harlan Beach in town last week end taking in the Viking-Green Bay game . . . Jim Stansfield and Jim Jr. in town for the day as was Gene Clennon . . . at Lieberman Music Co. last week were Bill Adair, President of the Seeburg Corp. and Stan Jarocki. Bill Adair addressed a group of operator's on the necessity of going 2 for 25¢ on the new Seeburg Spectra. With the economy rising the way it is the operator must go on 2 for a 25¢ to stay in business. Wonderful talk and to the point . . . Mr. & Mrs. Lawrence Sanford in the cities for the day, as was Gabby Cluseau . . . Stan Baeder, Fargo, in town for a few days on business . . . Red Kennedy in the cities buying records and parts . . . Stan Woznak in town for the day . . . Richard and David Hawkins in town for a few hours making the rounds . . . Martin Kallsen at Acme buying records and parts. . . .

California Clippings

MERRY CHRISTMAS TO ALL (especially those on phonorow). Bet we fooled you, usually we forget to send our holiday wishes at the right time and have to make them belated. This week though we cornered the calendar and it surrendered! Next week if everyone is really good, we'll even throw in Happy New Year. Seriously though, we, the staff of Cash Box want to wish all of you a very joyous holiday season. . . . Think Peace. . . . C. A. ROBINSON GETS "FACE LIFTING". . . . Hank Tronick reports that the C. A. R. building is getting a whole going over, both inside and out. We are told that the painters have been working over time in their effort to finish all the work before the holidays. The "friendly" room is getting a new look with paneling, wall paper and the installation of a new bar (we'll be right over, Hank). Brightness is the key word of the new decor. H. T. says that business is also bright, with Valley pool tables moving along very well, as well Midway's "Fire-bird" shuffle alley and the flying saucer rifle. We are also told that activity has been very strong on home equipment. Hank says, "This year the public has shown more interest than ever before in novelty games for the den, playroom and garage." As a matter of fact, a prominent professor at UCLA purchased a pin game for his

home in Beverly Hills, and he seemed more delighted with it than his kids." We heard that Mr. and Mrs. Tex Leerskov, of Jet Music Company, in Barstow, dropped in to say hello to Al Bettelman and Hank. They were just on their way home after vacationing in Bogota, Columbia. Before going there they spent some time seeing the sights of Florida and Nassau. . . .

CREDIT, WHERE CREDIT IS DUE. . . . Last week we ran some items about the big CMMA banquet that took place earlier this month, but we forgot to give credit to those who worked so hard to make it the success that it was. As I've said before, and will surely say again, better late than never. Marv Jones, Lou Zeider, Gabe Orland, Walt Hemple and Meredith McAlevey deserve a big hand for all the work they did. Now we feel much better. . . .

FROM THE RECORD RACKS. . . .

Jerry Barish of California Music reports the Rolling Stones are doing very well with their latest single for London, entitled "She's a Rainbo." Things are looking good for "Two Little Kids" by Peaches and Herb on Date. Engelbert Humperdinck is asking the age old question, "Am I that Easy to Forget" on a Parrot label. A new group on Imperial, called the Classics IV, are hitbound with their single "Spooky." Repeat performance (another way of saying it's their 5th hit in a row) for the Hollies with "Dear Eloise" on Epic. . . .

HERE AND THERE. . . . Finally got a chance to talk with Dean McMurdie, who was out of town for awhile. He made up for it by telling us that their new 25 column cigarette machine, with 3-dementional paneling is going great guns. As soon as he told us that it took the 100's we fell in love with it immediately. Also doing well, is the 100 selection cadette phonograph. . . .

Williams
Touchdown
SINGLE PLAYER • 3-5 BALL PLAY
now delivering
CORONADO B/A
ORION S/A
Williams ELECTRONICS, INC.
3401 N. California Ave. • Chicago, Ill. 60618 • Cable Address Wilcoin Chicago
Available For Immediate Delivery Through Your Williams Distributor
SEASON'S GREETINGS

★ WORLD WIDE WISHES YOU ★
★ A MERRY CHRISTMAS ★
★ and A HAPPY NEW YEAR ★

Thoroughly Reconditioned AMUSEMENT GUNS

CHICAGO COIN

CHAMPION GUN \$150	SUPER SCORE \$475
PLAYLAND 150	WILD WEST 495
PONY EXPRESS 175	WORLD'S FAIR 195

MIDWAY

CAPTAIN KID \$375	MONSTER GUN \$295
RIFLE CHAMP \$275	

SPECIAL! ALKY METER Counter Game—\$52.50 complete

DISTRIBUTORS FOR: SEEBURG • UNITED • WILLIAMS

TERMS: 50% deposit, Bal. Sight Draft or confirmed letter of credit.
We carry the most complete line of Phonographs, Games, Arcade and Vending Equipment. Write for Complete list!

WORLD WIDE distributors
2730 WEST FULLERTON AVE., CHICAGO 47, ILL.
EVerglade 4-2300 CABLE: GAMES - CHICAGO

CLASSIFIED ADVERTISING SECTION

CLASSIFIED AD RATE 20 CENTS PER WORD

Count every word including all words in firm name. Numbers in address count as one word. Minimum ad accepted \$5.00. CASH OR CHECK MUST ACCOMPANY ALL ORDERS FOR CLASSIFIED ADVERTISING. If cash or check is not enclosed with order your classified ad will be held for following issue pending receipt of your check or cash.

NOTICE—\$72 Classified Advertisers. (Outside USA add \$52 to your present subscription price). You are entitled to a classified ad of 40 words in each week's issue for a period of One Full Year, 52 consecutive weeks. You are allowed to change your Classified Ad each week if you so desire. All words over 40 will be billed at the rate of 20c per word. Please count words carefully. Be sure your Classified Ad is sent to reach New York publication office by Wednesday, 12 Noon, of preceding week to appear in the following week's issue.

Classified Ads Close WEDNESDAY

Send all copy to: CASH BOX, 1780 Broadway, New York 19, N.Y.

WANT

WANT—AUDIO-VIDEO MACHINES, SHUFFLEBOARDS with anti cheats, scoring units. Personal music equipment. Write stating make, model, condition and best cash price. ST. THOMAS COIN SALES, 669 Talbot St., St. Thomas, Ontario, Canada. Area 519-631-9550.

WANTED TO BUY: KICKER AND CATCHER games, also other penny games, can use Playland Rifles. RELIABLE COIN MACHINE CO., 1433 W. Sherwin Ave., Chicago, Ill.

RECORDS, 45's AND LP's SURPLUS RETURNS, overstock cut-outs, etc. HARRY WARRINER KNICKERBOCKER MUSIC CO. —453 McLEAN AVE., YONKERS, N.Y. (Tel. Greenleaf. 6-7778).

WANTED—YOUR USED 45 RPM RECORDS. We pay freight and up to 13c. REC-O-RAC 942 DEODAR, ESCONDIDO, CALIFORNIA. (TEL. 714-745-5942).

45 RPM RECORDS, NEW, NO QUANTITY TOO large or small. Highest prices paid. Write stating quantity on hand. TONY GALGANO DIST. CO., 4135 W. ARMITAGE, CHICAGO 39, ILL. (Tel. Dickens 2-7060).

WANT: RECORDS, 45's, USED OR NEW. ALSO LP stocks, any quantity. Will buy on steady basis. BEACON RECORD DISTRIBUTORS, 725 BRANCH AVENUE, PROVIDENCE, R. I. 02904. PHONE: UN-1-7500 or JA-1-5121.

USED 45 RPM RECORDS, ALL TYPES AS they run, right off the route. No sorting or picking. We pay freight from anywhere in U.S.A. Standing order available for regular shippers. JALEN AMUSEMENT CO., 1215 S. HOWARD STREET—BALTIMORE, MD 21230.

WANT TO BUY USED AND NEW PINBALL GAMES, ADDABAL one & two players every kind of models MFD 1964, 1965, 1966 and also guns, bowlers, arcade, make offer to Robert Mauro, ELECTROPHON, VIA MELCHIORRE 6101A 41a, MILANO (ITALY).

WANT: NEW OR USED 45 RPM SINGLE NOT over 6 months old. We pay 11¢ each and the freight and we can use 200 of one number. Phone: 312-344-3300. CHAS. ALZNER, 2000 So. 3rd Ave., Maywood Illinois.

WE ARE ALWAYS INTERESTED IN USED AND brand new phonographs, pinballs, bingos, guns, arcade, kiddie rides, slot machines, etc., all makes, all models. QUOTE FOB SEA VESSEL TO HOLLAND BELGIE EUROPE, SPRL., 276 AVENUE LOUISE, BRUSSELS 5, BELGIUM. CABLE: HOBELEUROP/BRUSSELS.

WANTED TO BUY USED AND NEW PINBALL games two or four players, Wurlitzer juke boxes, Jennings slot machines every kind of models 1965, 1966, 1967 and spare parts, make an offer to AUTOMAT-TJANST N STORGATAN 19 BJUV SWEDEN

WANTED: WURLITZER 2510, SEEBURG KD-VL-201, AMI H-200, I-200, J-200, K-200, Rockola 425-426, Gottlieb Buckaroo. All Add-A-Balls. CLEVELAND COIN MACHINE EXCHANGE, INC., 2029 Prospect, Cleveland, Ohio, To 1-6715.

DISTRIBUTORS WANTED: BELCANTO Records—The Great Singers—Caruso, Farrar, Sutherland, Etc. Catalogue of 49-12" LP's. Write: EICHLER RECORD CORP., 815 BROADWAY, NEW YORK, N.Y. 10003

WANT TO BUY: ALL TYPES OF COUNTER Games. All Makes and Models. Quantity available and price. Cash waiting. LOWELL ASSOCIATES, 2401 W. BALTIMORE ST., BALTIMORE, MARYLAND 21223. TEL: (301) 947-3785.

WANTED TO BUY—Model No. 11 and Model No. 14 Auto-Photo Machines. Will pay Top dollar for equipment in good condition. Write: CASH BOX, Box #803, 1780 B'way, New York, N.Y. 10019.

MECHANIC WANTED—Good working conditions, place to live—Good salary. Call direct at 827-9171. Mr. L. Puckett, Henderson Amusement Company, 101 South Second Street, Henderson, Kentucky.

WE ARE CONSTANT BUYERS OF ALL AMUSEMENT machines and surplus spare parts for same. Write MAX LOBO & CO., MEIR, 23, ANTWERP, BELGIUM.

FOR SALE

EAGLE EYE BILLIARD CUES: TRIPLE-TURNED for straightness, plastic-coated for lasting trueness. Ask your distributor for our economy 4-prong style cue. It's nice looking, rugged and durable. Sold only through distributors. ELLICOTTVILLE WOOD PRODUCTS CORP., READING, PA. 19603.

FOR SALE—300 LATE PIN BALL MACHINES fresh off of our summer locations. All machines shipped and reconditioned and are location ready. Call: GLOBE AUTOMATIC VENDING COMPANY, 378 Granite Street, Quincy, Mass. 02169, Tel: 617-479-0010.

FOR SALE: UNITED SHUFFLES—Pacer \$395; Mambo \$475; Tiger \$445; Orbit \$460; Cheeta \$550. Call or write: MOHAWK SKILL GAMES CO., 67 SWAGGERTOWN RD., SCOTIA, NEW YORK 12302.

ATTENTION POOL TABLE OPERATORS—POP-On Cue Tips fits all Brod Ferrules. 11 mm & 12 mm. Amazing material, more friction, longer lasting. 10¢ each in quantities of 50. Send check or M.O. to JFCOR INDUSTRIES INC., BOX 192, VALLEY STREAM, N.Y.

HI-SPEED, SUPER FAST SHUFFLEBOARD WAX. 24 one-pound cans per case, \$8.50 t.o.b. Dallas, Texas. Sold on money-back guarantee. Dist. for D. Gottlieb, Rock-Ola, American Shuffleboard, Irving Kuye & Midway Mfg. Co. STATE MUSIC DISTRIBUTORS INC., 3100 MAIN ST., DALLAS, TEXAS.

FOR SALE: SEEBURG 480, \$750.00, 220, \$275.00; Wurlitzer 2410, \$225.00; Rock-Ola 1458, \$115.00; 1465, \$115.00. Also used Pin Games, Bowlers and Guns, Bird Music Dist., Inc., 124 Poyntz, Manhattan, Kansas, Area Code 913 PR 8-5229.

FOR SALE: FLIPPER, FLIPPER PARADE, JOLLY Joker, Skill Ball \$100 each. Flipper Clown, Flipper Fair \$125 each. Wing Ding, Palooka, Bronco, Flipper Cowboy \$200 each. Write or Call: STARK NOVELTY CO., 239 30th St. N.W., Canton, Ohio. Phone: 492-5382.

BINGOS LARGEST STOCK IN THE COUNTRY For Export Uprights; AMI, Rockola & Seeburg Phonos, Lite A Line, Shoot A Line, Lotia Fun, Track Odds, Twin Super Bells, Spot Bells. Crosse-Dunham & Co., 225 Wright Ave., Gretna, Lo. 70053. Phone: 367-4365

FOR SALE: VANGUARD, STATE FAIR RIFLES, Circus and Titan Rifle, very reasonable, also twenty five assorted Shuffle Alleys, no junk, at your own price. JEWEL COIN MACHINE CO., 2734 W. Morse Chicago 60626 or phone SH 3-8545.

FOR SALE: WILLIAMS A GO GO \$425.00, Williams Hot Line \$300.00, United Avalon Shuffle Alley \$225.00, Major League Baseball \$150.00, Double Play Baseball \$125.00, Williams Three Coins \$85.00. Steppers for Seeburg LPC-1 \$49.95. Call or Write: OPERATORS SALES, INC., 4122 Washington Avenue, New Orleans, Louisiana, 822-2370 (504).

FOR SALE: GERMAN FOOSBALL \$299; Italian Mode \$125; Socko \$275; Keeney Poker Face Flipper \$90; Gottlieb 2-Player Lancer \$125. BUDGE WRIGHT'S WESTERN DISTRIBUTORS, 1226 SW 16TH AVE., PORTLAND, OREGON.

WE HAVE A CHOICE SELECTION OF LATE Williams Two Players. Write for prices MIDWEST DIST., 709 LINWOOD BLVD.—KANSAS CITY, MO.

RECORD RIOT, 455, BRAND NEW RECORDS. Some late hits, \$6.50 per 100, \$65.00 per 1000. All orders shipped immediately. Send check with order for prepaid postage. Only in United States. RELIABLE RECORD CO., BOX 136, GLEN OAKS POST OFFICE, GLEN OAKS, N.Y. 11004 PHONE: (212) 343-5881.

LATE MODELS SEEBURG AND ROCK-OLA Phonographs of lowest prices. DAVE STERN, SEACOAST DISTRIBUTORS, 1200 NORTH AVENUE, ELIZABETH, N.J.

BALLY! BALLY! BALLY! FRUIT SLOT MACHINES for export. We are the Largest Supplier of Used Slot Machines in the world. Call, Write, Wire: NEVADA FRUIT SLOT MACH. CO., P.O. BOX 5734, RENO, NEVADA, 702-329-3932.

FOR SALE: USED BALLY, MILLS, PACE, Jennings, Sego Slot Machines, Keeney Uprights, Bally Bingos. BALLY DISTRIBUTING COMPANY, 44 W. LIBERTY ST., RENO, NEV. TELEPHONE 702-323-6157.

SLOT/FRUIT MACHINES FROM £40 (\$112). All makes, models. Manual, Electric. Available English 6d only. Secondhand pintables, juke boxes, amusement machines, cheap, suitable for developing countries. HALEY ENTERPRISES LTD., 182A, NEW NORTH ROAD, LONDON, N. 1, ENGLAND.

FOR SALE—SLICK CHICK-MID. 2 PL RACEWAY-Will. Beat The Clock-Bally—Beauty Contest, Beach Beauty, Ice Frolics, Varieties, Bright Lights—6 cord Frolics, 6 card Showboats-UN, Starlets—Bally Surf Clubs & Atlantics. NOBRO NOVELTY CO., 142 Dore St., San Francisco, Calif.

GOTTLIEB, BALLY, WILLIAMS, CHICAGO Coin flippers, bowlers, shuffles, baseball games. Midway guns. Largest stock used bingos in U.S. Write, wire or call NEW ORLEANS NOVELTY COMPANY, 1055 Dryades Street, New Orleans, Louisiana, 70113. Tel.: (504) 529-7321. CABLE: NONOVCO.

CHANGERS—NEW HAMILTON CHANGERS—25¢ and 50¢ Below wholesale cost. Original Microscope Punching Bag A-1 \$250.00; Downey Johnson Coin Counter—Complete \$150.00. Complete stock new & used Guns — Phonos — Pool Tables — Cigarette Machines. PAUL A. LAYMON, INC., 1429 W. PICO, LOS ANGELES, CALIF., PHONE: 749-7351.

ACE LOCKS KEYS ALIKE. SEND LOCKS AND the key you want them mastered to \$1.00 each less 10% lots of 50 or more. RANDEL LOCK SERVICE, 61 ROCKAWAY AVENUE, VALLEY STREAM, N.Y. 11580. TEL: 516-VA 5-6216. Our 35th year in vending.

POOL TABLES, NEW COIN-OP 7 FT., \$500.00. Also home tables \$500-up. Antique jukebox 1930s. Also all kinds of vending equipment for sale at lowest prices. WEST PENN VENDING SALES, 1313 BARCOCK BLVD., PITTSBURGH, PA., 15237 (412) 931-2961.

FOR SALE: WMS. BIG DADDY 1-P. \$105.00; Wms. Three Coin 1-P. \$95.00; Gott. Show Boot 1-p. \$75.00; Gott. Aloha 2-p. \$110.00; Gott. Liberty Bell 4-p. \$150.00; Gott. Lancer 2-p. \$110.00. Write or call: TRI-STATE DIST., P.O. BOX 615, CALLIER SPRINGS RD., ROME, GEORGIA, Tel. 234-7123.

FOR SALE: 25 ASSORTED NEW ALBUMS: \$15.00. Our Choice Guaranteed New 33 1/3 RPM LP Albums—Moiled Insured—Post-paid—Limited Sale Offer Good Only in USA. Send Check or Money Order — NO COD'S. UNCLE JIM O'NEAL — BOX A — ARCADIA, CALIF. 91006.

IF WE DON'T HAVE IT—WE'LL GET IT! YOU name it. Jennings and Mills fruit machines. Complete line of parts. Bally and Keeney Consoles, pinballs and bingos. Exporters ATOMIC COIN, BOX 4321, N. LAS VEGAS, NEVADA. PHONE: 642-3847.

BUYERS OF USED PHONOGRAPHS—WHOLESALE or exporters. We guarantee our equipment. Write for prices. UNITED DISTRIBUTORS, INC. 902 W. Second St., Wichita, Kansas 67201. Phone: 316-AM 4-6111.

30 BINGOS, 20 TURF KINGS (TO BE SOLD in Virginia only), 25 Novelties, 4 Guns, 4 Shuffles, 3 Baseballs, Lord's Prayer. Call or write E. L. SIMMONS, DANVILLE AMUSEMENT CO., 620 WESTOVER DR., DANVILLE, VA. Phone: 792-5044.

FOR SALE—Cinebox with 20 films. Like new with less than 5000 plays, \$1200.00; 10 available. Bingos for export. D. & P. MUSIC, 27 E. PHILADELPHIA STREET, YORK, PA. Phone 848-1846.

READ ALL ABOUT IT . . . HEAR ALL ABOUT the "Paper Man" . . . the New Hit From Noah's Ark . . . Noah's Ark will save the world! J&B RECORD PRODUCTIONS, P.O. BOX 14422, TAMPA, FLA. 33609. 813-839-4880.

IF IT'S PANORAM PARTS YOU WANT PHIL GOULD HAS 'EM. ALL TYPES OF FILMS FOR Panoram Peeks. PHIL GOULD — 224 MARKET ST.—NEWARK, N.J. (Tel. 201-MARket 4-3297).

FIVE EXHIBITS: BIG BRONCO HORSE \$150.00 each, 1 Six-Shooter Gin, \$75.00 and 1 Gur-Potrol Exhibits \$75.00. CENTRAL MUSIC CO., 407 EAST AVENUE, D.P.O. BOX 284 KILEEN, TEXAS.

POKERINO, RECONDITIONED, REFINISHED IN Blond Birch, with new drop chute, points sockets, wire, knock off, trim, back-glass ployfield decals. Write for details. New socket and point drop board wired for your games. JAMES TRAVIS—P.O. BOX 206—MILLVILLE, N.J. 08332.

HI DOLLY, SWING A LONG, FASHION SHOW, Melody Lane; Bowling Queen, North Star, Skyline, World Fair, Sweethearts, Show Boat. Wms. Beat the Clock, Riverboat, Reserve, Spoco Ship, Soccer Bolly; Hootennony; Keeney; Eleven Belles. United: Avalon, Action, Crystal, Crest. D & L COIN MACHINE CO., 414 Keiker St., Harrisburg, Pa. 17105. Tel.: 234-1051.

DO YOU KNOW THAT EVERY CONCEIVABLE type of Coin operated machine, modern or antique, can be obtained from Munves? The leader in arcade equipment for over 50 years. Export-Import. Mike Munves Corp. 577 10th Avenue, Dept. CB-New York, N.Y. 10036.

FOR SALE: 19 NEW TWIN DRAGON MACHINES (Keeney) and 25 used ones. These have cash payout units but are easily converted to free play, also 70 Bally Grand Stands like new. SASKATCHEWAN COIN MACHINE CO., 1025-104 STREET, NORTH BATTLEFORD, SASKATCHEWAN, CANADA. PHONE 445-2989. AREA CODE 306.

RECORD ALBUM SALE—MONO ONLY. MAJOR labels. Current stock, no cutouts or D.J.'s. \$1.50 each lots of 50 or more PREPAID United States. No lists available. Remittance with orders. EMPIRE DISTRIBUTING CO., 4610 Liberty Ave., Pittsburgh, Pa. 15224 (Tel. (412) 682-8437)

WINTER SPECIALS off our own routes—Clean, mechanically reconditioned in our shop. Gottlieb 2 player: Bonanza—\$195, Lancer—\$125, Sea Shore—\$200, Swing Along—\$150, Thorobred—\$225. Gottlieb 4 player: Shipmotes—\$250. Gottlieb 1 player: Fito Finish—\$100, Cover Girl—\$100, Gigi—\$125, Sweethearts—\$135, Kings & Queens—\$200, North Star—\$190. Williams 2 player: Jumpin Jacks—\$125. 1 player—River Boat—\$150, Zig Zag—\$170. STAN HARRIS & CO., 508 W. Venango St., Philo., Pa. Baldwin 3-5362

UNITED PLAYBOY TARGETTE \$225.00. CHICO Gold Star \$395.00. Rockola 120 wallboxes \$12.00 ea. Wurl. 5210's \$29.50 ea. Send for list of more real buys. We'll trade too! Jules Olshain at Greco Brothers, 1288 B'way, Albany, N.Y. HO 5-0228.

FOR SALE: RECONDITIONED BARGAINS: Wurlitzer 2150 (200 Sel) \$145.00; 2900-8 (200 Sel. DISC) \$595.00; 3000-7 (200 Sel.) \$645.00; Bolly Shuffle Bowlers DeLuxe ABC—\$35.00; Bowling Lones 14"—\$50.00; Challenger Bowler 14"—\$95.00; United Bowling Alley 14"—\$50.00. Mickey Anderson Amusement Co., 314 East 11th St., Erie, Pa. Phone: 452-3207.

PANARAM USER'S—THEATRES—FILM DEVELOPERS 225 negatives 16 M.M. black-white, Mint condition App 400 Ft. each. Art Nudes, beautiful Calif. subjects good library, money makers. Also used film \$8.00 Loop. Write R. Richter, 1063 Market St. San Francisco, Calif.

MISC.

NEW FOR DEEJAYS! SIX VOLUME LIBRARY of 6,000 riotous classified one-liners, \$5.00. Copy of comedy monthly free with order! "Comedy spectacular", giant laugh smpler of one-liners breaks, etc., \$2.00. Catalog free. EDWARD ORRIN, Boyer Road, Mariposa, Calif. 95338.

30,000 PROFESSIONAL COMEDY LINES! Largest laugh library in show business. Forty books of classified material, plus Orben's Current Comedy the newsmaking topical gag service featuring hip deejay lines in each issue. Great sample selection, \$5.00. Catalog free. ORBEN DEEJAY LAUGHS, 3536 Daniel Crescent, Baldwin Harbor, N.Y. 11510.

HOLLYWOOD GAG DIGEST! NOW MONTHLY! DeeJays need topical, CLEAN quips . . . Yocks. Our service for DeeJays only! Sample \$2.00 or free info for stomp. Mention CASH BOX with sample order—receive Bonus Gag Sheets FREE! MORRIS, 711 N. CHEROKEE, HOLLYWOOD, CALIF. 90038.



Everyone at the WURLITZER factory and in the distributor organization extends very best Season's Greetings to you and yours

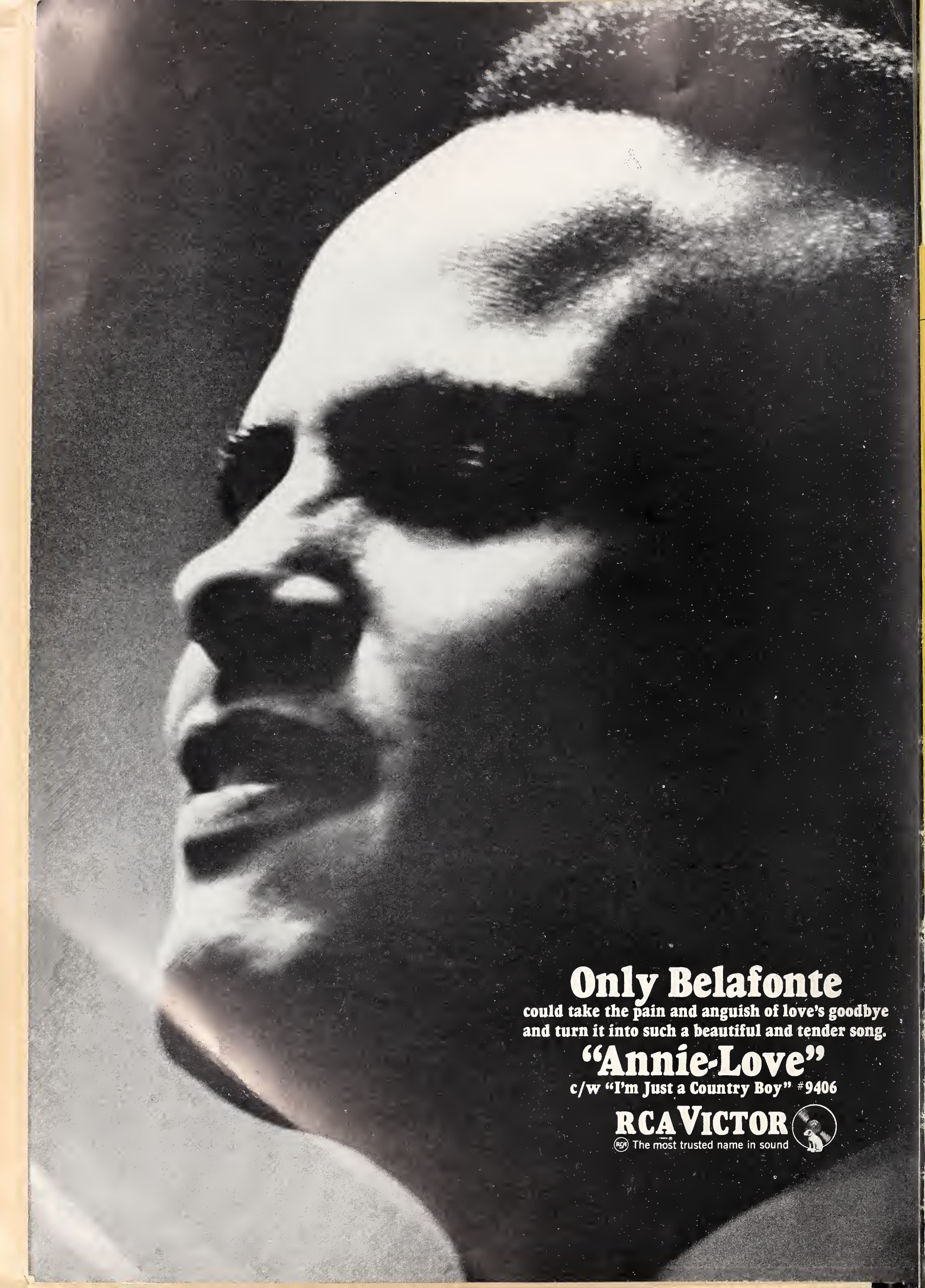

Only Belafonte

could take the pain and anguish of love's goodbye
and turn it into such a beautiful and tender song.

"Annie-Love"

c/w "I'm Just a Country Boy" #9406

RCA VICTOR

RCA The most trusted name in sound

