

CASHBOX

February 19, 1977

NEWSPAPER

\$1.50



*J.C. Penney Making Records Optional
CBS, Capitol, Casablanca,
Arista Financial Statements
Motown Sues CBS; Rod
Stewart Sues Private Stock*

*Cover Artist:
HENRY GROSS*

*RIAA Accord On Bar Code
Illberman Upped At RCA
New Orleans Joins
In \$2.99 Pricing
Penney Move: A Bad Omen Feb.*

Small Wonder's Big Moment.

It arrives once in a lifetime.

And so it's come to pass for Henry Small, Jimmy Phillips and Jerry Morin of Small Wonder. For years they've practiced, worked and developed together — from college dormitories to basement barrooms — all for this very moment.

All for this very album. Presenting "Growin'" — a fifty-minute celebration of rock and roll as it was meant to be.

And a fifty-minute confirmation that practice does indeed make perfect.

Small Wonder. They're in the big leagues now, and they don't intend to lose.

Small Wonder's "Growin'." On Columbia Records and Tapes.

Small Wonder Growin'

including:

Will You Be A Part Of Me?

Run Run Around/Whatever It Will Be

Nowhere Left To Turn/Right Side Of The Be



Produced by Joe Wissert PC 34425

Management: Elliot Abbott
Renaissance Management
433 Camden Drive — Suite 950
Beverly Hills, Ca. 90210

CASH BOX

VOLUME XXXVIII — NUMBER 40 — February 19, 1977

GEORGE ALBERT

President and Publisher

MARTY OSTROW

Executive Vice President

GARY COHEN

Editor In Chief

JULIAN SHAPIRO

East Coast Editor

New York Editorial

PHIL DIMAURO

KEN TERRY

CHARLES PAIKERT

MARK MEHLER

Hollywood Editorial

COOKIE AMERSON

DAVID BOYLES

MIKE FALCON

CHUCK COMSTOCK

ALAN SUTTON

RANDY LEWIS

J.B. CARMICHAEL

West Coast Advertising

Research

HOWARD LOWELL

STEVE OSTROW

BOB SPEISMAN

LARRY CARLAT

JEFF RAY

WAYNE MARECI

BILL FEASTER

CAROL RANDAL

JUDY ALBERT

DAN SEIDEN

CATHY WEIDMAN

Coin Machine

Chicago

CAMILLE COMPASIO, Manager

Hollywood

DAVID BOYLES

Art Director

WOODY HARDING

Circulation

THERESA TORTOSA

Manager

PUBLICATION OFFICES

NEW YORK

119 West 57th, N.Y., N.Y. 10019

Phone: (212) 586-2640

Cable Address: Cash Box N.Y.

CALIFORNIA

6363 Sunset Blvd. (Suite 930)

Hollywood, Ca. 90028

Phone: (213) 464-8241

NASHVILLE

JUANITA JONES

BARBARA O'DELL

1511 Sigler St., Nashville Tenn. 37203

Phone: (615) 244-2898

CHICAGO

CAMILLE COMPASIO

29 E. Madison St., Chicago, Ill. 60602

Phone: (312) 346-7272

WASHINGTON, D.C.

JOANNE OSTROW

6120 Robinwood Road

Bethesda, MD 20034

ENGLAND — KIM THORNE

97 Uxbridge Rd., London W.12

Phone: 01-749-6724

ARGENTINA — MIGUEL SMIRNOFF

Belgrano 3252, Piso 4 "B"

Buenos Aires, Argentina

Phone: 89-6796

BRAZIL — H. GANDELMAN

Av. Rio Branco, 156 Sala 627

Rio de Janeiro RJ

CANADA — DAVID FARRELL

1946 Bloor St. W. Apt. 14

Toronto, Ontario, Canada M6P 3K9

Phone: (416) 766-5978

HOLLAND — PAUL ACKET

P.O. Box 11621 (Prinsessegracht 3),

The Hague

Phone: (70) 624621, Telex: 33083

ITALY — GABRIELE G. ABBATE

Viaie A. Doria 10, 20124 Milano

BELGIUM — ETIENNE SMET

Postbus 56, B-2700 Sint-Niklaas

Phone: (03) 76-54-39

AUSTRALIA — PETER SMITH

6 Murillo Ct., Doncaster

Victoria, Australia 3108

Phone: 848-7878

JAPAN — Adv. Mgr., SACHIO SAITO

1-11-2-Chome Shinbashi, Minato-Ku, Tokyo

Phone: 504-1651

Editorial Mgr., FUMIYO TACHIBANA

1-11-2-Chome Shinbashi, Minato-Ku, Tokyo

Phone: 504-1651

FRANCE — CLAUDE EM MONNET

262 bis Rue des Pyrenees

Paris, France 75020

Phone: 797-4261

SUBSCRIPTION RATES \$60 per year anywhere in the U.S.A. Published weekly by CASH BOX, 119 West 57th St., New York, N.Y. 10019. Printed in the U.S.A. Second class postage paid at New York, N.Y., and additional mailing offices.

Copyright © 1977 by The Cash Box Publishing Co., Inc. All rights reserved. Copyright under Universal Copyright Convention.

POSTMASTER: Send form 3579 to CASH BOX, 119 West 57th St., New York, N.Y. 10019.

cash box editorial

J.C. Penney's Move: A Bad Omen

We were sorry to hear that the J.C. Penney company has authorized its store managers to remove record departments from stores, should they choose to do so. We must admit to fear that some of them may choose that route.

Penney executives blame, justifiably so, poor profit margins in their record departments for the decision. Why, they must be asking, should we sell records at low or no profit, when we can sell housewares, pantyhose, sporting goods or automotive supplies at a decent profit. And with today's market conditions what they are, many of their stores are selling records at or close to no profit.

That in a nutshell points up the sad state of the rack jobbing industry today. Many of the industry's rack jobbing veterans — the Heilichers, Handlemans, Liebermans, etc. — have been warning the industry it faced the possible loss of the discount center/department store market. But due to circumstances beyond their control — and possibly the entire industry's control — nothing has been done about it.

It's been suggested by some, especially on the retailer side, that the loss of record departments in rack jobber locations would be picked up by new full line retail record operations. Indeed, the Tower/Peaches type operation is in more markets now than ever before. But on the other hand, there are many consumers, especially in rural areas where full line retail record stores do not exist, who do their shopping only in a Sears or Wards or Penneys. Those consumers probably would not go into a retail record store just for a record — if such a store were available.

It is those consumers, and those dollars, and those impulse purchases, that the industry stands to lose. And elimination of record departments is not just an idle threat being used by rack jobbers to bargain for a lower price. With J.C. Penney's decision, the day of reckoning looms even closer.

Can we place much of the blame at the manufacturer's doorstep? Probably. But at this point pinpointing blame is not the main issue. Insuring the future of record departments in discount stores is.

We've stated in the past that we hoped it would not take a major retailer dropping record departments to spur the industry into action on pricing. We hope again for the same thing.

Perhaps we can look optimistically at what J.C. Penney is doing as a warning to the industry: They're giving us a few months to get things straightened out, or individual executives within their organization are free to replace records with pantyhose. The time for action, then, is now.



**NUMBER ONE
SINGLE OF THE WEEK**
TORN BETWEEN TWO LOVERS
MARY MACGREGOR
Ariola 7638

Writers: Peter Yarrow, P. Jarrell
Publisher: Muscle Shoals Sound Pub. —
BMI/Silver Dawn — ASCAP



**NUMBER ONE
ALBUM OF THE WEEK**
A STAR IS BORN
STREISAND, KRISTOFFERSON
Columbia JS 34403

CASH BOX TOP 100 SINGLES

February 19, 1977

Rank	Song	Artist	Weeks On Chart			Rank	Song	Artist	Weeks On Chart		
			2/12	2/5	Chart				2/12	2/5	Chart
1	TORN BETWEEN TWO LOVERS	MARY MACGREGOR (Ariola America/Capitol 7638)	1	2	15	35	WHISPERING/CHERCHEZ LA FEMME/C'EST SI BON	DR. BUZZARD'S ORIGINAL SAVANNAH BAND (RCA PB 10827)	33	31	15
2	NEW KID IN TOWN	EAGLES (Asylum E45373)	3	5	11	36	AFTER THE LOVIN'	ENGELBERT HUMPERDINCK (Epic 8-50270)	35	32	20
3	FLY LIKE AN EAGLE	STEVE MILLER (Capitol 4372)	5	8	10	37	IN THE MOOD	HENHOUSE FIVE PLUS TOO (WB 8301)	37	40	9
4	ENJOY YOURSELF	JACKSONS (Epic 8-50289)	4	6	15	38	SAY YOU'LL STAY UNTIL TOMORROW	TOM JONES (Epic/MAM 8-50308)	46	58	9
5	LOVE THEME FROM "A STAR IS BORN" (EVERGREEN)	BARBRA STREISAND (Columbia 1-0450)	11	16	11	39	AIN'T NOTHING LIKE THE REAL THING	DONNY & MARIE OSMOND (Polydor 14363)	36	35	14
6	I LIKE DREAMIN'	KENNY NOLAN (20th Century 2287)	7	9	15	40	FREE	DENIECE WILLIAMS (Columbia 3-10429)	43	45	13
7	YEAR OF THE CAT	AL STEWART (Janus J266)	8	14	11	41	DO YA	ELECTRIC LIGHT ORCHESTRA (United Artists UA XW 9394)	59	80	3
8	NIGHT MOVES	BOB SEGER (Capitol 4369)	10	13	12	42	MOODY BLUE	ELVIS PRESLEY (RCA PB 10857)	44	54	10
9	WEEKEND IN NEW ENGLAND	BARRY MANILOW (Arista 212)	9	10	13	43	LIVIN' THING	ELO (UA 888)	38	36	17
10	BLINDED BY THE LIGHT	MANFRED MANN (Warner Bros. 8252)	2	1	13	44	MAYBE I'M AMAZED	WINGS (Capitol 4385)	68	—	2
11	DANCING QUEEN	ABBA (Atlantic 3372)	13	17	11	45	TONIGHT'S THE NIGHT (GONNA BE ALRIGHT)	ROD STEWART (Warner Bros. 8262)	41	32	20
12	GO YOUR OWN WAY	FLEETWOOD MAC (Reprise 8304)	15	19	7	46	HERE COME THOSE TEARS AGAIN	JACKSON BROWNE (Asylum E45379)	55	71	3
13	THE THINGS WE DO FOR LOVE	10cc (Mercury 73875)	17	25	8	47	SO IN TO YOU	ATLANTA RHYTHM SECTION (Polydor 14373)	60	79	5
14	CARRY ON WAYWARD SON	KANSAS (Kirshner/Epic ZS 8-4267)	18	23	11	48	DISCO LUCY (I LOVE LUCY THEME)	WILTON PLACE STREET BAND (Island 078)	58	70	5
15	I WISH	STEVIE WONDER (Tamla/Motown T54274F)	6	3	12	49	DREAMBOAT ANNIE	HEART (Mushroom M7023)	34	34	10
16	DON'T LEAVE ME THIS WAY	THELMA HOUSTON (Tamla/Motown T54278F)	24	30	9	50	SORRY SEEMS TO BE THE HARDEST WORD	ELTON JOHN (MCA/Rocket 40645)	42	37	21
17	BOOGIE CHILD	BEE GEES (RSO/Polydor 867)	20	28	6	51	THE FIRST CUT IS THE DEEPEST	ROD STEWART (Warner Brothers WBS 8321)	72	—	2
18	LONG TIME	BOSTON (Epic 8-50329)	26	38	5	52	REACH	ORLEANS (Asylum E45375)	56	65	5
19	LIVING NEXT DOOR TO ALICE	SMOKIE (RSO/Polydor 860)	22	27	12	53	THIS SONG	GEORGE HARRISON (Dark Horse/WB DRC 8294)	45	39	14
20	RICH GIRL	DARYL HALL & JOHN OATES (RCA PB 0860)	29	48	5	54	BITE YOUR LIP (GET UP AND DANCE!)	ELTON JOHN (MCA 40677)	67	—	2
21	SAVE IT FOR A RAINY DAY	STEPHEN BISHOP (ABC 12232)	23	26	12	55	AT MIDNIGHT (MY LOVE WILL LIFT YOU UP)	RUFUS FEATURING CHAKA KHAN (ABC 12239)	71	85	3
22	LOST WITHOUT YOUR LOVE	BREAD (Elektra E45365)	12	12	14	56	KONG	DICKIE GOODMAN (Shock/Janus SH6)	61	77	4
23	WALK THIS WAY	AEROSMITH (Columbia 3-10499)	21	11	14	57	WINTER MELODY	DONNA SUMMER (Oasis/Casablanca 872)	63	73	7
24	HARD LUCK WOMAN	KISS (Casablanca 873)	19	20	10	58	THE RUBBERBAND MAN	SPINNERS (Atlantic 3355)	47	42	21
25	DAZZ	BRICK (Bang 727)	16	7	18	59	I'VE GOT LOVE ON MY MIND	NATALIE COLE (Capitol 4360)	70	78	3
26	DON'T GIVE UP ON US	DAVID SOUL (Private Stock 45129)	39	52	4	60	SAM	OLIVIA NEWTON-JOHN (MCA 40670)	66	76	4
27	JEANS ON	DAVID DUNDAS (Chrysalis 2094)	27	18	23	61	STAND TALL	BURTON CUMMINGS (Portrait/CBS 6-70001)	48	41	21
28	HOT LINE	SYLVERS (Capitol 4336)	14	4	16	62	YOU'VE GOT ME RUNNING	GENE COTTON (ABC 12217)	49	49	12
29	CAR WASH	ROSE ROYCE (MCA 40615)	25	15	16	63	FANCY DANCER	COMMODORES (Motown 1408)	64	67	9
30	YOU DON'T HAVE TO BE A STAR	MARILYN McCOO & BILLY DAVIS JR. (ABC 12208)	28	21	20	64	BE MY GIRL	DRAMATICS (ABC 12235)	65	69	9
31	YOU MAKE ME FEEL LIKE DANCING	LEO SAYER (Warner Bros. 8283)	30	24	19	65	HEY BABY	RINGO STARR (Atlantic 3371)	62	64	12
32	SATURDAY NIGHT	EARTH, WIND & FIRE (Columbia 1-0439)	32	29	13	66	I CAN'T SAY NO TO YOU	PARKER MCGEE (Big Tree/Atlantic 10682)	69	81	6
33	CRACKERBOX PALACE	GEORGE HARRISON (Dark Horse/WB DRC 8313)	40	57	4	67	BABY DON'T YOU KNOW	WILD CHERRY (Sweet City/Epic 8-50306)	57	59	7
34	SOMEBODY TO LOVE	QUEEN (Elektra E-45362)	31	22	14						
68	IT KEEPS YOU RUNNING	DOOBIE BROS. (WB 8282)	52	50	10						
69	ALL STRUNG OUT ON YOU	JOHN TRAVOLTA (Midland Intl./RCA MB 10907)	—	—	1						
70	LOVE SO RIGHT	BEE GEES (RSO/Polydor 859)	50	46	23						
71	FREE BIRD	LYNYRD SKYNYRD (MCA 1948)	51	47	12						
72	LOVE ME	YVONNE ELLIMAN (RSO/Polydor 858)	53	43	20						
73	HERE IS WHERE YOUR LOVE BELONGS	SONS OF CHAMPLIN (Ariola America/Capitol 7653)	73	75	3						
74	DRIVIN' WHEEL	FOGHAT (Bearsville/WB BSS 0313)	54	44	22						
75	RIGHT TIME OF THE NIGHT	JENNIFER WARNES (Arista AS 0223)	92	98	3						
76	MUSKRAT LOVE	CAPTAIN & TENNILLE (A&M 1870)	75	53	22						
77	LOVE BALLAD	LTD (A&M 1847)	77	55	22						
78	YOU KNOW LIKE I KNOW	OZARK MOUNTAIN DAREDEVILS (A&M 1888)	84	88	5						
79	YOU + ME = LOVE	UNDISPUTED TRUTH (Whitfield/WB WHI 8306)	85	93	3						
80	TRYIN' TO LOVE TWO	WILLIAM BELL (Mercury 73839)	—	—	1						
81	DIS-GORILLA	RICK DEES AND HIS CAST OF IDIOTS (RSO/Polydor 866)	82	84	5						
82	WHEN LOVE IS NEW	ARTHUR PRYSOCK (Old Town 1000)	76	74	9						
83	DEDICATION	THE BAY CITY ROLLERS (Arista ASO 233)	88	—	2						
84	I NEVER CRY	ALICE COOPER (Warner Bros. 8228)	74	51	22						
85	SOMETHIN' 'BOUT 'CHA	LATIMORE (Glades/TK 1739)	91	97	4						
86	GLORIA	ENCHANTMENTS (United Artists 912)	83	89	5						
87	SHAKE YOUR RUMP TO THE FUNK	BAR-KAYS (Mercury 73833)	78	61	15						
88	FIRE SIGN	CORY (Phantom/RCA 10856)	87	94	5						
89	UP YOUR NOSE	GABRIEL KAPLAN (Elektra E45369)	89	82	6						
90	I'LL ALWAYS CALL YOUR NAME	LITTLE RIVER BAND (Harvest/Capitol 4380)	95	100	3						
91	"ROOTS" MEDLEY	QUINCY JONES (A&M 1909)	—	—	1						
92	SOMETIMES	FACTS OF LIFE (Kayvette/TK 5128)	—	—	1						
93	COULDN'T GET IT RIGHT	CLIMAX BLUES BAND (ABC SAA 736)	96	—	2						
94	SOUTHERN NIGHTS	GLEN CAMPBELL (Capitol 4376)	—	—	1						
95	THEME FROM KING KONG PART ONE	LOVE UNLIMITED ORCHESTRA (20th Century TC 2325)	97	—	2						
96	SAILING SHIPS	MESA (Ariola/Capitol 7654)	98	—	2						
97	I DON'T WANNA LOSE YOUR LOVE	EMOTIONS (Columbia 3-10347)	79	62	14						
98	ANGEL IN YOUR ARMS	HOT (Atlantic BT 15085)	100	—	2						
99	I LIKE TO DO IT	K.C. AND THE SUNSHINE BAND (TK 1020)	86	63	10						
100	RACE AMONG THE RUINS	GORDON LIGHTFOOT (Reprise RPS 1380)	—	—	1						

ALPHABETIZED TOP 100 SINGLES (INCLUDING PUBLISHERS AND LICENSEES)

All Strung Out On You (Daddy Sam — ASCAP)	69	Fire Sign (Phantom/Apple Cider/Music of the Times — ASCAP)	88	Lost Without (Kipahula — ASCAP)	22	Sorry Seems (Big Pig/Leeds — ASCAP)	50
After The Lovin' (Silver Blue — ASCAP/Oceans Blue — BMI)	36	Fly Like (Sailor — ASCAP)	3	Love Ballad (Unichappell — BMI)	77	Southern Nights (Warner-Tamerlane/Marsaint — BMI)	94
Ain't Nothing (Jobete — ASCAP)	39	Free (Kee/Drick — BMI)	40	Love Me (Unichappell — BMI)	72	Stand Tall (Shillelagh — BMI)	61
Angel In Your (Song Tailors — BMI/I've Got The Music — ASCAP)	98	Free Bird (Duchess/Hustlers — BMI)	71	Love So Right (Stigwood — BMI)	70	The First Cut Is (Duchess — BMI)	51
At Midnight (Amer. B'casting/Elainea — BMI)	55	Gloria (Desert Moon/Willow Girl — BMI)	86	Love Theme (First Artists/Emanuel/20th Century — ASCAP)	5	Theme From King (Ensign — BMI)	95
Baby Don't (Bema — ASCAP)	67	Go Your (Gentoo/Now Sound — BMI)	12	Maybe I'm Amazed (Maclen — BMI)	44	The Rubberband (Mighty Three — BMI)	58
Be My (Electrocord — ASCAP)	64	Hard Luck (Cafe Amer./Kiss Songs — ASCAP)	24	Moody Blue (Screen Gems-Columbia/Sweet Glory — BMI)	42	The Things (Man-Ken — BMI)	13
Bite Your Lip (Big Pig — LTD/Lead — ASCAP)	54	Here Come Those (Swallow Turn/WB — ASCAP/Open Window/Warner-Tamerlane — BMI)	46	Muskrat Love (Wishbone — ASCAP)	76	This Song (Ganga/B.V. — BMI)	53
Blinded (Laurel Canyon — ASCAP)	10	Here Is Where You Love (JFH — ASCAP)	73	New Kid — BMI/ASCAP)	2	Tonight's The Night (Cock & Trumpet — ASCAP)	45
Boogie Child (Stigwood/Unichappell — BMI)	17	Hey Baby (Unart/LeBelle — BMI)	65	Night Moves (Gear — ASCAP)	8	Torn Between (Muscle Shoals — BMI/Silver Dawn — ASCAP)	1
Carry On (Don Kirshner — BMI)	14	Hot Line (Bull Pen — BMI/Perren Vibes — ASCAP)	28	Reach (Siren — BMI)	52	Tryin' To Love Two (Bell-Kat/Unichappell — BMI)	80
Car Wash (Duchess — BMI)	29	I Can't Say (Dawnbreaker — BMI)	66	Rich Girl (Unichappell — BMI)	20	Up Your Nose (Rotunda — BMI)	89
Couldn't Get It (Bleu Disque — ASCAP)	93	I Don't Wanna (Pamjokeen — BMI)	97	Right Time Of (Amer. B'casting — ASCAP)	75	Walk This (Dekset — BMI)	23
Crackerbox Palace (B.U. — BMI)	33	I Like (Sound of Nolan/Chelsea — BMI)	6	"Roots" Medley (Rashida/Smenya — ASCAP)	91	Weekend (Unart/Plano Picker — BMI)	9
Dancing Queen (Countless — BMI)	11	I Like To (Sherlyn/Harrick — BMI)	99	Sailing Ships (Song Tailors/Everybody's/International Tunes — BMI)	96	When Love (Mighty Three — BMI)	82
Dazz (Silver Cloud/Trolley — ASCAP)	25	I'll Always (Australian Tumbleweed — BMI)	90	Sam (John Farrar/Blue Gum/Dejamus — BMI/ASCAP)	60	Whispering (Miller/Fisher — ASCAP/Pink Pelican — BMI)	35
Dedication (Almo/Big Secret — ASCAP)	83	I Never Cry (Ezra/Early Frost — BMI)	84	Saturday (Saggifire — BMI)	32	Winter Melody (Rick's — BMI)	57
Disco Lucy (Desilu — ASCAP)	48	In The (Shapiro-Bernstein/Lewis — ASCAP)	37	Save It (Stephen Bishop — BMI)	21	Year Of (Dejamus/Purple Pepper — ASCAP)	7
Dis-Gorilla (Stafree/Gold Top — BMI)	81	It Keeps (Tauripin — BMI)	68	Say You'll (Dick James — BMI)	38	You Don't Have (Groovesville — BMI)	30
Don't Give Up On (Almo/Macaulay — ASCAP)	26	I've Got Love (Jay's Ent./Chappell — ASCAP)	59	Shake Your Rump (Barkay — BMI)	87	You Know Like I (Lost Cabin — BMI)	78
Don't Leave (Mighty Three — BMI)	16	I Wish (Jobete/Blackball — ASCAP)	15	So In To You (Low-Sal — BMI)	47	You Make Me (Brintree — BMI/Longmanor-Chrysalis — ASCAP)	31
Do Ya (UA/Jet/Innersong — ASCAP)	41	Jeans On (Moth/Dick James — BMI)	27	Sometimin' 'Bout 'Cha (Sherlyn — BMI)	85	You + Me (Stone Diamond — BMI)	79
Dreamboat Annie (Andorra — ASCAP)	49	Kong (Unichappell — BMI)	56	Sometimes (Stallion — BMI)	92	You've Got (Dawnbreaker — BMI)	62
Drivin' (Knee Trembler — ASCAP)	74	Living Next (Chinnichap — BMI)	19				
Enjoy Yourself (Mighty Three — BMI)	4	Livin' Thing (Unart/Jet — BMI)	43				
Fancy Dancer (Jobete/Commodores — ASCAP)	63	Long Time (Pure — BMI)	18				

JOHN MILES

is back with his second superb LP...

“Stranger In The City”



JOHN MILES
STRANGER IN THE CITY

**VOTED BRITAIN'S
MOST POPULAR
MALE SINGER**

“This is a totally convincing album
by one of the brightest, freshest
forces in British rock.”

Positive proof that Miles is
capable of turning on real heat.”

MELODY MAKER

**Produced & arranged by
Rupert Holmes**

The LP available now...The tour soon!

A
WIDESCREEN
PRODUCTION



PS 682
LONDON
RECORDS & TAPES

Mama's Pride is six boys from St. Louis who make some of the most dynamic rock 'n' roll you'll hear anywhere.

Their latest album, "Uptown & Lowdown," has enough to keep even a mother

feeling good for months. That, in itself, is a Mama's Pride.

Mama's Pride, "Uptown & Lowdown." On Atco Records and Tapes.

SD36-146



This is Mama's Pride.



J.C. Penney Makes Record Depts. Optional; Plans To Exclude LPs From New Stores

by Ken Terry

NEW YORK — J.C. Penney Co. has made the retention of record departments optional in the 400 of its 2,070 department stores which carry record lines. It has also announced that record departments will not be included in Penney stores opened after July 1.

According to a spokesman for the giant discount chain, "It is expected that some store managers will want to keep those (record) departments. But, if any of them indicate a desire to discontinue their record and book lines, management will honor their request."

The spokesman stated that Penney's

policy shift was "due to the low profit our record and book departments have been achieving. Although this has improved over the past few months, these product lines have not met our profit objectives."

Suppliers Comment

While no figures were available on Penney's total record business, the possible elimination of record departments in 400 stores is expected to have a sharp impact on the chain's album and tape suppliers. Representatives of two rack jobbers that supply a large part of Penney's records declined to comment on the potential consequences to them of losing the chain's business. However, according to industry sources, the managers of the affected Pen-

ney stores are unlikely to pull out of the record market immediately. "I don't think that all the suppliers of J.C. Penney will be called to come and get their records," asserted one source. "What will happen is that, over the next year, there will be a slow erosion of exposure to the consumer."

This informant believed that those who shop at stores like Penney's buy records strictly on impulse. Therefore, he argued, the closing of Penney's record departments will mean that a large portion of that



Mel Ilberman

Ilberman Given Added Duties In RCA Alignment

NEW YORK — Mel Ilberman has been promoted to division vice president of domestic operations as part of an executive realignment at RCA Records. He will now be responsible for popular and Red Seal A&R in addition to his established responsibilities in the areas of marketing, Nashville operations and direction of publishing activities.

Reporting to Ilberman under the new alignment will be Jack Kiernan, division vice president of marketing; Jerry Bradley, division vice president for Nashville operations; Don Burkheimer, division vice presi-

(continued on page 46)

CBS Posts New Dollar Highs In 1976; Records Group Tops 1/2 Billion Sales

NEW YORK — CBS Inc. and each of its four operating groups set new sales and income records in 1976, with 1976 fourth quarter results also setting records for that period.

CBS, Inc.'s net income for the year was \$163,995,000, up 33% over \$122,903,000 earned in 1975. Sales rose 15% from \$1,-

938,867,000 in 1975 to \$2,230,576,000 last year.

CBS Sales Awards Photos On Page 18

The CBS/Records Group posted record earnings of \$65.3 million in 1976, up 16% over \$56.3 million earnings in 1975. Sales also rose 16%, from \$484.3 million to \$563.8 million.

The CBS/Columbia group, which includes the Columbia record club, reported a 22% hike in earnings, from \$16.5 million to \$20.2 million, and a 12% increase in

sales, from \$352.7 million in 1975 to \$393.3 million in 1976. CBS attributed the unprecedented performances of its record operations to sharply increased domestic sales of records and tapes, and continued growth in international operations.

Fourth quarter 1976 earnings for CBS Inc. were \$47,887,000, compared with \$35,668,000 in the last quarter of 1975, an increase of 34%. Net sales in the 1976 fourth quarter were \$660,149,000, up 15% over \$574,772,000 in the comparable period of 1975.

The CBS board of directors also declared a dividend of 50¢ per share on common stock, payable March 11 to shareholders of record February 25.

This is the fifth consecutive year that net sales for the Records Group and the Columbia group have risen.

RIAA Says UPC Council OK'd Product Code Set-Up; McKinsey Representative Says 'No'

by Randy Lewis

LOS ANGELES — The RIAA announced last week that its proposed 10-digit code structure has been "officially accepted in principle by the Universal Product Code (UPC) council, policy-making body of the UPC coding system."

The RIAA's release also stated that "notification of approval was received by Stanley M. Gortikov, RIAA president, from Tom Wilson of McKinsey & Co., a spokesman for the UPC council."

Wilson, however, responded to the release saying, "That's a stretch. All I had was a verbal conversation with Gortikov. It's much more tentative than that. I didn't expect that they were going to release anything at this time."

"They had put a couple of proposals to us, which we took up with the board of governors of the UPC council. They saw no reason, in principle, why we couldn't accommodate the record industry's code."

Some Areas Need Exploration

"But they did suggest that there are a couple of areas that ought to be explored further before any final decision is made. One of these issues is whether that structure is going to be able to hold up under a few years of use," Wilson said.

The problem, according to Wilson, is in the way the industry has suggested the code be set up. Within the 10-digit framework, the first four numbers were to indicate the manufacturer. The next five digits would identify the product selection, with the last number denoting the configuration.

Since only one number is allocated to configuration identification, a maximum of 10 formats could be included in the code, represented by numbers 0 through 9.

"Does anybody know for sure that they are not going to expand beyond the 10 formats in the next three or four years? Anytime you get into a structured code, as this is," Wilson said, "there is always the worry whether the capacity will be sufficient in the future to accommodate it."

RIAA: No Official Word

Gortikov could not be reached for comment, but Henry Brief, executive director of the RIAA in New York, said "What I have heard I heard from Gortikov. If there is any dispute on the understanding of it, I wouldn't know about it." Brief said he has received no official word from the UPC council on the subject.

Wilson commented, "I have to admit that we haven't gotten back to him (Gortikov) in writing and some misinterpretation could easily exist on his part, but it would be pretty tough to wrap what I said to him last week into that sort of press release."

He also said the UPC is not rejecting the RIAA's proposed code structure, but that they want to be sure a specific code will not become obsolete within a short time.

"We just don't want to be a party to something that's going to break down after two or three years," Wilson said.

Conflict With Grocery Industry

Besides the problem with the one-digit configuration symbol, Wilson said the other main obstacle to be overcome is "whether the retail grocery people would be more in-

terested in a code arrangement such that the release number is not a part of the item record file in the store."

He explained that the UPC is usually used in two different ways in grocery stores, a factor which must be considered before

(continued on page 46)

Millenium Is Name Of New Biegel/Ienner Co.

NEW YORK — At press time, **Cash Box** learned that the new label owned by Irv Biegel and Jimmy Ienner has been named Millenium. Formal announcement is expected shortly.



GIANT EAR PAUSES — A pause was called during one of the Giant Ear sales meetings to pose with a plaque Elektra/Asylum awarded the branches to commemorate the label's gold and platinum record awards for 1976. Pictured (l to r) are: Rick Cohen, WEA branch marketing coordinator in Los Angeles; George Steele, E/A vice president of marketing services; Joe Smith, E/A chairman; Bob Murphy, WEA sales manager in Los Angeles; Russ Bach, WEA branch manager of Los Angeles; Bill Perasso, WEA sales manager in San Francisco; Bob Stevens, WEA sales manager in Denver; Stan Marshall, E/A vice president of sales; David Cline, E/A western region marketing manager; and Jack Shue, WEA sales manager from Seattle.

PABLO CRUISE



It takes
a powerful
album to
put a group
where they deserve
to be. "A PLACE
IN THE SUN"

A P L A C E I N T H E S U N



Produced by Bill Schnee

SP 4625

On A&M Records & Tapes



H&L Executives Receive Fines, Short Jail Terms

NEW YORK — Three executives of H&L Records, formerly Avco Records, received mild prison sentences and fines here on February 4, following their pleas of guilty to charges of conspiracy to bribe disc jockeys (**Cash Box**, January 8).

Current label owners Luigi Creatore and Hugo Peretti were each sentenced to six consecutive weekends in prison and fined \$10,000, while executive vice president of H&L Albert (Bud) Katzel received a sentence of three consecutive weekends imprisonment and a \$5,000 fine. They were sentenced before Judge Robert Carter of the Federal District Court, Southern District of New York.

The defendants were originally charged with making cash payments of approximately \$170,000 to radio station personnel from 1971 to 1975.

Contacted at the label's main office in Englewood Cliffs, New Jersey, H&L executives offered no comment on the issue.

FRONT COVER



The previous year saw crucial changes in the career of Brooklyn-born Henry Gross. He moved to Lifesong Records, newly formed by his longtime producers Terry Cashman and Tommy West. He recorded his first album for the label, "Release," and the first single from that album, "Shannon," became Gross' first million seller, certified gold on June 18; it was also Lifesong's first gold record.

Looking to the future from 1977, Gross' musical outlook continues to change. His new album, "Take Me To The Stage," is self-produced, the first time a Henry Gross record has not been produced by Cashman and West. The album has a ballad side and a rock side, containing songs such as "What A Sound" and "Painting My Love Songs."

A veteran of several tours as a solo artist as well as with Sha Na Na, Gross will shortly be taking to the road in support of his new album. On his 1976 tour, which lasted nearly six months, he and his group headlined in some markets as well as appearing with major artists such as Jeff Beck, Aerosmith and Fleetwood Mac.

Index

Album Reviews	22
Classified	49
Coin	47
Country Album Chart	36
Country Singles Chart	40
FM Analysis	26
For The Record	35
International Section	54
Jazz	42
Pop Album Chart	57
Pop Radio Analysis	32
Pop Radio Playlist Highlights	28
Pop Singles Chart	4
Radio News	24
Regional Album Action	34
R&B Album Chart	53
R&B Singles Chart	45
Singles Bullets	33
Singles Reviews	20

Print Ads For \$7.98 LPs Still Sluggish Pink Floyd's "Animals" Most Visible Of All

by Ken Terry

NEW YORK — Print ad campaigns for most single-disc pop albums which have been recently released at \$7.98 list remained sluggish this week.

The latest LPs by David Bowie on RCA and by George Benson on Warner Bros., for example, were only advertised in one market each out of the 21 markets surveyed. Bowie's "Low" was promoted for \$4.99/\$5.55 tape at Ayr-Way in In-

(continued on page 51)

Negotiations Still Pending On Proposed Pickwick Sale

by Mark Mehler

GREENWICH, CONN. — With "sensitive negotiations" still underway on the proposed purchase of Pickwick International by the giant American Can Co., Pickwick officials declined comment on the future of the record manufacturing/merchandising conglomerate as well as their own future under American Can ownership.

However, one source close to negotiations speculated that at least one top Pickwick official was "less than pleased" with the proposed merger, mainly because of American Can's total lack of experience in the record business.

Meanwhile, Pickwick stock, selling at \$14.25 per share only a few weeks ago, was selling at \$20.50 at the close of business on February 8, leading some security analysts to further deplore big companies "eating up" smaller ones through negotiated rates.

"Smaller firms like Pickwick, which generally sell at low price/earnings multi-

Retail Price Survey

New Orleans Retailer Begins Advertising 2.99 LP Specials

by Mark Mehler

NEW YORK — New Attitude Records and Tapes, a one-year old, 6,000 sq. ft. New Orleans store, has begun advertising four current releases for \$2.99 in the Sunday *New Orleans Times-Picayune*, and plans to continue the \$2.99 promotion in every Sunday paper.

Richard Lieberman, owner and manager of New Attitude, told **Cash Box** that he expects the lowballing to "stir things up considerably" in the city.

"Other retailers here have sold records for \$2.99 without advertising," Lieberman added, "but basically, people really aren't

used to it. It gets them in the store." However, Lieberman noted that all \$6.98 list LPs in his store always sell for \$3.99, and "when people realize that, they buy a lot more than just the really cheap stuff. We lose a lot on the \$2.99," he asserted. "But we get the automatic return, plus co-op ad dollars on any ads above \$3.89."

The idea for the \$2.99 promotion came from a representative of Sutton Distributors, the firm which owns Jimmy's Music World, a chain of 17 stores in metropolitan New York. Jimmy's has been advertising \$2.99 releases for over a year, and is considered a major instigator of New York City's current price war.

"I met a fellow from Sutton at a meeting down here and he suggested it (\$2.99)," Lieberman said. "He said buying at the sub-distributor price he only loses about 30¢ (an LP), but it was worth it as a loss leader."

Started In School Paper

Lieberman began advertising one LP at \$2.99 in the local Tulane University paper, and added that he promoted the latest

(continued on page 51)

ples, are plums to be picked by major conglomerates interested in boosting their earnings through diversification.

But Richard Steenken, a security analyst specializing in the record industry,

(continued on page 50)



BACKSTAGE WITH NATALIE COLE — Capitol recording artist Natalie Cole is congratulated backstage after her recent performance in the Los Angeles Music Center's Dorothy Chandler Pavilion. Pictured with guests (l to r) are: Kevin Hunter, Ms. Cole's manager; Marvin Yancy and Chuck Jackson, Ms. Cole's producers and songwriters; Bhaskar Menon, Capitol's chairman, president and chief executive officer; Natalie Cole; Don Zimmermann, Capitol's executive vice president and chief operating officer; and Larkin Arnold, Capitol's vice president and general manager soul division.

a market analysis / part four

FM Radio Rates Lead Advertising Cost Rise; Bigger Salaries Inflate Promotion Expenses

by Ken Terry and Mark Mehler

In recent interviews with **Cash Box**, executives of companies which have begun to issue selected discs at \$7.98 list explained that increasing costs have necessitated their price hikes. In the first three parts of a series, **Cash Box** examined

several areas in which costs have reportedly risen, including recording pressing and packaging, production and artist royalties. The fourth and final installment explores some of the costs involved in marketing records.

NEW YORK — Several industry sources agree that about a quarter of the wholesale

cost of a record is spent on marketing, which includes promotion, advertising, publicity and sales. For the purposes of this analysis, **Cash Box** has confined its investigations to advertising and promotion, since these are the areas of marketing in which, according to record company executives, costs have risen the most in recent years.

The accompanying lists of print and radio ad rates in 12 major markets provide convincing evidence that advertising costs have indeed risen substantially in those media since 1969. Open rates for ad space in the newspapers in these markets, for example, has increased an average of 45% during that period. In categories of frequency and time slots, spot rates of AM radio stations surveyed by **Cash Box** have only risen an average of 28% within the past seven years. However, rates of selected FM stations have shot up an incredible 393% on the average. In addition, several FM stations not included on the list now charge ad rates that are comparable to those at major AM stations in the same markets.

While TV time costs have also skyrocketed, increasing an estimated 30% within the past year alone, television is not yet a major medium for promoting records. As one source put it, "No one can figure out whether it pays or not."

Advertising Budgets

Advertising budgets are geared to unit

(continued on page 50)



BISHOP BOOGIES ATLANTA — Prior to his recent two-night stand at Atlanta's Great Southeast Music Hall, Capricorn's Elvin Bishop was joined backstage by a number of Capricorn executives and press and radio people. Pictured backstage (l to r) are: Don Schmitzerle, Capricorn's vice-president and general manager; Rhett Walker, music director of WQXI-FM and his friend Kathy; Mickey Thomas of Elvin's band; Phil Walden, president of Capricorn Records; and Elvin Bishop.

RCA Claims Record 1976 Sales; Earnings, International Division Up

NEW YORK — RCA Records achieved an all-time high in sales and doubled its earnings for a second consecutive year in 1976, according to Ken Glancy, president of the company.

Internationally, Glancy indicated 1976 was the best year in RCA Records' history. More than 50 percent of the company's revenues came from abroad last year, and eight of RCA's ten foreign subsidiaries scored their highest sales ever.

Among these foreign affiliates, the sales leaders were in Brazil, France and Australia. RCA's Australian subsidiary, for example, reportedly sold one million units of albums by the Swedish group Abba; in a country of 13 million people, this is equivalent to selling 17 million copies in the U.S. Also achieving excellent unit sales abroad in 1976 were these RCA-distributed artists: John Denver in the United Kingdom; Elvis Presley and Sweet in West Germany; Sylvie Vartan in France; K.C. and the Sunshine Band in Japan; and David Bowie in Canada.

Domestically, RCA attributed a significant portion of its success to the establish-

ment in the marketplace of Waylon Jennings and Daryl Hall and John Oates as well as first efforts by Dr. Buzzard's Original Savannah Band, John Travolta (on Midland International), Starland Vocal Band (on Windsong) and Vicki Sue Robinson.



TAYLOR SIGNS WITH COLUMBIA — Mick Taylor, a former member of the Rolling Stones, was signed recently to an exclusive contract with Columbia Records. Pictured at the signing ceremony are, from left: Arma Andon, vice president of artist development for Columbia Records; Taylor's girl friend; Mick Taylor; Bruce Lundvall, president of CBS Records Division; and Charles Levison, Taylor's attorney.

Capitol Earned \$2.8M In Qtr.

LOS ANGELES — Capitol Industries-EMI, Inc. earned net income of \$2,836,000 on revenues of slightly more than \$61.2 million for their second quarter ending December 31. During the same period last year, the company reported net income of \$2,802,000 on revenues of more than \$43.8 million.

For the first six months of fiscal 1977 Capitol's net income on revenues of more than \$112.2 million was \$6,001,000, or \$1.82 per share. This compares to net income of \$3,326,000 or \$1.00 per share, during the same period in fiscal 1976, when revenues totaled nearly \$77.7 million.

Commenting on the company's results, Bhaskar Menon, president and chief executive officer, stated, "Despite lower product margins during the second quarter, the company's performance in the first half year of fiscal 1977 reflects an increase in sales of 45% with net income 80% higher than the same period last year.

"The third quarter has commenced with widespread dislocation in the company's business due to unprecedented winter conditions prevailing currently in numerous areas of the United States where Capitol has manufacturing and distribution facilities and important markets for its products."

At its recent meeting, the board of directors declared a quarterly cash dividend of \$0.08 per share payable March 15 to shareholders of record February 25, 1977. Capitol currently has just over 3.3 million average shares outstanding.

Arista's 2nd Qtr. Sales Decline By A Third; Poor Performance Of Company's English Division Cited As Major Factor

by Ken Terry

NEW YORK — Arista Records' revenues for the second quarter of fiscal 1977, ended December 25, declined 35% to \$6,657,000 from \$10,288,000 during last year's second quarter. For the first half of fiscal 1977, Arista's volume dropped 22% to \$12,527,000 from \$16,071,000 during the prior-year period.

Elliot Goldman, executive vice president of Arista, would not give figures for the company's earnings during either the second quarter or the first half. He explained that, since Arista is a division of Columbia Picture Industries, Inc., the record company cannot give out any data which the parent corporation does not authorize for release.

English Division Has Problems

The major reason for the decline in Arista's worldwide sales, Goldman noted, was the poor performance by the label's English subsidiary. During the first half of 1977, he said, that company's volume fell 66%; for the second quarter, the figure was 65-70%. Sales of Arista's U.S. division, which includes its international licensing section, actually increased about three to four percent Goldman stated.

While admitting that domestic unit sales

of Arista's singles had fallen off slightly, Goldman asserted that, during the first half, the company had moved more album units than it had during the initial six months of fiscal 1976.

He emphasized the success that the label has had so far this year with such acts as Barry Manilow, Melissa Manchester, Lou Reed and Patti Smith. The major reason, he said, why Arista did not do as well domestically in the first half of 1977 as it did the prior year was that albums by other major acts, including the Kinks, Eric Carmen and the Outlaws, were not released in the first half as previously slated. "Of three major releases which were scheduled for the first half, one of them (the Kinks) has slipped into the third quarter and two of them into the fourth quarter."

Goldman pointed out that the midpoint of the English division's fiscal year came at the end of November, a month earlier than it arrived for the rest of the company. Riding on a hit single and a strong album by Showaddywaddy, as well as swelling U.K. sales of "Dreamboat Annie" by Heart, Goldman declared, the English division had "very strong" sales in December and January. Without giving exact figures, he stated that the subsidiary's volume for those two months equaled its revenues for

the previous six months.

Columbia Pictures

Columbia Pictures Industries, Inc., Arista's parent company, reported second quarter net earnings of \$3,422,000 on sales of \$84,782,000, compared with income of \$6,382,000 on \$86,886,000 in volume during the prior-year period. Deducting an extraordinary credit of \$825,000 during the second quarter of fiscal 1977, however, Columbia Pictures' after-tax operating earnings totalled \$2,597,000; and, after subtracting a gain of \$5,059,000 from the sale of a television station and a \$214,000 gain from a discontinued business, the corporation's operating earnings were \$1,109,000 during the prior-year period.

For the first half of fiscal 1977, net income rose to \$21,908,000 (including a \$14,854,000 gain on the sale of a business and \$2,401,000 in extraordinary credit) from the prior-year figure of \$9,116,000 (including the \$5,059,000 gain and a profit of \$408,000 from the sale of a discontinued business). Operating earnings, after taxes, from continuing operations were thus \$4,653,000, compared to \$3,649,000 during the first six months of fiscal year 1976. Sales during the same period, however, declined to \$174,545,000 from \$176,660,000 during the first half of 1976.

In addition to its record division, Columbia Pictures owns enterprises in many fields, including theatre, television, amusement games and broadcasting.

20th Records Reports \$4.6 Mil. Loss In 1976

LOS ANGELES — A loss of \$4,664,000 was recorded by 20th Century Records and 20th Century Music in fiscal 1976, according to a statement released by 20th Century-Fox Film Corp. The record and music divisions had a profit of \$595,000 in fiscal year 1975 ended Dec. 27, 1975.

Based on net revenues of \$3,339,000 for the last quarter of 1976, the company reported losses of \$821,000 for record and music publishing. Total record and music publishing revenues were similarly down, from \$17,927,000 in fiscal 1975 to \$9,936,000 in fiscal 1976, although the parent film company earned \$10,702,000 on revenues of \$355,038,000.

GRT's 3rd Quarter Sales Up 26% In '77

SUNNYVALE, CALIF. — The GRT Corp. reported sales of \$33,552,000 for the first nine months ended December 31 of the 1977 fiscal year, representing a 26% increase over \$26,636,000 for the preceding year. Earnings were \$1,199,000 after provisions for income tax, or 40¢ per share.

For the third quarter, recorded sales for the company were \$12,191,000, representing a 10% increase over the previous earning period mark of \$11,048,000. Pre-tax earnings for the third quarter were \$1,084,000, compared to \$1,302,000 the previous year, according to GRT president Alan J. Bayley.

Casablanca 1st Quarter Earnings Highest Ever

LOS ANGELES — Casablanca Record and FilmWorks has announced that the first quarter of their fiscal 1977 was the most successful in the firm's history. During the period ending January 31, the company reported revenues of \$11,072,000 or more than double last year's first quarter sales.

Domestic sales increased by 104% over 1976, while foreign revenues were up 538% as a result of increased foreign exposure of Casablanca artists and a series of new international affiliations, the company said.

First quarter revenues for Casablanca Record and FilmWorks were derived from the record division only, and do not reflect any of the projects that have recently been undertaken by the company in the motion picture, television and book publishing fields.



MOSS CONGRATULATES ARMATRADING — A&M artist Joan Armatrading has successfully completed her U.S. tour. She is shown here with A&M president Jerry Moss backstage at Santa Monica Civic, where she learned that she'd been named runner-up "artist of the year" in Rolling Stone's annual critic's poll.



TORNADER SIGNS WITH POLYDOR — Larry Alexander and Sandy Torano, who together form the group Tornader, have been signed to the Polydor label. Pictured at the signing ceremony were, seated left to right: Rick Stevens, east coast a&r director for Polydor Inc.; Irwin Steinberg, president of Polydor Inc. and president of the U.S. Polygram Record Group; and Alexander and Torano. Pictured standing, from left to right are: Lou Simon, executive vice president and general manager of Polydor Inc.; Dennis Kaplan, attorney; Peter Glick, manager for Tornader; Jack Richardson, producer; and Ekke Schnable, vice president of business affairs for the Polygram Record Group.

Believe It!

CIRCUS

Modern Music Makers Awards 1976



Best New Group or Artist

Angel

2nd: Heart
3rd: Boston

Angel's Helluva Band aced out Boston's More Than a Feeling and Heart's singular attempts for number one.

As voted by 40,000 readers of Circus Magazine.

Their New Single "Magic Touch"

NB 878

From their new album
"On Earth As It Is In Heaven."

NBLP 7043

Produced by Eddie Kramer



From Casablanca Record and FilmWorks
also available on tapes.

ATI

Casablanca
Record and Film Works

TOBY
ORGANIZATION, INC.

Gold Awards For Mason, Abba



MASON AND MOM GET GOLD — Columbia Records recently honored Dave Mason, his mother and members of his band at a luncheon to celebrate Mason's first gold album for the label, "Dave Mason." Pictured at the gold record presentation ceremony are, from left: Barry Rothman, Mason's attorney; Jason Cooper, Mason's manager; Bruce Lundvall, president of CBS Records Division; Mason's mother, Dave Mason; and Gerald Johnson, Mike Finnegan, Rick Jaeger and Jim Kreuger, band members



ABBA IN EUROPE — Abba, Atlantic recording artists, performed recently at Oslo's Ekeberghallen before the Norwegian royal couple, Prince Harald and Princess Sonja. The next night the group flew in a blizzard to give a concert in Gothenburg, Norway. Following that show, they were presented RIAA plaques for their first U.S. gold album, "Abba's Greatest Hits." Pictured from left are: Abba members Bjorn, Anna, and Benny; Jerry Greenberg, president of Atlantic; Stig Anderson, Abba's manager; Frida of Abba; and Earl McGrath, director of artist development for Atlantic.

Karma Plans Sixth Store Opening; Audio Equipment To Be Included

by Charles Paikert

NEW YORK — The Karma record retail chain, with outlets in Indiana and Kentucky, has scheduled the opening of its sixth, and largest, store in Indianapolis for the weekend of February 19 and 20.

David Crockett, vice president and director of Father's & Sun's, a large one-stop based in Indianapolis which is a similarly held corporation with Karma, cited "a need for a location with better parking, lighting, and more room to merchandise" as the primary reasons for the opening of the new store, the chain's third in Indianapolis.

Audio Section

Half of the free-standing store's 9,000 square feet has been designated for Karma's first full-line audio merchandise section, which will open on March 15,

Crockett said.

However, despite the store's large size, and inclusion of paraphernalia items for sale, Crockett indicated "We don't want to be a Peaches or Oz. I think carrying that much inventory is crazy. We're aiming for the 18 to 34 market, and we want to carry the product they want."

Free Concerts

Opening weekend ceremonies will include continual free admission concerts inside the new Indianapolis store, culminating with a performance by Epic recording artists Cheap Trick on Sunday night.

Future expansion plans for the Karma chain, according to Crockett, include opening three new stores during the year in as yet unspecified locations in Kentucky and Indiana.

Live Radio Show Lineup Revised

LOS ANGELES — In announcing "Live From The Bottom Line," a projected rock radio series to be syndicated by DIR Broadcasting Corp., **Cash Box** inadvertently reported "artists who will be spotlighted in live performances at the Bottom Line include Leo Sayer, Bruce Springsteen, Patti Smith, Miles Davis and Southside Johnny."

According to Stanley Snadowski, owner of the Bottom Line, "The people mentioned (in TDK Corp.'s press release) are just people who have played the club and there should be no direct or indirect reference that these will be the people on the radio show."

Pat Cox, publicity director for DIR, said

those artists whose names were mentioned are those "who have made reputations at the Bottom Line, who will probably be appearing again at the Bottom Line and who, in fact, might be on the show. But no contracts have been specifically worked out with each one of these people."

'Two Shows Done'

"Two shows have been done," Cox said, "and one has been aired already: Roger McGuinn and Sparks. The second show that is still to be aired is with Elvin Bishop and Tim Moore." Any future shows will be subject to a contract between Snadowski, DIR and the sponsors, which is scheduled to be signed this week, Cox said.

Speculative List For Royalty Tribunal Appts.

by Joanne Ostrow

WASHINGTON, D.C. — President Carter has six months from the enactment of the copyright law revision — until April 19 — to announce his five appointments to the newly established copyright royalty tribunal. The appointees must then be confirmed by the Senate before accepting their seven-year terms.

Resumes of some hopefuls were submitted directly to the White House personnel office and the Carter transition team had been soliciting names for some time prior to his taking office. By combining speculative lists from a number of sources (none anxious to speak for attribution), the following names emerge more than once.

Frontrunner, Six Others

Senate copyright counsel Tom Brennan has been called "the obvious leading candidate" and indeed his name turns up on top of all lists. Brennan said he has heard nothing from the White House to date. If the reorganization of his committee proceeds according to plan, said one source, nothing stands in his way for appointment.

Six others mentioned as "likely" candidates are: Herman Finkelstein, former general counsel for American Society of Composers, Authors & Publishers (ASCAP); Martin David Goldberg, copyright lawyer in New York active in the music business; William Krasilofsky, attorney also active in the industry and author of *This Business of Music and More About This Business of Music*; Miriam Stern, head of a New York agency mainly for songwriters (involved in copyright legislation early in the process, less so this time around); Harold Streibich, Memphis attorney involved in the music business (significantly, the only southerner with particular ties to the country music state of Tennessee); and Seymour Bricker, west coast attorney with many show business clients.

Gabriel Album Leads Atlantic Feb. Releases

NEW YORK — "Peter Gabriel," the first solo album by the former lead singer of Genesis, leads off Atlantic's eight album releases for February. The album, produced by Bob Ezrin, will precede Gabriel's first tour of North America scheduled for early March.

"No Goodbyes" by Hall and Oates, featuring three previously unreleased tracks as well as material from the group's previous three Atlantic albums and "Mr Flute" by Art Webb are also scheduled for February release.

Other February releases on Atlantic-distributed labels include "Uptown & Lowdown" by Mama's Pride on Atco, "The Kenny Rankin Album" on Little David, "Big City" by Lenny White on Nemperor, "Love In C Minor" by Cerrone and "Save," both on Cotillion.

Music People Open So Cal One Stop

LOS ANGELES — Music People, the largest one-stop operation in Oakland, California, has entered the Southern California market, opening Valley One Stop in Van Nuys, California. In Tune Music Music Distributors, also owned by Music People co-principals Mike Lipton and Elliot Blaine, will share company facilities with Music People.

Lipton, who was formerly senior vice president of United Artists Corporation, and Blaine, former vice president of Musical Isle, San Francisco, established the San Fernando Valley location to service the burgeoning retail record trade in the Los Angeles suburbs. The address of Valley Music and In Tune Music is 6737 Valley Ave., Van Nuys.

Epic Signs Bloodstone

LOS ANGELES — Bloodstone has signed an exclusive recording contract with Epic for a reported \$2.7 million over a five year period, according to George G. Braunstein and R.N. Hamady, officers of the Crystal Jukebox Company. Bloodstone, formerly with London Records, sold two million copies of their single, "Natural High."



STANKY BROWN WINS THE WEST — ABC/Sire recording artists The Stanky Brown Group are obviously quite pleased with the response to their west coast debut at L.A.'s Roxy where they were the opening set for the New Riders. Pictured (front row l to r) are: Hand Medress, The Stanky Brown Group's co-producer; Jimmy Miller, the group's guitarist; Rick Bunckiewicz, bassist; and Alan Ross, sax/flute/clarinetist; (back row l to r) Marvin Deane, trade liaison director of ABC Records; Charlie Minor, vice president of promotion for ABC Records; Herb Belkin, vice president of marketing and creative services for ABC Records; Seymour Stein, president of Sire Records; Steve Resnick, director of national singles promotion for ABC Records; John Scher, manager; Jeff Leynor, guitar & vocals; David Passick, manager; James Brown, keyboardist and vocals; and Dave Appell, co-producer.

HENRY GROSS

LISTEN TO HIS VOICE
WHAT A SOUND!

HENRY GROSS
Show Me To The Stage



LS 6010

SHOW ME TO THE STAGE

has a magic about it. Henry Gross sings like no one else. And what a voice he has!

Henry's music ranges from spirited rock 'n roll to moving love songs—all tied together by his incredible voice and familiar harmonies.

The sound that brought his music to millions is unmistakably here, ready to catapult Henry to center stage in '77.

SHOW ME TO THE STAGE

Produced by HENRY GROSS
Except "Help," produced by TERRY CASHMAN and TOMMY WEST
Executive Producers: TERRY CASHMAN and TOMMY WEST

AVAILABLE ON LIFESONG



RECORDS AND TAPES

Management: Budd Carr/**BNB** Associates, Ltd.

Distributed in Canada by Polydor, Ltd.



HILLAGE BEGINS U.S. TOUR — Steve Hillage, Atlantic recording artist, has started his first U.S. tour. Backstage at the Los Angeles Forum from left are: Steve Rowland, Los Angeles promotion man for Atlantic; Tony Mandich, director of west coast artist relations for the label; Hillage; Bob Greenberg, vice president and west coast general manager for Atlantic; and Steve Lewis, Hillage's manager.

Radio Stations Are Playing Album Cut From Wonder LP Despite Its Length

by Jeff Ray and Wayne Mareci

NEW YORK — More than half the pop radio stations surveyed by **Cash Box** are currently playing the album cut, "Isn't She Lovely," from Stevie Wonder's "Songs In The Key Of Life," on a regular basis. Of 143 stations queried, 75 reported playing the song as a charted, hitbound or recurrent selection or LP cut, although a number of other stations said they had played the cut when the "Songs In The Key Of Life" album was first released.

Of the 75 stations currently playing the song, 34 said they are playing the full version, while 33 reported playing an edited version. Eight station spokesmen said they didn't know the exact length of the cut they had selected.

Three stations reported "Isn't She Lovely" reaching number one over the past two weeks: WNOE in New Orleans; KVOL in Lafayette, La. and WFLI in Chattanooga, Tenn.

The cut also reached the top ten within the past two weeks at KAFY in Bakersfield, Calif.; WMPS in Memphis, Tenn. and WBT in Charlotte, N.C.

Of the edited versions of "Isn't She Lovely" currently being played, the most frequently selected edit cuts out the last harmonica instrumental and sound effects.

C.C. Courtney, program and music director at WNOE, said the full version of "Isn't She Lovely" is splitting play with Wonder's single, "I Wish," alternating in the number one rotation. Courtney said "Isn't She Lovely" had been stronger than "I Wish" up to last week, though at the beginning, teens did not like the LP cut.

Mike St. John, program director at WMPS in Memphis, which has been playing a 3:24 minute version of "Isn't She Lovely," explained that cutting the end of the song allows the cut to be played more often in rotation. St. John said it was currently playing in AA rotation (about every 90 minutes).

(continued on page 56)

Week's Developments In Washington, D.C.

FCC To Issue New CB Radio Rules

by Joanne Ostrow

WASHINGTON, D.C. — A proposed rulemaking to be released this week by the FCC will aim to ban linear amplifiers on citizens band radio service and place marketing restrictions on manufacturers of amateur transmitters and amplifiers.

By unofficial estimate, about 50 percent of all CBs on the market use amplifiers to illegally boost power from 50 to 2,000 watts. The going retail amp price is \$150 to \$200, ranging up to \$700 or \$800 for amateur radio equipment. The FCC's ban would affect linears capable of operating on any frequency or frequencies from 24 to 35 mhz. The CB frequency range is 26.9 to 27.4 mhz. The only frequency in that range which allows linear amplifiers is the 10 meter amateur band (CB operates on 11 meters) — but homemade amateur equipment will continue to be permissible, if only made for one's own use, on 28-29 mhz.

Type Acceptance

The second item in the rulemaking, pertaining to manufacturers only, will require type acceptance of all amateur transmitters and amplifiers. The rule is designed to "plain stop manufacturers from selling them," according to an FCC attorney in research and standards. The commission has been working toward this since November 1975, when linear amps operating on 24-35 mhz were banned unless amateur frequencies were included. Since last year it has been illegal to offer for sale any linears on the 11 meter band.

The FCC will put a 60-day comment period deadline on the notice and a 10-day reply comment period. The intention is to have the rule written by May 1 and a final rule out by June.

Postal Service Won't Raise Mail Rates During This Year

by Joanne Ostrow

WASHINGTON, D.C. — Postmaster General Benjamin F. Bailar announced that the Postal Service won't raise its rates this year and that it will act soon to recommend a price break for publishers and other major mailers who presort material. In a speech last week detailing improved postal service and continued budget surplus with promise for the short-term, Bailar revealed a "clouded" outlook for the long-term. He told a Sacramento, Calif. audience that it will not be necessary to raise postal rates in 1977, but additional income from some source will most likely be needed in 1978, and "we may formally apply for an increase within the next few months."

The effective date of any increase and the amount are undecided, but the request for an increase must be filed with the Postal Rate Commission some ten months in advance.

Presort Savings

Ballar's unexpected announcement concerned a new lower rate for major publishers and certain parcel post users, to be proposed soon. In the USPS's next rate filing, he said, "those publications which are presented to us pre-sorted in sufficient quantity to go directly to a delivery station would receive a lower rate based on their reduced handling cost, which appears to be 15-20 percent below the cost of handling other publications. Similarly, he said, USPS will take a harder look at "the monolithic rate structures for parcel post and other categories where there might be justification for similar changes." The actual price breaks have not been disclosed, but presumably, with a higher second-class

Motown Sues CBS For \$20 Million In Jackson Five Signing Controversy

LOS ANGELES — Charging conspiracy and inducing breach of contract, Motown Record Corp. will file a \$20 million lawsuit against CBS and its record label affiliates for actions taken prior to and following CBS's signing of the Jackson Five, according to Motown Industries vice chairman Michael Roshkind.

Other charges contained in the suit — which also names as defendants Joe Jackson, Richard Arons and Jackson/Arons Enterprises — include injurious falsehood, invasion of privacy, interference with prospective advantage and service mark infringement.

Roshkind said the most recent example of distortion of facts involved CBS ads which featured Jermaine Jackson as a member of the group.

Deceptive Advertising

"Despite the fact that obviously CBS and Epic had to be quite aware that Jermaine was being built as a solo star by Motown," he said, "Jermaine's photograph was used prominently in nationwide ads for the CBS television series, 'The Jacksons,' on which Jermaine never appears." CBS subsequently agreed to withdraw all such ads.

Roshkind added: "The whole thing had a severely damaging effect on our credibility and we feel false advertising by CBS caused us real dollar damage for which I am confident the courts will order fair restitution."

Much of Motown's legal action centers around what it alleges was a harmful press conference called by CBS in conjunction with negotiations conducted more than a year in advance of the date the Jackson Five contract was due to expire with Motown. It was at this press conference, held in New York, that CBS announced it

had signed the Jacksons effective almost a year hence.

No New Album

Roshkind emphasized that Motown was offended by CBS's action because it had tried in vain to have the group record a new album several months before the press conference took place.

"What's more, we asked again and again that Jackson/Arons have the group come to the studio to record according to the stipulations of their contract, and they never did. They didn't record a single bar of a song from several months before the CBS press conference to almost a year after it took place," Roshkind said.

Rod Stewart Sues Private Stock Records Over Album Release

NEW YORK — Rod Stewart has commenced a legal action against Private Stock Records, charging nonpayment of royalties and misrepresentation through the company's release of an album of Stewart material recorded over ten years ago. Stewart alleges that the material, collectively entitled "Rod Stewart — A Shot Of Rhythm And Blues," was recorded for demonstration purposes only, and was never authorized for release.

The suit, filed in the Federal Court of the Southern District of New York, seeks \$5,-000,000 in damages. Stewart is also asking that Private Stock be enjoined from further sale and manufacture of the album, and that all remaining product be destroyed.

The complaint further charges that the album has affected sales of his later releases through misleading packaging. The album cover contains recent photographs of Stewart, which the plaintiff feels might cause consumers to believe that the album contains new or recent Rod Stewart recordings.

Officials of Private Stock Records refused comment on the issue.

MCA Releases Nine Feb. \$7.98 2-LP Sets

LOS ANGELES — MCA will release nine double LP sets this month, bringing the total of \$7.98 "twofer" sets in the company catalog to 97. Early cuts by the Atlanta Rhythm Section headline the releases, which also include six new additions to the Leonard Feather Jazz Series, among them LPs by Sammy Davis Jr., Jimmy McPartland, Bobby Hackett, Carmen McRae and Art Tatum.



HIGH ROLLIN' STUDS IN L.A. — The New Riders Of The Purple Sage rode into Hollywood recently for a three-night stand at the Roxy, during which one of the shows was broadcast live over KMET-FM. Backstage after the first show, NRPS was visited by some "High Rollers" (l to r): MCA vice president of product development Ed Spacek; NRPS drummer Spencer Dryden; pedal steel guitarist Buddy Cage; lead singer and rhythm guitarist John Dawson; lead guitarist David Nelson; bass guitarist Steve Love; MCA vice president of promotion Ray D'Ariano; and Richard Bibby, MCA vice president of marketing.



*Gimme
Three
Steps*

A new single from their platinum album "One More From The Road"

*Lynyrd
Skynyrd*

Produced by Tom Dowd
Single: MCA-40647 Album: MCA2-6001

MCA RECORDS

In The New York Clubs



LOST AT THE OTHER END — The Lost Gonzo Band, MCA recording artists, appeared recently at the *Other End* in New York as part of their current northeastern United States tour. Pictured backstage are, from left: Barry Goodman, New York promotion staffer for MCA; Mike Holleman, group member; Sammy Vargas, New York promotion staffer for MCA; Kelly Dunn and Bob Livingston, group members; Alexander Harvey, opening act on the bill; and Bobby Smith and Gary Nunn, group members.



FANS OF FLAME — Flame, newly signed RCA recording artists, performed recently for RCA personnel and friends in New York to preview songs from their forthcoming "Queen of the Neighborhood" LP. Pictured after the show are, from left: Patti Smith; Marge Raymond, Flame's lead singer; Bruce Springsteen; Jimmy Iovine, Flame's producer; and Mike Berniker, vice president of pop A&R for RCA Records.

No Developments In Grand Jury Probe

LOS ANGELES — There were no new developments this past week as **Cash Box** sought additional information regarding the federal government's ongoing investigation of the record industry. The Justice Department antitrust division maintained a broad secrecy mandate; a policy which, in fact, is backed up by law in a grand jury proceeding. As one of the investigating attorneys explained to **Cash Box** somewhat apologetically, "The time

when we'll be able to say something, obviously, is the time if and when an indictment is issued. And at that point there will be a press release."

According to a Justice Department spokesman, the normal procedure at this point is for any witness that might have a problem complying with any provision of the subpoena to contact the antitrust division and set up an interview before the return date to discuss it.

**IN JUST ONE WEEK
YOU'LL BE IN HEAT.**

RCA Records

EXECUTIVES ON THE MOVE

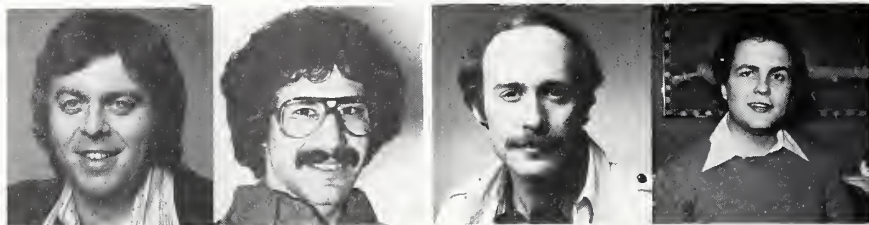

Zetland

Singer

Geller

Tanner

Stewart Leaves UA — Michael Stewart has resigned as chairman and president of United Artists Music Publishing Group. He will remain with the company until an orderly transition can be effected.

Zetland Appointed At Columbia — Tony Zetland has been appointed to the post of associate product manager, west coast of Columbia Records. Zetland joined CBS Records in London in 1974 as a salesman. Since then he worked in sales and promotion at CBS Records London before settling in the United States.

Changes At Arista — Robert Singer has been promoted to the newly created position of manager of field marketing at Arista Records. Singer has been Arista's local marketing manager in Philadelphia for the past 1½ years and prior to that was a retail store manager for Sam Goody's. Jim Cawley has been promoted to the position of singles sales manager. Prior to his promotion, Cawley spent the past 1½ years at Arista's New York headquarters serving as sales coordinator and will continue to be based in New York.

Geller Appointed At Columbia Records — Gregg Geller has been appointed to the post of director, A&R, east coast of Columbia Records. Geller joined CBS Records in 1972 in A&R. He became director, Epic A&R, east coast and then director, A&R, west coast. Prior to joining CBS Records, he was editor of *Record World Magazine*.

Promotions At WB — Seven local promotion representatives have been added to Warner Bros. Records' black music marketing operation. The seven are Barry Terry covering the Washington, D.C. market; Ted Astin in Charlotte; L.C. Sneed in Miami; Ted Joseph in Detroit; Willie Smith in Cleveland; Kirkland Burke in Chicago plus Charlie Geer in Atlanta, who also covers that market for Atlantic Records. Warner Bros. continues with the six regional men — Lou Wills (west coast); Ron Ellison (midwest); Howard Geiger (southwest); Jocko Carter (southeast); Harold Burnside (middle Atlantic); Bob Frost (New York); and national disco promotion coordinator Jackie Thomas.

Roulette/Pyramid Realigns Sales — Roulette/Pyramid have realigned their national staff. Joining the two New York-based labels is Mike Martucci as previously announced, who was just named director of national sales. Martucci comes to Roulette/Pyramid from Arista where he was national singles manager. Also named is Haskel Stanback, Atlanta Falcons football star, to that city's promotional field. Another new addition to promotion is Lenny Salamone covering L.A., Denver, Phoenix, and San Diego territories.

Leighton Joins Capitol — Ken Leighton will join press & artist relations department as copywriter/publicist. Previously, Leighton performed copywriting and national publicity duties for Chrysalis Records.

Capricorn Appoints Tanner — Geary Tanner has been appointed to the newly created post of Southwest regional promotion manager of Capricorn Records. Tanner will be based in Dallas, and will be responsible for the territory of Texas, New Mexico, Oklahoma, and Louisiana.



Scanlon

Calamita

Kalov

Pollock

Provenzano Named At E/A — John Michael Provenzano has been named promotion director southwest region for Elektra/Asylum. Provenzano spent two-and-a-half years as local promotion director for Elektra/Asylum in Houston. Provenzano will be based in Houston but will be working very closely with the Dallas branch of WEA.

Hudak Succeeds Heffernan — Nancy Hudak has become director of personnel for the American Society of Composers, Authors and Publishers. Hudak succeeds veteran ASCAP executive Margaret Heffernan, who has chosen early retirement after more than three decades with the performing rights society. In 1975, she was named assistant director of personnel for ASCAP.

Diskin Joins Amerama — Ellen Diskin has joined Amerama Records as administrative assistant. Prior to joining Amerama Records, she was advertising traffic manager with Al Paul Lefton Company and subscription manager at *Circus* magazine.

Scanlon Adds Responsibilities — Edward Scanlon, division vice president of industrial relations at RCA, has assumed responsibility for all operations services encompassing direction of all manufacturing and recording activities for RCA. This move is part of the executive alignment at RCA recently announced by Ken Glancy, president.

Calamita Appointed At CBS Records — Frank Calamita has been appointed to the post of administration and management development executive of CBS Records. He will be responsible for CBS Records administrative matters including the development of Division policies and procedures. Calamita has been with CBS since 1962 when he joined CBS international.

Three Join Little Angel — Ed Kominski has been named national sales director for Little Angel Records and Paul Gallas in Chicago and Carl Strube in New England have been added to promotion. Kominski comes to Little Angel from Brownbag Records, where he served as national sales manager. He is currently based in Nashville, but will soon relocate at the Little Angel offices in Los Angeles.

IHF Elects New Board Chairman, Board Member — The Institute of High Fidelity, trade organization for the component high fidelity industry, has elected Jerry Kalov as chairman of the board. Kalov, who succeeds George DeRado as IHF chairman, is also the president and chief operating officer of Jensen Sound Laboratories, a division of Pemcor, Inc. Also elected was Ken Busch who will serve on the IHF Board of Directors. Busch is the executive

(continued on page 48)

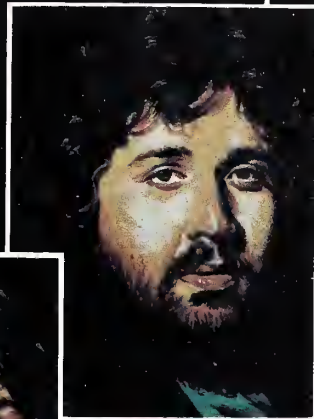

**MAYBE
I'M
AMAZED**

B/W

SOILY

4385

NEW WINGS SINGLE
FROM THE ALBUM
WINGS OVER AMERICA



© 1977 MPL Communications, Inc.



CBS PRESENTS AWARDS IN ATLANTA — Sales awards were presented by CBS Records to various personnel from the CBS branch operations at the company's sales and marketing meetings in Atlanta. Among the CBS personnel present at the salesman of the year awards ceremony were (left to right, top row): Joe Yoppolpo, Seattle; Bill Broege, Chicago; Larry Wall, Dallas; Tom Mabry, Washington; and Grant Brinser, Philadelphia. At the special markets awards ceremony for local promotion managers: Frank Mooney, regional director for the southwest; Charles Miller, LPM for St. Louis; Don Van Gorp, regional director for the midwest; Glenn Wright, LPM for Cleveland; Mike Bernardo, LPM for New York; Ron Piccolo, regional director for the northeast; Emma Garrett, LPM for Miami; Mert Paul, regional director for the southeast; Vernon Slaughter, associate director of promotion for special markets for CBS Records; and Richard Mack, vice president of promotion for special markets for CBS Records. (Middle row) At the Epic local promotion manager awards ceremony: Ron Alexen-

burg, senior vice president of Epic and the associated labels; Joel Newman, LPM for San Francisco; Del Costello, regional director for the west; Ron Douglas, LPM for Detroit; Don Van Gorp; Ray Free, LPM for New York; Ron Piccolo; Frank Mooney; Sam Harrell, LPM for Houston; Bill Bennett, LPM for Miami and, Mert Paul. At the Columbia local promotion manager award presentation: Don Van Gorp; Ray Welch, LPM for Detroit; Ron Piccolo; Jack Perry, LPM for Hartford; Earl Rollison, LPM for Washington; Mert Paul; Frank Mooney; Gene Denovich, LPM for St. Louis; Warren Williams, LPM for Los Angeles; and Del Costello. (Bottom row) At the Epic branch of the year award ceremony: branch managers Al Bergamo for Seattle; George Deacon for Washington; Phil Balsom for Hartford; Roger Metting for Houston; and Jim Scully for Chicago. At the Columbia branch of the year award ceremony: branch managers Joe Mansfield for Atlanta; Bob Jamieson for Cleveland; Roger Metting; Irv Medway for Philadelphia; and Dennis Hannon for Los Angeles.

Third Music Maze Opens In Baltimore

NEW YORK — The expansion of the Music Maze record retail chain continued with the opening of a third store in metropolitan Baltimore on January 29.

The new 900 square foot unit was described as a "neighborhood style shopping center store" by Sam Anoff, general manager for Action Distributing Company, owners of Music Maze. Anoff said the third store was added to the chain because "we found in our rack-jobbing and distributing operation that retail stores in this area don't fool with country product. So we decided to help ourselves and have another outlet to sell country music."

A fourth Music Maze store is scheduled to open in Baltimore sometime in March, Anoff said.

Action Distributing Company also owns Action Rack Merchandisers, rack jobbers in Maryland, Pennsylvania, Delaware, Virginia, West Virginia and Washington, D.C.

ABC Signs McCann

LOS ANGELES — ABC has signed Les McCann, noted jazz keyboardist, to an exclusive recording contract. His debut album, "Music Lets Me Be," is slated for Spring release.

Dylan Albums Seized By FBI In Penn. Raid

NEW YORK — More than 30,000 allegedly counterfeited and bootlegged record albums, including approximately 26,000 Bob Dylan albums, have been seized during an FBI raid on a music distributor in rural Pennsylvania.

FBI agents presented Scorpio Music Distributors in Croyden, Bucks County, Pennsylvania with a search warrant alleging the company illegally manufactured, distributed and sold unauthorized copyright sound recordings.

Among the albums confiscated by the FBI were allegedly counterfeit copies of Todd Rundgren's "Runt" album and a bootleg version of Bob Dylan performances called "The Little White Wonder," reportedly manufactured in Italy.

3 Albums Released By Fantasy & Milestone

LOS ANGELES — Fantasy/Prestige/Milestone will release three albums, shipping immediately: Ron Carter's "Pastels" and Sonny Rollin's "The Way I Feel" on Milestone, plus Cal Tjader's "At Grace Cathedral" on Fantasy.

Casablanca/Pye in Pact

LOS ANGELES — Final negotiations have been concluded between Casablanca Record and FilmWorks and Pye Records in London for a long-term licensing agreement for Casablanca product in the United Kingdom.

The announcement was made by Neil Bogart, president of Casablanca, and Louis Benjamin, chairman of the board of Pye, and the agreement is the culmination of talks that began earlier this year at the Midem gathering in France.

Viewlex Reports Profit Of \$129,000 For 1976

HOLBROOK, N.Y. — Viewlex, inc., a record presser and manufacturer of album sleeves and high-speed tape duplicating equipment, has reported a net profit of \$129,000 for the last quarter of fiscal 1976 ended November 30, 1976. This compares with a net loss of \$76,000 for the comparable three month period in 1975.

Results from the last six months of the fiscal year ended November 30 reflect a net loss of \$37,000 on sales of \$9,551,000, compared with a net loss of \$869,000 on sales of \$8,293,000 in the comparable period of 1975. The 1975 figures were restated to reflect operations that were disposed of or sold.

NARM Sets Nominees In 17 LP Categories

CHERRY HILL, N.J. — Nominees for NARM Awards for best-selling albums in 17 categories were announced last week. The awards will be presented at the awards banquet, which concludes the annual NARM Convention. This year's ceremony will be held Monday evening, March 7 in the Century Plaza Hotel in Los Angeles.

Joe Smith, chairman of Elektra/Asylum Records, will serve as master of ceremonies. Tony Orlando and Dawn, E/A recording artists, will entertain.

The 17 categories do not include best-selling single or best-selling classical album, whose winners were chosen by write-in ballot.

The nominees are: Nominees, 1976 NARM Awards

Best Selling Album
Their Greatest Hits 1971-75 — Eagles — Asylum
Fleetwood Mac — Fleetwood Mac — Warner Bros.
Frampton Comes Alive — Peter Frampton — A&M
Songs in the Key of Life — Stevie Wonder — Tamla (Motown)
Wings at the Speed of Sound — Paul McCartney and Wings — Capitol

Best Selling Movie Soundtrack
All This and World War II — 20th Century
A Star is Born — Barbra Streisand and Kris Kristofferson — Columbia
Car Wash — Rose Royce — MCA
Pipe Dreams — Gladys Knight and the Pips — Buddah
The Song Remains the Same — Led Zeppelin — Atlantic

Best Selling Broadway Cast Album
A Chorus Line — Columbia
Bubbling Brown Sugar — H&L Records

Best Selling Album By A Group
Boston — Boston — Epic
Their Greatest Hits 1971-75 — Eagles — Asylum
Fleetwood Mac — Fleetwood Mac — Warner Bros.

Best Selling Album By A Male Artist
A Night on the Town — Rod Stewart — Warner Bros.
Breezin' — George Benson — Warner Bros.
Dreamweaver — Gary Wright — Warner Bros.
Frampton Comes Alive — Peter Frampton — A&M
Silk Degrees — Boz Scaggs — Columbia
Songs in the Key of Life — Stevie Wonder — Tamla (Motown)

Best Selling Album By A Female Artist
Diana Ross' Greatest Hits — Diana Ross — Motown
Don't Stop Believin' — Olivia Newton-John — MCA
Hasten Down the Wind — Linda Ronstadt — Asylum
Helen Reddy's Greatest Hits — Helen Reddy — Capitol
Love Trilogy — Donna Summer — Casablanca

Best Selling Album By A Male Country Artist
Are You Ready for the Country — Waylon Jennings — RCA
The Outlaws — Waylon Jennings, Willie Nelson, Jessi Colter, Tompall Glaser — RCA
The Troublemakers — Willie Nelson — Columbia
20-20 Vision — Ronnie Milsap — RCA

Best Selling Album By A Female Country Artist
Don't Stop Believin' — Olivia Newton-John — MCA
Elite Hotel — Emmylou Harris — Warner Bros.
Hasten Down the Wind — Linda Ronstadt — Asylum
Here's Some Love — Tanya Tucker — MCA
Somebody Loves You — Crystal Gayle — United Artists

Best Selling Album By A Male Soul Artist
All Things in Time — Lou Rawls — Phila. International
Eargasm — Johnny Taylor — Columbia
I Want You — Marvin Gaye — Motown
Songs in the Key of Life — Stevie Wonder — Tamla (Motown)
You Are My Starship — Norman Connors — Buddah

Best Selling Album By A Female Soul Artist
Diana Ross' Greatest Hits — Diana Ross — Motown
Love Trilogy — Donna Summer — Casablanca
Natalie — Natalie Cole — Capitol
Sparkle — Aretha Franklin — Atlantic
This Is Niecey — Deniece Williams — Columbia

Best Selling Album By A Soul Group
Brass Construction II — Brass Construction — United Artists
Dr. Buzzard's Original Savannah Band — Dr. Buzzard's Original Savannah Band — RCA
Happiness is Being with the Spinners — The Spinners — Atlantic
Hot On The Track — Commodores — Motown
Message in Our Music — O'Jays — Phila. International
Ohio Players Gold — Ohio Players — Mercury (Phonogram)
Part 3 — K.C. and the Sunshine Band — T.K. Productions
Spirit — Earth, Wind and Fire — Columbia
The Clones of Dr. Funkenstein — Parliament — Casablanca

Best Selling Pop Instrumental Album
A Fifth of Beethoven — Walter Murphy Band — Private Stock
Nadia's Theme — Barry deVorzon and Perry Botkin, Jr. — A&M
Nice 'N' Naasty — Salsoul

Best Selling Album By A Jazz Artist
Bob James Three — Bob James Three — CTI

(continued on page 46)

**FEED DAILY
WITH CONTINUOUS AIRPLAY.**



“LET ME LIVE” (AM 1905)

THE NEW SINGLE FROM

TARGET

Target: Memphis' most outstanding new group in their first single release of songs from an album that's leaving audiences on their current tour hungry for more.



From their debut album,
“Target” (SP 4607)

Produced by John Ryan

ON A&M RECORDS & TAPES



Agency: Premier Talent
Management: Sweet-Tater Enterprises, Inc.

picks of the week

AVERAGE WHITE BAND (Atlantic 3388)

Cloudy (3:22) (Average — ASCAP) (Stuart, Gorrie)

The soul-stirring ballad as heard on the live-recorded platinum-certified "Person To Person" album. This performance finds Hamish Stuart in fine voice, exerting exacting textural control over his powerful falsetto. A dramatic buildup makes this good listening for pop or R&B formats.

ELVIN BISHOP (Capricorn 0269) (Dist: WB)

Keep It Cool (3:01) (Crabshaw — ASCAP) (Bishop)

From the "Hometown Boy Makes Good" album, this selection shows the most commercial side of this versatile artist. A high-stepping production suitable for disco play, the record shines with an arresting horn arrangement and were it not for several nimble blues-influenced guitar solos, you might not even know Elvin Bishop was at work here. For AM and commercial FMs.

GALLAGHER & LYLE (A&M 1904)

Every Little Teardrop (3:25) (Irving — BMI) (Gallagher, Lyle)

This talented songwriting/composing duo, constantly refining its style, has reached a peak with this first single from their "Love On The Airwaves" album. A constantly up-rhythmic feel and close vocal harmonies give the record pop appeal.

LEON HAYWOOD (Columbia 10477)

Dream Dream (3:12) (Oceans Blue/Van McCoy/Warner-Tamerlane — BMI) (McCoy)

This charming ballad written by Van McCoy is perfect for Haywood, exposing his gentler side through a very believable lyric. Wears well with repeated listenings, for the R&B airplay route.

AMBROSIA (20th Century 2327)

Magical Mystery Tour (3:54) (Comet — ASCAP) (Lennon, McCartney)

There haven't been many better rock and roll songs than this one: performed by Ambrosia on the first single from the "All This And World War II" soundtrack album. The introductory orchestration is lush and luxuriant in this Lou Reizner production. This record could be a shot in the arm not only for the LP, but also for a group that has yet to achieve a degree of success consummate with its level of talent.

JIMMY RUFFIN (Epic 50339)

Fallin' In Love With You (3:13) (Ruffin-Ready — BMI) (Ruffin, Dean, Glover)

A good-time, almost "bubblegum soul" record that communicates happy feelings from outset to finish via Ruffin's ebullient vocalization. Jumps with percussion, a funky sax solo and several "Skoo-bee-doo's" chimed in from the background.

CERRONE (Cotillion 44215) (Dist: Atlantic)

Love In 'C' Minor (3:58) (Fefee/Cerrone — SACEM) (Costandinos, Cerrone)

Though it sounds like it might make a good television theme, this European disco hit was strictly X-rated in its original form. This is an edited version of the original performance, retaining some of the initial dialogue at the beginning: three girls are picking up a guy. The music centers several instrumental sections over a recurring bass line.

SAMMY HAGAR (Capitol 4388)

Catch The Wind (3:33) (Southern — ASCAP) (Leitch)

Donovan's wispy folk melody is transformed via electric guitar effects, power chords and a string section, into a forceful orchestral statement. As a vocalist, Hagar has the strength and dramatic command to make it work. AM and FM.

JACKIE LOMAX (Capitol 4384)

More (Livin' For Lovin') (3:17) (Jaxmax/Warner-Tamerlane — BMI) (Lomax)

Multi-tracking effects color Lomax's vocals in the title track from his new album "Livin' For Lovin'." This experienced British figure's latest sound exhibits a strong R&B influence. For varied commercial airplay.

RALPH GRAHAM (RCA 10883)

Changes (3:49) (Tavvir — BMI) (Graham)

Graham tells a sad story in this simply orchestrated R&B ballad. A good progression, but the lyrics are most important, and the writer/vocalist delivers them with just the right feeling. From the album "Wisdom."

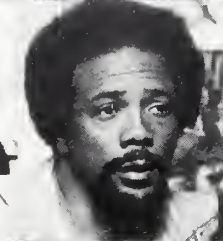

ROSE ROYCE (MCA 40662)

I Wanna Get Next To You (3:29) (Duchess — BMI) (Whitfield)

Taigating a number one single with the title track from the gold-certified soundtrack to "Car Wash," Rose Royce returns with this restrained melody. With Norman Whitfield at the helm, past and future successes for this score are a safe bet by any standard.

JOHN TRAVOLTA (Midland International 10807) (Dist: RCA)

All Strung Out On You (3:25) (Daddy Sam — ASCAP) (Tempo, Riopelli)

If you happen to be female, only sixteen and in love with this tall, dark and handsome matinee idol of television, films and pop music, this is just the sort of message you'd probably be thrilled to receive. Originally done in 1966 by Nino Tempo and April Stevens, this one's for top 40.

QUINCY JONES (A&M 1909)

"Roots" Medley (2:39) (DLW — ASCAP) (Fried, Jones)

From the special show that scored the all-time highest Nielsen ratings on television, this medley is introduced by a short section of melodic drums. The theme itself, a grand work of orchestration, has obvious possibilities in all airplay situations, considering the size of the familiarized television audience. From the "... Roots" album.

K.C. AND THE SUNSHINE BAND (TK 1022)

I'm Your Boogie Man (3:58) (Sherlyn/Harrick — BMI) (Casey, Finch)

A deceptively quiet intro breaks into an ascending bass line and blaring brass, along with the dry-and-wry vocals that are this group's trademark. A slight departure from the last few singles, and therefore a good choice from the "Part 3" album. For pop and R&B playlists.

T.G. SHEPPARD (Hitsville 6053) (Dist: Motown)

Lovin' On (3:20) (Ben Peters — BMI) (Peters)

A bouncing, upbeat tune written around a classic rock and roll chord progression. Sheppard, a country-based artist, has shown some degree of pop crossover potential in the past, and this single fulfills the requirements in terms of writing, performance and production.

DOROTHY MOORE AND EDDIE FLOYD (Malaco 1040) (Dist: TK)

We Should Really Be In Love (3:00) (East Memphis — BMI) (Floyd, Cropper)

A new duo, pairing Ms. Moore's high-soaring voice with Floyd's deep, throaty tones. A grandiose chorus is the focal point of this single, aimed at R&B playlists.

STEVE MARCH (UA XW949)

Ease Down Line (3:21) (Grillman — ASCAP) (March)

The title belies this record, a breakneck-paced arrangement full of irresistible energy, that travels down an imaginary railroad track, twisting and turning through complex vocal and instrumental arrangements. In this single from his debut album "Lucky," March shows great potential as a writer and a vocalist, though his lyrics might be a bit too philosophical for the average pop consumer.

THE FATBUTCH BAND (Spring 171) (Dist: Polydor)

Double Dutch (3:32) (Clitz — BMI) (Thomas, Curtis, Flip-pin, Ballad)

This new dance isn't for squares, although complete instructions on all the steps are in the verses if you listen closely. As the announcer states, this record is designed to create excitement on the disco floor in the tradition of "Do The Bus Stop."

THE SUPREMES (Motown 1415)

Let Yourself Go (3:17) (Stone Diamond/Gold Forever — BMI, Holland-Dozier-Holland — ASCAP) (Holland, Dozier, Beatty)

Aiming at the dance market, the Supremes here combine a strong upbeat with a message to lose all inhibitions. Echo effects enhance the lead vocals of Mary Smith, while the harmonies still bear a distinctive touch. For R&B playlists.

TIMMY THOMAS (Glades 1740) (Dist: TK)

Stone To The Bone (3:32) (Sherlyn — BMI) (Pinchot, Thomas)

Recorded for the dance floor, this is basically an instrumental with breathy female vocals as ornamentation. A steadily strummed guitar anchors the rhythm, while a very jazzy electric piano keeps the music changing throughout.

MIDWEST FRANCHISE (MCA 40681)

Come On Let's Dance (3:13) (Chappell/Jay's Enterprises — ASCAP) (Jackson, Yancy, Barge)

From the composition and production imaginations of Chuck Jackson and Marvin Yancy (who co-produces Natalie Cole), this is an intelligently arranged dance record, holding the pure listener's interest through frequent changes in rhythm, vocal timbre and instrumentation. Despite the big sound, a rough-edged funkiness is always there.

5 SPECIAL (Mercury 73885)

(Let's Stop Making) Small Talk (3:10) (Headquarters Of Entertainment And Music/Jibaro — BMI) (Roach)

The 5's specialty is harmony, in the tradition of groups like the Stylistics. The message is obvious in the title; they're not playing monopoly. Interesting effects from vocals with reverb deep in the background. Initially aimed at R&B radio.

HODGES, JAMES AND SMITH (London 249)

Situation (3:48) (Jobete — ASCAP) (Paris, Paris, Lamppu)

Timpani and racing guitar effects introduce this record, a stately love song arranged and orchestrated in classical scope. The vocals show a similar classical influence, and as part of this complete package, the song's qualities emerge. For varied formats, especially easy-listening.

TALKING HEADS (Sire 737) (Dist: ABC)

Love Goes To Building On Fire (2:56) (Index/Bleu Disque — ASCAP) (Byrne)

One of the more unusual bands to emerge on the New York scene, Talking Heads exhibit a slicker pop sound than would be expected of a New York "punk" band. Utilizing a horn section in addition to basic instrumentation, this record is lyrically obscure and generally bizarre.

THE HEART AND SOUL ORCHESTRA (Casablanca 876)

Love In 'C' Minor (3:43) (Cerrone — SACEM) (Cerrone)

This cover version of the Cerrone disco record, produced in part by Frankie Crocker, offers a few different twists in arrangement and instrumentation. The dialogue is completely left out.

JOHNNY HARTMAN (Musicor 6302) (Dist: Springboard)

Suzanne (3:35) (Gary — ASCAP) (Greenwood, Novello)

Hartman is a rich-voice balladeer reminiscent of Billy Eckstine. In this single, tailored for easy-listening airplay, he tells the story of a lost love over sobbing strings and a plaintively twinkling barroom piano.

DIRTY ANGELS (Private Stock 112)

Radio (3:36) (Jira/Medulla — ASCAP) (Gottehrer, Karp, Hull)

It might be wishful thinking, but these guys are singing about having their song played on the radio! Rock stardom seems to be a frequent theme for hard rock and roll bands lately, and this single fills the bill with raunchy guitar and some clever harmonies.

DIAMOND REO (Buddah 559)

Boys Will Be Boys (3:35) (Buddah — ASCAP) (Zuri, Nardini)

"Boys will be boys/Sometimes our music sounds like noise" sing the four punks known as Diamond Reo (they took their name from a make of truck). The music, characterized by unbelievable heavy guitar distortion, comes from a group that has reached pop playlists in the past.

**YOU'VE READ THE BOOK.
YOU'VE SEEN THE TV SHOW.
YOU'VE HEARD ABOUT THE ALBUM.**

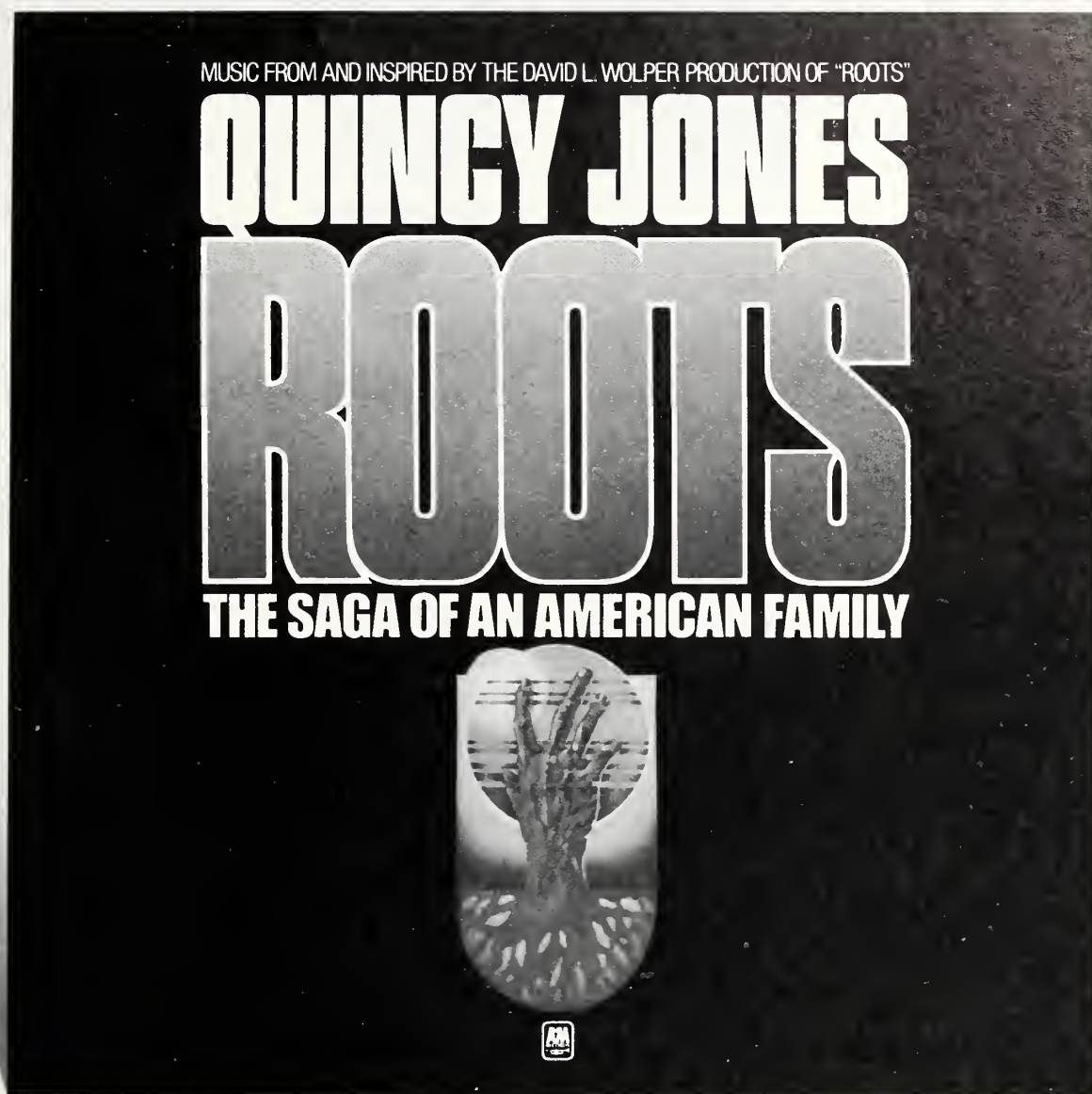

NOW HEAR THE SINGLE:
"ROOTS" MEDLEY (Motherland/Theme from "Roots")
MANY RAINS AGO (Oluwa) (AM 1909)

"Many Rains Ago" features Letta Mbulu with The Quincy Jones Orchestra and The Wattline Choir.

ON A&M RECORDS & TAPES
Conducted and produced by Quincy Jones



(SP 4626)

ALBUM REVIEWS

LOVE AT THE GREEK — Neil Diamond — Columbia KC 2-34404 — Producer: Robbie Robertson — List: 11.98

It's a shame that listeners of this album cannot also enjoy the visual spectacular that accompanied the performance at the Greek Theatre last August. But pure audiophiles will not be disappointed because this is a tasty album with superb orchestration featuring old favorites and a medley of songs from Diamond's Jonathan Livingston Seagull movie score.



JOHN DENVER'S GREATEST HITS (Vol. 2) — John Denver — RCA CPL 1-2195 — Producer: Milton Okun — List: 7.98

The epitome of positive thinking deals with some sadder themes in this collection of past favorites, but with his unbounded hopefulness throughout. Olivia Newton-John joins him on "Fly Away" and there is a live version of "Thank God, I'm A Country Boy," done a capella until the third verse but otherwise a re-packaging of past successes that should find airplay on country, top 40 and MOR stations.

CAN'T LET YOU GO — John Travolta — Midland BKL 1-2211 — Producer: Jeff Barry — List: 6.98

John is back with this second LP and his wholesome sex appeal that should be another commercial success. Most selections are soft and mellow but the arrangements highlight and emphasize his still maturing vocal style, with the help of unobtrusive session men. Should go on MOR and top 40 playlists.



IT FEELS SO GOOD — Manhattans — Columbia PC 34450 — Producer: The Manhattans Co./Bobby Martin — List: 6.98

The Manhattans are a fine group of musicians who deliver a soft R&B sound but why do they have to spend so much time impersonating Barry White? Their tenor and baritone vocals are perfectly suited for this collection of songs, which mainly suggest a romantic lovemaking mood. Mostly R&B play is expected but "Mind Your Business" is uptempo funk that could crossover.

CAROLINA DREAMS — Marshall Tucker Band — Capricorn CPK 0180 — Producer: Paul Hornsby — List: 7.98

As always, this band delivers a southern fried boogie sound that is tasteful and aurally pleasing. This time there is a softer mood and some excellent flute work that should ensure wider airplay than in the past. The instrumental variety and quieter tone should win a place on top 40, AOR, country and even MOR playlists.



SLEEPWALKER — The Kinks — Arista AL 4106 — Producer: Ray Davies — List: 6.98

For the first time in a long time, the Kinks are back with an album that doesn't revolve around a single theme. But they have not sacrificed any of their lyrical sharpness to make their point. Instead, each tune stands on its own, delivering shorter punches that still score points. Mostly AOR material but some good top 40 bets as well.

SAY YOU'LL STAY UNTIL TOMORROW — Tom Jones — Epic PE 34468 — Producer: Gordon Mills — List: 6.98

The title cut has just a touch of country spice but it is a subtle reminder that this LP should not be judged by previous standards. Tom has changed his style somewhat and is less prone to put his voice through the vocal contortions of the past. A tasty album with a softer touch, it will be heard on top 40, MOR and country playlists.



SHOW ME TO THE STAGE — Henry Gross — Lifesong LS 6010 — Producer: Henry Gross — List: 6.98

This original member of Sha Na Na has never had a stronger contender for commercial attention than this fourth album. He has a way of fusing 50's style rock with 70's style guitar riffs and a voice capable of being almost anywhere on the scale that dynamically showcases his myriad influences. Should play on AOR, top 40 and some MOR outlets.

SEA LEVEL — Sea Level — Capricorn CP 0178 — Producer: Stewart Levine — List: 6.98

The backbone of the former Allman Brothers Band have formed a rock and roll collective that should achieve instant acceptance. With a good blend of rock, jazz, southern boogie, and even some R&B, this is one of the best debut albums heard lately. There are some top 40 possibilities but the aim is to AOR playlists.



LOVE ON THE AIRWAVES — Gallagher & Lyle — A&M SP 4620 — Producer: David Kershenbaum — List: 6.98

With some excellent lyrics and a Seals & Crofts vocal style this album should please a variety of tastes with its pleasant harmonies and musical arrangements that are tight and effective. Though most songs are soft and melodic there are at least a couple of uptempo entries that should ensure varied airplay on top 40, AOR and some MOR outlets.

LOVE ME — Yvonne Elliman — RSO RS 1-3018 — Producer: Freddie Perren — List: 6.98

Yvonne has a refreshing approach to disco music that manages to keep the throbbing backbeat while offering arrangements and varied vocal interpretations that set her apart from others who toil in the same vineyard. That approach and a sampler of songs outside the disco genre should ensure airplay on a wide variety of playlists.

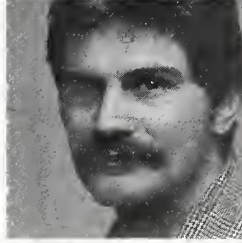

THE KENNY RANKIN ALBUM — Kenny Rankin — Little David LD 1013 — Producer: Michael Stewart — List: 6.98

Kenny's smoky coffeehouse style vocals are greatly enhanced on this, his best album, by not only his talented regular backup band but also a set of excellent musical arrangements that are nicely orchestrated. Soft jazz is the main mood but the vocal interpretations on two old favorites are distinctly and pleasantly his own. For MOR and top 40 playlists.

SWEET EVIL — Derringer — Blue Sky PZ 34470 — Producer: Jack Douglas — List: 6.98

Though the album fairly cooks with a blasting wall of blaring guitars, Derringer's lyrics come through with a clarity that is unusual in a band so known for volume. But this is good well-controlled rock that actually complements the vocalist instead of burying him. For AOR and top 40 playlists.



FUTURE GAMES — Spirit — Mercury SRM 1-1133 — Producer: Dr. Sardonius — List: 6.98

Though it is labeled a Spirit album, the work, as the cover implies is solidly that of fabled guitarist Randy California. Some of his freakier friends have stopped by to help out on this space-oriented offering that mixes a Hawaiian mood, CB and Star Trek. See for yourself or hear it on AOR playlists.

THE SAN FRANCISCO CONCERT — Hubert Laws — CTI 7071 — List: 7.98

With no less than 47 musicians contributing to this superb jazz offering, this album should be a solid jazz favorite but you can expect some AOR crossover as well. As you would imagine the songs are superbly orchestrated with the arranging talents of Bob James, who also plays keyboards on the LP.

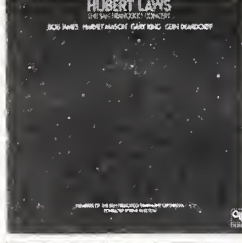

BE HAPPY FOR ME — Lorraine Frisaura — Pye 12141 — Producer: Danny Weiss — List: 6.98

With a powerful voice and a range of selections that goes from soft to rock, Lorraine has a strong entry in the newcomer field. She does other people's songs well but on her own (5 of them) she especially shines. She should get top 40, AOR and MOR airplay.

FUTURES — Burt Bacharach — A&M SP 4622 — Producer: Phil Ramone and Burt Bacharach — List: 6.98

Burt expands his exploration into jazz with this eclectic offering that is a talent showcase for two very interesting new vocalists. Of the four featured vocalists, newcomer Joshie Armstead is a solid standout with her powerful and confident vocal style, but she is greatly aided by some excellent brass work on this, Burt's 1st studio album in four years.

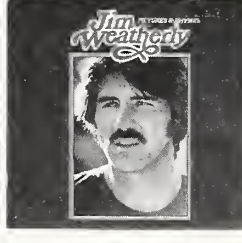

PICTURES AND RHYMES — Jim Weatherly — ABC AB 982 — Producer: Jim Weatherly and Larry Gordon — List: 6.98

His soft vocal style has just a hint of country but this talented songwriter is capable of rock but seems most comfortable with smooth and mellow ballads. That is the emphasis on this LP which should find room on top 40, country and MOR playlists.



Have a Wonderful Time With Mike and Stevie

Stevie Wonder rarely appears on television. But you can catch him on "The Mike Douglas Show" Tuesday, February 15,* in his first in-depth TV interview in a long time.

No need to wonder why Stevie's doing the Douglas show.

Mike's the host who draws more of the musical giants and draws the most from them.

He's the one who introduces the hottest new artists and gives their hits-to-be their first TV exposure.

Douglas viewers in recent months have been treated to such stars as Barry Manilow, Peter Frampton, The Bay City Rollers, The Beach Boys, Crosby & Nash, Billy Joel, Frank Zappa, Patti Smith, Al Stewart, Tom Waits, Dr. Hook, Harry Chapin, Robert Palmer, La Belle, Ray Charles, Neil Sedaka, The Kinks, Lou Rawls, The Jacksons, Doug Kershaw, Arlo Guthrie, Billy Paul, England Dan and John Ford Coley, The Bee Gees, Seals and Crofts, Janis Ian, Natalie Cole, Tony Bennett, The Sylvers, Melanie, Dr. Buzzard's Original Savannah Band, K. C. and the Sunshine Band and many more.

You may wonder though about this photo. Well, Mike believes in allowing his guests to relax, so part of the session with Stevie was taped in a whirlpool!

The Mike Douglas Show

*In New York, Channel 2, 5 pm
In Los Angeles, Channel 2, 3:30 pm

GROUP
PRODUCTIONS INC.
WESTINGHOUSE BROADCASTING COMPANY

NPR In Washington, D.C. Certain To Face AFTRA Strike; Talks Stalled

NEW YORK — National Public Radio's Washington, D.C. offices remain faced with the threat of an imminent strike by the American Federation of Television and Radio Artists (AFTRA).

Sanford I. Wolff, national executive for AFTRA, is expected to ask for an emergency meeting of AFTRA's board of directors to authorize a strike or other action by production and on-air employees of NPR's Washington studio.

Contract negotiations have been deadlocked on the issues of an arbitration provision, union security provisions, and salary increases since November 1976. Wolff has accused NPR administrators of being "unacquainted with the meaning of collective bargaining."

NPR, which services 180 public radio stations from its Washington facility, was incorporated in 1969, and is funded by the Corporation for Public Broadcasting.

WXLO Says Recent Personnel Shifts Will Not Affect Programming Format

NEW YORK — The departures of two programming directors within a month at WXLO-FM does not signal any change in format or decrease in audience, but represents only "the need for a program director who is not on the air, but is a part of management," according to station general manager Erica Farber.

'A Parting Of The Ways'

Lee Douglas, who served as an on-the-air personality as well as program director for over a year, left the station last month after what Farber termed "a parting of the ways." Ken Curtis, formerly with KAKC in Tulsa, replaced Douglas, but left the new job after only four days. Farber said the departure of Curtis was "a decision that was made," but a source close to the station said it was the result of a personality conflict

with management.

Personalities Not Involved

"Neither of these two decisions had anything to do with personalities," Farber asserted. "I don't believe you have to necessarily like someone to work with them. But I needed someone who is terribly strong, who will work closely with our sales manager to make this a New York radio station that is known as a major force (in New York)." She said the station would continue to "broaden its audience base" as it has done since adopting its current format several years ago.

Bill Garcia has since been hired as the new WXLO program director from WRBQ in Tampa. Douglas has joined WPEZ in Pittsburgh in a similar capacity while Curtis was staying in New York.

STATION BREAKS

Lee Douglas, former PD of **WXLO (99X)**, New York has assumed the same position at **WPEZ**, Pittsburgh.

WQXI AM/FM, Atlanta with changes: **Jack Fitzgerald** is out as program director of the sister stations. New PD for the AM is **Gary Corry**, former morning newsman at the station. **Mitch Braswell**, 10-noon and **Barry Chase & Scott Woodside**, 3-7 pm are new jocks. **Rhett Walker** moves into the 12-3 pm slot. Promoted to PD on the FM is **Don Benson**, former assistant PD for the stations.

Changes at **WAVZ**, New Haven: **Mike West**, former PD and **Paul Resnik**, former MD are out. **Pete Salant** who uses the air name **Pete Stone**, named program director while doing afternoon drive slot. The new MD is **Curt Hansen**. Hansen comes to the station from **WSAR**, Fall River. His replacement at **WSAR** is **Dan Hayden** who will also do the morning air shift.

Mark Driscoll has been named PD at **WAPE**, Jacksonville. Driscoll comes to the station from **KSTP**, Minneapolis and replaces **Wayne Shayne** who exits station and is looking for an opening. He can be reached at (904) 737-5491.

Frank Ferreri is the new PD at **WAZE**, Clearwater. Ferreri comes to the station from **WCCK**, Erie and replaces **Bob Hatfield** who goes to **WSBR**, Boca Raton, Fla. New afternoon jock at **WAZE** is **John Bozwell**, also from **WCCK**, Erie.

Tim Page is the new music director at **KNOE**, Monroe. Page comes to the station from **KDBS**, Alexandria and replaces **Mike Cochran** who joins **KNOE-TV**.

Andy Bickel has been promoted to assistant vice president and broadcast operations manager for **WBT**, Charlotte.

John Wade returns to **WIFI**, Philadelphia to do the 9-noon shift.

Butch Brady, from **KLVI**, Beaumont is the new 10-2 am jock at **KILT**, Houston.

Lee Hamilton is the new all night man at **WVBF**, Framingham.

Bob Gray comes to **WKTD (13Q)**, Pittsburgh from **WHBQ**, Memphis to do the

2-6 am air shift.

Kurt Kimball, from **KLMS**, Lincoln is the new afternoon jock at **KSLY**, San Luis Obispo. Kimball replaces **Ken Burke** who exits the station.

Linda Kelly, formerly with **KNUS**, Dallas is the new evening jock at **WFBR**, Baltimore. Former jock **Johnny Contino** goes to sister station **WBKZ** to do production.

Terry "Bulldog" Hesters is new 6-10 pm jock at **WMFJ**, Daytona Beach. Hesters is from **KDMS**, El Dorado, Arkansas and replaces **Dr. Bross** who goes to **WJFL**, Vicksburg, Miss.

Gail Sicilia has been named MD at **WNEW-AM**, New York. Sicilia previously held a similar position at **WNBC**, also New York.

KCPX, Salt Lake City has added **Eric Scott** to its lineup in the 2-6 am slot. Scott joins the station from **KAYK**, Provo, Utah.

Dan Foley has been promoted to operations manager at **WCAU-FM**, Philadelphia. Foley's replacement in the morning air shift is **Anita**.

John Barry joins **WRVZ (Q-94)**, Richmond as evening air personality. Barry is from **WSSV**, Petersburg.

KTRY, Bastrop, Louisiana is changing their "classical easy listening" format to a black format in February. **Mel O. Davis** has been appointed PD/MD. She previously worked at **WLLE** and **WSHA**, both Raleigh.

Changes at **WABC**, New York, **Carol Richardson** has been promoted to staff director of the station. Replacing her as operations assistant is **Janet Friedman**.

Paul Sebastian, former PD of **WFOM**, Marietta is looking for a position. He can be reached at (404) 422-7469.

KBEQ, Kansas City is looking for a jock. Send tapes and resumes to **Bob Laurence**, KBEQ, 3100 Broadway, Kansas City, Montana 64111.

WDBQ, Dubuque needs a jock. Forward tapes and resumes to **Chuck Bailey**, WDBQ, 1170 Iowa St., Dubuque, Iowa 52001.

jeff ray

MOST ADDED FM LPS

1. Rumours — Fleetwood Mac — WB
2. Sleepwalker — Kinks — Arista
3. Animals — Pink Floyd — Columbia
4. Sea Level — Capricorn
5. Carolina Dreams — Marshall Tucker Band — Capricorn
6. A Place In The Sun — Pablo Cruise — A&M
7. Sweet Evil — Rick Derringer — Blue Sky
Show Me To The Stage — Henry Gross — Lifesong
White Rock — Rick Wakeman — A&M
8. Stallion — Casablanca
Piper — A&M
Stranger In The City — John Miles — London
9. Next — Journey — Columbia
In Flight — George Benson — WB
RA — Todd Rundgren's Utopia — WB
Changes In Latitude — Jimmy Buffett — ABC
10. Novella — Renaissance — Sire
Just A Stone's Throw Away — Valerie Carter — Columbia

MOST ACTIVE FM LPS

1. Hotel California — Eagles — Asylum
— Hotel California/Life In The Fast Lane
2. Night Moves — Bob Seger — Capitol
— Night Moves/Rock & Roll Never Forgets/Main Street
3. Year Of The Cat — Al Stewart — Janus
— Year Of The Cat/On The Border
A Day At The Races — Queen — Elektra
— Tie Your Mother Down
4. Tejas — ZZ Top — London
— El Diablo
A Rock & Roll Alternative — Atlanta Rhythm Section — Polydor
— So In To You/Neon Nights
5. Animals — Pink Floyd — Columbia
— Pigs
The Light Of Smiles — Gary Wright — WB
— Water Sign
6. Wings Over America — Wings — Capitol
— Maybe I'm Amazed
7. Songs In The Key Of Life — Stevie Wonder — Tamla
A New World Record — ELO — UA
— So Fine
Boston — Epic
— Foreplay/Long Time
Low — David Bowie — RCA
— Sound In Vision
9. The Pretender — Jackson Browne — Asylum
— The Pretender
Wind & Wuthering — Genesis — Atco
Festival — Santana — Columbia
— Reach Up
9. Leftover — Kansas — Kirshner
— Carry On Wayward Son
10. Sleepwalker — Kinks — Arista
— Sleepwalker
Sammy Hagar — Capitol
Next — Journey — Columbia



ZORK SAYS FAREWELL — **KHJ**, Los Angeles air personalities, lead by program director **Charlie Van Dyke**, address a crowd of thousands at the specially created "Zork Farewell Plaza" at the Hollywood-Burbank airport. **KHJ** gave away more than \$30,000 in cash during the month long Zork promotion in January.

**A REMARKABLE
FIRST ALBUM!**



PIPER

FROM A REMARKABLE NEW BAND.

PIPER IS BILLY SQUIER, RICHARD FONTANA, ALAN NOLAN, TOMMY GUNN AND DANNY MCGARY.

**AUCOIN
MANAGEMENT
INC.**



SP-4615

**rock
steady**

WNEW-FM — NEW YORK — Tom Morrera

Most Active:

Pink Floyd — Animals — Columbia
 Kinks — Sleepwalker — Arista
 — Sleepwalker
 Kim Carnes — Sailing — A&M
 Eagles — Hotel California — Asylum
 Dirk Hamilton — Alias I — ABC
 Bob Seger — Night Moves — Capitol
 George Benson — In Flight — WB
 Jackson Browne — The Pretender — Asylum
 Valerie Carter — Just A Stone's Throw Away — Columbia
 Genesis — Wind & Wuthering — Atco

Adds:

Pablo Cruise — A Place In The Sun — A&M
 Blondie — Chaplin — Asylum
 Henry Gross — Show Me To The Stage — Lifesong
 Rick Wakeman — White Rock — A&M
 Yesterday & Today — London
 Corky Laing — Makin' It On The Street — Elektra
 Fleetwood Mac — Rumours — WB
 Neil Diamond — Love At The Greek — Columbia
 The Babys — Chrysalis

WPLJ-FM — NEW YORK — Corinne Baldassano

Most Active:

Eagles — Hotel California — Asylum
 Stevie Wonder — Songs In The Key Of Life — Tamla
 Boston — Epic
 Wings — Wings Over America — Capitol
 Queen — A Day At The Races — Elektra
 Pink Floyd — Animals — Columbia
 Al Stewart — Year Of The Cat — Janus
 ELO — A New World Record — UA
 Rod Stewart — Night On The Town — WB
 David Bowie — Low — RCA

Adds:

Kansas — Leftoverture — Kirshner
 Pink Floyd — Animals — Columbia
 Fleetwood Mac — Rumours — WB

WBAB-FM — LONG ISLAND — Bernie Bernard

Most Active:

Stanky Brown Group — If The Lights Don't Get You The Helots Will — Sire
 — Good To Me
 Gary Wright — The Light Of Smiles — WB
 — Are You Weeping
 Ace — No Strings — Anchor
 — Let's Hang On
 Eagles — Hotel California — Asylum
 — Try & Love Again
 Jackson Browne — The Pretender — Asylum
 Rufus — Ask Rufus — ABC
 — At Midnight
 Atlanta Rhythm Section — A Rock & Roll Alternative — Polydor
 — Georgia Rhythm
 Ambrosia — Somewhere I've Never Traveled — 20th Century
 — Cowboy Star
 Crack The Sky Live — Lifesong
 ELO — A New World Record — UA
 — So Fine
 Boston — Epic
 — Long Time
 Brian Auger & Oblivion Express — Happiness
 Heartaches — WB
 Joni Mitchell — Hejira — Asylum
 — Song For Sharon
 Starcastle — Fountains Of Light — Epic
 — Dawning
 Leo Sayer — Endless Flight — WB
 — Hold On To My Love

Adds:

Spirit — Future Games — Mercury
 Kinks — Sleepwalker — Arista
 Pink Floyd — Animals — Columbia
 John Miles — Stranger In The City — London
 Henry Gross — Show Me To The Stage — Lifesong
 Dean Friedman — Lifesong
 Corky Laing — Makin' It On The Street — Elektra
 Pablo Cruise — A Place In The Sun — A&M
 Andy Fairweatherlow — Be-Bop & Holler — A&M
 Piper — A&M
 Sea Level — Capricorn
 Marshall Tucker Band — Carolina Dream — Capricorn
 Todd Rundgren's Utopia — RA — WB
 Fleetwood Mac — Rumours — WB

WLIR-FM — LONG ISLAND — Denis McNamara

Most Active:

Pink Floyd — Animals — Columbia
 — Pigs On The Wing Part I/Part II/Part III
 Fleetwood Mac — Rumours — WB
 — Go Your Own Way
 Bob Seger — Night Moves — Capitol
 — Night Moves/Rock & Roll Never Forgets/Come To Papa
 ZZ Top — Tejas — London
 — It's Only Love/El Diablo
 Boston — Epic
 — Foreplay/Long Time/Hitch A Ride
 Sea Level — Capricorn
 — Tidal Wave
 Denim — Epic
 — Tequila/Throw Away
 Michael Walden — Garden Of Lovelight — Atlantic
 — Delightful
 Stevie Wonder — Songs In The Key Of Life — Tamla
 Michael Franks — Sleeping Gypsy — WB
 — Down In Brazil/The Lady Wants To Know

Adds:

Marshall Tucker Band — Carolina Dreams — Capricorn
 Sea Level — Capricorn
 Fleetwood Mac — Rumours — WB
 Kinks — Sleepwalker — Arista
 Rick Wakeman — White Rock — A&M
 John Miles — Stranger In The City — London
 Pablo Cruise — A Place In The Sun — A&M
 Piper — A&M
 Andy Fairweatherlow — Be-Bop & Holler — A&M
 Tim Rice & Andrew Lloyd Weber — Evita — MCA

WRNW-FM — WESTCHESTER COUNTY, N.Y. — Meg Griffin

Most Active:

David Bowie — Low — RCA
 — Sound In Vision
 Stevie Wonder — Songs In The Key Of Life — Tamla
 — As
 Bob Seger — Night Moves — Capitol
 — Night Moves
 801 Live — Island
 — You Really Got Me
 Jorge Dalto — Cevere — UA
 — Time For Some Changes
 Ramones — Leave Home — Sire
 — What's Your Game
 Muddy Waters — Hard Again — Blue Sky
 — Mannish Boy
 Michael Franks — Sleeping Gypsy — WB
 — I Really Hope It's You
 Pink Floyd — Animals — Columbia
 George Benson — In Flight — WB
 — Valdez In The Country

Adds:

Henry Gross — Show Me To The Stage — Lifesong
 Airta — Promises Of The Sun — Arista
 Cheap Trick — Epic
 Piper — A&M
 Television — Elektra
 Spirit — Future Games — Mercury
 Booker T. & M.G.'s — Universal Language — Elektra
 Rick Wakeman — White Rock — A&M
 Big Wah Koo — ABC
 Kinks — Sleepwalker — Arista
 John Miles — Stranger In The City — London
 Sonny Rollins — Milestone
 Anthony Phillips — The Geese & The Ghost — Passport
 Derringer — Sweet Evil — Blue Sky

WJCL-FM — CHICAGO — Trudy Fisher

Most Active:

Pink Floyd — Animals — Columbia
 — Dogs/Pigs/Sheep
 Journey — Next — Columbia
 — Space/People/Hustler
 City Boy — Dinner At The Ritz — Mercury
 — Narcissus/Dinner At The Ritz/Violin/State Secrets
 Graham Parker — Heat Treatment — Mercury
 Derringer — Sweet Evil — Blue Sky
 — Sweet Evil/Don't Stop Loving Me
 Kinks — Sleepwalker — Arista
 Sea Level — Capricorn
 — Fever/Sea Level/Rain In Spain
 Jimmy Buffett — Changes In Latitude — ABC
 — Tampico Trauma/Changes In Latitude/Margaritaville
 Genesis — Wind & Wuthering — Atco
 — Un Quiet Slumber/Afterglow/11th Earl Of Mar
 Atlanta Rhythm Section — A Rock & Roll Alternative — Polydor
 — Outside Woman Blues/Neon Nights/Sky High

Adds:

Kinks — Sleepwalker — Arista
 Pink Floyd — Animals — Columbia
 Derringer — Sweet Evil — Blue Sky
 Rick Wakeman — White Rock — A&M
 Dave Brubeck — 25th Anniversary Album — A&M
 Sea Level — Capricorn
 Pablo Cruise — A Place In The Sun — A&M

WSDM-FM — CHICAGO — Dave Logan

Most Active:

Bill Ouatemán — Night After Night — RCA
 Bob Seger — Night Moves — Capitol
 Eagles — Hotel California — Asylum
 Fleetwood Mac — Rumours — WB

Adds:

Andrew Gold — What's Wrong With This Picture — Elektra
 Ace — No Strings — Anchor
 Fleetwood Mac — Rumours — WB
 Kinks — Sleepwalker — Arista
 David Bowie — Low — RCA
 Genesis — Wind & Wuthering — Atco
 George Benson — In Flight — WB

WXRT-FM — CHICAGO — Harvey Wells

Most Active:

Eagles — Hotel California — Asylum
 — Life In The Fast Lane/Hotel California
 Atlanta Rhythm Section — A Rock & Roll Alternative — Polydor
 — Sky High/So In To You
 Genesis — Wind & Wuthering — Atco
 — All In A Mouse's Night
 Muddy Waters — Hard Again — Blue Sky
 Graham Parker — Heat Treatment — Mercury
 Bill Ouatemán — Night After Night — RCA
 — Down To The Bone/Au Claire
 Kansas — Leftoverture — Kirshner
 — The Wall/Miracles Out Of Nowhere
 Stevie Wonder — Songs In The Key Of Life — Tamla
 City Boy — Dinner At The Ritz — Mercury
 — Walk On The Water
 Queen — A Day At The Races — Elektra
 — Tie Your Mother Down
 George Harrison — Thirty Three & 1/3 — Dark Horse
 — Crackerbox Palace
 Santana — Festival — Columbia
 Starcastle — Fountains Of Light — Epic
 Brian Auger & Oblivion Express — Happiness
 Heartaches — WB
 Bob Seger — Night Moves — Capitol
 Wings — Wings Over America — Capitol
 ZZ Top — Tejas — London

Adds:

Pink Floyd — Animals — Columbia
 Sea Level — Capricorn
 Kinks — Sleepwalker — Arista
 Journey — Next — Columbia
 Derringer — Sweet Evil — Blue Sky
 Rick Wakeman — White Rock — A&M
 Pat Martino — Joyous Lake — WB
 Miles Davis — Water Babies — Columbia
 Anthony Phillips — The Geese & The Ghost — Passport

KLOS-FM — LOS ANGELES — Dabar Hoorelbeke

Most Active:

Eagles — Hotel California — Asylum
 Al Stewart — Year Of The Cat — Janus
 Wings — Wings Over America — Capitol
 Kansas — Leftoverture — Kirshner
 Stevie Wonder — Songs In The Key Of Life — Tamla
 Boston — Epic

Adds:

Orleans — Reach (45) — Asylum

KMET-FM — LOS ANGELES — Billy Juggs

Most Active:

Boston — Epic
 Eagles — Hotel California — Asylum
 Queen — A Day At The Races — Elektra
 ZZ Top — Tejas — London
 Kinks — Sleepwalker — Arista
 Bob Seger — Night Moves — Capitol
 ELO — A New World Record — UA

KWST-FM — LOS ANGELES — Mark Cooper

Most Active:

Bob Seger — Night Moves — Capitol
 Sammy Hagar — Capitol
 Gary Wright — The Light Of Smiles — WB
 ELO — A New World Record — UA
 ZZ Top — Tejas — London
 Queen — A Day At The Races — Elektra
 Racing Cars — Downtown Tonight — Chrysalis
 The Babys — Chrysalis
 Atlanta Rhythm Section — A Rock & Roll Overture — Polydor
 Journey — Next — Columbia
 Jackson Browne — The Pretender — Asylum
 Ace — No Strings — Anchor
 Eagles — Hotel California — Asylum
 Andrew Gold — What's Wrong With This Picture — Asylum

Adds:

Pink Floyd — Animals — Columbia
 Kinks — Sleepwalker — Arista
 Rick Derringer — Sweet Evil — Blue Sky
 Fleetwood Mac — Rumours — WB
 Sea Level — Capricorn
 Marshall Tucker Band — Carolina Dreams — Capricorn
 Lone Star — Columbia
 Henry Gross — Show Me To The Stage — Lifesong

WMMR-FM — PHILADELPHIA — Paul Fuhr

Most Active:

Eagles — Hotel California — Asylum
 Jefferson Airplane — Flight Log — Grunt
 Santana — Festival — Columbia
 David Bowie — Low — RCA
 Janis Ian — Miracle Row — Columbia
 Renaissance — Novella — Sire
 Gary Wright — The Light Of Smiles — WB
 ZZ Top — Tejas — London
 Queen — A Day At The Races — Elektra
 Bob Seger — Night Moves — Capitol

Adds:

Kinks — Sleepwalker — Arista
 Pink Floyd — Animals — Columbia
 Vangelis — Albedo 0.39 — RCA
 Bill Ouatemán — Night After Night — RCA
 Rahsaan Roland Kirk — Kinkatron — WB
 Stallion — Casablanca
 Dave Brubeck — 25th Anniversary — A&M
 Brian Auger & Oblivion Express — Happiness
 Heartaches — WB
 Locust — Playguy — Annuet Coeptis
 Anthony Phillips — The Geese & The Ghost — Passport

WABX-FM — DETROIT — Ken Calvert

Most Active:

Sammy Hagar — Capitol
 Gary Wright — The Light Of Smiles — WB
 Queen — A Day At The Races — Elektra
 Chilliwack — Dreams, Dreams, Dreams — Mushroom

Adds:

Pink Floyd — Animals — Columbia
 Fleetwood Mac — Rumours — WB
 Rick Derringer — Sweet Evil — Blue Sky
 Marshall Tucker Band — Carolina Dreams — Capricorn
 Sea Level — Capricorn
 Lone Star — Columbia
 Henry Gross — Show Me To The Stage — Lifesong
 Piper — A&M
 Rufus — Ask Rufus — ABC
 Cheap Trick — Epic

WWW-FM — DETROIT — Jerry Lubin

Most Active:

Eagles — Hotel California — Asylum
 — New Kid In Town/Life In The Fast Lane/Hotel California/Victim Of Love
 ELO — A New World Record — UA
 — So Fine/Do Ya/Livin'
 Bob Seger — Night Moves — Capitol
 — Rock & Roll Never Forgets/Come To Papa/Main Street
 Al Stewart — Year Of The Cat — Janus
 — Year Of The Cat/On The Border/If It Doesn't Come Naturally
 Queen — A Day At The Races — Elektra
 — Somebody To Love/You & I/Long Away/Tie Your Mother Down
 ZZ Top — Tejas — London
 — El Diablo/It's Only Love/Arrested For Driving While Blind
 Gary Wright — The Light Of Smiles — WB
 — Water Sign/Silent Fury/The Light Of Smiles/Phantom Writer
 Santana — Festival — Columbia
 — Reach Up/Let The Music Set You Free/Try A Little Harder
 David Bowie — Low — RCA
 — What In The World/Be My Wife/Sound In Vision
 Atlanta Rhythm Section — A Rock & Roll Alternative — Polydor
 — So In To You/Don't Miss The Message/Hitchhikers' Hero/Georgia Rhythm

Adds:

Runaways — Queens Of Noise — Mercury
 Chilliwack — Dreams, Dreams, Dreams — Mushroom
 Journey — Next — Columbia
 Barclay James Harvest — Octoberon — MCA
 Derringer — Sweet Evil — Blue Sky
 Fleetwood Mac — Rumours — WB

KSAN-FM — SAN FRANCISCO — Don Potoczak

Most Active:

Pink Floyd — Animals — Columbia
 Kinks — Sleepwalker — Arista
 Bob Seger — Night Moves — Capitol
 Sammy Hagar — Capitol
 David Bowie — Low — RCA
 Eagles — Hotel California — Asylum
 Tom Petty & The Heartbreakers — Shelter
 Atlanta Rhythm Section — A Rock & Roll Alternative — Polydor
 The Babys — Chrysalis
 Journey — Next — Columbia

Adds:

Joey — Elektra
 Booker T. & M.G.'s — Universal Language — Asylum
 Pablo Cruise — A Place In The Sun — A&M
 Smokey Robinson — Deep In My Soul — Tamla
 Country Joe McDonald — Goodby Blues — Fantasy
 Sea Level — Capricorn
 Fleetwood Mac — Rumours — WB
 Todd Rundgren's Utopia — RA — WB

KYA-FM — SAN FRANCISCO — Jay Hansen

Most Active:

Boston — Epic
 Jackson Browne — The Pretender — Asylum
 Eagles — Hotel California — Asylum
 ELO — A New World Record — UA
 Emmylou Harris — Luxury Liner — WB
 Pink Floyd — Animals — Columbia
 Bob Seger — Night Moves — Capitol
 Santana — Festival — Columbia
 Rod Stewart — A Night On The Town — WB
 Al Stewart — Year Of The Cat — Janus
 Wings — Wings Over America — Capitol
 Stevie Wonder — Songs In The Key Of Life — Tamla
 Genesis — Wind & Wuthering — Atlantic
 Sammy Hagar — Capitol
 Journey — Next — Columbia

Adds:

Fleetwood Mac — Rumours — WB
 Jimmy Buffett — Changes In Latitude — ABC
 Marshall Tucker Band — Carolina Dreams — Capricorn

WMMR-FM — PHILADELPHIA — Paul Fuhr

Most Active:

John Miles — Stranger In The City — London
 Sea Level — Capricorn
 Vangelis — Albedo 0.39 — RCA
 Jennifer Warnes — Arista

WHFS-FM — WASHINGTON, D.C. — Dave Einstein

Most Active:

Santana — Festival — Columbia
 Jennifer Warnes — Arista
 Jimmy Buffett — Changes In Latitude — ABC
 Rufus — Ask Rufus — ABC
 James Talley — Blackjacket Choir — Capitol
 John Lee & Gerry Brown — Still Can't Say Enough — Blue Note
 Pink Floyd — Animals — Columbia
 Atlanta Rhythm Section — A Rock & Roll Alternative — Polydor
 Muddy Waters — Hard Again — Blue Sky
 Dirk Hamilton — Alias I — ABC

Adds:

Sea Level — Capricorn
 David Allan Coe — Rides Again — Columbia
 Marshall Tucker — Carolina Dreams — Capricorn
 Fleetwood Mac — Rumours — WB
 Earl Scruggs — Live In Austin — Columbia
 Cal Hard — The Wiley Butter — Tacoma
 Valerie Carter — Just A Stone's Throw Away — Columbia
 Smokey Robinson — Deep In My Soul — Tamla

WBCN-FM — BOSTON — Eilen Darst

Most Active:

Joan Armatrading — A&M
 Atlanta Rhythm Section — A Rock & Roll Alternative — Polydor
 Eagles — Hotel California — Asylum
 ELO — A New World Record — UA
 Fleetwood Mac — Rumours — WB
 Pink Floyd — Animals — Columbia
 Piper — A&M
 — Sail Away/Who's Your Boyfriend/Telephone Relation
 Bob Seger — Night Moves — Capitol
 Thin Lizzy — Johnny The Fox — Mercury
 Wings — Wings Over America — Capitol

Adds:

Barclay James Harvest — Octoberon — MCA
 Boots Collins — The Name Is Boots — WB
 Jonathan Edwards — Sailboat — WB
 Fleetwood Mac — Rumours — WB
 Journey — Next — Columbia
 Kinks — Sleepwalker — Arista
 John Miles — Stranger In The City — London
 Renaissance — Novella — Sire
 Smokey Robinson — Deep In My Soul — Tamla
 Stallion — Casablanca
 Starcastle — Fountains Of Light — Epic
 Winters Bros. Band — Atco

WCOZ-FM — BOSTON — Beverly Mire

Most Active:

Boston — Epic
 — Hitch Hike
 Fleetwood Mac — Rumours — WB
 — Gold Dust Woman
 Kinks — Sleepwalker — Arista
 — Sleepwalker
 ELO — A New World Record — UA
 — Tight Rope
 Eagles — Hotel California — Asylum
 — Hotel California
 Queen — A Day At The Races — Elektra
 — You Take My Breath Away
 Pink Floyd — Animals — Columbia
 — Sheep

Stevie Wonder — Songs In The Key Of Life — Tamla
— Love Is In Need Of Love Today
Bob Seger — Night Moves — Capitol
— Fire Down Below
Stevie Miller — Fly Like An Eagle — Capitol
— Fly Like An Eagle

Adds:

Pink Floyd — Animals — Columbia
Kinks — Sleepwalker — Arista
B B King — King Size — ABC
George Benson — In Flight — WB
Rufus — Ask Rufus — ABC
Pablo Cruise — A Place In The Sun — A&M
Stallion — Casablanca
Fleetwood Mac — Rumours — WB

KFWD-FM — DALLAS — Tim Spencer

Most Active:

Eagles — Hotel California — Asylum
Bob Seger — Night Moves — Capitol
ZZ Top — Tejas — London
Kansas — Leftoverture — Kirshner
Pink Floyd — Animals — Columbia
Boston — Epic
Jackson Browne — The Pretender — Asylum
Al Stewart — Year Of The Cat — Janus
George Benson — In Flight — WB
Queen — A Day At The Races — Elektra
Santana — Festival — Columbia
Genesis — Wind & Wuthering — Atco
Gary Wright — The Light Of Smiles — WB

Adds:

Kinks — Sleepwalker — Arista
Jimmy Buffett — Changes In Latitude — ABC
The Babys — Chrystalis
Anthony Phillips — The Geese & The Ghost — Passport
Bread — Lost Without Your Love — Elektra
Sammy Hagar — Capitol
Timo Laine — Symphonic Slam — A&M
Rick Wakeman — White Rock — A&M

KZEW-FM — DALLAS — Charlie Kendall

Most Active:

Eagles — Hotel California — Asylum
Kansas — Leftoverture — Kirshner
ZZ Top — Tejas — London
Wings — Wings Over America — Capitol
Stevie Wonder — Songs In The Key Of Life — Tamla
Boston — Epic
Al Stewart — Year Of The Cat — Janus
Jackson Browne — The Pretender — Asylum
Bob Seger — Night Moves — Capitol
Joni Mitchell — Hejira — Asylum

Adds:

Pink Floyd — Animals — Columbia
City Boy — Dinner At The Ritz — Mercury
Journey — Next — Columbia
Brian Auger & Oblivion Express — Happiness
— Heartaches — WB
Jimmy Speeris — Ports Of The Heart — Epic
Marshall Tucker Band — Carolina Dreams —
Capricorn
Kinks — Sleepwalker — Arista

KADI-FM — ST. LOUIS — Pete Parisi

Most Active:

Pink Floyd — Animals — Columbia
— Pigs
Bob Seger — Night Moves — Capitol
— Night Moves
Denim — Epic
— Throw Away
Atlanta Rhythm Section — A Rock & Roll Alternative —
Polydor
— So In To You
Starcastle — Fountains Of Light — Epic
— Diamonds
Gary Wright — The Light Of Smiles — WB
— Water Sign
Foghat — Night Shift — Bearsville
— Take Me To The River
Barclay James Harvest — Octoberon — MCA
— Rock & Roll Star
Andrew Gold — What's Wrong With This Picture —
Elektra
— Lonely Boy
Heartsfield — Collector's Item — Columbia
— Lost Love

Adds:

Marshall Tucker Band — Carolina Dream — Capricorn
Todd Rundgren's Utopia — RA — WB
Sea Level — Capricorn
Beaverteeth — RCA
Chilliwack — Dreams, Dreams, Dreams — Mushroom
Locust — Playque — Annuet Coeptis
Stallion — Casablanca
James Talley — Blackjack Choir — Capitol

KSHE-FM — ST. LOUIS — Ted Habeck

Bob Seger — Night Moves — Capitol
ZZ Top — Tejas — London
Eagles — Hotel California — Asylum
Chilliwack — Dreams, Dreams, Dreams — Mushroom
ELO — A New World Record — UA
Atlanta Rhythm Section — A Rock & Roll Alternative —
Polydor
Queen — A Day At The Races — Elektra
Racing Cars — Downtown Tonight — Chrystalis
Sammy Hagar — Capitol
Gary Wright — The Light Of Smiles — WB
The Babys — Chrystalis
David Bowie — Low — RCA
Journey — Next — Columbia
Ace — No Strings — Anchor
Andrew Gold — What's Wrong With This Picture —
Asylum

Adds:

Kinks — Sleepwalker — Arista
Rick Derringer — Sweet Evil — Blue Sky
Fleetwood Mac — Rumour — WB
Sea Level — Capricorn
Marshall Tucker Band — Carolina Dreams —
Capricorn
Lone Star — Columbia
Henry Gross — Show Me To The Stage — Lifesong

WDVE-FM — PITTSBURGH — Marsy Posner

Most Active:

Eagles — Hotel California — Asylum
Kansas — Leftoverture — Kirshner
Queen — A Day At The Races — Elektra
Al Stewart — Year Of The Cat — Janus
— Year Of The Cat
Stevie Wonder — Songs In The Key Of Life — Tamla
Gary Wright — The Light Of Smiles — WB
ZZ Top — Tejas — London
Boston — Epic

Adds:

Henry Gross — Show Me To The Stage — Lifesong
John Miles — Stranger In The City — London
Marshall Tucker Band — Carolina Dream — Capricorn
Pablo Cruise — A Place In The Sun — A&M
Pink Floyd — Animals — Columbia
Renaissance — Novella — Sire
Valerie Carter — Just A Stone's Throw Away —
Columbia
Kinks — Sleepwalker — Arista
Jennifer Warnes — Arista
Fleetwood Mac — Rumours — WB

M-105-FM — CLEVELAND — Eric Stevens

Most Active:

Eagles — Hotel California — Asylum
Wings — Wings Over America — Capitol
Gary Wright — The Light Of Smiles — WB
Kansas — Leftoverture — Kirshner
ELO — A New World Record — UA
Average White Band — Person To Person — Atlantic
Al Stewart — Year Of The Cat — Janus
Boston — Epic
Bread — Lost Without Your Love — Elektra
Bob Seger — Night Moves — Capitol

Adds:

Todd Rundgren's Utopia — RA — WB

WMMS-FM — CLEVELAND — Shelly Stile

Most Active:

Al Stewart — Year Of The Cat — Janus
— Year Of The Cat/On The Border/Broadway Hotel
Genesis — Wind & Wuthering — Atco
Average White Band — Person To Person — Atlantic
Wings — Wings Over America — Capitol
Gary Wright — The Light Of Smiles — WB
— Phantom Writer/Water Sign
David Bowie — Low — RCA
— Sound In Vision
Manfred Mann — Roaring Silence — WB
Bob Seger — Night Moves — Capitol
ZZ Top — Tejas — London

Adds:

Todd Rundgren's Utopia — RA — WB
Marshall Tucker Band — Carolina Dream — Capricorn
Beach Boys — Love You — WB
Steve Gibbons — Rollin' On — MCA
Valerie Carter — Just A Stone's Throw Away —
Columbia
Sea Level — Capricorn
Fleetwood Mac — Rumours — WB
Kinks — Sleepwalker — Arista
Mr Big — Photographic Smile — Arista
Racing Cars — Downtown Tonight — Chrystalis
Sanford-Townsend Band — Smoke In The Distance
(45) — WB
Jennifer Warnes — Right Time Of Night (45) — Arista

WKLS-FM — ATLANTA — Drew Murray

Most Active:

Bob Seger — Night Moves — Capitol
— Main Street
Eagles — Hotel California — Asylum — Last Resort
Atlanta Rhythm Section — A Rock & Roll Alternative —
Polydor
— So In To You/Georgia Rhythm
Boston — Epic
— Long Time
Kansas — Leftoverture — Kirshner
— Carry On Wayward Son
Al Stewart — Year Of The Cat — Janus
— Year Of The Cat
Manfred Mann — Roaring Silence — WB
— On The Road To Babylon
Bread — Lost Without Your Love — Elektra
A Star Is Born — Streisand & Kristofferson — Columbia
Pink Floyd — Animals — Columbia
— Sheep

Adds:

Sammy Hagar — Capitol
Pablo Cruise — A Place In The Sun — A&M
Ace — No Strings — Anchor
Sea Level — Capricorn
John Miles — Stranger In The City — London
Marshall Tucker Band — Carolina Dream — Capricorn
Fleetwood Mac — Rumours — WB
Joan Armatrading — A&M

KEZY-FM — ANAHEIM — Ron Burnstein

Most Active:

Al Stewart — Year Of The Cat — Janus
Kinks — Sleepwalker — Arista
Frank Zappa — Zoot Allures — WB
David Bowie — Low — RCA
Leon Redbone — Double Time — WB

Adds:

Kinks — Sleepwalker — Arista
Marshall Tucker Band — Carolina Dreams —
Capricorn
Fleetwood Mac — Rumours — WB
Janis Ian — Miracle Row — Columbia
Taj Mahal — Music Fah Ya' — WB
Leo Kottke — Chrystalis
Sea Level — Capricorn
Pink Floyd — Animals — Columbia

KBPI-FM — DENVER, CO — Jean Valdez

Most Active:

Eagles — Hotel California — Asylum
Al Stewart — Year Of The Cat — Janus
Manfred Mann — The Roaring Silence — WB
Genesis — Wind & Wuthering — Atco
Kansas — Leftoverture — Kirshner
Jackson Browne — The Pretender — Asylum

Adds:

Pink Floyd — Animals — Columbia

Kinks — Sleepwalker — Arista
Pablo Cruise — A Place In The Sun — A&M
Stallion — Casablanca

KOME-FM — SAN JOSE — Dana Jang

Most Active:

Renaissance — Novella — Sire
Pablo Cruise — A Place In The Sun — A&M
George Benson — In Flight — WB
Sammy Hagar — Capitol
Atlanta Rhythm Section — A Rock & Roll Alternative —
Polydor
Journey — Next — Columbia

Adds:

Jimmy Buffett — Changes In Latitude — ABC
Rick Wakeman — White Rock — A&M
Pink Floyd — Animals — Columbia
Chilliwack — Dreams, Dreams, Dreams — Mushroom
Rick Derringer — Sweet Evil — Blue Sky
Gentle Giant — Playing The Fool — Capitol
Dirk Hamilton — Alias i — ABC
Piper — A&M
Spirit — Future Games — Mercury
Marshall Tucker Band — Carolina Dreams —
Capricorn
Brian Auger & Oblivion Express — Happiness
Heartaches — WB
Sea Level — Capricorn
Kinks — Sleepwalker — Arista

KSJO-FM — SAN JOSE — Paul Wells

Most Active:

Eagles — Hotel California — Asylum
Genesis — Wind & Wuthering — Kirshner
Wings — Wings Over America — Capitol
Sammy Hagar — Capitol
Santana — Festival — Columbia
Journey — Next — Columbia
Queen — A Day At The Races — Elektra
ZZ Top — Tejas — London
David Bowie — Low — RCA
ELO — A New World Record — UA
Gary Wright — The Light Of Smiles — WB
Pablo Cruise — A Place In The Sun — A&M
Rick Derringer — Sweet Evil — Blue Sky
Pink Floyd — Animals — Columbia
Kinks — Sleepwalker — Arista
New Riders Of The Purple Sage — Who Are Those
Guys? — MCA

Adds:

Sea Level — Capricorn
Marshall Tucker Band — Carolina Dreams —
Capricorn
John Miles — Stranger In The City — London
Spirit — Future Games — Mercury
Todd Rundgren's Utopia — RA — WB
Fleetwood Mac — Rumours — WB
Jimmy Buffett — Changes In Latitude — ABC
Piper — A&M
Andy Fairweatherlow — Be-Bop & Holler — A&M
Angel — On Earth As It Is In Heaven — Casablanca
Renaissance — Novella — Sire
Smokey Robinson — Deep In My Soul — Tamla
Stallion — Casablanca

KINK-FM — PORTLAND, OR — Mike Bailey

Most Active:

Stephen Bishop — Careless — ABC
Jackson Browne — The Pretender — Asylum
Jimmy Buffett — Changes In Latitude — ABC
Eagles — Hotel California — Asylum
ELO — A New World Record — UA
Hall & Oates — Bigger Than Both Of Us — RCA
Emmylou Harris — Luxury Liner — WB
George Harrison — Thirty Three & 1/3 — Dark Horse
Janis Ian — Miracle Row — Columbia
Elton John — Blue Moves — MCA
Wings — Wings Over America — Capitol
Joni Mitchell — Hejira — Asylum
Linda Ronstadt — Hasten Down The Wind — Asylum
Bob Seger — Night Moves — Capitol
Al Stewart — Year Of The Cat — Janus
Rod Stewart — A Night On The Town — WB
Sutherland Bros & Quiver — Columbia
Stevie Wonder — Songs In The Key Of Life — Tamla

Adds:

Sea Level — Capricorn
Valerie Carter — Just A Stone's Throw Away —
Columbia
Tony Wilson — I Like Your Style — WB
B B King — King Size — ABC
Pink Floyd — Animals — Columbia

WCOL-FM — COLUMBUS, OH — Guy Evens

Most Active:

Queen — A Day At The Races — Elektra
— Tie Your Mother Down/You & I
Bob Seger — Night Moves — Capitol
— Night Moves/Main Street/Rock & Roll Never
Forgets
Kansas — Leftoverture — Kirshner
— Carry On Wayward Son/Opus Insert
Wings — Wings Over America — Capitol
Eagles — Hotel California — Asylum
David Bowie — Low — RCA
— Speed Of Life/Sound In Vision
Joni Mitchell — Hejira — Asylum
— Coyote/Refugee Of The Roads
Santana — Festival — Columbia
— Reach Up/The River
George Harrison — Thirty Three & 1/3 — Dark Horse
— It's What You Value/Crackerbox Palace
Genesis — Wind & Wuthering — Atco
— 11th Earl Of Mar/All In A Mouse's Night

Adds:

Pink Floyd — Animals — Columbia
Michael Franks — Sleeping Gypsy — WB
George Benson — In Flight — WB
Muddy Waters — Hard Again — Blue Sky
Sammy Hagar — Capitol
Journey — Next — Columbia
Jennifer Warnes — Arista
Roadmaster — Village
Chilliwack — Dreams, Dreams, Dreams — Mushroom
Seawind — CTI
The Babys — Chrystalis
Allen Holdsworth — Velvet Darkness — CTI

Sea Level — Capricorn
Fleetwood Mac — Rumours — WB
Todd Rundgren's Utopia — RA — WB
Kinks — Sleepwalker — Arista

WMC-FM — MEMPHIS — Ron Olson

Most Active:

Leon Redbone — Double Time — WB
— Diddy Wah Diddy/Shine On Harvest Moon
Al Stewart — Year Of The Cat — Janus
— Year Of The Cat/On The Border/One Stage Before
Wings — Wings Over America — Capitol
— Maybe I'm Amazed
Eagles — Hotel California — Asylum
— Hotel California/New Kid In Town
Target — A&M
— Let Me Live
Stevie Wonder — Songs In The Key Of Life — Tamla
Atlanta Rhythm Section — A Rock & Roll Alternative —
Polydor
— So In To You/Georgia Rhythm/Neon Nights
Jackson Browne — The Pretender — Asylum
— The Pretender/Here Come Those Tears Again
ZZ Top — Tejas — London
— 10 Dollar Man/Arrested For Driving While Blind
Boston — Epic
— Foreplay/Longtime

Adds:

Sammy Hagar — Capitol
Jimmy Buffett — Changes In Latitude — ABC
Fleetwood Mac — Rumours — WB
Marshall Tucker Band — Carolina Dream — Capricorn
Henry Gross — Show Me The Way To The Stage —
Lifesong
New Riders Of The Purple Sage — Who Are Those Guys
— MCA
Barclay James Harvest — Octoberon — MCA
Emmylou Harris — Luxury Liner — WB
Pink Floyd — Animals — Columbia
George Benson — In Flight — WB
Michael Franks — Sleeping Gypsy — WB

KREM-FM — SPOKANE, WA — Don Adair

Most Active:

Eagles — Hotel California — Asylum
Al Stewart — Year Of The Cat — Janus
Wings — Wings Over America — Capitol
Joni Mitchell — Hejira — Asylum
Bob Seger — Night Moves — Capitol
Chick Corea — My Spanish Heart — Polydor
Stevie Wonder — Songs In The Key Of Life — Tamla
ZZ Top — Tejas — London
Atlanta Rhythm Section — A Rock & Roll Alternative —
Polydor
David Bowie — Low — RCA
Santana — Festival — Columbia
Queen — A Day At The Races — Elektra

Adds:

Pink Floyd — Animals — Columbia
Sea Level — Capricorn
Piper — A&M
Rick Wakeman — White Rock — A&M
Marshall Tucker Band — Carolina Dreams —
Capricorn
Timo Laine — Symphonic Slam — A&M
Dirk Hamilton — Alias i — ABC
Fleetwood Mac — Rumours — WB

WKDD-FM — AKRON — Bobby Knight

Most Active:

Genesis — Wind & Wuthering — Atco
— 11th Earl Of Mar/All In A Mouse's Night/Blood On
The Rooftops
Queen — A Day At The Races — Elektra
— Long Away/Tie Your Mother Down/You & I
Stevie Wonder — Songs In The Key Of Life — Tamla
Bob Seger — Night Moves — Capitol
— Night Moves/Main Street/Fire Down Below
Eagles — Hotel California — Asylum
— Life In The Fast Lane/Victim Of Love/Hotel
California
Gary Wright — The Light Of Smiles — WB
— Phantom Writer/Silent Fury/Water Sign/Are You
Weeping
Wings — Wings Over America — Capitol
— Maybe I'm Amazed/Live & Let Die/Venus & Mars
ZZ Top — Tejas — London
— It's Only Love/She's A Heartbreaker/10 Dollar Man
Atlanta Rhythm Section — A Rock & Roll Alternative —
Polydor
— Outside Woman Blues/Sky High/So In To You
ELO — A New World Record — UA
— Do Ya/Tight Rope/So Fine
Al Stewart — Year Of The Cat — Janus

Adds:

Steve Harley & Cockney Rebel — Love's A Prima Donna
— EMI
Beaverteeth — RCA
Angel — On Earth As It Is In Heaven — Casablanca
Sea Level — Capricorn
Marshall Tucker Band — Carolina Dreams —
Capricorn
Piper — A&M
Ace — No Strings — Anchor
Bill Ouateman — Night After Night — RCA
Journey — Next — Columbia
Kinks — Sleepwalker — Arista
Racing Cars — Downtown Tonight — Chrystalis
Rufus — Ask Rufus — ABC
Pink Floyd — Animals — Columbia

WKQQ-FM — LEXINGTON — Dick Hungate

Most Active:

Eagles — Hotel California — Asylum
Al Stewart — Year Of The Cat — Janus
Bob Seger — Night Moves — Capitol
Jimmy Buffett — Changes In Latitude — ABC
Gary Wright — The Light Of Smiles — WB
Jackson Browne — The Pretender — Asylum
Santana — Festival — Columbia
A Star Is Born — Streisand & Kristofferson — Columbia
Queen — A Day At The Races — Elektra
Emmylou Harris — Luxury Liner — WB

Adds:

Rufus — Ask Rufus — ABC
Renaissance — Novella — Sire
Journey — Next — Columbia

(continued on page 48)

POP RADIO PLAYLIST HIGHLIGHTS

WCUE — AKRON

2-1 — Eagles
 *Elton John
 *O — Dancin' Man
 *David Soul
 *Tom Jones
 *Dave & Sugar
 10 To 4 — Steve Miller
 15 To 10 — 10cc
 18 To 11 — Hall & Oates
 21 To 17 — Kansas
 24 To 18 — Ozark Mtn. Daredevils
 30 To 23 — George Harrison
 33 To 28 — Stephen Bishop
 34 To 26 — Boston
 36 To 27 — ELO
 Ex To 37 — Rod Stewart
 Ex To 38 — Wings
 Ex To 39 — Jackson Browne
 Ex To 40 — Parker McGee

WPTR — ALBANY

2-1 — Mary Macgregor
 George Harrison
 Jackson Browne
 Elton John
 Wings
 ELO
 14 To 6 — Al Stewart
 18 To 12 — Fleetwood Mac
 23 To 13 — 10cc
 24 To 16 — Smokie
 25 To 14 — Kansas

WAEB — ALLENTOWN

4-1 — Eagles
 Elton John
 Wings
 George Harrison
 Rod Stewart
 Jennifer Warnes
 13 To 4 — Al Stewart
 9 To 5 — Kenny Nolan
 18 To 10 — Barbra Streisand
 22 To 13 — Bob Seger
KEYZ — ANAHEIM
 3-1 — Mary Macgregor
 *Wings
 18 To 11 — Abba
 19 To 12 — Hall & Oates
 24 To 19 — Barbra Streisand
 31 To 26 — ELO
 34 To 29 — Barry Manilow
 35 To 30 — Stephen Bishop
 Ex To 31 — Kansas
 Ex To 32 — Elton John
 Ex To 33 — Atlanta Rhythm Section
 Ex To 34 — Bowie — Sound & Visions
 Ex To 35 — G. Wright — Water Sign

WISE — ASHEVILLE

1-1 — Barbra Streisand
 *Rod Stewart
 *Elvis Presley
 *Wings
 *Eagles — Hotel California
 *Orleans
 10 To 5 — Hall & Oates
 12 To 8 — Kansas
 13 To 9 — 10cc
 16 To 12 — Bee Gees
 19 To 14 — Boston
 20 To 13 — Dickie Goodman
 23 To 19 — Olivia Newton-John
 Ex To 23 — Jackson Browne
 Ex To 24 — Atlanta Rhythm Section
 Ex To 25 — Exile

WRFC — ATHENS

1-1 — Eagles
 David Soul
 Latimore
 Santana
 Elvin Bishop
 William Bell
 14 To 9 — Fleetwood Mac
 17 To 11 — Kansas
 18 To 13 — Atlanta Rhythm Section
 19 To 12 — Hall & Oates
 20 To 14 — 10cc
 25 To 20 — Thelma Houston
 26 To 16 — Orleans
 28 To 23 — George Harrison
 29 To 24 — ELO
 32 To 28 — Climax Blues Band
 33 To 26 — Rufus
 34 To 29 — Gary Wright
 35 To 30 — Andrea True

Z-93 — ATLANTA

2-1 — Mary Macgregor
 *Rod Stewart
 *Wings
 *David Soul
 8 To 3 — Barbra Streisand
 19 To 14 — Tom Jones
 23 To 13 — Abba
 25 To 21 — 10cc
 26 To 22 — Dickie Goodman
 Ex To 30 — Boston
WXQI — ATLANTA
 11-1 — Barbra Streisand
 Tom Jones
 Jackson Browne
 Boston
 Hall & Oates
 George Harrison
 10 To 5 — Eagles
 12 To 2 — Bob Seger
 19 To 9 — Elvis Presley
 21 To 14 — Abba
 23 To 18 — Bee Gees
 24 To 19 — 10cc

WBBO — AUGUSTA

1-1 — Eagles
 *David Soul
 *Elton John
 *Elvin Bishop
 10 To 5 — Bob Seger
 20 To 15 — 10cc
 30 To 24 — Boston
 Ex To 28 — Wings
 Ex To 29 — Elvis Presley
 Ex To 30 — Atlanta Rhythm Section

WAUG — AUGUSTA

1-1 — Eagles
 *Thelma Houston
 *Elton John
 *Elvin Bishop
 20 To 16 — Kansas
 25 To 19 — Dickie Goodman

KERN — BAKERSFIELD

1-1 — Manfred Mann
 *Wings

*Atlanta Rhythm Section

*Rod Stewart
 11 To 6 — Kenny Nolan
 14 To 14 — Hall & Oates
 24 To 16 — Wonder — Lovely
 Ex To 25 — David Soul
 Ex To 27 — Little River Band
 Ex To 29 — Eagles — Hotel California

KAFY — BAKERSFIELD

1-1 — Aerosmith
 *Rod Stewart
 *Atlanta Rhythm Section
 14 To 7 — Jacksons
 24 To 19 — Boston
 25 To 16 — Hall & Oates
 27 To 21 — 10cc
 28 To 23 — George Harrison
 Ex To 27 — ELO
 Ex To 30 — Wings

WCAO — BALTIMORE

1-1 — Mary Macgregor
 *Wilton Place Street Band
 *Jacksons
 *Atlanta Rhythm Section
 *ELO
 15 To 11 — Thelma Houston
 16 To 13 — Abba
 19 To 15 — Bee Gees
 21 To 17 — 10cc
 Ex To 27 — Elton John
 Ex To 28 — Wings
 Ex To 29 — Rufus
 Ex To 30 — Rod Stewart

WFBR — BALTIMORE

7-1 — Mary Macgregor
 Atlanta Rhythm Section
 Jackson Browne
 Parker McGee
 22 To 16 — Abba
 25 To 21 — Thelma Houston
 26 To 22 — Stephen Bishop
 27 To 23 — Fleetwood Mac
 29 To 24 — Smokie
 33 To 28 — Elvis Presley

WGUY — BANGOR

1-1 — Barbra Streisand
 *Eagles — Hotel California
 12 To 8 — Kansas
 13 To 9 — Boston
 17 To 13 — 10cc
 18 To 12 — Hall & Oates
 Ex To 28 — David Soul
 Ex To 29 — Elvis Presley
 Ex To 30 — Wings
 Ex To 31 — Elton John

WHNN — BAY CITY

1-1 — Abba
 *Rod Stewart
 15 To 7 — 10cc
 16 To 11 — KC & Sunshine
 22 To 9 — Hall & Oates
 24 To 20 — David Soul
 27 To 23 — Elvis Presley
 29 To 24 — J. "Guitar" Watson
 Ex To 26 — Ozark Mtn. Daredevils
 Ex To 27 — Jackson Browne
 Ex To 28 — George Harrison
 Ex To 29 — Smokey Robinson
 Ex To 30 — Fat Larry's Band

WERC — BIRMINGHAM

1-1 — Rose Royce
 *Wings
 *ELO
 *Deniece Williams
 *Tom Jones
 18 To 8 — Kansas
 15 To 10 — Jacksons
 19 To 14 — Al Stewart
 21 To 16 — Steve Miller
 Ex To 28 — Stephen Bishop
 Ex To 29 — Rod Stewart
 Ex To 30 — David Soul

WSGN — BIRMINGHAM

1-1 — Rose Royce
 *Atlanta Rhythm Section
 *Elton John
 *Rod Stewart
 *Wings
 15 To 11 — David Dundas
 16 To 6 — Barbra Streisand
 Ex To 22 — David Soul
 Ex To 23 — Tom Jones
 Ex To 30 — Thelma Houston

KFYR — BISMARCK

2-1 — Eagles
 *Hall & Oates
 *10cc
 *David Soul
 10 To 6 — Barbra Streisand
 17 To 13 — Kiss
 Ex To 16 — Olivia Newton-John
 Ex To 18 — Parker McGee
 Ex To 20 — Boston

WRKO — BOSTON

2-1 — Manfred Mann
 Hall & Oates
 Kansas
 13 To 7 — 10cc
 15 To 9 — Barbra Streisand
 17 To 10 — Thelma Houston

WBGN — BOWLING GREEN

1-1 — Steve Wonder
 *Andrea True
 *Rod Stewart
 *Jennifer Warnes
 10 To 6 — Fleetwood Mac
 12 To 7 — 10cc
 13 To 9 — Steve Miller
 17 To 10 — Al Stewart
 18 To 14 — Queen
 21 To 17 — Barbra Streisand
 25 To 21 — LTD
 27 To 23 — Little River Band
 Ex To 24 — Jacksons
 Ex To 27 — David Soul
 Ex To 28 — ELO

WICC — BRIDGEPORT

1-1 — Mary Macgregor
 *Smokie
 *Rod Stewart
 *Tom Jones
 *Love Unlimited
 12 To 6 — Barbra Streisand
 Ex To 29 — David Soul
 Ex To 30 — Wings

WKBW — BUFFALO

3-1 — Manfred Mann
 Kansas
 John Travolta

*Leo Sayer

*Wings
 11 To 5 — Barry Manilow
 14 To 10 — Bread
 23 To 15 — David Soul
 26 To 22 — Barbra Streisand
 29 To 23 — 10cc
 Ex To 25 — Dickie Goodman
 Ex To 29 — Ringo Starr

WYSL — BUFFALO

4-1 — Eagles
 *Exile
 *John Travolta
 *Jackson Browne
 *Elton John
 *Mr. Big
 14 To 5 — Al Stewart
 20 To 14 — Kansas
 27 To 19 — Boston
 Ex To 15 — Barbra Streisand
 Ex To 21 — Kenny Nolan
 Ex To 23 — Wonder — Lovely
 Ex To 30 — Ozark Mtn. Daredevils

WTMA — CHARLESTON

2-1 — Manfred Mann
 *Natalie Cole
 *George Harrison
 *Kansas
 *Rufus
 *Boston
 *Elton John
 *Wings
 18 To 11 — Bob Seger
 19 To 15 — Steve Miller
 23 To 19 — Commodores
 24 To 16 — Al Stewart
 25 To 20 — Abba
 Ex To 5 — Hall & Oates
 Ex To 21 — 10cc
 Ex To 24 — Kenny Nolan
 Ex To 25 — Dickie Goodman
 Ex To 27 — Bee Gees
 Ex To 28 — Fleetwood Mac
 Ex To 29 — Tom Jones
 Ex To 30 — Atlanta Rhythm Section

WBT — CHARLOTTE

3-1 — Barbra Streisand
 No new additions
 15 To 11 — 10cc
 16 To 12 — Stephen Bishop
 20 To 16 — Olivia Newton-John
 21 To 17 — Parker McGee

WAYS — CHARLOTTE

5-1 — Abba
 Boston
 ELO
 7 To 2 — Hall & Oates
 16 To 10 — Kenny Nolan
 18 To 9 — Fleetwood Mac
 20 To 13 — Al Stewart

WFLI — CHATTANOOGA

1-1 — Rose Royce
 *Jackson Browne
 *Wings
 *ELO
 13 To 6 — Abba
 17 To 11 — Fleetwood Mac
 23 To 19 — Atlanta Rhythm Section
 Ex To 20 — Tom Jones
 Ex To 23 — Bee Gees
 Ex To 25 — Olivia Newton-John

WGOW — CHATTANOOGA

1-1 — Rose Royce
 Stephen Bishop
 *Kansas
 *Glen Campbell
 *Burton Cummings
 *David Soul
 13 To 8 — Bob Seger
 17 To 11 — Barbra Streisand
 22 To 12 — 10cc
 27 To 22 — Heart
 28 To 15 — Olivia Newton-John
 29 To 21 — Parker McGee
 Ex To 24 — Tom Jones
 Ex To 25 — Atlanta Rhythm Section
 Ex To 27 — ELO
 Ex To 30 — Abba

WLS — CHICAGO

1-1 — Sylvers
 Barbra Streisand
 Kansas
 10cc
 3 To 2 — Eagles
 8 To 3 — Mary Macgregor
 11 To 7 — Steve Miller
 12 To 5 — Bob Seger
 16 To 11 — Al Stewart
 17 To 13 — Kiss
 18 To 14 — Fleetwood Mac
 20 To 16 — Jacksons

WMET — CHICAGO

5-1 — Eagles
 10cc
 Hall & Oates
 14 To 9 — Mary Macgregor
 16 To 12 — Bob Seger
 20 To 14 — Kansas

Q-102 — CINCINNATI

1-1 — Barbra Streisand
 No new additions
 13 To 7 — Mary Macgregor
 15 To 10 — Steve Miller
 18 To 12 — Al Stewart
 27 To 20 — Jackson Browne
 29 To 24 — Boston

WSAI — CINCINNATI

1-1 — Barbra Streisand
 Hall & Oates
 George Harrison
 21 To 11 — Bob Seger
 22 To 16 — Fleetwood Mac
 26 To 20 — Abba

WGCL — CLEVELAND

1-1 — Manfred Mann
 Natalie Cole
 15 To 6 — Bob Seger
 16 To 7 — Barry Manilow
 17 To 13 — Abba
 22 To 16 — Fleetwood Mac
 28 To 24 — Boston

WCOL — COLUMBUS

1-1 — Barbra Streisand
 ELO
 Atlanta Rhythm Section
 Jennifer Warnes
 15 To 11 — Wild Cherry
 20 To 14 — Bee Gees
 23 To 15 — Boston

30 To 21 — Hall & Oates

31 To 24 — David Soul
 34 To 29 — Olivia Newton-John
 36 To 32 — Orleans
WNCI — COLUMBUS
 3-1 — Barbra Streisand
 Bee Gees
 Hall & Oates
 Boston
 12 To 5 — Al Stewart
 15 To 10 — Kansas
 23 To 19 — Abba

KNUS — DALLAS

1-1 — Eagles
 Wings
 George Harrison
 Abba
 12 To 6 — Mary Macgregor
 13 To 9 — Al Stewart
 16 To 12 — Bob Seger
 25 To 19 — Jacksons
 28 To 22 — Aerosmith

KLIF — DALLAS

1-1 — Eagles
 Elton John
 Wings
 11 To 6 — Bob Seger
 13 To 7 — Al Stewart
 22 To 15 — Tom Jones
 24 To 18 — Kansas

WING — DAYTON

3-1 — Eagles
 Little River Band
 Donna Summer
 Wilton Place Street Band
 Rufus
 Jackson Browne
 Rod Stewart
 Wings
 42 To 32 — Bay City Rollers
 44 To 29 — Elton John
 45 To 36 — ELO

WMFJ — DAYTONA BEACH

8-1 — Mary Macgregor
 *Kansas
 *Hall & Oates
 *David Geddes
 22 To 12 — Barbra Streisand
 23 To 15 — Thelma Houston
 Ex To 27 — Hot
 Ex To 28 — Elton John
 Ex To 29 — Donna Summer
 Ex To 30 — Jackson Browne

KTLK — DENVER

3-1 — Mary Macgregor
 Hall & Oates
 Kansas
 ELO
 *Eagles — Hotel California
 21 To 16 — Abba
 28 To 23 — George Harrison
 30 To 25 — Orleans
 31 To 24 — Bee Gees
 33 To 26 — Jacksons
 37 To 29 — Tom Jones
 38 To 28 — Wings
 39 To 30 — Elton John
 40 To 35 — Atlanta Rhythm Section

KIMM — DENVER

1-1 — Manfred Mann
 Hall & Oates
 *Thelma Houston
 *Jackson Browne
 *Tom Jones
 10 To 5 — Barbra Streisand
 22 To 17 — Bee Gees
 Ex To 23 — David Soul
 Ex To 24 — Olivia Newton-John
 Ex To 25 — Elvis Presley

KIOA — DES MOINES

2-1 — Rose Royce
 10cc
 Elvis Presley
 Hall & Oates
 13 To 6 — Barbra Streisand
 16 To 5 — Jacksons
 23 To 14 — Bob Seger

CKLW — DETROIT

1-1 — Mary Macgregor
 *Elton John
 *William Bell
 *Kansas
 6 To 2 — Barbra Streisand
 18 To 13 — Undisputed Truth
 20 To 10 — Fleetwood Mac
 26 To 15 — Natalie Cole
 27 To 19 — Barry Manilow
 29 To 25 — Steve Miller
 30 To 18 — Hall & Oates
 Ex To 28 — Rod Stewart
 Ex To 29 — Burton Cummings
 Ex To 30 — Gordon Lightfoot

WDRQ — DETROIT

1-1 — Jacksons
 Donna Summer
 Atlanta Rhythm Section
 Al Stewart
 Fleetwood Mac
 Rufus
 7 To 2 — Leo Sayer
 8 To 4 — Manfred Mann
 9 To 5 — Hall & Oates
 10 To 6 — Eagles
 17 To 13 — Undisputed Truth
 18 To 14 — Thelma Houston
 22 To 18 — Steve Miller
 25 To 21 — Natalie Cole

WXYZ — DETROIT

1-1 — Mary Macgregor
 Natalie Cole
WDBQ — DUBUQUE
 1-1 — Mary Macgregor
 *Glen Campbell
 *ELO
 *Jennifer Warnes
 *Bee Gees
 12 To 5 — Stephen Bishop
 13 To 6 — Elvis Presley
 17 To 10 — Al Stewart
 23 To 16 — Fleetwood Mac
 26 To 18 — 10cc
 28 To 22 — Parker McGee
 Ex To 27 — Olivia Newton-John
 Ex To 28 — Tom Jones
 Ex To 29 — David Soul
 Ex To 30 — Johnny Rivers

WEBC — DULUTH

1-1 — Barbra Streisand
 *George Harrison

*Boston

*Kansas
 *Parker McGee
 *Winterwood — Love Music
 *K. Kristofferson
 21 To 16 — 10cc
 Ex To 25 — David Soul
 Ex To 26 — Wings

WEAQ — EAU CLAIRE

1-1 — Manfred Mann
 Wings
 10 To 5 — Leo Sayer
KINT — EL PASO
 1-1 — Mary Macgregor
 *Thelma Houston
 *Eagles — Hotel California
 *Wonder — Lovely
 *George Harrison
 *Gary Wright
 *Hall & Oates
 *ELO
 15 To 11 — Kiss
 16 To 10 — Barbra Streisand
 23 To 18 — Kansas
 Ex To 24 — 10cc
 Ex To 25 — Kenny Nolan

WJET — ERIE

7-1 — Manfred Mann
 *Jackson Browne
 *David Soul
 *George Harrison
 *Hall & Oates
 20 To 12 — Fleetwood Mac
 21 To 10 — Kansas
 28 To 23 — Bee Gees
 29 To 24 — Thelma Houston
 30 To 25 — Boston
 Ex To 26 — Elton John
 Ex To 27 — Dickie Goodman
 Ex To 29 — Olivia Newton-John

14-RKO — EVERETT

2-1 — Eagles
 *Jennifer Warnes
 *David Soul
 20 To 13 — Steve Miller
 21 To 15 — Glen Campbell
 22 To 16 — Manhattan Transfer
 25 To 19 — Ozark Mtn. Daredevils
 26 To 20 — 10cc
 29 To 21 — Hall & Oates
 Ex To 28 — Parker McGee
 Ex To 29 — Roger Whittaker

KQWB — FARGO

1-1 — Manfred Mann
 *Elton John
 *Elvis Presley
 *Jacksons
 *Climax Blues Band
 *Olivia Newton-John
 *Tom Jones
 *John Denver
 *Burton Cummings
 *Rod Stewart
 14 To 8 — Bob Seger
 22 To 16 — David Soul
 Ex To 22 — George Harrison
 Ex To 24 — Wings
 Ex To 25 — Little River Band
 Ex To 27 — Ambrosia

WFLB — FAYETTEVILLE

1-1 — 10cc
 *Burton Cummings
 *David Soul
 *Rose Royce
 *John Travolta
 *Andrea True
 13 To 8 — Love Unlimited
 14 To 10 — Fleetwood Mac
 16 To 9 — Stephen Bishop
 17 To 12 — Kansas
 18 To 13 — Gabriel Kaplan
 23 To 14 — Boston
 Ex To 26 — George Harrison
 Ex To 27 — Thelma Houston
 Ex To 28 — ELO
 Ex To 29 — Glen Campbell
 Ex To 30 — Rufus

KFJZ — FORT WORTH

5-1 — Mary Macgregor
 EWF
 10 To 7 — Aerosmith
WVBF — FRAMINGHAM
 2-1 — Mary Macgregor
 *Hall & Oates
 *Rod Stewart
 *Elton John
 6 To 2 — Eagles
 Ex To 22 — Thelma Houston
 Ex To 23 — Kansas
 Ex To 24 — Stephen Bishop
 Ex To 25 — Smokie

KYNO — FRESNO

2-1 — Stevie Wonder
 *Wings
 *David Soul
 6 To 2 — Eagles
 15 To 11 — Barry Manilow
 28 To 23 — Barbra Streisand
 Ex To 29 — Hall & Oates
 Ex To 30 — Elton John

KKXL — GRAND FORKS

6-1 — Smokie
 Atlanta Rhythm Section
 Tom Jones
 Kansas
 9 To 5 — Al Stewart
 21 To 10 — Barbra Streisand
 26 To 18 — Wonder — I Wish
 28 To 24 — David Soul

WLAV — GRAND RAPIDS

1-1 — Mary Macgregor
 *Brass Construction
 *Burton Cummings
 *Jackson Browne
 *Glen Campbell
 *Atlanta Rhythm Section
 16 To 9 — Kiss
 18 To 12 — 10cc
 Ex To 15 — Hall & Oates
 Ex To 23 — Parker McGee
 Ex To 27 — Ozark Mtn. Daredevils
 Ex To 28 — Jennifer Warnes

Z-96 — GRAND RAPIDS

1-1 — Mary Macgregor
 *Wings
 *Rod Stewart
 *Glen Campbell
 *Burton Cummings

*Rufus

*Seger — R&R
 21 To 12 — Boston
 25 To 19 — Deniece Williams
 27 To 22 — Bee Gees
 29 To 23 — George Harrison
 30 To 24 — Jackson Browne
 Ex To 25 — Hall & Oates
 Ex To 29 — David Soul
 Ex To 30 — Olivia Newton-John

KEIN — GREAT FALLS

1-1 — Barbra Streisand
 Glen Campbell
 *Tom Jones
 *Styx
 *David Soul

POP RADIO PLAYLIST HIGHLIGHTS CONT.

23 To 18 — 10cc
 Ex To 20 — Elvis Presley
 Ex To 27 — Tom Jones
 Ex To 28 — Olivia Newton-John
 Ex To 29 — Thelma Houston
 Ex To 30 — Orleans

KBEO — KANSAS CITY
 1-1 — Mary Macgregor
 Tom Jones
 Thelma Houston
 Stephen Bishop
 17 To 9 — David Dundas
 19 To 10 — Al Stewart
 25 To 13 — David Soul
 29 To 22 — Abba

KVOL — LAFAYETTE
 2-1 — Abba
 *Rod Stewart
 *William Bell
 *Elton John
 12 To 7 — Barbra Streisand
 22 To 15 — Bee Gees
 29 To 23 — Elvis Presley
 31 To 26 — Stephen Bishop
 35 To 30 — Atlanta Rhythm Section
 Ex To 33 — Hot
 Ex To 34 — Jackson Browne
 Ex To 36 — Rose Royce
 Ex To 37 — Olivia Newton-John
 Ex To 38 — Lakeland Construction

WOPD — BRASLAND
 1-1 — Barbra Streisand
 Kerry Chater — WB
 Hot
 *Mr Big
 *Rose Royce
 *Enchantment
 *Current — Playboy
 *Gary Wright
 13 To 3 — Steve Miller
 14 To 8 — Little River Band
 16 To 9 — Hall & Oates
 20 To 10 — Thelma Houston
 21 To 4 — Eagles
 26 To 14 — Parker McGee
 28 To 22 — Jackson Browne
 30 To 25 — Glen Campbell
 35 To 27 — Bay City Rollers
 38 To 12 — Rod Stewart
 39 To 32 — Wings
 40 To 28 — Elton John
 Ex To 21 — Natalie Cole
 Ex To 34 — Burton Cummings
 Ex To 35 — Dickie Goodman
 Ex To 36 — Donna Summer
 Ex To 37 — Love Unlimited
 Ex To 38 — Latimore

KENO — LAS VEGAS
 2-1 — Mary Macgregor
 Thelma Houston
 Wings
 Elton John
 *Atlanta Rhythm Section
 21 To 14 — Barbra Streisand
 23 To 15 — Al Stewart
 33 To 25 — George Harrison

KAAY — LITTLE ROCK
 3-1 — Eagles
 Elvis Presley
 Boston
 7 To 3 — Barbra Streisand
 14 To 7 — Abba

WBLI — LONG ISLAND
 1-1 — Mary Macgregor
 *Wings
 *Boston
 *ELO
 *Smokie
 8 To 2 — Eagles
 Ex To 10 — Bread

KHJ — LOS ANGELES
 1-1 — Mary Macgregor
 10cc
 Kansas
 Thelma Houston
 12 To 4 — Jacksons
 15 To 6 — Al Stewart
 23 To 15 — Abba
 24 To 18 — Steve Miller
 27 To 21 — Barbra Streisand

WAKY — LOUISVILLE
 2-1 — Mary Macgregor
 Atlanta Rhythm Section
 Rod Stewart
 *ELO
 *Glen Campbell
 19 To 14 — 10cc
 21 To 11 — Fleetwood Mac
 24 To 16 — Exile
 29 To 22 — Jackson Browne
 Ex To 28 — Hall & Oates
 Ex To 30 — Parker McGee

WKLO — LOUISVILLE
 1-1 — Mary Macgregor
 David Dundas
 *John Travolta
 *David Soul
 *Babys
 *Eagles — Hotel California
 *Wings
 *KC & Sunshine
 15 To 9 — Latimore
 Ex To 23 — Hall & Oates
 Ex To 24 — George Harrison

WISM — MADISON
 3-1 — Eagles
 *Wings
 *Parker McGee
 *Hall & Oates
 *Ambrosia
 *Ozark Mtn. Daredevils
 27 To 21 — David Soul
 Ex To 28 — George Harrison
 Ex To 29 — Atlanta Rhythm Section
 Ex To 30 — Elton John

WFOU — MARIETTA
 2-1 — Jacksons
 *Jackson Browne
 *Elton John
 *Donna Summer
 16 To 10 — Al Stewart
 17 To 9 — Abba
 19 To 13 — Kansas
 20 To 11 — Barbra Streisand
 28 To 23 — Boston
 Ex To 25 — Atlanta Rhythm Section
 Ex To 29 — Wings
 Ex To 30 — Rod Stewart

KRIB — MASON CITY
 6-1 — Smokie
 *Wings
 *Rod Stewart
 *Jackson Browne
 *Atlanta Rhythm Section
 *ELO
 *Dickie Goodman
 14 To 10 — Jacksons
 15 To 11 — Barbra Streisand
 19 To 13 — Kansas
 22 To 15 — Fleetwood Mac
 26 To 22 — David Soul
 28 To 21 — Boston
 29 To 24 — Orleans
 Ex To 26 — Elton John
 Ex To 29 — Elvis Presley
 Ex To 30 — Olivia Newton-John

WMPS — MEMPHIS
 3-1 — Mary Macgregor
 10cc
 Atlanta Rhythm Section
 ELO
 Thelma Houston
 14 To 8 — Wonder — Lovely
 17 To 9 — Barbra Streisand
 20 To 12 — Hall & Oates
 21 To 17 — George Harrison
 26 To 20 — Boston
 30 To 16 — Eagles — Hotel California

WHBQ — MEMPHIS
 1-1 — Manfred Mann
 Bee Gees
 13 To 9 — Al Stewart
 15 To 11 — Kiss
 18 To 8 — Barbra Streisand
 21 To 13 — Tom Jones
 25 To 19 — Boston
 26 To 21 — George Harrison
 30 To 23 — Abba

Y-100 — MIAMI
 2-1 — Manfred Mann
 Hall & Oates
 Fleetwood Mac
 11 To 8 — Dickie Goodman
 18 To 14 — Thelma Houston
 19 To 15 — Bob Seger
 21 To 16 — KC & Sunshine
 22 To 18 — Latimore

WOAM — MIAMI
 1-1 — Mary Macgregor
 Abba
 Kenny Nolan
 17 To 13 — Thelma Houston
 18 To 10 — Barbra Streisand
 19 To 12 — Al Stewart
 21 To 17 — 10cc
 22 To 18 — Fleetwood Mac

96X — MIAMI
 1-1 — Mary Macgregor
 No new additions
 11 To 7 — Barbra Streisand
 21 To 13 — Gary Wright
 22 To 16 — Thelma Houston
 34 To 20 — Enchantment
 35 To 30 — R.B. Hudmon
 41 To 35 — Latimore
 42 To 33 — Abba

KCRS — MIDLAND
 2-1 — Bob Seger
 *Jackson Browne
 *Rufus
 *Wilton Place Street Band
 *Elton John
 9 To 5 — Steve Miller
 12 To 7 — Jacksons
 14 To 10 — Thelma Houston
 16 To 12 — Fleetwood Mac
 Ex To 24 — Atlanta Rhythm Section
 Ex To 28 — ELO
 Ex To 29 — Rod Stewart
 Ex To 30 — Hall & Oates

WOKY — MILWAUKEE
 1-1 — Mary Macgregor
 Bob Seger
 George Harrison
 John Travolta
 13 To 9 — Barry Manilow
 15 To 10 — Al Stewart
 30 To 22 — 10cc
 33 To 28 — ELO

WZUU — MILWAUKEE
 1-1 — Mary Macgregor
 *Jennifer Warnes
 *Sanford-Townsend
 11 To 6 — Steve Miller
 16 To 12 — Bread
 19 To 7 — Al Stewart
 Ex To 14 — Kansas
 Ex To 17 — Abba
 Ex To 20 — Bob Seger

KDWB — MINNEAPOLIS
 2-1 — Mary Macgregor
 Beatles — Ob-La-Di
 Boston
 15 To 9 — Barbra Streisand
 19 To 14 — Abba

WDGY — MINNEAPOLIS
 3-1 — Mary Macgregor
 Bob Seger
 *Kansas
 17 To 8 — Hall & Oates
 24 To 15 — Kenny Nolan
 29 To 24 — David Soul
 Ex To 23 — Jacksons

KSTP — MINNEAPOLIS
 2-1 — Hall & Oates
 No new additions
 22 To 17 — Fleetwood Mac
 24 To 19 — 10cc
 27 To 22 — Kansas
 Ex To 27 — ELO

WABB — MOBILE
 4-1 — Barbra Streisand
 *Boston
 *Jennifer Warnes
 *Bar-Kays
 *Heart
 9 To 5 — J. "Guitar" Watson
 17 To 10 — Hall & Oates
 Ex To 29 — Hot
 Ex To 30 — George Harrison

KFIV — MODESTO
 1-1 — David Soul
 *Olivia Newton-John
 *Jackson Browne
 *Ambrosia
 *Kerry Chater

23 To 11 — Dickie Goodman
 Ex To 29 — Elton John

WHYY — MONTGOMERY
 2-1 — Barbra Streisand
 *Leo Sayer
 *Wings
 *Jennifer Warnes
 10 To 4 — George Harrison
 15 To 8 — Tom Jones
 21 To 9 — David Soul
 22 To 16 — Hot
 Ex To 22 — Hall & Oates
 Ex To 25 — Rod Stewart
 Ex To 26 — Styx

KVOX — MOORHEAD
 1-1 — Manfred Mann
 *Jackson Browne
 *Thelma Houston
 *Rod Stewart
 *Climax Blues Band
 *Stevie Wonder
 10 To 4 — Bob Seger
 19 To 12 — Barbra Streisand
 22 To 16 — Bee Gees
 28 To 18 — David Soul
 29 To 20 — Boston
 Ex To 25 — George Harrison
 Ex To 29 — Atlanta Rhythm Section
 Ex To 31 — Wings
 Ex To 32 — Ambrosia

WLAC — NASHVILLE
 2-1 — Eagles
 *David Soul
 *Boston
 10 To 6 — Barbra Streisand
 12 To 7 — Barry Manilow
 15 To 11 — Hall & Oates
 18 To 14 — Abba
 19 To 13 — 10cc
 Ex To 22 — Atlanta Rhythm Section
 Ex To 23 — Kansas
 Ex To 28 — Stephen Bishop

WMAK — NASHVILLE
 5-1 — Barbra Streisand
 *George Harrison
 *Donna Summer
 *Parker McGee
 *Olivia Newton-John
 *David Soul
 16 To 8 — David Dundas
 18 To 3 — Al Stewart
 22 To 18 — 10cc
 26 To 16 — Abba
 27 To 19 — Bee Gees
 28 To 17 — Tom Jones
 Ex To 20 — Hall & Oates
 Ex To 28 — Rod Stewart
 Ex To 29 — Atlanta Rhythm Section
 Ex To 30 — Kansas

WAVZ — NEW HAVEN
 1-1 — Eagles
 *Orleans
 *Olivia Newton-John
 *Rufus
 10 To 2 — Mary Macgregor
 22 To 5 — Kenny Nolan
 27 To 21 — David Soul
 28 To 23 — Stephen Bishop
 Ex To 13 — Hall & Oates
 Ex To 28 — Rod Stewart

WNOE — NEW ORLEANS
 2-1 — Wonder — Wish/Lovely
 Smokie (re-add)
 *Enchantment
 *Elton John
 *Fleetwood Mac
 *Boston
 *Thelma Houston
 9 To 5 — Barbra Streisand
 17 To 10 — Steve Miller
 19 To 13 — George Harrison
 20 To 15 — Jacksons
 Ex To 25 — Elvis Presley
 Ex To 30 — Orleans

WTIX — NEW ORLEANS
 1-1 — Manfred Mann
 Boston
 George Harrison
 Eagles (re-add)
 *Jackson Browne
 *Wings
 *Tom Jones
 *David Soul
 8 To 4 — Barbra Streisand
 17 To 13 — Bob Seger
 Ex To 27 — Hall & Oates
 Ex To 28 — Elton John

WABC — NEW YORK
 6-1 — Mary Macgregor
 Aerosmith (re-add)
 Bob Seger
 Thelma Houston
 9 To 6 — Manfred Mann
 16 To 10 — Barry Manilow
 19 To 13 — Bread

WPIX — NEW YORK
 1-1 — Manfred Mann
 Thelma Houston
 *Quincy Jones
 21 To 11 — Mary Macgregor
 23 To 16 — Al Stewart
 Ex To 26 — Barbra Streisand
 Ex To 28 — Kansas

99X — NEW YORK
 8-1 — Mary Macgregor
 Hall & Oates
 Wings
 Rod Stewart
 Elton John
 17 To 12 — Kenny Nolan
 23 To 17 — Barbra Streisand
 28 To 24 — David Soul
 36 To 29 — Boston

WGH — NORFOLK
 1-1 — Stevie Wonder
 *Hall & Oates
 *Kansas
 *Boston

WKY — OKLAHOMA CITY
 1-1 — Manfred Mann
 *Boston
 7 To 2 — Mary Macgregor
 12 To 3 — Barbra Streisand
 Ex To 17 — Hall & Oates

KOMA — OKLAHOMA CITY
 1-1 — McCoo/Davis
 Jacksons
 Thelma Houston
 Elton John
 Wings

Bee Gees
 Jackson Browne
 20 To 11 — Barbra Streisand

WOW — OMAHA
 3-1 — Abba
 *Tom Jones
 *Climax Blues Band
 12 To 8 — Al Stewart
 20 To 10 — Bread
 Ex To 17 — Thelma Houston
 Ex To 20 — Boston

WLOF — ORLANDO
 *Hall & Oates
 *Orleans
 *David Soul
 10 To 4 — Barbra Streisand
 14 To 5 — Al Stewart
 22 To 14 — 10cc
 25 To 11 — Abba
 Ex To 30 — Kansas
 Ex To 31 — ELO
 Ex To 32 — Hot

KACY — OXNARD
 2-1 — Mary Macgregor
 Parker McGee
 Orleans
 Jackson Browne
 ELO
 Wings
 Elton John
 Burton Cummings

WBSR — PENSACOLA
 2-1 — Aerosmith
 *ELO
 *Jackson Browne
 *Rod Stewart
 *Wings
 *Burton Cummings
 *Elton John
 19 To 13 — Tom Jones
 26 To 20 — Bee Gees
 34 To 26 — Thelma Houston
 35 To 28 — Olivia Newton-John
 36 To 30 — Boston
 37 To 32 — Hall & Oates
 Ex To 34 — Atlanta Rhythm Section
 Ex To 35 — George Harrison
 Ex To 37 — Ozark Mtn. Daredevils
 Ex To 38 — David Soul
 Ex To 39 — Parker McGee

WIRL — PEORIA
 3-1 — Eagles
 *David Soul
 *Elton John
 9 To 3 — Steve Miller
 19 To 4 — Al Stewart
 Ex To 12 — Kansas
 Ex To 20 — 10cc
 Ex To 23 — Stephen Bishop

WFIL — PHILADELPHIA
 1-1 — Mary Macgregor
 *Hall & Oates
 *Rod Stewart
 *Wonder — Lovely
 20 To 16 — Kenny Nolan
 23 To 13 — Barbra Streisand
 Ex To 22 — Bee Gees
 Ex To 23 — Elton John
 Ex To 24 — Wings

WIFI — PHILADELPHIA
 3-1 — Mary Macgregor
 *ELO
 *John Travolta
 *Enchantment
 13 To 7 — Barry Manilow
 15 To 11 — Kenny Nolan
 17 To 13 — Al Stewart
 19 To 12 — Barbra Streisand
 22 To 16 — Fleetwood Mac
 27 To 23 — 10cc
 Ex To 27 — Elton John
 Ex To 28 — Rufus
 Ex To 29 — Jackson Browne

KOTN — PINE BLUFF
 2-1 — Smokie
 Boston
 *Jackson Browne
 25 To 20 — David Soul
 Ex To 30 — Atlanta Rhythm Section

WPEZ — PITTSBURGH
 1-1 — Mary Macgregor
 Barbra Streisand
 Al Stewart
 7 To 3 — Eagles
 17 To 11 — Boney M
 19 To 10 — Barry Manilow
 25 To 16 — Hall & Oates

130 — PITTSBURGH
 1-1 — Manfred Mann
 Al Stewart
 Kenny Nolan
 11 To 7 — Barbra Streisand
 20 To 16 — Wonder — Lovely
 27 To 23 — Jacksons
 28 To 18 — Hall & Oates

KGW — PORTLAND
 1-1 — Manfred Mann
 *R. Royce — I Wanna
 *Atlanta Rhythm Section
 *Rod Stewart
 *ELO
 7 To 3 — Barbra Streisand
 16 To 12 — Barry Manilow
 19 To 10 — Jacksons
 20 To 14 — Kiss
 21 To 15 — Donny & Marie
 23 To 19 — 10cc
 30 To 26 — Smokie
 Ex To 20 — Hall & Oates
 Ex To 27 — Bee Gees
 Ex To 30 — Fleetwood Mac

KPAM — PORTLAND
 1-1 — Manfred Mann
 George Harrison
 *Olivia Newton-John
 *ELO
 *Rod Stewart
 16 To 10 — Kansas
 17 To 11 — Fleetwood Mac
 25 To 20 — Hall & Oates
 26 To 21 — Wings
 Ex To 29 — Wonder — Lovely
 Ex To 30 — Parker McGee

WPRO — PROVIDENCE
 4-1 — Barbra Streisand
 Orleans
 Olivia Newton-John
 Hall & Oates
 *Wings

*Kansas
 *Demiece Williams
 11 To 3 — Kenny Nolan
 15 To 9 — Thelma Houston
 22 To 15 — George Harrison
 Ex To 24 — 10cc
 Ex To 24 — Boston
 Ex To 25 — Elvis Presley

G-55 — PROVIDENCE
 4-1 — Eagles
 *Elton John
 *Atlanta Rhythm Section
 *Gate Brothers
 13 To 7 — Rose Royce
 21 To 13 — Thelma Houston
 23 To 12 — Bee Gees
 30 To 14 — Kenny Nolan
 Ex To 23 — Olivia Newton-John
 Ex To 25 — George Harrison
 Ex To 29 — Jackson Browne
 Ex To 30 — 10cc

WKIX — RALEIGH
 1-1 — Barbra Streisand
 *Elton John
 *Wings
 *Rod Stewart
 *Thelma Houston
 7 To 3 — Eagles
 10 To 6 — Mary Macgregor
 16 To 11 — Abba
 19 To 14 — Tom Jones
 23 To 19 — Bob Seger
 25 To 21 — Al Stewart
 30 To 20 — Kansas
 Ex To 27 — Olivia Newton-John
 Ex To 28 — David Soul
 Ex To 29 — George Harrison
 Ex To 30 — Atlanta Rhythm Section

KKLS — RAPID CITY
 3-1 — Mary Macgregor
 *Wings
 *Thelma Houston
 *Elton John
 21 To 16 — Bob Seger
 25 To 20 — Atlanta Rhythm Section
 28 To 21 — David Soul
 Ex To 29 — Jackson Browne
 Ex To 30 — Rod Stewart

WLEE — RICHMOND
 1-1 — Eagles
 *David Soul
 *Wings
 9 To 4 — Al Stewart
 16 To 11 — 10cc
 20 To 12 — Steve Miller
 23 To 17 — Smokie
 24 To 18 — George Harrison
 Ex To 24 — Jackson Browne
 Ex To 28 — Olivia Newton-John
 Ex To 29 — Rod Stewart
 Ex To 30 — Atlanta Rhythm Section

O-94 — RICHMOND
 2-1 — Abba
 *Parker McGee
 *Thelma Houston
 *Atlanta Rhythm Section
 *Wings
 7 To 3 — Sylvers
 12 To 9 — Smokie
 16 To 12 — Bee Gees
 21 To 17 — George Harrison
 22 To 18 — Barbra Streisand
 25 To 16 — Hall & Oates
 27 To 21 — Jackson Browne
 28 To 22 — Boston
 Ex To 26 — Kansas
 Ex To 27 — ELO
 Ex To 28 — Elton John

WBBF — ROCHESTER
 3-1 — Barry Manilow
 Jacksons
 Bee Gees
 Wings
 ELO
 John Travolta
 Kansas
 11 To 5 — David Soul
 20 To 16 — Orleans
 22 To 15 — Kenny Nolan
 Ex To 26 — Ringo Starr

WROK — ROCKFORD
 2-1 — Rose Royce
 Jacksons
 *Boston
 *Rod Stewart
 17 To 12 — Bread
 21 To 16 — Abba
 22 To 14 — Barbra Streisand
 23 To 19 — Al Stewart
 Ex To 33 — Bee Gees
 Ex To 34 — Jennifer Warnes
 Ex To 35 — Ozark Mtn. Daredevils

KNDE — SACRAMENTO
 3-1 — Mary Macgregor
 Hall & Oates
 *Jackson Browne
 13 To 9 — Brick
 20 To 16 — Fleetwood Mac
 Ex To 19 — Abba

KROY — SACRAMENTO
 1-1 — Eagles
 Hall & Oates
 George Harrison
 Kansas
 Rod Stewart
 *Wings
 11 To 6 — Barbra Streisand

WJON — ST. CLOUD
 3-1 — Manfred Mann
 Jackson Browne
 Glen Campbell
 Kansas
 Manhattan Transfer
 11 To 6 — Al Stewart
 20 To 16 — Fleetwood Mac

KSLO — ST. LOUIS
 1-1 — Manfred Mann
 Bee Gees
 Jackson Browne
 Hall & Oates
 Rufus
 Eagles — Hotel California
 *John Travolta
 *Babys
 13 To 2 — Mary Macgregor
 15 To 6 — Kansas
 25 To 20 — Al Stewart
 30 To 21 — Barbra Streisand
 31 To 18 — Abba

32 To 25 — Natalie Cole
 34 To 26 — Boston
 35 To 27 — Kenny Nolan
 36 To 28 — 10cc
 37 To 29 — George Harrison

KXOK — ST. LOUIS
 1-1 — Mary Macgregor
 Atlanta Rhythm Section
 10cc
 *Quincy Jones
 21 To 16 — Kansas
 24 To 19 — George Harrison

KCPX — SALT LAKE CITY
 5-1 — Jacksons
 *Rubinoos — Beserkley
 *Stallion
 *John Travolta
 *Ozark Mtn. Daredevils
 22 To 11 — 10cc
 23 To 12 — David Soul
 30 To 20 — Rose Royce
 Ex To 25 — Kansas
 Ex To 26 — Wings
 Ex To 27 — Elton John
 Ex To 29 — Olivia Newton-John
 Ex To 30 — Boston

KRSP — SALT LAKE CITY
 1-1 — Barbra Streisand
 *Rubinoos — Beserkley
 *Bay City Rollers
 *Rod Stewart
 10 To 5 — Olivia Newton-John
 13 To 6 — Al Stewart
 19 To 7 — David Soul
 25 To 18 — Kansas
 Ex To 24 — Dickie Goodman
 Ex To 25 — George Harrison
 Ex To 27 — Wings
 Ex To 28 — Elton John
 Ex To 29 — Jackson Browne

B100 — SAN DIEGO
 2-1 — Steve Miller
 *Wings
 *Elton John
 16 To 12 — Fleetwood Mac
 21 To 8 — Barbra Streisand
 28 To 21 — Boston
 30 To 25 — Bee Gees
 Ex To 27 — Hall & Oates
 Ex To 28 — Thelma Houston
 Ex To 29 — Atlanta Rhythm Section
 Ex To 30 — ELO

KCBQ — SAN DIEGO
 3-1 — Mary Macgregor
 10cc
 *John Travolta
 *Thelma Houston
 16 To 8 — Abba
 17 To 10 — Al Stewart
 25 To 21 — Fleetwood Mac
 27 To 22 — Smokie
 Ex To 27 — Hall & Oates
 Ex To 28 — Stephen Bishop

KFRC — SAN FRANCISCO
 2-1 — Steve Miller
 Tom Jones
 13 To 8 — Al Stewart
 15 To 9 — Jacksons
 18 To 14 — Fleetwood Mac
 26 To 18 — Boston

KYA — SAN FRANCISCO
 1-1 — Mary Macgregor
 *Kenny Nolan
 *Hall & Oates
 *Kansas
 10 To 5 — Barbra Streisand
 22 To 17 — David Soul
 25 To 20 — Bay City Rollers
 Ex To 23 — Boston
 Ex To 24 — Abba

KLIV — SAN JOSE
 1-1 — Al Stewart
 *Boston
 *ELO
 *Wings
 *Rubinoos
 *Eagles — Hotel California
 *Exile
 10 To 4 — Barbra Streisand
 Ex To 13 — Abba
 Ex To 20 — Hall & Oates

KSly — SAN LUIS OBISPO
 2-1 — Jacksons
 Eagles — Hotel California
 Leo Sayer
 Wilton Place Street Band
 17 To 13 — David Soul
 19 To 5 — Kansas
 22 To 18 — Parker McGee
 24 To 16 — 10cc
 30 To 24 — Jackson Browne

WSGA — SAVANNAH
 15-1 — Dickie Goodman
 Thelma Houston
 David Soul
 ELO
 13 To 9 — Hall & Oates
 14 To 8 — Barbra Streisand
 18 To 14 — Abba
 21 To 17 — Rick Dees
 25 To 20 — Smokie
 28 To 24 — Tom Jones

KJR — SEATTLE
 1-1 — Manfred Mann
 *George Harrison
 *Kansas
 *Eagles — Hotel California
 *ELO
 *Atlanta Rhythm Section
 17 To 11 — Barbra Streisand
 Ex To 18 — 10cc
 Ex To 24 — David Soul
 Ex To 25 — Smokie

KEEL — SHREVEPORT
 5-1 — Eagles
 Wings
 Elton John
 Thelma Houston

(continued on page 56)

"...WE CAN BE EVEN STRONGER THAN BEFORE."



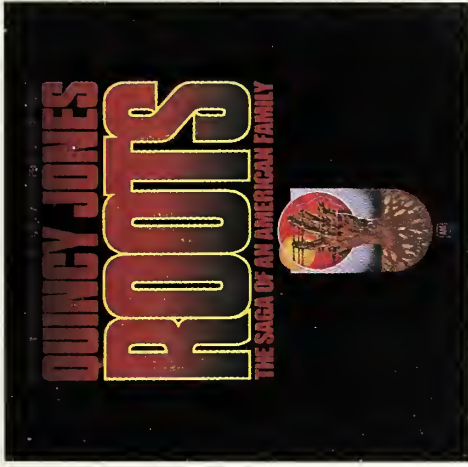

QUINCY JONES
... Roots SP4626
Produced by Quincy Jones



PABLO CRUISE
A Place in the Sun SP4625
Produced by Bill Schnee



BURT BACHARACH
Futures SP4622
Produced by Phil Ramone and Burt Bacharach



ANDY FAIRWEATHER LOW
Be Bop 'N' Holla SP4602
Produced by Glyn Johns



MEL LEWIS
Mel Lewis and Friends SP716
Produced by John Snyder



RICK WAKEMAN
White Rock (Film Soundtrack) SP4614
Produced by Rick Wakeman



PIPER
Piper SP4615
Produced by John Anthony and Eddie Kramer



GERRY NIEWOOD
Gerry Niewood & Timepiece SP719
Produced by Gerry Niewood

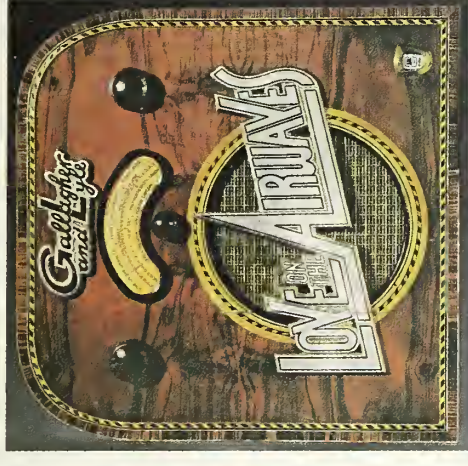

GALLAGHER AND LYLE
Love On The Airwaves SP4620
Produced by David Kershenbaum



DON CHERRY
Don Cherry SP717
Produced by Corrado Bacchelli



* Horizon

ANNOUNCING AN EXCITING NEW ERA ON A&M RECORDS & TAPES.

CASH BOX POP RADIO ANALYSIS

MOST ADDED RECORDS

This Week To Date

STATION ADDS THIS WEEK

Rank	Record	This Week	To Date	Stations
1.	Maybe I'm Amazed — Wings — Capitol	25%	41%	99X, KLIF, KNUS, Z93, WKBW, WPRO, KTAC, WSGN, WLEE, WBBF, KEEL, B-100, WISM, Q-94, Z-96, WHHY, WDRG, KERN, WORC, KJOY, KEZY, WKLO, KAKC, WING.
2.	Rich Girl — Hall & Oates — RCA	19%	74%	WRKO, 99X, Y100, WFIL, KSLQ, WQXI, WSAI, WMET, KYA, WGH, WPRO, WJET, WVBF, KNDE, KTLK, KIMN, WNCI, WISM, KIOA.
3.	Do Ya — ELO — UA	19%	34%	WCAO, KILT, WCOL, WIFI, KJR, WMPS, KGW, KPAM, KAKC, WFOM, WAYS, KTLK, KJRB, WSGA, WBBF, Z-96, WERC, WAKY, KJOY.
4.	The First Cut Is The Deepest — Rod Stewart — WB	16%	34%	WFIL, 99X, KRBE, Z93, KGW, KPAM, WING, WVBF, KJRB, WBG, WAPE, WSGN, Z-96, WDRG, KERN, WAKY.
5.	Long Time — Boston — Epic	14%	62%	WQXI, WNOE, WLAC, WGH, WAYS, KTAC, KJRB, WNDE, WAPE, WNCI, KDWB, WBBF, KEEL, WKY.
6.	So In To You — Atlanta Rhythm Section — Polydor	14%	33%	WPGC, WCAO, WCOL, KJR, WMPS, WDRQ, KXOK, KGW, KJRB, WSGN, Q-94, KERN, WORC, WAKY.
7.	Carry On Wayward Son — Kansas — Kirshner	13%	68%	WLS, KHJ, CKLW, WRKO, KJR, KYA, WKBW, WGH, WDG, WPRO, KTLK, KTAC, WBBF.
8.	Don't Leave Me This Way — Thelma Houston — Tamla	12%	62%	WABC, KHJ, WPIX, WMPS, WNOE, KCBQ, KBEQ, KTAC, KIMN, WSGA, KEEL, Q-94.
9.	Bite Your Lip — Elton John — Rocket/MCA	12%	32%	CKLW, 99X, KLIF, KRBE, WNOE, WFOM, WVBF, WSGN, KEEL, WBBQ, WIRL, B-100.
10.	Don't Give Up On Us — David Soul — Private Stock	11%	42%	Z-93, WLAC, WMAK, WKLO, KJRB, WLEE, WSGA, WBBQ, WIRL, WDRG, WJET.
11.	The Things We Do For Love — 10cc — Mercury	9%	67%	WLS, KHJ, WMPS, WMET, KING, KXOK, KLEO, KCBQ, KIOA.
12.	All Strung Out — John Travolta — Midland	9%	9%	KSLO, WGCL, WIFI, WKBW, KCBQ, WOKY, KCPX, WBBF, KEEL.
13.	Crackerbox Palace — George Harrison — Dark Horse/WB	8%	47%	WSAI, KNUS, KJR, WQXI, WMAK, WOKY, KPAM, WJET.
14.	Here Come Those Tears Again — Jackson Browne — Asylum	8%	35%	KSLQ, WQXI, KIMN, KNDE, WFOM, WING, KAKC, WJET.
15.	Say You'll Stay Until Tomorrow — Tom Jones — Epic	7%	31%	KFRC, WQXI, KBEQ, KIMN, WOW, WDRG, WERC.
16.	Boogie Child — Bee Gees — RSO	5%	51%	WHBQ, KSLQ, WNDE, WNCI, WBBF.
17.	I Just Can't Say No To You — Parker McGee — Big Tree	5%	18%	WMAK, WAPE, WISM, Q94, KJOY.
18.	Right Time Of The Night — Jennifer Warnes — Arista	5%	10%	KILT, WCOL, WZUU, WHHY, WBG.

RADIO ACTIVE SINGLES

- LOVE THEME FROM "A STAR IS BORN" — BARBRA STREISAND — COLUMBIA**
WFIL 23-13, CKLW 6-2, KHJ 27-21, WRKO 15-9, 99X 23-17, WMPS 17-9, WQXI 11-1, KJR 17-11, WQAM 18-10, WIFI 19-12, WLAC 10-6, Z93 8-3, 13Q 11-7, WMAK 5-1, WKBW 26-22, WPIX ex-26, KYA 10-5, WNOE 9-5, KRBE 12-8, KSLQ 30-21, WHBQ 18-8, KGW 7-3, WDRG 21-10, KIOA 13-6, WKY 12-3, O94 22-18, B-100 21-8, KEEL 9-2, KDWB 15-9, WSGA 14-8, WSGN 16-6, WAPE 9-4, WBG 21-17, KIMN 10-5, KJRB 15-9, WFOM 20-11, KEZY 24-19.
- DANCING QUEEN — ABBA — ATLANTIC**
KHJ 23-15, WPGC 18-13, WCAO 16-13, WQXI 21-14, WGCL 17-13, WLAC 18-14, Z93 23-13, WSAI 26-20, WMAK 26-16, KYA ex-24, KILT 36-29, KING 22-11, KSLO 31-18, WHBQ 30-23, KDWB 19-14, WSGA 18-14, WNCI 23-19, WZUU ex-17, WAPE 19-3, WNDE 25-17, KTLK 21-16, KNDE ex-19, WFOM 17-9, KBEQ 29-22, KCBQ 16-8, KEZY 18-11.
- YEAR OF THE CAT — AL STEWART — JANUS**
WLS 16-11, KHJ 15-6, KFRC 13-8, WPGC 12-7, WHBQ 13-9, WPIX 23-16, WOAM 19-12, WIFI 17-13, Q102 18-12, WMAK 18-13, KNUS 13-9, KSLQ 25-20, KLIF 13-7, WERC 19-14, WOW 12-8, WIRL 19-14, KEEL 11-6, WNCI 12-5, WLEE 9-4, WZUU 19-7, WBG 17-10, WAYS 20-13, WFOM 16-10, KBEQ 19-10, WOKY 15-10, KCBQ 17-10.
- THE THINGS WE DO FOR LOVE — 10cc — MERCURY**
WRKO 13-7, WCAO 21-17, WQXI 24-19, KJR ex-18, WQAM 21-17, WIFI 27-23, WLAC 19-13, Z93 25-21, WMAK 22-18, WKBW 29-23, KSLQ 36-28, KGW 23-19, WAKY 19-14, WORC 19-12, WIRL ex-20, WBBQ 28-15, KEEL 24-17, WLEE 16-11, KCPX 22-11, WBG 12-7, KTAC ex-26, WPRO ex-22, KSTP 24-19, WOKY 30-22, WBT 15-11.
- RICH GIRL — HALL & OATES — RCA**
CKLW 30-18, WPGC 6-1, WMPS 20-12, WOAM 27-23, WLAC 15-11, WCOL 30-21, 13Q 28-18, WMAK ex-20, WPEZ 25-16, WDRQ 9-5, KILT 29-24, KRBE 25-19, KING ex-15, KGW ex-20, WAKY ex-28, KERN 19-14, WKY ex-17, WHHY ex-22, Z96 ex-25, Q94 25-16, B-100 ex-27, WSGA 13-9, WAYS 7-2, WDG 17-8, KCBQ ex-27, WKLO ex-23, KPAM 25-20, KEZY 19-12, KLEO 23-17, KJOY 11-6, WAVZ ex-13.
- CARRY ON WAYWARD SON — KANSAS — KIRSHNER**
WPGC 14-10, WMET 20-14, WLAC ex-23, KXOK 21-16, WMAK ex-30, WPIX ex-28, KILT 34-23, KRBE 28-22, KSLQ 15-6, KLIF 24-18, WERC 13-8, Q94 ex-26, WIRL ex-18, KEEL ex-22, WNCI 15-10, WZUU ex-14, KCPX ex-25, KJRB ex-27, WFOM 19-13, KSTP 27-22, WVBF ex-23, WJET 21-10, KPAM 16-10, KEZY ex-31.
- LONG TIME — BOSTON — EPIC**
99X 36-29, KFRC 26-18, WHBQ 25-19, WMPS 26-20, WGCL 28-24, Q102 29-24, Z93 ex-30, WCOL 23-15, KYA ex-23, KRBE 30-24, KSLQ 34-26, WOW ex-20, Z96 21-12, O94 28-22, B-100 28-21, WBBQ 30-24, KCPX ex-30, WPRO ex-24, WFOM 28-23, WJET 30-25, KLEO 30-24.

SECONDARY RADIO ACTIVE

Titles listed below are receiving strong radio support from key secondary stations around the country.

- BITE YOUR LIP — ELTON JOHN — ROCKET**
Adds: WIFE, KACY, 98Q, WKIX, WCUE, WAIR, KQWB, WFOM, KENO, WTMA, KORS, WAUG, WBSR, WJDX, KKLS, WYSL, WAEB, G-55; Jumps: WING 44-29, KRSP ex-28, WKWK ex-29, WGSV ex-30, KYNO ex-30, WQPD 40-28, KFIV ex-29, WSPT ex-28, KELI ex-27, WTRY ex-30, WISM ex-30, WGLF ex-30, KRIB ex-26, WMFJ ex-28, WTLB ex-25.
- FIRST CUT IS THE DEEPEST — ROD STEWART — WB**
Adds: KACY, KRIB, WKIX, KELI, WHNN, WROK, KQWB, WISE, KAFY, WBG, WBSR, WJDX, KFIV, WSPT, WICC, WAAY, WING, WAEB, KRSP, KVOX; Jumps: WQPD 38-12, 98Q ex-36, WTLB ex-29, WCUE ex-37, WAIR ex-28, WGLF ex-28, KKLS ex-30, WFOM ex-30, WGSV ex-32.
- SAM — OLIVIA NEWTON-JOHN — MCA**
Adds: KQWB, WKWK; Jumps: KRSP 10-5, WGOW 28-15, WISE 23-19, KELI 27-21, WNDR 31-18, KFYP ex-16, WFLI ex-25, WBSR 35-28, WKIX ex-27, KRIB ex-30, WCRO ex-28, WDBQ ex-27, G-55 ex-23, KVOL ex-37.
- I CAN'T SAY NO TO YOU — PARKER MCGEE — BIG TREE**
Adds: KACY, WISM, WEBC, WFBR; Jumps: WQPD 26-14, KSLY 22-18, WGOW 29-21, WGSV 25-21, WDBQ 28-22, KFYP ex-18, WLAV ex-23, 14-RKO ex-28, 98Q 38-30, KELI ex-29, WCUE ex-40.
- YOU KNOW LIKE I KNOW — OZARK MTN. DAREDEVILS — A&M**
Adds: WISM, KAKC, WNDR; Jumps: WCUE 24-18, 14-RKO 25-19, WLAV ex-27, WBSR ex-37, WYSL ex-30, WROK ex-35, WHNN ex-26.
- I'M SCARED — BURTON CUMMINGS — PORTRAIT**
Adds: KACY, KQWB, 98Q, WGLF, WFLB, WGSV, WLAV, WGOW; Jumps: WQPD ex-34.
- KONG — DICKIE GOODMAN — SHOCK**
Adds: KRIB, WCRO; Jumps: 98Q 39-1, KFIV 23-11, WISE 20-13, WAUG 25-19, WTMA ex-25, KRSP ex-24, WQPD ex-35.
- RIGHT TIME OF THE NIGHT — JENNIFER WARNES — ARISTA**
Adds: WROK, WGLF, WDBQ, WBG, WAEB, WNDR, 14-RKO; Jumps: WLAV ex-28.
- SOUTHERN NIGHTS — GLEN CAMPBELL — CAPITOL**
Adds: WLAV, WDBQ, WJON, WGOW; Jumps: WAIR 25-19, 14-RKO 21-15, WQPD 30-25, WFLB ex-29.
- COULDN'T GET IT RIGHT — CLIMAX BLUES BAND — SIRE**
Adds: WOW, KQWB, KVOX; Jumps: WRFC 32-28, WGSV 30-26, WIFE ex-27, WAIR ex-30, WSPT ex-29.
- WINTER MELODY — DONNA SUMMER — OASIS**
Adds: WFOM, WAAY, WING; Jumps: WAIR 31-26, WGSV 20-16, WQPD ex-36, 98Q ex-39, WMFJ ex-29.

THE SINGLES BULLETS

- #1 MARY MACGREGOR** — #1 rotation at 38% of our reporting stations including Z-96, WMPS, WABC, WAKY, Z-93, WKLO, CKLW, KCBO, KYA, WPEZ, WOKY, WDGY, KBEO, KTLK, KNDE, KHJ, KTLK, 99X, WVBF, WCAO, WOAM, KTLK, WFIL, WIFI, KXOK. Top 5 airplay at 75% of our reporting stations. Late jumps at WMET 14-9, WABC 6-1, WLS 8-3, Q-102 13-7, WPIX 21-11, KNUS 12-6. #1 selling single at Bee Gee/Albany, Tower/Sac., Tosh/Seattle, Rec. Rack, City One Stop, Licorice Pizza/L.A., Peaches/Dallas, Richman Bros./Phila., Double B, El Roy/L.I., Zamoski/Balt., Dicks/Boston, King Karol/N.Y., Prospect/Cleve., Radio Dr./Milw., Harmony House/Det., United/Miami, Rec. Dept. Merch./Memphis. Top 5 in sales at 75% of our reporting accounts.
- #2 EAGLES** — #1 airplay at 20% of our reporters including KNUS, WING, KILF, WAVZ, WBBQ, WLS, WMET, WING, WISM, WLAC, WIRL, WLEE, KEEL, WORC. Top 5 rotation at 60% of our stations including majors CKLW-4, WPEZ-3, WOKY-4, WDGY-3, WSAI-3, 13Q-5, WMAK-2, KHJ-5, KFRC-2, WTIK-2, KRBE-4, WPGC-2, WQAM-3, WFI-3. Jumping at WLS 3-2, WPEZ 7-3, WOXI 10-5, KEEL 5-1. Top 3 sales at Mile Hi/Denver, Tower/Sac., Rec. Rack, Wallichs/L.A., Bee Gee/Albany, El Roy/L.I., King Karol/N.Y., Stark/Cleve., Galgano, Sound Unltd., Singer/Chi., Radio Dr./Milw., Bromo/Okla. City, Norman Cooper/Richman Bros./Phila., Moreys/Balt.
- #3 STEVE MILLER** — Top 5 airplay at WAKY-3, KNDE-4, WRKO-4, KFRC-1, WHBO-5, WJET-4, KGW-2, WAVZ-4, KING-2, WPGC-2, WCAO-5, WFOM-4, WLAC-4, WKY-5, WIRL-3, KXOK-4, KCPX-2, B-100-1, KJR-2. 9 jumps include WLS 11-7, O-102 15-10, CKLW 29-25, KHJ 24-18, WNOE 17-10, WLEE 20-12. Top 5 sales at Tosh/Seattle, Peaches/Dallas, Central/Hartford, Potomac/Wash., Wallichs/L.A., Stark/Cleve., Radio Dr./Milw., Consolidated/Det., Bromo/Okla. City, United/Miami, Central South/Nash.
- #5 BARBRA STREISAND** — #1 most active single with 37 prime movers including WQAM 18-10, WQXI 11-1, WMPS 17-9, Z-93 8-3, WLS 20-16, WFIL 23-13, WIFI 19-12, WKBW 26-22, WMAK 15-11, 13Q 11-7, WPIX ex-26, KYA 10-5, CKLW 6-2, 99X 23-17. Top 5 airplay at 40% of our reporters including #1 at WHHY, WOXI, WCOL, KAKC, WMAK, WSAI, WPRO, KLEO, WBT, Q-102, WNCI, KRSP. Top 5 at Z-93-3, CKLW-2, WOKY-2, WAYS-4, WNOE-5, WTIK-4, WMET-4, WGCL-5, Y-100-2, WLEE-3, WORC-3. Added at WPEZ. Top 5 selling single at Assoc./Phoenix, Tower/S.F., Music Street/Seattle, Banana/S.F., Music Plus/L.A., Peaches/Denver, Richman Bros./Phila., Zamoski/Balt., Dicks/Boston, El Roy/L.I., Peaches/L.A., Prospect, Stark/Cleve., Harmony House/Det., Bromo/Okla. City.
- #6 KENNY NOLAN** — Added at WQAM, 13Q, KYA. Good jumps at WBBF 22-15, WFIL 20-16, WIFI 15-11, WPRO 11-3, WAYS 16-10, WDGY 24-15, 99X 17-12. Top 5 airplay at KIOA-4, WKLO-4, WING-2, KAKC-5, KSTP-5, WPRO-3, WRKO-5, WAVZ-5, KILT-5, KRBE-5, KING-1, WCAO-4, WBT-4, WING-2, WZUU-5. Top 5 sales at Music Plus/L.A., Peaches/Cleve., Bee Gee/Albany, Waxie Maxie/D.C., Dicks/Boston, El Roy/L.I., Potomac/Wash., Stark/Cleve., Harmony House/Det.
- #7 AL STEWART** — #3 most active single with 26 big jumps including WQAM 19-12, WNCI 12-5, WLS 16-11, O-102 18-12, WIFI 17-13, WAYS 20-13, WMAK 18-13, WPIX 23-10, KNUS 13-9, KCBO 17-9, WHBO 13-9, KFRC 13-8, KHJ 15-6. Added at WPEZ, 13Q, WDRQ. Top 5 airplay at Z-96-5, WMPS-3, KSTP-2, WSAI-5, KING-4, WBBQ-4, WCAO-3, WSGN-3, WGCL-4, WNCI-5, WLAC-5, WLEE-4, B-100-2, KJRB-4. Top 10 sales at Tower/S.F., Mile Hi/Denver, Licorice Pizza/L.A., Peaches/Denver, Win/N.Y., Double B/L.I., Waxie Maxie/D.C., Peters/Boston, Potomac/Wash., Prospect, Stark/Cleve., Galgano/Chi., Giant/Va., Bromo/Okla. City, West. Merch./Amarillo.
- #8 BOB SEGER** — Key adds at WABC, WDGY, WOKY. Strong jumps at WQAM 28-22, WMET 16-12, WGCL 15-6, WZUU ex-20, WQXI 12-2, WBBQ-5, WLS-5, WAPE-1, WLAC-2, B-100-5, WORC-5. Top 5 airplay at WOXI-2, KBEO-5, WMAK-4, WRKO-3, WPGC-5, KEZY-5, WLS-5, WAPE-1, B-100-5, WORC-5. Top 10 sales at Tower/S.F., City One Stop/L.A., Richman Bros./Phila., Win/N.Y., Moreys/Balt., Dicks/Boston, Potomac/Wash., Wallichs/L.A., Stark/Cleve., Galgano, Sound Unltd./Chi., Harmony House/Det., Interstate/Miami, Central South/Nash.
- #11 ABBA** — #2 most active single with 26 big jumps including WGCL 17-13, WNCI 23-19, WCAO 16-13, WQXI 21-14, Z-93 23-13, WSAI 26-20, KTLK 21-16, KCBQ 16-8, WHBO 30-23, KHJ 23-15. Added at WQAM, KNUS. Top 5 airplay at WHHY-3, WPIX-2, WAYS-1, WVBF-4, WBGD-4, WBT-5, WAPE-3, B-100-4. Top 10 sales at Music Plus, Licorice Pizza/L.A., Bee Gee/Albany, Richman Bros./Phila., Waxie Maxie/D.C., Peters/Boston, Zamoski/Balt., El Roy/L.I., Potomac/Wash., King Karol/N.Y., Peaches/L.A., Prospect/Cleve., Giant/Va.
- #12 FLEETWOOD MAC** — Added at Y-100, WNOE, WDRQ. Big jumps at WQAM 22-18, WGCL 22-16, WLS 18-14, WIFI 22-16, WAYS 18-9, WSAI 22-16, CKLW 20-10, KFRC 18-14. Top 5 airplay at KJOY-2, KXOK-3. Strong sales at Tower/S.F./Sac., Mile Hi/Denver, City One Stop, Licorice Pizza/L.A., Peaches/Delwood, Double B/L.I., Dicks/Boston, Potomac/Wash., Galgano, Singer/Chi., Giant/Va., Central South/Nash.
- #13 10cc** — Added at KHJ, KXOK, WMPS, WMET, KIOA, KING. #4 most active single with 25 big jumps including WQAM 22-17, WCAO 21-17, WLEE 16-11, Z-93 25-21, WLAC 25-21, WKBW 29-23, WMAK 22-18, WRKO 13-7, WOKY 30-22. Strong sales at Tower/S.F., Peaches/L.A./Delwood, Central/Hartford, Richman Bros./Phila., Win/N.Y., Double B/L.I., Waxie Maxie/D.C., Rec. & Tape/Balt., Peters/Boston, El Roy/L.I., Potomac/Wash., Prospect, Stark/Cleve., Galgano/Chi., Giant/Va., Interstate/Miami, Central South/Nash.
- #14 KANSAS** — #6 most active single with 24 big jumps including WMET 20-14, WNCI 15-10, WZUU ex-14, WERC 13-8, KXOK 21-16, KJRB ex-27, WLAC ex-23, WFOM 19-13, WPIX ex-28, KSTP 27-22, KLIF 24-18. #7 most added single with 13 new stations including WLS, KTLK, CKLW, WRKO, KHJ, KYA, WDGY, WKBW. Top 5 at KBEQ-4, WAPE-2. Strong sales at Tower/Sac., City One Stop, Music Plus, Licorice Pizza/L.A., Peaches/St. Louis, Bee Gee/Albany, Win/N.Y., Waxie Maxie/D.C., Rec. & Tape/Balt., Potomac/Wash., King Karol/N.Y., Prospect, Stark/Cleve., Singer/Chi., Giant/Va., Central South/Nash.
- #16 THELMA HOUSTON** — #9 most added single with 12 new stations including WABC, WMPS, WPIX, KCBO, KHJ, WNOE, KBEO, KIMN. Jumps at WQAM 17-13, WCAO 15-11, Y-100 18-14, WSGN ex-30, WPRO 15-9, WRKO 17-10. Top 5 airplay at KJOY-4, KILT-4. Excellent sales at Tower/S.F., Bee Gee/Albany, Music Plus, Record Rack/L.A., Peaches/Ft. Laud./Dallas/St. Louis/L.A., Norman Cooper, Richman Bros./Phila., Double B, El Roy/L.I., Waxie Maxie/D.C., Rec. & Tape/Balt., Peters, Dicks/Boston, Town Hall/N.Y., Potomac/Wash., Stark/Cleve., Harmony House/Det., Giant/Va., West. Merch./Amarillo. (#2 bullet on CB R&B singles chart).
- #17 BEE GEES** — Added at WHBO, WNCI, WBBF. Good jumps at WCAO 19-15, WCOL 20-14, WAPE 25-19, WFIL ex-22, KIMN 22-17, WMAK 27-19, KTLK 31-24. Good sales at Tower/S.F., Mile Hi/Denver, Tosh/Seattle, City One Stop, Licorice Pizza/L.A., Peaches/Denver/St. Louis/L.A., Bee Gee/Albany, Richman Bros./Phila., Double B/L.I., Waxie Maxie/D.C., Dicks/Boston, Potomac/Wash., King Karol/N.Y., Prospect/Cleve., Galgano/Chi., Radio Dr./Milw., Giant/Va. (#41 bullet on CB R&B singles chart).
- #18 BOSTON** — #6 most added single with 14 new stations including WOXI, WNCI, WNOE, WAYS, WLAC, WAPE, KEEL, WTIK. #7 most active single with 21 prime movers including WGCL 28-24, Z-93 ex-30, WCOL 23-15, O-102 29-24, WPRO ex-24, WFOM 28-23, KYA ex-23, 99X 36-29, WHBO 25-19, KFRC 26-18. Good sales at Tower/S.F., Tosh/Seattle, Peaches/Dallas, Bee Gee/Albany, Norman Cooper, Richman Bros./Phila., Win/N.Y., Double B/L.I., Rec. & Tape/Balt., Peters, Dicks/Boston, El Roy/L.I., Potomac/Wash., King Karol/N.Y., Prospect, Stark/Cleve., Giant/Va.
- #19 SMOKIE** — Added at WPGC, WNOE. Last week added at KJR, KJRB, WVBF. Jumps at KCBO 27-22, WSGA 25-20, KJRB 28, WLEE 23-17, WDRQ ex-30, KILT 39-34, WVBF ex-25, KGW 30-26, KLEO 16-8. Good sales at Tower/S.F., Bee Gee/Albany, Win/N.Y., Rec. & Tape/Balt., Peters, Dicks/Boston, Wallichs/L.A., Radio Dr./Milw., Giant/Va., Bromo/Okla. City, West. Merch./Amarillo.
- #20 HALL AND OATES** — #2 most added single with 19 new stations including WQXI, WNCI, WMET, WFIL, WPRO, WSAI, KTLK, 99X, KYA, WRKO, WVBF. #5 most active single with 24 big jumps including WQAM 27-23, WMPS 20-12, WCOL 30-21, 13Q 28-18, WPEZ 25-16, KCBQ ex-27, CKLW 30-18. Top 5 airplay at KSTP-1, WAYS-2, WXYZ-5, WDRQ-5, WPGC-1. Excellent sales at Banana, Tower/S.F., Music Street/Seattle, City One Stop, Music Plus, Licorice Pizza/L.A., Peaches/Dallas, Cleve./Denver, Richman Bros./Phila., Double B/L.I., Dicks/Boston, Potomac/Wash., King Karol/N.Y., Prospect/Cleve., Harmony House/Det., Bromo/Okla. City, Interstate/Miami. (#60 bullet on CB R&B singles chart).
- #26 DAVID SOUL** — #10 most added single with 11 new stations including Z-93, WKLO, WMAK, WSGA, WBBQ, WLEE, WDRQ, WTIK. 12 big jumps include WBBF 11-5, 99X 28-24, WCOL 31-24, WKBW 23-15, KBEO 25-13, WDGY 29-24, KYA 22-17. Good sales at Tower, Banana/S.F., City One Stop, Music Plus, Licorice Pizza/L.A., Richman Bros./Phila., Waxie Maxie/D.C., Dicks/Boston, El Roy/L.I., Potomac/Wash., Peaches/L.A., Prospect, Stark/Cleve., Giant/Va.
- #33 GEORGE HARRISON** — Added at KNUS, WOKY, WSAI, WMAK, WQXI, WTIK. 10 big jumps include WNOE 19-13, WHBO 26-21, WKLO ex-24, KTLK 28-23, WPRO 22-15, KXOK 24-19, WMPS 21-17, WLEE 24-18. Sales at Tower/S.F., Tosh/Seattle, Banana/S.F., Waxie Maxie/D.C., Rec. & Tape/Balt., El Roy/L.I., Potomac/Wash., Prospect/Cleve., Galgano/Chi., Giant/Va.
- #38 TOM JONES** — Added at WERC, WOXI, KFRC, KBEQ, KIMN, WTIK. Good jumps at WHHY 15-8, Z-93 19-14, WSGN ex-23, WMAK 28-17, KTLK 37-29, KAKC ex-31, WHBO 21-13, KLIF 22-15. Top 5 airplay at WAKY-2, WKLO-2, KRBE-3. Sales at Tower/Sac., Peaches/Ft. Laud., Peters/Boston, King Karol/N.Y., Prospect, Stark/Cleve., Galgano/Chi., Harmony House/Det., Interstate/Miami, Central South/Nash.
- #41 ELO** — #3 most added single with 19 new stations including WMPS, WCAO, WCOL, WIFI, KAKC, Z-96, WSGA, KJRB, KILT. Jumps at KSTP ex-27, WING 45-36, WOKY 33-28. Sales at City One Stop, Licorice Pizza/L.A., Waxie Maxie/D.C., Moreys/Balt., Dicks/Boston, El Roy/L.I., Prospect/Cleve.
- #44 WINGS** — #1 most added single with 25 new stations including Z-93, WKBW, KAKC, WING, KNUS, 99X, WKLO, KLIF, WTIK. Jumps at WCAO ex-28, WFIL ex-24, KTLK 38-28, WFOM ex-29, WBBQ ex-28. Early sales at Waxie Maxie/D.C., Moreys/Balt., El Roy/L.I., King Karol/N.Y.
- #46 JACKSON BROWNE** — Added at WOXI, WING, KAKC, WFOM, KIMN, WTIK. Jumps at WIFI ex-29, O-102 27-20, WAKY 29-22, WLEE ex-24, WDRQ ex-28. Sales at Tosh/Seattle, Peaches/Dallas, Win/N.Y., Waxie Maxie/D.C., Rec. & Tape/Balt., Dicks/Boston, King Karol/N.Y.
- #47 ARS** — #5 most added single with 14 new stations including WMPS, WCAO, KXOK, WCOL, WCAO, WAKY, WDRQ. Jumps at WBBQ ex-30, WLEE ex-30, WLAC ex-22, KTLK 40-35, WFOM ex-25, KAKC ex-33. Sales at Mile Hi/Denver, Bee Gee/Albany, Galgano/Chi., Central South/Nash.
- #48 WILTON PLACE STREET BAND** — Added at WCAO, WING. Last week added at B-100. Excellent sales at Tower/S.F., Licorice Pizza/L.A., Peaches/Dallas, Jimmys, Win, Town Hall/N.Y., Waxie Maxie/D.C., Moreys/Balt., Dicks/Boston, El Roy/L.I., Potomac/Wash., Wallichs/L.A., Stark/Cleve., Radio Dr./Milw., Consolidated/Det., Giant/Va., Interstate/Miami. (#32 bullet on CB R&B singles chart).
- #51 ROD STEWART** — #4 most added single with 16 new stations including 99X, WFIL, Z-93, WING, WSGN, WAKY, Z-96, WVBF, KRBE. Jumps at WCAO ex-30, WLEE ex-29, WERC ex-29, WHHY ex-25, WFOM ex-30, CKLW ex-28. #2 most active single on the secondary level with new adds at KACY, KRIB, KELI, WHNN, WROK, KAFY, WBSR, WJDX, WSPT, WICC, WAEB. Early sales at City One Stop/L.A., Peaches/Cleve., Waxie Maxie/D.C., Dicks/Boston, El Roy/L.I., King Karol/N.Y., Prospect/Cleve.
- #54 ELTON JOHN** — #8 most added single this week with 12 new stations including WNOE, KLIF, 99X, CKLW, WBBQ, WVBF. Jumps at WCAO ex-27, WFIL ex-23, WIFI ex-27, KTLK 39-30, WING 44-39. #1 single on the secondary level with new adds at WIFE, KACY, 98Q, WCUE, WAIR, KENO, WAUG, WBSR, WAEB, G-55. Sales at City One Stop/L.A., Peaches/Cleve., Jimmys, King Karol/N.Y., Waxie Maxie/D.C., El Roy/L.I., Prospect/Cleve.
- #55 RUFUS** — Added at WING, Z-96, WDRQ, KSLQ, WAVZ. Last week added at WIFI, WCAO, WKLO. Jumps at WCAO ex-29, WIFI ex-28. Sales at Peaches/Dallas, Win, King Karol/N.Y., Waxie Maxie/D.C., Moreys/Balt., Wallichs/L.A., Giant/Va. (#29 bullet on CB R&B singles chart).
- #57 DONNA SUMMER** — Added at WDRQ, WING, WFOM, WMAK. Last week added at WIFI. #11 most active single on the secondary level with good movement at WAIR, WGSV, WQPD, WMFJ. (#54 bullet on CB R&B singles chart).
- #59 NATALIE COLE** — Added at WGCL, WXYZ. Last week added at WDRQ, WIFI. Sales at Peaches/Ft. Laud./St. Louis, Double B/L.I., Rec. & Tape/Balt., Town Hall/N.Y., Potomac/Wash., Prospect/Cleve., Consolidated/Det. (#8 bullet on CB R&B singles chart).
- #60 OLIVIA NEWTON-JOHN** — Added at WPRO, KPAM, WAVZ. Last week added at WDRQ, KLEO, WBGD. Jumps at WLEE ex-28, WCOL 34-29. #3 most active single on the secondary level with new adds at KQWB, WKWK. Strong movement at KRSP, WISE, KELI, WFLI, WBSR. Sales at Jimmys, King Karol/N.Y., Stark/Cleve., Consolidated/Det.

(continued on page 56)

REGIONAL ALBUM ACTION

NORTH CENTRAL

(Minnesota, Iowa, Nebraska, Kansas, N. & S. Dakota)

1. KISS (ALIVE)
2. BEACH BOYS (ENDLESS)
3. AEROSMITH (ROCKS)
4. BREAD (BEST OF)
5. ABBA (ARRIVAL)
6. PINK FLOYD (DARK SIDE)
7. DAVID SOUL
8. AVERAGE WHITE BAND
9. MICKEY MOUSE CLUB
10. LEON REDBONE

MIDWEST

(Cleveland, Detroit, Chicago, St. Louis, Indiana, Milwaukee, Pittsburgh, Kansas City)

1. AVERAGE WHITE BAND
2. STARCASTLE
3. LEON REDBONE
4. JOURNEY
5. BOOTSY'S RUBBER BAND
6. JEFFERSON AIRPLANE
7. BOB SEGER (LIVE)
8. GROVER WASHINGTON
9. DIANA ROSS
10. HALL & OATES
11. ATLANTA RHYTHM SECTION
12. RUNAWAYS
13. JEAN-LUC PONTY
14. DRAMATICS
15. 50 GUITARS

NORTHEAST

(Metro N.Y., Upstate N.Y., Boston, Connecticut, Philadelphia)

1. ATLANTA RHYTHM SECTION
2. THELMA HOUSTON
3. TRAMMPS
4. DIANA ROSS
5. ABBA
6. RENAISSANCE
7. GENTLE GIANT
8. BRAINSTORM
9. JEAN-LUC PONTY
10. JOAN ARMATRADING
11. MICHAEL FRANKS
12. CHICK COREA
13. STARCASTLE
14. SMOKEY ROBINSON
15. RUNAWAYS

WEST

(California, Seattle, Portland)

1. MICHAEL FRANKS
2. LEON REDBONE
3. JOURNEY
4. ABBA
5. GROVER WASHINGTON
6. THELMA HOUSTON
7. STARCASTLE
8. TAJ MAHAL
9. RENAISSANCE
10. GENTLE GIANT
11. HAROLD MELVIN & BLUE NOTES
12. DRAMATICS
13. GEORGE BENSON (CTI)
14. BRIAN AUGER
15. RICK DERRINGER

NATIONAL BREAKOUTS

- | | |
|------------------|---------------------|
| 1. BARRY MANILOW | 9. AEROSMITH (TOYS) |
| 2. BREAD | 10. EMMYLOU HARRIS |
| 3. GARY WRIGHT | 11. PINK FLOYD |
| 4. SANTANA | 12. MARY MACGREGOR |
| 5. DAVID BOWIE | 13. JANIS IAN |
| 6. MANFRED MANN | 14. GEORGE BENSON |
| 7. GENESIS | 15. JIMMY BUFFETT |
| 8. RUFUS | |

BALTIMORE/WASHINGTON

1. BOOTSY'S RUBBER BAND
2. GROVER WASHINGTON
3. LETTA MBULLU
4. ASHFORD & SIMPSON
5. THELMA HOUSTON
6. DENIECE WILLIAMS
7. AVERAGE WHITE BAND
8. RENAISSANCE
9. STEPHEN BISHOP
10. MICHAEL HENDERSON

SOUTH CENTRAL

(Dallas, Houston, New Orleans, Little Rock)

1. AVERAGE WHITE BAND
2. DENIECE WILLIAMS
3. LEON REDBONE
4. BOOTSY'S RUBBER BAND
5. BRIAN AUGER
6. LEO KOTTKE
7. JOURNEY
8. STARCASTLE
9. MICHAEL FRANKS
10. GATO BARBIERI
11. JEFFERSON AIRPLANE
12. GENTLE GIANT
13. TAJ MAHAL
14. MUDDY WATERS
15. MAZE

SOUTHEAST

(Atlanta, Memphis, Nashville, Charlotte, Richmond, Florida)

1. ATLANTA RHYTHM SECTION
2. AVERAGE WHITE BAND
3. JEFFERSON AIRPLANE
4. LEON REDBONE
5. BOOTSY'S RUBBER BAND
6. DIANA ROSS
7. JOURNEY
8. THELMA HOUSTON
9. GROVER WASHINGTON
10. STEPHEN BISHOP

DENVER/PHOENIX

1. MICHAEL FRANKS
2. RENAISSANCE
3. THELMA HOUSTON
4. JEFFERSON AIRPLANE
5. ATLANTA RHYTHM SECTION
6. GROVER WASHINGTON
7. STARCASTLE
8. JOURNEY
9. BLIND FAITH
10. SPIRIT

Albums listed as regional breakouts are consensus choices of the accounts listed below. These accounts assess hit potential of new LP releases based on regional sales, overall sales potential and personal predictions. Albums listed as national breakouts have been reported by a minimum of 75% of outlets listed below and have appeared in a minimum of six markets.

sonal predictions. Albums listed as national breakouts have been reported by a minimum of 75% of outlets listed below and have appeared in a minimum of six markets.

REGIONAL ALBUM ACTIVITY is compiled from sales information from the following national, regional and local wholesalers and retailers: **NATIONAL ACCOUNTS:** ABC Record & Tape Sales, Disc Records, Handelman, Korvettes, Lieberman Enterprises, J.L. Marsh/Musicland & Record Bar. **REGIONAL AND LOCAL ACCOUNTS:** Alexander's/N.Y., All Records/Oakland, Alta/Phoenix, Alwilk/N.J., Ambat/Cincinnati, Angott/Detroit, Apex-Martin/N.J., Aravox/N.Y., Banana/S.F., Bee Gee/Albany, Brass Ear/Seattle, Bromo/Dallas-Houston-Okla. City, Buffalo One Stop/Bufalo, Cactus/Houston, Capers Corner/Kansas City, Cassells/L.A., Cavages/Buffalo, Central/Hartford, Central South/Nashville, Circles/Phoenix, Commercial/Maine, Consolidated/Detroit, Norman Cooper/Phila., Cutlers/New Haven, Dan Jay/Denver, Dick's/Boston, Disco/Boston, D.J.'s/Seattle, Double B/Long Island, Ernie's/Chicago, 1812 Overture/Milwaukee, El Roy -TSS-Record World/Long Island, Everybody's Records/Portland, Evolution/Phoenix, Father's & Sun's/Indianapolis, For The Record/Baltimore, Franklin/Atlanta, Galgano/Chicago, Gardner's/Chicago, Gary's/Richmond, Giant/Virginia, Harmony House/Detroit, Harmony House/N.J., Harvard Coop/Boston, Independent/Denver, Inner Sanctum/Austin, Interstate/Miami, Jerry's/Phila., Jimmy's Music World/N.Y., King Karol/N.Y., Knox/Knoxville, Licorice Pizza/L.A., Lieberman One Stop/Minneapolis, M.J.S./Miami, Record Factory/S.F., Mile High/Denver, Modern/Milwaukee, Morey's One Stop/Balt., Mushroom/New Orleans, Music City/Nashville, Music

Menu/S.F., Music Millenium/Portland, Music Plus/L.A., Music Scene/Atlanta, Music Street/Seattle, National Record Mart/Midwest, New England Music City/Boston, Northern Records/Cleveland, Odyssey/Phoenix & Santa Cruz, Peaches/Atlanta, Cleveland, Dallas, Delwood, Denver, Ft. Lauderdale, L.A., Maple Heights & St. Louis, Peter's/Boston, Poplar/Memphis, Potomac/Washington, D.C., Prospect/Cleveland, Radio Doctors/Milwaukee, Rapid Sales/Madison, Record & Tape Collectors/Baltimore, Record Cove/Monterey, Record Dept. Merch./Memphis, Record Hole/San Antonio, Record Masters/Baltimore, Record Revolution/Cleveland, Record Shack/N.Y. & Atlanta, Record Theatre/Cleveland-Akron, Recordland/Midwest, Richman Bros./Phila., Rose/Chicago, Sam Goody/N.Y. & Phila., Schwartz Bros.-Harmony Huts/D.C., Sieberts/Little Rock, Shulman-Listening Booth/N.J.-Phila., Soul City One Stop/L.A., Soul Shack/D.C., Sound Town/Dallas, Sound Unlimited/Chicago, Sound Warehouse/Houston-Dallas, Southern/Miami, Spec's/Miami, Stark-Camelot/Midwest, Strawberrys/Boston, Streetside/St. Louis, Swallens/Cincinnati, Tape City/New Orleans, Tower/L.A., Sacramento, S.F. & San Diego, Town Hall/N.Y., Trans World/Albany, Two Guys/East Coast, United/Miami, Wax Museum/Minneapolis, Waxie Maxie/D.C., West Coast Music Sales/L.A., Western Merchandisers/Southwest, Warehouse/California, Wide World/Seattle, Wilcox-Okla. City, Win One Stop/N.Y., Zebra/Austin

Postal Rates Won't Go Up This Year

(continued from page 14)

months, partly due to the 15-state UPS strike and Christmas season volumes, he admitted. "It is likely that we will incur a deficit this year," he added.

The Postal Service will have to decide either to pare services to cut costs, or keep traditional services which are increasingly expensive. And in the opinion of the postmaster general, the intelligent choice is to "tailor our services to match the public's need and willingness to pay," reducing the specialized capacities for certain parcel shippers who now use the Postal Service as a backup "carrier of last resort."

The long-range prospect of rising costs and declining volume will be addressed by a study commission, established last year, in a report to Congress and the President expected by March 15.

Bailar warned that the public must get involved. "Otherwise, we run the risk of

having these postal issues . . . being addressed only by special interest groups which have an understandably, but nonetheless parochial interest in postal matters." (He did not specifically address the record industry's special problems at any point in his speech and a spokesman for the service in Washington declined to elaborate on how the postmaster general's comments apply to the industry.)

The Postal Reorganization Act of 1970, which has come under criticism for causing rate hikes of the past several years, as well as for sacrificing services in order to hold down costs, got unqualified support from Bailar. "(It) is a good law," he said. "I am not proposing that this mandate (to provide good service at reasonable cost) be changed. I am proposing that the new structure established to meet this mandate be continued and that the process of postal reform be continued."

Proposed Pickwick Sale Pending

(continued from page 9)

suggested that the ultimate success of American Can in operating Pickwick would depend mostly on its ability to retain the present Pickwick management. "Independent distribution and rack jobbing are rough businesses today," Steenken noted, rattling off a list of items contributing to a relatively tight cash flow at Pickwick.

Major Problems

Major problems for today's independent distributors include an increasingly low markup, approaching the break-even point, and regional distribution leaving fewer distributors to service more accounts. The rack jobber, for his part, is threatened by record company pricing policies, which according to industry sources, make record sales an unprofitable venture for the general merchandiser. Fortunately, sources say, Pickwick has nearly 300 Musicland, Discount Record and

Aurasound retail stores to fall back on.

Seymour Leslie, chairman of Pickwick, told **Cash Box** that to discuss his feelings about the proposed merger or his own future under new management would not be "meaningful" at this time. "I haven't thought about it," Leslie said of his own plans, but added, "obviously they (American Can) plan to keep the management here intact. They wouldn't be interested in acquiring this business (otherwise)."

Security analysts familiar with American Can had questioned the ability of the metal container and consumer products manufacturer to profitably run a record distribution and retailing operation (**Cash Box**, February 12). But American Can officials insisted their national consumer products distribution network could eventually be meshed with Pickwick's to their mutual benefit.

RETAIL LP SELLING PRICES

Atlanta

At **Franklin Music** (3 locations), these features over two pages: "Wings Over America" (3 LPs/\$13.98 list) for \$7.98/\$9.98 tape (with coupon); and the latest release by the Nitty Gritty Dirt Band (3 LPs/\$11.98 list) for \$7.99. (Sunday *Atlanta Journal and Constitution*).

Baltimore

At **Korvettes** (4 locations), these features: multi-label sale (including CBS, A&M, Motown, UA, MCA and Arista) for \$3.99/\$5.79 tape; three Verdi opera sets on Angel, including "Macbeth" (each 3 LPs/\$21.98 list) for \$12.72; and four other Angel releases, including Massenet's "Thais" featuring Beverly Sills (3 LPs/\$22.98 list) for \$12.72, Beethoven's "Missa Solemnis" (2 LPs/\$13.78 list) for \$7.98; Wagner's "Rienzi" (5 LPs/\$31.98 list for \$20.70 and Strauss' "Wiener Blut" (2 LPs/\$13.98 list) for \$8.73. At **Record and Tape Collector** (5), Jim Croce's "Time In A Bottle" for \$3.94/\$5.69 tape. At **Murphy's** stores, assorted cutout LPs at two for \$3; cutout tapes at two for \$5. At **Drug Fair** stores, 10 releases, including the latest LPs by Jimmy Buffett, Harold Melvin and the Blue Notes, Rufus and Engelbert Humperdinck for \$4.88/\$5.88 tape. (Sunday *Baltimore Sun*).

Boston

At the **Coop** (3 locations), these features over two pages: 15 releases, including the latest LPs by Gary Wright, Abba, Janis Ian, Santana, Tony Bird and Valerie Carter for \$3.89; and the latest releases by Pink Floyd and George Benson (\$7.98 list) for \$4.89. At **Strawberries** (3), these features over five pages: 37 releases, including the latest LPs by Larry Coryell, Roy Ayers, the Kinks, Al Stewart, Bob Seger, Steve Miller, David LaFlamme, Crown Heights Affair, Rick Dees, Rufus, Jackson Browne and Manfred Mann for \$3.89; the latest album by Thin Lizzy for \$3.89, tied to upcoming area concert; the debut LPs by Kerry Chater and the Sanford and Townsend Band for \$3.99 with ticket stub from "Odyssey '77" concert; the latest release by Millie Jackson for \$3.89, tied to special "Valentine's Night" promotion; and the newest LPs by Pink Floyd and George Benson (\$7.98 list) for \$4.89. At **Music City** (3), these features over three pages: 20 releases, including the latest albums by Thelma Houston, Tina Charles, Janis Ian, Rick Wakeman and the Salsoul Orchestra, and the soundtrack to "Roots" for \$3.89; the latest LP by Pink Floyd (\$7.98 list) for \$4.89; the newest release by Diana Ross (2 LPs/\$7.98 list) for \$4.89; the soundtrack to "A Star Is Born" (\$8.98 list) for \$5.89; and five "Golden Oldies" on Blue Note including 2 LP sets by Horace Silver, Booker Ervin and Freddie Hubbard (\$7.98 list) for \$4.89. At **Music Center** (2), the latest LP by Pink Floyd (\$7.98 list) for \$4.59/\$4.99 tape; and Pink Floyd's "Wish You Were Here" for \$3.99. At **Lechmere** (6), ad promoting Keith Herman's debut LP on Midland, tied to upcoming area concert, price not included. Ad promoting the latest LP by Queen (\$7.98 list) and the rest of the Queen catalog at the Coop, Discount Records, Music City, Musicland and Good Vibrations, tied to upcoming concert. Ad promoting six Atlantic releases, including the latest LPs by Herbie Mann and Nat Aschery, at the Coop, Strawberries and Music City, tied to in-store contest, price not included. (Sunday *Boston Globe* and the *Boston Phoenix*, February 8).

Chicago

At **Musicland** (8 locations), the latest release by Pink Floyd (\$7.98 list) for \$4.79/\$5.99 tape. (Sunday *Chicago Tribune*).

Cincinnati

No ads appeared in the Sunday *Cincinnati Enquirer*.

Cleveland

At **J.P. Snodgrass** (14 locations), all-label sale for \$3.99. (Cleveland *Plain Dealer*, February 4 and 6).

Dallas

At **Soundtown** (3 locations), the latest release by the Nitty Gritty Dirt Band (3 LPs/\$11.98 list) for \$6.89/\$8.89 tape. At **Treasury** stores, assorted cutout LPs and tapes for \$2. At **Gibson's** stores, assorted cutout LPs and tapes for \$1-\$2. (Sunday *Dallas Times-Herald* and *Dallas Morning News*, February 4 and 6).

Denver

At **Target** stores, eight CBS releases, including the latest LPs by EWF, Chicago, Boston and Ted Nugent for \$3.99; and the soundtrack to "A Star Is Born" (\$8.98 list) for \$5.99 per LP or tape. (Sunday *Denver Post*).

Detroit

At **Korvettes** (5 locations), these features over two pages: multi-label sale (including CBS, A&M, UA, Buddah, WEA, MCA, Casablanca and Capitol) for \$3.99/\$5.79 tape; the Barry Manilow catalog on Arista for \$3.99; the soundtrack to "Car Wash" and the latest LP by Lynyrd Skynyrd (both 2 LPs/\$7.98 list) for \$4.89; Elton John's "Blue Moves" (2 LPs/\$12.98 list) for \$7.49; the latest LP by Pink Floyd (\$7.98 list) for \$4.89/\$5.79 tape; and the soundtrack to "A Star Is Born" (\$8.98 list) for \$5.79/\$6.79 tape. (Sunday *Detroit News*).

Houston

At **Cactus Records and Tapes**, five London Collector Series releases, including the "Best Of Savoy Brown" and Thin Lizzy's "Rocker" for \$3.59/\$3.99 tape. (Sunday *Houston Chronicle*).

Indianapolis

At **Ayr Way** (8 locations), these features: 12 releases, including the latest albums by ZZ Top, Gary Wright, Rufus and Janis Ian for \$3.99/\$5.55 tape; the latest release by David Bowie (\$7.98 list) for \$4.99/\$5.55 tape; and the soundtrack to "A Star Is Born" for \$5.99; and Jefferson Airplane's "Flight Log" (2 LPs/\$10.98 list) for \$6.77/\$7.77 tape. (Sunday *Indianapolis Star*).

Kansas

No ads appeared in the Sunday *Kansas City Star*.

Los Angeles

At **The Wherehouse** (24 locations), these features over four pages: all CBS releases including the latest releases by Chicago, Santana, Burton Cummings, Janis Ian, Phoebe Snow, Aerosmith, The Jacksons, Ted Nugent, Boston, EWF, Engelbert Humperdinck and The Emotions, for \$3.96/\$4.77 tape; Pink Floyd's "Animals" (\$7.98 list) for \$4.77 LP or tape; the latest release by Dave Mason (2 LPs/\$7.98 list) for \$4.77/\$5.18 tape; the soundtrack of "A Star Is Born" (\$8.98 list) for \$5.18 LP or tape; all Columbia and Odyssey classics for \$3.96 and \$2.33 respectively; David Bowie's "Low" on RCA (\$7.98 list) for \$4.77 LP or tape; the latest release by the Jefferson Airplane on Grunt (2 LPs/\$10.98 list) for \$6.20/\$6.81 tape; three LPs by Steve Miller for \$3.96/\$4.77 tape tied to upcoming area concert appearance for \$3.96/\$4.77 tape; and RSO Collectors Editions, including albums by Cream, Eric Clapton and Blind Faith, for \$3.96/\$4.77 tape. At **Music Plus** (15), the latest release by the Nitty Gritty Dirt Band (2 LPs/\$11.98 list) for \$5.29/\$7.99 tape; and the newest LP by Engelbert Humperdinck, "After The

Lovin'" for \$3.69 per disk. At **Zodys** stores, "Time In A Bottle" by Jim Croce on Lifesong for \$3.66/\$4.66 tape. (Sunday *Los Angeles Times*).

Miami

No ads appeared in the Sunday *Miami Herald*.

New Orleans

At **New Attitude Records and Tapes**, four "features of the week," including "Fleetwood Mac" and Linda Ronstadt's "Greatest Hits" for \$2.99. At **Smith's Record Center**, all RCA Red Seal releases (\$7.98 list) for \$4.98 per disk. At **Woolco** stores, assorted cutout LPs at three for \$5, cutout tapes at two for \$5. (Sunday *New Orleans Times-Picayune*).

New York

At **Sam Goody** (27 locations), these features over three pages: all-label "rock-folk-soul" sale for \$3.74; 10 "Super Picks" including the latest albums by Boston, Bob Seger, McCoo/Davis, Santana, Carol Douglas, Al Green, the Blackbyrds, Genesis, Leo Kottke and Joan Baez for \$2.99/\$4.99 tape; two releases on Casablanca, including Donna Summer's "Love To Love You Baby" for \$3.49; "An Evening With Diana Ross" (2 LPs/\$7.98 list) for \$4.89/\$7.59 tape; 14 London and ABC classical releases, including Wolf-Ferrari's "The Secret Of Susanna" for \$3.99; 14 London and ABC classical releases (\$3.98 list) for \$2.39 per disk; and "20% off" all Capitol/EMI classical imports. At **Korvettes** (32), these features over three pages: multi-label sale (including CBS, A&M, Motown, MCA, UA, Island, Arista and Lifesong) for \$3.99/\$5.79 tape; 12 "Super Specials," including the latest albums by Donna Summer, Leo Sayer, Boz Scaggs, Brass Construction, John Denver, Kiss, Barry Manilow, EWF, McCoo/Davis, Crosby-Nash and Lonnie Liston Smith, and "War's Greatest Hits" for \$2.99 (limit one of each to a customer); the latest release by Pink Floyd (\$7.98 list) for \$4.89/\$5.79 tape; the latest release by Isaac Hayes and Dionne Warwick (2 LPs/\$8.98 list) for \$5.88; four Angel classical releases, including Verdi's "Macbeth" and "Aida" (all 3 LPs/\$23.98 list) for \$12.72; and three other Angel releases, including Wagner's "Rienzi" (5 LPs/\$31.98 list) for \$16.71; Strauss' "Wiener Blut" (2 LPs/\$13.98 list) for \$8.73; and Beethoven's "Missa Solemnis" (2 LPs/\$13.98 list) for \$7.98. At **Mups** stores, the latest release by Engelbert Humperdinck for \$3.99/\$4.99. At **Record Hunter** (2), these features: all-label sale for \$3.87/\$4.93 tape; and three DG classical imports, including Chopin's "Polonaises" (\$7.98 list) for \$4.69; Haydn's "Prussian Quartets" (3 LPs/\$23.94 list) for \$13.99; and Wagner's "Die Meistersinger" (5 LPs/\$39.90 list) for \$22.99. Casablanca Records tie-in to upcoming area Kiss concert with no store tie-in. (Sunday *New York Times*).

Philadelphia

At **Sam Goody** (5 locations), these features over two pages: all-label "rock-folk-soul" sale for \$3.99; and 20% off all other LPs and tapes; the latest albums by Pink Floyd (\$7.98 list) for \$4.99/\$5.79 tape; Meyerbeer's "La Prophete" (4 LPs/\$27.98 list) for \$16.76; "Leopold Stokowski Conducts Bizet" (no list price) for \$2.99; 11 London classical releases, including "Zubin

Mehta Conducting Dvorak's Symphony No. 8" for \$4.19; and 11 London treasury series LPs (\$3.98 list) for \$2.59 per disk. At **Korvettes** (5), these features: multi-label sale (including CBS, A&M, MCA, UA and Arista) for \$3.99/\$5.79 tape; the latest LPs by Queen and Pink Floyd (both \$7.98 list) for \$4.89/\$5.79 tape; and the soundtrack to "A Star Is Born" for \$5.79. At **Music Scene** (2), these features: 14 releases, including the latest LPs by the Atlanta Rhythm Section, Boz Scaggs, Santana, Janis Ian and Jim Croce's "Time In A Bottle" for \$3.88/\$5.44 tape; the latest release by Pink Floyd (\$7.98 list) for \$4.88/\$5.44 tape; "Leopold Stokowski Conducts Bizet" for \$2.99; the latest albums by Chick Corea (2 LPs/\$9.98 list) for \$6.99/\$8.99 tape; and three Columbia classical releases, including "Wild About Eubie" for \$4.88 (Sunday *Philadelphia Bulletin* and *Philadelphia Inquirer*).

Pittsburgh

At **Murphy's** stores, same ad with the identical features and prices that appeared in Baltimore. (Sunday *Pittsburgh Press*).

St. Louis

No ads appeared in the Sunday *St. Louis Globe-Democrat* or *St. Louis Post-Dispatch*.

San Diego

At **The Wherehouse** (10 locations), all CBS releases, including the latest LPs by Aerosmith, Burton Cummings, Chicago, EWF, The Emotions, Santana, Boston, Ted Nugent, Kansas, Phoebe Snow, The Jacksons and Janis Ian, for \$3.96/\$4.77 tape; Pink Floyd's "Animals" (\$7.98 list) for \$4.77 LP or tape; the latest release by Dave Mason (2 LPs/\$7.98 list) for \$4.77/\$5.18 tape; and the soundtrack of "A Star Is Born" (\$8.98 list) for \$5.18 LP or tape. (Sunday *San Diego Union*).

San Francisco

At **The Wherehouse** (19 locations), all CBS releases including the latest LPs by Chicago, EWF, Boston, Kansas, The Emotions, Ted Nugent, Phoebe Snow, Aerosmith, Janis Ian and The Jacksons, for \$3.96/\$4.77 tape; Pink Floyd's "Animals" (\$7.98 list) for \$4.77 LP or tape; Dave Mason's latest release (2 LPs/\$7.98 list) for \$4.77/\$5.18 tape; the soundtrack of "A Star Is Born" (\$8.88 list) for \$5.18 LP or tape; and all Columbia and Odyssey classical releases for \$3.96 and \$2.33 respectively. At **Tower** (3), RSO Collectors Editions, including albums by Cream, Eric Clapton and Blind Faith, for \$3.99 per disk; "Wheels Of Fire" by Cream (2 LPs/\$9.98 list) for \$5.99; "Layla" by Derek & The Dominos (2 LPs/\$9.98 list) for \$5.99; and Jim Croce's "Time In A Bottle" LP for \$3.99/\$4.99 tape. (Sunday *San Francisco Chronicle* Datebook/This World).

Tampa

No ads appeared in the Sunday *Tampa Tribune* and *Tampa Times*.

Tulsa

No ads appeared in the Sunday *Tulsa World*.

Washington

At **Korvettes** (5 locations), same ad with the identical features and prices that appeared in Baltimore. At **Sounds Impossible**, all-label "going out of business" sale for \$3.59. At **Record and Tape Ltd. and The Book Annex** (2), Jim Croce's "Time In A Bottle" for \$3.99. At **Kemp Mill Records** (5), these features: all-label sale for \$3.99; the soundtrack to "A Star Is Born" for \$5.99; and 10% off all cutout releases with purchase of two LPs, 20% off with purchase of three or more LPs. At **Discount Record and Book Shop** (2), all-label classical "Bach And Before" sale (all Medieval, Renaissance and Baroque classical LPs included). At **Serenade Record Shops** (3), four Verve jazz releases (2 LPs/\$7.98 list) for \$4.99. (Sunday *Washington Post*).

(All information in the above chart gathered from February 6 editions unless otherwise indicated.)



FUTURE FANS — A&M recording artist Burt Bacharach autographed his new LP, "Futures," for fans at Korvettes' main New York store. Pictured from behind the desk are: Bacharach; Dave Rothfield, vice president and divisional merchandising manager for Korvettes; and Harold Childs, vice president of promotion for A&M.

Cash Box Country

ACE Report Scores Country Stations

by Carmen Adams

NASHVILLE — In November 1958, a group of dedicated country music executives got together to organize the Country Music Association, which according to some is "America's most active trade association." Then in November 1974 a challenger to that title — the Association of Country Entertainers — was formed, in the words of Barbara Mandrell at a press conference marking the second anniversary of the group last year, "to permit our member artists to pool resources for the benefit of all members; to deal with the kinds of problems entertainers face while trying to make our livings; and, in all possible cases to bring the fans and entertainers closer together."

Although the formation of ACE was triggered by the 1974 CMA awards show, which saw Olivia Newton-John and John Denver receive top honors, its beginnings are rooted in a fervent dissatisfaction with country music practices and procedures. And while ACE has tried hard to bring its complaints to the attention of the industry, such actions often have had the effect of blurring the distinction between its role and that of CMA. According to executive director Jo Walker, the purpose of CMA — which is comprised of close to 4,000 annual members, as opposed to ACE's membership of slightly over 100 — is "to publicize and

promote country music. In the early sixties there were only 81 country music stations in the United States, where today there are more than 1,200 full country stations." While such figures suggest impressive growth in the popularity of country music, several performers have questioned the validity of many of these stations because their programming policies continue to weed out a lot of the music available to them. Which goes a long way, no doubt, toward explaining why since the 1974 row over the CMA awards presentations, ACE has turned its attention to a thorough examination of so-called "country music stations."

Survey Conducted

In so doing, ACE conducted an exhaustive survey of country music listeners, which has been compiled and distributed to the CMA board of directors as well as leading record company and radio and television representatives. Along with its report, ACE filed a position paper scoring country radio stations for their abbreviated playlists and outlining the need for such things as: detailed, up-to-date market research; more effective methods of record distribution; more accurate determination of listener preferences; and a program to increase proficiency, competency and professionalism within this important segment of the industry. In addition, the organization contends that most stations are adhering to a top 40 format that eliminates traditional country music and doesn't give upcoming talent an opportunity to be heard.

The ACE communication services package included a 36-page composite of letters from country music listeners rating stations in their area. The questionnaire was published in the September 1976 issue of *Music City News*, and asked listeners to evaluate stations according to the following system: 1 — Boring, the same thing over and over; 2 — Couldn't be better; 3 — Can hardly tell it's country; 4 — Never plays "hard" or traditional country; 5 — Plays good balance of all types of country; 6 — Sounds like no one at the station really likes country music; 7 — The station's disc jockeys love the music, and the listeners can tell it; 8 — I phone to make requests but they never get played; and 9 — I believe the station tries to play my requests when I phone them. Space for comment was provided as well.

Dissatisfaction characterized most of the letters from fans across the country. Stations most under fire for their programming were WHN in New York and WMAQ in Chicago. And the complaints most often voiced by listeners cited boring, repetitive formats and unresponsiveness to requests as major problems facing country stations. In all fairness, though, it should be pointed out that there were also some positive letters commending jocks for their knowledge of country music and receptivity of requests.

Program directors from top country stations around the nation offered comments in their defense, and these were also included in the ACE package.

Stations Respond

Roy Oden, general manager of KJJJ in Phoenix, said, "The major fact that (ACE) fails to understand, is that radio stations are not in business to further the careers of recording artists nor fill the coffers of the recording or publishing companies. Our primary business is to be a servant to the public, to operate our business on a profit basis and to please most of our listeners most of the time."

Charles Stone, music director of WKDR in Plattsburgh, New York explained that station's music policy. "Our slogan curren-

(continued on page 48)

Top 50 Country Albums

	Weeks On Chart		Weeks On Chart
1	11	25	19
2	13	26	2
3	8	27	25
4	15	28	26
5	10	29	3
6	14	30	19
7	11	31	10
8	3	32	2
9	15	33	23
10	20	34	26
11	14	35	17
12	33	36	9
13	14	37	2
14	14	38	4
15	15	39	12
16	13	40	39
17	24	41	33
18	7	42	7
19	8	43	1
20	24	44	3
21	8	45	2
22	4	46	1
23	18	47	1
24	11	48	6
		49	12
		50	11

Speakers Announced

NASHVILLE — The Country Radio Seminar, to be held March 18-19 at Nashville's Airport Hilton Motor Inn, will include George Duncan, Archie Campbell and Darrell Royal as featured speakers during the two-day radio dynamics meet.

George Duncan, president of Metromedia Radio, will deliver Friday's morning address for the opening day activities. "Hee Haw" star Archie Campbell is scheduled to speak during the opening day luncheon; and Darrell Royal, athletic director at the University of Texas, will give the wrap-up speech on Saturday.

This year's event, under the direction of seminar chairman Tom McEntee and agenda committee chairman Mac Allen, will center around the theme "The Business of Winning." The registration fee has been established at \$65 per person affiliated with broadcasting, and \$85 per person with other industry affiliations. For spouses not in either previous category, the charge will be \$25. The registration cost includes entrance to the seminar, two luncheons and one ticket to the New Faces Dinner & Show to be held Saturday evening, March 19. The seminar has outlined plans for a maximum of 300 registrants.

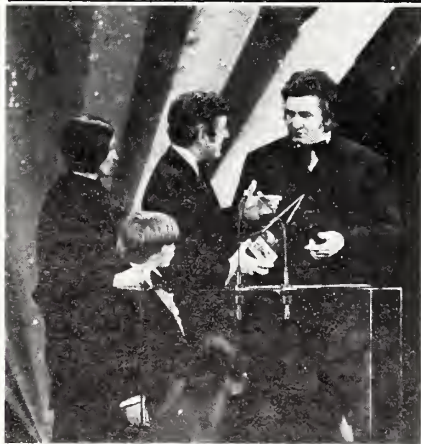

HONORS FOR CASH — Singer Johnny Cash was the recipient of a special merit award given to him during the recent American Music Awards. In photo above, Tennessee Governor Ray Blanton presents award to Cash, while June Carter and John Carter Cash look on.



NASHVILLE GATHERING — Actor Claude Akins, third from left, dropped by the Pickin' Parlor in Nashville to watch Monument's Larry Gatlin at his recent appearance there. Pictured above, from left to right, are Tom Rodden, vice president-sales for Monument; John Dorris, vice president-finance; Akins; Gatlin; Paul Lovelace, vice president-promotion; and Tex Davis, director of country promotion for the label.

WPLO — ATLANTA

#1 — Say You'll Stay Until Tomorrow — Tom Jones — Epic
9 To 3 — Uncloudy Day — Willie Nelson — Columbia
Ex To 30 — I'm Gonna Love You Right Out Of This World — David Rogers — Republic

WPOC — BALTIMORE

#1 — Let My Love Be Your Pillow — Ronnie Milsap — RCA
Adios Amigo — Marty Robbins — Columbia
Every Beat Of My Heart — Peggy Sue — Door Knob
18 To 13 — Heart Healer — Mel Tillis — MCA
22 To 17 — The Movies — The Statler Brothers — Mercury
Ex To 40 — Sam — Olivia Newton-John — MCA

WYDE — BIRMINGHAM

#1 — Lucille — Kenny Rogers — UA
Lately I've Been Thinking Too Much — David Allan Coe — Columbia
Family Man — Jerry Foster — Hitsville
16 To 5 — You're Free To Go — Sonny James — Columbia
23 To 6 — Say You'll Stay Until Tomorrow — Tom Jones — Epic

27 To 18 — I'm Gonna Love You Right Out Of This World — David Rogers — Republic
Ex To 37 — Slide Off Your Satin Sheets — Johnny Paycheck — Epic

Ex To 38 — I'm Living A Lie — Jeanne Pruett — MCA
Ex To 39 — She's Pulling Me Back Again — Mickey Gilley — Playboy
Ex To 40 — Just Getting By — Red Sovine — Starday
Ex To 41 — Never Really Been In Love — Jim Mundy — ABC/Dot

WCOP — BOSTON

#1 — Near You — George Jones & Tammy Wynette — Epic
Midnight Angel — Barbara Mandrell — ABC/Dot
Southern Nights — Glen Campbell — Capitol
He'll Play The Music, But You Can't Make Him Dance — Little David Wilkins — MCA

The Movies — The Statler Brothers — Mercury
Adios Amigo — Marty Robbins — Columbia
29 To 21 — In The Mood — Henhouse Five Plus Too — WB
26 To 18 — Ridin' Rainbows — Tanya Tucker — MCA
20 To 14 — Baby, You Look Good To Me Tonight — John Denver — RCA

17 To 10 — Say You'll Stay Until Tomorrow — Tom Jones — Epic
15 To 8 — Moody Blue — Elvis Presley — RCA
Ex To 27 — After The Lovin' — Engelbert Humperdinck — Epic

Ex To 28 — Sam — Olivia Newton-John — MCA
Ex To 29 — She's Just An Old Love Turned Memory — Charley Pride — RCA
Ex To 30 — New Kid In Town — Eagles — Asylum

WWOL — BUFFALO

#1 — Near You — Jones & Wynette — Epic
42 To 37 — Sam — Olivia Newton-John — MCA
43 To 36 — Adios Amigo — Marty Robbins — Columbia
40 To 35 — Easy Look — Charlie Rich — Epic
38 To 33 — I'm Gonna Love You Right Out Of This World — David Rogers — Republic

37 To 30 — Lucille — Kenny Rogers — UA
34 To 29 — Southern Nights — Glen Campbell — Capitol
33 To 28 — Wrap Your Love Around Your Man — Lynn Anderson — Columbia
32 To 26 — She's Just An Old Love Turned Memory — Charley Pride — RCA

31 To 25 — My Mountain Dew — Charlie Rich — RCA
30 To 24 — Your Pretty Roses Came Too Late — Lois Johnson — Polydor
10 To 5 — Uncloudy Day — Willie Nelson — Columbia
44 To 39 — It Couldn't Have Been Any Better — Johnny Duncan — Columbia

47 To 40 — Don't Throw It All Away — Dave & Sugar — RCA
46 To 41 — Right Time Of The Night — Jennifer Warnes — Arista
24 To 17 — Vegas — Bobby & Jeannie Bare — RCA
26 To 18 — Torn Between Two Lovers — Mary Macgregor — Ariola America/Capitol

29 To 19 — The Movies — The Statler Brothers — Mercury
28 To 21 — Just Came Home To Count The Memories — Cal Smith — MCA
Ex To 46 — He'll Play The Music, But You Can't Make Him Dance — Little David Wilkins — MCA
Ex To 47 — Paper Rosie — Gene Watson — Capitol
Ex To 48 — Mockingbird Hill — Donna Fargo — Warner Bros.

Ex To 49 — All The Sweet — Mel McDaniels — Capitol
Ex To 50 — She's Got You — Loretta Lynn — MCA

WAME — CHARLOTTE

#1 — Say You'll Stay Until Tomorrow — Tom Jones — Epic
Mockingbird Hill — Donna Fargo — Warner Bros.
You're Free To Go — Sonny James — Columbia
Adios Amigo — Marty Robbins — Columbia
Sweet City Woman — Johnny Carver — ABC/Dot
Yesterday's Gone — Vern Gosdin — Elektra
14 To 9 — After The Lovin' — Engelbert Humperdinck — Epic

21 To 16 — New Kid In Town — Eagles — Asylum
27 To 17 — Southern Nights — Glen Campbell — Capitol
28 To 22 — Loving Arms — Sammi Smith — Elektra
Ex To 28 — Desperado — Johnny Rodriguez — Mercury
Ex To 29 — He'll Play The Music, But You Can't Make Him Dance — Little David Wilkins — MCA
Ex To 30 — The Movies — The Statler Brothers — Mercury

WMAQ — CHICAGO
#1 — Near You — Jones & Wynette — Epic
20 To 11 — Torn Between Two Lovers — Mary Macgregor — Ariola America/Capitol
Ex To 28 — Southern Nights — Glen Campbell — Capitol
Ex To 30 — Twenty Four Hours From Tulsa — Randy Barlow — Gazelle

Ex To 31 — Heart Healer — Mel Tillis — MCA
Ex To 35 — It Couldn't Have Been Any Better — Johnny Duncan — Columbia
Ex To 36 — Sam — Olivia Newton-John — MCA
Ex To 37 — Sweet City Woman — Johnny Carver — ABC/Dot

WJJD — CHICAGO

#1 — Liars One, Believers Zero — Bill Anderson — MCA
Don't Throw It All Away — Dave & Sugar — RCA
Wrap Your Love Around Your Man — Lynn Anderson — Columbia
New Kid In Town — Eagles — Asylum
She's Got You — Loretta Lynn — MCA
Lucille — Kenny Rogers — UA
Mockingbird Hill — Donna Fargo — Warner Bros.
I'm Gonna Love You Right Out Of This World — David Rogers — Republic

30 To 25 — The Movies — The Statler Brothers — Mercury
29 To 23 — After The Lovin' — Engelbert Humperdinck — Epic
27 To 20 — She's Just An Old Love Turned Memory — Charley Pride — RCA
25 To 18 — Desperado — Johnny Rodriguez — Mercury
23 To 17 — Heart Healer — Mel Tillis — MCA
21 To 16 — Two Less Lonely People — Rex Allen Jr. — WB

17 To 10 — Ridin' Rainbows — Tanya Tucker — MCA
Ex To 26 — Southern Nights — Glen Campbell — Capitol
Ex To 27 — Whispers — Bobby Borchers — Playboy
Ex To 28 — You're Free To Go — Sonny James —

— ABC/Dot
Ex To 32 — New Kid In Town — Eagles — Asylum
Ex To 36 — I Just Came Home To Count The Memories — Cal Smith — MCA
Ex To 38 — I'm Gonna Love You Right Out Of This World — David Rogers — Republic
Ex To 39 — Wrap Up Your Love Around Your Man — Lynn Anderson — Columbia
Ex To 40 — Good 'N' Country — Kathy Barnes — Republic

— ABC/Dot
#1 — Say You'll Stay Until Tomorrow — Tom Jones — Epic
Whispers — Bobby Borchers — Playboy
She's Pulling Me Back Again — Mickey Gilley — Playboy
You're Free To Go — Sonny James — Columbia
Lay Something On My Bed Besides A Blanket — Charly McClain — Epic
22 To 10 — Paper Rosie — Gene Watson — Capitol
40 To 30 — Blue Eyes Cryin' In The Rain — Ace Cannon — Hi
20 To 11 — Desperado — Johnny Rodriguez — Mercury
29 To 20 — Good Old Fashioned Saturday Night Barroom Brawls — Vernon Oxford — RCA
31 To 21 — She's Just An Old Love Turned Memory — Charley Pride — RCA
37 To 24 — I'm Not Easy — Billie Jo Spears — UA
Ex To 36 — Lord If I Make It To Heaven (Can I Bring My Own Angel Along) — Billy Parker — SCR
Ex To 39 — He'll Play The Music, But You Can't Make Him Dance — Little David Wilkins — MCA
Ex To 40 — Midnight Angel — Barbara Mandrell — ABC/Dot

— ABC/Dot
#1 — Torn Between Two Lovers — Mary Macgregor — Ariola
Texas Angel — Jacky Ward — Mercury
Lord If I Make It To Heaven (Can I Bring My Own Angel Along) — Billy Parker — SCR
13 To 5 — In The Mood — Henhouse Five Plus Too — Warner Bros.
14 To 7 — My Mountain Dew — Charlie Rich — RCA
17 To 10 — Heart Healer — Mel Tillis — MCA
19 To 11 — Desperado — Johnny Rodriguez — Mercury
21 To 9 — Southern Nights — Glen Campbell — Capitol
22 To 13 — Paper Rosie — Gene Watson — Capitol

— ABC/Dot
#1 — Torn Between Two Lovers — Mary Macgregor — Ariola
She's Got You — Loretta Lynn — MCA
Lay Something On My Bed Besides A Blanket — Charly McClain — Epic
30 To 23 — Easy Look — Charlie Rich — Epic
29 To 20 — She's Just An Old Love Turned Memory — Charley Pride — RCA
28 To 18 — Lucille — Kenny Rogers — UA
24 To 19 — I Just Came Home To Count The Memories — Cal Smith — MCA
20 To 15 — You Could Be Coming To Me — Statler Brothers — Mercury
16 To 10 — Moody Blue — Elvis Presley — RCA
14 To 9 — He'll Play The Music, But You Can't Make Him Dance — Little David Wilkins — MCA
Ex To 29 — Don't Throw It All Away — Dave & Sugar — RCA

KLAC — LOS ANGELES
#1 — Near You — Jones & Wynette — Epic
57 To 49 — Adios Amigo — Marty Robbins — Columbia
55 To 48 — Your Pretty Roses Came Too Late — Lois Johnson — Polydor
56 To 47 — It Couldn't Have Been Any Better — Johnny Duncan — Columbia
53 To 45 — My Mountain Dew — Charlie Rich — RCA
54 To 43 — Wrap Your Love Around Your Man — Lynn Anderson — Columbia
47 To 40 — Good 'N' Country — Kathy Barnes — Republic
45 To 38 — Easy Look — Charlie Rich — Epic
40 To 26 — The Movies — The Statler Brothers — Mercury
22 To 14 — If Love Was A Bottle Of Wine — Tommy Overstreet — ABC/Dot
34 To 24 — She's Just An Old Love Turned Memory — Charley Pride — RCA
42 To 25 — Torn Between Two Lovers — Mary Macgregor — Ariola America/Capitol
Ex To 52 — Lucille — Kenny Rogers — UA
Ex To 53 — Mockingbird Hill — Donna Fargo — Warner Bros.
Ex To 54 — Don't Throw It All Away — Dave & Sugar — RCA
Ex To 55 — Slide Off Your Satin Sheets — Johnny Paycheck — Epic
Ex To 56 — Audobon — C.W. McCall — Polydor
Ex To 57 — The Last Gunfighter Ballad — Johnny Cash — Columbia

WINN — LOUISVILLE
#1 — Say You'll Stay Until Tomorrow — Tom Jones — Epic
I'm Living A Lie — Jeanne Pruett — MCA
Paper Rosie — Gene Watson — Capitol
Loving Arms — Sammi Smith — Elektra
Sorry For You My Friend — Moe Bandy — Columbia
17 To 6 — Torn Between Two Lovers — Mary Macgregor — Ariola America/Capitol
14 To 8 — He'll Play The Music, But You Can't Make Him Dance — Little David Wilkins — MCA
18 To 10 — Slide Off Your Satin Sheets — Johnny Paycheck — Epic
26 To 16 — Lucille — Kenny Rogers — UA
30 To 17 — Adios Amigo — Marty Robbins — Columbia
Ex To 26 — It Couldn't Have Been Any Better — Johnny Duncan — Columbia
Ex To 28 — She's Pulling Me Back Again — Mickey Gilley — Playboy

WMC — MEMPHIS
#1 — Near You — Jones & Wynette — Epic
All The Sweet — Mel McDaniels — Capitol
Mockingbird Hill — Donna Fargo — Warner Bros.
Your Pretty Roses Came Too Late — Lois Johnson — Polydor
Wrap Your Love Around Your Man — Lynn Anderson — Columbia
Sunday School To Broadway — Anne Murray — Capitol
Slide Off Your Satin Sheets — Johnny Paycheck — Epic
(There's Nothing Like The Love) Between A Woman And A Man — Reba McEntire — Mercury
Blue Eyes Cryin' In The Rain — Ace Cannon — Hi
26 To 12 — Heart Healer — Mel Tillis — MCA
22 To 11 — Why Lovers Turn To Strangers — Freddie Hart & The Heartbeats — Capitol
16 To 5 — Crazy — Linda Ronstadt — Asylum
14 To 3 — Uncloudy Day — Willie Nelson — Columbia
Ex To 24 — If Love Was A Bottle Of Wine — Tommy Overstreet — ABC/Dot
Ex To 25 — Whispers — Bobby Borchers — Playboy
Ex To 26 — It Couldn't Have Been Any Better — Johnny Duncan — Columbia
Ex To 28 — Midnight Angel — Barbara Mandrell — ABC/Dot
Ex To 29 — I Just Came Home To Count The Memories — Cal Smith — MCA

WUNI — MOBILE
#1 — Say You'll Stay Until Tomorrow — Tom Jones — Epic
Don't Throw It All Away — Dave & Sugar — RCA
Easy Look — Charlie Rich — Epic
She's Got You — Loretta Lynn — MCA

— ABC/Dot
#1 — Say You'll Stay Until Tomorrow — Tom Jones — Epic
Whispers — Bobby Borchers — Playboy
She's Pulling Me Back Again — Mickey Gilley — Playboy
You're Free To Go — Sonny James —

— ABC/Dot
#1 — Say You'll Stay Until Tomorrow — Tom Jones — Epic
Lucille — Kenny Rogers — UA
It Couldn't Have Been Any Better — Johnny Duncan — Columbia
Adios Amigo — Marty Robbins — Columbia
I'm Gonna Love You Right Out Of This World — David Rogers — Republic
Sam — Olivia Newton-John — MCA
I'm Not Easy — Billie Jo Spears — UA
I'm Getting High On Remembering — Bobby Lewis — RPA
Every Beat Of My Heart — Peggy Sue — Door Knob
14 To 8 — Torn Between Two Lovers — Mary Macgregor — Ariola America/Capitol
15 To 9 — Desperado — Johnny Rodriguez — Mercury
21 To 12 — There She Goes Again — Joe Stampley — Epic
23 To 13 — Southern Nights — Glen Campbell — Capitol
25 To 14 — Easy Look — Charlie Rich — Epic
Ex To 29 — Sunday School To Broadway — Anne Murray — Capitol
Ex To 30 — She's Just An Old Love Turned Memory — Charley Pride — RCA
Ex To 31 — Wrap Your Love Around Your Man — Lynn Anderson — Columbia
Ex To 32 — Sweet City Woman — Johnny Carver — ABC/Dot
Ex To 33 — Loving Arms — Sammi Smith — Elektra

KLAK — DENVER
#1 — Moody Blue — Elvis Presley — RCA
Don't Throw It All Away — Dave & Sugar — RCA
Adios Amigo — Marty Robbins — Columbia
I'm Not Easy — Billie Jo Spears — UA
Paper Rosie — Gene Watson — Capitol
Your Pretty Roses Came Too Late — Lois Johnson — Polydor
8 To 1 — Moody Blue — Elvis Presley — RCA
35 To 20 — Heart Healer — Mel Tillis — MCA
Ex To 30 — She's Just An Old Love Turned Memory — Charley Pride — RCA
Ex To 35 — Sam — Olivia Newton-John — MCA

— ABC/Dot
#1 — Say You'll Stay Until Tomorrow — Tom Jones — Epic
Mockingbird Hill — Donna Fargo — Warner Bros.
You're Free To Go — Sonny James — Columbia
Adios Amigo — Marty Robbins — Columbia
Sweet City Woman — Johnny Carver — ABC/Dot
Yesterday's Gone — Vern Gosdin — Elektra
14 To 9 — After The Lovin' — Engelbert Humperdinck — Epic
21 To 16 — New Kid In Town — Eagles — Asylum
27 To 17 — Southern Nights — Glen Campbell — Capitol
28 To 22 — Loving Arms — Sammi Smith — Elektra
Ex To 28 — Desperado — Johnny Rodriguez — Mercury
Ex To 29 — He'll Play The Music, But You Can't Make Him Dance — Little David Wilkins — MCA
Ex To 30 — The Movies — The Statler Brothers — Mercury

WDEE — DETROIT
#1 — Near You — Jones & Wynette — Epic
Every Beat Of My Heart — Peggy Sue — Door Knob
She's Just An Old Love Turned Memory — Charley Pride — RCA
Adios Amigo — Marty Robbins — Columbia
Don't Throw It All Away — Dave & Sugar — RCA
It Couldn't Have Been Any Better — Johnny Duncan — Columbia
Paper Rosie — Gene Watson — Capitol
After The Lovin' — Engelbert Humperdinck — Epic
16 To 8 — Say You'll Stay Until Tomorrow — Tom Jones — Epic
27 To 17 — Heart Healer — Mel Tillis — MCA
18 To 10 — Ridin' Rainbows — Tanya Tucker — MCA
29 To 19 — Midnight Angel — Barbara Mandrell — ABC/Dot
21 To 12 — Whispers — Bobby Borchers — Playboy
28 To 21 — Torn Between Two Lovers — Mary Macgregor — Ariola America/Capitol
23 To 15 — If Love Was A Bottle Of Wine — Tommy Overstreet — ABC/Dot
32 To 22 — Desperado — Johnny Rodriguez — Mercury
24 To 16 — There She Goes Again — Joe Stampley — Epic
33 To 28 — I Have A Dream, I Have A Dream — Roy Clark

33 To 23 — Good Old Fashioned Saturday Night Barroom Brawls — Vernon Oxford — RCA
35 To 25 — She's Just An Old Love Turned Memory — Charley Pride — RCA
38 To 29 — Lucille — Kenny Rogers — UA
40 To 24 — I'm Not Easy — Billie Jo Spears — UA
Ex To 38 — I Just Came Home To Count The Memories — Cal Smith — MCA
Ex To 39 — Loving Arms — Sammi Smith — Elektra
Ex To 40 — Blue Eyes Cryin' In The Rain — Ace Cannon — Hi

WIRE — INDIANAPOLIS
#1 — Near You — Jones & Wynette — Epic
She's Got You — Loretta Lynn — MCA
Memphis — Boots Randolph — Monument
Cheatin' Overtime — Mary Lou Turner — MCA
The Last Gunfighter Ballad — Johnny Cash — Columbia
Out Of My Mind — Cates — Caprice
The Feeling's Right — Narvel Felts — ABC/Dot
Audobon — C.W. McCall — Polydor
Loving Arms — Sammi Smith — Elektra
14 To 8 — Two Less Lonely People — Rex Allen Jr. — WB
20 To 11 — Say You'll Stay Until Tomorrow — Tom Jones — Epic
23 To 13 — After The Lovin' — Engelbert Humperdinck —

— ABC/Dot
#1 — Say You'll Stay Until Tomorrow — Tom Jones — Epic
Whispers — Bobby Borchers — Playboy
She's Pulling Me Back Again — Mickey Gilley — Playboy
You're Free To Go — Sonny James —

— ABC/Dot
#1 — Say You'll Stay Until Tomorrow — Tom Jones — Epic
Whispers — Bobby Borchers — Playboy
She's Pulling Me Back Again — Mickey Gilley — Playboy
You're Free To Go — Sonny James —

— ABC/Dot
#1 — Say You'll Stay Until Tomorrow — Tom Jones — Epic
Whispers — Bobby Borchers — Playboy
She's Pulling Me Back Again — Mickey Gilley — Playboy
You're Free To Go — Sonny James —

— ABC/Dot
#1 — Say You'll Stay Until Tomorrow — Tom Jones — Epic
Whispers — Bobby Borchers — Playboy
She's Pulling Me Back Again — Mickey Gilley — Playboy
You're Free To Go — Sonny James —

— ABC/Dot
#1 — Say You'll Stay Until Tomorrow — Tom Jones — Epic
Whispers — Bobby Borchers — Playboy
She's Pulling Me Back Again — Mickey Gilley — Playboy
You're Free To Go — Sonny James —

— ABC/Dot
#1 — Say You'll Stay Until Tomorrow — Tom Jones — Epic
Whispers — Bobby Borchers — Playboy
She's Pulling Me Back Again — Mickey Gilley — Playboy
You're Free To Go — Sonny James —

— ABC/Dot
#1 — Say You'll Stay Until Tomorrow — Tom Jones — Epic
Whispers — Bobby Borchers — Playboy
She's Pulling Me Back Again — Mickey Gilley — Playboy
You're Free To Go — Sonny James —

— ABC/Dot
#1 — Say You'll Stay Until Tomorrow — Tom Jones — Epic
Whispers — Bobby Borchers — Playboy
She's Pulling Me Back Again — Mickey Gilley — Playboy
You're Free To Go — Sonny James —

— ABC/Dot
#1 — Say You'll Stay Until Tomorrow — Tom Jones — Epic
Whispers — Bobby Borchers — Playboy
She's Pulling Me Back Again — Mickey Gilley — Playboy
You're Free To Go — Sonny James —

— ABC/Dot
#1 — Say You'll Stay Until Tomorrow — Tom Jones — Epic
Whispers — Bobby Borchers — Playboy
She's Pulling Me Back Again — Mickey Gilley — Playboy
You're Free To Go — Sonny James —

— ABC/Dot
#1 — Say You'll Stay Until Tomorrow — Tom Jones — Epic
Whispers — Bobby Borchers — Playboy
She's Pulling Me Back Again — Mickey Gilley — Playboy
You're Free To Go — Sonny James —

MOST ADDED SINGLES

- SHE'S GOT YOU — LORETTA LYNN — MCA**
Adds: WJJD, KGA, KNEW, WHOO, KERE, KHEY, WIRE, KFOX, WWOL, WKDA, WBAM, KNUZ, WWOK, WIVK, KRAK, KFDI, WUNI.
- SHE'S PULLING ME BACK AGAIN — MICKEY GILLEY — PLAYBOY**
Adds: WUBE, WHOO, WVOJ, WWOK, WONE, KTCR, KFDI, WSLC, KENR, KHAK, KRMD, KXLR, KNIX.
- DON'T THROW IT ALL AWAY — DAVE & SUGAR — RCA**
Adds: WXCL, WJJD, KHEY, KCKN, WDEE, KLAK, WHN, KVET, KRMD, WUNI.
- ADIOS AMIGO — MARTY ROBBINS — COLUMBIA**
Adds: WHOO, WAME, WHK, WPOC, WCOP, WDEE, WONE, KLAK, KVET, KRMD.

MOST ACTIVE SINGLES

- SHE'S JUST AN OLD LOVE TURNED MEMORY — CHARLEY PRIDE — RCA**
Jumps: KNIX 38-26, KICK 35-25, KXLR 34-20, KENR 31-21, KVET 26-11, WSLC 25-18, KLAK ex-30, WIVK 29-20, WONE ex-30, KKYX ex-39, WWOK 13-6, WCOP ex-29, WSUN 14-5, KNUZ 32-15, KLAC 34-24, WBAM 26-21, WHK ex-30, WWOL 32-26, WIRE ex-33, KNEW 24-16, KGA ex-17, WJJD 27-20.
- SOUTHERN NIGHTS — GLEN CAMPBELL — CAPITOL**
Jumps: WUNI 24-19, KNIX 34-27, KICK 21-9, KXLR ex-39, KRMD ex-40, WCMS ex-40, KRAK 30-23, WDAF ex-16, WMAQ ex-28, WHK 23-13, KCKC ex-15, WKDA ex-25, WAME 27-17, WWOL 34-29, KAYO 20-9, KFOX ex-36, KERE 20-11, WHOO 31-24, KNEW ex-26, WUBE 34-23, KGA ex-30, WJJD ex-26.
- LUCILLE — KENNY ROGERS — UA**
Jumps: WINN 26-16, KICK 38-29, KXLR 28-18, KRMD ex-34, KHAK 35-30, KVET 31-19, KEBC ex-57, KFDI ex-47, WIVK 28-18, WONE ex-36, WSUN ex-30, KNUZ 30-18, KLAC ex-52, WBAM 25-17, KCKC ex-29, WKDA 15-4, WWOL 37-30, KAYO ex-35, KHEY ex-39, WHOO 39-33, WUBE 31-19.
- TORN BETWEEN TWO LOVERS — MARY MACGREGOR — ARIOLA**
Jumps: WINN 17-6, KXLR 32-19, KRMD 22-13, KHAK 36-31, WCMS 29-16, KRAK ex-44, WDEE 28-21, WMAQ 20-11, WSUN 22-13, KLAC 42-25, WHK 14-8, KCKC 8-2, WKDA 26-18, WWOL 26-18, WIRE 38-29, KHEY 37-22, KERE 23-13, WHOO 26-17, KGA ex-20.
- DESPERADO — JOHNNY RODRIGUEZ — MERCURY**
Jumps: WUNI 19-14, KICK 19-11, KXLR 16-5, KHAK 28-23, KENR 20-11, KVET 18-9, KTCR ex-21, WDEE 32-22, WWOK ex-30, WHK 15-9, WAME ex-28, KAYO 25-17, WVOJ 30-24, WIRE 32-25, KERE 16-9, KNEW 17-5, KGA 20-10, WJJD 25-18.

Grand Ole Opry star **Barbara Mandrell** is busy researching the customs of Saudi Arabia since she and her group, **The Do-Rites**, leave February 13 for a 12-day tour of cities there. Ms. Mandrell is said to be the first country music artist to perform in that middle eastern country.

Johnny Paycheck has been signed for a featured role in a movie titled "Nashville Bust," to be filmed this spring in Texas and Tennessee. Paycheck was filming last week for his role in "Nashville 99."

New Epic recording starlet **Marshall Chapman's** latest album is out and she has begun a promotional tour that finds her at **Reno Sweeney's** in New York.

David Allan Coe will be playing the **Bottom Line** in New York February 10-12 as part of a national tour to promote his new album, "David Allan Coe Rides Again."

ABC/Dot recording artist **Billy "Crash" Craddock** received a standing ovation from an audience of more than 10,000 following a recent concert in his hometown of Greensboro, N.C. Craddock said the ovation was a special thrill because he had worked as a construction laborer on the coliseum before he became a professional performer. Radio station WGBG in Greensboro reportedly logged over 1,100 calls from fans wishing "Crash" a happy homecoming.

Contrary to reports being spread throughout Oklahoma, Texas and Louisiana that **Tommy Overstreet** has been involved in a shooting, he is alive and well and recording in Nashville. The mixup stemmed from a wire service story, later broadcast by Paul Harvey, about a **Tommie Overstreet** of St. Louis, Missouri, who was involved in a 1974 shooting there. Apparently many listeners missed the part of the report which said this particular Overstreet was convicted of a crime in connection with the shooting and was sent to prison. The case made news again last week because **Tommie W. Overstreet** is attempting to get himself sprung from prison by saying that when doctors removed a bullet from his buttocks it constituted unlawful search and seizure.

ABC/Dot recently welcomed five new artists. **John Conlee**, administrative assistant and air personality at WLAC radio in Nashville, will be produced by **Bud Logan**. His current Dot release is entitled "Back Side Of Thirty." **Allen Frizzell**, Lefty's younger brother and front-man for **Dottie West's** band, also joins ABC/Dot and will be produced by **Ron Chancey**. **George Hamilton IV**, who is already known as "International Ambassador of Country Music," is returning to ABC where he had his first hit, "A Rose And A Baby Ruth" in 1956. **Jack Lebock**, an ABC Music songwriter, and **John Wesley Riles**, who has a new ABC/Dot release produced by **Johnny Morris** entitled "Fool," round out the talent roster update.

Roy Clark is set to headline the main room at **Harrah's**, Lake Tahoe, February 25 through March 3.

Jacky Ward, who hosted the **Plant City, Florida, March of Dimes Telethon** on January 29 and 30, helped set a new, all-time record for that area when the amount reached \$45,000 — \$10,000 over the goal.

Billy Joe Shaver will be recording in Los Angeles soon with **Brian Aherne** producing his third album. Aherne is known for his excellent production of **Emmy Lou Harris**.

Capitol artists **Linda Hargrove** and **Larry Ballard** joined other featured recording artists who participated in **Goodwill Industry's Bag-a-thon**. **Dr. Hook** was also invited but couldn't attend due to a previous booking.

Lonnie Mack was signed to **Capitol** and **Don Light Management** recently. **Bob Wills' Original Texas Playboys** will be featured at the **Western Swing Festival** scheduled for March 6. Additional guests include the **Light Dough Boys**, **Hank Thompson**, and **Alvin Crow** and his band. The festival will be coordinated by **Rod Kennedy** and **Joe Gracey** in the **Austin Municipal Auditorium**.

Studio In The Country in Bogalusa, La. received its first gold album for **Kansas' "Leftoverture"** LP, recorded for **Kirshner Records** and distributed by **Epic**. The album was engineered by **Bill "Bleu" Evans**.

Eddie Rabbitt will be in Toronto February 10-11 to tape the **Tommy Hunter** country show for the **CBC**.

Mickey Gilley and **Loretta Lynn** are currently making personal appearances across western Canada and the Pacific Northwest. Gilley will also participate in the rodeo in San Antonio before hitting California where he'll be at the **Academy of Country Music Awards Show** February 17.

Mary Reeves, president of **Jim Reeves Enterprises**, began the new year by signing **Gene Bowel** to an exclusive songwriting contract with **Tuckahow Music, Inc.**, a **Jim Reeves Enterprises** affiliate firm.

During **Ray Griff's** first year of sponsoring a **Nashville Youth Hockey** team, the team wound up with an undefeated season and won its league championship. As a teenager in his native Canada, Griff was invited to compete in the **National Olympics** in the hockey competition. He chose instead to come to the U.S. to become a songwriter/performer.

Hank Snow, **Tompall Glaser** and **Mel Tillis** are recording consecutively at **Glaser's** studios the next few weeks.

Pat Resch and her husband of **Oak Brook, Minneapolis** were winners of a **WFIC** radio contest called "Are You Ready For The Country." The couple won a trip to **Minneapolis** to see the **December 2 Waylon Jennings** concert and were so elated that the lady, who was seven months pregnant, said if she has a boy she will name him **Waylon**. She didn't say what she'd name a girl... **Waylona?**

True Records, Inc. has signed a distribution pact with **World Wide Music, Inc.** for release of "I Can Give You Love" by **Mundo Earwood**. Earwood is a popular artist in his hometown of **Houston**, with the hit "Lonesome Is A Cowboy."

The first "Reunion of the Cherokee Cowboys" show, scheduled for February 18 at **Ft. Worth's Tarrant County Convention Center**, will bring together for the first time many of the musicians and singers who have worked as members of **Ray Price's** band through the years. Among those who will perform with Price are **Willie Nelson**, **Johnny Bush**, **Darrell McCall**, **Johnny Paycheck**, **Charlie Harris**, **Bob Collins** and **Buddy Einmons**.

Let it be known that **Lee Fry** is co-writer of **Mickey Newbury's** new single, "Hand Me Another Of Those." For some reason **Lee's** name was left off the label on the first printing, and it's time to give credit where credit is due.

The success of **RCA's** re-release of **Charlie Rich's** single, "My Mountain Dew," prompted a promotion campaign built around the record. One stops and radio stations received miniature jugs of mountain dew courtesy of **RCA**. The "dew" was the label's way of thanking everyone for their reception of the single, which has reached the #19 bullet spot on the **Cash Box** charts and is still climbing.

carmen adams

The New SMASH Country Single



Billboard

31

Cash Box

37

Record World

41

by

Lois Johnson

on **Polydor Records**

Your Pretty Roses Came Too Late

PERSONAL MANAGEMENT: DON SILVERS

PD#14371



Tex Ritter

Chappell Publishes Tex Ritter Biography

NEW YORK — Chappell Music Company has released the first comprehensive biography of the legendary country music artist Tex Ritter.

Written by his longtime friend and associate Johnny Bond, *The Tex Ritter Story* traces the multi-faceted career of "America's most beloved cowboy."

Although known to millions of Americans for his starring role in over 80 musical western films, Ritter was also a major recording star, and the first country artist to be signed by the newly-founded Capitol Records Co. in 1942. Among his many hits were "Jingle Jangle Jingle," "Jealous Heart" and "Hillbilly Heaven." In addition, he recorded the background soundtrack for the classic film *High Noon*. A respected spokesman and goodwill ambassador for country music, Ritter was president of the Country Music Association and was elected to the Country Music Hall of Fame.

The 397-page hardcover *Tex Ritter Story* contains many photographs (some rare) which span Ritter's career and personal life. Also featured is a special appendix including a chronology (1905-1974), a listing of Broadway plays in which Ritter appeared, a complete filmography and discography and lyrics to some of Ritter's most popular songs.

Bond, himself a songwriter and performer, was a former member of the CMA board and was also president of the Academy of Country Music. An artist who has recorded for Columbia and Capitol, Bond has spent a lifetime in country music. *The Tex Ritter Story* is based on his personal experiences and was written at the request of Mrs. Ritter.

'Hee Haw' PR Firm Set

NASHVILLE — Henderson, Kelley & Ward, Inc. was recently appointed regional public relations counsel for Yongestreet Productions' popular TV show, "Hee Haw." The firm will assist in public relations primarily for the southeast on an ongoing basis and will serve for two months each year as press liaison during the show's videotaping.

Cherokee Cowboys Reunion Scheduled

NASHVILLE — The premier Reunion of the Cherokee Cowboys show, slated for February 18 at Ft. Worth's Tarrant County Convention Center, will bring together for the first time many of the musicians and singers who have worked as members of ABC/Dot artist Ray Price's band through the years.

Among those who will perform with Price on the 8:00 p.m. bill are Willie Nelson, Johnny Bush, Darrell McCall, John Austin Paycheck, Charlie Harris, Bob Collins and Buddy Emmons.

The Cherokee Cowboys were born in the mid-'50s when Price hired his own band for the first time (he had been using Hank Williams' Drifting Cowboys to do his bigger shows), and over the years the group has contained many now-famous musicians.

The original group consisted of Blackie Crawford (guitar), Jimmy Dennis (drums), Bob Heppler (fiddle), "Little Red" Hayes (fiddle) and Bernie Annett (piano).

Others who were Cherokee Cowboys at one time or another include fiddlers Buddy Spicher, "Big Red" Hays, Johnny Manson and Gene Gaserway; guitarists Roger Miller, Charlie Harris, Tommy Hill, Ray "Curley" Sanders, Van Howard and Spider Wilson; steel players Buddy Emmons, Don Helms and Jack Evans; bassists Willie Nelson, Pete Burke and Darrell McCall; drummers Johnny Bush, Bob Collins and Jan Curtis and pianist Moises "Blondie" Calderon.

Clement Adds 24-Track

NASHVILLE — The management of Jack Clement Recording Studios unveiled a major renovation for Studio A on Feb. 1. With the installation of a 24-track system consisting of a 3-M tape machine and Harrison console, Clement has boosted output from the previous 16-track system in the larger of its two studios.

The first session in the revamped facility was Jan. 31, when Texas recording artist Joe Eddie Goff and producer Russ Reeder, who also produces Capitol recording artist Gene Watson, went into the studio for a 3-hour session.

Engineers had to work overtime to complete the studio for the Jan. 31 session, because the console was not delivered until Jan. 28.

Fifth Annual Gospel Radio Seminar Slated

NASHVILLE — The fifth annual Gospel Radio Seminar is scheduled to be held Friday and Saturday, May 6 & 7, at the Airport Hilton in Nashville. The announcement was made by Jim Black, chairman of the steering committee.

The theme for this year's seminar is "Realizing Your Potential." Registration fee will again be \$30 for broadcasters and \$50 for music industry personnel. The registration includes all seminar sessions plus luncheons and the Saturday night banquet and show.



CHARLIE RICH — Take Me — Epic KE 3-4444 — Producer: Billy Sherrill — List Price 5.98

The rich mellow voice of Charlie Rich will continue to haunt the airwaves after station music directors review this newest collection of Billy Sherrill produced tunes. "Easy Look" is the album's single, but "Spanish Eyes," "Take Me" and "Road Song" should also receive careful consideration. With this artist's track record, almost any cut off the LP will be suitable for airplay and it will become a must for all stations' libraries.



TANYA TUCKER — Ridin' Rainbows — MCA 2253 — Producer: Jerry Crutchfield — List Price: 6.98

Country and progressive stations will both pick up on this newest offering from Tanya Tucker. The album contains a variety of good cuts, including "Knee Deep In Lovin' You" that sounds like the old Tucker style, and "Love Me," a song with piano and vocal achievement that's phenomenal. The LP will prove to be refreshing material for country programmers, while progressive stations will catch the Joni Mitchell-Janis Ian vocal styles that are also evident.

ASLEEP AT THE WHEEL (ABC 12242)

Dancing The Night Away (3:59) (Fourth Floor Music, Inc./Rick Hall Music — ASCAP) (H.R. Smith-J.H. Brown, Jr.)

Although the song's length is unusually long for this group, the record's strong sensitive lyric content will make it an immediate add regardless of its timing. The record's vocals are totally acceptable, while instrumentation is of the typical quality of AATW. Very few jukeboxes, but airplay should be very well-rounded.

PURE PRAIRIE LEAGUE (RCA JB 10880)

Fade Away (4:09) (Rotgut Music/Fireball Music — ASCAP) (M. Reilly-L. Goshorn)

PPL's "Fade Away" should attract the attention of progressive as well as country programmers. It's a strong lyric tune, but more than that, the instrumental track laid down by the group makes this song's arrangement one of the week's strongest. Jukeboxes are doubtful although airplay should be plentiful.

C.W. McCALL (Polydor PD 14377)

Audubon (3:41) (American Gramophone — SESAC) (C.W. McCall-Bill Fries-Chip Davis)

In his best "Old Home Fill 'Er Up Cafe" style, C.W. McCall comes through with another recitation piece, this time about his hometown. Although this record is not nearly as strong as his "Convoy" hit, McCall's expertise at delivering punch lines ("my old home town was Audubon, located where it ought to have been") will make this another success for him. Jukeboxes are a maybe.

T.G. SHEPPARD (Hitsville H 6053 F)

Lovin' On (3:20) (Ben Peters Music — BMI) (B. Peters)

This uptempo selection is quite a surprise from this artist, who usually records ballads. Notwithstanding, Sheppard's strong vocals, accompanied by a perfect instrumental track, make this one a definite playlist add. The record's highlight comes near the end however, when Sheppard is joined by a soulful sounding female vocalist. Jukeboxes are not a probability, but programmers should have no problems fitting this one in.

LARRY GATLIN (Monument 45-212)

Anything But Leavin' (2:42) (First Generation Music Co. — BMI) (Larry Gatlin)

The strongest overall entry of the week! Gatlin's self-penned tune has great lyrics, and the song's arrangement — complete with strong Gatlin vocals — makes this record a candidate for his biggest yet. The record's :00 intro will prove it to be a strong contender out of any stop set or sweep. Jukeboxes will probably add this one while playlists are a certainty.

MARIE OWENS (MMI 1012A)

When Your Good Love Was Mine (3:21) (Jack & Bill Music Co. — ASCAP) (J. Foster-B. Rice)

Airplay on this tune should begin immediately. On the strength of Owens' vocals, programmers can't go wrong on this soulful rendition of the tune. The Foster-Rice composition, coupled with an artist who's been recognized by music directors before, will make "When Your Good Love Was Mine" a candidate for heavy airplay. Jukeboxes on this one are doubtful.

Introducing

JAK DANT

and

**"Let's Do It Again"
[Just One More Time]**

b/w

"Gone Woman Blues"

RPA 7614



"First Time with a Ballad"

JACK BARLOW

singing a Foster & Rice Smash

**"Would You Take
The Chance Again"**

RPA 7616

DISTRIBUTED BY RECORD PRODUCTIONS OF AMERICA, INC. 50 MUSIC SQUARE WEST NASHVILLE, TN 37203

CASH BOX TOP 100 COUNTRY

February 19, 1977

Rank	Song	Artist	Label	Weeks On Chart	Rank	Song	Artist	Label	Weeks On Chart	Rank	Song	Artist	Label	Weeks On Chart
1	NEAR YOU	GEORGE JONES & TAMMY WYNETTE	(Epic 8-50314)	10	33	GOOD 'N' COUNTRY	KATHY BARNES (Republic 338)	7	67	ALL THE SWEET	MEL McDANIELS (Capitol 4373)	4		
2	UNCLOUDY DAY	WILLIE NELSON (Columbia 3-10453)		10	34	I'M GONNA LOVE YOU RIGHT OUT OF THIS WORLD	DAVID ROGERS (Republic R343)	4	68	SLIDE OFF YOUR SATIN SHEETS	JOHNNY PAYCHECK (Epic 8-50334)	2		
3	LIARS ONE, BELIEVERS ZERO	BILL ANDERSON (MCA 40661)		12	35	WRAP YOUR LOVE AROUND YOUR MAN	LYNN ANDERSON (Columbia 3-10467)	5	69	MOCKINGBIRD HILL	DONNA FARGO (Warner Bros. 8305)	2		
4	MOODY BLUE	ELVIS PRESLEY (RCA PB 10857)		9	36	TWENTY FOUR HOURS FROM TULSA	RANDY BARLOW (Gazelle/IRDA 330)	12	70	TEXAS ANGEL	JACKY WARD (Mercury 73880)	3		
5	WHY LOVERS TURN TO STRANGERS	FREDDIE HART & THE HEARTBEATS (Capitol P4363)		12	37	YOUR PRETTY ROSES CAME TOO LATE	LOIS JOHNSON (Polydor PD 14371)	5	71	BILLY THE KID	CHARLIE DANIELS (Epic 8-50322)	4		
6	SAY YOU'LL STAY UNTIL TOMORROW	TOM JONES (Epic 8-50308)		8	38	YOU'RE FREE TO GO	SONNY JAMES (Columbia 3-10466)	4	72	SHE'S PULLING ME BACK AGAIN	MICKEY GILLEY (Playboy P6100)	1		
7	CRAZY	LINDA RONSTADT (Asylum E4536)		10	39	HE'LL PLAY THE MUSIC, BUT YOU CAN'T MAKE HIM DANCE	LITTLE DAVID WILKINS (MCA 40668)	5	73	I CAN'T BELIEVE SHE GIVES IT ALL TO ME	CONWAY TWITTY (MCA 40649)	14		
8	SAYING HELLO, SAYING I LOVE YOU, SAYING GOODBYE	JIM ED BROWN & HELEN CORNELIUS (RCA PB 10822)		14	40	SOUTHERN NIGHTS	GLEN CAMPBELL (Capitol P4376)	3	74	STATUES WITHOUT HEARTS	LARRY GATLIN (Monument 45201)	16		
9	TWO LESS LONELY PEOPLE	REX ALLEN JR. (WB 8297)		10	41	I'M NOT EASY	BILLIE JO SPEARS (UA XW 935Y)	4	75	SHE'S GOT YOU	LORETTA LYNN (MCA 40679)	1		
10	WIGGLE WIGGLE	RONNIE SESSIONS (MCA 40624)		14	42	IN THE MOOD	HENHOUSE FIVE PLUS TOO (WB 8301)	9	76	ME & THE ELEPHANT	KENNY STARR (MCA 40672)	3		
11	RIDIN' RAINBOWS	TANYA TUCKER (MCA 40550)		14	43	LUCILLE	KENNY ROGERS (UA XW 929Y)	3	77	YOUR PLACE OR MINE	GARY STEWART (RCA PB 10833)	16		
12	WHISPERS	BOBBY BORCHERS (Playboy P6092)		11	44	DON'T BE ANGRY	DONNA FARGO (ABC/Dot DOA 17660)	17	78	LORD IF I MAKE IT TO HEAVEN (CAN I BRING MY OWN ANGEL ALONG)	BILLY PARKER (SCR SC 136)	4		
13	IF LOVE WAS A BOTTLE OF WINE	TOMMY OVERSTREET (ABC/Dot DOA 17672)		8	45	EVERY BEAT OF MY HEART	PEGGY SUE (Door Knob DK 6021)	5	79	IT'S NOT SUPPOSED TO BE THAT WAY	STEVE YOUNG (RCA 10868)	5		
14	TWO DOLLARS IN THE JUKEBOX	EDDIE RABBITT (Elektra E45357)		16	46	PAPER ROSIE	GENE WATSON (Capitol 4378)	3	80	I'M GETTING HIGH REMEMBERING	BOBBY LEWIS (RPA 7613)	5		
15	MIDNIGHT ANGEL	BARBARA MANDRELL (ABC/Dot DOA 17668)		10	47	'ROUND THE WORLD WITH THE RUBBER DUCK	C.W. McCALL (Polydor PD 14365)	12	81	ANYTHING BUT LEAVIN'	LARRY GATLIN (Monument 212)	1		
16	HEART HEALER	MEL TILLIS (MCA 40667)		6	48	YOU NEVER MISS A GOOD THING	CRYSTAL GAYLE (United Artists UA XW 833Y)	16	82	SUMMIT RIDGE DRIVE	CHARLIE McCOY (Monument 45210)	3		
17	THERE SHE GOES AGAIN	JOE STAMPLEY (Epic 8-50316)		10	49	NEW KID IN TOWN	EAGLES (Asylum 45373)	6	83	THE FEELIN'S RIGHT	NARVEL FELTS (ABC/Dot DOA 17680)	1		
18	A MANSION ON A HILL	RAY PRICE (ABC/Dot DOA 17666)		11	50	IT COULDN'T HAVE BEEN ANY BETTER	JOHNNY DUNCAN (Columbia 3-10474)	2	84	POOR SIDE OF TOWN	BOBBY WAYNE LOFTIS (Charta 104)	4		
19	MY MOUNTAIN DEW	CHARLIE RICH (RCA PB 10859)		7	51	ADIOS AMIGO	MARTY ROBBINS (Columbia 3-10472)	2	85	AUDOBON	C.W. McCALL (Polydor PD 14377)	1		
20	DESPERADO	JOHNNY RODRIGUEZ (Mercury 73878)		5	52	MAY I SPEND EVERY NEW YEAR WITH YOU	T.G. SHEPPARD (Hitsville H6048F)	9	86	HE'S GOT A WAY WITH WOMEN	BOB LUMAN (Epic 8-50323)	4		
21	LET MY LOVE BE YOUR PILLOW	RONNIE MILSAP (RCA PB 10843)		13	53	THE CLOSEST THING TO YOU	JERRY LEE LEWIS (Mercury 73872)	8	87	I'M LIVING A LIE	JEANNE PRUETT (MCA 40678)	1		
22	TORN BETWEEN TWO LOVERS	MARY MACGREGOR (Ariola America/Capitol 7638)		6	54	SAM	OLIVIA NEWTON-JOHN (MCA 40670)	4	88	LOVE DOESN'T LIVE HERE ANYMORE	RANDY CORNOR (ABC/Dot DOA 17676)	2		
23	THE MOVIES	THE STATLER BROTHERS (Mercury 73877)		5	55	GOOD OLD FASHIONED SATURDAY NIGHT BARROOM BRAWLS	VERNON OXFORD (RCA PB 10872)	5	89	LATELY I'VE BEEN THINKIN' TOO MUCH LATELY	DAVID ALLAN COE (Columbia 3-10475)	1		
24	BABY, YOU LOOK GOOD TO ME TONIGHT	JOHN DENVER (RCA PB 10854)		10	56	CHEATIN' OVERTIME	MARY LOU TURNER (MCA 40674)	4	90	FOOL	JOHN WESLEY RYLES (ABC/Dot DOA 17679)	2		
25	THE LAST OF THE WINFIELD AMATEURS	RAY GRIFF (Capitol 4368)		9	57	DON'T THROW IT ALL AWAY	DAVE & SUGAR (RCA PB 10876)	2	91	LAY SOMETHING ON MY BED BESIDES A BLANKET	CHARLEY McCLAIN (Epic 8-50338)	1		
26	SHE'S JUST AN OLD LOVE TURNED MEMORY	CHARLEY PRIDE (RCA PB 10875)		4	58	DRINKIN' MY WAY BACK HOME	SHYLO (Columbia 3-10456)	7	92	WE FELL IN LOVE THAT WAY	CLAUDE GRAY (Granny 10002)	3		
27	I HAVE A DREAM, I HAVE A DREAM	ROY CLARK (ABC/Dot DOA 17667)		9	59	LOVING ARMS	SAMMI SMITH (Elektra E45374)	3	93	OUT OF MY MIND	GATES (Caprice 2030)	1		
28	ARE YOU READY FOR THE COUNTRY/SO GOOD WOMAN	WAYLON JENNINGS (RCA PB 10852)		14	60	SWEET CITY WOMAN	JOHNNY CARVER (ABC/Dot DOA 17675)	3	94	DADDY, THEY'RE PLAYIN' A SONG ABOUT YOU	KENNY SERATT (Hitsville H6049F)	1		
29	THE SON OF HICKORY HOLLER'S TRAMP/I WONDER HOW SHE'S DOING NOW	JOHNNY RUSSELL (RCA PB 10853)		9	61	EASY LOOK	CHARLIE RICH (Epic 8-50328)	2	95	RIGHT TIME OF THE NIGHT	JENNIFER WARNES (Arista AS 0223)	1		
30	VEGAS	BOBBY & JEANNIE BARE (RCA PB 10852)		8	62	CHEROKEE FIDDLE	MICHAEL MURPHEY (Epic 8-50319)	5	96	LITTLE THINGS MEAN A LOT	LINDA CASSIDY (Cin-Kay 115)	2		
31	I JUST CAME HOME TO COUNT THE MEMORIES	CAL SMITH (MCA 40671)		5	63	WHEN IT'S JUST YOU AND ME	DOTTIE WEST (United Artists UA XW 898Y)	16	97	TENNESSEE WOMAN	ALEXANDER HARVEY (Buddah 555)	2		
32	AFTER THE LOVIN'	ENGELBERT HUMPERDINCK (Epic 8-50270)		9	64	SUNDAY SCHOOL TO BROADWAY	ANNE MURRAY (Capitol P4375)	3	98	EVERYBODY'S HAD THE BLUES	MAURY FINNEY (Soundwaves 4541)	3		
					65	C.B. SAVAGE	ROD HART (Plantation PL 144)	14	99	PICK UP THE PIECES	CON HUNLEY (Prairie Dust 7608)	3		
					66	IF NOT YOU	DR. HOOK (Capitol P4364)	12	100	NEON WOMEN	CARMOL TAYLOR & STELLA PARTON (Elektra 45367)	5		

ALPHABETIZED TOP 100 COUNTRY SINGLES (INCLUDING PUBLISHERS AND LICENSEES)

Adios (Al Gallico/Algee — BMI)	51	Heart Healer (Sawgrass — BMI)	16	Mockingbird Hill (Southern — ASCAP)	69	Sunday School (Mandy — ASCAP)	64
After The Lovin' (Silver Blue — ASCAP/ Oceans Blue — BMI)	32	He'll Play (Ash Valley/Forest Hills — BMI)	39	Moody Blue (Screen Gems-Col./ Sweet Glory — BMI)	4	Sweet City (Covered Wagon — ASCAP)	60
All The Sweet (Combine — BMI/ Music City — ASCAP)	67	He's Got A (Lu-Ner — BMI)	86	My Mountain (Charles Rich — BMI)	19	Tennessee Woman (UA/Big Ax — ASCAP)	97
A Mansion On The Hill (Milene — ASCAP)	18	I Can't Believe (Twitty Bird — BMI)	73	Near You (Supreme — ASCAP)	1	Texas Angel (Jack & Bill — ASCAP)	70
Anything But (First Generation — BMI)	81	If Love (Tree — BMI)	13	Neon Lights (Window — BMI)	100	The Closest Thing (Hall-Clement — BMI)	53
Are You Ready (Silver Fiddle — BMI)	28	If Not You (Horse Hairs — BMI)	66	New Kid	49	The Last Of (Blue Echo — ASCAP)	25
Audobon (Amer. Gramophone — SESAC)	85	I Have A Dream (House of Bryant — BMI)	27	Out Of My Mind (Sound — ASCAP)	93	The Movies (American Cowboy — BMI)	23
Baby, You Look (Cherry Lane — BMI)	24	I Just (Contention — SESAC)	31	Paper Rosie (Double Play/Quality — BMI)	46	The Feelin's (Jack & Bill — ASCAP)	83
Billy The Kid (Hat Band/Rada Dara — BMI)	71	I'm Getting (Blue Echo — ASCAP)	80	Pick Up The Pieces (Annextra — BMI)	99	There She (Gallico — BMI)	17
C.B. Savage (Shelby Singleton — BMI)	65	I'm Gonna (Singletree — BMI)	34	Poor Side (Johnny Rivers — BMI)	84	The Son Of (Acuff-Rose — BMI)	29
Cheatin' Overtime (Hello Darlin' — SESAC)	56	I'm Living (Vogue/Maple Hill — BMI)	87	Ridin' (Paddle Wheel — ASCAP/Dick James — BMI)	11	Torn Between (Muscle Shoals — BMI/ Silver Dawn — ASCAP)	22
Cherokee (Mystery — BMI)	62	I'm Not Easy (Hotel — ASCAP)	41	Right Time (Amer. Broadcasting — ASCAP)	95	Twenty-Four Hours (Arch — ASCAP)	36
Crazy (Tree — BMI)	7	In The Mood (Shapiro-Bernstein — ASCAP)	42	Round The World (Amer. Gramophone — SESAC)	47	Two Dollars In (Briar Patch — BMI)	14
Daddy, They're (Weibeck — ASCAP/ATV — BMI)	94	It Couldn't Have Been (Blue Echo — ASCAP)	50	Sam (John Farrar/Blue Gum/ Dejamus — BMI/ASCAP)	54	Two Less Lonely (Maplehill/Vogue — BMI)	9
Desperado (WB/Kicking Bear — ASCAP)	20	It's Not (Willie Nelson — BMI)	79	Saying Hello (Don Kirshner — BMI/ Kirshner Songs — ASCAP)	8	Uncle Tom (Willie Nelson — BMI)	2
Don't Be Angry (Acuff-Rose — BMI)	44	Lately I've Been (Show For — BMI)	89	Say You'll (Dick James — BMI)	6	Vegas (Evil Eye — BMI)	30
Don't Throw It (Framus — ASCAP)	57	Lay Something (Julep/Partner — BMI)	91	She's Got You (Tree — BMI)	75	We Fell (Granny White/Babcock — BMI)	92
Drinkin' My (Partner/Julep — BMI)	58	Let My Love (Chess — ASCAP)	21	She's Just (Chess — ASCAP)	26	When It's Just You (House of Gold — BMI)	63
Easy Look (Tree — BMI)	61	Liars One (Tree — BMI)	3	She's Pulling (Jack & Bill — ASCAP)	72	Whispers (Chappell — ASCAP)	12
Every Beat (Lois — BMI)	45	Little Things Mean (Leo Feist — ASCAP)	96	Slide Off (Rose Bridge — BMI)	68	Why Lovers (Hartline — BMI)	5
Everybody's Had (Hit Kit/Lloyd Green — BMI)	98	Lord If I (Tommy Overstreet — SESAC)	78	Southern Nights (Warner Tamerlane/ Mersaint — BMI)	40	Wiggle (Ahab — BMI)	10
Fool (Narvel The Marvel — BMI)	90	Love Doesn't Live Here (Blue Echo — ASCAP)	88	Statues Without Hearts (First Generation — BMI)	74	Wrap Your Love (Starship — ASCAP)	35
Good 'N' Country (Singletree — BMI)	33	Loving Arms (Almo — ASCAP)	59	Summit Ridge (Intercollegiate — ASCAP)	82	You Never Miss (Hall-Clement — BMI)	48
Good Old (Sweet Dreams/Arabella — BMI)	55	Lucille (Bramhall/Andite — BMI)	43			You're Free (Intersong/USA — ASCAP)	38
		May I Spend (Highball — BMI/Lowball — ASCAP)	52			Your Place (Chappell — BMI)	77
		Me & The Elephant (Youngun — BMI)	76			Your Pretty (Jack And Bill — ASCAP)	37
		Midnight (Music City — ASCAP)	15				

PRESENTING THE NEW

TOMPALL GLASER



To form his Outlaw Band, Tompall went to the men who helped innovate American music in its original forms — blues, jazz, and country. He figured if he just put them in the same room together they'd come out with something new. And according to the critical response to his first ABC album, he wasn't wrong. Tompall Glaser rides again.

"Tompall's voice puts him in a class by himself. His music transcends all boundaries"— Walrus

"The interplay between Tompall's unique crushed velvet voice and the hot licks of his Country/R&B band is truly powerful stuff. They are making music that knows no boundaries."— Mike Reff

Everybody's Record Co.

"Excellent programming!!!"— Tom Allen
KBOX/Dallas

TOMPALL GLASER And His Outlaw Band



ABC Records

"Tompall's unique vocals and his super band are sure to get quick listener response"— Lisa Hartman
KFML/Denver

"A programming gem."— Cash Box

"Excellent...The songs show strong crossover capabilities into both pop and easy listening...The album launches Glaser powerfully ahead."— Billboard

AB-908

TOMPALL GLASER AND HIS OUTLAW BAND

Produced by Tompall Glaser and Ken Mansfield

On ABC Records and GRT Tapes

©1977 ABC Records, Inc. Printed in U.S.A.



FERGUSON FETED AT LUNCHEON — Columbia recording artist Maynard Ferguson was guest at a New York luncheon celebrating the completion of his latest LP, "Conquistador," and the release of his new single, "Theme From Rocky." Ferguson returns to New York February 18 and 19 for a stint at the Bottom Line. Pictured at the luncheon seated from left are: Mrs. Ferguson; Maynard Ferguson; and Kim Ferguson, his manager. Standing from left are: Don Dempsey, vice president of marketing for Columbia; Willard Alexander, agent, Stan Monteiro, vice president of national promotion for Columbia; Matty Matthews, local promotion manager for Columbia; Tom Callahan, field sales manager for Columbia; Don DeVito, vice president of talent acquisition, east coast, for Columbia; Bob Kasha, agent; Arma Andon, vice president of artist development for Columbia; Barbara Cooke, associate director of product management, east coast, for Columbia; Ron Picollo, regional northeast director for CBS Records; and Peter Levinson, Ferguson's public relations man.

Columbia Adds 8 Titles To Jazz, Theatre Scenes

NEW YORK — Columbia Records Special Products has added two releases to its jazz Collector Series and six theatre titles to its Encore Collection.

Heading the jazz list is the three-record set, "Jack Teagarden-King of the Blues

Trombone," featuring Teagarden, Artie Shaw, Joe Bushkin and Eddie Condon, among others. The other jazz release is "Take It, Bunny!," featuring Bunny Berigan on trumpet.

"Oh Captain," with Tony Randall and Eileen Rodgers, heads the theatrical releases. The others include a special repackaging of two previously uncoupled operettas, "The Chocolate Soldier" and "Naughty Marietta," both with Nelson Eddy; and the two-record "Columbia Album of George Gershwin" featuring Percy Faith and his orchestra; the Jerome Kern musical biography by Paul Weston; the Richard Rodgers musical biography by Andre Kostelanetz; and the soundtrack to Paramount's film "War And Peace" composed by Nina Rota.

Feb. Is 'Silver Month'

LOS ANGELES — February has been designated "Horace Silver month" by Blue Note Records' vice president and general manager George Butler. To commemorate Silver's 25 years with the label, the company has staged a special promotion program during February, of which a national press tour has been included.

Silver recorded his first album with Blue Note in 1952.

WRAM — Clark Terry — MPS/BASF 22676 — Producer: Egon Christmann — List: 6.98

This is one of the best Terry LPs in recent years and that in itself is something, since Clark Terry is playing brilliant trumpet most of the time these days. The set was done live in Hamburg with rhythm section accompaniment. Terry manages to cover a full range of jazz standard material with the title track (a revival of a Mildred Bailey number) perhaps the best. As usual with Clark Terry, there is a lot of good humor and warm music.

RIGHT PLACE WRONG TIME — Otis Rush — Bullfrog 301 — Producer: Otis Rush & Nick Gravenites — List: 6.98

Otis Rush is one of the most gifted bluesmen and this is, by some distance, the best album he has ever made. What is curious is the fact that the album was never issued by Capitol and it took the ingenuity of Bullfrog to bring this music to the public. What contributes to its success is excellent recorded sound and a tight, nine-piece band. Rush, in his tough down-home vocals and stinging guitar work, is compelling throughout the album. The best blues album we've heard in a long time.

MEL LEWIS AND FRIENDS — Horizon 716 — Producer: John Snyder — List: 6.98

Lewis is most often seen in front of the big band he co-leads with Thad Jones. Here his groups range in size from trio to seven pieces with Freddie Hubbard, Mike Brecker, Hank Jones and Ron Carter most often in attendance. Hubbard is the best soloist, sounding much more inventive than he does on his own albums. Thad Jones wrote three of the six tunes and the players are all fine throughout.

THE SOURCE — Dexter Gordon-Jackie McLean — Inner City 2020 — Producer: Nils Winther — List: 6.98

The emergence of Dexter Gordon as a leader of the current jazz revival should not be surprising since he has been at the top of his game for some time. This meeting with McLean is a memorable one and the live four-tune set features a couple of Charlie Parker specialties, a ballad and a new version of the Gordon classic "Dexter Digs In." The blowing is heated and inspired and the album is recommended for all lovers of hard-cooking modern jazz.

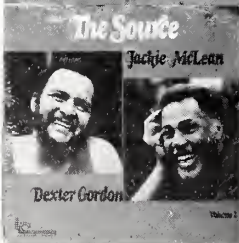
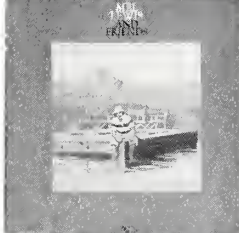
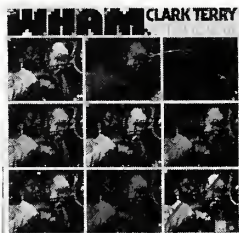

TOP 40 JAZZ ALBUMS

		Weeks On 2/12 Chart	Weeks On 2/12 Chart
1	IN FLIGHT GEORGE BENSON (Warner Bros BSK 2983)	4	2
2	SECRET PLACE GROVER WASHINGTON JR. (Kudu 32)	1	8
3	BREEZIN' GEORGE BENSON (Warner Bros BS 2919)	2	33
4	MY SPANISH HEART CHICK COREA (Polydor PD 2-9003)	3	7
5	IMAGINARY VOYAGE JEAN-LUC PONTY (Atlantic SD 18195)	5	13
6	VIBRATIONS ROY AYERS UBIQUITY (Polydor PD 1-6091)	6	8
7	CALIENTE GATO BARBIERI (A&M 4597)	8	21
8	MAIN SQUEEZE CHUCK MANGIONE (A&M 4612)	7	16
9	RENAISSANCE LONNIE LISTON SMITH & THE COSMIC ECHOES (RCA APL 1-1822)	9	12
10	UNFINISHED BUSINESS BLACKBYRDS (Fantasy F9518)	11	14
11	THE MAN WITH THE SAD FACE STANLEY TURRENTINE (Fantasy F9519)	12	14
12	SCHOOL DAYS STANLEY CLARKE (Nemperor/Atlantic NE 439)	13	22
13	BAREFOOT BALLET JOHN KLEMMER (ABC 950)	10	24
14	SHADES KEITH JARRETT (Impulse/ABC AS 9322)	25	3
15	GEORGE BENSON IN CONCERT AT CARNEGIE HALL GEORGE BENSON (CTI/Motown 6072 S1)	18	4
16	BIRD IN A SILVER CAGE HERBIE MANN (Atlantic SD 18209)	19	4
17	FOCAL POINT MCCOY TYNER (Milestone/Fantasy M9072)	15	9
18	LIVING INSIDE YOUR LOVE EARL KLUGH (Blue Note/UA BNLA 667G)	17	17
19	CARICATURES DONALD BYRD (Blue Note/UA BNLA 633G)	27	3
20	I HEARD THAT QUINCY JONES (A&M SP 3705)	14	21
21	THE LION AND THE RAM LARRY CORYELL (Arista AL 4108)	23	4
22	SOLID MICHAEL HENDERSON (Buddah 5662)	24	18
23	SOPHISTICATED FUNK JACK McDUFF (Chess ACH 19004)	20	7
24	THE BEST OF THE CRUSADERS (Blue Thumb/ABC BTSY 6027/2)	16	11
25	HANK CRAWFORD'S BACK (Kudu 33)	21	7
26	SECRETS HERBIE HANCOCK (Columbia PC 34280)	22	24
27	ROMEO & JULIET HUBERT LAWS (Columbia PC 34330)	28	16
28	JOYOUS LAKE PAT MARTINO (Warner Bros. BS 2977)	32	2
29	VERY TOGETHER DEODATO (MCA 2219)	26	21
30	STILL CAN'T SAY ENOUGH JOHN LEE & GERRY BROWN (Blue Note/UA BNLA 701G)	31	4
31	HAPPINESS HEARTACHES BRIAN AUGER'S OBLIVION EXPRESS (Warner Bros. BS 2981)	—	1
32	KINKATRON RAHSAAN ROLAND KIRK (Warner Bros. BS 2982)	—	1
33	MILTON MILTON NASCIMENTO (A&M SP 4611)	34	2
34	CLOSENESS CHARLIE HADEN (Horizon/A&M 710)	35	2
35	PASTELS RON CARTER (Milestone/ Fantasy 9073)	39	2
36	SEA WIND (CTI 5002)	36	3
37	RED BEANS JIMMY McGRUFF (Groove Merchant GM 3314)	37	3
38	HUMMIN' NAT ADDERLEY (Little David/Atlantic 1012)	38	3
39	SIT ON IT JIMMY SMITH (Mercury SRM 1-1127)	40	2
40	BOB JAMES THREE (CTI 6063)	29	33

MCCOY Tyner will begin recording his next LP early in March in New York. Another Milestone star, Ron Carter, will do his next LP live at Sweet Basil in New York. Fantasy/Prestige/Milestone vice president Orrin Keepnews will be on hand for both sessions.

Little David will release a single ("Hummin'/The Traveller") by Nat Adderley and The Basic Black Band.

Vanguard has just reissued a couple of splendid LPs from the 1950s under the title "The Essential Vic Dickenson." For once an album title is accurate; this is splendid middle-period jazz and with men like Ed Hall, Ruby Braff, Shad Collins and Sir Charles Thompson on hand this one is sure to interest all jazz fans. Vanguard has enough similar material, most of it produced by John Hammond, for several more two-fers. How about the Buck Clayton-Ruby Braff collaboration?

Crawdaddy, the New York restaurant specializing in New Orleans food and decor, is having its own Mardi Gras! The event will begin February 14 and run through February 22 (except Washington's Birthday). For the occasion the street signs will be changed, on the 14th, to read Bourbon Street North. Sam Price and friends continue to supply the music.

A New York-based label with a strong representative jazz catalog reportedly up for sale.

Trombonist Bill Watrous has settled in California. Watrous and trumpet man Bobby Shew will be featured at a UCLA concert on March 14 with Mike Miller's orchestra and singer Michael Katakis.

Sonny Rollins working east coast dates through March behind his latest Milestone release, "The Way I Feel."

The latest version of the Encyclopedia Of Jazz, co-authored by Leonard Feather and Ira Gitler, is due out shortly.

The next release from RCA Bluebird will be double albums from Artie Shaw, Charlie Barnet and Louis Armstrong. This will be Volume Two in the Bluebird series for Shaw and the first volume for both Barnet and Armstrong.

The latest word on the release of the fabulous Woody Herman Carnegie Hall concert says probably March. Shortly thereafter will come a multi-record set of Herman broadcasts and air checks covering the Herman band of the '40s.

Pianist Jack Reilly is out with a solo piano album titled "Tributes." A variety of music greats are saluted including jazzmen John Coltrane, Zoot Sims, Ben Webster and Lee Konitz.

Joe Pass currently at Hopper's playing solo guitar.

New from A&M Horizon: "Don Cherry" and "Gerry Niewood and Timepiece." Niewood is a multi-reed man formerly with Chuck Mangione.

bob porter

ARB Clarifies Methods That Are Used To Measure Black Audiences

by Cookie Amerson

LOS ANGELES — Bill Engel, vice president of radio sales for Arbitron, explained to **Cash Box** the methodology Arbitron uses in measuring black listeners. In response to a recent article in **CB** (Jan. 29, 1977) that allowed secondary market program directors to candidly air their opinions about ARB methods, Engel explained several misconceptions he thinks programmers have about Arbitron's methods of dealing with the black population. "We initially contact a household by mail, to make them aware of Arbitron, what we are all about, and tell them when to expect a phone call from us at a certain time. When we talk to that household we explain further, asking them to remember for one week what they have been listening to on each day as we will be calling them back each night that week to ask them for that information. We do not send diaries to black families in high density black areas as we frequently found that they are not returned. Since we contact black families by phone, we are taking into consideration that many people have unlisted telephone numbers, and for the April/May surveys we will be calling persons with unlisted numbers by using what we are calling 'the expanded sample frame.' The computer-drawn samples are used to focus in on key black areas which are determined by zip codes, and are explained in detail in the front of each Arbitron book."

Few Blacks

"Many programmers constantly complain that we are surveying areas that have few blacks or where their signals don't reach," Engel stated. "Programmers must keep in mind that we are taking a general

market estimate of who is listening to the radio with break-outs of the 'total area' and the 'metro area.'"

"Generally black formatted stations will show up better in the 'metro survey area' because more black families live in the cities. Arbitron does not investigate to see what format the stations are, as this particular information has no bearing on any of our results. When a station wishes to see how much penetration they are having with a particular segment of the population, such as blacks or spanish, it is then up to that station to have a special survey done for which Arbitron charges a nominal fee to its subscribers. We do periodically publish a special report on how blacks listen to radio in comparison to the general population. There is the constant effort made by Arbitron to make programmers understand our methods, to eliminate as many of the existing misconceptions as possible. We are constantly trying to improve our methods, and make every effort to stay out of situations that would result in our having a biased sample. Frequently, when people suggest that we use shopping centers or schools, they don't take into consideration that at these places there are no businessmen, which will certainly give you biased results."

Broadcast Rating

"Arbitron must adhere to standards set by the Broadcast Rating Council, and supply them with all information and details of our operation. So that it is completely explained, ARB publishes all survey information in the front of each book, and defines all terms used in the book in detail in the back of each book. Our telephone lines are open to any questions that anyone may have regarding our operation, and we welcome these inquiries."



Shown backstage after a gig at the Palace in San Francisco are A&M recording artists LTD, celebrating their second fast-rising single, "Love To The World." Back row (l to r) are group members Henry Davis; Melvin Webb; Jeffrey Osborne; Billy Osborne; Lorenzo Carnegie; Jimmy (J.D.) Davis; Carle Vickers, and Jake Riley. Front row (l to r) Kevin Black, promoter; Onion Miller, LTD; David Dashev, director of artist development for A&M and Johnny McGee from LTD.

Reflections N' Black

Former morning-man Tom Joyner will be returning to that slot at **KKDA**, starting February 9. Joyner who is best remembered for his police radar watch, which informed motorists where radar traps were. New line-up at the station will be: 6-10 Tom Joyner, 10-3 Steve Ladd, 3-sign-off Dwayne Dancer.

Percussionist **Ralph MacDonald** appears on a total of 16 of the Grammy nominees in all categories. In addition, MacDonald is responsible for the percussion on 14 of the 40 LPs currently on the **Cash Box** Jazz chart.

Twin brothers Ralph and Randolph Cummings have formed a record company in the Washington/Baltimore area, **Twins Records**. Their first release, "Electric Sound" is currently receiving attention

from several east coast radio stations. The brothers have obtained local distribution for their product, with expectations of releasing an album soon.

The Area Five Community Service, Incorporated, is sponsoring a testimonial dinner for program director **J.D. Black**, programmer at **KOKY** in Little Rock. The event will be held at the Camelot Inn in Little Rock Sunday March 6, 1977.

Spring Records will release an LP from **The Fatback Band** March 15 entitled "Nycnyusa." The group is presently more popular in Europe than they are in the United States, stating that they owe their success there to simply playing good funky music, and "rather than having people watching us perform, we simply go around the country teaching people to dance."

cookie amerson

TOP 75 R&B ALBUMS

	Weeks On 2/12 Chart		Weeks On 2/12 Chart
1 SONGS IN THE KEY OF LIFE STEVIE WONDER (Tamla/Motown T13-34062)	1 19	37 CHILDREN OF THE WORLD BEE GEES (RSO/Polydor RS 1-3003)	38 19
2 GOOD HIGH BRICK (Bang 408)	3 15	38 WELCOME TO OUR WORLD MASS PRODUCTION (Atlantic SD 9910)	40 8
3 SPIRIT EARTH, WIND & FIRE (Columbia PC 34241)	4 19	39 HOT ON THE TRACKS COMMODORES (Motown M6-867S1)	32 35
4 ASK RUFUS RUFUS FEATURING CHAKA KHAN (ABC AB 975)	8 3	40 SOMETHING SPECIAL SYLVERS (Capitol ST 11580)	24 14
5 CAR WASH ORIGINAL SOUNDTRACK (MCA 2-6000)	2 16	41 HARD CORE JOLLIES FUNKADELIC (Warner Bros. BS 2973)	31 13
6 THE JACKSONS (Epic KE 34229)	9 13	42 DR. BUZZARD'S SAVANNAH BAND (RCA APL 1-1504)	34 17
7 THIS IS NIECY DENIECE WILLIAMS (Columbia PC 34242)	5 22	43 HAPPINESS IS BEING WITH THE SPINNERS (Atlantic SD 18181)	35 30
8 UNFINISHED BUSINESS BLACKBYRDS (Fantasy F9518)	7 13	44 CATFISH FOUR TOPS (ABC ABCB 968)	4 18
9 BRASS CONSTRUCTION II (United Artists UA LA 677G)	6 14	45 JEAN CARN (Phila. Intl./Epic PZ 34394)	48 8
10 ANY WAY YOU LIKE IT THELMA HOUSTON (Motown T6-34551)	12 9	46 MELBA MELBA MOORE (Buddah BDS 5677)	43 9
11 MESSAGE IN THE MUSIC O'JAYS (Phila. Intl. Epic PZ 34245)	11 22	47 ALL MY LIFE ARTHUR PRYSOCK (Old Town 12-004)	51 6
12 TOO HOT TO STOP BAR-KAYS (Mercury SRM 1-1099)	10 15	48 LOVE TO THE WORLD LTD (A&M 4589)	42 28
13 PERSON TO PERSON AVERAGE WHITE BAND (Atlantic SD 2-1002)	17 5	49 GOLD OHIO PLAYERS (Mercury SRM 1-1122)	44 15
14 SECRET PLACE GROVER WASHINGTON JR. (Kudu 32)	16 6	50 RENAISSANCE LONNIE LISTON SMITH & THE COSMIC ECHOES (RCA APL 1-1822)	46 11
15 METHOD TO THE MADNESS UNDISPUTED TRUTH (Warner Bros. WH 2967)	20 5	51 PIPE DREAMS (ORIGINAL SOUNDTRACK) GLADYS KNIGHT & THE PIPS (Buddah BDS 5676 ST)	45 13
16 WITH YOU MOMENTS (Stang/All Platinum ST 1030)	19 11	52 AIN'T THAT A BITCH JOHNNY "GUITAR" WATSON (DJM/Amherst DJLPA-3)	50 30
17 REACHING FOR THE WORLD HAROLD MELVIN & THE BLUE NOTES (ABC ABCD 969)	27 3	53 DO IT YOUR WAY CROWN HEIGHTS AFFAIR (DeLite DEP 2022)	56 12
18 OPEN SESAME KOOL & THE GANG (DeLite DEP 2023)	13 14	54 SOUL SEARCHING AVERAGE WHITE BAND (Atlantic SD 18179)	57 31
19 VIBRATIONS ROY AYERS UBIQUITY (Polydor PD 1-6091)	21 7	55 WHAT YOU NEED SIDE EFFECT (Fantasy F9513)	58 15
20 FOUR SEASONS OF LOVE DONNA SUMMER (Oasis/Casablanca NBLP 7038)	22 16	56 FESTIVAL SANTANA (Columbia PC 34423)	59 3
21 IN FLIGHT GEORGE BENSON (Warner Bros. BSK 2983)	53 2	57 ENCHANTMENT (United Artists UA LA 682G)	62 3
22 JOY RIDE DRAMATICS (ABC ABCD 955)	23 17	58 KING SIZE B.B. KING (ABC AB 977)	— 1
23 ... AHH, THE NAME IS BOOTSY BABY BOOTSY'S RUBBER BAND (Warner Bros. BS 2972)	39 3	59 GEORGE BENSON IN CONCERT IN CARNEGIE HALL (CTI/Motown 6072S1)	63 3
24 FLOWERS EMOTIONS (Columbia PC 34163)	14 31	60 DEEP IN MY SOUL SMOKEY ROBINSON (Tamla/Motown T6-350S1)	67 2
25 DISCO INFERNO TRAMMPS (Atlantic SD 18211)	26 5	61 LIFE IS MUSIC RITCHIE FAMILY (Marlin/TK 2203)	64 2
26 LET 'EM IN BILLY PAUL (Phila. Intl. Epic PZ 34389)	28 10	62 CARICATURES DONALD BYRD (Blue Note/United Artists BNLA 633G)	69 2
27 THE CLONES OF DR. FUNKENSTEIN PARLIAMENT (Casablanca NBLP 7034)	15 20	63 HANK CRAWFORD'S BACK (Kudu 33)	65 6
28 CHAMELEON LABELLE (Epic PE 34189)	29 23	64 CALIENTE GATO BARBIERI (A&M SP 4597)	66 5
29 PART 3 KC & THE SUNSHINE BAND (TK 605)	30 18	65 HAVE A GOOD TIME AL GREEN (Hi/London SHL 32103)	55 14
30 BODY HEAT JAMES BROWN (Polydor PD 1-6093)	37 7	66 IT LOOKS LIKE SNOW PHOEBE SNOW (Columbia PC 34387)	70 11
31 HOPE WE GET TO LOVE IN TIME MARILYN MCCOO & BILLY DAVIS JR. (ABC ABCD 952)	18 21	67 IT AIN'T WHERE YOU BEEN LATIMORE (Glades/TK 7509)	68 4
32 SOLID MICHAEL HENDERSON (Buddah BDS 5662)	36 22	68 IS THIS WHATCHA WONT? BARRY WHITE (20th Century T516)	61 16
33 AN EVENING WITH DIANA ROSS (Motown M7-877R2)	47 2	69 SUITE FOR THE SINGLE GIRL JERRY BUTLER (Motown M6878S1)	— 1
34 BRISTOL'S CREME JOHNNY BRISTOL (Atlantic SD 18197)	33 14	70 BIGGER THAN BOTH OF US HALL & OATES (RCA APL 1-1467)	71 3
35 FEELING GOOD WALTER JACKSON (United Artists CHLA 656G)	25 20	71 ONCE UPON A JUKEBOX STYLISTICS (H&L HL 69015)	72 3
36 SO SO SATISFIED ASHFORD & SIMPSON (Warner Bros. BS 2992)	49 4	72 HUTSON II LEROY HUTSON (Curtom/WB CU 5011)	52 11
		73 BICENTENNIAL NIGGER RICHARD PRYOR (WB BS 2960)	54 20
		74 THERE'S MUSIC IN THE AIR LETTA MBULU (A&M 4609)	— 1
		75 OJAH AWAKE OSIBISA (Island ILP 9411)	— 1

ADDITIONS TO R&B PLAYLISTS

WIGO — ATLANTA — Rick Fly
 #1 — Tryin' To Love Two — William Bell
 Time Is Movin' — Blackbyrds — Fantasy
 Dancin' — Crown Heights Affair — DeLite
 Quality To Satisfy — Barry White — 20th Century
 26 To 19 — Spy For Brotherhood — The Miracles
 29 To 18 — Sometimes — Facts Of Life
 #1 LP — Rufus
 New LPs — Jupar Universal Orchestra

WAKO — ATLANTA — Frank Barrow
 #1 — Too Hot To Stop — Bar-Kays
 Time Is Movin' — Blackbyrds — Fantasy
 Reaching For The World — Harold Melvin & The Blue Notes — ABC
 There Will Come A Day — Smokey Robinson — Tamla
 Ain't Gonna Bump — Joe Tex — Epic
 I'm Your Boogie Man — K.C. & The Sunshine Band — TK
 I'm Going Down — Rose Royce — MCA (LP cut)
 Munchies For Your Love — Bootsy Collins — WB (LP cut)
 23 To 15 — I've Got Love On My Mind — Natalie Cole
 Ex To 21 — Gloria — Enchantment
 19 To 12 — Something 'Bout 'Cha — Latimore
 #1 LP — Bootsy Collins

WWIN — BALTIMORE — Don Brooks
 #1 — Gloria — Enchantment
 Ain't Gonna Bump — Joe Tex — Epic
 United We Stand — Roscoe And Mabel — Chocolate City
 Where Is The Love — Ralph MacDonald — Marlin
 Angel In Your Arms — Hot — Big Tree
 Double Dutch — Fatback — Spring
 Feel Free — Four Tops — ABC
 Boogie Child — Bee Gees — RSO
 Your Real Good Thing — Paulette Reaves — Blue Candle
 You're Gonna Get Next To Me — Bo Kirkland & Ruth Davis — Claridge
 Party — Silk — Prelude
 23 To 3 — I've Got Love On My Mind — Natalie Cole
 12 To 7 — Do It To My Mind — Johnny Bristol
 30 To 17 — Hideaway — Fantastic Four
 #1 LP — Stevie Wonder
 New LPs — Millie Jackson, Mystique, George Benson, Smokey Robinson

WBUL — BIRMINGHAM — Victor Boykin
 #1 — I'm Going Down — Rose Royce
 Steal Away — Luther Ingram — Cotillion
 Just Another Day — Peabo Bryson — Bullet
 Disco Lucy — Wilton Place Street Band — Island
 Do What You Want — Billy Preston — A&M
 Winter Melody — Donna Summer — Oasis
 Too Hot To Stop — Bar-Kays — Mercury
 Dancin' — Crown Heights Affair — DeLite
 Reaching For The World — Harold Melvin — ABC
 Love Is Better In The A.M. — Johnnie Taylor — Columbia
 Spy For Brotherhood — Miracles — Columbia
 I Tried To Tell Myself — Al Green — Hi
 Ex To 1 — I'm Going Down — Rose Royce
 Ex To 3 — Be My Girl — Dramatics
 22 To 6 — Love To The World — LTD
 24 To 7 — I've Got Love On My Mind — Natalie Cole
 36 To 12 — Look Into Your Heart — Aretha Franklin
 #1 LP — Car Wash
 New LPs — Sweet Thunder

WILD — BOSTON — Charlene Watts
 #1 — Don't Leave Me This Way — Thelma Houston
 At Midnight — Rufus — ABC
 Say You Love Me — Patti Austin — CTI
 Time Is Moving — Blackbyrds — Fantasy
 Disco Lucy — Wilton Place Street Band — Island
 My Love Is Free — Double Exposure — Salsoul
 Do What You Want — Billy Preston — A&M
 Free Love — Jean Carn — Phila. Intl.
 Rich Girl — Hall & Oates — RCA
 Fly Like An Eagle — Steve Miller Band — Capitol
 Comin' Round The Mountain — Funkadelic — WB
 29-19 Spy For Brotherhood — Miracles
 30-18 Reaching For The World — Harold Melvin
 31-17 Love To The World — LTD
 22-11 I've Got Love On My Mind — Natalie Cole
 27-10 Tryin' To Love Two — William Bell
 26-9 Gloria — Enchantment
 24-8 Dancin' — Crown Heights Affair
 New LPs — Jerry Butler, Maze, Originals, Smokey Robinson, Bootsy Collins, Brainstorm

WUFO — BUFFALO — Harold Lewis
 #1 — Be My Girl — Michael Henderson
 Too Hot To Stop — Bar-Kays — Mercury
 My Love Is Free — Double Exposure — Salsoul
 Do What You Want — Billy Preston — A&M
 There's Love In The World — Mighty Clouds — ABC
 Changes — Ralph Graham — RCA
 Reaching For The World — Harold Melvin — ABC
 30-8 I've Got Love On My Mind — Natalie Cole
 36-29 The Way You Make Me Feel — Melba Moore
 #1 LP — Undisputed Truth, Smokey Robinson, George Benson, Brainstorm, Originals, Maze, Tony Williams, Jerry Butler, Diana Ross, B.B. King, Brian Auger, Jean Carn, Jimmy Smith, Donald Byrd, Michael Franks

WGIV — CHARLOTTE — Manny Clark
 #1 — Time Is Movin' — Blackbyrds
 Blessed Is The Woman — Shirley Brown — Arista
 Welcome To Our World — Mass Production — Atlantic
 I Like To Do It — KC & The Sunshine Band — TK
 Reaching For The World — Harold Melvin & The Blue Notes — ABC
 There Will Come A Day — Smokey Robinson — Tamla
 I Want To Get Next To You — Rose Royce — MCA
 Boogie Bopper — Sun — Capitol
 21 To 9 — Comin' Round The Mountain — Funkadelic
 24 To 14 — Gato Barbieri — Fiesta
 New LPs — Letta Mbulu

WBXM — CHICAGO — Ernest James
 Additions
 Love Is Better In The A.M. — Johnnie Taylor — Columbia
 I Tried To Tell Myself — Al Green — Hi
 Blessed Is The Woman — Shirley Brown — Arista
 Stay Awhile With Me — Donnie Gerrard — Greedy
 Gloria — Enchantment — UA
 New LPs — Bootsy Collins, Philharmonic Orchestra

WVON — CHICAGO — E. Rodney Jones
 #1 — I Wish — Stevie Wonder
 Dancin' — Crown Heights Affair — DeLite
 Just Another Day — Peabo Bryson — Bullet
 Space Age — Jimmy Castor — Atlantic
 Love In C Minor — Cerrone — Cotillion
 22 To 17 — Your Real Good Thing — Paulette Reaves
 19 To 14 — Don't Leave Me This Way — Thelma Houston
 #1 LP — Blackbyrds
 New LPs — Lew Kirtan, Kool & The Gang

WJPC — CHICAGO — Richard Steele
 #1 — Free — Deniece Williams
 Gloria — Enchantment — UA
 My Love Is Free — Double Exposure — Salsoul
 Body Heat — James Brown — Polydor
 Just Another Day — Peabo Bryson — Bullet
 23 To 18 — Time Is Moving — Blackbyrds
 25 To 17 — Close To You — Tyrone Davis
 #1 LP — A&W

WCIN — CINCINNATI — Bob Long
 #1 — I've Got Love On My Mind — Natalie Cole

Dancin' — Crown Heights Affair — DeLite
 Laying Beside You — Eugene Record — WB
 The Roots Medley — Quincy Jones — A&M
 Love In C Minor — The Heart & Soul Orchestra — Casablanca
 24 To 10 — Reaching For The World — Harold Melvin
 22 To 11 — Do What You Want — Billy Preston
 #1 LP — Stevie Wonder
 New LPs — Harold Melvin & The Blue Notes, Manhattans, Olympic Runners, Quincy Jones

WJMO — CLEVELAND — Lynn Tolliver
 #1 — I Wish — Stevie Wonder
 Qualified To Satisfy — Barry White — 20th Century
 My Love Is Free — Double Exposure — Salsoul
 Dancin' Man — O — Sweet City
 Love In C Minor — Cerrone — Cotillion
 29 To 14 — At Midnight — Rufus
 22 To 16 — Too Hot To Stop — Bar-Kays
 24 To 18 — Love To The World — LTD
 25 To 19 — Reaching For The World — Harold Melvin & The Blue Notes
 27 To 20 — Feel Free — Four Tops
 #1 LP — A&W
 New LPs — Diana Ross, Melba Moore, Smokey Robinson

WVKO — COLUMBUS — Keth Willis
 #1 — Isn't It A Shame — Labelle
 Rigor Mortis — Cameo — Chocolate City
 I Wanna Get Next To You — Rose Royce — MCA
 Do What You Want — Billy Preston — A&M
 Stick Together — Minnie Riperton — Epic
 You're Only As Good As You Think You Are — Whispers — RCA
 #1 LP — Roy Ayers

KKDA — DALLAS — Church Smith
 #1 — I Wish — Stevie Wonder
 You're Gonna Get Next To Me — Bo Kirkland & Ruth Davis — Claridge
 I'm His Wife — Ann Sexton
 Heaven Is My Gold — Salem Travelers — One Way
 Qualified To Satisfy — Barry White — 20th Century
 Gonna Lay A Little Soul — Creators — Coconut
 10 To 3 — Sometimes — Facts Of Life
 16 To 10 — Tryin' To Love Two — William Bell
 19 To 15 — Just Another Day — Peabo Bryson
 21 To 16 — Look Into Your Heart — Aretha Franklin
 #1 LP — Brass Construction
 New LPs — Street Corner

WDAO — DAYTON — Dwayne Hoard
 #1 — Body Heat — James Brown
 Boogie Bopper — Sun — Capitol
 The Way You Make Me Feel — Melba Moore — Buddah
 I Can't Say Goodbye — Millie Jackson — Spring
 Welcome To Our World — Mass Production — Cotillion

6-1 Be My Girl — Michael Henderson
 12-3 Free — Deniece Williams
 25-12 Your Real Good Thing — Paulette Reaves
 24-15 Stay Awhile — Donnie Gerrard
 33-26 Just Another Day — Peabo Bryson
 #1 LP — EWF/Trammps
 New LPs — Natalie Cole, B.B. King, Mighty Clouds, Manhattans

WCKO — FT. LAUDERDALE — Joe Fisher
 #1 — Be My Girl — Michael Henderson
 Dream Of A Dream — Candi Staton — WB
 Love In C Minor — Cerrone — Cotillion
 Sweeter Than Sweet — Staples — WB
 11-7 Don't Leave Me This Way — Thelma Houston
 26-19 Your Real Good Thing — Paulette Reaves
 32-24 Blessed Is The Woman — Shirley Brown
 40-30 Just Another Day — Peabo Bryson
 #1 LP — EWF

WTLK — INDIANAPOLIS — Roger Holloway
 #1 — I've Got Love On My Mind — Natalie Cole
 Rigor Mortis — Cameo — Chocolate City
 Ha Cha Cha — Brass Construction — UA
 Gloria — Enchantment — UA
 10 To 3 — Close To You — Tyrone Davis
 11 To 7 — Body Heat — James Brown
 16 To 11 — At Midnight — Rufus
 22 To 14 — Look Into Your Heart — Aretha Franklin
 27 To 20 — Tryin' To Love Two — William Bell

WOKJ — JACKSON — Dick Dawkins
 #1 — I Wish — Stevie Wonder
 Body Heat — James Brown — Polydor
 Bionic Boogie — Freedom Machine — Alarm
 I Want To Get Next To You — Rose Royce — MCA
 Make Up For Lost Time — Mike Honeycutt — Ronn
 #1 LP — Stevie Wonder/Car Wash
 New LPs — G.C. Cameron, Maze, Donald Byrd

KPRS — KANSAS — Del Rice
 #1 — I Wish — Stevie Wonder
 Say You Love Me — Patti Austin — CTI
 Qualified To Satisfy — Barry White — 20th Century
 Boogie Child — Bee Gees — RSO
 Blessed Is The Woman — Shirley Brown — Arista
 #1 LP — Dramatics
 New LPs — Smokey Robinson, Love Unlimited Orchestra, George Benson, Rhythm Heritage, Maze

KALO — LITTLE ROCK — Barry Mayo
 #1 — Sometimes — Facts Of Life
 Rich Girl — Hall & Oates — RCA
 Time Is Movin' — Blackbyrds — Fantasy
 Ain't Gonna Bump — Joe Tex — Epic
 Love To The World — LTD — A&M

MOST PROGRAMMED NEW LP'S

- IN FLIGHT — GEORGE BENSON — WB**
 Adds: WUFO, KDIA, KALO, WTMP, WIBB, KPRS, WLOU, KYAC, WDAO, WWIN, WORL.
- DEEP IN MY SOUL — SMOKEY ROBINSON — TAMLA**
 Adds: KATZ, WUFO, WILD, KDIA, KJLH, WJMO, KPRS, KYAC, WWIN.
- MAZE — MAZE — CAPITOL**
 Adds: WUFO, WILD, KJLH, KUTE, WOKJ, KPRS.

MOST PROGRAMMED NEW SINGLES

- BLESSED IS THE WOMAN — SHIRLEY BROWN — ARISTA**
 Added: WGIV, WBMX, WCHB, KPRS, WANM, KJLH, WBL. Jumps: 32-24
 WCKO, 30-20 WORL.
- LOVE IS BETTER IN THE A.M. — JOHNNIE TAYLOR — COLUMBIA**
 Added: WBMX, WBUL, WWRL, KAYC, WORL, WIBB, KOWH. Jumps: 32-21
 WORL, 29-13 WDIA.
- TIME IS MOVING — BLACKBYRDS — FANTASY**
 Added: KALO, WIGO, WTMP, KALO, WJLB, WAOK. WILD. Jumps: 30-20
 WLOU, 23-18 WJPC.
- QUALIFIED TO SATISFY — BARRY WHITE — 20TH CENTURY**
 Added: KKDA, WIGO, WANT, KPRS, WJMO, WRBD, KOKY.

Rigor Mortis — Cameo — Chocolate City
 17 To 13 — I've Got Love On My Mind — Natalie Cole
 5 To 1 — Body Heat — James Brown
 18 To 14 — Easy To Love — Joe Simon
 #1 LP — Slave
 New LPs — George Benson, Bootsy Collins, Mighty Clouds

WCHB — DETROIT — Wade Briggs
 #1 — I've Got Love On My Mind — Natalie Cole
 Blessed Is The Woman — Shirley Brown — Arista
 Wake Up And Be Somebody — Brainstorm — Tabu
 Something 'Bout 'Cha — Latimore — Glades
 19 To 4 — Tryin' To Love Two — William Bell
 27 To 10 — Rigor Mortis — Cameo
 14 To 5 — You Make Me Feel Like Dancin' — Leo Sayer
 #1 LP — Undisputed Truth
 New LPs — Jean Carn

WJLB — DETROIT — Al Perkin
 #1 — Gloria — Enchantment
 The Way You Make Me Feel — Melba Moore — Buddah
 Time Is Moving — Blackbyrds — Fantasy
 Theme From "A Star Is Born" — Barbra Streisand — Columbia
 I Wanna Do It To You — Jerry Butler — Motown
 Real Love — Al Hurston — ABC
 Ain't Gonna Bump — Joe Tex — Columbia
 You Are What You Think You Are — Whispers — RCA
 Boogie Child — Bee Gees — RSO
 I Tried To Tell Myself — Al Green — Hi
 34 To 2 — You + Me — Undisputed Truth
 19 To 3 — I've Got Love On My Mind — Natalie Cole

WRBD — FT. LAUDERDALE — Crown Prince
 #1 — Be My Girl — Michael Henderson
 Love In C Minor — Cerrone — Cotillion
 Do What You Want — Lew Kirtan — Marlin
 Sweeter Than Sweet — Staples — WB
 Qualified To Satisfy — Barry White — 20th Century
 Dream Of A Dream — Candi Staton — WB
 Can't Say Goodbye — Millie Jackson — Spring
 Boogie Bopper — Sun — Capitol
 I Tried To Tell Myself — Al Green — Hi
 Two Steps — Milton Campbell — Glades
 Theme From King Kong — Love Unlimited Orchestra — 20th Century
 Look Into Your Heart — Aretha Franklin — Atlantic
 Feel The Beat — Ohio Players — Mercury
 Betcha By Golly Wow — Norman Connors — Buddah

Just Another Day — Peabo Bryson — Bullet
 Baby Don't You Know — Wild Cherry — Sweet City
 Reaching For The World — Harold Melvin — ABC
 Hots:
 Sometimes — Facts Of Life
 Tryin' To Love Two — William Bell
 Easy To Love — Joe Simon
 At Midnight — Rufus
 I've Got Love On My Mind — Natalie Cole
 #1 LP — Deniece Williams
 New LPs — Mystique, Roy Ayers, George Benson, Jupar Universal Orchestra, Ashford & Simpson, Archie Bell & The Drells, Confunkshun, Prysock, B.B. King

KOKY — LITTLE ROCK — J. D. Black
 #1 — Sometimes — Facts Of Life
 Qualified To Satisfy — Barry White — 20th Century
 I Wanna Get Next To You — Rose Royce — MCA
 Theme From Emma Mae — Keesha Brown — Marsel
 Free Love — Jean Carn — Phila. Intl.
 10-3 Good Thing Man — Frank Lucas
 Ex To 16 — I've Got Love On My Mind — Natalie Cole
 Do What You Want — Billy Preston — A&M
 #1 LP — Rufus
 New LPs — Manhattans, Mariena Shaw, B.B. King

KJLH — LOS ANGELES — Rod McGrew
 Additions:
 I Tried To Tell Myself — Al Green — Hi
 Blessed Is The Woman — Shirley Brown — Arista
 Love In C Minor — Heart & Soul Orchestra — Casablanca
 United We Stand — Roscoe & Mabel — Chocolate City
 K.Y. And The Curb — Harvey Mason — Arista
 Changes — Ralph Graham — RCA
 My Love Is Free — Double Exposure — Salsoul
 Stick Together — Minnie Riperton — Epic
 New LPs — Smokey Robinson, Diana Ross, Horace Silver, Maze, Richard Fields, Windy City

KDAY — LOS ANGELES — Jim Maddox
 #1 — Be My Girl — Dramatics
 Love Is Better In The A.M. — Johnnie Taylor — Columbia
 Too Hot To Stop — Bar-Kays — Mercury
 Feel The Beat — Ohio Players — Mercury
 Boogie Child — Bee Gees — RSO
 There Will Come A Day — Smokey Robinson — Tamla
 You're Gonna Get Next To Me — Bo Kirkland & Ruth Davis — Claridge
 Winter Melody — Donna Summer — Oasis
 Time Is Moving — Blackbyrds — Fantasy
 #1 LP — Bootsy Collins

KUTE — LOS ANGELES — Lucky Pierre
 #1 — Grover Washington
 New LPs — Jimmy McGriff, Brainstorm, Maze, Melba Moore, Jimmy Smith, Gato Barbieri

KGfJ — LOS ANGELES — Lucky Pierre
 #1 — Isn't It A Shame — Labelle
 Dr. Funkenstein — Parliament — Casablanca
 Too Hot To Stop — Bar-Kays — Mercury
 I'm Your Boogie Man — KC & The Sunshine Band — TK

WLOU — LOUISVILLE — Neal O'Rea
 #1 — Spring Affair — Donna Summer
 Magic Mountain — War — ABC
 Gloria — Enchantment — UA
 The Way You Make Me Feel — Melba Moore — Buddah
 I Want To Get Next To You — Rose Royce — MCA
 14 To 4 — Summer Snow — Blue Magic
 12 To 7 — Somethin' 'Bout 'Cha — Latimore
 17 To 8 — I've Got Love On My Mind — Natalie Cole
 18 To 10 — Love To The World — LTD
 27 To 19 — Do What You Want — Billy Preston
 30 To 20 — Time Is Moving — Blackbyrds
 New LPs — George Benson

WIBB — MACON — Hamp Swain
 #1 — Tryin' To Love Two — William Bell
 Love Is Better In The A.M. — Johnnie Taylor — Columbia
 19 To 13 — Sometimes — Facts Of Life
 Ex To 17 — Your Good Thing Man — Frank Lucas
 39 To 18 — I've Got Love On My Mind — Natalie Cole
 #1 LP — Bootsy Collins
 New LPs — George Benson, Deniece Williams, A&W, Rufus, Brass Construction

WDIA — MEMPHIS — Maxx Fortune
 #1 — Sometimes — Facts Of Life
 There Will Come A Day — Smokey Robinson — Tamla
 Blessed Is The Woman — Shirley Brown — Arista
 I Like To Do It — KC & The Sunshine Band — TK
 11 To 5 — Baby Don't You Know — Wild Cherry
 19 To 7 — Be My Girl — Dramatics
 13 To 8 — Don't Leave Me This Way — Thelma Houston
 14 To 9 — Spring Affair — Donna Summer
 28 To 12 — At Midnight — Rufus
 29 To 13 — Love Is Better In The A.M. — Johnnie Taylor
 26 To 16 — Rich Girl — Hall & Oates
 25 To 17 — Boogie Child — Bee Gees
 27 To 18 — Sure Feels Good — Confunktion
 #1 LP — Rufus

WWRL — NEW YORK — Sonny Taylor
 #1 — Free — Deniece Williams
 Welcome To Our World — Mass Production — Atlantic
 Love Is Better In The A.M. — Johnnie Taylor — Columbia
 Tryin' To Love Two — William Bell — Mercury
 13 To 8 — Reaching For The World — Harold Melvin
 16 To 10 — Sometimes — Facts Of Life
 19 To 11 — I've Got Love On My Mind — Natalie Cole
 20 To 14 — At Midnight — Rufus
 #1 LP — Trammps
 New LPs — Trammps

WBLB — NEW YORK — Wanda Ramos
 Top Single — I've Got Love On My Mind — Natalie Cole
 Life Goes On — Faith, Hope & Charity — RCA
 Love To The World — LTD — A&M
 Up Jumped The Devil — John Davis — Sam
 We've Got Love On Our Side — Silver Blue — Marlin
 Tryin' To Love Two — William Bell — Mercury
 Blessed Is The Woman — Shirley Brown — Arista
 Top LP — EWF

KOWH — OMAHA — Mike Jones
 #1 — Don't Leave Me This Way — Thelma Houston
 Boogie Bopper — Sun — Capitol
 Changes — Ralph Graham — RCA
 On & Off — David Ruffin — Motown
 Cold Blooded — Peoples Choice — TSOP
 Rigor Mortis — Cameo — Chocolate City
 Love Is Better In The A.M. — Johnnie Taylor — Columbia
 12-7 I've Got Love On My Mind — Natalie Cole
 15-10 — Look Into Your Heart — Aretha Franklin
 28-19 — Love To The World — LTD
 29-23 — Feel The Beat — Ohio Players
 #1 LP — Deniece Williams
 New LPs — First Cousins Jazz Ensemble, Rhythm Heritage, Manhattans, Osibisa

KDIA — OAKLAND — Keth Johnny Morls
 Additions:
 Disco Lucy — Wilton Place Street Band — Island
 #1 LP — Stevie Wonder
 New LPs — LTD, Mystique, George Benson, Grover Washington, Jimmy Smith, Smokey Robinson, Manhattans, Trammps

WORL — ORLANDO — Steve Crumbley
 #1 — Don't Leave Me This Way — Thelma Houston
 I Let You Walk Away — Randy Crawford — WB
 Can't Say Goodbye — Millie Jackson — Spring
 Dream Of A Dream — Candi Staton — WB
 I Wanna Do It To You — Jerry Butler — Motown
 Funk Machine — Funk Machine — TK
 Just One Step — Little Milton — Glades
 Laying Beside You — Eugene Record — WB
 The Way You Make Me Feel — Melba Moore — Buddah
 10-5 I've Got Love On My Mind — Natalie Cole
 12-7 — Too Hot To Stop — Bar-Kays
 31-2 — Love Is Better In The A.M. — Johnnie Taylor
 30-20 — Blessed Is The Woman — Shirley Brown
 #1 LP — Bootsy Collins
 New LPs — Loleatta Holloway, Softones, Jimmy Smith, Originals, Donald Byrd, B.B. King, George Benson, Undisputed Truth, Jean Carn

WAMO — PITTSBURGH — Mat Leadbetter
 #1 — Don't Leave Me This Way — Thelma Houston
 Rich Girl — Hall & Oates — RCA
 Comin' Round The Mountain — Funkadelic — WB
 Out Of The Blue — Caldera — Capitol
 Free Love — Jean Carn — Phila. Intl.
 Do What You Want — Billy Preston — A&M
 Too Hot To Stop — Bar-Kays — Mercury
 13 To 6 — Look Into Your Heart — Aretha Franklin
 25 To 9 — I've Got Love On My Mind — Natalie Cole
 #1 LP — Stevie Wonder
 New LPs — Wild Cherry

WENZ — RICHMOND — Mickey Arnold
 #1 — I've Got Love On My Mind — Natalie Cole
 Gloria — Enchantment — UA
 Somethin' 'Bout 'Cha — Latimore — Glades
 Love Is Better In The A.M. — Johnnie Taylor — Columbia
 Theme From Emma Mae — Keesha Brown — Marsel
 Free Love — Jean Carn — Phila. Intl.
 15 To 8 — Tryin' To Love Two — William Bell
 14 To 9 — I Can't Say Goodbye — Millie Jackson
 20 To 12 — Too Hot To Stop — Bar-Kays
 #1 LP — Stevie Wonder
 New LPs — Crackin', Confunkshun, Three Degrees

WANT — RICHMOND — Kirby Carmichael
 #1 — Be My Girl — Dramatics
 Ain't Gonna Bump — Joe Tex — Epic
 Qualified To Satisfy — Barry White — 20th Century
 Welcome To Our World — Mass Production — Atlantic
 Going Down To The Disco — Undisputed Truth — Whitfield
 Stick Together — Minnie Riperton — Epic

(continued on page 48)

CASH BOX TOP 100 R&B

February 19, 1977

	Weeks On 2/12 Chart		Weeks On 2/12 Chart		Weeks On 2/12 Chart
1 I WISH STEVIE WONDER (Tamla/Motown T54272F)	1	11	37 FEEL FREE FOUR TOPS (ABC 12236)	40	6
2 DON'T LEAVE ME THIS WAY THELMA HOUSTON (Tamla/Motown T54278F)	7	10	38 WITH YOU MOMENTS (Stang/All Platinum ST 5068)	35	21
3 DARLIN' DARLIN' BABY (SWEET, TENDER LOVE) O'JAYS (Phila. Intl./Epic ZS 8-3610)	2	14	39 LOVE TO THE WORLD LTD (A&M 1897)	44	5
4 FREE DENIECE WILLIAMS (Columbia 3-10429)	3	16	40 BETCHA BY GOLLY WOW NORMAN CONNORS FEATURING PHYLLIS HYMAN (Buddah 544)	42	8
5 FANCY DANCER COMMODORES (Motown 1408)	6	21	41 BOOGIE CHILD BEE GEES (RSO/Polydor 867)	49	4
6 BE MY GIRL DRAMATICS (ABC 12235)	9	10	42 TIME IS MOVIN' BLACKBYRDS (Fantasy F787)	52	3
7 DAZZ BRICK (Bang 727)	5	20	43 FEEL THE BEAT (EVERYBODY DISCO) OHIO PLAYERS (Mercury 73881)	45	5
8 I'VE GOT LOVE ON MY MIND NATALIE COLE (Capitol 4360)	15	5	44 DANCIN' CROWN HEIGHTS AFFAIR (DeLite 1588)	50	5
9 CAR WASH ROSE ROYCE (MCA 40615)	8	22	45 I DON'T WANNA LOSE YOUR LOVE EMOTIONS (Columbia 3-10347)	34	17
10 SOMETHIN' 'BOUT 'CHA LATIMORE (Glades/TK 1739)	14	12	46 EVER LOVIN' GIRL TYRONE DAVIS (Dakar 4561)	48	7
11 SATURDAY NIGHT EARTH, WIND & FIRE (Columbia 3-10439)	11	14	47 AIN'T GONNA BUMP NO MORE (WITH NO BIG FAT WOMAN) JOE TEX (Epic 8-50313)	56	4
12 ENJOY YOURSELF THE JACKSONS (Epic 8-50289)	10	19	48 JUST ANOTHER DAY PEABO BRYSON (Bullet 02)	55	6
13 HA CHA CHA (FUNKTION) BRASS CONSTRUCTION (UA XW 921)	19	9	49 COMIN' ROUND THE MOUNTAIN FUNKADELIC (WB 8309)	51	4
14 ISN'T IT A SHAME LABELLE (Epic 8-50513)	16	10	50 CHERCHEZ LA FEMME DR. BUZZARD'S ORIGINAL SAVANNAH BAND (RCA PB 10827)	36	15
15 TRYIN' TO LOVE TWO WILLIAM BELL (Mercury 73839)	20	10	51 LOVE IS BETTER IN THE A.M. PART 1 JOHNNIE TAYLOR (Columbia 3-10478)	71	2
16 SOMETIMES FACTS OF LIFE (Kayvette/TK 5128)	22	8	52 GOIN' UP IN SMOKE EDDIE KENDRICKS (Tamla/Motown 54277)	37	13
17 BODY HEAT (PART 1) JAMES BROWN (Polydor 14360)	13	11	53 YOU MAKE ME FEEL LIKE DANCING LEO SAYER (WB 8283)	57	7
18 LOOK INTO YOUR HEART ARETHA FRANKLIN (Atlantic 3373)	21	6	54 WINTER MELODY DONNA SUMMER (Casablanca NB 874)	59	3
19 GLORIA ENCHANTMENT (United Artists XW 912)	23	10	55 TOO HOT TO STOP BAR-KAYS (Mercury 73888)	62	4
20 WHEN LOVE IS NEW ARTHUR PRYSOCK (Old Town 1000)	4	16	56 CLOSE TO YOU TYRONE DAVIS (Columbia 3-10457)	39	9
21 FEELINGS WALTER JACKSON (UA CHXW 908Y)	12	15	57 I TRIED TO TELL MYSELF AL GREEN (Hi/London SN-2322)	77	2
22 BE MY GIRL MICHAEL HENDERSON (Buddah 552)	18	11	58 BABY DON'T YOU KNOW WILD CHERRY (Epic/Sweet City 50306)	46	6
23 REACHING FOR THE WORLD HAROLD MELVIN & THE BLUE NOTES (ABC 12240)	32	5	59 THEME FROM KING KONG PART ONE LOVE UNLIMITED ORCHESTRA (20th Century TC 2325)	67	4
24 I LIKE TO DO IT KC & THE SUNSHINE BAND (TK 1020)	17	12	60 RICH GIRL HALL & OATES (RCA PB 10860)	70	3
25 SUMMER SNOW BLUE MAGIC (WMOT/Atlantic WM 4003)	24	11	61 DO WHAT YOU WANT, BE WHAT YOU ARE DARYL HALL & JOHN OATES (RCA PB 10808)	53	18
26 SPRING AFFAIR DONNA SUMMER (Oasis/Casablanca 872)	25	10	62 GET UP AND DANCE MEMPHIS HORNS (RCA PB 10836)	54	10
27 HOT LINE SYLVERS (Capitol 4336)	26	19	63 THERE WILL COME A DAY SMOKEY ROBINSON (Tamla/Motown T54279F)	75	2
28 YOU GOTTA BELIEVE POINTER SISTERS (ABC/Blue Thumb 271)	27	13	64 SUPERMAN LOVER JOHNNY GUITAR WATSON (DJM/Amherst DJUS 1019)	58	14
29 AT MIDNIGHT (MY LOVE WILL LIFT YOU UP) RUFUS FEATURING CHAKA KHAN (ABC 12239)	47	4	65 WORN OUT BROKEN HEART LOLEATTA HOLLOWAY (Gold Mine/Salsoul GM 4000)	63	13
30 DO IT TO MY MIND JOHNNY BRISTOL (Atlantic 3360)	28	19	66 WHERE IS THE LOVE RALPH McDONALD (Marlin/TK 3308)	73	3
31 EASY TO LOVE JOE SIMON (Spring/Polydor SP 169)	29	12	67 SPACE AGE JIMMY CASTOR BUNCH (Atlantic 3375)	61	5
32 DISCO LUCY (I LOVE LUCY THEME) WILTON PLACE STREET BAND (Island 078)	43	6			
33 I KINDA MISS YOU MANHATTANS (Columbia 3-10430)	30	17			
34 OPEN SESAME KOOL & THE GANG (DeLite 1586)	31	18			
35 YOU DON'T HAVE TO BE A STAR MARILYN McCOO & BILLY DAVIS JR. (ABC 12208)	33	25			
36 SPY FOR BROTHERHOOD THE MIRACLES (Columbia 3-10464)	38	6			
68 OUT OF THE BLUE CALDERA (Capitol 4371)	74	4			
69 BLESSED IS THE WOMAN SHIRLEY BROWN (Arista 231)	88	2			
70 LET'S STEAL AWAY TO THE HIDEAWAY LUTHER INGRAM (Koko K0724)	89	2			
71 STICK TOGETHER MINNIE RIPERTON (Epic 8-50337)	—	1			
72 SWEETER THAN THE SWEET THE STAPLES (WB 8317)	83	2			
73 DO WHAT YOU WANT BILLY PRESTON (A&M 1892-S)	90	3			
74 MY LOVE IS FREE DOUBLE EXPOSURE (Salsoul 2012)	—	1			
75 LET IT FLOW TAMIKO JONES (Contempo/TK 7001)	79	11			
76 WHAT YOU NEED BABY CAPRELLS (Ariola America/Capitol 7649)	80	6			
77 S.O.S. SIDE EFFECT (Fantasy 784)	81	6			
78 THE WAY YOU MAKE ME FEEL MELBA MOORE (Buddah 562)	—	1			
79 LIFE GOES ON FAITH HOPE & CHARITY (RCA PB 10865)	86	2			
80 BOOGIE BOPPER SUN (Capitol 4382)	—	1			
81 TOGETHER O.C. SMITH (Caribou/Epic ZS 8-9017)	82	13			
82 THE WINDY CITY THEME CARL DAVIS ORCHESTRA (Chisound/United Artists 904)	84	5			
83 DR. FUNKENSTEIN PARLIAMENT (Casablanca 875)	—	1			
84 I FEEL LOVE IN THIS ROOM BO KIRKLAND & RUTH DAVIS (Claridge 421)	85	9			
85 SAY YOU LOVE ME PATTI AUSTIN (CTI OJ 33)	87	3			
86 I WANNA GET NEXT TO YOU ROSE ROYCE (MCA 40662)	—	1			
87 AT THE TOP OF THE STAIRS WILD HONEY (Drive/TK 6253)	91	3			
88 I CAN'T SAY GOODBYE MILLIE JACKSON (Spring/Polydor 170)	—	1			
89 RIGOR MORTIS CAMEO (Chocolate City/Casablanca 005)	—	1			
90 WE SHOULD REALLY BE IN LOVE DOROTHY MOORE & EDDIE FLOYD (Malaco/TK M1040)	—	1			
91 WELCOME TO OUR WORLD MASS PRODUCTION (Atlantic 44213)	92	3			
92 STAY AWHILE WITH ME DONNIE GERRARD (Greedy G109)	93	4			
93 THERE'S LOVE IN THE WORLD (TELL THE LONELY PEOPLE) MIGHTY CLOUDS (ABC 12241)	95	2			
94 I'M HIS WIFE ANN SEXTON (Sound Stage/Monument 7-2504)	—	1			
95 WHATEVER MAKES YOU HAPPY R.H. HUDMON (Atlantic 3366)	94	5			
96 IF YOU AIN'T MAN ENOUGH TOMMY TATE (Koko 0723)	96	3			
97 WAKE UP AND BE SOMEBODY BRAINSTORM (Tabu/RCA QB 10811)	—	1			
98 MY PEARL AUTOMATIC MAN (Island 063)	98	2			
99 CATCH A GROOVE JUICE (Greedy G108)	99	3			
100 THE COFFEE SONG OSIBISA (Island IS 080)	—	1			

ALPHABETIZED TOP 100 R&B (INCLUDING PUBLISHERS AND LICENSEES)

At Midnight (Amer. B'casting/Elainea — BMI) 29	Ever Lovin' (Julio-Brian/Content/Early — BMI) 46	Life Goes (V. McCoy/Warner Tamerlane — BMI) 79	Sweeter Than The Sweet (Mayfield — BMI) 72
At The Top (Mured/Double Diamond — BMI) 87	Fancy (Jobete/Commodores Ent. — ASCAP) 5	Look Into Your (Warner Tamerlane — BMI) 18	The Coffee Song (Cromwell — ASCAP) 100
Baby Don't (Bema — ASCAP) 58	Feel Free (ABC-Dunhill/Rall — BMI) 37	Love Is Better (Groovesville — BMI/Conquistador — ASCAP) 51	Theme From King Kong (Ensign — BMI) 59
Be My Girl (Electrocard — ASCAP) 6,22	Feel The Beat (Play One — BMI) 43	Love To The World (Alrubby — ASCAP) 39	There's Love (Traco/Screen Gems-EMI — BMI/Jobete — ASCAP) 93
Betcha By (Bel Boy/Assorted — BMI) 40	Feelings (Fermata Int'l. Melodies — ASCAP) 21	My Love Is Free (Lucky Tree/Top Bound/Mighty Three — BMI) 74	There Will Come (Jobete — ASCAP/Stone Diamond — BMI) 63
Blessed Is The Woman (Dejano — BMI) 69	Free (Kee/Drick — BMI) 4	My Pearl (Island/Automatic Man — BMI) 98	The Way You Make (Charles Kipps — BMI) 78
Body Heat (Dynamote/Belinda/Unichappell — BMI) 17	Get Up And (Bridgewood — ASCAP) 62	Open Sesame (Delighted/Gang — BMI) 34	The Windy City Theme (Thesaurus — BMI) 82
Boogie Booper (Glenwood/Osmosis — ASCAP) 80	Gloria (Desert Moon/Willow Girl — BMI) 19	Out Of The Blue (Riga/Irazu — BMI) 68	Time Is Moving (Blackbyrd — BMI) 42
Boogie Child (Stigwood/Unichappell — BMI) 41	Goin' Up (Stone Diamond — BMI) 52	Reaching For The World (Simi — BMI) 23	Together (Fox/Gimbel — BMI) 81
Car Wash (Duchess — BMI) 9	Ha Cha Cha (Desert Moon/Jeffmar — BMI) 13	Rich Girl (Unichappell/Hot Cha — BMI) 60	Too Hot To (Bar Kay/Dunbar — BMI) 55
Catch A Groove (Joyfully Sad/Almo — ASCAP) 99	Hot Line (Bull Pen — BMI/Perren Vibes — ASCAP) 27	Rigor Mortis (Better Days — BMI) 89	Tryin' To Love (Bell-Kat/Unichappell — BMI) 15
Chechez (Miller/Fisher — ASCAP/Pink Pelican — BMI) 50	I Can't Say (Gaucho/Bill-Lee — BMI) 88	Saturday Night (Saggifire — BMI) 11	Welcome To Our (Pepper — ASCAP) 91
Close To You (NY Times/Content/Little Bears — BMI) 56	I Don't Wanna (Pamjokeen — BMI) 45	Say You Love Me (Antisia — ASCAP) 85	We Should Really (East Memphis — BMI) 90
Comin' Round The Mountain (Malbiz — BMI) 49	I Feel (Claridge — ASCAP) 84	Somehtin' (Sheryl — BMI) 10	Whatever Makes (Dep/East Memphis — BMI) 95
Dancin' (Delightful/Cabrini — BMI) 44	If You Ain't Man (Klondike — BMI) 96	Sometimes (Stallion — BMI) 16	What You Need Baby (Arabella — BMI) 76
Darlin' (Silver Three — BMI) 3	I Kinda Miss (Nattahnam/Blackwood — BMI) 33	S O S (Effective/At Home — ASCAP) 77	When Love Is (Mighty Three — BMI) 20
Dazz (Milroy Cloud/Trolley — ASCAP) 7	I Like To Do (Sherlyn/Harrick — BMI) 24	Space Age (Jimerie — BMI) 67	Where Is The Love (Antisia — ASCAP) 66
Disco Lucy (Desilu — ASCAP) 32	I'm His Wife (Cape May — BMI) 94	Spring Affair (Ricks — BMI) 26	Winter Melody (Rick's Music — BMI) 54
Do It To My Mind (Bushka — ASCAP) 30	Isn't It A (Hastings — BMI) 14	Spy For (Crimora — ASCAP) 36	With You (Unichappell/Begonia Melodies/Aschken — BMI) 38
Don't Leave Me (Mighty Three — BMI) 2	I Tried To Tell (Jec/Al Green — BMI) 57	Stay Awhile (Warner Tamerlane/Interior/Van McCoy — BMI) 92	Worn Out Broken Heart (Moonsong — BMI) 65
Do What You (Unichappell — BMI) 73	I've Got Love (Jay's Ent./Chappell — ASCAP) 8	Stick Together (Dickie Bird/Jobete/Black Bull — ASCAP) 71	You Don't (Groovesville — BMI) 35
Do What You Want (Glenwood — ASCAP) 61	I Wanna Get Next (Duchess — BMI) 86	Summer Snow (WMOT/Friday's Child — BMI) 25	You Gotta Believe (Duchess — BMI) 28
Dr. Funkenstein (Rick's/Malbiz — BMI) 83	Just Another (Web IV — BMI) 48	Superman Lover (Uri-John — BMI) 64	You Make Me (Braintree — BMI/Longmanor-Chrysalis — ASCAP) 53
Easy To Love (Combine — BMI) 31	Let It Flow (Finger Lips/For Better Or Worse/Tamiko — BMI) 75		
Enjoy Yourself (Mighty Three — BMI) 12	Let's Steal Away (Klondike — BMI) 70		

EAST COASTINGS — Responding to a sense of urgency that the last detail of their magnum opus after a two-year absence from recording must approach perfection, Emerson, Lake & Palmer have apparently expressed dissatisfaction with the American pressings of their album "Works Volume I." Edgy over how their work will be presented, they have suggested that European pressings might be superior. To quell those uneasy feelings, Atlantic Records has dispatched technical expert **Ilhan Mimaroglu** (who is also head of the company's classical label, Finnidar) to Canada. He carries with him American pressings of the ELP album, as well as mint strikings of what are said to be the highest quality vinyl discs in the world — classical recordings manufactured by Deutsche Grammophon Gesellschaft. He will meet with the group in Montreal, where he is certain that an A-B blindfold comparison will convince the three members that their music is receiving the best possible reproduction on vinyl. . . . Aside from the full cast of **Queen** and **Thin Lizzy**, among those at the post-concert bash held at Oh Ho So were **Bernie Taupin**, **John Belushi**, **Eric Idle**, and **John McLaughlin**. In a fine show of label solidarity, **Corky Laing**, **Richard Lloyd** and **Fred Smith** of **Television**, and **Handsome Dick Manitoba** and **Ross "The Boss" Funicello** of the **Dictators** also showed up to say "Hi Joe!" (The Dictators' Elektra LP is due in early April.) . . . **Fleetwood Mac** and **Firefall** will be on tour together through March. . . . Strongly rumored to be the next **Bay City Rollers** producer is none other than **Jon Landau**. By the way kids, get home early from school February 14 through 18 and see the Rollers guest-host the **Mike Douglas Show**, broadcast live from balmy Miami Beach!

STONES TO POUNDS CONVERSION — We progressive thinkers are supposed to be looking toward the "metric," but in terms of traditional British weights and measures, how much are five Stones worth? If you guessed 70 pounds, you're dead wrong! Partially confirmed reports from the U.K. reveal that the **Rolling Stones'** foreign contract with Polydor Records guarantees them one and one-half million pounds over a three-year period. In cold American cash, that converts to approximately \$2.58 million. First release under the agreement is supposed to be the live album resulting from their 1976 European tour, with additional rumors that the Stones may re-record some of their old hit singles rather than settle for the paltry royalty rates from reissues.

MUSICAL CHAIRS — Now readying for live performance, Bryan Ferry's new band will include both **Chris Spedding** and **Phil Manzanera** on guitars. . . . The new **T. Rex** (**Marc Bolan**) lineup includes drummer **Tony Newman** of the defunct **Boxer**. . . . Keyboardist **Dave Greenslade's** new band includes drummer **John Hiseman** and bassist **Tony Reeves**, thus reuniting three members of **Coliseum**. . . . **Bad Co.'s** next LP is "Burnin' Sky." Watch for **Paul Rodger's** slick new short-haired look. . . . Down at the Bottom Line to check record label-less comedians **Proctor & Bergman**: **Mick Jagger** and **Eric Idle**. . . . Saddest Of All: **Peter Green**, remembered (by the over-21 set at least) as the brilliant guitarist and guiding light of **Fleetwood Mac's** golden age, has been arrested and committed to a mental institution in England, following a gun-brandishing incident where he demanded of his personal accountant that his royalties from old LPs (reportedly over \$50,000 a year) be stopped. Green has given away just about everything he owns since he left **Fleetwood Mac**, living in poverty and bumming around London. . . . **Illusion**, the band which ex-**Yardbirds** and **Renaissance** founder **Keith Relf** had been intending to form at the time of his mysterious death last year, is going through with plans and will have an Island album entitled "Out Of The Mist." (Have you ever seen the first Renaissance LP cover?)

SIXTIES NOSTALGIA — Electric Lady Studios was used as a set for the second episode of "Andros Targets," a new CBS television series. The episode, entitled "Treatment Succeeded, But Patient Died," deals with drug abuse, and the studio's psychedelic mural (by artist **Lance Jost**) was the main attraction to producers. Current projects at Electric Lady include some demo work by **Paul Stanley** of **Kiss**, and recording by two artist/producers: **Norman Connors** working with **Vitamin E** (Buddah) and **Roy Ayers** with **Ramps** (ABC). . . . **MPL/Big 3** has published the matching music folio to "Wings Over America". . . . **Santana**, along with guests **Ray Barretto** and **Gato Barbieri**, will be taped for "Soundstage" February 22. **Santana** also has scheduled an appearance on "Saturday Night Live". . . . **The Eighth Deadly Sin**: The much heralded **George Balanchine** production of "The Seven Deadly Sins," featuring **Bette Midler** for the New York City Ballet, has of course been cancelled due to the musicians' strike. . . . Beginning March 29, **Town Hall** will be the scene of Broadway shows produced by **Richard Grayson** and **John Bowab**: "She Loves Me," followed by "Knickerbocker Holiday" and "The Golden Apple." Players will include **Madeline Kahn**, **Rita Moreno**, **Richard Kiley**, **George Rose** and **Margaret Whiting**. . . . **Harry Chapin** will be the keynote speaker at the opening session of the National Entertainment and Campus Activity Association (NECAA) on February 16 in San Antonio, Texas.

MORE ANIMAL CRACKERS — According to CBS, **Pink Floyd's** new LP "Animals" has shipped platinum, as the group begins the first leg of its European tour. The stage show features myriad visual effects, including the actual inflatable 40-foot pig used for the LP's cover photography. And just in case you're tempted to call all this canine and porcine folderol just so much hogwash, consider but two examples of the degree of technical perfection reached on the current tour. Each mike on each piece of **Nick Mason's** drumkit must go through a special noisegate, which assures that the microphone will be on only at the precise instant that the drum is being hit, assuring perfect separation and cleanliness of sound. And bassist **Roger Waters** monitors an onstage oscilloscope to check the accuracy of his tuning! . . . The debut solo LP of **Peter Gabriel**, lead vocalist and frontman of **Genesis** up through the "The Lamb Lies Down On Broadway" album, will be released by Atlantic Records February 15. Cleverly entitled "Peter Gabriel," the LP was produced in Canada by **Bob Ezrin** and features **Steve Hunter**, **Robert Fripp**, **Larry Fast**, **Dick Wagner**, **Allan Schwartzberg**, **Tony Levin** (tuba as well as bass) and the **London Symphony** among others. Gabriel will headline a U.S. tour through March.

INSEPARABLE — Incredible just how far a production pact can go. **Natalie Cole** and one-half of her writing record producing team, **Marvin Yancy**, have revealed that they have been secretly married since July 31. They chose Valentine's Day to make it public. . . . **Southside Johnny** and **The Asbury Jukes** will make their film debut in "Between The Lines," the new film directed by **Joan Micklin Silver** ("Hester Street"). Premiering the end of April, the film is about the running of an underground newspaper. **Southside** should be gigging in New York about that time. . . . **Buttermilk Sky Associates**, the new firm formed by **Murray Deutch**, will act as marketing and promotion consultant to the **Charles H. Hansen Music Corporation**.

phil dimauro

POINTS WEST — Hundreds of enthusiastic fans mobbed **Stevie Wonder** in Nigeria, completely overpowering security officials to kiss and hug the singer, blind since infancy. His two-week visit to Nigeria "is the fulfillment of a lifelong dream," he says, and he will be the featured performer at the second world black and African festival of art and culture. . . . **Paul and Linda McCartney** announced in London that they are expecting their third child, and while continuing to tour, will maintain a lighter schedule until their child is born. . . . For the first time in the history of the show, **Dinah Shore** will salute a rock band in

(continued on page 56)

RIAA/McKinsey Rep On UPC Code

(continued from page 7)

deciding on one for the record industry. "On most items (in grocery stores), we have an individual item number, which goes into an item record file. When the scanner hits it, it goes in (to the record file stored in a computer), looks up that number and gives the price and everything else that is in that item record.

"The system we use for greeting cards, periodicals and paperbacks is different, in that it just sets categories of merchandise and not individual title numbers. The identity is carried in a four-digit suffix."

The advantage of this structure, Wilson said, is that unnecessary identification information is not kept at the store level, thereby leaving more room in the computer for other items. He said information that is needed for returns, etc., does not need to be scanned during each retail sale.

"What the record industry is talking about doing is putting the suffix on to that 10-digit code, which would contain the price information and so forth.

"What we are thinking about is saying, 'Maybe it would be better if you reversed that. Put the price information in the (10-digit) UPC portion and put the release number in the suffix' since that type of information only needs to be read on returns and

other inventory-type procedures.

Other Problems Technical

"It makes absolutely no difference. You are still using the same 10-digit number you have always used. We are just talking about what ought to be encoded where," Wilson said.

Once a code is agreed upon, however, there are other technical problems which will still have to be worked out, such as number assignments, where the symbol will be placed on each configuration and package interferences (such as cassette boxes and plastic-wrap crinkling), among others.

"It looks like there is going to be no real problem in solving this thing," Wilson said, "and it looks like these guys are moving well. **UPC Council Didn't Accept It**

"But the code council really didn't accept that 10-digit format. They said there is no horrendous objection to it. But," Wilson stressed, "it may not be the right one either.

"If further investigations indicate that their 10-digit code is the best thing, fine. We don't have any problem with it. But if it doesn't look like the right thing and it looks like it will run out of capacity in a couple of years, then we would have to tell them, 'hey, let's come up with something different.'"

Ilberman Promoted

(continued from page 7)

dent for the west coast; **Mike Berniker**, division vice president for popular A&R; **Thomas Z. Shepard**, division vice president for **Red Seal A&R**, and **Kelli Ross**, director of music publishing (Sunbury/Dunbar).

Ilberman's promotion establishes one of four major operational areas for RCA Records, the heads of each reporting to RCA Records president **Ken Glancy**. **Edward Scanlon** has assumed responsibility for all operational services encompassing manufacturing and recording, in addition to continuing as division vice president of industrial relations. **Robert Summer** remains as division vice president of RCA Records International, while **David Heneberry** remains in charge of RCA's record and tape clubs.

Commenting on the reorganization, Glancy stated, "During the past three years we have made significant progress in improving RCA Records' sales and profits and in order to maintain this momentum, I decided that restructuring was appropriate at the present time. This new organization format will enable me to devote more time to the acquisition of additional established artists throughout the world as well as to continue to work closely with many of our major acts. With the increase in the number of RCA subsidiaries overseas and the worldwide potential of much of our roster, I intend to give greater attention to the long range objectives of RCA Records — a broadly-based international company, talent oriented, but one which is constantly striving to achieve and maintain maximum profitability."

NARM Nominees

(continued from page 18)

Breezin' — **George Benson** — Warner Bros.
Feels So Good — **Grover Washington** — Kudu (CTI)
I Heard That! — **The Musical World of Quincy Jones** — Quincy Jones — A&M

Best Selling Comedy Album

Bicentennial Nigger — **Richard Pryor** — Warner Bros.
Live at City Center — **Monty Python** — Arista
NBC's Saturday Night Live — Arista
Sleeping Beauty — **Cheech and Chong** — Ode (A&M)

Best Selling Album By A New Artist

Boston — **Boston** — Epic
Dreamboat Annie — **Heart** — Mushroom
Firefall — **Firefall** — Atlantic
Look Out For #1 — **Brothers Johnson** — A&M
Starland Vocal Band — **Starland Vocal Band** — Windsong (RCA)
Wild Cherry — **Wild Cherry** — Sweet City (Epic)

There were no nominees for the Best Selling Hit Single or the Best Selling Classical Album. The winners were determined by a write-in vote.

Sears Ups Dividend; Also Set Stock Split

CHICAGO — **Sears, Roebuck and Co.** will ask its shareholders at the annual meeting May 16 to authorize a split of common stock. In addition, the company has increased its quarterly dividend rate 12.5% and declared a 30¢ per share extra dividend.

The stock split will increase common shares from 200 million to 400 million and reduce their par value from \$1.50 to 75¢.

The board of directors in making these decisions, said these actions were a reflection of their "confidence in the future." While earnings for the past fiscal year, ended January 31, have not yet been posted, sales reportedly increased by 9.7% over the prior fiscal year, with January's volume jumping 14.1% over the prior period.



FLACK HONORED — Atlantic recording artist **Roberta Flack** was honored in New York recently by the **United Negro College Fund**. The occasion was the organization's fifth "Aquarius Birthday" fund-raising celebration. Pictured from left are: **Stewart Bosley**, **Flack's husband**; **Roberta Flack**; **Percy Sutton**, **Manhattan borough president**; and **Connie Johnson** and her husband, **Hillery Johnson**, vice president and director of special markets for Atlantic Records.

CASH BOX COIN MACHINE

John Anderson Named Atari Vice President

SUNNYVALE, CA — John Anderson has been named vice president of administration at Atari, Inc., it was recently announced by Joseph Keenan, president.

Anderson will have corporate responsibility in the areas of personnel, facilities planning, data processing, office services and legal liaison.

He began his career with the company in October 1974 as cash manager. He became the controller for the Consumer Games Division in October 1975 and was appointed assistant treasurer in July 1976.

Anderson's previous experience has included positions as accounting manager at Unicorp and cost accounting supervisor at ISS Corp. At ISS he also held the posts of internal auditor and budget and forecasts supervisor.

Anderson holds an MBA degree from the University of Santa Clara (Calif.) and a B.S. degree in industrial management from San Jose State University.



John Anderson

Seeburg Names Sefco Distributing

CHICAGO — After a recent meeting finalizing negotiations, William F. Adair, vice president of sales-marketing, The Seeburg Products Division, Chicago, announced the appointment of Sefco Distributing Company, Inc. of Hanover, Md. as distributors for both the Seeburg music and vending product line.

The Sefco distribution territory will include the state of Maryland, except Alleghany and Garrett counties; the District of Columbia; the state of Virginia; and Grand, Pendleton, Mineral, Hardy, Hampshire, Morgan, Berkeley and Jeffer-

son counties in West Virginia.

Richard Vaughan, Sefco president, said the large 14,000 sq. ft. facility headquartered in Hanover will consist of offices, warehousing space and product display center. Vaughan also stated that full service and complete parts, accessory and supply inventory for Seeburg music and vending products will be available.

Vaughan has a substantial background in the games, music and vending industry, with 17 years in the coin-op business.

Sefco will also handle the complete line of Williams Electronics amusement games.

California Law Legalizes Slot Hobby

LOS ANGELES — New Year's Day 1977 is recently past us, but it didn't get by without a change in the law regarding some of the 'ancestors' of today's coin-op machines and games.

On Jan. 1, a state law went into effect making it legal to possess antique slot machines in California. Previously, the possession of the machines was a felony.

Basically, the new law says that if law enforcement officials arrest someone for possession of a slot machine manufactured before 1941, they can't destroy or dispose of the device until a court decides whether the owner used the machine for illegal gambling. If the owner is found innocent, he gets his machine back.

The collecting of old-fashioned slot machines has been a fairly popular hobby for a number of years. But California collectors, fearful of legal repercussions, have often been inclined to keep their machines

out of sight. The new law now allows collectors to enjoy their hobbies openly and without fear.

Assemblyman Alan Sieroty introduced bill AB 4173 last March as an "urgency statute," legislation which defined pre-1941 slot machines as antiques and also offered protection. Governor Edmund Brown signed the bill in September and it became effective on Jan. 1. With the passage of the law, California joined Nevada, Illinois, Ohio and Michigan as states where possession of old slot machines is legal. However, using the slot machines in California for gambling, or owning machines manufactured after 1941, is still illegal.

American Invention

Slot machines are actually the only such gambling devices to be invented in America, and they originated in California in 1895 when Charles Bey introduced his

(continued on page 48)



GRAND PRIX — Williams Electronics Inc. premiered its Grand Prix pinball game at last year's AMOA Expo. Scoring features on this four-player game include left and right bonus lanes with spinner units for 1,000 points; left and right center kick-out holes for bonus; advance bonus rebound rubbers and drop targets that light one to four stars (number two star scores an extra ball and number three star a special). The game is encased in a colorfully illustrated cabinet with car racing graphics.

IUC Declares Dividend

CHICAGO — The board of directors of Interstate United Corporation has declared a quarterly dividend of 6 cents per share on the common stock, payable March 17, 1977 to shareholders of record Feb. 28, 1977, it was announced earlier this month.

Service Hint: Flipper Assemblies

by Bernie Powers

Bally Manufacturing Corporation

The most misunderstood and neglected switch in a flipper game today is the flipper 'end of stroke switch.' This switch performs a vital function to the proper operation of a game. However, it does not stand out and



Bernie Powers

say, "This feature is not working properly," when it is not functioning.

Let us logically examine the function of this switch so that we may understand the effects of it not functioning properly.

The basic circuit drawing for a Bally flipper (figure A) shows a normally open switch (the flipper button); a double wound coil (flipper solenoid AF 25-500, AF 28-1000); and a normally closed switch (E.O.S.).

The normally open switch is the button on the side of the cabinet which, when pushed, closes the switch to connect the current to the solenoid. It completes the circuit to the pull-in winding of the coil, a heavier gauge strong winding magnet wire, to ensure a fast pull-in or actuation of the flipper. During this pull-in, or actuation, the circuit is completed through the flipper button switch, the pull-in winding of the coil, and the closed end-of-stroke switch.

The pull-in winding in this particular drawing is the AF 25-500. Upon actuation or pull-in of the plunger, the linkage arm opens the normally closed 'end-of-stroke' switch. This causes the circuit to go through both windings of the solenoid, AF 25-500 and AF 28-1000 in the accompanying drawing.

The hold-in winding is a weaker winding, using lighter gauge wire. The purpose is to

(continued on page 48)

State Association Calendar 1977

Mar. 11-13; Music Operators of Michigan, annual conv., Kalamazoo Center, Kalamazoo, Mich.
 Mar. 18-20; Wisconsin Music Merchants Assn. Inc., spring conv., Olympia Hotel & Spa, Oconomowoc, Wis.
 May 12-15; Music & Amusement Assn., Inc., conv. & trade show, Stevensville Country Club, Swan Lake, N.Y.
 May 20-22; Music Operators of Minnesota, conv. & trade show, Holiday Inn-Downtown, Minneapolis.

June 10-12; Colorado Coin Industries, annual mtg., Holiday Inn, Glenwood Springs, Colo.
 June 16-19; Illinois Coin Machine Operators Assn., annual conv. Hospitality Motor Inn, Earth City, Mo.
 Sept. 22-24; West Virginia Music & Vending Assn.; annual conv.; Heart-O-Town Motor Inn, Charleston, W. Va.
 Sept. 23-25; No. Carolina Coin Operators Assn., Inc., annual mtg., Raddison Hotel, Charlotte, N.C.

Williams' GRAND PRIX

NEW 4 PLAYER WINNER
3 OR 5 BALL - ADJUSTABLE
REPLAY OR EXTRA BALL MODEL

**ORDER
"GRAND PRIX"
NOW!**

Be first with the Best!

Today's Pricing
1 Play per Quarter
3 Ball Play
a Must

Williams
ELECTRONICS, INC.
3401 NORTH CALIFORNIA AVENUE
CHICAGO, ILLINOIS 60618
CABLE ADDRESS WILCOIN CHICAGO
Available For Immediate Delivery
Through Your Williams Distributor

Service Hint

(continued from page 47)

disperse heat and prevent a solenoid burn-out when the flipper button switch is held in or in the closed position.

Two major problems with a flipper can be understood with the knowledge of this circuit.

The first problem is solenoid burn out. A coil will burn out if this switch does not open upon actuation of the flipper. What is happening is the normal bat action of the flipper is taking place; yet the only windings on the coil that are being used is the strong, heavy gauge wire. A solenoid will burn out when the flipper button is held in.

The second is a weak flipper action. A weak flipper could be caused by the fact that this switch is never in the closed position. This could either be due to the adjustment or amount of dirt on the contact's surface, not allowing a circuit to be made.

What is taking place here is that the circuit is initially going through both windings of the solenoid, causing a slower pull-in of the plunger.

The adjustment on this switch should be made with the plunger completely depressed manually. The gap between contacts should be 3/32" and when the plunger is let out, the longer blade should follow thru the shorter blade 1/32" to ensure a good wiping action of the contacts.

Remember, when adjusting this or any other switch, adjust the static blade — not the actuating blade. The static blade on this assembly is the shorter blade; the actuating blade is the longer.

The only lubrication on this unit is needed for the linkage. Use the 'Bally Coin Machine Lubricant' which is provided in the instruction packet of every new Bally game.

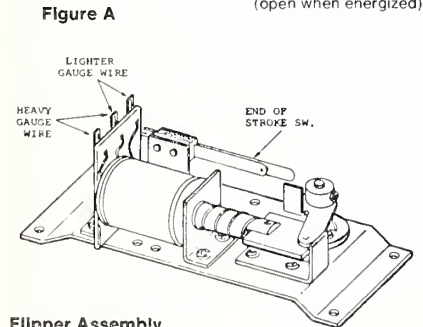
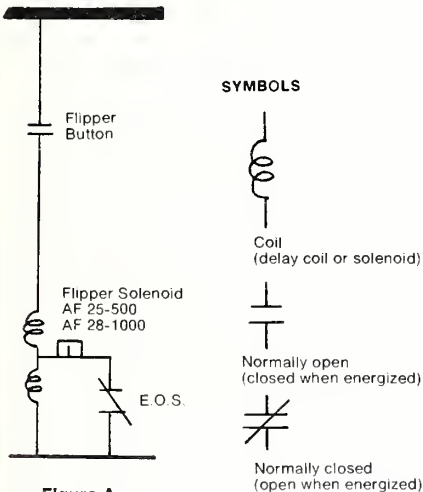

Flipper Assembly

California Slot Law

(continued from page 47)

first one in San Francisco.

Fey's machine, called the Liberty Bell, was first placed in a San Francisco saloon where it was immediately successful. He reportedly operated on a percentage basis with his subsequent machines, collecting 50 percent of the take and servicing his own machines.

Since patent laws didn't apply to slot machines, Fey's ideas were quickly adopted by Herbert S. Mills, owner of the Mills Novelty Co. Of Chicago. Other imitators also followed. By the early 1900s, a "second generation" of slots began to appear, devices which used fruit symbols instead of the usual playing cards on the reels. Some of the early machines even dispensed fruit-flavored chewing gum when a player inserted a coin, and the machines became the forerunners of the latter-day vending machine.

FM Analysis (continued from page 27)

WBLM-FM — LEWISTON, ME — Jose Diaz
Most Active:

- City Boy — Dinner At The Ritz — Mercury
- Walk On The Water
- Eagles — Hotel California — Asylum
- Life In The Fast Lane
- Joan Armatrading — A&M
- George Harrison — Thirty Three & 1/3 — Dark Horse
- Crackerbox Palace
- Emmylou Harris — Luxury Liner — WB
- Poncho & Lefty
- Jackson Browne — The Pretender — Asylum
- Taj Mahal — Music Fuh Ya — WB
- You Got It
- David Bowie — Low — RCA
- Sound In Vision
- Atlanta Rhythm Section — A Rock & Roll Alternative — Polydor
- So In To You/Neon Nights

Adds:

- Kinks — Sleepwalker — Arista
- Fleetwood Mac — Rumours — WB
- Ace — No Strings — Anchor
- Valerie Carter — Just A Stone's Throw Away — Columbia
- Renaissance — Novella — Sire
- New Riders Of The Purple Sage — Who Are Those Guys? — MCA
- Rufus — Ask Rufus — ABC
- George Benson — In Flight — WB
- Dirk Hamilton — Alias — ABC
- Pink Floyd — Animals — Columbia

WWJZ-FM — CHARLESTON, SC — Brooks Alsbrook

Most Active:

- Renaissance — Novella — Sire
- Touching Once
- Pink Floyd — Animals — Columbia
- Jimmy Buffett — Changes In Latitude — ABC
- Michael Franks — Sleeping Gypsy — WB
- Chain Reaction/Don't Be Blue
- George Benson — In Flight — WB
- Janis Ian — Miracle Row — Columbia
- Take Me To The Sky
- Emmylou Harris — Luxury Liner — WB
- Poncho & Lefty/Luxury Liner
- Average White Band — Person To Person — Atlantic
- Person To Person/If I Ever Lose This Heaven
- Pablo Cruise — A Place In The Sun — A&M
- A Place In The Sun/El Dorado
- Winters Bros. Band — Atco
- ZZ Top — Tejas — London
- Asleep In The Desert/El Diablo
- Andrew Gold — What's Wrong With This Picture — Elektra
- Lonely Boy/Stay
- Gary Wright — The Light Of Smiles — WB
- The Light Of Smiles/Water Sign
- Queen — A Day At The Races — Elektra
- Let Us Cling Together
- Ace — No Strings — Anchor
- C'est La Vie
- Barclay James Harvest — Octoberon — MCA
- Herbie Mann — Bird In A Silver Cage — Atlantic

Adds:

- Pink Floyd — Animals — Columbia
- Jimmy Buffett — Changes In Latitude — ABC
- George Benson — In Flight — WB
- Herbie Mann — Bird In A Silver Cage — Atlantic



ABC INKS McCANN — ABC Records has signed Les McCann to a recording contract where his debut album will be "Music Lets Me Be" to be released in the spring. Pictured at the signing in the front row (l to r) are: Jerry Rubinstein, chairman of the board of ABC Records; Les McCann, and Charlotte McCann, Les' wife. Back row (l to r) Richard Steckler, Les McCann's manager, and Otis Smith, vice president of ABC Records

ACE Report Scores Country Stations

(continued from page 36)

tly is 'all-hit country music.' On the surface this seems very restrictive. It is easy to be swayed by the success of the formula of a WHN, for instance, but this does not really help the industry. There are so many newcomers, artists and labels, that we decided early in the game to do whatever we could to help. So for about a year we played everything that was good. But for reasons that are obvious that did not work, so a reworking of our policy went into effect which separated the 'wheat from the chaff' and led to our present slogan. Our playlist includes approximately 100 titles under a two box system: the first, top 50, and the second is made up of up and coming songs. An hourly card system controls the rotation of songs," Stone said.

Family Station

Bob Pittman, program director of WMAQ in Chicago explained, "Since we are a family radio station, we feel the need to serve everyone regardless of age. . . . We let our listeners decide which songs we play. We receive about 18,000 phone calls for requests each week. We also receive a couple of thousand letters a week, many containing requests. And, on top of that, we call listeners every week asking them such questions as 'Are there songs that you dislike?'; 'Are there any songs or types of music that you feel we should be playing and are not?'; 'What are your favorite songs,' etc. And based on this information, we decide which songs to play."

Nevertheless, the results of the survey

clearly show that listeners are bored by hearing what appears for many stations to be a 1 1/2 hour rapid fire format. And many said they have stopped listening to radio in favor of records, adding that they felt the music was crammed down their throats.

Major Opposition

For the most part, ACE's major opposition mirrored the fan's response. The group further maintains there is little opportunity for the vast majority of available product to get exposure — album cuts, unestablished artists, unknown songwriters, previously untried musical approaches, traditional country performers and sub-groups, especially bluegrass, are ignored, according to ACE. Instead, less than one percent of the material recorded in the hundreds of Nashville recording sessions each year gets circulated on country radio stations. And sales for those records are lost because fans don't want to buy records that they're sick of hearing over and over again on radio. As a result, the identity of country music as the fans have known it is being destroyed, because the product chosen for recirculation bears, in many cases, little resemblance to the feel considered distinctively "country" for so long.

Finally, ACE has requested that CMA take issue along side them against stations practicing a country music masquerade while damaging the growth of product through regimentation of the music. According to Jo Walker, however, CMA is not a monitoring association, and so far it has not become actively involved.

R&B New Additions (continued from page 44)

- Keep It Cool — Elvin Bishop — Capricorn
- 15 To 7 — Tryin' To Love Two — William Bell
- New LPs — Wood, Brass & Steel
- KEAZ — SAN DIEGO — Bruce Ley**
- #1 — Dancin' — Crown Heights Affair
- Boogie Bopper — Sun — Capitol
- 18 To 8 — Love To The World — LTD
- 23 To 9 — Too Hot To Stop — Bar-Kays
- #1 LP — Dramatics
- KYAC — SEATTLE — Robert L. Scott**
- #1 — I've Got Love On My Mind — Natalie Cole
- At Midnight — Rufus — ABC
- Love Is Better In The A.M. — Johnnie Taylor — Columbia
- Theme From King Kong — Love Unlimited Orchestra — 20th Century
- Dancin' — Crown Heights Affair — DeLite
- #1 LP — Bootsie Collins
- New LPs — Dionne Warwick/Isaac Hayes, Smokey Robinson, George Benson
- KATZ — ST. LOUIS — Chico Brown**
- #1 — I Wish — Stevie Wonder
- Tryin' To Love Two — William Bell — Mercury
- Out Of The Blue — Caldera — Capitol
- The Way You Make Me Feel — Melba Moore — Buddah
- I Wanna Get Next To You — Rose Royce — MCA
- Don't Leave Me This Way — Thelma Houston — Tamla
- Reaching For The World — Harold Melvin — ABC
- New LPs — Smokey Robinson, B. B. King
- WANM — TALLAHASSEE — Joe Bullard**
- #1 — Gloria — Enchantment

- Dr. Funkenstein — Parliament — Casablanca
- Family Again — Sly Stone — Epic
- I Can't Say Goodbye — Millie Jackson — Spring
- Cloudy — A&W — Atlantic
- Blessed Is The Woman — Shirley Brown — Arista
- I Wanna Do It To You — Jerry Butler — Motown
- 15 To 1 — Gloria — Enchantment
- 11 To 6 — Look Into Your Heart — Aretha Franklin
- 12 To 7 — Spy For Brotherhood — Miracle
- 19 To 2 — Boogie Child — Bee Gees
- 20 To 3 — Feel Free — Four Tops
- 13 To 5 — Space Age — Jimmy Castor
- 14 To 8 — Sure Feels Good — Confunkshun
- 18 To 9 — Comin' Round The Mountain — Funkadelic
- 16 To 10 — I've Got Love On My Mind — Natalie Cole
- 17 To 11 — Love To The World — LTD
- 24 To 13 — Welcome To Our World — Mass Production
- #1 LP — Ashford & Simpson
- WTMP — TAMPA — Jerry Walker**
- Top Single — Be My Girl — Dramatics
- Rich Girl — Hall & Oates — RCA
- Do What You Want — Billy Preston — A&M
- Time Is Moving — Blackbyrds — Fantasy
- There Will Come A Day — Smokey Robinson — Tamla
- I'm Your Boogie Man — K.C. & The Sunshine Band — TK
- Hot
- I've Got Love On My Mind — Natalie Cole
- Tryin' To Love Two — William Bell
- Ain't Gonna Bump — Joe Tex
- Love Is Better In The A.M. — Johnnie Taylor
- #1 LP — Blackbyrds
- New LPs — George Benson, Harold Melvin, Rufus

EXECUTIVES ON THE MOVE

(continued from page 16)

vice president and general manager of Empire Scientific.

Pollock Joins Best — Sandy Pollock has joined Barbara Best, Inc. as executive vice president in charge of personality and music publicity. Pollock recently left I.C.P.R., where she headed the music department for two years.

Neckar Appointed At UA — Dave Neckar has been appointed vice president of manufacturing for United Artists Records, it was announced by L. Joseph Bos, chairman of the board, United Artists Music and Records Group, Inc.

Rodriguez Joins Mercado — Ralph Mercado and Ray Aviles of Ralph Mercado Management announced that William Rodriguez has joined the company as promotion director of college concerts. Mercado and Aviles are the two major promoters of latin music on the east coast.

CLASSIFIEDS

COIN MACHINES WANTED

WANTED: Bally Shoot-A-Lanes and Fun Spots. WILL PAY CASH. MICKEY ANDERSON, INC., P.O. Box 6369, Erie, PA 16512. Phone (814) 452-3207.

WANT Seeburg AY 160, DS160, LPC-1, LPC-480, Electra, Fleetwood, SS160, LS-1, LS-2. We pay cash and pick up our truck unpacked. PAN AMERICAN AMUSEMENTS, INC. 1211 Liberty Ave., Hillside, NJ 07205. (201) 353-5540.

WANTED: Cash paid for late model used pins. Premium paid for Wizards, Fireballs, Four Million B.C., Champ, Nip It, Wurlitzer 1050's and 1015's (any jukebox antiques). Call collect 1-313-792-2131.

OPPORTUNITY FOR ROUTE OWNERS: For overseas customer. Wanted: 300 to 1,000 pinballs (Gottlieb, Williams, Bally), 80 per cent one player, balance 2-4 players. 1970 to 1976, conditions not important, only quantity and prices. Also interested in arcade equipment. JAIME ROZOVSKI, 872 Massachusetts Ave., Apt. 903, Cambridge, Mass. 02139. (617) 247-6647.

COIN MACHINES FOR SALE

SALE: 400 assorted Gottlieb, Bally, Williams flippers, '70-'76, Bingos, Bali, Stockmarket, Tickertape, Wallstreet, Mysticgate. NEW PAN AMERICAN AMUSE., 1211 Liberty Ave., Hillside, New Jersey. (201) 353-5540.

FOR SALE: ADD-A-Balls — Gottlieb: Jungle King \$395, Captain Card \$425, Bally: Delta Queen \$395, Williams: Star Action \$395, Skylab \$450, Hi Deel \$645. No crating. (518) 377-2162. MOHAWK SKILL GAMES CO., 67 Swaggertown Road, Scotia, NY 12302

CONVERSION CARTRIDGES — Play stereo records on Seeburg monaural phono B thru 201. No adjustments required — just plug in — eliminate sound distortion, needle skipping, excessive record wear. \$24.95 postpaid. Satisfaction guaranteed. Quantity discounts. C.A. THORP SERVI. 1520 Missouri, Oceanside, Ca. 92054.

JUST OUT! Bally "Fireball" home professional pinball game, 4-player (no coin required), solid state electronics, easy diagnostic test circuits, LED digital scoring, plays seven songs. \$800 brand new — sealed carton. Request circular. ANIMATED PROD., INC., 1600 Broadway, New York 10019. (212) 265-2942.

50 SEEBURG 100 selection wall boxes \$5.00 each. 50 Seeburg 160 selection wall boxes \$37.50 each. 10,000 used 45 rpm records 15 each. CENTRAL MUSIC CO., P.O. Box 284, 407 E. Ave. D., Killeen, Texas 76541.

ATTENTION metropolitan & upstate New Yorkers: We have a large selection of new & used add-a-balls and arcade equipment. Also jukeboxes, pool tables, shuffles, cigarette & candy. We deliver & accept trades. COIN MACHINE DISTRIBUTORS, INC., 213 N. Division St., Peekskill, N.Y. 10566. Call (914) 737-5050.

NATIONAL WHITENBURG MODEL 400 FOOD VENDOR
1 National 21CE candy machine — Vendo Visi-Vend Rowe cigarette machines 20 700 \$175 or 7 for \$1000 — Rowe 2000 \$295, crating extra. Arcade equipment. Motor Cycle, Funland, Pennant, Sami, Sea Raider and Dune Buggy, pool tables, pinballs and many other items. VATHS VENDORS. Call (214) 792-2806, 793-3723 or 792-1810.

ALL TYPES OF COIN-OPERATED EQUIPMENT. Flippers, shuffle alleys, guns, TV games, Williams, Gottlieb, ChiCoin, Ramtek, Allied, Natting, Phonographs (large selection) Wurlitzer, Seeburg, AMI, Rock-Ola, Rock-Ola vending, Cigarettes, candy, cold drink. National Smokeshop, Rock-Ola. All kinds shipped to perfection or buy as-is and save. We have the right price and equipment on hand to serve your needs. Write or call: FLOWER CITY DISTRIBUTORS, INC., 389 Webster Ave., Rochester, N.Y.

CLASSIFIED AD RATE 25 CENTS PER WORD

Count every word including all words in firm name. Numbers in address count as one word. Minimum ad \$6.25. CASH OR CHECK MUST ACCOMPANY ALL ORDERS FOR CLASSIFIED ADVERTISING. If cash or check is NOT enclosed with order your classified ad will be held for following issue pending receipt of your check or cash. NOTICE — \$138 Classified Advertisers (Outside USA add \$78 to your present subscription price). You are entitled to a classified ad of 40 words in each week's issue for a period of one full year, 52 consecutive weeks. You are allowed to change your Classified each week if you so desire. All words over 40 will be billed at the rate of 25c per word. Please count words carefully. Be sure your Classified Ad is sent to reach Hollywood publication office by Wednesday, 12 noon, of preceding week to appear in the following week's issue.

Classified Ads Close WEDNESDAY

Send all copy to: CASH BOX, 6363 Sunset Blvd., Hollywood, CA 90028

FOR SALE: 5,000 jukebox 45s and EPs. 100 different \$8.50; foreign \$12. Rock, Disco, Polkas, Spanish, Country. 25 assorted EPs \$6.50. AL's, 2249 Cottage Grove, Cleveland Heights, Ohio 44118.

FOR SALE: Silver Sails, Ticker Tapes, Wall Streets, Blue Chips, Stock Markets. Also Barrel of Funs, Sweet Shawnees, Bally Jumbos and Super Jumbos, Big Threes, Blue Spots, Mt. Climbers. Also other uprights and OK games. Call WASSICK NOVELTY, Morgantown, W. Va., (304) 292-3791.

FOR SALE: Travel Time, Satin Doll, Wild Life, Flying Carpet, Super Star, Playball, Sky Jump, 2001 Mibs, Super Shifters, Tankers, Ramtek Baseball, TV Ping Pongs, World Series, Batting Champ, Sega Sea Devil, U Boat, Drag Races, Flying Carpet, Gun, Speedway, SAMI, Invaders, Winners, Paddle Battle, Pong, Computer Quiz, Brunswick Air Hockey, Wurlitzer 3110, Seeburg D S160 and Model R. D&L DISTR. CO. INC., Box 6007, Harrisburg, Pa. 17112. Phone (717) 545-4264.

FOR SALE: Spirit of '76 \$795, Jack In The Box \$600, "300" \$825, Quick Draw \$725, Oxo \$575, Fantastic \$375, Rogo \$645, Capt. Fantastic \$995, Bow and arrow \$845, Road Runner (shopped) \$125, Wizard \$880, Cinema \$700, Demolition Derby \$850, Speed King \$395, Sound Stage \$695, Top Ten \$575, Rock On (solid state) \$700, Super Shifter \$475, Chopper (motorcycle) \$465, Knock Out \$495, Goal Tender \$350, Ball Park \$525, Grand Prix \$195, Monte Carlo \$250, Air Attack \$395, Owak Gun \$450, Goal 4 \$375, Gran Trak 10 \$650, Stunt Cycle \$995, 4 in 1 cocktail table \$850, Bombs Away \$495, Gun Fight \$1,045, Ball Park \$525, TV Goalee \$250, Pace Race (shopped) \$175, Robot \$395, Tennis Tourney \$165, Clean Sweep \$395, Trivia \$695, Big Red \$210, Fire Chief \$525, Big Shot Rifle \$750, Pachinko \$295, Air Hockey \$300, Air Handball \$395, Horoscope \$395, Stripper \$795, Trivias (brand new) \$825, Bi-planes (brand new) \$875, Drop Zone 4 \$375, New Orleans Novelty Co., 1055 Dryades Street, New Orleans, La. 70113. Tel: (504) 529-7321, CABLE NONOVCO.

FOR SALE One of the largest selections of new & used add-a-balls & arcade machines in the northeast. Call or write for our list. COIN MACHINE DISTRIBUTORS, INC., 213 N. Division St., Peekskill, N.Y. 10566 (Westchester Co.) (914) 737-5050.

RECORD BINS FOR SALE: 4 LP wide step-ups \$80 each; 5 LP wide step-ups \$100 each; extra large browser bins \$125 each. Contact: Jack Baker (213) 240-6290.

FOR SALE: Midway Bulls Eye, Golf Champ, ESP Electro Dart, wall games \$150, D&L DISTRIBUTING CO., 6691 Allentown Blvd., Harrisburg, Pa. (717) 545-4264.

FOR SALE: Rock-Ola 504 wallbox \$100; Rock-Ola Receivers, 1725-8-2, 1765, 1755, 1721, 1769 \$65 each. WESTERN DISTRIBUTORS, 1226 SW 16th Avenue, Portland, Ore. 228-7565.

FOR SALE: We have in stock a great quantity of 5 year old pinball machines Gottlieb. Write to: SOVODA 51 Rue de Longvic, 21300 Chenove France telex 350018.

IMMEDIATE DELIVERY — Hollycrane motors, Bally Bingo Control Motors, Bally O.K. Games, Lido, Roller Derby, Circus Queen, Bikini, New Sweet Shawnee, New Twin Knight. Used Uprights, New Big Three backglasses. LOWELL ASSOCIATES, P.O. Box 386, Glen Burnie, Md. 21061. (301) 768-3400.

SEEBURG LPC 150, AMI 200, N 150. Johnson coin sorter & counter 295. Tennis Tourney 200. Electro Dart 100. BROWSER, 2009 Mott Ave., Far Rockaway, N.Y.

JUBILEE SHERIFF, Jack in Box, Hot Shot, Pro Football \$595 each. U.S. Billiards, Air Hockey \$400, Midway Sea Raider, Stunt Pilot, Invaders, Sea Rescue \$300 each. Foolsballs \$250. STARK NOVELTY CO. 239 30th St., N.W. Canton, Ohio. 44709. (216) 492-5382.

FOR SALE: Add-A-Balls — Williams: Tropic Fun \$395, Spanish Eyes \$325, Space Lab \$450, Lucky Ace \$575; Gottlieb: Pop-A-Card \$275, Pin Up \$650, World Series \$350, Free Fall \$450, Jungle King \$375; Bally: Wizard \$850, Boomerang \$750, Delta Queen \$450; Rockola 1488's to 454; Pool Tales: U.S. Billiards Pro I & II's. All equipment reconditioned. Pick-up or we deliver. Call Dick Kingston (914) 338-5700. R. WENZEL & SONS, INC., 183 Salem St., Port Ewen, N.Y., 12466.

WURLITZER Model 1100, Rockola model 2, Seeburg models B and C, Motoscope Candy Shoppe Grabber, Western Sweepstakes — Make Offer. BRENON'S COIN MACHINES, INC., P.O. Box 117, Brownville, New York, 13615.

NEW GAME CLOSE-OUT — LESS THAN FACTORY COST. Bio-Rhythm \$995, Allied Fire Power \$995, Century World Series Baseball w/stand \$695, C.C. Rifle Gallery \$795, Electra Eliminator IV \$795, Electra Pace Race \$495, Fun Games Bi-Plane \$995, Garlando Giant Soccer \$300, Meadows Drop Zone 4 \$595, PSE Maneater \$995, LIKE NEW USED GAMES — Bally Old Chicago \$995, C.C. Sound Stage \$845, C.C. Coney Island Gun \$1175. HARD TO GET PARTS FOR OLDER GAMES: We have back glasses and parts for many games dating back to 1956. Central Distributors, Inc., 2315 Olive St., St. Louis, Missouri 63103. Call toll free in USA 1-800-325-8997. (In Missouri 1-800-392-7747.)

FLIPPERS: At all times more than 400 late model Gottlieb, Bally, Williams, Chicago, Spanish mfr. available. Immediate delivery call for lists. PAN AMERICAN AMUSEMENTS, 1211 Liberty Avenue, Hillside, New Jersey. (201) 353-5540.

FOR SALE: Completely reconditioned: 1 Bally Twin-Win (4 pl) \$595; 1 Bally Sky Kings (1 pl) \$495; 1 Bally Hi-Lo Ace (1 pl) \$395; Midway Twin Pirate \$695; Midway Ball Park \$695; Playtime \$445; Leader Upright \$445; Leader Lo-Boy \$445; Winner IV \$395; Winner I \$195; Dart Champ \$95. MICKEY ANDERSON, INC., P.O. Box 6369, Erie, PA 16512. Phone (814) 452-3207.

BINGOS FOR EXPORT ONLY. Available 25 Big Wheels. Write for special price. Also OK games, and Ticker Tapes. Late pin balls, and Arcade equipment. D&P MUSIC CO., 1237 Mt. Rose Ave., York, Penn. 17403. P.O. Box 243. (717) 848-1846.

FOR SALE: Ready for Locations — Sea Raider \$125; Sea Rescue \$125; Midway Wirley Bird \$250; Pro Quiz Master \$75; Flipper Kiddie Ride \$250; Midway Stunt Pilot \$150; Midway Dune Buggy \$175; Travel Time Pinball \$400; Wurlitzer 3510 & 3500 \$425; Lotta Fun converted to Barrel O Fun \$800; Used National Cig. Machines and used Rowe 20-800 Cig. Machines, also new and used Pool Tables. Guerrini's 1211 West 4th St. Lewistown, Pa.

SALE: 1,000 Bally super continental slot machines. Excellent condition. \$1,250 each. F.O.B. Antwerp, Belgium. Machines subject to inspection. Pan American Amusements, 1211 Liberty Avenue, Hillside, New Jersey 07205, telephone 201-353-5540.

EMPLOYMENT SERVICE

WANTED: Expert Bingo mechanic. Resume. Three trade references. SHELTON MUSIC CO., Agana, Guam 96910.

BMI SONGWRITER-COMPOSER who has written for Tavares, Righteous Bros., Grass Roots, and others now auditioning soulful keyboard players for composing-collaboration. Also have contemporary soul and disco catalog for A&R men and producers. Willie H. Wilson (213) 299-6649.

YOUNG WRITER-PRODUCER with sources for artists and material desires association with a progressive record company needing same and prepared to make offers. Write C.K. Aspinwall of 652 Azalea Drive in La Grange, Ga. 30240.

WANTED: Expert bingo mechanic. No drunks, derelicts or drifters. No managers. Workers only. COLLINS MUSIC CO., INC., 1341 Rutherford Road, Greenville, S. Carolina 29609. Phone toll free 1-800-845-5160.

JO-BAR MUSIC PUBLISHING CORPORATION and BAR-JO Records, Inc. needs investors and stockholders to re-open music business. — Write BAR-JO at 83-45 Viotor Ave., Suite 2B, Elmhurst, NY 11373 or call (212) 898-1628 or 243-5668.

SCHOOL FOR GAMES AND MUSIC, two and three week courses. Phonos, Flippers and Bingos. By Schematics! CAL'S COIN COLLEGE, P.O. Box 810, Nicoma Park, Okla. 73066. (405) 769-5343.

WANTED: SERVICE MANAGER. Established music and game operator has excellent opportunity for service manager. Must have five year's working experience and thorough knowledge of audio and video electronics plus good mechanical ability. Excellent salary plus fringes. Send resume stating experience and references to: MODERN SPECIALTY CO., INC., 405 N. Broom Street, Madison, Wisconsin 53703.

SERVICE SCHOOL FOR GAMES AND MUSIC. Ten week night course teaches practical theory, schematics. \$575 full price. COMIT, 2115 Beverly Blvd., Los Angeles, Ca. 90057. (213) 483-0300.

SERVICES COIN MACHINE

ACE LOCKS KEYS ALIKE: Send locks and the key you want them mastered to: \$1.25 each, 10% D/C in lots of 50 or more. RANDEL LOCK SERVICE, 61 Rockaway Ave., Valley Stream, N.Y. 11580. (516) 825-6216. Our 38th year in vending.

RECORDS-MUSIC

LEADING TAPE AND RECORD DISTRIBUTORS of all labels. Will sell current & cut-out merchandise at lowest prices. Member of NARM. Send for free catalogues. CANDY STRIPE RECORDS, INC., 371 South Main Street, Freeport, New York 11520. (516) 379-5151. (212) 895-3930. Telex 126851 Canstripere Free.

RECORD/MUSIC POSITION wanted by young single male, B.A. (Economics), J.D., in management, promotion or production. Creative, highly motivated. Resume: CHRIS JOHNSON, 7220 Hollywood Bl. #234, Los Angeles 90046.

INTERNATIONAL RADIO STATIONS, MUSIC PUBLISHERS, discoteques and fanclubs subscribe to our Automatic Airmail Service for all singles and LPs from the charts. The fastest and most dependable service in the world. AIRDISC SPECIAL SERVICES. Box 835, Amityville, New York 11701.

WANT RECORDS & TAPES, 45s AND LPs, surplus returns, overstock cut-outs, etc. Call or write Harry Warriner at KNICKERBOCKER MUSIC CO., 453 McLean Ave., Yonkers, New York 10705. (914) GR 6-7778.

OPERATORS — We buy used records right off your jukeboxes on a steady basis. We pay fast. Call Mr. Andrews (516) 822-3733.

KING OF MUSIC RECORDS is looking for masters. Send copies to KING OF MUSIC RECORDS, 806-16th Avenue South, Suite 217, Nashville, Tennessee 37203, or call (615) 242-2023.

FOR SALE, Approx. 20,000 45's from 1966 through 1975. Take all 5c each plus ISC postage. Charles Zierer, P.O. Box 482, Tarpon Springs, Fla. 33589.

OPERATORS — We buy used records not over 1 year old — 10c each plus postage. JOHN M. AYLESWORTH & CO. 9701 Central Ave., Garden Grove, Calif. 92644 (714) 537-5939.

RARE RECORD SHOPS AND FINDERS. List of 31 United States shops. Up to date list personally compiled \$2. MACLEAN'S, 312 Belanger St., Houma, La. 70360.

HOUSE OF OLDIES — We are the world headquarters for out of print LPs and 45s. Also, the largest selections of old rock 'n' roll and rhythm and blues albums. Our famous 3 in 1 catalog. \$1.25. HOUSE OF OLDIES, 267 Bleeker St., N.Y., N.Y. 10014. (212) 243-0500.

FOR EXPORT: All labels of phonograph records, cartridges, cassettes. Also excellently priced selections of close-outs. Nearly 30 years of personalized service to importers world over. Wholesale only. DARO EXPORTS, LTD. 1468 Coney Island Avenue, Brooklyn, N.Y. 11230. Cable: EXPODARO, NEW YORK.

HUMOR

DEEJAYS! Here's top drawer comedy for you! 11,000 one-line gags for radio: only \$10! Unconditionally guaranteed! Catalog of one-liners, funny stories, putdowns, trivia, breaks, and lots more, free on request. Edmund Orrin, 2786-C West Roberts, Fresno, CA 93711.

CLASSIFIED ADVERTISING PAYS OFF

CLASSIFIED POWER!

Got machines to sell? Is there something you're looking to buy? Maybe you'd like to move some used 45's or need a route mechanic? See ad rates above.

Classified Ads Close WEDNESDAY

Send all copy to: CASH BOX, 6363 Sunset Blvd., Hollywood, CA 90028

Make sure your check is enclosed

FM Radio Rates Lead Advertising Cost Rise; Promo Expenses Also Higher

(continued from page 9)

sales, at least in theory. In practice, though, record companies don't place radio ads until an album is receiving substantial airplay, and print ads are usually reserved for "name" acts. Therefore, the percentage of gross sales which a company devotes to advertising varies according to the number of established or rising new acts it has on its roster. An inherent check on the advertising percentage is the fact that, once a group's albums begin to sell, the advertising cost per unit sold starts to decline.

Because of these factors, company executives were naturally reluctant to specify the percentage of gross sales which constitutes their advertising budgets. A "ballpark figure," however, according to several sources, lies between four and eight percent of wholesale cost.

Have advertising percentages been on the rise? On this question, there was about an even division of opinion between the executives who were consulted. Some said they have remained the same, while others asserted that they have increased — but not a great deal — since 1969.

An executive of a relatively small company complained that "a lot of manufacturers are going broke, charging \$6.98 (list) for a record and paying all the affiliated costs of advertising." He supported his contention with the observation that advertising rates have been increasing more rapidly than record sales, while the ratio of available advertising dollars to those sales has risen only slightly. As a result, he maintained, record companies cannot get as much media exposure at their present rate of spending as they did in 1969 for the smaller amount of dollars they were spending then.

The only way out of this predicament, the executive said, was to raise the list price of albums to \$7.98. "If you raise your prices, assuming advertising remains a fixed percentage of gross sales, advertising goes up, too, even though no more units are sold."

Record Sales Up

There is one problem with this neat theory. According to the RIAA, industry-wide record sales at list rose more than 42% from \$1.170 billion to \$1.668 billion between 1969 and 1975. During the same period, tape sales at list jumped 33% from \$460 million to \$692 million.

The increase in record and tape sales has thus kept pace with advancing print ad rates and has surpassed the percentage rise in AM spot radio rates. The major area in which growing record sales and the attendant increase in advertising budgets has not maintained parity with advertising rates is in the cost of FM radio spots.

Shift To FM

In 1969, FM was still a relatively new medium. A large percentage of FM stations were nonprofit, and many were affiliated with universities. Few FM stations had a large number of listeners, because not that many people owned FM receivers. Moreover, FM car radios were the exception rather than the rule.

Today, it is not unusual for commuters to have FM radios in their cars and most music listeners have FM receivers at home. The "progressive" music which was confined to FM radio in the '60s has now become common AM fare, while an increasing number of FM stations have tightly programmed playlists that are only slightly looser than top 40 AM playlists. For all these reasons, a big percentage of the audience that used to listen exclusively to AM radio now listens either to FM or to stations on both bands.

Despite the tightening of playlists on some FM stations, meanwhile, other stations on that band will take a chance on songs by new acts that AM programmers won't touch. Consequently, the expanding FM medium is the best place for record

companies to introduce new acts and to break album-oriented acts.

Additional Pressure

What does this mean in terms of record advertising? Several executives tacitly admitted that it signified the need for an expansion of advertising budgets. In an increasingly competitive marketplace, they indicated, neither AM radio nor print ad budgets can be reduced. Therefore, the bill for FM radio spots has to represent an addi-

stantial successes of such groups as Kiss and ZZ Top, which are regularly on the road, have been cited as incentives for manufacturers to increase tour support.

Greedy Promoters

Some industry executives, however, see "concertizing" as a drain on their advertising budgets. They feel that they have been hoodwinked into providing more money for tours by greedy promoters who want to line their own pockets at the manufacturer's ex-

Sunday Newspaper Ad Rates per line* (all rates open unless indicated)**

	Jan/1969	Jan/1977
New York Times-amusement	3.80	6.67
L.A. Times	3.15	4.90
Boston Globe-amusement	1.82	3.30
Baltimore Sun	1.30	2.20
-amusement	1.40	2.90
Washington Post-amusement	1.76	3.90
Philadelphia Inquirer	2.35	5.46
Dallas Times-Herald	0.66	1.50
S.F. Chronicle	2.80	4.30
Detroit News	1.90	3.78
Denver Post	0.97	1.57
Atlanta Journal and Constitution	1.41	2.15
Chicago Tribune	3.20	5.82

* 14 lines per column inch

** Open rate is the general charge for one-time ad

tion to the kinds of advertising budgets that were common in 1969.

An additional pressure is represented by the astronomical increase in FM ad rates. "Most of the FM radio stations now are dominant forces in the market," explained one executive, "and their rate card is equivalent to that of a major top 40 (AM station). In Chicago, for instance, WXRT-FM doesn't compete with WLS, but WDAI-FM certainly is comparable, with the exception of morning drive on WLS."

The importance of FM in the overall marketing picture was also emphasized by more than one source. "FM advertising has played a really big part in our advertising over the past five or six years, because that is really the first place you can get something played to any great degree," stated one executive. Another declared that "in most areas, it's FM radio time buys" that dominate his company's ad budget.

'Concertizing'

There is one other factor which has played a larger role in ad budgets over the past few years: tour support, or "concertizing," as one promotion man called it.

Most record companies regard "concertizing" as a valuable marketing tool which can be effectively used to create an aura of excitement around a group. The spectacular success of Aerosmith and the sub-

pense. "What we've seen over the past few years is an escalation of the record company doing what in many cases the concert promoter should be doing," commented an executive of one medium-sized label. "Tour support would start out as an artist-relations situation, and then, in order to make the concert into a special kind of event, the company would put a few bucks behind it. And now it's gotten to the point where the concert promoter calls the record company as soon as he signs the act and says, 'All right, what are you going to do for me?'"

Selectivity

As increasing costs in such areas as FM radio and "concertizing" generate a demand for more advertising dollars in relation to sales, record manufacturers have become more discriminating advertisers. Stated one marketing executive, "We have increased our budgets percentage-wise, but I think we are more selective." As examples of this approach, he cited his label's decision to decrease its budget for national print advertising while increasing the number of spots it buys on country and R&B-oriented radio.

Another executive pointed out that, in classical music ad placements, his company has tried to counter rising radio rates by substituting 30-second for 60-second

spots. "We've tried to get more quality into our advertising and at the same time stay within our budget."

According to a spokesman for a company which has maintained a constant advertising/sales ratio, rising print and radio ad rates have meant that "we're getting less advertising for our money." As a result, the label has had to abandon the "shotgun" approach that used to characterize its advertising posture. Besides placing greater reliance on before-and-after market research, the company now directs its "co-op" dollars (which are actually all supplied by the manufacturer) to the larger retail accounts. "It's simply the place where you're going to get your greatest return," he explained.

Promotion Costs Rise Gradually

Of the estimated 25% of overall record costs going to marketing, promotion represents only two to three percent of the total on the average. However, because it is one of the most "volatile" aspects of the business, depending so much on the vagaries of the purchasing public, record company executives find it difficult to put precise percentage figures on promotion expenses. Still, most of them believe promotion costs have not risen inordinately high, but are keeping pace with the overall inflationary cycle.

Basically, the standard national promotion budget, if there is such a thing, includes salaries for field personnel, the salaries of "backup" or independent promotion people, and travel and expenses costs both for staffers and artists on tour. Postage, telephone, press parties, and other related costs all figure into a promotion budget.

The vice president of promotion at one major record manufacturer broke down his \$2 million national promotion budget this way: about \$1.25 million in salaries for his "45 bodies" in the field, nationally, regionally, and locally; about \$250,000 for independents; and about \$500,000 for travel and expenses, phones, postage and miscellaneous items.

More Than Finger Snapping

The promotion executive attributed nearly all the increase in his budget over the past eight years to higher salaries, owing to the fact that "promotion men are now executives in their own right" and are therefore able to command comparable salaries. "The company realizes that nothing happens without promotion. Our job is more than dropping off the record with the deejay, finger-snapping and saying, 'Give me a hit.'" He said promotion staffers today are responsible for handling artists on tour, escorting them through press parties and other events, as well as helping to coordinate in-store promotions.

Yet the promotion head of a smaller record company disagreed with this assessment. "Everything (else) has gone up except promotion men's salaries," he said, adding that the major expense for a small manufacturer is the salaries of those who do the legwork of going to radio stations to plug for good airplay.

While this promotion director suggested that promotion at his company was an even greater expense than advertising, several other promotion directors said the percentage of co-op and other advertising costs ran two to three times that of promotion.

Across The Board Hikes

"Obviously, all promotion costs are up somewhat in the past few years," said the promotion manager of still another large label. "Airline tickets, hotel rooms, the cost of a simple postage stamp, and sending out the records to deejays is one of our big costs, as is printing up and distributing concert tickets."

The promotion director of a very large company added further discussion. He is on a "fixed budget." Unlike the firm's advertising budget, his promotion is not pegged

(continued on page 51)

SPOT RADIO RATES*

Market	Call Letters	AM		Call Letters	FM	
		1969	1976		1969	1976
Los Angeles	KHJ	\$114	\$140	KMET	\$ 20	\$ 80
Boston	WRKO	\$ 80	\$110			
Baltimore	WCAO	\$ 55	\$ 85			
		(1-52)**				
Washington, D.C.	WOL	\$ 54	\$ 70	WMOD	\$ 12	\$ 28
Philadelphia	WFIL	\$120	\$150	WMMR	\$ 15	\$ 60
Dallas	KLIF	\$ 65	\$100			
Atlanta	WSB	\$ 85	185	WKLS	10	\$ 58
		(12)**			(1-26)**	(12)
Chicago	WLS	\$180	\$210			
San Francisco	KSFO	\$120	\$125	KSAN	\$ 18	\$ 80
		(1-52)*	(5)**			
Detroit	WXYZ	\$ 74	\$155			
Denver	KTLK	\$ 30	\$ 40	KFML	\$8.50	\$ 28
					(1-52)**	
New York	WABC	\$173	\$240	WNEW	\$ 26	\$100
						(12)

*Rates taken from Spot Radio Rates and Data Handbook published by Standard Rate and Data Service. Unless otherwise indicated, the rates are for one minute spots aired six times per week in AA or AAA time slots. Although these differ from station to station, they are defined as the periods when a maximum number of people are listening to a station.

**Indicates number of spots per week at this rate.

New Orleans Retailer Begins Advertising \$2.99 LP Specials

(continued from page 9)

Stevie Wonder album for \$6.98 for a month. For the present, Lieberman plans to advertise only about four front-line LPs each week for \$2.99, but added optimistically, "As we expand, open another store, we'll put more albums on sale."

The New Attitude \$2.99 sale is the second one observed by **Cash Box** in New Orleans since the Retail Price Survey was initiated nine months ago. Robert Hall's three New Orleans stores promoted six current releases at that price the week after Christmas (**Cash Box**, January 8). Those LPs were purchased from Sutton Distributors, according to a Robert Hall spokesman. Lieberman said he did not buy the Sutton package of new releases because of the shipping problems from New York.

He added that he doesn't expect his competition, which comes mostly from nearby Mushroom Records, to meet his prices. "I don't see how they can," he said.

Fred Baines, manager of Mushroom, located about 10 blocks from New Attitude and incorporated by Tulane University students was surprised by the \$2.99 sale price. "I don't know how he (New Attitude) can make money," Baines noted that his store would not sell below cost, and didn't plan to go below its current sale price of \$3.89 on selected releases. "Basically, what New Attitude's trying to do is hold out until they can draw enough of our customers away. From our end, it's dirty pool. It has all the makings of a price war."

Other New Orleans retailers were equally incredulous. "Maybe he's making it up on cutouts and other stuff, but I don't see how," said one rival store manager, expressing a prevailing sentiment.

RCA Red Seal Sale

In an unrelated retail occurrence in New Orleans, Smith's Record Center advertised

all RCA Red Seal \$7.98 releases for \$4.98. This is the first time in the six weeks since the label's list price went from \$6.98 to \$7.98 that **Cash Box** has seen RCA Red Seal releases promoted in a major metropolitan Sunday newspaper.

Annette Smason, manager of one of Smith's three stores, said she had decided to advertise RCA Red Seal because "La Forze Del Destino hadn't been selling, and it's a good album." Smason said while budget buyers will not be drawn into her store, "buyers concerned about the artists and their art will come in. If you want to buy

Artur Rubinstein, you must get RCA."

Other Developments

Other retail developments last week included a "going out of business sale" in suburban Washington, D.C.; and sale prices back from a low \$2.99 to \$3.99 at Korvettes in Detroit.

In the Washington, D.C. area where prices have been coming down in recent weeks (**Cash Box**, January 22), Sounds Impossible of suburban Rockville, Md. advertised an all-label "going out of business" sale for \$3.59 in the Sunday *Washington Post*. The store manager termed the final

week "a madhouse," and said he didn't have time to discuss the store's demise until the sale was over.

However, the assistant manager of a competitive area store, said the stiff competition from suburban malls had been primarily responsible for Sounds Impossible's problems.

"They have essentially a walk-in store in a small business district. It's a mobile buyer in the suburbs. That location had been in trouble for some time." He added that Washington, D.C. stores' lower prices had not been a factor in Sounds Impossible's folding.

Korvettes Ups Detroit Price

After two weeks of advertising current releases at \$2.99, Korvettes' five Detroit stores went back to their previous practice of advertising multi-label sales for \$3.99 in the Sunday *Detroit News* (**Cash Box**, February 5 and 12). A Korvettes store manager and other area retailers had attributed the \$2.99 sale to the imminent opening of a new Peaches store about four miles from the inner-city, one of Korvettes' major markets. At that time Korvettes' managers said they were unsure about where their prices might go in the next few weeks.

Meanwhile, in New York, Sam Goody continued promoting its all-label "rock-folk-soul" sale for \$3.74 in the Sunday *New York Times*. In addition, Goody again advertised 10 "Super Picks" for \$2.99. George Levy, president of the Goody chain, in making the announcement, had said the new low prices were the result of "market conditions" (**Cash Box**, February 12). A Goody's store manager, however, went one step beyond that in defining those market conditions as the recent opening of three Jimmy's Music World stores on Long Island.



KOME DIGS 'YEAR OF THE CAT' — Following a recent concert appearance in San Jose, Janus recording star Al Stewart was joined by KOME disc jockeys who helped him celebrate the announcement that his "Year Of The Cat" LP has been certified gold. Standing from left: Ed Romig, program director; Jona Denz, dj; Stewart; Dana Jang, music director; Captain Reif, production director. Seated: B. Collins, public service director; and Gene Mitchell, dj.

Print Advertisements For \$7.98 LPs Continue Sluggish

(continued from page 9)

dianapolis, while Benson's "In Flight" was advertised for \$4.89 at both the Harvard Coop and Strawberries in Boston. In addition, a full-page multi-dealer ad appeared in Boston for Queen's newest disc, which was also promoted at Korvettes in Philadelphia for \$4.89/\$5.79 tape.

Many more print ads were seen for "Animals" by Pink Floyd, Columbia's entry in the \$7.98 list sweepstakes. The latest Pink Floyd album was advertised in these five markets: in Boston, at the Coop and Strawberries for \$4.89, at Music City for \$4.89 and at Music Center for \$4.59/\$4.99 tape; in Chicago, at Musicland for \$4.79/\$5.99 tape; in Detroit, New York and Philadelphia, at Korvettes for \$4.89/\$5.79 tape; and at Music Scene in Philadelphia for \$4.88/\$5.44 tape.

National Campaign

According to Don Dempsey, vice president of marketing for Columbia, the proliferation of print ads for "Animals" signals the beginning of a national "advertising posture" which will set the pace for Pink Floyd ads sponsored by local CBS branches. Dempsey stated that this initial phase of the campaign for "Animals," which will end when Pink Floyd's U.S. tour begins in April, is patterned after the recent and very successful ad campaign for the soundtrack to "A Star Is Born" (\$8.98 list). In both cases, he said, some of the branches' advertising money was funneled into the national ad campaign. Thus, instead of receiving a certain sum of money for dealer-tagged ads, the branches were presented with nationally coordinated ads, conceived in the New York headquarters of Columbia Records.

"Our national radio, TV and print campaign is running as an extension of the local ads that our branches are running in conjunction with their customers," Dempsey

remarked. "That way we have a constant momentum building on a national and local level for a period of eight weeks."

Dempsey argued that, in the case of Pink Floyd, this program doesn't reduce the flexibility of local branches "because this is the kind of act that would have the same priority in their minds that it would have in ours." While admitting that the album might pick up faster in some markets than others, he saw this as just another reason to work the release at a national level in order to "bring all markets into the same high-level performance."

Effect Of Higher List

Has the \$7.98 list price for "Animals" affected Columbia's marketing strategy for this LP? "It really has not," replied Dempsey, "simply because we're dealing with a group in terms of its music and its audience."

Dempsey further explained that Pink Floyd already has a high degree of name recognition, particularly among older rock record buyers. He noted that "it has been our experience" that consumers will buy albums on the basis of name recognition, regardless of price. In addition, he declared, "We price the record off of (the quality of) the music." If the music on any album is not up to snuff, he pointed out, "the marketplace will not digest the product."

How A \$7.98 LP Is Chosen

Several factors enter into Columbia's choice of an album that will be priced at \$7.98 list, Dempsey stressed. One criterion, for example, might be the artist's track record. "If we were looking at an act which had a past history of selling 1½-2 million copies of an album, obviously the initial thought would be to assign that as a possible candidate for \$7.98 pricing.

"However, we have to take a look at exactly how that album passed through the

marketplace. If it is an act that, as the result of a hit single, enjoyed the kind of sales that would make a \$7.98 list reasonable, I would then have to examine the existing FM base for this act, assuming that there may not be another hit single. If there is an FM base, to what degree would it be our experience to determine how many unit sales come off the FM play only, without the hit single? If we thought that the FM base was not substantial and it required the success again of a hit single to generate those kinds of sales, we as a company would insist on sending a hit single into the marketplace to re-establish the pattern again."

Intangible factors that are unique to a particular act must also be taken into account, Dempsey emphasized. "Under no circumstances would we ever damage the artist by going back into the marketplace and promiscuously putting the record out at that (\$7.98 list) price. The only thing that would preclude this would be a total industry move into that price range."

Michlin And Hill Branch Into Discs

NEW YORK — Michlin and Hill, TV and radio commercial producers, plan an expansion into record production and talent management.

The company expects to release its first three singles shortly, as all are in the final stages of production.

John Hill, a former producer for CBS, Epic and Buddah Records, and now a principal in Michlin and Hill, said the expansion is based on the belief that commercials and records are moving closer together, particularly in the disco area.

In addition, the jazz group, Children of All Ages, produced by Michlin and Hill, recently had its second album released.

FM Radio Rates Lead Advertising Cost Rise

(continued from page 50)

to gross sales and doesn't rise and fall accordingly.

"I'm satisfied being on a fixed budget," he said. "It's taught me a lot about dollars and cents. The key is you have to plan carefully in advance because if you get caught short, maybe you have to take it out of some national promotion man's pocket, who might be doing a great job of getting airplay for you. I don't want to do that to my staff."

The source said his fixed budget covers not only salaries, travel and expenses, and independent promotion costs, but any sales promotion or tour support that he or his staff initiates, plus press parties and other expenses.

Press parties, while not a large percentage of the typical promotion budget, are one of the fastest-rising costs. "You can't get away with a party nowadays for less than \$2,000," said one promotion director. "Record companies are competing with each other to put on the best (party), so it is not unlikely to see a company have a \$10,000 or \$15,000 party."

At smaller companies, advertising, promotion and sales budgets tend to overlap more, and spending controls tend to be less stringent.

"When I worked at smaller companies," recalled the promotion head at a major New York label, "it was, 'If you have the money, spend it.' Here I have to answer to financial vice presidents who take a dim view of overspending."

Goldfarb Moves Office

NEW YORK — Herb Goldfarb Associates, a sales, marketing and merchandising organization, has moved its operation to larger quarters at 250 West 57th Street, New York, New York, Suite 301.



GOOD EATS — Polydor International welcomed RSO president AI Coury to Europe with a Riviera dinner during MIDEM at the Oasis, La Napoule. Coury (seated left) is flanked by his wife and Chris Youle, RSO Records UK managing director. Standing from left are French Polydor pop product manager Frederic Noel; Italian pop product manager Antonio Cocco; UK Polydor manager Peter Sibley; RSO UK press officer Helen Walters; German Polydor marketing manager Rainer Schmidt-Walk; Janis Lundy, personal assistant to AI Coury, and Polydor group public relations officer Klaus Bulow.

EMI Set To Build \$15M Uden Facility

THE HAGUE — EMI is to build a new record and tape factory combined with a distribution center at Uden in the southern Netherlands to replace its existing production and distribution facilities at Haarlem and Alkmaar, near Amsterdam.

The project will cost approximately \$15 million and will be completed in two years. The new factory, scheduled to operate in 1978, will employ 350 people. An administration center on the same site is planned to become operative in 1979 and will provide jobs for about 100 people.

"EMI Holland has been very successful but its facilities must be modernized if it is to continue to be competitive," said Sir John Read, chairman of the EMI group of companies, recently. "This project represents the best method of ensuring the continued strength of EMI in the Netherlands, and of providing the group with necessary extra production capacity in mainland Western Europe."

When completed, the new factory will have an initial capacity of 16 million records and 4 million cassettes a year. Space will be provided to allow an increase of output when required. The factory will have a substantial printing capability mainly for record covers and labels to permit an integrated operation for raw material to finished packaged product.

Altogether this will provide sufficient spare capacity to meet foreseeable pressing and tape duplicating requirements from other EMI companies in Western Europe, which cannot be met from existing resources.

The decision to move to Uden was taken because of limitations on industrial

(continued on page 54)

CBS Israel Expands

TEL AVIV — CBS Records/Israel has become the first vertically integrated record company in Israel, with the recent addition and completion of its photography and plate department.

In 1964, CBS/Israel produced 20,000 records per shift monthly. A vinyl-compounding department was added in 1972, and today the production capacity has jumped to 130,000 records per shift monthly. A four-color offset printing plant was installed in 1975.

CBS Records/Israel is currently under the direction of Daniel Yadin, who is also regional director of manufacturing, CBS International.

CHUM's Documentary Traces Rock History

TORONTO — CHUM radio recently introduced a 64-hour music documentary tracing the evolution of rock from the 1950s through to the present, as seen through the eyes of the youth generation. Featured in three-hour blocks weekly on CHUM and CHUM group stations nationally, the program is now to be broadcast in the U.S. by eight major market situations.

Titled "The Evolution Of Rock," the documentary is to be broadcast by the RKO chain, consisting of WRKO, Boston; KHJ, Los Angeles; WMBQ, Memphis; KLIF, Dallas; KFRC, San Francisco; and 99X, New York. WLS in Chicago and CKLW in Windsor, Canada have also purchased rights to the broadcast.

CHUM commissioned rock critic Ritchie Yorke to research the project, which took over 20 months to compile and which produced voluminous material, enough for a book to also be produced, authored by Yorke, entitled "The History Of Rock."

The original script, written by Yorke, was adapted for radio by Bill MacDonald with assistance from Tom Brownlie and Pat Withrow.

Chuck Riley, U.S. contemporary radio announcer, was selected by CHUM to narrate the entire story.

In the production of the program, CHUM made extensive use of its artist interview files, and launched an intensive search for other material. Thousands of rare tapes and never-before-broadcast interviews were obtained from sources around the world. Interviews were conducted in Los Angeles, Nashville, New York, Switzerland and London, among other locales.

Production of the program was completed by the CHUM production team. It was directed by Warren Cosford and assisted by Bob McMillan, Zeke Zdebiak and Gary Milmine. Artist interviews and music research were coordinated by Roger Ashby with assistance provided by Nanci Krant.

CHUM is now interested in securing worldwide syndication for the program.

International Executives On The Move

Pewter Andry, general manager of EMI Records international classical division, was named director and general manager of group classical recording with effect from January 1. Andry joined EMI in 1956.

Tony Fell was named director of Boosey & Hawkes from January 1 and chairman of Boosey & Hawkes Music Publishing Ltd., of which he is also managing director. He has also become publisher-director on the Performing Right Society general council in succession to David Adams, who recently retired as Boosey & Hawkes MD.

Roger Greenaway has been named writer-director on the Performing Right Society general council in succession to Andrew Lloyd Webber, who has resigned. Greenaway has been a member of the PRS since 1965, and has over 50 chart hits to his writing credit.

MIDEM Report: Eleventh Meeting Generates Discussions, Agreements

by Kim Thorne and Nigel Hunter

CANNES — Looking back at MIDEM's past 11 years, it is obvious that MIDEM has maintained its record of being bigger each successive year. The number of participating countries rose to 43 this year, comprising over 1,000 companies for the first time and over 5,000 people. The UK, French and American contingents were particularly strong, and countries making their MIDEM debut were Iceland, the Philippines, Turkey and Ecuador.

Each MIDEM brings its problems, too, and this year saw discontent over hotel accommodations and booth arrangements in the Palais des Festivals. The latter complaint centered on the new extension between the ground floor and the basement, and companies located there, including Crazy Cajun Music and the Yamaha Corporation, rebelled shortly after MIDEM began when they realized that visitors had no idea they were there or how to get to them. Noticeboards were hurriedly put up in strategic positions and other steps taken to calm things down, including a free bar for a day.

Entertainment

The MIDEM entertainment plans ran into stormy waters once again. Paul Anka, due to headline a charity show organized by the

CRIA Chart To Debut

TORONTO — The Canadian Recording Industry Association (CRIA) is optimistic about introducing its national single and album charts by spring, according to a spokesman for the association.

At present the chart committee of the CRIA is resolving minor technical details involved in programming its computer. A four-week practice run is to be printed for internal evaluation before the chart is introduced in May or June.

The CRIA plans to provide a national chart based on sales for single and album product. The computer set-up is designed to provide regional charts which could be offered to provincial newspapers, radio stations and retailers if requested.

At present the Canadian music industry is without an industry accredited chart.



DUTCH TREAT — AI Stewart recently discussed plans with Robert Summer, division vice president, RCA Records International, prior to filming of a segment for the Dutch television program "Top Pop." The segment was filmed in New York and aired a few days later in the Netherlands.

Variety Club of France in aid of handicapped children, withdrew from the event without giving any reason, according to the organizers, and provoked a storm of hostility. The show went on with Petula Clark and Gilbert Becaud, and French stars such as Adamo, Hugues Aufray and Johnny Hallyday joining in.

Artie Mogull, president of United Artists Records, immediately offered to donate \$20,000 to the Variety Club of France when he heard that the show was likely to be cancelled because of Anka's withdrawal. Mogull said he was "very embarrassed" about the situation, but would make no further comment until he could talk with Anka and hear his side of the story.

According to one unconfirmed report, Anka decided to withdraw when efforts made from Paris in his behalf to check out rehearsal arrangements and other facilities did not elicit the guarantees he required, but the Variety Club of France in a statement said it "had accepted all his artistic conditions" and he had cancelled his performance at the last moment "for no valid reason."

The Nina Simone concert was also afflicted with misfortune. The artist and her first house audience seemed to take an almost instant dislike to each other, and the atmosphere and remarks passed did no credit to anyone. Ms. Simone, now a resident in Switzerland after two years in Africa, said before the show that she is seeking a manager and a recording deal.

Business

On the business side, some deals have already been announced and many more have been initiated for later completion. UA's Artie Mogull and Magnet Records managing director Michael Levy gave details of a pact whereby UA will release product from the UK label in the States on a first refusal basis, and Levy was continuing talks which may result in UA handling Magnet repertoire in Canada as well.

"We chose UA because it's a smaller, tighter operation than the American majors," said Levy, "and because Artie Mogull is one of the most experienced and professional people in the American record industry."

(continued on page 54)

Phonogram's Franz Dies

LONDON — The UK music industry has been saddened by the death of Johnny Franz on January 29 from a heart attack following hospitalization with suspected bronchitis.

Franz had been with Phonogram (formerly Philips) for nearly 23 years, and produced over 70 chart hits during that time. Artists associated with him were Shirley Bassey, Frankie Vaughan, the Springfields, the Walker Brothers, Dusty Springfield, Scott Walker, Harry Secombe, Peters and Lee, and Anne Shelton.

Franz left school to join Francis Day & Hunter as a trainee pluggger at the age of 15. He was an accomplished pianist, and at one time harmonica star Ronald Chesney invited him to become his concert accompanist. This role led to similar work with Anne Shelton, Vera Lynn, Eve Boswell and Doris Day, among others.

In 1954 Franz joined Philips as a producer, and scored a hit within weeks with Winifred Atwell's "Let's Have Another Party." He was impressed by a young singer called Frankie Vaughan whom he heard at a Belgian song contest, and produced Vaughan's first charter, "Tweedlee Dee."

Funeral services for Franz, who was 54, were private. He leaves a widow Moira and a brother Harold, who is with EMI Music.

CLAUDIO BAGLIONI

1.000.000 LP'S AND TAPES
SOLD IN ITALY

RCA

JUST RELEASED
HIS NEW ALBUM

"SOLO"

PL 31235



UEP FAMILY — Members of the United European Publishers (UEP) gathered above after their general meeting at this year's MIDEM. Seated left to right are: Francisco Vinuesa Gimenez (Spain), Peter Meisel (Germany), Nanou Lamblin (France), Trudy Meisel (Germany), Elisabel Mintangian (Italy). Standing (l to r) are: Julio Guiu Arbeloa (Spain), Julio Guiu Clara (Spain), Peter Phillips (England), Roland Kluger (Belgium), Anders Moren (Sweden), Lasse Torefeldt (Sweden), Kaj Lunden-Welden (Sweden) and Claude Pascal (France).

CRIA Announces Jan. Gold, Platinum Disks

TORONTO — The Canadian Recording Industry Association (CRIA) reported eight certifications for the month of January. Five gold albums, one gold single, and two platinum albums were recognized.

Gold LPs included "L'Heptade," Harmonium (CBS); "Christmas Jollies," Salsoul Orchestra (RCA); "K.C. And The Sunshine Band, Part 3," K.C. And The Sunshine Band (RCA); "Crystal Ball," Styx (A&M); and "Spitfire," Jefferson Starship (RCA). Burton Cummings' "Stand Tall" (CBS) was the lone gold single.

Platinum albums were "Boston," Boston (CBS) and "A New World Record," Electric Light Orchestra (UA).



GULL FLIES TO MIDEM — David and Irene Howells, from Gull Entertainments in England, attended this year's recently held junket to promote Gull Graphics, with books from Roger Dean, and to seek a French publishing and recording outlet for the Gull label. They also were meeting with present licensees.

Anchor Signs Hamilton

LONDON — Following a 16-year association with RCA, George Hamilton IV has signed a recording pact with Anchor Records in London. Hamilton will record for Anchor in Nashville with Allen Reynolds as producer, and his debut Anchor album is titled "Fine Lace And Homespun Cloth." Hamilton's disks will be released in the U.S. on the ABC/Dot label, representing almost a full circle for the artist, whose initial recordings, including the million-selling "A Rose And A Baby Ruth" in 1956, were issued by ABC Paramount.

Mellin Music Acquires Rights To Entebbe Film

NEW YORK — The Robert Mellin Music Publishing Corporation has acquired the worldwide rights to the music from "Operation Thunderbolt," the Israeli-made film on the Entebbe raid, it was announced today by Robert Mellin, president of the firm. The music score for the movie was written by Dov Zeltser, and has been recorded by the Israeli Philharmonic Orchestra. Mellin is also writing the lyrics to the songs in the film.



EAST GOES SOUTH — Ken East, vice president Motown international operations, visited New Zealand last month as part of a world tour. At EMI's head office in Lower Hutt, East was presented with a gold disc for sales of Stevie Wonder's "Songs In The Key Of Life" and a platinum disc for sales equivalent to one million units of the New Zealand compilation "Motown Gold." Pictured left to right are: Ken East; Danny Ryan, Motown A&R; and Jim Moss, marketing manager-EMI New Zealand.

Steinberg For Junos

TORONTO — Canadian comedian David Steinberg has been named to host the Juno Show this year, to be staged March 16 in the Canadian Room of the Royal York Hotel.

Brian Robertson, spokesman for the Canadian Academy of Recording Arts and Sciences, also has announced performers to appear on the show, to be televised live on the CBC-TV network. They include Carroll Baker, Patsy Gallant, Keith Barrie, the T.H.P. Orchestra and Wayne St. John, Ian Tyson, and the Four Lads.



CBS TRIO — In Cannes representing Gerard Lenorman's "Voici Les Cles" single were CBS Records France staffers (l to r) Michele Leger (April Music), Dennis Killeen, marketing director, and Martine Jalmain (CBS Records International).

Bruce Allen To Rep Todd, Hometown Band

VANCOUVER — Bruce Allen Talent Promotion Ltd. recently announced the exclusive representation rights for management and booking on London Records' Sweeney Todd and A&M's Hometown Band.

Lavender Hill Mob Set

TORONTO — The Lavender Hill Mob debut album is to have international worldwide release on March 15, according to Keith Patten, United Artists Canada's director of A&R.



NEW ASSIGNMENTS — Brian Hopkins (left) has been named general manager of Screen Gems-EMI Music, the UK company handling the American Screen Gems and Colgems catalogs in Britain. Hopkins will also be responsible for British copyrights assigned to the company, including the work of writers Ken Gold and Michael Denne, and will report to EMI Music managing director Ron White. Others in photo above are Screen Gems-EMI Music president Lester Sill (seated), vice president and general manager Irwin Robinson and professional activities vice president Irwin Schuster.

Eleventh Midem Spurs Business, Activity

(continued from page 52)

The deal will give UA access to product by hit Magnet acts such as Guys 'n' Dolls, Alvin Stardust, Peter Shelley, Adrian Baker, Silver Convention and Stevenson's Rocket.

Britain's ATV Corporation has negotiated, subject to the approval of the Bank of England and the Treasury of France, the purchase of the half interest in Allo Music now owned by the Librairie Hachette. Simultaneously ATV has acquired a half interest in Leros Music, which is an associate company of Allo Music and owns the copyrights of most of the songs recorded by Demis Roussos. Roussos has completed a new album for release this month including a number of Leros copyrights. ATV has also gained a 50% stake in Robin Song Music, another Allo associate which publishes compositions by James Bolden and Jack Robinson recorded by artists such as Tina Charles and Gloria Gaynor. The other half of Robin Song belongs to Robinson. Max Amphoux remains as the president and director general of Allo Music and Maurice Bouchoux will continue as international director.

Clive Woods, formerly with Polydor International, was at MIDEM pursuing plans for European TV promotion for artists. Now independent and connected with the GTO, RSO and MAM organizations in London, Woods is packaging what he terms "multi-national TV specials," and has already completed one starring Linda Ronstadt which he co-produced with the Scandinavian Norvison organization. His next project centers on Daryl Hall and John Oates, which has already been placed in Switzerland and is being discussed for Holland, Spain and Italy. Further projects for these 45-minute programs being lined up by Woods are rock 'n' roll and black music specials.

EMI Music has set a publishing deal with Elton John and his lyricist Bernie Taupin for sub-publishing rights to new songs by the duo for the world excluding the UK, Eire and North America. The negotiations were conducted by EMI Music managing director Ron White, John Reid of John Reid Enterprises and Geoffrey Ellis. A separate deal for Big Pig Music, John's publishing company, has been concluded for Australia with Castle Music, EMI's publishing arm in that territory. Initial copyrights involved

with be tracks on John's next album for the Rocket label.

Philip Solomon has formed Ashtree Records for release of product in the States, with the first album being a double featuring the cast of the African musical "Ipi Tombi." Ashtree is the name of Solomon's existing publishing enterprise in the States, and was chosen for the disk operation on account of his UK label Galaxy's name being in use already in America. Ashtree is represented in America through Audio-fidelity Enterprises of New York.

Leisure industry attorneys also met during MIDEM to discuss the implications of the developing audio visual market in terms of licensing agreements and copyrights. It emerged that nobody has a very clear idea of the future shape of this new innovation which is bringing new problems concerning the determination of royalties in its wake.

Other Notes

Clive Calder of the Musicpiece publishing company in South Africa has acquired sub-publishing rights for that territory and elsewhere in Africa for the Virgin Music catalog, including repertoire by Mike Oldfield, Steve Hillage and the Mighty Diamonds. Calder's own production company has acquired exclusive licensing rights for all Virgin's reggae product for South Africa, Rhodesia, Zambia and Kenya.

Peter Prince of Pye Records fixed a worldwide deal with Jonathan King for his new act, One Hundred Tons and a Feather, which was announced shortly before a ceremony organized by 20th Century Records at which Pye received an award as 'licensees of the year' from Russ Regan and Peter Pasternak. Pye managing director Walter Woyda said that the cash prize would be used to give a party for Pye's staff in the UK.

EMI To Build Plant

(continued from page 52)

development at the present locations. Uden is in a designated development area, with government grants and other fiscal incentives available for new industrial development.

Local EMI companies claim about one third of the \$150 million domestic record market in Holland. EMI's companies in the Netherlands market records and tapes through the record companies EMI-Bovema, Negram and Delta.

Additions To Country Playlists

(continued from page 37)

Mockingbird Hill — Donna Fargo — Warner Bros.
12 To 4 — Heart Healer — Mel Tillis — MCA
16 To 9 — There She Goes Again — Joe Stampley — Epic
19 To 14 — Desperado — Johnny Rodriguez — Mercury
24 To 19 — Southern Nights — Glen Campbell — Capitol
Ex To 30 — You're Free To Go — Sonny James — Columbia

Ex To 27 — Right Time Of The Night — J. Warnes — Arista
WBAM — MONTGOMERY

#1 — Let My Love Be Your Pillow — Ronnie Milsap — RCA
The Feeling's Right — Narvel Felts — ABC/Dot
Anything But Leavin' — Larry Gatlin — Monument
Family Man — Jerry Foster — Hitsville

Mockingbird Hill — Donna Fargo — Warner Bros.
She's Got You — Loretta Lynn — MCA

21 To 15 — Sam — Olivia Newton-John — MCA
25 To 17 — Lucille — Kenny Rogers — UA

26 To 21 — She's Just An Old Love Turned Memory — Charley Pride — RCA

30 To 24 — (C'est La Vie) You Never Can Tell — Emmylou Harris — WB

Ex To 34 — Somewhere Over The Rainbow — Bobby G. Rice — GRT

Ex To 37 — Sunday School To Broadway — Anne Murray — Capitol

Ex To 38 — Fool — John Wesley Ryles — ABC/Dot
Ex To 39 — Right Time Of The Night — Jennifer Warnes — Arista

Ex To 40 — Slide Off Your Satin Sheets — Johnny Paycheck — Epic

WKDA — NASHVILLE

#1 — She Thinks — Elvis Presley — RCA
She's Got You — Loretta Lynn — MCA

Paper Rosie — Gene Watson — Capitol
Sweet Thing — O.B. McClinton — Mercury

I've Got You — Donking — Con Brio
Me And The Elephants — Bobby Goldsboro — Epic

Lay Something On My Bed Besides A Blanket — Charly McClain — Epic

Wrap Your Love Around Your Man — Lynn Anderson — Columbia

12 To 2 — Heart Healer — Mel Tillis — MCA
15 To 4 — Lucille — Kenny Rogers — UA

10 To 5 — He'll Play The Music, But You Can't Make Him Dance — Little David Wilkins — MCA

32 To 25 — Two Less Lonely People — Rex Allen Jr. — WB
26 To 18 — Torn Between Two Lovers — Mary MacGregor — Ariola America/Capitol

Ex To 24 — Your Pretty Roses Came Too Late — Lois Johnson — Polydor

Ex To 23 — I'm Not Easy — Billie Jo Spears — UA
Ex To 25 — Southern Nights — Glen Campbell — Capitol

WHN — NEW YORK

#1 — Torn Between Two Lovers — Mary MacGregor — Ariola America/Capitol

If Love Was A Bottle Of Wine — Tommy Overstreet — ABC/Dot

The Movies — The Statler Brothers — Mercury
Sam — Olivia Newton-John — MCA

Southern Nights — Glen Campbell — Capitol
13 To 7 — Whispers — Bobby Borchers — Playboy

Ex To 15 — Say You'll Stay Until Tomorrow — Tom Jones — Epic

Ex To 16 — Ridin' Rainbows — Tanya Tucker — MCA
Ex To 17 — Two Less Lonely People — Rex Allen Jr. — WB

WHOO — ORLANDO

#1 — Say You'll Stay Until Tomorrow — Tom Jones — Epic
New Kid In Town — Eagles — Asylum

Adios Amigo — Marty Robbins — Columbia
Right Time Of The Night — Jennifer Warnes — Arista

She's Got You — Loretta Lynn — MCA
Anything But Leavin' — Larry Gatlin — Monument

She's Pulling Me Back Again — Mickey Gilley — Playboy
6 To 1 — Say You'll Stay Until Tomorrow — Tom Jones — Epic

24 To 14 — Heart Healer — Mel Tillis — MCA
26 To 17 — Torn Between Two Lovers — Mary MacGregor — Ariola America/Capitol

31 To 24 — Southern Nights — Glen Campbell — Capitol
32 To 25 — After The Lovin' — Engelbert Humperdinck — Epic

39 To 33 — Lucille — Kenny Rogers — UA
Ex To 36 — Sweet City Woman — Johnny Carver — ABC/Dot

Ex To 37 — Sam — Olivia Newton-John — MCA
Ex To 38 — Mockingbird Hill — Donna Fargo — Warner Bros.

Ex To 39 — It Couldn't Have Been Any Better — Johnny Duncan — Columbia

Ex To 40 — Easy Look — Charlie Rich — Epic

WRCP — PHILADELPHIA

#1 — After The Lovin' — Engelbert Humperdinck — Epic
Southern Nights — Glen Campbell — Capitol

The Movies — The Statler Brothers — Mercury
She's Just An Old Love Turned Memory — Charley Pride — RCA

Wrap Your Love Around Your Man — Lynn Anderson — Columbia

Living Next Door To Alice — Smokie — RSO
12 To 6 — Uncloudy Day — Willie Nelson — Columbia

15 To 9 — Say You'll Stay Until Tomorrow — Tom Jones — Epic

18 To 13 — Moody Blue — Elvis Presley — RCA
Ex To 19 — New Kid In Town — Eagles — Asylum

Ex To 20 — There She Goes Again — Joe Stampley — Epic

KNIX — PHOENIX

#1 — Two Less Lonely People — Rex Allen Jr. — WB
Out Of My Mind — Cates — Caprice

Cheatin' Overtime — Mary Lou Turner — MCA
He'll Play The Music, But You Can't Make Him Dance — Little David Wilkins — MCA

She's Pulling Me Back Again — Mickey Gilley — Playboy
10 To 4 — Whispers — Bobby Borchers — Playboy

34 To 27 — Southern Nights — Glen Campbell — Capitol
23 To 16 — Midnight Angel — Barbara Mandrell — ABC/Dot

40 To 29 — Good Old Fashioned Saturday Night Barroom Brawls — Vernon Oxford — RCA

26 To 18 — Heart Healer — Mel Tillis — MCA
39 To 30 — I Just Came Home To Count The Memories — Cal Smith — MCA

30 To 23 — The Son Of Hickory Holler's Tramp/I Wonder How She's Doing Now — Johnny Russell — RCA

37 To 32 — Cherokee Fiddle — Michael Murphey — Epic
38 To 26 — She's Just An Old Love Turned Memory — Charley Pride — RCA

Ex To 34 — You're Free To Go — Sonny James — Columbia

Ex To 36 — Adios Amigo — Marty Robbins — Columbia
Ex To 38 — He's Got A Way With Women — Bob Luman — Epic

KRAK — SACRAMENTO

#1 — Let My Love Be Your Pillow — Ronnie Milsap — RCA
Colorado Country Morning — Pat Boone — Hitsville

She's Got You — Loretta Lynn — RCA
Anything But Leavin' — Larry Gatlin — Monument

20/20 Vision — Geof Morgan — RCA
Drinkin' My Way Back Home — Shylo — Columbia

Semolita — Jerry Reed — RCA

Audobon — C.W. McCall — Polydor
45 To 30 — Adios Amigo — Marty Robbins — Columbia

30 To 23 — Southern Nights — Glen Campbell — Capitol
33 To 27 — Heart Healer — Mel Tillis — MCA

KKYX — SAN ANTONIO

#1 — Whispers — Bobby Borchers — Playboy
Fiddle Rag — Gene Davis — Maverick

Ex To 36 — When Your Good Love Was Mine — Marie Owens — MMI

Ex To 38 — Cheatin' Overtime — Mary Lou Turner — MCA
Ex To 39 — She's Just An Old Love Turned Memory — Charley Pride — RCA

Ex To 40 — Texas Angel — Jacky Ward — Mercury
Ex To 37 — The Movies — The Statler Bros. — Mercury

KGA — SPOKANE

#1 — Moody Blue — Elvis Presley — RCA
Cherokee Fiddle — Michael Murphey — Epic

Mockingbird Hill — Donna Fargo — Warner Bros.
Sweet City Woman — Johnny Carver — ABC/Dot

She's Got You — Loretta Lynn — MCA
He'll Play The Music, But You Can't Make Him Dance — Little David Wilkins — MCA

Lovin' On — T.G. Sheppard — Hitsville
Loving Arms — Sammi Smith — Elektra

I Need Something Easy Tonight — Danny Wood — London

8 To 3 — Say You'll Stay Until Tomorrow — Tom Jones — Epic

19 To 5 — Heart Healer — Mel Tillis — MCA
20 To 10 — Desperado — Johnny Rodriguez — Mercury

15 To 9 — If Love Was A Bottle Of Wine — Tommy Overstreet — ABC/Dot

23 To 13 — The Movies — The Statler Brothers — Mercury
21 To 15 — I Have A Dream, I Have A Dream — Roy Clark — ABC/Dot

Ex To 17 — She's Just An Old Love Turned Memory — Charley Pride — RCA

Ex To 20 — Torn Between Two Lovers — Mary MacGregor — Ariola America/Capitol

Ex To 22 — I'm Gonna Love You Right Out Of This World — David Rogers — Republic

Ex To 29 — I Just Came Home To Count The Memories — Cal Smith — MCA

Ex To 30 — Southern Nights — Glen Campbell — Capitol

WSUN — TAMPA

#1 — Crazy — Linda Ronstadt — Asylum
I'm Not Easy — Billie Jo Spears — UA

I'm Gonna Love You Right Out Of This World — David Rogers — Republic

Southern Nights — Glen Campbell — Capitol
Mockingbird Hill — Donna Fargo — Warner Bros.

12 To 3 — The Movies — The Statler Brothers — Mercury
14 To 5 — She's Just An Old Love Turned Memory — Charley Pride — RCA

22 To 13 — Torn Between Two Lovers — Mary MacGregor — Ariola America/Capitol

Ex To 24 — New Kid In Town — Eagles — Asylum
Ex To 25 — Your Pretty Roses Came Too Late — Lois Johnson — Polydor

Ex To 26 — Vegas — Bobby & Jeannie Bare — RCA
Ex To 28 — Good 'N' Country — Kathy Barnes — Republic

Ex To 29 — I Just Came Home To Count The Memories — Cal Smith — MCA

Ex To 30 — Lucille — Kenny Rogers — UA

KCUB — TUCSON

#1 — Let My Love Be Your Pillow — Ronnie Milsap — RCA
Sweet City Woman — Johnny Carver — ABC/Dot

Loving Arms — Sammi Smith — Elektra
9 To 4 — When The New Wears Off — Jody Miller — Epic

13 To 8 — Moody Blue — Elvis Presley — RCA
16 To 9 — If Not You — Dr. Hook — Capitol

20 To 15 — Crazy — Linda Ronstadt — Asylum
24 To 18 — Near You — Jones & Wynette — Epic

30 To 23 — She's Just An Old Love Turned Memory — Charley Pride — RCA

25 To 19 — Two Less Lonely People — Rex Allen, Jr. — WB

29 To 21 — Torn Between Two Lovers — Mary MacGregor — Ariola

Ex To 33 — Heart Healer — Mel Tillis — MCA
Ex To 35 — Desperado — Johnny Rodriguez — Mercury

Ex To 36 — If Love Was A Bottle Of Wine — Tommy Overstreet — ABC/Dot

Ex To 38 — The Son Of Hickory Holler's Tramp/I Wonder How She's Doing Now — Johnny Russell — RCA

KFDI — WICHITA

#1 — Let My Love Be Your Pillow — Ronnie Milsap — RCA
She's Pulling Me Back Again — Mickey Gilley — Playboy

Your Sweet Love — Sherril King — UA
God's Gift To Women — U.X. Lewis — Aquarian

Strawberry Curls — Freddy Weller — Columbia
She's Got You — Loretta Lynn — MCA

Audobon — C.W. McCall — Polydor
Sweet Thang — O.B. McClinton — Mercury

Do The Buck Dance — Ruby Falls — Fifty States
43 To 34 — Lord If I Make It To Heaven (Can I Bring My Own Angel Along) — Billy Parker — SCR

49 To 40 — It Couldn't Have Been Any Better — Johnny Duncan — Columbia

50 To 41 — You're Free To Go — Sonny James — Columbia

Ex To 45 — Paper Rosie — Gene Watson — Capitol
Ex To 46 — Adios Amigo — Marty Robbins — Columbia

Ex To 47 — Lucille — Kenny Rogers — UA
Ex To 48 — Daddy They're Playing A Song About You — K. Seratt — Hitsville

Ex To 49 — Slide Off Your Satin Sheets — Johnny Paycheck — Epic

Ex To 50 — Easy Look — Charlie Rich — Epic

WWVA — WHEELING

#1 — Say You'll Stay Until Tomorrow — Tom Jones — Epic
Your Pretty Roses Came Too Late — Lois Johnson — Polydor

She's Got You — Loretta Lynn — MCA
All The Sweet — Mel McDaniels — Capitol

Mockingbird Hill — Donna Fargo — Warner Bros.
Lucille — Kenny Rogers — UA

He'll Play The Music, But You Can't Make Him Dance — Little David Wilkins — MCA

39 To 31 — A Mansion On A Hill — Ray Price — ABC/Dot
40 To 32 — Whispers — Bobby Borchers — Playboy

35 To 27 — Easy Look — Charlie Rich — Epic
34 To 26 — Cheatin' Overtime — Mary Lou Turner — MCA

20 To 15 — Sam — Olivia Newton-John — MCA
20 To 14 — You're Free To Go — Sonny James — Columbia

22 To 11 — She's Just An Old Love Turned Memory — Charley Pride — RCA

9 To 4 — Heart Healer — Mel Tillis — MCA
29 To 18 — Southern Nights — Glen Campbell — Capitol

Ex To 35 — She's Pulling Me Back Again — Mickey Gilley — Playboy

Ex To 36 — Don't Throw It All Away — Dave & Sugar — RCA

Ex To 37 — It Couldn't Have Been Any Better — Johnny Duncan — Columbia

Ex To 38 — Slide Off Your Satin Sheets — Johnny Paycheck — Epic

Ex To 39 — Paper Rosie — Gene Watson — Capitol
Ex To 40 — Wrap Your Love Around Your Man — Lynn Anderson — Columbia

Expansion Underway At Sound Shop

NASHVILLE — The Sound Shop, Inc., a major music and commercial jingle studio in Nashville, recently announced that it has begun a \$300,000 expansion program, which will net the facility a second 24-track studio.

Ground-breaking for the Sound Shop's new structure took place Feb. 4 and marked the firm's first official day of construction on the new studio, a project stemming from a 31% overall increase in business this past year.

Aside from creating a completely new outside facade, the addition is expected to also greatly enhance the studio's inside operation, via extremely sophisticated equipment and capabilities. For example, the new facility is to be equipped with all necessary channels for video discs, thus enabling the Sound Shop to instantly expand whenever future demands dictate growth in this area.

The building also boasts an ultra-modern office complex located on the second floor, which is to house all administration members of the Sound Shop staff.

Consisting of 3,800 square feet, the new building is to be constructed at Sound Shop's current site of 1307 Division Street, and is slated for completion in 90 days.

Nashville architects on the project are Yearwood & Johnson, while all acoustical work has been designed by the audio consulting firm of Sugarloaf View in New York.

May 17 Country Show At Carnegie Hall Set

NASHVILLE — The "Country Comes to Carnegie Hall" concert, featuring ABC/Dot recording artists Roy Clark, Freddy Fender, Hank Thompson, Buck Trent and Don Williams, has been rescheduled for May 17 because of television commitments by the artists. The concert will be broadcast over radio stations in several major cities and recorded for release as a live album.

Arbitron Forms Small Radio Market Dept.

LOS ANGELES — Arbitron Radio has established a small radio market department to serve radio markets not regularly measured by the firm. The small radio market division will "stimulate communication between Arbitron Radio and stations in unsyndicated markets," according to William E. Engel, vice president of Arbitron Radio. "Now we will be able to offer individual attention to the broadcast audience research needs of small radio market stations," he added.

The new division, which will be based in Beltsville, Maryland, will be headed up by Penny Johnson and Richard Glaspell who both have years of experience with Arbitron. Ms. Johnson joined the firm a year ago as manager. Arbitron survey analysis from WSGN, Birmingham and Glaspell, Arbitron's manager of client services, has been with the firm for 19 years.

Anderson Scores Parachute Documentary

LOS ANGELES — Country/pop recording artist Casey Anderson has been chosen by producer Ed Hansen to score "Chute Out," a thirty-minute television documentary on the history of parachuting produced in association with Six Flags Productions. "Chute Out" was filmed on location in Switzerland, Texas, Georgia, Oklahoma, Utah and Montana, and utilizes historical footage obtained from the U.S. Air Force and Northrop Aviation. Hansen, who also wrote and directed the documentary, said "Chute Out" would be set for international syndication in March, with a preview showing tentatively scheduled at the NATPE Convention in Miami, February 12-16.



FIRST GOOD SOUNDS — Good Sounds Records, a new subsidiary of Criteria Recording Studios, presented its first act, the Billion Dollar Band, at a gala party at the Criteria mansion in Miami Beach. TK Productions will distribute Good Sounds releases internationally. Pictured at the party are: Mac Emerman, president of Criteria Good Sounds and Henry Stone, president of T.K.

Harman Int'l To Call Debentures March 31

LAKE SUCCESS, N.Y. — Harman International Industries, Inc. will call for redemption of its 5-3/8% convertible subordinated debentures of 1982 effective March 31, 1977, according to the corporation. The company announced that bond holders may redeem each \$1,000 in face value for \$1,013.75, principal amount, plus \$22.40 in accrued interest from November 1, 1976, for a total amount of \$1,036.15 per bond. After March 31, 1977, interest will no longer accrue and the bonds will not be convertible. Irving Trust Company, indenture trustee, will handle the redemption of the issue.

Capitol Releases New Cosby, Campbell LPs

LOS ANGELES — Capitol Records will release new albums by Bill Cosby and Glen Campbell on February 21, according to Jim Mazza, Capitol vice president, marketing. Cosby's first spoken comedy album in three-and-a-half years, "My Father Confused Me . . . What Must I Do? What Must I Do?" was recorded live in 1976 at the Las Vegas Hilton.

Campbell, recently re-signed to the label for his 15th year with Capitol, releases "Southern Nights," also the initial single title from the LP. Campbell's selections are composed by a variety of songwriters.

Buck Owens Single Is Re-cut With Changes

BAKERSFIELD, CA. — "World Famous Holiday Inn," the just-released single by Buck Owens, has been recalled for some last minute substitutions. Owing to various problems with the original title, it is currently being re-cut and will shortly be released as "World Famous Paradise Inn."

NARAS Moves Their N.Y. Chapter Offices

NEW YORK — The New York chapter of the National Academy of Recording Arts and Sciences has moved to 14 East 53rd Street, New York 10022.

UA Gets Chalice Deal

LOS ANGELES — United Artists Records has entered a long-term production agreement with the Chalice Music Group, Artie Mogull, UA president, announced last week. Under the agreement, Chalice-owned by Lee Lasseff and David Chackler, is to scout, develop and record artists for UA distribution. Glider's "You're Like A Melody" single is Chalice's first production under the new contract. Chalice was formed in 1973 and has since produced and published Queen, Fleetwood Mac, and Flash Cadillac, among others.

EAST COASTINGS / POINTS WEST

(continued from page 46)

"A Visit With The **Doobies**" to be aired Monday Feb. 21 nationally and Friday, Feb. 25 in California. The show will feature a collection of their hits and will have as guest stars the **Memphis Horns**, **Lily Tomlin**, **Paul Williams** and **Gary Frank**. . . . Though personal experiences are the inspiration for many a song lyric, few are as personal as those on the **Tommy Leonetti** single "Crossroads." Leonetti wrote the song after he won his second battle with cancer after an operation on his right lung last August. His just-completed round of talk show appearances will air later this month and in March.

AULD LANG SYNE — Though they may not have known it, the audience who saw the **Billy Cobham/George Duke Band** on New Year's Eve at the Roxy in LA were catching the last act. According to Rolling Stone the band has broken up to pursue their own separate interests. Though he expressed no rancor toward his former kemosabe, Cobham admits to some frustration with Atlantic, saying, "The support has always been too little and too late. The marriage is not a good one" . . . **Derringer** has struck upon a novel idea to promote his product, that confirms a marketing theory not often thought of — that the intimate relationship between the artist and the audience in a smaller club is often more conducive to album sales in the following days than are larger concert appearances. So, before their appearance at the Long Beach Arena, Derringer will play the smaller Whiskey in LA. Epic spokesmen expect the proof of the theory to show up in record store cash registers . . . It wasn't exactly a hero's welcome but **Joe Cocker** returned to England for a live performance, his first in more than four years. Waiting for him was a three-year-old summons on a drunk driving charge. Justice was swift and lenient — 50 pounds and no driving for a year . . . Remember **Ernest Breuer**? He is the author of such classics as "Does the Spearmint Lose Its Flavor On The Bedpost Overnight," and we hear from Pompano Beach, Florida that he has just celebrated his 90th birthday in excellent health and good spirits. Happy Birthday, Ernie.

OUR HAT'S OFF TO — **Barry White**, who will be the keynote speaker for commencement exercises at Paul Quinn College in Waco, Texas, where he will also receive an Honorary Doctorate of Humanities Degree for his contribution to humanity . . . **Nancy Wilson** has been honored by the Johnson & Johnson company and Chicago's Black Business Directory for her concern and contributions to the health of young black women and their babies. The Black Business Directory afforded her their highest national honor in giving her their "Par Excellence" award. Johnson & Johnson gave her their "Red Ruby" award, their highest accolade, and for the first time given to a non-employee and a black woman . . . **Natalie Cole** thought Valentine's Day was an appropriate time to announce her well-kept secret marriage to record producer Marvin Yancy. They were wed in Chicago July 31 and we wish them luck in mixing home and the studio since Yancy co-produces her albums.

TRACK NEWS — Though **Minnie Riperton's** album has been ready for some time, it will not be released until mid-April because she and Epic are at odds on the issue of the inclusion of a lyrics sheet in her album package . . . **Lynyrd Skynyrd** will go back into the studio in March, having just returned from their European tour . . . "Holly Days," a tribute to Buddy Holly by **Wings' Denny Laine**, will be out in March. **Paul McCartney** was the producer . . . **Doug Kershaw's** new album will be out the last of this month and will feature some of his friends, including **Elvin Bishop**, **Dr. John**, **Gregg Allman Band** members **Neil Larsen**, **Bill Stewart** and **Calvin Arline** plus **Bonnie Bramlett** and the **Muscle Shoals Horns**. . . Reggae rocker **Bob Marley** is finishing an album that will appear in April. On release he will tour England, parts of Europe, and possibly Africa, and in May, will launch his American tour with his **Wailers**.

ON THE DOTTED LINE — New York rockers **Talking Heads** have been signed by Sire Records and will start work later this month on their debut album . . . **Bobby Goldsboro** has just signed with Epic coinciding with the release of his first single "Me and the Elephants" . . . Former London recording artists **Bloodstone** have announced a 2.7-million-dollar five-year contract with Epic . . . Concert promoter **Don E. Branker** and **Bob Lefebvre** have teamed up to manage new pop group **C.Y. Walkin' Band**, who will be produced on record by **Flo & Eddie**.

AROUND TOWN — Ready or not, New Zealand's **Split Enz** invaded the LA environs with its strange blend of free-form rock and roll and mime-like theatrics. Playing the Roxy and the Golden Bear, the seven-member band alternately confused and entertained the audiences, who came mostly unprepared for the bizarre stage business and unusual musical qualities of this certainly unique band of mad musicians. At this point categorization is difficult, but the guess here is that next time around they will follow up their attention-getting appearances with music that Yanks can more easily relate to . . . "Me and Bessie," the Broadway musical export starring **Linda Hopkins** as **Bessie Smith**, will open March 8 at the Huntington Hartford Theatre for a three week engagement . . . **Iron Butterfly** re-emerged at the Cabaret recently for their first southern California appearance in years. Joining them on the bill was **Orange**, west coast newcomers who set a new record for unsigned bands by playing the Whiskey, the Starwood and the Cabaret all within an eight day period. At the Cabaret they drew **Phil Spector** on stage, who cheered them on and invited them up to his place for an informal party after the show . . .

SEEING RED — **Sammy Hagar's** new single is being released this week on a special 12-inch disc pressed in red vinyl to emphasize the album's theme, Hagar's favorite color and Valentine's Day. The single is "Catch the Wind" but can you guess the flip side? It's a tune called "Red" . . . **The Ramones** will try to promote some of the same hysteria that accompanies their concerts Saturday, Feb. 19, when they will give away 50 albums to the first 50 customers who ask for them in record stores in six major cities . . . "Do Ya' Wanna Puck?" will be the musical question asked of the first 3000 teenagers who attend the LA Kings/St. Louis Blues hockey game at the Forum on Feb. 22. Those who say yes will receive a free puck with the L.A. Kings logo on one side and the Electric Light Orchestra logo on the other. A cool promotion idea, don't you rink?

chuck comstock

Wonder LP Cut Gets Play Casablanca & Douglas Records Resume Ties

(continued from page 14)

Jim Pirkle, program director at WFLI in Chattanooga, said stores there were getting about three times more results for "Isn't She Lovely" than "I Wish," particularly among upper female demographics. And Richard Irwin, operations manager at KAFY in Bakersfield, said the album cut appealed to a broader audience than the single, which is more popular with blacks and young teens.

LOS ANGELES — Casablanca Record and FilmWorks, which severed ties with Douglas Records, has resumed relationship with the firm, according to Neil Bogart, president of Casablanca, and Alan Douglas, president of Douglas Records. "We've arrived at a mutually satisfying compromise on the direction and marketing of Douglas Records," said Bogart.



CRADDOCK IN CONCERT — WMAQ, Chicago program director Bob Pittman, recording artist Billy "Crash" Craddock, WMAQ general manager Charlie Warner and ABC/Dot vice president Larry Banauch chat before Craddock's Jan. 7 concert which was broadcast live over the station.

Pop Radio Playlist Highlights (continued from page 31)

- *Natalie Cole
 - *Boston
 - *John Travolta
 - 9 To 2 — Barbra Streisand
 - 11 To 6 — Al Stewart
 - 20 To 15 — Jacksons
 - 24 To 17 — 10cc
 - 28 To 18 — David Soul
 - 30 To 24 — Glen Campbell
 - Ex To 22 — Kansas
- WORD — SPARTANBURG**
- 1-1 — William Bell
 - *Natalie Cole
 - *David Soul
 - *Brass Construction
 - *Hot
 - *Mesa
 - 7 To 3 — Eagles
 - 21 To 10 — Aretha Franklin
 - Ex To 16 — Joe Tex
 - Ex To 19 — Orleans
 - Ex To 21 — Thelma Houston
- KJRB — SPOKANE**
- 1-1 — Mary Macgregor
 - *David Soul
 - *Boston
 - *Eagles — Hotel California
 - *Atlanta Rhythm Section
 - *Rod Stewart
 - 15 To 9 — Barbra Streisand
 - 18 To 13 — Barry Manilow
 - 21 To 16 — Bob Seger
 - Ex To 27 — Kansas
 - Ex To 28 — Smokie
- KREM — SPOKANE**
- 1-1 — Manfred Mann
 - *Thelma Houston
 - *Elton John
 - *Wings
 - 15 To 10 — Jacksons
 - 20 To 15 — Barbra Streisand
 - 22 To 17 — Abba
 - Ex To 28 — Hall & Oates
 - Ex To 29 — Smokie
 - Ex To 30 — Boston
- WSPT — STEVENS POINT**
- 1-1 — Barbra Streisand
 - *Wings
 - *Rod Stewart
 - *Tom Jones
 - 7 To 3 — Kansas
 - 9 To 5 — Abba
 - 14 To 9 — Atlanta Rhythm Section
 - Ex To 25 — Boston
 - Ex To 28 — Elton John
 - Ex To 29 — Climax Blues Band
 - Ex To 30 — Elvis Presley
- KJOY — STOCKTON**
- 1-1 — Barbra Streisand
 - ELO
 - Joe Tex
 - Winos
 - Parker McGee
 - 11 To 6 — Hall & Oates
 - 16 To 8 — David Soul
 - 23 To 8 — George Harrison
 - 28 To 20 — Emotions
 - 29 To 18 — Jackson Browne
- WNDR — SYRACUSE**
- 6-1 — Barbra Streisand
 - Manhattan Transfer
 - Jennifer Warnes
 - Ozark Mtn. Daredevils
 - John Davidson
 - DeVorzon & Botkin
 - 29 To 21 — Al Stewart
 - 30 To 19 — 10cc
 - 31 To 18 — Olivia Newton-John
- WOLF — SYRACUSE**
- 2-1 — Rose Royce
 - George Harrison
 - Al Stewart
 - 11 To 7 — Dean Brothers
 - 30 To 23 — Brick
 - 25 To 17 — Kenny Nolan
- KTAC — TACOMA**
- 5-1 — Bread
 - *Kansas
 - *Boston
 - *Thelma Houston
 - *Wings
 - 12 To 7 — Kenny Nolan
 - 13 To 8 — Steve Miller
 - Ex To 25 — Kiss
 - Ex To 26 — 10cc
- WGLF — TALLAHASSEE**
- 1-1 — Eagles
 - *ELO
 - *Burton Cummings
 - *Jennifer Warnes
 - *William Bell
 - 9 To 5 — 10cc
 - 12 To 8 — Barbra Streisand
 - 14 To 10 — Fleetwood Mac
 - 19 To 14 — Bee Gees
 - 20 To 15 — Boston
 - 25 To 21 — David Soul
 - 29 To 25 — Little River Band
 - 30 To 26 — Atlanta Rhythm Section
 - Ex To 28 — Rod Stewart
 - Ex To 29 — Wings
 - Ex To 30 — Elton John
- WLCY — TAMPA**
- 2-1 — Mary Macgregor
 - *Jackson Browne
 - *Gary Wright
 - *Wings
 - 12 To 5 — Barbra Streisand
 - 15 To 11 — Al Stewart
 - 19 To 14 — Kenny Nolan
 - 27 To 21 — Bee Gees
 - 28 To 20 — Wonder — Lovely
 - Ex To 27 — Little River Band
- KEWI — TOPEKA**
- 1-1 — Rose Royce
 - *Elton John
 - *Wings
 - *Jackson Browne
 - *Olivia Newton-John
- WTRY — TROY**
- 1-1 — Mary Macgregor
 - *ELO
 - *Gary Wright
 - 12 To 8 — Al Stewart
 - 25 To 12 — Hall & Oates
 - 32 To 25 — Tom Jones
 - Ex To 28 — Jackson Browne
 - Ex To 29 — Wings
 - Ex To 30 — Elton John
 - Ex To 35 — George Harrison
- KAKC — TULSA**
- 1-1 — Barbra Streisand
 - *ELO
 - *Wings
 - *Jackson Browne
 - *Ozark Mt. Daredevils
 - Ex To 31 — Tom Jones
 - Ex To 32 — Rod Stewart
 - Ex To 33 — Atlanta Rhythm Section
- KELI — TULSA**
- 1-1 — Manfred Mann
 - *ELO
 - *Atlanta Rhythm Section
 - *Rod Stewart
 - 9 To 4 — Kansas
 - 11 To 5 — Al Stewart
 - 17 To 11 — Bee Gees
 - 20 To 15 — David Soul
 - 24 To 19 — Thelma Houston
 - 27 To 21 — Olivia Newton-John
 - Ex To 25 — Tom Jones
 - Ex To 26 — Jackson Browne
 - Ex To 27 — Elton John
 - Ex To 28 — Wings
 - Ex To 29 — Parker McGee
- WTLB — UTICA**
- 1-1 — Manfred Mann
 - *Leo Sayer
 - *Atlanta Rhythm Section
 - *Mesa
 - *Elvis Presley
 - 9 To 5 — Barbra Streisand
- 14 To 9 — Fleetwood Mac
- 16 To 10 — Al Stewart
- 17 To 12 — Kenny Nolan
- 20 To 14 — Bee Gees
- 21 To 16 — Kansas
- 23 To 18 — 10cc
- 25 To 19 — Boston
- Ex To 25 — Elton John
- Ex To 28 — ELO
- Ex To 29 — Rod Stewart
- Ex To 30 — Hall & Oates

98Q — VIDALIA

- 39-1 — Dickie Goodman
- *Burton Cummings
- *Rufus
- *Elton John
- *Kerry Chater
- 9 To 5 — Hall & Oates
- 14 To 9 — Steve Miller
- 21 To 16 — Kansas
- 25 To 19 — Abba
- 27 To 22 — Bee Gees
- 30 To 25 — Gary Wright
- 38 To 30 — Parker McGee
- Ex To 28 — David Soul
- Ex To 36 — Rod Stewart
- Ex To 37 — Tom Jones
- Ex To 39 — Donna Summer
- Ex To 40 — Wings

WPGC — WASHINGTON

- 6-1 — Hall & Oates
- Smokie
- Atlanta Rhythm Section
- David Dundas
- 12 To 7 — Al Stewart
- 14 To 10 — Kansas
- 18 To 13 — Abba

WKWK — WHEELING

- 2-1 — Eagles
 - *Olivia Newton-John
 - *ELO
 - 13 To 9 — Bob Seger
 - 16 To 10 — 10cc
 - 18 To 14 — Abba
 - Ex To 28 — David Soul
 - Ex To 29 — Elton John
- KLEO — WICHITA**
- 2-1 — Barbra Streisand
 - 10cc
 - *Sanford Townsend
 - 16 To 8 — Smokie
 - 21 To 11 — Kenny Nolan
 - 23 To 17 — Hall & Oates
 - 30 To 24 — Boston
 - Ex To 29 — Olivia Newton-John

WAIR — WINSTON SALEM

- 1-1 — Kansas
- *Elton John
- *Enchantment
- *Tom Jones
- 10 To 4 — Abba
- 20 To 14 — Kenny Nolan
- 26 To 21 — Orleans
- 27 To 22 — Wings
- 29 To 23 — George Harrison
- 30 To 24 — Jackson Browne
- 31 To 26 — Donna Summer
- 32 To 25 — ELO
- Ex To 28 — Rod Stewart
- Ex To 29 — David Soul
- Ex To 30 — Climax Blues Band
- Ex To 31 — Atlanta Rhythm Section

WORC — WORCESTER

- 2-1 — Eagles
- Winos
- *Climax Blues Band
- *Atlanta Rhythm Section
- 19 To 12 — 10cc
- 22 To 16 — Stephen Bishop
- 23 To 17 — Olivia Newton-John
- 24 To 18 — Fleetwood Mac
- 27 To 22 — Wilton Place Street Band
- 28 To 23 — George Harrison
- 29 To 24 — Heart
- 30 To 25 — Bee Gees
- Ex To 30 — Jackson Browne

Singles Bullets (continued from page 33)

- #69 **JOHN TRAVOLTA** — 9 debut stations include WKLO, KCBQ, WGCL, WOKY, WKBW, WIFI, KEEL, KSLQ.
- #75 **JENNIFER WARNES** — Added at WCOL, WZUU, WHHY, KILT. Last week added at WPIX, WBGW. #8 most active on the secondary level with new adds at WRWK, WOLF, WDBQ, WGOW.
- #80 **WILLIAM BELL** — Added at KILT, CKLW. (#15 bullet on CB R&B singles chart).

CASH BOX TOP 100 ALBUMS

February 19, 1977

	Weeks On 2/12 Chart		Weeks On 2/12 Chart		Weeks On 2/12 Chart
1 A STAR IS BORN STREISAND, KRISTOFFERSON (Columbia JS 34403)	11	8.98	36 CHILDREN OF THE WORLD BEE GEES (RSO/Polydor RS 1-3003)	22	6.98
2 HOTEL CALIFORNIA EAGLES (Asylum 7E-1084)	9	6.98	37 GOOD HIGH BRICK (Bang 408)	16	6.98
3 SONGS IN THE KEY OF LIFE STEVIE WONDER (Tamla/Motown T13-340C2)	18	13.98	38 LUXURY LINER EMMYLOU HARRIS (Warner Bros. BS 2998)	5	6.98
4 WINGS OVER AMERICA WINGS (Capitol SWCO 11593)	9	13.98	39 ANIMALS PINK FLOYD (Columbia JC 34474)	1	7.98
5 BOSTON (Epic PE 34188)	24	6.98	40 AFTER THE LOVIN' ENGELBERT HUMPERDINCK (Epic PE 34381)	14	6.98
6 FRAMPTON COMES ALIVE PETER FRAMPTON (A&M 3703)	55	7.98	41 DREAMBOAT ANNIE HEART (Mushroom 5005)	46	6.98
7 FLY LIKE AN EAGLE STEVE MILLER BAND (Capitol ST 11497)	39	6.98	42 PERSON TO PERSON AVERAGE WHITE BAND (Atlantic SD 2-1002)	5	9.98
8 GREATEST HITS LINDA RONSTADT (Asylum 7E-1092)	10	6.98	43 FLEETWOOD MAC (Warner Bros. MS 2225)	82	6.98
9 YEAR OF THE CAT AL STEWART (Janus JXS 7022)	20	6.98	44 DESTROYER KISS (Casablanca NBLP 7025)	15	6.98
10 A DAY AT THE RACES QUEEN (Elektra 6E-101)	6	7.98	45 CHICAGO X CHICAGO (Columbia PC 34200)	34	6.98
11 TEJAS ZZ TOP (London PS 680)	6	6.98	46 BLUE MOVES ELTON JOHN (MCA/Rocket 2-1104)	15	12.98
12 BEST OF THE DOOBIES DOOBIE BROTHERS (Warner Bros. BS 2978)	14	6.98	47 ONE MORE FROM THE ROAD LYNYRD SKYNYRD (MCA 2-6001)	21	4.1
13 A NEW WORLD RECORD ELECTRIC LIGHT ORCHESTRA (United Artists UA-LA 679)	16	6.98	48 ROCKS AEROSMITH (Columbia PC 34165)	39	6.98
14 ROCK AND ROLL OVER KISS (Casablanca NBLP 7037)	14	6.98	49 ALIVE KISS (Casablanca NBLP 7020)	72	7.98
15 NIGHT MOVES BOB SEGER (Capitol ST 11557)	16	6.98	50 TORN BETWEEN TWO LOVERS MARY MACGREGOR (Ariola America/Capitol SMAS 850015)	7	6.1
16 THE PRETENDER JACKSON BROWNE (Asylum 7E-1079)	13	6.98	51 BIGGER THAN BOTH OF US HALL & OATES (RCA APL 1-1467)	26	5.1
17 CAR WASH ORIGINAL SOUNDTRACK (MCA 2-6000)	22	7.98	52 MIRACLE ROW JANIS IAN (Columbia PC 34440)	4	6.2
18 A NIGHT ON THE TOWN ROD STEWART (Warner Bros. BS 2938)	32	6.98	53 DOUBLE TIME LEON REDBONE (Warner Bros. BS 2971)	5	6.59
19 LEFTOVERTURE KANSAS (Kirshner/Epic PZ 34224)	16	6.98	54 SECRET PLACE GROVER WASHINGTON JR. (Kudu/CTI KU 32)	7	6.58
20 GREATEST HITS JAMES TAYLOR (Warner Bros. BS 2979)	12	6.98	55 IN FLIGHT GEORGE BENSON (Warner Bros. BSK 2983)	2	7.81
21 THIS ONE'S FOR YOU BARRY MANILOW (Arista 4090)	27	6.98	56 THE SONG REMAINS THE SAME LED ZEPPELIN (Swan Song/Atlantic SS 2-201)	16	11.46
22 THEIR GREATEST HITS EAGLES (Asylum 7E-1052)	51	6.98	57 DR. BUZZARD'S ORIGINAL SAVANNAH BAND THE SAVANNAH BAND (RCA APL 1-1504)	29	4.48
23 THIRTY-THREE & 1/3 GEORGE HARRISON (Dark Horse/WB DH 3005)	11	6.98	58 BURTON CUMMINGS (Portrait/CBS PR 34261)	17	6.56
24 LOST WITHOUT YOUR LOVE BREAD (Elektra 7E-1094)	5	6.98	59 NADIA'S THEME (THE YOUNG AND THE RESTLESS) BARRY DEVORZON & PERRY BOTKIN, JR. & VARIOUS ARTISTS (A&M SP 3412)	16	5.52
25 THE LIGHT OF SMILES GARY WRIGHT (Warner Bros. BS 2951)	5	6.98	60 DON'T STOP BELIEVIN' OLIVIA NEWTON-JOHN (MCA 2223)	16	6.54
26 FESTIVAL SANTANA (Columbia PC 34423)	5	6.98	61 MY SPANISH HEART CHICK COREA (Polydor PD 2-9003)	8	9.64
27 SPIRIT EARTH, WIND & FIRE (Columbia PC 34241)	19	6.98	62 A ROCK AND ROLL ALTERNATIVE ATLANTA RHYTHM SECTION (Polydor PD 1-6080)	8	6.67
28 LOW DAVID BOWIE (RCA CPL 1-2030)	4	7.98	63 SATURDAY NIGHT LIVE! THE NOT READY FOR PRIME TIME PLAYERS (Arista 4107)	10	6.45
29 THE ROARING SILENCE MANFRED MANN'S EARTH BAND (Warner Bros. BS 2965)	23	6.98	64 CERTIFIED LIVE DAVE MASON (Columbia PG 34174)	14	7.57
30 WIND & WUTHERING GENESIS (Atlantic SD 36-144)	5	6.98	65 ARRIVAL ABBA (Atlantic SD 18207)	5	6.71
31 SONG OF JOY CAPTAIN & TENNILLE (A&M SP 4570)	49	6.98	66 SUMMERTIME DREAM GORDON LIGHTFOOT (Warner Bros. MS 2246)	35	6.55
32 ASK RUFUS RUFUS FEATURING CHAKA KHAN (ABC 975)	3	6.98	67 UNFINISHED BUSINESS BLACKBYRDS (Fantasy F9518)	13	6.60
33 TOYS IN THE ATTIC AEROSMITH (Columbia PC 33479)	96	6.98	68 THIS IS NIECY DENIECE WILLIAMS (Columbia PC 34242)	21	6.69
34 SILK DEGREES BOZ SCAGGS (Columbia PC 33920)	50	6.98	69 NIGHT SHIFT FOGHAT (Bearsville/Warner Bros. BR 6962)	14	6.63
35 HEJIRA JONI MITCHELL (Asylum 7E-1087)	11	6.98	70 THE JACKSONS (Epic PE 34229)	13	6.72
			71 FLIGHT LOG JEFFERSON AIRPLANE (Grunt/RCA CYL 2-1255)	3	10.79
			72 BRASS CONSTRUCTION II (United Artists UA LA 677G)	14	6.65
			73 FLOWERS EMOTIONS (Columbia PC 34163)	25	6.68
			74 SPIRIT JOHN DENVER (RCA APL 1-1694)	26	6.66
			75 I HOPE WE GET TO LOVE IN TIME MARILYN MCCOO & BILLY DAVIS, JR. (ABC ABCD 952)	23	7.70
			76 FOUR SEASONS OF LOVE DONNA SUMMER (Oasis/Casablanca NBLP 7038)	17	6.74
			77 GREATEST HITS ABBA (Atlantic SD 18189)	22	6.78
			78 ANY WAY YOU LIKE IT THELMA HOUSTON (Motown T6-34551)	10	8.83
			79 CHANGES IN LATITUDE — CHANGES IN ALTITUDE JIMMY BUFFETT (ABC AB 990)	2	122.7
			80 NEW SEASON DONNY & MARIE OSMOND (Polydor PD 1-6083)	14	6.76
			81 LOVE WILL KEEP US TOGETHER CAPTAIN & TENNILLE (A&M SP 4552)	89	7.75
			82 FREE FOR ALL TED NUGENT (Epic PE 34121)	22	6.73
			83 ... , AHH, THE NAME IS BOOTSIE, BABY BOOTSIE'S RUBBER BAND (Warner Bros. BS 2972)	3	104.10
			84 ENDLESS FLIGHT LEO SAYER (Warner Bros. BS 2962)	14	6.80
			85 ENDLESS SUMMER BEACH BOYS (Capitol SVBB 11307)	75	6.86
			86 AN EVENING WITH DIANA ROSS DIANA ROSS (Motown M7877R2)	2	111.11
			87 HASTEN DOWN THE WIND LINDA RONSTADT (Asylum 7E-1072)	26	7.77
			88 BREEZIN' GEORGE BENSON (Warner Bros. BS 2919)	46	6.87
			89 WAYLON LIVE WAYLON JENNINGS (RCA APL 1-1108)	10	6.82
			90 NOVELLA RENAISSANCE (Sire/ABC SA 7526)	3	115.11
			91 MAIN SQUEEZE CHUCK MANGIONE (A&M SP 4612)	14	6.89
			92 REACHING FOR THE WORLD HAROLD MELVIN & THE BLUE NOTES (ABC 969)	3	101.10
			93 FOUNTAINS OF LIGHT STARCASTLE (Epic 34375)	4	107.10
			94 VIBRATIONS ROY AYERS UBIQUITY (Polydor PD 1-6091)	7	6.97
			95 CALIENTE GATO BARBIERI (A&M SP 4597)	19	6.99
			96 IMAGINARY VOYAGE JEAN-LUC PONTY (Atlantic SD 18195)	13	102.10
			97 LIVE BULLET BOB SEGER (Capitol SKBVB 11523)	43	100.10
			98 LEO KOTTKE (Chrysalis CHR 1106)	5	103.10
			99 DAVID SOUL (Private Stock PS 2019)	7	110.11
			100 A FIFTH OF BEETHOVEN WALTER MURPHY BAND (Private Stock PS 2015)	26	85.85

Cash Box Top Albums/101 to 200

February 19, 1977

		Weeks On	2/12 Chart			Weeks On	2/12 Chart			Weeks On	2/12 Chart		
101	CHICAGO'S GREATEST HITS (Columbia PC 33900)	6.98	88	65	134	6.98	125	22	165	SPITFIRE JEFFERSON STARSHIP (Grunt/RCA BFL 1-1557)	6.98	156	32
102	DISCO INFERNO TRAMMPS (Atlantic SD 18211)	6.98	113	5	135	6.98	138	66	166	HEAT TREATMENT GRAHAM PARKER (Mercury SRM 1-1117)	6.98	170	12
103	THE PLANETS TOMITA (RCA ARL 1-1919)	6.98	93	10	136	6.98	134	34	167	MIDNIGHT CAFE SMOKIE (RSO/Polydor 13005)	6.98	169	4
104	GOLD/VOLUME ONE BEE GEES (RSO/Polydor RS 1-3006)	6.98	106	15	137	6.98	130	25	168	DARK SIDE OF THE MOON PINK FLOYD (Capitol SMAS 11163)	6.98	174	6
105	THE BEST OF GEORGE HARRISON (Capitol ST 11578)	6.98	84	13	138	12.98	130	25	169	A MAN AND A WOMAN ISAAC HAYES AND DIONNE WARWICK (ABC AB 996/2)	8.98	—	1
106	CRYSTAL BALL STYX (A&M SP 4604)	6.98	108	18	139	6.98	137	14	170	HARD AGAIN MUDDY WATERS (Blue Sky/Epic PZ 34449)	6.98	176	3
107	TOO HOT TO STOP BAR-KAYS (Mercury SRM 1-1092)	6.98	96	15	140	6.98	149	12	171	OCTOBERON BARCLAY JAMES HARVEST (MCA 2234)	6.98	178	4
108	NIGHTS ARE FOREVER ENGLAND DAN & JOHN FORD COLEY (Big Tree/Atlantic BT 89517)	6.98	91	27	141	6.98	—	1	172	THE QUEENS OF NOISE THE RUNAWAYS (Mercury SRM 1-1126)	6.98	181	3
109	RENAISSANCE LONNIE LISTON SMITH & THE COSMIC ECHOES (RCA APL 1-1822)	6.98	105	12	142	6.98	—	1	173	SO SO SATISFIED ASHFORD & SIMPSON (Warner Bros. BS 2992)	6.98	179	4
110	IT LOOKS LIKE SNOW PHOEBE SNOW (Columbia PC 34387)	6.98	92	16	143	6.98	136	30	174	WHAT'S WRONG WITH THIS PICTURE ANDREW GOLD (Elektra 7E-1086)	6.98	172	5
111	THE BEST OF FRIENDS LOGGINS & MESSINA (Columbia PC 34388)	6.98	90	11	144	6.98	151	17	175	THERE'S MUSIC IN THE AIR LETTA MBULU (A&M 4609)	6.98	192	3
112	METHOD TO THE MADNESS UNDISPUTED TRUTH (Whitfield/WB 2967)	6.98	119	5	145	6.98	135	15	176	THE BABYS (Chrysalis CHR 1129)	6.98	182	3
113	AGENTS OF FORTUNE BLUE OYSTER CULT (Columbia PC 34164)	6.98	109	35	146	6.98	139	13	177	DINNER AT THE RITZ CITY BOY (Mercury SRM 1-1121)	6.98	184	3
114	DIRT, SILVER & GOLD NITTY GRITTY DIRT BAND (United Artists UA LA 670-L3)	11.98	95	10	147	6.98	145	12	178	THE LION AND THE RAM LARRY CORYELL (Arista AL 4108)	6.98	185	3
115	AT THE SPEED OF SOUND WINGS (Capitol SW 11525)	6.98	118	46	148	6.98	140	11	179	CARICATURES DONALD BYRD (Blue Note/UA BNLA 633G)	6.98	188	2
116	PART 3 KC & THE SUNSHINE BAND (TK 605)	6.98	98	18	149	6.98	151	17	180	SAMMY HAGAR (Capitol ST 11599)	6.98	187	3
117	GOLD OHIO PLAYERS (Mercury SRM 1-1122)	6.98	114	14	150	6.98	141	19	181	SWEET EVIL RICK DERRINGER (Blue Sky/Epic PZ 34470)	6.98	—	1
118	ALICE COOPER GOES TO HELL (Warner Bros. BS 2896)	6.98	94	32	151	6.98	142	9	182	DEEP IN MY SOUL SMOKEY ROBINSON (Tamla/Motown T6-350S1)	6.98	189	2
119	THE CLONES OF DR. FUNKENSTEIN PARLIAMENT (Casablanca NBLP 7043)	6.98	112	20	152	6.98	193	2	183	FUTURE GAMES SPIRIT (Mercury SRM-1-1133)	6.98	—	1
120	WHITE BIRD DAVID LaFLAMME (Amherst AMH 1007)	6.98	117	11	153	6.98	141	19	184	LET 'EM IN BILLY PAUL (Phila. Intl./Epic PZ 34389)	6.98	—	1
121	MUSIC FAH YA' (MUSICA PARA TU) TAJ MAHAL (Warner Bros. BS 2994)	6.98	133	5	154	6.98	142	9	185	LEAVE HOME RAMONES (Sire/ABC SA 7528)	6.98	190	2
122	GEORGE BENSON IN CONCERT AT CARNEGIE HALL (CTI/Motown 6072S1)	6.98	129	4	155	6.98	150	29	186	PHOTOGRAPHIC SMILE MR. BIG (Arista AL 4083)	6.98	183	3
123	BEACH BOYS '69 BEACH BOYS (Capitol ST 11584)	6.98	116	9	156	6.98	150	29	187	OJAH AWAKE OSIBISA (Island ILPS 9411)	6.98	—	1
124	FIREFALL (Atlantic SD 18174)	6.98	121	43	157	6.98	161	6	188	KING SIZE B.B. KING (ABC AB 977)	6.98	—	1
125	NEXT JOURNEY (Columbia PC 34311)	6.98	171	2	158	6.98	147	28	189	STORMIN' BRAINSTORM (RCA BQL1 2048)	6.98	—	1
126	TROUBADOUR J.J. CALE (Shelter/ABC SRL 52002)	6.98	128	23	159	6.98	141	19	190	THE RETURN OF THE 60 GUITARS (Musicor MUS 2500)	6.98	191	4
127	PLAYING THE FOOL GENTLE GIANT (Capitol SKBB 11592)	7.98	157	2	160	6.98	144	13	191	BLIND FAITH (RSO RS-1-3016)	6.98	—	1
128	BEAUTIFUL NOISE NEIL DIAMOND (Columbia PC 33695)	6.98	120	34	161	6.98	163	3	192	BODY HEAT JAMES BROWN (Polydor 1-6093)	6.98	196	4
129	LITTLE RIVER BAND (Capitol ST 11512)	6.98	123	25	162	6.98	155	60	193	THE ALL NEW MICKEY MOUSE CLUB ORIGINAL TV CAST (Disneyland 2501)	3.98	—	1
130	OPEN SESAME KOOL & THE GANG (DeLite DE 2023)	6.98	124	14	163	6.98	146	11	194	ALPHA BAND (Arista AL 4102)	6.98	195	2
131	HOT ON THE TRACKS COMMODORES (Motown M6-867S1)	6.98	127	34	164	6.98	164	7	195	SOLID MICHAEL HENDERSON (Buddah 5662)	6.98	—	1
132	SOMETHING SPECIAL SYLVERS (Capitol ST 11580)	6.98	132	14	165	6.98	148	31	196	BIRD IN A SILVER CAGE HERBIE MANN (Atlantic SD 18209)	6.98	197	2
133	DEDICATION BAY CITY ROLLERS (Arista 4093)	6.98	126	23	166	6.98	152	63	197	JEAN CARN (Phila. Intl./Epic PZ 34394)	6.98	—	1
					167	6.98	160	190	198	SHADES KEITH JARRETT (Impulse/ABC ASD 9322)	6.98	200	2
					168	6.98	167	8	199	ISRAELI GEARS CREAM (RSO RS-1-3010)	6.98	—	1
					169	6.98	159	80	200	MAZE (Capitol 11607)	6.98	—	1

ALPHABETIZED TOP 200 ALBUMS (BY ARTIST)

Abba	65.77	Brick	37	Fleetwood Mac	124	Kiss	14,44.49	Nugent, Ted	82.161	Spinners	142
Aerosmith	33.48	Brown, James	192	Foghat	69	Kool & The Gang	130	Ohio Players	117	Spirit	183
Alpha Band	194	Browne, Jackson	16	Frampton, Peter	6	Kottke, Leo	98	O'Jays	134	Starcastle	93
America	135	Buffett, Jimmy	79	Franks, Michael	141	LaFlamme, David	120	Osibisa	187	Stewart, Al	9
Armstrong, Joan	153	Byrd, Donald	179	Genesis	30	Led Zeppelin	56	Osmond, Donny & Marie	80,146	Stewart, Rod	18
Ashford & Simpson	173	Cale, J.J.	126	Gentle Giant	127	Lightfoot, Gordon	66	Parker, Graham	166	Styx	106
Atlanta Rhythm Section	62	Captain & Tennille, The	31,81	Gold, Andrew	174	Little River Band	129	Parliament	119	Summer, Donna	76
Auger, Brian	149	Carn, Jean	197	Hagar, Sammy	180	Loggins & Messina	111	Paul, Billy	184	Sylvers	132
Average White Band	42	Chicago	45,101	Hall & Oates	51,157	Lynyrd Skynyrd	47	Pink Floyd	39,168	Taylor, James	20
Ayers, Roy	94	City Boy	177	Harris, Emmylou	38	MacGregor, Mary	50	Ponty, Jean-Luc	96	Tomita	103
Babys	176	Clapton, Eric	150	Harrison, George	23,105	Mahal, Taj	121	Prime Time Players	63	Trammps	102
Bachman-Turner Overdrive	154	Commodores	131	Hayes, Isaac and Dionne Warwick	169	Mangione, Chuck	91	Oueen	10	Turrentine, Stanley	155
Baez, Joan	144	Cooper, Alice	118	Heart	41	Maniow, Barry	21,163	Ramones	185	Undisputed Truth	112
Barbieri, Gato	95	Corea, Chick	61	Henderson, Michael	195	Mann, Manfred	29	Redbone, Leon	53	War	137
Barclay James Harvest	171	Coryell, Larry	178	Hillage, Steve	151	Mason, Dave	64	Renaissance	90	Washington, Grover	54
Bar-Kays	107	Cream	199	Houston, Thelma	78	Mass Production	159	Robinson, Smokey	182	Waters, Muddy	170
Bay City Rollers	133	Cummings, Burton	58	Humperdinck, Engelbert	40	Maze	200	Ronstadt, Linda	8.87	Wild Cherry	160
Beach Boys	85,123	Daniels, Charlie	145	Ian, Janis	52	Mbulu, Letta	175	Ross, Diana	86,152	Williams, Deniece	68
Bee Gees	36,104	Denver, John	74,162	Jacksons	70	McCoo/Davis	75	Rufus	32	Wings	4,115
Benson, George	55,88,122	Derringer, Rick	181	Jarrett, Keith	198	Melvin, Harold & Blue Notes	92	Runaways	172	Wonder, Stevie	3
Bishop, Stephen	140	DeVorzon & Botkin	59	Jefferson Airplane	71	Mickey Mouse Club	193	Santana	26	Wright, Gary	25,164
Blackbyrds	67	Diamond, Neil	128	Jefferson Starship	165	Original T.V. Cast	193	'Savannah Band	57	Zappa, Frank	148
Blind Faith	191	Doobie Bros.	12	Jennings, Waylon	89	Miller, Steve	7	'Sayer, Leo	84	ZZ Top	11
Blue Oyster Cult	113	Dramatics	143	John, Elton	46,139	Mitchell, Joni	35	'Scaggs, Boz	34		
Bootsy's Rubber Band	83	Eagles	2,22	Journey	125	Moore, Melba	147	'Seals & Crofts	158		
Boston	5	Earth, Wind & Fire	27	Kansas	19	Murphy, Walter	100	'Seger, Bob	15.97		
Bowie, David	28	Electric Light Orch.	13,136	KC & The Sunshine Band	116	Newton-John, Olivia	60	Smith, Lonnie Liston	109		
Brainstorm	189	Emotions	73	King, B.B.	188	Nitty Gritty Dirt Band	114	Smokie	167	All This & WW II	138
Brass Construction	72	England Dan/Coley	108					Snow, Phoebe	110	A Star Is Born	1
Bread	24,156	50 Guitars	190					Soul, David	99	Car Wash	17

INTERNATIONAL BEST SELLERS

Argentina

- 1 **MI Promesa** — Pomada — RCA
- 2 **Si** — Jose Luis Perales — Microfon
- 3 **El Amor Duele** — Nazareth, Yndio — Philips
- 4 **Respirando** — Barbara & Dick — RCA
- 5 **En Este Momento Y A Estas Horas** — Mario Echeverria — EMI
- 6 **Porque Te Vas** — Jeanette — Microfon
- 7 **Esclavo Y Amo** — Los Mensajeros — CBS
- 8 **Humanos** — Pastoral — Cabal
- 9 **Por Ejemplo** — Nicola de Bari — RCA
- 10 **Amor . . . Que Triste Es El Adios** — Juan Marcelo — CBS
- 11 **Y Hoy Me Recuerdas** — Danny — RCA
- 12 **No Hablemos De Amor** — Adamo — CBS
- 13 **Disco Pato** — Rick Dees — Philips
- 14 **Echame A MI La Culpa** — Albert Hammond — CBS
- 15 **Ese Amor Soy Yo** — Fernando de Madariaga — RCA
- 16 **Muy Despacio** — Los Angeles Negros — EMI
- 17 **Amor Sentimental** — Juan Eduardo — RCA
- 18 **Amor No Me Abandones** — Rabito — EMI
- 19 **No Habra Problema** — Jose Augusto — EMI
- 20 **Dos Cosas** — Los Terricolas — EMI

TOP TEN LPs

- 1 **America** — Julio Iglesias — CBS
- 2 **Entre Gauchos Y Mariachis, Vol. 2** — C. del Alba — Polydor
- 3 **Exitos Del Rock** — Selection — CBS
- 4 **40 Minutos** — Pepe Galan — TK
- 5 **Hits Calientes** — Selection — RCA
- 6 **Romanticos De Hoy** — Selection — EMI
- 7 **El Amor** — Julio Iglesias — CBS
- 8 **Recital** — Cacho Tirao — CBS
- 9 **Latinoamerica** — Los Wawanco — EMI
- 10 **Contata Crlolla 5 Movimiento** — Luis Landriscina — PH

France

- 1 **If You Leave Me Now** — Chicago — CBS
- 2 **Money, Money, Money** — Abba — Vogue
- 3 **Happy Days** — Pratt & McLain — WEA
- 4 **Le Pere De Sylva** — Sacha Distel — Carrere
- 5 **Mourir En France** — Serge Lama — Phonogram
- 6 **Je N'AI Pas Le Coeur A Sourire** — Daniel Guichard — Barclay
- 7 **Chantons La Meme Chanson** — Tino et Laurent Rossi — Pathe Marconi
- 8 **Deux Femmes A Dublin** — Enrico Macias — Phonogram
- 9 **Daddy Cool** — Boney M. — Carrere
- 10 **S'Asseoir Par Terre** — Alain Souchon — RCA
- 11 **Laisse Une Chance A Notre Amour** — Claude Francois — Fleche/Phonogram
- 12 **Chanson D'Amour** — Manhattan Transfer — WEA
- 13 **L'Amour Qui Brule En Moi** — Sheila — Carrere
- 14 **Hey Mister Lee** — Philippe Lavil — Sonopresse
- 15 **Il Viendra** — Michele Torr — AZ Records
- 16 **Le Temps Des Colonies** — Michel Sardou — Trema/RCA
- 17 **Un Enfant Malheureux** — C. Jerome — AZ Records
- 18 **Vis Ta Vie** — Michel Fugain — RCA
- 19 **Gabrielle** — J. Cl. Borely — AZ Records
- 20 **Don't Leave Me This Way** — Thelma Houston — EMI/Pathe Marconi

TOP TEN LPs

- 1 **Volci Les Cles** — Gerard Lenorman — CBS
- 2 **Songs In The Key Of Life** — Stevie Wonder — EMI/Pathe Marconi
- 3 **Sur La Route De Memphis** — Eddy Mitchell — Barclay
- 4 **Les Jours De Jole** — Julien Clerc — Pathe Marconi
- 5 **Nouvelles Chansons** — Georges Brassens — Phonogram
- 6 **Le Chanteur** — Serge Lama — Phonogram
- 7 **Le Jardin Du Luxembourg** — Joe Dassin — CBS
- 8 **Hamlet** — Johnny Hallyday — Phonogram
- 9 **Blue Moves** — Elton John — EMI/Pathe Marconi
- 10 **I Went To The Market** — Gilles Vigneault — Phonogram

Holland

- 1 **Sunny** — Boney M. — Dureco
- 2 **Living Next Door To Alice** — Smokie — Bovema
- 3 **Who's That Lady With My Man** — Patricia Paay — Bovema
- 4 **I Wish** — Stevie Wonder — Bovema
- 5 **Somebody To Love** — Queen — Bovema
- 6 **Belng As Slim As Your Daughter** — Corry van Gorp — WEA
- 7 **January, February** — Dutch Rhythm Steel And Show Band — Negram
- 8 **Magc Man** — Heart — Negram
- 9 **Soul Dracula** — Hot Blood — Dureco
- 10 **Moody Blue** — Elvis Presley — Inelco

TOP TEN LPs

- 1 **A Day At The Races** — Queen — Bovema
- 2 **Hotel California** — Eagles — WEA
- 3 **New Year's Eve '76** — Wim Kan — Inelco
- 4 **Songs In The Key Of Life** — Stevie Wonder — Bovema
- 5 **Arrival** — Abba — Polydor
- 6 **A New World Record** — ELO — Bovema
- 7 **Once Upon A Time In The West** — Ennio Morricone — Inelco
- 8 **Take The Heat Off Me** — Boney M. — Dureco
- 9 **Low** — David Bowie — Inelco
- 10 **Lost Without Your Love** — Bread — WEA

Italy

- 1 **Sei Forte Papa'** — Gianni Morandi — RCA
- 2 **Disco Duck** — Rick Dees — RSO
- 3 **Johnny Bassotto** — Lino Toffolo — RCA
- 4 **Due Ragazzi Nel Sole** — Collage — SaAR
- 5 **Regina Al Troubadour** — Le Orme — Philips
- 6 **Dancing Queen** — Abba — Dig-It
- 7 **Don't Make Me Wait** — Barry White — Philips
- 8 **Linda** — Pooh — CBS
- 9 **Mamma Tutto** — Iva Zanicchi — Rifi
- 10 **Ave Maria No No** — Santo California — YeP

TOP TEN LPs

- 1 **Four Seasons Of Love** — Donna Summer — Durium
- 2 **Singolare-Plurale** — Mina — PDU
- 3 **Verita' Nascoste** — Le Orme — Philips
- 4 **Festival** — Santana — CBS
- 5 **XXIII Raccolta** — Fausto Papetti — Durium
- 6 **Winds & Wuthering** — Genesis — Charisma
- 7 **Songs In The Key Of Life** — Stevie Wonder — Motown
- 8 **Arabian Nights** — Ritchie Family — CBS
- 9 **Ullalla'** — Antonello Venditti — RCA
- 10 **PIU'** — Ornella Vanoni — Vanilla

Great Britain

- 1 **Don't Give Up On Us** — David Soul — Private Stock
- 2 **Don't Cry For Me Argentina** — Julie Covington — MCA
- 3 **Side Show** — Barry Biggs — Dynamic
- 4 **Isn't She Lovely** — David Parton — Pye
- 5 **When I Need You** — Leo Sayer — Chrysalis
- 6 **Daddy Cool** — Boney M. — Atlantic
- 7 **You're More Than A Number In My Little Red Book** — Drifters — Arista
- 8 **Car Wash** — Rose Royce — MCA
- 9 **I Wish** — Stevie Wonder — Motown
- 10 **Things We Do For Love** — 10cc — Mercury
- 11 **Suspcion** — Elvis Presley — RCA
- 12 **Wild Side Of Life** — Status Quo — Vertigo
- 13 **Don't Believe A Word** — Thin Lizzy — Vertigo
- 14 **Don't Leave Me This Way** — Harold Melvin & The Blue Notes — CBS
- 15 **Jack In The Box** — Moments — All Platinum
- 16 **Dr. Love** — Tina Charles — CBS
- 17 **Living Next Door To Alice** — Smokie — Rak
- 18 **New Kid In Town** — Eagles — Asylum
- 19 **Grandma's Party** — Paul Nicholas — RSO
- 20 **Portsmouth** — Mike Oldfield — Virgin

TOP TEN LPs

- 1 **Red River Valley** — Slim Whitman — United Artists
- 2 **David Soul** — David Soul — Private Stock
- 3 **Arrival** — Abba — Epic
- 4 **Songs In The Key Of Life** — Stevie Wonder — Tamla/Motown
- 5 **Hotel California** — Eagles — Asylum
- 6 **Abba's Greatest Hits** — Abba — Epic
- 7 **Evita** — Rice & Webber — MCA
- 8 **A Day At The Races** — Queen — EMI
- 9 **Wings Over America** — Wings — EMI
- 10 **Showaddywaddy's Greatest Hits** — Showaddywaddy — Bell
- 11 **Wind And Wuthering** — Genesis — Charisma
- 12 **A New World Record** — Electric Light Orchestra — Jet
- 13 **Low** — David Bowie — RCA
- 14 **20 Golden Greats** — Glen Campbell — Capitol
- 15 **The Greatest Hits Of Frankie Valli And The Four Seasons** — K-Tel
- 16 **Disco Rocket** — Various Artists — K-Tel
- 17 **Vicious But Fair** — Streetwalkers — Vertigo
- 18 **Endless Flight** — Leo Sayer — Chrysalis
- 19 **Luxury LIner** — Emmylou Harris — Warner Bros.
- 20 **100 Golden Greats** — Max Bygraves — Ronco

Japan

- 1 **Seishunjidayi** — Kooichi Morita & Top Gallan — CBS/Sony
- 2 **SOS** — Pink Lady — Victor
- 3 **Musashino Shijin** — Goro Noguchi — Polydor
- 4 **Hatsukoizooshi** — Momoe Yamaguchi — CBS/Sony
- 5 **Pepper Keibu** — Pink Lady — Victor
- 6 **Shitsuren Restaurant** — Kentaro Shimizu — CBS/Sony
- 7 **Soul Korekkiridesuka** — Minor Chewing Band — CBS/Sony
- 8 **Country Road** — Olivia Newton-John — Toshiba/EMI
- 9 **Last Scene** — Hideki Saijo — RVC
- 10 **Doozo Konomama** — Keiko Maruyama — King
- 11 **Shiawase Miman** — Hiromi Oota — CBS/Sony
- 12 **Mooichidodake Furimuyite** — Junko Sakurada — Victor
- 13 **Kitano Yadokara** — Harumi Miyako — Columbia
- 14 **Akai Shoogeki** — Momoe Yamaguchi — CBS/Sony
- 15 **Jolene** — Olivia Newton-John — Toshiba/EMI

TOP TEN LPs

- 1 **Toozakaru Fuukeyl** — Keyi Ogura — Polydor
- 2 **Dedication** — Bay City Rollers — Toshiba/EMI
- 3 **Come On Over** — Olivia Newton-John — Toshiba/EMI
- 4 **Bay City Rollers** — New Best — Toshiba/EMI
- 5 **A Day At The Races** — Queen — Warner/Pioneer
- 6 **The 14th Moon** — Yumi Araya — Toshiba/EMI
- 7 **Wings USA** — Paul McCartney & Wings — Toshiba/EMI
- 8 **Eagles** — Hotel California — Warner/Pioneer
- 9 **Koolchi Morita & Top Gallan Hit All Collection** — CBS/Sony
- 10 **Kikyorayl** — Masashi Sada — Warner Pioneer

THE MARSHALL MATTUCKER BAND

Carolina
Dreams



HOME SWEET HOME NEVER SOUNDED SO GOOD



Produced by Paul Hornsby

ON CAPRICORN RECORDS AND TAPES