

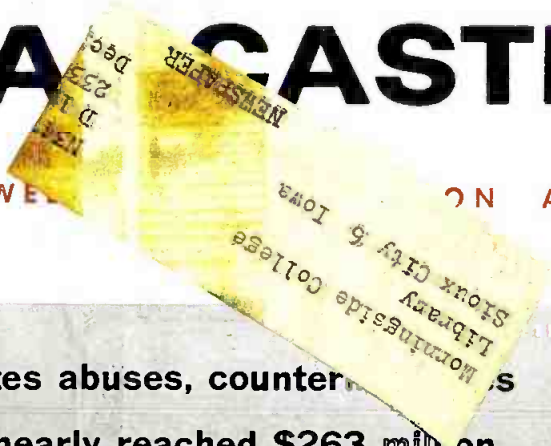

# BROADCASTING

THE BUSINESS WEEKLY OF TELEVISION AND RADIO



|  |          |
|--|----------|
| Triple-spotting blasted; ANA recites abuses, counter...        | Page 31  |
| Spot-network tv's big quarter: it nearly reached \$263 million | Page 33  |
| SRA unveils network time adjacency plan at Barrow hearing      | Page 70A |
| On-air editorializing draws criticism, praise in four cities   | Page 84  |



you get greater  
**selectivity**  
 with SPOT-TV...  
 the basic  
 advertising medium!

and hundreds of advertisers are using these great stations for their basic advertising:

- |                              |                                  |   |  |                               |                                      |
|------------------------------|----------------------------------|---|--|-------------------------------|--------------------------------------|
| AB-TV . . . . . Albuquerque  | WFAA-TV . . . . . Dallas         | WHTN-TV . . . . . Huntington-Charleston | KSTP-TV . . . . . Minneapolis-St. Paul | WJAR-TV . . . . . Providence  | KTBS-TV . . . . . Shreveport         |
| AT-TV . . . . . Atlanta      | WICU-TV . . . . . Erie           | KARK-TV . . . . . Little Rock           | WSM-TV . . . . . Nashville             | WTVD . . . . . Raleigh-Durham | WNDU-TV . . . . . South Bend-Elkhart |
| BAF-TV . . . . . Bakersfield | WNEM-TV . . . . . Flint-Bay City | KCOP . . . . . Los Angeles              | WTAR-TV . . . . . Norfolk              | KCRA-TV . . . . . Sacramento  | KREM-TV . . . . . Spokane            |
| BAL-TV . . . . . Baltimore   | WANE-TV . . . . . Fort Wayne     | WPST-TV . . . . . Miami                 | KMTV . . . . . Omaha                   | WOAI-TV . . . . . San Antonio | KOTV . . . . . Tulsa                 |
| CHI-TV . . . . . Chicago     | KPRC-TV . . . . . Houston        | WISN-TV . . . . . Milwaukee             | WTVH . . . . . Peoria                  | KFMB-TV . . . . . San Diego   | KARD-TV . . . . . Wichita            |

Television Division

## Edward Petry & Co., Inc.

The Original Station Representative

New York • Chicago • Atlanta • Boston • Detroit • Los Angeles • San Francisco • St. Louis

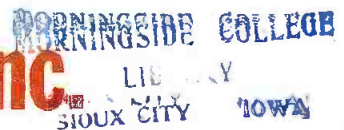

**TV: Bingo in the Home**  
 Adaptation of Game for Mass Playing Is Started on Daily

By JAC  
 BINGO came to the home television screen yesterday and it could play with the afternoon housewives and children.

As adapted and Stations playing P. M. 5, Bing

# Newsweek

Reprinted from the Issue of March 3, 1958

**TV-RADIO**  
**How to Create Bullman**

Every afternoon these days, thousands of New York housewives sit about their TV sets, phone books at hand, and their eyes fixed on the screen for immovable

to be awarded for each game. The phone company made (month by \$9,600) calls received after the first game, towards, at least, it failed to handle the calls. The station was further complicated by the fact that contestants played by mail in the winning phone number.

# TIME

THE WEEKLY NEWS MAGAZINE

March 3, 1958

**Bingo!**  
 Into TV's big bin of parlor games last week fell one of the oldest and simplest: bingo. With the legalized numbers game breaking records in New Jersey and New York State\* all set to play, Manhattan's

\* When Governor Averell Harriman last week named Brooklyn Lawyer Richard W. Hannah as first head (at \$2,000 a year) of the new Lottery Control Commission to boss bingo across the state.

WNYW decided that bingo would be a good bet for TV (too). It was. Opening day, thousands of housewives dropped their after-lunch chores to play, and within ten minutes some 6,000 phone callers had deluged the station's specially installed phones to ask questions of "Bingo!" The exchange was so hotly fanned that the New York Telephone Co. pleaded with the station to stop airing the phone numbers, but within the hour 35,000 more calls flooded in. Next day the station asked winners to send in their programs by mail. The prizes ranged from a set to a tankful of fish.

Electronic bingo on the daily for the first time. The five digits out under extension. Then each figure was rows. If called consecutively for five card was called 7-1001, his bingo this:

|       |   |   |   |   |
|-------|---|---|---|---|
| BINGO |   |   |   |   |
| 8     | 0 | 9 | 1 |   |
| 2     | 1 | 0 | 2 |   |
| 9     | 3 | 2 | 1 | 3 |
| 0     | 4 | 3 | 2 | 4 |
| 1     | 5 | 4 | 3 | 5 |

By week's end WNYW claimed that "a lot of people are cheating" by scanning the phone directory and locating winning numbers that would fit the winning numbers. Up came a new rule: henceforth a viewer must select phone numbers only from the column in which his own name appears.

Bingo's overnight success fits right in with TV's new rage for parlor games, which are cheap to produce and pull in good ratings. This week NBC will pull in its *Archie Francis Show* and replace it with *Win-Go* instead of *The Eve Arden Show*. CBS is planning to put on *Win-Go* instead of *The Eve Arden Show*. *Duchess* to *Lucky Dollar*, is also grooming three other games for the air.

TELEVISION

# LIFE

APRIL 7, 1958

**FOR TV: BINGO!**  
 Hit in New York, the game goes national

By week's end WNYW claimed that "a lot of people are cheating" by scanning the phone directory and locating winning numbers that would fit the winning numbers. Up came a new rule: henceforth a viewer must select phone numbers only from the column in which his own name appears.

Bingo's overnight success fits right in with TV's new rage for parlor games, which are cheap to produce and pull in good ratings. This week NBC will pull in its *Archie Francis Show* and replace it with *Win-Go* instead of *The Eve Arden Show*. CBS is planning to put on *Win-Go* instead of *The Eve Arden Show*. *Duchess* to *Lucky Dollar*, is also grooming three other games for the air.

# WE GOT IT!

BIGGEST, HOTTEST TV GAME IN AMERICA  
 "BINGO AT HOME" IS EXCLUSIVELY ON  
 KCOP IN THE LOS ANGELES AREA.  
 PARTICIPATIONS AVAILABLE! \*  
 CALL YOUR ACCOUNT EXEC. OR PETRY MAN.

**KCOP**

**13**

\* Mon. thru Fri. 4:30 to 5:30

1000 N. CAHUENGA BLVD., HOLLYWOOD 38

Los Angeles' most powerful television station. Represented nationally by Edward Petry & Co., Inc.

1300 ANNOUNCEMENTS  
INTRODUCE AND SELL

# LESTOIL

**Lansing - Flint - Jackson**  
in the hold  
**area**  
on

# WJIM-TV

LANSING .. FLINT .. JACKSON

Represented by PETERS, GRIFFIN, WOODWARD Inc.

*Michigan's Great Area Station serves the NATION'S 39th TELEVISION MARKET\* with the finest programs from All Three Networks. Preferred by Client and Viewer since 1950.*

*\*Television Magazine*



NBC.. CBS.. ABC

**Eighteen of the twenty top-rated TV shows**

Published every Monday, 53rd issue (Yearbook Number) published in September by BROADCASTING PUBLICATIONS Inc., 1735 DeSales St., N. W., Washington 6, D. C. Entered as second class matter March 14, 1933 at Post Office, Washington, D. C., under act of March 3, 1879.



**your advertising  
dollar produces  
more sales  
on **WGAL-TV****

And there's a reason. This pioneer station is foremost in the three standard metropolitan markets in its coverage area: Lancaster, Harrisburg, York, as well as in numerous other cities—Gettysburg, Hanover, Lebanon, Chambersburg, Carlisle, Lewistown, etc. In short, you find that WGAL-TV's multi-city coverage costs you less than buying single-city coverage. Put your advertising dollar to work producing *more*—on WGAL-TV.

**wgal-tv**  
**LANCASTER, PA.**  
**NBC and CBS**

STEINMAN STATION • Clair McCollough, Pres.

Representative: The MEEKER Company, Inc. • New York • Chicago • Los Angeles • San Francisco

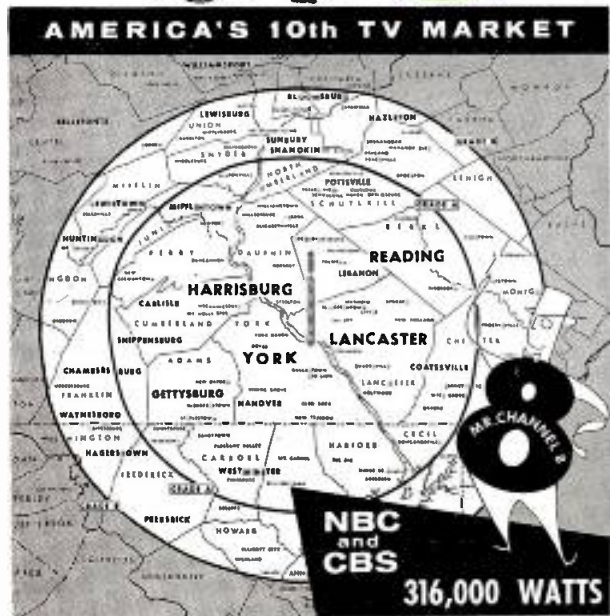

**ALTERNATE OUTLET** • What is labelled as first "alternate" affiliation contract with CBS-TV has been effected with ch. 5 WHDH-TV Boston, which has primary affiliation with ABC-TV. Primary CBS affiliate is ch. 7 WNAC-TV, whose present affiliation contract with that network runs until March 31, 1959.

*Under CBS affiliation criteria filed with FCC at Barrow Network hearings alternate affiliation becomes effective if primary affiliate does not accept program offered by network within 72 hours. Agreement with WHDH-TV led to speculation in Boston that major tv affiliations might shift in next few months.*

**CUE FROM KELLOGG** • All eyes of station representatives will be glued this week on Leo Burnett to see which way Kellogg turns in fall buying plans. On behalf of \$11 million-plus tv customer, agency is reappraising network-spot picture, in which renewal of ABC-TV children's strips and other network shows are at stake. Of concern to reps is whether cereal firm will revert, in small or large measure, to heavy spot schedule (about \$5 million) it curtailed last summer for ABC-TV series *Superman*, *Sir Lancelot*, *Wild Bill Hickok*, *Woody Woodpecker* and *The Buccaneers*. Kellogg in 1957 spent \$2.8 million in spot, \$7.9 million in network (with ABC-TV package representing well over half of latter).

*While American Medical Assn. is taking "let's-improve-our-liason" attitude with media (story page 32), it's known that pressure for better self-corrective action on drug advertising is building up among AMA's members and governmental agencies. Favorite observation runs like this—"If media don't improve voluntary controls, then government will do the job." Curious angle of agitators' pressure is their refusal to concede that medical products and advertising claims should be subjected to corrective action before they reach media.*

**CRUMBLING FOUNDATION** • After some 17 months' operation, People-to-People Foundation, organized at President Eisenhower's suggestion to build program of international friendship and communications on people-to-people rather than government-to-government basis, is set to fold at end of this month. Reason: inability to raise funds. But President Charles E. Wilson, former General Electric head, and other officials hope that many of foundation's 42 committees will be able to continue. Example: sports committee, which can raise its own funds through tickets for sports events it sponsors. Radio-tv committee, headed jointly by CBS Presi-

dent Frank Stanton and NAB President Harold E. Fellows, is another question. But it's pointed out that broadcasters engaged in international exchange before as well as after foundation's formation and undoubtedly will continue to do so, whether through this committee or not.

*With passing of People-to-People Foundation (see above) some widely-known radio-tv names may be heading back into broadcasting. Two of chief ones are George V. Denny, former moderator of America's Town Meeting of the Air, who is Foundation's program vice president, and Col. Edward M. Kirby, former Army radio-tv chief and also former publicity head for NAB, who is P-to-P public relations director.*

**REVLON SPOTS** • Revlon Inc. is understood—after radio-tv testing—to be ready to unveil multi-million dollar national drive on behalf of Hi-and-Dri roll-on deodorant, marking cosmetics-toiletries house's first major national spot effort. Product also will be billboarded on Revlon network shows and in print. It's reported Revlon—through Emil Mogul Co.—is using lot of spot to catch up with rivals Ban and Trig (Bristol-Myers) and other roll-on deodorants now splurging in spot.

*William Esty Co., New York, is one agency understood to be aggressively against tv stations triple-spotting (see story, page 31). Agency, in fact, spells out its warning to stations in insertion orders which refer specifically to "triple spotting" and contain words "not acceptable." R. J. Reynolds Tobacco Co. (Esty handles all of its cigarette brands) said to be partly responsible for policy—report which agency refuses to discuss.*

**PROGRAM SOCIETY** • New radio-tv trade association has been organized quietly and expected to unveil plans within few weeks. It's National Assn. of Radio & Tv Program Executives, with some 110 reportedly in founding group. Officers are James E. Kovach, Hearst radio and tv, president; Bob Martin, WJBK Detroit, radio v.p.; Chuck Gay, WHIO-TV Dayton, tv v.p.; Doug Elleson, KRON-TV San Francisco, West Coast v.p.; E. Marvin Camp, WOR-AM-TV New York, secretary, and Ed Hamilton, KENT Shreveport, treasurer. Formation of program managers group such as this has been long-time objective of Vic Campbell, himself a radio program manager for many years and now one of producers on NBC Radio's *Monitor*.

*NBC Radio's Monitor, which was bad word to some stations before advertisers got busy putting money into it, is due for expansion. Matthew J. Culligan, vice presi-*

*dent in charge of network, is planning Monitor Holiday, in which Monitor week-end service will be adapted to six major holidays. Thus instead of regular programming on these days, Monitor will also be heard on Labor Day, Thanksgiving, Christmas, New Year's, Memorial Day and July 4. Plan set to start Labor Day.*

**DRY DRIVE** • Having just presented their case before Senate [GOVERNMENT, May 5], temperance leaders now are after House Commerce Committee Chairman Oren Harris (D-Ark.) to schedule hearings on proposed ban of liquor advertising in interstate commerce. Rep. Harris is holding off on ground proponents have nothing new to present. Drys want hearings based on charge all alcoholic beverage advertising is "false and misleading." Rep. Harris has agreed to poll members of committee by letter to see if majority wants new hearings on much heard subject.

*Reports keep cropping up about organizational changes afoot at Young & Rubicam. Top officials won't confirm, but at other executive echelons feeling of uneasiness is apparent and sometimes admitted. Said one member of this group: "We natives are restless tonight."*

**SAFETY PLAN** • House Commerce Committee is understood to have decided to place before Congress after Decoration-Day recommendations of House Subcommittee on Traffic Safety, which recently heard testimony from MBS, NAB and individual broadcasters on how radio can better be used to improve traffic safety and overcome driving hazards. It is believed Congressional resolution will follow endorsing subcommittee's conclusions which include recommendations that governor of each state arrange for coordination of facilities within state for interchange of information; assignment of traffic clerk on 24-hour duty to make traffic and weather information available to radio stations and also to make this data available to sister states, thus establishing national network for weather and road conditions.

*Will Eastern Air Lines, confirmed year-round radio spot user in its 30-market area in Eastern U. S., expand into spot tv this summer? Eastern, according to industry estimates, spends approximately \$600,000 per year in radio, but is reportedly thinking of using tv to show off its new Lockheed "Electras"—first U. S. made jet-prop airliners slated for delivery within two months. Eastern has restricted tv activity to date to Miami and Atlanta, would like to expand to Chicago and New York. Fletcher D. Richards, New York, is agency.*

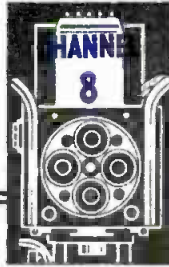

# WHEN-TV

MEREDITH  
SYRACUSE  
TELEVISION CORP.

Now Operating at Maximum Power of 316,000 Watts.

101 COURT STREET, SYRACUSE 8, NEW YORK

We salute the sales promotion abilities and facilities of the following stations:

|         |         |         |         |         |         |         |         |
|---------|---------|---------|---------|---------|---------|---------|---------|
| KIVA    | WTVT    | WTHI-TV | WHYN-TV | KHAS-TV | WHIO-TV | WBTW    | KWTX-TV |
| KRBB    | WEAT-TV | WTTV    | WWLP    | KHOL-TV | WLW-D   | WFBC-TV | KFDX-TV |
| KFSA-TV | WPTV    | WHBF-TV | WPAG-TV | KOLN-TV | WIMA-TV | WSPA-TV | KSYP-TV |
| KNAC-TV | WALB-TV | WOC-TV  | WWTW    | KSTF    | WSPD-TV | KOTA-TV | WCAJ-TV |
| KCMC-TV | WJBF    | KQTV    | WK20-TV | KMTV    | WFMJ-TV | KELO-TV | WCYB-TV |
| KBAK-TV | WRDW-TV | KGLO-TV | WOOD-TV | WOW-TV  | WKBN-TV | WDEF-TV | WSVA-TV |
| KERO-TV | WDAK-TV | KTVO    | WJIM-TV | KOLO-TV | WHIZ-TV | WRGP-TV | KVOS-TV |
| KHLS-TV | WRBL-TV | KTIV    | WDMJ-TV | WMUR-TV | KTEN    | WDXI-TV | KIMA-TV |
| KIEM-TV | WMAZ-TV | KVTV    | WKNX-TV | WMTW    | KVSO-TV | WCYB-TV | WHIS-TV |
| KVIP-TV | WROM-TV | KCKT-TV | WNEM-TV | KAVE-TV | KGEO-TV | WJHL-TV | WJPD-TV |
| KNTV    | WSAV-TV | WIBW-TV | WPBN-TV | KICA-TV | KSWO-TV | KPAR-TV | WTAP    |
| KSBW-TV | WTOC-TV | WLEX-TV | KMMT    | KSW5-TV | KWTV    | KRBC-TV | WSTV-TV |
| KVEC-TV | WCTV    | WAVE-TV | KDAL-TV | WINR-TV | WKY-TV  | KFDA-TV | WTRF-TV |
| KEY-T   | KBOL-TV | WHAS-TV | WDSM-TV | WBNF-TV | KVAL-TV | KGNC-TV | WEAU-TV |
| KOVR    | KIDO-TV | WPSD-TV | KROC-TV | WCNY-TV | KOTI    | KTBC-TV | WKBT    |
| KKTV    | KID-TV  | KALB-TV | WCBI-TV | WSYR-TV | KBES-TV | KFDM-TV | WSAU-TV |
| KRDO-TV | KLEW-TV | WAFB-TV | WDAM-TV | WKTU    | KPIC-TV | KEDY-TV | WFLA-TV |
| KREX-TV | KLIX-TV | WBRZ    | WJTV    | WISE-TV | WGLV    | KGBT-TV | WSUN-TV |
| KCSJ-TV | WBLN-TV | KLFY-TV | WLBT    | WLOS-TV | WLEV-TV | KRGV-TV | WFAM-TV |
| KKTV    | WCIA    | KPLC-TV | WTOK-TV | WBTU    | WFBG-TV | KRLD-TV | WLBC-TV |
| WICC-TV | WDAN-TV | KTAG-TV | WTWV    | WSOC-TV | WICU    | WFAA-TV | WAGM-TV |
| WHCT    | WTVP    | KNOE-TV | KFVS-TV | WFLB-TV | WSEE-TV | KFJZ-TV | WBOC-TV |
| WNBC    | WSIL-TV | WDSU-TV | KOMU-TV | WITN    | WARD-TV | WBAP-TV | KFBB-TV |
| WNHC-TV | WEEK-TV | WJMR-TV | KRCG-TV | WNCT    | WJAC-TV | KHAD-TV | KMSO-TV |
| WATR-TV | WTVH    | KSLA-TV | KODE-TV | WMFD-TV | WGAL-TV | KCBD-TV | KXJB-TV |
| WPFH    | WGEM-TV | KTBS-TV | KFEG-TV | KBMB-TV | WLBR-TV | KDUB-TV | WAKR-TV |
| WESH-TV | WREX-TV | WABI-TV | KDRO-TV | KFYR-TV | WJAR-TV | KTRE-TV | WIS-TV  |
| WINK-TV | WTVO    | W-TWO   | KTTS-TV | KDIX-TV | WPRO-TV | KMID-TV | WNOK-TV |
| WDBO-TV | WICS    | WMTW    | KYTV    | WDAY-TV | WAIM-TV | KOSA-TV | KLTV    |
| WJDM-TV | WANE-TV | WCSH-TV | KOOK-TV | KNOX-TV | WCSC-TV | KTXL-TV | KCEN-TV |
| WEAR-TV | WKJG-TV | WGAN-TV | KXLF-TV | KCJB-TV | WUSN-TV | KCMC-TV |         |

Cordially,

Paul Adanti  
Vice President

P. S. All of the fine stations above were in the 1958 Billboard - TV Age Sales promotion competition category in which we were fortunate to win first place.

AFFILIATED WITH BETTER HOMES AND GARDENS AND SUCCESSFUL FARMING MAGAZINES



**MEREDITH STATIONS**  
**KCMO and KCMO-TV, Kansas City • KPHO and KPHO-TV, Phoenix**  
**KRMG, Tulsa**  
**WOW and WOW-TV, Omaha • WHEN and WHEN-TV, Syracuse**

# THE WEEK IN BRIEF

**ANA Lashes Triple-Spotting**—Survey shows “important segment of advertisers” are triple-spot victims, reveals methods used by some sponsors to combat abuse. Page 31.

**Spot-Network Tv’s Quarterly Gross**—It’s near the \$263 million mark. Page 33.

**Bulova’s “Time Bomb”**—Watch company, which has invested about \$4 million in spot tv this broadcast year, is cancelling extensive schedule as of June 15 and is undecided about its future participation in spot tv. Page 36.

**Breakfast in a Bowl**—How and why General Mills is using television to hypo Hi-Pro’s introduction. A case history of a new cereal that is using tv to “demonstrate” a theme. Page 39.

**Warm Up to Spot Radio**—That’s what Peters, Griffin, Woodward asks advertisers to do in the summertime. A drive for new business and increased budgets in the hot months opened by station representative. Page 40.

**The Poof That Refreshes**—Tv stations are alerted to hot success story of 1958 as Parry Labs’ Myomist looks to tv spot to carry mouth spray clear across the country. Page 40.

**Have Networks Grown Sterile?**—Pat Weaver believes so, and he draws both argument and support. Page 58.

**Electronic Records**—Production at alltime peak during fiscal year, delegates at Electronic Industries Assn. convention are told in Chicago. Tv is down but military, radio and phonograph business is offsetting this trend. Page 62.

**Radio Is Good, But!**—Richard Borden, Atlantic Refining Co., figures it is a fine medium but it could be better. Pennsylvania Assn. of Broadcasters hears some tips. Page 68.

**Adjacency Plan Offered at Barrow Hearing**—SRA members submit plan to give them prime time network adjacencies on tv stations while leaving option time intact. They and another independent rep ask that networks be shorn of their spot sales representation, while tv affiliates represented by their networks defend this activity. Page 70A.

**FCC Warns Crosley of Violation**—Commission tells Crosley Broadcasting Corp. it believes the firm used threats to NBC-TV to keep tv network’s programs off other stations, says it will not act “at present,” but will associate rule violation with Crosley’s FCC record. Page 71.

**Oversight’s Probes Another Grant**—Harris subcommittee accuses top Republicans of improperly influencing FCC on grant of ch. 2 Springfield, Ill. Promised this week—more ex-parte contacts in several different St. Louis tv cases, all to be tied-in with Springfield decision. Page 72.

**BMI Supporters Testify**—Final round of testimony taken from anti-Smathers bill witnesses, winding up several weeks of hearings. NBC, CBS and their recording arms heard last week. Page 76.

**Views on Extended Hours**—More than 250 comments flood FCC on daytime proposal; as expected, daytimers favor, clears and regionals oppose. Page 78.

**FCC Wants Information**—Commission asks how catv systems—and boosters, translators and satellites—impinge on local tv outlets; seek also policy and legal suggestions on dealing with problem. Page 80.

**Tougher Conflict of Interest Law**—Rep. Celler introduces measure which would bar former government employes from ever representing in civilian life a case they handled while in government. Bribery laws also would be strengthened. Page 82.

**Presidential Dedication**—New \$4 million plant of NBC Washington formally opened Thursday by President Eisenhower, first president to be presented on live color tv from nation’s capital. Page 83.

**Editorials Make News All Over**—Stations criticized, lauded, backed for editorial stands. The developments come from four cities. Page 84.

**Let Meany Rule on VTR**—That’s proposal SAG makes to AFTRA relative to jurisdiction over video tape recording. Page 89.

**Etv In New York**—Its future hangs in balance as Metropolitan Educational Television Assn. suspends operations June 1 due to a lack of funds. Page 90.

**Allard Stays**—Canadian broadcasters reappoint executive vice president, squelching dismissal talk. Group re-assumes Canadian Assn. of Broadcasters name. Page 91.



MR. HOWELLS

**Something More Than Madison Ave.**—A man who used to work there tells the world about how the other half lives: the agencies who don’t work in New York. It’s in this week’s MONDAY MEMO, written by J. Harvey Howells of Fitzgerald Adv., New Orleans. Page 109.

## DEPARTMENTS

|                        |     |                       |    |
|------------------------|-----|-----------------------|----|
| ADVERTISERS & AGENCIES | 32  | OPEN MIKE             | 14 |
| AT DEADLINE            | 9   | OUR RESPECTS          | 26 |
| BUSINESS BRIEFLY       | 44  | PEOPLE                | 96 |
| CHANGING HANDS         | 88  | PERSONNEL RELATIONS   | 89 |
| CLOSED CIRCUIT         | 5   | PROGRAMS & PROMOTIONS | 92 |
| EDITORIAL              | 110 | PROGRAM SERVICES      | 60 |
| EDUCATION              | 90  | STATIONS              | 83 |
| FILM                   | 46  | TRADE ASSNS.          | 62 |
| FOR THE RECORD         | 99  | UPCOMING              | 98 |
| GOVERNMENT             | 70A |                       |    |
| IN PUBLIC INTEREST     | 107 |                       |    |
| IN REVIEW              | 22  |                       |    |
| INTERNATIONAL          | 91  |                       |    |
| LEAD STORY             | 31  |                       |    |
| MONDAY MEMO            | 109 |                       |    |
| NETWORKS               | 58  |                       |    |



# A Time-Buyer can relax in Miami

... where one station—WQAM  
is first in 432 out of 432 Pulse quarter hours.

You really can't get anything but a good time on WQAM. Take Pulse: WQAM is first 432 out of 432 quarter hours! (Mon.-Sat., 6 a.m.-midnight). Hooper? WQAM is first with 38.6% of the audience—three times the next station's listenership. And 259 of 262 daytime Hooper quarters belong to WQAM. Trendex? Practically a carbon copy of the Hooper. And, finally, WQAM is first on the latest Southern Florida Area Pulse which measures the listening habits of 31.5% of the state's population. Get the details from those good time charlies at Blair . . . or WQAM General Manager Jack Sandler.

## WQAM

covering all of  
Southern Florida  
with 5,000 watts  
on 560 kc.  
and radio #1 in  
**MIAMI**



## STORZ STATIONS

TODAY'S RADIO FOR TODAY'S SELLING  
TODD STORZ, PRESIDENT • HOME OFFICE: OMAHA, NEBRASKA

WDGY Minneapolis St. Paul  
REPRESENTED BY JOHN BLAIR & CO.  
WHB Kansas City  
REPRESENTED BY JOHN BLAIR & CO.  
WTIX New Orleans  
REPRESENTED BY ADAM YOUNG INC.  
WQAM Miami  
REPRESENTED BY JOHN BLAIR & CO.



# at deadline

## Magnuson Committee All Set For New Allocations Hearings

List of witnesses released today (Mon.) for Senate Commerce hearings on allocations and tv service to small communities, starting tomorrow, bear out feeling majority of time will be devoted to community antenna tv problems [GOVERNMENT, May 5]. Beyond FCC and NAB, all scheduled witnesses are broadcasters facing CATV competition and others directly connected with problem.

Hearings actually are continuation of committee's overall tv study begun in 83rd Congress. Kenneth Cox, special counsel during much of prior inquiry, returns to conduct current phase. Allocations-CATV probe scheduled for Tuesday-through-Thursday this week but indications are study will continue into following week.

Committee is scheduled to begin hearings June 2 on S 376, introduced by Sen John W. Bricker (R-Ohio), placing networks under direct regulation of FCC. Schedule will be set back if allocations-CATV hearings are not completed this week.

FCC will open testimony tomorrow in Room G-16 of Capitol, according to Sen. Warren Magnuson (D-Wash.), chairman. Other witnesses:

**WEDNESDAY:** Vincent Waslewski, NAB manager of government relations; Barclay Craighead, KXLI-TV Helena, Mont.; Frank Reardon, KGEZ-TV Kallispell, Mont.; Ed Craney, KXLF-TV Butte, Mont.; Lou Moore, KXGN-TV Glendive, Mont.; Art Mosby, KSMO-TV Missoula, Mont.; D. N. Latus, Helena tv equipment wholesaler; Gordon Glasmann, KDIX-TV Twin Falls, Idaho; D. N. Layne, KID-TV Idaho Falls, Idaho; Tom Bostic, KLEW-TV Lewiston, Idaho; Bill Grove, KFBC-TV Cheyenne, Wyo.; Dwight Dahlman, secretary, Wyoming Public Service Commission; Marshall H. Pengra, KLTV (TV) Tyler, Tex., and William Smullen, KBES-TV Medford, Ore.

**THURSDAY:** Edwin C. Johnson, former Colorado governor and senator (and ex-chairman of Senate Commerce Committee) who has openly defied rules of FCC on boosters and satellites; E. Stratford Smith, National Community Tv Assn.; Milton J. Shapp, Jerrold Electronics Corp.; Cliff Collins, Pacific Northwest Community Tv Assn.; Archer S. Taylor, Montana Community Antenna Tv Assn.; Charles Crowell, Wyoming Community Tv Assn.; Wallace M. Bradley, Committee for Competitive Tv; George R. Town, Tv Allocations Study Organization, and Pat Beacom, Fairmount, W. Va.

## NBC-TV Frowns With Rest

NBC joined other tv networks Friday in going on record against triple-spotting, target of blast being loosed by Assn. of National Advertisers (story page 31). NBC said:

"NBC and the NBC Affiliates Board of Delegates agree that the practice of triple-spotting in station breaks is undesirable and have consistently opposed it. With the growing recognition on the part of the NBC affiliates of the adverse effects of triple spotting, the practice has been reduced to relatively few cases and all efforts are being made to have it terminated in these cases."

ABC-TV and CBS-TV already had taken similar positions.

## Comr. Cross Takes Oath; FCC Back at Full Strength

FCC stands at full seven members today following swearing-in of John S. Cross Friday by FCC Chairman John C. Doerfer before large audience of government officials and friends. Mr. Cross takes place of former Comr. Richard A. Mack, who resigned under fire, with term running to 1962.

New commissioner is former assistant chief, State Dept.'s Telecommunications Div. He was born in Birmingham, Ala., in 1904; received B. S. in electrical engineering from Alabama Polytech. in 1923; worked in various capacities with Studebaker Corp., Realty Trust Co. (Detroit), S. S. Kresge Co., Michigan State Highway Dept. He entered federal government service in 1931 with National Park Service. He was Navy captain (communications) during World War II, after which he joined State Dept. As State Dept. telecommunications expert, Mr. Cross was associated with FCC in many international conferences.

Mr. Cross is married to former Ruth Fuller of Eureka Springs, Ark., has two sons. He is Democrat and Presbyterian.

Staffing his office (Room 7235 Post Office Bldg.) are Miss Rose Hahlen, formerly in FCC's common carrier division and since 1945 with State Dept. where she was Mr. Cross' secretary, as confidential assistant; Misses Frankie Fox and Lilian Watson, secretaries.

## UP, INS Merger Said in Works

Merger of United Press Assn. and International News Service was in offing at weekend, with formal announcement expected Sunday, according to UP wire service. Dow Jones service said deal had been confirmed by spokesman for William Randolph Hearst Jr., head of INS, but Mr. Hearst's office denied any such statement had been made.

## STATISTICAL DEFENSE

Look for Adam Young, one of most outspoken defenders of rock 'n' roll music on radio, to cite Pulse statistics garnered in 10 top U. S. markets in move to spike "myth" that "modern radio" fans are mostly youngsters devoid of purchasing power. Station rep next week will publish special report on audience composition, will claim 84.9% of "modern radio" audience in Monday-Friday 6 a.m.-6 p.m. periods is adult; that teenagers comprise 11.7% and children 3.4%. Figures represent "average" composition of Los Angeles, New York, Chicago, Minneapolis, Cincinnati, Milwaukee, Atlanta, Miami, Seattle and New Orleans.

## BUSINESS BRIEFLY

Late-breaking items about broadcast business; for earlier news, see ADVERTISERS & AGENCIES, page 31.

**PRO-BROADCAST OUTLOOK** • Though still being formed, Pharma-Craft Co.'s advertising budget for next fiscal year (starting in June) probably will channel more dollars to broadcast media. Sales and advertising strategy covered with its two agencies, J. Walter Thompson and Cohen & Aleshire, at Atlantic City meeting last week. Pharma-Craft makes Coldene medicines and Fresh deodorants, last fiscal year allocated more than \$5 million out of \$7 million budget to radio-tv (tv getting about \$3.5 million). Allocation expected to be increased next year, particularly on behalf of Coldene.

**BINGO BUYERS** • Associated Products (5-Day deodorant pads), N. Y., and Hazel Bishop will sponsor *Music Bingo* (Thurs. 10:30-11 p.m.) on NBC-TV effective May 29. Show replaces Jane Wyman, sponsored by Bishop alone. Agency for Associated Products is Grey Adv., for Hazel Bishop is Raymond Spector, both N. Y.

**GETTING TOGETHER, APART** • CBS-TV close to solving tobacco product protection problem between P. Lorillard and Brown & Williamson with following plan: B&W expected to drop out of *Lineup* (Fri., 10-10:30 p.m.) preceding *Person to Person*, which will be sponsored by Lorillard. Brown & Williamson will sponsor *Number Please* (Tues. 8-8:30 p.m.) starting July 22, and continue half of *Top Dollar*, Saturdays, 8:30-9 p.m. until fall when it will underwrite *The Texans* in same period. Meanwhile, Lorillard expected to sponsor *Wanted Dead or Alive* (Thurs., 8:30-9 p.m.). Agency for B&W is Ted Bates & Co.; for Lorillard, Lennen & Newell.

**NEWS FOR TWO** • General Foods Corp. (Jell-O) and P. Lorillard (Kent cigarettes) each signed for packages of 24 weekly newscasts on CBS Radio. GF schedule effective today (Mon.) on alternate-week basis. Lorillard starting June 30. Jell-O agency is Young & Rubicam; Kent, Lennen & Newell, both N. Y.

**SATURATED FLAVOR** • Good Humor Co. of California has ordered saturation campaigns on KABC Los Angeles, KDAY Santa Monica, and KBIG Avalon, directed to teenage and adult markets. Agency: Cole, Fischer & Rogow Inc., Beverly Hills.

**SHEER DELIGHT** • Penick & Ford, N. Y., will introduce new product, My-T-Fine Chiffon pie filling, in New York market June 2 with saturation spot schedule on seven New York radio stations and one tv station. BBDO, N. Y., is agency.

# at deadline

## EIA, Iowa Broadcasters Ask Census Set Count

Inclusion of am-fm radios, phonographs and vhf-uhf set breakdown in 1960 decennial census asked by Consumer Products Div. of Electronic Industries Assn. at Chicago meeting (early story, page 62). EIA has agreed to resume breakdown of fm sets in monthly manufacturing data, starting in July.

EIA board Friday re-elected James D. Secrest as executive vice president and secretary, and Leslie F. Muter, of Muter Co., as treasurer and finance chairman. William L. Reynolds was re-elected general counsel.

Board voted to extend drive for reduction of 10% excise tax on receivers to grass-roots level, with manufacturers working through employes. Board endorsed proposal of H. Leslie Hoffman, recipient of 1958 EIA Medal of Honor, for federal tax credit as research incentive and aid to economy. Funds for development of EIA guidebook on educational tv were voted, directors feeling broadcast and closed-circuit etv offer vast new market potential. Code of ethics for receiving tube section was approved. Dr. W. R. G. Baker, formerly of General Electric Co., was re-elected director of EIA engineering department.

Plea for set count in 1960 census also came up Friday at Iowa Broadcasters Assn. meeting. Iowans followed lead of Illinois and Wisconsin associations earlier in week.

## Koehler Heads Pa. Broadcasters

George Koehler, WFIL Philadelphia, elected president of Pennsylvania Assn. of Broadcasters Friday at Wernersville meeting (early story, page 68). Other officers: Cecil Woodland, WEJL Scranton, first vice president; Milton Bergstein, WMAJ State College, second vice president; Thomas Metzger, WMRF Lewistown, secretary; J. Robert Gulick, WGAL Lancaster, secretary.

Albert Matamoros, associate economist of Armstrong Cork Co., told PAB broadcasters had tremendous responsibility to keep nation informed and to give citizens proper prospective toward world events. He voiced prediction that current recession would hit bottom in two or three months and then start gradual recovery lasting two or three years.

## Conn. Assn. Elects Schwartz

Julian Schwartz, WSTC Stamford, elected president of Connecticut Broadcasters Assn. Friday at meeting in New Britain (early story, page 64). Other officers elected were Walter Johnson, WTIC Hartford, vice president, and Peter Kenny, WNBC (TV) New Britain, secretary-treasurer. Directors elected for two-year terms were Sol Robinson, WLAD Danbury, and Ed Waller, WTOR Torrington; one-year, Ed Taddei, WNHC-AM-TV New Haven, and John L. Ellenger,

WNAB Bridgeport; *ex officio*, Charles Bell Jr., WHAY New Britain.

## FCC Grants Eight Translators

FCC on Friday granted six new translator stations to Millard County, Utah, to translate programs of Salt Lake City outlets KUTV (TV), KSL-TV and KTVT (TV) to five communities. Chs. 70, 80 and 74 will serve jointly communities of Fillmore, Meadow and Kanosh and chs. 83, 72 and 77 will serve Delta and Oak City. Mohave County Board of Supervisors received ch. 73 to translate programs of KLRJ-TV Henderson, Nev., to Peach Springs, Ariz., and Seaside Video Club was granted ch. 75 to translate programs of KOIN-TV Portland to Seaside, Ore.

Also Friday, WCNY-TV Carthage, N. Y., received FCC permission to identify ch. 7 outlet with Watertown, N. Y., as well.

## Tampa-St. Petersburg Case Set

FCC on Friday designated for consolidated hearing six applications for ch. 10 in Tampa-St. Petersburg, Fla. All asked for new station except WSUN-TV St. Petersburg, which wants to move from ch. 38. Others:

Florida Gulfcoast Broadcasters Inc. (Times Publishing Co. interests); Suncoast Cities Broadcasting Corp.; Tampa Telecasters Inc. (chief stockholder Kenneth R. Giddens has interests in WKRG-AM-FM-TV Mobile, Ala.); WSTP-TV Inc. (WSTP St. Petersburg and other Rahall broadcast properties), and Bar Area Telecasting Corp. (Louis Fried, former CBS-TV President J. L. Van Volkenburg and others).

## CBS-TV Slices Story Department

CBS-TV has cut its story department in half, from 20 persons to 10, with readers of free lance offerings predominant among those let go. Reason assigned is that with *Studio One* and *Climax!* departing, much less script reading is necessary. Among those leaving is Ed Roberts, who as eastern story editor headed department. He's succeeded by William G. Morwood, who held that post before becoming executive producer in network programming department in September 1956.

## Mutual Sets Status Report

Mutual has invited more than 100 advertising agency executives in New York to luncheon at Hotel Roosevelt Wednesday to hear progress report from Armand Hammer, network board chairman, on MBS' first year of streamlined operation, featuring twice-hourly news broadcasts. Formal anniversary date is June 2. Mr. Hammer plans to present statistics on "impact and efficiency" of network approach, plus data on its station pre-clearance method.

## PEOPLE

**WILLARD BENNER**, copy group head, Ted Bates & Co., N. Y., elected vice president. **JAMES H. O'NEIL JR.** and **CHARLES N. CRITTENTON**, both account executives, elected assistant vice presidents.

**GROVER J. ALLEN**, formerly executive producer-director at WBKB (TV) Chicago, to Geoffrey Wade Adv. there as associate radio-tv director.

**KENNETH FLEMING**, member of account service group, Leo Burnett Co., Chicago, to McCann-Erickson there as account executive.

**GEORGE J. RAPP**, formerly with John Blair & Co., Chicago, appointed account executive in CBS Television Spot Sales' Chicago office.

**FRANK GIANATTASIO**, formerly time-buyer with Ogilvy, Benson & Mather, New York, to WOV New York as sales representative.

**JOHN C. McCRUDDEN**, formerly in research department, Benton & Bowles, N. Y., joins research department, Calkins & Holden, N. Y. In past he was with Henry Stampleman Co., merchandising consultants, and with Ted Bates.

## DuMont Unveils 1959 Sets

Two new series of tv receivers in "fine furniture styling" and line of stereophonic and monaural phonograph sets introduced Friday for 1959 by Allen B. DuMont Jr., manager, television receiver division, Allen B. DuMont Labs., Clifton, N. J. New portable tv receiver features all wood cabinet while other new tv set features include permanent fine tuning and remote control units.

## Skyland Buys KATT for \$300,000

KATT Pittsburg, Calif., bought by Skyland Broadcasting Corp., operating WONE Dayton, Ohio, for \$300,000 from Les Malloy & Assoc., subject to FCC approval. Broker: Hamilton, Stubblefield, Twining & Assoc. Station operates on 990 kc with 5 kw. Ronald B. Woodward, president, and Louis Froelich, vice president, represented Skyland in transaction. They said Jack Grant would continue as KATT general manager with Benny Strong as operations manager.

## Local 47 Appeals Vote Decision

Hollywood Local 47 of American Federation of Musicians Friday appealed ruling of Judge Bayard Rhone of Los Angeles Superior Court, who had ordered new election of directors of Musicians Club (story page 89) to be held June 26.

Complying with regular election procedure, Judge Rhone ordered appointment of nominating committee and call of election on June 9, nominating committee to report June 12, election to be held June 26 and new board to be seated July 3.

With national AFM convention starting June 2 at Philadelphia, Officers of Local 47 might be unable to return home by June 9.



*This is the kind of hold our station has on people*

You meet people face to face and heart to heart here — the growing-up and grown-up people of 747,640 T.V. homes. These are flourishing and happy homes, in the thriving 41 counties in the 3 states of the WHIO-TV market. Our loyalty is expressed in our programming, in public service — in such little things as

no triple spots. Theirs we learn about through mail counts and ratings in which we consistently excel.

These people comprise one of the most rewarding areas you can reach — both in quality and size. Let National Representative George P. Hollingbery tell you all about them.



ONE OF AMERICA'S GREAT AREA STATIONS

*Reaching 2,881,420 People*

# LET'S FACE IT!...

Music is the mainstay of radio programming..  
quiz shows are more popular than ever...  
marry the two and you come up with



# tune

A DAZZLING SUCCESS ON STATION  
AFTER STATION... A HEAVEN-SENT  
ANSWER FOR 1958 RADIO PROGRAMMING!

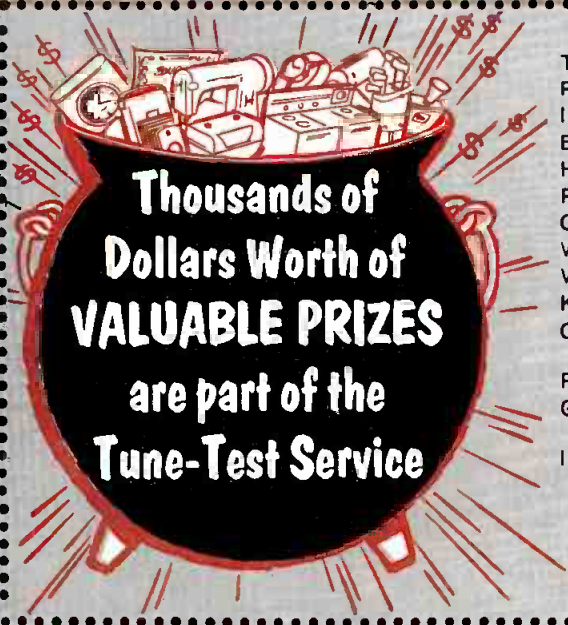

TAPPAN RANGE  
PFAFF SEWING MACHINE  
IN-SINK-ERATOR DISPOSER  
BOOK OF KNOWLEDGE—20 vols.  
HELBROS WRISTWATCH  
POLAROID LAND CAMERA  
COLUMBIA FIREARROW BICYCLE  
WESTINGHOUSE ROASTER OVEN  
WITTNAUER CAMERA  
KROMEX PANTRY SET  
CABIN CRAFTS SPREAD &  
CURTAINS  
PROCTOR ELECTRIC SET  
GARCIA "MITCHELL" FISHING  
REEL  
INGRAHAM ELECTRIC CLOCK

ROPER RANGE  
\$100.00 U.S. SAVINGS BOND from  
Luchow's  
WESTINGHOUSE VACUUM CLEANER  
COLUMBIA DIAMOND RING  
LUCIEN PICCARD WRISTWATCH  
SCHIAPARELLI PERFUME & CASE  
RONSON SHAVER  
MIRROMATIC ALUMINUM SET  
ELECTRIC ITEMS from Meika Glasses  
U.S. TRUNK "SOCIALITE"  
LUGGAGE  
SHIP'N SHORE WARDROBE of  
6 blouses  
HARKERWARE POTTERY  
McGREGOR GOLF BAG  
WEST BEND ALUMINUM SET

This is the jackpot for Chicago. Our prize department (a division of Radio Features, Inc.) will get you the biggest jackpot possible, depending on the size of your market. (No extra charge for this—it is part of the TUNE-TEST service.)

BY THE PRODUCERS OF **TELLO-TEST**, RADIO'S MOST POPULAR



*Can be programmed as a 15-minute or a half-hour show  
across the board—or integrated into a disc jockey show;  
or as a 5-minute show, several times a day.*

# test

- Will send ratings soaring
- Contains a merchandising hook that's a traffic puller for chain stores
- Ideal for national spot participation



*'une-Test is priced realistically low—  
as little as  
10 per week for  
small markets*

Write, wire or phone for  
prices, audition disc,  
brochure.



## RADIO FEATURES, INC.

Walter Schwimmer, President

75 E. Wacker Dr., Chicago  
Phone FRanklin 2-4392

527 Madison Ave., New York  
Phone ELdorado 5-4616

**INDICATED SHOW!**





## With the Catalina Station You Can Take It With You!

**VACATION TIME**... when KBIG, always a **GOOD** radio buy in Southern California, becomes a **MUST** buy for advertisers who want to keep their sales message before their prospects!

**THE CATALINA STATION** is The Vacation Station for millions of southlanders and an additional million out-of-state tourists, because it's the station *you can take with you*... from L. A. to Vegas, Laguna to Arrowhead, Ensenada to Santa Barbara.

Mail tabulation of current contest entries confirms the surveys: KBIG has listeners in 234 communities of all eight Southern California counties, *plus* the huge tourist bonus.

**FOR STAY-AT HOMES**, KBIG provides a *daily musical vacation*, weaving the magic of romantic Catalina into every program... conjuring up visions of honeymoon and holiday on the isle which symbolizes attainable escapism to Southern Californians.

**KBIG SUPPLEMENTS** its great musical programs with award-winning newscasts and hot-weather specials which are hot summer buys!

- **FISH & GAME REPORTS**
- **MARINE WEATHER REPORTS**
- **BEACH WEATHER REPORTS**
- **JIM HEALY SPORTS REPORTS**
- **HOURLY NEWS HEADLINES**

A KBIG summer feature may be tailor-made for you. Ask your station or Weed contact for details.



**JOHN POOLE BROADCASTING CO.**  
6540 Sunset Blvd., Los Angeles 28, California  
Telephone: HOllYwood 3-3205  
**Nat. Rep. WEED and Company**

## OPEN MIKE

### Support All the Way

EDITOR:

As I read the four editorials in the May 12 issue, I found myself nodding my head in enthusiastic agreement with all four positions.

First and foremost, as a former associate of FCC Comr. Robert T. Bartley while at the NAB, I have the highest personal and professional respect for him. As I read the other three editorials... "Radio and ASCAP"... "Propaganda and ASCAP"... "No License for Hooliganism"... I was reminded again how fortunate we are in this business to have such an alert, courageous and virile trade journal as **BROADCASTING** to represent our point of view.

*Lewis H. Avery*  
*Avery-Knodel Inc.*  
*New York*

### Teed Off With Wrong Club

EDITOR:

Thank you for the story on Max Factor's search for an agency [ADVERTISERS & AGENCIES, May 12]. But a chide to you for not crediting the Hollywood Advertising Club with the meeting at which the story was presented. **BROADCASTING** had the Los Angeles Ad Club as the springboard.

Hollywood is discrete from Los Angeles in advertising circles... Many agencies have both Los Angeles and Hollywood offices.

Main problem is that the Advertising Assn. of the West at its annual convention gives credit to member clubs for publicity materials generated. While the Hollywood club is buddy-buddy with Los Angeles in many ways, we don't want them to get credit for what we did.

*George Burt*  
*Managing Director*  
*Hollywood Advertising Club*  
*Hollywood*

### Why Is It an Obligation?

EDITOR:

The recent chidings at the broadcasting industry in general for "lagging" (behind newspapers) in the "right" to editorialize reflects an apparent insensitivity to the media... It would seem to be a fair distinction that while broadcasters are likely to consider it their right, many would also contend it is not their obligation. While the newspapers consider their right to editorialize sacrosanct (and there's no denying editorial importance), the radio and tv media have their own peculiar problems which are not always easily resolved.

Radio is unique in its immediacy between subject and listener. This "group" intimacy has bred what is understandably radio's greatest sensitivity: not to offend. The broadcast industry is dealing with a mass heterogeneous audience—one which cannot turn a page and exercise individual selectivity. The raw, gruesome details pictured by the printed word are never as jarring nor

# MISSOURI'S THIRD TV MARKET

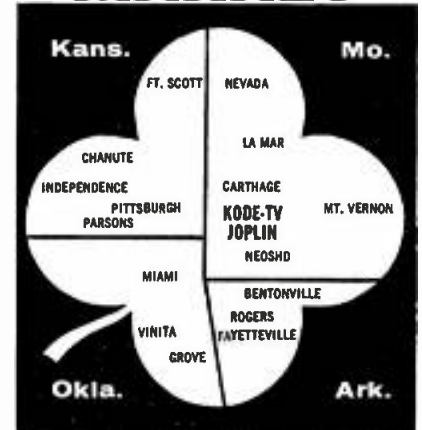

**162,799 TV HOMES\***

KODE-TV in the Joplin market covers a 4-state area with 162,799 TV homes, 669,800 population and \$776,919,000 buying power.

Joplin is the urban center of 11 communities in an 18-mile radius with a combined population of 97,750.

KODE-TV in the Joplin market is 28 percent taller, and 29 percent more powerful than any competitor.

\* Television Mag. Set Count—May '58

CREATED BY

# KODE-TV

JOPLIN, MO.



A member of the Friendly Group

Harry D. Burke,  
VP & Genl. Mgr.  
Rep. by  
Avery-Knodel

WSTV, WSTV-TV, Steubenville; WBOY, WBOY-TV, Clarksburg; KODE, KODE-TV, Joplin; WPAR, Parkersburg; WPIT, Pittsburgh; KMLB, Monroe, La.; Colmes-Werrenrath Prod., Inc., Chicago

# NO SWEAT FOR TIME BUYERS



... when you come to the Shreveport Market.  
Simply run down this quickie check list:

WHICH TV STATION IN SHREVEPORT HAS ...

- ... Dominated every survey made?
- ... BASIC affiliation with CBS Television?
- ... Well-established local shows and talent?
- ... Integrated itself more fully into its community?
- ... Unexcelled full-power engineering facilities?
- ... Longer on-the-air experience?
- ... Full scale promotion?
- ... Twice as much national spot?

The answer to each, of course, is KSLA-TV.  
Next step? A "no sweat" session with your Raymer man  
... and then on to the next market on your list!

**KSLA**  
**TV**  
basic  **channel 12** *shreveport, la.*

Represented by PAUL H. RAYMER CO., INC.

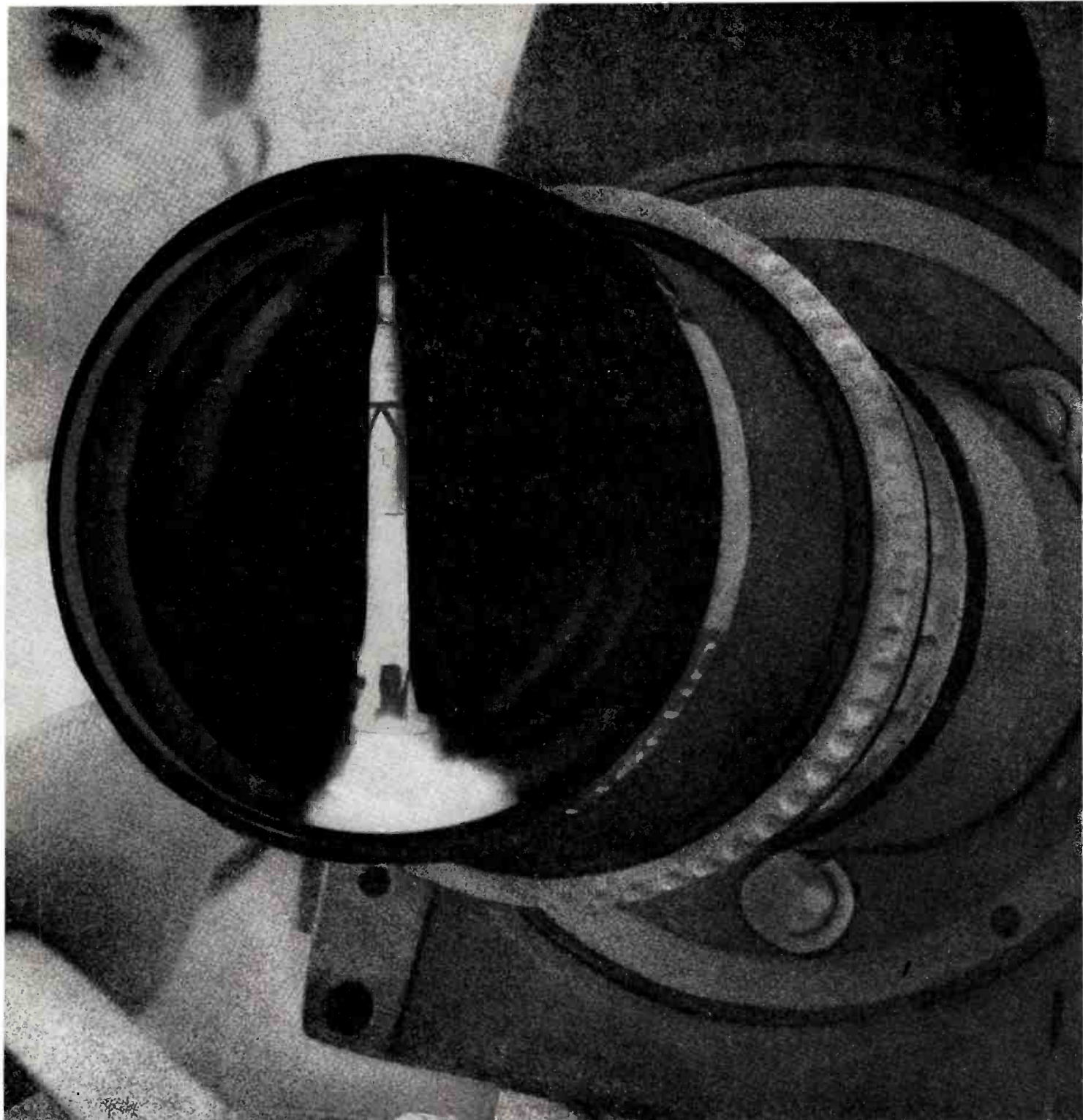

## SHARP FOCUS ON HISTORY AS IT HAPPENS

When Explorer I soared into orbit, the story was first flashed to a waiting world by NBC News. Such speed, responsibility and drama are characteristic. This year, they have helped NBC News win more awards than any other news service in the broadcasting industry.

The Sylvania "Best Network News Award" was given to the NBC News department "because it has taken a big step in 1957 in doing more things and greater things with news than it has ever done before."

The Saturday Review award for Distinguished Achieve-

ment in the Public Interest went to NBC News for showing "independence of editorial opinion . . . symptomatic of the general emergence of NBC as the leader in radio and television news coverage."

The Overseas Press Club honored Chet Huntley for "Best Radio or Television Interpretation of Foreign Affairs," and cited Welles Hangen, NBC Cairo, for "Best Radio or Television Reporting from Abroad."

Du Pont honored commentator Clifton Utley, of NBC News in Chicago, "for his authoritative, intelligent,



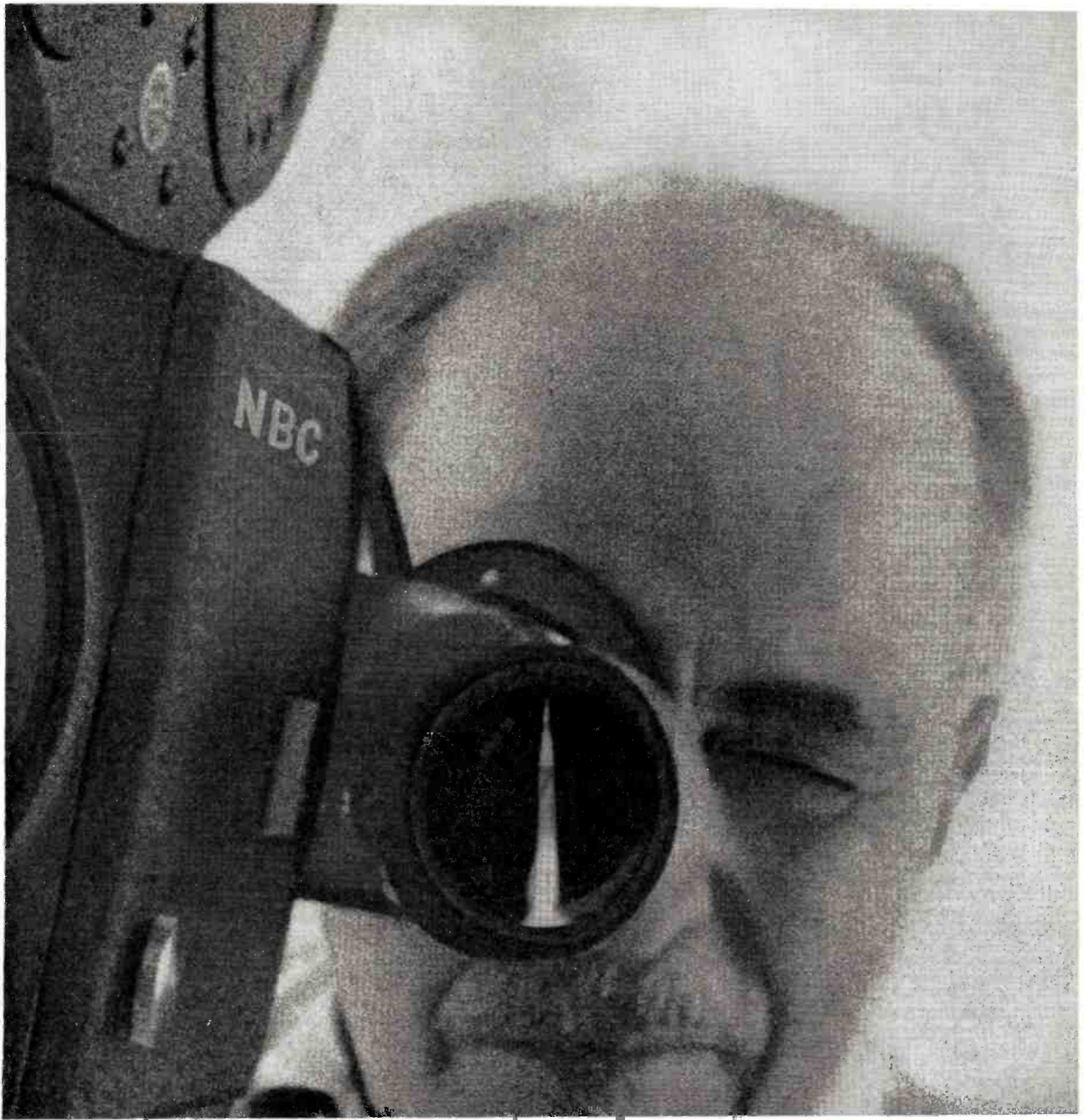

responsible and literate reporting and analysis" and because "he epitomizes the best in American news."

Eight of the fifteen National Press Photographers Annual Awards went to NBC News cameramen. Maurice Levy, with his film of a tornado in Dallas, won a Headliners Award for the best coverage of a news event.

The NBC News series with Chet Huntley and David Brinkley was voted the best news program on the air in the annual Look-Listen Opinion Poll conducted by

the American Council for Better Broadcasts. "Outlook" was honored by the National Conference of Christians and Jews and by the National Association for Better Radio and Television.

More and more, America is turning on its broadcast dials for the sight and sound of history as it happens. NBC News provides that history with a force, clarity and conviction that have made it, this year, the most honored news-gathering organization in broadcast journalism.

**NATIONAL BROADCASTING COMPANY**

# KYW's ON CLOUD 1 'CAUSE OUR RADIO RATINGS ARE OUT OF THIS WORLD!

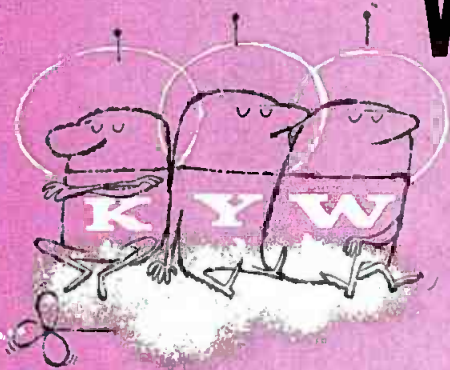

No Asterisks  
No Averages  
No Ifs, Buts,  
or Exceptions  
Just **FIRST**

PULSE • HOOPER • NIELSEN

**KYW** Cleveland

Represented by Peters, Griffin, Woodward

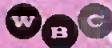

WESTINGHOUSE BROADCASTING COMPANY, INC.



## OPEN MIKE CONTINUED

as easily offensive as the communal voice of radio.

Furthermore, there are structural differences in the makeup of broadcasting stations in general (as opposed to newspapers) which presents an understandable reluctance to tackle editorials. In many instances it would mean an increase in staff. Radio is not solely in the news-gathering business and its budget restrictions therefore are frequently a rigid restriction to news growth.

Radio's heritage (in part self-assumed and in part dictated by the FCC) has been to report the news objectively and accurately on the premise that a well-informed public is able to reach its own conclusions. There are those who would say that radio's scope ends here, and there are those who would argue that given the needed tools it need not. Penetrating analysis is concomitant to honest editorializing. In short, it seems to me that editorial-broadcasting while not an obligation, is certainly a right which broadcasters have the option of assuming or discarding.

It's my personal opinion that it's not so much a question of how far broadcasting should go (in this regard) with programs of enlightenment . . . but how far is it equipped to go and still do an honest job. And this is the problem of the individual station.

*George Reading  
Night News Editor  
WROW Albany, N. Y.*

## It Was Flat to Some

EDITOR:

Cute as the May 19 editorial page cartoon may be, let's not add to the old-guard stereotypes of uhf. This is the type of thing which does little good for 92 uhf stations, most of which have done quite well.

*Wallace Bradley  
Executive Director  
Committee for Competitive  
Television  
Washington, D. C.*

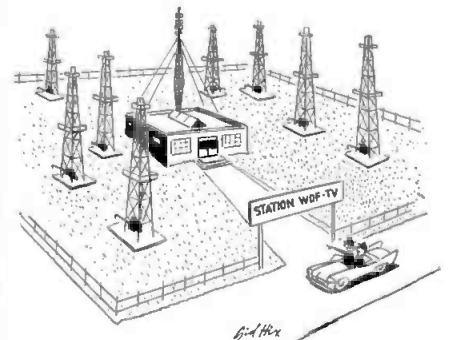

"I hear it's one of the few uhf stations that's actually making a profit."

## In Total Agreement

EDITOR:

You have treated the community antenna subject [SPECIAL REPORT, May 12] very thoroughly and quite accurately.

*William C. Grove  
General Manager  
KFBC-TV Cheyenne, Wyo.*

PRESENTING . . .

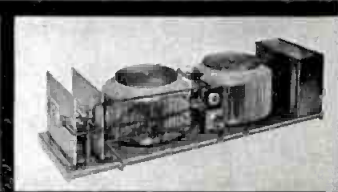
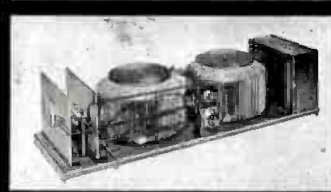

# THE ULTIMATE IN MAGNETIC AMPLIFIER DIMMERS

FOR LIGHTING LOADS UP TO 10,000 WATTS

## AND NOW

. . . a radically new concept in Magnetic Amplifier design, specifically developed by LUMITRON for TV and Stage Lighting Control.

Featuring totally inert components, the modularly designed LUMITRON Magnetic Amplifier has a unique universal load ratio. Comparison proves that this new Magnetic Amplifier provides nearly twice the load capacity of competitive Dimmers. Comparison also proves that the LUMITRON Dimmer offers the multiple advantages of a Magnetic Amplifier in a more compact, *infinitely superior* unit which costs less, weighs less and takes up much less space. *Guaranteed for three years.*

**COMPARE . . .** and you will find the dependable, economical LUMITRON Magnetic Amplifier to be the only *logical* choice for low cost, high quality Lighting Control.

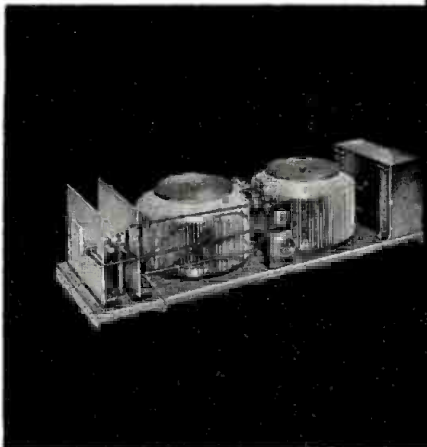

| SPECIFICATIONS          | LUMITRON<br>Magnetic<br>Amplifier                                 | MAGNETIC<br>AMPLIFIER "A"      | MAGNETIC<br>AMPLIFIER "B"      |
|-------------------------|---|--------------------------------|--------------------------------|
| POWER CAPACITY          | 10,000 Watts  | 6300 Watts                     | 6300 Watts                     |
| LOAD RANGE              | 1-10,000 Watts  | 210-6300 Watts                 | 210-6300 Watts                 |
| SIZE                    | 1.4 cubic feet  | 2.7 cubic feet                 | 2.1 cubic feet                 |
| WEIGHT                  | 146 pounds*   | 158 pounds*                    | 156 pounds*                    |
| LINE VOLTAGE REGULATION | ±2% for<br>±15% line<br>voltage                                   | none                           | none                           |
| OUTPUT CURVE CONTROL    | from linear<br>Light to linear<br>voltage exactly<br>as specified | slight arbitrary<br>adjustment | slight arbitrary<br>adjustment |
| PRICE                   | competitive*  | competitive*                   | competitive*                   |

\*Note that the price and weight of the LUMITRON 10,000 Watt Dimmer is compared with the other 2 units of 6300 Watt capacity. It is, therefore, less expensive and lighter.

Because of the size, weight and rugged construction of the LUMITRON Dimmer, a system utilizing it can be supplied which will "troupe" satisfactorily.

C. L. Schuler, Inventor  
PATENTS PENDING

CREATIVE ENGINEERING FOR THE LIVING THEATRE BY . . .

# LUMITRON

DIVISION

METROPOLITAN ELECTRIC MANUFACTURING CO.

2252 STEINWAY AVENUE

LONG ISLAND CITY 5, N. Y.

LIGHTING CONTROL SINCE 1892

METROPOLITAN

ASTORIA 8-3200

# RCA AMPLIPHASE

50 KW AM TRANSMITTER

**earns top rating  
at major stations**

**WINS, New York** • Says Paul vonKunits:

“Installation of this new transmitter has saved WINS plus \$1000 per month on power. We are on-air 24 hours a day, 7 days a week.”

**KSTP, St. Paul** • Says Bill Sadler:

“I have been very much impressed by its long-term stability.”

**WGN, Chicago** • Says Carl Meyers:

“Its space-saving features were a definite advantage in changing our previous installation.”

**WCAR, Detroit** • Says Jim Balmer:

“Tuning up the RCA BTA-50G for the first time might be compared to aligning a receiver—it’s just that simple.”

---

The distinguished RCA BTA-50G Transmitter, designed with Ampliphase Modulation, is the only new 50 KW AM Transmitter that has been proved in station operation... further evidence of RCA leadership in the broadcast equipment field.)



RCA 50 Kilowatt AM Transmitter—BTA-50G  
designed with the Ampliphase system of modulation.

## Some of the Reasons Why They Bought the RCA BTA-50G :

**ECONOMICAL TO OPERATE**—Ampliphase cuts operating costs by substantial margins. Power consumption is approximately 100 KW at average modulation. Only two high power tubes are required . . . long-life RCA 5671 Triodes proved many times over in 50 KW service.

**EASY TO INSTALL**—No wiring trench is required. Shielded built-in wire duct is used along the back, at top of cabinets. No external blowers. No bulky modulation transformers or reactors. No costly water cooling systems. Install while your present transmitter is in operation.

**SIMPLE TO OPERATE**—Only one daily adjustment is needed (the power output control). Retuning is not required with tube change. Interelectrode capacities have negligible effect on broad RF circuits. Designed for unattended operation . . . it is simply a matter of turning the selector switch and operational control circuits are transferred to a remote control terminal bus.

**RELIABLE**—Proved and improved in daily operation at five stations.\*

**MORE PROGRAM COVERAGE**—Its ability to achieve and consistently maintain a higher average of modulation, with minimum distortion and excellent response assures more program coverage.

**SOUNDABILITY**—The BTA-50G provides faithful transmission of the input audio signal. To be competitive you need this advantage of the BTA-50G, to deliver the "best sound possible."

**SPACE SAVING**—Ampliphase reduces floor space. The BTA-50G is housed in four cubicles. It eliminates half of present power tubes, along with bulky components, such as modulation transformers, reactors and accessories.

Transmitter: 75 sq. feet.  
Transformers: 12 sq. feet.  
Switch gear: (Wall Mounted) — requires no floor space.

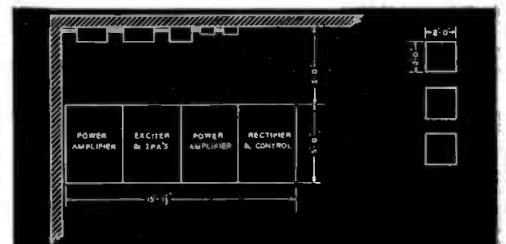

\*Including DZXL, Manila, Philippine Islands

Your RCA Broadcast Representative will gladly furnish more information. In Canada: Write RCA VICTOR Company Limited, Montreal.



Tmk(s) ©

# RADIO CORPORATION of AMERICA

BROADCAST AND TELEVISION EQUIPMENT

CAMDEN, N. J.

IN 6 MONTHS:

NOW

8<sup>th</sup>

NATIONALLY!

8th (from 19th) among all CBC shows! Outrates "Have Gun Will Travel", "Dinah Shore", "Disneyland", etc.

Network rating higher every rating period, now 41.0!

21% increase in homes reached!

30% increase in viewers!

Pre-tested as popular movie and through dozens of famous Saturday Evening Post stories, TUGBOAT ANNIE helps Lever Brothers Limited of Canada win friends and influence sales. Lever Brothers' success story gives proof of greater profit than ever for you in your own market. Of course, the American premiere market showing is swamping all competition too!



the adventures of

TUGBOAT  
ANNIE

tpa

TELEVISION PROGRAMS OF AMERICA, INC.  
488 MADISON • N.Y. 22 • PLaza 5-2100

IN REVIEW

OUTLOOK

With a shoe-string budget and an obvious feeling of admiration, NBC's news and public affairs department last week focused its camera eyes on the decade-old state of Israel. The picture it brought back on *Outlook* May 18 was indeed heartening, for in the words of commentator Chet Huntley, "the real importance of Israel's 10th anniversary (on May 14) is that there is one."

Carefully skirting the two explosive issues of (a) the "lop-sided" economy and (b) the "refugee problem," NBC found in the hills of Galilee a latter-day, modern-dress version of the David v. Goliath legend. It is the story of a "stiff-necked people" (Exodus, 33:3) who, in 10 short years, have conquered both nature and a hostile set of neighbors through sheer brains—agriculture and nucleonics—and brawn—a "citizen army" comprised of "every able-bodied Israeli" up to the age of 49.

The role of both atom and army in Israeli life today was the focal point of *Outlook*. It took 2,500 work hours to cull through 45,000 feet of film to come up with 6,200 feet of used footage; there was little waste. Whatever was said was said forcefully and to the point. For the outlook on atomic energy, Mr. Huntley and fellow reporters Piers Anderton and Reuven Frank went to Dr. David E. Bergmann, Israel's counterpart to our AEC's Lewis Strauss; for that on the army and the socio-military part it has in the growth of the state *Outlook* talked with 38-year old Maj. Gen. Chaim Laskov, Chief of Staff of the Israeli Army.

NBC was indeed fortunate to have come upon two men who could carry the conversational ball so well; after they were through, there was little else that needed saying.

There was considerable food for thought offered by this 90-minute program—more so by the fact that NBC was able to bring back this comprehensive report on the atom and the army for no more than \$35,000—including transportation, billets and actual production.

Production costs: \$35,000  
Sustaining on NBC-TV Sun. May 18, 4-5:30 p.m.

Producer: Reuven Frank; director: Jack Sughrue; cameraman: Tom Priestley; writers: Piers Anderton, Chet Huntley, Reuven Frank; film editors: Walter Kravetz, Gerald Polikoff.

KRAFT THEATRE

It is a good thing that *Kraft Theatre* is going off the air. Were its future not so neatly labeled "Retirement, fall 1958," this veteran of the tv boards might be heading for the type of second coming that sometimes hits show business veterans after lean years. It is much simpler that this is not to be; it saves viewers from wasting their time anticipating any live excitement from that corner next season, and viewers are obviously much more pliable when not subject to undue excitement or stimulation.

Prompting this fruitless speculation is *Kraft's* most recent offering under the aegis of David Susskind's Talent Associates—a

two-part dramatization of *All the King's Men*.

It was not the be-all and end-all of live drama. There is some doubt whether any production, and especially one as dependent on characterization and mood as this one, can successfully be strung over two weeks. One did not sit down to the second half of *King's Men* with intensity intact from a week before, and part of the second hour had gone before the empathy developed again.

There were problems inherent in the vehicle which the television dramatization did not fully overcome. Robert Penn Warren's Pulitzer-prize winning novel, and the excellent movie made from it, told the harsh and ugly story of Willie Stark, a red-necked hick who learned about politics so well that nothing could stop him except the final bullet that left him sprawled on the steps of the state capitol. Of the people involved and what Willie's career did to them the tv adaptation could not completely detail; because of this, some of the impact of the final scenes did not ring true.

Whatever the faults of this two-hour essay on demagoguery, one must still fall back on a bromide of sorts: this was live theatre, and as such, it had a compelling excitement.

An excellent adaptation by Don McKewicz got top-notch support all the way. Hair falling in his face, collar pulled open, shirt ballooning over his waistline, the Willie Stark of Neville Brand changed effectively from a raw country boy with big ideas to a lecherous, manipulating little Caesar. Maureen Stapleton as Sadie Burke and Fred Scollay as Jack Burden, who "made" Willie Stark governor and stayed on to learn what they had wrought, gave fine performances.

Camerawork and production abetted the effectiveness of the program, suggesting the excitement of a clamoring crowd, magnifying the hold of a man over individuals and a crowd, etching the face of chicanery and fear and disillusionment.

Tight direction gave form and pace, and excellent musical background underscored the action to its relentless and inevitable end.

So it was good. Worth watching, worth even thinking about a few moments, perhaps, after the final commercial. Which may, after all, have gotten in the way of concentrating on *This is Your Life*, whose particular brand of drama follows *Kraft Theatre*. And certainly it is unfair for a program's effectiveness to impinge on another's, or to offer a challenging comparison. It is a good thing that *Kraft Theatre* is going off the air.

Production costs: \$100,000.  
Sponsored by Kraft Foods Co. through J. Walter Thompson on NBC-TV Wed., May 14 and 21, 9-10 p.m., live in color and black-and-white.

Production by Talent Associates; executive producer: David Susskind; producer: Robert Herridge; director: Sidney Lumet; assoc. producer: Charles Schultz; asst. director: Claire Sheridan; musical director: John Geller.

Cast: Neville Brand, William Prince, Frank Conroy, Robert Emhardt, Maureen Stapleton, Anne Meacham, Fred Scollay, Perry Wilson.

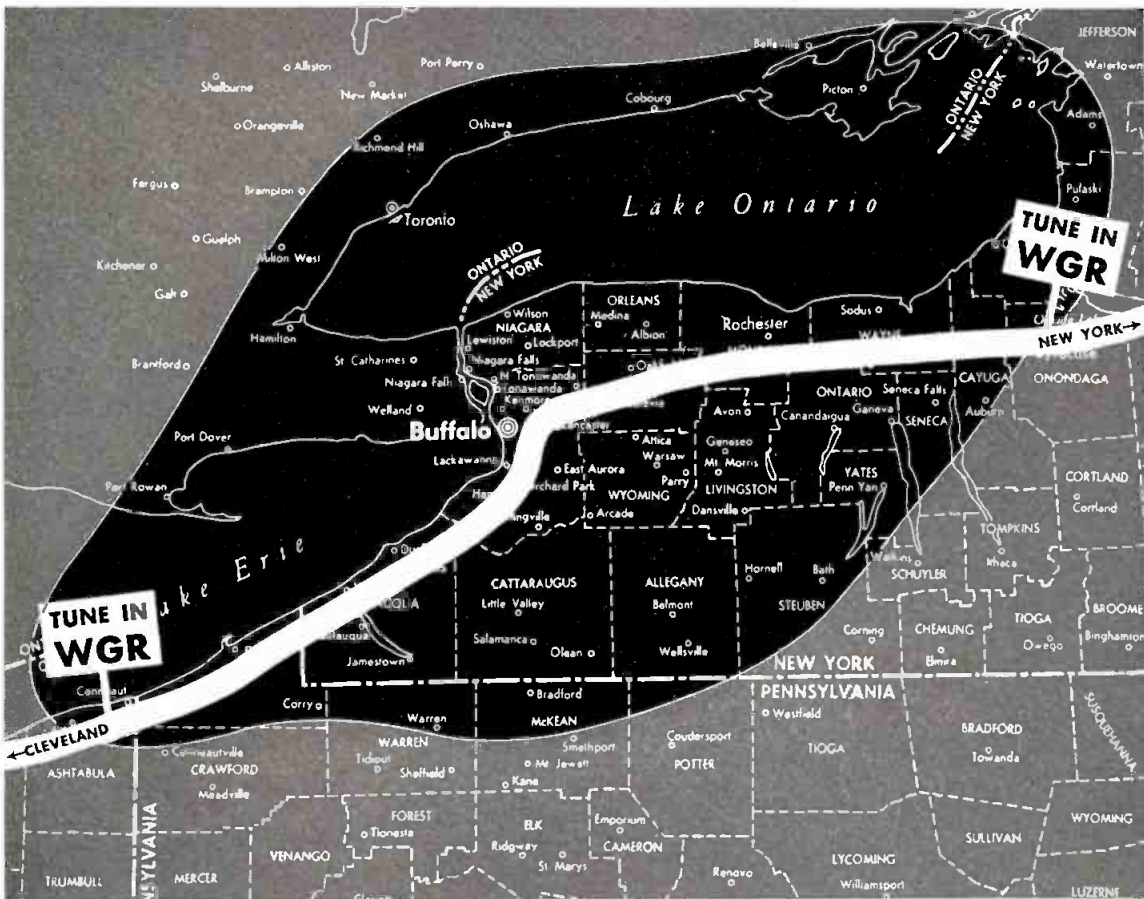

**the only  
Buffalo  
Station  
that can  
pass the  
"Thruway  
Test"**

**COMING EAST** to the New York State Thruway, you pick up WGR RADIO loud and clear, way out in Ohio.

**GOING WEST** on the Thruway, you pick up WGR RADIO loud and clear, just past Syracuse.

**IF YOU WANT** maximum coverage in the \$4 billion Western New York market (plus big bonus audience in Canada and on the Thruway) buy WGR RADIO. 1,000,000 homes . . . 1,000,000 cars.

ABC Affiliate. Represented by Peters, Griffin, Woodward, Inc.

**BUY WGR RADIO**

**BUFFALO'S FIRST STATION**

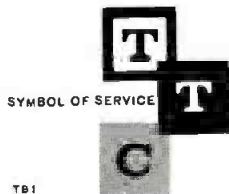

SYMBOL OF SERVICE

**A TRANSCONTINENT STATION**

WROC-TV, Rochester • WGR Radio, WGR-TV, Buffalo • WSAV Radio, WSAV-TV, Harrisonburg

WNEP-TV/WILK-TV — Scranton — Wilkes-Barre

TBI

To sell Indiana,  
you need both  
the 2nd and 3rd  
ranking markets.

**NOW  
ONE BUY**  
delivers both —  
**AT A 10%  
SAVINGS!**

# YOU NEED TWIN BILLING in Indiana!

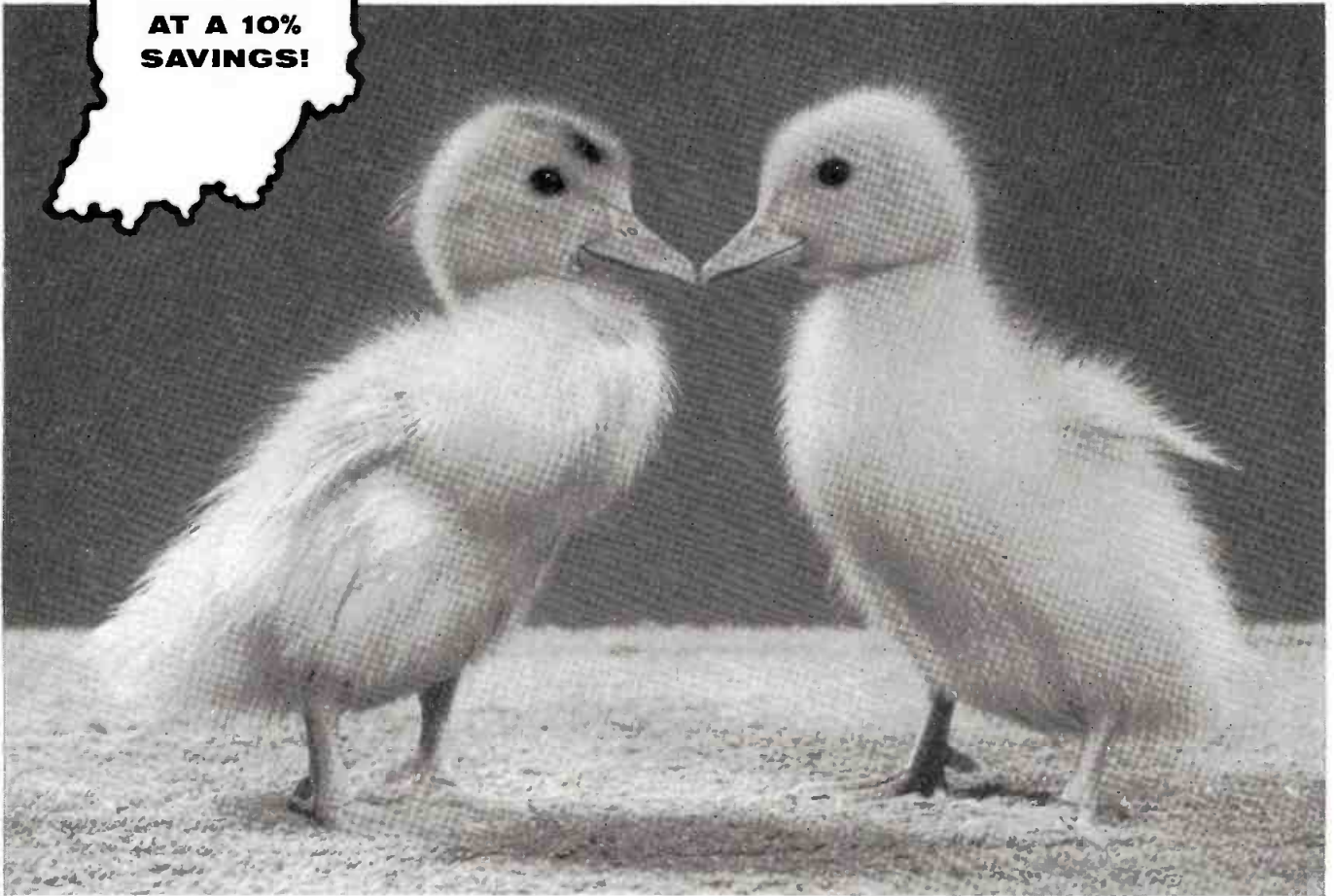

Now, a new, two-station TV buy blankets *both* the South Bend-Elkhart and Fort Wayne markets, plus healthy chunks of Southern Michigan and Western Ohio. Over 1.6 million population — \$2.8 billion Effective Buying Income. Alert buyers are covering these rich markets in combination — and saving 10%! They're buying them right along with Indianapolis — thus covering all the best of Indiana from within — with just two buys!

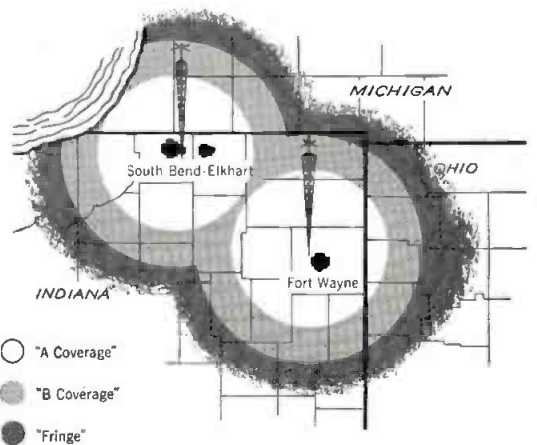

see your **H-R** man soon!



**W S j v**  
SOUTH BEND ELKHART

**28**

**w k j g**  
FORT WAYNE

**33**



Broadcasting Publications Inc.

Sol Taishoff President, Maury Long Vice President, Edwin H. James Vice President, H. H. Tash Secretary, B. T. Taishoff Treasurer, Irving C. Miller Comptroller



BROADCASTING\* TELECASTING

THE BUSINESSWEEKLY OF TELEVISION AND RADIO Published every Monday by Broadcasting Publications Inc.

Executive and Publication Headquarters Broadcasting \* Telecasting Bldg. 1735 DeSales St., N. W., Washington 6, D. C. Telephone: Metropolitan 8-1022

EDITOR & PUBLISHER: Sol Taishoff MANAGING EDITOR: Edwin H. James SENIOR EDITORS: Rufus Crater (New York), J. Frank Beatty, Bruce Robertson (Hollywood), Fred Fitzgerald, Earl B. Abrams NEWS EDITOR: Donald V. West SPECIAL PROJECTS EDITOR: David Glickman ASSOCIATE EDITOR: Harold Hopkins ASSISTANT EDITORS: Dawson Nail, Jacqueline Eagle STAFF WRITERS: Frankie Pelzman, Myron Scholnick, Benjamin Seff, Ann Tasseff, Jim Thomas EDITORIAL ASSISTANTS: Rita Cournoyer, Richard Erickson, Coleen Rothenberg SECRETARY TO THE PUBLISHER: Gladys L. Hall

BUSINESS

VICE PRESIDENT & GENERAL MANAGER: Maury Long SALES MANAGER: Winfield R. Levi (New York) SOUTHERN SALES MANAGER: Ed Sellers PRODUCTION MANAGER: George L. Dant TRAFFIC MANAGER: Harry Stevens CLASSIFIED ADVERTISING: Doris Kelly ADVERTISING ASSISTANTS: John Henner, Ada Michael, Lois DeShields COMPTROLLER: Irving C. Miller ASSISTANT AUDITOR: Eunice Weston SECRETARY TO GENERAL MANAGER: Eleanor Schadi

CIRCULATION & READER'S SERVICE

MANAGER: John P. Cosgrove SUBSCRIPTION MANAGER: Frank N. Gentile CIRCULATION ASSISTANTS: Gerry Cleary, Christine Harageones, Charles Harpod, Marilyn Peizer

BUREAUS

NEW YORK 444 Madison Ave., Zone 22, Plaza 5-8355 Editorial

SENIOR EDITOR: Rufus Crater BUREAU NEWS MANAGER: Lawrence Christopher AGENCY EDITOR: Florence Small ASST. NEW YORK EDITOR: David W. Berlyn NEW YORK FEATURES EDITOR: Rocco Famighetti ASSISTANT EDITOR: Frank P. Model STAFF WRITERS: Margot Holland, Diane Schwartz

Business

SALES MANAGER: Winfield R. Levi SALES SERVICE MANAGER: Eleanor R. Manning EASTERN SALES MANAGER: Kenneth Cowan ADVERTISING ASSISTANT: Donna Trolinger

CHICAGO

360 N. Michigan Ave., Zone 1, Central 6-4115 MIDWEST NEWS EDITOR: John Osbon MIDWEST SALES MANAGER: Warren W. Middleton, Barbara Kolar

HOLLYWOOD

6253 Hollywood Blvd., Zone 28, HOLLYWOOD 3-3148 SENIOR EDITOR: Bruce Robertson WESTERN SALES MANAGER: Bill Merritt, Virginia Stricker Toronto, 11 Burton Road, Zone 10, HUDSON 9-2694 James Montagnes

SUBSCRIPTION PRICES: Annual subscription for 52 weekly issues \$7.00. Annual subscription including Yearbook Number \$11.00. Add \$1.00 per year for Canadian and foreign postage. Subscriber's occupation required. Regular issues 35¢ per copy; Yearbook Number \$4.00 per copy.

SUBSCRIPTION ORDERS AND ADDRESS CHANGES: Send to BROADCASTING Circulation Dept., 1735 DeSales St., N.W., Washington 6, D. C. On changes, please include both old and new addresses.

BROADCASTING\* Magazine was founded in 1931 by Broadcasting Publications Inc., using the title: BROADCASTING\*—The News Magazine of the Fifth Estate. Broadcast Advertising\* was acquired in 1932, Broadcast Reporter in 1933 and Telecast\* in 1953.

\*Reg. U. S. Patent Office Copyright 1958 by Broadcasting Publications Inc.

LETTER FROM THE EDITORS



FRANK SILVERNAIL, dean of broadcast advertising media men, has become a consultant to BROADCASTING.

Mr. Silvernail has already begun advising BROADCASTING editors in the preparation of the new BROADCASTING YEARBOOK which will be published next September. He will also be available for consultation on special projects for the weekly BROADCASTING magazine.

Most of our readers know Frank Silvernail, personally or at least by reputation. He retired as manager of station relations at BBDO, New York, last March 31 after 33 years of association with broadcasting and advertising.

By conservative estimate Mr. Silvernail bought \$25 million in radio and television station time during his 20 years as an agency man.

He has served as chairman of the Standing Committee on Broadcast Media of the American Assn. of Advertising Agencies and as member of the AAAA's Media Relations Committee.

MANY of BROADCASTING's editors have known Mr. Silvernail intimately during his distinguished service

as an agency media man and have called upon him frequently for advice and information. We are delighted, of course, to formalize that long association.

Having Mr. Silvernail as a consultant is made the more pleasurable by our unanimity of attitude toward the relationship of television and radio. It is Mr. Silvernail's view (and ours) that tv and radio, although operated competitively, are thought of jointly by the buyers of broadcast advertising. Together radio and tv constitute the broadcast media and as such are a single province of responsibility within most agencies.

At one period of television evolution, there was a trend toward divorcement of television and radio functions within some major agencies. That trend has disappeared, and accordingly the new BROADCASTING YEARBOOK will contain complete details about both television and radio.

Our promotion people are calling it the "one-book library of television and radio information." With the considerable help of Frank Silvernail, we editors are working to prove the soundness of that slogan.



BROADCASTING

THE BUSINESSWEEKLY OF TELEVISION AND RADIO

1735 DeSales St., N. W. Washington 6, D. C.

PLEASE START MY SUBSCRIPTION WITH THE NEXT ISSUE

- 52 weekly issues of BROADCASTING \$ 7.00
52 weekly issues and Yearbook Number 11.00
Enclased Bill

Form with fields for name, title/position, company name, address, city, zone, state

Please send to home address

Occupation Required

**MORE THAN  
100%  
Greater Listening Audience**



|             | 7:00 A.M.—12:00 Noon<br>Monday Thru Friday | 12:00 Noon—8:00 P.M.<br>Monday Thru Friday |
|-------------|--|--|
| <b>WILS</b> | <b>58.3</b>                                | <b>60.5</b>                                |
| Sta. B      | 25.6                                       | 21.2                                       |
| Sta. C      | 7.7  | 9.8  |
| Sta. D      | 3.7  | 3.2  |

C. E. Hooper, March-April, '58



**MORE LISTENERS  
THAN ALL OTHER STATIONS  
HEARD IN LANSING COMBINED**



**CONTACT  
VENARD  
RINTOUL &  
McCONNELL, INC.**



81  
ASSOCIATED WITH WPON, PONTIAC,  
MICHIGAN

## OUR RESPECTS to Frank Philip Fogarty



**I**N AUGUST 1950 Frank Fogarty, at 45, was a successful businessman in a responsible post with a well-known, active wholesale company. There was no hint that he was about to take on a brand new career.

Then came a telephone call from Washington. His friend Francis P. Matthews, then Navy Secretary and a stockholder in WOW Omaha, asked Frank if he was interested in succeeding the late John Gillin as head of that broadcast operation. He was.

Eight years later, now vice president and general manager of WOW-AM-TV, Frank Fogarty is well-established in his new career. In addition to his Omaha duties he is a veteran of the Broadcast Music Inc. program clinic circuit, serves on the Radio Advertising Bureau executive committee, is a board member of the CBS Radio Affiliates Advisory Assn. and is on the NAB Freedom of Information committee.

Frank Philip Fogarty was born Jan. 23, 1905, a son of Omaha letter carrier Frank Fogarty and Elizabeth Costello. When he was 11 he began his business career as a lamplighter. It was a twice-a-day job—at dusk he climbed the poles to light the gas lamps, and at dawn climbed them again to put them out. It was only one of the many odd jobs—paper boy, shipping room clerk at U. S. Rubber, etc.—he did while soaking up an education at Omaha schools.

Mr. Fogarty earned his Bachelor of Arts at Creighton U., Omaha, in 1926 (English, philosophy, history and a year of law). He was managing editor of the school paper and captain of the debating team. To round out finances he became secretary to the dean of the arts college and in his senior year investigated insurance prospects for a local credit firm. Upon graduation he became engaged in alumni work and an instructor in public speaking, then left the school in 1929.

At that date Mr. Fogarty entered community service, traveling with various trade groups as an Omaha Chamber of Commerce official to conventions where he "sold" Omaha as the next convention site. In 1939 he became the chamber's general manager, worked on the War Dept. in Washington to locate military installations and plants (the Omaha area received several installations). In 1944 he went to Paxton & Gallagher Co. in Omaha (markets Butter-Nut, a leading coffee brand, and wholesales a line of groceries, hardware and liquor), was sales manager of the grocery division and active in department store planning and counseling (for retailers).

**W**HEN Mr. Fogarty took over the WOW operation in 1950 he wasn't going in completely blind. Butter-Nut used radio and, in some respects, had built the coffee brand through radio advertising ("although I never bought radio time for Butter-Nut I saw radio's results on the selling side").

Mr. Fogarty finds it "hard to imagine a more interesting field" than broadcasting—"it's omnipresent." Invariably in any group, the conversations turns to radio and tv, he says, "usually on programming." From these comments, Mr. Fogarty, who is sensitive to what the public thinks of his commodity, forms judgments of his own. In fact, the station keeps a record of every phone call from a listener and whenever any reaction or comment "assumes a significant pattern" the station looks into the subject—"we keep a close ear to the ground."

The WOW stations, noted for their news and farm service, emphasize organization: the tv station has three mobile units, 12-14 photographers and reporters and 100 stringers in a territory that reaches as far as 150 miles; WOW has a farm service department which annually conducts the now famous farm tour and made the two documentary radio shows and films on which the stations' two Peabody awards were based.

Mr. Fogarty's community interest extends to his wife: he was married in 1936 to a girl from Omaha, Patricia Scanlan. They have four children, Kathleen, 21; Sharon, 20; Frank Jr., 17, and Tish, 7.

He is past president of the Omaha Chamber of Commerce (only Omaha citizen to serve first as paid and later as voluntary officer), and is a former president of the Omaha Rotary Club and Omaha Mfrs. Assn. He is president of United Community Services there. Principal away-from-the-desk occupation is golf.

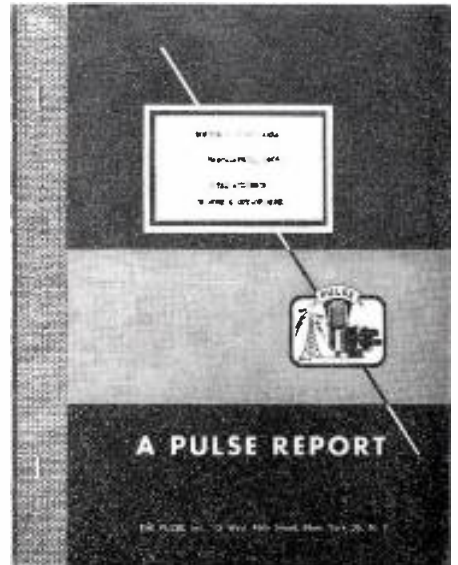
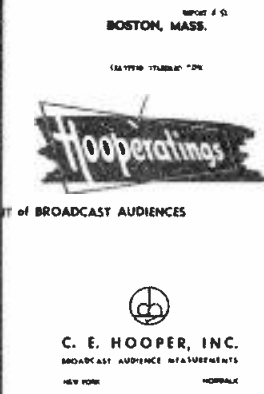

Boston  
March-April  
**NIELSEN !**

Boston  
March-April  
**HOOPER !**

Boston  
March-April  
**PULSE !**

agree that

**Radio Boston**

**WCOB**

is **BOSTON'S BEST BUY!**

Keep your eye on these other Plough, Inc. Stations:

Radio Baltimore | Radio Chicago | Radio Memphis  
**WCAO | WJJD | WMPS**

REPRESENTED NATIONALLY BY RADIO-TV REPRESENTATIVES, INC.

NEW YORK    CHICAGO    LOS ANGELES    BOSTON    ATLANTA    SAN FRANCISCO    SEATTLE



# *AGAIN!*

# FABULOUS

---

# FIRST

We knew these first TARGET ratings would be fabulous! It's just the beginning. TARGET is terrific in over 100 markets. It still may be available in yours.

# RATINGS!



# TARGET

## SCORES BULLSEYES IN FIRST SHOWING!

**BIRMINGHAM**  
WBRC-TV Thurs. 9:00 P.M.

# 34.8

Beats: Wyatt Earp, Perry Mason, Burns & Allen, Wells Fargo, Groucho Marx, Steve Allen, Loretta Young, Dinah Shore, Playhouse 90, Cheyenne and many others.

Pulse Apr. '58

**DENVER**  
KLZ-TV Sat. 8:30 P.M.

# 20.8

Beats: Lawrence Welk, Father Knows Best, Dragnet, Burns & Allen, The Millionaire, Cifmax, Zorro, Studio One, I Love Lucy, People Are Funny, and many others.

ARB Apr. '58

**LAS VEGAS**  
KLAS-TV Fri. 9:30 P.M.

# 23.5

Beats: Thin Man, Shirley Temple's Storybook, Schlitz Playhouse, Kraft Theatre, Studio One, Zorro, The Millionaire, Welk's Top Tunes, Lawrence Welk, Big Record and many others.

ARB Apr. '58

**BOISE**  
KBOI-TV Fri. 9:30 P.M.

# 23.7

Beats: Twenty One, Dinah Shore, Steve Allen, The Millionaire, G. E. Theatre, People Are Funny, U.S. Steel Hour, Robin Hood, Big Record, Your Hit Parade, and many others.

ARB Apr. '58

**PORTLAND**  
KOIN-TV Tues. 10:00 P.M.

# 17.9

Beats preceding and following shows and tops: Colt 45, Your Hit Parade, Jim Bowie, Alcoa Theatre, Amateur Hour, Truth or Consequences, Top Dollar, Navy Log and Patrice Munsel.

Pulse Apr. '58

**CHARLESTON, S. C.**  
WUSN-TV Tues. 7:00 P.M.

# 19.2

Beats: \$64,000 Challenge, Thin Man, Top Dollar, Rosemary Clooney, Studio One, Your Hit Parade, 20th Century, Jane Wyman Presents, Frank Sinatra and Amateur Hour.

ARB Apr. '58

WEEK AFTER WEEK...

**GREAT STARS! GREAT IMPACT STORIES!**

PAT O'BRIEN  
CESAR ROMERO  
BONITA GRANVILLE  
DAVID BRIAN  
GENE BARRY  
HOWARD DUFF

MARIA RIVA  
JOHN IRELAND  
STEVE McNALLY  
MARIE WINDSOR  
HANS CONRIED  
SKIP HOMEIER

LOLA ALBRIGHT  
KENT TAYLOR  
NEVILLE BRAND  
HUGH MARLOWE  
ADOLPHE MENJOU, Host  
and many more.

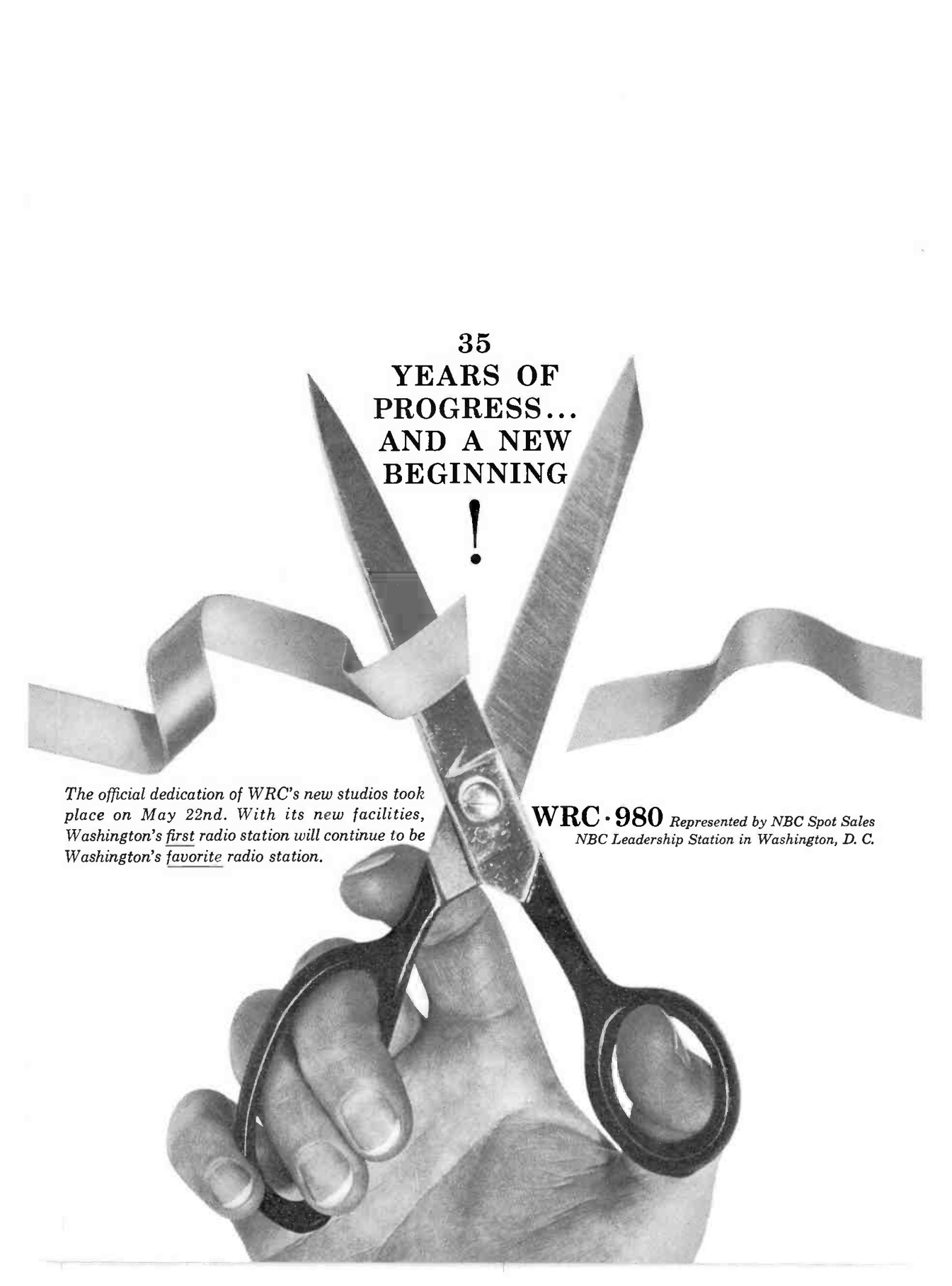

A black and white photograph of a hand holding a pair of scissors, cutting a ribbon. The ribbon is split into two strands that curve outwards. The hand is positioned at the bottom, with the thumb and index finger gripping the handles of the scissors. The blades are open, and the ribbon is caught between them.

**35  
YEARS OF  
PROGRESS...  
AND A NEW  
BEGINNING**

**!**

*The official dedication of WRC's new studios took place on May 22nd. With its new facilities, Washington's first radio station will continue to be Washington's favorite radio station.*

**WRC·980** *Represented by NBC Spot Sales  
NBC Leadership Station in Washington, D. C.*

# ANA OPENS WAR ON TRIPLE-SPOTTING

- Survey of ANA members turns up 32 'victims' of tv spot abuses
- Advertisers demand better station discipline, tightened NAB code

The powerful Assn. of National Advertisers moved last week to bring a long-simmering pot of trouble to a quick boil.

In a report being announced today, the ANA let it be known that triple-spotting in tv—a source of aggravation for years—has got to go.

Its language was not quite that direct, but its intent was plain. The announcement carried examples of contract devices that ANA said are used by some advertisers to protect themselves against abuse—examples that other advertisers and agencies presumably are free to copy in their own timebuying negotiations.

The announcement said a survey of ANA members showed that “an important segment of advertisers are victims of the triple-spotting abuse in television.” Of 115 advertisers who responded to the survey, ANA said, 32 “complained of triple-spotting in recent months.” Sixty were “reasonably certain” they had not been triple-spot victims, and the rest didn’t know.

George Abrams of Revlon, chairman of the ANA Radio-Tv Committee, which conducted the survey, told BROADCASTING the big complaint was that network advertisers get less time than they pay for when stations triple-spot, because the multiple announcements eat into the network program time.

The ANA announcement pinned the responsibility for corrective action on stations, networks and the NAB.

“Ultimately,” it said, “it would seem that what is needed is a revision of the NAB code and an agreement, between the networks and their affiliates, as to the amount of time that is available for sale by local stations after a network program has been bought by a network advertiser.”

The networks generally agree that it was the responsibility of themselves and their affiliates to deliver to each network advertiser the amount of time he had ordered, and that when triple-spotting clips off any of the network advertiser’s time it must be stopped.

NBC had no immediate comment pending study of the ANA statement, but officials of both CBS-TV and ABC-TV said they were doing everything possible to stamp out this type of spotting. They claimed that actually very few of their affiliates were guilty of clipping network advertisers’

time, but acknowledged that any violation is too much.

The code as it now stands stipulates that “more than two back-to-back announcements plus the conventional sponsored 10-second station ID are not acceptable between programs or within the framework of a single program. Announcements scheduled between programs shall not interrupt a preceding or following program.”

Although both the ANA announcement and Mr. Abrams indicated prime concern was for preservation of the network advertiser’s full allotment of time, the preventative measures cited by ANA seemed more applicable to spot schedules.

One big but otherwise unidentified tv user who has not had trouble with triple-spotting, according to ANA, reported that

of all spot tv contracts:

“1. Station agrees that this advertiser will share between program periods with only one other advertiser.

“2. Station agrees that in the instance of within-program participations, no other advertiser will be scheduled immediately adjacent to this advertiser.

“3. Station agrees to advise agency, in writing, in advance of any change of adjacencies.”

Mr. Abrams told BROADCASTING that few advertisers currently employ this sort of contractual protection against triple-spotting but that he expected the practice to spread. Observers were inclined to agree—especially since ANA is putting the samples out for all advertisers to see.

Mr. Abrams also noted that agencies

**Benton & Bowles media chief deplors  
excess commercialism on tv and radio  
Page 32**

**American Medical Assn. huddles  
to stamp out drug ads it objects to  
Page 32**



## DOCTORS PRESCRIBE TV PURGE

The American Medical Assn. is concerned over "offensive and misleading advertising" of drug products and last week decided to do something about it.

A secret meeting attended by advertising and media representatives was held in New York last Monday by AMA. After an all-day discussion, the National Better Business Bureau was invited to draw up an informal program to meet the problem.

Broadcast, newspaper and magazine groups attended the meeting along with representatives of American Assn. of Advertising Agencies, American Assn. of Newspaper Representatives, Assn. of National Advertisers, Proprietary Assn. and the business bureau.

The problem is all-media in scope, it appeared at the meeting. AMA voiced the opinion that voluntary action might be effective in cleaning up misleading, distasteful and deceptive advertising.

Leo A. Brown, AMA assistant general manager and public relations director, presided at the Monday meeting. Member complaints and resolutions from medical groups continue to demand steps to prevent advertising that might endanger the public, he said.

Representing broadcasters at the AMA

session were Stockton Helffrich, NBC-TV; Herbert Carlborg, CBS-TV and Edward Bronson, NAB tv code affairs director. The network officials explained how copy and claims are screened. Mr. Bronson outlined operation of the NAB tv code.

No specific medium was singled out for criticism by AMA. The Proprietary Assn. described its work in previewing ads and labels for its members.

The atmosphere at the meeting was in contrast to a stinging resolution adopted recently by the House of Delegates of the Medical Society of New York. This resolution criticized "adroit references to doctors" who use or prescribe "nos-trums." The *New York Times* carried an editorial May 16 based on this action and calling on networks and sponsors to do "some badly needed housecleaning." The newspaper criticized "outrageous and nauseating charts of what purports to be the human anatomy."

Said the *Times*, "It is a sorry commentary on our enlightenment when the old 'snake oil' technique can be used on millions of persons to make millions of dollars in profits." The newspaper called for voluntary industry action "to take these phony 'doctors' off the air."

## CAN 50 SECONDS FIT IN 30?

"Multiple consecutive spotting in any manner cannot be condoned," Lee N. Rich, vice president and media director of Benton & Bowles, New York, said last Wednesday.

Addressing the Pennsylvania Assn. of Broadcasters [PAB story, page 68], Mr. Rich said his agency considers triple-spotting practices "unethical during prime tv hours and fails to see "any justification in this procedure."

"It is inconceivable to me how 50 seconds of commercial time can be placed between network television programs when only 30 seconds are allocated for local sale," he said.

Mr. Rich explained B&B's clients "agree with the steps we have taken to curb this overcommercialization" and added, "We will continue to exert all our efforts towards eliminating this unhealthy practice."

Radio, too, drew sharp comments from



MR. RICH

Mr. Rich. He said: "Unfortunately the number of commercials that one hears on radio between the hours of 7 and 9 in the morning and 5 and 7 in the evening is enough to stagger the imagination. I must admit that in this area the advertiser and agency must share some of the blame.

"However, no matter whose fault it is, the very number of commercials in these heavily trafficked hours can only serve to diminish the effectiveness of any single commercial. I think there has been some improvement in this area through research that shows that listening levels in other than these supposedly prime periods are not as low as we had formerly thought.

"The situation as it exists today requires a meeting of the minds. If there are values which can accrue to the advertiser, your customer, from this practice of triple-spotting, they can only be brought to the fore by working together towards a better understanding of the problem."

Mr. Rich said consecutive spotting affects not only the community and advertiser but the stations as well because "viewers and listeners drift away and ultimately so will the advertiser."

the most active triple-spot foes, have been put on record a number of times, most recently by vice president and media director Lee Rich in a speech before the Pennsylvania Assn. of Broadcasters last week (story, this page).

At Compton Adv., also in the forefront of the fight against commercial excesses, vice president and media director Frank Kemp said that "too many stations are triple-spotting and if anything can be done to reduce the practice, it would be good for the industry."

But both he and Bert Mulligan, head timebuyer, saw little need to write triple-spotting into contract. "Wherever we find triple-spotting," said Mr. Mulligan, "we move our commercials to another time."

Methods of detecting commercial offenses also were explored in the ANA survey. The association reported:

"Of the 32 members who complained about triple-spotting, 20 monitor their shows.

"Ten of these members have informal systems of checking programs through their own advertising personnel, distributors or salesmen.

"Six members report that their agencies monitor for them and two advertisers use commercial monitoring organizations.

"Of the 60 members who are reasonably certain that they have not been victims of triple-spotting, 18 rely on monitoring."

One advertiser who uses contract safeguards against triple-spotting, ANA said, also reported "that his field sales force continually sends in criticisms or commendations on the spot program. His agencies find that competitive stations are the first to inform them if anything such as triple-spotting has occurred."

The other advertiser whose contract conditions were cited by ANA reported that "as a safeguard against such contract violations as might occur, the agency frequently conducts field monitors to determine whether or not stations are adhering to this contract."

At the networks the advertisers seemed assured of cooperation.

ABC-TV was challenged a few months ago by Compton Adv., which charged that 12 ABC-TV affiliates were triple-spotting before or after Wyatt Earp, which Compton services for Procter & Gamble. At that time ABC-TV officials said they had contacted the affiliates and that all had agreed not to triple-spot [ADVERTISERS & AGENCIES, March 17].

In a statement last week Oliver Treyz, president of ABC-TV, reiterated the network's stand against triple-spotting. He said:

"ABC is very much aware of the adverse effects of triple-spotting, and it has been discussed with our affiliates on many occasions. Last January the managers of all ABC affiliates were alerted that triple-spotting poses a serious problem and if it continues is bound to have an adverse effect on all of us. We pointed out that it was impossible to triple-spot between network programs without cutting into the time which had been contracted for by our network advertisers and that the cutting into the advertisers' time in



that the cutting into the advertisers' time in this fashion was a violation of our affiliation agreement with the stations. We asked for the cooperation of all stations in the elimination of this spotting.

"We are confident that virtually all ABC-TV affiliated stations now are cooperating toward the elimination of this practice."

At CBS-TV Edmund Bunker, vice president and director of station relations, agreed that where triple-spotting cuts into the time ordered by a network advertiser, it must be stopped. He said the network has reason to believe that only "a relatively tiny segment of stations" are guilty, but that CBS-TV is "doing everything in our power to detect such instances and to stop them."

Though seemingly apt to be brought to a head by the ANA move, overcommercialization generally and triple-spotting specifically have been under attack for years.

Three years ago John P. Cunningham, president of Cunningham & Walsh, had publicly protested that "I have counted as many as five commercials at station break time, one right after another." He agreed that "the advertisers and the agencies also are at fault with the broadcasters—except that the broadcasters have the veto power" [ADVERTISERS & AGENCIES, Dec. 5, 1955].

In April 1957 Arthur Pradoll, media group director at Foote, Cone & Belding, warned in a speech that "when 20 or more one-minute and 20-second commercials are crowded into an hour, the effectiveness of radio is seriously vitiated." He said that although he was talking about radio, the same views could be applied to television [ADVERTISERS & AGENCIES, April 29, 1957].

At the NAB convention earlier this month Marion Harper Jr., president of McCann-Erickson, told the broadcasters that although only 2% of station breaks went beyond code allowances last year, "a simple statement of these proportions can be misleading—for the effect of violations is far more serious."

The issue has been analyzed in other forums.

In a MONDAY MEMO written for BROADCASTING almost exactly a year ago, Emil Mogul, president of Emil Mogul Co., saw the overloading of commercials as one ugly head of a "three-headed monster" confronting spot broadcasting [MONDAY MEMO, May 27, 1957]. And last fall Benton & Bowles' Lee Rich, in another MONDAY MEMO for this magazine, lashed out at triple-spotting specifically, just as he did again last week at the Pennsylvania broadcasters' meeting. In his MONDAY MEMO Mr. Rich also proposed a solution virtually identical to the one advanced last week by ANA. He said:

"It seems that there are two ways to control properly the amount of time available for local sale between network programs. The first is a further revision of this portion of the NAB code in order to provide a more concise definition of a station's obligation. The second is the agreement, and its strict observance, between the networks and their affiliates as to the amount of network program time to be utilized by a 15-minute, half-hour or hour program and the amount remaining for sale by the local station." [MONDAY MEMO, Nov. 11, 1957].

## SPOT-NETWORK TV GROSS BILLING NEAR \$263 MILLION FOR QUARTER

● Network times sales running 13.5% above 1957 pace

● Spot continues healthy, up 1.8% over last year

Advertisers spent \$262,766,116 for network and spot television time during the first quarter of 1958—almost 8% more than they did in the same period a year ago.

This gain in the face of general economic recession is shown in compilations of spot and network totals released last week and today (Monday) by Television Bureau of Advertising.

The figures showed first-quarter network time sales amounted to \$143,704,116, or 13.5% ahead of the 1957 first-quarter total of \$126,540,198.

First-quarter spot sales were placed at \$119,062,000, up 1.8% from the \$116,935,000 recorded in the first three months of 1957.

The network figures are compiled for TvB by Leading National Advertisers and Broadcast Advertisers Report; the spot figures by N. C. Rorabaugh Co. All figures are gross.

Norman E. Cash, TvB President, said that while this year's first-quarter data on spot spending, based on reports from 333 stations, represented a 1.8% increase, an analysis comparing 275 stations which reported in both years reflected a 2.4% gain.

The network statistics represented the first complete quarterly report since TvB signed LNA-BAR to make the compilations. Included were estimated expenditures of the top 25 network spenders by both company and brand, network gross billings by day parts, and estimated expenditures by product classification, plus data on March alone. The spot figures included first-quarter expenditures by the top 100 spot users, spending by product classification, and spending by time of day and type of spot activity (see accompanying tables).

At the same time TvB also released results of a study showing that television was gaining in terms of viewing hours as well as advertising outlays.

Harvey Spiegel, TvB assistant research director, said the new study, based on A. C. Nielsen Co. data, showed that during the 12 months from April 1957 through March 1958 the average tv home spent 5 hours 13

minutes a day watching television—a gain of 12 minutes per day per tv home as compared to the preceding 12-month period.

"Eleven of the last 12 months," he added, "were all-time highs for the amount of time the average tv home spent with their television set each day."

In another report TvB noted that audiences, too, are gaining. This report said that during the first four months of 1958 the average audience gained 7% in the case of nighttime shows and 14% for daytime programs. The average weekday daytime program was reaching 489,000 more homes per broadcast than in 1957, and the average evening program was reaching 655,000 more homes than a year ago. Current totals: average evening program 9,741,000 homes; average daytime program 3,978,000 homes.

In the first-quarter spot report, being released today (Monday), President Cash noted substantial increases in expenditures in six product categories: ale, beer and wine up from \$8.5 million in the first quarter of 1957 to \$9.4 million in first quarter 1958 (10%); dental products from \$1.5 million to \$3.3 million (112%); cosmetics and toiletries from \$10.7 million to \$11.5 million (8%); clothing, furnishings and accessories from \$2.2 million to \$2.9 million (33%); consumer services from \$3.2 million to \$3.5 million (10%) and household laundry products from \$3.7 million to \$8.6 million (132%).

Five advertisers joined the top 100 spot spenders for the first time: Comstock Foods, Heublein Inc., International Milling, Lewis Food Co. and Tidy House Products. Procter & Gamble again led the list with almost \$7.8 million, followed by Lever with more than \$3.5 million and Colgate-Palmolive with just under \$3 million.

In network spending P&G also was first by a wide margin for the first quarter: almost \$12 million. General Motors was second with almost \$5.4 million and Chrysler third with \$5.2 million. Tide (\$2.3 million), Ford passenger cars (\$2.1 million) and Anacin (\$2 million) were one-two-three among brands for the quarter.

## WHAT THE TOP 100 SPENT FOR SPOT TV

|                             |             |                           |             |
|-----------------------------|-------------|---------------------------|-------------|
| 1. PROCTER & GAMBLE ..      | \$7,768,700 | 14. PHILIP MORRIS .....   | \$1,184,700 |
| 2. LEVER BROTHERS ..        | 3,565,500   | 15. AVON PRODUCTS .....   | 1,151,000   |
| 3. COLGATE-PALMOLIVE ..     | 2,981,300   | 16. ANDREW JERGENS .....  | 1,121,700   |
| 4. GENERAL FOODS .....      | 2,847,700   | 17. COCA-COLA BOTTLES ... | 1,082,100   |
| 5. BROWN & WILLIAMSON ..    | 2,589,000   | 18. CARTER PRODUCTS ..... | 1,047,100   |
| 6. ADELL CHEMICAL .....     | 2,217,300   | 19. BULOVA WATCH .....    | 1,034,000   |
| 7. CONTINENTAL BAKING ..    | 2,141,600   | 20. CHARLES ANTELL .....  | 968,100     |
| 8. MILES LABORATORIES ..    | 2,127,000   | 21. SHELL OIL .....       | 966,000     |
| 9. P. LORILLARD .....       | 1,843,600   | 22. STANDARD BRANDS ..... | 955,500     |
| 10. WARNER-LAMBERT .....    | 1,506,800   | 23. ROBERT HALL .....     | 947,200     |
| 11. STERLING DRUG .....     | 1,457,500   | 24. AMERICAN CHICLE ..... | 934,100     |
| 12. AM. HOME PROD. CORP. .. | 1,392,700   | 25. J. A. FOLGER .....    | 840,100     |
| 13. NATIONAL BISCUIT .....  | 1,238,900   |                           |             |

CONTINUED

|                              |           |
|------------------------------|-----------|
| 26. INTL. LATEX              | \$791,300 |
| 27. CHESEBROUGH-PONDS        | 723,700   |
| 28. GENERAL MOTORS           | 720,200   |
| 29. PEPSI-COLA BOTTLERS      | 720,100   |
| 30. WARD BAKING              | 717,600   |
| 31. EXQUISITE FORM           | 698,500   |
| 32. LIGGETT & MYERS          | 637,500   |
| 33. FOOD MFGRS.              | 636,300   |
| 34. CORN PROD. REFINING      | 617,600   |
| 35. R. J. REYNOLDS           | 611,700   |
| 36. FALSTAFF BREWING         | 610,000   |
| 37. WANDER CO.               | 595,000   |
| 38. MARATHON CORP.           | 589,700   |
| 39. BRISTOL-MYERS            | 588,600   |
| 40. ANHEUSER-BUSH            | 569,700   |
| 41. PLOUGH                   | 556,100   |
| 42. ESSO STANDARD OIL        | 553,200   |
| 43. WRIGLEY                  | 532,600   |
| 44. BORDEN                   | 530,900   |
| 45. TEXIZE CHEMICALS         | 504,000   |
| 46. SWIFT & CO.              | 500,900   |
| 47. SALADA-SHERRIFF-HORSEY   | 493,000   |
| 48. DUMAS-MILNER             | 489,800   |
| 49. TEXAS CO.                | 486,400   |
| 50. STANDARD OIL OF IND.     | 478,600   |
| 51. PETER PAUL               | 475,400   |
| 52. PIEL BROS.               | 468,700   |
| 53. AMERICAN TOBACCO         | 465,400   |
| 54. U. S. BORAX & CHEM.      | 458,500   |
| 55. MAYBELLINE               | 439,700   |
| 56. DRUG RESEARCH            | 425,600   |
| 57. TEA COUNCIL OF U.S.A.    | 418,700   |
| 58. HAROLD F. RITCHIE        | 413,900   |
| 59. COMSTOCK FOODS, INC.     | 406,800   |
| 60. INTERSTATE BAKERIES      | 405,500   |
| 61. M. J. B. CO.             | 405,300   |
| 62. FORD MOTOR               | 402,100   |
| 63. QUAKER OATS              | 396,500   |
| 64. BLOCK DRUG               | 394,700   |
| 65. NORWICH PHARMACAL        | 391,000   |
| 66. ALBERTO-CULVER           | 371,900   |
| 67. H. J. HEINZ              | 370,400   |
| 68. PHILLIPS PETROLEUM       | 363,400   |
| 69. HILLS BROS. COFFEE       | 361,500   |
| 70. CARLINGS BREWING         | 356,200   |
| 71. BEST FOODS               | 354,700   |
| 72. P. BALLANTINE            | 345,000   |
| 73. BURGERMEISTER BREW.      | 341,600   |
| 74. NESTLE                   | 334,800   |
| 75. TIDY HOUSE PRODS.        | 329,700   |
| 76. GENERAL CIGAR            | 328,100   |
| 77. PACIFIC TEL. & TEL.      | 319,200   |
| 78. GROVE LABORATORIES       | 318,400   |
| 79. NEHI CORP. BOTTLERS      | 315,400   |
| 80. WM. B. REILY & CO.       | 312,100   |
| 81. ASSOCIATED PRODS.        | 306,100   |
| 82. THEO. HAMM BREWING       | 300,300   |
| 83. GENERAL MILLS            | 297,800   |
| 84. GREAT A & P TEA          | 294,600   |
| 85. PAXTON & GALLAGHER       | 291,400   |
| 86. AMERICAN BAKERIES        | 290,100   |
| 87. MINUTE MAID              | 279,600   |
| 88. INTERNATIONAL MILLING    | 277,200   |
| 89. DUNCAN COFFEE            | 276,800   |
| 90. SAFEWAY STORES           | 270,900   |
| 91. KROGER CO.               | 270,600   |
| 92. NATIONAL BREWING         | 266,300   |
| 93. KELLOGG                  | 263,000   |
| 94. ROBERT CURLEY            | 262,400   |
| 95. J. SCHLITZ BREW.         | 261,400   |
| 96. E. & J. GALLO WINERY     | 257,100   |
| 97. LEWIS FOOD               | 256,300   |
| 98. HEUBLEIN                 | 255,800   |
| 99. G. WIEDEMANN BREW.       | 255,200   |
| 100. WESSON OIL & SNOW DRIFT | 243,800   |

## SPOT TV BUYING BY PRODUCT CATEGORIES

|  |            |  |              |
|--|------------|--|--------------|
| AGRICULTURE                                    | \$ 388,000 | HOME PERMANENTS & COLORING                     | \$ 1,464,000 |
| FEEDS, MEALS                                   | 188,000    | PERFUMES, TOILET WATERS, ETC.                  | 135,000      |
| MISCELLANEOUS                                  | 200,000    | RAZORS, BLADES                                 | 25,000       |
| ALE, BEER & WINE                               | 9,399,000  | SHAVING CREAMS, LOTIONS, ETC.                  | 481,000      |
| BEER & ALE                                     | 8,490,000  | TOILET SOAPS                                   | 3,000,000    |
| WINE   | 909,000    | MISCELLANEOUS                                  | 207,000      |
| AMUSEMENTS, ENTERTAINMENT                      | 84,000     | DENTAL PRODUCTS                                | 3,263,000    |
| AUTOMOTIVE                                     | 2,089,000  | DENTRIFICES                                    | 2,966,000    |
| ANTI-FREEZE                                    | 3,000      | MOUTHWASHES                                    | 90,000       |
| BATTERIES                                      | 15,000     | MISCELLANEOUS                                  | 207,000      |
| CARS   | 1,536,000  | DRUG PRODUCTS                                  | 11,560,000   |
| TIRES & TUBES                                  | 225,000    | COLD REMEDIES                                  | 2,712,000    |
| TRUCKS & TRAILERS                              | 17,000     | HEADACHE REMEDIES                              | 2,063,000    |
| MISCELLANEOUS ACCESSORIES & SUPPLIES           | 293,000    | INDIGESTION REMEDIES                           | 2,566,000    |
| BUILDING MATERIAL, EQUIPMENT, FIXTURES, PAINTS | 514,000    | LAXATIVES                                      | 846,000      |
| FIXTURES, PLUMBING, SUPPLIES                   | 143,000    | VITAMINS                                       | 969,000      |
| MATERIALS                                      | 165,000    | WEIGHT AIDS                                    | 303,000      |
| PAINTS   | 111,000    | MISCELLANEOUS DRUG PRODUCTS                    | 1,916,000    |
| POWER TOOLS                                    | 10,000     | DRUG STORES                                    | 185,000      |
| MISCELLANEOUS                                  | 85,000     | FOOD & GROCERY PRODUCTS                        | 33,331,000   |
| CLOTHING, FURNISHINGS, ACCESSORIES             | 2,879,000  | BAKED GOODS                                    | 7,031,000    |
| CLOTHING                                       | 2,489,000  | CEREALS  | 2,254,000    |
| FOOTWEAR                                       | 286,000    | COFFEE, TEA & FOOD DRINKS                      | 8,778,000    |
| HOSIERY  | 94,000     | CONDIMENTS, SAUCES, APPETIZERS                 | 1,128,000    |
| MISCELLANEOUS                                  | 10,000     | DAIRY PRODUCTS                                 | 1,539,000    |
| CONFECTIONS & SOFT DRINKS                      | 6,278,000  | DESSERTS                                       | 1,009,000    |
| CONFECTIONS                                    | 3,249,000  | DRY FOODS (FLOUR, MIXES, RICE, ETC.)           | 1,819,000    |
| SOFT DRINKS                                    | 3,029,000  | FRUITS & VEGETABLES, JUICES                    | 1,466,000    |
| CONSUMER SERVICES                              | 3,481,000  | MACARONI, NOODLES, CHILI, ETC.                 | 515,000      |
| DRY CLEANING & LAUNDRIES                       | 25,000     | MARGARINE, SHORTENINGS                         | 2,440,000    |
| FINANCIAL                                      | 419,000    | MEAT, POULTRY & FISH                           | 1,440,000    |
| INSURANCE                                      | 632,000    | SOUPS  | 115,000      |
| MEDICAL & DENTAL                               | 48,000     | MISCELLANEOUS FOODS                            | 1,478,000    |
| MOVING, HAULING, STORAGE                       | 121,000    | MISCELLANEOUS FROZEN FOODS                     | 290,000      |
| PUBLIC UTILITIES                               | 1,847,000  | FOOD STORES                                    | 2,029,000    |
| RELIGIOUS, POLITICAL, UNIONS                   | 242,000    | GARDEN SUPPLIES & EQUIPMENT                    | 251,000      |
| SCHOOLS & COLLEGES                             | 35,000     | GASOLINE & LUBRICANTS                          | 5,177,000    |
| MISCELLANEOUS SERVICES                         | 112,000    | GASOLINE & OIL                                 | 4,905,000    |
| COSMETICS & TOILETRIES                         | 11,544,000 | OIL ADDITIVES                                  | 227,000      |
| COSMETICS                                      | 2,300,000  | MISCELLANEOUS                                  | 45,000       |
| DEODORANTS                                     | 790,000    | HOTELS, RESORTS, RESTAURANTS                   | 84,000       |
| DEPILATORIES                                   | 51,000     | HOUSEHOLD CLEANERS, CLEANSERS, POLISHES, WAXES | 1,987,000    |
| HAIR TONICS & SHAMPOOS                         | 2,159,000  | CLEANSERS, CLEANSERS                           | 1,365,000    |
| HAND & FACE CREAMS, LOTIONS                    | 932,000    | FLOOR & FURNITURE POLISHES, WAXES              | 314,000      |
|  |            | GLASS CLEANERS                                 | 93,000       |
|  |            | HOME DRY CLEANERS                              | 97,000       |
|  |            | SHOE POLISH                                    | 21,000       |
|  |            | MISCELLANEOUS CLEANERS                         | 97,000       |
|  |            | HOUSEHOLD EQUIPMENT—APPLIANCES                 | 1,083,000    |
|  |            | HOUSEHOLD FURNISHINGS                          | 661,000      |
|  |            | BEDS, MATTRESSES, SPRINGS                      | 497,000      |

### Spot Tv Expenditures By Time of Day, Type of Activity (1st Quarter)

|                |                  |               |
|----------------|------------------|---------------|
| Day            | \$ 39,543        | 33.2%         |
| Night          | 67,798           | 56.9          |
| Late Night     | 11,721           | 9.9           |
|                | <u>\$119,062</u> | <u>100.0%</u> |
| Announcements* | 83,760           | 70.3%         |
| ID's           | 14,037           | 11.8          |
| Programs       | 21,265           | 17.9          |
|                | <u>\$119,062</u> | <u>100.0%</u> |

\* Includes Participations

|   |    |                      |
|---|----|----------------------|
| FURNITURE & OTHER FURNISHINGS                             | \$ | 164,000              |
| <b>HOUSEHOLD LAUNDRY PRODUCTS</b>                         |    | <b>8,643,000</b>     |
| BLEACHES, STARCHES  |    | 1,029,000            |
| PACKAGED SOAPS, DETERGENTS                                |    | 7,149,000            |
| MISCELLANEOUS   |    | 465,000              |
| <b>HOUSEHOLD PAPER PRODUCTS</b>                           |    | <b>1,284,000</b>     |
| CLEANSING TISSUES   |    | 335,000              |
| FOOD WRAPS  |    | 195,000              |
| NAPKINS   |    | 83,000               |
| TOILET TISSUE   |    | 262,000              |
| MISCELLANEOUS   |    | 409,000              |
| <b>HOUSEHOLD, GENERAL</b>                                 |    | <b>1,058,000</b>     |
| BROOMS, BRUSHES, MOPS, ETC.                               |    | 159,000              |
| CHINA, GLASSWARE, CROCKERY, CONTAINERS                    |    | 7,000                |
| DISINFECTANTS, DEODORIZERS                                |    | 359,000              |
| FUELS (HEATING, ETC.)                                     |    | 152,000              |
| INSECTICIDES, RODENTICIDES                                |    | 42,000               |
| KITCHEN UTENSILS  |    | 33,000               |
| MISCELLANEOUS   |    | 306,000              |
| <b>NOTIONS</b>  |    | <b>65,000</b>        |
| <b>PET PRODUCTS</b>                                       |    | <b>1,477,000</b>     |
| <b>PUBLICATIONS</b>                                       |    | <b>300,000</b>       |
| <b>SPORTING GOODS, BICYCLES, TOYS</b>                     |    | <b>260,000</b>       |
| BICYCLES & SUPPLIES                                       |    | 10,000               |
| GENERAL SPORTING GOODS                                    |    | 216,000              |
| TOYS & GAMES  |    | 216,000              |
| MISCELLANEOUS   |    | 34,000               |
| <b>STATIONERY, OFFICE EQUIPMENT</b>                       |    | <b>36,000</b>        |
| <b>TELEVISION, RADIO, PHONOGRAPH, MUSICAL INSTRUMENTS</b> |    | <b>342,000</b>       |
| ANTENNAS  |    | 77,000               |
| RADIO & TELEVISION SETS                                   |    | 49,000               |
| RECORDS   |    | 207,000              |
| MISCELLANEOUS   |    | 9,000                |
| <b>TOBACCO PRODUCTS &amp; SUPPLIES</b>                    |    | <b>8,072,000</b>     |
| CIGARETTES  |    | 7,400,000            |
| CIGARS, PIPE TOBACCO                                      |    | 603,000              |
| MISCELLANEOUS   |    | 69,000               |
| <b>TRANSPORTATION &amp; TRAVEL</b>                        |    | <b>666,000</b>       |
| AIR   |    | 268,000              |
| BUS   |    | 168,000              |
| RAIL  |    | 220,000              |
| MISCELLANEOUS   |    | 10,000               |
| <b>WATCHES, JEWELRY, CAMERAS</b>                          |    | <b>1,362,000</b>     |
| CAMERAS, ACCESSORIES, SUPPLIES                            |    | 77,000               |
| CLOCKS & WATCHES  |    | 1,044,000            |
| JEWELRY   |    | 21,000               |
| PENS & PENCILS  |    | 211,000              |
| MISCELLANEOUS   |    | 9,000                |
| <b>MISCELLANEOUS</b>                                      |    | <b>1,444,000</b>     |
| TRADING STAMPS  |    | 162,000              |
| MISCELLANEOUS PRODUCTS                                    |    | 527,000              |
| MISCELLANEOUS STORES                                      |    | 755,000              |
| <b>TOTAL</b>  |    | <b>\$119,062,000</b> |

BROADCASTING

## NETWORK TV BUYING BY PRODUCT CATEGORIES

|   | March 1958          | Jan.-March 1958      |
|---|---------------------|----------------------|
| AGRICULTURE & FARMING   | \$ . . . . .        | \$ 13,066            |
| APPAREL, FOOTWEAR & ACCESSORIES   | 408,269             | 865,611              |
| AUTOMOTIVE, AUTOMOTIVE ACCESSORIES & EQUIPMENT                          | 5,321,245           | 15,264,539           |
| BEER, WINE & LIQUOR   | 592,910             | 1,791,245            |
| BUILDING MATERIALS, EQUIPMENT & FIXTURES                                | 237,509             | 357,293              |
| CONFECTIONERY & SOFT DRINKS   | 851,523             | 2,512,450            |
| CONSUMER SERVICES   | 385,475             | 1,250,787            |
| ENTERTAINMENT & AMUSEMENT   | 212,616             | 212,616              |
| FOOD & FOOD PRODUCTS  | 9,179,795           | 26,952,336           |
| GASOLINE, LUBRICANTS & OTHER FUELS                                      | 158,241             | 690,559              |
| HORTICULTURE  | 57,120              | 115,098              |
| HOUSEHOLD EQUIPMENT & SUPPLIES  | 2,041,349           | 5,491,882            |
| HOUSEHOLD FURNISHINGS   | 261,460             | 789,655              |
| INDUSTRIAL MATERIALS  | 1,688,933           | 5,258,599            |
| INSURANCE   | 480,666             | 1,631,295            |
| JEWELRY, OPTICAL GOODS & CAMERAS  | 750,794             | 2,308,345            |
| MEDICINES & PROPRIETARY REMEDIES  | 5,149,104           | 15,617,567           |
| OFFICE EQUIPMENT, STATIONERY & WRITING SUPPLIES                         | 663,077             | 1,666,212            |
| POLITICAL   | . . . . .           | 66,174               |
| PUBLISHING & MEDIA  | 111,180             | 453,925              |
| RADIOS, TELEVISION SETS, PHONOGRAPHS, MUSICAL INSTRUMENTS & ACCESSORIES | 723,958             | 2,171,465            |
| SMOKING MATERIALS   | 4,974,782           | 14,556,716           |
| SOAPS, CLEANERS & POLISHES  | 5,519,606           | 16,135,043           |
| SPORTING GOODS & TOYS   | 179,222             | 432,158              |
| TOILETRIES & TOILET GOODS   | 8,693,826           | 24,731,359           |
| TRAVEL, HOTELS & RESORTS  | 222,322             | 616,845              |
| MISCELLANEOUS   | 594,355             | 1,751,276            |
| <b>Total</b>  | <b>\$49,459,337</b> | <b>\$143,704,116</b> |

LNA-BAR: Gross Time Costs Only

## GROSS NETWORK TV BILLING BY DAY PARTS

|              | MARCH               |                     |              | JANUARY-MARCH        |                      |              |
|--------------|---------------------|---------------------|--------------|----------------------|----------------------|--------------|
|              | 1957                | 1958                | % Change     | 1957                 | 1958                 | % Change     |
| Daytime      | \$13,092,877        | \$14,135,538        | + 8.0        | \$38,164,945         | \$41,992,436         | +10.0        |
| Mon.-Fri.    | 10,619,260          | 11,583,422          | + 9.1        | 31,847,391           | 35,240,580           | +10.7        |
| Sat. & Sun.  | 2,473,617           | 2,552,116           | + 3.2        | 6,317,554            | 6,751,856            | + 6.9        |
| Nighttime    | 30,560,118          | 35,323,799          | +15.6        | 88,375,253           | 101,711,680          | +15.1        |
| <b>TOTAL</b> | <b>\$43,652,995</b> | <b>\$49,459,337</b> | <b>+13.3</b> | <b>\$126,540,198</b> | <b>\$143,704,116</b> | <b>+13.5</b> |

LNA-BAR: Gross Time Costs Only

## NETWORK TV'S TOP 25

By Company, 1st Quarter

|                          |              |
|--------------------------|--------------|
| 1. PROCTER & GAMBLE      | \$11,933,899 |
| 2. GENERAL MOTORS        | 5,391,337    |
| 3. CHRYSLER              | 5,232,263    |
| 4. GENERAL FOODS         | 5,165,950    |
| 5. LEVER BROTHERS        | 5,070,603    |
| 6. COLGATE-PALMOLIVE     | 5,020,935    |
| 7. BRISTOL-MYERS         | 4,842,986    |
| 8. AM. HOME PRODS.       | 4,683,316    |
| 9. FORD MOTOR            | 3,725,625    |
| 10. R. J. REYNOLDS       | 3,591,865    |
| 11. GILLETTE             | 3,393,602    |
| 12. KELLOGG              | 2,966,246    |
| 13. AMERICAN TOBACCO     | 2,830,380    |
| 14. LIGGETT & MYERS TOB. | 2,817,789    |
| 15. PHARMACEUTICALS INC. | 2,489,475    |
| 16. STERLING DRUG        | 2,071,018    |
| 17. P. LORILLARD         | 2,052,309    |
| 18. GENERAL MILLS        | 2,036,713    |
| 19. REVLOX               | 1,976,432    |

|                           |              |
|---------------------------|--------------|
| 20. NATIONAL DAIRY PRODS. | \$ 1,964,719 |
| 21. BROWN & WILLIAMSON    | 1,761,773    |
| 22. RADIO CORP. OF AM.    | 1,590,932    |
| 23. EASTMAN KODAK         | 1,455,448    |
| 24. PHILIP MORRIS         | 1,452,858    |
| 25. GENERAL ELECTRIC      | 1,351,383    |

LNA-BAR: Gross Time Costs Only

## NETWORK TV'S TOP 25

By Brand, 1st Quarter

|                         |             |
|-------------------------|-------------|
| 1. TIDE (P & G)         | \$2,325,404 |
| 2. FORD PASS. CARS      | 2,152,418   |
| 3. ANACIN (WHITEHALL)   | 2,060,660   |
| 4. BUFFERIN (B-M)       | 2,056,099   |
| 5. WINSTONS (REYNOLDS)  | 1,820,088   |
| 6. CHEVROLET PASS. CARS | 1,669,850   |
| 7. PLYMOUTH PASS. CARS  | 1,667,917   |
| 8. DODGE PASS. CARS     | 1,649,153   |
| 9. VICEROY (B & W)      | 1,351,992   |
| 10. L & M'S             | 1,205,213   |

CONTINUED

|                                 |             |
|---------------------------------|-------------|
| 11. COLGATE DENTAL CREAM        | \$1,157,837 |
| 12. WISK DETERGENT (LEVER)      | 1,112,979   |
| 13. GLEEM (P & G)               | 1,083,972   |
| 14. KENTS (LORILLARD)           | 1,058,175   |
| 15. FAB (C-P)                   | 1,036,916   |
| 16. PRUDENTIAL INS.             | 1,026,170   |
| 17. CHESTERFIELDS (L & M)       | 1,015,086   |
| 18. CHEER (P & G)               | 989,356     |
| 19. CAMELS (REYNOLDS)           | 970,956     |
| 20. PALL MALLS (AMERICAN)       | 966,255     |
| 21. GERITOL<br>(PHARMACEUTICAL) | 964,497     |
| 22. HIT PARADES (AMERICAN)      | 906,880     |
| 23. EASTMAN KODAK CAMERAS       | 895,487     |
| 24. MERCURY PASS. CARS          | 888,381     |
| 25. BELL TEL. SYSTEMS           | 858,387     |

LNA-BAR: Gross Time Costs Only

### NETWORK TV'S TOP 15

By Company, March

|                          |             |
|--------------------------|-------------|
| 1. PROCTER & GAMBLE      | \$4,013,873 |
| 2. GENERAL FOODS         | 1,883,133   |
| 3. GENERAL MOTORS        | 1,849,755   |
| 4. CHRYSLER              | 1,762,715   |
| 5. BRISTOL-MYERS         | 1,709,742   |
| 6. LEVER BROTHERS        | 1,693,638   |
| 7. COLGATE-PALMOLIVE     | 1,686,581   |
| 8. AM. HOME PRODS.       | 1,487,854   |
| 9. R. J. REYNOLDS TOB.   | 1,294,950   |
| 10. FORD MOTOR           | 1,221,464   |
| 11. GILLETTE             | 1,192,565   |
| 12. AMERICAN TOBACCO     | 1,013,586   |
| 13. KELLOGG CO.          | 927,805     |
| 14. PHARMACEUTICALS INC. | 917,064     |
| 15. LIGGETT & MYERS TOB. | 893,702     |

LNA-BAR: Gross Time Costs Only

### NETWORK TV'S TOP 15

By Brand, March

|                            |           |
|----------------------------|-----------|
| 1. TIDE (P & G)            | \$825,427 |
| 2. BUFFERIN (B-M)          | 738,622   |
| 3. DODGE PASS. CARS        | 663,597   |
| 4. FORD PASS. CARS         | 637,864   |
| 5. ANACIN (WHITEHALL)      | 612,129   |
| 6. WINSTONS (REYNOLDS)     | 611,784   |
| 7. PLYMOUTH PASS. CARS     | 555,570   |
| 8. CHEVROLET PASS. CARS    | 544,996   |
| 9. VICEROYS (B & W)        | 502,269   |
| 10. COLGATE DENTAL CREAM   | 395,921   |
| 11. PRUDENTIAL INS.        | 383,968   |
| 12. KENTS (LORILLARD)      | 372,892   |
| 13. GLEEM (P & G)          | 363,876   |
| 14. WISK DETERGENT (LEVER) | 360,879   |
| 15. SALEMS (REYNOLDS)      | 361,787   |

LNA-BAR: Gross Time Costs Only

### Chevron Sets Spot Campaign

California Oil Co., Perth Amboy, N. J., will send \$2 million in a 26-week radio-tv-newspaper campaign, which starts this week in eastern states from Maine to North Carolina. The schedule is to promote the change of name from Calso to Chevron gasoline. Tv spots featuring the cartoon character Hy Finn, an American motorist who becomes a satisfied Chevron customer, will run about \$800,000 and radio spots will cost about \$200,000. Agency is BBDO, New York.

## BULOVA BRAKES SPOT TV SLATE

- Summer sales lag blamed
- Future course undecided

Bulova Watch Co., New York, which has a history of spot broadcasting dating back to 1929, is cancelling its current spot tv schedule amounting to \$4 million this year as of June 15—and is undecided about its future plans.

Bulova, which dropped out of spot radio several years ago after a lengthy and profitable association, notified station representatives of its latest decision in a letter from its advertising agency, McCann-Erickson, New York. The letter gave no indication of Bulova's future plans but pointed out that although watch sales are seasonal, the company in the past has been using spot tv on a 52-week basis. This year, the letter continued, Bulova has decided "to cancel all spot tv for the low selling summer months."

A spokesman for Bulova later told BROADCASTING that the company would be back in television this fall "in one form or another," but could not specify the type of tv participation. In addition to the spot tv schedule amounting to about \$4 million this broadcast year (usually beginning in September) Bulova also has invested about \$2.5 million on network specials—co-sponsorship of 10 *Frank Sinatra Show* programs on ABC-TV and several musical shows on NBC-TV. The Bulova official said he could not speculate on the fate of spot tv for the future at this time, pointing out that meetings are scheduled for the next three weeks between representatives of the company and McCann-Erickson, during which Bulova's advertising considerations will be evaluated.

The Bulova spokesman stressed that the

summer season is "the slowest in the watch business" and indicated that the company's sales, like others in the hard-goods field, had been affected by the current recession. Bulova is considered one of the world's bigger watch firms along with U. S. Time Corp. (Timex) and Gruen.

Since 1948, Bulova has been a consistent user of spot tv on a 52-week basis using largely 20-second IDs and some 10-second spots. As far back as July 1941, Bulova used spot tv on WNBTV (TV) (now WRCA-TV) New York but stepped up its participation in the medium seven years later. It is believed the company bought time in virtually every tv market in the country.

Bulova's decision caught station representatives by surprise but they declined to comment on the action, hoping the move is a temporary one only for this summer.

### Bates Promotes Hill, MacNelly

E. L. Hill and C. L. MacNelly Jr., vice presidents and directors of Ted Bates & Co., New York, have been elected senior vice presidents. Mr. Hill has been with the



MR. MacNELLY



MR. HILL

agency for 10 years, and before that was a brand manager with Procter & Gamble. Mr. MacNelly has been with Ted Bates for eight years.

## ACTIVITY

### HOW PEOPLE SPEND THEIR TIME

There were 124,943,000 people in the U. S. over 12 years of age during the week May 11-17. This is how they spent their time:

|       |                     |                       |                       |
|-------|---------------------|-----------------------|-----------------------|
| 68.5% | (85,586,000) spent  | 1,713.4 million hours | WATCHING TELEVISION   |
| 56.4% | (70,468,000) spent  | 991.5 million hours   | LISTENING TO RADIO    |
| 81.7% | (102,078,000) spent | 407.0 million hours   | READING NEWSPAPERS    |
| 29.8% | (37,233,000) spent  | 160.8 million hours   | READING MAGAZINES     |
| 19.3% | (24,114,000) spent  | 275.1 million hours   | WATCHING MOVIES ON TV |
| 24.9% | (31,124,000) spent  | 126.0 million hours   | ATTENDING MOVIES*     |

These totals, compiled by Sindlinger & Co., Ridley Park, Pa., and published exclusively by BROADCASTING each week, are based on a 48-state, random dispersion sample of 7,000 interviews (1,000 each day). Sindlinger's weekly and quarterly "Activity" report, from which these weekly figures are drawn, furnishes comprehensive breakdowns of these and numerous other categories, and shows the duplicated and unduplicated audiences between each specific medium. Copyright 1958 Sindlinger & Co.

\* All figures are average daily tabulations for the week with exception of the "attending movies" category which is a cumulative total for the week. Sindlinger tabulations are available within 2-7 days of the interviewing week.

**SINDLINGER'S SET COUNT:** As of May 1, Sindlinger data shows: (1) 107,850,000 people over 12 years of age see tv (86.3% of the people in that age group); (2) 41,779,000 U. S. households with tv; (3) 46,019,000 tv sets in use in U. S.

# **SELECT STATION REPRESENTATIVES**

*proudly announces*

*its appointment as representative for*

## **WUSN-TV**

*Charleston, South Carolina*

## **NBC—Channel 2**

*Effective June 1, 1958*

Represented by:

**Select Station Representatives** in New York, Philadelphia, Baltimore, Washington

**Simmons Associates** in Boston, Chicago and the West Coast

**James S. Ayers Company** in Atlanta and Charleston

# as basic as the alphabet



## EGYPTIAN

Searching for the ancient ancestor of our letter C, many scholars eye with favor the Egyptian picture-sign for corner or angle.

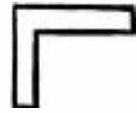

## PHOENICIAN

With the passage of time, far-traveling Phoenician merchants adapted the corner sign and let it stand for the first sound of *game!*—precise meaning of which is not certain.



## GREEK

The Greeks changed *game!* to *gamma* and wrote it in various ways. The form pictured here was officially adopted by the Athenians in 403 B.C.



## ROMAN

From one of the Greek *gamma* forms, the Romans created two Latin letters. One was our letter G; the other, our letter C.



Historical data by

Dr. Donald J. Lloyd, Wayne State University



## Cream of the Michigan market

Seventy per cent of Michigan's population commending 75 per cent of the state's buying power lives within WWJ's daytime primary coverage area.

**Changing listeners** into customers is much easier when you buy WWJ. Nearly thirty-eight years of quality radio service to Detroit and southeastern Michigan have built a tremendously loyal audience which accepts WWJ-advertised products quickly and enthusiastically.

**Start your radio campaign here**—with the WWJ Melody Parade, WWJ News, with popular personalities like Hugh Roberts, Faye Elizabeth, Bob Maxwell and Jim De Land. It's the basic thing to do!

# WWJ RADIO

AM and FM

WORLD'S FIRST RADIO STATION

Owned and operated by **The Detroit News**

NBC Affiliate

National Representatives: *Peters, Griffin, Woodward, Inc.*

# General Mills new cereal goes on shelf; tv's out to get it off

As shoppers filed into grocery stores dotting a wide eastern slice of the U. S. on May 1 (a Thursday), their buying moves were being watched closely by one group of executives in Minneapolis and another set of strategists in New York. That was "I-Day" (introductory day), the beginning of a test of a marketing plan three years in the making.

May 1 was the official debut of General Mills' new entry in the cereal mart, a package of high-protein breakfast food called Hi-Pro. It is the first cereal of any consequence to enter the super-competitive cereals food area in two years.

That anxious look from Minneapolis (head offices of General Mills) and from Madison Ave. (head offices of Dancer-Fitzgerald-Sample, agency on Hi-Pro) will continue. As of last week, the Hi-Pro watchers saw "encouraging reports" in movement of the new product. But the cereal campaigners will need more than this to go on. The curse or the blessing will be the future strength of re-orders. In a drive to establish a new product of this kind, the initial sale is not as important as subsequent sales—will the customer come back for more?

General Mills and D-F-S think try-out customers will become repeaters. They are supporting this faith with a television canonade (backed up by other media) that repeats a copy theme of a "whole breakfast in a bowl" and "three times the high quality protein" of any other cereal and demonstrates just how nutritious a breakfast Hi-Pro can be (see tv commercial).

The same day the campaign opened (distribution machinery already had Hi-Pro stocked on the shelf), General Mills and D-F-S laid down the tv spot barrage that now covers the box-like sector etched out of the U. S. East. The introductory territory runs generally west to Chicago north to the U. S.-Canada border and as far south as Washington, D. C.

There are perhaps some 50 major market areas in this section where the Hi-Pro tv "message" is being seen and heard (mostly one-minute announcements with some 20-second spots). In addition to the tv spot umbrella, General Mills called on long-range (or national) advertising support in the form of cut-ins in the network tv shows it sponsors (ABC's *Wyatt Earp* and *American Bandstand*, CBS's *Verdict Is Yours* and *Beat the Clock*).

Starting June 1 General Mills and D-F-S will bring up additional advertising to supplement the yeoman chore delegated to tv. A radio spot schedule is being placed in about the same markets where tv has been running [CLOSED CIRCUIT, May 12].

What's the budget? The silence on "budgets" in the cereal field is deafening. The talk is on product, not money. This much is known, however. Tv and radio are getting two-thirds of the Hi-Pro introductory ad budget; television alone is receiving approximately twice the amount that goes into print.

Television spots are running at a high rate

in such markets as New York City and low in frequency in some "secondary" markets. (D-F-S is buying its tv spot on "rating points"). How long will this be kept up? Simple—as long as it's needed. In other parts of the country? Not so simple.

Assuming there are re-orders of Hi-Pro at a sufficient rate and as the product becomes available and capacity permits, the campaign will march westward and southward. With it presumably will go an expansion of radio and tv spot.

Another 'image' is being used in the Hi-Pro advertising for the first time in any brand of General Mills' cereals: Betty Crocker. The name appears on the box in support of the Hi-Pro target: to influence women (not just children), "who have the greatest concern of family health and welfare." Betty Crocker has been a leading personality in the food field, is looked to by GM customers for tips on recipes and baking (General Mills is the leading milling company in the U. S.) but more importantly is known for influence in consumption of food for its nutritional value (the whole advertising base of Hi-Pro's appeal).

As explained by an executive: Hi-Pro is a whole breakfast in a bowl. It is for today's "economy-minded person—the woman who wants a whole breakfast in convenient form—a substantial meal but no time to prepare it."

How important is Hi-Pro to General Mills? Very.

The company (which had sales of \$527.7 million last year) has two kingpins, Cheerios and Wheaties, and also markets Kix (a corn-puff) and Jets and Trix, sugar-coated cereals. What GM has not but Kellogg's has (on the market for about two years) is a premium-priced cereal (Hi-Pro retails in the 27-29 cent range). Kellogg's entry is Special K, a rice-tasting nutritive-packed package that rates sixth in sales tonnage (topped by Corn Flakes, Cheerios, Wheaties, Post Toasties, and Rice Krispies) and third in dollar volume (Corn Flakes and Cheerios precede it).

General Mills developed Hi-Pro over a three-year span, most of the food laboratory work conducted by a highly respected food research laboratory, Wisconsin Alumni Research Foundation, and with consultation by a leading expert in the nutrition field, Dr. F. J. Stare of Harvard.

D-F-S knew where it wanted to go in media for good reason. It is generally conceded the agency was assigned Hi-Pro because of its spectacular success with Cheerios, now pushing Corn Flakes in sales percentage (Cheerios has shown substantial increases over the last three years). Since tv's arrival on the advertising scene, Cheerios has allocated between 80-85% of all its media dollars to broadcasting, with television getting the major share.

Television turned out to be a genie for Cheerios. General Mills is rubbing the lamp again.



## Hi-Pro's tv pitch

- (1) Now for you and your family a new breakfast.
- (2) It's Hi-Pro . . . new protein flakes . . . with at least . . .
- (3) . . . three times the high quality protein of any leading ready-to-eat cereal.
- (4) A serving of Hi-Pro and milk . . . gives you as much protein as an egg and two slices of bacon.
- (5) A combination of more of the important vitamins than many fruits.
- (6) More of the important minerals than two slices of whole wheat toast.
- (7) So much balanced food value . . . it's called a "whole breakfast in a bowl."
- (8) And Hi-Pro is such a welcome change of taste in the morning . . . wheat, corn and rice blended into each crisp, man-sized flake.
- (9) Hi-Pro, the new breakfast with at least three times the high quality protein of any leading ready-to-eat cereal.

## PGW FORECASTING HOT RADIO SUMMER

- Slump is myth, salesmen say
- New kit offers proof for am

Advertisers ought not to put their spot radio plans into the deep freeze during the summertime. And, for those who have a few radio plans frozen for the time being, the summer period is just the time to defrost.

A drive for new spot radio business on the basis of the summer's attractiveness comes from Peters, Griffin, Woodward, station representative. PGW looks, too, to the advertiser already using spot radio and is urging him to maintain schedules and perhaps to increase.

The whole PGW pitch is contained in a new kit, called "In the Big New Summertime." The firm's radio salesmen are being equipped with the kits to aid them in their selling rounds at agencies and to advertisers. This week the salesmen met with Robert H. Teter, PGW vice president and director of radio, at a "Summer Clinic" to go over the problem of the "Myth of the Summer Slump," which Mr. Teter says the evidence in the kit "explodes."

Basically, the material prepared by PGW attacks the myth by stressing statistically the importance of the summer months—June, July and August—in consumer habits and buying.

PGW cites National Industrial Conference Board figures which show that half of the people take their vacations at times other than the summer (50% in the summer, 20% in the fall, 20% in the spring and 10% in the winter). Very few families, according to NICB, are away "all summer" and 80% of Americans are away from their homes and jobs for less than three weeks out of the entire year.

Thus, says PGW, "the balance of the summer is like any other time of the year. . . . People go to work, buy things they want, enjoy themselves." Chief difference, the station representative notes, is that people spend more time outdoors and they drive their cars more and "radio goes with them wherever they go."

In pointing up time spent with radio, PGW includes figures showing the total time individuals spent with media (from a Sindlinger & Co. survey). Radio, according to these figures, has the highest "score" for June, July and August compared with other media. Another set of figures (taken from Pulse) emphasizes radio's use in and out of the home in such widely separated markets as New York, Chicago, New Orleans and Los Angeles. Compared are both winter and summer listening according to average quarter-hour sets in use from six in the morning to midnight. In each of the markets, the summer average topped the winter figure.

Other sets of statistics probe various markets in the U. S., showing further summer and winter listening comparisons and radio summer use growth; increase in summer travel on the highways (with em-

phasis on the fact that 87.5% of the more than 5 million cars sold last year were radio-equipped); 25.7% of annual retail sales in the U. S. are made during the summer months (Commerce Dept. figures).

PGW notes that 32% of all radios travel with people in the summertime. Cited are surveys of the percentage of portable radios taken along on weekends and on weekdays by certain groups to outdoor events

and the percentage of these portables in use.

In specific fields (food-grocery stores, hardware-appliance retailers, gas stations and lumber-building material dealers), PGW observes that retail sales during the summer months go over the average for the nation.

Against all these "summer facts," PGW asks the advertisers to "check your media objectives."



**MYOMIST** and the people who launched its campaign on WRCA-TV New York (l to r): Jay Heitin, sales manager, WRCA-TV; Shari Lewis, m.c. of the Hi, Mom show; Ted Braude, account executive, Joseph Katz Co.; Harry W. Bennett, senior vice president, Katz; Josie McCarthy, culinary expert, and Alfred Kovnat, Parry marketing chief.

## Tv gets a hot prospect as Myomist goes national

Attention, tv station sales managers: there's a new spray wafting your way which may leave you breathless in more ways than one. Called Myomist, the new antiseptic oral spray—which is packaged by Parry Labs, New York, in a small (2¾-inch high) portable, infantry-blue plastic squeeze bottle,—is hellbent on achieving national distribution within 60 days and is banking primarily on tv to put it over.

To date, Myomist has been introduced in only a few selected markets, but where it has made its bow, its impact has been clearly felt. Precisely how successful its sales have been in the six months Myomist has been sold no one can tell, least of all executives at Parry Labs, who know but won't talk. Conscious of the threat of a Bristol-Myers or Colgate-Palmolive—both of which have had long-established, intricate networks of distribution and marketing pipelines—Parry, founded only late last year by a nucleus of ex-Helene Curtis employes, also has instructed its agency, Joseph Katz Co., to keep "absolutely mum." But station people who have watched Myomist debut in their market are unreservedly enthusiastic about the product's progress.

Myomist "premiered" in Cleveland last January on WEWS (TV) and WJW-TV; shortly thereafter, it popped up in Washington, using all four stations there—WTOP-TV, WRC-TV, WMAL-TV and WTTG (TV). Then it tested Chicago on WNBQ (TV) and WBKB (TV), switched to Philadelphia's WFIL-TV. But not until a fortnight ago did Myomist truly get underway. It signed a 52-week schedule on WRCA-TV

New York under that station's "Double Dividend Plan," agreeing to spend no less than \$325,000 at the outset. It also bought supplementary time on WPIX (TV) and WABC-TV New York. Next week, Myomist should enter Baltimore, using WMAR-TV there.

From all indications, Parry Labs' buying strategy can best be called erratic; aside from WRCA-TV, it has bought no set schedule in terms of 13 weeks. In some of the above markets, it went "in" and "out". The reason: Myomist is a pioneer product. While it may be "competing" with other oral hygiene preparations, it has no peer in that it's a mouthspray that one may easily carry around on one's person, thus has "no track record" it can follow.

So far, Parry Labs reportedly is spending upwards of \$1.3 million in five markets, 85% in tv spot. It is understood to be considering barter but when questioned, a Parry executive said that most of its time purchases will be "for cash." While its number one market potential is with the businessman who can't gargle or brush his teeth after a garlic-flavored luncheon session—thus using early morning and late night tv—Parry Labs will make a concerted effort to "reach" the groom-conscious teenager. It is presently considering buying its first network participation in ABC-TV's *American Bandstand*.

*Quo vadis* Myomist? Notes one leading station representative: "With over \$1 million being spent in tv in only a handful of cities and apparently meeting with phenomenal consumer reaction, can you imagine what they'll [Parry Labs] be spending in only a few months' time? Why, this may be the Lestoil story of 1958!"





## talk to **Neal Welch**

Even a few minutes with General Manager Neal Welch will give you an inkling of the major role that the Paul H. Raymer Company has played in the development of WSBT as the dominant . . . overwhelmingly dominant . . . Radio/TV property in South Bend. In national spot, Raymer Representation delivers better than 80% of all the radio business and grabs more than fifty percent of all the TV schedules in this hot 3-station market. No one can tell you better than Neal Welch how intelligent management, programming showmanship and aggressive representation can make a station **the buy . . . the only buy . . .** in a major market.

## then talk to Raymer

WSBT has been represented by Raymer for **twenty-three years . . .** a unique record in station representation (most representatives haven't even been in business that long). Perhaps it would pay you to talk to Raymer and find out for yourself what it is that makes Raymer Representation tick . . . and stick. Certainly it would help you decide if your representative is doing for you what Raymer Representation has done for WSBT.

**THE PAUL H. RAYMER COMPANY, INC.**

**Exclusive National Representatives**

**Since 1932**

**New York • Chicago • Hollywood**

**San Francisco • Dallas • Detroit**

**Atlanta**



It was a hard fight





Still is. In television the competition never lets up. It keeps going day and night, 52 weeks a year. And each year it gets tougher.

With the final Nielsen Report now in for the October to April season (the period of peak audience competition among networks) it is now clear that all three networks have delivered larger audiences than ever—an average of 14% more at night and 15% more during the day.

It is also clear that during this season the CBS Television Network—again attracted the largest average audiences in broadcasting—816,000 more homes at night and 115,000 more homes during the day than any other network with a full daytime schedule

—achieved the season's largest audience for a single program—the 23 million homes that watched a Lucille Ball-Desi Arnaz show—presented more of the most popular programs than any other network—a monthly average of 6 of the top 10

—won the largest number of program awards for adding new dimensions to the presentation of entertainment and the promotion of public information and understanding—a total of 60

—earned a 16% larger investment from advertisers than the second largest advertising medium.

Whether you consider it in terms of the biggest audiences, the most important awards, or the largest advertising investment, the decision is plain. The winner and still champion in every round, as it has been for the last 68 consecutive Nielsen Reports, is still...

**THE CBS TELEVISION NETWORK**

**BUSINESS BRIEFLY** **WHO'S BUYING WHAT, WHERE**

**AMOCO SIGNS** • American Oil Co., N. Y., has launched its annual 13-week summertime radio-tv campaign with theme, "More Gas per Gallon." Drive got underway May 12 on 150 radio and 35 tv stations on East Coast from Maine to Florida. Additionally, Amoco, through Joseph Katz Co., N. Y. and Baltimore, has signed for 17th consecutive year to sponsor Washington Redskins pro football games this fall over regional radio-tv network.

**BAT GUANO BOOM** • Purex Corp. is extending its advertising campaign for Bat Guano through 11 western states, following successful introductory campaign in Southern California. Radio and newspapers will be used with something more than 50% going to radio, according to Ben Potts, president. Potts-Ray & Assoc., agency for Bat Guano advertising. One-minute transcriptions will be used from 4 to 40 per station per week during 13-week campaign. On June 2, radio spots will start on 24 stations, adding two more June 16. Three stations will pick up schedule June 23, five June 30, four more on July 1. Plant food campaign also is continuing on seven Southern California stations, plus three additional outlets coming in June 2.

**ON BINGO CARD** • Associated Products, West New York, N. J., through Grey Adv., N. Y., has signed to sponsor ABC-TV's new audience and home participation musical quiz *Music Bingo* (Fri., 8:30-9 p.m.) when show debuts June 6.

**WHEATIES WARM-UP** • General Mills Inc. (Wheaties) will sponsor NBC-TV's new quarter-hour program *The Wheaties Sports Page* to be programmed preceding major sports events telecast on network during 1958 and 1959. Program, which will start June 14, will precede each Saturday afternoon *Major League Baseball Game*, all-star baseball game, July 8, World Series starting Oct. 1 and football *Game of the Week* in fall. Knox Reeves Adv. is agency for GM.

**FORD SHUFFLE** • Ford Div. of Ford Motor Co. and Ford Dealers of America through J. Walter Thompson, New York, to sponsor new filmed western *Buckskin* as summer replacement for *The Ford Show* (Tennessee Ernie Ford) on NBC-TV (Thursday, 9:30-10 p.m.), starting July 3 with *Ford* to resume Oct. 2. At same time, CBS Radio confirmed that Tennessee Ernie Ford will replace Arthur Godfrey in late afternoon segment of *The Ford Road Show* effective June 2 with time period cut 10 minutes, now 5:05-5:20 p.m., Mon.-Fri. [ADVERTISERS & AGENCIES, May 19]. *Buckskin* will be produced by Bedford Productions and filmed by Revue Productions in Hollywood.

**HERO WORSHIP** • The Sweets Co. of America (Tootsie Rolls, Tootsie Roll Pops, Caramels and Fudge and Rockwood Chocolate confections), Hoboken, N. J., has signed to sponsor ABC-TV's *Superman* (Mon. 5-5:30 p.m.) and *Wild Bill Hickok*

(Wed. 5-5:30 p.m.) effective April 30. Order, placed through Harry Eisen Adv., N. Y., is for 22 weeks.

**RIFLE AMMO** • Procter & Gamble, (Tide) Miles Labs and Ralston Purina Co. will sponsor *The Rifleman* during fall season on Tuesdays, 9-9:30 p.m. on ABC-TV. Starting date will be announced later. Agency for P&G is Benton & Bowles, for Miles, Geoffrey Wade and for Ralston Purina, Guild, Bascom & Bonfigli.

**HAS GUNN** • Bristol-Myers Co., N. Y., has signed to sponsor new half-hour adventure tv film series *Pete Gunn* over NBC-TV (9-9:30 p.m.), starting in fall. Precise starting date and products to be advertised will be determined later. Agency: Doherty, Clifford, Steers & Shenfield, N. Y.

**P&G EXTENDS** • Procter & Gamble Co. has extended sponsorship of NBC-TV *Suspicion* (Mon., 10-11 p.m.) for additional 12 weeks through Sept. 22. Agency: Benton & Bowles, N. Y.

**SMOKE SCENE** • P. Lorillard Co., through Lennen & Newell, N. Y., has signed to sponsor ABC-TV's *Rough Riders* (Thurs. 9:30-10 p.m.) effective Sept. 18.

**POPULAR COMIC** • If new hour-long Garry Moore show goes into prime evening time on CBS-TV next season as currently contemplated by network, it will not lack sponsorship interest. Shulton Inc. (men's toiletries), N. Y., via Wesley Assoc., N. Y.,

reportedly has order in for alternate half-hour of show. Program could premiere in Tuesday night spot. Understood other advertisers (unidentified) have bids in for participation.

**DAYTIME IN MIND** • H. J. Heinz Co., Pittsburgh, planning to participate in four quarter-hour daytime shows on NBC-TV. Specific shows still being selected. Maxon Inc., N. Y., is agency.

**LUCKY SEVEN** • NBC-TV recorded \$7 million in gross daytime business during past week, by five advertisers, according to Walter D. Scott, vice president, NBC-TV network sales. Advertisers placing order: Alberto-Culver and Miles Labs. through Geoffrey Wade, Chesebrough-Pond's and Mentholatum through J. Walter Thompson and Standard Brands through Ted Bates.

**Ad Council to Back Political Fund Drive**

Public service advertising in radio-tv and other media will be used experimentally this year to finance political campaigns. A "Don't Pass the Buck—Give a Buck" drive was previewed last week by the Advertising Council and American Heritage Foundation.

Brig. Gen. David Sarnoff, board chairman of RCA and the foundation, introduced the campaign to Washington newsmen Wednesday. The idea was developed by Philip L. Graham, publisher of the *Washington Post & Times-Herald* (WTOP-AM-FM-TV).

In essence, the campaign is based on contributions by a large segment of the public,



**PREVIEW**

**Sailors mutiny for new Chevrolet**

Capt. Pat Boone is faced with mutiny in a new Chevrolet commercial when his men refuse to mop the decks although they "truly love to mop" and want to "leave the sea" because they have "fallen in love with something sweet on land."

The musical commercial is one of Chevrolet's new "fun series" entitled "She's All Fun." The idea is to compare the fun of driving the new Chevy with the fun of outdoor sports.

Although Capt. Boone is skeptical, the sailors get him to inspect the Chevrolet and tell him to "Take a little pleasure trip in this lovely highway ship and you'll want to take 'er away . . . For she's all fun and all one could ask for. She's the smooth-sailing, new Chevrolet."

After getting Capt. Boone to try the convertible, the sailors succeed in selling him on it. Throwing away his cap and whiskers, he sings: "If this be mutiny . . . It's mutiny for me . . . Drive a Chevrolet soon . . . You will throw your anchors away."

The spot will be used on the May 29 *Pat Boone Chevy Showroom* and later on the *Dinah Shore Chevy Show*.

A. J. (Pete) Miranda produced the commercial for Campbell-Ewald (Chevy agency) under the supervision of Phil McHugh, tv vice president, and Hugh Lucas, tv supervisor of the account. The music was written by Gene Forrell, the lyrics by Fred Lounsbury. Van Praag Productions filmed the commercial in Fox Movietone's New York studios.

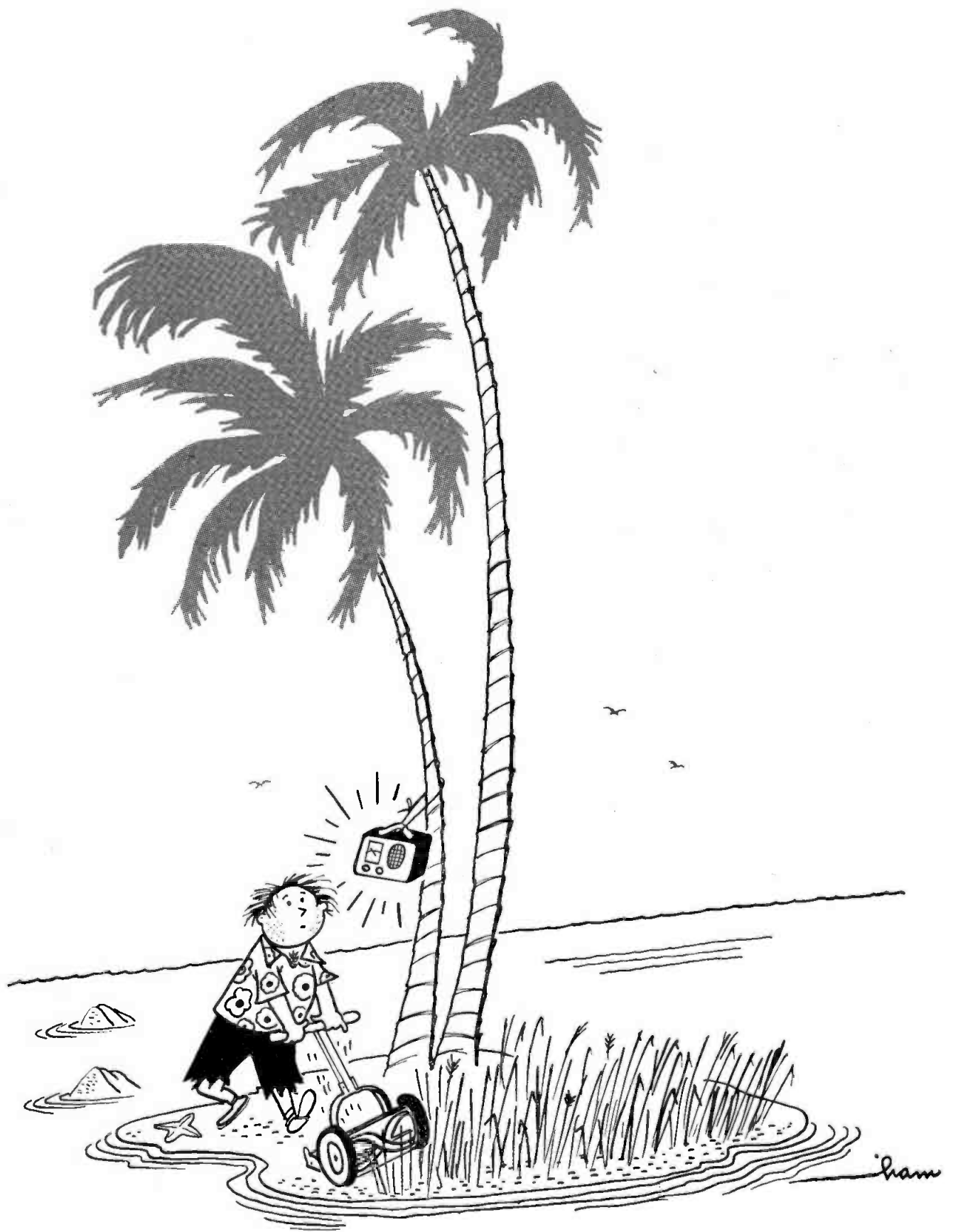

**He's Listening to AP News**

urging citizens to "come to the aid of their parties." Media will provide promotional impetus and the political parties will conduct nationwide door-to-door solicitation for contributions of \$1 or more.

Gen. Sarnoff explained that only 2% of the American people contribute financially to a political party. He said this "is not a healthful condition." The idea is endorsed by both Republican and Democratic National Committees as well as by President Eisenhower.

Volunteer contributions of free time and space will provide the basis of the project. David N. Laux, vice president and account supervisor of Foote, Cone & Belding, New York, said his organization as volunteer agency for the campaign will use radio and tv stations and networks, outdoor, newspapers, consumer and house journals, business magazines and other media. Michael P. Ryan, advertising director of Allied Chemical Corp., is volunteer coordinator and advertising manager of the project.

The Advertising Council and the Foundation have cooperated in several register-inform yourself-vote campaigns but have never before asked the public through Council advertising to contribute money to political candidates or parties.

Theodore S. Repplier, Council president, said, "It is not too illogical that the Advertising Council, which conducts voluntary fund-raising campaigns for the colleges, the Red Cross and the community chests, should now also endeavor to come to the aid of the parties." John C. Cornelius, Foundation president, described the program as "an investment in clean politics, a movement to free our elected representatives from the necessity of seeking campaign contributions with political strings attached. It will bring the parties closer to the people and reduce the present dangerous dependence on relatively few sources of support, many with axes to grind."

The Council and task agency have produced radio-tv spots of varying length and animated tv spots. These will be distributed to stations and networks.

### Timebuyer Scanlan Leaves BBDO

Elenore Scanlan, spot broadcast buyer at BBDO, New York, for the past 22 years, has resigned. Miss Scanlan is one of the first radio timebuyers in the business. During the course of her activity with the agency, she serviced almost every major account handled by BBDO. Her future plans are expected to be announced shortly.

### William B. Henri Dies at 71

Funeral services were conducted this past weekend for William B. Henri, 71, retired founder-president of Henri, Hurst & McDonald, Chicago advertising agency. He died in Passavant Hospital Wednesday after a short illness. A pioneer in advertising and merchandising, Mr. Henri founded the agency in 1914 and retired in 1956, leading to a reorganization, with Martin Zitz elected president. The agency bills in the \$10-\$12 million range.

Survivors include a daughter, Mrs. Helen Ladewig, and a son, William H., account executive at H&M.

## FILM

# TV HAUNTS 20TH-CENTURY MEET

- Stockholder questions preoccupied with subject
- Skouras regrets cooperation with 'great competitor'

The "spectre" of television hung heavily over the annual stockholders meeting Tuesday afternoon at 20th Century-Fox Film Corp.'s New York home office. Most of the open floor session—questions posed to 20th Century President Spyros P. Skouras—was devoted to "our great competitor" and the profoundest anguish was voiced by Mr. Skouras himself.

Though reporting consolidated 1957 film rental earnings (including tv) of \$117,537,070—a gain of \$4,756,201 over 1956 film rental revenues—Mr. Skouras "deeply regretted our role" in selling to tv. (For the first quarter of 1958—13 weeks that ended March 29—the studio's film rental income, also including tv, dropped \$704,206 from 1956's figure of \$30,898,398.)

Though noting that 20th Century-Fox is expanding its tv operations via its wholly-owned tv production subsidiary, TCF Productions Inc. and that it has signed a release "deal" with National Telefilm Assoc. as well as a production contract for two new NTA series, Mr. Skouras left no doubt as to the position of his loyalties and sentiments.

"Tv," he said, "is largely responsible for the decline in motion picture attendance. We ourselves have contributed to our loss by selling to tv. To me, this was a great mistake. We have supplied our great competitor with great films. I only hope we won't repeat our mistake with post-1948 films." The "we," he added, was meant on an industry-wide scale rather than 20th Century individually.

Via TCF, the studio now has on the air NBC-TV's *Broken Arrow* Tuesday nights on 128 stations for Miles Labs and Ralston-Purina Co.; *My Friend Flicka* is sustaining on 77 NBC-TV stations Sunday evening. The studio's special-tv *20th Century Fox Hour* episodes now are being seen as reruns on the NTA Network (financed partly by the studio). Additionally, TCF is producing for NTA *How to Marry a Millionaire* and *Man Without a Gun*—two new series of 39 episodes each. NTA also is the sole tv distributor of 20th's pre-1948 film product.

Mr. Skouras explained that the studio went into tv "reluctantly . . . and out of necessity." He blamed competitors for "starting the trend," and "fervently" prayed that his colleagues would continue to resist the pressure of the guilds. Their demands he asserted, "are beyond reason," and would, if met, force 20th Century to increase its earnings by 165% before it could hope to break even on its post-1948 product.

He urged the theatrical exhibitors to "unite into one strong organization" which would appeal to Congress to (a) enact "some sort of protective legislation" or (b) grant "subsidies" to the motion picture industry. "I don't believe," Mr. Skouras said, "that there's any other private enterprise

that renders a greater service to the public than motion pictures."

To questions from the floor, Mr. Skouras replied that the studio's 1957 advertising budget (including radio-tv allocations) had shrunk \$1.1 million from 1956's \$6.6 million for domestic promotion.

He maintained, to another stockholder, that had Hollywood resisted the blandishments of commercial tv by refusing to sell pre-1948 films to tv, "box office attendance would be 25-40% better today than it is."

He admitted that much of the pre-1948 film now seen on tv would have rested in the vaults but that the income from "occasional re-issues" would have been "substantial."

Would 20th Century Fox now stop distributing its film to tv? "No," said Mr. Skouras. "We can't afford to." But he felt that "we sell to tv too cheap," maintaining that "we are practically giving away our film" to stations who in turn capitalize on the product by selling it to advertisers. Why not, asked another shareholder, up the price tag on film-to-tv? "Because," said Mr. Skouras, evoking considerable laughter, "then nobody would buy it."

Another round of laughs followed this exchange between Mr. Skouras and a stockholder. The latter felt it was "a mistake" to "dignify" comparison between theatrical film quality and film seen on tv, saying that "the mechanical reproduction is bad, it's all small screen black-and-white . . . and it's constantly interrupted by advertising." Mr. Skouras agreed in principle, but asked, "Tell me, if it was so bad, how come you stayed to watch the pictures on tv . . . why did you see the film [a pre-1948 20th Century Fox Film starring Will Rogers] if you didn't like it?"

Mr. Skouras pinpointed the opposition not as tv stations or advertisers but as "60 million theatres." He meant living rooms.

Asked by BROADCASTING to break down 20th Century Fox film rental earnings into theatrical and tv film categories, Donald A. Henderson, company treasurer and secretary declined to do so on grounds of "policy."

## ROSE AMONG THE THORNS

20th Century-Fox President Spyros Skouras admits that television may also help the movie making business. In the midst of reciting 20th's tv woes at the annual stockholder meeting, Mr. Skouras noted that the studio had signed production-direction contracts with such tv creators as Martin Manulis (*Playhouse 90*) and Martin Ritt (*Studio One*). "We are happy to have taken something from tv, as well," he declared. "It has given us some benefits, too."

Anything  
you can do  
on tape  
you can  
do better  
on the  
new Presto  
800



**S**UDDENLY problems that have plagued recording engineers for years are *gone!* Work that usually takes costly hours can be done much more efficiently—at far less cost.

THE PRESTO 800 Professional Tape Recorder is the answer. Its single-action individualized controls mastermind each detail—deliver a higher rate of production at significantly lower operating costs.

For example: Separate switches provide correct playing tape tension even when reel sizes are mixed. Three rewind speeds are push-button selected. Cue switch allows hand-winding and cueing without fighting the brakes. Pop-up playback head shield for right-hand

head disappears in STOP and FAST, completely exposing all heads for easy sweep loading and fast, sure editing. Five color-coded illuminated switches provide interlocked relay control of the five basic functions. Spring-loaded playback head can be adjusted for azimuth even with snap-on head cover in place. Safe tape handling with top speed is assured because interlocked relay control prevents accidental use of record circuit.

If you've done your share of editing,

one thing is clear... the recorder you *have* to have is the PRESTO 800 Professional. Available in console, portable and rack-mounted models, in stereo or monaural. For facts and figures, write, or wire collect to Tom Aye.

**PRESTO**  
Paramus, New Jersey  
A Subsidiary of The Siegler Corporation

TURNTABLES • TAPE RECORDERS •  
DISC RECORDERS DISCS • STYLI •  
AND HIGH FIDELITY CABINETRY



800  
PROFESSIONAL  
EXCLUSIVE:

Edit switch allows one-hand runoff during editing and assembly of master tapes, eliminates messy tape overflow.



800  
PROFESSIONAL  
EXCLUSIVE:

New linen-base, phenolic drum brake system features double shoes, eliminates brake maintenance headaches.



800  
PROFESSIONAL  
EXCLUSIVE:

Four-position plug-in head assemblies offer optimum flexibility. Can be instantly interchanged without re-alignment.



## Some homes are more VALUABLE



**FOOD FOR THOUGHT:** *GET AGE* homes comprise the most valuable audience in America today. Because the *GET AGE* (the years between 16 and 49) includes families when they're young and growing . . . when their wants and appetites are most prodigious . . . whose buying habits have yet to jell. It includes, too, families at the very peak of their earning power – who are buying more than they ever will again. *GET AGE* families spend an average of one-third more money, per household, than any other age group.\*

\*Source: Alfred Politz, "Life Study of Consumer Expenditures," 1957. \*\*Average audience based only on homes with housewife as classified by A. C. Nielsen. \*\*\*Average audience and program cost data based on A. C. Nielsen, January-February, 1958 (Sunday through Saturday, 7:30-10:30 P.M., NYT). Cost per thousand homes per commercial minute for housewife homes (16-49 years of age) based on programming costs prorated to include all A. C. Nielsen housewife-classified homes.



than others



**COLD FACTS:** 72% of ABC Television's average audience\*\* is made up of *GET AGE* homes. Corresponding figure for each of the other two networks is 64%. What's more, cost per thousand for *GET AGE* householders on ABC-TV is \$3.92. The other two: \$4.95 and \$4.55.\*\*\*

Household for household, *GET AGE* families buy far more groceries than anyone else. They buy far more home appliances, far more automobiles, far more of almost everything that's advertised on television. And remember:

You get them at the ***GET AGE*** on ***abc-tv***

## UA TV Revenue Up By \$2.7 Million

A "healthy continuation of the record of growth" of United Artists Corp. was noted last week by UA Board Chairman Robert S. Benjamin and UA president Arthur B. Krim. One figure cited was the \$4.7 million racked up in 1957 on sale to tv of a total of 91 post-1948 feature films [CLOSED CIRCUIT, May 19].

In UA's first annual report to stockholders issued Tuesday, Messrs. Benjamin and Krim announced 1957 gross revenues of \$70,371,170 representing an increase of \$5,599,386 over 1956 gross revenues. Tv earnings in 1956 were announced at \$2 million; thus UA—which formed a tv subsidiary last fall—upped its television business \$2.7 million last year.

Declaring that "it is obvious that there is room for major expansion in this [tv] direction," UA talked about "a large number of television projects [now] under analysis." One of them was announced last week as being ready for the 1958-59 season: a series of 30-minute films produced by ex-CBS and MGM producer-director-writer Fletcher Markle titled *The Young In Heart*. This new program series, packaged under the Aries banner for UA-TV, will feature actress Mercedes McCambridge (Mrs. Markle) and will deal with collegiate life. The first pilot film will arrive in New York today (Monday), UA announced last week.

UA became a public corporation a year ago last month after being taken over by a new management group in 1951. It went into television in 1956 with a packet of 39 post-1948 films and distributes only post-1948 products. Since taking over seven years ago, Messrs. Benjamin, Krim and partners have "insisted wherever possible on a grant of television rights in its distribution agreements with feature film producers." During the past six years, UA noted, it has acquired such rights for over 250 motion pictures, some of which now are being shown on tv.

It is expected that at UA's annual stockholder meeting June 10 there will be considerable stress played on UA's relationship with exhibitors *vis-a-vis* tv distribution.

### NTA Appoints Lester Krugman

The appointment of Lester Krugman as executive director of advertising, promotion and merchandising for National Telefilm



MR. KRUGMAN

Assoc., New York, was announced last week by Oliver A. Unger, NTA president. Mr. Krugman has been publisher of the *Cooperative Advertising Newsletter* and earlier had served as advertising director of the Bulova Watch Co. and of Decca Records. In his new post, he will be responsible for the operations of the divisions, with Kermit Kahn, director of advertising, and Martin Roberts, director of promotion, reporting directly to him.

### SINCERE SELL

The television business that has changed the nature of the film industry in Hollywood also is affecting the role of the California film maker. In an unusual turn about, Sam Marx, executive producer of MGM-TV, arrived in New York last week and began making the rounds of agencies and advertisers with a pilot of MGM-TV's *Min and Bill* tv series.

MGM-TV reasoned that the man heading production ought to be able to best give Madison Avenue the details on a new series. For Mr. Marx, onetime story editor for MGM, it was a first time change of hats, to that of a salesman. The pilot film was produced sometime ago but MGM-TV has had it on the shelf since last November (the series was withdrawn from sale at that time).

## Four Star Films Plans \$28 Million Season

Four Star Films, Hollywood production company owned by three actors, Dick Powell, Charles Boyer and David Niven, expects to produce \$28 million worth of tv films during the 1958-59 season.

This figure is the estimated time-and-talent cost of 312 half-hour programs in preparation for six series, with the possibility that three new series will be added.

All of the programs will be filmed at the Western Avenue studio of 20th Century-Fox, Mr. Powell, Four Star President, announced.

He said that Four Star will be the sole occupant of the studio, which holds seven sound stage plus production buildings and offices.

The rental agreement could eventually evolve in Four Star's purchase of the studio, Mr. Powell stated.

In addition, the arrangement makes available to Four Star the 20th Century-Fox 2,000-acre ranch at Malibu, Calif., the western street at the main studio and whatever other main studio space may be needed. Four Star has also purchased the Hertz-Topange Ranch in the San Fernando Valley, for its own use as a location site and for rental to other producers.

Two Four Star series, *Dick Powell's Zane Grey Theatre* and *Trackdown*, have been renewed for the coming year by their present sponsors; two new series, *Wanted, Dead or Alive* and *The Rifleman*, have been sold and the company anticipates that *Richard Diamond, Private Detective*, will be renewed. The *Anthology* series, sponsored last season by Goodyear and Alcoa, will be offered to a new sponsor, and a new Jeannie Carson show and an Alaskan Adventure series, *Johnny Risk & MacCreedy's Woman*, starring Jane Russell, are also ready for sale. William Morris Agency is sales representative for all the Four Star programs.

## Guild's Cole Reports New Film Sales Policy

In an annual report for stockholders, James J. Cole, president of Guild Films Co., last week announced a new sales policy, summarized the accomplishments of the past two months under his supervision and reported the financial status of the company.

Under the new sales policy the firm will concentrate on the sale of television film for time spots on the stations, under the barter system. This move, Mr. Cole pointed out, "would put the company in two businesses: production and sale of film to tv stations and the securing of time for sponsors already under contract."

In the financial statistics, Mr. Cole said that the new management has cut operating expenses to \$18,000. The report also showed that some \$2,200,000 in income previously included was eliminated due to contract cancellations earlier this year and that approximately \$560,000 in accounts receivable were written off as uncollectible. As a result, the company showed a loss of \$463,228.

Among the accomplishments reported by Mr. Cole was the elimination of some \$193,500 in cash payments per month. Of this amount \$143,000 was eliminated through an agreement with C & C Television Corp. and Reynard International, by which monies owed them for acquisition of film would be paid off in television spot time rather than cash.

The remaining \$53,500 a month was eliminated by voiding a stock purchase plan under which prior management had agreed to acquire Robbins International, 173,000 shares of Guild stock held by that company.

In the foreign field, Mr. Cole explained that the total revenue to Guild Films during the past five years was only \$350,000. Other companies, he said, report as much as 25% or more of their annual income in this field. He revealed that he was currently in negotiation for a distribution company which he hoped would be a "most beneficial arrangement" for the company.

Mr. Cole also announced that Guild would no longer tie up its cash in the production of an entire series of programs for syndication. "We will concentrate on sales to national sponsors before undertaking production of any series. The company," he added, "presently has in preparation 10 one-half hours for which pilot films will be made."

### AAP Releases April-May Figures

Associated Artists Productions, New York, grossed \$4 million in two months (April and May), W. Robert Rich, general sales manager, announced May 19. Release of the figures is a sudden departure for AAP, which in the past has been reticent to reveal sales figures, and can be attributed in part to one of its largest sales just concluded to the Hearst Corp. for its WBAL-TV Baltimore and WISN-TV Milwaukee [FILM, May 19].

**AS USUAL**  
things are looking  
\* **UP!**

**280  
FIRSTS**  
AND 5 TIES OUT OF  
350 QUARTER HOURS

ON TOP ALL MORNING  
ON TOP ALL EVENING

**11**  
OF THE TOP  
12 ROCHESTER  
FAVORITES

TIED FOR FIRST AFTERNOONS

\* Rochester Metropolitan Area PULSE March 1958



**WHEC**

**AM-TV**  
OF  
ROCHESTER

Representatives: EVERETT-McKINNEY, Inc., New York, Chicago, Los Angeles, San Francisco

**we're tired of shouting it . . .**



**BUT THE FACT IS . . .**

**K-NUZ** is

**NO. 1\***



**\*PULSE -** (Jan.-Feb. 1958) Places K-NUZ in No. 1 position Monday thru Friday for total broadcast day average 6 A.M. to 12 midnight.

**\*NIELSEN -** (Jan.-Feb. 1958) Places K-NUZ in No. 1 position Monday thru Friday 6 A.M. to 6 P.M. for total broadcast day average.

**“On-The-Go” RADIO IN HOUSTON**

**Kay-News**  
**K-NUZ**  
**Radio Center**  
 Houston's 24-Hour  
 Music and News

**National Reps.:**  
**Forjoe & Co.—**  
 New York • Chicago  
 Los Angeles • San Francisco  
 Philadelphia • Seattle

**Southern Reps.:**  
**CLARKE BROWN CO.—**  
 Dallas • New Orleans • Atlanta  
 In Houston—Call DAVE MORRIS—JA 3-2581

**FILM CONTINUED**

**Flav-R-Straws Buys Texas Show To Run in New York Via VTR**

What claims to be the first use of Ampex videotape recording to syndicate a live program in new markets was to begin over the weekend as WOR-TV New York scheduled *Don Mahoney and His Kiddie Troupers* in the Saturday noon-12:30 p.m. period under sponsorship of Flav-R-Straws Inc, Mt. Vernon, N. Y. It is a test for Flav-R-Straws, which is re-entering tv following corporate reorganization and which may use the program in additional markets via VTR.

The program is recorded at KENS-TV San Antonio where Mr. Mahoney has a live series. The cowboy star flies several thousand miles weekly throughout Texas to present live ranch parties on seven stations. The WOR-TV show is his first via VTR .

Flav-R-Straws dropped out of tv last summer after spending \$3 million in tv over a 12-month period and having exhausted its working capital in over-production of product inventory, according to Lee Wagner, an original stockholder who temporarily has been retained by the firm to help its re-entry into tv. Mr. Wagner was the original publisher of *Tv Guide*. Flav-R-Straws now is headed by Victor Kendall, former executive vice president of Diamond Match Co., with Barney O'Brien as national sales manager. Since January Flav-R-Straws has been buying into children's programs on tv and now is using three stations on the West Coast and three in New England in addition to WOR-TV. Agency for the WOR-TV purchase is WABE Inc., New York, headed by station representative Charles Bernard.

**Tv Brings Most Income—Disney**

With television credited as the largest source of income, Walt Disney Productions reports a consolidated net profit of \$1,633,250, or \$1.06 a share of outstanding common stock, for the six-month period ended March 29, after provision for taxes. For the corresponding period the previous year, the net was \$1,532,391, or \$1.03 per share. Gross income, including that from the Disneyland Amusement Park, shown for the first time, was \$22,499,750, compared to \$16,457,933 for the six-month period ended March 30, 1957. Television was the largest source of income for the Disney organization, bringing in \$7,886,027 in the six months, compared to \$7,707,280 for film rentals, \$3,876,686 from Disneyland and \$3,029,757 from other sources.

**Hyman Re-elected AAP Head**

Eliot Hyman was re-elected president of Associated Artists Productions Corp. (a major distributor of feature films and cartoons to tv) at a board meeting in Wilmington, Del., last week. The board met after a special stockholders session at which Mr. Hyman, Raymond Stark, David B. Stillman, Louis Stillman and Henry J. Zittau, were re-elected members of AAP's board. Mr. Zittau was re-elected secretary-treasurer of the corporation.



## Ambassador with a clarinet . . .

His portfolio carries only a sheaf of music — his credentials: more than twenty years as one of the greats of American music. Benny Goodman is his name, and all this week he and his orchestra will be swinging in the American Theatre at the Brussels World's Fair in a series of concerts presented and produced by the Westinghouse Broadcasting Company.

Music speaks every man's language. It is a way of communication that overrides many barriers and brings people closer together. Jazz has become one of our country's prime exports in the field of popular culture. When Benny Goodman's clarinet speaks, it sounds out a message of goodwill that has made friends for the United States all over the world. Last year, when Goodman toured the Far East for the State Department, the Saturday Review called it "... a brilliant piece of statesmanship for America."

Communications is WBC's business, too . . . communicating through sight and sound, with ideas and entertainment on its radio\* and television stations. Westinghouse Broadcasting Company is proud to be contributing to building the American Performing Arts Program at the Brussels World's Fair.

\*Incidentally, the Goodman concerts from Brussels will be broadcast nightly on the WBC radio stations.

*Your future is great in a growing America.*



**WBC** WESTINGHOUSE BROADCASTING COMPANY, INC.

*Jim Barton 1958*

Boston. WBZ+WBZA. WBZ-TV • Baltimore. WJZ-TV • Pittsburgh. KDKA. KDKA-TV • Cleveland. KYW. KYW-TV • Fort Wayne. WOWO • Chicago. WIND • Portland. KEX • San Francisco. KPDX

# THE 10 TOP FILMS IN 10 MAJOR MARKETS

AS RATED BY ARB IN MARCH

FROM the monthly audience surveys of American Research Bureau, BROADCASTING each month lists the 10 top-rated syndicated film programs in 10 major markets, selected to represent all parts of the country with various degrees of competition. Despite all precautions, occasional errors will occur in these tables, due to use of the same program name for both a syndicated and a network series and the practice of some stations of substituting local titles (such as [advertiser] Theatre) for real program names.

## NEW YORK seven-station market

| Rank | Program              | Distr.         | Day & Time  | Sta.    | Rating |
|------|----------------------|----------------|-------------|---------|--------|
| 1.   | Sea Hunt             | (Ziv)          | Sat. 10:30  | WCBS-TV | 26.6   |
| 2.   | Highway Patrol       | (Ziv)          | Mon. 7:00   | WRCA-TV | 18.8   |
| 3.   | Honeymooners         | (CBS Film)     | Tues. 7:00  | WRCA-TV | 17.5   |
| 4.   | If You Had a Million | (MCA-TV)       | Sat. 7:00   | WCBS-TV | 17.0   |
| 5.   | Mike Hammer          | (MCA-TV)       | Tues. 10:30 | WCBS-TV | 17.0   |
| 6.   | Code 3               | (ABC Film)     | Wed. 10:30  | WRCA-TV | 14.1   |
| 7.   | Death Valley Days    | (Pacifi-Borax) | Wed. 7:00   | WRCA-TV | 13.9   |
| 8.   | Silent Service       | (NBC Film)     | Fri. 7:00   | WRCA-TV | 12.8   |
| 9.   | Annie Oakley         | (CBS Film)     | Sun. 6:00   | WABC-TV | 11.7   |
| 10.  | Woody Woodpecker     | (AAP)          | Thurs. 5:00 | WABC-TV | 10.1   |
|      | Popeye               | (AAP)          | M-F 6:00    | WPIX    | 10.1   |
|      |                      |                | Sat. 5:30   |         |        |

## CHICAGO four-station market

| Rank | Program          | Distr.     | Day & Time  | Sta.   | Rating |
|------|------------------|------------|-------------|--------|--------|
| 1.   | Silent Service   | (NBC Film) | Tues. 9:30  | WNBQ   | 24.0   |
| 2.   | State Trooper    | (MCA-TV)   | Wed. 9:30   | WNBQ   | 22.2   |
| 3.   | Sea Hunt         | (Ziv)      | Wed. 8:30   | WGN-TV | 17.2   |
| 4.   | Sky King         | (Nabisco)  | Thurs. 6:00 | WGN-TV | 17.0   |
| 5.   | Annie Oakley     | (CBS Film) | Fri. 6:00   | WGN-TV | 17.0   |
| 6.   | Brave Eagle      | (CBS Film) | Tues. 6:00  | WGN-TV | 17.0   |
| 7.   | Woody Woodpecker | (AAP)      | Thurs. 5:00 | WBEK   | 14.1   |
| 8.   | Honeymooners     | (CBS Film) | Thurs. 9:30 | WGN-TV | 14.0   |
| 9.   | Highway Patrol   | (Ziv)      | Fri. 8:00   | WGN-TV | 14.0   |
| 10.  | Cisco Kid        | (Ziv)      | Mon. 6:00   | WGN-TV | 13.9   |
|      | Western Marshal  | (NBC-Film) | Wed. 6:00   | WGN-TV | 13.1   |
|      | Whirlybirds      | (CBS Film) | Thurs. 9:00 | WGN-TV | 13.1   |
|      | Bugs Bunny       | (AAP)      | M-F 6:30    | WGN-TV | 12.8   |
|      |                  |            | Sat. 8:30*  |        |        |
|      | Flash Gordon     | (Gulld)    | Sun. 12:00* | WNBQ   | 11.8   |

## MINNEAPOLIS-ST. PAUL four-station market

| Rank | Program           | Distr.         | Day & Time   | Sta.    | Rating |
|------|-------------------|----------------|--------------|---------|--------|
| 1.   | State Trooper     | (MCA-TV)       | Tues. 9:30   | KSTP-TV | 23.2   |
| 2.   | Death Valley Days | (Pacifi-Borax) | Sat. 9:30    | WCCO-TV | 23.0   |
| 3.   | Popeye            | (AAP)          | M-F 5:30     | WCCO-TV | 16.3   |
| 4.   | Sky King          | (Nabisco)      | Sat. 9:00    | WCCO-TV | 15.2   |
| 5.   | Highway Patrol    | (Ziv)          | Thurs. 10:30 | KSTP-TV | 14.7   |
| 6.   | Harbor Command    | (Gulld)        | Thurs. 9:30  | KSTP-TV | 13.6   |
| 7.   | Studio 57         | (MCA-TV)       | Wed. 9:30    | KSTP-TV | 13.1   |
| 8.   | Annie Oakley      | (CBS Film)     | Sat. 5:30    | KSTP-TV | 12.8   |
| 9.   | Waterfront        | (MCA-TV)       | Fri. 10:45   | KSTP-TV | 11.9   |
| 10.  | Bugs Bunny Time   | (AAP)          | M-F 4:30     | WCCO-TV | 11.8   |

## CLEVELAND three-station market

| Rank | Program           | Distr.         | Day & Time  | Sta.   | Rating |
|------|-------------------|----------------|-------------|--------|--------|
| 1.   | Popeye            | (AAP)          | M-F 5:30    | KYW-TV | 27.0   |
| 2.   | Frontier Doctor   | (H-TV)         | Mon. 7:00   | KYW-TV | 26.7   |
| 3.   | Silent Service    | (CNP)          | Sat. 10:30  | WJW-TV | 26.2   |
| 4.   | Death Valley Days | (Pacifi-Borax) | Thurs. 7:00 | KYW-TV | 22.5   |
| 5.   | Annie Oakley      | (CBS Film)     | Sat. 6:30   | WJW-TV | 21.3   |
| 6.   | Honeymooners      | (CBS Film)     | Tues. 10:30 | KYW-TV | 20.6   |
| 7.   | Capt. David Grief | (Gulld)        | Wed. 7:30   | KYW-TV | 19.6   |
| 8.   | Highway Patrol    | (Ziv)          | Wed. 6:00   | WJW-TV | 18.5   |
| 9.   | Kit Carson        | (MCA-TV)       | Sun. 6:00   | WEWS   | 18.2   |
| 10.  | Code 3            | (ABC Film)     | Tues. 10:30 | WEWS   | 17.8   |

## COLUMBUS three-station market

| Rank | Program            | Distr.         | Day & Time  | Sta.    | Rating |
|------|--------------------|----------------|-------------|---------|--------|
| 1.   | Honeymooners       | (CBS Film)     | Sat. 7:00   | WBNS-TV | 28.2   |
| 2.   | Death Valley Days  | (Pacifi-Borax) | Sun. 9:30   | WBNS-TV | 26.0   |
| 3.   | Highway Patrol     | (Ziv)          | Tues. 10:30 | WBNS-TV | 25.6   |
| 4.   | Casey Jones        | (Screen Gems)  | Tues. 6:00  | WTVN-TV | 23.2   |
| 5.   | Frontier Doctor    | (NBC Film)     | Tues. 6:30  | WTVN-TV | 22.6   |
| 6.   | The Tracer         | (MPA)          | Tues. 7:00  | WTVN-TV | 21.2   |
| 7.   | Whirlybirds        | (CBS Film)     | Thurs. 7:00 | WTVN-TV | 20.7   |
| 8.   | Sky King           | (Nabisco)      | Fri. 6:30   | WBNS-TV | 20.1   |
| 9.   | Sheriff of Cochise | (NTA)          | Fri. 10:30  | WTVN-TV | 19.8   |
| 10.  | Annie Oakley       | (CBS Film)     | Mon. 6:00   | WBNS-TV | 19.5   |

## LOS ANGELES seven-station market

| Rank | Program            | Distr.         | Day & Time                   | Sta.   | Rating |
|------|--------------------|----------------|------------------------------|--------|--------|
| 1.   | Death Valley Days  | (Pacifi-Borax) | Thurs. 7:00                  | KRCA   | 22.1   |
| 2.   | Whirlybirds        | (CBS Film)     | Mon. 7:30                    | KHJ-TV | 15.6   |
| 3.   | Sea Hunt           | (Ziv)          | Mon. 7:30                    | KTTV   | 15.2   |
| 4.   | Highway Patrol     | (Ziv)          | Mon. 9:00                    | KTTV   | 14.6   |
| 5.   | Sheriff of Cochise | (NTA)          | Sat. 7:30                    | KTTV   | 13.9   |
| 6.   | 26 Men             | (ABC Film)     | Mon. 7:00                    | KRCA   | 13.3   |
| 7.   | Amos 'n' Andy      | (CBS Film)     | Sun. 6:00                    | KNXT   | 11.9   |
| 8.   | Men of Annapolis   | (Ziv)          | Thurs. 7:30                  | KNXT   | 11.1   |
| 9.   | Studio 57          | (MCA-TV)       | Sat. 8:00                    | KTTV   | 10.8   |
|      | Little Rascals     | (Interstate)   | Mon., Tues., Thu., Fri. 7:00 | KHJ-TV | 10.8   |
| 10.  | Susie              | (TPA)          | M-F 6:15                     | KTTV   | 10.5   |
|      | Search for Adven.  | (Bagnall)      | Thurs. 7:00                  | KCOP   | 10.5   |

## WASHINGTON four-station market

| Rank | Program                 | Distr.        | Day & Time  | Sta.    | Rating |
|------|-------------------------|---------------|-------------|---------|--------|
| 1.   | 26 Men                  | (ABC Film)    | Sun. 6:30   | WMAL-TV | 24.0   |
| 2.   | Highway Patrol          | (Ziv)         | Sat. 7:00   | WTOP-TV | 21.7   |
| 3.   | Science Fiction Theatre | (Ziv)         | Sun. 6:00   | WMAL-TV | 18.7   |
| 4.   | Annie Oakley            | (CBS Film)    | Fri. 7:00   | WTOP-TV | 17.5   |
| 5.   | Gray Ghost              | (CBS Film)    | Sat. 10:30  | WTOP-TV | 17.2   |
| 6.   | Sheriff of Cochise      | (NTA)         | Thurs. 7:00 | WRC-TV  | 16.9   |
| 7.   | Sheena                  | (ABC Film)    | Mon. 6:00   | WMAL-TV | 15.7   |
| 8.   | Jungle Jim              | (Screen Gems) | Thurs. 6:00 | WMAL-TV | 15.5   |
| 9.   | Woody Woodpecker        | (AAP)         | Thurs. 5:00 | WMAL-TV | 15.1   |
| 10.  | Tales of Texas Rangers  | (Screen Gems) | Sun. 5:00   | WMAL-TV | 13.9   |

## SEATTLE-TACOMA five-station market

| Rank | Program            | Distr.         | Day & Time  | Sta.    | Rating |
|------|--------------------|----------------|-------------|---------|--------|
| 1.   | Highway Patrol     | (Ziv)          | Thurs. 7:00 | KOMO-TV | 35.8   |
| 2.   | Honeymooners       | (CBS Film)     | Sun. 6:30   | KING-TV | 27.3   |
| 3.   | Death Valley Days  | (Pacifi-Borax) | Sun. 6:00   | KING-TV | 27.2   |
| 4.   | Death Valley Days  | (Pacifi-Borax) | Thurs. 9:00 | KOMO-TV | 26.4   |
| 5.   | Sea Hunt           | (Ziv)          | Sun. 7:00   | KING-TV | 25.4   |
| 6.   | Search for Adven.  | (Bagnall)      | Mon. 7:00   | KING-TV | 22.9   |
| 7.   | Kingdom of the Sea | (Gulld)        | Tues. 7:00  | KOMO-TV | 19.7   |
| 8.   | Silent Service     | (NBC Film)     | Sat. 6:00   |         |        |
| 9.   | Sheriff of Cochise | (NTA)          | Mon. 7:30   | KING-TV | 19.3   |
| 10.  | 26 Men             | (ABC Film)     | Sat. 7:00   | KING-TV | 18.8   |
|      |                    |                | Mon. 7:00   | KOMO-TV | 17.5   |

## ATLANTA three-station market

| Rank | Program              | Distr.        | Day & Time  | Sta.    | Rating |
|------|----------------------|---------------|-------------|---------|--------|
| 1.   | Amos 'n' Andy        | (CBS Film)    | M-F 6:00    | WSB-TV  | 25.6   |
| 2.   | Honeymooners         | (CBS Film)    | Fri. 7:00   | WSB-TV  | 24.8   |
| 3.   | If You Had a Million | (MCA-TV)      | Mon. 7:00   | WSB-TV  | 24.7   |
| 4.   | Sheriff of Cochise   | (NTA)         | Tues. 7:00  | WSB-TV  | 23.8   |
| 5.   | Whirlybirds          | (CBS Film)    | Wed. 7:00   | WSB-TV  | 21.8   |
| 6.   | Code 3               | (ABC Film)    | Wed. 10:30  | WAGA-TV | 21.4   |
| 7.   | Casey Jones          | (Screen Gems) | Mon. 7:00   | WAGA-TV | 20.6   |
| 8.   | Highway Patrol       | (Ziv)         | Fri. 7:30   | WAGA-TV | 19.2   |
| 9.   | Gray Ghost           | (CBS Film)    | Wed. 7:00   | WAGA-TV | 16.5   |
| 10.  | Boots and Saddles    | (NBC Film)    | Fri. 7:00   | WAGA-TV | 15.3   |
|      | Woody Woodpecker     | (AAP)         | Thurs. 5:00 | WLWA    | 15.3   |

## BOSTON three-station market

| Rank | Program            | Distr.     | Day & Time  | Sta.    | Rating |
|------|--------------------|------------|-------------|---------|--------|
| 1.   | Whirlybirds        | (CBS Film) | Tues. 7:00  | WBZ-TV  | 28.1   |
| 2.   | Silent Service     | (CNP)      | Fri. 7:00   | WBZ-TV  | 27.1   |
| 3.   | Frontier Doctor    | (H-TV)     | Thurs. 7:00 | WBZ-TV  | 26.9   |
| 4.   | Honeymooners       | (CBS Film) | Sat. 10:30  | WNAC-TV | 25.7   |
| 5.   | Highway Patrol     | (Ziv)      | Sat. 7:00   | WBZ-TV  | 25.2   |
| 6.   | Official Detective | (NTA)      | Mon. 7:00   | WBZ-TV  | 24.6   |
| 7.   | Decoy              | (Official) | Sun. 10:30  | WBZ-TV  | 24.3   |
| 8.   | Gray Ghost         | (CBS Film) | Wed. 7:00   | WBZ-TV  | 24.0   |
| 9.   | 26 Men             | (ABC Film) | Sun. 7:00   | WBZ-TV  | 20.3   |
| 10.  | Annie Oakley       | (CBS Film) | Sun. 5:00   | WNAC-TV | 19.5   |
|      | Harbor Command     | (Ziv)      | Sun. 7:00   | WNAC-TV | 19.5   |

\*INDICATES A.M.



38-story bronze skyscraper at 375 Park Avenue designed by Mies van der Rohe and Philip Johnson. Associate architects: Kahn & Jacobs. General contractor: George A. Fuller Company. Architectural metals fabricator: General Bronze Corp.

# BRONZE

Age-old copper alloy in a brand new setting

There's a striking new face adorning Manhattan's skyline these days. It's the world's first bronze building. Radiating warmth and color, the 38-story office building at 375 Park Avenue brings forth intriguing new concepts in building design. Massive masonry walls have given way to lightweight "curtains" of glass and architectural bronze.

For bronze endures and endures . . . ages ever so gracefully. But, until recently, architectural bronze extrusions were unknown in the large sizes needed for a building like this. Formerly, bronze extrusions were confined commercially to those whose cross-section would fit in a six-inch circle.

The extrusion problem was studied intensively by Anaconda's American Brass Company. Working closely with the architects and the architectural metals fabricator, Anaconda men found the answer. Then, as principal supplier, The American Brass Company used its specially designed dies and modern extrusion equipment to produce the 26-foot-long I-shaped bronze mullions and many other extrusions that helped transform a pace-setting architectural concept into a functional and beautiful reality.

Creativity with bronze is just one more illustration of how Anaconda uses its technology to serve industry. Ranging from aluminum to uranium, Anaconda's many areas of endeavor lead the way to ever-expanding uses for non-ferrous metals and mill products . . . and to important attainments in America's pattern of progress.

The  
**ANACONDA**<sup>®</sup>  
Company

*The American Brass Company  
Anaconda Wire & Cable Company  
Andes Copper Mining Company  
Chile Copper Company  
Greene Cananea Copper Company  
Anaconda Aluminum Company  
Anaconda Sales Company  
International Smelting and  
Refining Company*

AB254-A



*\*Latest NTI: April 6-19, 1958*





**I**t is not particularly surprising that a company whose business is involved with other people's future should be astute about insuring its own.

Convinced that for companies, as well as for people, the present is the best time to protect the future, the Prudential Insurance Company renewed its schedule on the CBS Television Network—a program series which averages 23 million viewers each week.

Each year since 1950 Prudential has placed increasing reliance on the persuasive power of network television. Last year, for example, it devoted more than two-thirds of its entire advertising appropriation to television.

## **Prudential buys insurance**

And apparently with notable success. Prudential reports “Our 22,000 agents throughout the country are proud to be associated with CBS Television in a programming venture with the scope of *The Twentieth Century*. They consider television a tremendous help in winning the confidence of potential policy holders.”

In the present period of stiffening competition American business employs the most efficient sales tools it can get—which is why more and more advertisers are announcing their renewals on the CBS Television Network each week: Lever Brothers, S. C. Johnson, Liggett & Myers, U. S. Steel, the Nestle Company and Westinghouse.

Like Prudential, they find their best insurance in the network whose vital statistics reveal that for the past 68 consecutive Nielsen Reports\* it has provided the largest nationwide audiences in all advertising.

**THE CBS TELEVISION NETWORK**

# HAVE TV NETWORKS GROWN STERILE?

Pat Weaver says they have and gets agreement and dispute at forum

Sylvester L. (Pat) Weaver, former NBC president and board chairman, believes that "a declining television program vitality and a disintegrating motion picture business" can trigger a revolution in entertainment and possibly pave the way for pay tv.

He said so last Tuesday in an address at Emerson College, Boston, on Annual Broadcasting Day. It was one of his rare public appearances since leaving NBC in September 1956 to enter the consulting field and with plans to embark upon a specialized creative programming service to a tailor-made network.

Mr. Weaver disclosed that his own new programming operation is dormant. "The slashing of time rates by the networks, in effect, although disguised as discounts, put this plan on the shelf for now," he said.

Mr. Weaver described a plan he had evolved with Henry J. Kaiser and the late Mike Todd designed toward reshaping the entertainment business [PROGRAM SERVICES, Nov. 11, 1957]. This involved the building of 25 or so Kaiser aluminum domes to cover trading areas where over two-thirds of all retail sales are made. Into these houses would be booked great attractions on films, plus other motion picture spectacles, as well as symphony orchestras and recitals and personal appearances (whether Harry Belafonte or Elvis Presley, Jackie Gleason or Victor Borge, in Mr. Weaver's words).

In discussing the "immense profits" of NBC, Mr. Weaver departed from his prepared address to comment that in the two years he headed NBC, the network passed CBS in total revenue. NBC, he said, made "close to \$85,000,000 in two years" which he asserted was more than the total investment.

In relation to NBC, he said: "I had believed and had worked toward making NBC the power that catalyzed this revolution [in communications] since it could have done so, while always increasing its already immense profits. The facilities psychology, however, is not sympathetic to the bold, the imaginative. Indeed the very scope and size of the profit possibilities act as a brake on conventional management, who wrongly believe that safety lies in repeating what they have done before, or in appealing to the sure audiences or markets, rather than opening up new ones. In the past two years I have regretfully come to the conclusion that my plans for this glowing future communications complex cannot be implemented through the network operation."

As to pay television, Mr. Weaver said he believed several years ago that it would come over the wires and that he had been opposed to its invasion of the broadcast frequencies. Then he alluded to the possibility of using frequencies not now usable in commercial broadcasting—the uhfs in cities of multiple vhf stations.

He concluded his address this way:

"It is important to have a sound national

network service free to the homes, and to have it advertising supported. It is important to have the theatre and the motion picture house. But dwarfing these is the absolute indispensability of a full, complete communications service to our people, in their home and out of it.

"We cannot depend on the good will of managements to throw bones to us in television, a few good things on a largely trash base, or in movies an occasionally fine picture on creature-feature and pap foundations. We will have a gross national product of way over four hundred and fifty billion dollars in 1958. We can afford to spend a certain amount of that on the exciting world of adult interests that is just beginning to

programming is "no intellectual ghetto."

These views and others were expressed at a free-swinging forum on "The Status of Creative Programming" at the Annual Broadcasting Day at Emerson College, Boston, last Tuesday. Moderator was Frank Tooke, general manager of WBZ-TV Boston. Among the auditors was Henry Schachte, advertising vice president of Lever Brothers, and a trustee of Emerson. Mr. Schachte is also chairman of the Broadcasting Advisory Committee of Emerson, which has a major sequence in radio and tv broadcasting, including closed-circuit tv and aural broadcast facilities.

Mr. Foreman lamented the sad programming situation, but, said advertising does not



MR. WEAVER



MR. FOREMAN



MR. SUSSKIND



MR. COURTNEY

intrigue and attract most of us and that in 20 years will be more important to us than anything else. Nothing is as obsolete as the present interests in this whole field, and the sights of their managements are not on the targets that their obligation to the public entitles the public to demand.

"Something has got to give. In my opinion, it will not be the present interests, but a repetition of the old, old story, and a new enterprise, or many of them, will show the way to this exciting new world, the enriching new service to all of us in all of our moods and all of our persons. This new service starts on the premise that each of us must receive service of value and importance to him or her, and that each of us is many persons in interests, activities, arts and passions."

## Forum on Programming

Network programming for the new broadcast year is good, or bad, depending upon where you sit.

Robert Foreman, executive vice president in charge of tv and radio at BBDO, New York, believes that creative programming is "sadly lacking" for the new year.

Producer David Susskind, head of Talent Associates, thinks that "tv, circa 1958, is an ocean of mediocrity and inertia, with few islands of quality."

Alan Courtney, director of night programming NBC-TV New York, says the tempo in programming was changed a bit to help sagging ratings, but that next year's

pay for programs to uplift, but to sell products, with audience size the major criterion. He said it was practically impossible to evaluate tv and prove whether it sells or not.

"Tv has the worst features of Las Vegas and the Preakness combined," he said. An advertiser gambles \$2.5 million on 26 half-hours after looking at one pilot film. The cost per thousand is still the best yardstick.

But Mr. Foreman hasn't despaired of all programming next year. He felt the greater use of the old spectacles, or specials—"one-time-shots," he called them—would improve the value of tv in the new year.

Mr. Susskind, exponent of live television, upbraided the networks for "the travesty of bad taste" in next year's schedules. He said the networks were being programmed by "a bunch of salesman." He yearned for the days of Pat Weaver, who as NBC president until about two years ago, was responsible for much of the creative programming on that network.

Mr. Susskind countered Mr. Courtney's argument that the network gives the public what it wants with the comment that the networks underestimate the public. The public, he said, has an appetite for quality. But "the public has no choice between what they want and what will sell."

Mr. Courtney wrapped it up with the observation that he was glad NBC had such programs as *Restless Gun* and *Wagon Train* which enabled his network to afford the creative luxuries espoused by Messrs. Weaver and Susskind.

# F.R.P.\* HAS INTEGRITY

F.R.P. is many things ... and F.R.P. has integrity...

The willingness and the necessity to meet fully our responsibility as the largest, the most trusted, the most important radio station in Maryland ...

A sure knowledge that you demand and must receive more from WBAL than any other station in the entire state ...

A firm belief shared by all of us as individuals ... engineers and performers ... salesmen and executives ... that we must perform functions for our listeners that only WBAL can ...

A tight control over the quality of products and services offered our listeners ... careful scrutiny of the claims made for them ... advertiser assurance of listener satisfaction in everything we sell ...

The rigid control of length of commercial copy, so that a minute announcement is no longer than 60 seconds and a newscast is never over-commercialized.

The certainty that we bring our listeners every event important to their lives ... presidential addresses, political conventions and the like ... regardless of the cost to us ...

The right to say with conviction and truth "WBAL is one of America's great radio stations".

F.R.P. is integrity and you'll find F.R.P. only on WBAL-RADIO ... the station that expects you to expect more.

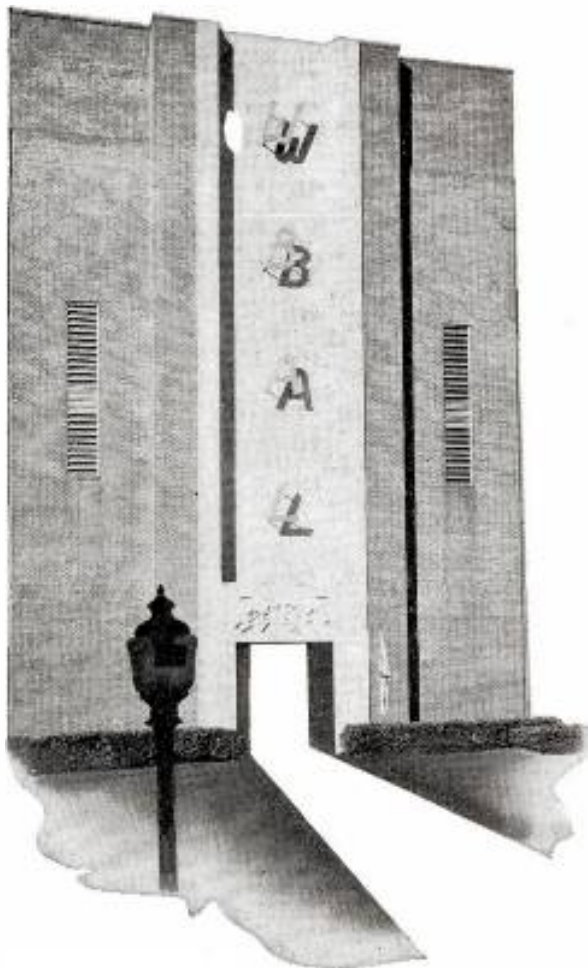

\*FULL RANGE PROGRAMMING

## WBAL RADIO

BALTIMORE, MARYLAND ★ 50,000 WATTS

NBC Affiliate—Nationally Represented by  
THE HENRY I. CRISTAL CO., INC.



## GOLDENSON REPORTS AB-PT 'IMPROVEMENT'

- Outlook good for 2nd quarter
- Credit due ABC-TV, he says

Business to date in the second quarter of 1958 is paralleling that of the first quarter when volume and earnings were higher than for the comparable period of 1957, Leonard H. Goldenson, president of American Broadcasting-Paramount Theatres, reported to stockholders at the company's annual meeting in New York last Tuesday.

Mr. Goldenson said that both broadcasting and theatre business for the second quarter is running ahead of last year and based on these results, he predicted that AB-PT will "show some improvement again for the full second quarter, compared with the same period of 1957."

He credited ABC-TV with having played the dominant role in improved earnings in the first quarter of this year, pointing out that the radio and theatre operations were not up to last year's figures.

Mr. Goldenson cited these accomplishments for ABC-TV during 1957-58: "Higher earnings and expanded program schedule, greater recognition by advertisers of the network's ability to gain audiences, better program ratings and new primary station affiliations in key markets, which have materially boosted the direct 'live' coverage of ABC-TV programs."

He told stockholders that the ABC Radio concept of "live programming" had been abandoned because advertisers and stations did not support this approach. He explained that the radio organization has been streamlined and costs "materially reduced," and that the company is attempting to establish

an operation that "will best serve the public, attract advertisers, retain and gain important station affiliates who generally have seen greener fields as independent stations."

In other areas of the company's business, Mr. Goldenson reported, Am-Par records continue to show "fine progress"; Disneyland Park is "doing well," and the electronic companies in which AB-PT has an interest have been expanding their product lines.

"The long range outlook for the nation's economy and for the broadcasting business is upward despite current uncertainty in the economic picture," he asserted.

Mr. Goldenson replied to a stockholder's question on the prospects for ABC-TV's entry into color by saying that the company did not consider the time "ripe" yet for colorcasting but is laying the groundwork now for the future. He said that there is only slight interest in color tv by sponsors because of the paucity of color television sets and he voiced the belief that by the fall of 1960 the time would be "right" for ABC-TV's entry into color.

Mr. Goldenson added that, as reported earlier, the network is prepared to invest \$20 million initially and "a substantially larger amount later" to convert to color tv. He stressed, however, that if the breakthrough in color comes earlier than anticipated, ABC-TV will "not be caught short." He explained that at the company's owned station in Chicago, WBKB (TV), its new studios were so designed and constructed that conversion to color tv would be simple and swift. Similar precautions, he said, are being taken for the company's new studios in Detroit and Los Angeles that will be under construction within the next six months.

Stockholders re-elected current directors to serve for the coming year. They are Earl

E. Anderson, A. H. Blank, John A. Coleman, E. Chester Gersten, Leonard H. Goldenson, Robert Hinckley, Robert L. Huffines Jr., Sidney M. Markley, Walter P. Marshall, H. Hugh McConnell, Edward J. Noble, James G. Riddell, Simon B. Siegel and Robert B. Wilby.

### Fetter Elected ABC V.P.

Ted Fetter, ABC-TV program director, has been elected a vice president of ABC. He will



MR. FETTER

continue as program director, a post he has held since joining ABC-TV in 1956, and will report to Thomas W. Moore, vice president in charge of programming for the network. Before joining ABC-TV he was a producer with CBS-TV from 1953 to 1956, and was

with BBDO from 1950 to 1953.

### Elmer Davis Memorial Held

Funeral services and a memorial service were held in Washington last week for Elmer Davis, 68, ABC news commentator, writer and head of the World War II Office of War Information, who died May 18 at George Washington U. Hospital, Washington. He had been hospitalized March 17 with a stroke and complications followed. Poor health had forced Mr. Davis to restrict his broadcast activities in recent years. Beginning as a newspaperman and later a free lance writer, Mr. Davis started broadcasting in 1939 for CBS. After wartime service with the OWI, he joined ABC.

## PROGRAM SERVICES

### Telemovies System Officially Expires

The world's first Telemovies operation will go dead June 6. The Bartlesville, Okla., closed circuit community tv-subscription tv system will close down next month after eight rocky months—and an investment of over \$100,000 [SPECIAL REPORT, May 12].

The announcement was made by Robert L. Getter, manager of the Bartlesville theatres for Video Independent Theatres Inc. While the system has continued to gain customers in recent weeks, he said, "its acceptance has been too little and too late."

Mr. Getter said that the reason for the shutdown order was the lack of a metering device.

Equipment will be left in homes, he said, on the assumption that when a proper meter is perfected the system might be resumed.

He said that Telemovies has 800 subscribers at the present time. This occurred, it was pointed out, when the monthly fee was cut from \$9.50 to \$4.95. At the same time the program was cut from first runs and reruns to a single feature picture on

one channel—with a Muzak-type music program on the other channel. The system also was used to provide catv service of the three Tulsa stations.

In the last few months, the Bartlesville experiment has been losing as much as \$10,000 per month.

The Telemovies operation began with high hopes in September 1957. In December the first crisis appeared, when subscribers dropped from a high of 500 to less than 300. It was then that the fee was cut and the programming modified.

Henry Griffing, president of Video Independent Theatres, said that the major problem was lack of meters; people would not pay a flat fee for viewing feature films. He also laid some of the blame at the door of Tulsa tv stations, which have more than doubled their feature film broadcasts.

Video Independent operates 12 community tv systems in the Southwest, mostly in smaller towns and cities. It is also building or planning eight new ones. It has invested about \$2 million in these catv operations. Video Independent also operates about 150 theatres in the Southwest, and holds a 12.5% interest in KWTU (TV) Oklahoma City,

and a construction permit for ch. 2 in Santa Fe, N. M. A Video Independent subsidiary, Vumore Co., runs the catv systems.

### Audio-Radio Sets National Open As First Offering to Stations

Audio-Radio for Modern America has incorporated in Oklahoma and as its first program service is offering hourly reports on the U. S. Golf Assn. National Open Championship to be played June 12-14 at Tulsa. The announcement was made last week by Kenny A. Green, president of Audio.

Audio coverage of the three-day golf event will consist of two-minute and 30-second reports transmitted to stations by conference call-beeper telephone.

After the special-events offering, Audio will pick up its original plan [PROGRAM SERVICES, July 22], offering a basic news service 24 hours a day. Plans are to cover national and international news live. Service charges, still to be determined, probably will run to \$10 a day plus toll charges, Mr. Green said.

Stations interested in subscribing may address Audio-Radio for Modern America Inc. at P. O. Box 14, Tulsa.

# *If Railroads did not exist—the U. S. would have to invent them!*

*From a recent editorial in the  
Canton (Ohio) REPOSITORY*

**S**UPPOSE that everybody in the United States were to learn for the first time about a marvelous method of transportation called a railroad.

The idea would be sensational.

High-speed tractors running on steel rails laid on privately-owned rights-of-way, with minimum curves and grades, would be capable of pulling long processions of trailers full of merchandise. Imagine!

Trains of trailers would be kept rolling day in and day out until they reached their destinations. They would be shuttled into and out of vast marshaling yards, where the trailers would be grouped in the right combinations. Of all things!

Everything connected with the procedure, moreover, would be subject to taxation. It would be expected to pay for itself. What a switch that would be!

The high-speed tractors on their twin ribbons of steel could even haul human beings, in addition to freight. If necessary, the human beings could be bedded down and hauled from one place to another in special cars with comfortable seats and all the comforts of home.

It would be an absolutely revolutionary idea — railroading. Provided it had just been invented, that is.

All the progressives and the folks who try to lend a helping hand to get new ideas off

the ground would be 100 per cent for it.

All the politicians and administrators would be 100 per cent for it.

As for the militarists and hard-headed security planners, they would be 150 per cent for it, because it would represent a mode of transportation more dependable for long-haul movement of heavy cargo than anything ever dreamed of heretofore.

The whole country would welcome the useful stranger with open arms and be alert for opportunities to give it a boost.

Cities and counties would tumble over one another to build things for it and to make free land available for its terminals.

Politicians would get into higher mathematics to subsidize it with financial gimmicks.

Nothing would be too good for the railroads if the idea of transporting things on steel rails were brand new. . . .

All railroads want is a chance to be as good as they know how to be if they are unshackled — set free from regulations that were designed to curb them when they were new and threatening to abuse a monopoly in high-speed, straight-line transportation.

Railroads should be born again.

That is what would have to happen if they went out of existence.

If they did not exist, the United States would have to invent them. . . .

## *Association of American Railroads*

WASHINGTON, D. C.

# ATMOSPHERE BULLISH AT EIA MEET

- Total industry figures up despite recession
- Hull succeeds Baker as president; Hoffman honored

The electronics manufacturing industry has reached an all-time peak of \$7.5 billion for the 1957-58 fiscal year though tv set production and sales have declined.

Electronic Industries Assn. was told by speakers at its annual convention in Chicago last week that a phenomenal increase in the radio and phonograph markets has offset the tv set production drop from 6.7 million to 6.1 million units. This occurred despite the recession in sale of automobiles which brought a 14% decline (5.6 million to 4.8 million auto radios).

EIA's board elected David R. Hull, defense vice president of Raytheon Mfg. Co., as association president. He succeeds Dr. W. R. G. Baker, who retired last year as vice president of General Electric Co. and this year concluded his second term as EIA president. Dr. Baker was unable to attend the Chicago meet-



MR. HULL

ing because of illness.

Mr. Hull is a retired electronics engineering officer and naval captain. He has been an electronics industry executive for a decade and had previously been vice president-director of Federal Telecommunication Labs, IT&T subsidiary, and executive vice president-director of Capehart-Farnsworth Corp.

H. Leslie Hoffman, president of Hoffman Electronics Corp., Los Angeles, was awarded the 1958 EIA Medal of Honor at the Thursday banquet in recognition of his contributions to the advancement of the electronics industry. Mr. Hoffman is a former principal of KOVR (TV) Stockton, Calif., and is applicant for a new station.

In his acceptance speech Mr. Hoffman proposed a federal tax credit as an incentive to commercial research and stimulus to the economy. He said the plan would help create a \$600 billion gross national product. Corporations would be given a direct credit on their federal taxes amounting to 35% of the amount they spent on approved research and development of commercial products and services, under the Hoffman plan. Expenditures allowable would be limited to 1% of gross sales and the tax credit would be limited to 35% of such expenditures or \$500,000 each year, whichever was the lesser.

Mr. Hoffman estimated the total potential tax credit at \$900 million, or a third of the \$3 billion budget currently allocated by the government for military research. The new research investment would go into projects that would raise the living standard and sustain an expanding economy, he explained.

Tv receiver inventories have been maintained at or below normal levels during the

past fiscal year despite the drop in production and sales, according to Robert S. Bell, Packard-Bell Electronics Corp., Los Angeles, chairman of the EIA Consumer Products Div. He said "industry stability has been achieved in the face of reduced consumer buying resulting from the recession."

Mr. Bell said that while radio sales also have suffered, "they remain lively and promising for the future. The popularity of the transistor radio has made portables a profitable item, and the resurgence of fm has sharply stepped up the sales of fm-am receivers. Remarkable technical improvements have resulted in record sales of phonographs, and new developments, such as stereophonic reproduction of sound, make the outlook for radio-phonographs very encouraging indeed."

The consumer products unit unanimously agreed to continue the drive toward repeal or reduction of the radio-tv-phonograph excise tax; continue to study the problem of increased radio imports; fight municipal bans on the sale of metal tv cabinets; cooperate with all segments of the radio-tv industry in promoting consumer interest in the purchase of new receivers, and continue to make equipment available on favorable terms to the EIA-initiated educational tv project at Hagerstown, Md.

Frank W. Mansfield, Sylvania Electric Products, chairman of EIA's Marketing Data Policy Committee, said total billing of the electronics industry is about \$12.5 billion compared to \$11 billion in the previous fiscal year. The figure includes distribution, service, installation and broadcast revenue as well as manufacturing.

Dr. Baker said in a statement read for him by James D. Secrest, EIA executive vice president, that the electronics industry has expanded 12-fold since World War II. He added, "And we are just on the threshold of the electronic era." Military orders have not taken up the slack in employment and plant capacity but most signs point to an economic upturn later this year, he said, adding, "The electronics industry should be in the forefront of this recovery."

Home entertainment business dropped from 58% to 20% of total electronic sales in five years while military rose from 20% to over 52%, Dr. Baker said. He lauded EIA's sponsorship of the Hagerstown project, where 473 tv receivers and five fully equipped studios are serving 23 schools and 12,000 pupils. He forecast intensive promotion of educational tv by EIA members during the coming year.

Kenneth H. Brown, Westinghouse Electric Corp., chairman of EIA's Service Committee, said the servicing industry has nearly tripled in the last seven years. He described EIA's campaign to improve radio-tv serv-

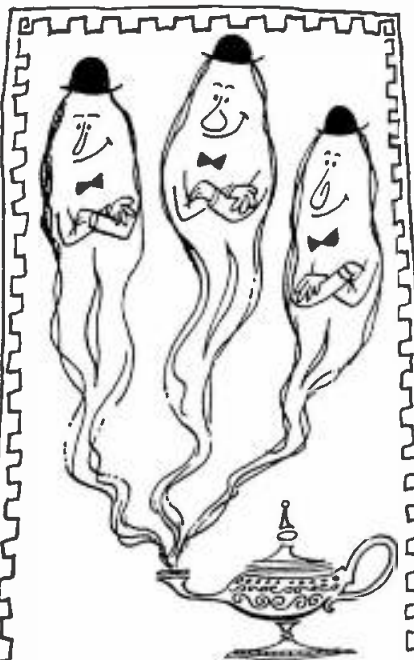

on how to spread your light in 3 Texas markets with one lamp...

No abra-kadabra necessary, just say "yes" to the West Texas Television Network Your picture simultaneously lights 314,508 sets! For the magic details conjure up your Branham genie or call ole "Aladdin" Hassett in Lubbock

**BIG** *over let TEXAS*

**K/DUB stations**

**KDUB-TV**  
LUBBOCK, TEXAS

**KPAR-TV**  
ARILENE SWEETWATER

**KEDY-TV**  
BIG SPRING, TEXAS

**CBS**

PRESIDENT & GEN. MGR.: W. O. "DUB" BOGERS  
NAT'L. SALES MGR.: E. A. "BUZZ" HASSETT

NATIONAL REPRESENTATIVE: THE BRANHAM COMPANY



## TOUCHDOWN...EVERY THIRTY SECONDS

The weather has closed in. You peer out the window and see nothing – perhaps not even the wingtip.

You are orbiting. “Stacked” over the airport. Waiting your turn to land.

**“We will land in 12 minutes”**

The Captain’s reassuring words come over the intercom. “We will land in 12 minutes.”

Now you are being brought down in easy stages—safely—over the Outer Marker Beacon . . . the Middle Marker . . . the Inner Marker . . . then *touchdown* . . . on the runway.

Every 30 seconds, somewhere in the free world, a plane is landed safely by “ILS,” the Instrument Landing System developed by IT&T, and installed in every major airport here and abroad.

### **Air passengers relax—pilots too!**

Air passengers everywhere know this feeling of security.

The pilot likes it too. Because he controls the landing at all times. Once he is on the glide-path he needs no

further instructions – nothing except the electronic information he sees before him on the instrument panel, and the meaningful “beeps” in his earphones.

### **Another “first” for IT&T**

IT&T has long been a pioneer in radio aids to air navigation. IT&T laboratories developed the first radio compass. The first distance-measuring equipment. For the Navy and the Air Force they developed and perfected TACAN (Tactical Air Navigation), the system that gives military aircraft their pinpoint position in the air—at every instant of flight.

Last year the Civil Aeronautics Administration accepted VORTAC—an application of TACAN for all civil aircraft. The

CAA has awarded to IT&T the contract to build 132 VORTAC ground stations throughout the U.S. Thanks to VORTAC the nation’s airways will soon be ready for the fastest jet transports.

The next time you are aloft in bad weather . . . remember IT&T and relax. Your skilled pilot will bring you to a smooth touchdown . . . with “ILS.”



*. . . the largest American-owned world-wide electronic and telecommunication enterprise, with 80 research and manufacturing units, 14 operating companies and 128,000 employees.*

**INTERNATIONAL TELEPHONE AND TELEGRAPH CORPORATION** 67 Broad Street, New York 4, N. Y.

FARNSWORTH ELECTRONICS COMPANY · FEDERAL ELECTRIC CORPORATION · FEDERAL TELECOMMUNICATION LABORATORIES · FEDERAL TELEPHONE AND RADIO COMPANY · IT&T COMPONENTS DIVISION · IT&T INDUSTRIAL PRODUCTS DIVISION · INTELEX SYSTEMS, INC. · INTERNATIONAL STANDARD ELECTRIC CORPORATION · KELLOGG SWITCHBOARD AND SUPPLY COMPANY · ROYAL ELECTRIC CORPORATION · AMERICAN CABLE & RADIO CORPORATION · LABORATORIES AND MANUFACTURING PLANTS IN 20 FREE-WORLD COUNTRIES

icing and to encourage training courses for servicemen.

FCC Comr. Robert E. Lee said over two-thirds of broadcast stations have made arrangements to take part in the new Emergency Weather Warning system authorized last December. He said the U. S. Weather Bureau reported the system has been used effectively 25 times during the current tornado season.

Comr. Lee said an ideal home receiver would be portable; have rechargeable batteries and provision for solar cell operation; Conelrad alarm; volume control at minimum volume level; muting switch for Conelrad alarm, and self-contained alarm clock for use when operated from an ac source. He observed that Conelrad will warn the general public of an impending enemy attack by the same means by which weather warnings are issued.

### Carroll to NAB Radio Board

Joe D. Carroll, KMYC Marysville, Calif., was elected to represent NAB District 15 (No. Calif., Nev., Hawaii) on the association's Radio Board. He won over W. K. Foster, KLX Oakland, Calif., in a mail election to fill a vacancy. Two directors to represent radio networks were appointed last week, NAB announced. They are Edward DeGray, ABC radio vice president, and Armand Hammer, MBS president-board chairman, representing their respective networks.

## PROGRAMMING NEEDS CITED AT CBA MEET

- Mickelson stresses news
- Harris urges improvements

A five-point program for overcoming broadcasting's lack of equality as a news medium was advanced by Sig Mickelson, vice president of CBS Inc. and general manager of CBS News, in a speech prepared for delivery Friday to the Connecticut Broadcasters Assn.'s annual convention.

CBA Friday also heard Rep. Oren Harris (D-Ark.) warn of pitfalls that programming irresponsibility can cause.

Mr. Mickelson told the group, meeting at Cheshire, Conn., that stations should put more emphasis on:

1. Improved news personnel ("many stations are doing a superb job . . . but I am afraid that there are still too many stations relying on ex-disc jockeys, former saxophone players or inexperienced recent college graduates to provide a quality news service.")

2. Original reporting ("A station or network simply cannot depend on rewrites of wire services . . . being on the scene day after day, hammering at the door, is more likely to succeed than a torrent of speeches, complaints or resolutions. And the listener or viewer gains the benefits of first-hand reporting.")

3. Quality performance ("If we don't have integrity, if we are not objective, if we don't have some sense of showmanship, at least to the extent of making facts interesting, then our job of purveying information is hopeless. If our staffs don't have these qualities, then we'd better recruit replacements.")

4. Sound financial footing ("It is almost impossible [for a network] to operate an international newsgathering agency on a break-even basis [but] stations are generally more favorably situated . . . and indeed the records show many substantial money makers among the better and larger news operations. It stands to reason that the news department of a broadcasting station which can operate on a break-even, or profit, basis is in a better position to serve the community.")

5. Greater respect for news operations among station management, and greater unity among broadcasters "when we are under attack." ("It seems to me one of the most damaging elements in our quest for prestige and equality is the low esteem in which broadcast journalists are held by some station operators . . . the press sets up a clamor when it is attacked. We have a tendency to sit back supinely until the storm blows itself out.")

Mr. Mickelson noted that NAB's Freedom of Information Committee "has fought vigorously against the American Bar Assn.'s Canon 35 and not without some success." But, he added, "I wish it would broaden its efforts to include a major campaign for equality of access to a far greater diversity of government agencies—national, state and local."

He said the Radio & Television News Directors Assn. "has also been effective on many fronts" but that RTNDA "has its weaknesses, too, stemming largely from the fact that it does not have nearly the support from management it needs and that its membership of some 400 is pitifully low when compared to the total number of broadcasting stations in the U.S."

What broadcasting needs is "an organization with the strength and prestige of the American Society of Newspaper Editors," he asserted, "but as of now we don't have it and prospects for the immediate future do not seem very bright."

Rep. Harris, chairman of the House Commerce Committee, described an "awful" dream Friday as he addressed the Connecticut Broadcasters Assn. in New Britain.

The dream, which he labeled "Nightmare 1960," stemmed from an editorial he had read in "a widely read" trade weekly, "Nightmare 1958", [EDITORIAL, April 28].

"It gave me pause," Chairman Harris said. "It made me think about the relationship between the Congress and the broadcasting industry, and what the future may hold if some of the trends which I believe can be observed today continue to run their course."

His nightmare, he said, is concerned "with the possibility that by 1960 economics in broadcasting may be seriously affected if—

*on their way*

*to Sesac Subscribers*

**SESAC  
TRANSCRIBED  
LIBRARY**

Series "N"

NOVELTIES

N-1900

**DICK JACOBS  
AND HIS ORCHESTRA**

*featuring*  
**BETTY MADIGAN**

**SESAC**

*"the best music in America"*

THE COLISEUM TOWER • 10 COLUMBUS CIRCLE • NEW YORK 19, N. Y.



**NOTICE TO EDITORS**—This advertisement currently appears in leading national magazines. For more than 30 years, Metropolitan Life has sponsored similar messages on national health and safety. Because of public interest in the subject matter of these advertisements, Metropolitan offers all news editors (including radio news editors), free use of the text of each advertisement in this series.

The text may be used in regular health features, health columns or health reports with or without credit to Metropolitan. The Company gladly makes this material available to editors as one phase of its public-service advertising in behalf of the nation's health and safety.

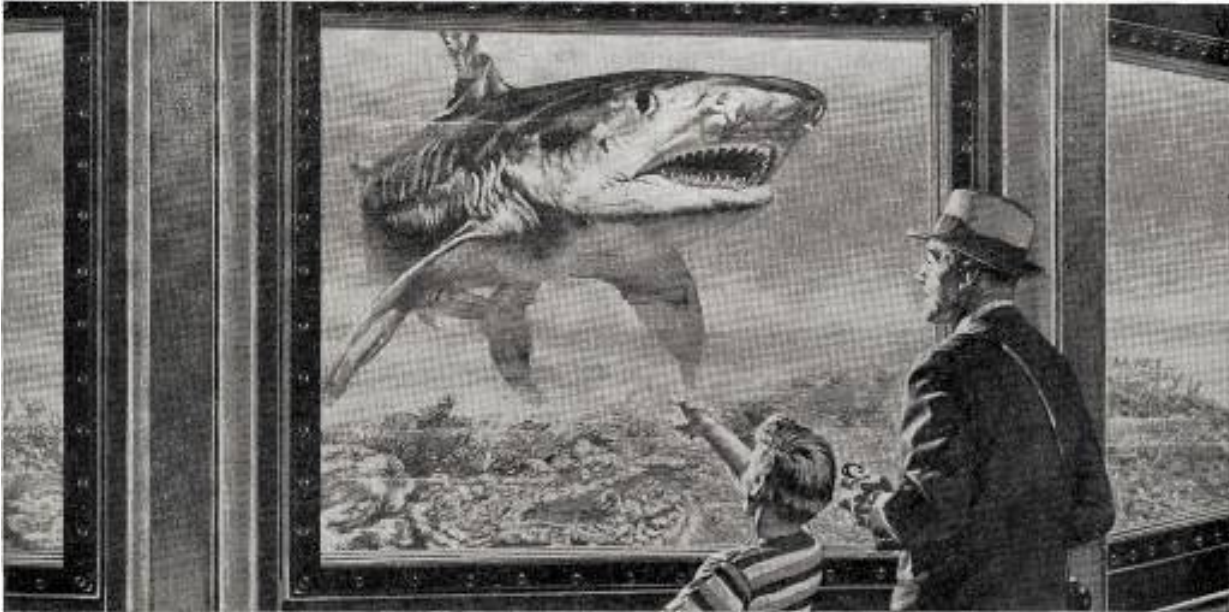

## The strange case of the shark's teeth

*... and some important facts about yours*

Had Mother Nature made the same provisions for our teeth as she did for the shark's, good dental health would be no problem.

For when a shark loses a tooth, a new one soon grows in its place. Once we lose a tooth, however, it is gone for good.

Yet, our second set of teeth is strong enough to last a lifetime . . . if we give them proper care. Unfortunately, too few of us do so.

In fact, the American Dental Association reports that only 40 percent of all Americans get reasonably adequate and regular dental care.

The rest get emergency care or none. Moreover, one out of seven adults has never been to a dentist.

There is more to be gained from regular dental care than simply keeping the teeth clean, bright and healthy. For when decay strikes, a center of infection is established from which germs may enter the blood stream and cause disease in other parts of the body.

Even the smallest break in the enamel can pave the way for infection inside a tooth. The dentist can usually detect such trouble by X-ray and check it before serious damage occurs. Healthy teeth . . . for children as well as adults . . . depend upon three things.

1. Diet—which should supply all the elements for good teeth, especially calcium and vitamins C and D.
2. Cleanliness—or proper brushing, which should be done after meals and always before retiring.
3. Check-ups—which should be made every six months or as often as your dentist recommends.

If you see your dentist regularly, he will get to know your individual dental requirements and how they can be met to your best advantage. If you cooperate with him, your chances will be far better to keep most of your teeth most of your life.

COPYRIGHT 1958—METROPOLITAN LIFE INSURANCE COMPANY

### Metropolitan Life Insurance Company

(A MUTUAL COMPANY)

1 MADISON AVENUE, NEW YORK 10, N. Y.



and that is a big if—there should be a considerable drop in the number of hours which the average American family spends in viewing television programs.”

Look at the auto industry, Chairman Harris suggested. “The year 1958 could very well go down in history as the year in which many people of this country began to tire of being offered by most automobile makers the same long, low, expensive, chrome-trimmed and expensive-to-operate car.”

That helped inspire his “Nightmare 1960.”

His dream went like this: “I am wondering how long it may take before some people discover that not unlike the car makers, most broadcasters are offering substantially the same fare on their stations.”

The chairman indicated he wasn't convinced that ratings are the exact answer to the public's preferences, noting the rising popularity of foreign cars, which he said are “different.”

“Do you, the broadcasters, stand ready to offer the public something ‘different?’” he asked, adding:

“Most broadcasters appear to be aiming at the maximum number of shows with the highest rating. The result may be that if many people decide that they want to see something else and if they are unable to find something else by turning the knob to another station, they may decide to turn the knob of their sets to the ‘off’ position, and they could decide to leave it in that position for prolonged periods of time.”

Chairman Harris told broadcasters, “The responsibility for proper programming under the Communications Act is yours.” He reminded that pending legislation before Congress would control price methods in the auto industry but said it could not tell factories how to build the type of attractive, safe and useful vehicle the public will buy.

“It is the same with broadcasting,” he explained. “The FCC may adopt regulations and Congress may pass laws designed to eliminate undesirable concentration of control by networks. However, the Commission and the Congress must leave to the individual broadcaster the problem of presenting to the public the kind of programs which appeal to the viewer.” He suggested editorializing as a means of making programming more diversified (see editorializing story, page 84).

### RAB Lays Out Its Tasks

Expansion of the “money-making bulletin” series, plans for a “promotion bible” of selling ideas and distribution of “advertiser information sheets” covering 12-15 fields has been announced by the Radio Advertising Bureau following the semi-annual meeting of its plans committee in New York. Second-half 1958 plans reported by RAB President Kevin B. Sweeney, Vice President-General Manager John F. Hardesty and Promotion Director Miles David also involve several new projects including “The News Era,” presentation on radio news program composition and audience; “Why Weekend Radio?” advertiser success stories in use of weekend radio, and “Your Future Is Sound,” presentation unveiled at the NAB convention which uses recorded sound to sell radio-style.

## RAB SCHEDULES REGIONAL MEETS

Radio Advertising Bureau last week announced details of seven regional management conferences scheduled by the organization for 1958. The series of two-day sessions for radio station owners and managers will be held throughout September.

The format of the conferences will be similar to the one employed in the past two years, according to Kevin Sweeney, RAB president. The four half-day sessions will cover “management areas that relate to selling more radio advertising,” and will include programming, promotion, managing the sales department and general management. Attendance again will be limited to a maximum of 60 stations per session, Mr. Sweeney said, with a \$25 per person registration fee.

The schedule for the conferences follows: Sept. 4-5, the Ponte Vedra Inn, Ponte Vedra Beach, Fla.; Sept. 8-9, Rickey's Studio Inn, Palo Alto, Calif.; Sept. 11-12, Hotel Moraine-on-the-Lake, Highland Park, Ill.; Sept. 15-16, The Greenbrier, White Sulphur Springs, W. Va.; Sept. 22-23, Western Hills Lodge, Sequoyah State Park, Okla.; Sept. 25-26, St. Clair Inn and Country Club, St. Clair, Mich., and Sept. 29-30, The Princeton Inn, Princeton, N. J.

Mr. Sweeney reported that an extra session has been added this year to accommodate additional stations. He said that six sessions last year had a turnout of more than 98%, with 355 station executives in attendance out of a possible 360.

### Income, Membership ‘Higher Than Ever’: RAB

Radio Advertising Bureau income rate and membership are “higher than ever,” Kevin B. Sweeney, RAB president, told the organization's semi-annual board meeting in New York last week. Present annual income rate, Mr. Sweeney said, is at \$913,000 and he estimated target income figures will bring the bureau's income to \$915,000 annually by June, \$930,000 by September and \$950,000 by January, 1959.

Mr. Sweeney also announced a new service to member stations which will aid them in putting on formal presentations to local advertisers. “Projection and sound equipment, slides, tapes and tailor-made taped commercials will be made available to stations on a below-retail-cost basis through this service,” he explained.

Among the major national and local presentations RAB has planned for the rest of 1958 are quarterly spot and network advertiser reports, started by the bureau at the end of 1958's first quarter; weekend and nighttime radio studies; radio-tv awareness tests; full-scale presentations designed to attract more drug store and supermarket advertisers to radio, and advertiser information sheets.

RAB regional management conferences will be held this year in seven areas, Mr. Sweeney said, adding that last year there were only six such conferences, but increased membership has warranted addition of a seventh. The national radio advertising clinic will be held in mid-November at the Waldorf-Astoria Hotel in New York, he announced.

Attending the board meeting were Hugh K. Boice Jr., WEMP Milwaukee; Kenyon Brown, KGLC Miami, Okla.; Richard D. Buckley, WNEW New York; Henry B. Clay, KWKH Shreveport, La.; Edward DeGray, ABC Radio, New York; Herbert Evans, Peoples Broadcasting Corp., Columbus, Ohio; Simon Goldman, WJTN Jamestown, N. Y.; Arthur Hull Hayes, CBS Radio, New York; John S. Hayes, Washington Post Broadcast Div., Washington; Frank M. Headley, H-R Representatives Inc., New York; Elroy McCaw, WINS New York; William B. McGrath, WHDH Boston;

Robert T. Mason, WMRN Marion; Weston C. Pullen Jr., Time Inc., New York; Don Searle, Farm & Home Radio, Grand Island, Neb.; Lester Smith, KJR Seattle; Ben Strouse, WWDC Washington; Donald W. Thornburgh, WCAU Philadelphia; Allen M. Woodall, WDAK Columbus, Ohio, and Adam J. Young Jr., Adam J. Young Inc., New York.

Not present at the meeting were Edward Breen, KVFD Fort Dodge, Iowa; Charles C. Caley, WMBD Peoria, Ill.; Matthew J. Culligan, NBC Radio, New York; Victor C. Diehm, WAZL Hazleton, Pa.; Frank P. Fogarty, WOW Omaha; Alex Keese, WFAA Dallas; Donald H. McGannon, Westinghouse Broadcasting Co., New York, and William E. Rine, Storer Broadcasting, Miami Beach.

### Illinois Assn. Covers Wages, ASCAP, Census

The Illinois Broadcasters Assn. last week went on record regarding set data in the 1960 census, ASCAP-industry music license negotiations and small market station exemptions from wage-hour law overtime provisions.

IBA members also heard discussions on national and local station rates, broadcast coverage of a murder trial, recruiting graduates for broadcast careers, Conelrad weather warning system techniques and plans for the 1959 industry-wide Voice of Democracy contest, plus talks on employer-employee relations. The spring meeting was held at the St. Nicholas Hotel in Springfield, May 19-20.

The state broadcasters' group adopted resolutions favoring (1) exemption of small market broadcasters from the overtime provisions of the wage-hour law; (2) exemption of radio station revenues derived from news-sports-special events shows not requiring use of licensed music before determining the basis for license fees payable to ASCAP, and (3) appropriation of funds by Congress to the Census Bureau for incorporating data on “the number of am and fm radio receivers and vhf and uhf television receivers in households on a county-by-county basis” in its 1960 census. The resolution pointed out that such information is “extremely

# New, all-new G-E color camera

IS SMALLER, LIGHTER—AND DEPICTS TRUER COLORS!



You are looking at a "break-through" in broadcast engineering —the first color television camera ever built with printed circuits and transistors replacing bulky wiring and tubes.

Result: a remarkable new camera that's smaller on the outside, yet gives more elbow room on the inside for easier maintenance—that's 75 pounds lighter, yet is more ruggedly built—that produces truer colors yet uses a simpler optical system and needs

only one small cable to do its work!

We are providing interested parties with complete data, price information, etc. on this new camera and its associated equipment. May we reserve a set for you? Call your Broadcast Equipment Sales Manager, or write General Electric Company, Section 558, Electronics Park, Syracuse, N. Y. In Canada, Broadcast Equipment Sales, 830 Lansdowne Ave., Toronto.

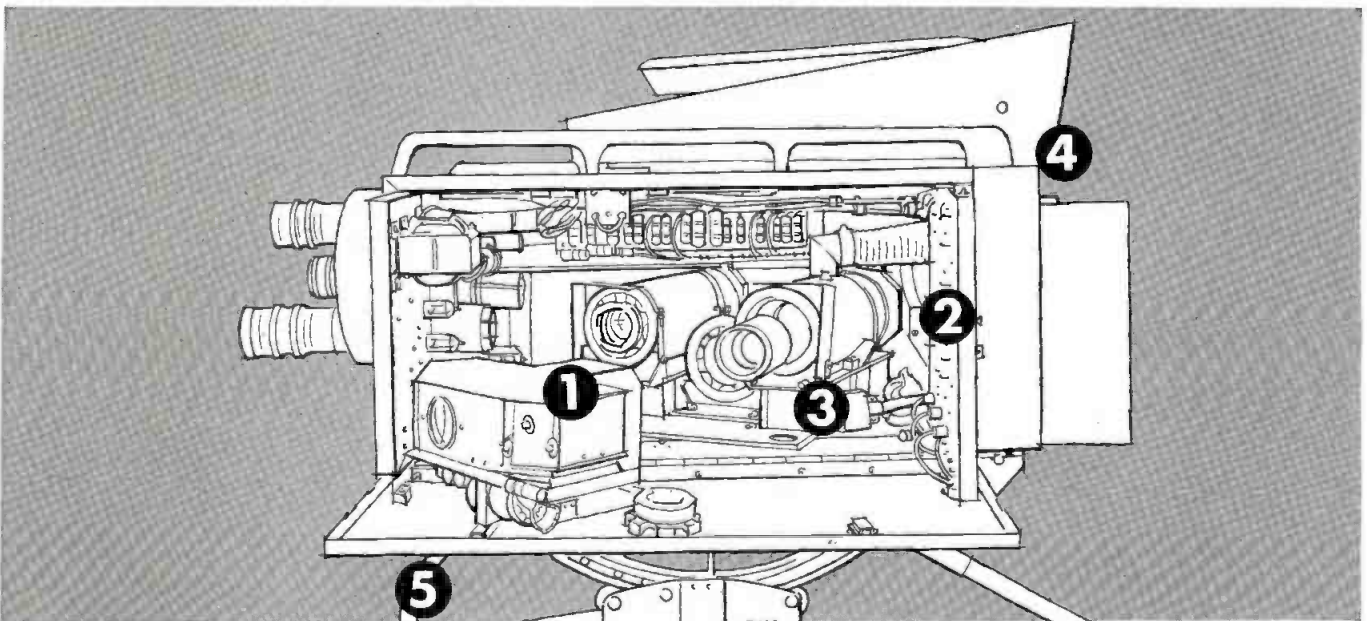

① New optical system reduces shading, eliminates astigmatism, spherical aberration, and ghosting. ② Printed circuits and transistors increase reliability, simplify and miniaturize video preamps, eliminate this source of microphonics. ③ Maintenance simplified by "lazy susan" mounting of optics and image orthicon. Chassis swings out, assemblies plug in. ④ Fast alignment with controls concentrated on the camera

and the ability to view difference signals on the 7" viewfinder. ⑤ Maneuverability. The single cable is 1-1/16" diameter; camera has 25% less weight, 33% less volume (34" x 18" x 22") than current cameras. ⑥ Sure, stable registration results from special design of deflection and other circuitry. ⑦ Competitively priced.

GENERAL  ELECTRIC

# KFSA-TV DOMINANT LEADER IN FORT SMITH ARKANSAS



**ARB**  
October-  
November,  
1957

Sign-On to Sign-Off—  
Sunday thru Saturday

**KFSA-TV .....53.9**

Station B .....37.1

All others .....14.4

**\* KFSA-TV leads in 9  
of the TOP 10 shows**

**\* KFSA-TV leads in 17  
of the TOP 20 shows**

For Choice Availabilities,  
Contact—

**NBC-ABC**



Represented Nationally by  
**Venard, Rintoul & McConnell, Inc.**

Regional Representative:  
**Clyde Melville Company, Dallas**

## TRADE ASSNS. CONTINUED

important to the broadcasting and electronic manufacturing industries."

Monday's opening session was devoted to talks by Lars C. Christensen, Springfield meteorologist, on the Conelrad weather warning system; by Carl Nicholson, chief of state radio division, on monitoring the police radio system for weather forecasts and emergencies, and by a panel on recruiting and training college personnel.

H. V. Cordier, radio-tv chief of the U. of Illinois' College of Journalism and Communications, and Buren C. Robbins, radio-tv department chairman and director of the Southern Illinois U. broadcasting service, urged broadcasters to assist them and other schools offering radio tv courses in recruiting and training individuals for jobs. At the suggestion of Mr. Cordier, Charles R. Cook, WJPF Herrin and IBA president, appointed a three-man committee to work with university personnel. It comprises George C. Biggar, WLBK DeKalb; William Holm, WLPO LaSalle and Vernon R. Nunn, WIZZ Streator, Ill.

Possibilities of employing a paid staff member in IBA were explored and a committee including Leslie C. Johnson, WHBF-AM-TV Rock Island; Vernon Nolte, WJBC Bloomington, and Merrill Lindsay, WSOY Decatur was appointed to study the proposal. Jim Firmin, WMOK Metropolis, reviewed his station's success in airing taped broadcasts of a murder trial, while Duane A. Branagan, director of the U. of Illinois' School of Music, discussed the possibility of IBA member stations carrying the university's taped music programs.

Other speakers Monday were Mr. Nolte, Illinois chairman for the Voice of Democracy contest; R. Karl Baker, WLDS Jacksonville and Thomas S. Land, WFIW Fairfield, on national and local rate structures, and Raymond J. Cheney, WMIX Mount Vernon. Daytime Broadcasters Assn. met Monday evening under DBA Chairman J. Ray Livesay, WLBH Mattoon.

Charles H. Tower, NAB employer-employee relations manager, said current practices under the Fair Labor Standards Act impose impractical burdens on operators of broadcast stations in small markets. He said legislation (HR 12095) introduced in Congress by Rep. Thomas G. Abernethy (D-Miss.) offers hope for relief. The bill would exempt from overtime provisions of the law any radio or tv employe of a station not located in a standard metropolitan area.

## WBA Attendance Record Set At Milwaukee Spring Meet

The Wisconsin Broadcasters Assn. held its annual spring meeting in Milwaukee last Tuesday and a record turnout of over 125 members attended the all-day session.

Talks by Merrill Lindsay, executive vice president of WSOY Decatur, Ill., and John Meagher, NAB vice president in charge of radio, were featured. Mr. Lindsay spoke on am radio and cited the strength of independent radio, reviewing some of his station's activities. Mr. Meagher discussed the current ASCAP-BMI music licensing situa-

tion. In addition, Milwaukee Mayor Frank Zeidler was a special guest.

A \$500 student scholarship was presented to Wayne E. Vander Putten, 21-year-old junior at St. Norberts College, West Depere, Wis., and a plaque for "meritorious service" to actor Pat O'Brien, a native of Wisconsin, for his "outstanding record" in radio and tv nationally. The presentations were made at a noon luncheon by Hugh K. Boice Jr., WBA president and vice president-general manager of WEMP Milwaukee. These were the first such awards made by WBA and will be an annual event.

Program arrangements were handled by Bruce Wallace, WTMJ-AM-TV Milwaukee; Mig Figi, WAUX Waukesha, WBA treasurer, and Mr. Boice.

## RESTORE GLAMOUR TO RADIO—BORDEN

- Atlantic ad chief faces PAB
- Waslewski cites music crisis

Radio is doing an effective job, along with tv, for Atlantic Refining Co., but radio stations could enlarge their influence and attract more advertising if they improved their promotion, according to Richard Borden, advertising manager of the oil company.

Addressing the Pennsylvania Assn. of Broadcasters meeting Thursday at Wernersville, Mr. Borden offered a series of promotion tips for radio stations. He contended they would help restore "some of radio's glamour" and "make it wanted by the local merchant."

"I am sure that a great deal of the success we have enjoyed in Pennsylvania can be attributed to the effectiveness of the broadcast media," Mr. Borden said. He added that Atlantic is using 125 radio and 42 tv stations on a regular basis in its sustained advertising effort in the company's 17-state eastern marketing area.

Atlantic's sports include the Phillies and Pirates baseball for the 23rd straight year in Pennsylvania, using both radio and tv; the Red Sox in New England, and the Yankees on radio throughout New York state. Other broadcasts include year-round weather in 33 tv markets and radio newscasts in 30 markets. Short spot campaigns include over 250 radio stations.

Atlantic's agency, N. W. Ayer & Son, and his media men may study a market and find that radio is clearly the most effective for the job, Mr. Borden said, but dealers may not want radio because "they're carried away by the aura of glamour that has grown around tv." He continued, "They think that anything on tv will do a better job for them. Again, I'm not deprecating tv but we know that there are a lot of things on tv that won't do the job that radio will do for many retail outlets, particularly with our customers on wheels."

The retail merchant, according to Mr. Borden, doesn't read the trade press "about the re-birth of radio." He conceded radio stations have done much effective promotion for short-range projects, such as building an audience for a time slot or boosting

a personality, but he argued "little is done for the medium as a whole."

Radio Advertising Bureau does "a fine national job," he believes, asking, "Isn't there a job to be done at the local level?" He said he never sees anything in newspapers or hears anything on the air about "the great comeback radio has made."

Here, Mr. Borden contended, is "a real opportunity" to sell the value of the medium, to get the interest of local merchants and to re-educate them to "the tremendous power of radio." Then the advertising buyers "will have the courage to buy it," he suggested, since "home office people must buy the programs that will get maximum support from our local retail outlets." He said Atlantic provides radio scripts and plans in its training courses for dealers.

Mr. Borden asked, "Are radio people acting confident and proud?"

"I know of some markets where radio station personnel have done a wonderful sales job on the community to a point where our dealers and sales people are fully convinced that it is the only medium for them," he said. "This has been accomplished by hard work, but also by the way the people at the station exude enthusiasm. They believe in radio and its contagiousness.

"We need your help on this if we are to allocate to radio the full share of advertising dollars this important medium deserves."

The PAB was told Thursday by Vincent T. Wasilewski, NAB government relations director, that the radio industry faces "most serious negotiations" this autumn in negotiating a new music license contract with ASCAP. Pointing out that the negotiations are the first since 1941 and will be handled by an all-industry committee outside NAB, he said the project deserves the support of the industry if it is to succeed. The committee was organized at an all-industry session during the NAB convention in Los Angeles.

Mr. Wasilewski discussed the problem of broadcaster property rights in connection with community tv antenna systems, predicting a court decision will eventually hold that delivering of copyrighted programs into private homes for a fee, without permission, is a copyright infringement.

The Pennsylvania group, meeting Wednesday-Friday at Wernersville, awarded plaques to three past presidents—Clair R. McCollough, Steinman Stations; Roy Thompson, former owner of WRTA Altoona, and George Coleman, formerly of WGBI Scranton.

Lawrence Webb, managing director of Station Representatives Assn., urged stations to supply accurate information about their national and regional spot business on a monthly or at least a reliable quarterly basis. He said newspapers and magazines have exact and continuing reports on how they are doing and where they are going whereas "we are flying blind."

Warren Boorum, member service director of Radio Advertising Bureau, said broadcasters must "sell ideas—advertising and promotion ideas that have worked for other retailers with sales problems similar to your prospect's."

Norman Cash, president of Television

## Sitting down in your home town

We travel constantly to meet with station owners by appointment or on a "drop by" chat, and we learn a lot from such visits.

We believe it is our responsibility to get first hand knowledge of a property and the market area. Mail order technique is not good enough.

You will find us heading your way in a hurry when you call us, and we will do our best to be helpful.

The next time you read about a shift in radio or television holdings which we negotiated, you can be sure it was started and completed on a personal contact basis between buyer and seller.

It is the only way of serving broadcasters on either side of a transaction—now or later.

### ALLEN KANDER AND COMPANY

*Negotiators for the Purchase and Sale  
of Radio and Television Stations*

|            |                      |                    |
|------------|----------------------|--------------------|
| WASHINGTON | 1625 Eye Street N.W. | NAtional 8-1990    |
| NEW YORK   | 60 East 42nd Street  | MUrray Hill 7-4242 |
| CHICAGO    | 35 East Wacker Drive | RAndolph 6-6760    |
| DENVER     | 1700 Broadway        | AComa 2-3623       |

Bureau of Advertising, spoke on "Television, the Hard-Sell Medium." He narrated an outstanding tv success story—the rise of Lestoil through video promotion.

Laurence Roslow, associate director of The Pulse Inc., outlined qualitative studies made by the service "to get at the factors that are important in determining the radio audience in general and the specific station audience in particular."

## RADIO-TV PITCH RETAIL MERCHANTS

- **Cash: Make use of discounts**
- **Sweeney: RAB offers financing**

Both radio and tv, as well as print media, got in their licks at a retailers' meeting in Chicago last week, with store executives on the receiving end.

The occasion was the sales promotion convention of the National Retail Merchants Assn. at the Palmer House Monday through Wednesday. Key speakers included Kevin Sweeney, president of Radio Advertising Bureau, and Norman E. Cash, president of Television Bureau of Advertising.

Department and specialty store retailers were told that:

- They should " earmark at least 15% of your media budget for television—as a starter" and that "there is no recession in tv."

- RAB is prepared to help finance any store in a one-year radio campaign (putting

up \$2 for every dollar allocated by the store, up to \$64,000) to prove radio's effectiveness in moving merchandise.

- Retailers should not "pull in their promotional horns" because of recession fears.

- "There is more than enough room in this country for any advertising medium that serves the people."

Mr. Cash, discussing costs, suggested retailers check their local tv stations for discount arrangements covering multiple time usage. Retailers should take a leaf from national advertisers, now spending over \$1 billion annually in the visual medium, and get into tv, Mr. Cash urged. A store gets top billing in television, without "distracting influences from competitive advertising," and reaches out into areas "with greater depth than local newspapers," he claimed. Mr. Cash showed filmed examples of retailers effectively using the medium.

Over and above a minimum 15% outlay for tv, Mr. Cash suggested, department stores should allot more funds to reach a specific audience. He noted retailers have a "large potential in the co-op field," in which all media allowances run about \$2 billion annually, and tv's share is increasing steadily. He suggested stores consider services (filmed commercials, etc.) provided by manufacturers in this field and check TvB's co-op department for assistance.

Mr. Sweeney chided retail department stores for "shortchanging themselves by their concentration on one-media promo-

tion and by their refusal to scientifically analyze advertising media in relation to their problems." He noted that while radio devoted a good deal of time to department stores from 1953 to 1956, "today radio is nowhere near as interested in department store dollars as we were three years ago." Discussing radio's advantages, Mr. Sweeney stressed that "no combination of the daily newspapers in any city can reach as many as 80% of the families in the city and the retail trading zones" and that stores are not effectively reaching the suburban market.

"Stores are not using even the minimum amount of radio and television that they should, largely because the stores' responsible advertising executive is not doing what he should to push the use of these media," Mr. Sweeney also charged. He suggested stores need at least three fulltime experienced personnel to go into either radio or tv on a basis "which will materially increase your total advertising effectiveness."

Under its new financing project, Mr. Sweeney explained, RAB proposes to invest up to \$64,000 in radio advertising time for a store doing \$30 million or more worth of business over a 52-week period. RAB would select the stations, write the copy, help select the items and have access to advertising results for later publication. "Radio will not revolutionize your store," Mr. Sweeney said. "But radio is an essential part of department store advertising and we are prepared to prove it by putting our money where our mouth is."

As one problem, Mr. Sweeney observed that few advertising agencies are geared to handle department store radio properly. The only way stores can use the medium successfully, he remarked, is to "have people equipped to do the job or to pay an advertising agency a fee over and above its 15%—if you're lucky enough to find an agency that knows enough about retailing to be able to distinguish between a markdown and a mark-on."

Appearing on a media panel with Messrs. Cash and Sweeney Monday morning, Charles T. Lipscomb Jr., president of the American Newspaper Publishers Assn.'s bureau of advertising, called on retailers to take a more "positive, aggressive, creative approach to sales promotion," particularly newspaper advertising. Retailers still rely primarily on newspapers as their basic advertising medium, with local advertisers spending over six times as much as in radio and eight times as much as in tv during 1957, he said.

Robert E. Kenyon Jr., president of Magazine Publishers Assn., said that "far from fading as an influence," the magazine industry has enjoyed its greatest growth during tv's rise and radio's comeback over the past 10 years. Circulation has risen, he said, from 135.6 million to 181.4 million and advertising revenue from \$440.1 million to \$741.4—a 68.5% gain.

Other speakers during the three-day convention included E. R. Richter, vice president and supervisor of retail products, Grey Adv. Agency, N. Y., and Sylvan Freund, president, National Assn. of Display Industries.

*In Upstate New York*

## WSYR-TV Delivers Two Separate Markets For the Cost of One!

By itself, WSYR-TV delivers 70,000 more homes than its major competitor—making it far and away the best buy in a \$2½ billion market.

In addition to that . . . when you buy WSYR-TV, you also get its power-packed satellite, WSYE-TV, delivering big plus coverage of the Elmira-Corning area. You get a complete additional market at no additional cost!

. . . and, incidentally, if ratings fascinate you, read the current ARB report for Syracuse, showing WSYR-TV's clear margin of superiority from sign-on to sign-off.

Get the Full Story from HARRINGTON, RIGHTER & PARSONS

# WSYR • TV



Channel 3 • SYRACUSE, N. Y. • 100 KW

Plus WSYE-TV channel 18 ELMIRA, N. Y.

# SRA NETWORK ADJACENCIES PLAN SUBMITTED AT BARROW HEARING

- Provides for non-network programs next to option time
- Divorce of CBS, NBC from spot representation discussed

A brand-new plan to give non-network sales and program people access to network program adjacencies in prime evening television time while retaining intact the networks' option time practices was the feature of testimony last week before the FCC on the Barrow Report.

The plan, presented by Station Representatives Assn., came as the FCC wound up broadcast industry testimony with hearings all day Monday and Tuesday and on Thursday morning. Tentative plans for the next phase, before the FCC takes up consideration of the controversial document, are to bring back its author, U. of Cincinnati Law School Dean Roscoe L. Barrow, and perhaps Dr. Jesse Markham, Princeton U. economics professor who was a member of the Barrow staff, for testimony sometime next month.

Testimony last week was principally on the Barrow Report's recommendation that CBS and NBC should be divorced from national spot sales representation of affiliates not owned by the networks. Considerable testimony was given on network option time practices by six independent national spot representatives in tv—five testifying under the aegis of SRA and one, Edward Petry & Co., on its own viewpoints.

Defending network representation of affiliates in national spot sales were Jay W. Wright, KSL-TV Salt Lake City, and Glenn Marshall Jr., WMBR-TV Jacksonville, Fla., who are represented by CBS Spot Sales, and Nathan Lord, WAVE-TV Louisville, by NBC Spot Sales.

SRA member witnesses who opposed network spot sales representation were Lloyd Griffin, Peters, Griffin, Woodward; Lewis H. Avery, Avery-Knodel; Frank Headley, H-R Television; Eugene Katz, The Katz Agency, and John Blair, Blair Tv and Blair Tv Assoc. Mr. Katz offered SRA's new "Station Reserved Time" plan, which would earmark for non-network use an hour of time adjacent to network programs in option time during each of the four seg-

ments of the tv broadcast day. This time would be effective in markets of three or more tv outlets where the stations have the normal three-hour option time contracts. The reserved hour would be reduced in the case of fewer option hours or fewer stations in a market. The plan was a modification of one proposed by 10 SRA members two years ago in replies to a Barrow staff query.

Edward E. Voynow, Edward Petry & Co., testified in behalf of that representative firm, defending network option time but opposing national spot representation by the networks.

John W. English, WSEE (TV) Erie, Pa., and WNAO-TV Raleigh, N. C. (both uhf), and chairman of the Committee for Competitive Tv, representing a group of uhf stations, called for FCC authorization of a five-year network affiliation period, and William L. Putnam, WWLP (TV) Springfield, Mass., and WRLP (TV) Greenfield, Mass. (both uhf), also representing CCTV, urged the FCC to do something about allocations to make tv stations competitive in each market.

Five tv outlets—WCSH-TV Portland, Me., WFLA-TV Tampa, Fla., KVAR (TV) Phoenix-Mesa, Ariz., WLAC-TV Nashville, and KFDM-TV Beaumont, Tex.—defended network option time and must-buys and opposed the Barrow recommendation for reinstatement of the former FCC "Avco Plan" on station transfers.

Presiding was FCC Chairman John C. Doerfer, with Comrs. Rosel H. Hyde, Robert T. Bartley, Robert E. Lee, T. A. M. Craven and Frederick W. Ford. Questioning were Robert Rawson, chief of the Broadcast Bureau's hearing division, and Herbert Schulkind, assistant chief of the rules and standards division.

Stations supporting the network spot sales arms saw benefits in the small number of outlets each network represents and in the general similarity in their network program structure for spot sales purposes,

while SRA witnesses took the view that there is "no magic number" for optimum representation by one firm and that station program situations vary in desirability in different markets because of different ratings and other factors.

All the SRA members castigated the practice of film bartering, saying that it not only is a "reprehensible" practice akin to time brokerage, but that it affects a licensee's public interest responsibilities by requiring him to accept commercials he may not want and depriving him of dollar income to improve his programming. Mr. Headley called attention to his remarks against film bartering in a debate with Erwin H. Ezzes of C & C Tv Corp. last January [ADVERTISERS & AGENCIES, Jan. 27].

Last week's testimony:

Mr. Wright charged the Barrow Report's conclusion that networks should be prohibited from spot sales representation is based on "inferences and presumptions" rather than facts. The eight tv affiliates represented by CBS Tv Spot Sales and the seven represented by NBC Spot Sales account for only 3% of total tv stations and only 4.1% and 3.6% of the affiliates of the respective networks, he said.

The eight CBS affiliates represent only 5% of the nation's national spot revenue, Mr. Wright said. They are not concentrated in the largest markets and seven are in markets of at least two tv stations.

He said CBS Tv Spot Sales activities do not place independent representatives at a disadvantage, as claimed in the Barrow Report, because independent reps represent 95.9% of all the network's affiliates and because CBS has a policy of not expanding its station list.

The eight stations, he said, think CBS Spot Sales does a better sales job than any other rep because of its separation of radio and tv spot sales, its high type personnel, the small number of stations represented compared to many independent reps, excellent liaison between station and rep, leadership in research, effective sales promotion, sales development and sales service.

Mr. Wright didn't feel any of the affiliates' relationships with CBS Tv Spot Sales had affected their stability of affiliation with the network and he did not believe the network had ever attempted to influ-



MR. VOYNOW



MR. WRIGHT



MR. MARSHALL



MR. PUTNAM



MR. ENGLISH



MR. LORD

ence the choice of a national rep by any of the eight.

Mr. Wright held strongly to his opinion that CBS Spot Sales and CBS-TV Network are entirely different organizations competitively, though commonly owned, and at one point caused the usually mild-mannered Mr. Schulkind to snap back, "Let's not quibble over semantics!"

Mr. Marshall disputed the Barrow Report's conclusion that representation of CBS-TV affiliates by CBS Spot Sales re-strains competition between national spot business and the network business.

Answering the report's charges that CBS Spot Sales and CBS-TV Network exchanged information on rates and that CBS waged a "campaign to equalize national spot and network rates," Mr. Wright said the CBS policy is that the two entities shall not cooperate and that the network shall not discuss with the affiliate the latter's spot rate. He submitted tables to show that the spot rates for the eight affiliates are higher in 75% of the time periods weekly and are identical in only 5% of the periods. Another table showed a "greater similarity" between the two rates of affiliates represented by independent reps.

Mr. Marshall said the Barrow Report's finding that CBS Spot Sales and the CBS Network compete at the "operating or working level" is enough to disprove its "presumption" that competition is modified at the "policy" level.

Mr. Lord said WAVE-AM-TV once were represented by Free & Peters (now Peters, Griffin, Woodward), but became concerned as the rep kept adding more station clients, feeling WAVE-AM-TV were not getting "their share" of the national spot business and that the Louisville stations "were lost in the large number of stations represented by this company."

After conducting its own investigation, Mr. Lord said, his company quit PGW and negotiated a contract with NBC Spot Sales on its own initiative [at this time, in 1953, PGW represented 10 tv stations and NBC Spot Sales 11, including owned stations]. He said his company believes it would suffer financial reverses if compelled to disassociate from NBC Spot Sales.

Mr. Lord felt NBC Spot Sales offers "a homogeneous NBC service rather than varied services"—that the salesman is under no compulsion to state that NBC is better in Market A, CBS in Market B, ABC in Market C, etc., based on ratings or other information. The Louisville stations also prefer NBC Spot Sales because the stations it represents all are in major markets and because it employs more people per station "than any other representative organization that we studied."

The Louisville stations executive told commissioners flatly that "we'll quit" if NBC Spot Sales adds stations to its list which are not NBC-TV affiliates, and that he'd like to see NBC Spot Sales add three or four more stations in the top 50 markets, but if it goes beyond that, "we'll quit."

He said he once tried to persuade a group of NBC-TV affiliates and regional NBC

Radio affiliates in top southern and mid-western markets to form their own national representation organization, but he "couldn't get it off the ground." "I'd still like to," he added.

Mr. Griffin led off the SRA presentation by describing the role of the national representative in tv broadcasting. Denying that the SRA testimony is "anti-network," he described the rep association's position as "pro-national spot advertising."

He described the evolution of national apparatus of national representation, its functions, advantages of spot broadcasting and spot advertising's importance to station programming.

During questioning, he said the ideal is for a station's national spot rate to be slightly less than the network rate for that station.

He knew of no present scarcity of good film and thought some of the present supply is comparable to network program quality. He felt a rep firm prefers a network affiliated station as a client because network programs attract larger audiences.

Mr. Avery summed up "the position of the networks in television" in preparation for Mr. Katz' later testimony on SRA-supported recommendations on network option time.

Networks in 1956, through their owned stations, through sale of network time and sales for 15 owned tv stations and 16 tv affiliates represented that year and through incidental broadcast revenues, were responsible for 62% of all tv revenue, according to FCC records, Mr. Avery said.

They control 18 tv station licenses (soon 19), with CBS owned stations able to reach 30.3% of the 41.4 million tv homes, NBC 30.2% and ABC 29.1%, he said. CBS, with its owned stations and the eight affiliate stations represented by CBS Spot Sales, can reach 37.5% of tv homes for a national spot campaign. NBC, with owned stations and seven represented affiliates, can reach 37.4%.

Network programs on 299 stations in over 100 markets (including a "small proportion" of ABC programs) occupy 78.2% of evening option time and 35.5% of evening (6-11 p.m.) non-option time, Mr. Avery continued, with option time reaching 96.4% of prime time in the top five markets and 90% in the top 50.

Mr. Headley said SRA feels national spot representation by a network is not in the public interest. He said it is "difficult" to see why CBS and NBC, which "so thoroughly dominate" network tv gross billings, should be allowed to participate in national spot—"the only facet of the business which is competitive with network television."

A conflict of interest is involved in the formulation of network rates and spot rates if a station is represented by CBS or NBC Spot Sales, he said, and "the dominant interest of CBS and NBC is network revenue."

He felt the Barrow Report's description of a "campaign" by a network to equalize spot and network rates was "no more than an incident," but that it clearly indicates the conflict which SRA feels should make separation of networks from national spot sales mandatory.

Mr. Headley estimated 65% to 75% of a station's income comes to it if it is both affiliated with and represented by the network and that this cannot fail to influence the affiliate to subordinate other considerations to his network relationship.

Mr. Katz presented SRA's "Station Reserved Time" plan to provide a period or periods of station time, exclusively for non-network programs, adjacent to programs in network option time.

This proposal (SRA would retain the FCC's division of the tv broadcast day into four segments: 8 a.m.-1 p.m., 1-6 p.m., 6-11 p.m. and 11 p.m.-8 a.m.) would operate as follows:

In markets of three tv stations or more, in each segment of the broadcast day, one hour on each station would be designated as "station reserved time" to follow the regular three-hour network option time period. During this one-hour reserved period no program of any network could be broadcast.

If placement of network option hours in the time segment forced all the one-hour station reserved time period over into another segment, then the reserved time period would precede the option time period in the same segment. The station reserved time period would be split to fall both before and after option time if the network option time period left, for instance, only a half-hour following the option time period for a particular broadcast segment; for example, if network option time occupied the 7:30-10:30



TESTIMONY in behalf of Station Representatives Assn. at FCC's hearings last week on the Barrow Report were (l to r) John Blair, Blair Tv and Blair Tv Assoc.; Lloyd Griffin, Peters, Griffin, Woodward; Eugene Katz, The Katz Agency; Frank Headley, H-R Television, and Lewis H. Avery, Avery-Knodel.



# Success Stories

One of a series of salutes to successful TV stations across the nation... and to the Northwest School graduates who have contributed to their success.

## KEPR

**Radio and TV**

Pasco, Washington



MONTE L. STROHL, General Manager

KEPR was the first satellite TV station authorized by the FCC and the first in operation in the country—"orbiting" on December 28, 1954. Within a year, KEPR had its own studios and its own satellites, KLEW in Lewiston, Idaho—another nationwide "first". In 1957 still another

satellite, KBAS in Ephrata, Washington, was added. Now broadcasting on 153 kilowatts, KEPR operates with a staff of 25 and two full camera chains plus two additional cameras for remote facilities, covering the rich Southern "Inland Empire" market.



Dick Gassaway was one of the first Northwest graduates hired by KEPR, joining the station a year and a half ago as an announcing assistant. He is now Sales Manager for the city of Kennewick.



Rudy Vsetecka is KEPR's Floor Manager for Studio Operations. Just 15 months ago this Northwest grad joined the station as production assistant.



Dale Hall is KEPR's newest Northwest employee. Hired 4 months ago as studio assistant, Dale is now in charge of the Prop Department and an KEPR's announcing staff.

**Here is what Monte Strohl says about his experience with Northwest School graduates:**

"We are certainly more than pleased with the Northwest graduates that have been in our employ, and have found them all to have a sound understanding of our business. I would not hesitate to recommend your students or to hire more graduates."

*For further information on Northwest training and graduates available in your area, write, phone or wire*

## NORTHWEST SCHOOLS

1221 N. W. 21ST AVENUE, PORTLAND 9, OREGON

Phone CApitol 3-7246

737 N. Michigan Avenue, Chicago • 1440 N. Highland, Hollywood

p.m. period, then station reserved time would be 7-7:30 and 10:30-11 p.m.

If the network option time were only two hours, station reserved time would be reduced to 45 minutes, and if less than two hours, such reserved time would be only 30 minutes.

In two-station markets the one-hour period of station reserved time would be reduced to 45 minutes, the 45-minute period to 30 minutes and the 30-minute period to 15 minutes. In one-station markets there would be no provision for station reserved time.

Station reserved time would apply to only six days of the week and operation of such requirements could not prevent "completion of a special event, or special sports spectacle, etc., which might run into 'station reserved time'."

Mr. Katz said the SRA proposal represents a modification of the position taken by 13 SRA members who, answering a questionnaire in 1956, charged that option time is "harmful" to them as non-network sellers of time, and the position of 10 of the 13 that network option time should be kept at three hours for each segment of the broadcast day, but that consecutive network programming should be limited to 1½ hours per segment and that one half-hour of each two hours of network option time should be set aside for non-network programming.

The Katz Agency head said SRA now opposes elimination of option time because it has had time to study the problems involved over the two years since the 1956 Barrow staff questionnaire. SRA "agrees" that networks "need" option time and feels that healthy networks with stronger programming increase the value of the time representatives sell.

SRA believes, Mr. Katz said, that its plan would remove the threat of network exemption from a significant number of time periods and thus allow local elements to develop programs without fear their investment "will be wiped out" by exercise of a network option.

He said SRA "perceives" a "tacit argument" by networks that nothing should be done about option time because a present softness in network tv has left plenty of time available. But it is such periods of recession when the present effect of option time brings the most adverse results, he said, for although a network may be unable to supply enough commercial programming to the station, option time prevents other organizations from "stepping into the breach."

He acknowledged that the SRA station reserved time plan "can undoubtedly be improved" by constructive criticism and comments and asked the FCC to invite such comments from within the broadcast industry.

During questioning by Mr. Rawson, Mr. Katz said stations accept many network programs in non-option time because they feel they should cooperate with the network and thus may move non-network programs "reluctantly." He said he "knows," but could cite no instances, that networks sometimes

return optioned periods to the station in exchange for non-option time.

He did not question the fact station representatives' business has expanded the past few years despite option time, but said the reps would have sold even more time had they had "free access" to station time.

Questioned on whether the SRA station reserved time plan might not, in effect, be a form of option time itself by restricting the reserved time periods from use by all other sources except the one to whom such a period is under contract, including all the networks, Mr. Katz said that in a three-station market the plan would provide a total of 36 half-hours weekly in each broadcast segment for the various non-network program sources. He felt this is a substantial amount and would furnish time periods to many programs sources, while leaving plenty of time for networks.

Mr. Katz warned against complete elimination of option time. The result of such an action, he said might be more network programming than ever on many affiliate stations because the burden of bargaining for every program would fall on the affiliate and many affiliates would not be able to counter the network bargaining position effectively.

Mr. Blair presented SRA's catch-all views on all Barrow Report recommendations except those on option time and network spot sales representation. SRA opposed most of the recommendations, but felt that if Secs. 3.658 (a) and (b) of FCC Rules and Regulations have been violated, as intimated in Recommendations 5 and 13, then appropriate action is recommended.

On Recommendation 7 to retain the two-year affiliation period, SRA felt a longer period would be desirable but thought the present rule has worked out well in practice. SRA supported Recommendation 10 which would retain the right of affiliates for first call on network programs.

On Recommendations 15-19 involving rates, SRA felt networks can be restrained from influencing both network and spot rates through enforcement of present rules rather than adoption of a requirement for publication of rate-making procedures.

Mr. Blair said SRA's viewpoint on must-buy is that while this practice is advantageous to the network, the minimum buy rule contemplated should prove no obstacle to successful networking. He said SRA is in favor of any step to make line facilities available to stations on as reasonable a basis as possible (Recommendations 25-26).

SRA opposed all other recommendations.

Mr. Voynow presented the Petry firm's endorsement of network option time and its opposition to network spot sales representation of non-network owned stations.

The Petry executive vice president, appearing for Mr. Petry who is recovering from surgery and was unable to testify, said, "To cripple the networks and the stations through a further restriction of network option time would do a disservice to every person in the country now enjoying the wonders of television."

Option time, he said, provides order and

supplies efficiency to a station's schedule.

Mr. Voynow supported earlier network testimony that abolishment of option time would result in "gradual erosion" of the network schedule through "checkerboarding" of clearances all over the country.

He felt that if a network were to lose a time period it could never be recaptured without option time because the national spot sales contracts filling such a period terminate on different dates, on different stations and in different cities.

Mr. Voynow indicated he didn't believe networks have influenced their spot sales organizations in setting national spot rates of stations, but felt they have cooperated in other ways.

His explanation of this was not entirely clear, but his point seemed to be that a network's ownership of stations in the larger markets makes this group attractive to an affiliate station which would like to be included in such an elite list for spot sales representation. He agreed also that a network might be able to gain an advantage over an independent representative in a "four-station" market by using its power to affiliate or disaffiliate with a station.

The Petry official didn't feel the small number of stations represented by CBS and NBC should be considered in gauging the extent of their operation. He cited 1957 estimates showing that combined hourly rates and percentage of U. S. tv homes covered by the CBS and NBC owned and represented lists of stations each exceeded Petry's, although they included less than half as many stations as Petry's list of 30.

Mr. Voynow thought there is now and will be a sizable supply of "good" syndicated film next fall. He acknowledged that network "straddle" programs have the "effect" of extending option hours. He didn't feel Petry is "hindered" by having a large number of station clients and felt the variance of ratings from one market to another are a consideration in spot sales.

He was quite skeptical of statements by Messrs. Wright and Lord on the respective sizes of the CBS and NBC spot sales staffs. He felt the two firms concentrate most of their salesmen on sale of the major market stations to the detriment of stations which they represent in smaller-sized cities.

Referring to the difference between the spot rates of CBS-represented stations (96.4% of network rate) and those of NBC (84.7% of network rates), Mr. Voynow told the FCC that either "CBS told the stations their true worth or NBC was not too generous."

The Petry executive said the company had informed its network-affiliated clients of its position on option time and they endorsed this stand.

He said it is up to the FCC to "protect" independent reps from network spot sales competition because "you gave them [networks] stations in superior markets."

Mr. English asked the FCC to authorize extension of affiliation contracts from the present two years to five, saying the present two-year limitation has worked out in most instances to benefit of networks only.

He said uncertainty of continued network

affiliation has "certainly been a factor aggravating the uhf problem"; that a five-year contract would not solve that problem, but would be helpful in many instances in enabling stations to establish themselves and "to face and plan the expenditure of large sums of money necessary in any sort of a mixed market to establish a uhf facility."

Mr. English said he sent questionnaires to 50 uhf stations which have gone off the air and received 13 replies, which he thought a good average for such inactive firms. Of the 13 which replied, 7 said network affiliation problems contributed to their demise. WNAO-TV (ch. 28) recently went off the air.

Mr. Putnam indicted the present allocations system and the lack of three competitive tv stations in each market for uhf troubles. He thought the Barrow Report's conclusions are sound but they are not the answer to "more or better television service."

Mr. Putnam said the FCC's allocations have not been as effective in practice as they "looked on paper" and that an improvement in this area will render moot the "whole matter of network relations."

The problem of making changes in network operations is small compared with the far greater problem of allocations, which, Mr. Putnam said, "this Commission knowingly perpetuates day after day."

Mr. Putnam revealed that WWLP, WRLP and the company's translator stations in Claremont, N. H., and White River, Vt., have a combined rate of \$700 and that the company is making a profit and employs 76 people.

The joint statement by WCSH-TV, WFLA-TV, KVAR (TV), WLAC-TV and KFDM-TV defended network option time and must-buys and opposed Barrow recommendations on publication of affiliation contracts and on re-instatement of the Avco Rule governing station sales.

The statement said option time is lawful and essential to networking and its abolishment would have a serious impact on live programming. It added that the Barrow Report suggests no substitute to assure live programming.

It favored the must-buy practice and said the practice is to be preferred to a "minimum-buy" practice because the latter would give each advertiser the power to determine the composition of the network for his show.

The statement said rate and compensation negotiations with networks are legitimate secrets and should not be disclosed by the FCC to competitors.

The stations said FCC experience with the Avco Rule has demonstrated it is a "thoroughly mischievous doctrine leading only to delays and confusion" and opposed the Barrow recommendation to reinstate it.

## FCC Accuses Crosley Of Intimidating NBC

The FCC last week told multiple-owner Crosley Broadcasting Corp. it believes the Crosley tv stations in Ohio have violated Sec. 3.658 (b) of Commission Rules & Regulations in an "understanding" with NBC-



# There are 1,452,800 people in our 274,101 TV homes\*

A man's living room is the best place in the world to make friends for your company and customers for your products. The families you meet in the Jackson, Mississippi, market have an average of \$5,735<sup>00</sup> to buy what they want. Why not make them want what you have? They're in a tremendous period of economic growth, with spendable income up 40% since 1950 and retail sales up 125% since 1947! Get your foot in the door now! Need more sell? Call Hollingbery or Katz for a fact file.

\*Television Magazine \*\*Sales Management 1957 Survey of Buying Power

**MISSISSIPPI IS SOLD ON TELEVISION**

**WLBT**

CHANNEL **3**  
HOLLINGBERY

**WJTV**

CHANNEL **12**  
KATZ

**JACKSON, MISSISSIPPI**

TV, but is taking no action on the matter "at the present time."

But, added the FCC in a letter to Crosley, 'the correspondence and material concerning said violation are being associated with the Commission's files for the Crosley stations for such further consideration as your future operations may warrant.'

Sec. 3.658 (b) prohibits a tv licensee from making an agreement with a network which would prevent another station in the same or a different community from carrying a program of the network. (The section does not prohibit affiliates from using their "first call" rights, however.)

Crosley tv stations are WLWT (TV) Cincinnati, WLWD (TV) Dayton and WLWC (TV) Columbus, all Ohio; WLWA (TV) Atlanta and WLWI (TV) Indianapolis.

The alleged Crosley violation was cited in the Barrow Report but the principals were not identified.

The FCC noted last week that it wrote Crosley April 23 charging Crosley threatened NBC with canceling a number of NBC-TV programs on its stations if NBC placed programs on other stations. The FCC did not identify the Crosley station nor the other stations involved.

This, the FCC charged, "deterred NBC from placing its programs on other stations and therefore resulted in an understanding between Crosley and NBC which prevented or hindered the presentations of NBC's programs not taken by Crosley stations."

The FCC cited Crosley's reply May 6 to the Commission in which the multiple owner said that "... in our opinion we have at all times complied with the provisions of the Commission's Network Rules." Crosley noted it had made a statement of policy to the FCC Feb. 25, but that it was adding its "formal assurance" that it would not engage in violation of Sec. 3.658 (b) and that the firm further assured the FCC it would "see to it that personnel charged with the handling of such matters are so informed."

The FCC noted that the Crosley letter was signed by John T. Murphy, Crosley vice president for television, "who was the individual mentioned in the Commission's letters concerning this matter."

**FCC Grants Texas Tech. Ch. 5, Chooses Onondaga Tv Applicant**

The FCC last week finalized a supplemental initial decision granting Texas Technological College tv ch. 5 at Lubbock, Tex.

At the same time a majority of the Commission directed preparation of a document looking toward granting applications by Television Corp. of Michigan Inc. and the State Board of Agriculture for new tv stations to operate ch. 10 on a share-time basis in Onondaga, Mich. This grant would be subject to the condition that the State Board of Agriculture would surrender its permit for ch. 60 WKAR-TV East Lansing, Mich., and the denial of competing applications of Triad Television Corp., Booth Broadcasting Co., and Jackson Broadcasting & Television Corp., seeking the same channel in Parma, Mich. An initial decision in the spring of last year had looked toward this action.

**SPRINGFIELD TV GRANT PROBED**

- Harris subcommittee hears charges on vhf grant
- Top GOP names mentioned as exerting influence

Rep. Oren Harris (D-Ark.)—through staff attorney Stephen J. Angland—Thursday revealed the first of several cases in which his Legislative Oversight Subcommittee charges the FCC made comparative tv grants on the basis of exparte contacts rather than established criteria [LEAD STORY, May 19].

The case in question was the June 1956 grant of ch. 2 Springfield, Ill., to WMAY.

Top Republican names were high on the list of those charged with working behind the scenes on behalf of WMAY, which was competing for the channel with Sangamon Valley Tv Corp. (40% owned by WTAX Springfield). Among the charges:

- Comr. Robert E. Lee changed his vote on the day instructions were given to the staff after learning that he had voted for "a bunch of New Dealers."
- Orville Hodge, former Illinois auditor now serving a prison term for embezzling state funds, was responsible for swinging the grant to WMAY.
- Leonard Hall, then chairman of the National Republican Committee, at the urging of Mr. Hodge, was active in working for WMAY.
- Reps. Leslie C. Arends and Sid Simpson, both Republicans of Illinois, also were brought into the case on behalf of WMAY by Mr. Hodge.

Mr. Angland barely had time Thursday to begin his report, which follows several weeks of research on the ch. 2 grant and the St. Louis tv situation. Other facets to be covered: (1) the subsequent move of ch. 2 to St. Louis and Terre Haute, Ind., and its grant to KTVI (TV) St. Louis; (2) the grant of ch. 11 St. Louis to CBS and the network's later purchase of ch. 4 KWK-TV St. Louis; (3) assignment of ch. 11 to 220 Tv Inc., a competing applicant of CBS's for the facility, and (4) the *St. Louis Globe Democrat* purchase of an interest in KTVI after selling its stock in KWK-TV to CBS.

Rep. Harris said the St. Louis actions all are intertwined with ch. 2 Springfield grant and will show an FCC pattern of grants based on illegal contacts. Subcommittee Chief Counsel Robert Lishman said that he was deliberately reserving several questions on the entire matter. "It would appear," he stated, "that the ex parte pressures were more responsible for the decision than the announced standards themselves. . . . The so-called standards and reasons for decisions apparently have no substance in reality." Mr. Lishman said he was prepared to prove the charges "beyond a reasonable doubt."

Comr. Lee's name came into the case via a letter from Loring C. Merwin, publisher of the *Bloomington (Ill.) Pantagraph*, to Rep. Arends. In it, Mr. Merwin quoted Oliver Keller, president of Sangamon, as saying an unnamed FCC employe stated Rep. Arends had taken an active part on behalf of the WMAY application. The let-

ter to Rep. Arends went on to relate:

"This employe reported that Comr. Lee had returned from a luncheon with you and asked the staff why he had not been told that the WTAX [Sangamon Valley] applicants were a bunch of New Dealers. He then announced he was changing his vote in favor of WMAY." The examiner's initial decision had favored Sangamon.

Mr. Hodge was accused by several individuals interviewed by Mr. Angland of being the "mastermind" behind the alleged political influence web. Mr. Hodge himself, when interviewed in the Illinois State prison where he is serving 10-15 years, said that he was asked to intervene in the case by close personal friends Louis and Herman Cohen. Richard Cohen, son of Louis, is vice president-18% owner of WMAY-TV.

Mr. Hodge admitted talking to Reps. Arends and Simpson and Sen. Everett Dirksen (R-Ill.) on behalf of the WMAY application. He said he did not remember talking to Mr. Hall but "may have," and that he had never met any member of the FCC. He refused to give a sworn statement because his firm would build the plant.

Mr. Keller was quoted as saying that Leslie C. Johnson, vice president-25% owner of WHBF-AM-TV Rock Island, Ill., stated Mr. Hodge told him (Johnson) that he (Hodge) was supporting WMAY because his firm would build the plant if that application was successful.

The losing applicant also stated that, after learning of Mr. Hodge's activities, he and three other Sangamon principals went to see Sen. Dirksen. All four confirmed that Sen. Dirksen stated Mr. Hall also was active in the behind-the-scenes skirmishes



INVESTIGATOR ANGLAND

for ch. 2. Mr. Keller also stated that Sen. Dirksen told him one unnamed commissioner had committed his vote to Mr. Hall.

Mr. Keller said the only political activity engaged in by Sangamon was to try to counteract the "New Dealer" tag. The record on this respect shows that all Sangamon principals are active Republicans except Mrs. Ernest Ives (sister of two-time Democratic presidential nominee Adlai Stevenson), whose family owns less than 5%.

Mr. Keller said that his Washington counsel, on Thanksgiving Eve 1955, told him that a preliminary vote had gone against Sangamon but advised him it would be improper to try to approach the commissioners.

Entered into the record was a telegram from Mr. Hall to C. H. Lanphier, a Sangamon stockholder, in which the Republican chairman denied taking any role in the ch. 2 Springfield case.

Replying from Chicago, where he was addressing an EIA meeting, Comr. Lee stated: "I don't know anything about it. To my knowledge, I have never met any of the parties to this case nor did I ever discuss the merits with anyone."

[Comr. Lee's office said Friday that a thorough check of FCC records in the ch. 2 cases disprove the charge that Comr. Lee ever switched his vote from Sangamon to WMAY.]

Rep. Arends admitted that Mr. Hodge asked him to intercede with the Commission and that he in turn asked Comr. Lee



MR. McMAHON

to give WMAY "a fair shake." He said the commissioner replied the case would be judged on its merits. A short time later, Rep. Arends said, Sangamon contacted him and he immediately called the FCC to "get completely neutral." He added that he did lunch with Comr. Lee but had no knowledge of the politics involved and did not call anybody "a bunch of New Dealers."

Rep. Simpson said that he was a good friend of Mr. Hodge, who frequently visited

his office when in Washington. He said he did not remember if ch. 2 was ever discussed and he had "no recollection in any shape or form" of ever contacting FCC.

Although he did not vote on the decision, former Comr. Richard A. Mack also was involved in Mr. Angland's presentation of the Springfield case. Two letters from Florida attorney J. Kenneth Ballinger were read into the record. They consisted of a character recommendation for Lee Ruwitch, executive vice president-general manager of WTVJ (TV) Miami. Mr. Ruwitch also is a vice president of WMAY-TV (which is not on the air on its presently assigned ch. 36) and was to become the new station's general manager. Mr. Ballinger said that "from time to time" industry friends asked him to contact another friend—Comr. Mack.

Also made a part of the record were several telephone calls between then Comr. Mack and Tampa, Fla., attorney Sam Bucklew, plus a memorandum on the Springfield contest prepared for Mr. Mack for relay to Mr. Bucklew. The Tampa attorney loaned the resigned commissioner money in the past, according to committee records.

Mr. Angland testified that Mr. Bucklew stated he was merely getting information for a friend on the ch. 2 case. He refused to identify the friend but stated he has given a sworn statement to the Justice Dept.

Mr. Angland will be back on the House Caucus Room stand today (Monday) to con-

## "LIVE" FROM COLUMBUS



# Bill Corley

In 1945, Bill Corley started his successful sportscasts for WBNS Radio. His Monday thru Friday program is one of the top 10 shows in the market with 8.7 Pulse. Continuing sponsorship and loyal listeners attest to Bill's acceptance in the rich Central Ohio area.



## wbns radio

COLUMBUS, OHIO • Ask JOHN BLAIR



**10,000  
POWERFUL  
WATTS**

reaching 5,500,000 people . . .  
at an **AMAZINGLY LOW, LOW  
COST-PER-THOUSAND!**

**DELIVERS THE  
2nd LARGEST MARKET  
IN NEW YORK STATE . . .  
GREATER LONG ISLAND  
(NASSAU-SUFFOLK)  
RETAIL STORE SALES  
\$657,030,000**

"PULSE" proves WHLI HAS THE  
LARGEST DAYTIME AUDIENCE IN  
THE MAJOR LONG ISLAND MARKET.



**GOVERNMENT CONTINUED**

tinue his testimony on the Springfield and St. Louis tv cases. Mr. Lishman stated that there are instances of numerous other ex-parte contacts with the FCC on these and many other cases, all to be made part of a pattern of "improper" Commission grants.

Staffer Robert McMahon returned to the witness stand Tuesday and Wednesday of last week to complete his testimony on six station sales [LEAD STORY, May 19], plus shift of ch. 2 from Springfield to St. Louis. Cases discussed last week: CBS grant of ch. 11 St. Louis and subsequent purchase of ch. 4 KWK-TV St. Louis; Storer Broadcasting Co. purchase of WVUE (TV) Wilmington, Del., and WIBG-AM-FM Philadelphia; United Tv Inc. purchase of KMGM-AM-TV Minneapolis; the sale of Universal Broadcasting Co. properties (WISH-AM-TV Indianapolis and WANE-AM-TV Ft. Wayne, Ind.) to the J. H. Whitney & Co.'s Indiana Broadcasting Co., and the Providence, R. I., ch. 12 merger agreement.

Mr. McMahon cited the Providence case in charging that the FCC permits huge "windfall profits" and "pay-off" that benefit "shrewd operators and not the public." He said two Providence men, Robert T. Engles and C. George Taylor, dropped their application for an "apparent profit of \$200,000 on no investment."

He charged this case "stands out as one of the more striking examples of so-called 'pay-offs' and 'quickie grants' in recent years." Mr. Lishman added that this was possible through FCC rules which are "conducive to quick profit and no risk." He said there are many cases where an application is filed "apparently solely for the purpose of making a quick profit and getting out."

Mr. Lishman said the Communications Act forbids broadcast licenses to be treated as private property. Rep. Harris stressed a channel allocation is private property. "The question for Congress is should the FCC permit trafficking of these awards as anyone sees fit," he said.

Rep. John Moss asked that the subcommittee staff begin an investigation of the Commission action granting KOVR (TV) Stockton, Calif., permission to move its transmitter to a site where it could place a Grade A signal into Sacramento. This action, he said, caused ch. 40 KCCC-TV to lose its ABC affiliation with the result the station went dark.

Rep. Peter Mack asked for an investigation of all FCC deintermixture decisions, with special emphasis on ch. 2 Springfield. He called the shift of ch. 2 to St. Louis a "breach of contract." Mr. Lishman said that a staff study on deintermixture already had been instituted.

Rep. Harris ordered the staff to summarize its conclusions on the transfer and comparative cases it has studied and submit them to the FCC for comment.

**KLIF Gets Boost to 50 kw**

The FCC last week granted KLIF Dallas, Tex., an increase in daytime power from 5 kw to 50 kw with directional antenna, engineering conditions. The station will continue to operate on 1190 kc, with 1 kw night. KLIF is licensed to the McLendon Investment Corp.

**FCC ACTS TO REHEAR MIAMI CH. 10 GRANT**

- Staff asked to draft order
- Issues set in court remand

FCC last week instructed its staff to draw up an order on the controversial Miami ch. 10 case setting it for "expeditious" hearing on the issues specified by the U. S. Court of Appeals.

The order, being drawn by the Commission's Office of Opinions & Review, is expected to be issued this week.

Basic issues are expected to be (1) whether former Comr. Richard A. Mack should have voted on the grant and (2) whether there was undue influence on any commissioners in behalf of any of the applicants.

The Commission is also expected to set as one of the issues whether the grant of ch. 10 to Public Service Television Inc. (subsidiary of National Airlines) should be voided.

It was understood that the Commission feels that it can accept testimony given under oath before the House Legislative Oversight Committee without recalling these witnesses to retestify before the FCC.

It was still not certain how the Commission will handle this hearing—whether it will appoint an examiner to sit on this case, or someone else.

The court also told the Commission to inform the Dept. of Justice of the hearing, and to permit it to participate if it desires. It also told the FCC that not only all original parties must be permitted to participate, but also all persons who might be involved in the allegations of impropriety in one way or another with the right of cross examination and rebuttal.

The case was remanded to the FCC last month by a U. S. Appeals Court.

The FCC granted the contested ch. 10 to the National Airlines subsidiary in 1957. This was appealed by WKAT Inc. (WKAT Miami), one of the unsuccessful applicants. The other two unsuccessful applicants were North Dade Video Inc. and L. B. Wilson Inc. An appeal also was lodged in the appeals court by Eastern Airlines. Eastern was refused permission by the FCC to intervene, in the comparative hearing.

The court retained jurisdiction of the case and ordered the FCC to report the status of the proceedings within six weeks.

Early this month the FCC asked the court to clarify certain aspects of the remand, principally whether the Commission should act with full authority to make a decision after the hearing or whether it was only to act as a fact finding body for the court. The court informed the FCC that it could proceed with full control.

The Miami ch. 10 case was the object of an intensive investigation by the House subcommittee earlier this year, resulting in the resignation of Comr. Mack and the interrogation of a number of principals by the committee. In March a federal grand jury was impaneled by the Dept. of Justice with orders to look into the case for possible criminal indictments.

# THE DECADE OF THE TRANSISTOR

IRE commemorates the tenth anniversary of a major breakthrough in solid state electronics by devoting the entire June issue of PROCEEDINGS OF THE IRE to an up-to-date summary of progress and advances in transistors. So small that many can be held in the palm of one hand, these tiny components have ended our 50 year dependence on vacuum tubes. Without transistors, our intricate guidance and communication systems for missiles would be incredibly big and heavy. With them, whole new technologies are being developed, not only for defense but for industry and commerce as well.



## June Issue of Proceedings of the IRE is the New Standard Reference

### Work on Transistors

Only once before has PROCEEDINGS devoted an entire issue to transistors. That was in November, 1952. Despite a substantial overprinting, every copy was sold within 3 months. This classic issue, coming at a time when there were no books and few papers on the subject, is still considered one of the basic references on the subject...a suitable companion to the definitive Solid-State Electronic issue of December, 1955 and the Ferrites issue of October, 1956.

Now, to mark the tenth anniversary of the transistor, PROCEEDINGS presents the latest advances in theory and application in the June, 1958 issue. Here you will find introductory articles by its inventors—Shockley, Bardeen and Brattain—specially invited papers reviewing progress in all facets of the subject, contributed papers reporting the latest and more important advances in the field. Be sure to order your copy, today!

### Partial Contents:

- "The Technological Impact of Transistors," by J. A. Morton & W. J. Pietenpol, Bell Labs.
- "The Status of Transistor Research in Compound Semiconductors," by D. A. Jenny, RCA.
- "Survey of Other Semiconductor Devices," by S. J. Angello, Westinghouse.
- "Electrons, Holes and Traps," by W. Shockley, Shockley Semiconductor Lab.
- "Recombination in Semiconductors," by G. Bemski, Bell Labs.
- "Noise in Junction Transistors," by A. van der Ziel, University of Minnesota.
- "Formation of Junction Structures by Solid State Diffusion," by F. M. Smits, Bell Labs.
- "Germanium and Silicon Rectifiers," by H. Henkels, Westinghouse.
- "The Potential of Semiconductor Diodes in High-Frequency Communications," by A. Uhlir, Bell Labs.
- "Advances in the Understandings of the P-N Junction Triode," by R. L. Pritchard, Texas Instruments.
- "Power Transistors," by M. A. Clark, Pacific Semiconductors.
- "Application of Transistors in Computers," by R. A. Henle & J. L. Walsh, IBM.
- "Application of Transistors in Communication Equipment," by D. D. Holmes, RCA.
- "Characteristics Data on Silicon and Germanium," by E. Conwell, Sylvania.

### The Institute of Radio Engineers

1 East 79th St., New York 21, N. Y.

Enclosed is \$3.00

Enclosed is company purchase order for the June 1958 issue on Transistors.

Send this special issue of **Proceedings of the IRE** to:

NAME \_\_\_\_\_

COMPANY \_\_\_\_\_

ADDRESS \_\_\_\_\_

CITY & STATE \_\_\_\_\_

All IRE members  
will receive this June  
issue as usual.

Extra copies to  
members, \$1.25 each  
(only one to a member).



# BMI SUPPORTERS WIND UP DEFENSE

Six witnesses testified last Wednesday against a bill to divorce broadcasters from ownership in BMI and/or recording companies before a subcommittee of the Senate Commerce Committee, winding up pro and con testimony that began over two months ago [GOVERNMENT, March 17].

The latest dissenters—from CBS, NBC and their owned recording companies and the movie industry—again hit proponents' charges that broadcasters are discriminating against ASCAP songs in favor of BMI tunes, or that any monopoly exists in the music business.

Subject of the lengthy hearings has been S 2834, introduced last summer by Sen. George Smathers (D-Fla.). Several score of witnesses, including famous personalities, composers, educators, station owners and one disinterested spectator [GOVERNMENT, May 12] have testified during the course of the hearings.

Still to be heard, probably sometime in July, is rebuttal and sur-rebuttal testimony. Also expected to give their views on the proposed legislation at that time are the FCC and Justice Dept.

Testifying for CBS, Vice President Richard S. Salant strongly defended the network and its Columbia Records affiliate against discrimination charges. He likewise refuted point by point the testimony of many proponents for the bill.

The network is testifying "for the right to continue its stock ownership in BMI [9%] for precisely the reason that CBS went into it in the first place: to assure, to the extent that is proper, the maintenance of continued competition in the music licensing field," Mr. Salant stated.

"We do not care, and we could not afford to care, whether the music is BMI or ASCAP. Indeed, management does not get into the choice of particular pieces of music at all." Since 1954, he said, music performed on both the CBS radio and tv networks has been from 74-80% ASCAP annually, while BMI performances have never been more than 19% for any given year.

In answer to charges of discrimination against ASCAP, he pointed out that since 1952 CBS-TV has broadcast six programs devoted to saluting ASCAP. "We will not jeopardize our most valuable assets—our licenses and our audiences—for the sake of the possibility of a few extra dollars on the

recording side through free plugs," Mr. Salant said. "We must cater—not pander—to the public taste."

Goddard Lieberson, President of Columbia Records, told the subcommittee how ownership by CBS has permitted the recording arm to make financial commitments for valuable, if unprofitable, recording programs which otherwise would have been impossible. Also, he said, Columbia's development of long-play records in 1948 was made possible through cooperation with CBS laboratories.

Charges of discrimination against ASCAP are "patently false . . . a self defeating business practice," he said, and pointed out that Columbia has no direct dealing with ASCAP, BMI or any licensor of performance rights. Mr. Lieberson cited the following figures to show the "incredibility" of the charges:

In 1957, CBS recorded 60.2% ASCAP music and 39.3% BMI. Since 1940, 72.6% of Columbia's popular recordings have been ASCAP songs, 15.7% BMI.

Joseph A. McDonald, NBC assistant general attorney, said that existing laws are adequate to take care of any "abuses of the sort to which the bill seems to be directed. Most important is the fact that the alleged abuses simply do not exist and there is no practical prospect that they ever could exist."

He said proponents' charges of discrimination are refuted by "common sense and the economic facts of life in the broadcasting industry." Pointing out the high percentage of ASCAP songs played on radio and tv, Mr. McDonald said that if broadcasters are attempting to favor BMI, "theirs is a fantastically inept performance."

George R. Marek, vice president and general manager of the RCA Victor Record Div., used several charts to illustrate points in opposing S 2834. "We are asked to believe the argument that the public sit in front of their radios or phonographs or tv sets, hungering for music which we, the all-powerful record companies, deliberately suppress—and that all the public gets from us is an inferior type of music which we foist upon them for one reason only—that we get some kind of economic advantage

from this inferior type of music," Mr. Marek said of proponents' charges.

" . . . We have no incentive whatsoever to do anything of the kind. Even if we had, it would have to be supposed that we are powerful enough to ram down the throats of the public music that they don't want, and to do this through association with a network."

NBC could not show favoritism toward RCA Victor recordings even if it wanted to, Mr. Marek testified. He said two things pointed out the fallacy of a proponent's charge RCA entered the phonograph business to record music controlled by NBC, through BMI, and exploit those recording on NBC stations:

(1) RCA acquired Victor Talking Machine Co. in 1929, 10 years before BMI was formed; (2) NBC did not permit the use of phonograph records on network broadcasts until 1949 and was one of the last holdouts against records on its owned stations.

Eric Johnston, president of the Motion Pictures Assn. of America, told the subcommittee that "restrictions on business expansion and diversification are unwise where no legal wrong exists." He said this is the age of diversification in American business and asked: "Does it make sense to prohibit diversification in such allied and closely related fields as music, broadcasting and film making?"

He cited the "outstanding" record of movie and theatre chains which also own broadcasting properties, recording and publishing companies. "Instead of using a rifle to bring down their targets, the proponents are firing a 12-gauge shotgun blast which, in its scattering, would wound many, including hapless bystanders."

MPA opposes the Smathers bill for three principal reasons, he said. These include: (1) "It would establish a new philosophy running directly contra to our basic economic system. . . ."

(2) It would proscribe a certain class of persons from being licensees "in a manner heretofore rejected by this very committee [he cited newspaper ownership of radio-tv stations, expressly approved by the Senate]."

(3) "The remedy proposed would do a greater harm than the wrong complained of—in fact there is no such wrong. The bill would create a tighter and more grievous



MR. LIEBERSON



MR. MAREK



MR. SALANT



MR. TOLCHIN



MR. McDONALD



monopoly than the one alleged to exist now. . . ."

Arthur M. Tolchin, vice president of WMGM New York, testified for Joseph Vogel, president of Loew's Inc., which owns WMGM, M-G-M Records and three music publishing firms. "No one has ever charged that in the operation of our radio station we have abused our position as a licensee of FCC by favoring our record or music publishing interests," Mr. Tolchin stated.

"Yet this proposed legislation assumes that we have been guilty of such abuses. There is no basis whatsoever for requiring our company to surrender the operation of WMGM, or in the alternative to divest itself of its record business and music interests."

## Court Says FCC Erred In WJMR-TV Grant

The U.S. Court of Appeals in Washington last week, in a two to one decision, ruled that the FCC "erred" in granting the applications of WJMR-TV New Orleans to broadcast simultaneously on ch. 20 and (experimentally) on ch. 12 in that city. The court remanded the case to the Commission for a hearing on the allegations of ch. 12 WJTV (TV) Jackson, Miss., that WJMR-TV was "not proposing a *bona fide* experiment" with its dual operations in New Orleans.

Early last year [GOVERNMENT, March 4, 1957] the Commission decided, with no objections at the time being raised, that ch. 12 should be added to New Orleans. Both Supreme Broadcasting Co., licensee of ch. 20 WJMR-TV, and Oklahoma Television Corp., licensee of ch. 9 KWTV (TV) Oklahoma City, among others, applied for regular commercial operation on ch. 12. WJMR-TV also made what proved to be a successful move by requesting Commission permission to construct an experimental station on ch. 12, to transmit simultaneously its entire ch. 20 program schedule, in order to test directional antenna limitation of radiation and the providing of a basis for comparative coverage studies of picture quality. WJMR-TV began its simultaneous operation of vhf-uhf last autumn [GOVERNMENT, Oct. 7, 1957.]

Although the order allocating ch. 12 to New Orleans specified that any transmitter on that channel must be the minimum of 190 miles from the ch. 12 transmitter at Jackson, the WJMR-TV experimental application showed its transmitter as falling twenty eight miles short of the minimum (later modified by a lower tower and less power). The Commission granted WJMR-TV a modification of its experimental construction permit without a hearing, although both KWTV and WJTV asked for one.

The Court unanimously held that KWTV, one of three applicants for ch. 2 New Orleans, "lacks standing" in this case. Other applicant for ch. 12, besides WJMR-TV's request for authorization to be changed from ch. 20 to ch. 12, is Coastal Television Co.

### proposed new issue

500,000 SHARES

## MISSILES-JETS & AUTOMATION FUND, INC.

CAPITAL STOCK

(par value \$1)

**offering price \$10 per share**

(In single transactions involving less than \$10,000)

### objectives:

The Fund's investments will be concentrated principally in the common stocks of companies engaged in missiles-jets and automation. The Fund will emphasize possible long-term growth in its selection of securities in these fields.

These shares will be offered to the public commencing on or about June 17, 1958 through a group of underwriters headed by the undersigned.

A registration statement relating to these securities has been filed with the Securities and Exchange Commission but has not yet become effective. These securities may not be sold nor may offers to buy be accepted prior to the time the registration statement becomes effective. This advertisement shall not constitute an offer to sell or the solicitation of an offer to buy nor shall there be any sale of these securities in any State in which such offer, solicitation or sale would be unlawful prior to registration or qualification under the securities laws of any such State.

### preliminary prospectus on request

A copy of the Preliminary Prospectus may be obtained from your local broker or dealer or by writing the undersigned.

## IRA HAUPT & CO.

Members New York Stock Exchange and other principal exchanges

111 BROADWAY, NEW YORK 6

WOrth 4-6000

## DAYTIME COMMENTS FORECAST HASSLE

- Close to 300 filed with FCC
- Opposing forces in majority

The battle lines were drawn at the FCC last week when more than 250 comments were filed on the proposal that daytime am stations should be permitted to extend their hours of operation.

These were in addition to the 30-odd comments filed before the deadline last Monday [GOVERNMENT, AT DEADLINE, May 19].

Opposing forces—clear channel stations, regionals, networks and group owners—had about a 1½ to 1 lead over those favoring—all daytime stations.

The gist of the arguments of those favoring was that local listeners need local station broadcasts for local news, weather, farm and business reports, and civil defense.

Proponents of the FCC's proposal—which was issued late last year following a petition by Daytime Broadcasters Assn.—included in almost every instance letters of support from local government and civic leaders.

Opponents maintained that the extension of daytime operating hours would defeat the allocation principles, would cause interference to listeners to clear channel and regional stations at night hours, and would not be as good for daytimers as they believe because they too would receive interference from other stations on the same frequencies.

The daytime broadcasters ask that the FCC permit them to operate from 5 a.m. or sunrise to 7 p.m. or sunset whichever is longer. Daytime stations are now limited to local sunrise-sunset operation.

Representative comments filed last week follow:

The Daytime Broadcasters Assn. filing was an out-and-out attack on the principle of clear channels. Fifty-nine clear channels—only 2% of the U. S. stations—occupy 42% of the entire am band, the organization said.

There are, DBA said, 1,475 daytime stations forced to operate on "severely restricted schedules only because of the artificial and unnatural scarcity created by the clear channel philosophy."

The situation is due to an "outmoded and obsolescent" radio philosophy that is 35 years old, DBA said.

Skywave service is no longer reliable, the organization stated. And, it added, skywave service is no longer necessary, since there are other and more stable signals now available.

Clear channel stations do not serve the rural public, DBA averred, because they are all located in metropolitan cities and have no interest in bringing agricultural, weather and local news to farmers and rural dwellers. And even those which do have such programs, DBA stated, cannot give varying communities the local news and advice they need.

The fluctuating hours of operation by the daytimers, DBA said, causes difficulties in management, staffing, weather service, civil defense.

Extended hours of operation for daytime stations would cause a minimum of interfer-

ence to clear channel stations, DBA stated. And, this interference would occur for only a few months of the year (winter months), it said.

DBA also suggested that if the Commission approves the extended hour proposal, regionals now required to switch to directional operation at sunset be given permission to continue non-directional operation for the same hours as daytimers operate.

WLBH Mattoon, Ill., owned by Ray Live-say, chairman of the DBA organization, enumerated the fluctuating hours of operation it is subject to because of its sunrise-sunset operation.

WLBH recited its experience when it began operating pre-sunrise in 1952 and continued for four years without complaint. In 1956 the FCC ordered the station to cease pre-sunrise operation because of complaints of interference from Class 1-B 1170 kc stations KVOO Tulsa, Okla., and WWVA Wheeling, W. Va. When these stations were asked to approve pre-sunrise operation by WLBH they refused. FCC rules permit a daytime station to operate pre-sunrise if there is no interference to the dominant stations.

WLBH quoted a 1956 Nielsen survey indicating that 65% of the people in Coles County, Illinois, listened to the local Mattoon station, but that at night a much smaller number listened to Chicago full time stations, 180 miles away. Percentages of night listening amounted to as low as 2% to one Chicago station and as high as 14% to another Chicago outlet.

KMMJ Grand Island, Neb., made its approach on the sentiment that "people should take precedence over outmoded engineering rules."

The dominant station on its 750 kc is WSB Atlanta, the Grand Island station said, and for years WSB's listener coverage has declined. In 1946, the station said, WSB had a large night time audience extending to within 480 miles from Grand Island. In 1952, WSB coverage had shrunk so its listenership was 650 miles from Grand Island. In 1956 this distance had increased to 740 miles from Grand Island.

ABC said that the impact on the vast numbers of people receiving skywave service would be heavier than those who would gain a primary service. Daytimers have failed to understand, ABC said, that they too will receive interference from clear channel and regional stations during the night hours they operate. Proposal complicates the clear channel case, the daytime skywave case and is contrary to NARBA and the U. S.-Mexico agreement, the network stated and would have an adverse effect on fm. It also presented studies showing what the move would mean to WABC New York and WXYZ Detroit.

CBS said that the daytime petition cannot be granted within the framework of present allocation principles which insure maximum service to the maximum number of people. CBS alluded to daytimers' pleadings as a "plethora of claims and a minimum of facts." In an engineering study, CBS deduced that daytime stations would definitely not be serving the same number

of people at night as in the day.

NBC said that it opposed the DBA proposal because it would cause more loss to the public than would be gained. Through an engineering study of 660 kc, NBC showed that WRCA New York would lose more than 6 million people and more than 49,000 square miles in its groundwave coverage if daytimers extended hours of operation in December, while the three daytime stations on the same frequency (WESC Greenville, S. C.; KSKY Dallas, Tex., and KOWH Omaha, Neb.) would gain all together a little over 1 million people and 4,300 square miles. WRCA-TV would lose skywave service affecting 321,300 people in an area of 6,340 square miles.

The Clear Channel Broadcasting Service comments, consisting of 120 pages of text and 147 exhibits, cited interference to 25 stations plus two share-time radio outlets. The CCBS comments [AT DEADLINE, May 19] said engineering studies show "conclusively" that the revision would destroy all clear channel service in the winter and partly in the spring and fall, depriving 25 million people of service. CCBS also cited loss of groundwave and said interference would be substantial to all Class 1-B, unlimited Class II and II stations and that additional potential damage would be caused with the grant of future daytime stations on Class I channels.

WISH Indianapolis, Ind., a Class III-B station on 1310 kc, using 5 kw daytime and 1 kw night, opposed the daytime proposal because of destructive mutual interference among daytimers which this move would cause. It also emphasized that the daytime broadcasters knew they were unequivocally limited to sunrise-sunset operation when they applied. WISH also said extended hours would violate international agreements (NARBA and U. S.-Mexico agreement).

Meredith Publishing Co. said the proposed revision would cause interference to its KPHO Phoenix by KBIM Roswell, N. M., reducing its nighttime interference-free area 62% from the present 2,170 square miles coverage and that 11% of its 31,160 population coverage would lose primary service; that interference to its KRMG Tulsa by WBAM Montgomery, Ala., would reduce its 1,373-square-mile coverage 63% and 92,448 population 30%. Interference to its WOW Omaha by WRAG Carrollton, Ark., and KBHS Hot Springs, Ark., would result in loss, to its 1.4 mv/m contour, of 91.6% of its 40,665-square-mile coverage and 72% of its 1,160,559 population coverage, Meredith said.

Storer Broadcasting Co. said a revision would reduce clear channel and regional stations to the status of local outlets and that the FCC station classification theory to insure nationwide radio service would be "largely abandoned." Storer said interference to its WSPD Toledo is typical of the effect on more than 700 unlimited regional stations. The 19 daytimers on 5-kw WSPD's 1370 kc frequency within 600 miles would push the station's 11.0 mv/m contour back, shrinking service from 3,094 to 556 square miles and coverage from 647,682 people to 367,121 for six hours daily in the winter

# "Ad Age has been required reading for me since 1937"

says **FRANK B. SAWDON**  
*Vice-President*  
Robert Hall Clothes



"I depend on Advertising Age to keep me informed and up-to-date on all that's going on in the advertising business. Since Robert Hall uses newspapers, radio, television and national magazines, I feel I can't afford to miss even one issue of Ad Age. It has been required reading for me since 1937."

You'll find that most of the executives of importance to you—those who *influence* as well as those who *activate* today's broadcast decisions—consider Advertising Age "required reading." For here they find not only the news of their fast-changing fields, but trends, developments and sharp analyses which help them select markets and media.

Take Robert Hall Clothes, for example. The nation's largest family-clothing chain (260 stores), the Robert Hall concern also ranks as the major user of broadcast media in the retailing field—with spots placed in about 150 markets. (During 1957, this firm earmarked more than \$4,900,000\* for spot television alone.) Every week, advertising planners at Robert Hall, along with decision-makers at their agency—Frank B. Sawdon, Inc., depend on Ad Age to keep abreast of marketing developments affecting them.

Add to this AA's more than 40,000 paid circulation, its tremendous penetration of advertising with a weekly paid circulation currently reaching over 12,000 agency people alone, its intense readership by top executives in national advertising companies—and you'll recognize in Advertising Age a most influential medium for swinging broadcast decisions your way.

\*N. C. Rorabaugh Co. for Television Bureau of Advertising.

## FRANK B. SAWDON

Mr. Sawdon has been associated with Robert Hall Clothes since it was founded in 1941. As the only vice-president, he handles diversified responsibilities in both advertising and sales, and also chooses new-store sites for this coast-to-coast organization. Before joining Robert Hall, he operated his own advertising agency—Frank B. Sawdon, Inc., which is still a "going concern," numbering among its accounts the Robert Hall chain. Mr. Sawdon continues to hold the title of president at the agency and, in addition, is a member of Burke-Stuart Co., Inc., station representatives. Outside the business world, he is active in several charities and pursues his favorite recreation—golf.

*important to important people*

200 EAST ILLINOIS STREET • CHICAGO 11, ILLINOIS  
480 LEXINGTON AVENUE • NEW YORK 17, NEW YORK

1 Year (52 issues) \$3



months and to a lesser degree toward summer. Other disruption would be caused to 13 other fulltime stations on 1370 kc and the same thing would happen to stations on the 40 other regular frequencies, Storer said. All 160 unlimited stations on clear channels would be reduced in service and clear channel service would be reduced to a "shambles" in the winter, Storer added, the whole effect being to "scuttle" daylight rural service and "prejudge" the clear channel and daytime skywave matters before the FCC.

A. Earl Cullum Jr., Dallas consulting engineer, stated that if daytimers were allowed to begin operating before sunrise and continue after sunset, the public would suffer since the ability to listen to clear or regional stations would be affected, as would the ability to hear the local daytimer which would be receiving interference from these other stations.

If the FCC should decide to permit daytime stations to extend their hours of operation, Class 1 stations should be required to cease skywave radiation at 6 a.m. and be permitted to resume at 7 p.m. This would protect daytime stations from disastrous interference from clear channel stations during the transition period from nighttime to daylight. This proposal was made by Lee Hollingsworth of Hollingsworth Co. Enterprises Inc. (electronics), West Hempstead, N. Y.

## FCC ASKS FOR CATV COMMENTS

The FCC last week asked for guidance on the community tv system problem.

It asked for comments on a host of questions by June 27.

After it reviews the comments, the Commission said, it will be able to make up its mind as to what to do, if anything, on the situation.

The Commission action came less than a week before it is scheduled to appear before the Senate Commerce Committee for a resumption of hearing on tv allocations. Community tv operations are on the committee's agenda. The FCC is due to appear before the Senate committee tomorrow (Tuesday).

The impact of catv systems on small town tv became a vital subject of discussion last month at the NAB convention in Los Angeles, which resulted in the establishment of a special committee. It was fed in more recent weeks by a group of northwest broadcasters who asked the FCC to reconsider an April 3 decision holding that catv operations are not common carriers, and by the charges that a Kalispell tv station had to close down because of competition from the local catv system; that a Helena, Mont., station might close down if the FCC permits a local catv system to bring Spokane, Wash., signals to that city via microwave relay; that a \$600,000 station purchase col-

lapsed at the threat of the establishment of a catv system in Great Falls, Mont. [SPECIAL REPORT, May 12].

The catv problem, the Commission said, raises two types of questions: jurisdictional and policy. The central problem, the Commission said, was the evaluation of the economic impact exerted by small town television facilities of the various kinds on the construction and successful operation of regular tv stations. There are about 550 catv systems serving 500,000 homes.

The alternatives facing the Commission, the notice said was this:

If the catv system or other small town program distribution facility is obliged to discontinue, the local residents would be deprived of two, three, four or five services which these facilities can provide them. They would thus be reduced to a single source of programs—the local station—which in many cases cannot provide even the amount of network programs which the catv or other local system brings in over a single channel. As against this the continued operation of catv systems, repeaters and translators is charged by some as threatening and in some cases causing the demise of local stations. This not only removes a local outlet for the broadcast of local events, but also deprives service to persons who may be within the reach of the regular tv station but are not served by the catv system or other types of local service facilities. . . ."

The questions the FCC wants answered are these:

1. In which communities, and to how many persons are 1, 2, 3 or more tv program services provided by (a) catv systems; (b) boosters and unauthorized translators; (c) authorized translators, and (d) satellite tv stations?
2. In which of the communities under (1) are there (a) tv stations authorized but not yet operating; (b) tv stations in operation; (c) tv stations built but now off the air, and (d) foreseeable opportunities for the operation of one or more tv stations?
3. How many persons receive their only satisfactory tv service from regular tv stations located in or near communities in which catv systems, boosters or translators are operating?
4. How many of the communities under (1) had no local tv station but receive satisfactory direct reception from a tv station in a nearby city or town?
5. In what ways and to what extent do the operations of catv systems, boosters, translators and satellites affect the ability of existing and potential tv stations to obtain revenues and programs? What significant light has been cast on this question by experience to date in the operation of regular tv stations in communities where catv systems, boosters and translators have been in operation?
6. What areas and populations receive no tv service of any kind and what steps would it be desirable for the Commission to take to encourage and foster the provision

*In Louisville*  
it's **WAVE-TV**  
for

- BALANCED PROGRAMMING
- AUDIENCE RATINGS
- COVERAGE
- COSTS PER THOUSAND
- TRUSTWORTHY OPERATION

NBC AFFILIATE  
NBC SPOT SALES, EXCLUSIVE NATIONAL REPRESENTATIVES

WFIE-TV, Channel 14, the NBC affiliate in Evansville, is now owned and operated by WAVE, Inc.

of service to such areas and populations?

7. In what circumstances, if any, would public interest considerations justify prohibiting or limiting the operation of catv systems, boosters, translators or satellites?

8. Could the Commission justifiably distinguish between communities which have or do not have regular local tv stations, in determining whether the public interest would be served by the provision of one or more program services by local catv systems, boosters or translators?

9. If the choice had to be made, would it be more in the public interest to maintain the only service provided to people living in rural areas by a tv station, or to permit the provision of multiple program services to a smaller number of persons residing in a town served by a catv system, boosters or translators at the cost of or at serious risk to the continuation of service to other persons wholly dependent on the local tv station?

10. What specific kinds of limitations and restrictions might it be in the public interest to impose on catv systems, boosters or translators, and what standards or criteria should govern the imposition of such limitations or restrictions?

11. What basis, if any, is there for the assumption by the FCC, under present law, of licensing and regulatory powers over catv systems?

12. Would it constitute a legally valid exercise of FCC's regulatory jurisdiction

over common carriers to deny authorization for common carrier microwave, wire or cable transmission of tv programs to catv systems on the ground of adverse competitive impact on the construction or successful operation of local or nearby tv stations?

13. Can economic injury to a tv station be a valid public interest justification for denial of authorization to local program distribution services which compete with a local regular tv station?

14. What legislative recommendations might it be appropriate to submit to Congress in respect to FCC jurisdiction over catv systems?

## HANDS-OFF ORDERED ON IN-STORE PLANS

- Practice discriminatory
- Seven firms, networks named

Broadcasters no longer can offer sponsors chain-store-only display premiums without subjecting the sponsor to a federal offense.

This is the effect of a Federal Trade Commission ruling made last week—not against stations—but against seven large grocery suppliers which used store merchandising benefits offered by network-owned stations in New York, Boston and Chicago.

The FTC has ordered the manufacturers “to stop granting illegal promotional allow-

ances to favored customers through the major radio-tv networks.” Using broadcast in-store promotion-aids involving “favored grocery chains” violates anti-discrimination provisions of the Robinson-Patman Act, the trade commissioners have ruled.

Respondents are General Foods Corp., Groveton Paper Co., Hudson Pulp & Paper Corp., P. Lorillard Co., Piel Bros. Inc., Sunkist Growers Inc. and Sunshine Biscuits Inc.

The FTC's oblique attack on chain-store merchandising by stations began nearly two years ago [LEAD STORY, July 30, 1956].

Named in the decision are ABC, CBS and NBC. Contracts for time-plus bonus promotional displays with network-owned stations were illegal the FTC held, because smaller merchants were given no chance to participate in the time-for-display space swap. The FTC said that the manufacturers by buying time on the stations offering the in-store premium were in effect financing free air time for favored stores.

Typical amounts paid in a year by the seven manufacturers ranged from about \$122,000 to \$210,000, the FTC said. Contracts cited in the action went back to 1951. In 1955 it was estimated by one surveyor that about 34% of television stations in the country offered some sort of display merchandising. It is likely that as many or more radio stations at that time had store promotion plans.



The February '58 ARB reports —

From Sign-on to Sign-off

Sunday through Saturday

KMJ-TV leads with 213 quarter-hour firsts

while Station A has 158, and

Station B has 98

**IN TOTAL  
RATED TIME  
PERIODS**

KMJ-TV • FRESNO, CALIFORNIA • McCLATCHY BROADCASTING COMPANY •

The Katz Agency,  
National Representative



## Eisenhower does the honors for WRC

A \$4 million NBC broadcasting plant was dedicated in Washington Thursday afternoon by President Eisenhower. Impressed by the complexity of the facilities and the service potentiality of the medium, he said:

"I think all of us realize that in these fast moving times it is highly important that our nation's capital should be attached to every single citizen in this country by the very fastest kind of communications."

As Brig. Gen. David Sarnoff, RCA board chairman, and his son, Robert W. Sarnoff, NBC president, participated in the ceremony, broadcast coast-to-coast on NBC radio-tv networks, the President added:

"Decisions of a nation and of a government that at one time could tolerate three or four weeks of study now demand almost instantaneous reaction. So it is again apparent that unless our citizenry can be informed of the things that happen in the world and are reflected through the eyes of legislative and executive leaders in such a way that they may understand exactly what these things mean, then the United States cannot react as it should."

The President said the maze of equipment reminded him somewhat of the radar room in a battleship or some other complex thing entirely beyond his comprehension. He had tinkered with the tv controls in a pre-ceremony tour of the plant, located several miles northwest of downtown Washington near the intersection of Massachusetts and Nebraska avenues.

Gen. Sarnoff addressed the studio audience, including many figures in high government places, recalling he had served under the President in both war and peace. Noting the President's close attention to the color monitors in the studio, Gen. Sarnoff referred to "some persons in the world who may not be very keen about being seen in their true and natural colors. Happily this is not so in America. Here we fear no revelations. We have nothing to hide. On the contrary, we want everyone in the world to see America in its true and natural colors."

Robert Sarnoff observed that presidents have contributed many chapter headings to broadcast history. He recalled President Wilson was the first to try radio; President Harding the first to speak over a network (three stations); President Coolidge the first to broadcast from the White House; President Roosevelt the first to use the fireside chat and President Eisenhower the first to appear in live color from the capital city.

He said the color program was being taped on two recorders in Burbank. One copy will go to the President, the other to the Library of Congress. A plaque commemorating the dedication was mounted on a wall.

The new plant, housing NBC, WRC-AM-FM and WRC-TV offices, was described as the most modern color facility ever installed in a tv station. The main color studio is 100x60 feet.

The building is located on a seven-acre

tract on one of the highest spots in the District of Columbia. Contemporary in style, the exterior consists of gray modular brick, limestone and colored porcelain enamel. The antenna reaches 849 feet, highest in the area. Parking space is provided for 150 cars. Three radio studios can be operated

simultaneously from three interchangeable control rooms.

A second tv studio is 60x40 feet, with control rooms separating it from the larger studio. A community room will be available to civic and social organizations.

Carleton D. Smith, NBC Washington vice president and general manager of the stations, opened the ceremonies with greetings to guests.



**THE PRESIDENT** took a turn at controls in the WRC technical center when he toured the new studios last Thursday. With him in the photo above are Carleton Smith (l), NBC vice president and general manager of WRC-AM-FM-TV, and Robert W. Sarnoff, NBC president. A plaque carrying the President's likeness was pointed out to him (picture at left)



by Brig. Gen. David Sarnoff, RCA board chairman, and Robert Sarnoff. The picture below shows the front elevation of the \$4 million broadcasting plant.



# HECTIC WEEK FOR EDITORIALIZING

Broadcast editorials were damned, praised, probed and supported last week.

- In Berlin, New Hampshire, a station was sued for libel and had its assets attached after an editorial criticizing a local theatre.

- In Washington, D. C., a station was praised for stirring judicial action against a wave of child molesting cases.

- In Providence, R. I., the state legislature started an investigation of a station editorial saying there was drinking in legislative committee rooms.

- And in New Britain, Conn., a U. S. congressman advised broadcasters to shoulder the editorial burden and its accompanying responsibility.

The details follow.

## BERLIN, N.H.

WKCB Berlin, N. H., found itself without enough money to pay its employees last week. It had been sued for libel resulting from an editorial blast at a local movie house.

Richard B. McKee, owner of the 250 w Berlin independent, said that a writ of attachment on all assets had been secured by John Voudoukis, owner of the Princess Theatre in Berlin. The attachment included the station's bank account. The writ of attachment is the first step in a damage suit in New Hampshire, and indicated that the

station was to be sued for \$150,000 damages.

The attachments and the forthcoming suit resulted from a series of editorials on juvenile delinquency which ran on the station during the past few months. The station carries a 10-minute editorial daily at 12:10 p.m., sponsored by the local community tv system. This has been a regular feature of WKCB since November 1957 when Mr. McKee bought the station from John W. Guider for \$165,000. This also included Mr. Guider's WBNC Conway, N. H.

The specific editorial involving the alleged libel was broadcast two weeks ago and mentioned a theatre (the Princess is one of two there) as the hangout for a gang of young hoodlums. The editorial stated that the theatre permitted young rowdies to play pinball machines and jukeboxes and to engage in fornication on the premises.

The juvenile delinquency series has brought threats of bodily harm and of death to Mr. McKee and other station personnel, Mr. McKee said. He added that on one occasion the station was invaded by a gang of hoodlums.

Mr. McKee said that local merchants have begun paying their bills in cash in order to help him meet his payroll—even though payment is not due until the first of the month.

According to his lawyers, Mr. McKee

said, he will not have an opportunity to have the writ set aside until July. There is some possibility that the court will accept a bond in order to dissolve the attachment writ, he said.

Notwithstanding his present plight, Mr. McKee has nothing but good to say of editorializing by radio stations. "It has made us a force in the community." He pointed out that Berlin has no local daily newspaper and no other local radio service. Although he has only been in the area since last November, the station's forceful editorials have won him a place in the community. He is president of the Whitefield, N. H., Chamber of Commerce and a director of the Berlin Community Club. The station has even dared to criticize the Brown Co. (paper products), the major manufacturing company in the city, Mr. McKee stated, and has won the respect of the company officials. In fact, he added, the Brown Co. asked him to mediate a strike several weeks ago, but this fell through when the union insisted on a federal mediator.

## WASHINGTON, D.C.

A sustained editorial campaign by WWDC Washington was credited with adoption of a "get-tough policy" in the District of Columbia toward persons charged with sexual molestation of children.

Last week Assistant U. S. Attorney Edward O'Connell asked \$25,000 bond in the case of an offender accused of an indecent act with a 10-year-old girl. Judge John Lewis Smith Jr. of Municipal Court agreed, ordering the accused held for grand jury action.

Starting last March WWDC broadcast a series of one-minute editorials calling attention to the lax handling of these cases by public officials and the hazards of releasing offenders on low bail for a trial many months in the future.

WWDC supported its editorials, carried as often as 10 times a day, with a direct mail campaign. Copies of air editorials dealing with child molesters were mailed to court and law officers, officers of community associations and others.

This particular campaign began when a mother phoned WWDC to report her 6-year-old daughter had been molested. Police had released the accused on \$2,000 bail and he was back in the neighborhood the next day. The mother was afraid to let her three school-age children leave the house.

Joe Phipps, WWDC news director, started looking into the subject. He contacted police, the district attorney's office and others. An air comment brought a call from Don Feldman, assistant counsel for the Senate District of Columbia Committee. That led to contacts with psychiatrists and others familiar with the subject as well as police.

After three weeks of research, Mr. Phipps felt the station was ready to undertake the campaign. Public reaction was prompt. Last week's increase of D. C. bond to \$25,000 resulted. This figure is accepted as "no bond," since few bondsmen will risk that



AND if you want results . . . try KJEO-TV. KJEO-TV consistently serves Fresno and the fabulous San Joaquin Valley better for less. Call your BRANHAM man for complete details. We GUARANTEE you'll save your energy, get more for your money on KJEO-TV. ACT TODAY!



sum. Large numbers of approval letters have been received from civic groups.

WWDC recently extended its am editorial schedule to its fm affiliate, which programs separately with a background music format. The editorials on fm are concentrated in evening hours.

Ben Strouse, WWDC president, presents the editorials on the air after this introduction, "For the Record—Here is WWDC's president with a 60-second editorial of opinion." A somewhat similar signoff is used.

Final decision on editorials is made by Mr. Strouse after consulting Norman Reed, program vice president, Mr. Phipps and other staff members. All staffers are encouraged to suggest editorial ideas.

By running editorials 10 times a day, rotated and staggered, WWDC figures it reaches the "habit audience" as well as "dial-grazers." The frequency is equivalent to a saturation commercial campaign.

Editorial subjects have included support for the President's Pentagon reorganization plan, with time granted opponents; support of a candidate for school superintendent; Potomac River drownings and opposition to building a highway along the Potomac bank.

"Editorializing requires a dedication to principle," Mr. Phipps said. He added, on the basis of results, that it's "commercially good," stirring up interest in the station even among listeners who disagree. Library and research facilities are needed in documenting and preparing editorials. "An image of the station as someone the troubled person can turn to is created," he said. "We intend to keep it up."

## PROVIDENCE, R. I.

WICE Providence, R. I., an Elliot station, was editorializing normally last week, unruffled by a legislative storm that followed an editorial carried May 15. The controversial broadcast had referred to a "shocking" legislative situation—presence of liquor in committee rooms while official business was being conducted by the legislature.

A special five-man bipartisan legislative committee held a May 17 hearing on the editorial. John F. Crohan, WICE vice president and general manager, appeared voluntarily before the committee. He explained the editorial position was taken in the hope the General Assembly would act to prevent continuation of the practice.

Mr. Crohan refused to back down from the editorial position or to tell who was responsible for the editorial. He explained it was not a blanket indictment.

The special committee took no action last week. Rumored suggestions that the legislature censure the station did not lead to action.

WICE has been editorializing thrice-weekly for a year, as has its sister station, WCUE Akron, Ohio. An editorial board directs the WICE editorializing. Last Tuesday a follow-up editorial was broadcast, explaining the drinking in the Capitol is known to many and expressing hope the legislature leaders insist on a set of ground rules to stop the practice.

General reaction to the drinking editorials



## PERSON-TO-PERSON to IGOR GREGORIAN

The same day Russia launched Sputnik #2, KWFT listeners heard the voice of Igor Gregorian, Russian government official, chatting by telephone from Moscow with Dave Dary, KWFT News Director.

The Cuban revolt . . . the Starkweather killings . . . the Mike Todd crash . . . all were reported BY PHONE FROM THE SPOT, over KWFT.

Alert reporting by Dave Dary and Bill Ritchie . . . backed by AP, UP, and over 50 correspondents . . . makes KWFT's daily newscasts uniquely exciting . . . and puts *solid impact* behind sponsor commercials!

LEARN MORE . . . about the Southwest's *sellingest* radio station! Call your H-R man!

Ben Ludy  
President & General Manager

LOW  
FREQUENCY

MAXIMUM CONDUCTIVITY

**620 KWFT** Call Your  
H-R  
Man

620 kc -- Wichita Falls, Texas

**BROADCASTER'S FIRST CHOICE**

**GATES**

*Leader in Creative Engineering*



"But Boss...

reform Traffic Court???"

"Certainly! We have always taken an editorial interest in civic affairs."



"But Boss, pop off on politics? Think of CITY HALL! Why not play it safe like everybody else?"



"That's not how we got to be FIRST in Cincinnati!"



Come to think of it, I guess he's right.

But Gosh... City Hall...



CINCINNATI

GORDON BROADCASTING COMPANY  
SHERWOOD R. GORDON, BOSS  
SOLD NATIONALLY BY ADAM YOUNG, INC.



**WSYR-AM-TV** Syracuse, N. Y., will move into these new quarters at 1030 James St. June 22. It was announced last week by E. R. Vadeboncoeur, president and general manager. New building, estimated to cost in excess of \$1 million, will house complete broadcast operations including studios, executive and sales offices and engineering personnel. Up to now, the stations have been at two separate sites.

The week following the opening will be devoted to a series of special guest events for various civic and industrial and business groups, as well as the press, clients and staffers' families. Families living immediately adjacent to the new broadcast center will also be hosted. Open houses for the public will be held June 28-29.

has been good, according to Mr. Crohan. A number of comments have been carried on the *Speak Up Neighbor* program and many advertisers have lauded the station for its stand, he said.

### NEW BRITAIN, CONN.

Broadcasters should editorialize freely, observing "the rules of fairness imposed by the Communications Act," Chairman Oren Harris of the House Commerce Committee said Friday in an address to the Connecticut Broadcasters Assn. in New Britain.

Chairman Harris predicted editorializing will have an important side effect as broadcasters shoulder responsibility for such programs, thus relying less on ratings and to a greater extent on their own proper sense of values. "Such increasing self-reliance," he said, "will, I hope, give you the courage to offer to different segments of your listeners and viewers the kind of programs which they may learn to like."

He suggested this increasing diversification of programming "may help to avoid the debacle now experienced by most automobile manufacturers who insisted on offering to too many too much of the same."

### Bagwell Named Station Manager For WKY-AM-TV Oklahoma City

Norman P. Bagwell, business manager of WTVT (TV) Tampa, Fla., has been appointed station manager of WKY-AM-TV Oklahoma City and a director of the WKY Television System Inc. (WKY-AM-TV, WTVT and WSFA-TV Montgomery, Ala.)

The appointment of Mr. Bagwell, former administrative assistant at WKY, fills a vacancy created by the resignation of Raymond W. Welpott, WKY Television System vice president and manager of WKY-AM-TV, who is joining the NBC Owned Stations and Spot Sales Div. in a general executive capacity [AT DEADLINE, May 19].

Other personnel changes announced by E. K. Gaylord, president of Oklahoma Pub-

lishing Co., parent firm of the WKY Television System:

Jim Terrell, WKY-TV commercial manager, to assistant station manager; John Moler, director of radio operations, to assistant station manager of WKY; John M. Haberman, WTVT commercial manager to assistant station manager (announced by Eugene B. Dodson, vice president-station manager of WTVT), and Carter Hardwick, manager of WSFA-TV, named a director of the WKY Television System.

### Plough Radio Stations Sales Increase 11% in First Quarter

Sales of the four radio stations in the Plough Inc. group are running 11% ahead of last year's record level, Plough executives were told at a Wednesday-Thursday conference held at the Sheraton-Belvedere Hotel, Baltimore.

Harold R. Krelstein, president of the Plough stations (WCAO Baltimore, WJJD Chicago, WMPS Memphis, WCOP Boston), said the sales increase was based on the first 20 weeks of 1958. They also were told WCOP now has highest ratings in its history. The executives discussed plans to improve local radio selling and to explore new business sources in their communities.

Officials considered methods of promoting appreciation of the nighttime radio audience; ways to integrate the Plough stations into community affairs; program plans, and the strengthening of news programming.

### KMBC-TV's Davis Cops Top Award In 'Lone Ranger' Promotion

Donald D. Davis, general manager, commercial manager and promotion manager of KMBC-TV Kansas City, Mo., has won the top award for the best local campaign conducted by any U. S. tv station in connection with the 25th anniversary of *The Lone Ranger* and the forthcoming United Artists theatrical release, "The Lone Ranger

and the Lost City of Gold." Mr. Davis will receive a cash award of \$2,500 for his winning campaign, one of 22 prizes totaling \$10,000 to be distributed this week to tv station promotion managers by the Jack Wrather Organization, owner of the veteran radio-tv series.

General Mills and American Bakeries, who sponsor *The Lone Ranger* on ABC-TV and CBS-TV, and United Artists Corp. are participating with the Wrather firm in the awards.

Second of the promotion manager awards, for \$2,000, was won by Burt Toppan, WTVJ (TV) Miami, Fla. Roy Pedersen, WDAY-TV Fargo, N. D. will receive the third prize of \$1,500 and Gene Godt of WCCO-TV Minneapolis, Minn., the \$1,000 fourth award.

Two awards of \$500 each will go to D. M. Kelly Jr., WJBF-TV Augusta, Ga., and Chuck Olson, WREX-TV Rockford, Ill.

Five \$250 awards will be distributed to Robert Peel, WHEN-TV Syracuse, N. Y.; Charles R. Garrison, WSLs-TV Roanoke, Va.; Joseph A. Haeffner, WBEN-TV Buffalo, N. Y.; Vera Schulte, WCPO-TV Cincinnati, and William Adams, WSB-TV Atlanta.

Four \$100 awards will be given to Hughes Drumm, WWL-TV New Orleans; Walter Paschall, WSB-TV Atlanta; Gwen Bird, KFRE-TV Fresno, Calif., and Harvey Tepper, KBET-TV Sacramento, Calif.

Additional awards for \$50 each will go to Henry Clark, WREC-TV Memphis; George Lord, WTCN-TV Minneapolis; David Mosier, WNTC-TV Greenville, N. C.; Tony Picha, WMAR-TV Baltimore; Mel Richardson, KID-TV Idaho Falls, Idaho; Whiteford Smith, WBTW-TV Florence, S. C., and David H. Witherspoon, WRAL-TV Raleigh, N. C.

### Miller, Joyce Named Katz V.P.'s; Gunst Retires as Chicago Head

Roy Miller, who joined The Katz Agency, station representative, in 1942 as Chicago radio sales manager, succeeds Gerald H. Gunst as vice president in charge of Katz'



MR. MILLER MR. GUNST MR. JOYCE

Chicago office. Mr. Gunst's retirement effective June 1 was announced last week.

Also announced was the election of William Joyce to a vice presidency. Mr. Joyce is Chicago tv sales manager; he has been with the representation firm since 1945.

Mr. Gunst joined The Katz Agency in 1919, opened the firm's Atlanta office in 1920 and then returned to the New York office. He took charge of the Chicago office in 1940. Mr. Miller continues as Chicago radio sales manager in addition to his new duties.

Portable  
Versatile  
Dependable

## CECO\* Vidicon SUPPORT EQUIPMENT

gives top performance—Indoors or Outdoors

Expressly designed for the ever increasing TV field, this equipment consists of a pan and tilt Tripod Head with internal Balancing spring. Vidicon Cameras with electronic viewfinder can be easily mounted and operated. The head mounts on the CECO Professional Tripod (or any other standard mounting flange) and the CECO Pro Senior Collapsible Three Wheel Dolly makes this a complete versatile package.



Professional Jr. Spring Head

Ideal for Viewfinder Vidicon Cameras weighing up to 35 lbs. Internal balancing spring. Built-in spirit level. Fits standard Pro Jr. Tripod, Baby and Hi-Hat (low mount).



### Specifications:

CECO Vidicon Head designed for use with a variety of Vidicon cameras, weighing from 45 pounds up. Vertical and horizontal movement of tilt head controlled by independent friction locking devices. Super-smooth action.

Tripod folds quickly and compactly. Offers a height range from 36 to over 53 inches. Double leg locks.

Pro Senior Collapsible Dolly is lightweight and compact. Rubber-tired wheels may be locked or set in a straight line position.

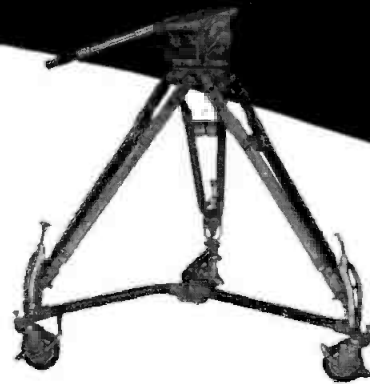

\*CECO trademark of  
Camera Equipment Company

FRANK C. ZUCKER

CAMERA EQUIPMENT CO., INC.

Dept. B 315 West 43rd St., N. Y. 36, N. Y. JUdson 6-1420

1  
United Press news produces!

use  
**CHANNEL 4-SIGHT**

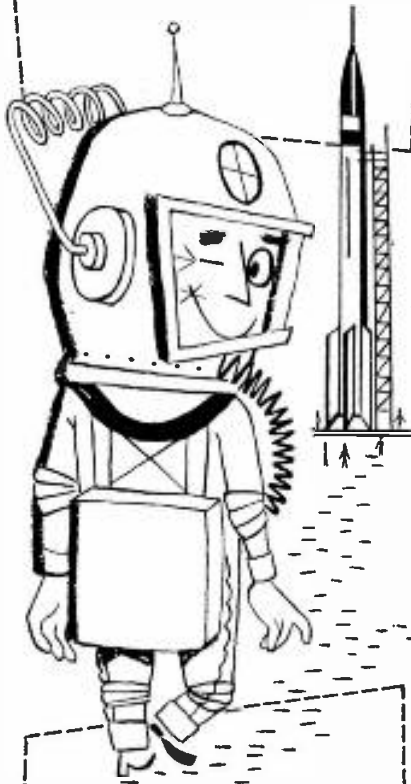

No need to flirt with success on the great Golden Spread. Get jet-propelled results with Channel 4-Sight.

More than 100,000 TV sets in a vastly healthy and wealthy market.

Power: Visual 100 kw  
Aural 50 kw

Antenna Height 833 feet  
above the ground

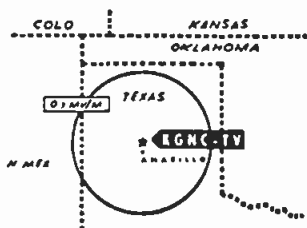

**KGNC-TV**  
CHANNEL 4  
AMARILLO, TEXAS

CONTACT ANY KATZ MAN

STATIONS CONTINUED

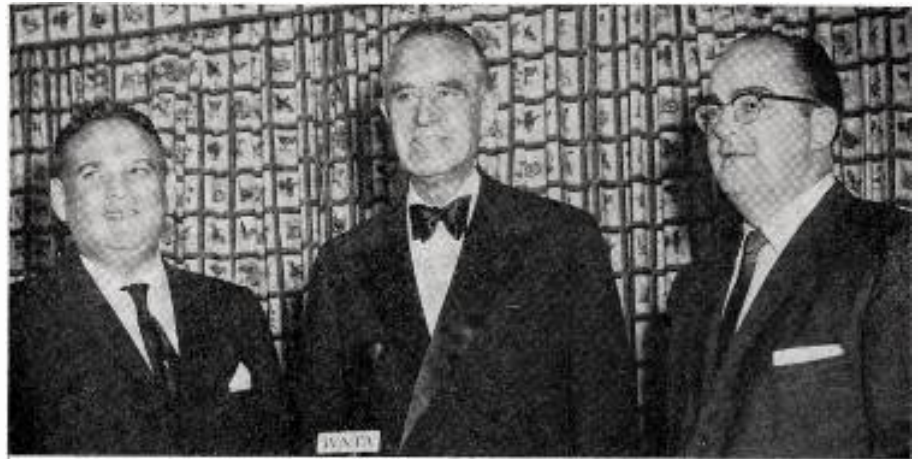

**PRESENT** for the inauguration of New York market activity by WNTA-TV Newark, N. J., was Averell Harriman (c), governor of New York, with Oliver A. Unger (l), president, and Ely A. Landau, chairman of the board of National Telefilm Assoc., owner of WNTA-TV. The ceremony took place at NTA headquarters in New York.

**WCKR-AM-FM Brings \$800,000 In Sale to Sun Ray WPEN-AM-FM**

WCKR-AM-FM Miami was sold last week for \$800,000 (see CHANGING HANDS, below) to the Sun Ray Drug Co., owner of WPEN-AM-FM Philadelphia. Ch. 7 WCKT (TV) Miami, the WCKR sister station, stays under the ownership of Biscayne Tv Corp., Niles Trammell president. The sale is, of course, subject to FCC approval.

In the announcement of sale, by Sun Ray Drug-WPEN executives Harry S. and William H. Sylk, it was noted that the sale agreement includes all facilities of WCKR and use of its present building, housing the offices, studios and transmission equipment. Sun Ray is leasing the radio portion of the Biscayne plant under a 10-year arrangement at \$18,000 a year as part of the overall transaction. Of the \$800,000 paid for the Miami stations, \$700,000 was borrowed on a bank note.

The new licensee of WCKR will be the Dade Broadcasting Corp., with Harry S. Sylk as board chairman, William H. Sylk

as president and William B. Caskey as executive vice president. Mr. Caskey, former president of the Philadelphia Radio and Television Broadcasters Assn., has been executive vice president of WPEN.

**Eastman, Former ABC Radio Head, Opens Own Representation Firm**

Robert E. Eastman & Co., new station representation firm, opened New York offices last week at 527 Madison Ave., telephone Plaza 9-7760, and plans to open June 2 in the Russ Building in San Francisco and at 333 N. Michigan Ave., Chicago. The company, which already has signed a nucleus group of client stations [CLOSED CIRCUIT, May 12], is headed by Robert E. Eastman, former president of ABC Radio and before that executive vice president of John Blair & Co., station representative. Mr. Eastman said Dick Arbuckle, former Chicago manager of NBC Spot Sales, would be midwest manager for the new firm and that Dick Schutte, former sales manager of KCBS San Francisco, would be western manager.

**CHANGING HANDS**

**ANNOUNCED** The following sales of station interests were announced last week. All are subject to FCC approval.

**WCKR-AM-FM MIAMI, FLA.** • Sold to Sun Ray Drug Co. (which owns WPEN-AM-FM Philadelphia) for \$800,000 by Biscayne Tv Corp., licensee of ch. 7 WCKT (TV), which is jointly owned by principals of *Miami Herald* and *Miami News* with Niles Trammell, former NBC president, present general manager and 15% stockholder. WCKR operates on 610 kc with 5 kw; WCKR-FM on 97.3 mc with 15 kw. WCKR is an NBC affiliate.

**WSUZ PALATKA, FLA.** • Sold by Carmen Macri to Ray P. McMillin for \$80,000. Mr. McMillin is Jacksonville, Fla., businessman. Mr. Macri also owns WWOK Charlotte, N. C., and WZOK Jacksonville, Fla. The

**TRACK RECORD ON STATION SALES, APPROVALS**

sale was handled by Blackburn & Co. WSUZ operates on 800 kc with 1 kw, day.

**WCHF CHIPPEWA FALLS, WIS.** • Sold by Walter F. Kean to Stephen P. Bellinger, Morris K. Kemper, Joel W. Townsend, Ben H. Townsend, T. Keith Coleman, Vernon R. Nunn and Charles H. Green for \$76,650. All of the buyers have interests in WVMC Mount Carmel, Ill. All of them, with the exception of Mr. Green, are also stockholders in WRAM Monmouth, Ill., and WWIZ Streator, Ill. The sale was handled by Allen Kander and Co. WCHF operates on 1150 kc with 5 kw, day.

**KWEL MIDLAND, TEX.** • Sold to P. D. Johnson, co-owner of KVWC Vernon, Tex., by Jerry Covington for \$60,000. Hamilton, Stubblefield, Twining & Assoc. handled the sale. KWEL operates on 1580 kc with 1 kw, day.

## SAG: LET MEANY RULE ON VTR

The Screen Actors Guild has proposed that its dispute with the American Federation of Television-Radio Artists over jurisdiction in video tape commercials be arbitrated by George Meany, president of the AFL-CIO.

The SAG proposal was made in a letter to be air mailed last night from the SAG board to the AFTRA board in New York and to AFTRA Chicago and Los Angeles sections.

SAG stipulated that both unions agree in advance to be bound by Mr. Meany's decision.

The SAG letter stated in part: "At this moment we two actors' unions are faced with a division of opinion as to how to divide our negotiating activities in the video tape television commercial field.

"SAG has proposed that AFTRA cover all such work done at television stations and networks and that SAG cover all such work done outside television stations and networks.

"You disagree. However, the area of our disagreement, as we see it, is not great. In

recent informal discussions between us you have recognized that the guild should cover all video tape television commercials produced by motion picture studios as we have recognized that AFTRA cover all such commercials produced by television network and station broadcasting studios.

"We propose that this division be mutually confirmed. This leaves as the only area in dispute between us the following: taped commercials produced by studios devoted to this purpose and not engaged in production in either of the above excluded areas . . .

"We therefore wish to propose that in lieu of a long, expensive and possibly bitter fight before the NLRB, the question of whether AFTRA or the Guild should have jurisdiction over work done in the disputed area above described be determined by arbitration, and we hereby offer to arbitrate the matter and propose that the president of the AFL-CIO, Mr. George Meany, be the sole arbitrator, both sides agreeing to abide by his decision."

## SHOWDOWN DELAYED IN UNION WRANGLE

- Hollywood dispute hangs fire
- Action delayed for AFM meet

Showdown between the administration and anti-administration forces within Local 47, Hollywood, of the American Federation of Musicians has been postponed until after the AFM national convention, starting June 2 in Philadelphia. Following the announcement of AFM President James C. Petrillo that he would not be a candidate for the office he has held since 1940 [PERSONNEL RELATIONS, May 19], the AFM put off its investigation of the local's suspension of seven members on charges of dual unionism, which was to have begun May 15, until sometime in June.

Also put off until the union's delegates have had a chance to elect a new national leader is the National Labor Relations Board hearing of the application of the Musicians Guild of America, newly formed rival to AFM [PERSONNEL RELATIONS, March 31], for the right to challenge AFM's representation of the musicians normally employed by the major motion picture studios, but out on strike [PERSONNEL RELATIONS, Feb. 24]. The hearing, set to begin last Tuesday in Los Angeles, was postponed until June 12.

June 12 also is the date now set for a new election of directors of the Musicians Club, originally scheduled for June 5 but, like the other actions, delayed until after the AFM convention. Six of the seven suspended members of Local 47 were elected directors of the Musicians Club, which controls the real estate and bank deposits of the union. Before they were seated, however, they lost their membership in the local, a requirement for membership in the Musicians Club, on charges that they had supported the cause of MGA and so were guilty of dual unionism.

When the suspended musicians protested

to the Los Angeles Superior Court, Judge Bayard Rhone issued a preliminary injunction ordering the local not to interfere with the employment opportunities of these men until they had been given the opportunity of appealing their suspension within the AFM itself [PERSONNEL RELATIONS, May 12]. Mr. Daniel subsequently filed an appeal to Judge Rhone's injunction which in effect stays its provisions until a hearing has been held, according to a spokesman for Local 47.

The AFM's investigation of the suspension of the seven members of Local 47 will be conducted by Los Angeles attorney George E. Bodle, appointed by the national union as referee in this matter.

Essentially, MGA's President Cecil Read and his supporters are rebels against policies they attribute to Mr. Petrillo personally. Now that he has announced his intention to retire at the June convention, there may be a new AFM president, new AFM policies. A reconciliation between the opposing forces is possible, with a modification of trust fund policies to give musicians employed in films and recording a larger share of the moneys expended by companies in these fields for the employment of their services, with reinstatement of the rebels into the national AFM and Local 47, and MGA dissolution.

Tonight (Monday) Local 47's members will vote on an administration motion that the local's delegates to the national convention be instructed to fight for four changes in national policy: removal of the 5% charge on new tv film [a trust fund payment required if AFM members are employed]; resumption of payment of \$25 for the re-use of theatrical motion pictures on tv to individual musicians, instead of to the trust fund; that the 21% increase in scale on phonograph records be paid to the individual musicians instead of to the trust fund and that "no contracts be entered into without the ratification of the individuals affected thereby."

FOR IMMEDIATE RELEASE  
To Television Stations Only

A Public Service Film Available For  
Any 10-Day Period Without Charge

## "CHALLENGE IN ASIA"

Narrated by  
**Lowell Thomas**

◆ A 13½ minute film short on today's challenge in Asia. Will the Philippine people and their President, with their English-speaking, Christian heritage on an Oriental background provide a fresh means of Peace in Asia and understanding with the West? In this film President Garcia gives his answer.

◆ Here is an inside look at President Garcia at work in Malacanang Palace, the Philippine White House. The film includes a special sequence on his role as host to the SEATO conference, which helped firm up the anti-Communist alliance in Asia. There are live sound statements by Secretary of State John Foster Dulles and Philippine President Garcia, also intimate glimpses into the workday and the private home life of President Garcia . . . including Cabinet Meetings, as host at a state dinner for SEATO foreign ministers . . . receiving a newly appointed ambassador . . . talking with a delegation of American boys . . . welcoming world-renowned personalities, Marian Anderson and others . . . relaxing with his family . . . playing chess . . . with a final interview of broad impact on tomorrow in Asia!

◆ A remarkably different public service film for the TV program director seeking to give his viewers a fresh insight into Asia and President Garcia's objectives for the betterment of Philippine-American understanding.

◆ Produced by Alfred Wagg Pictures, narrated by Lowell Thomas, directed by Alfred Wagg, written by Joe DiMona, photographed in 35mm black and white, and 16mm prints are available, with synchronized sound and music.

*For additional information,  
please write or wire:*

**ALFRED WAGG PICTURES**  
7801 Woodmont Avenue  
Washington 14, D. C.  
Telephone: Oliver 6-3161

# N.Y. ETV HINDERED—NO MONEY

The situation was nip-and-tuck late last week in New York educational tv circles following an announcement Wednesday by the Metropolitan Educational Television Assn. that it would be forced "with profound regrets"—to suspend active production operations as of June 1. META president Dr. Alan Willard Brown said his action was irrevocable "unless emergency funds could be raised within the next 10 days." The suspension was deemed temporary.

Though prospects for a sudden windfall to meet outstanding bills and salaries seemed "highly remote"—prompting META to pinkslip its entire working staff of 45 effective May 30—the financial S.O.S. was answered 24 hours later. META confirmed reports that a number of aroused viewers had responded with gifts; one New Yorker sent in a check for \$2,000, another a personal pledge for \$5,000, and several high school students in Englewood, N. J., pooled their allowances and sent in \$18. With \$6,000 already in the coffers as a result of an intensive 6-week fund raising drive, META detected "a glimmer of hope on the horizon" but confessed that these funds represented "only a drop in the bucket."

Dr. Brown, head of New York's embryonic non-profit etv production center, blamed lack of financial and civic support

for META's suspension. He also scored New York state legislators for their "general disinterest" in educational tv. Dr. Brown admitted that the current recession also had "something to do with our situation," explaining that people on whom META had depended for financial aid now were taking a "long, hard look at the tax-deductible dollar." He put META's needs for the next six months at \$200,000. Its annual budget has been \$400,000 (supplied wholly by grants). Supporting foundations have been the Avalon Foundation, Rockefeller Bros. Fund, Old Dominion Foundation, Fund for Adult Education, New York Foundation and Carnegie Foundation for the Endowment of Peace, which together had initially supplied META with \$650,000.

Three of these groups jointly have pledged \$100,000 but the pledge will remain unfulfilled until calendar year 1959. META began operations last Sept. 25 after building from scratch a \$100,000 telecenter (with feed lines to various New York stations) and spending \$250,000 on equipment. The telecenter will black out June 1. META thus is left with only \$300,000 to meet expenses running \$400,000.

A few months ago, the Board of Regents of the State of New York (under whose charter META exists) was granted \$600,000 by the state legislature, these monies to

## ETV S.O.S. ANSWERED

Public-service conscious WMCA New York was quick to heed META's S.O.S. last week and by Friday had gone on the air with an intensive volunteer spot radio drive to solicit public contributions for META. WMCA President Nathan Strauss explained:

"Education is a basic community responsibility. Etv is not licensed as a commercial operation and cannot exist without public support. When the fact is made clear that META is a non-profit educational enterprise, we think the public will act accordingly. There is no competition between commercial radio and educational television. WMCA is happy to donate its facilities in order to make the public aware of META's great need."

be used for etv in greater New York. The regents earlier had sought to purchase ch. 13 (WATV [TV] Newark), now WNTA-TV, but terminated negotiations shortly before the take over by National Telefilm Assoc., present owners. The regents then approached WOR-TV (ch. 9) as a possible etv outlet, requesting that the station turn over the daytime hours which are generally low on commercial sponsorship. WOR-TV in exchange was to have received the \$600,000 for time and programming this fall, but META was reported to have slated \$365,000 of this allocation to pay for production and programming. The balance was to be WOR-TV's. Station Vice President-General Manager Gordon Gray acquiesced, agreed to turn over the Mon.-Fri., 9 a.m.-5 p.m. hours after rejecting the initial regents request for 8 a.m. to 7 p.m.

But with the fate of META in doubt, Mr. Gray said Thursday, it "would seem, I suppose, that now nothing will come of this" unless META were suddenly to get a transfusion.

The programs now seen on WPIX (TV) and those planned for WCBS-TV will black out June 1. The filmed and/or kinescoped etv shows aired on WABC-TV and WNTA-TV will end with the current cycle.

## NAEB, Government Convening First Media Meeting in 8 Years

The future course of television and other media in relation to education will be explored starting today (Monday) at a conference co-sponsored by the National Assn. of Educational Broadcasters and the U. S. Office of Education in Washington, D. C.

Nearly 100 specialists from education and educational radio-tv are expected to attend the three-day sessions at the Dept. of Health, Education & Welfare. They will exchange views on etv's current status and trends. Speakers will represent the NAEB, Joint Council on Educational Television, Educational Television & Radio Center, and tv committees of the American Council on Education.

The conference will be the first such meeting in nearly eight years.

## The Sound of Quality

**DAY** and

In a quality market of 14 counties where 598,800 people spent \$1,016,738,000 — a per capita average of \$1,885.00. (\$204 above the national average.)  
Salesmanagement's "Survey of Buying Power — 1957"

A quality rural market of 28,520 farm homes with a gross income of \$377,957,000 — a per farm average gross income of \$14,307.00.  
Census - U.S. Department of Agriculture

**NIGHT**

For over 35 years the Quint-Cities' senior station

(Davenport and Bettendorf, Iowa — Rock Island, Moline and East Moline, Illinois)

**WOC RADIO**

Tri-City Broadcasting Co., Davenport, Iowa

Col. B. J. Palmer, President  
Ernest C. Sanders, Manager  
Mark Wodlinger, Sales Mgr.

Peters, Griffin, Woodward, Inc.  
Exclusive National Representatives

## ALLARD RETAINED AS HEAD OF CARTB

- Group's name reverts to CAB
- Need to form networks stressed

Jim Allard remains for the present as executive vice-president of the Canadian Assn. of Broadcasters, with the incoming board of directors left the job of finding a paid president to take his place. Although corridor gossip at the CAB convention at Montreal, May 11-14, hinted that Mr. Allard would not be reappointed, it was left for the Atlantic Assn. of Broadcasters to word a resolution at a closed business session to leave the matter of his successor to the incoming board. Mr. Allard's dismissal had been urged by a group in the association last month [INTERNATIONAL, April 28].

The association decided at its closed meeting that the CARTB should again become the Canadian Assn. of Broadcasters. CARTB had been in use since 1953.

The CAB emphasized going after the right to establish independent networks as quickly as possible, and members were urged at the closed business session to develop program production and network operating standards so that the CAB member stations can form networks when its directors can obtain the necessary authority. A committee to look into all phases of network operations is to be formed by the new CAB board.

Despite an announcement on May 12 by the Canadian government that a new agency is to be established for control of both the Canadian Broadcasting Corp. and independent stations, the broadcasters' group convention passed a resolution regarding separation of the regulatory and actual broadcasting functions of a state-operated broadcasting system. Such separation, the resolution stated, would "permit the best service to the public by both the state operated broadcasting agency and the large non-government broadcasting industry."

The CAB also went on record favoring the establishment of second television stations by non-government applicants "in any area of Canada consistent with the best interests of the community" as soon as possible and on "a basis of equality with existing stations as to regulation and obligations in order to encourage full development of the television medium in the best interests of the Canadian public, and so as to best serve those areas of Canada within the reach of competitive U.S. broadcasting."

At the convention, Vern Dallin, CFQC-AM-TV Saskatoon, Sask., was re-elected president, with Phil Lalonde, CKAC Montreal, Que., as vice-president for radio, and Geoff Stirling, CJON-TV St. John's, Nfld., as vice-president for television. Regional directors elected were, from the Atlantic region, J. A. Manning, CKCL Truro, N. S.; D. M. Neill, CFNB Fredericton, N. B., and Mr. Stirling; for the French-language group, D. A. Gourde, CKRN Rouyn, Que.; Roland Couture, CKSB St. Boniface, Man.; Mr. Lalonde, and Tom Burham, CKRS-TV Jonquiere, Que.; for Ontario and English-speaking Quebec stations, J. A. Dupont,

CJAD Montreal, Que.; W. H. Stovin, CJBQ Belleville, Ont.; W. N. Hawkins, CFOS Owen Sound, Ont.; Murray Brown, CFPL London, Ont., and R. T. Snelgrove, CKVR-TV Barrie, Ont.; for the three prairie provinces, R. J. Buss, CHAT Medicine Hat, Alta.; D. Dawson, CKCK Regina, Sask.; J. O. Blick, CJOB Winnipeg, Man., and Norman Botterill, CJLH-TV Lethbridge, Alta.; for British Columbia, J. A. Sayers, CFUN Vancouver, B. C.; A. B. Seabrook, CJIB Vernon, B. C., and D. M. Armstrong, CHEK-TV Victoria, B. C.

### State Dept. Asks Proposals For Russian Radio-Tv Exchange

The State Dept., implementing the East-West exchange agreement signed with the U.S.S.R. [GOVERNMENT, Feb. 3], has asked interested parties to notify the department what programs they wish to offer the Soviet government for sale or exchange.

Broadcast subjects covered by the agreement are science, technology, industry, agriculture, education, public health, sports, music, dramatic and literary shows. Programs on international political problems must be discussed in advance and may be rejected by either government, the agreement specifies.

Program lists submitted to the State Dept. will be transmitted to the Soviet government and similar lists from the Soviet Union subsequently will be made available to interested companies in this country.

The department has asked that lists con-

tain a brief description of contents and broadcast time for each program. Proposals should reach the State Dept. Office of East-West Contacts not later than June 1.

### State Budget Estimate for CBC Up \$20 Million for 1958-59

Budget estimates of the Canadian government for the 1958-59 fiscal year included \$61,358,135 for the Canadian Broadcasting Corp., as compared with \$42,294,222 in the fiscal year which ended March 31, 1958.

Included in the sum requested is more than \$39,000,000 towards anticipated operating deficits of the CBC for both radio and television, more than twice the figure granted last fiscal year. CBC receives the 15% excise tax on manufacturers' sales of radio and tv sets and parts, which this year is expected to yield \$12,000,000, a drop of \$4,000,000 due to a drop in sales of receivers. CBC also will receive in its grant from the federal treasury \$8,414,000 for capital expenditures, up from last year's \$6,572,490.

### INTERNATIONAL SHORTS

ABC-TV's comedy-panel show *Make Me Laugh* (Thurs. 10-10:30 p.m.) will be presented on British commercial television next fall, it has been announced by Mort Green and George Foster, creators of program, and Jack Hylton, president of Jack Hylton Tv Productions, London. Program, purchased by Associated Rediffusion, will feature English comedians.

## JACKSONVILLE'S FAVORITE COWBOYS . . .

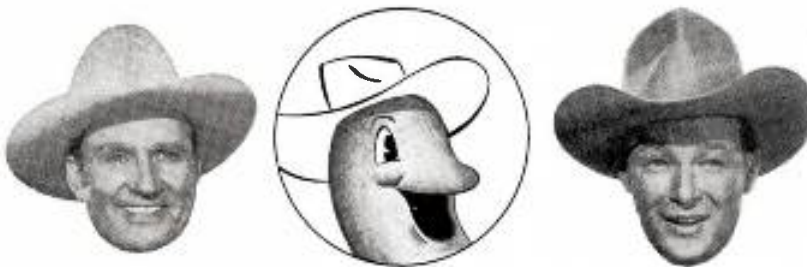

These "Six Gun Saturday" ranch hands are riding right into the hearts of Jacksonville viewers and corraling top brand results and ratings.

Take a bead on these wild and woolly ratings—

Sunrise Ranch with Gene Autry—average rating for the hour from 7:30-8:30 AM was a high riding 17.3\*.

Cartoon Corral—rating for this 8:30-8:45 AM show was a blistering 19.8\*.

Prairie Playhouse with Roy Rogers—the average rating for the hour from 9:00-10:00 AM was hotter than a blazing six gun at 22.5\*.

So Pardner, you'd better saddle-up and flip the old sales lariat around one minute availabilities on these low cost per thousand shows.

Call Ralph Nimmons in Jacksonville at ELgin 6-3381 or contact your nearest P.G.W. "Colonel". They'll be happy to put your brand on these top one minute availabilities.

\* March 1958 ARB Ratings

Represented by Peters, Griffin, Woodward, Inc. NBC-ABC

**WFGA-TV Channel 12**  
Jacksonville, Florida  
**FLORIDA'S COLORFUL STATION**

## GOOD RESPONSE TO RADIO MONTH

National Radio Month, successor celebration to the annual week-long event, entered its final week with the array of promotional efforts ranging from community events to the nationwide campaigns of NAB, Electronic Industries Assn., Radio Advertising Bureau and related organizations.

The cumulative impact of the month-long drive was generally described as much greater than the effect of the Radio Week of the past. In practically every community radio stations individually and in concert staged promotions that ranged from special programming to spectacular stunts.

Congressional leaders joined in paying tribute to radio. Speeches were made in both the House and Senate. Legislators included radio references in their broadcasts back home and in reports mailed to constituents. President Eisenhower and Vice President Richard M. Nixon led government officials in recognizing the industry's achievements.

Radio today "may be said to be the very breath of life in the first amendment to the Constitution of the U. S.," Rep. John McCormack (D-Mass.) told his colleagues from the House floor in a speech honoring National Radio Month.

"When the Constitution enjoins the Congress from making any law abridging the freedom of speech it extends the infinite blessings of the prohibition by the very nature of things to the electronic miracles of communication," Rep. McCormack said. "Without electronic communication, as we live today, it is almost impossible to think either of the democratic process or modern civilization in the free world. It is for these reasons that I attach such great importance to National Radio Month during May.

"Radio stands out as a phenomenon unparalleled in its time, unless it is by tv, in the acceleration of modern industrial progress. . . . A self-governed people can never in the future say that inadequate communication was responsible for any of its ills."

The House majority leader congratulated the radio industry proper and the NAB for a commendable job and pointed out that "this durable, tireless, relatively inexpensive device . . ." reaches 97% of all American homes. Personal research on radio, Rep. McCormack stated, "reveals a wealth of further data that is, on the whole, illustrative of superior management by private industry . . . with enlightened regulation by government.

NAB President Harold E. Fellows and staff executives of the association carried the radio message to many audiences. In addition NAB supplied elaborate kits that included speech material for use by member and non-member stations. RAB, too, sent promotional kits to stations. Kevin B. Sweeney, RAB president, led that organization's staff in addressing Radio Month meetings.

President Fellows described radio's circulation and impact in his Washington, D. C., talk, delivered to the Ad Club, including a statement that 27.1 million people now live in homes with fm receiving equipment. He

observed that radio and other media "can help to convey to Americans everywhere a true understanding of the world in which we live." He added that understanding brings positive action in all the aspects of human relationships.

Mr. Fellows added, "Those in both advertising and communications can help keep this country's economy strong by salesmanship which will keep the flow of goods and services moving through the market place." Other broadcasters joined Mr. Fellows in explaining the industry's part in the nation's welfare.

Varied station promotions sparked the observance. KMOX St. Louis reported success with its listener contest. The station gave away four Zenith radios a day all through May for the best postcards explaining why listeners like the station. WWJ Detroit had a tieup with high school students aiming at radio careers and gave them disc jockey experience. The station also gave away radios at its two remote locations at shopping centers.

Programming included such events as a WPEO Peoria, Ill., forum with three executives of major national advertising agencies. A sample promotion was "The Big Surprise" of KCMO Kansas City, with 81 radios given away each week for two weeks to listeners. In Washington, D. C., stations donated 36 transistorized radios at an Ad Club luncheon—two from each station in the area. Another agency idea was used by KNX Los Angeles, which is giving prizes, including a sailboat, to agency executives.

The Flint (Mich.) Radio Broadcasters Assn. is running a contest with a two-week vacation at a Lake Huron cottage as the prize. The winner and family will have free use of a boat, free food, free meals out and many other types of service and products. The Tawas (Mich.) Chamber of Commerce is cooperating with WAMM, WBBC, WFDF, WKMF, WMRP and WTAC in the promotion. Over 50,000 entry blanks were distributed around Flint stores. The blanks have provision for information on family size, home and car radios and listening habits.

WDON Wheaton, Md., staged two contests, sending out Earl Robbin, disc jockey, to prepare pancake breakfasts as one attraction. American U. radio students ran the station for a day. KBKC Kansas City loaned staffer Chuck Goodman to a high school or college girl for an evening as a contest award.

KGFJ Los Angeles carried salutes from a dozen major movie-radio-tv stars. KRIZ Phoenix, Ariz., held a daily KRIZ Quiz based on radio's history, with retail stores participating. Radios were given as prizes. KVOO Tulsa sent scores of regular advertisers bouquets of May flowers via high school girl graduates.

The Southern Baptist Radio & Television Commission presented personalized public service awards to 460 stations which carry its *Baptist Hour* each week. Vocal presentation was made on the program by Paul M.

Stevens, who is the commission director.

Each Tuesday during May the three stations in Tallahassee, Fla.—WTAL, WMEN and WTNT—broadcast a three-station musical program with a d.j. from each station as host. The public was advised to place three radios around a room to obtain a stereophonic effect. Cooperative announcements have been carried in newspapers and on the air.

A combined luncheon of the Pittsburgh Ad Club and Radio & Television Club was addressed by RAB President Sweeney.

Art Holbrook, managing director of the Southern California Broadcasters Assn., has addressed numerous organizations in the region, starting with a May 5 talk to the Santa Barbara Advertising & Merchandising Club. WJAM Marion, Ala., cooperated in a Dream-Come-True promotion of local businessmen, with a seven-day trip to Miami Beach for four as the prize.

WGN Chicago's observance included a spot campaign in cooperation with the Electric Assn. to combat dangerous and faulty electric wiring in homes. Personalities from the four Fort Wayne, Ind., stations—WANE, WGL, WOWO and WKJG—paraded in a 31-car caravan. Civic officials and leaders participated. Radio personalities were dressed in fashions of the 1920s.

At Vero Beach, Fla., WTTB staffers are wearing sport shirt-short outfits with call letters on the back, plus labeled pith helmets. They are known as the Knobby Knees Club. Special feature programs have been broadcast, including the arrest of two staffers for indecent exposure.

WXYZ Detroit offered space age news maps, drawing a quick response.

### ABA Offers Booklet on Canon 35

A transcript of the special Canon 35 hearing during the American Bar Assn.'s House of Delegates meet in Atlanta, Feb. 24, is being offered by ABA to "interested editors, publishers, broadcasters or others in press, radio and television industries." A stenographic summary of the hearing has been published in booklet form, including full statements by proponents and opponents of the canon, which prohibits radio-tv photography coverage of courtroom proceedings.

The booklet also contains a reprint of American Bar Foundation committee's report recommending a re-phrasing of Canon 35. The House of Delegates deferred action on a proposed new version until ABA's annual meeting in Los Angeles, Aug. 25-29. Report is being made available as a public service to media representatives and bar members.

### Views on Every Newscast on WKMH

Editorials on state and local affairs are presented on every newscast over WKMH Dearborn, Mich. Two editorials are prepared daily and Bob Runyon, news director, presents them alternately on the station's hourly newscasts. He reads both editorials on the 7:45 a.m. and 6 p.m. editions.



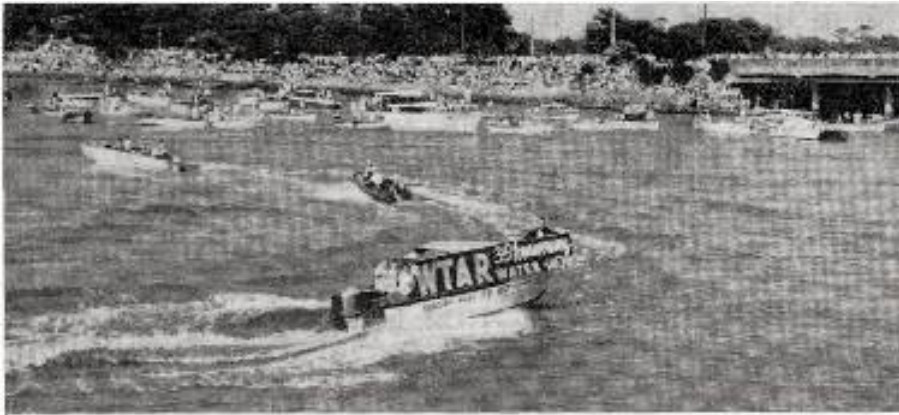

**BROADCAST** promotion by WTAR Norfolk, Va., turned out a 30,000-person live audience for its 35th anniversary Water Thrill Show. Tommy Bartlett, owner of the water troupe, acknowledged the record turnout resulting from two weeks of daily spots on WTAR, with preliminary contests to pick an Aqua Queen and award boats, water skis and bathing suits. (The telecast version of the show over WTAR-TV was sponsored by a local department store featuring Jantzen bathing suits.) The WTAR water event was the first in a series of promotions celebrating the station's 35th birthday Sept. 21.

### WTIC, WOOD in Old Car Drives

WTIC-AM-TV Hartford, Conn., and WOOD-AM-TV Grand Rapids, Mich., find classic automobiles excellent vehicles on which to hang attention-getting promotions.

The WTIC stations May 8 joined the Hartford Automobile Dealers Assn.'s Parade of Progress in connection with the 10-day "Drive into Summer—First Class" sales campaign. The stations' staffers rode in such cars as a 1903 Stanley Steamer and a 1910 Thomas Flyer that were interspersed between the 1958 models. The parade was telecast by WTIC-TV and a commentary given over WTIC.

WOOD-AM-TV and the Grand Rapids chapter of the Horseless Carriage Club of America staged their fourth Antique Auto Tour over the weekend. This is a 115-mile excursion in which more than 100 ancient cars tour WOOD's coverage area. The parade's start and finish were carried on the stations, as were remotes from the inn where the entourage stayed over Saturday night.

### KOA Staffer Tends '1891 Store'

Members of early Colorado surrounded KOA Denver personality Pete Smythe when he broadcast from an "1891 Country Store." The store was resurrected at the downtown office of the Industrial Federal Savings Co.,

in connection with its 67th anniversary celebration. Mr. Smythe minded the store during the noon hour for a week at the beginning of the month. Authentic merchandise and decor were culled from old stores in the Colorado mountains and such goods as hoarhound candy and licorice whips (three cents a quarter-pound) were on sale at 1891 prices.

### KFXM Aims Building, Steel News

Newscasts of interest to people in the construction and steel industries are aired on KFXM San Bernardino, Calif., in *Construction News* (Mon.-Fri. 7-7:05 a.m.) and *Steel News and Views* (Mon.-Fri. 4:55-5 p.m.). *Construction* is sponsored by Tri-City Transit Mix Concrete Co., San Bernardino and narrated by Jimmie Williams, manager, Allied Construction Industries Inc. *Steel* is sponsored by Fontana Steel Co., Fontana, Calif., with Dale Ware, public relations man for the company, as newscaster.

### WTTW (TV) Seeks New Tv Writers

A national competition for tv scripts is being jointly sponsored by WTTW (TV) Chicago, non-commercial station, and Video-Stage '58, radio-tv unit of a newly-formed dramatic organization. The contest is open to amateur and professional writers. Winners will be able to see and hear their scripts in complete professional production on WTTW's six-program series starting next December. Scripts may be original tv plays, original stage plays adapted for tv or adaptations of other literary forms. The contest is designed to give writers "on camera" experience in tv writing and help develop new writers for television.

Deadline for scripts is Oct. 31, 1958. Information may be obtained from WTTW, 1761 East Museum Drive, Chicago 37, or Video-Stage '58, 161 E. Erie St., Chicago 11. Network tv officials will be selected later to serve as judges.

**WREX-TV MEANS ROCKFORD AND A BILLION DOLLAR MARKET NETWORK AT THE CROSSROADS OF MID-AMERICA**

The sales power of WREX-TV's combined coverage, spans market portions of 23 countries in Illinois and Wisconsin. Brings preferred CBS-ABC network programs to over 260,000 television homes.

Rockford's metropolitan area is the sales jewel in the WREX-TV market crown . . . 55,760 households—\$6,949 sales potential per household 16th in national ranking of C.S.I. per household

J. M. BAISCH, General Manager  
REPRESENTED BY  
H-R TELEVISION, INC.

**WREX-TV**  
CHANNEL 13 ROCKFORD

## another hit

in Washington, D. C.

the top station from

noon to 10 p.m. Monday

through Friday . . . without

a hint of loading ratings . . . is

# wmal-tv

### SHARE OF AUDIENCE

|           | noon to 10 p.m.<br>Monday-Friday | when all 4<br>stations compete<br>Sunday-Saturday |
|-----------|----------------------------------|---|
| WMAL-TV   | 31.7%                            | 28.9%   |
| Station 2 | 29.3%                            | 31.5%   |
| Station 3 | 24.7%                            | 26.7%   |
| Station 4 | 13.9%                            | 11.1%   |

AMS, April 8-14, 1958

represented by H-R Television, Inc.

**HOWARD E. STARK**  
BROKER AND FINANCIAL CONSULTANT  
RADIO AND TELEVISION STATIONS

80 EAST 90TH STREET  
NEW YORK 22, N.Y. ELDORADO 5-6405

ALL INQUIRIES CONFIDENTIAL

### Radio-Tv 'Bulletin' To Cover American Medical Assn. Meeting

A series of 10 special radio and tv broadcasts will be offered at the American Medical Assn.'s annual meeting in San Francisco June 23-27 as a means of keeping physicians and the public informed on convention activities.

Produced by the California Academy of Sciences in cooperation with Merck, Sharp & Dohme, pharmaceutical firm, the programs are titled *AMA Daily Bulletin of the Air* and will be tied in with a newspaper to be distributed daily at the convention. Half of the bulletins will be aired on KQED (TV) San Francisco, educational station, and the balance on KROW that city. The series is described by AMA as a "new type of radio-television journalism." The opening program will be an hour-long telecast June 22. AMA plans to edit kinescopes of the telecasts into a film on convention highlights for distribution to state and county medical societies.

### Procedures Set for Royal Visit

Accreditation procedures for the forthcoming visit of Princess Margaret to Canada in July and August have been announced at Ottawa. News reporters, cameramen, photographers, sound engineers and others covering the tour must apply through an executive of their station or publication to Mr. G. E. McElroy, Accreditations Office, Royal Visit 1958, Government Hospitality Committee, Department of External Affairs,

Ottawa, Canada, Photographers and cameramen are required to accompany the application with passport-type photos. Accreditations must be picked up in person and applications should state where it will be picked up. For those covering only the British Columbia section, where the Princess will go first in connection with the centennial celebrations of the province, accreditations can be applied for through Mr. A. H. Williamson, 475 Howe St., Vancouver 1, B. C.

### WNEW Plays Good Humor Game

WNEW New York, in association with the Good Humor Corp., Brooklyn, last week began a promotional give-away contest called "Lucky Listener Card Game." Good Humor dealers distribute cards with numbers and pictures of WNEW personalities. The winning cards will be drawn each day at the station for cash prizes.

### WMTW (TV) Hosts Food Dealers

A party of food distributors from Maine, Vermont and New Hampshire was hosted by WMTW (TV) Poland Spring, Me., Saturday. The station plans a series of promotions aimed at wholesalers and distributors in all fields. Guests golfed during the day and met the station staff at dinner in the evening.

### Film Buyer Wins Trip From Comet

Dick Woollen, film buyer, KTTV (TV) Los Angeles, threw the lucky dart in the Comet Distributing Corp., Hollywood, *Space Patrol* contest at the NAB convention. CDC asked conventioners to write their names on a dart and throw it at a map of the world. The film syndication company announced that the person whose dart came closest to a pre-selected, but undisclosed, locality would be given airline tickets for two to that place. The locality was eventually disclosed as Mauritius Island (in the Indian Ocean) and, as Mr. Woollen's dart was closest to it on the map, he wins the trip.

### KTRK (TV) Looking for Tv Star

Warner Bros. Pictures Inc., Tv Div., Burbank, Calif., has asked KTRK (TV) Houston to aid it in a search for "The Texan," a new western tv star. Men aged 23-33 who are 6 ft. or over may send the station their photos before May 23. Those entering are eligible for screening by local judges and an interview. WB will send a representative to select, from the men chosen by the judges, the ones who will receive an expense-paid trip to Warner's studios for a screen test.

### CBS Issues Essays in Brochure

CBS Radio is issuing a 54-page illustrated brochure titled "Listening to Radio," that is designed as a guide to classroom and community radio listening. The brochure, which contains an introduction by Arthur Hull Hayes, CBS Radio president, consists of essays by prominent figures in the fields of information, drama, public affairs, music, news, sports, the community and schools.

### Students Operate KVOO For a Day

Activities of the students from the five Tulsa, Okla., high schools who—since 1936—have been annually invited to operate KVOO there for a day, will be greatly expanded this year. Students will not only do on-air work but more than 74 students will participate in the sales, engineering, continuity, programming, traffic, promotion and news gathering departments. KVOO is giving the schools five half-hour segments to sell to sponsors (three one-minute spots at \$15 each); the money will go into the schools' activity funds. The 9:05-9:30 segment will feature a drama written, produced and performed by students.

### KTTV (TV) to Run 'Gable Week'

A new method of presenting old movies on tv will be launched by KTTV (TV) Los Angeles June 2, when "Clark Gable Week" starts on KTTV's *First Show* feature movie series (Mon.-Fri. 10:40 p.m.) On Monday, KTTV will broadcast "The Secret Six," with Mr. Gable supporting Jean Harlow and Wallace Beery, followed on successive evenings by "Men in White," "Love on the Run," "Too Hot to Handle" and "Homecoming." Each picture features Mr. Gable and will be repeated one night later on KTTV's *Second Show* (12:05 a.m.). During the week of June 9, KTTV will broadcast the five "Thin Man" movies with William Powell and Myrna Loy and a movie history of Jean Harlow will occupy KTTV's late evening time the week of June 16.

### On The Square

WABC New York is programming its weekday d.j. program, the *Ed Jordan Show*, from a storefront on Times Square for the two weeks ending Friday. Origination point is the Regal Shoe Store window at 44th St. and Broadway. Record albums and pictures of the station's disc jockeys are displayed in the window studio.

**TV TOLL: \$80 TILL**

Fred Redford was late one night relieving his wife at their Miami, Fla., neighborhood store because he just couldn't tear away from *White Hunter* on WPST-TV Miami. Leaving after the show, he arrived at the store to find his wife had had an adventure of her own. A robber had made off with \$80 from the till.

It was the latest blow in a season of sickness, operations (Mr. Redford's leg still was in a cast) and another earlier robbery. But the sponsors of *White Hunter*, reading in the paper of Mr. Redford's devotion to their show, were unwilling to let him suffer for it. The Ejax Oil Co. and the Johnnie and Mack Paint and Body Shop, co-sponsors, pre-empted their time on the next *White Hunter* show to make a tv presentation of \$80 to the Redfords.

INTRODUCING :

# the new MINI - STUDIO



THE COMPLETE COLLAPSIBLE PORTABLE STUDIO FOR ALL SPECIAL EVENT REMOTES



- Folds Flat — Fits in a Car Trunk
  - Highest Fidelity—4-Channel Mixer
- IMMEDIATE DELIVERY**

WRITE FOR DETAILS AND PRICES

## SHOPPER STOPPER CO.

NORTHWEST BANK BLDG. BROOKINGS. S. D.

### Tiger's 10th Birthday on WEWS (TV)

The success of a group of Cleveland stores known as Giant Tiger can be directly attributed to the firm's sponsorship of an amateur talent show on WEWS (TV) there.

The two have run parallel. When Lou

of them planned for the future.

About 5,000 performers have appeared on *WEWS Giant Tiger Amateur Show* (Sun., noon-1 p.m.) during its run.

The sponsor finds that, as the stores are open on Sundays, there is a definite in-



Weisberg, in 1948, hired entertainment veteran Gene Carroll (pictured above making his entrance on a show) to emcee a weekly variety program, Mr. Weisberg had one small store. Now, 520 shows and a decade later, with 50% of the company's ad budget allotted to the show, there are 10 Giant Tiger stores, with more

crease in sales for merchandise specifically mentioned by Mr. Carroll on the show. WEWS and Giant Tiger are experimenting with mail orders and report that results are "exceeding all hopes."

Ed Baer, supervisor of GT stores, gives full credit: "the success of Giant Tiger stores can be traced to our . . . WEWS tv program."

### KLIN Joins Wedding Party

To prove further that radio is everywhere, KLIN Lincoln, Neb., has offered the following:

When a young couple wanted to be the first married in the new chapel of the Vine Congregational Church, but learned that an organ had not yet been installed, they contacted KLIN for help, asking the station to play the wedding march.

As a result, the station interrupted its programming to play the music at the exact time the couple walked down the aisle and it was picked up on a small radio in the church. The station reports it received a great deal of favorable comment from its listeners.

### WHCT (TV) to Air Golf Tourney

For the fourth consecutive year WHCT (TV) Hartford will carry the \$28,000 Insurance City open golf tournament. The match, which attracts some of the nation's top golfers, is being sponsored, as it has previously, by the Connecticut Bank & Trust Co.

### Boston Pops to Air WCRB Themes

WCRB-AM-FM Boston good music outlet, is broadcasting a total 15 hours of stereophonic music a week as part of its 10th anniversary celebrations. The stations play host to advertiser and agency contacts June 1 when it takes over Symphony Hall for the Boston "Pops" Symphony. That afternoon the Symphony will present a program based principally on WCRB program themes. The station is selling any remaining tickets to its audience.

### ABC Furthers News Competition

ABC Radio last Friday announced it would begin competing with CBS Radio and NBC Radio on a world-wide news roundup scale by adding remote pickups from abroad to its *News Around the World* shows, Mon.-Sat., 8-8:15 a.m. The network has hired veteran CBS newsmen Bill Shadel, who will act as anchor man to reporters Robert Sturdevant (Paris), Yale Newman (London), Mel Davis (Rome), Ray Falk (Tokyo), Charles Arnot (Cairo), Omer Anderson (Bonn) and George Bailey (Vienna).

**Two More Reasons why Channel 2 is first choice of St. Louis families.**

### TOM DAILEY SHOW

11:30 A.M. - 12:30

Monday through Friday

Tom is tops . . . a popular personality and a hard-selling MC on his new live-audience show.



### FRED MOEGLE SHOW

11:00 A.M. - 12:00

Saturday

A brand new show . . . filled with fun, cartoons and well-liked Fred Moegle.



Represented nationally by



# KTVI

CHANNEL **2** SAINT LOUIS



# WHBF

RADIO & TELEVISION

the station of marketing success in the Quad-Cities



# PEOPLE

A WEEKLY REPORT OF FATES AND FORTUNES

## ADVERTISERS & AGENCIES

**ROBERT T. ENGLS**, former president of Intercity Broadcasting Co., and presently with Cherry & Webb Broadcasting Co., elected to board of directors of Creamer-Trowbridge Co. and will maintain executive offices in Providence, R. I.



MR. ENGLS

**ROBERT W. BODE**, executive art director, Kudner Adv., N. Y., and **ROBERT M. HAIG**, co-copy chief, elected v.p.'s of Kudner. **DONALD GIBBS**, v.p.-co-copy chief, named member of executive committee.

**ROBERT L. DELLINGER**, v.p. and account supervisor, Grant Adv., Hollywood, appointed vice president and manager of agency's Dallas office. He succeeds **JACK EDWARDS**, retired.



HECK

STERN

POMERANCE

**HOMER HECK**, director of broadcasting, Foote, Cone & Belding, Chicago; **EDWARD M. STERN**, director of media department and **EUGENE C. POMERANCE**, director of research, elected v.p.'s.

**W. M. STARKEY**, account supervision on Rexal Drug account, BBDO, L. A., has been elected v.p. of agency. He joined firm in 1948.

**MAYNARD H. PATTERSON**, general manager of international division, Minnesota Mining & Mfg. Co., St. Paul; **ROBERT W. MUELLER**, general manager of industrial tapes division, and **LYLE H. FISHER**, director of industrial and personnel relations, elected v.p.'s. **HAROLD F. IARSON**, general office manager, elected assistant treasurer.



**ROBERT R. ROY**, formerly supervisor of merchandising and sales training on Chrysler Div. account, Ross Roy Inc., Detroit, elected v.p. and member of executive board.

**KENNETH FLEMING JR.**, member of account service group, Leo Burnett Co., Chicago, joins McCann-Erickson, Chicago, as account executive.

MR. ROY

**JAMES P. DODD**, Shering Ethical Pharmaceutical Corp., joins Sullivan, Stauffer, Colwell & Bayles, N. Y., as account executive and will work on drug products and allied items. **EDWARD J. GOING**, marketing executive, N. W. Ayer & Co., joins SSC&B as account executive and will be on cigarettes and tobacco accounts; **DONALD J. MOONE**, Snow Crop marketers, will be account executive on grocery and foods products.

**RICHARD M. DONNELLY** promoted from assistant account executive to account executive, Gardner Adv., St. Louis.

**ROBERT B. JARVIS**, manager of Prestige Inc., and **ALAN BERGER**, director of radio and tv, Stillier, Rouse, Berggren & Hunt, join Dreyfus Co. as account executive and radio-tv director, respectively.

**JACK M. BEAVEN**, formerly director and copywriter, KFJZ-TV Fort Worth, Tex., joins Reast & Connolly Adv., South Orange, N. J., as assistant account executive.

**EDWARD KOGAN**, executive tv producer and N. Y. office manager, Edward H. Weiss & Co., to Joseph Katz Co., N. Y., as radio-tv director, succeeding **BOB SWAN**. Mr. Swan will announce his future plans shortly. Mr. Kogan's post at Weiss has been filled by **PEGGY SCHILLING**, promoted from tv commercial producer.

**A. J. BREMMER** promoted from v.p. and copy director to creative director at Foote, Cone & Belding, Chicago.

**HOWARD C. SCHELLENBERG**, formerly assistant radio-tv director with Buffalo (N.Y.) agency, joins Comstock & Co., Buffalo, as creative director. Other appointments: **DAUNE PALMER**, with Comstock & Co. for several years, named creative writer on special account group; **MICHAEL DANYLA**, formerly copywriter with BBDO, Cleveland; **STUART F. LEVIN**, tv producer for WEWS-TV and WJW-TV, both Cleveland, and **JOSEPH PETRINO**, art director with another Buffalo agency, join Comstock radio-tv department.

**GEORGE DRAKE**, creative v.p. at Erwin Wasey, Ruthrauff & Ryan, Chicago, appointed copy director.

**CALVIN HOLMES**, formerly senior writer at Erwin Wasey & Co. (now Erwin Wasey, Ruthrauff & Ryan), to M. M. Fisher Assoc., Chicago, as copy chief.

**GEORGE STANTON**, formerly assistant media director at Tatham-Laird Inc., Chicago, to Leo Burnett Co. as media group supervisor.

**AUGUST TONNE**, formerly associate production manager, Earle Ludgin & Co., Chicago, to Keyes, Madden & Jones, Chicago, as production manager. **JOHN H. BAXTER**, creative vice president of Ludgin agency, also resigns.

**ALFRED W. deJONGE**, formerly with Harold M. Mitchell Inc. and Vick Chemical Co., to BBDO, N. Y., as European coordinator in international department.

**DONALD A. PEMBER**, member of advertising department of Swift & Co., Chicago, to research, marketing and creative department of **RICHARD CRABB ASSOC.**, agricultural advertising agency, Chicago.

**AUSTIN E. TREWORY** joins Brooke, Smith, French & Dorance creative staff.

## FILM

**GERALD B. ZORNOW**, formerly director of sales for apparatus and optical division of Eastman Kodak Co.; **THEODORE F. PEVEAR**, director of sales ad-

ministration, and **W. B. POTTER**, director of advertising, appointed v.p.'s.

**ARTHUR SPIRT**, Television Programs of America, elected v.p. for central division. He will continue to report to **MICHAEL M. SILLERMAN**, executive v.p., TPA, N. Y. TPA's central division headquarters are in Chicago.

**BERNARD WEITZMAN**, with Desilu Productions, Hollywood, for past four years, named v.p. in charge of business affairs.

**REED BINGHAM** promoted to executive v.p. at Bill Burrud Productions. **JACK HEINTZ**, formerly station manager, KCOP (TV) Los Angeles, joins Burrud as business counselor.

**AL MARKIM**, former CBS producer-director, to Teletudios Inc. as executive assistant to president. Mr. Markim will work closely with Teletudios' expanding VTR operations [Special Report, May 12].

**PETER DEL NEGRO**, previously midwestern sales representative, UPA Pictures Inc., to MGM-TV's commercial division as sales representative for company's tv film commercials in Midwest.

## NETWORKS

**SID GARFIELD**, director of exploitation for CBS Radio since September 1951, appointed director of press information for network. Mr. Garfield succeeds **CHARLES S. STEINBERG**, named director of information services for CBS-TV. **RICHARD GOLDEN**, director of sales presentations for CBS since June 1954, to CBS-TV in similar capacity.

**HARRY BUDINGER**, turnable operator at NBC Chicago and member of network's original National Farm & Home Hour orchestra, died May 10.

## STATIONS



MR. EDELMAN

**HERBERT EDELMAN**, formerly with KDAY Santa Monica, Calif., has taken over as owner-general manager of KEAP Fresno, Calif.

**RICHARD JOSEPH BUTTERFIELD**, station manager, KCRG-TV Cedar Rapids, Iowa, joins KMSP-TV Minneapolis-St. Paul as v.p. in charge of sales.



MR. EICHER

**P. HOWARD EICHER**, assistant local sales manager, WSAI Cincinnati, Ohio, promoted to v.p. and general manager. He joined WSAI in 1956 as account executive and prior to that spent seven years as freelance announcer and actor.

**WILLIAM J. MUELLEN**, formerly sales manager of WPOR Portland, Me., named national sales manager of Hildreth Network (WPOR, WABI-AM-TV Bangor and WAGM-AM-TV Presque Isle, all Maine).



MR. EVANS

**ROBERT E. EVANS**, manager of WELO Tupelo, Miss., has been named general manager of Mid-South Radio Network, succeeding **BOB McRANEY**. Mr. McRaney resigned to head Southern Electronics Co., which holds interests in WROB West Point, WAMY Amory, both Mississippi.



MR. KEPLER

**RICHARD P. KEPLER**, veteran of 19 years in broadcasting, joins WJMR-TV New Orleans as station manager.

**CARL ZIMMERMAN**, manager of WISN Milwaukee, has accepted appointment as manager of WFOX Milwaukee, date to be announced.

**DICK GIFFORD**, sales manager of Dallas office, KFJZ-TV Dallas-Fort Worth, named national sales manager, succeeding **JOE EVANS**, who joined WVUE-TV Wilmington, Del., as general sales manager.

**EARL W. WELDE**, administrative assistant to tv sales manager, WSUN-TV St. Petersburg, Fla.

# Cincinnati's Most Powerful Independent Radio Station

50,000 watts of SALES POWER

# WCKY

CINCINNATI, OHIO  
THE *L.B. Wilson*  
STATION



On the Air everywhere 24 hours a day—seven days a week



MR. KAHN



MR. HILTON



MR. CLIFFORD



MR. CHESLEY

ABOVE are the top echelon of the newly-created advertising agency, Kastor, Hilton, Chesley & Clifford Inc. [ADVERTISERS & AGENCIES, May 19]. They include H. Kastor Kahn, chairman of KHC&C; Peter Hilton, president; Charles E. J. Clifford, vice chairman, and W. S. Chesley Jr., chairman of the executive committee and treasurer. The agency was formed when Kastor, Farrell, Chesley & Clifford merged with Hilton & Riggio.



MR. WHEELER

promoted to tv sales manager, succeeding BARNEY KOBRES, who resigned to form his own advertising agency.

CLAUDE WHEELER, sales staff, WCHS Charleston, W. Va., named general sales manager for WCHS-TV. He has been with WCHS sales staff since 1951.

SEYMOUR WHITELAW, CBS Radio Spot Sales account executive, appointed sales manager of KCBS San Francisco, succeeding RICHARD H. SCHUTTE, who has joined Robert E. Eastman Co., radio representative, as west coast manager.



MR. WHITELAW

RAY C. SMUCKER, veteran in show business and broadcasting, joins KTAR and KVAR (TV) Mesa, Ariz., as sales manager. Mr. Smucker formerly was manager of KYUM Yuma, Ariz., and will continue to have charge of overall operations of that station in addition to his new post.



MR. SMUCKER

BILL EXLINE, tv sales head of Peters, Griffin, Woodward, S. F. office, joins KIRO-TV Seattle-Tacoma, Wash., as sales manager.

MEG KINGBAY, radio personality, WCCO Minneapolis-St. Paul, joins WPBC Minneapolis-St. Paul as manager of station's Southdale branch office.

LEE COFFEE, announcing staff, WIBV Belleville, Ill., named promotion manager.

EDWARD W. PARO, WEAR Pensacola, to WILZ St. Petersburg Beach, both Florida, as commercial manager.

ALAN EATON, formerly on publicity staff of ILLINOIS GOV. WILLIAM STRATTON, appointed manager of radio press information at WBBM Chicago. BILL MASLOWE, Chicago newspaperman, to WBBM-TV Chicago in similar press information capacity.



MR. BLOYD

JAMES E. BLOYD, engineer and engineering supervisor with WEWS (TV) Cleveland, promoted to chief engineer. Post is newly-created because JOSEPH B. EPPERSON, engineering v.p. of Scripps-Howard Radio Inc. had served as chief engineer of all S-H radio-tv stations.

JOHN STRUCKELL, formerly v.p. of WFPG Atlantic City and manager of WOND Pleasantville and WWBZ Vineland, all New Jersey, joins WKDN Camden, N. J., as program director. He succeeds DAVID A. MOSS, who has been appointed commercial manager of WKDN.

SIDNEY GABY, formerly assistant program director at WNEW New York, to WGR Buffalo as program director.

JIM HARDEN, formerly newscaster with KWWL Waterloo, Iowa, joins KLWN Lawrence, Kan., as news director.

CHARLES MINNEHAN, assistant manager of marketing for Los Angeles Examiner, joins KABC-TV Los Angeles as director of marketing, succeeding ROBIN ROSEFIELD, who resigned to go to England and study acting.

MARVIN HUGHES, Dot recording artist, joins WSM Nashville, Tenn., as musical director.

JOHN CORPORON, formerly United Press bureau manager in New Orleans, joins WDSU-TV New Orleans as fulltime Washington correspondent.

WILLIAM S. GAILMOR, veteran of 20 years as newspaper man and radio commentator, joins WPEN Philadelphia as news editor.

WAYNE GRIFFIN, head of own travel organization, appointed travel editor at WBKB (TV) Chicago.

KEITH RYAN, formerly news and sports announcer, WKDA Nashville, Tenn., to WCKY Cincinnati, Ohio, as news announcer.

BETH ROBINSON, formerly account executive, KPRO Riverside, Calif., joins KRHM (FM) Los Angeles as sales representative.

ED FLEMING, newscaster, WPIX-TV New York, joins KNXT (TV) Los Angeles as tv news personality.

HARRY BIRRELL, WNOE New Orleans, La., joins KCBQ San Diego as d.j., effective June 1.

ZOEL P. SILVERMAN, formerly with KQV Pittsburgh, joins KDKA Pittsburgh sales staff.

JACK BROWN, formerly with KOBY San Francisco, joins KGO San Francisco sales staff.

SCOTT MUNI, formerly announcer for WAKR Akron, Ohio, to WMCA New York musical announcing staff.

JIM PASSANT, sports publicist at Cleveland's Western Reserve U., joins KYW-AM-TV Cleveland publicity staff.

ANDREW M. ROWLEY, veteran oil writer (52 years) for Tulsa Tribune and featured for many years as "Mr. Oil" on KVOO Tulsa, died May 14.

MANUFACTURING

PERRY R. ROEHM, formerly president and director of Norden-Ketay Corp., Stamford, Conn., appointed director of marketing for International Telephone & Telegraph, N. Y.

MICHAEL BALOG, general manufacturing manager for Sylvania Electric Products semiconductor division appointed to new post of manager of manufacturing and engineering for division. Also appointed were DR. SUMNER MAYBURG, division manager of research and materials, to division chief engineer; and THEODORE R. BUNNELL, division industrial engineer, to manager of manufacturing services.

DERMOT A. DOLLAR, previously manager, RCA Camden, N. J., showroom, to newly created post

WSLS • TV  
a subliminal ad  
ROANOKE, VA.  
we have  
WSLS • TV  
the largest share  
ROANOKE, VA.  
of audience  
WSLS • TV  
by the latest  
ROANOKE, VA.  
ARB  
WSLS • TV  
Feb.-Mar. '58  
ROANOKE, VA.

A HAZARD THAT NEVER SLEEPS

A daily occurrence —  
Radio and TV Stations  
are accused of

LIBEL — SLANDER  
PIRACY — PLAGIARISM  
INVASION OF PRIVACY  
COPYRIGHT VIOLATION

through act of station,  
staff, announcer, speaker,  
talent, commentator, sponsor.

THE SPOKEN WORD IS MASTER!  
BUT you can  
INSURE

against embarrassing loss  
by having our unique  
Excess Policy  
at amazingly low cost.  
Write for details and rates

EMPLOYERS  
REINSURANCE  
CORPORATION

21 WEST TENTH STREET  
KANSAS CITY, MO.

New York, 107 William St.  
Chicago, 176 W. Jackson  
San Francisco, 100 Bush St.

PEOPLE CONTINUED

of director, exhibits, RCA. Named to assist Mr. Dollar were RICHARD H. HOOPER, as manager, special exhibits; RICHARD F. NORDHORN, as manager, RCA Chicago showroom; HARRY P. O'BRIEN as manager, RCA Exhibition Hall, N. Y., and JOHN H. SCHAFF as manager, RCA Camden showroom.

MARSHALL A. WILLIAMS, formerly with Philco Corp., appointed director of marketing for Farnsworth Electronics Co., Fort Wayne, Ind.

GEORGE O. CROSSLAND, formerly manager of distributor development and trade relations at General Electric's Owensboro, Ky., plant appointed central regional equipment sales manager in Chicago for GE's receiving tubes.

PERSONNEL RELATIONS

MARY ELIZABETH MITCHELL, 50, membership secretary of Chicago chapter of American Television & Radio Artists, died following heart attack May 8. She had entered Henrotin Hospital, Chicago, for physical checkup three days earlier.

PROFESSIONAL SERVICES

WALTER L. WEST, formerly with RCA government service department, joins Page Communications Engineers, Washington, as head of its new Land and Structures Dept.

PROGRAM SERVICES

WILLIAM P. GALLAGHER, national sales director of Columbia Records, named director of sales for company, succeeding HAL COOK, who joins Warner Bros. Records, Burbank, Calif., as v.p. and director of sales. Other personnel changes announced involved WALTER L. DEAN of company's legal department, appointed director of business affairs; ROBERT EARL, St. Louis branch manager, promoted to merchandise manager, and DALE PEYTON, salesman in St. Louis, named branch manager there.

DON BLOCKER, formerly with Hart Distributors, joins Liberty Records as national promotion director.



FOR a "decade of dedication," Mark Evans, WTOP-AM-FM-TV Washington personality, was given a scroll and testimonial dinner on this tenth anniversary as director of WTOP Washington Area Housewives' Protective League. At the presentation (l to r): Lloyd Dennis, WTOP vice president; Ed Wood, general manager of the Housewives' Protective League, New York; George Marshall, owner, Washington Redskins football club; Mr. Evans; Jules Dundes, vice president, CBS Radio, and Gordon Hayes, general manager, CBS Radio Spot Sales. A group of business, civic and government leaders saluted Mr. Evans as "broadcaster, businessman, church member, citizen, club man, director of the HPL program, family man, foods man, lecturer, reporter, salesman and traveler . . . [and] friend."

TRADE ASSNS.

LOUIS BENITO, Tampa (Fla.) advertising agency president, elected to governor of fourth district Advertising Federation of America.

ROBERT GAGE, art director, Doyle Dane Bernbach, elected second v.p. of Art Directors Club, N. Y., WILLIAM DUFFY, tv art director, McCann-Erickson named ADC secretary and LOUIS DORFSEMAN, art director, CBS Radio, appointed member of executive committee.

ARNOLD KATINSKY, promotion writer at Radio Advertising Bureau since February 1956, named assistant to member service director. Mr. Katinsky will be responsible for processing requests for information, research and other data for RAB's membership.

INTERNATIONAL

WILLIAM JEYNES, chief engineer of CHCH-TV Hamilton, Ont., won Col. Keith S. Rogers Memorial Award for "his contribution to the technical advancement of television, for the development of an excellent and inexpensive special effects generator for tv picture mixing." Presentation was made at annual dinner of Canadian Assn. of Broadcasters at Montreal on May 12 by Canadian General Electric Co. Ltd., Toronto.

DON SMITH, All-Canada Radio & Television Ltd., Toronto, elected treasurer of Advertisers' Guild of Toronto, for 1958.

CLAY HAWKINS, 39, sales manager of CKNW New Westminster, B.C., and formerly of CKY Winnipeg, Man., died April 17 of pneumonia.

J. ALAN SAVAGE, radio-tv director of Cockfield Brown & Co. Ltd., Toronto advertising agency, elected director, along with ROSS W. BOOTH and HARRY C. CLARKE, account group managers at Toronto office, and R. H. COOPER and J. McBRIDE, account executives of Montreal office.

JOHN G. BUTLER, formerly with MacLaren Adv. Ltd., Toronto, to advertising manager of Philco Corp. of Canada Ltd., Toronto.

ARTHUR C. HARRISON to manager of Toronto office of Jos. A. Hardy & Co. Ltd., station representative, and GUY DAVIAULT to manager of Montreal office.

JOSEPH G. MORGAN, formerly with Columbia Pictures Inc. distribution organization in Britain, appointed sales representative of Fremantle of Canada Ltd., distributor of tv film programming in Britain.

UPCOMING

May

May 26-28: American Management Assn., annual packaging conference, Hotel Statler, New York.

May 26-28: Conference on Educational Tv and Related Media, Department of Health, Education and Welfare, Washington.

May 26-30: National Packaging Exposition, New York Coliseum, New York.

May 28-29: Kentucky Broadcasters Assn., Sheraton-Seelbach Hotel, Louisville.

June

June 3-6: 36th annual conference, National Industrial Advertisers Assn., Chase and Park Plaza Hotels, St. Louis.

June 4-6: Armed Forces Communications and Electronics Assn. Exhibit, Sheraton Park Hotel, Washington, D. C.

June 5-7: Western Assn. of Broadcasters, Banff Springs, Hotel Banff, Alta.

June 6-7: Colorado Broadcasters Assn., Hotel Antlers, Colorado Springs.

June 7: UP Broadcasters of Connecticut, Colonial House, Hamden.

June 7-8: Broadcasters Assn. of Texas, Town House Hotel, San Angelo.

June 8-11: Advertising Federation of America, national convention, Statler-Hilton Hotel, Dallas.

June 14: UP Broadcasters of Pennsylvania, Holiday Motor Hotel, Mechanicsburg.

June 19-20: Virginia Broadcasters Assn., Tidewater Inn, Irvington.

June 19-21: Maryland-D. C. Radio & Tv Broadcasters Assn., Stephen Decatur Hotel, Ocean City, Md.

June 19-21: Florida Assn. of Broadcasters, Colonial Inn, St. Petersburg Beach.

June 22-28: Advertising Assn. of the West, annual convention, Vancouver, B. C.

July

July 19: Conference on Tv for Women in Home Economics, Business and Education, UCLA, Los Angeles.

July 21-25: National Assn. of Educational Broadcasters, seminar, Allerton House, Monticello, Ill.

August

Aug. 1-2: Oklahoma Broadcasters Assn., Lake Texoma Lodge, Lake Texoma.

Aug. 4-23: Summer Tv Workshop, College of Communication Arts and WKAR-TV Michigan State University, East Lansing.

\* MINITAPE



. . . a fully transistorized, battery-operated, portable tape recorder of network recording quality.

AMAZING OPERATING EFFICIENCY . . .

No other recorder can do the job of Minitape. Where you go, Minitape goes, with its own power and precision recording unit in one compact aluminum case. Minitape weighs only 13 pounds and equals the finest AC-operated units in recording quality.

- Automatic volume control by transistor amplifiers holds constant full recording level from lip distance to 10 ft.
- Flat frequency response to 10,000 cycles at 7½ ips.
- 2 hours continuous recording on one charge. Lifetime nickel cadmium battery.

Write for prices and specifications

\*trademark registered

Cable Address: STANHOFF



921 N. Highland Avenue

Hollywood 38, California

# Station Authorizations, Applications

As Compiled by BROADCASTING

May 15 through May 21

Includes data on new stations, changes in existing stations, ownership changes, hearing cases, rules & standards changes and routine roundup.

## Abbreviations:

DA—directional antenna. cp—construction permit. ERP—effective radiated power. vhf—very high frequency. uhf—ultra high frequency. ant.—antenna. aur.—aural. vis.—visual. kw—kilowatts. w—watt. mc—megacycles. D—day. N—

night. LS—local sunset. mod.—modification trans.—transmitter. unl.—unlimited hours. kc—kilocycles. SCA—subsidiary communications authorization. SSA—special service authorization. STA—special temporary authorization. \*—educ.

## New Tv Stations

### ACTIONS BY FCC

Duluth, Minn.—Rex Television Co.—Granted ch. 10 (129-198 mc); ERP 316 kw vis., 158 kw aur.; ant. height above average terrain 588 ft., above ground 576 ft. Estimated construction cost \$641,882. First year operating cost \$400,000, revenue \$480,000. P. O. address 2230 N. Farwell Ave., Milwaukee 2, Wis. Studio location Duluth. Trans location St. Louis County. Geographic coordinates 46° 48' 08" N. Lat., 92° 06' 39" W. Long. Trans.-ant. RCA. Legal counsel Cohn & Marks, Washington, D. C. Consulting engineer Lohnes & Culver, Washington, D. C. Principals include L. F. Gran (25%), Louis Caster (50%), and Bruce R. Gran (25%) who have sold interest in WREX TV Rockford, Ill. though sale not yet consummated. Announced May 15.

Lubbock, Tex.—Texas Technological College—Granted ch. 5 (78-82 mc); ERP 11.1 kw vis., 5.55 kw aur.; ant. height above average terrain 444 ft., above ground 485 ft. Estimated construction cost \$88,189, first year operating cost \$36,000. P. O. address % Dr. E. N. Jones, president. Studio location Texas Tech. campus. Geographic coordinates 37° 17' 26" N. Lat., 107° 54' 42" W. Long. Trans. and ant. RCA. Legal counsel Elliot C. Lovett, Washington. Consulting engineer Frank H. McIntosh & Assoc., Washington. Announced May 21.

### APPLICATION

Durango, Colo.—Farmington Bcstg. Co., vhf ch. 6 (82-88 mc); ERP 10.5 kw vis., 5.25 kw

aur.; ant. height above average terrain 723 ft., above ground 138 ft. Estimated construction cost \$41,820, first year operating cost \$25,000. P. O. address 407 West Broadway, Farmington, N. M. Studio location Farmington, N. M. Trans. location Top of Perins Pk., Durango. Geographic coordinates 37° 17' 26" N. Lat., 107° 54' 42" W. Long. Trans. ant. RCA. Legal counsel Smith and Pepper, Washington. Consulting engineer Vandiver and Cohen, Washington. Application is for satellite to station applied for by applicant in Farmington (ch. 12) and is contingent on grant thereof. Announced May 16.

## Existing Tv Stations

### ACTIONS BY FCC

KSTP-TV St. Paul, Minn.—Granted waiver of Sec. 3.652 to permit KSTP-TV to identify itself as Minneapolis as well as St. Paul. Announced May 15.

KHQA-TV Hannibal, Mo.—Granted waiver of Sec. 3.652 to permit KHQA-TV to identify itself as Quincy, Ill., as well as Hannibal, Mo. Announced May 15.

## Translators

### CALL LETTERS ASSIGNED

K72AP, K76AK and K80AM Window Rock, Ariz.—Navajo Tribal Council.  
K74AN and K75AI Chloride and Big Sandy

Valley-Hualpai Mt. Park, Ariz.—Mohave County Board of Supervisors.  
K76AL Canby, Calif.—Canby Tv Club.  
W74AA North Warren, Pa.—Conewango Valley Tv Inc.

## New Am Stations

### ACTIONS BY FCC

Winter Haven, Fla.—Winter Haven Bcstg. Co.—Granted 1360 kc, 1 kw D. P. O. address 51 Fifth St., S.W., Winter Haven. Estimated construction cost \$19,636, first year operating cost \$51,600, revenue \$54,000. Angelo Fazzari, sole owner, is in tv service. Announced May 15.

Belzoni, Miss.—Roth E. and Lucille Hook, d/b as Humphreys County Bcstg. Co.—Granted 1460 kc, 1 kw D. P. O. address % Mr. Hook, Aliceville, Ala. Estimated construction cost \$13,112, first year operating cost \$24,000, revenue \$36,000. Mr. and Mrs. Hook will be equal partners. Mr. Hook owns 49% WRAG Carrollton, Ala., 45% WMAG Forrest, Miss., 75% WRUS Russellville, Ky., and 20% WDOB Aliceville. Mrs. Hook owns 30% WDOB. Announced May 21.

Rocky Mount, N. C.—M. R. Robbins—Granted 1490 kc, 250 w unl. P. O. address 202 Peoples Bank Bldg., Rocky Mount. Estimated construction cost \$34,881, first year operating cost \$60,000, revenue \$70,000. Sole owner Robbins is in insurance, banking, etc. Announced May 15.

Loris, S. C.—Loris Bcstg. Co.—Granted 1570 kc, 1 kw D. P. O. address Box 317, Tabor City, N. C. Estimated construction cost \$11,235, first year operating cost \$25,000, revenue \$30,000. Ownership: Terrell Rozier, appliance and insurance man (40%); publisher M. Horace Carter (30%), and Winston Vaught, attorney (30%). Announced May 15.

Plainview, Tex.—Plainview Radio—Granted 1050 kc, 1 kw D. P. O. address Box 322, Plainview. Estimated construction cost \$19,815, first year operating cost \$36,000, revenue \$48,000. Equal partners: Earl S. Walden, 50% owner of KERB Kermit, Tex.; Homer T. Goodwin, pastor, and Leroy R. Durham, farmer. Announced May 15.

### APPLICATIONS

Willcox, Ariz.—Paul Merrill, 1340 kc, 250 w unl. P. O. address 105 Yucca Dr., Safford, Ariz. Estimated construction cost \$10,662, first year operating cost \$18,000, revenue \$24,000. Paul Merrill, sole owner, has 17½% interest in KGLU Safford, KWJB-AM-FM Globe, KCKY Coolidge, KVNC Winslow and KCLP Clifton, all Arizona. Announced May 15.

**NATION-WIDE NEGOTIATIONS • FINANCING • APPRAISALS**  
**RADIO • TELEVISION • NEWSPAPER**

| EASTERN   | CENTRAL  | MIDWEST   | SOUTH  | SOUTHWEST  | WEST   |
|---|--|---|--|--|--|
| <b>NEW ENGLAND INDEPENDENT</b>  | <b>MICHIGAN FULLTIMER</b>  | <b>FULLTIME REGIONAL</b>  | <b>REGIONAL DAYTIMER</b>   | <b>MAJOR INDEPENDENT</b>   | <b>NORTHERN CALIFORNIA</b>   |
| <b>\$115,000</b>  | <b>\$100,000</b>   | <b>\$650,000</b>  | <b>\$100,000</b>   | <b>\$175,000</b>   | <b>\$230,000</b>   |
| Single-station market. Low overhead. Just right for sales-minded owner-manager. | Recently established. Now going into black. Single station market. Ready to show good profit for owner-operator. | #1 station in metropolitan market. \$100,000 in cash and account receivables to go along with deal. | Excellent facility showing good profits. In growing secondary market with diversified income and above-average retail sales. | Daytime 1 kw station well in the black. Fair real estate and some net quick assets. 29½% down. 7 years on balance. | Kilowatt fulltime in excellent diversified agricultural and industrial market. |

# HAMILTON, STUBBLEFIELD, TWINING & ASSOCIATES

|   |   |                                       |   |  |  |
|---|---|---------------------------------------|---|--|--|
| Washington, D. C.<br>1737 DeSales St., N. W.<br>EX 3-3456 | Cleveland<br>2414 Terminal Tower<br>TO 1-6727 | Chicago<br>Tribune Tower<br>DE 7-2754 | Atlanta<br>1515 Healey Bldg.<br>JA 3-3431 | Dallas<br>Fidelity Union Life Bldg.<br>RI 8-1175 | San Francisco<br>111 Sutter St.<br>EX 2-5671 |
|---|---|---------------------------------------|---|--|--|

# Planning a Radio Station?

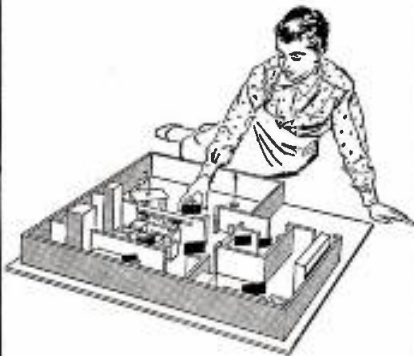

RCA can help you with equipment and planning. For example, three basic floor plans, for three different size stations illustrate how the very latest equipment can be arranged to perform efficiently with a minimum of capital and personnel.

Complete brochure, including floor plans, equipment requirements and discussion of current trends now available. For your free copy, write to RCA, Dept. FD-22, Building 15-1, Camden, N.J.

**RADIO CORPORATION  
of AMERICA**



TM & ©

## FOR THE RECORD CONTINUED

Clearwater, Fla.—Radio Clearwater Inc., 860 kc. 500 w D. P. O. address Box 1876, Clearwater. Estimated construction cost \$48,968, first year operating cost \$65,000, revenue \$75,000. Charles Adams and Gene Robinson, both of WTAN Clearwater, at present own 44% each. Announced May 21.

Easton, Md.—Easton Bcstg. Co., 1460 kc, 500 w D. P. O. address 3855 N. 30th St., Arlington, Va. Estimated construction cost \$21,900, first year operating cost \$38,000, revenue \$45,000. Owners are Mary and Richard Cobb (50% each). Mother and son are in frozen foods. Announced May 15. Caro, Mich.—Tuscola Bcstg. Co., 1360 kc, 500 w D. P. O. address 2168 1st St., Bay City, Mich. Estimated construction cost \$22,988, first year operating cost \$46,000, revenue \$52,000. Robert Benkelman (3/5 owner) is operations manager and announcer, WWBC Bay City. Announced May 15.

East Grand Forks, Minn.—Merlin Obie, 1590 kc, 1 kw D. P. O. address 715 5th St., W.W., Wadena. Estimated construction cost \$15,945, first year operating cost \$38,000, revenue \$52,000. Sole owner Obie owns one-third of KWAD Wadena. Announced May 21.

## Existing Am Stations

### ACTIONS BY FCC

WCAS Gadsden, Ala.—By letter, denied request for waiver of Sec. 1.354 (c) of rules and immediate grant of application to change facilities on 570 kc from 5 kw D, to 500 w, 5 kw-LS, DA-N. Announced May 15.

KAGE Winona, Minn.—Granted change in frequency from 1570 kc to 1380 kc, continuing operation with 1 kw D; remote control permitted. Announced May 15.

KABQ Albuquerque, N. M.—Granted change of facilities from 1340 kc, 250 w untl., to 1350 kc, 500 w, 5 kw-LS, DA-N; engineering conditions; remote control permitted during daytime hours only. Announced May 15.

### APPLICATIONS

WTWA Thomson, Ga.—Mod. of license to change Sunday specified hours from 7:25 a.m. to 7:15 p.m. to 7:25 a.m. to 9:00 p.m. Announced May 15.

WPRT Prestonsburg, Ky.—Cp to increase power from 1 kw to 5 kw; change ant.-trans. and studio location, install DA-D, make changes in ground system and install new trans. Announced May 15.

KJOE Shreveport, La.—Cp to increase power from 1 kw to 5 kw; change ant.-trans. location, install directional ant. for daytime use, make changes in ground system and install new trans. Announced May 20.

WCAP Lowell, Mass.—Cp to increase power from 1 kw to 5 kw and install new trans. Announced May 15.

KPLK Dallas, Ore.—Cp to increase power from 500 w to 1 kw and install new trans. Announced May 15.

WKOK Sunbury, Pa.—Cp to change frequency from 1240 kc to 1550 kc; increase power from 250 w to 1 kw; change ant.-trans. location; install directional ant. night and day (DA-1); make changes in ground system and install new trans. Announced May 15.

KVNU Logan, Utah.—Cp to increase daytime power from 1 kw to 5 kw and install new trans. (610 kc). Announced May 20.

KRSC Othello, Wash.—Cp to change frequency from 1450 kc to 1400 kc; increase power from 100 w to 250 w, make changes in ant. (increase height) and ground systems. (Contingent on grant of KFDE frequency change.) Announced May 20.

## CALL LETTERS ASSIGNED

KIKO Miami, Ariz.—Willard Shoecraft, 1340 kc. WMET Miami Beach, Fla.—Community Service Bcstrs. Inc., 1490 kc. Changed from WAHR, effective May 15.

WCLA Claxton, Ga.—Evans County Bcstg. Co. WCRM Clare, Mich.—Gateway to the North Bcstg. Corp., 1450 kc.

KPRB Redmond, Ore.—Radio Station KPRB, 1240 kc. Changed from KJUN.

KOBH Hot Springs, S. D.—Fall River Bcstg. Corp., 580 kc.

## New Fm Stations

### ACTIONS BY FCC

Cleveland, Ohio—Moody Bible Institute of Chicago—Granted 103.3 mc, 21.5 kw U. P. O. address 820 N. LaSalle St., Chicago 10, Ill. Estimated construction cost \$22,268, first year operating cost \$45,000. Expenses to be met by funds on hand plus donations. Applicant is non-profit organization. Announced May 15.

Carlisle, Pa.—Richard Field Lewis Jr. Inc. of Carlisle—Granted 101.7 mc, 760 w untl. P. O. address Radio Station WHYL, Carlisle. Estimated construction cost \$6,000, first year operating cost \$4,000, revenue to be included with am station. Applicant is licensee of WHYL Carlisle. Announced May 15.

### APPLICATION

Alameda, Calif.—Patrick Henry and David Larsen, 92.7 mc, 275 kw. P. O. address 6515 Mountain Blvd., Oakland. Estimated construction cost \$5,760, first year operating cost \$12,000, revenue \$16,000. Mr. Henry (75%) is KROW Oakland announcer-engineer. Mr. Larsen is radio and tv information man in U S Marine Corps. Announced May 19.

## Ownership Changes

### ACTIONS BY FCC

WHBS Huntsville, Ala.—Granted (1) assignment of license to Smith Bcstg. Inc. (WJIG Tullahoma, Tenn., and WBYE, Calera, Ala.); consideration \$125,000 and (2) renewal of license; grant is without prejudice to such action as Commission may determine is warranted, if any, as result of its pending inquiry into alleged violations by television stations of Commission's policy concerning editorializing by broadcast licensees. Announced May 15.

KJML (FM) Sacramento, Calif.—Granted assignment of license and cp from William T. White and Virgil J. Nugent to Town & Country Bcstrs. Inc. (Messrs. White, Louis and Gerlinger and James Crow equal owners); consideration \$15,000. Announced May 15.

WKXP-TV Lexington, Ky.—Granted assignment of cps to WTAF Inc. (Radio Cincinnati Inc., sole owner, is licensee of WKRC-AM-TV Cincinnati, Ohio, WBR-AM-FM-TV, Knoxville, Tenn., WBRC-AM-FM-TV, Birmingham, Ala., and WTVN-TV Columbus, Ohio); consideration \$100,000 which includes \$35,000 for agreement not to compete for 5 years. Announced May 15.

WTWO (TV) Bangor, Me.—Granted assignment of licenses to WLBZ Television Inc. (Adeline B. Rines, president, is majority stockholder of WRDO Augusta, and WLBZ Bangor, and as trustee, of WCSH-AM-TV Portland, Me.); consideration \$600,000. Announced May 15.

KWK St. Louis, Mo.—Granted assignment of licenses to KWK Radio Inc. (A. M. Speeris, president, and others have interests in WEMP Milwaukee, Wis.); consideration \$1,025,000. Announced May 15.

**West  
\$100,000.00**

A top facility in one of the west's major markets. Excellent assets and potential. Now showing some profit. Reasonable terms can be arranged.

**South  
\$500,000.00**

This is a combination offering of two southern properties, both in major markets. Both are top-rated stations, with excellent earnings. Terms to responsible buyers.

Exclusive with

**Blackburn & Company**

NEGOTIATIONS • FINANCING • APPRAISALS

WASHINGTON, D. C.  
James W. Blackburn  
Jack V. Harvey  
Washington Building  
Sterling 3-4341

ATLANTA  
Clifford B. Marshall  
Stanley Whitaker  
Healey Building  
JACKSON 5-1576

CHICAGO  
H. W. Cassill  
William B. Ryan  
333 N. Michigan Avenue  
Financial 6-6460



# PROFESSIONAL CARDS

**JANSKY & BAILEY INC.**  
Executive Offices  
135 De Sales St., N. W. ME. 8-5411  
Offices and Laboratories  
1339 Wisconsin Ave., N. W.  
Washington, D. C. FEderal 3-4800  
Member AFCCE

**JAMES C. McNARY**  
Consulting Engineer  
National Press Bldg., Wash. 4, D. C.  
Telephone District 7-1205  
Member AFCCE

—Established 1926—  
**PAUL GODLEY CO.**  
Upper Montclair, N. J. Pilgrim 6-3000  
Laboratories, Great Notch, N. J.  
Member AFCCE

**GEORGE C. DAVIS**  
CONSULTING ENGINEERS  
RADIO & TELEVISION  
501-514 Munsey Bldg. Sterling 3-0111  
Washington 4, D. C.  
Member AFCCE

**Commercial Radio Equip. Co.**  
Everett L. Dillard, Gen. Mgr.  
INTERNATIONAL BLDG. DI. 7-1319  
WASHINGTON, D. C.  
P. O. BOX 7037 JACKSON 5302  
KANSAS CITY, MO.  
Member AFCCE

**A. D. RING & ASSOCIATES**  
30 Years' Experience in Radio  
Engineering  
Pennsylvania Bldg. Republic 7-2347  
WASHINGTON 4, D. C.  
Member AFCCE

**GAUTNEY & JONES**  
CONSULTING RADIO ENGINEERS  
1052 Warner Bldg. National 8-7757  
Washington 4, D. C.  
Member AFCCE

**Lohnes & Culver**  
MUNSEY BUILDING DISTRICT 7-8215  
WASHINGTON 4, D. C.  
Member AFCCE

**RUSSELL P. MAY**  
114th St., N. W. Sheraton Bldg.  
Washington 5, D. C. REpublic 7-3984  
Member AFCCE

**L. H. CARR & ASSOCIATES**  
Consulting  
Radio & Television  
Engineers  
Washington 6, D. C. Fort Evans  
1000 Conn. Ave. Leesburg, Va.  
Member AFCCE

**PAGE, CREUTZ,  
STEEL & WALDSCHMITT, INC.**  
Communications Bldg.  
710 14th St., N. W. Executive 3-5670  
Washington 5, D. C.  
Member AFCCE

**KEAR & KENNEDY**  
1302 18th St., N. W. Hudson 3-9000  
WASHINGTON 6, D. C.  
Member AFCCE

**A. EARL CULLUM, JR.**  
CONSULTING ENGINEERS  
INWOOD POST OFFICE  
DALLAS 9, TEXAS  
LAKESIDE 8-6108  
Member AFCCE

**GUY C. HUTCHESON**  
P. O. Box 32 CRestview 4-8721  
1100 W. Abram  
ARLINGTON, TEXAS

**ROBERT M. SILLIMAN**  
John A. Moffet—Associate  
1405 G St., N. W.  
Republic 7-6646  
Washington 5, D. C.  
Member AFCCE

**LYNNE C. SMEBY**  
CONSULTING ENGINEER AM-FM-TV  
7615 LYNN DRIVE  
WASHINGTON 15, D. C.  
Oliver 2-8520

**W. P. ADAIR ENG. CO.**  
Consulting Engineers  
Radio-Television  
Communications-Electronics  
610 Eye St., N.W., Washington, D. C.  
Executive 3-1230 Executive 3-3851  
Member AFCCE

**WALTER F. KEAN**  
CONSULTING RADIO ENGINEERS  
Associates  
George M. Sklom, Robert A. Jones  
1 Riverside Road—Riverside 7-2153  
Riverside, Ill.  
(A Chicago suburb)

**WILLIAM E. BENNS, JR.**  
Consulting Radio Engineer  
3802 Military Rd., N. W., Wash., D. C.  
Phone EMerson 2-8071  
Box 2468, Birmingham, Ala.  
Phone STate 7-2601  
Member AFCCE

**HAMMETT & EDISON**  
CONSULTING RADIO ENGINEERS  
BOX 68, INTERNATIONAL AIRPORT  
SAN FRANCISCO 28, CALIFORNIA  
DIAMOND 2-5208

**JOHN B. HEFFELFINGER**  
401 Cherry St. Hilland 4-7010  
KANSAS CITY, MISSOURI

**Vandivere & Cohen**  
Consulting Electronic Engineers  
610 Evans Bldg. NA. 8-2698  
1420 New York Ave., N. W.  
Washington 5, D. C.  
Member AFCCE

**CARL E. SMITH**  
CONSULTING RADIO ENGINEERS  
4900 Euclid Avenue  
Cleveland 3, Ohio  
HEnderson 2-3177  
Member AFCCE

**J. G. ROUNTREE, JR.**  
5622 Dyer Street  
EMerson 3-3266  
Dallas 6, Texas

**VIR N. JAMES**  
SPECIALTY  
Directional Antennas  
316 S. Kearney Skyline 6-1603  
Denver 22, Colorado

**JOHN H. MULLANEY**  
Consulting Radio Engineers  
2000 P St., N. W.  
Washington 6, D. C.  
Columbia 5-4666

**A. E. TOWNE ASSOCS., INC.**  
TELEVISION and RADIO  
ENGINEERING CONSULTANTS  
420 Taylor St.  
San Francisco 2, Calif.  
PR. 5-3100

**RALPH J. BITZER, Consulting Engineer**  
Suite 298, Arcade Bldg., St. Louis 1, Mo.  
Garfield 1-4954  
"For Results in Broadcast Engineering"  
AM-FM-TV  
Allocations • Applications  
Petitions • Licensing Field Service

## SERVICE DIRECTORY

**COMMERCIAL RADIO  
MONITORING COMPANY**  
PRECISION FREQUENCY  
MEASUREMENTS  
A FULL TIME SERVICE FOR AM-FM-TV  
P. O. Box 7037 Kansas City, Mo.  
Phone Jackson 3-5302

**CAPITOL RADIO  
ENGINEERING INSTITUTE**  
Accredited Technical Institute Curricula  
3224 16th St., N.W., Wash. 10, D. C.  
Practical Broadcast, TV Electronics engi-  
neering home study and residence courses.  
Write For Free Catalog, specify course.

SPOT YOUR FIRM'S NAME HERE,  
To Be Seen by 79,497\* Readers  
—among them, the decision-making  
station owners and managers, chief  
engineers and technicians—applicants  
for am, fm, tv and facsimile facilities.  
\*ARB Continuing Readership Study

Contact  
**BROADCASTING MAGAZINE**  
1735 DeSales St., N. W.  
Washington 6, D. C.  
for availabilities

**PETE JOHNSON**  
CONSULTING ENGINEERS  
KANAWHA HOTEL BLDG PHONE:  
CHARLESTON, W. VA. DI. 3-7503

**MERL SAXON**  
Consulting Radio Engineer  
622 Haskins Street  
Lufkin, Texas  
NEptune 4-4242 NEptune 4-9558

WCBE Cheraw, S. C.—Granted assignment of license from E. G. Robinson Jr. and William R. Wagner to Pee Dee Bestg. Co. (WATP Marion, S. C.); consideration \$20,000. Announced May 15.  
 KNEL Brady, Tex.—Granted assignment of license to Gene M. Burns (son); consideration \$17,700. Announced May 15.

**APPLICATIONS**

WTCB Flomaton, Ala.—Seeks transfer of control of licensee (Tri-City Bestg. Co.) from present stockholders to Andrew Lee and George Haskew Sr. (50% each) for \$47,500. Mr. Lee is retail merchant; Mr. Haskew was WPBB Jackson, Ala. manager. Announced May 21.

KPBA Pine Bluff, Ark.—Seeks assignment of license from W. L. Kent tr/ as Radio Pine Bluff to Radio Pine Bluff Inc. Corporate change. No control change. Announced May 19.

KAFA Colorado Springs, Colo.—Seeks assignment of license and cp from Taylor Bestg. Co. to General Bestg. Corp. for \$69,700. New owners (one-third each): John Hunter, WCMF, Pine City, Minn. (58%) and KOWB Laramie, Wyo. (80%); Kenneth Palmer, v.p., Intermountain Network, and Robert Donner Jr., no previous occupation. Announced May 21.

KULA-TV Honolulu, Hawaii.—Seeks assignment of license from Television Corp. of America Ltd. to Kaiser Hawaiian Village for \$685,000. Purchaser, licensee of KHVH-AM-TV Honolulu, will dispose of that station if present application is granted. Announced May 15.

WKAI Macomb, Ill.—Seeks assignment of license from Macomb Bestg. Co. to WKAI Bestg. Co. for \$79,000. Owner-to-be is William Rudolph, publisher, Macomb Daily Journal. Announced May 21.

KMNS Sioux City, Iowa.—Seeks assignment of license from William Johns Jr., William Johns Sr., Patricia and Penrose Johns and Robert Flynn d/b as Siouxland Bestg. Co. to Siouxland Bestg. Inc. for \$175,000. New owner James Stuart, president and director of Stuart Investment Co., has authority to vote 100% of stock of KFOR Lincoln and KRGI Grand Island, both Nebraska. Announced May 19.

WAAN Marlborough, Mass.—Seeks assignment of cp from Clernew Bestg. Corp. to WGLO Inc. for \$17,000. Assignee is owned by Lewis Sargent (52%) and others. Mr. Sargent is commercial manager, WKOX Framingham, Mass. Announced May 21.

KOOO Omaha, Neb.—Seeks assignment of license from Central Plains Bestg. Co. Inc. to KOOO Corp. for \$200,000. New owners: Clifford Bowers, M. D. (26.6%); James Fenlon, KTRI Sioux City salesman (16.6%); Eugene, John and Fred Kelly, 25% interest in KTRI apiece (each 12.5%); Anthony Kelly, M. D. (12.5%), and Wallace Huff, attorney. (6.6%). Announced May 19.

WOOW Washington, N. C.—Seeks assignment of license from John Gallagher to WOOW Inc. Corporate change. No control change. Announced May 19.

KGLC Miami, Okla.—Seeks acquisition of positive control of licensee (Miami Bestg. Co.) by Kenyon Brown, who now holds 22.15%, through purchase of 52.95% from M. K. Huttis, George Coleman and John Robinson for total of \$2,085. Mr. Brown has interest in KCOF-TV Los Angeles (25%), KFOX-AM-FM Long Beach (17%) and KIMO Independence, Mo. (40%). Announced May 21.

WTRO Dyersburg, Tenn.—Seeks assignment of license from Hamilton Parks and Franklin Pierce d/b as Southern Bestg. Co. to William Davis and Pinkney Cole Jr. (each 50%) for \$74,000. Mr. Davis is chief engineer and Mr. Cole, announcer-manager, with WTRO. They have simultaneous application incorporate under name of Southern General Bestg. Co. Inc. Announced May 20.

KBTX-TV Bryan, Tex.—Seeks relinquishment of positive control of licensee (Brazos Bestg. Co.) by KWTX Bestg. Co. through issuance of

**COMMERCIAL STATION BOXSCORE**

*As Reported by FCC through April 30*

|   | AM    | FM  | TV               |
|---|-------|-----|------------------|
| LICENSED (all on air)                           | 3,196 | 521 | 415 <sup>1</sup> |
| CPs ON AIR (new stations)                       | 43    | 19  | 96 <sup>2</sup>  |
| CPs NOT ON AIR (new stations)                   | 82    | 80  | 106              |
| TOTAL AUTHORIZED STATIONS                       | 3,321 | 620 | 661              |
| APPLICATIONS FOR NEW STATIONS (not in hearing)  | 430   | 46  | 74               |
| APPLICATIONS FOR NEW STATIONS (in hearing)      | 107   | 14  | 54               |
| TOTAL APPLICATIONS FOR NEW STATIONS             | 537   | 60  | 128              |
| APPLICATIONS FOR MAJOR CHANGES (not in hearing) | 252   | 22  | 41               |
| APPLICATIONS FOR MAJOR CHANGES (in hearing)     | 34    | 0   | 14               |
| TOTAL APPLICATIONS FOR MAJOR CHANGES            | 286   | 22  | 55               |
| LICENSES DELETED                                | 0     | 2   | 0                |
| CPs DELETED                                     | 1     | 1   | 3                |

**SUMMARY OF STATUS OF AM, FM, TV**

*Compiled by BROADCASTING through May 21*

|                 | Lic.             | ON AIR          |  | CP Not on air | TOTAL APPLICATIONS For new stations |
|-----------------|------------------|-----------------|--|---------------|-------------------------------------|
|                 |                  | Cps             |  |               |                                     |
| AM              | 3,196            | 50              |  | 87            | 548                                 |
| FM              | 521              | 21              |  | 84            | 65                                  |
| TV (Commercial) | 415 <sup>1</sup> | 96 <sup>2</sup> |  | 108           | 129                                 |

**OPERATING TELEVISION STATIONS**

*Compiled by BROADCASTING through May 21*

|                | VHF | UHF | TOTAL            |
|----------------|-----|-----|------------------|
| COMMERCIAL     | 425 | 86  | 511 <sup>1</sup> |
| NON-COMMERCIAL | 24  | 7   | 31 <sup>4</sup>  |

<sup>1</sup> There are, in addition, eight tv stations which are no longer on the air, but retain their licenses.  
<sup>2</sup> There are, in addition, 35 tv cp-holders which were on the air at one time but are no longer in operation and one which has not started operation.  
<sup>3</sup> There have been, in addition, 177 television cps granted, but now deleted (33 vhf and 144 uhf).  
<sup>4</sup> There has been, in addition, one uhf educational tv station granted but now deleted.

25 shares of unissued stock to Harry Gillam, station manager. Announced May 19.

KMBL Junction, Tex.—Seeks assignment of license from Kible County Bestg. Co. to Mr. and Mrs. Charles Evans, d/b as Junction Bestg. Co., for \$24,000. Mr. Evans has been announcer with KORA Bryan, Tex. Announced May 16.

KGKO Dallas, Tex.—Seeks assignment of license from Lakewood Bestg. Co. Inc. to Radio Station KGKO for \$450,000. New owners are H & E Radio Corp. and Atlantic Brewing Co. (one-third each) and others. H & E is wholly owned subsidiary of H & E Balaban Corp. which has interest in: WIL St. Louis (one-third), WRIT Milwaukee (50%), WICS-TV Springfield, Ill. (50%), and WTVO-TV Rockville, Ill. (50%). Atlantic is associated in ownership of WIL (one-third) and WRIT (50%) and owns 25% of KFBI Wichita, Kan. Announced May 19.

KWEL Midland, Tex.—Seeks assignment of license and cp from Great Western Radio Co. to Petty Johnson for \$60,000. Mr. Johnson owns 67% of KVWC Vernon, Tex. Announced May 21.  
 KSUB Cedar City, Utah.—Seeks acquisition of positive control of Beehive Telecasting Corp. (which holds control of licensee [Southern Utah Bestg. Co.] by Samuel Nissley through issuance of stock to him for cancellation of Beehive's debt to him. Announced May 15.  
 WBCR Christiansburg, Va.—Seeks assignment of license from Montgomery Bestg. Co. Inc. to

WBCR Inc. for \$60,000. A. Hundley Griffith Jr., 98.9% owner of assignee, is account executive with Modern Teleservice. Announced May 15.

KITN Olympia, Wash.—Seeks acquisition of negative control of licensee (KITN Corp.) by Harold Singleton (now 49.5%) through purchase of 5% from Donald Whitman (now 50.5%) for \$150. Announced May 21.

KLAN Renton, Wash.—Seeks involuntary transfer of control of licensee (Interlake Bestg. Corp.) from Ralph Sander to Ralph Sander Jr., executor of estate of Ralph Sander, deceased. Announced May 15.

KLAN Renton, Wash.—Seeks assignment of license from Interlake Bestg. Co. to Mesabi Western Corp. for \$200,000 (contingent on grant of above application). New owners are to be Pacific National Bank of Seattle, trustee (80%), and William Boeing Jr., Bertha Boeing and Donald Drew, executors of estate of W. E. Boeing, deceased, (20%). William Boeing Jr. owns one-third of KWLK Longview, Wash. Bertha Boeing and Donald Drew are in timber. Announced May 19.

**Hearing Cases**

**INITIAL DECISIONS**

Hearing Examiner Herbert Sharfman issued an initial decision which concluded that Dec. 9, 1954, grant of application of Sacramento Telecasters Inc., for mod. of cp to change trans. and studio site of KBET-TV (ch. 10) Sacramento, Calif., change type ant. and make other equipment changes, would serve public interest, convenience and necessity. Court of Appeals remanded case to Commission, but did not stay effectiveness of Dec. 9, 1954 grant. Announced May 20.

Hearing Examiner Elizabeth C. Smith issued initial decision looking toward granting application of Albany Bestg. Corp. for new am station to operate on 990 kc, 250 w D, in Albany, Ore. Announced May 20.

**OTHER ACTIONS**

By memorandum opinion and order, Commission dismissed petition by WKBW-TV Inc. for clarification of April 2 memorandum opinion and order which permitted company to change trans. site, ant. height and power and make other necessary engineering and financial changes in its application for new tv station to operate on ch. 7 in Buffalo, N. Y., which is in consolidated hearing with Great Lakes Television Inc., and Greater Erie Bestg. Co. Announced May 21.

By memorandum opinion and order, Commission (1) granted request by Coastal Television Co. for leave to answer reply, and (2) denied motion by Oklahoma Television Corp. to enlarge issues in New Orleans, La., tv ch. 12 com-

*Continues on page 106*



*"Whatever your broadcast needs, go straight to Collins"*

# CLASSIFIED ADVERTISEMENTS

Payable in advance. Checks and money orders only.

- DEADLINE: Undisplayed—Monday preceding publication date. Display—Tuesday preceding publication date.
- SITUATIONS WANTED 20¢ per word—\$2.00 minimum • HELP WANTED 25¢ per word—\$2.00 minimum.
- All other classifications 30¢ per word—\$4.00 minimum. • DISPLAY ads \$20.00 per inch.
- No charge for blind box number. Send replies to BROADCASTING, 1735 DeSales St., N.W., Washington 6, D. C.

APPLICANTS: If transcriptions or bulk packages submitted, \$1.00 charge for mailing (Forward remittance separately, please). All transcriptions, photos, etc., sent to box numbers are sent at owner's risk. BROADCASTING expressly repudiates any liability or responsibility for their custody or return.

## RADIO

### Help Wanted

Wanted: Station manager for new kilowatt day-timer opening soon in Murphy, North Carolina. Also salesmen, announcers, engineers, copywriters. Write Jimmy Childress, Box 1114, Sylva, North Carolina.

### Sales

Commercial manager for leading network station in medium size midwest city. Substantial weekly salary plus commission on billing. This is exceptional position. Send experience resume and recent picture to Box 270E, BROADCASTING.

Sales manager wanted with solid experience sales ideas and push—unlimited future with 5 kw in Florida. \$5200 plus over-ride. Box 342E, BROADCASTING.

Wanted—Experienced salesman for radio station in rich midwest market. All applications confidential. Good salary plus incentive plan. No pressure. Write Box 472E, BROADCASTING.

Fulltime salesman for top New England market. Want man who will shake bushes. Do not want prima donnas or talkers. Need doers. Gene Morrison, Assistant General Manager, WWCO, Waterbury, Conn.

### Announcers

Opportunity for married staff announcer. Send resume. ABC Network. Texas. Box 345E, BROADCASTING.

Announcer with sales experience, 20 hour announcing shift, upper midwest, guarantee \$115.00 per week, commission, established station, permanent furnish references and resume of experience. Box 448E, BROADCASTING.

Brand new station in greater Pittsburgh market needs experienced announcers with executive potential. Require minimum one year commercial experience. Above average wages, good working conditions, finest equipment. Personal interview necessary. Send tape, photo, resume immediately. Box 450E, BROADCASTING.

Experienced sportscaster wanted for high school and junior college football, basketball and staff announcing. Send resume, tape and salary requirements. Frank O. Myers, Manager, KCMC, Texarkana, Texas-Ark.

Old, 23 years, well established 5000 watt, independent station, KIUP, Durango, Colorado, has opening for a dependable, experienced engineer-announcer, accent on announcing no maintenance. Must have 1st ticket, floaters, drunks, glamour boys, do not apply. References will be thoroughly checked. Send tape, resume of background and salary expected to KIUP, P. O. Box 641, Durango, Colorado.

Announcer for radio station KLEA, Lovington, New Mexico, population around 11,000. Would consider recent "radio school" graduate. Send tape and resume to Hoyt Caldwell, KLEA, Box 877, Lovington, New Mexico.

Just a good, solid announcer, 40 hours per week, Sundays off. \$100.00 per week. KRFO, Owatonna, Minnesota.

Metropolitan market station going up wants live wire man to go along. Must have quality voice plus ideas. Send tape, resume, salary. Fred Epstein, KSTT, Davenport, Iowa.

New York. Experienced, versatile Negro announcer for full-time summer replacement now. Here's an opportunity to establish with an 8 station radio-tv chain. Rush tape to Hal Walton, WNJR, P. O. Box 1258, Newark, N. J.

Experienced announcer needed immediately for local news beat in fabulous hunting and fishing area, in upstate New York. Salary open. Contact Tom Leighton, WSLB, Ogdensburg, New York.

### Technical

Chief engineer single market southern network station using remote control. Inquiries confidential. Box 214E, BROADCASTING.

## RADIO

### Help Wanted—(Cont'd)

#### Technical

Chief engineer-announcer. Excellent position, ideal working conditions. Number one station in market in beautiful Florida. Good pay and opportunity for advancement. Box 444E, BROADCASTING.

Need chief engineer for newly acquired station in major Pennsylvania market. Must have thorough knowledge of disc recording and studio engineering directional experience helpful. Prefer young man with progressive ideas. Send full background, references and salary requirements. Box 451E, BROADCASTING.

Frequent openings experienced first class engineers. Directional antenna; studio operation. Union scale \$135.00 base. KOBV, 340 Mason Street, San Francisco.

Immediately. Chief engineer. Experienced am-fm remote operation. Maintenance, construction, full charge. Must be capable announcer. Rush tape, resume, references. Advise when available and salary expected. KSON, San Diego.

Opening soon for chief engineer 1000 watts Gates-equipped station. Excellent spot for sober man with experience. Send complete resume. WCLB, Camilla, Georgia.

Transmitter engineer. Contact Jerry Norman, WIIN, Atlanta, Ga. TR 5-8453.

Need man with first class ticket. No experience necessary. Physically handicapped person preferred. Apply Roger Moyer, WTIM, Taylorville, Illinois.

#### Production-Programming, Others

Mr. News Director! Can you see beneath the surface news—get behind handouts? Are you a newsman who always knows what's going on? We need such a man. Why not apply and discuss your ideas? Send resume, photo Box 179E, BROADCASTING.

Executive secretaries with knowledge and experience in the fields of radio and television broadcasting. Must be able to assume office responsibilities as right hand to top executives in major broadcast operation. Stimulating, interesting, rewarding work for qualified girls with extensive backgrounds in this field. Please furnish detailed resume in reply. All inquiries in strict confidence. Box 253E, BROADCASTING.

Sales promotion manager for top-flight major market, radio-television operation. Must be thoroughly experienced in all phases of sales promotion, advertising and research. This is an excellent and rewarding opportunity for qualified man in this field. All replies held in confidence. Box 254E, BROADCASTING.

Radio and tv opportunity for experienced news man who wants to locate in Iowa. Immediate opening, good salary, excellent working conditions. All replies held confidential. Box 460E, BROADCASTING.

News director wanted immediately. Send tape, experience, references. WFAH, Alliance, Ohio.

Continuity director. WRFD, Worthington, Ohio, looking for man who can write imaginative copy that sells. This is a permanent position with Ohio's outstanding regional radio station. Ideal working conditions and fringe benefits. Send complete resume of background and experience, present and expected salary, copy samples and references. All replies held confidential. Write direct to Phil Sheridan, Program Director.

Immediate opening radio-tv film producer. Want man who can write motion picture, shoot and edit single and double system sound, ½ time in radio planning and announcing programs. Prefer man with masters degree. Good salary, month vacation, federal retirement plan. Contact or visit Ken Thomas, Radio-TV Department, Kansas State College, Manhattan, Kansas.

## RADIO

### Situations Wanted

Available immediately due to unusual circumstances. Contact Jerry Berens, Radio Station WRIC, Richlands, Virginia.

#### Management

Formulas don't faze me. Successful record ideal programming 250w-50 kw. Currently—net flagship operation visiting southwest, coast July. Competition minded? Let's talk. Box 384E, BROADCASTING.

Management or sales. Small to medium market. One fifty minimum. Box 420E, BROADCASTING.

Experienced broadcaster—26, desires to learn management, 1st class license, promotion minded. Holds executive position with large firm—willing to work. Box 425E, BROADCASTING.

7 years experience. First phone, announcing, traffic, copy, supervision. Desire management or position with future. Box 428E, BROADCASTING.

With 15 years experience in radio, known as a good executive, with a law background, now disposing of present radio ownership and looking for the unusual opportunity of working with a good organization in the states. Puerto Rico or Hawaii. Family man. Looking for the right location and the right organization. Available this fall. Write Box 437E, BROADCASTING.

Wanted! Management of a station in Texas or Arkansas that needs the guidance of a man who has spent 30 years in radio. Major, medium and small markets. Fine record for longevity. Sales, programming, production, promotion, personnel, continuity. Always a step ahead of the trend. Now employed, as always. Box 445E, BROADCASTING.

Manager/commercial manager. Specializes in selling. 24 years radio experience. Nine years manager, ten years commercial manager. Small and medium markets, network and independent. Interested turning problem station into profitable, solid operation. Desire stock purchase privilege from profit participation after proof of performance. Prefer medium or small south-east market. Age 43, married, two children. Box 449E, BROADCASTING.

Young, aggressive manager, experienced in all phases, desires position in the south. Available immediately. First phone. Box 467E, BROADCASTING.

#### Sales

Go-getter, experienced, seeking good potential. Prefer deal including air work. Can run own board. All-around man—what you're looking for. Box 174E, BROADCASTING.

Available. Hard driving, creative salesman; a real "heavyweight", early thirties, well-liked, well-known. Ten years radio and television sales experience; local, regional and national. Have contacts in practically every advertising agency in New York. Sales record—excellent. (Actually it's tremendous) know just about everyone in this field. Now employed seeking new assignment in New York or vicinity. Excellent references. Box 387E, BROADCASTING.

First phone announcer. Six years experience all phases including chief. Ready to learn sales your way. Presently employed. Box 427E, BROADCASTING.

Young woman with five years experience radio sales seeks sales or sales management position with sound mid-western indie. Box 434E, BROADCASTING.

Excellent radio sales-management record. Interested in small market management, sales, sales-program combination or television sales. South only. Box 475E, BROADCASTING.

#### Announcers

Negro dee Jay. Good board man. Fast patter, smooth production. I'm the one you're looking for. Tape and resume. Box 172E, BROADCASTING.

Girl d.j. announcer. Go anywhere. Ready now. Run own board. Can sell, too. Steady—no bad habits. Love to build audiences and grab accounts. Tape and resume. Box 173E, BROADCASTING.

## RADIO

### Situations Wanted—(Cont'd)

#### Announcers

Personality-dj strong commercials, gimmicks, etc. Run own board. Steady, eager to please. Go anywhere. Box 175E, BROADCASTING.

Young staff announcer strong dj. Thoroughly trained in all phases. Run own board. Tapes and resume available. Box 285E, BROADCASTING.

Well rounded in all phases of radio. Strong in news and sports with executive experience in management and sales. Desire opportunity with solid station in the Tennessee-Virginia area. No tv experience but am interested. Personal interview only. Box 349E, BROADCASTING.

Announcer. Recent grad, A.B., radio major. Single, 4A. Will travel or relocate. Box 354E, BROADCASTING.

Experienced disc jockey, three years, good commercial, knows music, family. Box 366E, BROADCASTING.

Terrific sportscaster. Sports director. Employed, 5 years experience. References. Box 381E, BROADCASTING.

Mature p.m. d.j. Now doing 3 hour show with 50 kw in one of the top 10 markets in the country. Want a jazz-minded operation. I have a success story, how about you? Write 399E, BROADCASTING.

Copywriter-dj, 35, experienced, desires "sell-write-announce" combination. Resume. Box 397E, BROADCASTING.

College graduate, 21, married, draft exempt, 3 years radio experience as announcer and manager. Desires job in southeast as announcer-salesman or manager. Tape on request, excellent references. Box 406E, BROADCASTING.

Staff experience 250-50 kw, news, d.j., console, all phases operation-parttime Los Angeles area, \$1.50 hour. Box 407E, BROADCASTING.

D. J., news, continuity. Run board. Likes work. Looking for spot to grow in. Tapes and resume. Box 409E, BROADCASTING.

Announcer salesman, experienced, currently employed. Excellent references. Married. South or west. Box 411E, BROADCASTING.

Disc jockey, 3½ years experience. Would like to settle within 200 miles of Chicago. News, operate board, tape recorders, 25, married, veteran. Can you help me? Box 412E, BROADCASTING.

Experienced announcer, newscaster, deejay, desires permanent position. Excellent references. Box 415E, BROADCASTING.

Summer replacement or full time, you "auto" try me. 2 years college, radio announcing major. Prefer midwest or California, but will accept anywhere. Say when. . . . Box 417E, BROADCASTING.

Announcer, restricted ticket. Well-trained negro. College background. Handle all-round staff job. Operate board. Will travel anywhere. Tape, resume on request. Box 421E, BROADCASTING.

Announcer-disc jockey. News commercials, operate board. Tape and resume. Box 422E, BROADCASTING.

Top fite jockey, newsman desires position in larger market. Ticket. Box 426E, BROADCASTING.

Twelve years broadcast experience. First phone. Available June. Prefer south. Box 430E, BROADCASTING.

Experienced young announcer wants job with future. Reliable. Very good sell. Veteran. Prefers relocation in the south. Box 431E, BROADCASTING.

Newsman, dj, sports. Know all phases radio work. Available June 8. Married. College. Box 435E, BROADCASTING.

Foreign language man. English, French, German, Italian, Rumanian. M. A. Degree Northwestern University. First phone license. Have had own radio programs. Age 40, married, two children. Knowledge of classical, pops and foreign music. Box 438E, BROADCASTING.

Highly recommended announcer-deejay needs employment. Versatile, all phases. Negro. Box 446E, BROADCASTING.

Announcer, experienced, first phone, professional newscast, bright dj, college, married. Box 452E, BROADCASTING.

Versatile—conscientious announcer. Experienced 500 to 50 kw. First phone. Negro. Box 453E, BROADCASTING.

## RADIO

### Situations Wanted—(Cont'd)

#### Announcers

Starting and startling! Voice swell for all sell. Have staff? Say dj? Glib adlib! No trite when I write. Vet with knowledge gained from college with well sent talent! Box 454E, BROADCASTING.

Prefer northeastern seaboard. Presently employed—smooth, mature delivery. Operate boards, pops, classics, news, spots. Box 455E, BROADCASTING.

Negro dj dying . . . to make money for your station. Eager to please easy to mold. Try me and see. Have tape, will travel. Box 456E, BROADCASTING.

Deep, resonant voiced announcer with working knowledge of the business. Prefer news, commercial, dj. Available immediately. Box 457E, BROADCASTING.

Experienced announcer seeks permanent position in Long Island, New Jersey area. Box 459E, BROADCASTING.

1st class phone announcer some experience. BCA-RCA grad. Conn.-Rhode Island-Vermont-New Hampshire. Box 462E, BROADCASTING.

Experienced radio announcer seeks permanent position in, or near New York state. Box 466E, BROADCASTING.

First phone announcer, eighteen months experience. Classical, pop, gospel, news. No maintenance. Single, college. Formerly Norfolk good music station, South. Available immediately. Box 470E, BROADCASTING.

Experienced news, sports announcer; gathering, writing, play-by-play. Family man, will work. \$90. Box 473E, BROADCASTING.

Staff announcer, five years experience some sales, talent, qualified to manage station. Locate anywhere U.S.A. Personal interview only. If you have immediate opening call 2166 Whitesburg, Kentucky, before 8:00 A.M. or after 5:00 P.M. If no answer try 610 Harriman, Tenn., ask for Ray.

Available immediately. Presently employed. Telephone Gene Romance (Dickens-3-8233) Charleston, West Virginia.

Quality dj announcer: June 58-Sept, 59 or summer work anywhere. College grad. Experienced. Top references. Art Top, Box 115, Concordia Seminary, St. Louis.

Swinging dj now doing daily two hour show on KGGM Radio and TV Albuquerque desires to relocate southeast. Do voices and personality or straight show. After June first contact: Stan "The Record Man" Vainrib, 2151-15th Avenue, South, Birmingham 5, Alabama, ALpine 1-3082.

#### Technical

Chief engineer. Interested in technical directorship for group ownership in Carolinas or nearby areas. Box 405E, BROADCASTING.

Transmitter position, two years experience, dir. experience, car, 1st radiotelephone. Box 443E, BROADCASTING.

Chief engineer, fifteen years experience all phases radio broadcasting from 250 thru high power directional am and fm. Limited announcing if desired. Future and security desired. Box 463E, BROADCASTING.

Engineer, first phone. Experienced. Transmitter, studio and recording. No announcing. Box 464E, BROADCASTING.

Good combo man wants work in southwest U.S. Ten years radio; four broadcast. Country, pop, news. Prefer chief. First phone, good technician. Hamp Clark, WCLB, Camilla, Georgia. Call 2776 Camilla, before one P.M.

First class FCC license. No experience, but willing and anxious to learn. C. J. Stoll, 5304 Parkland Ave., Dallas, Texas.

#### Production-Programming, Others

Newsman; gather, write, deliver authoritative, intelligent newscasts. 6 years solid experience, all phases. College graduate; family. Prefer radio-tv news combination. Presently employed major market. Box 312E, BROADCASTING.

News director, 13 years experience every phase of radio-television. Solid family man. Veteran. College. Presently in top ten market. Excellent references. Available after June 15th. \$150 per week. East-midwest only. Box 369E, BROADCASTING.

## RADIO

### Situations Wanted—(Cont'd)

#### Production-Programming, Others

Production manager, art director, photographer, promotion, set designer and carpenter, kid show personality, 5 years experience. Married, 3 children. 12 years in staging and show business. Can boost your market dollars. S. O. F. and art samples on request. Box 408E, BROADCASTING.

Experience in announcing, copywriting, traffic, news, music dept. Familiar with programming duties. Will begin very reasonably for opportunity as p.d., or job leading toward same. References. 25 years old. 3 years radio. Dry climate essential. Box 414E, BROADCASTING.

Program and news director, 250 watt independent, desires relocation central New York state. B.S. Speech and Drama, M.S. Radio-Television; Married, family; veteran. Interested educational broadcasting. Available July first. Empire Services, 219 Green Street, Syracuse, New York.

## TELEVISION

### Help Wanted

#### Announcers

Experienced announcer for booth and on-camera work. Medium mid-south market. Full power vhf. Box 129E, BROADCASTING.

Imaginative, experienced on-camera strong, hard-sell commercial announcer. Good ad libbing a must. State salary requirements. Send recent photo and tape along with references. Large southeast market. Box 469E, BROADCASTING.

#### Technical

Assistant to chief engineer, midwest station. E.E. degree, demonstrated technical ability as well as administrative and organizational experience, salary open. Box 440E, BROADCASTING.

Large southwestern university requires assistant engineer for educational tv station. Must have 1st class license, preferably married, over the age of thirty. Salary \$5200 per year. Send resume and references to Box 441E, BROADCASTING.

#### Production-Programming, Others

TV copywriter, female. Must write good sell copy and perform other duties. California station. Box 419E, BROADCASTING.

Continuity writer: One with creative ideas with top rated NBC television station in midwest. This is an opportunity to put your commercial ideas to work in a production minded station. Write Box 424E, BROADCASTING.

## TELEVISION

### Situations Wanted

#### Management

Builder of human machinery. 12 years experience in tv and am sales, programming, and administration of stations and groups of stations, including working with advertising agencies and clients. With this is combined a faith that the greatest need in being competitively successful is high morale in own outfit. Know how to build such morale, breathe confidence and fun into daily work so that all play above their heads and win. Am fundamentally a seller, not a buyer; dramatic background, so that talking with people from one to a group is pleasure not burden. Education: B.A. and Phi Beta Kappa. Married, 3 children. Age 38. Box 423E, BROADCASTING.

Sales manager: Constructive planning now will pay fall-winter dividends. I offer: substantiated personal top sales volume; highly regarded industry reputation/ability sales staff organization/training, and an exclusive use of six year industry proven selling procedure guaranteeing sales results. I'm a dedicated, efficient, experienced sales executive in my 40's, possessing quality acceptance, top industry references. College, married, two youngsters. Now employed sales manager leading vhf. Intelligent reason for seeking new association. Confidential. Box 461E, BROADCASTING.

#### Announcers

Talented tv-radio announcer, fifteen years professional experience. \$125.00 week and up. Box 433E, BROADCASTING.

## TELEVISION

### Situations Wanted—(Cont'd)

#### Technical

1st phone, married, RCA graduate. Ten years same company radio-television. Audio, projection, switcher, some maintenance. Interview July vacation. References. Box 429E, BROADCASTING.

Engineer, first phone, CTI grad. Midwest or southwest, preferably maintenance and construction. Experienced with RCA and GE equipment and micro-wave, also operations. Box 432E, BROADCASTING.

10 years am-tv experience. 3 years chief and 4 years supervisory. Desire chief or supervisory position. Box 447E, BROADCASTING.

TV technician, first phone. Willing to travel, resume upon request. Box 465E, BROADCASTING.

#### Production-Programming, Others

Wanted tv production! R-tv graduate B.S. Single, vet. 24. AFRS/experience, will consider other suitable openings. can relocate. Box 439E, BROADCASTING.

Television producer, and director: Six years experience, all phases television production. Excellent references. Married, one child, 33 years old. Box 442E, BROADCASTING.

Sales service, client relations. Graphic arts, like production. BKG weatherman. Box 458E, BROADCASTING.

Program director, production manager, announcer, director. Can fill any of these jobs. Presently in medium market as head of program department. Looking for permanent location. Box 474E, BROADCASTING.

## FOR SALE

1958 radio station plan book. Five complete floor plans. Practical, economy minded, proven. \$3.75 postpaid. Station Planning Service. Box 2001 Station A, Fort Wayne, Indiana.

### Stations

Daytime station in major mid-west market. Not a powerhouse, but a good operation with potential under local ownership-operation. Present owner leaving area. Terms available but approximately \$40,000 down payment required. Information will be given to qualified people only. Write Box 436E, BROADCASTING.

Top rated station. Northeast U. S. 250 w. full time. Good signal in vacationland city of 20,000. Trading area 100,000. Price of \$250,000 with 29 pct. down includes real estate. Cash throw-off to owner near \$50,000 a year. Box 476E, BROADCASTING.

California-daytimer. \$55,000.00. \$20,000.00 down. Exclusive. Wilt Gunzendorfer and Associates, 8630 W. Olympic, Los Angeles.

Waiting buyers, listings wanted, Hollingsworth Co., Inc., "Guess The Lucky Secret Word." Program. 514 Hempstead Ave. W. Hempstead, N. Y.

Metropolitan market, growth area south, price of \$225,000 is within 6 times owners income, 29% down. Chapman Company, 1182 W. Peachtree, Atlanta, Georgia.

Oregon quarter-kilowatt. \$55,000.00. Terms. Exclusive. Wilt Gunzendorfer and Associates, 8630 W. Olympic, Los Angeles.

Norman & Norman, Inc., 510 Security Bldg., Davenport, Iowa. Sales, purchases, appraisals, handled with care and discretion. Experienced. Former radio and television owners and operators.

Florida small market stations (7) priced from \$33,000 to \$75,000 and can be handled with as little as \$5,000 cash. Chapman Company, 1182 W. Peachtree, Atlanta, Georgia.

California daytimer. Grossing \$120,000.00. Wilt Gunzendorfer and Associates, 8630 W. Olympic, Los Angeles.

Write now for our free bulletin of outstanding radio and tv buys throughout the United States, Jack L. Stoll & Associates, 6381 Hollywood Blvd., Los Angeles, Calif.

Midwest large market station \$275,000, monopoly market, \$80,000. Chapman Company, 1182 W. Peachtree, Atlanta; 17 E. 48th St., New York, or 33 W. Micheltorena, Santa Barbara, California.

## FOR SALE—(Cont'd)

### Stations

Oregon. 3 station-market. Quarter-kilowatt \$125,000.00. Exclusive. Wilt Gunzendorfer and Associates, 8630 W. Olympic, Los Angeles.

### Equipment

Tape recorders: replacing with new. 3, PT6-AH. 2, PT6-M. 2, PT6-J, Magneorders in service less than three years. 2 PT-6 AH need some repair, others in excellent condition. Rack mounted. \$900 buys all, no partial sale. Contact Richard Tuck Enterprises, KBEC Waxahachie, Texas.

For sale—WE 310 B 250 watt transmitter 1240 kc excellent condition with external voltage control. Just removed from service—complete set spare tubes. Ideal for spare unit or Conelrad. \$500 FOB. Bert Wick, KDLR, Devils Lake, N. Dak.

Transmission line. 15-20 ft. lengths 3 1/2 inch—51.5 OHM equivalent RCA MI 19113 flanged, pressurized. Has not been gassed but stored dry clean. Best offer FOB. KSTP, St. Paul, Minn.

Tower—115' new self-standing Dresser-Ideco. In crates, never erected. Complete drawings. KTWO-TV, Casper, Wyoming.

Weather warning receivers—for Conelrad and disaster weather warnings. Air Alert II—\$46.50; Air Alert I—\$89.50. Write Miratel, Inc., 1080 Dionne St., St. Paul 13, Minn.

WE 5 kw transmitter, type 104C modified to 5C with crystal for 740 kc. \$1,500 Florida location. May Brothers, Binghamton, N. Y.

Two (2) Magnecord PT6-AH tape transport mechanisms, complete with audio and power cables in carrying cases. Just overhauled and in excellent condition with new heads. \$225.00 each, one or both. Guaranteed. Radio Engineering & Maintenance Corp., 208 W. Third Street, Lexington, Kentucky. Phone 2-4432.

12 assorted towers, 165-300 ft. All makes. Most like new. Priced \$1,000 to \$6,000. Write for list. May Brothers, Binghamton, N. Y.

## WANTED TO BUY

### Stations

New England or New Jersey. Must be currently profitable. Box 339E, BROADCASTING.

Experienced operator wants best deal \$20,000 will buy. Confidential reply. Box 395E, BROADCASTING.

Small market station, southwest or Texas. Prefer fm. Give complete information first letter. Box 410E, BROADCASTING.

Ad agency exec wants small, medium market radio station. Give details, terms. All replies confidential. Box 471E, BROADCASTING.

### Equipment

Transmitter, 5 kw am air cooled, not over 10 years old. Give details. Box 413E, BROADCASTING.

Tower—150' Windcharger type 300 or any guyed tower over 250'. Send information to Box 418E, BROADCASTING.

1000 watt fm amplifier. KYFM, 4516 North Libby, Oklahoma City, Okla.

Wanted, two used camera friction heads and one field tripod for use with a Raytheon KTR-100 microwave system (4 ft. dishes). Contact CE, WIS-TV, 1111 Bull Street, Columbia, S. C.

## INSTRUCTIONS

FCC first phone preparation by correspondence or in resident classes. Our schools are located in Hollywood, California and Washington, D. C. For free booklet, write Grantham School, Desk B2, 821 - 19th Street, N. W., Washington, D. C.

FCC first phone license in six weeks. Guaranteed instruction by master teacher. G.I. approved. Phone FLeetwood 2-2733. Elkins Radio License School, 3605 Regent Drive, Dallas, Texas.

A job for you! The National Academy of Broadcasting starts summer term June 5. Many radio and tv jobs are offered to professional graduates as announcers, disc jockeys, news and sports directors, managers of women's programs, traffic and sales.

## INSTRUCTIONS—(Cont'd)

Since 1946. The original course for FCC 1st phone license. 5 to 6 weeks. Reservations required. Enrolling now for classes starting June 25, September 3, October 29. For information, references and reservations write William B. Ogden Radio Operational Engineering School, 1150 West Olive Avenue, Burbank, California.

## MISCELLANEOUS

Bingo Time U.S.A. printers of personalized bingo type game sheets for radio and television programs. We also distribute 1/2 hr. bingo type film series, mc'd by popular film personalities. P.O. Box 1871, Hollywood 28, Calif. Tel: Hollywood 2-4038.

## RADIO

### Help Wanted

## Looking for NEW TALENT? PRODUCTION PERSONNEL?

Leading Radio and TV studios call Leland Powers School for well-trained talent and production personnel. Competent young men and women skilled in radio and TV techniques including programming and production, announcing, acting, make-up, copywriting, script and continuity writing. Graduates recognized throughout the industry for sound, comprehensive training.

Write Graduate Relations Department today. Placement service free to employer and graduate. 54th year.

## LELAND POWERS SCHOOL OF RADIO TELEVISION AND THEATRE

25 Evans Way, Boston 15, Mass.

### Production-Programming, Others

## NEWS DIRECTOR KFSD AM & TV SAN DIEGO

Newsman with "Nose for News", extensive newspaper, radio, and TV background. authoritative voice, journalism degree, administrative ability. If your experience includes only newscasting and re-write DON'T answer. If you KNOW news, how to really dig for it, rush tape, resume, picture, salary requirement, and theories on radio news to Lee Ellis, KFSD, Radio, San Diego 12, California.

## Situations Wanted

### ABILITY - VERSATILITY - STABILITY

Twelve years radio and TV, 250 watt to 50 K. Announcer, writer, producer, entertainer, P-B-P, salesman. College Grad. Family man, 36, active in civic affairs. Finest personal and professional references. An abundance of ideas, plus the ability and drive to put them to work for you. Manager, Assistant Manager, Program Director? The title isn't important. Opportunity is. Box 416E, BROADCASTING

## NEED A D. J.?

B. C. A. Placement Service has them . . . with and without experience. All eager to please and make you money! Best trained anywhere, run own boards. No prima donnas. Thoroughly screened. Write or wire collect immediately:

### Milt Stillman, Placement Service Broadcast Coaching Associates

1639 Broadway, Capital Theatre Bldg.

N. Y. C. 19, N. Y.

Judson 6-1918. No charge for either party.

## TELEVISION

### Help Wanted

Production-Programming, Others

#### SALES PROMOTION AND MERCHANDISING MANAGER WANTED

Mid Atlantic major market network, basic network affiliate needs man strong in merchandising and able to direct staff of six people in department. Fine opportunity. Send resume to  
**Box 468E, BROADCASTING**

## FOR SALE

### Stations

**THE PIONEER FIRM OF TELEVISION  
AND RADIO MANAGEMENT  
CONSULTANTS—ESTABLISHED 1946**  
NEGOTIATIONS MANAGEMENT  
APPRAISALS FINANCING  
**HOWARD S. FRAZIER, INC.**  
1736 Wisconsin Ave., N.W.  
Washington 7, D. C.

### Equipment

**RADIO AND TELEVISION STATIONS  
YOUR SOURCE FOR:  
HIGH CONDUCTIVITY ELECTROLYTIC**  
Bonding copper strapping—.016" to .064" thick  
1" to 12" widths  
Copper ground wire—#8—#10—#12 gauge  
Copper expanded screen mesh—.026" x 8' x 24'  
Write for quotation—advise footage needed  
J. L. Clark Metals Co. 2108 S. Ashland Ave.  
Chicago 8, Ill. Haymarket 1-4533

### TAPE RECORDERS

All Professional Makes  
New—Used—Trades  
Supplies—Parts—Accessories  
**STEFFEN ELECTRO ART CO.**  
4401 W. North Avenue  
Milwaukee 8, Wisc.  
Uptown 1-8150 TWX: MI-193  
America's Tape Recorder Specialists

## INSTRUCTIONS

### SELECTED ANNOUNCERS AVAILABLE

Trained, reliable men and women, graduates of the School of Announcing are interested in acquiring experience. Complete information including audition tapes sent on request. Let us help you find the right man for your staff. There is no charge for this service. Write or phone

**DETROIT SCHOOL  
of  
ANNOUNCING AND SPEECH**  
5840 Second Blvd., Detroit, Mich.

## Dollar for Dollar

you can't beat a classified ad in  
getting top-flight personnel.

## FOR THE RECORD continues from page 102

parative proceeding. Announced May 21.

By order, Commission denied appeal petition by Video Independent Theatres Inc. (KVIT ch. 2) Santa Fe, N. M., and sustained examiner's grant of request by New Mexico Bcstg. Co. Inc., and Alvarado Television Co. Inc., Albuquerque, N. M., protestants, for subpoena duces tecum for various documents and materials in KVIT proceeding. Announced May 21.

By memorandum opinion and order, Commission denied petitions by Joseph M. Ripley Inc., to strike exhibits and grant its application for new am station in Jacksonville, Fla., and to enlarge issues in proceeding on its application and that of Dan Richardson, Orange Park, Fla., but granted Mr. Ripley's alternative request to allow the examiner to enlarge issues relative to sufficiency of available funds. Announced May 21.

By separate memorandum opinion and order, Commission granted petition by Dan Richardson and enlarged issues in above proceeding to include availability and adaptability of Ripley's proposed site in compliance with Commission's rules and standards. Announced May 21.

Majority of Commission on May 21 directed preparation of document looking toward granting applications of Tv Corp of Mich. Inc., and State Board of Agriculture for new tv stations to operate on ch. 10 on share-time basis in Onondaga, Mich., subject to condition that State Board of Agriculture shall surrender its permit for station WKAR-TV (ch. 60) East Lansing Mich., and denial of competing applications of Triad Television Corp., Booth Bcstg. Co., and Jackson Bcstg. & Tv Corp., seeking same channel in Parma, Mich. Initial decision of Mar. 7, 1957, looked toward this action.

By order, Commission denied petition by Circle Corp. (WKILZ) Kalamazoo, Mich., to enlarge issues in am proceeding, and, on Commission's own motion, ordered stricken, for non-compliance with Sec. 1.13 of procedural rules, supplement to opposition filed by William Kuiper and William Eugene Kuiper, d/b as Dowagiac Bcstg. Co., Dowagiac, Mich., response thereto by Circle Corp., and Kuipers' reply to response. Commissioner Hyde dissented. Announced May 21.

By order, Commission made effective immediately initial decision and granted application of Greylock Bcstg. Co. to change trans. location and make changes in ant. system of am station WBRK Pittsfield, Mass. Announced May 21.

Ordered that initial decision which looked toward grant of application of Western Nebraska Television Inc., for new tv station to operate on ch. 13 in Alliance, Neb., which would have become effective on May 15 pursuant to Sec. 1.153 of rules, shall not become final pending further review by Commission of recently filed petitions in this proceeding. Announced May 15.

Commission scheduled proceeding on applications of Albuquerque Bcstg. Co. (KOB) Albuquerque, N. M., for oral argument on May 26.

By memorandum opinion and order, Commission granted protests and petitions by Valley Telecasting Co. (WFRV-TV ch. 5) and Northville Fathers (WBAY-TV ch. 2), both Green Bay, Wis., to extent of designating for hearing application for transfer of control of M & M Bcstg. Co. (WMAM and WMBV-TV ch. 11) Marinette, Wis., from William Walker, et al., to Evening Telegram Co., Norman M. Postles and Walter C. Bridges, but denied request for postponement of effective date of Mar. 19 grant of application; made protestants parties to proceeding. Announced May 15.

Commission designated for hearing application of Camellia Bcstg. Co. Inc., to change trans. site of KLFY-TV Lafayette, La., from 2.1 miles west of center of Lafayette to about 11 miles northwest of that city, near Bristol, La., and increase ant. height from 440 ft. to 940 ft., in consolidated proceeding with applications of KTAG Associates for mod. of cp of KTAG-TV Lake Charles, La., to specify operation on ch. 3 instead of ch. 25, and Evangeline Bcstg. Co. Inc., and Acadian Television Corp., for new tv stations to operate on ch. 3 in Lafayette. In same order, Commission granted in part and denied in part various petitions by Evangeline and Acadian; denied petition by Camellia for rule making proceedings to determine whether ch. 3 should be assigned to Lafayette or Lake Charles, or to assign that channel to Lake Charles-Abbeville-Kaplan, in lieu of Lafayette-Lake Charles; and set forth new issues to supersede previous designation order. Announced May 15.

North Star Bcstg. Co., Windom, Minn.; KCHA Radio Inc., Charles City, Iowa—Designated for consolidated hearing applications of North Star for new am station to operate on 1580 kc, 250 w DA, D, and KSHA to increase power from 250 w to 500 w, continuing operation on 1580 kc D; made KLGA Algona, Iowa, party to proceeding. Announced May 15.

Wilson Bcstg. Corp.; E. Anthony & Sons Inc.; Eastern States Bcstg. Corp.; New England Tele. Co. Inc., New Bedford, Mass.—Designated for consolidated hearing applications for new tv stations to operate on ch. 8; made United States Coast Guard party to proceeding. Announced May 15.

## Routine Roundup

Commission on May 21 instructed its staff to prepare order setting for expeditious hearing matters specified by U. S. Court of Appeals for

District of Columbia, in remanding Miami, Fla., ch. 10 cases to Commission.

## ACTIONS ON MOTIONS

By Hearing Examiner Herbert Sharfman  
on May 16

Granted petition by Broadcast Bureau for extension of time from May 19 to May 26 to file proposed findings of fact and conclusions and for replies from May 29 to June 5, in proceeding on am application of Capitol Bcstg. Corp. (WCAW) Charleston, W. Va.

By Hearing Examiner H. Gifford Irlon  
on May 16

Hearing conference scheduled for 10 a.m., May 20 is continued to 1:45 p.m., same date, in Erie, Pa., ch. 66 proceeding.

By Hearing Examiner Charles J. Frederick  
on May 16

Reopened hearing record in proceeding on am applications of Enterprise Bcstg. Co., Fresno, Calif., Air Waves Inc. (KONG) Visalia, Calif., and Radio Dinuba Co. (KRDU) Dinuba, Calif., for purpose of hearing oral argument on petition by Enterprise to reopen record and accept additional engineering statement; oral argument will commence at 10 a.m., May 21, and the parties will be limited to 10 minutes each with provisions that such proper parties as may desire may reserve any amount of their allotted time for rebuttal.

By Hearing Examiner Annie Neal Hunting  
on May 16

Continued from May 20 to June 6 hearing on am application of Pierce Brooks Bcstg. Corp. (KGIL) San Fernando, Calif.

### BY FCC

Commission on May 14 granted motion by Plains Television Corp. (WICS ch. 20) Springfield, Ill., for extension of time from May 20 to June 9 to file responses to petition by Lafayette Bcstg. Inc. (WFAM-TV ch. 59) Lafayette, Ind., for rehearing and reconsideration of April 7 report and order in Lafayette-Terre Haute, Ind., tv rule making proceeding.

By Hearing Examiner Jay A. Kyle on May 15

Granted motion by J. B. Falt Jr., Sheffield, Ala., for continuance of time to June 23 for exchange of exhibits and to July 8 for further prehearing conference in am proceedings.

Dismissed as moot motion for continuance and opposition thereto in proceeding on am application of Hardin County Bcstg. Co., Silsbee, Tex.

By Hearing Examiner Hugh B. Hutchison  
on May 14

Granted petition by Logansport Bcstg. Co. for leave to amend its application for new am station in Aurora-Batavia, Ill., to show that its proposed equipment would be purchased rather than leased and to submit modified plan of financing construction of station.

By Elizabeth C. Smith on May 15

Scheduled prehearing conference on May 23 on applications of Willamsport Radio Bcstg. Associates Inc., for cp and mod. of cp of WARC Milton, Pa.

By Hearing Examiner Millard F. French  
on May 15

Scheduled prehearing conference on June 5 on am application of Birch Bay Bcstg. Co., Blaine, Wash.

By Hearing Examiner Herbert Sharfman  
on May 15

Scheduled prehearing conference on June 5 on am application of Mecklenburg Bcstg. Co., Chase City, Va.

By Commissioner Rosel H. Hyde  
on May 13

Granted petition by Marshall County Bcstg. Co., Arab, Ala., for extension of time to June 2 to oppose petition for review of examiner's ruling sustaining a motion to quash notice of Walter G. Allen, Huntsville, Ala., of taking depositions in am proceeding.

By Chief Hearing Examiner James D. Cunningham on dates shown

Scheduled hearings on the following am applications on dates shown: July 10—Mecklenburg Bcstg. Co., Chase City, Va.; Pompano Beach Bcstg. Co., Pompano Beach, Fla.; et al.; July 14—Union Bcstg. Co., Elizabeth, N. J.; et al.; July 16—Nick J. Chaconas, Gaithersburg, Md., et al.; July 16—Grady M. Sinyard, New Boston, Ohio, and States Bcstg. System Inc., St. Marys, Ohio; James W. Miller, Milford, Conn., et al.; July 17—Austin Radio Co., Austin, Tex.; July 18—Bridgeport Bcstg. Co. (WICC) Bridgeport, Conn., and fm applications of Electronic Music Co. and WSBC Bcstg. Co., Chicago, Ill. (Actions May 12.)

Denied petition by WBRB Inc. (WBRB) Mt. Clemens, Mich., to intervene in am hearing on applications of Binder-Carter-Durham Inc. (WAMM) Flint, Mich., et al. Action May 13.

Continued indefinitely prehearing conference set for May 14 on am application of Hardin County Bcstg. Co., Silsbee, Tex. (Action May 14.)

By Hearing Examiner J. D. Bond on May 13

Pursuant to informal conference, extended time to file supplemental proposed findings to May 26 in proceeding on application of New

Hanover Bestg. Co. for new tv station to operate on ch. 3 in Wilmington, N. C.; granted United Bestg. Co. Inc., leave to participate in pleading procedure.

## BROADCAST ACTIONS

By Broadcast Bureau  
Actions of May 16

WJBK-TV Detroit, Mich.—Granted license covering ant. facilities authorized in STA dated 4-25-56 as aux. ant.

KCMJ Palm Springs, Calif.—Granted license covering change of facilities. installation directional ant. (DA-2), new trans., change ant. location and make changes in ant. and ground system.

WNK Arcibo, P. R.—Remote control permitted.

Following stations were granted change of remote control authority: WHHY Charles W. Holt, Connie I. Holt and Robert N. Robinson, Montgomery, Ala., while using non-directional ant.; WCNY, Middlesex Bestg. Co., Middletown, Conn.; WHEC, WHEC, Inc. (main & aux.) Rochester, N. Y. while using non-directional ant.; WKZO Felzer Bestg. Co., Kalamazoo, Mich., while using non-directional ant.

WGFS Covington, Ga.—Granted authority to sign-off at 6:00 p.m. except for special events from 6-1 to 9-30.

Actions of May 15

KQED (TV)\* San Francisco, Calif.—Granted license for noncommercial educational tv station; ant. 1210 ft.

KETA (TV)\* Oklahoma City, Okla.—Granted license for noncommercial educational tv station.

KEPR-TV Pasco, Wash.—Granted license covering changes in tv station; ERP vis. 97.7 kw, aur. 49 kw. ant. height 1250 ft.

WJBK-TV Detroit, Mich.—Granted license covering changes in tv station (main trans. & ant.); and license covering installation of aux. trans. at main trans. site.

WNBF-TV, WFIL-TV Binghamton, N. Y., and Philadelphia, Pa.—Granted cps to install aux. trans. at main trans. site.

KPCS (FM)\* Pasadena, Calif.—Granted cp to install new type ant., increase ERP to 370 watts, and decrease ant. height to 540 ft. of noncommercial educational fm station.

WFIL-TV Philadelphia, Pa.—Granted license covering changes in tv station; ant. 1090 ft.

KATO Reno, Nev.—Granted cp to change ant.-

trans. location and make changes in ground system.

KPLO-TV Reliance, S. D.—Granted cp to change ERP to vis. 100 kw, aur. 60 kw; type of trans. and other equipment change.

WJBK-TV Detroit, Mich.—Granted cp to replace expired cp which maintains ant. facilities authorized in STA dated 4-25-56 as aux. ant.

WFLN Philadelphia, Pa.—Granted mod. of cp to change type trans. and make changes in directional ant. system.

WNBE-TV New Bern, N. C.—Granted extension of completion date to 10-9.

Actions of May 14

WCNR Bloomsburg, Pa.—Remote control permitted.

Actions of May 13

WMIA Arcibo, P. R.—Granted acquisition of positive control by Manuel Pirallo Lopez, et al., as a family group, through purchase of stock from Jose Donate Casanova and Gloria Ramos de Donate.

WCMW Canton, Ohio.—Granted transfer of negative control from Geneva P. and Richard Schultz as special administrators of estate of J. Irvin Schultz, deceased, to Geneva P. and Richard W. Schultz as trustees of trust funds created by will of J. Irvin Schultz, deceased.

WWOL Buffalo, N. Y.—Granted cp to install new main trans.

KRSI Hopkins-Edina-St. Louis Park, Minn.—Granted mod. of cp to change type trans.

WSM-TV Nashville, Tenn.—Granted extension of completion date to 11-21.

Actions of May 12

KLOR-TV Provo, Utah.—Granted transfer of positive control from Samuel B. Nissley, James R. Winterton et al., to Samuel B. Nissley through acquisition of stock.

Granted licenses for following fm stations: KSFR Hanon Nathan Levitt, San Francisco, Calif.; WBZ-FM Westinghouse Bestg. Co. Inc., Boston, Mass.; WEBH Buddy Black Bestg. Co. Inc., Chicago, Ill.; KFMK James R. Corry, Houston, Tex.

WPTF-FM Raleigh, N. C.—Granted license covering increase in ERP, ant. height and change of type trans.

KFAC-FM Los Angeles, Calif.—Granted license covering installation of trans. as aux. trans.

WKPA New Kensington-Tarentum, Pa.—Granted cp to install old main trans. as aux. trans. at main trans. site.

WARE Ware, Mass.—Granted cp to replace expired cp which authorized change hours of operation.

WLNA Peekskill, N. Y.—Granted cp to install new trans. as alternate main trans. at present main trans. site.

WACL Waycross, Ga.—Granted cp to make changes in ant. system.

WIBX Utica, N. Y.—Granted cp to install new auxiliary trans. and increase power to 1 kw.

WNEW-FM New York, N. Y.—Granted mod. of cp to decrease ERP to 0.54 kw, change type trans. and type ant., increase ant. height to 1360 ft.; remote control permitted.

WEBY Milton, Fla.—Granted mod. of cp to change type trans.

WEZN Elizabethtown, Pa.—Granted mod. of cp to change type trans.

KZOL Muleshoe, Tex.—Granted authority to sign-off at 4:00 p.m. for period ending July 15.

Following were granted extensions of completion dates as shown: WEDU Tampa, Fla. to 11-19 and KPAX (FM) San Bernardino, Calif. to 12-31.

Following stations were granted renewal of license:

KAPK Minden, La.; KBBA Benton, Ark.; KCLP Rayville, La.; KDBS Alexandria, La.; KFAY Fayetteville, Ark.; KGAN Bastrop, La.; KHOZ Harrison, Ark.; KLIC Monroe, La.; KLLA Leesville, La.; KLOU Lake Charles, La.; KLPL Lake Providence, La.; KLLA Little Rock, Ark.; KBLW Walnut Ridge, Ark.; KTCS Fort Smith, Ark.; KTML Marked Tree, Ark.; KFRY Bastrop, La.; KVOM Morrilton, Ark.; KWBC Searcy, Ark.; WAZF Yazoo City, Miss.; WBIP Booneville, Miss.; WBOK New Orleans, La.; WCPC Houston, Miss.; WDSU & aux. WDSU-FM New Orleans, La.; WFOR Hattiesburg, Miss.; WGMV Greenville, Miss.; WKOZ Kosciusko, Miss.; WLAU Laurel, Miss.; WLCS & aux. Baton Rouge, La.; WLOX Biloxi, Miss.; WMIS Natchez, Miss.; WNAT Natchez, Miss.; WNAU New Albany, Miss.; WNSL Laurel, Miss.; WOKK Meridian, Miss.; WQBC Vicksburg, Miss.; WROB West Point, Miss.; WSJC Magee, Miss.; WSUH Oxford, Miss.; WTPS New Orleans, La.; WVMI Biloxi, Miss.; WWL New Orleans, La.; WXOK Baton Rouge, La.; WXXX Hattiesburg, Miss.; WYLD New Orleans, La.; WAFB-TV Baton Rouge, La.; WBRZ (TV) Baton Rouge, La.; WCBT-TV Columbus, Miss.; WDM-TV Hattiesburg, Miss.; KHBM Monticello, Ark.

## IN PUBLIC INTEREST

**BIG ASSIST** • KYW-AM-TV Cleveland presented a check for more than \$13,000 to parents who lost five of their six children in an April 10 fire at their Cleveland home. A three-day appeal to listeners and viewers resulted after the stations contacted the family's minister for his approval to establish a fund in the family's name.

**HIGH WATER** • KCNY San Marcos, Tex., broadcast emergency announcements and assisted the dispatching of National Guard troops May 2, after eight inches of rain flooded the Blanco river in the San Marcos area. When necessary, flood bulletins warned listeners to evacuate from danger areas.

**CLEAN PASTURES** • WEJL Scranton, Pa., is supporting an anti-litter and clean-up campaign sponsored by the Scranton Century Club and the City of Scranton. With regularly scheduled interviews and heavy spot announcements, the station is reminding listeners to live up to the campaign slogans: "Keep God's Dooryard Clean" and "Over Hill, Over Dale, Please Don't Leave a Messy Trail."

**WEEKEND APPEAL** • WICU-TV Erie, Pa., tallied more than \$80,000 in pledges May 10-11 in a 17-hour telethon drive for funds to build a training home for exceptional children in behalf of the Erie Assn. for Retarded Children. Cash contributions from an estimated 10,000 children who filed through the studios on Mother's Day to meet Cochise of ABC's *Broken Arrow* were

expected to raise the campaign total to more than \$100,000. National stars on the telethon included Eddie Bracken, Virginia Graham, Juanita Hall, Denise Lor and Billy Lee. A total of 68 amateur and professional acts from the Erie area performed in the spectacle.

**HIGH LIVING** • KMAN Manhattan, Kan., announcer Shel Smith raised his goal of \$2,500 for the Manhattan Park Development Assn. during a two-day stay on the catwalk of the city water tower. Provided with a sleeping bag, shelter halves, and a telephone with which to take pledges, Mr. Smith lived on his 115-foot high perch until his goal was reached April 29.

**NO TRAP** • KING Seattle, Wash. offers the driving public a special radar report several times each morning on the *King's Klock* show. The announcements, in cooperation with the Seattle Police Dept., give the location of one police radar check point each day. The reports emphasize that the police are not out to trap motorists but are actually trying to protect the unsafe driver, program director Jack Link explained.

**STORM CARD** • KMOX St. Louis presented 6,000 copies of the KMOX Radio-Tornado Disaster Storm Card to the mayor of Glendale, Mo., for distribution to residents in that city. The card explains proper safety rules to follow in the event of tornadoes and windstorms. KMOX is the key area station in the nation-wide radio broadcasting plan whereby Conelrad signals are

used to alert the public when severe storms are imminent.

**A NEW LIFE** • KTTV (TV) Los Angeles newsman George Putnam appealed to listeners to aid the family of a would-be-robber whose wife had appeared on the program *Confidential File*, prior to his newscast. The woman's husband had attempted to hold up a Los Angeles bank in order to provide for his destitute family. Immediate response was received by the station with offers of money, food, clothing, employment, a used car and down-payment on a house.

**"ASK THE DOCTOR"** • KFOX Long Beach, Calif., has a new series of programs featuring answers to medical questions provided by physician David Ascher. Questions from listeners are answered in layman's language by Dr. Ascher five times a day, Monday-Saturday.

## CIRCULATION GUARANTEE

The Red Cross is advising people in bad weather zones to pay close attention to radio and television during the tornado season at hand. Attending to radio and television during the next five months may mean the difference between life and death, Robert Edson, national director of Red Cross disaster services, warns. The admonition is contained in a list of safety rules issued for residents of tornado danger areas.

# 4

channel

this  
is  
**WBEN-TV**  
land

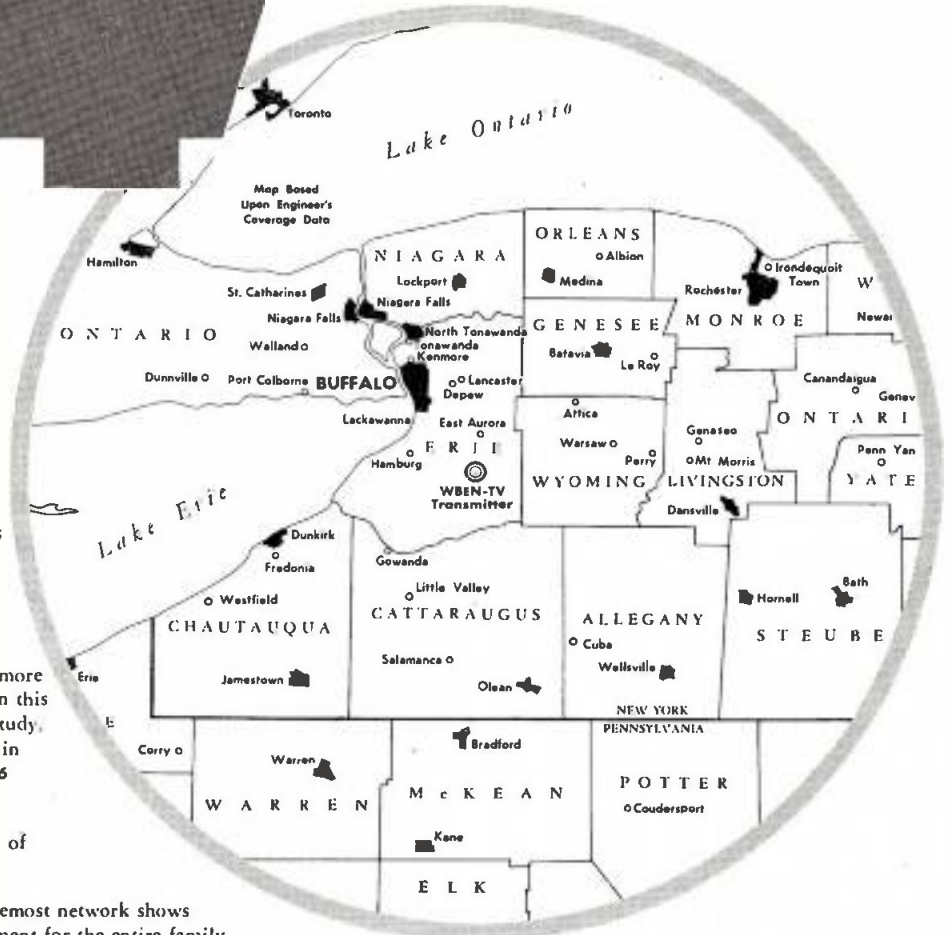

*In this busy area . . .  
most television viewers  
watch WBEN-TV  
most of the time*

The independent Trendex program-rating service made more than 100,000 telephone calls in this area during its latest AREA study. It found that WBEN-TV was in **FIRST PLACE** in 120 out of 156 MEASURED HALF HOURS.

WBEN-TV was first in 76.9% of the time periods measured.

Quality programming, the foremost network shows from CBS, balanced entertainment for the entire family, perfect pictures and perfect sound — all for more than 4 million people on Channel 4.

TV viewers of Buffalo, Western New York, nearby Pennsylvania and Canada have voted overwhelmingly in favor of the entertainment, educational, cultural and informative programs presented as a community responsibility — year in year out — by WBEN-TV on Channel 4.

Proof again — your TV dollars count for more on Channel 4.

*Represented nationally by*  
**HARRINGTON, RIGHTER AND PARSONS**

**WBEN-TV**



**CBS** the nation's top network

A SERVICE OF THE BUFFALO EVENING NEWS



from J. HARVEY HOWELLS, *Fitzgerald Adv., New Orleans*

## Confessions of a reformed New Yorker: There's more to life than Madison Ave.

In 1946 I achieved the goal of every advertising aspirant. Madison Avenue. At Fifty-Seventh Street, to be precise. I immediately fell in love with New York.

How could I help it? J. Walter Thompson and Ted Bates were my agencies. Louis & Armand's and the Stork were my corner drugstores. My secretary—my own secretary—could get tickets for a hit show three hours before curtain time. Raoul Dufy prints on the walls of my office. Wow! I was a \$10,000 a year millionaire.

What a wonderful town Manhattan is. Any civilized person must love it. It is the fountainhead, the center of the United States—perhaps of the world.

When you think of finance, banking, the theatre, culture, the tv networks (cultural every now and then), book publishing, magazine publishing—you think of New York.

And, of course, when any man, woman or child in this country thinks of advertising, he thinks of Madison Avenue. But since leaving New York a year ago, a disturbing thought has been growing on me.

Is it possible that an advertising man located in New York is a little atypical of the rest of the country?

For only one example, he doesn't eat much home-cooked food. He lunches and dines out a great deal, probably more in a month than the average American does in five years. He loves the theatre, modern art, \$150 suits, clams, oysters and Bloody Marys. It's a little removed from the staple American diet of mashed potatoes, ground meat, half a bottle of catsup, and "Hurry up, Maw, or we'll be late for the basketball game."

Mark you, he wasn't born to this luxury. He was probably born in Maine or Virginia or Indiana or even Scotland. But it takes a strong man to avoid becoming a New Yorker. It's a delightful sybaritic trap. I know, because I fell in.

As a cub in the early '40's, I joined with other cubs in a semi-humorous attempt to get my old boss, Neil McElroy, to move the advertising department of P & G from Cincinnati to New York. "Look at the money and energy it would save, Mac. We spend all our time traveling back and forth to our New York agencies—"

Of course we got nowhere. Mac had a one-word reply: "Perspective." We

could not get around the fact that an advertiser with one foot in America and one in Manhattan had a better idea of the needs and desires and habits of the average U. S. citizen.

This suggests a very happy hunting ground for new business for a non-New York agency—New York itself. Certainly there are more prospects there, just as there is more of everything, including more good advertising and more bad advertising.

New York has more creative talent, but not better creative talent. And I submit that *quantity* of creative talent is a snare and a delusion. What an advertiser needs is *quality* of creative talent. And New York has not cornered that. How could it? Creativity has nothing to do with geography. Creativity is in a brain, not in an avenue.

### BRAINS, NOT GEOGRAPHY

If I were advising a manufacturer, today, on selection of an agency, I would tell him to look for one with creativity, and not to be bound by the unnecessary crimp of geography. I would tell him that if he could find creative brains outside Madison Avenue, he would get some valuable pluses.

First and foremost, he would get the plus of perspective. His agency would probably not let him run a tv spot I saw recently. It was selling a national gasoline because it had the power to pull a car up a hill in heavy snow. This in New Orleans where there are no hills, and a one-inch snowfall last Feb. 17 was the heaviest of the century.

He would also get the plus of stability in agency personnel. Job insecurity is the great hidden waste in New York manpower today. If an account man stays in the same job four years, he's either in a rut, owns a piece of the

agency, or is married to a client's daughter. But outside New York there is more stability and consequently less need for small boys to shout, "Watch your back, Mister!" Not that people outside New York are nicer than people in it. It's just that the business climate is nicer, more equable, less given to extreme changes.

The third plus that the non-New York agency seems to offer is creative daring. Who comes to mind when you think of creative daring in New York? David Ogilvy and Bill Bernbach. Any more? Come outside New York, and there's Leo Burnett and Marlboro. There's Knox-Reeves and Wheaties. Fitzgerald Advertising and Wesson Oil. Campbell-Mithun and Hamm's beer. Guild, Bascom & Bonfigli and Ralston-Purina. The bright sparkle of truly creative advertising seems to be coming from somewhere West of Madison Avenue.

This is not surprising when you analyze it. The nature of the business in New York breeds stereotypes. Men go from one agency to another and sometimes back to the first, taking their stereotypes with them. It's positively incestuous.

But your agency man outside New York has to be original. If he copies Madison Avenue trends he's dead. He must create his own trends or he loses his reason for existence, and his account to New York.

An advertiser *can* get a good job done on Madison Avenue. Perhaps he can get an even better job done if he has the courage to look West or South of Madison Avenue. If he can find the brains with marketing creativity somewhere West of Madison Avenue, he may get, in addition, the invaluable pluses of perspective, stability and creative daring.

*J. Harvey Howells, b. May 1, 1912, Glasgow, Scotland. Arrived America 1938. Trained by Procter & Gamble Adv. Dept. Ad manager of Standard Brands Grocery Dept.; Good Luck Div., Lever Bros.; Lever Div., Lever Bros. In 1956 became creative director, Wesson Oil products, for Fitzgerald Adv., New Orleans. Won Writers Guild Award for comedy 1956, with "Goodbye Grey Flannel" on Robert Montgomery Presents. His first novel, The Big Company Look, to be published by Doubleday in Aug.*



## Fall Springboard

AT THE urging of their own consciences, their leaders and the government, more and more broadcasters are beginning to editorialize.

They are also beginning to run into trouble because of it.

Some of them are wondering if the rewards of editorializing are worth the difficulties it provokes. At this point there is a very real danger that a good many broadcasters may retreat from the course they have so recently, and tentatively, chosen.

This danger must be faced and overcome if radio and television are to mature to their potential as the principal organs of journalism.

Like all dangers, this one may be faced more comfortably by a group than by an individual. The broadcaster who receives a letter from the FCC questioning his treatment of an editorial subject will be less alarmed if he knows his colleagues will assist in his defense. He cannot cede to them his own responsibility for editorial presentation, but he can take comfort in the awareness that they accept with him the general obligation to protect the rights of broadcasting to editorialize.

To date, editorializing has been largely an individual development occurring here and there around the country. As such it lacks the cohesiveness necessary to establish national acceptance of radio and television as editorial forces.

If enough individuals persist in developing sound editorial programs, the sum of their effort will eventually be the elevated prestige of all radio and television. That process, however, will be painfully slow. It could be dramatically hastened if all the broadcasters who wish to accept the risks and rewards of editorializing were to unify their efforts.

What editorializing broadcasters need now is a place to exchange ideas and experiences and an organization loose enough to assure individual freedom but tight enough to provide a strong defense against the attempts which inevitably will be made to weaken or destroy the right of broadcasting to editorialize.

An opportunity for the creation of that kind of structure will begin with the eight NAB regional conferences this fall. It seems to us that editorializing should occupy an important part of the agenda at each conference.

Every serious broadcaster who has tried editorializing has quickly realized that he is moving into largely unexplored ground. At this stage of editorial development, a whole conference program could be built from editorializing experiences. How more quickly can the novice learn to editorialize than from mistakes of others?

It is within the NAB's power to advance substantially the evolution of radio and television editorializing by doing no more than putting the subject on the agenda of the fall meetings and giving it a chance to be thoroughly explored.

## Where Legislation is Needed

MEMBERS of Congress now are registering surprise and indignation over the sudden "discovery" that a number of television stations came into being by way of mergers and the elimination of contestants through what are now called "pay-offs."

The surprise element is about as convincing as a tomato surprise on a luncheon menu. All these gentlemen had to do was to look at the published record—and perhaps their own office records. There were mergers and payment of out-of-pocket expenses (and more in some cases) because the pressures came from people in public life to get new stations on the air. It would be hard to prove but it was widely known that some people entered television cases with "strike applications" intended either to delay a grant or force a merger or pay-off.

Wholly repugnant but nevertheless lawful pay-offs were made to strike applicants because Congress, in 1952, adopted the so-called McFarland Amendments which gave any applicant standing and the automatic right of hearing. The only way to get a new service on the air without delay that might run several years was to pay off the strike applicant, or cut him in, or both.

There was nothing secret about these transactions. So far as we are aware, all mergers or pay-offs growing out of strike applications were known in the trade. Certainly this journal reported the events as they occurred, and in detail. At the same time we editorially condemned the provisions of law that made pay-offs to irresponsible applicants possible by tying the hands of the FCC.



Drawn for BROADCASTING by Sid Hix

"This commercial introduces their new cake mix for stag parties . . . the blond is an ingredient!"

Members of the House Oversight Committee also suddenly have discovered that "trafficking" in stations goes on; that stations are sold at figures far in excess of the value of the physical plant and equipment. Here again it is a matter of law, with little or no discretion left to the Commission. Congress alone can remedy this condition. The question is how.

Admittedly, something is asking when a television station authorized after a comparative hearing involving several qualified applicants, is sold after a few months for a substantial price to another party who did not have to stand the rigors of hearing, and who probably could not have won if he had. That has happened many times. Yet the FCC has no legal basis on which it can reject such transfers when the purchaser in all respects is qualified.

The answer is not to be found in a return to the so-called Avco procedure of open bidding for station properties, or some variation of it. That inevitably would mean that the most desirable stations would go to those with the most money.

The answer might be found in legislation that would require the grantee to retain the station for a specified minimum period—perhaps for the duration of the license term which now runs three years, but which should be at least five years. There, of course, should be an escape to cover extenuating circumstances, such as death, illness or economic reverses and inability to carry on. Or perhaps transfers should be considered only at the time of license renewal.

Here is an area in which the Oversight Committee can do good through enactment of affirmative legislation that will correct shortcomings in the existing law and abuses that stem from them.

## Elmer Davis Legacy

ALMOST every news program and newspaper editorial page last week paid tribute to Elmer Davis, the distinguished journalist who died on May 17 at 68. His life-long friend, Rep. Robert Hale (R-Me.) said on the House floor that he would be longest remembered as a news broadcaster.

Yet Mr. Davis' career as a broadcaster actually covered a span of only a few years, as against a virtual lifetime on newspapers and as an author. He was with CBS from 1939 until 1942, when President Roosevelt appointed him director of the Office of War Information. In those three years he earned the respect and the confidence of more people than anyone on the air before or since. After leaving government in 1945 he returned to the air over ABC.

Elmer Davis made the transition from the printed page to the spoken word overnight. He talked the way he wrote. The public believed him. He made the five-minute newscast the standard.

Tangible recognition should be given for what Elmer Davis did for radio. An award in his name would be appropriate, even though in life he was disposed to regard awards as so much nonsense.



**TIRED OF  
RATING  
CLAIMS?**

## Let's talk about **RESPONSE!**

At the present time, KSTP-TV has a few choice availabilities in the news cut-ins within the TODAY Show (7:00-9:00 am, M-F) and in the popular TREASURE CHEST (12:20-1:00 pm, M-F.) But rather than just quote you a few ratings, let us *show* you the astounding response these shows can deliver—for you!

Recently, KSTP-TV commentator George Grim, who handles the four 5-minute TODAY cut-ins, invited viewers to send him a post card for a drawing on a portable TV set. There was no second prize—and no promotion for the drawing outside of Mr. Grim's own announcements.

In two weeks, KSTP-TV received 45,047 post card

entries—an incredible average of 3,217 cards per day for this one prize.

And, a few weeks ago, TREASURE CHEST offered a \$500 Easter wardrobe to the person who guessed the number of Easter eggs in a jar.

In four weeks the contest pulled 59,366 entries or 2,968 per day.

This tremendous response is *your best proof* of the selling job these available shows on KSTP-TV can do for you. For further information on reaching this actively-participating KSTP-TV audience, contact your nearest Petry office or a KSTP-TV representative.

**KSTP**

television

Basic NBC Affiliate

100,000  
WATTS

MINNEAPOLIS · ST. PAUL

"The Northwest's Leading Station"

CHANNEL

**5**

Why NOT put all your eggs  
 ... in ONE basket?



**One Station That Provides Complete Coverage**

Why take chances on having your sales story scrambled by too many cooks . . . at higher than necessary costs! Get the full, top-quality coverage of this rich and vital market with WNEM-TV . . . A FOUR BILLION DOLLAR MARKET no other one station can cover!

See Your Petryman

**WNEM-TV**

**CHANNEL 5**

NATIONAL SALES OFFICES  
 FLINT STUDIOS  
 FLINT AIRPORT, FLINT, MICHIGAN

OPERATIONS OFFICES  
 SAGINAW-BAY CITY STUDIOS  
 5700 BECKER RD., SAGINAW, MICHIGAN

