

MORNINGSIDE COLLEGE
LIBRARY
SIOUX CITY 5 IOWA
N347
X 10
1001
Dec 5
NEWSPAPER

CASTING

OF TELEVISION AND RADIO

IN THIS ISSUE:

COMPLETE INDEX PAGE 7

Radio networking crisis: today's vexing problems	Page 35
Focus fixed on multiple-spotting, clipping markets	Page 45
Momentum mounts for action now on space relays	Page 66
NAB preview: a rundown on next week's convention	Page 79

MORNINGSIDE COLLEGE
LIBRARY
SIOUX CITY IOWA

Houston salesmen choose

KPRC-TV

Afloat or ashore . . . men who appreciate trimness and speed in television sales results choose KPRC-TV.

KPRC-TV is television cut in the modern English slimline, with a light weight inherently American. And never before has such faultlessly tailored, self-supporting advertising been offered in such a wide variety of lengths, prices, and availabilities. *Now* is your time for KPRC-TV, Houston.

You can learn all about KPRC-TV from any Edward Petry & Co. man, from coast to coast, or write KPRC-TV, P. O. Box 1234, Houston 1, Texas.



Tailored on CHANNEL 2, Houston, Texas



"The trousers shown above are British DAKS trousers featured by Norton-Ditto, Houston."

Judging from the impact CNP's **LIFE OF RILEY** is making throughout the land as a syndicated strip, there can't be many citizens left who haven't laid laughing eyes on that amiable clown. Like, say, Detroit —over a million home impressions per week— Number One half-hour adult strip series in the market. Likewise in Philadelphia with 963,000 home impressions weekly, and in Houston with 387,512 home impressions a week. ■ Since millions watch **RILEY** *wherever* it's telecast, what a dandy place to put your sales message *wherever* you want to advertise.

NBC TELEVISION FILMS—A DIVISION OF

CNP

CALIFORNIA NATIONAL PRODUCTIONS, INC.

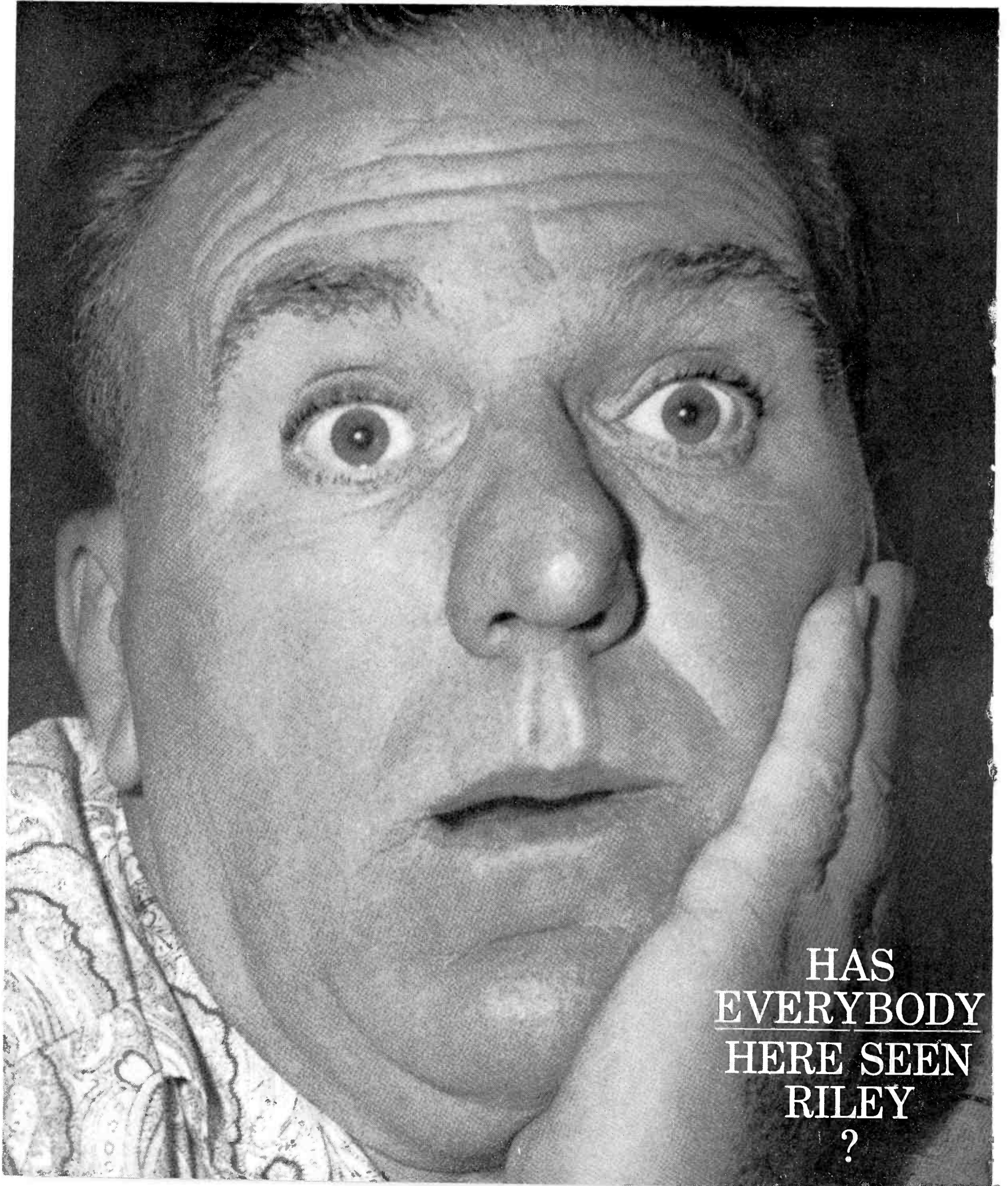

HAS
EVERYBODY
HERE SEEN
RILEY
?

*buy St. Louis 'a la card**

***KTVI RATE CARD...**
*your lowest cost per thousand
TV buy in St. Louis*



Represented
nationally by



KTVI
CHANNEL **2** ST. LOUIS



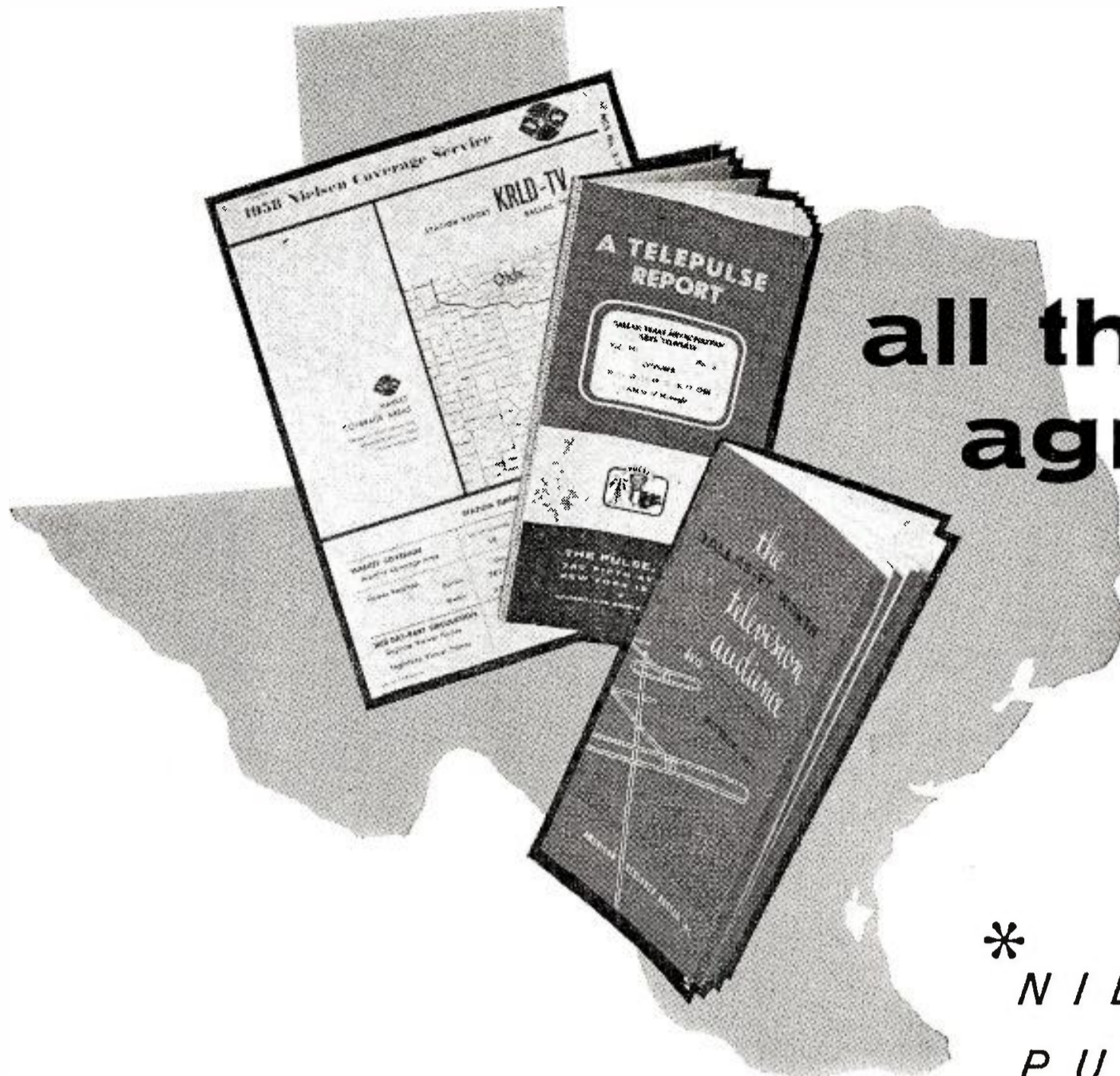

**all three*
agree in
Texas**

*
N I E L S E N
P U L S E
A R B

KRLD-TV is your best buy

FIRST IN AUDIENCE: ARB's latest Dallas-Fort Worth report shows that KRLD-TV dominates in audience share from sign-on Sunday morning to sign-off Saturday night. The Nielsen Station Index (December, 1958) also shows more TV homes watch KRLD-TV than any other station in the Dallas - Fort Worth area!

FIRST IN POPULARITY: The latest Dallas Telepulse lists 15 out of the top 18 once-a-week shows and eight of the top ten multi-weekly shows — all on KRLD-TV.

FIRST IN AREA OF COVERAGE: KRLD-TV, with its low-band channel, and telec with maximum power from its tremendous tower (1,685 feet above average ter has the largest circulation of any station in the southern United States!

KRLD-TV

The Branham Company, Exclusive Representative.

THE DALLAS TIMES HERALD STATIONS

Channel 4, Dallas
MAXIMUM POWER

JOHN W. RUNYON
Chairman of the Board

CLYDE W. REMBERT
President



CLOSED CIRCUIT[®]

Public offer • Impetus is given trend toward public stock participation in broadcasting enterprises (Storer, Metropolitan, etc.) with decision of Wometco Enterprises Inc. to offer 35% of its share to public. Under notice given FCC, positive control goes to Mitchell Wolfson, president and operating head, through acquisition by his family of 5% of holdings of his brother-in-law, Sidney Meyer, vice president, giving Mr. Wolfson 55%. Mr. Meyer will retain 10% with remaining 35% to be sold public. He will retire as vice president, but will become honorary board chairman, director and consultant.

Wometco station properties include ch. 4 WTVJ (TV) Miami; control of ch. 13 WLOS-TV Asheville, and 20% of WFGA-TV Jacksonville. Other interests include theatres and vending machines. At price of about \$10.75 per share, public sale of 35%, or about 290,000 shares, would yield about \$3 million. Class A stock for public sale yields about 5½%, while Class B, held by Wolfson family, yields about 2%. What has been Wometco Television and Theatre Co. becomes Wometco Enterprises Inc. with public stock sale.

Intermountain to ABC • Signing of Intermountain Network and its 40-plus stations to ABC Radio affiliation was reported in final negotiation stage late last week. Major regional has been associated with now-troubled Mutual (see page 35), presumably will take on ABC Radio almost immediately. Details worked out by George Hatch, Intermountain chairman, and Edward De-Gray, vice president in charge of ABC Radio.

Rate increases • Straw in wind on state of spot tv business: Edward Petry & Co., station representative, is urging number of its stations to reduce discounts on package buys and gradually raise prices of daytime and late-night minutes. In addition it's recommending widening of spread between minute and station-break rates, because of greater opportunity for hard sell in minutes. Recommendations are being made on market-by-market rather than general basis, in line with audience growth and competitive position of stations involved, but Petry company does not feel that even established markets have yet reached maximum rate potential. Company reasons that as long as there are programming changes there will be need for re-examination of rates.

Alas, alert • Biggest communications riddle in Washington: Will am radio stations be ordered to conduct mid-day Conelrad test during Operation Alert 1959 to be conducted April 17? Mixup between FCC and Office of Civil & Defense Mobilization, kept inside classified boundaries, has delayed decision over loss of half-hour of prime time—11:30-12 noon, plus switching delays before and after Conelrad. OCDM asked FCC some weeks ago to order Conelrad alert, finally announcing date without any mention of Conelrad angle. FCC notified OCDM Friday (March 6) it is willing to cooperate but wants concurrence of broadcasting industry, which stands to lose \$250,000 in revenue, as well as Pentagon. FCC-OCDM may resolve conflict at meeting this week.

Rental gear • New facet in tv station financing has emerged—leasing of equipment. At Tampa-St. Petersburg, Fla., ch. 10 hearing last week, Tampa Telecasting Inc. (Kenneth R. Giddens and others) introduced through Eric H. Biddle, vice president of U.S. Leasing Corp. plan covering lease of \$350,000 worth of studio equipment. Tampa Telecasters would pay \$7,000 per month for: four Ampex VTRs, two installed in mobile units; one helicopter, three station wagons, one with microwave relay gear, and lighting apparatus.

U.S. Leasing Corp. isn't making this one-time shot. Mr. Biddle said his company believes leasing will become widespread in tv, presumably because of economic benefits and pay-as-you-use financing. He said he is negotiating with an existing tv station and with another prospective applicant. Tampa Telecasters, which proposes \$900,000 installation, is one of six applicants for Florida vhf facility.

Space date • While air is full of talk about communications satellites capable of transmitting television and practically all other modes of intelligence, it probably will be five years before provision can be made for space communications. International Telecommunications Conference, which meets in Geneva later this year, will receive requests for allocations (United States already has one). About all it will be able to do is propose that subject be studied, with allocations to be considered at next conference, five years hence.

If this action is taken, instructions would go to International Radio Consultative Committee (CCIR) which meets between international conferences. It's generally thought that space communications will be answer to global communications problem, since crowded short waves cannot accommodate new demand, particularly for data-processing (President Eisenhower's "Merry Christmas" message was first example of space use of data-processing).

Now, now • Effort to calm fears of broadcasters that White House-originated move to conduct one-year spectrum study was based on military pressure will be made opening day of NAB Chicago convention by Leo A. Hoegh, director, Office of Civil & Defense Mobilization. Mr. Hoegh will address Monday afternoon tv session, along with Rep. William G. Bray (R-Ind.), who says military demands for spectrum space are excessive. OCDM is thinking in terms of best needs of whole country, its director will tell broadcasters. He will deny military pressure moved OCDM to ask spectrum study by five-man Presidential named committee instead of by three-man Congressionally named group as suggested by advisory committee (BROADCASTING, Feb. 9).

Reconnaissance • First formal steps have been taken by FCC to ascertain whether military is willing to discuss frequency swapping to permit assignment to tv of additional, contiguous vhf bands. This would be above ch. 13 (210-216 mc) and in line with suggestions of several FCC commissioners that such a move would be in best interest of tv. Result of first probes was termed "encouraging," according to one source. "They didn't say no," he said.

Medical pitches • Federal Trade Commission's radio-tv unit is doing major study of medicinal product advertising, with special attention to "white coat" endorsements in broadcast medium. By white coat, it was explained, is meant whole area of sales announcements giving aura of professional sponsorship to product. Literal white coat pitch has been cleared up pretty well, it was said, via crackdown through NAB Code. FTC interest spurred, it's thought, by urging of Sen. Warren Magnuson (D-Wash.), chairman of Senate Commerce Committee, for investigation of antibiotic claims (BROADCASTING, Feb. 9).

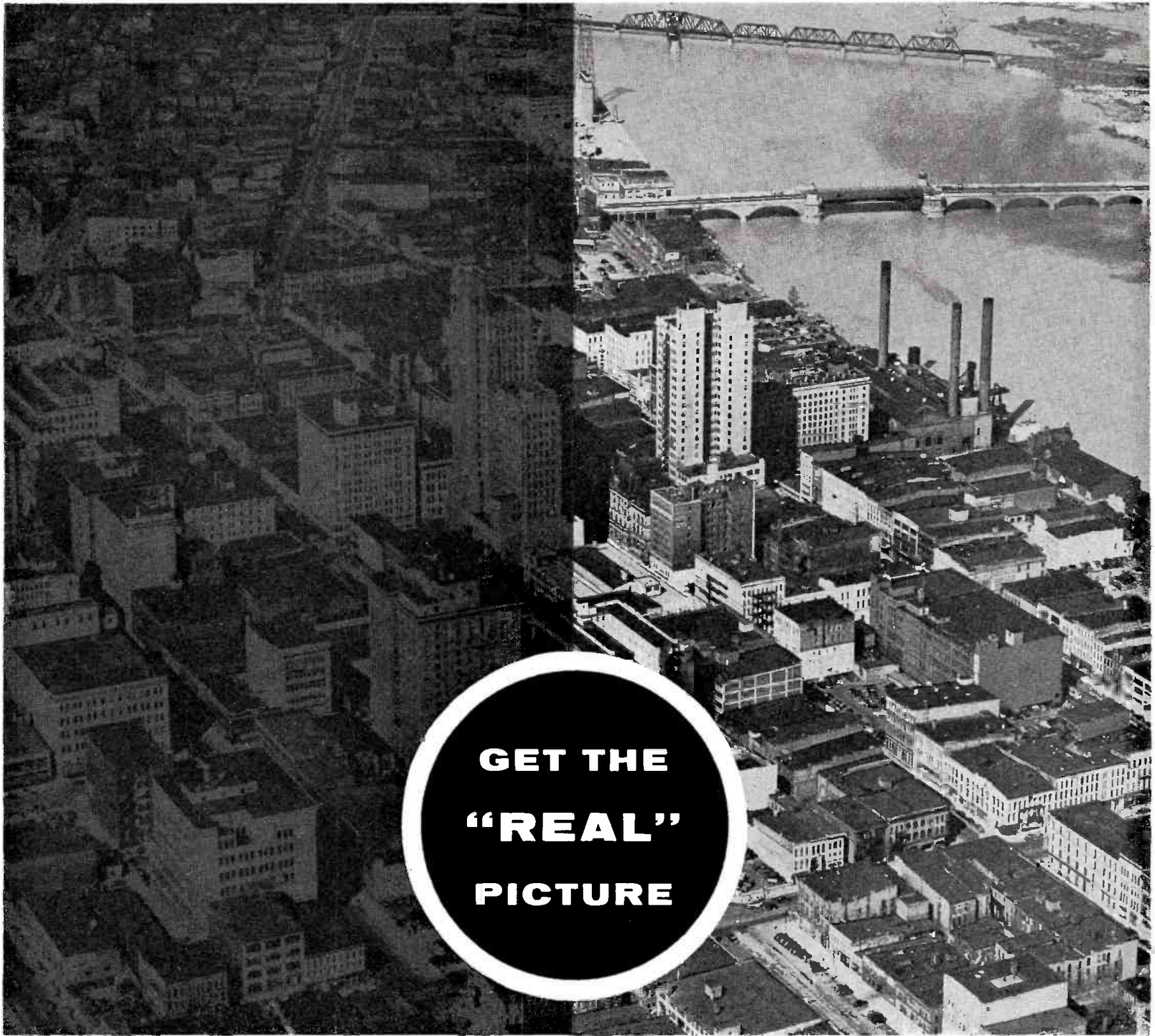

**GET THE
"REAL"
PICTURE**

The Toledo Market is Sold by WSPD Television

Despite the proximity of larger markets, the "Billion Dollar Pocketbook" of the Toledo Market is dominated by WSPD-TV. With variety programming from *Comedy, Top Movies, Music, Mystery, Westerns, News, Sports, etc.*, Channel 13 holds the listener every day of the week. Ask your Katz man for the facts! TOLEDO TELEVISION IS WSPD TELEVISION!!

"Famous on the local scene"

WSPD-TV

CHANNEL 13 • TOLEDO

Storer Television



WSPD-TV Toledo WAGA-TV Atlanta WJBK-TV Detroit WJW-TV Cleveland WITI-TV Milwaukee

WEEK IN BRIEF

NAB convention preview • A special section giving a detailed account of events, exhibits, programming, non-agenda events and advance registrations for annual industry meeting in Chicago. Begins Page 79.

OFFICIAL, UNOFFICIAL AGENDAS	Page 80
"WHERE TO FIND IT" DIRECTORY	Page 84
WHAT THEY'LL SHOW AT EXHIBITS	Page 86
HOSPITALITY SUITES	Page 94
STATION REPRESENTATIVES	Page 94A
NETWORK PLANS	Page 94B
ENGINEERING CONFERENCE PAPERS	Page 94D
LATEST ADVANCE REGISTRATION	Page 102



MR. DONALDSON

Management: reluctant audience? • No! says this agency man. But executives must be weaned of their bad habit of *saying* they don't watch tv just because it might hit them in the briefcase. Edgar J. Donaldson, vice president and director, radio-tv department, Ketchum, MacLeod & Grove, Pittsburgh, talks about it in this week's MONDAY MEMO. Page 29.

Radio networks have troubles • Affiliates unhappy, but network executives voice optimism though conceding business is off. Spot, too, is lowest in years. A roundup of the radio network situation. Page 35.

Mutual's brinkmanship • Network's creditors, principally AT&T, are pressing demands for payment of past-due accounts, could force network off the air if new money isn't found quickly. New developments in Guterma-Jacobs-Roach case further complicate position. Page 36.

Multiple spotting and clipping • Broadcast Advertiser Reports finds high incidence in 25 medium-sized markets, covering 71 television stations. Page 45.

Como is Kraft's big cheese • Singer receives two-year contract with foods advertiser, described as \$25 million deal; gets 10-year "employment" with Kraft as "consultant" in addition. Page 56.

Sky-high radio-tv relays • Space satellites drenching the earth with communications are "just around the corner," House group is told. It can be done quickly, says GE engineer. Bell Telephone researcher says balloons could do the job. Page 66.

Justice Dept. drops its Latin • Government trust buster insists network option time violates antitrust trust but strikes out *per se*. Page 70.

Spectrum caught in middle • White House-defense mobilization plan for study of the way frequencies are used is met by Capitol Hill opposition. Administration asks for five-man, one-year commission to explore spectrum use and federal management of telecommunications. Page 73.

ASCAP settlement looms • Negotiators for All-Industry Committee and ASCAP reach broad agreement as talks are resumed in court. Lower fees foreseen. Accord may come this week. Page 114.

DEPARTMENTS

AT DEADLINE	9	LEAD STORY	35
BROADCAST ADVERTISING	45	THE MEDIA	57
BUSINESS BRIEFLY	52	MONDAY MEMO	29
CHANGING HANDS	64	OPEN MIKE	20
CLOSED CIRCUIT	5	OUR RESPECTS	141
COLORCASTING	116	PROGRAMMING	114
DATEBOOK	15	WEEK'S HEADLINERS	10
EDITORIAL PAGE	142		
EQUIPMENT & ENGINEERING	126		
FANFARE	127		
FATES & FORTUNES	121		
FOR THE RECORD	128		
GOVERNMENT	66		

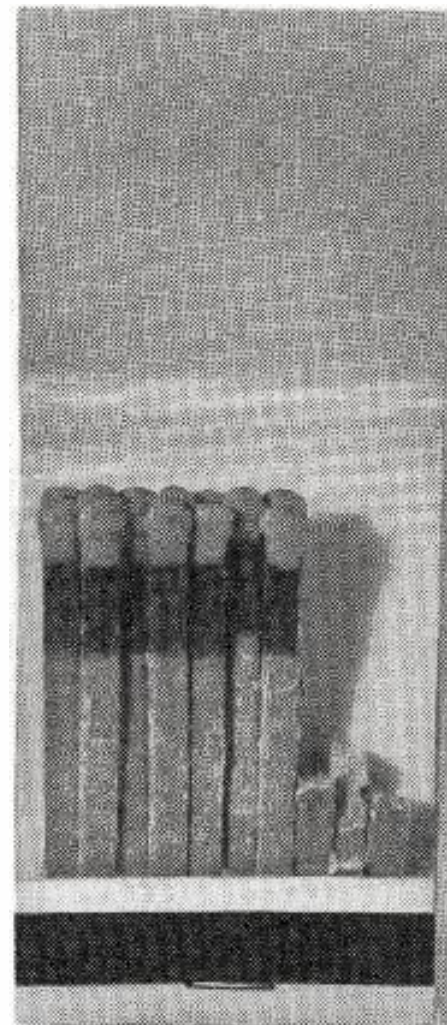

R. J. REYNOLDS earmarks most of its network radio appropriation for CBS Radio. Because it's what's up front that counts! This network has delivered largest commercial minute audiences all along. And the new Program Consolidation Plan—with unified station clearances and strong program sequencing—will increase this leadership.

CBS RADIO NETWORK:

42% LARGER AUDIENCES PER COMMERCIAL MINUTE THAN ANY OTHER RADIO NETWORK, AVERAGING OVER 16 CONSECUTIVE MONTHS.

WOW's Farm Sales Team Sells Farmers Every Day!

Farmers know them
personally... they trust
and believe
them!



FRANK ARNEY
Assistant Farm Director

A family-farm operator with 6 years
on-the-air selling . . . trusted . . . believed!

ARNOLD PETERSON
WOW Farm Director

Seven years of every-day
service to WOW-LAND farmers!

Farmers don't buy a \$4,000 tractor or a \$1,000 load of feed on impulse. They're thinking men. They insist on facts and figures—carefully weigh and compare them before they buy.

The job of selling farmers is half-done if the prospect knows, trusts and believes the Salesman. WOW-land farmers do know, trust and do believe Arnold and Frank, and the entire WOW Farm Sales-Team.

If you want to sell threshing machines or toothpaste to the 129,000 Iowa-Nebraska WOW area farm families, Arnold and Frank will do it—not once a week, or once a month but by talking to them man-to-man every day.

REGIONAL RADIO **WOW** *Omaha*
CBS
AFFILIATE
IN OMAHA AND
103 COUNTIES

FRANK P. FOGARTY, Vice President and General Manager
BILL WISEMAN, Sales Manager
JOHN BLAIR & COMPANY, Representatives

A MEREDITH STATION — affiliated with Better Homes and Gardens and Successful Farming Magazines

Smith group picks up option to buy Mutual

Efforts to sell Mutual radio network entered new stage Friday night (March 6) when group headed by Malcolm Smith, name new to broadcasting, obtained option to purchase network from Robert Hurleigh, MBS senior vice president, who heads negotiating committee (page 36). Mr. Smith is president of Harrison Home Products Co., firm with number of activities including import business and minor-label records. Other members of prospective purchaser not identified.

Mr. Smith's group understood to have put up \$50,000 earnest money. During option period group will participate with network's executive committee in running Mutual. First order of business: Negotiating with AT&T this week in regard to \$275,000 in past due line charges, plus further negotiations March 15 on another \$14,000 owed.

According to authoritative sources Smith *et al* would put up no money besides assuming debts of company, reportedly now \$1,050,000.

Mr. Hurleigh had obtained 30-day option on network from Hal Roach Jr., MBS chairman, and head of both Scranton Corp. and Hal Roach Studios, companies which now own Mutual. It was that option which Mr. Smith's group purchased. Any sale of network must meet approval, both of Securities & Exchange Commission and U.S. District Court of New York.

Figuring prominently in discussions on buying side was Ade Hult, one of first Mutual staffers who was network's sales vice president until resignation several years ago. Mutual negotiators were Mr. Hurleigh; Blair Walliser, executive vice president, and James Gladstone, comptroller. Mr. Hurleigh held proxies from Fulton Lewis jr., network commentator, and Victor Diehm, affiliates chief, also members of executive committee.

Among labels in Harrison Home Products camp are Gold Medal, Waldorf, Audition and Whitehouse records. One of products Harrison imports is Addiator, pocket-size adding machine.

BPA meet set

Broadcasters Promotion Assn. fourth annual convention will be held at Warwick Hotel in Philadelphia Nov. 2-4, Charles A. Wilson, WGN-AM-TV Chicago and BPA president, announced Friday.

Hope to Continue

Buick and agency McCann-Erickson are confident that Bob Hope will continue tv work through this season (NBC-TV). He has three more hour-long shows to go, one each month (March-May). Portions of first show already are on tape and Mr. Hope's associates told agency in New York, where comedian was examined for eye ailment, that star would be able to fulfill commitments this year. Doctors told Mr. Hope he must work less, rest more. What Buick will do about next year is not clear—other considerations, such as show's performance of this season, also are important to plans.

Orlando ch. 9 loser presses for hearing

Mere FCC "inquiry" into ch. 9 Orlando, Fla., grant instead of full hearing "would be an absolute waste of time" without benefit of sworn testimony subject to cross-examination, losing applicant WORZ Inc. told U.S. Court of Appeals in Washington Friday (March 6). Appellant told court, in answer to FCC filing of previous week asking court to wait 40 days before remanding case, that hearing is just as necessary as in Miami ch. 10 and Boston ch. 5 tv cases.

Also Friday, WORZ Inc. told FCC it "is confident that improper *ex parte* representations were made to the Commission by winning applicant Mid-Florida Tv Corp. [WLOF-TV], or on its behalf and/or with its actual or tacit consent or approval. Proof of this is, indeed, available and will be produced in a proper proceeding to which WORZ Inc. is a party with full rights to cross-examine and to subpoena witnesses and records." This filing came after Commission had written Eliot Lovett, WORZ attorney, that it would welcome any further information in *ex parte* inquiry (BROADCASTING, March 2).

Supreme Court remanded case to appeals court last October because of testimony concerning alleged *ex parte* contacts before House Legislative Oversight Subcommittee.

Rayburn on MBS

Speaker Sam Rayburn (D-Texas), who wields iron-fist ban against radio-tv coverage of House floor and committee proceedings, was to make one of his rare broadcast appearances Sunday (March 8). He was to take part in taped panel program, *MBS Reporters' Roundup*, 5:05-5:30 p.m. For years he has been one of toughest political figures in Washington for panel producers. Senate permits radio-tv coverage of many committee sessions in contrast to Rayburn ban in House.

Guterman tells 'his side'

A.L. Guterman, ex-president of Mutual and ex-head of F. L. Jacobs Co., called press conference Friday to "tell my side of story." His side: claim that Paul Windels Jr., New York regional administrator for Securities & Exchange Commission, and Edward C. Jaegerman, SEC attorney working on case, were engaged in "vendetta" against him.

He attributed Mr. Windels' actions to ambitions for federal judgeship. Mr. Guterman denied Hal Roach Jr. was "standing in his shoes" as cited in SEC request for receivership filed previous day (see page 36). Mr. Roach, in separate statement to press, said he would oppose action for receivership.

Westinghouse buys

Westinghouse Electric Corp. and Desilu Productions Inc. announce more than \$12 million (in time and talent) agreement for Desilu to continue one-hour series under Westinghouse banner next tv season. *Westinghouse Desilu Playhouse* has been in Monday lineup of CBS-TV since last October. Current contract includes 42 one-hour shows but next season additional specials will be produced. Star Desi Arnaz, also Desilu's president, said early decision on sponsorship permits producer to plan ahead in committing stars and properties. McCann-Erickson, N.Y., is agency.

RCA declares dividend

RCA declared quarterly dividend Friday (March 6) of 25 cents per share on common stock payable April 27 to holders of record at close of business March 16. Company also declared dividend of 87½ cents per share on first preferred stock for period April 1-June 30, payable July 1 to holders of record June 8.

AT DEADLINE

• Business briefly

• U.S. Rubber Co., for Keds sneakers, is placing average of three animated "Kedso the Clown" minute participations per week on children's tv shows in some 150 markets between now and June. Agency: Fletcher Richards, Calkins & Holden, N.Y.

• Singer Sewing Machine Co. will sponsor filmed series *The David Niven Show* on NBC-TV starting April 7 (Tues., 10-10:30 p.m.). New weekly dramatic series starring actor David Niven as host and featuring other stars will be produced by Four Star Films, company founded by Mr. Niven, Dick Powell and Charles Boyer. Producer: Vincent Fennelly. Agency: Young & Rubicam, N.Y.

• Salada-Shirrif-Horsey Inc., Toronto, through its SEA Div., Tampa, is introducing its SEA frozen shrimp in selected markets with spot tv. Sullivan, Stauffer, Colwell & Bayles, N.Y., which handles Salada Tea and entire line of six Junket food products for Salada-Shirrif-Horsey, is agency assigned to frozen shrimp.

• Pepsi-Cola Bottlers of St. Louis Inc. appoints Kenyon & Eckhardt, Chicago, to handle its advertising as of April 1.

WEEK'S HEADLINERS



Mr. Levy

DAVID LEVY, v.p. in charge of talent and new programs and associate director, radio and tv department, Young & Rubicam, N.Y., elected vice president by NBC's board of directors (CLOSED CIRCUIT, March 2). Mr. Levy, who joins NBC-TV officially April 1, reports to Walter D. Scott, executive v.p., NBC-TV. Mr. Levy, with Y&R for 20 years, started as writer of *We the People* radio program; wrote, directed and supervised many of Y&R's radio shows including *People*, *The Kate Smith Hour*, *Manhattan at Midnight* and *March of Time*. After World War II, Mr. Levy was supervisor of daytime programming, became agency's first tv supervisor in 1957. He was named v.p. in charge of talent and new programs in 1950, and associate director of radio and tv department last April.



Mr. Jackson

RICHARD S. JACKSON, assistant director of radio-tv department, J.M. Mathes Inc., N.Y., since 1951, elected v.p. and director of radio-tv. Mr. Jackson was formerly director of special events at WAVE-TV Louisville, Ky., where he produced first Kentucky Derby telecast in 1949. He was with King Features Syndicate for two years before entering tv, serving as assistant editor of comic art division.



Mr. Kockritz



Mr. Edney

EWALD KOCKRITZ and GRADY EDNEY named national program directors of Storer Broadcasting Co.'s tv and radio divisions, respectively. Mr. Kockritz joined Storer in 1941 at WAGA Atlanta, Ga., as promotion manager and moved to WGBS Miami in 1948 in similar capacity. In 1954 he was promoted to national program director and was elected v.p. two years later. Mr. Edney entered broadcasting at WSJS Winston-Salem, N.C., in 1941. After military service during World War II, he joined WLOS Asheville, N.C., as program manager. In 1955 he moved to WBZ Boston in similar capacity and joined Storer in 1957 as program manager when company acquired WIBG Philadelphia.

JOHN B. BURNS, formerly v.p. in charge of national sales, ABC Film Syndication Inc., appointed director of national sales for MGM-TV, it is being announced today (March 9). Mr. Burns joins George Shupert, formerly president of ABC Films Inc., who now heads Loew's tv sales-distribution

activity as v.p. in charge of MGM-TV. Mr. Burns became associated with ABC Films in fall of 1953, before that was with CBS Television Film Sales. Other past connections include ABC Radio sales staff in Chicago and Chicago newscaster.



Mr. Hede

HENRY HEDE, administrative sales manager of ABC-TV, elected v.p. of ABC in charge of sales department, including liaison between sales, program, research, sales development and business affairs department. Mr. Hede joined network in 1942 and has served as general services manager, business manager of tv program department and administrative assistant to financial officer. Within ABC-TV sales department, he was business manager and eastern sales manager, prior to his promotion to administrative sales manager in December 1957.

DR. GEORGE H. BROWN elected by RCA board Friday as vice president, engineering, succeeding O. B. Hanson, who retired week before (WEEK'S HEADLINERS, March 2). Dr. Brown has been with RCA 25 years, since January 1957 as chief engineer for industrial electronic products. JACK S. BELDON elected to newly created post as vice president and general manager, RCA home instruments. He joined RCA last month from General Electric, where he was marketing manager of radio-tv unit.

• JACK MOHLER, account executive of Blair-Tv, station representative, named eastern sales manager of Television Adv. Representatives, new firm which will take over sales representation of Westinghouse Broadcasting Co. tv stations July 1, according to announcement being issued today (March 9) by LARRY H. ISRAEL, TVAR general manager. Mr. Israel also announced that TVAR's New York office will be at 666 Fifth Ave., effective in near future. Mr. Mohler, described as "our first choice from among more than 400 unsolicited applicants" for TVAR eastern sales managership, has been with Blair-Tv since 1957. Before that he was account executive and director of sales development of CBS-TV Spot Sales from 1954. He entered broadcasting on graduation from Princeton in 1941, starting with WOR New York. After World War II service in which he attained rank of captain in Army intelligence, he returned to WOR in 1946 as account executive and served there, with time out in 1952-53 for duty as Army major assigned as liaison officer between Defense and State Depts., until 1954, rising to assistant sales manager.



Mr. Mohler

FOR OTHER NEWS OF PEOPLE SEE FATES & FORTUNES



TWIN CITIES VIEWERS
like their

ACTION AT 6:00

**A Different Action Packed Adventure
Every Night at 6:00 on WTCN-TV...
All First Run in the Market!**

**MONDAYS AT 6:00
DIAL 999**



**TUESDAYS AT 6:00
UNION PACIFIC**



**WEDNESDAYS AT 6:00
CITIZEN
SOLDIER**



**THURSDAYS AT 6:00
SILENT
SERVICE**

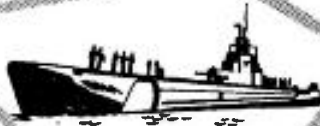

**FRIDAYS AT 6:00
CANNONBALL**



Twin Cities viewers are caught up in the suspense and excitement of a whole new series of dramatic adventures on WTCN-TV. They tune in for a different action show every night at 6:00.

Dial 999 . . . Union Pacific . . . Citizen Soldier . . . Silent Service . . . Cannonball!

“Action at 6:00” has captured a tremendous audience of loyal, receptive viewers—all anticipating these first run, Class A early evening shows.

Capture the growing “Action at 6:00” audience on WTCN-TV. Get sales action in the important Twin Cities market. See your Katz man for remaining participations.

*Represented nationally by
the KATZ Agency*

ABC-TV 11 WTCN-TV
Minneapolis Saint Paul

GENIE



TOP MONEY-MAKERS

ROY RO

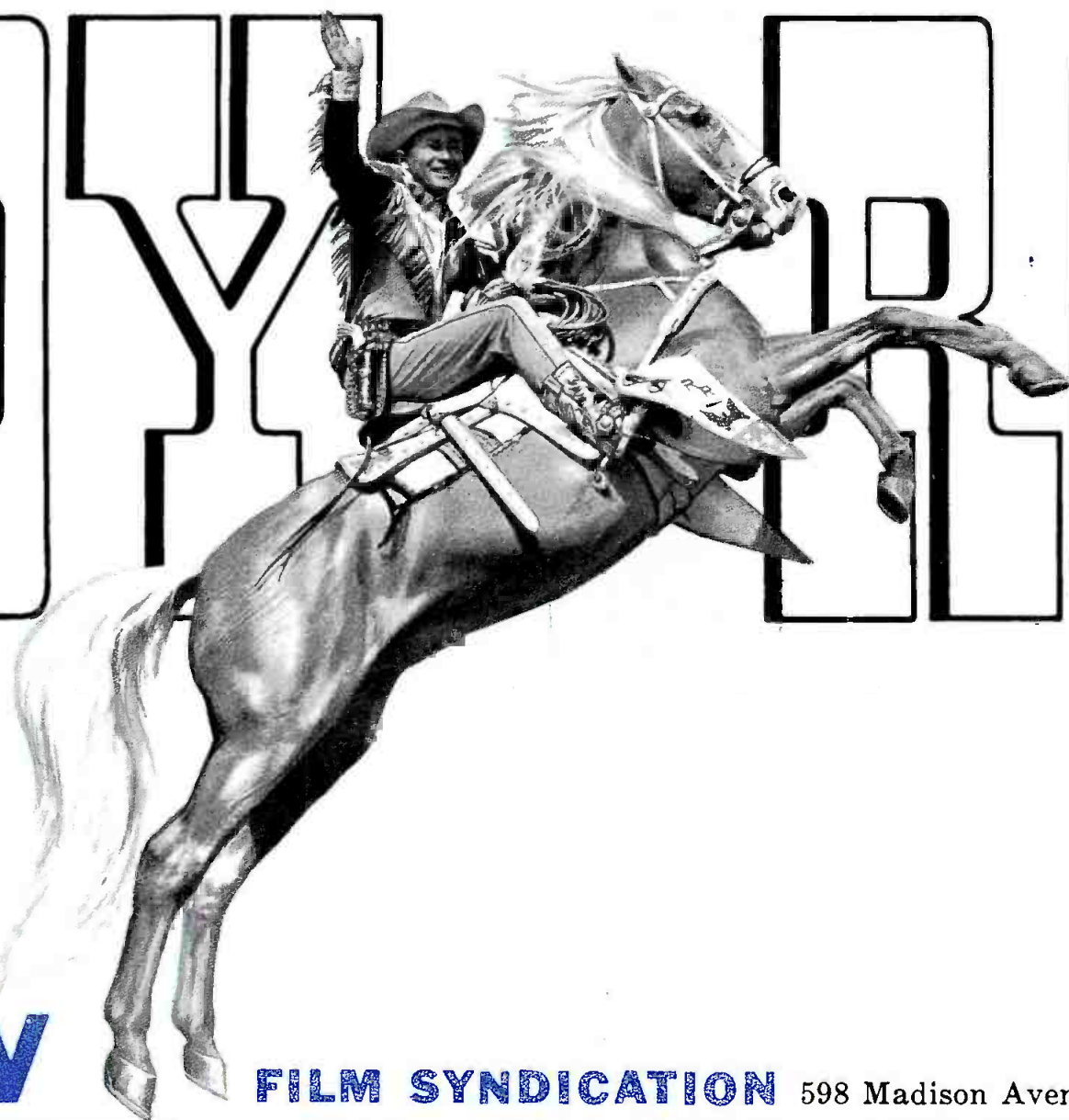

mca tv

FILM SYNDICATION 598 Madison Avenue, New York

Flexibility!

*Early morning or early evening, strips
or single programs — top audience and sales
— 50% adults, 50% kids.*

WHY

*Made by Republic Pictures
Corporation and now being
renewed in market after
market for profitable
programming.*

50

hour films

IN TV HOUR STRIPS!

WHY

Durability!

*More staying power year after year —
regardless of run — great audience
interest and acceptance.*

50

hour films

*Made by Republic Pictures
Corporation and now being
renewed in market after
market for profitable
programming.*

PLaza 9-7500 and principal cities everywhere

"Traveling Showcase" for Sales...



Give your clients this WKMH merchandising PLUS in Detroit

Staffed by Detroit's top radio personalities, the new WKMH MOBIL-RAMA is shown above on Washington Boulevard, as it helped promote the March of Dimes and Symphony Week in Detroit. The WKMH MOBIL-RAMA is more than a vehicle for public service. It offers a potent merchandising tool, available to help sell your sponsors' products in the rich Detroit market. This "traveling showcase" is equipped with complete display facilities to tell your client's story and show his products at *point of sale* as well as on the air. Why not put the WKMH MOBIL-RAMA to work for *YOU*?

Represented by Headley-Reed

knorr BROADCASTING CORPORATION

WKMH Dearborn-Detroit

WKMF Flint, Michigan

WELL Battle Creek, Michigan

WSAM Saginaw, Michigan

WKHM Jackson, Michigan

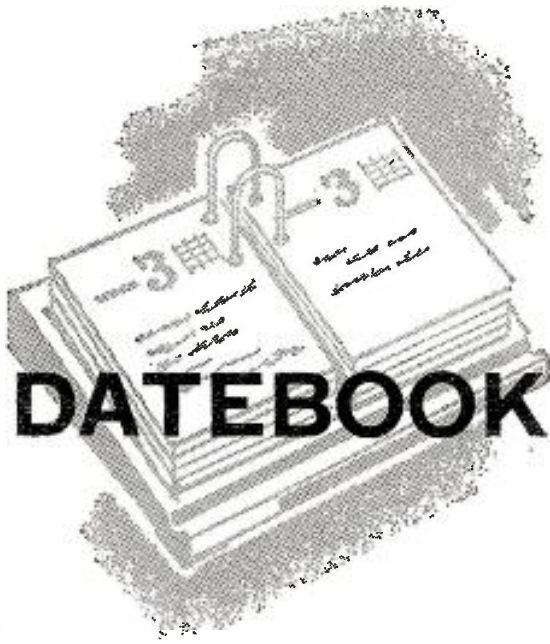

**A CALENDAR OF MEETINGS AND EVENTS
IN BROADCASTING AND RELATED FIELDS**

(*Indicates first or revised listing)

MARCH

March 13-14—Arkansas Broadcasters Assn., spring meeting, Hotel Marion, Little Rock.

March 13-15—Fm Development Assn., Conrad Hilton Hotel, Chicago.

March 14-15—CBS-TV affiliates meeting, WBBM-TV studios, Chicago.

March 15—Assn. of Maximum Service Telecasters, annual membership meeting, Conrad Hilton Hotel, Chicago, 9:30 a.m.

March 15—Mutual Affiliates Advisory Committee, Conrad Hilton Hotel, Chicago.

*MARCH 15-19—NAB Annual Convention and Broadcast Engineering Conference, Conrad Hilton Hotel, Chicago (see page 79 for complete report on convention exhibits, program features, special meetings and hospitality suites).

March 16-18—Canadian Board of Broadcast Governors, public hearings, Tariff Board Hearing Room, 70-74 Elgin St., Ottawa, Ont.

March 16 and 23—Hearing before Securities & Exchange Commission, Washington, D.C. March 16, on charges F. L. Jacobs Co. (Alexander Guterma) failed to report financial transactions. Mr. Guterma, until his troubles with SEC began, was president and chief owner of Mutual Broadcasting System. Similar Bon Ami Co. hearing March 23.

March 18—Symposium on social and economic forces of advertising co-sponsored by St. Louis Council of American Assn. of Adv. Agencies and U. of Missouri School of Journalism, Sheraton-Jefferson Hotel. Dr. Earl F. English, dean of school, will moderate. Registration, \$22.50.

March 18-20—Quarterly conference, Electronic Industries Assn., Statler Hilton Hotel, Washington.

*March 21—American Women in Radio and Television, Chicago chapter, second annual conference, open to tv and radio industry, Guildhall, Ambassador West Hotel, Chicago.

*March 23—Tentative date for argument before U. S. Supreme Court in Farmers Union v WDAY Inc. (WDAY-TV Fargo, N.D.) involving question of immunity of broadcast station when political candidate, invoking Sec. 315 of Communications Act, utters libel on air. Case No. 248.

March 23-26—Annual convention Canadian Assn. of Radio & Television Broadcasters, Royal York Hotel, Toronto, Ont.

March 23-26—National convention, Institute of Radio Engineers, Waldorf-Astoria, New York. The nation's leading electronic scientists will attend. Advances in space technology and major new electronic fields will be explored.

March 23-28—Short Course in Crime News Analysis & Reporting, Northwestern U., Fisk Hall, Evanston, Ill. Journalism and law schools, with Ford Foundation grant, will conduct intensive instruction for radio-tv, press and magazine newsmen. Courtroom broadcasting is one of topics. Attendance fee \$100. Registration must be received by March 16. Scholarships for needy avail-

able. Members of lecture staff will be available for interviews.

March 25—Comments due on proposed FCC rule-making to change ch. 12 Wilmington, Del., from commercial to educational or, in alternative, move ch. 12 to Atlantic City, N.J., or allocate it to Atlantic City-Wilmington. Docket No. 12,779.

March 30—Deadline for filing copies of direct testimony in FCC's inquiry into allocation of frequencies between 25 mc and 890 mc. Number of copies to be filed: 1 notarized original, and 20 copies.

March 30—Du Pont Awards Dinner, Mayflower Hotel, Washington.

APRIL

April 1—Research workshop Assn. of National Advertisers, Hotel Pierre, New York.

*April 1—Assn. of National Advertisers workshop at Hotel Pierre, New York. Topic: "How to Get More Productive Advertising Through Management-Oriented Research." Henry Schachte, executive v.p., Lever Bros. Co., and chairman of ANA board of directors, will be keynote speaker.

April 3-4—Oregon Assn. of Broadcasters, U. of Oregon, Eugene.

April 3-5—Mississippi Broadcasters Assn., annual meeting, Buena Vista Hotel, Biloxi.

*April 4—National Headliner Club awards luncheon, Atlantic City, N. J.

April 4—United Press Intl. Broadcasters of Minnesota Assn., Spring Meeting, Radisson Hotel, Minneapolis.

April 5-8—National Retail Merchants Assn., sales promotion division, Eden Roc Hotel, Miami Beach.

April 6-9—National Premium Buyers, 26th annual exposition, Navy Pier, Chicago. Premium Advertising Assn. of America will meet April 7, same site.

April 7—Trial of former FCC Comr. Richard A. Mack and friend, Thurman A. Whiteside, for conspiracy to defraud U.S. Presiding: Judge Burnita S. Matthews, U.S. District Court, Washington, D.C.

April 8—Deadline for comments to FCC on daytime radio stations' request to operate from 6 a.m.-6 p.m. or sunrise-sunset, whichever is longer. Docket 12,729.

*April 10-11—Republican National Committee meets at Sheraton Park Hotel, Washington. Host city for the 1960 nominating convention will be picked.

April 10-11—West Virginia Broadcasters Assn. spring meeting, Press Club, Charleston.

April 12-13—Spring meeting Texas Assn. of Broadcasters, Commodore Perry Hotel, Austin. Members of Legislature will be April 13 luncheon guests.

April 12-14—Assn. of National Advertisers, annual west coast meeting, Santa Barbara Biltmore, Santa Barbara, Calif.

*April 12-19—Technical symposium on aircraft and space communications sponsored by Electronic Industries Assn., McCarren Field, Las Vegas, Nev., during First World Congress of Flight.

April 20-23—American Newspaper Publishers Assn., Waldorf-Astoria Hotel, New York.

April 23—Oral argument before FCC en banc on Miami ch. 10 case involving charges of behind-the-scenes wirepulling. Initial decision by Examiner Horace Stern recommended grant to Public Service Television Inc. (National Airlines) be revoked and allegations of ex parte representations by applicants be weighed against them in new comparative hearing. Docket No. 9321 et al.

April 23-24—Assn. of National Advertisers two-day workshop on advertising expenditures, Westchester-Biltmore, Rye, N.Y.

April 23-25—Western States Advertising Agencies Assn., ninth annual conference, Oasis Hotel, Palm Springs, Calif.

April 23-25—American Assn. of Advertising Agencies, annual meeting at The Greenbrier in White Sulphur Springs, W. Va. Annual dinner will be held April 24.

April 24—Ohio Assn. of Broadcasters, Terrace-Hilton Hotel, Cincinnati.



**My Mommy Listens
to KFVB**

More mommies, more daddies, more everybody's listen to KFVB around the clock in Los Angeles.

Hooper rates KFVB a fat first with a 32.4% share ... more audience than all four networks combined! Pulse confirms KFVB's leadership... proving that KFVB leads the second station in the market by 33%, the third station by 42%.

Buy KFVB... first in Los Angeles. It's the thing to do!



6419 Hollywood Blvd., Hollywood 28 / HO 3-5151

ROBERT M. PURCELL, President and Gen. Manager
MILTON H. KLEIN, Sales Manager
Represented nationally by JOHN BLAIR & CO.

...We wanted to know... so we asked PULSE to ask the people of Nations 27th Largest Market the following

THE RESULTS:

**November 1958
Qualitative
Survey of the
22 County
Tidewater, Va.
Area**

Question 1:

When you first turn on the radio, is there any particular station you try first?

Answer:



Question 2:

Which radio station, if any, do you prefer for music?

Answer:



Question 3:

Which radio station, if any, do you prefer for news?

Answer:



Question 4:

If you heard conflicting accounts of the same story on different radio stations which station would you believe?

Answer:

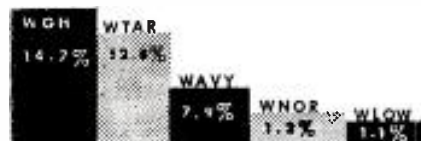

...ranks 1st during 155 out of 180 rated half hours...

Represented Nationally by
JOHN BLAIR & COMPANY

April 24-25—New Mexico Broadcasters Assn., Bishop's Lodge, Santa Fe.
 April 26-29—National Assn. of Transportation Advertising convention, The Greenbrier, White Sulphur Springs, W. Va.
 *April 26-29—U. S. Chamber of Commerce annual meeting, chamber hdqrs., Washington.
 *April 27-May 2—Journalism & Broadcasters Week, School of Journalism & Communications, U. of Florida, Gainesville. (April 27 is Broadcasters Day).
 April 29—Comments due on FCC proposal to prohibit networks from representing tv stations other than their own in spot representation field. Docket No. 12,746.
 April 29-30—International Advertising Assn. convention, Hotel Roosevelt, New York.
 April 30-May 2—Alabama Broadcasters Assn., Buena Vista Hotel, Biloxi, Miss.
 April 30-May 3—Assn. of Women in Radio & Television, annual national convention, Waldorf-Astoria Hotel, New York.
 April 30-May 3—4th district, Advertising Federation of America, Tides Hotel & Bath Club, St. Petersburg, Fla.

MAY

May 1—National Radio Month opens.
 May 1—National Law Day.
 May 1-3—Texas Assn. of Sigma Delta Chi, Hotel Galvez, Galveston. Annual meeting.
 May 4-6—Assn. of Canadian Advertisers, annual conference, Royal York Hotel, Toronto, Ont.
 May 4-8—Society of Motion Picture & Tv Engineers, semi-annual convention, Fontainebleau Hotel, Miami Beach, Fla. Theme will be "Films and Television for International Communications."
 May 6—National Academy of Television Arts & Sciences, 11th annual Emmy awards presentation on NBC-TV, 10-11:30 p.m. (EST).
 May 7-8—Kentucky Broadcasters Assn., Sheraton-Seelbach Hotel, Louisville.
 *May 12—Wisconsin FM Clinic, Center Bldg., U. of Wisconsin, Madison.
 May 13-15—Pennsylvania Assn. of Broadcasters, Bedford Springs. Frank Palmer, WFBG-AM-TV Altoona will direct panel on reduction of operating costs and Ralf Brent, WIP Philadelphia, will be chairman of panel on service to local advertiser. Presidents from adjoining state associations will attend.
 May 16-17—Illinois News Broadcasters Assn., spring meeting, Southern Illinois U., Carbondale; also, United Press Intl. business meeting.
 May 20-22—Assn. of National Advertisers, spring meeting, Edgewater Beach Hotel, Chicago.
 May 21-23—Montana Radio Stations Inc., Great Falls.
 May 21-23—Electronic Industries Assn., annual convention, Sheraton Hotel, Chicago.
 May 24-27—Associated Business Publications, annual meeting and management conference, Skytop Lodge, Skytop, Pa.
 *May 28-31—Second Annual Radio Programming Seminar and Pop Music Disc Jockey Convention, Americana Hotel, Miami, Fla. Speakers will include Matthew J. Culligan, NBC Radio executive vice president, and Gordon McLendon, head of McLendon station group. Storz stations are sponsoring seminar with Bill Stewart, Kilpatrick Bldg., Omaha, Neb., as convention coordinator.

JUNE

June 1-3—National microwave symposium, Professional Group on Microwave Theory & Techniques, Boston Section, Paine Hall, Harvard U., Cambridge, Mass.
 June 7-10—Advertising Federation of America, annual convention, Hotel Leamington, Minneapolis.
 June 9-11—National Community Television Assn. annual convention, Mayflower Hotel, Washington, D.C.
 June 12-16—National Federation of Advertising Agencies, annual convention, Chatham Bars Inn, Chatham, Mass.
 June 14-17—National Industrial Advertisers Assn., national convention, Fairmont and Mark Hopkins Hotels, San Francisco.
 June 17-19—American Marketing Assn., national conference, Hotel Statler, Cleveland.
 June 17-20—National Assn. of Radio-Television Farm Directors convention, Hotel Statler, New York.

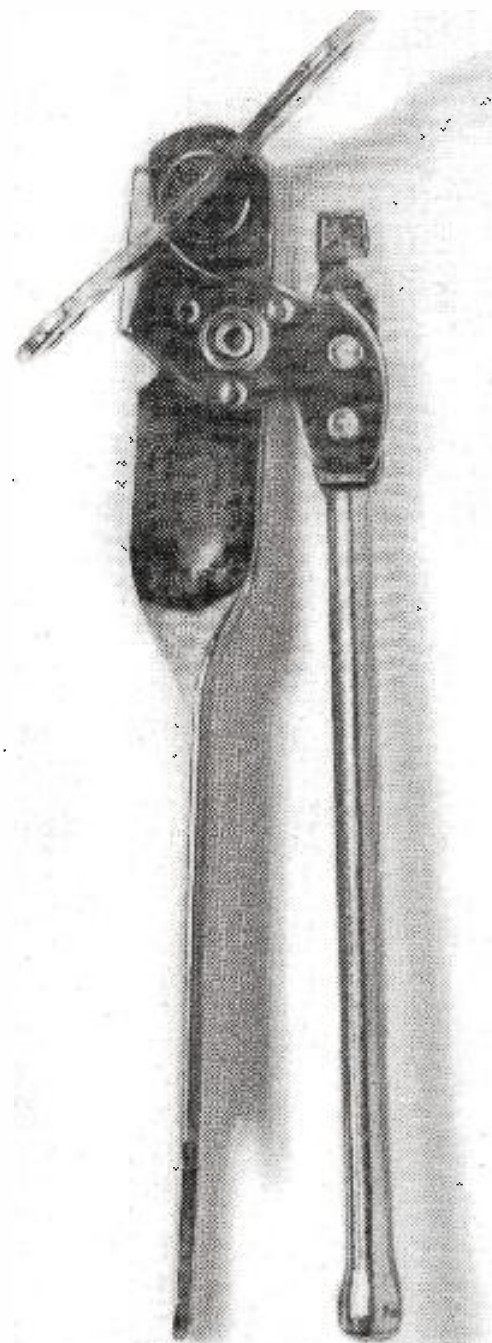

CAMPBELL SOUP places all of its network radio business on CBS Radio. For biggest helpings! This network has delivered largest commercial minute audiences all along. And the new Program Consolidation Plan—with unified station clearances and strong program sequencing—will increase this leadership.

CBS RADIO NETWORK:
 42% LARGER AUDIENCES PER COMMERCIAL MINUTE THAN ANY OTHER RADIO NETWORK, AVERAGING OVER 16 CONSECUTIVE MONTHS.

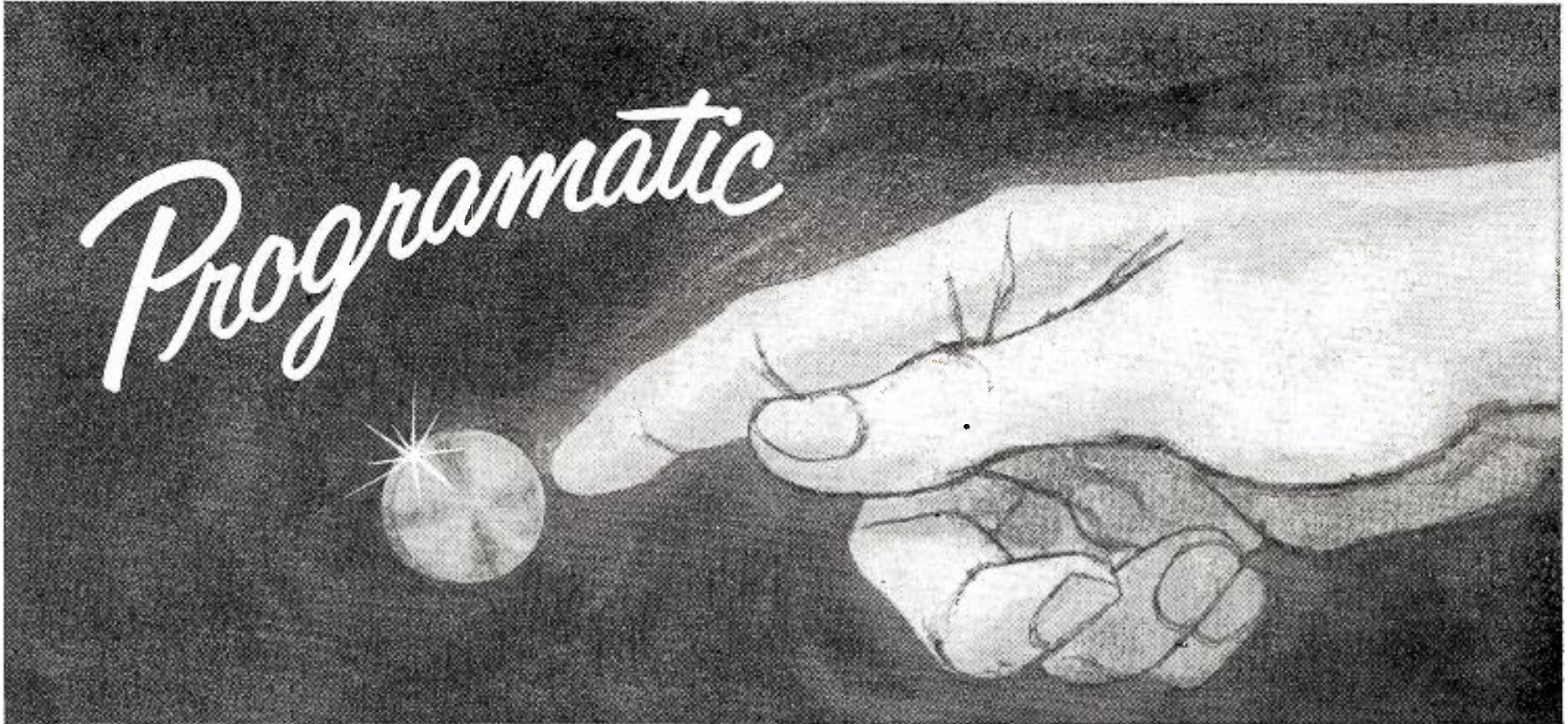

RADIO'S FIRST COMPLETE FULLY AUTOMATIC BROADCASTING SERVICE

PROGRAMMING • EQUIPMENT • COMMERCIAL INJECTION

**Be sure to see and hear Programatic
at the NAB Convention**

Regardless of your programming structure, Programatic can enhance it by —

- Saving costly programming and production man hours
- Automating any part or all of your programming
- Giving maximum programming flexibility
- Assuring superior adult music programming

Already contracted for by many leading stations — Programatic is sold on an exclusive basis in each radio market. Typical of the leading broadcasters who have already signed up for Programatic are:

Omaha-Lincoln
Tulsa
Phoenix
Kansas City

Norfolk
Jacksonville
Duluth-Superior
Diboll
Tucson

San Diego
Los Angeles
Santa Ana
Indianapolis

Don't get left out. Be sure to see Programatic in action in the No. 1 spot (Exhibit Space No. 1) at the NAB Convention.

FREE Audition LP ideal for playing at staff meetings. On this platter is a complete explanation of how Programatic works, together with an actual demonstration of how it might sound on your station. Be sure to pick yours up at the Programatic NAB Convention Display.

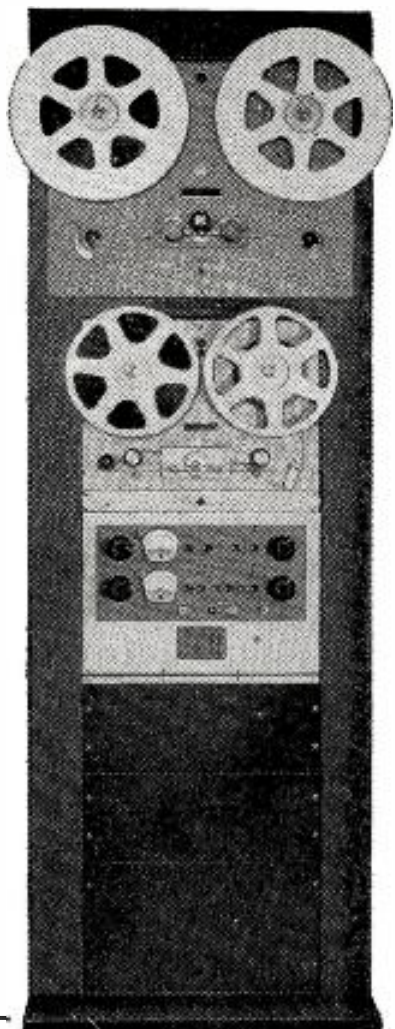

The Programatic playback unit assures "split-second" broadcast accuracy.

Programatic BROADCASTING SERVICE
A Jack Wrather enterprise

229 Fourth Avenue, New York 3, N. Y. • ORegon 4-7400

WILLIAM CAMPBELL,
as Jerry Austin, riding the roads to
adventure and action, as "Cannonball"
Mike Malone's driver-partner Sidekick,
in the new series by Robert Maxwell,
famed creator of LASSIE!

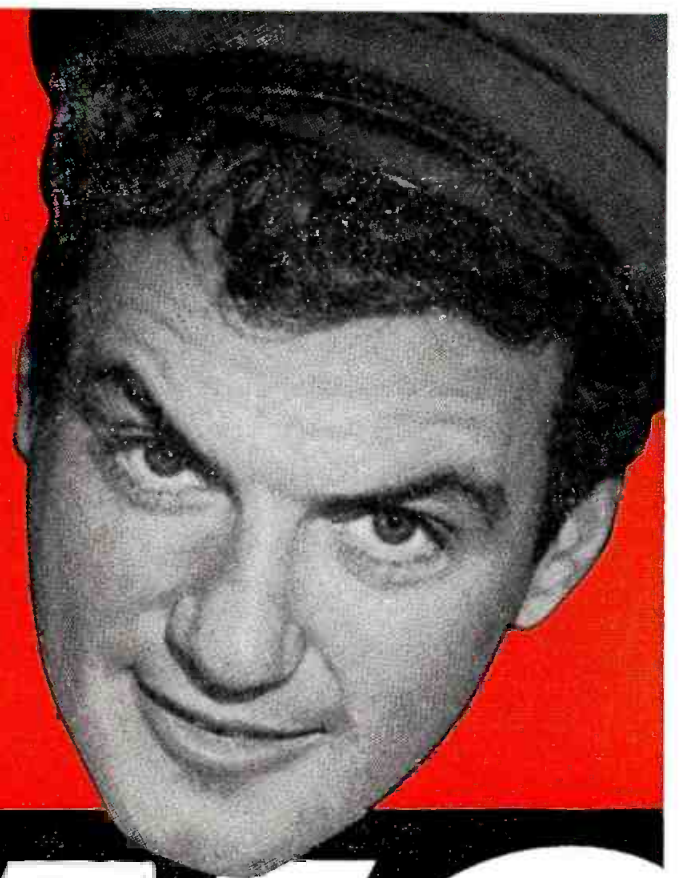
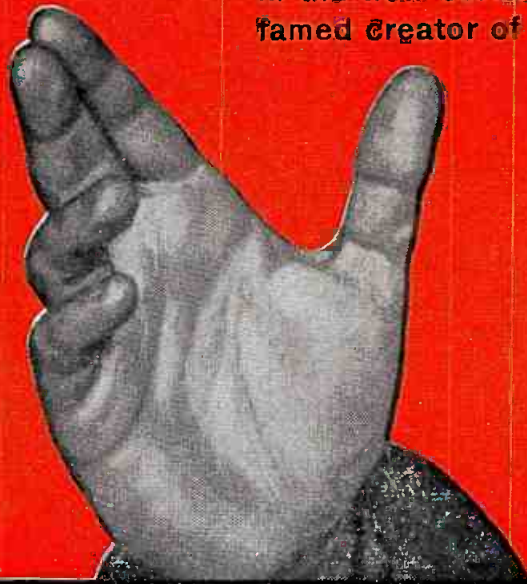

CANNONBALL

**ADVERTISERS EVERYWHERE CLIMB ABOARD THE
CANNONBALL SALES CARAVAN! FIRESTONE TIRES!
GENERAL PETROLEUM! THE GREAT ATLANTIC & PACIFIC
TEA CO.! WINN-DIXIE FOOD STORES! JOHNSON'S WAX!
ROBIN HOOD FLOUR! SCHMIDT BEER! STANDARD
RADIATOR COMPANY! MARY JANE BAKERIES! PRICE'S
DAIRY! SHEPHERD'S LAUNDRIES! BURGER-KING!
JORDAN JEWELRY! FACTORY MOTOR EXCHANGE!**

A FEW TOP MARKETS ARE STILL AVAILABLE! DON'T BE DISAPPOINTED—WIRE TODAY FOR YOURS!

**CANNONBALL RACES TO DYNAMIC
ACTION—HUMAN INTEREST SALES RECORD!
ONLY A FEW CHOICE MARKETS ARE STILL
AVAILABLE! PHONE—WIRE COLLECT TODAY!**

CANNONBALL



PAUL BIRCH,
as "Cannonball" Mike Malone,
one of the rugged men
entrusted to maintain the
nation's commercial lifeline—
the long-haul truckers!



**SOLD IN
MARKETS LIKE**
Philadelphia
San Francisco
Detroit
Salt Lake City
Cleveland
Denver
Minneapolis-St. Paul
Columbus, O.
San Diego
Dallas-Fort Worth
Jacksonville
New Orleans
New Haven-Hartford
Seattle-Tacoma
Portland
**AND 95 OTHERS!
EAST—WEST!
NORTH—SOUTH!**

**INDEPENDENT
TELEVISION
CORPORATION**

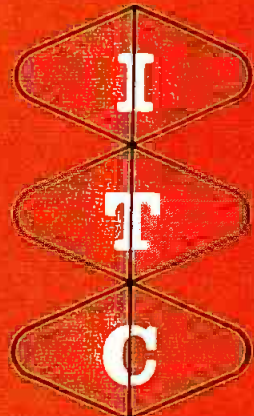

488 Madison Ave. • New York 22 • PLaza 5-2100

"JAXIE" says—
ALWAYS THE
BEST OF NBC . . .
AND NOW THE
BEST OF ABC

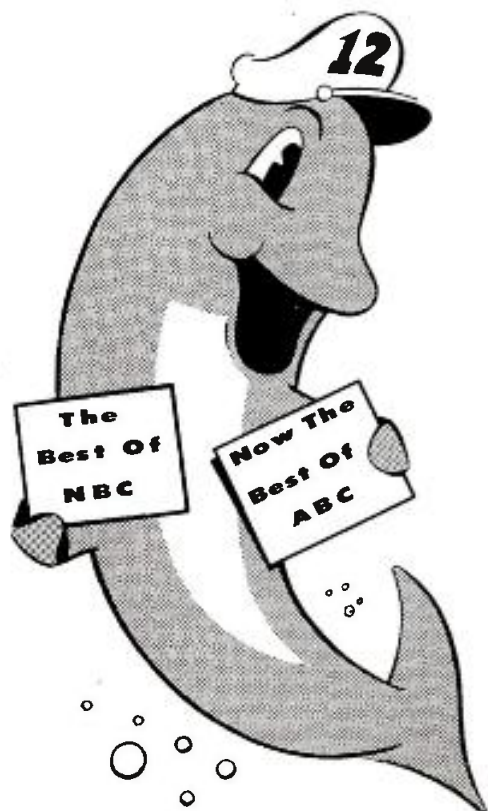

To reach the rich \$1½ billion North Florida - South Georgia market—use WFGA-TV—the station with PLUS PROGRAMMING. With such features as:

- Maverick
- Dinah Shore
- Loretta Young
- Wells Fargo
- Restless Gun
- Sugarfoot—Cheyenne
- Wyatt Earp
- Wagon Train
- Bat Masterson
- Zorro
- Walt Disney
- The Real McCoys
- Tennessee Ernie Ford
- Perry Como
- 77 Sunset Strip

For top availabilities on WFGA-TV contact your nearest Peters, Griffin, Woodward representative.

WFGA-TV
Channel 12

Jacksonville, Florida

FLORIDA'S
COLORFUL STATION

OPEN MIKE

Favorable impression

EDITOR:

My compliments to you on some very interesting recent issues.

Newman F. McEvoy
Senior Vice President and
Media Director
Cunningham & Walsh
New York

Retail success story

EDITOR:

Please send 100 reprints of . . . "Stores Miss Radio-Tv Boat" (Jan. 26, page 35) . . . This article has a lot of meat to help local tv stations overcome some of the retail store apathy toward broadcast media.

Lawrence Carino
General Sales Manager
WVL-TV New Orleans

EDITOR:

Your article . . . raised some thought-provoking arguments in behalf of the industry. Congratulations to Jack Miller for his close examination of the "cost-to-sell" ratio . . . please send 25 reprints . . .

Deane D. Osborne
Promotion Manager
WSPD-TV Toledo, Ohio

EDITOR:

Your report on the retail advertising conference in Chicago featuring the views of Jack Miller, advertising director of Leonard Dept. Store, Fort Worth, Tex., is the kind of news reporting that continues to make your publication the number one business weekly for radio-tv industry. Please send 50 reprints . . .

Keith Oliver
Sales Manager
WJIM-AM-TV Lansing, Mich.

[EDITOR'S NOTE: Reprints 5¢ each.]

Yearbook in September

EDITOR:

We find BROADCASTING most informative and helpful in support of our program of economic development in Maine . . . One of the services provided . . . is the Yearbook. We are looking forward to receiving a copy.

Charles G. H. Evans
Public Relations Director
Dept. of Economic Development
State of Maine

[EDITOR'S NOTE: A copy of the 1958 Yearbook issue is enroute. The 1959 radio-tv Yearbook will be published next September.]

Tall tower builder

EDITOR:

In your Feb. 23 issue . . . you ran an article on page 54 . . . in which you featured the 1,619 ft. structure for

[WGAN-TV] Portland, Me. . . . this tower will be designed, fabricated and erected by the Kline Iron & Steel Co. of Columbia, S.C. (KIMCO Towers). . . . When the Portland job is completed, we will have the distinction of the five tallest towers east of the Mississippi River, plus the tallest structure in the world.

J. R. Trotter
Sales Mgr., Tower Dept.
Kline Iron & Steel Co.
Columbia, S.C.

'Why Advertisers Take to the Air'

EDITOR:

We sincerely appreciate the copy of "Why Advertisers Take to the Air" recently mailed by you to our station. It is a masterpiece of valuable information about "Radio," the greatest medium of them all. If reprints are available . . . please advise the cost of 100.

Raymond Gaddell
Vice President-General Manager
WHSC Hartsville, S.C.

[EDITOR'S NOTE: Reprints are 10¢ each.]

Wisk makes a splash

EDITOR:

We wish to thank you for the fine story on the *County Fair* program and its tie-in with one of our sponsors, Wisk (Jan. 26, page 91) . . . wherein Herb Landon was named as executive producer for the program. This, of course, is wrong as the executive producer of the show is Perry Cross. Mr. Cross was also in charge of all production in connection with the Cypress Gardens feature . . . [also] the m.c. of the program, Bert Parks, was not mentioned.

Herbert Landon
General Manager
County Fair
New York

A uhf view of TASO report

EDITOR:

. . . I finally caught up with your issue of Jan. 19 and, being a director of TASO, I read with some interest your article on page 100.

I note that your spy understands that the TASO report finds that uhf is far less effective than vhf in coverage, expense of operations, power potential, receiver sensitivity, antenna criticality and maintenance.

It strikes me that it would be of more service to your readers and to the public and also a little bit more accurate if your spy had also noted that the TASO report also finds that uhf is far superior to vhf in freedom from man-made interference, ignition noise, airplane flutter, co-channel interference and many

GROWTH! EXPERIENCE!

*The two prime requisites
for sound representation . . .*

healthy, continued growth
and balanced experience.



VENARD, RINTOUL & McCONNELL, INC.

TV & Radio Station Representatives

NEW YORK CHICAGO DETROIT LOS ANGELES SAN FRANCISCO DALLAS

Convention Headquarters 2100 Conrad Hilton Hotel

Farm Public Service in
the KWTV Community
makes

KWTV
OKLAHOMA CITY

Oklahoma's No. 1
Television Station

BUY the
TOWER
with
SALES-
power
in
Oklahoma!

Traveling to obtain on-the-air reports during 1958, KWTV's two farm directors visited the more than 100 towns shown on the map . . . many, several times. Proof of KWTV's community coverage!

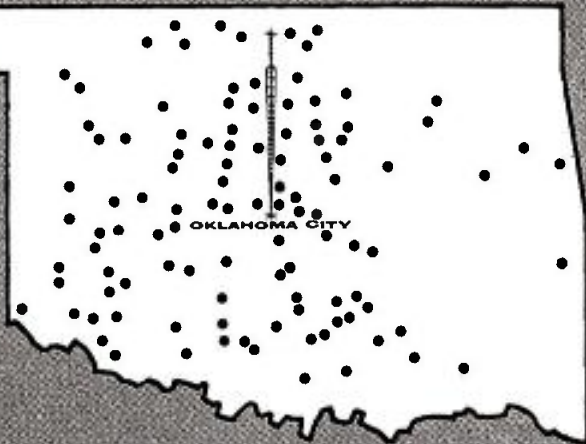

See your PETRYman

in Shorthand . . .



it's Gregg

in TV and Radio . . .

**IT'S
BROADCASTING
YEARBOOK!**

To the uninitiated, a page of Gregg is so much Greek. But a secretary trained in the symbology of shorthand's foremost authority can translate it into a meaningful communication. To a bus-driver, a page from the 1959 **BROADCASTING YEARBOOK** won't be very lucid either. But the men and women who make important decisions in broadcast advertising look upon this comprehensive volume as **THE** authority for a multitude of facts about television and radio . . . dependable facts they can

translate into more profitable advertising plans. Nowhere is so much useful TV-radio information assembled within a single set of covers, or consulted so often day-after-day throughout the year. The 1959 **BROADCASTING YEARBOOK**, packed with more data about the broadcast media than ever before, will be delivered to 16,000 paid subscribers in August. Your message gets a big bonus of attention and long life at regular **BROADCASTING** rates. Today's the day to reserve a good spot for it.

Deadlines? July 1 if proofs are needed; July 15, no proofs.



BROADCASTING

THE BUSINESSWEEKLY OF TELEVISION AND RADIO

1735 DeSales Street, N. W., Washington 6, D. C.

of the other difficulties that plague vhf reception.

Those of us who operate in the uhf part of the band have troubles enough, due to the economic and political hurdles we must face, without having to deal with unfair and biased news coverage as well.

William L. Putnam
President
WWLP (TV) Springfield, Mass.

[EDITOR'S NOTE: The TASSO story was written under handicap, without benefit of the report. The reporter relied on the best sources then available. We certainly don't intend to slight uhf. Our editorial record shows that.]

Wanamaker success story

EDITOR:

Would you be so kind as to send us a half-dozen reprints of the Wanamaker's success story (page 35, Oct. 20, 1958).

Robert O. Moran
General Manager
WBEL Beloit, Wis.

[EDITOR'S NOTE: Reprints 5¢ each.]

Joe Gans' fm views score

EDITOR:

Enclosed find \$1 for which please send me 20 reprints of "Fm listener: good game but hard to flush" by Joe Gans (page 93, Dec. 15, 1958).

Elmer G. Sulzer, Director
Radio and Television
Communications
Indiana U.
Bloomington, Ind.

EDITOR:

I would greatly appreciate . . . 200 reprints . . .

Russell C. Jones
General Manager
WSOM (FM)
Salem, Ohio

EDITOR:

I am enclosing a check . . . for 100 reprints.

William L. Weinrod
General Manager
KHFM (FM)
Albuquerque, N.M.

EDITOR:

Please enter our order for 200 copies . . .

Wallace Dunlap
WTAO (AM)-WXHR (FM)
Cambridge, Mass.

EDITOR:

Please send us 100 reprints. . . .

Jim Hodges
KQXR (FM) Bakersfield, Calif.

EDITOR:

. . . Since I am an applicant for an

It's the care
we give the "inner tube"
that adds the
extra hours

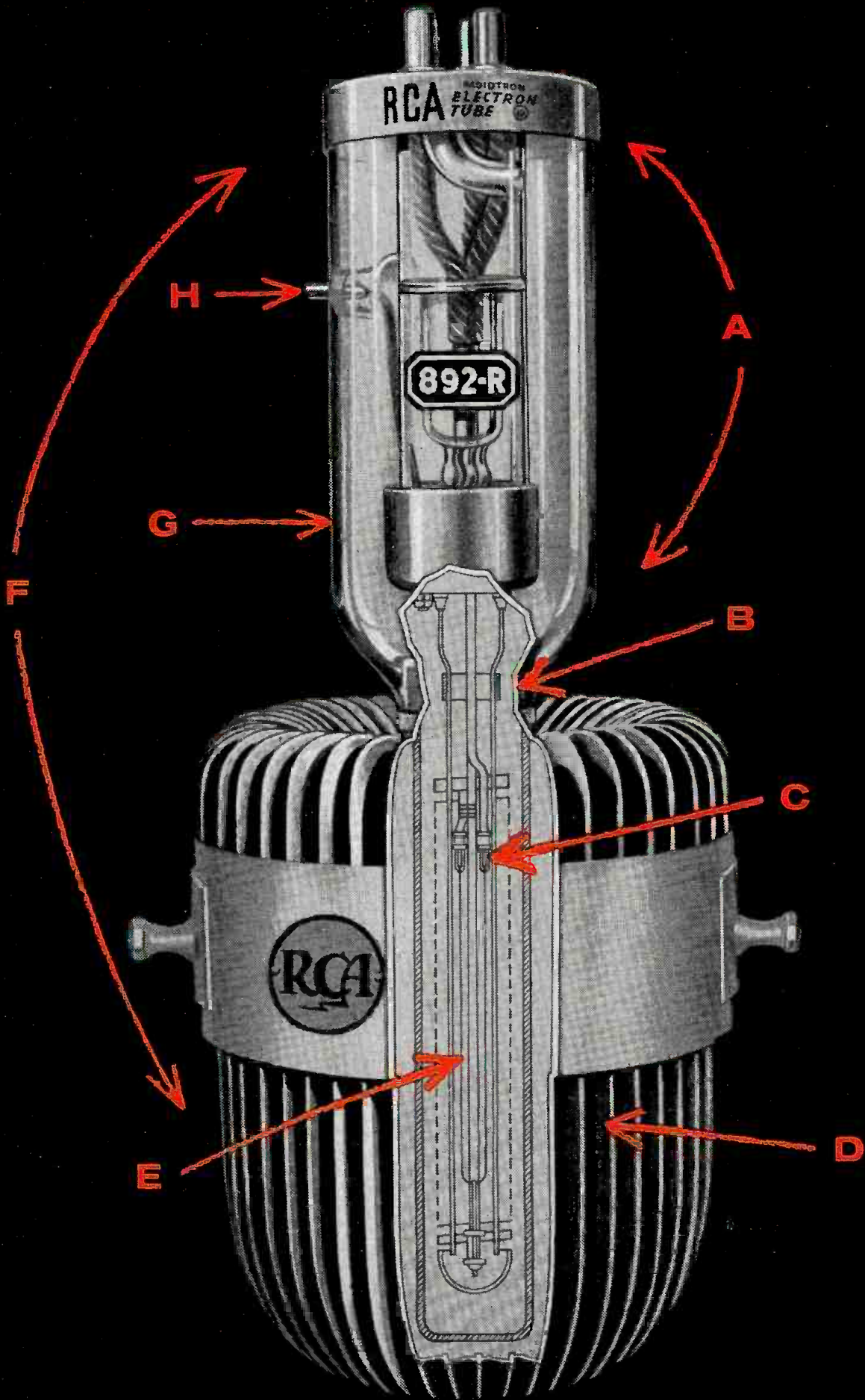

The long-life characteristic of the RCA-892-R is due in no small way to the constant attention we pay to the details of the "inner tube". Manufacturing techniques, for example, have kept pace with the experience we have gained in building broadcast power tubes for a generation. Design refinements have been evolved—through our continued effort to make a good tube even better.

Type 892-R is another typical example of RCA time-proved design that is paying dividends in lower tube cost per hour of operation—and uninterrupted program time for stations everywhere.

For long-term power delivery, always specify RCA Tubes. Your RCA Industrial Tube Distributor handles the entire RCA line.

- A** All glass seals—microscopically inspected
- B** Grid and Support Assembly "vacuum-fired" at more than 2000° F to assure maximum freedom from gas
- C** Sag-proof Filament Supports—to prevent stress on filament strands and to improve life
- D** Interlocked-Fin Radiator—for improved heat radiation
- E** Filament material controlled for internal grain structure—assures superior strength
- F** Entire Tube is "spot-knocked" at tens of thousands of volts to reduce internal leakage
- G** Stress-free Glass Bulb—individually inspected with polariscope
- H** Sandblasted Grid Arm—torsion-tested to insure high strength



RADIO CORPORATION OF AMERICA
Electron Tube Division
Harrison, N. J.

CHAMPIONSHIP

Leads the TV IN RATINGS AND

Typical spring-summer ratings in 20 major markets

Cincinnati, Ohio
WKRC-TV-16.3

Detroit, Mich.
WXYZ-TV-13.3

Cleveland, Ohio
WEWS-TV-16.5

Duluth, Minn.
WDSM-TV-18.4

Kansas City, Mo.
KCMO-TV-17.9

Lubbock, Tex.
KDUB-TV-15.5

Minneapolis, Minn.
WCCO-TV-12.7

New Orleans, La.
WDSU-TV-11.5

Indianapolis, Ind.
WFBM-TV-11.9

San Antonio, Tex.
KONO-TV-15.9

Grand Rapids, Mich.
WOOD-TV-19.8

Seattle, Wash.
KOMO-TV-16.1

Tulsa, Okla.
KOTV-TV-14.2

Memphis, Tenn.
WHBQ-TV-14.4

Hartford, Conn.
WTIC-TV-21.1

Scranton, Pa.
WDAU-TV-22.8

Spokane, Wash.
KREM-TV-18.2

Corpus Christi, Tex.
KRIS-TV-15.6

Ft. Wayne, Ind.
WKJG-TV-17.7

Peoria, Ill.
WEEK-TV-15.0

**RATING...
16.2
AVERAGE**

**No other sports program on TV
comes up with ratings like
"CHAMPIONSHIP BOWLING"**

**SPECIAL PACKAGE DEAL for once a week,
twice a week, or strip programming.**

*Also available, 26 of the top matches
in a special "BEST OF BOWLING" package.*

TOP BOWLING

Sports Parade

COST-PER-THOUSAND

"CHAMPIONSHIP BOWLING"
has the top bowling stars.

Don Carter	Lou Campi	Ray Bluth
Bill Lillard	Buddy Bomar	Glenn Allison
Buzz Fazio	Tom Hennessey	& many others
Steve Nagy	Therman Gibson	

"CHAMPIONSHIP BOWLING"
now available for
spring-summer release.

130 one-hour
programs!

The only complete bowling show in
America with three entire games—not
condensed or cut.

WALTER SCHWIMMER, INC.

CHICAGO ● MAIN OFFICE ● 75 E. Wacker Drive
FRanklin 2-4392

NEW YORK ● 527 Madison Ave.
ELdorado 5-4616

Produced in co-operation with the

BRUNSWICK-BALKE-COLLENDER CO.

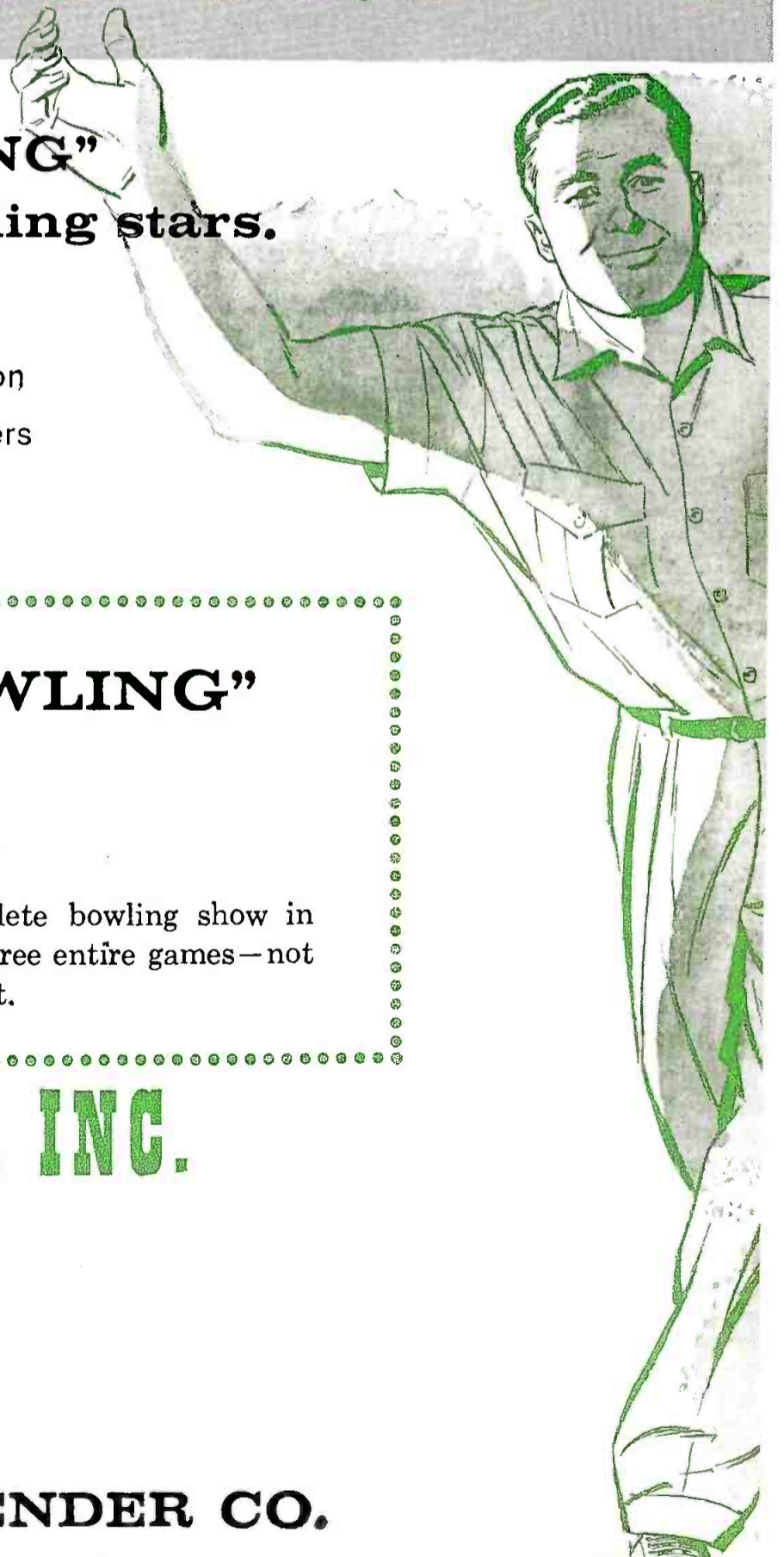

**RATINGS ARE IMPORTANT
ONLY IF YOU CAN GET
THE AVAILABILITIES**

Get Both

In time that counts — like week nights, week in and week out, when the most people watch television consistently, KJEO gives you the top time buys.

KJEO

channel 47



See your H-R representative today — the only undiluted network channel in all of Central California.

FRESNO

*we'd like to put it
right in your lap*

46.3% of all Michigan's retail filling station sales outside Metropolitan Detroit are made in Michigan's Golden Triangle area, which includes Jackson, Lansing and Battle Creek. And this rich area can be reached powerfully with only one station . . .

WILX-TV
Hotel Hayes
Jackson, Michigan

CHANNEL
10



This is just part of WILX-TV's coverage story. Venard, Rintoul & McConnell, Inc. has the whole interesting picture. Ask them about it. You will be surprised at how much you can sell in Out-State Michigan,



fm radio station . . . I would like . . . 50 or 100 reprints . . .

*Jack L. Katz
Jack L. Katz Enterprises
Omaha, Neb.*

EDITOR:

We would appreciate . . . 25 tear-sheets . . .

*Sydney A. Abrams
President, Market-Casters
Seattle, Wash.*

[EDITOR'S NOTE: Reprints are 5¢ each.]

Trip To Europe May 29

EDITOR:

Your readers might be interested to know that on May 29 a group of tv and radio executives will depart with me on a study trip to Europe.

We will visit radio-tv facilities in Portugal, Spain, Italy, Switzerland, Germany, France, England, Ireland and Luxembourg . . . Wives and families . . . are naturally welcome . . . We hope some of your readers can join us . . .

*Powell Ensing
Executive Vice President
Everett-McKinney Inc.
New York*

Turn back your radio

EDITOR:

There is something that would give that tv set a rest—network radio programming, vintage 1939-45. Television as a curiosity is passe. Entertainment, whether listened to or looked at, isn't. Oddly enough, to teenagers, radio programming, which they don't know ever existed, could be the new satisfying curiosity. As for us oldsters, we remember many hours of radio enjoyment and we would turn television off if radio offered a better half hour of entertainment.

I would, therefore, like to suggest a practical experiment to the networks. Take one weekday night and, with all the fanfare that can be mustered, throw "the audio book" at the video audience. I'm referring to things like *I Love a Mystery*, *Sherlock Holmes*, *Bob Hope*, *Red Skelton*, *Lux Playhouse*, *Lum and Abner*, *Charley McCarthy* et al.

*William D. Hayward
Associate Director for Radio-Tv
New Jersey Education Assn.
Trenton, N. J.*

BROADCASTING

SUBSCRIPTION PRICES: Annual subscription for 52 weekly issues \$7.00. Annual subscription including Yearbook Number \$11.00. Add \$1.00 per year for Canadian and foreign postage. Subscriber's occupation required. Regular issues 35¢ per copy; Yearbook Number \$4.00 per copy.

SUBSCRIPTION ORDERS AND ADDRESS CHANGES: Send to BROADCASTING Circulation Dept., 1735 DeSales St., N.W., Washington 6, D.C. On changes, please include both old and new addresses.



IT'S A

LARK

BY STUDEBAKER

AND IT CAN BE YOURS FREE

AT TELEPROMPTER'S BOOTH
BE SURE TO SEE

Model V TelePrompTer. The foolproof way to provide network quality at the local level.

TelePro 6000 Rear Projector. Provides the brilliant rear screen image to spark up commercials with life-like background scenes.

New TeleMation. Our electronic "stage manager" which enables you to trigger hundreds of staging effects . . . with split-second timing . . . from a single TelePrompTer script.

T P T L S N. An association of 131 TV stations geared to provide the national spot advertiser with top local live performance.

TELEPROMPTER
CORPORATION

ORIGINATORS OF

GROUP COMMUNICATIONS

311 West 43 St., New York 36, N. Y.
Los Angeles • Washington, D. C. • Chicago
Huntsville, Ala. • Toronto • London

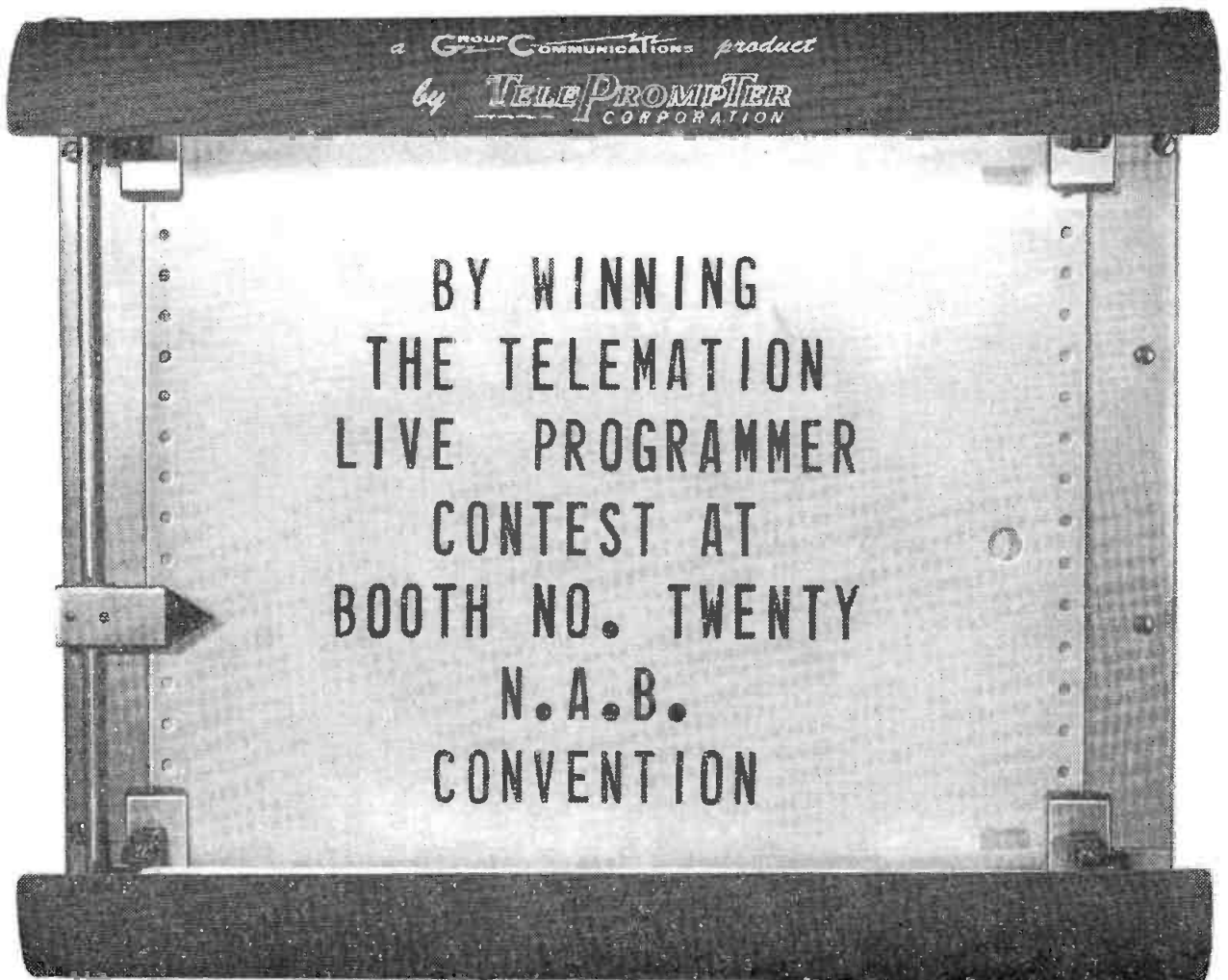

in PITTSBURGH

Take TAE and See

brewed hot with
plenty of
local flavor!

WTAE
BIG TELEVISION IN PITTSBURGH

CHANNEL **4**

WTAE

REPRESENTED BY THE KATZ AGENCY / BASIC ABC IN PITTSBURGH

GATEWAY
TO THE FUTURE
1758
PITTSBURGH BICENTENNIAL 1958-59
GROWING WITH
PITTSBURGH'S
RENAISSANCE

MONDAY MEMO

from EDGAR J. DONALDSON, vice president and director, radio-tv dept., Ketchum, MacLeod & Grove

Management: reluctant audience?

How many people do you know who once said: "I wouldn't have a television set in my home"?

Fortunately, for our business, most of these comments have been relegated to history with national set saturation now approaching 90%.

But now the "fourth best sport" seems to be the utterance of comments such as: "I never watch television. I've got three sets—one in the living room, one in the den and one in the bedroom. There's nothing on but westerns. And besides—I don't have the time, etc."

This is a typical businessman-at-lunch remark. It goes hand in hand with idle chatter about the weather, the standing of his favorite ball club and the 350 horses under the hood of his new car.

Nielsen Clocked Him • With Nielsen showing family viewing at better than six hours per home per day, this man would be highly unusual if he "never" watched television—especially when it is a known fact that the better educated, higher income families spend more time with tv than do their less fortunate brethren.

It would be nice if we could continue to turn our backs on harmless conversations like this—but we can't. It does more harm than we know.

It contributes to the "light regard" much of industry management has for the ability of television to perform in non-consumer areas; specifically its ability to deliver the quality of audience necessary to justify expenditures on certain types of corporate messages.

At dinner not long ago, I sat next to the president of a large corporation. His company has never used television. When he found out my business, he proceeded to give me his views. They were very close to the above statement. He was not critical of television. He just wanted to be sure that I understood he had no time for such frivolities.

A Bedtime Story • He said he was usually in bed by 8 p.m.—with his briefcase. He did suffer the bedside radio to be on low (fm) while he worked. Sometimes he stayed awake through the 11 o'clock news, but most often not. Usually his wife had to tiptoe in, take off his glasses and put his papers away.

Then he went on to say that he had

one of the first color sets in Pittsburgh. And he even had a special dining room installation made so he could watch Dave Garroway in the morning. But he said he never did. (My private opinion is—he was up so late watching Jack Paar he missed Garroway.)

Whether or not this man watches much television is immaterial. It's the damaging effect of his stated routine that concerns me. After all—if the boss doesn't think he can admit to wasting a few hours with television, how can his subordinates admit to it. So they play back the same tune.

But meanwhile—they watch. Not several hours a day—true—but they watch.

Very Selective Audience • These management people are more selective than the average. They have an inclination not to spend too much time with the *Gunsmites* and *Have Guns*. But they do just like the rest of us. It's that they just won't admit it. After all, they can't be doing justice to those bulging briefcases they carry home if they waste their time with television.

When these people will admit to television viewing, they name the programs in the news and public affairs area that they seldom miss. They also throw in a special or two like *Annie Get Your Gun*. Or even admit to a few minutes of *Steve Allen*. But ask them how they liked *Wagon Train* last week and you'll get a blank stare.

Who lives in the 18 million homes that tune in on such programs as

Wagon Train? Does corporate advertising on television have to be confined just to programs that America's opinion leaders admit they listen to? I don't think so.

Television programming has more universal appeal than most of its detractors will admit. Sure, much of it is escapist. But ask any psychiatrist about the therapeutic values of escape. And ask yourself, "How much of American management is included in Palladin's 16 million homes on a Saturday night?" Or does Palladin appeal only to "Un-thinking Men?"

When a corporation appropriates several million dollars for a television vehicle to carry its advertising messages, it hopefully expects this vehicle to attract people representative of all its customers. The proper program can do this. Garry Moore is doing it for Pittsburgh Plate Glass Co. The corporate commercials prepared by KM&G for this show are reaching into 10 million homes each Tuesday evening.

Management Not Missing • And our research shows these homes are not devoid of the management element.

More research is needed on this subject. The audience quality is there—let's prove it beyond a doubt!

And let's promote to top management the therapeutic value of escape via television. We'd lose fewer executives in the middle of the race of life if more of them would relax and watch shows like Palladin for 30 minutes.



Edgar J. Donaldson is vice president and director of the radio-television department of Ketchum, MacLeod & Grove, Pittsburgh. He began his broadcasting career with WSLB Ogdensburg, N.Y., while completing studies for a B.A. degree in English at St. Lawrence U. After graduating he joined WSYR Syracuse, N.Y. When the station expanded into television in 1950, he was named production supervisor. He joined KM&G in 1952 as an assistant director in the radio-tv department. He was named radio-tv director in 1956 and a vice president in 1957. A native of Syracuse, he was a Navy communications officer in World War II.

. . . No! 'It's that they just won't admit it'

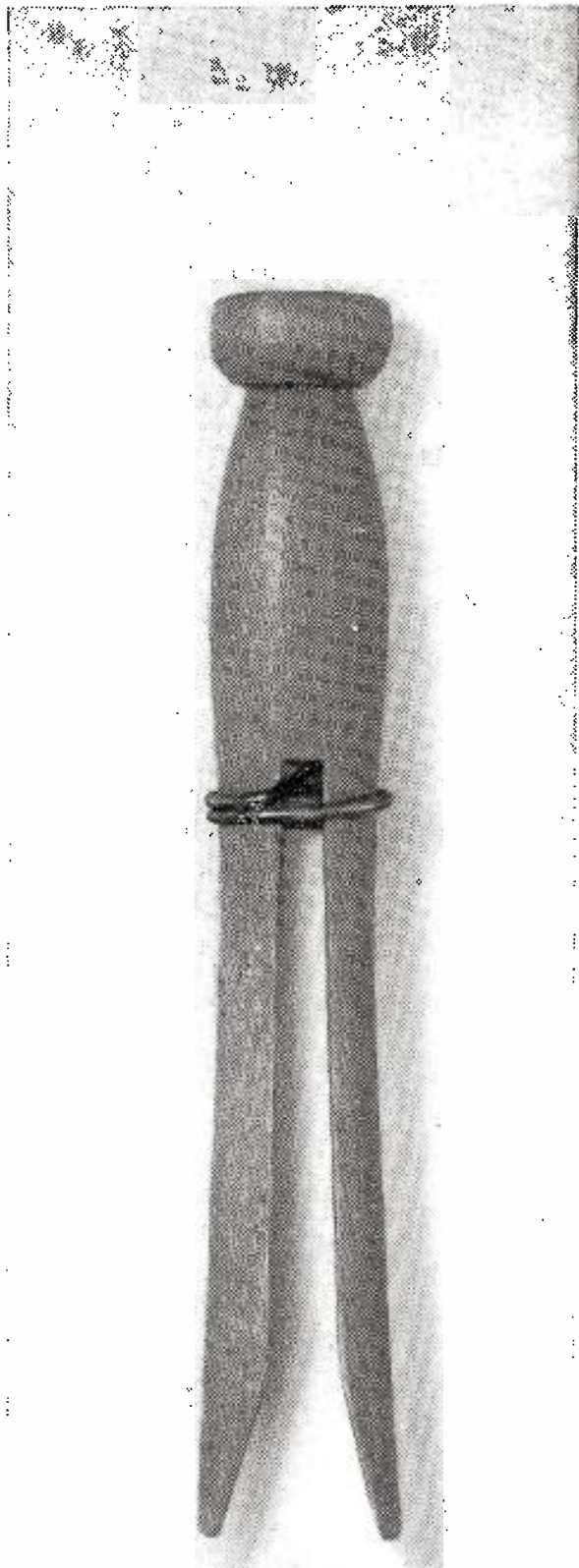

LEVER BROTHERS increased its program sponsorships on CBS Radio by 32% since PCP. Just clean logic! This network has delivered largest commercial minute audiences all along. And the new Program Consolidation Plan—with unified station clearances and strong program sequencing—will increase this leadership.

CBS RADIO NETWORK:

42% LARGER AUDIENCES PER COMMERCIAL MINUTE THAN ANY OTHER RADIO NETWORK, AVERAGING OVER 16 CONSECUTIVE MONTHS.

BROADCASTING PUBLICATIONS INC.

PRESIDENT.....Sol Taishoff
 VICE PRESIDENT.....Maury Long
 VICE PRESIDENT.....Edwin H. James
 SECRETARY.....H. H. Tash
 TREASURER.....B. T. Taishoff
 COMPTROLLER.....Irving C. Miller
 ASST. SEC.-TREAS.....Lawrence B. Taishoff

BROADCASTING THE BUSINESS WEEKLY OF TELEVISION AND RADIO

Executive and publication headquarters:
 BROADCASTING • TELECASTING Bldg., 1735
 DeSales St., N.W., Washington 6, D.C. Tele-
 phone: Metropolitan 8-1022.

EDITOR AND PUBLISHER.....Sol Taishoff
 MANAGING EDITOR.....Edwin H. James
 SENIOR EDITORS: Rufus Crater (New York),
 J. Frank Beatty, Bruce Robertson (Holly-
 wood), Fred Fitzgerald, Earl B. Abrams,
 Lawrence Christopher.
 SPECIAL PROJECTS EDITOR..David Glickman
 ASSOCIATE EDITOR.....Harold Hopkins
 ASSISTANT EDITORS: Dawson Nail, Jacque-
 line Eagle; STAFF WRITERS: George Darling-
 ton, Lee Edwards, Myron Scholnick, Jim
 Thomas; EDITORIAL ASSISTANTS: Malcolm
 Oettinger, Rita Cournoyer, Patricia Funk;
 SECRETARY TO THE PUBLISHER: Gladys L.
 Hall.

BUSINESS

V.P. & GENERAL MANAGER....Maury Long
 SALES MANAGER: Winfield Levi (New York)
 SOUTHERN SALES MANAGER.....Ed Sellers
 PRODUCTION MANAGER.....George L. Dant
 TRAFFIC MANAGER.....Harry Stevens
 CLASSIFIED ADVERTISING.....Doris Kelly
 ADVERTISING ASSISTANTS: Merylyn Bean,
 John Henner, Ada Michael.
 COMPTROLLER.....Irving C. Miller
 ASSISTANT AUDITOR.....Eunice Weston
 SECRETARY TO GEN. MGR....Eleanor Schadi

CIRCULATION & READER'S SERVICE

MANAGER.....John P. Cosgrove
 SUBSCRIPTION MANAGER...Frank N. Gentile
 CIRCULATION ASSISTANTS: Charles Browne,
 Gerry Cleary, David Cusick, Christine Hara-
 geones, Charles Harpold, Marilyn Peizer.

BUREAUS

New York: 444 Madison Ave., Zone 22,
 Plaza 5-8355.

Editorial

SENIOR EDITOR.....Rufus Crater
 BUREAU NEWS MANAGER...Donald V. West
 ASSOCIATE EDITOR:.....David W. Berlyn
 N. Y. FEATURES EDITOR: Rocco Famighetti
 STAFF WRITERS: Richard Erickson, Mary
 Hurley, Diane Schwartz, Benjamin Seff.

Business

SALES MANAGER.....Winfield R. Levi
 SALES SERVICE MGR....Eleanor R. Manning
 EASTERN SALES MANAGER..Kenneth Cowan
 ADVERTISING ASSISTANT...Donna Trolinger

Chicago: 360 N. Michigan Ave., Zone 1,
 Central 6-4115.

MIDWEST NEWS EDITOR.....John Osbon
 MIDWEST SALES MGR.: Warren W. Middleton
 ASSISTANT.....Barbara Kolar

Hollywood: 6253 Hollywood Blvd., Zone 28,
 Hollywood 3-3148.

SENIOR EDITOR.....Bruce Robertson
 WESTERN SALES MANAGER.....Bill Merritt
 ASSISTANT.....Virginia Stricker

Toronto: 11 Burton Road, Zone 10, Hudson
 9-2694. CORRESPONDENT: James Montagnes.

BROADCASTING* Magazine was founded in 1931
 by Broadcasting Publications Inc., using the title:
 BROADCASTING*—The News Magazine of the
 Fifth Estate.

Broadcast Advertising* was acquired in 1932,
 Broadcast Reporter in 1933 and Telecast* in 1953.

* Reg. U. S. Patent Office

Copyright 1959 by Broadcasting Publications Inc.



BROADCASTING, March 9, 1959

EASTERN AMERICA'S TALLEST TV TOWER

1526 FEET
above ground

The TOWERING PRIDE of South Carolina

More than a quarter of a mile in the sky over South Carolina, this tower has doubled previous coverage. From Columbia, the capital city, WIS-TV serves more of South Carolina, by far, than any other television station . . . plus coverage in adjoining states.

MAXIMUM POWER

The MAJOR SELLING FORCE in South Carolina

WIS-TV Channel 10
Columbia
South Carolina



A station of the Broadcasting Company of the South

G. Richard Shafto, *Exec. Vice-Pres.*

Charles A. Batson, *Managing Dir.*

Law Epps, *Sales Manager*

represented nationally by
Peters, Griffin, Woodward, Inc.

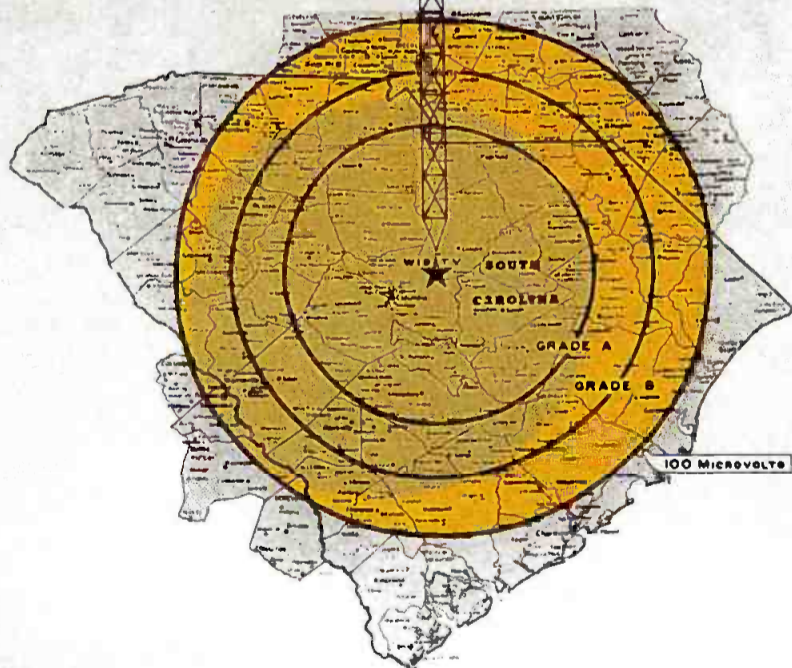

Darker tinted crescent area shows increased coverage from new tower, based on predicted contours drawn by the engineering firm of Lohnes and Culver, Washington, D. C.

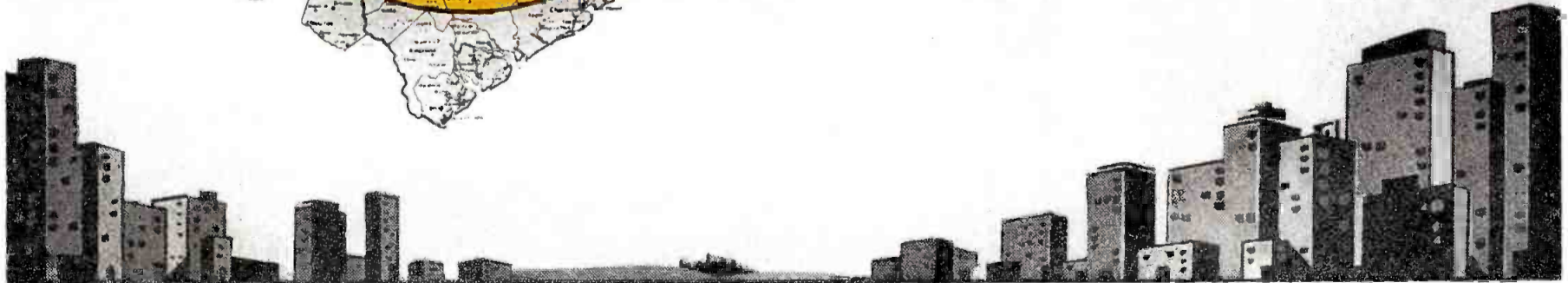

78
Fact-Based
Half Hours!



Host-
Narrator
TRUMAN
BRADLEY

SCIENCE FICTION THEATRE

TV's unique series of space-age adventures with big name stars in exciting fiction dramas. Winning top multi-run ratings . . . Las Vegas 20.5, Wichita 24.8, Orlando 20.3, Harlingen-Weslaco . . .

27.4

Economee TV

Citizen!
Communist!
Counterspy!



Starring
RICHARD
CARLSON

I LED 3 LIVES

From the secret files of a counterspy for the FBI, 117 gripping half-hour stories of the patriotic American who led three lives for his country. Buffalo 17.2, Colorado Springs 16.3, Honolulu 16.2, Albany-Schenectady-Troy . . .

24.9

Economee TV

Action!
Gallantry!
Excitement!



Starring
The Corps
Of Cadets

WEST POINT

Economee's star-spangled rating winner now available for first off-network showings! Ratings like these: Buffalo 22.9, Philadelphia 19.2, Wichita 25.3, Green Bay . . .

26.3

SMASH RE-RUN RATINGS

AND RESULTS... for stations and advertisers!

Economee TV

Glorious as
our country's
history!



Starring
The U. S.
Midshipmen

MEN OF ANNAPOLIS

Already snapped up by a host of leading stations and advertisers who see top rating opportunities for this power-packed prestige series. Boise 28.4, Buffalo 20.2, Beaumont-Port Arthur 24.8, Charlotte . . .

28.7

Economee TV

Mystery!
Thrills!
Romance!



Starring
KENT
TAYLOR

BOSTON BLACKIE

America's most successful mystery show! 58 high-scoring half hours with ratings like these: Birmingham 20.3, Buffalo 18.5, Mobile 21.0, Burlington-Plattsburgh . . .

25.2

America's
Favorite
Family Show!



Starring
MACDONALD
CAREY

DR. CHRISTIAN

39 quality-produced, success-proved half hours winning sensational ratings like these for the show that delivers the all-family audience: New Orleans 21.2, Kansas City 18.6, Cincinnati 20.2, Pittsburgh . . .

26.8

78
High-Rated
Half Hours!



Starring
DAVID
BRIAN

MR. DISTRICT ATTORNEY

Rated No. 1 nationally time after time! Look at these recent multi-run ratings scored by these authentic behind-the-scenes law-enforcement dramas: Portland, Ore. 24.4, Albany-Schenectady-Troy 18.4, San Antonio 19.2, Birmingham . . .

21.3

CURRENT FILES PACKED WITH SUCCESS STORIES

In market after market, for show after show, the story's the same: Economee TV series offer unlimited opportunities to strengthen programming, win larger audiences, build sales and profits! All series available for full or alternate sponsorship or as spot carriers to fit sales or program needs.

RATING-PROVED! ZIV-PRODUCED!

Economee TV

ECONOMEETV PROGRAMS, INC.,
488 Madison Ave., New York 22, N.Y.

Other Economee TV Series: The Unexpected, Your TV Theatre, The Eddie Cantor Comedy Theatre, Yesterday's Newsreel, Sports Album, The Living Book.

Action and
suspense . . .
romance and
humor!



Host
HERBERT
MARSHALL

TIMES SQUARE PLAYHOUSE

Top Hollywood stars, brilliant stories, and masterful showmanship in every half hour program. 39 exciting dramas with ratings like Philadelphia 13.6, St. Louis 19.5, Cleveland 20.6, San Antonio . . .

32.5

ALL RATINGS SHOWN ARB or PLUSE, 1958

Great new
stars in
each show!



Host-
Narrator
ADOLPHE
MENJOU

FAVORITE STORY

78 success-proved half hours based on stories written by the world's greatest authors. Charleston 18.3, Huntington-Ashland 22.1, Birmingham . . .

31.3

Puts a smile
in your
programming!



Starring
ANN
BAKER

MEET CORLISS ARCHER

39 sparkling half-hour situation comedies, lavishly staged, skillfully directed. Pensacola 17.4, Buffalo . . .

20.0

PLANE FACTS



"Northeast Airlines has been selling air travel on WRC Radio for less than one year and already the results are very gratifying. I'm sure the sound of quality on WRC is an important factor in the presentation of Northeast Airlines' sales message in the Washington market." (signed) JOEL S. DANIELS JR., ASSISTANT VICE PRESIDENT IN CHARGE OF ADVERTISING AND PROMOTION, NORTHEAST AIRLINES.

Further proof that The Sound of Quality is getting results for local and national advertisers on

WRC RADIO-980

NBC LEADERSHIP STATION IN WASHINGTON, D. C. SOLD BY NBC SPOT SALES

TIME OF TRIAL FOR RADIO NETWORKS

Mutual takes worst buffeting but others have their troubles, too

Radio networking today is in a ferment unmatched since its "crisis days" of the early 1950's.

Of all networks, Mutual last week faced the most trying difficulties (see page 36) but none was free of problems. All four national networks have been moving in different directions, each in the hope that its way is the right way, and some of the oldest, biggest and most respected affiliates have become so disenchanted that they are ready to forget networks and to try to set up their own substitute, a straight program service (BROADCASTING, Feb. 2, et seq.).

Network pricing has been and still is the prime target of network critics, both within and outside affiliate ranks, but the main fermenting agent at this point is the harsh but unchallenged fact that for the past two or three months the spot radio business has been in its worst doldrums since 1952.

Critics' Complaint • Historically, affiliates have complained that after television shoved network radio into a slide, the payments they received from the networks steadily diminished. Now two of the four networks—first Mutual and more recently CBS Radio—have abandoned cash payments as a basic form of compensation. With spot busi-

ness suffering too, the pain among these affiliates is becoming intense.

This at least is the argument advanced by some of the country's top stations, including affiliates of most of the networks.

But the networks take a different view. For the most part they are optimistic—some of them exuberantly so. This even though most of them acknowledge that network business, along with spot, is considerably less lively right now than it was a year ago.

Of the four networks, only one is not involved in some sort of affiliate relationship maneuver or other problem. The exception is ABC, which less than a year ago was on the verge of going out of business. While not quite left for dead, it suffered major program amputations but since has appeared to be regaining strength slowly through a cautious and conservative operation.

Mutual's Plight • Among the others, Mutual has been finding itself forced to operate in a sort of no-man's land. It either is being sold or it isn't—it's hard to tell from day to day—with the natural result that advertisers and agencies are cautious about new commitments. In addition there have been bookkeeping disputes with affiliates

about network payments, and last week affiliates were being told by AT&T representatives that it might be necessary to cut off line service unless network phone bills were paid.

CBS' PCP • CBS Radio meanwhile is putting into effect its marked departure from old-line network operation policies, the Program Consolidation Plan, involving a substantial cutback in program hours and substitution of free programs for money as basic compensation. And NBC, striding off in the other direction, is adding programming—but doing so in a way that has brought charges of "barter"—and is asking for network option time changes which some affiliates privately, if not publicly, deplore.

The most constant gripe among critics of networks, however, remains one of the oldest: prices. The networks, they contend, are selling so cheaply that all radio prices are debased. Why, they want to know, should an advertiser spend \$25 or \$50 for a spot announcement on a station when he can buy the same station, through a full-network order, for \$5 to \$10?

The rate cards lend some support to this arithmetic. A 7½ minute segment on CBS Radio, with approximately 200

CONTINUED on page 38



ABC's De Gray



CBS's Hayes

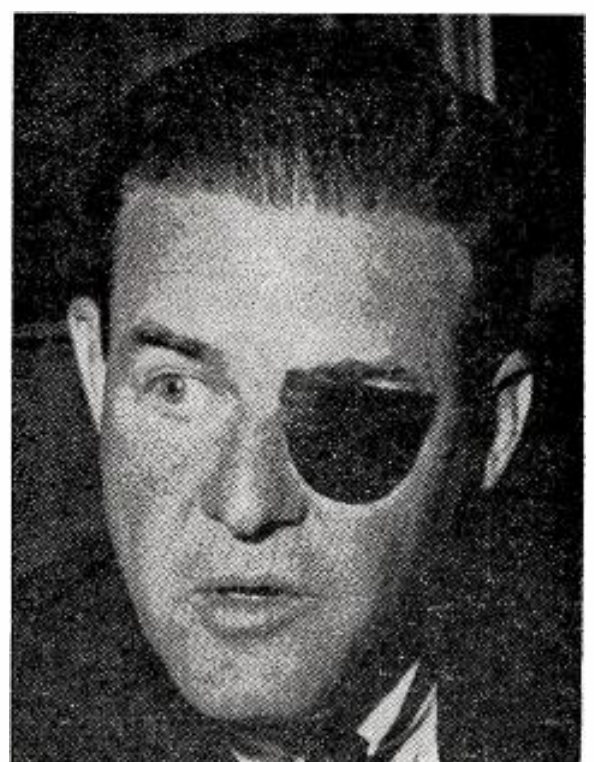

NBC's Culligan

SOS from Mutual as courts and creditors close in

The Mutual Broadcasting System was in danger of going under last week. It looked as though only a last-minute sale to a moneyed angel could keep it afloat.

That sale had not come through late Thursday night (March 5), although the network was breathing hard after at least one prospect who seemed interested in picking up the tab for Mutual's growing losses. Officials said they expected the deal to be completed Friday. Breathing hard after Mutual was AT&T, which says it wants overdue line charges paid (reportedly by this Wednesday) or it will pull the plug shutting the network off from its affiliates.

Some of those affiliates are impatient, too. It's known that Mutual is "in excess of \$100,000" behind in payments to an undisclosed number of affiliates. Some of them have threatened to disaffiliate if payment isn't forthcoming soon.

An authoritative source says that Mutual at this moment is \$1.05 million in the hole. Additionally, it was disclosed last week that an attorney for Hal Roach Jr., Mutual's chairman, told a U.S. district court that the network is losing \$100,000 a month. Earlier, papers filed with the Securities & Exchange Commission showed the network's deficits at some \$1.8 million last July 31.

Looking for Takers • Mutual started looking for a buyer shortly after Hal Roach assumed control of the F.L. Jacobs organization and its subsidiaries from A.L. Guterma, who until Feb. 13 was president of Mutual. The first hot prospect was Max Factor Co., cosmetics manufacturer. That sale fell through Feb. 27 (BROADCASTING, March 2), reportedly because Factor could not figure out how to apply Mutual's losses to its revenue in such a way as to gain a tax advantage.

On that same day Mr. Roach gave a 30-day option to sell the network to Robert Hurleigh, the network's Washington vice president, who immediately set out after other buyers. Mr. Hurleigh was being aided in his search by Blair Walliser, executive vice president; James Gladstone, MBS controller; Fulton Lewis Jr., network commentator, and Vic Diehm, chairman of the Mutual Affiliates Advisory Committee.

One of the buyers they were after is known to be Gordon McLendon, independent station operator who

owns KLIF Dallas, KILT Houston, KTSA San Antonio, KEEL Shreveport and WAKY Louisville. Mr. McLendon, who had trying experiences with another network operation (Liberty Broadcasting) some years back, reportedly decided to stick with his independent stations for the moment.

Any deal that Mr. Hurleigh, *et al.*, come up with will be subject to approval by both the SEC and a U.S. court before it can be consummated. Judge Sidney Sugarman of the U.S. District Court in New York imposed this condition when he granted a Jacobs motion to stay a Detroit court from taking action on a petition for receivership filed by Jacobs stockholders two weeks ago and returnable last Monday.

The attitude of urgency which surrounds Mutual's negotiations for a buyer has another aspect besides the demands of creditors. That's the possibility that a court-appointed receiver might take over the F.L. Jacobs Co., deposing Mr. Roach and conceivably nullifying the option Mr. Hurleigh holds to sell the network.

Roach's Problem • The SEC filed an affidavit Thursday asking that the court appoint a receiver to protect the company's stockholders and creditors. Judge Sugarman issued a show cause order on the receivership application returnable today (March 9) at 10:30 a.m.

The SEC labeled Mr. Roach a Guterma puppet, saying he "stands in the shoes" of Mr. Guterma and does not represent the best interests of both stockholders and creditors. Further, the SEC said, Mr. Roach



Mr. Hurleigh: he has the option

has not demonstrated either "business acumen or judgment" which would qualify him to run the company. The affidavit cited a number of transactions between Mr. Roach and Mr. Guterma which it alleged pose a "complete conflict of interest" between Mr. Roach and the Jacobs company.

Mr. Roach took over the company after saying he had acquired Mr. Guterma's 100,000 shares in return for releasing Mr. Guterma from some obligations. The SEC says those obligations are of "doubtful collectibility and origin." Beyond that, the SEC cites Mr. Guterma's having pledged these same stocks as making it questionable whether Mr. Guterma owned them in the first place.

How AT&T Fits In • The matter of continuation of AT&T's long line service to the network is crucial in the problems surrounding Mutual.

A week ago Thursday (Feb. 26) AT&T renewed its requests for money, saying that it would discontinue service the next day if the network couldn't raise it. It was then that Mr. Hurleigh reportedly went to Mr. Roach and got his option, subject to his getting AT&T to hold off.

Although acceding for the moment, AT&T has been notifying Mutual affiliates—according to affiliates—that it may be yet necessary to discontinue service. This Wednesday is that day most prominently mentioned as the deadline. AT&T declined to comment.

Meanwhile • The man whose troubles started it all found himself before still another court last week. The FBI arrested Mr. Guterma last Thursday on charges of participating in an unauthorized deal involving the Security National Bank of Huntington, N.Y. Mr. Guterma allegedly "counseled, aided and abetted" George A. Heaney, former president of the bank (Mr. Heaney was arrested several months ago), in obtaining \$500,000 in unauthorized financing from the bank. Mr. Guterma was released under \$15,000 bond. A hearing is set for March 23.

Mutual itself was carrying on as best it could. Charles Godwin, stations vice president, went on a closed circuit to affiliates last Thursday to inform them of progress in the sales negotiations and to assure them that no advertisers had left the network during the crisis period.

first again!

A W-I-T-H BALTIMORE EXCLUSIVE

Radio Press

DIRECT WORLDWIDE NEWS COVERAGE

Every hour, 24 hours a day, W-I-T-H RADIO PRESS brings the world's news into sharp focus. Expert news analysts, with reportorial minds sharpened by *personal on-the-spot* coverage, relay exciting eye-witness accounts to listeners while these events are headline-hot!

Small wonder that these direct W-I-T-H newscasts have already become a top audience attraction in the booming Baltimore market.

Get on the W-I-T-H RADIO PRESS sales steamroller! Choice time slots are now available.

W I T H

Tom Tinsley, *Pres.*

Radio Baltimore

R. C. Embry, *Vice Pres.*

National Representatives:

Select Station Representatives in New York, Philadelphia, Baltimore, Washington

Clarke Brown Co. in Dallas, Houston, Denver, Atlanta, New Orleans

McGavren-Quinn in Chicago, Detroit and on West Coast

Ohio Stations Representatives in the state of Ohio

WILS

**5,000
LIVELY WATTS**

LANSING

FIRST IN AUDIENCE

... more than 100% greater audience* than any station heard in the Lansing area.

FIRST IN POWER AND COVERAGE

With 20 times the power of any station in Lansing . . . WILS produces the most coverage for your money.

FIRST IN MICHIGAN'S MONEY MARKET

WILS reaches 210,490 Radio homes in the 17 county central Michigan area . . . 1st in Michigan in C.S.I.

CONTACT
VENARD
RINTOUL &
McCONNELL, INC.

*C. E. HOOPER



WILS
music news sports

ASSOCIATED WITH

CHANNEL 10
WILX-TV
LANSING • JACKSON • BATTLE CREEK
AND
WPON
PONTIAC

CONTINUED from page 35

affiliates, sells for \$3,100 or an average of about \$15 per station; on NBC a one-minute daytime participation is pegged at \$1,150, or \$5.75; on ABC five minutes is \$2,056 or about \$7, and on Mutual some five-minute periods are priced at \$500, or a little over a dollar a station. These are gross figures, before discounts.

Networks' Position • The answer of the networks, of course, is that they offer nation-wide coverage; that the nature of radio has changed and selling patterns have had to change with it; and that their prices are realistic, forced down by competitive pricing tactics.

In their most jubilant statement since PCP was announced, CBS Radio officials reported last week—after a review session with affiliate leaders—that PCP not only was going to succeed but that CBS Radio would be in the profit columns in 1960 for the first time—for any network—in years.

They cited Nielsen figures showing impressive audience gains for PCP programming in its first month, January, as compared to the ratings for pre-PCP December. President Arthur Hull Hayes said Nielsen's second January report showed a 27% average increase in CBS Radio program audiences and a 30% gain in share of audience. Moreover, he said, the data gives CBS Radio 23 of the top 25 network radio programs for the measured period.

Breaking it down, Mr. Hayes said that, as compared to the latest audience measurements before PCP was launched Jan. 5, the new report showed a 29% increase for the network's seven daytime serials; a 35% gain for Art Linkletter's *House Party*; a 5% increase for *Arthur Godfrey Time*; a 37% rise for Monday-Friday evening programs and a 14% boost for the afternoon and early-evening dramatic and Mitch Miller shows on Sundays.

"This," Mr. Hayes said, "confirms our belief that even the big lead held by our programs before PCP would improve with the better sequencing and improved clearances made possible by the plan. Stations have been emphatic in their approval of our mood-sequencing programming, and all have vigorously endorsed the network's action in designating 50 weekly newscasts as eligible for local sale."

The affiliates who met with CBS Radio officials—the executive committee of the Affiliates Assn.'s board of directors and consisting of Chairman Charles C. Caley, WMBD Peoria, Ill., John S. Hayes, WTOP Washington, and Lee B. Wailes, Storer Broadcasting Co.—were quoted as joining network authorities in hailing PCP as "a great boon to the program stability of the affiliate stations and a major contribution to

the maintenance of network service to the nation."

Signed and Unsigned • Mr. Hayes also reported that 174 out of some 196 affiliates have signed up under the new plan, agreeing to clear network programs in return for the 50 newscasts which they may sell without payment to the network. Ten other stations have cancelled since PCP was announced, and 12 others were classified as "undecided."

Mr. Hayes declined to identify the undecided dozen, explaining that he did not wish to embarrass them or in any way make it hard for them to get on the bandwagon. Those who do sign must do so retroactive to PCP's Jan. 5 starting date; this means that if they accept compensation while in the undecided period, they must refund it if they join up. Mr. Hayes said most of them had requested the network to withhold payments while they're making up their minds. In many cases, he said, the indecision lay not with the station operators but with their need to clear it with associates or higher management who were not available now for consultation.

All 12 of the undecided stations have been served with six-month cancellation notices by the network. This means they have until about July 1 to make up their minds.

Program Service • At least some of the 12 are among the approximately 40 affiliates, including NBC as well as CBS stations, who have been considering the formation of an alternative to network affiliation—a program service to be known as Radio World Wide. The RWW committee consists of John Patt of WJR Detroit and Herbert Krueger of WTAG Worcester, Mass., both of whom have disaffiliated CBS because of PCP, and Paul W. Morency of WTIC Hartford, an NBC affiliate.

These approximately 40 stations will hold a closed meeting in Chicago's Sheraton-Blackstone Hotel on March 17, during the NAB convention, and developments at that session could determine whether the CBS affiliates among them who haven't already signed under PCP, will do so or not.

Hayes Confident • Mr. Hayes and other CBS officials express complete confidence that PCP will work, and that perfectly satisfactory replacements will be found wherever needed. They reported 30 applications for new affiliates were received in 31 days after PCP was announced, and noted that they replaced KTUL Tulsa (5 kw, 1430 kc) with Meredith Publishing's KRMG (50 kw day, 25 kw night, 740 kc) within eight days after KTUL cancelled, and signed the Richmond *News-Leader* and *Times Dispatch's* WRNL (5 kw, 910



1st PRIZE

A ROUND TRIP TO ROME VIA KLM AIRLINES

Sam Vitt, Doherty, Clifford, Steers & Shenfield, N. Y.

2nd PRIZE

A WEST INDIES CRUISE VIA HOME LINES' M.S. ITALIA

Chester Slaybaugh, Ted Bates & Company, N. Y.

3rd PRIZE

1959 ROYAL PORTABLE TYPEWRITER

James Geffert, Cunningham & Walsh, N. Y.

4th PRIZE

HELBROS 17 JEWEL WRIST WATCHES

Helen Lavendis, Kenyon & Eckhardt, N. Y.—Robert Turner, Cohen & Aleshire, N. Y.—Murray Roffis, McCann-Erickson, N. Y.—Harriet Mados, BBDO, N. Y.—Al Sessions, Lawrence C. Gumbinner, N. Y.—Ellen V. Carlson, J. Walter Thompson, Chicago—Mary Ann Young, J. Walter Thompson, N. Y.—Marie Coleman, Donahue & Coe, N. Y.—Dorothy Glasser, Herschel Z. Deutsch, N. Y.—Marvin Berns, J. Walter Thompson, Chicago

5th PRIZE

ITALIAN CERAMICS & GLASSWARE

Irene Hess, Erwin Wasey, Ruthrauff & Ryan, Chicago—Ed Richardson, Geyer, Morey, Madden & Ballard, N. Y.—Sandy Metlis, The Metlis & Lebow Corp., N. Y.—Nancy M. O'Hagen, Wherry, Baker & Tilden, Chicago—Rose Ann Gordon, Kastor, Hilton, Chesley & Clifford, N. Y.—Mary Franklin, Doner & Peck, N. Y.—Sally Reynolds, Lennen & Newell, N. Y.—Marie Barbato, J. Walter Thompson, N. Y.—Jackie Moore, BBDO, N. Y.—Mary Cummings, Young & Rubicam, San Francisco—Lenny Kay, McCann-Erickson, Chicago—Henry Halpern, McManus, John, Adams, N. Y.—Otis V. Hutchins, Doyle, Dane & Bernbach, N. Y.—Cecilia Burchell, Sullivan, Stauffer Colwell & Bayles, N. Y.—Dell Zetlin, Michael Newmark Agency, N. Y.

These are the happy people who saved the most Wovbugs in the recent WOV CONTEST for Advertising Agency Personnel. Your prizes are on the way. We hope you enjoy them as much as we enjoy sending them along. We hope, too, that everyone who entered knows a good deal more about the great Negro Market and the tremendous Italian Market covered best in greater New York by WOV

WOV NEW YORK -ROME
Representatives: John E. Pearson Co.



They like PCP • Three affiliates voiced approval of CBS Radio's Program Consolidation Plan in talks with network executives during affiliates' meeting in New York. Left to right: James M. Seward, CBS Radio executive vice president; Charles C. Caley, WMBD Peoria, Ill., president of CBS Radio Affiliates Committee; Arthur Hull Hayes, CBS Radio president; John S. Hayes, WTOP Washington; William A. Schudt Jr., CBS Radio affiliate relations vice president; Lee B. Wailes, Storer Broadcasting Co.

kc) nine days after Larus & Bros'. 50-kw WRVA Richmond cancelled because of unhappiness over PCP.

In addition they noted CBS had just signed WHTN Huntington, W. Va. (1 kw daytimer on 800 kc) to replace WCMI Ashland, Ky. (1340 kc, 250 w), starting as secondary affiliate March 15 and as primary outlet July 26.

Stations which have cancelled and have not yet been replaced are WJR Detroit (50 kw, 760 kc), WTAG Worcester (5 kw, 580 kc), WJQS Jackson, Miss. (250 w, 1400 kc), WSAN Allentown, Pa. (5 kw, 1470 kc), WGUY Bangor, Me. (250 w, 1230 kc); WKNE Keene, N.H. (5 kw, 1290 kc) and WGIR Manchester, N.H. (5 kw day, 1 kw night, 610 kc).

While PCP's ratings are up substantially and station acceptance—currently at about 88% of the total rate card—appears to be giving officials no real concern for the future of PCP, it has been a different story in sales the last couple of months. But the same is substantially true at all four networks.

Sales Lag • A few weeks after PCP was announced, CBS took out ads announcing some \$4.1 million in sales during the first 30 days following the unveiling of PCP plans. Since then, however, sales have dropped off sharply. In the second 60 days following PCP's announcement, officials estimate, total sales have come to around \$450,000 to \$500,000.

Sales Slowdown Examined • Critics of network practices and of PCP specifically offer a number of reasons for the current slack in both spot and network radio business. One of the culprits they accuse is PCP itself.

By cutting back on programming, instituting a "barter system" for station compensation, and through continuation of long-criticized low-selling tactics, these critics contend CBS Radio has undermined confidence in the medium

to the point where buyers of spot as well as network are cautious to the point of being stand-offish. Only local business, they claim, is really standing up at this point.

These charges are by no means directed against CBS alone. All networks are equal targets—on the underpricing charge, especially. But some of the other networks hang their own slow sales on the PCP project. They, and others, contend that historically any major departure instituted by a network has at least a temporary depressing effect on all network radio business, while buyers sit back and wait to see whether the innovation will succeed or fail.

Recession Blamed • Another factor blamed, perhaps more than the network situation, is the general economic recession that hit the U.S. a year ago. Radio was the last to feel its effects, and to many observers what is happening now in network and spot business is to a great extent a delayed reaction to the overall recession.

While many advertisers moved into radio rather than risk big-budget television and print expenditures when the recession first struck, according to this line of reasoning, they returned to the higher-priced media without making adequate provision for radio when the downturn hit bottom and things began to brighten. Right now, these observers feel, with too many advertisers radio is in the unfortunate position of being an afterthought, getting little more than the leftovers from the basic budgets.

While CBS Radio, through PCP, is trimming its total programming NBC is moving in the other direction and adding programming—meanwhile seeking to capitalize on PCP by calling it a "drastic retrenchment" and "negative course."

NBC Plan • The essentials of the NBC Radio expansion, detailed a few

weeks ago by Matthew J. Culligan, executive vice president in charge of the network, call for the addition of five-minute *Stardust* entertainment vignettes—17 a day, mostly at 25 minutes past the hour—to be sold equally by affiliates and network. Each vignette will have two commercial positions, one 30 seconds and one 60, and NBC and the stations will alternate in selling them.

In connection with this new project, NBC Radio has asked the affiliates to sign new agreements changing network option time so that it will include the *Stardust* periods as well as the five-minute news-on-the-hour programs and other established option periods. The net result, it is understood, is that option time under the new plan would total 8 hours 50 minutes a day, Monday through Friday, as against about seven hours under the old plan (FCC regulations allow nine hours a day).

To help spur clearances for *Stardust*, NBC reportedly told stations last week that a leading cigarette—reportedly L&M cigarettes—stood ready to buy the entire network portion, about \$2.1 million worth. NBC hopes to get *Stardust* started, with this or another advertiser, around April 1.

While NBC officials reported that acceptances were coming in smartly—they estimated about 60 stations had been heard from, averaging 80% clearance, aside from o&o's and the affiliates committee, which they said had unanimously approved the plan—at least a few stations were known to be unhappy with the plan. Their opposition was directed especially to what they called "splintering effects" of the new option time periods. In nine instances, the new option periods would fall at 23:50 to 28:50 minutes past the hour. In the opinion of these stations, meaningful local programming around these minute islands would be difficult to achieve.

Under the *Stardust* plan, the stations will be compensated at regular rates for sales of the network portion of the time. In return for the half which they sell, they are charged flat co-op fees. The gimmick, NBC points out, is that the stations "can't lose"—if network compensation falls short of the co-op fee, then the network will waive the difference.

"Barter" Charged, Denied • Critics have different semantics for this arrangement. They call it barter. Unless a station clears virtually all 17 periods and the network sells all of its portion of their time, they calculate, the station will not get compensation exceeding what it has to pay in co-op fees. Hence, in practice, the deal would be one in which the station exchanged its time for programs which it can sell.

NBC, denying "barter," calls it a

IN INLAND CALIFORNIA (AND WESTERN NEVADA)

BEELINE[®]

RADIO

*delivers more
for the money*

The lure of the West continues. Throughout Inland California, population figures climb steadily to make it one of the fastest growing areas in the nation. For example, Sacramento county's population is up 63% since 1950 while retail sales in 1958 were 92.5% higher than in 1950. Impressive gains were also scored in other Beeline areas. All over this booming area, purchasers of homes, furniture, autos, appliances and all the necessities of life are listening by the hundreds of thousands to Beeline radio.

As a group The Beeline stations give you more radio homes than any combination of competitors . . . at by far the lowest cost per thousand.

**McClatchy
Broadcasting
Company**



SACRAMENTO, CALIFORNIA

PAUL H. RAYMER CO.
NATIONAL REPRESENTATIVE

KOH • RENO
KFBK • SACRAMENTO
KBEE • MODESTO
KMJ • FRESNO
KERN • BAKERSFIELD

A map of California is shown with several dots indicating the locations of Beeline radio stations. The dots are labeled with call letters and city names: KOH (Reno), KFBK (Sacramento), KBEE (Modesto), KMJ (Fresno), and KERN (Bakersfield).

New home construction in Sacramento county. The valuation of construction in Sacramento county in '58 was 98.7% more than in 1950.

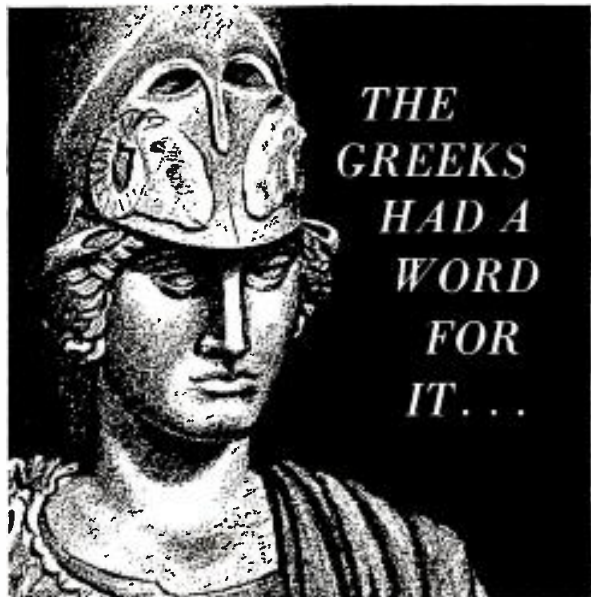

MINERVA ΣΟΦΙΑ Wisdom

MINERVA (Gr.—Pallas Athena) was thought by the Greeks to have had no mamma—supposedly she sprang, full grown and in full armor, from the brow of her father, Zeus (which strikes us as a likely story!). She may have given her father a terrific headache, but to the Greeks this goddess embodied Wisdom and Reason.

We like to think that a lot of agency time-buyers and WCKY advertisers have the same Minerva-like qualities of Wisdom and Reason, because after they have applied the logic of Reason to the buying of Radio time in Cincinnati, they exercise Wisdom in selecting WCKY to carry their advertising.

And the reasons are ample:

1. Adult listening audience
2. 50,000 Watts of Selling Power, covering ALL of the Cincinnati trading area.
3. Modern music, news and service, 24 hours a day.
4. Air salesmen who SELL your product.
5. Listener loyalty built over 30 years of broadcasting.

..... You can be a Minerva, too! Let Tom Welstead in WCKY's New York office or AM Radio Sales in Chicago and the West Coast, show you the REASON and the WISDOM in buying WCKY.

WCKY
50,000 WATTS
OF SELLING POWER

Cincinnati, Ohio

"deal" whenever station compensation does not equal or exceed the co-op fee, and points out, moreover, that none of this includes the money stations stand to make from selling their half of the time to local advertisers. They see it as a logical extension of their "local-national" sales plan, under which, they said, NBC affiliates in the last 18 months have sold 172,000 local spots related to network campaigns. The idea in the national plan is for stations to tie-in sales efforts with national campaigns, selling spots to the local outlets or distributors of the national advertisers.

NBC, which was severely hit some two and a half years ago when Westinghouse Broadcasting Co. stations disaffiliated to go independent, has been building gradually and, through such devices as "imagery transfer," "engineered circulation," the no-waste and national-local plans, has raised itself to a point where affiliates who once snarled in public were passing out garlands at the last NBC convention, four months ago.

Sales Claims • NBC officials, in detailing the network's progress, have claimed that better than 48% of all sponsored time on NBC, CBS Radio and ABC (Mutual figures were unavailable) was to be found on NBC. This claim backfired a bit last week following publication of a report, attributed to NBC corporate planners, estimating that the four radio networks last year totaled \$53 million in business, with \$21 million of this on CBS Radio, \$19 million on NBC Radio and the rest divided between ABC and Mutual. Said a CBS Radio executive:

"NBC claims it has 48% of the business, but this report says it has only 36% of the dollar. Apparently their corporate planners don't talk to their radio division, or vice versa."

The CBS executive also claimed the \$21 million estimate for CBS Radio's 1958 radio network business was substantially low.

NBC Radio authorities acknowledge that the pace of their sales has slowed "modestly" in the last couple of months. Early this year, after CBS advertised \$4.1 million in sales on the heels of PCP, NBC countered with an advertisement of its own. This claimed NBC Radio had racked up \$7.2 million between PCP's announcement and mid-January—compared to the \$4.1 million reported by CBS in the first 30 days after PCP was announced. Since then, NBC officials estimated last week they have signed \$3 to \$4 million more, and they predicted further gains in the near future.

ABC Rebuilding • ABC Radio meanwhile has been in a rebuilding operation ever since last spring, when officials

were on the verge of closing the network. The first step was to cut programming to the bone—primarily to *Breakfast Club*, newscasts and commercial religion—and the practice since then has been largely one of adding programs only if they have been sold (unless they're sold, officials point out, affiliates won't clear them).

Under Edward DeGray, vice president in charge of the radio network, ABC also is strengthening its affiliate lineup. It claims to have stations in more of the top 200 markets than either CBS or NBC, and reports continue to circulate that it will shortly tie-up with an important regional network. It also plans to put emphasis on closed-circuit meetings for advertisers, enabling them to address their dealers and distributors gathered at affiliated stations around the country and thus getting the affiliates in close touch with good local prospects. ABC's going in for exclusive public service features, is looking toward more sports coverage, is feeding news coverage beyond that broadcast on the network and, in general, feels things are looking up.

Radio World Wide • It is against this sort of overall network background that the movement for Radio World Wide, a straight program service which would sell no advertising, is shaping up. But it would be wrong to say that the movement results from anything the networks have done lately. Such a project has been in the talk stage for at least 18 months; the function of recent developments, notably PCP, was to turn the talk into action.

Whether it can be made to go, on the scale its planners envision, is under debate. At least some network officials maintain that it is much too costly ever to get off the ground. Its backers, however, are optimistic.

The start of operations, according to inside sources, is contingent upon commitments from at least 25 major stations in major markets for a minimum of two years at a subscription rate of 30 times the station's highest one-time, one-minute rate per week. The unofficial word last week was that 25 had not yet been signed. The objective is for RWW to make available to its member stations 40 hours of news and other programming a week—covering all major program categories—with subscribers free to use or not use what they want.

While RWW supporters voice pleasure at the way interest has picked up in the last few weeks, they emphasize that station managers usually must sell top ownership on the letter of intent. Ownership naturally covers a broad base—tobacco, newspaper, retail and many other types of corporations. The fate of RWW may be decided at the March 17 meeting.

MEDIUM MARKET SPOT SQUEEZE

BAR monitors find tv multiple spotting is widespread

A high incidence of multiple spotting by tv stations has been traced in 25 medium-sized markets selected geographically across the country.

The conclusion: "Questioned station practices affected television advertisers 5,036 times" during nighttime hours in those markets over the period surveyed.

The monitoring analysis was conducted by Broadcast Advertisers Reports Inc. and was revealed last week on a confidential basis to a limited number of agency and broadcast executives.

In distributing the full report also to news publications, BAR expressly requested that names of markets, advertisers and network shows listed in the 19 printed pages of tabulations not be revealed.

Multiplying and Subtracting • In the commercial areas covered, BAR drew attention to such specific practices as "triple" or "multiple spotting" and "clipping" by tv stations (clipping refers to stations nibbling away network time in order to place additional spots during program breaks).

Each of the markets was monitored

for a week, with the full job accomplished over an October-December period. In all, 71 stations were covered.

BAR said this was the first time it had monitored in these markets. The service only last fall upped its total markets to 75.

Last spring BAR checked multiple spotting in 20 of the nation's top markets and a scattering of smaller cities (LEAD STORY, June 23, 1958).

The Count • As summarized by BAR, the survey finds spot and network advertisers affected by:

Triple participations (60 sec.—10 sec.—60 sec. or less), 327 times; triple participations (over 60—10—60), 411 times; four or more participations back-to-back, 111 times; triple station breaks, 1,287 times; four or more spots in station breaks, 254 times; two 20-second spots between network programs, 306 times; crowded quarter hours, 389 times; competitive product conflicts, 262 times, and network advertisers affected by overtime local station breaks (clipping), 1,689 times.

Noted on station clipping was the

fact the practice is used primarily to accommodate triple- or quadruple-spotted breaks. Average length of such overtime breaks in the tabulation was 42 seconds.

Looked at carefully, too, were practices affecting national spot advertisers. Triple-spotting involved the majority of advertisers mentioned in the study, and triple-spotting extension into quadruple-spotting was recorded in 13 markets. One station placed six spots in a single break, the BAR study revealed.

Most Crowded • A leading advertiser's network and local spot schedules were involved 192 times and another heavy tv user was mentioned 137 times in the tabulations.

In the BAR reports, it is not possible to determine whether an advertiser mentioned is guilty in the multiple spotting or whether it is the station, or again whether the advertiser is victim of another advertiser's practice. An agency checking approximate dates and with knowledge of the markets most likely could dig out the information, however.

New media group debates single rate

The single-rate debate at the agency level surged on last Tuesday evening (March 3) as the newly-formed New York Advertising Media Planners held its first meeting.

Most of the 67 members and guests convened at the New York Advertising Club seemed in accord with speaker E.L. Deckinger, vice president of Grey Adv., who saw justification for multiple rates providing stations clearly define their policies and then stick by them.

From the station's viewpoint, Dr. Deckinger felt the relatively precarious nature of local retail advertising might tend to revert it to newspapers once a station introduced a single rate for both the local and national advertiser. Indicated was the hard pull over the years by radio to draw local retail business from newspapers, which have the dual-rate system.

Bryan Houston Vice President Robert Boulware added that ill-defined multiple rates, primarily in radio, make life miserable for national advertisers and their agencies who can never be sure

competitors are not receiving preferential treatment. He said the atmosphere is one of "all the traffic will bear."

The newly organized Media Planners, which will meet the first Tuesday of each month, has elected following officers: Newman F. McEvoy, senior vice president and media director, Cunningham & Walsh, president; W.E. (Pete) Mathews, vice president in charge of media, Young & Rubicam, vice president; J. Joseph Jr., vice president and media director, Heineman, Kleinfeld, Shaw & Joseph, secretary, and William Schink, vice president and media director, Basford Co., treasurer.

Pay on area sales not per inquiry—Hadacol

Hadacol Inc. is currently spending about \$1 million for spot announcements on 300 radio-tv stations in 14 southern states and plans further expansion of television into larger cities, it was reported last week.

At the same time, a novel "merchandising" pattern involving "different deals with different stations" and bypassing agencies and representatives, came to light in Chicago. Miss Victoria

Corcoran, Hadacol president, denied any of the various arrangements with stations represented "per inquiry" deals.

Some stations have been approached to carry new Super Hadacol spots and "earn a nice revenue by putting to work 'unsold time' that was earning nothing." They were advised Hadacol would pay them 35% of factory shipments into your primary area" in return for one-minute run-of-the-schedule spots, with the firm supplying films or transcriptions and copy.

One letter, signed by Miss Corcoran, stresses that, "no, this is not a P. I. deal. . . . You don't have to bother with mail or money . . . It's a confidential arrangement between you and us . . . advertising agencies and reps are not involved."

Miss Corcoran told BROADCASTING that the deals vary, depending on the station's reputation and power, market conditions, previous advertising factors and other factors, but declined to discuss them for competitive reasons. The present Hadacol schedule started Jan. 1.

Hadacol's regular agency is Mohr & Eicoff, which places some of its business, and specializes in direct mail sales through radio and tv.

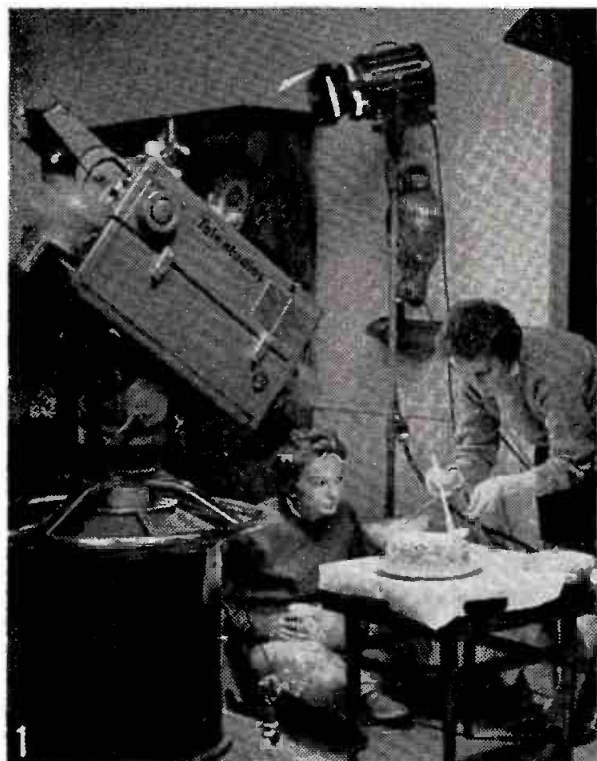

A cakeathon for General Mills, BBDO

The caloric intake shot up at Telestudios in New York when more than 100 cakes were used—and many consumed—for a day's taping of 10 one-minute tv commercials for 10 different cake and frosting mixes under General Mills' Betty Crocker label. The commercials will run in GM's daytime lineup on CBS-TV (*Love of Life*, *The Verdict Is Yours*, *Jimmy Dean Show* and *Secret Storm*).

Taping started at 10 a.m. on Feb. 27, and while lighting of the set was completed the night before, the lighting of the cakes (a key facet) started at 7 a.m. The day's operation was over, and 10 commercials on tape by 6:30 p.m., only 1½ hours behind a rigid schedule arranged by BBDO and General Mills (which originally gave only 30 minutes for both rehearsal and tape "take" for each commercial). To show other General Mills' agencies how Betty Crocker commercials are taped, the client, meantime, called in representatives of Knox Reeves, Tatham-Laird and Dancer-Fitzgerald-Sample to attend the morning session.

Cakes were baked at a home economist's kitchen some 40 blocks away (Telestudios is at Times Square), came in by messenger all day long and stacked in a freezer at the studio.

1 Camera is on the hands of Ann Zekauskas, home economist, who applies finishing touches to a cake made with Betty Crocker mix. Assisting her at left is her apprentice and sister, Betty Zekauskas.

2 Adelaide Hawley, who is identified on commercials as Betty Crocker, talks with package in hand about the cake mix product for General Mills during tape sequence.

3 Top management representing client, agency and studio confer in

clients room at luncheon break during all-day tape session: Joseph E. Ratner, director, creative and marketing services, and Joseph H. Weaver, manager of advertising services, both General Mills, Minneapolis; Kingsley Horton, sales manager, Telestudios; William E. Conner, BBDO broadcast account executive for General Mills, Minneapolis and New York, and Bernard Ryan, tv creative head for General Mills, BBDO, New York.

'Personality selling' big draw for RTES

Radio personalities featured at last week's timebuying and selling seminar put on in New York by the Radio & Television Executives Society proved their point on "personality selling" before they had uttered a word.

Gene Klavan and Dee Finch, the radio comedy team of early morning hours on WNEW New York, and Rage Cordic of KDKA Pittsburgh (Cordic & Co.) drew double the usual attendance at the weekly seminar.

Mr. Cordic told how he set out to "beat the formula stations" by getting people to listen to the words between the music and "if some of the words happened to be commercials—well . . ."

The Klavan & Finch team demonstrated their method of operation, "shock selling, no we mean *schlock* selling."

In a serious tone (which lasted but a few minutes) the two explained how they wove a routine around a "basic fact" sheet about a product. Only time they failed to draw a chuckle: Mr. Klavan pulled forth a sliderule, noting it was a "new device for timebuyers."

Parlay on Popeye brings in new money

A merchandising firm has parlayed a paying plan into a timebuy. But the time purchase is not in place of the merchandising; it's an addition.

The purchase is a 52-week contract by National Vitamin Pops Labs of Newark, N.J., on WPIX (TV) New York for two 20-second spots daily (Mon.-Fri.) for a new product, Popeye Vitamin Pops. It was arranged by Associated Artists Enterprises, New York, which handles merchandising for tv cartoon character Popeye. The timebuy began March 2.

If the purchase meets expectations, comparable purchases are expected in late spring on other tv stations which participate in the Popeye "merchandising network."

For merchandiser Associated Artists Enterprises, Popeye cartoons on tv certainly have been good.

These are the cartoons whose tv rights were acquired by Associated Artists Productions in July 1956 from Paramount Pictures Corp. and King Features for \$2,250,000. (AAP now is owned by United Artists and is known as United Artists Associated). AAE for nearly two years has been merchandising the Popeye cartoon character with some 40 stations taking part in a profit-sharing plan.

The animated 20-second commercial is built around a cartoon character who

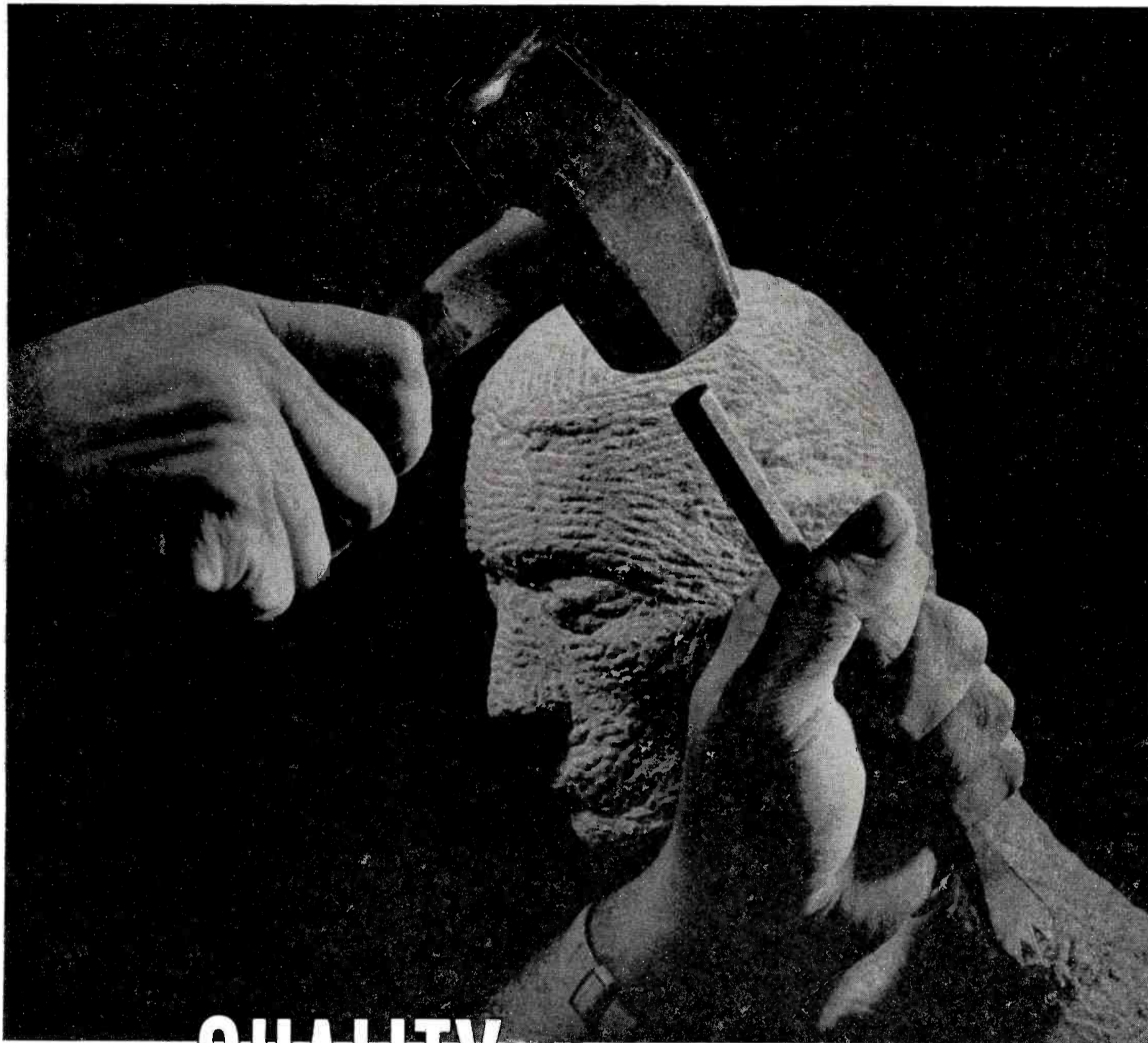

THE QUALITY TOUCH

The works of a master sculptor require no inscription to be recognized by the trained eye.

Similarly, that "quality touch" which sets apart great radio and television stations is just as quickly identifiable by those who know and value its importance in any successful campaign.



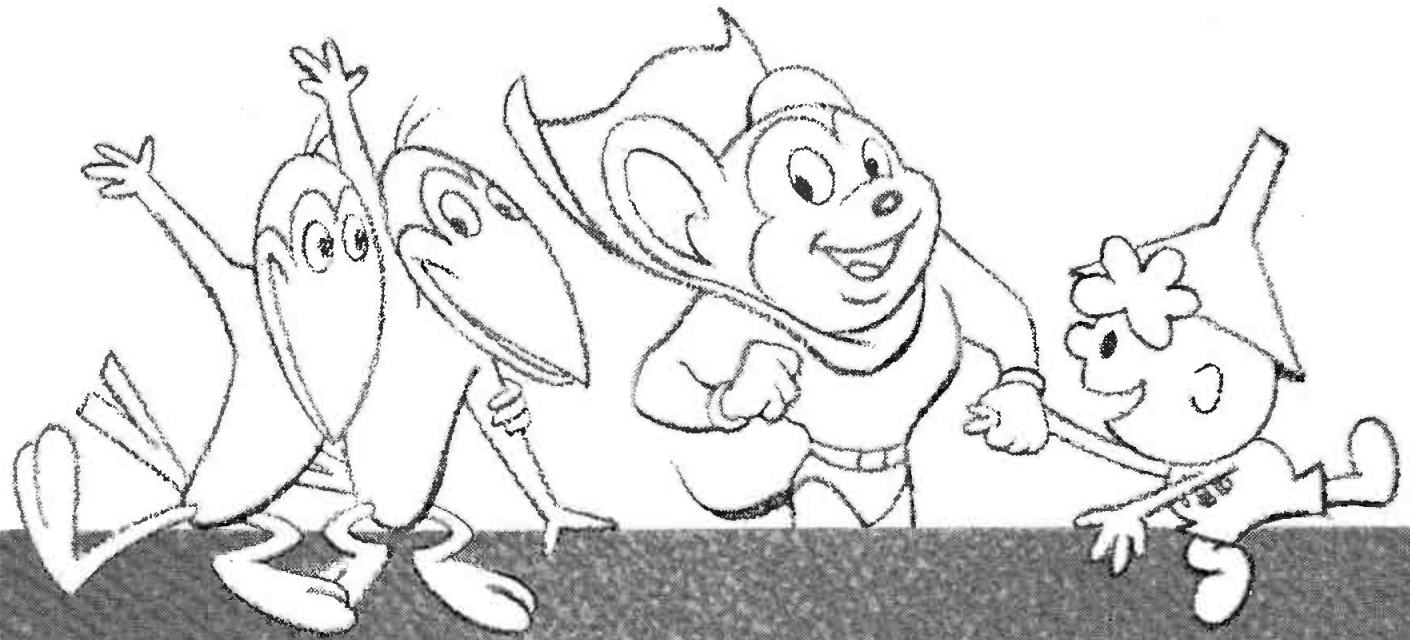

TERRYTOONS



TOP DRAWER

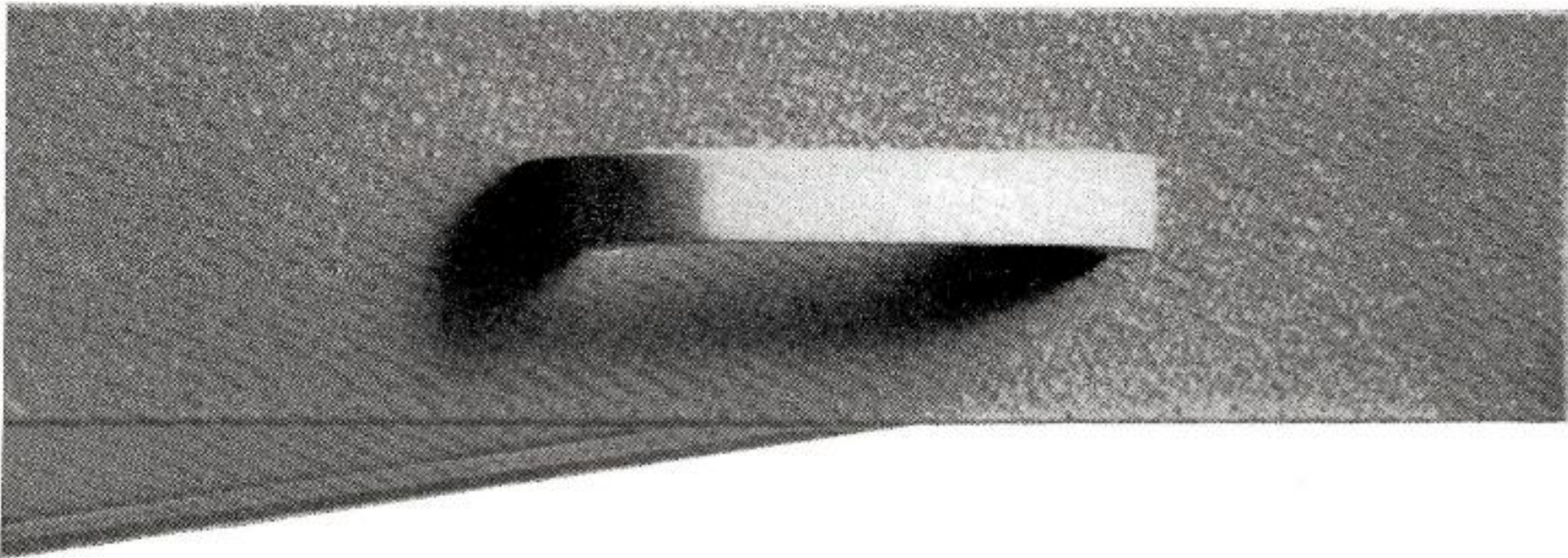

Commercial television or television commercials, TERRYTOONS does both equally well.

On the CBS Television Network, TERRYTOONS-created "Mighty Mouse Playhouse" and "Heckle and Jeckle" consistently rank among the top-rated week-end daytime programs. And "Tom Terrific," created by TERRYTOONS especially for television, has an audience of more than 3.5 million viewers daily, as a regular feature of the "Captain Kangaroo" show. (Nielsen)

This same ability to captivate millions can perform for you. For TERRYTOONS' full-time staff of nearly 100 artists, musicians, writers and technicians is at your service to create commercials combining entertainment savvy with creative, hard-hitting selling. Name your format: lowbrow or sophisticated; full animation, semi-animation, or animation mixed with live action. TERRYTOONS does the job for you...any or all of it!

Dozens of major agencies and advertisers have turned to top drawer TERRYTOONS for best-selling commercials. Why don't you?

A Division of CBS FILMS INC.  **TERRYTOONS**

flexes his muscles in the manner of Popeye. Theme of the commercial is that the lollipops contain several vitamins good for the children. Production was handled by David Piel Inc., New York, an animation studio.

At WPIX-TV, one commercial will be in the early evening adjacent to the Popeye cartoon show; the other will be run-of-station but past 7 p.m. (aimed at adults and mostly spotted in periods where motion pictures are shown).

Those unseen ads

Subliminal messages on television are a bit too subliminal—they just don't influence viewers.

This is the conclusion of two Indiana U. faculty members after five weeks of flashing stills on tv below the level of conscious perception. Robert M. Petranoff of the university's radio-tv department, and Prof. Melvin De Fleur of the sociology department, conducted their experiments regularly on WTTV (TV) Bloomington during a two-hour evening feature movie program.

The subliminal commercials were for

ACTIVITY

HOW PEOPLE SPEND THEIR TIME

There were 126,403,000 people in the U.S. over 12 years of age during the week Feb. 13-19. They spent:

2,148.9 million hours	Watching Television
1,079.8 million hours	Listening to Radio
474.5 million hours	Reading Newspapers
223.9 million hours	Reading Magazines
355.0 million hours	Watching Movies on Tv
91.9 million hours	Attending Movies

These totals compiled by Sindlinger & Co., Ridley Park, Pa., and published exclusively by BROADCASTING each week, are based on a 48-state, random dispersion sample of 7,000 interviews (1,000 each day). Sindlinger's weekly "Activity" report, from which these figures are drawn, furnishes comprehensive breakdowns of these and numerous other categories, and shows the duplicated and unduplicated audiences between each specific medium. Tabulations are available from Sindlinger & Co. within two to seven days of the interviewing week.

(Copyright 1959 Sindlinger & Co.)

SINDLINGER'S SET COUNT: As of Feb. 1, Sindlinger data shows: (1) 113,686,000 people over 12 years of age have access to tv (89.9% of the people in that age group); (2) 44,272,000 households with tv; (3) 48,879,000 tv sets in use in the U.S.

a grocery product and a news telecast. Messrs. De Fleur and Petranoff report that a study of the product's sales show no increase; the audience for the news-cast suffered a slight decline. The experimenters reported more positive reactions in closed-circuit tv tests with the subjects guessing which of several symbols was projected onto the screen.

\$171 million given public service ads

American advertising — advertisers, agencies and media—put \$171 million behind 18 public service advertising campaigns of the Advertising Council during 1958, Allan M. Wilson, Ad Council vice president, reported Monday (March 2) to the Hollywood Ad Club. A 15-minute color sound slide film was shown, summarizing one of the Council's major achievements of the year, the "Confidence in America" campaign which started on radio last April, added other media until a total of more than \$10 million in time and space had been contributed and by August was credited with restoring public confidence and ending the recession.

Also marking Advertising Council Day at the Hollywood Ad Club, the Assn. of State Foresters presented to Russell Z. Eller, advertising director of Sunkist, a resolution of appreciation for his service since 1942 as volunteer coordinator of the oldest continuing Ad Council campaign, to prevent forest fires. In this period the acreage lost through forest fires has dropped from 31 million acres in 1942 to three million last year. Mr. Wilson, on behalf of the Council, also presented Mr. Eller with a special Smoky Bear award for the 1958 forest fire prevention campaign.

Agencies hear plea for humorous tv spots

Radio-tv producers should cooperate more closely with their agency copywriters on the utilization of humor in commercials, Edward J. Graham Jr., president of Goulding-Elliott-Graham, told a Chicago Agency Producers' Workshop session.

But, Mr. Graham said, inducing humor in commercials is a "tricky"



NO, THIS IS "KNOE-LAND"

(embracing industrial, progressive North Louisiana, South Arkansas, West Mississippi)

JUST LOOK AT THIS MARKET DATA

Population	1,520,100	Drug Sales	\$ 40,355,000
Households	423,600	Automotive Sales	\$ 299,539,000
Consumer Spendable Income	\$1,761,169,000	General Merchandise	\$ 148,789,000
Food Sales	\$ 300,486,000	Total Retail Sales	\$1,286,255,000

KNOE-TV AVERAGES 79.4% SHARE OF AUDIENCE

According to December 1958 ARB we average 79.4% of audience from Sign On to Sign Off 7 days a week. During 363 weekly quarter hours it runs 80% to 98%.

KNOE-TV

Channel 8

Monroe, Louisiana

Photo: Forest Products Division, Olin-Mathieson Chemical Corp, West Monroe, Louisiana.

CBS • ABC

A James A. Noe Station

Represented by

H-R Television, Inc.

YOUR BEST LINK WITH THE MARYLAND AUTOMOBILE MARKET

SELLING AUTOMOBILES ?

**WBAL-Radio
and
WBAL-TV are
Maryland's Best
Automobile Salesmen!**

New cars, used cars,
American cars, foreign
cars . . . WBAL-Radio
and WBAL-TV sell more
cars faster in Maryland.

When you want to sell
automobiles, beer, cigars,
cigarettes or any
product or service . . . be
sure you get Maryland's
best selling job from
Maryland's best salesmen—
WBAL-Radio and
WBAL-TV.

**WBAL-Radio and
WBAL-TV sell more
people more of the time**

WBAL-TV

Baltimore, Maryland
Channel 11 N.B.C. Affiliate
Nationally represented by
Edward Petry & Company

WBAL-RADIO

Baltimore, Maryland
50,000 Watts N.B.C. Affiliate
Nationally represented by
Henry I. Christal Company 

Maryland's only Radio and vhf Television Combination

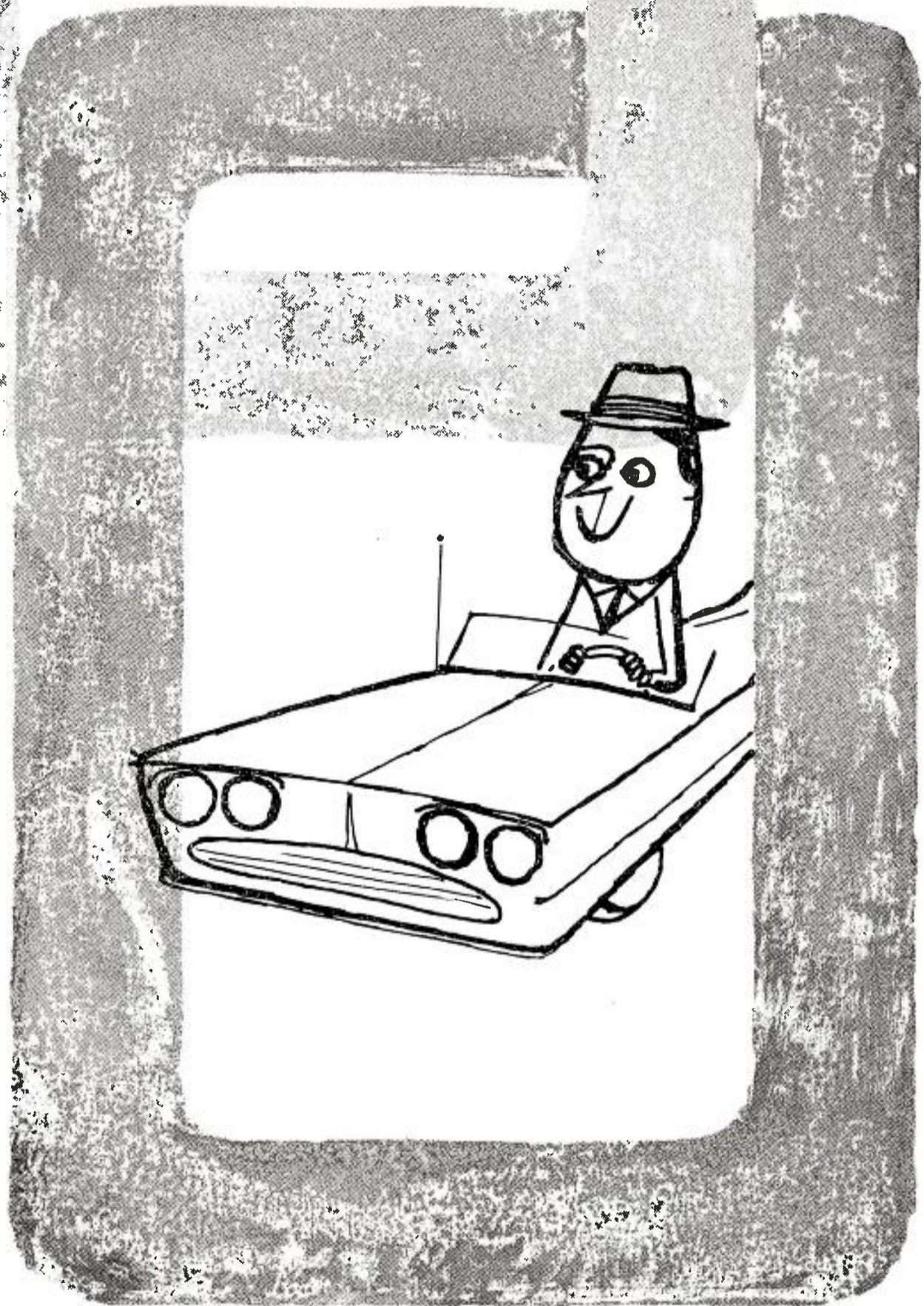



ARBITRON'S DAILY CHOICES

Listed below are the highest-ranking television network shows for each day of the week Feb. 26-Mar. 4 as rated by the multi-city Arbitron instant ratings of American Research Bureau.

DATE	PROGRAM and TIME	NETWORK	RATING
Thur., Feb. 26	Real McCoys (8:30 p.m.)	ABC-TV	27.0
Fri., Feb. 27	77 Sunset Strip (9:30 p.m.)	ABC-TV	24.5
Sat., Feb. 28	Gunsmoke (10 p.m.)	CBS-TV	28.0
Sun., March 1	Maverick (7:30 p.m.)	ABC-TV	24.1
Mon., March 2	Danny Thomas (9 p.m.)	CBS-TV	27.0
Tue., March 3	Some of Manie's Friends (7:30 p.m.)	NBC-TV	32.5
Wed., March 4	Wagon Train (7:30 p.m.)	NBC-TV	26.6

Copyright 1959 American Research Bureau

business and should be limited to those product categories which provide a "natural setup" for their use. G-E-G is an organization devoted to production of tv commercials, comprising Mr. Graham; Robert B. Elliott, secretary, and Raymond W. Goulding (Bob and Ray), treasurer.

Chicago Agency Producers' Workshop also elected new officers, including Lee Randon (Henri, Hurst & McDonald), president; Clair Callihan, (Earle Ludgin & Co.), vice president; Dwight Reynolds (Young & Rubicam), secretary, and Rolf Brandeis (Edward H. Weiss & Co.), treasurer.

The new organization plans to hold monthly meetings to exchange views and problems in radio-tv production,

according to Mr. Randon. For the March session, APW will take over the Ampex Corp. suite at the NAB Convention in the Conrad Hilton Hotel (March 18, 1 to 2 p.m.) to witness videotape recording developments.

• Business briefly

Time sales

• Continental Wax Corp., Mt. Vernon, N.Y., has started a \$1.5 million spring campaign for its Six Month floor wax, with nearly total reliance on broadcast media. Included are six new markets—Washington, Baltimore, Boston, Chicago, Providence and Portland, Me.—using two weeks of 10-second radio spots over at least two stations per

market, each station averaging 250 spots per week. A Tv campaign follows 20 stations in these markets, averaging 75 spots per week per station agency: Product Services Inc., N.Y.

• Kings Wine Co., Philadelphia, kicks off a television spot campaign on seven stations Saturday (March 14). The campaign, featuring "The Frenchman" (a character established three years ago), will place up to 25 spots a week on some of the stations, lasting through April.

• Dr. Pepper Co., soft drink, Dallas, Tex., to sponsor *Pepper-Upper Time Starring Eydie Gorme*, starting April 6 on ABC Radio (Mon.-Wed.-Fri., 6:50-6:55 p.m. EST). The new musical series marks Dr. Pepper's first use of national network radio and the first network radio show for Miss Gorme. The order was placed through Grant Adv.

• Reynolds Metals Co., through Lennen & Newell, N.Y., and Miller Brewing Co., through Mathisson & Assoc., both Milwaukee, have ordered *All Star Golf* on 160 ABC-TV stations, Saturdays, starting Oct. 10. The series, owned by Glen Films and distributed by Walter Schwimmer Co., is in its third year. Peter DeMet is producer and Sidney G. Goltz director.

• ABC-TV will present an hour-long musical fable, *Art Carney Meets the Sorcerer's Apprentice* (Sun., April 5, 5-6 p.m.), sponsored by Minnesota Mining & Mfg. Co. Mr. Carney is to be the only human visible, with supporting roles to be played by Bil Baird Marionettes. Production staff for the show, which is based on music of Paul Dukas, is almost entirely the same as last November's *Art Carney Meets Peter and the Wolf*. Agency: BBDO.

Agency appointments

• Farber Bros. (pillows and hassocks) and Schilling Motors, both Memphis, Tenn., name Simon & Gwynn Adv., that city.

• Formfit Co. (foundation garments), Chicago, appoints Tatham-Laird, that city, as third U.S. agency to share in \$1 million account. Clinton E. Frank (which handles tv) and MacFarland, Aveyard & Co., both Chicago, will continue as other agencies.

• Salada-Shirriff-Horsey Ltd. appoints Leo Burnett Co. of Canada Ltd. to handle advertising for its Salada Tea and Shirriff and Lushus desserts, effective April 1. The account previously was handled by McKim Adv. Ltd.

• Watchmakers of Switzerland, with Foote, Cone and Belding until late last year, has named Cunningham & Walsh

*More than a decade
of Constructive Service
to Broadcasters and the
Broadcasting Industry*

HOWARD E. STARK
Brokers — Consultants

50 EAST 58TH STREET NEW YORK, N. Y. ELDORARO 5-0405

NAB Convention
Conrad Hilton Hotel Suite 933A-34A For Appointments

From left to right: Bob Crane, Russ Arms, Bill Weaver and, of course, The Great Godfrey. They—and a lot of other highly talented people—have three things in common. Each is a live and lively specialist in personal entertainment. Each creates the kind of setting in which your message is heard—and heeded. Each is featured on KNX Radio. Indeed, that's the kind of setting that helps make KNX what it is—Southern California's leading radio station!



Represented by CBS Radio Spot Sales

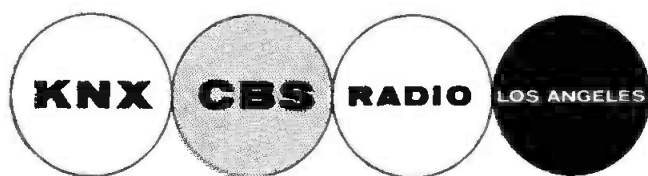

WGN-RADIO

**A clear channel
voice serving
rural and small
town America in
the great Midwest**



IN addition to the best in music, news, sports and public service,
WGN RADIO offers the most comprehensive coverage of
events of interest to Rural Mid-America:

AUGUST, 1958

WGN's daily (Mon.-Sat.) noontime "Country Fair"* program originates from the Illinois Farm Bureau Tent at the State Fair. It ran for five days and included interviews with the top livestock winners.

SEPTEMBER, 1958

WGN co-sponsors "Tractorama" from Anchor, Illinois—acts as co-host to more than 75,000 people—and originates five broadcasts from the site of the two-day farm event. It included a speech by the Honorable Ezra Taft Benson, U.S. Secretary of Agriculture.

OCTOBER, 1958

Interviews are recorded at the Annual Convention of the Future Farmers of America in Kansas City for playback on WGN's "Country Fair" and "Milking Time"** weekday programs.

NOVEMBER, 1958

"Country Fair" originates for five days from the International Dairy Show—and includes interviews with winning exhibitors as well as prominent people in the dairy world.

WGN Farm Director and his assistant cover the State Farm Bureau Conventions in Illinois, Indiana, Michigan, Wisconsin, and Iowa during October and November. "Country Fair" originates from the Illinois convention for three days.

Farm director covers annual convention of the National Grange at Grand Rapids, Michigan, and State Grange Conventions in Illinois, Michigan, Indiana and Wisconsin, and reports to midwest listeners.

DECEMBER, 1958

Farm Director covers and reports on annual convention of the American Farm Bureau Federation in Boston.

Interviews are recorded with winners of 4-H Projects at the National 4-H Club Congress held in Chicago for broadcast on "Milking Time" and "Country Fair."

"Country Fair" originates for five days from the International Live Stock Exposition and includes exclusive interviews with the Honorable Ezra Taft Benson, U.S. Secretary of Agriculture and the important livestock men in attendance.

JANUARY, 1959

WGN Farm Director covers and reports on the Annual Convention of the National Council of Farmer Co-Operatives in New Orleans, Louisiana.

When the nation makes farm news, WGN is there first! First with the best in coverage for the rural and small town audiences in the middlewest.

WGN-RADIO 441 NORTH MICHIGAN AVENUE, CHICAGO 11, ILLINOIS

*WGN Farm Director, Norman Kraeft, conducts "Country Fair," 12:10-1:00 P.M., Mon.-Sat.
**Assistant WGN Farm Director, Joe Gregory, conducts "Milking Time," 5:30-6:00 A.M. Mon.-Fri.
Four market reports Monday thru Friday 9:04 A.M., 9:58 A.M., 11:28 A.M., 2:04 P.M.

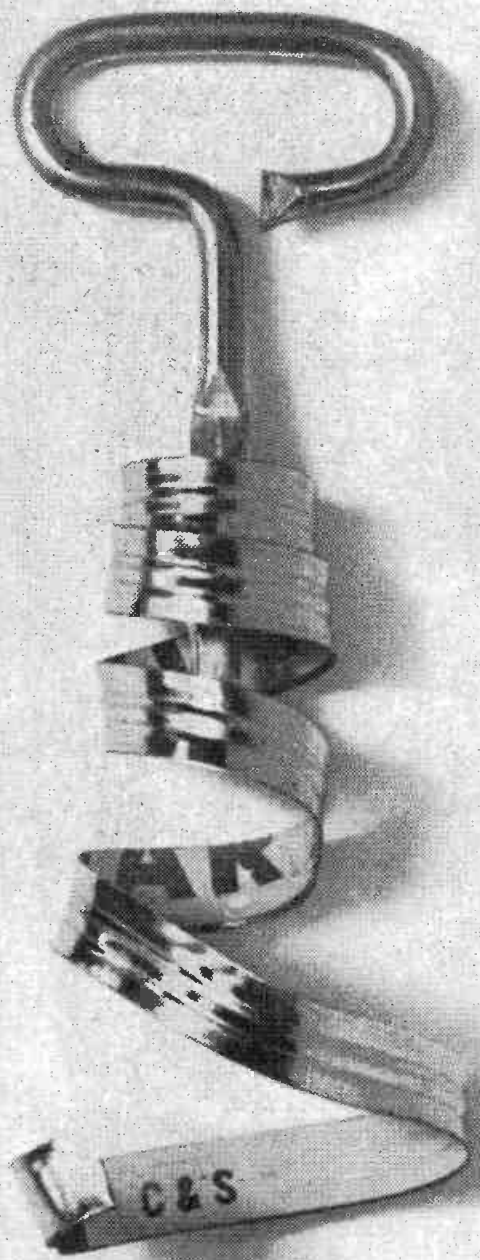

STANDARD BRANDS spends most, by far, of its network radio dollars on CBS Radio. Where the most popular program "brands" are! This network has delivered largest commercial minute audiences all along. And the new Program Consolidation Plan—with unified station clearances and strong program sequencing—will increase this leadership.

CBS RADIO NETWORK:

42% LARGER AUDIENCES PER COMMERCIAL MINUTE THAN ANY OTHER RADIO NETWORK, AVERAGING OVER 16 CONSECUTIVE MONTHS.



Como takes the cheese • Signing what is believed to be the biggest money contract for the personal services of any star in television to date, Perry Como agrees to sing for his supper to the tune of Kraft Foods Co. for the next two years on NBC-TV in the Wednesday 9-10 p.m. period. The \$25-million deal covers time, talent, production and guest stars. The 104-week cycle (including 66 colorcasts) starts the end of May with film summer replacements produced by Mr. Como's Roncom Productions. Mr. Como begins his own show for Kraft Sept. 30. Agency: J. Walter Thompson Co.

As befits any \$25-million signature, the event was well witnessed by numerous lawyers, photographers and "star" executives including (l to r): Robert E. Kintner, NBC president; J.C. Loftis, president, Kraft Foods Div. of National Dairy Products, and Robert W. Sarnoff, NBC board chairman.

Why did Kraft put so many eggs in the Como basket? "As Kraft's business expands, and as our need for ever stronger communications with consumer and food retailer alike grows, we seek expansion of our tv programming," said Robert A. Davis, Kraft advertising manager.

But that's no solace to NBC-TV in one sense. Who goes on after Como in the prime Saturday 8-9 p.m. time which the singing star now vacates this spring?

as new agency. Though broadcast media were not used in the past, they may be included in C&W's planning.

• Also in advertising

• James Thomas Chirurg Co., Boston and New York advertising agency will move its headquarters to a new two-story building in Chestnut Hill, Mass. President Wallace L. Shepardson announced that his company expects to complete the transfer from Boston to Chestnut Hill by May 1. This move follows last month's transfer of the agency's New York office to a floor at 60 E. 56th St.

• The Advertising Federation of America has established an annual award for contributions by advertising people to a better public image of the advertising industry. Anyone engaged in advertising may submit nominations to a selection committee composed of Robert E. MacNeal, president, Curtis Publishing Co., Philadelphia; AFA Vice Chairman James S. Fish, vice president and advertising director of General Mills, and Arthur C. Fatt, president, Grey Advertising. Nominations for initial awards, to be presented at the AFA June convention in Minneapolis, should be sent to 250 W. 57th St., New York, before the May 1 deadline.

Sinclair wins round in Outlet sale fight

The contentious Providence, R.I., department store-radio-tv properties sale received a setback last week when a Rhode Island Superior Court judge granted a preliminary injunction.

The ruling brings to a halt for the time being the \$12 million sale of the Outlet Co. to William Zeckendorf, New York realtor, and John C. Mullins, Denver broadcaster (BROADCASTING, Jan. 26; Dec. 15, 8, 1958).

The suit to stop the sale was brought by Joseph (Dody) Sinclair, general manager of WJAR-AM-TV, and grandson of the founder of the Rhode Island multi-million dollar department store.

Judge Joseph Mullens concluded that one of the trustees, the Industrial National Bank of Providence, has brought about such "a conflict of interest between itself individually and as trustee of so substantial a nature as to prevent the exercise of its independent judgment of the Sinclair trust in determining upon a sale" and that "complainant Sinclair and his children as contingent beneficiaries will suffer some detriment." He also ruled that the trustees did not perform their duties during the 20-day period after execution of the sale contract, resulting in "a probable failure to obtain a higher price for the Outlet stock."

Under terms of the agreement, the buyers offered to pay \$120 a share for the Outlet Co. stock. The agreement involved about 55% of the 55,230 shares outstanding. The contract provides, however, that the buyers must secure 70% of the outstanding stock.

During the court trial, Mr. Sinclair offered \$122.50 per share for the stock. His backer, United Printers & Publishing Co. (greeting cards), is controlled by Louis and Jack N. Berkman, principals of the Friendly Group of radio-tv stations.

KLEO blasts print ads

KLEO Wichita has drawn a bead on the American Newspaper Publishers Assn.'s new "total selling" approach and is countering local newspaper advertisements with its own barrage, it was learned last week.

Starting the weekend of Feb. 28-March 1, KLEO has been running minute announcements aimed directly at Wichita businessmen. The spot campaign, to be concentrated on weekends, is designed to offset full-page house ad-

vertisements placed twice weekly by the *Wichita Eagle* and *Wichita Beacon*, according to Kenneth R. Greenwood, general manager of KLEO (formerly KANS).

The themes will be varied and imply the inequality of comparisons between newspaper readership and audience rating figures as between apples and oranges, Mr. Greenwood told BROADCASTING. The first theme: "There must be a reason." And the next: "Why do newspapers themselves run full-page ads to sell themselves and urge you to take out quarter pages?"

The announcements use the alternating two-announcer technique. Sample from this past weekend's script: (First Announcer)—"There must be a reason why the newspapers have suddenly found it necessary to personally acclaim their sales ability. (Second)—Why has an advertising medium that has always been supposedly the "end all" of advertising embark on an obvious campaign to re-sell itself? (First)—There must be a reason. (Second)—At KLEO we know the reason. We know why. There is a simple explanation. The facts can be backed up with eloquent proof. The lower advertising cost of radio, the greater sales effect of

radio is just part of the reason. If you are a man who advertises a service or a product we suggest you get the story . . ." The announcement closes by asking the listener to contact KLEO.

As to "the reason" itself: newspapers were appraised of it in considerable detail by ANPA's Bureau of Advertising at the "total selling" convention of the Newspaper Advertising Executives Assn. in Chicago early this year. Various newspaper groups agreed to launch an all-out campaign to raise overall revenues from \$3.2 to \$3.5 billion in 1959 (BROADCASTING, Jan. 26). It was presumed the Wichita newspapers' drive was based on mats or at least ideas suggested by ANPA.

Station rating use up to raters—NAB

It's up to radio research and survey companies to police the way stations promote their findings, according to NAB's Radio Research Committee.

Acting on an NAB Radio Board suggestion, the committee last Thursday (March 5) released a set of minimum standards to be used in preparation of radio survey reports.

Copies of the standards along with text of the committee's resolution were distributed to NAB radio member stations and to radio survey and rating companies. The committee recommended:

Standard Preface • "Each radio survey report should be prefaced by a statement including the following minimum specifications:

"1. The dimensions of the audience surveyed: State which persons in the household were interviewed. State what household radios were included. State whether out-of-home listening was included. If included, state what types of listening were covered (e.g., whether the survey counted in auto radio, listening in public places, etc., specifying those places included).

"2. The area surveyed: Specific information covering location of sample households and individuals reported upon; whether by city limits, metropolitan area, county, or other. Area should be *clearly defined!*

"3. The method of survey: State how information was obtained, whether by telephone coincidental, recall, or combination of these two; personal interview at home whether coincidental, recall, or a combination of both; mail ballot, diary or log; mechanical recorder or other.

"4. Size of sample: The number of



Managers meet • McLendon station managers held their annual sales meeting Feb. 23-27 in New York City. William Morgan (standing l), vice president, announced that sales revenues for the five McLendon stations increased 23% over the previous year. Seated l to r: Jack Fiedler, KTSA San Antonio; Charles Farmer, WAKY Louisville; Richard Wilcox, KEEL Shreveport. Standing with Mr. Morgan of KLIF Dallas is William Weaver of KILT Houston, Tex.

CBS Owned KMOX-TV's
and sky-high tower have

TALLEST IN ST. LOUIS — 1,214 FEET — 651 FEET HIGHER THAN THE OLD TOWER!

first by a wide margin,

7,100 SQUARE MILES MORE COVERAGE — AND A CRYSTAL-CLEAR SIGNAL EVERYWHERE!

rating services, channel 4

and handsome new

A PRETTY PICTURE: BIG AUDIENCE LEADERSHIP... BROAD NEW COVERAGE!

advertisers in the rich

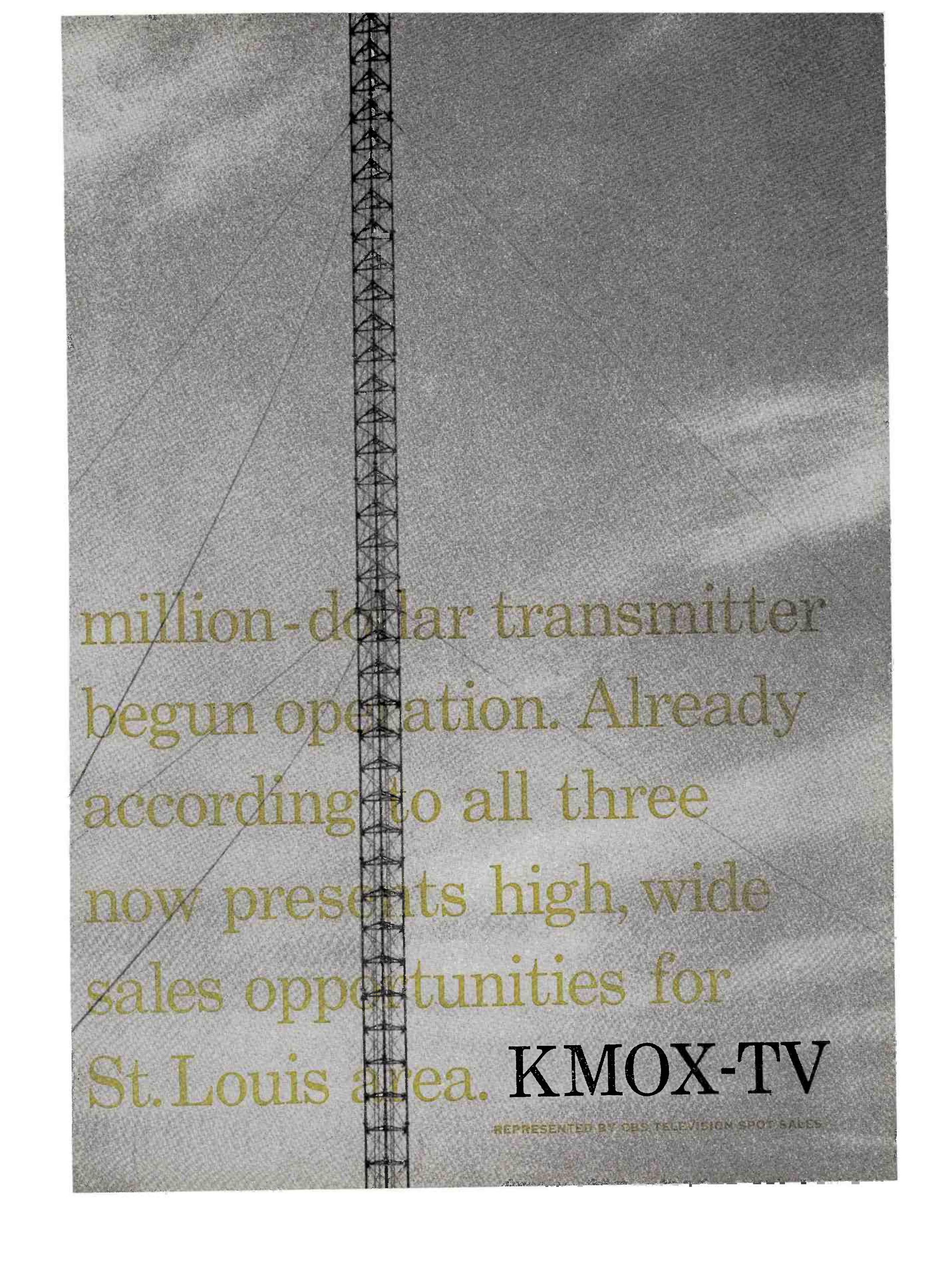

million-dollar transmitter
begun operation. Already
according to all three
now presents high, wide
sales opportunities for
St. Louis area. **KMOX-TV**

REPRESENTED BY CBS TELEVISION SPOT SALES

completed interviews, diaries or logs, ballots, mechanical recordings, must be reported. This information, both overall in relation to population of universe measured and per program or unit of time measured, should be clearly stated.

"5. Survey dates: Date(s) the survey occurred must be reported."

Signers • Members of the Radio Research Committee are E.K. Hartenbowler, KCMO Kansas City, chairman; George H. Clinton, WEBC Duluth, Minn.; Simon Goldman, WJTN Jamestown, N.Y.; Charles E. Hamilton, KFI Los Angeles; Harper Carraine, CBS; Dr. Thomas E. Coffin, NBC and Harold Cranton, ABC.

Trees may shadow uhf

The screening effect of trees and foliage may be one of the most significant factors in the loss of signal strength in the uhf band. This was the finding of a report submitted to the Assn. of Maximum Telecasters last week. The field test on 483.26 mc was made during December 1958 and January this year at Salisbury, Md., using ch. 16 WBOC-TV Salisbury (620 ft. antenna height above average terrain). Measurements over this flat terrain were made using an antenna 30-ft. above ground.

The report was submitted to the

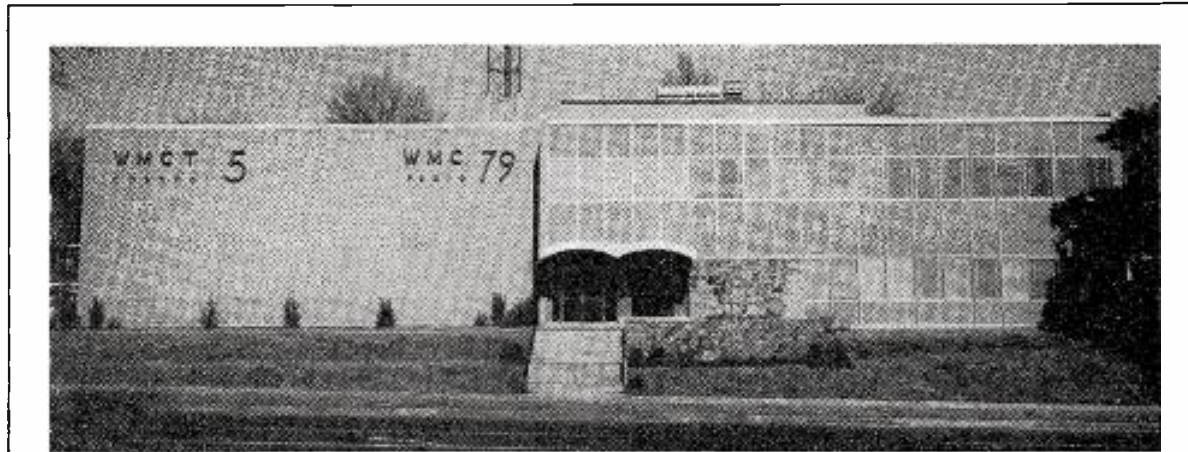

New home • WMC-WMCT (TV) Memphis is now occupying new studio-office building. The plant contains 29,000 square feet of floor space, cost \$1 million. The stations are licensed to Memphis Publishing Co., publisher of the *Memphis Commercial Appeal* and *Press-Scimitar* (Scripps-Howard), and are affiliated with NBC.

AMST engineering committee which met last Tuesday (March 3) in Washington. Present at the meeting were Joseph B. Epperson, WEWS (TV) Cleveland, chairman; Orrin W. Towner, WHAS-TV Louisville; John H. DeWitt Jr., WSM-TV Nashville; Henry Rhea, WFIL-TV Philadelphia, and Tom Howard, WBTB (TV) Charlotte, N.C. Also present were Lester W. Lindow, AMST executive director; Ernest Jennes, Washington attorney for AMST, and Howard T. Head, AMST engineering consultant.

Three RKO stations adopt 'common image'

RKO Teleradio Pictures Inc. is close to molding its stations into the "common image" charted for them some time back. On March 16, KHJ Los Angeles, KFRC San Francisco and WNAC Boston will inaugurate music and news formats. The move toward a uniform look for the stations began at WHBQ Memphis more than a year ago.

When the RKO Teleradio stations adopt similar programming features, it will be possible to attract advertisers through consolidated sales techniques, an RKO spokesman said. Historically the stations have the reputation of being "talk" stations. The current move is to reach an adult audience through a music-news and "lively" disc jockey approach, he explained. No date for a format change at CKLW Windsor, Ont.-Detroit has been announced. WOR New York and WGMS Washington will be unaffected, the spokesman said.

New Yorkers hear of cooperation need

Speakers at the second annual legislative dinner of the New York State Assn. of Broadcasters in Albany last Tuesday (March 3), including FCC Comr. Robert E. Lee and Gov. Nelson A. Rockefeller, stressed the need for closer cooperation between the broadcasting industry and the government.

Robert J. Leder, vice president and general manager of WOR-AM-TV New York and president of the association, told the assemblage of more than 300 broadcasters and legislators that NYSAB was moving toward "extremely closer liaison" with members of the state legislature. He pointed out that since New York State is searching continually for new tax revenues and is scrutinizing the public aspects of broad-

21 YEARS of dynamic selling

Welcome to our
Hospitality Suite 1900,
Conrad Hilton Hotel
NAB Convention
March 15 - 18

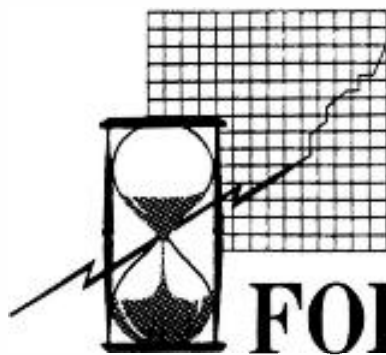

FORJOE & CO., INC.

NATIONAL STATION REPRESENTATIVES

Sales Offices in NEW YORK • CHICAGO • LOS ANGELES
SAN FRANCISCO • PHILADELPHIA • ATLANTA
Headquarters — 580 5th Avenue, New York 36, N. Y.

**MEET
THE
BRITISH
PEOPLE
IN...**

Topic



Joan and Julius Evans visit an automobile factory in Coventry . . . one of their many interesting and informative TOPIC jaunts.

A new series, a new look at Britain and the British today . . . through the eyes of Joan and Julius Evans, an American couple abroad.

You will meet an attractive lady chemist with definite views on marriage and careers . . . a 20th Century "Mr. Chips" . . . an out-of-fiction London cabbie . . . a dedicated atomic physicist . . . a pretty young theater hopeful . . . a Rhodes Scholar from North Carolina . . . and many others.

Among the places you will visit are Bohemian Soho, busy London Airport (where jets came of age), Ulster (which sent America 14 Presidents), Harwell (crucible of nuclear research) and rebuilt Coventry, Britain's Detroit.

"TOPIC" is no quaint tourist trip . . . but rather, a frank and friendly visit with an energetic and dynamic people, and their country . . . it's exciting, stimulating TV, a *must* for your *best* public service time!

13 Quarter-Hour Programs—FREE for TV!

Write NOW for first-run availabilities in your area.
Call your local BIS man or contact—



Radio — Television Division

BRITISH INFORMATION SERVICES

an Agency of the British Government
45 Rockefeller Plaza • New York 20, N. Y.

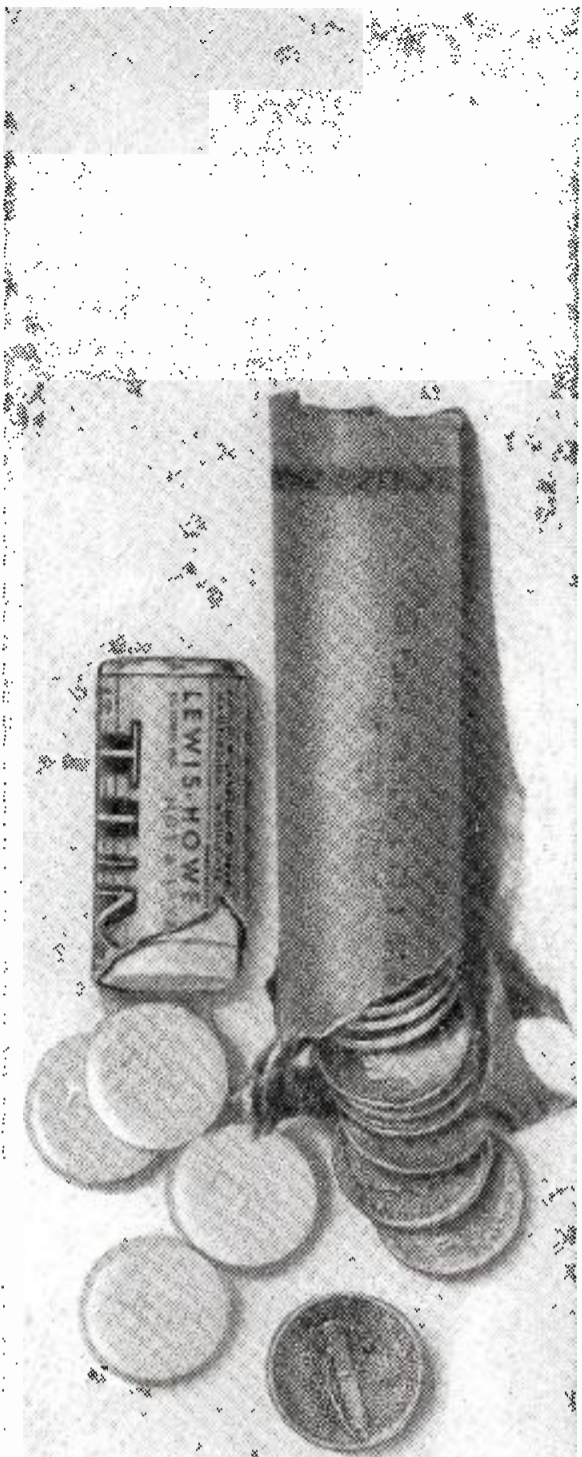

LEWIS-HOWE is one of many leading companies making major investments on CBS Radio since PCP. Best new prescription for advertising efficiency! This network has delivered largest commercial minute audiences all along. And the new Program Consolidation Plan—with unified station clearances and strong program sequencing—will increase this leadership.

CBS RADIO NETWORK:

42% LARGER AUDIENCES PER COMMERCIAL MINUTE THAN ANY OTHER RADIO NETWORK, AVERAGING OVER 16 CONSECUTIVE MONTHS.

casting, station owners and officials must solidify their association with legislators as a means of heading off "discriminatory and unfair bills."

He cited the annual legislative dinner as an example of a move towards cooperation, stating this event "has done more to establish a mutually beneficial rapport between broadcasters and the legislators than anything the association had done previously." Mr. Leder added that since NYSAB had retained an attorney to report on all bills related to broadcasting, association members were "more aware of the continuing legal situation than they had been before."

Comr. Lee suggested to the New York State Legislature that a state broadcasting liaison body, similar to the FCC's National Advisory Board, be appointed to work closely with state officials in the organization and development of a statewide defense program. Mr. Lee outlined the CONELRAD system of instantaneous warning and denied reports that the system was outmoded.

Gov. Rockefeller told the group that the State of New York would cooperate fully with any broadcasting committee organized to develop a civil defense program. He also urged broadcasters to carry programming that would provide "more complete information about the various aspects of government rather than spotlighting only the controversial."

KIT sues Pulse

KIT Yakima, Wash., has announced filing of a \$15,000 damage suit against The Pulse Inc., charging survey results published last year had been defamatory to the station. The suit asks for \$10,000 damages to business reputation, and \$5,000 for business lost as a result of Pulse reports. Pulse Inc. spokesmen withheld comment pending study of the complaint.

Media reports

- KSD-AM-TV St. Louis reports that more than \$85,000 has been contributed to its fund for the victims of the January tornado (BROADCASTING, Feb. 16). The money was raised with the help of the *St. Louis Post-Dispatch*, parent company of the stations.

- KICU (TV) ch. 14 Bakersfield, Calif., scheduled to commence operations by next July, will be affiliated with ABC-TV. Studios and offices will be in downtown Bakersfield.

- KFHA Tacoma-Lakewood, Wash., has started broadcasting with 1 kw on 1480 kc. Robert E. Hall, partner in the new station, is general manager of KFHA, which is co-owned by Adlai C. Ferguson Jr. (WPRS-AM-FM Paris,

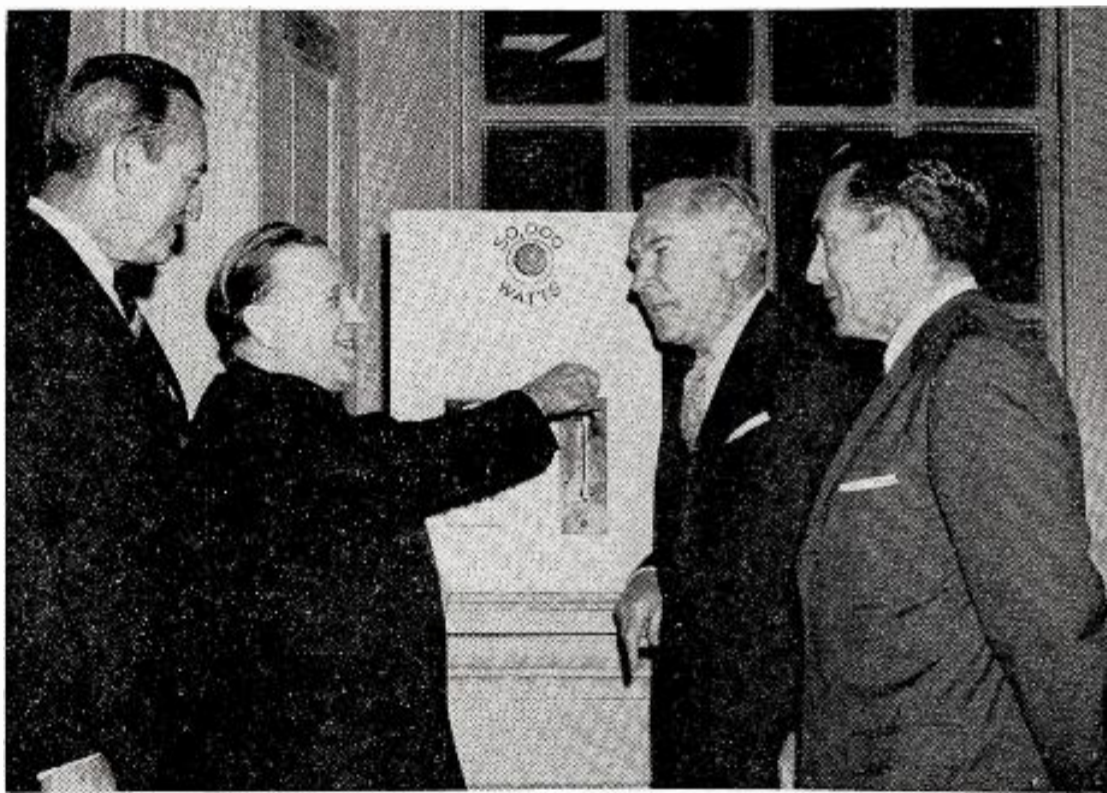

Power boost blast-off • WIBG Philadelphia goes from 10 to 50 kw, as state and station officials preside at switch-throwing ceremonies in Independence Hall Feb. 23 (BROADCASTING, March 2). L to r: Stanton P. Kettler, vice president, operations, of Storer Broadcasting Co., which owns WIBG; John Morgan Davis, lieutenant governor of Pennsylvania; Lee B. Wailes, Storer executive vice president, and Glenn G. Boundy, vice president, engineering.

DRAW!

Take a bead on KFMB Radio in San Diego. Because here in the 19th market people are working, playing and buying at breakneck speed and KFMB is their reflection. Friendly voices with wonderful music. Authoritative voices with factual news from CBS, from our own reporters covering a market that relies on us to get the news first and get it right. Intimate voices with variety programming. Overall, a sound that has caught the bounce, verve and life of the San Diego area and has captured its ears as no other radio ever has. It all adds up to the biggest audiences in the better part of Southern California. It's no time to hold your fire in San Diego. Shoot straight at it with KFMB Radio. DRAW NOW!



KFMB RADIO  **SAN DIEGO**

REPRESENTED BY EDWARD PETRY & CO., INC.

Don't knock!

just come in

SUITE 1119A

Step into our NAB convention headquarters at the Conrad Hilton anytime it's convenient.

Our TV-Radio staff from all over the country will be assembled there to greet you.

They will rejoice in your good fortune or sooth troubled brows. They might even have some interesting news for you.

They all join in best wishes for a most successful convention—one that will give you a personal lift to do an even better job in 1959.

That is our sincere hope for all the folks in the broadcasting industry.

ALLEN KANDER AND COMPANY

*Negotiators for the Purchase and Sale of
Important Radio and Television Stations*

WASHINGTON 1625 Eye Street N.W. NAional 8-1990

NEW YORK 60 East 42nd Street MUrray Hill 7-4242

Ill.). Gregg Martin, formerly of the staff of Ohio State U., is in charge of programming.

- WHOO Orlando, Fla., has moved to 311 N. Rosalind Ave. The station spent \$110,000 to remodel the new quarters.

- Edward Petry & Co. has moved into new Los Angeles offices at 3424 Wilshire Blvd. Telephone: Dunkirk 8-1143.

Changing hands

ANNOUNCED • *The following sales of station interests were announced last week, subject to FCC approval:*

- WALT Tampa, Fla.: Sold to Consolidated Sun Ray Drug (WPEN-AM-FM Philadelphia) by multiple owners Emil Arnold, Robert Wasdon and Jack Siegel for \$300,000 (CLOSED CIRCUIT, March 2). The sale was handled by Blackburn & Co. WALT is on 1110 kc with 10 kw, day, directional antenna.

- KSDA Redding, Calif.: Sold to Van C. Newkirk, Beverly Hills, Calif., advertising agency principal by Kal Lines, trustee appointed by the court following bankruptcy proceedings, for more than \$20,000. The sale was handled by Wilt Gunzendorfer & Assoc. KSDA is on 1400 kc with 250 w.

- KRFO Owatonna, Minn.: 25% sold to Arnold K. Schumann by Ivan Earl Gilbert for \$15,000 cash. Remaining 25% equal partners in KRFO are Robert W. Behling, Gerald J. Boos and Duane Allen. The sale was handled by Haskell Bloomberg. KRFO is on 1390 kc with 500 w, day.

APPROVED • *The following transfers of station interests were approved by the FCC last week (also see FOR THE RECORD, page 91):*

- WHAM, WHFM (FM) Rochester, N.Y.: Sold to Genesee Broadcasting Corp. (Henry I. Christal Co. and Combined Century Theatres Inc.) by Riggs & Greene Broadcasting Corp. for \$838,580. WHAM is on 1180 kc with 50 kw and is affiliated with NBC. WHFM is on 98.9 mc with 20 kw.

- WFEA Manchester, N.H.: Sold to WFEA Broadcasting Corp. (William F. Malo Jr., president) by Public Information Inc. (a Rahall Stations interest) for \$275,000. WFEA Broadcasting Vice President Frank E. Pellegrin has interests in WATO Oak Ridge and WLAJ LaFollette, both Tennessee. WFEA is on 1370 kc with 5 kw, directional antenna same pattern day-night.

- KAIR Tucson, Ariz.: Sold to Andrew J. Griffith Jr. and Jerome K. McCauley by Joe Dumond Radio Enterprises Inc. for \$175,000. KAIR is 1490 kc, 250 w.



James W. Blackburn—Washington



Jack V. Harvey—Washington



Joseph M. Sitrick—Washington



Clifford B. Marshall—Atlanta



Stanley Whitaker—Atlanta



H. W. Cassill—Chicago



William B. Ryan—Chicago



Colin M. Selph—West Coast

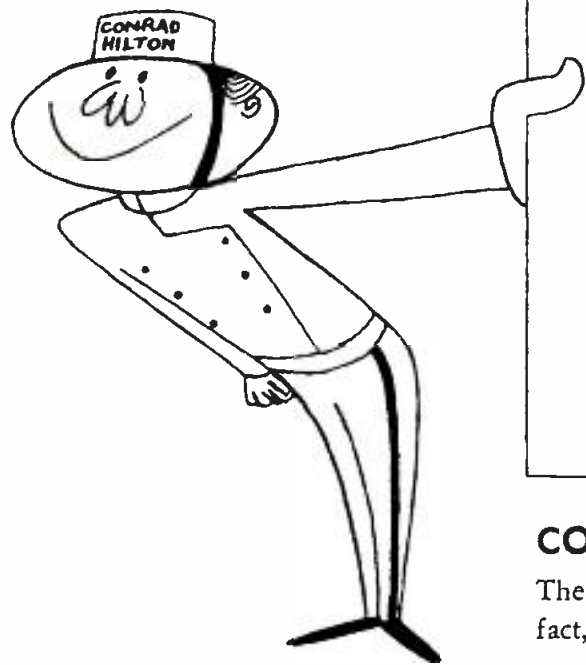

*An invitation to visit us
during the V.I.B. convention
Chicago
Conrad Hilton Hotel
Suite 1322-23-24
March 15-18, 1959*

CORDIALLY EXTENDED BY OUR NATION-WIDE STAFF .

The one time during the year you'll meet them all under one roof (as a matter of fact, the only time we will!) . . . both hospitality and information will be on hand . . . so accept our invitation to enjoy both old and new friendships . . . see you there!
Conrad Hilton Suite 1322-23-24

Negotiations — Financing — Appraisals

Blackburn & Company

RADIO - TV - NEWSPAPER BROKERS

WASHINGTON, D. C. OFFICE

James W. Blackburn
Jack V. Harvey
Joseph M. Sitrick
Washington Building
STerling 3-4341

MIDWEST OFFICE

H. W. Cassill
William B. Ryan
333 N. Michigan Avenue
Chicago, Illinois
Financial 6-6460

SOUTHERN OFFICE

Clifford B. Marshall
Stanley Whitaker
Healey Building
Atlanta, Georgia
JACKson 5-1576

WEST COAST OFFICE

Colin M. Selph
California Bank Bldg.
9441 Wilshire Blvd.
Beverly Hills, Calif.
CRestview 4-2770

TV SPACE RELAYS SOON?

GE experts get Congressional backing for early launching

Live radio-tv transmissions via space satellites are just around the corner, a team of top scientists told the House Science & Astronautics Committee last week.

In fact, this breakthrough in communications is so close that one congressman recommended an immediate postponement of military space shots and lunar probes with the missiles thus freed to be used to launch communications satellites in orbit.

The experts, in testimony last Wednesday (March 4), discussed many different sizes, shapes and types of satellites, some almost ready for launching and others in the distant future. There was general agreement that it would be up to the government to place the first communications satellites in orbit with private industry taking over as soon as possible.

R. P. Haviland, General Electric engineer, said that presently available rockets of the Atlas type could immediately put communications satellites weighing 500 pounds in orbit.

"I am personally convinced that the most important application of satellite vehicles is in the field of civilian and commercial communications," he told

the committee, which is holding hearings on international telecommunications and communication satellites.

These small satellites, he said, would be a means of securing immediate space communications, preceding much larger manned satellites in the future (see picture). Sixteen of the smaller satellites in low orbits, each costing about \$2.5 million, would be necessary for worldwide coverage, Mr. Haviland estimated. Up-keep would be about \$50 million yearly, "not an insignificant sum but certainly within the budget capabilities," he said. This type of satellite would be solar powered.

Immediate Use Possible • The basic know how for continued expansion of the established communications system through space is available, the GE engineer said, only detailed engineering now is required. "We can immediately extend present communications, first by single satellites, then by a network. . . . With further development of the satellite, we can start other services, such as relaying television signals between continents. Later we can establish worldwide television broadcasts and other worldwide services."

Mr. Haviland also discussed at length

the larger satellite which would be utilized in the future. It would contain living quarters for personnel, with three such vehicles needed to cover the entire earth. They would orbit 22,000 miles above the earth and would transmit tv, radio and special communication signals.

He estimated that the cost of such a satellite would be \$2 billion, but that the cost per communication channel would be relatively low. These large stations are within reach, Mr. Haviland said, but it will be a number of years before they will be built.

"Passive" Satellites • Dr. John R. Pierce, director of research for Bell Telephone Labs, discussed balloon-type "passive" satellites which merely would reflect tv signals back to the earth. With 24 such balloons, any given portion of the earth could receive worldwide communications 99% of the time, he said. The spheres, 150 feet in diameter, orbiting 3,000 miles above the earth, would be made of Mylar and coated with a very thin layer of aluminum.

Large and expensive ground installations would be needed to transmit the signal to the satellite, Dr. Pierce said, but the equipment could be easily installed and repaired. Signals to the earth would be very weak and the public would need highly sensitive receivers with elaborate outside antennas.

The balloon, one-quarter of a millimeter thick, would be inflated by water evaporation after it reaches its orbit. It would be only 30 inches in diameter prior to inflation. After inflation, it would reflect 98% of the signal energy it receives.

Advantages of Balloon • This type of satellite would be practically impossible for foreign powers to jam the scientists agreed, and Mr. Pierce pointed out it contained no parts to wear out. He said however that in the long run it may be less economical than "active" satellites containing their own sources of power and transmitting equipment.

"It could be well worth the expense and the effort to try to get satellite communications immediately regardless of how reliable it will prove or how costly," Dr. Pierce concluded. He pointed out the National Aeronautics & Space Administration plans to put up a balloon satellite for its own use within a year (BROADCASTING, Feb. 9).

Edgar M. Cortright chief of the NASA advanced technology program,

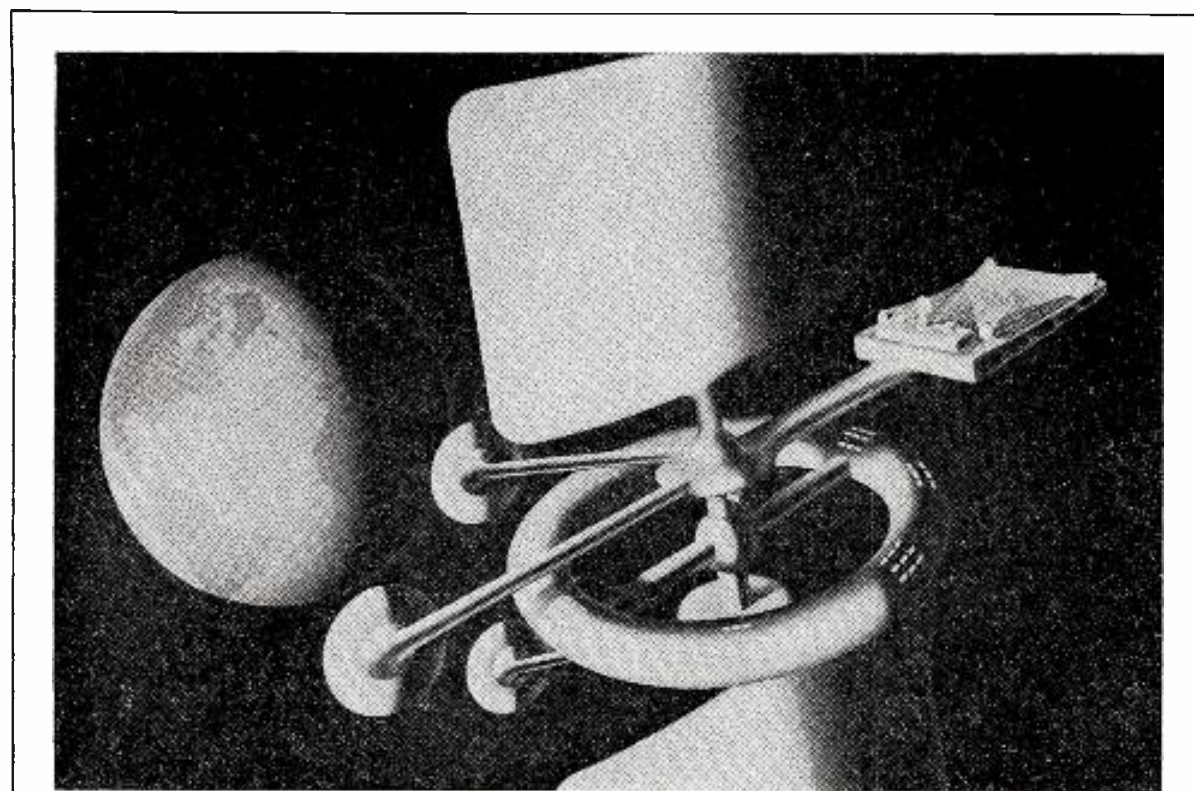

Relay station • This the \$2 billion communications satellite for the future as envisioned by GE, three of which would be placed in orbit to provide live, worldwide tv coverage. In the center is a rotating wheel containing living quarters, with two major antenna reflectors above and below. Small side antennas would be used for reception and transmission of signals. The platform sticking out to the side would serve as a landing field for space ships.

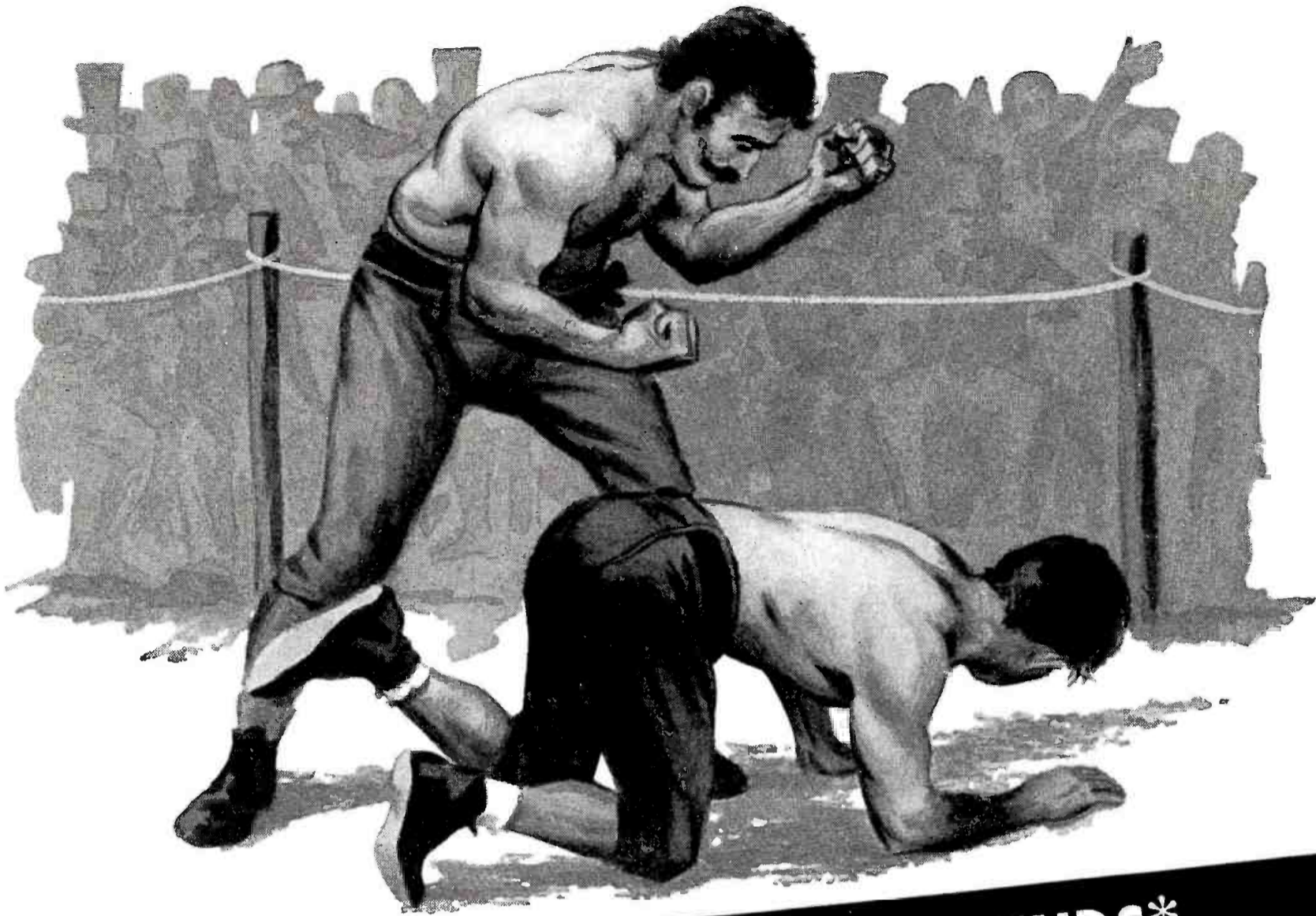

YOU MAY NEVER GO 75 ROUNDS* —

**BUT... WKZO-TV Gives You
The Old "One-Two" Punch
In Kalamazoo - Grand Rapids!**

**NCS No. 3 CIRCULATION
SPRING, 1958**

STATION	DAYTIME		NIGHTTIME	
	DAILY	WEEKLY	DAILY	WEEKLY
WKZO-TV	265,990	390,330	386,280	472,250
Station 'B'	202,190	314,950	304,780	384,570
Station 'C'	152,910	264,330	222,400	349,890

Lead with WKZO-TV and you'll take sales "off the ropes" in Western Michigan! WKZO-TV covers more television homes than any other station in its area — 606,780 homes in 34 counties according to NCS No. 3.

NCS No. 3 shows that WKZO-TV gives you more circulation by far — monthly, weekly, daily — than any other Michigan station outside of Detroit!

And remember that by adding WWTV, Cadillac, to your WKZO-TV schedule you'll *get all the rest of Michigan worth having!*

**On July 8, 1889 John L. Sullivan beat Jake Kilrain for the heavyweight championship in 75 rounds.*

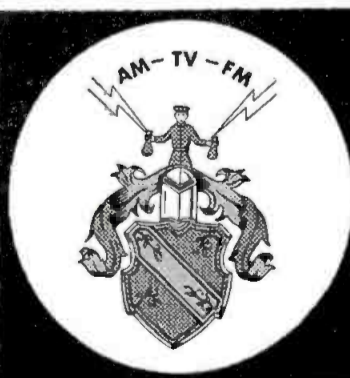

The Fetzer Stations
 WKZO-TV — GRAND RAPIDS-KALAMAZOO
 WKZO RADIO — KALAMAZOO-BATTLE CREEK
 WJEF RADIO — GRAND RAPIDS
 WJEF-FM — GRAND RAPIDS-KALAMAZOO
 WWTV — CADILLAC, MICHIGAN
 KOIN-TV — LINCOLN, NEBRASKA
 Associated with
 WMBD RADIO — PEORIA, ILLINOIS
 WMBD-TV — PEORIA, ILLINOIS

WKZO-TV

100,000 WATTS • CHANNEL 3 • 1000' TOWER

Studios in Both Kalamazoo and Grand Rapids
 For Greater Western Michigan
 Avery-Knodel, Inc., Exclusive National Representatives

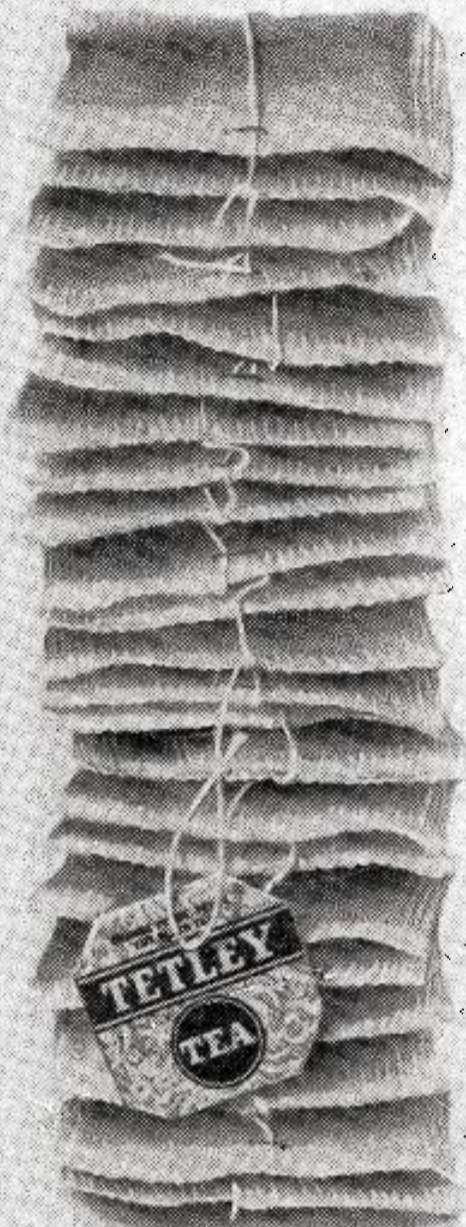

TETLEY TEA uses one radio network: CBS Radio. For those tiny little tea leaves, only the best will do! This network has delivered largest commercial minute audiences all along. And the new Program Consolidation Plan—with unified station clearances and strong program sequencing—will increase this leadership.

CBS RADIO NETWORK:

42% LARGER AUDIENCES PER COMMERCIAL MINUTE THAN ANY OTHER RADIO NETWORK, AVERAGING OVER 16 CONSECUTIVE MONTHS.

also discussed the balloon or "passive" satellite at length. The NASA balloon, however, would orbit only 1,000 miles above the earth.

Active Satellites More Powerful • Mr. Cortright explained to the committee plans for "active" satellites weighing 800 to 3,000 pounds which would be equipped with their own antennas and power supply, either solar cells or reactors. They would give a much stronger signal than the balloons, he said, and one station could cover all of North and South America. Their expected life is two to three years and they would orbit the earth 16 times daily, 22,300 miles up.

Current launchers are not capable of putting such satellites in orbit, Mr. Cortright stated, but rockets are being developed to do the job.

Dr. Henri Busignies, director of International Telephone & Telegraph Labs, also predicted a bright future for satellite communications. And, he said, "we have solutions available in the communications industry to start making immediately a system of communications using satellites."

Law Out There • Andrew G. Haley, recognized expert on space legal matters, stressed the importance of establishing international laws to regulate space travel and vehicles. He recommended that any nation sending radio equipment into space be required to have complete command of such equipment at all times. Otherwise, he said, satellites with solar power, whose life can become indefinite, can be the source of interference for "decades to come."

Also, Mr. Haley said, nations should not be allowed to put anything into orbit which cannot be brought back to earth or completely destroyed. And, he pointed out, such satellites cannot be destroyed with ordnance because fragments probably would become an even greater menace to space navigation.

Steps should be taken immediately, he said, to reach agreement among nations on the use of tv satellites. He said there currently is a "strange indifference" among nations concerning laws for outer space. He urged an international commission to define space limits of a nation's sovereignty, with all planets declared outside such a definition.

Mr. Haley, president of the International Astronautical Federation and general counsel of the American Rocket Society, gave the committee a lengthy summary of past national and international actions relating to space law.

Rep. Overton Brooks (D-La.), chairman of the committee, limited questions until all witnesses had testified. He asked then how soon voices through space would be an actuality. Mr. Haviland predicted radio-tv satellites could

be operative within one year after vehicles are assigned to put them in orbit.

Priority Recommended • Rep. James Fulton (R-Pa.) urged that steps be taken to expedite satellites into orbit for such commercial enterprises as radio and television. He stated he planned to recommend that Cape Canaveral military operations be sidetracked in favor of pushing efforts to send broadcast satellites aloft.

Mr. Busignies estimated that the cost of space communications would be about the same as under the current system, while all the scientists agreed space satellites would open up new vistas in frequency space. Mr. Pierce agreed with Rep. Victor Anfuso (D-N.Y.) that additional channels would be needed for space tv but that no existing allocations would be upset.

Moon Not Feasible • Rep. Gordon McDonough (R-Calif.) asked if a permanent relay base could be established on the moon. Mr. Pierce agreed this would be possible but not feasible because the moon is visible to the U.S., for instance, for less than 12 hours daily, thus there would be considerable periods when such a satellite would be useless. Also, he said, there is a delay of seconds in sending and receiving communications from the moon.

On Tuesday, Roy W. Johnson, chief of Defense Dept. space research, told the committee of military plans in the field of communication satellites. "There will undoubtedly be elements and gains made through this program which can provide rake-offs to the civilian communication needs, but it is a program specifically tailored to the more rigorous military requirements of reliability, security and resistance to interference and jamming," he stated.

He said present communications facilities do not meet the stringent military requirements. Mr. Johnson discussed the military program for communication satellite development, beginning with the successful Score last December and running through Courier (completion in three years) and Discoverer (four years away).

Huge Booster Planned • He told the committee details of a new booster rocket, the Saturn, which will be capable of producing a 1.5 million pound thrust—and will make possible development of better communication through a much heavier payload. The Saturn will make it possible to place a 10,000 pound satellite in orbit within the next few years, Mr. Johnson predicted.

PLANNING FM BROADCASTING?

See page No. 109

G
E
L

DOMINATE

with **WTVT**

1st in total share of audience . . . now at an all-time high in

TAMPA - ST. PETERSBURG!

Latest ARB proves definitely that in the MARKET ON THE MOVE . . . THE STATION ON THE MOVE is WTVT! Penetrate this dynamic, growing market . . . now 30th in the nation in retail sales . . . with the top-rated station, WTVT!

Check the Top 50 Shows! *Latest ARB*

	TOP 5	TOP 10	TOP 15	TOP 25	TOP 50
WTVT	4	8	11	15	34
Station B	1	2	4	9	13
Station C	0	0	0	1	3

Check these 15 top-rated shows!

(ARB based on 4-week average)

SHOW	STAS.	RATING	RANK
Wagon Train	B	42.1	1
I've Got a Secret	WTVT	39.9	2
Gunsmoke	WTVT	39.4	3
I Love Lucy	WTVT	38.0	4
Highway Patrol*	WTVT	37.1	5
Perry Mason	WTVT	36.7	6
State Trooper*	WTVT	36.5	7
Millionaire	WTVT	34.3	8
Wells Fargo	B	33.8	9
Red Skelton	WTVT	33.7	10
Sheriff of Cochise*	WTVT	33.5	11
Decoy*	WTVT	32.3	12
Peter Gunn	B	31.9	13
Price Is Right	B	31.8	14
Zane Grey Theatre	WTVT	31.3	15

*NOTE—4 WTVT syndicated shows in top 15

station on the move...

WTVT

TAMPA - ST. PETERSBURG



Channel 13

The WKY Television System, Inc.

WKY-TV WKY-RADIO WSFA-TV
Oklahoma City Oklahoma City Montgomery

Represented by the Katz Agency

JUSTICE STILL ANTI-OPTION TIME

But says it won't decide next step until FCC makes its move

The Justice Dept. last week stuck to its guns that contend option time is a violation of the antitrust laws—but it dropped a Latin phrase.

Justice's chief trust buster, Victor R. Hansen, told the FCC that "option time runs afoul of the Sherman Act."

Last year, Justice Dept. officials told the FCC that option time and must buy practices of networks were antitrust violations *per se*.

The Justice Dept.'s 14-page memorandum was in reply to an FCC submission last January of its findings that option time was "reasonably necessary for successful network operation and is in the public interest (BROADCASTING, Jan. 12, 19).

The FCC findings, adopted by a narrow 4 to 3 vote, were the first major result of the Commission's special network study. Comrs. Rosel H. Hyde, Robert T. Bartley and Frederick W. Ford disagreed with the majority's views on the necessity for option time.

The Commission's viewpoint and the Justice Dept.'s response were made public last week by the FCC.

The Commission announced that the Justice Dept.'s memorandum was being made a part of the record in the network study proceedings.

Background of Issue • In its Jan. 14 letter to the Justice Dept., the Commission stated that when Justice's reply was received it would be incorporated in the record and that the "Commission will then determine what course of action is most appropriate under its authority."

The Commission request to the Justice Dept. was for a formal opinion of the Attorney General. It was stressed that the Hansen response was a memorandum of the antitrust division, and did not bear the official weight of the Attorney General.

Asked what its next step would be, a spokesman for the Justice Dept. stated that the next move is up to the FCC. "The Justice Dept. will decide what it should do after the FCC acts," he said.

The Commission must now issue a final decision in the option time matter. There was some discussion of the subject on Friday, it was learned, but no definite action was taken. A further meeting on option time is scheduled for this week.

The FCC majority found that although there were some undesirable results in the option time practice, it was necessary to enable networks to assure

advertisers of a national line up of stations in the time periods sold, and that this stability benefits not only the networks but the public in the quality of programs presented.

Dissenting commissioners balked only at the ultimate findings by the Commission majority that option time is necessary. All three questioned whether networks would suffer irreparable harm by the proscription of option time. Other methods of maintaining national hookups would be found, they said.

Hansen Objections • In his memorandum to the FCC, Mr. Hansen contended that option time was similar to the block booking feature of motion picture film renting in which theatre owners were required to buy films they did not want in order to secure rights to show films they desired. This practice was outlawed in 1950 by the Supreme Court in the Paramount case.

Issue No. 3

The option time imbroglio—now focused between the FCC majority and the Dept. of Justice (see above)—is only one of three proceedings now underway by the FCC as a result of its two-year long Network Study which operated under a \$221,000 grant from Congress for this purpose. The study was directed by U. of Cincinnati Law School Dean Roscoe Barrow.

The FCC has issued a proposed rulemaking which would prohibit networks from representing any television stations other than its owned outlets. Comments on this proposal are due April 29.

Two weeks ago, the Commission ordered an inquiry into allegations that networks required a "cut" in the ownership of independent programs before placing them in prime time. Chief Hearing Examiner James D. Cunningham was named to preside at this inquiry (BROADCASTING, March 2).

The Barrow Report listed more than 30 recommendations, including changes in multiple ownership rules, the publicizing of affiliation contracts, etc. No FCC action has thus far been taken on these.

Key point made by Mr. Hansen was that the Communications Act provides that broadcasting must be conducted in a free and open competitive market.

"Viewed either as an 'exclusive dealing' or 'tying' device, the Commission's own findings require the conclusion that option time runs afoul of the Sherman Act," the Justice Dept. discussion held. It continued:

"Beside the point, therefore, is affiliates' limited right to reject network programs . . . as well as the view of the narrow Commission majority that option time 'is reasonably necessary' for successful network operation and is in the public interest . . . For, as in Paramount, so here, the right to reject a limited share of tied copyrights cannot avoid illegality . . ."

"Similarly rejected must be the 'earnest argument that' removal of option time provisions 'will be very disadvantageous to [networks] and will greatly impair [their] ability to operate profitably.'" This runs counter to the Paramount decision which held that the antitrust laws may not be "qualified or conditioned" by the convenience of those whose conduct is regulated, Justice said.

The Justice document also quoted from the U.S. Supreme Court decision two weeks ago in the NBC-Philadelphia case that "the field of broadcasting is one of free competition. (BROADCASTING, March 2)."

In other comments on the Commission findings, the Justice Dept. declared:

• "In practical operation the Commission's findings make clear that option time does curtail affiliated stations' ability to deal in the program services of non network competitors . . ."

• "From all this it seems clear that option time, viewed in the context of its practical market effects, substantially restrains the ability of affiliates to deal with the wares of network competitors during prime viewing time . . ."

• "From much the same findings flows the further conclusion that option time, in practical effect, illegally conditions each affiliate's access to one network-sponsored program on agreement to take others . . . The facts of option time's operation are legally indistinguishable from the practices condemned in Paramount . . ."

In Barrow Pattern • The Justice Dept.'s views are much the same as those in the network study staff report. The Barrow Report recommended that

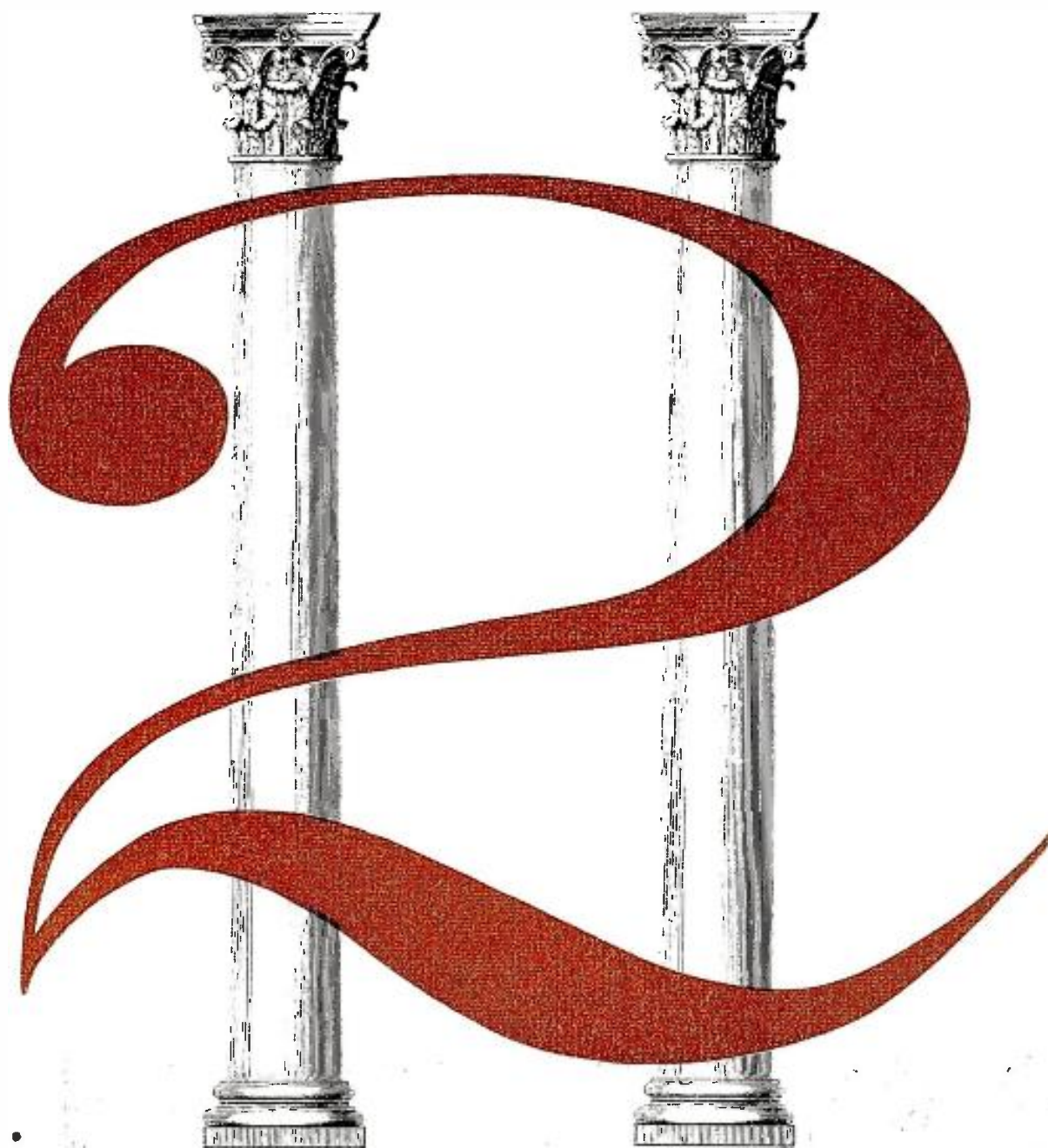

Indiana's
second
richest
television
market...

Fort Wayne

...where WANE-TV is now the first station. Fort Wayne is now the second richest television market in Indiana with . . . *more retail sales, more food sales, more drug sales, more effective buying income* . . . than any other Indiana TV market except Indianapolis. And WANE-TV is now the leading station in Fort Wayne with a larger share of audience than any other station in the market. Represented by Petry.

SOURCES SALES MANAGEMENT, APR. NOV. 58.

 **WANE** -TV FORT WAYNE

A CORINTHIAN STATION *Responsibility in Broadcasting*

KOTV Tulsa KGUL-TV Houston WANE & WANE-TV Fort Wayne WISH & WISH-TV Indianapolis

Junior medium

The Senate Rules Committee officially changed the name of the Radio Correspondents' Gallery to the Radio-TV Correspondents' Gallery.

"By approving this resolution," Sen. Thomas Hennings (D-Mo.), committee chairman, said, "the Senate recognizes that television does, indeed, exist. However, we will be bound by the Senate's rule of seniority and continue to list radio first in the gallery's new name."

option time be abolished and that option time and must buy practices constituted an antitrust violation.

In recent months both CBS and NBC have eliminated the must buy provision in favor of minimum dollar buys. In the must buy practice, networks required advertisers to accept a basic number of affiliated stations. ABC has always operated on a minimum buy basis.

Last April at a meeting between FCC and Justice Dept. antitrust officials, it was the Justice Dept.'s position that option time and must buys constituted

per se violations of the antitrust laws. It was agreed then that the FCC would submit findings to the Justice Dept. on this.

In last week's memorandum, the Justice Dept. said it was not necessary to detail the impact of option time and must buy as a combination between networks and affiliates in illegal restraint of trade.

Last spring the Commission held public hearings on the Barrow Report, with testimony given by networks and station licensees on all aspects of the Report. The Commission's findings on option time were adopted after the completion of those sessions.

Although there is no question that the FCC can issue a final report on option time, it is understood that if any change in the current Chain Broadcasting Rules is recommended a formal notice of proposed rule-making would be issued.

Colo. Judge McDonald to lead federal probe

Colorado District Judge Joseph M. McDonald has been named chief counsel of the new Senate Judiciary Subcommittee on Administrative Practice & Procedures. The appointment was an-

nounced Sunday (March 1), by Sen. John Carroll (D-Colo.), subcommittee chairman.

The subcommittee was formed to investigate administrative practices in government agencies, including the FCC (BROADCASTING, Feb. 16). Judge McDonald resigned his judicial post, effective yesterday (Sunday) and is due in Washington this week. Sen. Carroll said his first duty will be to interview more than 100 applicants for the remaining eight subcommittee staff positions.

Judge McDonald, 41, served four years as Denver municipal judge and has been district judge for the past four years. He presided over the murder trial of John Gilbert Graham and permitted radio-tv coverage of the courtroom proceedings.

Sen. Carroll said Judge McDonald was picked over a long list of applicants because of his outstanding legal ability. "The task of inquiring and probing into administration practice and procedure in government agencies will be a long, tedious and tremendously important task," Sen. Carroll stated. "I am certain that Judge McDonald has the ability to get into this administrative jungle and come up with something constructive."

KIMN tells and sells more people for less cost per thousand than any other radio station in the Greater Denver Market

KIMN

No. 1 music and news station in denver *

entertaining and selling in 156,000 homes weekly

KIMN
5000 WATTS AT 950

* DECEMBER, 1958 PULSE

Radio homes reached by each station in thousands . . .

Network Station A	183.6
Network Station B	177.4
KIMN	156.0
Independent Station D	149.6
Independent Station E	149.3
Independent Station F	147.4
Independent Station G	82.8
Independent Station H	66.1
Network Station C.	61.4
Independent Station I	53.3
Independent Station J	37.6

KEY STATION
INTERMOUNTAIN NETWORK
REPRESENTED NATIONALLY
BY AVERY-KNODEL, INC.

Cecil Heftel, President

FLAREUP IN SPECTRUM ISSUE

Ike's letter, Hoegh resolution draw fire

The radio spectrum is getting another kicking-around between Capitol Hill and the White House.

Plans to find better ways of dividing the airwaves among the military, government, industrial and broadcasting services became involved in pressure politics last week. A move by the White House, aimed at a professional study of the spectrum by a Presidential body, stirred up fast bipartisan opposition in Congress.

At the weekend the situation looked like this:

- Chairman Oren Harris (D-Ark.), of the House Commerce Committee, has \$150,000 in his desk to conduct a subcommittee spectrum study and wants to get it started.

- Rep. William G. Bray (R-Ind.), wants a Congressional study of the way the Pentagon uses the spectrum. He is a member of the Armed Services Committee.

- President Eisenhower and his communications chief, Director Leo A. Hoegh of the Office of Civil & Defense Mobilization, released their own plan to study the spectrum.

- Both Chairman Harris and Rep. Bray deem this plan an Administration boondoggle and an effort to keep large hunks of the spectrum in the Pentagon's pockets. They are afraid the public will lose some of its frequencies to the generals and admirals.

In a letter to Speaker Sam Rayburn (D-Tex.) and Vice President Richard M. Nixon, President Eisenhower termed telecommunication systems "essential to the national security, to the safety of life and property, to international relations, to a better-informed public, and to the business, social, education, religious and political life of the country." He called them "one of the nation's most valuable assets."

The President said technical advances and changing government and non-government needs offer problems that require searching study. Topping the confusion is the arrival of the space age, with satellites, space vehicles and defense systems.

Last autumn's preliminary study by an OCDM advisory committee is being reviewed by the Administration. The committee proposed creation of a three-

man spectrum committee, to be named by Congress (BROADCASTING, Feb. 9). President Eisenhower said this group did not have time to make detailed studies of radio frequency usage. Its job was to review the government's role in telecommunication management.

Hoegh Makes Move • Immediately after the President sent his letter to Capitol Hill, Mr. Hoegh announced he was sending up a resolution calling for creation of the five-man commission to be named by the President. He included this key provision, presumably because of Capitol Hill opposition to his Feb. 4 announcement of the advisory group's report: The commission would be set up by a joint Senate and House resolution.

At this point Mr. Hoegh was endeavoring to let Congress (1) give its blessing to a Presidential study and (2) provide the funds and authority for a complete investigation. One problem that has escaped Congressional scrutiny is the way federal and Pentagon agencies utilize the vast spectrum areas they enjoy. Ex-Sen. Charles Potter (R-Mich.) proposed a federal-use spectrum study at the last session of Congress. It passed the Senate and went through the House Commerce Committee but was lost in

**KARK-TV
DELIVERS
MORE
TV
HOMES
THAN ANY OTHER LITTLE ROCK STATION**

SEE PETRY FOR FACTS ON KARK-TV'S BIG LEADS . . . IN COVERAGE AS SHOWN BY NCS No. 3 . . . IN AUDIENCE DURING PRIME TIMES AS SHOWN BY OCT. AREA ARB.

the confusion of Congress' adjournment (BROADCASTING, Aug. 11, 1958) and some fancy political maneuvering and lobbying.

Mr. Hoegh said creation of the Presidential commission with the support of Congress would be "a major step toward the formulation of long-range solutions to complex problems considered by the special advisory committee." He again commended the advisory group for its work though his Feb. 4 announcement of its report deviated sharply from the committee recommendations.

The White House-Capitol Hill differences may come to a head at the NAB Chicago convention March 16 when Mr. Hoegh and Rep. Bray meet on the same platform to discuss the spectrum (BROADCASTING, March 2).

Mr. Hoegh, as defense-mobilization director, is vested by President Eisenhower with authority over government use of the spectrum. FCC regulates non-government use. He said demands for spectrum space are heavy. Recently he completed hearings on requests of Federal Aviation Agency, the Pentagon and other government offices for the same band. He told BROADCASTING there is unusually heavy demand within the government for the 100-150 mc band.

No political or military interests would control the proposed commission study of the spectrum, he said.

Congressional Comments • Capitol Hill comment on the White House-OCDM study proposal came quickly last week. Here are samples:

• REP. BRAY—"This is further evidence the President wants to try a new approach to solve the spectrum problem. Some of the commission's members should be named by the legislative branch." He plans to reintroduce his spectrum probe legislation of the last Congress (similar to Potter plan) and said the Harris approach is the proper one.

• CHAIRMAN HARRIS—"They've had since last fall to make the proposal but waited until we started with our own plan." He said there was no basis to charges he had "jumped the gun" on the White House because he had been trying to get a spectrum study since last July.

• REP. J. J. FLYNT (D-GA.)—"It's an unwarranted attempt to prevent a Congressional committee from carrying out its announced intention to make such a study."

• SPEAKER RAYBURN—No comment

on the merits of the Administration request. He surmised the White House would conduct the study "if it got the authority."

Five-man Commission • The Hoegh recommendations called for a five-man commission to be appointed by the President, with each member receiving \$75 per day on duty plus travel and allowances. It would conduct a thorough study into:

The government's role in management of the telecommunications resource; administrative organizational review to decide if this management should be changed; methods used in allocating frequencies among government and non-government users, reviewing technological advances to find if frequencies are efficiently utilized; apportionment of the spectrum to find if changes should be made.

Recommendations of the commission, to be made within a year, would be submitted to the President for transmission to Congress. The commission then would die.

Routine language gives the commission operating powers outside civil service laws, including the right to hire personnel and consult experts. It would have the right to obtain information from any government agency.

An important clause would provide operating funds. A commission designated by the President without Congressional sanction would face the problem of financing out of White House funds plus the usual political repercussions on Capitol Hill.

The Potter resolution was buried last August under an avalanche of Democratic Congressional pressure after the White House and OCDM proposed to change the plan by including the entire spectrum instead of just government frequencies. The Administration ideas were adopted by the House Commerce Committee but the whole idea perished before it could reach the House floor.

Loyola ruling upheld

The right of a Roman Catholic religious order to control the licensee of a television station was upheld in effect by the U.S. Supreme Court last week. The high tribunal refused to review a lower court decision which had denied a contention that the Jesuits' Loyola U., New Orleans, is ineligible to own ch. 4 WWL-TV in that city.

The challenge to Loyola's ownership of the tv outlet had been raised by James A. Noe, former governor of Louisiana and owner of WNOE New Orleans and KNOE-AM-TV Monroe, La., who claimed that Loyola is an "alien" corporation under communica-

"IF IT HASN'T GOT IT HERE.."

POWER ★ ★ PROGRAMS
PERSONALITIES ★ PRESTIGE

IT HASN'T GOT IT!"

THAT'S **WMAZ** NOW **50,000 WATTS***

THE BIG 50

940 . . . CBS
MACON, GA.
*10,000 DA-N

"With Thanks to WINSTON!"

tions law and therefore cannot run WWL-TV. In the unanimous, three-judge decision of the U.S. Court of Appeals in Washington last autumn (BROADCASTING, Oct. 20), it was stated that the limitation on alien control of communications was primarily based on the desire to prevent alien activities against the government during war and "the relationship of Loyola to the Society of Jesus hardly seems to endanger our national security."

Loyola has owned WWL New Orleans since 1922. The Appeals Court noted that never has the Catholic Church hierarchy impinged upon the independence of the university in its operation of the radio station.

Hansen to testify on McConnaughey call

The chief of the Justice Dept.'s Antitrust Division is to testify in the FCC's hearing today (March 9) or tomorrow in the Boston ch. 5 case.

Victor E. Hansen, assistant attorney general in charge of the Antitrust Division, is to answer questions concerning his written statement—offered last week in lieu of personal testimony—that he told former FCC Chairman George C. McConnaughey on March 28, 1957, that the Justice Dept. felt a continuing investigation was necessary in antitrust charges brought against the *Boston Herald-Traveler* (WHDH) by the *Boston Globe*.

Mr. McConnaughey had testified earlier (BROADCASTING, Feb. 23) that Mr. Hansen told him during the conversation the *Globe* allegations were groundless and could not be dignified as antitrust charges. The Boston hearing is being heard by Judge Horace Stern.

Edgar W. Holtz, FCC associate general counsel, said last week he could not accept the statement offered in lieu of sworn testimony by Mr. Hansen. Because Mr. McConnaughey appeared in person and because the two versions of the 1957 conversation are contradictory, Mr. Hansen's testimony should be in the same "judicial posture" as that of the former FCC chairman, he said. The conversation took place about three weeks before the FCC's decision in April 1957 awarding ch. 5 to the *Herald-Traveler*, reversing a hearing examiner's initial decision favoring another applicant for ch. 5 and denying the *Globe's* petition to intervene with antitrust charges against the *Herald-Traveler*.

The current hearing is being held under remand of the case in July 1958 by the U.S. Appeals Court for the District of Columbia, which upheld the FCC grant but ordered a hearing after

testimony last year before the House Legislative Oversight Subcommittee that ch. 5 applicants had made *ex parte* representations to FCC members.

Losing applicants Massachusetts Bay Telecasters Inc., Greater Boston Tv Corp. and Allen B. DuMont Labs and the *Globe*, intervenor, have questioned whether Warren E. Baker, former FCC general counsel, improperly advised Mr. McConnaughey on the antitrust question contrary to FCC rules and the Administrative Procedure Act.

Another witness likely to be called is former Secretary of Commerce Sinclair Weeks, who was contacted by some of the applicants in the ch. 5 contest. DuMont Labs, the only applicant which has asked for testimony from Mr. Weeks, said last week that Mr. Weeks (not available for testimony this week) has been contacted and asked to set a date within two weeks when he can appear to testify.

Meanwhile, the possibility that five members of the FCC might testify in the hearing had begun to wane last week. Mr. Holtz said none of the commissioners had indicated a desire to correct testimony by John and Davis Taylor, *Globe* officials, of their talks to commissioners in a move to prevent award of ch. 5 to the competing *Herald-Traveler*.

Mr. Hansen's statement last week said Mr. McConnaughey called him on the phone March 28, 1957, about Justice's investigation of antitrust charges against the *Herald-Traveler* and that he told the FCC chairman Justice felt there were sufficient antitrust questions to justify its inquiry; that it would continue to conduct the probe; that Justice was not prepared either to bring charges or to close its inquiry; that whatever the FCC decided could not affect any decision by Justice as to whether to sue, and that the question of which of the applicants was best fitted for the tv grant should "appropriately" be determined by the FCC.

More court support of out-of-state taxes

The U.S. Supreme Court last week took another step in authorizing states to tax out-of-state companies engaged in interstate commerce. The court, in a unanimous, unsigned opinion, gave brief dismissal to an appeal from a Louisiana Supreme Court ruling which upheld a state income tax on Brown-Foreman Distillers Corp., Louisville.

The Louisiana court had indicated that the extent of a company's activities in the state had no bearing on the tax liability of an out-of-state corporation. Brown-Foreman argued that since it maintained no offices or plants in

Louisiana it was not liable to the Louisiana tax. The distiller claimed that the salesmen used in Louisiana were engaged in "missionary" work, sales are made and accepted in the company's headquarters in Louisville.

In another tax case, the high court upheld 6-3 a North Carolina tax on an interstate trucking company which operates a series of freight terminals within the state. The dissenters were the same as those dissenting from the Minnesota and Georgia rulings two weeks ago (BROADCASTING, March 2).

Kevin Sweeny, RAB president, commented on the court's decisions:

"A tax which puts added costs on the advertising structure is bound to hurt the economy beyond the ability of the state imposing the tax to gain from the new revenues. It's to be hoped an added burden on media will not result from the Supreme Court decision on taxation on out-of-state companies. If a state increases advertising costs by taxation, it hits at one of the major forces which keeps business going. . . ."

Rep. Cunningham plans Sec. 315 bill

If the FCC was trying to force Congress' hand when it ruled a political candidate is entitled to equal time as a result of his opponent's appearance on a regular news show (BROADCASTING, Feb. 23), it has partially succeeded.

Saying he is "greatly distressed" by the ruling, Rep. Glenn Cunningham (R-Neb.) last week announced plans to introduce a bill to amend Sec. 315 (which requires that equal time be given to political candidates) of the Communications Act. Rep. Cunningham said the Commission decision will result in a decided reduction in radio-tv coverage of charity drives and news events which "must of necessity show a person who is incidentally a candidate for election or re-election."

In a 4-3 decision, the FCC ruled that Lar Daly, a splinter candidate in the Chicago primary for mayor, must be given equal time as a result of regular newscasts in which incumbent Mayor Richard Daley appeared. Rep. Cunningham said his bill, which he plans to introduce this week, would exempt newscasts from equal-time requirements.

NAB President Harold E. Fellows protested the FCC action allowing Mr. Daly equal time to that of his opponents during the campaign for the mayoralty nomination (BROADCASTING, March 2), telling FCC its action was a "genuine threat to freedom of information."

The American Civil Liberties Union also protested, saying coverage of Mayor Daley in various official capacities had nothing to do with politics.

To sell Indiana,
you need both
the 2nd and 3rd
ranking markets.

**NOW
ONE BUY**

delivers both —

**AT A 10%
SAVINGS!**

YOU NEED TWO TO TUNE UP sales in Indiana!



In this rich, diversified interurbia, automotive manufacturing is only one of many reasons for bulging purses. Fertile farms and varied business each contribute their share. Over 1.6 million population—\$2.8 billion Effective Buying Income! There are two major markets in this live sales sector—South Bend-Elkhart and Fort Wayne. You can cover *both* from within, with *one* combination TV buy, and save 10%! Add Indianapolis—get *all* the best in just *two* buys!

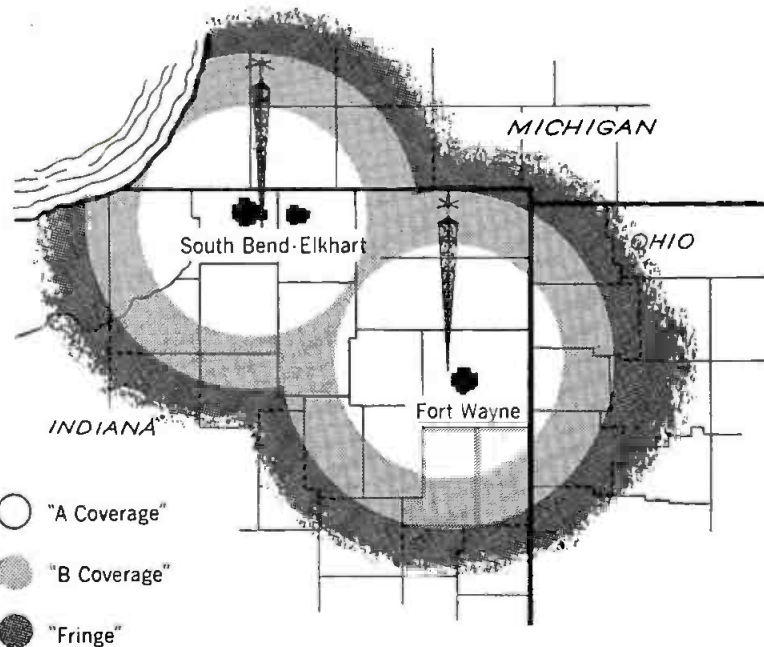

call your **H-R** man now!



W S j v
SOUTH BEND ELKHART

28
ABC

w k j g
FORT WAYNE

33
NBC



Paramount Pictures Rating Power*

mca tv

*PRE '48

“Me an’ J.K.”

is just like this!” WJAR-TV not only has a corner on quality feature films in the Providence market, but also exposes them with rare showmanship. Morning and afternoon films, for example, are emceed daily by personable Jay Kroll who asks viewers to write and tell him what they would like to see, then waits for the mailman to clue him on local tastes. Between “acts”, Jay interviews visiting celebrities, and leaders of local and national civic groups. “The Jay Kroll Show” — another good reason why WJAR-TV has won the TV heart of the PROVIDENCE MARKET.

10th Anniversary of CHANNEL 10



WJAR-TV

Cock-of-the-walk in the PROVIDENCE MARKET

NBC · ABC · Represented by Edward Petry & Co., Inc.





NEXT WEEK IN CHICAGO

Advance report on people, places, events at NAB convention

The business of broadcasting moves this weekend to the Conrad Hilton Hotel, Chicago, the only hotel that can house most of the station, network, program, service, equipment and related industries. They will meet under the auspices of NAB's 37th annual convention.

While formal convention programming opens Monday morning, March 16, satellite meetings will get under way Friday, March 13. Final event will be the annual banquet the night of March 18.

Three meetings are scheduled Friday. They include a dinner meeting of the board of the Assn. of Maximum Service Telecasters, dinner meeting of Assn. for Professional Broadcasting Education and FM Development Assn. meeting.

CBS-TV affiliates will meet Saturday as well as the Fm Development Assn. and APBE.

Advance registrations for the convention closed Feb. 27 (see list page 102). Attendance is expected to equal or exceed that at Los Angeles a year ago despite the change in format to concentrate on management ownership delegates.

The concurrent Broadcast Engineering Conference opens March 16 (see summaries of technical papers, page 94-D).

Interest in the problem of spectrum allocation was heightened last week when Leo H. Hoegh, director of the Office of Civil & Defense Mobilization transmitted to Congress a proposal to name a five-man spectrum study committee (see GOVERNMENT). Mr. Hoegh will appear the afternoon of March 16 on the tv management program along with Rep. William G. Bray (R-Ind.), who has urged a Congressional probe of military demands for spectrum space.

Formal convention programming opens March 16 with the award of NAB's keynote medal to Robert W. Sarnoff, NBC board chairman. Mr. Sarnoff will deliver the keynote speech, to be followed by the opening luncheon. Featuring the luncheon will be the annual address to the membership by NAB President Harold E. Fellows (see condensed program, page 80).

The first NAB Engineering Award

will go to John T. Wilner, vice president and engineering director of radio-tv of Hearst Corp.

A full list of events is scheduled Sunday, March 15, including the annual NAB convention golf tournament for the BROADCASTING trophies at the Midwest Country Club, Hinsdale, Ill. Buses leave the south entrance of the Conrad Hilton Hotel at 9:15 a.m.

The Sunday schedule includes MBS, ABC-TV, ABC, Daytime Broadcasters Assn. and Clear Channel Broadcasting Service events.

The annual exposition of broadcast equipment (see page 86) opens Sunday in Exhibition Hall, located on the lower lobby floor of the Conrad Hilton.

Convention registration starts Saturday. Co-chairmen of the convention are Robert T. Mason, WMRN Marion, Ohio, and G. Richard Shafto, WIS-TV Columbia, S.C.

Official and sidebar events page 80
'Where to find it' directory page 84
Technical papers, agenda page 94-D
Major displays at exhibits page 86
Registration: who'll attend page 102



ON TAP IN CHICAGO

Official agenda events and unofficial sessions. Conrad Hilton Hotel unless otherwise designated. Engineering Conference agenda page 94D.

REGISTRATION • Lower Lobby. Saturday, March 14, 9 a.m.-5 p.m.; Sunday-Monday, March 15-16, 7 a.m.-7 p.m.; Tuesday-Wednesday, March 17-18, 9 a.m.-5 p.m. **EXHIBITS** • Exhibition Hall. Sunday, March 15, 12 noon-7 p.m.; Monday, March 16, 9 a.m.-9 p.m.; Tuesday, March 17, 9 a.m.-7 p.m.; Wednesday, March 18, 9 a.m.-6 p.m.

MONDAY, March 16

9-10:45 a.m. Williford Room

"FM: FURTHER MOMENTUM" •

Participants: Ben Strouse, WWDC-FM Washington, chairman; William B. Caskey, WPEN-FM Philadelphia; Everett L. Dillard, WASH (FM) Washington; Raymond S. Green, WFLN-FM Philadelphia; Merrill Lindsay, WSOY-FM, Decatur, Ill.; Fred Rabell, KITT (FM) San Diego. *Guest:* FCC Comr. Robert E. Lee.

9-10:45 a.m. Upper Tower

LABOR CLINIC • Closed session. *Moderator:* Charles H. Tower, manager, NAB Broadcast Personnel and Economics Dept.

Participants: G. Maynard Smith, attorney, Atlanta; William C. Fitts, vice president for labor relations, CBS Inc., New York; Ward L. Quaal, WGN Inc., Chicago, chairman, NAB Labor Relations Advisory Committee.

11 a.m.-12 noon. Grand Ballroom

GENERAL ASSEMBLY • Management assemblies and Engineering Conference. *Presiding:* G. Richard Shafto, WIS-TV Columbia, S.C., 1959 Convention co-chairman. *Invocation:* The Right Rev. G. Francis Burrill, Bishop, Diocese of Chicago (Episcopal). *Presentation of the Colors:* VFW, Department of Illinois Color Guard. *The National Anthem:* Fifth U.S. Army Band.

Welcome: The Honorable Richard J. Daley, Mayor of Chicago.

Keynote address: Robert W. Sarnoff, chairman of the board, NBC.

Keynote award presentation to Mr. Sarnoff: Mr. Fellows.

12:30-2 p.m. Grand Ballroom.

LUNCHEON AND GENERAL ASSEMBLY • *Presiding:* Robert T. Mason, WMRN Marion, Ohio, 1959 Convention co-chairman. *Invocation:* The Most Rev. Albert Gregory Meyer, Archbishop of Chicago.

Address: Harold E. Fellows, president and chairman of the board, NAB.

Presentation: National Commander John W. Mahon, Veterans of Foreign Wars.

2:30-5 p.m. Grand Ballroom

RADIO ASSEMBLY • *Presiding:* John F. Meagher, vice president for radio, NAB.

Opening remarks: J. Frank Jarman, WDNC Durham, N.C., chairman, NAB Radio Board of Directors.

Trends in Radio Programming: Howard G. Barnes, CBS Radio, New York; Robert D. Enoch, WXLW

Indianapolis; Frank Gaither, WSB Atlanta; Duncan Mounsey, WPTR Albany, N.Y.; Robert E. Thomas, WJAG Norfolk, Neb.

Radio's Standards of Good Practice: Cliff Gill, KEZY Anaheim, Calif., chairman, NAB Standards of Good Practice Committee.

"The Station Representative—or What Have You Done for Us Lately?": Lawrence Webb, director, Station Representatives Assn.; Arthur H. McCoy, vice president, John Blair & Co., chairman, Radio Trade Practices Committee, SRA.

Report of the All-Industry Radio Music License Committee: Robert T. Mason, WMRN Marion, Ohio, chairman.

2:30-5 p.m. Williford Room

TELEVISION ASSEMBLY • *Presiding:* Thad H. Brown Jr., vice president for television, NAB.

Welcome: C. Howard Lane, KOIN-TV Portland, Ore., chairman, NAB Television Board of Directors.

The Television Code: Roger W. Clipp, WFIL-TV Philadelphia, chairman, Television Code Review Board.

The New Congress—and Television: Vincent T. Wasilewski, manager of government relations, NAB.

Your Channel and You—Tv Allocations: (Remarks and discussion). Leo Arthur Hoegh, director, Office of Civil and Defense Mobilization; Rep. William G. Bray (R-Ind.).

TUESDAY, March 17

10 a.m.-12 noon Grand Ballroom.

RADIO ASSEMBLY • *Presiding:* Mr. Meagher.

10 a.m.—*Radio Audience Research:* E.K. Hartenbower, KCMO Kansas City, chairman, NAB Radio Research Committee; John K. Churchill, vice president, A.C. Nielsen Co., Chicago; Theodore F. Olson, Bureau of the Census, Washington; Ed Fitzgerald, J. Walter Thompson Co., Chicago; Russell Tolg, Batten, Barton, Durstine & Osborn, Chicago; Charles Harriman Smith, research consultant, Minneapolis.

11 a.m.—*Radio Advertising Bureau Presentation:* "The meeting you won't enjoy but don't dare miss if you want to stay in the radio business." Kevin B. Sweeney, president, RAB; John F. Hardesty, vice president, RAB.

10 a.m.-12 noon Williford Room

TELEVISION MANAGEMENT AND OWNERSHIP CONFERENCE • Closed session.

10 a.m.—*Television Business Session:* The Television Board elections. *Presiding:* Mr. Fellows.

11 a.m.—*The Ownership and Management Conference:* "The Image of Television." *Presiding:* Mr. Lane.

12:30-2 p.m. Grand Ballroom

LUNCHEON AND GENERAL ASSEMBLY • *Presiding:* Mr. Shafto. *Invocation:* The Rev. Paul M. Robinson, president, Church Federation of Greater Chicago and Bethany Biblical Seminary. *Introduction of the speaker:* Mr. Fellows.

Address: FCC Chairman John C. Doerfer.

Special feature: James W. Rachels Jr., Columbus, Ga., national winner, Voice of Democracy.

WEDNESDAY, March 18

9:30-10:30 a.m. Grand Ballroom

COFFEE HOUR

10:30 a.m.-12 noon Grand Ballroom

GENERAL ASSEMBLY • Management assemblies and Engineering Conference. *Presiding:* Mr. Mason.

FCC. Panel discussion: FCC Chairman John C. Doerfer and Comrs. Rosel H. Hyde, Robert T. Bartley, Robert E. Lee, T.A.M. Craven, Frederick W. Ford and John S. Cross. *Moderator:* Mr. Fellows.

12:30-2 p.m. Grand Ballroom

LUNCHEON AND GENERAL ASSEMBLY • *Presiding:* Allan T. Powley, WMAL-AM-TV Washington, chairman, 1959 Broadcast Engineering Conference Committee. *Invocation:* Rabbi Joseph M. Strauss, Temple Menorah, Chicago.

Presentation of the first NAB Engineering Award by A. Prose Walker, manager of engineering, NAB, to: John T. Wilner, vice president and director of engineering for radio-tv, The Hearst Corp.

Introduction of the speaker: Mr. Fellows.

Address: "Research and Development for the Space Age" by Lt. Gen. Arthur G. Trudeau, chief of research and development, Department of the Army.

Annual NAB business session: Mr. Fellows presiding.

2:30-5 p.m. Grand Ballroom

RADIO ASSEMBLY • *Presiding:* Mr. Meagher.

"Editorializing on Radio": (Radio members of the NAB Committee on Editorializing). Alex Keese, WFAA Dallas, co-chairman; Simon Goldman, WJTN Jamestown, N.Y.; Daniel W. Kops, WAVZ New Haven, Conn.; Robert L. Pratt, KGGF Coffeyville, Kan.

"Radio in 1970—A Look at the Future": Irving Schweiger, associate professor of marketing, Graduate School of Business, U. of Chicago; Dale G. Moore, KBMN Bozeman, Mont.; Ward L. Quaal, WGN Chicago; Hyman Goldin, chief, FCC Economics Div.; Charles H. Tower, NAB.

"Trends in Automation": A. Prose Walker, NAB Engineering Dept.

2:30-4:15 p.m. Williford Room

TELEVISION ASSEMBLY • *Presiding:* Mr. Brown.

Television Film: Joseph Floyd, KELO-TV Sioux Falls, S.D., chairman, NAB Tv Film Committee.

"The Future of Television Sales and Television Costs" • Panel discussion: George Storer Jr., Storer Broadcasting Corp., Miami; John W. Davis, vice president, Blair Television; Hugh M. Beville, vice president, planning and research, NBC, New York; Maxwell Ule, senior vice president, Kenyon & Eckhardt, New York.

4:15 p.m. Eighth St. Theatre

TELEVISION BUREAU OF ADVERTISING • Presentation of "Plus Over Normal." Norman (Pete) Cash, president, TvB.

7:30 p.m. Grand Ballroom

ANNUAL CONVENTION BANQUET.

Satellite Activities

FRIDAY, March 13

All day: **MCA-TV** sales convention, Drake Hotel.

6 p.m. **ASSN. FOR PROFESSIONAL BROADCASTING EDUCATION.** Dinner meeting. Room 18.

6:30 p.m. **ASSN. OF MAXIMUM SERVICE TELECASTERS.** Dinner meeting. Room 9.

7 p.m. **FM DEVELOPMENT ASSN.** Lower Tower.

SATURDAY, March 14

All day: **CBS-TV AFFILIATES** annual general conference. WBBM-TV studios. Cocktail party 6:30 p.m., banquet 8 p.m., both at Gold Coast Room, Drake Hotel.

9 a.m.-6 p.m. **ASSN. FOR PROFESSIONAL BROADCASTING EDUCATION** meeting. Room 18.

9 a.m.-6 p.m. **FM DEVELOPMENT ASSN.** meeting. Lower Tower.

SUNDAY, March 15

All day: **CBS AFFILIATES**, WBBM-TV studios.

All day: **FM DEVELOPMENT ASSN.** meeting. Room 19.

9:15 a.m. Buses leave south entrance of Conrad Hilton for the **BROADCASTING** golf tournament.

9:30 a.m.-12:30 p.m. **ASSN. OF MAXIMUM SERVICE TELECASTERS** membership meeting. Bel Air Room; 12:30-3 p.m. luncheon meeting. Room 9.

12:30-4 p.m. **MBS ADVISORY COMMITTEE** luncheon and meeting. Room 18.

2 p.m. **ABC-TV AFFILIATES.** Blackstone Hotel.

3 p.m. **DAYTIME BROADCASTERS ASSN.** meeting. Room 12.

4 p.m. **MBS AFFILIATES** meeting. Waldorf Room.

4 p.m. **CLEAR CHANNEL BROADCASTING SERVICE** meeting. Room 13.

5 p.m. **ABC RECEPTION.** Williford Room.

5:30 p.m. **MBS RECEPTION.** Waldorf Room.

MONDAY, March 16

8 a.m. **QUALITY RADIO GROUP** breakfast meeting. Room 9.

9:30 a.m. **NAB TELEVISION CODE REVIEW BOARD** meeting. Room 10.

6:30 p.m. **BROADCAST MUSIC INC.** cocktails Chippendale Room, Ambassador West; dinner, 7:30 p.m., Four Georges.

TUESDAY, March 17

2:30 p.m. Projected **RADIO WORLD WIDE** program network. Closed meeting. Regency Room, Sheraton Blackstone Hotel.

7:30 p.m. **BROADCAST PIONEERS** banquet. Williford Room.

WEDNESDAY, March 18

8:30-9:30 a.m. **TELEVISION PIONEERS** membership breakfast. Lower Tower.

"The RCA Television Tape Recorder Meets Fondest Dreams

"Monochrome and color pictures recorded and produced by the RCA color television tape recorder are

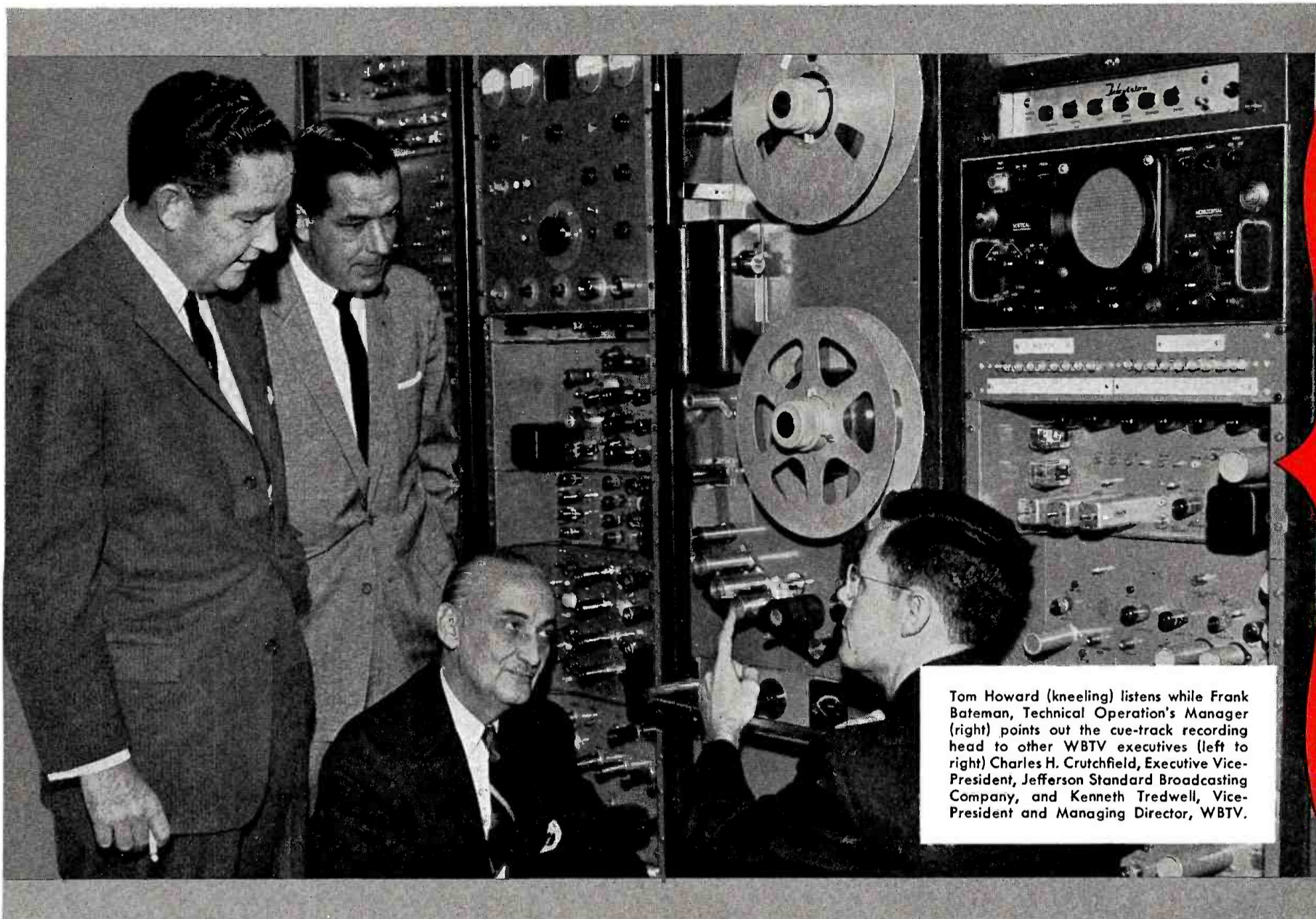

Tom Howard (kneeling) listens while Frank Bateman, Technical Operation's Manager (right) points out the cue-track recording head to other WBTV executives (left to right) Charles H. Crutchfield, Executive Vice-President, Jefferson Standard Broadcasting Company, and Kenneth Tredwell, Vice-President and Managing Director, WBTV.

WBTV, Charlotte, North Carolina—first television station to record and air a locally produced color television tape recording, has been using RCA Color Television Tape Equipment since September 5, 1958. Their experience has led Tom Howard to report: "It is evident that RCA's design engineers did not limit their efforts to just getting video and audio signals on tape—they remembered that their customers had to maintain and operate the gear day-in and day-out.

MASTER ERASE HEAD A TIME-SAVER

"We like the master erase head. It eliminates the necessity for bulk erasing, assures a clean tape at

all times and in many cases allows for selective erasing and re-recording of spots or other program material without destroying the entire contents of the reel. It is a time saver. For instance, if there has been a false start or a fluff in a spot or in the early part of a recording, it is only necessary to back up the tape and start again. There is no need to remove the reel, bulk erase, replace the reel and start all over again.

BUILT-IN FACILITIES COMMENDED

"We commend the decision of the RCA design engineers that necessary operational equipment should be built-in instead of being made available as 'accessories.' We appreciate their facing the facts of operational life by incorporating the master erase head, the built-in audio monitoring speaker for cuing and continuity, the built-in picture monitor, the built-in CRO, the built-in switcher for picture monitor and CRO input signal selection, the elapsed time meter for slip rings and brushes, the metering of individual



Be Sure to See the New Features of the RCA Color Television Tape Recorder in Operation at NAB Convention, Chicago, March 15-18.

of WBTB Engineers in Daily Operating Conveniences!"

—Says Thomas E. Howard, V.P. Engineering and General Services, WBTB. superb, and we are impressed by the convenience and versatility designed into the equipment."

"WE LIKE the master erase head.

"WE LIKE the built-in facilities.

"MOST OF ALL, WE LOVE that cue track. In our opinion, it is destined to be a must in every tape operation."

**TOM HOWARD
WBTB**

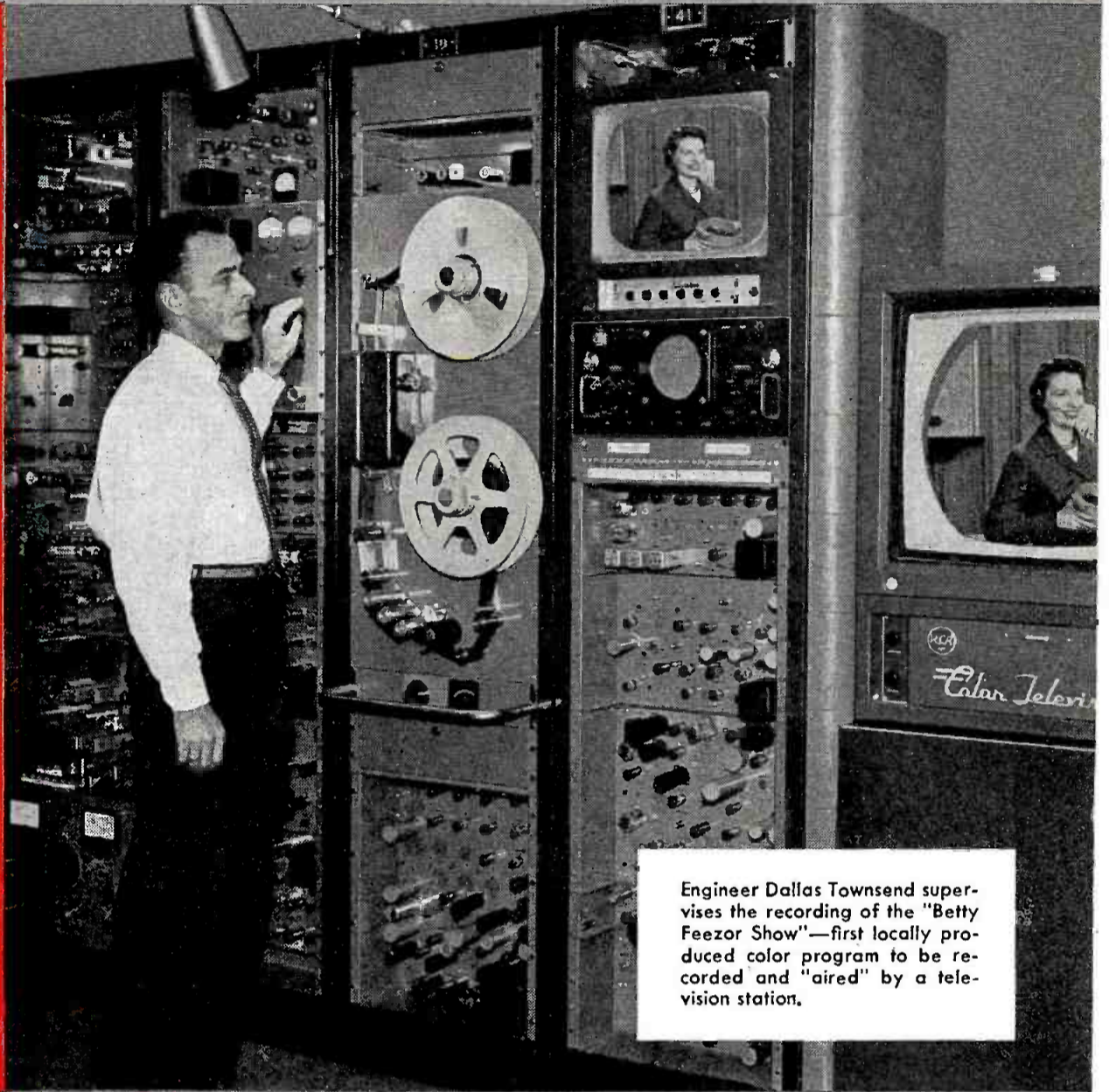

Engineer Dallas Townsend supervises the recording of the "Betty Feezor Show"—first locally produced color program to be recorded and "aired" by a television station.

video head recording currents, the continuously adjustable tape wind and rewind speeds for rapid and accurate cuing of tape, and the built-in test signal channel for rapid check and trimming of color processing equipment, even while a color signal is being recorded.

CUE TRACK A "MUST"

"Most of all we love that cue track—in our opinion it is destined to be a 'must' in every tape operation. The value of the cue track seems to be limited only by the imagination and ingenuity of the user.

"We use the cue track to bridge the program director's channel during record operation. This

channel becomes our cue reference. This big feature has enabled us to salvage some 'fluffed' spots in programs or to insert new spots—live or on film—in a program that has already been recorded.

AVENUE TO AUTOMATION

"RCA's pioneering in incorporating the cue track in television tape recorders is a valuable contribution to smoother tape operation and definitely opens another avenue to automation."

Your RCA Broadcast Representative will gladly provide further particulars about the RCA Color Television Tape Recorder and help to integrate this equipment into your facilities. In Canada, write to RCA VICTOR Company, Limited, Montreal.



RADIO CORPORATION of AMERICA

BROADCAST AND TELEVISION EQUIPMENT

CAMDEN, N. J.



WHERE TO FIND IT

All exhibits of equipment manufacturers will be in the lower lobby Exhibition Hall of the Conrad Hilton, during the NAB convention.

Exhibit space of equipment firms and the hospitality suites of these equipment exhibitors in the Conrad Hilton or other hotels are shown.

Information on networks, publications, program services, station representatives and research organizations is based on information at NAB convention headquarters as of March 5, plus checks with other hotels as well as non-member firms of NAB.

Giant directory boards in the Conrad Hilton and Sheraton Blackstone lobbies will show where associate members' suites are located.

All room and suite designations are in the Conrad Hilton Hotel unless otherwise specified. (E) indicates exhibit space; (H) indicates hospitality suite.

EQUIPMENT MANUFACTURERS

Adler Electronics(H) 923A
(E) Space 28
Alford Mfg. Co.(E) Space 29
Ampex Corp.(E) 2200 Space 34
Browning Labs.(H) 823A
Century Lighting(E) Space 22
Collins Radio Co.(E) Space 38
Caterpillar Tractor Co.(E) Space 26
Conrac Inc.(E) Space 31
Continental Electronics Mfg. Co.(H) 723A
(E) Space 36
Dresser-Ideco Co.(H) 723 (E) Space 27
Electronic Applications(E) Spaces 8, 9
Foto-Video Labs.(E) Space 23
Gates Radio Co.(H) 1023 (E) Spaces 2, 3
General Electric Co.(H) 1500 (E) Space 33
General Electronic Labs.(H) 1106A
(E) Space 35
General Precision Lab.(E) Space 15
General Radio Co.(E) Space 25
Harwald Co.(E) Space 17
Hughey & Phillips(H) 2106 (E) Space 27
Industrial Transmitters & Antennas
(E) Space 14
Kahn Research Labs(E) Space 6
Kliegl Bros.(E) Space 19
Kline Iron & Steel Co.(H) 834A
Minneapolis Honeywell Regulator Co.
(E) Space 10
Phelps Dodge Copper Products Corp.
(H) 1319 (E) Space 4
RCA(H) 605A (E) Space 24
Raytheon Mfg. Co.(E) Space 18
Schafer Custom Engineering(H) 1205-06A
(E) Space 16
Stainless Inc.(H) 1124
Standard Electronics(H) 1019
(E) Space 32
Sarkes Tarzian Inc.(E) Space 21
Telechrome Mfg. Corp.(E) Space 30A
TelePrompTer Corp.(E) 505 Space 20
Telescript-CSP(H) 1234A (E) Space 11
Utility Tower Co.(E) Space 5
Visual Electronics Corp.(H) 1218

GOVERNMENT

U. S. Army(E) Spaces 7-11A

NAB CONVENTION OFFICES

Convention ManagerRoom 1
Everett E. Revercomb, Secretary-
Treasurer
Ella Nelson, Administrative Assistant
Engineering ConferenceRoom 1
A. Prose Walker, Manager
Convention ExhibitsExhibition Hall
George E. Gayou, Exhibit Manager
Registration DeskLower Lobby
William L. Walker, Assistant Treasurer
Convention NewsRoom 3
Donald N. Martin, Assistant to the
President in charge of Public Relations
Convention ProgramRoom 4
Howard H. Bell, Assistant to the
President in charge of Joint Affairs

NAB STAFF OFFICES

RadioRoom 2
John F. Meagher, Vice President
TelevisionRoom 2
Thad H. Brown Jr., Vice President

Broadcast Personnel and Economics Room 4
Charles H. Tower, Manager
Government RelationsRoom 2
Vincent T. Wasilewski, Manager
LegalRoom 2
Douglas A. Anello, Chief Attorney
Organizational Services and APBE Room 4
Frederick H. Garrigus, Manager
ResearchRoom 4
Richard M. Allerton, Manager
Station RelationsLower Lobby
William Carlisle, Manager
Television Code AffairsRoom 4
Edward H. Bronson, Director

NETWORKS

ABC-Radio and ABC-TV(H) Skyway
Suite 2306
CBS-Radio(H) 1806A
CBS-TV(H) 2320-25
Mutual(H) 1806
NBC(H) Sheraton Blackstone 508-10
NTA Television Network(H) 1104
Sheraton Blackstone
Keystone Broadcasting System
(H) 804-05-06

PROGRAM SERVICES

CBS Films Inc.(H) 2319
California National Productions
(H) Sheraton-Blackstone
Governor Television Attractions
(H) 1018-19-20A
Community Club Services(H) 1218A
Governor Television Attractions ..(H) 1018A
Guild Films(H) Ambassador East
Independent Television Corp.(H) 2506A
Lang-Worth Feature Programs(H) 919
MCA-TV(H) 2400
MGM-TV(H) 2406
Magne-Tronics(H) Sheraton-Blackstone
Modern Talking Picture Service(H) 823
Official Films(H) Unassigned
Programatic Broadcasting
Service (Muzak)(H) 706
RCA Recorded Program Services(H) 600
Roy Rogers Syndication(H) 918A
Screen Gems(H) 2500
SESAC(H) 1206A
Standard Radio Transcription Services
(H) Flower Room, Sheraton-Blackstone
Trans-Lux Television Corp.
(H) 1314 S. Wabash
United Artists Associated(H) 1905-06
World Broadcasting System ..(H) 1822-23-24
Ziv (Economee Div.)(H) 2311A
Ziv Tv Programs(H) 2306A

RESEARCH ORGANIZATIONS

American Research Bureau(H) 800
A. C. Nielsen Co.(H) 1000
Pulse Inc.(H) 2106A

STATION REPRESENTATIVES

Avery-Knodel(H) 718-19-20
Sheraton-Blackstone
Elisabeth M. BeckjordenUnassigned
Blair Television Assoc. (H) Executive House
Blair-TV(H) Executive House
John Blair & Co.(H) Executive House
The Bolling Co.(H) 1100
Branham Co.(H) Unassigned
CBS Television Spot Sales(H) Congress
Robert E. Eastman(H) 1935A

Henry I. Christal Co.(H) 1306
Forjoe & Co.Unassigned
Gill-Perna(H) 900-01-02A
H-R Representatives(H) 3710
Executive House
H-R Television(H) 3710
Executive House
Harrington, Righter & Parsons(H) 1705
Headley-Reed(H) 700
George P. Hollingbery Co.(H) 1600
Hal Holman Co.(H) 500-01
The Katz AgencyUnassigned
Meeker Co.(H) 1700
McGavren-Quinn Corp.(H) 3511
Executive House
NBC Spot Sales ..(H) Sheraton-Blackstone
John E. Pearson Cos.(H) Congress
Peters, Griffin, Woodward
(H) Sheraton-Blackstone
Edward Petry & Co.(H) 1400
Radio-Tv RepresentativesUnassigned
Rambeau, Vance, HoppleUnassigned
Paul H. Raymer Co.(H) Executive House
Vernard, Rintoul & McConnell(H) 2100
Weed Radio Corp.(H) Congress
Weed Television Corp.(H) Congress
Adam Young Cos.(H) 2022
Prudential Plaza

TELEPHONE & TELEGRAPH COMPANIES

American Telephone & Telegraph
Unassigned

NEWS SERVICES, PUBLICATIONS

TRADE PUBLICATIONS & ASSOCIATIONS

Advertising Age(H) 1306A
Associated Press ..(H) Sheraton-Blackstone
BillboardUnassigned
Broadcast Advertisers Reports(H) 1534A
BROADCASTING(H) 704-05-06A
Media-Scope(H) 935A
Printers Ink(H) 1319A
Radio Advertising Bureau(H) 1524
Radio Press(H) 2506
Radio Television Daily(H) 906
Sponsor(H) 1106
Standard Rate & Data Service ..(H) 1706A
Television Age(H) 1606
Television Bureau of Advertising(H) 819
Television Magazine(H) 1434A
U. S. Radio(H) 923
Variety(H) 806A

Unassigned

The following firms are listed in the official NAB convention directory as associate members that had not been assigned Chicago convention suites as of March 5:

M&A Alexander Productions; Allied Record Mfg. Co.; Ampex Electronic Corp.; John F. Beasley Construction Co.; Bell & Howell Co.; Blaw-Knox Co.; Bonded Tv Film Service; Bryg Inc.; Comet Distributing Corp.; Dage Tv Div.; Thompson Products; Eastman Kodak Co.; Erco Radio Labs; Flamingo Telefilm Sales; Houston-Fearless Corp.; Magnetic Sound Camera Corp.; Mohawk Business Machines Corp.; Art Moore & Assoc.; Nems-Clarke Co.; Pams Advertising Agency; Rust Industrial Co.; Stancil-Hoffman Corp.; Sterling Television Co.; Telechrome Mfg. Corp.; Telemat; Telematics; Television Zoomar Corp.; Tower Construction Co.; Trans-Lux Television Corp.; United Press Movietone News.

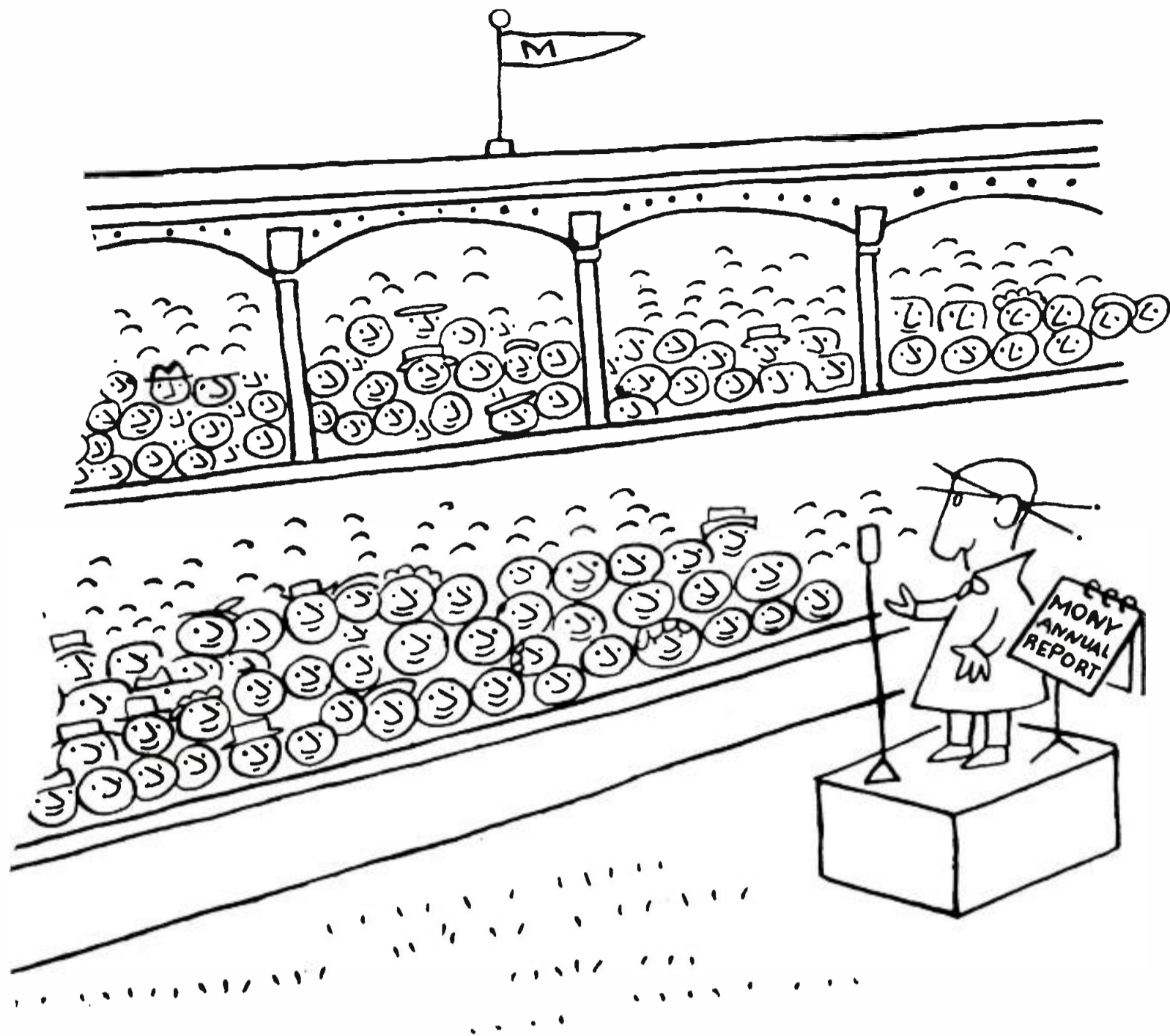

**we tell 1,000,000 families our business—
because it's their business, too**

About this time each year, we're busy getting ready to tell more than 1,000,000 people what we did the previous year. These people are our policyholders. MONY is operated for them, and for them alone, and our Annual Report is now being mailed to *each one*. In this way, *all* our policyholders have an opportunity to study MONY's stewardship of the funds they have entrusted to our care.

Printing and mailing our Annual Report to more than a million policyholders is no small task. Many

people may wonder why we do it, as this procedure is quite uncommon in our industry. But we feel very strongly that every single policyholder should receive a report of the financial progress of his Company in a simple and readable fashion. And the Report is comprehensive enough to show clearly what makes a mutual life insurance company tick.

Perhaps you would like a copy. If so, drop a line to: MONY, Public Relations Department, Broadway at 55th Street, New York 19, New York.

MUTUAL OF NEW YORK

The Mutual Life Insurance Company Of New York, New York, N.Y.
Offices located throughout the United States and in Canada

FOR LIFE, ACCIDENT & SICKNESS, GROUP INSURANCE, PENSION PLANS
MONY TODAY MEANS MONEY TOMORROW!





CONVENTION EXHIBITS

Progress in the state of the broadcasting arts—technical and service—will be shown in Exhibition Hall of the Conrad Hilton Hotel, Chicago, during the March 15-18 convention. All exhibits will be located in the hall, or lower lobby of the hotel. Program and film service groups will have hospitality suites located all over the hotel as well as in the neighboring Sheraton Blackstone.

Following are summaries of the individual exhibits to be shown in Exhibition Hall:

Equipment manufacturers

ADLER ELECTRONICS INC.

Space 28

Adler's equipment and displays to be featured include its RT-3 heterodyne repeater, tv microwave system for off-air pickup, inter-city relaying, tv-STL and remote pickups; UST-10, 10-w translator, FCC-approved, for extending tv station coverage to unserved areas; RA-7, 100-w translator-amplifier, claimed by Adler to be the first FCC-approved equipment for extending translator coverage to larger unserved communities;

UST-100, 100-w uhf tv transmitter for serving communities with locally originated programs; unitized uhf antennas, for tv translators and upper uhf frequency transmitters, may be stacked horizontally or vertically for any desired gain or coverage pattern; VCA-1 low noise vhf preamplifier, for use in weak signal areas by translators, RT-3 microwave equipment and community antenna tv systems; RR-1 rebroadcast receiver (uhf to vhf) for translators rebroadcasting an originating uhf station or another translator.

Displays include a map showing the route of three-hop tv inter-city relay carrying CBS programs from Los Angeles to KLAS-TV Las Vegas; map showing all Adler translator installations in the U.S.; maps showing coverage of a low-power, low-cost educational tv network proposed for northern Michigan.

Personnel: Ben Adler, Alfred Strogoff, Dr. Byron St. Clair, Carmen J. Auditore, Edward Galuska, Henry Shapiro, Emanuel Strunin, Martin Silver, John Klindworth, L.A. Wallace, T.W. Kirksey, Wilson Leeper, Robert Sinks, Robert J. Myers, James (Pat) Quinn, Don Carmichael and Joseph DeBragga.

ALFORD MANUFACTURING CO.

Space 29

Alford manufactures tv broadcast antennas, diplexers, coaxial switches, vestigial sideband filters and rf measuring instruments.

Personnel: Harold H. Leach and Fred Abel.

AMPEX CORP.

Space 34

Ampex Corp. will exhibit and demonstrate an extensive line of accessories and associated equipment for the company's VR-1000 videotape recorder, five of which have not been previously exhibited.

The equipment includes:

A cue and erase kit, a tape timer, an

overhead accessory rack for the VR-1000 console, a monitor switching panel and an amplifier-speaker audio monitor unit. Such previously-announced vtr equipment as the VR-1010 color accessory, bulk tv tape eraser, recording head demagnetizer, industry standard referenced tape and automatic tape splicer will be on display at Ampex' 2,500-sq.-ft. exhibit.

Use of the various accessories, including the color unit, will be demonstrated in conjunction with three VR-1000 recorders installed in separate areas on the four-section booth.

The new Ampex Model 9901 Audio Monitor Unit also will be unveiled at the exhibition. The unit consists of a speaker and amplifier built in standard rack mount fixtures for installation in the VR-1000 overhead accessory rack or elsewhere. The speaker may be removed from the rack fixture, revealing a cabinet for wall mounting.

CATERPILLAR TRACTOR CO.

Space 26

Diesel and spark-ignition electric sets for primary or standby power are manufactured by Caterpillar's engine division. The company has nearly 800 branch offices around the world.

Personnel: C.U. Stone, J.C. Frisby, R.V. Bradley, C.D. Shrake, B.P. Bessert and G.M. Cervenka.

CENTURY LIGHTING INC.

Space 22

Twelve distributors, many of whom have NAB convention exhibits, handle Century's line of tv studio lighting, wiring and control systems. The line includes complete tv studio lighting complement; Fresnels, scoops, the Big Leko, pattern projectors, strips, wiring devices, switchboards, C-1 boards, Cen-trol, C-core C-Lector, Magnatrol boards; remote Fresnels, project-o-rama, mike booms, mobilrail and complete rental deals.

Personnel: Edward F. Kook, James J. Fedigan, N. Sonny Sonnenfeld, Louis Erhardt, George Gill, Dale Rhodes, Earl Kohler, Stanley McCandless, Fred M. Wolff and Bill Merrill.

COLLINS RADIO CO.

Space 38

New automatic tape control equipment will be introduced by Collins. The push-button-controlled equipment features automatic cueing, rewind and stopping;

instantaneous no-wow starting, and simplified handling and storing, either cabinet or rack mounted. Collins also will display the 212G, a new 9-channel audio console, a new limiting amplifier and weather radar equipment.

Personnel: John Haerle, Thiel Sharpe, Glen Bergman, Harold Olson, Robert Hite, J.L. Singleton, Evan Maloney, Gerry Balcar, Cal Glade, Ray Welsh, Forrest Wallace, Paul Comstock, Jim Speck, Ralph Edwards, John Stanberry, George Wetmore, Linn Leggett, Jack Powell and Gene Randolph.

CONRAC INC.

Space 31

Conrac will show the industry its television picture tube with curved safety glass laminated to the face. The tube, developed by Pittsburgh Plate Glass, has been installed in Conrac's Fleetwood line of consumer tv sets. Its application to monitors will be demonstrated. The tube minimizes cleaning problems and provides a wider viewing area.

Also at the exhibit will be the complete line of black-and-white monitors, 8 to 27 inches, audio-video tuner for rebroadcast and recording purposes and other items in the line.

Personnel: W.J. Moreland, J.G. Jones, R.M. Alston, Parker Wickham and Don Ryrice.

CONTINENTAL ELECTRONICS

Space 36

The new 317B, 50-kw am transmitter will highlight the Continental exhibit. It features a compact design, with all components except the PA blower contained in 72 sq. ft. The firm also will display its Type TRC remote control equipment, Type MR2A fm monitor and "Magni-phase" line transmission protection system.

Personnel: James A. Weldon, W.M. Witty, Thomas B. Moseley, Mark W. Bullock, Vernon Collins, Richard P. Buckner, W.D. Mitchell and Joseph B. Sainton.

DRESSER-IDECO CO.

Space 37

A color film case history of "How a Taller Tv Tower Pays Off for You" will be shown to visitors. Caricaturist Len Redman will make personality sketches of visitors.

Personnel: J. Roger Hayden, Joseph M. Hogan, Orville Pelkey, Austin Woodward and Dan Byrd.

"NITE-WATCH...IS ONE OF THE BEST INVESTMENTS WE HAVE EVER MADE..."

SAYS TED NELSON OF KFEQ-AM AND KFEQ-TV

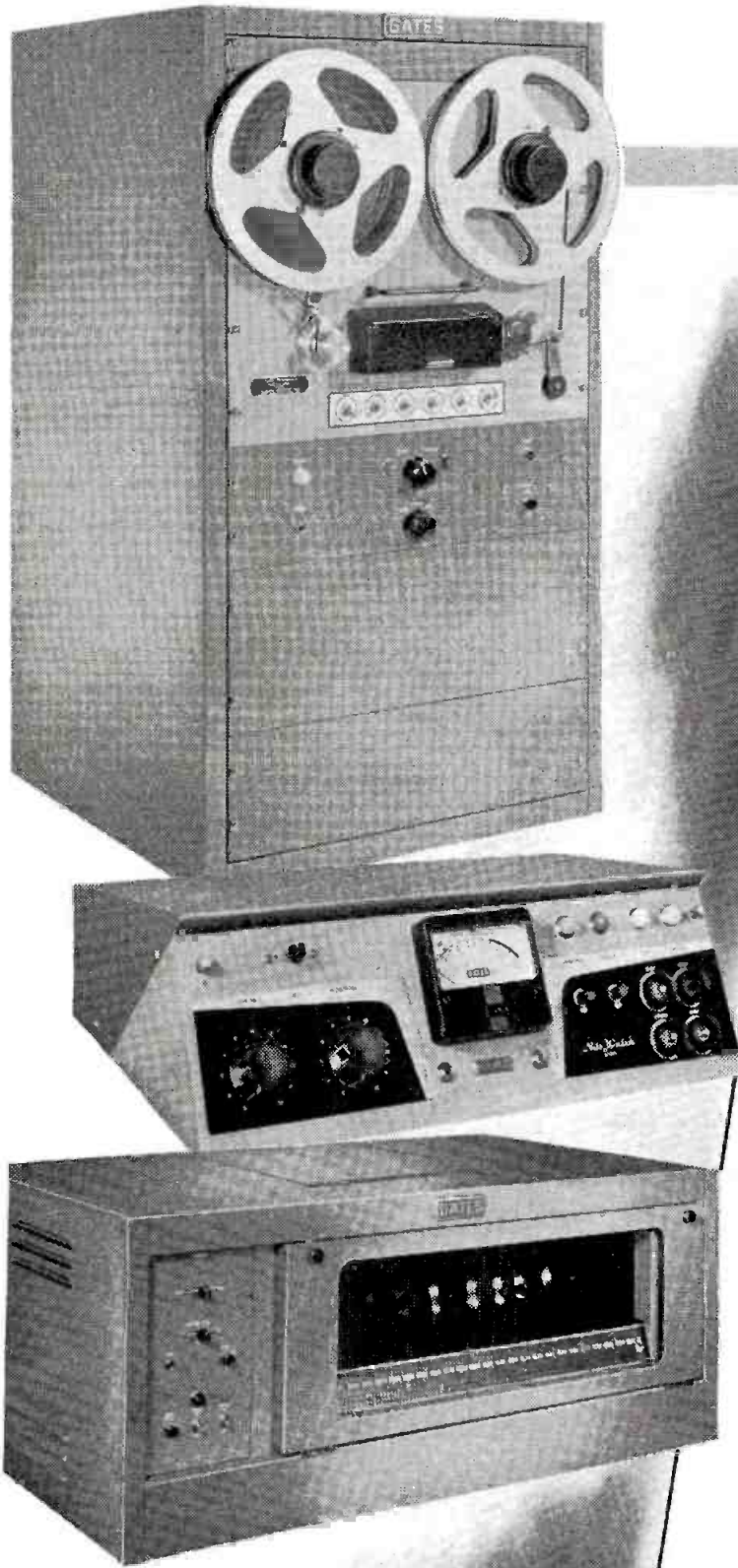

TED NELSON
VICE PRESIDENT

KFEQ BROADCASTING CO.
KFEQ-TV · KFEQ-AM
ST. JOSEPH, MISSOURI

November 17, 1958

Mr. John R. Price
Gates Radio Company
Advertising Director
Quincy, Illinois

Dear Mr. Price:

We have your inquiry of November 13 concerning the Nite Watch Unit and rather than simply fill out your form, I am sending this letter to bring you up to date on our experience with the unit. You have our permission to use any part of this letter in your advertising or promotion as you see fit.

The unit that we have does everything that Gates has claimed for it and we feel that as we get to know the unit better, we will find ways to use it that will make it an even more versatile tool. We bought it because of the things Gates said it would do and it is more than satisfactory. To try to tell you the one thing we like best about the Nite Watch is not practical for it does many things and we like the overall performance and the whole job.

We now use Nite Watch to program four (4) hours each day and very frankly I doubt very much if anyone could tell when we're running on Nite Watch and when we're running live. The principle difference is that Nite Watch doesn't make mistakes since we have the advantage of previewing every sentence before it goes on the air.

The tape recording equipment which is with the unit is of excellent quality and we feel that it is equal to or better than the comparable equipment sold under other brand names.

There is no question but that Nite Watch has been a great benefit to our operation and we feel that it is one of the best investments we have ever made in equipment.

Very sincerely yours,

Ted Nelson
Ted Nelson

TN:ps

The new Gates Nite-Watch Automatic programming system provides up to 7½ hours of continuous programming. Three basic requirements are supplied as a complete package with Nite-Watch: (1) production console, (2) tape control unit (a top grade tape recorder/playback mechanism of advanced professional design), and (3) the 100 record (up to 200 plays, both sides) 45 RPM automatic cueing transcription changer. This transcription unit may be operated, when not automatically programming, as a Gates Auto-Trans by purchasing an inexpensive remote control operations box. All 45 RPM records may then be pushbutton started with assured automatic cue-up.

Write today for 8-page brochure describing each outstanding feature of this new automatic programming system—yours for the asking.

GATES

**HARRIS
INTERTYPE
CORPORATION**

GATES RADIO COMPANY

QUINCY, ILLINOIS

Subsidiary of Harris-Intertype Corporation

OFFICES — NEW YORK — WASHINGTON, D. C. — HOUSTON — ATLANTA

spot
summer radio goes where



the family goes

Vacation may mean getting away from home...but Radio goes along.

You're traveling "right" with SPOT RADIO in your summer media plans.

Reach people—wherever they are, at home or on vacation—with SPOT RADIO.



SPONSORED BY MEMBER FIRMS OF



Avery-Knode Inc. — John Blair & Company — Broadcast Time Sales
Thomas F. Clark Co. Inc. — Harry E. Cummings — Robert E. Eastman & Co. Inc.
H-R Representatives Inc. — The Katz Agency Inc. — McGavren-Quinn Company
The Meeker Company Inc. — Art Moore Associates Inc. — Richard O'Connell Inc.
Peters, Griffin, Woodward, Inc. — William J. Reilly, Inc.
Radio-TV Representatives Inc. — Weed Radio Corporation — Adam Young Inc.

NAB PREVIEW

EXHIBITS CONTINUED

FOTO-VIDEO LABS INC.

Space 23

Foto-Video will demonstrate the following new pieces of equipment: all-transistor studio power supply system; all-transistor image orthicon orbiter/tracker systems; line of 14-24 in. video monitors; long-line and multi-channel video transmission and distribution gear; video transmission test equipment. The firm's test equipment has been augmented by a Monoscope camera with either Indian Head or 800 line pattern. Also being introduced is the Foto-Video Stair Step Generator, featuring variable duty cycle, variable number of steps, 1 mc and 3.58 mc modulation and integral sync and power.

Personnel: Albert J. Baracket, John Mahler, Bert Findlay, Jim Palmere, Gilbert Walton, Hans Nord, Irwin Lowenstein, H.A. Kazanjian, Pat Quinn.

GATES RADIO CO.

Space 2-3

New products to be shown by Gates include a spot tape recorder, a broadcast frequency monitor, a remote control system for unattended operation and its "Level Devil" program gated amplifier. The Level Devil is designed for tv and fm as well as am broadcasting. Where the lower signal level, referred to as noise during a period of program silence, was expanded in older leveling amplifiers, this difficulty has been overcome in the Level Devil. In the absence of signal, noise level does not rise above the original level established by the average signal, Gates says.

Other products for showing: new 5-kw tv and am transmitters; new transcription turntable; new 5-kw fm transmitter with multiplex; 50-kw am transmitter; 1-kw am transmitter; Nite-Watch automatic programming system; Dualux, Studioette and Gatesway consoles; CB-4 Horseshoe desk assembly, and broadcast remote amplifiers.

Personnel: P.S. Gates, Larry Cervone, Norbert Jochem, Edward J. Wilder, John R. Price, Dick Spruill, Bill Moats, Urlin Whitman, Stan Whitman, Ken Neubrecht, Bud Ayer, C.O. Morgan, Robert Kuhl, Jay Blakesley, Gene Edwards, Ed Hurt and Frank Grasett.

GENERAL ELECTRIC

Space 33

GE will exhibit more than a half million dollars worth of broadcast equipment which has been over two years in design and development. Among the new products, all now in production, are small and economical vidicon tv cameras and a 50 kw transmitter, the first to incorporate germanium rectifiers.

New GE transistorized equipment includes color and black-and-white tv cameras, audio console, sync generators and audio amplifiers. Other products to be shown include low-band tv transmitters, color film scanner, automatic programmer, a full-size section of a vhf helical

antenna, 2,000 mc microwave relay system (portable and rack-mounted), studio monitors, special effects generator and amplifier and a complete line of audio equipment.

Personnel: Harold G. Towlson, M. Alves, Paul L. Chamberlain, Marshall E. Minich, John Wall, M.R. Duncan and S.J. Eby.

GENERAL ELECTRONIC LABS

Space 35

Products manufactured by General Electronic Labs include fm transmitters with fm multiplex exciters including main channel exciter, subchannel generator and power supply mounted in cabinet as a complete integrated system.

Personnel: Victor W. Storey, Philip Hayden, Robert Pritchard, Sal Fulchino, Capt. W.G.H. Finch.

GENERAL PRECISION LABORATORY

Space 15, 30

Information on GPL broadcast and educational tv equipment will be featured in space 15. Some GPL equipment will be on display and operated in space 30 by Visual Electronics GPL's national distributor for tv equipment.

Personnel: N.M. Marshall, L.L. Pourciau, E.J. Manzo and A.F. Brundage.

GENERAL RADIO CO.

Space 25

General Radio will display its precision instruments for measuring transmitters, antennas, transmission lines and tv transmitter frequency-checking system.

The firm also will show its new 1650-A impedance bridge, a self-contained and portable instrument to measure inductance and storage factor of inductors, capacitance and dissipation factor of capacitors and a-c and d-c resistance of all types of resistors. It was also claimed to be useful in the laboratory to measure circuit constants, test samples and identify unlabeled parts.

Other features include meter-type null indication, direct-reading dials and completely transistorized generator and detector.

Personnel: Charles A. Cady, Joseph E. Belcher, Lane W. Gorton, William M. Ihde and Robert E. Bard.

HARWALD CO.

Space 17

Harwald will exhibit automatic film inspection and editing equipment, splicers, racks and related items.

Personnel: Robert Grunwald, Sam Caldwell, Richard Wallace, Howard Bowen.

HUGHEY & PHILLIPS INC.

Space 27

The company's tower obstruction lighting equipment display will feature its new tower lighting isolation transformers. Also to be demonstrated are its remote lamp failure indicator system for continuous monitoring of tower lamp conditions; its tower light control and alarm units for unattended microwave relay stations; its

combination photoelectric control and beacon flasher units; beacons; obstruction lights, and various control units.

Personnel: J.H. Ganzenhuber, H.V. Claeson, H.J. Geist, R.L. Lang and F.J. Little Jr.

ELECTRONIC APPLICATIONS INC.

Space 8-9

A Swiss transistorized tape recorder, the Nagra III B, will be shown for the first time by Electronic Applications. The recorder contains 30 transistors and can be operated at speeds of 3¾, 7½ and 15 inches-per-second. It operates from self-contained monocytes and provides studio-grade reproduction. Also to be introduced will be the Studer "30," a professional tape unit designed for high timing accuracy and constant tape tension.

Shown at the exhibit will be the new miniature Model 24 B dynamic and 28 C condenser microphones and a Model 0815 spherical loudspeaker, the Kugel. The new microphones were designed for minimum visual obstruction and professional standards. The firm's EMT 140 Reverberation unit also will be demonstrated, as will rack-mounted fm broadcast tuners.

Harvey Radio, New York, is distributor in the New York area.

Personnel: V.J. Skee, Wilhelm Franz, S. Hoisl, E. Stern, H. Sampson Jr., Ray Hutmacher and Lester Karg.

INDUSTRIAL TRANSMITTERS AND ANTENNAS

Space 14

A complete line of fm broadcast transmitters, ranging in power from 10 w to 10 kw will be displayed. There will also be a display of the firm's 10 w fm multiplex exciter.

Personnel: Bernard Wise, Fred Gayer, Robert Jordan and Stanley Friedman.

KAHN RESEARCH LABS

Space 6

Kahn will show for the first time its Model STR-59-1A stereophonic adapter which permits compatible stereophonic broadcasts over a single am transmitter with reception on two am receivers. When used with any standard transmitter, the adapter produces two independent sidebands individually modulated by stereo channels. Kahn also will show a compatible single-sideband adapter for am transmitters and Symmetra-peak, Model SP-58-1A, a passive network used by broadcasters to increase coverage range of voice transmissions.

Personnel: Leonard B. Kahn and Kenneth B. Boothe.

KLIEGL BROS.

Space 19

The S.C.R. dimmer will be shown, demonstrating a new method of dimming control (controlling levels of light brightness). This is the first commercial application of the newly developed silicon controlled rectifier, according to Kliegl Bros. A complete working board will be demonstrated under full operating conditions. Herbert R. More will describe the dimmer at the Engineering Conference on March 18.

find out
how little
a Collins custom
control desk
will cost you

Collins now offers the most attractive custom control desks available. At lower cost than "catalog" desks! Fully custom designed to meet your requirements. "Cabinet-maker" construction. Natural wood finish, or painted to match or harmonize with your color scheme. No-mar Formica top.

For a free estimate on the desk you need, make a rough sketch of available space and mail with this coupon. There's no obligation of any kind.

*This desk designed for and in use by KOEL, Oelwein, Iowa.



COLLINS RADIO COMPANY • 315 2nd AVE. S.E. • CEDAR RAPIDS, IOWA

Please send me an estimate on a Collins Custom Control Desk. Desk will incorporate:

Turntables (make)	(size)	(number)
Console (make)	(size)	
Record Compartment for (number)		Records
Name	Title	
Station or Company Name		
Call Letters	Address	
City	Zone	State



COLLINS RADIO COMPANY • CEDAR RAPIDS • DALLAS • BURBANK



BRISTOL-MYERS gives over twice as much business to CBS Radio as to the one other network it uses. To put more muscle in the message, of course! This network has delivered largest commercial minute audiences all along. And the new Program Consolidation Plan—with unified station clearances and strong program sequencing—will increase this leadership.

CBS RADIO NETWORK:

42% LARGER AUDIENCES PER COMMERCIAL MINUTE THAN ANY OTHER RADIO NETWORK, AVERAGING OVER 16 CONSECUTIVE MONTHS.

NAB PREVIEW

EXHIBITS CONTINUED

MINNEAPOLIS-HONEYWELL

Space 10

The Brown Instrument Div. of Minneapolis-Honeywell will show transmitting station automatic logging equipment and remote control automatic logging equipment.

Personnel: George W. McKnight and Gustav Ehrenberg.

MUZAK CORP.

Space 1

Programatic Broadcasting Services, a division of Muzak, will demonstrate the "push-button broadcasting service" which consists of an electronically-controlled, time-synchronized tape playback device and a supply of eight-hour tapes delivered regularly to subscribing broadcasters. These tapes are pre-recorded and programmed with music "designed to appeal to American adult audiences." The system will be available to broadcasters on an exclusive basis in each radio market.

Personnel: Charles C. Cowley, Joseph Roberts, John Esau, Norman Ostby, E.F. Hembrooke, John Jarvis and Edward Hochhauser.

PHELPS DODGE COPPER PRODUCTS CORP.

Space 4

Products to be shown in Exhibition Hall include air dielectric coaxial cable, Styroflex, Spirafil and Foamflex.

Personnel: F.W. DeTurk, H.M. Edwards, R. Plant and H. Magnuson.

RAYTHEON MFG. CO.

Space 18

Products to be shown at the convention will be based on Raytheon's extensive line of microwave television relay systems for remote pickup or STL applications. Portable and rack-mounted equipment will be in the exhibit along with program audio channel units for application to existing systems. Microwave waveguide accessories will include antennas, diplexers and other items.

Personnel: H. J. Geist, J. J. Sedik, W. B. Taylor, A. F. Conrad, Hugh Bannon.

RCA

Space 24

Highlighting the RCA display will be a production model of the advanced RCA tv tape recorder and an automation system designed to handle the switching functions of a tv station. The videotape recorder was designed to meet strict industry requirements and its tapes can be used interchangeably with those of other recorders. The recorder is housed in five compact "stand-up" cabinets for monochrome and a sixth cabinet can be added for color.

An electronic system permits precise adjustment of the electrical quadrature relationship between the four video playback heads. The cueing system includes a variable speed control to roll the tape in

forward or rewind, a special cue channel and a separate cue signal erase head. The main tape guideposts force air through tiny holes so that the tape rides on an air cushion, helping to eliminate scratches.

The RCA automation system is designed to eliminate many operating errors common to tv stations. Switching sequence is arranged in advance and the unit automatically starts and stops film projectors, slide projectors, operates video and audio switching equipment and switches film room multiplexer mirrors in the predetermined order.

Other highlights of the RCA exhibit will be a new vidicon tv camera (TK-205), "suitcase size" self-contained master monitor (TM-35), medium-power high-band transmitter (TT-11AH), radio automation equipment and a tv special effects system.

Personnel: T.A. Smithe, C.H. Colledge, J.J. Graham, J.P. Taylor, H.R. Henken, E.C. Tracy, A.F. Inglis, M.A. Trainer, V.E. Trouant, Paul Bergquist, P.A. Greenmeyer, E.N. Luddy, Dana Pratt, W.B. Varnum, David Bain, V.S. Mattison, B.K. Kellom, L.W. Haeseler, Max Berry, J.H. Cassidy, J.E. Dilley, E.T. Griffithy, J.E. Hill, A.M. Miller and C.F. Strawley. Representing the Tube Div. will be H.C. Vance, J.E. Kelly, R.E. Johnson and R.E. Lawrence.

PAUL SCHAFER CUSTOM ENGINEERING

Space 16

Schafer will show in operation a program automation system for all types of radio stations, the M-60 model, which the firm says permits complete programming up to 24 hours and can be prepared in a fraction of airtime. Timing is not affected by interruption of the program for news or other inserts. The M-60 automation package includes three tape recorders, two 100-record Seeburg libraries, full four-channel automation and all necessary remote controls and cabinets. The firm also offers "automation trailers," self-contained mobile units for on-spot demonstration at any station.

STANDARD ELECTRONICS INC.

Space 32

Standard will exhibit its all new, space saving line of fm and tv equipment, including 250 w and 3 kw fm transmitters for stereo or multiplex operation and a 10 kw vhf transmitter. Also shown will be fm serrasoid replacement modulators for modernizing older-model transmitters. The new Standard equipment features add-a-unit, patchover, semi-conductor rectifiers in fm transmitters with no rectifier tubes and built-in multiplex. All the tubes are visible on the tv transmitter through glass doors. The air cooled unit is self-contained with no external transformers.

Personnel: William H. Zillger, H.R.

PLANNING FM BROADCASTING?

See page No. 109

G
E
L



so you want to grow bigger...

... no trick at all — just grow taller

See and hear the compelling story on "How a taller tower can pay off for you." Come to the Dresser-Ideco booth in the Conrad Hilton Exhibition Hall at the NAB Convention next week in Chicago. It's a story full of facts, by the builders of more than half of all the 1000'-plus TV towers in service today. After hours, you'll be welcome in our Hospitality Suite at the Conrad Hilton, to pose for one of those famous Lenn Redman caricatures.

Dresser-Ideco Company

Division of Dresser Industries, Inc.

TOWER DIVISION, DEPT. T-95
875 MICHIGAN AVE., COLUMBUS 8, OHIO



NAB PREVIEW

EXHIBITS CONTINUED

Smith, Allen R. Taylor, William H. Rappolt, James T. Campbell, Robert C. Hutchins, Lewis E. Pett and H. Duncan Peckham Jr.

SARKES TARZIAN INC.

Space 21

The Sarkes Tarzian exhibit will include vhf transmitter packages, including studio equipment; tv 16 mm projectors; tv 35 mm projectors; racks, console and chassis; tv studio equipment—vidicon film and live cameras, switches, orthicon cameras, monitors, multiplexers, sync generators, audio equipment and tv film equipment.

Personnel: Biagio Presti, Dan Meadows, Wendell Fuller, Neff Cox Jr., Gene Keith, Dale Buzan, Henry Cronin, Nubar Donoyan, Russ Ide, Dick Swan, Mel Berstler, Fred Steiner.

TELECHROME MANUFACTURING CORP.

Space 30A

Telechrome's studio-oriented tv special effects generator (model 490-A) for wipes and matting will be featured. The generator produces 72 different wipes and limitless special insert effects in both color and monochrome.

Also to be shown is the sine-squared window generator (model 1073-DR). This produces new wave form for testing tv or other pulse units or systems for amplitude and phase characteristics. A vertical interval keyer (model 1008-A) will be exhibit-

ed. The keyer permits any test or control signal to be transmitted simultaneously with program material between frames of a tv picture. Test signals are then always present for checking transmission conditions without impairing picture quality. In addition, Telechrome will display a video transmission test set (model 1005-A), a video transmission test signal receiver (model 1004-A) and an oscilloscope camera (model 1521-A).

Personnel: H. Charles Riker, S. Krinsky, D. Chapman, D. Dudley and R. Wulfe.

TELEPROMPTER CORP.

Space 20

Among the products featured will be the TelePrompter Model V cueing equipment, with selector dual hand control, ring control, foot pedal, lens adapter and new accessories. Also, the new TelePro 6000 rear screen projection system with 85 slide-per-minute changer, short throw, complete remote control, dramatic light power, new automatic douser and new tandem head single control projector system will be shown. The display will include the new single contact 12 channel Tele-Mation automation of pre-set effects.

Personnel: Irving B. Kahn, Hubert J. Schlafly Jr., William V. Sargent, James Blair, Ted Atwood, Alfred N. Greenberg, Ted Boisumeau, Kirk Logie, Joe Munisteri, and Larry Lantry.

TELESCRIPT-CSP INC.

Space 11

The company's latest cueing and prompting equipment for tv studios fea-

tures the variable speed foot control; the Lens-Vue Tv for into-the-lens delivery; the MagniScript, which magnifies type to 3/4-in. height and allows the performer to read at distances of 30 to 35 feet from the camera. The firm will unveil its new rear screen projector with these features: 3,000 w lamp producing 6,500 lumens, automatic slide changer holding 70 slides, two blowers for cooling, adjustable legs, electric douser and remote control focusing.

Personnel: Peter Jackson, Robert P. Swanson, Trygve W. Lund and Curt Howard.

U.S. ARMY

Space 7, 11A (Hospitality Suite Room 707A)

The Army exhibit will show Army progress in development of firepower, mobility, communications and human resources. It will feature the latest Army space probe, including a full scale model of the Army's Pioneer IV instrumented payload (final stage).

Personnel: Col. Robert V. Shinn, Maj. Robert Cranston, Maj. George Morris, Stanley Field, M/Sgt. Stuart A. Queen, SFC Don Cosgrove.

UTILITY TOWER CO.

Space 5

Utility Tower manufactures and erects radio towers. Sections of towers and hardware will be shown as well as insulators and lighting controls.

Personnel: C.E. Nelson, Jerry Nelson, V.G. Duvall and Nathan Sholar.

Syndicated radio-television programs and services

CBS FILMS INC.

Suite 2319

Guests will receive plastic helicopters (*Whirlybirds* show) and ball point pens.

Personnel: Sam Cook Digges, John F. Howell, Fred J. Mahlstedt, Walter A. Scanlon, Ralph M. Abruch, Barr Sheets, George Diedrich, James H. McCormick, Carter Ringlep, Henry Gillespie, Robert T. Donnelly, William Hooper, Richard P. Moran Jr., Lee Stone and Howard L. Kany.

CALIFORNIA NATIONAL PRODUCTIONS

Sheraton-Blackstone

Personnel: Jacque Liebenguth.

COMMUNITY CLUB SERVICES

Suite 1218A

Personnel: John C. Gilmore, William M. Carpenter, Boyd Lawlor, Len Hornsby, Richard N. Robbins, Ralph Durham, Phil Peterson, Martin White, Todd Branson, Tom Dugga, Jerry Hauser, Russell O. Hudson, John Karr.

GOVERNOR TELEVISION ATTRACTIONS

Suite 1018-19-20A

Personnel: Arthur Kerman, Frank Spiegelman, Ben Barry, Howard Grafman.

GUILD FILMS

Ambassador East

Personnel: John J. Cole, Art Gross, Gerald Liddiard, Marvin Grieve.

INDEPENDENT TELEVISION CORP.

Suite 2505-06A

Souvenir gifts will be given all visitors to Independent's convention suite by Al Unger, administration manager, Arrow Productions. They will consist of a plastic pocket secretary with provision for the recipient's name. Others attending will be Hardie Frieberg, Stan Levey and Lee Cannon.

LANG-WORTH FEATURE PROGRAMS

Suite 919-20

John D. Langlois, Hugh Allen, Robert Boehmer, Ed Gardiner, John Courcier.

MCA-TV LTD.

Suite 2400

Personnel: Dave Sutton, Lou Friedland, Bob Greenberg, Dearv Barton.

MGM-TV

Suite 2404-05-06

The MGM-TV library includes groups of short subjects as well as an extensive list of pre-1948 feature films.

Personnel: Richard Harper, Maurice Gresham, Paul Mowrey.

MAGNE-TRONICS INC.

Sheraton-Blackstone

The company, which furnishes functional background music service on magnetic tape, available on exclusive franchise

basis, will not have an exhibit but will have a hospitality suite.

Personnel: Thomas L. Clarke, Joseph F. Hards and George W. Hamilton.

MODERN TALKING PICTURE SERVICE

Suite 823

MUZAK CORP.

(Programatic Broadcasting Service)

Suite 704-05-06. (see exhibition space 1)

NTA TELEVISION NETWORK

Sheraton-Blackstone, Suite 1104-05-06

Personnel: Charles C. (Bud) Barry, Anthony Azzato, Lynn Christenson, Charles King. From National Telefilm Assoc., parent company: Ely A. Landau, Oliver A. Unger, Harold Goldman, Martin Roberts.

OFFICIAL FILMS

Three new shows will be unveiled at the convention by Official Films. A private telephone line, Randolph 6-9635, will be installed in the suite. The Official Film library includes such shows as *Robin Hood*, *Star Performers*, *My Little Margie* and *Decoy*.

Heading the delegation will be Stan Smith, sales vice president. Others in the suite: Art Breecher, Mary Cox, Don Fuller, Alex Sherwood, Barney Mackall and Barry Winton.

RCA RECORDED PROGRAM SERVICE*Suite 600-01-02*

Personnel: E. B. Dunn, A. B. Sambrook, William F. Reilly, Ben Selvin, E. H. Kelly, Donald D. Axt, Milton B. Kaye, J. J. Alves, Wally Cocgran, Jack Dill, George Field, Bill Gartland, Hugh Grauel, Gus Hagenah, Jack Nadeau.

Because St. Patrick's Day falls during the convention, RCA will furnish Irish coffee.

ROY ROGERS SYNDICATION*Suite 918A***ROY ROGERS SYNDICATION***Suite 919A*

Personnel: Edward L. Koenig Jr., Peter M. Robeck.

SCREEN GEMS INC.*Suite 2500-01-02A*

This producer and distributor of tv film programs offers first-run series such as *Rescue 8* and *Stakeout*, reruns such as *Burns & Allen*, comedies such as "The Three Stooges" and feature films such as

"Powerhouse" group 78.

Personnel: Jerry Hyams, Bob Seidelman, Dick Dinsmore, Frank Parton, Bill Young, Stan Dudelson, Don Bryan and Ben Coleman.

SESAC INC.*Suite 1205-06A*

SESAC will push its newly-developed "Special Series Programs," consisting of scripts and records for all types of shows and available on an outright sale basis. The new SESAC library service also will be featured, with all visitors to receive souvenirs.

Personnel: Alice Heinecke, E. S. Prager, W. F. Myers, S. Guber, E. Cooney, H. Fitzgerald, G. Ramsey.

STANDARD RADIO TRANSCRIPTION SERVICES INC.*Flower Room, Sheraton-Blackstone*

Standard will introduce a satirical soap-opera format to lead into commercials; there will also be three new five-minute open-end radio program series as well as twenty new sides added to the first Hi Fi sounds released two months ago and estab-

lished Standard services such as the Musi-'Que' Library and the commercial aids and jingles library.

Personnel: Milt Blink, Olga Blohm, Robert Hall (Robert Hall Productions).

UNITED ARTISTS ASSOCIATED*Suite 1905-06*

Personnel: W. Robert Rich, Donald Klauber.

WORLD BROADCASTING SYSTEM*Suite 1822-23-24*

Personnel: James H. Weathers, John S. Murphy, James McKnight, Hal Tunis and Dick Crane.

ZIV TELEVISION PROGRAMS*Suite 2306A*

Personnel: M. J. Riskin, Len Firestone, Robert W. Friedheim, Jerry Kirby.

ZIV ECONOMEE DIV.*Suite 2311A*

Personnel: Pierre Weis, Dick Lawrence, Ken Joseph.

Station Representation firms

VERY-KNODEL*Sheraton-Blackstone, Suite 718-19-20*

Personnel: Lewis Avery, J.W. Knodel, Charles C. Coleman Jr., Philip Schloeder Jr., Michael T. Joseph.

ELISABETH M. BECKJORDEN*Unassigned*

Personnel: Elisabeth M. Beckjorden.

BLAIR TELEVISION ASSOC.*BLAIR-TV***JOHN BLAIR & CO.***Executive House*

Personnel: John Blair, Ed Shurick, Art McCoy, Dick Foote.

THE BOLLING CO.*Suite 1100*

Personnel: George W. Bolling, Robert H. Bolling, G. Richard Swift, Morton A. Barrett, John D. Stebbins, Gale Blockie.

CBS TELEVISION SPOT SALES*Congress Hotel*

Personnel: Bruce Bryant, Arthur C. Elliott, Howard Marsh, Lamont Thompson, Ben Margolis, Jack White.

ROBERT E. EASTMAN*Suite 1935A-36A*

Personnel: Robert E. Eastman, Richard Arbuckle, George Dubinetz, Edward Denten.

HENRY I. CRISTAL CO.*Suite 1306***FORJOE & CO.***Suite 1900*

Personnel: Joseph Bloom, Frederick L.

Bernstein, Lawrence J. Krasner, Robert A. Lazar, John Hartigan.

GILL-PERNA*Suite 900-01-02A*

Personnel: Helen Gill, John J. Perna Jr., Walter Beadell, Irwin Unger, Donald Dalton, Daniel W. Bowen, Allan Young.

H-R REPRESENTATIVES**H-R TELEVISION***Executive House, 3710-11-12*

Personnel: Frank M. Headley, Frank E. Pellegrin, James M. Alspaugh, Avery Gibson, Dwight S. Reed, John T. Bradley, French L. Eason, Rex Lathen, Terrence Hughes, Bernard Slavin, Stewart Lewis, Arthur Kelly, Grant Smith, Clark R. Browne.

HARRINGTON, RIGHTER & PARSONS*Suite 1705*

Personnel: John E. Harrington Jr., Volney Righter, James O. Parsons Jr., William Snyder, Frank Dougherty, Carroll R. Layman.

HEADLEY-REED*Suite 700*

Personnel: Frank Miller Jr., Sterling Beeson, Jack Hardingham, Robert Schmid, Geno Cioe, John Wrath, Don Hamel, John Buzby, Earl Gallagher, William Shaw.

GEORGE P. HOLLINGBERY CO.*Suite 1600*

Personnel: George Hollingbery, F.E. Spencer Jr., Fred Hague, Harry Wise, Frank McCarthy, Warren Nelson, Ray Edwards, George Hemmerle, Richard N. Hunter, Joseph D. Payne Jr.

HAL HOLMAN CO.*Suite 500-01*

Personnel: Hal Holman.

THE KATZ AGENCY

Personnel: Edward Codel.

MEEKER CO.*Suite 1700*

Personnel: Robert D.C. Meeker, Edgar B. Filian, Robert L. Dudley, Charles E. Standard, Carl Jewett, Bob Manning, Charles Compton, Don Pontius, Donald Palmer.

McGAVREN-QUINN CORP.*Executive House, Suite 3511*

Personnel: Daren McGavren, Donald J. Quinn, Ralph Guild, William T. Heaton, Ed Tilden, Walter Lake, Cy Ostrup, Wendell Parmallee, Bob Galen.

NBC SPOT SALES*Sheraton-Blackstone*

Personnel: Richard H. Close, Edwin T. Jameson, George Dietrich, Morton Gaffin, Jack Mulholland, Frank De Rosa, Frank Morgan, Robert Ewing, Verne Herron, Richard Cahill, Tom Montgomery, Ed Gardner, Harry Jacobs, Joseph Lutzke, William Scharton, William Buschgen.

JOHN E. PEARSON COs.*Congress Hotel*

Personnel: John E. Pearson, William Wilson, Ray Henze, James Bowden, John Palmer.

PETERS, GRIFFIN, WOODWARD*Sheraton-Blackstone***EDWARD PETRY & CO.***Suite 1400*

Personnel: Edward E. Voynow, Ernest Lee Jahncke, Martin Nierman, Ben Holmes, Richard Hughes, David Milam,

Fred Johnson, William Cartright, John Ashenhurst, Louis Smith, William Pipher.

RADIO-TV REPRESENTATIVES

Personnel: Peggy Stone, Ed Nickey.

RAMBEAU, VANCE, HOPPLE

Unassigned

PAUL H. RAYMER CO.

Executive House

Personnel: Paul H. Raymer, Fred C. Brokaw, Stuart Kelly.

VENARD, RINTOUL & McCONNELL

Suite 2100

Personnel: Lloyd George Venard, Jim McConnell, Howdee Meyers, Clyde Melville, Jerry Mulderrig, Steve Rintoul Jr., Gordon Copeland, John Dragomier.

WEED RADIO CORP.

WEED TELEVISION CORP.

Congress Hotel

Personnel: C.C. Weed Sr., Joseph J. Weed, Edwin J. Fitzsimmons, Bates Halsey, Jerry Lyons, Herb Hobler, George P.

Lindsay, Chuck Linton, Sam Eadie, Warren Tommasine, John Thorson, Bill Fallon, Neal Weed Jr., Robert R. Reardon, Mel Whitmire, B.P. Pearse Jr., Fred Edwards, E.C. Metcalfe Jr., Boyd Rippey.

ADAM YOUNG COs.

ADAM YOUNG INC.

YOUNG TELEVISION CORP.

YOUNG CANADIAN LTD.

Prudential Plaza, Suite 2022

Personnel: Adam Young, James O'Grady, Steve Machcinski.

On deck for the networks in Chicago

ABC RADIO AND ABC-TV

Conrad Hilton, Skyway Suite

Reception for both ABC radio affiliates and ABC-TV affiliates in Parlors A and B of Williford Suite, Conrad Hilton, March 15, starting at 5 p.m. Affiliate meeting for ABC-TV will be in Crystal Room, Sheraton Blackstone, March 15, 2 p.m.

Personnel: Leonard H. Goldenson, president of AB-PT; Simon B. Siegel, financial vice president of AB-PT; Oliver Treyz, president of ABC-TV; Edward J. DeGray, ABC vice president in charge of radio network; Michael J. Foster, ABC vice president in charge of press information; Robert H. Hinckley, vice president in charge of Washington office; Frank Marx, vice president in charge of engineering; James G. Riddell, ABC vice president Western Div.

The following from ABC-TV: Thomas W. Moore, vice president, programming; Donald W. Coyle, vice president and general sales manager; Alfred R. Beckman, vice president in charge of station relations; James W. Beach, director of tv network and vice president of Central Div.; William C. Gillogly, director of sales, tv network, Central Div.; Donald S. Shaw Jr., director of station clearance; Ralph S. Hatcher, manager of station relations; Dean Linger, director of advertising; Joseph Giaquinto, manager of station clearance; Malcolm Laing, Robert Coe and Joseph Merkel, regional managers for station relations; Robert Curran, station relations assistant regional manager; Steven Riddleberger, ABC vice president for o&o stations; Slocum Chapin, ABC vice president for western division and tv network sales; Theodore H. Fetter, ABC vice president and programming director; Giraud Chester, vice president, ABC-TV daytime programming; Julius Barnathan, ABC-TV director of research; Bert Briller, ABC-TV director of sales development; Rosario Calabrese, ABC-TV art director; Vincent Francis, ABC-TV sales manager and Pacific manager, San Francisco; G. Edward Hamilton, ABC director of engineering operations; Joseph Stammler, vice president and general manager, WABC New York; Harold Cranton, director of sales development and research, ABC Radio; Earl Mullin, manager of station relations, ABC; Frank Atkinson, station relations regional manager.

Non-network personnel: John Pival, vice president for tv, Detroit; Harold Neal, vice

president for radio, Detroit; Charles Kocher, chief engineer, WXYZ-AM-TV Detroit; Sterling C. Quinlan, vice president, WBKB (TV) Chicago; Mathew Vieracker, general manager, WBKB; William P. Kusack, manager of engineering department, Chicago; Elliot W. Henry Jr., director of publicity and promotion, Central Div.; Ted Grenier, chief engineer, Western Div.; Selig Seligman, vice president and general manager, KABC-TV Los Angeles; Ralph Andrews, film director, WBKB Chicago; John Fitzpatrick, production manager, WBKB and ABC Central Div.; Daniel Schuffman, programming manager, WBKB, and David Wallerstein, president of Balaban & Katz.

CBS INC., CBS TELEVISION NETWORK

Conrad Hilton, Suite 2325

Personnel: Louis G. Cowan, president, CBS-TV; William B. Lodge, vice president, affiliate relations; Carl S. Ward, vice president and director, affiliate relations; Joseph H. Ream, vice president CBS Inc. Washington; Richard S. Salant, vice president, CBS Inc.; William H. Hylan, vice president, sales administration, CBS-TV; Gordon F. Hayes, vice president, Spot Sales, CBS Radio; Robert Wood, manager, affiliate relations (station contracts); Edward E. Scovill, midwest manager, affiliate relations; David Williams, eastern manager, affiliate relations; Bert Lown, western manager, affiliate relations; James Kane, CBS-TV press information; Leonard F. Morreale, sales manager—Extended Market Plan, network sales; George Zurich, sales service manager; network sales; K. Blair Benson, engineer, engineering; Robert B. Monroe, engineer, engineering; Richard O'Brien, director, audio, video engineering; James D. Parker, director radio frequency engineering; Ogden Prestholdt, engineer, engineering.

CBS RADIO NETWORK

*Conrad Hilton, Suite 1806—
(Roundup Room)*

Personnel: Arthur Hull Hayes, president, CBS Radio; James M. Seward, executive vice president of CBS Radio; H. Leslie Atlass, vice president of Central Div.; William A. Schudt Jr., vice president in charge of affiliate relations; Louis Hausman, vice president, advertising and promotion; Jules Dundes, vice president in charge of station administration; Howard Barnes, vice president in charge of net-

work programs; Eric H. Salline, national manager of affiliate relations; William H. Brennan Jr., western division manager of affiliate relations; Edward E. Hall, administrative manager of affiliate relations; Jane Ann McGettrick, coordinator of affiliate relations; Sidney Garfield, director of press information; William S. Brower, manager of program promotion and merchandising.

The general managers of the seven CBS owned radio stations will attend. They are: Sam Slate, WCBS New York; Maurie Webster, KCBS San Francisco; Robert Hyland, KMOX St. Louis; Fred Ruegg, KNX Los Angeles; Mr. Atlass, WBBM Chicago; Thomas Gorman, WEEI Boston, and Joseph Connolly, WCAU Philadelphia.

KEYSTONE BROADCASTING SYSTEM

Conrad Hilton, Suite 804-5-6

Personnel: Sidney J. Wolf, president-director; Edwin R. Peterson, senior vice president; Blanche Stein, station relations director.

MUTUAL BROADCASTING SYSTEM

Conrad Hilton

Mutual Affiliates Advisory Committee will meet for full day agenda March 15, at Conrad Hilton.

Personnel: Blair A. Walliser, executive vice president; Robert F. Hurligh, vice president in charge of Washington office; Charles Godwin, station special projects; Sidney P. Allen, sales vice president; Ray Diaz, director of station services; Frank Erwin, director of sports and co-op programs; Joseph Keating, director of programming; James Gladstone, comptroller; Les Learned, engineering director, and Harold Gold, public relations. (Above plans subject to change with new Mutual management prior to convention.)

NBC

Sheraton Blackstone

Robert W. Sarnoff, chairman of board, NBC; Robert E. Kintner, president, NBC; David C. Adams, senior executive vice president; Kenneth Bilby, executive vice president, public relations; J.M. Clifford, executive vice president, administration; P.A. Sugg, executive vice president, NBC owned stations and spot sales; Thomas Knode, vice president, NBC station relations; Sid Eiges, vice president, press and publicity; Earl Rettig, president of California National Productions; H. Weller

Keever, vice president and general manager of CNP; William Davidson, vice president and general manager of WRCA-AM-FM-TV; William Hedges, vice president, general services, NBC; Harry Bannister, vice president, station relations, Don Mercer, director of station relations, and Paul Rittenhouse, William Kelley, A.A. Cervini, Ogden Knapp, Ray O'Connell, Joseph Berhalter, Paul Hancock, all with NBC station relations; Richard Close, director of NBC Spot Sales; Robert L. Stone, vice president, NBC facilities operations; Sheldon Hickox, director of NBC station relations, Pacific Div.; Andrew Hammerschmidt, vice president, engineering, NBC facilities administration. Matthew J. Culligan, executive vice president in charge of NBC Radio network, at Ambassador Hotel; George A. Graham Jr., vice president of NBC Radio sales planning, Ambassador; Ludwig W. Simmel, manager of sales service and traffic, NBC Radio, Sheraton Blackstone.

Miscellaneous

AMERICAN RESEARCH BUREAU Suite 800

Daily Chicago Arbitron rating reports, based on ARB's instantaneous electronic ratings, will be available to delegates in the ARB suite. Staffers will be prepared to discuss problems affecting the 150 markets served by ARB.

Personnel: James W. Seiler, Roger Cooper, Bill Shafer, Ralph Crutchfield, Garry Eckard and Al Petgen.

ASSOCIATED PRESS

Sheraton Blackstone, Sheraton Room

Personnel: Oliver Gramling, Louis J. Kramp, Al Stine, Al Orton, Andy Anderson, Paul Breining, Jim Coldsmith, Tom Cunningham, Jerry Gill, Howard Graves, Doug Lovelace, Bob Myers, Tom Pendergast, Bob Rousek, Jim Smith, Frank Stearns, Tom Stuetzer, Bob Sundry, Bob Wells and Frank Wetzel.

BROADCAST ADVERTISERS REPORTS Suite 1534A

A. C. NIELSEN CO. Suite 1000

Free data available will include updated U.S. tv ownership figures (usually \$10 the copy) and the annual broadcast media reports for both radio and tv for 1959.

Personnel: Henry Rahmel, John Churchill, George Blechta, Bill Wyatt, Joe Mathews, George Baillie, Ed Evans, Dave Traylor, Ben Wilson, Bill Weseloh, George Ralph and Erwin Ephron.

PULSE INC. Suite 2106A

Pulse will stress its special qualitative "station image" and new qualitative "audience image" studies. Information and exhibits on all the firm's research services will be available.

Personnel: George Sternberg, Allen Klein and George Herro.

STANDARD RATE & DATA SERVICE Suite 1705-06A

Complimentary copies of all SRDS publications will be available as well as advance page proofs of the 1959 SRDS Consumer Market estimates.

Portable Versatile Dependable CECO* Vidicon SUPPORT EQUIPMENT

gives top performance—Indoors or Outdoors

Expressly designed for the ever increasing TV field, this equipment consists of a pan and tilt Tripod Head with internal Balancing spring. Vidicon Cameras with electronic viewfinder can be easily mounted and operated. The head mounts on the CECO Professional Tripod (or any other standard mounting flange) and the CECO Pro Senior Collapsible Three Wheel Dolly makes this a complete versatile package.



Specifications:

CECO Vidicon Head designed for use with a variety of Vidicon cameras, weighing from 45 pounds up. Vertical and horizontal movement of tilt head controlled by independent friction locking devices. Super-smooth action.

Tripod folds quickly and compactly. Offers a height range from 36 to over 53 inches. Double leg locks.

Pro Senior Collapsible Dolly is lightweight and compact. Rubber-tired wheels may be locked or set in a straight line position.



Professional Jr. Spring Head

Ideal for Viewfinder Vidicon Cameras weighing up to 35 lbs. Internal balancing spring. Built-in spirit level. Fits standard Pro Jr. Tripod, Baby and Hi-Hat (low mount).

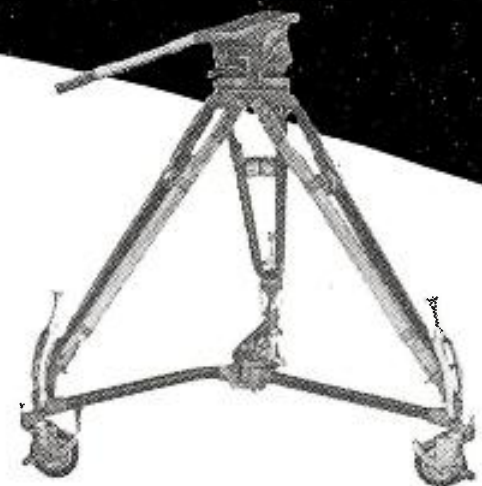

CECO trademark of
Camera Equipment Company

FRANK C. ZUCKER
CAMERA EQUIPMENT CO., INC.

Dept. B 315 West 43rd St., N. Y. 36, N. Y. JUdson 6-1420

		BROADCASTING	
THE BUSINESSWEEKLY OF TELEVISION AND RADIO			
1735 DeSales St., N. W. Washington 6, D. C.			
PLEASE START MY SUBSCRIPTION WITH THE NEXT ISSUE			
<input type="checkbox"/>	52 weekly issues of BROADCASTING	\$ 7.00	
<input type="checkbox"/>	52 weekly issues and Yearbook Number	11.00	
<input type="checkbox"/>	Enclosed	<input type="checkbox"/>	Bill
_____ name _____		_____ title/position*	
_____ company name _____			
_____ address _____			
_____ city _____		_____ zone _____	_____ state _____
Please send to home address — —			

* Occupation Required



Widespread use of videotape recording provides a key topic for the NAB's 13th annual Broadcast Engineering Conference, to be held concurrently with the NAB management-ownership convention in Chicago March 15-18. Sessions will be in the Waldorf Room of the Conrad Hilton Hotel.

Allan Powley, chief engineer of WMAL-AM-FM-TV Washington, is chairman of the conference program committee. Raymond F. Guy, NBC senior staff engineer, will preside at the opening of the agenda March 16, 8:45 a.m. A. Prose Walker, NAB engineering manager, is conference arrangements director, aided by his assistant, George W. Bartlett.

The three days of programming will open with a panel discussion of the Technical Allocations Study Organization, headed by Dr. George R. Town, TASO executive director. The range of topics includes antenna and guy-wire vibration, multiplex, tower marking and lighting, intercity microwave tv relays, transmitter components and antenna performance.

Public and technical interest in stereophonic broadcasting will be reflected in two papers. A new type of tape recorder holding a large number of spot announcements will be described and an FCC executive will go into problems of remote control operations. Program automation, automatic test equipment, transistors, radar weather-casting, antenna array design and a new silicon controlled rectifier dimmer will be the subjects of other papers.

Engineering delegates will take part in the keynote session opening the management-ownership convention as well as joint lunches and the annual FCC-industry roundtable. The Tuesday joint luncheon will be addressed by FCC Chairman John C. Doerfer. Lt. Gen. Arthur Gilbert Trudeau, U.S. Army Chief of Research & Development, will address the Wednesday luncheon.

Monday Morning

8:45 a.m.—Waldorf Room

Presiding: **Raymond F. Guy**, senior staff engineer, NBC.

Session Coordinator: **James D. Parker**,

TECHNICAL PAPERS

director, radio frequency engineering, CBS Television.

9:05-10:45 a.m.



Town

TASO—A Resume of Activities and Accomplishments, panel discussion by: **Dr. George R. Town**, executive director of TASO (Dean of Engineering, Iowa State College); **Dr. William L. Hughes**, associate professor, Iowa State; **Dr. Charles E. Dean**, Hazeltine Corp.; **Harold G. Towlson**, manager of engineering, Broadcast Transmitter Section, General Electric Co.; **Lucien E. Rawls**, L. H. Carr & Assoc.

The activities of TASO were directed chiefly along three lines: studies of performance characteristics of transmitting and receiving equipment; studies of picture quality in the laboratory and in the home; and studies of propagation. A comprehensive compilation and analysis of equipment characteristics has been completed. Thorough laboratory experiments have produced information on the quality of television pictures in the presence of interference and extensive field studies have shown the correlation between picture quality and



Hughes



Dean



Towlson



Rawls

field strength. Careful measurements of uhf and vhf field strength have been made and prediction methods have been developed. Tests of directional antennas are continuing.

Monday Afternoon

2:30 p.m.—Waldorf Room

Presiding: **George W. Bartlett**, assistant manager of engineering, NAB.

Session Coordinator: **Allan T. Powley**, chief engineer, WMAL-AM-FM-TV Washington, D.C.

2:30-2:55 p.m.



Hayden

Vibration Problems in Tall Tower Construction by: **J. Roger Hayden**, manager, commercial sales, Tower Division, Dresser-Ideco Co.

The paper will deal with vexing problems of vibrations in guy wires and antennas which have arisen to plague the structural engineer. The various styles of vibration affecting the guy wires as well as means of preventing any damage due to vibration will be discussed. The possibility of vibration throughout the tower proper and a means of holding this to a minimum will also be discussed. A short movie will show the effect of vibration caused by wind on structures.

3-3:25 p.m.

Fm Multiplex Receiver Developments by: **Dwight (Red) Harkins**, Harkins Radio Inc.

The problems existing in multiplex receivers are outlined. Cross-talk, noise intermodulation, sensitivity, and stability are each detailed along with the causes and cures. The development of measuring techniques and a description of the equipment itself will be presented. The correct methods for installation of the receiver are detailed together with actual case histories of various installa-



Harkins

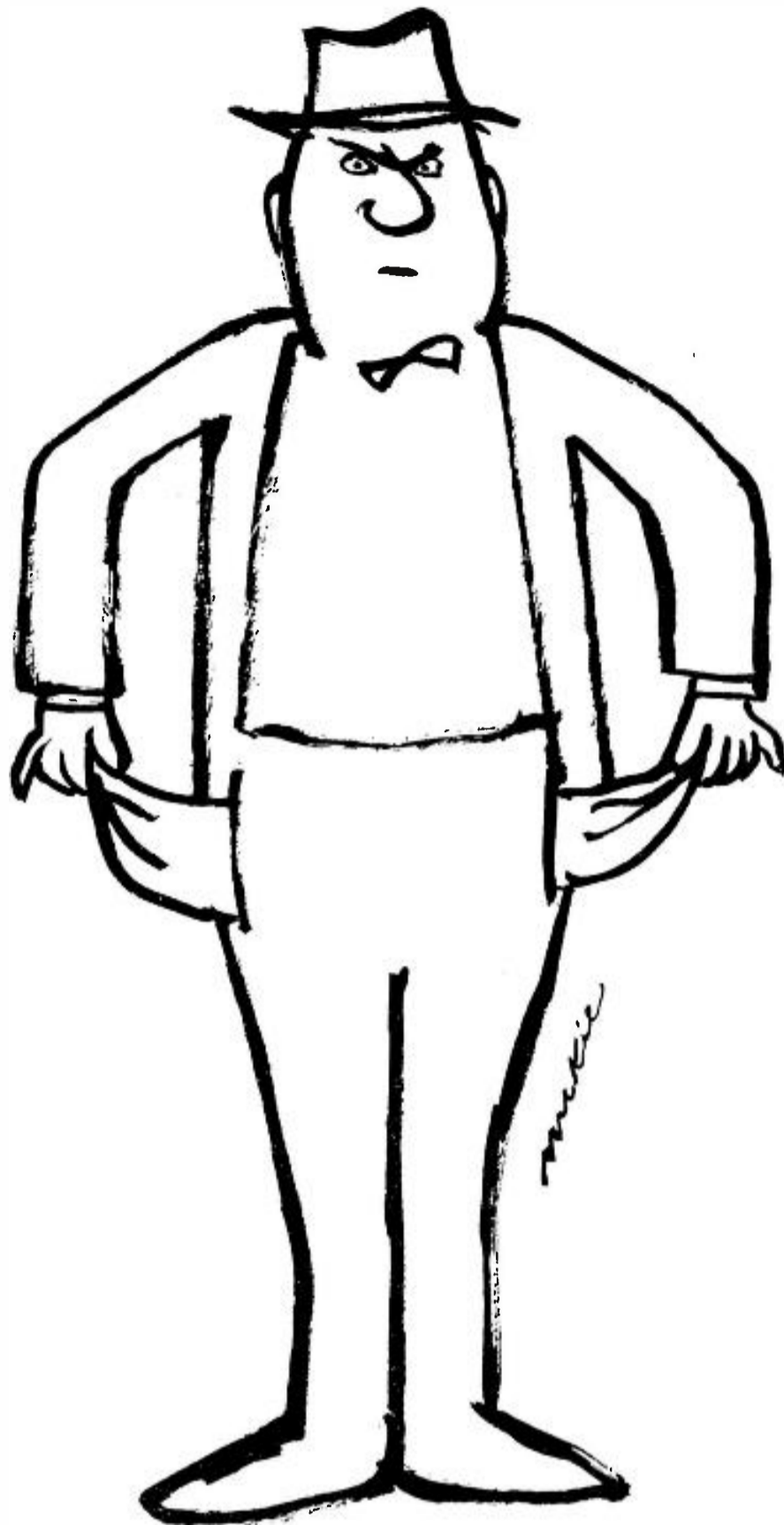

When “public power” wins—you lose!

Every time the lobbyists for federal “public power” push another government electricity project through Congress, you are taxed to pay the bill!

You and other Americans have already been taxed about \$5,500,000,000 to pay for federal “public power.” That’s how much has been taken out of taxpayers’ pockets and put into federal power dams and plants in certain parts of the U. S.

But that’s just the beginning—if the federal “public power” lobbyists and pressure groups have their way. They want *more* of your tax money—\$10,000,000,000

more—so that the federal government can take over a still bigger share of the electric business.

Yet they know, as well as everybody else, that America’s hundreds of *independent* electric light and power companies are ready to supply all the electricity the nation needs—*without* depending on your taxes.

How can this needless spending of your taxes be stopped? As soon as enough people know what “public power” is *really* costing them, they will call a halt to it. The quickest way to bring that about is to spread the word among your friends and neighbors.

America’s Independent Electric Light and Power Companies

Company names on request through this magazine

NAB PREVIEW

TECHNICAL PAPERS CONTINUED

tions around the country where weak signals and high noise level existed. The problems of fringe area multiplex reception are detailed together with actual description of successful installations.

3:30-3:55 p.m.



Towner

Effective Lighting and Marking for Radio and Television Towers by: **Orrin W. Towner**, director of engineering, *W H A S Inc.*, Louisville, Ky.

A new system of lighting and marking for radio and television towers provides exceptional visibility under adverse or good weather conditions. Existing requirements were tested and new ideas such as synchronous white rotating beacons, reflectors and high contrast marking were investigated by an experimental installation on the WHAS radio tower. After several years of qualitative observations of this installation, quantitative measurements were made on a scale model tower in artificially produced fog, proving that a tower lighting and marking system can be designed to be visible at a distance greater than the meteorological range. Recommendations resulting from this work are made for lighting and marking specifications.

4-4:25 p.m.



Minor

Planning, Construction and Operation of a Reversible Intercity Microwave Relay System with Automatic Fault Report Equipment by: **M. J. Minor**, transmitter and field engineering manager, *Jefferson Standard Broadcasting Co.*

This paper describes the planning, construction and operation of the five-station intercity relay system recently installed between WBTW (TV) Charlotte, N.C., and WBTW (TV) Florence, S.C., a distance of 93 miles. The system is designed for remote control, reversible transmission and the three repeater stations are unattended. The system is capable of monochrome or color television video signal transmission in either direction with television audio contained within the channel as a diplexed sub-carrier signal. Audio

diplexing is provided in both directions. A single telephone line is used as a medium for switching signals and for reporting the status of each switched station as well as reporting faults existing at stations other than the controlling terminal.

4:30-5 p.m.



Zellmer

Semi-Conductor Transmitter Plate Supplies by: **Lynn R. Zellmer**, broadcast transmitter engineering, *Technical Products Dept.*, *General Electric Co.*

Semi-conductor rectifiers used in the plate supplies of the BT-50-A, 50 kw am transmitter and the AN/FRC-47 klystron power amplifier have demonstrated increased rectifier efficiency and reliability. The germanium rectifiers used in the BT-50-A have delivered trouble-free service. Silicon rectifiers are used in the AN/FRC-47 klystron beam supply. The problems encountered in the design of semi-conductor plate supplies are discussed. These include rectifier selection, adequate surge protection, inverse voltage distribution and corona suppression.

5:05-5:30 p.m.



Peterson

Tv Broadcasting Antenna System Performance Requirements by: **Donald W. Peterson**, *RCA Lab.*

The electrical specification in vogue for a tv broadcasting antenna system is not capable of conveying to the broadcaster an adequate description of the system. Both the manufacturer and the broadcaster are badly served by this specification which the manufacturers imposed on themselves in the early days of tv broadcasting. The old approach will be critically examined and a new approach proposed, which it is believed will relate system performance and antenna and transmission line specification positively and unequivocally.

Tuesday Morning

8:45 a.m.—Waldorf Room

Presiding: James H. Butts, chief engineer, *KBTW (TV) Denver.*

Session Coordinator: Julius Hetland, technical director, *WDAY-AM-TV Fargo, N. D.*

8:45-9:10 a.m.



Vincent

Stereophonic Broadcasting by: **Emil P. Vincent**, chief audio facilities engineer, *ABC.*

ABC-owned stations KGO San Francisco and KABC Hollywood have been transmitting stereophonic broadcasts by the use of the am and fm channels. These programs, transmitted for approximately 19 hours a week, have been eminently successful. The experience gained by these stations will be described. In am-fm stereo transmission there is a question as to whether compatibility, insofar as separate channel listening is concerned, is necessary or desirable. While am-fm stereo transmission is the simplest method at the moment, certain other methods now under consideration will be reviewed briefly.

9:15-9:40 a.m.



Chassey

Stereo Mixing Problems by: **Frederick Chassey**, chief engineer, *WFLN (FM) Philadelphia.*

The time is fast approaching when stereo discs and tapes will comprise the greater part of the program material on high fidelity good music stations using various stereo systems such as am-fm, fm multiplex, tv multiplex and later two channel am systems. WFLN is now broadcasting more than 10 hours of stereo every week. Because there is no stereo mixing equipment commercially available, WFLN originally had to employ stop-gap equipment which proves to be inadequate to an increasing stereo schedule. This equipment will be discussed, as well as practical problems arising from stereocasting. Also to be presented will be a design for a console capable of handling stereo program material. Already under construction, this equipment represents a practical solution to problems which confront a growing number of broadcast engineers.

9:45-10:10 a.m.

Spot Tape Recorder by: **Jay Blakesley**, manager, audio sales, *Gates Radio Co.*

This paper will describe a "spot tape recorder" utilizing a tape width of 13/4 inches and capable of recording and reproducing 101 separate an-

5 reasons . . .

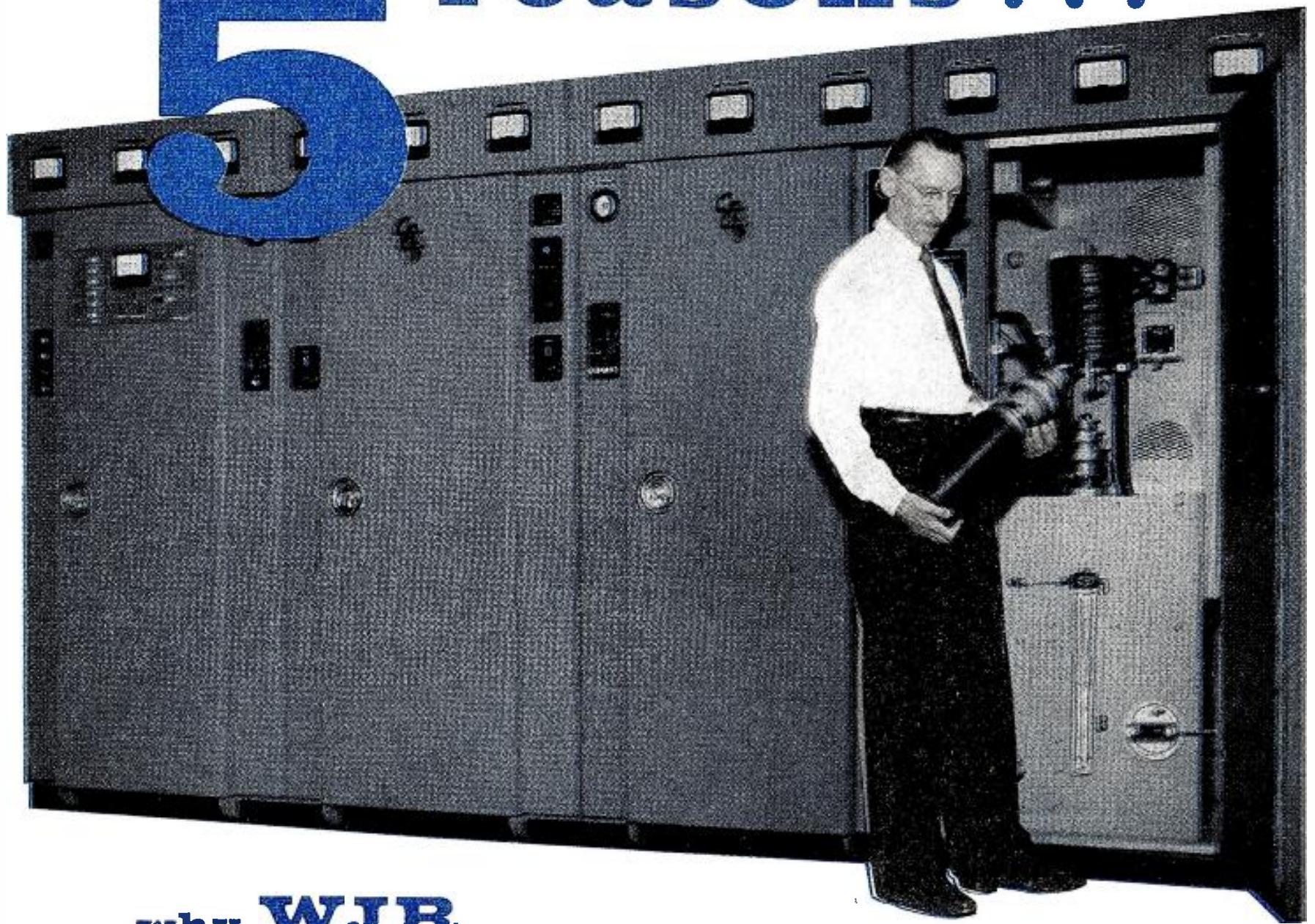

why **WJR** installed **Continental's 50 KW transmitter**

"The Continental Electronics 317B 50 KW Transmitter is Simplicity itself . . . in installation . . . in operation.

"For WJR, The Goodwill Station, these were the requirements for a new 50 KW transmitter:

1. Efficient, modern design
2. Simple, compact installation
3. Built-in automatic power cutback
4. Instantaneous switchover to CONELRAD
5. Built-in remote control

"We are indeed pleased with the operational simplicity of the remote control features, and additionally, all of the requirements necessary for our method of operation are fully satisfied."

WJR, The Goodwill Station, Inc.

Andrew Friedenthal
Andrew Friedenthal, Chief Engineer

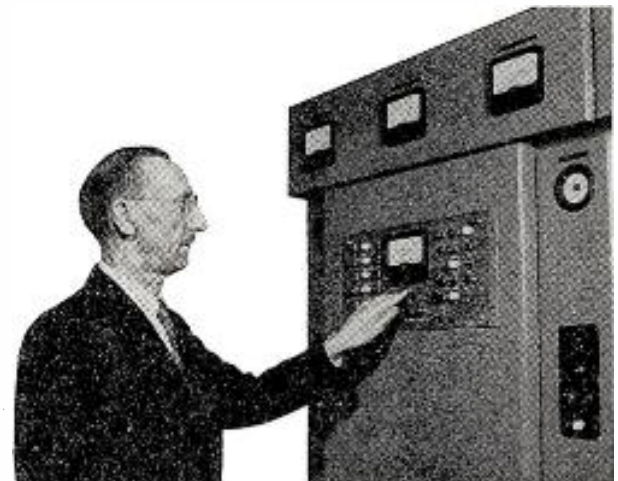

Andrew Friedenthal at Continental's Type TRC remote control panel . . . built into the Type 317B 50 KW transmitter.

*Continental
Electronics*

MANUFACTURING COMPANY
4212 S. Buckner Blvd. • EVergreen 1-1135
Dallas 27, Texas



DESIGNERS AND BUILDERS
OF SUPER POWER TRANSMITTERS



VIDEOTAPE

Look who's advertising on TV now!

Local businessmen — most of whom never could afford spot commercials until the advent of Ampex Videotape* Recording. For tape cuts production costs to ribbons — brings "live local" spots within the reach of almost everyone.

Scheduling to reach selected audiences is much easier too. Commercials can be pre-recorded at the convenience of both station and advertiser, then run in any availability, anytime.

Opening new retail markets and expanding income potentials for stations are just two of many benefits of Videotape recording. Write today for the complete story. Learn too how easy it is to acquire a VR-1000 through Ampex purchase or leasing plans.

CONVERTS TO COLOR ANYTIME • LIVE QUALITY • IMMEDIATE PLAYBACK • PRACTICAL EDITING • TAPES INTERCHANGEABLE • TAPES ERASABLE, REUSABLE • LOWEST OVERALL COST

934 CHARTER STREET, REDWOOD CITY, CALIFORNIA
Offices in Principal Cities

AMPEX
CORPORATION
*professional
products division*

*TM AMPEX CORP.

NAB PREVIEW

TECHNICAL PAPERS CONTINUED

nouncements, each up to 90 seconds in length. These announcements can be played either in sequential or random manner with automatic tape reversal at the end of the tape, or manual reversal at any time interval before automatic reversal. Positive indexing of each announcement allows simplified announcement logging. The spot tape recorder requires only 8¾ inches of rack or table top mounting space and has a frequency response of 30-8000 cycles ± 2 db with wow and flutter of 0.1%.



Blakesley

ing space and has a frequency response of 30-8000 cycles ± 2 db with wow and flutter of 0.1%.

10:15-10:40 a.m.



Kassens

FCC Experience With Remote Control of Am and Fm Broadcast Stations by: **Harold L. Kassens**, chief, Aural Existing Facilities Branch, Broadcast Bureau, FCC.

Remote control for certain am and fm stations was authorized by the FCC in 1953. Subsequently, the rules were amended to permit remote control of all am and fm broadcast stations. The processing of applications for remote control is analyzed, with particular emphasis on matters considered in determining the stability of directional antenna systems. Consideration is also given to certain problems encountered by stations operating by remote control.

10:45-11:10 a.m.



Tharpe

A Building Block Television Program Automation System by: **James B. Tharpe**, president, Visual Electronics Corp.

A unitized electronic television program automation system will be described and demonstrated which can be built up to provide varying amounts of station automation as required in the station development. The system features maxi-

mum convenience and minimum confusion due to its "shift register" storage and display system. Changes or corrections can be made on any stored event at any time. In order to provide ultra-reliability in this equipment, beam switching tubes with 50,000-hour life expectancy are used for the heart of this system. Mercury-wetted contact relays rated at one billion operations are used for the shift register function.

11:15-11:40 a.m.



Byloff

Automation of Technical Equipment at Station WRC-TV Washington by: **Robert W. Byloff**, manager of project planning, NBC.

The automation of technical equipment in a television station allows more efficient operation and fewer errors. This paper will first describe the new plant at WRC-TV Washington, with particular emphasis on some of its unusual operating features. Then the automation equipment which controls signal levels, stops and cues up projectors, and controls switching and projector operation will be described. The speaker will go through a typical program routine sheet and show how it is set up in the machine to perform required operations. Presently obtained benefits to the operation will be discussed.

11:45 a.m.-12:15 p.m.

The Transistor—A New Friend For The Broadcaster by: **R. N. Hurst** and **J. W. Wentworth**, broadcast and television equipment division, RCA (To be presented by Mr. Wentworth).



Hurst



Wentworth

Transistors are beginning to appear more and more frequently in both audio and video equipment, where their small size, low power requirements, and long service life offer attractive advantages to broadcasters. This paper is intended to serve as a friendly introduction to transistors for the many broadcasters

We taped Ramblers



Doug Elleson, Program Manager
KRON-TV, San Francisco

"We taped a whole series of Rambler spots at one time for local Nash dealers. Accurately timed, error-free, easily scheduled commercials, with a 'live' look at less than live cost, impressed both client and agency."



934 CHARTER STREET, REDWOOD CITY, CALIFORNIA

professional
products division

NAB PREVIEW

TECHNICAL PAPERS CONTINUED

whose education and experience has been confined to tube-type circuits. The basic principles of transistor operation will be explained, and helpful hints for the operation and servicing of transistorized equipment will be presented.

Wednesday Afternoon

2:30 p.m.—Waldorf Room

Presiding: Clure Owen, administrative assistant, engineering dept., ABC.

Session Coordinator: Joseph Epperson, vice president in charge of engineering, Scripps-Howard Radio Inc.

2.30-3:25 p.m.

Videotape Standards and Operational Problems, panel discussion by: Raymond Bowley, (coordinator), director, audio-video engineering, Westinghouse Broadcasting Co.; Robert M. Morris, radio facilities engineer, ABC; Bill Michaels, managing director, WJBK-TV Detroit, Mich.; J. L. Berryhill, chief engineer, KRON-TV San Francisco; Virgil Duncan, chief engineer, WRAL-TV Raleigh, N. C.; Edward Benham, chief engineer, KTTV (TV) Los Angeles.



Bowley



Berryhill



Morris



Duncan



Michaels



Benham

One of the liveliest topics confronting

the television industry today is video tape. The use of video tape opens up to the broadcaster a new world of programming concepts and is daily becoming a tool of seemingly limitless possibilities. This year the NAB Conference Committee has scheduled a Video Tape Panel Discussion which should be of extreme interest to all users of this method of recording, both present and potential. The Panel is composed of leading authorities in the technical and programming aspects and will discuss such diversified topics as proposed SMPTE standards, maintenance, adjustment and operation of the recorder and problems involved in the production, scheduling and syndication of programs and commercials.

3:30-3:55 p.m.



Snyder

Laboratory Contributions to the Solution of Various Problems Encountered in Videotape Recording by: Ross H. Snyder, video products manager, Professional Products Div., Ampex Corp.

The Ampex videotape recorder development program has continued to benefit from the advice of its users in the broadcast industry. Applications far beyond those originally contemplated have been found by broadcasters and these have kept the laboratories hard at work developing accessories and new facilities for use with the recorder. New solutions have been found to these problems. Details are presented on videotape recording methods and devices.

4-4:25 p.m.

Weathercasting with Radar by: R. Craig Christie, aviation engineer, Collins Radio Co.

This paper will present operational and technical considerations involved in the use of weather forecasting. The points to be covered will include discussion of the theory of the operation of weather radar equipment, a discussion of the problems associated with installation of weather radar and, last, effective presentation and interpretation of weather radar for the viewing audiences. The technical aspect of the paper will be augmented with appropriate slides and the presentation of weather radar pat-



Christie

terns will be implemented by appropriate pictures.

4:30-4:55 p.m.



Brown

Pattern Synthesis — Simplified Methods of Array Design to Obtain a Desired Directive Pattern by: Dr. George H. Brown, chief engineer, Industrial Electronics Products, RCA.

The physics of mathematical methods of array design will be described. Simplified means of proceeding from a desired directional radiation pattern to a physical radiating structure are available. In addition, it will be shown that a wide choice of current distribution or array configurations for obtaining a single desired pattern become available by adding to this real pattern another pattern in an imaginary zone.

5-5:25 p.m.

The Silicon Controlled Rectifier Dimmer by: Herbert R. More, manager, Television Div., Kleigl Bros.; Albert W. Malang, video facilities engineer, ABC.



More



Malang

A new device has been developed which makes possible startling new concepts in lighting. By radically reducing volume, weight and heat generated per kilowatt, without any sacrifice in electrical characteristics, it has become possible to package this semi-conductor device as a portable plug-in module. Its advantages over present state of the art methods will be demonstrated. In addition, these advantages make possible a new systems concept. The specific application of the aforementioned will be detailed as utilized by a new broadcasting center.

Exhibits of equipment manufacturers will be on display in the Exhibition Hall on the following dates: Sunday, March 15, from 12 noon to 7 p.m.; Monday, March 16, from 9 a.m. to 9 p.m.; Tuesday, March 17, from 9 a.m. to 7 p.m., and Wednesday, March 18, from 9 a.m. to 6 p.m. For list of specific exhibits see page 86.

We are pleased to announce the appointment of

WFBM-AM-TV

TWIN-STATE BROADCASTING, INC.

wholly-owned subsidiary of Time, Inc.

as exclusive franchiser in

INDIANAPOLIS, INDIANA, AREA

and

KING-AM-FM-TV

KING BROADCASTING COMPANY

as exclusive franchiser in

SEATTLE, WASHINGTON AREA

Muzak[®]

229 FOURTH AVENUE • NEW YORK 3, N. Y.

A Jack Wrather enterprise



ADVANCE REGISTRATION

NAB CONVENTION

A

Abbott, C. S. Jr., Standard Rate & Data Service, Evanston, Ill.
 Abbott, Frank J. Jr., WWGP-AM-FM Sanford, N.C.
 Abel, Charles, KFMB-AM-TV San Diego, Calif.
 Abel, Fred, Alford Mfg. Co., Boston, Mass.
 Abrams, Earl B., BROADCASTING, Washington, D.C.
 Adams, Irwin S., KGON Portland, Ore.
 Adler, Ben, Adler Electronics Inc., New Rochelle, N.Y.
 Agostino, James R., KXLY-AM-TV Spokane, Wash.
 Akers, C. B., KVOO-TV Tulsa, Okla.
 Alberston, Roy L. Jr., WBNY Buffalo, N.Y.
 Aldridge, Mahlon, KFRU Columbia, Mo.
 Alexander, Arthur, M & A Alexander Prod. Inc., Los Angeles
 Alexander, John, WFLA Tampa, Fla.
 Allen, Philip P., WLVA Lynchburg, Va.
 Allison, Duanne B., KHAS-TV Hastings, Neb.
 Anderson, Furman L. Jr., Kline Iron & Steel Co., Columbia, S.C.
 Anderson, William G., WOBT Rhinelander, Wis.
 Anson, A. E., WINE Buffalo, N.Y.
 Anthony, George, KXLY Spokane, Wash.
 Arkedis, George, WBBM-TV Los Angeles
 Armstrong, George W., Storz Bcstg. Co., Kansas City, Mo.
 Athanas, Peter, WRCO Richland Center, Wis.
 Atkinson, Frank, ABC, N.Y.
 Atlas, Leslie, WBBM-TV Chicago, Ill.
 Atwood, Jack S., WCSH-TV Portland, Me.
 Augspurger, Glen, KMBC-KFRM Kansas City, Mo.
 Autry, Gene, Golden West Bcstrs., KMPC Los Angeles
 Avery, Lewis H., Avery-Knodel Inc., N.Y.

B

Babcock, John, WLWI (TV) Indianapolis, Ind.
 Bacus, Roy, WBAP Ft. Worth, Tex.
 Bagwell, Norman P., WKY-AM-TV Oklahoma City, Okla.
 Bailey, Ted, WJBC Bloomington, Ill.
 Baker, R. K., WLDS Jacksonville, Ill.
 Baker, T.B., Jr., WLAC-TV Nashville, Tenn.
 Baker, Vernon H., WESR Tasley, Va.
 Baker, Warren E., Chadbourne, Parke, Whiteside & Wolff, Washington, D.C.
 Balch, Frank, WJOY Burlington, Vt.
 Baldwin, John M., WTCN-AM-TV Minneapolis, Minn.
 Baltimore, David M., WBRE Wilkes-Barre, Pa.
 Bannister, Harry, NBC, N.Y.
 Barnes, Howard, CBS Radio, N.Y.
 Barnes, Tom, WDAY Fargo, N.D.
 Barnett, Edward P., KBES-TV Medford, Ore.
 Barr, James E., FCC, Washington, D.C.
 Barrett, Mike, KTFY Brownfield, Tex.
 Barry, Ben, Governor Tv Attractions Inc., N.Y.
 Barry, William O., WFMB Nashville, Tenn.
 Bartell, Gerald A., Bartell Family Radio, Madison, Wis.
 Bartell, Melvin, WOKY Milwaukee, Wis.
 Bartlett, Marcus, WSB-TV Atlanta, Ga.
 Barton, Edward, KPLC Lake Charles, La.
 Barton, Morris C. Jr., KSLA-TV Shreveport, La.
 Batson, Charles A., WIS-TV Columbia, S.C.
 Baudino, Joseph E., Westinghouse Broadcasting Co., Washington, D.C.
 Baughn, Edward F., WPAG Ann Arbor, Mich.
 Baxter, Tom, KBAY-FM San Francisco
 Beadell, Walter, Gill-Perina Inc., Chicago
 Beal, Tom E., KBKC Kansas City, Mo.
 Beam, Henry, WAAY Huntsville, Ala.
 Beard, Fred L., WJDX (AM), WLBT (TV) Jackson, Miss.
 Beatty, J. Frank, BROADCASTING, Washington, D.C.
 Beatty, Richard V., East Liverpool Bcstg. Co., East Liverpool, Ohio
 Beaudin, Ralph W., KQV Pittsburgh
 Beckman, Alfred R., ABC-TV, N.Y.
 Beckham, Ben Jr., KSLA-TV Shreveport, La.

Beemster, Rev. M.J., WBAY Green Bay, Wis.
 Beeson, Sterling B., Headley-Reed Co., N.Y.
 Bell, Edgar T., KWTW(TV) Oklahoma City, Okla.
 Bell, Ridley, WRBL-TV Columbus, Ga.
 Bellwood LeRoy A., KFSD San Diego, Calif.
 Bennett, David J., Triangle Stations, Philadelphia
 Bentson, N.L., WLOL Minneapolis-St. Paul, Minn.
 Berger, Lawrence, KTWO-TV Casper, Wyo.
 Bergquist, P., RCA, Camden, N.J.
 Berk, Roger G., WAKR-AM-TV Akron, Ohio
 Berkman, Jack N., WSTV-TV Steubenville, Ohio
 Bernard, J.J., KTVI (TV) St. Louis, Mo.
 Bernstein, Fred L., Forjoe & Co., N.Y.
 Berryhill, Lee, KRON-TV San Francisco
 Bessert, B.P., Caterpillar Tractor Co. Engine Division, Peoria, Ill.
 Betts, J.W., WFTM Maysville, Ky.
 Beville, Ross, WWDC Washington, D.C.
 Bice, Max H., KTNT Tacoma, Wash.
 Bignell, Frank, WKOW-AM-TV Madison, Wis.
 Bilby, Kenneth W., NBC, N.Y.
 Bishop, J. Dige, WCTA Andalusia, Ala.
 Bissell, George F., WEAU Plattsburgh, N.Y.
 Bittinger, G.N., Standard Rate & Data Service, N.Y.
 Blackburn, James W., Blackburn & Co., Washington, D.C.
 Blackburn, Richard K., WHEC Rochester, N.Y.
 Bland, Thomas A., Crosley Bcstg. Co., Cincinnati, Ohio
 Blechta, George E., A. C. Neilsen Co., N.Y.
 Bloom, Joseph, Forjoe & Co., N.Y.
 Blumenthal, Syd, Frank Block Assoc., St. Louis
 Bohm, Carolyn Sholdar, Carolyn Sholdar Assoc., N.Y.
 Bohm, David, Carolyn Sholdar Assoc., N.Y.
 Boice, Hugh K., Jr., WEMP Milwaukee, Wis.
 Bolling, George W., The Bolling Co., N.Y.
 Bolling, G. William, III, The Bolling Co., N.Y.
 Bonansinga, Joe, WGEM Quincy, Ill.
 Bondy, Hugo A., WAGA-TV Atlanta, Ga.
 Bookwalter, L.S., KOIN-AM-FM-TV Portland, Ore.
 Booth, John S., WCHA Chambersburg, Pa.
 Booth, Robert M. Jr., WSAL Logansport, Ind.
 Bostic, Tom, Cascade Bcstg. Co., Yakima, Wash.
 Boundy, Glenn G., Storer Bcstg. Co., Miami Beach, Fla.
 Bowden, J.L., WKBN Youngstown, Ohio
 Bowen, Dan W., Gill-Perna Inc., Detroit, Mich.
 Bowles, R.L., WWIL Ft. Lauderdale, Fla.
 Box, John F. Jr., Balaban Stations, St. Louis
 Boyd, Roy, Noe Enterprises Inc., Monroe, La.
 Brace, Clayton H., KLZ-AM-TV Denver, Colo.

Brackbill, Charles, New Jersey Council of Churches, Newark, N.J.
 Braden, Paul F., WPFB Middletown, Ohio
 Braden, Mrs. Ruth M., WPFB Middletown, Ohio
 Bradshaw, Joseph D., WRFD Worthington, Ohio
 Brakefield, Charles B., WREC-AM-TV Memphis, Tenn.
 Brandborg, Gustav, KVOO Tulsa, Okla.
 Brandt, Otto, King Bcstg. Co., Seattle, Wash.
 Brechner, Joseph L., WLOF Orlando, Fla.
 Bremser, Lyell, KFAB Omaha, Neb.
 Brennan, Charles E., Charles E. Brennan & Assoc., Milwaukee, Wis.
 Bridge, H. A. Jr., KMHT Marshall, Tex.
 Brines, Paul C., WSJV-TV South Bend-Elkhart, Ind.
 Brokaw, Fred C., Paul H. Raymer Co., N.Y.
 Brokaw, Harold L., WOWO Ft. Wayne, Ind.
 Broman, Edward J., Ziv TV Programs Inc., N.Y.
 Brown, Bruce, WKAN Kankakee, Ill.
 Brown, Charles R., Maine Bcstg. System, Portland, Me.
 Brown, George H., RCA, Camden, N.J.
 Brown, H. Stilwell, Northeast Radio Network, WRRD Ithaca, N.Y.
 Brown, Jim, KONO-AM-FM-TV San Antonio, Tex.
 Brown, Kenyon, KCOP (TV) Hollywood, Calif.
 Brown, Mrs. Doris B., WKBC N. Wilkesboro, N.C.
 Brown, R.M., KPOJ Portland, Ore.
 Bryan, Don, Screen Gems Inc., N.Y.
 Bryan, Robert F., Corinthian Bcstg. Corp., N.Y.
 Bryant, Bruce, CBS-TV Spot Sales, N.Y.
 Buchan, Alex, WING Dayton, Ohio
 Buford, Lucille Mrs., KLTV (TV) Tyler, Tex.
 Bullitt, Dorothy, King Bcstg. Co., Seattle, Wash.
 Bullitt, Stimson, King Bcstg. Co., Seattle, Wash.
 Burchfiel, Norman, WSEV Sevierville, Tenn.
 Burda, Orville F., KDIX-AM-TV Dickinson, N.D.
 Burk, Sam A., KIRX Kirksville, Mo.
 Burke, Harry, KODE Joplin, Mo.
 Burtis, Charles W., WPEN Philadelphia
 Burton, Herbert, KFMQ(FM) Lincoln, Neb.
 Burton, Robert J., Broadcast Music Inc., N.Y.
 Bushnell, John M. Jr., KVOO-TV Tulsa, Okla.
 Butler, James T., WISN Milwaukee, Wis.
 Butler, Joseph F., WKLZ Kalamazoo, Mich.
 Butts, James, TV Denver Inc., Denver, Colo.
 Byrd, Daniell, Dresser-Ideco Co., Columbus, Ohio
 Byrd, E.L., WLS Lansing, Mich.
 Byrne, John E., WTVN St. Johnsbury, Vt.

C

Cady, Charles A., General Radio Co., West Concord, Mass.
 Cady, William R. Jr., KADY St. Charles, Mo.
 Cagle, Gene, KFJZ Fort Worth, Tex.
 Cain, Claude W., KID-TV Idaho Falls, Idaho
 Caldwell, S.W., S.W. Caldwell Ltd., Toronto, Canada.
 Calibraro, Dan, WGN Chicago
 Callison, Glenn, The McLendon Corp., Dallas, Tex.
 Campbell, Eldon, WFBM-AM-TV Indianapolis, Ind.
 Campbell, Johnnie S., WSM Nashville, Tenn.
 Campbell, Marianne B., WJEH Gallipolis, Ohio
 Campbell, Theodore E., WJAC-TV Johnstown, Pa.
 Carino, Lawrence M., WWL New Orleans, La.
 Carlson, George, WDSM-AM-TV Duluth, Minn.
 Carr, Eugene, WHBC Canton, Ohio
 Carr, Tom, Media Scope, N.Y.
 Carr, Thomas S., WBAL Baltimore, Md.
 Carter, Ken, WMAL Washington, D.C.
 Carter, Paul D., KCRG-TV Cedar Rapids, Iowa
 Case, Ross E., KWAT Watertown, S.D.
 Caskey, William B., WPEN Philadelphia
 Cassens, G. J., WLDS-AM-FM Jacksonville, Ill.
 Cassill, H.W., (Dutch), Blackburn & Co., Chicago.
 Castle, Clemens X., Storer Bcstg. Co., Miami Beach, Fla.
 Caudle, L.L., Jr., WSOC Charlotte, N.C.
 Cerney, Jerry, WJOL Joliet, Ill.
 Cervone, Larry, Gates Radio Co.
 Chamberlain, J.W., Standard Rate & Data Service, Evanston, Ill.
 Chambers, G. Russell, WMAS Wilmington, Del.
 Chambers, J.L., WINN Louisville, Ky.

Open house

Headquarters of the BROADCASTING magazine staff during the NAB convention will be in Suite 704-05-06A of the Conrad Hilton Hotel. A complete editorial newsroom will be set up, with a full complement of reporters covering every phase of the convention.

Attending will be Sol Taishoff, Maury Long, Edwin H. James, J. Frank Beatty, Rufus Crater, Win Levi, Earl Abrams, Kenneth Cowan, Fred Fitzgerald, Warren Middleton, Bill Merritt, Ed Sellers, John Osbon, Barbara Kolar, Lawrence Taishoff.



One frame from WFAA-TV's film, "Disaster Dallas," shot entirely on Du Pont 931.

"Shooting fast, in the worst conditions,

WE CAN COUNT ON 931"

That's what Chief News Cameraman Marion Carlton, of Station WFAA-TV, Dallas, Texas, told us. "Du Pont Type 931 Rapid Reversal Film is the standard load in our cameras," says Mr. Carlton. "With 931, we know we can get usable TV footage indoors or out, in any light, without having to change film."

Mr. Carlton specially praises the wide latitude of Du Pont 931. "When we shot 'Disaster Dallas,' a news documentary of the tornadoes that hit Dallas in 1957," he explains, "we were out shooting during the worst of the storms. We didn't have much time to take meter readings—we just had to guess. We had our hands full just

hanging on and getting our shots. But the latitude of 931 helped give us a film that was cited as the outstanding news story of 1957."

Concludes Mr. Carlton: "Considering the high quality of the film and the fast and thoughtful service offered by Du Pont, it just makes good sense for us to continue to shoot most of our footage on Type 931."

Whatever your motion picture needs, you'll find there's a Du Pont film that's just right for you. For more information, get in touch with the nearest Du Pont Sales Office, or write Du Pont, 2432A Nemours Bldg., Wilmington 98, Del. In Canada: Du Pont of Canada Limited, Toronto.



Better Things for Better Living . . . through Chemistry



NOW



SOLVES YOUR FM PROBLEMS

*Getting on
the air at
minimum cost*

*Getting on the
air with a
powerful signal*

*Putting more
punch in your
signal*

*Updating
your present
transmitter*

with equipment for simplex, FM/FM stereo, other



FM, AM and TV transmitters and auxiliary equipment manufactured by

STANDARD ELEC

Division of

RADIO ENGINEERING LABORATORIES, INC.

29-01 Borden Avenue, Long Island City 1, N. Y. Stillwell 6-2100 Teletype NY4-2816

See S-E's new FM line—Space 32 at the 1959 NAB

S-E 250 watt FM Multiplex Transmitter economically puts you on the air now with a high-quality signal, simplex or multiplex, lets you "Add-A-Unit" for higher power later.

Available soon, **S-E 1 kw FM Multiplex transmitter.**



S-E 3 kw FM Multiplex Transmitter takes less space than comparable equipment, can't be surpassed for signal quality, operating simplicity, all-around economy.

Available soon, **S-E 10 kw FM Multiplex Transmitter.**



S-E 3 kw Amplifier uses your present low-power transmitter as a driver, has minimum requirements in the way of space, power consumption, operating and maintenance attention.

Available soon, **S-E 10 kw Amplifier.**

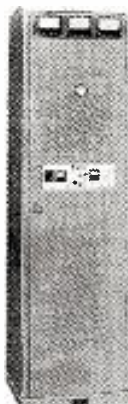

S-E FM SERRASOID® Multiplex Exciter replaces modulator panels in old Western Electric or similar FM transmitter to bring performance up to present-day standards.

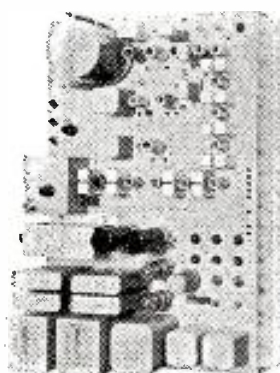

© TRADEMARK REGISTERED U. S. PATENT OFFICE

ADVANCED FEATURES

make Standard Electronics your
best buy in FM
transmitting equipment

- Provision for multiplexing as standard equipment, with 30 to 15,000 cps on both main and subchannel for FM/FM stereo broadcasting.
- SERRASOID® modulator for inherent stability, simple design and operation, low first cost and upkeep.
- Built-in "Patchover" system, pioneered by S-E in TV, now available for the first time in FM to keep you on the air despite emergencies. Impedance matched units permit connecting driver direct to antenna in seconds in event of trouble in amplifier.
- "Add-A-Unit" design, another TV-proven feature, now offered exclusively by S-E to let you start with an economical FM transmitter, later add an amplifier when you're ready to boost your power.
- Compact, accessible. These FM transmitters save as much as 45% of the space required by others of the same rating. All parts are readily accessible for easy servicing.
- Rectifiers are semi-conductor type, with unlimited life cutting tube replacement costs, power consumption, heat dissipation, space requirements.
- These and dozens of other features add up to improved signal quality, simplified installation, operation and maintenance, and all-around economy from Standard Electronics FM transmitters, amplifiers, and exciters. They're ready for delivery...use the coupon to get the full story.

multiplex operations

TRONICS

Distributed throughout Canada by

NORTHERN ELECTRIC COMPANY LIMITED, overseas by CBS INTERNATIONAL.

Standard Electronics Division
Radio Engineering Laboratories, Inc.
29-01 Borden Avenue, Long Island City 1, N. Y.

I'm interested in upping my station's earning power with your new, FM transmitting equipment. Please send me the data checked:

- | | |
|---|--|
| <input type="checkbox"/> FM-MUX SERRASOID Multiplex Exciter, type 936 | <input type="checkbox"/> FM 3 kw Multiplex Transmitter, type 2012 |
| <input type="checkbox"/> FM 250 watt Multiplex Transmitter, type 930 | <input type="checkbox"/> FM 10 kw Multiplex Transmitter, type 2013 |
| <input type="checkbox"/> FM 1 kw Multiplex Transmitter, type 940 | <input type="checkbox"/> FM 3 kw Amplifier, type 938 |
| | <input type="checkbox"/> FM 10 kw Amplifier, type 941 |

Name

Title Station

Address

Convention, Conrad Hilton Hotel, Chicago, March 15 to 18

NAB PREVIEW

REGISTRATION CONTINUED

Chandler, Robert M., WKNX-AM-TV Saginaw-Bay City, Mich.
 Chapin, Dick, KFOR Lincoln, Neb.
 Chapman, Paul H., Chapman Co., Atlanta, Ga.
 Chapman, Reid G., WANE-AM-TV Ft. Wayne, Ind.
 Chase, Seymour M., Attorney, Washington, D.C.
 Chenoweth, Jack A., KADY St. Charles, Mo.
 Christal, Henry I., Henry I. Christal Co., N.Y.
 Church, Abiah A., Storer Bcstg. Co., Miami Beach, Fla.
 Churchill, John K., A. C. Nielsen Co., Chicago
 Clark, Edward H., Booth Bcstg. Co., Detroit
 Clay, Henry B., KWKH Shreveport, La.
 Clay, John, WSAZ-TV Huntington, W. Va.
 Clayton, Vincent E., KSL-AM-TV Salt Lake City, Utah
 Clinton, George H., WEBC Duluth, Minn.
 Cobb, Wilton, WMAZ Macon, Ga.
 Coddling, William, WSUN-AM-TV St. Petersburg, Fla.
 Coe, Dee O., WWCA Gary, Ind.
 Coe, Robert, ABC-TV, N.Y.
 Cohan, John C., KSBW-TV Salinas, Calif.
 Cohen, Israel, WCAP Lowell, Mass.
 Cohen, Julius, George C. Davis Co., Washington, D.C.
 Cohn, Marcus, Cohn & Marks, Washington, D.C.
 Colledge, C. H., RCA, Camden, N.J.
 Collins, J.M., ASCAP, N.Y.
 Colman, Ben, Screen Gems Inc., N.Y.
 Compton, Charles, The Meeker Co., Chicago
 Comstock, Herbert L., KAVL Lancaster, Calif.
 Conley, Jim, WCAU-TV Philadelphia, Pa.
 Connolly, Joseph T., WCAU Philadelphia, Pa.
 Constant, Al, KBAK-TV Bakersfield, Calif.
 Cook, Louis R., KNOW Austin, Tex.
 Cooney, Edward, Sesac Inc., N.Y.
 Cooper, Jim W., WFAA Dallas, Tex.
 Cooper, Robert E., WSM Nashville, Tenn.
 Corken, Maurice, WHBF-AM-FM-TV Rock Island, Ill.
 Cornell, Weldon M., WAWK Kendallville, Ind.
 Corwin, Sherrill C., KBAY-FM San Francisco
 Cottone, Ben, WHOW Clinton, Ill.
 Covell, Arthur, WKZO-AM-TV Kalamazoo, Mich.
 Covington, Oscar P., WCOV Montgomery, Ala.
 Cowan, Kenneth, BROADCASTING, Washington, D.C.
 Cowan, Louis G., CBS-TV, N.Y.
 Cowdery, Ben H., KETV (TV) Omaha, Neb.
 Crafton, Patrick H., WCPO Cincinnati
 Cranton, Harold S., ABC, N.Y.
 Crater, Patrick H., BROADCASTING, N.Y.
 Crisler, Richard C., R. C. Crisler & Co., Cincinnati
 Crocker, M. H., WBT-WBTV (TV) Charlotte, N.C.
 Croll, James, KCSJ-TV Pueblo, Colo.
 Cross, Robert, KRCC Rochester, Minn.
 Crotty, A. Burke, Ellington & Co., N.Y.
 Crouch, George, KPAC Port Arthur, Tex.
 Crowley, J. Robert, WDBJ Roanoke, Va.
 Crowther, Frank, WMAZ Macon, Ga.
 Crutchfield, Charles H., WBT-WBTV (TV) Charlotte, N.C.
 Culver, Ronald H., Lohnes & Culver, Washington, D.C.
 Cuneen, Mike, WDLA Walton, N.Y.
 Cunningham, Marion L., KTWO-TV Casper, Wyo.
 Curran, Robert, ABC-TV, N.Y.
 Currie, Bill, WRAL Raleigh, N.C.
 Curtis, Ralph W., (WRAMC-TV) Walter Reed Army Medical Center, Washington, D.C.

D

Dahl, Howard, WKBH-WKBT (TV) La Crosse, Wis.
 Dailey, Gordon, WNAM Neenah, Wis.
 Dakin, Hollis, Lt. Col., Tv division, Army Pictorial Center, Long Island City, N.Y.
 Dalton, Don, Gill-Perna Inc., Chicago
 Danbom, M.E., KTBB Tyler, Tex.
 Danforth, Harold P. Jr., WDBQ-AM-TV Orlando, Fla.
 Daniels, Eli, KDSJ Deadwood, S.D.
 Daniels, Harry, KDSJ Deadwood, S.D.
 Daniels, Warren, Media Scope, Evanston, Ill.
 Dapping, William O., WMBO Auburn, N.Y.
 Davidson, Bryan, WFIW Fairfield, Ill.
 Davidson, Mrs. Georgia M., KTVB Inc., Boise, Idaho
 Davidson, Sid, KOA-AM-TV Denver, Colo.
 Davidson, William N., WRCA-AM-TV New York
 Davis, Don, KMBC-AM-TV Kansas City, Mo.
 Davis, Edward, KDFC San Francisco
 Davis, George C., George C. Davis Co., Washington, D.C.

Davis, Walter L., George C. Davis Co., Washington, D.C.
 Dawson, William A. Jr., WARA Attleboro, Mass.
 Day, A.G., Famous Players Canadian Corp., Toronto
 Dean, Charles E., Hazeltine Research Corp., Little Neck, N.Y.
 Deason, Willard, KVET Austin, Tex.
 DeDominicis, Aldo, WHAY New Britain, Conn.
 DeGray, Edward J., ABC, N.Y.
 DeHaven, Robert E., KYSM Mankato, Minn.
 Del Coro, R.J., Modern Talking Picture Service Inc., N.Y.
 DeLier, Jack, KWTV(TV) Oklahoma City, Okla.
 Dellar, Lincoln, Lincoln Dellar & Co., Santa Barbara, Calif.
 Dennis, Ed, KMBC-TV Kansas City, Mo.
 Dennis, Harry, WERE Cleveland, Ohio
 Dennis, Walter L., WBBM-FM Chicago, Ill.
 Denny, Charles E., WBNY Buffalo, N.Y.
 Denton, Ralph F., WSFC Somerset, Ky.
 DeRose, Charles N., WHYN-AM-TV Springfield, Mass.
 DeSmith, Donald, WKZO-TV Kalamazoo, Mich.
 Dettman, Robert, KDAL-AM-TV Duluth, Minn.
 DeVries, Van Beuren W., WGR-TV Buffalo, N.Y.
 DeWitt, John H. Jr., WSM-AM-TV Nashville, Tenn.
 Dickey, Perry, KONO-TV San Antonio, Tex.
 Diehm, Victor C., WAZL Hazleton, Pa.
 Dillaber, Maynard E., WMVA-AM-FM Martinsville, Va.
 Dillard, Douglas C., KVSQ Ardmore, Okla.
 Dillard, Everett L., WASH-FM Washington, D.C.
 Dillard, Mrs. Jean M., WASH-FM Washington, D.C.
 Dille, John F., Jr., WSJV (TV) South Bend-Elkhart, Ind.
 Dinsmore, Dick, Screen Gems Inc., N.Y.
 Dippell, Ralph E., Jr., George C. Davis Co., Washington, D.C.
 Dirks, Dietrich, KTIV (TV) Sioux City, Iowa
 Dixon, John J., WROK-AM-FM Rockford, Ill.
 Dobin, Paul, Cohn & Marks, Washington, D.C.
 Dodson, Eugene B., WTVT (TV) Tampa, Fla.
 Dolberg, Glenn, Broadcast Music, Inc., N.Y.
 Dolgoff, Herbert S., Storz Bcstg. Co., Omaha, Neb.
 Dorschug, Harold A., WTIC-AM-FM-TV Hartford, Conn.
 Dorsey, Eugene C., WVLN-AM-FM Olney, Ill.
 Dougherty, Frank, Harrington, Richter & Parsons, San Francisco
 Douglas, Harold, KMMO Marshall, Mo.
 Draughon, Louis R., WSIX Nashville, Tenn.
 Dresbach, O.T., WPAY Portsmouth, Ohio
 Drilling, Joe C., KJEO-TV Fresno, Calif.
 Drown, Douglas N., WTVN St. Johnsbury, Vt.
 Dudelson, Stanley, Screen Gems Inc., N.Y.
 Dudley, Richard D., WSAU-AM-TV Wausau, Wis.
 Dudley, Robert L., The Meeker Co., N.Y.
 Duhamel, Helen S., KOTA-AM-TV Rapid City, S.D.
 Duke, Charles R., WSIX Nashville, Tenn.
 Duncan, Virgil D., WRAL-AM-TV Raleigh, N.C.
 Dundes, Jules, CBS Radio, N.Y.
 Dunham, George R., WBNF-AM-FM-TV Binghamton, N.Y.
 Dunlop, W. John., CBC, Toronto
 Dunn, Emmett B., RCA Recorded Program Services, N.Y.
 Dunville, R.E., Crosley Bcstg. Co., Cincinnati
 Duvall, Charles F., Fisher, Wayland, Duvall & Southmayd, Washington, D.C.

E

Eagan, R. Russell, Kirkland, Ellis, Hodson, Chaffetz & Masters, Washington, D.C.
 Earle, Robert, WIBR Baton Rouge, La.
 Eastman, Robert E., Robert E. Eastman & Co., N.Y.
 Eastmond, L.E., AT&T, Kansas City, Mo.
 Eastwood, Clove, CFRB Toronto
 Ebel, A. James, KOLN-TV Lincoln, Neb.
 Eckersley, Vance L., WDAU-TV Scranton, Pa.
 Edison, Edward, Hammett & Edison, San Francisco
 Edwards, Henry M., Phelps Dodge Copper Products, N.Y.
 Edwards, Neal J., WMAL-TV Washington, D.C.
 Edwards, William J., WKNX-AM-TV, Saginaw-Bay City, Mich.
 Ehrenberg, Gustav, Honeywell-Brown Inst. Div., Philadelphia
 Eickmeyer, Robert W., Lee Bcstg. Co., Quincy, Ill.
 Eiges, Sydney H., NBC, N.Y.
 Eiland, Theodore A., WLOS-AM-TV Asheville, N.C.
 Ekberg, William A., Meyer Bcstg. Co., Bismarck, N.D.
 Ellerman, Gene, WWTW (TV) Cadillac, Mich.
 Elliot, I.A., KATL Miles City, Mont.
 Ellis, Lee D., Lee Bcstg. Co., Quincy, Ill.
 Elmer, John, WCBM Baltimore, Md.
 Engelbrecht, John A., WIKY Evansville, Ind.
 Engelhardt, Robert G., KVTW (TV) Sioux City, Iowa

Enoch, Robert D., WXLW Indianapolis, Ind.
 Ephron, Erwin H., A.C. Nielsen Co., N.Y.
 Ernst, Mildred V., KRTR Thermopolis, Wyo.
 Evans, Al, WCVS Springfield, Ill.
 Evans, Hayden R., WBAY Green Bay, Wis.
 Evans, Herbert E., Peoples Bcstg. Corp., Columbus, Ohio
 Evans, James L., WKRG-TV Mobile, Ala.
 Evans, Ralph, WOC-AM-FM-TV Davenport, Iowa

F

Faber, Marshall L., TV Denver Inc., Denver, Colo.
 Fagan, William E., WFBS-TV Indianapolis, Ind.
 Fagans, A.J., Standard Rate & Data Service, N.Y.
 Faraghan, J.E., WFLA-TV Tampa, Fla.
 Faust, A.D., WJRT (TV) Flint, Mich.
 Fehlman, Robert C., WHBC Canton, Ohio
 Ferguson, Robert W., WTRF-TV Wheeling, W.Va.
 Ferrise, A. Garen, WMMN Fairmont, W.Va.
 Fetzer, John E., Fetzer Bcstg. Co., Kalamazoo, Mich.
 Field, Keith S., WARA Attleboro, Mass.
 Figi, Mig, WAUX Waukesha, Wis.
 Fillion, Edgar B., The Meeker Co., N.Y.
 Finch, J.M., Jr., WFTM Maysville, Ky.
 Fine, Isadore, KFEQ St. Joseph, Mo.
 Fine, Jesse, KFEQ St. Joseph, Mo.
 Finney, E. Dean, WTVN St. Johnsbury, Vt.
 Firestone, Len., Ziv TV Programs Inc., N.Y.
 Fisher, Ben C., Fisher, Wayland, Duvall & Southmayd, Washington, D.C.
 Fisher, C.H., KVAL-TV Eugene, Ore.
 Fisher, John S., Stainless Inc., North Wales, Pa.
 Fitch, J. S., Standard Rate & Data Service, N.Y.
 Fitzgerald, Fred, BROADCASTING, Washington
 Fitzgerald, Harold, Sesac Inc., N.Y.
 Fitzgibbons, A.P., CKMI-TV Quebec
 Fitzgibbons, CKCO-TV Kitchener, Ont.
 Fitzpatrick, Horace S., Shenandoah Life Stations Inc., Roanoke, Va.
 Flaherty, Eugene, KTIV (TV) Sioux City, Iowa
 Flambo, G. LaVerne, WQMA Moline, Ill.
 Flanders, Robert W., WFBS-AM-TV Indianapolis, Ind.
 Fleckenstein, William, WHOT Youngstown, Ohio
 Fletcher, Frank U., Spearman & Roberson, Washington, D.C.
 Fletcher, Fred, WRAL-TV Raleigh, N.C.
 Floyd, C.W., AT&T, White Plains, N.Y.
 Floyd, Joseph L., KELO Sioux Falls, S.D.
 Foerster, Richard D., WISN Milwaukee, Wis.
 Fortin, G., CKMI-TV Quebec
 Foster, Joe B., KTBS-TV Shreveport, La.
 Foster, Michael J., ABC, N.Y.
 Fox, Bill, KFMB-TV San Diego, Calif.
 Frase, E.C. Jr., WMC-WMCT (TV) Memphis, Tenn.
 Frechette, Geo. T., WFHR Wisconsin Rapids, Wis.
 Friedheim, Robert W., Ziv TV Programs Inc., N.Y.
 Fulton, John, Rounsaville Radio Stations, Atlanta, Ga.

G

Gaguine, Benito, Fly, Shuebruk, Blume & Gaguine, Washington, D.C.
 Gaillard, P.W., AT&T, N.Y.
 Gaines, James M., WOI-AM-TV San Antonio, Tex.
 Gaither, Frank, WSB Atlanta, Ga.
 Gallimore, J.A., Blue Ridge Bcstg. Seneca, S.C.
 Gamble, Joseph A., WRBL-AM-FM-TV Columbus, Ga.
 Gamble, Joseph E., KJOY Stockton, Calif.
 Ganzenhuber, J.H., Hughey & Phillips Inc., Burbank, Calif.
 Gardner, Redd, KCRG-TV Cedar Rapids, Iowa
 Garten, C. Tom, WSAZ-TV Huntington, W.Va.
 Gaston, Tony, WKZO Kalamazoo, Mich.
 Gatchell, Creighton E., WGAN-AM-TV Portland, Me.
 Gay, Connie B., WTCR Ashland, Ky.
 Geist, H.J., Hughey & Phillips Inc., Stamford, Conn.
 Gelder, John T., WCHS-TV Charleston, W.Va.
 Gentling, G. David, KRCC Rochester, Minn.
 George, Carl E., WGAR Cleveland, Ohio
 George, Clark, KNXT (TV) Los Angeles
 George, L.M., WGPC Albany, Ga.
 Gersh, Samuel H., WFME-FM Chicago
 Giaquinto, Joseph E., ABC-TV, N.Y.
 Giarraputo, Len, Media Scope, N.Y.
 Gibbens, Tom E., WAFB-TV Baton Rouge, La.
 Giddens, Kenneth, WKRG-TV Mobile, Ala.
 Gilbert, Jack, KHOL-TV Kearney, Neb.
 Gilbert, Miss P., WCAO Baltimore, Md.
 Gill, Miss Helen, Gill-Perna Inc., N.Y.
 Gillen, Albert J., WAPI-AM-TV Birmingham, Ala.
 Gingell, George A., WRBL-AM-FM-TV Columbus, Ga.
 Girola, Louis J., Houston Fearless Corp., N.Y.



KEN COOPER announces the arrival...

of the
Television and Radio Station
SOUNDS of the FUTURE

In time for the NARTB Convention
Sounds that will REVOLUTIONIZE
TELEVISION CHANNEL and
RADIO STATION IDENTIFICATION

Be sure that your station has the
most modern sounds in your market!

Ask for our suite;
CONGRESS HOTEL, CHICAGO

MODERN BROADCAST SOUND CO.
Box 1101 Albany, N. Y. UNion 9-6000

NAB PREVIEW

REGISTRATION CONTINUED

Gittleston, Norman A., WMUR-TV Manchester, N.H.
 Glycagdis, Bruce, WJEF Grand Rapids, Mich.
 Gochenour, Lloyd, WAFC-AM-FM Staunton, Va.
 Godwin, Al. W., Independent Tv Corp., N.Y.
 Goetze, William E., KFSD San Diego, Calif.
 Golden, James R., WSEV Sevierville, Tenn.
 Goldenberg, Henry, KMBC-AM-TV Kansas City, Mo.
 Goldenson, Leonard, American Broadcasting-Paramount Theatres Inc., N.Y.
 Goldman, Paul H., Noe Enterprises Inc., Monroe, La.
 Goodman, Simon, WJTN Jamestown, N.Y.
 Goodnow, William C., WISN Milwaukee, Wis.
 Gorman, Thomas Y., WEEI Boston
 Gould, Robert, WBAP Ft. Worth, Tex.
 Grace F. Cecil, Visual Electronics Corp., N.Y.
 Grafman, Howard, Governor Tv Attractions Inc., N.Y.
 Graham, J.J., RCA, Camden, N.J.
 Gramling, Oliver, Associated Press, N.Y.
 Grams, Harold, KSD-AM-TV St. Louis
 Grant, William, KOA Denver, Colo.
 Gray, George, WLWD (TV) Dayton, Ohio
 Gray, J.E., Lee Bcstg. Inc., Quincy, Ill.
 Green, Howard L., WOND Pleasantville, N.J.
 Greenmeyer, P.A., RCA, Camden, N.J.
 Greep, Malcolm, WVJS Owensboro, Ky.
 Greiner, Mori, KMBC-TV Kansas City, Mo.
 Grenier, Theodore B., KABC-AM-FM-TV Los Angeles
 Gresham, Maurice, MGM-TV (Loew's, Inc.), Culver City, Calif.

Gresham, Stokes, Jr., WISH-AM-TV Indianapolis, Ind.
 Griffin, John T., KTUL-AM-TV Tulsa, Okla.
 Griffith, E.T., RCA, Camden, N.J.
 Grimes, Walter, Allen Kander & Co., Washington, D.C.
 Grisham, Charles F., WAPI-TV Birmingham, Ala.
 Grogan, Bill, KEPR-TV Pasco, Wash.
 Gross, Irvin, Henry I. Christal Co., N.Y.
 Grove, William C., KFBC-AM-TV Cheyenne, Wyo.
 Grysén, J.C., Ollawa Bcstg. Co., Holland, Mich.
 Guber, Sidney, Sesac Inc., N.Y.
 Gunderson, Allen, KTVT (TV) Salt Lake City
 Gunn, Hartford N. Jr., WGBH Boston
 Gunts, Brent O., WBAL-TV Baltimore, Md.
 Gunzendorfer, Wilton, Wilt Gunzendorfer & Assoc., Los Angeles
 Guy, Raymond F., NBC, N.Y.
 Guy, Robert I., KTNT-TV Tacoma, Wash.
 Guzewicz, Henry J., Stainless Inc., North Wales, Pa.

H

Haas, Joseph, WWCA Gary, Ind.
 Haeg, Larry, WCCO Minneapolis, Minn.
 Haehnle, Clyde, Crosley Bcstg. Corp., Cincinnati
 Haerle, John M., Collins Radio Co., Cedar Rapids, Iowa
 Hague, Fred, Geo. P. Hollingbery Co., N.Y.
 Haigh, Joseph B., WJBK-AM-FM-TV Detroit
 Haines, Homer M., WNAE Warren, Pa.
 Hale, William E., WBEJ Elizabethton, Tenn.
 Haley, Andrew G., Haley, Wollenberg & Kenehan, Washington, D.C.
 Halle, Charles F., WCCM Lawrence, Mass.
 Hambacher, James R., KBUN Bemidji, Minn.
 Hamilton, Charles E., KFI Los Angeles
 Hamilton, G. Edward, ABC, N.Y.

Hamilton, Ray V., Hamilton, Stubblefield, Twining & Assoc., Chicago
 Hammett, Robert L., Hammett & Edison, San Francisco
 Hance, Kenneth M., KSTP St. Paul-Minneapolis, Minn.
 Hancock, Paul, NBC, N.Y.
 Hancock, Warren J., KGHL-AM-TV Billings, Mont.
 Hanks, Gordon, WNAE Warren, Pa.
 Hanni, Kenneth J., KTVT (TV) Salt Lake City
 Hansen, William, KBUR Burlington, Iowa
 Hardwick, Carter, WSFA-TV Montgomery, Ala.
 Hariu, Walter, WISC-AM-TV Madison, Wis.
 Harkaway, Harvey A., Standard Rate and Data Service, N.Y.
 Harkrader, John, WDBJ-TV Roanoke, Va.
 Harlow, Roy, Broadcast Music Inc., N.Y.
 Harmon, Glen A., WINN Louisville, Ky.
 Harper, Richard, MGM-TV (Loew's, Inc.), N.Y.
 Harrington, John E., Jr., Harrington, Righter & Parsons, N.Y.
 Harris, Burt I., KTWO-TV Casper, Wyo.
 Harris, Jack, KPRC-AM-TV Houston, Tex.
 Harris, Wiley P., WJDX Jackson, Miss.
 Harrison, Arthur, WLIB New York
 Harrison, Gerald, WMAS-AM-FM Springfield, Mass.
 Harrison, William, WIMA Lima, Ohio
 Hart, Donald J., Smith Kline & French Labs., Philadelphia
 Hart, John P., WBIR Knoxville, Tenn.
 Hart, William J., WPON Pontiac, Mich.
 Harwood, Kenneth, U. of S. Calif., Los Angeles
 Harvey, George W., WFLA-AM-TV Tampa, Fla.
 Harvey, Jack V., Blackburn & Co., Washington, D.C.
 Hash, Earl F., WTMT Louisville, Ky.
 Hastie, Kenneth L., WMT Cedar Rapids, Iowa
 Hatcher, Ralph, ABC-TV, N.Y.
 Hausman, Louis, CBS Radio, N.Y.
 Haverlin, Carl, Broadcast Music Inc., N.Y.
 Hayden, J. Roger, Dresser-Ideco-Co., Columbus, Ohio
 Hayes, Arthur Hull, CBS Radio, N.Y.
 Hayes, Gordon, CBS-TV, N.Y.
 Hayes, Leslie W., CCIR, Geneva, Switzerland
 Hayward, Robert M., WSFA-TV Montgomery, Ala.
 Head, Howard T., A. D. Ring & Assoc., Washington, D.C.
 Heald, Robert L., Spearman & Roberson, Washington, D.C.
 Hedges, William S., NBC, N.Y.
 Heffron, Norm, KOTA-AM-TV Rapid City, S.D.
 Heinecke, Alice, Sesac Inc., N.Y.
 Heller, C.B., WIMA Lima, Ohio
 Henderson, W.C., KSLA-TV Shreveport, La.
 Henson, Milton B., WREL Lexington, Va.
 Herman, A.M., WBAP Ft. Worth, Tex.
 Herold, Joseph, TV Denver, Inc., Denver, Colo.
 Herro, George, Pulse, Inc., N.Y.
 Hess, F. Leroy, Media Scope, Evanston, Ill.
 Hetland, Julius, WDAY Fargo, N.D.
 Heyne, Donald G., WINA Charlottesville, Va.
 Hickox, Sheldon B. Jr., NBC, Hollywood, Calif.
 Hicks, James W., WRDW-AM-TV Augusta, Ga.
 Hiebert, A.G., KTVA (TV) Anchorage, Alaska
 Higgins, J.M., WTHI-AM-FM-TV Terre Haute, Ind.
 Higgins, James W., WCNY-TV Watertown, N.Y.
 Hildreth, Richard, Spearman & Roberson, Washington, D.C.
 Hilker, Robert R., WCGC Belmont, N.C.
 Hill, J.D., KWHK Hutchinson, Kan.
 Hill, J.E., RCA, Camden, N.J.
 Hilton, Greeley N., WBUY-AM-FM Lexington, N.C.
 Hilton, M.H., KSOP Salt Lake City, Utah
 Hilton, Omar G., WBUY-AM-FM Lexington, N.C.
 Hinckley, Robert H., ABC, Washington, D.C.
 Hirsch, Oscar C., Hirsch Bcstg. Co., Cape Girardeau, Mo.
 Hirsch, Robert O., Hirsch Bcstg. Co., Cape Girardeau, Mo.
 Hixenbaugh, George P., The WMT Stations, Cedar Rapids, Iowa
 Hladky, J.F., Jr., KCRG-AM-TV Cedar Rapids, Iowa
 Hoberman, Ben, WABC New York
 Hobler, Herbert W., sales consultant, Princeton, N.J.
 Hodgkins, Roger W., WGAN-AM-TV Portland, Me.
 Hoffman, Phil, WTCN-AM-TV Minneapolis
 Hoffman, Roger, WJEF Grand Rapids, Mich.
 Hogan, Thomas P., WPFM Middletown, Ohio
 Hogg, Anthony, WHLM Bloomsburg, Pa.
 Hogg, John L., KOY Phoenix, Ariz.
 Hogue, Richard, WXIX Milwaukee
 Holbrook, Robert, WSB-AM-TV Atlanta, Ga.
 Holcomb, Madge Megargee, Mrs., WGBI Scranton, Pa.
 Hollingbery, George P., Geo. P. Hollingbery Co., Chicago
 Holm, William, WLPO LaSalle, Ill.

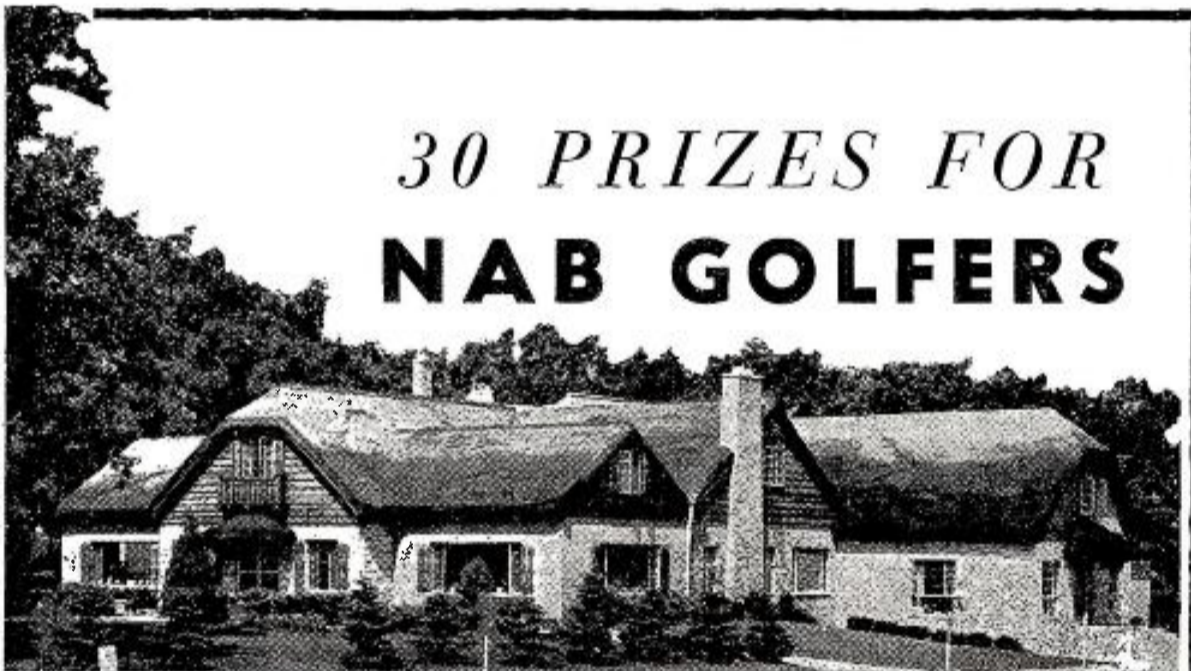

30 PRIZES FOR NAB GOLFERS

BROADCASTING's annual NAB golf tournament will be held Sunday, March 15, at the 27 hole Midwest Country Club (above), Hinsdale, Ill. To qualify for one of the 30 prizes golfer must play 9 holes. A few of the prizes: BROADCASTING Magazine 36" master trophy; Chicago stations are donating: 8 mm Revere Movie Camera (WGN); Roto-Broil "400" rotisserie (WBKB); 2 transistor radios (WIND); 10 long playing CBS records (WBBM); Sunbeam Wall Clock (WLS); Sunbeam Shavemaster, Branham Co.; Clock Radio, (Keystone Broadcasting System); Gold golf trophy, KMLA (FM) Los Angeles; Attache case, Station Rep. Assoc., New York; Portable Bar-B-Que Grill, WEEK-TV, Peoria; other prizes to be announced will be donated by WMAQ-WNBQ; WJJD, WCFL, WFMT-FM, Chicago stations; Edward Petry & Co.; H-R Representatives, Inc.; Avery-Knodel; John Blair & Co.; Headley-Reed Co.; John Pearson Co.

MAIL THIS RESERVATION TODAY, TO:

BROADCASTING, 1735 DeSales St., N. W., Wash., D. C.

Name

Address

Firm I will want a ride to the club

March 15

Tee-off time: 10 a.m.

Holt, Thad, WATV Birmingham, Ala.
 Holtman, H.B., WAVE-AM-TV Louisville, Ky.
 Honeycutt, B.B., KRLD-TV Dallas, Tex.
 Horning, E.M., KSIB Creston, Iowa
 Hornung, Dale B., WMIC Monroe, Mich.
 Horton, Keith W., WELM Elmira, N.Y.
 Hough, Hal, CBS-TV, N.Y.
 Hough, Harold, WBAP Ft. Worth, Tex.
 Houwink, Frederick S., WMAL Washington, D.C.
 Hovel, Ben F., WKOW-AM-TV Madison, Wis.
 Howard, Leo, WEAU Eau Claire, Wis.
 Howard, Thomas E., WBT Charlotte, N.C.
 Howe, James L., WIRA Ft. Pierce, Fla.
 Hudson, Wilbur E., WAVE Louisville, Ky.
 Huhndorff, Paul, KPRC-TV Houston, Tex.
 Huiskamp, B.W., WKOW-TV Madison, Wis.
 Hunt, Edward T., KBOX Dallas, Tex.
 Hunter, William C., WJHL-AM-FM-TV Johnson
 City, Tenn.
 Hurlbut, John, WFBM-AM-TV Indianapolis, Ind.
 Hurley, Raymond, WALA-TV Mobile, Ala.
 Hussman, Walter E., KCMC-TV Texarkana, Tex.
 Hyams, Jerome, Screen Gems Inc., N.Y.
 Hylan, William, CBS-TV N.Y.
 Hyland, Robert, KMOX St. Louis, Mo.

I-J-K

Immell, Ralph, WISC-AM-TV Madison, Wis.
 Ing, George, KOMO-AM-FM-TV San Antonio, Tex.
 Inglis, A.F., RCA, Camden, N.J.
 Ingram, A.L., Standard Rate & Data Service,
 Evanston, Ill.
 Ingram, Ward D., KTVU (TV) San Francisco-Oak-
 land, Calif.
 Ioset, Don, WPIT Inc., Pittsburgh, Pa.
 Jackson, Richard E., WSAL Logansport, Ind.
 Jackson, William J., KENS-AM-TV San Antonio,
 Tex.
 Jacobs, Bernard, WFMT (FM) Chicago
 Jacobs, George G., Corinthian Bcstg. Corp., N.Y.
 Jacobs, Harry N., KGO-AM-FM-TV San Francisco
 Jahncke, Ernest Lee Jr., Edward Petry & Co.,
 N.Y.
 James, Ed, BROADCASTING, Washington, D.C.
 Jarman, J. Frank, WDNC Durham, N.C.
 Jeffers, Charles L., WOAI-AM-TV San Antonio
 Jenkins, Eugene, KLZ-TV Denver, Colo.
 Jenkins, Jack, WJBC Bloomington, Ill.
 Jennes, Ernest W., Assn. of Maximum Service
 Telecasters Inc., Washington, D. C.
 Jett, E.K., WMAR-TV Baltimore, Md.
 Jewett, Carl, The Meeker Co., Chicago
 Johnson, Arnold E., Needham, Louis & Brorby, Chi-
 cago
 Johnson, Howard, WIBA Madison, Wis.
 Johnson, Leslie C., WHBF-AM-FM-TV Rock Is-
 land, Ill.
 Johnson, Merrill C., WGL Ft. Wayne, Ind.
 Johnson, Tom, KTOK Oklahoma City, Okla.
 Johnston, Sam T., WTVN Columbus, Ohio
 Johnstone, G.W., National Assn. of Manufacturers,
 N.Y.
 Jones, E.Z., WBBB Burlington, N.C.
 Jones, Kathryn, WJET Erie, Pa.
 Jones, Merle, CBS-TV, N.Y.
 Jones, Myron, WJET Erie, Pa.
 Jones, Robert A., Walter F. Kean Consulting Radio
 Engrs., Riverside, Ill.
 Jones, Theodore E., WTMT Louisville, Ky.
 Jordan, James A., WOKY Milwaukee, Wis.
 Jordan, Maitland, KOMO Seattle, Wash.
 Joseph, Ken, Ziv-Economex Tv Programs, N.Y.
 Kahle, Douglas, Allen Kander & Co., Stockton,
 Calif.
 Kaiser, Henry R., WIIC Inc., Pittsburgh
 Kanago, Eldon, KICD Spencer, Iowa
 Kane, Dan, Ellington & Co., N.Y.
 Kapel, George J., KBET-TV Sacramento, Calif.
 Kassens, Harold L., FCC, Washington, D.C.
 Kaye, Richard L., WCRB Boston, Mass.
 Kaye, Sydney M., Broadcast Music Inc., N.Y.
 Kean, Walter F., Walter F. Kean Consulting Ra-
 dio Engr., Riverside, Ill.
 Kearney, Don L., Corinthian Bcstg. Corp., N.Y.
 Keeble, G.F., S.W. Caldwell Ltd., Toronto, Canada
 Keenan, John J., WANE-TV Ft. Wayne, Ind.
 Keese, Alex., WFAA Dallas, Tex.
 Keese, Frederick L., WMBD Auburn, N.Y.
 Keever, H. Weller, California National Productions
 Inc., N. Y.
 Kelley, Boyd, KTRN Wichita Falls, Tex.
 Kelley, Gaines, WFMY-TV Greensboro, N.C.
 Kelly, Charles, WCKT Miami, Fla.
 Kelly, Edward H., RCA Recorder Program Services,
 N.Y.
 Kelly, Ewing C., KCRA-TV Sacramento, Calif.
 Kelsner, Philip L., Philip L. Kelsner & Assoc., N.Y.
 Kemme, Marjorie D., WLW Cincinnati
 Kenehan, Edward F., Haley, Wollenberg & Kenehan,
 Washington, D.C.

The Nation's Foremost Manufacturer of Multiplex Equipment

introduces

A NEW LINE OF FM TRANSMITTERS

250 watts

5,000 watts

10,000 watts

These transmitters use the same high quality Multi-
 plex Exciters whose outstanding performance has
 captured the confidence of Broadcast* owners and
 operators from coast to coast.

*names on request

VISIT US

NAB SHOW

Statler-Hilton Hotel, Chicago

March 15-18 Booth No. 35

G
 E
 L

GENERAL ELECTRONIC LABORATORIES, INC.

195 MASSACHUSETTS AVENUE, CAMBRIDGE, MASS*

NAB PREVIEW

REGISTRATION CONTINUED

Kennedy, Vann M., KSIX Corpus Christi, Tex.
 Kenney, T.C., KDKA Pittsburgh
 Kepner, Leonard, WTAE (TV) Pittsburgh
 Kerman, Arthur, Governor Tv Attractions Inc., N.Y.
 Kettler, Stanton P., Storer Broadcasting Co., Miami Beach, Fla.
 Kiefer, J.B., KMLA-FM Los Angeles
 Kiichli, Jeff, KGHL-AM-TV Billings, Mont.
 Kilpatrick, Leroy E., WSAZ-TV Huntington, W. Va.
 Kimble, R. David, Grey Adv. Agency, N.Y.
 Kinder, Harry W., KWLM Willmar, Minn.
 King, Paul L., WAWK Kendallville, Ind.
 Kinsley, Charles, KHSL Chico, Calif.
 Kirby, Joseph B., KFBI Wichita, Kan.
 Klatt, John F., Media Scope, Evanston, Ill.
 Klaus, Richard M., WERE Cleveland, Ohio
 Klein, Allen, The Pulse Inc., N.Y.
 Knapp, Ogden, NBC, N.Y.
 Knodel, Thomas E., NBC, N.Y.
 Knodel, J.W., Avery-Knodel Inc., Chicago
 Kobak, Edgar, WTWA Thomson, Ga.
 Kocher, Charles F., WXYZ Detroit, Mich.
 Kockritz, Ewald, Storer Broadcasting Co., Miami Beach, Fla.
 Koehler, Frank E., WDBJ Roanoke, Va.
 Koelker, Anthony J., KMA Shenandoah, Iowa
 Koenig, Edward L., Jr., Roy Rogers Syn. Inc., Beverly Hills, Calif.
 Koenitzer, Howard, WOBT Rhinelander, Wis.
 Kolar, Barbara, BROADCASTING, Chicago
 Kolata, Carl V., WTTN Watertown, Wis.
 Konyenburger, F. Van, WCCO Minneapolis, Minn.
 Kops, Daniel W., WAVZ New Haven, Conn.
 Koster, H. William, WEAN Providence, R.I.
 Koteen, Bernard, Koteen & Burt, Washington, D.C.
 Kramer, Worth, WJR Detroit, Mich.
 Krasner, Lawrence, Forjoe & Co., Los Angeles
 Krueger, Herbert L., WTAG Worcester, Mass.
 Kusack, William P., WBKB (TV) Chicago
 Kuykendall, Abe, WREC Memphis, Tenn.

L

Lackey, F.E., WHOP Hopkinsville, Ky.
 Laing, Malcolm (Bud), ABC-TV, N.Y.
 Laird, Ben A., Green Bay Bcstg. Co., Green Bay, Wis.
 Lake, Joseph E., WISH-TV Indianapolis, Ind.
 Lamb, M.J., WIMA-TV Lima, Ohio
 Lambe, Robert M., WTAR Norfolk, Va.
 Lamberth, Frank S., WMFR High Point, N.C.
 Lambourne, E.W., KTVT (TV) Salt Lake City, Utah
 Lancaster, W. Hanes, Jr., WJHL-AM-TV Johnson City, Tenn.
 Land, Thomas S., WFIW Fairfield, Ill.
 Landis, H. DeWitt, Hamilton, Stubblefield, Twining & Assoc., Dallas, Tex.
 Lane, C. Howard, KOIN-TV Portland, Ore.
 Lanford, T.B., KRMD Shreveport, La.
 Lang, R.L., Hughey & Phillips, Chicago
 Langlois, John D., Lang-Worth Feature Programs, N.Y.
 Lansing, Livingston, WBRV Boonville, N.Y.
 Lareau, Michael O., WOOD Grand Rapids, Mich.
 Larkins, Charles, Griffin Radio & Tv Interests, Muskogee, Okla.
 Larson, G. Bennett, KTVT (TV) Salt Lake City, Utah
 Lasker, H. Peter, Crosley Bcstg. Corp., N.Y.
 Lasko, Edwin J., WSJV (TV) South Bend-Elkhart, Ind.
 Laughlin, Frank E., WGEM Quincy, Ill.
 Laux, John J., WSTV-TV Steubenville, Ohio
 Lawrence, Craig, CBS-TV, N.Y.
 Lawrence, Dick, Ziv-Economex Tv Programs, Inc., N.Y.
 Lay, Lt. Col. John H., Department of Defense, Washington, D.C.
 Layman, Carroll, Harrington, Righter & Parsons, Chicago, Ill.
 Layman, Mike, WSFC Somerset, Ky.
 Leach, Harold H., Alford Mfg. Co., Boston
 Leach, Robert, KTVU (TV) San Francisco-Oakland, Calif.
 Leake, James C., KTUL Tulsa, Okla.
 Lee, Carl E., WKZO-TV Kalamazoo, Mich.
 Leeman, Alvin, WKBT (TV) La Crosse, Wis.
 Leibach, Jay, WLEC Sandusky, Ohio
 Leich, Martin L., WGBF Evansville, Ind.
 LeMasurier, Donald, KDAL Duluth, Minn.
 LeMasurier, Mrs. Dorothy, KDAL Duluth, Minn.
 LeMoyné, Joseph, WPAY Portsmouth, Ohio
 Leonard, James, WLWC (TV) Columbus, Ohio
 Leonard, Joe M. Jr., KGAF Gainesville, Tex.
 Lepple, Howard, Crosley Bcstg. Corp., Cincinnati
 Levey, Stan, Independent Tv Corp., N.Y.

Levi, Winfield R., BROADCASTING, New York
 Lewin, Richman, KTRE-AM-TV Lufkin, Tex.
 Lewis, Mrs. Marion, WINC Winchester, Va.
 Liebenguth, Jacques, Victory Program Sales of CNP, N.Y.
 Little, F.J., Jr., Hughey & Phillips Inc., Washington, D.C.
 Linam, Henry E., KSLA-TV Shreveport, La.
 Linam, Winston B., KSLA-TV Shreveport, La.
 Linder, H. Willard, Jr., KWLM Willmar, Minn.
 Lindow, Lester W., WWRI West Warwick, R.I.
 Lindsay, Paul N., WOWO Fort Wayne, Ind.
 Lindsey, Bill, KVOY Yuma, Ariz.
 Livesay, J.R., WLBH-AM-FM Mattoon, Ill.
 Livingston, Sam, WPSD-TV Paducah, Ky.
 Lockerd, Benjamin G., KDIX Dickinson, N.D.
 Lodge, William B., CBS-TV, N.Y.
 Lohnes, George M., Lohnes & Culver, Washington, D.C.
 London, Howard J., The National Foundation, N.Y.
 Long, Maury, BROADCASTING, Washington, D.C.
 Lorentz, Edward F., Commercial Radio Equipment Co., Washington, D.C.
 Love, Edgar J., WWJ-AM-TV Detroit, Mich.
 Lovell, Jack, WKY Oklahoma City, Okla.
 Lucy, C.T. WRVA Richmond, Va.
 Luddy, E.N., RCA, Camden, N.J.
 Lukkason, Robert C., KNOX Grand Falls, N.D.
 Lutz, E.G., Modern Talking Pictures Service Inc., N.Y.
 Lyford, Elmore B., Maine Radio & Tv Co., Portland, Me.
 Lyke, Ervin F., WVET-AM-TV Rochester, N.Y.
 Lyons, Eugene, WKY-AM-TV Oklahoma City, Okla.

M

MacFarland, F.R., AT&T, N.Y.
 MacKay, J. Stuart, All-Canada Radio & Tv Ltd., Toronto
 MacMillan, Lowell H., WHEC Rochester, N.Y.
 Magee, Robert G., WHUM Reading, Pa.
 Main, Guy, WCIA-TV Champaign, Ill.
 Malang, Albert W., ABC, N.Y.
 Mall, Dr. Richard M., Peoples Bcstg. Corp., Columbus, Ohio
 Manning, Robert, The Meeker Co., Chicago
 Manning, Robert J., WHLD-AM-TV Niagara Falls, N.Y.
 Manship, Douglas L., WBRZ-TV Baton Rouge, La.
 Manson, D., S.W. Caldwell Ltd., Toronto
 Marcoux, Rudolph O., WLBZ-TV Bangor, Me.
 Marks, Leonard H., Cohn & Marks, Washington, D.C.
 Markward, John S., WOOD Grand Rapids, Mich.
 Marlin, Al, Broadcast Music Inc., N.Y.
 Marsden, Bernard, Associated Tv Ltd., London, England
 Marshall, Clifford B., Blackburn & Co., Atlanta, Ga.
 Marshall, Glenn, Jr., WJXT Jacksonville, Fla.
 Martin, Arthur L., WMRN Marion, Ohio
 Martin, Dwight W., WAFB-TV Baton Rouge, La.
 Martin, Frank L., WTSB Lumberton, N.C.
 Martin, J. Edward, KNUZ Houston, Tex.
 Martin, Stuart T., WCAX-TV Burlington, Vt.
 Marx, Frank, ABC, N.Y.
 Mason, Bob, WMRN Marion, Ohio
 Mason, Richard H., WPTF Raleigh, N.C.
 Massarand, W.H., AT&T, Chicago
 Mathiesen, George H., KYW-TV Cleveland, Ohio
 Mathiot, J.E., WGAL Lancaster, Pa.
 Matthews, Joseph R., A.C. Nielsen Co., Menlo Park, Calif.
 Mayes, Wendell, KBWD Brownwood, Tex.
 Mayeux, Jules L., WBRZ-TV Baton Rouge, La.
 Mayfield, W.E., WMBI Chicago, Ill.
 McAbee, Charles, KMOX-TV St. Louis, Mo.
 McCabe, Aloysius B., Kirkland, Ellis, Hodson, Chef-fetz & Masters, Washington, D.C.
 McClennahan, William, WQUA Moline, Ill.
 McClung, Mrs. Mickey, KHSL San Francisco
 McClure, Eugene E., KCRG-TV Cedar Rapids, Iowa
 McClymonds, Clyde C., Storer Bcstg. Co., Miami Beach, Fla.
 McCollough, Clair, WGAL-AM-TV Lancaster, Pa.
 McConnell, James V., Venard, Rintoul & McConnell, N.Y.
 McConnell, Robert B., WISH-AM-TV Indianapolis
 McCoy, John E., Storer Bcstg. Co., Miami Beach, Fla.
 McCready, S.W., KVAL-TV Eugene, Ore.
 McDaniel, I.V., KCRG-AM-TV Cedar Rapids, Iowa
 McDermott, Andy, Tv Radio Sta. Rep., Toronto, Canada
 McDermott, G.B., KBRU Burlington, Iowa
 McDermott, Mrs. G.B., KBRU Burlington, Iowa
 McDermott, John, WJBC Bloomington, Ill.
 McDonald, Joseph A., Smith, Kennessey & McDonald, Washington, D.C.
 McDonough, Francis X., Dow, Lohnes & Albertson, Washington, D.C.

McDowell, Theodore N., WMAL-TV Washington, D.C.
 McGannon, Donald H., Westinghouse Bcstg. Co., N.Y.
 McGregor, W.D., CKCO-TV Kitchener, Ont.
 McHargue, Ralph, WCVS Springfield, Ill.
 McIntosh, Robert J., WWJ Detroit, Mich.
 McKenna, Edward, Allen Kander & Co., Washington, D.C.
 McKenna, James A. Jr., McKenna & Wilkinson, Washington, D.C.
 McKnight, George W., M-H Regulator Co., Brown Instrument Div., Philadelphia
 McNally, William J., WCCO-AM-TV Minneapolis
 McNamara, Jim, WALA-TV Mobile, Ala.
 Meehan, Edward J. Jr., WDAU-TV Scranton, Pa.
 Meeker, Robert D. C., The Meeker Co., N.Y.
 Megargee, Frank E., WGBI Scranton, Pa.
 Melloh, Clifford, WHO-AM-TV Des Moines, Iowa
 Mendelson, Robert P., WJNC Jacksonville, N.C.
 Menke, Don, WFBM-TV Indianapolis, Ind.
 Mercer, Donald J., NBC, N.Y.
 Merkle, Joe, ABC-TV, N.Y.
 Merritt, Bill, BROADCASTING, Los Angeles
 Meyer, August C., WCIA-TV Champaign, Ill.
 Meyers, Carl J., WGN Chicago, Ill.
 Meyers, Howard B., Venard, Rintoul & McConnell, Inc., Chicago
 Michael, Jack, WREC-AM-TV Memphis, Tenn.
 Michaels, Bill, WJBK-TV Detroit, Mich.
 Middlebrooks, James, King Bcstg. Co., Seattle, Wash.
 Middleton, Warren, BROADCASTING, Chicago
 Miller, A.M., RCA, Camden, N.J.
 Miller, C.E., KOMO-AM-TV Seattle, Wash.
 Miller, R.E., Alexandria Bcstg. Co., Alexandria, La.
 Miller, Samuel, attorney, Washington, D.C.
 Mills, J. Dexter, WDBJ, Roanoke, Va.
 Minahan, Michael J., ABC-TV, N.Y.
 Minor, Marvin J., WBT Charlotte, N.C.
 Mishler, George M., WOHO Toledo, Ohio
 Mitchell, Joseph H., WFLA-AM-FM-TV Tampa, Fla.
 Mittendorf, E.S., KOLD-TV Tucson, Ariz.
 Moe, Tony, KSO Des Moines, Iowa
 Moler, John, WKY Oklahoma City
 Monahan, Richard J., WAVZ New Haven, Conn.
 Moore, Art, Art Moore & Assoc., Seattle
 Moore, Dale G., KBMN Bozeman, Mont.
 Moore, F.S., WJR Detroit, Mich.
 Morby, Ole G., Time Inc., New York
 More, Herbert R., Kliegl Bros., N.Y.
 Moreland, W.J., CONRAC Inc., Glendora, Calif.
 Morency, Paul W., WTIC-AM-FM-TV Hartford, Conn.
 Morgan, John Carl, WFVA Fredericksburg, Va.
 Moroney, J.M., Sr., A.H. Belo Corp., Dallas
 Moroney, J.M., Jr., A.H. Belo Corp., Dallas
 Morris, Dave, KNUZ Houston, Tex.
 Morris, Joseph, Radio-Television Daily, N.Y.
 Morris, Robert M., ABC, N.Y.
 Morris, Truman A., WBEX Chillicothe, Ohio
 Morrison, Wendell C., RCA, Camden, N.J.
 Mortensen, Robert A., WIIC Pittsburgh
 Motley, Lyle C., WBTM Danville, Va.
 Moudy, Dale, WING Dayton, Ohio
 Mounsey, Duncan, WPTR Albany, N.Y.
 Mowery, Paul, MGM-TV, N.Y.
 Mowrey, Paul B., consultant, New York
 Moyer, William J., KARD-TV Wichita, Kan.
 Mueller, Fred C., WEEK Peoria, Ill.
 Mullin, Earl, ABC, N.Y.
 Murdoch, D. Lennox, KSL-TV Salt Lake City, Utah
 Murphy, John S., World Broadcasting System, N.Y.
 Murphy, John T., Crosley Bcstg. Corp., Cincinnati
 Murphy, Kieran T., Crosley Bcstg. Corp., Cincinnati
 Murphy, Kingsley H. Jr., KOTE Fergus Falls, Minn.
 Murtha, Andrew J., Time Inc., N.Y.
 Myers, Robert L., WCIA-TV Champaign, Ill.
 Myers, W.F., SESAC, N.Y.

N

Nadeau, Ralph WMUR-TV Manchester, N.H.
 Neal, Harold L. Jr., WXYZ Inc., Detroit
 Nelson, Ivar, Meyer Bcstg. Co., Bismarck, N.D.
 Nelson, Louis J., Wade Advertising, Chicago
 Nelson, T.M., KFEQ St. Joseph, Mo.
 Newman, J. Edward, WDBJ-TV Roanoke, Va.
 Nielsen, Sam S., WTRY Troy, N.Y.
 Nierman, Martin L., Edward Petry & Co., N.Y.
 Nolan, Jim, Cascade Bcstg. Co., Yakima, Wash.
 Nolte, Vernon A., WJBC Bloomington, Ill.
 Nopper, Carlton G., WMAR-TV Baltimore
 Nord, Evans A., KELO-AM-TV Sioux Falls, S.D.
 Norman, George I. Jr., KMUR Inc., Salt Lake City, Utah
 Northrop, Johnston F., Corinthian Bcstg. Corp., N.Y.
 Norton, George W. IV, WAVE Inc., Louisville, Ky.

and now
STEREO!

RCA

Recorded Program Services

is first to enter

the field of

stereo libraries

for

radio stations

WRITE NOW FOR A FREE DEMONSTRATION RECORD of the new RCA Stereo Commercial Aids and Recorded Musical Programs. This sample disc, offered without obligation, contains a cross-section of the top-quality programming and commercial features that will be available in the new Stereo service.

Included: Lawrence Welk . . . music from "The Music Man" and "Gigi" . . . sound effects . . . "Music to Sell By" . . . jingles . . . The Melachrino Orchestra . . . and other entertainment and commercial features.

Whether you are now broadcasting in Stereo, or are planning to do so in the future, you'll want to hear this sample of RCA Recorded Program Services features. Just use this coupon.

For more information and audition of Demonstration Disc, visit Suite 600 at the Conrad Hilton during the NAB Convention.

RCA RECORDED PROGRAM SERVICES
155 E. 24th St., New York 10, N. Y.

Sirs: Please send me your brand-new Stereo Demonstration Disc. I understand there is no cost, except for 35¢ for postage and handling (enclosed). Our station is _____/is not _____ making Stereo broadcasts at present. We broadcast _____ hours per week in Stereo. We do _____/do not _____ plan to commence Stereo broadcasts in the future. Possible starting date _____. The kind of library material that we require most is _____

YOUR NAME _____

TITLE _____

STATION _____ ADDRESS _____

CITY _____ ZONE _____ STATE _____



RECORDED PROGRAM SERVICES

55 E. 24th St., New York 10, N. Y., MUrray Hill 9-7200 • 445 N. Lake Shore Drive, Chicago 11, Ill., WHitehall 4-3530 • 134 Peachtree Street, N.W., Atlanta 3, Ga., JACKson 4-7703
901 Empire Freeway, Dallas 35, Texas, FLeeTwood 2-3911 • 1016 N. Sycamore Ave., HOLLYWOOD 38, Calif., OLdfield 4-1660 • 800 17th Ave. South, Nashville, Tenn., ALPine 5-6691

NAB PREVIEW

REGISTRATION CONTINUED

Novy, Joe, WJOL Joliet, Ill.
Nunan, Thomas R. Jr., WGAL Lancaster, Pa.
Nybo, Ken, KBMY Billings, Mont.



Oakley, Ron, KFAC Los Angeles
O'Connell, Raymond T., NBC, N.Y.
O'Connor, Harry, KTXO Sherman, Tex.
O'Connor, J.W., WCVS Springfield, Ill.
O'Connor, Ralph, WISC-TV Madison, Wis.
O'Connor, Timothy, Allen Kander & Co., Denver
Ohleyer, Robert F., WISH Indianapolis, Ind.
Oliver, Treyz, ABC, N.Y.
Olson, Harold O., Collins Radio Co., Cedar Rapids, Iowa
Osborn, John, BROADCASTING, Chicago
Osborne, Jim, WXIX-TV, Milwaukee
Owen, Clure H., ABC, N.Y.



Pabst, William D., San Francisco-Oakland TV Inc., San Francisco-Oakland
Palmer, Donald, The Meeker Co., Los Angeles
Pamphilon, L. Edward, U.S.I.A., Hyattsville, Md.
Parham, Carter M., WDEF-AM-TV Chattanooga, Tenn.
Paris, Herman, WWDC Inc., Washington, D.C.
Parsons, James O., Harrington, Righter & Parsons, N.Y.
Parsons, Nellie, KR0D-TV El Paso, Tex.
Parton, Frank, Screen Gems, N.Y.
Paske, Rolland E., WEMP Milwaukee.
Patt, John F., WJR Detroit, Mich.
Patterson, W. Kenneth, WSIV Pekin, Ill.
Patton, Billy, WJAR-TV Providence, R.I.
Paul, Mary, Corinthian Bcstg. Corp., N.Y.
Paxton, E.J. Jr., WPSD-TV, Paducah, Ky.
Peck, Harry D., KODY North Platte, Neb.
Peebles, Hala D., WRCO Richland Center, Wis.
Peele, Billey E., WFMO Fairmont, N.C.
Peffer, John C., WTAR Norfolk, Va.
Pegler, Bill, Television Zoomar Corp., N.Y.
Pegler, Jack A., Television Zoomar Corp., N.Y.
Pehlman, Carl, KKTU (TV) Colorado Springs, Colo.
Pell, Ernest, WPSD-TV Paducah, Ky.
Pellegrin, Frank E., WATO Oak Ridge, Tenn.
Pengra, Marshall H., KLTU (TV) Tyler, Tex.
Pepper, Vincent A., Smith & Pepper, Washington.
Perkins, C.A., Capitol Bcstg. Co., Jackson, Miss.
Perna, John J. Jr., Gill-Perna, N.Y.
Persons, Charles B., WELY Ely, Minn.
Persons, C.P. Jr., WKRG-TV Mobile, Ala.
Persons, June A., WELY Ely, Minn.
Peters, F.J., WMRN-AM-FM Marion, Ohio
Petersmeyer, C. Wrede, Corinthian Bcstg., N.Y.
Peterson, Edwin R., Keystone Bcstg. System, Chicago.
Petrik, Jack, KETV (TV) Omaha, Neb.
Petty, J.B., WLTC Gastonia, N.C.
Pfeiffer, Edwin, KOTV (TV) Tulsa, Okla.
Phelps, Wayne, KALG Alamogordo, N.M.
Phillips, Elaine, WDSU-TV New Orleans
Pierce, W.F., Standard Rate & Data Service, N.Y.
Podolinsky, Edward, KTNT-TV Tacoma, Wash.
Pointer, R.L., ABC, N.Y.
Pomeroy, John C., WILS Lansing, Mich.
Pontius, Don, The Meeker Co., San Francisco
Porter, Charles P., KIRX Kirksville, Mo.
Posner, Gene, WMIL Milwaukee, Wis.
Potter, Ben H., WHBF-AM-TV Rock Island, Ill.
Potter, David, WNAE Warren, Pa.
Potter, Hugh O., WOMI Owensboro, Ky.
Potter, Roland B., WKBC N. Wilkesboro, N.C.
Power, P.V., Standard Rate & Data Service, Evanston, Ill.
Powers, Donald, WCSH Portland, Me.
Powley, Allan T., Evening Star Bcstg. Co., Washington, D.C.
Prager, Evarard S., Sesac, New York.
Pratt, Dana, RCA, Camden, N.J.
Pratt, Robert L., KGGF Coffeyville, Kan.
Pratt, Roy W., WHO-AM-TV Des Moines, Iowa.
Preston, John G., ABC, N.Y.
Priault, William J., WRAC Inc., Racine, Wis.
Provost, D.L., WBAL Baltimore
Pryor, Emerson J., WDVA Danville, Va.
Pullen, Weston C. Jr., Time Inc., N.Y.
Pushker, Harvey M., WFMF (FM) Chicago.

Q-R

Quaal, Ward L., WGN Inc., Chicago
Quarton, William B., The WMT Stations, Cedar Rapids, Iowa.

Quinlan, S.C., WBKB (TV) Chicago.
Quinn, J. William, WBTW (TV) Florence, S.C.
Rabell, Dorothy, KITT San Diego, Calif.
Rabell, Fred, KITT San Diego, Calif.
Radetsky, Ralph, KOA-AM-TV Denver.
Rahall, N. Joe, Rahall Stations, Allentown, Pa.
Rahmel, Henry A., A.C. Nielsen Co., Chicago.
Ramsay, William R., KFMQ (FM) Lincoln, Neb.
Ramsey, Glenn, Sesac, N.Y.
Ramsland, Odin, KDAL Duluth, Minn.
Raney, Wilson, WREC Memphis, Tenn.
Rauer, Guy C., WEJL Scranton, Pa.
Rawls, Lucien E., L.H. Carr & Assoc., Washington, D.C.
Ray, C. Robert, WBBB Burlington, N.C.
Raymer, Paul H., Paul H. Raymer Co., N.Y.
Read, A. Louis, WDSU New Orleans, La.
Ream, Joseph H., CBS, New York.
Reber, Jack, Cascade Bcstg. Co., Yakima, Wash.
Reed, Elmo W., WJPG Green Bay, Wis.
Reed, Oscar, Jansky & Bailey, Washington, D.C.
Reilly, William F., RCA Recorded Program Services, Chicago.
Reineke, E.C., WDAY Fargo, N.D.
Reinsch, J. Leonard, WSB-AM-TV Atlanta, Ga.
Reuschle, R.M., WLAC-TV Nashville.
Reynolds, Donald W., KFSA Ft. Smith, Ark.
Reynolds, George A., WSM-AM-TV Nashville, Tenn.
Reynolds, Paul, WDBJ-TV Roanoke, Va.
Rhea, Henry E., Triangle Stations, Philadelphia.
Rice, G.R.A., CFRN-AM-TV Edmonton, Alta.
Rice, Roger D., WIIC Inc., Pittsburgh.
Rich, Robert J., WDSM-AM-TV Duluth, Minn.
Rich, W. Robert, United Artists Associated, N.Y.
Richards, G.P., WCEM Cambridge, Md.
Richardt, Roland W., WSAU-AM-TV Wausau, Wis.
Richardt, Walter R., KOTI-TV Klamath Falls, Ore.
Richdale, James C. Jr., KGUL-TV Houston, Tex.
Riddle, Lindsey G., WDSU New Orleans
Riddleberger, Stephen C., ABC, N.Y.
Rifkin, Maurice J., Ziv-TV Programs, N.Y.
Riggs, John S., WELM Elmira, N.Y.
Righter, Volney, Harrington, Righter & Parsons, N.Y.
Rine, William E., Storer Bcstg. Co., Miami Beach, Fla.
Rissler, H.D., WHO-AM-TV Des Moines, Iowa.
Rittenhouse, Paul, NBC, New York.
Robeck, Peter M., Roy Rogers Syndication, N.Y.
Robertson, B.G., KTHV (TV) Little Rock, Ark.
Robinson, Charles, WOOD Grand Rapids, Mich.
Robinson, F.A. Jr., AT&T, Cincinnati.
Robinson, R.V., WCYB-AM-TV Bristol, Va.
Roche, Dwyer, Standard Rate & Data Service, Evanston, Ill.
Rockwell, R.J., Crosley Bcstg. Corp., Cincinnati.
Roeder, George H., WCBM Baltimore.
Rogers, James G., KFSD-AM-FM-TV San Diego, Calif.
Rogers, W.D. (Dub), KDUB-TV Lubbock, Tex.
Rollins, O. Wayne, WAMS Wilmington, Del.
Rollo, Reed T., Kirkland, Ellis, Hodson, Chaffetz & Masters, Washington, D.C.
Romig, Jerry, WDSU-TV New Orleans, La.
Rosenthal, Henry, Lafayette Bcstg. Co., Lafayette, Ind.
Roth, Bob, KONO-AM-FM-TV San Antonio, Tex.
Roth, Eugene J., KONO-AM-FM-TV San Antonio, Tex.
Roth, Gene W., KXLY-TV Spokane, Wash.
Roth, Jack, KONO-AM-FM-TV San Antonio, Tex.
Rothrum, W.V., WSYR Syracuse, N.Y.
Rothschild, Walter J., Lee Bcstg. Inc., Quincy, Ill.
Rounsaville, R.W., Rounsaville Radio Stations, Atlanta.
Rountree, J.G., consulting engineer, Dallas
Routt, Edd, KNOE Monroe, La.
Rowell, Russell, Spearman & Roberson, Washington, D.C.
Rudloff, Everett, WJLK Asbury Park, N.J.
Ruegg, Fred, KNX Los Angeles.
Ruhle, Paul L., WSIX Nashville, Tenn.
Runnerstrom, Robert O., WMBD Peoria, Ill.
Russell, James D., KKTU (TV) Colorado Springs, Colo.
Russell, Percy H., Kirkland, Ellis, Hodson, Chaffetz & Masters, Washington, D.C.
Ruwitch, Lee, WTVJ (TV) Miami
Ryan, William B., Blackburn & Co., Chicago.
Ryan, William J., WNOG Naples, Fla.
Ryder, J. Maxim, WQUA Moline, Ill.

S

Saddler, Owen, May Bcstg. Co., Omaha.
Salant, Richard, CBS Inc., N.Y.
Salk, Robert H., Corinthian Bcstg. Corp., N.Y.
Sambrook, A.B., RCA Recorded Program Services, N.Y.
Samuels, Hartley L., KODY North Platte, Neb.

Sanders, Ben B., KICD Spencer, Iowa.
Sandler, Jack L., WQAM Miami.
Sanjek, Russell, Broadcast Music Inc., N.Y.
Sauber, Robert H., WTIV & WFRA Titusville, Pa.
Saxon, Joe H., WTOK-TV Meridian, Miss.
Saxon, Merl, consulting radio engineer, Lufkin, Tex.
Schaaf, Harold, WRFD Worthington, Ohio.
Scherer, J.P., WHFB-AM-FM Benton Harbor, Mich.
Schiavone, James, WWJ-TV Detroit.
Schilling, John T., KMBC-AM-TV Kansas City.
Schlinkert, R.T., WBRC-TV Birmingham, Ala.
Schneider, Jack, WCAU-TV Philadelphia.
Schneck, Leroy, WNAE Warren, Pa.
Schoen, Arnold F. Jr., WPRO-AM-TV Providence, R.I.
Schofield, Arthur C., Storer Bcstg. Co., Miami Beach, Fla.
Schoonover, Jim, KTUL Tulsa, Okla.
Schroeder, Frank C. Jr., WDZ Decatur, Ill.
Schroeder, Ray J., KMTV (TV) Omaha, Neb.
Schroeder, Willard, WOOD Grand Rapids, Mich.
Schudt, William A. Jr., CBS Radio, N.Y.
Schwieder, A.W., KID-AM-TV Idaho Falls, Idaho
Schofield, Charles L., KEYZ Williston, N.D.
Scott, Claude, KTBS-TV Shreveport, La.
Screen, John, WDSU New Orleans, La.
Seavey, Hollis M., Clear Channel Bcstg. Service, Washington, D.C.
Sebastian, Charles F., WTAQ La Grange, Ill.
Sebastian, Daryl, WWTU (TV) Cadillac, Mich.
See, Harold P., KRON-TV San Francisco.
Seebeck, Charles E., WTON Staunton, Va.
Segal, David M., KOSI Denver.
Segler, Otis H., WDEF-TV Chattanooga, Tenn.
Segrest, Charles, KPAC Port Arthur, Tex.
Seideman, Robert, Screen Gems, N.Y.
Seiler, James W., American Research Bureau Inc., Beltsville, Md.
Sellers, Ed, BROADCASTING, Washington, D.C.
Sells, Harry G., Dow, Lohnes & Albertson, Washington, D.C.
Selph, Colin, Blackburn & Co., Beverly Hills, Calif.
Sepaugh, L.M., Capitol Bcstg. Co., Jackson, Miss.
Severn, Donald W., Ted Bates & Co., N.Y.
Severson, E.C., WKOW-TV Madison, Wis.
Seward, James W., CBS Radio, N.Y.
Shafto, G. Richard, WIS-AM-TV Columbia, S.C.
Shaheen, Richard, Allen Kander & Co., Chicago.
Shakespeare, Frank, WCBSTV New York.
Shapiro, M.H., Broadcast Pioneers, N.Y.
Shapiro, Mike, WFAA-TV Dallas.
Sharpe, Virgil, KOWH Omaha, Neb.
Shaw, Donald S. Jr., ABC-TV, N.Y.
Shawn, Fred, WSUN-AM-TV St. Petersburg, Fla.
Shay, John A., WTVJ (TV) Miami, Fla.
Shepard, Harwell V., KDNT Denton, Tex.
Sherman, John M., WCCO-AM-TV Minneapolis
Shiple, W.H., KDUB-TV Lubbock, Tex.
Shively, Dick, WTVW (TV) Evansville, Ind.
Shomo, Ernest H., WBBM Chicago
Shuebruk, Peter, Fly, Shuebruk, Blume & Gaguine, Washington, D.C.
Shurtleff, David, WJAR Providence, R.I.
Sigmon, Loyd C., KMPC Hollywood.
Silverman, Mort, WJBO Baton Rouge, La.
Simmons, Lamar, WLCS Baton Rouge, La.
Simon, Arthur, Radio Television Daily, N.Y.
Sinclair, Joseph S., WJAR-TV Providence, R.I.
Sinnott, Robert J., WHBF-AM-FM-TV Rock Island, Ill.
Sitrick, Joseph M., Blackburn & Co., Washington.
Skaran, Raymond O., WKBT LaCrosse, Wis.
Skinner, Paul F., WHBL Sheboygan, Wis.
Skrom, George M., Walter F. Kean Consulting Radio Engrs., Riverside, Ill.
Slate, Sam, WCBSTV New York
Slavick, H.W., WMC-WMCF-WMCT Memphis, Tenn.
Sloan, Sam W., WOHO Toledo, Ohio.
Slusser, Jesse A., KOA Denver.
Small, Burrell L., WKAN Kankakee, Ill.
Small, Frank, WFBM Indianapolis, Ind.
Smathers, Robert R., WLBT-TV Jackson, Miss.
Smith, Al, KTIV (TV) Sioux City, Iowa
Smith, Calvin J., KFAC Los Angeles.
Smith, Carleton D., WRC-AM-TV Washington, D.C.
Smith, Charles E., WEBC Duluth, Minn.
Smith, Charles H., Corinthian Bcstg. Corp., N.Y.
Smith, Dick, KMBC-KFRM Kansas City, Mo.
Smith, E. Stratford, Smith & Pepper, Washington, D.C.
Smith, George S., Smith, Hennessey & McDonald, Washington, D.C.
Smith, Hugh M., WCOV Montgomery, Ala.
Smith, H.R., Standard Electronic, Long Island City, N.Y.
Smith, Lester M., KXL Portland, Ore.
Smith, Mrs. Lester M., KXL Portland, Ore.
Smith, M.D. III, WAAY Huntsville, Ala.
Smith, R.H., WCYB-AM-TV Bristol, Va.

Smith, Roy A., WLAC-TV Nashville, Tenn.
 Smith, T.A., RCA, Camden, N.J.
 Smith, W. Edwin, KIEM-TV Eureka, Calif.
 Smullin, William B., KIEM-TV Eureka, Calif.
 Smullin, Mrs. William B., KIEM-TV Eureka, Calif.
 Snider, Robert, KTUL Tulsa, Okla.
 Snyder, Franklin C., WTAE (TV) Pittsburgh
 Snyder, William, Harrington, Righter & Parsons, Detroit.
 Sonderling, Egmont, WOPA Oak Park, Ill.
 Southmayd, John P., Fisher, Wayland, Duvall & Southmayd, Washington, D.C.
 Sparnon, Ken, Broadcast Music Inc., N.Y.
 Spence, Mrs. Sylvia, Sylvia Spence Assoc., N.Y.
 Spencer, Lester G., WKBV Richmond, Ind.
 Spheeris, A.M., WEMP Milwaukee, Wis.
 Spiegelman, Frank, Governor Tv Attractions, N.Y.
 Spokes, A.E., WEAV Plattsburgh, N.Y.
 Spragg, Leonard A., Storer Bcstg. Co., Miami Beach, Fla.
 Sprague, Charles A., WMAX Grand Rapids, Mich.
 Spring, J.L., WIMA-TV Lima, Ohio.
 Stadig, Sidney V., KYW-AM-TV Cleveland.
 Standard, Charles E., The Meeker Co. Inc., N.Y.
 Stanfield, Ray M., WIST Charlotte, N.C.
 Stangel, Wallace, WBAY Green Bay, Wis.
 Stanley, Al G., WTSB Lumberton, N.C.
 Stanley, Earl R., Dow, Lohnes & Albertson, Washington, D.C.
 Stapp, Jack S., WKDA Nashville, Tenn.
 Stark, Howard E., Howard E. Stark Assoc., N.Y.
 Starnes, Jack, WFNS Burlington, N.C.
 Starnes, Rudy, KDUB-TV Lubbock, Tex.
 Stauffer, Ray, WHO-AM-TV Des Moines, Iowa
 Stebbins, John D., The Bolling Co., Chicago.
 Stecher, Bentley A., WEBB Baltimore, Md.
 Steele, V.J., WVJS Owensboro, Ky.
 Stein, Blanche, Keystone Bcstg. System, Chicago.
 Steinle, David H., KBUR Burlington, Iowa
 Stern, Edgar B., Jr., WDSU New Orleans, La.
 Sternberg, George, The Pulse, N.Y.
 Stevens, George, KOTV (TV) Tulsa, Okla.
 Stewart, David V., WKBN Bcstg. Corp., Youngstown, Ohio.
 Stewart, Larry, Independent Tv Corp., N.Y.
 Stewart, Russ M., KNEB Scottsbluff, Neb.
 Stoll, Jack L., Jack L. Stoll & Assoc., Los Angeles.
 Stone, Robert L., NBC, N.Y.
 Storer, George B., Jr., Storer Bcstg. Co., Miami Beach, Fla.
 Storer, Peter, WSPD-TV Toledo, Ohio.
 Storz, Todd, Storz Bcstg. Co., Omaha, Neb.
 Stout, Clair L., Dow, Lohnes & Albertson, Washington, D.C.
 Strachota, Bernie, WRIT Milwaukee, Wis.
 Strack, Eugene W., WXLW Indianapolis, Ind.
 Strouse, Ben, WWDC Washington, D.C.
 Struthers, Harvey, CBS-TV, N.Y.
 Stuart, Harold C., KVOO-AM-TV Tulsa, Okla.
 Stubblefield, Bill, Wm. T. Stubblefield Co., Washington, D.C.
 Stuckwisch, Milburn H., WSOY-AM-FM Decatur, Ill.
 Sturtz, Howard, Jr., WCCN, Neillville, Wis.
 Suitt, Cecil, KTHV (TV) Little Rock, Ark.
 Sullivan, Cornelius K., NBC, N.Y.
 Sullivan, Donald D., KVTU (TV) Sioux City, Iowa.
 Sullivan, Robert J., Corinthian Bcstg. Corp., N.Y.
 Sundberg, Harold C., Jr., WMBD Inc., Peoria, Ill.
 Swanson, Bill, KTUL-TV Tulsa, Okla.
 Swartley, W.C., WBZ-AM-TV Boston.
 Swezey, Robert D., WDSU New Orleans, La.
 Swift, Arthur M., WTCN Minneapolis.
 Swift, G. Richard, The Bolling Co., N.Y.
 Swisher, Arden, KMTV (TV) Omaha.

T

Taishoff, Lawrence B., BROADCASTING, Washington, D.C.
 Taishoff, Sol, BROADCASTING, Washington, D.C.
 Tanner, E.S., WSIX Nashville, Tenn.
 Tanner, Harold I., WLDM Detroit, Mich.
 Tansey, John B., WRVA, Richmond, Va.
 Tarlow, Sherwood J., WHIL Boston.
 Tarter, George L., KCBF-TV Lubbock, Tex.
 Taylor, J.P., RCA, Camden, N.J.
 Taylor, Maj. Richard I., Army Pictorial Services Division, Washington, D.C.
 Teich, W.J., KOEL Oelwein, Iowa.
 Telford, Donald H., KBES-TV, Medford, Ore.
 Temkin, Charles S., Copy Service Bureau, Chicago.
 Tenenbaum, Harry, KTVI (TV) St. Louis
 Terrell, James R., WKY-TV Oklahoma City
 Terry, Hugh B., KIZ-AM-TV Denver
 Tharpe, James B., Visual Electronics Corp., N.Y.
 Thayer, Jack, WDGW Minneapolis.
 Thomas, C.L., KXOK St. Louis
 Thomas, Eugene S., KETV-TV Omaha, Neb.
 Thomas, Max W., WKNX-AM-TV Saginaw-Bay City, Mich.

Thomas, Morris W., KWTU (TV) Oklahoma City.
 Thomas, Robert E., WJAG Norfolk, Neb.
 Thomas, Robert R., Jr., WOAY-AM-FM-TV Oak Hill, W.Va.
 Thomforde, Cliff, KNOX Grand Forks, N.D.
 Thompson, C. Robert, WBEN Buffalo, N.Y.
 Thompson, Doyle D., WFMY-TV Greensboro, N.C.
 Thorpe, George W., WVCG Coral Gables, Fla.
 Thurston, Donald A., WIKE Newport, Vt.
 Tilley, Harry, Visual Electronics Corp., N.Y.
 Tilton, Robert F., Storz Bcstg. Co., Omaha, Neb.
 Tipton, Jack, KLZ-TV Denver.
 Tisdale, James M., WVCH Chester, Pa.
 Tomberlin, William, KMLA (FM) Los Angeles.
 Tong, Edward, WDSU New Orleans, La.
 Tooke, Roland V., KYW-AM-TV Cleveland.
 Torge, George R., WBEN-TV, Buffalo, N.Y.
 Tornberg, Edwin, Allen Kander & Co., N.Y.
 Torrey, William H., KGNC-AM-FM-TV Amarillo, Tex.
 Towison, Harold G., General Electric Co., Syracuse, N.Y.
 Town, George R., TASO, Ames, Iowa.
 Tracy, E. C., RCA, Camden, N.J.
 Trainer, M. A., RCA, Camden, N.J.
 Trigg, Cecil L., KOSA-TV Odessa, Tex.
 Troman, R.A., Blaw-Knox Equipment Div., Pittsburgh.
 Trotter, Hugh E., WSEV Sevierville, Tenn.
 Trouant, V.E., RCA, Camden, N.J.
 Tunnell, G.W., RCA Service Co., Camden, N.J.
 Turchan, Paul J., Central Ontario Tv Ltd., Kitchener, Ont.
 Turner, William F., KOTA-AM-TV, Rapid City, S.D.
 Tweet, Art, KNOX Grand Forks, N.D.
 Twining, W.R., Hamilton, Stubblefield, Twining & Assoc., San Francisco.

U

Udley, Donald E., WRRD Ithaca, N.Y.
 Uimer, James G., Fort Worth, Tex.
 Unger, Alvin E., Independent Tv Corp., N.Y.
 Unger, Irwin, Gill-Perna, Chicago.
 Urner, Edward E., KLYD Bakersfield, Calif.
 Utley, George K., WFAA Dallas.

V

Vadeboncoeur, E.R., WSYR Syracuse, N.Y.
 Vanagriff, Carl W., WOWO Ft. Wayne, Ind.
 VanNostrand, Lew, WMT-TV Cedar Rapids, Iowa.
 Varnum, W.B., RCA, Camden, N.J.
 Vatn, John L., WWL New Orleans, La.
 Vaugann, Jack C., Television Properties Inc., Amarillo, Tex.
 Veihmeyer, Fred D., Lohnes & Culver, Washington, D.C.
 Venard, Lloyd George, Venard, Rintoul & McConnell, N.Y.
 Vieracker, Math, WBKB (TV) Chicago.
 Vincent, Emil P., ABC, N.Y.
 Volger, George J., KWPC-AM-FM Muscatine, Iowa.
 Voruermark, Ernest B., WJXT (TV) Jacksonville, Fla.
 Voss, Victor H., WWCA Gary, Ind.
 Voynow, Edward E., Edward Petry & Co., Chicago.

W

Waddell, Hal, WKBZ Muskegon, Mich.
 Wagner, George A., KFI Los Angeles.
 Wagner, Jay, WLEC Sandusky, Ohio.
 Wagner, William D., WOC-AM-FM-TV Davenport, Iowa.
 Wahlmann, Theodore R., KADY St. Charles, Mo.
 Wailes, Lee B., Storer Bcstg. Co., Miami Beach, Fla.
 Walker, Fred, WTTM Trenton, N.J.
 Walker, Harold F., Rounsaville Radio Stations, Atlanta.
 Walker, Larry, WSOC Bcstg. Co., Charlotte, N.C.
 Walker, Merrill H., WOAP Owosso, Mich.
 Walker, William L., NAB, Washington, D.C.
 Wall, Thomas H., Dow, Lohnes & Albertson, Washington, D.C.
 Wallace, M.G., AT&T, N.Y.
 Walt, Norm, WCBS-TV, New York.
 Wannamaker, Allen, WBIG Greensboro, N.C.
 Ward, Carl, CBS-TV, N.Y.
 Ward, G. Pearson, KTTS-AM-FM-TV Springfield, Mo.
 Warren, W. W., KOMO-AM-TV Seattle
 Watkins, F.A., KTHS, Little Rock, Ark.
 Watts, C.R., KVII (TV) Amarillo, Tex.
 Watts, Duane L., KHAS-TV Hastings, Neb.
 Waugh, Irving C., WSM-TV Nashville.

Wayland, Charles V., Fisher, Wayland, Duvall & Southmayd, Washington, D.C.
 Waymire, Dee, KHQ Spokane, Wash.
 Wayne, E.O., WJR Detroit
 Wearn, Wilson C., WMRC Greenville, S.C.
 Weathers, James H., World Bctsg. System, N.Y.
 Weathersby, J. Patrick, WBRZ-TV Baton Rouge, La.
 Weaver, Shelton, WIIC Inc., Pittsburgh.
 Weber, Fred, WSTV Inc., Steubenville, Ohio.
 Weber, Louis E., ASCAP, N.Y.
 Webster, Maurie E., KCBS San Francisco
 Wehrman, Harvey E., KLZ Denver
 Wehrmann, H.F., WDDO Chattanooga, Tenn.
 Weis, Pierre, Ziv-Economoe Tv Programs, N.Y.
 Weldon, James O., Continental Electronics Mfg., Dallas.
 Weller, Donald A., WISN Milwaukee, Wis.
 Wells, H.W., WFMW Madisonville, Ky.
 Welpott, R.W., WRCV-AM-TV Philadelphia.
 Werling, Rupe, WMAL Washington, D.C.
 Wetter, Edward, Allen Kander & Co., N.Y.
 Wheeler, Edward A., WEAW-AM-FM Evanston, Ill.
 Wheeler, Edwin K., WWJ-AM-FM-TV Detroit.
 Whillock, Westerman, KBOI-AM-TV Boise, Idaho.
 Whitacre, John, WILS Lansing, Mich.
 White, Pat J., KTBS-TV Shreveport, La.
 Whitley, Charles W., WSOC Charlotte, N.C.
 Whitney, George, KFMB-AM-TV-KERO-TV San Diego, Calif.
 Whitney, Philip, Richard F. Lewis Jr., Inc., Winchester, Va.
 Whittemore, Harry, Visual Electronics Corp., N.Y.
 Wittenberg, Lionel, WISN Milwaukee, Wis.
 Wiig, Gunnar O., WROC-TV Rochester, N.Y.
 Wilkey, Gene, KMOX-TV St. Louis.
 Wilkinson, Oral J., KMUR Inc., Salt Lake City, Utah.
 Wilkinson, Vernon L., McKenna & Wilkinson, Washington, D.C.
 Williams, Charles E., WAUX Waukesha, Wis.
 Williams, Jack G., Standard Rate & Data Service, Evanston, Ill.
 Williamson, W.P. Jr., WKBN Broadcasting Corp., Youngstown, Ohio.
 Williamson, W.P. III, WKBN Broadcasting Corp., Youngstown, Ohio.
 Wilner, John T., WBAL Baltimore.
 Wilson, George, WWTU (TV) Cadillac, Mich.
 Wilson, James C., WOPI Inc., Bristol, Tenn.
 Wilson, Robert, KGUL-TV Houston, Tex.
 Wilson, Robert J., WHLD-AM-FM Niagara Falls, N.Y.
 Wilson, Thomas W., Dow, Lohnes & Albertson, Washington, D.C.
 Windsor, Walter M., KCMC-TV, Texarkana, Tex.
 Wirth, Don C., WNAM Neenah, Wis.
 Wise, Bernard, ITA, Upper Darby, Penna.
 Wise, Harry, Geo. P. Hollingbery Co., N.Y.
 Wismer, John F., Stevens-Wismer Bcstg. Co., Port Huron, Mich.
 Witt, William U., WTVT (TV) Tampa, Fla.
 Wolf, Frederick, WDOK Cleveland, Ohio.
 Wolfe, Howard H., WKNX-AM-TV Saginaw-Bay City, Mich.
 Wolfenden, Robert C., WMEV, Marion, Va.
 Wolfson, Louis, WLOS-AM-TV Asheville, N.C.
 Wood, Robert, KNXT (TV) Los Angeles.
 Wooddell, Ken, WLBH-AM-FM, Mattoon, Ill.
 Woodland, Cecil, WEJL, Scranton, Pa.
 Woodruff, J. W., Jr., WRBL-AM-FM-TV Columbus, Ga.
 Wooten, Hollis R., WREC Memphis, Tenn.
 Wooten, Hoyt B., WREC-AM-TV Memphis, Tenn.
 Wray, Charles W., KTBS-TV Shreveport, La.
 Wray, E. Newton, KTBS-TV Shreveport, La.
 Wright, Jay W., KSL Salt Lake City, Utah.
 Wright, Robert F., WTOK-TV, Meridian, Miss.
 Wyatt, William R., A.C. Nielsen Co., Chicago.
 Wyatt, W. Judd, KMMO Marshall, Ma.

Y

Young, Allan S., Gill-Perna, San Francisco.
 Young, Bill, Screen Gems, N.Y.
 Young, J. Norman, WCGC Belmont, N.C.
 Younger, Charles A., ABC, N.Y.

Z

Zellmer, Les, WSJV-TV & WTRC South Bend-Elkhart, Ind.
 Zellmer, Lynn R., General Electric Co., Syracuse, N.Y.
 Zellner, Fred L., Jr., KQV Pittsburgh.
 Zillger, William H., Standard Electronics, Long Island City, N.Y.

ASCAP MUSIC LICENSE NEARER?

Twice-stalled radio talks resume, 30% reduction hinted

A settlement of negotiations for new ASCAP music licenses for radio stations loomed suddenly and unexpectedly last week after twice-stalled talks were resumed under the sponsorship of a federal judge.

Representatives of the All-Industry Radio Music License Committee and those of ASCAP were reported to have reached broad agreement on terms involving a reduction in payments required under the contracts that expired Dec. 31, but the details and the final formula remained to be worked out.

Further discussions were slated for this week. The atmosphere and progress made in last week's session encouraged hope that final agreement would be reached in these further talks. The tentative underlying agreement, subject to polishing of details, envisioned a five-year renewal, according to participants.

Reductions Reported • It was understood the tentative agreement includes

reductions in both commercial and sustaining fees for local stations' use of ASCAP music. The extent of the reductions was not disclosed.

When and if final agreement is reached by the negotiators, the All-Industry Committee will recommend to its subscribing stations—and the ASCAP negotiators to top ASCAP officials—that the terms be accepted. It will be for each station individually to decide whether to accept or reject the terms.

The resumption of negotiations came Wednesday in the chambers of Judge Sylvester J. Ryan of the U.S. District Court for the Southern District of New York. The session was to hear argument on motions for the court to set interim fees for the use of ASCAP music while the court went through a rate case to decide what reasonable fees should be. Some 685 stations supporting the All-Industry Committee had rejected ASCAP's offer of one-year renewal of

the old licenses—and its contention that "reasonable" rates should be much higher—and had asked the court to determine "reasonable fees under the ASCAP 1950 consent decree." ASCAP earlier had asked the court to fix interim fees.

After hearing arguments on interim fees, Judge Ryan suggested a basis for resumption of negotiation—which then got underway in his chambers. If the new talks prove successful and stations accept the result, the court case presumably will be dropped.

Proposes 30% Cut • Emanuel Dannett, counsel for the All-Industry Committee, had filed a 36-page brief proposing that interim fees be set at 70% of those payable under the expired license. He based his argument on these grounds:

"The percentage of ASCAP's compositions used by local radio stations has declined by approximately 40% of the total music broadcast [since the old fees were set in 1941]; the size of local radio stations' audience has decreased by 40%; the increase in the number of radio stations has decreased the average local radio station's net income by 30%; and ASCAP's revenue from the broadcast industry has increased by 230% [EDITOR'S NOTE: see tables this page]. Any one of these criteria alone warrants a 30% decrease in the local radio rates contained in the 1941 licenses."

A meeting of the All-Industry Committee, headed by Robert M. Mason of WMRN Marion, Ohio, is slated in New York Thursday (March 12).

ASCAP and its money

ASCAP's revenues from radio and television grew from \$7 million in 1949 to \$23 million in 1957. This estimate was given to the U.S. Court of Appeals for the Southern District of New York last week by Emanuel Dannett, counsel to the All-Industry Radio Music License Committee.

The figures were contained in a 36-page affidavit in connection with a petition asking the court to set reasonable interim fees for ASCAP music (see above). They were described as coming from "various sources" and as possibly containing "some minor inaccuracies which ASCAP is invited to correct." Participants said that at the hearing, held in the judge's chambers, ASCAP made no move to correct them.

The revenue estimates are shown in the following table (1954 figures not shown). In the second table, taken from a House Small Business Subcommittee report, are shown the percentages of 1957 ASCAP revenues derived from various sources and the way ASCAP assigned performance credits to the various

sources in making its distribution to ASCAP members in those categories.

ASCAP revenue derived from radio-tv

Year	From radio (millions)	From tv (millions)	From radio-tv (millions)
1949	\$6.8	\$ 0.2	\$ 7.0
1950	8.0	1.0	9.0
1951	8.5	3.0	11.5
1952	8.5	4.0	12.5
1953	8.5	6.0	14.5
1955	9.0	11.0	20.0
1956	9.0	13.0	22.0
1957	9.0	14.0	23.0

Percentage of ASCAP income and allocation of performance credits for 1957

Source of revenue	% of total revenue	% of total credit considered in royalty distribution
Radio:		
Local stations	33.03	24.0
Networks	3.28	18.5
Television:		
Local stations	28.68	11.5
Networks	23.42	45.0
Bars, grills, taverns and restaurants	3.10	
Nightclubs and lounges	2.27	
Hotels	1.54	
Dance halls, ballrooms and skating rinks	1.04	
Miscellaneous	2.22	
Wired music	1.09	
Symphonic and concert	0.33	1.0
Total	100.00	100.00

Pulitzer for tv asked

An appeal to broaden the scope of Pulitzer Prizes to include recognition for original television plays, broadcast news and documentaries was made last week by Robert W. Sarnoff, NBC board chairman, in a letter to Dean Edward W. Barrett of the Columbia Graduate School of Journalism. The letter will be submitted for consideration to the advisory board on the Pulitzer Prizes at the next annual meeting April 24, Mr. Sarnoff was told.

Recognition would be in keeping with Joseph Pulitzer's conception of the prizes, Mr. Sarnoff wrote, because he meant them "for the encouragement of

public service, public morals, American literature and the advancement of education." Mr. Sarnoff maintained the new prize categories would be feasible, would not be unprecedented and would be in the spirit of the prize donor's own wishes.

STATE MUSIC TAX BMI, ASCAP revenues vulnerable under bills

Bills which would impose state taxes or elaborate filing requirements on performing rights societies such as BMI and ASCAP were waiting action in three state legislatures last week.

The significance of the bills, observers said, could be drawn from the fact that ASCAP last week sought court permission to refuse to license users of its music in one state (Washington) which has a law after which these bills appear to be patterned.

Judge Sylvester J. Ryan of the U.S. Court for the Southern District of New York, where the ASCAP request was made, was said to have reserved judgment during a hearing conducted in his chambers.

The pending bills are in the legislatures of South Dakota, New Mexico and Texas. Those in South Dakota and New Mexico had passed at least one legislative house last week, but the Texas bill was considered likely to be dropped or modified.

Much Paper Work • The common factor in the various measures was said to be their requirement for the filing of elaborate detail on all copyrighted works before they can be offered for licensing. The South Dakota bill also would impose an annual franchise tax of 25% of the applicant's entire gross receipts from the licensing of music compositions within the state during the preceding year. The New Mexico bill, in addition to requiring detailed filings, would impose a 2% tax on the licensing organization's gross receipts within that state, while the Texas bill would put a \$100 tax on each user of such copyrighted music—stations, nightclubs, etc.

The South Dakota measure had a companion bill whose purpose was not immediately clear to legal observers. This bill would hold that when any phonograph record, musical transcription or tape recording has been "sold or leased in commerce for use within this state," then "all asserted common law rights to further restrict or to collect royalties on the commercial or other public use made of any such recorded performances by any person are hereby abrogated and repealed."

Observers said that if the purpose

NEW TRANSISTOR POWER SUPPLY SYSTEM

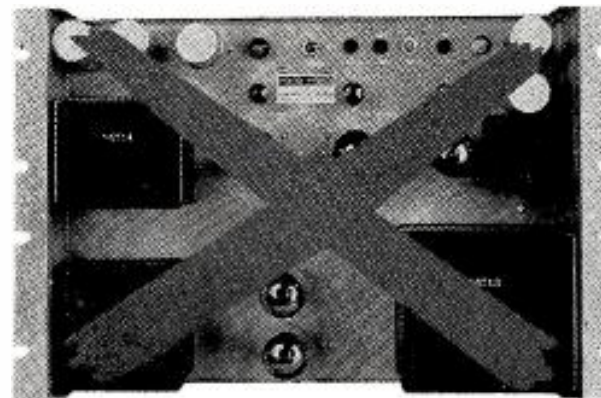

Replaced by:

SEE
AT
BOOTH 23

3 Amperes
Independent Regulator
Modules
Master Rectifier
Module
Short Circuit
Protection

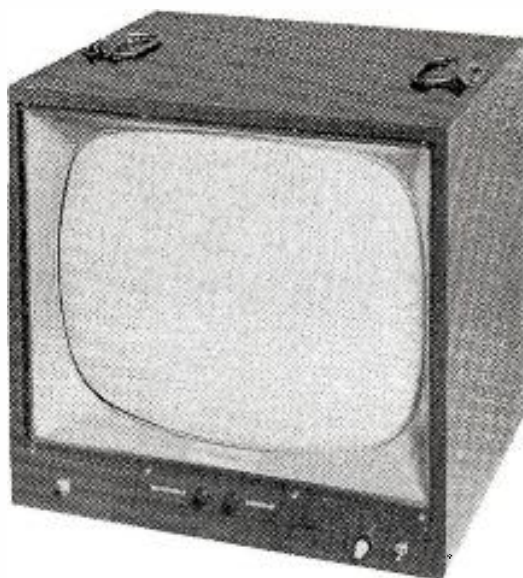

NEW VIDEO MONITORS

Wide Band
High Reliability
Modular Plug Ins
Professional & Utility
Models

NEW ORBITER/TRACKER SYSTEMS

Doubles IO Life
Stabilized all Transistor
Circuit
Fits inside the Camera
Models on exhibit for
Inside RCA, GE, and
Dumont Cameras and
for outside any camera

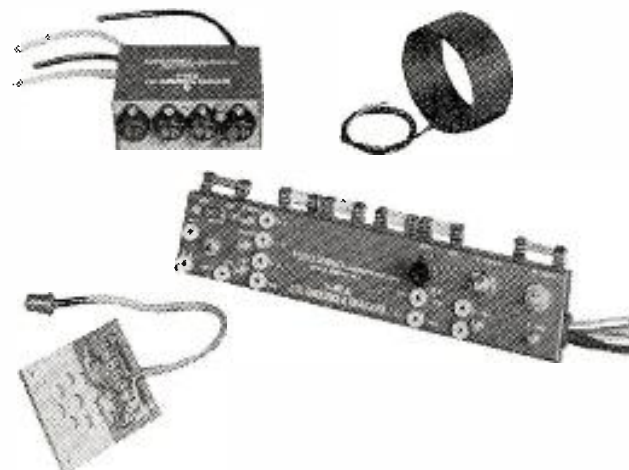

Model for TK-11

FOTO-VIDEO[®]
LABORATORIES, INC.

ELECTRONICS • ENGINEERING AND MANUFACTURING

36 Commerce Road • Cedar Grove, N. J. • CEnter 9-6100



NAB—BOOTH 23 MAIN FLOOR

was to prevent the collection of performing rights fees on copyrighted music, the bill was clearly contrary to the federal copyright law and violated the U.S. Constitution.

Broadcaster Backing? • Whether the bills would reach enactment stage—the South Dakota and New Mexico legislature were near adjournment last week—appeared problematical. Those in South Dakota were said to have the backing of juke-box interests—who themselves pay no performing rights fees at all—while the New Mexico measure was said to have the support of some of the state's broadcasters. Counsel for performing rights organizations maintained that a 25% tax such as proposed in South Dakota would be "confiscatory" to the point of illegality and said that even without taxes the filing requirements in all the measures were so complex as to make it difficult if not impossible for such societies to do business in those states. If taxes were imposed, authorities asserted, they inevitably would be passed along by the performing rights organizations to the stations and other users of the music.

Pioneers like Petrillo

James C. Petrillo, considered an ogre by the broadcasting industry during his long tenure as president of the American Federation of Musicians, will receive a special citation from the Broadcasting Pioneers during its annual dinner in Chicago March 17.

The citation to Mr. Petrillo will read: "for his understanding of broadcasting's problems in the use of music on the air; for his continuous efforts throughout the years to bring music in all forms to the American public; for the love and respect he has earned through his inspired leadership."

The pioneers' Hall of Fame Award, which is given posthumously, will honor the late Walter Wade, president of Wade Adv., Chicago. It will be accepted by his son, Henry G. Wade, president of the agency. Other citations will be presented to Raymond F. Guy, communications engineer; Goar Mestre, president of the CMQ Network, Havana, and Don McNeill, host on ABC-TV's *Breakfast Club*.

Educational radio aid

Grants-in-aid to support educational radio programs are available from the National Assn. of Educational Broadcasters, Urbana, Ill., the National Educational Television & Radio Center, Ann Arbor, Mich., reports. Producers are invited to apply by May 1 for grants (less than \$7,000) for educational radio programs with the theme "The American in the 20th Century."

CBS FILMS, MGM-TV DICKER

Talking about distribution agreement

CBS Films would like a tie-in with MGM-TV.

An agreement, if consummated, would work this way: the principals would determine which MGM-TV production CBS Films should distribute. The selected properties would be offered for sale to any network, to national or regional advertisers or placed in syndication to stations (that is, market-per-market).

This essentially is the proposal of CBS Films, prompted in part by a search for new film production to beef up its inventory.

Merle S. Jones, president of CBS tv stations division (which includes the film entity), notes that before 1958 CBS Films was receiving for syndication two to four properties a year from CBS-TV. But this situation has changed and the properties haven't been coming in.

In an interview last week, Mr. Jones indicated that a meeting would be coming up this week in New York with George Shupert, vice president in charge of tv for Metro-Goldwyn-Mayer. Mr. Shupert for the past week was on the West Coast at MGM studios

where production for tv is on an accelerated basis.

CBS Films, says Mr. Jones, takes the position that in tv film sales and distribution, both domestic and foreign, it is "second to none." But there is a time lag and a film distributor needs a formidable catalog.

Based on current indicators, CBS Films expects sales to be up a minimum of 25% this year over last, and the figure will more likely go higher. A 50% gain is mentioned as the topside increase.

CBS Films production sources now break down into two general classifications: those conceived, produced and financed by CBS Films (four to five shows this year), and those co-produced in this country or abroad (also four to five shows this year). In addition, CBS Films, on a more "experimental" basis, is about ready to go with its first taped series, *Theatre for a Story*, produced by Robert Herridge. The first show will be taped on April 2 (jazz show with Billie Holiday, Miles Davis, Ben Webster and Charles Mingus). It will be followed by two other tape sessions April 10 and 17, both for dramatic programs.

MGM-TV's production plans in television are heavy (including seven film pilots), and Mr. Shupert has been busy working on a sales program. MGM-TV announces today (March 9) appointment of John B. Burns as director of national sales (see WEEK'S HEADLINERS, page 10). For some time it has been considering the formation of its own distribution facility.

Ross back in tv film

Martin Ross, one of the founders of National Telefilm Assoc., has established Key Productions and Teleworld in Hollywood for the production and distribution of tv programs. Associated with Mr. Ross in the new organizations are Robert Lippert, motion picture producer; Dave Robbins, lumber tycoon who formerly owned Kling Studios, and Charles B. Brown, previously vice president of Bing Crosby Enterprises and before that director of advertising for NBC and RCA Victor.

Key already has five half-hour series in production. Ed Leftwich, Key vice president in charge of production, is producing four, and the other is by Sandy Howard Productions, with Key financing.

Key and Teleworld have opened offices at 8544 Sunset Blvd., Hollywood 46, Calif. Telephone is Olympia 2-4600.

COLORCASTING

Here are the next 10 days of network color shows (all times are EST):

NBC-TV

March 9-13, 16-18 (2-2:30 p.m.) Truth or Consequences, participating sponsors.

March 9-13, 16-18 (2:30-3 p.m.) Haggis Baggis, participating sponsors.

March 9, 16 (10-10:30 p.m.) Arthur Murray Party, P. Lorillard through Lennen & Newell and Pharmaceuticals Inc. through Parkson Adv.

March 10 (8-9 p.m.) George Gobel Show, RCA through Kenyon & Eckhardt.

March 11, 18 (8:30-9 p.m.) The Price Is Right, Speidel through Norman, Craig & Kummel and Lever through J. Walter Thompson.

March 11, 18 (9-9:30 p.m.) Milton Berle, Kraft Foods Co. through J. Walter Thompson.

March 12 (9:30-10 p.m.) The Ford Show, Ford through J. Walter Thompson.

March 12 (10:30-11 p.m.) Masquerade Party, P. Lorillard through Lennen & Newell.

March 13 (7:30-8 p.m.) Northwest Passage, Helene Curtis through Edward H. Weiss.

March 14 (8-9 p.m.) Perry Como Show, participating sponsors.

March 15 (7:30-9 p.m.) Steve Allen Show, RCA through K&E and Mutual of Omaha through Bozell & Jacobs and Dupont through BBDO.

March 15 (9-10 p.m.) Dinah Shore Chevy Show, Chevrolet through Campbell-Ewald.

March 15 (10-11 p.m.) Frances Langford Presents, Rexall Drugs through BBDO.

March 17 (8-9 p.m.) Eddie Fisher Show, Liggett & Myers through McCann-Erickson.

ESSO RESEARCH works wonders with oil

Oil helps preserve today for tomorrow

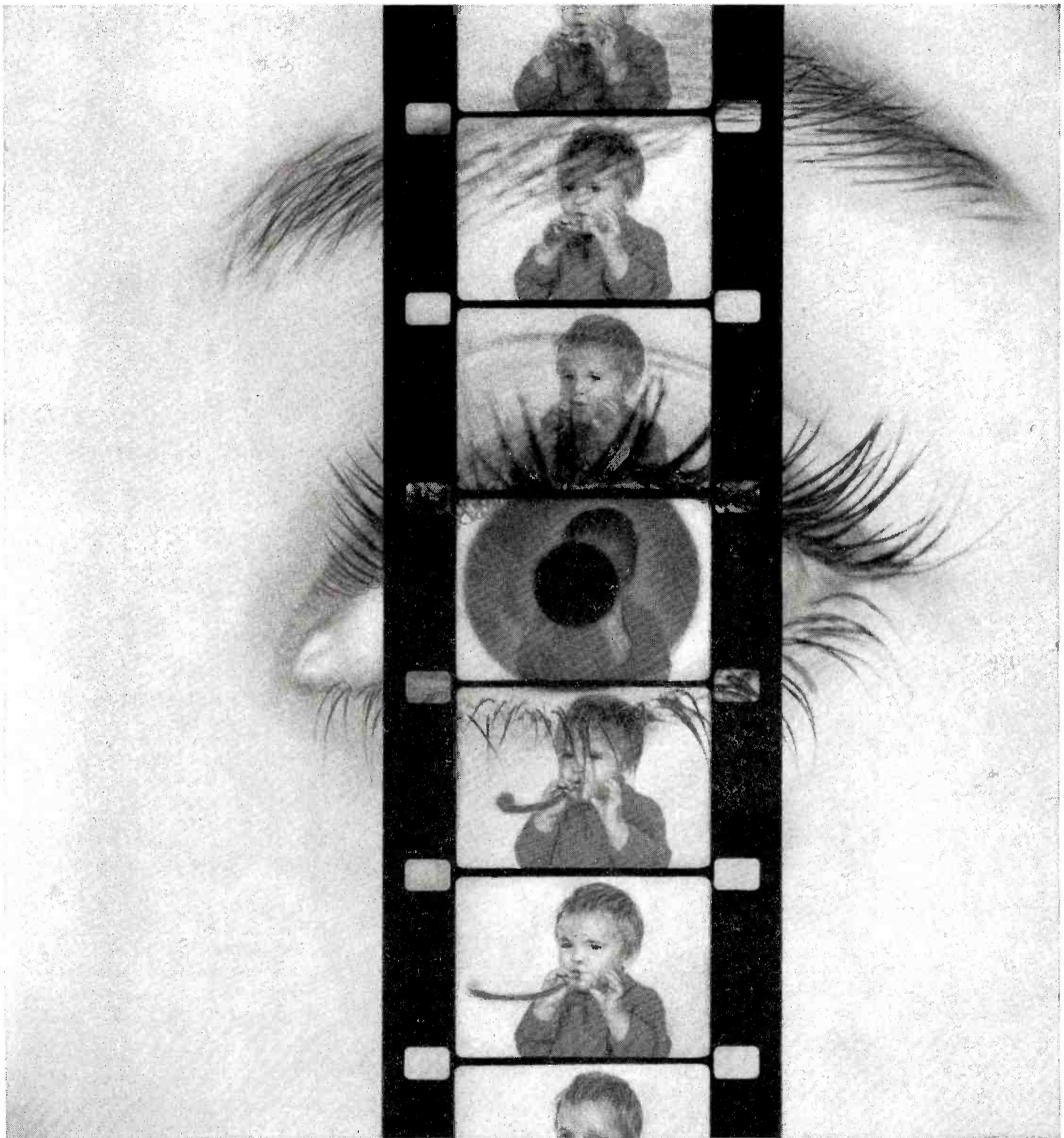

*The high points in life keep their warmth in movies made at home. Baby's first bath... first step... first birthday party — and all the other firsts to come. They're captured for keeping on safety film made with an oil-based chemical. Esso Research helped provide the process for making this important chemical directly from oil. In film, as in fuel, **ESSO RESEARCH** works wonders with oil.*





GENERAL MOTORS assigns the biggest share of its total network radio business (91% in 1958) to CBS Radio. For more power on the road! This network has delivered largest commercial minute audiences all along. And the new Program Consolidation Plan—with unified station clearances and strong program sequencing—will increase this leadership.

CBS RADIO NETWORK:

42% LARGER AUDIENCES PER COMMERCIAL MINUTE THAN ANY OTHER RADIO NETWORK, AVERAGING OVER 16 CONSECUTIVE MONTHS.

Award for WCCO-TV as 'newsfilm station'

WCCO-TV Minneapolis has been named "Newsfilm Station of the Year" and six other stations received citations in the 16th annual newspaper competition sponsored by Encyclopaedia Britannica, National Press Photographers Assn. and the U. of Missouri School of Journalism. Awards also went to network and independent services.

Other stations honored for excellence in "photo-communication" were WBBM-TV Chicago, WTVJ (TV) Miami, KOMO-TV Seattle, WBZ-TV Boston, WHAS-TV Louisville and WDAU-TV Scranton, Pa. Tom Priestly, NBC News, was chosen "cameraman of the year."

A total of 52 stations competed in the tv newsfilm division, which also included first, second and third prizes, plus honorable mentions for spot and general news, features, sports, documentary. Judges screened 187 film stories. In the station category alone, 27 outlets were entered.

Judges were Howard Kany, manager of CBS Newsfilm syndication; Don Meaney, NBC national tv news assignment editor; Ralph Renick of WTVJ and president of Radio Television News Directors Assn., and Wendell Hoffman, 1957 "Newsfilm Cameraman of the Year" for his CBS documentary on Cuba's Fidel Castro.

Standouts • Other winners, their affiliations and film subjects follow:

SPOT NEWS

First prize: Jack White, KTVT (TV) Salt Lake City, "Drowning"; second prize: Paul Bruck, CBS News, "Street Combat in Beirut"; third prize: Maurice Levy, NBC News, "Maria Callas in Dallas"; honorable mentions: Gene Barnes, NBC News, "Malibu Fire"; Richard E. Merkey, WTVJ, "Braniff Air Crash"; Stan Zieve, WCCO-TV, "Colfax Tornado."

GENERAL NEWS

First prize: Keith Leslie, WTVJ, "Courtroom Sentencing"; second prize: G. Bradford Kress, NBC News, "Unknown Soldier Selected"; third prize: Don Norling, CBS News, "Leopold Released at Joliet"; honorable mentions: Kung Su Kwon, NBC News, "Gift to Family of Girard Victim"; Bruce Powell, NBC News, "Atlas Satellite Launching."

FEATURE

First prize: Mr. Priestly, NBC, "Boy in Shenandoah"; second prize: John Tiffin, CBS News, "Tiddlywinks"; third prize: Mr. Powell, NBC, "Between the Halves."

SPORTS

First prize: Gordon Yoder, Telenews,

"Swim and Dive Meet"; second prize: Earl Crotchett, NBC News, "Indianapolis Race Wreck"; third prize: Frank Koza, Telenews, "Buckeyes Upset Big Ten Champs"; special citation: Telenews, for Excellence in Sports Coverage.

DOCUMENTARY

First prize: Rolph Gilhousen, CBS News, "Chinese Communes"; second prize: Mr. Priestly, NBC, "American Stranger"; third prize: George Markman, CBS News, "Refugees in Tunis"; honorable mentions: Mr. Levy, NBC, "End of Southwest Drought"; Joe Falletta, CBS News, "Kuwait"; special citation: Cameraman John J. Davin and news staff of WHDH-TV Boston for the documentary "Inmate".

SPECIAL SOUND-FILM AWARD

Presented to a single story in the competition which demonstrates especial achievement by a cameraman in obtaining sound-on-film: Mr. Bruck, CBS, "Street Combat in Beirut."

ITC cameras to grind nonstop around world

The sun that never sets on the British Empire also shines brightly for Jack Wrather.

As he put it last week: Once Independent Television Corp.'s tv film production is underway, "there will be weeks at a time when the sun will never set on cameras turning on ITC productions." Mr. Wrather, ITC's board chairman, said 12 major tv programs will be in production across the world next month, in the U.S., England, Canada, Australia, the European continent and the Near East, under supervision of Ted Rogers, ITC's production director.

Here's the schedule from Mr. Wrather:

Hollywood—Robert J. Enders now is filming *Treasury Agent* at MGM Studios and on location in Washington with Michael Higgins in title role; *Guns West* also is at MGM, for which shooting began March 2 and starring Wayne Morris and Jim Westerfield; *Command* (Everett Sloane, Ben Cooper and Louis Jean Heydt, stars) shoots on location March 16 in Tucson; *Go West, Young Man* rolls March 16; *The Adventures of Tom Swift*, a 39-episode Citadel Production (stars Gary Vinson), has one segment filmed and scripts being completed for remainder of series; an anthology series, 21 already completed, five more to come at MGM and 13 to be filmed in England during summer; more episodes to come of *The Gale Storm Show (Oh! Susannah)* (goes on ABC-TV).

New York—Now before the camera is *Emergency!* starring Arthur Hill.

London—*The Four Just Men* (Sap-

Olympic outlook

Year-ahead planning for tv coverage of 1960 Olympics—winter games at Squaw Valley, Calif. next February and summer games in Rome mid-1960—is already getting underway, but planners don't look for so much trouble as at Australia Olympics last time. Tv and newsreels have now been reclassified as news media (but with limitations to keep their coverage in news rather than entertainment category), so apparently they won't be faced with fee demands that led them to pass up Melbourne events. But Squaw Valley's location poses some problems: it's hard to get to for live coverage. One possibility, both here and in Rome, is pool set up such as that proposed for Australia coverage but blocked by Olympics committee's demands for money. Representatives of three U.S. tv networks have been slated to meet on preliminary plans, with similar sessions with newsreel authorities to follow.

phire Films Ltd. in association with The Jack Wrather Organization) with stars Dan Daily, Jack Hawkins, Vittorio de Sica and Richard Conte; *Interpol Calling* with Charles Korvin in lead. Both films also will be on location in various European countries and in the Near East.

Australia—Clarke Reynolds is writing and Incorporated Television Programmes Ltd. will produce *Whiplash* with star to be announced and shooting slated for early next month.

Canada—*Cannonball* already in 65 markets, continues in ITC production.

• Program notes

• Trans-Lux Television Corp., New York, announced Friday (March 6) that WNEW-TV New York has bought the *Felix the Cat* cartoon series for an estimated \$500,000 marking the first sale on the package of 260 four-minute episodes. Trans-Lux Tv is making the series available to stations throughout the country and overseas. It is being produced by Felix the Cat Creations Inc., New York, for starting dates in the late fall.

• NBC-TV will produce a new film series, *Fibber McGee and Molly*, with production to start March 15 in Hollywood under the direction of Jim Jordan Jr., son of Jim and Marian Jordan who

originated and starred in the *McGee and Molly* radio series. The new series will debut in network's fall lineup. Five-minute radio segments will be continued on NBC's *Monitor*. The tv roles will be played by different actors, it was reported, and sponsorship is so far unannounced.

• Panel Programs Inc., N.Y., has been formed to package "low-budget" entertainment programs for tv. Offices are at 232 Madison Ave. Telephone: Murray Hill 3-7095. Officers are John Luter, president and Hardy Burt, vice president in charge of production. First program to be packaged by Panel Programs Inc. is *Let's Face Television*, a discussion program devoted to specific shows on tv.

• WAVE-TV Louisville, Ky., is telecasting visual disaster warnings, as well as the usual aural warnings, for the benefit of deaf people in the area.

• World of Fashions Inc., N.Y. reports that its *World of Fashion* radio program, featuring fashion consultant Alfred Davidson, is being syndicated to 12 stations under new format. The program, consisting of interviews and news, is sent to stations as 15 one-minute features, which can be scheduled as 90-second shows (including commercial) on women's interest programs or on music-and-news outlets. World of Fashions Inc. is located at 38 E. 57th St., New York, N.Y., and is headed by producer W.H. Bertanshaw.

• George Murphy, former MGM dancing star and now Desilu public affairs vice president, will be featured in the studio's *You're Only Young Twice*. The tv series is about a couple who face life after their children are married.

• Pageant Productions Inc., Hollywood, announces that Oscar Nichols has contracted to write and produce *Little Man, Fast Gun*, a tv series about the life of Al Jennings, described as "the last of the legendary frontier outlaws." Mr. Jennings, 95, is technical editor.

• Modern Broadcast Sound Co., Albany, New York, has been formed by Kenneth M. Cooper to create custom musical identifications for radio and tv stations. Mr. Cooper is former owner of WTRY Albany-Troy-Schenectady and recent buyer of WICC-AM-TV Bridgeport, Conn. Products will be demonstrated at Congress Hotel, Chicago, during NAB convention. Address of company is Box 1101, Albany.

• The Mirisch Co., Hollywood, has contracted with NBC-TV to produce *Wichita Town*, a western tv series starring Joel McCrea. There will be a minimum 26 episodes. NBC-TV also has engaged Mirisch to make a pilot film of *The Iron*

PHENOMENAL KOCO-TV



says Charles Keys, General Manager

OKLAHOMA CITY

Socko—Popeye wins again! One Popeye hour couldn't satisfy all the sponsors for KOCO-TV so they had to schedule a second one! Here's the record-breaking, money-making story from Charles Keys:

"Clients love Popeye even more than kids. Phenomenal Popeye sell-out necessitates scheduling additional Popeye Hour Saturdays 11 to 12 a.m. Regular Popeye Theatre Monday thru Friday 6 to 6:30 p.m. scored whopping 25.0 Nov.—Dec. four week Nielsen."

Popeye has been piling up sponsors and top ratings scores for years. Kids never tire of him. And sponsors are enthusiastic about the reception he builds for their products.

Popeye is whaling the tar out of competition for KOCO-TV. Want a share of the spinach? Write or phone:

U.A.A.

UNITED ARTISTS ASSOCIATED, INC.

NEW YORK, 345 Madison Ave., MUrray Hill 6-2323
CHICAGO, 75 E. Wacker Dr., DEarborn 2-2030
DALLAS, 1511 Bryan St., RIVERSIDE 7-8553
LOS ANGELES, 9110 Sunset Blvd., CRestview 6-5886

Horseman, a tv series slated for production next summer.

- Paris fashions are to be the focus of an hour-long live colorcast next fall. The French fashion industry, through Edward Gottlieb & Assoc., has granted exclusive rights to the William Morris Agency to sell, lease or license the show in which 14 major French designers will participate. Planned as an entertainment package for network presentation, the show has reportedly elicited sponsor interest.

- National Telefilm Assoc., N.Y., reports sales of its *Television Hour of Stars* series to 11 additional stations, raising total markets sold to 34. Latest sales were to KLZ-TV Denver, KSTP-TV Minneapolis-St. Paul, WPST-TV Miami, WAVY-TV Norfolk, plus WTVH (TV) Peoria, Ill.; WTRI (TV) Albany, N.Y.; WKYT (TV) Lexington, Ky.; KNOE-TV Monroe, La.; KMMT (TV) Austin, Minn.; KHOL-TV Kearney, Neb., and WCIA (TV) Champaign, Ill.

- American Society of Composers, Authors and Publishers in 1958 had a record income of \$28,441,754, George Hoffman, comptroller, reported Feb. 25 to ASCAP west coast members in

Los Angeles. ASCAP has distributed \$23,261,671 to its members, Mr. Hoffman said. The organization's expenses of \$5,180,083 amounted to only 18% of its gross income, he noted.

- Over \$3 million was spent last year by foreign television stations in purchases of United Artists Associated motion picture library, it has been reported.

- Four i Productions, new tv packaging company, has established offices at 510 Madison Ave., N.Y. Telephone: Eldorado 5-5633. Donald Kurz and Jay Weitzner are partners in firm.

- A directory of radio-tv news departments of all stations in Illinois (and adjoining areas) has been printed and distributed by the Illinois News Broadcasters Assn. Copies have gone to INBA members and additional copies are available to non-members at \$1 each from Prof. Donald E. Brown, U. of Illinois, at the university's College of Journalism and Communications.

- ABC Films has sold its J. Arthur Rank *Festival 35* package to WHDH-TV Boston, WTVJ (TV) Miami,

WDAU-TV Scranton, WMAR-TV Baltimore, KTVU (TV) San Francisco, KOMO-TV Seattle, WNEW-TV New York and WGAL-TV Lancaster, Pa. The Rank "Special Six" feature package has been bought by WBRZ (TV) Baton Rouge, KDKA-TV Pittsburgh, WSM-TV Nashville, KOA-TV Denver, WREC-TV Memphis, KROC-TV Rochester, and KHSL-TV Chico, Calif.

- Official Films, N.Y., reports it has acquired distribution rights to a new half-hour tv film series, *Police Station*, which is being produced by Sandy Howard Productions, N.Y.

- Nominations for the 1959 advertising Woman of the Year are currently being accepted by the Advertising Federation of America. The award is open to all women in advertising. Entries should be mailed no later than April 5 to AFA, 250 W. 57th St., New York 19. This year's judges will include Dr. Earl English, dean, School of Journalism, U. of Missouri; Mary Busch, executive vice president, Emery Advertising Co., Baltimore; Ray Krings, advertising manager, Anheuser-Busch Inc., St. Louis.

schafer AUTOMATIC PROGRAMMER

-complete and true automation for radio stations

The highly successful Schafer M-60 provides up to 24 hours of fully automated programming. Material can be prepared in a fraction of air time and program format may be interrupted or changed at any time without interfering with the timing. Schafer Automation offers an economical and practical solution to many of your operating problems.

price: \$7950 or terms lease: \$200 per month

Write for complete catalog information or an actual demonstration at your station.

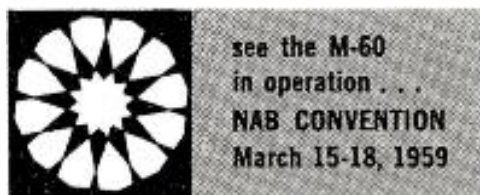

see the M-60
in operation . . .
NAB CONVENTION
March 15-18, 1959

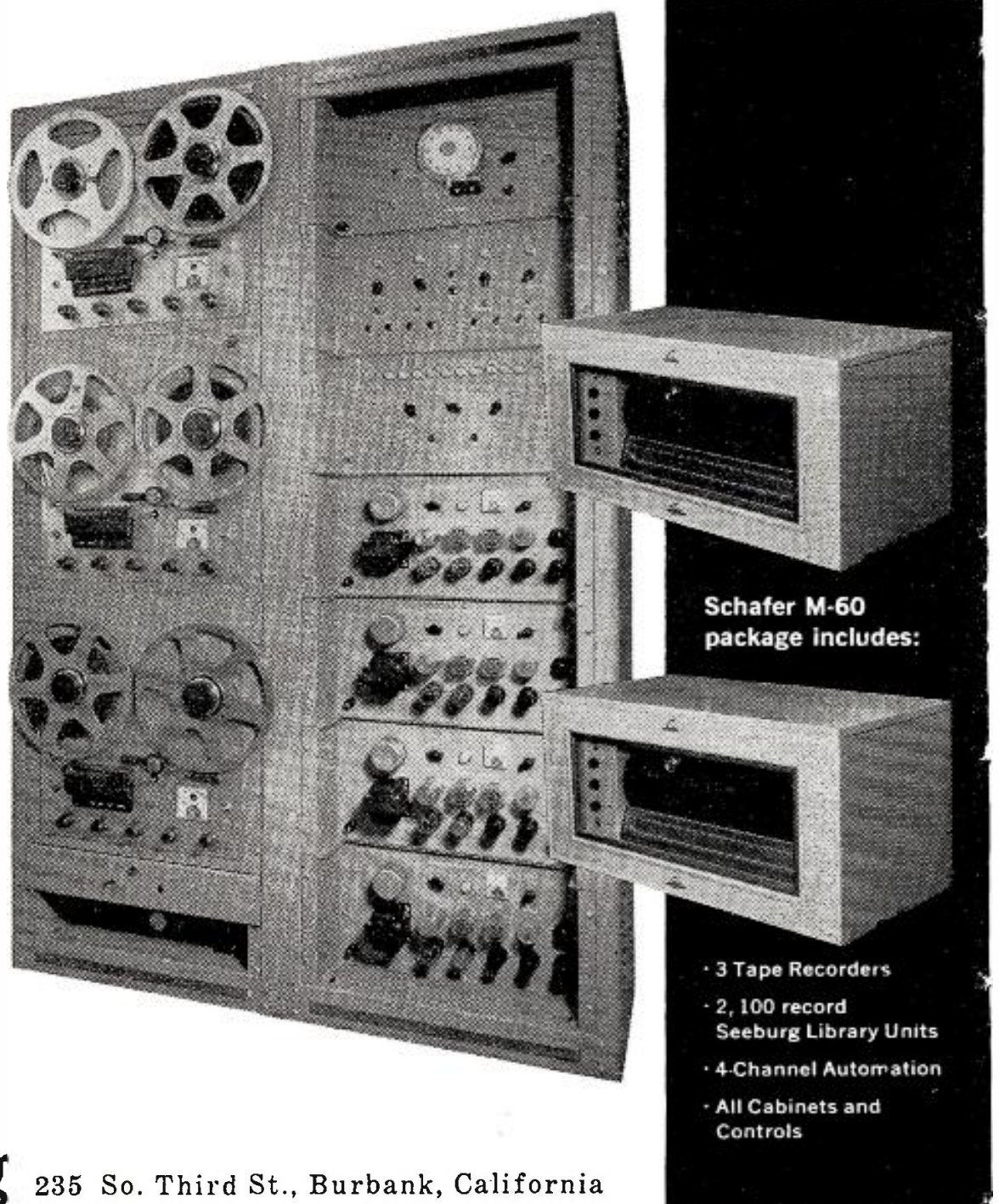

Schafer M-60
package includes:

- 3 Tape Recorders
- 2, 100 record Seeburg Library Units
- 4-Channel Automation
- All Cabinets and Controls

schafer custom engineering 235 So. Third St., Burbank, California

FATES & FORTUNES

Advertisers

• GEN. EDWIN W. RAWLINGS (U.S. Air Force, ret.), elected to board of directors of General Mills Co., Minneapolis, and appointed financial v.p. At time of his retirement last month, Gen. Rawlings was commander of air materiel command.

• ROBERT E. KAHL, assistant v.p. in charge of marketing of Borden Foods Co., appointed v.p. in charge of marketing.

• WILBUR E. REHMANN, formerly general sales and advertising manager of Hawthorn-Mellody Farms Dairy, appointed promotion director of American Dairy Assn., Chicago.

Agencies

• SHELDON MOYER, v.p. of D.P. Brother & Co., Detroit, promoted to senior v.p. Three other v.p.'s similarly elevated to senior v.p.: THOMAS J. KING and KENNETH G. MANUEL, both Detroit, and FRANK E. EGAN, N.Y.



Mr. Prochazka

• OTTO PROCHAZKA, formerly of Benton & Bowles as v.p. and creative supervisor and before that, Anderson & Cairns as creative director, to Compton Adv., N.Y., as v.p. and assistant creative director.

• ROBERT E. ANDERSON, v.p. in charge of BBDO's Detroit office, and McDONALD GILLESPIE, v.p. and account supervisor, BBDO, N.Y., elected directors.

• GAIL M. RAPHAEL, formerly v.p. of Lennen & Newell, to Doherty, Clifford, Steers & Shenfield, N.Y., as v.p. and copy supervisor.

• HERBERT KING, controller of Sullivan, Stauffer, Colwell & Bayles, N.Y., elected treasurer. NELSON O. ARGUESO, formerly treasurer of Doherty, Clifford, Steers & Shenfield, N.Y., succeeds Mr. King as controller. T. NEWTON WEATHERBY, former SSC&B treasurer, named v.p., director, and chief administrative officer.

• A. MICHAEL FROTHINGHAM, Ted Bates & Co., N.Y., general counsel, elected secretary and v.p.

• MICHAEL W. GRADLE, manager of Hollywood office of Needham, Louis & Brorby, elected v.p.



Mr. Wolff

• NAT WOLFF, 59, v.p. in radio-tv department of Young & Rubicam, N.Y., died Tuesday (March 3) in Roosevelt Hospital, N.Y., during exploratory throat operation. Mr. Wolff was appointed to Y&R post several weeks ago (WEEK'S HEADLINERS, Jan. 12). He started with Buffalo Broadcasting Corp., served with MGM, later became talent representative. He joined Y&R in 1951 as v.p. in charge of radio and tv production, left in 1956 to become NBC's director of program development and in 1957 was made partner in Don Sharpe Enterprises, packaging firm. Surviving are his wife, actress Edna Best; his mother, Mrs. Minna Wolff, and stepdaughter, actress Sarah Marshall.

• THOMAS J. CARNESE, EDWARD A. GREY, WILLIAM A. O. GROSS, WILLIAM E. HATCH, WALTER W. MCKEE, DAN RODGERS and ALLEN M. WHITLOCK, all v.p.'s of Ted Bates & Co., N.Y., promoted to senior v.p.'s. Agency was inadvertently given as Grey Adv. last week (BROADCASTING, March 2).

• JOHN HEVERLY, v.p. and account executive of Botsford, Constantine & Gardner, Seattle, Wash., has resigned.

• JUNE BARTH, v.p. and publicity director of Carson/Roberts, L.A., to resign April 1.

• GUY S. WARREN JR. has resigned as executive v.p. of D.P. Brother & Co., Detroit.

• JOHN D. LUCAS, 66, v.p. of Charles W. Hoyt Co., N.Y., died March 3 in New York.

• IRVING SMITH KOGAN, with Hicks & Greist, N.Y., since 1957 as director of public relations and made v.p. in 1958, elected to board of directors.

• DONALD CLARK, assistant to president of Sudler & Hennessey Inc., N.Y., and STUART WILLIAMS and JAMES COLLETTE, S&H account executives, named v.ps.

• EDWIN W. BODENSIEK, Fuller & Smith & Ross, N.Y. account executive, promoted to merchandising director.

• THOMAS J. MAYNARD, media supervisor, Young & Rubicam, Detroit, named director of media relations and planning, succeeding RODNEY C. HOL-



STEWART-WARNER (Alemite Division) returns to network radio—CBS Radio—with its biggest appropriation in years. PCP was the additive that did it! This network has delivered largest commercial minute audiences all along. And the new Program Consolidation Plan—with unified station clearances and strong program sequencing—will increase this leadership.

CBS RADIO NETWORK:

42% LARGER AUDIENCES PER COMMERCIAL MINUTE THAN ANY OTHER RADIO NETWORK, AVERAGING OVER 16 CONSECUTIVE MONTHS.

BROOK, transferred to New York office.

• LEO HIGDON, formerly of Leo Burnett Co. as copy supervisor, and BERNARD LUBAR, formerly copy group head of McCann-Erickson, named creative supervisors, Benton & Bowles, N.Y. JEREMIAH C. HARMON, previously copy chief of BBDO's Pittsburgh office, named copy group head at B&B.

• LOU LALKO, formerly of Manufacturer's Products, Milwaukee, named art director of Scott Henderson Adv., Tucson, Ariz. ROBERT FINK, formerly production head of printing firm, Keller-Crescent, Evansville, Ind., to agency as account executive and production head.

• VERNON MORELOCK, formerly v.p. of Winius-Brandon Adv., St. Louis, named v.p. and account executive of Lowe Runkle Co., Oklahoma City.

• GEORGE E. HALLEMAN JR., formerly of NBC Spot Sales, Chicago, to Duncan Scott & Co., L.A., as head of radio-tv department.

• ROBERT OTTER, art director at Doner & Peck, N.Y., named executive art director and head of creative services.

• CHARLES W. TENNANT JR., formerly account supervisor on Pharma-Craft (Coldene, Fresh products) account at J. Walter Thompson Co., Chicago, and previously advertising director of Miles Labs, Elkhart, Ind., to Leo Burnett Co., that city, as account supervisor.

• ART LAMB, formerly air personality of WRC-TV Washington, joins Larabee Assoc., that city, as account supervisor.

• LLOYD G. DELANEY, formerly of Kudner Agency, to William Esty Co., N.Y., as account executive on Sun Oil Co.

• LARRY HOLDER, formerly account executive of BBDO, N.Y., to Bozell & Jacobs, N.Y., as account executive on Mutual of Omaha.

• LOUIS CARRAFIELLO, formerly of Pfizer Labs, to account staff of Erwin Wasey, Ruthrauff & Ryan, N.Y., on American Cyanamid Co. account.

• COMPTON S. JONES, formerly public relations account executive of J. Walter Thompson in Washington, D.C., to Ketchum, MacLeod & Grove in similar capacity in agency's Washington office.

• DON B. AMSDEN, with Allen & Reynolds Adv., Omaha, Neb., past 10 years, named manager of radio-tv department. ROBERT SPITTLER, formerly producer-

director of WOW-TV Omaha, to A&R as production assistant.

• JOHN ANTHONY, formerly public relations account executive at Hazard Adv., and Jeanne Taylor, previously in public relations department of J.M. Hickerson Inc., to J.M. Mathes Inc., N.Y., in public relations and publicity department.

• GEORGE CISNEROS, formerly of Gaylor & Ducas Inc. and Buchanan Co., both New York, to Erwin Wasey, Ruthrauff & Ryan Inc., N.Y., as production manager.

• NICK GIBSON, formerly of Compton Adv., N.Y., as producer, to Kenyon & Eckhardt, that city, as commercial producer.

• ARTHUR BURDGE, formerly president of Direct Mail Assn., to Young & Rubicam, N.Y., copy department.

• CARL GREEN, formerly of Henry C. Brown Agency, New York talent agent, as tv consultant and package producer, to Ted Bates & Co., N.Y., as tv-radio supervisor.

• DEXTER E. GLUNZ, formerly v.p., copy chief and member of Dancer-Fitzgerald-Sample's New York creative review board, to copy department of Los Angeles office of BBDO.

• JOSEPH C. HANTIN, formerly editor of newsprint department, American Newspapers Publishers Assn., to Radio Advertising Bureau as promotion writer; FRANCES NEWTON, previously librarian with BBDO, joins RAB as chief librarian.

• WILLIAM A. GREGG JR., formerly of Scripture Press, Wheaton, Ill., to Clinton E. Frank, Chicago, as illustrator in art department.

Networks

• PETER AFFE, director of operations, WRCA-AM-FM-TV New York, appointed manager of facilities planning and utilization for NBC-TV.

• DAVID DORTORT, producer of NBC-TV's *Restless Gun*, has signed long-term contract with network, with first assignment as producer of *Bonanza*, new hour-long western series.

• GEORGIANA CARHART, 93, star of ABC-TV's *Life Begins At Eighty*, series discontinued in 1956, died March 2 in New York. Mrs. Carhart also made several guest appearances on NBC-TV's *Jack Paar Show*.

Stations

• FRANK ATLASS, program director at WBBM-TV Chicago, appointed gen-

eral sales manager, succeeding GEORGE J. ARKEDIS, newly-named v.p. in Chicago of CBS Radio Network Sales (WEEK'S HEADLINERS, Feb. 23).



Mr. Sandler

• JACK SANDLER, general manager of WQAM Miami, Storz station, named v.p. of corporation. Mr. Sandler will continue as local and national sales manager.



Mr. Beaston

• GENE P. LOFFLER, formerly v.p. and general manager of KICA-AM-TV Clovis, N.M., named executive v.p. in charge of KQTV (TV) Fort Dodge, Iowa.

• FLOYDE E. (BUD) BEASTON, with Storer Broadcasting Co. since 1957 and named midwest sales manager for radio-tv in 1958, appointed general sales manager of WSPD-TV Toledo, Ohio, succeeding WILLIAM ASHWORTH, who moves to New York as national sales manager of WSPD-TV. FRANCIS X. MCNERNEY, station account executive, named local sales manager.

• CHARLES BOLAND, formerly of KBOX Dallas and KWTX-TV Waco, both Texas, to KIXZ Amarillo, Tex., as general manager.

• WILLIAM F. RUSSELL, formerly of WKYW Louisville, to WSON-AM-FM Henderson, both Kentucky, as station director. BETTY DAVIS, formerly of WIKY-AM-FM Evansville, Ind., to WSON as continuity director.

• LEONARD BRIDGE, controller and assistant secretary-treasurer of WOOD-AM-TV Grand Rapids, Mich., named business manager and assistant secretary-treasurer.



Mr. Hennessy

• EDWARD J. HENNESSY, formerly general manager of WEAT-TV West Palm Beach, Fla., named general sales manager of WAVY-TV Norfolk-Portsmouth, Va. Mr. Hennessy was previously general sales manager of WTVM (TV) Columbus, Ga.

• LEWIS DICKEY, formerly eastern division manager in New York for Guild Films, named local sales manager of WAGA-TV Atlanta, Ga.

• CHARLIE GRANT, program director of WWJB (formerly WKTS) Brooksville, Fla., named station manager.



Democratic demonstration • J. Leonard Reinsch (l), executive director of the Cox stations, was named executive director of the 1960 Democratic National Convention in Los Angeles at the DNC dinner in Washington, Feb. 28. His two amiable acquaintances are Sen. Lyndon B. Johnson (c), majority leader, whose wife owns radio and tv properties in Texas, and Sen. John F. Kennedy of Massachusetts. Mr. Reinsch was also appointed special assistant to Paul Butler, Democratic national chairman.

• HY M. STEED promoted from sales staff to sales manager of WGHN Grand Haven, Mich. He formerly was manager of WLAV-AM-FM Grand Rapids, Mich.

• JACK FOX, formerly with WJIM-TV Lansing, Mich., named local sales manager of WNBC (TV) New Britain, Conn. ROBERT A. GRUSKEY and GEORGE BRONSON join WNBC sales staff. GEORGE WUCHERT and LADD KUDLACH join WKNB New Britain (WNBC's radio affiliate) as salesmen.



Mr. Probst

in BROADCASTING last week (March 3).

• DON SAILORS, formerly national sales manager of KIOA Des Moines, Iowa, to WING Dayton, Ohio, as sales manager.

• MURRAY C. EVANS, formerly v.p. in charge of sales, WGBB Freeport, to WBAB Babylon, both New York, as sales manager.

• LOUIS SCIORTINO, formerly assistant local advertising manager of *Wichita Eagle*, appointed local sales manager of KTVH (TV) Hutchinson-Wichita, Kan.

• DON FREDRICK, formerly news director at KASI Ames, Iowa, to WBEL Beloit, Wis., in similar capacity. He succeeds MAYNARD A. SCHNEIDER, re-

signed to join news staff of WTMJ-AM-TV Milwaukee.

• BOB SCOTT, formerly news director of KOWB Laramie, Wyo., to KRIZ Phoenix, Ariz., in similar capacity. DON LINCOLN to KRIZ as air personality.

• JOE K. PHIPPS, director of news operations, WWDC-AM-FM Washington, D.C., adds duties of director of special projects.

• DON PETERS, formerly promotion manager of WCMW Canton, Ohio, to WAND, that city, in similar capacity.

• FRANK GAAL, news director of WJBK-AM-FM Detroit, promoted to program-news director. DON MACKINNON, formerly program director of WPON Pontiac, Mich., to WJBK as newsman.

• HERBERT WEISS, formerly television account executive of Katz Agency, N.Y., to WABC New York sales staff as account executive. SHIRLEY LAIRD, continuity script routing supervisor, appointed operations manager of station in addition to present duties.

• ERNEST M. STIRES, formerly salesman of KGO-AM-FM San Francisco, to KNBC-AM-FM, that city, as account executive in local sales.

• CATHERINE CHAPMAN joins KROW Oakland, Calif., as head of commercial copy and continuity department, replacing KAREN THOMSEN, resigned.

• ELI WINKLER KAUFMAN, WCBS New York staff director, named merchandising manager of "Housewives Protective League" program.

• BILL GRAMMER, country music performer with Jimmy Dean of CBS-TV and formerly of WWVA-AM-FM Wheeling, W.Va., to *Grand Ole Opry* on WSM Nashville, Tenn.

• BILL CERRI, formerly air personality of WOL-AM-FM Washington, D.C., to WGMS-AM-FM, that city, in similar capacity.

• HOWARD MILLER, air personality of WIND and WBBM Chicago, to WMAQ, that city, in similar capacity.

• BURT BURDEEN signed for *Radio 11*, new nightly record program on WCLM-FM Chicago.

• MIKE ROY to KCKC San Bernardino, Calif., as air personality.

• RON MERONEY, formerly d.j. of WDXI Jackson, Tenn., and presently freshman, Memphis State U., signed by WHBQ-TV Memphis as m.c. of Saturday night *Dance Party* show. He replaces WINK MARTINDALE, who moves to KHJ-AM-FM-TV Los Angeles as air personality.

• BOB GREGORY, formerly news direc-

KOBY is the No. 1 Record IN SAN FRANCISCO



There's a great new record in San Francisco—and it's **KOBY**! This record gives **KOBY** the *highest average all daytime rating—14.5* (from November-December Pulse). That's why **KOBY** is the top San Francisco seller, with an audience that *buys and buys!* No double spotting!

10% discount when buying **KOBY**—and **KOSI**, Denver!

KOBY 10,000 Watts in San Francisco

See *Petry* and make your own sales record with **KOBY**!

For Greenville, Miss.—**WGVM**

Mid-America Broadcasting Co.

One hundred eleven* national and regional spot advertisers know **Terre Haute** is not covered effectively by outside TV

*Basis: 1958

WTHI-TV CHANNEL 10 CBS ABC

TERRE HAUTE, INDIANA
Represented Nationally by Bolling Co.,

Los Angeles - San Francisco - Boston - New York - Chicago - Dallas

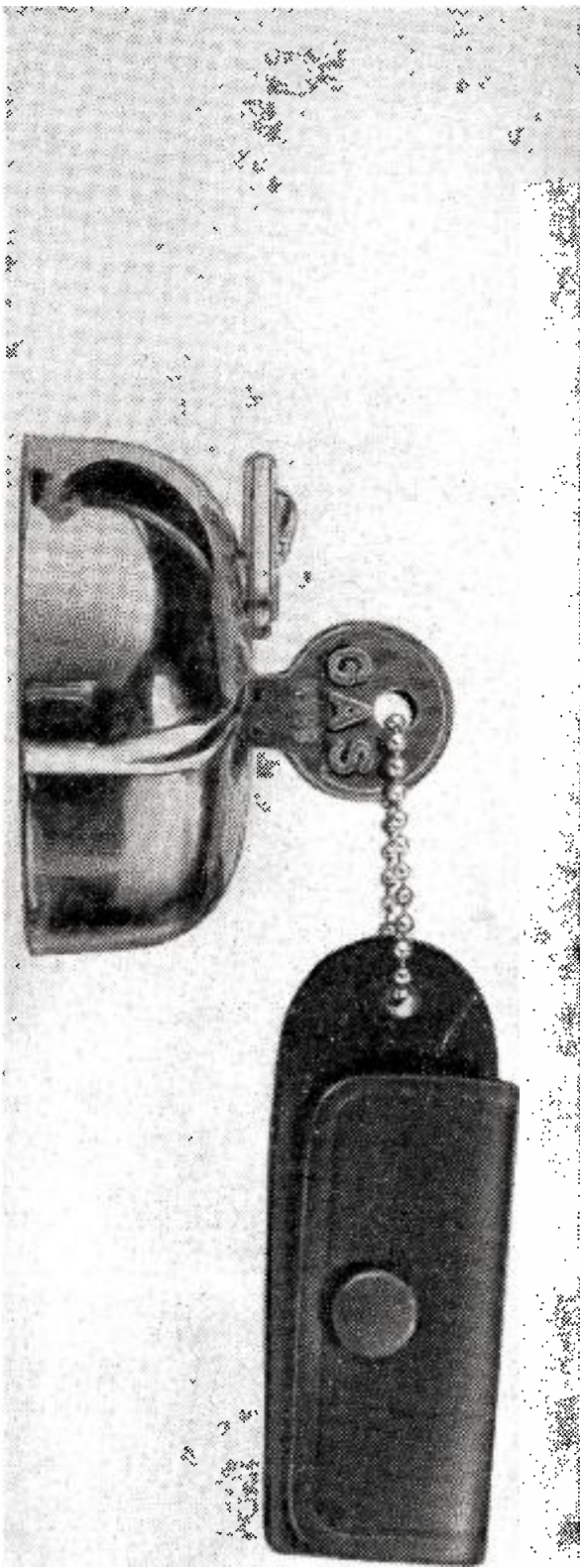

TEXAS COMPANY makes CBS Radio its exclusive network radio choice. For maximum mileage! This network has delivered largest commercial minute audiences all along. And the new Program Consolidation Plan—with unified station clearances and strong program sequencing—will increase this leadership.

CBS RADIO NETWORK:

42% LARGER AUDIENCES PER COMMERCIAL MINUTE THAN ANY OTHER RADIO NETWORK, AVERAGING OVER 16 CONSECUTIVE MONTHS.

tor of KRDO-AM-TV Colorado Springs, to KTUL Tulsa, Okla., as announcer.

- DAVE FENTON, formerly of WBIS Bristol, to WCCC Hartford, both Connecticut, as announcer.

- CHARLES NORWOOD, formerly news director of WHCT (TV) Hartford, Conn., named m.c. of station's *Strikes 'n' Spares* show.

- JOE MCKINNEY to WBAP-AM-FM Ft. Worth, Tex., as announcer.

- PHIL LIND, air personality of WTAQ LaGrange, Ill., adds duties of m.c. of musical interview show over WAIT Chicago.

Representatives

- RICHARD C. ARBUCKLE, midwest manager, Eastman Co., elected v.p.

- ROY EDWARDS, manager of Los Angeles branch, George P. Hollingbery Co., appointed director of west coast operation. GEORGE HEMMERLE, formerly of KOVR (TV) Stockton, Calif., named manager of San Francisco branch, replacing GEORGE E. LINDMAN, resigned.

- JOHN A. HICKS, since 1954 with Clarke Brown Co., southern radio-tv representative firm, in its Atlanta, Ga., office, appointed manager of New Orleans office. BILL JONES, formerly of General Outdoor Adv., replaces Mr. Hicks in Atlanta.

- RICHARD G. KOENIG, for past five years with Bolling Co., as tv account executive, to Peters, Griffin, Woodward Inc., N.Y., in similar capacity.

- JULIAN KANTER, account executive with WBBM-TV Chicago for past three years, to midwest sales staff of Peters, Griffin, Woodward Inc., Chicago, as tv account executive.

- WILLIAM E. MILLER, formerly account executive on radio sales at Adam Young Inc., Chicago, station representative, to Am Radio Sales, that city, in similar capacity.

- KENNETH I. DE VRIES, formerly of Mutual as account executive, to sales staff of H-R Representatives Inc., N.Y.

Programming



Mr. Lerner

- ARTHUR R. LERNER, assistant treasurer of Guild Films, N.Y., since 1955, appointed administrative v.p. and treasurer.

- LAWRENCE T. YOUNG promoted from manager of Cleveland sales district of Wilding Pic-

ture Productions, Chicago film firm, to v.p. in charge of its central sales division, headquartering in Cleveland.

- HERBERT L. BERGER, business manager of radio-tv department of Dancer-Fitzgerald-Sample, N.Y., to Screen Gems as director of business affairs.

- JERRY SCHNITZER, v.p. of Lawrence-Schnitzer Productions, Hollywood, appointed executive v.p. of Robert Lawrence Productions, N.Y. Companies are affiliated and produce filmed tv commercials.



Mr. Plant



Mr. Schlank

- WALT PLANT and MEL SCHLANK appointed v.p.'s of program sales division of National Telefilm Assoc. in Los Angeles and New York, respectively. Their assignments are with Famous Films, sales unit for NTA rerun product. Mr. Plant was formerly v.p. of western division of Television Programs of America, and Mr. Schlank was v.p. in charge of sales for Gross-Krasne-Sillerman Inc.

- WILL COWAN, producer of tv commercials at Universal-International, has joined Warner Bros. as production head of tv commercial and industrial film division, of which David H. Depatie is administrative and business head.

- TOM FROST, formerly of Decca Records as musical director in classical division, appointed director of artists-repertoire, Urania Records, Belleville, N.J.

- DOM CERULLI, formerly New York editor of *Downbeat* magazine, named director of eastern promotion-publicity office of Warner Bros. Records in New York.

- AUDREY MEADOWS, star on CBS-TV's *The Honeymooners* with Jackie Gleason, has been signed to co-star with Sid Caesar in new situation filmed comedy, *It's a Living*, which Mr. Caesar's firm, Shellric Corp., will produce in association with Screen Gems. The show was created by writer Arthur Orloff and William Sackheim, programming director of Screen Gems. Shooting is due to start within month.

- JACK CREAMER, for past five years radio-tv account executive of Young & Rubicam, N.Y. to national sales division of Ziv Television Programs Inc., N.Y.

Equipment and Engineering

• **REAR ADM. FREDERICK J. BELL** (USN, ret.), formerly executive v.p. of National Automobile Dealers Assn., Washington, D.C., elected senior v.p. of Sylvania Electric Products Inc., N.Y., in charge of industrial relations. **ROGER A. SWANSON**, formerly of Westinghouse Electric Corp., named product sales specialist-microwave diodes for semiconductor division of Sylvania.

• **DAVID R. HULL**, v.p. of Raytheon Mfg. Co. and current president of Electronic Industries Assn., elected to board of directors of Mycalex Corp. of America, N.Y.

• **RICHARD A. LIPSEY**, previously in consumer research department of Motorola Inc., appointed assistant to manager of distribution in consumer products division.

• **GEORGE LOOMIS** named manager of receiving tube division, Raytheon Mfg. Co., Waltham, Mass. **WILLIAM T. WELSH**, formerly sales manager of Raytheon's microwave and power tube division, rejoins firm as sales manager of equipment-systems division. Four assistant managers named in research division: **HUGH R. BOYD**, **DR. LUTHER DAVIS JR.**, **DR. WALTER F. LEVERTON** and **DR. HERMANN STATZ**.

• **MALVERN B. STILL**, manager of RCA Victor Radio and "Victrola" plant, Canonsburg, Pa., named manager of RCA's Bloomington, Ind., plant.

• **WALTER R. KUZMIN**, formerly of Minneapolis Honeywell Regulator Co., Duarte, Calif., named manager of reliability engineering, technical products division, Packard-Bell Electronics Corp., L.A.

Allied Fields

• **PAUL M. SEGAL**, D.C. attorney since 1929, and **ROBERT A. MARMET**, Naval Academy and Georgetown U. grad who spent nine years as Naval officer before resigning in 1955, announce formation of law partnership under name of Segal & Marmet. Messrs. Segal and Marmet were affiliated with firm of Segal, Smith & Hennessey until its dissolution Jan. 1, 1958 (when it became Smith, Hennessey & McDonald). Segal & Marmet's office: 816 Conn. Ave., Wash. 6, D.C. Telephone: St. 3-1400.

• **JAMES S. HOWIE**, secretary-treasurer

PLANNING FM BROADCASTING?

See page No. 109



of Assn. of Motion Picture Producers, Hollywood, has retired after 21 years. He will continue in advisory and consultant capacity.



Mr. Weaver
Ft. Wayne, Ind.

• **JOE WOLHANDLER**, formerly v.p. of Rogers & Cowan public relations firm, N.Y., has formed Wolhandler Assoc., N.Y., which will specialize in promotion of tv programs and motion pictures. Firm's east coast headquarters: 406 E. 50th St., N.Y. Phone: Eldorado 5-7020.

• **DAVID W. TALBOTT**, with United Press International since 1956, named manager of UPI's Cleveland bureau, succeeding **HOWARD H. BABCOCK**, resigned.

• **W.F. STOVER**, formerly divisional sales promotion manager of General Motors, appointed midwest representative of Paul H. Chapman Co., Atlanta brokerage firm. Mr. Stover will maintain offices at 205 W. Wacker Drive, Chicago.

International



Mr. Page • **GEORGE MATHER**, Port Credit, Ont., elected president of newly organized Canadian Assn. of Broadcast Consultants, whose members are accredited by Canadian Department of Transport to appear for radio-tv stations and applicants. New organization will serve on Canadian Radio Technical Planning Board. **A.G. DAY** of Waterloo, Ont., elected v.p., and **H.Z. ROGERS**, Toronto, secretary-treasurer.

• **JACK SAYER**, CFUN Vancouver, B.C., elected president of British Columbia Assn. of Broadcasters, succeeding **GIL SEABROOK**, CJIB Vernon. **KEN HUTCHESON**, CJAV Port Alberni, elected v.p.; **WILLIAM HUGHES**, CKNW New Westminster, and **ROY CHAPMAN**, CHBC-TV Kelowna, directors.

• **PIERRE FAVREAU** to sales promotion manager of CKAC Montreal, Que.

• **RICK WEAVER**, sports director of KFH-AM-FM Wichita, Kan., elected executive v.p. of National Assn. of Fans Inc., new national sports attendance promotion organization with headquarters in

IMPACT
WITH THE
INTER MOUNTAIN NETWORK

IN BILLINGS, MONT.

KBMY

Intermountain Network Affiliate

IS

The Hottest Sounding

HOTTEST BUY

IN

TOWN!!!

The Nation's Most Successful Regional Network
HEADQUARTERS • SALT LAKE CITY • DENVER
Contact Your Avery-Knodel Man

AVOID TOWER LIGHTING ISOLATION TRANSFORMER TROUBLES

INSTALL MODERN DESIGN

... by **HUGHEY & PHILLIPS, Inc.**
... your most dependable source of Obstruction Lighting Equipment
... the widest selection of Control and Alarm Apparatus in the Industry.

FEATURING:

- HIGHER EFFICIENCY
- IMPROVED REGULATION
- ADDITIONAL TAPS
- FIBER GLASS INSULATION
- EPOXY ENCASED
- VERSATILE MOUNTING

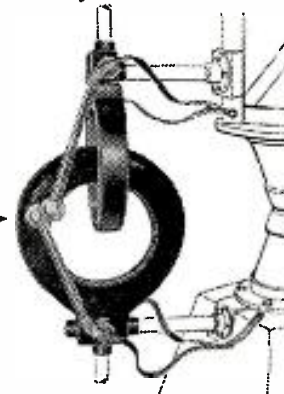

THREE SIZES . . . 750, 1750, 3500 WATTS

Essential wherever 60 cycle power must be transferred efficiently across two points with very low capacitance or at very high voltages.

REQUEST DESCRIPTIVE BULLETIN
HPS-152

HUGHEY & PHILLIPS, INC.

MANUFACTURERS OF

300MM Beacons, Obstruction Lights, Photo-Electric Controls, Beacon Flashers, Special Junction Boxes, Microwave Tower Light Control and Alarm Systems, Tower Isolation Transformers, and Complete Kits for: Tower Lighting, Sleetmelter Power and Control.

3200 N. San Fernando Blvd. Burbank, Calif.

Westinghouse, RCA show am stereo plans

Two new compatible am stereo broadcast systems were brought out in New York last week, joining the steadily increasing ranks of those competing for approval by the National Stereophonic Radio Committee.

Westinghouse's Television-Radio Div. demonstrated its single-channel am system which transmits a double signal by simultaneous amplitude and frequency modulation of the carrier. Owners of two am receivers can have stereo by tuning one set somewhat below and the other somewhat above a station's number on the dial. Reception for the single-set listener is said to be unaffected. Westinghouse explains the system this way:

"The amplitude modulation is essentially that of the normal commercial broadcast band signal and the stereophonic information is supplied by varying the carrier frequency. The stereophonic information is contained in the band from 300 to 3,000 cycles per second; therefore, it is practical to use frequency modulation for the stereophonic information without interfering with adjacent am channels."

If demand warrants, Westinghouse is prepared to market a single receiver designed for this system with separate circuits and multiple speakers. Estimated expenditures for stations installing the Westinghouse transmission: \$2,500.

RCA reports having successfully tested a stereo system of the am variety over WRCA New York last week. Conventional sets were said to have produced normal reception. The stereophonic effect was received via the type of equipment required for stereophonic phonographs, i.e. twin speakers and amplifiers. Also needed by the listener to this RCA system is an am stereo radio

which would have some additional circuitry and cost "slightly more" than conventional radios. Broadcasters are said to need a "minor addition" to their am transmitter.

RCA countersues

RCA is seeking a total of \$1,158,065 in royalties and assorted damages from Philco Corp., Philadelphia, and one of its subsidiaries, Lansdale Tube Co.

RCA's demands were contained in a counter-claim filed in U.S. District Court in Philadelphia on Feb. 27 in connection with a \$150 million treble damage antitrust suit, filed in January 1957 by Philco against RCA, General Electric Co., AT&T and two AT&T subsidiaries. Philco charged that these companies were monopolizing patents in the radio, television and electronics field and claimed they were violating antitrust laws.

In its counter-suit, embodying three separate claims, RCA asserted that Philco owes it \$294,475 for royalties on licenses of RCA patents on radio sets and electrical phonographs from Jan. 1, 1950, to Dec. 31, 1954; the second claims damages of \$450,000 covering the licensing by Philco of commercial radio apparatus patents from June 1, 1950, to Dec. 31, 1954, and the third claim is against Lansdale for \$413,590 for the licensing of radio tube patents from June 1, 1950, to Dec. 31, 1954. In the past, Philco has denied it owed RCA any back royalties.

Raytheon-Machlett

Stockholders of Raytheon Mfg. Co., Waltham, Mass., and Machlett Labs, Springdale, Conn., will vote April 23, on a merger agreement approved by company directors, Charles F. Adams, Raytheon president, and W. E. Steven-

son, Machlett president, have announced.

Under the agreement, Machlett, makers of X-ray and electron tubes, would continue to operate under its present name and management but as a division of Raytheon. Machlett sales in 1958 were about \$10 million. There is virtually no overlap between company products, according to Raytheon, whose 1958 sales of electronic equipment and systems were approximately \$375 million.

• Technical topics

- Minnesota Mining & Manufacturing Co., St. Paul, had consolidated sales of \$376,293,016 in 1958, a company record. 1957 sales were \$370,106,838. Common stock earnings last year were \$43,669,033 (equal to \$2.58 a share). Earnings in 1957 totaled \$39,446,588 (\$2.34 a share). Before-tax earnings in 1958: \$84,279,033; in 1957: \$76,326,558. Provision for 1958 federal and Canadian income taxes was \$40,400,000.

- WGAN-TV Portland, Me., has awarded Kline Iron & Steel Co., Columbia, S.C., the contract to construct the station's 1,619-ft. tower (BROADCASTING, Feb. 23).

- Paul Dean Ford, broadcast engineering consultant, Terre Haute, Ind., has moved to 4341 S. Eighth St. there.

- Kay Electric Co., Pine Brook, N.J., announces that it has been appointed distributor in the U.S. and Canada for DRD meters, the complete line of direct-reading digital frequency meters made by Sivers Lab, Stockholm, Sweden. Meters come in nine models covering a frequency range of 1,100 to 18,000 mc. Frequency is read directly in megacycles by an in-line digital counter. All models of DRD meters have two coupling windows to which different coupling elements can be connected. Information is available from Kay Electric, Dept. BT, 14 Maple Ave., Pine Brook.

- The Electronic Industries Assn.'s Spectrum Study Committee will review developments in Congress and the Office of Civil Defense & Mobilization at the association's spring conference March 17-20 at the Statler Hilton Hotel, Washington. EIA has proposed that the government undertake a long-range study of military and civilian use of the spectrum. Thirty other sessions are scheduled for the conference, including the Consumer Products Div.'s review of a tv public relations proposal to encourage more than one tv set into homes.





Blue ribbon story • Management and representatives of KIOA Des Moines called on Chicago agencies last month, taking along a model to help make the Iowa sales pitch. Here she pins a blue KIOA ribbon, a prop in the presentation, on William Kennedy, group supervisor at McCann-Erickson.

Lester Kamin, president of KIOA, and Jim Dowell, vice president-general manager of the station, led salesman teams from Weed Radio Corp., KIOA sales representative in the two-day agency promotion.

They visited dozens of offices, covering among others: Leo Burnett Co.; McCann-Erickson; Needham, Louis & Brorby; J. Walter Thompson Co.; Clinton E. Frank, and Aubrey, Finlay, Marley & Hodgson.

Stars come out for WABC

WABC New York added vision to its broadcasting schedule Feb. 16 when it took its entire programming schedule outdoors and played to an estimated 55,000 in front of New York's Paramount Theatre. Station personalities conducted shows from the WABC mobile unit for a total 14½ hours and played host to such recording artists as Connie Boswell, Les Paul & Mary Ford and Teresa Brewer. The station plans to take a troupe of disc jockeys to other points in the metropolitan area in the future.

KDKA-TV crowds gather

KDKA-TV Pittsburgh has sent a presentation to clients and agencies pointing up 15 of the station's publicity and promotion campaigns. The storyboard is titled "Crowd-winning Promotions." They range through a baseball contest that attracted a full house at the city's Forbes Field, a Santa Claus promotion for a local department store and a KDKA-TV Day for 20,000 children at an amusement park. Another 20,000 went to KDKA-TV Night at the Ice Capades.

Stereo stands trial

A jury of Pittsburgh residents was invited to KDKA there last week to hear demonstrations of stereophonic broadcasting. The station broadcast a program using am-fm and fm-fm, and the guests, not knowing which they were hearing, gave their views on the reception. Similar tests were conducted later in the week with the jury tuned in from Sharon, Pa. Results of the experiments will be submitted to the FCC.

Polished performance

"Get a free Griffin shine from wonderful WIL" was the invitation on the red jackets of a corps of shoeshine boys in downtown St. Louis. The St. Louis station sent its troops into shopping centers and advertising agencies with the merchandising service.

WZIP fans rally 'round

About 1,800 letters were received by WZIP Covington, Ky., in answer to an appeal from the management. The vote of confidence was solicited by the station's board of governors, which wanted proof that WZIP's classical music programming is popular.

For one week, announcements were broadcast asking listeners to write to the station with their views on its format.

Other side of the counter

Beeper phone interviews with the staffs of department store sponsors are a feature of commercials on WEJL Scranton, Pa. In the broadcasts the

store representative points up a special value or service. Listeners are then invited by an announcer to ask for the staffer they've just heard when they visit the store.

WITI-TV industry salute

Milwaukee industry is the subject of a series of service announcements by WITI-TV Milwaukee. Starting with a list of 40 top concerns in the area, WITI-TV is being solicited by others for inclusion in the project.

WITI-TV announcements made three or four times daily, emphasize personnel and human interest phases of the companies, reporting anniversaries, company awards, employe accomplishments, health and welfare programs, executive appointments and other items. Industries are saluted on a rotating basis.

Houston howdy

James Garner was in town to plug a movie, "Up Periscope," but KTRK-TV Houston wasn't going to let audiences forget he's *Maverick* every Sunday on ABC-TV. Alighting from an airplane dubbed *Maverick Special*, Mr. Garner found himself starring in a three-hour KTRK show, *Soundtrack*, which was remoted from the Houston airport. Mr. Garner made two appearances on the ABC-TV station and accepted honorary membership in the county sheriff's mounted posse.

My experience of 25 years in management, ownership, and operation of radio and television stations is now available to you, if you are interested in the purchase or sale of broadcasting properties in the western states. Your inquiry, of course, will be treated in confidence.

Lincoln Dellar

LINCOLN DELLAR & COMPANY
SELECT RADIO AND TELEVISION PROPERTIES
MANAGEMENT CONSULTANTS • APPRAISALS • FINANCING
1470 EAST VALLEY ROAD, SANTA BARBARA, CALIF., WOODLAND 9-0770
EASTERN AFFILIATE — R. C. CRISLER & CO., INC.

Station squad • Sports at XETV (TV) Tijuana-San Diego, Calif., got caught up in the spirit of the station's weekly jai alai telecasts and organized an off-camera management squad. Julian M. Kaufman (standing l) vice president-general manager of the ABC-TV affiliate, has challenged other tv stations to tangle on the court with the XETV team "any time, any place."

His teammates (seated l to r) are Hank Guzek, local sales manager; Lou Meiers, business manager, and (standing r) Harrison Eagles, program director.

Mr. Kaufman also announced last week that local response to the Saturday night televised games (8-9 p.m.) has been such that XETV has arranged with Guild Films to syndicate the programs.

The jai alai games, telecast from



Tijuana's Fronton Palacio, will be videotaped in Los Angeles for national distribution.

Single-minded schedule

WHAT-FM Philadelphia started programming jazz music 18 hours a day last Monday (March 2). *Jazz at 96.5* (WHAT-FM's frequency) is broadcast between 11 a.m. and 5 a.m. from the station's new studios. The schedule was increased from a 15-hour all-jazz day.

WNTA-TV hosts admen

More than 500 admen, agency men and newsmen were introduced to the WNTA-TV Newark, N.J., "New House of Entertainment," new personalities and programs, at a cocktail party Feb. 26 at the local Savoy-Hilton Hotel.

Among WNTA-TV's new programs, *Mike Wallace Interviews* starts today (March 9); *Alex In Wonderland* (author Alexander King conducting weekly interviews) starts Wednesday (11-midnight); *Juke Box Jury*, starring Peter Potter from Hollywood, also debuts on WNTA-TV this week, and Bishop Fulton J. Sheen begins a weekly half-hour commentary tomorrow. All the shows are on videotape.

Admen's Olympics

The "Olympic Games," staged by Hugh Feltis & Assoc., Seattle station representative, attracted 110 advertiser and agency contestants last month. The main event was a bingo game played

on a special board featuring a combination of numbers and call letters of eight northwest radio stations represented by Mr. Feltis in the Olympic Empire group. Stakes were a \$3,000 Washington lakefront lot, speedboats and transistor radios. To qualify, players answered questions based on station ratecards.

The Olympic Games took place at Seattle's Broadmoor Golf Club. Co-hosts were KBKW Aberdeen, KENY Bellingham, KBRO Bremerton, KITI Chehalis, KQTY Everett, KITN Olympia, KOL Seattle and KTAC Tacoma, all Washington.

• Drumbeats

• WXYZ Detroit is letting listeners do the promoting. Each one who submits a usable idea for a station break gets \$1.

• One appeal by KFMB-TV San Diego for viewers to contribute to a bail fund to get Americans out of a Mexican jail after their arrest on gambling charges, met with an \$800 response. The money was donated by 125 listeners.

• KWTU (TV) Oklahoma City, Okla., is applying electronic dramatics to its reception-room product display. Products are placed on plastic shelves, one to a shelf, in total darkness. Individually timed spotlights alternate their flashes to present one item at a time for 5 seconds every 50 seconds, giving the spotlighted items the illusion of being suspended in space.

• D.j.'s of KIXZ Amarillo, Tex., for 39 consecutive hours played a disc called "Grayson Goofed" to herald its change of call letters from KLYN.

FOR THE RECORD

Station Authorizations, Applications

As Compiled by BROADCASTING

Feb. 26 through March 4: Includes data on new stations, changes in existing stations, ownership changes, hearing cases, rules & standards changes and routine roundup.

Abbreviations:

DA—directional antenna. cp—construction permit. ERP—effective radiated power. vhf—very high frequency. uhf—ultra high frequency. ant.—antenna. aur.—aural. vis.—visual. kw—kilowatts. w—watt. mc—megacycles. D—day. N—night. LS—local sunset. mod.—modification. trans.—transmitter. unl.—unlimited hours. kc—kilocycles. SCA—subsidiary communications authorization. SSA—special service authorization. STA—special temporary authorization. *—educational. Ann.—Announced.

New Tv Stations

ACTION BY FCC

*Buffalo, N.Y.—Western New York Educational Television Assn. Inc.—Waived sect. 1.355 (30-day rule) and granted uhf ch. 17 (488-494 mc); ERP 151.7 kw vis., 75.85 kw

aur.; ant. height above average terrain 313 ft., above ground 327.8 ft. Estimated construction cost \$123,475, first year operating cost \$86,650; revenue \$100,00 (through donations). P.O. address % Hodgson, Russ, Andrews, Woods & Goodyear, 800 M & T Bldg., Buffalo 2. Studio location Buffalo. Trans. location Buffalo. Geographic coordinates 42° 57' 13.02" N. Lat., 78° 52' 78" W. Long. Trans. B GE, ant. GE. Legal counsel Allaire Karzon. Consulting engineer William S. Duttera. Ann. March 4.

APPLICATION

Charlotte Amalie, St. Thomas, V.I.—Virgin Islands Bestg. System vhf ch. 10 (192-198 mc); ERP 0.190 kw vis., 0.095 kw aur.; ant. height above average terrain 361.2 ft., above ground 73.77 ft. Estimated construction cost \$40,000, first year operating cost \$45,000, revenue \$45,000. Studio location 'Solberg', Charlotte Amalie. Trans. location 'Solberg', Charlotte Amalie. Geographic coordinates 182° 20' 49" N. Lat., 64° 56' 15" W. Long.

Trans. RCA, ant. RCA. Applicant is Mary Louise Vickers, who has cps for WDTV, WIUS (FM) Charlotte Amalie, V.I. Ann. March 2.

Existing Tv Stations

ACTION BY FCC

WNEP-TV Scranton, Pa.—Waived section 3.614(b) of rules and granted application to increase average horizontal vis. ERP from 316 to 537 kw and maximum vis. ERP in vertical plane from 1000 to 1700 kw; conditioned to reducing latter to 1000 kw if incompatible with Canadian use of ch. 16. Ann. March 4.

CALL LETTERS ASSIGNED

KPLR-TV St. Louis, Mo.—220 Television Inc. ch. 11. Changed from KCPP (TV). *WIPM-TV Mayaguez, P.R.—Dept. of Education of Puerto Rico.

Translators

ACTION BY FCC

Tea Kettle Tv Assn. Inc., Columbia Falls, Mont.—Granted cp for new tv translator station on ch. 77 to translate programs of KXLY-TV (ch. 4), Spokane, Wash.

New Am Stations

ACTIONS BY FCC

Grayson, Ky.—Carter County Bestg. Co.—Granted 1370 kc, 5 kw, D. P.O. address Box

SUMMARY OF COMMERCIAL BROADCASTING

Compiled by BROADCASTING through March 4

	ON AIR		CP	TOTAL APPLICATIONS
	Lic.	Cps	Not on air	For new stations
AM	3,297	42	119	627
FM	545	46	139	67
TV	448 ¹	69	103	112

OPERATING TELEVISION STATIONS

Compiled by BROADCASTING through March 4

	VHF	UHF	TOTAL
Commercial	437	80	517 ²
Non-commercial	32	8	40 ⁴

COMMERCIAL STATION BOXSCORE

As reported by FCC through Jan. 31, 1959

	AM	FM	TV
Licensed (all on air)	3,289	543	441 ¹
CPs on air (new stations)	45	38	75 ²
CPs not on the air (new stations)	113	128	106
Total authorized stations	3,447	709	668
Applications for new stations (not in hearing)	484	45	40
Applications for new stations (in hearing)	122	26	65
Total applications for new stations	606	71	105
Applications for major changes (not in hearing)	498	34	41
Applications for major changes (in hearing)	47	0	17
Total applications for major changes	545	34	58
Licenses deleted	2	1	1
CPs deleted	0	0	0

¹There are, in addition, six tv stations which are no longer on the air, but retain their licenses.

²There are, in addition, 39 tv cp-holders which were on the air at one time but are no longer in operation and one which has not started operation.

³There have been, in addition, 211 television cps granted, but now deleted (44 vhf and 167 uhf).

⁴There has been, in addition, one uhf educational tv station granted but now deleted.

355, Grayson. Estimated construction cost \$29,129, first year operating cost \$35,000, revenue \$45,000. Harold Shufflebarger, physician, is 75% owner. Ann. March 4.

La Grange, Tex.—Colorado Valley Bestg. Co. Granted 1570 kc, 250 w D. P.O. address Box 569. Estimated construction cost \$12,279, first year operating cost \$17,436, revenue \$24,520. Principals include Leon Schmidt, 12.32%, E. B. Mayer, 18.48%, Ike J. Petras, 12.32%, Hattie Kruschel, 12.32%, and others. Ann. March 4.

APPLICATIONS

Ashburn, Ga.—Emory L. Pope 1570 kc, 1 kw D. P.O. address Box 582, Moultrie, Ga. Estimated construction cost \$19,359, first year operating cost \$24,000, revenue \$36,000. Mr. Pope is in insurance business. Ann. Feb. 27.

Nashville, Ga.—Hanson R. Carter 1600 kc, 1 kw D. P.O. address Box 211. Estimated construction cost \$20,628, first year operating cost \$37,500, revenue \$40,350. Mr. Carter is business manager KWEM Memphis, Tenn. Ann. March 4.

Baton Rouge, La.—James A. Noe 1550 kc, 5 kw, D. P.O. address Box 1472, Monroe, La. Estimated construction cost \$127,869, first year operating cost \$120,000, revenue \$150,000. Applicant is owner WNOE New Orleans, KNOE-AM-TV Monroe, La. Ann. Feb. 26.

Canton, N.C.—Vernon E. Pressley 920 kc, 500 w D. P.O. address 34 Pearl St., Canton, N.C. Estimated construction cost \$16,150, first year operating cost \$36,000, revenue \$40,000. Mr. Pressley is salesman WSKY Asheville, N.C. Ann. March 4.

Littleton, N.H.—McKee Bcstg. Inc. 1230 kc, 250 w. P.O. address 27 Green Square, Berlin, N.H. Estimated construction cost \$5,000, first year operating cost \$35,000, revenue \$40,000. Applicant is licensee WKCB, WKCQ (FM) Berlin, N.H. Ann. Feb. 27.

Lordsburg, N.M.—Alan A. Koff 950 kc, 1 kw, D. P.O. address Box EE. Estimated construction cost \$16,165, first year operating cost \$36,000, revenue \$40,000. Mr. Koff is in construction business. Ann. March 4.

Beaufort, S.C.—Sea Island Bcstg. Co. 1490 kc, 100 w. P.O. address Box 50. Estimated construction cost \$8,749, first year operating cost \$24,500, revenue \$38,000. Applicants are Lee J. Berry (35%), T.D. Hiers (35%), Edwin W. Pike Jr. (15%) and others. Messrs. Berry and Hiers are partners in real estate development, and Mr. Pike is manager of loan business. Ann. March 4.

Houston, Tex.—Taft Bcstg. Co. 1010 kc, 1 kw D. P.O. address 3419 Mercer St. Estimated construction cost \$86,923, first year

operating cost \$120,000, revenue \$120,000. Sole owner is Paul E. Taft, owner of KHGM (FM) and minority owner KGUL-TV, both Houston. Ann. March 4.

Existing Am Stations

ACTION BY FCC

WMPM Smithfield, N.C.—Granted increase of power from 1 kw to 5 kw, continuing operation on 1270 kc, D. Ann. March 4.

APPLICATIONS

KRAK Stockton, Calif.—Mod. of cp to change ant.-trans. location and change type trans. Ann. Feb. 26.

WIOK Mount Dora, Fla.—Cp to change ant.-trans. location to Westmoreland Dr. and Piedmont St., Orlando, Fla., change studio location to "To be determined," Orlando, Fla., operate trans. by remote control from studio location, make changes in ant. (decrease height), changes in ground system and change station location to Orlando, Fla. Ann. March 4.

WAVO Avondale Estates, Ga.—Cp to increase power from 500 w to 1 kw, make changes in DA ant. system and change station location to Decatur, Ga. Ann. March 4.

KCOG Centerville, Iowa—Mod. of license to change hours of operation from unl. to specified hours. Ann. March 4.

KWNA Winnemucca, Nev.—Cp to increase daytime power from 250 w to 1 kw and install new trans. Ann. March 4.

KRTN Raton, N.M.—Cp to change frequency to 1290 kc, increase power from 250 w to 1 kw, change hours of operation from unl. to daytime and install new trans. Ann. March 4.

WABY Albany, N.Y.—Cp to increase daytime power from 250 w to 1 kw and install new trans. Ann. Feb. 26.

WBEX Chillicothe, Ohio—Cp to increase daytime power from 250 w to 1 kw and install new trans. Ann. March 4.

WMOH Hamilton, Ohio—Cp to increase daytime power from 250 w to 1 kw and install new trans. Ann. March 4.

CALL LETTERS ASSIGNED

WABT Tuskegee, Ala.—Radio Tuskegee Inc. 580 kc. Changed from WTUS.

KDOL Mojave, Calif.—Mojave Bcstrs. 1340 kc.

KHOE Truckee, Calif.—Truckee Bcstrs. 1400 kc.

WAZE Clearwater, Fla.—Radio Clearwater Inc. 860 kc.

WZEP De Funiak Springs, Fla.—Leonard

(KTUL Howls About CCA)

In a letter to Mr. Jerry Hauser, South West Sales Manager of Community Club Services, Inc., Mr. James H. Schoonover, General Manager of Radio Station KTUL (Griffin Broadcast Group) said:—



Mr. SCHOONOVER

"Although we haven't actually launched our CCA Campaign and are in the midst of selling it, I can assure you it will be a financial success! In addition, because of its unique character, CCA has stimulated tremendous interest on the part of Tulsa Woman's Clubs. Coupled with the fine efforts of our CCA Director, Sue Behrens, we feel that the campaign will be an even greater success for our sponsors.

"CCA was a natural for KTUL, coming at a time when we are exhausting every possibility to build both audience and volume! I'm confident that CCA will do the job!"

CAA CONVENTION HOSPITALITY SUITE

CONRAD HILTON HOTEL—SUITE 1218A

COMMUNITY CLUB AWARDS



PENTHOUSE SUITE
527 Madison Avenue
New York 22, N. Y.
Phone: Plaza 3-2842

Program Guide For FM-SCA LICENSEES

Present and Prospective

The only background music on tape that isn't also on transcriptions available to any broadcaster is



Exclusive franchise territories for this exclusive tape program service now being allocated. No franchise fees. No percentages. For franchise particulars, availabilities and audition—

NAB—Blackstone Suite

MAGNE-TRONICS, Inc.
49 West 45th Street, New York 36, N. Y.

Please rush complete particulars on exclusive franchise plan for FM-SCA and wire services.

NAME.....
STATION.....
STREET.....
CITY..... STATE.....

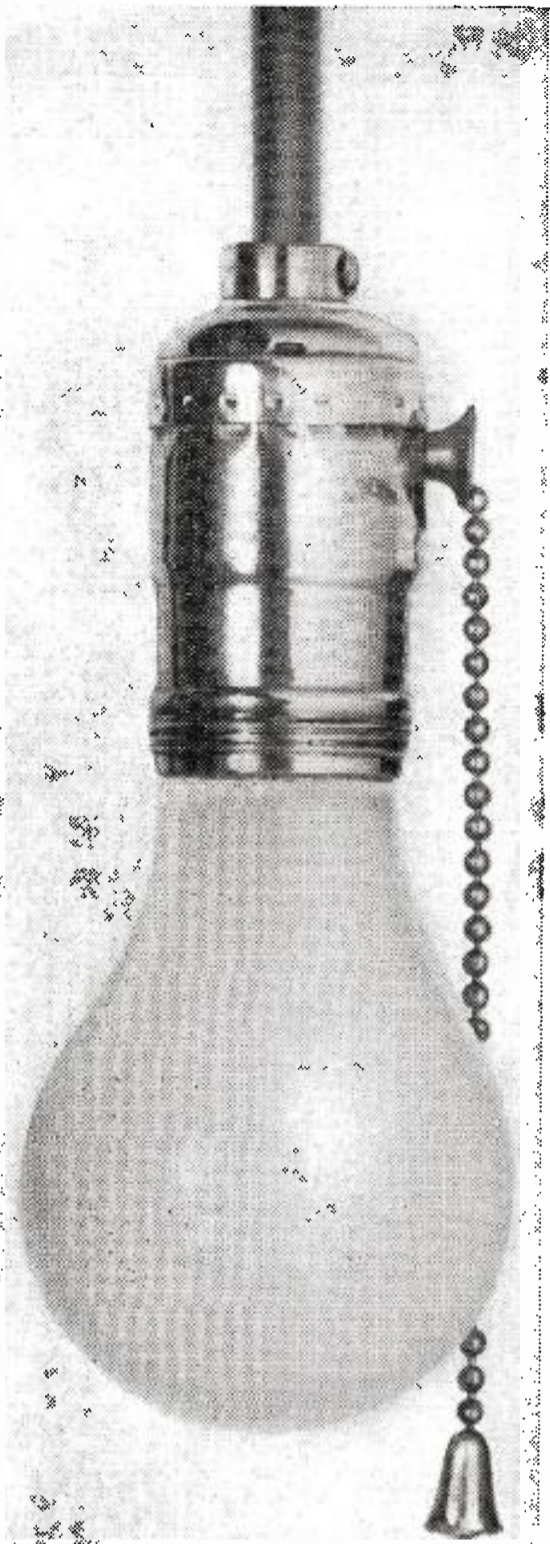

GENERAL ELECTRIC (Lamp Division) lights on one radio network of the four: CBS Radio. Strongest current here! This network has delivered largest commercial minute audiences all along. And the new Program Consolidation Plan—with unified station clearances and strong program sequencing—will increase this leadership.

CBS RADIO NETWORK:

42% LARGER AUDIENCES PER COMMERCIAL MINUTE THAN ANY OTHER RADIO NETWORK, AVERAGING OVER 16 CONSECUTIVE MONTHS.

S. Zepp. 1460 kc. Changed from WFNM.
WVOX New Rochelle, N.Y.—Radio New Rochelle Inc. Changed from WWES.
WRKM Carthage, Tenn.—Carthage Bcstg. Inc.

New Fm Stations

ACTIONS BY FCC

Indianapolis, Ind.—Twin State Bcstg. Inc. Granted 94.7 mc, 52 kw. P.O. address 1330 N. Meridian St. Estimated construction cost \$43,550, first year operating cost \$5,000. Applicant owned by Time Inc., licensee of WFBM-AM-TV Indianapolis and WTCN-AM-TV Minneapolis. Ann. March 4.

Cleveland, Ohio—Northern Ohio Bcstg. Co. Granted 107.9 mc, 135 kw. P.O. address 131 Main St., Chardon, Ohio. Estimated construction cost \$54,100, first year operating cost \$60,000, revenue \$80,000. Ann. March 4.

APPLICATIONS

Bridgeport, Conn.—Connecticut-New York Bcstrs. Inc. 99.9 mc, 9 kw. P.O. address 97 Elm St., Hartford 14, Conn. Estimated construction cost \$17,845. Applicant owns WICC-AM-TV Bridgeport. Ann. March 4.

*Chicago, Ill.—Moody Bible Institute of Chicago 90.1 mc, 47.4 kw. P.O. address 820 N. LaSalle St., Chicago 10. Estimated construction cost \$32,330, first year operating cost \$20,560. Applicant owns WMBI Chicago, WCRF-FM Cleveland and has cp for am station in Moline, Ill., all non-commercial. Ann. Feb. 26.

Minneapolis, Minn.—People's Bcstg. Co. 101.3 mc, 5.23 kw. P.O. address 1133 Stinson Blvd. Estimated construction cost \$16,872, first year operating cost \$18,000, revenue \$20-25,000. Applicant is licensee WPBC Minneapolis. Ann. March 4.

Elizabeth, N.J.—Camden Bcstg. Co. 105.9 mc, 37 kw. P.O. address Box 131. Estimated construction cost \$1,600, first year operating cost \$5,400, revenue \$13,000. Sole owner is Donald Jerome Lewis, president, Multiplex Transmitter Co. Ann. March 2.

Trenton, N.J.—Concert Network Inc. 101.5 mc, 20 kw. P.O. address 171 Newbury St., Boston, Mass. Estimated construction cost \$46,500, first year operating cost \$19,000, revenue \$27,000. Concert owns WBCN (FM) Boston, WXCN (FM) Providence, R.I., WNCN (FM) New York City and WHCN (FM) Hartford, Conn. Ann. March 4.

Existing Fm Stations

ACTION BY FCC

KDKA-FM Pittsburgh, Pa.—Granted temporary authority to Sept. 30 to transmit play-by-play description of baseball games for rebroadcast by other broadcast stations; multiplex operation on subcarrier frequency of about 67 kc to conform with Sec. 3.319 (subsidiary communications rules). Held like authority in 1958. Ann. March 4.

APPLICATION

WHIL-FM Medford, Mass.—Mod. of cp to change frequency from 107.9 mc to 107.5 mc. Ann. March 4.

CALL LETTERS ASSIGNED

KJAZ (FM) Alameda, Calif.—Patrick Henry and David J. Larsen. Changed from KAZY (FM).

WFMK (FM) Louisville, Ky.—Jefferson Bcstg. Inc. Changed from WTMT-FM.

WASA-FM Havre De Grace, Md.—Chesapeake Bcstg. Corp. 103.7 mc.

KQAL-FM Omaha, Neb.—Jack L. Katz Enterprises. 94.3 mc.

*WVHC (FM) Hempstead, N.Y.—Hofstra College. 88.7 mc.

WVOX-FM New Rochelle, N.Y.—Radio New Rochelle Inc. Changed from WWES-FM.

KLUE (FM) Marshall, Tex.—Harrison County Bcstg. Co. 97.3 mc.

KXLY-FM Spokane, Wash.—Northern Pacific Radio Corp. 99.9 mc.

WMIL-FM Milwaukee, Wis.—Cream City Bcstg. Inc. 95.7 mc.

Ownership Changes

ACTIONS BY FCC

KAIR Tucson, Ariz.—Granted transfer of control to Andrew J. Griffith, Jr., and Jerome K. McCauley; consideration \$175,000. Ann. March 4.

KWRF Warren, Ark.—Granted assignment of license from Paul Fiser, John G. Rye and Lee Reaves, to Weldon and Violet Sledge, d/b Pines Bcstg. Co.; consideration \$50,000. Ann. March 4.

KTKR Taft, Calif.—Granted assignment of licenses from Kenneth Aiken, George J. Tschumy Jr., and John A. Smith, to Louise E. and Gerald K. Mann; consideration \$60,000. Ann. March 4.

WMBH-AM-FM Joplin, Mo.—Granted assignment of licenses to Radio Joplin Inc.

(KSTL St. Louis); consideration \$82,000. Ann. March 4.

KBTN Neosho, Mo.—Granted assignment of license to William Montgomery Harlow (member of Missouri House of Representatives); consideration \$45,000. Ann. March 4.

WFEA Manchester, N.H.—Granted assignment of license to WFEA Bcstg. Corp. (William F. Malo Jr., president); Frank E. Pellegrin, vice president, has interest in WATO Oak Ridge, and WLAJ LaFollette, both Tennessee.; consideration \$275,000. Ann. March 4.

WNTA-AM-FM-TV Newark, N.J., KMSP-TV Minneapolis, Minn.—Granted transfer of control from Ely A. Landau, et al. (National Telefilm Associates) to National Theatres Inc. (WDAF, WDAF-TV Kansas City, Mo.); no officer, director or shareholder owns more than 2% of stock and no officer, director or shareholder having 1% or more of stock has any other broadcast interests; stock transaction; without prejudice to whatever action Commission may deem appropriate in light of any determination (1) in United States v. National Telefilm Associates, Inc., civil action 119-287 (U.S.D.C.S.D. of N.Y.) and Standard Radio & Television Co. v. The Chronical Publishing Co. et al. (Supreme Court, Calif., Santa Clara County case No. 103194); and (2) with respect to studies and inquiries now being considered or conducted by Commission as part of its study of network broadcasting. Comr. Bartley dissented. Ann. Feb. 26.

WHAM WHFM (FM) Rochester, N.Y.—Granted assignment of licenses to Genesee Bcstg. Corp. (Henry I. Christal Inc., and Combined Century Theatres Inc.); consideration \$838,580. Ann. March 4.

KZEY Tyler, Tex.—Granted assignment of license to Tyler Bcstg. Co. (Edward McLemore and Roy Thomas Gibson); consideration \$38,337 for 50% interest. Ann. March 4.

WMNF Richwood, W.Va.—Granted transfer of control from Herman G. Dotson, et al., to W. Courtney Evans (WSUX Seaford, Del.); consideration \$40,000. Ann. March 4.

APPLICATIONS

KBJT Fordyce, Ark.—Seeks assignment of cp from Kermit F. Tracy to KBJT Inc., 98% owned by Mr. Tracy. Ann. March 4.

KWYN Wynne, Ark.—Seeks transfer of minority interests from Thompson B. Murray Jr. and Luther V. Pillow (5% each) to Hannah Marie Raley for total consideration of \$2,800. Ann. March 4.

WKUL Cullman, Ala.—Seeks assignment of license from Cullman Bcstg. Co. to Cullman Bcstg. Inc. No change in ownership involved. Ann. March 4.

KGEE-FM Bakersfield, Calif.—Seeks assignment of cp from KGEE Inc. to Edward F. Urner for \$1,000. Applicant is owner KLYD Bakersfield, and 20% partner in Kern County Bcstg. Co., permittee of KICU (TV) ch. 17, Bakersfield. Ann. March 4.

KUDE Oceanside, Calif.—Seeks assignment of license from Pacific Bcstrs. (Walter N. Nelskog and Darrell R. Anderson) to Dolph-Petty Bcstg. Co. (Herbert L. Pettay and William B. Dolph and others), for \$171,000. Mr. Pettay (41%) and Mr. Dolph (43%) are owners of KJBS San Francisco, Calif. and KMYR Denver, Colo. Ann. Feb. 27.

KSDA Redding, Calif.—Seeks assignment of license from Kai W. Lines, trustee of bankrupt estate of VALR Inc. San Francisco, Calif. to Van C. Newkirk for \$20,000. Mr. Newkirk is owner advertising agency and has interest in KOLD Yuma, Ariz. He is former stockholder in VALR Inc. Ann. Feb. 26.

WAVP Avon Park, Fla.—Seeks assignment of license from Albert B. Gale to John B. Marshall for \$12,500. Mr. Marshall is Orlando businessman. Ann. Feb. 26.

WGRO Lake City, Fla.—Seeks assignment of license from George S. Walker to Columbia County Bcstg. Co. for \$12,201. Purchasers are John A. Dowdy (50%), Donald E. Dockery (25%) and Robert E. Dobelstein (25%). Mr. Dowdy has interests in WMGR Bainbridge, Ga. and WJOT Lake City, S.C. Mr. Dockery is editor Lake City Reporter and Mr. Dobelstein is service station operator. Ann. Feb. 26.

WCEH Hawkinsville, Ga.—Seeks transfer of control of Tri-County Bcstg. Inc. from Dallam R., Alice and D. Rivers Jackson (as family group) through stock sale to James D. and Peggy W. Popwell. Popwells currently own 41.4% interest in WCEH. Mr. Popwell is WCEH manager. After transfer will own 50% negative interest. Consideration \$5,715. Ann. Feb. 26.

KSRA Salmon, Idaho.—Seeks assignment of license from Snake River Radio & Television Inc. to Salmon River Radio & Television Inc. Equal owners will be David G. Ainsworth and Snake River Radio & Television Inc. Mr. Ainsworth is a farmer. Snake River is licensee KRXX Rexburg, Idaho. Ann. March 2.

WPEO Peoria, Ill.—Seeks assignment of

license from Dandy Bcstg. Corp. to Radio One Corp. for \$325,000. Purchasers are William B. Dolph and Herbert L. Pettey (25% each), John R. Stark Trust (40%) and Sam J. Johnson, trustee of Walter Seinselmer Trust. Messrs. Pettey and Dolph have interest in KJBS San Francisco. Ann. March 2.

WLBZ-AM-TV Bangor, Me.—Seeks transfer of control from Adeline B. Rines, present majority owner through gifts to her children, William H. Rines, Mary Rines Thompson, and her grandchildren. Mr. Rines is licensee WCSH-AM-TV Portland and WRDO Augusta, both Maine. Ann. March 4.

KRBI St. Peter, Minn. Seeks transfer of control of Gateland Broadcasting Corp. from Mavis L. Peterson to David Bryce Ekberg for \$46,800. Mr. Ekberg is chief engineer WLOL Minneapolis. Ann. March 2.

WKIT Mineola, N.Y.—Seeks transfer of control of WKIT Inc. from Seymour Weintraub to VIP Radio Inc. for \$165,000. Purchasers are Martin Stone (50%) and Plymouth Rock Publications Inc. (50%). Plymouth Rock is owned by John Hay Whitney. VIP Radio Inc. is sole stockholder WWES-AM-FM New Rochelle, N.Y., majority owner WVIP Mount Kisco, N.Y. Mr. Whitney also has interests in WISH-AM-TV Indianapolis, WANE-AM-TV Fort Wayne, Ind., KOTV(TV) Tulsa, Okla. and KGUL-TV Houston. Ann. Feb. 26.

KVLH Pauls Valley, Okla.—Seeks assignment of license from Garvin Bcstg. Co. to Pauls Valley Bcstg. Co. for \$40,000. Applicants are E. J. Ballard (50%), John E. Hampton (25%) and Stephen L. Lloyd (25%). Applicants have no other broadcast interests. Ann. March 4.

KGRO Gresham, Ore.—Seeks transfer of control of Gresham Bcstg. Co. from Thomas B. Purcell to Daniel M. McPeak for \$67,500, minus current indebtedness. Mr. McPeak is chief engineer KPDQ Portland, Ore. Ann. March 4.

WRKM Carthage, Tenn.—Seeks transfer of control of cp of Carthage Bcstg. Inc. from Bill L. Parsons to Reggie L. Honey and Sidney L. Martin, presently 24.375% owners of permittee, and Chester L. Hamby for \$500. After transfer, each will own one-third interest. Ann. March 4.

KPEP San Angelo, Tex.—Seeks assignment of license from Concho Bcstg. Co., wholly owned by David P. Pinkston to Western Bcstg. Co., equal partnership consisting of Mr. Pinkston and Leroy Elmore. Consideration \$10,000. Messrs. Pinkston and Elmore are equal partners in operation of KDAV Lubbock, Tex. and KPIK Colorado Springs, Colo. Ann. March 2.

KTXL San Angelo, Tex.—Seeks assignment of license from San Angelo Bcstg. Co. to Burkhardt Bcstg. Corp. for \$55,000. Applicants, each owning one-third interest are Charles K. Burkhardt, program director KENS San Antonio; Harry G. Burkhardt III, cattle rancher and oil producer and Elizabeth C. Burkhardt. Ann. March 4.

Hearing Cases

FINAL DECISIONS

By order, Commission made effective immediately Jan. 28 initial decision and granted application of Beacon Bcstg. Corp. to increase power of am station WICO, Salisbury, Md., from 500 w to 1 kw, continuing operation on 1320 kc, D. Ann. March 4.

By decision, Commission denied application of Oregon Radio Inc., for extension of time to construct station KSLM-TV (ch. 3), Salem, Ore. Chrmn. Doerfer and Comr. Craven not participating. Initial decision of March 26, 1958 looked toward this action. Ann. March 4.

By decision, the Commission (1) denied protest by Southern Bcstg. Co. (WUSN-TV ch. 2), Charleston, S.C., and (2) affirmed Aug. 1, 1957 grant of cp to Atlantic Coast Bcstg. Corp. of Charleston for new tv station (WTMA-TV) to operate on ch. 4 in Charleston. Comr. Ford not participating. June 10, 1958 initial decision looked toward this action. Ann. March 4.

INITIAL DECISION

Hearing Examiner H. Gifford Irion issued initial decision looking toward granting application of Norman O. Protsman for new am station to operate on 1450 kc, 250 w, during specified hours 6 a.m. to 7 p.m., in Valdosta, Ga. Ann. March 4.

OTHER ACTIONS

By separate memorandum opinions and orders, Commission denied following petitions in connection with Miami, Fla., ch. 10 proceeding: (1) by North Dade Video Inc., which requested Commission to make final disposition of four pending applications in this proceeding at same time it considers issues in further hearing pursuant to order

of remand issued by Court of Appeals, and (2) by Elzey Roberts, which sought permission to file application, contingent upon setting aside cp of Public Service Television Inc., and to participate in oral argument to urge that additional applications also be considered if Public Service grant is set aside. Comr. Craven not participating.

Majority of Commission on March 4 directed preparation of document looking toward granting application of Fred H. Whitley for new am station to operate on 960 kc, 1 kw, D, in Dallas, N.C., and denying mutually exclusive application of Wayne M. Nelson for new station on same frequency with 500 w, D, in Concord, N.C. May 14, 1958 initial decision looked toward this action. Ann. March 4.

By memorandum opinion and order, Commission modified its Dec. 10, 1958 order to extent of reinstating grants to Tomah-Mauston Bcstg. Inc., for new am station (WTMB) to operate on 1390 kc, 500 w, D, in Tomah, Wis., and mod. of cp, pending decision after hearing on protest by William C. Forrest (WRDB), Reedsburg, Wis. Comrs. Hyde and Cross dissented. Ann. March 4.

By memorandum opinion and order, Commission denied petition by Jack L. Goodsitt for reconsideration of Dec. 17, 1958 stay of grant of his application for new am station (WTOJ) to operate on 1460 kc, 1 kw, D, in Tomah, Wis., pending decision after hearing on protest by Tomah-Mauston Bcstg. Inc. (WTMB), Tomah. Comr. Cross dissented. Ann. March 4.

By report and order, Commission postponed from Jan. 1, 1959 to Jan. 1, 1960, time for tv translator stations to comply with rules relating to suppression of out-of-band emissions, and extended from Sept. 1, 1958 to Sept. 1, 1959 time for limited type approval of translator equipment meeting certain minimum requirements. Ann. Feb. 26.

By order, Commission dismissed as moot Jan. 2 petition by Southland Television Co. (losing applicant in Shreveport, La., ch. 12 comparative proceeding) for leave to amend its application to show extension of expiration date of agreement relating to its financing. July 1, 1957 memorandum opinion and order dismissed as moot similar petition, for reason that Southland application had been denied on comparative grounds, and there has been no change in status of application before Commission. (Shreveport Television Co. operates station KSLA-TV on ch. 12 in Shreveport.) Ann. March 4.

By order, Commission dismissed as moot that portion of July 18, 1958 motion by Community Telecasting Corp. requesting enlargement of issues in Moline, Ill., ch. 8 comparative proceedings to include determination of legal qualifications of Iowa-Illinois Television Co. (since dismissed). Ann. March 4.

WNNJ Newton, N.J.—Designated for hearing application to increase power from 500 w to 1 kw, continuing operation on 1360 kc, D; made WKOP Binghamton, N.Y., and WPPA Pottsville, Pa., parties to proceeding. Ann. Mar. 4.

Camden Bcstg. Co. Inc., Providence, R.I.—Granted request for waiver of 309 (b) letter and designated for hearing application for new am station to operate on 990 kc, 50 kw, DA-D, in consolidated proceeding with applications of Moyer Radio, Golden Gate Corp., Radio Rhode Island Inc., Providence, and Bristol County Bcstg. Co., Warren for new am stations on 990 kc—Moyer, Golden Gate and Radio Rhode Island with 50 kw, DA-D, and Bristol with 500 w, D. Comr. Ford dissented to waiver of 309 (b) letter and issued statement. Ann. March 4.

WHEY Millington, Tenn.—Is being advised that application to assign license to Memphis-Millington Bcstg. Co. indicates necessity of hearing. Ann. March 4.

Commission scheduled for oral argument on April 17 protest proceeding on application of Triangle Publications Inc., for mod. of cp of station WNHC-TV (ch. 8), New Haven, Conn., to change trans. location, ant. height, etc. Ann. March 4.

Commission cancelled oral argument scheduled for March 12 on am application of Ottaway Stations Inc. (WDOS), Oneonta, N.Y. Ann. March 4.

Commission allowed parties 20 minutes each for oral argument on April 23 in Miami, Fla., tv ch. 10 remand proceeding. Comr. Craven not participating. Ann. March 4.

23 AM APPLICATIONS IN CONSOLIDATED HEARING

By order, Commission took following actions with respect to 27 am applications involving interlocking interference:

(1) Consolidated 20 applications with previously designated hearing for three stations—Radio St. Croix Inc., New Richmond, Wis.; Florida East Coast Bcstg. Inc., South St. Paul, Minn., and Hennepin County Bcstg. Co., Golden Valley, Minn., which seek operation on 1590 kc—specified new hearing issues and denied certain pleadings. Addi-

Planning a Radio Station?

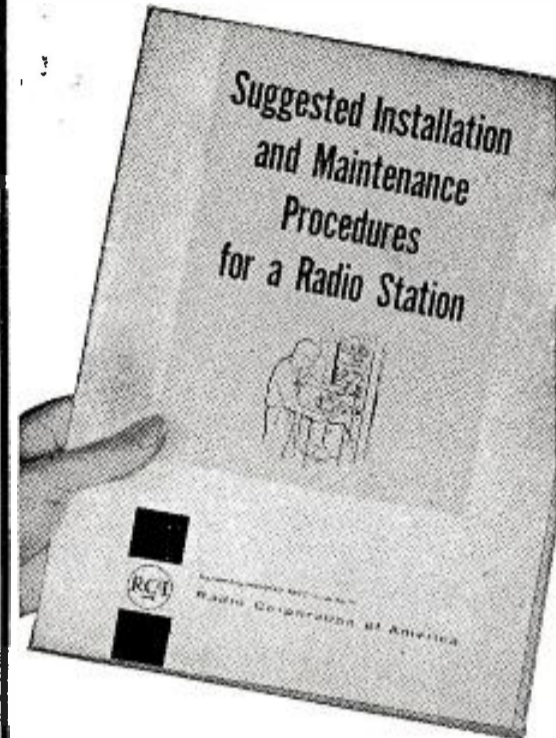

This valuable planning guide will help you realize a greater return on your equipment investment. Installation and maintenance procedures, outlined in this new brochure, will show you how to get long equipment life and top performance for your station.

For your free copy of this brochure, write to RCA, Dept. RB-22, Building 15-1, Camden, N. J. In Canada: RCA VICTOR Company Limited, Montreal.

**RADIO CORPORATION
of AMERICA**



Tmk(s) ®

PROMINENT BROADCASTERS choose Stainless TOWERS



Joe M. Baisch, General Manager

WREX-TV

ROCKFORD, ILLINOIS



Richard Peck, Chief Engineer

And for good reasons, too:

- * Stainless EXPERIENCE in design and fabrication
- * RELIABILITY of Stainless installations
- * LOW MAINTENANCE COSTS of Stainless towers

Ask today for free literature and information.

Stainless, inc.
NORTH WALES • PENNSYLVANIA

tional applicants placed in hearing are Elmwood Park Bcstg. Corp., Elmwood Park, Ill. (1540 kc); Walter L. Follmer, Hamilton, Ohio (1560 kc); Charles J. Lamphier, Golden Valley, Minn. (1570 kc); United Bcstrs. Inc., Muncie, Ind. (1550 kc); Interstate Bcstg. Inc., New York, N.Y. (to change DA of WQXR on 1560 kc); Delaware County Bcstrs., Muncie, Ind. (1550 kc); Minnesota Radio Co., Hopkins-Edina, Minn. (1550 kc); Booth Bcstg. Co., Toledo, Ohio (to increase power of WTOD on 1560 kc); S. M. Supply Co., Eau Claire, Wis. (1550 kc); Rollins Bcstg. Co., Harvey, Ill. (to shift WBEE from 1570 to 1550 kc); Courier-Times Inc., New Castle, Ind. (1550 kc); Elder C. Stangland, Sheldon, Iowa (1550 kc); Radio Crawfordsville Inc., Crawfordsville, Ind. (1550 kc); Sullivan County Bcstrs. Inc., Sullivan, Ind. (1550 kc); North Shore Bcstg. Inc., Madison, Wis. (1550 kc); Somerset Bcstg. Co., Delaware, Ohio (1550 kc); Skokie Valley Bcstg. Co., Evanston, Ill. (1550 kc); Southern Wisconsin Inc., Lake Geneva, Wis. (1550 kc); Guy E. McGaughey Jr., Jacksonville, Ill. (1550 kc), and Grundy Bcstg. Co., Morris, Ill. (1550 kc).

(2) Made KRES St. Joseph, Mo.; WAAY Huntsville, Ala.; WCKY Cincinnati, Ohio; WLOI LaPorte, Ind.; WTAY Taylorville, Ill.; WTKM Hartford, Wis.; WTNS Coshocton, Ohio; KWCO Chickasha, Okla.; KXEL Waterloo, Iowa, and WDXR Paducah, Ky., parties to proceeding.

(3) Dismissed for lack of prosecution applications for four new am stations—Lake Shore Bcstg. Co., Evanston, Ill. (1520 kc); Lake States Bcstg. Co., Milwaukee, Wis. (1520 kc); Waukegan Bcstg. Corp., Waukegan, Ill. (1550 kc), and Lake County Bcstg. Corp., Hammond, Ind. (1520 kc).

Routine Roundup

BROADCAST ACTIONS

By Broadcast Bureau
Actions of Feb. 27

KBTO El Dorado, Kan.—Granted involuntary assignment of license to O. A. Tedrick, individually and as trustee for interests of W.B. Tedrick, deceased, Jack M. Tedrick, et al.

WGSR Millen, Ga.—Granted assignment of license to Jenkins Bcstg. System Inc.

WYSR Franklin, Va.—Granted acquisition of positive control by S.L. Goodman through purchase of stock from Howard H. Keller.

Actions of Feb. 26

KRHD Duncan, Okla.—Granted involuntary assignment of license to R.H. Drewry, J.R. Montgomery, Ted R. Warkentin, Edith H. Scott, executrix of estate of Robert P. Scott, deceased, and John C. Halliburton.

KSWO-AM-TV Lawton, Okla.—Granted involuntary assignment of license to Oklahoma Quality Bcstg. Co.

KWCL Oak Grove, La.—Granted assignment of license to Carroll Bcstg. Inc.

WQDY Calais, Me.—Granted assignment of cp to St. Croix Bcstg. Inc.

KASK Ontario, Calif.—Granted mod. of cp to change type trans.

WJMJ Philadelphia, Pa.—Granted extension of completion date to April 24.

Actions of Feb. 25

WQOK Greenville, S.C.—Granted relinquishment of negative control by each, James A. and Marilyn M. Dick, through

sale of stock to Tecumseh Hooper and Charles A. Dick.

Granted licenses for following am stations: WDEA Ellsworth, Me.; WERT Van Wert, Ohio; WOVE Allegan, Mich., remote control permitted; WNSM Valparaiso-Niceville, Fla.

WBEN-FM Buffalo, N.Y.—Granted license covering changes in frequency, installation new ant. and increase ERP to 110 kw and ant. height (main trans.).

KDMC (FM) Corpus Christi, Tex.—Granted license covering change in ERP and increase in trans. power output (ERP 4.1 kw).

KCLE Cleburne, Tex.—Granted license covering installation new trans. as alternate main trans. at present main trans. site; remote control permitted.

KCLE Cleburne, Tex.—Granted license covering changes in ant. system.

WTKM Hartford, Wis.—Granted license covering move of trans. location, and change of studio location; remote control permitted.

WOUB Athens, Ohio—Granted license covering increase in power.

WBFO Buffalo, N.Y.—Granted license for non-commercial educational fm station.

WHOH (FM) Hamilton, Ohio—Granted license for fm station; remote control permitted.

WHOK-FM Lancaster, Ohio—Granted license for fm station, ERP 16.2 kw.

WFBC-FM Greenville, S.C.—Granted license covering changes in ERP and ant. height, location of ant.-trans. and installation of new type ant.; ERP 9.9 kw.

KONI Phoenix, Ariz.—Granted license covering change ant.-trans. location and studio location; remote control permitted.

KCSJ-TV Pueblo, Colo.—Granted cp to change ERP to vis. 100 kw, aur. 50 kw; trans. location; type of trans. and ant. and other equipment; ant. 1,040 ft.

WAAA Winston-Salem, N.C.—Granted cp to install new trans.

KCMS-FM Manitou Springs, Colo.—Granted cp to increase ERP to 21.5 kw; ant. height to 2,080 ft.; install new type ant. and trans., and change trans. location; remote control permitted; conditions.

KTJS Hobart, Okla.—Granted mod. of cp to change type trans.

KBBI (FM) Los Angeles, Calif.—Granted mod. of cp to change type trans.; remote control permitted; condition.

WQMN Superior, Wis.—Granted extension of completion date to Sept. 23.

ACTIONS ON MOTIONS

By Hearing Examiner Annie Neal Hunting on March 2

Granted petition by Regional Bcstg. Co., Halfway, Md., for leave to amend its am application so as to make changes in information furnished in section II of its application.

By Hearing Examiner J.D. Bond on March 2

Scheduled oral argument for 9 a.m., March 4, on petition by Donald W. Huff, Lansdale, Pa., for leave to amend his am application, together with separate oppositions to petition by Equitable Publishing Co. and Broadcast Bureau.

Continued prehearing conference to 2 p.m., March 13 in New Bedford Mass., ch. 6 proceeding (Wilson Bcstg. Corp., et al.)

By Hearing Examiner Basil P. Cooper on March 2

Scheduled further prehearing conference
Continued on Page 139

RADIO STATION

NATION-WIDE
NEGOTIATIONS · FINANCING · APPRAISALS

Daytimer—two station
market—30 miles from
heart of Pittsburgh.
\$170,000—\$50,000 down.
Profitable operation.

WESTERN PENNSYLVANIA

Contact the WASHINGTON, D. C. OFFICE, 1737 De Sales St. N.W., EXecutive 3-3456, or the office nearest you

Call HAMILTON · STUBBLEFIELD · TWINING and Associates, Inc.

BROKERS · RADIO AND TELEVISION STATIONS · NEWSPAPERS

• CHICAGO {Tribune Tower
Delaware 7-2754} • DALLAS {1511 Bryan St.
Riverside 8-1175} • SAN FRANCISCO {111 Sutter St.
EXbrook 2-5671}

PROFESSIONAL CARDS

JANSKY & BAILEY INC.
Executive Offices ME. 8-5411
1735 DeSales St., N. W.
Offices and Laboratories
1339 Wisconsin Ave., N. W.
Washington, D. C. Federal 3-4800
Member AFCCE

JAMES C. McNARY
Consulting Engineer
National Press Bldg.,
Wash. 4, D. C.
Telephone District 7-1205
Member AFCCE

—Established 1926—
PAUL GODLEY CO.
Upper Montclair, N. J.
Pilgrim 6-3000
Laboratories, Great Notch, N. J.
Member AFCCE

GEORGE C. DAVIS
CONSULTING ENGINEERS
RADIO & TELEVISION
501-514 Munsey Bldg.
Sterling 3-0111
Washington 4, D. C.
Member AFCCE

Commercial Radio Equip. Co.
Everett L. Dillard, Gen. Mgr.
INTERNATIONAL BLDG. DI. 7-131
WASHINGTON, D. C.
P. O. BOX 7037 JACKSON 5302
KANSAS CITY, MO.
Member AFCCE

A. D. Ring & Associates
30 Years' Experience in Radio
Engineering
Pennsylvania Bldg. Republic 7-2347
WASHINGTON 4, D. C.
Member AFCCE

GAUTNEY & JONES
CONSULTING RADIO ENGINEERS
1052 Warner Bldg. National 8-7757
Washington 4, D. C.
Member AFCCE

Lohnes & Culver
Munsey Building District 7-8215
Washington 4, D. C.
Member AFCCE

RUSSELL P. MAY
711 14th St., N. W. Sheraton Bldg.
Washington 5, D.C. REpublic 7-3984
Member AFCCE

L. H. Carr & Associates
Consulting
Radio & Television
Engineers
Washington 6, D. C. Fort Evans
1000 Conn. Ave. Leesburg, Va.
Member AFCCE

KEAR & KENNEDY
1302 18th St., N. W. Hudson 3-9000
WASHINGTON 6, D. C.
Member AFCCE

A. EARL CULLUM, JR.
CONSULTING ENGINEERS
INWOOD POST OFFICE
DALLAS 9, TEXAS
LAKESIDE 8-6108
Member AFCCE

GUY C. HUTCHESON
P. O. Box 32 CRestview 4-8721
1100 W. Abram
ARLINGTON, TEXAS

**SILLIMAN, MOFFET &
ROHRER**
1405 G St., N. W.
Republic 7-6646
Washington 5, D. C.
Member AFCCE

LYNNE C. SMEBY
CONSULTING ENGINEER
AM-FM-TV
7615 LYNN DRIVE
WASHINGTON 15, D. C.
Oliver 2-8520

GEO. P. ADAIR ENG. CO.
CONSULTING ENGINEERS
Radio-Television
Communications-Electronics
1610 Eye St., N. W.
Washington, D. C.
Executive 3-1230 Executive 3-5851
Member AFCCE

WALTER F. KEAN
CONSULTING RADIO ENGINEERS
Associates
George M. Sklom, Robert A. Jones
19 E. Quincy St.—Riverside 7-2153
Riverside, Ill.
(A Chicago suburb)

WILLIAM E. BENNS, JR.
Consulting Radio Engineer
3802 Military Rd., N. W.,
Wash., D. C.
Phone EMerson 2-8071
Box 2468, Birmingham, Ala.
Phone STate 7-2601
Member AFCCE

HAMMETT & EDISON
CONSULTING RADIO ENGINEERS
Box 68, International Airport
San Francisco 28, California
Diamond 2-5208

JOHN B. HEFFELFINGER
8401 Cherry St. Hiland 4-7010
KANSAS CITY, MISSOURI

Vandivere & Cohen
Consulting Electronic Engineers
617 Albee Bldg. Executive 3-4616
1426 G St., N. W.
Washington 5, D. C.
Member AFCCE

CARL E. SMITH
CONSULTING RADIO ENGINEERS
8200 Snowville Road
Brecksville, Ohio
(a Cleveland Suburb)
Tel: JAcKson 6-4386 P. O. Box 82
Member AFCCE

J. G. ROUNTREE
CONSULTING ENGINEER
5622 DYER STREET
EMERSON 3-3266
DALLAS 6, TEXAS

VIR N. JAMES
SPECIALTY
DIRECTIONAL ANTENNAS
1316 S. Kearney Skyline 6-1603
Denver 22, Colorado

JOHN H. MULLANEY
Consulting Radio Engineers
2000 P St., N. W.
Washington 6, D. C.
Columbia 5-4666

A. E. Towne Assocs., Inc.
TELEVISION and RADIO
ENGINEERING CONSULTANTS
420 Taylor St.
San Francisco 2, Calif.
PR. 5-3100

PETE JOHNSON
Consulting am-fm-tv Engineers
Applications—Field Engineering
Suite 601 Kanawha Hotel Bldg.
Charleston, W. Va. Dickens 2-6281

MERL SAXON
CONSULTING RADIO ENGINEER
622 Hoskins Street
Lufkin, Texas
NEptune 4-4242 NEptune 4-9558

Service Directory

COMMERCIAL RADIO
Monitoring Company
PRECISION FREQUENCY
MEASUREMENTS
A FULL TIME SERVICE
FOR AM-FM-TV
P. O. Box 7037 Kansas City, Mo.
Phone Jackson 3-5302

CAMBRIDGE CRYSTALS
PRECISION FREQUENCY
MEASURING SERVICE
SPECIALISTS FOR AM-FM-TV
445 Concord Ave.,
Cambridge 38, Mass.
Phone TRowbridge 6-2810

FREQUENCY
MEASUREMENT
AM-FM-TV
WLAK Electronics Service, Inc.
P.O. Box 1211, Lakeland, Florida
Mutual 2-1431. 5-5544

contact
BROADCASTING MAGAZINE
1735 DeSales St. N.W.
Washington 6, D. C.
for availabilities

SPOT YOUR FIRM'S NAME HERE,
To Be Seen by 85,000* Readers
—among them, the decision-mak-
ing station owners and manag-
ers, chief engineers and techni-
cians—applicants for am, fm, tv
and facsimile facilities.

*ARB Continuing Readership Study

CLASSIFIED ADVERTISEMENTS

(Payable in advance. Checks and money orders only.) (FINAL DEADLINE—Monday preceding publication date.)

- SITUATIONS WANTED 20¢ per word—\$2.00 minimum • HELP WANTED 25¢ per word—\$2.00 minimum.
- DISPLAY ads \$20.00 per inch—STATIONS FOR SALE advertising require display space.
- All other classifications 30¢ per word—\$4.00 minimum.
- No charge for blind box number. Send replies to Broadcasting, 1735 DeSales St., N.W., Washington 6, D. C.

APPLICANTS: If transcriptions or bulk packages submitted, \$1.00 charge for mailing (Forward remittance separately, please). All transcriptions, photos, etc., sent to box numbers are sent at owner's risk. BROADCASTING expressly repudiates any liability or responsibility for their custody or return.

RADIO

Help Wanted—Management

Manager with sales and program know-how for medium station market. Excellent opportunity for clean, capable young family man with all-around experience and ability, to move up. Send complete details, including photo and present income. Box 808H, BROADCASTING.

Commercial manager needed for enterprising station. Good salary, commission and percentage await a real producer. Prefer middle-aged man. WDDY, Gloucester, Virginia. Oxford 3-4302.

Sales manager. Experienced. Excellent opportunity. WHTG, Asbury Park, N. J.

Sales

Maine radio station requires ambitious hard working man combining talents of live wire salesman and top announcer. We want a man who can assume responsibility. Some air work. Emphasis on sales. Guarantee over \$5,000 plus commissions. No prima donnas. Box 724H, BROADCASTING.

Michigan independent adding to sales staff. Major market over 100,000. Top job for money and climbing upstairs. Send picture and details of previous experience to Box 894H, BROADCASTING.

Radio salesman. The "Yankees" need three new additional pitchers! Why pitch in the minors when you can make big league money pitching in top ten market. Be a big leaguer and get on a real big league team. Salary, commission, bonuses, vacation, car expenses. Money making opportunity of life time for young rookies ready for majors. Work with winning team in number one place. For the best pitching job you've ever had rush photo, data. Box 935H, BROADCASTING.

Wanted: Salesman qualified to become sales manager top station Florida east coast. Box 943H, BROADCASTING.

There's a wonderful opportunity in Colorado for a salesman willing to work. Guarantee of \$400 per month and an account list that can make real money for you. This is a permanent connection with the top station in town. Send full information and references. Box 965H, BROADCASTING.

We will be interviewing at the NAB applicants for tv sales manager midwest 350,000 sets. Box 110K, BROADCASTING.

Sales manager major central Ohio market. Top money and future for man who loves to sell. Box 123K, BROADCASTING.

California, KCHJ, Delano. Serves 1,300,000. Increasing sales staff.

Broadcast time salesmen and 1st class combo men. Tired of snow? Ask Leroy from Montana how he likes Eureka, California's March-blooming flowers. Write Don Telford, KIEM, Box 1021, Eureka.

National sales manager. KWWL, Waterloo, Iowa.

Experienced radio salesman with ideas and follow through to sell for leading regional station in highly competitive market. Send resume, proven record and references to Gene Conrad, WERC, R.D. #4, Robinson Road, Erie, Pennsylvania. 9-9647.

Hartford-New Britain, Conn.—lively, powerful network affiliate seeks lively salesman. \$50.00 salary, plus 10% commission. Active account list provided. Send details of background to WHAY, New Britain, Connecticut.

Wanted, 2 experienced salesmen. Salary commensurate with ability. Contact Radio Station WJSO, Johnson City, Tenn.

Help Wanted—(Cont'd)

Announcers

New south Florida station metropolitan market needs 3 dj's. Experienced, smooth, fast paced professionals only. \$110 week to start. Send tape, references, resume! Box 251H, BROADCASTING.

Staff announcer for independent Pennsylvania station. 48-hour week, large market, excellent salary plus over-time, vacations. Desire an experienced man looking for a permanent job in a chain organization with an opportunity for advancement. Tape and resume required. Box 455H, BROADCASTING.

Experienced-mature-versatile for morning shift at number one small market station in Iowa. Must know radio and be conversant with all phases including news, sports and interviews. We want a family man tired of looking and ready to start living in a small town on better than average salary—starting at \$90 per week. Send all information including tape and photo in first letter. Box 688H, BROADCASTING.

North-west station needs announcer capable of informal dry humor on regular record show. Opportunity of lifetime. Reply Box 723H, BROADCASTING.

Good announcer with ability to handle full range of duties on staff of excellent small station. Give details, including photo, audition tape (we'll return it) and present income. Box 809H, BROADCASTING.

Announcer, experienced, for New York state regional 5000 watter. Concentration on gathering and reporting local news. Rush tape to General Manager, Box 893H, BROADCASTING.

New Mexico kilowatt full timer needs good announcer with sales ability. Send tapes and resume. Box 901H, BROADCASTING.

California station wants announcer who is unable to vent his humorous personality on air where now employed. Top pay. Box 942H, BROADCASTING.

Outstanding news man by high-rated Minneapolis-St. Paul independent with adult appeal. Send audition tape, picture, background, references, and salary requirements in first letter to Box 982H, BROADCASTING.

Sparkling personality—experienced. Music-news-play-by-play. Must have new ideas and drive to execute them. Possibility pd for right man. 1st phone preferred. Ohio daytimer. Send tape, background resume, and salary expected. Box 105K, BROADCASTING.

News-caster gather, write, read local news in major Michigan market. Also need disc jockey, smooth, versatile, saleable knowledge of music. Send tape, resume, picture. Experienced only apply. Box 113K, BROADCASTING.

Morning man. Boston. Tight production. Humor. Imagination. Top 50, tape and resume. Box 132K, BROADCASTING.

Announcer-first phone. No maintenance. Two weeks vacation, health insurance, new studios and equipment mobile units, air and auto. Adult programming start at \$433.00. Need immediately. Phone Mr. Jae, KHMO, Hannibal, Missouri, NO 3450.

Permanent position now open for experienced announcer. Nicest town in California to live in. Progressive growing music and news station. Record must stand investigation, KONG, Visalia, California.

Announcer—Immediate opening. Minimum salary \$85.00. If you're fast paced and bright, even more. Send details, tape to Manager, Kenn Maloney. KUVR, Holdrege, Nebraska.

Help Wanted—(Cont'd)

Announcers

Fast-paced, bright deejay, desiring opportunity both number one rated radio station and tv experience. Midwest market over 100,000. Send tape, picture and resume to Bill Baldwin, KWVL-AM-TV, Waterloo Iowa.

Wanted. Experienced deejay for top-rated station. Send full information, including starting salary, photo and tape to: Bob Wylie, WAKR, Akron 20, Ohio.

Washington D.C. area's number one station auditioning exceptional, fast, modern announcers. Send tape. WEAM.

Wanted: Immediate dj personality replace am man; moving up 13th market—5000 watts; music, news, swinging operation. First ticket? More money. Rush tape, photo, background. WGGH, Marion, Illinois.

Two combo men needed. Must have voices good enough for southeast's largest market. Engineering minor. Got to handle fast paced adult radio. \$150 possible in year's time. Hope you're particular—we are. Contact Don Meyers, WIIN Radio, Atlanta, Georgia.

Fast growing Michigan station needs announcers with superb ability to sell on the air. Must be dependable and know production and quality. Good pay to the right men. Send tapes and resume or apply in person. WION, Ionia, Michigan.

Announcer with first phone. Engineering secondary. Contact Don C. Wirth, WNAM, Neenah, Wisconsin.

Want announcer with first phone. Please send tape and resume. WOIA, Box 76, Ann Arbor, Michigan.

Disc jockeys boost your ratings! Order your "Deejay showmanship Kit", includes: "Book of 2400 anecdotes and one-liners"; and "Radiomanship Guide", containing proven formulas for building larger audiences. Also, "Hints for DJ Comedy". \$2.95 DeBu Features, 20 E. Huron St., Chicago, Illinois.

Technical

Engineer-announcer with ability to do maintenance and a fair announcing job. Send details, including photo and audition tape (we'll return it). Salary \$80 to \$100 depending on ability. Box 810H, BROADCASTING.

Immediate opening in northeast for first phone engineer. Experienced preferred. Well rounded duties include studio, transmitter, operation maintenance. Box 968H, BROADCASTING.

Capable technician for E. Pennsylvania station. Must be a man with pride in his work. Accent on maintenance and construction. No announcing. WCOJ, Coatesville, Penna.

Combination engineer-announcer immediately. \$85 per week. Send audition to WCPH, P.O. Box 85, Etowah, Tenn.

Want first phone engineer who can announce. Please send tape and resume. WOIA, Box 76, Ann Arbor, Michigan.

Opening beginning this summer for maintenance-supervisor engineer for radio-television studios and other electronic equipment in new quarters on college campus. Contact Donald Kleckner, Bowling Green State University, Bowling Green, Ohio.

Production-Programming, Others

Experienced newsman needed for Wisconsin location, send qualifications, experience, past employers, family status, salary requirements, to Box 990H, BROADCASTING.

Help Wanted—(Cont'd)

Production-Programming, Others

Can you deliver a top-notch, interesting newscast? Can you gather, evaluate and re-write local news? Can you present a comprehensive editorial? If you fill the bill, a happy, alert daytime independent in one of Ohio's top markets would like to have your tape and resume. Salary open. Box 919H, BROADCASTING.

Experienced news man—to serve as news director Hudson Valley station with heavy emphasis on local news. Gather, write and broadcast three local news programs daily. Share coverage night meetings with pd. Become part of community life in city of 30,000. Send resume and tape, Box 997H, BROADCASTING.

Farm director . . . At small station in farm market. Pleasant working conditions, wonderful country. State salary requirements and experience in first letter. KRXX, Rexburg, Idaho.

Newsman skilled at writing and experienced in air work to join top-notch news staff of midwest 50,000 watt radio station. Send tape and resume to WJR, The Goodwill Station, Detroit.

Writer-producer with flair for compelling commercial copy writing and radio production know-how needed by 50-kilowatt WOWO, Fort Wayne. Rush photo, copy samples and complete resume to: Cal Bollwinkel, WOWO, Fort Wayne, Indiana.

Growing Chicago area indie needs a copy-writer. Good pay, fine future to the right person. Contact WRMN, Elgin, Ill.

RADIO

Situations Wanted—Management

General manager, 9 years from ground up. Family man, college graduate, first phone, excellent sales record, employed. Box 699H, BROADCASTING.

Doctor says move family to better climate. Three children, susceptible to lung congestion and pneumonia. My health is fine. Offer you 15 years of radio background. Experienced all phases. Manager and majority stockholder in No. 1 rated station in three station market, at present time. Have worked 250 watt ABC, 250 watt indie., 5 kw ABC, and 1 kw CBS. Morning man 10 years top ratings. 38, sober, love radio, can give you top programming and increased sales minus gimmicks. Must be southern California, New Mexico, Arizona. Market 25 to 50,000. Looking for management with air work. Earnings now five figures annually. Must sacrifice ownership, but will be happy to do so in order to give family better health and better opportunities. Box 876H, BROADCASTING.

Em-plied — em-ambitious — em-ready. College, 12 years radio, mid-thirties, family. Complete broadcasting experience. Heavy production-sales. News, sports, programming, dj. Good references. Want management-part ownership. Mid-west preferred. All considered. Box 906H, BROADCASTING.

General manager topping industry records at several stations. Twenty-five years specializing productivity in sales and operations. Seeking new opportunity for maximum revenue expansion. Box 923H, BROADCASTING.

Aggressive broadcast executive with 18 years experience now available. Experience includes 13 years as working sales manager, and general manager in radio and television in medium and metropolitan markets. Extremely able, capable, best references, married, college graduate, age 42. Confidential. Box 924H, BROADCASTING.

Station manager. Capable all phases, including sales. Proven record. Box 956H, BROADCASTING.

Aggressive young sales manager desires management position. Prefer western states. Excellent references. Box 978H, BROADCASTING.

Workhorse manager available. 13 years experience. Sells. Holds nut down. In top 10 markets now. Consider any reasonable offer. Can invest. Box 980H, BROADCASTING.

Situations Wanted—(Cont'd)

Management

Presently employed in midwest as manager, chief engineer, program director, announcer and bookkeeper. First phone construction and directional experienced. 6 years in the business. Have developed very efficient methods of operations. No rock and roll, but good solid adult programming. Box 983H, BROADCASTING.

Assistant manager devotes ten years preparing for managership. 36, married, now in Chicago area. Owners, let's localize your station. Box 120K, BROADCASTING.

Station managers . . . RE: Position open or soon to be open your station, for energetic first phone maintenance engineer, who also does good straight smooth announcing job. Experienced modern personality, music-news operation. Conscientious, with know how of production spots. Top potential for your organization! Family. Box 121K, BROADCASTING.

Management, Pennsylvania area. Manager with successful history. Family man, thirties. Experience covers station, sales, and office management, programming, continuity, traffic, bookkeeping, announcing including sports. Excellent industry and personal references. Write Box 128K, BROADCASTING.

Sales

Sales. Apply broad sales background to broadcasting. Capable. Announcing. Copy. Box 881H, BROADCASTING.

Salesman/announcer. Love challenging sales problems. Write copy. Operate board. Box 957H, BROADCASTING.

Aggressive salesman, 35, family, thorough experience with top station in competitive market, seeks top sales position with future in medium or large market. Radio only career. Box 976H, BROADCASTING.

Announcers

Can you offer me the big 3-baseball-football-basketball? Box 709H, BROADCASTING.

Staff announcer, workhorse. 11 years experience small market to 50 kilowatt as disc jockey, newsman, programming. Production conscious with know-how. Want security. Family, 35. College. Presently employed. Specialty: record mc. Agency references. Want jobs done as you would do them yourself? Pay me \$150 week—I'll move fast. Prefer east. No rock-roll. Box 833H, BROADCASTING.

Country/western music. My strongest suit. Capable-staff, controls, sales. Box 880H, BROADCASTING.

Announcer, mature. Sales minded. Copy-writer. Good background. Operate board. Cooperative. Box 882H, BROADCASTING.

Announcer, young. Eager to learn. Good background. Cooperative. Operate board. Box 883H, BROADCASTING.

Situations Wanted—(Cont'd)

Announcers

Young man. Determined to succeed. Well trained. Any reasonable offer. Box 884H, BROADCASTING.

Announcer-dj. 4 years experience. 2 years at 1 kw, 2 years at 5 kw. Married, veteran. available April 1st. Box 936H, BROADCASTING.

Highly professional dj seeks relocation. Excellent background in music, news, production. College graduate, Harvard, age 35, married. Box 914H, BROADCASTING.

Negro announcer/dj. Intelligent. Versatile. Good background. Salesman. Handle controls. Box 958H, BROADCASTING.

Female, announcer plus. Good background. Women's programs, plus. Reliable. Versatile. Box 959H, BROADCASTING.

Alert, aggressive, single, vet. 13 months' announcing experience to 5 kw network. Can write, will sell. Resume, photo, tape. Prefer medium northeast market. Box 960H, BROADCASTING.

Experienced announcer, age 35, sober, three years experience, good music, top 40, and c and w, news. Best references. Box 961H, BROADCASTING.

Employed, 26, married, veteran, responsible. Want job with future. Box 962H, BROADCASTING.

Announcer strong on sports play-by-play experience in baseball, football, basketball. One year experience. Sales, news, dj. Relocate anywhere. Box 964H, BROADCASTING.

Top-rated dj, program director multi-station market wants advancement. Major markets, major money only please. Young, personable, college, hard worker. Ideas, proven ability. Tape, resume will answer letter explaining your operation, available position, financial arrangements. Box 966H, BROADCASTING.

Good announcer-dj. 5 years experience middle west. Box 967H, BROADCASTING.

Experienced combo-man, smooth flawless delivery. Good radio voice, believable. Family man. 3 years of good solid experience in announcing, 2 years in engineering. Tech school grad. Present employer very satisfied. College, young, steady, don't drink. Tight production. Easy to work with. Excellent references. First class license. Hard worker. Prefer work near college. Wanting to move up. Will send tape. Box 970H, BROADCASTING.

Announcer-dj—2 years experience in all phases. Deep resonant voice. Good references. Prefer Florida or California. Box 972H, BROADCASTING.

Newsman-announcer. 8 years radio-tv experience. Good on-camera delivery. Phone Murray 2-6881, Wichita, Kansas. Box 985H, BROADCASTING.

Staff announcer. Good crisp delivery, can sell. Excellent play-by-play potential. Veteran USAF. Box 986H, BROADCASTING.

WANTED

Promotion Manager for Group
of Well Established Radio
Stations.

Apply, Box 977H, BROADCASTING

Situations Wanted—(Cont'd)

Announcers

Available immediately—first rate announcer, 6 years experience, highly versatile. News, dj, pd, and sales. Minimum \$125. All offers considered. Box 987H, BROADCASTING.

Announcer. Recent graduate of professional broadcasting school. Operate board. Married. Prefer northeast. Tape, photo on request. Box 991H, BROADCASTING.

Announcer-dj; two years radio. Desire radio-tv operation. Commercials my first love. Mature, pleasing voice, efficient and reliable. Prefer east coast. Box 992H, BROADCASTING.

Excellent sports-programming-productions-deejay-sales! Any combination. 12 years all phases! Top rated personality-play-by-play. Stations right arm. Reliable family man currently limited! Box 996H, BROADCASTING.

Good announcer, capable engineer. Can deliver news and commercials without shouting. Experienced am-fm-directional and construction. First phone for 18 years. Prefer southwest or west coast. Box 102K, BROADCASTING.

Impact . . . with your listeners plus results for your sponsors. Deejay. Comes fully equipped with character voices, ideas, and gimmicks. Metropolitan market. First phone. Prefer selling privileges. 33. Maturity, sincerity, dependability, believability. Box 103K, BROADCASTING.

Announcer-dj. Any type show. Can run own board. Tape, references, etc., upon request. Box 109K, BROADCASTING.

Topnotch announcer, successful, stable. Presently in key market. Desires alert station. Box 114K, BROADCASTING.

Staff announcer experienced, solid professional background. College grad. Box 115K, BROADCASTING.

Young, married announcer. DJ newsman, salesman. Operate board. Good voice and delivery. Well trained with some experience. Box 124K, BROADCASTING.

Situations Wanted—(Cont'd)

Announcers

Young staff announcer, strong dj, 1 year experience, run own board, married, tape and resume available. Box 126K, BROADCASTING.

Top voice announcer—Strongest on play-by-play, news, radio-tv production. 7 years experience. College English major. Army discharge in April. Box 130K, BROADCASTING.

Country dj available. For the last three years I have been program director, dj with a top ranking, money making country operation. I'd like to relocate. Worker. Know promotion, production, top dj. 29, sober, reliable, artist. Best references. Write Box 127K, BROADCASTING.

Summer work, college student, commercially experienced. Will work anywhere. Prefer D.C. Box 131K, BROADCASTING.

West coast only—Experienced announcer-engineer, 1st phone. No top forty. Able to hold adult audience with relaxed, easy style. Midnight to dawn or late show. Strong on news. Personal interview required 500 mile radius of Los Angeles. P.O. Box 7351, Long Beach 7, California.

Contact us for announcers! Calumet Broadcasting, 671 Washington, Gary, Indiana. Turner 5-3038.

Versatile announcer—newsman ten years experience currently employed. Gil Clark, 704 North Avenue, Antigo, Wisconsin.

DJ full of ambition, enthusiasm, ideas, radio school graduate would like fast paced show. Bill Montgomery, 4 Sage Ave., Lebanon, Ohio.

All phases news, programming, announcing. Family, vet, college grad, 25, 4 years experience. Remotes, interviews, special events specialist. TV preferred. Keith Walker, 504 N. 12th, Manhattan, Kansas. PR 6-8755.

Situations Wanted—(Cont'd)

Technical

Chief engineer, ten years experience, construction, maintenance. Directional and remote control systems. AM, fm and tv. Ambitious, agreeable, skillful. Available two weeks from date of acceptance. Box 973H, BROADCASTING.

1st phone engineer. Have schooling, looking for experience in television. Box 984H, BROADCASTING.

First phone, experienced transmitters, remotes, equipment construction, and control rooms. Box 993H, BROADCASTING.

Chief engineer—Over twenty years experience am directional, remote, am-fm and tv transmitter and studio installation. Last ten years maintenance and supervision. Seniority prevents further advancement with present employer. Family man. Box 994H, BROADCASTING.

First class phone, married, non-drinker, dependable, some experience with am and fm, transmitters. I would prefer to stay in mid-west, but I will relocate anywhere. Please write Box 101K, BROADCASTING.

5 years experienced country announcer with first ticket. Some maintenance, dependable, sober. No sign on. Making change for programming reasons. Ted Foster, WHBT, Phone 661, Harriman, Tennessee.

Mature radio chief engineer-announcer, available for tv or radio. Howard Spidle, 605 E. Third, Albany, Oregon, Wabash 6-2015.

Production-Programming, Others

Radio-tv program-production manager. California net, desires east. References. Box 856H, BROADCASTING.

Continuity director. Eleven years radio-tv. Fast, co-operative, excellent references. Available immediately. Box 887H, BROADCASTING.

Newsman with professional delivery. Exceptionally clear style. Will do radio and/or television. Network and local news background. Box 988H, BROADCASTING.

Top flight news and sportsman. News director at 2 stations. Excellent on sports. 7 years news experience. Good public relations. Dependable, aggressive, will do job. Write at once. Box 117K, BROADCASTING.

We write radio copy \$1.00 per spot. Guaranteed. Box 5861, Tucson, Arizona.

TELEVISION

Help Wanted—Announcers

Staff announcer to do live television commercials and ad-lib commentary on NBC affiliated station. Live news and weather experience essential. Top salary, plus profit-sharing plan. Send photo and full experience, Box 874H, BROADCASTING.

Wanted: Top flight news and staff announcer for Texas 100 kw network affiliate. Permanent. Good pay. Will consider experienced radio announcer. Send tape, recent photo or snapshot, full details. Box 989H, BROADCASTING.

Expanding staff wants experienced, hard-sell, on-camera announcer. Air mail special resume and photo to John Radeck, P.D., WJBF, Channel 6, Augusta, Georgia.

Technical

Transmitter engineers for combined radio-tv operation. Southeast. Good pay scale commensurate with ability and experience. Excellent working conditions in major market. Send picture and complete background information first letter. Box 828H, BROADCASTING.

Need experienced television engineer with first phone desiring to live in Nebraska. Box 917H, BROADCASTING.

Technical supervisor to handle engineering staff at mid-west television station. Only top technical men with experience on maintaining transmitters, studio control and microwave need apply. Address Box 981H, BROADCASTING.

Vacancy for television engineer. Permanent job, good climate. Would consider competent radio engineer who wants to learn television. Send complete details, including small snapshot to Manager, KSWV-TV, Roswell, N.M.

VIDEO FIELD ENGINEERS

AMPEX CORPORATION, world's largest manufacturer of precision magnetic recorders, needs qualified video engineers at several field locations and home office. Will be engaged in applications engineering, installations, maintenance and service of Ampex VR-1000 Videotape* Recorder and associated systems at commercial, industrial and military locations throughout United States.

Substantial audio and video technical education plus three years television station operation or maintenance experience, or equivalent, required. Moderate travel. Opportunities for advancement to supervisory engineering and sales positions for anyone with energy, talent, and self-drive.

To qualify you must have the appearance, manner, and ability to meet and deal with management and engineering personnel. Salary plus profit sharing and liberal company benefits. Send resume, availability and salary requirements to John Doolittle, Supervisor Technical Recruiting.

2402 BAY ROAD
REDWOOD CITY, CALIFORNIA



* TM AMPEX CORP.

Help Wanted—(Cont'd)

Production-Programming, Others

Program director . . . to plan, direct and co-ordinate all live programming of basic CBS station in mid-west. Past pd experience in commercial television operation necessary. Include full details first letter. Excellent opportunity and salary to right man. Box 875H, BROADCASTING.

Need experienced sales promotion man to assist with presentations, merchandising and associated creative assignments for top CBS outlet. Good copy writing and a flair for workable ideas is required. Please send complete information on your background, references, samples of your work if possible and salary requirements. Job open immediately. Contact KRLD-TV, Dallas, Texas.

Promotion director wanted. Excellent opportunity for good man. Must have experience in radio and/or television. Job entails supervision, as well as execution, of newspaper advertising, program, station, and market promotion in trade press, on the air promotion, research and development of sales promotion aids. This is a four-person department in a 10-year CBS station. Excellent market of over 400,000 television homes. You will like our climate, living conditions and fellow workers. Send complete story of your experience, family status, salary requirements and photograph, if available. Write General Manager, WFMY-TV, Greensboro N.C.

Mature, experienced staff announcer with good news background. NBC basic station on eastern seaboard. Write Bob Grossman, WXEX-TV, Petersburg, Va.

TELEVISION

Situations Wanted—Management

Experienced tv station manager available immediately. Background includes installation of two vhf stations from hiring personnel, buying film to operations. Well versed all phases programming, sales. References. Box 831H, BROADCASTING.

Don't sell—celebrate! Profits, efficiency, prestige—or money back. Box 955H, BROADCASTING.

Announcers

TV announcer; experienced, live, film, commercials. Ready for top market. Box 896H, BROADCASTING.

Good tv announcer. Personality presently employed in major midwest market seeks position with larger station. Reason for change—ready to advance. Married, best of references, well above average presentation, commercials, mc, creative, industrious, craving to add to good experience. Proven ability to sell, self included. Try me! Box 975H, BROADCASTING.

Personality announcer, all types on-camera work, produces, directs, excellent tv background and experience. Employed, college graduate, Harvard, age 35, married. Box 999H, BROADCASTING.

Experienced announcer, news, excel on kiddy show, family man, mature, no bad habits. Will relocate. \$125.00. Box 104K, BROADCASTING.

TV announcing, news. Summer replacement work wanted. 2 years radio. BA in history. Now working on MA in speech. Box 112K, BROADCASTING.

Technical

11 years experience, supervisory and chief medium sized am-fm-tv desires opportunity in medium or large station. Box 774H, BROADCASTING.

Tv cameraman, studio, control room operations work desired. Light experience, have first phone, projectionist license, tv workshop grad. Willing to relocate. Box 946H, BROADCASTING.

Chief engineer—High power experience, installation, maintenance, supervision. TV or am. Must relocate, prefer midwest or midsouth. Box 963H, BROADCASTING.

TV engineer, studio-transmitter experience. GE and RCA. Southeast preferred. Box 969H, BROADCASTING.

Situations Wanted—(Cont'd)

Technical

Chief engineer—9 years experience. Planning, construction and operation. Past five years assistant chief engineer. Proven ability, excellent references. Box 974H, BROADCASTING.

Staff announcer-engineer at vhf-tv station seeks a position in the midwest. First phone. Uhf-vhf, engineering, film, announcing, production and direction experience. Will consider radio CE position. Box 106K, BROADCASTING.

Chief engineer nine years professional engineering, 5 years color studio engineering, engineered and constructed two color systems, experienced in design and construction of video equipment, consultant engineering experience, proficient in all phases of station engineering and supervisory operations. 30, married, children. Box 108K, BROADCASTING.

Production-Programming, Others

Writer-producer-director. Practical experience, local, regional. Creative. Versatile. Cooperative. Box 897H, BROADCASTING.

Operations or production manager. Presently employed program director small market vhf. Family, college. Best references, proven record all phases. Flexible. Sales and organization minded. It will take more than this ad, I know, but I feel resume and personal interview will convince. Box 869H, BROADCASTING.

Experienced television photographer. Excellent photography background. Top references. Write, Box 911H, BROADCASTING.

Available—Production supervisor. Eight years network experience. For resume and information write Box 937H, BROADCASTING.

Hard-hitting news editor can be your top personality. Audience builder. Powerful, authoritative style radio and television. Network and local news background. Family man. Box 107K, BROADCASTING.

Production manager. Experienced 9 years film, radio, television. Engineering degree. Box 116K, BROADCASTING.

News director large southern radio-tv station wants staff job or better with larger news operation. Experienced script-writer, cameraman, editor. Strong on-camera delivery. Box 118K, BROADCASTING.

Promotion—experience in continuity, advertising, production and sales. Young, married, degree, employed. Box 129K, BROADCASTING.

FOR SALE

Equipment

Raytheon RA-250 transmitter in excellent condition. Save 1/3 price of new transmitter. Box 692H, BROADCASTING.

G.E. fm transmitter model BT-3-A 3 kw completely reconditioned and tested. Price \$5500 fob. Box 125K, BROADCASTING.

Two-230 foot Ideco self-supporting towers, transmission lines, coupling units, Austin lighting chokes, lights. Ready for shipment soon. Write KCBQ, San Diego, Calif.

FOR SALE

Equipment—(Cont'd)

UHF equipment used but in perfect condition. GE TT25A 12kw transmitter including filterplexer, TY25D 5-bay antenna with PY19B feed adapter, 4TX7A dummy load, Tv-21 visual demodulator, sweep oscillator and General Radio monitors. Also 430' Stainless type G tower with lighting, 400 feet 7 1/2"x15-inch wave guide, 2 4' Raytheon 7000 mc parabolas with horns and mounting brackets. Contact Beecher Hayford, WESH-TV, Daytona Beach, Fla.

Westinghouse type fm-3 transmitter \$4700. Collins type 37ma antenna (tuned for 100.5 mcs) \$450. REL frequency and modulation monitor \$150. All prices quoted f.o.b. location and subject to prior sale. Contact W. E. Garrison, WFBC, P.O. Box 1140, Greenville, S. C.

Two portable battery operated minitape recorders, complete instruction book \$75 ea., fob W.E. 110A limiter instruction book \$50 fob Radio Station WINF, Manchester, Connecticut.

One Ampex type 3761 four channel hi-level mixer unit \$150. Will crate and ship collect WNIB, Chicago 24, Illinois.

Western Electric 10 kw fm transmitter. Excellent condition with unimpaired operating record. Price \$10,000. Parker Lee, Inc., 3639 Eighth St., Riverside Calif., Phone: Overland 3-6200.

1 kw-fm transmitter G.E. type—BT-2-A. Best offer over \$2,000.00. Contact: Norman Paul, 44 W. El Caminito Ave., Campbell, Calif.

Eimac 4-1000A tubes. Brand new. \$90 each express prepaid. Radio Communication Company, 1020 E. Land Place, Milwaukee 2, Wisc.

10 kw fm power amplifier, Westinghouse type fm-10 complete power supply and 10 kw amplifier in two cabinets. Good condition. The price is right. Call or wire for details Rixon Electronics, Inc., 2414 Reedie Drive, Silver Spring, Maryland. L0ckwood 5-4578.

AM-fm-tv transmitters, studio terminal equipment (color and mono), cameras, consoles, STL, etc. We want 15 kw uhf transmitters. Department LD, Technical Systems Corp., 12-01 43rd Avenue, L.I.C. 1, N.Y.

Several used towers in top condition, including insulated am broadcast towers. Inquire Tower Construction Co., P.O. Box 1828, Sioux City, Iowa.

WANTED TO BUY

Stations

CP or station in difficulty, sought by responsible operator. Box 902H, BROADCASTING.

\$250 watt or 1 kw fulltime or daytime. Small market. List price and terms. Box 979H, BROADCASTING.

Man with years of producing-writing-performing in radio and tv wishes to become owner-operator of station. East, southeast or Florida preferred. Modest down payment. Box 998H, BROADCASTING.

Qualified and financially able party will buy station or cp with good potential. Write confidentially and in detail. Box 100K, BROADCASTING.

In TEN years as GENERAL and SALES MANAGER of WNOR, Norfolk, Va.

- (1) Built station business from zero to \$450,000 yearly.
- (2) Made over \$800,000 profit for owner.
- (3) Increased station value over ONE MILLION DOLLARS.

Interested in management with part ownership or management with salary plus commissions or share of profits.

EARL HARPER
1000 Manchester-Norfolk, Va.

Madison 2-1930

WANTED TO BUY

Stations—(Cont'd)

Florida, N.C. stations wanted by experienced advertising man, well financed. New or rundown station in large market or 1-2 small-medium market stations. Only realistically priced properties considered. 1958 gross, net first letter. Box 111K, BROADCASTING.

Radio broadcaster will buy or participate in Florida east coast cp or station. Address Box 514—Delray Beach, Florida.

Equipment

Wanted, 3 to 5 kw fm transmitter, antenna monitors and associated equipment. Send complete information and cost to Box 971H, BROADCASTING.

Wanted. Capital transcription library. Prefer Hal Derwin and Frank DeVol programs. Box 995H, BROADCASTING.

Wanted uhf tubes type 6181 and type 6161 new or used. Contact John Randolph, WISE, Asheville, N. C.

INSTRUCTIONS

F.C.C. first phone preparation by correspondence or in resident classes. Our schools are located in Washington, Hollywood, and Seattle. For details, write Grantham School, Desk 2, 821—19th Street, N. W., Washington, D. C.

FCC first phone license in six weeks. Guaranteed instruction by master teacher. G.I. approved. Phone FLeetwood 2-2733. Elkins Radio License School, 3605 Regent Drive, Dallas, Texas.

Since 1946. The original course for FCC 1st phone license, 5 to 6 weeks. Reservations required. Enrolling now for classes starting June 24, Sept. 2, Oct. 28, 1959, January 6, March 2, 1960. For information, references and reservations write William B. Ogden Radio Operational Engineering School, 1150 West Olive Avenue, Burbank, California.

MISCELLANEOUS

Personalized playing card bingo cards, size 3 3/4 x 5 3/4 \$2.50 per 1,000. Bingo Time U.S.A., P.O. Box 906, Denver 1, Colorado. Phone Acoma 2-7539.

EMPLOYMENT SERVICE

We need Continuity Writers, Salesmen, Announcer, D.J.s, Engineers, Newsmen & more Continuity Writers.

We invite experienced personnel to register free for future openings. Minimum fee for placement.

MIDWEST RADIO-TV PLACEMENT
54 W. 30th St., Indianapolis
CL-3-3693 Lic. Agency.

Top placements in the dynamic new southeast in top jobs.

for
RADIO — TV — ADVERTISING
Announcers — DJ's — Copywriters
Engineers — Salesmen — TV Production
PROFESSIONAL PLACEMENT
458 Peachtree Arcade
Atlanta, Ga.
JACKSON 5-4841

PERSONNEL SERVICE

Looking for . . .
QUALIFIED BROADCASTERS?
A BETTER JOB?

Employers and Applicants Contact
DISK JOCKEY
PLACEMENT CENTER, INC.
Agency Specializing in
BROADCASTING • ADVERTISING
PERSONNEL

PAUL BARON, *Managing Director*
100 West 42nd Street, New York 36, N.Y.
WIconsin 7-6322 (Phone for appointments)
(Enclose return postage with tapes)

RADIO

Help Wanted—Sales

**SALES ENGINEER
COMMUNICATION
EQUIPMENT**

Nationally known electronic equipment manufacturer offers responsible position in mid-west home office sales staff for sales engineer thoroughly familiar with modern communication transmitters. Excellent opportunity for growth and advancement in salaried position which includes many company benefits. Limited travel. Send resume to Box 119K, BROADCASTING.

SALESMAN

Top station in top market . . . full-time 5000 watts in May of 59—offers position to energetic, go-getter. Direct and agency account list. Guarantee and most attractive sales plan in town. Write to WICE—Providence—send full details.

MISCELLANEOUS

Buck Rosner no longer associated with this firm. Notification of his whereabouts would be appreciated.

Wire or call collect.

The Jingle Mill
201 West 49th Street
New York 19, New York

**NOW! DYNAMIC . . . NEW LEADERSHIP
IN MARKETS RARELY COVERED**

**NOW NEW NATIONAL REPRESENTATION FORMING
FOR RURAL, SMALL AND MEDIUM MARKETS**

That will assure you to have your share of national sales. Now the national spot picture is yours with this new pulsating and dynamic national representation now forming that will exclusively sell, promote and extend all efforts and facilities in research to guarantee your share of national sales and prestige. Plus to assist you in any form to increase further profits by offering consultation on format, programming, promotion, merchandising and research to make it even more a must for you to take part of the national spot picture. Here's your opportunity to participate on how you can take part for your share of national spot sales. Be among the first to participate, the first to benefit from national representation now forming, offering pulsating leadership in this hitherto under-developed markets. Potential . . . ? Greatest! Lucrative . . . ? You Bet! Call, telegram, or write to: 1472 Broadway, Suite 308, New York 36, New York. Bryant 91883. There will be attractive national spot packages that will lure national advertisers to your radio station now with new and a dynamic national representation now forming.

BUSINESS OPPORTUNITY

**FOR LEASE
SAN DIEGO'S ONLY
BACKGROUND MUSIC
BUSINESS**

One million population
Nation's 20th market

- Will lease on minimum plus percentage basis
- Will transfer trade name "Music Unlimited"
- Will transfer better than 100 existing accounts which have been under contract for 3 to 5 years. Now grossing \$2500 a month. Fine potential.

CONTACT: Fred or Dorothy Rabell at NAB Convention, Chicago, or at KITT, U.S. Grant Hotel, San Diego, California.

FOR SALE

Equipment

**USED TRADE-IN TRANSMITTERS
IN STOCK**

**GATES RADIO COMPANY
QUINCY, ILLINOIS**

Available for prompt shipment—subject to prior sale. All transmitters, except W.E., refurbished and tuned to your frequency and line impedance. Complete with one set of operating tubes and one crystal. Prices F.O.B. Quincy, Illinois.

5 KW

Collins 21B purchased in 1950. Very clean and well maintained. 10 kw power increase kit available extra cost.
\$6750.00

1 KW

Gates BC—1J—only 3 years service and in excellent condition. Original owner increased power and purchased Gates BC-5P.
\$3395.00

Gates BC—1F—1953 De-Luxe model, 13 meters. Traded in on Gates BC-5P.
\$3250.00

Raytheon RA-1000 approximately 10 years old. Single cabinet, horizontal construction—motor tuned.
\$2850.00

Western Electric 443-A, low mileage—used as stand-by only in 5KW station tuned to 930 KC.
\$1250.00

250 Watt

Collins 300G approximately 10 years old. Station granted power increase.
\$1495.00

To place order or for additional information write or call:

Gene Edwards
Manager, Broadcast Transmitter Sales
Gates Radio Company
Quincy, Illinois

Continued from Page 132

for March 4 at 1:30 p.m., on applications of Armin H. Wittenberg Jr., and Pasadena Presbyterian Church for fm facilities in Los Angeles and Pasadena, Calif.

By Comr. Robert E. Lee on Feb. 26

Granted petition by Broadcast Bureau for extension of time to March 2 to file replies to petition for review of order of chief hearing examiner, by Plains Tele. Corp., in Terre Haute, Ind., ch. 10 proceeding.

By Hearing Examiner Charles J. Frederick on Feb. 25

Scheduled prehearing conference for March 20 in proceeding on am applications of Sanford L. Hirschberg and Gerald R. McGuire, Cohoes-Watervliet, N.Y., and Fairview Bcstrs., Rensselaer, N.Y.

By Hearing Examiner H. Gifford Irion on Feb. 26

Continued hearing from Feb. 27 to March 5 in proceeding on applications of Frank

James and San Mateo Bcstg. Co. for fm facilities in Redwood City and San Mateo, Calif.

By Hearing Examiner Thomas H. Donahue on Feb. 27

Granted petition by Venice-Nokomis Bcstg. Co., Venice, Fla., for continuance of hearing from March 2 to March 23 on its am application.

By Chief Hearing Examiner James D. Cunningham on Feb. 20

Scheduled hearing for April 20 in proceeding on am applications of Farmville Bcstg. Co., Farmville, N.C., and WYSR Inc., Franklin, Va.

By Hearing Examiner Herbert Sharfman on Feb. 20

Because of pendency of various pleadings continued conference from Feb. 24 to March 26, in Terre Haute, Ind., ch. 10 proceeding.

By Hearing Examiner Jay A. Kyle on Feb. 24

On request of Telecasting Inc., continued prehearing conference from 9:00 a.m., Feb.

27 to 9:00 a.m., March 5 in Weston, W. Va., ch. 5 proceeding.

By Hearing Examiner Annie Neal Huntting on Feb. 24

Granted petition by Tri-County Bcstg. Co., Jerseyville, Ill., for continuance without date of hearing and exchange of exhibits scheduled for March 23 and 16 respectively, pending action by Commission upon petition for reconsideration of grant without hearing filed by Tri-County in proceeding on its am application and that of grantee Radio Missouri Corp. (WAMV), East St. Louis, Ill.

By Hearing Examiner Millard F. French on Feb. 24

Granted request of Fayetteville Bcstg. Inc. (KHOG), Fayetteville, Ark., for continuance of date for exchange of written affirmative case from Feb. 24 to March 2 in proceeding on its am application.

Granted petition by Rev. Haldane James Duff, Seattle, Wash., for extension of time for exchange of exhibits from March 4 to March 18 in proceeding on his am application and that of Northwest Bcstrs Inc., Bellevue, Wash.

By Hearing Examiner J.D. Bond on Feb. 24

Granted petition by Broadcast Bureau for extension of time for filing reply pleadings from Feb. 20 to March 2 in Hampton-Norfolk, Va., ch. 13 proceeding.

By Hearing Examiner Thomas H. Douahue on dates shown

Granted petition by Lakeside Bcstrs., Sparks, Nev., for continuance of hearing from 2 p.m., Feb. 25 to 2 p.m., March 6 in proceeding on its am application. Action Feb. 24.

Granted petitions by Melody Music Inc. (WGMA), Hollywood, Fla., for leave to amend and to remove from hearing its am application which is in consolidated proceeding with Venice-Nokomis Bcstg. Co., Venice, Fla., accepted amendment to change site, engineering proposal, etc., and returned application to processing line. Action Feb. 24.

Issued memorandum of ruling regarding examiner's refusal to permit schedule 6 of exhibit 56, tendered by KEED Inc., to be marked for identification in proceeding on its application and Liberty Television Inc., for new tv stations to operate on ch. 9 in Eugene, Ore. Action Feb. 19.

Granted two pleadings by South Coast Bcstg. Co., Laguna Beach, Calif.—"Request for additional time to file opposition to petition of Upland Broadcasting Co." and "Request for reconsideration of order permitting amendment of application of upland Broadcasting Co." to extent that they are here considered and that by March 15 South Coast may petition examiner to vacate Feb. 10 order granting Upland's petition for leave to amend and in other respects denied. Action Feb. 25.

By Chief Hearing Examiner James D. Cunningham on Feb. 25

Scheduled hearings in following am proceedings on dates shown: April 16—Seaside Bcstg. Co. (KSRG), Seaside, Ore.) April 20—Moyer Radio, Providence, R.I., et al.

Granted petition by KOOS Inc. (KOOS-TV), Coos Bay, Ore., for dismissal without prejudice of its application to change from ch. 16 to ch. 11 which is in consolidated proceeding with application of Pacific Television Inc., for new tv station to operate on ch. 11 in Coos Bay.

By Hearing Examiner Charles J. Frederick on Feb. 25

Rescheduled hearing heretofore scheduled for March 23 to commence on April 22 in proceeding on am applications of Alkima Bcstg. Co., West Chester, Pa., et al.

PETITION FOR RULEMAKING DENIED

WTTV (TV) Bloomington, Ind. (7-1-58)—Request for deletion of ch. 4 from Bloomington, Ind., and allocation of same to Indianapolis, Ind., denied by memorandum opinion and order adopted Feb. 18, 1959. Ann. Feb. 25.

License Renewals

Following stations were granted renewal of license: KANA Anaconda, Mont.; KANO Anoka, Minn.; KATL Miles City, Mont.; KAUS Austin, Minn.; KBOW Butte, Mont.; KBRK Brookings, S.D.; KBTK Missoula, Mont.; KCMS Manitou Springs, Colo.; KDAL Duluth, Minn.; KDEN Denver, Colo.; KDGO Durango, Colo.; KDIX Dickinson, N.D.; KDMA Montevideo, Minn.; KELO Sioux Falls, S.D.; KEVE Minneapolis, Minn.; KEYJ Jamestown, N.D.; KEYZ Williston, N.D.; KFAM St. Cloud, Minn.; KFBB Great Falls, Mont.; KFNW Fargo, N.D.; KFSC Denver, Colo.; KFTM Fort Morgan, Colo.; KFJR Bismarck, N.D.; KGCX Sidney, Mont.; KGEK Sterling, Colo.; KGIW Alamosa, Colo.; KGLN Glenwood Springs, Colo.; KTIS Minneapolis, Minn.

STATIONS • FOR SALE

 * Either 25% or 50% interest. Buyer must become resident General Manager.
 *
 * Box 818H, Broadcasting

LARGE 75,000 WATT FM STATION

In large metropolitan area with several hundred multiplex accounts. Main channel and multiplex billing \$6000 a month. Large potential. No competition.

Box 122K, Broadcasting

HASKELL BLOOMBERG
 Station Broker, Lowell, Mass.

Minnesota — \$105,000; Virginia — \$140,000; Florida — \$300,000; New Mexico — \$95,000; Indiana — \$600,000; Pennsylvania — \$125,000; Maryland — \$75,000; West Virginia — \$60,000; North Carolina — \$135,000; Florida — \$65,000. WRITE.

THE PIONEER FIRM OF TELEVISION AND RADIO MANAGEMENT CONSULTANTS
 ESTABLISHED 1946

NEGOTIATIONS MANAGEMENT
 APPRAISALS FINANCING
HOWARD S. FRAZIER, INC.
 1736 Wisconsin Ave., N.W.
 Washington 7, D. C.

NORMAN & NORMAN
 INCORPORATED
 Brokers — Consultants — Appraisers
RADIO-TELEVISION STATIONS

visit us during
NAB Convention in Chicago
 March 15-17 Conrad Hilton Hotel
 Security Bldg. Davenport, Iowa

MIDWEST DAYTIMER

In two station market. Clean, compact, remote operation. \$25,000 down, balance on terms. Phone Tremont 6-1395.

J. Rogers & Co., P.O. Box 437
 Rockford, Ill.

STATIONS FOR SALE

Be sure that you put us on your **MUST SEE** schedule.

SUITE 1035A-1036A
 Conrad Hilton Hotel
JACK L. STOLL & ASSOCIATES

Texas	Single	1kw-D	\$30M	terms
Fla.	Single	250w-F	55M	terms
Ala.	Medium	1kw-D	65M	terms
Calif.	Single	500w-D	100M	terms
W.Va.	Small	250w-F	30M	cash
S.E.	Monop.	A.M. & N.P.	150M	terms
Ky.	Single	500kw-D	70M	terms
Pa.	Sm-med.	1kw-D	100M	terms
Fla.	Medium	250w-F	155M	terms
N.C.	Medium	1kw-D	200M	terms
Gulf	Medium	1kw-D	98M	terms
Va.	Metro	1kw-D	150M	terms
S.E.	Major	5kw-D	250M	cash
Fla.	Large	250-w	250M	terms
East	Large	250w-D	450M	terms
S.W.	Large	clear	325M	terms
Ga.	Large	500w-D	75M	terms
South	Medium	VHF-TV	750M	terms

N.A.B. Convention
 Conrad Hilton, Chicago
PAUL H. CHAPMAN COMPANY
 INCORPORATED
 MEDIA BROKERS
 atlanta chicago
 1182 w. peachtree 205 w. wacker
 new york santa barbara
 1270 ave. of americas 33 w. micheltorena

how metals from
ANACONDA
 make sweet music for you

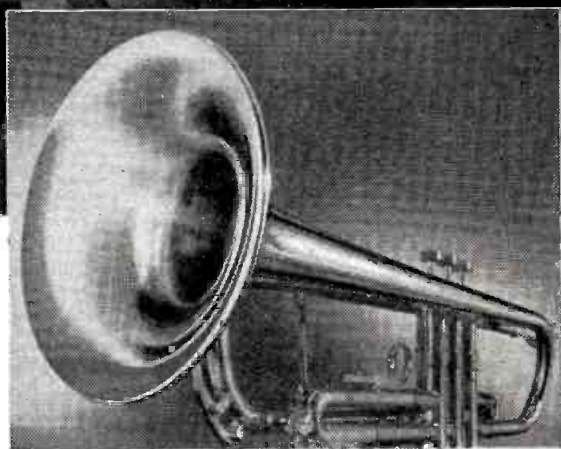

ALSO ELECTROFORMED with "Plus-4" Anodes are the bells of Conn instruments. This seamless unit-method of construction gives still further control of entire tone chamber. Bells have same density throughout—increased resonance produces live, powerful tone.

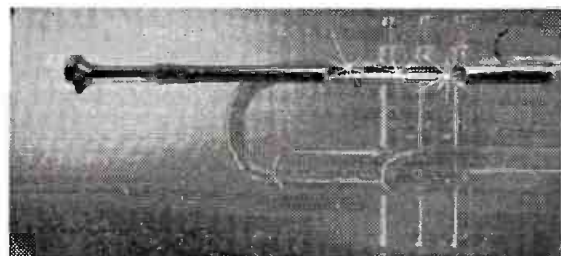

CUT-AWAY VIEW of tone chamber shows "micro-finish" of interior surface. Another cost and quality advantage: by acid-copper electro-deposition, both chamber and mouthpiece are made as a single part. They were formerly made as two pieces of sheet metal and soldered together.

True, vibrant tone of cornets, trumpets, and trombones depends largely on the inside shape and finish of their tone chambers.

A pioneer in improving tonal quality since 1875, C. G. Conn, Ltd., makes many of the wind instruments used by professional musicians as well as America's thousands of amateur bands and orchestras.

Conn has found that better tone results when mouthpipes (or tone chambers) are made of copper—built up electrolytically on removable precision forms, using "Plus-4"® Phosphorized Copper Anodes. Mouthpipes produced this way have consistent dimensional accuracy to millionths of an inch—and without the further finishing required when these particular parts were shaped from tube or sheet.

Other industries depend on "Plus-4" Anodes for the production of intricately shaped precision parts, among them microwave components of extreme interior complexity.

"Plus-4" Anodes, one of many developments Anaconda has pioneered, demonstrate what Anaconda research is always striving for in the whole nonferrous metal field: New ways to do things better—more value for less money—in home and industry.

59172 A

ANACONDA®

PRODUCERS OF: COPPER · ZINC · LEAD · ALUMINUM · SILVER
 GOLD · PLATINUM · PALLADIUM · CADMIUM · SELENIUM · TELLURIUM
 URANIUM OXIDE · MANGANESE · ARSENIC · BISMUTH · INDIUM

Martin Bass Umansky

It was purely a matter of fates and fortunes that one of Wichita's most community-conscious citizens took up abode there nearly 20 years ago as an aspiring young journalist fresh out of the University of Missouri.

Martin Umansky (born in New York City, July 18, 1916) had probably only a nodding knowledge of Kansas oil, beef and wheat when he went to the Midwest in 1936. He had attended New York public schools, junior high in Sunnyside, Queens, and was graduated from Grover Cleveland High School where he played basketball and emerged as an All-Queens center. He set his sights on journalism, became editor-in-chief on the *Missouri Student* and received a bachelor of journalism degree from the University of Missouri in 1940.

He settled in Kansas because he started hitch-hiking to find a newspaper job and simply ran out of money there.

He was hired by KANS (now KLEO) Wichita and worked a then-typical radio stint (7 a.m.-11 p.m.) editing 13 daily newscasts (announcing four of them), servicing and writing commercials for about 30 accounts and handling other assorted duties. After four years in the Army (including the European theatre) he returned to civilian life and developed and sold his own record show, *Nightcap with Martin*, as a freelance d.j.

The Switch to KAKE • With the start of KAKE radio in 1947, he became production supervisor and continued as d.j. Short of able salesmen, KAKE persuaded him to turn salesman ("I learned the excitement and challenge of selling in those days," he recalls. "It was a new and rewarding experience, and there was nothing to equal the thrill of creating a new sale.") Within two months, he was named sales manager, compiling an enviable local selling record that put him in line for the general manager's post of KAKE-TV in 1954.

KAKE-TV's physical plant (recognized as one of the finest in the country), the carefully selected staff and the station's creative programming are all a direct reflection of Mr. Umansky's personal ability.

As the third tv station on the air in the market and with network fare from ABC-TV limited, he concentrated on local personalities and fresh programs to win high audience acceptance and economic success in the four-year pull.

The market also has six radio stations and two newspapers.

No Hat in Hand • During his early radio days, Mr. Umansky became regularly disturbed by the policy of radio stations to "stand hat in hand" at the newspaper office waiting for and reporting election results. He felt this was an area in which the broadcast industry could best serve the public and those seeking office if proper use were made of the facilities available. This belief was projected into fact with KAKE-TV's first election night coverage just two weeks after going on the air in 1954. A pattern was established which has grown and expanded with each new challenge. Gone are the archaic hand operated adding machines. Instead, KAKE-TV televises an "Election Party." A team of over 200 volunteer workers rush the results to the studios where there are fast IBM electronic computers and tabulators, a continuous posting of results on giant tote boards and a huge studio buffet dinner. Most satisfying is the recognition by the public and candidates of the speed and accuracy of the returns.

Mr. Umansky believes that a network can be first in a competitive market regardless of where it stands nationally on the rating scale. He says "the local operation makes the difference. It is important that clients judge the station first-hand if they are to determine who is doing the best job in the market. Ratings should never be the sole means of judging a buy. The station that is closely integrated with the community is the one that will produce the greatest results for its advertisers."

Full News Schedule • Under Mr. Umansky's supervision the combined KAKE-AM-TV news team turns out 42 tv newscasts and 150 radio newscasts weekly and has won its spurs on various network feeds and special events coverage. Among its awards are Sigma Delta Chi, National Press Photographers Assn., American Heritage Foundation, United Cerebral Palsy and the National Safety Council.

So-called public service programs get the same highly-polished KAKE treatment as commercial shows. *Meet Your Candidate*, *Opportunity Knocks*, *Wichita Questions*, and other information-discussion shows are produced and promoted with the same enthusiasm and planning lavished on the most valued commercial venture, he notes.

The *Opportunity Knocks* program, a



The local touch is vital

departure in programming with many innovations, has as its purpose the recognition and encouragement of the American system of private enterprise. The program was the subject of an article in a November issue of *Time* magazine and resulted in calls, letters and personal visits by stations across the country and drew the attention of all three tv networks. As its most recent special event, KAKE-TV is carrying live a Roman Catholic Mass in a seven-week series which will end Easter Sunday.

Mr. Umansky credits his highly capable staff and its good sense of showmanship for the production of such shows as the *IGA Party Line*. This is a live audience participation program with close to three years of full sponsorship and a studio audience waiting list three months ahead. This gives KAKE-TV an identity with the community that is hard to beat, he notes.

Golden 'K' Network • KAKE-TV feeds programming to two independently owned tv stations, KTVC (TV) Ensign and KAYS-TV Hays, Kan. This network, which covers 70% of all Kansas tv homes, was recently named the Golden "K" Network in a contest with a producing oil well as top prize.

Mr. Umansky's interest in community affairs and keen appreciation of talent pervades his private life too. He business-manages the Wichita Community Theatre, his "main love," and serves also as president and board member. He is a board member of the Family Consultation Service, Wichita Advertising Club and other civic groups.

He married the former Mary Webb and they have two children—Barry David, 11, and Daniel Webb, 6.

Evening the weight

PRESIDENT Eisenhower wants Congress to give him the money for a full-scale study of spectrum use and management, but all that he wants he won't get.

Mr. Eisenhower also wants the power to appoint all five members of his proposed study commission. That power he will be given on the same day this Congress passes a unanimous vote of confidence in his defense program.

A spectrum study was first proposed in Congress a year ago—primarily as a means of finding out whether those frequencies assigned to government and allocated under direction of the President were being fully used. Some Congressmen thought it possible that the government was sitting on large blocks of frequencies that might be put to better use commercially.

We can't imagine Congress being persuaded that a commission whose members were all appointed by the administration would be apt to produce a report critical of the administration's use of spectrum space. Perhaps, however, there is a way to get a better balanced commission.

What about a commission composed of two members appointed by the President, one by the FCC, one by the Vice President as presiding officer of the Senate and one by the Speaker of the House? Practical politicians will say the defect in that proposal is that all those with appointive power, save the Speaker of the House, are Republicans. But we suggest that partisanship could be disposed of by the insistence that the appointees be men of outstanding stature and that their appointments be confirmed by the Senate.

At least that sort of a system would promise a commission of more widely dispersed interests than one entirely named by the President.

Section 315 travesty

SOME broadcasters and some lawyers think we are foolish to keep criticizing Section 315, the political broadcasting law.

They don't want to see the law repealed. They say that although it has its faults, it is better than no law at all.

If there were no law at all, these broadcasters would have to make editorial decisions of their own and their lawyers would have less business. These prospects are, respectively, terrifying.

Fortunately, the majority of broadcasters and the majority of communications lawyers have a higher regard for the profession of broadcasting. They would like to see Section 315 repealed so that television and radio could present political information intelligently. If they were not already members of that majority, the television broadcasters of Chicago are members now. They have just experienced a perfect illustration of the imbecilic Section 315 at work.

Lar Daly, of Chicago, is a perennial candidate who has run for everything from minor municipal office to the presidency of the U.S., with a record of consistent failure. True to his pattern, he ran for both Republican and Democratic nominations for mayor in Chicago primaries which were held two weeks ago. He lost both by spectacular margins—but not for lack of exposure to the electorate.

By FCC fiat Mr. Daly was given free time on Chicago television stations to compensate for their having broadcast newsfilm of the incumbent mayor, a Democrat running to succeed himself, and of the major Republican candidate.

CBS and ABC have petitioned the FCC for reconsideration on the grounds that the appearance of a public figure on a newscast, even though he may be a candidate, does not entitle other candidates to equal time. Whether this view prevails or the FCC's original ruling stands, the main point

of issue will not be met. The main point is that as long as Section 315 is on the books, no FCC can administer it intelligently. It is the law itself which is unintelligent, and unintelligent law cannot be converted into intelligent administration. The law may even be unconstitutional.

In some of its applications Section 315 is now on trial before the U.S. Supreme Court and, hopefully, relief will come from there. Arguments in the WDAY-TV Fargo libel case will be presented to the court the week of March 23.

The most to hope for, of course, is that the Supreme Court will throw out Section 315 on constitutional grounds. That failing, broadcasters must make their own effort to persuade the Congress to repeal the law. Nothing less than elimination of Section 315 will assure the introduction of realistic good sense into the art of political broadcasting.

Basic weapon

IT is not out of yearning for the good old days (which in most ways weren't as good as these) that we are saddened by the present lot of the radio networks.

Cold realism dictates the need for some kind of network service. We don't pretend to know whether it is possible or even desirable that networks continue in their traditional methods of operation. Perhaps the program service which sells no advertising is the answer. Perhaps not. You can get very cogent arguments on both sides of that question.

But whatever the structure or operational scheme, some form of live, interconnected service is as necessary to radio, and indeed to the national welfare, as anything we can think of—not excluding missiles and space probes. Take away the system that can instantaneously distribute a message to all parts of the nation and you have weakened the nation's defense, possibly fatally.

That is the gravest reason for maintaining networks, in some form. There are other reasons. Radio is basic to the communications habits and needs of the country. Independent stations, however imaginatively they may be programmed, cannot satisfy those needs by themselves—no more than networks and network stations can do the whole job without the independents.

Obviously, networking cannot indefinitely exist unless its existence is justified economically. We cling to the belief that from the various experiments now in progress a pattern of practical operation will develop. It has to.



Drawn for BROADCASTING by Adam Dumack

"Which of you guys says we hafta pay to watch The Masked Rider?"

Это Радио Москвы*

Careful, Moscow... Kansas City Is Listening!

Every day now, WDAF monitors and records the most pertinent comments of Radio Moscow. Kansas Citians are hearing these English-language broadcasts *direct* from the Russian capital.

Bill Leeds, shown below at his listening post, is WDAF Radio's foreign news editor. It's part of Bill's job to analyze and comment on these Radio Moscow broadcasts, to keep them in perspective with national and world news, for Heartland listeners.

Bill has just inaugurated this section of the New Sound from Signal Hill. It's his first special project since returning from a six-month hitch in London as NBC news foreign correspondent. This was part of his prize for receiving the first annual Earl Godwin Memorial Award which goes to the newsman who "demonstrates the greatest degree of initiative, enterprise, judgment and professionalism in covering a news or feature story for the NBC Radio Network".

This is the kind of news treatment WDAF Radio stands for . . . and this is the kind of man it takes to get the job done. Bill would be the first to tell you that he's just one of *twelve* full time men and women who make our news coverage what it is.

People in six states understand it, appreciate it and *listen* to it. Why not hear it for yourself? The Christal Company men have audition tapes they'll be happy to play for you any time.

**This is Radio Moscow*



WDAF

600
on the dial

SIGNAL HILL
KANSAS CITY, MO.

NBC



IN KANSAS CITY

AMERICA'S 18th MARKET



the SWING is to

KMBC-TV

• **NOW SERVING 34,142 MORE TV HOMES WITH CLASS A POWER THAN ANY OTHER TV STATION IN THE KANSAS CITY MARKET.**

Six Reasons Why the SWING is to "BUY KMBC-TV"

1. POWER: 316,000 Watts from a "Tall Tower" make KMBC-TV the most far-reaching TV station in the Kansas City Area.

2. PREFERRED PROGRAMMING of ABC network productions including a popular, new DAYTIME schedule plus the station's own local program features.

IN PROGRAM POPULARITY from 3 P. M. to 10 P. M. KMBC-TV LEADS BY 18.8% over its nearest competitor and 28.8% over the third station!

Above figures from ARB 4 wk. survey Nov. '58
Metropolitan area (Mondays thru Fridays)

3. POPULATION of 1,055,000 in Greater Kansas City area.

4. INCOME the Effective Buying Income of Greater Kansas City is more than 2 Billion, 49 Million Dollars annually!

5. RETAIL SALES of 1 Billion, 400 Million Dollars annually!

6. STABILITY "Kansas City ranks third among cities in the nation enjoying prosperous business conditions. It is the largest city showing outstanding gains over a year ago."...says Forbes Business and Finance Magazine of December 1958.

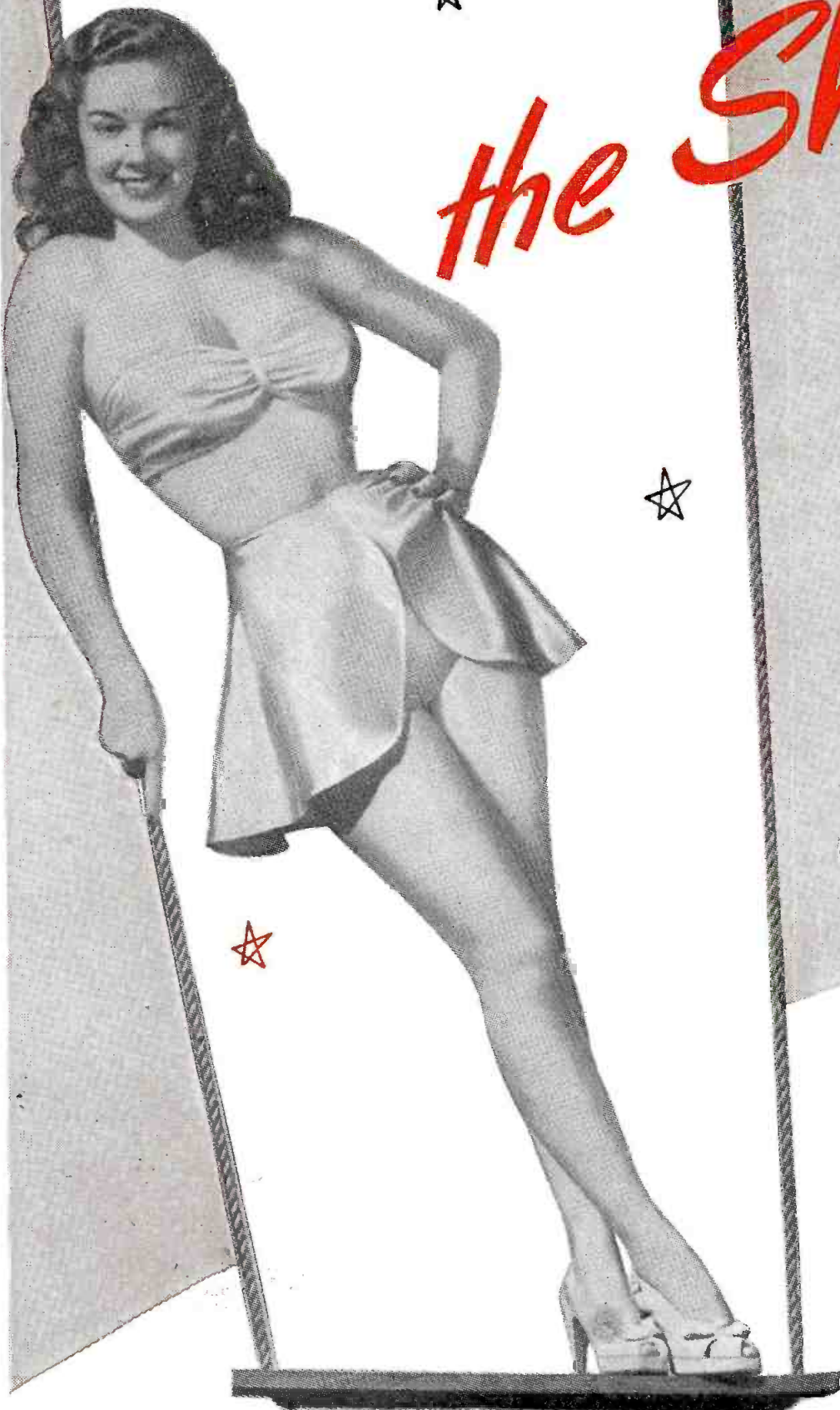

KMBC-TV
Channel 9



**PETERS. GRIFFIN,
WOODWARD, INC.**
Exclusive National Representatives

In Kansas City the Swing is to

KMBC-TV

Kansas City's Most Popular and Most Powerful TV Station

DON DAVIS, President
JOHN SCHILLING, Executive Vice President
GEORGE HIGGINS, Vice Pres. & Sales Manager
MORI GREINER, Manager of Television

*... and in Radio, it's **KMBC of Kansas City—KFRM** for the State of Kansas*