



Mullard

Technical
handbook

BOOK

2

Valves and tubes

Part 3

Gasfilled tubes

January 1971

GASFILLED TUBES

CONTENTS

SELECTION GUIDE

GENERAL SECTION

SWITCHING DIODES, REED INSERTS

VOLTAGE STABILISER & REFERENCE TUBES

COUNTING TUBES

NUMERICAL & CHARACTER INDICATING TUBES

SMALL THYRATRONS & TRIGGER TUBES

LARGE THYRATRONS

IGNITRONS

POWER RECTIFIERS

ACCESSORIES

ABRIDGED DATA FOR EARLIER TYPES & INDEX

A

B

C

D

E

F

G

H

J

K

L

The issue of the information contained in this publication does not imply any authority or licence for the utilisation of any patented feature.

'Mullard' is the trademark of Mullard Limited and is registered in most of the principal countries of the world.

© Mullard Limited January 1971

Book 2 comprises the following parts—

Part 1 Receiving valves, television picture tubes.

Part 2 Electro-optical devices, radiation detectors.

Part 3 Gasfilled tubes.

Part 4 Transmitting and industrial heating tubes.

Part 5 Microwave tubes and components.

Made and printed in England by WIGHTMAN & CO. LTD



BOOK 2 (Part 3)

VALVES AND TUBES

Gasfilled tubes

Issued by

CENTRAL TECHNICAL SERVICES

**MULLARD LTD., MULLARD HOUSE, TORRINGTON PLACE,
LONDON, WC1E 7HD**

Telephone 01-580 6633

Telex: 264341

DATA HANDBOOK SYSTEM

The Mullard data handbook system is made up of three sets of Books, each comprising several parts.

The three sets of books, easily identifiable by the colours of their covers, are as follows:

Book 1	(blue)	Semiconductor Devices and Integrated Circuits
Book 2	(orange)	Valves and Tubes
Book 3	(green)	Passive Components, Materials, and Assemblies

THESE BOOKS REPLACE THE OLD SYSTEM OF LOOSE-LEAF HANDBOOKS.

New editions will be issued at approximately yearly intervals.

The data contained in these books are as accurate and up to date as it is reasonably possible to make them. It must however be understood that no guarantee can be given here regarding the availability of the various devices or that their specifications may not be changed before the next edition is published.

The devices on which full data are given in these books are those around which we would recommend equipment to be designed. Where appropriate, other types no longer recommended for new equipment designs, but generally available for equipment production are listed separately with abridged data. Data sheets for these types may be obtained on request. Older devices on which data may still be obtained on request are also included in the index of the appropriate part of each Book.

Information regarding price and availability of devices must be obtained from our authorised agents or from our representatives.

SELECTION GUIDE

SELECTION GUIDE—BOOK 2, PART 3

Section B

SWITCHING DIODES, REED INSERTS

Switching Diodes

Description	Type No.
Subminiature neon filled switching diode with a large and stable difference between ignition and maintaining voltage intended for low speed switching and counting in combination with a cadmium sulphide photoconductive cell detecting the light output	ZA1002
Subminiature neon filled diode for use as a visual indicator to display the state of a low voltage switching transistor	ZA1004

Reed insert

Description	Type No.
Miniature magnetic dry reed switch in a gas filled capsule primarily designed for telephone exchanges. Double ended type, single pole single throw with normally open contacts.	RI-12

Section C

VOLTAGE STABILISER & REFERENCE TUBES

Voltage stabiliser tubes

Nominal maintaining voltage (V)	Burning current (mA)		Max. regulation voltage (V)	Type No.
	max.	min.		
78	60	2	8	{ 75C1 M8225 90C1
90	40	1	14	
108	30	5	3.5	
150	15	5	5	{ 150B2 M8163
150	30	5	6	
150	30	5	5	{ 150C2 150C4 M8223

Note: Types commencing with 'M' are special quality types.

Section C (continued)

Voltage reference tubes

Maintaining voltage (V)	Preferred current (mA)	Base	Type No.
80·1 to 81·9	3	Flying lead	ZZ1000
83 to 84·5	4·5	B7G	83A1
83 to 87	6	B7G	{ 85A2
84 to 88	2	Flying lead	{ M8098
			{ M8190

Note: Types commencing with 'M' are special quality types.

Section D

COUNTING TUBES

Description	Max. stepping speed (kHz)	Type No.
End viewing decade tube with cathodes 0 to 9 brought out separately	5	{ Z504S
		{ ZM1070
Similar tube with higher speed	50	{ Z505S
		{ ZM1060

Section E

NUMERICAL & CHARACTER INDICATING TUBES

Viewing direction	Characters displayed	Character height (mm)	Base	Type No.
Side	0 to 9 and left decimal pt.	14	For printed circuit grid	ZM1000 *ZM1000R
Side	+,-,~,X,Y,Z	14	For printed circuit grid	ZM1001 *ZM1001R
Side	0 to 9	13	Flying lead	*ZM1080 ZM1082
Side	-, +, ~	10.5	Flying lead	*ZM1081 ZM1083
End	0 to 9	15.5	Rectangular	ZM1162
Side	0 to 9	15.5	Flying lead	*ZM1170 ZM1172
Side	0 to 9 and left decimal pt.	15.5	Flying lead	*ZM1174 ZM1175
Side	0 to 9 and right decimal pt.	15.5	Flying lead	*ZM1176 ZM1177
Side	0 to 9	15.5	Flying lead (inverted)	*ZM1230 ZM1232
Side	0 to 9, decimal point, punctuation mark. Multiple display of 14 numerals in line.	10	2 × 17 pin	ZM1200

Note: Types marked * incorporate a red filter.

Section F

SMALL THYRATRONS & TRIGGER TUBES

Trigger Tubes

Description	Nominal trigger ignition voltage (V)	Type No.
Triode suitable for stand-by operation on 117V a.c. supply Close tolerance tube with stable characteristics for d.c. operation	80	Z900T
	132	Z803U

Small tetrode thyratrons

Max. $I_k(av)$ (mA)	Max. peak anode voltage		Base	Type No.
	Forward	Inverse		
25	500	500	B7G	{ EN92 EN91 M8204 EN32
100	650	1300	B7G	
300	650	1300	Octal	

Note: M8204 is a special quality type.

Section G

LARGE THYRATRONS

Inert gas triode thyratrons

Max. $I_k(av)$ (A)	Max. peak anode voltage		Base	Type No.
	Forward	Inverse		
2.5	1500	1500	B4G	{ ZT1011 XR1-1600A XR1-3200A XR1-6400A
3.2	1500	1500	B4D	
6.4	1500	1500	B4D	

Section G (continued)

Mercury vapour triode thyratrons

Max. $I_k(av)$ (A)	Max. peak anode voltage		Base	Type No.
	Forward	Inverse		
2.5	1000	1500	B4G	XG1-2500
6.4	2500	2500	B4D	XG2-6400

Section H

IGNITRONS

International size	2 tubes connected in inverse parallel on 600V supply for single phase welding		Type No.
	Max. demand (kVA)	Max. average current (A)	
B	200	56	ZX1051
	600	30.2	
C	400	140	ZX1052
	1200	75.6	
D	800	355	ZX1053
	2400	192	
Up-rated B	400	70	ZX1061
	1200	38	
Up-rated C	760	180	ZX1062
	2280	110	

Section J

POWER RECTIFIERS

D.C. output for 2 tubes, single phase full-wave (A)	Max. peak inverse voltage (kV)	Filling	Base	Type No.
0.5	6.5	Mercury-vapour	British 4-pin	RG1-240A
0.5	10	Mercury-vapour	Medium Edison Screw	RG3-250
0.5	10	Mercury-vapour	B4G	RG3-250A
0.5 1.0	10 5	Inert gas	B4G	RR3-250
2.5	13	Mercury-vapour	Goliath Edison Screw	RG3-1250
2.5	10	Inert gas	B4F	RR3-1250
2.5	13	Inert gas	Goliath Edison Screw	*RR3-1250A
2.5	13	Inert gas	Goliath Edison Screw	*RR3-1250B
2.5	20	Mercury-vapour	Goliath Edison Screw	RG4-1250
6 10	15 2.5	Mercury-vapour	B4D	RG4-3000

*See data for different filament currents between these 2 types.

GENERAL SECTION

A



LIST OF SYMBOLS

These symbols are based on British Standard Specification No. 1409 : 1950, " Letter Symbols for Electronic Valves ".

1. SYMBOLS FOR ELECTRODES

Anode a	Fluorescent Screen or Target... .. t
Cathode k	External Metallisation M
Grid g	Internal Metallisation m
Heater h	Deflector Electrodes x or y
Filament f	Internal Shield s
Beam Plates bp	Resonator Res

NOTE 1. In valves having more than one grid, the grids are distinguished by numbers— g_1, g_2 , etc., g_1 being the grid nearest the cathode.

NOTE 2. In multiple valves, electrodes of the different sections may be distinguished by adding one of the following letters:

Diode d	Hexode	} h
Triode... .. t	Heptode	
Tetrode q	Octode	
Pentode p	Rectifier r	

Thus, the grid of the triode section of a triode-hexode is denoted by g_t .

NOTE 3. Two or more similar electrodes which cannot be distinguished by any of the above means may be denoted by adding one or more primes to indicate to which electrode system the electrode forms a part.

Thus, the anode of the first diode in a double diode valve is denoted a' .

2. SYMBOLS FOR ELECTRIC MAGNITUDES

Voltagcs

Direct Voltage V
Alternating Voltage (r.m.s.) $V_{r.m.s.}$
Alternating Voltage (mean) V_{av}
Alternating Voltage (peak) V_{pk}
Peak Inverse Voltage ... P.I.V.

Current

Direct Current I
Alternating Current (r.m.s.) $I_{r.m.s.}$
Alternating Current (mean) I_{av}
Alternating Current (peak) I_{pk}
No Signal Current I_0

Miscellaneous

Frequency f	Anode Efficiency η
Amplification Factor ... μ	Sensitivity S
Mutual Conductance ... g_m	Brightness B
Conversion Conductance... g_c	Temperature T
Distortion D	Time t



LIST OF SYMBOLS

	Inside Valve	Outside Valve
Resistance	r	R
Reactance	x	X
Impedance	z	Z
Admittance	y	Y
Mutual Inductance	m	M
Capacitance	c	C
Capacitance at Working Temperature	c_w	
Power	p	P

3. AUXILIARY SYMBOLS

Battery or other source of supply	b
Inverse (Voltage or Current)	inv
Ignition (Voltage)	ign
Extinction (Voltage)	ext
No Signal	o
Input	in
Output	out
Total	tot
Centre Tap	ct

4. COMPLEX SYMBOLS

Symbols in Sections 1 and 3 above may be used as subscripts to symbols in Section 2, to denote such magnitudes as Anode Current, Grid Volts, etc., e.g.:-

Anode Voltage ...	V_a	Anode Current (A.C. r.m.s.)	$I_{a(r.m.s.)}$
Control-Grid Voltage	V_{g1}	No Signal Anode Current ...	$I_{a(o)}$
Anode Supply Voltage	$V_{a(b)}$	Control-Grid Current ...	I_{g1}
Filament Voltage ...	V_f	Total Distortion ...	D_{tot}
Heater Voltage ...	V_h	3rd Harmonic Distortion ...	D_3
Anode Dissipation ...	P_a	Equivalent Noise	
Output Power ...	P_{out}	Resistance ...	R_{eq}
Drive Power ...	P_{drive}	Limiting Resistor ...	R_{lim}
Anode Current (D.C.)	I_a	Cathode Bias Resistor	R_k
		Internal	External
Anode Resistance	r_a		R_a
Insulation Resistance (heater to cathode)	r_{h-k}		
Resistance between Control-Grid and Cathode	r_{g1-k}		R_{g1-k}
Capacitance (cold)—			
Anode to all other electrodes			C_{a-all}
Anode to control-grid			C_{a-g1}
Control-grid to cathode at working temperature			$C_{g1-k(w)}$
Control-grid to all other electrodes except anode (Input Capacitance)			C_{in}
Anode to all other electrodes except control-grid (Output Capacitance)			C_{out}
Inner Amplification Factor			μ_{g1-gs}



A new comprehensive type nomenclature system for transmitting and industrial valves and tubes has recently been introduced. In general, new Mullard devices will have type numbers in the 'new system', earlier devices will retain numbers in one of the 'old systems'.

NEW SYSTEM

The type number for valves or tubes used primarily in 'professional' applications (e.g. transmitters, navigation or communication equipment, industrial applications) consists of two letters followed by four figures. This system does not apply to receiving-type valves.

The first letter indicates a fundamental characteristic of the device:

- X—photosensitive tube
- Y—vacuum valve or tube (except photodevices)
- Z—gasfilled valve or tube (except photodevices)

The second letter indicates the construction or application of the device:

- A—diode
- C—trigger tube
- D—triode or double triode
- G—miscellaneous
- H—travelling wave tube
- J—magnetron
- K—klystron
- L—tetrode, pentode, double tetrode or double pentode
- M—cold cathode indicator or counter tube
- P—photomultiplier tube or radiation counter tube
- Q—camera tube
- T—thyatron
- X—ignitron, image intensifier or image converter
- Y—rectifier
- Z—voltage stabiliser or reference tube

The group of four figures is a serial number. The last figure is 0 for basic types; variants of the basic type are indicated by the figures 1 to 9.

Example

YL1030 Transmitting double tetrode

Receiving-type valves

The type number of receiving valves used primarily in 'professional' applications is similar to that for normal receiving valves except that there are four figures instead of two or three. The letters and first figure have the same significance as in the receiving valve type numbering system.

Example

EC1000 Triode for professional applications, special base, 6.3V heater

OLD SYSTEMS

Transmitting and large industrial valves and tubes

The type number generally consists of two or more letters followed by two sets of figures. These symbols provide information concerning the principal uses and ratings of the valves according to the following code.

The first letter indicates the general functional class of valve:

- B—backward wave tube
- J—magnetron
- K—klystron
- L—travelling wave tube
- M—l.f. amplifying or modulator triode
- P—r.f. power pentode
- Q—r.f. power tetrode
- R—power rectifier
- T—r.f. power triode
- X—large thyatron. (All hydrogen thyatrons and other thyatrons having max. mean anode current of 500mA or more.)

Note.—For valves having dual electrode systems, the code letters for both systems are used, e.g. 'QQ' for a double tetrode.

The second letter indicates some structural property in each class of valve:

- (a) For transmitting valves and vacuum rectifiers, the type of cathode.
- (b) For thyatrons and gasfilled rectifiers, the type of gas present.
- (c) For microwave devices, a basic structural feature.

- A—outputs up to 1W
- B—outputs of 1W and over
- D—disc-seal construction
- G—mercury-vapour filled
- H—hydrogen-filled
- N—external magnet required (in magnetrons)
- P—packaged construction (in magnetrons)
- R—inert-gas filled
- S—reflex (single resonator) construction (in klystrons)
- T—multiple resonator construction (in klystrons)
- V—indirectly heated oxide-coated cathode
- X—directly heated tungsten filament
- Y—directly heated thoriated-tungsten filament
- Z—directly heated oxide-coated filament

} In backward wave and travelling wave tubes

The third letter

Transmitting valves with a silica envelope have a third letter 'S'.
Thyatrons with a shield grid (tetrode construction) have a third letter 'Q'.
Microwave devices that are tunable have a third letter 'T'.



The first group of figures, immediately following the letters, indicates:

- (a) The approximate anode voltage in kV for transmitting valves and rectifiers:

Thus 05 represents $0.5\text{kV} = 500\text{V}$
2 represents $2\text{kV} = 2000\text{V}$

For valves intended for pulse operation this figure is the peak anode voltage in kV.

- (b) The approximate peak inverse voltage in kV for thyratrons.
(c) The approximate frequency of operation in Gc/s for magnetrons, klystrons, backward wave tubes and travelling wave tubes:

Thus 9 represents $9\text{Gc/s} = 9000\text{Mc/s}$.

The second group of figures indicates:

- (a) For transmitting valves, the maximum permissible anode dissipation in W. For dissipations of 10kW or more the dissipation in kW is given.
(b) For transmitting valves primarily intended for pulse operation this group is prefixed by the letter 'P' and the figures indicate the maximum peak current in amps.
(c) For backward wave and travelling wave tubes, the output power in mW or W depending on the second letter ('A' or 'B').
(d) For magnetrons, the pulse power output in kW.
(e) For klystrons, the power output in mW.
(f) For rectifiers, the approximate rectifier output current in mA.
(g) For thyratrons, the approximate maximum permissible mean anode current in mA. This group consists of at least three digits, the first one being 0 if the current is between 10 and 100mA. For currents of 10A or more the current in amps is given.

Thus 045 represents 45mA
6400 represents $6400\text{mA} = 6.4\text{A}$
12 represents 12A

A final letter occasionally follows the second group of figures. This is usually a serial letter to denote a particular design or development. Types designed for water cooling are indicated by the letter 'W' and if these types also have a forced air-cooled version this is indicated by the letter 'A'.

Examples

- JP9-7 Magnetron with packaged construction for operation at a frequency of approximately 9000Mc/s with pulse power output of 7kW .
KS9-20 Klystron of reflex construction for operation at a frequency of approximately 9000Mc/s with a power output of 20mW .
LA4-250 Travelling wave tube for operation at a frequency of approximately 4000Mc/s with an output of 250mW .

- QQV03-10 Double beam tetrode with indirectly heated oxide-coated cathode. Rated to work at 300V and to dissipate 10W continuously (5W at each anode).
- QV20-P18 R.F. power tetrode with indirectly heated oxide-coated cathode. Designed for pulse operation with maximum peak anode voltage of 20kV and maximum peak anode current of 18A.
- RG3-250 Mercury-vapour rectifier rated to work at 3kV and to give a maximum rectified output of 250mA.
- XG5-500 Mercury-vapour thyratron having a rated peak inverse voltage of approximately 5kV and a maximum permissible mean anode current of approximately 500mA.

Cold cathode tubes

The type number for cold cathode tubes (excluding photocells and stabilisers) consists of one letter followed by a group of three figures which are followed by a second letter.

The first letter is always Z, indicating a cold cathode gasfilled tube.

The first figure indicates the type of base, the significance of the figure being the same as for Mullard receiving valves.

The second and third figures are serial numbers indicating a particular design or development.

The second letter indicates the function of the tube:

- A—amplifier tube (continuous operation)
- B—binary counter of switching tube
- C—multistage counter tube
- E—electrometer trigger or amplifier tube
- G—gating tube
- M—indicator (metering) tube
- S—multistage switching tube
- T—3-electrode trigger tube
- U—4-electrode trigger tube
- W—5-electrode trigger tube

Example

Z803U 4-electrode cold cathode trigger tube with B9A base.

SWITCHING DIODES REED INSERTS

B



TENTATIVE DATA

QUICK REFERENCE DATA

Miniature dry reed switch with gold plated contacts, hermetically sealed in a gas-filled glass capsule. Double ended type, single pole, single throw with normally open contacts, containing two magnetically actuated reeds, operated by an electromagnet, permanent magnet or a combination of both. Intended for use in telephone equipment and other applications requiring exceptional reliability.

This switch conforms to Post Office specification T4547.

Contacts	Single pole, single throw, normally open	
Maximum switched power	5.0	W
Switched voltage	50	V
Switched current	100	mA

CHARACTERISTICS (using standard test coil)

The standard test coil consists of 5000 turns of 42 s.w.g. enamelled copper wire on a coil former of 25.4mm winding length with a core diameter of 8.75mm.

Non-operate

Minimum breakdown voltage	1.0	kV
Minimum initial insulation resistance (at 100V)	10 ⁵	MΩ
Capacitance without test coil	0.7	pF
with earthed test coil	0.35	pF
Maximum non-operate ampere turns	30	At

Operate

Minimum operate ampere turns	58	At
Operating time, including bounce (measured at 80At)	average	0.6 ms
	max.	1.0 ms
Maximum switched current	100	mA

Hold

Minimum hold ampere turns	27	At
Maximum current through closed contacts	1.0	A
Initial contact resistance (measured at 40At)	min.	60 mΩ
	max.	150 mΩ

CHARACTERISTICS (continued)

Release

Maximum release ampere turns	15	At
Maximum release time (measured from the instant of switching off 80At energisation)	50	μ s
Maximum switched current	100	mA
Maximum switched power	5.0	W

LIFE EXPECTANCY AND RELIABILITY

End of life is assumed to be reached when:

- the contact resistance exceeds 1Ω for no load conditions or 2.5Ω for loaded conditions, or
- the release time exceeds 1.5ms (latching or contact sticking)

No load conditions

Life expectancy $> 10^7$ operations with a failure rate $< 5.5 \times 10^{-9}$ at 90% confidence level.

Loaded conditions (see note below)

Life expectancy $> 5 \times 10^6$ operations with a failure rate $< 10^{-8}$ at 90% confidence level.

Reliability

Life expectancy $> 5 \times 10^6$ operations with a failure rate $< 8.5 \times 10^{-9}$ under the following conditions:

Capacitive loading resulting in a peak current of 1.4A, $i_1/i_2 = 1.4$, $t_1 = 80$ to 100ns (see fig.1). Nominal switched voltage = 50V, nominal switched current = 100mA.

Note

If inductive loads are to be interrupted, contact protection is recommended (diode or RC network). Higher loads may be switched if reduced life expectancy and reliability are acceptable. The manufacturer should be consulted before doing this.

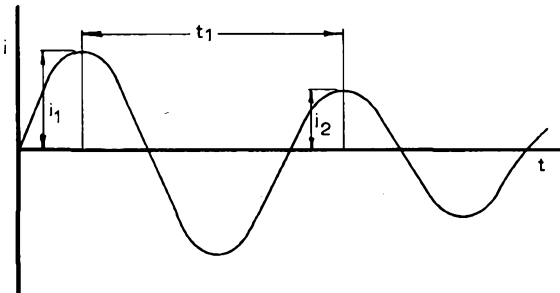

Fig. 1



RATING (ABSOLUTE MAXIMUM SYSTEM)

(See also 'Life expectancy and reliability')

Maximum switched power	5.0	W
Maximum switched voltage	65	V
Maximum switched current	100	mA
Maximum surge current (for 100ns max.)	1.5	A
T _{amb} min.	-55	°C
T _{amb} max.	+100	°C

SHOCK AND VIBRATION

Shock

50g acceleration for 11ms, caused by an impact perpendicular to the flat sides of the reeds. Such an impact will not cause an open contact to close (no magnetic field present), or a contact closed by 80At energisation to open.

Vibration

Frequency range 50 to 1500Hz, 20g acceleration caused by a force perpendicular to the flat sides of the reeds. Such a vibration will not cause an open contact to close (no magnetic field present), or a contact closed by 80At energisation to open.

SOLDERING RECOMMENDATIONS

The switch may be soldered directly into the circuit but heat conducted to the glass-to-metal seals should be kept to a minimum by the use of a thermal shunt.

Dip soldering is permitted to a minimum of 4mm from the seals at a solder temperature of 240°C for a maximum of 10 seconds.

Solderability is tested according to I.E.C.* publication 68-2-20, test T solder globule method.

MOUNTING POSITION

Any. The leads should not be bent nearer than 2mm from the glass-to-metal seals, and stress on the glass-to-metal seals should be avoided. The robustness of the terminations is tested according to I.E.C.* publication 68-2-21, tests Ua (load 3kg), Ub (load 1kg, 4 bends) and Uc. Care must be taken to prevent stray magnetic fields from influencing the operating and measuring conditions.

*International Electrotechnical Commission.



MECHANICAL DATA

Contacts	Single pole, single throw, normally open	
Contact material	gold	
Terminal finish	tinned	
Resonant frequency of single reed (approx.)	1650	Hz
Weight (approx.)	0.6	g

OUTLINE DRAWING

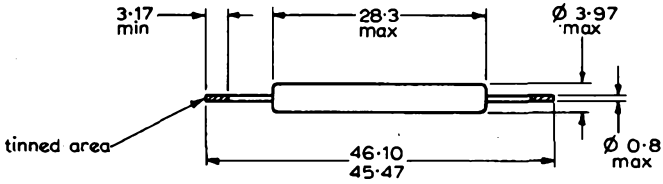

All dimensions in mm

QUICK REFERENCE DATA

Cold cathode, neon filled subminiature switching diode with a large and stable difference between ignition and maintaining voltage. Intended for low speed switching and counting in combination with cadmium sulphide photoconductive cells.

Ignition voltage	170	V
Maintaining voltage	109	V
Cathode current	3.5	mA

CHARACTERISTICS AND RANGE VALUES FOR EQUIPMENT DESIGN

Measured at an ambient temperature of 25°C unless otherwise stated. The values given state the range over which the tube will operate, both initially and during life. The characteristics are independent of ambient light.

NON-CONDUCTION

Maximum anode-to-cathode voltage below which no ignition will occur	163	V
Minimum anode-to-cathode leakage resistance	300	MΩ

IGNITION

Minimum anode-to-cathode voltage to ensure ignition	178	V
Typical maximum individual variation during life	5	V
Maximum temperature coefficient of ignition voltage averaged over the range -55°C to +70°C	±15	mV/degC
Average ignition delay	See pages 5 and 6	



CONDUCTION

Cathode current

Minimum average during any conduction period	2.2	mA
Maximum average (maximum averaging time=1s)	4.5	mA
Maximum peak	50	mA

Maintaining voltage

See page 4

Typical maximum individual variation of maintaining voltage during life

-4 to +2 V

Typical maximum temperature coefficient of maintaining voltage averaged over the range -55°C to +70°C

±15 mV/degC

Typical rise in bulb temperature

10 degC/mA

Minimum light output (see note 1)

20 lux/mA

Typical maximum variation of light output

-3 %/1000h

EXTINCTION

Typical minimum RC components to ensure self extinction at anode supply voltage of 250V for different values of current limiting resistor R_{lim} .

R_{lim}	0	1	10	47	100	kΩ
R_a	1	1	1.5	2	3	MΩ
C	5	22	22	22	22	nF

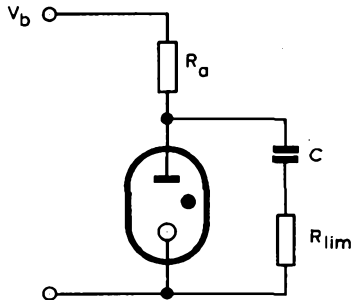

D357

LIFE EXPECTANCY

The conditions given in the section Characteristics and Range Values for Equipment Design will apply for a life period of at least 15000 hours operation (i.e. conducting). A life of 3000 hours may be expected when the tube is operated within the preferred current range or 2.4×10^6 ignitions discharging a capacitor of maximum value $16 \mu\text{F}$ with a suitable series impedance to limit the peak current to 50mA maximum.



COLD CATHODE SWITCHING AND LIGHT DIODE

ZAI002

RATINGS (ABSOLUTE MAXIMUM SYSTEM)

Maximum negative peak anode voltage	200	V
Cathode current (see note 2)		
minimum (continuous)	2.2	mA
maximum average (maximum averaging time = 1s)	4.5	mA
maximum peak	50	mA
Bulb temperature		
maximum	70	°C
minimum	-55	°C
Altitude, maximum	24	Km

SHOCK AND VIBRATION RESISTANCE

These conditions are used solely to assess the mechanical quality of the tube. The tube should not be continuously operated under these conditions.

Shock resistance

500g, applied by an NRL impact machine for electronic devices. Five blows of the hammer lifted over an angle of 30° in each of four positions of the tube.

Vibration resistance

2.5g(pk) applied for 32 hours at a frequency of 50Hz in each of three directions of the tube.

NOTES

1. The light output is measured over an angle of 70° at a distance of 3.6mm from the tube axis at a normal to the anode cylinder. A Standard Weston Cell adapted to eye sensitivity is used.
Because the light emission of the neon discharge is mainly contained in the red region, the illumination resistance of a cadmium sulphide cell will be 1.5 to 2 times lower than for irradiation by a 2700K incandescent light source. The exact conversion factor will depend upon the type of cadmium sulphide cell used.
2. Under conditions such as extreme supply voltage variation, a minimum of 1mA and maximum of 5mA is permitted for short current excursions. These must never exceed 24 hours.
3. The leads are tinned and may be dip-soldered to a minimum of 5mm from the seals at a solder temperature of 240°C for a maximum of 10 seconds. The tube may be soldered directly into the circuit, but heat conduction to the glass-to-metal seals should be kept to a minimum by the use of a thermal shunt.
4. Care should be taken not to bend the leads nearer than 1.5mm from the seals.
5. Due to the small physical size of the device, code number stamping has not been possible, therefore for recognition purposes a red dot has been painted on the side of the envelope.



DIMENSIONS AND CONNECTIONS

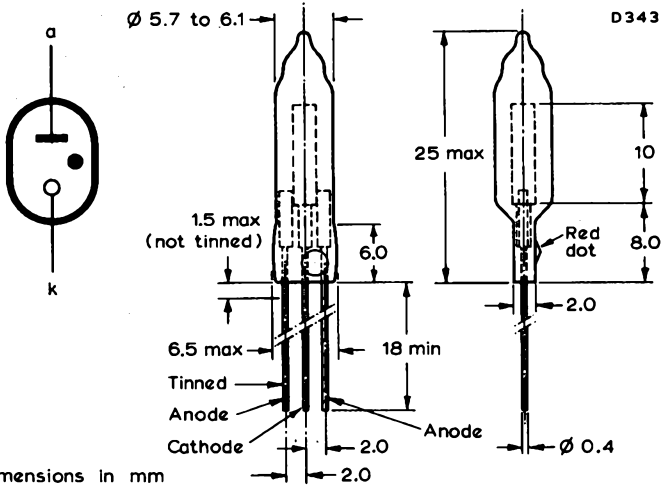

All dimensions in mm

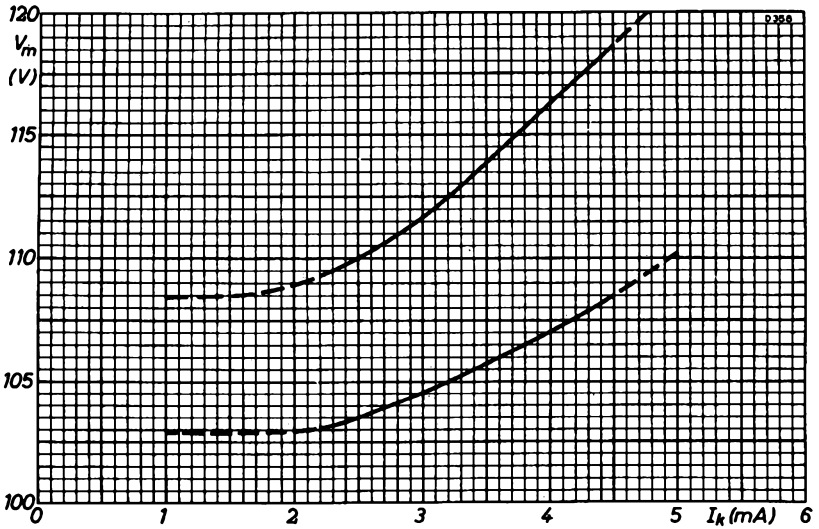

ANODE-TO-CATHODE MAINTAINING VOLTAGE
PLOTTED AGAINST CATHODE CURRENT



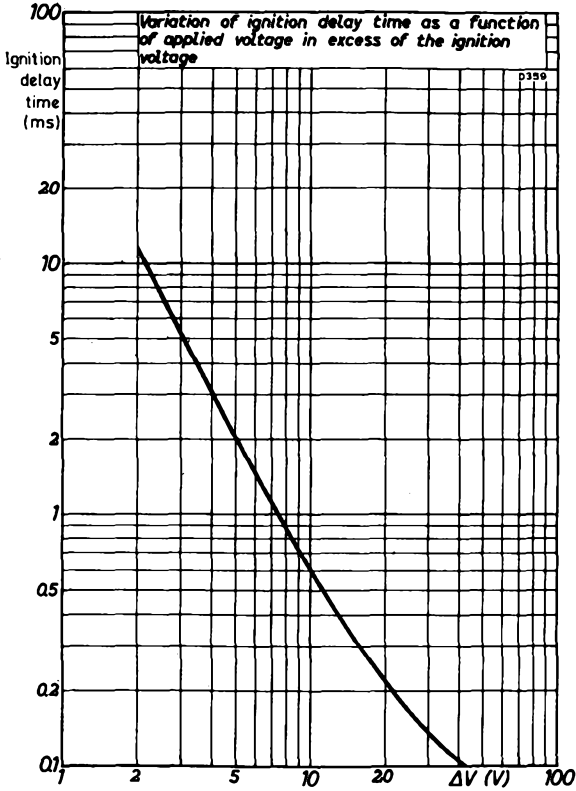

IGNITION DELAY TIME PLOTTED AGAINST
APPLIED VOLTAGE MINUS IGNITION VOLTAGE



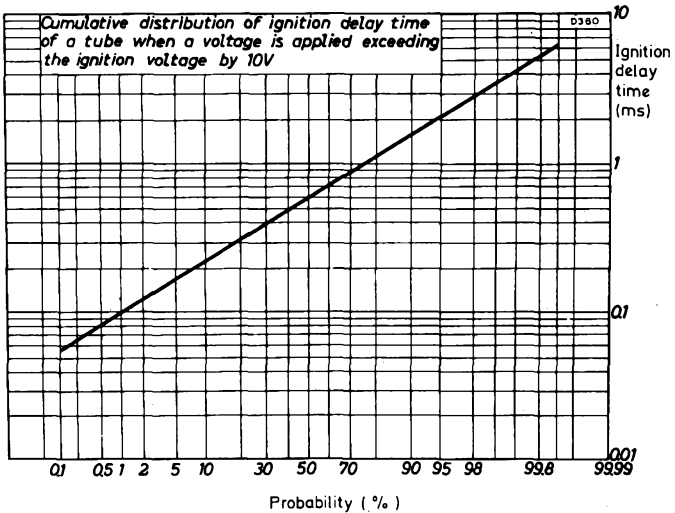

CUMULATIVE DISTRIBUTION OF IGNITION DELAY TIME



QUICK REFERENCE DATA

Neon filled sub-miniature diode for use as a visual indicator to display the state of a low voltage switching transistor. Operation of this tube is independent of ambient illumination.

Ignition voltage	90	V
Extinction voltage	83.5	V
Cathode current	1.0	mA
Light output at $I_k = 1\text{mA}$	60	lux

CHARACTERISTICS AND RANGE VALUES FOR EQUIPMENT DESIGN

At an ambient temperature of 20 to 30°C unless otherwise stated.

The values given state the range over which the tube will operate both initially and during life. No allowance has been made for supply voltage and component variations.

NON-CONDUCTION

Maximum anode-to-cathode voltage below which no ignition will occur	88	V
Minimum anode-to-cathode leakage resistance	300	MΩ

IGNITION

D. C. Conditions

Minimum anode-to-cathode voltage to ensure ignition (see note 1)	93	V
Individual variation during life	< 2.5	V
Typical maximum temperature coefficient of ignition voltage	-15	mV/degC
Average ignition delay ($V_a = 93\text{V}$; see note 2)	0.05	s

A. C. Conditions

Ignition voltage (see note 3)		
maximum	101	V
minimum	96.5	V

CONDUCTION

Maintaining voltage (see curve on page 5 and note 4)

maximum	$86 + 4.25 I_k$	V
minimum	$83 + 2.5 I_k$	V
individual variation during life	1.5	V
Typical maximum temperature coefficient of maintaining voltage	-15	mV/degC
Typical rise in bulb temperature	10	degC/mA
Minimum light output (see notes 5 and 6)	30	lux/mA ←
Individual minimum light output (see notes 5 and 6) measured over an angle of 70°, averaged over the full circumference of the tube	60	lux/mA ←

EXTINCTION

Minimum anode-to-cathode voltage below which all tubes extinguish See note 1 and page 5

LIFE EXPECTANCY

The conditions given in the section Characteristics and Range values for Equipment Design will apply for a life period of at least 10 000 hours operation (i.e. conducting).

A life of 25 000 hours may be expected when the tube is operated at a continuous cathode current of 1mA and a bulb temperature of 35°C.

RATINGS (ABSOLUTE MAXIMUM SYSTEM)

Maximum negative anode voltage	70	V
Cathode current		
minimum (continuous)	0.1	mA
maximum (maximum averaging time = 5s)	2.5	mA
peak	3.0	mA
Bulb temperature		
maximum	$70^{\circ}\text{C} + 10\text{degC/mA}$	
minimum	-55	°C

NOTES

1. The ignition and extinction voltage depression (hysteresis) is 0.75V/mA max. measured 50ms after extinction.
2. Due to the statistical nature of ignition, values of delay time $\geq 1\text{s}$ may occur.
3. When the tube is operated from a full wave rectified unsmoothed supply, the tube ignites on the rising edge of the half-sinewave. Owing to ignition delay, the values quoted are greater than the d.c. voltage required for ignition. These values apply when the tube is used with a 220V^{+10%}_{-15%}, 50 to 60Hz, full wave rectified, unsmoothed supply, assuming conduction during the previous half-cycle of the mains so that residual ionisation minimises the ignition delay.

NOTES

4. I_k is in milliamps and is valid over the range 0.1 to 3.0mA. The preferred operating range is 0.4 to 2.0mA.
5. The light output at a distance of 3.6mm from the tube axis at a normal ← to the anode cylinder is measured with a standard Weston cell adapted to eye sensitivity. Because the emission of the neon discharge is mainly contained in the red region the illumination resistance of a cadmium sulphide cell will be 1.5 to 2 times lower than for irradiation by a 2700K incandescent light source. The exact conversion factor depends on the type of cadmium sulphide cell used.
6. At least 90% of the tubes will meet the figures stated. ←
7. The leads are tinned and may be dip-soldered to a minimum of 5mm from the seals at a solder temperature of 240°C for a maximum of 10 seconds. The tube may be soldered directly into the circuit, but heat conducted to the glass-to-metal seals should be kept to a minimum by the use of a thermal shunt.
8. Care should be taken not to bend the leads nearer than 1.5mm from the seals. If the tube is held in position by the leads only, connection of both anode leads is recommended.

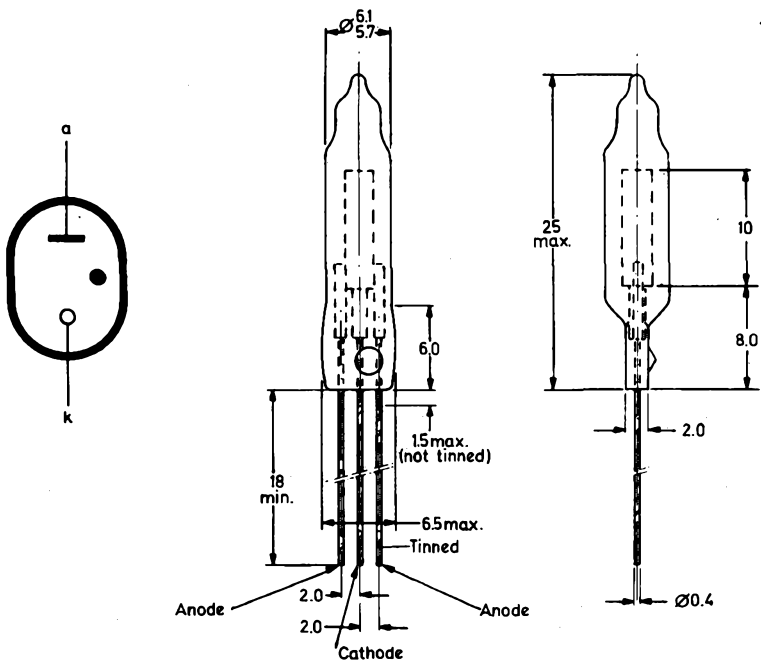

All dimensions in mm

61787

Due to the small physical size of the device, code number stamping has not been possible, therefore for recognition purposes a yellow dot has been painted on the side of the envelope.

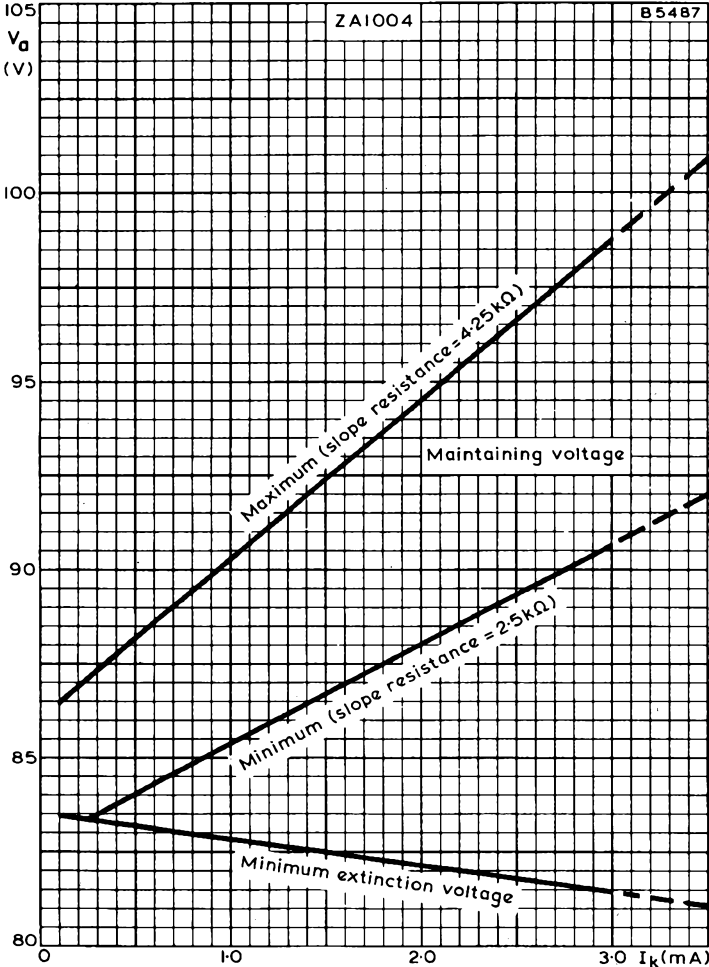

ANODE VOLTAGE CHARACTERISTICS

VOLTAGE STABILISER AND REFERENCE TUBES

C



Ignition Voltage (starting voltage, striking voltage)

The minimum voltage which must be applied between the anode and cathode of a tube in order to initiate a glow discharge.

Burning Voltage (maintaining voltage)

The voltage between anode and cathode when a glow discharge has been established and the tube is passing current within its specified limits.

Regulation Voltage

The change in the burning voltage when the current is changed from the maximum to the minimum value.

Incremental Resistance

The slope of the burning voltage against burning current characteristic at some specified tube current.

Temperature Coefficient of Burning Voltage

The rate of change of burning voltage with tube ambient temperature for a fixed tube current.

Stability

The change in burning voltage with life caused by changes in tube characteristics. This excludes changes due to variations in tube current, temperature, etc.

1. INTRODUCTION

A VOLTAGE STABILISER tube is a glow discharge tube designed to have a maintaining voltage which is substantially constant over the current operating range.

A VOLTAGE REFERENCE tube is a glow discharge tube designed to have a constant maintaining voltage at fixed values of current and temperature.

2. DATA PRESENTATION

In general, the data is presented under the following four main headings: (a) quick reference data, (b) characteristics and range values for equipment design (c) absolute maximum rating system (d) life information. The data given under each heading is described below and more detailed information is given in the later sections. Specific information is also given in the data sheets for the different tubes.

2.1 QUICK REFERENCE DATA

This section contains the nominal values of the main characteristics of the tubes to allow rapid comparison with the characteristics of other tubes. The items usually given for quick reference are: anode maintaining voltage, cathode current range and any special features.

2.2. CHARACTERISTICS AND RANGE VALUES FOR EQUIPMENT DESIGN

Information given in this section is intended as a basis for circuit design and normally indicates the range over which the tube will operate both initially and during life. No allowance is made for supply voltage and component variations. There is no objection to operation outside the stated ranges,

provided no absolute maximum rating is thereby exceeded but no guarantee is given on the performance of the tube in a circuit under these conditions. However, once the tube is again operated within the stipulated range values, the performance is again guaranteed.

2.3 ABSOLUTE MAXIMUM RATINGS

This section states the absolute maximum ratings as defined by the I.E.C. as follows:

Absolute maximum ratings are limiting values of operating and environmental conditions applicable to any tube of a specified type as defined by its published data, and should not be exceeded under the worst probable conditions.

These values are chosen by the tube manufacturer to provide acceptable serviceability of the tube, taking no responsibility for equipment variations, environmental conditions due to variations in the characteristics of the tube under consideration and all other electron devices in the equipment. The equipment manufacturer should design so that initially and throughout life no absolute maximum value for the intended service is exceeded with a tube under the worst probable operating conditions with respect to supply voltage variations, equipment component variation, equipment control adjustment, load variations, signal variation, environmental conditions, and variations in characteristics of the tube under consideration and of all other devices in the equipment.

2.4 LIFE INFORMATION

In this section, the general pattern of life behaviour is given when the life behaviour is of particular interest, the pattern is described fully.



3. TERMINOLOGY

3.1. MINIMUM VOLTAGE FOR IGNITION

The ignition voltage is the lowest d.c. potential which when applied initiates a self-sustaining discharge.

The data normally states the minimum voltage for ignition. Although some tubes may ignite at a somewhat lower voltage, the specified voltage should always be applied to ensure ignition of all tubes.

3.2. IGNITION DELAY TIME

The ignition delay time is the interval between the application of the ignition voltage across the anode-cathode gap and the establishment of a self-sustaining discharge in that gap.

Certain tubes may be affected by ambient light and in darkness the delay time may increase.

3.3. MAINTAINING VOLTAGE

The maintaining voltage is the d.c. voltage between the anode and cathode with the tube conducting. It is measured under the conditions stated in the data and will vary with current, temperature and time. When a noise signal is present the average value of the composite voltage is taken.

3.4. TEMPERATURE COEFFICIENT OF MAINTAINING VOLTAGE

The temperature coefficient is the change in maintaining voltage at a specified current that occurs for 1°C change in bulb temperature. The value quoted is normally an average value which applies over the temperature range stated.



3.5. REGULATION VOLTAGE

The regulation voltage is the difference between the maintaining voltages at two different cathode currents and is normally measured over the full current range of the tube, at the temperature specified.

3.6 INCREMENTAL RESISTANCE

The incremental resistance is the slope of the characteristic of anode maintaining voltage plotted against cathode current and is measured at a specified current and temperature.

3.7 NOISE ON MAINTAINING VOLTAGE

Noise voltages arise from several different sources, and are defined as follows:

3.7.1. Random noise

A voltage random in nature and similar to thermal noise. It is normally quoted as r.m.s. voltage measured over a specific frequency range.

3.7.2. Oscillation noise

A voltage generated within the tube and having a major component at one frequency. It occurs only in some types of tubes and then only over a restricted current range.

3.7.3. Vibration noise

A voltage resulting from a sinusoidal vibration of the tube. Where this information is given it is for guidance only and it is not recommended that the tube be operated under these conditions for long periods.



3.7.4. Microphonic noise

A voltage caused by mechanical excitation due to a single blow.

3.8. VOLTAGE JUMPS

A voltage jump is an abrupt change or discontinuity in maintaining voltage during operation and is not due to a negative incremental resistance. The jump may occur either during life under constant operating conditions or as the current or temperature is varied over the operating range.

3.9. NEGATIVE ANODE VOLTAGE

Under no circumstances should reference tubes or stabilisers be allowed to pass reverse current. To ensure this, the specified maximum inverse peak voltage applied to the tube should never be exceeded.

3.10. CATHODE CURRENT

3.10.1 Maximum cathode current for continuous operation

The maximum value of cathode current for a tube is that instantaneous value which should not be exceeded during the normal operation of the tube. When the tube is initially switched on, this value may be exceeded (see maximum surge current).

3.10.2 Maximum surge current (starting current)

The maximum surge current is the peak current which may safely be passed through the tube. The maximum permissible value, together with duration and frequency of occurrence, is normally given. When a value is not given, the current should be restricted to 2.5 times the maximum continuous



current and should not be allowed to occur for more than approximately 30 seconds in each 8 hours use. The surge current should be limited as much as possible where maximum stability is required.

3.10.3 Minimum cathode current

The minimum cathode current is the continuous current below which satisfactory operation of the tube is not guaranteed. Operation below this current may also result in deterioration of the subsequent performance of the tube.

3.10.4 Preferred operating current

For reference tubes a preferred operating current is also quoted. Wherever possible this value of current should be adopted and maintained constant because it represents a condition which is not only free from discontinuities in characteristics but also has maximum stability during life. If the current is changed during life and then returned to its original value, the high order of stability may be impaired for some time.

3.11. BULB TEMPERATURE

The bulb temperature is taken as the temperature caused by internal or external effects of the hottest part of the tube envelope.

To maintain a reliable performance the bulb temperature should be kept as close to the room temperature as possible.



4. MECHANICAL CONSIDERATIONS

4.1. MOUNTING POSITION

Unless otherwise stated in the published data, tubes can be mounted in any position.

4.2. TUBE SOCKETS

Detailed drawings of pin spacing, diameter and length are given in BS448: 1953 "Electronic-Valve Bases, Caps and Holders".

When a tube holder is wired for a tube having a glass base integral with the glass envelope, a metallic dummy base should be fitted to prevent the displacement of the contacts, otherwise possible displacement can cause damage to the pins when the tube is inserted. Pins marked I.C. on the base diagram in the data sheet may have been used for connections within the tube. The corresponding contacts on the tube holder must be left free and not used as anchoring points for wiring.

4.3. TUBES WITH FLEXIBLE LEADS

Tubes with flexible leads do not normally employ plug-in tube sockets. Usually the tube is held in position by a form of clamp or strap fitted round the envelope. If the tube is mounted in this way, it is important that:

- a) Undue stress should not be placed on the flexible leads.
- b) The bulb temperature should not exceed the specified value.
- c) If the tube is secured by means of a metal clamp the clamp should be isolated.

Direct soldered connections to the leads must be at least 5mm from the seal and any bending of the leads must be at least the



GENERAL OPERATIONAL RECOMMENDATIONS

REFERENCE TUBES STABILISER AND

specified distance from the seal. Care should be taken during soldering to ensure that the glass temperature at the seal is not allowed to rise excessively. One simple precaution is to clamp a thermal shunt on the wire between the glass and the point being soldered.

4.4. DIMENSIONS

Only the dimensions given on the data sheets should be used in the design of equipment. Dimensions taken from individual tubes should never be used for this purpose.

5. CIRCUIT CONSIDERATIONS

5.1. BASIC CIRCUIT

A simple circuit is shown in Fig.1. To ensure that the tube will ignite and operate under the correct current conditions, the following conditions must be satisfied:

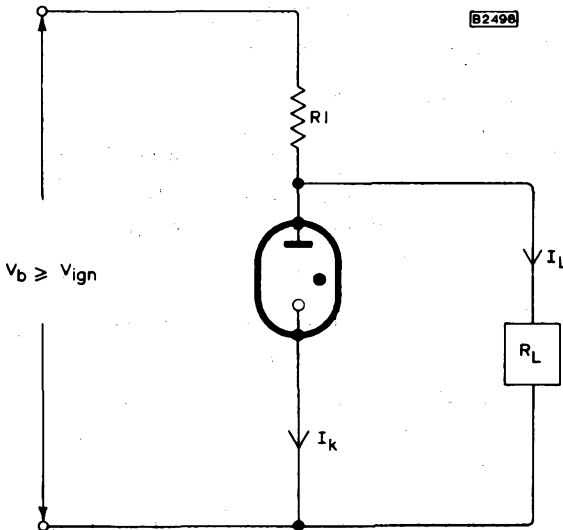

FIG.1



$$R_1 < \frac{V_b \text{ min} - V_m \text{ max}}{I_k \text{ min} + I_L \text{ max}} \cdot \frac{1}{1 + \frac{p}{100}}$$

$$R_1 > \frac{V_b \text{ max} - V_m \text{ min}}{I_k \text{ max} + I_L \text{ min}} \cdot \frac{1}{1 - \frac{p}{100}}$$

$$R_1 < R_L \left(\frac{V_b \text{ min}}{V_{\text{ign}} \text{ max}} - 1 \right) \cdot \frac{1}{1 + \frac{p}{100}}$$

Where

V_b = applied supply voltage.

V_m = tube maintain-
ing voltage.

I_k = tube current.

I_L = load current.

p = % tolerance of R_1 .

R_L = load resistance

For reference tubes the same fundamental conditions apply but the specified preferred operating conditions (3.10.4) should also be taken into consideration.

5.2 SERIES OPERATION

It is possible to operate several tubes of this class in a series configuration providing the current range falls within the limits of all tubes.

The circuit shown in Fig. 2 illustrates one method of ensuring that all tubes ignite. With this arrangement the voltage necessary for ignition is equal to $V_{\text{ign}}(V1) + V_m(V2) + V_m(V3)$ where

V_{ign} = ignition voltage of the associated tube.

V_m = maintaining voltage of the associated tube.

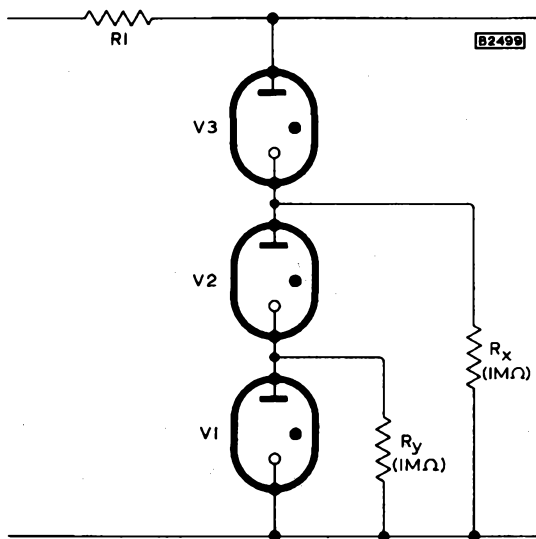

FIG.2

If the resistors R_y and R_x cannot be considered as being large compared to the tube load, the conditions applied to each tube must be considered in its own merits as an extension of the basic circuit given in 5.1.

5.3. PARALLEL OPERATION

It is not advisable to operate stabilisers in parallel with each other because of the difficulty of providing the correct current distribution.

5.4. SHUNT CAPACITOR

The impedance of stabiliser and reference tubes is low at zero frequency (d.c.), but rises as the frequency approaches the upper end of the audio frequency range. However, the output impedance can be maintained at a constant value by a capacitor connected in parallel with the tube. Both the value and the

circuit position of the capacitor are important design factors determined primarily by the function of the tube .

Stabilising tubes may have voltage jumps in the current range and it is essential that a capacitor is connected directly across the tube, otherwise it is possible for voltage jumps to generate oscillations .

In reference tubes operated at the preferred working current, voltage jumps are either very small or non-existent. When a capacitor is connected across the tube a resistor must be connected in series with the capacitor if effects due to the resonance of the capacitor with the effective inductance of the tube are to be avoided.

The value of the resistor should approximately equal the incremental resistance of the tube . The value of the capacitor should be such that the impedance of the capacitor and resistor in series approximately equals the effective impedance of the tube at the frequency at which the effective tube impedance is 1.4 times the d.c. value . This combination will maintain the effective output impedance of the tube reasonably constant up to the frequency at which the capacitor becomes predominantly inductive .

These general notes include definitions and general test procedures. They should be read in conjunction with the data sheets for Special Quality Tubes. Where reference should be made to a specific note, this is indicated on the data sheet by an index number, e.g. Group Quality Level?

1. **Limiting Values.** The limiting values quoted on the data sheets are absolute ratings. Absolute maximum ratings are limiting values of operating and environmental conditions applicable to any tube of a specified type as defined by its published data, and should not be exceeded under the worst probable conditions.

These values are chosen by the tube manufacturer to provide acceptable serviceability of the tube, taking no responsibility for equipment variations, environmental variations, and the effects of change in operating conditions due to variations in the characteristics of the tube under consideration, and of all other electron devices in the equipment.

The equipment manufacturer should design so that initially and throughout life no absolute maximum value for the intended service is exceeded with any tube under the worst probable operating conditions with respect to supply variations, equipment control adjustment, load variations, signal variation, environmental conditions and variations in characteristics of the valve under consideration and of all other devices in the equipment.

The life expectancy of a tube may be appreciably reduced if the maximum ratings are exceeded. Furthermore, in gas-filled tubes certain limiting values, such as the minimum voltage necessary for ignition must be met completely or the tube may show a total failure to operate at any time after installation.

In the interests of reliability the bulb temperature should always be kept as low as possible.

2. **The A.Q.L. (Acceptable quality level)** is the limit below which the average level of defectives is controlled.
3. **Maximum and minimum values for the individuals** are the limits to which tubes are tested.

-
4. *Maximum and minimum for lot average* are the limits between which the average value of the characteristic of a lot or batch is controlled.
 5. *Lot standard deviation* is the standard deviation of a lot or batch.
 6. *Bogey value* is the target value.
 7. *Group quality level*. This is the A.Q.L. over a whole group of tests.
Sub-group quality level. The A.Q.L. over a number of tests which do not constitute a complete group.
 8. *Glass envelope strain test*.
 - (A) This test is carried out on a sampling basis and consists of completely submerging the tubes in boiling water at a temperature between 97 and 100°C for 15 seconds and then immediately plunging them in ice cold water for 5 seconds. The tubes are then examined for glass cracks.
 - (B) This test is carried out on a sampling basis and consists of completely submerging the tubes in boiling water not less than 85°C for 15 seconds and then immediately plunging them in ice cold water not more than 5°C for 5 seconds. The tubes are then examined for glass cracks.
 9. *Base strain test*. This test is carried out on a sampling basis and consists of forcing the pins of the tubes over specified cones and then completely submerging the tubes and cones in boiling water at a temperature between 97 and 100°C for 10 seconds. The tubes and cones are allowed to cool to room temperature before examining for glass cracks.
 10. *Lead fragility test*.
 - (A) This test is carried out on a sampling basis and consists of holding the tubes vertically and having a 1-lb weight freely suspended from the lead under test. The tubes are inclined slowly so as to bend the weighted lead through 45°, back to 45° in the other direction, back to 45° in the first direction and finally back to the vertical, the entire action taking place in one vertical plane. The tubes are examined for cracks and broken leads.

-
- (B) This test is carried out on a sampling basis and consists of holding the tubes vertically and having a 1-lb weight freely suspended from the lead under test. The tubes are inclined slowly so as to bend the weighted lead through 90° and return it to the vertical, the entire action taking place in one vertical plane. This cycle is repeated for the number of times shown on the data sheet. The tubes are examined for broken leads.
11. This test is carried out on a sampling basis under the conditions detailed in the data.
 12. *Shock test.* This test is carried out on a sampling basis and subjects the tubes to 5 blows of the specified acceleration in each of 4 directions.
 13. *Inoperatives.* An Inoperative is defined as a tube having an open or short circuit electrode, an air leak or a broken pin.

SPECIAL QUALITY VOLTAGE REFERENCE TUBE

M8098

85V gas-filled reference tube for use in equipment where mechanical vibration and shocks are unavoidable.

This data should be read in conjunction with the GENERAL OPERATIONAL RECOMMENDATIONS - VOLTAGE STABILISER AND REFERENCE TUBES and the GENERAL NOTES - SPECIAL QUALITY VOLTAGE STABILISER AND REFERENCE TUBES which precede this section of the handbook; the index numbers are used to indicate where reference should be made to a specific note.

LIMITING VALUES¹ (absolute ratings)

Minimum voltage necessary for ignition (Note 1)	115	V
Cathode current		
Maximum	10	mA
Minimum	1.0	mA
Maximum bulb temperature (Note 2)		
During operation (Note 3)	90	°C
During storage and stand by	70	°C
Minimum ambient temperature	-55	°C
Maximum negative anode voltage	75	V
Maximum starting current (Note 4)	40	mA
Maximum vibrational acceleration	}	For details see Test specification
Maximum shock (short duration)		

PREFERRED OPERATING CONDITION

Cathode current	6.0	mA
-----------------	-----	----

CHARACTERISTICS (at preferred operating condition, 20 to 30°C, Note 5)

Initial values

Maintaining voltage (variation from tube to tube)	83 to 87	V
Maximum jump voltage (1 to 10mA)	100	mV
Typical noise voltage (30c/s to 10kc/s)	60	(pk) μV (r.m.s.)
Incremental resistance		
Maximum	450	Ω
Average	300	Ω

Life performance

Maximum variation of maintaining voltage at 25°C		
For continuous operation at preferred current		
0 to 300 hours	0.26	V
300 to 1000 hours	0.17	V
Typical variation of maintaining voltage per 1000 hours, after the first 1000 hours	0.09	V

SHORT-TERM STABILITY

Maximum short-term variation of maintaining voltage for any 8 hour period after the first 100 hours life will be better than 0.01% provided there is an initial warming-up period of 3 minutes.

Maximum short-term (100 hours max.) variation of maintaining voltage after the first 300 hours of life is 0.1%.

In order to avoid voltage variations due to temperature fluctuations it will in general be sufficient to draught shield the tube.

NOTES

1. This value holds good over life in light or darkness. In total darkness an ignition delay of up to approx. 5 seconds may occur.
2. During conduction the bulb temperature is approximately 10°C above ambient temperature.
3. If the tube is to be operated with a bulb temperature above 70°C the cathode current should not be less than 6.0mA.
4. To be restricted for long life to 60 seconds once or twice in every 8 hours use.
5. Equilibrium conditions are reached within 3 minutes.

6317

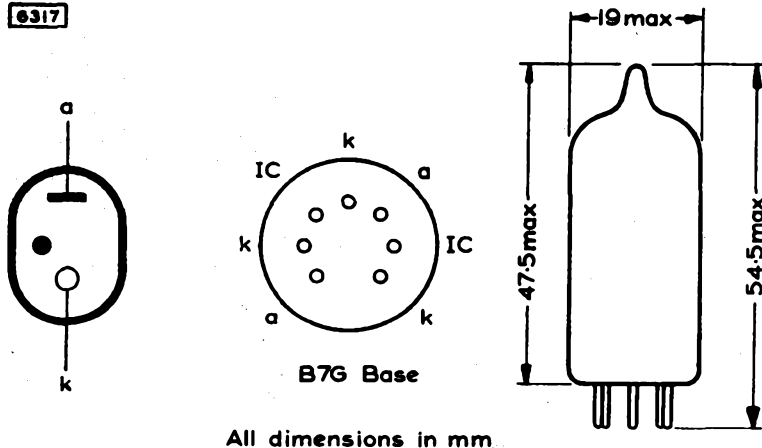

All dimensions in mm.

The bulb and base dimensions of this tube are in accordance with BS448, Section B7G.

TEST CONDITIONS (unless otherwise specified)

R_{11m}	$I_{burning}$
(k Ω)	(mA)
5.0	6.0

After initial warming-up period of 3 minutes at burning current of 6mA.

TESTS

GROUP A

	A.Q.L. ² (%)	Individuals ³ Min. Max.	
Ignition voltage. Illumination 5 to 50 ft. cd.	†	— 115	V
Maintaining voltage	†	83 87	V
Change in maintaining voltage for burning current change from 5.8 to 6.2mA ..	†	— 180	mV
Voltage jumps. Burning current varies from 1 to 10mA. $R_a = 500\Omega$..	†	— 100	mV (pk-pk)
Oscillation. Burning current varies from 1 to 10mA. $R_a = 500\Omega$	†	— 5	mV (pk-pk)
Microphonic noise. $R_a = 500\Omega$	†	— 15	mV (pk-pk)
Leakage current. Supply voltage = 55V, $R_a = 1M\Omega$	†	— 5	μ A

†This test is carried out on a 100% basis.

GROUP B

Ignition voltage in darkness, after 24 hours in darkness	2.5	— 115	V
Change in maintaining voltage for burning current change from 1 to 10mA ..	2.5	— 4.0	V





M8098

SPECIAL QUALITY VOLTAGE
REFERENCE TUBE

TESTS

GROUP C

Glass strain test.^{8A}. No applied voltage
Base strain test.⁹. No applied voltage

A.Q.L.²
(%)

Individuals³
Min. Max.

Resonance search

Vibrated at 2g over frequency range specified.

Frequency Range	A.Q.L. (%)	Min. Individuals	Max. Individuals	Measurement
25 to 500c/s	2.5	—	5	mV (r.m.s.)
500 to 2500c/s	2.5	—	15	mV (r.m.s.)

Fatigue¹¹

No applied voltage, 5g min. peak acceleration, f = 170c/s for 33 hours in each of 3 mutually perpendicular planes

Post fatigue tests

Test Description	A.Q.L. (%)	Min. Individuals	Max. Individuals	Measurement
Change in maintaining voltage	2.5	—	±0.7	V
Microphonic noise as in Group A	2.5	—	30	mV (pk-pk)
Sub-group quality level ⁷	4.0	—	—	—

Shock¹²

No applied voltage, 500g

Post shock tests

Test Description	A.Q.L. (%)	Min. Individuals	Max. Individuals	Measurement
Change in maintaining voltage	2.5	—	±0.7	V
Microphonic noise as in Group A	2.5	—	30	mV (pk-pk)
Sub-group quality level ⁷	4.0	—	—	—



GROUP D

*Life test*¹¹

Burning current = 6mA continuous

Life test end points. 1000 hours

Inoperatives ¹³	2.5	—	—	
Ignition voltage	2.5	—	115	V
Change in maintaining voltage	2.5	—	±0.4	V
Change in maintaining voltage for burning current change from 5.8 to 6.2mA									2.5	—	180	mV

GROUP E

Tubes are held for 28 days and retested for

Inoperatives ¹³	0.5	—	—	
Ignition voltage	0.5	—	115	V
Maintaining voltage	0.5	83	87	V
Change in maintaining voltage for burning current change from 5.8 to 6.2mA									0.5	—	180	mV



M8098

SPECIAL QUALITY VOLTAGE
REFERENCE TUBE

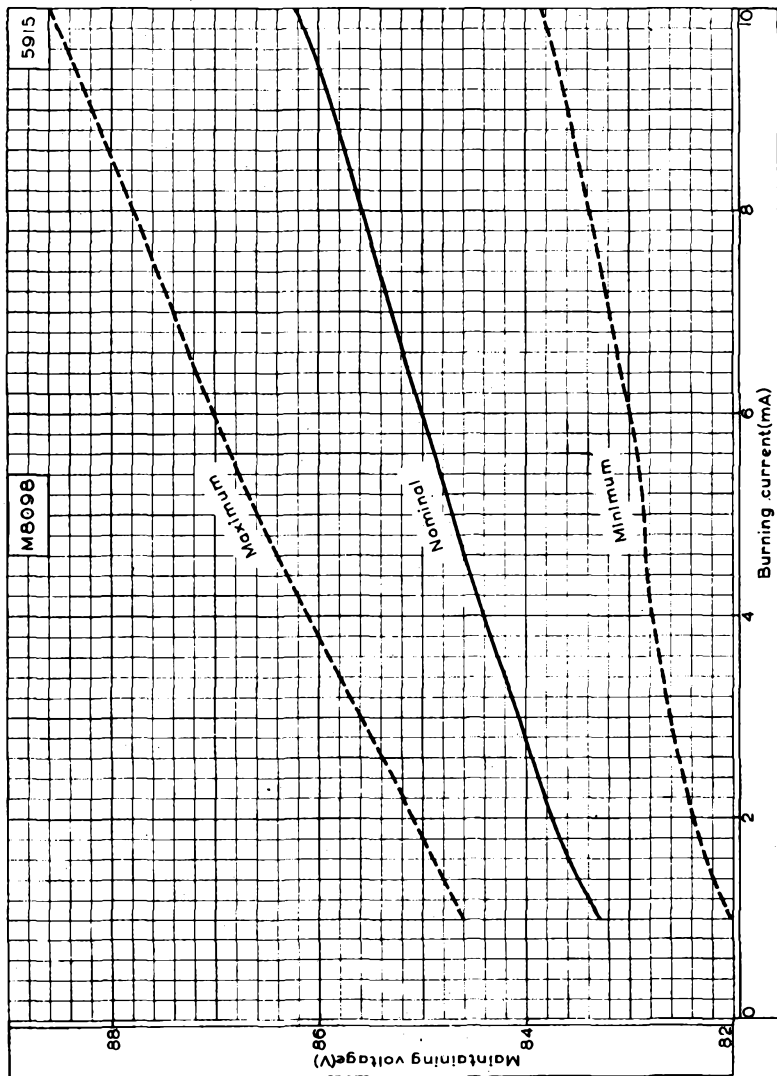

MAINTAINING VOLTAGE PLOTTED AGAINST BURNING CURRENT



SPECIAL QUALITY STABILISING TUBE

M8163

Special Quality 150 volt gas-filled voltage stabiliser for use in equipment where mechanical vibration and shocks are unavoidable.

This data should be read in conjunction with the GENERAL OPERATIONAL RECOMMENDATIONS — VOLTAGE STABILISER AND REFERENCE LEVEL TUBES and the GENERAL NOTES—SPECIAL QUALITY VOLTAGE STABILISER AND REFERENCE TUBES which precede this section of the handbook. The index numbers are used to indicate where reference should be made to a specific note.

LIMITING VALUES¹ (absolute ratings)

Minimum voltage necessary for ignition (Note 1)	180	V
Cathode current		
Maximum	15	mA
Minimum	5	mA
Maximum negative anode voltage	130	V
*Maximum vibrational acceleration	2.5	g
*Maximum shock (short duration)	500	g
*See page D3		

CHARACTERISTICS at room temperature (Note 2)

Initial values

Maintaining voltage at $I_a = 10\text{mA}$		
Maximum	154	V
Minimum	146	V
Cathode current above which the incremental resistance is positive	5	mA
Incremental resistance (approx.) at $I_a = 10\text{mA}$	250	Ω
Temperature coefficient of maintaining voltage (approx.) at $I_a = 10\text{mA}$	0.007	%/°C (10mV/°C)
Voltage jumps ($R_a = 2k\Omega$)		
Typical maximum over the current range 10 to 15mA	75	mV
Maximum over the current range 5 to 15mA	250	mV
Increase in maintaining voltage as cathode current is increased over the range 5 to 15mA (regulation)		
Maximum	5.0	V
Typical	< 4.0	V

Life performance

At a continuous cathode current of 10mA, and at room temperature

Limits of variations of maintaining voltage		
In 1000hrs. (maximum)	± 1.0	%
In 10,000hrs. (typical)	± 2.0	%
Typical regulation after 10,000 hours	< 6.0	V

NOTES

- This value covers operation in light or darkness. In total darkness an ignition delay of up to about 300ms may occur.
- Thermal equilibrium is reached within 3 minutes of igniting the tube.



TEST CONDITIONS (unless otherwise stated)

R_a (k Ω)	I_a (mA)
5	10

After initial warming-up period of 3 minutes at cathode current of 10mA.

TESTS	AQL ² (%)	Individuals ³		
		Min.	Max.	
GROUP A				
Leakage current (Supply voltage = 55V, $R_a = 1M\Omega$) *	—	5	—	μA
Ignition time (illumination 5 to 50 lm/ft ²) $V_b = 180V$ *	—	300	—	ms
*This test is carried out on a 100% basis.				
GROUP B				
Maintaining voltage	0.65	146	154	V
Change in maintaining voltage for cathode current change from 5 to 15mA	0.65	—	5	V
Microphonic noise	0.65	—	30	mV (pk-pk)
GROUP C				
Voltage jumps. Cathode current varied from 15 to 5mA $R_a = 2k\Omega$	2.5	—	250	mV
Ignition time ($V_b = 180V$) In complete darkness after 24 hours in darkness	2.5	—	300	ms

GROUP D	AQL ²	Individuals ³		
		Min.	Max.	
Glass strain ^{8A}	6.5	—	—	
Base strain ⁹	6.5	—	—	
Resonance search, vibrated at 2g over the frequency range specified				
20 to 400c/s	2.5	—	4	mV (pk-pk)
400 to 2000c/s	2.5	—	20	mV (pk-pk)

Fatigue¹¹

No applied voltage. 5g min. peak acceleration $f = 170\text{c/s}$ for 33hrs. in each of 3 mutually perpendicular planes.

Post fatigue tests

Ignition time (illumination 5 to 50 lm/ft ²) $V_b = 180\text{V}$	2.5	—	300	ms
Change in maintaining voltage	2.5	—	± 1.5	V
Change in maintaining voltage for cathode current change from 15 to 5mA	2.5	—	5.5	V

Shock¹²

No applied voltage 500g

Post shock tests

Ignition time (illumination 5 to 50 lm/ft ²) $V_b = 180\text{V}$	2.5	—	300	ms
Change in maintaining voltage	2.5	—	± 1.5	V
Change in maintaining voltage for cathode current change from 15 to 5mA	2.5	—	5.5	V



GROUP E	AQL ²	Individuals ³	
	(%)	Min.	Max.
Life test¹¹			
Cathode current = 10mA continuous			
Life test end points 500hrs.			
Inoperatives ¹³	2.5	—	—
Ignition time (illumination 5 to 50 lm/ft ²) V _b = 180V	2.5	—	300 ms
Change in maintaining voltage	2.5	—	±1.5 V
Change in maintaining voltage for cathode current change from 15 to 5mA	2.5	—	5.5 V
Sub-group quality level ⁷	6.5	—	—
Life test end points 1000hrs.			
Inoperatives ¹³	4.0	—	—
Ignition time (illumination 5 to 50 lm/ft ²) V _b = 180V	4.0	—	300 ms
Change in maintaining voltage	4.0	—	±1.5 V
Change in maintaining voltage for cathode current change from 15 to 5mA	—	—	5.5 V
Sub-group quality level ⁷	10	—	—
GROUP F			
Tubes are held for 28 days and retested for			
Inoperatives ¹³	0.5	—	—
Ignition time (illumination 5 to 50 lm/ft ²) V _b = 180V	0.5	—	300 ms
Maintaining voltage	—	146	154 V

4716

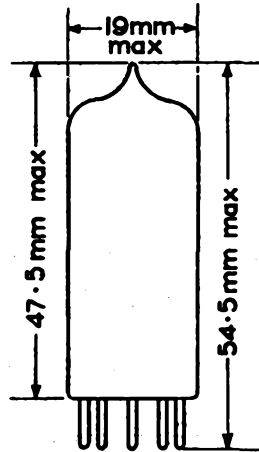
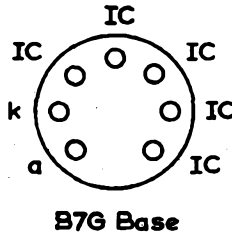
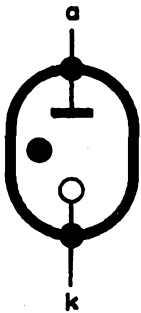

The bulb and base dimensions of this valve are in accordance with BS448, Section B7G

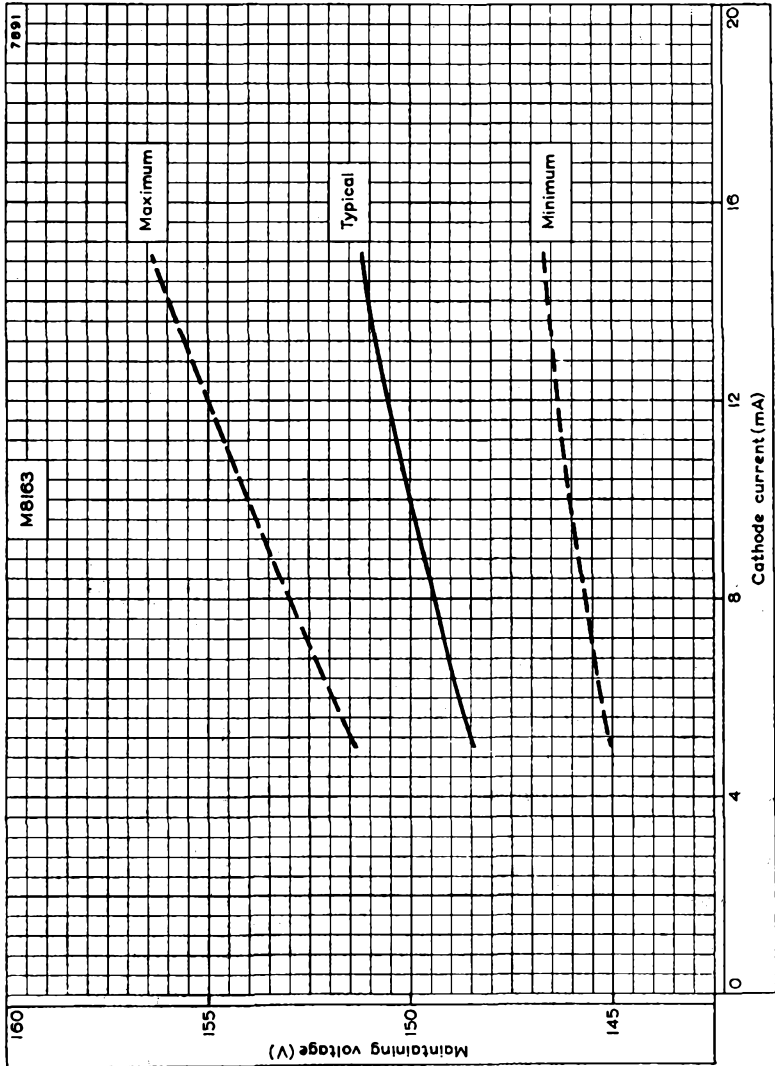

MAINTAINING VOLTAGE PLOTTED AGAINST CATHODE CURRENT

SPECIAL QUALITY SUBMINIATURE VOLTAGE REFERENCE TUBE

M8190

Special quality 85V subminiature gas-filled voltage reference tube for use in equipment where mechanical vibration and shocks are unavoidable and where statistically controlled major electrical characteristics are required.

This data should be read in conjunction with the GENERAL NOTES—SPECIAL QUALITY VOLTAGE STABILISER & REFERENCE TUBES which precede this section of the handbook, and the index numbers are used to indicate where reference should be made to a specific note.

ABSOLUTE MAXIMUM RATINGS¹

*Minimum voltage necessary for ignition	125	V
Cathode current		
Maximum	3.5	mA
Minimum	0.5	mA
Maximum negative anode voltage	75	V
Minimum ambient temperature	-55	°C
Maximum bulb temperature	+90	°C

*This value covers operation in daylight and complete darkness.

PREFERRED OPERATING CONDITION

Cathode current	2.0	mA
-----------------	-----	----

CHARACTERISTICS

Measured at preferred operating condition and $T_{amb} = 25^{\circ}\text{C}$

Maintaining voltage (variation from tube to tube)	84 to 88	V
Maximum maintaining voltage difference over current range 0.5 to 3.5mA	3.0	V
Maximum incremental resistance	1.0	k Ω
Variation of maintaining voltage during the first 1000 hours of life		
Maximum	± 1.0	%
Typical	± 0.5	%

OPERATING NOTES

A steady maintaining voltage is reached within 3 min.

The greatest constancy of maintaining voltage is obtained if the tube is operated at the preferred current.

M8190

SPECIAL QUALITY SUBMINIATURE
VOLTAGE REFERENCE TUBE

TEST CONDITIONS (unless otherwise specified)

$R_{lim.}$ (k Ω) 30
 $I_{burning}$ (mA) 2.0

After initial warming-up period of 3 minutes at burning current of 2.0mA

TESTS

GROUP A

	A.Q.L. ² (%)	Individuals ³		
		Min.	Max.	
Ignition voltage	†	—	125	V
Maintaining voltage	†	84	88	V
Change in maintaining voltage for burning current change from 1.9 to 2.1mA	†	—	0.2	V
Voltage jumps. Burning current varies from 1.2 to 3.5mA	†	—	25	mV (pk-pk)
Oscillation. Burning current varies from 1.2 to 3.5mA	†	—	15	mV (pk-pk)
Microphonic noise	†	—	25	mV (pk-pk)

†This test is carried out on a 100% basis.

GROUP B

Ignition voltage in darkness after 24 hours in darkness	2.5	—	125	V
Leakage current. Supply voltage = 50V $R_b = 1M\Omega$	2.5	—	15	μA
Change in maintaining voltage for burning current change from 0.5 to 3.5mA	2.5	—	3.0	V
Maintaining voltage at burning current of 3.5mA	2.5	—	89	V
Group quality level ⁷	6.5	—	—	

GROUP C

Glass strain test ^{8A} . No applied voltage	6.5	—	—	
Lead fragility test ^{10A} . No applied voltage	6.5	—	—	
Resonance search				
Vibrated at 2g over frequency range specified.				
25 to 500c/s	2.5	—	5.0	mV (r.m.s.)
500 to 2500c/s	2.5	—	15	mV (r.m.s.)



Fatigue¹¹

No applied voltage, 5g min. peak acceleration, $f = 170 \pm 5$ /s for 33 hours in each of 3 mutually perpendicular planes

Post fatigue tests

Change in maintaining voltage	2.5	—	± 0.8	V
Microphonic noise	2.5	—	50	mV
				(pk-pk)
Sub-group quality level ⁷	4.0	—	—	

Shock¹²

No applied voltage, 750g

Post shock tests

Change in maintaining voltage	2.5	—	± 0.8	V
Microphonic noise	2.5	—	50	mV
				(pk-pk)
Sub-group quality level ⁷	4.0	—	—	

GROUP D

Life test¹¹

Burning current = 2mA continuous

Life test end points. 1000 hours

Ignition voltage	2.5	—	125	V
Change in maintaining voltage from 0 to 300 hours	2.5	—	± 0.4	V
Change in maintaining voltage from 0 to 1000 hours	2.5	—	± 0.8	V
Change in maintaining voltage for burning current change from 1.9 to 2.1mA	2.5	—	+0.2	V
Group quality level ⁷	6.5	—	—	



M8190

SPECIAL QUALITY SUBMINIATURE VOLTAGE REFERENCE TUBE

5807

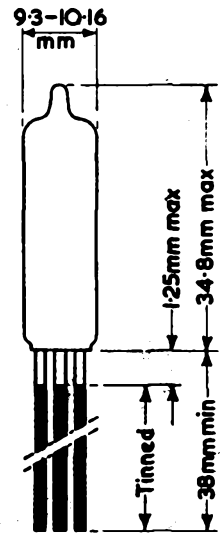
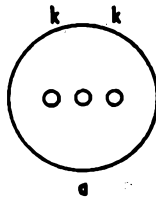
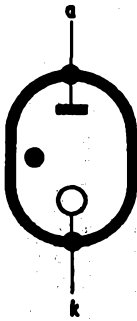

The bulb dimensions of this tube are in accordance with BS448, Section B8D.

Note.—Direct soldered connections to the leads of the tube must be at least 5mm from the seal and any bending of the leads must be at least 1.5mm from the seal.



QUICK REFERENCE DATA (nominal values)

For use in equipment where mechanical vibration and shocks are unavoidable.

Maintaining voltage	150	V
Cathode current range	5 to 30	mA
Regulation voltage	3	V
Ignition delay time	10	s

This data should be read in conjunction with GENERAL OPERATIONAL RECOMMENDATIONS—VOLTAGE STABILISER AND REFERENCE LEVEL TUBES and the GENERAL NOTES—SPECIAL QUALITY VOLTAGE STABILISER AND REFERENCE TUBES which precede this section of the handbook. The index numbers are used to indicate where reference should be made to a specific note.

CHARACTERISTICS AND RANGE VALUES FOR EQUIPMENT DESIGN measured at an ambient temperature of between 20 and 30°C unless otherwise stated.

The values given state the range over which the tube will operate both initially and during life. No allowance has been made for supply voltage and component variations.

Initial values

Minimum voltage necessary for ignition (Note A)	165	V
Ignition delay time	See page C1	
Maintaining voltage (all tubes) over the range 5 to 30mA		
Maximum	154	V
Minimum	143	V
Increase in maintaining voltage as cathode current is increased from 5 to 30mA (regulation voltage)		
Maximum	5.0	V
Average	3.0	V

Life performance (Note B)

	$I_k = 20\text{mA}$ $T_{\text{dub}} = 150^\circ\text{C}$ $t = 500\text{hrs}$	$I_k = 30\text{mA}$ $T_{\text{amb}} = 20 \text{ to } 30^\circ\text{C}$ $t = 1000\text{hrs}$	
Minimum voltage necessary for ignition (Note A)	165	165	V
Maintaining voltage			
Maximum ($I_k = 30\text{mA}$)	155	156	V
Minimum ($I_k = 5.0\text{mA}$)	142	139	V
Typical maximum variation of maintaining voltage	± 2	± 1	%
Increase in maintaining voltage as cathode current is increased from 5 to 30mA (regulation voltage)			
Maximum	8.0	8.0	V
Typical	3.0	3.0	V
Maximum altitude		120,000	ft



M8223

SPECIAL QUALITY STABILISING TUBE

ABSOLUTE MAXIMUM RATINGS¹

Cathode current		
Maximum for continuous operation	30	mA
Maximum surge (Note C)	75	mA
Minimum	5.0	mA
Maximum negative anode voltage	125	V
Minimum bulb temperature ($I_k = 0\text{mA}$)	-55	°C
Maximum bulb temperature		
For operation	+150	°C
For storage	+100	°C
Maximum vibrational acceleration (page D4)	2.5	g
Maximum shock (short duration) page D4	900	g

OPERATING NOTES

- This value holds good over life in light or darkness. See graph on page C1.
- These figures apply only when the tube is operated continuously at the currents stated.
- To be restricted for long life to approximately 30 seconds in each 8 hours use.

1616

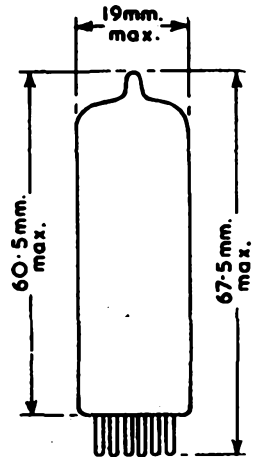
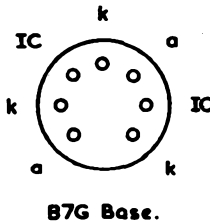
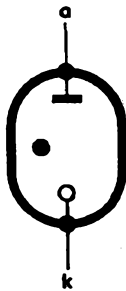

The bulb and base dimensions of this tube are in accordance with BS448
Section B7G



TEST CONDITIONS (unless otherwise specified)

$R_a = 1k\Omega$ $T_{amb} = 20$ to $25^\circ C$

Test	Test Conditions	AQL ² (%)	Individuals ³		
			Min	Max	
GROUP A					
Ignition voltage	Illumination = 50 to 500lux	0.65	—	165	V
Maintaining voltage (1)	$I_k = 30mA$	0.65	144	153	V
Maintaining voltage (2)	$I_k = 5.0mA$	0.65	144	153	V
Regulation	$I_k = 5.0$ to $30mA$	0.65	—	± 5	V
Group quality level ⁷	1.0	—	—	
GROUP B					
Continuity and short	0.4	—	—	
Microphonic noise	Note a, $I_k = 30mA$	1.0	—	5	mV
Oscillation	$V_{sig} = 100mV$, $I_k = 5.0$ to $30mA$	1.0	—	—	
Voltage jumps	$I_k = 5.0$ to $30mA$	2.5	—	600	mV _{pk-pk}
Ignition	$V_a = 165V$, Total darkness, Note b	2.5	—	20	s
Leakage current	$V_a = 50V$, $R_a = 3k\Omega$	2.5	—	5	μA
Maintaining voltage (3)	$I_k = 20mA$	2.5	144	153	V
Repeatability	$I_k = 10mA$, Note c	2.5	—	600	mV
Low pressure voltage breakdown	Note d, $I_k = 20mA$, Pressure = $3.1 \pm 0.2mm$ Hg	6.5	—	—	
Vibration	$I_k = 20mA$, $R_a = 10k\Omega$, Acceleration = 2.5g, $f = 25c/s$, Note e	2.5	—	100	mV





M8223

SPECIAL QUALITY
STABILISING TUBE

GROUP C

Shock¹²

No applied voltage, 1000g

Post shock tests

Vibration	as in group B	—	—	100	V
Ignition voltage	as in group A	—	—	165	V
Maintaining voltage (1)	$I_k = 30\text{mA}$	—	142	155	V
Maintaining voltage (2)	$I_k = 5.0\text{mA}$	—	142	155	V
Regulation	$I_k = 5.0 \text{ to } 30\text{mA}$	—	—	± 5	V
Continuity and short	—	—	—	
Sub-group quality level ⁷	20	—	—	

Fatigue¹¹

No applied voltage, 2.5g peak acceleration, $f = 50\text{c/s}$, for 32 hours in each of 3 mutually perpendicular directions

Post fatigue tests

Vibration	as in group B	—	—	100	mV
Ignition voltage	as in group A	—	—	165	V
Maintaining voltage (1)	$I_k = 30\text{mA}$	—	142	155	V
Maintaining voltage (2)	$I_k = 5.0\text{mA}$	—	142	155	V
Regulation	$I_k = 5.0 \text{ to } 30\text{mA}$	—	—	± 5	V
Continuity and short	—	—	—	
Sub-group quality level ⁷	2.5	—	—	
Base strain ⁹	6.5	—	—	
Glass strain ^{8A}	2.5	—	—	

GROUP D

Stability life test

$I_k = 20\text{mA}$, 1hr

Stability life test end point

Change in maintaining voltage(3)	$I_k = 20\text{mA}$	1.0	—	2.0	V
----------------------------------	---------------------	----	----	----	----	----	-----	---	-----	---

Survival rate life test

$I_k = 20\text{mA}$, 100hrs

Survival rate life test end point

Continuity and short	0.65	—	—	
Change in maintaining voltage(3)	$I_k = 20\text{mA}$	1.0	—	5.0	V



Test	Test Conditions	Permitted Rejects	Individuals ³		
			Min	Max	
Intermittent life test					
$I_k = 20\text{mA}$, $T_{\text{bulb min}} = 150^\circ\text{C}$, note f					
Intermittent life 500hrs end point tests					
Inoperatives ¹³		1	—	—	
Regulation	$I_k = 5.0$ to 30mA	1	—	± 6	V
Maintaining voltage (1)	$I_k = 30\text{mA}$	1	142	155	V
Maintaining voltage (2)	$I_k = 5.0\text{mA}$	1	142	155	V
Maintaining voltage (3)	$I_k = 20\text{mA}$	1	142	155	V
Change in maintaining voltage (3)	$I_k = 20\text{mA}$	1	—	6	V
Ignition voltage	as in group A	1	—	165	V
Total rejects		4	—	—	
Intermittent life 1000hrs end point tests					
Inoperatives ¹³		2	—	—	
Regulation	$I_k = 5.0$ to 30mA	2	—	± 5	V
Maintaining voltage (1)	$I_k = 30\text{mA}$	2	140	158	V
Maintaining voltage (2)	$I_k = 5.0\text{mA}$	2	140	158	V
Maintaining voltage (3)	$I_k = 20\text{mA}$	2	140	158	V
Change in maintaining voltage (3)	$I_k = 20\text{mA}$	2	—	8	V
Ignition voltage	as in group A	2	—	165	V
Total rejects		5	—	—	

NOTES

- The tube is tapped with a specified hammer and the output observed on a meter of specified dynamic response.
- The tube is held non-conducting and in total darkness for the 24 hours immediately prior to the test.
- The maintaining voltage at the specified cathode current is measured. The tube is then switched off for one minute. It is then restarted and operated at the specified cathode current for one minute, and the maintaining voltage remeasured. The on-off cycle is repeated a minimum of five times and the maximum difference in maintaining voltage taken as a measure of repeatability.
- With the tube operating under the stated conditions there must be no corona at the pins of the tube.
- The tube is operated during vibration for 60 seconds in each of two lateral directions and the output voltage measured. After the vibration the tube is checked for shorts.
- This test is performed on 20 tubes per lot.



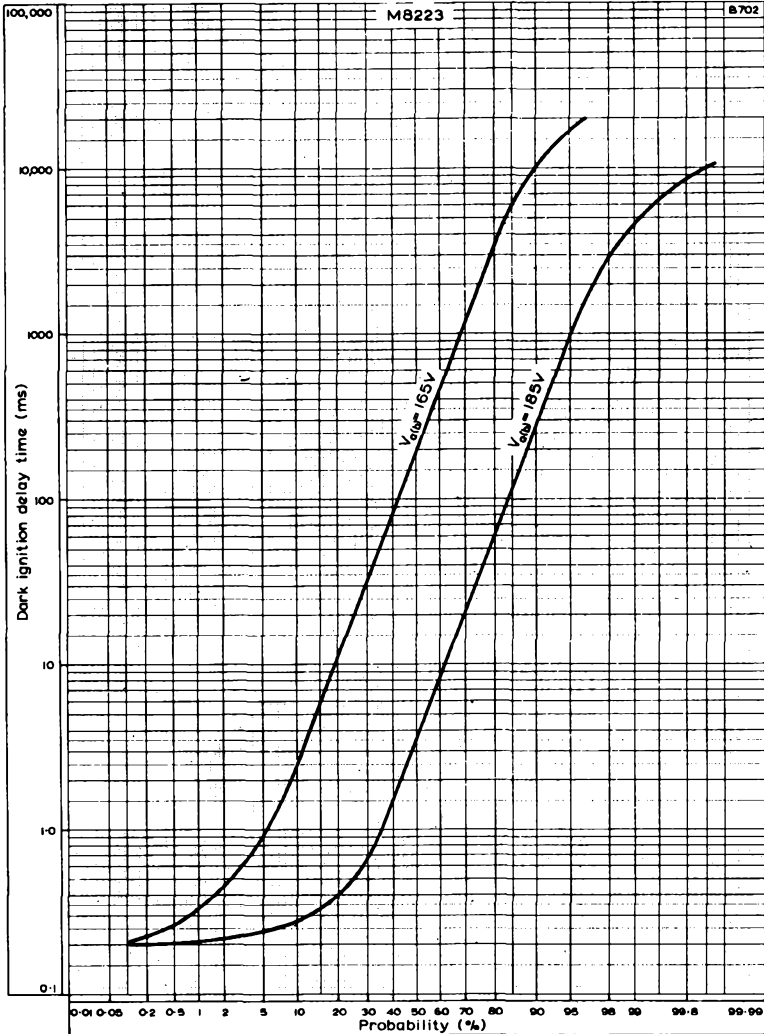

CUMULATIVE DISTRIBUTION OF DARK IGNITION DELAY TIME
 These curves show the probability that a tube will ignite in less than the time shown. This will be to some extent dependent on the supply voltage. In general an increase in the supply voltage will reduce the ignition delay time.



M8223

SPECIAL QUALITY
STABILISING TUBE

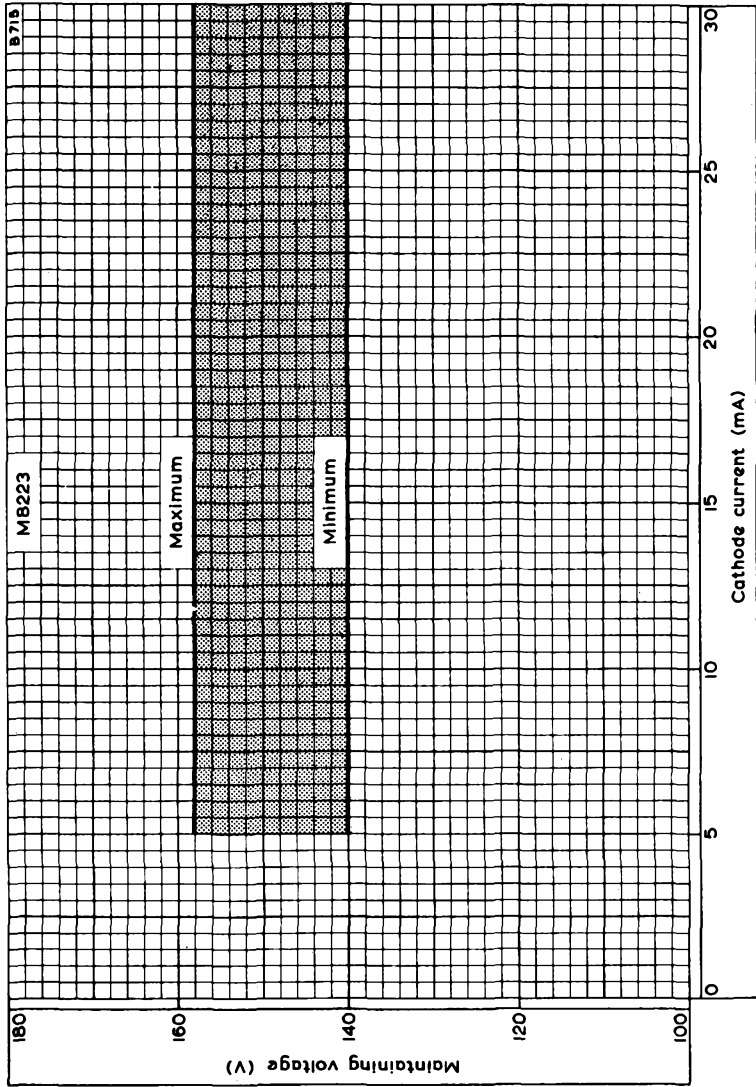

MAXIMUM VARIATION OF MAINTAINING VOLTAGE WITH CATHODE CURRENT (All tubes over life)



QUICK REFERENCE DATA (nominal values)

For use in equipment where mechanical vibration and shocks are unavoidable and where statistically controlled major electrical characteristics are required.

Maintaining voltage	108	V
Cathode current range	5.0 to 30	mA
Regulation voltage	1.5	V
Ignition delay time	1.3	s

This data should be read in conjunction with GENERAL OPERATIONAL RECOMMENDATIONS—VOLTAGE STABILISER AND REFERENCE LEVEL TUBES and the GENERAL NOTES—SPECIAL QUALITY VOLTAGE STABILISER AND REFERENCE TUBES which precede this section of the handbook. The index numbers are used to indicate where reference should be made to a specific note.

CHARACTERISTICS AND RANGE VALUES FOR EQUIPMENT DESIGN

measured at an ambient temperature of between 20 and 30°C unless otherwise stated.

The values given state the range over which the tube will operate both initially and during life. No allowance has been made for supply voltage and component variations.

Initial values

Minimum voltage necessary for ignition (Note A)	130	V
Ignition delay time	See page C1	
Maintaining voltage		
Maximum ($I_k = 30\text{mA}$)	112	V
Minimum ($I_k = 5.0\text{mA}$)	105	V
Increase in maintaining voltage as cathode current is increased from 5 to 30mA (regulation voltage)		
Maximum	3.5	V
Average	1.5	V

Life performance (Note B)

Minimum voltage necessary for ignition (Note A)	133	V
Increase in maintaining voltage as cathode current is increased from 5.0 to 30mA		
Maximum	3.5	V
Typical	1.5	V
Typical percentage variation of maintaining voltage at 20mA during 500 hrs life at $T_{\text{bulb}} = 150^\circ\text{C}$	± 2.0	%
Maximum altitude	60,000	ft

ABSOLUTE MAXIMUM RATINGS¹

Cathode current		
Maximum for continuous operation	30	mA
Maximum surge (note C)	75	mA
Minimum	5.0	mA
Maximum negative anode voltage	75	V
Minimum bulb temperature ($I_k = 0\text{mA}$)	-55	°C
Maximum bulb temperature		
For operation	+150	°C
For storage	+70	°C
Maximum vibrational acceleration (page D5)	2.5	g
Maximum shock (short duration) page D5	450	g

OPERATING NOTES

- A. This value holds good over life in light or darkness. See graph on page C1.
- B. These figures apply only when the tube is operated continuously at the currents stated.
- C. To be restricted for long life to approximately 30 seconds in each 8 hours use.

1616

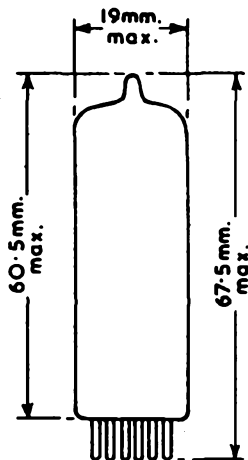
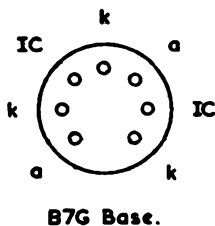
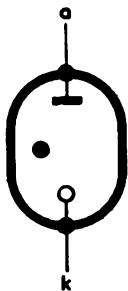

The bulb and base dimensions of this tube are in accordance with BS448, Section B7G

TESTS	A.Q.L. ²	Individuals ³		Lot average ⁴		Lot standard deviation ⁵		
	(%)	Bogey ⁶	Min.	Max.	Min.	Max.	Max.	
GROUP A								
Ignition voltage. Illumination 5 to 50ft.cd.	0.65	—	—	130	—	—	—	V
Maintaining voltage								
Cathode current = 30mA	0.65	108.5	—	111	—	—	—	V
		—	—	—	—	109.5	0.87	V
Cathode current = 5.0mA	0.65	107.5	105	—	—	—	—	V
		—	—	—	—	106.5	0.87	V
Change in maintaining voltage for cathode current change from 5.0 to 30mA ..	0.65	—	—	3.0	—	—	—	V
Group quality level ⁷	1.0	—	—	—	—	—	—	
GROUP B								
Continuity and short	0.4	—	—	—	—	—	—	
*Microphonic noise. Cathode current = 30mA	2.5	—	—	5.0	—	—	—	mV
Oscillation. $V_{sig} = 100mV$, cathode current change from 5.0 to 30mA ..	2.5	—	—	—	—	—	—	
Ignition voltage in complete darkness, after 24 hours in darkness	6.5	—	—	210	—	—	—	V
Leakage current. $V_a = 50V$, $R_a = 3.0k\Omega$	6.5	—	—	5.0	—	—	—	μA

*The tube is tapped with a specified hammer and the output observed on a meter of specified dynamic response.



GROUP C

Glass strain^{8A}. No applied voltage .. 2.5 — — —

Fatigue¹¹

No applied voltage, 2.5g peak acceleration
 $f = 25 \pm 2c/s$ for 32 hours in each of 3
mutually perpendicular planes.

Post fatigue tests

Ignition voltage as in group A	—	—	—	133
Maintaining voltage				
Cathode current = 30mA	—	—	—	113
Cathode current = 5.0mA	—	—	103	—
Change in maintaining voltage for cathode current change from 5.0 to 30mA	—	—	—	4.0
Sub-group quality level ⁷	6.5	—	—	—

Shock¹²

No applied voltage, 500g

Post shock tests

Ignition voltage as in group A	—	—	—	133
Maintaining voltage				
Cathode current = 30mA	—	—	—	113
Cathode current = 5.0mA	—	—	103	—
Change in maintaining voltage for cathode current change from 5.0 to 30mA	—	—	—	4.0
Sub-group quality level ⁷	20	—	—	—



M8224

SPECIAL QUALITY
STABILISING TUBE

> >> > > >>> >

| | | | | | | | | |

| | | | | | | | | |

| | | | | | | | | |



GROUP D	A.Q.L. ² (%)	Individuals ³		Lot average ⁴		Lot standard deviation ⁵		
		Bogey ⁶	Min.	Max.	Min.	Max.	Max.	
Intermittent life test								
Cathode current = 20mA								
T _{bulb} = 150°C								
Intermittent life test end points 500 hours								
Change in maintaining voltage for current change from 5.0 to 30mA	—	—	—	4.0	—	—	—	V
Maintaining voltage								
Cathode current = 30mA	—	—	—	113	—	—	—	V
Cathode current = 5.0mA	—	—	103	—	—	—	—	V
Ignition voltage as in group A	—	—	—	133	—	—	—	V
Change in maintaining voltage								
Cathode current = 30mA	—	—	—	—	—	2.0	—	%
Cathode current = 5.0mA	—	—	—	—	—	2.0	—	%
GROUP E								
Valves are held for 28 days and tested for Inoperatives								
	0.5	—	—	—	—	—	—	—



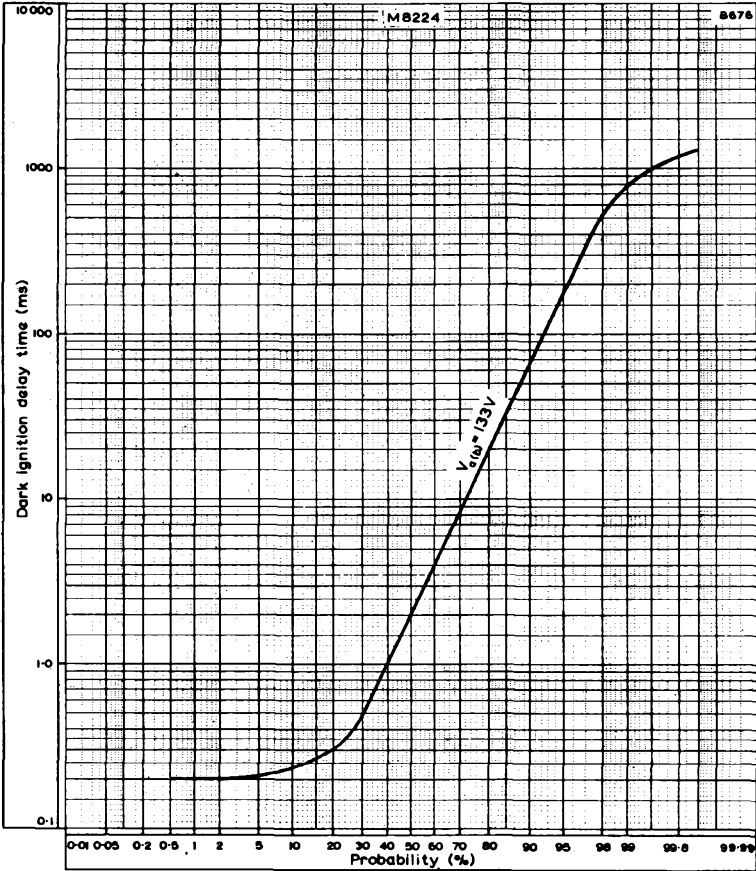

CUMULATIVE DISTRIBUTION OF DARK IGNITION DELAY TIME

This curve shows the probability that a tube will ignite in less than the time shown. This will be to some extent dependent on the supply voltage. In general an increase in the supply voltage will reduce the ignition delay time.



M8224

SPECIAL QUALITY
STABILISING TUBE

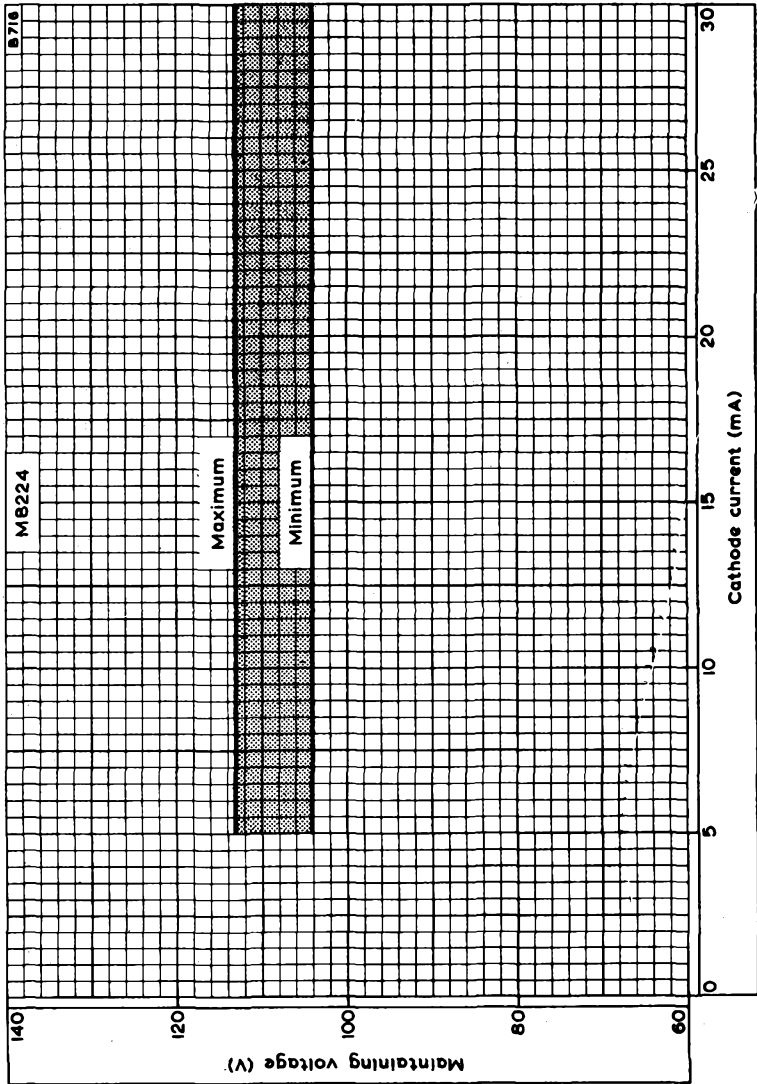

MAXIMUM VARIATION OF MAINTAINING VOLTAGE WITH CATHODE CURRENT (All tubes over life)



QUICK REFERENCE DATA (nominal values)

For use in equipment where mechanical vibration and shocks are unavoidable.

Maintaining voltage	78	V
Cathode current range	2 to 60	mA
Regulation voltage	5	V
Ignition delay time	10	ms

This data should be read in conjunction with GENERAL OPERATIONAL RECOMMENDATIONS—VOLTAGE STABILISER AND REFERENCE LEVEL TUBES and the GENERAL NOTES—SPECIAL QUALITY VOLTAGE STABILISER AND REFERENCE TUBES which precede this section of the handbook. The index numbers are used to indicate where reference should be made to a specific note.

CHARACTERISTICS AND RANGE VALUES FOR EQUIPMENT DESIGN measured at an ambient temperature of between 20 and 30°C unless otherwise stated.

The values given state the range over which the tube will operate both initially and during life. No allowance has been made for supply voltage and component variations. (Note A)

Initial values

Minimum voltage necessary for ignition (Note B)	110	V
Ignition delay time	See page C1	
Maintaining voltage at 30mA		
Maximum	81	V
Minimum	75	V
Increase in maintaining voltage as cathode current is increased from 2 to 60mA (regulation voltage)		
Note C		
Maximum	8.0	V
Average	5	V
Temperature coefficient of maintaining voltage	See page C2	
Typical maximum voltage jumps in the current range		
2 to 20mA	100	mV
20 to 60mA	15	mV
Cathode current above which the incremental resistance is positive	7	mA
Incremental resistance in the current range 10 to 60mA (approx.) Note C	130	Ω

Life performance (Note D)

	$I_k = 30\text{mA}$	$I_k = 60\text{mA}$	
Minimum voltage necessary for ignition (Note B)	115	115	V
Typical maximum percentage variation of maintaining voltage at cathode current (room temperature)			
In 1,000 hrs	-0.2 to +0.9	-0.7 to +0.2	%
In 10,000 hrs	-0.2 to +1.0	-0.7 to +1.4	%
In 30,000 hrs	-0.2 to +1.2	-0.7 to +2.0	%
Typical maximum increase in maintaining voltage as cathode current is increased over the range 2 to 60mA (Note C)	6.5	6.5	V

ABSOLUTE MAXIMUM RATINGS¹

Cathode current		
Maximum for continuous operation	60	mA
Maximum surge (Note E)	100	mA
Minimum	2.0	mA
Maximum negative anode voltage	50	V
Minimum bulb temperature ($I_k = 0\text{mA}$)	-55	°C
Maximum ambient temperature		
For operation (Note F)	+90	°C
For storage	+70	°C
Maximum vibrational acceleration (page D5)	2.5	g
Maximum shock (short duration) page D5	450	g

OPERATING NOTES

- A. Thermal equilibrium is reached within 3 minutes of igniting the tube.
- B. This value holds good over life in light or darkness. See graph on page C1.
- C. Following a sudden large change in the tube current the change in maintaining voltage may be up to 2.5 volts greater than that given until tube thermal equilibrium is re-established (within 3 minutes).
- D. These figures apply only when the tube is operated continuously at the currents stated.
- E. To be restricted for long life to approximately 30 seconds in each 8 hours use.
- F. This tube will operate satisfactorily at ambient temperatures up to 90°C, providing the tube is not used at either extreme of the current range.

TEST CONDITIONS (unless otherwise specified)

R_{lim}	I_k
(k Ω)	(mA)
1.0	30

After an initial warming-up period of 3 minutes at a cathode current of 30mA.

GROUP A

	AQL ² (%)	Individuals ³		
		Min.	Max.	
Ignition voltage. Illumination 5 to 50ft. cd.	†	—	110	V
Maintaining voltage	†	75	81	V
Change in maintaining voltage for cathode current change of 2 to 60mA.	†	—	8.0	V
Voltage jumps. Cathode current varied from 2 to 10mA	†	—	300	mV (pk-pk)
10 to 60mA	†	—	100	mV (pk-pk)
Oscillation. Cathode current varied from 2 to 60mA	†	—	20	mV (pk-pk)

†This test is carried out on a 100% basis.

GROUP B

Ignition voltage in darkness after 24 hours in darkness	2.5	—	110	V
Leakage current. Supply voltage = 55V, $R_{lim} = 1M\Omega$	2.5	—	10	μ A
Microphonic noise	2.5	—	5.0	mV (pk-pk)
Group quality level ⁷	6.5	—	—	

GROUP C

Base strain test ⁹ . No applied voltage	6.5	—	—	
Glass strain test ^{8A} . No applied voltage	6.5	—	—	



GROUP D

Resonance search

Vibrated at 2g over the frequency range 25 to 500c/s,

Output voltage at $R_{lim} = 27k\Omega$, $I_k = 10mA$

GROUP E

Fatigue¹¹

No applied voltage. 5g min. peak acceleration. $f = 170c/s \pm 5c/s$ for 33 hours in each of three mutually perpendicular planes.

Post fatigue tests

Ignition voltage as in group A

Change in maintaining voltage

Microphonic noise

Sub-group quality level?

Shock test¹²

No applied voltage, 500g

Post shock tests

Ignition voltage as in group A

Change in maintaining voltage

Microphonic noise

Sub-group quality level?

GROUP F

Life test 500 hours

Ignition voltage as in group A

Change in maintaining voltage from 0 to 500 hours

Change in maintaining voltage for cathode current change from 2 to 60mA

Inoperatives¹³

Group quality level?





M8225

SPECIAL QUALITY
STABILISING TUBE

2.5 — 5.0 mV
(r.m.s.)

2.5 — 110 V
2.5 — ±1.0 V
2.5 — 10 mV
(pk-pk)

6.5 — —

2.5 — 110 V
2.5 — ±1.0 V
2.5 — 10 mV
(pk-pk)

6.5 — —

2.5 — 110 V
2.5 — ±1.5 V
2.5 — 8.0 V
2.5 — —
6.5 — —

**SPECIAL QUALITY
STABILISING TUBE**

M8225

GROUP G	AQL ² (%)	Individuals ³		V
		Min.	Max.	
Valves held for 28 days and retested for				
Inoperatives ¹³	0.5	—	—	—
Ignition voltage as in group A	0.5	—	110	V
Maintaining voltage	0.5	75	81	V

4716

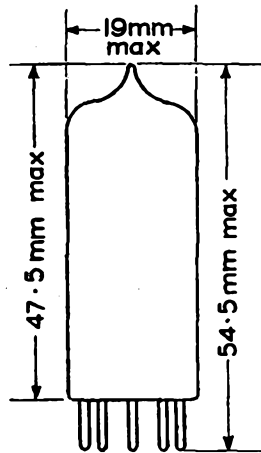
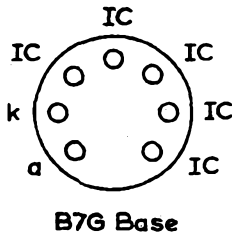
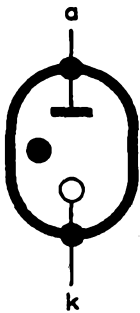

The bulb and base dimensions of this tube are in accordance with BS448, Section B7G.



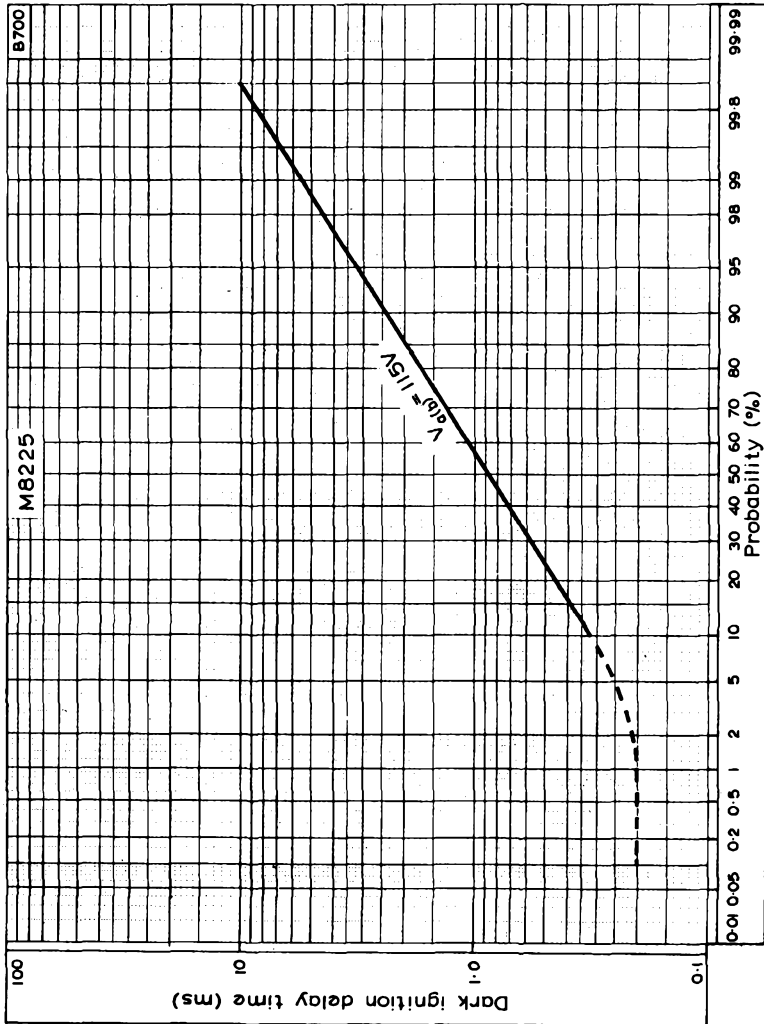

CUMULATIVE DISTRIBUTION OF DARK IGNITION DELAY TIME
 These curves show the probability that a tube will ignite in less than the time shown. This will be to some extent dependent on the supply voltage. In general an increase in the supply voltage will reduce the ignition delay time.



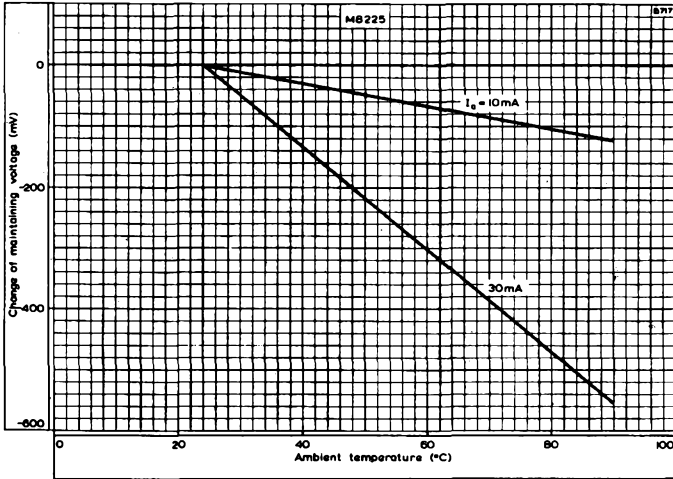

AVERAGE VARIATION OF MAINTAINING VOLTAGE
WITH AMBIENT TEMPERATURE

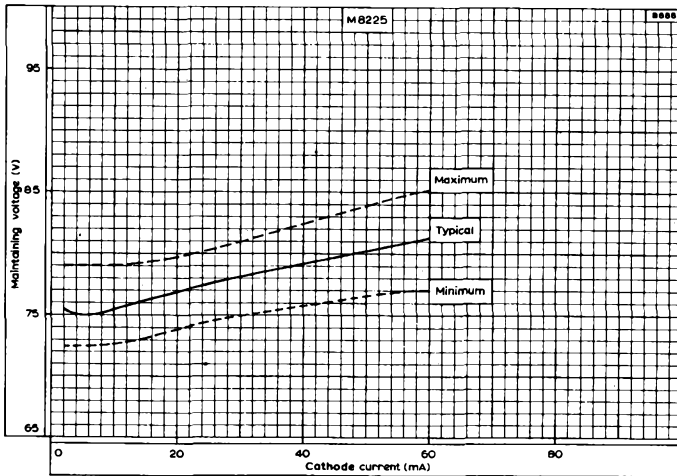

MAXIMUM VARIATION OF MAINTAINING VOLTAGE
WITH CATHODE CURRENT (Initial values)

SUBMINIATURE VOLTAGE REFERENCE TUBE

ZZ1000

QUICK REFERENCE DATA

81V gas-filled voltage reference tube. Shock and vibration resistant.

Preferred cathode current	3.2	mA
Maintaining voltage	81	V
Incremental resistance	200	Ω
Temperature coefficient of maintaining voltage		
averaged over the range +20 to +125 ^o C	-1.2	mV/degC
averaged over the range -55 to +20 ^o C	-3.2	mV/degC

This data should be read in conjunction with GENERAL OPERATIONAL RECOMMENDATIONS - STABILISER AND REFERENCE TUBES

CHARACTERISTICS AND RANGE VALUES FOR EQUIPMENT DESIGN

Measured at an ambient temperature of between 20 and 30^oC. The values given state the range over which the tube will operate, no allowance being made for supply voltage and component variations.

Limits applicable to all tubes (initial values)

Maximum ignition voltage		115	V
Maintaining voltage at $I_k = 3.2\text{mA}$ (see note 1)		80.1 to 82.5	V
Incremental resistance	max.	400	Ω
	typ.	200	Ω

Typical limits (initial values)

Maximum voltage jump at $I_k = 2.0$ to 4.0mA (see note 2)		100	mV
Maximum ignition delay in darkness at $V_b = 115\text{V}$		5.0	ms
Maximum tube impedance at $I_k = 2.7$ to 3.7mA , 50Hz sinusoidal variation		400	Ω
Maximum r.m.s. noise voltage (oscillation + random) at $I_k = 2.0$ to 4.0mA , frequency band = 10Hz to 10kHz		1.0	mV
Maximum vibration noise voltage at $I_k = 3.2\text{mA}$, 2.5g peak acceleration, $f = 10$ to 50Hz, frequency band = 1 to 100Hz		100	mV



CHARACTERISTICS AND RANGE VALUES FOR EQUIPMENT DESIGN (cont'd)

Temperature coefficient of maintaining voltage at $I_k = 3.2\text{mA}$

averaged over the range +20 to +125°C	max.	-2.0	mV/degC
	typ.	-1.2	mV/degC
averaged over the range -55 to +20°C	max.	-4.0	mV/degC
	typ.	-3.2	mV/degC

Life performance

Typical maximum variation in maintaining voltage

Continuous operation at preferred current; $T_{\text{bulb}} = 45^\circ\text{C}$

0 to 100 hours	0.3	V
0 to 2000 hours	0.7	V

Storage and standby; $T_{\text{bulb}} = 25^\circ\text{C}$

0 to 2000 hours	0.3	V
-----------------	-----	---

RATINGS (ABSOLUTE MAXIMUM SYSTEM)

I_k max. (see note 3)	4.0	mA
I_k min.	2.0	mA
$i_{k(pk)}$ max. (starting) for 20s max.	20	mA
$-v_a(pk)$ max.	100	V
T_{bulb} max. during operation	+125	°C
T_{bulb} max. during storage and standby	+100	°C
T_{bulb} min.	-55	°C

CIRCUIT DESIGN VALUES

Minimum voltage to ensure ignition	120	V
Maximum value of shunt capacitor	30	nF

SHOCK AND VIBRATION RESISTANCE

These conditions are used solely to assess the mechanical quality of the tube. The tube should not be continuously operated under these conditions.

Shock resistance

500g, using a NRL impact machine for electronic devices. 5 blows of the hammer lifted over an angle of 30° in each of four positions of the tube.

Vibration resistance

2.5g (peak). 32 hours at a frequency of 50Hz in each of three directions of the tube.

NOTES

1. Thermal equilibrium is reached within two minutes of igniting the tube.
2. To avoid voltage jumps over life, current variations around the preferred current should be limited to 0.3mA.
3. For use as a stabiliser tube, I_k max. = 8.0mA. At cathode currents between 2.0 and 8.0mA voltage jumps of 0.5V may occur.



SUBMINIATURE VOLTAGE REFERENCE TUBE

ZZ1000

NOTES (cont'd)

4. The tube may be soldered directly into the circuit, but heat conducted to the glass-to-metal seals should be kept to a minimum by the use of a thermal shunt.
5. The tube may be dip-soldered at a maximum solder temperature of 240°C for a maximum of ten seconds up to a point 5mm from the seal.
6. Care should be taken not to bend the leads nearer than 1.5mm from the seal.

OUTLINE AND DIMENSIONS

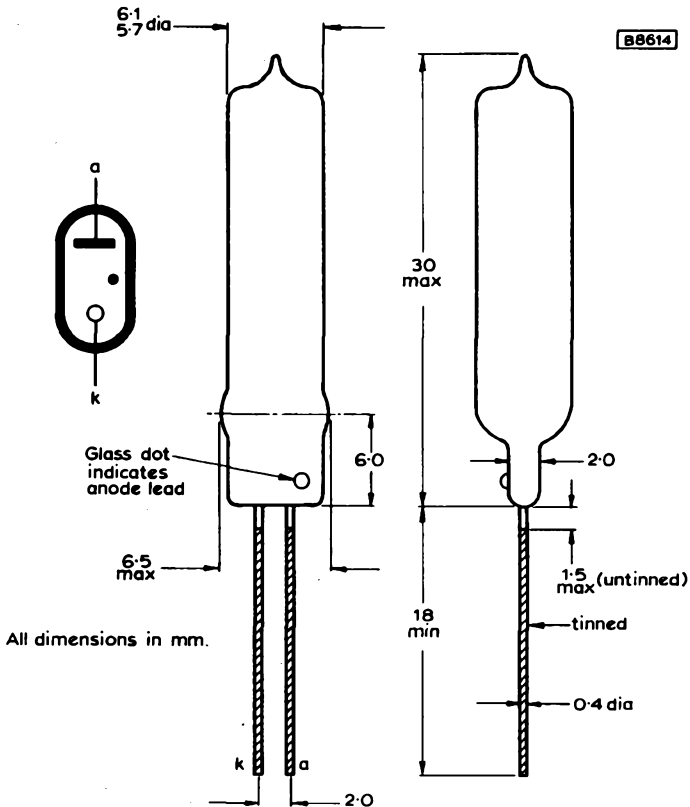

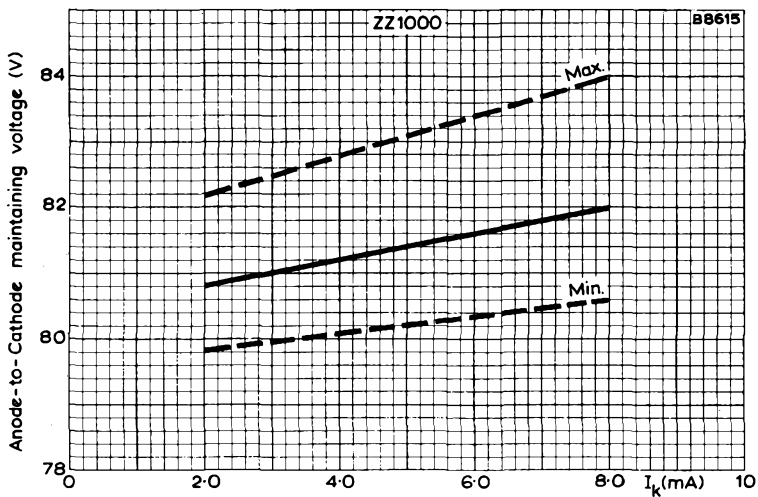

ANODE-TO-CATHODE MAINTAINING VOLTAGE PLOTTED AGAINST CATHODE CURRENT

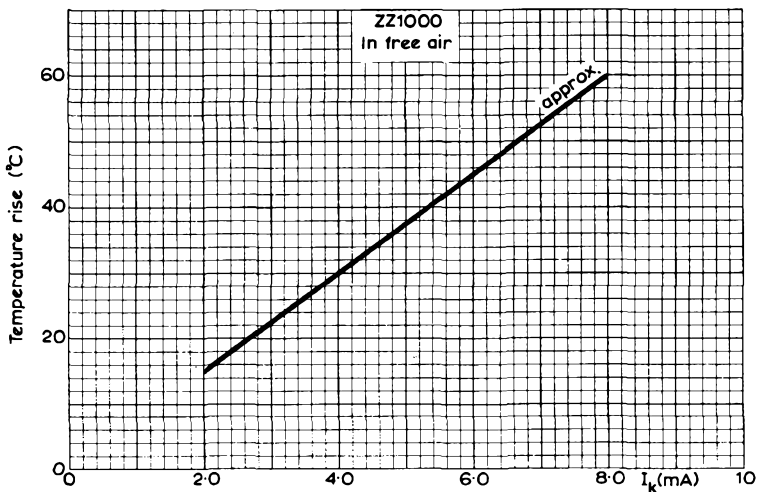

APPROXIMATE TEMPERATURE RISE OF BULB PLOTTED AGAINST CATHODE CURRENT



QUICK REFERENCE DATA (nominal values)

Maintaining voltage	78	V
Cathode current range	2 to 60	mA
Regulation voltage	5	V
Ignition delay time	10	ms

This data should be read in conjunction with GENERAL OPERATIONAL RECOMMENDATIONS—VOLTAGE STABILISER AND REFERENCE LEVEL TUBES which precede this section of the handbook.

CHARACTERISTICS AND RANGE VALUES FOR EQUIPMENT DESIGN measured at an ambient temperature of between 20 and 30°C unless otherwise stated.

The values given state the range over which the tube will operate both initially and during life. No allowance has been made for supply voltage and component variations. (note 1)

Initial values

Minimum voltage necessary for ignition (note 2)	115	V
Ignition delay time	See page C1	
Maintaining voltage at 30mA		
Maximum	81	V
Minimum	75	V
Increase in maintaining voltage as cathode current is increased from 2 to 60mA (regulation voltage) note 3		
Maximum	8.0	V
Average	5	V
Temperature coefficient of maintaining voltage	See page C2	
Typical maximum voltage jumps in the current range		
2 to 20mA	100	mV
20 to 60mA	15	mV
Cathode current above which the incremental resistance is positive	7	mA
Incremental resistance in the current range 10 to 60mA (approx.) note 3	130	Ω

Life performance (note 4)

	$I_k = 30\text{mA}$	$I_k = 60\text{mA}$	
Minimum voltage necessary for ignition note 2	115	115	V
Typical maximum percentage variation of maintaining voltage (room temperature)			
In 1,000 hrs	-0.2 to +0.9	-0.7 to +0.2	%
In 10,000 hrs	-0.2 to +1.0	-0.7 to +1.4	%
In 30,000 hrs	-0.2 to +1.2	-0.7 to +2.0	%
Typical maximum increase in maintaining voltage as cathode current is increased over the range 2 to 60mA (note 3)	6.5	6.5	V



ABSOLUTE MAXIMUM RATINGS

Cathode current

Maximum for continuous operation	60	mA
Maximum surge (<i>note 5</i>)	100	mA
Minimum	2.0	mA
Maximum negative anode voltage		
Maximum bulb temperature ($I_k = 0\text{mA}$)	50	V
Minimum bulb temperature	-55	°C
Maximum ambient temperature		
For operation (<i>note 6</i>)	+90	°C
For storage	+70	°C

OPERATING NOTES

1. Thermal equilibrium is reached within 3 minutes of igniting the tube.
2. This value holds good over life in light or darkness. See graph on page C1.
3. Following a sudden large change in the tube current the change in maintaining voltage may be up to 2.5 volts greater than that given until tube thermal equilibrium is re-established (within 3 minutes).
4. These figures apply only when the tube is operated continuously at the currents stated.
5. To be restricted for long life to approximately 30 seconds in each 8 hours use.
6. This tube will operate satisfactorily at ambient temperatures up to 90°C, provided the tube is not used at either extreme of the current range.

4716

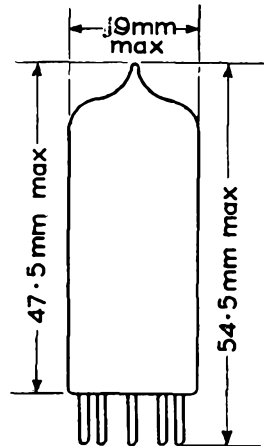
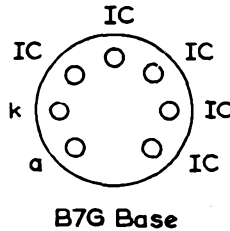
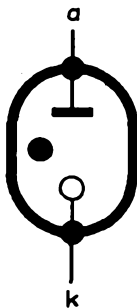

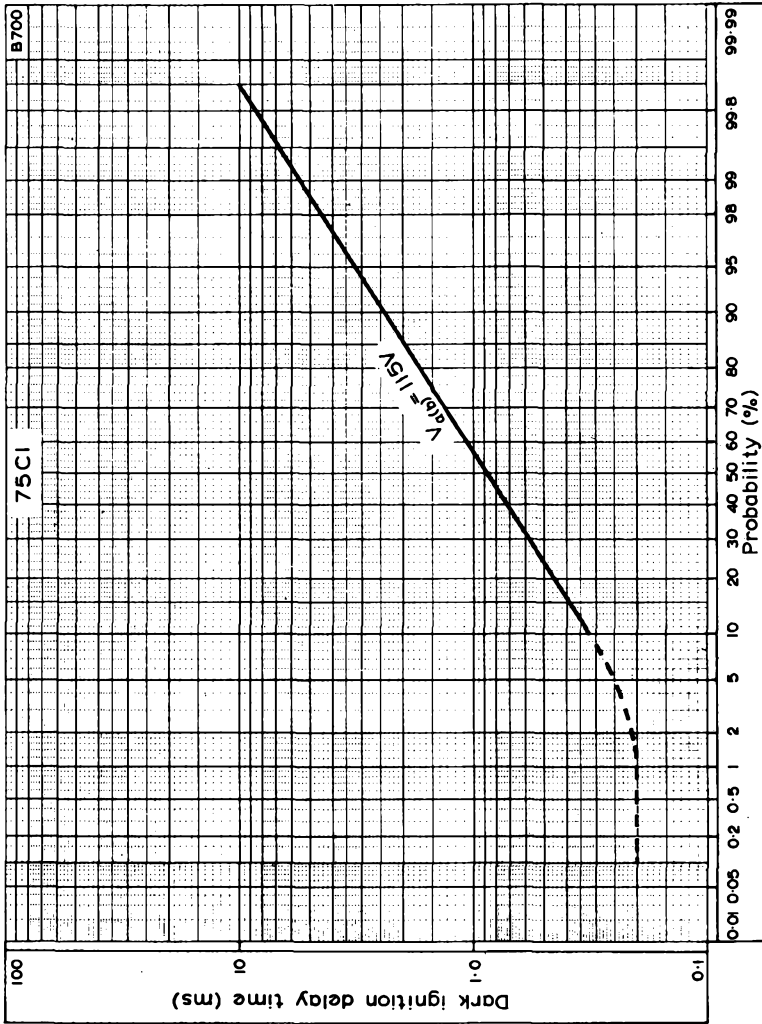

CUMULATIVE DISTRIBUTION OF DARK IGNITION DELAY TIME

This curve shows the probability that a tube will ignite in less than the time shown. This will be to some extent dependent on the supply voltage. In general an increase in the supply voltage will reduce the ignition delay time.



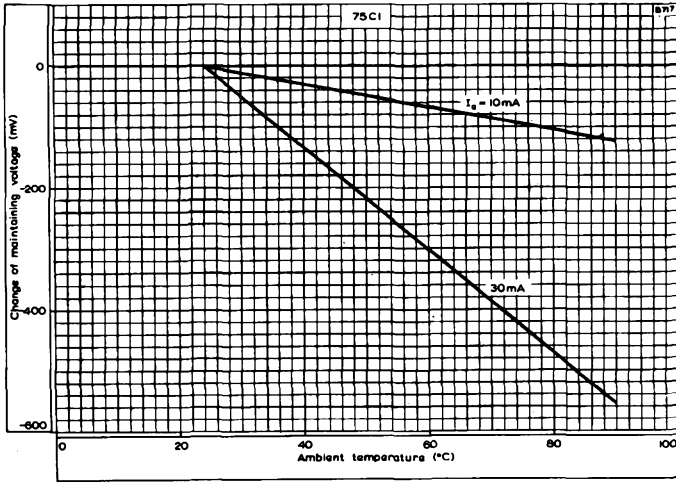

AVERAGE VARIATION OF MAINTAINING VOLTAGE WITH AMBIENT TEMPERATURE

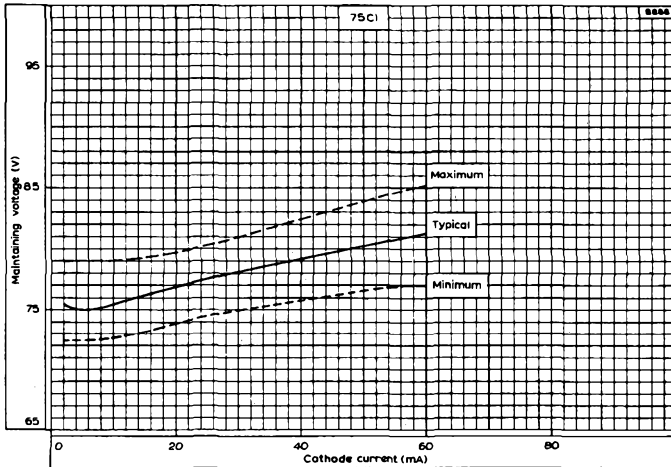

MAINTAINING VOLTAGE PLOTTED AGAINST CATHODE CURRENT
(Initial values)

VOLTAGE REFERENCE TUBE

83V gas-filled reference tube.

83A1

DATA FOR EQUIPMENT DESIGN

LIMITING VALUES (absolute ratings)

Minimum voltage necessary for ignition (Notes 1 and 2)	130	V
Cathode current		
Maximum	6.0	mA
Minimum	3.5	mA
Maximum bulb temperature (Note 3)		
During operation	150	°C
During storage and stand-by	100	°C
Maximum negative anode voltage	50	V
Maximum starting current (Note 4)	10	mA

PREFERRED OPERATING CONDITION

Cathode current	4.5	mA
-----------------	-----	----

CHARACTERISTICS (Note 5) at preferred operating condition

Initial values (measured at 25 to 30°C)

Maintaining voltage (variation from tube to tube) 83.0 to 84.5	V
*Maximum jump voltage (3.5 to 6.0mA)	1 mV
*Typical r.m.s. noise voltage (30c/s to 10kc/s)	100 μ V
*Incremental resistance	
Maximum	350 Ω
Minimum	110 Ω

*Nominal temperature coefficient (Note 7)
average over the range 25 to 120°C $-0.003\%/^{\circ}\text{C} (-2.5\text{mV}/^{\circ}\text{C})$

*See note 6.

Life performance

Limits of the typical variations of maintaining voltage at the temperatures shown and over the period indicated.

For continuous operation at preferred current

Bulb temperature	25	100	150	°C
Life period				
0 to 300hrs.	0 to +0.35	0 to +0.35	0 to +2	V
300 to 2500hrs.	0 to +0.2	0 to +0.2	-2 to +4	V
300 to 10,000hrs.	+0.05 to +0.35	+0.05 to +0.35	—	V

For storage or stand-by

0 to 500hrs.	Negligible	<1.5 (Note 8)	—	V
0 to 3000hrs.	Negligible	<6 (Note 8)	—	V



83A1

VOLTAGE REFERENCE TUBE

NOTES

1. The effective resistance in series with the tube should never be less than 2k Ω .
2. This value holds good over life, in light or darkness. In total darkness an ignition delay of up to 5s may occur.
3. During conduction the bulb temperature is approximately 20°C above ambient temperature.
4. To be restricted for long life to approx. 30s once or twice in each 8hrs. use.
5. Equilibrium conditions are reached within 1min.
6. Information to date indicates that these values hold good, with little or no change, over life.
7. The characteristics curve connecting temperature coefficient and bulb temperature is continuous and repeatable. The typical tube to tube variations in maintaining voltage with temperature are shown on page C1.
8. Subsequent operation of the tube for approximately 50hrs. at 4.5mA at not more than 100°C will restore the maintaining voltage to within 0.2V of its original value.

4716

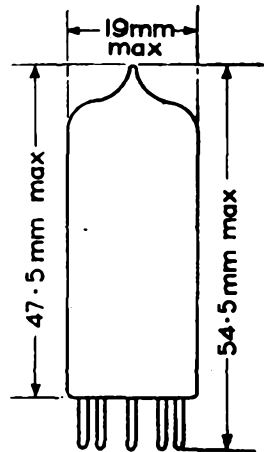
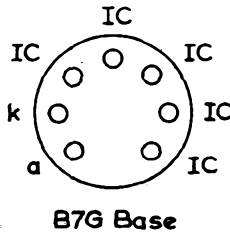
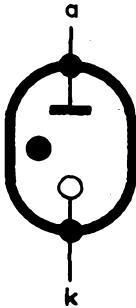

QUALITY ACCEPTANCE TESTS AND CONTROLS**Introduction**

This voltage reference tube is produced with the processes of manufacture controlled to tolerances usually associated with special quality tubes. In order to check that all processes have been performed correctly, each batch of tubes is subjected to a standard assessment procedure which has been designed to ensure that the characteristics (electrical, mechanical and life) of the tube satisfy certain fixed quality standards. This assessment procedure has been drawn up using the British Reliable Valve Specification (CV4000 series) as a guide and it is presented on pages D5, D6, D7, D8 and D9. This supplements the normal data by showing the standard of quality to which the tube is controlled.

The tests and limits given in the assessment procedure are those applied to tubes leaving the factory. They do not represent recommended operating conditions as they are designed to protect the normal data and control the quality. The limits and test conditions given are in many cases more stringent than those in the normal data to allow for the very small changes which may occur during storage. The data on pages D1 and D2 includes an allowance (where applicable) for the changes which may occur during life under various conditions. Because of this it is important that any circuit design work and subsequent tube measurements should be performed using the ratings and conditions of the Data for Equipment Design given on page D1.

Acceptance procedure

The assessment tests are arranged in groups (A to G) which correspond to electrical tests of varying importance, mechanical tests, life tests, etc. The principal electrical tests are given in group A, and tubes which pass these tests, and have been produced in a given period, usually one month, are collected together into a 'lot'. Random samples are then taken from each lot for the tests in groups B to F inclusive. Detailed test results on all sample tests are recorded. After a storage period during which the sample tests are performed, the remaining tubes are submitted to the group G tests to ensure that no appreciable changes have occurred.

For each acceptance test an Acceptable Quality Level (A.Q.L.) is fixed and is the percentage of failures that may be allowed for a particular test. It does not represent the percentage of failures to be expected in a lot, but is the standard to which the test is controlled.

In general the percentage of tubes which fail in any given lot will be a much smaller percentage than the A.Q.L. It should be noted that a high A.Q.L. for this tube means that a small sample is used.

For all acceptance tests (i.e. all tests except those in group F2), if the A.Q.L. is not satisfied the lot is rejected. Thus every tube which is delivered comes from a lot which has satisfied all the acceptance tests.

The tests are grouped as follows:

Group A tests

These are tests of the principal electrical characteristics and are performed on every tube.



Group B tests

These tests are similar or identical to those in group A. They are repeated here so that the results of measurements can be recorded and any trend towards a limit can be corrected. A large sample is used for this group of tests and the A.Q.L. is 0.65%. Tubes from the group B tests are used for the tests in groups C to F. The sample size, however, may be smaller.

Group C tests

These tests measure the secondary electrical characteristics including some outside the normal current range of the tube. In this way it has been found possible to obtain a more sensitive control of the characteristics inside the recommended operating range. The sample used is the same as that for the group B tests, but a slightly higher A.Q.L. is given.

Group D tests

The tests in this group are of characteristics which are known from experience to remain constant provided the manufacturing process is unaltered and the requirements of groups B and C are met. Because of this only a small sample is needed to confirm that these characteristics are in fact unchanged. The A.Q.L. is relatively high because only a small sample is used.

Group E tests

This group consists of mechanical tests to check that the quality of the glass envelope and base is adequate, and to ensure that the ruggedness of the electrode structure does not depart from the set standard. These tests are performed on small samples.

Group F1 tests

This group contains life and storage tests under various conditions. They are acceptance tests, and any lot which fails to satisfy these requirements is rejected.

Group F2 tests

In this group information is given as to the changes expected on long term life or storage. These tests cannot be acceptance tests as it would be impracticable to retain the tubes in store until this information on each lot had accumulated. These tests are performed on a regular basis.

Group G tests

Tubes which were not used in the sample tests are rechecked for some of their principal characteristics after one month in store. These tests ensure that no appreciable changes have occurred during storage.

Rejected lots

If the given A.Q.L. is not satisfied when performing any acceptance tests, the lot is rejected.



ACCEPTANCE TESTS AND CONTROLS

Unless otherwise specified $I_k = 4.5\text{mA}$, $R_a = 10\text{k}\Omega$, $T_{\text{ambient}} = 20 \text{ to } 25^\circ\text{C}$

Test	Test conditions	A.Q.I. (%)	Notes (pp.D8/9)	Limits		
				Min.	Max.	
GROUP A (100% Tests)						
Ignition	$V_a = 118\text{V}$, Illumination 5 to 50 lm/ft^2	—	a	—	5	s
Maintaining voltage		—	—	83.2	84.3	V
Incremental resistance		—	—	125	350	Ω
Voltage jumps	$I_k = 3.5 \text{ to } 6.0\text{mA}$	—	b	—	1	mV (pk-pk)
GROUP B						
		0.65	c			
Ignition voltage	Illumination 5 to 50 lm/ft^2	—	d	—	120	V
Maintaining voltage		—	—	83.1	84.4	V
Incremental resistance		—	—	125	350	Ω
Voltage jumps	$I_k = 3.5 \text{ to } 6.0\text{mA}$	—	b	—	1	mV (pk-pk)
GROUP C						
		2.5	c			
Maintaining voltage	$I_k = 3.0\text{mA}$	—	e	—	Note e.	V
Regulation	$I_k = 3.0 \text{ to } 6.0\text{mA}$	—	—	—	1.1	V
Microphony		—	f	—	30	mV (pk-pk)
GROUP D						
Ignition	$V_a = 120\text{V}$, Total darkness	6.5	a, g	—	5	s
Leakage	$V_a = 55\text{V}$, $R_{\text{lim}} = 1\text{M}\Omega$	6.5		—	4	μA
Temperature coefficient		6.5	h			
	$T_{\text{bulb}} = 25 \text{ to } 90^\circ\text{C}$		i	-2.0	-4.0	$\text{mV}/^\circ\text{C}$
	$T_{\text{bulb}} = 90 \text{ to } 120^\circ\text{C}$		i	0	-4.0	$\text{mV}/^\circ\text{C}$
A.C. impedance		6.5	h, j			
	$f = 100\text{c/s}$	—	—	110	350	Ω
	$f = 1000\text{c/s}$	—	—	—	500	Ω
	$f = 10,000\text{c/s}$	—	—	—	1500	Ω



Test	Test conditions	A.Q.L. (%)	Notes (pp.D8/9)	Limits	
				Min.	Max.
GROUP E					
		6.5	c		
Glass strain	No applied voltage	—	k	—	—
Base strain	No applied voltage	—	l	—	—
Resonance search	Acceleration = 20g, f = 60 to 2000c/s	—	m	—	—
GROUP F1 Life Acceptance Tests					
Life test	$V_{a(b)} = 250V,$ $R_a = 37k\Omega,$ $T_{ambient} = 20 \text{ to } 25^\circ C$		n, o		
End point tests at 500 hours		6.5	h, p		
Change in maintaining voltage	0 to 500 hours	—	q	—	0.35 V
Ignition voltage	Illumination 5 to 50 lm/ft ²	—	d	—	125 V
High temperature life test	$V_a = 250V,$ $R_a = 37k\Omega,$ $T_{bulb} = 100^\circ C$		n, o		
End point tests at 500 hours		6.5	h, p		
Change in maintaining voltage	0 to 500 hours	—	q	—	0.35 V
Ignition voltage	Illumination 5 to 50 lm/ft ²	—	d	—	125 V
High temperature storage test	No applied voltage, $T_{ambient} = 100^\circ C$		n, o		
End point tests at 100 hours		6.5	h, p		
Change in maintaining voltage	0 to 100 hours	—	q	—	0.5 V
Average change in maintaining voltage	0 to 100 hours	—	r	—	0.2 V
Ignition voltage	Illumination 5 to 50 lm/ft ²	—	d	—	125 V



Test	Test conditions	A.Q.L. (%)	Notes (pp.D8/9)	Limits		
				Min.	Max.	
GROUP F2 Life Information Tests			s			
Room temperature life test						
	$V_a = 250V,$ $R_a = 37k\Omega,$ $T_{ambient} = 20 \text{ to } 25^\circ C$		n			
Change in maintaining voltage	500 to 3000 hours	—	t	0	+0.2	V
Change in maintaining voltage	500 to 10,000 hours	—	t	+0.05	+0.35	V
Ignition voltage	at 10,000 hours	—	d	—	125	V
High temperature life test						
	$V_a = 250V,$ $R_a = 37k\Omega,$ $T_{bulb} = 100^\circ C$		n			
Change in maintaining voltage	500 to 3000 hours	—	t	0	+0.2	V
Change in maintaining voltage	500 to 10,000 hours	—	t	+0.05	+0.35	V
Ignition voltage	at 10,000 hours	—	d	—	125	V
High temperature storage test						
	No applied voltage, $T_{ambient} = 100^\circ C$		n			
Change in maintaining voltage	0 to 500 hours	—	t	—	1.5	V
Change in maintaining voltage	0 to 3000 hours	—	t	—	6	V
Ignition voltage	at 3000 hours	—	d	—	130	V
GROUP G Retest after 28 days storage			u			
Ignition	$V_a = 120V,$ Illumination 5 to 50 lm/ft ²	0.5	a	—	5	s
Maintaining voltage		0.5	—	83.1	84.4	V
Incremental resistance		0.5	—	125	350	Ω



Notes on tests

General: All results except for those on group A and group G tests are recorded.

- a. The tube must ignite within the specified time.
- b. The tube is ignited with V_a adjusted to give I_k of 3.5mA and the current is increased slowly to 6.0mA. Time of sweep = 5s.
- c. The A.Q.L. given applies separately to each test in the group.
- d. A potential of 100V is applied to the anode of the tube for a period of 2 seconds. If ignition does not occur the voltage is increased by 2V and applied for a further 2 seconds. If ignition still does not occur, the voltage is increased as before and so on until ignition occurs. If ignition occurs during a 2 second period at a fixed (numerically even) voltage, that voltage is recorded. If ignition occurs while the voltage is being increased, the intermediate (numerically odd) voltage is recorded.
- e. The value of maintaining voltage in each tube shall not be greater than that measured at 4.5mA in group B.
- f. This test is performed by tapping the tube with a standard hammer as described in the British Services Specification K1006 paragraph 4.7.5. The output is measured on a triggered oscilloscope with scan time 10ms approx.
- g. The tube is held non-conducting and in total darkness for the 24 hours immediately prior to this test.
- h. The A.Q.L. is a combined A.Q.L. for the sub-group of tests.
- i. This is the average temperature co-efficient over the stated temperature range. The tube is immersed in turn in baths of oil kept at the temperatures of the extremities of the range only, and the maintaining voltage at each temperature is measured as soon as it is stable.
- j. This is the effective a.c. impedance of the tube measured at the specified frequencies.
- k. In this glass envelope strain test the tubes are completely submerged in boiling water at a temperature between 97 and 100°C for 15 seconds and then immediately plunged into ice-cold water for 5 seconds. The tubes are then examined for glass cracks.
- l. In this base strain test, the pins of the tubes are forced over specified cones and the tubes and cones are then submerged in boiling water at a temperature between 97 and 100°C for 10 seconds. The tubes and cones are allowed to cool to room temperature before examining for glass cracks.
- m. The tube is operated during vibration at a fixed acceleration of 20g in a direction at an angle of 45° to each of the axes of the tube. The frequency is swept once through the range 60 to 2000c/s at a rate not exceeding 1 octave in 30 seconds.

N.B. - These conditions are used solely to assess the mechanical quality of the tube. The tube must not be operated under such conditions.

-
- n. This test is run continuously under the stated conditions.
 - o. This test is performed on 15 tubes per lot.
 - p. These end point tests are acceptance tests and lots not satisfying these requirements are rejected.
 - q. This is the maximum change on the individual tubes over the stated period.
 - r. This is the average change over the complete sample of tubes, ignoring sign. The combined A.Q.L. does not apply to this test.
 - s. These control measurements are performed regularly but they are not acceptance tests on each lot.
 - t. These are limits which individual tubes are expected to satisfy over the stated period.
 - u. These tests are performed on tubes not used in sample tests, at least 28 days after the group A tests.



83A1

VOLTAGE REFERENCE TUBE

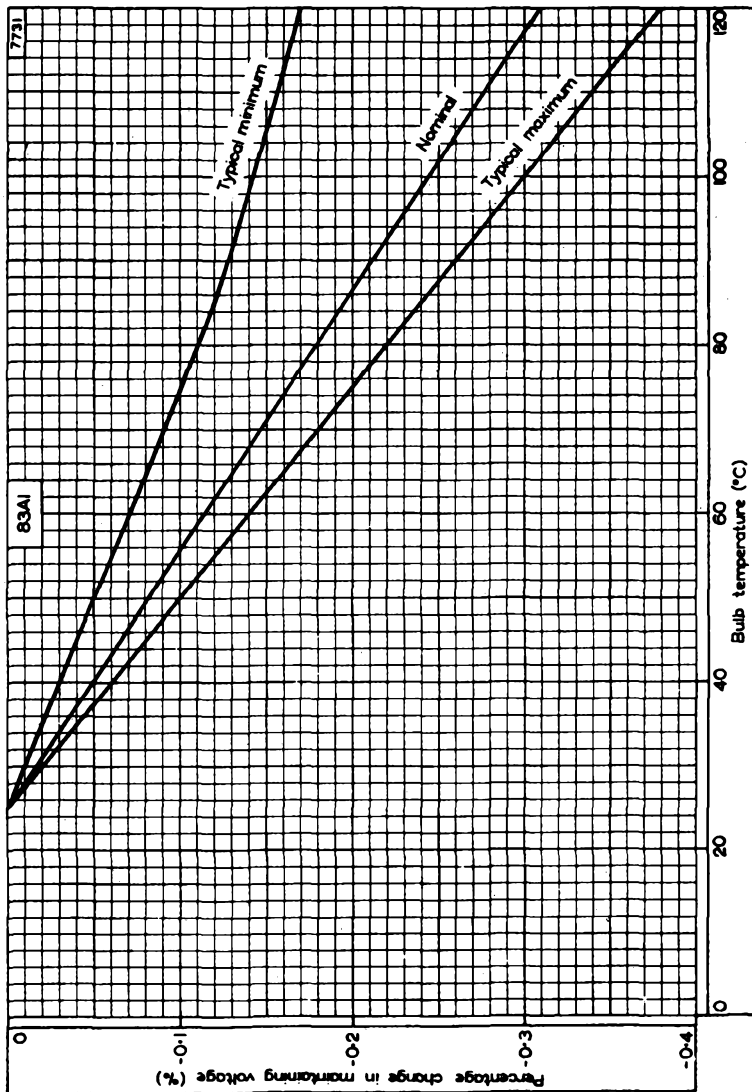

PERCENTAGE CHANGE IN MAINTAINING VOLTAGE PLOTTED AGAINST BULB TEMPERATURE



VOLTAGE REFERENCE TUBE

85A2

Gos-filled two-electrode tube intended
for use as a voltage reference.

LIMITING VALUES (Absolute Ratings)

Min. voltage necessary for ignition	115	V
Max. burning current	10	mA
Min. burning current	1	mA
Ambient temperature limits	-55 to +90	°C

PREFERRED OPERATING CONDITION

Burning current	6	mA
-----------------	---	----

CHARACTERISTICS

At Preferred Operating Condition

Max. ignition voltage	115	V
Burning voltage (variation from tube to tube)	83 to 87	V
Incremental resistance		
Average	300	Ω
Maximum	450	Ω
Temperature coefficient of burning voltage over temperature range 15 to 90°C	-4.0	mV/°C
*Max. percentage variation of burning voltage		
During the first 300 hours of life	0.3	%
During the subsequent 1,000 hours	0.2	%
Typical percentage drift of burning voltage per 1,000 hours after 1,300 hours	0.1	%

*After the initial warming-up period of 3 minutes.

DISCONTINUITIES OF THE I_a/V_a CHARACTERISTIC

Typical voltage jumps over current range 4 to 10 mA	5.0	mV
Maximum voltage jumps over current range 4 to 10 mA	50	mV

SHORT-TERM STABILITY

Maximum short-term variation of burning voltage for any 8 hour period after the first 100 hours life will be better than 0.01% provided there is an initial warming-up period of 3 minutes.

Maximum short-term (100 hours max.) variation of burning voltage after the first 300 hours of life is 0.1%.

In order to avoid voltage variations due to temperature fluctuations it will in general be sufficient to draught shield the tube (see temperature coefficient of tube).

85A2

VOLTAGE REFERENCE TUBE

Gas-filled two-electrode tube intended for use as a voltage reference

OPERATING NOTES

1. To obtain a good life a reverse current must not be drawn from this tube. This condition is satisfied if any inverse voltage does not exceed 75 V.
2. The maximum ignition voltage quoted is the greatest voltage which is necessary to ignite any tube in the presence of some ambient illumination. A voltage of at least this value must be available if reliability of ignition is to be obtained. In complete darkness there may be considerable delay in igniting the tube.
3. A steady burning voltage is reached within 3 minutes.
4. The greatest constancy of burning voltage is obtained if the tube is operated at only one value of current.
5. The noise generated by the tube over a frequency band of 30 to 10,000 c/s is of the order of $60 \mu\text{V}$, which is equivalent to the noise generated by a resistor of approximately $22 \text{ M}\Omega$ at a temperature of 300°K . The noise is evenly distributed over the frequency range.

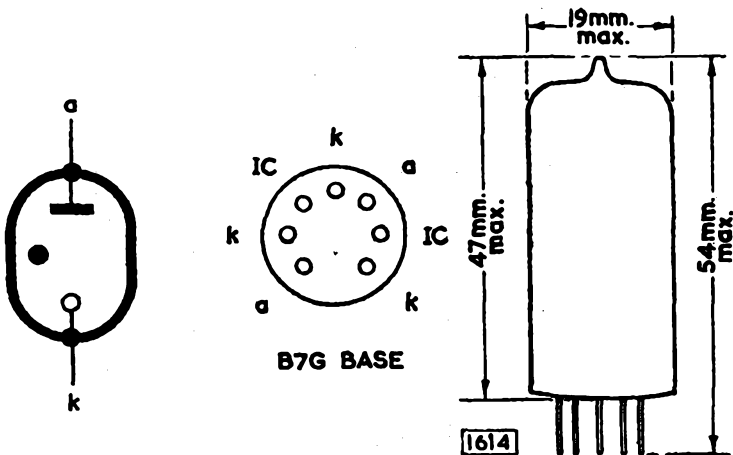

VOLTAGE REFERENCE TUBE

85A2

Gas-filled two-electrode tube intended for use as a voltage reference.

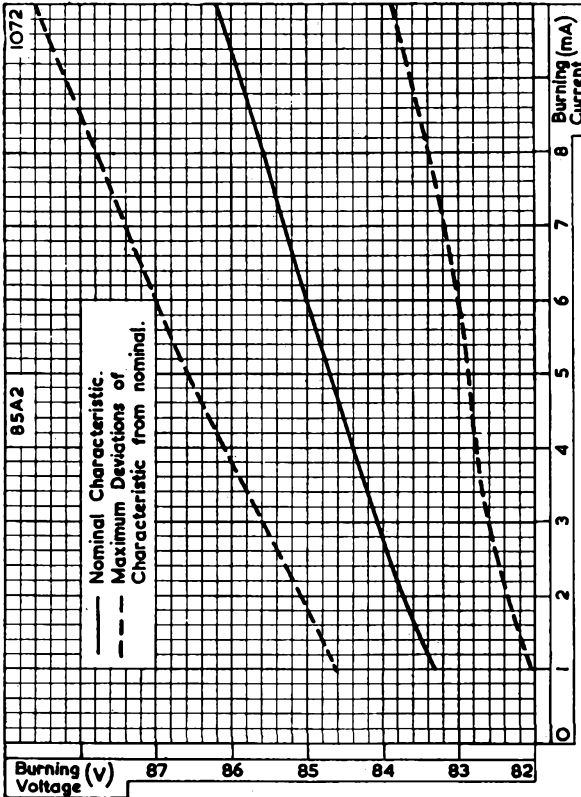

BURNING VOLTAGE PLOTTED AGAINST BURNING CURRENT



QUICK REFERENCE DATA (nominal values)

Maintaining voltage	90	V
Cathode current range	1 to 40	mA
Regulation voltage	12	V
Ignition delay time	2	s

This data should be read in conjunction with GENERAL OPERATIONAL RECOMMENDATIONS—VOLTAGE STABILISER AND REFERENCE LEVEL TUBES which precede this section of the handbook.

CHARACTERISTICS AND RANGE VALUES FOR EQUIPMENT DESIGN measured at an ambient temperature of between 20 and 30°C unless otherwise stated.

The values given state the range over which the tube will operate both initially and during life. No allowance has been made for supply voltage and component variations. (note 1)

Initial values

Minimum voltage necessary for ignition (note 2)	115	V
Ignition delay time	See page C1	

Maintaining voltage at 20mA

Maximum	94	V
Minimum	86	V

Increase in maintaining voltage as cathode current is increased from 1 to 40mA (regulation voltage)

Note 3

Maximum	14	V
Average	12	V

Cathode current above which the incremental resistance is positive

2 mA

Typical maximum incremental resistance in the current range 1 to 40mA (note 3)

300 Ω

Life performance (note 4)

$I_k = 20\text{mA}$ $I_k = 40\text{mA}$

Minimum voltage necessary for ignition (note 2)	115	115	V
---	-----	-----	---

Percentage variation of maintaining voltage at cathode current (room temperature)

In 1,000 hrs (maximum)	±1	+5	-1	%
In 10,000 hrs (average)	+3.5	+5		%

Typical maximum increase in maintaining voltage as cathode current is increased over the current range

13 15 V



ABSOLUTE MAXIMUM RATINGS

Cathode current

Maximum for continuous operation	40	mA
Maximum surge (note 5)	100	mA
Minimum	1.0	mA
Maximum negative anode voltage	80	V
Minimum bulb temperature ($I_k = 0\text{mA}$)	-55	°C
Maximum ambient temperature		
For operation (note 6)	+70	°C
For storage (note 7)	+70	°C

OPERATING NOTES

1. Thermal equilibrium is reached within 3 minutes of igniting the tube.
2. This value holds good over life in light or darkness. See graph on page C1.
3. Following a sudden large change in the tube current, the change in maintaining voltage may be slightly greater than that given until tube thermal equilibrium is re-established (within 3 minutes).
4. These figures apply only when the tube is operated continuously at the currents stated.
5. To be restricted for long life to approximately 30 seconds in each 8 hours use.
6. This tube will operate satisfactorily at ambient temperatures up to 70°C providing the tube is not used at the upper end of the current range.
7. The tube should not be stored for more than 4 months at this maximum temperature without intermediate operation.

6317

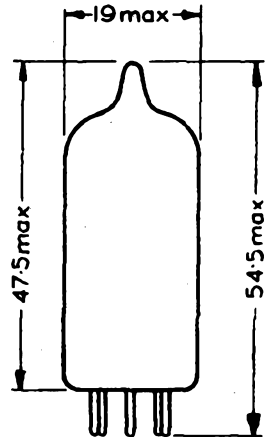
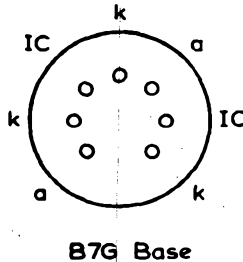
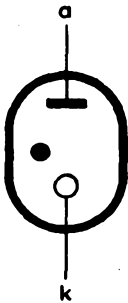

All dimensions in mm

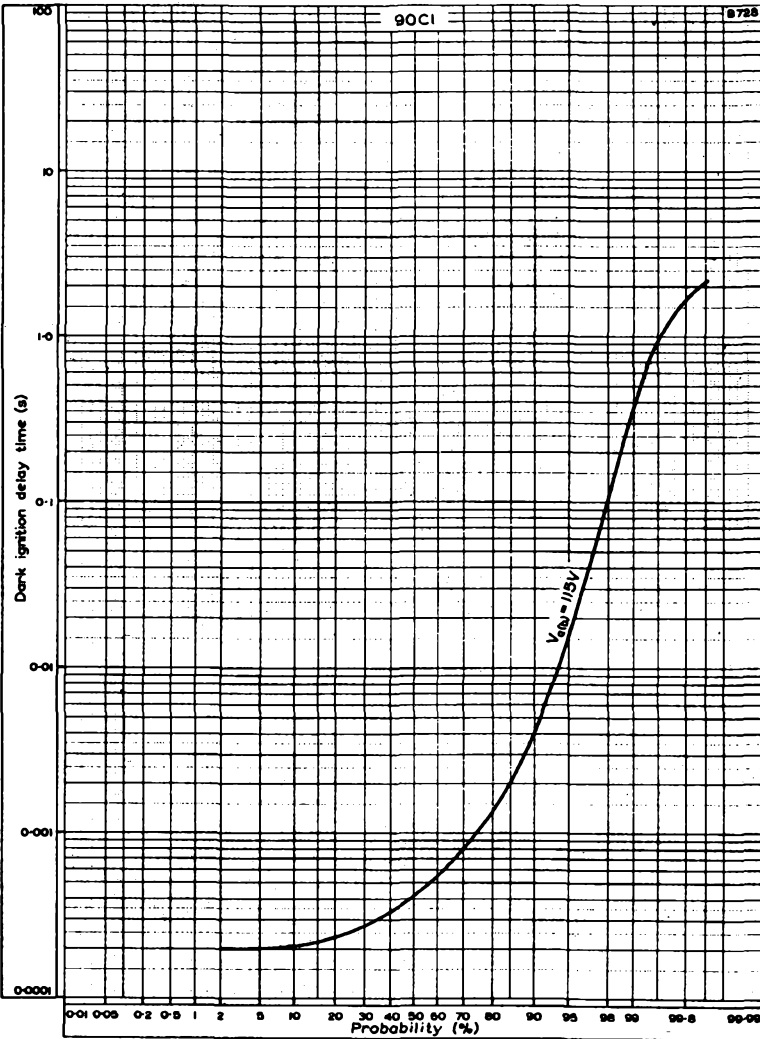

CUMULATIVE DISTRIBUTION OF DARK IGNITION DELAY TIME

This curve shows the probability that a tube will ignite in less than the time shown. This will be to some extent dependent on the supply voltage. In general an increase in the supply voltage will reduce the ignition delay time.



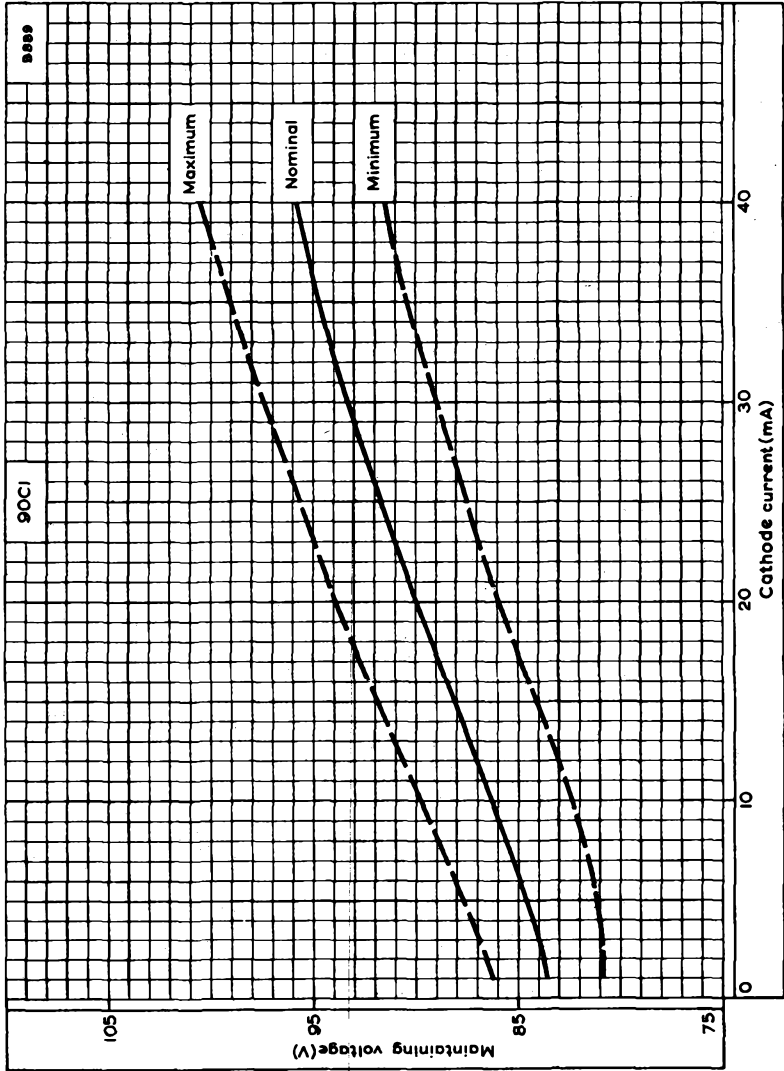

MAINTAINING VOLTAGE PLOTTED AGAINST CATHODE CURRENT
(Initial values)



QUICK REFERENCE DATA (nominal values)

Maintaining voltage	108	V
Cathode current range	5.0 to 30	mA
Regulation voltage	1.5	V
Ignition delay time	1.3	s

This data should be read in conjunction with GENERAL OPERATIONAL RECOMMENDATIONS—VOLTAGE STABILISER AND REFERENCE LEVEL TUBES which precede this section of the handbook.

CHARACTERISTICS AND RANGE VALUES FOR EQUIPMENT DESIGN measured at an ambient temperature of between 20 and 30°C unless otherwise stated.

The values given state the range over which the tube will operate both initially and during life. No allowance has been made for supply voltage and component variations.

Initial values

Minimum voltage necessary for ignition (note 1)	133	V
Ignition delay time	See page C1	
Maintaining voltage		
Maximum (at $I_k = 30\text{mA}$)	112	V
Minimum (at $I_k = 5.0\text{mA}$)	105	V
Increase in maintaining voltage as cathode current is increased from 5 to 30mA (regulation voltage)		
Maximum	3.5	V
Average	1.5	V

Life performance (note 2)

Minimum voltage necessary for ignition (note 1)	133	V
Maintaining voltage		
In 1000 hrs		
Maximum (at $I_k = 30\text{mA}$)	113	V
Minimum (at $I_k = 5.0\text{mA}$)	104	V
In 3000 hrs (note 3)		
Maximum (at $I_k = 30\text{mA}$)	113	V
Minimum (at $I_k = 5.0\text{mA}$)	104	V
Increase in maintaining voltage as cathode current is increased from 5.0 to 30mA		
Maximum	3.5	V
Typical	1.5	V
Percentage variation of maintaining voltage at 30mA during 1000 hrs life		
Maximum	± 3.0	%
Typical	± 1.0	%

ABSOLUTE MAXIMUM RATINGS

Cathode current		
Maximum for continuous operation	30	mA
Maximum surge (note 4)	75	mA
Minimum	5.0	mA
Maximum negative anode voltage	75	V
Minimum bulb temperature ($I_k = 0\text{mA}$)	-55	°C
Maximum bulb temperature		
For operation	+150	°C
For storage	+70	°C

OPERATING NOTES

1. This value holds good over life in light or darkness. See graph on page C1.
2. These figures apply only when the tube is operated continuously at the currents stated.
3. The maintaining voltage for all tubes will stay within the limits given and the change in any individual tube will not exceed +3V or -4V.
4. To be restricted for long life to approximately 30 seconds in each 8 hours' use.

1616

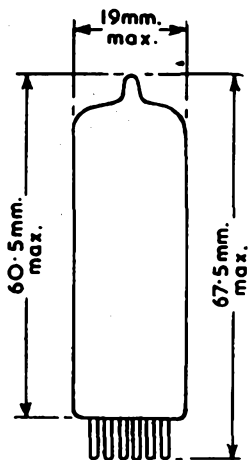
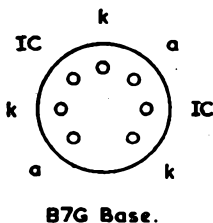

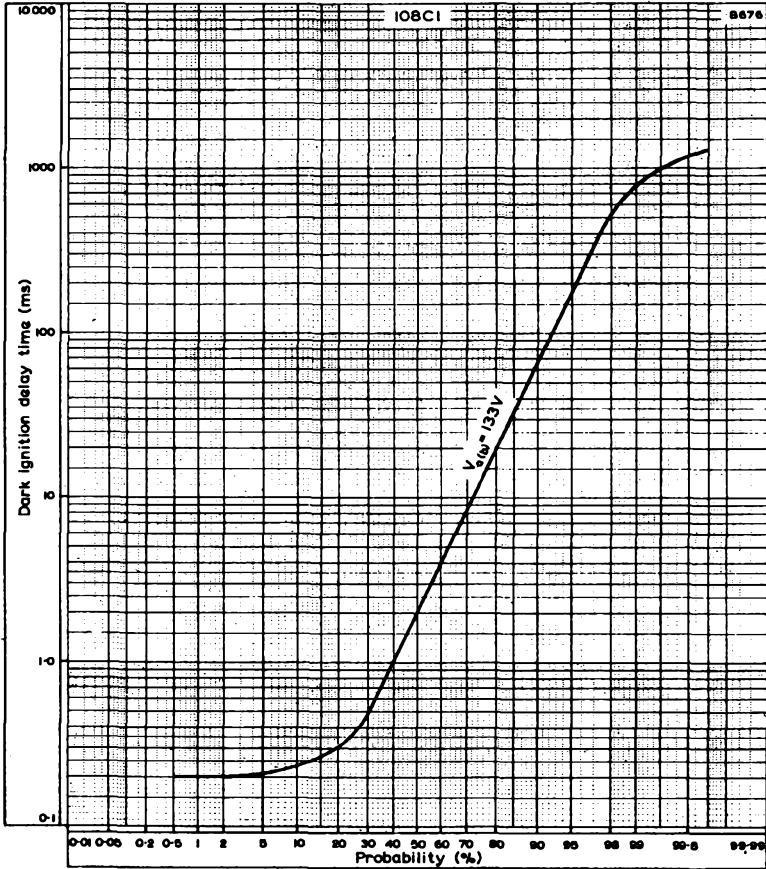

CUMULATIVE DISTRIBUTION OF DARK IGNITION DELAY TIME

This curve shows the probability that a tube will ignite in less than the time shown. This will be to some extent dependent on the supply voltage. In general an increase in the supply voltage will reduce the ignition delay time.



QUICK REFERENCE DATA (nominal values)

Maintaining voltage	150	V
Cathode current range	5 to 15	mA
Regulation voltage	4	V
Ignition delay time	250	ms

This data should be read in conjunction with GENERAL OPERATIONAL RECOMMENDATIONS—VOLTAGE STABILISER AND REFERENCE LEVEL TUBES which precede this section of the handbook.

CHARACTERISTICS AND RANGE VALUES FOR EQUIPMENT DESIGN measured at an ambient temperature of between 20 and 30°C unless otherwise stated.

The values given state the range over which the tube will operate both initially and during life. No allowance has been made for supply voltage and component variations. (note 1)

Initial values

Minimum voltage necessary for ignition (note 2)	180	V
Ignition delay time	See page C1	
Maintaining voltage at 10mA		
Maximum	151	V
Minimum	146	V
Increase in maintaining voltage as cathode current is increased from 5 to 15mA (regulation voltage)		
Maximum	5.0	V
Average	3.0	V
Temperature coefficient of maintaining voltage (approximate) at 10mA	+0.007%	per °C
Typical maximum voltage jumps in the current range 10 to 15mA	75	mV
Cathode current above which the incremental resistance is positive	5.0	mA
Incremental resistance (approx.) at 10mA	250	Ω

Life performance (note 3)

Minimum voltage necessary for ignition (note 2)	180	V
Percentage variation of maintaining voltage at room temperature		
In 1000 hrs at 10mA (maximum)	$\left. \begin{matrix} +1 \\ -0.5 \end{matrix} \right\}$	%
In 10,000 hrs at 5 and 10mA (typical maximum)		%
In 30,000 hrs at 5 and 10mA (typical maximum)	$\left. \begin{matrix} +2 \\ -1 \end{matrix} \right\}$	%
In 30,000 hrs at 5 and 10mA (typical maximum)		%
Typical maximum increase in maintaining voltage as cathode current is increased from 5 to 15mA		
In 1000 hrs	4.0	V
In 10,000 hrs	6.0	V



I50B2

STABILISING TUBE

ABSOLUTE MAXIMUM RATINGS

Cathode current		
Maximum for continuous operation	15	mA
Maximum surge (note 4)	40	mA
Minimum	5.0	mA
Maximum negative anode voltage	130	V
Minimum bulb temperature ($I_k = 0\text{mA}$)	-55	°C
Maximum ambient temperature		
For operation	+70	°C
For storage	+70	°C

OPERATING NOTES

1. Thermal equilibrium is reached within 3 minutes of igniting the tube.
2. This value holds good over life in light or darkness. See graph on page C1.
3. These figures apply only when the tube is operated continuously at the currents stated.
4. To be restricted for long life to approximately 30 seconds in each 8 hours' use.

B4716

4716

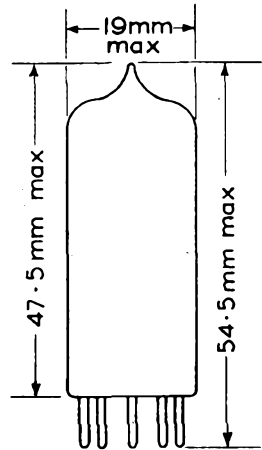
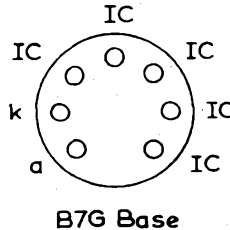
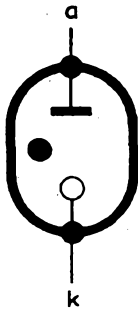

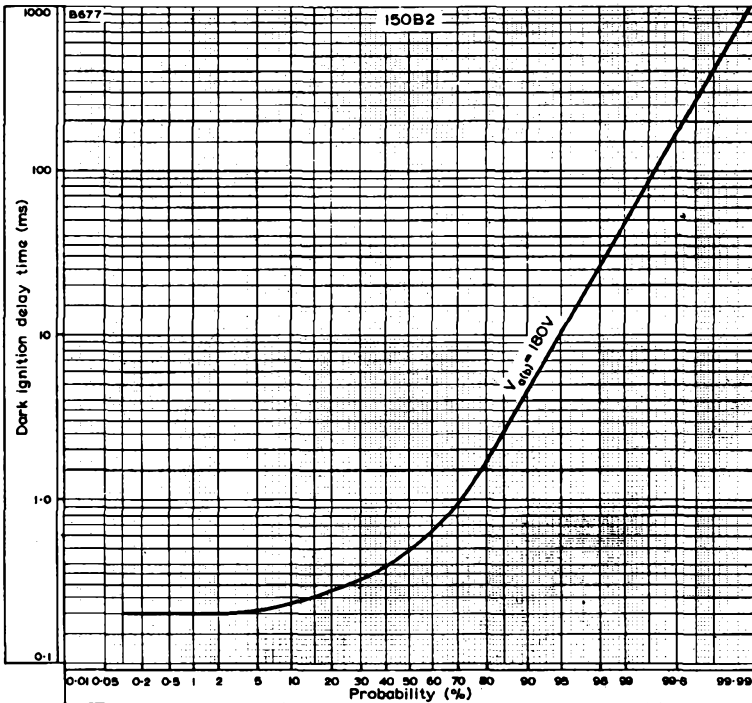

CUMULATIVE DISTRIBUTION OF DARK IGNITION DELAY TIME

This curve shows the probability that a tube will ignite in less than the time shown. This will be to some extent dependent on the supply voltage. In general an increase in the supply voltage will reduce the ignition delay time.



STABILISING TUBE

150C2

150V gas-filled stabiliser with a current range of 5 to 30mA.

This data should be read in conjunction with the GENERAL OPERATIONAL RECOMMENDATIONS — VOLTAGE STABILISER AND REFERENCE TUBES which precede this section of the handbook.

LIMITING VALUES (absolute ratings)

Minimum voltage necessary for ignition		
In some ambient light	185	V
In complete darkness	225	V
Burning current		
Maximum	30	mA
Minimum	5.0	mA
Maximum starting current	75	mA
Maximum negative anode voltage	125	V
Ambient temperature limits during operation	-55 to +90	°C

CHARACTERISTICS (at room temperature)

Initial values

Maintaining voltage (all tubes)		
Maximum (at $I_a = 30\text{mA}$)	165	V
Minimum (at $I_a = 5.0\text{mA}$)	142	V
Difference between maintaining voltages at $I_a = 30\text{mA}$ and $I_a = 5.0\text{mA}$ (Individual tube)		
Maximum	6	V
Typical	4	V

*Life performance

Percentage variation of maintaining voltage at $I_a = 30\text{mA}$ during 1000 hrs. life		
Maximum	± 3	%
Typical	± 1	%
Typical maximum difference between maintaining voltages at $I_a = 30\text{mA}$ and $I_a = 5.0\text{mA}$ (Individual tube)	5	V

*These figures apply when the tube is operated continually at 30mA at room temperature.



I50C2

STABILISING TUBE

1616

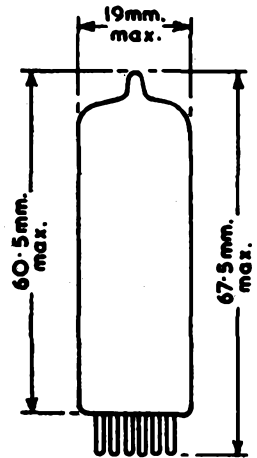
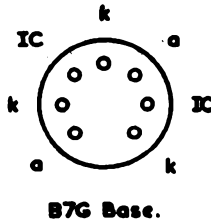
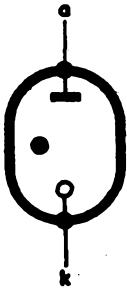

QUICK REFERENCE DATA (nominal values)

Maintaining voltage	150	V
Cathode current range	5 to 30	mA
Regulation voltage	3	V
Ignition delay time	10	s

This data should be read in conjunction with GENERAL OPERATIONAL RECOMMENDATIONS—VOLTAGE STABILISER AND REFERENCE LEVEL TUBES which precede this section of the handbook.

CHARACTERISTICS AND RANGE VALUES FOR EQUIPMENT DESIGN measured at an ambient temperature of between 20 and 30°C unless otherwise stated.

The values given state the range over which the tube will operate both initially and during life. No allowance has been made for supply voltage and component variations.

Initial values

Minimum voltage necessary for ignition (note 1)	185	V
Ignition delay time	See page C1	
Maintaining voltage (all tubes)		
Maximum (at $I_k = 30\text{mA}$)	156	V
Minimum (at $I_k = 5.0\text{mA}$)	143	V
Increase in maintaining voltage as cathode current is increased from 5 to 30mA (regulation voltage)		
Maximum	5.0	V
Average	3.0	V

Life performance (note 2)

Minimum voltage necessary for ignition (note 1)	185	V
Maintaining voltage		
Maximum (at $I_k = 30\text{mA}$)	156	V
Minimum (at $I_k = 5.0\text{mA}$)	139	V
Percentage variation of maintaining voltage at 30mA during 1,000 hrs life (room temperature)		
Maximum	$\left\{ \begin{array}{l} +1.5 \\ -5 \end{array} \right.$	%
Average		%
Average	± 1	%
Increase in maintaining voltage as cathode current is increased from 5 to 30mA		
Maximum	8.0	V
Average	3.0	V

ABSOLUTE MAXIMUM RATINGS

Cathode current		
Maximum for continuous operation	30	mA
Maximum surge (note 3)	75	mA
Minimum	5.0	mA
Maximum negative anode voltage	125	V
Minimum bulb temperature ($I_k = 0\text{mA}$)	-55	°C
Maximum bulb temperature		
For operation	+150	°C
For storage	+100	°C

OPERATING NOTES

1. This value holds good over life in light or darkness. See graph on page C1.
2. These figures apply only when the tube is operated continuously at 30mA.
3. To be restricted for long life to approximately 30 seconds in each 8 hours' use.

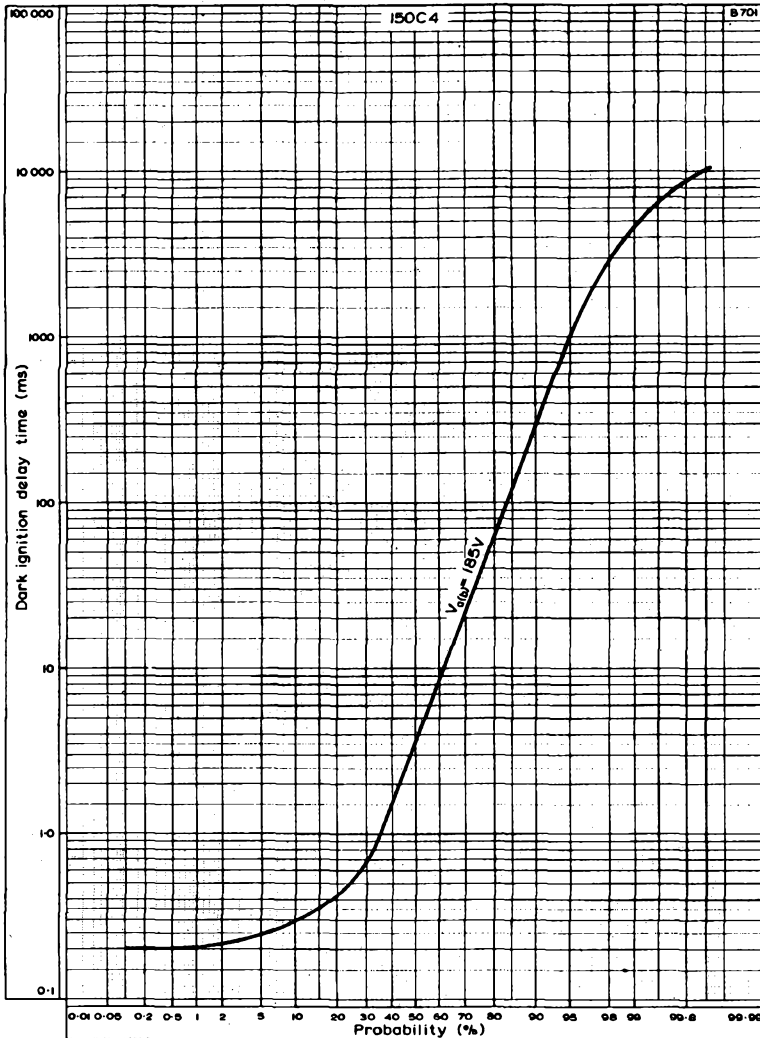

CUMULATIVE DISTRIBUTION OF DARK IGNITION DELAY TIME

This curve shows the probability that a tube will ignite in less than the time shown. This will be to some extent dependent on the supply voltage. In general an increase in the supply voltage will reduce the ignition delay time.



COUNTING TUBES



Construction

The Mullard counter and selector tubes consist of 30 identical rod-shaped cathodes arranged in a circle concentric with the common circular plate anode. The 30 cathodes are divided into three groups of ten and arranged so that every third electrode going around the ring belongs to the same group. The three groups are called main cathodes, guide A cathodes, and guide B cathodes. The order of the electrodes proceeding in a clockwise direction around the tube as seen from the dome is a main cathode, a guide A cathode, guide B cathode, next main cathode etc.

In both the counter tube and the selector tube all the guide A electrodes are connected internally and brought out to a single pin. The guide B electrodes are similarly connected and brought out. In the counter tube the main cathodes 1 to 9 are connected together internally and connected to a single pin. The 0 or tenth main cathode is brought out separately so that the tube can be set to zero and also an electrical output obtained for driving a succeeding tube. In the selector tube all the main cathodes are brought out individually so that an electrical output pulse can be obtained at any point around the tube.

Function of the electrode groups

Main cathodes

The glow normally rests on a main cathode thus providing indication, and electrical output may also be obtained from this cathode. The position of the discharge may be seen through the dome of the tube as an orange 'cathode glow' at the tip of the cathode concerned. The position of the discharge can be related to the number of input pulse by the use of an external numbered escutcheon aligned so that the numbers coincide with the position of the main cathodes.

Guide cathodes (A and B)

The function of the guide cathodes is to transfer the discharge from one main cathode to the next on the receipt of an input signal.

Basic circuit

The basic circuit is shown in Figure 1 on the individual data sheets and is essentially the same for both counter and selector tubes. An h.t. voltage, normally 475V, (which is greater than the anode-cathode ignition voltage) is applied to the circuit and breakdown to one of the main cathodes will, therefore, occur. Breakdown to more than one cathode cannot occur since conduction causes a voltage drop across the anode resistor and reduces the anode voltage across the tube to the maintaining voltage.

The transfer mechanism

The method usually employed to move the discharge around the tube is to convert the input signal into a pair of negative pulses. The first pulse is applied to all guide A cathodes followed immediately by the second pulse applied to all guide B cathodes.

Assume that the discharge is resting on the third main cathode k_3 : when the pulse is applied to guides A the voltage between anode and guides A exceeds the ignition voltage and breakdown can therefore occur. Because of the priming from the discharge to the conducting main cathode k_3 , breakdown will always occur to the adjacent guide A cathode GA_4 . The discharge to k_3 will be extinguished since the anode voltage falls by the magnitude of the applied negative pulse. Similarly breakdown to GB_4 will take place on the arrival of the second pulse and the potential of guides A will return to the bias level. Finally at the end of the second pulse the potential of guides B will also return to the bias level. The anode voltage rises towards a potential equal to the guide bias plus the maintaining voltage. However, when the anode to k_4 voltage exceeds the ignition value the discharge will move to k_4 and the transfer has then been completed. This sequence results in rotation in the clockwise direction. Counting in the anti-clockwise direction can be obtained by applying pulses to guides A and B in the reverse order.



Output pulse

A resistor is connected in series with k_0 (In Figure 1) so that an output pulse can be obtained when the discharge rests on k_0 . This resistor must be chosen so that when the glow rests on k_0 , the voltage on k_0 does not exceed the positive guide bias. It is common practice to take the earthy end of the resistor back to a negative bias supply to obtain a larger pulse. However, the magnitude of the bias should not at any time be more negative than -20 volts.

In the selector tube an output can be obtained by inserting a resistor in series with any of the main cathodes.

The maximum value of the main cathode resistor for either selector or counter is given by

$$R_k \text{ max.} = \frac{(V_G + V_k - 10) R_a}{(V_{ht} - V_M - V_G + 10)}$$

and the output voltage for any value of R_k is

$$V_{out} = \frac{(V_{ht} - V_M + V_k) R_k}{(R_k + R_a)}$$

where V_{ht} is the supply voltage

V_M is the maintaining voltage

V_G is the positive guide bias

V_k is bias to k_0 (numerical value only)

R_k is the cathode resistor

R_a is the anode resistor

Set zero

The discharge can conveniently be returned to k_0 by momentarily disconnecting all cathodes except k_0 . An alternative method is to pulse k_0 negatively to -120 volts. Care must be taken if this method is adopted that spurious pulses are not fed down the chain of counter tubes at the termination of the pulse.

DECADE SELECTOR AND COUNTING TUBE

Z504S

QUICK REFERENCE DATA

Short construction, bi-directional cold cathode, 10 output selector tube with neon type glow.

Maximum counting speed	5.0	kHz
Supply voltage	475	V
Output		
voltage	35	V
current	340	μ A
Indication	Self indicating	

No individual adjustment is necessary to align the bulb with the escutcheon.

This data should be read in conjunction with OPERATING NOTES-
COUNTER AND SELECTOR TUBES

CHARACTERISTICS AND RANGE VALUES FOR EQUIPMENT DESIGN (at an ambient temperature between 10° and 50°C unless otherwise stated.)

The values given state the range over which the tube will operate both initially and during life. No allowance has been made for supply voltage and component variations.

All voltages are referred to the most positive supply voltage to which any main cathode (not guide cathode) is returned.

IGNITION REQUIREMENTS

Anode supply voltage range $V_{a(b)}$ 375 to 1000 V

Minimum time constant of rise
of anode supply voltage (see note 1)

$V_{a(b)} < 550V$	1.0	ms
$V_{a(b)} \geq 550V$	6.0	ms

DISCHARGE AT REST ON A MAIN CATHODE

Maintaining voltage of anode to
main cathode (see curve on page 10)

($I_a = 340 \mu A$, $V_{GD(b)} = +25$ to $+50V$)

Typical maximum	205	V
Typical minimum	185	V
Main cathode current		
maximum (except during reset)	525	μA
minimum	250	μA
recommended	340	μA
Positive guide supply voltage $V_{GD(b)}$		
maximum	60	V
minimum	25	V
Maximum resistance between guides and guide supply		
	220	k Ω
Main cathode potential (except during reset)		
Non-conducting cathode		
maximum negative voltage	14	V
Conducting cathode		
maximum positive voltage (see note 2)	$V_{GD(b)}$ minus 10	V
maximum negative voltage	0	V

STEPPING REQUIREMENTS

This section should be considered in conjunction with the figures given on pages 7 and 8.

Minimum discharge dwell time

Main cathode	75	μs
guide A cathode	60	μs
guide B cathode	60	μs
Maximum interval between trailing edge of guide A pulse and leading edge of guide B pulse (double rectangular pulse drive)		
	3.0	μs

DECADE SELECTOR AND COUNTING TUBE

Z504S

Negative guide voltage to step the discharge from a main cathode to an adjacent guide cathode.

maximum	140 minus $V_{GD(b)}$	V
minimum	45	V

Voltage difference required between a guide cathode and the adjacent guide cathode in order to step the discharge.

maximum	140	V
minimum (see note 3)	45	V

Positive guide supply voltage to step the discharge from a guide cathode to the next cathode.

maximum	50	V
minimum	25	V

Main cathode potential

Non-conducting cathodes

maximum negative voltage	14	V
--------------------------	----	---

Conducting cathode

maximum positive voltage		V
(see note 2)	$V_{GD(b)}$ minus 10	V
maximum negative voltage	0	V

RESETTING REQUIREMENTS

Reset to Cathodes
(7, 8, 9, 0, 1, 2, 3) (4, 5, 6)

Maximum permitted negative

main cathode voltage	240	140	V
----------------------	-----	-----	---

Minimum negative main cathode voltage

pulse duration $>1.0\text{ms}$	120	120 (see note 4)	V
--------------------------------	-----	---------------------	---

pulse duration $\geq 200\mu\text{s}$	130	-	V
--------------------------------------	-----	---	---

Minimum pulse duration	200	-	μs
------------------------	-----	---	---------------

Maximum reset cathode current (see note 5)	800	650	μA
--	-----	-----	---------------

LIFE AND RELIABILITY

With this tube an average failure rate of less than 0.5%/1000 hours has been obtained. When operated continuously this failure rate applies for a period in excess of 25 000 hours, but the visual read-out may be impaired after the first 15 000 hours.

These figures have been obtained under the following typical conditions

Anode current	340	μA
Positive guide supply voltage	40	V
Negative guide voltage for transfer	80	V
Output cathode (K_0) voltage		
Non-conducting	-12	V
Conducting	0	V
Guide A dwell time	110	μs
Guide B dwell time	250 to 650	μs
Counting speed	0.2 pulse/h to 500 pulse/s	
Temperature	20 \pm 5	$^{\circ}\text{C}$

A typical tube can be expected to count correctly with the above conditions after standing on one main cathode for a period of approximately 4500 hours.

ABSOLUTE MAXIMUM RATINGS

Maximum continuous main cathode current (except during reset)	525	μA
Maximum reset cathode current (cathodes 7, 8, 9, 0, 1, 2, 3)	800	μA
(cathodes 4, 5, 6)	650	μA
Maximum voltage between any two main or guide cathodes (except during reset)	140	V
Maximum positive guide supply voltage	60	V
Maximum ambient temperature for operation and standby (see note 6)	50	$^{\circ}\text{C}$

DECADE SELECTOR AND COUNTING TUBE

Z504S

NOTES

1. If the power supply does not have a suitable time constant as one of its characteristics, it can be conveniently obtained by inserting a resistor in series with the supply voltage and a capacitor to earth ($4.7k\Omega$ and $0.25\mu F$ for 1.0ms, $6.8k\Omega$ and $1.0\mu F$ for 6.0ms).
2. This value should not exceed 40V.
3. The adjacent guide cathode (the cathode to which the discharge is being transferred) must also be 45V negative with respect to the most positive main cathode supply voltage.
4. For cathodes 4, 5 and 6, the leading edge of the resetting pulse should have a rate of fall not exceeding 140V per ms. Resetting will occur within 1ms after the voltage has reached 120V.
5. The high current permitted during reset should not be allowed to flow for more than a few seconds.
6. It is preferable to store the tube as near as possible to room temperature.

ACCESSORIES

Valve holder
Escutcheon

B8 700 67
101065

The issue of the information contained in this publication does not imply any authority or licence for the utilisation of any patented feature.

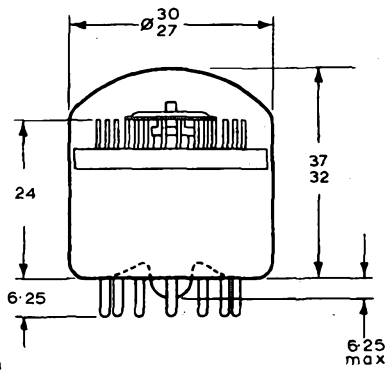

All dimensions in mm

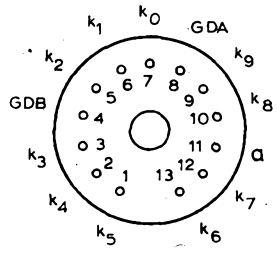
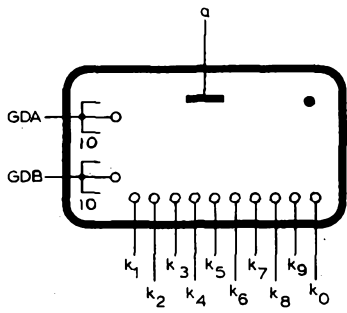

B13B Base

k_0 is aligned with pin 7 to within $\pm 3^\circ$

D1792

DECADE SELECTOR AND COUNTING TUBE

Z504S

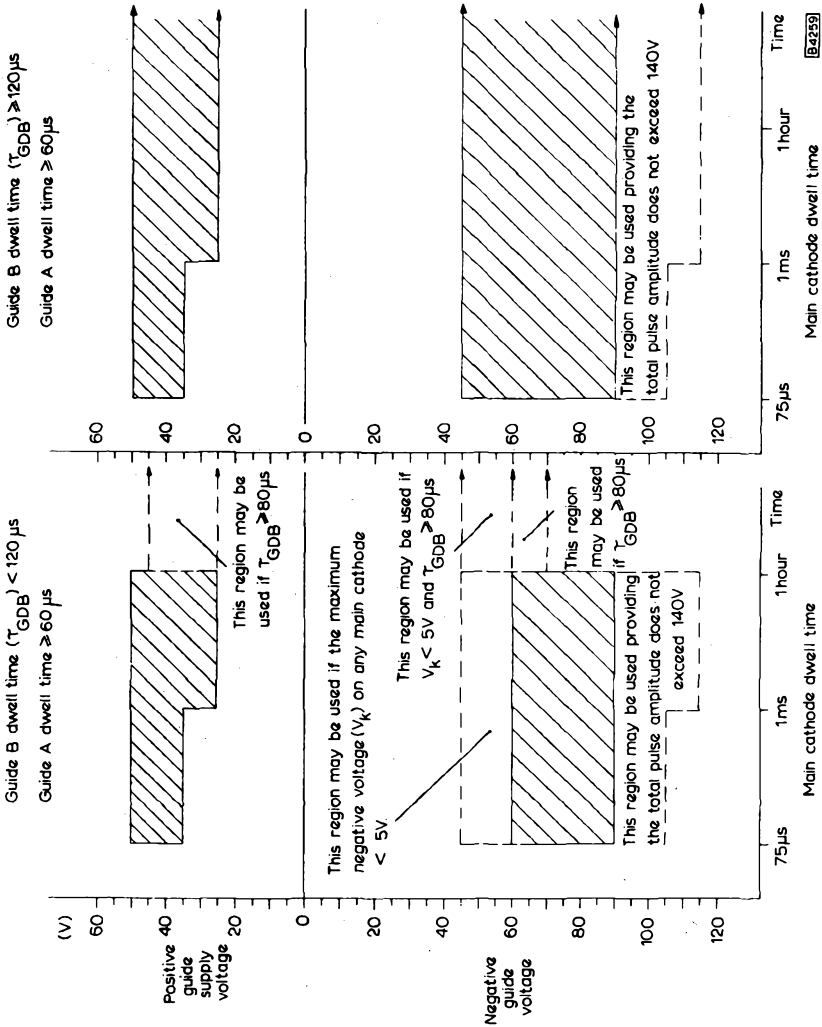

GUIDE OPERATING VOLTAGES

The shaded areas represent regions where the tube may be used without restriction initially and during life



GUIDE WAVEFORMS

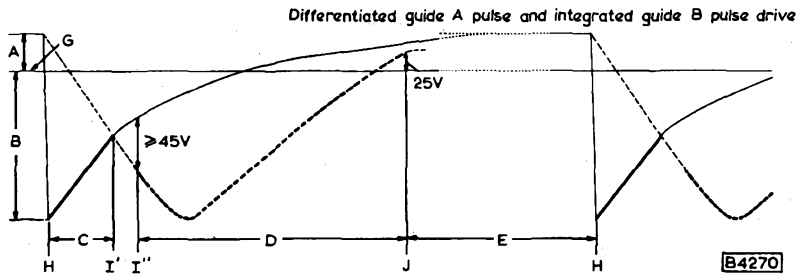
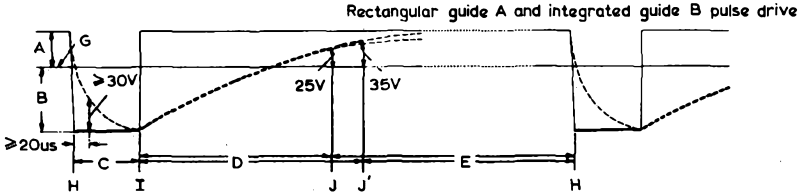
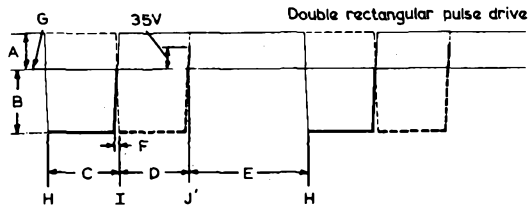

B4270

- A Positive guide supply voltage
- B Negative guide voltage
- C Guide A dwell time
- D Guide B dwell time
- E Main cathode dwell time
- F Interval between trailing edge of guide A pulse and leading edge of guide B pulse
- G Potential of most positive main cathode supply voltage
- H Discharge transfers from main cathode to guide A cathode
- I Discharge transfers from guide A cathode to guide B cathode
- I' Earliest instant for discharge transfer from guide A cathode to guide B cathode
- I'' Latest instant for discharge transfer from guide A cathode to guide B cathode
- J Latest instant for discharge transfer from guide B cathode to main cathode, for a main cathode dwell time $>1\text{ms}$
- J' Latest instant for discharge transfer from guide B cathode to main cathode dwell time $\leq 1\text{ms}$

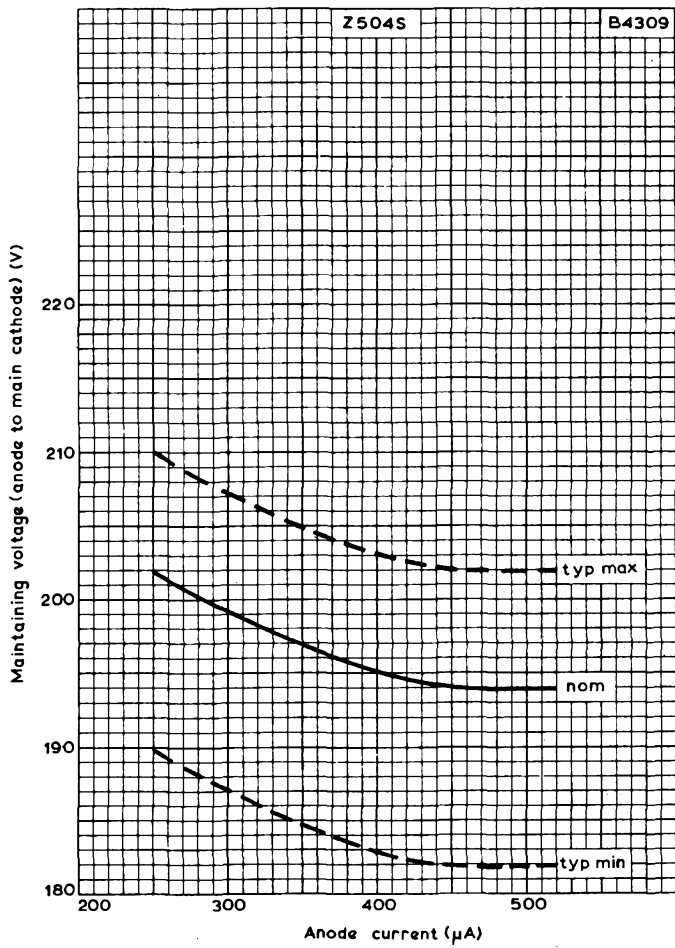

ANODE TO MAIN CATHODE MAINTAINING VOLTAGE PLOTTED AGAINST ANODE CURRENT

DECADE SELECTOR AND COUNTING TUBE

Z504S

APPLICATION DATA

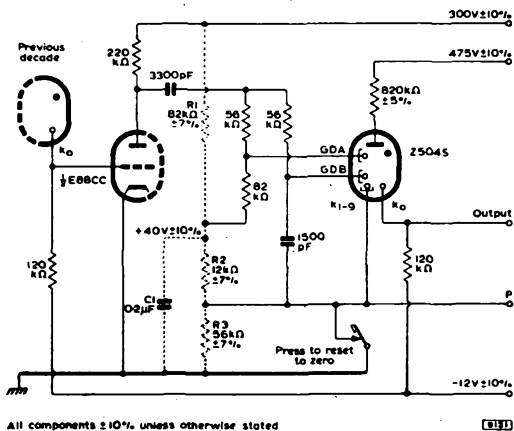
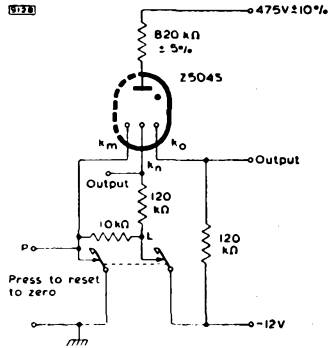

Fig. 1

Coupling stage suitable for use with Z504S

The potential divider R1, R2, R3 and C1 is used to define the positive guide bias and the reset voltages. The potential divider may be used as a common supply for up to five further coupling stages.

Two circuits illustrating alternative methods of connecting the main cathodes of Z504S are shown in figure 2.



All components $\pm 10\%$ unless otherwise stated

Fig. 2a

This circuit gives an output of 35V from k_o and outputs of 35V from each of the cathodes in group k_n .

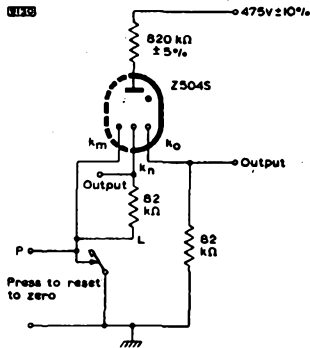

All components $\pm 10\%$ unless otherwise stated

Fig. 2b

This circuit gives an output of 23V from k_o and outputs of 23V from each of the cathodes in group k_n . This circuit cannot be directly coupled to the coupling stage in figure 1.

In the two circuits in figure 2, k_m refers to the main cathodes from which no output is required, whilst k_n refers to the main cathodes, excepting k_o from which an output pulse is required. Each cathode in the k_n group must be connected to point L via a separate resistor.

DECADE SELECTOR AND COUNTING TUBE

Z505S

QUICK REFERENCE DATA

Short construction, bi-directional, cold cathode, 10 output selector tube with glow indication.

Maximum counting speed	50	kHz
Supply voltage	500	V
Output		
voltage	24	V
current	800	μ A
Indication	Self indicating	

No individual adjustment is necessary to align the bulb with the escutcheon.

This data should be read in conjunction with OPERATING NOTES - COUNTER AND SELECTOR TUBES

CHARACTERISTICS AND RANGE VALUES FOR EQUIPMENT DESIGN (at an ambient temperature between 10°C and 50°C unless otherwise stated).

The values given state the range over which the tube will operate both initially and during life. No allowance has been made for supply voltage and component variations.

All voltages are referred to the most positive supply voltage to which any main cathode (not guide cathode) is returned.

IGNITION REQUIREMENTS

Anode supply voltage range $V_{a(b)}$	400 to 1000	V
Minimum time constant of rise of anode supply voltage (see note 1)	2.0	ms

DISCHARGE AT REST ON A MAIN CATHODE

Maintaining voltage of anode to main cathode

($I_a = 800\mu A$, $V_{GD(b)} = 55V$)

Typical maximum	275	V
Typical minimum	240	V

Main cathode current

Maximum (except during reset)	1000	μA
Minimum	600	μA
Recommended	800	μA

Positive guide supply voltage $V_{GD(b)}$

Maximum	65	V
Minimum	40	V

Maximum resistance between guides and guide supply

22 $k\Omega$

Main cathode potential (except during reset)

Non-conducting cathode

Maximum negative voltage	14	V
--------------------------	----	---

Conducting cathode

Maximum positive voltage (see note 2)	28	V
Maximum negative voltage	0	V

STEPPING REQUIREMENTS

This section should be considered in conjunction with the figures given on pages 6 and 7.

Minimum discharge dwell time

Main cathode	8.0	μs
Guide A cathode	6.0	μs
Guide B cathode	6.0	μs

Maximum interval between trailing edge of guide A pulse and leading edge of guide B pulse (double rectangular pulse drive)

0.3 μs

Negative guide voltage to step the discharge from a main cathode to an adjacent guide cathode.

Maximum	80	V
Minimum	30	V

DECADE SELECTOR AND COUNTING TUBE

Z505S

Voltage difference required between a guide cathode and the adjacent guide cathode in order to step the discharge.

Maximum	140	V
Minimum (see note 3)	30	V

Positive guide supply voltage to step the discharge from a guide cathode to the next main cathode.

Maximum	65	V
Minimum	40	V

Main cathode potential

Non-conducting cathodes

Maximum negative voltage	14	V
--------------------------	----	---

Conducting cathode

Maximum positive voltage (see note 2)	28	V
Maximum negative voltage	0	V

RESETTING REQUIREMENTS (see note 4)

Maximum permitted negative main cathode voltage	140	V
Minimum negative main cathode voltage (see note 5)	100	V

LIFE

A TYPICAL TUBE CAN BE EXPECTED TO COUNT CORRECTLY WITH THE FOLLOWING CONDITIONS AFTER STANDING ON ONE MAIN CATHODE FOR A PERIOD OF APPROXIMATELY 4500 HOURS.

Anode current	800	μ A
Positive guide supply voltage	60	V
Negative guide voltage for transfer	50	V
Output cathode (K_0) voltage		
Non-conducting	5.0	V
Conducting	-5.0	V
Guide A dwell time	6.0	μ s
Guide B dwell time	6.0	μ s
Main cathode dwell time	8.0	μ s
Temperature	20 \pm 5	$^{\circ}$ C

RATINGS (ABSOLUTE MAXIMUM SYSTEM)

Maximum continuous main cathode current (except during reset)	1000	μ A
Maximum voltage between any two main or guide cathodes (except during reset)	140	V
Maximum positive guide supply voltage	65	V
Maximum negative reset voltage	140	V
Maximum ambient temperature for operation and standby (see note 6)	50	$^{\circ}$ C

NOTES

1. If the power supply does not have a suitable time constant as one of its characteristics, it can be conveniently obtained by inserting a resistor in series with the supply voltage and a capacitor to earth (4.7k Ω and 0.5 μ F for 2.0ms).
2. The maximum voltage difference between any two main cathodes except during reset must not exceed 28 volts.
3. The adjacent guide cathode (the cathode to which the discharge is being transferred) must also be 30 volts negative with respect to the most positive main cathode supply voltage.
4. The high current which passes during reset should not be allowed to flow for more than a few seconds.
5. If the cathode current falls below 700 μ A and the positive guide supply voltage applied to the tube approaches the minimum value of 40 volts, the negative voltage required for resetting may rise to 110 volts.
6. It is preferable to store the tube as near as possible to room temperature.

ACCESSORIES

Valve holder	B8 700 67
Escutcheon	101065

DECADE SELECTOR AND COUNTING TUBE

Z505S

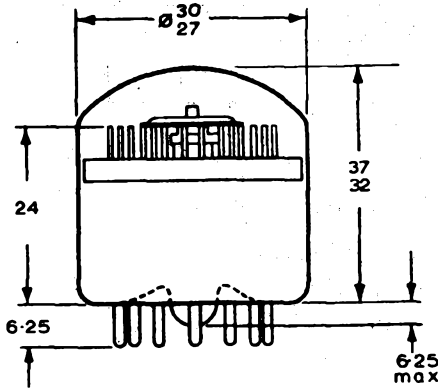

The tubulation does not project beyond the pins

All dimensions in mm

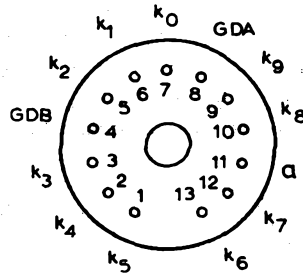
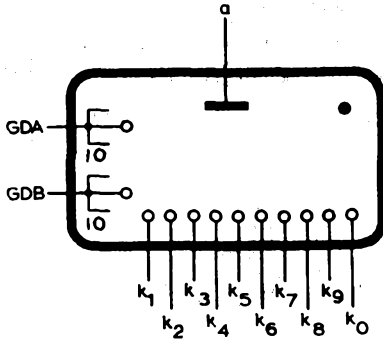

B13B Base

k_0 is aligned with pin 7 to within $\pm 3^\circ$

D1792

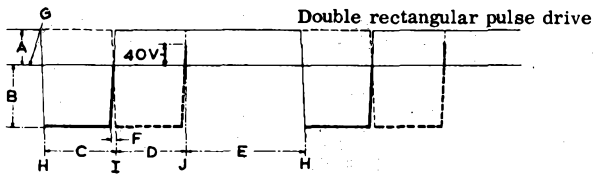

GUIDE WAVEFORMS

- A Positive guide supply voltage
- B Negative guide voltage
- C Guide A dwell time
- D Guide B dwell time
- E Main cathode dwell time
- F Interval between trailing edge of guide A pulse and leading edge of guide B pulse
- G Potential of most positive main cathode supply voltage
- H Discharge transfers from main cathode to guide A cathode
- I Discharge transfers from guide A cathode to guide B cathode
- J Latest instant for discharge transfer from guide B cathode to main cathode, dwell time $\leq 500\mu\text{s}$.

DECADE SELECTOR AND COUNTING TUBE

Z505S

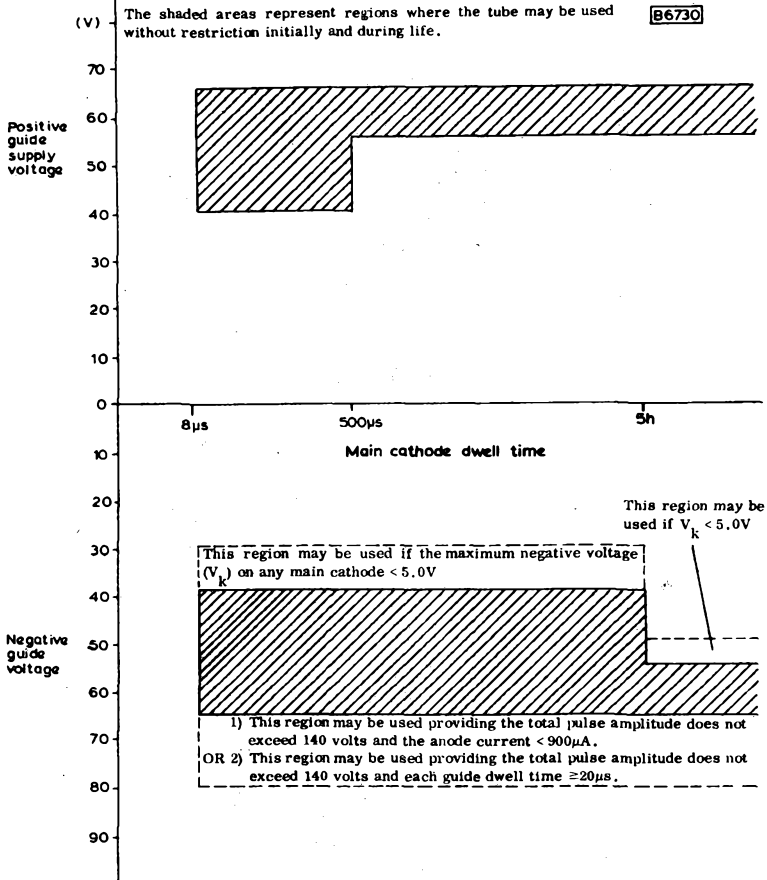

GUIDE OPERATING VOLTAGES

NUMERICAL AND CHARACTER INDICATING TUBES

E



QUICK REFERENCE DATA

Cold cathode, neon filled, side viewing indicator tubes with long life expectancy. The ZM1000R is coated with a red filter to improve the contrast of display. These tubes incorporate a decimal point and are fitted with a pin base to suit the standard grid (2.54mm). A primer allows ionisation without delay in strobe type or blanking applications.

Numeral height	14	mm
Minimum distance between mounting centres	19	mm
Numerals	1 2 3 4 5 6 7 8 9 0	
Decimal point	to the left of the numerals	
Cathode current, average	2.5	mA
maximum peak	12	mA
Minimum supply voltage	170	V

CHARACTERISTICS AND OPERATING CONDITIONS (Measured at 0 to 70°C)

Minimum anode-to-cathode voltage necessary for ignition	170	V
Anode-to-cathode maintaining voltage		See page 3
Anode-to-cathode voltage below which all tubes will extinguish	118	V
Cathode current (with or without decimal point $V_{kk} > V_{kk \text{ min.}}$, I_{kk} +ve see page 4)		
Minimum (see note 1)	1.5	mA
Maximum	4.5	mA
Cathode selecting voltage		See page 4
Cathode resistor, decimal point (see note 2)	100 ± 10%	kΩ
Primer resistor	10 ± 10%	MΩ

D.C. OPERATION

See pages 3, 4, 5 and 6

PULSE OPERATION

Minimum pulse duration	100	μs
------------------------	-----	----

Peak currents up to 12mA can be allowed provided the average current value does not exceed 2.5mA. To avoid excessive glow on "off" cathodes, the cathode selecting voltage should exceed 65V.

LIFE EXPECTANCY at anode current of 2.5mA (see note 3)

Sequentially changing the display from one numeral to another, every 1000 hours or less	100 000	h
---	---------	---

RATINGS (ABSOLUTE MAXIMUM SYSTEM)

Minimum anode-to-cathode voltage necessary for ignition	170	V
Cathode current		
Maximum average (averaged over any 20ms)	4.5	mA
Maximum peak	12	mA
Minimum average (averaged over any conduction period)	1.5	mA
Cathode selecting voltage		See page 4
Bulb temperature		
Maximum	+70	°C
Minimum (see note 3)	-50	°C

MOUNTING POSITION

Any

OPERATING NOTES

1. The minimum average current (averaged over any conduction period) of 1.5mA is necessary to ensure complete cathode coverage initially and throughout life.
2. Lower values of this resistor are permitted. The anode current should be increased due to the increase of decimal point current resulting from the decrease of this resistor.
3. For bulb temperatures below 10°C the life expectancy of the tube is substantially reduced and the characteristics are changed (see page 3). For equipment to be used over a wide temperature range, "constant current operation" (high supply voltage with a high anode series resistor) is recommended.
4. The pins are tinned and may be dip-soldered to a minimum of 5mm from the seals at a solder temperature of 240°C for a maximum of 10 seconds.
5. The natural frequencies of the numeral cathodes lie within the range from 300Hz to 800Hz.

ACCESSORIES

Printed wiring mounting board (19 × 100mm) on which the tube can be mounted. Afterwards the combination can be mounted on a vertical printed wiring board carrying the drive circuit. Can also be used with the snap-fit tube holder 55703	55701
Tube socket (for 2.54mm grid). Phenolic. Tinned contacts	55702
Snap-fit tube holder	55703
Set of one left-hand and one right-hand end piece to complete the snap-fit indicator tube assembly	55704

NUMERICAL INDICATOR TUBES

ZM1000 ZM1000R

OUTLINE AND DIMENSIONS

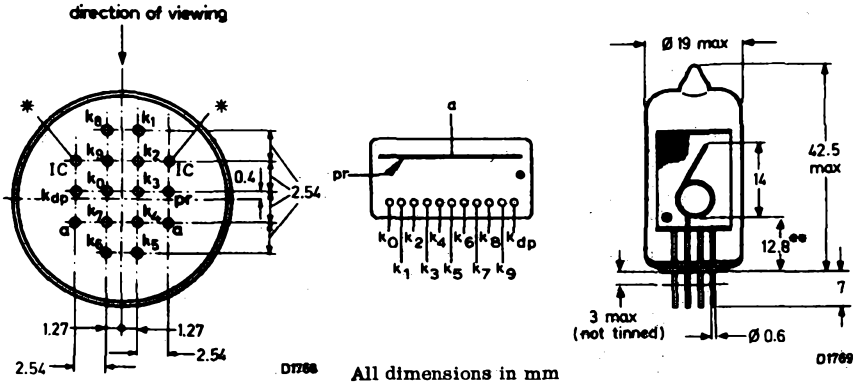

* Length of 2 pins marked * = 2.8mm max. ** Standard deviation = 0.13mm

All pin centres lie within an area of 0.3mm diameter around the true geometrical position.

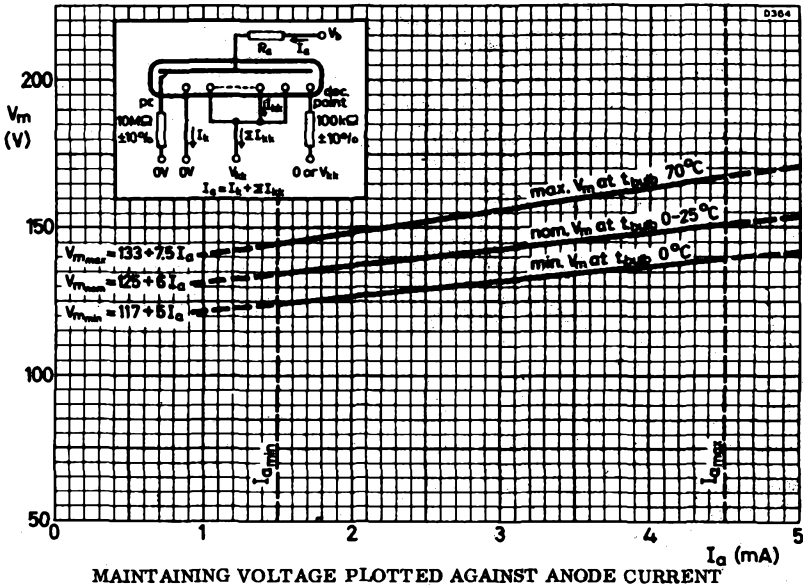

Mullard

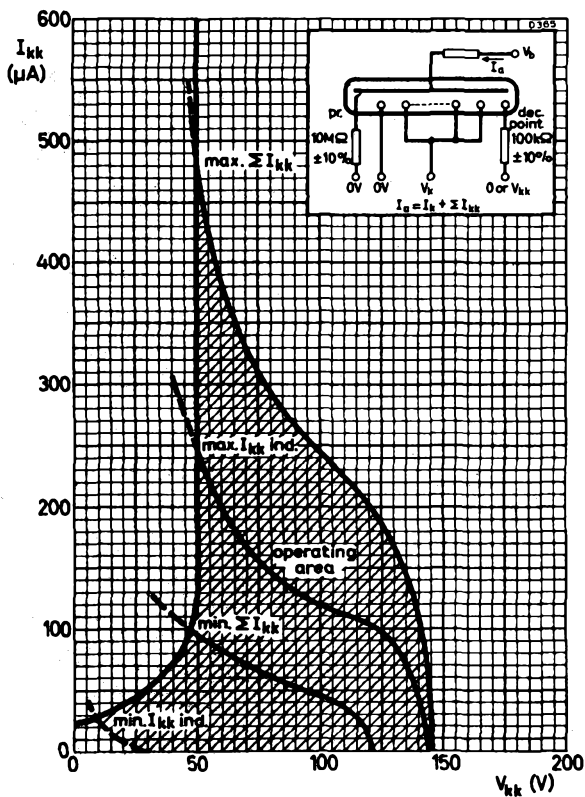

PROBE CURRENT PLOTTED AGAINST SELECTING VOLTAGE

I_{kk} individual and ΣI_{kk} versus cathode selecting voltage V_{kk} at $I_a = 2.5\text{mA}$.

I_{kk} and ΣI_{kk} are proportional to the anode current within the operating range of I_a and with $V_{kk} = 0$ to 100V.

The curves are valid for instantaneous values and for average values of anode current.

Reverse probe current is not permitted.

NUMERICAL INDICATOR TUBES

ZM1000 ZM1000R

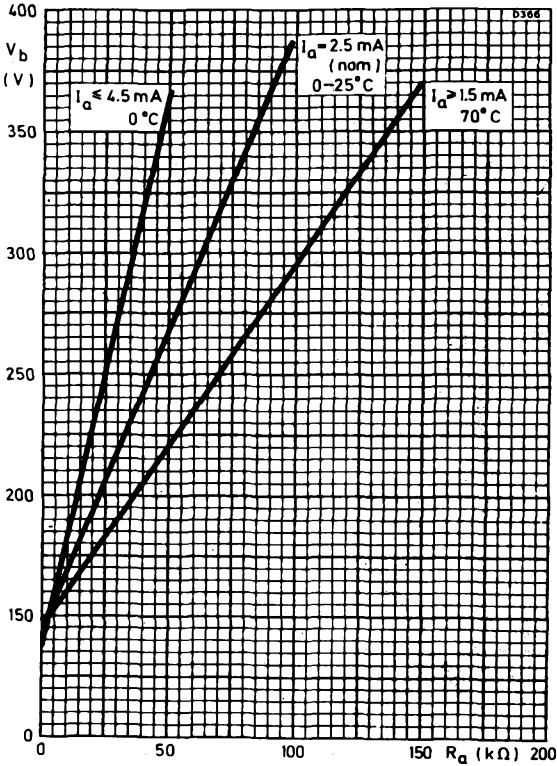

RELATIONSHIP BETWEEN D. C. SUPPLY VOLTAGE AND
ANODE RESISTOR

Mullard

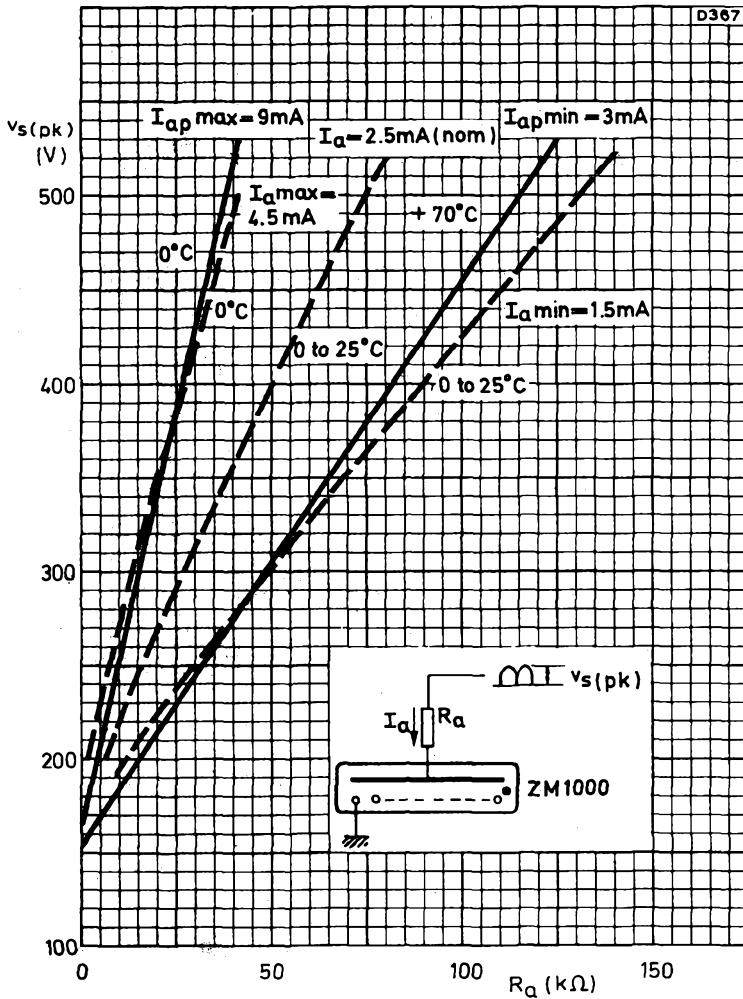

RELATIONSHIP BETWEEN PULSE SUPPLY VOLTAGE AND ANODE RESISTOR.

QUICK REFERENCE DATA

Cold cathode, side viewing character indicator tubes with long life expectancy to be used in conjunction with ZM1000 or ZM1000R numerical indicator tubes. The ZM1001R incorporates a red filter to improve the contrast of display.

Character height	10 to 14	mm
Characters	+, -, ~, X, Y, Z	
Cathode current, average	2.5	mA
maximum peak	12	mA
Minimum supply voltage	170	V

CHARACTERISTICS, OPERATING CONDITIONS AND RATINGS

These are identical to type ZM1000

MOUNTING AND ACCESSORIES

These are the same as for type ZM1000

OUTLINE AND DIMENSIONS

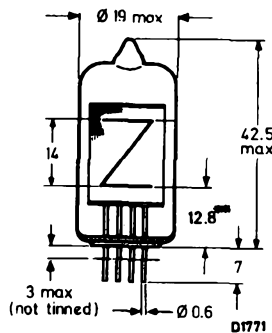
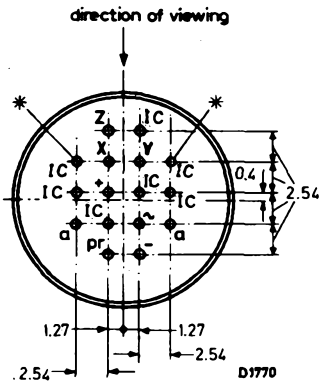

All dimensions in mm

*Length of 2 pins marked * = 2.8mm max. **Standard deviation = 0.13mm

All pin centres lie within an area of 0.3mm diameter around the true geometrical position.

QUICK REFERENCE DATA

Cold cathode, neon filled, side viewing indicator tubes with long life expectancy. The ZM1080 incorporates a red filter to improve the contrast of display. The ZM1082 is electrically identical but has no filter coating. These tubes are particularly suitable where several tubes are displayed side by side.

Numeral height	13	mm
Distance between mounting centres	min. 19	mm
Viewing angle	120	deg
Numerals	1 2 3 4 5 6 7 8 9 0	
Cathode current	2.0	mA
Supply voltage	min. 170	V

Unless otherwise stated, data is applicable to both types

CHARACTERISTICS AND RANGE VALUES FOR EQUIPMENT DESIGN

(Measured at 20 to 50°C)

The values given state the range over which the tube will operate both initially and during life. No allowance has been made for supply voltage and component variations.

IGNITION REQUIREMENTS

Anode-to-cathode voltage	min. 170	V
Ignition delay time		see page 4

CONDUCTION REQUIREMENTS

D. C. Operation

Cathode current (see note 1)	max. 3.5	mA
	min. 1.5	mA

Anode-to-cathode maintaining voltage at 2.0mA (see page 5)	nom. 140	V
--	----------	---

Probe current to individual non-conducting cathodes (I_{kk})		see pages 6 and 7
--	--	-------------------

Pulse Operation

Cathode current, peak	max. 12	mA
-----------------------	---------	----

Cathode current, average (averaging time = 20ms)	max. 2.5	mA
--	----------	----

Cathode current for satisfactory display, average	min. 0.8	mA
---	----------	----

Pulse duration	max. 20	ms
	min. 100	μs

CONDUCTION REQUIREMENTS (contd.)

Pulse Operation (contd.)

Anode-to-cathode maintaining voltage		see page 5
Probe current to individual non-conducting cathodes		see pages 6 and 7

EXTINCTION REQUIREMENTS

Anode-to-cathode voltage to ensure extinction	max. 115	V
---	----------	---

LIFE EXPECTANCY at recommended operating conditions and room temperature

Continuous display of one digit (see note 1)	min. 5000	h
Sequentially changing the display from one digit to the next every 100 hours or less	min. 30 000	h

RATINGS (ABSOLUTE MAXIMUM SYSTEM)

Cathode current (each digit)

Maximum average (maximum averaging time = 20ms)	3.5	mA
Maximum peak	12	mA
Minimum average during conduction	1.5	mA

Bulb temperature

Maximum	+70	°C
Minimum (see note 2)	-50	°C

MOUNTING POSITION

Any

The numbers are viewed through the side of the envelope. The numbers will appear upright (within $\pm 3^\circ$) when the tube is mounted vertically.

OPERATING NOTES

1. The life expectancy figures given above relate to operation with d.c. cathode currents between 1.5 and 2.5mA, and at all permitted pulsed cathode currents. When a d.c. cathode current range of 1.5 to 3.5mA is used, the life expectancy exceeds 3000 hours with continuous display of one digit.
2. For bulb temperatures below 0°C the life expectancy of the tube is substantially reduced.
3. The leads are tinned and may be dip-soldered to a minimum of 5mm from the seals at a solder temperature of 240°C for a maximum of 10 seconds.
4. Care should be taken not to bend the leads nearer than 1.5mm from the seals.
5. The tube may be soldered directly into the circuit but heat conducted to the glass-to-metal seals should be kept to a minimum by the use of a thermal shunt.

NUMERICAL INDICATOR TUBES

ZMI080 ZMI082

OUTLINE DRAWING

01772

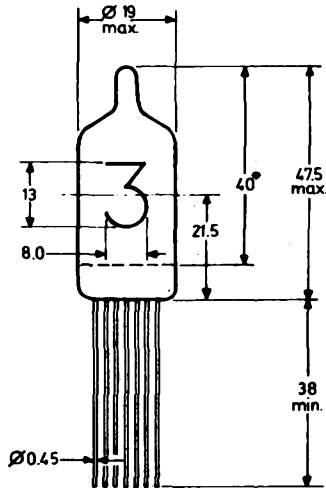

This part of the bulb is filter coated.
(ZMI080 only)

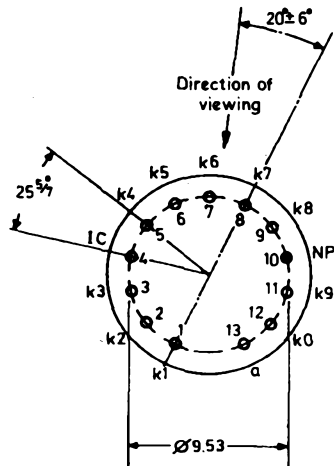
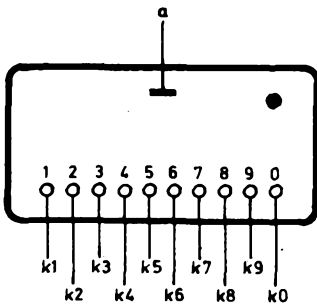

All dimensions in mm.

Mullard

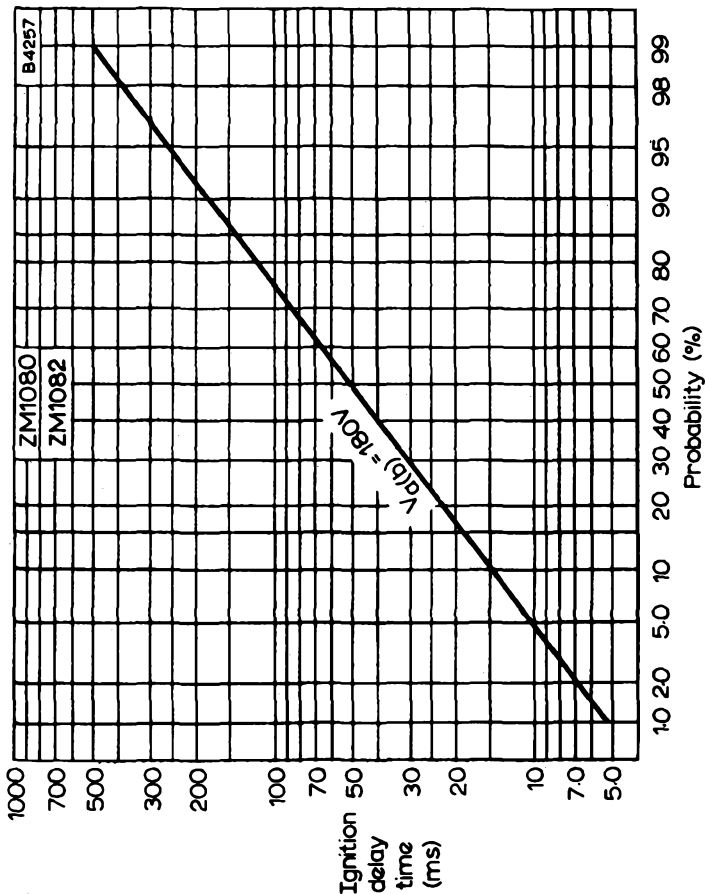

CUMULATIVE DISTRIBUTION OF IGNITION DELAY TIME

This curve shows the probability that a tube will ignite in less than the time shown after a non-conduction period of a few seconds. The ignition delay time will be appreciably reduced when the interval between conduction periods is less than 100 milliseconds. In general, an increase in the supply voltage will reduce the ignition delay time.

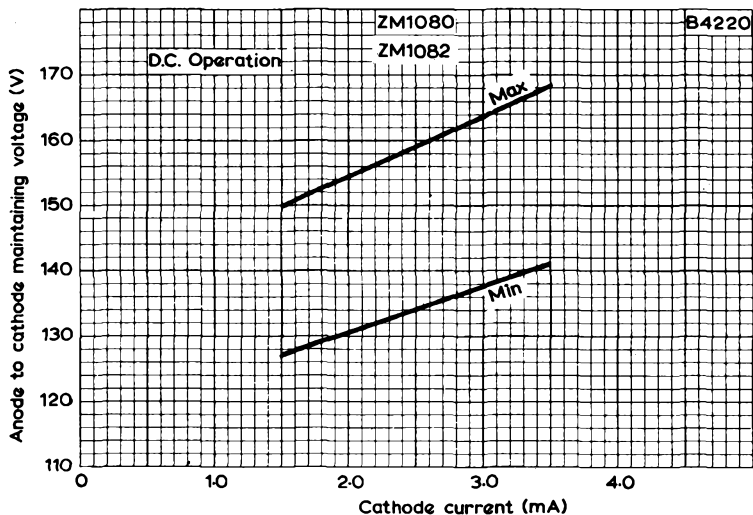

ANODE TO CATHODE MAINTAINING VOLTAGE PLOTTED AGAINST CATHODE CURRENT

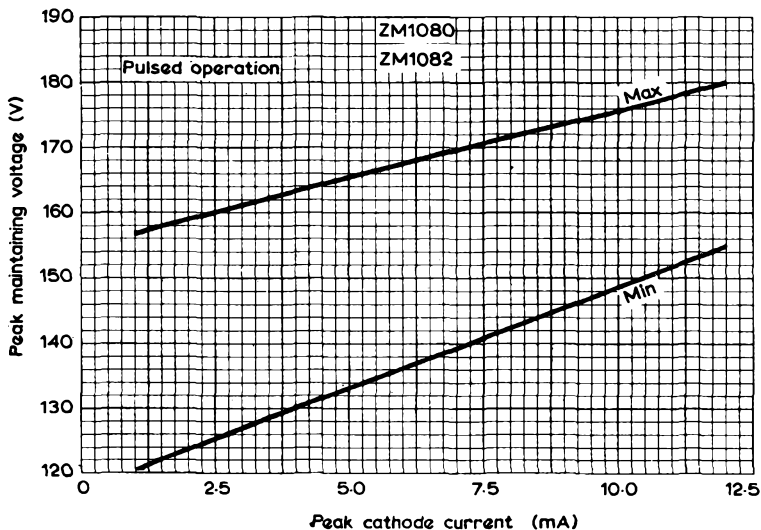

PEAK MAINTAINING VOLTAGE PLOTTED AGAINST PEAK CATHODE CURRENT

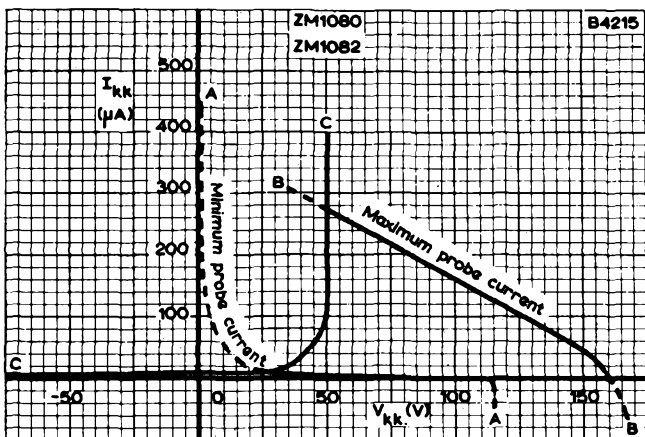

PROBE CURRENTS TO INDIVIDUAL CATHODES. D. C. ANODE CURRENT
RANGE 1.5 to 2.5mA

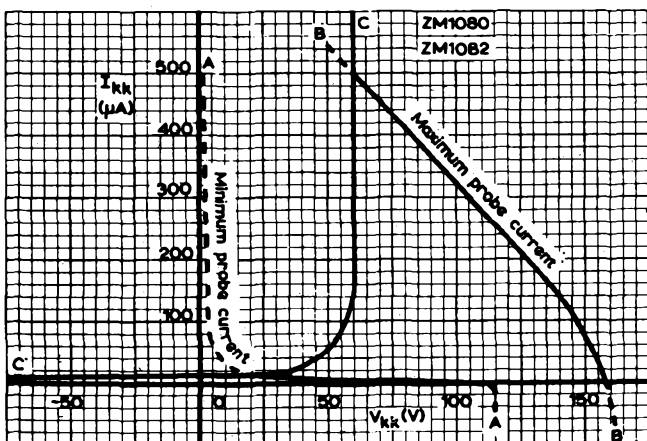

PROBE CURRENTS TO INDIVIDUAL CATHODES. D. C. ANODE CURRENT
RANGE 1.5 to 3.5mA

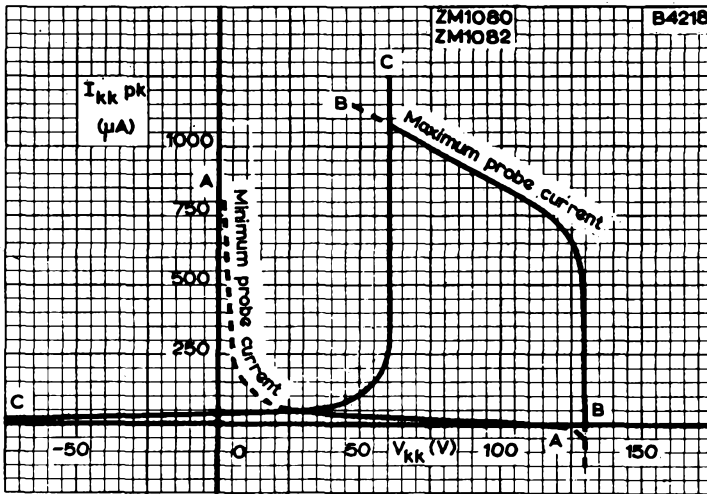

PEAK PROBE CURRENTS TO INDIVIDUAL CATHODES. PULSED ANODE CURRENT 10mA pk. 10% DUTY FACTOR

NOTE

PROBE CURRENT CURVES

The boundaries A-A and B-B of the graphs represent, for the shown anode current ranges, the range of probe currents to individual non-conducting cathodes plotted against the voltage difference between the non-conducting cathodes and the conducting cathode.

For optimum display, the probe current to any non-conducting cathode should be as low as possible. In addition, reverse probe current should not be permitted.

These conditions can be satisfied in two ways:-

1. With a low impedance voltage source connected to the non-conducting cathodes. For example, when using a current range of 1.5 to 2.5mA a voltage between 50 and 115V is required.
2. With a separate high impedance connected to each non-conducting cathode and returned to a voltage source of less than 115V. In this case the load line of the voltage source must lie to the right of boundary C-C.

QUICK REFERENCE DATA

Cold cathode, neon-filled, side-viewing indicator tubes with long life expectancy. The ZM1081 incorporates a red filter to improve the contrast of display; particularly suitable where many tubes are displayed side by side. The ZM1083 is electrically identical but has no filter coating. Compatible with numerical indicators ZM1080, ZM1082.

Character height	10.5	mm
	0.4	in
Minimum distance between mounting centres	19	mm
	0.75	in
Viewing angle	120	deg
Characters	- + ~	
Cathode current	2.0	mA
Minimum supply voltage	170	V

CHARACTERISTICS AND RANGE VALUES FOR EQUIPMENT DESIGN

(Measured at 20 to 50°C unless otherwise stated)

The values given state the range over which the tube will operate both initially and during life. No allowance has been made for supply voltage and component variations.

Minimum anode-to-cathode voltage necessary for ignition	170	V
Nominal anode-to-cathode maintaining voltage at 2.0mA (see page 3)	140	V
Anode-to-cathode voltage below which all tubes will extinguish	115	V

D.C. operation

Maximum cathode current	3.5	mA
Minimum cathode current	1.5	mA
Probe current to individual non-conducting cathodes (I_{kk})		See page 4

LIFE EXPECTANCY at recommended operating conditions and room temperature
(see note 1)

Continuous display of one character	> 5000	h
Sequentially changing the display from one character to the others, every 100 hours or less	> 15 000	h

RATINGS (ABSOLUTE MAXIMUM SYSTEM)

Cathode current (each character)

Maximum average (max. averaging time = 20ms)	3.5	mA
Maximum peak	12	mA
Minimum average during conduction	1.5	mA

Bulb temperature

Maximum	+70	°C
Minimum (see note 2)	-50	°C

MOUNTING POSITION

Any. The characters are viewed through the side of the envelope. The characters will appear upright (within $\pm 3^\circ$) when the tube is mounted vertically.

OPERATING NOTES

1. The life expectancy figures given above relate to operation with d.c. cathode currents between 1.5 and 2.5mA.
2. For bulb temperatures below 0°C the life expectancy of the tube is substantially reduced.
3. The leads are tinned and may be dip-soldered to a minimum of 5mm from the seals at a solder temperature of 240°C for a maximum of 10 seconds.
4. Care should be taken not to bend the leads nearer than 1.5mm from the seals.
5. The tube may be soldered directly into the circuit but heat conducted to the glass-to-metal seals should be kept to a minimum by the use of a thermal shunt.

CHARACTER INDICATOR TUBES

ZM1081 ZM1083

OUTLINE DRAWING

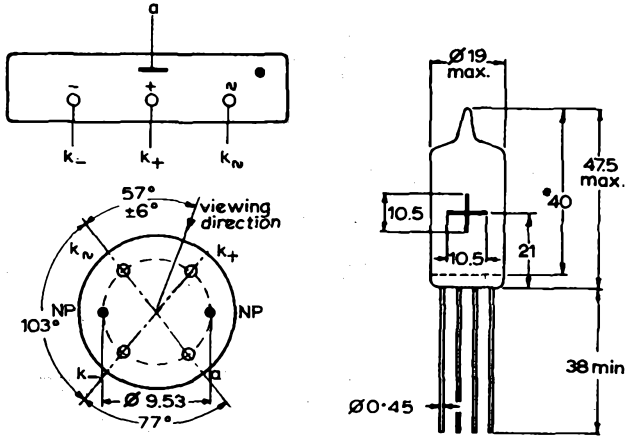

*This part of the bulb is filter coated (ZM1081 only)

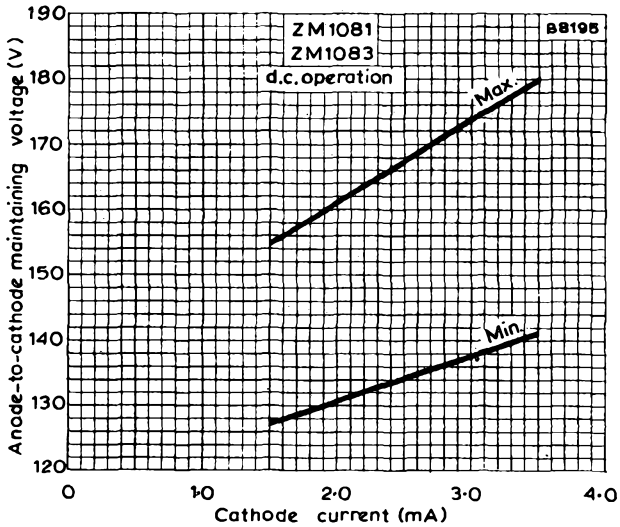

ANODE-TO-CATHODE MAINTAINING VOLTAGE PLOTTED AGAINST CATHODE CURRENT

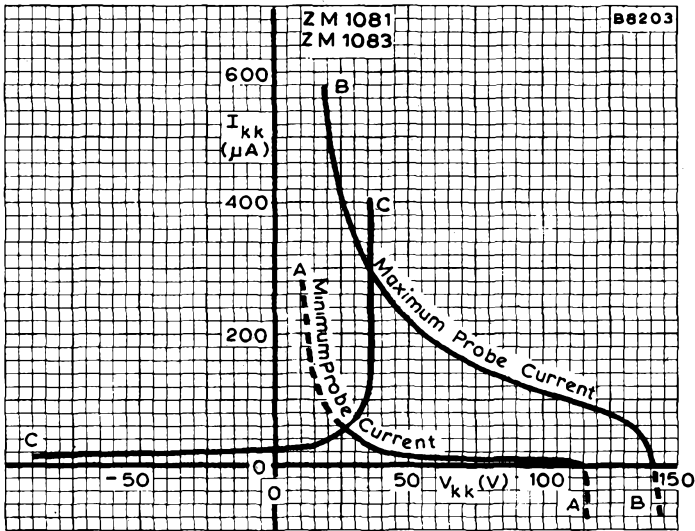

PROBE CURRENTS TO INDIVIDUAL CATHODES
D.C. ANODE CURRENT RANGE 1.5 to 3.5mA

PROBE CURRENT CURVES

The boundaries A-A and B-B of the graphs represent, for the shown anode current range, the range of probe currents to individual non-conducting cathodes plotted against the voltage difference between the non-conducting cathodes and the conducting cathode.

For optimum display, the probe current to any non-conducting cathode should be as low as possible. In addition, reverse probe current should not be permitted.

These conditions can be satisfied in two ways:-

1. With a low impedance voltage source connected to the non-conducting cathodes. A low impedance voltage source of 36 to 115V should be connected between the conducting and non-conducting cathodes.
2. With a separate high impedance connected to each non-conducting cathode and returned to a voltage source of less than 115V. In this case the load line of the voltage source must lie to the right of boundary C-C.

QUICK REFERENCE DATA

Cold cathode, neon-argon filled rectangular end viewing numerical indicator tube with long life expectancy. The rectangular envelope allows for close tube-to-tube spacing, both in the horizontal and vertical axes.

Numeral height	15.5	mm
	0.6	in
Minimum distance between mounting centres	20	mm
	0.79	in
Viewing angle	90	deg
Numerals	1 2 3 4 5 6 7 8 9 0	
Cathode current	2.5	mA
Minimum supply voltage	170	V

CHARACTERISTICS AND OPERATING CONDITIONS (Measured at 20 to 50°C)

Minimum anode-to-cathode voltage necessary for ignition	170	V
Ignition delay time		See page 3
Anode-to-cathode maintaining voltage		See page 4
Anode-to-cathode voltage below which all tubes will extinguish	115	V
Recommended cathode current, d.c.	2.5	mA
Minimum cathode current, d.c. (during any conduction period)	1.5	mA
D.C. operation		See pages 5 to 9

LIFE EXPECTANCY at recommended operating conditions and room temperature (see operating note)

Continuous display of one numeral	> 5000	h
Sequentially changing the display from one numeral to another, every 100 hours or less	> 30 000	h

RATINGS (ABSOLUTE MAXIMUM SYSTEM)

Cathode current (each digit)

Maximum average (maximum averaging time = 20ms)	3.0	mA
Maximum peak	3.5	mA
Minimum average (during any conduction period)	1.5	mA

Bulb temperature

Maximum	+70	°C
Minimum (see operating note)	-10	°C

MOUNTING POSITION

Any. The numerals are viewed through the top of the envelope. The numerals will appear upright (within $\pm 3^\circ$) when the tube is mounted with the line through pins 6 and 12 vertical, pin 6 uppermost.

OPERATING NOTE

For bulb temperatures below $+10^\circ\text{C}$ the life expectancy of the tube is substantially reduced.

ACCESSORIES (supplied as additional items)

Sockets

55705 and 55706

88630

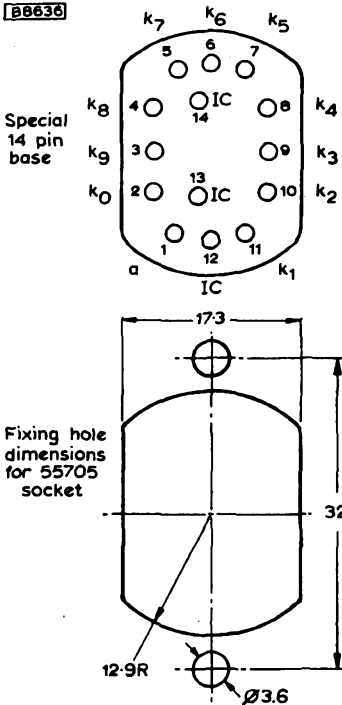

All dimensions in mm

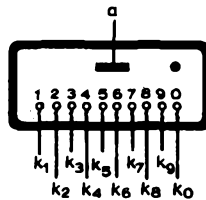
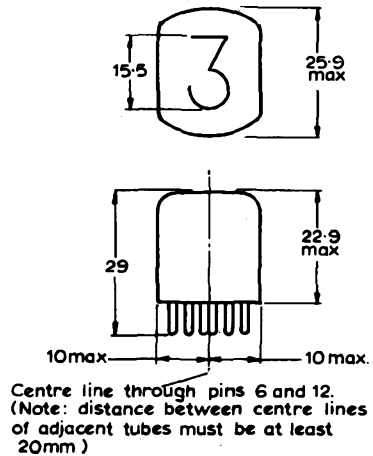

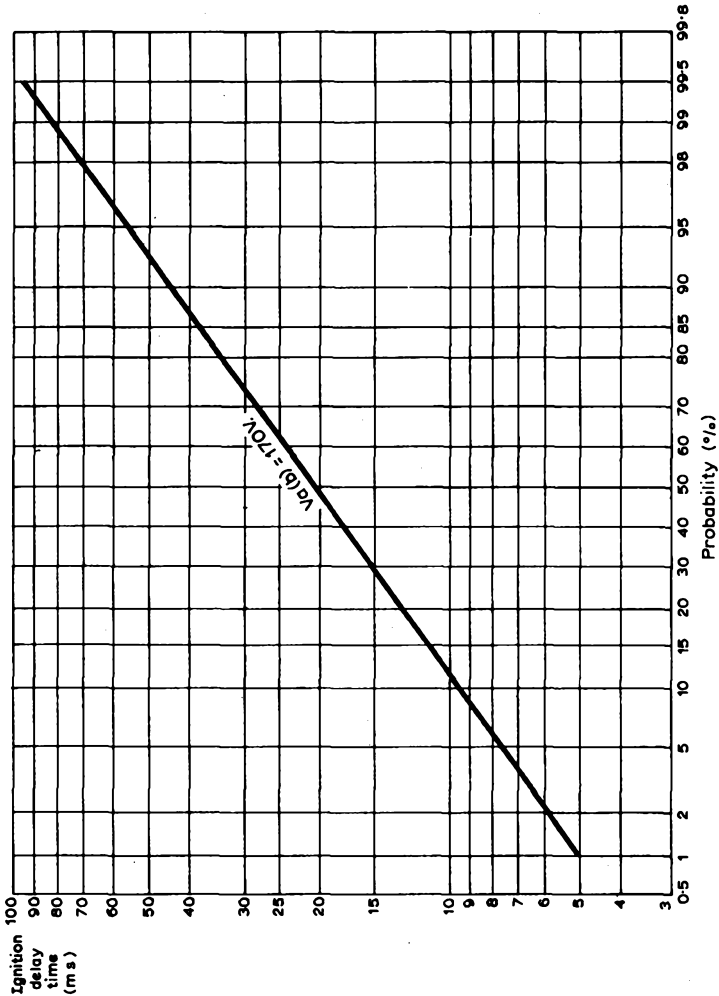

CUMULATIVE DISTRIBUTION OF IGNITION DELAY TIME

This curve shows the probability that a tube will ignite in less than the time shown after a non-conduction period of a few seconds. The ignition delay time will be appreciably reduced when the interval between conduction periods is less than 100 milliseconds. In general, an increase in the supply voltage will reduce the ignition delay time.

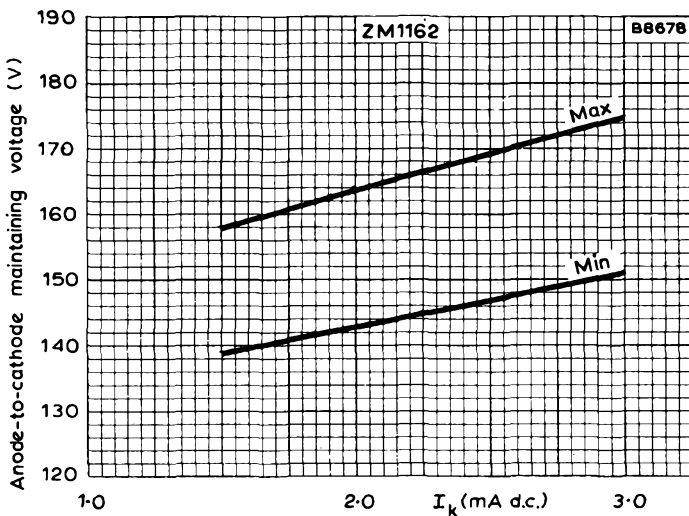

ANODE-TO-CATHODE MAINTAINING VOLTAGE
PLOTTED AGAINST CATHODE CURRENT

NOTE

PROBE CURRENT CURVES (Page 5)

For low cathode selecting voltages (V_{kk}) the current I_{kk} to the non-conducting cathode will increase, and the readability of the conducting cathode will be affected.

It is therefore recommended to use a nominal operating point to the right of line C-C. Under the worst operating conditions the operating point should never reach the area left of the line D-D.

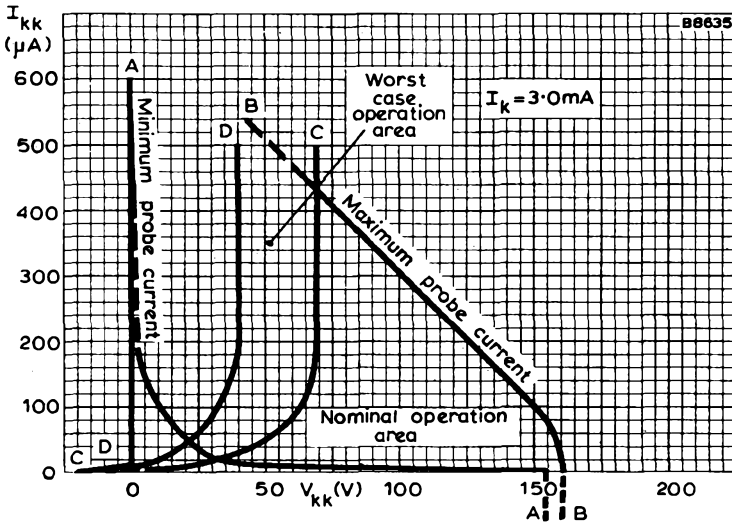
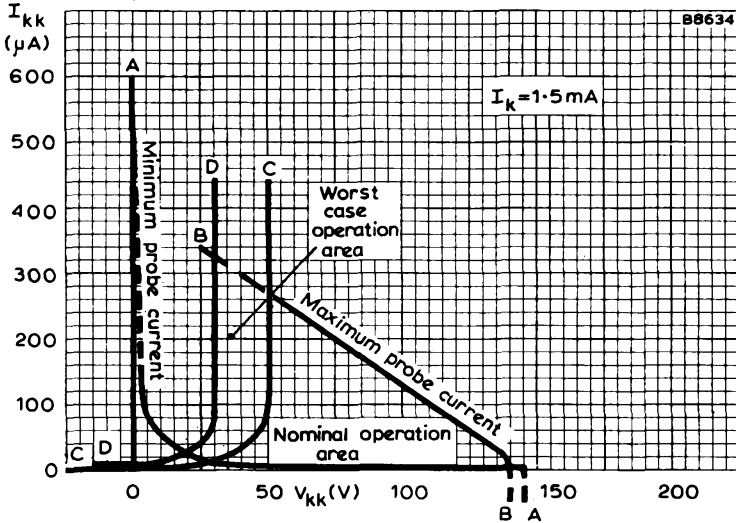

PROBE CURRENTS TO INDIVIDUAL NON-CONDUCTING CATHODES

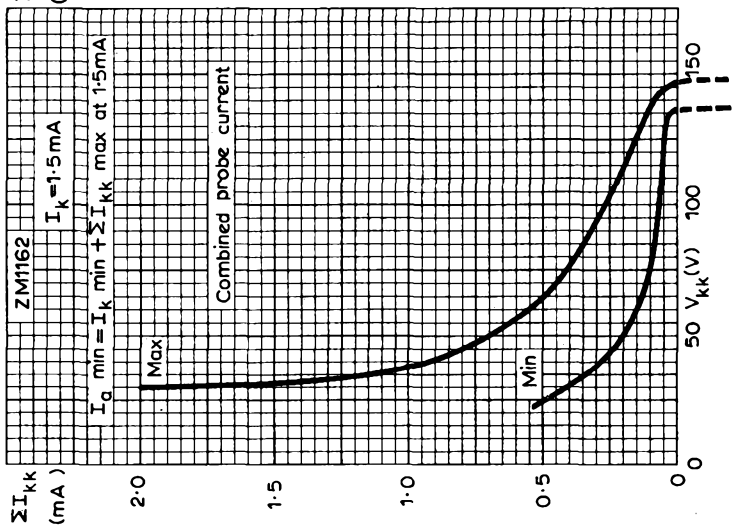
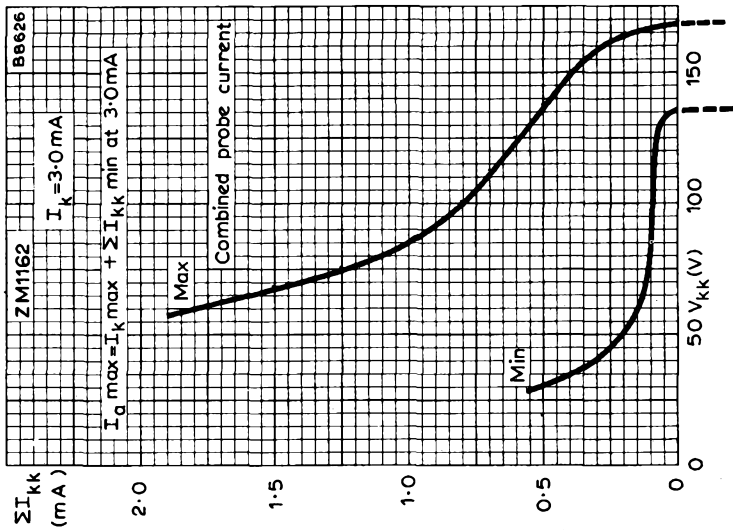

COMBINED PROBE CURRENT TO ALL NON-CONDUCTING CATHODES

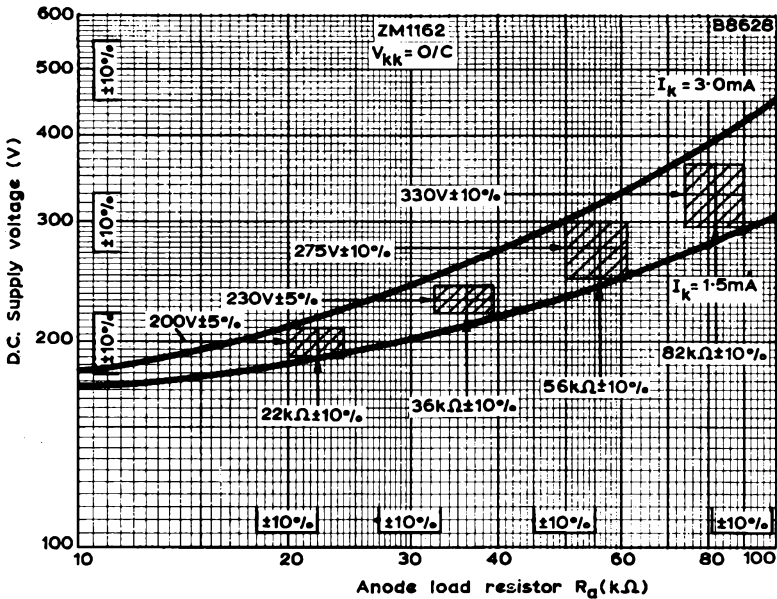

**D.C. SUPPLY VOLTAGE PLOTTED AGAINST ANODE LOAD RESISTOR:
NON-CONDUCTING CATHODES OPEN CIRCUIT**

NOTE - SUPPLY VOLTAGE/LOAD RESISTOR

The graphs on pages 7 to 9 give the relationship between the d.c. anode supply voltage and the required anode load resistor for fixed values of V_{kk} (voltage difference between conducting and non-conducting cathodes).

Each graph is plotted on log-log graph paper; therefore a given tolerance expressed as a percentage can be represented as a fixed length at any point on the x and y axis. This is shown on the graph above by taking points on each axis with a fixed tolerance.

Examples are shown on the graph above of the supply voltages and load resistors with tolerances expressed as a percentage so as to remain within the recommended operating region.

On page 9 details are given of the method of calculating corresponding values of supply voltage and anode load resistor, for fixed values of V_{kk} .

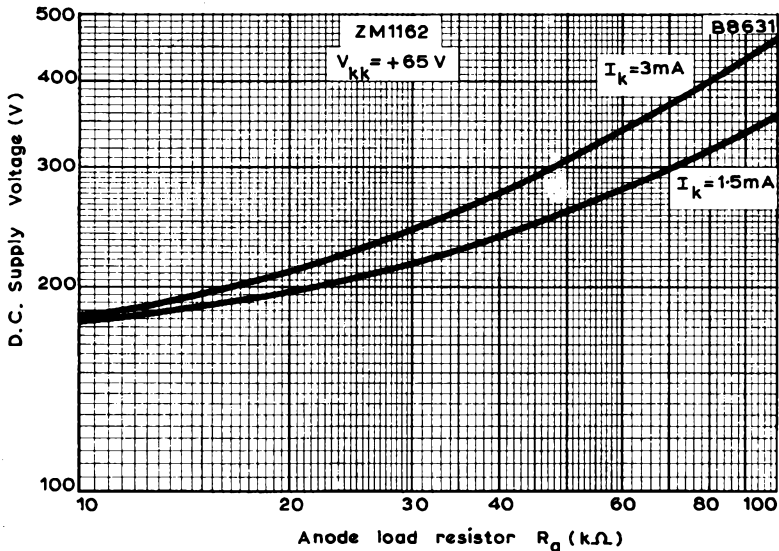
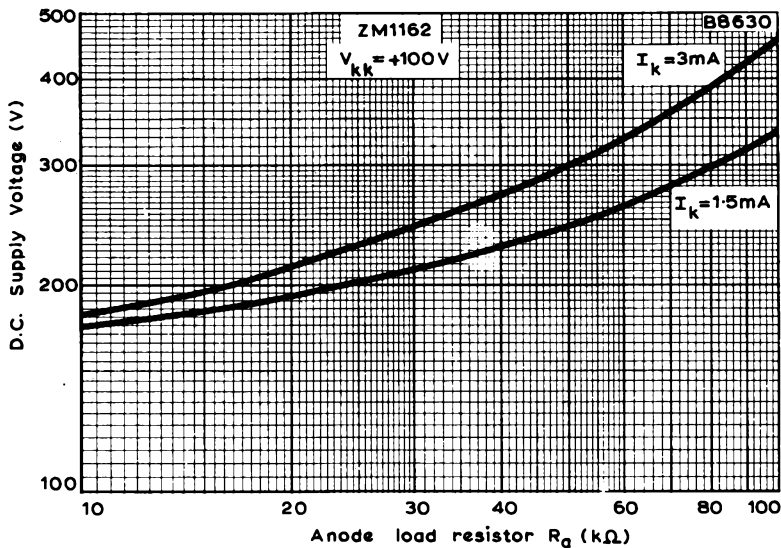

D.C. SUPPLY VOLTAGE PLOTTED AGAINST ANODE LOAD RESISTOR

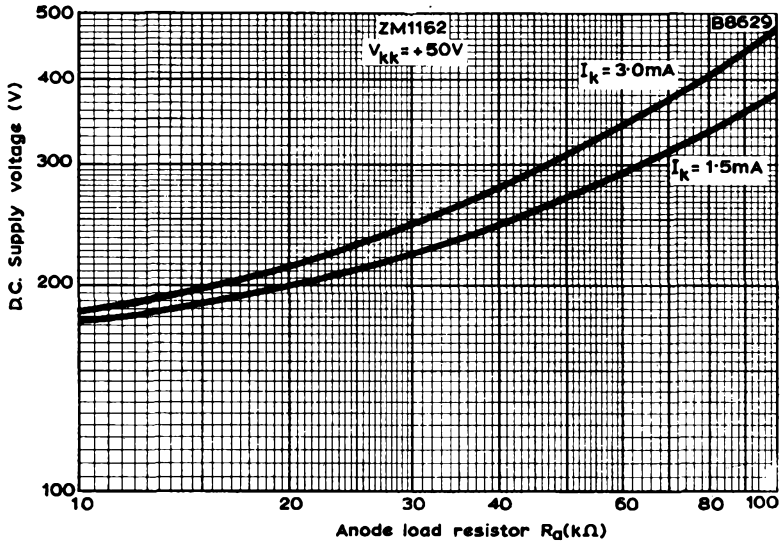

D.C. SUPPLY VOLTAGE PLOTTED AGAINST ANODE LOAD RESISTOR

NOTE - The supply voltage/load resistor curves are derived from:

$$V_s = I_a \cdot R_a + V_m \text{ (General formula)}$$

$$V_s = [I_k + \Sigma I_{kk}] R_a + V_m$$

The value of ΣI_{kk} will depend on the bias voltage V_{kk}

Supply voltage required to work above the minimum value of I_k :

$$V_s = [1.5mA + \Sigma I_{kk} \text{ max. at } I_k = 1.5mA] R_a + 158V$$

Supply voltage required to work below the maximum value of I_k :

$$V_s = [3.0mA + \Sigma I_{kk} \text{ min. at } I_k = 3.0mA] R_a + 151V$$

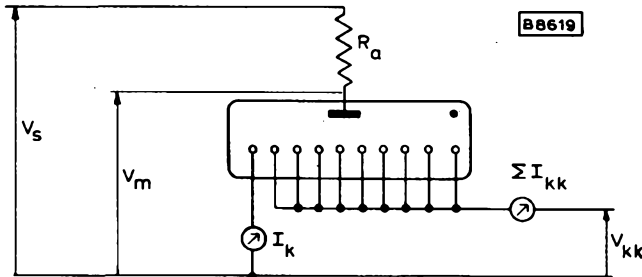

NUMERICAL INDICATOR TUBES

ZM1170 ZM1172

QUICK REFERENCE DATA

Cold cathode, neon filled, side viewing indicator tubes with long life expectancy. The ZM1170 is coated with a red filter to improve the contrast of display. These tubes are similar to ZM1080, ZM1082 but incorporate a larger numeral and a fine wire anode to give improved visibility.

Numeral height	15.5	mm
	0.6	in
Minimum distance between mounting centres	19	mm
	0.75	in
Numerals	1 2 3 4 5 6 7 8 9 0	
Cathode current	2.5	mA
Minimum supply voltage	170	V

CHARACTERISTICS AND OPERATING CONDITIONS (Measured at 20 to 50°C)

Minimum anode-to-cathode voltage necessary for ignition	170	V
Ignition delay time	See page 4	
Anode-to-cathode maintaining voltage	See page 5	
Anode-to-cathode voltage below which all tubes will extinguish	115	V
Cathode current		
Maximum peak	12	mA
Maximum average (averaged over any 10ms) (see note 1)	3.5	mA
Minimum average (averaged over any 10ms) (see note 1)	0.8	mA
Minimum average (averaged over any conduction period) (see note 1)	1.5	mA
Recommended average (during any d.c. conduction period)	2.5	mA
Probe current		
Probe current to individual non-conducting cathodes (I_{kk})	See pages 6 and 11	
Probe current to combined non-conducting cathodes (ΣI_{kk})	See pages 7, 11 and 12	

D.C. operation

See pages 5 to 10

Pulse operation

Minimum pulse duration 100 μ s

See pages 5, 11, 12 and 13

LIFE EXPECTANCY at recommended operating conditions and room temperature (see note 2)

Continuous display of one numeral > 5000 h

Sequentially changing the display from one numeral to another, every 100 hours or less > 30 000 h

RATINGS (ABSOLUTE MAXIMUM SYSTEM)

Cathode current (each digit)

Maximum average (averaged over any 10ms) 3.5 mA

Maximum peak 12 mA

Minimum average (averaged over any conduction period) 1.5 mA

Bulb temperature

Maximum +70 $^{\circ}$ C

Minimum (see note 2) -50 $^{\circ}$ C

MOUNTING POSITION

Any. The numerals are viewed through the side of the envelope. The numerals will appear upright (within $\pm 3^{\circ}$) when the tube is mounted vertically, base down.

OPERATING NOTES

1. The minimum average current (averaged over any 10ms) of 0.8mA is necessary for adequate light output without flicker in applications other than d. c. The minimum average current (averaged over any conduction period) of 1.5mA is necessary to ensure complete cathode coverage initially and throughout life.
2. For bulb temperatures below 0° C the life expectancy of the tube is substantially reduced.
3. The tube may be soldered directly into the circuit, but heat conduction to the glass-to-metal seals should be kept to a minimum by the use of a thermal shunt.
4. The leads are tinned and may be dip-soldered to a minimum of 5mm from the seals at a solder temperature of 240° C for a maximum of 10 seconds.
5. Care should be taken not to bend the leads nearer than 1.5mm from the seals.



NUMERICAL INDICATOR TUBES

ZM1170 ZM1172

OUTLINE AND DIMENSIONS

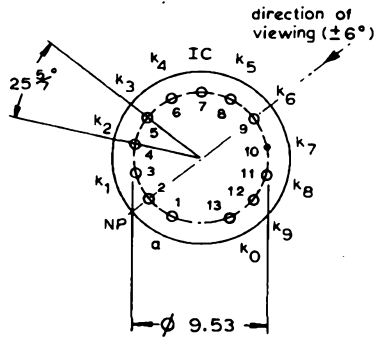
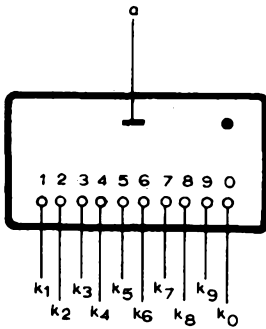
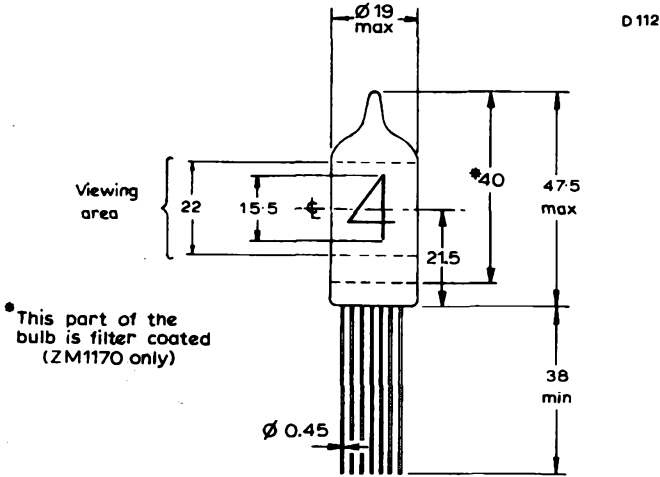

All dimensions in mm



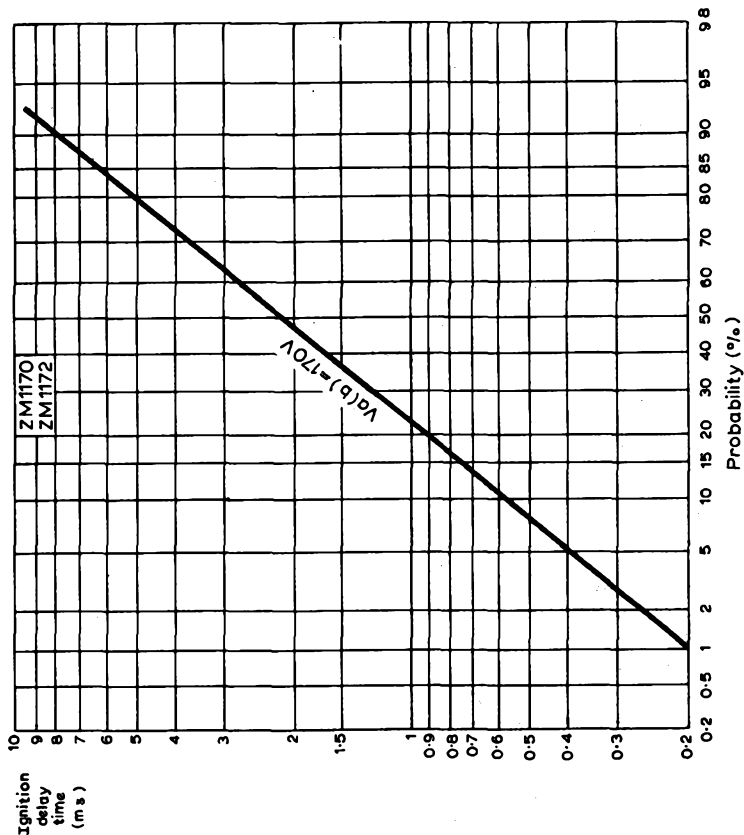

CUMULATIVE DISTRIBUTION OF IGNITION DELAY TIME

This curve shows the probability that a tube will ignite in less than the time shown after a non-conduction period of a few seconds. The ignition delay time will be appreciably reduced when the interval between conduction periods is less than 100 milliseconds. In general, an increase in the supply voltage will reduce the ignition delay time.



NUMERICAL INDICATOR TUBES

ZM1170 ZM1172

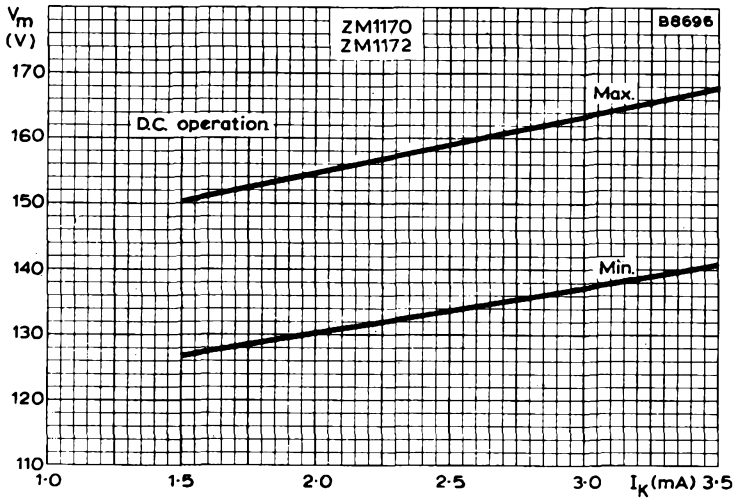

ANODE-TO-CATHODE MAINTAINING VOLTAGE
PLOTTED AGAINST CATHODE CURRENT

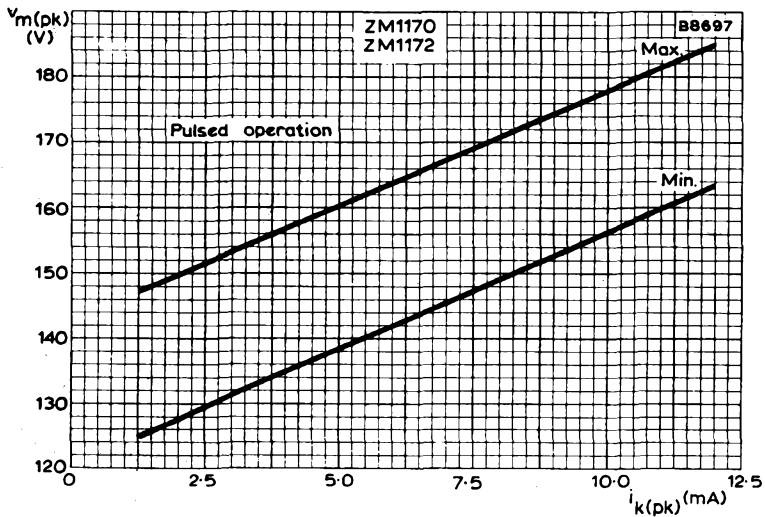

PEAK ANODE-TO-CATHODE MAINTAINING VOLTAGE
PLOTTED AGAINST PEAK CATHODE CURRENT



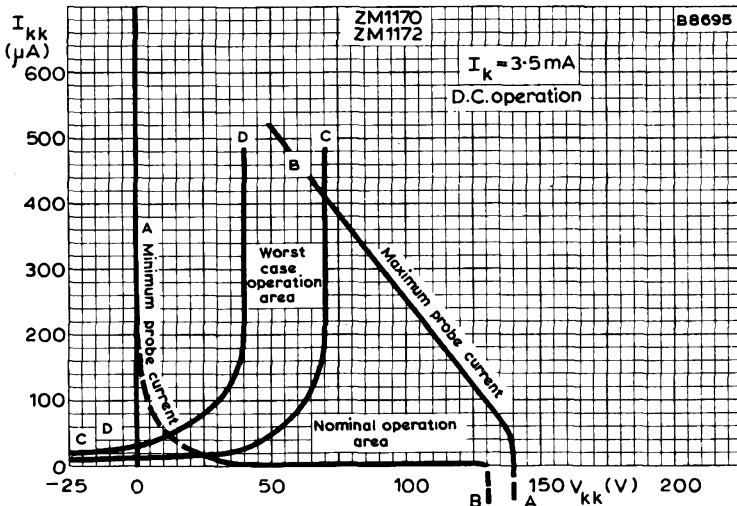
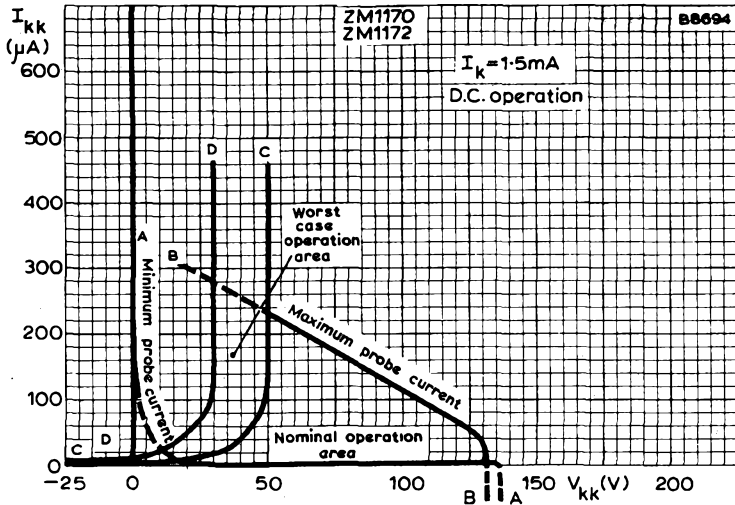

PROBE CURRENT TO INDIVIDUAL NON-CONDUCTING CATHODES

The boundaries A-A and B-B of the graphs represent, for the shown cathode current range, the range of probe current (I_{kk}) to individual non-conducting cathodes plotted against the voltage difference between the non-conducting cathodes and the conducting cathode (V_{kk}).

For low cathode selecting voltages (V_{kk}) the current I_{kk} to the non-conducting cathode will increase, and the readability of the conducting cathode will be affected.

It is therefore recommended to use a nominal operating point to the right of line C-C. Under the worst operating conditions the operating point should never reach the area left of the line D-D.



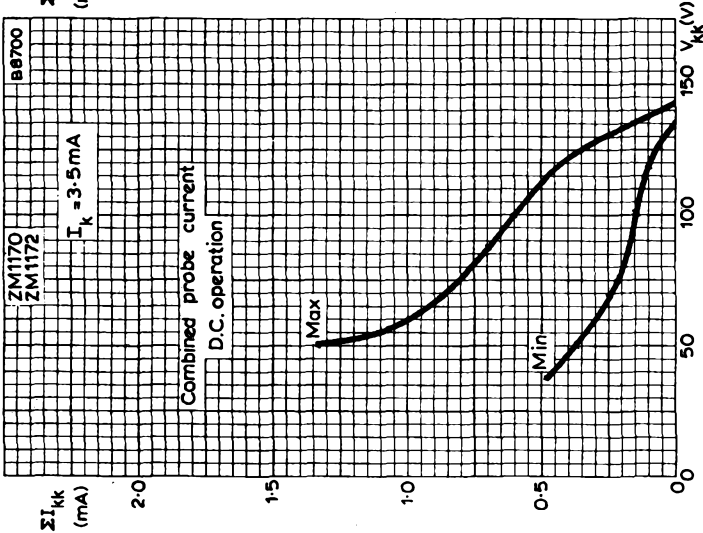
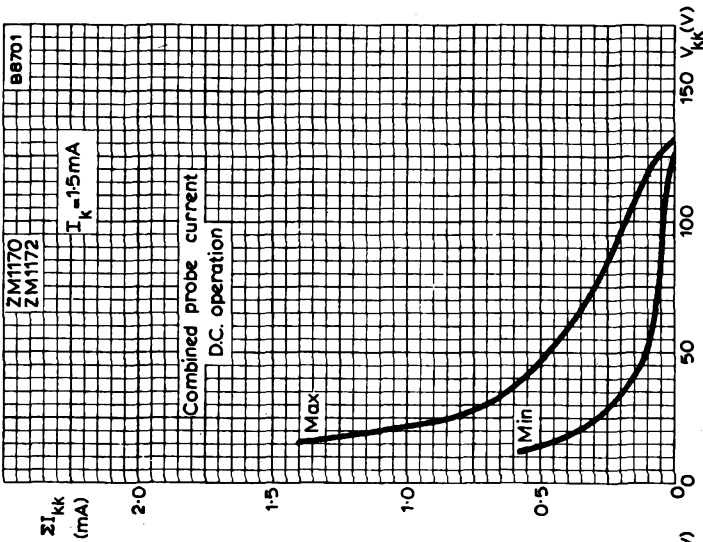

COMBINED PROBE CURRENT TO ALL NON-CONDUCTING CATHODES

Sum of the probe currents to the non-conducting cathodes (ΣI_{kk}) plotted against the voltage difference between the non-conducting cathodes and the conducting cathode (V_{kk}), showing the minimum and maximum values of probe current for a particular cathode current (I_k).



SUPPLY VOLTAGE/LOAD RESISTOR

The graphs on pages 9, 10 and 13 give the relationship between the anode supply voltage and the required anode load resistor for fixed values of V_{kk} (voltage difference between conducting cathode and non-conducting cathodes).

Each graph is plotted on log-log graph paper; therefore a given tolerance expressed as a percentage can be represented as a fixed length at any point on the x and y axes. This is shown on the first graph by taking points on each axis with a fixed tolerance.

Examples are shown on the first graph of the supply voltages and load resistors with tolerances expressed as a percentage so as to remain within the recommended operating region.

The curves are derived from:-

$$V_s = I_a \cdot R_a + V_m$$

$$I_a = I_k + \Sigma I_{kk}$$

$$V_s = (I_k + \Sigma I_{kk}) R_a + V_m$$

For a given value of R_a , the minimum supply voltage limit to ensure that the cathode current exceeds I_k min. is given by:

$$V_s \text{ min.} = [I_k \text{ min.} + \Sigma I_{kk} \text{ max. (at } I_k \text{ min.)}] R_a + V_m \text{ max. (at } I_k \text{ min.)}$$

For the same value of R_a , the maximum supply voltage limit to ensure that the cathode current does not exceed I_k max. is given by:

$$V_s \text{ max.} = [I_k \text{ max.} + \Sigma I_{kk} \text{ min. (at } I_k \text{ max.)}] R_a + V_m \text{ min. (at } I_k \text{ max.)}$$

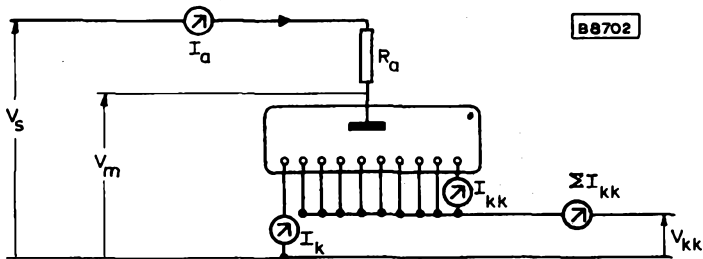

NUMERICAL INDICATOR TUBES

ZM1170 ZM1172

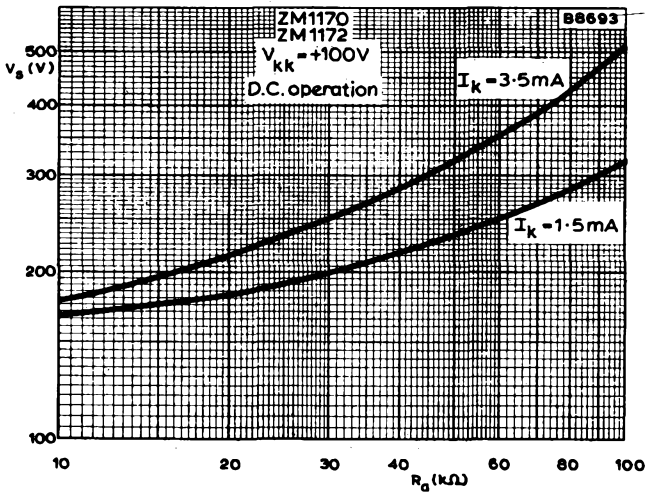
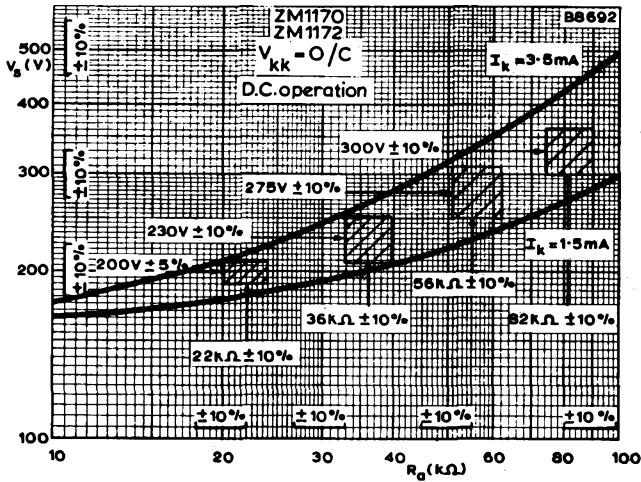

D. C. SUPPLY VOLTAGE PLOTTED AGAINST ANODE LOAD RESISTOR



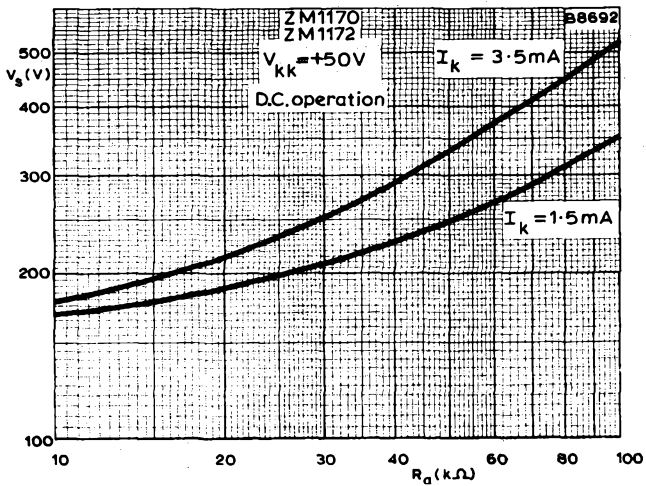
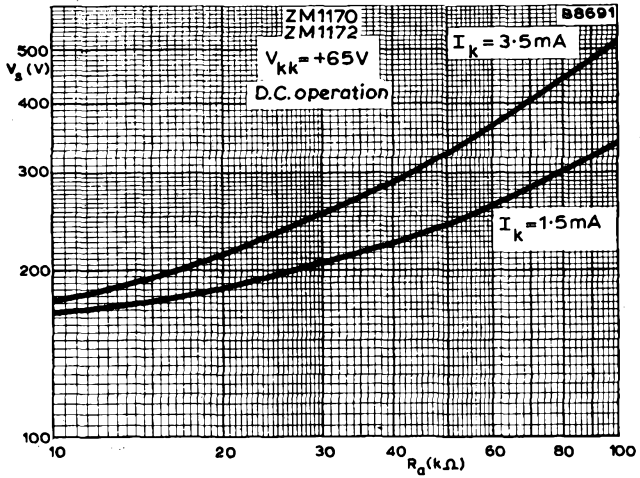

D.C. SUPPLY VOLTAGE PLOTTED AGAINST ANODE LOAD RESISTOR



NUMERICAL INDICATOR TUBES

ZM1170 ZM1172

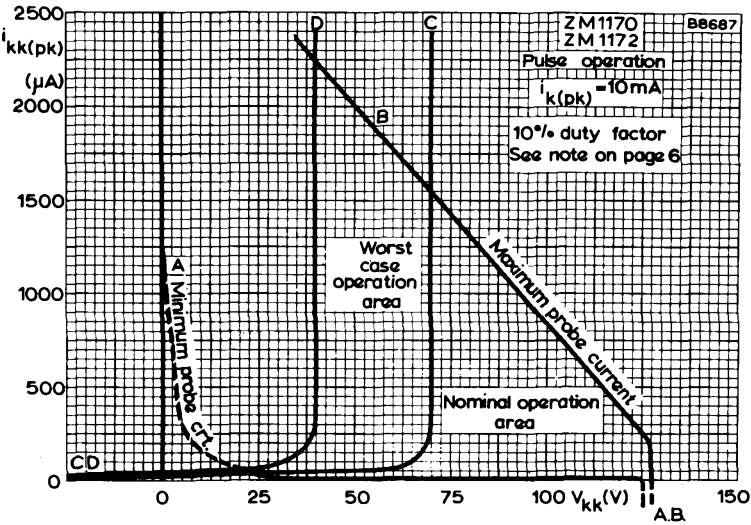

PEAK PROBE CURRENT TO INDIVIDUAL NON-CONDUCTING CATHODES

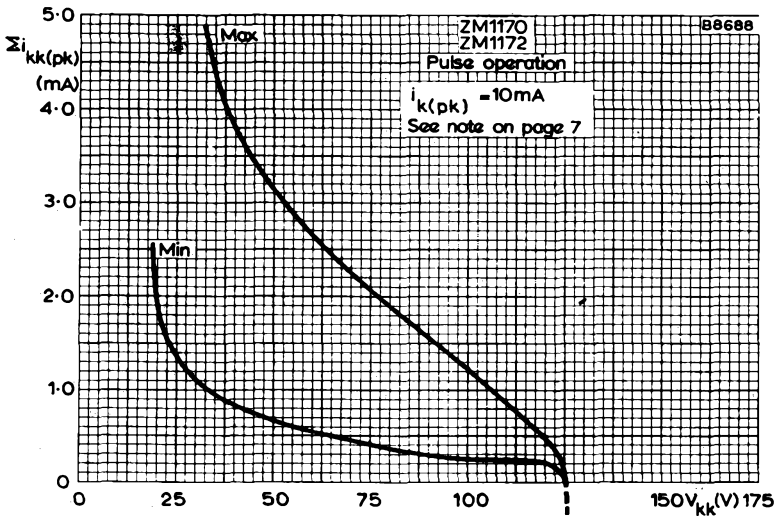

COMBINED PEAK PROBE CURRENT TO ALL NON-CONDUCTING CATHODES





COMBINED PEAK PROBE CURRENT TO ALL NON-CONDUCTING CATHODES

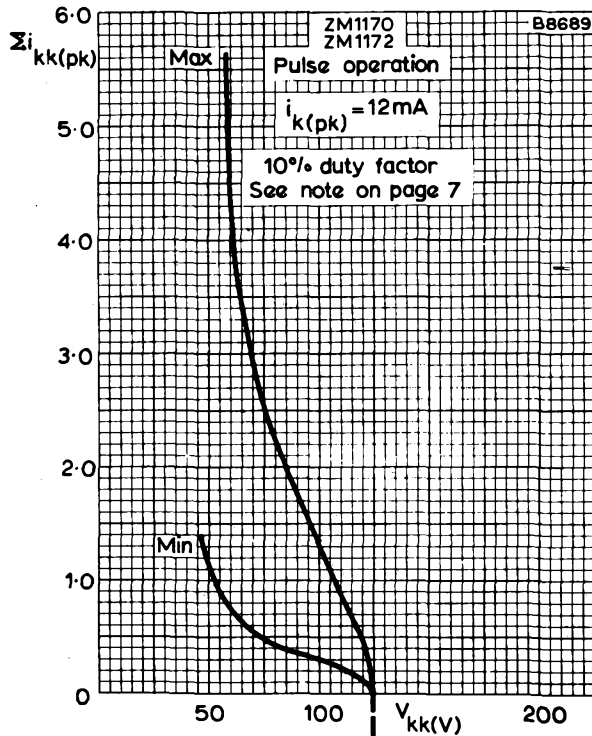
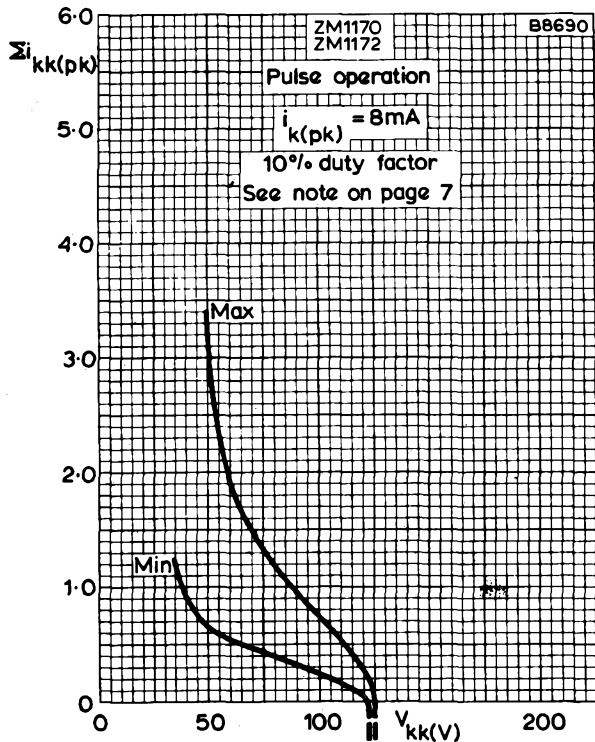

NUMERICAL INDICATOR TUBES

ZM1170 ZM1172

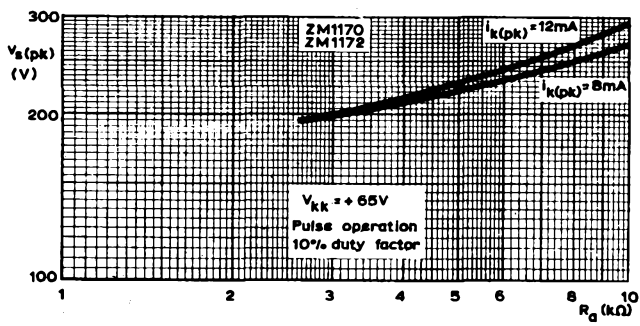
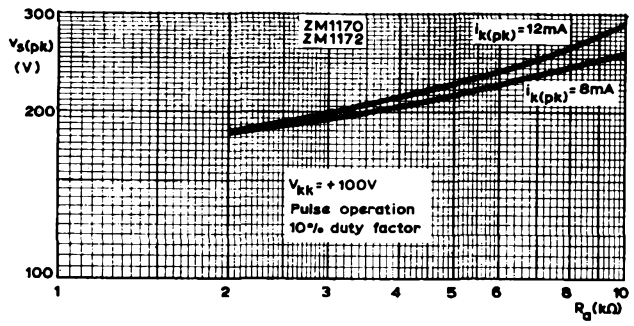
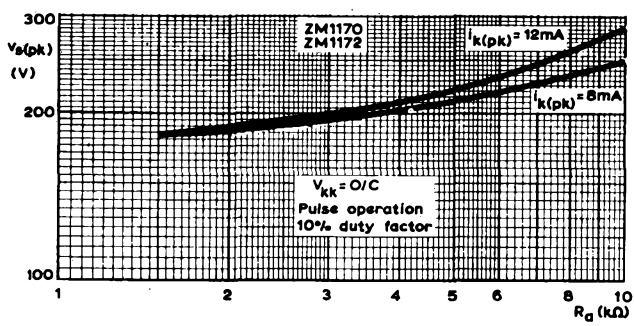

PEAK SUPPLY VOLTAGE PLOTTED AGAINST ANODE LOAD RESISTOR



NUMERICAL INDICATOR TUBES

ZM1174
ZM1175
ZM1176
ZM1177

QUICK REFERENCE DATA

Cold cathode, neon filled, side viewing numerical indicator tubes with long life expectancy. These tubes are similar to the ZM1172, but incorporate a decimal point. The four types are electrically identical, but differ in the position of the decimal point and the inclusion of a red filter to improve the contrast of display.

ZM1174 - Decimal point on left hand side. Red contrast filter.

ZM1175 - Decimal point on left hand side. No red filter.

ZM1176 - Decimal point on right hand side. Red contrast filter.

ZM1177 - Decimal point on right hand side. No red filter.

Numeral height	15.5	mm
Minimum distance between mounting centres	19	mm
Numerals	1 2 3 4 5 6 7 8 9 0	
Numeral cathode current	2.5	mA
Decimal point cathode current (nom.)	0.5	mA
Minimum supply voltage	170	V

Unless otherwise stated, data is applicable to all types

CHARACTERISTICS AND OPERATING CONDITIONS (measured at 20 to 50°C)

Minimum anode-to-cathode voltage necessary for ignition	170	V
Anode-to-cathode maintaining voltage	See page 4	
Anode-to-cathode voltage below which all tubes will extinguish	115	V
Numeral cathode current		
Maximum peak	12	mA
Maximum average		
(averaged over any 10ms)	3.5	mA
Minimum average (see notes 1 and 2)		
(averaged over any 10ms)	0.8	mA
Minimum average (see notes 1 and 2)		
(averaged over any conduction period)	1.5	mA
Recommended average		
(during any d.c. conduction period)	2.5	mA

Decimal point cathode current (see note 3)		
Maximum peak	2.5	mA
Minimum average (averaged over any conduction period)	0.05	mA
Recommended average (during any d.c. conduction period)	0.15	mA ←
Minimum pulse duration (pulsed operation)	100	μs

LIFE EXPECTANCY at recommended operating conditions and room temperature
(see note 4)

Continuous display of one numeral	> 5000	h
Sequentially changing the display from one numeral to another, every 100 hours or less	> 30 000	h

RATINGS (ABSOLUTE MAXIMUM SYSTEM)

Numeral cathode current (each digit)		
Maximum average (averaged over any 10ms)	3.5	mA
Maximum peak	12	mA
Minimum average (averaged over any conduction period)	1.5	mA
Bulb temperature		
Maximum	+70	°C
Minimum (see note 4)	-50	°C

MOUNTING POSITION

Any. The numerals and the decimal point are viewed through the side of the envelope. The numerals will appear upright (within ±3°) when the tube is mounted vertically, base down.

OPERATING NOTES

1. This value applies, irrespective of whether the decimal point is running or not.
2. The minimum average current (averaged over any 10ms) of 0.8mA is necessary for adequate light output without flicker in applications other than d.c. The minimum average (averaged over any conduction period) of 1.5mA is necessary to ensure adequate cathode coverage, initially and throughout life.
3. In order to ensure that the decimal point cathode ignites it should be ← returned to a negative supply of 10V minimum with respect to the numeral cathode carrying the main discharge. This condition is required when the numeral peak current is less than 8mA. Above 8mA peak current the decimal point cathode may be directly connected to the potential of the numeral cathode carrying the main discharge.
4. For bulb temperatures below 0°C the life expectancy of the tube is substantially reduced.

NUMERICAL INDICATOR TUBES

ZM1174
ZM1175
ZM1176
ZM1177

- The tube may be soldered directly into the circuit, but heat conduction to the glass-to-metal seals should be kept to a minimum by the use of a thermal shunt.
- The leads are tinned and may be dip-soldered to a minimum of 5mm from the seals at a solder temperature of 240°C for a maximum of 10 seconds.
- Care should be taken not to bend the leads nearer than 1.5mm from the seals.

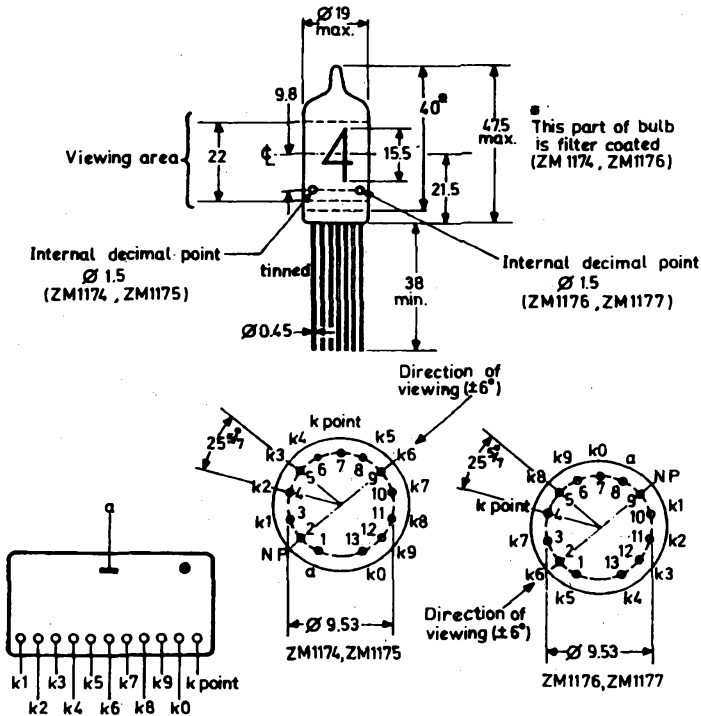

All dimensions in mm.

D1783

Mullard

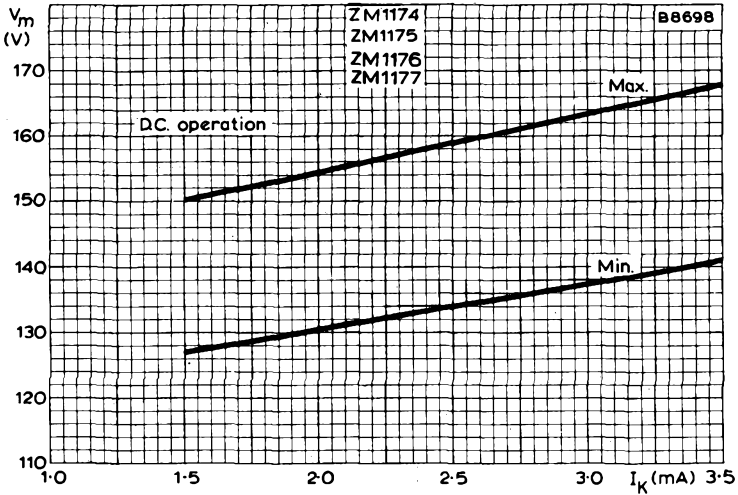

ANODE-TO-CATHODE MAINTAINING VOLTAGE
PLOTTED AGAINST CATHODE CURRENT

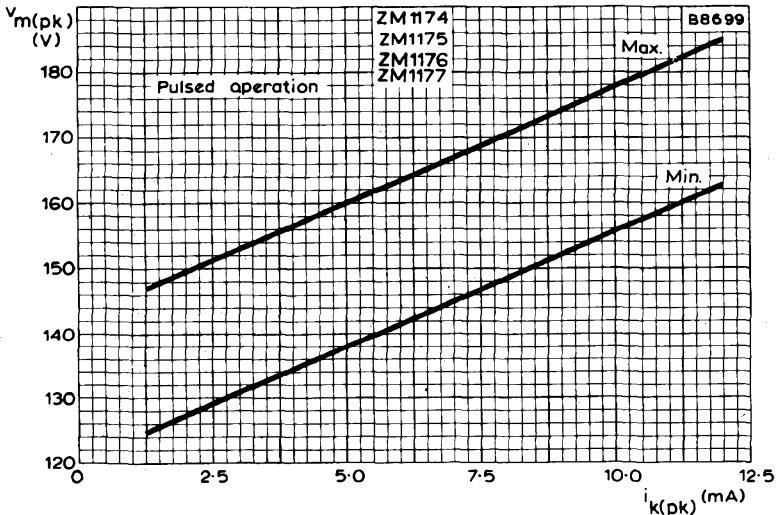

PEAK ANODE-TO-CATHODE MAINTAINING VOLTAGE
PLOTTED AGAINST PEAK CATHODE CURRENT

NUMERICAL INDICATOR TUBE PANDICON*

ZMI200

TENTATIVE DATA

QUICK REFERENCE DATA

Multiple cold cathode, gasfilled numerical indicator tube with long life expectancy. The tube is intended for use in numerical display applications where a large number of digits are to be displayed in a minimum of space (electronic desk top calculators). For reading large numbers, punctuation marks can be made to appear at suitable places. Decimal points are incorporated.

Numeral height	10	mm
Number of decades	14	
Numerals	1 2 3 4 5 6 7 8 9 0	
Decimal points	to the lower right of the numerals	
Punctuation marks	to the upper right of the numerals	
Decade pitch	10	mm
Supply voltage, peak	min. 170	V
Anode current, peak	9.0	mA

*Registered trade mark for multiple indicator tubes.

Mullard

CHARACTERISTICS AND OPERATING CONDITIONS

Anode-to-cathode voltage necessary for ignition		min.	170	V
Ignition delay time				
first ignition		max.	0.5	s
subsequent ignitions			10	μ s
Anode-to-cathode maintaining voltage	V_m		see page 5	
'Off' anode voltage		max.	115	V
		min.	85	V
Anode current, peak		max.	12	mA
Anode current, peak				
with or without decimal point and /or				
punctuation mark at pulse duration of				
50 μ s		min.	6.0	mA
150 μ s		min.	5.0	mA
1000 μ s		min.	4.0	mA
Cathode selecting voltage	V_{kk}	max.	100	V
(see note 1)		min.	70	V
Shield voltage	V_s	rec.	10V below 'off' anode voltage	
Decimal point resistor (see note 2)			10 (+10%)	k Ω
Punctuation mark resistor (see note 2)			10 (+10%)	k Ω
Pulse duration		rec.	150 to 500	μ s

LIFE EXPECTANCY at recommended operating conditions

The life is inversely proportional to the instantaneous value of the peak operating current and to the pulse repetition operating frequency. Life tests have shown a life expectancy of 50 000 hours in a typical application. Integration of 14 full decades and the associated interconnections in a single package improves the mechanical reliability by a factor between 7 and 14 compared to a row of individual tubes. Minimum mean time between failures is estimated to be 500 000 operating hours.

RATINGS (ABSOLUTE MAXIMUM SYSTEM)

Anode supply voltage	$V_{a(b)}$	max.	220	V
		min.	170	V
'Off' anode voltage	$V_{a(off)}$	max.	115	V
		min.	85	V
Cathode selecting voltage	V_{kk}	max.	100	V
Shield voltage	V_s	max.	100	V
		min.	70	V
Voltage between any pair of electrodes (operating anode excluded)		max.	120	V

NUMERICAL INDICATOR TUBE PANDICON

ZM1200

RATINGS (contd.)

Numerical cathodes

Anode current, peak	max.	12	mA
Anode current, peak each anode with or without decimal point and/or punctuation mark at pulse duration of			
50 μ s	min.	6.0	mA
100 μ s	min.	5.0	mA
1500 μ s	min.	4.0	mA
Anode current, average (averaged over 1 s)	max.	1.5	mA

Decimal point/Punctuation mark cathodes only

Anode current, peak (see note 2)	max.	2.0	mA
	min.	0.5	mA
Anode current, average (averaged over 1 s)	max.	0.25	mA
Ambient temperature (see note 3)	max.	+70	$^{\circ}$ C
	min.	-50	$^{\circ}$ C

OPERATING NOTES

1. At lower values of V_{kk} the contrast of the display will be reduced due to glow on adjacent numerals but will not affect the life of the tube. After switching the bias must be restored within 20 μ s.
2. The decimal point and/or punctuation mark cathode may not be operated without extra current limiting resistor.
3. For bulb temperatures below 10 $^{\circ}$ C the life expectancy of the tube is substantially reduced.

The issue of the information contained in this publication does not imply any authority or licence for the utilisation of any patented feature.

Mullard

OUTLINE AND DIMENSIONS

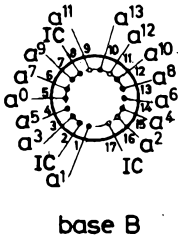
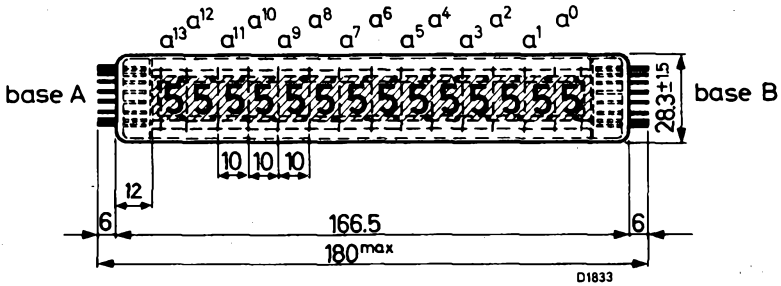

base B

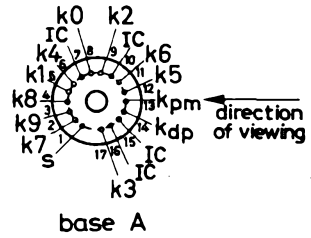

base A

No undue stress should be placed on the base pins. All dimensions in mm

NOTES TO GRAPHS ON PAGE 5

1. The decimal point maintaining voltage $V_m(dp)$ and the punctuation mark maintaining voltage $V_m(pm)$ include the voltage drop at the 10k Ω series resistor.
2. V_m max. is related to the maximum operating temperature and assumes the decimal point or punctuation mark not operating.
3. V_m min. is related to the minimum operating temperature and assumes the decimal point or punctuation mark operating.
4. The maintaining voltage V_m can be considered as the sum of a constant voltage and a current dependent voltage (V/mA).

NUMERICAL INDICATOR TUBE PANDICON

ZM1200

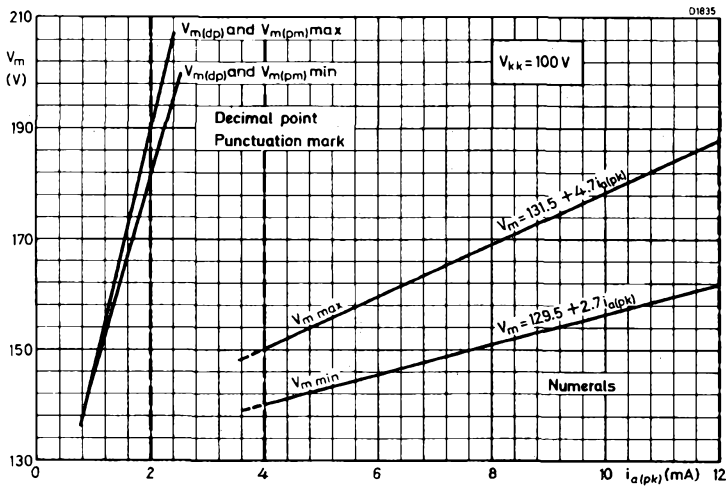
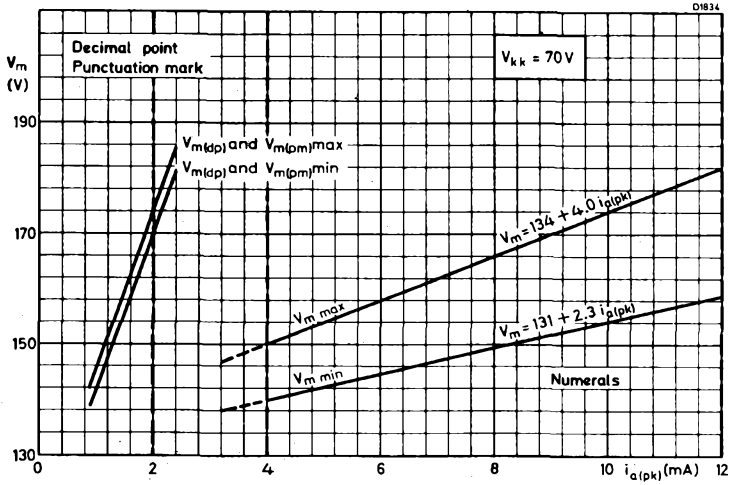

ANODE-TO-CATHODE MAINTAINING VOLTAGE PLOTTED AGAINST
PEAK ANODE CURRENT

Mullard

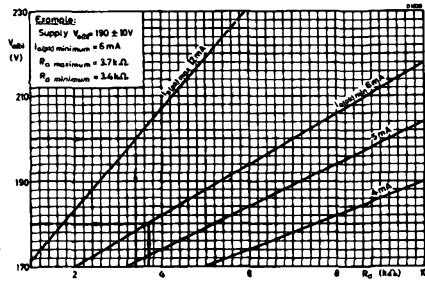

ANODE SUPPLY VOLTAGE PLOTTED AGAINST ANODE RESISTANCE

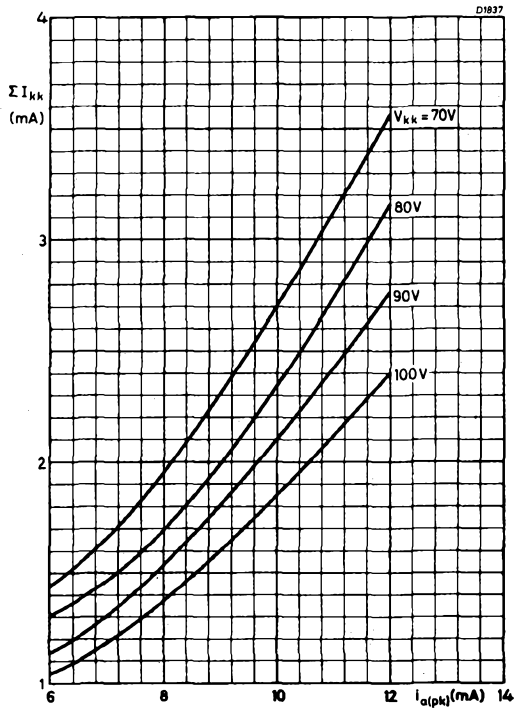

COMBINED PROBE CURRENT PLOTTED AGAINST PEAK ANODE CURRENT

NUMERICAL INDICATOR TUBE PANDICON

ZM1200

CIRCUIT APPLICATION

The tube contains 10 common numeral cathode rails, one common decimal point cathode rail, one common punctuation mark cathode rail, a common shield and 14 decade anodes.

The application of a suitable coincidence voltage (pulse) on the cathode rail and on one anode causes the selected numeral to light up in the desired decade. Sequential drive of either the cathode rails or the anodes, whilst simultaneously selecting the corresponding anode or cathode, respectively, with a minimum cycling frequency of approximately 70Hz allows flicker-free numerical presentation.

In a practical circuit both the 'off' anodes and the 'off' cathodes are to be kept in the quiescent state by a bias voltage in such a way that they will neither act as cathodes nor as anodes.

The cathode numeral (with or without decimal point and/or punctuation mark) to be selected is to be driven negative and the anode to be selected positive with respect to the bias.

The shield must be kept at a steady potential during operation to prevent 'cross-talk' between the decades. (See basic circuit).

Remark: Because a gas discharge is not current limiting in itself, the electrode currents must be limited to safe values by using resistors or (limited) current sources.

Basic circuit

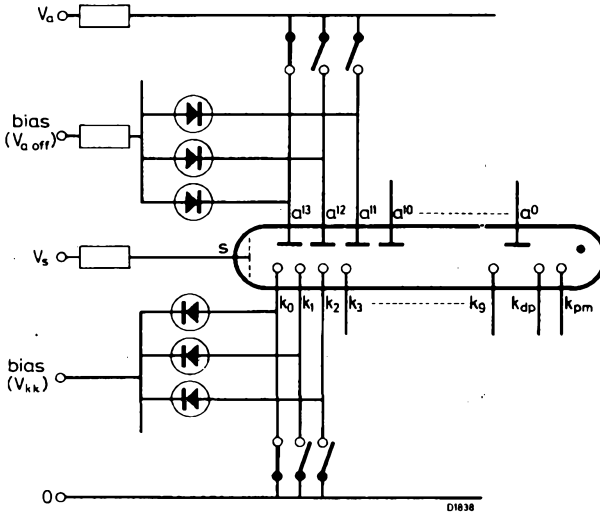

Mullard

NUMERICAL INDICATOR TUBES

ZM1230 ZM1232

QUICK REFERENCE DATA

Cold cathode, neonfilled, side viewing indicator tubes with long life expectancy. The ZM1230 is coated with a red filter to improve contrast of display. These tubes are similar to ZM1170, ZM1172 but are inverted with leads mounted at the top.

Numeral height	15.5	mm
	0.6	in
Minimum distance between mounting centres	19	mm
	0.75	in
Numerals	1 2 3 4 5 6 7 8 9 0	
Cathode current	2.5	mA
Minimum supply voltage	170	V

CHARACTERISTICS AND OPERATING CONDITIONS (Measured at 20 to 50°C)

Minimum anode-to-cathode voltage necessary for ignition	170	V
Ignition delay time	See page 4	
Anode-to-cathode maintaining voltage	See page 5	
Anode-to-cathode voltage below which all tubes will extinguish	115	
Cathode current		
Maximum peak	12	mA
Maximum average (averaged over any 10ms) (see note 1)	3.5	mA
Minimum average (averaged over any 10ms) (see note 1)	0.8	mA
Minimum average (averaged over any conduction period) (see note 1)	1.5	mA
Recommended average (during any d. c. conduction period)	2.5	mA
Probe current		
Probe current to individual non-conducting cathodes (I_{kk})	See pages 6 and 11	
Probe current to combined non-conducting cathodes (ΣI_{kk})	See pages 7, 11 and 12	



D.C. operation

See pages 5 to 10

Pulse operation

Minimum pulse duration 100 μ s

See pages 5, 11, 12 and 13

LIFE EXPECTANCY at recommended operating conditions and room temperature (see note 2)

Continuous display of one numeral > 5000 h

Sequentially changing the display from one numeral to another, every 100 hours or less > 30 000 h

RATINGS (ABSOLUTE MAXIMUM SYSTEM)

Cathode current (each digit)

Maximum average (averaged over any 10ms) 3.5 mA

Maximum peak 12 mA

Minimum average (averaged over any conduction period) 1.5 mA

Bulb temperature

Maximum +70 $^{\circ}$ C

Minimum (see note 2) -50 $^{\circ}$ C

MOUNTING POSITION

Any. The numerals are viewed through the side of the envelope. The numerals will appear upright (within $\pm 3^{\circ}$) when the tube is mounted vertically, base up.

OPERATING NOTES

1. The minimum average current (averaged over any 10ms) of 0.8mA is necessary for adequate light output without flicker in applications other than d.c. The minimum average current (averaged over any conduction period) of 1.5mA is necessary to ensure complete cathode coverage initially and throughout life.
2. For bulb temperatures below 0° C the life expectancy of the tube is substantially reduced.
3. The tube may be soldered directly into the circuit, but heat conduction to the glass-to-metal seals should be kept to a minimum by the use of a thermal shunt.
4. The leads are tinned and may be dip-soldered to a minimum of 5mm from the seals at a solder temperature of 240° C for a maximum of 10 seconds.
5. Care should be taken not to bend the leads nearer than 1.5mm from the seals.



NUMERICAL INDICATOR TUBES

ZM1230 ZM1232

OUTLINE AND DIMENSIONS

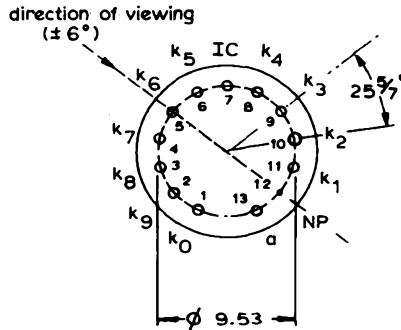
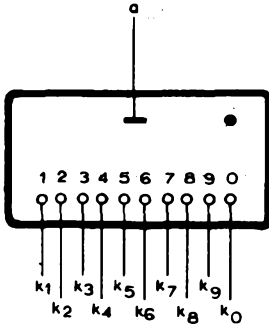
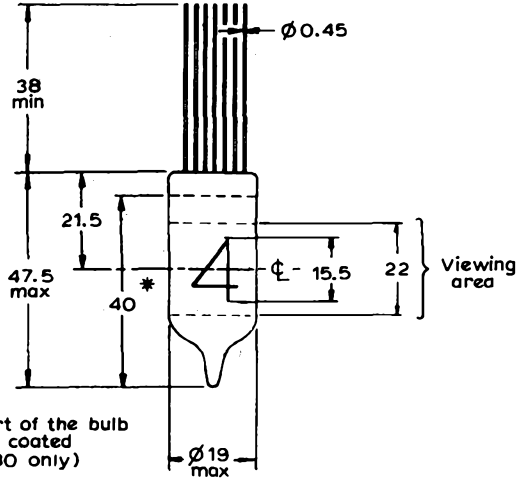

All dimensions in mm



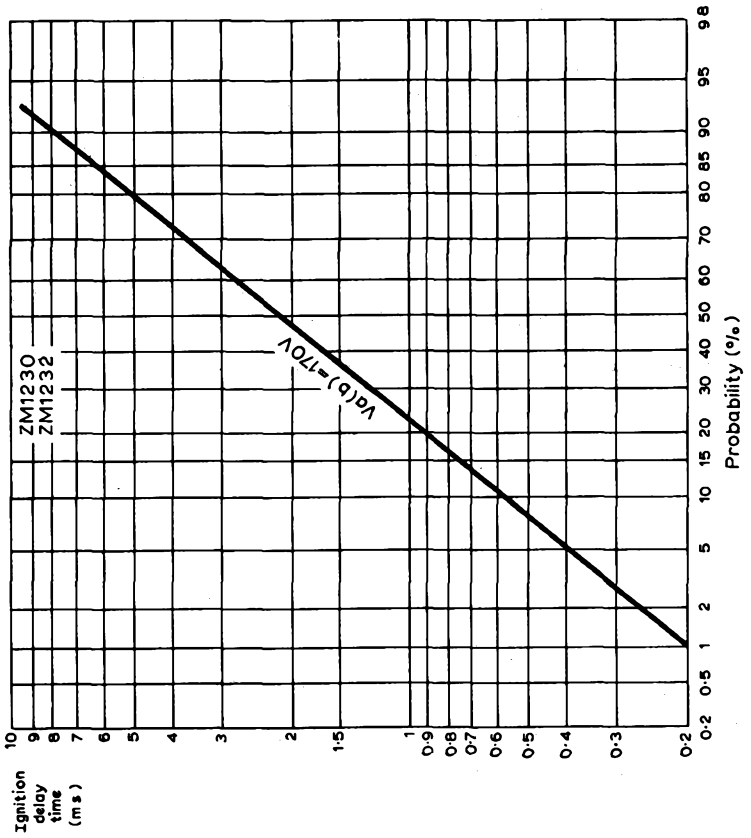

CUMULATIVE DISTRIBUTION OF IGNITION DELAY TIME

This curve shows the probability that a tube will ignite in less than the time shown after a non-conduction period of a few seconds. The ignition delay time will be appreciably reduced when the interval between conduction periods is less than 100 milliseconds. In general, an increase in the supply voltage will reduce the ignition delay time.



NUMERICAL INDICATOR TUBES

ZM1230 ZM1232

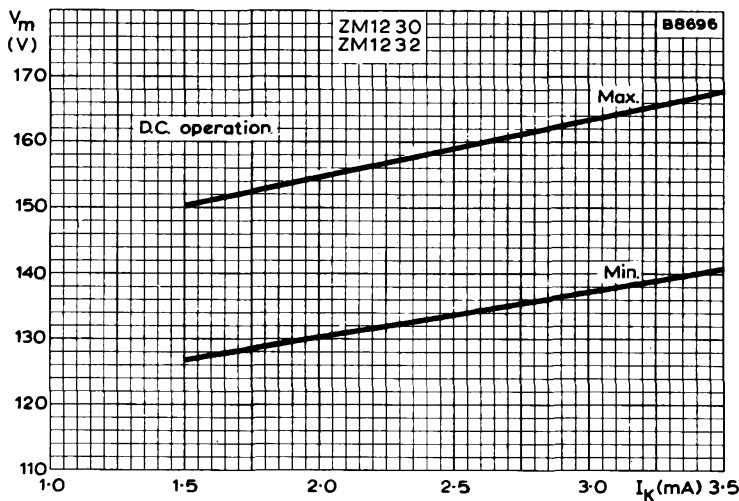

ANODE-TO-CATHODE MAINTAINING VOLTAGE
PLOTTED AGAINST CATHODE CURRENT

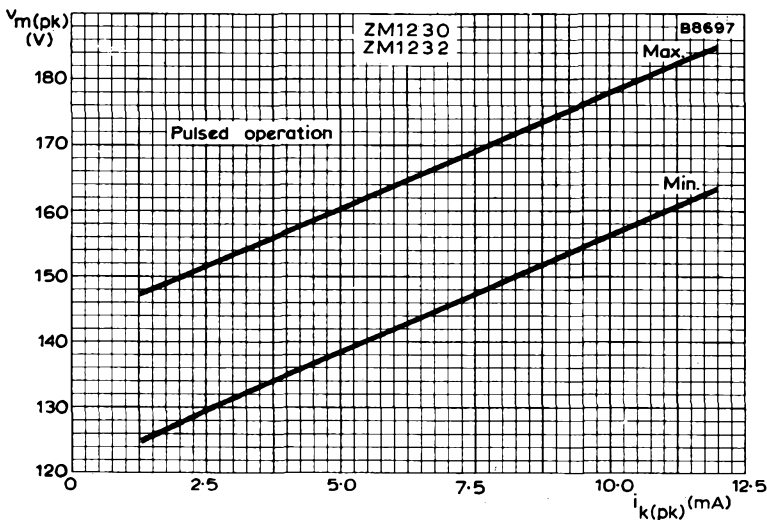

PEAK ANODE-TO-CATHODE MAINTAINING VOLTAGE
PLOTTED AGAINST PEAK CATHODE CURRENT



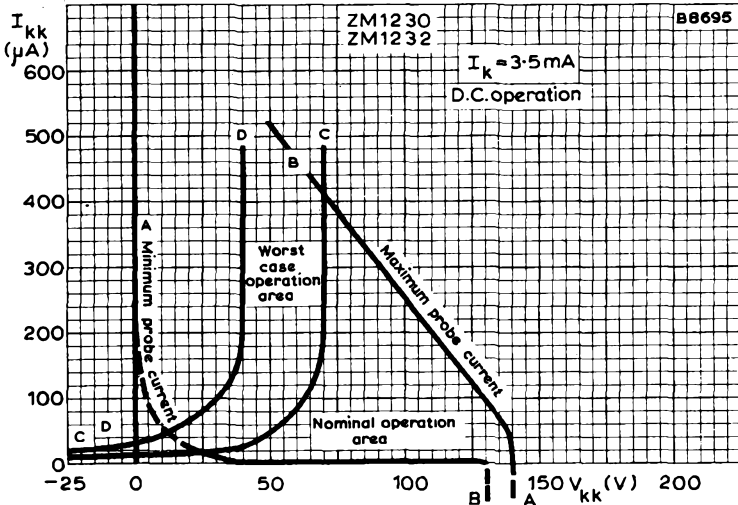
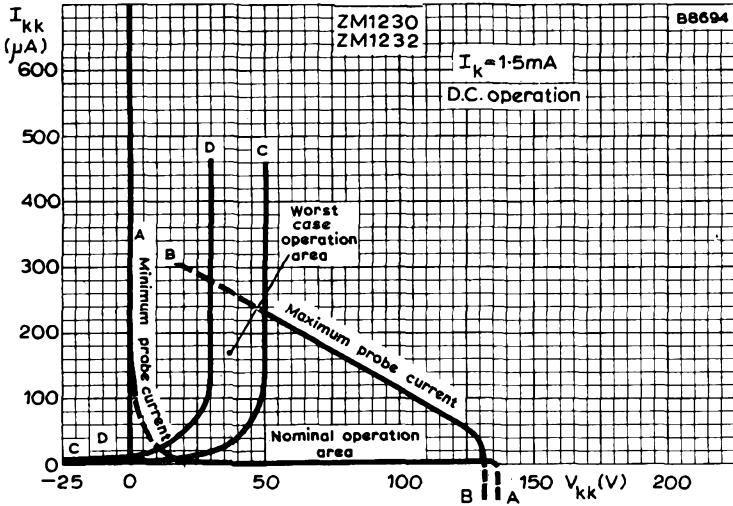

PROBE CURRENT TO INDIVIDUAL NON-CONDUCTING CATHODES

The boundaries A-A and B-B of the graphs represent, for the shown cathode current range, the range of probe current (I_{kk}) to individual non-conducting cathodes plotted against the voltage difference between the non-conducting cathodes and the conducting cathode (V_{kk}).

For low cathode selecting voltages (V_{kk}) the current I_{kk} to the non-conducting cathode will increase, and the readability of the conducting cathode will be affected.

It is therefore recommended to use a nominal operating point to the right of line C-C. Under the worst operating conditions the operating point should never reach the area left of the line D-D.



NUMERICAL INDICATOR TUBES

ZM1230 ZM1232

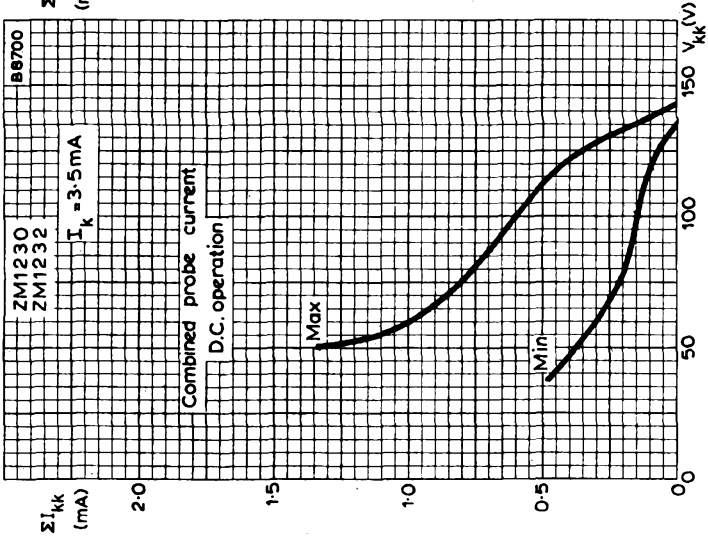
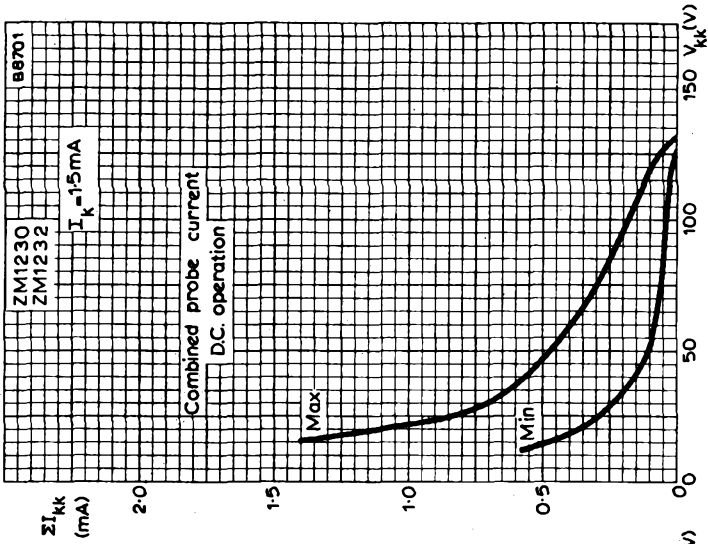

COMBINED PROBE CURRENT TO ALL NON-CONDUCTING CATHODES

Sum of the probe currents to the non-conducting cathodes (ΣI_{kk}) plotted against the voltage difference between the non-conducting cathodes and the conducting cathode (V_{kk}), showing the minimum and maximum values of probe current for a particular cathode current (I_k).



SUPPLY VOLTAGE/LOAD RESISTOR

The graphs on pages 9, 10 and 13 give the relationship between the anode supply voltage and the required anode load resistor for fixed values of V_{kk} (voltage difference between conducting cathode and non-conducting cathodes).

Each graph is plotted on log-log graph paper; therefore a given tolerance expressed as a percentage can be represented as a fixed length at any point on the x and y axes. This is shown on the first graph by taking points on each axis with a fixed tolerance.

Examples are shown on the first graph of the supply voltages and load resistors with tolerances expressed as a percentage so as to remain within the recommended operating region.

The curves are derived from:-

$$V_s = I_a \cdot R_a + V_m$$

$$I_a = I_k + \Sigma I_{kk}$$

$$V_s = (I_k + \Sigma I_{kk}) R_a + V_m$$

For a given value of R_a , the minimum supply voltage limit to ensure that the cathode current exceeds $I_k \text{ min.}$ is given by:

$$V_s \text{ min.} = \left[I_k \text{ min.} + \Sigma I_{kk} \text{ max. (at } I_k \text{ min.)} \right] R_a + V_m \text{ max. (at } I_k \text{ min.)}$$

For the same value of R_a , the maximum supply voltage limit to ensure that the cathode current does not exceed $I_k \text{ max.}$ is given by:

$$V_s \text{ max.} = \left[I_k \text{ max.} + \Sigma I_{kk} \text{ min. (at } I_k \text{ max.)} \right] R_a + V_m \text{ min. (at } I_k \text{ max.)}$$

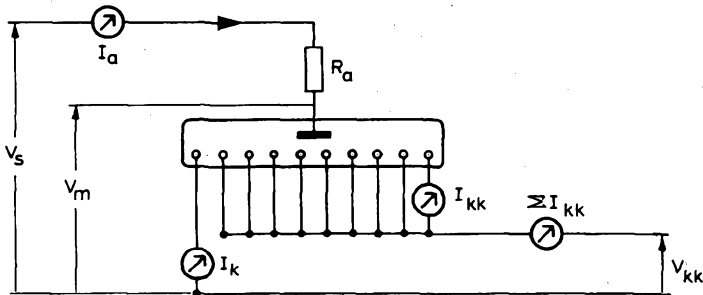

NUMERICAL INDICATOR TUBES

ZM1230 ZM1232

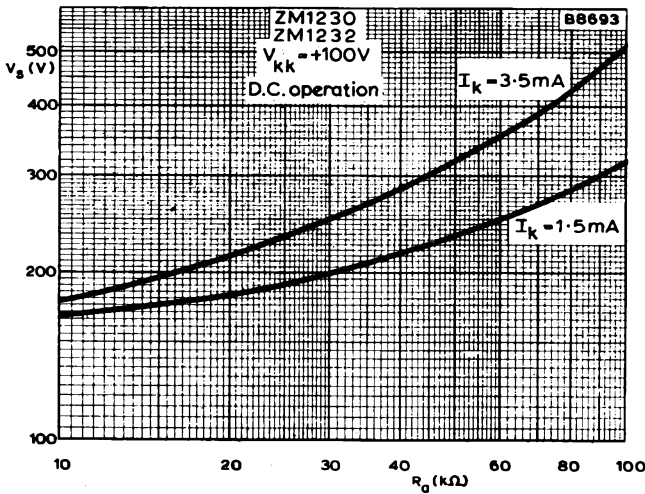
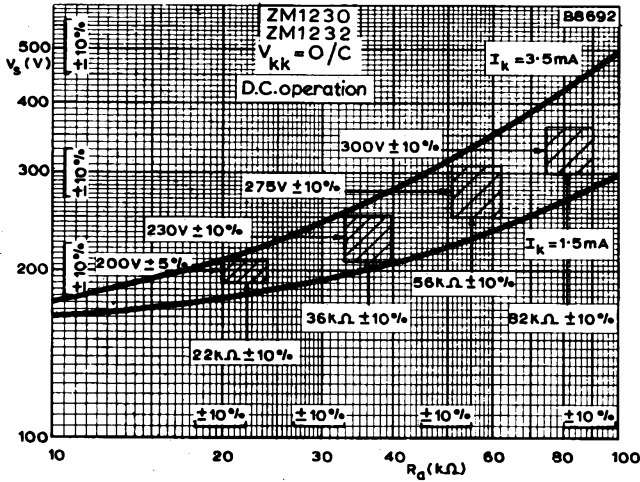

D.C. SUPPLY VOLTAGE PLOTTED AGAINST ANODE LOAD RESISTOR



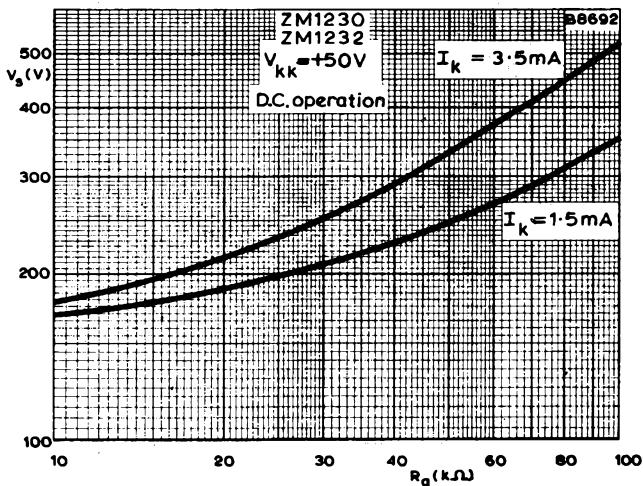
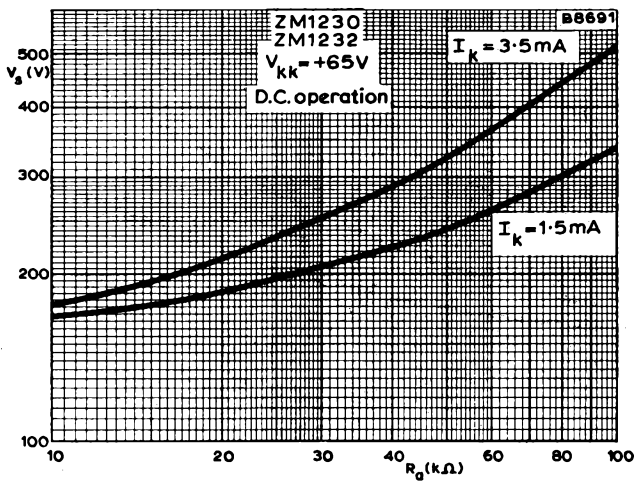

D.C. SUPPLY VOLTAGE PLOTTED AGAINST ANODE LOAD RESISTOR



NUMERICAL INDICATOR TUBES

ZM1230 ZM1232

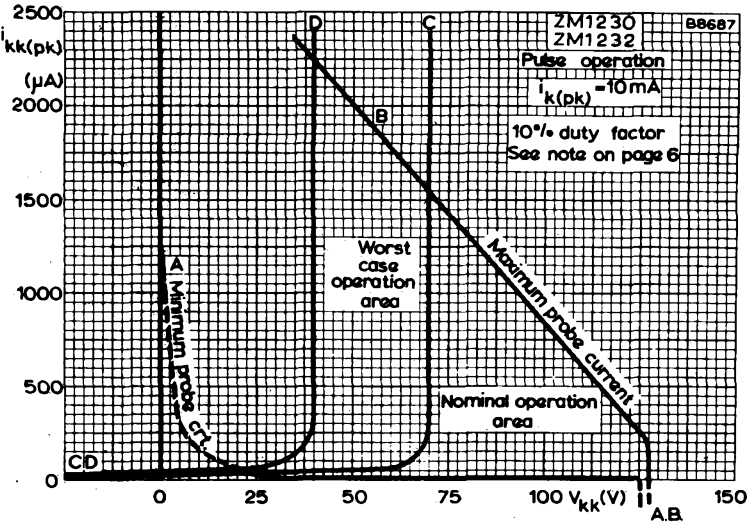

PEAK PROBE CURRENT TO INDIVIDUAL NON-CONDUCTING CATHODES

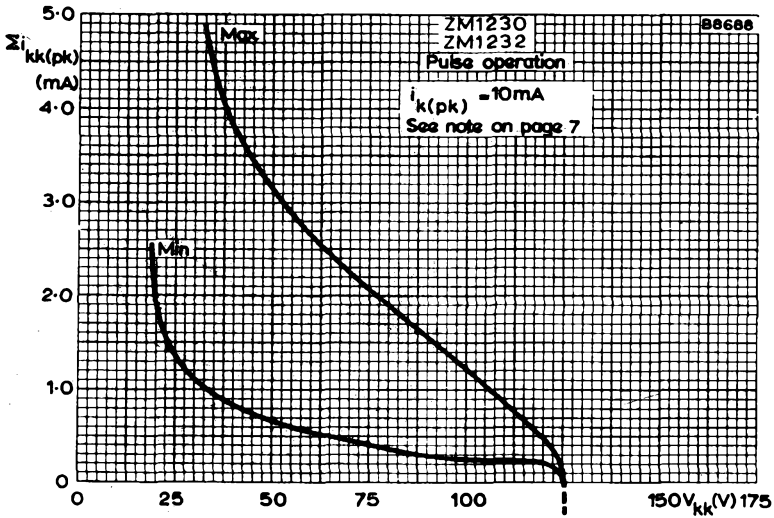

COMBINED PEAK PROBE CURRENT TO ALL NON-CONDUCTING CATHODES





COMBINED PEAK PROBE CURRENT TO ALL NON-CONDUCTING CATHODES

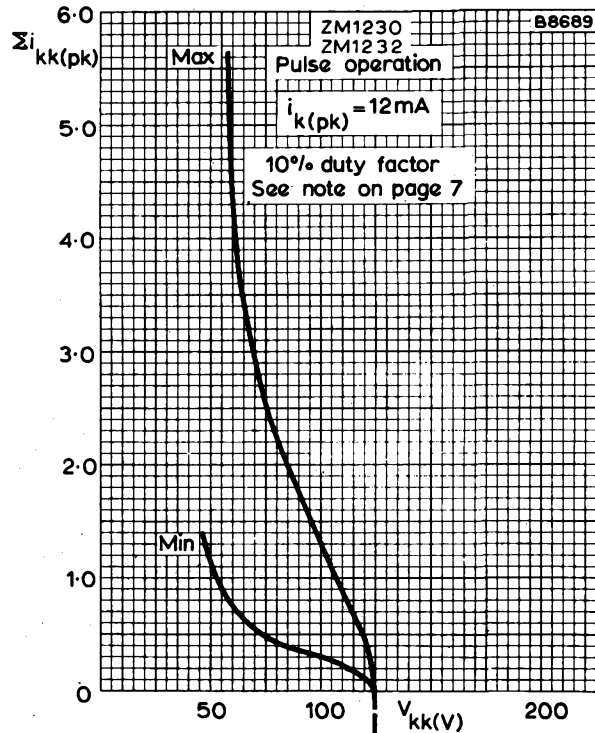
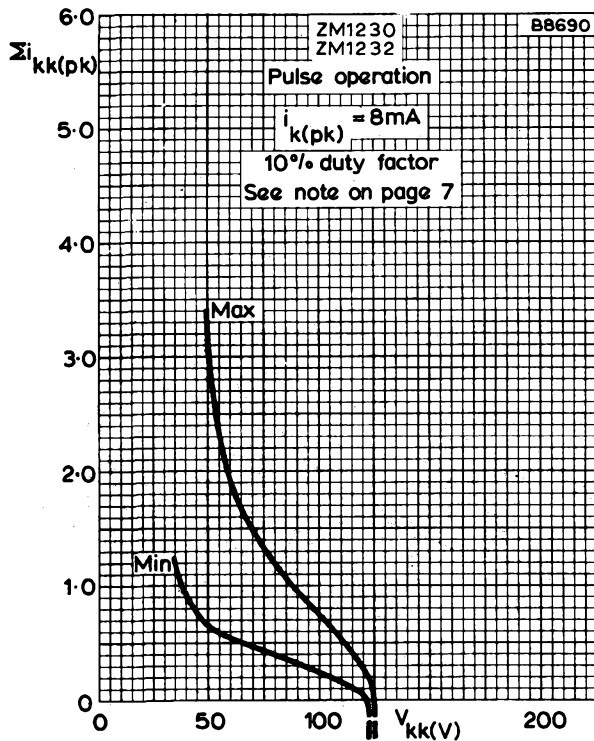

NUMERICAL INDICATOR TUBES

ZM1230 ZM1232

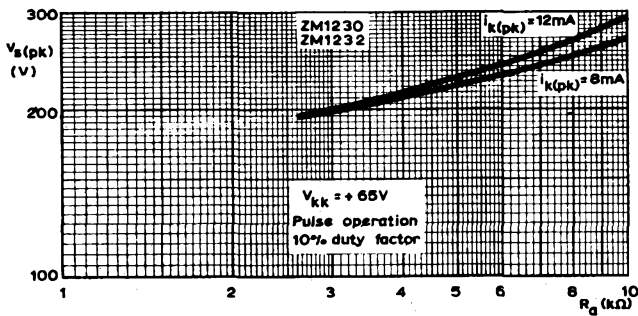
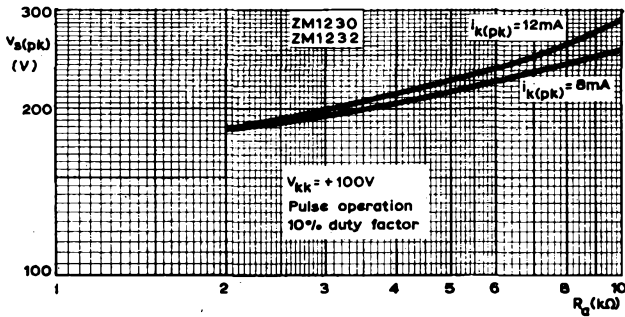
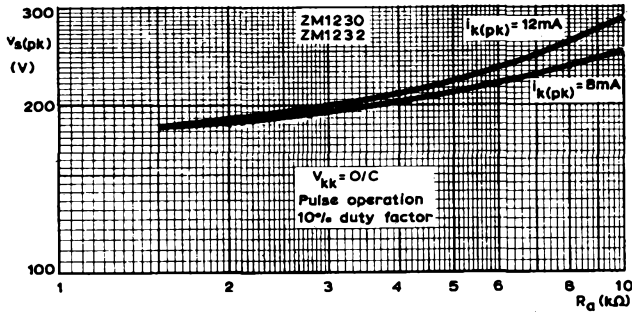

PEAK SUPPLY VOLTAGE PLOTTED AGAINST ANODE LOAD RESISTOR



SMALL THYRATRONS AND TRIGGER TUBES

F



COLD CATHODE TRIGGER TUBES NOTES

1. INTRODUCTION

A cold cathode trigger tube is a non-thermionic gasfilled switching device, having two characteristic stable states, one of high impedance, the other low impedance. Switching from the high-impedance state to the low-impedance is brought about by a signal applied to a control electrode of high input impedance; switching from the low impedance to the high-impedance state cannot be effected by the control electrode.

In the low-impedance state, a glow discharge conducts between the anode and cathode gap; this discharge is referred to as the main discharge, and the path between anode and cathode as the main gap. The discharge path across the main gap is characterised by three voltages:

- (a) the ignition voltage or breakdown voltage, which is the voltage which must be applied across the gap before a discharge can be initiated;
- (b) the maintaining voltage, which is generally lower than the ignition voltage and substantially constant over the current operating range of the gap;
- (c) the extinction voltage, which is the value below which the anode-cathode voltage must be decreased to extinguish any glow discharge between anode and cathode.

The ignition voltage of the main anode-cathode gap can effectively be decreased and a discharge brought about by initiating a glow discharge across a control gap. The amount by which the ignition voltage is decreased is dependent on the power which is fed into such a control gap. The control gap is usually that between trigger and cathode. Once the main discharge is established (the tube in the conducting state) the trigger has no further control of the anode-cathode discharge. The extinction of the anode-cathode discharge can only be effected by decreasing the voltage across the gap below the extinction voltage for a certain period of time (recovery time). The control-gap discharge must also be extinguished before the anode supply can be re-applied.

The ignition voltage across a discharge gap is the voltage that must be applied before a discharge can be initiated. However, the application of a voltage in excess of the ignition voltage is not sufficient in itself, a further requirement before a discharge can be initiated is the presence of priming gas ions or electrons, and to provide these, a priming electrode is often used in cold cathode trigger tubes. This is explained more fully in section 5 on priming.

In addition to the anode, cathode, trigger and priming electrodes, other electrodes are sometimes used to incorporate special characteristics.

It is a property of cold cathode trigger tubes that the gap between any two metallic surfaces (e.g. anode and trigger) can act as a path or gap for a glow discharge with either electrode acting as the cathode. Any such gap is characterised by the three voltages defined earlier, viz.: ignition, maintaining and extinction voltages. In general the characteristics of certain gaps only are controlled. Two such gaps are the anode-cathode and trigger-cathode gaps. However, the characteristics of gaps which are not controlled during manufacture may be of the same order of magnitude as those gaps which are controlled. The spread in characteristics of the uncontrolled gaps are likely to be considerably greater.

If a discharge does occur in an uncontrolled gap, it may result in spurious triggering of the main gap. In addition if the surface acting as cathode is other than the true cathode, the discharge will normally cause changes to the controlled characteristics of the tube, and if the discharge is permitted to occur repeatedly or if the current is large, irreparable damage to the tube will result.

COLD CATHODE TRIGGER TUBES NOTES

Because of priming effects during and immediately following a discharge in a tube, the ignition voltage across all gaps will be considerably less than static values obtained in absence of the discharge. However, the tube will recover its original characteristics after the tube recovery time has elapsed (see section 3.7). Maximum permissible voltages across the gaps (where applicable) are normally given in the individual data sheets. These voltages can be given graphically by means of a lozenge characteristic as shown in fig. 1; this gives the locus of ignition and extinction voltages for a simple three electrode trigger tube. The vertical axis gives the anode-cathode voltage and the horizontal axis the trigger-cathode voltage; the tube will be conducting outside the 'lozenge' and extinguished within the inner area. The ignition associated with the individual sections of the characteristics is shown in the inset sketches.

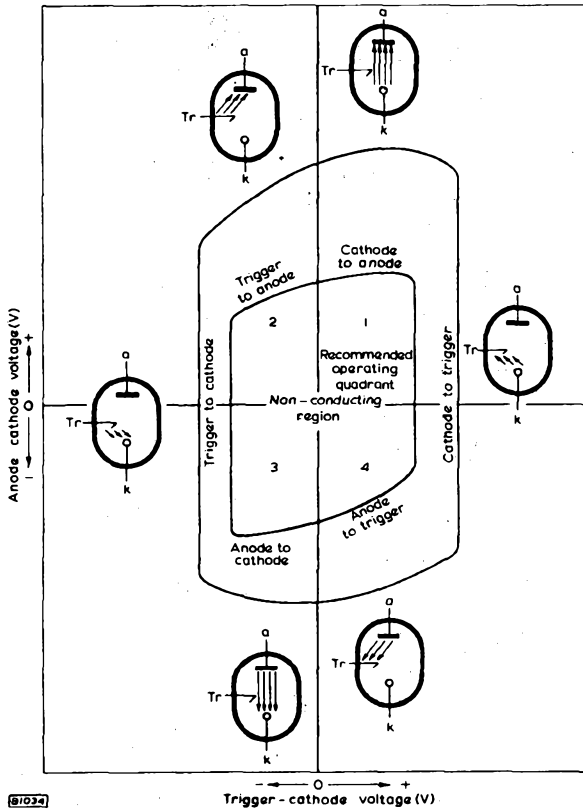

Fig. 1

COLD CATHODE TRIGGER TUBES NOTES

2. DATA PRESENTATION

In general, the data is divided into four main headings, namely, quick reference data, characteristics and range values for equipment design, absolute maximum ratings and life information. Each of these is described below and more detailed information is given for the individual gaps in the later sections. Specific information is also given in the data sheets for the different tubes.

2.1 Quick reference data

The section comprising quick reference data contains the nominal values of the main characteristics of the tube to allow rapid comparison with the characteristics of other tubes. The information for circuit design should be obtained from the succeeding section. The items usually given for quick reference are: anode supply voltage, anode maintaining voltage, maximum average cathode current trigger ignition voltage, trigger transfer capacitance and current, and any special features.

2.2 Characteristics and range values for equipment design

The values given in this section normally indicate the range over which the tube will operate both initially and during life. No allowance is made for supply voltage and component variations. There is no objection to operation outside the stated ranges, provided no absolute maximum rating is thereby exceeded, but no guarantee is given on the performance of the tube in a circuit under these conditions. However, once the tube is again operated within the stipulated range values, the performance is again guaranteed.

2.3 Absolute maximum rating system (I.E.C. definition)

Absolute maximum ratings are limiting values of operating and environmental conditions applicable to any tube of a specified type as defined by its published data, and should not be exceeded under the worst probable conditions.

These values are chosen by the tube manufacturer to provide acceptable serviceability of the tube, taking no responsibility for equipment variations, environmental variations, and the effects of changes in operating conditions due to variations in the characteristics of the tube under consideration and all other electron devices in the equipment. The equipment manufacturer should design so that initially and throughout life no absolute maximum value for the intended service is exceeded with a tube under the worst probable operating conditions with respect to supply voltage variations, equipment component variation, equipment control adjustment, load variations, signal variation, environmental conditions, and variations in characteristics of the tube under consideration and of all other devices in the equipment.

2.4 Life information

Where the general pattern of life behaviour of a particular characteristic is of particular interest in the main application for which the tube is intended, the pattern will be described. This pattern will normally give times to fail for certain parameters.



COLD CATHODE TRIGGER TUBES NOTES

3. ANODE-CATHODE GAP

3.1 Maximum anode supply voltage

The maximum anode supply voltage is the maximum permissible voltage that can be applied to the anode and still allow trigger-controlled operation. If it is exceeded, the tube may ignite spontaneously.

3.2 Minimum anode supply voltage

The minimum anode supply voltage is the minimum voltage that must be applied to the anode when the trigger is ignited to ensure reliable transfer of the trigger discharge to the anode-cathode gap. If a lower voltage is applied it may be found that:

3.2.1 A trigger-cathode discharge is established but may fail to establish the anode-cathode discharge if the amount of power in the trigger circuit is insufficient (See section 7).

To inhibit anode-cathode conduction in the presence of a trigger-cathode discharge, it is normally necessary to ensure that the anode supply voltage is reduced below the anode maintaining voltage.

3.2.2 The priming discharge (where applicable) will not be initiated.

3.3 Maximum negative anode voltage

The maximum negative anode voltage is the maximum permissible negative voltage that can be applied to the anode and still allow reliable operation without the possibility of inverse breakdown occurring. The figure applies to the conditions specified in the data sheets. If the figure is exceeded a spurious discharge between the anode (acting as cathode) and another electrode (acting as anode) may occur. Such a discharge may cause damage to the tube.

3.4 Anode maintaining voltage

The anode maintaining voltage is the direct voltage between anode and cathode when the tube is conducting. It is measured at the conditions specified in the data sheets and will vary with current, temperature and time. In the presence of noise, the average value is taken.

3.4.1 Noise on maintaining voltage

3.4.1.1 Random noise voltage

Random noise voltage is similar to thermal noise. It is normally given as the r.m.s. voltage measured over a specified frequency range.

3.4.1.2 Oscillation noise

Oscillation noise is a noise voltage which is generated solely within the tube and has a major component at one frequency.

3.4.1.3 Vibration noise

Vibration noise is the noise output resulting from sinusoidal vibration of the tube. Where information is given under this heading it is for guidance only, and the tube must not be operated under these conditions for long periods.

3.4.1.4 Microphonic noise

Microphonic noise is the noise output caused by mechanical excitation resulting from a single blow.



COLD CATHODE TRIGGER TUBES NOTES

3.5 Recovery and de-ionisation time

See section 6.2.

3.6 Impedance

The impedance quoted is the total impedance at a given frequency between anode and cathode of the tube during conduction at specified values of direct and alternating components of anode current.

3.7 Anode-cathode ignition voltage depression (hysteresis)

The anode-cathode ignition voltage is lowered after a period of conduction, but returns to its initial value after a recovery period. The magnitude of the depression is dependent on the cathode current and the period of conduction. Unless otherwise stated the value given for the maximum ignition voltage takes this depression into account.

3.8 Influence of external fields on anode-to-cathode ignition

The correct operation of trigger tubes may be affected by external electrostatic fields. In applications where a high alternating or pulsating voltage exists between the cathode and the tube surroundings, it may be recommended that the tube be enclosed in a screening can which should be connected to cathode.

The individual data sheets should be consulted.

3.9 Cathode current range

The specified current range should be adhered to in order to ensure continued satisfactory reliable operation and to achieve the published life expectancy. The total cathode current is composed of the algebraic sum of the currents between the cathode and any other electrodes in the tube.

3.9.1 Maximum cathode current

The life of a trigger tube is inversely proportional to some power law of the rate of sputtering away of the cathode material, which in turn is related to the cathode current. With some trigger tubes, the relationship between life and the inverse power law of the cathode current can be derived, thus giving the conducting life of the tube at any cathode current. This enables the user to determine the total life of the tube according to the mode of operation. Thus, for a tube that is normally in the standby off position, the required long life can be achieved even with the use of high cathode current. If the tube is conducting continuously the same life can be achieved by the use of lower values of cathode current.

When the required value of cathode current is being considered, it must be remembered that there is a maximum value above which the tube must not be used. This maximum is given in the Absolute Maximum Ratings, and is that value above which the behaviour is no longer predictable or known, or above which harm may be done to the tube.



COLD CATHODE TRIGGER TUBES NOTES

3.9.2 Minimum cathode current

Incomplete coverage of the cathode by the discharge glow in some types of trigger tube may give rise to a trigger ignition voltage in excess of the published value. This can be overcome in these trigger tubes by ensuring that during any conducting period the cathode current exceeds a certain minimum value. If a value less than the minimum permissible cathode current is drawn, a rise in the trigger ignition voltage may occur. Thus a minimum current during any conducting period is given in the Absolute Maximum Ratings. It is stressed that the time over which this average is taken is the period of conduction, and should not include any period of non-conduction.

4. TRIGGER-CATHODE GAP

4.1. Trigger-cathode ignition voltage

The trigger-cathode ignition voltage is the voltage that must be applied to the trigger to establish a glow discharge between the trigger and cathode, and is followed by sufficient power being fed into such a discharge to bring about an anode-cathode discharge.

4.1.1. Pulsed trigger ignition voltage

When it is required to initiate the trigger-cathode discharge by applying a positive pulse to a biased trigger, it should be noted that the trigger-cathode ignition voltage is dependent on the pulse shape, pulse duration and circuit component values. In general, the voltage required to cause ignition will increase over that required for d.c. ignition as the pulse duration is reduced. See sections 6.1.1 and 6.1.2.

4.2 Trigger maintaining voltage

The trigger maintaining voltage is the voltage between trigger and cathode when a glow discharge has been established between trigger and cathode and in the absence of an anode-cathode discharge.

4.3 Maximum negative trigger-cathode voltage

The maximum negative trigger-cathode voltage is the maximum permissible negative voltage at the trigger with respect to the cathode, that does not cause unwanted ignition in the tube. If this figure is exceeded irreparable damage to the tube may result.

4.4. Trigger ignition voltage depression (hysteresis)

The trigger-cathode ignition voltage may be altered (generally lowered) after a period of conduction, but it returns to its initial value after a recovery period. The change in trigger ignition voltage is dependent on the cathode current and the period of conduction.

COLD CATHODE TRIGGER TUBES NOTES

4.5 Negative trigger current

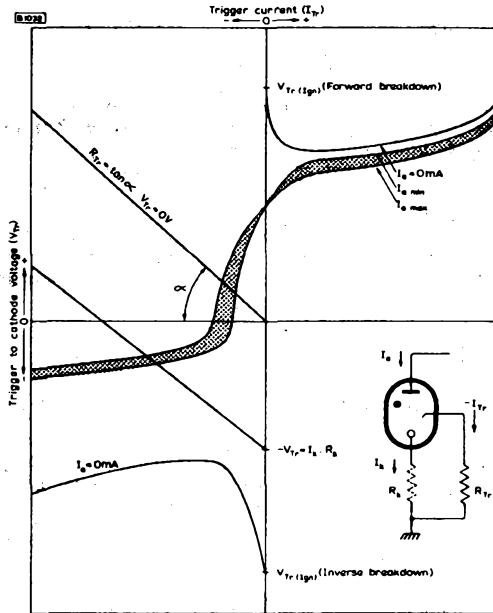

Fig. 2

TRIGGER VOLTAGE-CURRENT CHARACTERISTIC

During anode conduction, the trigger-cathode potential assumes a value which is determined by the trigger and anode currents.

A typical trigger voltage-current characteristic is given in Fig. 2. Negative trigger current is defined as a conventional current flowing from the tube into the trigger circuit. In this way the trigger acts as a cathode and is consequently sputtered. In some tube types this may lead to an increase in the trigger ignition voltage $V_{TR(ign)}$ and the transfer current I_{TR} .

The magnitude of the negative trigger current is found from the intersection of the line representing R_{TR} and the trigger voltage-current characteristic. When the cathode is returned to earth via a cathode resistor R_K (as may be the case in counter circuits) the load-line intersects with the V_{TR} axis at $V_{TR} = -I_K \times R_K$ (See fig. 2).

In most tubes negative trigger current shall always be limited as much as possible, and in these tubes must never be permitted to flow when the main gap is not conducting, as this may cause irreparable damage to the tube.

COLD CATHODE TRIGGER TUBES NOTES

4.6 Pre-ignition trigger current

The establishment of a glow discharge between the trigger and cathode is dependent on the trigger supply voltage, $V_{Tr(b)}$, the trigger pre-ignition current, $I_{Tr(pre-ign)}$, the trigger series resistor, R_{Tr} , and the trigger ignition voltage, $V_{Tr(ign)}$. These should be arranged so that,

$$V_{Tr(b)} - I_{Tr(pre-ign)} \cdot R_{Tr} > V_{Tr(ign)}$$

The pre-ignition trigger current, if any, depends mainly on the priming current. Values of $I_{Tr(pre-ign)}$ and $V_{Tr(ign)}$ are normally given, as also are limiting values of R_{Tr} . If large values of R_{Tr} are used then the priming electrode may be left disconnected. In this case, the trigger-cathode gap ionisation time may be of the order of seconds.

At voltages less than the trigger ignition voltage, a small current, called the pre-ignition current, flows between the trigger and cathode. This current is in part due to ohmic leakage between the trigger and cathode and in part due to ionisation. The part due to ionisation may be a function of the priming discharge.

4.7 Maximum trigger series resistance

See section 4.6.

4.8 Temperature coefficient of trigger ignition voltage $\frac{\Delta V_{Tr(ign)}}{\Delta T_{bulb}}$

The temperature coefficient of the trigger-ignition voltage is defined as the quotient given by the change of trigger ignition voltage divided by the change of bulb temperature. The value given is generally an average value which applies over a specified bulb temperature operating range.

5. PRIMING

5.1 Introduction

To establish a trigger-cathode glow discharge it is not sufficient to have a trigger voltage in excess of $V_{Tr(ign)}$. In addition, the tube must be primed by means of ionised gas or priming electrons.

In some tubes a priming gap is provided to reduce the trigger-cathode delay time. If natural sources (cosmic radiation) are relied upon to provide priming, then long statistical delays of up to 1 minute may occur between application of trigger voltage and establishment of a discharge. To overcome these long delays, cold cathode tubes are usually additionally primed by one or more of the following methods:

5.1.1 Photo-electric emission of electrons from the cathode or other active surface.

5.1.2 Stray ionisation from an auxiliary priming discharge. It can be achieved by the use of a priming cathode or a priming anode. In any circuit care must be taken to ensure that the priming discharge is maintained whenever the main glow is extinguished. The requirements for individual tubes will be found on the separate data sheets.

5.1.3 Radioactive source, which is introduced to assist the other two methods; it helps to establish rapidly the priming discharge and reduces the statistical delay. Unless otherwise stated, the amount of radioactivity is well below the level at which special precautions are needed and cannot be detected outside the bulb.

COLD CATHODE TRIGGER TUBES NOTES

5.2 Minimum primer supply voltage

The minimum primer supply voltage is the minimum voltage that must be applied through the primer resistor to the primer gap to ignite the primer. At voltages lower than this value, the primer may fail to ignite.

5.3 Primer series resistance

The primer series resistance is the value of resistance required to ensure the primer current operates between the limits given at a specified supply voltage. The primer series resistor should be mounted as close as possible to the primer connection to keep stray capacitance at a minimum. Otherwise, if the primer discharge is initiated whilst voltages are applied to other electrode gaps, spurious breakdown may occur.

5.4 Illumination

To ensure reliable operation of trigger tubes, it is necessary that:

5.4.1 The ambient illumination on the sensitive part of the cathode is greater than a specified minimum value, for tubes which rely on photoelectric emission from the cathode or other active surface to provide priming.

5.4.2 The ambient illumination is less than a maximum value, where specified, to prevent spurious firing.

6. IONISATION, DEIONISATION AND RECOVERY TIME

6.1 Ionisation time (anode delay time)

The interval between the application of the triggering voltage and the establishment of the main anode-cathode discharge, is defined as the ionisation time (anode delay time). It consists of three time periods:

6.1.1 The 'statistical delay' before a number of charged particles present in the trigger-cathode gap is sufficient to cause a trigger-cathode ignition. This time depends on the priming source, and on the trigger over-voltage (i.e. voltage above the static breakdown value).

6.1.2 The 'formative delay' before the trigger-cathode discharge is established. This time depends on the trigger over-voltage.

6.1.3 The 'transfer time' is the time between the establishment of the trigger-cathode discharge and the establishment of the anode-cathode discharge. This time is dependent on the power in the trigger-cathode gap for any given anode voltage.

6.2 Recovery time (Deionisation time)

The recovery time is the time between the extinction of the main discharge and the instant at which the given anode voltage can be re-applied to the tube without anode ignition recurring. This is sometimes also known as deionisation time.



COLD CATHODE TRIGGER TUBES NOTES

7. TRANSFER REQUIREMENTS

If surplus ions are introduced into the anode-cathode gap of a trigger tube, the ignition voltage is lowered and a discharge established. The surplus ions are normally introduced by initiating a trigger-cathode discharge and feeding in sufficient power.

The power in the trigger gap can be provided by means of a direct current or by discharging a capacitor through the gap; the amount of power necessary to establish an anode discharge (i.e. to cause transfer) is dependent on the anode voltage.

Under d.c. conditions for igniting the trigger-cathode gap (see fig. 3a), the following must hold:

$$V_{Tr(b)} - R_{Tr} \cdot I_{Tr} > V_{Tr(\text{maint})}$$

where $V_{Tr(\text{maint})}$ = trigger-cathode maintaining voltage

I_{Tr} = trigger current necessary for transfer to the anode-cathode gap.

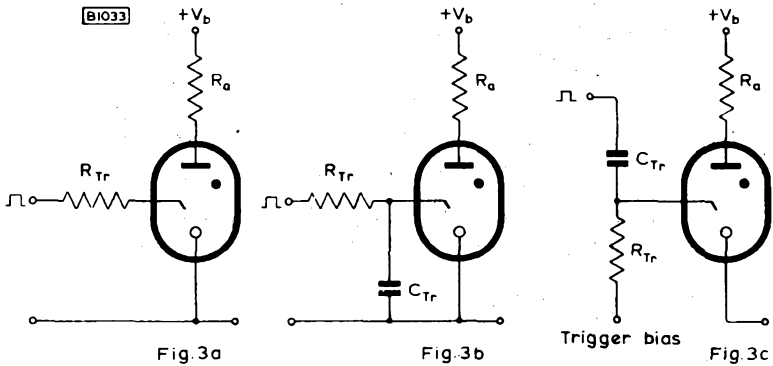

With this method, although the trigger current necessary to cause transfer is specified, the transfer time is not given. This time is not known from the method of measurement, but increasing the trigger current reduces the transfer time. To obtain rapid transfer, capacitive ignition of the trigger gap is preferred, and two methods of doing so are given in Figs. 3b and 3c. The minimum value of the capacitor required is dependent on the anode potential. If a large value of capacitor is used, a series resistor is required in the trigger discharge path to limit the current through the gap.

In Fig. 3c (pulse + bias method) the power through the gap will depend on the pulse duration as well as the amplitude. Care must be taken to ensure that the main glow discharge is established.

COLD CATHODE TRIGGER TUBES NOTES

8. SELF-EXTINGUISHING CIRCUITS

A self-extinguishing circuit is one in which the discharge is extinguished without the aid of any external pulses or any mechanical interruption of the discharge current. Self extinction can relate to either or both of the anode-cathode and trigger-cathode discharges.

The anode self-extinguishing circuit has an associated anode series resistor R_a and an anode shunt capacitor C_a . The discharge is established in the normal manner and C_a is discharged through the anode-cathode gap to a voltage below $V_{a(\text{maint.})}$. The manner in which C_a discharges below $V_{a(\text{maint.})}$ is dependent on the characteristics of the tube, the value of C_a and the magnitude of any resistance in the capacitor discharge circuit. Provided R_a is sufficiently large and the time constant $R_a C_a$ is greater than the recovery time, the tube is extinguished and the capacitor recharged to the h.t. potential via R_a . An output can be obtained by inserting a small resistance in the capacitor discharge circuit. If C_a is very large a limiting resistor must be used to keep the tube current within its ratings. Suitable values of R_a and C_a are usually given. However, if no other guide is available and the time constant $R_a C_a$ is made greater than the recovery time, operation will be ensured and there will be a considerable safety margin.

Similar considerations arise if self extinction of the trigger discharge is desired. The anode must have exceeded its minimum supply voltage before the tube can be operated again.

9. TEMPERATURE

9.1 Maximum ambient storage temperature

The maximum ambient storage temperature is the maximum permissible temperature at which the tube may be stored. If it is exceeded, the tube characteristics may change and the tube fail to meet its published data.

9.2 Maximum ambient operating temperature

The maximum ambient operating temperature is the maximum permissible temperature at which the tube can be used and still give reliable operation. If it is exceeded, the tube characteristics may change and the tube fail to meet its published performance.

9.2.1 Standby operation

When the tube is non-conducting, the ambient temperature must not exceed the maximum ambient storage temperature.

9.3 Bulb temperature

The bulb temperature is taken as the temperature of the hottest part of the tube envelope whether it is due to internal or to external causes. In the interests of reliability, the bulb temperature should be kept as close to room temperature as possible.

10. MECHANICAL CONSIDERATIONS

10.1 Mounting position

Unless otherwise stated in the published data, tubes can be mounted in any position.



COLD CATHODE TRIGGER TUBES NOTES

10.2 Tube sockets

Detailed drawings of pin spacing, diameter and length are given in BS448; 1953 'Electronic—Valve Bases, Caps and Holders'.

When a tube holder for an all-glass based tube is wired, a wiring jig should be inserted to prevent the contacts being displaced. Such displacement could cause damage to the pins when a tube is inserted in the holder. Dimensions for suitable jigs are given in BS448. Pins marked I.C. on the base diagram in the data sheet may have been used for connections within the tube. The corresponding contacts on the tube holder must be left free and not be used as anchoring points when wiring.

10.3 Tubes with flexible leads

Tubes with flexible leads do not normally employ plug-in tube sockets, and it is usual to secure them in position by means of the envelope. When this is done, it is important that:

- 10.3.1 Undue stress should not be placed on the flexible leads.
- 10.3.2 The bulb temperature should not exceed the specified value.
- 10.3.3 If the tube is secured by means of a metal clamp, the clamp should be isolated.
- 10.3.4 In applications where a high alternating voltage exists between the cathode and the tube surroundings, an isolated metal clamp enclosing the tube and connected to cathode, should be used.

Direct soldered connections to the leads must be at least 5mm from the seal and any bending of the leads must be at least the specified distance from the seal. Care should be taken during soldering to ensure that the glass temperature at the seal is not allowed to rise excessively. One simple precaution is to clamp a thermal shunt to the wire between the glass and the point being soldered.

10.4 Dimensions

Only the dimensions given on the data sheets should be used in the design of equipment. Dimensions taken from individual tubes should never be used for this purpose.



These general notes include definitions and general test procedures. They should be read in conjunction with the data sheets for Special Quality Thyratrons. Where reference should be made to a specific note, this is indicated on the data sheet by an index number, e.g. Group quality level.⁹

1. **Heater voltage.** Life and reliability of performance are a function of the value and degree of regulation of the heater voltage. In order to achieve the maximum useful life the heater should be maintained as close as possible to its rated value, and unless specific recommendations are made on individual data sheets, designers should aim to maintain the voltage at the valve pins within $\pm 5\%$ of the published nominal value.
2. **Capacitances.** Unless otherwise stated the capacitances quoted are measured with the valve cold in a fully screened socket. The measurements are made with or without an external shield, as stated on the individual data sheets.
3. **Limiting Values.** The limiting values given on the data sheets are absolute ratings. Absolute maximum ratings are limiting values of operating and environmental conditions applicable to any valve of a specified type as defined by its published data, and should not be exceeded under the worst probable conditions.

These values are chosen by the valve manufacturer to provide acceptable serviceability of the valve, taking no responsibility for equipment variations, environmental variations, and the effects of changes in operating conditions due to variations in the characteristics of the valve under consideration and of all other electron devices in the equipment.

The equipment manufacturer should design so that initially and throughout life no absolute maximum value for the intended service is exceeded with any valve under the worst probable operating conditions with respect to supply voltage variations, equipment component variation, equipment control adjustment, load variations, signal variation, environmental conditions, and variations in characteristics of the valve under consideration and of all other devices in the equipment.

Heater to cathode voltage. In the interests of reliability the heater to cathode voltage should always be kept as low as possible, and it is preferable to have the cathode positive with respect to the heater.

Bulb temperature. In the interests of reliability the bulb temperature should always be kept as low as possible.

-
4. *The A.Q.L. (Acceptable quality level) is the limit below which the average percentage of defectives is controlled.*
 5. *Maximum and minimum values for the individuals are the limits to which valves are tested.*
 6. *Maximum and minimum for lot average are the limits between which the average value of the characteristic of a lot or batch is controlled.*
 7. *Lot standard deviation is the standard deviation of a single lot or batch.*
 8. *Bogey value is the target value.*
 9. *Group quality level. This is the A.Q.L. over a whole group of tests. Sub-group quality level. The A.Q.L. over a number of tests, which do not constitute a complete group.*
 10. *Glass envelope strain test.*
 - (A) *This test is carried out on a sampling basis and consists of completely submerging the valves in boiling water at a temperature between 97 and 100°C for 15 seconds and then immediately plunging them in ice cold water for 5 seconds. The valves are then examined for glass cracks.*
 - (B) *This test is carried out on a sampling basis and consists of completely submerging the valves in boiling water not less than 85°C for 15 seconds and then immediately plunging them in ice cold water not more than 5°C for 5 seconds. The valves are then examined for glass cracks.*
 11. *Base strain test. This test is carried out on a sampling basis and consists of forcing the pins of the valves over specified cones and then completely submerging the valves and cones in boiling water at a temperature between 97 and 100°C for 10 seconds. The valves and cones are allowed to cool to room temperature before examining for glass cracks.*
 12. *This test is carried out on a sampling basis under the conditions detailed in the data.*
 13. *Shock test. This test is carried out on a sampling basis and subjects the valves to 5 blows of the specified acceleration in each of 4 directions.*
 14. *Inoperatives. An inoperative is defined as a valve having an open or short circuited electrode, an air leak or a broken pin.*

Tetrode inert gas-filled thyatron with negative control characteristic. Primarily designed for industrial control applications.

This data should be read in conjunction with DEFINITIONS AND GENERAL OPERATIONAL RECOMMENDATIONS—THYRATRONs, preceding this section of the handbook.

LIMITING VALUES (absolute ratings, not design centre)

It is important that these limits are never exceeded and such variations as mains fluctuations, component tolerances and switching surges must be taken into consideration in arriving at actual valve operating conditions.

Max. peak anode voltage		
Inverse	1.3	kV
Forward	650	V
Max. cathode current		
Peak	2.0	A
Average (max. averaging time 15s)	300	mA
Surge (fault protection max. duration 0.1s)	10	A
Max. negative control-grid voltage		
Before conduction	250	V
During conduction	10	V
Max. average positive control-grid current for anode voltage more positive than -10V (averaging time 1 cycle)	20	mA
Max. control-grid resistance		
$I_a < 200\text{mA}$	10	M Ω
$I_a > 200\text{mA}$	2.0	M Ω
Max. negative shield-grid voltage		
Before conduction	100	V
During conduction	10	V
Max. average positive shield-grid current for anode voltage more positive than -10V (averaging time 1 cycle)	20	mA
Max. screen-grid resistor	1.0	M Ω
Max. peak heater-cathode voltage		
Cathode negative	25	V
Cathode positive	100	V
Min. valve heating time (for $I_{k(DK)}$ max = 2.0A)	20	s
Ambient temperature limits	-75 to +90	$^{\circ}\text{C}$

Note—Where circuit conditions permit, the shield-grid should be connected directly to the cathode.

EN32

TETRODE THYRATRON

Tetrode inert gas-filled thyatron with negative control characteristic. Primarily designed for industrial control applications.

CHARACTERISTICS

Electrical

Heater voltage	6.3	V
Heater current at 6.3V	950	mA
Capacitances		
Anode to grid	0.25	pF
Anode to cathode	0.06	pF
Grid to cathode	0.2	pF
Anode to shield-grid	3.0	pF
Control ratio		
g_2 to k and $R_{g1}=0\Omega$	275	
g_1 to k and $R_{g2}=0\Omega$	370	
Anode voltage drop	10	V
Recovery (deionisation) time		
$V_a=650V, i_{a(pk)}=2A, R_{g1}=100k\Omega$		
$V_{g1}=-100V$	240	μs
$V_{g1}=-50V$	1.0	ms

Mechanical

Type of cooling	Convection
Mounting position	Any

CONTROL CHARACTERISTIC (See page 5).

The curves given indicate the spread in characteristics due to:

- Variations in characteristics due to changes in heater voltage.
- Variations in characteristics during life.
- Variation in grid resistor.

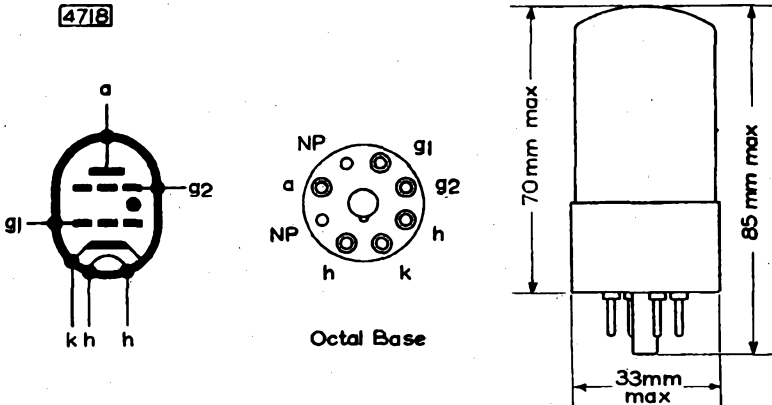

TETRODE THYRATRON

EN32

Tetrode inert gas-filled thyatron with negative control characteristic. Primarily designed for industrial control applications.

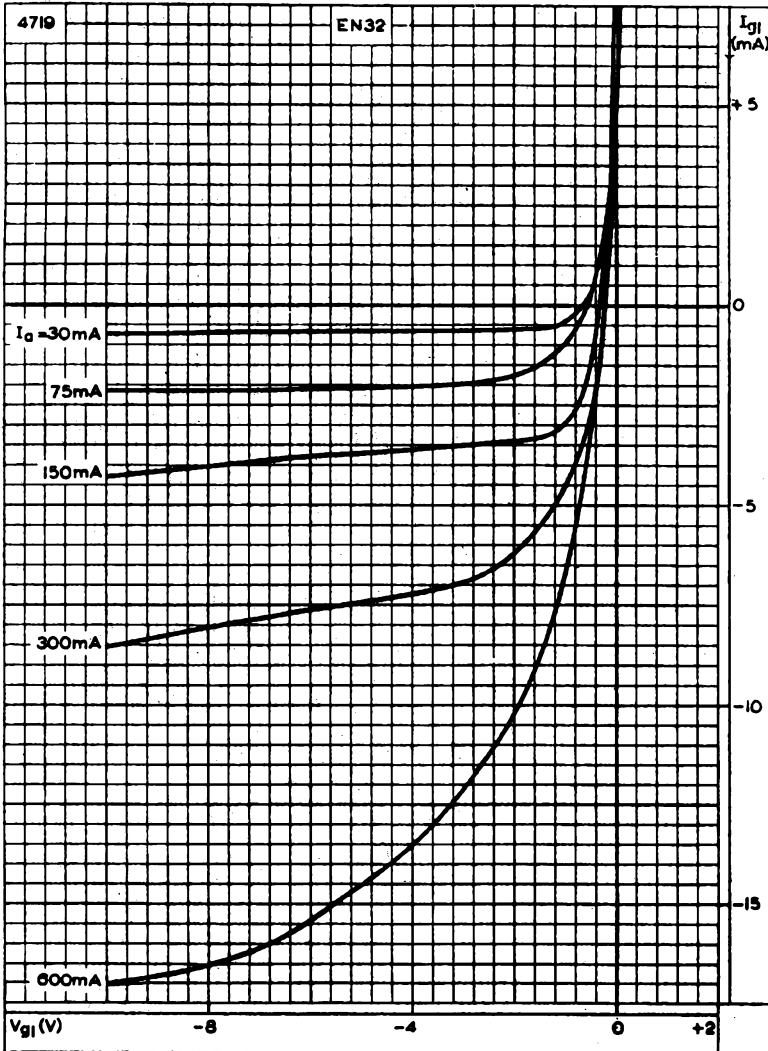

GRID ION CURRENT CHARACTERISTICS



EN32

TETRODE THYRATRON

Tetrode inert gas-filled thyatron with negative control characteristic. Primarily designed for industrial control applications.

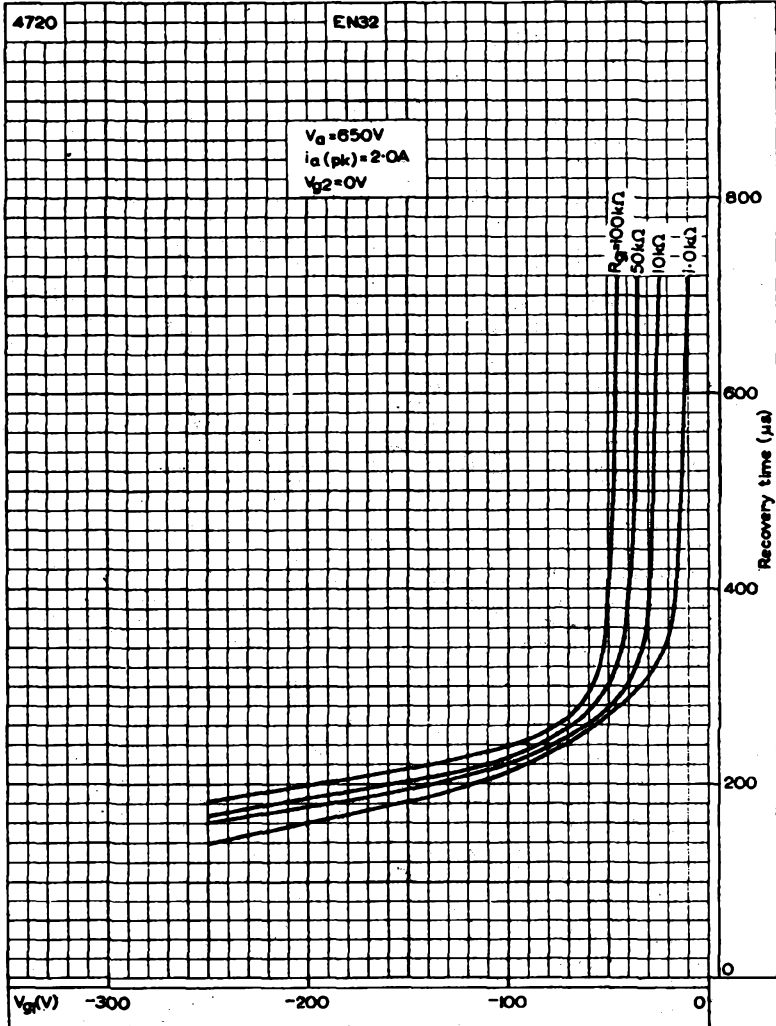

RECOVERY TIME PLOTTED AGAINST CONTROL-GRID VOLTAGE



TETRODE THYRATRON

EN32

Tetrode inert gas-filled thyatron with negative control characteristic. Primarily designed for industrial control applications.

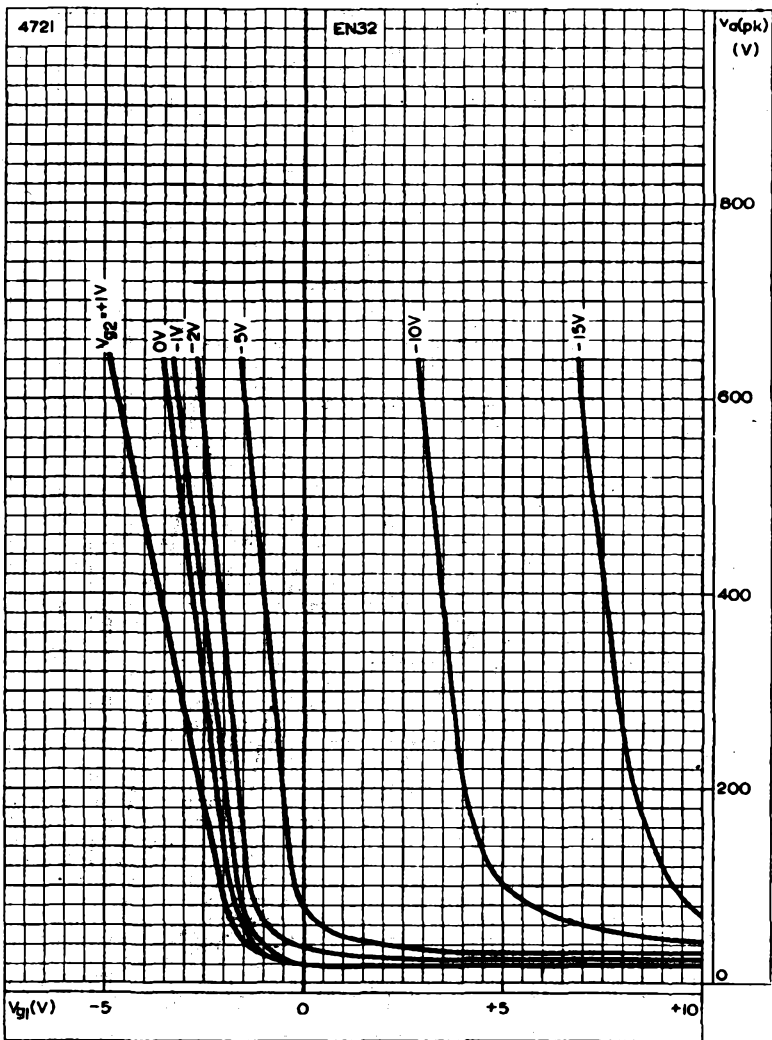

CONTROL CHARACTERISTIC (see page 2)



EN32

TETRODE THYRATRON

Tetrode inert gas-filled thyatron with negative control characteristic. Primarily designed for industrial control applications.

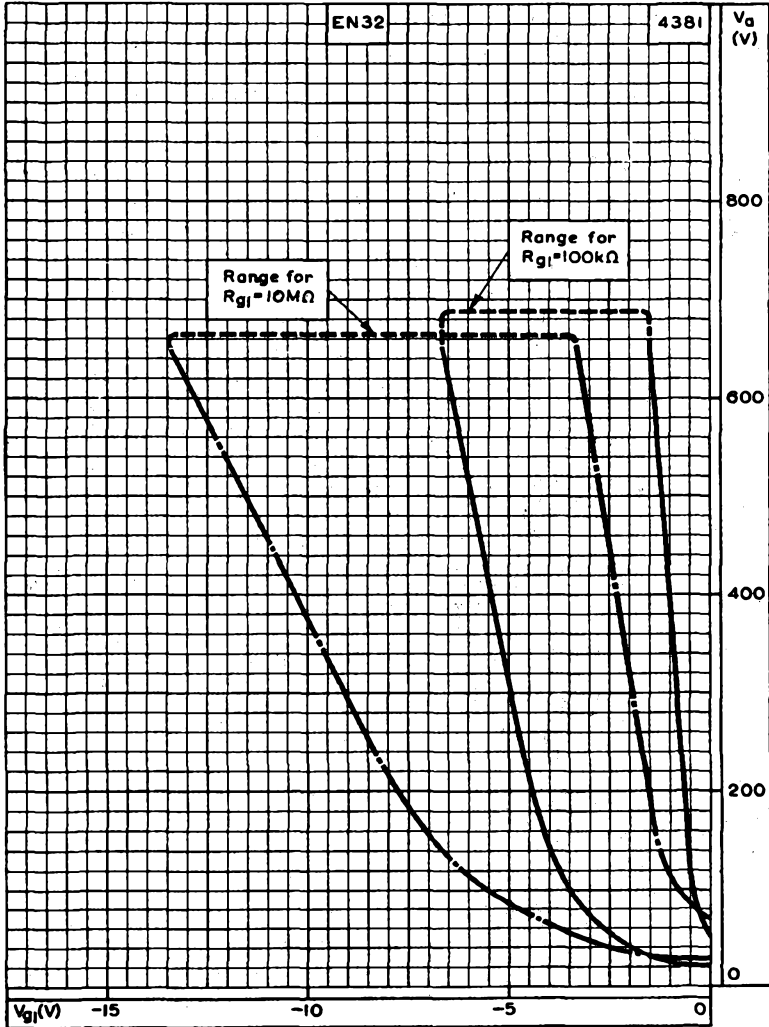

OPERATING RANGE OF CRITICAL GRID VOLTAGE



TETRODE THYRATRON

EN91

Tetrode inert gas-filled thyatron with negative control characteristic. Primarily designed for use in relay or grid-controlled rectifier circuits.

(2D21)

This data sheet should be read in conjunction with "DEFINITIONS AND OPERATIONAL RECOMMENDATIONS—THYRATRONs", preceding this section of the Handbook.

LIMITING VALUES (absolute ratings, not design centre)

It is important that these limits are never exceeded and such variations as mains fluctuations, component tolerances and switching surges must be taken into consideration in arriving at actual valve operating conditions.

Max. peak anode voltage		
Inverse	1.3	kV
Forward	650	V
Max. cathode current		
Peak	500	mA
Average (Max. averaging time 30 secs.)	100	mA
Surge (Fault protection max. duration 0.1 secs.)	10	A
Max. negative control-grid voltage		
Before conduction	100	V
During conduction	10	V
Max. average positive control-grid current for anode voltage more positive than -10 V (averaging time 1 cycle)	10	mA
Max. peak positive control-grid current during the time that the anode voltage is more positive than -10 V	50	mA
*Max. peak positive control-grid current during the time that the anode voltage is more negative than -10 V	30	μA
Max. control-grid resistor	10	MΩ
*(Recommended min. control-grid resistor 0.1 MΩ)		
Max. negative shield-grid voltage		
Before conduction	100	V
During conduction	10	V
Max. average positive shield-grid current for anode voltage more positive than -10 V (averaging time 1 cycle)	10	mA
**Max. shield-grid resistor	1.0	MΩ
Max. peak heater-cathode voltage		
Heater positive	25	V
Heater negative	100	V
Heater voltage limits	5.7 to 6.9	V
Min. valve heating time	10	s
Max. operating frequency	500	c/s
Ambient temperature limits	-75 to +90	°C

*It is not desirable that the control-grid should be positive when the anode is more negative than -10 V, but where this condition is unavoidable the control-grid resistor may need to be greater than the recommended minimum value.

**Where circuit conditions permit, the shield-grid should be connected directly to the cathode.

EN91

(2D21)

TETRODE THYRATRON

Tetrode inert gas-filled thyatron with negative control characteristic. Primarily designed for use in relay or grid-controlled rectifier circuits.

CHARACTERISTICS

Electrical

Heater voltage	6.3	V
Heater current at 6.3 V		
Average	0.60	A
Maximum	0.66	A
Anode to control-grid capacitance	0.03	pF
Control-grid to cathode and shield-grid capacitance	2.5	pF
Deionisation time (approx.)		
(a) $V_{g1} = -100$ V, $I_a = 100$ mA	35	μ s
(b) $V_{k1} = -10$ V, $I_a = 100$ mA	75	μ s
Ionisation time (approx.)	0.5	μ s
Anode voltage drop	8	V
Critical grid current at $V_a = 460$ V r.m.s.	0.5	μ A

Mechanical

Type of cooling	Convection
Mounting position	Any
Max. net weight	{ 0.5 oz 14 g

116

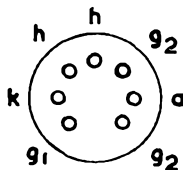
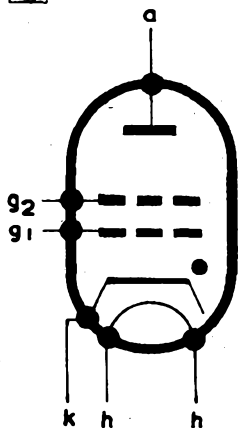

B7G BASE

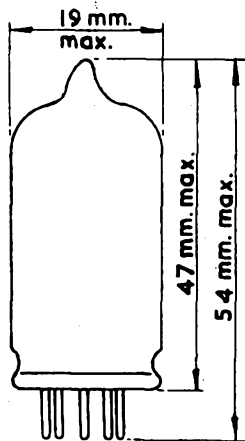

TETRODE THYRATRON

EN91

Tetrode inert gas-filled thyatron with negative control characteristic. Primarily designed for use in relay or grid-controlled rectifier circuits.

(2D21)

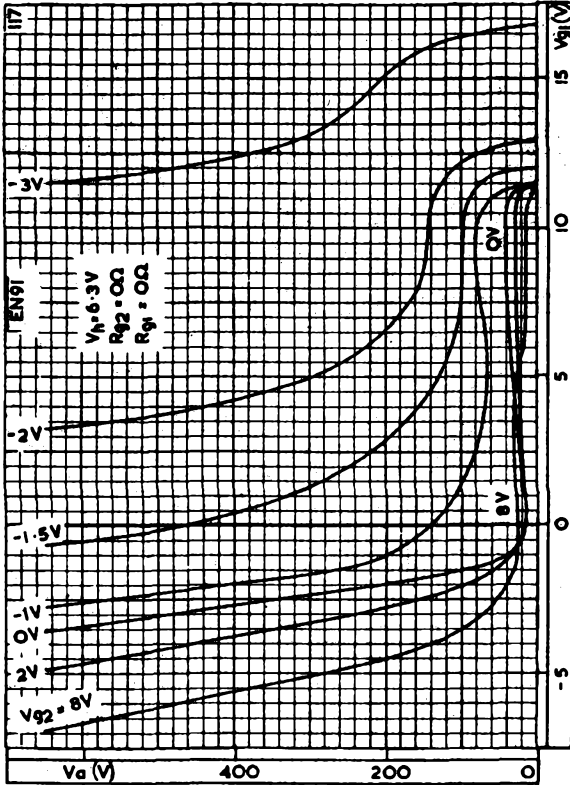

CONTROL CHARACTERISTIC



EN91

(2D21)

TETRODE THYRATRON

Tetrode inert gas-filled thyatron with negative control characteristic. Primarily designed for use in relay or grid-controlled rectifier circuits.

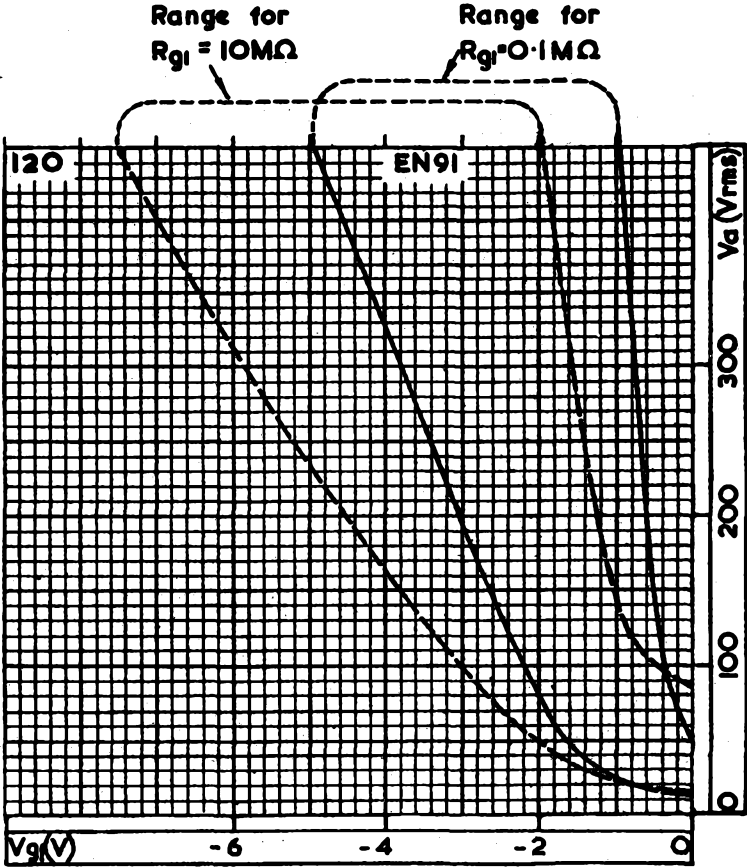

OPERATING RANGE OF CRITICAL GRID VOLTAGE



TETRODE THYRATRON

EN91

Tetrode inert gas-filled thyatron with negative control characteristic. Primarily designed for use in relay or grid-controlled rectifier circuits.

(2D21)

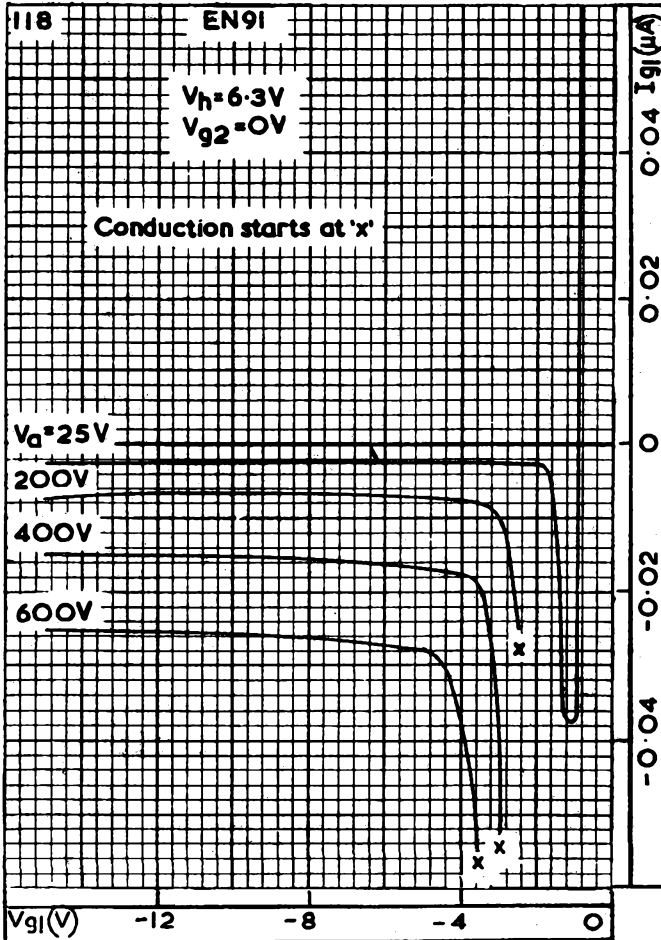

CONTROL-GRID CURRENT PLOTTED AGAINST CONTROL-GRID VOLTAGE BEFORE CONDUCTION



EN91

(2D21)

TETRODE THYRATRON

Tetrode inert gas-filled thyatron with negative control characteristic. Primarily designed for use in relay or grid-controlled rectifier circuits.

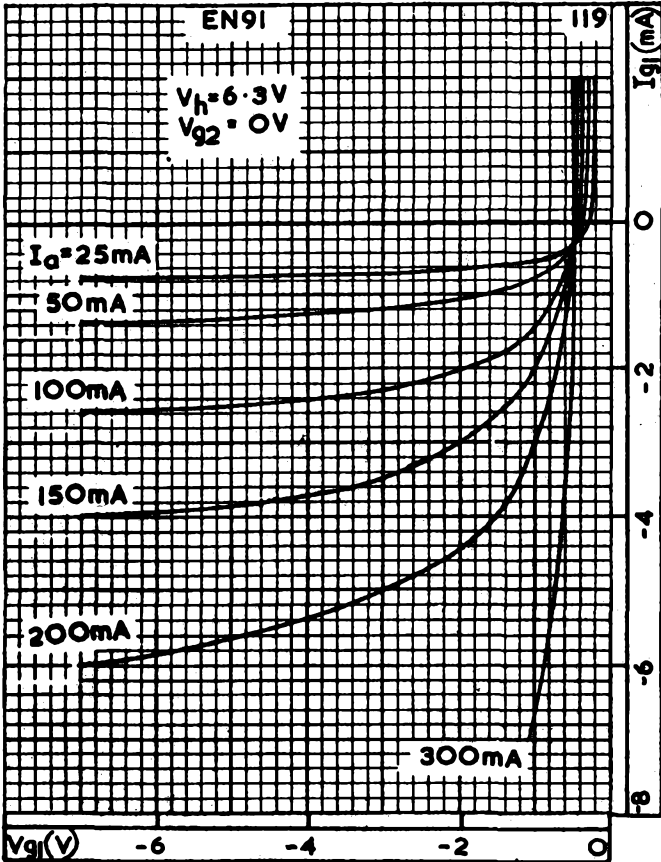

CONTROL-GRID CURRENT PLOTTED AGAINST CONTROL-GRID VOLTAGE DURING CONDUCTION



TETRODE THYRATRON

EN92

25mA tetrode inert gas-filled thyatron with negative control characteristic. Primarily intended for industrial control applications.

This data should be read in conjunction with GENERAL OPERATIONAL RECOMMENDATIONS - THYRATRONs which precede this section of the handbook.

LIMITING VALUES (absolute ratings, not design centre)

It is important that these limits are never exceeded and such variations as mains fluctuations, component tolerances and switching surges must be taken into consideration in arriving at actual valve operating conditions.

Max. peak anode voltage		
Inverse	500	V
Forward	500	V
Max. cathode current		
Peak	100	mA
Average (max. averaging time = 30s)	25	mA
Surge (fault protection, max. duration = 0.1s)	2.0	A
Max. negative control-grid voltage		
Before conduction	100	V
During conduction	10	V
Max. positive control-grid current for anode voltage more positive than -10V		
Peak	25	mA
Average (averaging time 1 cycle)	5.0	mA
Max. peak positive control-grid current for anode voltage more negative than -10V	30	μ A
Max. control-grid resistor	10	M Ω
Max. negative shield-grid voltage		
Before conduction	50	V
During conduction	10	V
Max. average positive screen-grid current for anode voltage more positive than -10V	5.0	mA
Max. peak heater-to-cathode voltage		
Cathode negative	25	V
Cathode positive	100	V
Min. valve heating time	10	s
Ambient temperature limits	-55 to +90	$^{\circ}$ C

Note: Where circuit conditions permit the shield-grid should be connected directly to the cathode.

CHARACTERISTICS

Electrical

Heater voltage	6.3	V
Heater current at 6.3V	150	mA
Capacitances		
C_{a-g1}	30	mpF
C_{in}	2.0	pF
C_{out}	1.5	pF
Control ratio		
g_1 to k, with $R_{g2} = 0\Omega$	250	
g_2 to k, with $R_{g1} = 0\Omega$	15	
Anode voltage drop	10	V
Recovery (deionisation) time (20 μ s pulse)		
$V_a = 500V$, $i_{k(pk)} = 100mA$, $R_{g1} = 50k\Omega$		
$V_{g1} = -50V$	40	μ s
Critical grid current at $V_a = 350V_{r.m.s.}$	0.5	μ A

Mechanical

Type of cooling	Convection
Mounting position	Any

CONTROL CHARACTERISTIC (see page C4)

The curves given indicate the spread in characteristics due to:

- Variations in characteristics due to changes in heater voltage.
- Variations in characteristics during life.
- Variation in grid resistor.

3539

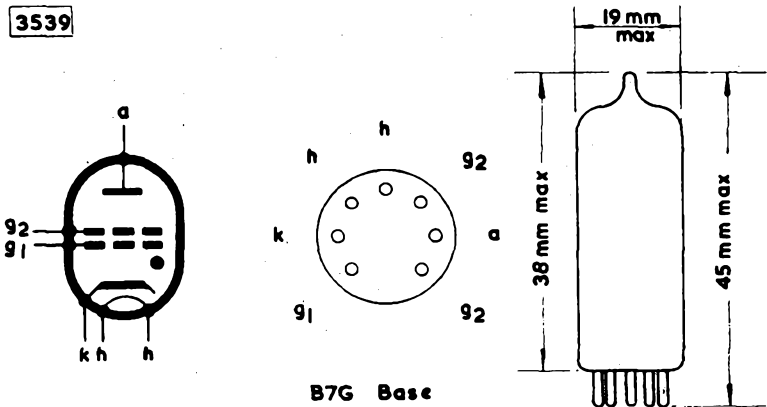

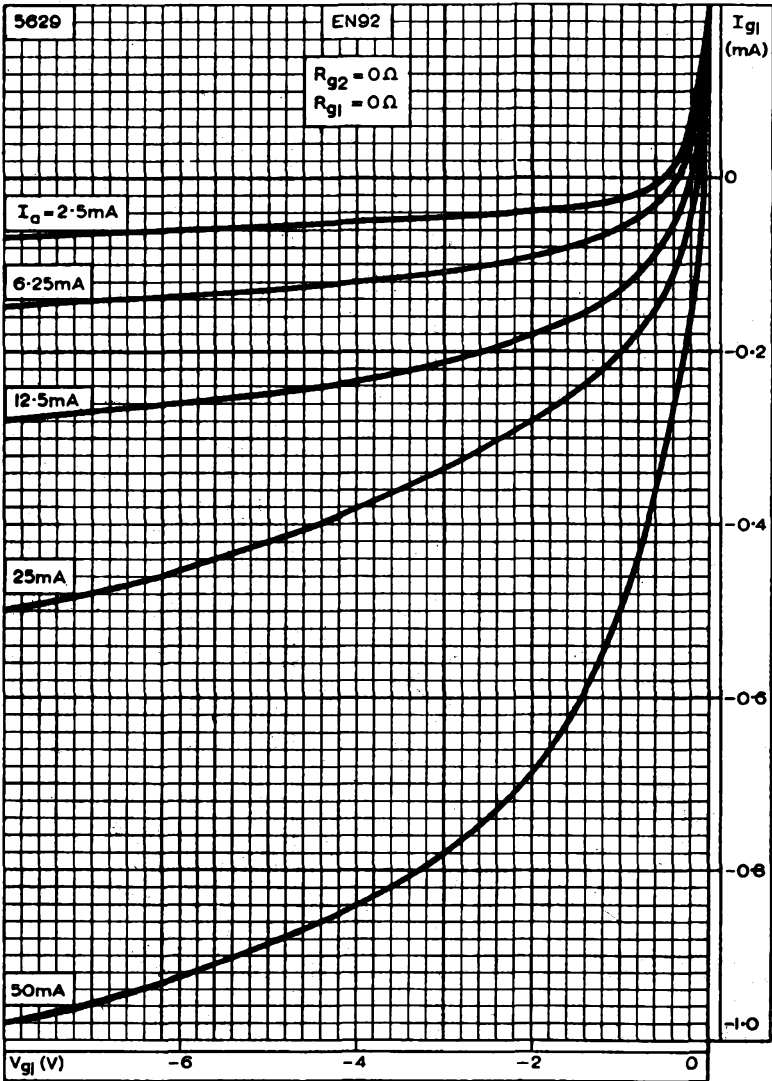

GRID ION CURRENT CHARACTERISTICS



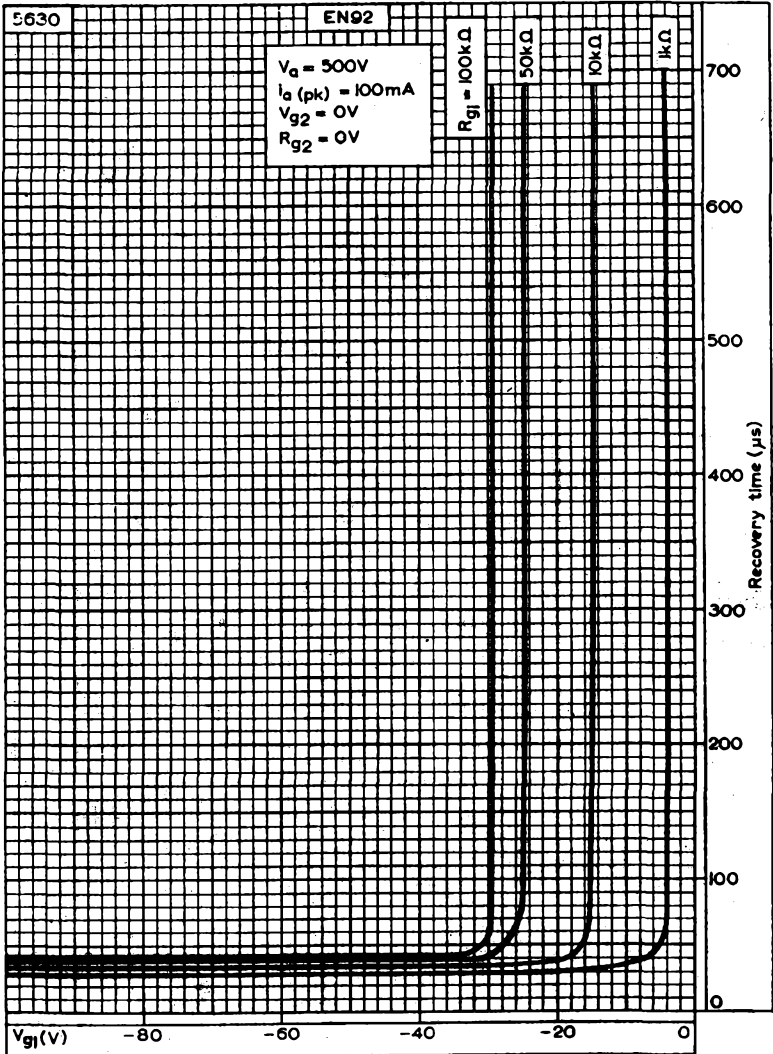

RECOVERY TIME PLOTTED AGAINST CONTROL-GRID VOLTAGE



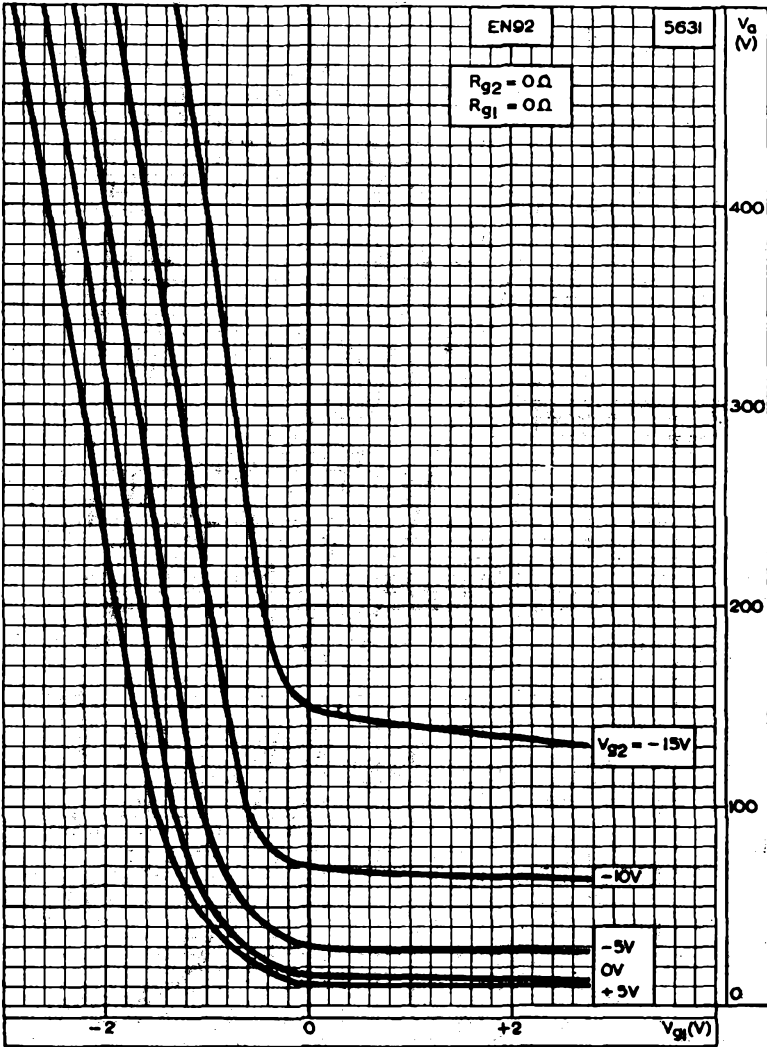

CONTROL CHARACTERISTICS



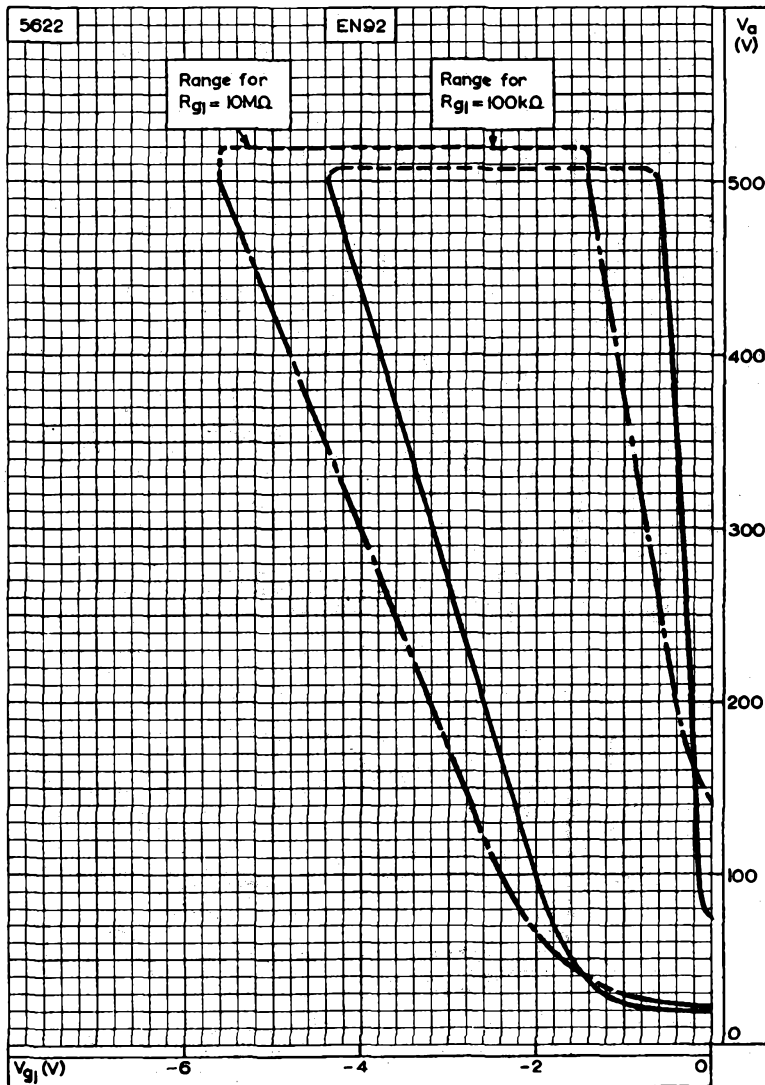

OPERATING RANGE OF CRITICAL GRID VOLTAGE
(See Page D2)



SPECIAL QUALITY TETRODE THYRATRON

M8204

100mA special quality tetrode xenon thyatron with negative control characteristic for use in equipment where mechanical vibration and shocks are unavoidable and where statistically controlled major electrical characteristics are required.

This data should be read in conjunction with GENERAL OPERATIONAL RECOMMENDATIONS - THYRATRONS and GENERAL NOTES - SPECIAL QUALITY THYRATRONS which precede this section of the handbook, and the index numbers are used to indicate where reference should be made to a specific note.

LIMITING VALUES³ (absolute ratings, not design centre)

It is important that these limits are never exceeded and such variations as mains fluctuations, component tolerances and switching surges must be taken into consideration in arriving at actual valve operating conditions.

	Relay service and grid-controlled rectifier	Pulse modulator service	
*Max. anode supply voltage	—	500	V
Max. peak anode voltage			
Inverse	1300	100	V
Forward	650	500	V
Max. cathode current			
Peak	0.5	10	A
Average (max. averaging time 30s)	100	10	mA
Surge (fault protection max. duration 0.1s)	10	10	A
Max. negative control-grid voltage			
Before conduction	100	100	V
During conduction	10	10	V
Max. average positive control-grid current for anode voltage more positive than -10V (averaging time 30s)	10	—	mA
Max. peak positive control-grid current during the time that the anode voltage is more positive than -10V	50	20	mA
Max. peak positive control-grid current during the time that the anode voltage is more negative than -10V	30	—	μA
Max. control-grid resistor	10	0.5	MΩ
Recommended min. control-grid resistor	100	—	kΩ
Max. negative shield-grid voltage			
Before conduction	100	50	V
During conduction	10	10	V

M8204

SPECIAL QUALITY TETRODE THYRATRON

Max. average positive shield-grid current for anode voltage more positive than -10V (averaging time 30s)	10	—	mA
Max. shield-grid resistor	—	25	kΩ
Max. peak heater-to-cathode voltage			
Cathode negative	25	0	V
Cathode positive	100	0	V
Heater voltage	6.3V ± 10%	6.3V +10% -5%	
Min. valve heating time	20	20	s
Ambient temperature limits	-75 to +90	-75 to +90	°C
Max. pulse duration	—	5.0	μs
*Max. pulse repetition frequency	—	500	c/s
Max. duty cycle	—	0.001	
Max. rate of rise of current pulse	—	100	A/μs

*After completion of a pulse a 20μs delay is required before a positive voltage of more than 10V is applied to the anode.

CAPACITANCES:

Anode to control grid	—	30	mpF
Control grid to cathode and shield grid	—	2.5	pF

4087

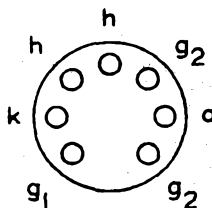
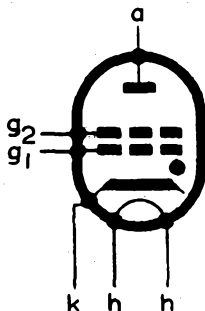

B7G Base

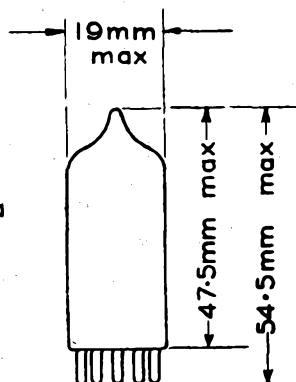

The bulb and base dimensions of this valve are in accordance with BS 448, Section B7G



TEST CONDITIONS (unless otherwise specified)

V_h	V_{g2}
(V)	(V)
6.3	0

**TESTS
GROUP A**

	A.Q.L. ⁴ (%)	Individuals ⁵		Lot average ⁶			
		Bogey ⁸	Min.	Max.	Min.		Max.
Heater current	{ 0.65	600	540	660	—	—	mA
Heater-to-cathode leakage current	{ —	—	—	—	567	633	mA
$V_{h-k} = 25V$ cathode negative	0.65	—	—	15	—	—	μA
$V_{h-k} = 100V$ cathode positive	0.65	—	—	15	—	—	μA
*Grid 1 voltage $V_a = 460V_{r.m.s.}$, $R_{g1} = 100k\Omega$, $R_a = 3.0k\Omega$	{ 0.65	-3.7	-2.9	-4.5	—	—	V
	{ —	—	—	—	-3.4	-4.0	V
*Grid 1 voltage $V_a = 460V_{r.m.s.}$, $R_{g1} = 10M\Omega$, $R_a = 3.0k\Omega$	0.65	-4.2	—	-5.6	—	—	V
*Anode voltage $V_{g1} = 0V$, $R_{g1} = 100k\Omega$, $R_a = 1.0k\Omega$	{ 0.65	22	—	38	—	—	V
	{ —	—	—	—	—	33	V
Anode voltage $V_h = 0V$, $V_{g1} = -100V$, $R_a = 10k\Omega$	0.65	—	650	—	—	—	V
No breakdown must occur	0.65	—	650	—	—	—	V
Operation. I_{load} (pulse)	0.65	—	16	—	—	—	A
Measured at $V_{a(b)} = 500V$, $V_{a(pk)} = 1.0kV$, $V_{g1(pk)} = 100V$, $V_{g1} = -50V$, $R_{g1} = 10k\Omega$, $R_{g2} = 25k\Omega$.							
P.R.F. = 500pps, $\tau_p = 2 \pm 0.2\mu s$.							
Modulator line impedance $Z_o = 25\Omega$.							
Load resistance = 20Ω , min. P.I.V. = 100V.							
Pulse rise time = $0.2\mu s$ max.							
Pulse fall time = $0.4\mu s$ max.							





M8204

SPECIAL QUALITY
TETRODE THYRATRON

	A.Q.L. ⁴ (%)	Individuals ⁵		Lot average ⁶			
		Bogey ⁸	Min.	Max.	Min.		Max.
Pulse emission $V_h = 6.3V$, $V_a = V_{g2} = V_{g1} = 180 \pm 9V$, min. P.I.V. = 100V, $t_p = 5 \pm 0.25\mu s$, pulse rise time = $0.5\mu s$ max., pulse fall time = $1.0\mu s$ max., p.r.f. = 100 ± 5 pps. Pulse applied across valve and 10Ω resistor in series.							
Voltage measured across valve	{ 0.65	—	—	76	—	—	V
Group quality level ⁹	1.0	—	—	—	—	65	V
*Adjust voltage to initiate conduction.							
GROUP B							
Inoperatives ¹⁴	0.4	—	—	—	—	—	
GROUP C							
Insulation							
g_2 -a measured at $V_{a-g2} = \pm 380V$	2.5	—	760	—	—	—	M Ω
*Anode voltage. $V_h = 5.7V$, $V_{g1} = 0V$, $R_{g1} = 100k\Omega$, $R_a = 1.0k\Omega$	{ 2.5	—	—	50	—	—	V
	—	—	—	—	—	45	V
*Grid 1 voltage. $V_h = 7.0V$, $V_a = 460V_{r.m.s.}$, $R_{g1} = 10M\Omega$, $R_a = 3.0k\Omega$ (Following special pre-heat condition)	6.5	-4.6	—	-6.4	—	—	V
*Grid 2 voltage. $V_a = 150V_{r.m.s.}$, $R_a = 1.0k\Omega$, $R_{g2} = 2.5k\Omega$ V_{g2} supply in phase with V_a supply, V_{g2} in antiphase: r.m.s. voltage	6.5	2.45	1.85	3.05	—	—	V
Vibration. No applied voltages. Vibrate for 60s at 25c/s 2.5g then repeat group B test	6.5	—	—	—	—	—	

*Adjust voltage to initiate conduction.



GROUP D

Shock¹³

No applied voltages, 750g.

Post shock tests

Heater to cathode leakage current

$V_{h-k} = 25V$ cathode negative	—	—	—	40	—	—	μA
$V_{h-k} = 100V$ cathode positive	—	—	—	40	—	—	μA
Anode voltage as in Group A ($V_{g1}=0V$)	—	—	—	50	—	—	V
Pulse emission as in Group A	—	—	—	76	—	—	V
Grid 1 voltage as in Group A ($R_{g1}=100k\Omega$)	—	—	-2.9	-4.5	—	—	V
Sub-group quality level ⁹	20					

Fatigue¹⁴

$V_h = 6.3V$, no other applied voltages, 2.5g acceleration, $f = 25 \pm 2c/s$ for 32 hours in each of three mutually perpendicular planes

Post fatigue tests

Heater to cathode leakage current

$V_{h-k} = 25V$ cathode negative	—	—	—	40	—	—	μA
$V_{h-k} = 100V$ cathode positive	—	—	—	40	—	—	μA
Anode voltage as in Group A ($V_{g1}=0V$)	—	—	—	50	—	—	V
Pulse emission as in Group A	—	—	—	76	—	—	V
Grid 1 voltage as in Group A ($R_{g1}=100k\Omega$)	—	—	-2.9	-4.5	—	—	V
Sub-group quality level ⁹	20					
Base strain test ¹¹	6.5					



GROUP E

Heater cycling life test $V_h = 7.5V$, 1 minute on, 1 minute off, 2000 cycles. $V_{h-k} = 100V$ cathode positive. No other applied voltages

Heater cycling life test end points

Heater to cathode leakage current

$V_{h-k} = 25V$ cathode negative

$V_{h-k} = 100V$ cathode positive

Intermittent life¹²

Running conditions as grid controlled rectifier 500 hours

$V_a = 460V$ r.m.s., $I_k = 80mA$ (d.c.) $R_{g1} = 50k\Omega$,

$i_{k(pk)} = 0.5A$, Cathode heating time = $20^{+0}_{-1}s$

Room temperature

Intermittent life test end points

Inoperatives¹⁴

Heater to cathode leakage current

$V_{h-k} = 25V$ cathode negative

$V_{h-k} = 100V$ cathode positive

Anode voltage as in Group A ($V_{g1} = 0V$)

Pulse emission as in Group A

Insulation g_{2-a} as in Group C

Continuous life, 200 hours' duration¹²

Adjust $v_{a(pk)}$ for $I_{load\ pulse} = 20A$ initially

Running conditions, pulse modulator service

$V_{a(b)} = 250V$, $V_{a(pk)} = 500V$, $V_{g1(pk)} = 100V$,

$V_{g1} = -50V$, $V_{g2} = 0V$, $R_{g1} = 10k\Omega$, $R_{g2} = 25k\Omega$,

p.r.f. = 1000pps., modulator line impedance

$Z_o = 12.5\Omega$, load resistance = 7.5Ω . $t_p = 2 \pm 0.2\mu s$

Life test end points

$I_{load\ pulse}$

Average life

Pulse emission as in Group A



M8204

SPECIAL QUALITY
TETRODE THYRATRON

			A.Q.L. ⁴ (%)	Individuals ⁵		
				Min.	Max.	
..	1.0	—	—	
..	—	—	20	μ A
..	—	—	20	μ A
..	—	—	20	μ A
..	—	—	20	μ A
..	—	—	20	μ A
..	—	—	50	V
..	—	—	100	V
..	—	380	—	M Ω
..	—	16	—	A
..	—	180	—	hrs
..	—	—	100	V

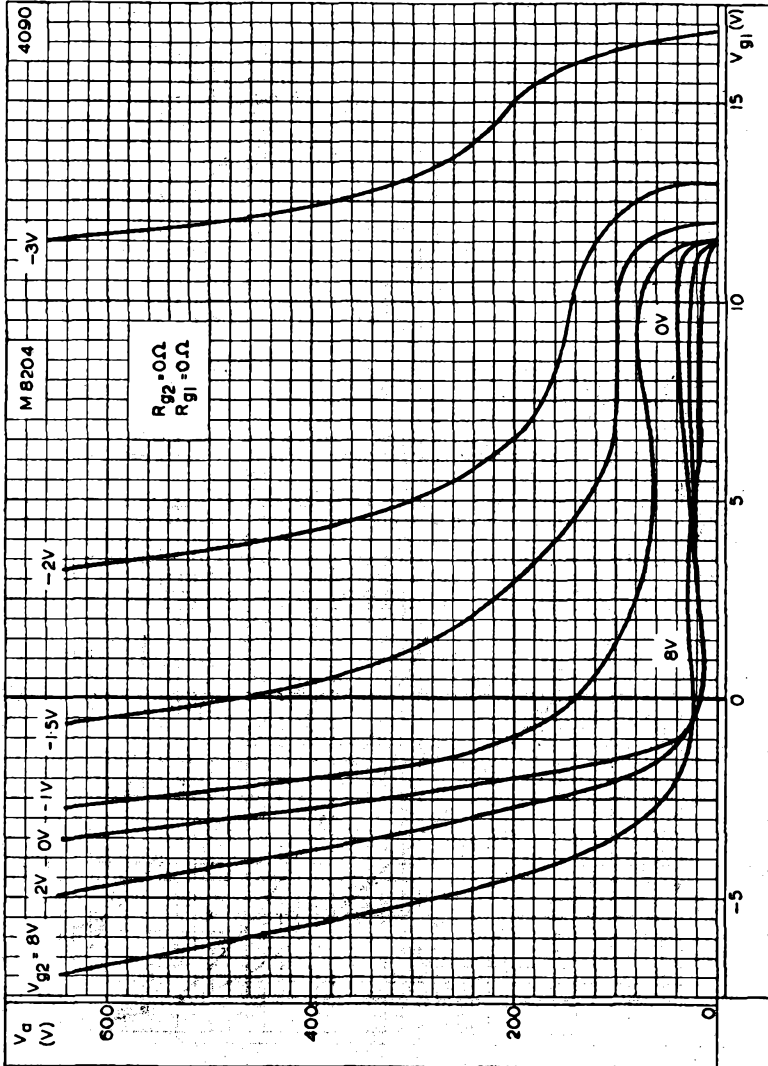

CONTROL CHARACTERISTIC



M8204

SPECIAL QUALITY
TETRODE THYRATRON

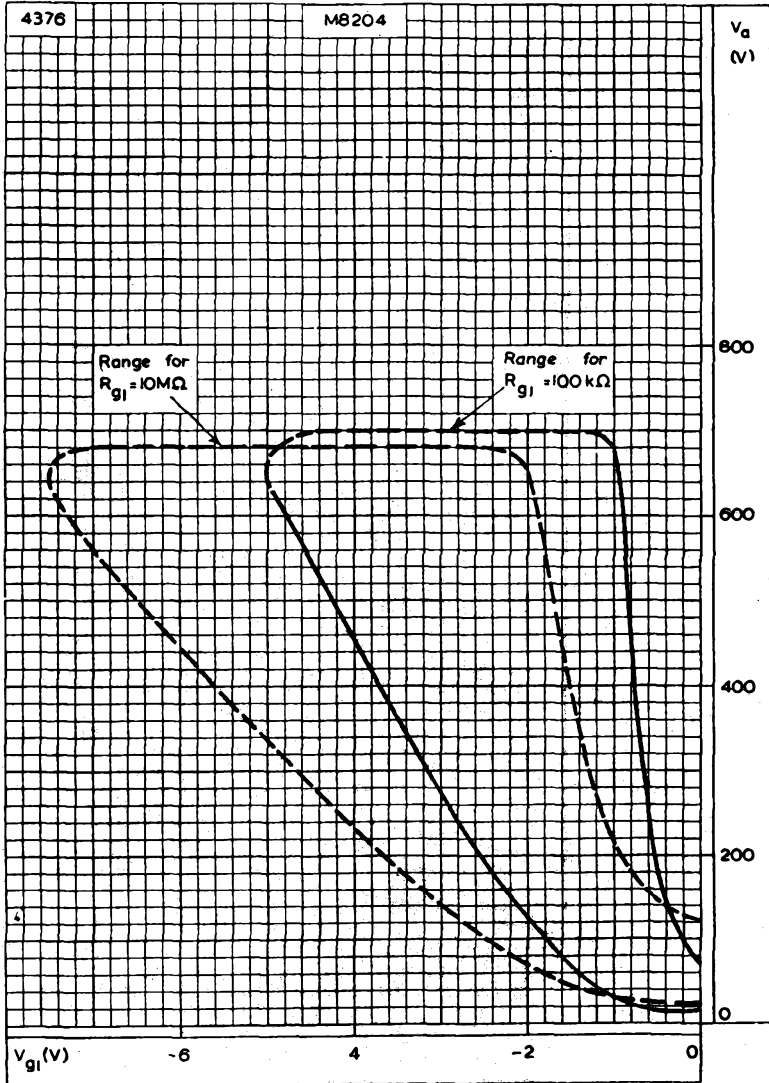

OPERATING RANGE OF CRITICAL CONTROL-GRID VOLTAGE



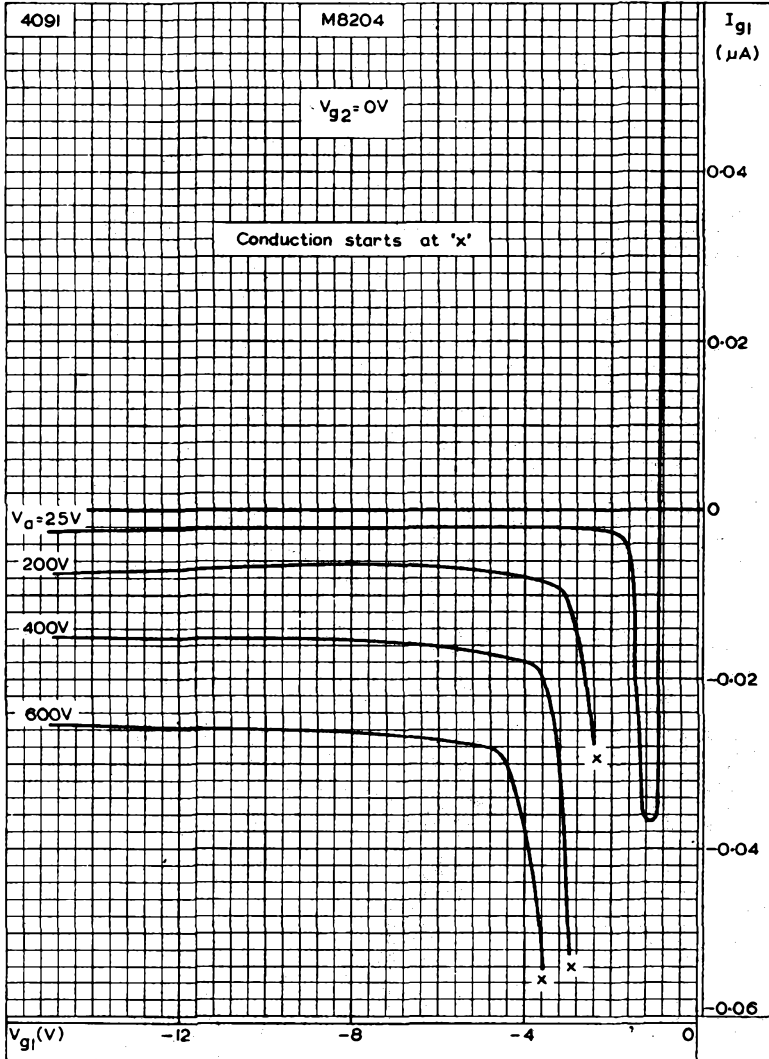

CONTROL-GRID CURRENT PLOTTED AGAINST CONTROL-GRID VOLTAGE BEFORE CONDUCTION



M8204

SPECIAL QUALITY TETRODE THYRATRON

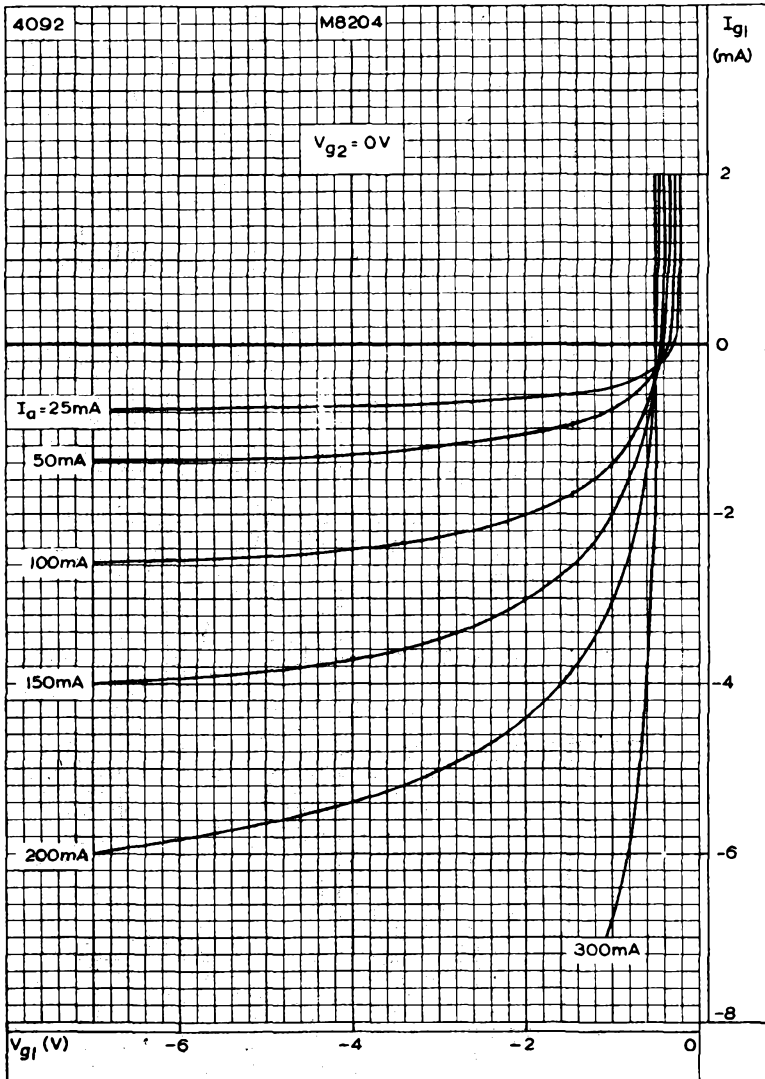

CONTROL-GRID CURRENT PLOTTED AGAINST CONTROL-GRID VOLTAGE
DURING CONDUCTION



QUICK REFERENCE DATA (nominal values)

Trigger tube, with stable trigger ignition characteristics, primarily intended for use in timers, voltage control and sensitive relay applications.

Anode supply voltage	240	V
Anode maintaining voltage	105	V
Maximum average cathode current	40	mA
Trigger ignition voltage	132	V
Trigger transfer requirements		
Capacitance	500	pF
Current	45	μ A
Stability of trigger ignition voltage during life	± 2	%

CHARACTERISTICS AND RANGE VALUES FOR EQUIPMENT DESIGN

The values given state the range over which the tube will operate both initially and during life. No allowance has been made for supply voltage and component variations.

This tube has been designed to be ignited only with positive voltages on the anode and trigger, but will withstand negative voltages within the limits given. To reduce the ignition time to a minimum, a priming discharge flowing continuously between the priming anode and cathode is necessary. In the absence of a priming discharge, the ignition time may be of the order of seconds. Apart from the priming discharge the tube behaves as a triode trigger tube.

Anode-to-cathode gap**Anode supply voltage (see note 1)****Positive, for trigger-controlled ignition**

Maximum ($I_{k(av)} < 25\text{mA}$, $I_{k(pk)} < 100\text{mA}$, see note 2)	290	V
Maximum ($I_{k(av)} > 25\text{mA}$)	250	V
Maximum ($I_{k(pk)} > 100\text{mA}$, see note 3)	250	V
Minimum	170	V

Negative

Maximum ($I_{Tr} = 0\text{mA}$)	90	V
-----------------------------------	----	---

Nominal anode-to-cathode maintaining voltage

($I_a = 10\text{mA}$, see note 4 and curve on page C2)	105	V
--	-----	---

Trigger-to-cathode gap

Trigger-to-cathode ignition voltage ($V_a = 280V$)		
Initial (see note 5 and curves on page C3)		
Maximum	137	V
Minimum	128	V
Maximum variation during life (see page C1)	± 2	%
Maximum decrease of trigger ignition voltage (V_a changed from 170V to 290V)		
	1.5	V
Nominal trigger-to-cathode maintaining voltage	95	V
Nominal trigger pre-ignition current		
I_a priming = 2 to 25 μA (see note 6)	4×10^{-8}	A
I_a priming = 0 μA	5×10^{-10}	A
Recommended maximum trigger series resistance		
I_a priming = 2 to 25 μA	100	M Ω
I_a priming = 0 μA	1000	M Ω

Priming anode-to-cathode gap

Priming-anode supply voltage (see note 7)		
Maximum	290	V
Minimum	150	V
Nominal priming anode-to-cathode maintaining voltage		
	100	V
Priming-anode current (see note 6)		
Maximum	25	μA
Minimum	2	μA
Recommended priming-anode resistor (see note 8)		
	10	M Ω

Transfer requirements

Minimum value of trigger-to-cathode capacitance for transfer (limiting resistor = 0 to 2.2k Ω , see note 9)		
$V_a = 170V$	2700	pF
$V_a = 200V$	1000	pF
$V_a = 240V$	500	pF
Minimum value of trigger limiting resistor (see note 9)		
$C_{Tr} < 4700pF$	0	Ω
$C_{Tr} = 4700$ to 15,000pF	2.2	k Ω
$C_{Tr} > 15,000pF$	5.6	k Ω
Minimum value of trigger current required for transfer		
$V_a = 240V$	25	μA
$V_a = 170V$	500	μA

Components for self-extinguishing circuits

Minimum value of anode resistor $V_{a(b)} = 290V$, $R_{lim} = 1k\Omega$		
$C_a > 2700pF$	1	M Ω
Minimum value of trigger resistor		
$C_{Tr} > 500pF$	1	M Ω

Ionisation and deionisation

Nominal ionisation time (see curve on page C4)

 $i_{a \text{ priming}} = 2 \text{ to } 25 \mu\text{A}, V_{Tr} = V_{Tr(\text{ign})} + 0.5V$ 2 ms $i_{a \text{ priming}} = 0 \mu\text{A}, V_{Tr} = V_{Tr(\text{ign})} + 4V$ 5 s

Nominal deionisation time

 $i_{k(\text{pk})} = 8 \text{ to } 20\text{mA}$ 3.5 ms $i_{k(\text{pk})} = 20 \text{ to } 100\text{mA}$ 12 ms**ABSOLUTE MAXIMUM RATINGS**

Maximum anode voltage

Positive 290 V

Negative ($I_{Tr} = 0\text{mA}$) 90 V

Maximum cathode current

Average

Maximum averaging time = 15s 25 mA

Maximum averaging time = 20ms 40 mA

Peak

50c/s duty or repetitive operation 200 mA

Maximum duration = 1ms 1 A

Minimum average cathode current during any conduction period 8 mA

Maximum negative trigger-to-cathode voltage

($I_k = I_{Tr} = 0\text{mA}$) 75 V

Maximum peak trigger current

Positive 8 mA

Negative ($I_k = 0\text{mA}$, see note 10) 0 mAMaximum anode-to-trigger voltage ($I_k = 0\text{mA}$)

Anode positive 290 V

Anode negative 140 V

OPERATING NOTES

1. In applications where a high alternating voltage exists between the cathode and the tube surroundings, it is recommended that the tube be enclosed in a screening can which should be connected to cathode.
2. With an average current of the order of 15mA or above and the tube conducting for a period in excess of 5s, the anode breakdown voltage may be temporarily reduced to below 290V and will not return to the initial value until after a recovery period of 20s.
3. In self-extinguishing circuits with currents up to 200mA, the maximum supply voltage may be 290V d.c.
4. In this tube, oscillations of up to 10V peak-to-peak are superimposed on the maintaining voltage. Due to this effect the measured value of maintaining voltage will depend on the circuit conditions. These oscillations are of no significance in normal applications.



Z803U

COLD CATHODE TRIGGER TUBE

5. After a period of conduction, the trigger ignition voltage is depressed: however, the effect is reversible and the ignition voltage will return to its initial value after a recovery period with the tube non-conducting.

The magnitude of the final depression is dependent on the cathode current during the conduction period, and is reached in an exponential manner. The curves on page C3 give the formation and recovery of the depression at various cathode currents for a nominal tube.

In a repetitive circuit where the non-conducting period is short compared with the recovery time constant (e.g. 50c/s operation), the depression can be obtained from the curve by using a direct current equal to the mean current passing through the tube.

Further information on the use of these curves can be obtained from the Special Industrial Valve Department, Mullard Ltd.

6. In applications where pre-ignition current $< 4 \times 10^{-8} \text{A}$ is required the priming anode should be left disconnected. In this case, the trigger-to-cathode gap ionisation time may be of the order of seconds.
7. A period of the order of several seconds may elapse between the application of supply voltage to the priming anode and the establishment of a priming discharge.
8. The resistor between the priming anode and the supply voltage must be soldered directly to pin 6 of the tube socket. Stray circuit capacitance at the priming anode must be kept to less than 4pF.
9. This is the sum of any resistors in the capacitance discharge circuit which may include the cathode resistor.
10. Negative trigger current will flow during anode-to-cathode conduction in any circuit in which the trigger is returned via a resistor to a potential with respect to cathode which is less than the trigger-to-cathode maintaining voltage.

It is preferable that the circuit should be designed to avoid this condition by keeping the trigger supply voltage greater than the trigger maintaining voltage. In those applications where this cannot be achieved, the maximum anode supply voltage must be reduced from 290 to 250V and the magnitude of the negative trigger current must be less than 1% of the cathode current.

5956

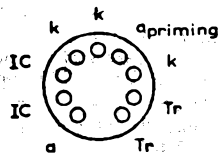
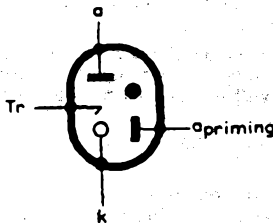

B9A Base

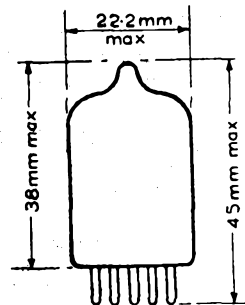

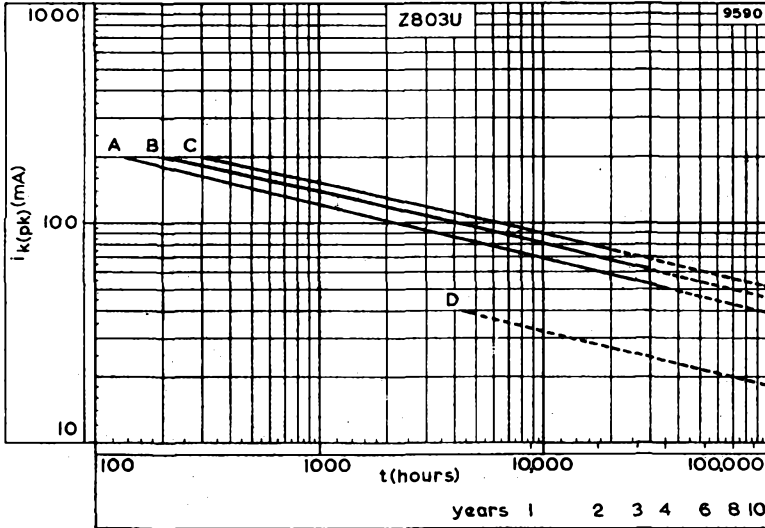

LIFE EXPECTANCY

The curves show the life expectancy when the tube is run continuously at room temperature.

During periods of non-operation at room temperature the characteristics of the tube remain substantially constant. The total life expectancy in any given application is the sum of the non-operating periods and the operating life obtained from the curve.

For a given value of cathode current, it is estimated that 80% of all tubes will remain within the end points concerned for longer than the time shown.

The time during which the trigger ignition voltage will remain within $\pm 2\%$ of its original value, when the tube is operating continuously at room temperature from a half-wave rectified supply, is dependent on the peak cathode current passed. Curve A shows the relationship between the peak current and the expected time for which the trigger ignition voltage will remain within these limits. After this time the trigger ignition voltage will fall steadily and the times at which it can be expected to have fallen by 4 and 8% are shown by lines B and C respectively.

Curve D shows the estimated length of time for which the change of trigger ignition voltage can be expected to remain within $\pm 2\%$ when passing direct current at room temperature.

In self-extinguishing circuits with $I_{k(pk)} < 200\text{mA}$ and $I_{k(av)} < 0.8\text{mA}$, the change of trigger ignition voltage can be expected to remain within $\pm 2\%$ for more than 30,000 hours.



Z803U

COLD CATHODE TRIGGER TUBE

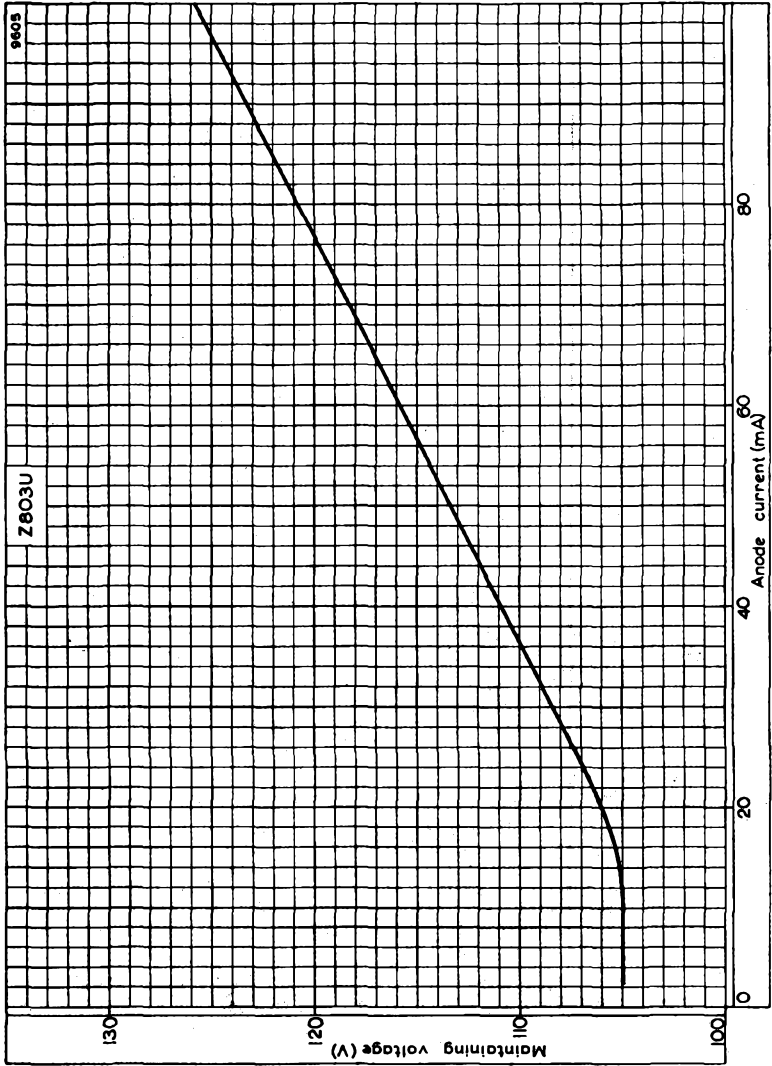

MAINTAINING VOLTAGE PLOTTED AGAINST ANODE CURRENT



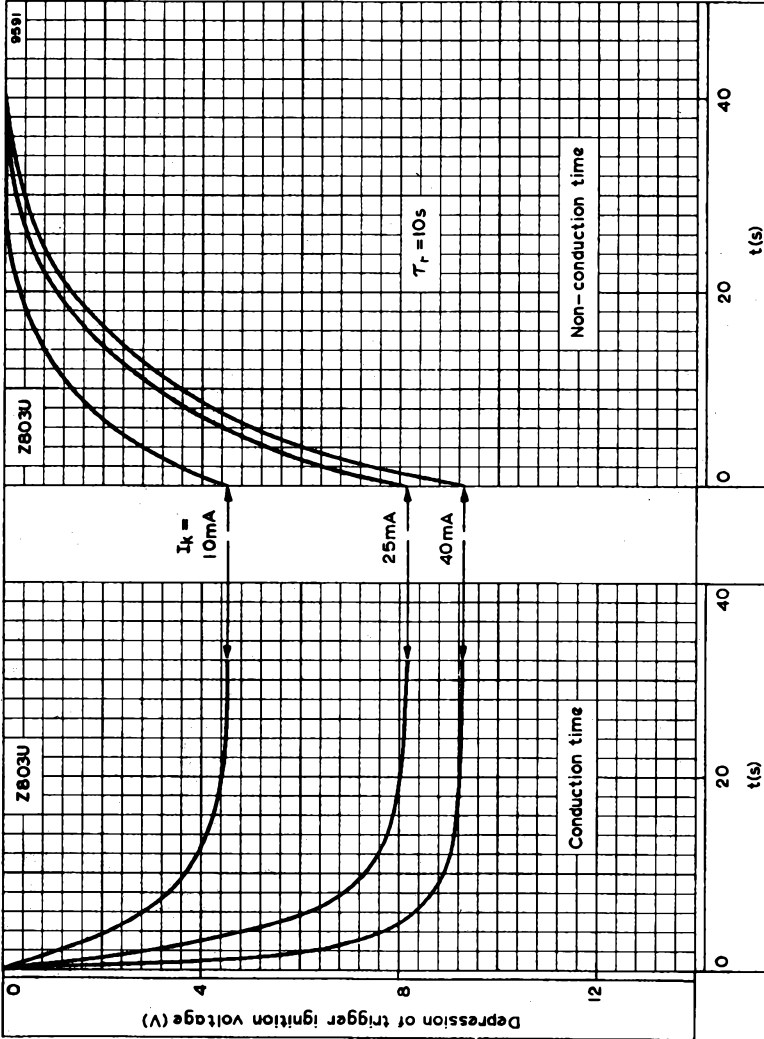

FORMATION AND RECOVERY CURVES OF THE TRIGGER IGNITION VOLTAGE FOR A NOMINAL TUBE





TRIGGER OVERVOLTAGE PLOTTED AGAINST NOMINAL IONISATION TIME

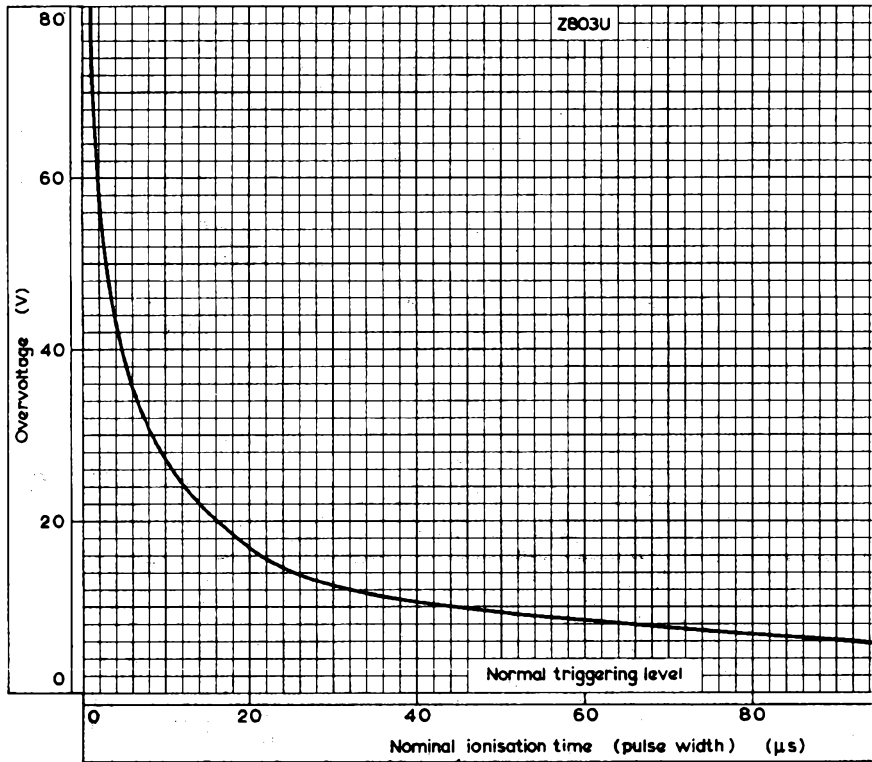

Z803U

COLD CATHODE TRIGGER TUBE

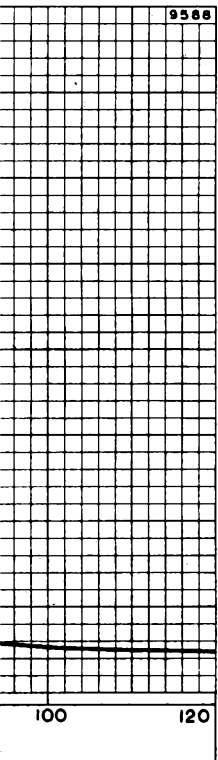

COLD CATHODE TRIGGER TUBE

Z900T

Trigger tube primarily intended for relay applications for operation from d.c. or a.c. supplies.

QUICK REFERENCE DATA (nominal values)

Anode supply voltage		
a.c.(r.m.s.)	117	V
d.c.	175	V
Anode maintaining voltage	62	V
Maximum average cathode current	35	mA
Trigger ignition voltage	80	V
Trigger transfer current	160	μ A

CHARACTERISTIC AND RANGE VALUES FOR EQUIPMENT DESIGN

The values given state the range over which the tube will operate both initially and during life. No allowance has been made in the data for supply voltage and component variations. This tube has been designed to be ignited with positive voltages on the anode and trigger but will withstand negative voltages within the limits given.

Anode supply voltage (see note 2 and page C2)

Positive for trigger-controlled ignition		
Maximum	200	V
Minimum	140	V
Negative		
Maximum ($V_{Tr} = 0$ to $-65V$)	200	V

Anode-to-cathode maintaining voltage ($I_a = 50mA$) see note 3

Initial		
Nominal	62	V
Maximum	75	V
End of life (see page C1)		
Maximum	85	V

Trigger-to-cathode ignition voltage ($V_a = 0V$) see note 2

Initial maximum	95	V
End of life maximum (see note 2 and page C1)	105	V
Minimum	73	V

Maximum anode-to-trigger voltage

Anode positive (V_{Tr} from 0 to $-65V$)	200	V
Anode negative (V_{Tr} between 0 and $+73V$)	180	V

Nominal trigger maintaining voltage

	60	V
--	----	---

Typical maximum ionisation time (see note 2)

In daylight (approx. ≥ 1 ft. cd.)	20	μ s
In darkness	250	μ s

Deionisation time (approx)

	500	μ s
--	-----	---------

Transfer requirements

Minimum trigger current for transfer (see page C3)

$V_a = 140V$		
Initial	200	μ A
End of life (see page C1)	400	μ A
$V_a = 175V$		
End of life	160	μ A

Minimum value of capacitor for triggering

$V_a = 175V$	400	pF
--------------	-----	----

Components for self-extinguishing circuits

Minimum value of anode resistance, $V_{a(b)} = 200V$, $R_{lim} = 1k\Omega$		
$C_a = 0.001\mu F$	1.2	M Ω
$C_a = 0.005\mu F$	450	k Ω
$C_a = 0.01\mu F$	300	k Ω



ABSOLUTE MAXIMUM RATINGS

Maximum anode voltage		
Positive	200	V
Negative	200	V
Maximum cathode current (see page C1)		
Average		
Maximum averaging time = 15s	25	mA
Maximum averaging time = 20ms	35	mA
Peak	150	mA
Maximum peak trigger current	100	mA
Maximum anode-to-trigger voltage		
Anode positive (V_{Tr} from 0 to -65V)	200	V
Anode negative (V_{Tr} between 0 and +73V)	180	V

OPERATING NOTES

1. The tube must not be allowed to pass current when the anode is negative.
2. Bright sunlight should be avoided.
With instantaneous anode voltage of 185V, trigger bias voltage of +70V, trigger input pulse of 50V and trigger series resistor of 100k Ω .
3. In this tube, oscillations of up to approximately 14V peak-to-peak are superimposed on the maintaining voltage. Due to this effect the measured value of maintaining voltage will depend on the circuit conditions. These are of no significance in normal applications.

3354

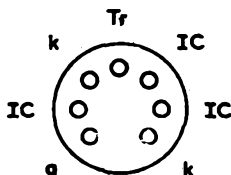
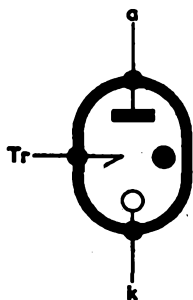

B7G Base

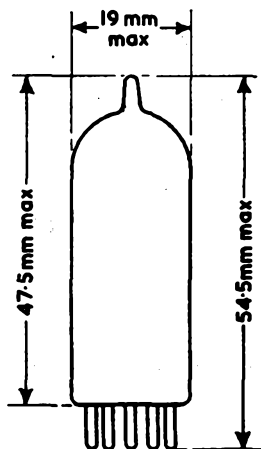

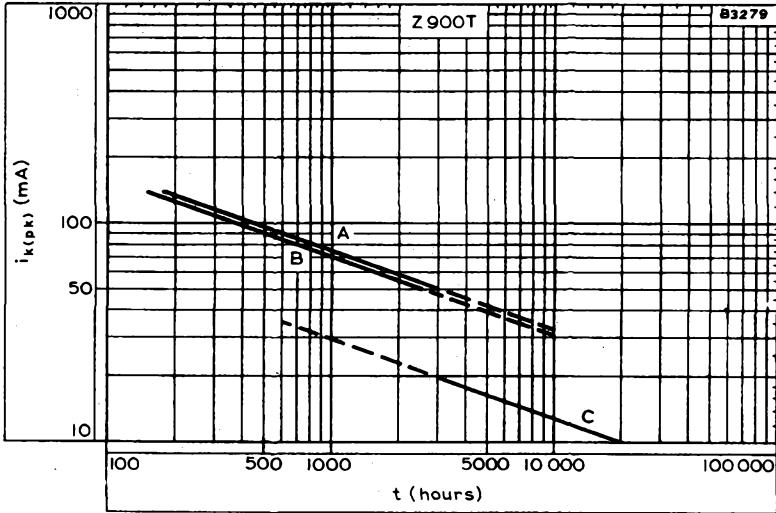

LIFE EXPECTANCY

The curves show the times for which at least 80% of all tubes will remain within the end of life limits if the tubes are run continuously.

During non-operation at temperatures up to 50°C the characteristics of the tube will remain constant for several months. At temperatures above this the periods of non-conduction should be restricted, and at 100°C should not exceed one hour. The total life expectancy in any given application is the sum of the non-operating periods and the operating life obtained from the curves.

Curves A and B show the life expectancy under a.c. conditions. Curve A shows the time for $V_{t(I_{GN})}$ to rise to 105V. Curve B shows the time for $V_{t(I_{GN})}$ to rise to 95V. Other characteristics will remain within values quoted in the data. It should be noted that to obtain the life time represented by Curve B some negative trigger current should be drawn on the inverse half cycle, but its peak value must not exceed 4% of the peak forward current.

Curve C shows the life time under d.c. conditions to a $V_{t(I_{GN})}$ limit of 105V when the trigger current is either positive or less than 1% of the cathode current.



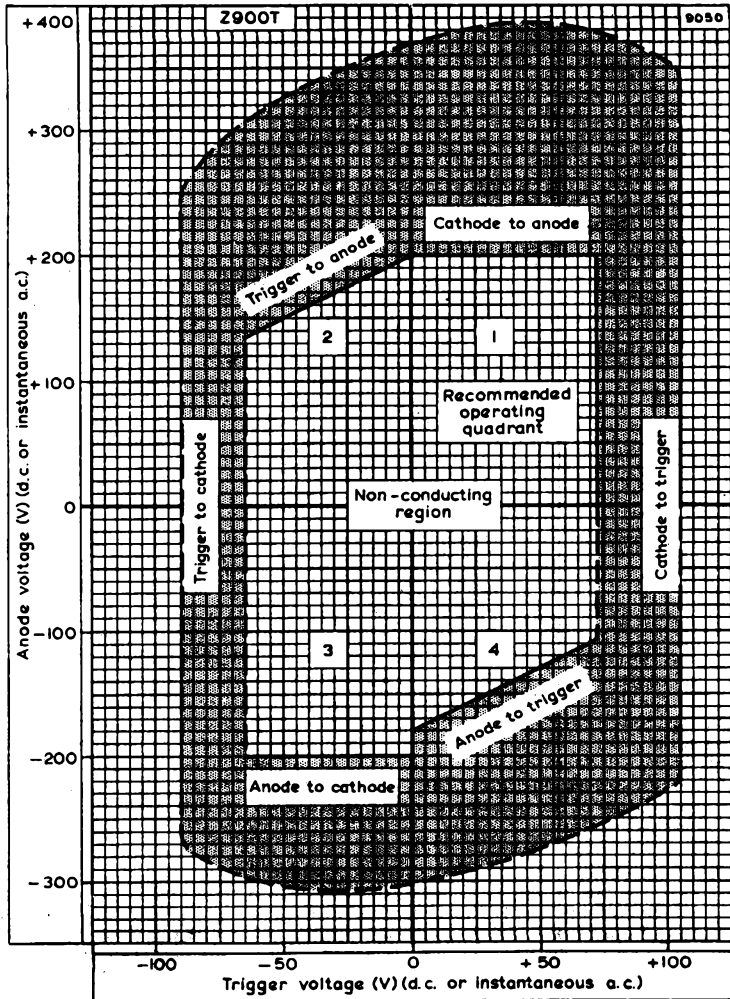

BREAKDOWN CHARACTERISTICS

Ranges shown between inside and outside curves take into account maximum and minimum, positive and negative values for individual tubes and for changes during tube life. The values shown by dashed sections are approximate.



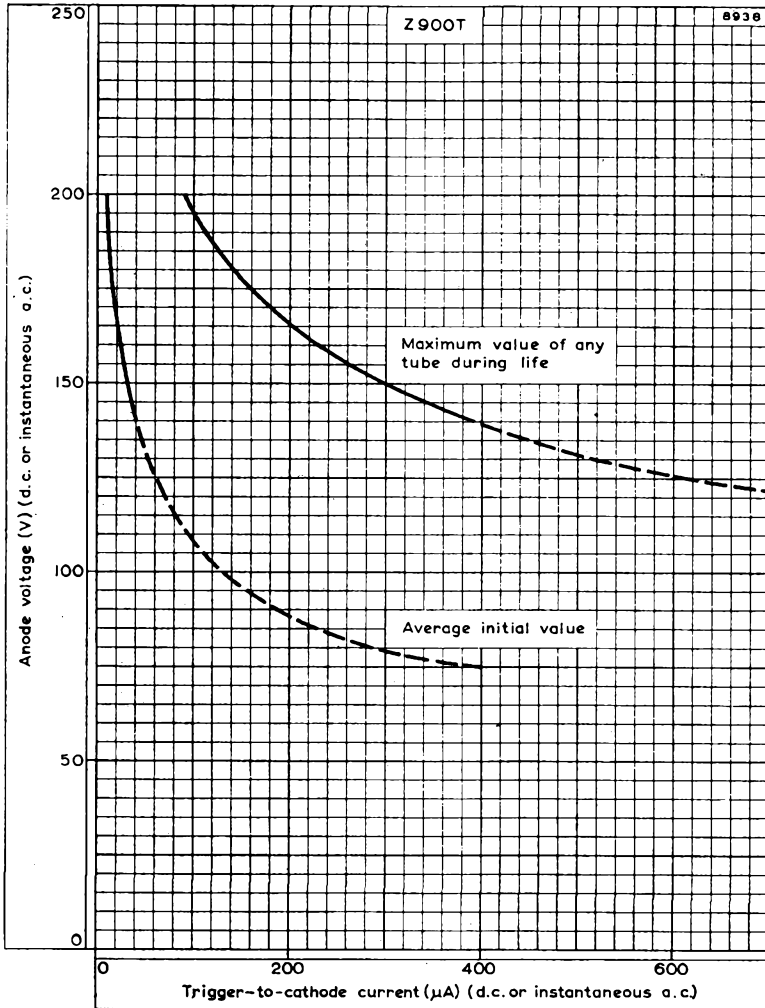

TRANSFER CHARACTERISTIC



LARGE THYRATRONS



Valve heating time

The time required for a valve to attain minimum operating temperature with normal voltage applied to the heating element. For a mercury vapour valve this time is generally much longer than that required to bring the cathode to the normal operating temperature.

Anode voltage drop

The potential difference between anode and cathode or midpoint of the filament during the time when the valve is conducting.

Critical grid voltage

The instantaneous value of grid voltage at which anode current commences to flow.

Control characteristic

The relationship between the critical grid voltage and the anode voltage. This is usually depicted graphically.

Positive current

Conventional current flowing into the valve through the electrode named.

Critical grid current

The instantaneous value of grid current immediately before anode current commences to flow.

Commutation factor

The product of rate of decay of anode current ($A/\mu s$) immediately prior to current extinction, and the initial rate of rise of the inverse anode voltage ($V/\mu s$) immediately following extinction of current.

Recovery time (Deionisation time)

The time between the cessation of anode current and the instant when the grid regains control.

Ionisation time

The time required for the anode current to rise to 90 per cent of its rated peak value, the time being measured from the instant of application of critical grid voltage (see also Anode Delay Time).

Maximum averaging time

The longest period of time over which it is permissible to compute the maximum average value of the characteristic under consideration.

Anode delay time

The interval between the time when the rising portion of the grid pulse would reach 26% of its full amplitude if it were unloaded and the instant when anode conduction takes place.

Jitter

The maximum variation of anode delay time from pulse to pulse.

Condensed mercury temperature

The temperature of the external surface of that part of the valve envelope at which the mercury is seen to condense during normal operation of the valve.



The following recommendations should be interpreted in conjunction with British Standard Code of Practice No CP1005: Parts 1 and 2: 1954, 'The Use of Electronic Valves', upon which these notes have, in part, been based.

LIMITING VALUES

The operating limits quoted on data sheets for individual valves should on no account be exceeded. Two methods of specifying limiting values are used, the 'absolute' and 'design centre' systems, and these should be interpreted as follows:

Absolute Ratings

The equipment designer must ensure that these ratings are never exceeded and in arriving at the actual valve operating conditions variations caused by mains fluctuations, component tolerances and switching surges must be taken into account.

Design Centre Ratings

With a set of nominal valves inserted in an equipment connected to the highest permitted nominal supply voltage within a given tapping range, and in which all components have their nominal value, the valve operating conditions may at no time exceed the published maximum design centre value. The phrase 'at no time' in the above paragraph means that increases in the valve working conditions, due to operating changes in equipment (e.g. switching, etc.), should be taken into account by the equipment designer. Mains voltage variations (of up to $\pm 6\%$) are allowed for in the valve ratings, provided good practice is followed in the design of the equipment.

FILAMENT OR HEATER SUPPLY

Unless otherwise stated the filament or heater voltage of a thyatron should be set within $\pm 2.5\%$ of the nominal value. Temporary mains fluctuations up to $\pm 6\%$ are permissible. To ensure maximum life from a directly heated valve the filament supply should be $90^\circ \pm 30^\circ$ out of phase with the anode supply unless otherwise specified. Measurement of the filament or heater voltage should be made at the valve pins

VALVE TEMPERATURE LIMITATIONS

The ratings published for Mullard mercury vapour thyratrons apply only when they are operated within the limits stated for the temperature of the condensed mercury.

With the filament or heater voltage applied, the time required to reach the minimum permissible condensed mercury temperature is a function of the ambient temperature and can be determined from the heating and cooling characteristic. Thus a direct measurement of the condensed mercury temperature, although desirable, is not essential. Ideally, no cathode current should be drawn until the filament or heater supply has been on for this time, but in practice little damage is done if the current is drawn when the condensed mercury temperature is within 5 or 10°C of the minimum permissible value (see individual data sheets). Thus with normal usage, where the valve is started only two or three times per day, an adequate life can still be obtained with a reduced heating time. The ambient conditions, however, must be such that the minimum permissible condensed mercury temperature is eventually reached and the filament or heater voltage must be within the specified tolerances. In any case the heating time must not be less than the specified minimum cathode heating time.

It is necessary to provide adequate ventilation around the valve so that the maximum ambient or condensed mercury temperature is never exceeded for any condition of loading. This avoids the danger of arc-back. Whenever it may be necessary to check the condensed mercury temperature of thyratrons the following procedure is recommended. A temperature indicator of low thermal capacity, such as a fine-wire thermocouple, should be attached to the valve at the mercury condensation point by the minimum amount of adhesive. Care should be taken to ensure that other conditions of operation, such as load current, ambient temperature of the air outside the equipment, and the ventilation remain unchanged during the measurement.

With inert-gas thyratrons ambient temperature limitations are given and in general it is only necessary to employ the minimum cathode heating time before switching on.

CURRENT RATINGS

For each rating of maximum average current, a maximum averaging time is quoted. This is to ensure that current greater than the maximum permissible average value is not drawn for such a length of time as would give rise to an excessive temperature within the



valve. For periods less than the maximum averaging time it is permissible to draw average currents greater than the maximum rated value provided that the product of this current and time does not exceed the product of the maximum rated average current and the maximum averaging time. When more than one value of peak current is quoted depending upon the frequency of operation, this must be taken into consideration.

SHORT CIRCUIT PROTECTION

The figure given on each data sheet for maximum surge (fault protection) cathode current is intended as a guide to equipment designers. It indicates the maximum value of current, resulting from a sudden overload or short circuit, which the thyatron will pass for a period not exceeding 0.1 second without resulting in its immediate destruction. Several overloads of this nature, will, however, appreciably reduce the life of the valve. When thyratrons are used as grid-controlled rectifiers it is advisable to include a fuse of suitable rating in the anode circuit of each valve.

POWER SUPPLY FREQUENCY LIMITATIONS

In general, when thyratrons are operated at frequencies below 25c/s, a lower maximum peak cathode current is applicable. This is necessary to ensure that cathode fatigue does not result. The maximum frequency at which a thyatron will operate satisfactorily is dependent upon the recovery time and therefore upon the conditions of operation. At higher frequencies the valve will fail to operate due to arc-back and loss of grid control. When operation at high frequencies is desired the commutation factor should be kept as low as possible in order to ensure satisfactory life.

EFFECTS OF POSITIVE ION CURRENT

When a thyatron is conducting, a positive ion current of magnitude proportional to the cathode current is generated. This current will, in general, flow to that electrode which is at the most negative potential during conduction. In order to prevent damage to the valve it is necessary to ensure that the voltage of this electrode is more positive than -10V during this phase. This precaution will prevent an increase in electrode emission due to excessive electrode dissipation, sputtering of electrode material, changes in the control characteristics caused by shift in contact potential and, in the case



of inert gas-filled valves, a rapid gas clean-up. In circuits where the control grid is held negative during anode conduction, a suitable choice of resistor in series with the grid will maintain an effective grid bias more positive than $-10V$. The minimum value of the resistor may be determined from the grid ion current characteristic. If the instantaneous value of anode current is low then the restriction on grid bias does not apply. In general, the grid should be more positive than $-10V$ for all values of anode current greater than 10 per cent of the rated maximum average current. In circuits where the anode potential changes from a positive to a negative value and the control-grid is at a positive potential, thereby drawing cathode current, a small positive ion current flows to the anode. In such a case the inclusion of a high value of anode resistor is precluded by circuit requirements, as the anode will usually reach a high negative potential. It is essential to limit the magnitude of the positive ion current by severely restricting the current flowing from cathode to grid. This may be effected by using the maximum permitted series grid resistor and/or alternatively, keeping the positive grid voltage swing as low as possible.

In those circuits where the anode potential changes very rapidly from a positive to a high negative value, such as with inductive loads fed from polyphase supplies, there will be residual positive ions within the valve which will be drawn towards the anode with considerable energy. In the case of an inert gas-filled valve this will result in excessive gas clean-up and it is therefore necessary to observe the limitations imposed by the appropriate commutation factor.

PARALLEL OPERATION OF THYRATRONS

Thyratrons cannot normally be operated directly in parallel. An alternative arrangement must be adopted if a higher current output is required. Information on suitable methods will be supplied on request.

USE OF CONTROL CHARACTERISTICS

In most cases the control characteristic given on the data sheets is shown by upper and lower boundary curves within which all valves may be expected to remain during life. The control characteristic of a particular valve may move within these boundaries although, as a rule, these limits should be considered as extreme cases. This should be taken into consideration when designing grid excitation circuits for thyratrons.



SCREENING AND R.F. FILTER CIRCUITS

(a) In order to prevent spurious ionisation of the gas or mercury vapour (and consequent flash-over) due to strong r.f. fields, it may be necessary to enclose the thyratrons in a separate screening box. For the same reason r.f. filters should be used to prevent high frequency current circulating in the thyatron circuits via the wiring.

(b) High frequency disturbances, usually due to oscillation in the transformer windings and associated wiring, are often produced by gaseous valves, and may cause interference in apparatus situated near the thyatron unit. Small r.f. chokes or resistors in the anode leads will generally reduce the interference, and screening as recommended in paragraph (a) above may also be adopted, with r.f. filters in all leads emerging from the screen.

INSTALLATION

Mercury vapour thyratrons should always be mounted vertically with the cathode connections at the lower end. When a mercury vapour thyatron is first installed, and before it is put into service, it should be run for at least half an hour at its normal heater or filament voltage but without any other electrode voltages applied in order to vaporise any mercury which may have been deposited upon the electrode assembly during transit. This precaution should also be taken before putting into service a mercury vapour valve which has been out of use for any considerable time.

The mounting requirements for inert gas thyratrons are less stringent and are specified for each valve.



ADDITIONAL NOTES FOR HYDROGEN THYRATRONS

HEATER AND REPLENISHER VOLTAGES

The heater and replenisher voltages should be maintained within the rated limits, to avoid abnormal hydrogen or gas pressure. This might cause premature failure of cathode emission, gas clean-up, excessive anode dissipation or continuous conduction.

CURRENT RATINGS

For each rating of maximum average current a maximum averaging time is quoted. This is to ensure that an anode current greater than the maximum average value is not drawn for such a length of time as would give rise to excessive temperature within the valve. The maximum peak anode current is determined by the safe cathode emission, whereas the average current is limited by its heating effects.

SHORT CIRCUIT PROTECTION

Failure of the thyatron to regain control at the end of a current pulse may occur at the first or second attempt of instantaneous starting or as a result of an adverse mismatch occurring between the pulse forming network and load impedance; for example this may occur when a magnetron fails to oscillate. In the event of such a failure the thyatron mean current will rise considerably and a circuit breaker or fuse which will act within 0.1s with 200% current overload should be incorporated to avoid the destruction of the thyatron.

RATINGS INTER-RELATION PRODUCT

A limitation placed on the product of peak anode voltage, peak anode current and pulse repetition frequency which is designed to avoid excessive power dissipation in the valve.

COMMUTATION

When the thyatron is conducting, the number of positive ions generated is proportional to the cathode current. After the cessation of anode conduction several microseconds elapse before the number of positive ions has substantially diminished.

If the anode develops a high negative potential immediately after the current pulse, these ions will bombard the anode and this may



result in excessive anode dissipation and gas clean-up. A special inverse voltage rating, applicable for a period of $25\mu\text{s}$ after each current pulse, is therefore specified for each valve type.

RECOVERY TIME

A delay must be allowed between the cessation of the current pulse and the re-application of anode voltage. This will ensure that the concentration of ions has decayed to a level which will not cause spurious anode firing. The recovery time may be minimised by providing a low impedance d.c. path from grid to cathode (e.g. the secondary coil of a suitable pulse transformer) or by applying a negative bias to the grid. The necessary delay between the cessation of anode current and the rise of anode voltage may, in many applications, be produced by allowing the anode voltage to swing negative after the current pulse. A minimum overswing of 5% of the peak forward voltage is normally specified. (The danger of an excessive overswing has already been mentioned under Commutation.)

The rapid rise of anode voltage is delayed further if the pulse-forming network is charged through an inductor rather than through a resistor.

GRID EXCITATION CIRCUIT

Hydrogen thyratrons are usually designed with positive firing characteristics so that a negative bias is not essential. Normally a grid current of several milliamperes must be drawn before anode conduction is initiated. A steeply rising grid voltage derived from a source of low impedance should ensure a small and steady anode delay time. A maximum rise time and source impedance are specified on individual data sheets.

INSTALLATION

Hydrogen thyratrons may be mounted in any position and, if desired, the valve may be clamped, preferably on the base. If the clamp is applied to the envelope it should have a low thermal inertia and should not be applied above the point specified on the individual data sheet. The anode lead should be arranged so that it is not close to the glass envelope and the valve should be screened from r.f. fields.

An air blast may be used to cool the anode lead if necessary but it must not be directed upon the glass envelope of the valve.

Hydrogen thyratrons may emit harmful X-radiation and should be suitably screened to protect personnel.



TRIODE THYRATRON

Triode mercury vapour thyatron with negative control characteristic. Primarily designed for motor control and other industrial applications.

XG1-2500

This data should be read in conjunction with DEFINITIONS AND OPERATIONAL RECOMMENDATIONS—THYRATRONs, preceding this section of the handbook.

LIMITING VALUES (absolute ratings, not design centre)

It is important that these limits are never exceeded and such variations as mains fluctuations, component tolerances and switching surges must be taken into consideration in arriving at actual valve operating conditions.

Max. peak anode voltage

*Inverse	1.5	1.0	kV
Forward	1.0	1.0	kV

*Condensed mercury temperature limits	40 to 75	40 to 80°	C
---------------------------------------	----------	-----------	---

Max. cathode current

Peak (25 c/s and above)	15	A
Peak (below 25c/s)	5.0	A
Peak (ignitor firing service)	40	A
Average (max. averaging time 15s)	2.5	A
Average (ignitor firing service)	1.0	A
Surge (fault protection max. duration 0.1s)	200	A

Max. negative control-grid voltage

Before conduction	500	V
During conduction	10	V

Max. average positive control-grid current for anode voltage more positive than -10V (averaging time, 15s)	250	mA
--	-----	----

Max. peak positive control-grid current during the time that the anode voltage is more positive than -10V	1.0	A
---	-----	---

Max. peak positive control-grid current during the time that the anode voltage is more negative than -10V	100	mA
---	-----	----

Max. control-grid resistor (Recommended min. control-grid resistor 10k Ω)	100	k Ω
--	-----	------------

Heater voltage limits	4.5 to 5.5	V
-----------------------	------------	---

Min. valve heating time
(See heating and cooling characteristics on pages 2 and 6)

Max. power supply frequency	150	c/s
-----------------------------	-----	-----

*Max. condensed mercury temperature rating for intermediate anode voltages may be determined by linear interpolation.



XGI-2500

TRIODE THYRATRON

Triode mercury vapour thyatron with negative control characteristic. Primarily designed for motor control and other industrial applications

CHARACTERISTICS

Electrical

Heater voltage	5.0	V
Heater current at 5.0V		
Average	4.5	A
Maximum	4.8	A
Anode to control-grid capacitance	4.0	pF
Control-grid to cathode capacitance	8.0	pF
Recovery (deionisation) time approx.	1,000	μ s
Ionisation time (approx.)	10	μ s
Anode voltage drop	16	V
Critical grid current at $V_a = 1.0$ kV	<20	μ A

Mechanical

Type of cooling	Convection
Equilibrium condensed mercury temperature rise above ambient	
At full load (approx.)	42 °C
At no load (approx.)	33 °C
Mounting position	Vertical, base down
Max. net weight	{ 6.0 oz. 170 g

HEATING-UP TIME

The preferred minimum value of the valve heating-up time can be obtained from the heating and cooling curve on page 6. This shows how the condensed mercury temperature rises above the ambient temperature from the instant of switching on the heater supply.

Under normal conditions, however, cathode current may be drawn when the condensed mercury temperature is within approximately 7°C of the minimum quoted value. (See appropriate section of 'General Operational Recommendations—Thyatrions'.) The total heating-up time under this duty can be obtained from the curve on page 7.

Minimum cathode heating time	5.0 min
------------------------------	---------



TRIODE THYRATRON

XG1-2500

Triode mercury vapour thyatron with negative control characteristic. Primarily designed for motor control and other industrial applications.

Control characteristic (see page 4)

The shaded area between the curves indicates the spread in characteristics due to:

- (a) Initial differences between individual valves.
- (b) Variations in characteristics during life.
- (c) Variations in characteristics due to changes in heater voltage.
- (d) The effects of circuit loading.

The effects of different values of series grid resistor have been ignored.

3291

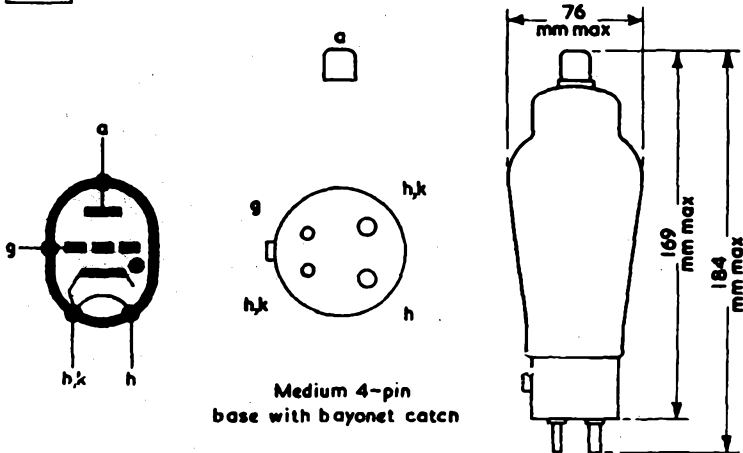

XG1-2500

TRIODE THYRATRON

Triode mercury vapour thyatron with negative control characteristic. Primarily designed for motor control and other industrial applications.

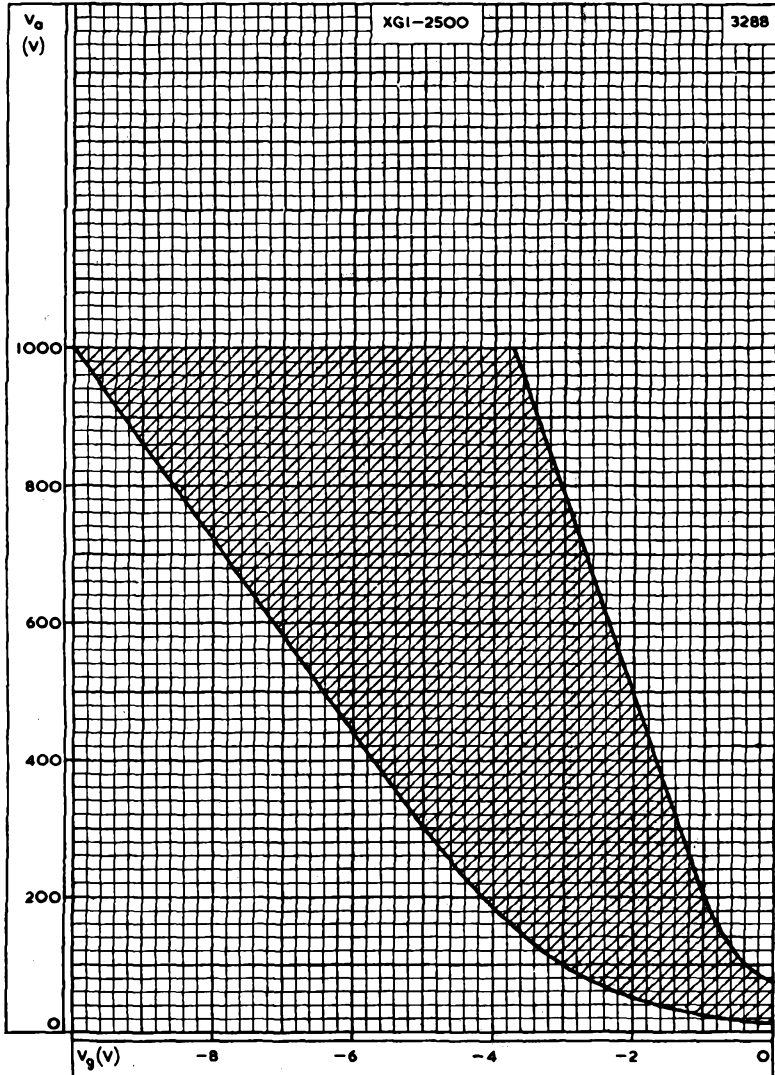

CONTROL CHARACTERISTIC
(See note on page 3)



TRIODE THYRATRON

Triode mercury vapour thyatron with negative control characteristic. Primarily designed for motor control and other industrial applications.

XGI-2500

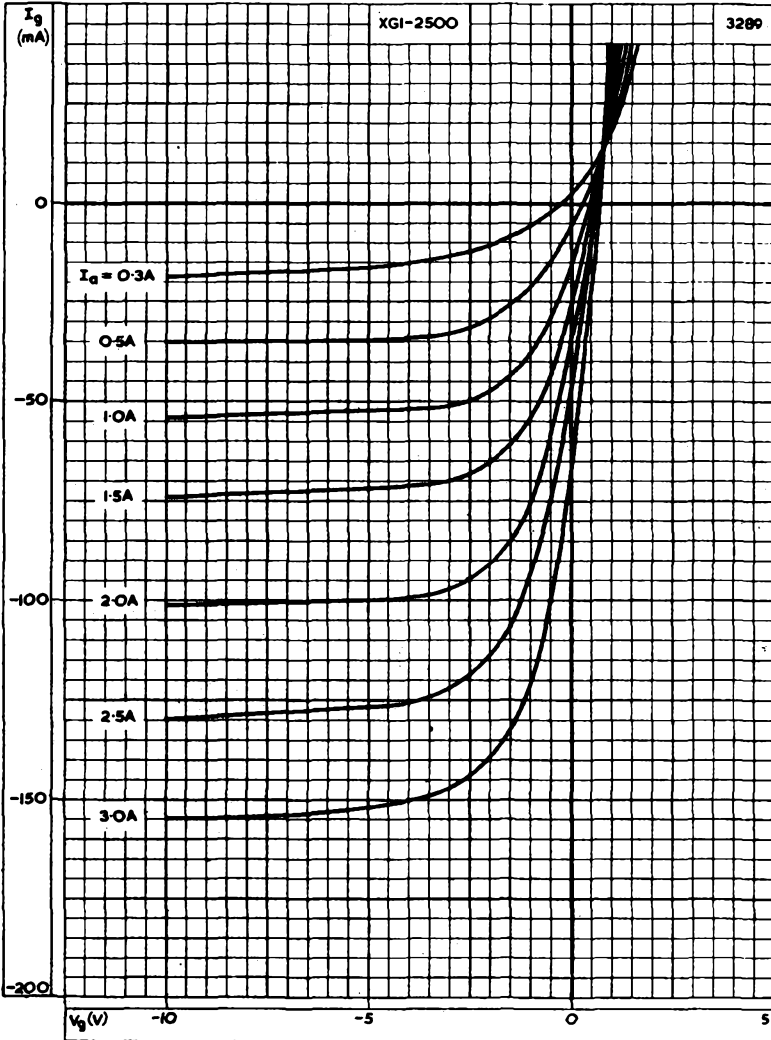

GRID ION CURRENT CHARACTERISTIC



XG1-2500

TRIODE THYRATRON

Triode mercury vapour thyatron with negative control characteristic. Primarily designed for motor control and other industrial applications.

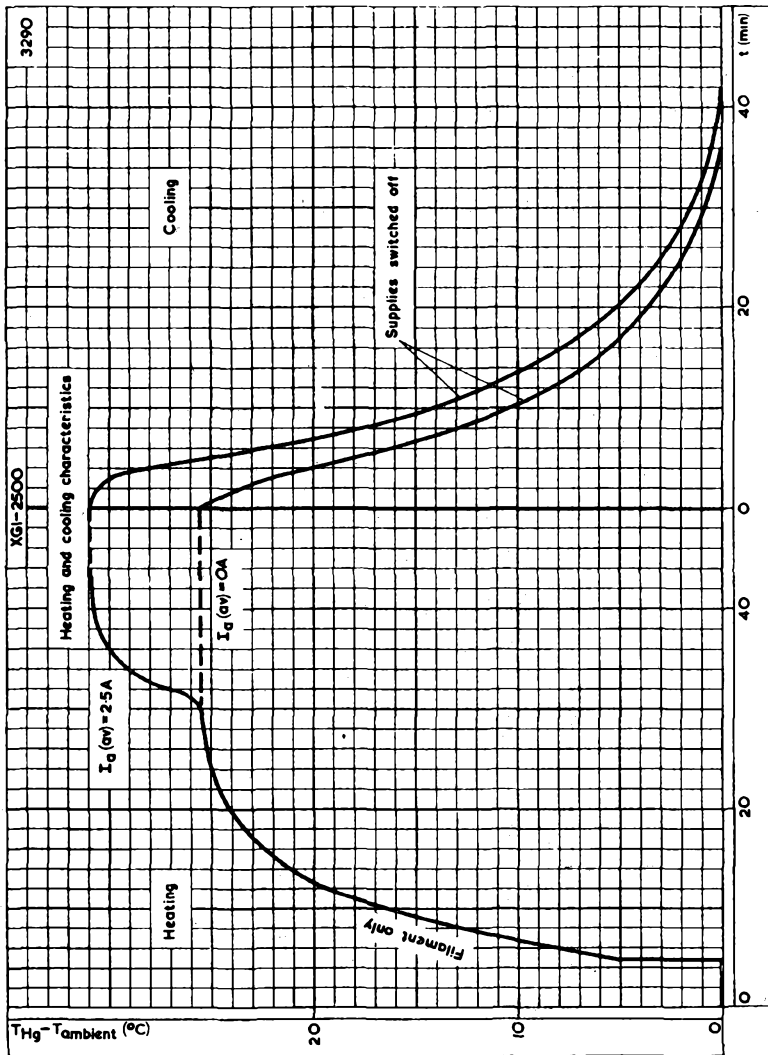

HEATING AND COOLING CHARACTERISTIC. EXCESS TEMPERATURE OVER AMBIENT PLOTTED AGAINST TIME



TRIODE THYRATRON

Triode mercury vapour thyatron with negative control characteristic. Primarily designed for motor control and other industrial applications.

XGI-2500

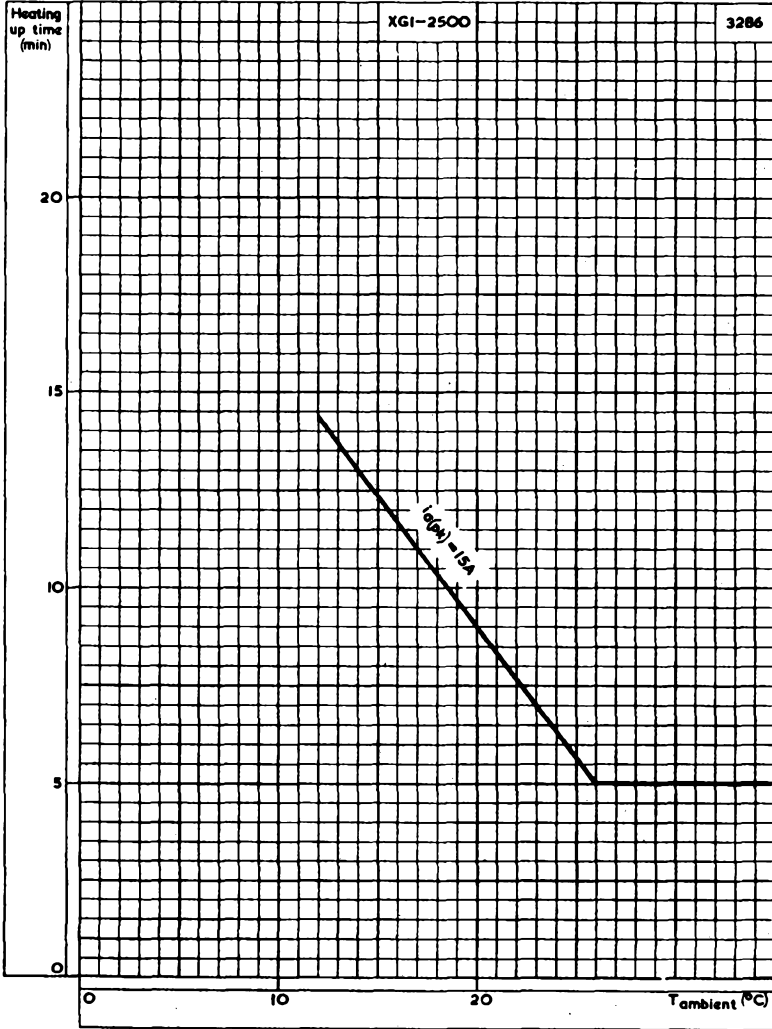

TOTAL HEATING-UP TIME PLOTTED AGAINST AMBIENT TEMPERATURE



TRIODE THYRATRON

XG2-6400

6.4 amp triode mercury vapour thyatron with negative control characteristic. Designed for industrial power control applications.

This data should be read in conjunction with DEFINITIONS AND GENERAL OPERATIONAL RECOMMENDATIONS - THYRATRONs, which precede this section of the handbook.

LIMITING VALUES (absolute ratings, not design centre)

It is important that these limits are never exceeded and such variations as mains fluctuations, component tolerances and switching surges must be taken into consideration in arriving at actual valve operating conditions.

Max. peak anode voltage			
Inverse	2.5	kV	
Forward	2.5	kV	
Max. cathode current			
Peak (25c/s and above)	40	A	
Average (Max. averaging time 15s)	6.4	A	
Surge (Fault protection max. duration 0.1s)	400	A	
Max. negative grid voltage			
Before conduction	1.0	kV	
During conduction	10	V	
Max. average positive grid current for anode voltage more positive than -10V (averaging time 15s)	250	mA	
Max. peak positive grid current during the time that the anode voltage is more positive than -10V	1.0	A	
Max peak positive grid current during the time that the anode voltage is more negative than -10V	15	mA	
Grid resistor			
Maximum	100	kΩ	
Recommended minimum	10	kΩ	
Condensed mercury temperature limits	35 to 80	°C	

CHARACTERISTICS

Electrical

Heater voltage	5.0	V
Heater current at 5.0V		
Average	10	A
Maximum	11.5	A
Anode-to-grid capacitance	< 0.1	pF
Grid-to-cathode capacitance	15	pF
Recovery time (approx.)	1000	μs
Ionisation time (approx.)	10	μs
Anode voltage drop	16	V
Critical grid current at $V_a = 2.5kV$	< 20	μA

Mechanical

Type of cooling	Convection					
Mounting position	Vertical, base down					
Max. net weight	<table border="0"> <tr> <td>400</td> <td>g</td> </tr> <tr> <td>14</td> <td>oz</td> </tr> </table>	400	g	14	oz	
400	g					
14	oz					
Weight of thyatron in packing	<table border="0"> <tr> <td>1150</td> <td>g</td> </tr> <tr> <td>2 lb</td> <td>9 oz</td> </tr> </table>	1150	g	2 lb	9 oz	
1150	g					
2 lb	9 oz					
Dimensions of packing	<table border="0"> <tr> <td>12.5 × 6.25 × 6.25</td> <td>in</td> </tr> <tr> <td>317.5 × 158.8 × 158.8</td> <td>mm</td> </tr> </table>	12.5 × 6.25 × 6.25	in	317.5 × 158.8 × 158.8	mm	
12.5 × 6.25 × 6.25	in					
317.5 × 158.8 × 158.8	mm					

HEATING-UP TIME

The minimum value of the total valve heating-up time can be obtained from the heating and cooling curve on page C3. This shows how the condensed mercury temperature rises above ambient temperature from the instant of switching on the heater supply.

Under normal conditions, however, cathode current may be drawn when the condensed mercury temperature is approximately within 7°C of the minimum quoted value. See appropriate section 'General operational recommendations - thyratrons'.

During long shut down periods e.g. overnight, the heater supply may be reduced to 60 to 80% of normal instead of being switched off. This greatly reduces the minimum delay required after restoring the heater supply to normal. The total heating-up time under this duty can be obtained from the curve on page C4.

Minimum cathode heating time 5 min

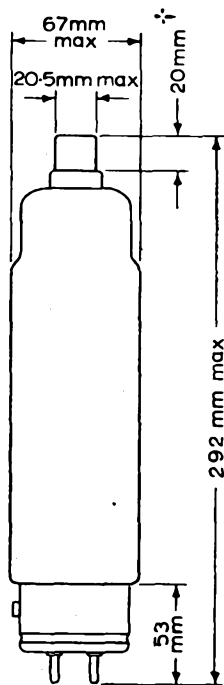
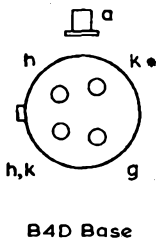
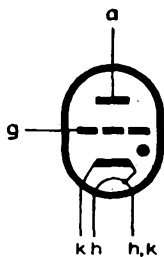

*Return lead of grid and anode circuits
†Contact length 17.5 mm min

6405

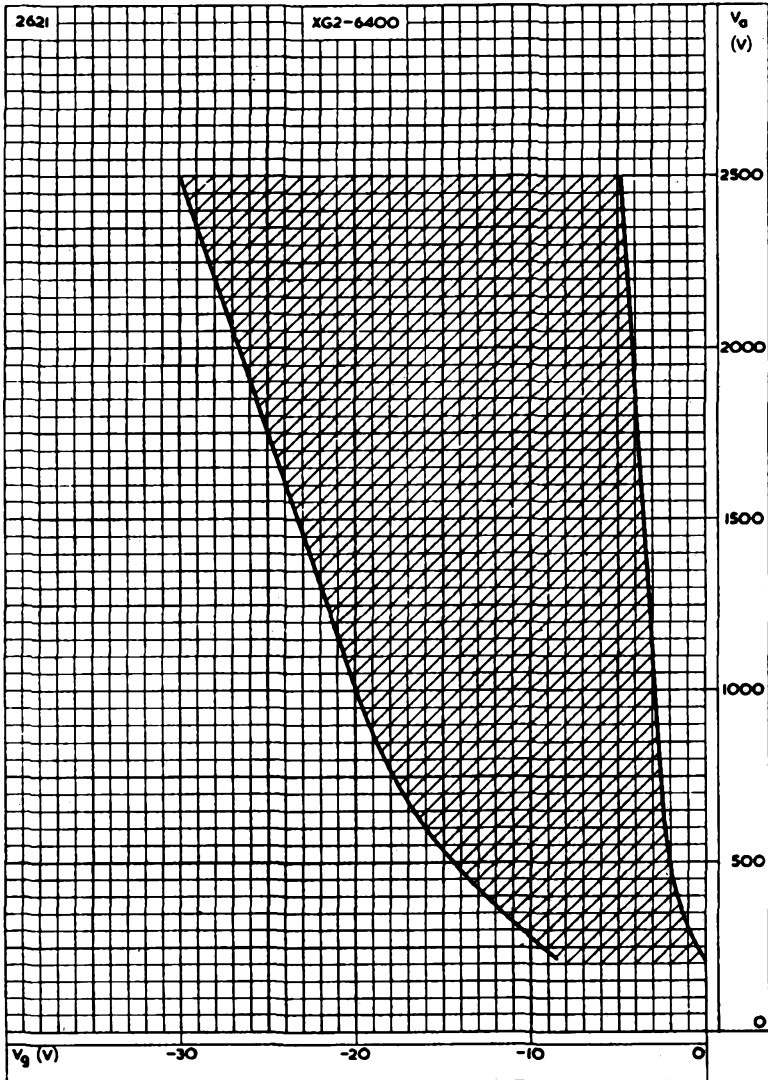

CONTROL CHARACTERISTIC



XG2-6400

TRIODE THYRATRON

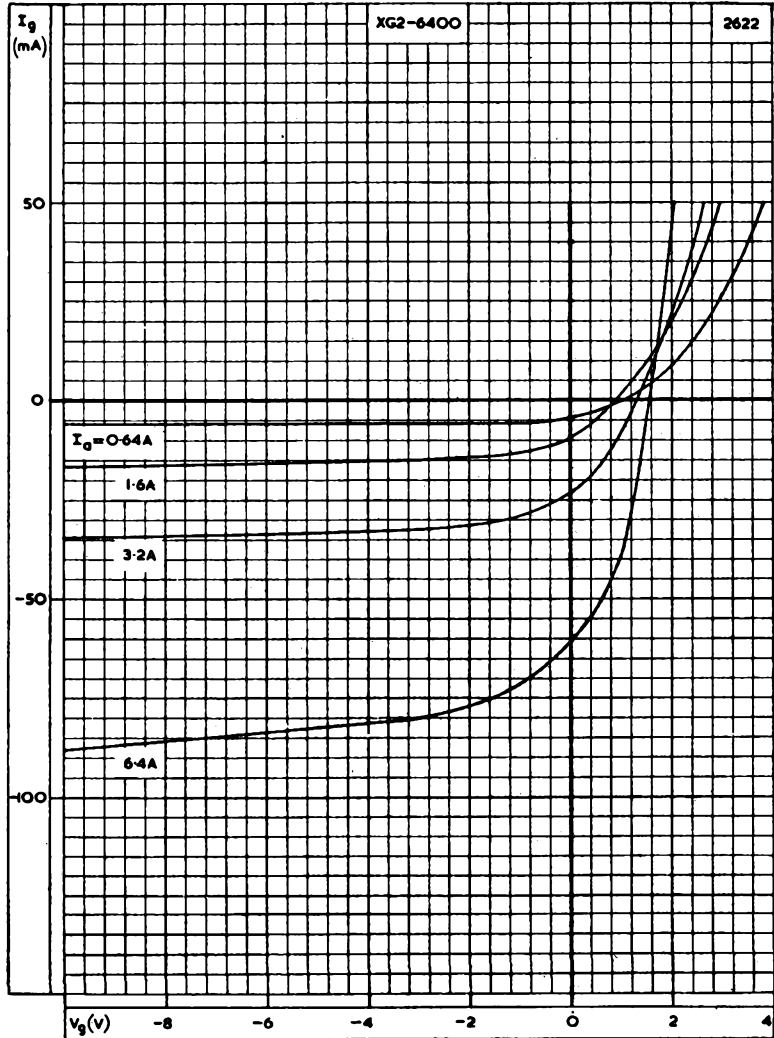

GRID ION CURRENT CHARACTERISTIC



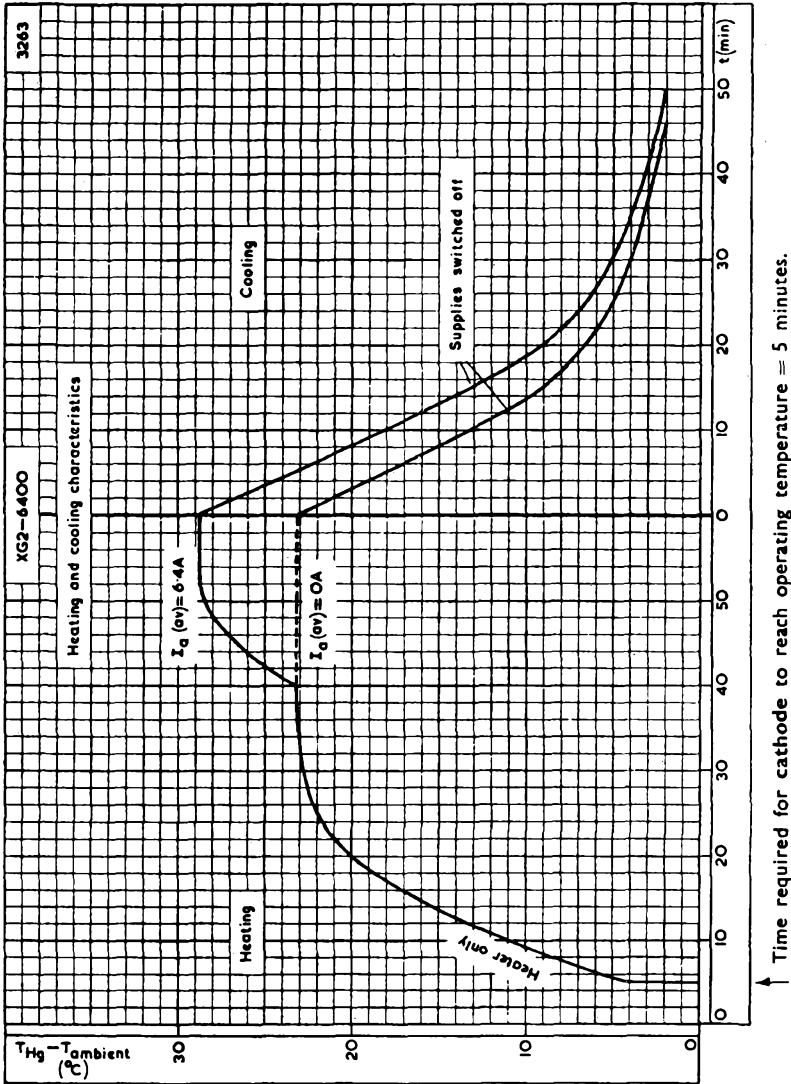

HEATING AND COOLING CHARACTERISTIC. EXCESS TEMPERATURE OVER AMBIENT PLOTTED AGAINST TIME



XG2-6400

TRIODE THYRATRON

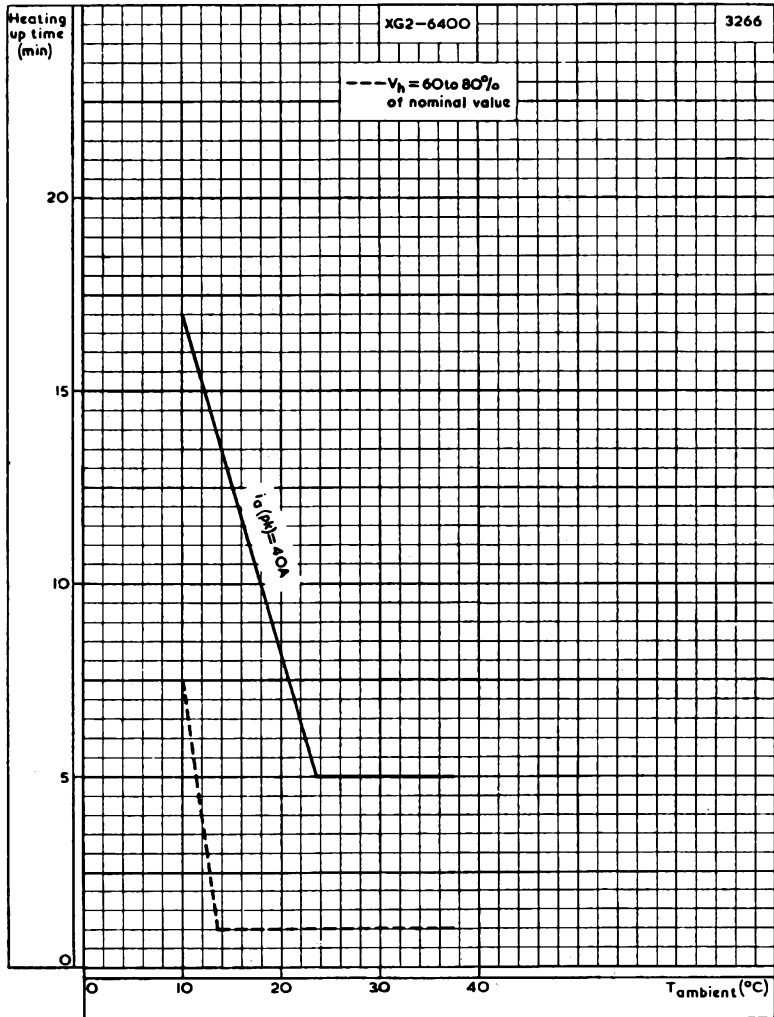

TOTAL HEATING-UP TIME PLOTTED AGAINST AMBIENT TEMPERATURE
(See notes on page D2)



QUICK REFERENCE DATA (maximum values)

Inert gas-filled triode for power control applications

Peak anode voltage	1.5	kV
Cathode current		
peak	40	A
average	3.2	A

This data should be read in conjunction with DEFINITIONS AND GENERAL OPERATIONAL RECOMMENDATIONS - THYRATRONs which precede this section of the handbook.

CHARACTERISTICS AND RANGE VALUES FOR EQUIPMENT DESIGN

The values given state the range over which the valve will operate. No allowance has been made in the data for supply voltage and component variations.

Anode

Peak anode operating voltage (forward and inverse)	1.5	kV
Anode voltage drop (approx. instantaneous value)		
$i_k = 3.2A$	12	V
$i_k = 40A$	18	V
Maximum commutation factor (see note 1)	130	VA/ μs^2
Ignition delay time	see page C1	
Anode Recovery time	see page C2	

Grid

Control characteristic	see page C1	
Maximum negative grid voltage		
before conduction	250	V
during conduction	10	V
Maximum positive grid current for anode voltage more positive than -10V		
peak	2.5	A
average (maximum averaging time = 20ms)	200	mA
Maximum peak positive grid current for anode voltage more negative than -10V	25	mA
Grid resistance		
maximum	100	k Ω
minimum (see page C2)		
Maximum critical grid current	20	μA

Cathode (see note 2)

Maximum cathode current		
peak	40	A
average (maximum averaging time = 15s) see page C3	3.2	A
surge (fault protection only, maximum duration = 100ms)	560	A
Minimum cathode heating time	60	s
Filament voltage	2.5	V
Filament current at 2.5V ($I_k = 0A$)	13.5	A

Capacitances

Grid-to-cathode capacitance	15	pF
Grid-to-anode capacitance (see note 3)	0.7	pF

Mechanical

Type of cooling	Convection	
Mounting position	Any position between vertical with base downwards and horizontal	
Net weight (approx.)	9.2	oz
	260	g
Weight of valve in carton	11b	10oz
	725	g
Nominal dimensions of packing	5.5 x 5.5 x 12.25 in	
	140 x 140 x 310 mm	

RATINGS (ABSOLUTE MAXIMUM SYSTEM)

It is important that these ratings are never exceeded and such variations as mains fluctuations, component tolerances and switching surges must be taken into consideration in arriving at the actual valve operating conditions.

Anode

Maximum peak anode voltage (forward and inverse)	1.5	kV
--	-----	----

Grid

Maximum negative grid voltage		
before conduction	250	V
during conduction	10	V
Maximum positive grid current		
for anode voltage more positive than -10V		
peak	2.5	A
average (maximum averaging time = 20ms)	200	mA
Maximum peak positive grid current		
for anode voltage more negative than -10V	25	mA



Cathode

Maximum cathode current		
peak	40	A
average (maximum averaging time = 15s) see page C3	3.2	A
surge (fault protection only, maximum duration = 100ms)	560	A
Minimum cathode heating time	60	s
Filament voltage		
minimum	2.3	V
maximum	2.7	V
Ambient temperature		
minimum	-55	°C
maximum	+70	°C

OPERATING NOTES

1. In order to minimise gas clean-up, the inverse voltage applied across the valve should be kept to a minimum during the immediate post conduction period. Therefore, the inverse voltage should not exceed 250V during the first 500 μ s after the cessation of anode current.
2. The anode and grid circuit returns should be made to the centre tap of the filament transformer.
3. In order to prevent spurious ignition due to capacitive anode-to-grid coupling, a capacitor should be connected between grid and cathode.



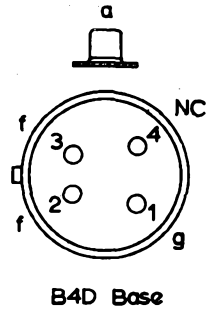
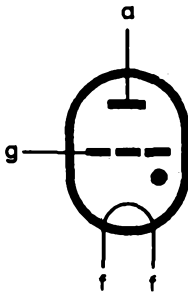
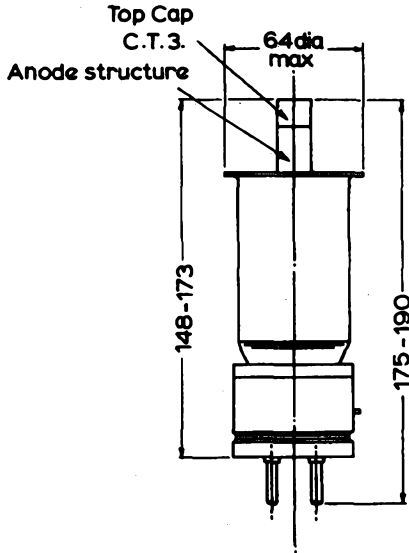

All dimensions in mm.

The anode structure must be left free to ensure adequate cooling by free convection

B4677



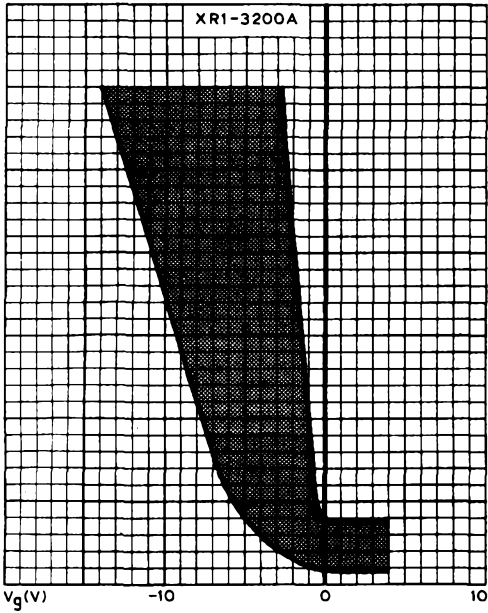

CONTROL CHARACTERISTIC

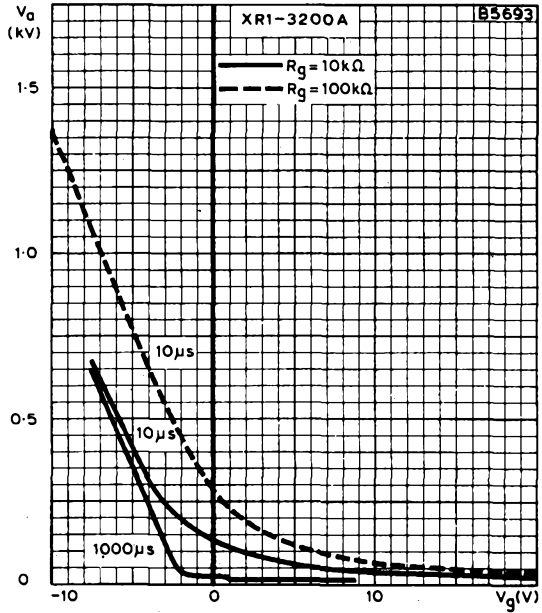

NOMINAL VARIATION BETWEEN ANODE AND GRID VOLTAGES FOR DIFFERENT IGNITION DELAY TIMES

THYRATRON

XR1-3200A





Instantaneous
forward
anode
voltage (V)

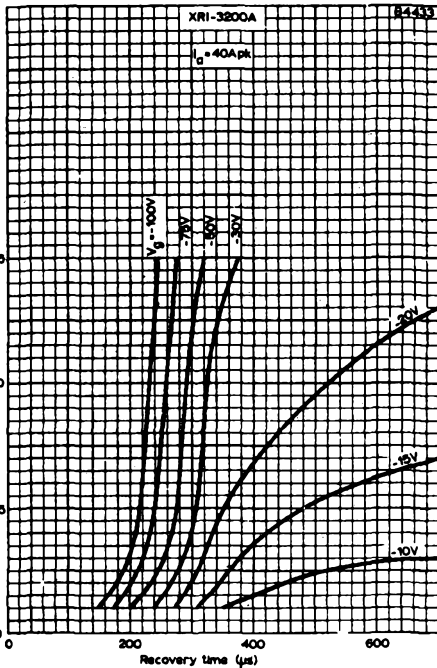

NORMAL RELATIONSHIP BETWEEN FORWARD ANODE
VOLTAGE WHICH WILL NOT CAUSE RE-IGNITION AND
TIME FROM CESSATION OF CONDUCTION



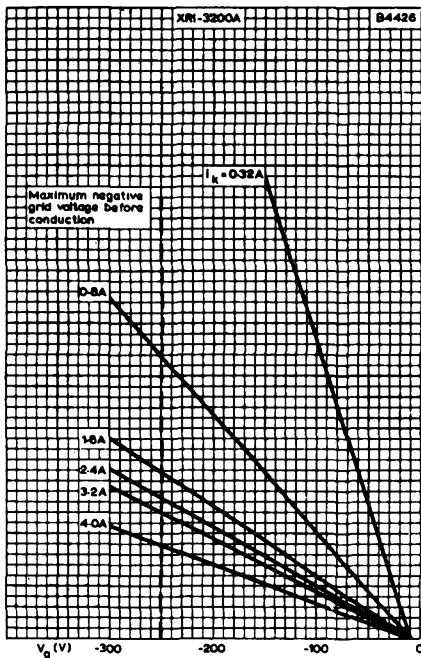

Minimum grid resistance (kΩ)

25

20

15

10

5

0

V_g (V)

-300

-200

-100

0

MINIMUM GRID RESISTANCE PLOTTED AGAINST
NEGATIVE SUPPLY VOLTAGE WITH INSTANTANEOUS
CATHODE CURRENT AS PARAMETER

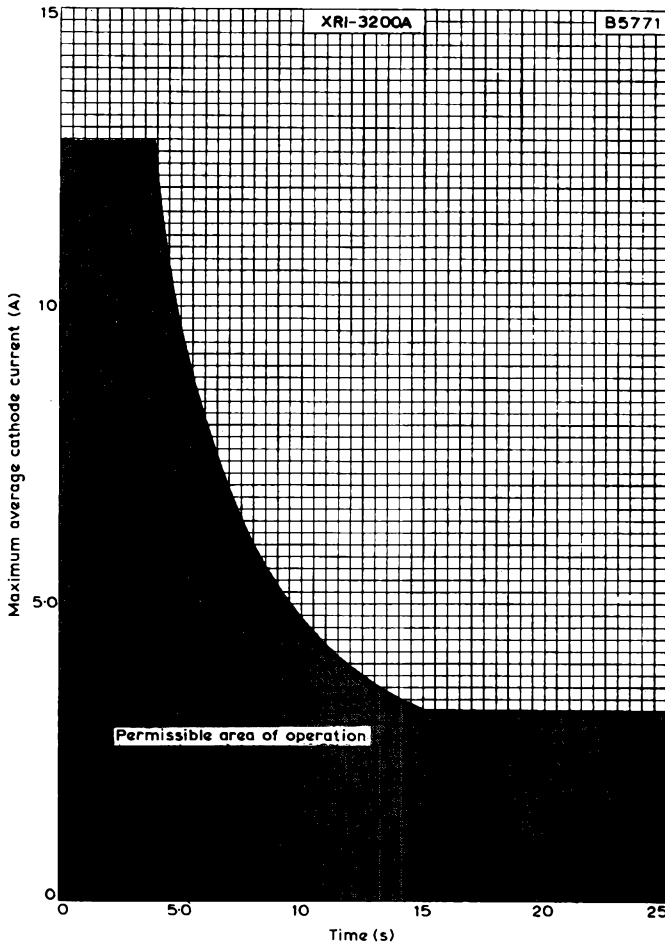

This curve shows the maximum number of seconds in any fifteen second period for which a given average current may be drawn from a sinusoidal supply.



QUICK REFERENCE DATA (maximum values)

Inert gas-filled triode for power control applications.

Peak anode voltage	1.5	kV
Cathode current		
Peak	80	A
Average	6.4	A

This data should be read in conjunction with DEFINITIONS AND GENERAL OPERATIONAL RECOMMENDATIONS - THYRATRONS which precede this section of the handbook.

CHARACTERISTICS AND RANGE VALUES FOR EQUIPMENT DESIGN

The values given state the range over which the valve will operate. No allowance has been made in the data for supply voltage and component variation.

Anode

Peak anode operating voltage (forward and inverse)	1.5	kV
Anode voltage drop (approx. instantaneous value)		
$i_k = 6.4A$	12	V
$i_k = 80A$	18	V
Maximum commutation factor (note 1)	130	VA/ μs^2
Anode-to-grid capacitance (note 2)	7	pF
Anode-to-cathode capacitance	0.2	pF
Ignition delay time	See page C1	
Recovery (deionisation) time (approx.)	800	μs

Grid

Control characteristic	See page C1	
Maximum negative grid voltage		
Before conduction	-250	V
During conduction	-10	V
Maximum positive grid current for anode voltage more positive than -10V		
Peak	2.5	A
Average (maximum averaging time = 20ms)	200	mA
Maximum peak positive grid current for anode voltage more negative than -10V	25	mA
Grid resistance		
Maximum	100	k Ω
Minimum	See page C2	
Maximum critical grid current	20	μA
Grid-to-cathode capacitance	5	pF

Cathode (note 3)

Maximum cathode current			
Peak (note 4)	80	A	
Average (maximum averaging time = 15s) See page C3	6.4	A	
Surge (fault protection only, maximum duration = 0.1s)	1120	A	
Minimum cathode heating time	60	s	
Filament voltage (note 5)	2.5	V	
Filament current range at 2.5V ($I_k = 0mA$)	19 to 23	A	

Mechanical

Type of cooling	Convection										
Mounting position	Any position between vertical with base downwards and horizontal										
Net weight (approx.)	<table> <tr><td>13</td><td>oz</td></tr> <tr><td>370</td><td>g</td></tr> <tr><td>18</td><td>oz</td></tr> <tr><td>510</td><td>g</td></tr> </table>	13	oz	370	g	18	oz	510	g		
13		oz									
370		g									
18	oz										
510	g										
Weight of valve in carton (approx.)											
Nominal dimensions of packing	<table> <tr><td>5.5 × 5.5 × 12.25</td><td>in</td></tr> <tr><td>140 × 140 × 310</td><td>mm.</td></tr> </table>	5.5 × 5.5 × 12.25	in	140 × 140 × 310	mm.						
5.5 × 5.5 × 12.25		in									
140 × 140 × 310	mm.										

ABSOLUTE MAXIMUM RATINGS

It is important that these ratings are never exceeded and such variations as mains fluctuations, component tolerances and switching surges must be taken into consideration in arriving at the actual valve operating conditions.

Anode

Maximum peak anode voltage (forward and inverse)	1.5	kV
--	-----	----

Grid

Maximum negative grid voltage		
Before conduction	-250	V
During conduction	-10	V
Maximum positive grid current for anode voltage more positive than -10V		
Peak	2.5	A
Average (maximum averaging time = 20ms)	200	mA
Maximum peak positive grid current for anode voltage more negative than -10V	25	mA

Cathode

Maximum cathode current		
Peak (note 4)	80	A
Average (maximum averaging time = 15s) See page C3	6.4	A
Surge (fault protection only, maximum duration = 0.1s)	1120	A
Minimum cathode heating time	60	s
Filament voltage		
Minimum	2.3	V
Maximum	2.7	V
Ambient temperature		
Minimum	-55	°C
Maximum	+70	°C

OPERATING NOTES

1. In order to minimise gas clean up, the inverse voltage applied across the valve should be kept to a minimum during the immediate post conduction period. Therefore, the inverse voltage should not exceed 250V during the first 500 μ s after the cessation of anode current.
2. In order to prevent spurious ignition due to capacitive anode-to-grid coupling, a capacitor of approximately 1000pF should be connected between grid and cathode.
3. The anode and grid circuit returns should be made to the centre tap of the filament transformer.
4. In welding applications, a single pulse cathode current of up to 120A may be passed provided the average cathode current does not exceed 1A averaged over 1s.
5. Quadrature operation of the filament is recommended.
 When quadrature operation is used, the voltage of filament pin 2 should be crossing zero from positive towards negative when the anode voltage is at the peak of the positive half cycle.
 In three phase systems, each valve should be connected so that its anode and filament voltages approximate to quadrature phasing, i.e. filament voltage $90 \pm 30^\circ$ out of phase with the anode voltage.
 When quadrature operation is not practicable, filament pin 2 should be negative when the anode is positive.



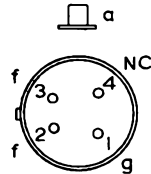
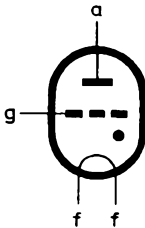
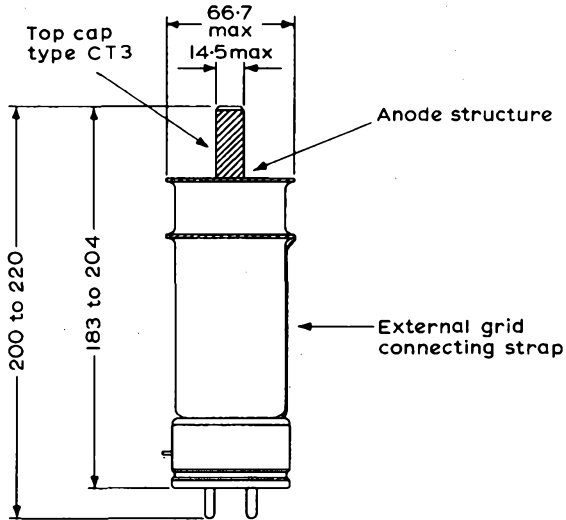

B4D Base

All dimensions in mm

The anode structure must be left free to ensure adequate cooling by free convection

Care should be taken to avoid damage to or contact with the external grid connecting strap

1013

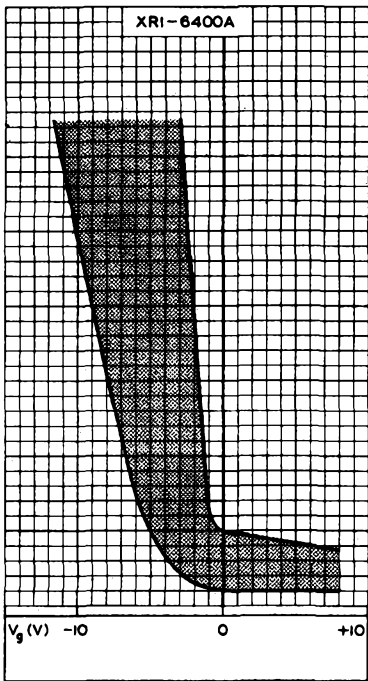

CONTROL CHARACTERISTIC

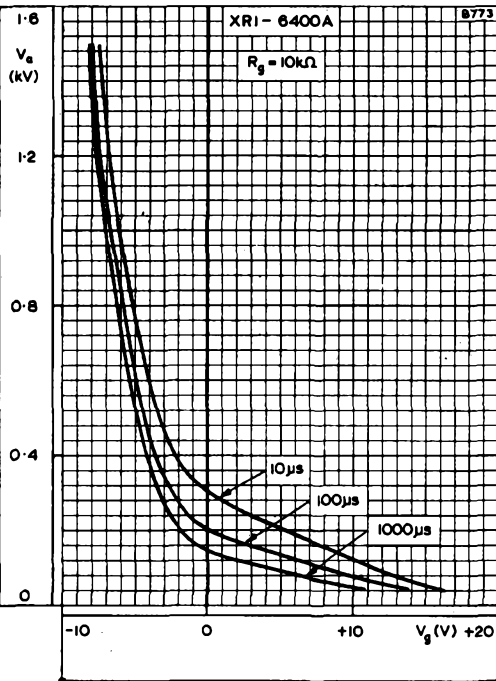

NOMINAL VARIATION BETWEEN ANODE AND GRID VOLTAGES FOR DIFFERENT IGNITION DELAY TIMES

THYRATRON

XRI-6400A



XRI-6400A

THYRATRON

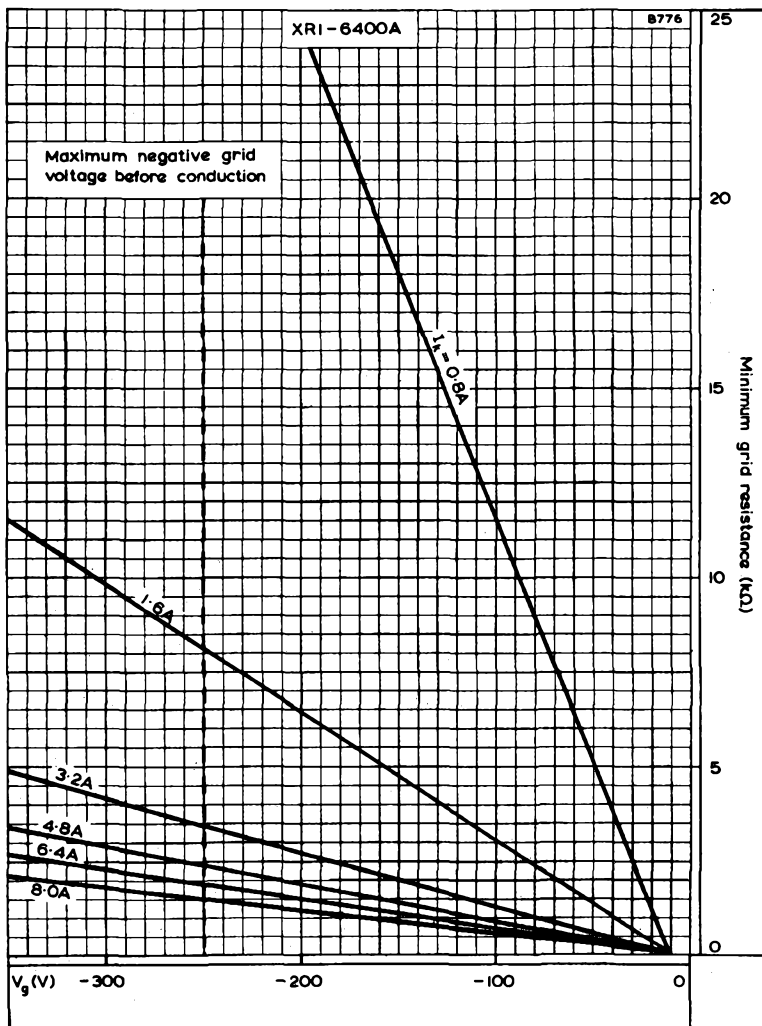

MINIMUM GRID RESISTANCE PLOTTED AGAINST NEGATIVE SUPPLY VOLTAGE WITH CATHODE CURRENT AS PARAMETER



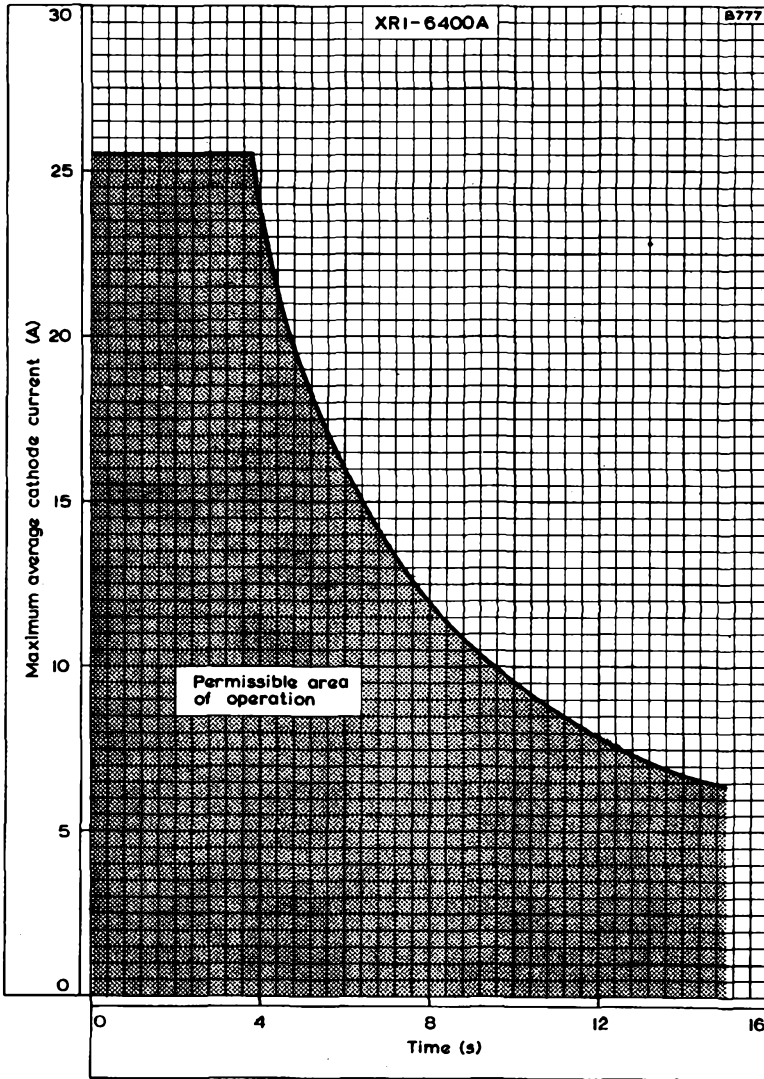

This curve shows the maximum number of seconds in any fifteen second period for which a given average current may be drawn from a sinusoidal supply.



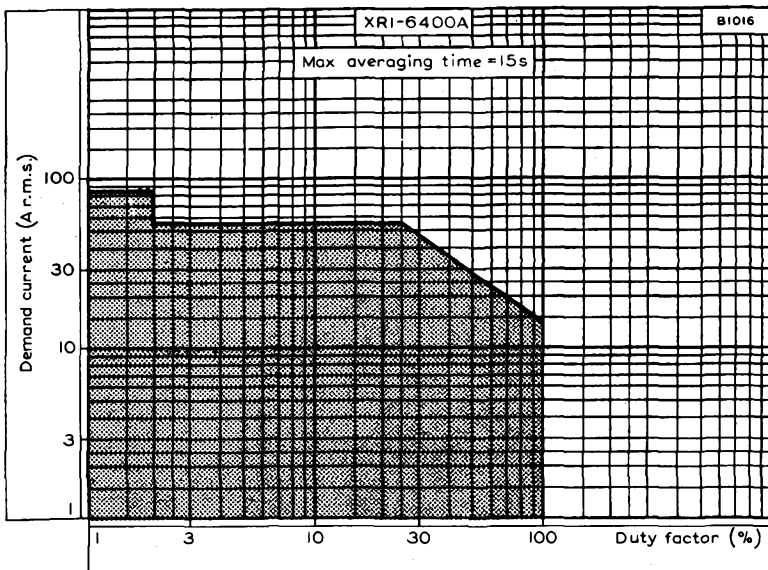

WELDER CURRENT RATING FOR TWO VALVES CONNECTED IN INVERSE PARALLEL ('Back to Back')

$$\text{Duty factor} = \frac{\text{Weld time}}{\text{Weld} + \text{'off' time}}$$

The maximum weld + 'off' time which may be considered in the calculation of the duty factor is 15s.

The current ratings in the above chart are absolute maximum ratings and must never be exceeded.

QUICK REFERENCE DATA (maximum values)

Inert gas-filled triode for power control and ignitor firing.

Peak anode voltage	1.5	kV
Cathode current		
Peak	30	A
Average	2.5	A

This data should be read in conjunction with DEFINITIONS AND GENERAL OPERATIONAL RECOMMENDATIONS—THYRATRONS, which precede this section of the handbook.

CHARACTERISTICS AND RANGE VALUES FOR EQUIPMENT DESIGN

The values given state the range over which the valve will operate. No allowance has been made in the data for supply voltage and component variations.

Anode

Peak anode operating voltage (forward and inverse)

$i_{k(av)} \leq 1.6A, i_{k(pk)} \leq 20A$	1.5	kV
$i_{k(av)} > 1.6A$	1.25	kV
Anode voltage drop (approx.)	10	V
Anode-to-grid capacitance	350	mpF
Commutation factor	10	VA/ μs^2
Ignition delay time	see page C2	

Grid

Maximum negative grid voltage

Before conduction	-300	V
During conduction	-10	V

Maximum positive grid current during the time that the anode voltage is more positive than -10V

Peak	1.25	A
Average (maximum averaging time = 20ms)	100	mA

Maximum peak positive grid current during the time that the anode voltage is more negative than -10V

	5.0	mA
--	-----	----

Grid-to-cathode capacitance

	10	pF
--	----	----

Grid resistance

Maximum	100	k Ω
Minimum	See page C3	

Recovery (deionisation) time (approx.)

$V_g = -250V$	200	μs
$V_g = -100V$	300	μs

Critical grid current at $V_a = 1.5kV$	<20	μA
--	-----	---------

ZT1011

THYRATRON

(Formerly XR1-1600A)

Cathode

Maximum cathode current (see note 1)

Peak (25c/s and above) see note 5

$V_a \leq 1.25kV$	30	A
$V_a = 1.5kV$	20	A

Average (see page C4)

Maximum averaging time = 15s, $V_a = 1.5kV$	1.6	A
Maximum averaging time = 10s, $V_a \leq 1.25kV$	2.5	A

Surge (fault protection, maximum duration, = 0.1s)
see note 3

300	A
-----	---

Minimum cathode heating time (see note 2)

$i_{k(pk)} \leq 20A$	10	s
$i_{k(pk)} > 20A$	30	s

Filament voltage (see note 5)

2.5	V
-----	---

Filament current range at 2.5V and $i_k = 0A$

7.5 to 9.5	A
------------	---

Mechanical

Type of cooling

Convection

Mounting position

Any between horizontal
and vertical with base down

Net weight (approx.)

115	g
4.1	oz

Weight of valve in carton (approx.)

275	g
9.7	oz

Nominal dimensions of carton

$3.5 \times 3.5 \times 8.5$	in
$90 \times 90 \times 125$	mm

ABSOLUTE MAXIMUM RATINGS

It is important that these ratings are never exceeded and such variations as mains fluctuations, component tolerances and switching surges must be taken into consideration in arriving at the actual valve operating conditions.

Anode

Maximum peak anode voltage (forward and inverse)

$i_{k(av)} \leq 1.6A$, $i_{k(pk)} \leq 20A$	1.5	kV
$i_{k(av)} > 1.6A$	1.25	kV

Grid

Maximum negative grid voltage

Before conduction	-300	V
During conduction	-10	V

Maximum positive grid current during the time that
the anode voltage is more positive than -10V

Peak	1.25	A
Average (maximum averaging time = 20ms)	100	mA

Maximum peak positive grid current during the time that
the anode voltage is more negative than -10V

5.0	mA
-----	----



Cathode

Maximum cathode current (see note 1)

Peak (25c/s and above) see note 5

$V_a \leq 1.25kV$	30	A
$V_a = 1.5kV$	20	A

Average (see page C4)

Maximum averaging time = 15s, $V_a = 1.5kV$	1.6	A
Maximum averaging time = 10s, $V_a \leq 1.25kV$	2.5	A

Surge (fault protection, maximum duration = 0.1s)
see note 3

300	A
-----	---

Minimum cathode heating time (see note 2)

$i_{k(pk)} \leq 20A$	10	s
$i_{k(pk)} > 20A$	30	s

Heater voltage

Minimum	2.25	V
Maximum		
($i_k > 0.5A$)	2.75	V
($i_k \leq 0.5A$)	3.0	V

Ambient temperature (see note 4)

Minimum	-55	°C
Maximum	+70	°C

OPERATING NOTES

1. The centre tap of the filament should be connected to the centre tap of the filament transformer. This connection is essential when the average current exceeds 6.4A averaged over any 1 second period. When two or more valves are used with one filament transformer, the filament centre taps must never be connected together without the further connection to the centre tap of the filament transformer.
2. Peak currents greater than 20A should not be drawn until 1 minute after the application of the filament voltage.
3. The rating applies when the filament and filament transformer centre taps are connected together. The maximum surge current must not exceed 140A, if the cathode current return is to only one of these points.
4. The anode structure must be left free to ensure cooling by free convection.
5. For operation with peak currents in excess of 20A and a mean current of less than 0.5A, such as occurs under ignitron firing service, a nominal heater voltage of 2.75V may be used. Under these conditions a maximum peak anode voltage of 1.5kV is permissible.



ZT1011

(Formerly XR1-1600A)

THYRATRON

B.591

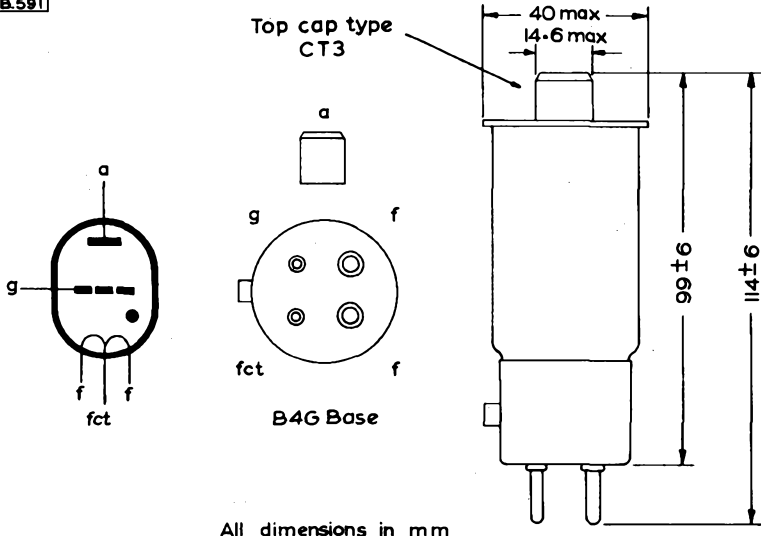

THYRATRON

ZT1011

(Formerly XR1-1600A)

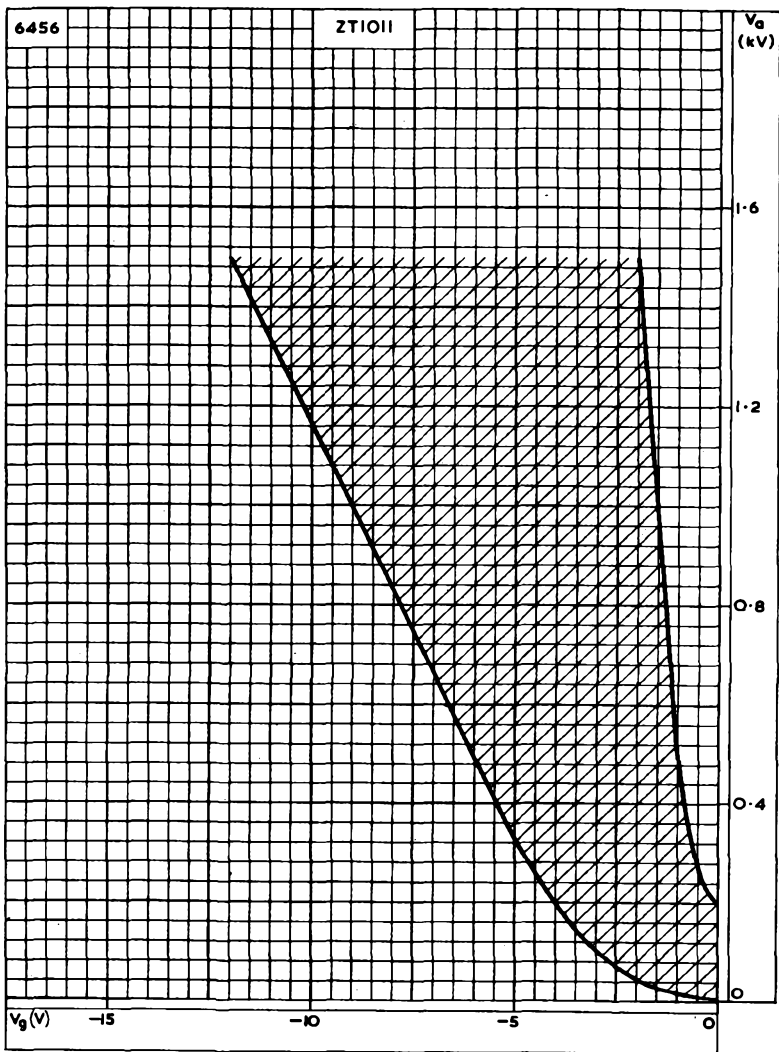

CONTROL CHARACTERISTIC



ZT1011

(Formerly XR1-1600A)

THYRATRON

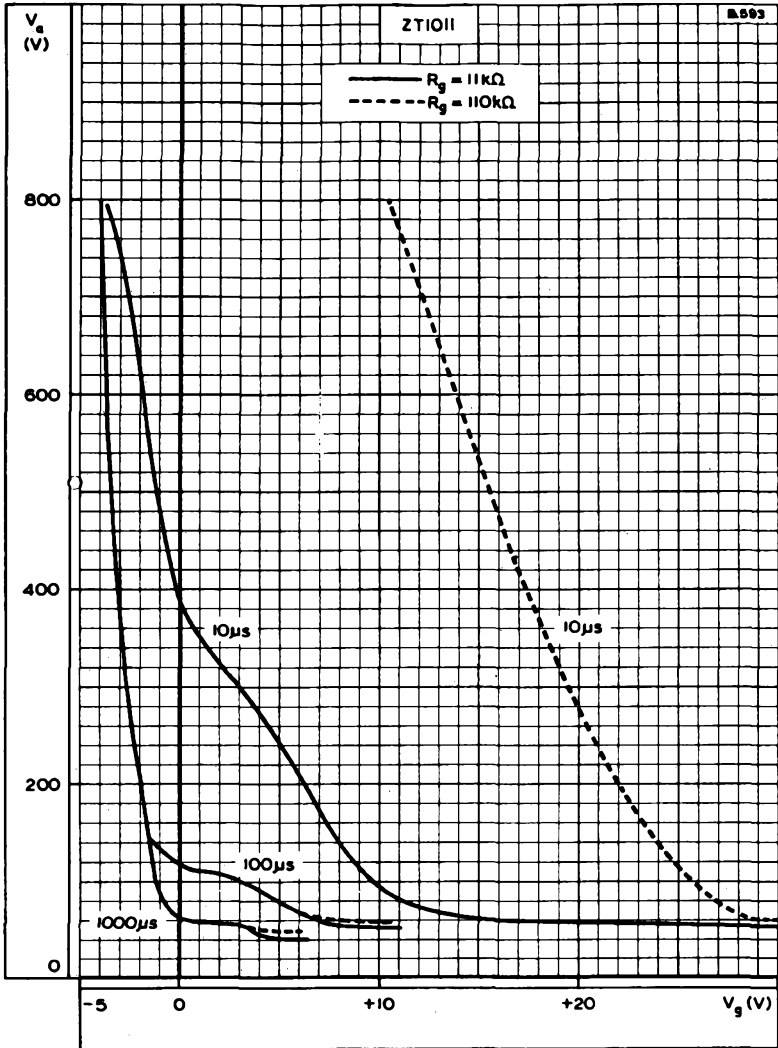

NOMINAL VARIATION BETWEEN ANODE AND GRID VOLTAGES FOR DIFFERENT IGNITION DELAY TIMES



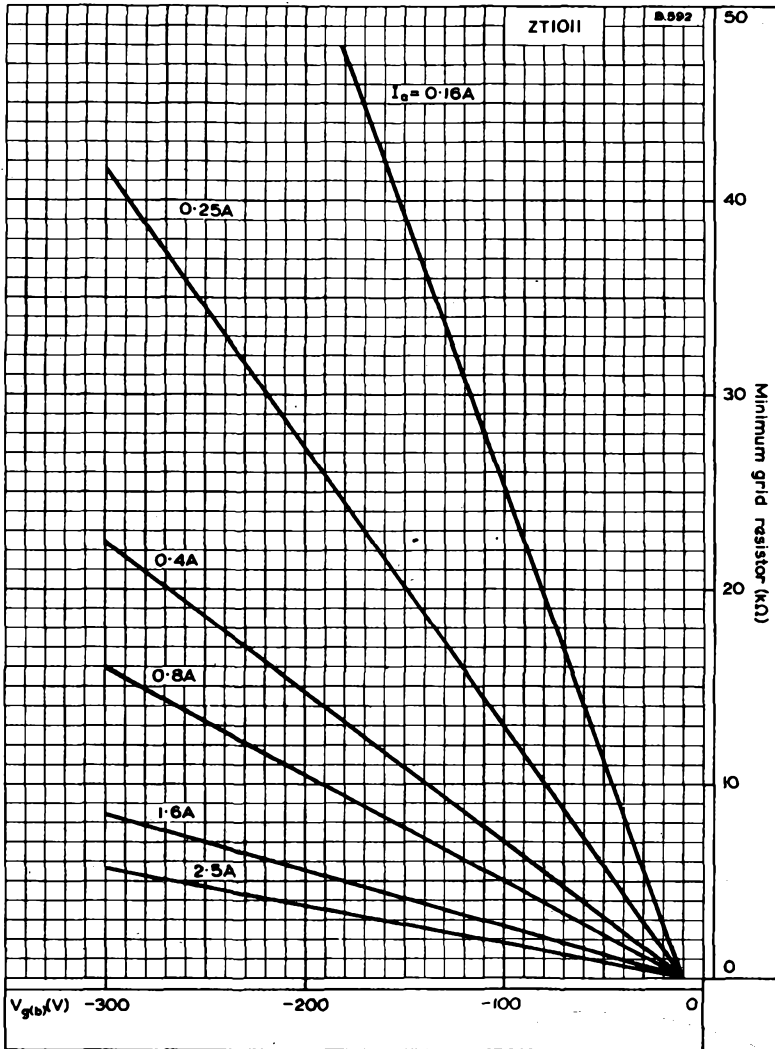

MINIMUM GRID RESISTANCE PLOTTED AGAINST NEGATIVE SUPPLY VOLTAGE WITH ANODE CURRENT AS PARAMETER



ZT1011

(Formerly XR1-1600A)

THYRATRON

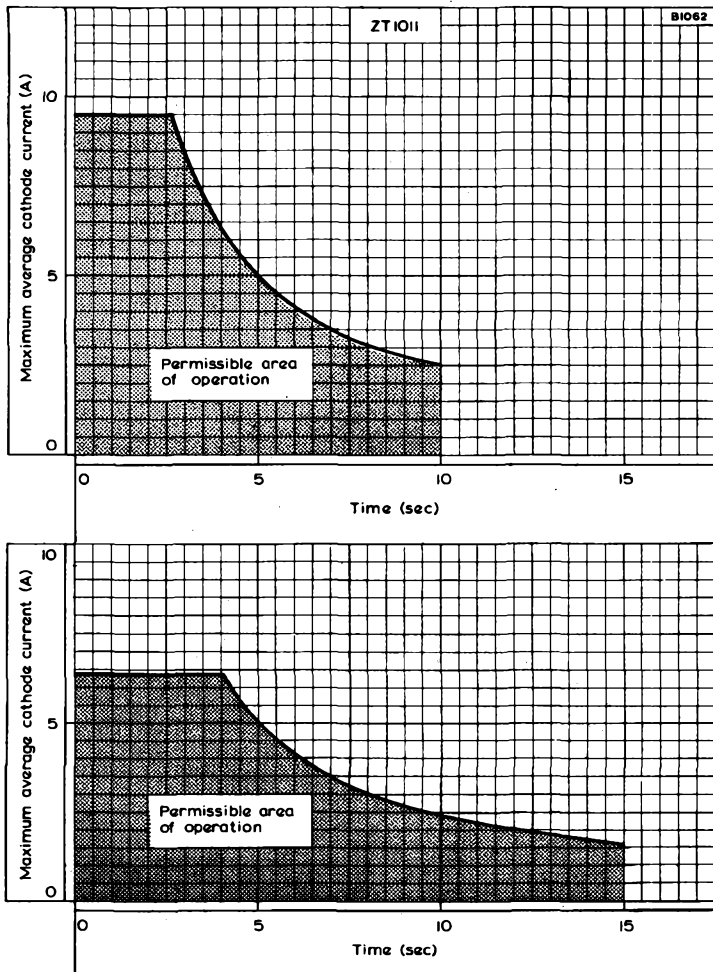

The top curve shows the maximum number of seconds in any 10 second period for which a given average current may be drawn from a sinusoidal supply if the peak voltage applied to the valve is less than 1.25kV. The bottom curve shows the maximum number of seconds in any 15 second period for which a given average current may be drawn from a sinusoidal supply if the applied peak voltage lies between 1.25 and 1.5kV.



IGNITRONS

H 

DEFINITIONS

Maximum average current

The rated maximum average anode current of an ignitron is based on full cycle conduction, regardless of whether phase control is used or not. It is the arithmetic mean current over a period not greater than the rated maximum averaging time.

Surge current

The figure given on each data sheet for maximum anode surge current is for fault protection only and is intended as a guide to equipment designers. It indicates the maximum value of current, resulting from a sudden overload or short circuit, which the ignitron will pass for a period not exceeding the time specified.

Demand current

The maximum demand current is the r.m.s. current conducted by a pair of ignitrons in inverse parallel, during a single cycle at mains frequency. For ratings purposes full cycle conduction must be assumed.

Demand kVA

The demand kVA is given by the product of demand r.m.s. current and the actual r.m.s. voltage applied to the ignitrons.

Arc voltage drop

This is the instantaneous potential difference between the anode and cathode during normal conduction.

Duty factor

The duty factor is the percentage ratio of conducting time to total time during a period not greater than the maximum averaging time. Thus a 100% duty factor specifies continuous conduction.

Maximum averaging time

A maximum averaging time is quoted for each supply voltage. This is the longest period of time during which it is permissible to compute the maximum average current.

Maximum conduction period

This is the maximum period within the maximum averaging time during which maximum demand may be conducted.

GENERAL OPERATIONAL RECOMMENDATIONS

IGNITRONS

IGNITOR CIRCUIT REQUIREMENTS

To ignite an ignitron, a current pulse of short duration and preferably fast rise time must flow through the ignitor. Ignition has a certain energy requirement which, according to the ignitor characteristic, is a function of current, voltage and time. To ensure satisfactory ignition the total ignitor circuit must be able to deliver the required peak current within $100\mu\text{s}$ from the minimum specified voltage measured on the ignitor. If the load impedance, the series resistor or the losses across the switching device do not satisfy these requirements, the ignitor may not fire and may even become seriously damaged. Under no circumstances must the ignitor voltage be allowed to fall more negative than -5V with respect to the cathode as this will cause destruction of the ignitor.

Two systems of excitation are in common use:-

Anode excitation

This form of excitation is primarily used for resistance welding applications. The ignitor is fired from the anode circuit via a current limiting resistor, two fuses, a diode and a thyristor.

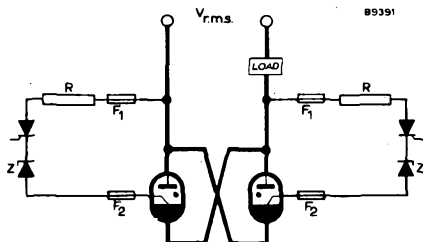

The "Min. peak ignitor voltage for ignition", must not be interpreted as the instantaneous value of mains voltage at the instant of ignition, but as the voltage measured between the ignitor lead-in and cathode. The values of the resistors in the ignition circuit and the level of supply voltage should be chosen so that the prescribed value of voltage is applied to the ignitor.

Recommended values of R are given in the data sheets. Deviations from these recommended values may impair the performance of the tube.

To ensure a short and reproducible delay between the firing of the ignitor and anode take-over, the rate of rise of ignition current must be sufficiently high. The rate of rise of current is mainly determined by the reactance of the load and at high load reactances it may be too small for proper ignition. In such circumstances separate excitation can be successfully used.

Separate excitation

Separate excitation enables the ignitor to be fired independently of anode circuit conditions. By this means it is possible to control a.c. circuits of lower voltages than is possible with anode excitation. It is also possible to control inductive loads, where the low power factor would preclude satisfactory anode excitation. Separate excitation is also necessary when ignitrons are used as rectifiers. In practice a capacitor is discharged into the ignitor via a thyristor and an inductor as in the diagram.

It is inadvisable to operate separate excitation in the absence of anode supply voltage.

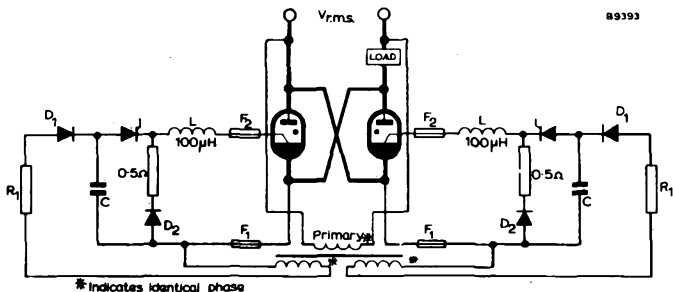

Note:

In each circuit two fuses are recommended; F₁ safeguards the ignition circuit, F₂ is connected directly in series with the ignitor, protecting it against shorting between the main anode and ignition circuits or earth faults.

The ignitor must be connected to its control circuit by a screened lead which affords protection against r.f. fields.

The thyristor or combination of thyristor and voltage regulator diode may be replaced by a thyatron.

AUXILIARY ANODE CIRCUIT

When a rectifier feeds a load which generates a back e.m.f., the available voltage between the main anode and cathode will often be insufficient to ensure takeover of the arc discharge when the tube is fired. Moreover, if the ignitron anode current is too small, the main discharge may cease prematurely.

For this reason ignitrons designed for use in rectifying equipment are provided with an auxiliary anode which maintains the arc discharge during the period when the main anode voltage falls below the minimum value necessary for continued conduction of the tube. The auxiliary anode should be connected to a low voltage a.c. source so that auxiliary anode current flows throughout tube conduction.

MAIN CIRCUIT

When the main discharge of an ignitron is interrupted voltage transients are produced in the transformer primary due to its self-inductance, which may puncture the insulation of the transformer.

In resistance welding circuits the transients may be reduced by a damping resistor mounted across the transformer primary terminals. The values of the current drawn by this resistor are determined by the duty factor of the machine.

In rectifier circuits damping is obtained by a series R.C. circuit shunted across the transformer primary.

Cathode or anode breakers are usually required in addition to the supply switches, particularly when a back e.m.f. is present.

RATINGS FOR RESISTANCE WELDING

In all cases these ratings are based on full cycle conduction of each half-cycle. No uprating is permissible when phase-shift control of conduction is used.

Demand kVA

The maximum demand kVA which may be obtained from a pair of ignitrons, connected in inverse parallel, is shown plotted against maximum average current per tube. It will be seen that max. kVA demand is constant up to the maximum average current per tube value, after which it diminishes to a point where it intersects the maximum average current ordinate, at the absolute maximum average current value.

Demand current

The maximum demand current varies with the supply voltage being used, and is plotted for voltages of 250, 440 and 500V against duty factor. Since 100% duty factor is actually the maximum averaging time, this is shown for each value of supply voltage. The maximum demand current refers to two tubes connected in inverse parallel.

RATINGS FOR FREQUENCY CHANGING DUTY

These ratings are given showing the relationship between maximum peak anode current per tube where the tube is suitable for this application. Curves are given for several anode voltages.



RATINGS FOR RECTIFIER DUTY

A curve is given showing the relationship between maximum peak anode current and maximum average current per tube and for several peak inverse voltages.

COOLING

The cooling water must satisfy the following requirements as regards the content of solids and soluble chemicals:

1. pH 7 to 9
2. Max. concentration of chlorides 15mg/l
Max. concentration of nitrates 25mg/l
Max. concentration of sulphates 25mg/l
Max. concentration of insoluble solids 25mg/l
3. Max. total hardness: 10 German degrees, 18 French degrees,
12.5 English degrees, 10.5 U.S. degrees.
4. Min. specific resistance 2000Ωcm.

In most cases tap-water will satisfy these requirements. If the water locally available is unsuitable a system of cooling employing a heat exchanger with sufficient suitable water in circulation can alternatively be used.

The temperature of the cooling water should be at least 10°C.

The water-hoses must be of electrically insulating material and should be connected to the ignitrons so that the water enters the water jacket at the bottom and leaves it at the top. Up to 3 tubes may be cooled in series. The hoses should have a length of at least 50cm in order to ensure that the electrical resistance of the internal water column is sufficiently high. They should be fixed by means of clamps to the hose nipples, care being taken that no leakage can occur. The water must be allowed to flow freely from the last tube into a funnel, which enables the water flow to be easily checked and prevents the water pressure in the jackets from becoming excessive. The water pressure in the tube jackets should never exceed 3.5atm (50 pounds/square inch).

The water jackets of ignitrons are normally connected to the mains and thus have mains potential to earth. When thermostatic switches are used they must therefore be capable of withstanding this operating voltage. Should the thermostat not be rated for mains voltages an isolating step-down transformer can be used to protect it from damage.

The tubes should not be put into operation until all air is removed from the cooling system and filling completed. This is indicated by water flowing from the outlet pipe on the last tube.

The cooling system should be installed so that the water jackets are not emptied by the water flowing or syphoning away. As an aid to ensuring that the tubes have been correctly installed a useful test is to momentarily close the stop valve after filling and check that after a brief interval the outflow of water ceases. A continuous flow of water when the stop valve is closed is evidence of faulty installation and may result in the tubes being completely drained when the equipment is finally shut down. When recommencing operations, unless an interval is allowed for refilling, this may endanger the tubes.

Important note

In the ignitron data, ratings are given for the required waterflow as a function of the average tube current and water inlet temperature. It is often more economical to use continuous water cooling according to the reduced cooling ratings rather than a water saving thermostat and solenoid valve. This enables a more constant tube temperature to be obtained which, moreover, improves the life expectancy of the tube.

IGNITRON PROTECTION

Care must be taken to ensure that the prescribed temperature limits of ignitrons are never exceeded. When the tubes are cooled with tap water the temperature of which remains within the rated limits, it is generally sufficient to ensure that an adequate quantity of water flows through the jacket. To prevent the temperature of the tubes becoming excessive in the event of a failure of the water supply, e.g. stopped-up or defective hoses, insufficient pressure of the water mains, accidentally closed main cock etc. a protective thermostat should be used. If the temperature limit set by the protective thermostat is exceeded, either the ignition circuits of the ignitrons are interrupted or the main circuit breaker is tripped by means of a relay. The protective thermostat, which should be mounted on the last tube of a series, should not actuate its relay under normal operating conditions.

In three phase welding service using 6 tubes it is recommended that not more than 3 tubes are connected hydraulically in series for cooling purposes. When ignitrons are used for heavy power switching at a high duty factor the internal tube temperature rises very rapidly. Under such conditions it is advisable for the cooling water to circulate through the jackets as soon as the master switch is closed.

Note.

When ignitrons are used as rectifiers with the cathode not at earth potential, an electrolytic erosion target connected to the metal envelope may be used to avoid corrosion of tube parts.

SWITCHING

Before firing and during operation the anode and lead-in insulator should always be at a higher temperature than the cooling water. If necessary, a suitable heating device can be used to maintain the required temperature difference.



Care must be taken not to touch live parts, such as the water jackets which are at full line voltage. Some ignitron types have a plastic-coated water jacket which can withstand voltages up to 3kV. With this type water condensation on the jacket is kept to a minimum under conditions of high humidity and low cooling water temperature. The uncoated tube parts are at full line voltage.

To prevent mercury from re-condensing on the anode and the anode insulator when the installation is switched off, the cooling water should be allowed to flow through the tubes so that all internal parts are evenly cooled down; this normally takes from 15 to 30 minutes.

Incompletely cooled tubes must always be kept with the anode connection uppermost.

Mercury may also condense on the anode insulator as a result of cold air draught in the vicinity of the tube. It is then necessary either to prevent the occurrence of the air flow or to ensure that the anode and anode insulator are not cooled down to a temperature below that of the cooling water.

SPARE IGNITRONS

In order to have some tubes available in a ready-for-use condition it is advisable to place an adequate number of tubes with the anodes uppermost under a lighted incandescent lamp. The heat produced by the lamp is sufficient to remove any mercury deposits on the anode insulator.

MECHANICAL REQUIREMENTS

All ignitrons should be supported by the cathode connection, vertically to within $\pm 3^\circ$ with the anode uppermost. The bolts used should be of mild steel to ensure that the current passes mainly through the contact surfaces and not through the bolt.

The ignitron should not be subjected to strong r.f. or magnetic fields.

Ignitrons should always be transported or handled in an upright position since otherwise particles of mercury could be trapped on or adjacent to the anode, and when put into service this could cause the tube to arc back. Should an ignitron be changed from a vertical position to the horizontal or anode down position, there is the possibility that the mercury will flow rapidly into the anode insulator, and damage it.

INSTALLATION

When an ignitron is installed, or if the tube has not been in a vertical position, it is recommended that the anode of the tube is gently heated for 30 minutes using a 250W infra-red lamp. During this period cooling water should flow.

The anode lead should be clamped so that no undue strain is imposed on the anode insulator. The equipment should be as free from vibration as possible since turbulence of the mercury cathode could cause unreliable operation.



QUICK REFERENCE DATA

Water-cooled ignitron primarily intended for resistance welding and a.c. control applications. The tube has a plastic coated stainless steel water jacket.

International size	B	
Maximum demand power (two tubes in inverse parallel)	600	kVA
Maximum average current	56	A
Minimum ignitor requirements to fire all tubes		
Peak voltage	150	V
Peak current	12	A

CHARACTERISTICS AND RANGE VALUES FOR EQUIPMENT DESIGN

The values in each section state the range over which the tube will operate. No allowance has been made in the data for supply voltage and component variations. The values given apply to all tubes, both initially and during life, with the specified cooling conditions.

Anode and Cathode

See under sections listed in "Full Load Operating Conditions":-

1. Single phase welding service and A.C. control
 - a. Maximum demand power
 - b. Maximum average current
2. Intermittent rectifier or three phase frequency changer resistance welding service.

Arc voltage drop

See graph, page 9

Ignitor

See section "Ignitor characteristics, etc."

FULL LOAD OPERATING CONDITIONS

The figures given in the data are based on full cycle conduction, with equally distributed load on all ignitrons, regardless of whether or not phase delayed firing is used. The load must be limited so that at zero phase delay no overload will result. No allowance has been made for supply voltage or component variations.

SINGLE PHASE WELDING SERVICE AND A.C. CONTROL. Supply frequency 50Hz, two tubes in inverse parallel connection (see graph on page 10)

A. Maximum demand power

Supply voltage (r. m. s.)	220	250	380	440	500	600	V
Max. demand power	530	600	600	600	600	600	kVA
Max. average current per tube	30.2	30.2	30.2	30.2	30.2	30.2	A
Max. r. m. s. demand current	2.4	2.4	1.6	1.4	1.2	1.0	kA
Max. averaging time	18	18	11.8	10.4	9.0	7.5	s
Duty factor	2.8	2.8	4.2	4.8	5.6	6.7	%
Max. number of cycles in max. averaging time	25	25	25	25	25	25	
Integrated r. m. s. load current	400	400	320	310	280	260	A

B. Maximum average current

Supply voltage (r. m. s.)	220	250	380	440	500	600	V
Max. average current per tube	56	56	56	56	56	56	A
Max. demand power	180	200	200	200	200	200	kVA
Max. r. m. s. demand current	800	800	530	450	400	330	A
Max. averaging time	18	18	11.8	10.4	9.0	7.5	s
Duty factor	15.6	15.6	23.5	26	31.1	37.7	%
Max. number of cycles in max. averaging time	140	140	140	140	140	140	
Integrated r. m. s. load current	320	320	260	230	220	200	A
Max. surge current for max. 0.15s	6.7	6.7	4.5	3.8	3.4	2.8	kA

Notes

1. For supply voltages less than 250V r.m.s., the values of maximum demand current and maximum averaging time at 250V r.m.s. must not be exceeded.
2. The "maximum number of cycles in the maximum averaging time" is the maximum integrated number of cycles that a pair of tubes may conduct, with or without interruption, during the maximum averaging time.

Max. no. of cycles = Duty factor × Max. averaging time × Supply frequency

INTERMITTENT RECTIFIER OR THREE PHASE FREQUENCY CHANGER RESISTANCE WELDING SERVICE. Supply frequency 50Hz (see graph page 11)

Max. peak voltage (forward and inverse)	1.2	1.5	kV
For use at max. peak current			
Max. peak current	600	480	A
Max. average current	5.0	4.0	A
For use at max. average current			
Max. peak current	135	108	A
Max. average current	22.5	18	A
Max. averaging time	10	10	s
Max. value of the ratio of average current to peak current (averaging time = 0.5s)	0.17	0.17	
Max. value of the ratio of surge current to peak current (averaging time = 150ms)	12.5	12.5	



IGNITOR CHARACTERISTICS, RATINGS AND IGNITION CIRCUITS

Ignitor characteristics

Minimum voltage required for ignition (all tubes)	150	V
Minimum current required for ignition (all tubes)	12	A
Typical current required for ignition	6 to 8	A
Minimum period of application of voltage or current	50	μ s

Ignitor ratings (Absolute maximum system)

Maximum peak positive voltage	2.0	kV
Maximum peak negative voltage (including any transients)	5.0	V
Maximum peak forward current	100	A
Maximum peak inverse current	zero	A
Maximum r.m.s. forward current	10	A
Maximum average forward current for maximum averaging time of 5 seconds	1.0	A

Anode excitation circuit requirements

For recommended circuit using two thyristors see figure 1, or for one common thyristor see figure 2.

Minimum peak ignitor voltage for ignition	200	V
Minimum peak ignitor current for ignition	12	A
Minimum rate of rise of ignitor current	0.1	A/ μ s

V r.m.s.	220	250	380	440	500	600	V
R	2	2	4	4.7	5	6	Ω
F ₁	2A fast response time fuse						
F ₂	10A fast response time fuse						
Z	Silicon voltage regulator diode. Zener voltage \geq 18V						

Separate excitation circuit requirements

For recommended circuit see figure 3.

Capacitor (C)	2.0	8.0	μ F
Capacitor voltage (\pm 10%)	650	400	V
Peak value of closed circuit current	80 to 100		A
Maximum ohmic resistance of series inductance (L)	0.2		Ω

NOTE

In each circuit the thyristor or combination of thyristor and voltage regulator diode may be replaced by a thyatron.

The issue of the information contained in this publication does not imply any authority or licence for the utilisation of any patented feature.

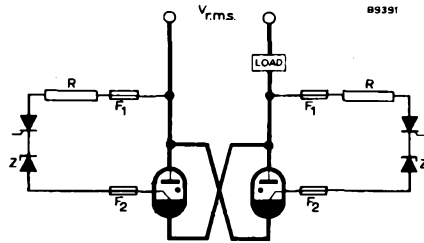

Figure 1:- Anode excitation (two thyristors)

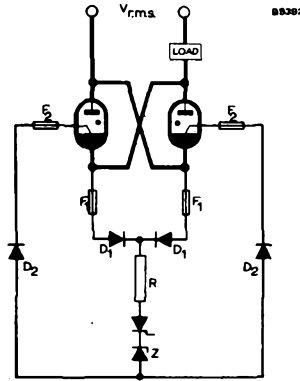

Figure 2:- Anode excitation (Common thyristor)

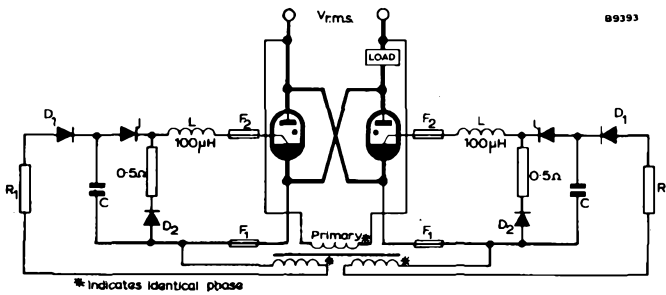

Figure 3:- Separate excitation

MOUNTING POSITION

The ignitron should be mounted within 3° of vertical, anode uppermost, and supported by the cathode lug only. It should not be subjected to vibration or the influence of magnetic or radio frequency fields.

When connecting the anode lead, care should be taken not to stress the anode insulator.

COOLING

Characteristics at flow of 2 litres/min

Typical maximum pressure drop	0.08	kg/cm ²	←
	1.13	lb/in ²	
Typical maximum temperature rise at maximum average current	6.0	°C	

A.C. control service ratings (Absolute maximum system)

Minimum water flow at maximum average current (see graph on page 9)	2.0	l/min ←
Minimum inlet temperature (see note 1)	10	°C
Maximum inlet temperature (see note 1)	40	°C
Maximum temperature at the thermostat plate (see note 2)	50	°C

Intermittent rectifier or three-phase welding service ratings (Absolute maximum system)

Minimum water flow at maximum average current (see graph page 9)	2.0	l/min ←
Minimum inlet temperature (see note 1)	10	°C
Maximum inlet temperature (see note 1)	35	°C
Maximum temperature at the thermostat plate (see note 2)	45	°C

NOTES

1. When the cooling systems of two or three tubes are connected in series, the minimum inlet temperature applies to the coldest tube and the maximum inlet temperature applies to the hottest tube.

The protective thermostat should be mounted on the hottest tube and the water economy thermostat on the tube immediately preceding the hottest tube.

In three phase welding service using six tubes, not more than three tubes should be cooled in series.

Hoses should be of insulating material and the minimum length between tube and tube, or between tube and earth, should be 500mm.

2. The thermostat plate is at the supply voltage.
3. The main casing of the ignitron is made from stainless steel, but care should be taken not to use water with a high mineral content.

WEIGHT

Net weight (approx.)	1.42	kg
Weight of tube in carton (approx.)	2.04	kg

ACCESSORIES

Water economy thermostat assembly	55305
Water failure or overload protective thermostat assembly	55306
Ignitor connector lead	55351
Water hose connections	
nipple	TE1051C
nut	TE1051B

OUTLINE DRAWING
OF ZX1051

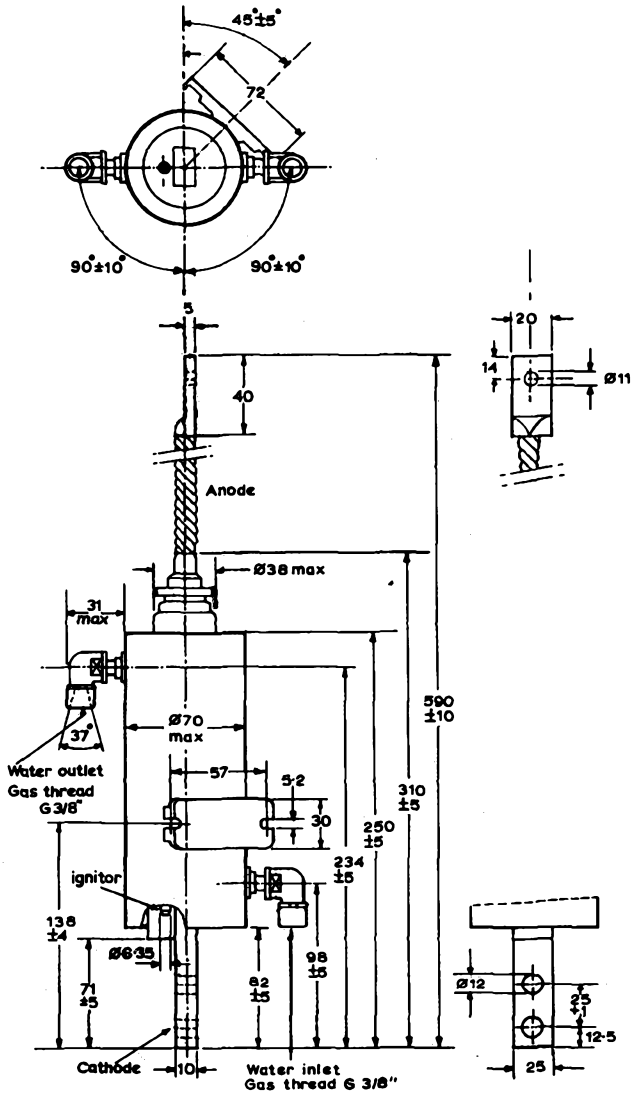

All dimensions in mm

D1784

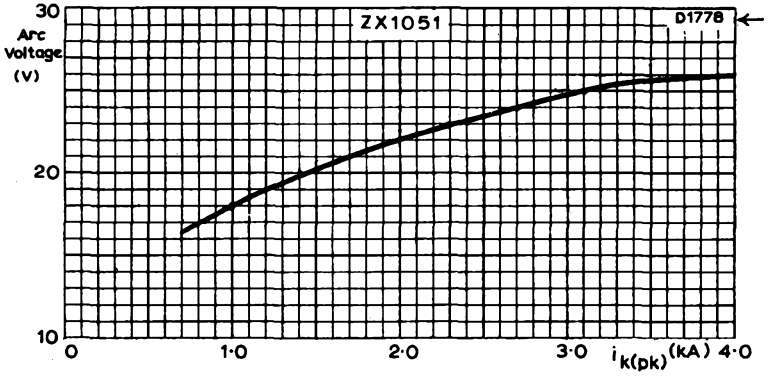

TYPICAL ARC VOLTAGE PLOTTED AGAINST CATHODE CURRENT

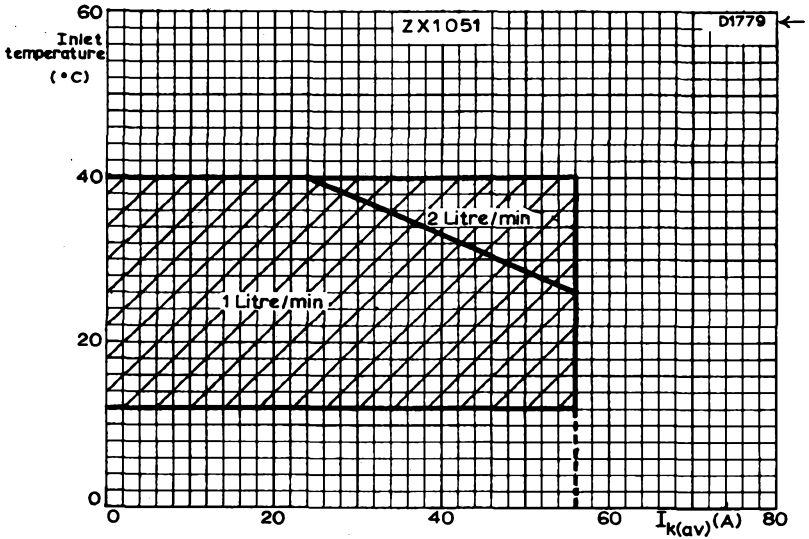

MINIMUM REQUIRED CONTINUOUS WATERFLOW
(TWO TUBES COOLED IN SERIES)



GRAPH RELATING DEMAND CURRENT WITH DUTY FACTOR AS A
FUNCTION OF THE MAINS VOLTAGE. WELDING SERVICE ONLY

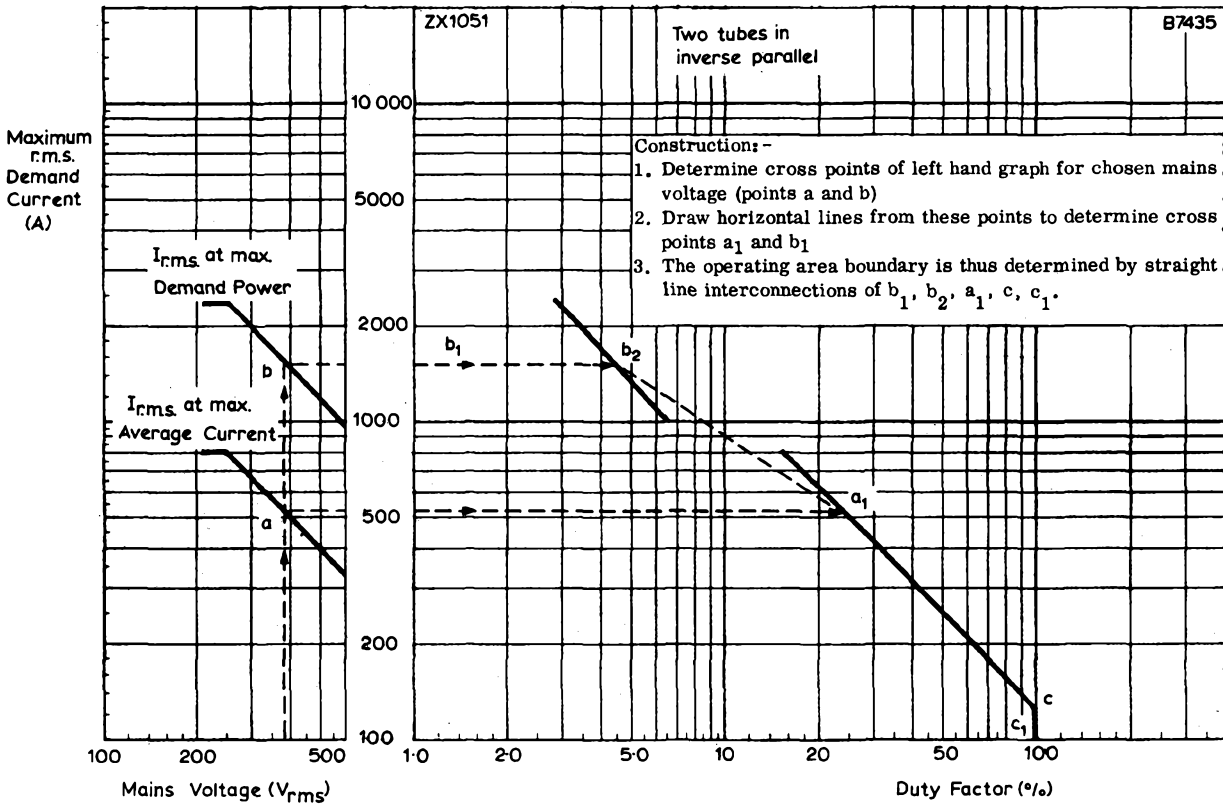

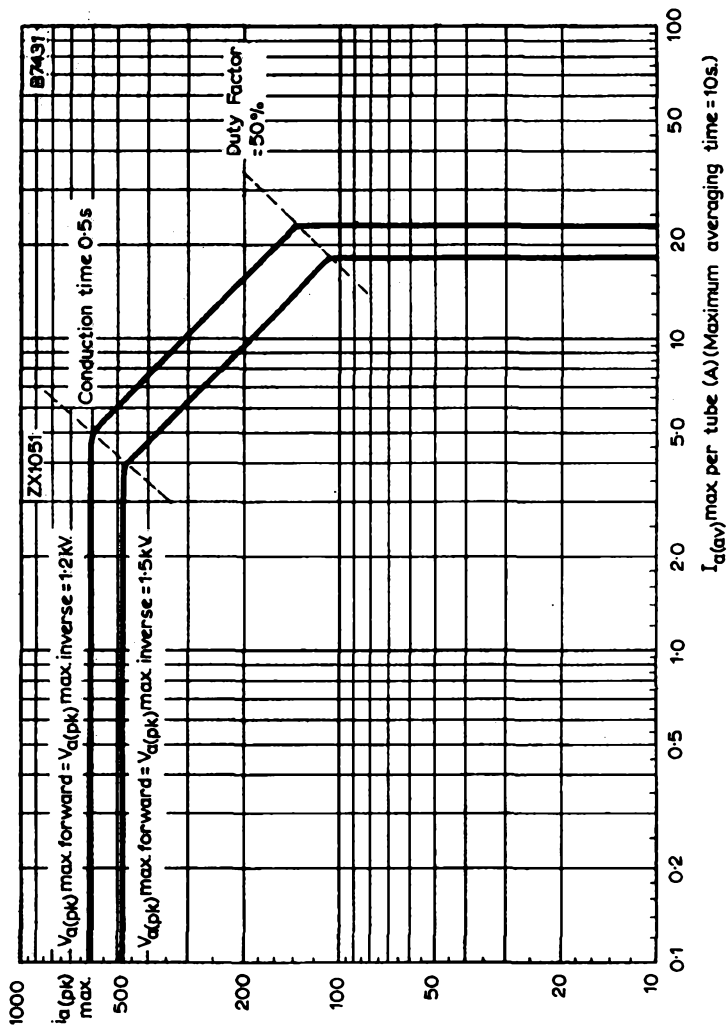

MAXIMUM PEAK ANODE CURRENT PLOTTED AGAINST AVERAGE ANODE CURRENT, INTERMITTENT RECTIFIER SERVICE

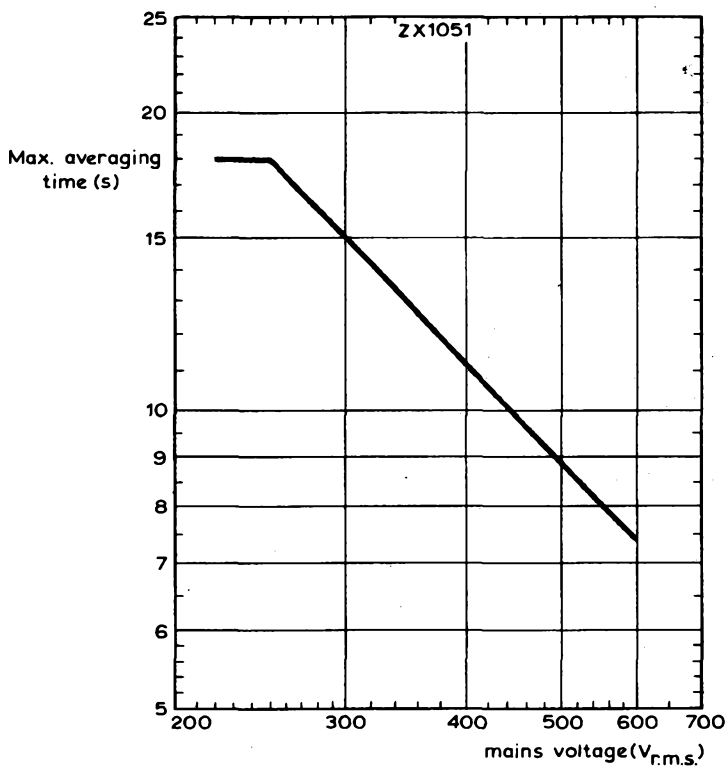

MAXIMUM AVERAGING TIME PLOTTED AGAINST MAINS VOLTAGE

QUICK REFERENCE DATA

Water-cooled ignitron primarily intended for resistance welding and a.c. control applications. The tube has a plastic coated stainless steel water jacket.

International size	C	
Maximum demand power (two tubes in inverse parallel)	1200	kVA
Maximum average current	140	A
Minimum ignitor requirements to fire all tubes		
Peak voltage	150	V
Peak current	12	A

CHARACTERISTICS AND RANGE VALUES FOR EQUIPMENT DESIGN

The values in each section state the range over which the tube will operate. No allowance has been made in the data for supply voltage and component variations. The values given apply to all tubes, both initially and during life, with the specified cooling conditions.

Anode and Cathode

See under sections listed in "Full Load Operating Conditions":-

- Single phase welding service and A.C. control
- a. Maximum demand power
- b. Maximum average current

Arc voltage drop

See graph, page 7

Ignitor

See section "Ignitor characteristics, etc."

FULL LOAD OPERATING CONDITIONS

The figures given in the data are based on full cycle conduction, with equally distributed load on all ignitrons, regardless of whether or not phase delayed firing is used. The load must be limited so that at zero phase delay no overload will result. No allowance has been made for supply voltage or component variations.

SINGLE PHASE WELDING SERVICE AND A.C. CONTROL. Supply frequency 50Hz, two tubes in inverse parallel connection (see graph on page 8)

A. Maximum demand power

Supply voltage (r.m.s.)	220	250	380	440	500	600	V
Max. demand power	1060	1200	1200	1200	1200	1200	kVA
Max. average current per tube	75.6	75.6	75.6	75.6	75.6	75.6	A
Max. r.m.s. demand current	4.8	4.8	3.15	2.92	2.4	2.0	kA
Max. averaging time	14	14	9.4	8.0	7.0	5.8	s
Duty factor	3.5	3.5	5.3	6.2	7.0	8.4	%
Max. number of cycles in max. averaging time	25	25	25	25	25	25	
Integrated r.m.s. load current	900	900	720	670	630	580	A

B. Maximum average current

Supply voltage (r.m.s.)	220	250	380	440	500	600	V
Max. average current per tube	140	140	140	140	140	140	A
Max. demand power	350	400	400	400	400	400	kVA
Max. r.m.s. demand current	1600	1600	1050	910	800	660	A
Max. averaging time	14	14	9.4	8.0	7.0	5.8	s
Duty factor	19.4	19.4	29.5	34.0	39.0	47.0	%
Max. number of cycles in max. averaging time	140	140	140	140	140	140	
Integrated r.m.s. load current	700	700	570	530	500	450	A
Max. surge current for max. 0.15s	13.5	13.5	9.0	7.7	6.7	5.7	kA

Notes

1. For supply voltages less than 250V r.m.s., the values of maximum demand current and maximum averaging time at 250V r.m.s. must not be exceeded.
2. The "maximum number of cycles in the maximum averaging time" is the maximum integrated number of cycles that a pair of tubes may conduct, with or without interruption, during the maximum averaging time.

Max. no. of cycles = Duty factor \times Max. averaging time \times Supply frequency

IGNITOR CHARACTERISTICS, RATINGS AND IGNITION CIRCUITS

Ignitor characteristics

Minimum voltage required for ignition (all tubes)	150	V
Minimum current required for ignition (all tubes)	12	A
Typical current required for ignition	6 to 8	A
Minimum period of application of voltage or current	50	μ s

Ignitor ratings (Absolute maximum system)

Maximum peak positive voltage	2.0	kV
Maximum peak negative voltage (including any transients)	5.0	V
Maximum peak forward current	100	A
Maximum peak inverse current	zero	A
Maximum r.m.s. forward current	10	A
Maximum average forward current for maximum averaging time of 5 seconds	1.0	A

Anode excitation circuit requirements

For recommended circuit using two thyristors see figure 1, or for one common thyristor see figure 2.

Minimum peak ignitor voltage for ignition	200	V
Minimum peak ignitor current for ignition	12	A
Minimum rate of rise of ignitor current	0.1	A/ μ s

V	220	250	380	440	500	600	V
R	2	2	4	4.7	5	6	Ω
F ₁	2A fast response time fuse						
F ₂	10A fast response time fuse						
Z	Silicon voltage regulator diode. Zener voltage \geq 18V						

Separate excitation circuit requirements

For recommended circuit see figure 3.

Capacitor (C)	2.0	8.0	μ F
Capacitor voltage (\pm 10%)	650	400	V
Peak value of closed circuit current	80 to 100		A
Maximum ohmic resistance of series inductance (L)	0.2		Ω

The issue of the information contained in this publication does not imply any authority or licence for the utilisation of any patented feature.

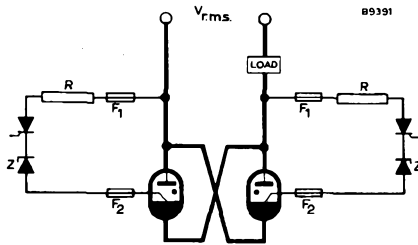

Fig. 1: Anode excitation (Two thyristors)

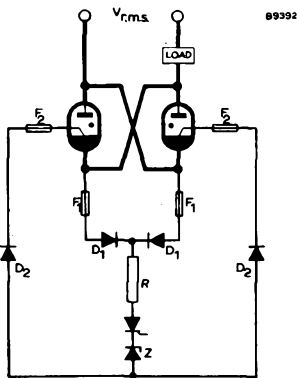

Fig. 2. Anode excitation (Common thyristor)

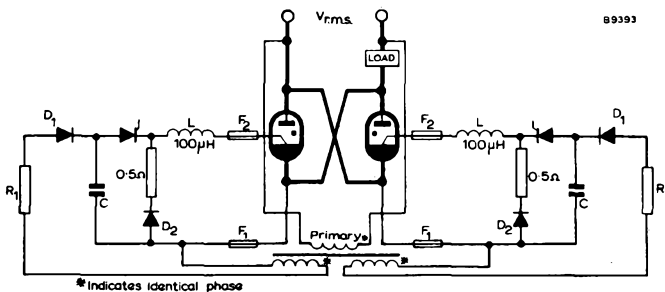

Fig. 3: Separate excitation

NOTE

In each circuit the thyristor or combination of thyristor and voltage regulator diode may be replaced by a thyatron.

MOUNTING POSITION

The ignitron should be mounted within 3° of vertical, anode uppermost, and supported by the cathode lug only. It should not be subjected to vibration or the influence of magnetic or radio frequency fields.

When connecting the anode lead, care should be taken not to stress the anode insulator.

COOLING

Characteristics at flow of 5 litres/min

Typical maximum pressure drop	0.16	kg/cm ²
	2.2	lb/in ²
Typical maximum temperature rise at maximum average current	6.0	°C

A. C. control service ratings (Absolute maximum system)

Minimum water flow at maximum average current (see graph on page 7)	5.0	l/min
Minimum inlet temperature (see note 1)	10	°C
Maximum inlet temperature (see note 1)	40	°C
Maximum temperature at the thermostat plate (see note 2)	50	°C

NOTES

1. When the cooling systems of two or three tubes are connected in series, the minimum inlet temperature applies to the coldest tube and the maximum inlet temperature applies to the hottest tube.

The protective thermostat should be mounted on the hottest tube and the water economy thermostat on the tube immediately preceding the hottest tube.

In three phase welding service using six tubes, not more than three tubes should be cooled in series.

Hoses should be of insulating material and the minimum length between tube and tube, or between tube and earth, should be 500mm.

2. The thermostat plate is at the supply voltage.
3. The main casing of the ignitron is made from stainless steel, but care should be taken not to use water with a high mineral content.

WEIGHT

Net weight (approx.)	2.82	kg
Weight of tube in carton (approx.)	4.08	kg

ACCESSORIES

Water economy thermostat assembly	55305
Water failure or overload protective thermostat assembly	55306
Ignitor connector lead	55351
Water hose connections	
nipple	TE1051C
nut	TE1051B

OUTLINE DRAWING OF ZX1052

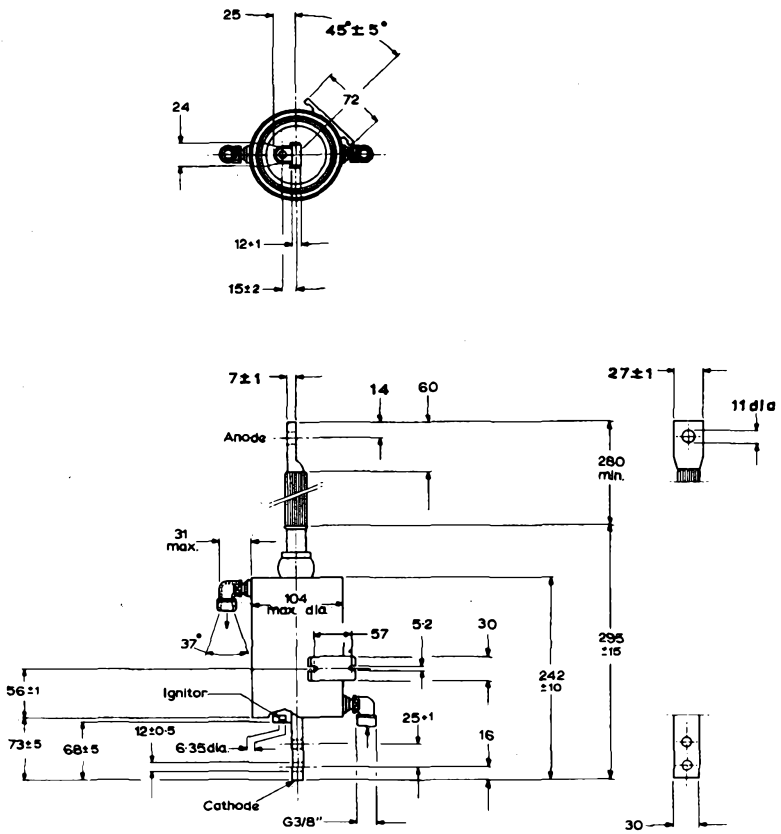

All dimensions in mm

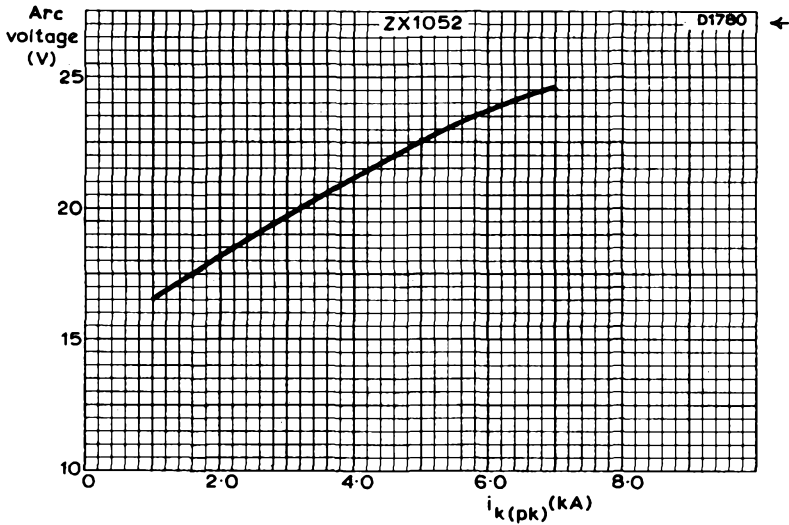

TYPICAL ARC VOLTAGE PLOTTED AGAINST CATHODE CURRENT

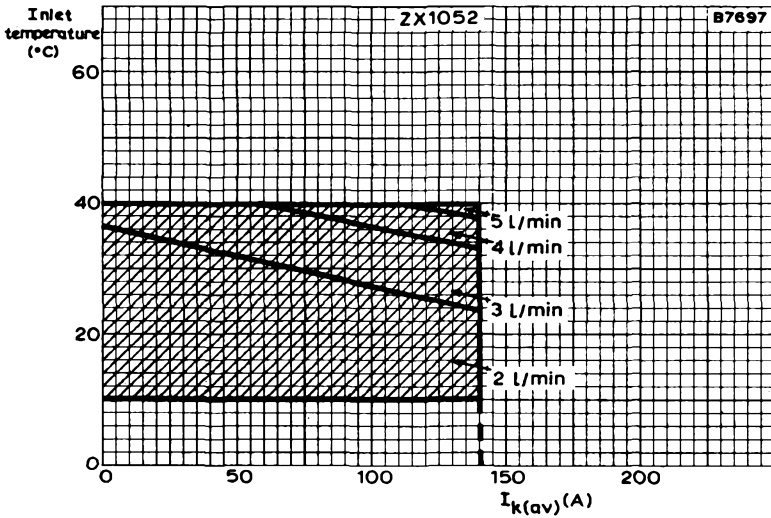

MINIMUM REQUIRED CONTINUOUS WATERFLOW
(TWO TUBES COOLED IN SERIES)

GRAPH RELATING DEMAND CURRENT WITH DUTY FACTOR AS A FUNCTION OF THE MAINS VOLTAGE, WELDING SERVICE ONLY

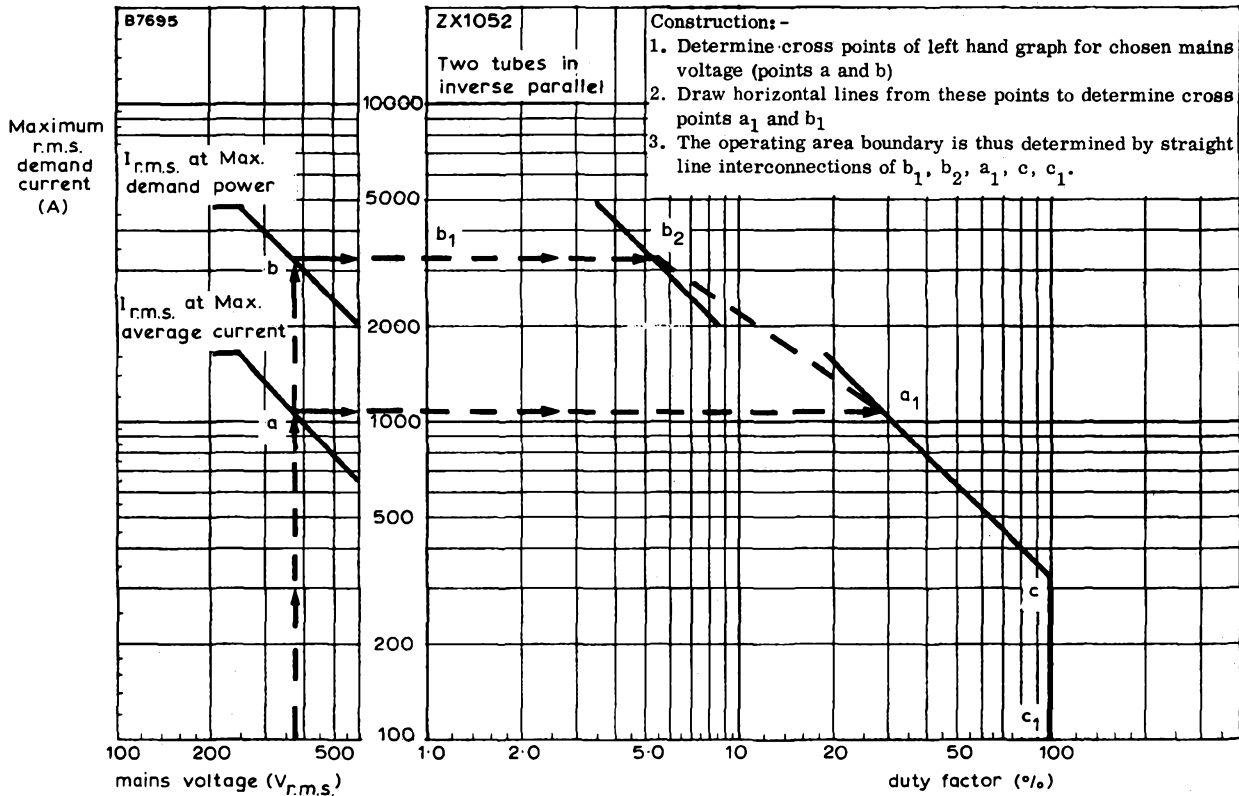

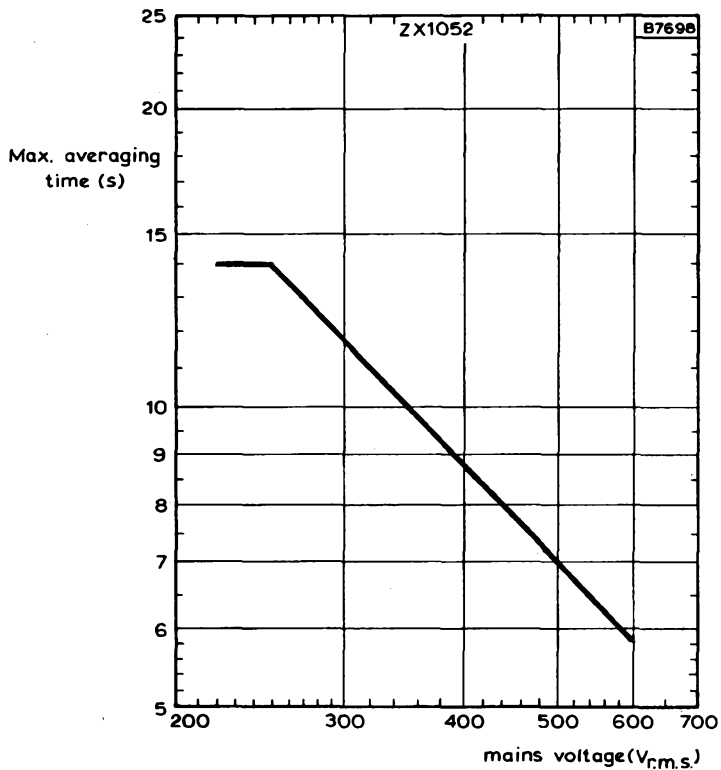

MAXIMUM AVERAGING TIME PLOTTED AGAINST MAINS VOLTAGE

QUICK REFERENCE DATA

Water-cooled ignitron primarily intended for resistance welding and a.c. control applications. The tube has a plastic coated stainless steel water jacket.

International size	D	
Maximum demand power (two tubes in inverse parallel)	2400	kVA
Maximum average current	355	A
Minimum ignitor requirements to fire all tubes		
Peak voltage	180	V
Peak current	12	A

CHARACTERISTICS AND RANGE VALUES FOR EQUIPMENT DESIGN

The values in each section state the range over which the tube will operate. No allowance has been made in the data for supply voltage and component variations. The values given apply to all tubes, both initially and during life, with the specified cooling conditions.

Anode and Cathode

See under sections listed in "Full Load Operating Conditions":-

1. Single phase welding service and A.C. control
 - a. Maximum demand power
 - b. Maximum average current
2. Intermittent rectifier or three phase frequency changer resistance welding service.

Arc voltage drop

See graph, page 9

Ignitor

See section "Ignitor characteristics, etc."

FULL LOAD OPERATING CONDITIONS

The figures given in the data are based on full cycle conduction, with equally distributed load on all ignitrons, regardless of whether or not phase delayed firing is used. The load must be limited so that at zero phase delay no overload will result. No allowance has been made for supply voltage or component variations.

SINGLE PHASE WELDING SERVICE AND A.C. CONTROL. Supply frequency 50Hz, two tubes in inverse parallel connection (see graph on page 10).

A. Maximum demand power

Supply voltage (r.m.s.)	220	250	380	440	500	600	V
Max. demand power	2120	2400	2400	2400	2400	2400	kVA
Max. average current per tube	192	192	192	192	192	192	A
Max. r.m.s. demand current	9.6	9.6	6.3	5.5	4.8	4.0	kA
Max. averaging time	11	11	7.3	6.4	5.6	4.6	s
Duty factor	4.4	4.4	6.8	7.8	8.8	10.6	%
Max. number of cycles in max. averaging time	25	25	25	25	25	25	
Integrated r.m.s. load current	2.0	2.0	1.64	1.52	1.42	1.3	kA

B. Maximum average current

Supply voltage (r.m.s.)	220	250	380	440	500	600	V
Max. average current per tube	355	355	355	355	355	355	A
Max. demand power	700	800	800	800	800	800	kVA
Max. r.m.s. demand current	3.2	3.2	2.1	1.85	1.6	1.32	kA
Max. averaging time	11	11	7.3	6.4	5.6	4.6	s
Duty factor	24.6	24.6	37.5	43.0	49.3	60.0	%
Max. number of cycles in max. averaging time	140	140	140	140	140	140	
Integrated r.m.s. load current	1.6	1.6	1.3	1.21	1.13	1.02	kA
Max. surge current for max. 0.15s	27	27	17.8	15.5	13.5	11.2	kA

Notes

1. For supply voltages less than 250Vr.m.s., the values of maximum demand current and maximum averaging time at 250Vr.m.s. must not be exceeded.
2. The "maximum number of cycles in the maximum averaging time" is the maximum integrated number of cycles that a pair of tubes may conduct, with or without interruption, during the maximum averaging time.

Max. no. of cycles = Duty factor × Max. averaging time × Supply frequency

**INTERMITTENT RECTIFIER OR THREE PHASE FREQUENCY CHANGER
RESISTANCE WELDING SERVICE. Supply frequency 50Hz (see graph page 11)**

Max. peak voltage (forward and inverse)	600	1200	1500	V
--	-----	------	------	---

For use at max. peak current

Max. peak current	4.0	3.0	2.4	kA
Max. average current	54	40	32	A

For use at max. average current

Max. peak current	1140	840	672	A
Max. average current	190	140	112	A

Max. averaging time	6.25	6.25	6.25	s
---------------------	------	------	------	---

Max. value of the ratio of average current to peak current (averaging time = 0.5s)	0.17	0.17	0.17	
--	------	------	------	--

Max. value of the ratio of surge current to peak current (averaging time = 150ms)	12.5	12.5	12.5	
---	------	------	------	--

IGNITOR CHARACTERISTICS, RATINGS AND IGNITION CIRCUITS

Ignitor characteristics

Minimum voltage required for ignition (all tubes)	180	V ←
Minimum current required for ignition (all tubes)	12	A
Typical current required for ignition	6 to 8	A
Minimum period of application of voltage or current	100	μs

Ignitor ratings (Absolute maximum system)

Maximum peak positive voltage	2.0	kV
Maximum peak negative voltage (including any transients)	5.0	V
Maximum peak forward current	100	A
Maximum peak inverse current	zero	A
Maximum r.m.s. forward current	10	A
Maximum average forward current for maximum averaging time of 5 seconds	1.0	A

*Anode excitation circuit requirements

For recommended circuit using two thyristors see figure 1, or for one common thyristor see figure 2.

Minimum peak ignitor voltage for ignition	200	V
**Minimum peak ignitor current for ignition	15 to 30	A
Minimum rate of rise of ignitor current	0.1	A/μs
V r.m.s.	220 250 380 440 500 600	V
R	2 2 4 4.7 5 6	Ω
F ₁	2A fast response time fuse	
F ₂	10A fast response time fuse	
Z	Silicon voltage regulator diode. Zener voltage ≥ 18V	

*Separate excitation circuit requirements

For recommended circuit see figure 3

Capacitor (C)	2.0	μF
Capacitor voltage (±10%)	650	V
Peak value of closed circuit current	80 to 100	A
Maximum ohmic resistance of series inductance (L)	0.2	Ω

*In each circuit, the thyristor or combination of thyristor and voltage regulator diode may be replaced by a thyratron.

**Higher peak ignitor currents are required at lower anode voltages and lower water inlet temperatures; lower peak ignitor currents are required at higher anode voltages and higher water inlet temperatures.

The issue of the information contained in this publication does not imply any authority or licence for the utilisation of any patented features.

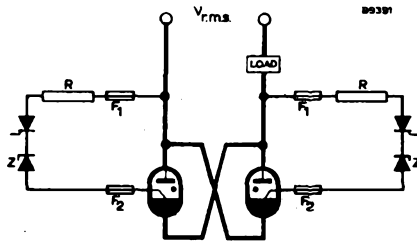

Figure 1:- Anode excitation (two thyristors)

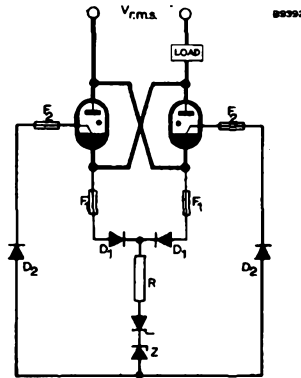

Figure 2:- Anode excitation (common thyristor)

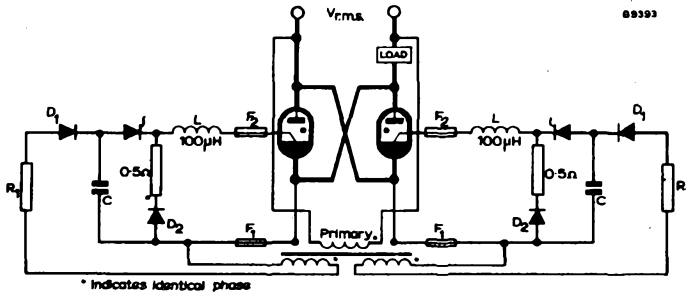

Figure 3:- Separate excitation

MOUNTING POSITION

The ignitron should be mounted within 3° of vertical, anode uppermost, and supported by the cathode lug only. It should not be subjected to vibration or the influence of magnetic or radio frequency fields.

When connecting the anode lead, care should be taken not to stress the anode insulator.

COOLING

Characteristics at flow of 9 litres/min

Typical maximum pressure drop	0.35	kg/cm ²
	5.0	lb/in ²
Typical maximum temperature rise at maximum average current	9.0	°C

A.C. control service ratings (Absolute maximum system)

Minimum water flow at maximum average current	9.0	l/min
Minimum inlet temperature (see note 1)	10	°C
Maximum inlet temperature (see note 1)	40	°C
Maximum temperature at the thermostat plate (see note 2)	50	°C

Intermittent rectifier or three-phase welding service ratings (Absolute maximum system)

Minimum water flow at maximum average current	9.0	l/min
Minimum inlet temperature (see note 1)	10	°C
Maximum inlet temperature (see note 1)	35	°C
Maximum temperature at the thermostat plate (see note 2)	45	°C

NOTES

1. When the cooling systems of two or three tubes are connected in series, the minimum inlet temperature applies to the coldest tube and the maximum inlet temperature applies to the hottest tube.

The protective thermostat should be mounted on the hottest tube and the water economy thermostat on the tube immediately preceding the hottest tube.

In three phase welding service using six tubes, not more than three tubes should be cooled in series.

Hoses should be of insulating material and the minimum length between tube and tube, or between tube and earth, should be 500mm.

2. The thermostat plate is at the supply voltage.
3. The main casing of the ignitron is made from stainless steel, but care should be taken not to use water with a high mineral content.

WEIGHT

Net weight (approx.)	8.7	kg
Weight of tube in carton (approx.)	11	kg

ACCESSORIES

Water economy thermostat assembly	55305
Water failure or overload protective thermostat assembly	55306
Ignitor connector lead	55351
Water hose connections	
Nipple	TE1051c
Nut	TE1051b

OUTLINE DRAWING
OF ZX1053



D1785

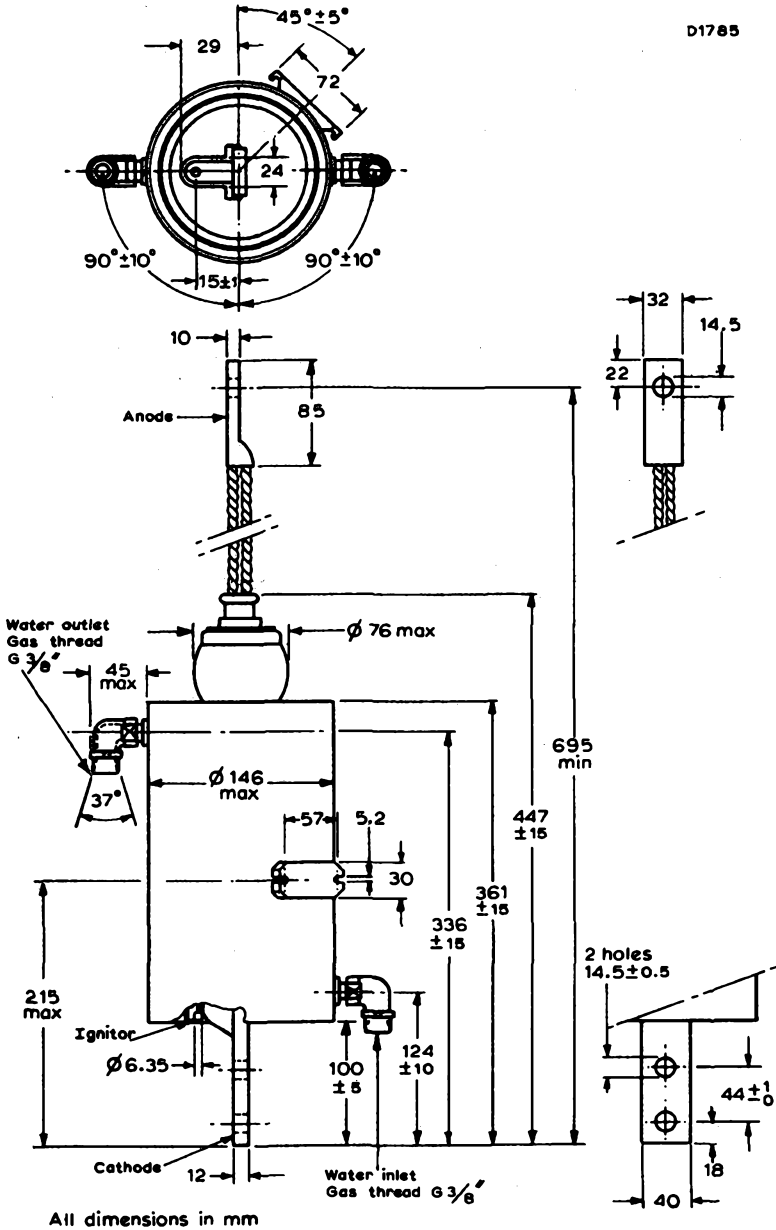

All dimensions in mm

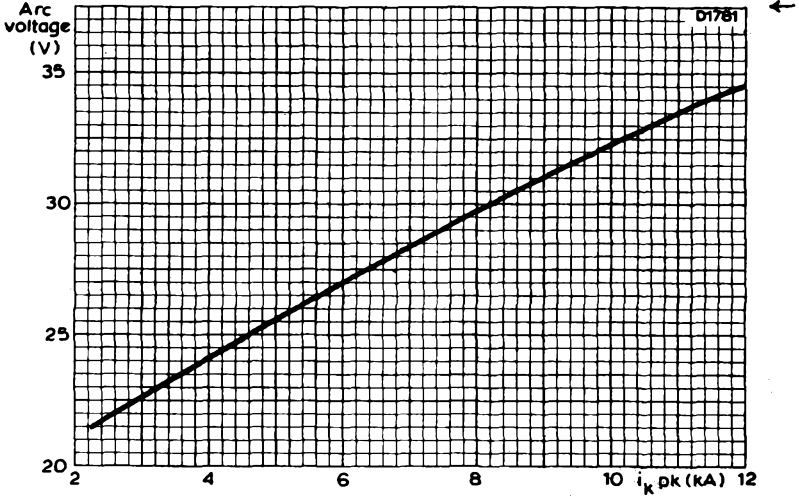

TYPICAL ARC VOLTAGE PLOTTED AGAINST CATHODE CURRENT

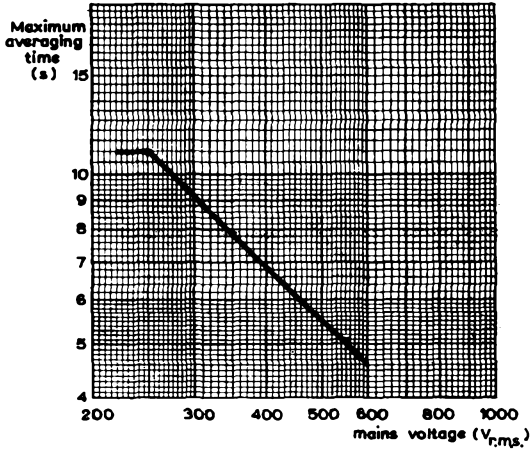

MAXIMUM AVERAGING TIME PLOTTED AGAINST MAINS VOLTAGE

GRAPH RELATING DEMAND CURRENT WITH DUTY FACTOR AS A
FUNCTION OF THE MAINS VOLTAGE. WELDING SERVICE ONLY

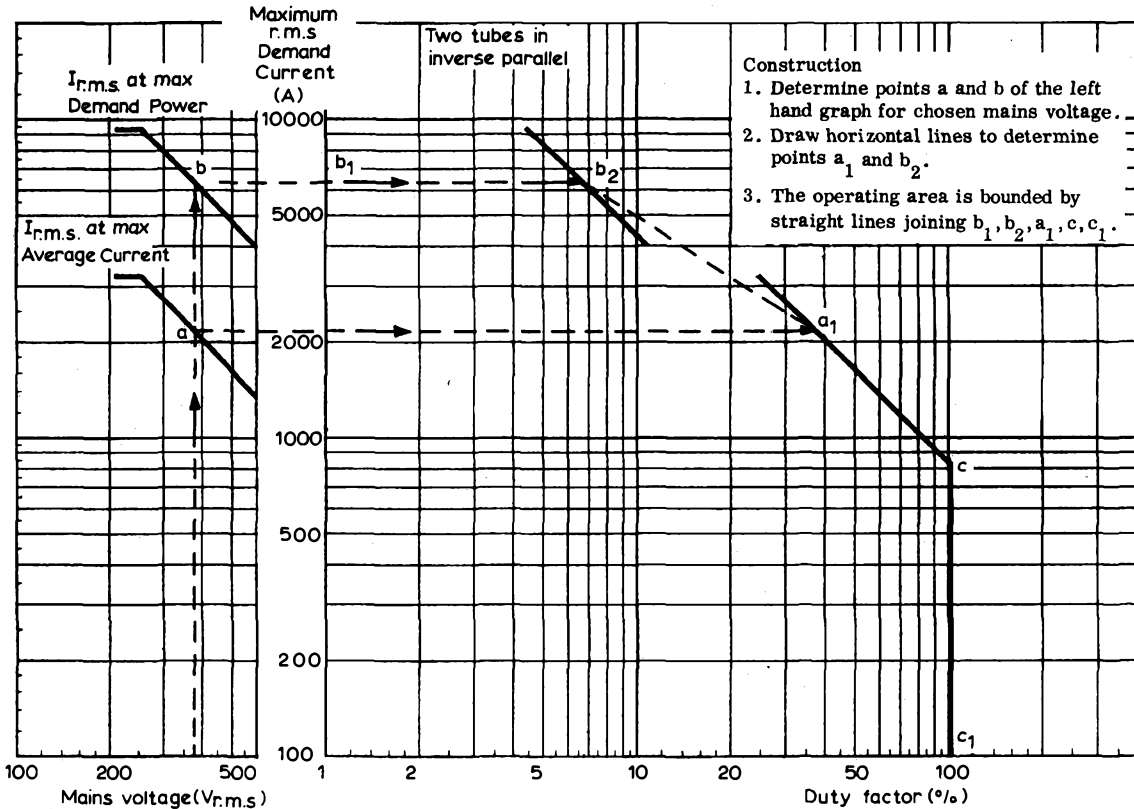

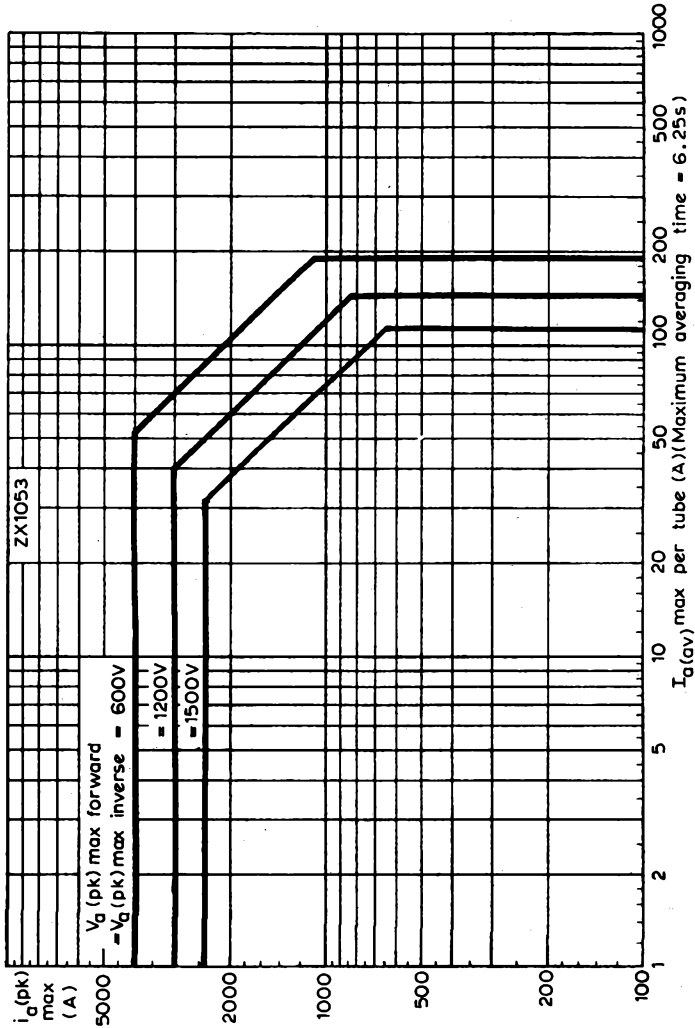

MAXIMUM PEAK ANODE CURRENT PLOTTED AGAINST AVERAGE ANODE CURRENT. INTERMITTENT RECTIFIER SERVICE

QUICK REFERENCE DATA

Water-cooled ignitron primarily intended for resistance welding and a.c. control applications. The tube has a plastic coated stainless steel water jacket.

International size	B	
Maximum demand power (two tubes in inverse parallel)	1200	kVA
Maximum average current	70	A
Minimum ignitor requirements to fire all tubes		
Peak voltage	150	V
Peak current	12	A

CHARACTERISTICS AND RANGE VALUES FOR EQUIPMENT DESIGN

The values in each section state the range over which the tube will operate. No allowance has been made in the data for supply voltage and component variations. The values given apply to all tubes, both initially and during life, with the specified cooling conditions.

Anode and Cathode

See under sections listed in "Full Load Operating Conditions":-

1. Single phase welding service and A.C. control
 - a. Maximum demand power
 - b. Maximum average current
2. Intermittent rectifier or three phase frequency changer resistance welding service.

Arc voltage drop

See graph, page 9

Ignitor

See section "Ignitor characteristics, etc."

FULL LOAD OPERATING CONDITIONS

The figures given in the data are based on full cycle conduction, with equally distributed load on all ignitrons, regardless of whether or not phase delayed firing is used. The load must be limited so that at zero phase delay no overload will result. No allowance has been made for supply voltage or component variations.

SINGLE PHASE WELDING SERVICE AND A.C. CONTROL. Supply frequency 50Hz, two tubes in inverse parallel connection (see graph on page 10)

A. Maximum demand power

Supply voltage (r.m.s.)	220	250	380	440	500	600	V
Max. demand power	550	630	850	950	1050	1200	kVA
Max. average current per tube	38	38	38	38	38	38	A
Max. r.m.s. demand current	2.5	2.5	2.25	2.2	2.1	2.0	kA
Max. averaging time	24	24	15.8	13.6	12	10	s
Duty factor	3.3	3.3	3.8	3.9	4.0	4.2	%
Max. number of cycles in max. averaging time	40	40	30	27	24	21	
Integrated r.m.s. load current	460	460	440	430	420	410	A

B. Maximum average current

Supply voltage (r.m.s.)	220	250	380	440	500	600	V
Max. average current per tube	70	70	70	70	70	70	A
Max. demand power	180	210	280	310	350	400	kVA
Max. r.m.s. demand current	850	850	750	720	700	660	A
Max. averaging time	24	24	15.8	13.6	12	10	s
Duty factor	18.3	18.3	20.8	21.5	22.2	23.5	%
Max. number of cycles in max. averaging time	220	220	164	148	134	118	
Integrated r.m.s. load current	360	360	340	334	330	320	A
Max. surge current for max. 0.15s	7.0	7.0	6.3	6.0	5.9	5.6	kA

Notes

1. For supply voltages less than 250Vr.m.s., the values of maximum demand current and maximum averaging time at 250Vr.m.s. must not be exceeded.
2. The "maximum number of cycles in the maximum averaging time" is the maximum integrated number of cycles that a pair of tubes may conduct, with or without interruption, during the maximum averaging time.

$$\text{Max. no. of cycles} = \text{Duty factor} \times \text{Max. averaging time} \times \text{Supply frequency}$$

INTERMITTENT RECTIFIER OR THREE PHASE FREQUENCY CHANGER RESISTANCE WELDING SERVICE. Supply frequency 50Hz (see graph page 11)

Max. peak voltage (forward and inverse)	1.2	1.5	kV
For use at max. peak current			
Max. peak current	1.5	1.2	kA
Max. average current	20	16	A
For use at max. average current			
Max. peak current	420	336	A
Max. average current	70	56	A
Max. averaging time	6.25	6.25	s
Max. value of the ratio of average current to peak current (averaging time = 0.5s)	0.17	0.17	
Max. value of the ratio of surge current to peak current (averaging time = 150ms)	12.5	12.5	

IGNITOR CHARACTERISTICS, RATINGS AND IGNITION CIRCUITS

Ignitor characteristics

Minimum voltage required for ignition (all tubes)	150	V
Minimum current required for ignition (all tubes)	12	A
Typical current required for ignition	6 to 8	A
Minimum period of application of voltage or current	50	μ s

Ignitor ratings (Absolute maximum system)

Maximum peak positive voltage	2.0	kV
Maximum peak negative voltage (including any transients)	5.0	V
Maximum peak forward current	100	A
Maximum peak inverse current	zero	A
Maximum r.m.s. forward current	10	A
Maximum average forward current for maximum averaging time of 5 seconds	1.0	A

Anode excitation circuit requirements

For recommended circuit using two thyristors see figure 1, or for one common thyristor see figure 2.

Minimum peak ignitor voltage for ignition	200	V
Minimum peak ignitor current for ignition	12	A
Minimum rate of rise of ignitor current	0.1	A/ μ s
V r.m.s.	220 250 380 440 500 600	V
R	2 2 4 4.7 5 6	Ω
F ₁	2A fast response time fuse	
F ₂	10A fast response time fuse	
Z	Silicon voltage regulator diode. Zener voltage \geq 18V	

Separate excitation circuit requirements

For recommended circuit see figure 3

Capacitor (C)	2.0	8.0	μ F
Capacitor voltage (\pm 10%)	650	400	V
Peak value of closed circuit current	80 to 100		A
Maximum ohmic resistance of series inductance(L)	0.2		Ω

NOTE

In each circuit, the thyristor or combination of thyristor and voltage regulator diode may be replaced by a thyatron.

The issue of the information contained in this publication does not imply any authority or licence for the utilization of any patented feature.

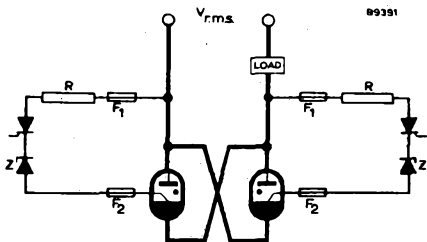

Figure 1:- Anode excitation (two thyristors)

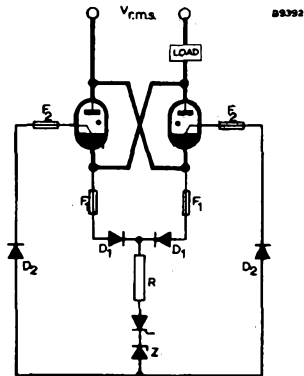

Figure 2:- Anode excitation (common thyristor)

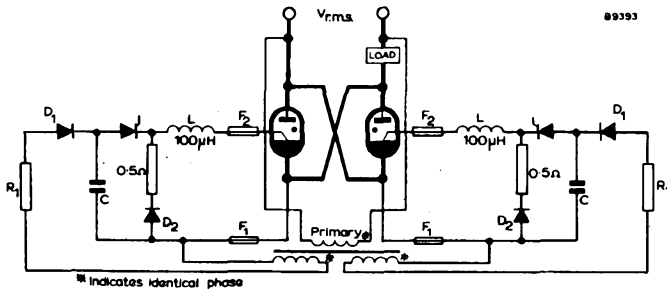

Figure 3:- Separate excitation

MOUNTING POSITION

The ignitron should be mounted within 3° of vertical, anode uppermost, and supported by the cathode lug only. It should not be subjected to vibration or the influence of magnetic or radio frequency fields.

When connecting the anode lead, care should be taken not to stress the anode insulator.

COOLING

Characteristics at flow of 3 litres/min

Typical maximum pressure drop	0.1	kg/cm ²
	1.4	lb/in ²
Typical maximum temperature rise at maximum average current	5.5	°C

A. C. control service ratings (Absolute maximum system)

Minimum water flow at maximum average current (see graph on page 9)	3.0	l/min
Minimum inlet temperature (see note 1)	10	°C
Maximum inlet temperature (see note 1)	40	°C
Maximum temperature at the thermostat plate (see note 2)	50	°C

Intermittent rectifier or three-phase welding service ratings (Absolute maximum system)

Minimum water flow at maximum average current (see graph on page 9)	4.0	l/min
Minimum inlet temperature (see note 1)	10	°C
Maximum inlet temperature (see note 1)	35	°C
Maximum temperature at the thermostat plate (see note 2)	45	°C

NOTES

1. When the cooling systems of two or three tubes are connected in series, the minimum inlet temperature applies to the coldest tube and the maximum inlet temperature applies to the hottest tube.

The protective thermostat should be mounted on the hottest tube and the water economy thermostat on the tube immediately preceding the hottest tube.

In three phase welding service using six tubes, not more than three tubes should be cooled in series.

Hoses should be of insulating material and the minimum length between tube and tube, or between tube and earth, should be 500mm.

2. The thermostat plate is at the supply voltage.
3. The main casing of the ignitron is made from stainless steel, but care should be taken not to use water with a high mineral content.

WEIGHT

Net weight (approx.)	1.66	kg
Weight of tube in carton (approx.)	2.28	kg

ACCESSORIES

Water economy thermostat assembly	55305
Water failure or overload protective thermostat assembly	55306
Ignitor connector lead	55351
Water hose connections	
Nipple	TE1051C
Nut	TE1051B

OUTLINE DRAWING
OF ZX1061

88213 ←

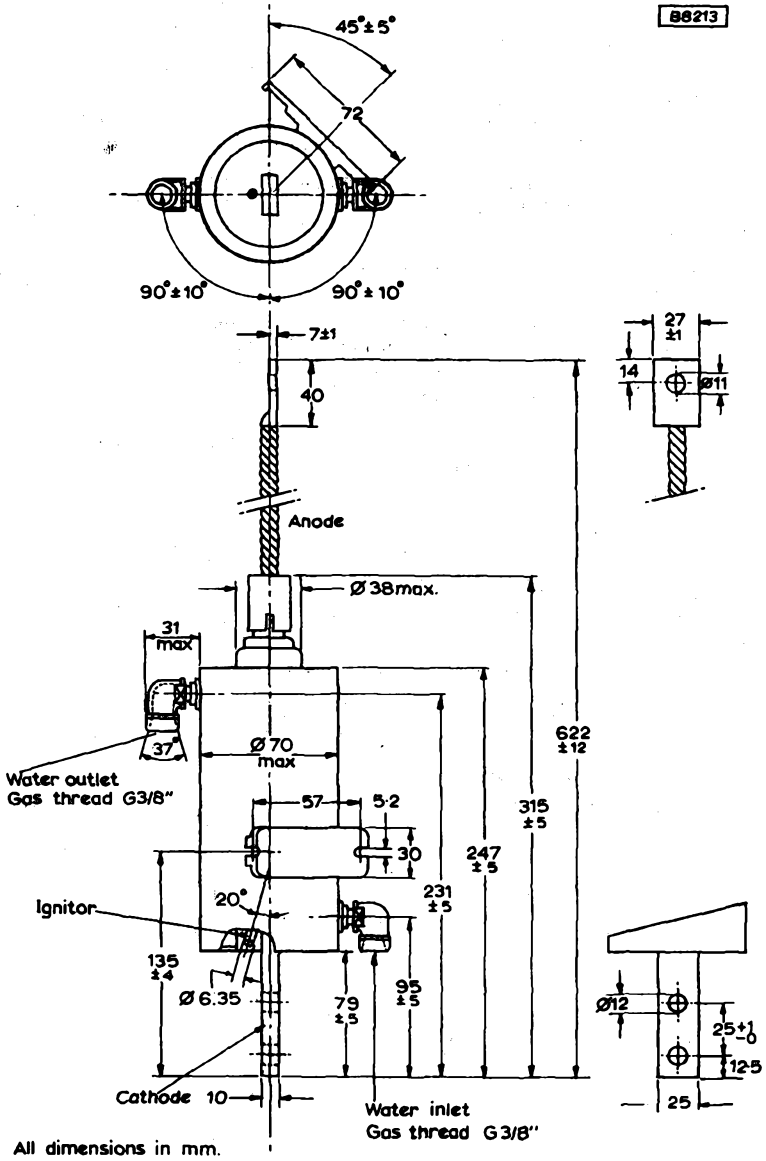

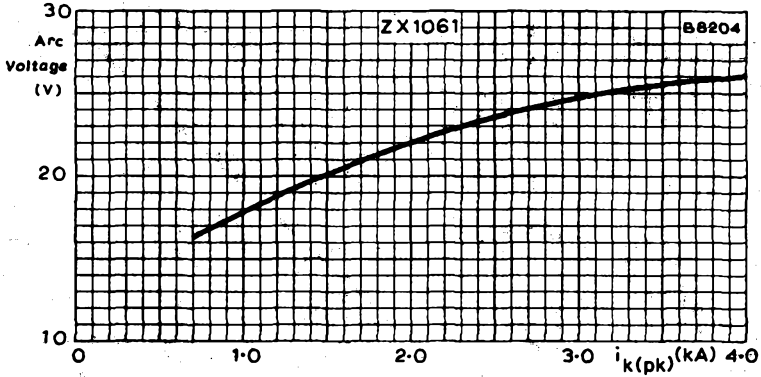

TYPICAL ARC VOLTAGE PLOTTED AGAINST CATHODE CURRENT

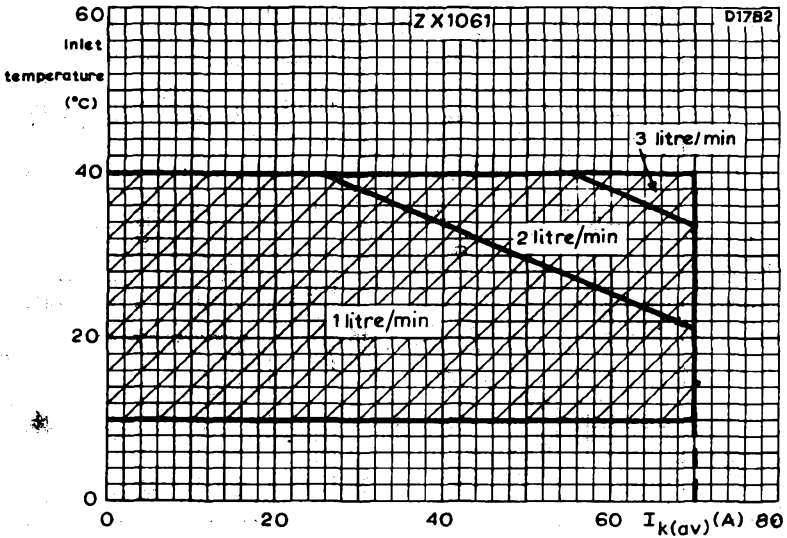

MINIMUM REQUIRED CONTINUOUS WATERFLOW
(TWO TUBES COOLED IN SERIES)



GRAPH RELATING DEMAND CURRENT WITH DUTY FACTOR AS A FUNCTION OF THE MAINS VOLTAGE. WELDING SERVICE ONLY

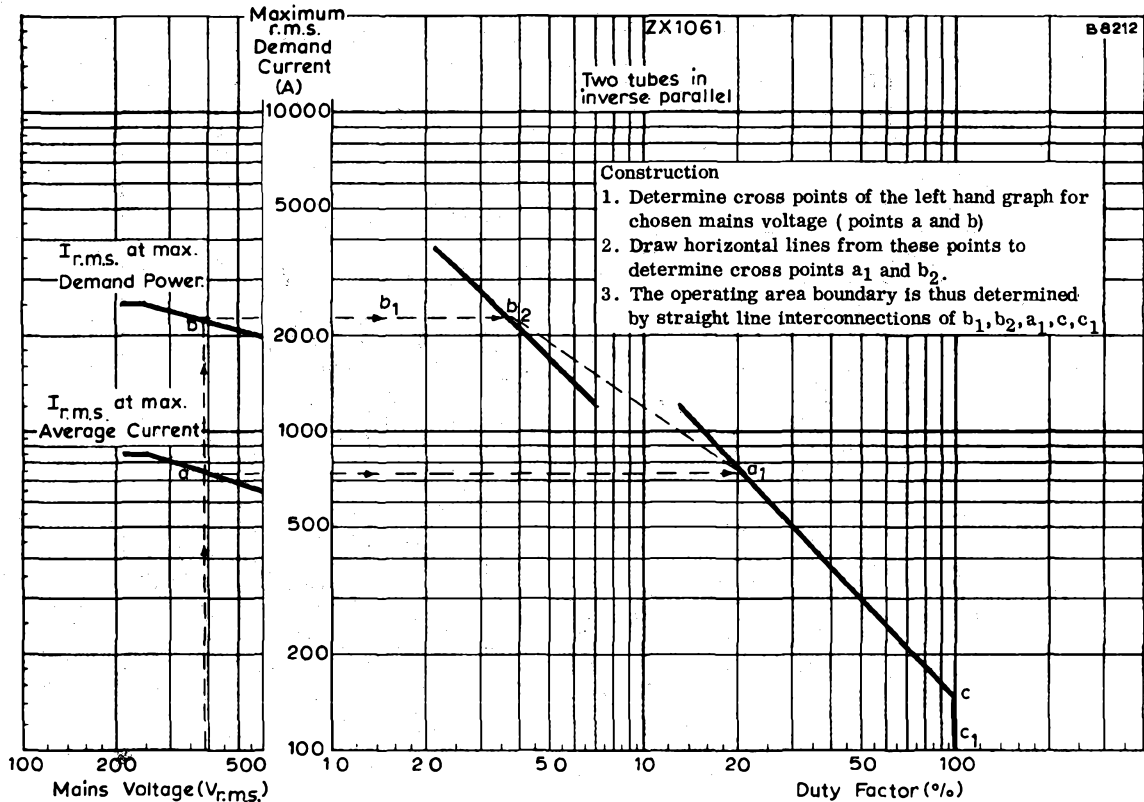

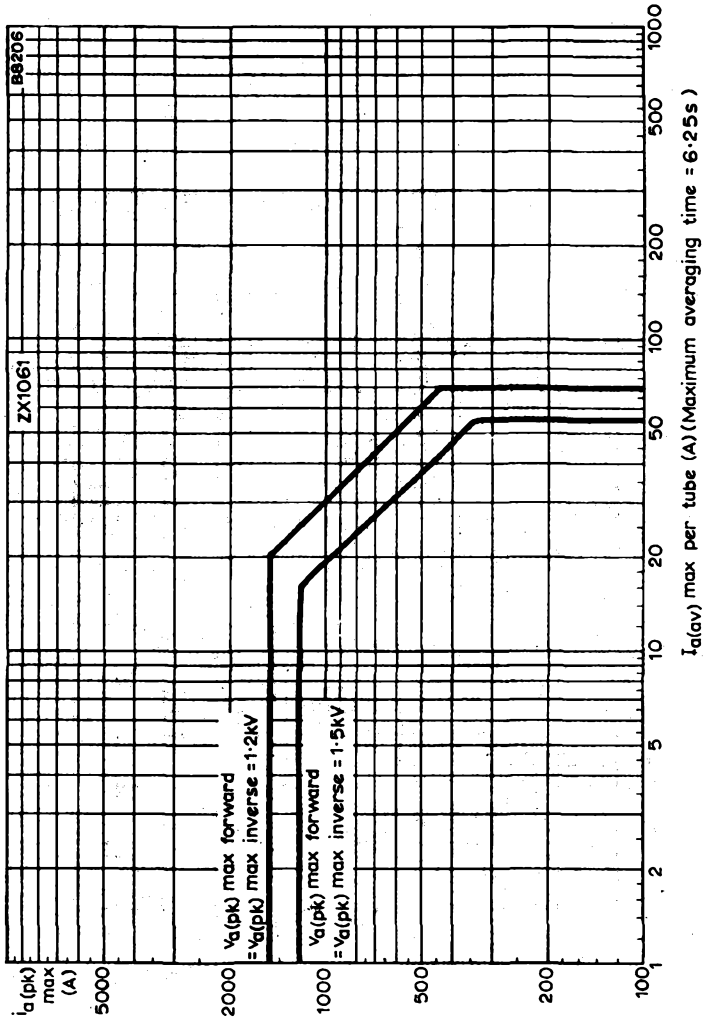

MAXIMUM PEAK ANODE CURRENT PLOTTED AGAINST AVERAGE ANODE CURRENT. INTERMITTENT RECTIFIER SERVICE

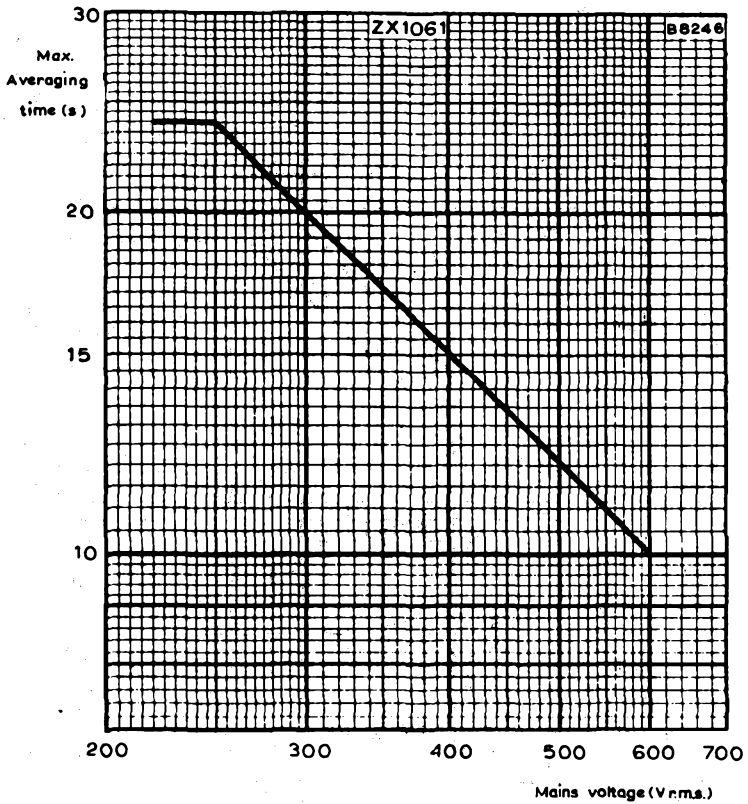

MAXIMUM AVERAGING TIME PLOTTED AGAINST MAINS VOLTAGE

QUICK REFERENCE DATA

Water-cooled ignitron primarily intended for resistance welding and a.c. control applications. The tube has a plastic coated stainless steel water jacket.

International size	Uprated C	
Maximum demand power (two tubes in inverse parallel)	2300	kVA
Maximum average current	180	A
Minimum ignitor requirements to fire all tubes		
Peak voltage	150	V
Peak current	12	A

CHARACTERISTICS AND RANGE VALUES FOR EQUIPMENT DESIGN

The values in each section state the range over which the tube will operate. No allowance has been made in the data for supply voltage and component variations. The values given apply to all tubes, both initially and during life, with the specified cooling conditions.

Anode and Cathode

See under sections listed in "Full Load Operating Conditions":-

Single phase welding service and A.C. control

- a. Maximum demand power
- b. Maximum average current

Arc voltage drop

See graph, page C1

Ignitor

See section "Ignitor characteristics, etc."

FULL LOAD OPERATING CONDITIONS

The figures given in the data are based on full cycle conduction, with equally distributed load on all ignitrons, regardless of whether or not phase delayed firing is used. The load must be limited so that at zero phase delay no overload will result. No allowance has been made for supply voltage or component variations.

SINGLE PHASE WELDING SERVICE AND A.C. CONTROL. Supply frequency 50Hz, two tubes in inverse parallel connection (see graph on page C2)

A. Maximum demand power

Supply voltage (r.m.s.)	220	250	380	440	500	600	V
Max. demand power	1000	1250	1650	1820	2000	2300	kVA
Max. average current per tube	110	110	110	110	110	110	A
Max. r.m.s. demand current	5.0	5.0	4.35	4.2	4.0	3.8	kA
Max. averaging time	21	21	13.8	11.8	10.5	8.7	s
Duty factor	4.9	4.9	5.6	5.8	6.1	6.4	%
Max. number of cycles in max. averaging time	51	51	38	35	32	27	
Integrated r.m.s. load current	1100	1100	1030	1010	990	970	A

B. Maximum average current

Supply voltage (r.m.s.)	220	250	380	440	500	600	V
Max. average current per tube	180	180	180	180	180	180	A
Max. demand power	340	*415	550	610	670	760	kVA
Max. r.m.s. demand current	1.65	1.65	1.45	1.40	1.33	1.27	kA
Max. averaging time	21	21	13.8	11.8	10.5	8.7	s
Duty factor	24.2	24.2	27.2	28.5	30.0	31.4	%
Max. number of cycles in max. averaging time	254	254	190	171	157	136	
Integrated r.m.s. load current	810	810	760	745	730	710	A
Max. surge current for max. 0.15s	14.0	14.0	12.2	11.8	11.2	10.6	kA



Notes

1. For supply voltages less than 250V r.m.s., the values of maximum demand current and maximum averaging time at 250V r.m.s. must not be exceeded.
2. The "maximum number of cycles in the maximum averaging time" is the maximum integrated number of cycles that a pair of tubes may conduct, with or without interruption, during the maximum averaging time.
 Max. no. of cycles = Duty factor × Max. averaging time × Supply frequency

IGNITOR CHARACTERISTICS, RATINGS AND IGNITION CIRCUITS

Ignitor characteristics

Minimum voltage required for ignition (all tubes)	150	V
Minimum current required for ignition (all tubes)	12	A
Typical current required for ignition	6 to 8	A
Minimum period of application of voltage or current	50	μs

Ignitor ratings (Absolute maximum system)

Maximum peak positive voltage	2.0	kV
Maximum peak negative voltage (including any transients)	5.0	V
Maximum peak forward current	100	A
Maximum peak inverse current	zero	A
Maximum r.m.s. forward current	10	A
Maximum average forward current for maximum averaging time of 5 seconds	1.0	A

Anode excitation circuit requirements

For recommended circuit using two thyristors see figure 1, or for one common thyristor see figure 2.

Minimum peak ignitor voltage for ignition	150	V
Minimum peak ignitor current for ignition	12	A
Minimum rate of rise of ignitor current	0.1	A/μs

V r.m.s.	220	250	380	440	500	600	V
R	2	2	4	4.7	5	6	Ω

F₁ 2A fast response time fuse

F₂ 10A fast response time fuse

Z Silicon voltage regulator diode. Zener voltage ≥ 18V

Separate excitation circuit requirements

For recommended circuit see figure 3.

Capacitor (C)	2.0	8.0	μF
Capacitor voltage (±10%)	650	400	V
Peak value of closed circuit current	80 to 100		A
Maximum ohmic resistance of series inductance (L)	0.2		Ω



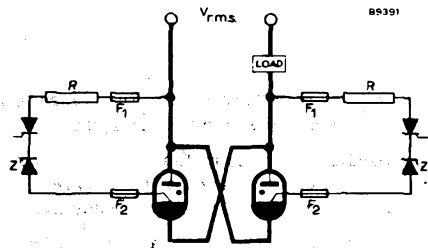

Fig.1: Anode excitation (Two thyristors)

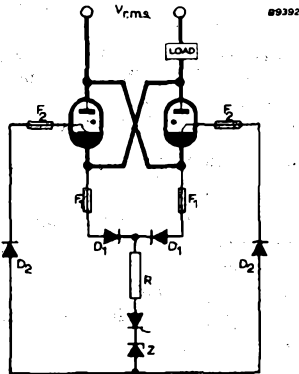

Fig.2: Anode excitation (Common thyristor)

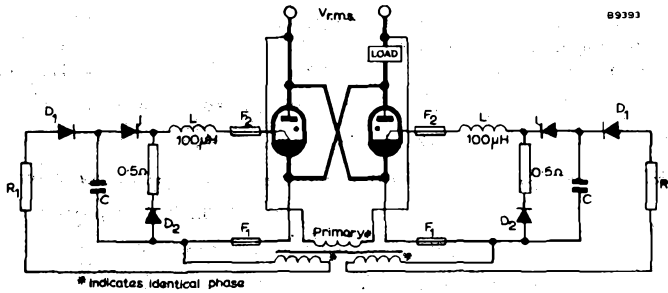

Fig.3: Separate excitation

NOTE

In each circuit the thyristor or combination of thyristor and voltage regulator diode may be replaced by a thyatron.



MOUNTING POSITION

The ignitron should be mounted within 3° of vertical, anode uppermost, and supported by the cathode lug only. It should not be subjected to vibration or the influence of magnetic or radio frequency fields.

When connecting the anode lead, care should be taken not to stress the anode insulator.

COOLING

Characteristics at flow of 6 litres/min

Typical maximum pressure drop	0.2	kg/cm ²
	2.8	lb/in ²
Typical maximum temperature rise at maximum average current	6.0	°C

A.C. control service ratings (Absolute maximum system)

Minimum water flow at maximum average current (see graph on page C1)	6.0	l/min
Minimum inlet temperature (see note 1)	10	°C
Maximum inlet temperature (see note 1)	40	°C
Maximum temperature at the thermostat plate (see note 2)	50	°C

NOTES

1. When the cooling systems of two or three tubes are connected in series, the minimum inlet temperature applies to the coldest tube and the maximum inlet temperature applies to the hottest tube.

The protective thermostat should be mounted on the hottest tube and the water economy thermostat on the tube immediately preceding the hottest tube.

In three phase welding service using six tubes, not more than three tubes should be cooled in series.

Hoses should be of insulating material and the minimum length between tube and tube, or between tube and earth, should be 50cm.

2. The thermostat plate is at the supply voltage.
3. The main casing of the ignitron is made from stainless steel, but care should be taken not to use water with a high mineral content.

WEIGHT

Net weight (approx.)	2.90	kg
Weight of tube in carton (approx.)	4.16	kg



ACCESSORIES

Water economy thermostat assembly	55305
Water failure or overload protective thermostat assembly	55306
Ignitor connector lead	55351
Water hose connections nipple	TE1051C
nut	TE1051B

OUTLINE DRAWING OF ZX1062

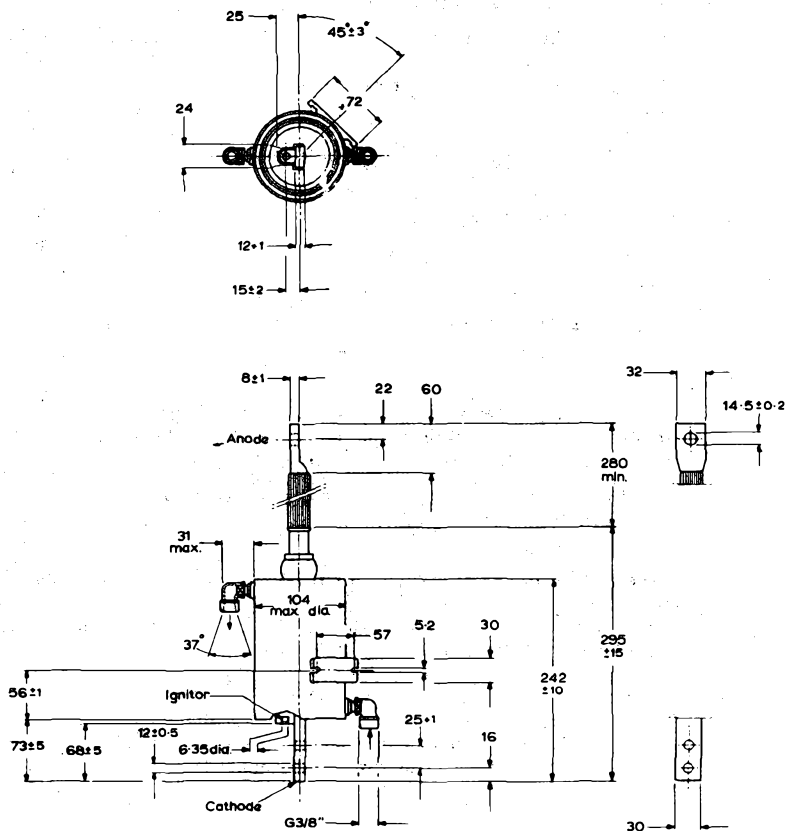

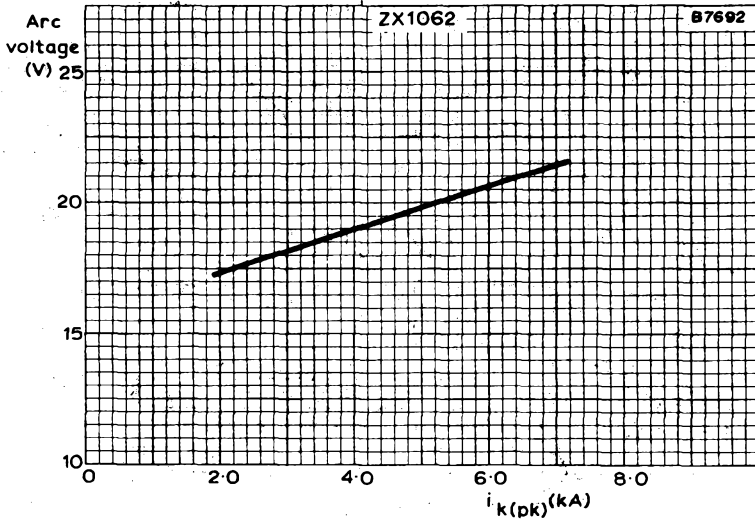

TYPICAL ARC VOLTAGE PLOTTED AGAINST CATHODE CURRENT

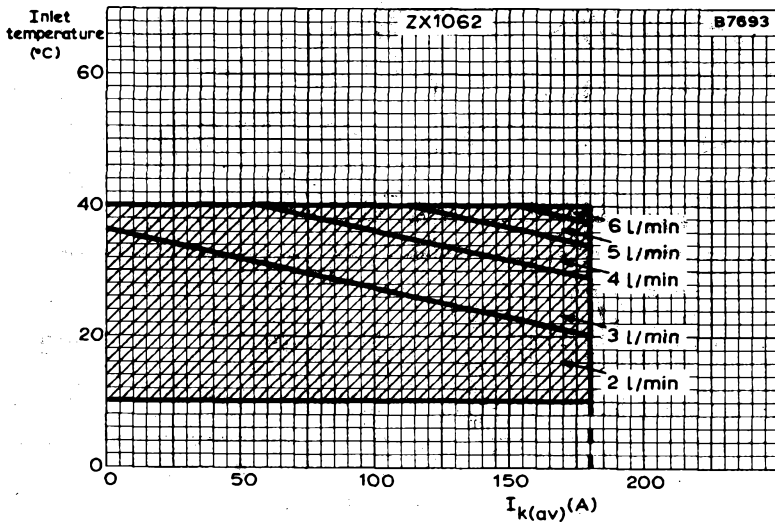

MINIMUM REQUIRED CONTINUOUS WATERFLOW
(TWO TUBES COOLED IN SERIES)





GRAPH RELATING DEMAND CURRENT WITH DUTY FACTOR AS A FUNCTION OF THE MAINS VOLTAGE. WELDING SERVICE ONLY

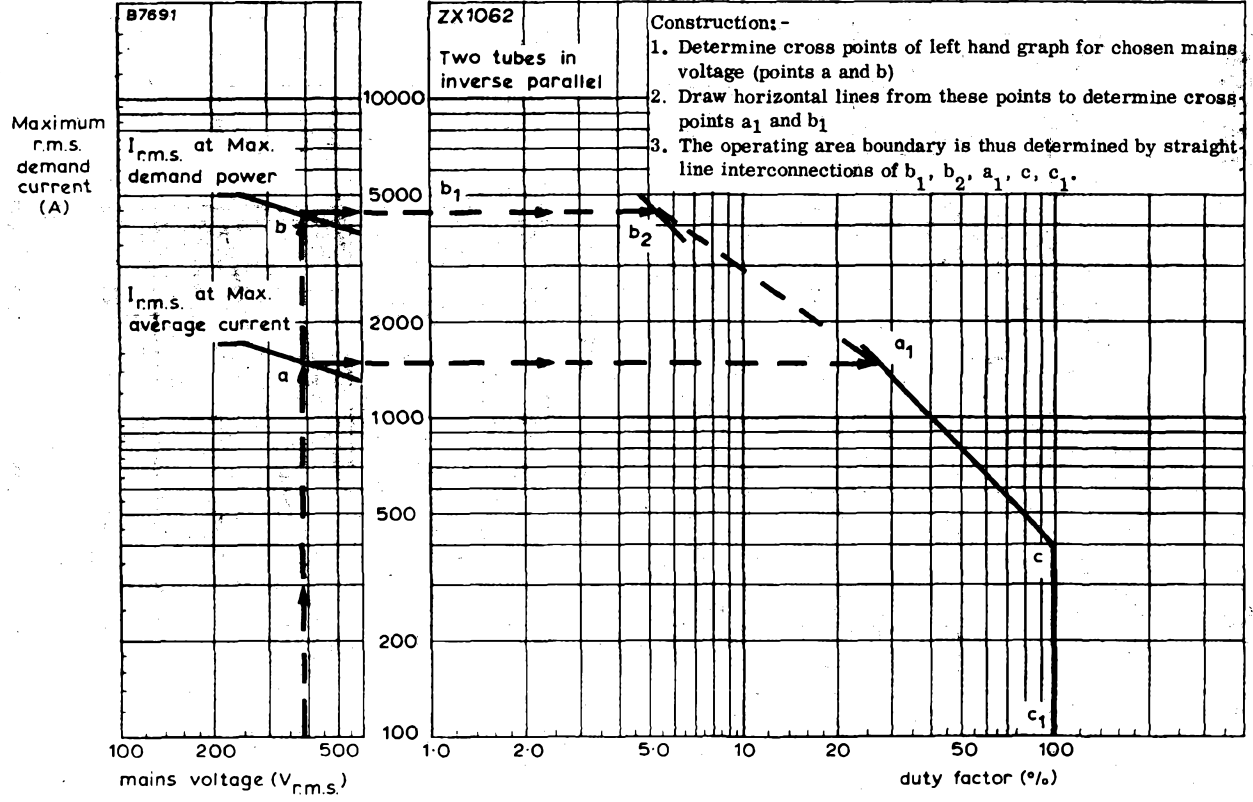

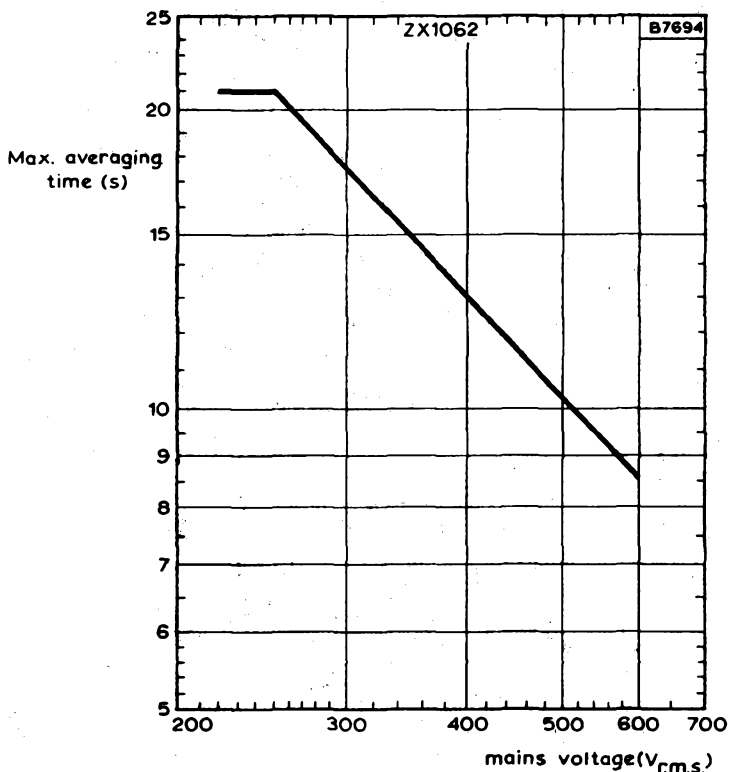

MAXIMUM AVERAGING TIME PLOTTED AGAINST MAINS VOLTAGE



POWER RECTIFIERS



The following recommendations should be interpreted in conjunction with British Standard Code of Practice No. CP1005: Parts 1 and 2: 1954, 'The Use of Electronic Valves', upon which these notes have, in part, been based.

LIMITING VALUES

The operating limits quoted on data sheets for individual values should on no account be exceeded. Two methods of specifying limiting values are used, the 'absolute' and 'design centre' systems, and these should be interpreted as follows:—

Absolute Ratings

The equipment designer must ensure that these ratings are never exceeded and in arriving at the actual valve operating conditions such variations as mains fluctuations, component tolerances and switching surges must be taken into account.

Design Centre Ratings

With a set of nominal valves inserted in an equipment connected to the highest permitted nominal supply voltage within a given tapping range, and in which all components have their nominal value, the valve operating conditions may at no time exceed the published maximum design centre value.

The phrase 'at no time' in the above paragraph means that increases in the valve working conditions, due to operating changes in equipment (e.g. switching, etc.), should be taken into account by the equipment designer. Mains voltage variations (of up to $\pm 6\%$) are allowed for in the valve ratings, provided good practice is followed in the design of the equipment.

FILAMENT OR HEATER SUPPLY

For satisfactory operation the filament or heater voltage of a rectifier should be set within $\pm 2.5\%$ of the nominal value. Temporary mains fluctuations up to $\pm 6\%$ are permissible.

To ensure maximum life from a directly heated valve the filament supply should be $90^\circ \pm 30^\circ$ out of phase with the anode supply unless otherwise specified.

VALVE TEMPERATURE LIMITATIONS

The ratings published for Mullard mercury vapour rectifiers apply only when they are operated within the limits stated for the temperature of the condensed mercury.

GENERAL OPERATIONAL RECOMMENDATIONS

GAS-FILLED
RECTIFIERS

With the filament or heater voltage applied, the time required to reach the minimum permissible condensed mercury temperature is a function of the ambient temperature and can be determined from the heating and cooling characteristic. Thus a direct measurement of the condensed mercury temperature, although desirable, is not essential.

Ideally, no cathode current should be drawn until the filament or heater supply has been on for this time, but in practice little damage is done if the current is drawn when the condensed mercury temperature is within 7°C of the minimum permissible value. Thus with normal usage, where the valve is started only two or three times per day, an adequate life can still be obtained with a reduced heating time. The ambient conditions, however, must be such that the minimum permissible condensed mercury temperature is eventually reached and in any case the heating time must not be less than the specified minimum cathode heating time.

With rare-gas rectifiers ambient temperature limitations are given and in general it is only necessary to employ the minimum cathode heating time before switching on.

It is necessary to provide adequate ventilation around the valve so that the maximum ambient or condensed mercury temperature is never exceeded for all conditions of loading. This avoids the danger of arc-back.

Whenever it may be necessary to check the condensed mercury temperature of rectifiers the following procedure is recommended. A temperature indicator of low thermal capacity, such as a fine-wire thermocouple, should be attached to the valve at the mercury condensation point by the minimum amount of adhesive.

Care should be taken to ensure that other conditions of operation, such as load current, ambient temperature of the air outside the equipment, and the ventilation remain unchanged during the measurement.

CURRENT RATINGS

For each rating of maximum average current, a maximum averaging time is quoted. This is to ensure that an anode current greater than the maximum permissible average value is not drawn for such a length of time as would give rise to an excessive temperature within the valve. For periods less than the maximum averaging time it is permissible to draw average currents greater than the maximum rated value provided that the product of this current and the time does not exceed the product of the maximum rated average current



and the maximum averaging time. When more than one value of peak current is quoted depending upon the frequency of operation, this must be taken into consideration.

SHORT CIRCUIT PROTECTION

The figure given on each data sheet for maximum surge fault protection cathode current is intended as a guide to equipment designers. It indicates the maximum value of transients, resulting from a sudden overload or short circuit, which the rectifier will pass for a period not exceeding 0.1 second without resulting in its immediate destruction. Several overloads of this nature will, however, appreciably reduce the life of the valve.

To prevent damage to the rectifier in the event of a short circuit on the d.c. side, it is advisable to include a fuse of suitable rating in the anode circuit of each rectifier.

POWER SUPPLY FREQUENCY LIMITATIONS

Unless otherwise stated, the maximum peak inverse voltage quoted for each valve is that permissible at a maximum supply frequency of 150c/s.

PARALLEL OPERATION OF RECTIFIERS

Because individual rectifiers may have slightly different striking voltages two or more valves must not be connected directly in parallel. An alternative arrangement must be adopted if a higher current output is required. Information on suitable methods will be supplied on request.

SMOOTHING CIRCUITS

In order to limit the peak cathode current in a rectifier it is necessary that a choke, having the specified minimum inductance, should precede the first smoothing capacitor. Appropriate values for L and C for full load conditions are given on each valve data sheet. In some rectifier circuits however, the value of the inductance may be considerably reduced if the initial surge of current is further limited by employing a starting resistor in series with the primary of the transformer or the first capacitor.

When load currents appreciably lower than those shown are to be taken, the use of filter components of the values given may result in poor regulation. An improvement can be obtained by increasing the inductance of the choke inversely as the load current, i.e., at half



load the inductance should be doubled. To ensure good voltage regulation on fluctuating loads, the value of capacitance should be suitable for the maximum current to be taken and the inductance should be large enough to give uninterrupted current at minimum load.

The output voltages quoted on the data sheets refer to ideal conditions and in practice allowance must be made for voltage losses in the valve, choke and transformer. When rectifier circuits are designed to provide maximum output voltage at a specified load, the permissible peak inverse voltage will be exceeded if the load current is decreased.

The single-stage filter specified will not always give sufficient smoothing; this may be improved by increasing inductance or by adding a further stage to the filter. The initial choke and capacitor must not resonate at the supply or ripple frequencies.

The filter circuit values given in the tables are calculated for a supply frequency of 50c/s and will not necessarily be suitable for any other frequency.

Users are invited to apply for detailed proposals to meet individual requirements.

SCREENING AND R.F. FILTER CIRCUITS

(a) In order to prevent spurious ionisation of the gas or mercury vapour (and consequent flash-over) due to strong r.f. fields, it may be necessary to enclose the rectifiers in a separate screening box. For the same reason r.f. filters should be used to prevent high-frequency current circulating in the rectifier elements via the wiring.

(b) High-frequency disturbances, usually due to oscillation in the transformer windings, are often produced by gaseous rectifiers, and may cause interference in apparatus situated near the rectifier unit. Small r.f. chokes or resistors in the anode leads will generally reduce the interference, and screening as recommended in paragraph (a) above may also be adopted, with r.f. filters in all leads emerging from the screen.

INSTALLATION

Mercury vapour rectifiers should always be mounted vertically with the cathode connections at the lower end. When a mercury vapour rectifier is first installed, and before it is put into service, it should be run for at least half an hour at its normal filament or heater



voltage but without any electrode voltages applied, in order to vaporise any mercury which may have been deposited upon the electrode assembly during transit. This precaution should also be taken before putting into service a mercury vapour valve which has been out of use for any considerable time.

CIRCUITS

The four circuits shown in the accompanying diagrams are those referred to in the data sheets and cover all normal requirements. In these circuits, fuses and r.f. stopper resistors are not shown.



GENERAL OPERATIONAL RECOMMENDATIONS

GAS-FILLED RECTIFIERS

In these circuits

V_{out} = Output voltage on load

$V_{r.m.s.}$ = Voltage of each section of transformer secondary

P.I.V. = Maximum permissible inverse peak voltage

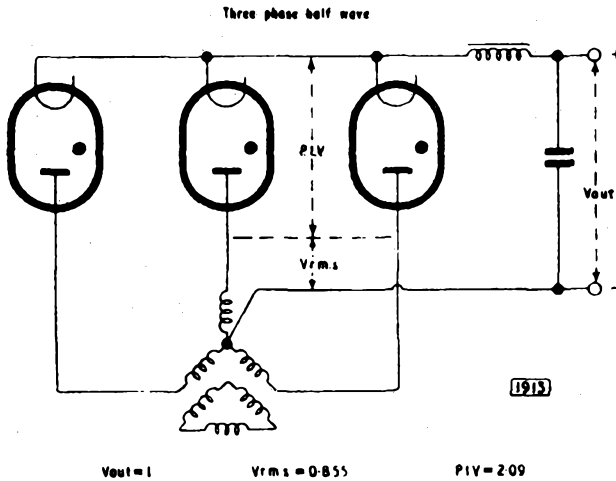
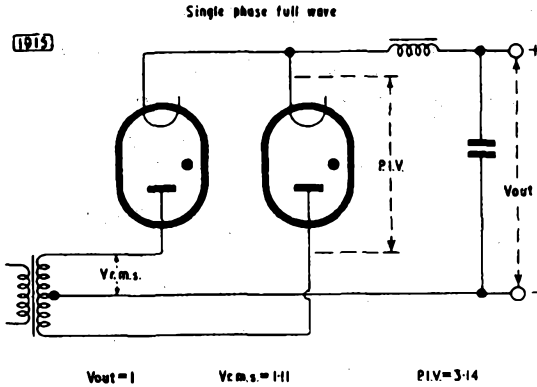

**GAS-FILLED
RECTIFIERS**

**GENERAL OPERATIONAL
RECOMMENDATIONS**

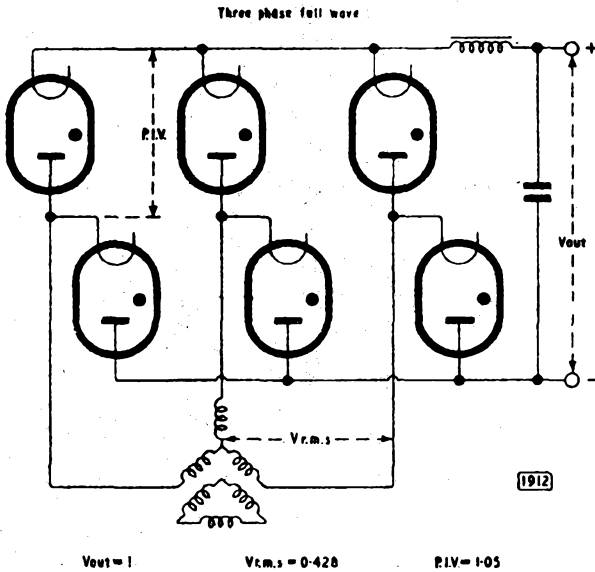
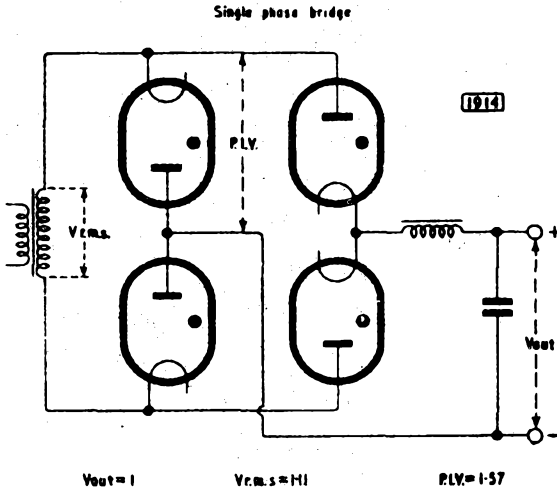

HALF-WAVE RECTIFIER

RG1-240A

Voltage: 6.5kV peak inverse.
Current: 250mA maximum average
Application: Power rectification.
Gas filling: Mercury vapour.

This data should be read in conjunction with GENERAL OPERATIONAL RECOMMENDATIONS – GAS-FILLED RECTIFIERS which precede this section of the handbook.

ABSOLUTE MAXIMUM RATINGS

It is important that these ratings are never exceeded and such variations as mains fluctuations, component tolerances and switching surges must be taken into consideration in arriving at the actual operating conditions.

Maximum peak inverse anode voltage	6.5	kV
Condensed-mercury temperature		
Maximum	65	°C
Minimum	25	°C
Maximum cathode current		
Average	250	mA
Peak	1.25	A
Surge (fault protection, maximum duration = 0.1s)	25	A
Maximum operating frequency	150	c/s

CHARACTERISTICS

Filament voltage	4.0	V
Nominal filament current at 4.0V	2.7	A
Nominal anode voltage drop	12	V
Nominal ignition voltage (see note 1)	12	V
Equilibrium condensed-mercury temperature rise above ambient	See note 2	
Heating time	See note 3	
Net weight (approx.)	{ 2.6 75	oz g
Weight of valve in carton (approx.)	{ 8.1 230	oz g
Nominal dimensions of carton	{ 8.5 × 3.5 × 3.5 220 × 90 × 90	in mm



FULL LOAD OPERATING CONDITIONS

These figures are based upon the absolute maximum ratings of the valve and no account has been taken of mains variations or transformer, valve and choke losses. In practice, due consideration must be given to these factors.

See, also, appropriate sections of 'General Operational Recommendations - Gas-Filled Rectifiers'.

Circuit	No. of valves	Full load d.c. output		Applied a.c. voltage (kV _{r.m.s.})	Initial filter elements	
		(kV)	(mA)		L (H)	C (μF)
Single phase full-wave	2	2.0	500	2.22 (per valve)	7.0	5.0
Single phase bridge	4	4.0	500	4.44	14	2.5
Three phase half-wave	3	2.75	750	2.35 (per phase)	2.5	2.0
Three phase full-wave	6	6.0	750	2.57 (per phase)	5.0	1.0

OPERATING NOTES

1. In order to obtain an ignition delay time of approximately 10μs, an anode voltage of at least 50V is required.
2. Under normal conditions, if the ambient temperature lies within the range of approximately 10 to 40°C, the absolute maximum ratings for condensed-mercury temperature will probably be satisfied.
3. It is recommended that a period of at least 1 min. shall elapse between the time the filament voltage is applied and the application of anode voltage. Under normal conditions cathode current may be drawn when the condensed-mercury temperature is approximately within 7°C of the minimum value given. (See appropriate section of 'General Operational Recommendations - Gas-Filled Rectifiers').

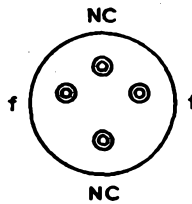
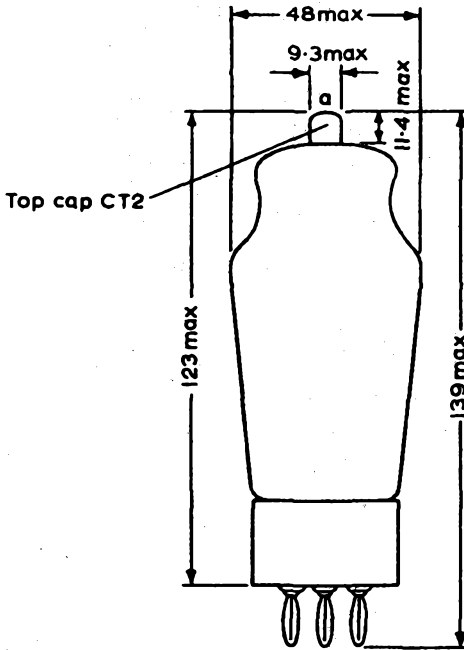

British 4-Pin Base

All dimensions in mm

6700



HALF-WAVE RECTIFIER

Mercury vapour half-wave rectifier for use
in high voltage rectifier circuits.

RG3-250 RG3-250A

This data should be read in conjunction with GENERAL OPERATIONAL RECOMMENDATIONS—GAS-FILLED RECTIFIERS which precede this section of the handbook

LIMITING VALUES (absolute ratings, not design centre)

It is important that these limits are never exceeded and such variations as mains fluctuations, component tolerances and switching surges must be taken into consideration in arriving at actual valve operating conditions.

Maximum peak inverse anode voltage	10	kV
Condensed mercury temperature limits	25 to 65	°C
Maximum cathode current		
Peak	1.0	A
Average (max. averaging time = 15s)	250	mA
Surge (fault protection max. duration = 0.1s)	100	A
Maximum operating frequency	150	c/s

CHARACTERISTICS

Electrical

Filament voltage	2.5	V
Average filament current at 2.5V	5.0	A
Anode voltage drop (approx.)	16	V
Typical ignition voltage	30	V

Mechanical

Equilibrium condensed mercury temperature rise
above ambient

At full load (approx.)	25	°C
At no load (approx.)	22.6	°C

Mounting position Vertical, base down

Maximum net weight	{ 90	g
	{ 3.0	oz



FULL LOAD OPERATING CONDITIONS (for peak inverse anode voltage of 10kV and peak cathode current of 1.0A)

Circuit	No. of valves	Full load d.c. output		Applied a.c. volts (kV _{r.m.s.})	Initial filter elements	
		(kV)	(mA)		Lmin. (H)	Cmax. (μF)
Single phase full-wave	2	3.1	500	3.5 (per valve)	10	2.0
Single phase bridge	4	6.3	500	7.0 (total)	20	1.0
Three phase half-wave	3	4.1* (4.7)	750	3.5* (4.1) (per phase)	6.0	1.0
Three phase full-wave	6	9.5	750	4.1 (per phase)	10	0.5

*These figures take into account the increase in peak inverse voltage which occurs if the power supply is lightly loaded. For operation with a constant load the voltages may be increased to the value shown in brackets.

HEATING UP TIME

The preferred minimum value of the total valve heating up time can be obtained from the heating and cooling curve on page C2. This shows how the condensed mercury temperature rises above the ambient temperature from the instant of switching on the filament supply.

Under normal conditions, however, cathode current may be drawn when the condensed mercury temperature is approximately within 7°C of the minimum quoted value. (See page C3 and also appropriate section of 'General operational recommendations—gas-filled rectifiers'.)

Minimum cathode heating time

1.0 min



HALF-WAVE RECTIFIER

RG3-250 RG3-250A

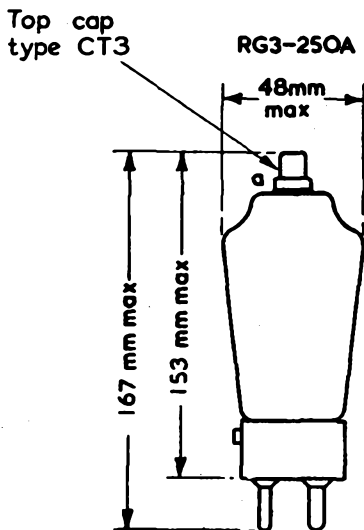
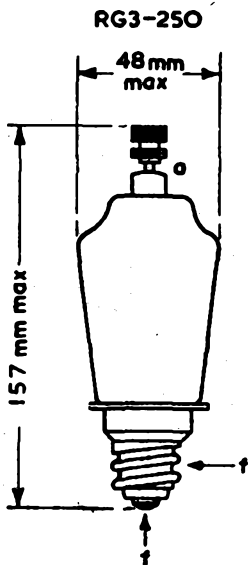

Medium Edison screw base

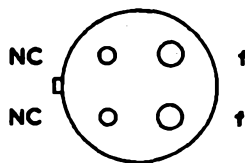

Medium 4-pin base with bayonet catch

7852



RG3-250 RG3-250A

HALF-WAVE RECTIFIER

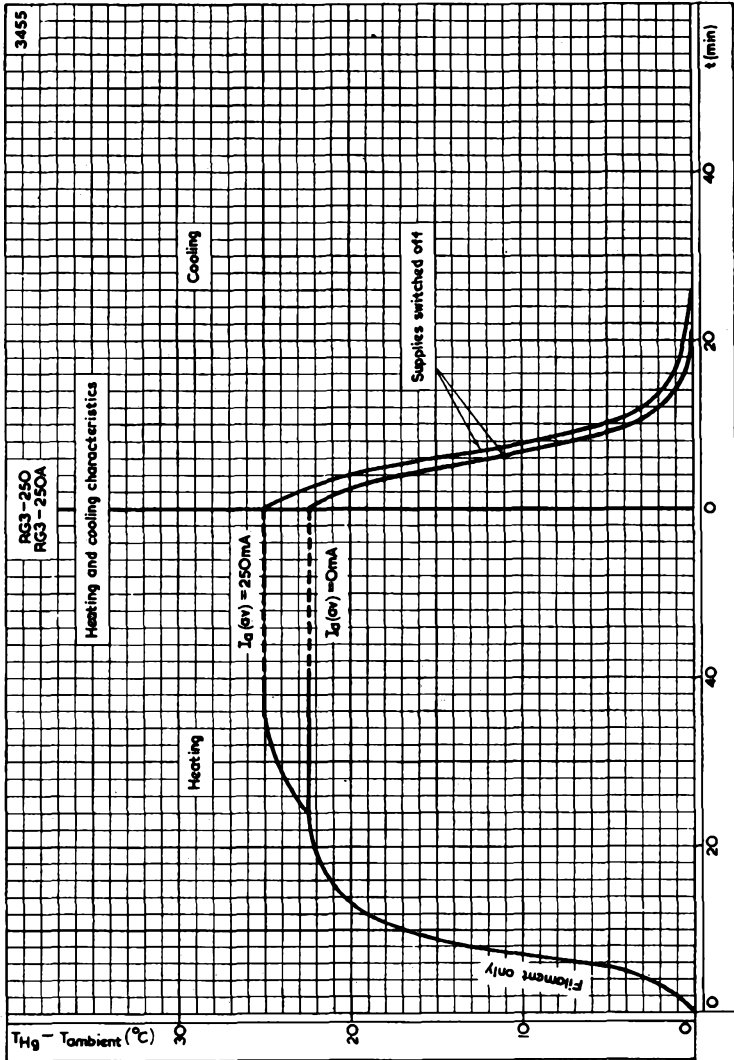

Time required for cathode to reach operating temperature = 1 min.

HEATING AND COOLING CHARACTERISTICS. EXCESS TEMPERATURE OVER AMBIENT PLOTTED AGAINST TIME



HALF-WAVE RECTIFIER

RG3-250
RG3-250A

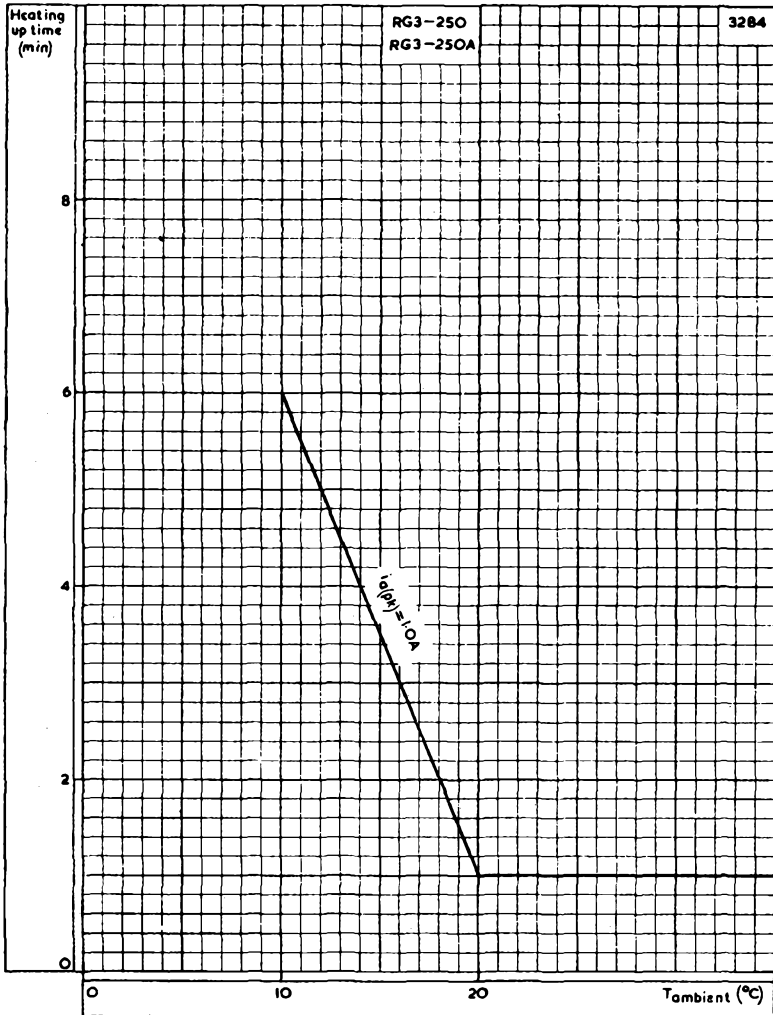

TOTAL HEATING UP TIME PLOTTED AGAINST AMBIENT TEMPERATURE



HALF-WAVE RECTIFIER

RG3-1250

Mercury vapour half-wave rectifier for use
in high voltage rectifier circuits.

This data should be read in conjunction with GENERAL OPERATIONAL
RECOMMENDATIONS - GAS-FILLED RECTIFIERS preceding this
section of the handbook.

LIMITING VALUES (absolute ratings, not design centre)

It is important that these limits are never exceeded and such variations
as mains fluctuations, component tolerances and switching surges must
be taken into consideration in arriving at actual valve operating
conditions.

*Max. peak inverse anode voltage	13	10	8.0	kV
*Condensed mercury temperature limits	25 to 55	25 to 60	25 to 65	°C
Max. cathode current				
Peak			5.0	A
Average (max. averaging time 15s)			1.25	A
Surge (fault protection max. duration 0.1s)			100	A
Max. operating frequency			150	c/s

*Max. condensed mercury temperature rating for intermediate
anode voltages may be determined by linear interpolation.

CHARACTERISTICS

Electrical

Filament voltage	4.0	V
Average filament current at 4.0V	7.0	A
Anode voltage drop	16	V

Mechanical

Equilibrium condensed mercury temperature rise above ambient		
At full load (approx.)	18	°C
At no load (approx.)	15	°C
Mounting position	Vertical, base down	
Max. net weight	{ 300 10	{ g oz

RG3-1250

HALF-WAVE RECTIFIER

*Mercury vapour half-wave rectifier for use
in high voltage rectifier circuits.*

FULL LOAD OPERATING CONDITIONS (for peak inverse anode voltage ← of 13kV and peak cathode current of 5.0A)

Circuit	No. of valves	Full load d.c. output		Applied a.c. volts (kV _{r.m.s.})	Initial filter elements	
		(kV)	(A)		Lmin. (H)	Cmax. (μF)
Single phase full-wave	2	4.1	2.5	4.5 (per valve)	2.5	6.0
Single phase bridge	4	8.2	2.5	9.1 (total)	5.0	3.0
Three phase half-wave	3	5.3* (6.2)	3.75	4.5* (5.3) (per phase)	1.5	4.0
Three phase full-wave	6	12.4	3.75	5.3 (per phase)	3.0	2.0

*These figures take into account the increase in peak inverse voltage which occurs if the power supply is lightly loaded. For operation with a constant load the voltages may be increased to the value shown in brackets.

HEATING UP TIME

The preferred minimum value of the total valve heating up time can be obtained from the heating and cooling curve on page 4. This shows how the condensed mercury temperature rises above the ambient temperature from the instant of switching on the filament supply.

Under normal conditions, however, cathode current may be drawn when the condensed mercury temperature is approximately within 7°C of the minimum quoted value. (See page 5 and also appropriate section of 'General operational recommendations - gas-filled rectifiers').

Minimum cathode heating time 1 min



HALF-WAVE RECTIFIER

Mercury vapour half-wave rectifier for use
in high voltage rectifier circuits.

RG3-1250

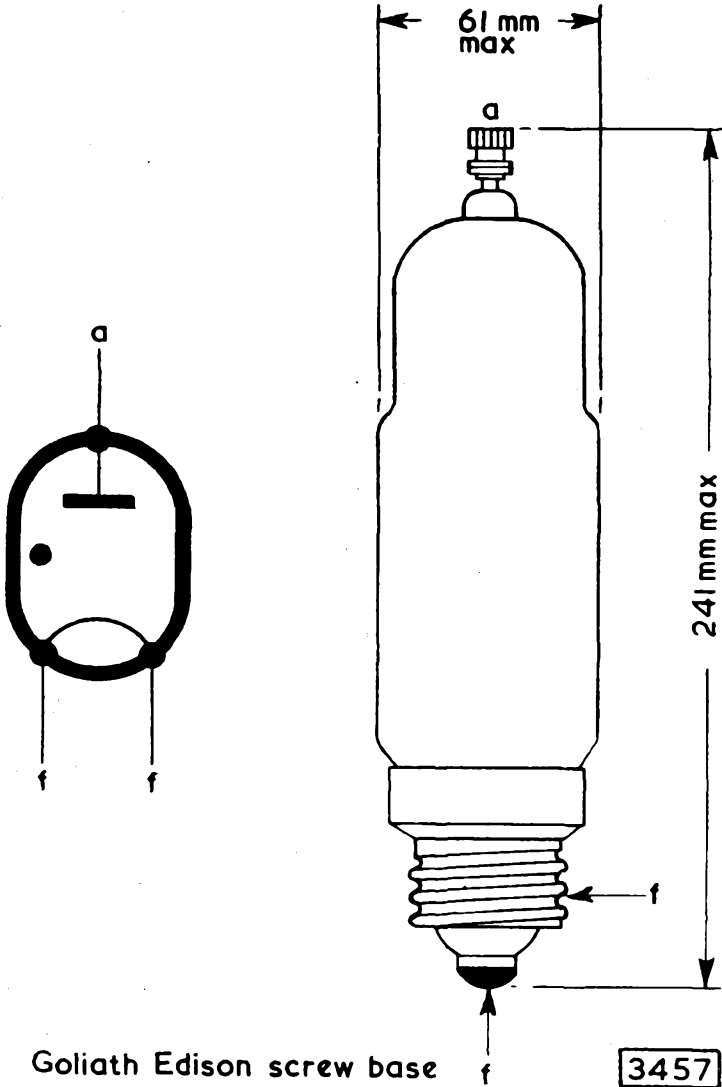

RG3-1250

HALF-WAVE RECTIFIER

Mercury vapour half-wave rectifier for use
in high voltage rectifier circuits.

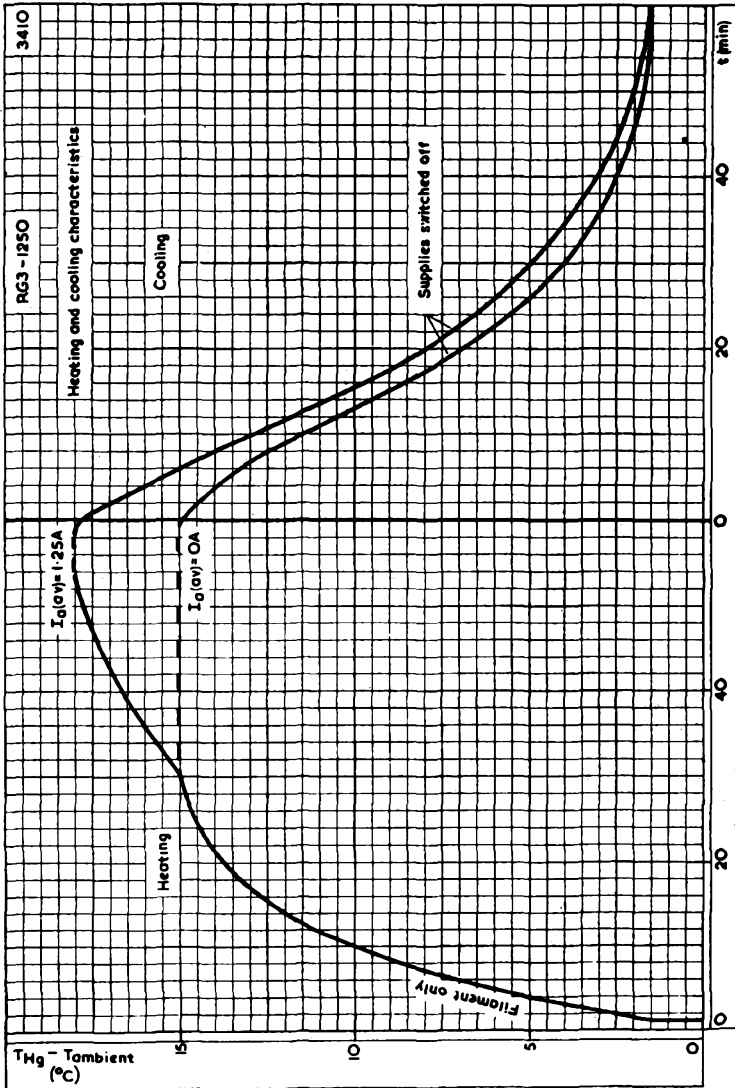

Time required for cathode to reach operating temperature = 1 min.

HEATING AND COOLING CHARACTERISTIC. EXCESS TEMPERATURE
OVER AMBIENT PLOTTED AGAINST TIME



HALF-WAVE RECTIFIER

RG3-1250

Mercury vapour half-wave rectifier for use
in high voltage rectifier circuits.

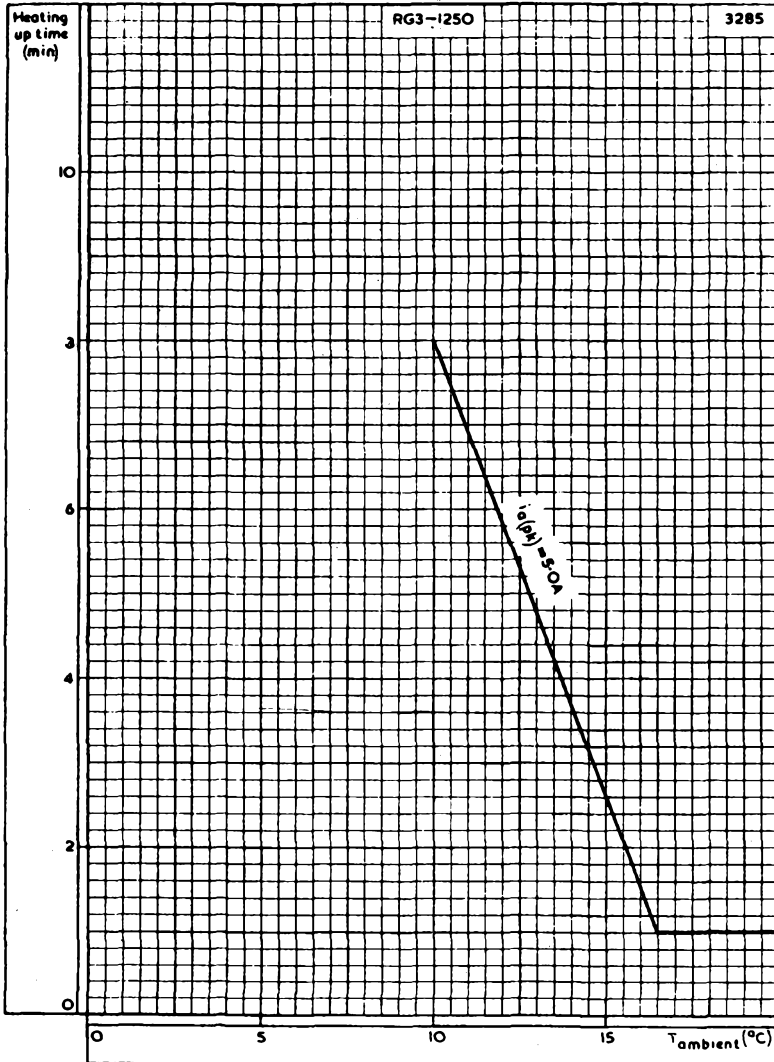

TOTAL HEATING-UP TIME PLOTTED AGAINST AMBIENT TEMPERATURE



QUICK REFERENCE DATA (maximum values)

Mercury vapour half-wave rectifier for power rectification.

P.I.V. max.	20	kV
$I_{k(av)}$ max.	1.25	A

This data should be read in conjunction with GENERAL OPERATIONAL RECOMMENDATIONS—GAS-FILLED RECTIFIERS which precede this section of the handbook.

ABSOLUTE MAXIMUM RATINGS

It is important that these ratings are never exceeded and such variations as mains fluctuations, component tolerances and switching surges must be taken into consideration in arriving at the actual operating conditions.

Maximum peak inverse anode voltage (see note 1)	20	10	kV
Condensed mercury temperature (see note 1)			
Maximum	40	55	°C
Minimum	20	20	°C
Maximum cathode current			
Average (maximum averaging time = 15s)		1.25	A
Peak		5.0	A
Surge (fault protection, maximum duration = 0.1s)		25	A
Filament voltage			
Maximum		4.1	V
Minimum		3.9	V
Maximum operating frequency		150	c/s
Valve heating time	See note 3		
Minimum cathode heating time (see note 4)		1	min

CHARACTERISTICS

Filament voltage	4.0	V
Nominal filament current at 4.0V	11	A
Nominal anode voltage drop	12	V
Nominal ignition voltage	See note 2	
Equilibrium condensed mercury temperature rise above ambient		
At full load (approx.)	16	°C
At no load (approx.)	14	°C
Net weight (approx.)	{ 10.5	oz
	{ 300	g
Weight of valve in carton (approx.)	{ 28	oz
	{ 800	g
Nominal dimensions of carton	{ 12 × 5.5 × 5.5	in
	{ 300 × 140 × 140	mm

FULL LOAD OPERATING CONDITIONS

These figures are based upon the absolute maximum ratings of the valve and no account has been taken of mains variations or transformer, valve and choke losses. In practice, due consideration must be given to these factors. See, also, appropriate sections of 'General Operational Recommendations—Gas-Filled Rectifiers'.

Circuit	No. of valves	Full load d.c. output		Applied a.c. voltage	Initial filter elements	
		(kV)	(A)	(kV _{r.m.s.})	(H)	(μ F)
Single phase full-wave	2	6.3	2.5	7.0 (per valve)	4.0	5.0
Single phase bridge	4	12.6	2.5	14	8.0	2.5
Three phase half-wave	3	8.2* (9.5)	3.75	7.0* (8.1) (per phase)	3.0	2.0
Three phase full-wave	6	19.1	3.75	8.1 (per phase)	4.0	1.0

*These figures take into account the increase in peak inverse voltage which occurs if the power supply is lightly loaded. For operation with a constant load the maximum voltages are the values shown in brackets.

OPERATING NOTES

1. The maximum condensed-mercury temperature rating for intermediate anode voltages may be determined by linear interpolation.
2. In order to obtain an ignition delay time of approximately 10 μ s, an anode voltage of at least 50V is required.
3. The preferred minimum value of the total valve heating-up time can be obtained from the heating and cooling curve on page C1. This shows how the condensed-mercury temperature rises above the ambient temperature from the instant of switching on the filament supply. Under normal conditions cathode current may be drawn when the condensed-mercury temperature is approximately within 7°C of the minimum value given. (See page C2 and appropriate section of 'General Operational Recommendations—Gas-Filled Rectifiers').
4. Under no circumstances should the anode voltage be applied until at least one minute after the application of the filament voltage.

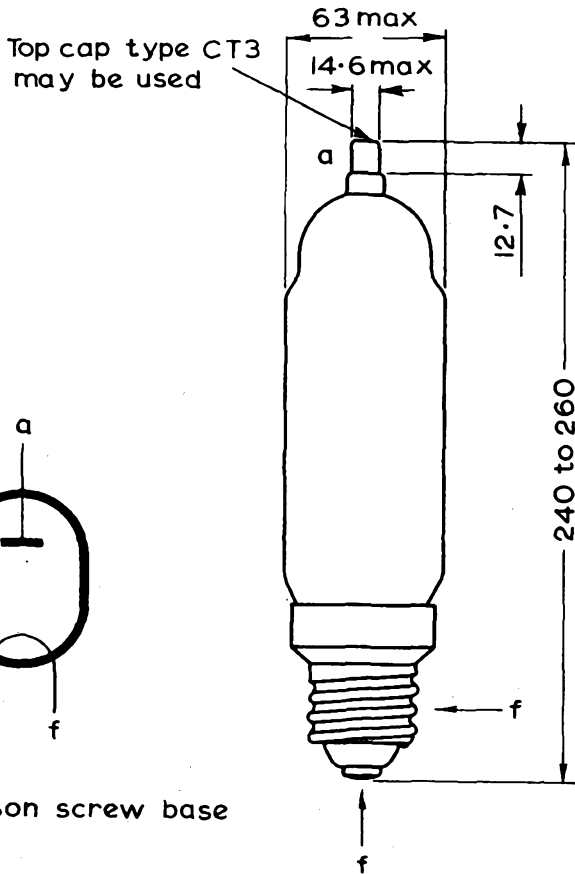

Goliath Edison screw base

All dimensions in mm

8707



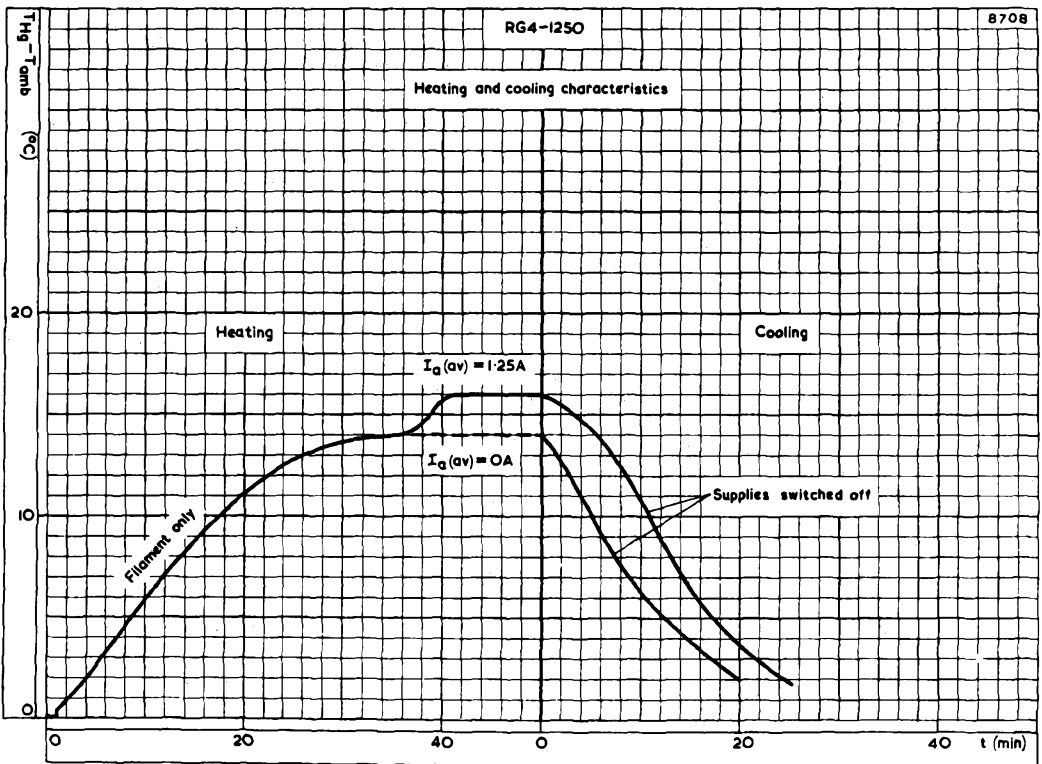

Time required for cathode to reach operating temperature=1 min.

HEATING AND COOLING CHARACTERISTIC. EXCESS TEMPERATURE OVER AMBIENT PLOTTED AGAINST TIME



RG4-1250

HALF-WAVE RECTIFIER

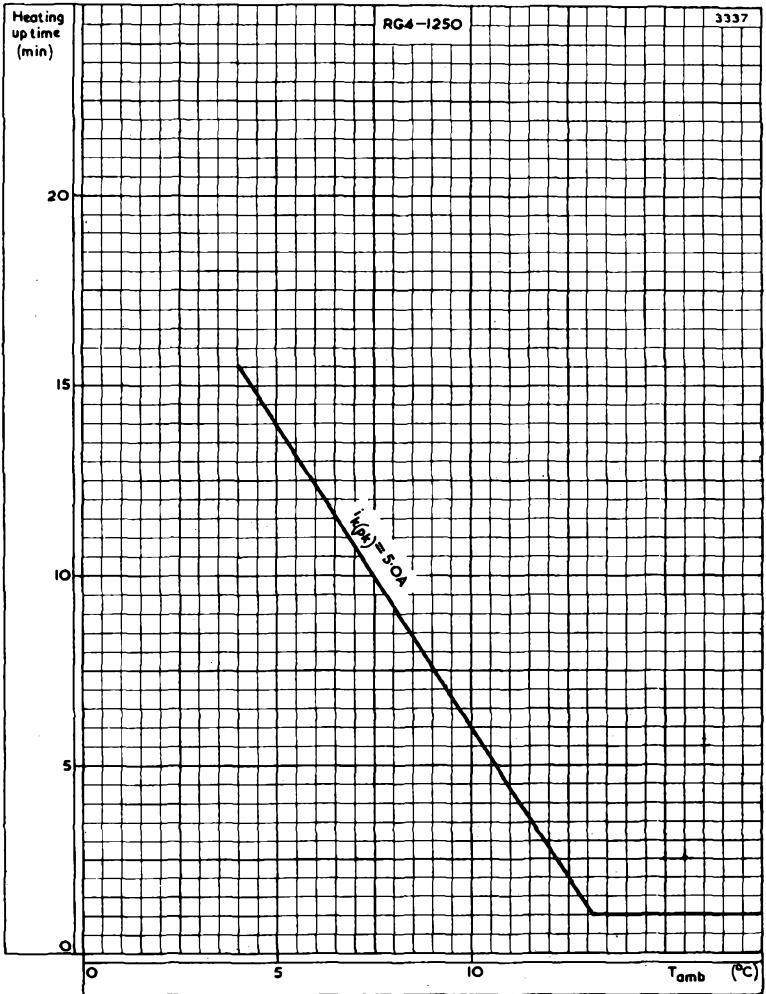

TOTAL HEATING-UP TIME PLOTTED AGAINST AMBIENT TEMPERATURE



HALF-WAVE RECTIFIER

RG4-3000

Mercury vapour half-wave rectifier
for use in high voltage rectifier circuits.

This data should be read in conjunction with GENERAL OPERATIONAL RECOMMENDATIONS — GAS-FILLED RECTIFIERS, preceding this section of the handbook.

LIMITING VALUES (absolute ratings, not design centre)

It is important that these limits are never exceeded and such variations as mains fluctuations, component tolerances and switching surges must be taken into consideration in arriving at actual valve operating conditions.

*Max. peak inverse anode voltage	2.5	10	15	kV
*Condensed mercury temperature limits	25 to 75	25 to 60	25 to 55	°C
Max. cathode current				
Peak	20	12	12	A
Average (max. averaging time 10s)	5.0	3.0	3.0	A
Surge (fault protection max. duration 0.1s)	200	120	120	A
Max. operating frequency	150	150	150	c/s

*Max. condensed mercury temperature rating for intermediate anode voltages may be determined by linear interpolation.

CHARACTERISTICS

Electrical

Filament voltage	5.0	V
Average filament current at 5.0V	11.5	A
Anode voltage drop	12	V

Mechanical

Equilibrium condensed mercury temperature rise above ambient		
At full load (approx.)	21	°C
At no load (approx.)	19	°C
Mounting position	Vertical, base down	
Max. net weight	{ 450 g 15.5 oz	
Weight of rectifier in packing	{ 1.8 kg 63 oz	
Dimensions of packing	{ 8.5 × 8.5 × 17.25 in 216 × 216 × 438 mm	



FULL LOAD OPERATING CONDITIONS

For peak inverse anode voltage of 15kV and a peak cathode current of 12A.

Circuit	No. of valves	Full load d.c. output		Applied a.c. voltage (kV _{r.m.s.})	Initial filter elements	
		(kV)	(A)		L min. (H)	C max. (μF)
Single phase full-wave	2	4.8	6.0	5.3 (per valve)	1.5	16
Single phase bridge	4	9.6	6.0	10.6 (total)	3	8
Three phase half-wave	3	6.2* (7.2)	9.0	5.3* (6.1) (per phase)	1	8
Three phase full-wave	6	14.4	9.0	6.1 (per phase)	2	4

For peak inverse anode voltage of 2.5kV and a peak cathode current of 20A.

Circuit	No. of valves	Full load d.c. output		Applied a.c. voltage (kV _{r.m.s.})	Initial filter elements	
		(kV)	(A)		L min. (H)	C max. (μF)
Single phase full-wave	2	0.79	10	0.88 (per valve)	0.2	100
Single phase bridge	4	1.58	10	1.76 (total)	0.4	50
Three phase half-wave	3	1.03* (1.19)	15	0.88* (1.02) (per phase)	0.1	50
Three phase full-wave	6	2.38	15	1.02 (per phase)	0.2	25

*These figures take into account the increase in peak inverse voltage which occurs if the power supply is lightly loaded. For operation with a constant load the voltages may be increased to the value shown in brackets.

HEATING UP TIME

The preferred minimum value of the total valve heating up time can be obtained from the curve on page C2. This shows how the condensed mercury temperature rises above the ambient temperature from the instant of switching on the filament supply.

Minimum cathode heating time 1 min



HALF-WAVE RECTIFIER

RG4-3000

3691

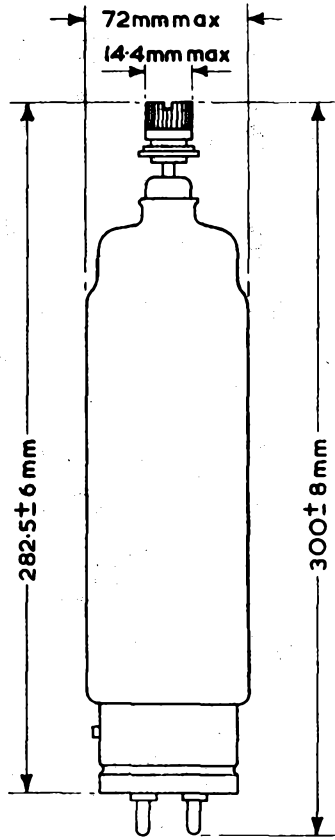
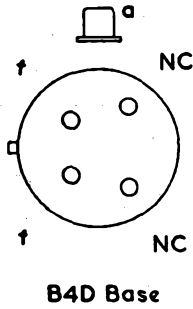

RG4-3000

HALF-WAVE RECTIFIER

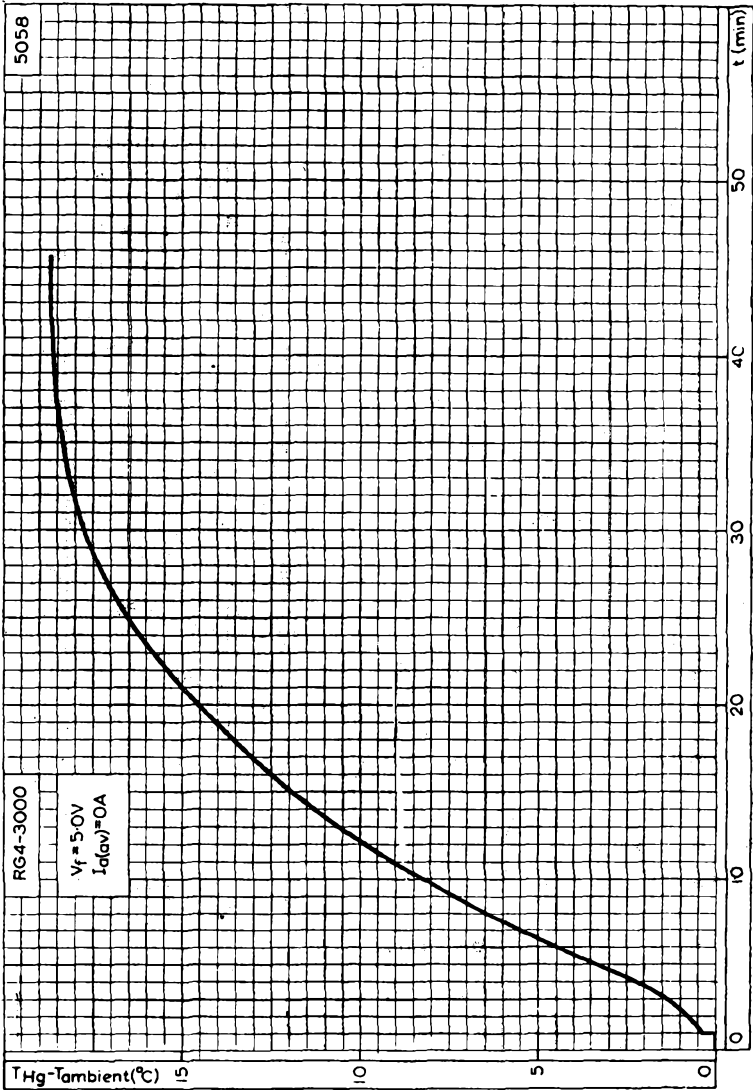

Time required for cathode to reach operating temperature = 1 min

HEATING CHARACTERISTICS. EXCESS TEMPERATURE OVER AMBIENT
PLOTTED AGAINST TIME



HALF-WAVE RECTIFIER

RR3-250

Inert gas-filled half-wave rectifier for use in high voltage rectifier circuits.

LIMITING VALUES (Absolute ratings)

It is important that these limits are never exceeded and such variations as mains fluctuations, component tolerances and switching surges must be taken into consideration in arriving at actual valve operating conditions.

Max. peak inverse anode voltage	5.0	10	kV
Max. cathode current			
Peak	2.0	1.0	A
Average (max. averaging time 15s)	500	250	mA
Surge (fault protection max. duration 0.1s)	20	20	A
Min. valve heating time	10	10	s
Max. supply frequency	500	150	c/s
Ambient temperature limits	-55 to +75	-55 to +75	°C

CHARACTERISTICS

Electrical

Filament voltage	2.5	V
Average filament current at 2.5V	5.0	A
Anode voltage drop ($I_a=500\text{mA}$)	12	V

Mechanical

Type of cooling	Convection
Mounting position	Any
Max. net weight	{ 3.5 oz 100 g

FULL LOAD OPERATING CONDITIONS

Circuit	No. of valves	P.I.V. (kV)	Full load		Applied a.c. volts (kV _{r.m.s.})	Initial filter elements	
			d.c. output (kV)	(A)		L min. (H)	C max. (μF)
Single phase full-wave	2	{ 10 5.0	3.1	0.5	3.5 (per valve) 1.7 (per valve)	10	2.0
			1.5	1.0		2.5	8.0
Single phase bridge	4	{ 10 5.0	6.3	0.5	7.0 (total) 3.5 (total)	20	1.0
			3.1	1.0		5.0	4.0



RR3-250

HALF-WAVE RECTIFIER

Inert gas-filled half-wave rectifier for use in high voltage rectifier circuits.

FULL LOAD OPERATING CONDITIONS (cont.)

Circuit	No. of valves	P.I.V. (kV)	Full load		Applied a.c. volts (kV _{r.m.s.})	Initial filter elements	
			d.c. output (kV)	(A)		L min. (H)	C max. (μF)
Three phase half-wave	3	10	4.1* (4.7)	0.75	3.5* (4.1) (per phase)	6.0	1.0
		5.0	2.0* (2.3)	1.5		1.5	4.0
Three phase full-wave	6	10	9.5	0.75	4.1 (per phase)	10	0.5
		5.0	4.7	1.5		2.0 (per phase)	2.5

*These figures take into account the increase in peak inverse voltage which occurs if the power supply is lightly loaded. For operation with a constant load the voltages may be increased to the value shown in brackets.

CIRCUIT NOTES

When quadrature operation is used the filament voltage (pin 4 with respect to pin 1) should be crossing zero from positive to negative when the anode voltage is at the peak of the positive half cycle.

When quadrature operation is not practicable filament pin 4 should be positive when the anode is positive.

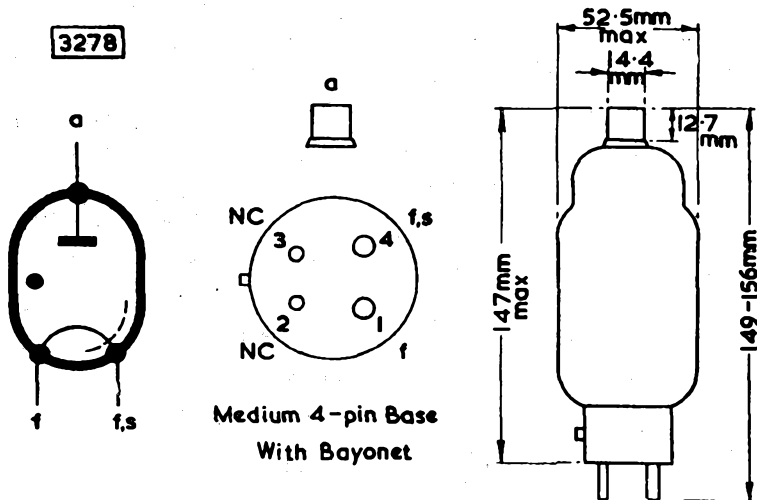

HALF-WAVE RECTIFIER

RR3-1250

Inert gas-filled half-wave rectifier for use in high voltage rectifier circuits.

This data should be read in conjunction with GENERAL OPERATIONAL RECOMMENDATIONS—GAS FILLED RECTIFIERS, preceding this section of the handbook.

LIMITING VALUES (absolute ratings)

It is important that these limits are never exceeded and such variations as mains fluctuations, component tolerances and switching surges must be taken into consideration in arriving at actual valve operating conditions.

Max. peak inverse anode voltage	10	kV
Max. cathode current		
Peak	5.0	A
Average (max. averaging time 15s)	1.25	A
Surge (fault protection max. duration 0.1s)	50	A
Min. valve heating time	30	s
Max. operating frequency	150	c/s
Ambient temperature limits	-55 to +70	°C

CHARACTERISTICS

Electrical

Filament voltage	5.0	V
Average filament current at 5.0V	7.0	A
Anode voltage drop ($I_a = 1.25A$)	13	V

Mechanical

Type of cooling	Convection	
Mounting position	Any	
Max. net weight	{ 8.0	oz
	{ 220	g

FULL LOAD OPERATING CONDITIONS (for peak inverse voltage of 10kV and peak cathode current of 5.0A)

Circuit	No. of valves	Full load		Applied a.c. volts ($kV_{r.m.s.}$)	Initial filter elements	
		d.c. output (kV)	(A)		Lmin. (H)	Cmax. (μF)
Single phase full-wave	2	3.1	2.5	3.5 (per valve)	2.0	10
Single phase bridge	4	6.3	2.5	7.0 (total)	4.0	5.0
Three phase half-wave	3	4.1* (4.7)	3.75	3.5* (4.1) (per phase)	1.5	4.0
Three phase	6	9.5	3.75	4.1 (per phase)	2.0	2.5

*These figures take into account the increase in peak inverse voltage which occurs if the power supply is lightly loaded. For operation with a constant load the voltage may be increased to the value shown in brackets.

RR3-1250

HALF-WAVE RECTIFIER

Inert gas-filled half-wave rectifier for use
in high voltage rectifier circuits.

3970

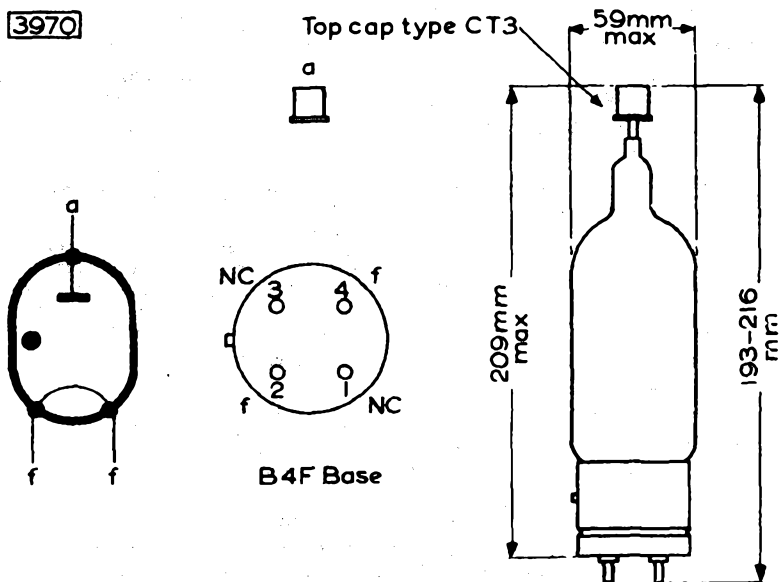

Inert gas-filled half-wave rectifier for use in high voltage rectifier circuits.

This data should be read in conjunction with **GENERAL OPERATIONAL RECOMMENDATIONS—GAS FILLED RECTIFIERS**, preceding this section of the handbook.

LIMITING VALUES (absolute ratings)

It is important that these limits are never exceeded and such variations as mains fluctuations, component tolerances and switching surges must be taken into consideration in arriving at actual valve operating conditions.

Max. peak inverse anode voltage	13	kV
Max. cathode current		
Peak	5.0	A
Average (max. averaging time 15s)	1.25	A
Surge (fault protection max. duration 0.1s)	50	A
Min. valve heating time	30	s
Max. operating frequency	150	c/s
Ambient temperature limits	-55 to +70	°C

CHARACTERISTICS

Electrical

Filament voltage	4.0	V
Average filament current at 4.0V	11	A
Anode voltage drop ($I_a = 1.25A$)	13	V

Mechanical

Type of cooling	Convection
Mounting position	Any

FULL LOAD OPERATION CONDITIONS (for peak inverse voltage of 13kV and peak cathode current of 5.0A)

Circuit	No. of valves	Full load d.c. output		Applied a.c. volts ($kV_{r.m.s.}$)	Initial filter elements	
		(kV)	(A)		L min. (H)	C max. (μF)
Single phase full-wave	2	4.1	2.5	4.5 (per valve)	2.5	6.0
Single phase bridge	4	8.2	2.5	9.1 (total)	5.0	3.0
Three phase half-wave	3	5.3* (6.2)	3.75	4.5* (5.3) (per phase)	1.5	4.0
Three phase full-wave	6	12.4	3.75	5.3 (per phase)	3.0	2.0

*These figures take into account the increase in peak inverse voltage which occurs if the power supply is lightly loaded. For operation with a constant load the voltages may be increased to the value shown in brackets.



RR3-1250A

3971

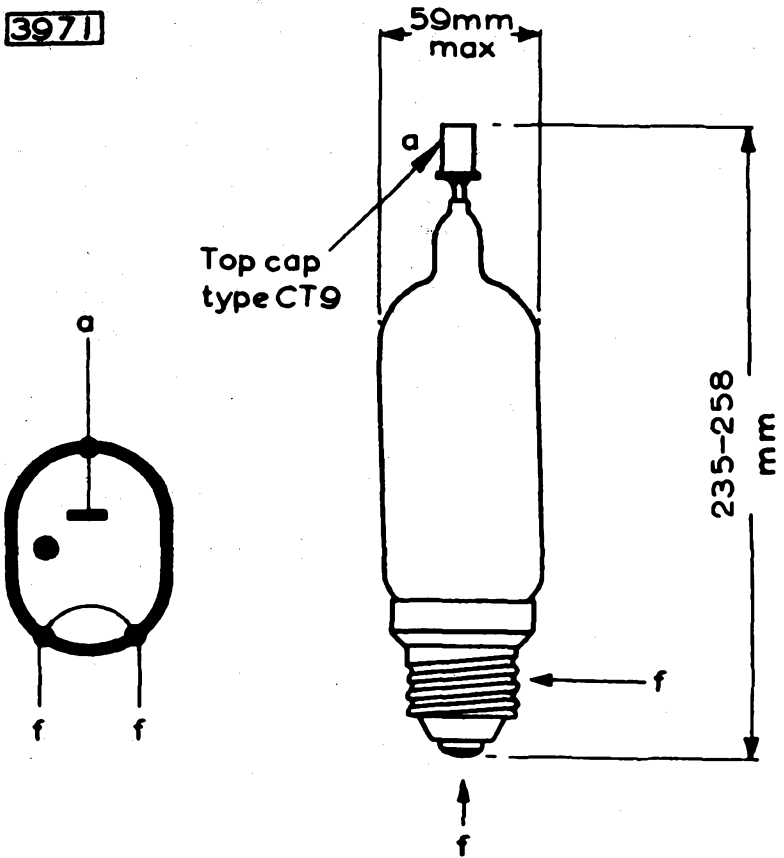

Goliath Edison Screw Base



Inert gas-filled half-wave rectifier for use in high voltage rectifier circuits.

This data should be read in conjunction with GENERAL OPERATIONAL RECOMMENDATIONS—GAS FILLED RECTIFIERS, preceding this section of the handbook.

LIMITING VALUES (absolute ratings)

It is important that these limits are never exceeded and such variations as mains fluctuations, component tolerances and switching surges must be taken into consideration in arriving at actual valve operating conditions.

Max. peak inverse anode voltage	13	kV
Max. cathode current		
Peak	5.0	A
Average (max. averaging time 15s)	1.25	A
Surge (fault protection max. duration 0.1s)	50	A
Min. valve heating time	30	s
Max. operating frequency	150	c/s
Ambient temperature limits	-55 to +70	°C

CHARACTERISTICS

Electrical

Filament voltage	4.0	V
Average filament current at 4.0V	7.0	A
Anode voltage drop ($I_a = 1.25A$)	13	V

Mechanical

Type of cooling	Convection
Mounting position	Any

FULL LOAD OPERATING CONDITIONS (for peak inverse voltage of 13kV and peak cathode current of 5.0A)

Circuit	No. of valves	Full load d.c. output		Applied a.c. volts (kV _{r.m.s.})	Initial filter elements	
		(kV)	(A)		Lmin. (H)	Cmax. (μF)
Single phase full-wave	2	4.1	2.5	4.5 (per valve)	2.5	6.0
Single phase bridge	4	8.2	2.5	9.1 (total)	5.0	3.0
Three phase half-wave	3	5.3* (6.2)	3.75	4.5* (5.3) (per phase)	1.5	4.0
Three phase full-wave	6	12.4	3.75	5.3 (per phase)	3.0	2.0

*These figures take into account the increase in peak inverse voltage which occurs if the power supply is lightly loaded. For operation with a constant load the voltages may be increased to the value shown in brackets.

RR3-1250B

B4616

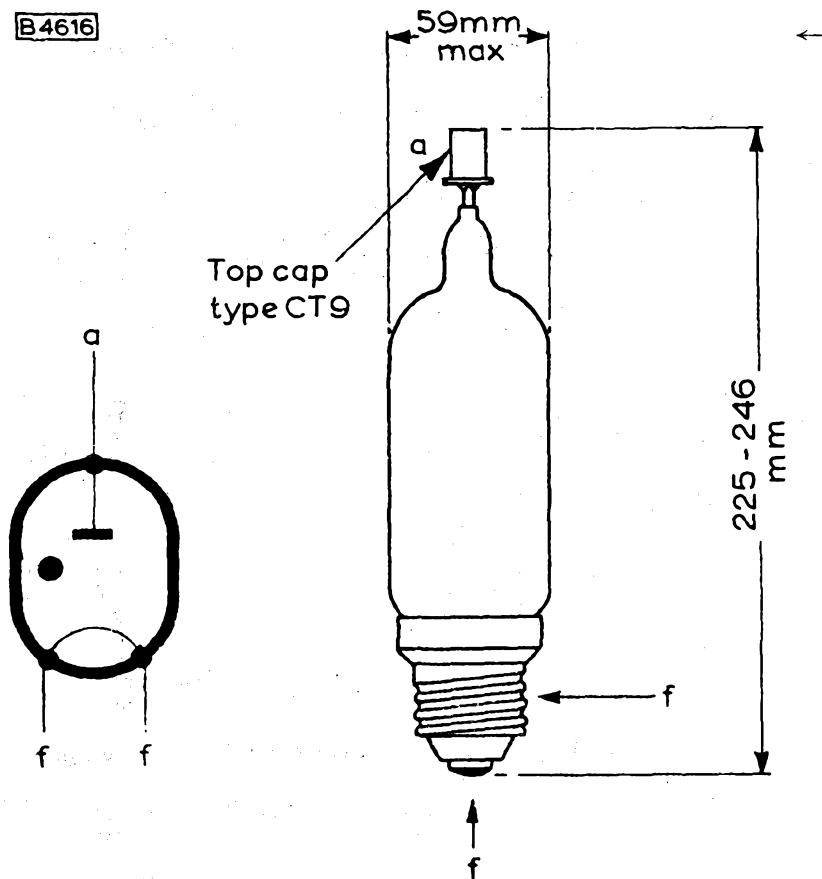

Goliath Edison Screw Base



ACCESSORIES



VALVE SOCKET

B8 700 67

This valve socket is for use with valves having a B13B base.

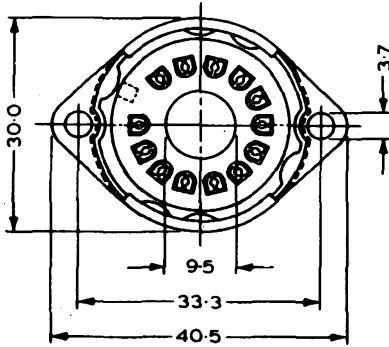
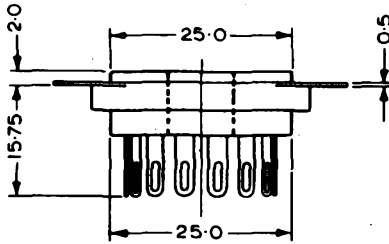

Mounting holes

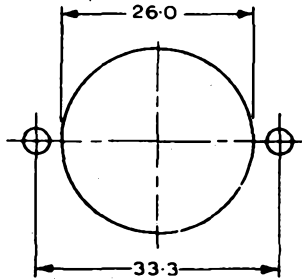

All dimension in mm

VALVE SOCKET

B8 702 28

This valve socket is for use with valves having a B13B base.

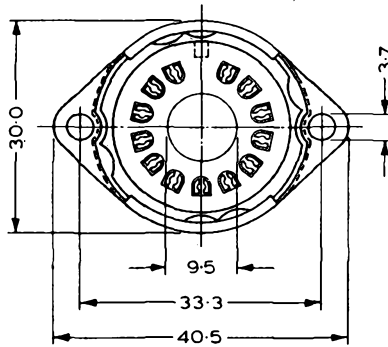
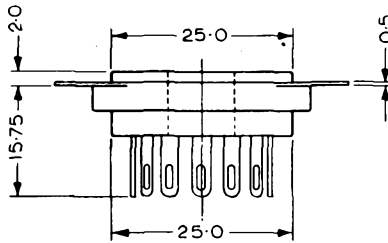

Mounting holes

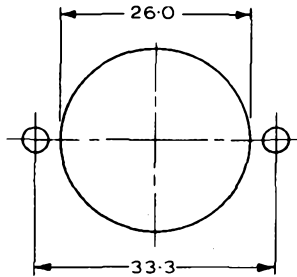

All dimension in mm

B6595

Mounting board on which ZM1000 and similar based types can be soldered and the combination connected to a vertical printed wiring board containing the drive circuit.

- Material: Phenol paper 0.8mm thick
- Holes: For soldering tube $\varnothing 0.8\text{mm}$ on pitch 2.54mm
soldering islands $\varnothing 2.0^{+0}_{-0.1}\text{mm}$
- For connections $\varnothing 1.1\text{mm}$ on pitch 5.08mm
soldering islands $\varnothing 3.0 \pm 0.1\text{mm}$
- Minimum creepage distance: 0.35mm
- Minimum track width: 0.35mm

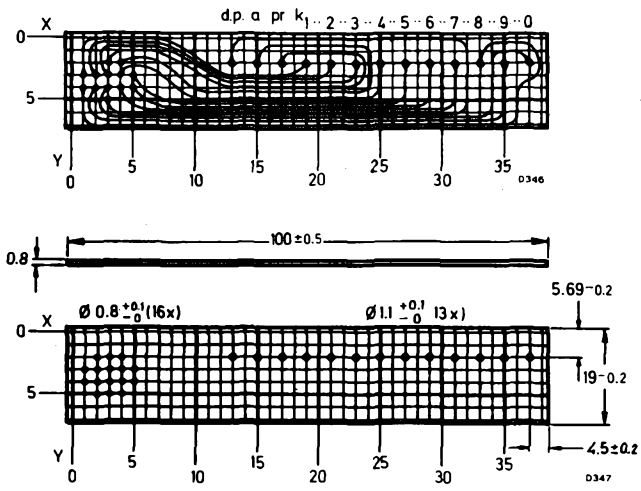

All dimensions in mm



TUBE SOCKET

55702

14-pin socket intended for mounting on a chassis or on a printed wiring board. The socket is compatible with the 14-pin base used on indicator tubes such as type ZM1000.

Material: Phenolic

Contacts: Fork shaped, silver plated

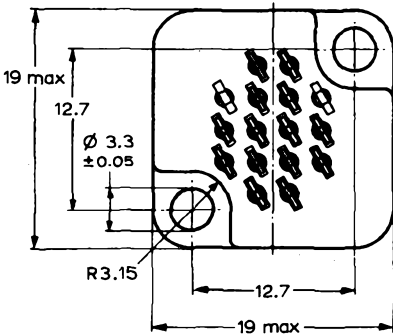
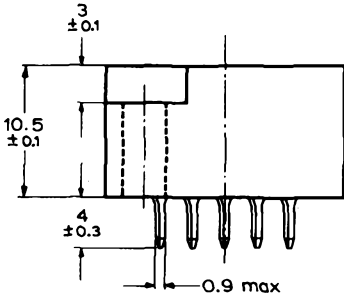
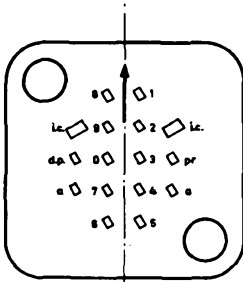

All dimensions in mm
Hole pattern in printed wiring board
(for bottom view of socket)

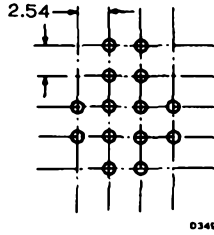

SNAP-FIT INDICATOR TUBE ASSEMBLY

55703
55704

A snap-fit indicator-tube assembly which consists of a left-hand end piece (1), as many snap-fit tube holders (2) as there are indicator tubes to be fitted side by side, a right-hand end piece (3) and a filter plate (4) which forms the front panel. The filter plate should preferably be of circular-polarised blue-light absorbing material. The separate pieces can be inserted into a rectangular window cut in the front panel (thickness $1.6 \pm 0.2\text{mm}$) of a piece of equipment. No tools are needed and insertion can be made from the front.

Material: Grey plastic

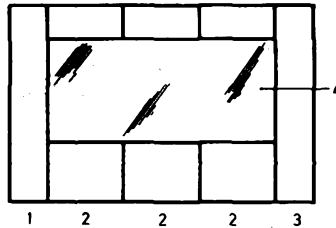

0390

All dimensions in millimetres

Left-hand end piece

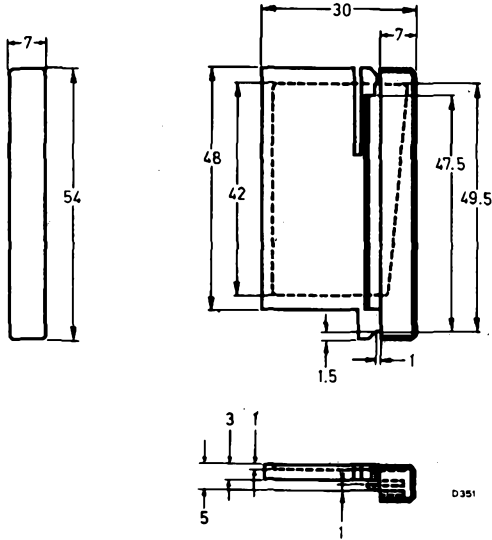

Right-hand end piece

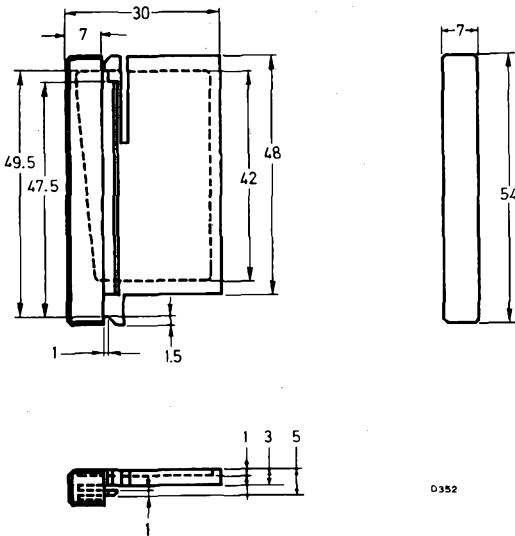

These two items are supplied together under type number 55704



SNAP-FIT INDICATOR TUBE ASSEMBLY

55703 55704

All dimensions in millimetres

Snap-fit tube holder - Type number 55703 Holes eg for mounting
a printed wiring board

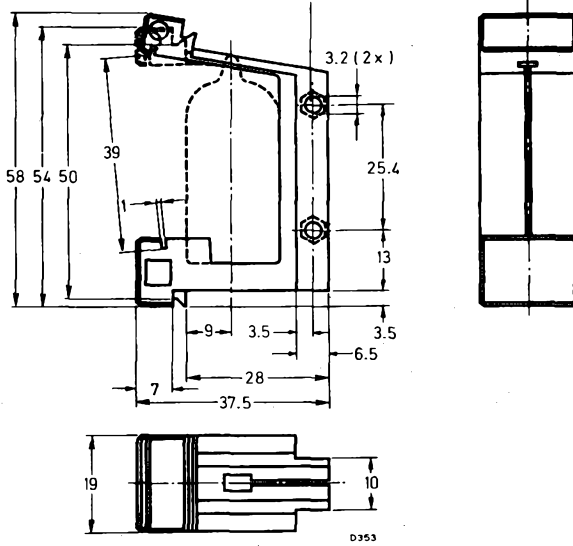

Window to be cut in the front panel

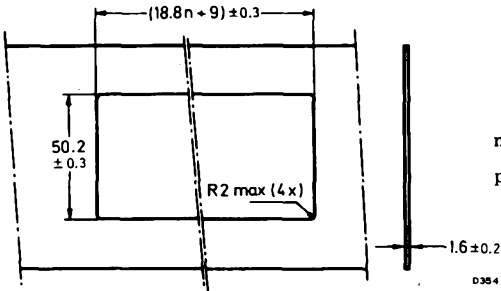

n = number of tube holders type 55703
panel thickness 1.6 ± 0.2 mm

Filter plate (not supplied)

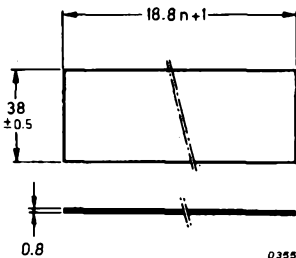

n = number of tube holders type 55703



MOUNTING INSTRUCTIONS

1. Slide one of the end pieces into position in the window cut in the front panel. Left-hand end piece is shown in figs. 1a and 1b.

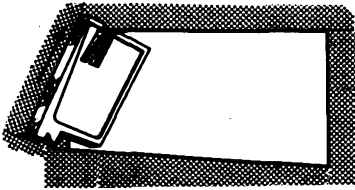

Fig. 1a

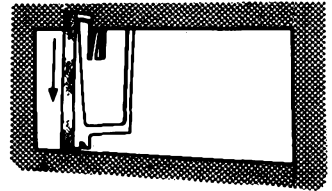

Fig. 1b

2. Slide the snap-fit tube holders into position one by one, as in figs. 2a and 2b.

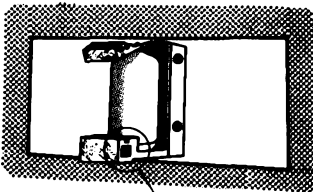

Fig. 2a

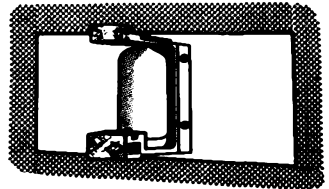

Fig. 2b

3. After the last tube holder is in position, slide the filter plate into the grooves provided for this purpose as in fig. 3. Slide the other end piece into position.

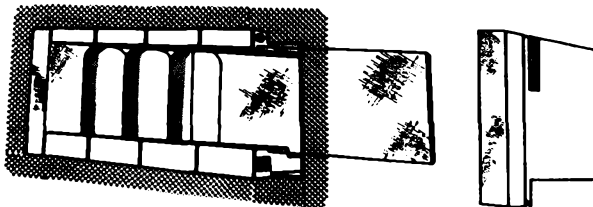

Fig. 3

Removal takes place in the reverse order.

TUBE SOCKET

55705

14-pin socket, intended for use with close mounted rectangular envelope indicator ← tubes.

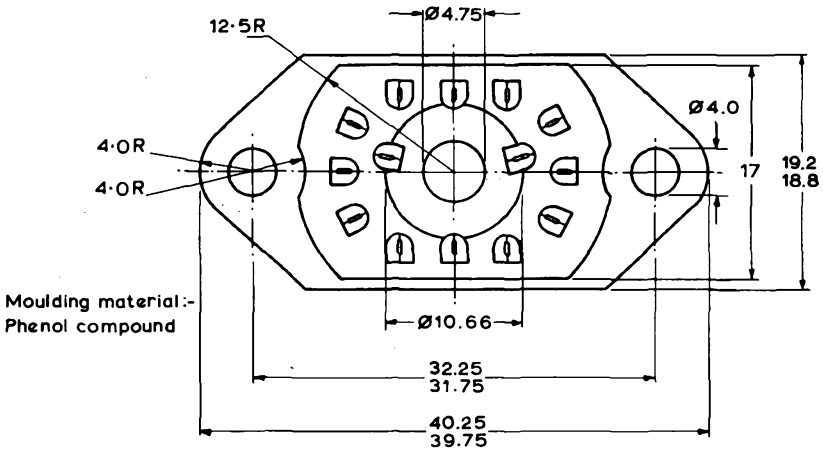
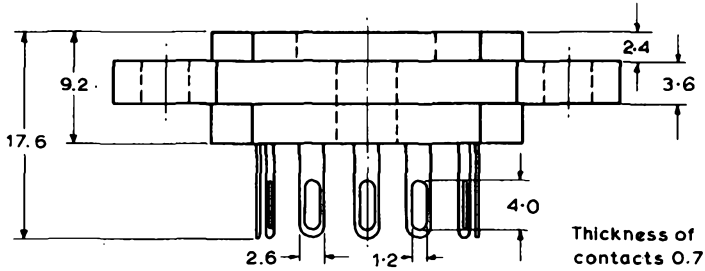

For minimum spacing between adjacent sockets see individual tube data sheets

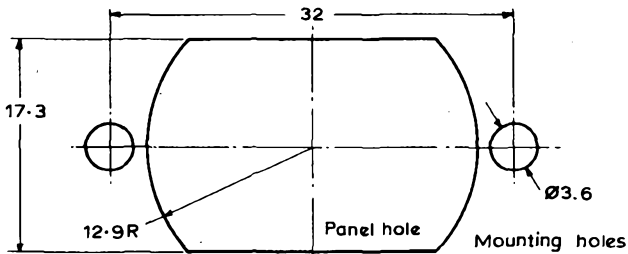

All dimensions in mm

D1812

Mullard

MOUNTING BRACKET FOR INDICATOR TUBES

56022

This bracket provides a simple means of mounting an indicator tube of dimensions similar to the ZM1080 series directly to the edge of a printed circuit board.

Material: - Plastic



56022

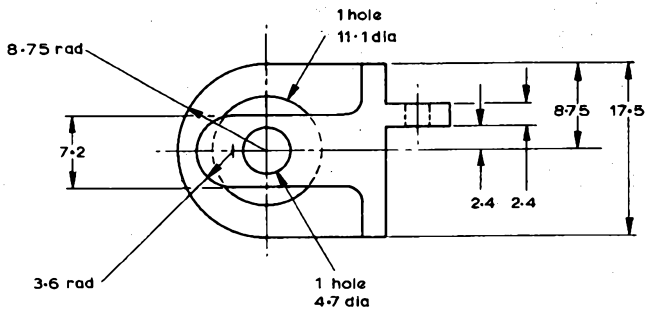
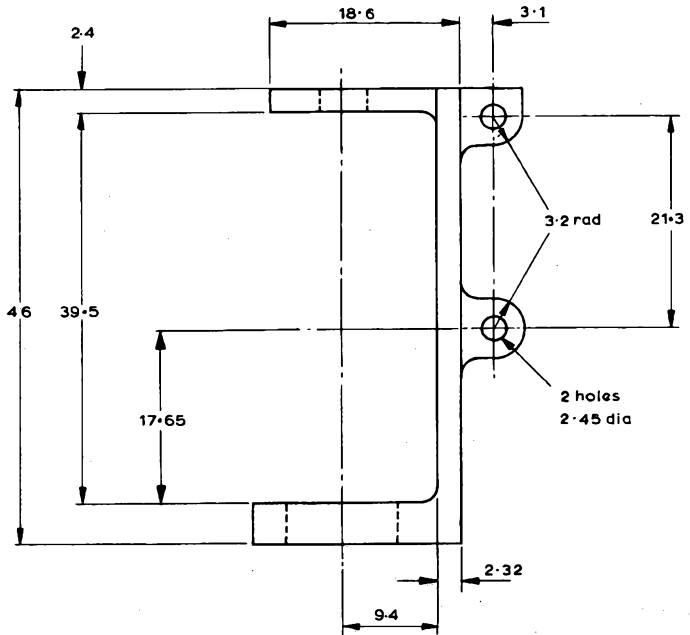

B6030

All dimensions in millimetres



ESCUTCHEON

101065

Black polystyrene escutcheon with numbers 0 to 9 engraved in white for use with a decade counter tube.

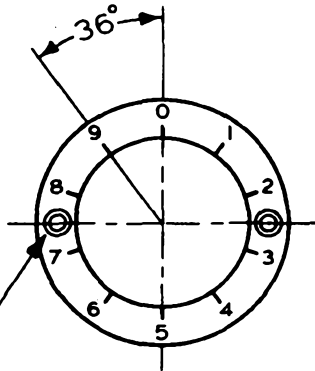
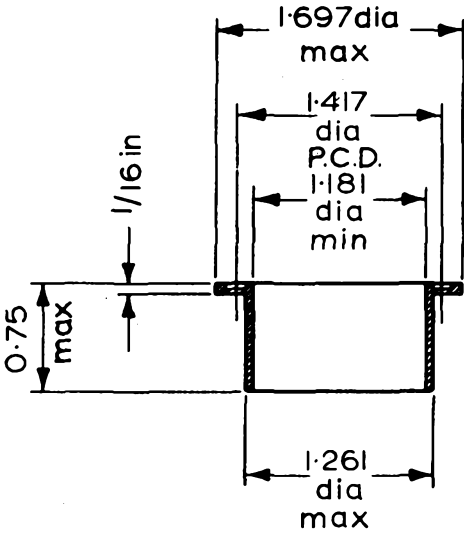

2 holes C.S.K.
8BA clear.

9412

All dimensions in inches.

**ABRIDGED DATA
FOR EARLIER TYPES
AND INDEX**



ABRIDGED DATA FOR EARLIER TYPES

BOOK 2 PART 3—GASFILLED TUBES

Abridged data only are given in these tables.
Full data for these types are available on request.

Numerical and character indicating tubes

Type No.	Description	Characters Displayed	Character Height (mm)	Minimum Supply Voltage (V)	Maintaining Voltage (V)	Recommended Cathode Current (mA)	Base
ZM1020 ZM1022	In line, end-viewing indication Incorporates a red filter As ZM1020 but without red filter	Numbers 0-9	15.5	170	140	2.0	B13B
ZM1021 ZM1023	In line, end-viewing indication Incorporates a red filter As ZM1021 but without red filter	Characters A, V, Ω , +, -, %, ~	15.5	170	140	2.0	B13B



INDEX TO BOOK 2 PART 3

GASFILLED TUBES

Type No.	Section	Type No.	Section
B8 700 67	K	ZM1000R	E
B8 702 28	K	ZM1001	E
E1T	.	ZM1001R	E
EN32	F	ZM1020	L*
EN91	F	ZM1021	L*
EN92	F	ZM1022	L*
ET51	.	ZM1023	L*
M8098	C	ZM1040	.
M8142	.	ZM1041	.
M8163	C	ZM1042	.
M8190	C	ZM1080	E
M8204	F	ZM1081	E
M8223	C	ZM1082	E
M8224	C	ZM1083	E
M8225	C	ZM1162	E
RG1-240A	J	ZM1170	E
RG3-250	J	ZM1172	E
RG3-250A	J	ZM1174	E
RG3-1250	J	ZM1175	E
RG4-1250	J	ZM1176	E
RG4-3000	J	ZM1177	E
RI-12	B	ZM1200	E
RR3-250	J	ZM1230	E
RR3-1250	J	ZM1232	E
RR3-1250A	J	ZT1000	.
RR3-1250B	J	ZT1011	G
RY12-100	.	ZX1051	H
XG1-2500	G	ZX1052	H
XG2-12	.	ZX1053	H
XG2-25	.	ZX1061	H
XG2-6400	G	ZX1062	H
XG5-500	.	ZZ1000	C
XG15-10	.	75C1	C
XG15-12	.	83A1	C
XH3-045	.	85A2	C
XH8-100	.	90C1	C
XR1-12A	.	108C1	C
XR1-1600A (see ZT1011)	.	150B2	C
XR1-3200A	G	150C2	C
XR1-6400A	G	150C4	C
Z300T	.	55701	K
Z504S	D	55702	K
Z505S	D	55703	K
Z803U	F	55704	K
Z900T	F	55705	K
ZA1002	B	55706	K
ZA1004	B	56022	K
ZM1000	E	101065	K

*Not recommended for the design of new equipment.

Full data for these types are available on request.

GASFILLED TUBES

CONTENTS

SELECTION GUIDE (see coloured pages)

A GENERAL SECTION

B SWITCHING DIODES, REED INSERTS

C VOLTAGE STABILISER & REFERENCE TUBES

D COUNTING TUBES

E NUMERICAL & CHARACTER INDICATING TUBES

F SMALL THYRATRONS & TRIGGER TUBES

G LARGE THYRATRONS

H IGNITRONS

J POWER RECTIFIERS

K ACCESSORIES

L ABRIDGED DATA FOR EARLIER TYPES & INDEX

MULLARD LIMITED

MULLARD HOUSE, TORRINGTON PLACE, LONDON, WC1E 7HD