Mullard technical handbook

Book three

Components, materials and assemblies

Part one

Capacitors Resistors

March 1981



CAPACITORS RESISTORS

CONTENTS

SELECTION GUIDE
PREFERRED NUMBER SERIES



METALLISED FILM CAPACITORS

A

FILM/FOIL CAPACITORS

B

CERAMIC CAPACITORS

C

ELECTROLYTIC CAPACITORS

D

VARIABLE CAPACITORS

E

LINEAR RESISTORS

F

NEGATIVE TEMPERATURE
COEFFICIENT THERMISTORS

G

POSITIVE TEMPERATURE
COEFFICIENT THERMISTORS

H

VOLTAGE DEPENDENT RESISTORS

J

INDEX



The issue of the information contained in this publication does not imply any authority or licence for the utilisation of any patented feature.

'Mullard' is the trademark of Mullard Limited and is registered in most of the principal countries of the world.

© Mullard Limited, March 1981

Book 3 comprises the following parts —

- Part 1 Capacitors, resistors**
- Part 2 Magnetic materials and components**
- Part 3 Vinkor inductor cores**
- Part 4 RM inductor cores**
- Part 5 Loudspeakers, television assemblies and modules**
- Part 6 Circuit blocks, input and output devices, peripheral devices**

Made and printed in England by Burrup, Mathieson & Co. Ltd.



BOOK 3 (Part 1)

**COMPONENTS
MATERIALS
AND
ASSEMBLIES**

Capacitors Resistors

MULLARD LTD., MULLARD HOUSE, TORRINGTON PLACE,
LONDON, WC1E 7HD

Telephone: 01-580 6633

Telex: 264341

DATA HANDBOOK SYSTEM

The Mullard data handbook system is made up of four sets of books, each comprising several parts; plus the Signetics technical handbooks.

The four sets of books, easily identifiable by the colours on their covers, are as follows:

Book 1	(blue)	Semiconductor devices
Book 2	(orange)	Valves and tubes
Book 3	(green)	Passive components, materials, and assemblies
Book 4	(purple)	Integrated circuits

Each part is completely reviewed annually; revised and reprinted where necessary. Revisions to previous data are indicated by an arrow in the margin.

The data contained in these books are as accurate and up to date as it is reasonably possible to make them at the time of going to press. It must however be understood that no guarantee can be given here regarding the availability of the various devices or that their specifications may not be changed before the next edition is published.

The devices on which full data are given in these books are those around which we would recommend equipment to be designed. Where appropriate, other types no longer recommended for new equipment designs, but generally available for equipment production are listed separately with abridged data. Data sheets for these types may be obtained on request. Older devices on which data may still be obtained on request are also included in the index of the appropriate part of each book.

Requests for information on the data handbook system (including Signetics data) and for individual data sheets should be made to

Technical Publications Department
Mullard Limited
New Road
Mitcham
Surrey CR4 4XY
Telex: 22194

Information regarding price and availability of devices must be obtained from our authorised agents or from our representatives.

Mullard manufacture and market electronic components
under the Mullard, Philips and Signetics brands.

SELECTION GUIDE

Sections A and B

METALLISED FILM AND FILM/FOIL CAPACITORS

Capacitance range	Working voltage	Terminations	Encapsulation	Type No. Series	Section
100 to 39 000 pF	63, 160, 250, 630 V	axial	sleeved	424,425,426,427	B
1000 to 36 000 pF	160, 250 V	axial	sleeved	456, 457	B
100 to 34 000 pF	63 V	radial	resin potted	443	B
2.2 to 680 nF	100, 250, 400, 630 V	radial	lacquered	347	B
10 to 470 nF	} 250/175 V _{ac} }	axial	} moulded	330	B
10 to 330 nF		radial			
47 to 680 nF	250 V	radial	moulded	357 5	B
1.5 to 330 nF	630, 1000, 1500, 2000 V	radial	moulded	357 6 to 9	B
0.0047 to 2.2 μF	250, 400 V	radial	lacquered	352	A
0.01 to 1.0 μF	100, 250, 400 V	radial	resin dipped	358	A
0.01 to 2.2 μF	250, 400 V	axial	moulded	C281	A
0.0047 to 6.8 μF	100, 250, 400, 630 V	radial	moulded	344	A

Section C

CERAMIC CAPACITORS

Capacitance range	Working voltage	Terminations	Encapsulation	Type No. Series
1.8 to 330 pF	100 V	radial	lacquered	632, 642
1000 and 2200 pF	250 V _{ac}	radial	lacquered	660
390 to 4700 pF	100 V	radial	lacquered	630
1.0 to 22 nF	63 V	radial	lacquered	629
Tubulars				
1 to 22 000 pF	50 V	radial	coated	561

Section C

MULTILAYER CHIP CERAMIC CAPACITORS

Capacitance range	Working voltage	Terminations	Encapsulation	Type No. Series
10 to 10 000 pF 100 to 470 000 pF	NPO 50 V X7R 50 V	Solder lands	—	851 to 856 Series

Section D

ELECTROLYTIC CAPACITORS

Capacitance range	Working voltage	Electrodes	Electrolyte	Terminations	Type No. Series
0.1 to 47 μ F	6.3 to 40 V	Aluminium	solid	radial	122
1 to 22 μ F	160 to 385 V	Aluminium	wet	axial and single ended	041
1 to 470 μ F	4 to 63 V	Aluminium	wet	axial	015/016
2.2 to 330 μ F	4 to 63 V	Aluminium	solid	axial	121
10 to 100 μ F	160 to 385 V	Aluminium	wet	axial and single ended	042/043
47 to 1000 μ F	250, 385 V	Aluminium	wet	solder tags or p.w. pins	052
0.47 to 3300 μ F	6.3 to 100 V	Aluminium	wet	single ended	034
2.2 to 2200 μ F	6.3 to 63 V	Aluminium	wet	axial	108
150 to 4700 μ F	250, 385	Aluminium	wet	screws	115
150 to 4700 μ F	6.3 to 63 V	Aluminium	wet	axial	032
1000 to 10 000 μ F	6.3 to 63 V	Aluminium	wet	axial and single ended	033
470 to 68 000 μ F	10 to 100 V	Aluminium	wet	solder tags or p.w. pins	050
680 to 47 000	6.3 to 63 V	Aluminium	wet	solder tags	071
1150 to 150 000 μ F	63 to 100 V	Aluminium	wet	screws	106/107

Section E

VARIABLE CAPACITORS

Capacitance swing	Working voltage	Dielectric	Function	Type No. Series
1–3.5 to 2–18 pF	300 V	film	trimmer	809 05
1.4–5.5 to 2–18 pF	300 V	film	trimmer	809 09
1.4–5.5 to 5.5–65 pF	250 V	film	trimmer	808
4–40 to 5–60 pF	300 V	film	trimmer	809 08
4–40 to 7–100 pF	200 V	film	trimmer	809 07

Section F

LINEAR RESISTORS

Resistance range	Power dissipation	Description	Style
1 Ω to 1 M Ω	0.2 to 0.5 W	carbon film	CR16, 25, 37
4.99 to 1 M Ω	0.25 W	metal film	MR16
4.99 to 1 M Ω	0.4 to 0.5 W	metal film	MR25, 30, 308
10 Ω to 27 k Ω	1.6 to 2.5 W	metal film	PR37, 52
1 Ω to 1 M Ω	0.33 W	metal film	SFR25
1 M Ω to 68 M Ω	0.25 to 1 W	metal glaze	VR25, 37, 68

Section G

NEGATIVE TEMPERATURE COEFFICIENT THERMISTORS

Disc and rod types

Resistance (Ω)	B-value (K)	Power rating (W)	Shape	Type No.
at 25 °C				
1.1	2650	1	disc	2322 610 11118
2.2	2675	1	disc	VA1086
4	2800	1	disc	VA1033
6	2825	1	disc	VA1074
8	2900	1	disc	VA1053
10	2950	1	disc	2322 610 12109
15	3000	1	disc	VA1100
15	3350	see note 1	disc	VA1104
33	3250	1	disc	2322 610 11339
50	3300	1	disc	VA1034
130	4600	1	disc	VA1040
150	3280	0.6	disc	VA1096
470	3620	0.6	disc	VA1097
500	5200	1	disc	VA1039
1300	5450	1	disc	VA1038
1500	3775	0.6	disc	VA1098
2200	3915	0.6	disc	VA1106
4700	3300	0.6	rod	VA1066S
4700	4200	0.6	disc	VA1109
15 000	3600	0.6	rod	VA1055S
15 000	4375	0.6	disc	VA1108
22 000	4200	0.6	disc	VA1112
33 000	4250	0.6	disc	VA1111
47 000	3925	0.6	rod	VA1056S
150 000	4075	0.6	rod	VA1067S

Note 1: Max. r.m.s. current = 2.2 A

Section G (Continued)

NEGATIVE TEMPERATURE COEFFICIENT THERMISTORS

Two-point types

Temp. range (°C)	Resistance (kΩ)	B-value (K)	Power rating (W)	Type No.
-30 to -10	15 to 50	4000	0.25	2322 640 90013
-20 to +25	2.7 to 15	4000	0.25	2322 640 90015
+25 to +100	0.95 to 12	3750	0.25	2322 640 90004
+100 to +200	1.12 to 16.7	4300	0.25	2322 640 90005

Miniature bead types

Resistance (Ω)	B-value (K)	Dissipation factor (mW/°C)	Description	Type No.
at 25 °C				
1000 to 470 000	2375 to 4030	0.1	plain bead	VA3100
1000 to 470 000	2375 to 4030	0.4	gasfilled glass tube	VA3200
1000 to 220 000	2375 to 3920	0.75	glass dipped bead	VA3400
1000 to 470 000	2375 to 4030	0.7	thermometer type	VA3700

Section H

POSITIVE TEMPERATURE COEFFICIENT THERMISTORS

Resistance at 25 °C (Ω)	Switch temperature (°C)	Max. voltage (V)	Application	Type No.
30	45	50	General purpose	E220ZZ/02
40	110	50		E220ZZ/04
50	25	40		E220ZZ/01
50	80	50		E220ZZ/03
80	75	265*	De-gaussing	VA8650
30+8	75	265	Dual degaussing	2322 662 98003
40+1 k to 6 k	—	265	Dual degaussing	2322 669 98009
30	105	265*	Overload Protection	2322 662 93004

*With series current limiting resistor

Section J**VOLTAGE DEPENDENT RESISTORS****Silicon Carbide types**

Reference voltage (V)	Reference current (mA)	Shape	Type No.
8	100	disc	E299DD/P116
8	10	disc	E299DD/P216
10	100	disc	E299DD/P118
10	10	disc	E299DD/P218
12	100	disc	E299DD/P120
12	10	disc	E299DD/P220
15	10	disc	E299DD/P222
18	10	disc	E299DD/P224
22	10	disc	E299DD/P226
27	10	disc	E299DD/P228
33	10	disc	E299DD/P230
39	10	disc	E299DD/P232
47	10	disc	E299DD/P234
56	10	disc	E299DD/P236
56	1.0	disc	E299DD/P336
68	10	disc	E299DD/P238
68	1.0	disc	E299DD/P338
82	1.0	disc	E299DD/P340
100	1.0	disc	E299DD/P342
120	1.0	disc	E299DD/P344
150	1.0	disc	E299DD/P346
180	1.0	disc	E299DD/P348
220	1.0	disc	E299DD/P350
270	1.0	disc	E299DD/P352
330	1.0	disc	E299DD/P354

Section J (Continued)

VOLTAGE DEPENDENT RESISTORS

Zinc Oxide types

Min. voltage at 0.1 mA (V)	Max. voltage at 1.0 A (V)	Shape	Type No. 2322 594
82	140	disc	18202
100	170	disc	11102
150	255	disc	11512
190	325	disc	11912
220	375	disc	12212
270	400	disc	12712
330	565	disc	13312
350	600	disc	13512
390	665	disc	13912
470	805	disc	14712
620	1050	disc	16212
680	1160	disc	16812

R.M.S. working voltage (V)	Clamping voltage max. at 100 A (V)	Shape	Type No. 2322 594
60	220	disc	76002
75	260	disc	77502
95	330	disc	79502
130	440	disc	71312
150	510	disc	71512
175	570	disc	71712
230	760	disc	72312
250	820	disc	72512
275	900	disc	72712
300	980	disc	73012
420	1410	disc	74212
460	1550	disc	74612

CAPACITORS AND RESISTORS

PREFERRED NUMBER SERIES

The figures given in the tables below, and their decimal multiples and submultiples, are the series of preferred values for Mullard capacitors and resistors, in accordance with BS2488 and IEC publication 63.

E6:	10	15	22	33	47	68						
E12:	10	12	15	18	22	27	33	39	47	56	68	82
E24:	10	11	12	13	15	16	18	20	22	24	27	30
	33	36	39	43	47	51	56	62	68	75	82	91
E96:	100	102	105	107	110	113	115	118	121	124	127	130
	133	137	140	143	147	150	154	158	162	165	169	174
	178	182	187	191	196	200	205	210	215	221	226	232
	237	243	249	255	261	267	274	280	287	294	301	309
	316	324	332	340	348	357	365	374	383	392	402	412
	422	432	442	453	464	475	487	499	511	523	536	549
	562	576	590	604	619	634	649	665	681	698	715	732
	750	768	787	806	825	845	866	887	909	931	953	976

METALLISED FILM CAPACITORS

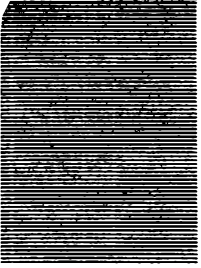

A

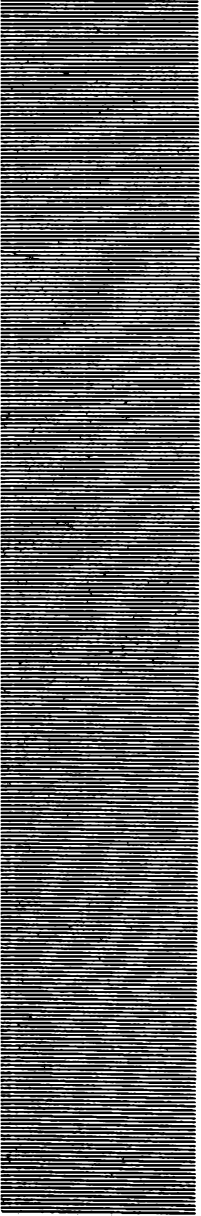

CALCULATION OF MAXIMUM A.C. POWER RATINGS

The alternating voltage rating of a metallised film capacitor is determined ultimately by its ability to dissipate heat, generated by the passage of the current through its internal resistance. This rating is further subject to a voltage limitation, at low frequencies and normal temperatures, together with a maximum rate of change of applied voltage. Both these values are quoted in the data for individual series.

When a capacitor is used at the maximum alternating voltage (quoted in the individual series data sheet), the source impedance must not be less than $1k\Omega$.

The power dissipated by a capacitor at a particular frequency is determined, by the effective series resistance, the current flowing through that resistance and the applied alternating voltage. The effective series resistance of a capacitor is composed of:-

- (a) the dielectric loss
- (b) the metallised surface on the film
- (c) the connections at each end of the capacitor

The equivalent circuit of a capacitor used in an a.c. application is shown below in Fig. 1.

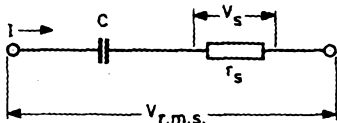

Fig. 1

- I = current in amps
- C = capacitance in farads
- r_s = effective series resistance in ohms
- V_s = voltage across effective series resistance
- $V_{r.m.s.}$ = total applied voltage in volts r.m.s.

From the standard formula:

$$P = I^2 \cdot R = \frac{V^2}{R} = V_{r.m.s.} \times I \times \tan \delta, \text{ where } P = \text{power in watts}$$

we can derive

$$P = I^2 \cdot r_s = \frac{(V_s)^2}{r_s} = V_s \cdot I \quad \text{----- (1)}$$

This gives

$$V_s = I \cdot r_s$$

but

$$I = \frac{V_{r.m.s.}}{Z}$$

where

$$Z = \sqrt{(r_s)^2 + (X_C)^2}$$

and

$$X_C = \frac{1}{\omega C}$$

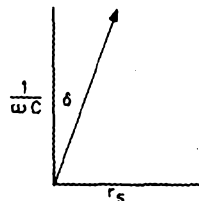

Thus
$$V_s = \frac{V_{r.m.s.} \cdot r_s}{Z} = \frac{r.m.s. \cdot r_s}{\sqrt{(r_s)^2 + (X_C)^2}}$$

this can be written as

$$(V_s)^2 = \frac{(V_{r.m.s.})^2 (r_s)^2}{(r_s)^2 + (X_C)^2} = (V_{r.m.s.})^2 (r_s)^2 [(r_s)^2 + (X_C)^2]^{-1}$$

substituting for X_C , we have

$$(V_s)^2 = (V_{r.m.s.})^2 (r_s)^2 \left[(r_s)^2 + \left(\frac{1}{\omega C}\right)^2 \right]^{-1}$$

$$(V_s)^2 = (V_{r.m.s.})^2 (r_s)^2 \left[\frac{(r_s)^2 (\omega C)^2 + 1}{(\omega C)^2} \right]^{-1}$$

Since, $\tan \delta = r_s \cdot \omega C$ and for polyethyleneterephthalate and polycarbonate metallised film capacitors $\tan \delta$ is never greater than 0.1; $(r_s)^2 (\omega C)^2$ is less than 0.01 and can be neglected in the above equation.

Therefore:

$$(V_s)^2 = (V_{r.m.s.})^2 (r_s)^2 \left[\left(\frac{1}{\omega C}\right)^2 \right]^{-1} = (V_{r.m.s.})^2 (r_s)^2 (\omega C)^2$$

using equation (1)

$$P = \frac{(V_s)^2}{r_s} = \frac{(V_{r.m.s.})^2 (r_s)^2 (\omega C)^2}{r_s}$$

Simplified

$$P = (V_{r.m.s.})^2 (r_s) (\omega C)^2$$

or
$$P = (r_s C) C \cdot \omega^2 (V_{r.m.s.})^2 \quad \text{----- (2)}$$

The term $(r_s \cdot C)$ has been plotted against frequency in Fig.2 (see page 3). The application of equation (2), and the value of $(r_s \cdot C)$ at a particular frequency, will give the maximum power dissipation of the capacitor.

The maximum dissipation that a capacitor can tolerate is dependent on its surface area and on the ambient temperature. Graphs relating size and ambient temperature to maximum dissipation are given in the individual Series data sheets. Thus the use of equation (2) and the power dissipation graphs on the individual Series data sheets, enables the correct size of capacitor to be selected.

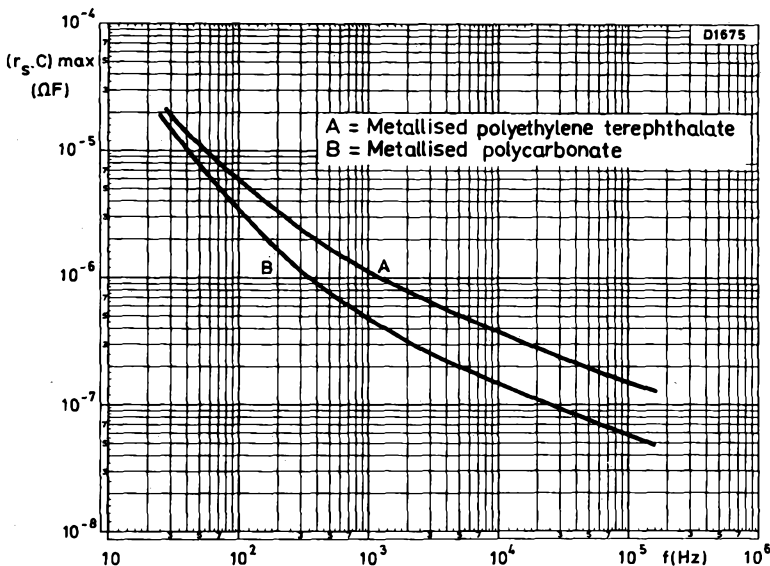

Fig. 2

Example

A capacitor with a polycarbonate dielectric and a value of $0.33\mu\text{F}$ is required for a circuit in which 180V at 1kHz is present, at an ambient temperature of 50°C .

From Fig. 2 the $(r_s \cdot C)$ product is $5 \times 10^{-7} \Omega\text{F}$, therefore the power dissipated is

$$\begin{aligned}
 P &= (r_s \cdot C) C \omega^2 (V_{r.m.s.})^2 \\
 &= 5 \times 10^{-7} \times 0.33 \times 10^{-6} \times (2\pi \times 1000)^2 \times 180^2 \\
 &= 214\text{mW}
 \end{aligned}$$

Referring to the power/dissipation graphs and size tables for the C281 Series, at 50°C it can be seen that the following type could be used: -

C281CD/A330K

Mullard

METALLISED POLYESTER FILM CAPACITORS

Axial leads—moulded
(341 Series)

C281

Series

QUICK REFERENCE DATA

For use where a high component density is required.

Capacitance ranges (E6 Series)

250 V working	0.01 to 2.2	μF
400 V working	0.01 to 0.47	μF
Capacitance tolerance	± 10	%
Climatic category (IEC 68)		
at rated voltage (U_R)	55/085/56	
at $0.8 U_R$	55/100/56	

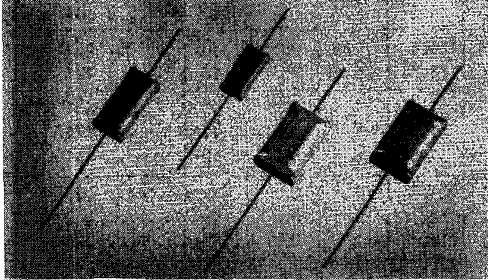

DIELECTRIC

250 V version
400 V version

polyethylene terephthalate film
polycarbonate film

CASING

Yellow synthetic resin moulding.

TERMINATIONS

Axial leads of tinned copper wire. One lead is longer than the other to facilitate mounting vertically.

TYPE NUMBER DESIGNATION

250 V Post Officer version to specification D2283,
type 8017B ($\pm 10\%$ tolerance)
400 V version

C281VV/.... (341 05...)
C281CD/.... (341 59...)

SPECIAL FEATURES

The capacitors are manufactured by using 'extended electrode' technique, resulting in low inherent inductance. They may be subjected to short term overvoltage.

Mullard

DIMENSIONS (millimetres) AND TYPE NUMBERS

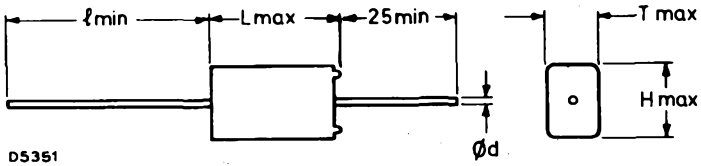

D5351

→ 250V version

Capacitance (μ F)	Dimensions in millimetres					Code No. 341 05...†	Type No. C281VV /... †
	L	H	T	d	l		
0.010	14.6	8.8	4.8	0.8	40	... 103	... /A10K
0.015	14.6	8.8	4.8	0.8	40	... 153	... /A15K
0.022	14.6	8.8	4.8	0.8	40	... 223	... /A22K
0.033	14.6	8.8	4.8	0.8	40	... 333	... /A33K
0.047	14.6	8.8	4.8	0.8	40	... 473	... /A47K
0.068	14.6	9.5	5.6	0.8	40	... 683	... /A68K
0.10	14.6	9.5	5.6	0.8	40	... 104	... /A100K
0.15	18.1	10.5	6.6	0.8	40	... 154	... /A150K
0.22	18.1	10.5	6.6	0.8	40	... 224	... /A220K
0.33	23.6	11.6	7.5	0.8	40	... 334	... /A330K
0.47	23.6	11.6	7.5	0.8	40	... 474	... /A470K
0.68	23.6	12.9	8.8	0.8	40	... 684	... /A680K
1.0	31.1	14.7	10.5	0.8	49	... 105	... /A1M
1.5	31.1	19.6	12.5	0.8	49	... 155	... /A1M5
2.2	31.1	19.6	12.5	0.8	49	... 225	... /A2M2

400V version

Capacitance (μ F)	Dimensions in millimetres					Code No. 341 59...	Type No. C281CD /...
	L	H	T	d	l		
0.010	14.6	8.8	4.8	0.8	40	... 103	... /A10K
0.015	14.6	8.8	4.8	0.8	40	... 153	... /A15K
0.022	14.6	8.8	4.8	0.8	40	... 223	... /A22K
0.033	14.6	9.5	5.6	0.8	40	... 333	... /A33K
0.047	14.6	10.5	6.6	0.8	40	... 473	... /A47K
0.068	18.1	10.5	6.6	0.8	40	... 683	... /A68K
0.10	18.1	11.6	7.7	0.8	40	... 104	... /A100K
0.15	23.6	11.6	7.5	0.8	40	... 154	... /A150K
0.22	23.6	12.9	8.8	0.8	40	... 224	... /A220K
0.33	23.6	14.5	10.5	0.8	40	... 334	... /A330K
0.47	31.1	14.7	10.5	1.0	49	... 474	... /A470K

† Post Office type.

Mullard

METALLISED POLYESTER FILM CAPACITORS

Axial leads—moulded
(341 Series)

C281 Series

ELECTRICAL DATA

Unless otherwise stated, all characteristics apply at an ambient temperature of $20 \pm 5^\circ\text{C}$, atmospheric pressure of 10^5Pa (1000mbars) and a relative humidity of 75% maximum.

	Conditions	C281VV/... 341 05... (250V)	C281CD/... 341 59... (400V)
Capacitance range (E6 Series)	—	0.01 to 2.2 μF	0.01 to 0.47 μF
Capacitance tolerance	—	$\pm 10\%$	$\pm 10\%$
Rated voltage (d. c.)	-55 to $+85^\circ\text{C}$	250V	400V
Rated voltage (r. m. s.) (see note)	$f = 50\text{Hz}$, source impedance $> 1\text{k}\Omega$	160V	200V
Rated current (mean)	—	400mA	400mA
Tangent of loss angle ($\tan \delta$)	$f = 10\text{kHz}$	$< 150 \times 10^{-4}$	$< 75 \times 10^{-4}$
Category temperature range	—	-55 to $+85^\circ\text{C}$	-55 to $+85^\circ\text{C}$
Extended temperature range	Voltage derating 1.25% per deg C above 85°C	$+85$ to 100°C	$+85$ to 100°C
Insulation resistance	0.01 to 0.33 μF	$> 30\ 000\ \Omega$	$> 30\ 000\ \Omega$
	0.47 to 2.2 μF	$> 10\ 000\ \Omega, \mu\text{F}$	$> 10\ 000\ \Omega, \mu\text{F}$
Maximum rate of change of voltage	Capacitor length L (see DIMENSIONS)		
	= 14.6mm	20V/ μs	30V/ μs
	= 18.1mm	10V/ μs	20V/ μs
	= 23.6mm	7V/ μs	10V/ μs
	= 31.1mm	5V/ μs	8V/ μs
Surge voltage (d. c.)	1 min per hour	350V	500V
Test voltage (r. m. s.) between case and leads	Applied for 1 minute	2500V	2500V
Long term stability	1000 hrs at 85°C $1.5 \times$ rated d. c. voltage applied	$\frac{\Delta C}{C} \leq 3\%$	$\frac{\Delta C}{C} \leq 3\%$
	1000 hrs at 85°C rated a. c. voltage applied	Capacitor length L =14.6mm $\leq 15\%$ =18.1mm $\frac{\Delta C}{C} \leq 10\%$ =23.6mm $\leq 7\%$ =31.1mm $\leq 5\%$	
Climatic category (IEC Publication 68)	At rated voltage (U_R)	55/085/56	55/085/56
	At $0.8 U_R$	55/100/56	55/100/56

Mullard

NOTE

The maximum r.m.s. voltage at frequencies higher than 50 Hz can be calculated from the relevant formula in METALLISED FILM CAPACITORS - INTRODUCTORY NOTES and the graph on the last page of this data sheet.

SOLDERING CONDITIONS

For stress free mounted capacitors

Solder temperature °C	Maximum solder time (seconds)				
	Distance between solder point and capacitor body				
	0.8mm	1.6mm	2.5mm	4mm	6mm
250	—	5	6	8	10
260	2.5	3	4	6	8
270	—	—	2	4	6

MARKING

The capacitors are marked with:

Capacitance, tolerance and rated voltage
Code number

In addition, capacitors of the C281VV/... version (Post Office) are marked with "8017B".

The 10% capacitance tolerance may be indicated by the letter K.

ORDERING PROCEDURE

The capacitors should be ordered by their type or code number as shown in the table.

Example: A 0.33 μ F \pm 10%, 250V working capacitor, should be ordered by quoting the type number C281VV/A330K, or 341 05334.

METALLISED POLYESTER FILM CAPACITORS

Axial leads—moulded
(341 Series)

C281
Series

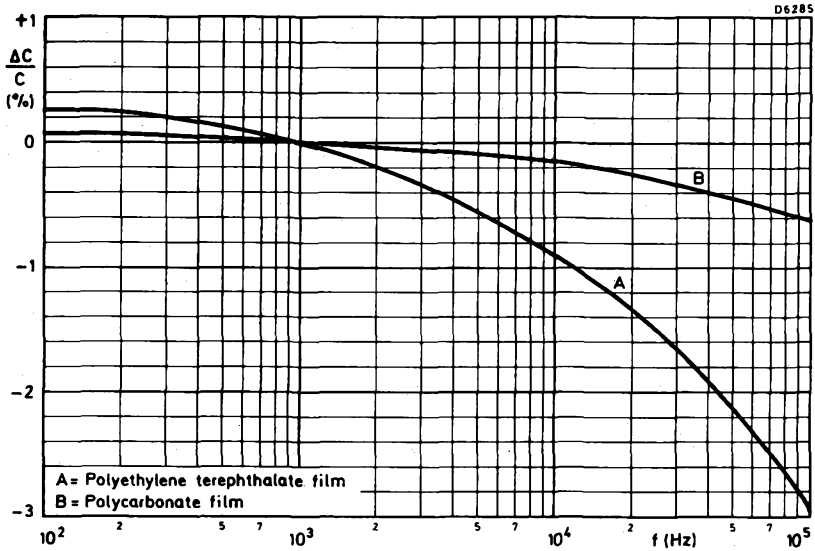

TYPICAL CAPACITANCE CHANGE AS A FUNCTION OF FREQUENCY

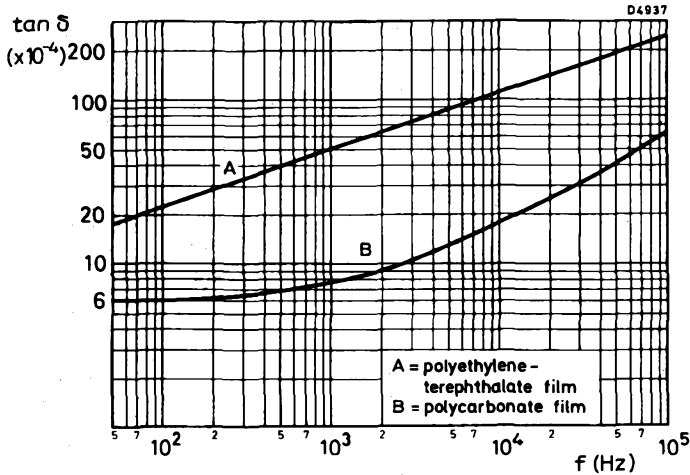

TYPICAL LOSS FACTOR AS A FUNCTION OF FREQUENCY

Mullard

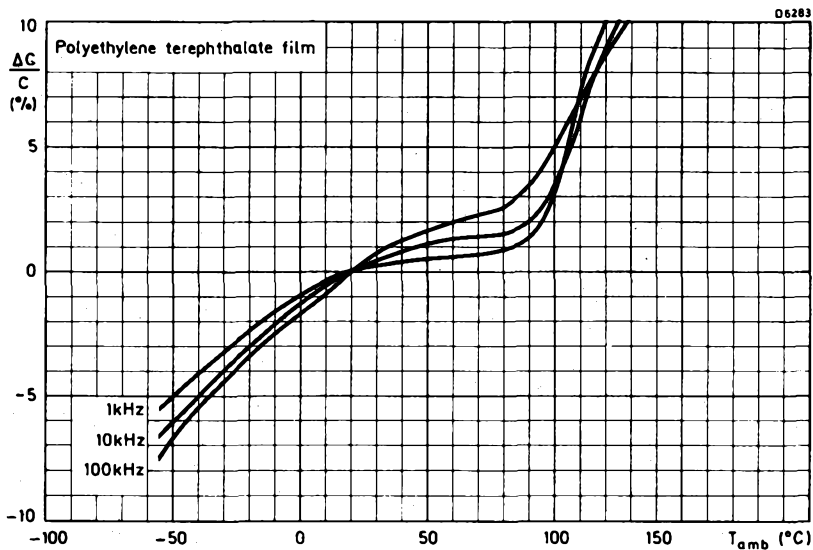

TYPICAL CAPACITANCE CHANGE AS A FUNCTION OF AMBIENT TEMPERATURE FOR POLYETHYLENE TEREPHTHALATE FILM

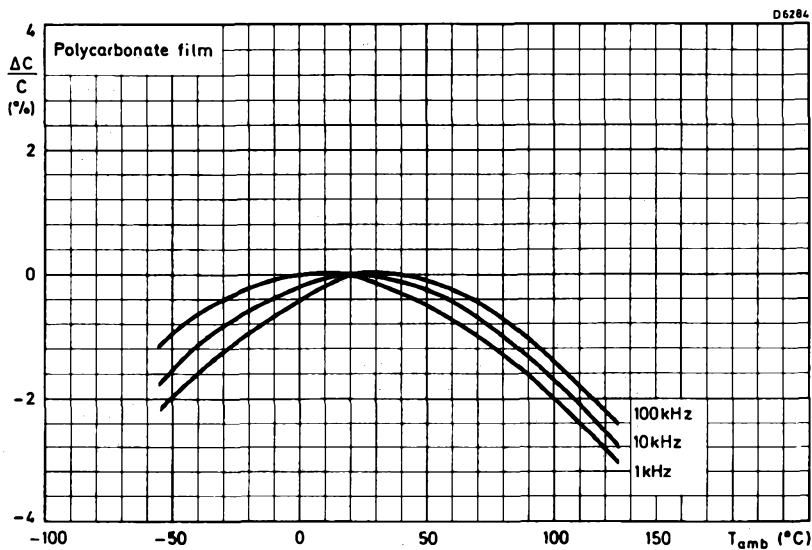

TYPICAL CAPACITANCE CHANGE AS A FUNCTION OF AMBIENT TEMPERATURE FOR POLYCARBONATE FILM

METALLISED POLYESTER FILM CAPACITORS

Axial leads—moulded
(341 Series)

C281
Series

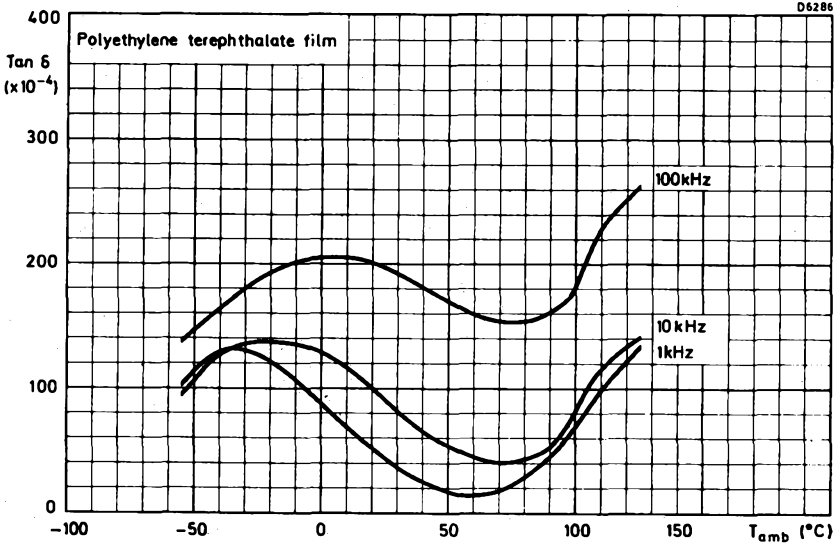

TYPICAL LOSS FACTOR AS A FUNCTION OF AMBIENT TEMPERATURE
FOR POLYETHYLENE TEREPHTHALATE FILM

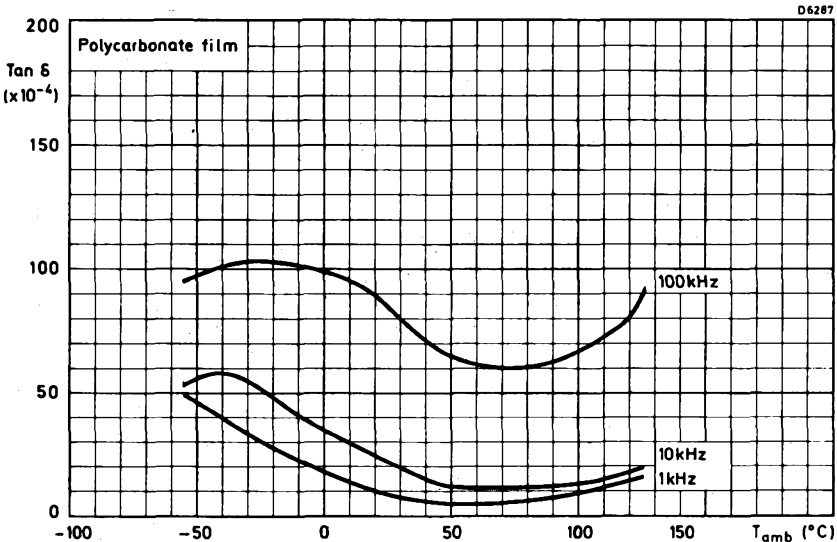

TYPICAL LOSS FACTOR AS A FUNCTION OF AMBIENT TEMPERATURE
FOR POLYCARBONATE FILM

Mullard

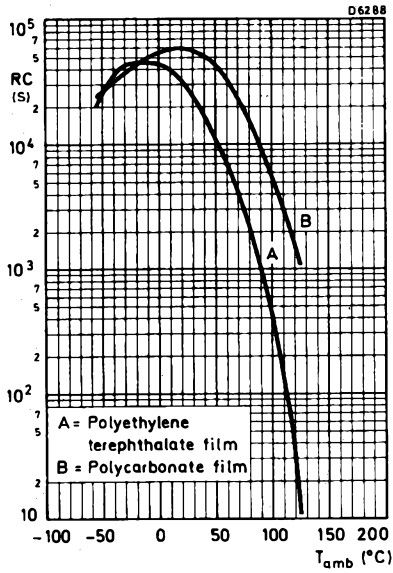

TYPICAL INSULATION RESISTANCE AS A FUNCTION OF AMBIENT TEMPERATURE

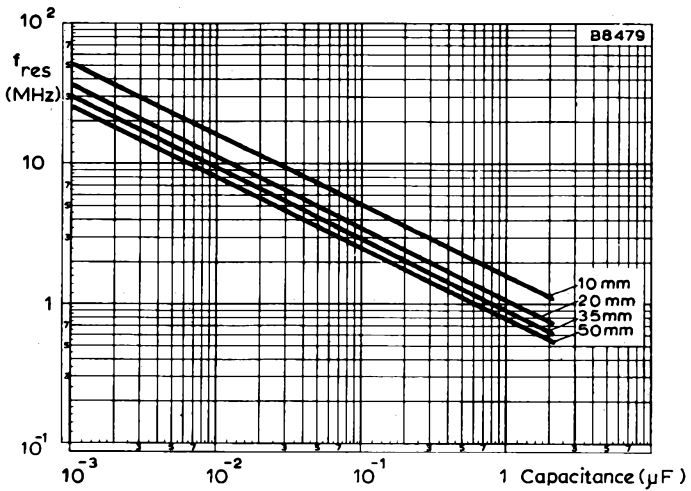

SELF RESONANCE FREQUENCY AS A FUNCTION OF CAPACITANCE FOR VARIOUS TOTAL LEAD LENGTHS

METALLISED POLYESTER FILM CAPACITORS

Axial leads—moulded
(341 Series)

C281

Series

ALTERNATING VOLTAGE RATINGS

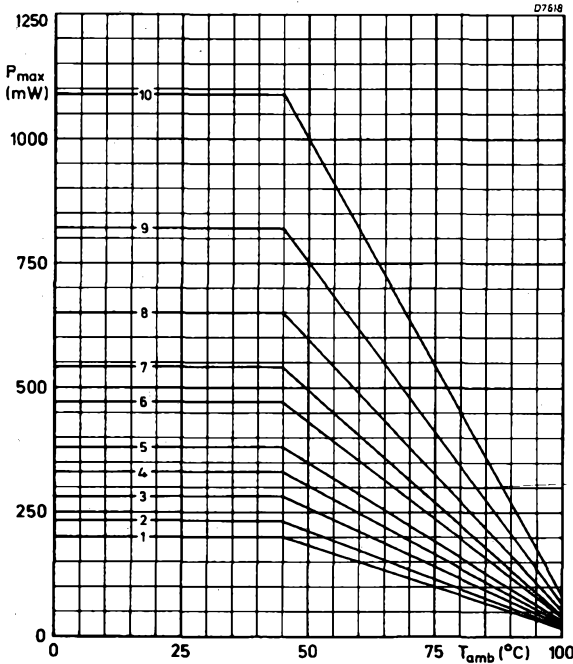

MAXIMUM PERMISSIBLE POWER DISSIPATION AS A
FUNCTION OF AMBIENT TEMPERATURE

TABLE OF CASE SIZES

Curve	Dimensions in millimetres		
	L	H	T
1	14.6	8.8	4.8
2	14.6	9.5	5.6
3	14.6	10.5	6.6
4	18.1	10.5	6.6
5	18.1	11.6	7.7

Curve	Dimensions in millimetres		
	L	H	T
6	23.6	11.6	7.5
7	23.6	12.9	8.8
8	23.6	14.5	10.5
9	31.1	14.7	10.5
10	31.1	19.6	12.5

Mullard

METALLISED FILM CAPACITORS

Radial leads-moulded

For use on printed-wiring boards, where a high component density is required.

QUICK REFERENCE DATA

Capacitance range (E6 Series)	0.0047 to 6.8	μF
Capacitance tolerance	± 10	%
Voltage ranges (d.c.)	63, 100, 250, 400, 630	V
Climatic category (IEC68)		
at rated voltage (U_R)	55/085/56	
at 0.8 U_R	55/100/56	

DIELECTRIC

63 V (344 17. . .), 344 15. . .)
100 V (344 25. . .), 250 V (344 41. . .),
400 V (344 55. . .) versions etc.

polyethylene terephthalate
(p.e.t.p.) film

100 V (344 21. . .), 250 V (344 45. . .),
400 V (344 51. . .) versions etc.

polycarbonate film

CASING

The capacitor is potted with an epoxy resin in a polypropylene case, with small pips moulded on to the base to give a clearance between the capacitor and the printed-wiring board.

TERMINATIONS

Radial leads of tinned copper wire, for use with printed-wiring boards having a 2.5 mm grid.

APPROVAL SPECIFICATIONS

Post Office approved and RSRE recommended.

SPECIAL FEATURES

The capacitors are manufactured by using 'extended electrode' technique resulting in low inherent inductance. They may be subjected to short term overvoltages.



DIMENSIONS (millimetres) AND TYPE NUMBERS

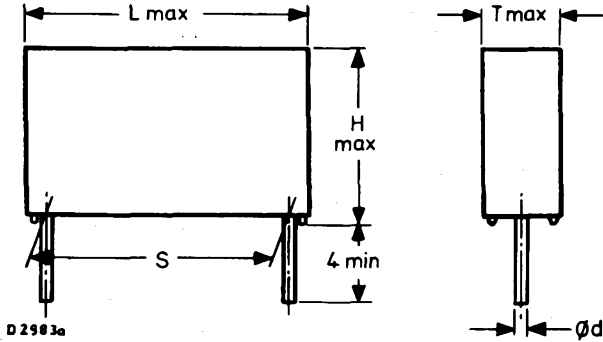

63 V version (p.e.t.p. film)

Capacitance (μF)	dimensions in millimetres					Type numbers
	L	H	T	S	d	
0.15	10.5	10	4.5	7.5	0.6	344 17154
0.22	13	10	4.5	10		344 15224
0.33	13	11	5	10	0.8	344 15334
0.47	13	12	6	10		344 15474
0.68	17.5	11.5	6	15		344 15684
1.0	17.5	13	7	15		344 15105
1.5	17.5	14.5	8.5	15		344 15155
2.2	26	15.5	6.5	22.5		344 15225
3.3	26	18	8.5	22.5		344 15335
4.7	26	19	9.5	22.5		344 15475
6.8	30	20.5	11	27.5	344 15685	
10	30	23	13.5	27.5	344 15106	



100 V version (p.e.t.p. or polycarbonate)

Capacitance (μF)	Dimensions in millimetres					Type numbers
	L	H	T	S	d	
0.047	10.5	10	4.5	7.5	0.6	344 27473
0.068	10.5	10	4.5	7.5		344 27683
0.1	10.5	10	4.5	7.5		344 27104
0.10	13	10	4.5	10	0.8	344 2*104
0.15	13	10	4.5	10		344 2*154
0.22	13	11	5	10		344 2*224
0.33	17.5	11	5	15	0.8	344 2*334
0.47	17.5	11.5	6	15		344 2*474
0.68	17.5	13	7	15		344 2*684
1.0	17.5	14.5	8.5	15		344 2*105
1.5	26	15.5	6.5	22.5	0.8	344 3*155
2.2	26	18	8.5	22.5		344 2*225
3.3	26	19	9.5	22.5		344 2*335
4.7	30	20.5	11	27.5	0.8	344 2*475
6.8	30	23	13.5	27.5		344 2*685

* Polyethylene terephthalate film = 5, e.g. 344 25474

Polycarbonate film = 1, e.g. 344 21474

250 V version (p.e.t.p.)

Capacitance (μF)	Dimensions in millimetres					Type numbers
	L	H	T	S	d	
0.022	10.5	10 ^a	4.5	7.5	0.6	344 47223
0.033	10.5	10	4.5	7.5		344 47333
0.047	13	10	4.5	10	0.8	344 41473
0.068	13	11	5	10		344 41683
0.10	17.5	11	5	15	0.8	344 41104
0.15	17.5	11	5	15		344 41154
0.22	17.5	11.5	6	15		344 41224
0.33	17.5	13	7	15		344 41334
0.47	26	15.5	6.5	22.5	0.8	344 41474
0.68	26	15.5	6.5	22.5		344 41684
1.0	26	18	8.5	22.5		344 41105
1.5	30	20.5	11	27.5	0.8	344 41155
2.2	30	20.5	11	27.5		344 41225

The smaller values are of p.e.t.p. construction = 7 e.g. 344 47223



250 V version (polycarbonate)

Capacitance (μF)	Dimensions in millimetres					Type numbers
	L	H	T	S	d	
0.047 0.068	13 13	10 11	4.5 5	10 10	0.8	344 45473 344 45683
0.10 0.15 0.22 0.33	17.5 17.5 17.5 17.5	11 11.5 13 14.5	5 6 7 8.5	15 15 15 15	0.8	344 45104 344 45154 344 45224 344 45334
0.47 0.68 1.0	26 26 26	15.5 16.5 19	6.5 7.5 9.5	22.5 22.5 22.5	0.8	344 45474 344 45684 344 45105
1.5 2.2	30 30	20.5 23	11 13.5	27.5 27.5	0.8	344 45155 344 45225

400 V version (p.e.t.p. or polycarbonate)

Capacitance (μF)	Dimensions in millimetres					Type numbers
	L	H	T	S	d	
0.01 0.015	10.5 10.5	10 10	4.5 4.5	7.5 7.5	0.6	344 57103 344 57153
0.010 0.015 0.022 0.033	13 13 13 13	10 10 10 11	4.5 4.5 4.5 5	10 10 10 10	0.8	344 5*103 344 5*153 344 5*223 344 5*333
0.047 0.068 0.10 0.15	17.5 17.5 17.5 17.5	11 11.5 13 14.5	5 6 7 8.5	15 15 15 15	0.8	344 5*473 344 5*683 344 5*104 344 5*154
0.22 0.33 0.47	26 26 26	15.5 16.5 19	6.5 7.5 9.5	22.5 22.5 22.5	0.8	344 5*224 344 5*334 344 5*474
0.68 1.0	30 30	20.5 23	11 13.5	27.5 27.5	0.8	344 5*684 344 5*105

*Polyethylene terephthalate film = 5, e.g. 344 55473

Polycarbonate film = 1, e.g. 344 51473

630 V version (p.e.t.p.)

Capacitance (μF)	Dimensions in millimetres					Type numbers
	L	H	T	S	d	
0.0047 0.0068	10.5 10.5	10 10	4.5 4.5	7.5 7.5	0.6	344 67472 344 67682

The smaller values are of p.e.t.p. construction = 7 e.g. 344 57103



ELECTRICAL DATA

Unless otherwise stated, all characteristics apply at an ambient temperature of 20 ± 5 °C, atmospheric pressure of 10^5 Pa (1000 mbars) and a relative humidity of 75% maximum.

	Conditions	63 V types	100 V types	250 V types	400/630 V types
Capacitance range (E6 Series)	—	0.15 to 10 μ F	0.1 to 6.8 μ F	0.047 to 2.2 μ F	0.0047 to 1.0 μ F
Capacitance tolerance	—	$\pm 10\%$	$\pm 10\%$	$\pm 10\%$	$\pm 10\%$
Rated voltage (d.c.)	-55 to +85 °C	63 V	100 V	250 V	400 V
Rated voltage (r.m.s.) (see note)	f = 50 Hz, source impedance > 1 k Ω	40 V	63 V	160 V	200 V
Rated current (mean)	—	400 mA	400 mA	400 mA	400 mA
Tangent of loss angle (tan δ)	p.e.t.p. f = 10 kHz Polycarbonate	$\leq 150 \times 10^{-4}$ —		$\leq 150 \times 10^{-4}$ $\leq 75 \times 10^{-4}$	
Temperature range	—	-55 to +85 °C	-55 to +85 °C	-55 to +85 °C	-55 to +85 °C
Extended temperature range	Voltage derating 1.25%/°C above 85 °C	+85 to +100 °C	+85 to +100 °C	+85 to +100 °C	+85 to +100 °C
Insulation resistance	0.0047 to 0.33 μ F	> 15 000 M Ω	> 15 000 M Ω	> 30 000 M Ω	> 30 000 M Ω
	0.47 to 6.8 μ F	> 5000 M Ω . μ F	> 5 000 M Ω . μ F	> 10 000 M Ω . μ F	> 10 000 M Ω . μ F
Maximum rate of change of voltage	Capacitor length L				
	= 10.5 mm	6.3 V/ μ s	10 V/ μ s	25 V/ μ s	40/60 V/ μ s
	= 13 mm	4.2 V/ μ s	10 V/ μ s	20 V/ μ s	30 V/ μ s
	= 17.5 mm	2.8 V/ μ s	7 V/ μ s	10 V/ μ s	20 V/ μ s
	= 26 mm	1.7 V/ μ s	3.5 V/ μ s	6 V/ μ s	9 V/ μ s
	= 30 mm	1.4 V/ μ s	3 V/ μ s	5 V/ μ s	8 V/ μ s
Surge voltage (d.c.)	1 min. per hour	85 V	140 V	350 V	500/790 V
Minimum casing breakdown voltage (d.c.)	Applied for 1 min.	1000 V	1000 V	1000 V	1000 V
Long term stability	1000 hrs at 85 °C 1.5 x rated d.c. voltage applied	$\frac{\Delta C}{C} < 3\%$	$\frac{\Delta C}{C} < 3\%$	$\frac{\Delta C}{C} < 3\%$	$\frac{\Delta C}{C} < 3\%$
	1000 hrs at 85 °C rated a.c. voltage applied	Capacitor length L 10.5 mm 13.0 mm 17.5 mm 26 mm 30 mm		$\frac{\Delta C}{C}$	$\leq 20\%$ $\leq 15\%$ $\leq 10\%$ $\leq 7\%$ $\leq 5\%$
Climatic category	Rated voltage (U_R)	55/085/56	55/085/56	55/085/56	55/085/56
	0.8 U_R	55/100/56	55/100/56	55/100/56	55/100/56



NOTE

The maximum r.m.s. voltage at frequencies higher than 50 Hz can be calculated from the relevant formula in METALLISED FILM CAPACITORS - INTRODUCTORY NOTES and the graph on the last page of this data sheet.

SOLDERING CONDITIONS

For stress free mounted capacitors

Solder temperature (°C)	Maximum solder time (seconds)			
	Distance between solder point and capacitor body			
	0.8 mm	1.6 mm	2.5 mm	4 mm
250	—	5	6	8
260	2.5	3	4	6
270	—	—	2	4

MARKING

The capacitors are marked on the top face, by embossed print, with:

Capacitance, tolerance, and rated voltage

Type number code

The method of marking is shown below: -

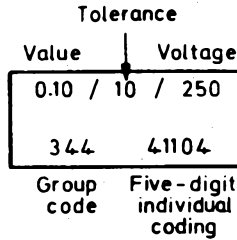

ORDERING PROCEDURE

The capacitors should be ordered by their type numbers as shown in the table.

Examples: A 0.1 μ F \pm 10%, polyethylene terephthalate film, 100 V rated capacitor should be ordered by quoting the type number 344 25104

A 0.1 μ F \pm 10%, polycarbonate film, 100 V rated capacitor should be ordered by quoting the type number 344 21104.



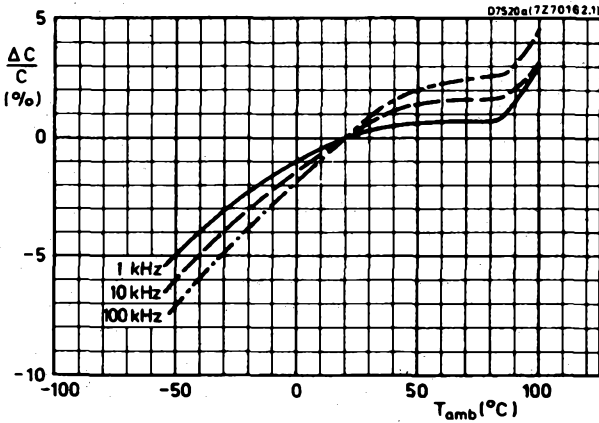

Typical capacitance change as a function of ambient temperature for polyethylene terephthalate film

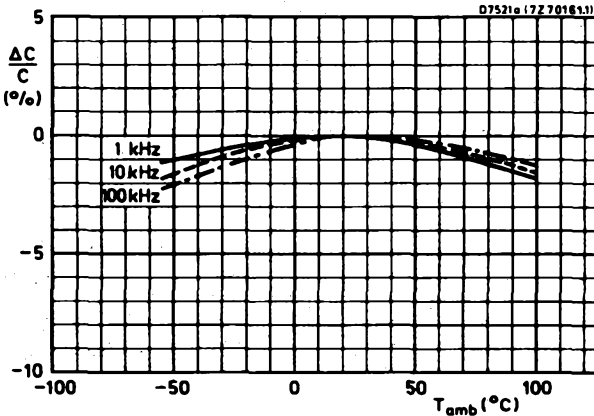

Typical capacitance change as a function of ambient temperature for polycarbonate film



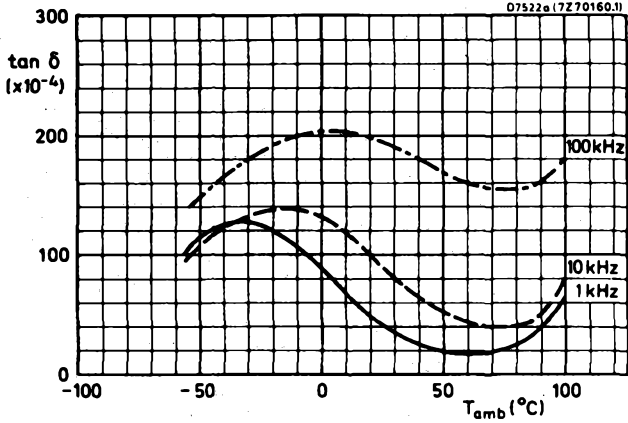

Typical loss factor as a function of ambient temperature for polyethylene terephthalate film

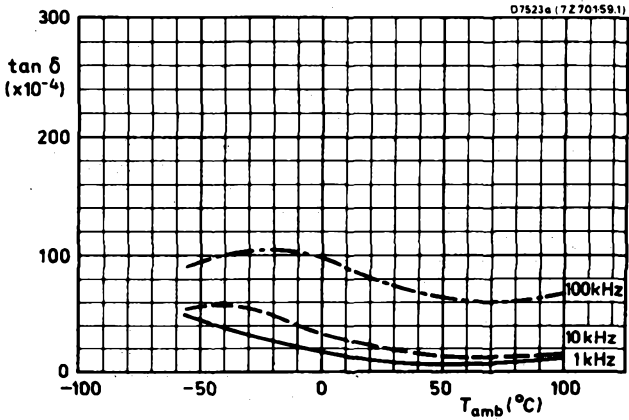

Typical loss factor as a function of ambient temperature for polycarbonate film



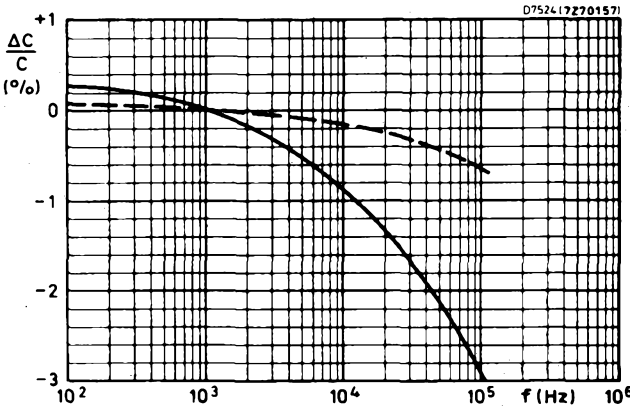

Typical capacitance change as a function of frequency

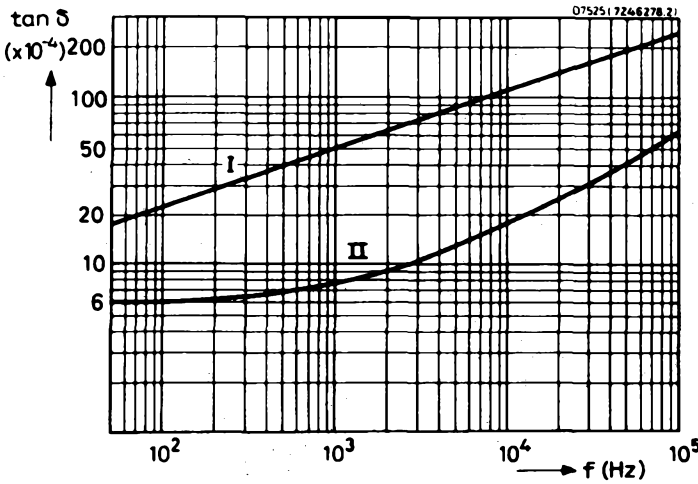

Typical loss factor as a function of frequency



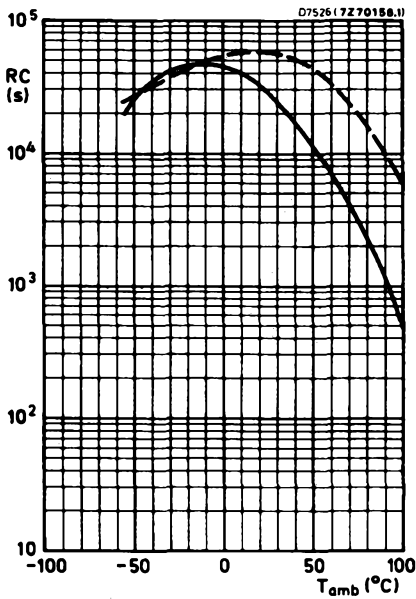

— Metallized PETP film dielectric
 --- Metallized polycarbonate film dielectric

Typical insulation resistance as a function of ambient temperature

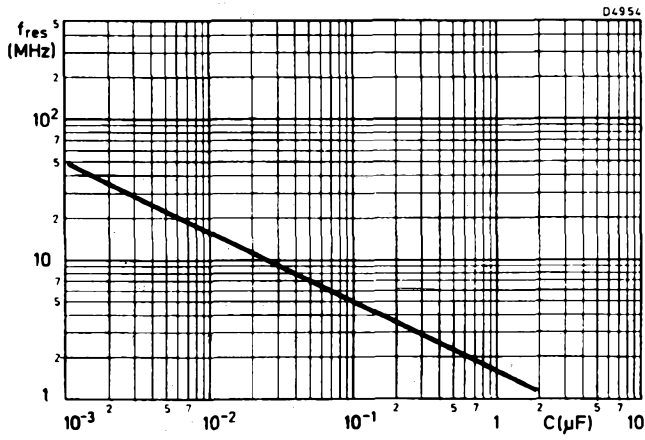

Self resonance frequency as a function of capacitance for a total lead length of 10mm



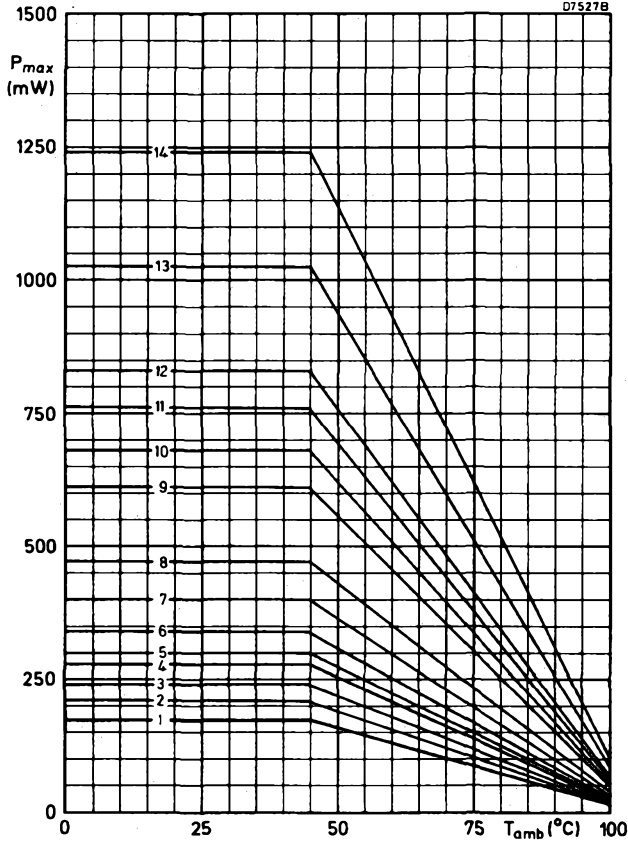

Curve	Dimensions in millimetres		
	L	H	T
1	10.5	10	4.5
2	13	10	4.5
3	13	11	5
4	13	12	6
5	17.5	11	5
6	17.5	11.5	6
7	17.5	13	7

Curve	Dimensions in millimetres		
	L	H	T
8	17.5	14.5	8.5
9	26	15.5	6.5
10	26	16.5	7.5
11	26	18	8.5
12	26	19	9.5
13	30	20.5	11
14	30	23	13.5



METALLISED POLYESTER FILM CAPACITORS

Crimped radial leads - lacquered

**352
Series**

QUICK REFERENCE DATA

Designed for coupling and decoupling applications on printed wiring boards.

Capacitance ranges (E6 Series)

250 V working	0.0047 to 2.2	μF
400 V working	0.01 to 1.0	μF

Capacitance tolerances

0.0047 to 0.22 μF	± 10 and ± 20	%
0.33 to 2.2 μF	± 10	%

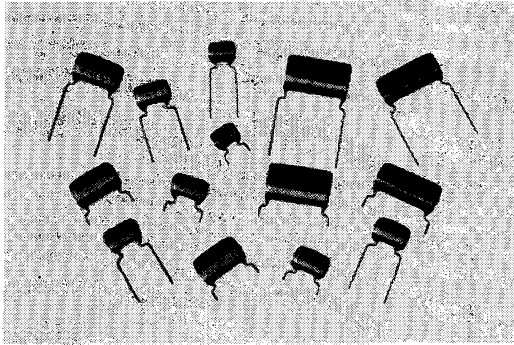

DIELECTRIC

Polyethylene terephthalate film

CASING

Hard, water repellent, lacquer.

TERMINATIONS

Radial leads of solder coated copper wire, crimped with a new profile to improve the 'seating' when mounted on printed circuit boards. The lead pitch is suitable for use with printed wiring boards having a 2.54 mm (0.1 in) grid.

TYPE NUMBER DESIGNATION

	Long leads	Cropped leads
250 V version	352 44 and 45	352 47 and 48
400 V version	352 54 and 55	352 57 and 58

SPECIAL FEATURES

The capacitors are manufactured by using 'extended electrode' technique, resulting in low inherent inductance. They may be subjected to short term over-voltage. The cropped style of termination facilitates immediate assembly into the boards, with no prior wire cutting operation.

Mullard

→ DIMENSIONS (millimetres) AND TYPE NUMBERS

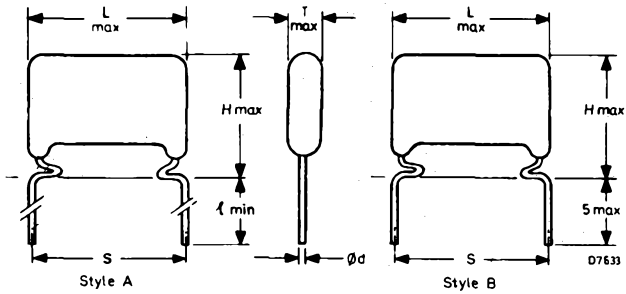

250 V version

Capacitance (μF)	Dimensions in millimetres						Style A	Style B
							Code No.	Code No.
	L	H	T	d	ϕ	S	352 44... 20%	352 47... 20%
0.0047	12.5	12.5	4.5	0.6	13	10.2 (0.4 in)	.. 472	.. 472
0.0068	12.5	12.5	4.5	0.6	13	10.2 (0.4 in)	.. 682	.. 682
0.010	12.5	12.0	4.0	0.6	13	10.2 (0.4 in)	.. 103	.. 103
0.015	12.5	12.0	4.0	0.6	13	10.2 (0.4 in)	.. 153	.. 153
0.022	12.5	12.0	4.0	0.6	13	10.2 (0.4 in)	.. 223	.. 223
0.033	12.5	12.0	4.0	0.6	13	10.2 (0.4 in)	.. 333	.. 333
0.047	12.5	12.0	4.0	0.6	13	10.2 (0.4 in)	.. 473	.. 473
0.068	12.5	12.5	4.5	0.6	13	10.2 (0.4 in)	.. 683	.. 683
0.10	12.5	13.0	5.0	0.6	13	10.2 (0.4 in)	.. 104	.. 104
0.15	17.5	15.0	6.0	0.8	13	15.3 (0.6 in)	.. 154	.. 154
0.22	17.5	16.0	7.0	0.8	13	15.3 (0.6 in)	.. 224	.. 224
0.33	22.5	15.5	6.5	0.8	21	20.3 (0.8 in)	45334	48334
0.47	22.5	16.5	7.5	0.8	21	20.3 (0.8 in)	45474	48474
0.68	22.5	18.0	9.0	0.8	21	20.3 (0.8 in)	45684	48684
1.0	30.0	18.0	9.0	0.8	19	27.9 (1.1 in)	45105	48105
1.5	30.0	21.5	9.5	0.8	19	27.9 (1.1 in)	45155	48155
2.2	30.0	23.5	11.5	0.8	19	27.9 (1.1 in)	45225	48225

400 V version

Capacitance (μF)	Dimensions in millimetres						Style A	Style B
							Code No.	Code No.
	L	H	T	d	ϕ	S	352 54... 20%	352 57... 20%
0.010	12.5	12.5	4.5	0.6	13	10.2 (0.4 in)	.. 103	.. 103
0.015	12.5	12.5	4.5	0.6	13	10.2 (0.4 in)	.. 153	.. 153
0.022	12.5	12.5	4.5	0.6	13	10.2 (0.4 in)	.. 223	.. 223
0.033	12.5	13.5	5.5	0.6	13	10.2 (0.4 in)	.. 333	.. 333
0.047	12.5	14.5	6.5	0.6	13	10.2 (0.4 in)	.. 473	.. 473
0.068	17.5	15.0	6.0	0.8	13	15.3 (0.6 in)	.. 683	.. 683
0.10	17.5	16.0	7.0	0.8	13	15.3 (0.6 in)	.. 104	.. 104
0.15	22.5	15.5	6.5	0.8	21	20.3 (0.8 in)	.. 154	.. 154
0.22	22.5	16.5	7.5	0.8	21	20.3 (0.8 in)	.. 224	.. 224
0.33	22.5	18.5	9.5	0.8	21	20.3 (0.8 in)	55334	58334
0.47	30.0	18.5	9.5	0.8	19	27.9 (1.1 in)	55474	58474
0.68	30.0	22.0	10.0	0.8	19	27.9 (1.1 in)	55684	58684
1.0	30.0	24.0	12.0	0.8	19	27.9 (1.1 in)	55105	58105

METALLISED POLYESTER FILM CAPACITORS

Crimped radial leads - lacquered

352 Series

ELECTRICAL DATA

Unless otherwise stated, all characteristics apply at an ambient temperature of $20 \pm 5^\circ\text{C}$, atmospheric pressure of 10^5Pa (1000mbars) and a relative humidity of 75% maximum.

	Conditions	352 Series 250 V	352 Series 400 V
Capacitance range (E6 Series)		0.0047 to 2.2 μF	0.01 to 1 μF
Capacitance tolerance	0.01 to 0.22 μF	$\pm 10\%$, $\pm 20\%$	$\pm 10\%$, $\pm 20\%$
	0.33 to 2.2 μF	$\pm 10\%$	$\pm 10\%$
Rated voltage (d. c.)	over the category temperature range	250 V	400 V
Rated voltage (r. m. s.) (see note)	$f = 50\text{ Hz}$, source impedance $> 1\text{ k}\Omega$	160 V	200 V
Rated current (mean)	—	400 mA	400 mA
Tangent of loss angle ($\tan \delta$)	$f = 10\text{ kHz}$	$< 150 \times 10^{-4}$	$< 150 \times 10^{-4}$
Temperature range	at rated voltage	-40 to $+85^\circ\text{C}$	-40 to $+85^\circ\text{C}$
Extended temperature range	Voltage derating 1.25% per deg C above 85°C	$+85$ to $+100^\circ\text{C}$	$+85$ to $+100^\circ\text{C}$
Insulation resistance	0.0047 to 0.33 μF	$> 30\,000\text{ M}\Omega$	$> 30\,000\text{ M}\Omega$
	0.47 to 2.2 μF	$> 10\,000\text{ M}\Omega \cdot \mu\text{F}$	$> 10\,000\text{ M}\Omega \cdot \mu\text{F}$
Maximum rate of change of voltage	Capacitor length L (see DIMENSIONS)		
	= 12.5 mm	20 V/ μs	30 V/ μs
	= 17.5 mm	10 V/ μs	20 V/ μs
	= 22.5 mm	7 V/ μs	10 V/ μs
	= 30 mm	5 V/ μs	8 V/ μs
Surge voltage (d. c.)	1 min per hour	350 V	500 V
Long term stability	1000 hrs at 85°C 1.5 \times rated d. c. voltage applied	$\frac{\Delta C}{C} \leq 5\%$	$\frac{\Delta C}{C} \leq 5\%$
	1000 hrs at 85°C rated a. c. voltage applied	Capacitor length L = 12.5 mm $\leq 15\%$ = 17.5 mm $\leq 10\%$ = 22.5 mm $\frac{\Delta C}{C} \leq 7\%$ = 30 mm $\leq 5\%$	

Mullard

NOTE

The maximum r. m. s. voltage at frequencies higher than 50 Hz can be calculated from the relevant formula in METALLISED FILM CAPACITORS - INTRODUCTORY NOTES and the graph on the last page of this data sheet.

SOLDERING CONDITIONS

5 seconds max. at 250°C max.

MARKING

The capacitors are coded with:

- Capacitance
- Tolerance
- Rated voltage

The method of marking is shown below: -

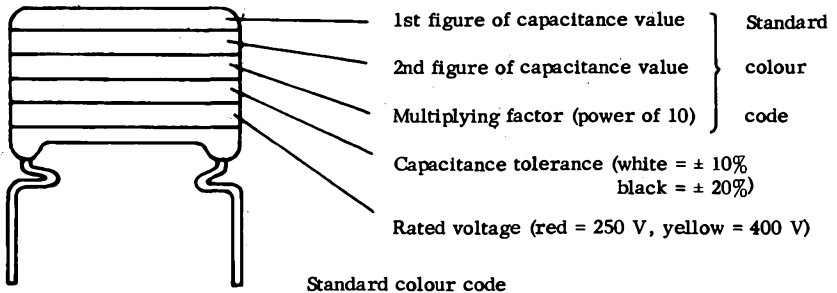

Black = 0	Green = 5
Brown = 1	Blue = 6
Red = 2	Violet = 7
Orange = 3	Grey = 8
Yellow = 4	White = 9

→ ORDERING PROCEDURE

The capacitors should be ordered by their code number as shown in the table.

Example: A 0.1 μ F ± 20%, 250 V rated capacitor with crimped, long wire terminations, should be ordered by quoting the code number 352 44104.

A 0.1 μ F ± 20%, 250 V rated capacitor with crimped and cropped terminations, should be ordered by quoting the code number 352 47104.

**METALLISED POLYESTER
FILM CAPACITORS**
Crimped radial leads - lacquered

**352
Series**

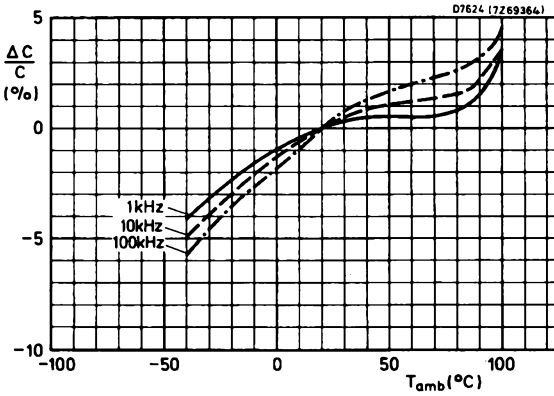

Typical capacitance change as a function of ambient temperature

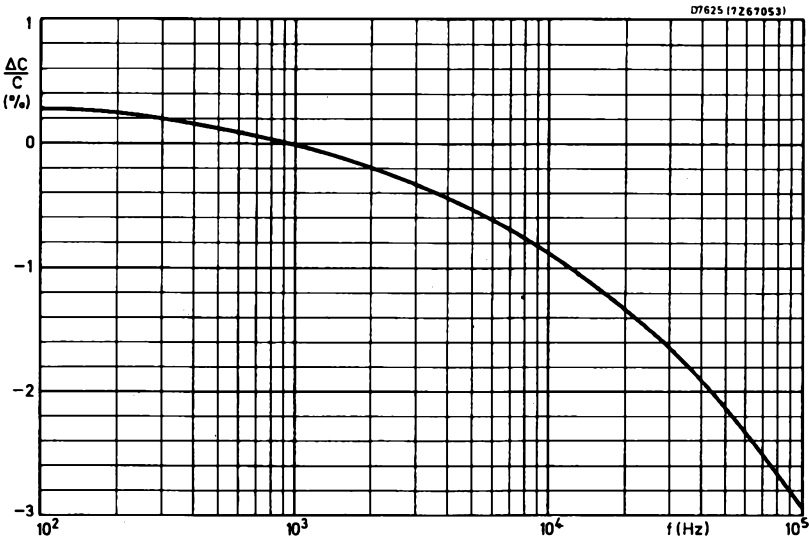

Typical capacitance change as a function of frequency

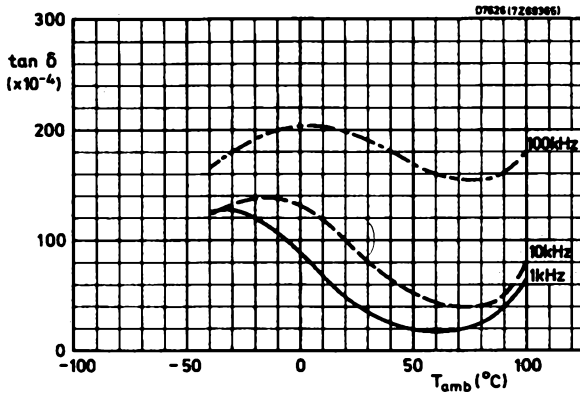

Typical loss factor as a function of ambient temperature

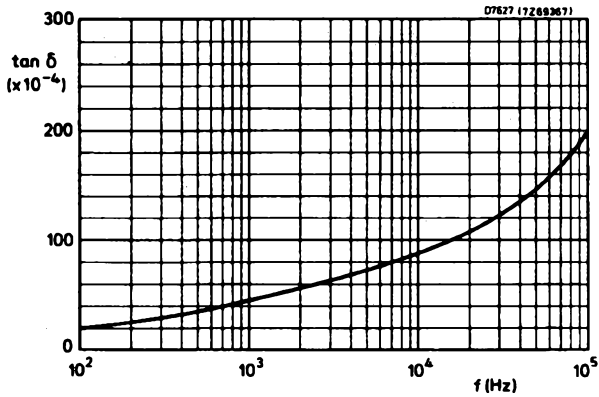

Typical loss factor as a function of frequency

**METALLISED POLYESTER
FILM CAPACITORS**
Crimped radial leads - lacquered

**352
Series**

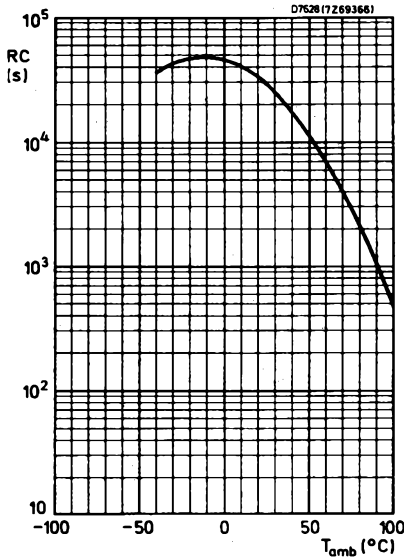

Typical insulation resistance as a function of ambient temperature

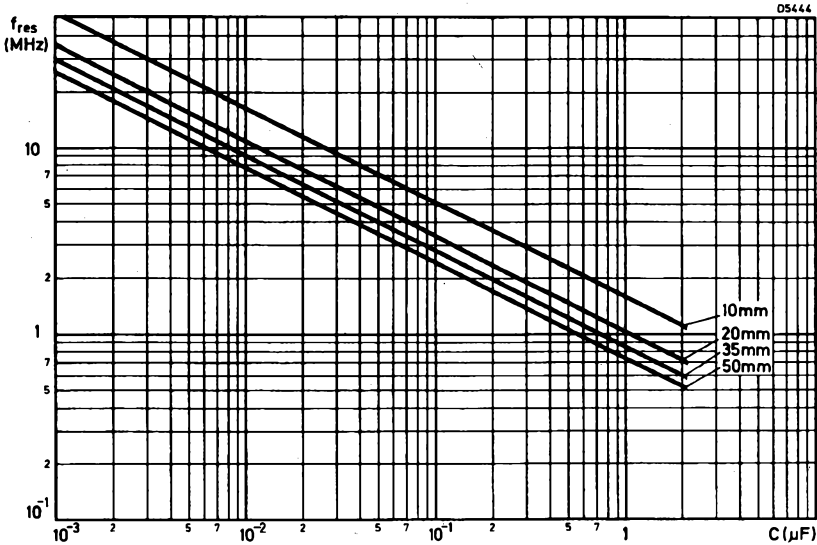

Self resonance frequency as a function of capacitance for various total lead lengths

Mullard

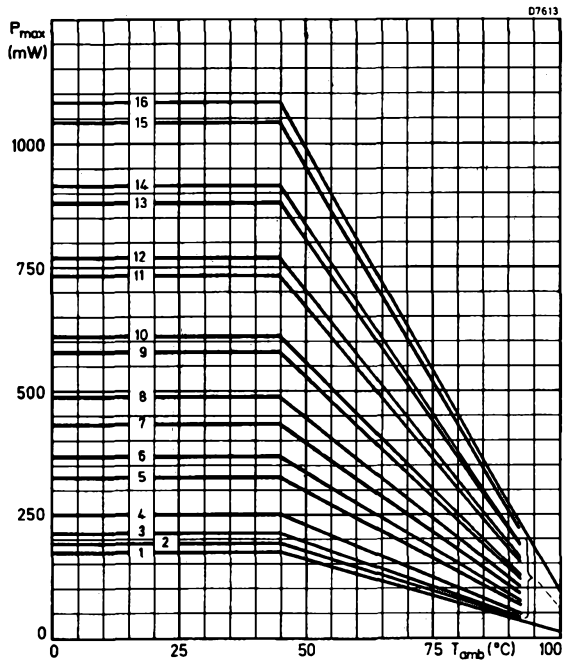

Maximum permissible power dissipation as a function of ambient temperature

TABLE OF CASE SIZES

Curve	Dimensions in millimetres		
	L	H	T
1	12.5	12.0	4.0
	12.5	12.5	4.5
2	12.5	13.0	5.0
3	12.5	13.5	5.5
4	12.5	13.5	6.5
5	17.5	15.0	6.0
6	17.5	16.0	7.0
7	22.5	15.5	6.5
8	22.5	16.5	7.5

Curve	Dimensions in millimetres		
	L	H	T
9	22.5	18.0	9.0
10	22.5	18.0	9.5
11	30	18.0	9.0
12	30	18.5	9.5
13	30	21.5	9.5
14	30	22.0	10.0
15	30	23.5	11.5
16	30	24.0	12.0

METALLISED POLYESTER FILM CAPACITORS

Radial leads - epoxy coated - flame retardant

Designed for coupling and decoupling applications on printed-wiring boards.

The epoxy encapsulant makes these capacitors flame retardant and resistant to modern cleaning solvents.

QUICK REFERENCE DATA

Capacitance ranges (E6 Series)

100 V working	0.10 to 2.2	μF
250 V working	0.01 to 2.2	μF
400 V working	0.01 to 1.0	μF

Capacitance tolerance

100 V working	± 10	%
250 and 400 V working	± 20	%

Climatic category, at rated voltage U_R
at 0.8 U_R

40/085/21
40/100/21

DIELECTRIC

Polyethyleneterephthalate film

CASING

Hard, flame retardant epoxy

TERMINATIONS

Radial leads of solder coated copper wire, crimped with a new profile and cropped, for use with printed-wiring boards having a 2.54 mm (0.1 in) grid.

TYPE NUMBER DESIGNATION

100 V version	358 13...
250 V version	358 16...
400 V version	358 20...

SPECIAL FEATURES

The capacitors are manufactured by using 'extended electrode' techniques resulting in low inherent inductance. They are flame retardant to three cycles of fifteen seconds in a butane gas flame, and self extinguishing within 10 seconds.

The burner comprises of a 0.5 mm diameter needle, and the flame is adjusted to a height of 12 mm. The series is identified by black printing on a light blue epoxy resin encapsulation.



DIMENSIONS and TYPE NUMBERS

Dimensions in mm

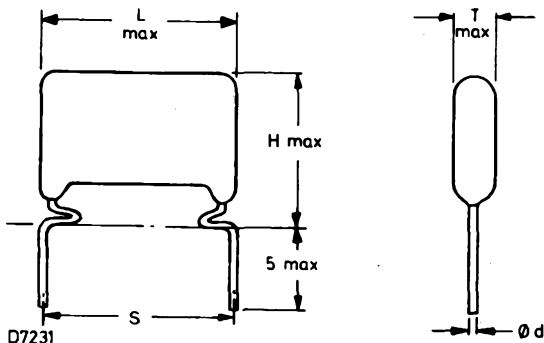

100 V version

Capacitance μF	Tol. %	Dimensions					Type number
		L	H	T	ød	S	
0.10	±10	13.5	13.5	6.5	0.6	10.16 (0.4 in.)	358 13104
0.15		13.5	14.0	6.5	0.6	10.16 (0.4 in.)	358 13154
0.22		13.5	15.0	7.0	0.6	10.16 (0.4 in.)	358 13224
0.33		17.5	16.0	7.0	0.8	15.24 (0.6 in.)	358 13334
0.47		17.5	17.0	8.0	0.8	15.24 (0.6 in.)	358 13474
0.68		24.5	16.5	7.5	0.8	20.32 (0.8 in.)	358 13684
1.0		24.5	17.0	8.5	0.8	20.32 (0.8 in.)	358 13105
1.5		24.5	19.0	10.0	0.8	20.32 (0.8 in.)	358 13155
2.2		32.5	17.5	9.5	0.8	27.94 (1.1 in.)	358 13225

250 V version

0.010	±20	13.5	13.5	6.5	0.6	10.16 (0.4 in.)	358 16103
0.015		13.5	13.5	6.5	0.6	10.16 (0.4 in.)	358 16153
0.022		13.5	13.5	6.5	0.6	10.16 (0.4 in.)	358 16223
0.033		13.5	13.5	6.5	0.6	10.16 (0.4 in.)	358 16333
0.047		13.5	13.5	6.5	0.6	10.16 (0.4 in.)	358 16473
0.068		13.5	14.5	6.5	0.6	10.16 (0.4 in.)	358 16683
0.10		13.5	15.5	7.5	0.6	10.16 (0.4 in.)	358 16104
0.15		17.5	16.5	7.5	0.8	15.24 (0.6 in.)	358 16154
0.22		17.5	17.5	8.5	0.8	15.24 (0.6 in.)	358 16224
0.33		24.5	17.0	8.0	0.8	20.32 (0.8 in.)	358 16334
0.47		24.5	18.0	9.0	0.8	20.32 (0.8 in.)	358 16474
0.68		25.5	19.0	10.0	0.8	20.32 (0.8 in.)	358 16684
1.0		32.5	18.5	12.0	0.8	27.94 (1.1 in.)	358 16105
1.5		32.5	20.5	11.5	0.8	27.94 (1.1 in.)	358 16155
2.2		32.5	20.5	13.5	0.8	27.94 (1.1 in.)	358 16225



400 V version

0.010	±20	13.5	13.5	6.5	0.6	10.16 (0.4 in.)	358 20103
0.015		13.5	13.5	6.5	0.6	10.16 (0.4 in.)	358 20153
0.022		13.5	13.5	6.5	0.6	10.16 (0.4 in.)	358 20223
0.033		13.5	14.5	6.5	0.6	10.16 (0.4 in.)	358 20333
0.047		13.5	15.5	7.5	0.6	10.16 (0.4 in.)	358 20473
0.068		17.5	16.5	7.5	0.8	15.24 (0.6 in.)	358 20683
0.10		17.5	17.5	8.5	0.8	15.24 (0.6 in.)	358 20104
0.15		24.5	17.5	8.0	0.8	20.32 (0.8 in.)	358 20154
0.22		24.5	18.0	9.0	0.8	20.32 (0.8 in.)	358 20224
0.33		24.5	19.0	10.0	0.8	20.32 (0.8 in.)	358 20334
0.47		32.5	18.5	12.0	0.8	27.94 (1.1 in.)	358 20474
0.68		32.5	23.5	12.5	0.8	27.94 (1.1 in.)	358 20684
1.0		32.5	23.5	13.5	0.8	27.94 (1.1 in.)	358 20105



ELECTRICAL DATA

Unless otherwise stated, all characteristics apply at an ambient temperature of $20 \pm 5^\circ\text{C}$, an atmospheric pressure of 10^5 Pa (1000 mbars) and a relative humidity of 75% maximum.

Parameter	Conditions	358 13... (100 V)	358 16... (250 V)	358 20... (400 V)	Unit
Capacitance range (E6 Series)		0.10 to 2.2	0.010 to 2.2	0.010 to 1.0	μF
Capacitance tolerance		± 10	± 20	± 20	%
Rated voltage (d.c.)	-40 to $+85^\circ\text{C}$	100	250	400	V
Rated voltage (r.m.s.) (see NOTE below)	$f = 50$ Hz, minimum source impedance > 1 k Ω	63	160	200	V
Rated current (mean)		400			mA
Tangent of loss angle ($\tan \delta$)	$f = 10$ kHz	$< 150 \times 10^{-4}$			—
Category temperature range		-40 to $+85$			$^\circ\text{C}$
Extended temperature range	Voltage derating 1.25% per $^\circ\text{C}$ above 85°C	$+85$ to $+100$			$^\circ\text{C}$
Insulation resistance	0.010 to 0.33 μF 0.47 to 2.2 μF	$> 15\ 000$ $> 5\ 000$	$> 30\ 000$ $> 10\ 000$	$> 30\ 000$ $> 10\ 000$	M Ω s
Maximum rate of change of voltage	Capacitor length L				
	13.5 mm	10	20	30	V/ μs
	17.5 mm	7	10	20	V/ μs
	24.5 mm	4	7	10	V/ μs
32.5 mm	3	5	8	V/ μs	
Surge voltage	1 min. per hour	140	350	500	V
Long term stability	1000 hrs at 85°C 1.5 x rated d.c. voltage applied	$\frac{\Delta C}{C} \leq 5$			%
	1000 hrs at 85°C rated a.c. voltage applied	Capacitor length L			
		13.5 mm	≤ 15	%	
		17.5 mm	$\frac{\Delta C}{C} \leq 10$	%	
		24.5 mm	≤ 7	%	
		32.5 mm	≤ 5	%	
Climatic category (IEC publication 68)	at rated voltage (U_R) at 0.8 U_R	40/085/21 40/100/21			

NOTE

The maximum r.m.s. voltage at frequencies higher than 50 Hz can be calculated from the relevant formula in METALLISED FILM CAPACITORS – INTRODUCTORY NOTES and the power rating graph on the last page of this data sheet.



SOLDERING CONDITIONS

5 s max. at 250 °C max.

MARKING

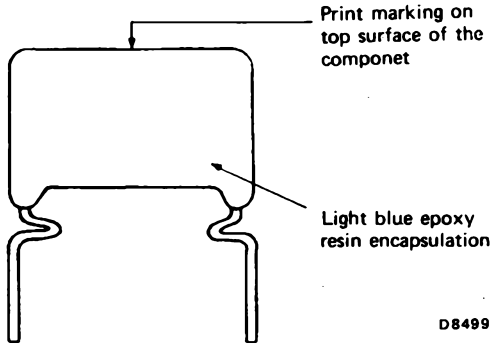

These capacitors are marked with the following information:—

- Capacitance value
- Capacitance tolerance (M = 20%; K = 10%).
- Voltage
- Manufacturer's name (Philips)
- Production date code (in accordance with IEC 62)
- Dielectric code (MKT = metallised polyester).

ORDERING PROCEDURE

These capacitors should be ordered by quoting the type number shown in the tables on page 2, for example:

- 0.10 μF , $\pm 10\%$, 100 V working capacitor — 358 13104,
- 0.047 μF , $\pm 20\%$ 250 V working capacitor — 358 16473.

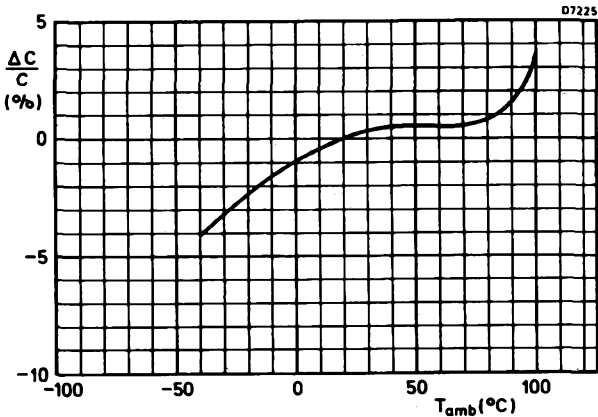

Fig.1 Typical capacitance change as a function of ambient temperature.



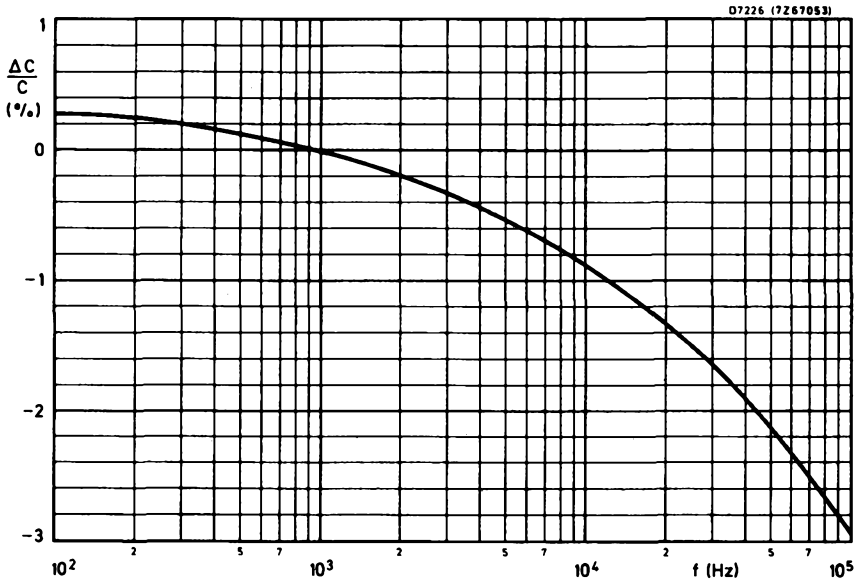

Fig.2 Typical capacitance change as a function of frequency

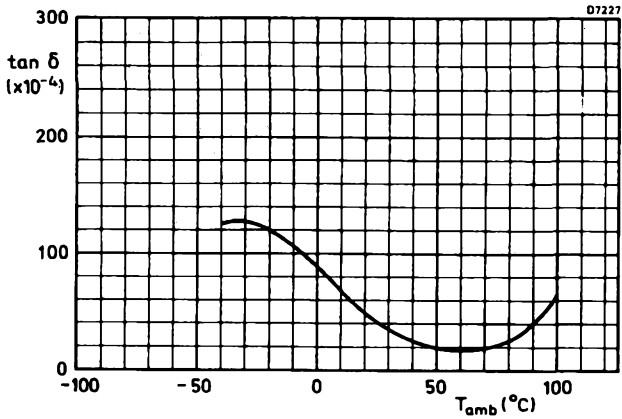

Fig.3 Typical loss factor as function of ambient temperature



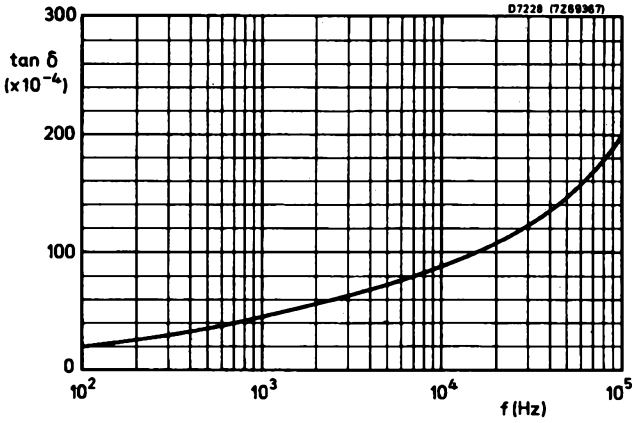

Fig.4 Typical loss factor as a function of frequency

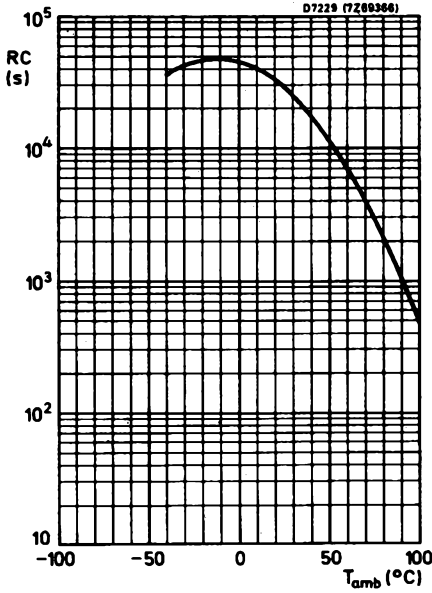
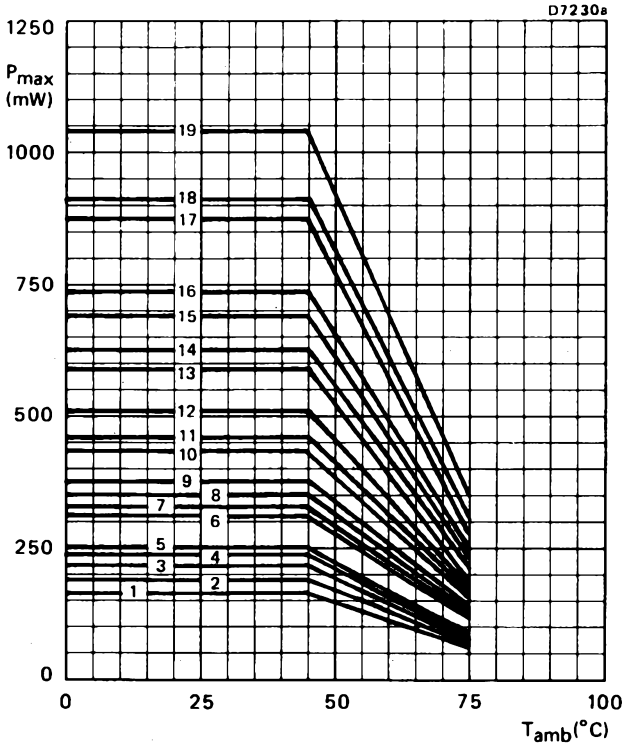

Fig.5 Typical insulation resistance as a function of ambient temperature





Curve No.	Maximum case dimensions (millimetres)		
	L	H	T
1	13.5	13.5	6.5
2	13.5	14.0	6.5
3	13.5	14.5	6.5
4	13.5	15.0	7.0
5	13.5	15.5	7.5
6	17.5	16.0	7.0
7	17.5	16.5	7.5
8	17.5	17.0	8.0
9	17.5	17.5	8.5
10	24.5	16.5	7.5

Curve No.	Maximum case dimensions (millimetres)		
	L	H	T
11	24.5	17.5	8.0
12	24.5	17.0	8.5
13	24.5	18.0	9.0
14	24.5	19.0	10.0
15	32.5	17.5	9.5
16	32.5	18.5	12.0
17	32.5	20.5	11.5
18	32.5	23.5	12.5
19	32.5	23.5	13.5

Fig.6 Maximum permissible power dissipation as a function of temperature



FILM/FOIL CAPACITORS

B

INTERFERENCE SUPPRESSION CAPACITORS (Class X)

For suppression of electrical interference from domestic appliances operating on 250 V (a.c.) supplies in the class 'X' mode of operation, i.e. directly across the mains.

QUICK REFERENCE DATA

Rated capacitance range	
types with axial leads	0.01 to 0.47 μ F
types with radial leads	0.01 to 0.33 μ F
Capacitance tolerance	
VDE approved types	$\pm 20\%$
Rated voltages	
VDE approved types	250 V _{ac}
Climatic category (IEC 68)	40/085/21

DIELECTRIC

Metallised polyethyleneterephthalate (PETP) film and impregnated paper.

CASING

Yellow flame retardant polypropylene.

TERMINATIONS

Radial or axial leads of solder coated copper wire.

TYPE NUMBER DESIGNATIONS

Radial lead versions	330 40. . .
Axial lead versions	330 00. . .

SPECIAL FEATURES

These capacitors are intended to operate directly across the incoming 250 V a.c. mains supply (class 'X' mode) and may be approved to VDE 0560-7 specifications. Capacitors have to withstand an endurance test of 1000 hours at maximum rated temperature and with 1.25 U_R (rated voltage) applied i.e. 312.5 V_{rms}.



MECHANICAL DATA

Dimensions in mm

Axial lead versions

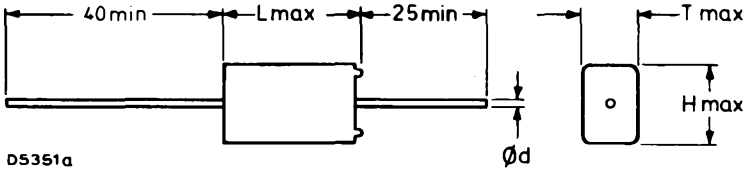

Fig.1

Table 1

rated capacitance μF	rated voltage r.m.s.	L	H	T	d	specification	type number
0.01	250	18	10.4	6.5	0.8	VDE-0560-7	330 00103
0.015	250	18	10.4	6.5	0.8	VDE-0560-7	330 00153
0.022	250	18	10.4	6.5	0.8	VDE-0560-7	330 00223
0.033	250	18	10.4	6.5	0.8	VDE-0560-7	330 00333
0.047	250	18	10.4	6.5	0.8	VDE-0560-7	330 00473
0.068	250	18	11.5	7.6	0.8	VDE-0560-7	330 00683
0.1	250	23.5	11.5	7.4	0.8	VDE-0560-7	330 00104
0.15	250	23.5	12.8	8.7	0.8	VDE-0560-7	330 00154
0.22	250	23.5	14.4	10.4	0.8	VDE-0560-7	330 00224



Radial lead versions

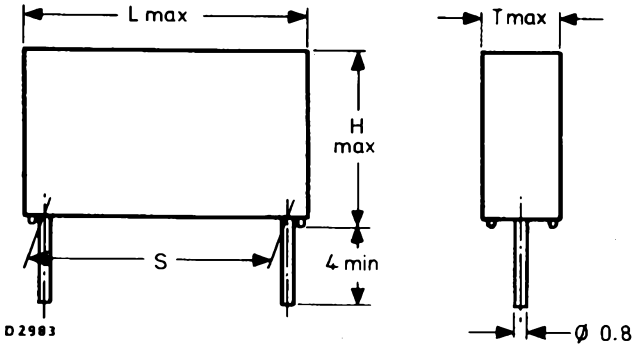

Fig.2

Table 2

rated capacitance μF	rated voltage r.m.s.	L	H	T	S	specification	type number
0.010	250	17.5	11	5	15	VDE-0560-7	330 40103
0.015	250	17.5	11	5	15	VDE-0560-7	330 40153
0.022	250	17.5	11	5	15	VDE-0560-7	330 40223
0.033	250	17.5	11	5	15	VDE-0560-7	330 40333
0.047	250	17.5	11.5	6	15	VDE-0560-7	330 40473
0.068	250	17.5	13	7	15	VDE-0560-7	330 40683
0.10	250	17.5	14.5	8.5	15	VDE-0560-7	330 40104
0.15	250	26.0	15.5	6.5	22.5	VDE-0560-7	330 40154
0.22	250	26.0	16.5	7.5	22.5	VDE-0560-7	330 40224
0.33	250	26.0	19	9.5	22.5	VDE-0560-7	330 40334

ELECTRICAL DATA

Unless otherwise specified all values apply at an ambient temperature of 15 – 35 °C, an atmospheric pressure of 860 to 1060 mbar and a relative humidity of 45 to 75%.

Capacitance

Capacitance range

types with axial leads	0.01 to 0.47 μF
types with radial leads	0.01 to 0.33 μF

Tolerance on capacitance

VDE approved types	$\pm 20\%$
--------------------	------------

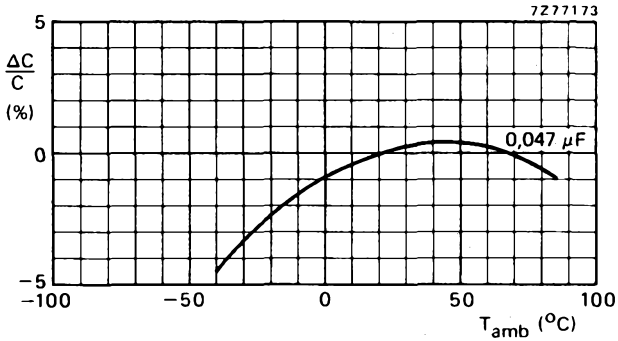

Fig.3 Typical variation of capacitance with temperature:
measured at 1 kHz, 0.3 V.

Voltage

Rated voltage (U_R) 50 – 60 Hz	250 V_{ac}
Test voltage (d.c.) for 1 min between terminals	750 V_{dc}
Test voltage (a.c.) for 1 min between interconnecting terminals and casing ($f = 50$ Hz)	2000 V_{ac}
Insulation resistance at 23 °C measured between terminals at 100 V d.c. after 1 minute	$> 15\,000\ M\Omega$



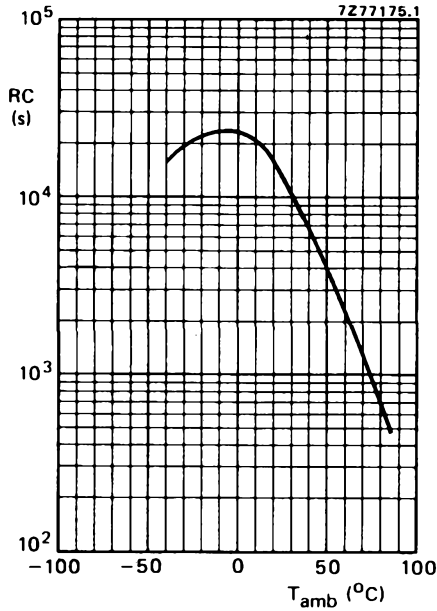

Fig.4 Typical variation of the RC-product as a function of temperature

Tan δ (tangent of loss angle)

Tan δ at 10 kHz

$\leq 130 \times 10^{-4}$ (typ 90×10^{-4})

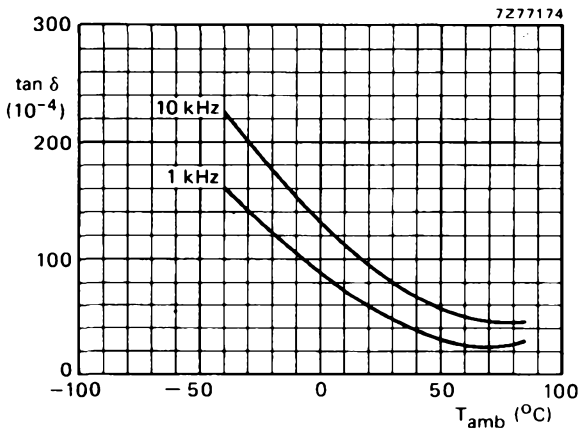

Fig.5 Typical variation of tan δ as a function of temperature; measured at 0.3 V



Pulse steepness

Maximum pulse steepness

100 V/ μ s

Resonant frequency

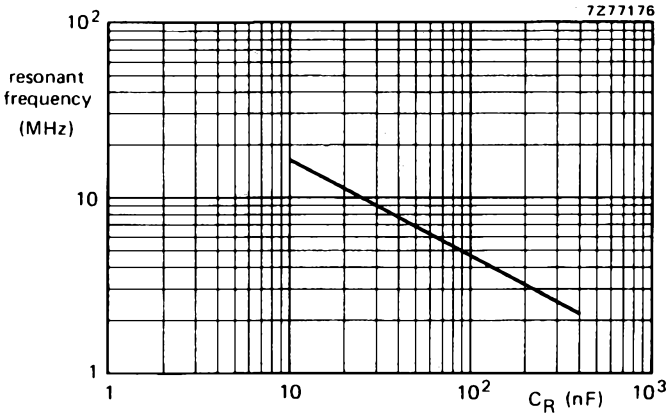

Fig.6 Resonant frequency as a function of rated capacitance

Temperature

Rated temperature

85 °C

Category temperature range

-40 to +85 °C

Storage temperature range

-55 to +85 °C

Climatic category, IEC 68

40/085/21

MARKING

Each capacitor is marked with the following information.

Capacitance in μ F, rated voltage and class of operation ('X')

Series number (330) and code for dielectric materials.

Manufacturer's identification symbol.

VDE approval stamp

Date code (year and month)

For class 'Y' capacitors refer to 660 Series (Ceramic Section)



POLYESTER FILM/FOIL CAPACITORS

Radial leads - lacquered

QUICK REFERENCE DATA

For general purpose and pulse applications on printed wiring boards, where metallised construction is unacceptable.

Capacitance range (E6 Series)	1.0 to 680	nF
Capacitance tolerance	± 10	%
Rated voltage (d.c.)	100, 250, 400, 630	V
Climatic category (IEC 68)		
at rated voltage (U_R)	40/085/21	
at 0.8 U_R	40/100/21	

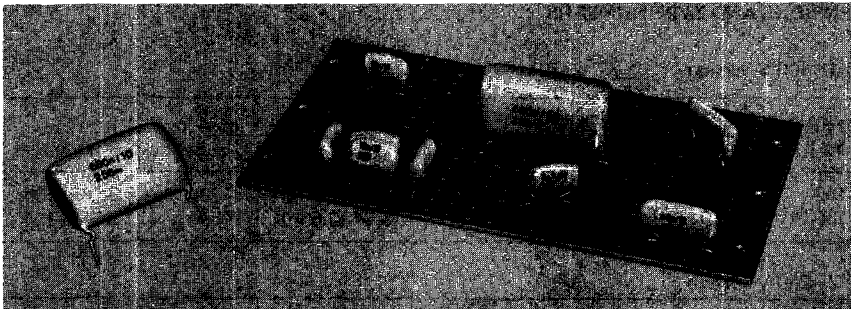

DIELECTRIC

Polyethyleneterephthalate film.

CASING

Hard, water repellent lacquer.

TERMINATIONS

Radial leads of solder coated copper wire, crimped and cropped for use with printed wiring boards having a 2.54 mm (0.1 in) grid.

SPECIAL FEATURES

These capacitors are manufactured using 'extended foil' technique, resulting in low inherent inductance and also making them suitable for use in pulse circuits where high peak currents are experienced. The crimping and cropping of the leads enables the capacitors to be inserted into printed wiring boards without preparatory operations and improves the solderability of the component in flow line production techniques.



MECHANICAL DATA

Dimensions in mm

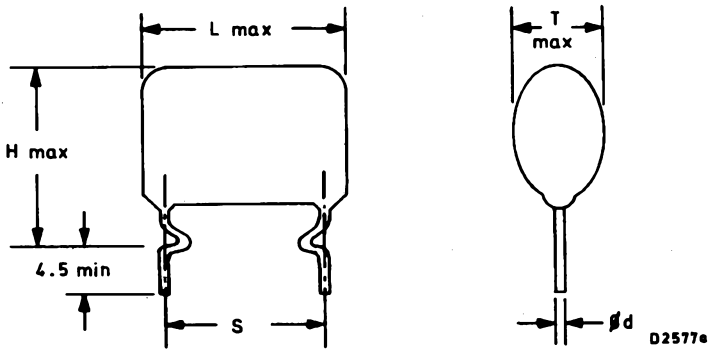

DIMENSIONS AND TYPE NUMBERS

Table 1 100 V version

capacitance (nF)	dimensions in millimetres					marking code	type number
	L	H	T	d	S		
100	19	15.5	7	0.8	15.24 (0.6 in)	100n	347 21104
150	19	16.5	8	0.8	15.24 (0.6 in)	150n	347 21154

Table 2 250 V version

capacitance (nF)	dimensions in millimetres					marking code	type number
	L	H	T	d	S		
40	13.5	12.5	5	0.6	10.16 (0.4 in)	10n	347 41103
15	13.5	13	5.5	0.6	10.16 (0.4 in)	15n	347 41153
22	13.5	14	6.5	0.6	10.16 (0.4 in)	22n	347 41223
33	19	14	5.5	0.8	15.24 (0.6 in)	33n	347 41333
47	19	15	6.5	0.8	15.24 (0.6 in)	47n	347 41473
68	19	16	7.5	0.8	15.24 (0.6 in)	68n	347 41683
100	27	18	6.5	0.8	22.86 (0.9 in)	100n	347 41104
150	27	19.5	8	0.8	22.86 (0.9 in)	150n	347 41154
220	27	21	9.5	0.8	22.86 (0.9 in)	220n	347 41224
330	32	21.5	10	0.8	27.94 (1.1 in)	330n	347 41334
470	32	23.5	12	0.8	27.94 (1.1 in)	470n	347 41474
680	32	26.5	15	0.8	27.94 (1.1 in)	680n	347 41684



Table 3 400 V version

capacitance (nF)	dimensions in millimetres					marking code	type number
	L	H	T	d	S		
4.7	13.5	12	4.5	0.6	10.16 (0.4 in)	4n7	347 51472
6.8	13.5	13	5.5	0.6	10.16 (0.4 in)	6n8	347 51682
10	13.5	13.5	6	0.6	10.16 (0.4 in)	10n	347 51103
15	13.5	14.5	7	0.6	10.16 (0.4 in)	15n	347 51153
22	19	14.5	6	0.8	15.24 (0.6 in)	22n	347 51223
33	19	15.5	7	0.8	15.24 (0.6 in)	33n	347 51333
47	19	16.5	8	0.8	15.24 (0.6 in)	47n	347 51473
68	27	18.5	7	0.8	22.86 (0.9 in)	68n	347 51683
100	27	20	8.5	0.8	22.86 (0.9 in)	100n	347 51104
150	27	22	10.5	0.8	22.86 (0.9 in)	150n	347 51154
220	32	22.5	11	0.8	27.94 (1.1 in)	220n	347 51224
330	32	25	13.5	0.8	27.94 (1.1 in)	330n	347 51334

Table 4 630 V version

capacitance (nF)	dimensions in millimetres					marking code	type number
	L	H	T	d	S		
1.0	13.5	13	5.5	0.6	10.16 (0.4 in)	1n0	347 61102
1.5	13.5	13	5.5	0.6	10.16 (0.4 in)	1n5	347 61152
2.2	13.5	12	4.5	0.6	10.16 (0.4 in)	2n2	347 61222
3.3	13.5	13	5.5	0.6	10.16 (0.4 in)	3n3	347 61332



ELECTRICAL DATA

Unless otherwise specified, all characteristics apply at an ambient temperature of 20 ± 5 °C, atmospheric pressure of 10^5 Pa (1000 mbars) and a relative humidity of 75% maximum.

	Conditions	347 21... (100 V)	347 41... (250 V)	347 51... (400 V)	347 61... (630 V)
Capacitance range (E6 Series)	—	100 to 150 nF	10 to 680 nF	4.7 to 330 nF	1.0 to 3.3 nF
Capacitance tolerance	—	$\pm 10\%$	$\pm 10\%$	$\pm 10\%$	$\pm 10\%$
Rated voltage (d.c.)	-40 to +85 °C	100 V	250 V	400 V	630 V
Rated voltage (r.m.s.)	f = 50 Hz -40 to +85 °C	50 V	80 V	125 V	200 V
Tangent of loss angle (tan δ)	f = 1 kHz	$<60 \times 10^{-4}$	$<60 \times 10^{-4}$	$<60 \times 10^{-4}$	$<60 \times 10^{-4}$
	f = 10 kHz	$<110 \times 10^{-4}$	$<110 \times 10^{-4}$	$<110 \times 10^{-4}$	$<110 \times 10^{-4}$
Temperature range: category extended	—	-40 to +85 °C	-40 to +85 °C	-40 to +85 °C	-40 to +85 °C
	voltage derating 1.25%/°C	+85 to 100 °C	+85 to 100 °C	+85 to 100 °C	+85 to 100 °C
Insulation resistance at 20 °C	measured C > 330 nF at 100 V d.c. after 1 minute C \leq 330 nF	>16 500 seconds >50 000 M Ω	>16 500 seconds >50 000 M Ω	>16 500 seconds >50 000 M Ω	*>16 500 seconds *>50 000 M Ω
Long term stability	1000 hrs at 85 °C 1.5 x rated d.c. voltage applied	$\frac{\Delta C}{C} \leq 5\%$	$\frac{\Delta C}{C} \leq 5\%$	$\frac{\Delta C}{C} \leq 5\%$	$\frac{\Delta C}{C} \leq 5\%$
	1000 hrs at 85 °C rated a.c. voltage applied	$\frac{\Delta C}{C} \leq 5\%$	$\frac{\Delta C}{C} \leq 5\%$	$\frac{\Delta C}{C} \leq 5\%$	$\frac{\Delta C}{C} \leq 5\%$
Climatic category	at rated voltage (U_R)	40/085/21	40/085/21	40/085/21	40/085/21
	at 0.8 U_R	40/100/21	40/100/21	40/100/21	40/100/21

*At 500 V d.c.



MARKING

The capacitors are marked with:—

- Rated capacitance and tolerance
- Rated voltage, dielectric code (FA = film*/foil)

*Polyethyleneterephthalate (PETP) film

ORDERING PROCEDURE

The capacitors should be ordered by quoting their type number, as shown in the tables.

Example: A 220 nF ± 10% capacitor, 250 V version should be ordered by quoting the type number 347 41224.

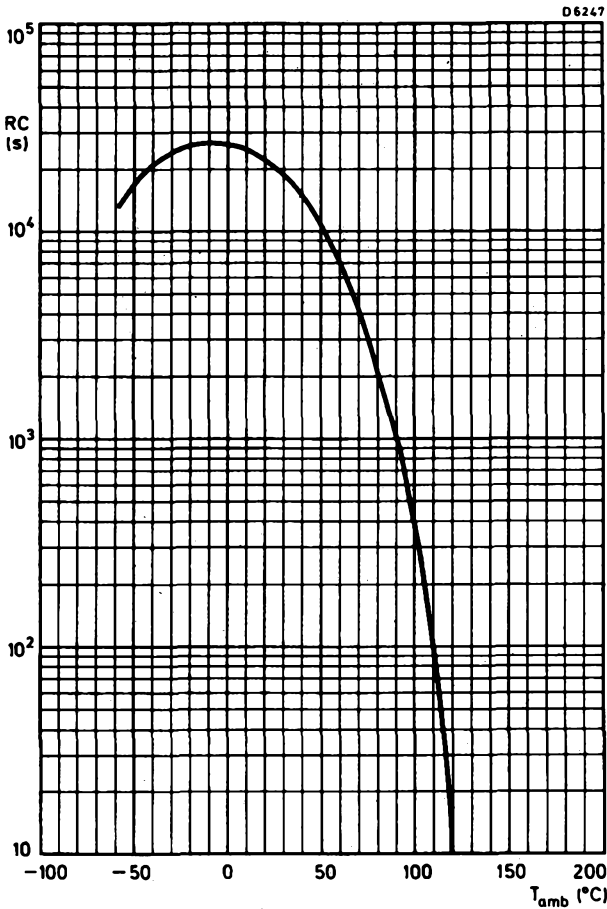

Typical insulation resistance as a function of ambient temperature



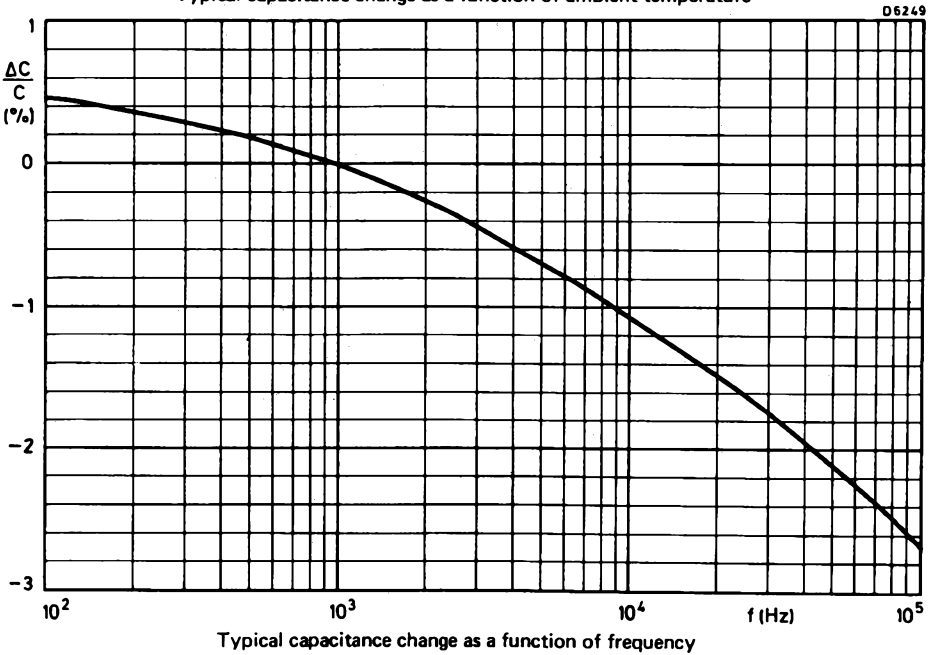
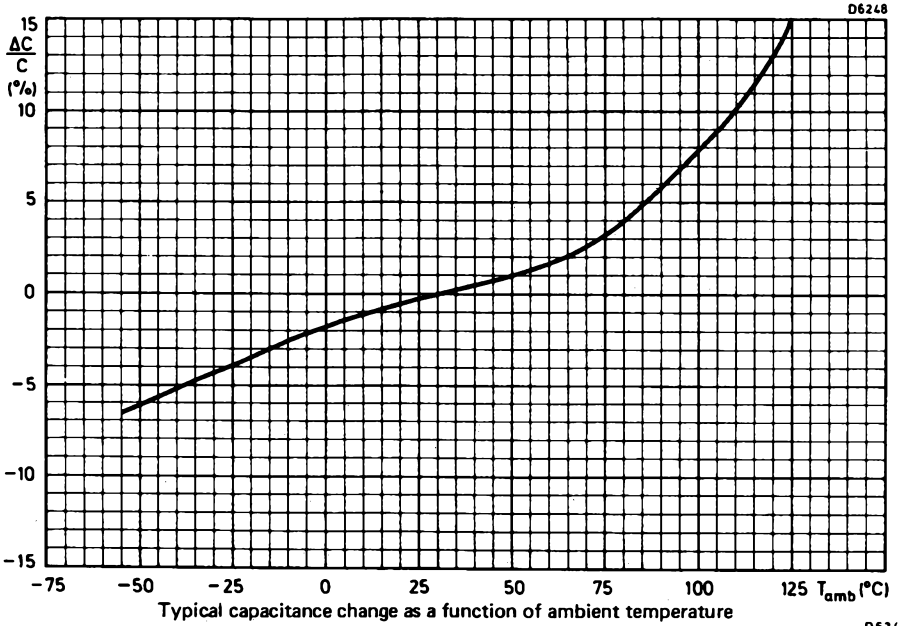

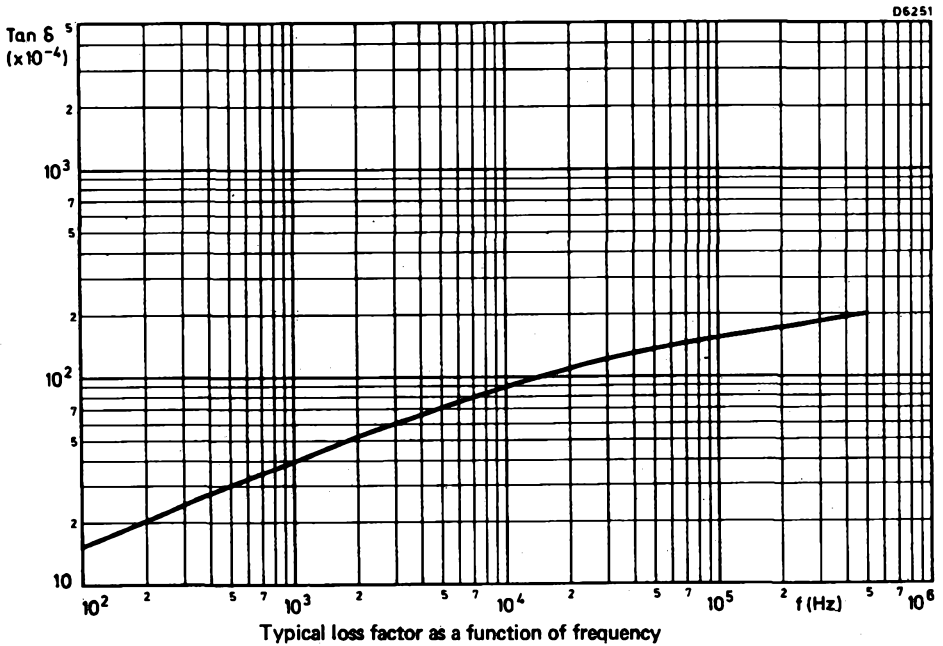
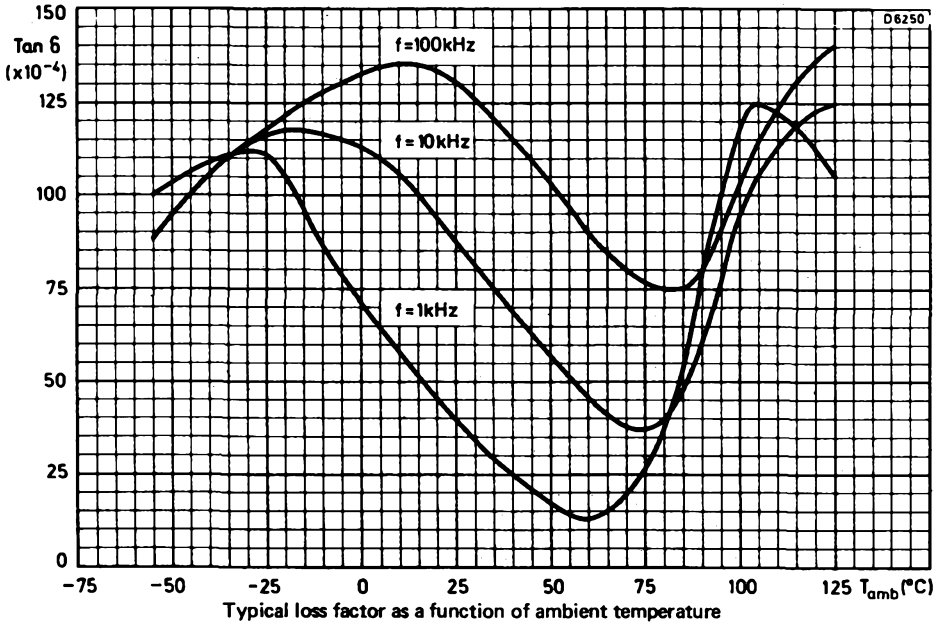

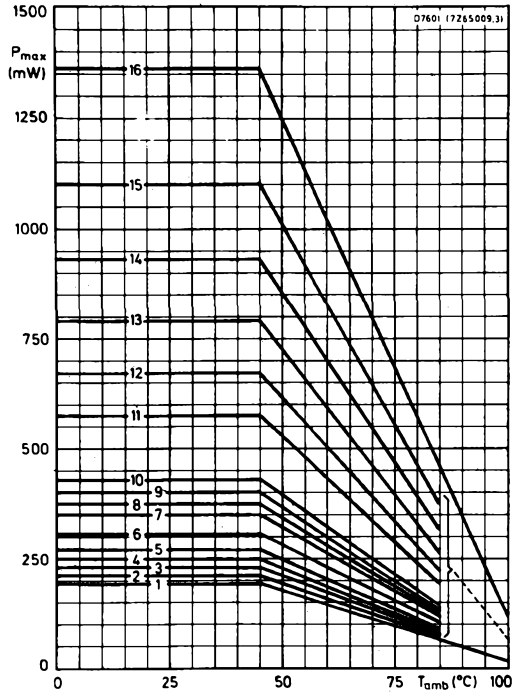

Maximum permissible power dissipation as a function of ambient temperature for various case sizes

Table of case sizes

curve	dimensions in millimetres		
	L	H	T
1	13.5	12	4.5
2	13.5	12.5	5
3	13.5	13	5.5
4	13.5	13.5	6
5	13.5	14	6.5
6	19	14	5.5
7	19	15	6.5
8	19	15.5	7
9	19	16	7.5
10	19	16.5	8

curve	dimensions in millimetres		
	L	H	T
11	27	18	6.5
12	27	19.5	8
13	27	21	9.5
14	32	21.5	10
15	32	23.5	12
16	32	26.5	15



POLYPROPYLENE FILM/FOIL CAPACITORS radial leads — moulded

Designed for high frequency/high current applications on printed wiring boards.

QUICK REFERENCE DATA

Capacitance range	47 to 680 nF
Capacitance tolerance	±10%
Rated voltage (U_R) (d.c.)	250 V
Rated voltage (a.c.) (50 Hz)	160 V
Climatic category (IEC 68)	40/085/56

DIELECTRIC

Polypropylene film.

CASING

Flame retardant polypropylene case, sealed by epoxy resin, with small pips on to the base to give a clearance between the capacitor and the printed-wiring board.

TERMINATIONS

Radial leads of tinned copper wire, 0.8 mm diameter, for use with printed-wiring boards having a 2.54 mm (0.1 in) grid.

SPECIAL FEATURES

The capacitors are manufactured using 'extended foil' technique, resulting in low inherent inductance. They are mainly intended for 'S' correction in transistorized tv receivers, where high peak currents at line frequency occur. It is, however, possible to use the capacitors in other applications, i.e. inverters operating at other frequencies.



MECHANICAL DATA

Dimensions in mm

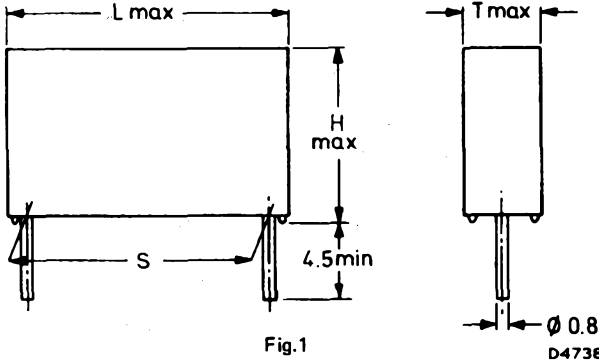

capacitance (nF)	Dimensions in millimetres				type numbers
	L	H	T	S	
47	21.5	15	8	15	357 51473
100	29	18.5	8.5	22.5	357 51104
220	34	20	10	27.5	357 51224
330	34	22	12	27.5	357 51334
470	34	25	15	27.5	357 51474
560	34	25	15	27.5	357 51564
680	34	28	18	27.5	357 51684

ELECTRICAL DATA

Unless otherwise stated, all characteristics apply at an ambient temperature of $20 \pm 5^\circ\text{C}$, atmospheric pressure of 10^5Pa (1000 mbars) and a relative humidity of 75% maximum.

	conditions	value
capacitance range	—	47 to 680 nF
capacitance tolerance	—	$\pm 10\%$
rated voltage (d.c.)	-40 to $+85^\circ\text{C}$	250 V
rated voltage (a.c.)	$f = 50$ Hz	160 V
tangent of loss angle ($\tan \delta$)	$f = 10$ kHz	$\leq 5 \times 10^{-4}$
category temperature range	—	-40 to $+85^\circ\text{C}$
insulation resistance at 20°C	$C < 0.1 \mu\text{F}$	$> 50\,000 \text{ M}\Omega$
	$C > 0.1 \mu\text{F}$	$RC > 5000 \text{ s}$
minimum casing breakdown voltage (d.c.)	applied for 1 minute	1000 V
minimum breakdown voltage between terminals	applied for 1 minute	500 V



SOLDERING CONDITIONS

For capacitors in printed-wiring board applications, where the distance between the solder point and the capacitor body is 1.5 mm minimum, the maximum permissible soldering time at 250 °C is 5 seconds.

MARKING

The capacitors are marked on the top face by embossed print, with

1st line: rated capacitance in μF , tolerance and rated d.c. voltage without unit symbols.

2nd line: series number (357), code for dielectric material (FP) and code for factory of origin.

ORDERING PROCEDURE

The capacitors should be ordered by quoting their type number, as shown in the table.

Example: A 470 nF \pm 10% capacitor should be ordered by quoting the type number 357 51474.

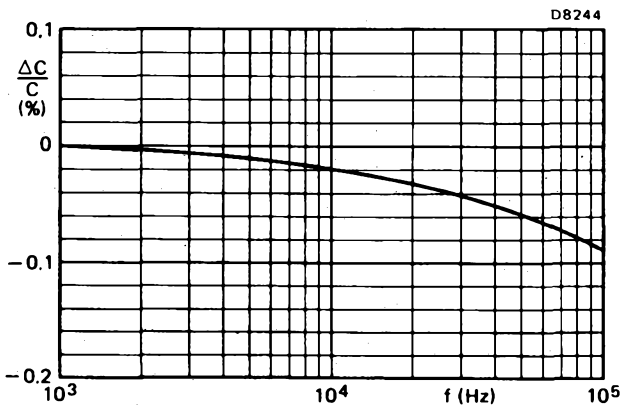

Fig.2 Capacitance as a function of frequency: typical curve, measuring voltage is 0.3 V.



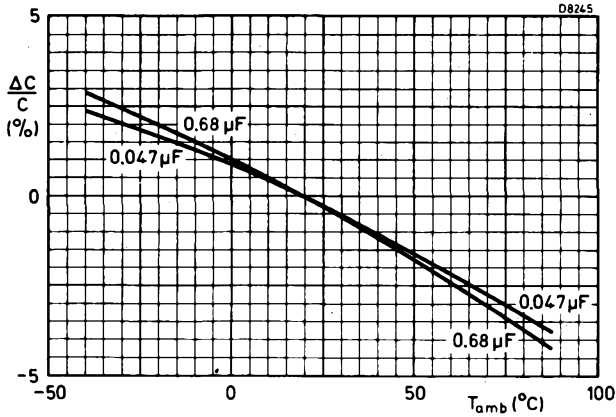

Fig.3 Capacitance as a function of temperature; typical curves.
Measuring voltage 0.3 V, measuring frequency 10 kHz.

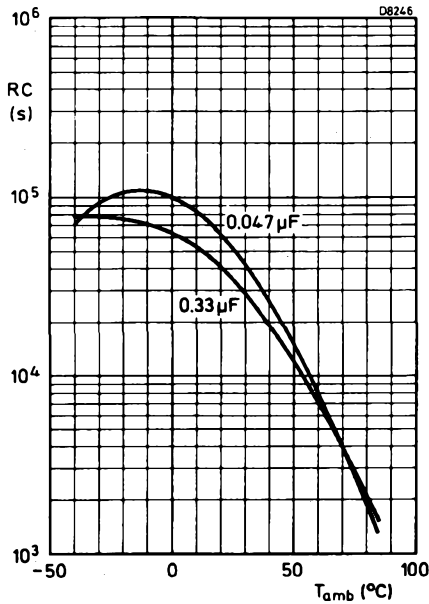

Fig.4 R-C product as a function of temperature; typical curves.



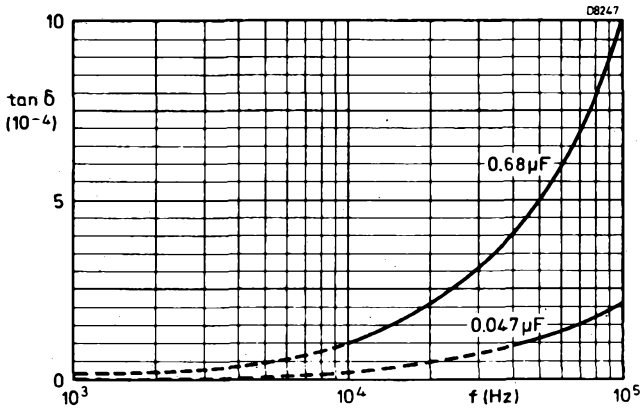

Fig.5 Tan δ as a function of frequency; typical curves



ADDITIONAL INFORMATION

The rated a.c. voltage, which has been specified at 50 to 60 Hz must also never be exceeded at other frequencies. Moreover this voltage value may further be limited by the maximum permissible power dissipation (P_{\max}).

The power dissipated by a capacitor is a function of the voltage over the series resistance (R_s) or of the current through the series resistance and is expressed by

$$P = \frac{VR_s^2}{R_s} = I^2 R_s \quad (1)$$

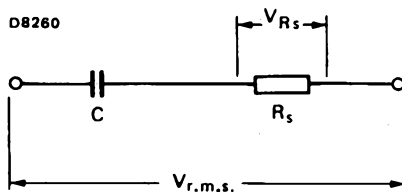

$$VR_s^2 = \frac{R_s^2}{R_s^2 + 1/\omega^2 C^2} V_{rms}^2 \quad (2a)$$

As $\tan \delta = R_s \omega C$ for these capacitors is always < 0.1 , equation (2a) can be simplified to

$$VR_s^2 = \frac{R_s^2}{1/\omega^2 C^2} V_{rms}^2 = R_s^2 \omega^2 C^2 V_{rms}^2 \quad (2b)$$

$$\text{Thus } P = R_s \omega^2 C^2 V_{rms}^2 = (R_s C) C \omega^2 V_{rms}^2 \quad (3)$$

in which $\omega = 2\pi f$; the term $(R_s C)$ is 7.96×10^{-9} .

The maximum permissible power dissipation (P_{\max}), which depends on the dimensions of the capacitor and on the ambient temperature, can be found from Fig.6.

Example

A capacitor of $0.47 \mu\text{F}$ is to be used at 40 kHz and an ambient temperature of 75°C . The $R_s C$ -product at 40 kHz is $7.96 \times 10^{-9} \Omega\text{F}$. The maximum permissible power dissipation at 75°C is 780 mW (Fig.6)

The maximum a.c. voltage can be calculated from Eq. (3):

$$\begin{aligned} V_{rms} &= \sqrt{\left\{ \frac{P_{\max}}{(R_s C) C \omega^2} \right\}} \\ &= \sqrt{\left(\frac{0.78}{7.96 \times 10^{-9} \times 0.47 \times 10^{-6} \times 4\pi^2 \times 16 \times 10^8} \right)} = 57 \text{ V.} \end{aligned}$$



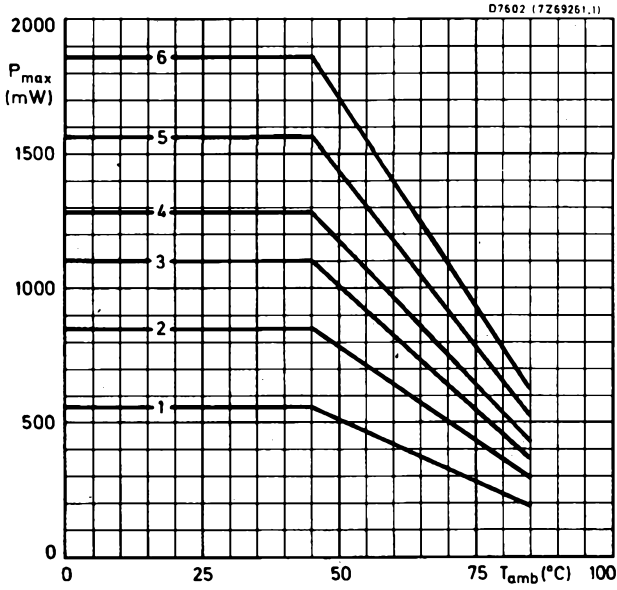

Fig.6 Maximum permissible power dissipation as a function of ambient temperature for various case sizes.

Table of case sizes

curve	Dimensions in millimetres		
	L	H	T
1	21.5	15	8
2	29	18.5	8.5
3	34	20	10
4	34	22	12
5	34	25	15
6	34	28	18



POLYPROPYLENE CAPACITORS

series construction (KP/MKP)

QUICK REFERENCE DATA

Rated capacitance range (E12 series)	1500 pF to 0,33 μ F
Tolerance on rated capacitance	\pm 5% and \pm 10%
Rated voltage U_R (d.c.)	630 V, 1000 V, 1500 V, 2000 V
Rated voltage U_R (a.c.), 50 to 60 Hz	300 V, 400 V, 600 V, 700 V
Rated temperature	85 $^{\circ}$ C
Climatic category, IEC 68	40/085/56

APPLICATION

These capacitors are intended for applications where high currents, high voltages and steep pulses occur. They are mainly used for deflection circuits in television receivers (e.g. flyback), for commutation in thyristor circuits (e.g. motor control) and pulse steepness suppression networks.

When requiring advice, please send oscillograms of current and voltage waveforms.

DESCRIPTION

The capacitors consist of an impregnated, series constructed, low-inductive wound cell of polypropylene film, aluminium foil and metallized polypropylene film. The cell is potted with epoxy resin in a yellow polypropylene case. The radial leads are solder-coated copper wire.

The capacitors are flame retardent and can withstand solvents and rinsing liquids without damage. They are provided with small stand-off pips to allow removal of solder flux etc., when cleaning the printed-wiring board.

Composition of the catalogue number

357

code for rated voltage and

capacitance tolerance

61 = 630 V; \pm 10%

62 = 630 V; \pm 5%

71 = 1000 V; \pm 10%

72 = 1000 V; \pm 5%

81 = 1500 V; \pm 10%

82 = 1500 V; \pm 5%

92 = 2000 V; \pm 5%

code for capacitance



MECHANICAL DATA

Dimensions in mm

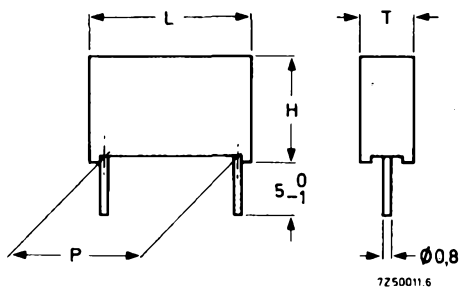

Fig. 1 For dimensions T, L, H and P, see Tables 1 to 4.

Table 1 U_R (d.c.) = 630 V; U_R (a.c.) = 300 V

rated capacitance * μF	T_{max}	L_{max}	H_{max}	P	mass g	catalogue number 357	
						tol. $\pm 5\%$	tol. $\pm 10\%$
0,047	8,5	29	18,5	$22,5 \pm 0,4$	6	62473	61473
0,056	8,5	29	18,5		6	62563	61563
0,068	10	29	20		9	62683	61683
0,082	10	29	20		9	62823	61823
0,10	10	29	20		9	62104	61104
0,12	10	34	20	$27,5 \pm 0,4$	10	62124	61124
0,15	12	34	22		14	62154	61154
0,18	12	34	22		14	62184	61184
0,22	15	34	25		20	62224	61224
0,27	18	34	28		28	62274	61274
0,33	18	34	28		28	62334	61334

* Besides the values of the E12 series as quoted, intermediate values of the E24 series (with a tolerance $\pm 5\%$) are available. Other capacitance values and tolerances are available to special order.



Table 2 U_R (d.c.) = 1000 V; U_R (a.c.) = 400 V

rated capacitance* μF	T_{max}	L_{max}	H_{max}	P	mass g	catalogue number 357	
						tol. \pm 5%	tol. \pm 10%
0,018**	8,5	29	18,5	22,5 \pm 0,4	6	72183	
0,022**	8,5	29	18,5		6	72223	
0,027**	8,5	29	18,5		6	72273	
0,033	8,5	29	18,5	22,5 \pm 0,4	6	72333	71333
0,039	8,5	29	18,5		6	72393	71393
0,047	10	29	20		9	72473	71473
0,056	10	29	20		9	72563	71563
0,068	10	34	20		10	72683	71683
0,082	12	34	22		13	72823	71823
0,10	12	34	22	27,5 \pm 0,4	13	72104	71104
0,12	15	34	25		18	72124	71124
0,15	18	34	28		26	72154	71154
0,18	18	34	28		26	72184	71184
0,22	18	34	28		26	72224	71224

Table 3 U_R (d.c.) = 1500 V; U_R (a.c.) = 600 V

rated capacitance* μF	T_{max}	L_{max}	H_{max}	P	mass g	catalogue number 357	
						tol. \pm 5%	tol. \pm 10%
0,0082**	8,5	29	18,5	22,5 \pm 0,4	6	82822	
0,010**	8,5	29	18,5		6	82103	
0,012**	8,5	29	18,5		6	82123	
0,015**	8,5	29	18,5		6	82153	
0,018	8,5	29	18,5	22,5 \pm 0,4	6	82183	81183
0,022	8,5	29	18,5		6	82223	81223
0,027	8,5	29	18,5		6	82273	81273
0,033	10	29	20		9	82333	81333
0,039	10	29	20		9	82393	81393
0,047	10	34	20		10	82473	81473
0,056	12	34	22	27,5 \pm 0,4	13	82563	81563
0,068	12	34	22		13	82683	81683
0,082	15	34	25		18	82823	81823
0,10	15	34	25		18	82104	81104
0,12	18	34	28		26	82124	81124
0,15	18	34	28		26	82154	81154

* Besides the values of the E12 series as quoted, intermediate values of the E24 series (with a tolerance \pm 5%) are available. Other capacitance values and tolerances are available to special order.

** Especially suited for fly-back purposes.



Table 4 U_R (d.c.) = 2000 V; U_R (a.c.) = 700 V

rated capacitance* μF	T_{max}	L_{max}	H_{max}	P	mass g.	catalogue number 357	
						tol. \pm 5%	tol. \pm 10%
0,0015**						92152	
0,0018**						92182	
0,0022**						92222	
0,0027**						92272	
0,0033**	8,5	29	18,5	$22,5 \pm 0,4$	6	92332	
0,0039**						92392	
0,0047**						92472	
0,0056**						92562	
0,0068**						92682	
0,0075**						92752	

Marking

The capacitors are marked on the top face by embossed print, with:

- rated capacitance in pF or μF , tolerance and rated d.c. voltage, without unit symbols;
- 5th, 6th and 7th digits of the catalogue number, code for dielectric materials (KP/MKP), code for factory of origin and production date code (according to IEC 62, clause 5);
- manufacturer's identification symbol.

The capacitors which are especially suited for flyback purposes are also marked with peak-to-peak voltage and repetition frequency (16 kHz).

Mounting

The capacitors are suited for mounting on printed-wiring boards. When a number of capacitors are connected to form a capacitor bank, and considerable power dissipation is expected, their mounting proximity should allow a free circulation of air.

- * Besides the values of the E12 series as quoted, intermediate values of the E24 series (with a tolerance \pm 5%) are available. Other capacitance values and tolerances are available to special order.
- ** Especially suited for flyback purposes.



ELECTRICAL DATA

Unless otherwise specified all electrical values apply at an ambient temperature of 15 to 35 °C, an atmospheric pressure of 860 to 1060 mbar and a relative humidity of 45 to 75%.

Capacitance

Rated capacitance values (C_R) at 1 kHz	see Tables 1 to 4
Tolerance on rated capacitance	$\pm 5\%$ or $\pm 10\%$
Temperature coefficient at $T_{amb} = 20\text{ °C}$	$-400 \pm 50\text{ ppm/°C}$
Frequency dependence between 100 Hz and 100 kHz	negligible

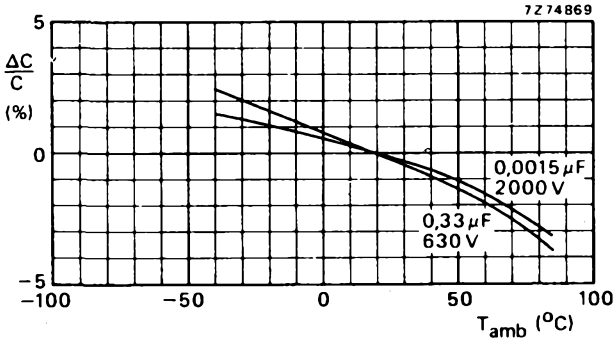

Fig. 2 Capacitance as a function of temperature; typical curves. Measuring voltage is 0,3 V, measuring frequency is 1 kHz.

Voltage

Rated voltage U_R (d.c.)	630 V, 1000 V, 1500 V, 2000 V
Rated voltage U_R (a.c.), 50 to 60 Hz	
630 V version	300 V
1000 V version	400 V
1500 V version	600 V
2000 V version	700 V
Maximum permissible peak-to-peak voltage for flyback capacitors, pulse duration 10 to 14 μ s, repetition frequency 15 to 20 kHz	
1000 V version	1000 V (p-p)
1500 V version	1500 V (p-p)
2000 V version	2000 V (p-p)
Over-voltage (d.c.) for 1 min/h	$\leq 20\%$ of U_R (d.c.)
Test voltage for 1 min	
between terminals	$1,6 \times U_R$ (d.c.)
between interconnected terminals and case	$2 \times U_R$ (d.c.)

Notes

The following requirements must be satisfied:

- the sum of the d.c. voltage and the peak value of the superimposed a.c. voltage must be \leq rated d.c. voltage;
- the peak-to-peak value of the a.c. voltage must be \leq maximum permissible a.c. voltage $\times 2\sqrt{2}$;
- for other than sinusoidal waveforms, the maximum permissible dissipation must not be exceeded.



357 6... Series
to
357 9... Series

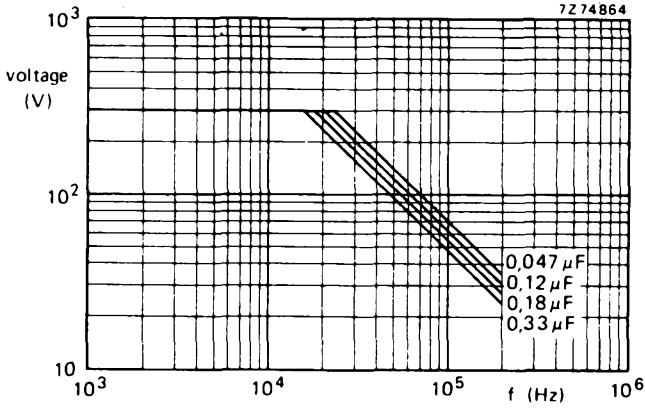

Fig. 3 Maximum permissible r.m.s. value of sinusoidal voltages as a function of frequency at $T_{amb} \leq 70^\circ C$, for 630 V version.

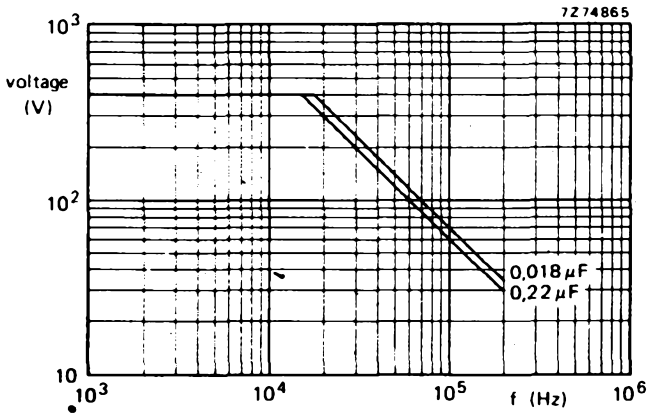

Fig. 4 Maximum permissible r.m.s. value of sinusoidal voltages as a function of frequency at $T_{amb} \leq 70^\circ C$, for 1000 V version.



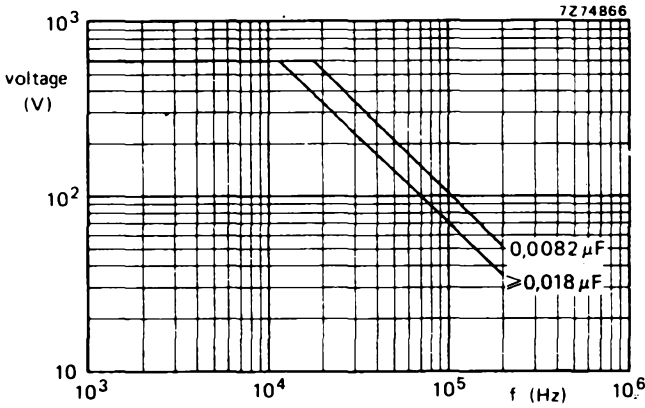

Fig. 5 Maximum permissible r.m.s. value of sinusoidal voltages as a function of frequency at $T_{amb} \leq 70^\circ C$, for 1500 V version.

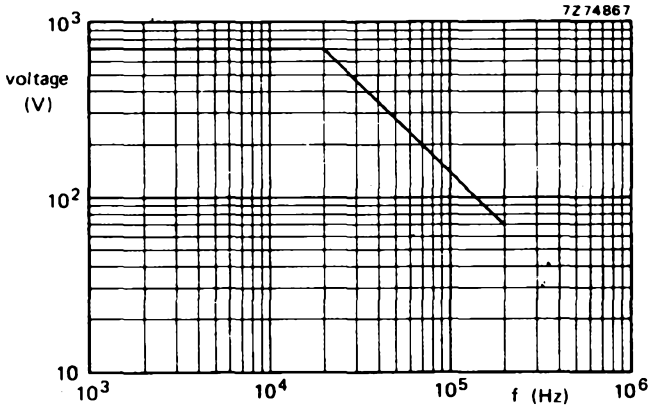

Fig. 6 Maximum permissible r.m.s. value of sinusoidal voltages as a function of frequency at $T_{amb} \leq 70^\circ C$, for 2000 V version.



Insulation resistance

The insulation resistance is measured after a voltage of 500 ± 50 V has been applied for $1 \text{ min} \pm 5 \text{ s}$.

	ambient temperature	
	23 °C	85 °C
R between terminations, for $C_R \leq 0,1 \mu\text{F}$	$> 50\,000 \text{ M}\Omega$	$> 500 \text{ M}\Omega$
RC between terminations, for $C_R > 0,1 \mu\text{F}$	$> 5\,000 \text{ s}$	$> 50 \text{ s}$

Tan δ (tangent of the loss angle)

Tan δ at 100 kHz	$\leq 10 \times 10^{-4}$
for capacitors with pitch P = 22,5 mm	$\leq 15 \times 10^{-4}$
for capacitors with pitch P = 27,5 mm	

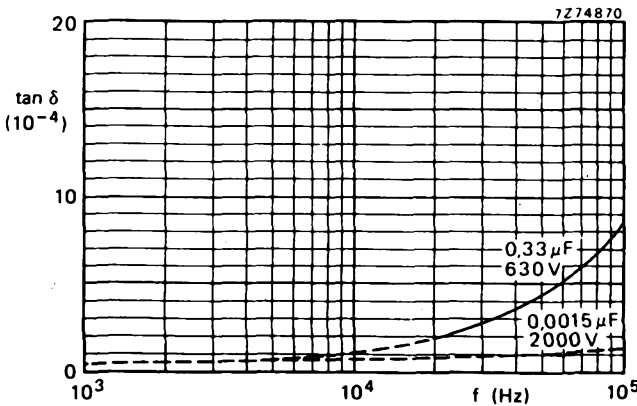

Fig. 7 Tan δ as a function of frequency; typical curves.

Temperature dependence at 100 Hz,
1 kHz, 10 kHz and 100 kHz

negligible

Power dissipation

Maximum permissible power dissipation

see Additional information

Pulse steepness

limited by network conditions

Temperature

Rated temperature

85 °C

Category temperature range

-40 to + 85 °C

Storage temperature range

-55 to + 85 °C

Climatic category, IEC 68

40/085/56



ADDITIONAL INFORMATION

The rated a.c. voltage, which has been specified at 50 to 60 Hz must also never be exceeded at other frequencies. * Moreover this voltage value may further be limited by the maximum permissible power dissipation (P_{\max}).

For a capacitor used with a sinusoidal voltage, the power dissipation is expressed by:

$$P = V_{\text{rms}} I_{\text{rms}} \cos \varphi. \quad (1)$$

As $I_{\text{rms}} = \omega C V_{\text{rms}}$, and $\cos \varphi \approx \tan \delta$, equation (1) can be rewritten as :

$$P = V^2_{\text{rms}} \omega C \tan \delta = V^2_{\text{rms}} 2\pi f C \tan \delta. \quad (2)$$

For capacitors of the 357 series, $\tan \delta$ is about proportional to the frequency, thus:

$$\tan \delta = \frac{f}{10^5} \tan \delta_{100\text{kHz}}. \quad (3)$$

Substituting equation (3) in equation (2) gives:

$$P = 2\pi \cdot 10^{-5} V^2_{\text{rms}} f^2 C \tan \delta_{100\text{kHz}}. \quad (4)$$

For capacitors with a pitch of 22,5 mm the maximum $\tan \delta$ at 100 kHz is 10^{-3} , thus:

$$P = 2\pi \cdot 10^{-8} V^2_{\text{rms}} f^2 C. \quad (5)$$

For capacitors with a pitch of 27,5 mm the maximum $\tan \delta$ at 100 kHz is $1,5 \times 10^{-3}$, thus:

$$P = 3\pi \cdot 10^{-8} V^2_{\text{rms}} f^2 C. \quad (6)$$

The maximum permissible power dissipation (P_{\max}), which depends on the dimensions of the capacitor and on the ambient temperature, can be found from Fig. 8.

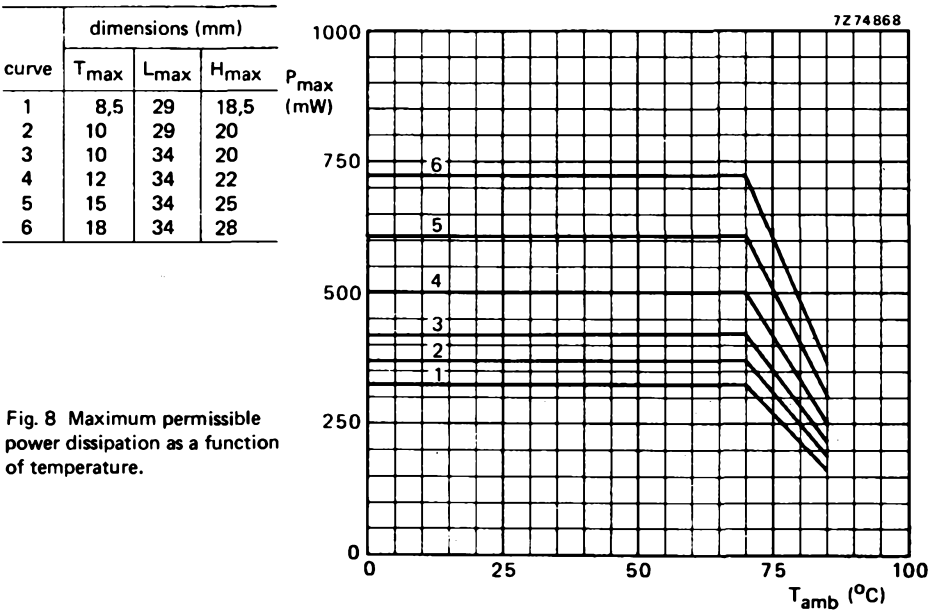

Fig. 8 Maximum permissible power dissipation as a function of temperature.

* At $T_{\text{amb}} \leq 70^\circ\text{C}$ the maximum permissible sinusoidal voltage can be found in Figs 3 to 6.



Example 1

A capacitor of 0,12 μF (27,5 mm pitch) is to be used at a 20 kHz sinusoidal voltage of 300 V and an ambient temperature of 80 °C. The power to be dissipated is

$$\begin{aligned}
 P &= 3\pi \cdot 10^{-8} V_{\text{rms}}^2 f^2 C \\
 &= 3 \times 3,14 \times 10^{-8} \times 300^2 \times 20\,000^2 \times 0,12 \times 10^{-6} \text{ W} \\
 P &= 407 \text{ mW.}
 \end{aligned}$$

Fig. 8 shows that at 80 °C, capacitors with curve number 5 can be used, thus a size of 15 mm x 34 mm x 25 mm. It can be seen from Tables 1 to 4 that a 0,12 $\mu\text{F}/1000 \text{ V}$ capacitor must be chosen.

Example 2

For a capacitor used with a half sinewave pulse, (Fig. 9), V_{rms} can be expressed by

$$V_{\text{rms}}^2 = \frac{1}{2} V_p^2 \frac{T_1}{T_2} \tag{7}$$

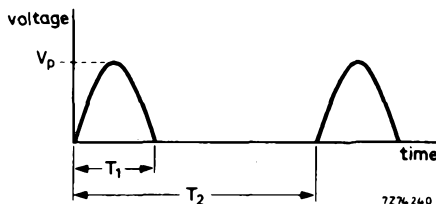

Fig. 9.

With $f = \frac{1}{2T_1}$, and substitution of equation (7) in equation (5), the maximum power dissipation for a capacitor with a pitch of 22,5 mm is

$$P = \frac{\pi}{4} \cdot 10^{-8} V_p^2 \frac{1}{T_1 \cdot T_2} C \tag{8}$$

A capacitor of 0,0075 μF is to be used with a half sinewave pulse (pulse duration 12 μs , repetition time 60 μs), peak value 1500 V at an ambient temperature of 80 °C.

The maximum dissipated power is

$$\begin{aligned}
 P &= \frac{\pi}{4} \times 10^{-8} \times 1500^2 \times \frac{1}{12 \times 60} \times 0,0075 \times 10^{-6} \text{ W} \\
 P &= 184 \text{ mW}
 \end{aligned}$$

From Fig. 8 it can be seen that this power value is permitted for all capacitor sizes.



For use in circuits where precision, reliability, stability and low losses are of prime importance, e.g., in tuned circuits, filter networks, discriminators, etc.

QUICK REFERENCE DATA

Capacitance range (E24 series)	100 to 39 000	pF
Capacitance tolerance (425, 426 and 427 series)	± 1 or ± 5	%
(424 series)	± 1	%
Rated voltage range (d.c.)	63, 160, 250 and 630	V
Climatic category (IEC 68)		
424	40/070/21	
425, 426 and 427	40/085/21	

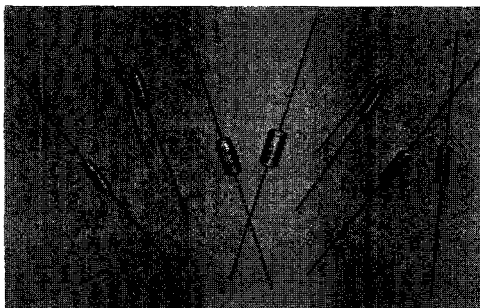

DIELECTRIC

Polystyrene film.

CASING

Polycarbonate sleeving.

TERMINATIONS

Welded axial leads, 0.6 mm diameter

TYPE NUMBER DESIGNATION

63 V	424.
160 V	425.
250 V	426.
630 V	427.

SPECIAL FEATURES

The capacitance cell is wound with polystyrene film and tin/lead foil using 'extended foil' technique, resulting in low inherent inductance and low series resistance. This, combined with a low temperature coefficient of capacitance, makes these capacitors suitable for use in professional and general purpose applications.



DIMENSIONS (millimetres) AND TYPE NUMBERS

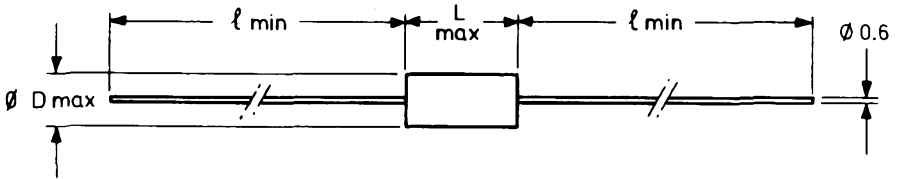

Table 1 630 V version [427 4. . . ($\pm 1\%$ tolerance 'F') or 427 2. . . ($\pm 5\%$ tolerance 'J')]*

Capacitance (pF)	L	D	ℓ	Capacitance code	Type number suffix
100	10.9	3.8	30	100p	1001
110	10.9	3.8	30	110p	1101
120	10.9	3.8	30	120p	1201
130	10.9	3.8	30	130p	1301
150	10.9	3.8	30	150p	1501
160	10.9	3.8	30	160p	1601
180	10.9	3.8	30	180p	1801
200	10.9	3.8	30	200p	2001
220	10.9	3.8	30	220p	2201
240	10.9	3.8	30	240p	2401
270	10.9	3.8	30	270p	2701
300	10.9	3.8	30	300p	3001
330	10.9	4.0	30	330p	3301
360	10.9	4.0	30	360p	3601
390	10.9	4.0	30	390p	3901
430	10.9	4.0	30	430p	4301
470	10.9	4.5	30	470p	4701
510	10.9	4.5	30	510p	5101
560	10.9	4.0	30	560p	5601
620	10.9	4.5	30	620p	6201
680	10.9	4.5	30	680p	6801
750	10.9	5.0	30	750p	7501

*See MARKING



Table 2 250 V version [426 4... ($\pm 1\%$ tolerance 'F') or 426 2... ($\pm 5\%$ tolerance 'J')]

Capacitance (pF)	L	D	ℓ	Capacitance code	Type number suffix
820	10.9	4.0	30	820p	8201
910	10.9	4.0	30	910p	9101
1000	10.9	4.0	30	1n0	1002

Table 3 160 V version [425 4... ($\pm 1\%$ tolerance 'F') or 425 2... ($\pm 5\%$ tolerance 'J')]*

Capacitance (pF)	L	D	ℓ	Capacitance code	Type number suffix
1100	10.9	3.8	30	1n1	1102
1200	10.9	4.0	30	1n2	1202
1300	10.9	4.0	30	1n3	1302
1500	10.9	4.0	30	1n5	1502
1600	10.9	4.0	30	1n6	1602
1800	10.9	4.5	30	1n8	1802
2000	10.9	4.5	30	2n0	2002
2200	10.9	4.5	30	2n2	2202
2400	10.9	4.5	30	2n4	2402
2700	10.9	4.5	30	2n7	2702
3000	10.9	5.0	30	3n0	3002
3300	10.9	5.0	30	3n3	3302
3600	10.9	5.0	30	3n6	3602
3900	10.9	5.0	30	3n9	3902
4300	15	5.0	28	4n3	4302
4700	15	5.0	28	4n7	4702
5100	15	5.0	28	5n1	5102
5600	15	5.0	28	5n6	5602
6200	15	5.0	28	6n2	6202
6800	15	5.5	28	6n8	6802
7500	15	5.5	28	7n5	7502
8200	15	6.0	28	8n2	8202

*See MARKING



Table 4 63 V version [424 4. . . . (± 1% tolerance 'F')]

Capacitance (pF)	L	D	ℓ	Capacitance code	Type number suffix
9100	15	5.0	28	9n1	9102
10 000	15	5.0	28	10n	1003
11 000	15	5.5	28	11n	1103
12 000	15	5.5	28	12n	1203
13 000	15	5.5	28	13n	1303
15 000	15	5.5	28	15n	1503
16 000	15	6.0	28	16n	1603
18 000	15	6.0	28	18n	1803
20 000	15	6.0	28	20n	2003
22 000	15	6.5	28	22n	2203
24 000	15	6.5	28	24n	2403
27 000	15	7.0	28	27n	2703
30 000	15	7.0	28	30n	3003
33 000	15	7.5	28	33n	3303
36 000	15	7.5	28	36n	3603
39 000	15	8.0	28	39n	3903

*See MARKING

ELECTRICAL DATA

Unless otherwise specified, all characteristics apply at an ambient temperature of 20 ± 5 °C, atmospheric pressure of 10⁵ Pa (1000 mbars) and a relative humidity of 75% maximum.

Characteristic	Conditions	427. (630 V)	426. (250 V)	425. (160 V)	424. (63 V)
Capacitance range (E24 Series)	—	100 to 750 pF	820 to 1000 pF	820 to 8200 pF	9100 to 39 000 pF
Capacitance tolerance	—	± 1 or ± 5%	± 1% or ± 5%	± 1 or ± 5%	± 1%
Rated voltage (d.c.)	category temperature range	630 V	250 V	160 V	63 V



ELECTRICAL DATA (continued)

Characteristic	Conditions	427.(630 V)	426.(250 V)	425.(160 V)	424. (63 V)
Rated voltage (r.m.s.)	at f = 50 Hz, over temperature range	250 V	125 V	63 V	25 V
Tangent of loss angle (tan δ)	f = 10 kHz C > 20 000 pF				≤ 10 × 10 ⁻⁴
	f = 100 kHz C ≤ 20 000 pF > 10 000 pF			≤ 15 × 10 ⁻⁴	≤ 15 × 10 ⁻⁴
	f = 100 kHz C ≤ 10 000 pF > 1000 pF			10 × 10 ⁻⁴	≤ 10 × 10 ⁻⁴
	f = 1 MHz C ≤ 1000 pF	≤ 10 × 10 ⁻⁴	≤ 10 × 10 ⁻⁴		
Category temperature range	—	-40 to + 85 °C.	-40 to + 85 °C	-40 to + 85 °C	-40 to + 70 °C
Temperature coefficient	category temperature range	(-125 ± 60) × 10 ⁻⁶ °C	(-125 ± 60) × 10 ⁻⁶ °C	(-125 ± 60 × 10 ⁻⁶ °C	(-125 ± 60) × 10 ⁻⁶ °C
Insulation resistance	after 1 min. at indicated voltage	min. 10 ⁵ MΩ at 500 V	min. 10 ⁵ MΩ at 100 V	min. 10 ⁵ MΩ at 100 V	min. 10 ⁵ MΩ at 10 V
Test voltage terminals to case (d.c.)	applied for 1 minute	1250 V	500 V	400 V	400 V
Voltage proof (d.c.)	applied for 1 minute	1250 V	500 V	320 V	125 V

SOLDERING CONDITIONS

For capacitors in printed-wiring board applications, where the distance between the solder point and the capacitor body is 1.5 mm minimum, the temperature and soldering times are as follows:-

Solder temperature	Maximum solder time
240 °C	3 seconds
260 °C	2 seconds

If longer soldering times are necessary, a greater distance between the solder point and the capacitor body must be used.



**424 425
426 427
SERIES**

MARKING

The capacitors are marked with:-

Capacitance code

Tolerance code (F = $\pm 1\%$, J = $\pm 5\%$) and rated voltage

Dielectric code (KS = polystyrene)

Date code, month, year.

COMPOSITION OF TYPE NUMBER

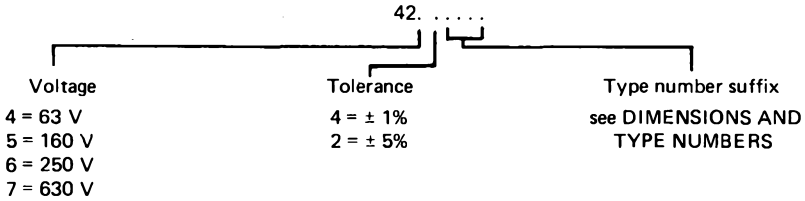

ORDERING PROCEDURE

These capacitors should be ordered by quoting their full type number, as indicated under COMPOSITION OF TYPE NUMBER above.

Example:- A 100 pF $\pm 1\%$ 630 V rated capacitor should be ordered by quoting the type number 427 41001.

The 424, 425, 426 and 427 series can be supplied in bandoliers to facilitate automatic handling by either crop and form processing or by fully automatic insertion. Full details of the bandoliering specification, type numbers and drum quantities can be obtained from Mullard Ltd.



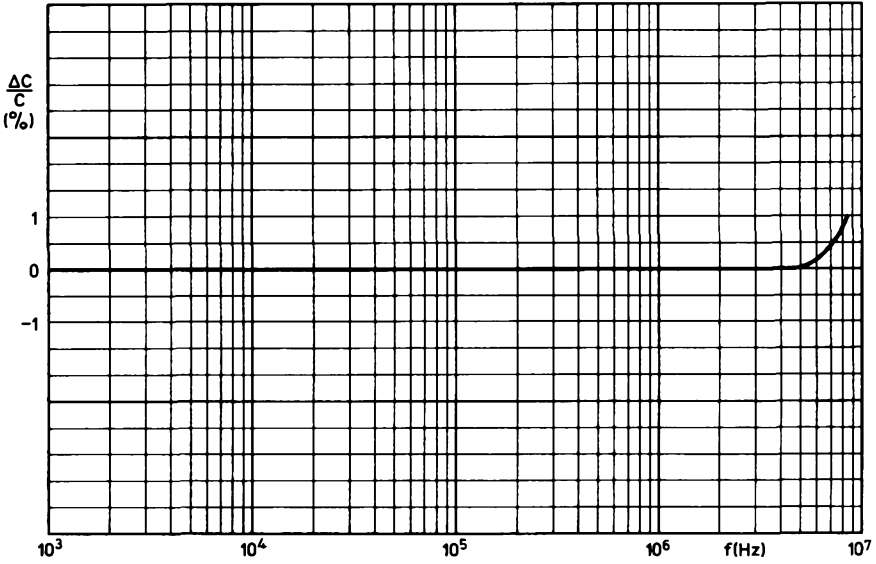

Typical change in capacitance as a function of frequency

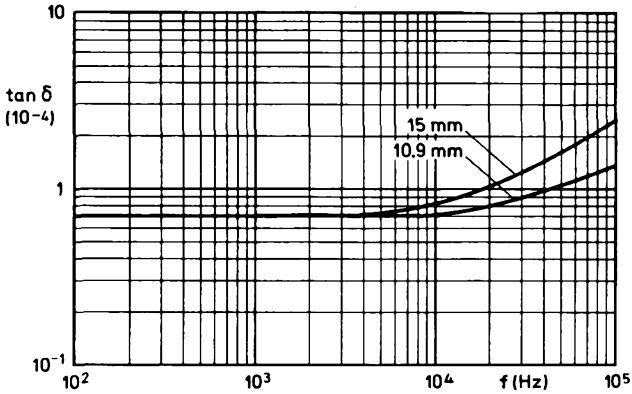

Typical loss factor as a function of frequency



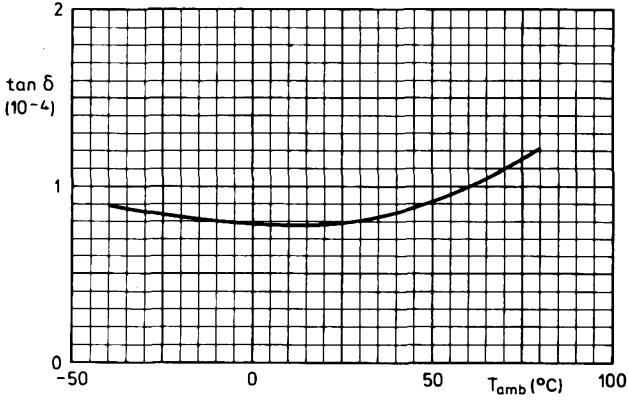

Typical loss factor as a function of temperature

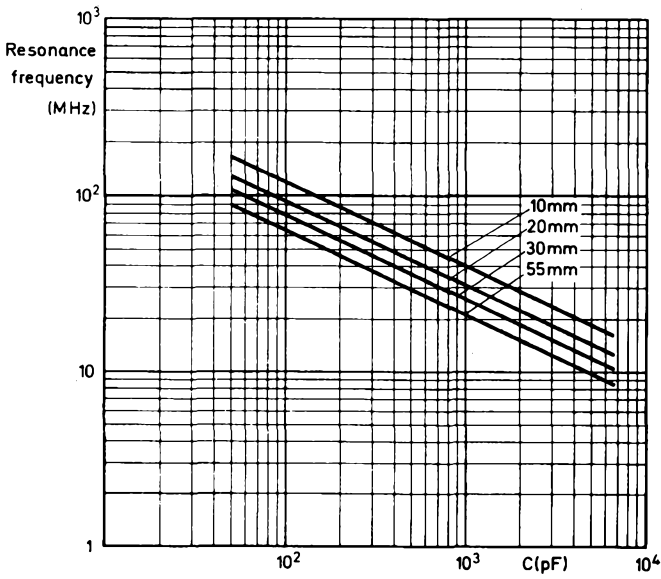

Self resonance frequency as a function of capacitance, for various total lead lengths



POLYSTYRENE FILM/FOIL CAPACITORS

radial leads — moulded

QUICK REFERENCE DATA

Rated capacitance range (E96-series)	100 to 34 000 pF
Tolerance on rated capacitance	± 1%
Rated voltage U_R (d.c.)	63 V
Rated voltage U_R (a.c.), 50 to 60 Hz	25 V
Rated temperature	70 °C
Climatic category, IEC 68	40/070/56
Basic specification	IEC 275

APPLICATION

For use in LC filters, particularly in telephony equipment, where high requirements are imposed on precision, stability, humidity, dissipation factor and reliability. The dimensions are such that, in combination with currently available ferrites, a high package density is possible.

DESCRIPTION

The capacitors consist of a low-inductive wound cell of polystyrene film and tin/lead foil. The cell is potted with epoxy resin in a yellow flame retardant polypropylene case, which can withstand solvents and rinsing liquids.

The low thermal conductivity of the radial leads provides optimum soldering conditions. The capacitors are provided with stand-off ridges to give a clearance between the capacitor and the printed-wiring board.

Composition of the catalogue number

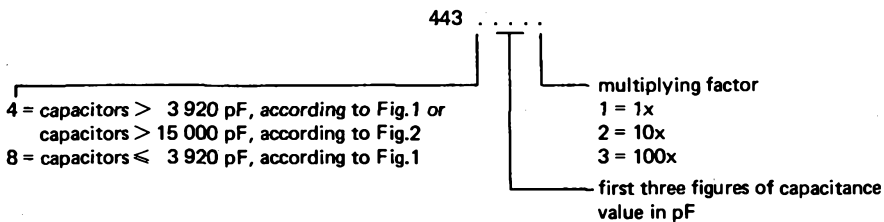

For ordering purposes please quote the catalogue number.

Examples

A capacitor of 4750 pF should be ordered as 443 44752.

A capacitor of 121 pF should be ordered as 443 81211.

A capacitor of 12 100 pF should be ordered as 443 41213



MECHANICAL DATA

Dimensions in mm

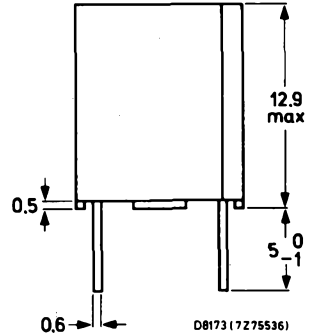
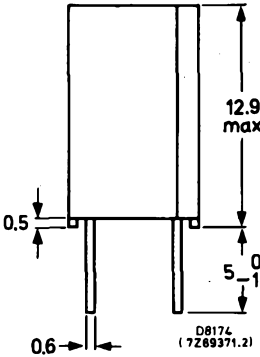
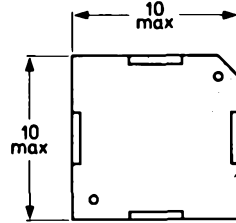
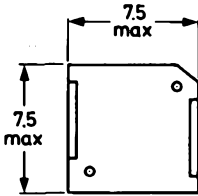

Fig.1 Capacitors of rated capacitance range 100 to 15 000 pF.

Fig.2 Capacitors of rated capacitance range 15 400 to 34 000 pF.

Marking

Capacitors according to Figs 1 and 2 are marked in ink on the top with:

1st line: rated capacitance (in pF to 976 pF, in nF above this value);

2nd line: tolerance code (F = ± 1%) and rated voltage (d.c.);

3rd line: 5th, 6th and 7th digits of the catalogue number;

4th line: production date code according to IEC 62, clause 5, and code for dielectrics (KS = polystyrene)

The manufacturer's identification symbol is indicated to the left of the 2nd and 3rd lines of marking.

Note

The earth side is indicated by a vertical line to the left of the 2nd, 3rd and 4th lines of marking, and by the bevelled corner.



Mounting

The capacitors are designed for mounting on printed-wiring boards. The required space on the printed-wiring board for a hole diameter of 1 mm is given in Figs. 3 and 4.

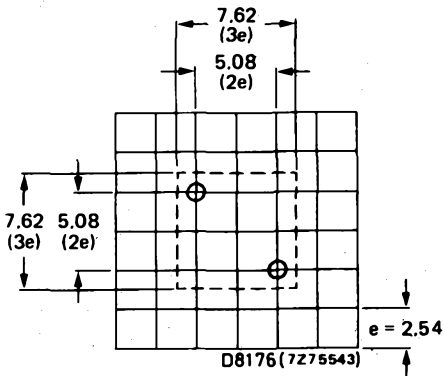

Fig.3 Required space for capacitors according to Fig.1

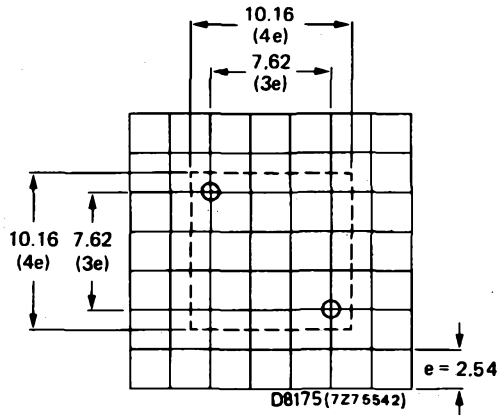

Fig.4 Required space for capacitors according to Fig.2



ELECTRICAL DATA

Unless otherwise specified all electrical values apply at an ambient temperature of 23 ± 1 °C, an atmospheric pressure of 860 to 1060 mbar and a relative humidity of $50 \pm 2\%$.

Capacitance

Rated capacitance values (C_R)

at 1 kHz, $C_R > 1000$ pF and

at 1 MHz, $C_R \leq 1000$ pF

100 to 34 000 pF (E96-series)

Tolerance on rated capacitance

$\pm 1\%$

Temperature coefficient

$C_R \leq 6000$ pF

$-(95 \text{ to } 155)$ ppm/°C

$C_R > 6000$ pF

$-(120 \text{ to } 185)$ ppm/°C

Frequency dependence between 100 Hz and 1 MHz

none

Voltage

Rated voltage U_R (d.c.)

63 V

Rated voltage U_R (a.c.), 50 to 60 Hz

25 V

Test voltage for 1 min

between terminals

$2 \times U_R$ (d.c.)

between interconnected terminals and case

400 V (d.c.)

Insulation resistance

The insulation resistance is measured after a voltage of 10 ± 1 V has been applied for 1 min ± 5 s.

	ambient temperature	
	23 °C	70 °C
R between terminals	$> 500\,000\text{ M}\Omega$	$> 100\,000\text{ M}\Omega$
R between interconnected terminals and case	$> 500\,000\text{ M}\Omega$	$> 100\,000\text{ M}\Omega$

Tan δ (tangent of the loss angle)

Tan δ

at 1 MHz, $C_R \leq 500$ pF

$\leq 5 \times 10^{-4}$

at 1 MHz, $500\text{ pF} < C_R \leq 1000$ pF

$\leq 10 \times 10^{-4}$

at 1 kHz, $C_R > 1000$ pF

$\leq 2 \times 10^{-4}$

Temperature

Rated temperature

70 °C

Category temperature range

-40 to $+70$ °C

Storage temperature range

-55 to $+70$ °C

Climatic category, IEC 68

40/070/56



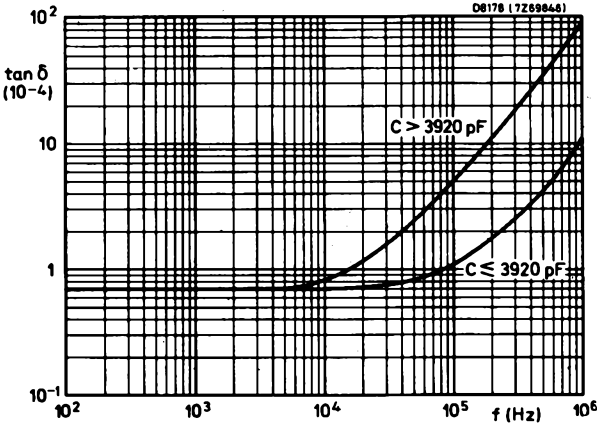

Fig.5 Tan δ as a function of frequency; typical curves

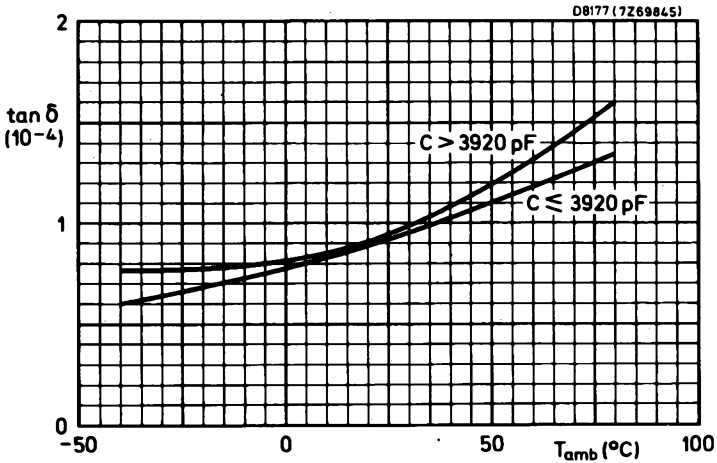

Fig.6 Tan δ as a function of temperature; typical curves

Resonant frequency

Resonant frequency, total lead length 2 x 1 mm

$$\geq \frac{8.5 \times 10^2}{\sqrt{C}} \text{ MHz (C in pF)}$$



DEVELOPMENT SAMPLE DATA

This information is derived from development samples made available for evaluation. It does not necessarily imply that the device will go into regular production.

455, 457
SERIES

POLYPROPYLENE FILM/FOIL CAPACITORS

QUICK REFERENCE DATA

Capacitance range	47 to 56 000 pF
Tolerance on rated capacitance	$\pm 2\%$ (E24-series)*
Rated voltage U_R (d.c.)	63 V, 250 V,
Rated voltage U_R (a.c.), 50 to 60 Hz	25 V, 125 V,
Rated temperature	85 °C
Climatic category, IEC 68	40/100/21

APPLICATION

For use in circuits where precision, reliability, and low losses are of prime importance, e.g. tuned circuits, filter networks, timing networks, etc.

DESCRIPTION

The capacitors consist of a low-inductive wound cell of aluminium foil with a polypropylene film. The cell is covered with a blue plastic film. The long, axial leads of solder-coated wire make the capacitor suitable for vertical or horizontal mounting on printed-wiring boards.

Composition of the catalogue number

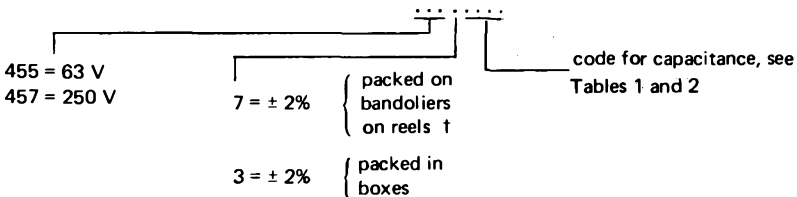

* E48 series can be supplied to special order.

† Reel packing to special order only.



MECHANICAL DATA

Dimensions in mm

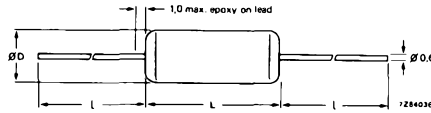

Fig.1 For dimensions D, L and I see tables below.

Table 1 U_R (d.c.) = 63 V; U_R (a.c.) = 25 V

Capacitance (E24-series, tol. $\pm 2\%$)* pF	$D_{max.}$	$L_{max.}$	$I_{min.}$	approx. mass g	catalogue number (packed in boxes)				
3 300	4.0	11.0	30	0.3	455 33302				
3 600					33602				
3 900					33902				
4 300					34302				
4 700	4.5			15.0	28	0.4	34702		
5 100							35102		
5 600							35602		
6 200							36202		
6 800	5.0					15.0	28	0.4	36802
7 500									37502
8 200		38202							
9 100		39102							
10 000	4.5	15.0	28					0.5	31003
11 000									31103
12 000				31203					
13 000				31303					
15 000	5.0			15.0	28			0.6	31503
16 000									31603
18 000						31803			
20 000						32003			
22 000	5.5					15.0	28	0.6	32203
24 000									32403
27 000		32703							
30 000		33003							
33 000	6.0	15.0	28					0.7	33303
36 000									33603
39 000				33903					
43 000				34303					
47 000	7.0			15.0	28			0.8	34703
51 000									35103
56 000						35603			
	7.5					15.0	28	0.9	
	8.0	15.0	28					1.0	



Table 2 U_R (d.c.) = 250 V; U_R 9a.c.) = 125 V

Capacitance (E24-series, tol. \pm 2%)* pF	D_{max}	L_{max}	l_{min}	approx. mass g	catalogue number (packed in boxes)
47	4.0	11.0	30	0.3	457 34709
51					35109
56					35609
62					36209
68					36809
75					37509
82					38209
91					39109
100					31001
110					31101
120					31201
130					31301
150					31501
160					31601
180					31801
200					32001
220					32201
240					32401
270					32701
300					33001
330					33301
360					33601
390					33901
430					34301
470					34701
510					35101
560					35601
620	36201				
680	36801				
750	37501				
820	38201				
910	39101				
1 000	31002				
1 100	31102				
1 200	31202				
1 300	31302				
1 500	31502				
1 600	31602				
1 800	31802				
2 000	32002				
2 200	32202				
2 400	32402				
2 700	32702				
3 000	33002				
	4.5				
	5.0				



MARKING

The capacitors are marked as follows:

1st line: capacitance value in pF or nF

2nd line: tolerance code (G = $\pm 2\%$) and rated voltage (d.c.);

3rd line: production date code and code for dielectric material (KP = polypropylene film/foil);

4th line: name of manufacturer.

Note: capacitance, tolerance, and production date code are according to IEC62.

PRODUCTION DATE CODE

2-digit date code year/month in accordance with BS1852/IEC62

1980 = M	January = 1	July = 7
1981 = N	February = 2	August = 8
1982 = O	March = 3	September = 9
1983 = P	April = 4	October = O
1984 = Q	May = 5	November = N
1985 = R	June = 6	December = D

MOUNTING

The capacitors are suited for horizontal or vertical mounting on printed wiring boards. When mounting vertically on boards with plated through holes, the capacitance must be mounted with a minimum height of 1 mm above the board.



Mounting

The capacitors are suited for horizontal or vertical mounting on printed-wiring boards. When mounting vertically on boards with plated-through holes, the capacitors must be mounted with a minimum height of 1 mm above the board.

ELECTRICAL DATA

Unless otherwise specified all electrical values apply at an ambient temperature of 23 ± 1 °C, an atmospheric pressure of 86 to 106 kPa and a relative humidity of $50 \pm 2\%$.

Capacitance

Rated capacitance values (C_R) at 1 kHz	see Tables 1 to 3
Tolerance on rated capacitance	$\pm 2\%$
Temperature coefficient	-125 ± 60 ppm/°C

Voltage

Rated voltage U_R (d.c.)	63 V, 250 V,
Rated voltage U_R (a.c., 50 to 60 Hz)	
63 V version	25 V
250 V version	125 V
Category voltage U_C	$0.8 \times U_R$ (d.c.)
Test voltage for 1 min.	
between terminals	$2 \times U_R$ (d.c.)
between interconnected terminals and coating	$2 \times U_R$ (d.c.) (minimum 400 V)

Insulation resistance

The insulation resistance is measured after a voltage has been applied for 1 min. ± 5 s, the voltage being 10 ± 1 V for the 63 V version and 100 ± 15 V for the 250 V version.

	ambient temperature	
	23 °C	85 °C
R between terminals	$> 100\,000$ M Ω	$> 100\,000$ M Ω
Tan δ (tangent of loss angle)		
Tan δ at 1 MHz, for $C_R \leq 1000$ pF	$\leq 10 \times 10^{-4}$	
Tan δ at 100 kHz		
for 1000 pF $< C_R \leq 5000$ pF	$\leq 10 \times 10^{-4}$	
for 5000 pF $< C_R \leq 20\,000$ pF	$\leq 15 \times 10^{-4}$	
Tan δ at 10 kHz for $C_R > 20\,000$ pF	$\leq 10 \times 10^{-4}$	

Induction

Maximum induction	10 nH/cm lead and capacitor length
-------------------	------------------------------------

Temperature

Rated temperature	85 °C
Category temperature range	-40 to $+100$ °C
Storage temperature range	-40 to $+100$ °C
Climatic category, IEC 68	40/100/21



455, 457
SERIES

PACKING

The capacitors are supplied on bandoliers on reels or in cardboard boxes

Packing on bandoliers on reels

Dimensions in mm

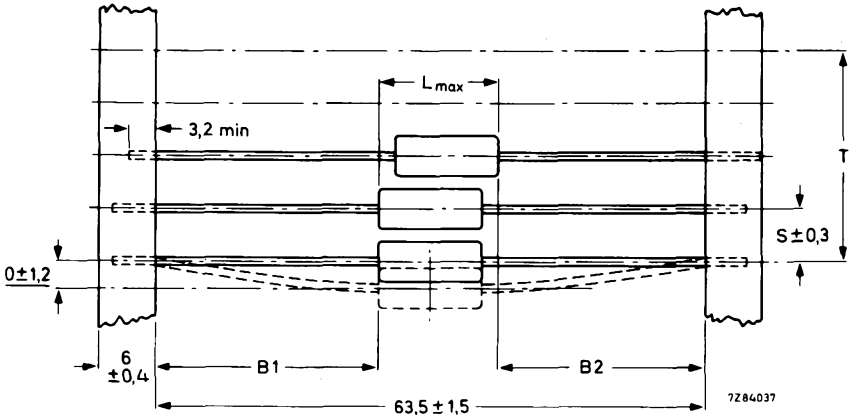

Fig.2 | $B1 - B2$ | = max. 1.4; for dimension L_{max} see Tables 1 to 4

capacitance values (pF) of		S	T for number (n) of capacitors	
63 V version	250 V version		n < 50	50 < n < 100
3 300– 6 200	47–2 200	5	$5(n - 1) \pm 2$	$5(n - 1) \pm 4$
6 800–56 000	2 400–3 000	10	$10(n - 1) \pm 2$	$10(n - 1) \pm 4$



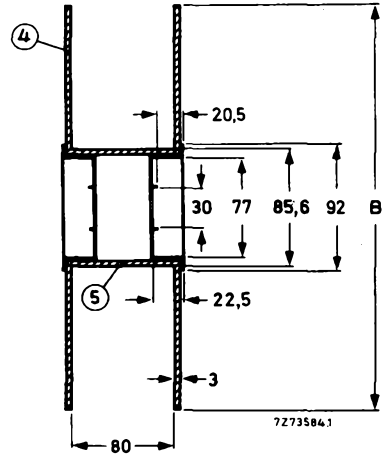
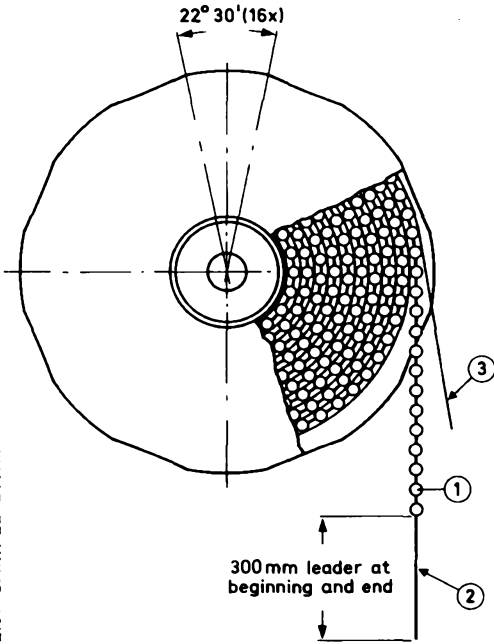

Fig.3 1: capacitor 2: bandolier 3: paper 4: flange 5: cylinder

capacitance values (pF) of		B	number of capacitors on one reel
63 V version	250 V version		
3 300– 6 200	47–2 200	305	2500
6 800– 9 100	2 400–3 000	356	1500
10 000–12 000		305	2500
13 000–27 000		356	1500
30 000–56 000		356	1000

Packing in cardboard boxes

capacitance values (pF) of		number of capacitors per box
63 V version	250 V version	
3 300– 4 300	47–1 500	400
4 700– 6 200	1 600–2 200	300
6 800– 9 100	2 400–3 000	250
10 000–12 000		400
13 000–16 000		300
18 000–27 000		250
30 000–33 000		200
36 000–56 000		150



DEVELOPMENT SAMPLE DATA

CERAMIC CAPACITORS



C



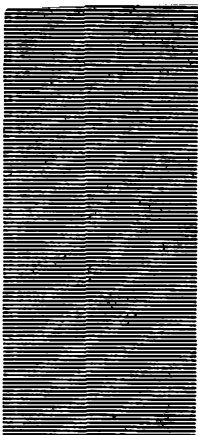

C

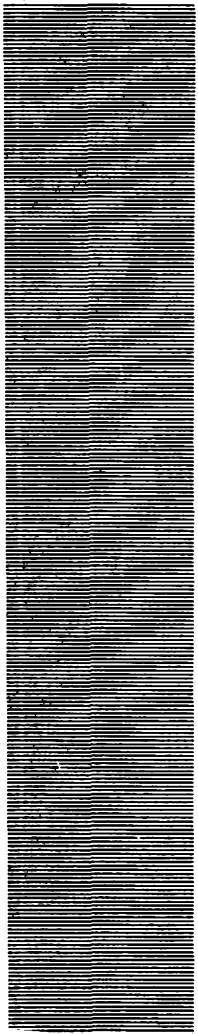

GENERAL

Ceramic capacitors are widely used in electronic circuits for coupling and decoupling, and in filters. These different functions require different ceramic materials, which can be divided into three classes:

Class 1. The dielectric materials, used in these capacitors, have a very high specific resistance, a very good Q, and a linear temperature dependence (permittivities ϵ from 6 to 250). They are used in applications, such as oscillators and filters, where low losses and a high stability are required. They are also known as low-K types, with defined temperature coefficients.

Class 2. These capacitors show higher losses and have non-linear temperature characteristics (permittivities $\epsilon > 250$). They are used in various electronic circuits for coupling and decoupling purposes, and are also known as medium and high-K types.

The survey below shows the various materials and their basic chemical composition.

Class 1 ($\epsilon = 6$ to 250) Low-K types	Class 2 ($\epsilon > 250$) Medium- and high-K types
NPO (0 ppm/°C) $[M_g TiO]$	$\epsilon_r = 2000 [Ba Ti O_3]$
N150 (-150 ppm/°C) $[Ba_2 Ti_9 O_{20} + Ti O_2]$	$\epsilon_r = 4000 [BaO + CaO + Ti O_2 + Zr O_2]$
N750 (-750 ppm/°C) $[Ti O_2 + additions]$	$\epsilon_r = 12000 [BaO + CaO + Ti O_2 + Zr O_2]$

Class 3. Capacitors of this class have a special semiconductive dielectric material which, together with the electrodes, is oxidized on both sides, thus forming diodes in anti-series. The very high capacitance per mm^2 results in capacitance values up to 0.1 μF , but with a limiting d. c. working voltage of 6 V. They are also known as barrier layer capacitors, and are used for coupling and decoupling purposes in small transistorized equipment.

CONSTRUCTION

The capacitance of a ceramic capacitor depends on the area of the electrodes (A), the thickness of the ceramic dielectric (t) and the dielectric constant or permittivity of the ceramic material (E); and on the number of dielectric layers (n) with multilayer ceramic capacitors:

$$C = \frac{\epsilon A \times 10^{12}}{4\pi \times 9 \times 10^{11}} n = \frac{\epsilon A \times 0.0885}{t} n$$

where C = capacitance in pF
E = permittivity of dielectric material
A = surface area of one plate in cm²
t = thickness of dielectric in cm
n = number of parallel connected plates

The working voltage is dependent on the dielectric thickness.

Typical constructions are shown in the figures below:

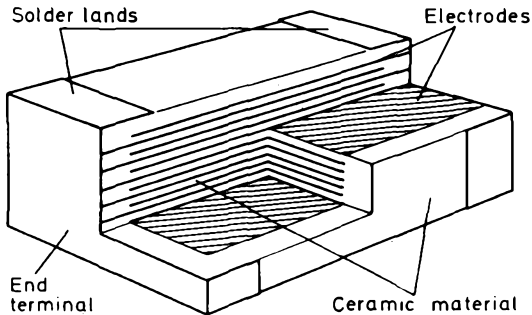

Fig. 1 Cross-section of a multilayer chip capacitor

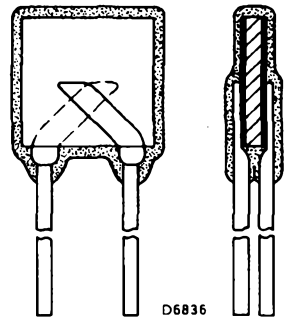

Fig. 2 Single plate capacitor

The electrodes of a single plate capacitor consist normally of nickel-chromium, silver or some other good electrical conductor. For multilayer capacitors, palladium or platinum is used.

DIELECTRIC MATERIAL

The raw materials are finely ground, carefully mixed, and compressed into suitable shapes. These are calcined at a temperature below the melting point and the resultant mass is then reground. The calcined, finely ground material is mixed with water and binding matter and the required shape is obtained by extruding or rolling. A carefully controlled drying sequence follows, and finally, the capacitor bodies are fired in a controlled atmosphere at temperatures between 1200 °C and 1400 °C

Normally the leads are soldered to the electrodes of the capacitor body with a high melting point solder.

DIELECTRIC MATERIAL (continued)

The capacitors are lacquered to ensure good behaviour under humid conditions and to protect the electrodes.

The capacitance value is marked or coded and the temperature coefficient is indicated by a colour band in accordance with international practice.

EQUIVALENT CIRCUIT

Fig. 3 shows the equivalent circuit of a capacitor.

C is the capacitance between the two electrodes, plus the stray capacitances at the edges and between the leads.

R_s represents the losses in the leads, the electrodes, and the contacts, and is generally extremely low.

L represents the inductance of the leads and the inherent internal inductance of the capacitor.

R_p represents the combined insulation resistances of the dielectric material and protective lacquer coating.

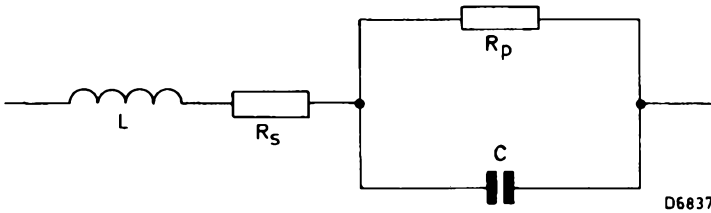

Fig. 3

TANGENT OF THE LOSS ANGLE

The losses of a capacitor are expressed in terms of $\tan \delta$ which is the relation between the resistive and reactive parts of the impedance, as shown below.

$$\tan \delta = \left| \frac{R}{X} \right| = \frac{R_p + R_s [1 + (\omega C R_p)^2]}{\omega C R_p^2 - \omega L [1 + (\omega C R_p)^2]}$$

At frequencies below resonance, $\tan \delta$ approximates to $\frac{1}{\omega C R_p}$, (where the inductive component is insignificant).

TUBULAR CERAMIC CAPACITORS

QUICK REFERENCE DATA

Capacitance range	1 pF to 22 000 pF
Rated d.c. voltage	
Type 1	50 V
Type 2	50, 25, or 16 V
Temperature coefficient, type 1	NPO, N220, N750, SL
Temperature dependence, type 2	V (SB2), SB (2B4), X (2C2), Y (2D4), SD (2E4)

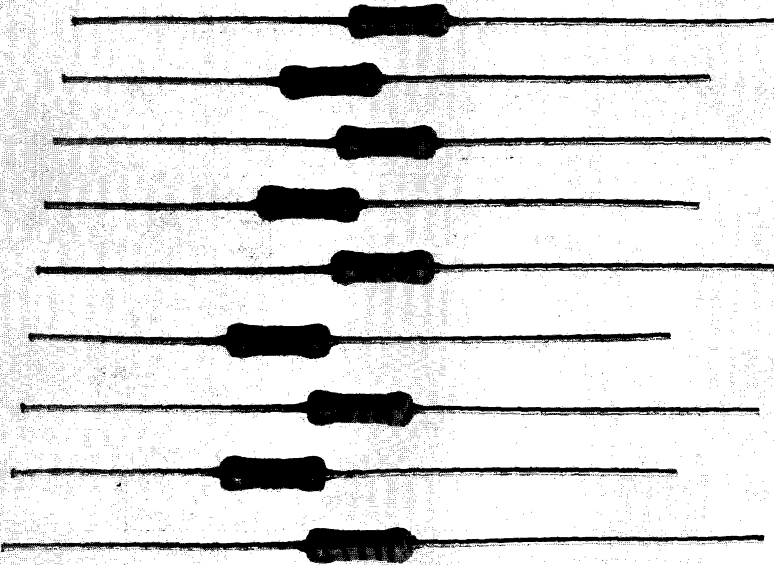

APPLICATION

Axial-lead tubular ceramic capacitors are developed for automatic insertion into printed circuits

DESCRIPTION

The capacitors consist of a ceramic tube, internally and partly externally metallized. Contact caps of special alloy are pressed onto the ends of the tube and tinned copper connecting wires are welded to these caps. A coating protects the capacitors against atmospheric influences.



MECHANICAL DATA

Dimensions in mm

Outlines

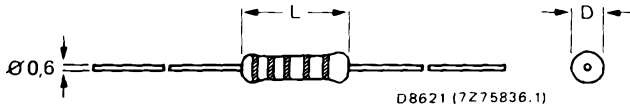

Fig.1

Configuration of tape

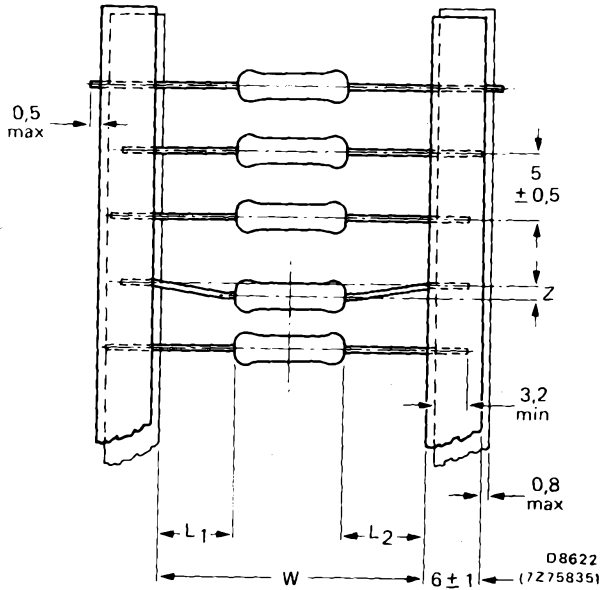

Fig.2

size	L max.	D max.	W	Z max.	L ₁ - L ₂ max.
125	7.1	2.8	52 $\begin{smallmatrix} +2 \\ -1 \end{smallmatrix}$	0.8	1
250	9.1	3.0			

	box packing (ammunition box)	reel packing (supplied to special order only)
Size 125	2000 pieces	5000 pieces
Size 250	1500 pieces	4000 pieces



Marking

The capacitors are marked as follows

Fig.3.

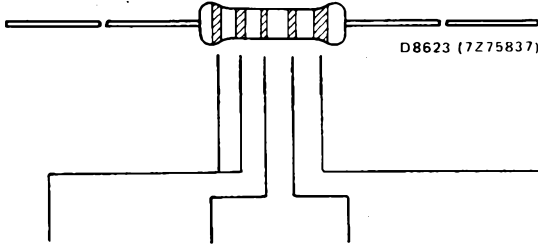

	capacitance value		tolerance on capacitance	temperature coeff char.
	1st, 2nd digit	multiplier		
Black	0	10^0	$\pm 20\%$	NP0
Brown	1	10^1		Y
Red	2	10^2		SD
Orange	3	10^3		
Yellow	4	10^4		N220
Green	5			
Blue	6			
Purple	7			N750
Grey	8		$\pm 30\%$	X
White	9			SL
Gold		10^{-1}	$\pm 5\%$	V
Silver		10^{-2}	$\pm 10\%$	SB



ELECTRICAL DATA – TYPE 1

Capacitance values		1 to 180 pF, E12 series
	non-preferred	10 to 100 pF, E24 series
Tolerance on capacitance		± 5, ± 10, or ± 20%, see Table 1
Rated d.c. voltage		50 V
Test voltage (d.c.) for 1 to 5 s		150 V
Insulation resistance		min. 10 000 MΩ
Q at 1 MHz (see Fig.4)		
C ≥ 30 pF		min. 1000
C < 30 pF		min. 400
Category temperature range		-25 to +85 °C

See further Table 1

D8624 (7Z75834)

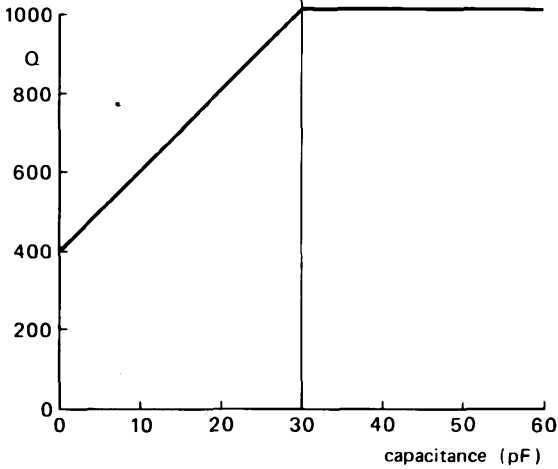

Fig.4

In addition to the temperature coefficients shown in Table 1, enquiries are invited for the following coefficients:

N30, N80, N150, N330, N470.

The general-purpose coefficient SL may be between P100 and N750.



Table 1, Type 1 – 50 V

suffix of catalogue number for box packing

capacitance pF Preferred values in heavy type	tol.	NPO ± 60 Preferred range	N220 ± 60	N750 ± 120	SL Preferred range
1	$\pm 20\%$				18108
1,2					18128
1,5					18158
1,8	$\pm 10\%$				18188
2,2					19228
2,7					19278
3,3		02338	10338		19338
3,9		02398	10398		19398
4,7	02478	10478		19478	
5,6	02568	10568		19568	
6,8	02688	10688		19688	
8,2	02828	10828		19828	
10	$\pm 5\%$	03109	11109	16828	20109
11		03119	11119	17109	20119
12		03129	11129	17119	20129
13		03139	11139	17129	20139
15		03159	11159	17139	20159
16		03169	11169	17159	20169
18		03189	11189	17169	20189
20		03209	11209	17189	20209
22		03229	11229	17209	20229
24		03249	11249	17229	20249
27	03279	11279	17249	20279	
30	03309	11309	17279	20309	
33	03339	11339	17309	20339	
36	03369	11369	17339	20369	
39	03399	11399	17369	20399	
43	03439	11439*	17399	20439	
47	03479*	11479*	17439	20479	
51	03519*	11519*	17479	20519	
56	03569*	11569*	17519	20569	
62	03629*	11629*	17569	20629	
68	03689*	11689*	17629	20689	
75		11759*	17689	20689	
82			17759	20759	
91			11829*	20829	
100				17919*	20919
120				17101*	20101
150				17121*	20121
180					20151*
					20181*
for reel packing replace (Reel packing supplied to special order only)		02 by 31 03 by 32	10 by 39 11 by 40	16 by 45 17 by 46	18 by 47 19 by 48 20 by 49

*These capacitors are size 250, all other capacitors are size 125.



ELECTRICAL DATA – TYPE 2

Capacitance values	150 to 1500 pF, E12 series 2200 to 33 000 pF, E6 series
Tolerance on capacitance	± 10, ± 20 and/or ± 30%
Rated d.c. voltage (U_R)	
150 to 10 000 pF	50 V
6800 to 22 000 pF	25 V
22 000 pF	16 V
Test voltage (d.c.) for 1 to 5 s	
temp. characteristics SB and SD	3 × U_R
temp. characteristics V and X	2 × U_R
temp. characteristics Y	18 V
Insulation resistance	
50 V types	min. 10 000 MΩ
25 V and 16 V types	min. 1000 MΩ
Tan δ at 1 kHz	max. 1.5% (1000 pF char. SB, 22 000 pF char. Y max. 3%)
Category temperature range	–25 to +85 °C
See further Table 2 and graphs	



Table 2, Type 2

Preferred range

CHARACTERISTIC SB

Capacitance pF	size	voltage	temperature characteristics	box packing		
				suffix of catalogue number for capacitance tolerance of:		
				± 10%	± 20%	± 30%
150	125	50 V	SB	21151		
180						
220						
270						
330						
390						
470						
560						
680						
820						
1000						
1200	250			21102		
1500				21122		

CHARACTERISTICS SD,V,X,Y

1000	125	50 V	SD	22152	23102	
1200			X		23122	
1500			V		24152	
1500			X		24222	
2200			V		24332	
2200			X		24472	
3300			V		22472	
3300			X		25682	
4700			V		25103	
4700			X			
6800			125		25 V	
10 000	125	25 V	X			
15 000	125	25 V	X			
22 000	250	25 V	X			28153
22 000	125	16 V	Y			28223
						30223
for reel packing replace (Reel packing supplied to special order only)				21 by 50 22 by 51	23 by 52 24 by 53 25 by 54	28 by 57 30 by 59



Capacitance change with respect to the capacitance at + 20 °C as a function of temperature for the different dielectrics; guaranteed limits.

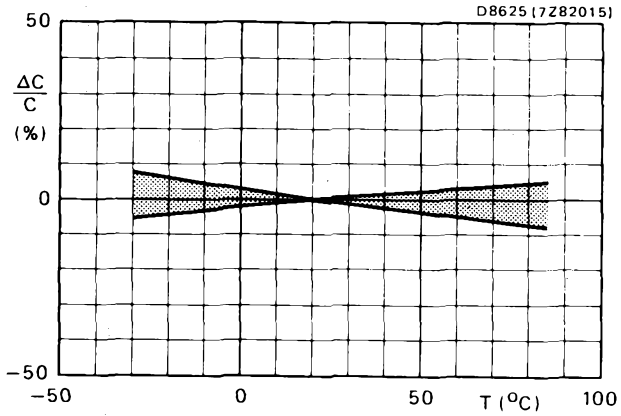

Fig.5 Characteristic V (2B2, Y5F)

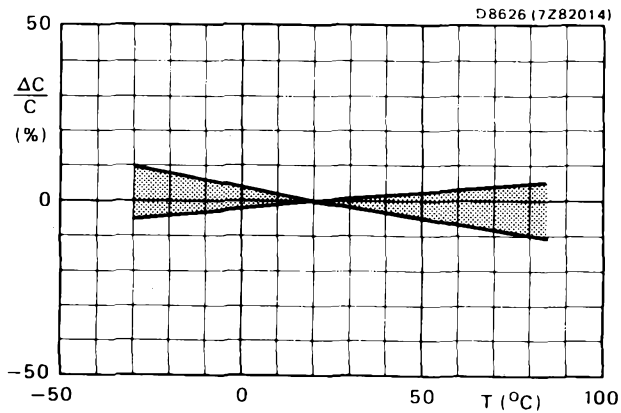

Fig.6 Characteristic SB (2B4, Y5P)



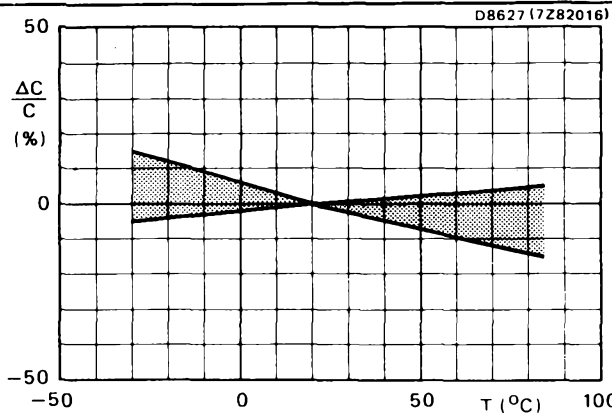

Fig.7 Characteristic X (2C2, Y5R)

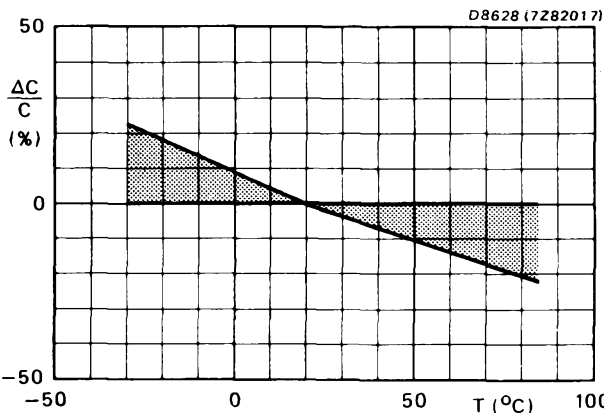

Fig.8 Characteristic Y (2D4, Y5S)

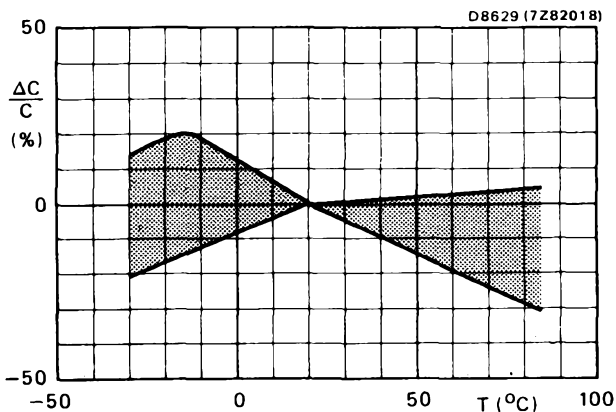

Fig.9 Characteristic SD (2E4, Y5T)



**METALLISED CERAMIC
PLATE CAPACITORS**
Miniature, high K, radial leads—lacquered

629
Series

QUICK REFERENCE DATA

For use in coupling and decoupling applications, where capacitance stability is not critical.

Capacitance range (E3 series)	1 to 22	nF	
Capacitance tolerance	-20 to +80	%	←
Rated voltage (d. c.)	63	V	←
Climatic category (IEC 68) at rated voltage (U_R)	10/055/21		
	at 0.63 U_R	10/085/21	

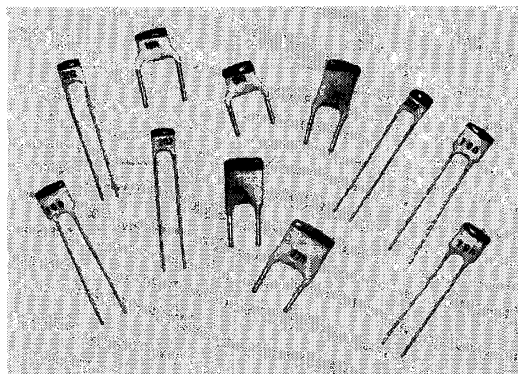

DIELECTRIC

High K, rectangular ceramic plate with a permittivity of approximately 10 000.

CASING

Hard, water repellent lacquer.

TERMINATIONS

Radial leads of tinned-copper wire. Available with either 0.4 mm diameter long leads on a 2.54 mm (0.1 in) pitch, or 0.6 mm diameter cropped leads on a 5.08 mm (0.2 in) pitch.

SPECIAL FEATURES

The electrode system does not employ silver in its construction, consequently the entire surface of the dielectric is utilised, resulting in smaller dimensions per capacitance value. Therefore, problems associated with "silver migration" do not occur with this series.

Mullard

DIMENSIONS (millimetres)

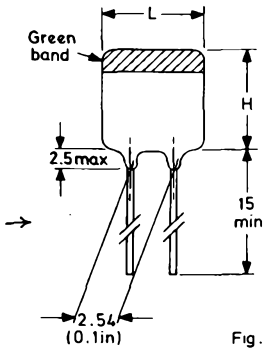

Fig. 1

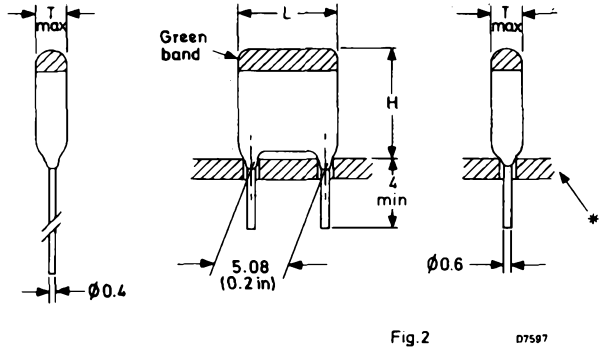

Fig. 2

D7597

*Lacquer on the terminations is controlled so that it does not impair solderability when the capacitors are mounted on printed-wiring boards: - 1.5 mm thick using $\phi 1.3$ mm holes, or 1 mm thick using $\phi 0.8$ mm holes.

Table 1. Long lead version

Capacitance (nF)	L max.	H max.	T max.	Capacitance code	Type number
1	3.5	4.5	2.1	1n0	629 02102
2.2	3.5	4.5	2.1	2n2	629 02222
4.7	3.5	4.5	2.1	4n7	629 02472
10	4.5	5.5	2.1	10n	629 02103
22	6.5	7.5	2.1	22n	629 02223

Table 2. Cropped lead version

Capacitance (nF)	L max.	H max.	T max.	Capacitance code	Type number
1	6.5	6	2.1	1n0	629 06102
2.2	6.5	6	2.1	2n2	629 06222
4.7	6.5	6	2.1	4n7	629 06472
10	6.5	7	2.1	10n	629 06103
22	6.5	9	2.1	22n	629 06223

**METALLISED CERAMIC
PLATE CAPACITORS**
Miniature, high K, radial leads—lacquered

629
Series

ELECTRICAL DATA

Unless otherwise stated, all characteristics apply at an ambient temperature of $20 \pm 5^\circ\text{C}$, an atmospheric pressure of 10^5 Pa (1000 mbars) and a relative humidity of 75% maximum.

	Conditions	Value
Capacitance range (E3 series)	measured at 1 kHz with <1.5 V a. c. applied	1 to 22 nF
Capacitance tolerance		-20 to +80% ←
Rated voltage (d. c.)		63 V ←
Tangent of loss angle ($\tan \delta$)	measured at 1 kHz with <1.5 V a. c. applied	$<350 \times 10^{-4}$
Insulation resistance	measured at 10 V d. c. after 1 minute	$>1000 \text{ M}\Omega$
Test voltage to casing (d. c.)		200 V

MOUNTING

The version with 0.4 mm diameter leads may be used in point to point or printed-wiring board applications. When bending, cropping or flattening the leads, care must be taken to relieve any applied stress from the capacitor body. The cropped lead version (0.6 mm diameter leads) is suitable for direct insertion into printed-wiring boards.

SOLDERING CONDITIONS

5 seconds max. at 250°C max.

MARKING

The capacitors have a green band (signifying high K permittivity), in position shown on the outline drawing, and on one face the appropriate capacitance code.

ORDERING PROCEDURE

The capacitors should be ordered by their type number, as shown in tables.

Examples :

A 4.7 nF, long lead version capacitor should be ordered by quoting 629 02472.

A 4.7 nF, cropped lead version capacitor should be ordered by quoting 629 06472.

PACKING

Supplied in multiples of 1000 pieces.

Capacitors can also be supplied bandoliered. For details contact Mullard Ltd.

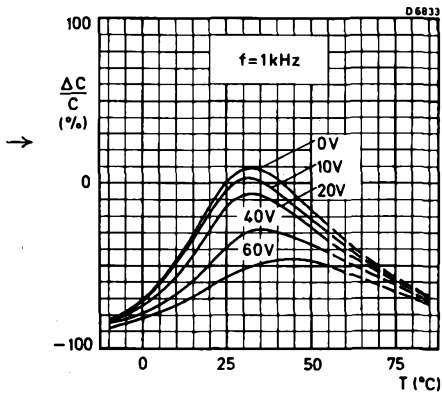

Fig. 3

Typical capacitance change versus temperature

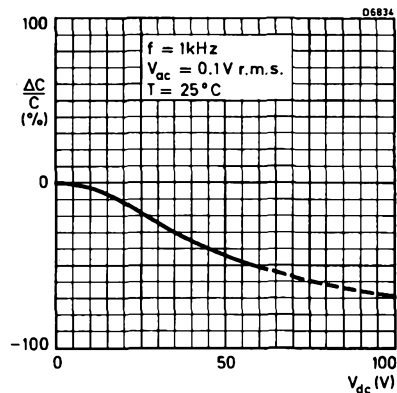

Fig. 4

Typical capacitance change versus d. c. voltage

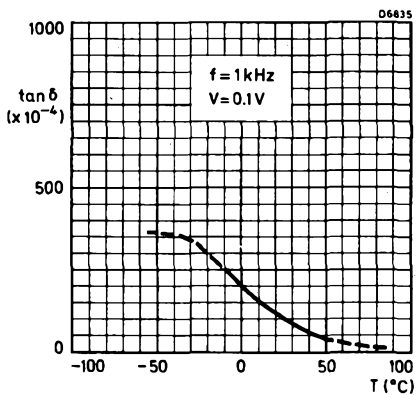

Fig. 5

Typical $\tan \delta$ versus temperature

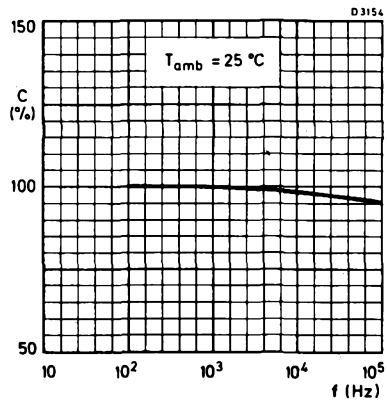

Fig. 6

Typical capacitance change versus frequency

METALLISED CERAMIC PLATE CAPACITORS

Miniature, medium K, radial leads—lacquered

630
Series

For use in coupling and decoupling applications, where a non-linear change of capacitance with temperature is permissible.

QUICK REFERENCE DATA

Capacitance range (E12 series)	390 to 4700	pF
Capacitance tolerance	±10	%
Rated voltage (d. c.)	100	V
Climatic category (IEC 68)	55/085/21	

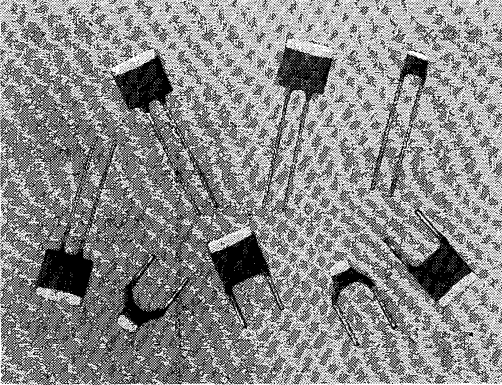

DIELECTRIC

Medium K, rectangular ceramic plate with a permittivity of approximately 2000.

CASING

Hard, water repellent lacquer.

TERMINATIONS

Radial leads of tinned-copper wire. Available with either 0.4 mm diameter long leads on a 2.54 mm (0.1 in) pitch, or 0.6 mm diameter cropped leads on a 5.08 mm (0.2 in) pitch.

SPECIAL FEATURES

The electrode system does not employ silver in its construction, consequently the entire surface of the dielectric is utilised, resulting in smaller dimensions per capacitance value. Therefore, problems associated with "silver migration" do not occur with this series.

Mullard

DIMENSIONS (millimetres)

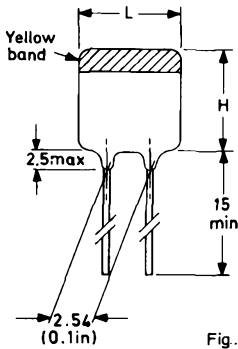

Fig. 1

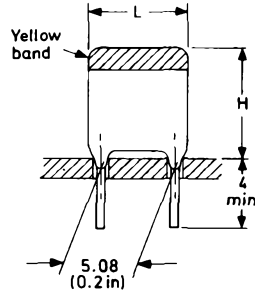
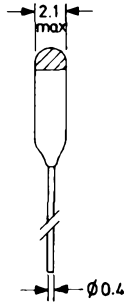
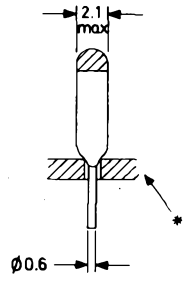

Fig. 2



07598

*Lacquer on the terminations is controlled, so that it does not impair solderability when the capacitors are mounted on printed-wiring boards: - 1.5 mm thick using $\varnothing 1.3$ mm holes, or 1 mm thick using $\varnothing 0.8$ mm holes.

		Long lead version Fig. 1			Cropped lead version Fig. 2		
Capacitance		L	H	Type number	L	H	Type number
(pF)	code	max.	max.		max.	max.	
390	n39	3.5	4.5	630 02391	6.5	6	630 06391
470	n47	3.5	4.5	630 02471	6.5	6	630 06471
560	n56	3.5	4.5	630 02561	6.5	6	630 06561
680	n68	3.5	4.5	630 02681	6.5	6	630 06681
820	n82	3.5	4.5	630 02821	6.5	6	630 06821
1000	1n0	4.5	5.5	630 02102	6.5	7	630 06102
1200	1n2	4.5	5.5	630 02122	6.5	7	630 06122
1500	1n5	4.5	5.5	630 02152	6.5	7	630 06152
1800	1n8	4.5	5.5	630 02182	6.5	7	630 06182
2200	2n2	5.5	6.5	630 02222	6.5	7.5	630 06222
2700	2n7	5.5	6.5	630 02272	6.5	7.5	630 06272
3300	3n3	6.5	7.5	630 02332	6.5	9	630 06332
3900	3n9	6.5	7.5	630 02392	6.5	9	630 06392
4700	4n7	6.5	7.5	630 02472	6.5	9	630 06472

**METALLISED CERAMIC
PLATE CAPACITORS**
Miniature, medium K, radial leads—lacquered

630
Series

ELECTRICAL DATA

Unless otherwise specified, all characteristics apply at an ambient temperature of $20 \pm 5 \text{ }^\circ\text{C}$, an atmospheric pressure of 10^5Pa (1000 mbars) and a relative humidity of 75% maximum.

	Conditions	Value
Capacitance range (E12 series)	measured at 1 kHz with 1.5 V a. c. applied	390 to 4700 pF
Capacitance tolerance	—	$\pm 10\%$
Rated voltage (d. c.)	—	100 V
Tangent of loss angle ($\tan \delta$)	measured at 1 kHz with 1.5 V a. c. applied	$<350 \times 10^{-4}$
Insulation resistance	measured at 100 V d. c. after 1 minute	$>1000 \text{ M}\Omega$
Test voltage to casing (d. c.)	applied for 1 minute	300 V

MOUNTING

The version with 0.4 mm diameter leads may be used in point or printed-wiring board applications. When bending, cropping or flattening the leads, care must be taken to relieve any applied stress from the capacitor body. The cropped lead version (0.6 mm diameter leads) is suitable for direct insertion into printed-wiring boards.

SOLDERING CONDITIONS

5 seconds max. at $250 \text{ }^\circ\text{C}$ max.

MARKING

The capacitors have a yellow band (signifying medium K permittivity), in position shown on the outline drawing, and on one face the appropriate capacitance code.

ORDERING PROCEDURE

The capacitors should be ordered by their type number, as shown in table.

Example: A 1500 pF capacitor with a lead pitch of 2.54 mm (0.1 in) should be ordered by quoting 630 02152.

A 3900 PF capacitor with a lead pitch of 5.08 mm (0.2 in) should be ordered by quoting 630 06392.

PACKING

Supplied in multiples of 1000 pieces.

Capacitors can also be supplied bandoliered. For details contact Mullard Ltd.

Mullard

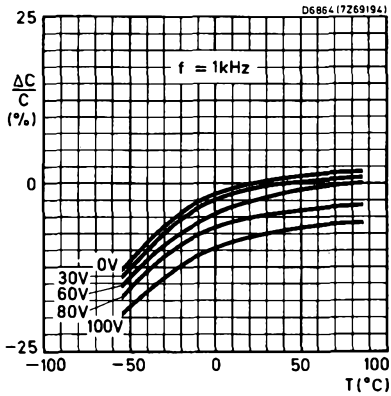

Fig. 2

Typical capacitance change versus temperature

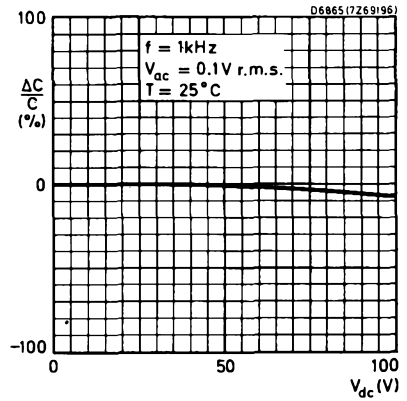

Fig. 3

Typical capacitance change versus d. c. voltage

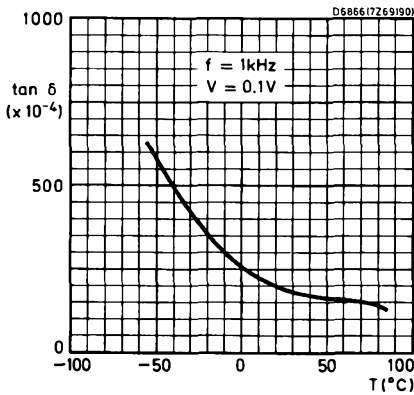

Fig. 4

Typical $\tan \delta$ versus temperature

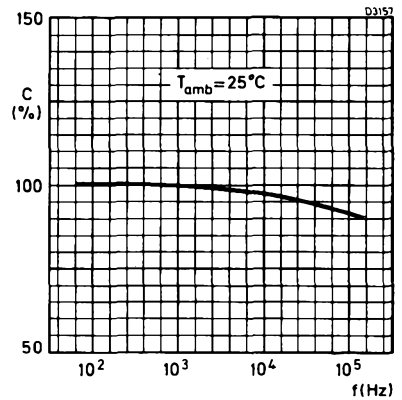

Fig. 5

Typical capacitance change versus frequency

**METALLISED CERAMIC
PLATE CAPACITORS**
Miniature, low K, radial leads—lacquered

**632
642**
Series

QUICK REFERENCE DATA

For temperature compensation in tuned circuits where low losses, close tolerance and high stability are required.

Capacitance range (E12 Series)	1.8 to 330	pF
Capacitance tolerance		
1.8 to 8.2pF	±0.25	pF
10 to 330pF	±2	%
Rated voltage (d. c.)	100	V
Climatic category (IEC 68)	55/085/21	

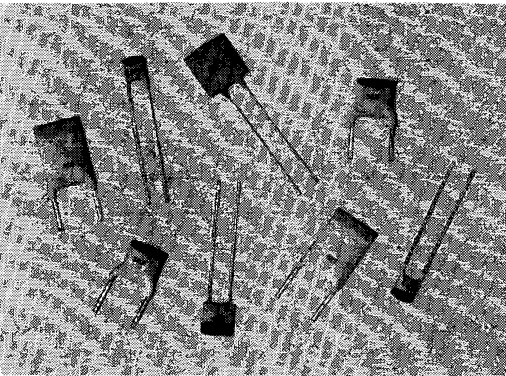

DIELECTRIC

Low K, rectangular ceramic plate with a permittivity of approximately 100.

CASING

Hard, water repellent lacquer.

TERMINATIONS

Radial leads of tinned-copper wire. Available with either 0.4mm diameter long leads on a 2.54mm (0.1 in) pitch, or 0.6mm diameter cropped leads on a 5.08mm (0.2 in) pitch.

SPECIAL FEATURES

The electrode system does not employ silver in its construction, consequently the entire surface of the dielectric is utilised, resulting in smaller dimensions per capacitance value. Therefore, problems associated with "silver migration" do not occur with this series.

Mullard

→ DIMENSIONS (millimetres)

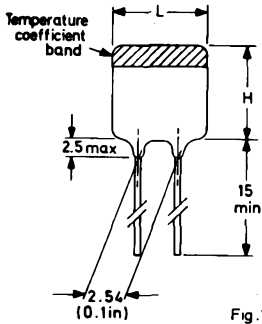

Fig. 1

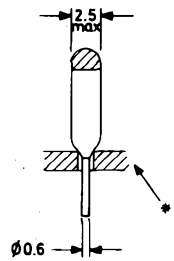
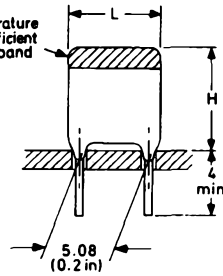
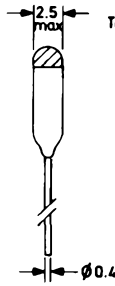

Fig. 2

07589

*Lacquer on the terminations is controlled, so that it does not impair solderability when the capacitors are mounted on printed-wiring boards: - 1.5 mm thick using $\varnothing 1.3$ mm holes, or 1 mm thick using $\varnothing 0.8$ mm holes.

Case size	Long lead version Fig. 1		Cropped lead version Fig. 2	
	L max.	H max.	L max.	H max.
1	3.5	4.5	6.5	6
2	4.5	5.5	6.5	7
3	5.5	6.5	6.5	8
4	6.5	7.5	6.5	9
5	6.5	10.5	6.5	12

→ ELECTRICAL DATA

Unless otherwise specified, all characteristics apply at an ambient temperature of $20 \pm 5^\circ\text{C}$, atmospheric pressure of 10^5Pa (1000mbars) and a relative humidity of 75% maximum.

	Conditions		Value
Capacitance range (E12 Series)	measured at 1 MHz with <5 V a. c. applied		1.8 to 330 pF
Capacitance tolerance	1.8 to 8.2 pF		± 0.25 pF
	10 to 330 pF		$\pm 2\%$
Rated voltage (d. c.)	—		100 V
Tangent of loss angle (tan δ)	measured at 1 MHz with <5 V a. c. applied	for C < 50 pF	$\leq 15 \left(\frac{15}{C_{\text{pF}}} + 0.7 \right) \times 10^{-4}$ max. 55×10^{-4}
		for C > 50 pF	$\leq 15 \times 10^{-4}$
Insulation resistance	measured at 100 V d. c. after 1 minute		> 10 000 M Ω
Test voltage to casing (d. c.)	applied for 1 minute		300 V

**METALLISED CERAMIC
PLATE CAPACITORS**
Miniature, low K, radial leads—lacquered

**632
642**
Series

Capacitance (pF)	Capacitance tolerance	Case size	Temperature coefficient (ppm/degC)	Capacitance code	Type number long lead version Fig. 1	Type number cropped lead version Fig. 2	
1.8	±0.25pF	1	0 (Black)	1p8	632 09188	642 09188	
2.2		1		2p2	632 09228	642 09228	
2.7		1		2p7	632 09278	642 09278	
3.3		1		3p3	632 09338	642 09338	
3.9		1		3p9	632 09398	642 09398	
4.7		1		4p7	632 09478	642 09478	
5.6		1		5p6	632 09568	642 09568	
6.8		1		6p8	632 09688	642 09688	
8.2		1		8p2	632 09828	642 09828	
10		+2%		1	10p	632 10109	642 10109
12				1	12p	632 10129	642 10129
15				1	15p	632 10159	642 10159
18				1	18p	632 10189	642 10189
22				1	22p	632 34229	642 34229
27	2		27p	632 34279	642 34279		
33	2		33p	632 34339	642 34339		
39	2		39p	632 34399	642 34399		
47	2		47p	632 34479	642 34479		
56	3		56p	632 34569	642 34569		
68	3	68p	632 34689	642 34689			
82	4	82p	632 34829	642 34829			
100	4	n10	632 34101	642 34101			
120	5	n12	632 34121	642 34121			
150	5	n15	632 34151	642 34151			
180	+2%	4	-750 (Violet)	n18	632 58181	642 58181	
220		4		n22	632 58221	642 58221	
270		5		n27	632 58271	642 58271	
330		5		n33	632 58331	642 58331	

Mullard

→ MOUNTING

The version with 0.4mm diameter leads may be used in point to point or printed-wiring board applications. When bending, cropping or flattening the leads, care must be taken to relieve any applied stress from the capacitor body. The cropped lead version (0.6mm diameter leads) is suitable for direct insertion into printed-wiring boards.

SOLDERING CONDITIONS

5 seconds max. at 250°C max.

MARKING

The capacitance value is indicated on one face of the component by the capacitance code (see table on Page 3). The temperature coefficient is indicated by colour marking in accordance with I. E. C. recommendations as follows:

Temperature coefficient	Marking colour
0	Black
-150×10^{-6}	Orange
-750×10^{-6}	Violet

→ ORDERING PROCEDURE

The capacitors should be ordered by their type number, as shown in the table.

Example: A $6.8\text{pF} \pm 0.25\text{pF}$ capacitor with a lead pitch of 2.54mm (0.1 in) should be ordered by quoting the type number 632 09688. A $220\text{pF} \pm 2\%$ capacitor with a lead pitch of 5.08mm (0.2 in) should be ordered by quoting the type number 642 58221.

Capacitors can also be supplied bandoliered. For details contact Mullard Ltd.

INTERFERENCE SUPPRESSION CAPACITORS (Class Y)

For suppression of electrical interference from domestic appliances operating on 250 V(a.c.) supplies.

QUICK REFERENCE DATA

Capacitance range (E3 series)	1000 and 2200 pF
Capacitance tolerance	±20%
Rated voltage (a.c.)	250 V
Climatic category (IEC 68)	40/085/21

DIELECTRIC

Metallised ceramic disc

CASING

Flame retardant, solvent resistant lacquer.

TERMINATIONS

0.6 dia. radial leads of solder coated copper wire.

MARKING

The capacitors are marked with

Capacitance value

Tolerance (M = 20%)

The rated voltage

Manufacturer's trade mark

VDE approval mark.

SPECIAL FEATURES

These capacitors are approved to VDE 0560 part 7/11.67 and are generally used in class 'Y' suppression applications i.e., connected between line and the case of the appliance.



MECHANICAL DATA

Dimensions in mm

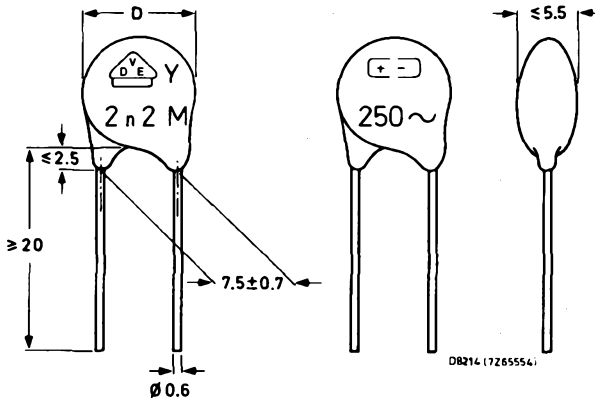

capacitance pF	rated voltage V_{rms}	D	type number
1000	250	10	660 01102
2200	250	11	660 01222

ELECTRICAL DATA

Unless otherwise specified all electrical values apply at an ambient temperature of 20 ± 2 °C, an atmospheric pressure of 930 to 1060 mbar and a relative humidity of 45 to 75%.

Capacitance values

measured at 1 kHz, 1.5 V max. applied

1000 and 2200 pF

Tolerance on capacitance

$\pm 20\%$

Tangent of loss angle ($\tan \delta$) measured at 1 kHz, 1.5 V max. applied

$\pm 3.5\%$

Rated a.c. voltage

250 V

Test voltage (a.c.) for 2 s

1800 V (100% tested)

Test voltage (a.c.) for 1 min at 85 °C

1500 V (type test)

Insulation resistance at 500 V (d.c.)
after 1 min

$\geq 10\ 000\ M\Omega$

Category temperature range

-40 to +85 °C

Stability (measured after 425 V_{ac}
applied for 1000 hrs at 85 °C)

$\frac{\delta C}{C} \leq 10\%$



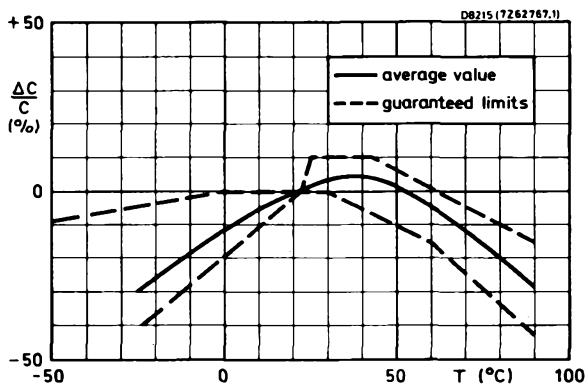

Capacitance change as a function of temperature.

For class 'X' interference suppression capacitors refer to 330 Series.



MULTILAYER CERAMIC CHIP CAPACITORS**QUICK REFERENCE DATA**

Capacitance range	
NPO (C0G) dielectric	10 to 33 000 pF (E12 series)
K1800 (X7R) dielectric	180 to 470 000 pF (E12 series)
Rated d.c. voltage	50 V (EIA), 63 V (IEC)
Tolerance on capacitance	
NPO (C0G)	± 10%, ± 5%
K1800 (X7R)	± 20%, ± 10%
Basic specification	IEC 384-10 (EIA RS198/B)
Climatic category (IEC68)	
NPO (C0G)	55/125/56
K1800 (X7R)	55/125/56

APPLICATION

These multilayer ceramic capacitors provide a very high capacitance per unit volume which, together with physical size and performance, makes them very suitable for use in hybrid and other micro-circuitry. These small size components can be applied to the same functions as other ceramic capacitors i.e. coupling, by-passing, blocking, frequency discrimination, etc.

DESCRIPTION

The capacitors consist of a rectangular block of ceramic dielectric in which a number of interleaved precious-metal electrodes yield a high capacitance per unit volume. The capacitors are Pd Ag metallized at the end terminal (see Fig. 2).



MECHANICAL DATA

Dimensions in mm

Outlines

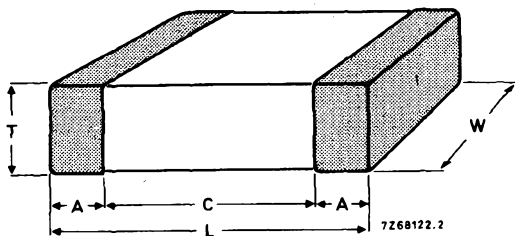

Fig. 1

Table 1

size	L	W	T		A		C min.
			min.	max.	min.	max.	
0805	$2,0 \pm 0,15$	$1,25 \pm 0,15$	0,51	1,27	0,25	0,75	0,4
1206	$3,2 \pm 0,15$	$1,6 \pm 0,15$	0,51	1,60	0,3	1,0	
1210	$3,2 \pm 0,2$	$2,5 \pm 0,2$	0,51	1,90	0,3	1,0	
1808	$4,5 \pm 0,2$	$2,0 \pm 0,2$	0,51	1,90	0,3	1,0	
1812	$4,5 \pm 0,2$	$3,2 \pm 0,2$	0,51	1,90	0,3	1,0	
2220	$5,7 \pm 0,2$	$5,0 \pm 0,2$	0,51	1,90	0,3	1,0	

Soldering

Limiting conditions min. 220 °C, 3 s
 max. 250 °C, 60 s

PACKAGING

Multiples of 100 pieces.



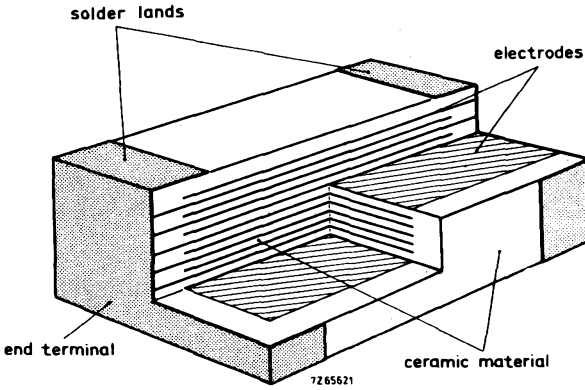

Fig.2.

COMPOSITION OF THE CATALOGUE NUMBER

2222

style code

capacitance value code, first two significant figures of the capacitance value according to E12 series followed by multiplying factor:

	tolerance	
NPO (COG)	5%	12
	10%	13
K1800 (X7R)	10%	47
	20%	48

9 for x 1
1 for x 10
2 for x 10²
3 for x 10³
4 for x 10⁴

See Tables 2 and 3.



ELECTRICAL DATA

Unless otherwise specified all electrical values apply at an ambient temperature of $20 \pm 7 \text{ }^\circ\text{C}$, an atmospheric pressure of 86 to 106 kPa and a relative humidity of 45 to 75%.

Type 1, High-Q, NP0 (EIA: COG)

Capacitance range

- $\leq 1000 \text{ pF}$ measured at 1 MHz, 1 V
- $> 1000 \text{ pF}$ measured at 1 kHz, 1 V

see Table 2, (E12 series)

Tolerance on capacitance

$\pm 10\%$, $\pm 5\%$

Rated d.c. voltage (U_R)

50 V (EIA), 63 V (IEC)

D.C. test voltage for 1 min

200 V

Dissipation factor, measured at 1 V,
1 MHz, $C < 30 \text{ pF}$

$10 \left(\frac{10}{C} + 0,7 \right) \times 10^{-4}$

- 1 MHz, $30 \text{ pF} < C \leq 1000 \text{ pF}$
- 1 kHz, $C > 1000 \text{ pF}$

$< 10 \times 10^{-4}$

$< 10 \times 10^{-4}$

Insulation resistance

$> 100\,000 \text{ M}\Omega$

Category temperature range

-55 to $+125 \text{ }^\circ\text{C}$

Capacitance change as a function of
temperature. -55 to $+125 \text{ }^\circ\text{C}$

$\pm 30 \times 10^{-6}/\text{K}$

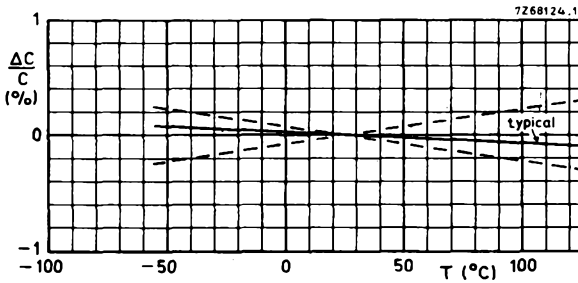

Fig. 3 Typical capacitance change as a function of temperature. Dotted lines indicate the limits.



Table 2: NPO (COG)

size	capacitance range	capacitance tolerance	catalogue number
0805	10 to 1 000 pF	5%	2222 851 12 ...
		10%	2222 851 13 ...
1206	33 to 3 300 pF	5%	2222 853 12 ...
		10%	2222 853 13 ...
1210	100 to 8 200 pF	5%	2222 852 12 ...
		10%	2222 852 13 ...
1808	100 to 10 000 pF	5%	2222 854 12 ...
		10%	2222 854 13 ...
1812	1 000 to 15 000 pF	5%	2222 855 12 ...
		10%	2222 855 13 ...
2220	10 000 to 33 000 pF	5%	2222 856 12 ...
		10%	2222 856 13 ...

code for capacitance value:
 first two significant figures
 of capacitance value according
 to E12 series followed by:
 $\underline{9}$ for 10 to 82 pF
 $\underline{1}$ for 100 to 820 pF
 $\underline{2}$ for 1 000 to 8 200 pF
 $\underline{3}$ for 10 000 to 33 000 pF
 e.g.: fill in 272 for 2700 pF.



851 - 856
Series

Type 2, K1800 (EIA: X7R)

Capacitance range
measured at 1 kHz, 1 V

Tolerance on capacitance

Rated d.c. voltage (U_R)

D.C. test voltage for 1 min

Dissipation factor, measured at 1 kHz, 1 V

Insulation resistance

$C \leq 10\,000\text{ pF}$

$C > 10\,000\text{ pF}$

Category temperature range

Maximum capacitance change as a function
of temperature

see Table 3 (E12 series)

$\pm 20\%$

50 V (EIA), 63 V (IEC)

200 V

$< 2,5\%$

$> 100\,000\text{ M}\Omega$

$R_{ins} \times C > 1000\text{ s}$

$-55\text{ to }+125\text{ }^\circ\text{C}$

$\pm 15\%$, see Fig. 4

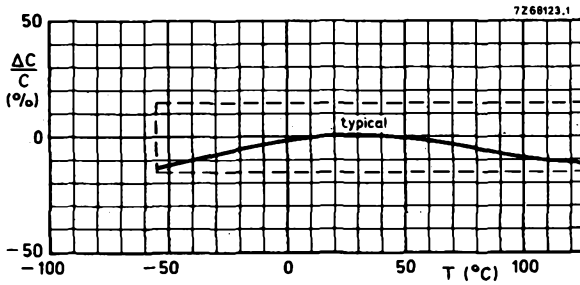

Fig. 4 Typical capacitance change as a function of temperature. Dotted lines indicate the limits.



Table 3: K1800 (X7R)

size	capacitance range	capacitance tolerance	catalogue number
0805	180 to 22 000 pF	10%	2222 851 47 ...
		20%	2222 851 48 ...
1206	1 800 to 56 000 pF	10%	2222 853 47 ...
		20%	2222 853 48 ...
1210	2 700 to 100 000 pF	10%	2222 852 47 ...
		20%	2222 852 48 ...
1808	10 000 to 150 000 pF	10%	2222 854 47 ...
		20%	2222 854 48 ...
1812	10 000 to 270 000 pF	10%	2222 855 47 ...
		20%	2222 855 48 ...
2220	100 000 to 470 000 pF	10%	2222 856 47 ...
		20%	2222 856 48 ...

code for capacitance value:
first two significant figures
of capacitance value according
to E12 series followed by:

1 for 180 to 820 pF

2 for 1 000 to 8 200 pF

3 for 10 000 to 82 000 pF

4 for 100 000 to 470 000 pF

e.g.: fill in 683 for 68 000 pF.



ELECTROLYTIC CAPACITORS

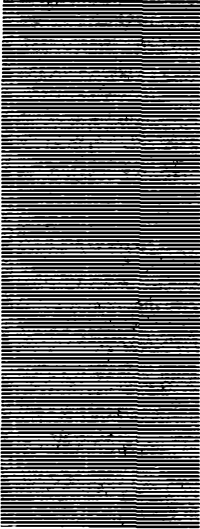

D

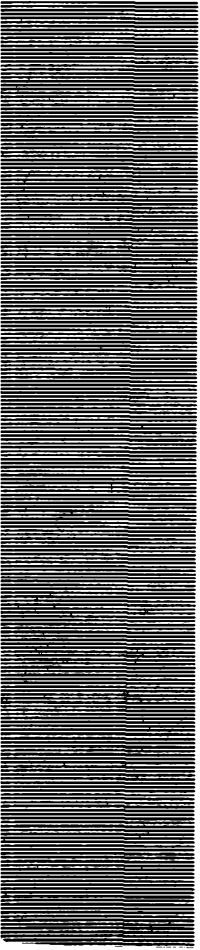

GENERAL

The Mullard range of electrolytic capacitors are classified into three main groups.

1. Aluminium - general purpose with a liquid or non-solid electrolyte. They may be classified as IEC 384-4 long life grade or G.P. Grade.
2. Aluminium - long life with a liquid or non-solid electrolyte, IEC 384-4 long life grade.
3. Aluminium - long life with a solid electrolyte.

NOTE

Non-solid electrolyte capacitors may contain chemicals which can be regarded as hazardous if incorrectly handled. Caution is necessary should the outer case be fractured.

CONSTRUCTION

All electrolytic capacitors have a dielectric which comprises an oxide layer. This layer is produced by an electro-chemical process known as 'forming' and the thickness is a function of the dielectric strength and hence the voltage rating.

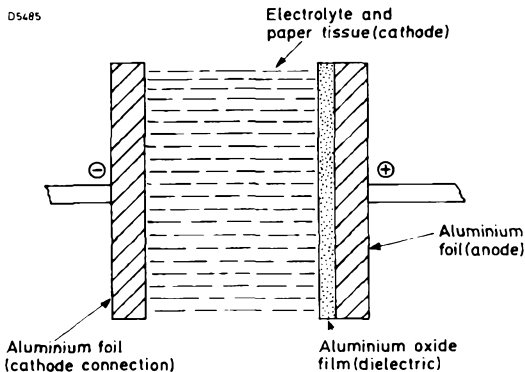

Fig. 1

Schematic representation of an aluminium electrolytic capacitor with a liquid or non-solid electrolyte

In many cases, the anode (+ve) foil has a roughness surface which effectively increases the surface area and thus enables very high capacitances with respect to the volume. This foil is 'formed' and subsequently wound together with a cathode (-ve) foil, interleaved with an absorbent paper tissue. The assembly is then impregnated with an electrolyte (which is the true cathode) and finally sealed in an aluminium case.

Solid electrolyte capacitors are constructed in a somewhat similar way except that the electrolyte comprises manganese dioxide impregnated into a glass fibre tape.

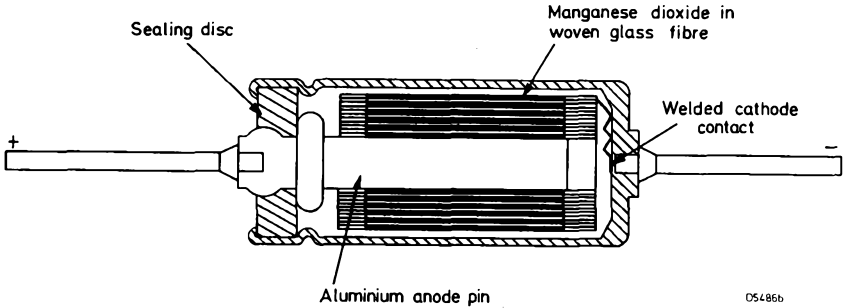

Fig. 2

Cross-section of a solid electrolyte aluminium capacitor

EQUIVALENT CIRCUIT

The equivalent circuit of a non-solid electrolytic capacitor is given in Fig. 3.

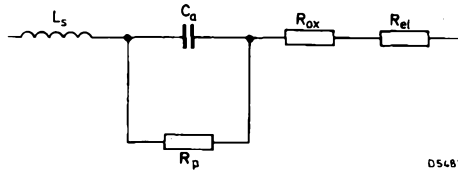

Fig. 3

Equivalent circuit of an electrolytic capacitor

where

C_a = capacitance at the anode

R_p = parallel resistance or leakage current

R_{ox} = series resistance of the oxide layer

R_{el} = series resistance of the non-solid electrolyte and paper tissue

L_s = series inductance

The equivalent series resistance R_s of the capacitor is given by

$$R_s = R_{ox} + R_{el}$$

This resistance is an important property as it is responsible for the heating effects of ripple currents. It varies inversely with temperature and is also related to capacitance and frequency.

The following measurements are of principal interest to the designer:

1. Capacitance, C_a , measured at 100Hz.
2. Loss factor or $\tan \delta$, measured at 100Hz, $\tan \delta = \omega C_a R_s$
3. Impedance Z , where $Z = \sqrt{R_s^2 + (\omega L_s - \frac{1}{\omega C_a})^2}$

At various frequencies 'f', the following simplified formula for Z may be used:

at 100Hz
$$Z \approx \frac{1}{\omega C_a} = \frac{1}{2 \pi f C_a}$$

at 100kHz
$$Z \approx R_{el} \approx R_s$$

at 100MHz
$$Z \approx \omega L_s = 2 \pi f L_s$$

TAN δ and SERIES RESISTANCE

The losses in an electrolytic capacitor as seen from Fig. 3 are mainly the series resistance R_s . It is sometimes called ESR (equivalent series resistance) and can be calculated, at any particular frequency from

$$R_s = \frac{\tan \delta \text{ (measured)}}{\omega C \text{ (measured)}} = \text{ESR}$$

The loss angle δ is the complementary angle to the phase angle ϕ .

The vector diagram, Fig. 4 shows that the current leads the voltage by slightly less than the theoretical 90° .

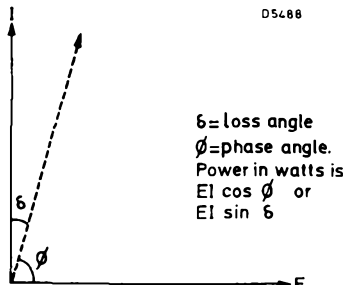

Fig. 4

Vector diagram showing the relationship between current and voltage

In practice, and for convenience of measurement, the tangent of δ is used which approximates to the sine of δ . The losses or dissipation factors are therefore always expressed as $\tan \delta$.

→ The series resistance is dependent on the electrolyte and also on the temperature and frequency. It is also a function of the permissible ripple current rating.

Figs. 5 and 6 show examples of the effect of frequency on the dissipation factor ($\tan \delta$) and the series resistance (R_s).

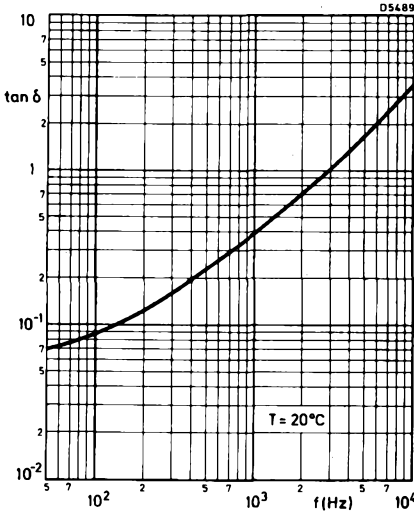

Fig. 5

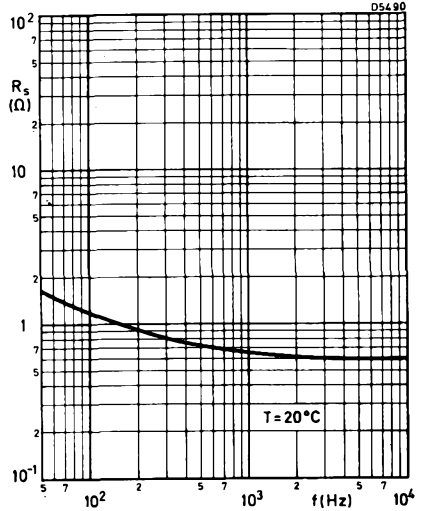

Fig. 6

VOLTAGE

The voltage rating is dependent on the thickness of the oxide layer and it should not be exceeded except for limited periods, such as, switch-on surge. The applied voltage may be the sum of a d.c. component plus a superimposed a.c. voltage and the sum of these two should not exceed the rated voltage.

The operation of capacitors with applied voltage less than the rated voltage has no adverse effect.

The limits of loading an electrolytic capacitor with an a.c. voltage or alternating current are subject to the following:

1. The peak value of the voltage should not exceed the permissible rated voltage, neither should it subject the capacitor to a reverse polarity of more than 2V or 10% of the rated voltage, whichever is smaller.

→ 2. The alternating or ripple current is limited by the internal heating of the capacitor which is generally fixed at $\Delta T = 10^\circ\text{C}$ max. between the winding and the can.

IMPEDANCE

In practice, the impedance Z of an electrolytic capacitor approximates to:

$$Z = \sqrt{R_s^2 + \left(\frac{1}{\omega C}\right)^2}$$

Fig. 7 shows a typical relationship of impedance with temperature for a 150 μ F, 25V capacitor. Fig. 8 shows the typical variation of impedance with frequency and temperature for 10 000 μ F, 6.3V capacitor.

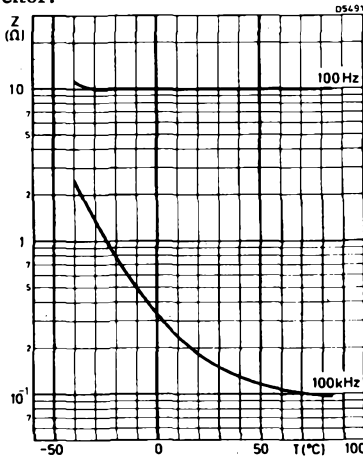

Fig. 7

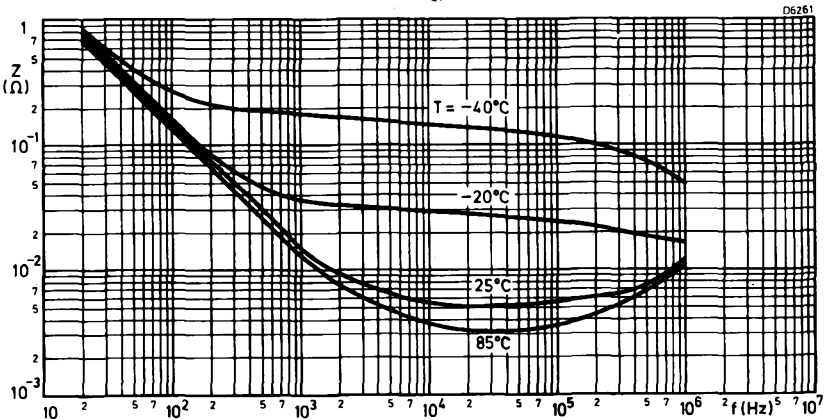

Fig. 8

→ It can be seen that resonance occurs at approximately 100kHz for low values of capacity and 20kHz for high values, and at these frequencies R_g will predominate. For this reason, the impedance at 100kHz or 20kHz is usually given in the characteristics. At higher frequencies, the capacitor will behave like an inductance and this should be avoided.

→ LEAKAGE CURRENT (NON-SOLID ELECTROLYTE)

The leakage current is the small continuous direct current flowing through a capacitor. It is usually specified at 20°C, and for type 1 capacitor is expressed by the formula:

$$\begin{aligned} &\leq 1000CV, I_L = 0.01CV \text{ or } 1\mu A \text{ whichever is the greater} \\ &> 1000CV, I_L = (0.006CV + 4) \mu A \end{aligned}$$

where CV is the product of capacitance in μF and the rated voltage.

The leakage current is very dependent on the applied voltage and temperature. At 85°C, it may be as much as 5 times the figure derived from the formula.

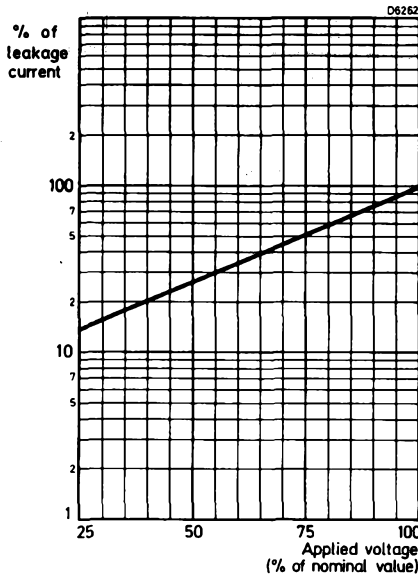

Fig. 9

Typical variation of leakage current with applied voltage

After prolonged storage without voltage being applied, the initial leakage current may be up to 100 times the normal. This phenomena, however, only occurs for a very short time and the normal value will be attained within five minutes.

LEAKAGE CURRENT (SOLID ELECTROLYTE)

In the case of aluminium capacitors with solid electrolyte the leakage current I_L is $\leq 0.1CV$ expressed in μA .

RIPPLE CURRENT (NON-SOLID ELECTROLYTE)

The ripple current rating is dependent on a number of factors which together are responsible for a temperature rise in the capacitor. These losses are principally I^2R , where I is the ripple current in amperes and R is the equivalent series resistance. The factor determining the limit is when the can temperature rises to the rated temperature of the capacitor. The power dissipation can also be calculated for a particular capacitor by applying a loading factor to the effective surface area. This calculation applies to capacitors whose CV products exceeds 1000 and where the can temperature is 70°C.

$$\begin{aligned} 14\text{mW/cm}^2 & \text{ for } \leq 160\text{V ratings} \\ 11\text{mW/cm}^2 & \text{ for } > 160\text{V ratings} \end{aligned}$$

The ripple current rating is usually quoted at 100Hz. At 50Hz, this rating will be reduced to 0.7 of the 100Hz figure. Conversely, at frequencies above 10kHz, the ripple current rating may be increased by 20% or more.

TEMPERATURE

Electrolytic capacitors usually have a positive temperature coefficient which is dependent on the voltage rating.

The temperature rating of a non-solid electrolytic capacitor is dependent on the electrolyte, whose characteristics are chosen to provide adequate life at high temperatures, and a tolerable increase in impedance at low temperatures. The actual life is determined by a "drying out" of the electrolyte (see SERVICE LIFE).

The limiting conditions for the maximum operating temperature can be derived from

- a) ambient temperature in which the capacitor is operated as measured in the immediate neighbourhood of the capacitor.
- b) the temperature produced by loading the component with a ripple current due to the I^2R loss, where R is the equivalent series resistance (E.S.R.) at a particular temperature and frequency.
- c) the temperature produced by the leakage current which is usually insignificant except for high CV products.
- d) the combination of a), b) and c) which raises the temperature of the can to the upper temperature category of the capacitor. This is the maximum safe operation of any electrolytic capacitor.

To summarize; the effect of operation at the maximum category temperature compared to that at 20°C is

- a) the capacitance increases by approximately 10%.
- b) the $\tan \delta$ decreases by approximately 20%.
- c) the E.S.R. decreases by approximately 30%.
- d) the leakage current increases by approximately 5 times.

NOTE: The above figures are intended as a general guide and should not be used as operating parameters.

Specifications are issued by the IEC (International Electrotechnical Commission) who establish the performance after electrical and mechanical tests. The standard for aluminium electrolytic capacitors is:

IEC 384-4 long life grade capacitors which may also be used for general purpose applications. The life is defined by a number of tests on various parameters of which the capacitance change is probably the most important for the user. This permissible capacitance change occurs after an endurance test of 2000 hours at the maximum category temperature. It is invariably negative and due to evaporation of the electrolyte.

IEC 384-4 general purpose grade capacitors will have a higher permissible change after a 1000 hours endurance test.

REQUIREMENTS AFTER AN ENDURANCE TEST FOR CAPACITORS WITH A NON-SOLID ELECTROLYTE

IEC 384-4	Rated voltage	Permissible ΔC
Long life grade	≤ 160	< 15%
	> 160	< 10%
G.P. Grade	≤ 160	< 25%
	> 160	< 15%

The corresponding figure for solid electrolyte aluminium capacitors is $\Delta C < 10\%$, and as there is no "drying out" of the electrolyte the category temperature can be higher than components with a non-solid electrolyte.

SERVICE LIFE

The service life is not necessarily defined by the IEC parameters, and many circuits will function satisfactorily when the capacitance has declined by nearly 50% of the original value. The important point is that life is dependent on ambient temperature, and for maximum life, an electrolytic capacitor should be operated at temperatures below 40°C. This can extend the ultimate life of any non-solid electrolyte capacitor by a factor of 10 compared with that at the maximum temperature rating.

In the case of solid electrolyte, the life is usually much greater than non-solid or liquid electrolyte types and it is not so dependent on temperature.

ELECTROLYTIC CAPACITORS

MOUNTING CLIPS

Mounting clips for use with large electrolytic capacitors 071, 105 and 106/107 Series, are available. They are supplied without screws or nuts and are suitable for the following can sizes

Capacitor Series	Can size	Type number (for ordering purposes)	For dimensions (mm) and outline drawings see page
071	5	B1 271 21	3
	6	B1 271 22	4
	7	B1 271 22	
	8	DT2402	2
	9	B1 271 24	4
	10	B1 271 25	
105, 106/107	11	DT2401	
	12	DT2401	2
	14	DT2254	3
	15	DT2254	
	16	DT2400	1

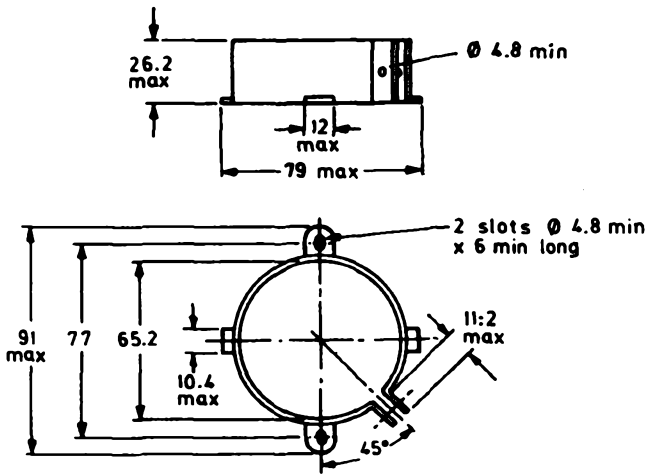

Material:- 1.2mm (18 s.w.g.) mild steel
cadmium plated

Type number DT2400

Mullard

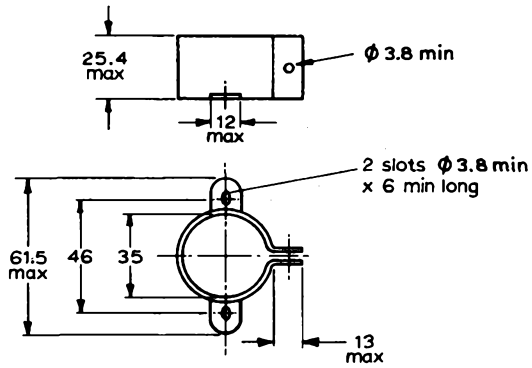

Material :- 0.9mm (20 s.w.g) mild steel
cadmium plated

Type number DT2401

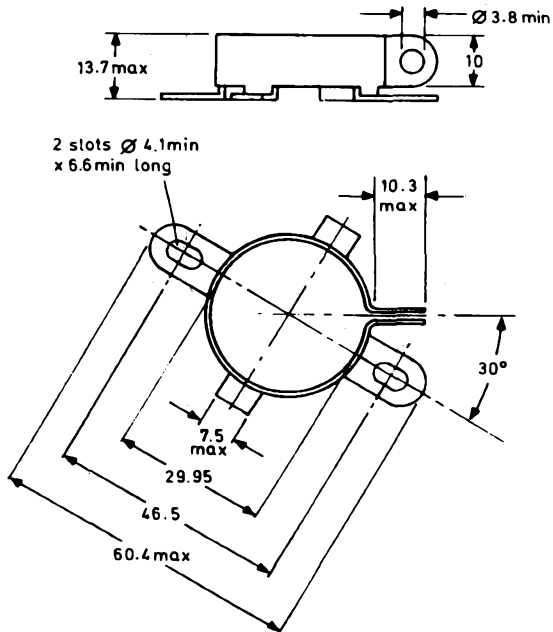

Material:- 1.2mm (18 s.w.g.) mild steel,
cadmium plated

D 2184

Type number DT2402

Mullard

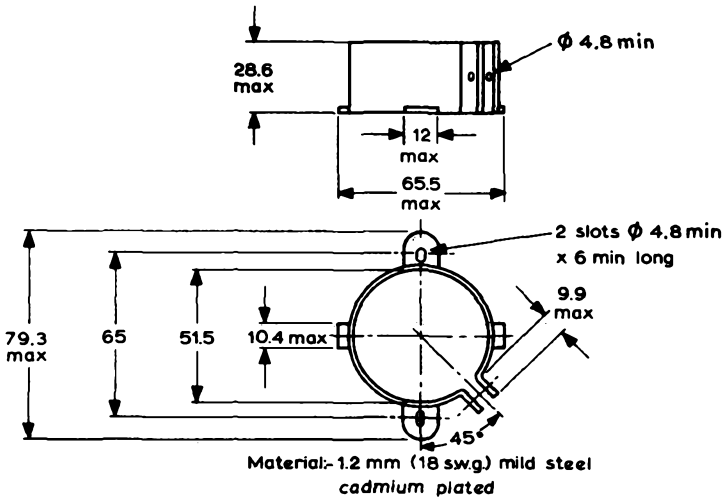

Type number DT2254

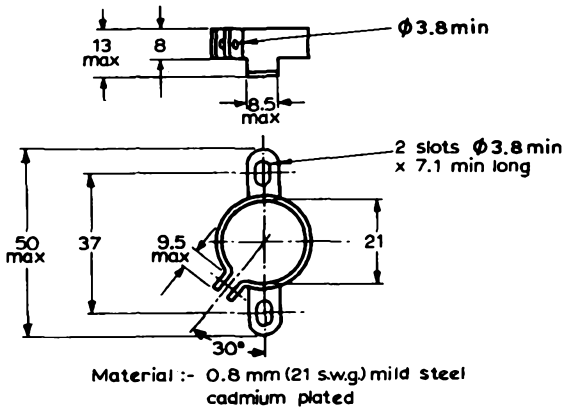

Type number B1 271 21

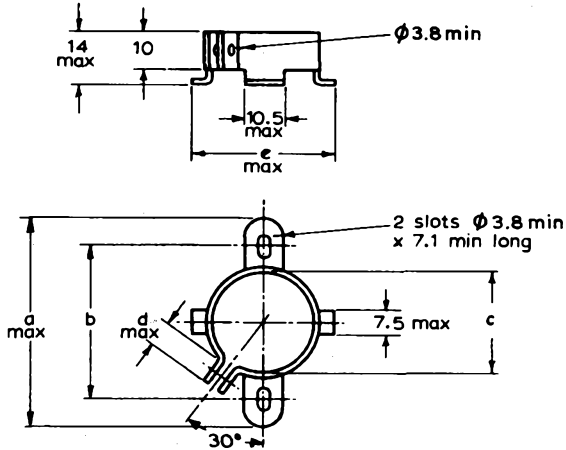

Material:- 1 mm (19s.wg) mild steel
cadmium plated

Dimensions					Type number
a	b	c	d	e	
56	41.5	25	11.5	36	B1 271 22
71	56.5	40	11.5	51	B1 271 25

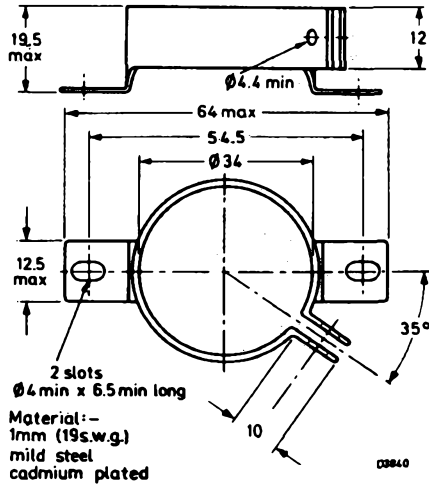





Material:- 1mm (19s.w.g.) mild steel
cadmium plated

Clip type number B1 271 24



ALUMINIUM ELECTROLYTIC CAPACITORS





type	series number
Miniature 	015 016
Small 	032
Small  	033

Mulard

February 1980

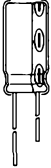
application	category temperature °C	nominal capacitance μF	rated voltage (U _R) V
general industrial Supplied radially bandoliered in boxes or drums 015 Series approved to BS9078 F003	-25 to +85 -40 to +85	470 to 1	4 to 63
general, industrial long life grade	-40 to +85	4700 to 68	6.3 to 100
general industrial, long life grade	-40 to +85	10 000 to 1000	6.3 to 63



type	series number
Miniature/small 	034
Miniature 	041
Small  	042 043
Small 	108

**WET & SOLID
ELECTROLYTIC
CAPACITORS**



application	category temperature °C	nominal capacitance μF	rated voltage (U _R) V
general purpose grade	-40 to +85	3300 to 0.47	6.3 to 100
general, industrial general purpose grade	-40 to +85	22 to 1	160 to 385
Axial leaded type supplied bandoliered			
general, industrial long life grade	-40 to +70	100 to 10	160 to 385
industrial long life grade	-40 to +85	2200 to 2.2	6.3 to 63



Mullard

February 1980

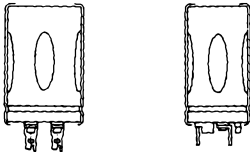
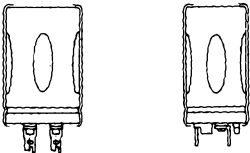

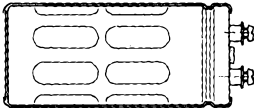

3

type	series number
<p>Large</p> 	050*
<p>Large</p> 	052*
<p>Large</p> 	071†
<p>Large</p> 	115

* Development type

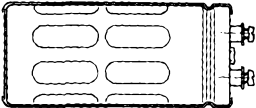
† Maintenance type

application	category temperature °C	nominal capacitance μF	rated voltage (U_p) V
industrial long life grade	-40 to +85	68 000 to 470	10 to 100
industrial long life grade	-40 to +85	1000 to 47	250 and 385
industrial long life grade	-40 to +85	47 000 to 680	6.3 to 63
industrial long life grade	-40 to +85	4700 to 150	250 and 385

type	series number	application
<p>Large</p> 	<p>106 107</p>	<p>industrial military</p> <p>long life grade</p>
<p>Small Solid electrolyte</p> 	<p>121</p>	<p></p> <p>military industrial long life grade</p> <p>industrial long life grade</p>
<p>Small, resin dipped Solid electrolyte</p> 	<p>122</p>	<p></p> <p>general industrial long life grade</p>

Mullard



**WET & SOLID
ELECTROLYTIC
CAPACITORS**

category temperature °C	nominal capacitance μF	rated voltage (U _p) V
-40 to +85 (106) -25 to +85 (107)	150 000 to 1500	6.3 to 100
-55 to +125	330 to 2.2	6.3 to 40
-55 to +125	33 to 2.2	50
-55 to +125	68 to 0.1	6.3 to 40

ALUMINIUM ELECTROLYTIC CAPACITORS

miniature — axial leads — insulated

Suitable for coupling, decoupling and general purpose applications.
The 015 Series is also available to BS9078 F003.

QUICK REFERENCE DATA

Capacitance range (E6 Series)	1 to 470 μ F
Capacitance tolerance	-10 to +50%
Rated voltage range (R5 Series)	4 to 63 V
Climatic category (IEC 68)	
015 Series	25/085/56
016 Series	40/085/56

ELECTROLYTE

Impregnated into high purity grade paper.

CASING

Aluminium can, insulated with a plastic sleeve and sealed with a s.r.b.p. and rubber faced disc.

TERMINATIONS

Axial leads of tinned copper wire 0.6 mm diameter for can sizes 2 and 3, with 0.8 mm for can sizes 4 to 6 (see DIMENSIONS).

PACKING

The capacitors are supplied on a continuous tape (bandolier) conforming to Fig.2 either in boxes or on reels. ←

SPECIAL FEATURES

The use of high etch factor foils, together with improved electrolyte, enables the capacitors to be produced with both wide operating temperatures and high capacitance per can size.



QUICK SELECTION CHART

D8217

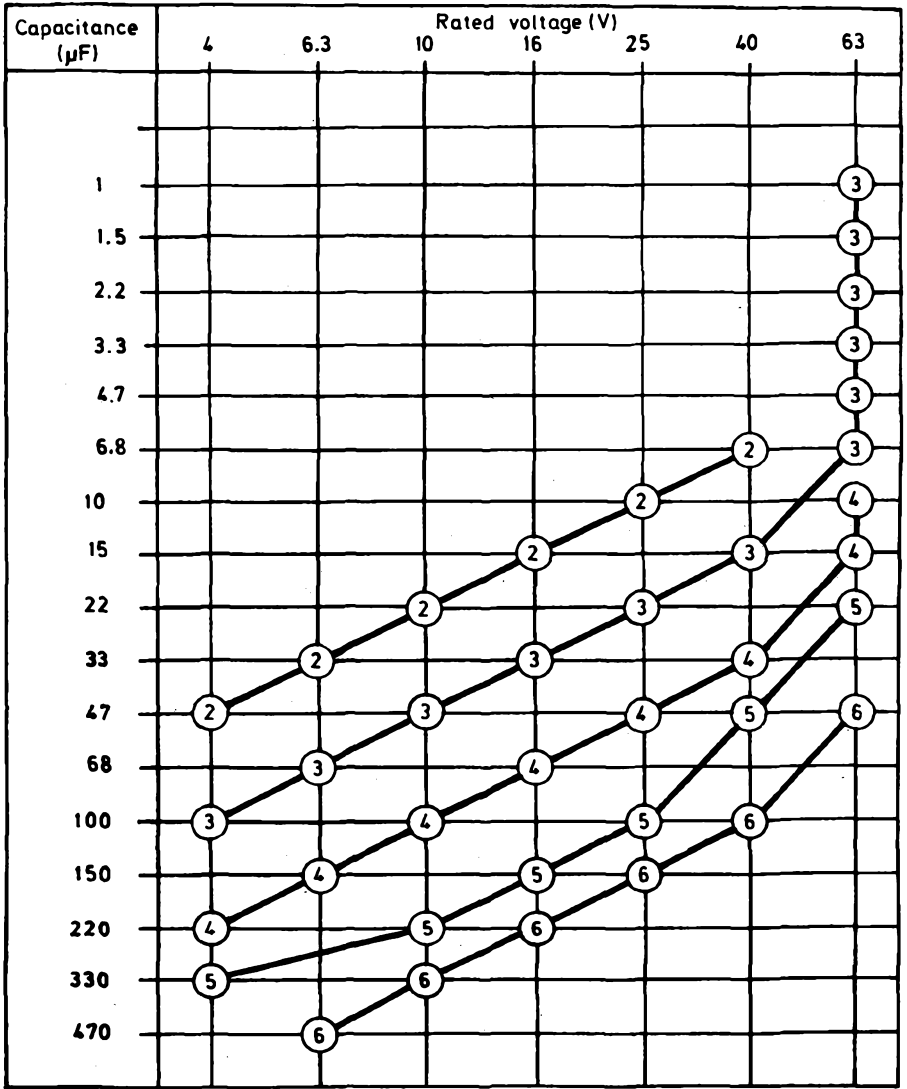

MECHANICAL DATA

Dimensions in mm

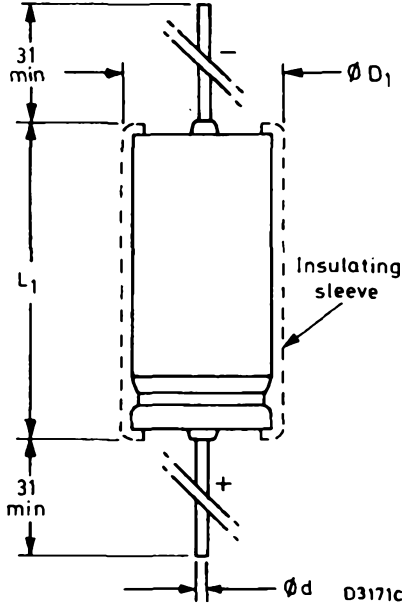

Fig.1

can size	dimensions in mm			typical weight (g)
	L_1 max.	D_1 max.	d nom.	
2	10.5	5.0	0.6	0.5
3	10.5	6.3	0.6	0.7
4	18.5	6.9	0.8	1.5
5	18.5	8.5	0.8	2.0
6	18.5	10.5	0.8	2.7



→ ELECTRICAL DATA

Unless otherwise stated, all parameters apply at an ambient temperature of 20 ± 5 °C, a frequency of 100 Hz, an atmospheric pressure of 10^5 Pa (1000 mbars) and a relative humidity of 75% maximum.

rated voltage U_R (notes 1 and 2)	capacitance (-10 to +50%)	can size	max. leakage current (note 3)	max. permissible ripple current (at 85 °C) (note 4)	max. tangent of loss angle	max. h.f. impedance (f = 100 kHz)	type number	
							com-ponents in boxes	com-ponents on reels
(V)	(μ F)		(μ A)	(mA)	(tan δ)	(Ω)		
4	47	2	10	26	0.40	6.8	015 32479	015 22479
	100	3	20	44	0.40	3.4	015 32101	015 22101
	220	4	9	85	0.38	0.8	016 32221	016 22221
	330	5	12	125	0.38	0.55	016 32331	016 22331
6.3	33	2	11	26	0.32	6.8	015 33339	015 23339
	68	3	22	44	0.32	3.4	015 33689	015 23689
	150	4	10	85	0.30	0.8	016 33151	016 23151
	470	6	22	190	0.30	0.3	016 33471	016 23471
10	22	2	11	26	0.26	6.8	015 34229	015 24229
	47	3	24	44	0.26	3.4	015 34479	015 24479
	100	4	10	85	0.24	0.8	016 34101	016 24101
	220	5	18	125	0.24	0.55	016 34221	016 24221
	330	6	24	190	0.24	0.3	016 34331	016 24331
16	15	2	12	26	0.18	6.3	015 35159	015 25159
	33	3	27	44	0.18	3.4	015 35339	015 25339
	68	4	11	85	0.17	0.8	016 35689	016 25689
	150	5	19	125	0.17	0.55	016 35151	016 25151
	220	6	26	190	0.17	0.3	016 35221	016 25221
25	10	2	13	23	0.15	6.8	015 36109	015 26109
	22	3	28	37	0.15	3.4	015 36229	015 26229
	47	4	12	72	0.14	0.8	016 36479	016 26479
	100	5	19	105	0.14	0.55	016 36101	016 26101
	150	6	27	155	0.14	0.3	016 36151	016 26151
40	6.8	2	14	23	0.12	6.8	015 37688	015 27688
	15	3	30	37	0.12	3.4	015 37159	015 27159
	33	4	12	72	0.11	0.8	016 37339	016 27339
	47	5	16	105	0.11	0.55	016 37479	016 27479
	100	6	28	155	0.11	0.3	016 37101	016 27101



ELECTRICAL DATA (continued)

rated voltage U_R (notes 1 and 2)	capacitance (-10 to +50%)	can size	max. leakage current (note 3)	max. permissible ripple current (at 85 °C) (note 4)	max. tangent of loss angle	max. h.f. impedance ($f = 100$ kHz)	type number	
							com- ponents in boxes	com- ponents on reels
(V)	(μ F)		(μ A)	(mA)	($\tan \delta$)	(Ω)		
63	1	3	5	10	0.09	5	015 38108	015 28108
	1.5	3	5	12	0.09	4.5	015 90043	015 90041
	2.2	3	7	15	0.09	3.5	015 38228	015 28228
	3.3	3	11	17	0.09	3.5	015 38338	015 28338
	4.7	3	15	22	0.09	3.5	015 90044	015 90042
	6.8	3	22	25	0.09	3.5	015 38688	015 28688
	10	4	7	44	0.09	0.95	016 38109	016 28109
	15	4	10	55	0.09	0.8	016 38159	016 28159
	22	5	13	80	0.09	0.55	016 38229	016 28229
	47	6	22	115	0.09	0.3	016 38479	016 28479

Notes

1. Rated voltage is the sum of the direct voltage plus the peak ripple voltage. The peak ripple voltage relates to the maximum ripple current at 85 °C. The capacitors may be operated on an alternating voltage (without a direct voltage present), up to the value shown in the table below:

	voltage (V)						
rated voltage (U_R)	4	6.3	10	16	25	40	63
r.m.s. voltage	0.4	0.63	1	1	1	1	1

2. A surge voltage may be applied for a maximum of 1 minute per hour. The rated voltage plus surge voltage equals the maximum permissible voltage as shown in the table below:

	voltage (V)						
rated voltage (U_R)	4	6.3	10	16	25	40	63
maximum permissible voltage at $T_{amb} \leq 40$ °C	5.1	7.9	12.7	20.2	31.7	50.6	79.8
maximum permissible voltage at $T_{amb} > 40$ °C	4.6	7.2	11.5	18.4	28.8	46	72.5



Capacitors are supplied on continuous bandolier tape to facilitate automatic handling by either crop and form processing or by fully automatic insertion.

→ The basic dimensions of the bandoliers and reels are given below.

BANDOLIERS

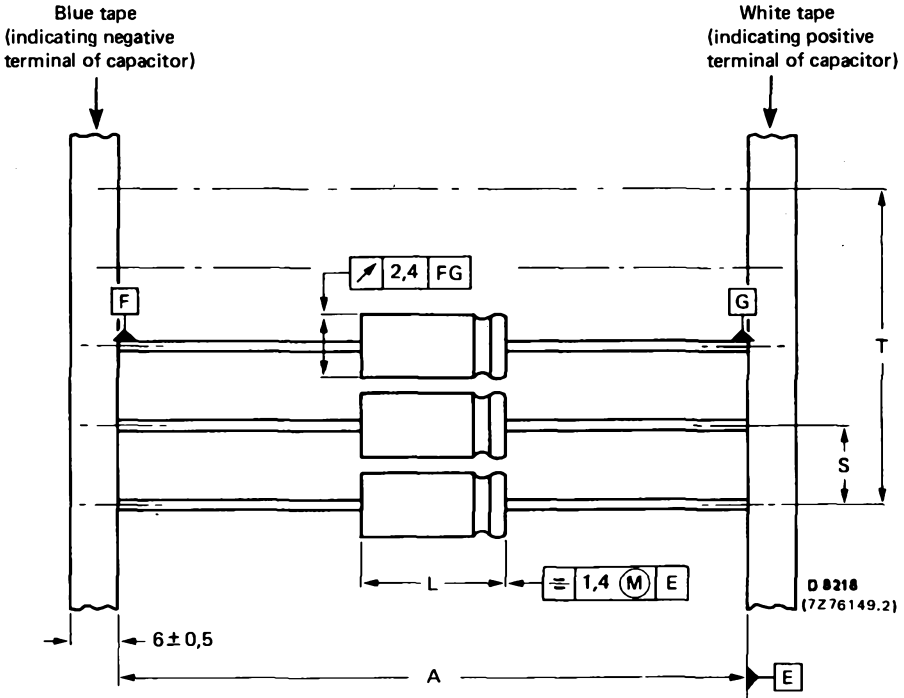

Fig.2

Table (dimensions in mm)

size	A	S	T for number (n) of capacitors		L _{max}
			n < 50	50 < n < 100	
2	63.5 ± 1.6	5 ± 0.4	5 (n-1) ± 2	5 (n-1) ± 4	10.5
3	63.5 ± 1.6	10 ± 0.4	10 (n-1) ± 2	10 (n-1) ± 4	10.5
4	73 ± 1.6	10 ± 0.4	10 (n-1) ± 2	10 (n-1) ± 4	18.5
5	73 ± 1.6	10 ± 0.4	10 (n-1) ± 2	10 (n-1) ± 4	18.5
6	73 ± 1.6	15 ± 0.75	15 (n-1) ± 2	15 (n-1) ± 4	18.5



REELS

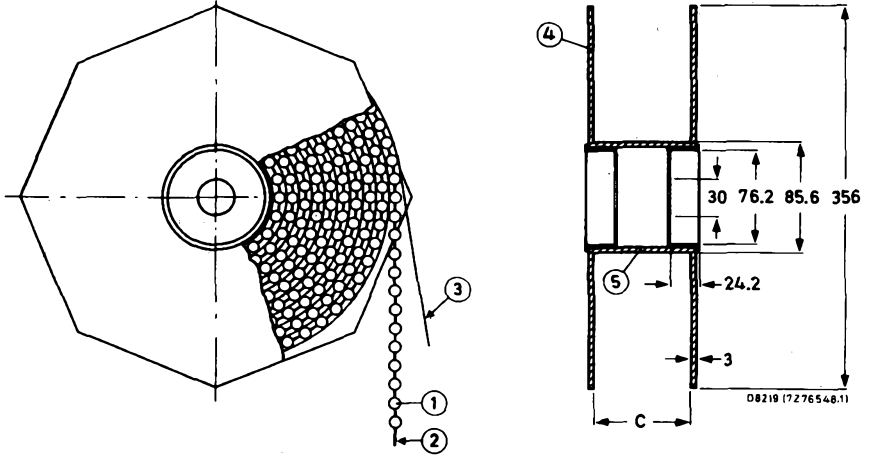

Dimension C is 84.5 mm for can sizes 2 and 3 and 88.0 mm for can sizes 4, 5 and 6, the overall width of the reel is 94.5 mm and 99.5 mm respectively.

- 1 = capacitor
- 2 = bandolier
- 3 = interleaving paper
- 4 = flange
- 5 = cylinder

Fig.3

→PACKING

Capacitors in bandoliers are supplied on reels or in boxes with a fixed number of components only, in accordance with the following table.

can size	reel quantity	box quantity
2	3000	1000
3	1000	1000
4	1000	1000
5	500	500
6	500	500



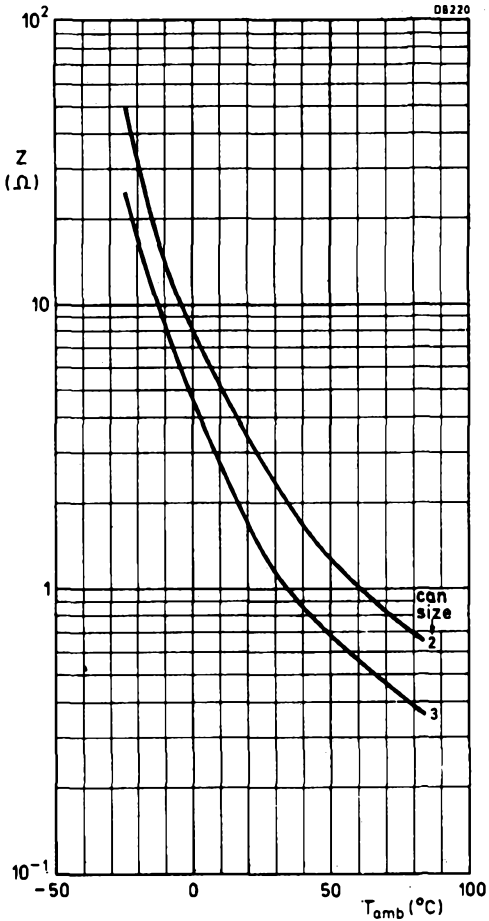

Fig.4 Impedance as a function of temperature at 100 kHz

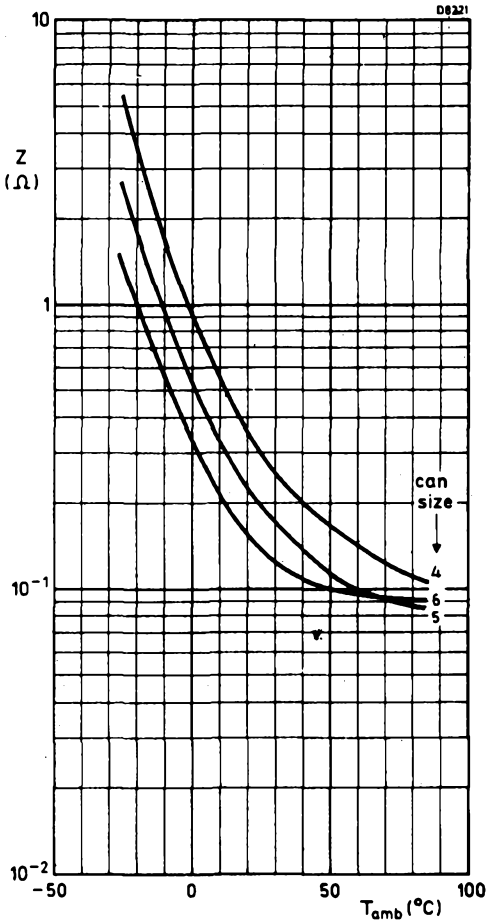

Fig.5 Impedance as a function of temperature at 100 kHz

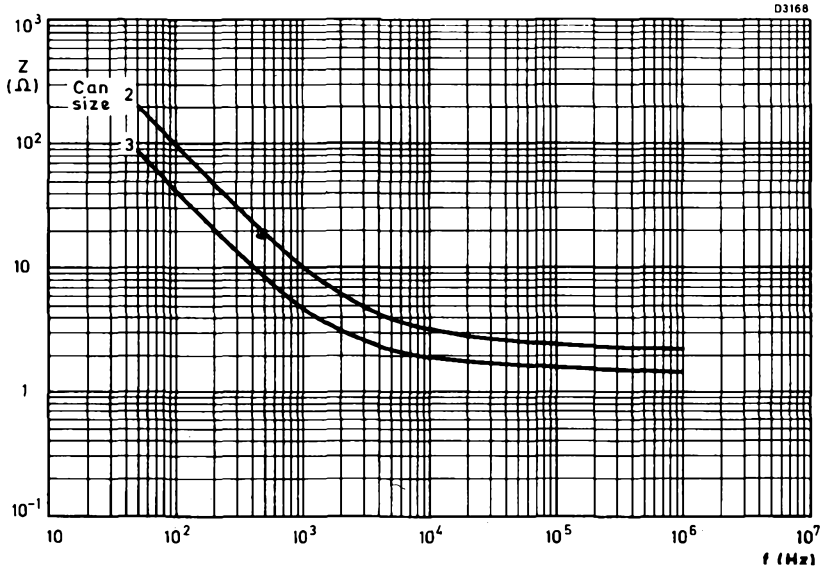

Fig.6 Typical impedance plotted against frequency, $T_{amb} = 20\text{ }^{\circ}\text{C}$

Can sizes 2 and 3

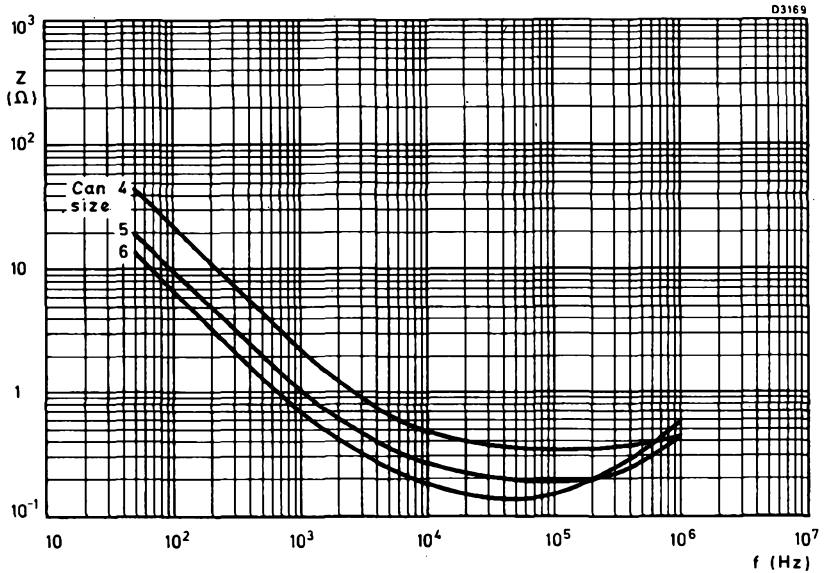

Fig.7 Typical impedance plotted against frequency, $T_{amb} = 20\text{ }^{\circ}\text{C}$.

Can sizes 4,5 and 6



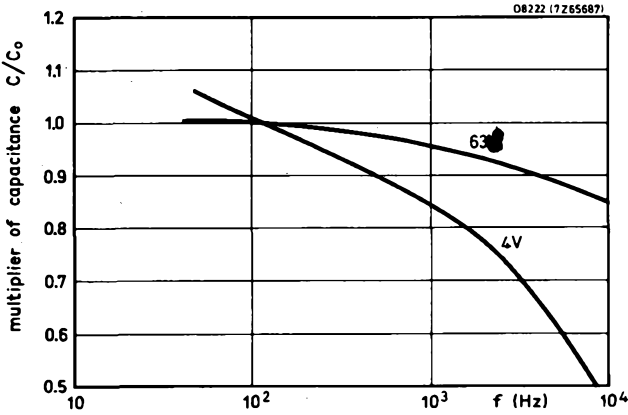

Fig.8 Typical capacitance as a function of frequency

Can sizes 2 and 3

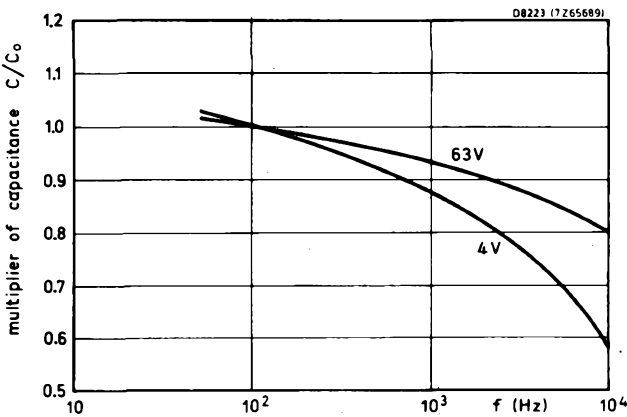

Fig.9 Typical capacitance as a function of frequency

Can sizes 4,5 and 6



ALUMINIUM ELECTROLYTIC CAPACITORS small — axial leads — insulated

Suitable for coupling and decoupling in general purpose applications.

QUICK REFERENCE DATA

Nominal capacitance range	68 to 4700 μ F
Tolerance on nominal capacitance	-10 to +50 %
Rated voltage range (U_R)	6.3 to 100 V
Climatic category	40/085/56

ELECTROLYTE

Porous paper spacer impregnated with an electrolyte.

CASING

Aluminium can sealed by a plastic disc and insulated with a blue plastic sleeve.

DESCRIPTION

The use of high etch factor foils, together with an improved electrolyte enables the capacitors to be produced with both wide operating temperature and high capacitance per can size. All internal connections are welded to allow high ripple current ratings.



SELECTION CHART

D8281a

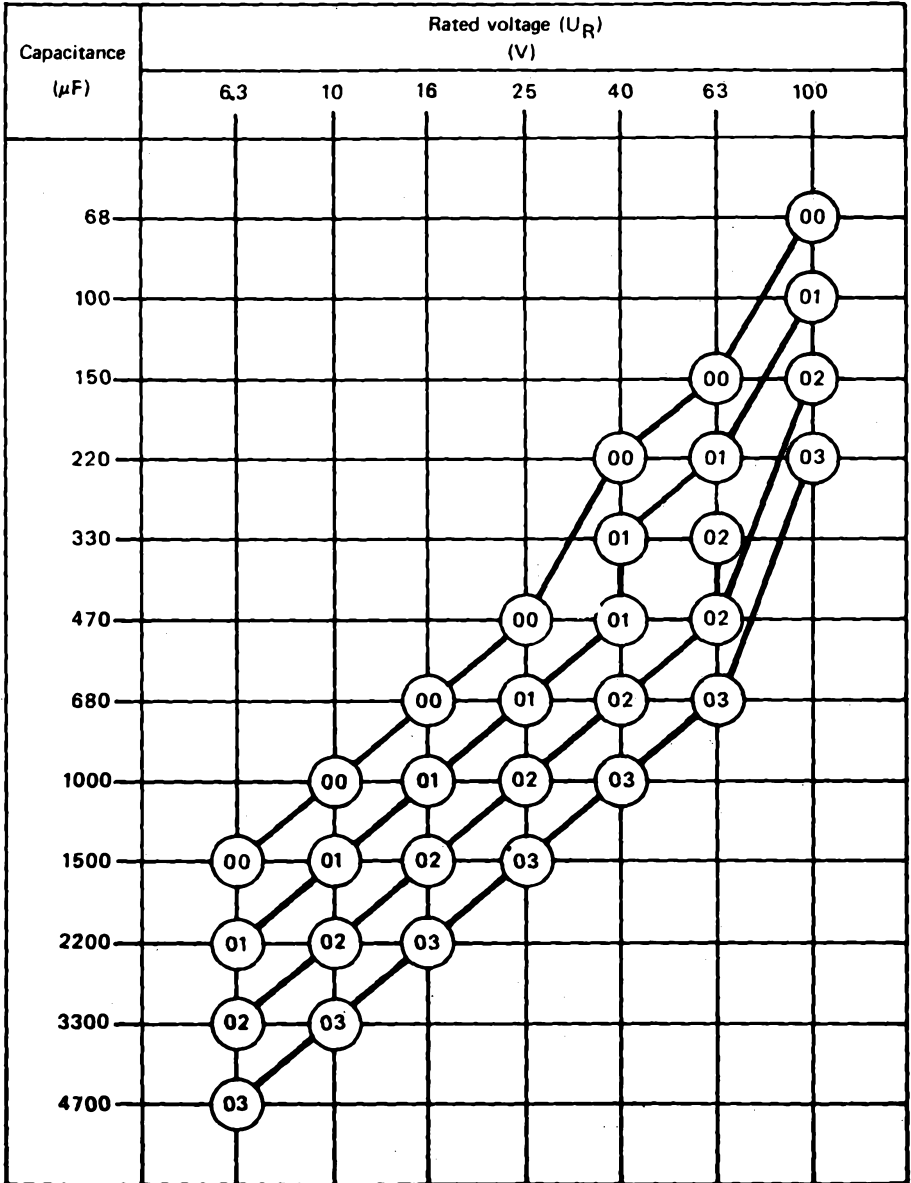

MECHANICAL DATA

Dimensions in mm

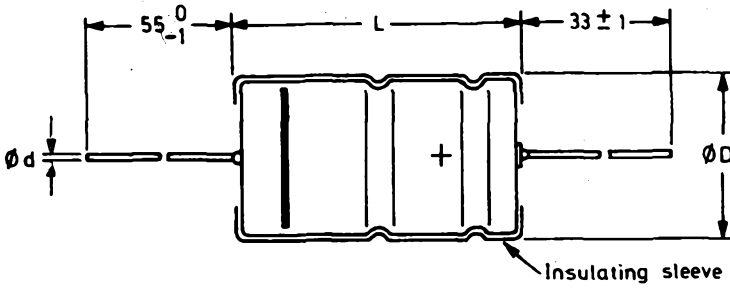

D8232

can size	D_{max}	L_{max}	d
00	10.5	30.5	0.8
01	13.0	30.5	0.8
02	15.5	30.5	0.8
03	18.5	30.5	0.8



ELECTRICAL DATA

Unless otherwise stated, all parameters apply at an ambient temperature of $20 \pm 5^\circ\text{C}$, a frequency of 100 Hz, an atmospheric pressure of 10^5 Pa (1000 mbars) and a relative humidity of 75% maximum.

U_R	nominal capacitance	maximum r.m.s. ripple current at $T_{\text{amb}} = 85^\circ\text{C}$	maximum leakage current at U_R after 5 min	maximum ESR	can size	type number
(V)	(μF)	(mA)	(μA)	(Ω)		
6.3	1500	450	61	0.299	00	032 13152
6.3	2200	610	87	0.214	01	032 13222
6.3	3300	790	129	0.153	02	032 13332
6.3	4700	1000	182	0.117	03	032 13472
10	1000	430	64	0.320	00	032 14102
10	1500	570	94	0.245	01	032 14152
10	2200	740	136	0.177	02	032 14222
10	3300	950	202	0.128	03	032 14332
16	680	400	70	0.382	00	032 15681
16	1000	550	100	0.260	01	032 15102
16	1500	680	148	0.205	02	032 15152
16	2200	880	216	0.150	03	032 15222
25	470	360	75	0.468	00	032 16471
25	680	500	106	0.323	01	032 16681
25	1000	660	154	0.220	02	032 16102
25	1500	810	229	0.179	03	032 16152
40	220	260	57	0.864	00	032 17221
40	330	370	84	0.576	01	032 17331
40	470	440	117	0.404	01	032 17471
40	680	580	167	0.279	02	032 17681
40	1000	780	244	0.190	03	032 17102
63	150	260	61	0.900	00	032 18151
63	220	350	88	0.614	01	032 18221
63	330	480	129	0.409	02	032 18331
63	470	570	182	0.287	02	032 18471
63	680	770	261	0.199	03	032 18681
100	68	130	45	3.53	00	032 19689
100	100	190	64	2.40	01	032 19101
100	150	250	94	1.6	02	032 19151
100	220	330	136	1.09	03	032 19221

Endurance test

After application of the rated voltage for 2000 hours at $+85^\circ\text{C}$

Capacitance: Within 15% of the initial measured value

Leakage current: Less than the initial specified value.

Tan δ (dissipation factor)

Tan $\delta = \text{ESR} \times \omega C$



Temperature range

Category temperature range

-40 to +85 °C

CAPACITANCE

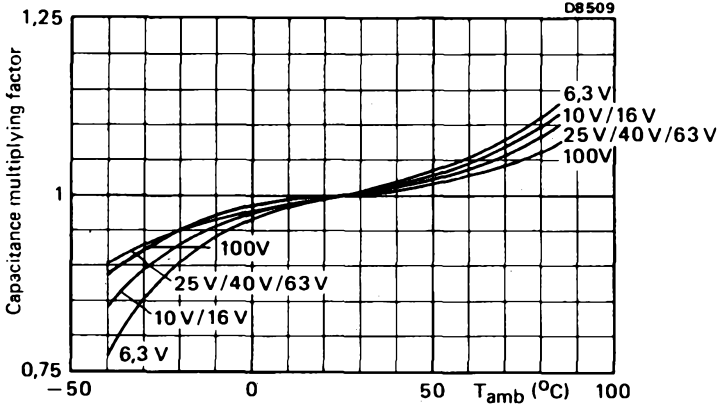

Fig.5 Typical capacitance as a function of ambient temperature

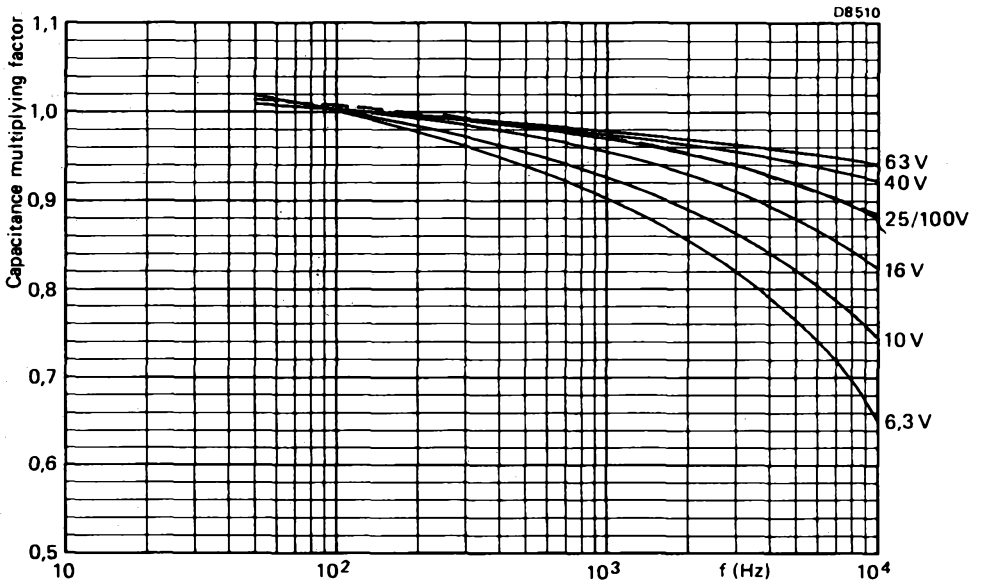

Fig.6 Typical capacitance as a function of frequency



Voltage

Rated voltage = maximum permissible voltage

Ripple voltage* = maximum permissible a.c. voltage providing the following three conditions are met:

- a) maximum (d.c. + peak a.c.) voltage
- b) maximum peak a.c. voltage with d.c. voltage applied
- c) maximum peak a.c. voltage without d.c. voltage supplied

Surge voltage = maximum permissible voltage for short periods

Reverse voltage = maximum d.c. voltage applied in the reverse polarity at the maximum category temperature for short periods

Ripple current**

Maximum permissible r.m.s. ripple current at 100 Hz and $T_{amb} = 85\text{ }^{\circ}\text{C}$

< 40 °C	40 to 85 °C
$1.1 \times U_R$	U_R
$\leq 1.1 \times U_R$	$\leq U_R$
$\leq \text{applied d.c. voltage} + 1\text{ V}$	1 V
	$1.15 \times U_R$
	1 V

see page 4

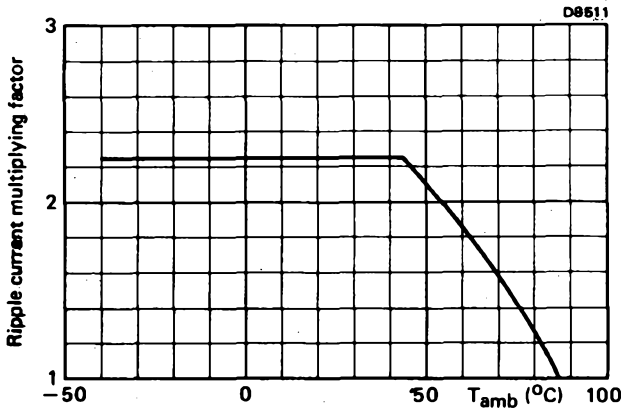

Fig. 7 Typical ripple current as a function of ambient temperature at 100 Hz

- * Ripple voltages are not applicable if the maximum permissible ripple current is exceeded. In that case the ripple current is decisive.
- ** Ripple currents are not applicable if the maximum permissible ripple voltage is exceeded. In that case the ripple voltage is decisive.



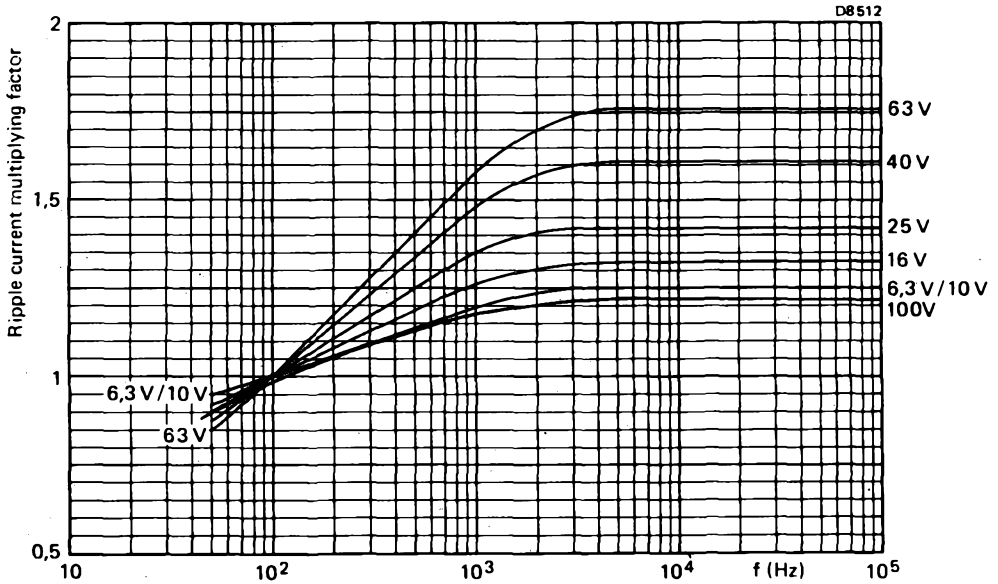

Fig.8 Typical ripple current as a function of frequency

Charge and discharge current

The capacitors may be charged from a source without internal resistance and they may be discharged by short-circuiting. If the capacitors are charged and discharged continuously at a rate of several times per minute, the charge and discharge currents have to be considered as ripple currents flowing through the capacitor. The r.m.s. value of these currents should be determined and the value thus found must not exceed the applicable limit.



Leakage current

Maximum leakage current 5 min after application of the rated voltage at $T_{amb} = 25\text{ }^{\circ}\text{C}$

see page 4 (0.006 CU + 4 μA)

Leakage current during continuous operation at U_R , at $T_{amb} = 25\text{ }^{\circ}\text{C}$

approx. 0.01 of value stated on page 4.

at $T_{amb} = 85\text{ }^{\circ}\text{C}$

\leq value stated on page 4

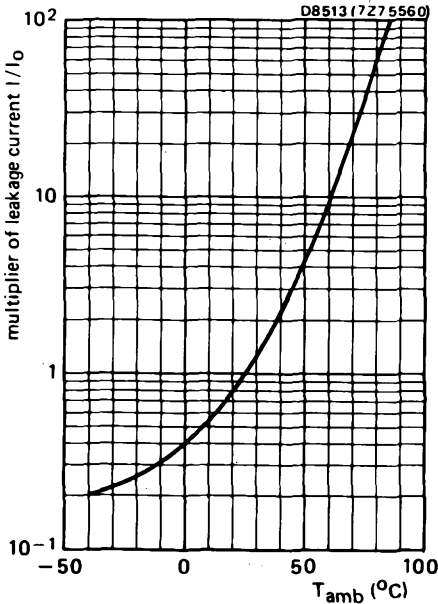

Fig.9 Typical leakage current as a function of ambient temperature; I_0 = leakage current during continuous operation at 25 $^{\circ}\text{C}$ and U_R .

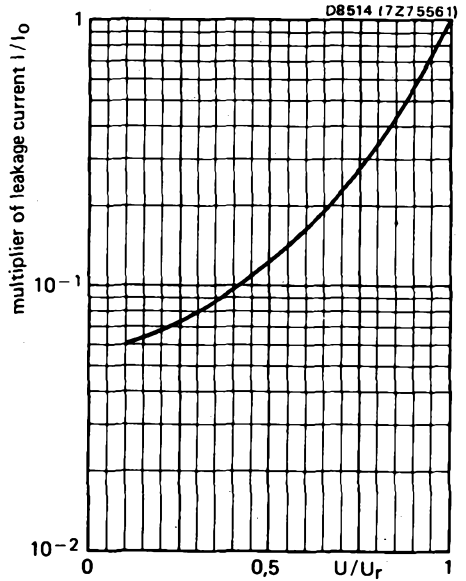

Fig.10 Typical leakage current as a function of U/U_R ; I_0 = leakage current during continuous operation at 25 $^{\circ}\text{C}$ and U_R .



Equivalent series resistance (ESR)

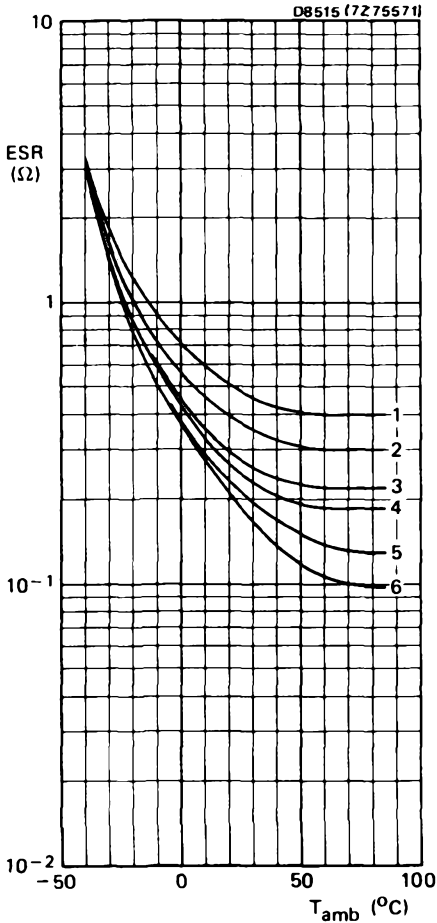

Fig.11 Typical ESR as a function of ambient temperature at 100 Hz

Can size 00:

- curve 1 = 150 μF , 63 V;
- curve 2 = 220 μF , 40 V;
- curve 3 = 470 μF , 25 V;
- curve 4 = 680 μF , 16 V;
- curve 5 = 1000 μF , 10 V;
- curve 6 = 1500 μF , 6.3 V.

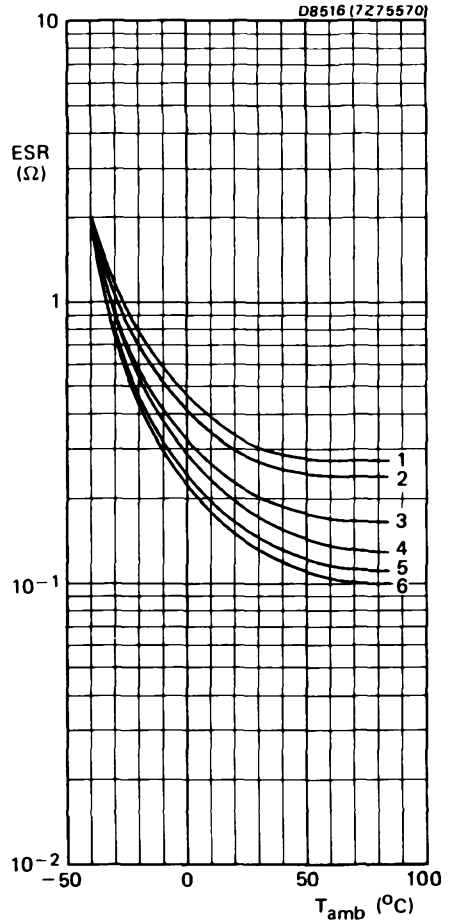

Fig.12 Typical ESR as a function of ambient temperature at 100 Hz

Can size 01:

- curve 1 = 220 μF , 63 V;
- curve 2 = 330 μF , 40 V;
- curve 3 = 470 μF , 40 V;
- curve 4 = 680 μF , 25 V;
- curve 5 = 1000 μF , 16 V;
- curve 6 = 1500 μF , 10 V and 2200 μF , 6.3 V.



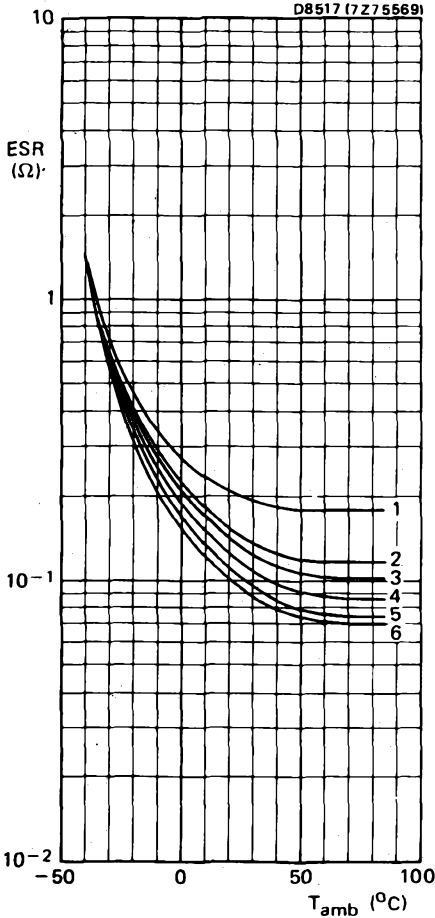

Fig.13 Typical ESR as a function of ambient temperature at 100 Hz

Can size 02:

- curve 1 = 330 μ F, 63 V;
- curve 2 = 470 μ F, 63 V;
- curve 3 = 680 μ F, 40 V;
- curve 4 = 1000 μ F, 25 V;
- curve 5 = 1500 μ F, 16 V;
- curve 6 = 2200 μ F, 10 V and 3300 μ F, 6.3 V

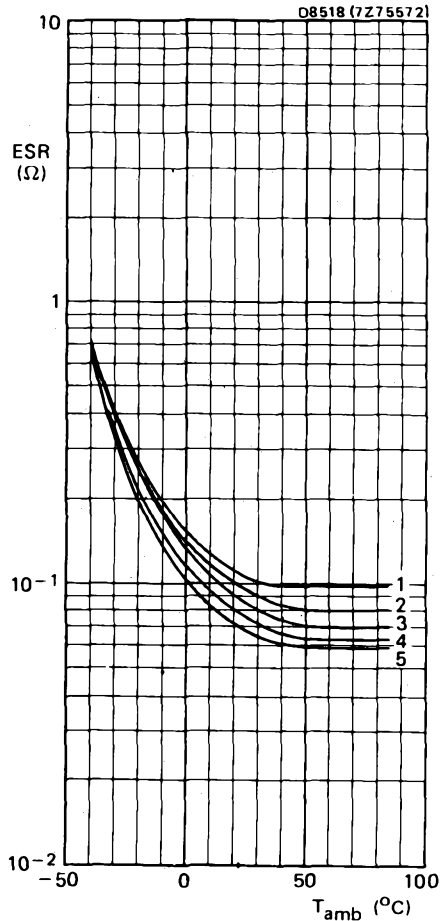

Fig.14 Typical ESR as a function of ambient temperature at 100 Hz.

Can size 03:

- curve 1 = 680 μ F, 63 V;
- curve 2 = 1000 μ F, 40 V;
- curve 3 = 1500 μ F, 25 V;
- curve 4 = 2200 μ F, 16 V;
- curve 5 = 3300 μ F, 10 V and 4700 μ F, 6.3 V



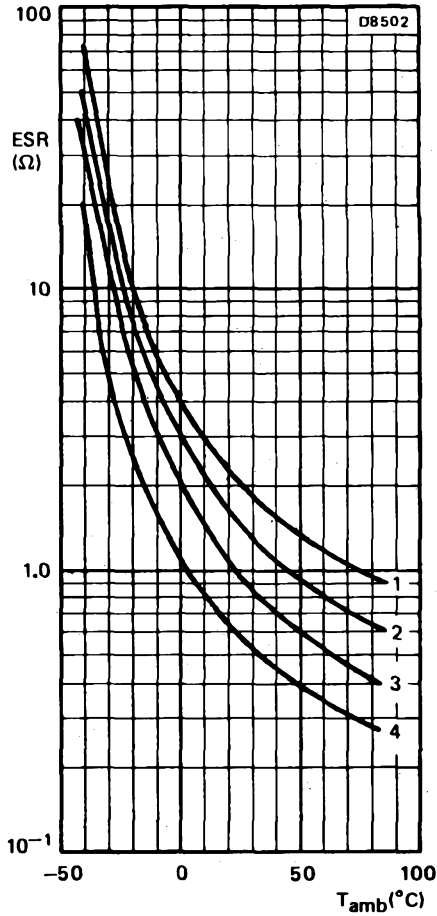

Fig.15 Typical ESR as a function of ambient temperature at 100 Hz.

curve 1 = 68 μ F, 100 V, can size 00
 curve 2 = 100 μ F, 100 V, can size 01
 curve 3 = 150 μ F, 100 V, can size 02
 curve 4 = 220 μ F, 100 V, can size 03



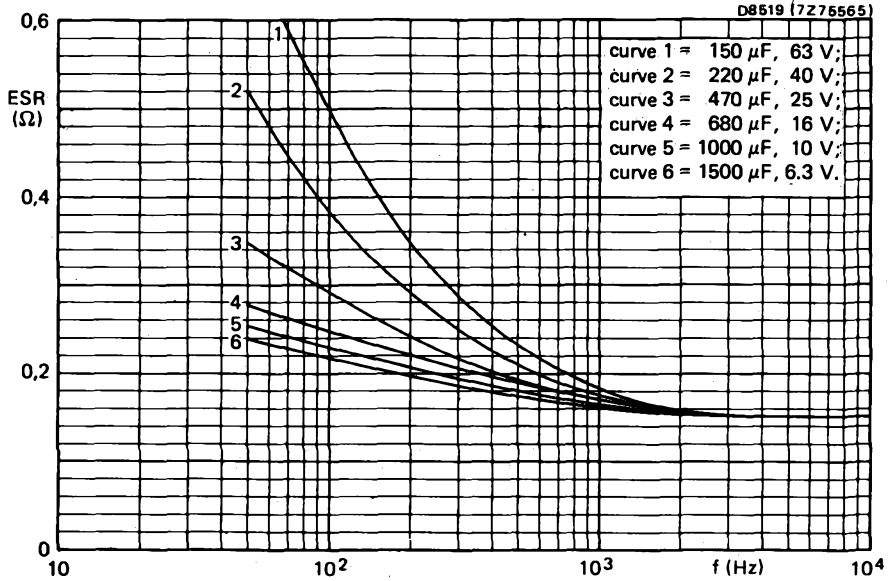

Fig.16 Typical ESR as a function of frequency at 25 °C

Can size 00

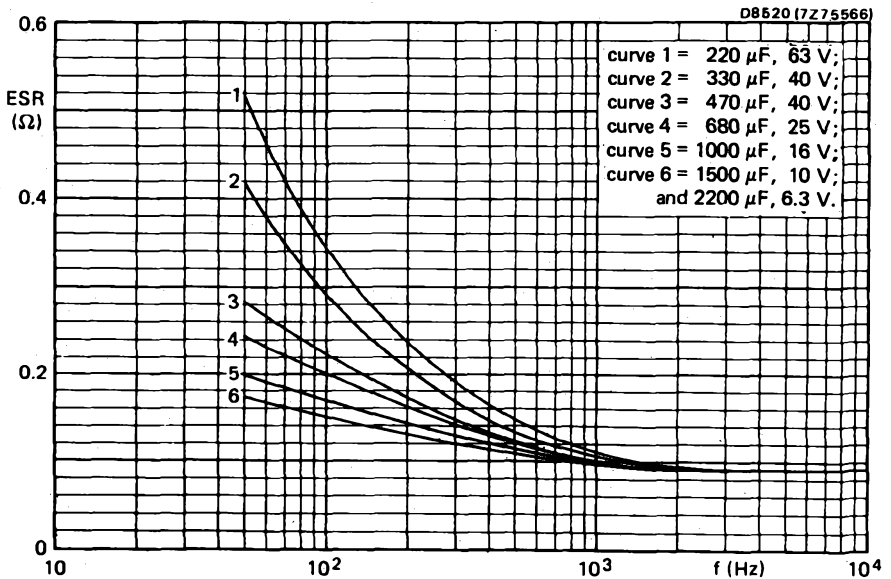

Fig.17 Typical ESR as a function of frequency at 25 °C

Can size 01



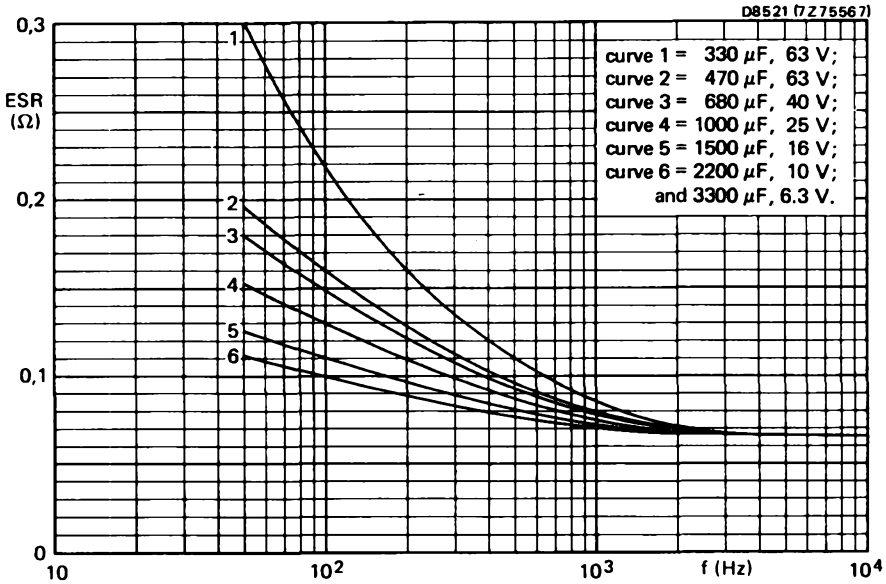

Fig.18 Typical ESR as a function of frequency at 25 °C

Can size 02

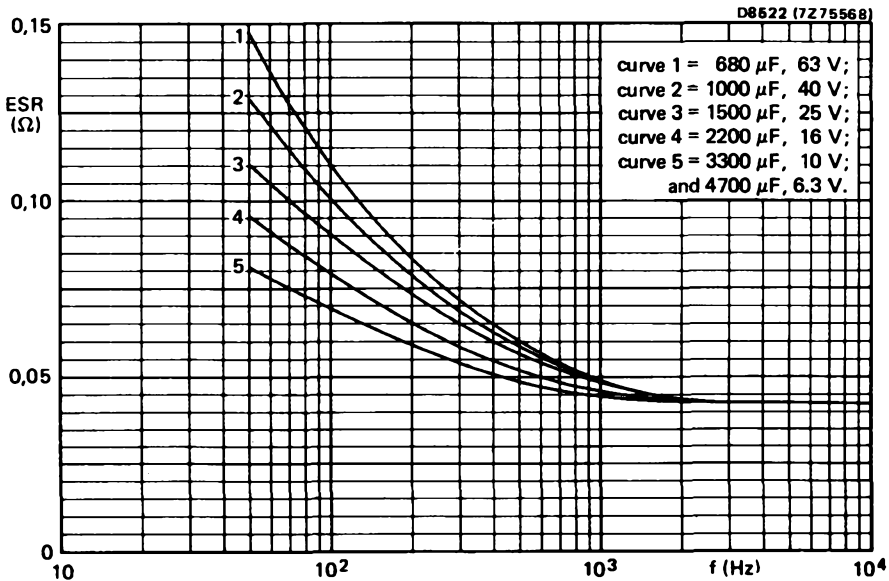

Fig.19 Typical ESR as a function of frequency at 25 °C

Can size 03



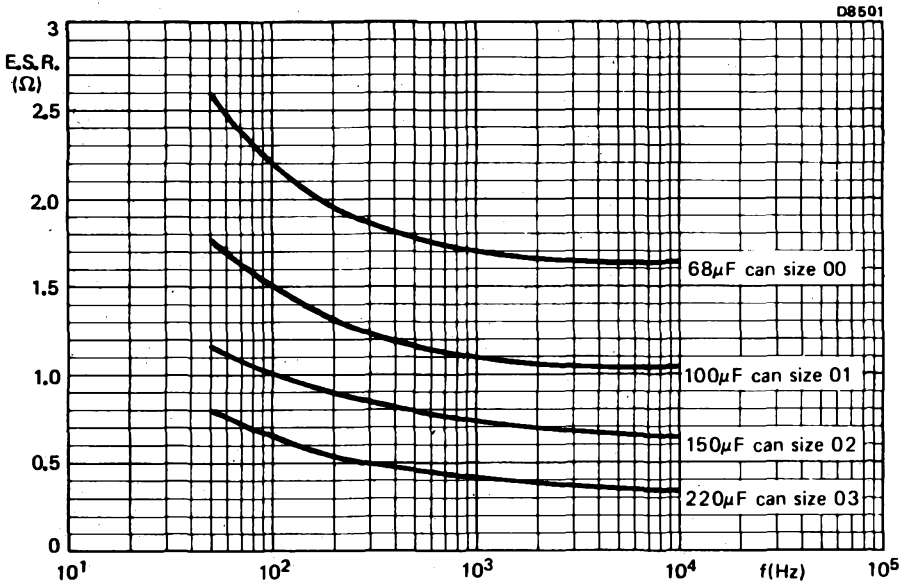

Fig.20 Typical ESR as a function of frequency at 25 °C

100 V versions



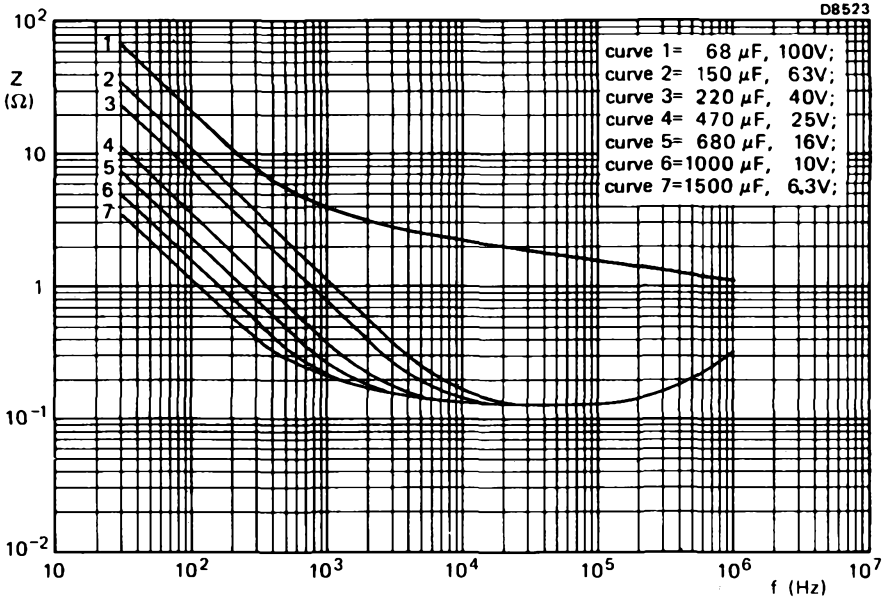

Fig.21 Typical impedance as a function of frequency at 25 °C

Can size 00

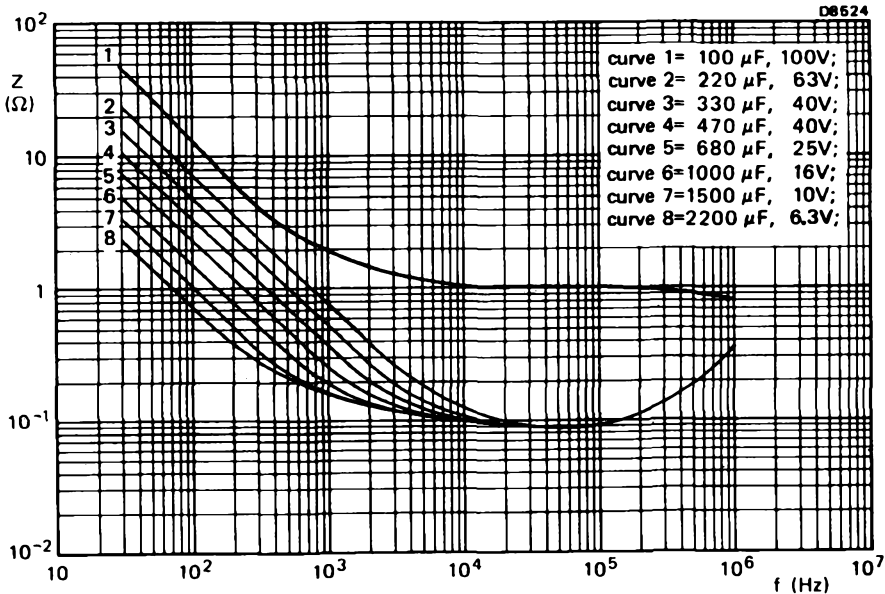

Fig.22 Typical impedance as a function of frequency at 25 °C

Can size 01



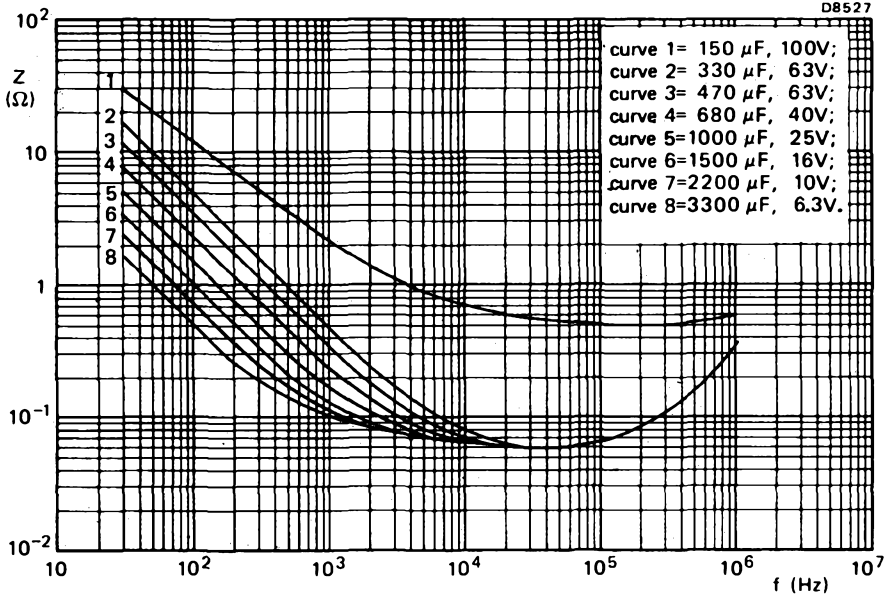

Fig.23 Typical impedance as a function of frequency at 25 °C

Can size 02

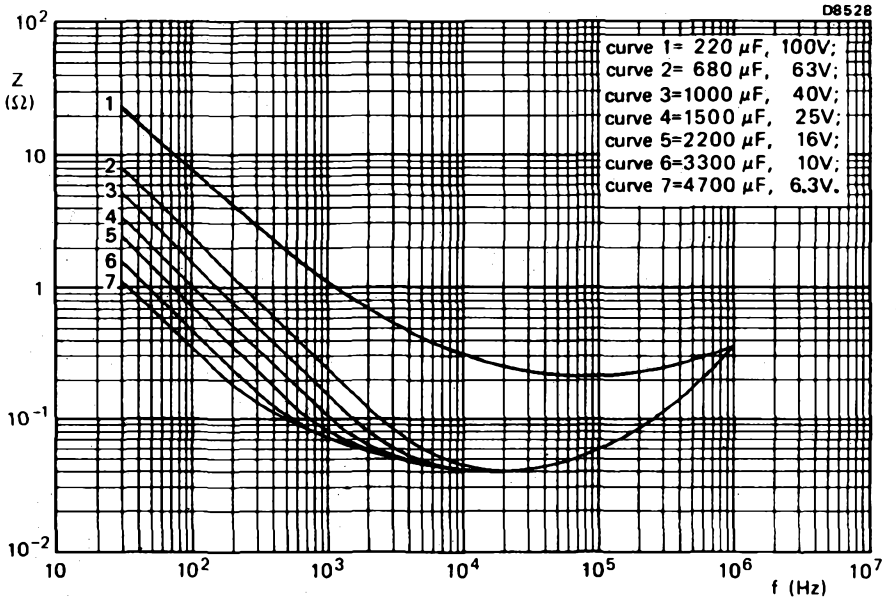

Fig.24 Typical impedance as a function of frequency at 25 °C

Can size 03



ALUMINIUM ELECTROLYTIC CAPACITORS

- Small type
- Axial leads or single ended
- Long life
- General and industrial applications

QUICK REFERENCE DATA

Nominal capacitance range (E6 series)	1000 to 10 000 μF
Tolerance on nominal capacitance	-10 to + 50%
Rated voltage range, U_R (R5 series)	6,3 to 63 V
Category temperature range	-40 to + 85 $^{\circ}\text{C}$
Endurance test at 85 $^{\circ}\text{C}$	2000 h
Basis specifications	IEC 384-4, long-life grade DIN 41316
Climatic category	
IEC 68	40/085/56
DIN 40040	GPF

Selection chart for $C_{\text{nom}} \cdot U_R$ and relevant case sizes.

C_{nom} μF	U_R (V)					
	6,3	10	16	25	40	63
1000						05
1500					04	
2200				04	05	
3300			04	05		
4700		04	05			
6800	04	05				
10000	05					

case size	nominal dimensions (mm)
04	\emptyset 18 x 40
05	\emptyset 21 x 40

APPLICATION

These capacitors with high CU-product per unit volume are mainly used for smoothing, coupling and decoupling purposes in consumer applications, such as audio and television circuits, and in other applications such as measuring, regulating, timing and delay circuits.



DESCRIPTION

The capacitor has etched aluminium-foil electrodes rolled up with a porous paper spacer which separates the anode and the cathode. The spacer is impregnated with an electrolyte which is the electrical connection between dielectric and cathode foil and retains its good characteristics both at low and at high temperatures. The capacitor is housed in an aluminium case.

The capacitor is available in 2 styles, all with soldered-copper leads.

Style 1: axial leads; case insulated with a blue plastic sleeve.

Style 2: single ended; with mounting ring with printed-wiring pins; especially for use in applications with severe shocks and vibrations.

MECHANICAL DATA

Dimensions in mm

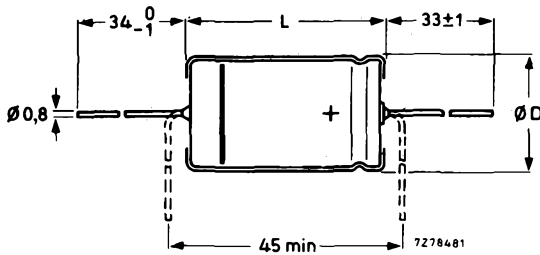

Fig. 1 Style 1; see Table 1a for dimensions D and L.

Table 1a

case size	style 1				approx. mass g
	D _{nom}	L _{nom}	D _{max}	L _{max}	
04	18	40	18,5	41,5	14
05	21	40	21,5	41,5	19



Table 1b

case size	style 2		
	D1	D2 _{max}	D3
04	18	20,5	18,5
05	21	23,5	21,5
			} ± 0,2

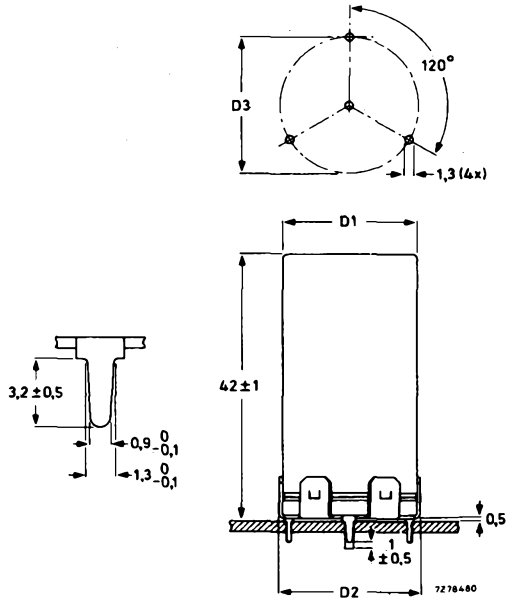

Fig. 2 Style 2; see Table 1b for dimensions D1, D2, D3.

Marking

The capacitors are marked with:
 nominal capacitance;
 tolerance on nominal capacitance;
 rated voltage;
 group number 033; code of origin;
 name of manufacturer;
 date code (year and month) according to IEC 62;
 band to identify the negative terminal.

Mounting

The diameter of the mounting holes in the printed-wiring board is 1 + 0,1 mm for style 1 capacitors, and 1,3 + 0,1 mm for style 2 capacitors.



ELECTRICAL DATA

Table 2

Unless otherwise specified all electrical values in Table 2 apply at an ambient temperature of 20 to 25 °C, a frequency of 100 Hz, an atmospheric pressure of 860 to 1060 mbar and a relative humidity of 45 to 75%.

U _R	nom. cap.	max. r.m.s. ripple current at T _{amb} = 85 °C mA	max. leakage current at U _R after 5 min μA	max. ESR mΩ	case size	catalogue number 2222 033 followed by	
	μF					style 1	style 2
6,3	6 800	1280	261	91	04	13682	43682
6,3	10 000	1570	382	72	05	13103	43103
10	4 700	1220	286	100	04	14472	44472
10	6 800	1500	412	79	05	14682	44682
16	3 300	1160	321	111	04	15332	45332
16	4 700	1430	455	87	05	15472	45472
25	2 200	1060	334	132	04	16222	46222
25	3 300	1340	499	99	05	16332	46332
40	1 500	970	364	159	04	17152	47152
40	2 200	1220	532	118	05	17222	47222
63	1 000	1140	382	135	05	18102	48102



Capacitance

Nominal capacitance values at 100 Hz and $T_{amb} = 25\text{ }^{\circ}\text{C}$

see Table 2

Tolerance on nominal capacitance at 100 Hz

-10 to +50%

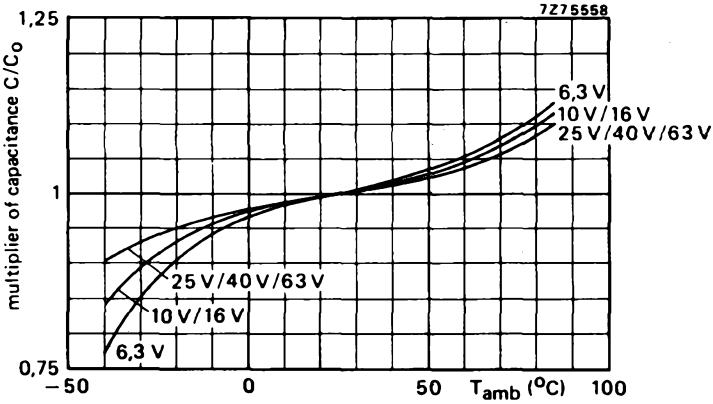

Fig. 3 Typical capacitance as a function of ambient temperature; C_0 = capacitance at $25\text{ }^{\circ}\text{C}$, 100 Hz.

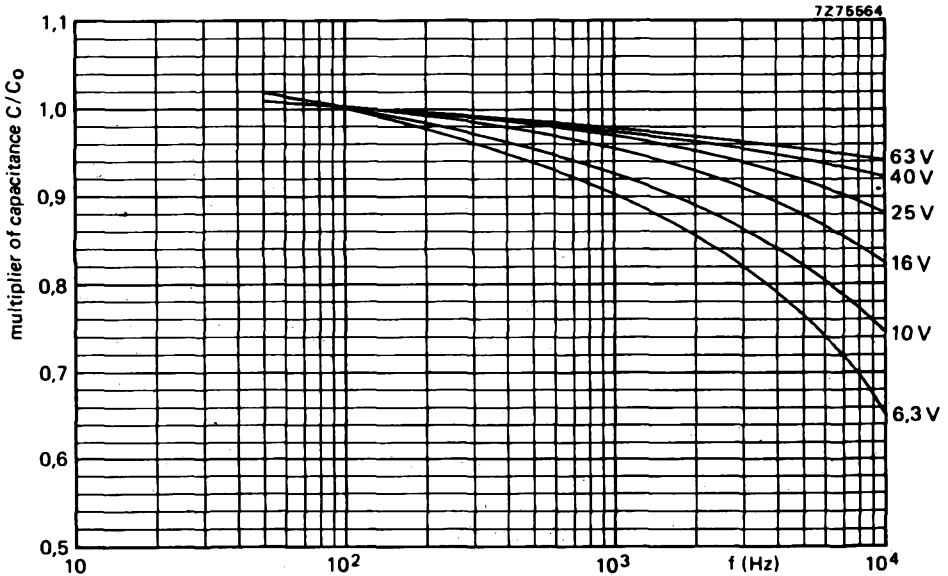

Fig. 4 Typical capacitance as a function of frequency; C_0 = capacitance at $25\text{ }^{\circ}\text{C}$, 100 Hz.



Voltage

Rated voltage = max. permissible voltage

Ripple voltage * = max. permissible a.c. voltage providing the following three conditions are met:

- a) max. (d.c. + peak a.c.) voltage
- b) max. peak a.c. voltage with d.c. voltage applied
- c) max. peak a.c. voltage without d.c. voltage applied

Surge voltage = max. permissible voltage for short periods

Reverse voltage = max. d.c. voltage applied in the reverse polarity at the maximum category temperature for short periods

< 40 °C	40 to 85 °C
$1,1 \times U_R$	U_R
$\leq 1,1 \times U_R$	$\leq U_R$
$\leq \text{applied d.c. voltage} + 1 \text{ V}$	1 V
	$1,15 \times U_R$
	1 V

Ripple current **

Maximum permissible r.m.s. ripple current at 100 Hz and $T_{amb} = 85 \text{ °C}$

see Table 2

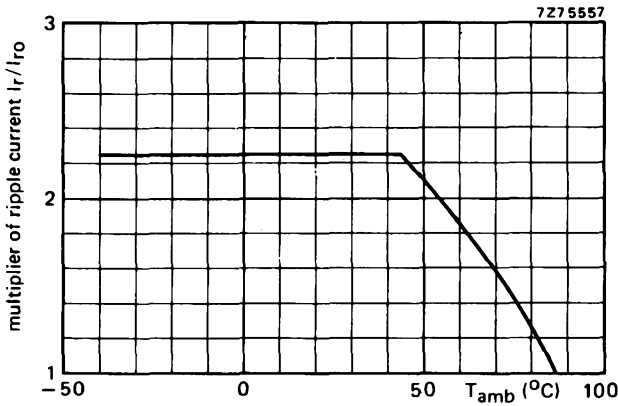

Fig. 5 Typical ripple current as a function of ambient temperature; I_{r0} = ripple current at 85 °C, 100 Hz.

* Ripple voltages are not applicable if the maximum permissible ripple current is exceeded. In that case the ripple current is decisive.

** Ripple currents are not applicable if the maximum permissible ripple voltage is exceeded. In that case the ripple voltage is decisive.



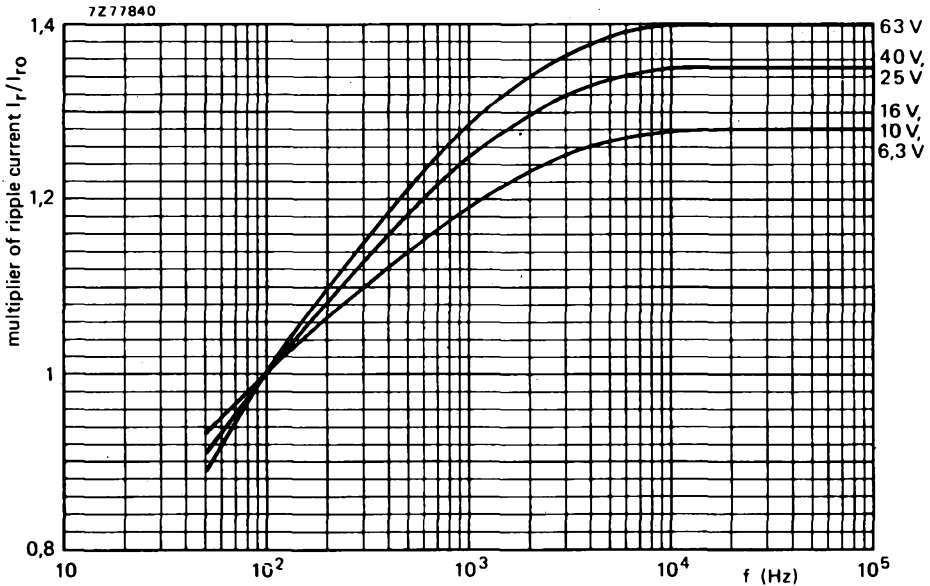

Fig. 6 Typical ripple current as a function of frequency; I_{r0} = ripple current at 85 °C, 100 Hz.

Non-sinusoidal ripple currents have to be analyzed into a number of sinusoidal currents and the following requirements shall then be satisfied:

$$\sum_n \frac{I_n^2}{r_n} \leq I_{r \max}^2$$

$I_{r \max}$ = maximum ripple current at 100 Hz and applicable ambient temperature;

I_n = ripple current at a certain frequency;

$r_n = I_r/I_{r0}$ = multiplying factor at a same frequency.

Charge and discharge current

The capacitors may be charged from a source without internal resistance and they may be discharged by short-circuiting. If the capacitors are charged and discharged continuously at a rate of several times per minute, the charge and discharge currents have to be considered as ripple currents flowing through the capacitor. The r.m.s. value of these currents should be determined and the value thus found must not exceed the applicable limit.



Leakage current

Maximum leakage current 5 min after application of the rated voltage at $T_{amb} = 25\text{ }^{\circ}\text{C}$

see table 2 (0,006 CU + 4 μA)

Leakage current during continuous operation at U_R , at $T_{amb} = 25\text{ }^{\circ}\text{C}$

approx. 0,01 of value stated in Table 2

at $T_{amb} = 85\text{ }^{\circ}\text{C}$

\leq value stated in Table 2

If the leakage current is too high, owing to prolonged storage and/or storage at an excessive temperature ($> 40\text{ }^{\circ}\text{C}$), application of the rated voltage for some hours will cause the leakage current to fall to a value lower than specified in Table 2.

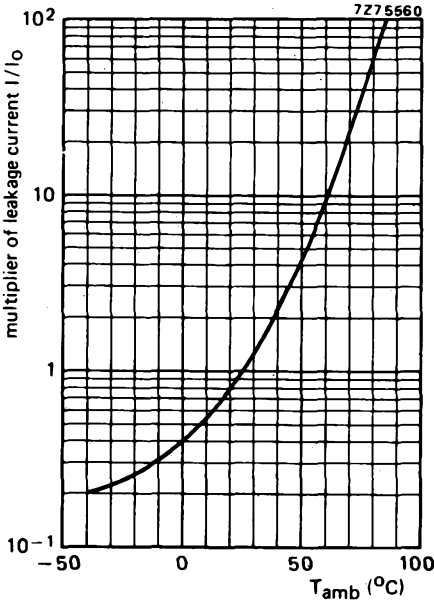

Fig. 7 Typical leakage current as a function of ambient temperature; I_0 = leakage current during continuous operation at $25\text{ }^{\circ}\text{C}$ and U_R .

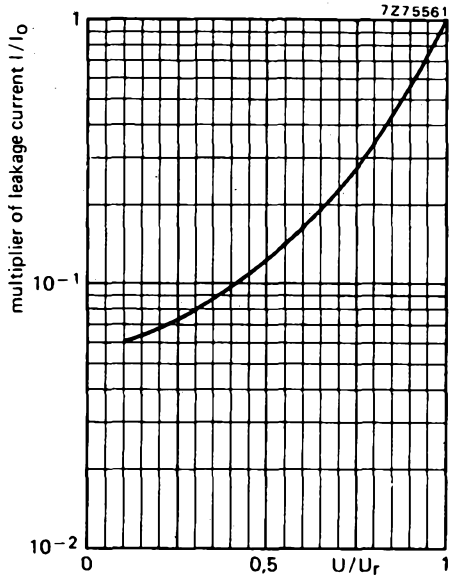

Fig. 8 Typical leakage current as a function of U/U_R ; I_0 = leakage current during continuous operation at $25\text{ }^{\circ}\text{C}$ and U_R .



Equivalent series resistance (ESR)

ESR at 100 Hz and $T_{amb} = 25\text{ }^{\circ}\text{C}$, measured by means of a four-terminal circuit (Thomson circuit)

see Table 2

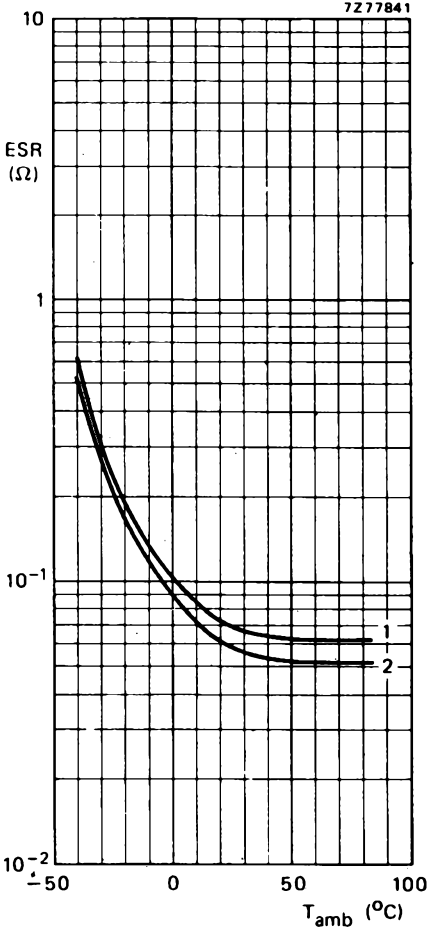

Fig. 9 Typical ESR as a function of ambient temperature at 100 Hz

Case size O4:

curve 1 = 1500 μF , 40 V and 2200 μF , 25 V;

curve 2 = 3300 μF , 16 V, 4700 μF , 10 V and 6800 μF , 6,3 V.

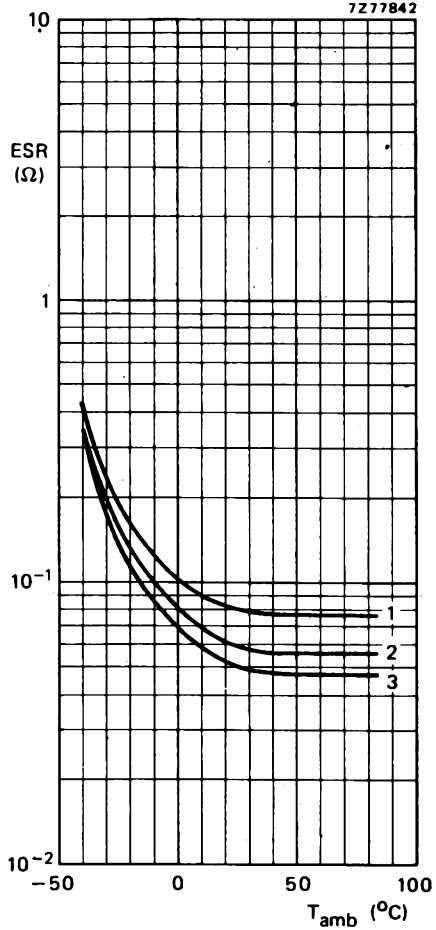

Fig. 10 Typical ESR as a function of ambient temperature at 100 Hz

Case size O5:

curve 1 = 1000 μF , 63 V; curve 2 = 2200 μF , 40 V and 3300 μF , 25 V;

curve 3 = 4700 μF , 16 V, 6800 μF , 10 V and 10000 μF , 6,3 V.



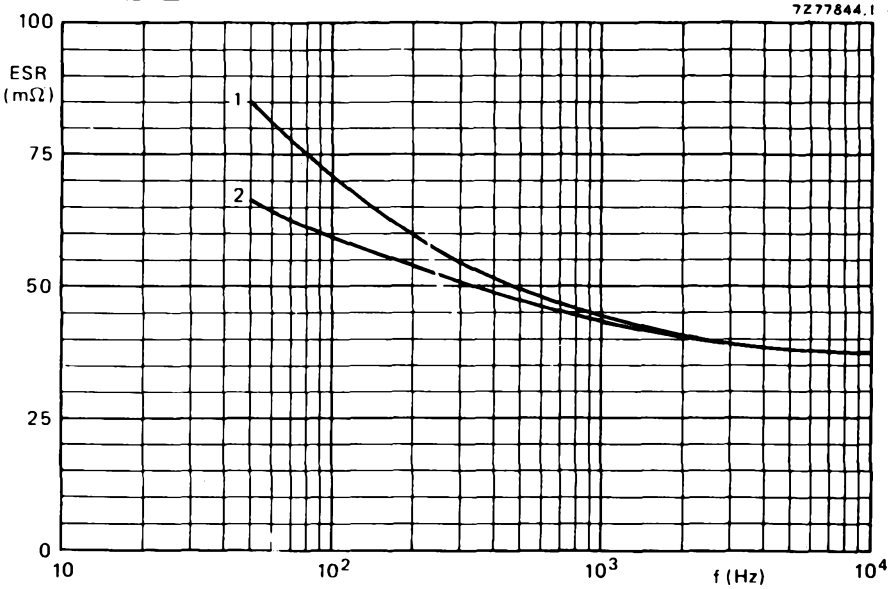

Fig. 11 Typical ESR as a function of frequency at 25 °C. Case size 04: curve 1 = 1500 μF, 40 V and 2200 μF, 25 V; curve 2 = 3300 μF, 16 V, 4700 μF, 10 V and 6800 μF, 6,3 V.

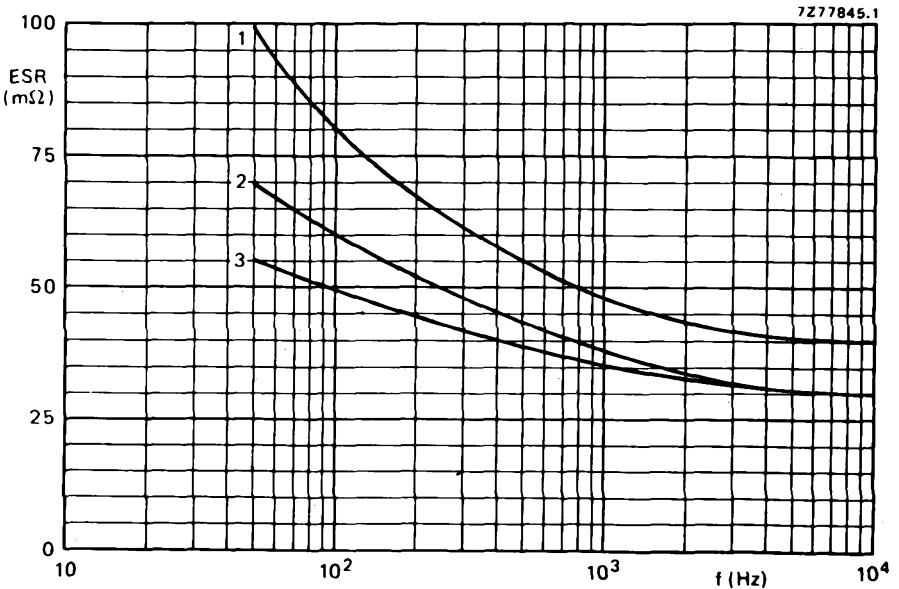

Fig. 12 Typical ESR as a function of frequency at 25 °C. Case size 05: curve 1 = 1000 μF, 63 V; curve 2 = 2200 μF, 40 V and 3300 μF, 25 V; curve 3 = 4700 μF, 16 V, 6800 μF, 10 V and 10 000 μF, 6,3 V.



Tan δ (dissipation factor)

$$\text{Tan } \delta = \text{ESR} \times \omega C$$

Impedance

The impedance is measured by means of a four-terminal circuit (Thomson circuit).

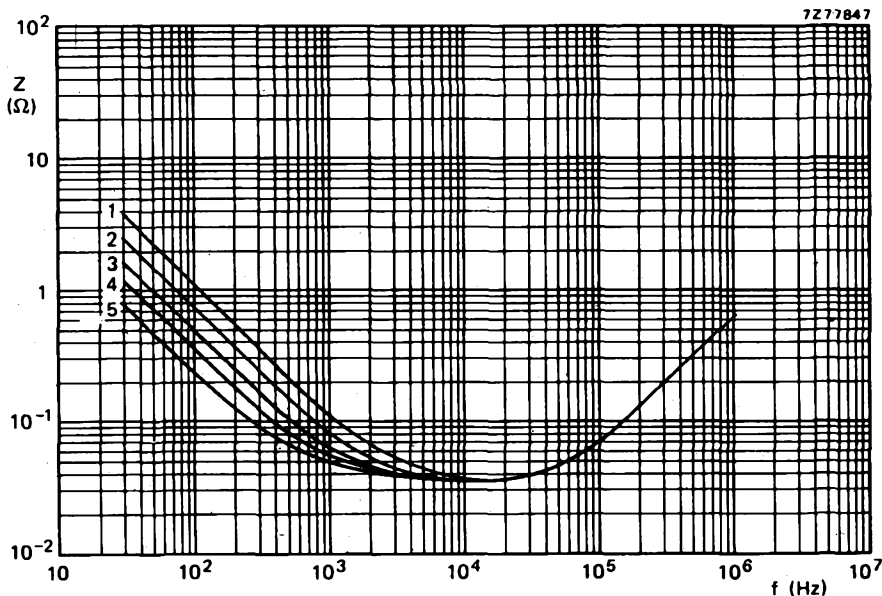

Fig. 13 Typical impedance as a function of frequency at 25 °C. Case size 04:

curve 1 = 1500 μF , 40 V;

curve 3 = 3300 μF , 16 V;

curve 5 = 6800 μF , 6,3 V.

curve 2 = 2200 μF , 25 V;

curve 4 = 4700 μF , 10 V;



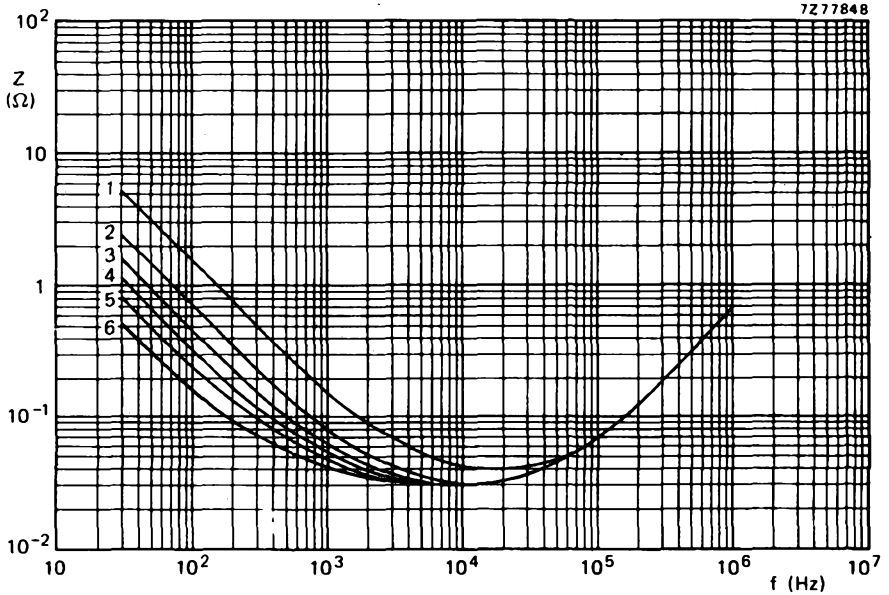

Fig. 14 Typical impedance as a function of frequency at 25 °C. Case size 05:

curve 1 = 1000 μ F, 63 V;
 curve 2 = 2200 μ F, 40 V;

curve 3 = 3300 μ F, 25 V;
 curve 4 = 4700 μ F, 16 V;

curve 5 = 6800 μ F, 10 V;
 curve 6 = 10 000 μ F, 6,3 V.

OPERATIONAL DATA

Category temperature range

-40 to +85 °C

PACKING

The capacitors are packed in boxes containing 100 pieces.



ALUMINIUM ELECTROLYTIC CAPACITORS

- Miniature and small types
- Single ended
- General purpose

QUICK REFERENCE DATA

Nominal capacitance range (E6 series)	0,47 to 3300 μF
Tolerance on nominal capacitance	-10 to +50%
Rated voltage range, U_R (R5 series)	6,3 to 100 V
Category temperature range	-40 to +85 $^{\circ}\text{C}$
Endurance test	1000 h at 85 $^{\circ}\text{C}$
Basic specification	IEC 384-4, G.P. grade DIN 41259/41233
Climatic category	
IEC 68	40/085/56
DIN 40040	GPF

Selection chart for $C_{\text{nom}} - U_R$ and relevant case sizes.

C_{nom} (μF)	U_R (V)									
	6,3	10	16	25	35	40	50	63	100	
0,47								11	11	
0,68								11		
1								11	11	
1,5								11		
2,2								11	12	
3,3								11		
4,7						11		12	13	
6,8				11			12	13		
10			11			12		13	15	
15			11	12			13	14	16	
22		11	12			13	14	15	16	
33			12	13		14		15	17	
47		12	13		14		15	16	17	
68			13	14	15		16	17	18	
100		13	14	15	16			17	18	19
150			14	15	16		17	18	19	20
220	14	15	16	17		18	19	20		
330	15	16	17	18		19	20			
470	16		17		19	20				
680	16	17	18	19	20					
1000	17	18	19	20						
1500	18	19	20							
2200	19	20								
3300	20									

case size	nominal dimensions (mm)
11	ϕ 5 x 11
12	ϕ 6 x 11
13	ϕ 8 x 12
14	ϕ 10 x 12
15	ϕ 10 x 16
16	ϕ 10 x 20
17	ϕ 12,5 x 20
18	ϕ 12,5 x 25
19	ϕ 16 x 25
20	ϕ 16 x 31



APPLICATION

These capacitors are mainly used for smoothing, coupling and decoupling purposes in consumer applications, such as audio and television circuits. Other applications are in timing and delay circuits.

DESCRIPTION

The capacitor has etched aluminium foil electrodes rolled up with a porous paper spacer which separates the anode and the cathode. The spacer is impregnated with an electrolyte which is the electrical connection between dielectric and cathode foil. The capacitor is housed in an aluminium case, which is insulated with a blue plastic sleeve.

MECHANICAL DATA

Dimensions in mm

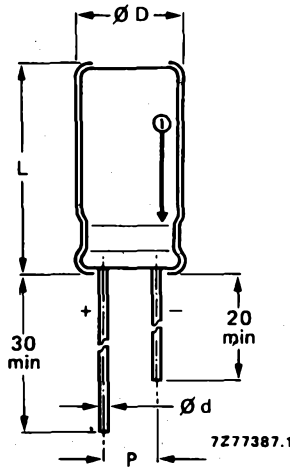

Fig. 1 Style 1; see Table 1 for dimensions d , D , L and P .



Table 1

case size	dimensions			
	d	D _{max}	L _{max}	P
11	0,5	5,5	12,0	2,0
12	0,5	6,5	12,0	2,5
13	0,6	8,5	13,0	3,5
14	0,6	10,5	13,0	5,0
15	0,6	10,5	17,0	5,0
16	0,6	10,5	21,0	5,0
17	0,6	13,0	21,0	5,0
18	0,6	13,0	26,0	5,0
19	0,6	16,5	26,0	7,5
20	0,6	16,5	32,0	7,5

± 0,2

Marking

The capacitors are marked with: nominal capacitance, rated voltage, a symbol to identify the negative terminal, name of manufacturer and date code (year and month) according to IEC 62.



ELECTRICAL DATA

Table 2

Unless otherwise specified all electrical values in Table 2 apply at an ambient temperature of 20 to 25 °C, a frequency of 100 Hz, an atmospheric pressure of 860 to 1060 mbar and a relative humidity of 45 to 75%.

U _R	nom. cap. V μF	max. r.m.s. ripple current at T _{amb} = 85 °C mA	max. leakage current at U _R after 5 min μA	max. tan δ	max. impedance ratio		max. impedance at T _{amb} = + 20 °C (Ω)		case size	catalogue number 2222 034 followed by style 1	
					Z at -25 °C Z at + 20 °C	Z at -40 °C Z at + 20 °C	at 1 kHz	at 10 kHz			
6,3	220	115	47	0,22	4	7		0,91	14	53221	
	330	160	68	0,22	4	7		0,61	15	53331	
	470	211	94	0,22	4	7		0,43	16	53471	
	680	237	134	0,22	4	7		0,29	16	53681	
	1000	314	194	0,22	4	7		0,20	17	53102	
	1500	420	289	0,22	4	7	0,23		18	53152	
	2200	526	421	0,22	4	7	0,16		19	53222	
	3300	670	629	0,22	4	7	0,11		20	53332	
	10	22	25	12	0,20	3	5		7,27	11	54229
		47	40	19	0,20	3	5		3,40	12	54479
100		70	35	0,20	3	5		1,6	13	54101	
150		98	50	0,20	3	5		1,07	14	54151	
220		140	71	0,20	3	5		0,73	15	54221	
330		184	104	0,20	3	5		0,48	16	54331	
680		278	209	0,20	3	5		0,24	17	54681	
1000		371	305	0,20	3	5		0,16	18	54102	
1500		479	455	0,20	3	5	0,20		19	54152	
2200		625	665	0,20	3	5	0,14		20	54222	



16	10	20	10	0,16	2	5	12,0	11	55109
	15	23	12	0,16	2	5	8,0	11	55159
	22	31	16	0,16	2	5	5,45	12	55229
	33	38	21	0,16	2	5	3,64	12	55339
	47	56	28	0,16	2	5	2,55	13	55479
	68	67	38	0,16	2	5	1,76	13	55689
	100	91	53	0,16	2	5	1,20	14	55101
	150	127	77	0,16	2	5	0,80	15	55151
	220	168	111	0,16	2	5	0,55	16	55221
	330	225	164	0,16	2	5	0,36	17	55331
	470	260	231	0,16	2	5	0,26	17	55471
	680	345	332	0,16	2	5	0,18	18	55681
	1000	450	485	0,16	2	5	0,12	19	55102
	1500	593	725	0,16	2	5		20	55152
						0,17			
25	6,8	18	10	0,14	2	4	13,2	11	56688
	15	26	16	0,14	2	4	6,00	12	56159
	33	50	30	0,14	2	4	2,73	13	56339
	68	80	56	0,14	2	4	1,32	14	56689
	100	112	80	0,14	2	4	0,90	15	56101
	150	153	118	0,14	2	4	0,60	16	56151
	220	208	170	0,14	2	4	0,41	17	56221
	330	272	253	0,14	2	4	0,27	18	56331
	680	412	515	0,14	2	4	0,13	19	56681
	1000	534	755	0,14	2	4	0,09	20	56102
35	47	75	54	0,12	2	4	1,60	14	90003
	68	101	77	0,12	2	4	1,10	15	90012
	100	134	110	0,12	2	4	0,75	16	90001
	470	386	499	0,12	2	4	0,16	19	90015
	680	504	719	0,12	2	4	0,11	20	90017





U _R	nom. cap. V	max. r.m.s ripple current at T _{amb} = 85 °C mA	max. leakage current at U _R after 5 min μA	max. tan δ	max. impedance ratio		max. impedance at T _{amb} = + 20 °C (Ω)		case size	catalogue number 2222 034 followed by	
					Z at -25 °C Z at + 20 °C	Z at -40 °C Z at + 20 °C	at 1 kHz	at 10 kHz			style 1
40	4,7	17	11	0,12	2	4		14,9	11	57478	
	10	26	17	0,12	2	4		7,00	12	57109	
	22	44	31	0,12	2	4		3,18	13	57229	
	33	61	45	0,12	2	4		2,12	14	57339	
	150	182	185	0,12	2	4		0,47	17	57151	
	220	289	269	0,12	2	4		0,32	18	57221	
	330	388	401	0,12	2	4		0,21	19	57331	
	470	495	569	0,12	2	4		0,15	20	57471	
	50	6,8	26	15	0,10	2	4		8,82	12	90004
		15	47	28	0,10	2	4		4,00	13	90005
22		64	38	0,10	2	4		2,73	14	90006	
47		101	76	0,10	2	4		1,28	15	90019	
68		138	107	0,10	2	4		0,88	16	90022	
100		187	155	0,10	2	4		0,60	17	90024	
150		253	230	0,10	2	4		0,40	18	90026	
220		325	335	0,10	2	4		0,27	19	90028	
330		444	500	0,10	2	4		0,18	20	90031	
63		0,47	6,2	6	0,08	2	4		117	11	58477
	0,68	7,4	6	0,08	2	4		80,9	11	58687	
	1,0	9,2	7	0,08	2	4		55,0	11	58108	
	1,5	10	8	0,08	2	4		36,7	11	58158	
	2,2	13	9	0,08	2	4		25,0	11	58228	
	3,3	15	11	0,08	2	4		16,7	11	58338	
	4,7	20	14	0,08	2	4		11,7	12	58478	
	6,8	30	18	0,08	2	4		8,09	13	58688	
	10	36	24	0,08	2	4		5,50	13	58109	
	15	51	33	0,08	2	4		3,67	14	58159	
	22	75	47	0,08	2	4		2,50	15	58229	
	33	88	68	0,08	2	4		1,67	15	58339	
	47	118	94	0,08	2	4		1,17	16	58479	



Mullard

January 1979

7

	68	161	134	0,08	2
	100	211	194	0,08	2
	150	288	289	0,08	2
	220	378	421	0,08	2
100	0,47	6,2	7	0,07	2
	1,0	9,2	8	0,07	2
	2,2	15	12	0,07	2
	4,7	27	19	0,07	2
	10	52	35	0,07	2
	15	70	50	0,07	2
	22	83	71	0,07	2
	33	113	104	0,07	2
	47	132	146	0,07	2
	68	182	209	0,07	2
	100	249	305	0,07	2
	150	326	455	0,07	2

Aluminium electrolytic capacitors

4		0,81	17	58689
4		0,55	18	58101
4		0,37	19	58151
4		0,25	20	58221
4		95,7	11	59477
4		45,0	11	59108
4		20,5	12	59228
4		9,57	13	59478
4		4,50	15	59109
4		3,00	16	59159
4		2,05	16	59229
4		1,36	17	59339
4		0,96	17	59479
4		0,66	18	59689
4		0,45	19	59101
4		0,30	20	59151

034 Series

Capacitance

Nominal capacitance values at 100 Hz and $T_{amb} = 25\text{ }^{\circ}\text{C}$

see Table 2

Tolerance on nominal capacitance at 100 Hz

-10 to +50%

Voltage

Rated voltage = max. permissible voltage

< 40 °C	40 to 85 °C
---------	-------------

$1,1 \times U_R$	U_R
------------------	-------

Ripple voltage* = max. permissible a.c. voltage providing the following three conditions are met:

- a) max. (d.c. + peak a.c.) voltage
- b) max. peak a.c. voltage with d.c. voltage applied
- c) max. peak a.c. voltage without d.c. voltage applied

$\leq 1,1 \times U_R$	$\leq U_R$
\leq applied d.c. voltage + 1 V	1 V

Surge voltage = max. permissible voltage for short periods (see also Tests and requirements)

$1,15 \times U_R$

Reverse voltage = max. d.c. voltage applied in the reverse polarity at the maximum category temperature for short periods (see also Tests and requirements)

1 V

Ripple current**

Maximum permissible r.m.s. ripple current at 100 Hz and $T_{amb} = 85\text{ }^{\circ}\text{C}$

see Table 2

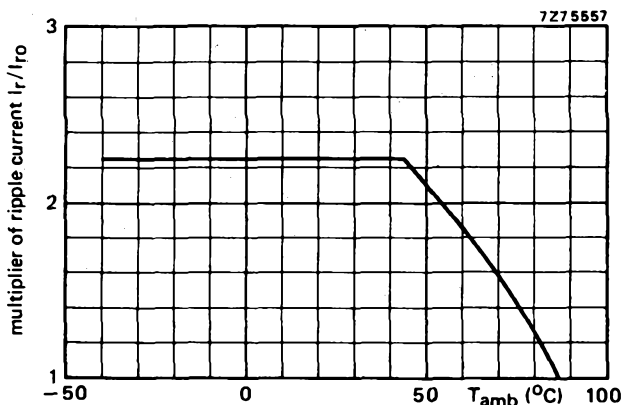

Fig. 2 Typical ripple current as a function of ambient temperature; I_{r0} = ripple current at 85 °C; 100 Hz.

* Ripple voltages are not applicable if the maximum permissible ripple current is exceeded. In that case the ripple current is decisive.

** Ripple currents are not applicable if the maximum permissible ripple voltage is exceeded. In that case the ripple voltage is decisive.



Non-sinusoidal ripple currents have to be analyzed into a number of sinusoidal currents and the following requirements shall then be satisfied:

$$\sum_n \frac{I_n^2}{r_n} \leq I_{r \max}^2$$

$I_{r \max}$ = maximum ripple current at 100 Hz and applicable ambient temperature;

I_n = ripple current at a certain frequency;

$r_n = I_r / I_{r0}$ = multiplying factor at a same frequency.

Charge and discharge current

The capacitors may be charged from a source with negligible internal resistance and they may be discharged by short-circuiting. If the capacitors are charged and discharged continuously at a rate of several times per minute, the charge and discharge currents have to be considered as ripple currents flowing through the capacitor. The r.m.s. value of these currents should be determined and the value thus found must not exceed the applicable limit. (See also Tests and requirements.)

Leakage current

Maximum leakage current 5 min after application
of U_R at $T_{amb} = 25^\circ\text{C}$

see Table 2 (0,03 CU + 5 μA)

Leakage current during continuous operation at U_R ,
at $T_{amb} = 25^\circ\text{C}$
at $T_{amb} = 85^\circ\text{C}$

approx. 0,2 x value stated in Table 2
 \leq value stated in Table 2

If owing to prolonged storage and/or storage at an excessive temperature ($> 40^\circ\text{C}$) the leakage current is too high, application of the rated voltage for some hours will cause the leakage current to fall to a value lower than specified in Table 2.

Tan δ (dissipation factor)

Maximum tan δ at 100 Hz and $T_{amb} = 25^\circ\text{C}$, measured by means
of a four-terminal circuit (Thomson circuit)

see Table 2

Equivalent series resistance (ESR)

$\text{ESR} = \tan \delta / \omega C$

Maximum tan δ and C at 100 Hz and $T_{amb} = 25^\circ\text{C}$

see Table 2

Impedance (Z)

Maximum impedance at $T_{amb} = 20^\circ\text{C}$ and
10 kHz ($C_{nom} \leq 1000 \mu\text{F}$) or 1 kHz ($C_{nom} > 1000 \mu\text{F}$),
measured by means of a four-terminal
circuit (Thomson circuit)

see Table 2

$z = Z \times C_{nom}$

see Table 3



Table 3

	T _{amb}	z = Z x C _{nom} (Ω μF) at U _R								
		6,3 V	10 V	16 V	25 V	35 V	40 V	50 V	63 V	100 V
C _{nom} > 1000 μF, at 1 kHz	+ 20 °C	350	300	250	220	—	200	—	180	175
	-25 °C	1700	1100	800	570	—	430	—	330	300
	-40 °C	4500	2800	2000	1400	—	1100	—	800	700
C _{nom} ≤ 1000 μF, at 10 kHz	+ 20 °C	200	160	120	90	75	70	60	55	45
	-25 °C	1200	750	560	400	330	300	220	180	130
	-40 °C	3200	2000	1500	1100	950	900	700	500	350

Ratio between impedances at T_{amb} = -25 °C and + 20 °C,
and at T_{amb} = -40 °C and + 20 °C, at 100 Hz
measured by means of a four-terminal
circuit (Thomson circuit)

see Table 2

OPERATIONAL DATA

Category temperature range

-40 to + 85 °C

Life expectancy

at T_{amb} = 85 °C

2000 h

at T_{amb} = 105 °C

500 h

PACKING

The capacitors are packed in boxes; the number per box is:

1000 for case sizes 11 to 14,

500 for case sizes 15 to 18,

200 for case sizes 19 and 20.

TESTS AND REQUIREMENTS

See Introduction, section 9, under aluminium electrolytic capacitors.

Note: Capacitors 2222 034 belong to the miniature and small types, general-purpose grade.



ALUMINIUM ELECTROLYTIC CAPACITORS

- Miniature type
- Axial leads or single ended
- High voltage
- General and industrial applications

QUICK REFERENCE DATA

Nominal capacitance range (E3 series)	1 to 22 μF
Tolerance on nominal capacitance	-10 to +50%
Rated voltage range U_R	160 to 385 V
Category temperature range	-40 to +85 $^{\circ}\text{C}$
Endurance test at 85 $^{\circ}\text{C}$	1000 h
Basis specifications	IEC 384-4, general-purpose grade DIN 41316
Climatic category	
IEC 68	40/085/56
DIN 40040	GPF

Selection chart for C_{nom} - U_R and relevant case sizes.

C_{nom} μF	U_R (V)			
	160	250	350	385
1				4
2,2		4		5
4,7	4	5	6	7
10	5	7		
22	7			

case size	nominal dimensions (mm)
4	\emptyset 6,5 x 18
5	\emptyset 8 x 18
6	\emptyset 10 x 18
7	\emptyset 10 x 25



APPLICATION

These capacitors are mainly used for high voltage smoothing purposes in consumer applications. The bandoliered version is extremely suitable for automatic insertion and for cutting and forming equipment.

DESCRIPTION

The capacitor has etched aluminium foil electrodes rolled up with a porous paper spacer which separates the anode and the cathode. The spacer is impregnated with an electrolyte which is the electrical connection between dielectric and cathode foil. The capacitor is housed in an aluminium case, which is insulated with a blue plastic sleeve.

The capacitor is available in 3 styles, all with soldered-copper leads.

Style 1: axial leads; supplied on bandoliers in boxes or on reels;

Style 2: single ended; with self-locking lead;

Style 3: single ended.

MECHANICAL DATA

Dimensions in mm

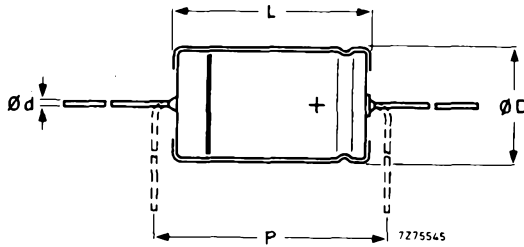

Fig. 1 Style 1; see Table 1a for dimensions d, D, L and P.

Table 1a

case size	d	style 1					mass approx. g
		D _{nom}	L _{nom}	D _{max}	L _{max}	P _{min}	
4	0,8	6,5	18,0	6,9	18,5	25	1,3
5	0,8	8,0	18,0	8,5	18,5	25	1,7
6	0,8	10,0	18,0	10,5	18,5	25	2,5
7	0,8	10,0	25,0	10,5	25,0	30	3,3



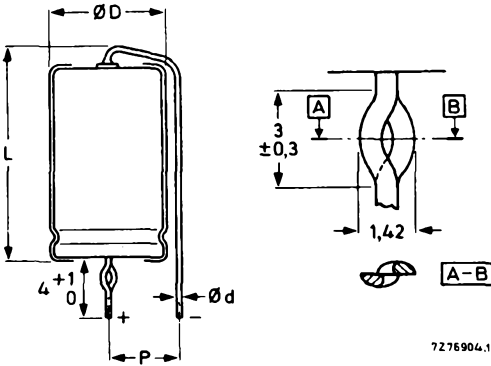

Fig. 2 Style 2; non-preferred; see Table 1b for dimensions d, D, L and P.

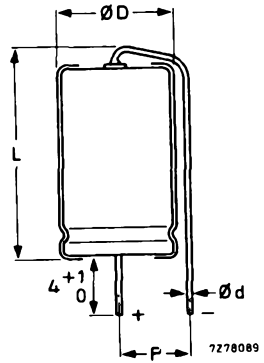

Fig. 3 Style 3; see Table 1b for dimensions d, D, L and P.

Table 1b

case size	d	Styles 2 and 3			mass approx. g
		D _{max}	L _{max}	P	
4	0,8	6,9	21,5	5 -10	1,2
5	0,8	8,5	21,5	5 -10	1,6
6	0,8	10,5	21,5	7,5-12,5	2,3
7	0,8	10,5	28,0	7,5-12,5	3,1

Marking

- The capacitors are marked with:
- nominal capacitance;
 - tolerance on nominal capacitance;
 - rated voltage;
 - group number 041; code of origin;
 - name of manufacturer;
 - date code (year and month) according to IEC 62;
 - band to identify the negative terminal;
 - + signs to identify the positive terminal.

Mounting

The diameter of the mounting holes in the printed-wiring board is $1 + 0,1$ mm, except that of the hole for the anode lead of style 2 capacitors: $1,3 + 0,1$ mm.



ELECTRICAL DATA

Table 2

Unless otherwise specified all electrical values in Table 2 apply at an ambient temperature of 20 to 25 °C, a frequency of 100 Hz, an atmospheric pressure of 860 to 1060 mbar and a relative humidity of 45 to 75%.

U_R	nom. cap.	max. r.m.s. ripple current at $T_{amb} = 85\text{ °C}$	max. leakage current at U_R after 5 min	max. ESR	case size	catalogue number *
V	μF	mA	μA	Ω		
160	4,7	26	38	53,2	4	2222 041 .1478
160	10	41	68	25,0	5	.1109
160	22	77	126	11,4	7	.1229
250	2,2	18	28	132	4	.3228
250	4,7	29	55	61,7	5	.3478
250	10	55	95	29	7	.3109
350	4,7	32	69	68,1	6	.5478
385	1	12	19	335	4	.8108
385	2,2	23	42	152	5	.8228
385	4,7	43	71	71,3	7	.8478

Capacitance

Nominal capacitance values at 100 Hz and $T_{amb} = 20\text{ °C}$

see Table 2

Tolerance on nominal capacitance at 100 Hz

-10 to +50%

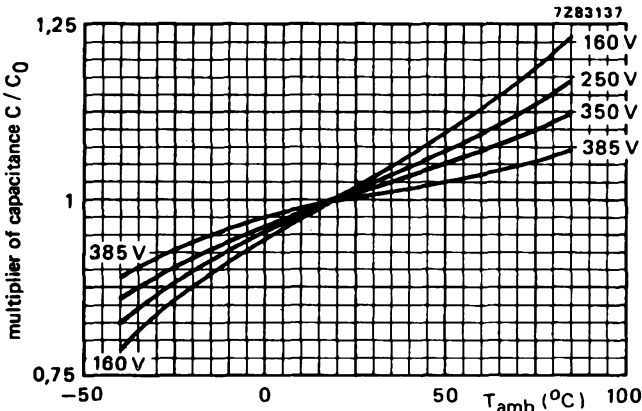

Fig. 4 Typical capacitance as a function of ambient temperature; C_0 = capacitance at 20 °C, 100 Hz.

- * Replace dot in catalogue number by:
- 2 for style 1 on bandoliers on reel;
- 3 for style 1 on bandoliers in box;
- 7 for style 2;
- 8 for style 3.



Voltage

Rated voltage = max. permissible voltage

at $< 40\text{ }^{\circ}\text{C}$ at $40\text{ to }85\text{ }^{\circ}\text{C}$

$1,1 \times U_R$

U_R

Ripple voltage * = max. permissible a.c. voltage providing the following three conditions are met:

a) max. (d.c. + peak a.c.) voltage

b) max. peak a.c. voltage without d.c. voltage applied

c) momentary value of applied voltage

U_R

1 V

between U_R and -1 V

Surge voltage = max. permissible voltage for short periods

for $U_R = 160\text{ V}$ or 250 V for $U_R = 350\text{ V}$ or 385 V

$1,15 \times U_R$

$1,1 \times U_R$

Reverse voltage = max. d.c. voltage applied in the reverse polarity at the maximum category temperature for short periods

1 V

Ripple current **

Maximum permissible r.m.s. ripple current at

 100 Hz and $T_{\text{amb}} = 85\text{ }^{\circ}\text{C}$

see Table 2

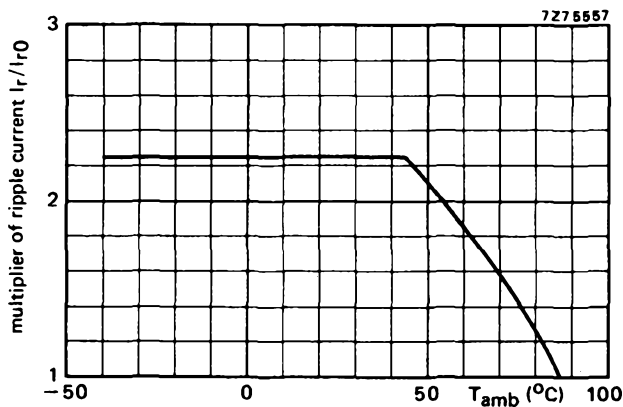
Fig. 5 Typical ripple current as a function of ambient temperature; I_{r0} = ripple current at $85\text{ }^{\circ}\text{C}$, 100 Hz .

* Ripple voltages are not applicable if the maximum permissible ripple current is exceeded. In that case the ripple current is decisive.

** Ripple currents are not applicable if the maximum permissible ripple voltage is exceeded. In that case the ripple voltage is decisive.



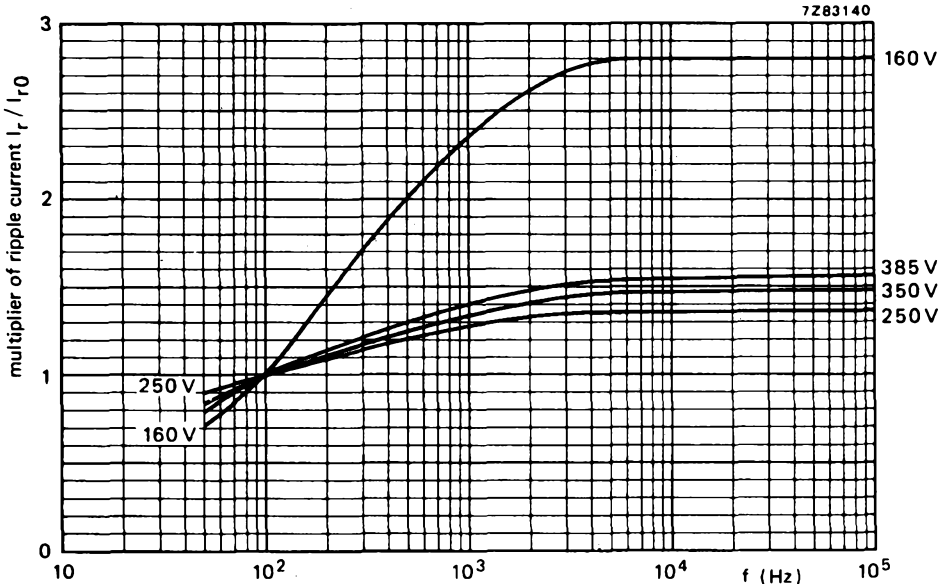

Fig. 6 Typical ripple current as a function of frequency; I_{r0} = ripple current at 85 °C, 100 Hz.

Non-sinusoidal ripple currents have to be analyzed into a number of sinusoidal currents and the following requirements shall then be satisfied:

$$\sum_n \frac{I_n^2}{r_n} \leq I_{r \max}^2$$

$I_{r \max}$ = maximum ripple current at 100 Hz and applicable ambient temperature;

I_n = ripple current at a certain frequency;

$r_n = I_r / I_{r0}$ = multiplying factor at a same frequency.

Leakage current

Maximum leakage current 5 min after application
of the rated voltage at $T_{amb} = 20\text{ °C}$

see Table 2 (0,05 CU or 5 μA
for $CU \leq 1000\ \mu\text{C}$; 0,03 CU
+20 μA for $CU > 1000\ \mu\text{C}$)

If the leakage current is too high, owing to prolonged storage and/or storage at an excessive temperature (> 40 °C), application of the rated voltage for some hours will cause the leakage current to fall to a value lower than specified in Table 2.



Equivalent series resistance (ESR)

ESR at 100 Hz, measured by means of a four-terminal circuit (Thomson circuit)

see Table 2

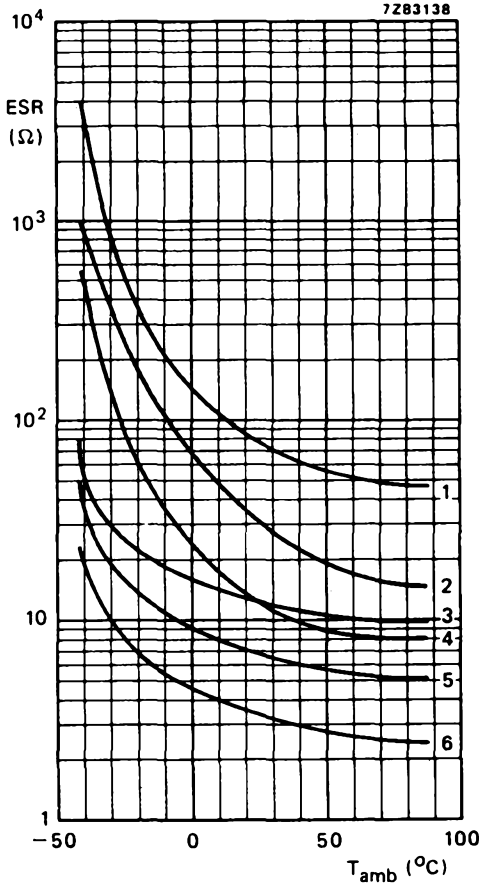

Fig. 7 Typical ESR as a function of ambient temperature at 100 Hz.

Curve 1 = case size 4, 385 V;
Curve 2 = case size 5, 385 V;
Curve 3 = case size 4, 160 V;

Curve 4 = case size 7, 385 V;
Curve 5 = case size 5, 160 V;
Curve 6 = case size 7, 160 V.



7283139

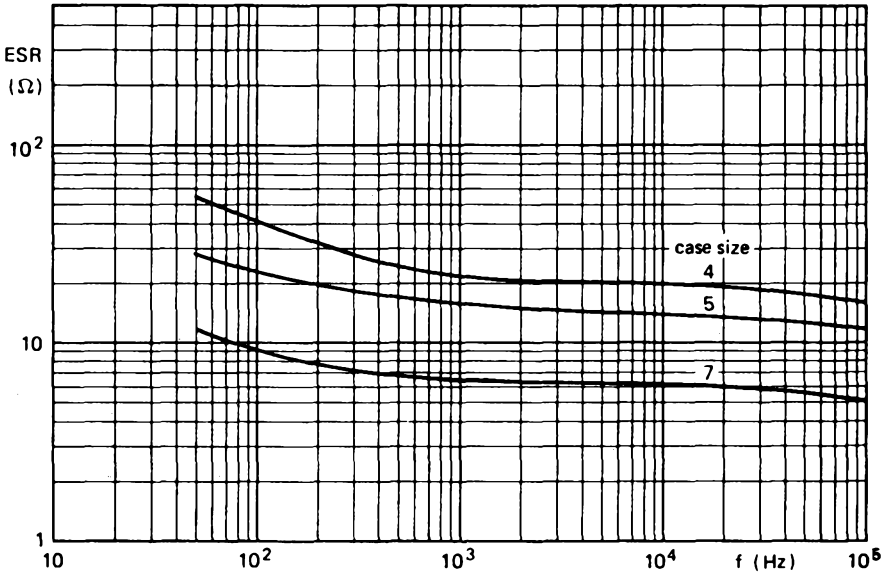

Fig. 8 Typical ESR as a function of frequency at 20 °C; $U_R = 250$ V.

Impedance

The impedance is measured by means of a four-terminal circuit (Thomson circuit).



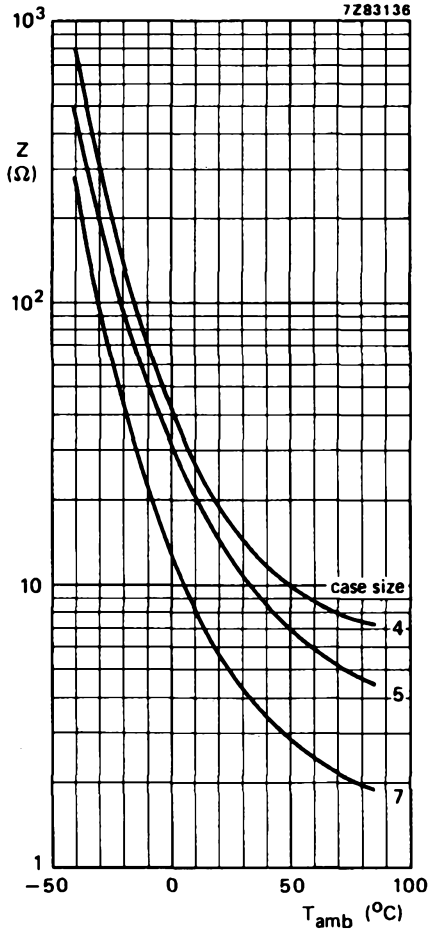

Fig. 9 Typical impedance as a function of ambient temperature at 10 kHz; $U_R = 250$ V.



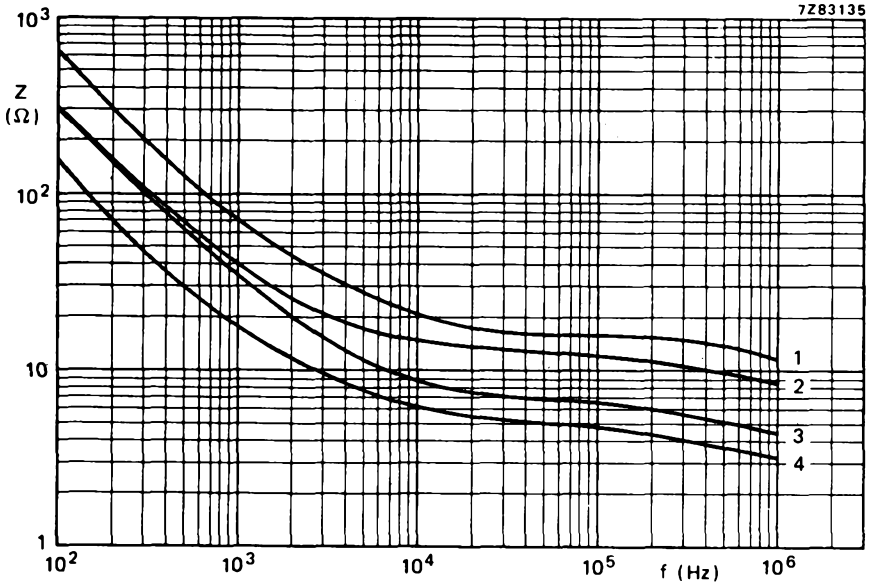

Fig. 10 Typical impedance as a function of frequency at 20 °C.

- curve 1 = case size 4, 250 V;
- curve 2 = case size 5, 250 V;
- curve 3 = case size 6, 350 V;
- curve 4 = case size 7, 250 V.

OPERATIONAL DATA

Category temperature range

-40 to +85 °C

PACKING

Capacitors of styles 2 and 3 are supplied in boxes of 1000 pieces of case size 4, or 500 pieces of case sizes 5, 6 or 7.

Capacitors of style 1 are supplied on bandoliers in boxes or on reels of 1000 pieces of case size 4, or 500 pieces of case sizes 5, 6 or 7.



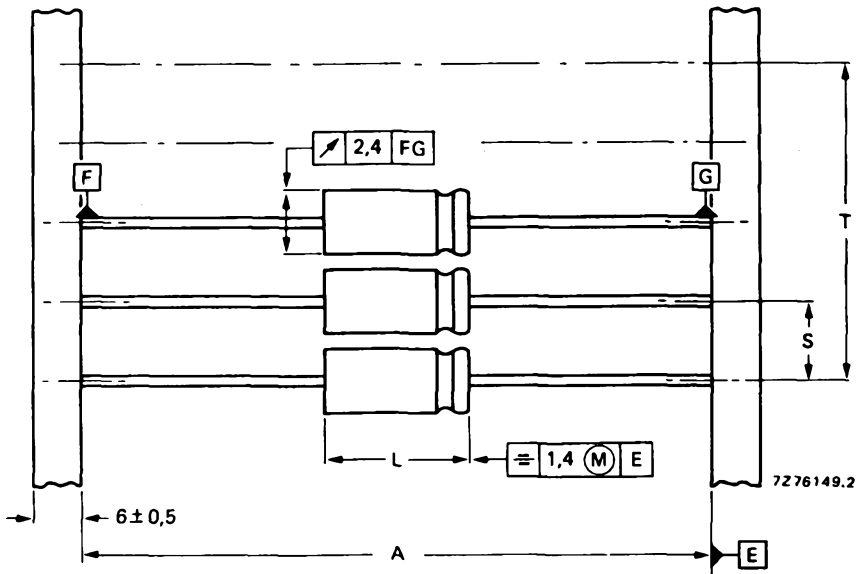

Fig. 11 Style 1 capacitors on bandoliers: the bandolier to which the negative capacitor terminals are connected is blue. See Table 3 for dimensions A, S, T and L.

Table 3
Dimensions in mm

case size	A	S	T for number (n) of capacitors		L _{max}
			n < 50	50 < n < 100	
4	73 ± 1,6	10 ± 0,4	10 (n-1) ± 2	10 (n-1) ± 4	18,5
5	73 ± 1,6	10 ± 0,4	10 (n-1) ± 2	10 (n-1) ± 4	18,5
6	73 ± 1,6	15 ± 0,75	15 (n-1) ± 2	15 (n-1) ± 4	18,5
7	73 ± 1,6	15 ± 0,75	15 (n-1) ± 2	15 (n-1) ± 4	25,0

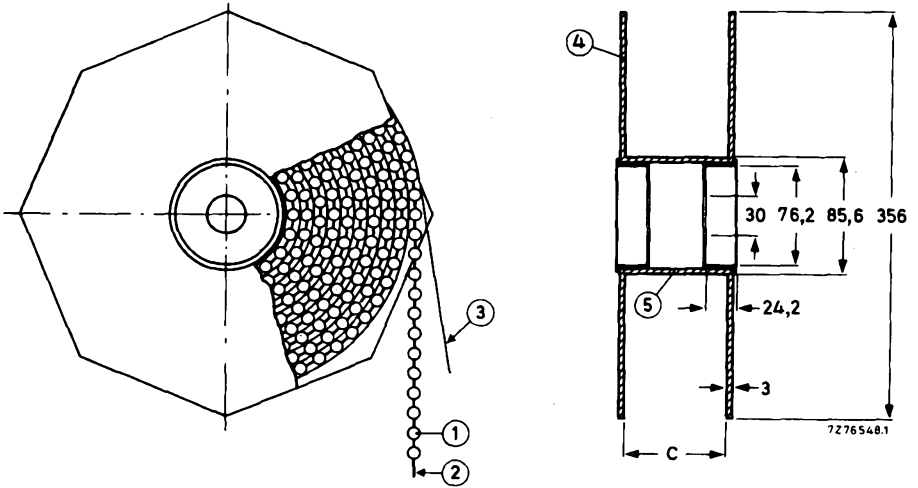

Fig. 12 Style 1 capacitors on bandoliers on reel; dimension C is 88,5 mm; the overall width of the reel is 99,5 mm.

1 = capacitor
2 = bandolier

3 = paper
4 = flange

5 = cylinder



ALUMINIUM ELECTROLYTIC CAPACITORS

- Small type
- Axial leads or single ended
- Long life
- General and industrial applications

QUICK REFERENCE DATA

Nominal capacitance range (E3 series)	10 to 100 μ F
Tolerance on nominal capacitance	-10 to + 50%
Rated voltage range, U_R (R5 series)	160 to 385 V
Category temperature range	-40 to + 70 $^{\circ}$ C
Endurance test at 70 $^{\circ}$ C	2000 h
Basis specifications	IEC 384-4, type 1, long-life grade
Climatic category, IEC 68	40/070/56

Selection chart for C_{nom} - U_R and relevant case sizes.

C_{nom} μ F	U_R (V)			
	160	250	350	385
10			01	01
22		01	02	03
47	02	03	04	
100	03			

case size	nominal dimensions (mm)
01	\emptyset 12,5 x 30
02	\emptyset 15 x 30
03	\emptyset 18 x 30
04	\emptyset 18 x 41

APPLICATION

For smoothing, coupling and decoupling purposes in circuits where a high voltage is required.



DESCRIPTION

The capacitors are available in 3 styles, all with soldered-copper leads.

Style 1: axial leads; case insulated with a blue plastic sleeve.

Style 2: single ended; with mounting ring with printed-wiring pins; especially for use in applications with severe shocks and vibrations; case sizes 03 and 04.

Style 3: single ended; case insulated with a blue plastic sleeve; case sizes 01 and 02.

MECHANICAL DATA

Dimensions in mm

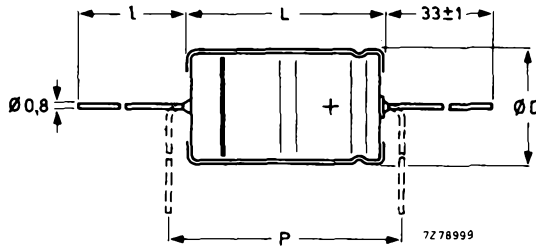

Fig. 1 Style 1; see Table 1a for dimensions D, L, l and P.

Table 1a

case size	style 1					
	D _{nom}	L _{nom}	D _{max}	L _{max}	l	P _{min}
01	12,5	30,0	13,0	30,5	55 ± 1	35,0
02	15,0	30,0	15,5	30,5	55 ± 1	35,0
03	18,0	30,0	18,5	30,5	55 ± 1	35,0
04	18,0	40,0	18,5	41,5	34 ± 1	45,0



Table 1b

case size	style 2				
	d	D1	D2 _{max}	D3	L
03	0,8	18,0	20,5	18,5 ± 0,2	31 ± 1
04	1,0	18,0	20,5	18,5 ± 0,2	42 ± 1

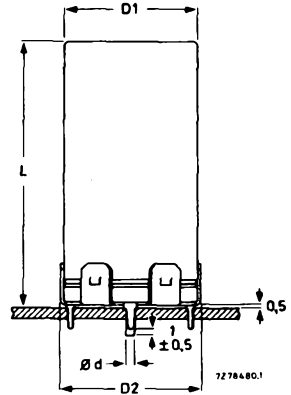
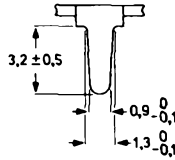
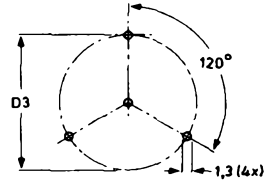

Fig. 2 Style 2; see Table 1b for dimensions d, D1, D2, D3 and L.

Table 1c

case size	style 3			
	d	D _{max}	L _{max}	P
01	0,8	13,0	34,0	7,5-12,5
02	0,8	15,5	34,0	10,0-15,0

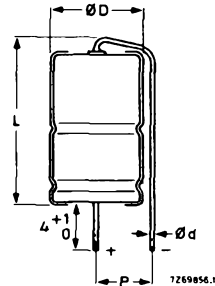

Fig. 3 Style 3; see Table 1c for dimensions d, D, L and P.



Marking

The capacitors are marked with:

- nominal capacitance;
- tolerance on nominal capacitance;
- rated voltage;
- group number 042 or 043; code of origin;
- name of manufacturer;
- date code (year and month) according to IEC 62;
- band to identify the negative terminal.

Mounting

The diameter of the mounting holes in the printed-wiring board is 1 + 0,1 mm for style 1 and style 3 capacitors, and 1,3 + 0,1 mm for style 2 capacitors. (The diameter of the centre hole for the anode lead of style 2 capacitors, case size 03, is 1 + 0,1 mm).

Minimum atmospheric pressure

8,5 kPa

ELECTRICAL DATA

Table 2

Unless otherwise specified all electrical values in Table 2 apply at an ambient temperature of 20 to 25 °C, a frequency of 100 Hz, an atmospheric pressure of 860 to 1060 mbar and a relative humidity of 45 to 75%.

U_R	nom. cap.	max. r.m.s. ripple current at $T_{amb} = 70\text{ °C}$	max. leakage current at U_R after 5 min	max. ESR	case size	catalogue number *
V	μF	mA	μA	Ω		
160	47	173	246	3,2	02	2222 042 . 1479
160	100	280	500	1,5	03	2222 042 . 1019
250	22	100	185	8,1	01	2222 042 . 3229
250	47	176	373	3,8	03	2222 042 . 3479
350	10	50	125	19	01	2222 042 . 5109
350	22	81	251	8,8	02	2222 042 . 5229
350	47	148	514	4,1	04	2222 043 . 5479
385	10	49	140	20	01	2222 042 . 8109
385	22	88	284	9,2	03	2222 042 . 8229

* Replace dot in catalogue number by:

- 1 for style 1,
- 4 for style 2,
- 8 for style 3.



Capacitance

Nominal capacitance values at 100 Hz

see Table 2

Tolerance on nominal capacitance at 100 Hz

-10 to +50%

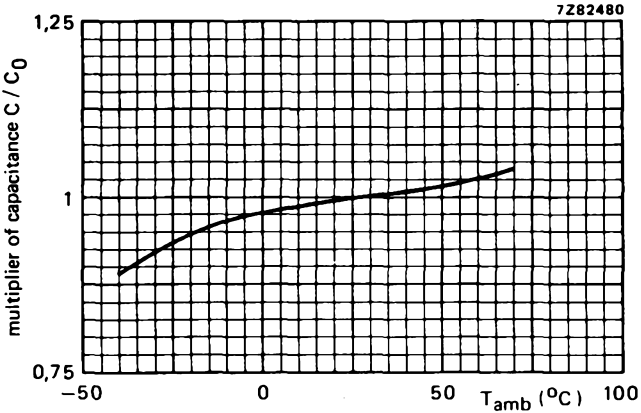
Fig. 4 Typical capacitance as a function of ambient temperature; C_0 = capacitance at 25 °C, 100 Hz.**Voltage**

Rated voltage = max. permissible voltage

at < 40 °C

 $1,1 \times U_R$

at 40 to 70 °C

 U_R

Ripple voltage* = max. permissible a.c. voltage providing the following three conditions are met:

a) max. (d.c. + peak a.c.) voltage

 U_R

b) max. peak a.c. voltage without d.c. voltage applied

1 V

c) momentary value of applied voltage

between U_R and -1 V

Surge voltage = max. permissible voltage for short periods

for $U_R = 160$ V or 250 V $1,15 \times U_R$ for $U_R = 350$ V or 385 V $1,10 \times U_R$

Reverse voltage = max. d.c. voltage applied in the reverse polarity at the maximum category temperature for short periods

1 V

* Ripple voltages are not applicable if the maximum permissible ripple current is exceeded. In that case the ripple current is decisive.



Ripple current *

Maximum permissible r.m.s. ripple current at
100 Hz and $T_{amb} = 70^{\circ}\text{C}$

see Table 2

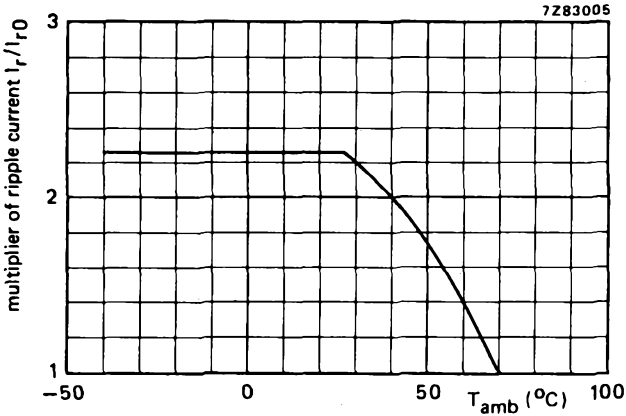

Fig. 5 Typical ripple current as a function of ambient temperature; I_{r0} = ripple current at 70°C , 100 Hz.

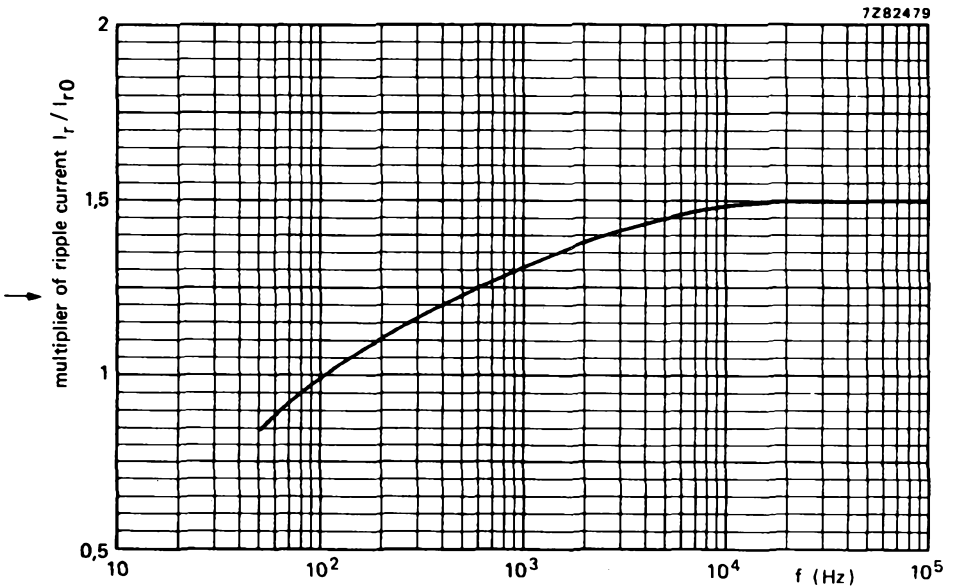

Fig. 6 Typical ripple current as a function of frequency; I_{r0} = ripple current at 70°C , 100 Hz.

* Ripple currents are not applicable if the maximum permissible ripple voltage is exceeded. In that case the ripple voltage is decisive.



Non-sinusoidal ripple currents have to be analyzed into a number of sinusoidal currents and the following requirements shall then be satisfied:

$$\sum_n \frac{I_n^2}{r_n} \leq I_{r \max}^2$$

$I_{r \max}$ = maximum ripple current at 100 Hz and applicable ambient temperature;

I_n = ripple current at a certain frequency;

$r_n = I_r/I_{r0}$ = multiplying factor at a same frequency.

Charge and discharge current

The capacitors may be charged from a source without internal resistance and they may be discharged by short-circuiting. If the capacitors are charged and discharged continuously at a rate of several times per minute, the charge and discharge currents have to be considered as ripple currents flowing through the capacitors. The r.m.s. value of these currents should be determined and the value thus found must not exceed the applicable limit.

Leakage current

Maximum leakage current 5 min after application of the rated voltage

see Table 2 (0,03 CU + 20 μ A)

If the leakage current is too high, owing to prolonged storage and/or storage at an excessive temperature (> 40 °C), application of the rated voltage for some hours will cause the leakage current to fall to a value lower than specified in Table 2.

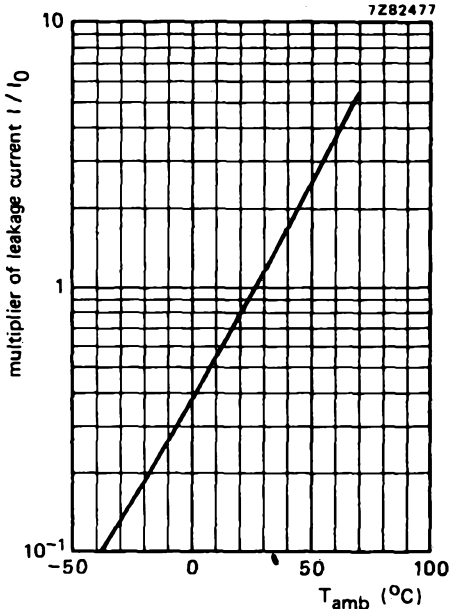

Fig. 7 Typical leakage current as a function of ambient temperature; I_0 = leakage current during continuous operation at 25 °C and U_R .

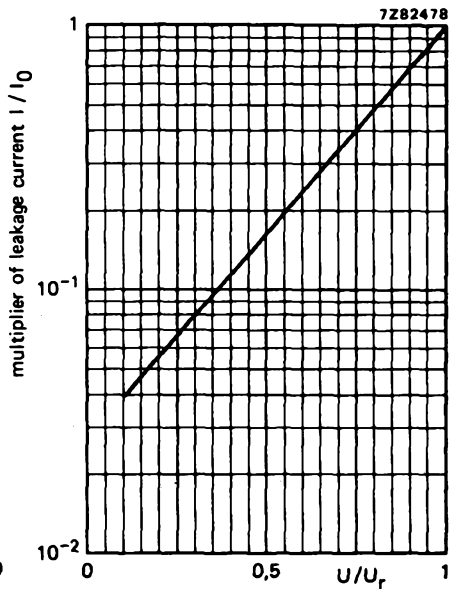

Fig. 8 Typical leakage current as a function of U/U_R ; I_0 = leakage current during continuous operation at 25 °C and U_R .



Equivalent series resistance (ESR)

ESR at 100 Hz, measured by means of a four-terminal circuit (Thomson circuit)

see Table 2

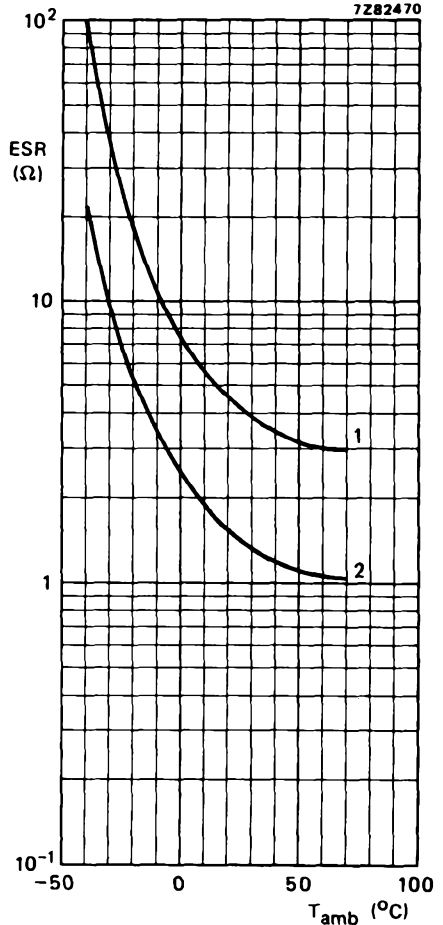
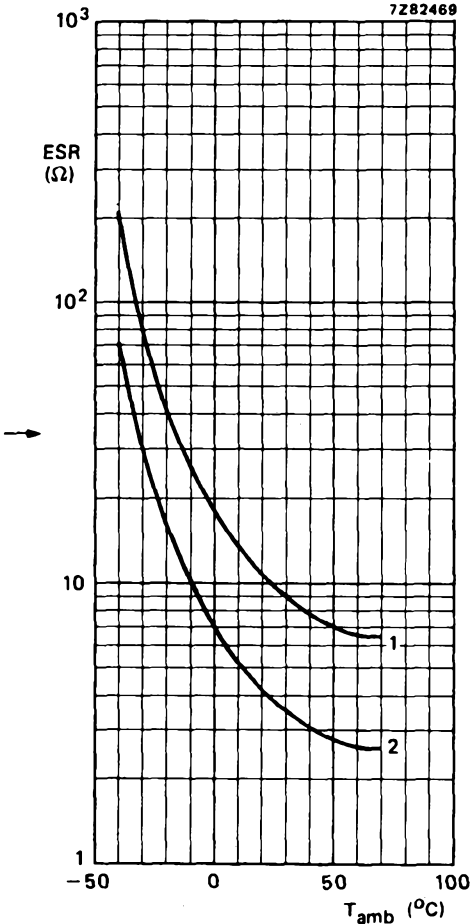

Fig. 9 Typical ESR as a function of ambient temperature at 100 Hz.

Case size 01:

curve 1 = 10 μ F, 350 V/385 V;
curve 2 = 22 μ F, 250 V.

Fig. 10 Typical ESR as a function of ambient temperature at 100 Hz.

Case size 02:

curve 1 = 22 μ F, 350 V
curve 2 = 47 μ F, 160 V



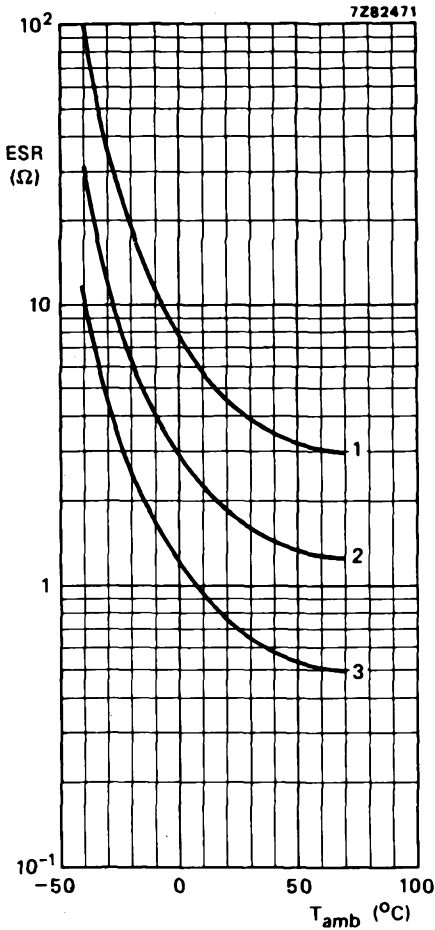

Fig. 11 Typical ESR as a function of ambient temperature at 100 Hz.

Case size 03:

- curve 1 = 22 μ F, 385 V;
- curve 2 = 47 μ F, 250 V;
- curve 3 = 100 μ F, 160 V.

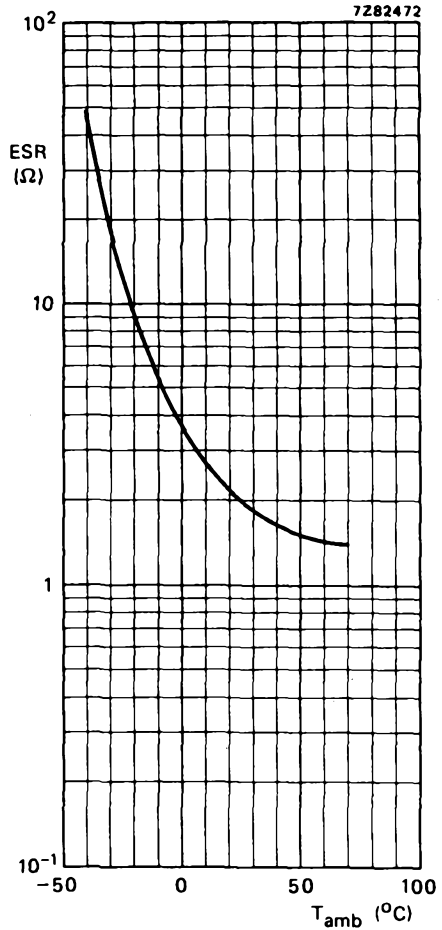

Fig. 12 Typical ESR as a function of ambient temperature at 100 Hz.

Case size 04: 47 μ F, 350 V.



7Z82473

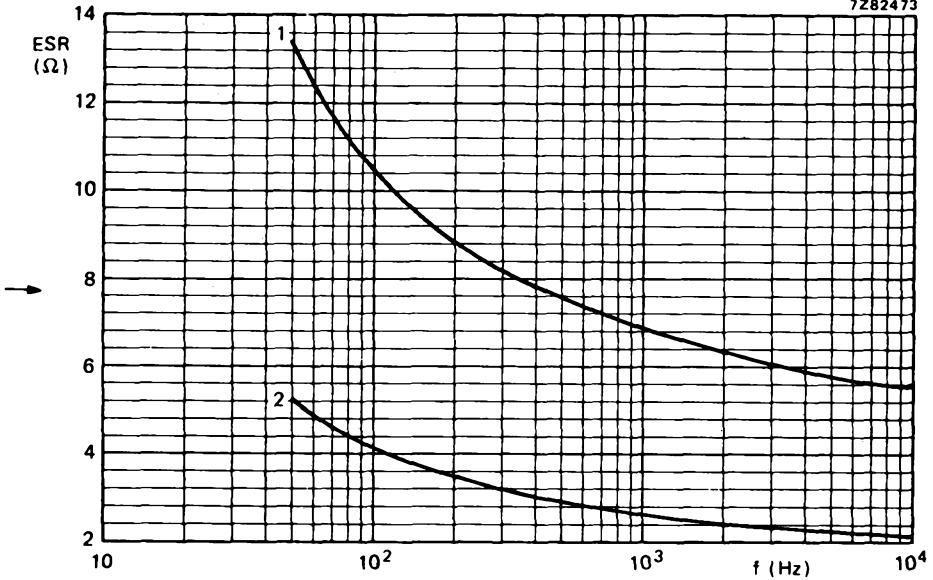

Fig. 13 Typical ESR as a function of frequency at 20 °C. Case size 01:
curve 1 = 10 μ F, 350 V/385 V; curve 2 = 22 μ F, 250 V.

7Z82474

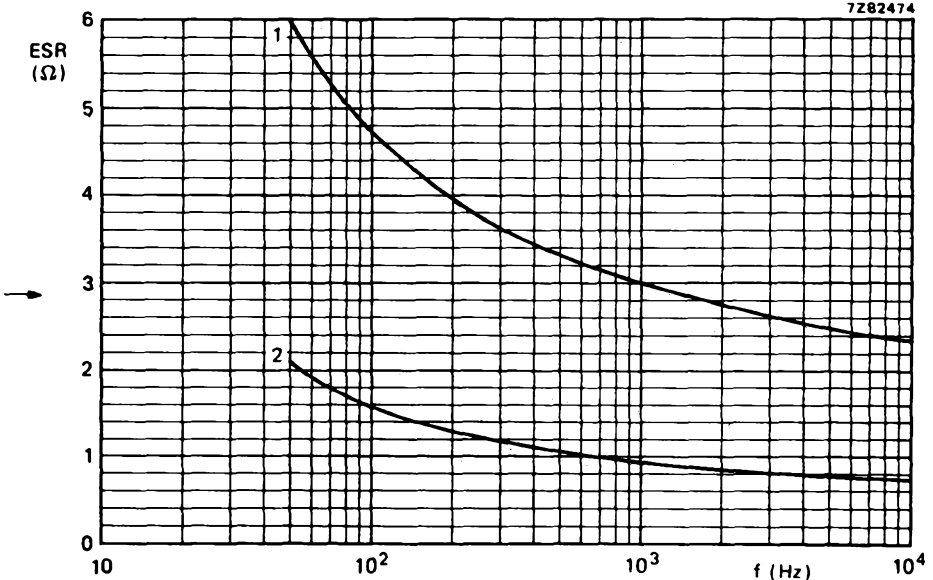

Fig. 14 Typical ESR as a function of frequency at 20 °C. Case size 02:
curve 1 = 22 μ F, 350 V; curve 2 = 47 μ F, 160 V.



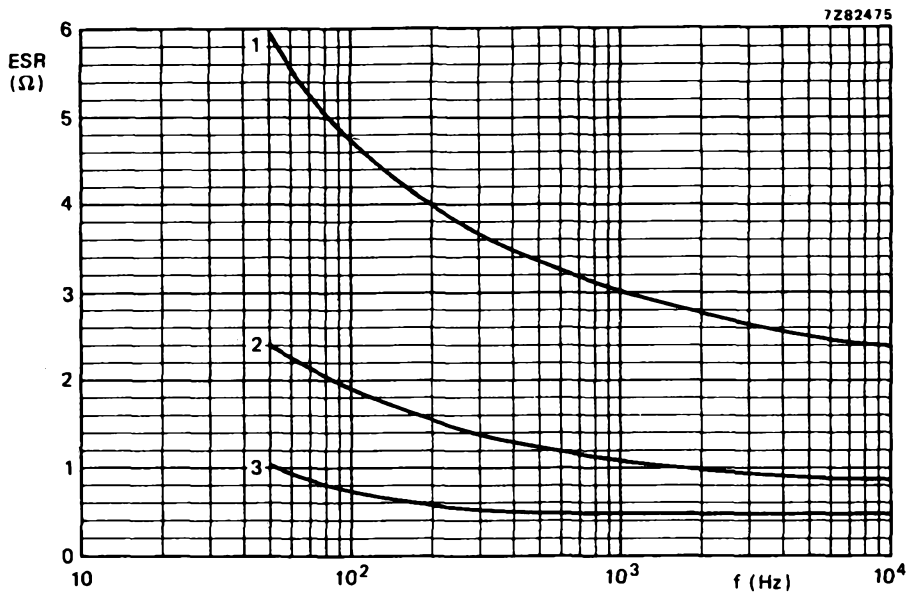

Fig. 15 Typical ESR as a function of frequency at 20 °C. Case size 03:
curve 1 = 22 μ F, 385 V; curve 2 = 47 μ F, 250 V; curve 3 = 100 μ F, 160 V.

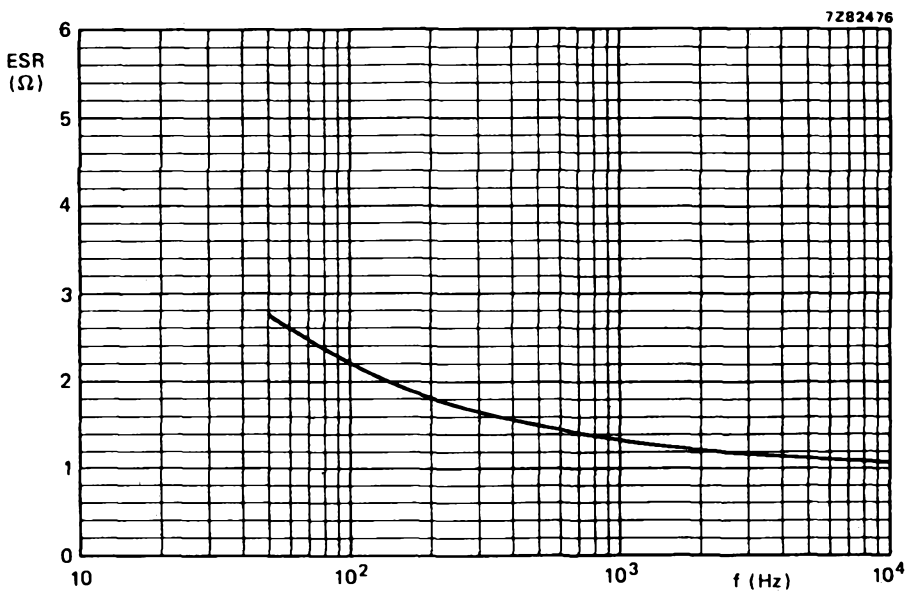

Fig. 16 Typical ESR as a function of frequency at 20 °C. Case size 04: 47 μ F, 350 V.



→ Impedance

The impedance is measured by means of a four-terminal circuit (Thomson circuit).

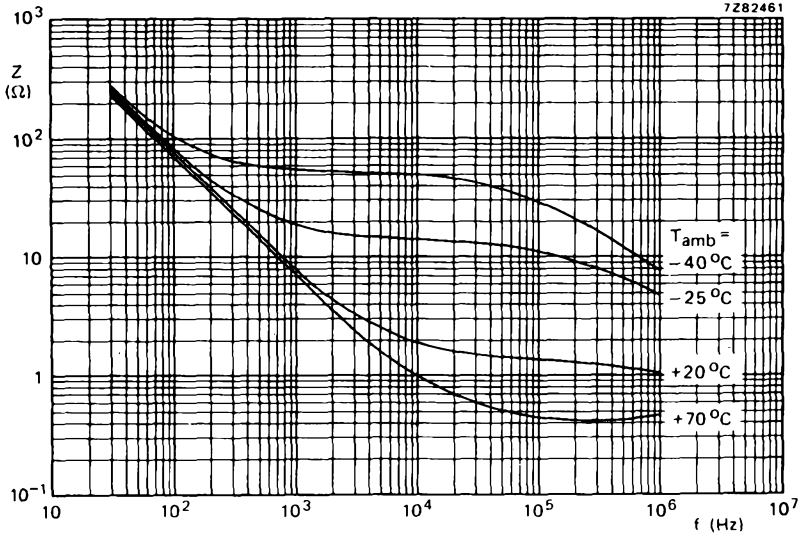

Fig. 17 Typical impedance as a function of frequency at different temperatures. Case size 01: 22 μ F, 250 V.

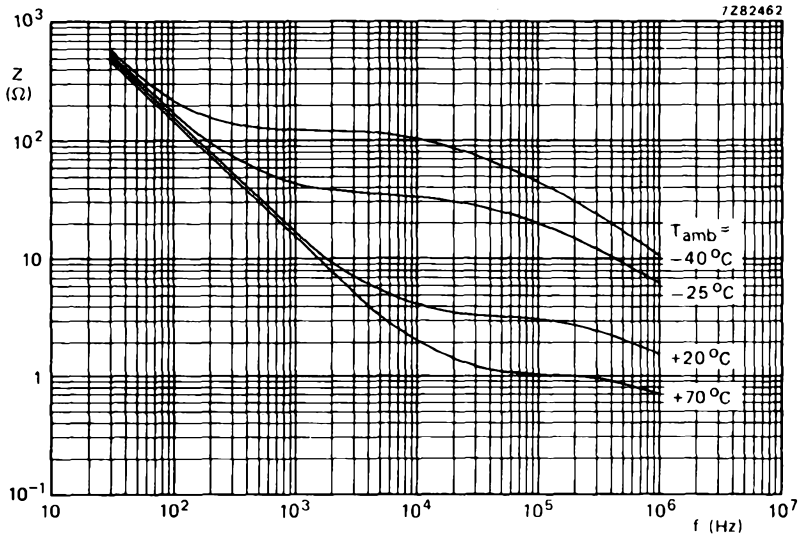

Fig. 18 Typical impedance as a function of frequency at different temperatures. Case size 01: 10 μ F, 350 V/385 V.



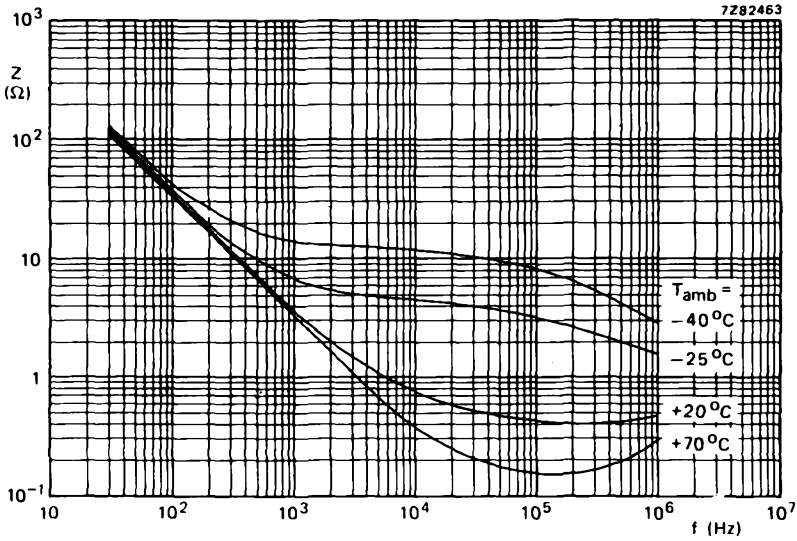

Fig. 19 Typical impedance as a function of frequency at different temperatures. Case size 02: 47 μF , 160 V.

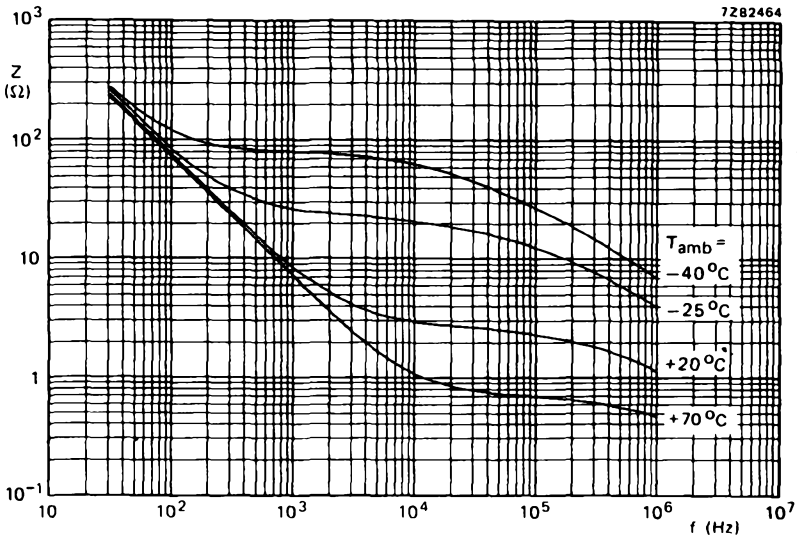

Fig. 20 Typical impedance as a function of frequency at different temperatures. Case size 02: 22 μF , 350 V.



7282465

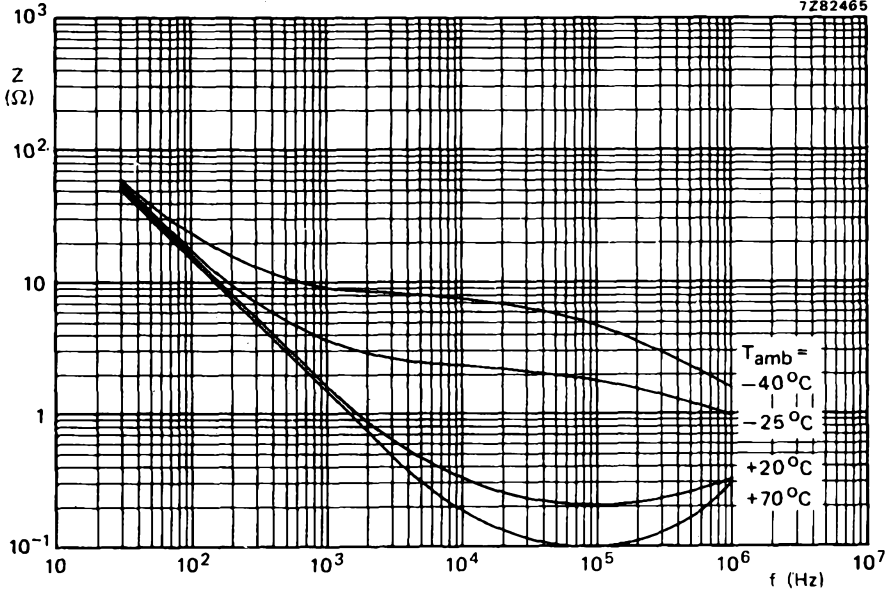

Fig. 21 Typical impedance as a function of frequency at different temperatures. Case size 03: 100 μ F, 160 V.

7282466

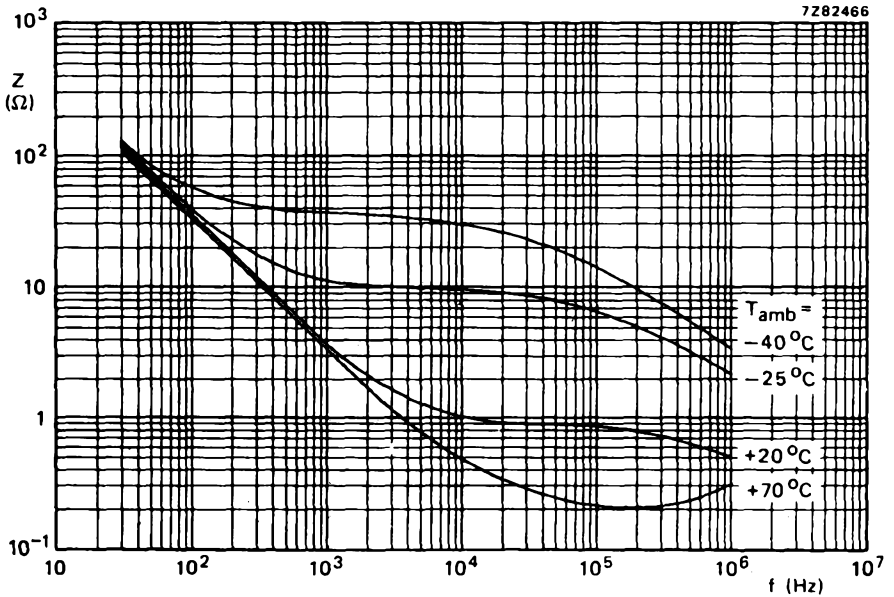

Fig. 22 Typical impedance as a function of frequency at different temperatures. Case size 03: 47 μ F, 250 V.



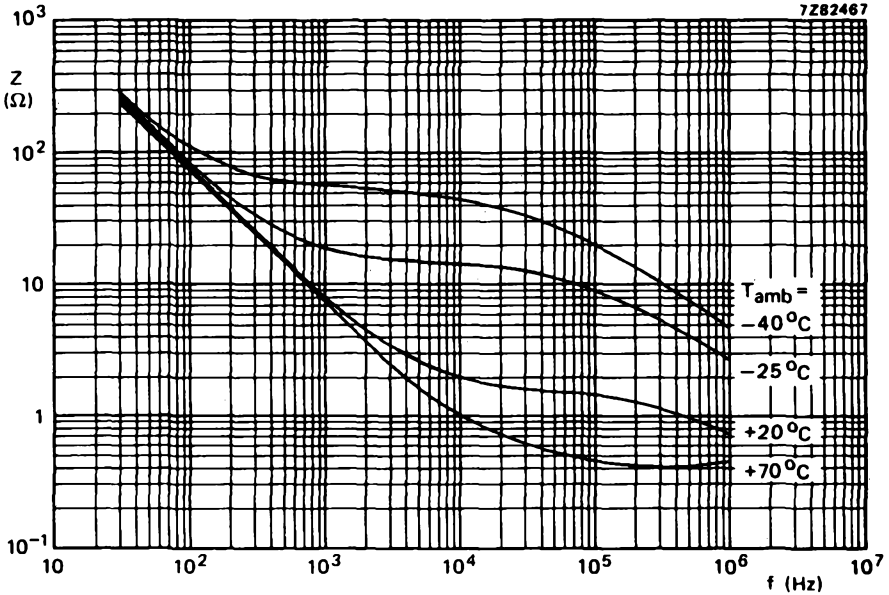

Fig. 23 Typical impedance as a function of frequency at different temperatures. Case size 03: 22 μF , 385 V.

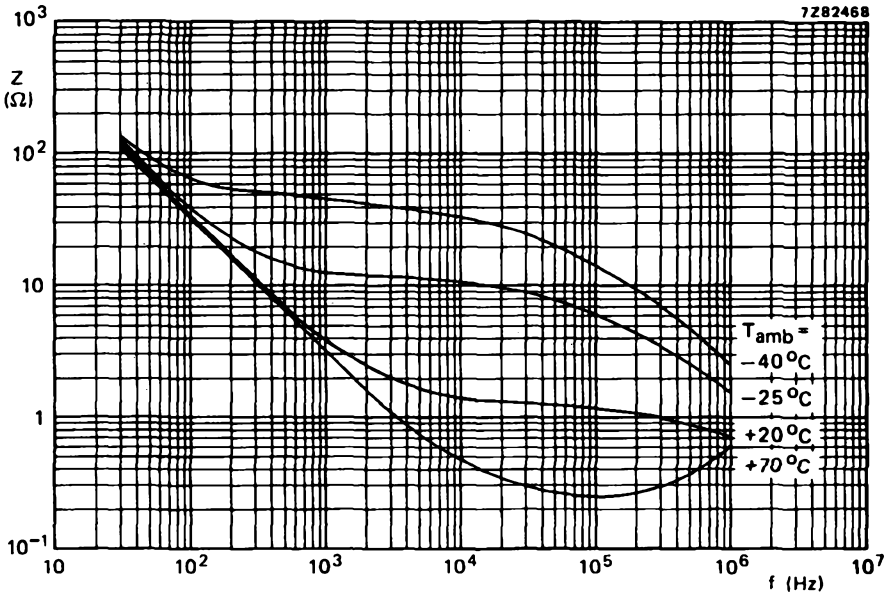

Fig. 24 Typical impedance as a function of frequency at different temperatures. Case size 04: 47 μF , 350 V.



042 Series
043 Series

Inductance (ESL)

Case size 01	50 nH	} typical values
Case size 02	55 nH	
Case size 03 and 04	60 nH	

OPERATIONAL DATA

Category temperature range for rated voltage -40 to + 70 °C

PACKING

Capacitors 2222 042: 500 per box.

Capacitors 2222 043: 100 per box.



DEVELOPMENT SAMPLE DATA

This information is derived from development samples made available for evaluation. It does not form part of our data handbook system and does not necessarily imply that the device will go into production

050 SERIES

ALUMINIUM ELECTROLYTIC CAPACITORS

- Large type with solder tags or printed-wiring pins
- Long life
- Industrial applications

QUICK REFERENCE DATA

Nominal capacitance range (E6 series)	470 to 68 000 μ F
Tolerance on nominal capacitance	-10 to +30%
Rated voltage, U_R	10 to 100 V
Category temperature range	-40 to +85 $^{\circ}$ C
Endurance test at 85 $^{\circ}$ C, at U_R	2000 h
Basic specification	IEC 384-4, long-life grade; DIN 41240
Dimensional specification	DIN 41238
Climatic category, IEC 68	40/085/56

Selection chart for C_{nom} - U_R and relevant case sizes.

C_{nom} μ F	U_R (V)					
	10	16	25	40	63	100
470						1
680						2
1 000					1	3
1 500				1	2	4
2 200			1	2	3	5/6
3 300		1	2	3	4	7
4 700	1	2	3	4	5/6	8
6 800	2	3	4	5/6	7	9
10 000	3	4	5/6	7	8	
15 000	4	5/6	7	8	9	
22 000	5/6	7	8	9		
33 000	7	8	9			
47 000	8	9				
68 000	9					

nominal dimensions (mm)		
case size	versions with solder tags	versions with printed-wiring pins
1	ϕ 25 x 35	ϕ 25 x 35
2	ϕ 25 x 45	ϕ 25 x 45
3	ϕ 30 x 45	ϕ 30 x 45
4	ϕ 35 x 45	ϕ 35 x 45
5	ϕ 35 x 55	ϕ 35 x 55
6		ϕ 40 x 45
7	ϕ 40 x 55	ϕ 40 x 55
8	ϕ 40 x 75	ϕ 40 x 75
9	ϕ 40 x 105	ϕ 40 x 105



Mullard

July 1980

1

APPLICATION

These capacitors have low ESR and ESL values and a high resistance to shock and vibration which render them suitable for application such as:

- switched-mode power supplies;
- power supplies in digital equipment;
- energy storage in pulse systems;
- filters in measuring and control apparatus.

DESCRIPTION

The resistance to shock and vibration is achieved by a special internal construction. The capacitors are completely cold welded and charge/discharge proof. The aluminium case is fully insulated. The solder tag versions have a safety vent in the discs, the printed-wiring versions have a safety vent in the case bottom.

MECHANICAL DATA

Dimensions in mm

Capacitors with solder tags

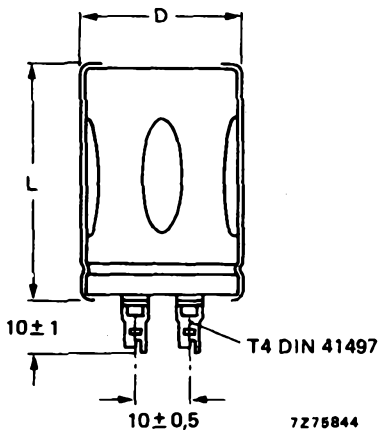
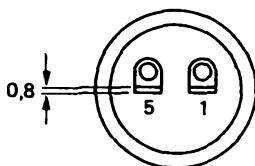

1 = plus
5 = minus

Table 1a

case size	D	L	mass approx. g
1	25	35	25
2	25	45	30
3	30	45	40
4	35	45	55
5	35	55	65
7	40	55	85
8	40	75	115
9	40	105	160



Capacitors with printed-wiring pins

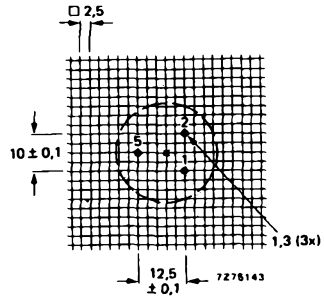
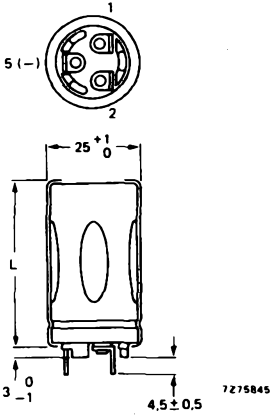

Piercing diagram viewed from component side.

Table 1b

case size	L	mass approx. g
1	35	25
2	45 + 1,3	30

DEVELOPMENT SAMPLE DATA

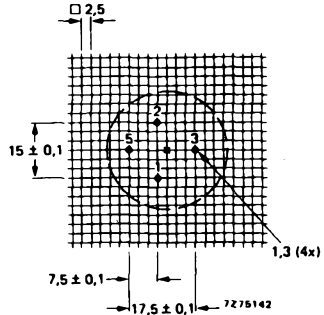
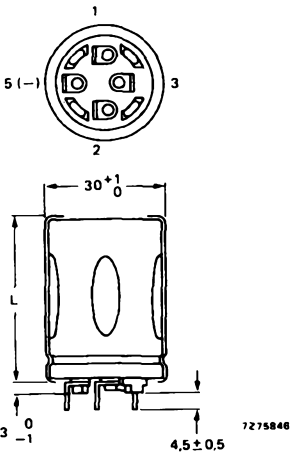

Piercing diagram viewed from component side.

Table 1c

case size	L	mass approx. g
3	45 + 1,3	40



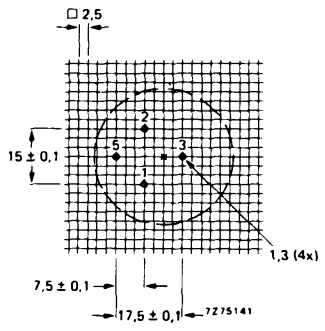
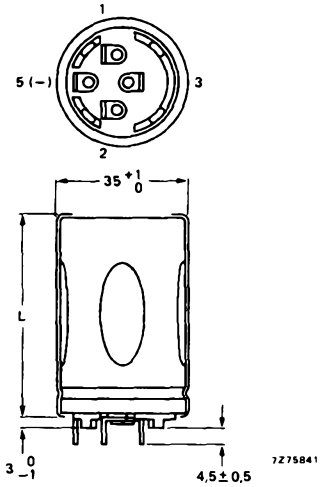

Piercing diagram viewed from component side.

Table 1d

case size	L	mass approx. g
4	45	55 65
5	55	

} + 1,3

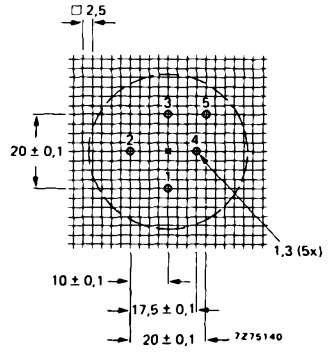
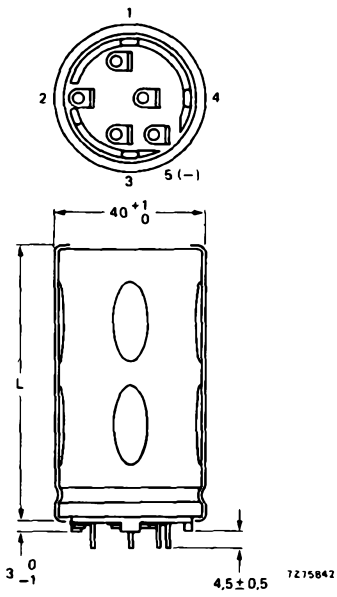

Piercing diagram viewed from component side.

Table 1e

case size	L	mass approx. g
6	45	70 85 115 160
7	55	
8	75	
9	105	

} + 1,3



Marking

The capacitors are marked with: nominal capacitance, tolerance on capacitance, rated voltage, temperature range, IEC grade, catalogue number, date code (year, month) according to IEC 62, name of manufacturer, indication of production centre, polarity of the terminals and dimensional specification DIN 41238.

The terminals are marked as shown in the dimensional figures.

Mounting

The capacitors may be mounted in any position with or without a mounting clamp. Where a number of capacitors are connected to form a capacitor bank, the proximity to one another must not be less than 15 mm, when no derating of ripple current and/or temperature is applied.

If the case has to be at a specified potential, it should be connected to the negative terminal only.

Minimum atmospheric pressure

8,5 kPa

DEVELOPMENT SAMPLE DATA



ELECTRICAL DATA

Unless otherwise specified all electrical values apply at an ambient temperature of 20 °C, a frequency of 100 Hz, an atmospheric pressure of 86 to 106 kPa and a relative humidity of 45 to 75%.

Table 2 (note is at the end of the table)

U _R	nom. cap.	max. r.m.s. ripple current (A) at		max. leakage current at U _R after 5 min (mA)	typ. tan δ	max. ESR	max. impedance at 10 kHz	case size	catalogue number* 050 followed by
		100 Hz, 85 °C	20 kHz, 70 °C						
V	μF					mΩ	mΩ		
10	4 700	2,4	4,6	0,28	0,19	74	40	1	.4472
	6 800	3,2	6,1	0,41	0,18	51	28	2	.4682
	10 000	3,8	7,2	0,60	0,24	39	25	3	.4103
	15 000	4,1	7,8	0,90	0,33	35	24	4	.4153
	22 000	5,0	9,5	1,32	0,37	27	21	5	.4223
	22 000	4,2	8,0	1,32	0,48	36	25	6	.4223
	33 000	5,0	9,5	1,98	0,58	29	21	7	.4333
	47 000	6,8	12,9	2,82	0,58	20	17	8	.4473
	68 000	9,2	17,5	4,08	0,62	15	14	9	.4683
16	3 300	2,4	4,6	0,32	0,13	75	42	1	.5332
	4 700	3,1	5,9	0,45	0,14	52	30	2	.5472
	6 800	3,7	7,0	0,65	0,17	40	27	3	.5682
	10 000	4,1	7,8	0,96	0,22	36	26	4	.5103
	15 000	5,0	9,5	1,44	0,25	28	21	5	.5153
	15 000	4,2	8,0	1,44	0,33	36	25	6	.5153
	22 000	5,0	9,5	2,12	0,38	29	21	7	.5223
	33 000	6,7	12,7	3,17	0,41	20	17	8	.5333
	47 000	9,1	17,3	4,51	0,42	15	14	9	.5473
25	2 200	2,3	4,4	0,33	0,10	78	44	1	.6222
	3 300	3,1	5,9	0,49	0,11	53	32	2	.6332
	4 700	3,7	7,0	0,70	0,12	42	27	3	.6472
	6 800	4,1	7,8	1,02	0,15	37	26	4	.6682
	10 000	5,0	9,5	1,50	0,17	28	21	5	.6103
	10 000	4,2	8,0	1,50	0,22	36	25	6	.6103
	15 000	5,0	9,5	2,25	0,26	29	21	7	.6153
	22 000	6,8	12,9	3,30	0,27	20	17	8	.6223
	33 000	9,2	17,5	4,95	0,30	15	14	9	.6333
40	1 500	2,0	3,8	0,36	0,085	102	60	1	.7152
	2 200	2,7	5,1	0,53	0,087	69	42	2	.7222
	3 300	3,3	6,3	0,79	0,10	52	35	3	.7332
	4 700	3,8	7,2	1,13	0,12	44	32	4	.7472
	6 800	4,7	8,9	1,64	0,13	33	26	5	.7682
	6 800	4,1	7,8	1,64	0,17	41	30	6	.7682
	10 000	4,9	9,3	2,40	0,19	32	25	7	.7103
	15 000	6,6	12,5	3,60	0,21	23	20	8	.7153
	22 000	9,0	17,1	5,28	0,22	17	16	9	.7223



Table 2 (continued)

U _R	nom. cap.	max. r.m.s. ripple current (A) at		max. leakage current at U _R after 5 min (mA)	typ. tan δ	max. ESR	max. impedance at 10 kHz	case size	catalogue number* 050 followed by
V	μF	100 Hz, 85 °C	20 kHz, 70 °C			mΩ	mΩ		
63	1 000	1,8	3,4	0,38	0,064	122	70	1	.8102
	1 500	2,5	4,7	0,57	0,065	83	48	2	.8152
	2 200	3,1	5,9	0,83	0,076	57	39	3	.8222
	3 300	3,6	6,8	1,25	0,094	48	35	4	.8332
	4 700	4,4	8,3	1,78	0,10	36	27	5	.8472
	4 700	3,8	7,2	1,78	0,13	45	33	6	.8472
	6 800	4,7	8,9	2,57	0,14	35	27	7	.8682
	10 000	6,2	11,8	3,78	0,15	25	20	8	.8103
	15 000	8,5	16,1	5,67	0,16	18	16	9	.8153
	100	470	1,2	2,3	0,28	0,086	342	300	1
680		1,7	3,2	0,41	0,087	229	210	2	.9681
1 000		2,2	4,2	0,60	0,092	160	150	3	.9102
1 500		2,6	4,9	0,90	0,10	117	120	4	.9152
2 200		3,2	6,1	1,32	0,11	84	90	5	.9222
2 200		3,0	5,7	1,32	0,12	96	110	6	.9222
3 300		3,6	6,8	1,98	0,14	70	75	7	.9332
4 700		5,0	9,5	2,82	0,13	49	55	8	.9472
6 800		6,9	13,1	4,08	0,14	34	40	9	.9682

DEVELOPMENT SAMPLE DATA

* To complete the catalogue number, replace dot by:

1 = solder tag version;

4 = printed-wiring version, case size 6 only;

5 = printed-wiring version, except case size 6;



Capacitance

Nominal capacitance values at 100 Hz and $T_{amb} = 20\text{ }^{\circ}\text{C}$

see Table 2

Tolerance on nominal capacitance at 100 Hz

-10 to +30%

Voltage

Rated voltage = max. permissible voltage

$< 50\text{ }^{\circ}\text{C}$	50 to 85 $^{\circ}\text{C}$
--------------------------------	-----------------------------

$1,1 \times U_R$

U_R

Ripple voltage* = max. permissible a.c. voltage providing the following conditions are met:

- (a) max. positive voltage on anode (d.c. + peak a.c.)
- (b) max. positive voltage on cathode (reverse voltage)

$< 1,1 \times U_R$

$\leq U_R$

2 V

Surge voltage = max. permissible voltage for short periods

$1,25 \times U_R$

$1,15 \times U_R$

Reverse voltage = max. d.c. voltage applied in the reverse polarity at the maximum category temperature for short periods

2 V

Ripple current**

Maximum permissible r.m.s. ripple current

at 100 Hz and $T_{amb} = 85\text{ }^{\circ}\text{C}$

see Table 2

at 20 kHz and $T_{amb} = 70\text{ }^{\circ}\text{C}$

see Table 2

at 100 Hz and other temperatures

see Table 3

at other frequencies and $T_{amb} = 85\text{ }^{\circ}\text{C}$

see Table 4

Table 3

ambient temperature $^{\circ}\text{C}$	multiplier of max. ripple current
85	1,00
80	1,22
75	1,41
70	1,58
65	1,73
60	1,87
55	2,00
50	2,12
45	2,24
≤ 40	2,35

Table 4

frequency Hz	multiplier of max. ripple current, \sqrt{f}
50	0,83
100	1,00
200	1,10
400	1,15
1000	1,19
≥ 2000	1,20

* Ripple voltages are not applicable if the maximum permissible ripple current is exceeded. In that case the ripple current is decisive.

** Ripple currents are not applicable if the maximum permissible ripple voltage is exceeded. In that case the ripple voltage is decisive.



Non-sinusoidal ripple currents have to be analyzed into a number of sinusoidal currents and the following requirements shall then be satisfied:

$$\sum_n \frac{I_n^2}{r_n} \leq I_{r \max}^2$$

$I_{r \max}$ = maximum ripple current at 100 Hz and applicable ambient temperature

I_n = ripple current at a certain frequency

$\sqrt{r_n}$ = multiplying factor at same frequency (Table 4).

Charge and discharge current

The capacitors may be charged from a source with negligible resistance and they may be discharged by short-circuiting. If the capacitors are charged and discharged continuously, the charge and discharge currents have to be considered as ripple currents flowing through the capacitor. The r.m.s. value of these currents should be determined and the value thus found must not exceed the applicable limit.

Leakage current

Maximum leakage current 5 min after application
of the rated voltage at $T_{amb} = 20^\circ\text{C}$

see Table 2 (0,006 CU + 4 μA)

Maximum leakage current 15 min after application
of the rated voltage

at $T_{amb} = 20^\circ\text{C}$

0,125 x value stated in Table 2

at $T_{amb} = 85^\circ\text{C}$

0,625 x value stated in Table 2

If owing to prolonged storage and/or storage at an excessive temperature the leakage current is too high, application of the rated voltage for some hours will cause the leakage current to fall to a value lower than specified in Table 2.

Tan δ (dissipation factor)

Tan δ at 100 Hz and $T_{amb} = 20^\circ\text{C}$,
measured by means of a four-terminal
circuit (Thomson circuit)

see Table 2

Impedance

Maximum impedance at 10 kHz and $T_{amb} = 20^\circ\text{C}$,
measured by means of a four-terminal circuit
(Thomson circuit)

see Table 2

Equivalent series resistance (ESR)

Maximum ESR at 100 Hz and $T_{amb} = 20^\circ\text{C}$

see Table 2

Inductance (ESL)

10 V, 16 V, 25 V and 40 V versions

max. 30 nH

63 V and 100 V versions

max. 50 nH



OPERATIONAL DATA

Category temperature range

-40 to + 85 °C

Life expectancy

Typical life time

at $T_{amb} = 85\text{ °C}$

> 5000 h

at $T_{amb} = 40\text{ °C}$

> 200 000 h

Guaranteed life time at maximum ripple current and different temperatures

see Table 5

Table 5

ambient temperature °C	guaranteed life time (h) at maximum ripple current
85	2 000
80	3 100
75	4 800
70	7 500
65	12 000
60	18 000
55	27 000
50	42 000
45	65 000
≤ 40	100 000

Failure rate

Failure rate, catastrophic, at rated voltage, $T_{amb} = 40\text{ °C}$ and confidence level 60%

$< 0,5 \times 10^{-7}$

PACKING

The capacitors are packed in boxes containing 100 pieces.



DEVELOPMENT SAMPLE DATA

This information is derived from development samples made available for evaluation. It does not necessarily imply that the device will go into regular production.

052 SERIES

ALUMINIUM ELECTROLYTIC CAPACITORS

- Large type with solder tags or printed wiring pins
- Long life grade
- High voltage for industrial applications

QUICK REFERENCE DATA

Nominal capacitance range (E6 Series)	47 to 1000 μF
Tolerance on nominal capacitance	-10 to +30%
Rated voltage range	250 and 385 V
Category temperature range	-40 to +85 $^{\circ}\text{C}$
Endurance test at U_R	2000 hours at +85 $^{\circ}\text{C}$
Basic specification	IEC384-4, long-life grade DIN41240
Dimensional specification	DIN41238
Climatic category, IEC68	40/085/56

Selection chart for C_{nom} - U_R and relevant case sizes

C_{nom} μF	U_R (V)	
	250	385
47		1
68		2
100	1	3
150	2	4
220	3	5/6
330	4	7
470	5/6	8
680	7	
1000	8	

nominal dimensions (mm)		
case size	versions with solder tags	versions with printed-wiring pins
1	$\phi 25 \times 35$	$\phi 25 \times 35$
2	$\phi 25 \times 45$	$\phi 25 \times 45$
3	$\phi 30 \times 45$	$\phi 30 \times 45$
4	$\phi 35 \times 45$	$\phi 35 \times 45$
5	$\phi 35 \times 55$	$\phi 35 \times 55$
6	—	$\phi 40 \times 45$
7	$\phi 40 \times 55$	$\phi 40 \times 55$
8	$\phi 40 \times 75$	$\phi 40 \times 75$



APPLICATION

The capacitors have low ESR and ESL values and a high resistance to shock and vibration which renders them suitable for applications such as:

- switched mode power supplies
- energy storage in pulse systems
- filters in measuring and control apparatus

DESCRIPTION

The resistance to shock and vibration is achieved by a special internal construction. The capacitors are completely cold welded and charge/discharge proof. The aluminium case is fully insulated. The solder tag versions have a safety vent in the discs, the printed wiring versions have a safety vent in the case bottom.

MECHANICAL DATA

Dimensions in mm

Capacitors with solder tags

D8825

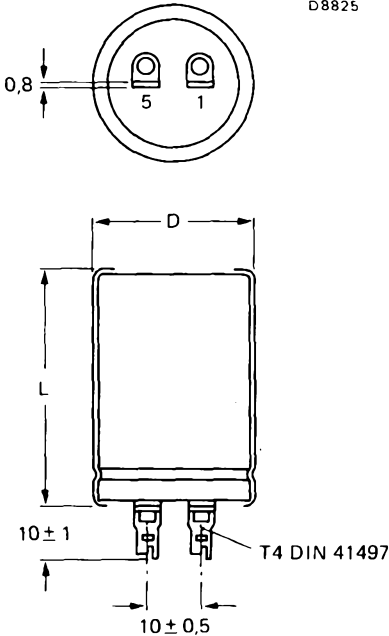

Table 1a

case size	D	L	approx. mass g
1	25	35	25
2	25	45	30
3	30	45	40
4	35	45	55
5	35	55	65
7	40	55	85
8	40	75	115

tag 1 = positive
tag 5 = negative



Capacitors with printed-wiring pins

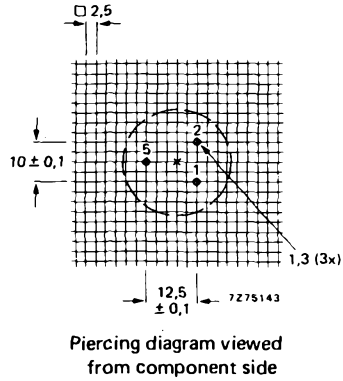
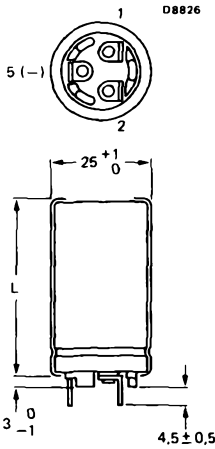

Table 1b

case size	L	approx. mass g
1	35	25
2	45	30

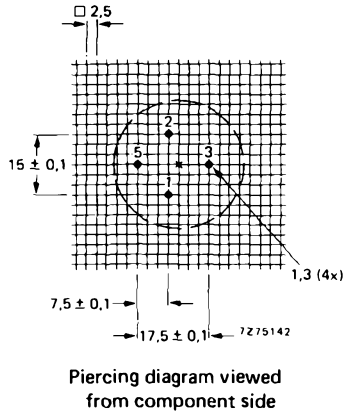
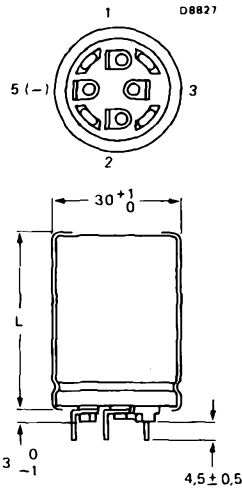
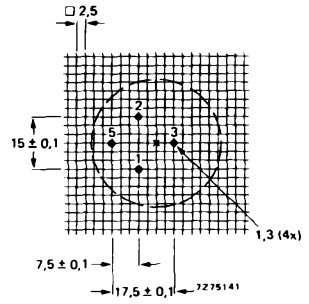
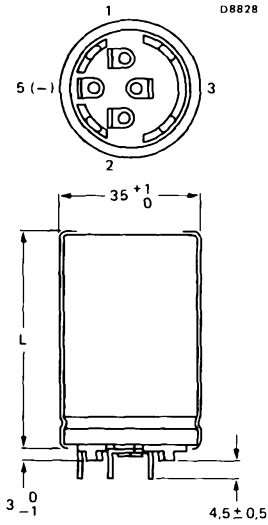

Table 1c

case size	L	approx. mass g
3	45 + 1.3	40

tag 1 = positive
tag 5 = negative
Other tags not connected





Piercing diagram viewed from component side

Table 1d

case size	L	approx. mass g
4	45	55
5	55	
	+1.3	65

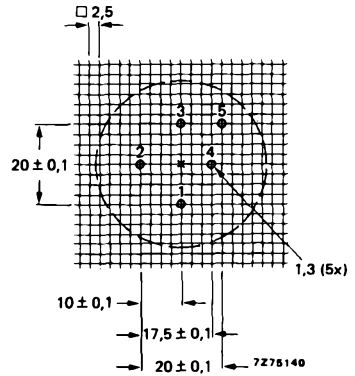
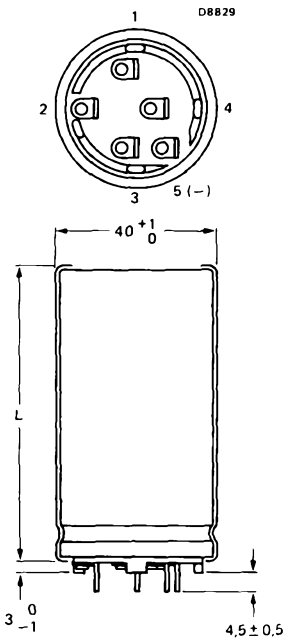

Piercing diagram viewed from component side

Table 1e

case size	L	approx. mass g
6	45	70
7	55	
8	75	
	+1.3	85
		115

tag 1 = positive
tag 5 = negative
Other tags not connected



Marking

The capacitors are marked with;

- Nominal capacitance
- Tolerance on capacitance
- Rated voltage
- Temperature range
- IEC grade
- Catalogue number
- Date code (year, month) according to IEC62
- Name of manufacturer
- Indication of production centre
- Polarity of the terminals
- Dimensional specification DIN41238

The terminals are shown as marked on the dimensional figures.

Mounting

The capacitors may be mounted in any position with or without a mounting clamp. Where a number of capacitors are connected to form a capacitor bank, the proximity one to another must not be less than 15 mm, where no derating of ripple current and/or temperature is applied.

If the case has to be at a specified potential, it should be connected to the negative terminal only.

Minimum atmospheric pressure

8.5 kPa

DEVELOPMENT SAMPLE DATA



ELECTRICAL DATA

Unless otherwise specified all electrical values apply at an ambient temperature of 20 °C, a frequency of 100 Hz, an atmospheric pressure of 86 to 106 kPa and a relative humidity of 45 to 75%.

Table 2 (note is at the end of the table)

U_R	nom. cap.	max. r.m.s. ripple current (A) at 100 Hz (1)		max. leakage current at U_R after 5 min. (1)	typ. $\tan \delta$ (1)	max. ESR (1)	max. impedance at 10 kHz (1)	case size	catalogue number 052 followed by*
	V	μF	85 °C						
250	100	0.6	0.95	150	0.085	1800	1300	1	.3101
	150	0.8	1.3	230	0.08	1100	850	2	.3151
	220	1.0	1.6	330	0.08	750	550	3	.3221
	330	1.4	2.2	490	0.08	500	400	4	.3331
	470	1.8	2.8	700	0.08	360	290	5	.3471
	470	1.8	2.8	700	0.095	420	350	6	.3471
	680	2.3	3.6	1020	0.08	250	190	7	.3681
	1000	3.0	4.7	1500	0.08	170	140	8	.3102
385	47	0.4	0.65	110	0.065	2800	2200	1	.8479
	68	0.6	0.95	160	0.055	1700	1350	2	.8689
	100	0.8	1.3	230	0.055	1100	850	3	.8101
	150	1.0	1.6	340	0.055	725	525	4	.8151
	220	1.3	2.1	500	0.055	500	350	5	.8221
	220	1.3	2.1	500	0.065	600	420	6	.8221
	330	1.7	2.7	750	0.055	340	230	7	.8331
	470	2.8	4.5	1060	0.055	240	160	8	.8471

(1) see also corresponding paragraph

*Replace dot in catalogue number (4th digit) by

- 1 — for solder lug type
- 4 — for printed wiring (case size 6 only)
- 5 — for printed wiring (except case size 6)



CapacitanceNominal capacitance values at 100 Hz and $T_{amb} = 20\text{ }^{\circ}\text{C}$

See Table 2

Tolerance on nominal capacitance at 100 Hz

-10 to +30%

Voltage

	< +50 °C	+50 to +85 °C
Rated voltage = maximum permissible voltage	$1.1 \times U_R$	U_R
Ripple voltage* = maximum permissible voltage provided that the following conditions are met:		
(a) maximum positive voltage on anode (d.c. + peak a.c.) $\leq 1.1 \times U_R$		U_R
(b) maximum positive voltage on cathode (reverse voltage)		2 V

Surge voltage

	< +50 °C	+50 to +85 °C
Maximum permissible voltage for short periods	$1.25 U_R$ $1.20 U_R$	$1.15 U_R$ ($U_R = 250\text{ V}$) $1.05 U_R$ ($U_R = 385\text{ V}$)

Reverse voltage

Maximum d.c. voltage applied in the reverse polarity at the maximum category temperature for short periods

2 V

Ripple current*Maximum permissible r.m.s. ripple current at 100 Hz and $T_{amb} = 85\text{ }^{\circ}\text{C}$

See Table 2

Non-sinusoidal currents have to be analyzed into a number of sinusoidal currents and the following requirements shall then be satisfied:

$$\sum_n \frac{I_r^2}{r_n} \leq I_r^2 \text{ max.}$$

 $I_r \text{ max.}$ = maximum ripple current at 100 Hz and applicable ambient temperature I_r = ripple current at a certain frequency $\sqrt{r_n}$ = multiplying factor at same frequency = $\sqrt{\frac{\text{ESR (100 Hz)}}{\text{ESR (}f_n\text{)}}}$

*These ripple currents are not applicable if the maximum permissible ripple voltage is exceeded. In that case the ripple voltage is decisive.



Table 3

ambient temperature (°C)	multiplying factor of maximum ripple current
85	1.0
80	1.22
75	1.41
70	1.58
65	1.73
60	1.87
55	2.00
50	2.12
45	2.24
≤40	2.35

Table 4

frequency (Hz)	multiplying factor of maximum ripple current
50	0.8
100	1.0
200	1.19
400	1.24
1000	1.33
≥2000	1.35

Charge and discharge current

The capacitors may be charged from a source with negligible resistance and they may be discharged by short circuiting. If the capacitors are charged and discharged continuously, the charge and discharge currents have to be considered as ripple currents flowing through the capacitor. The r.m.s. value of these currents should be determined and the value thus found must not exceed the applicable limits.

Leakage current

Maximum leakage current 5 min. after application of the rated voltage at $T_{amb} = 20\text{ }^{\circ}\text{C}$

See Table 2 (0.006 CU + 4 μA)

Maximum leakage current after 15 min. at U_R
 at $T_{amb} = 20\text{ }^{\circ}\text{C}$
 at $T_{amb} = 85\text{ }^{\circ}\text{C}$

0.125 x value stated in Table 2
 0.625 x value stated in Table 2

If, owing to prolonged storage and/or storage at an excessive temperature the leakage current is too high, application of the rated voltage for some hours will cause the leakage current to fall to a value lower than specified in Table 2.

Tan δ (dissipation factor)

Tan δ at 100 Hz and $T_{amb} = 20\text{ }^{\circ}\text{C}$
 measured by means of a four-terminal circuit (Thomson circuit)

See Table 2

Impedance

Maximum impedance at 10 kHz and $T_{amb} = 20\text{ }^{\circ}\text{C}$
 measured by means of a four-terminal circuit (Thomson circuit)

See Table 2

Equivalent series resistance

Measured at 100 Hz and $T_{amb} = 20\text{ }^{\circ}\text{C}$

See Table 2



OPERATIONAL DATA**Category temperature range**

For rated voltage -40 to +85 °C

Life expectancy**Typical life time**at $T_{amb} = 85\text{ °C}$ at $T_{amb} = 40\text{ °C}$

>5000 hours

>200 000 hours

Guaranteed life time at maximum ripple current and different temperatures

See Table 5

Table 5

ambient temperature (°C)	guaranteed life time at maximum ripple current (hours)
85	2 000
80	3 100
75	4 800
70	7 500
65	12 000
60	18 000
55	27 000
50	42 000
45	65 000
≤40	100 000

Failure rateFailure rate, catastrophic, at rated voltage, $T_{amb} = 40\text{ °C}$ and confidence level 60%<10⁻⁷**PACKING**

The capacitors are packed in boxes of 100 pieces



MOUNTING ACCESSORIES

Dimensions in mm

Clamps

To facilitate vertical mounting, a series of rigid clamps made of cadmium-plated steel are available. They can easily be slid over the capacitor and then fixed to it with a nut and bolt. They are provided with two mounting lugs. Four types are available, one for each case diameter of the capacitor range. They are delivered without nuts or bolts.

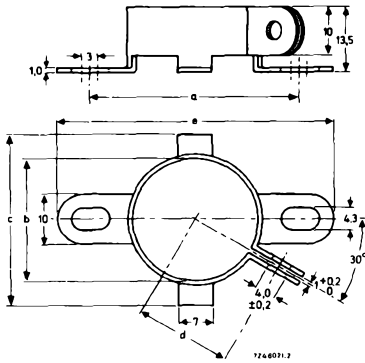

For case sizes 1,2,3,7 and 8

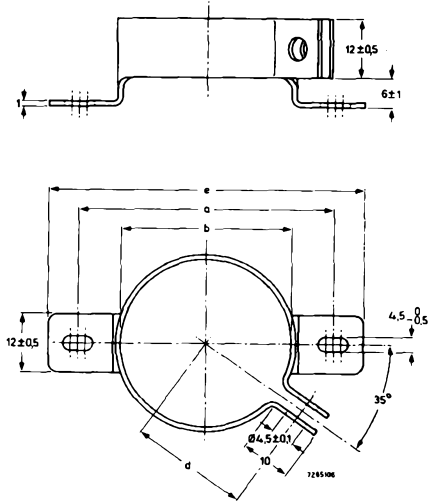

For case sizes 4 and 5.

case size	dimensions (mm)					catalogue number
	a	b	c	d	e	
1, 2	41.5 ± 0.2	25	35	18.5	56	4322 043 03301
3	46.5 ± 0.2	30	40	21	61	4322 043 03311
4, 5	51.5 ± 0.2	35	—	23.5	63	4322 043 04272
7, 8	56.5 ± 0.2	40	50	26	71	4322 043 03331



ALUMINIUM ELECTROLYTIC CAPACITORS

large, high grade, general purpose

For use in power supplies and similar applications in transistorized equipment.

QUICK REFERENCE DATA

Nominal capacitance range	680 to 47 000 μF
Capacitance tolerance	-10 to +50%
Rated voltage range (U_R)	6.3 to 63 V
Climatic category (IEC 68)	40/085/56 (IEC 384-4 long life grade).

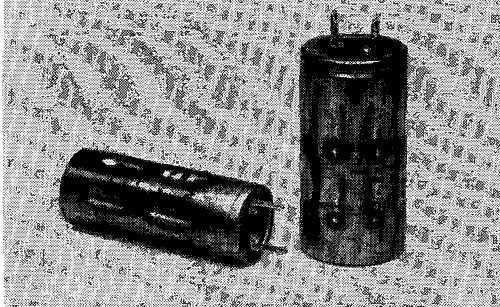

ELECTROLYTE

Impregnated into high purity grade paper.

CASING

Aluminium can with longitudinal crimps sealed by a rubber faced plastic disc and insulated by a plastic sleeve. A rupture vent is incorporated in the disc which will operate if the internal pressure becomes excessive due to overloading.

TERMINATIONS

Solder tags marked with a square (\square) for the positive terminal and a Δ for the negative terminal.

SPECIAL FEATURES

The longitudinal crimping of the casing holds the core in position, allowing it to withstand severe vibration and shocks, also to increase the thermal dissipation from the core centre. The capacitors utilize other forms of advanced technology to achieve relatively small size coupled with high quality and long life. Typical life is greater than 5000 hours at 85 $^{\circ}\text{C}$ or greater than 80 000 hours at 40 $^{\circ}\text{C}$.



QUICK SELECTION CHART

D7495 (845)

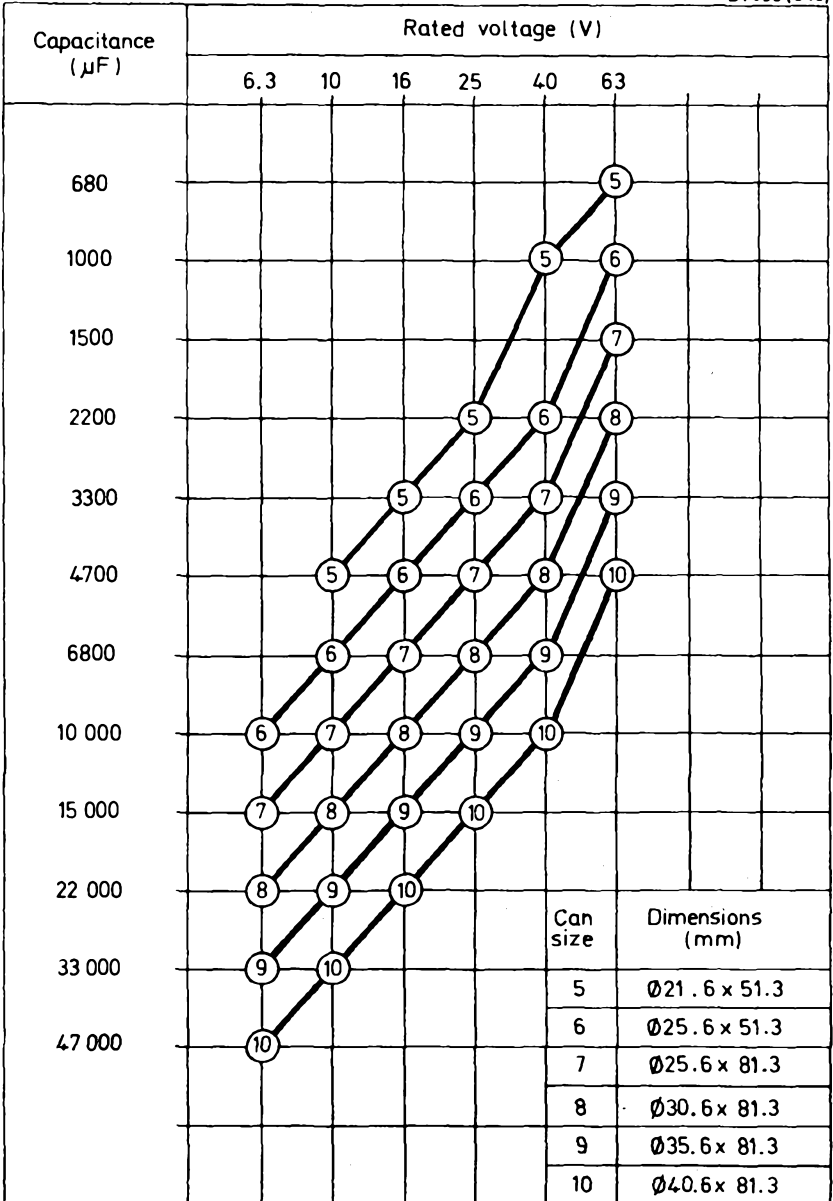

MECHANICAL DATA

Dimensions in mm

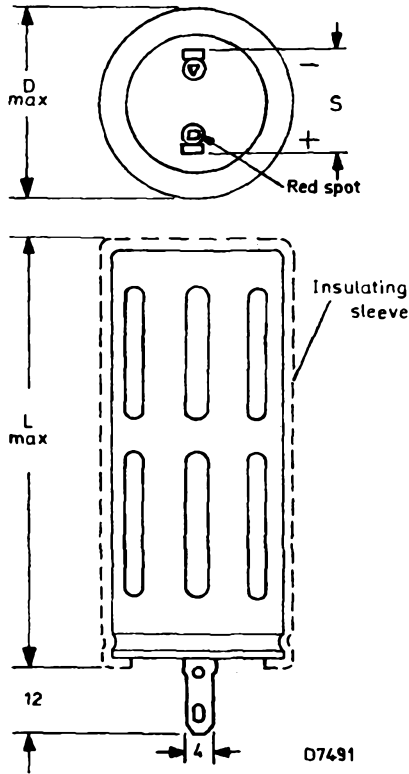

can size	L max.	D max.	S	Typical weight (g)
5	51.3	21.6	13	20
6	51.3	25.6	13	30
7	81.3	25.6	13	45
8	81.3	30.6	19	70
9	81.3	35.6	19	100
10	81.3	40.6	19	130



ELECTRICAL DATA

Unless otherwise stated, all parameters apply at an ambient temperature of 20 ± 5 °C, a frequency of 100 Hz, an atmospheric pressure of 10^5 Pa (1000 mbars) and a relative humidity of 75% maximum.

rated voltage U_R (notes 1 and 2)	capacitance (-10 to +50%)	can size	max. leakage current (note 3)	max. permissible ripple current (note 4)			max. tangent of loss angle	max. h.f. impedance ($f = 100$ kHz)	type number		
				(A)							
(V)	(μF)		(mA)	50 °C	70 °C	85 °C	($\tan \delta$)	(Ω)			
6.3	10 000	6	0.38	4.0	3.1	1.8	0.50	0.06	071 13103		
	15 000	7	0.57	6.1	4.8	2.7			0.50	0.05	071 13153
	22 000	8	0.84	8.3	6.4	3.7			0.50	0.05	071 13223
	33 000	9	1.25	11.0	8.5	4.9			0.50	0.025	071 13333
	47 000	10	1.78	14.2	11.0	6.3			0.50	0.025	071 13473
10	4 700	5	0.28	2.5	1.9	1.1	0.35	0.08	071 14472		
	6 800	6	0.41	4.0	3.1	1.8			0.35	0.06	071 14682
	10 000	7	0.60	6.0	4.6	2.7			0.35	0.05	071 14103
	15 000	8	0.90	8.2	6.3	3.7			0.35	0.05	071 14153
	22 000	9	1.32	10.6	8.3	4.8			0.35	0.025	071 14223
33 000	10	1.98	13.4	10.4	6.0	0.35	0.025	071 14333			
16	3 300	5	0.32	2.4	1.9	1.1	0.25	0.08	071 15332		
	4 700	6	0.45	3.9	3.0	1.7			0.25	0.06	071 15472
	6 800	7	0.655	5.8	4.5	2.6			0.25	0.05	071 15682
	10 000	8	0.96	7.9	6.1	3.5			0.25	0.05	071 15103
	15 000	9	1.44	10.5	7.6	4.7			0.25	0.025	071 15153
22 000	10	2.12	13.8	10.6	6.1	0.25	0.025	071 15223			
25	2 200	5	0.33	2.2	1.7	1.0	0.20	0.08	071 16222		
	3 300	6	0.495	3.7	2.8	1.7			0.20	0.06	071 16332
	4 700	7	0.705	5.4	4.2	2.4			0.20	0.05	071 16472
	6 800	8	1.02	7.3	5.6	3.3			0.20	0.05	071 16682
	10 000	9	1.5	9.6	7.4	4.3			0.20	0.025	071 16103
15 000	10	2.25	12.6	9.8	5.7	0.20	0.025	071 16153			
40	1 000	5	0.24	2.1	1.6	1.0	0.15	0.125	071 17102		
	2 200	6	0.53	2.9	2.2	1.3			0.15	0.1	071 17222
	3 300	7	0.795	5.2	4.1	2.4			0.15	0.08	071 17332
	4 700	8	1.13	7.0	5.4	3.1			0.15	0.08	071 17472
	6 800	9	1.64	9.1	7.1	4.1			0.15	0.04	071 17682
10 000	10	2.4	12.0	8.7	5.3	0.15	0.04	071 17103			
63	680	5	0.26	2.1	1.4	0.8	0.10	0.125	071 18681		
	1 000	6	0.38	2.9	2.2	1.3			0.10	0.1	071 18102
	1 500	7	0.57	4.3	3.4	2.0			0.10	0.08	071 18152
	2 200	8	0.835	5.8	4.5	2.6			0.10	0.08	071 18222
	3 300	9	1.25	7.8	6.0	3.5			0.10	0.04	071 18332
4 700	10	1.78	10.0	7.8	4.5	0.10	0.04	071 18472			



ELECTRICAL DATA (continued)

Notes

1. Rated voltage is the sum of the direct voltage plus the peak ripple voltage. The peak ripple voltage relates to the maximum ripple current at 85 °C. The capacitors may be operated on an alternating voltage (without a direct voltage present), up to the value shown in the table below:

	voltage (V)					
rated voltage (U_R)	6.3	10	16	25	40	63
r.m.s. voltage	0.63	1	1	1	1	1

2. A surge voltage may be applied for a maximum of 1 minute per hour. The rated voltage plus surge voltage equals the maximum permissible voltage as shown in the table below:

	voltage (V)					
rated voltage (U_R)	6.3	10	16	25	40	63
maximum permissible voltage at $T_{amb} \leq 50$ °C	8.3	13	20.5	31.8	50.5	79.3
maximum permissible voltage at $T_{amb} > 50$ °C	7.5	11.7	18.5	28.6	45.5	71.3

3. Maximum leakage current is measured at 20 °C, 5 minutes after the application of the full rated voltage.

Maximum leakage current during continuous operation at U_R

at 20 °C: approx. .125 x value shown in table.

at 85 °C: \leq value shown in the table.

4. Maximum ripple current is measured at 85 °C. At ≤ 65 °C ambient, the rating may be increased by a factor of 2.2.

OPERATIONAL DATA

Equivalent series resistance ($ESR = \frac{\tan \delta}{\omega C}$)

This can be calculated from measurements at any frequency and ambient temperature.

Insulation test voltage (d.c.)

measured between insulating sleeve and both leads 1000 V

Climatic category (IEC Publication 68)

40/085/56 (IEC 384-4 long life grade)

Soldering conditions

250 °C max. for 5 seconds max.



MOUNTING

The capacitors may be mounted in any position. Suitable mounting clips from the Mullard range (see data sheet MOUNTING CLIPS) are given in the table below:

can size	mounting clip type number
5	B1 271 21
6	B1 271 22
7	B1 271 22
8	DT2402
9	B1 271 24
10	B1 271 25

MARKING

The capacitors are marked with:

Capacitance and tolerance

Rated voltage

Category temperature range

Maximum permissible ripple current

Type number code

Polarity indication

ORDERING PROCEDURE

The capacitors should be ordered by their type number, as shown in the table.

Example: A 6800 μ F, 16 V rated capacitor should be ordered by quoting the type number 071 15682.

Note:

Non-solid electrolyte capacitors may contain chemicals which can be regarded as hazardous if incorrectly handled. Caution is necessary should the outer case be fractured.



D5160

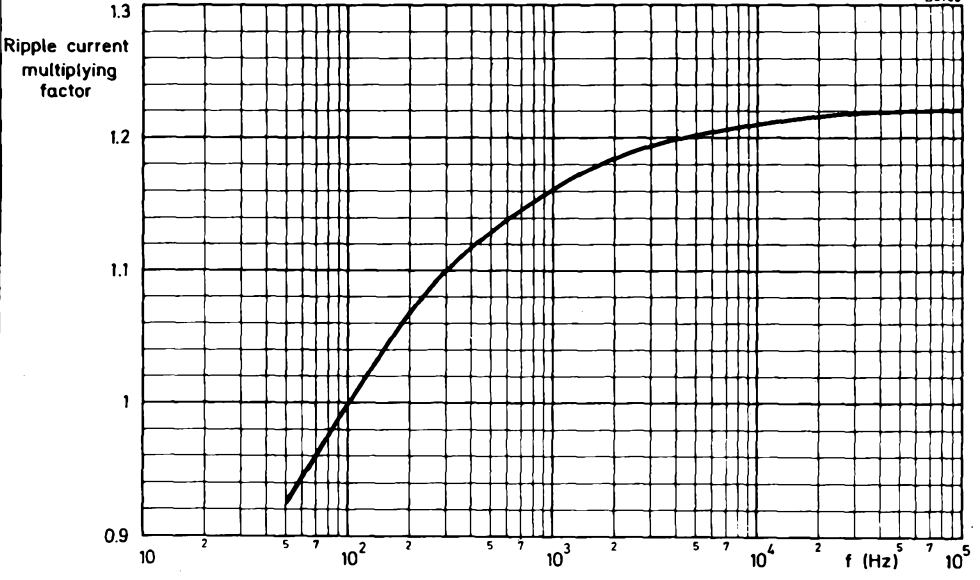

Typical ripple current multiplying factor plotted against frequency

D7508(17265677)

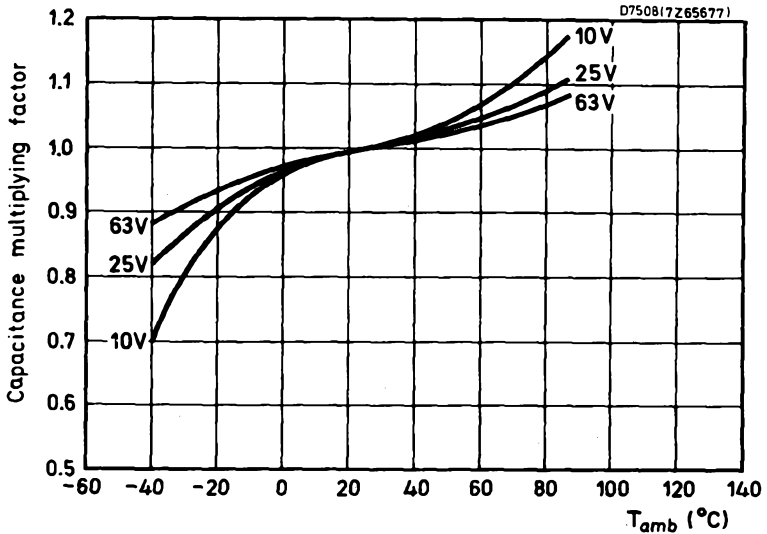

Typical capacitance as a function of ambient temperature



June 1978

Mullard

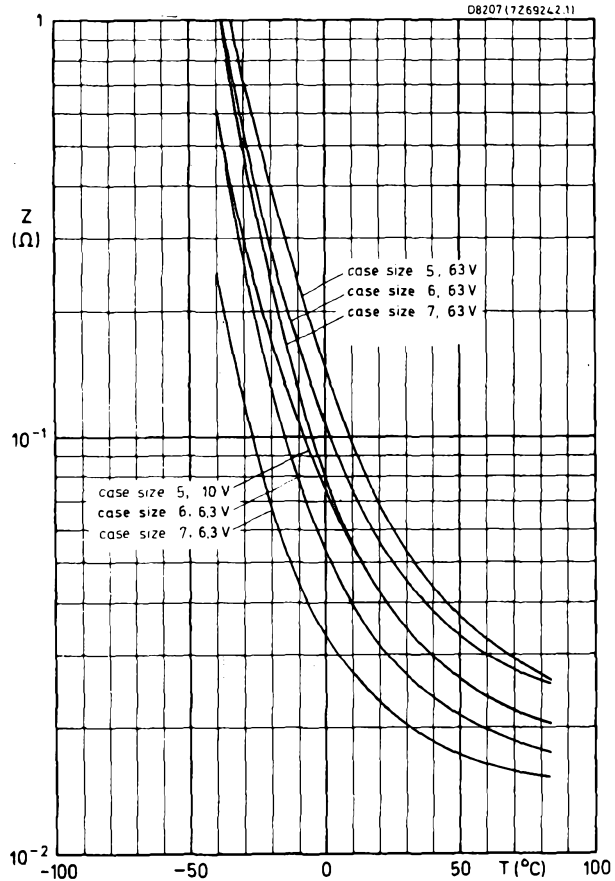
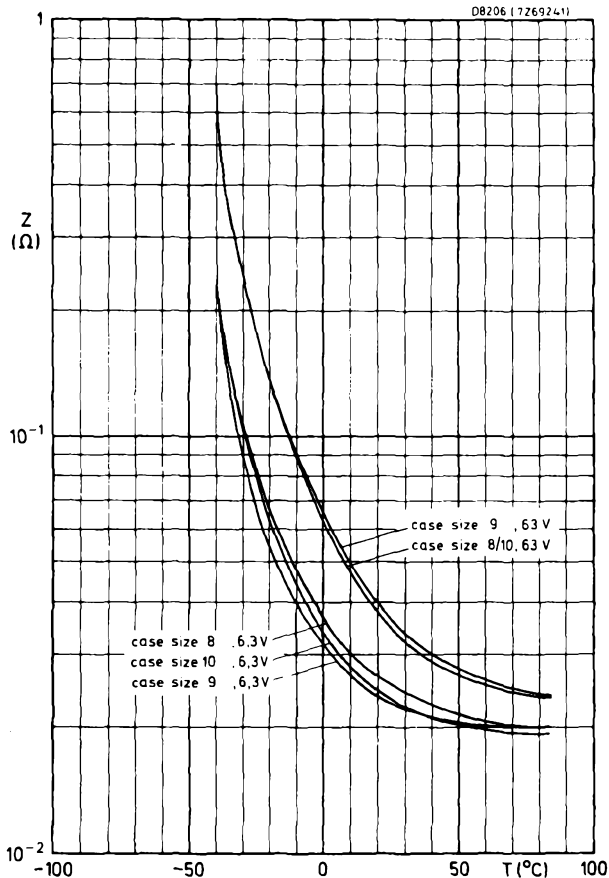

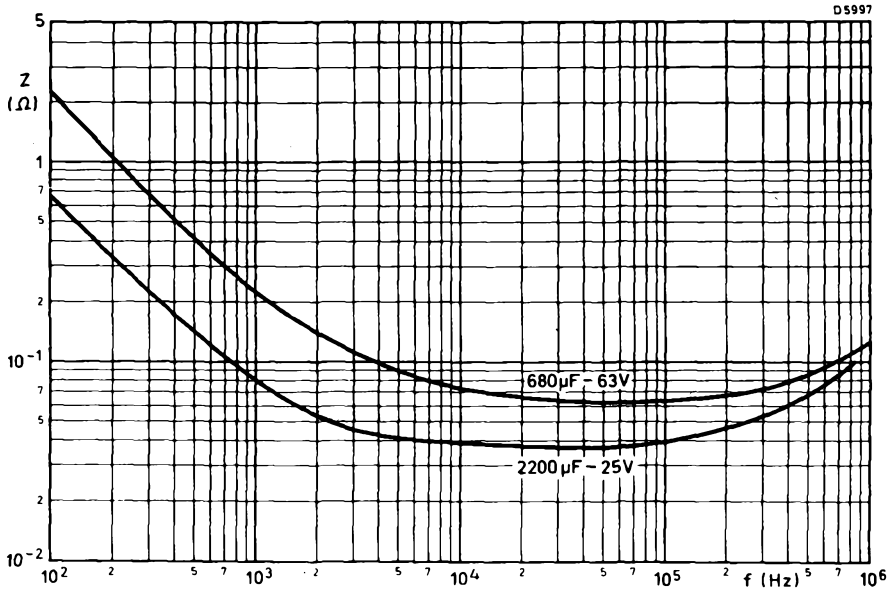

Typical impedance plotted against frequency. $T_{amb} = 20\text{ }^{\circ}\text{C}$

Can size 5

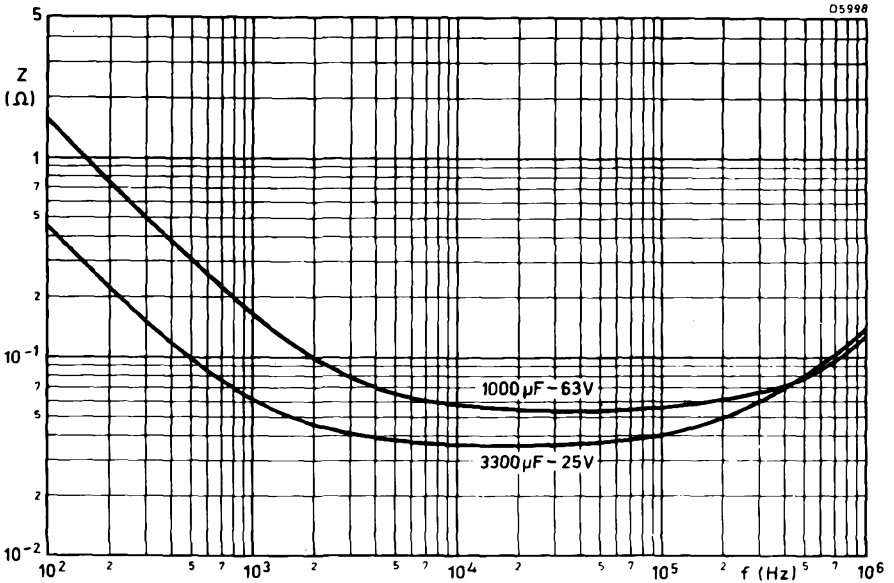

Typical impedance plotted against frequency. $T_{amb} = 20\text{ }^{\circ}\text{C}$

Can size 6



071 Series

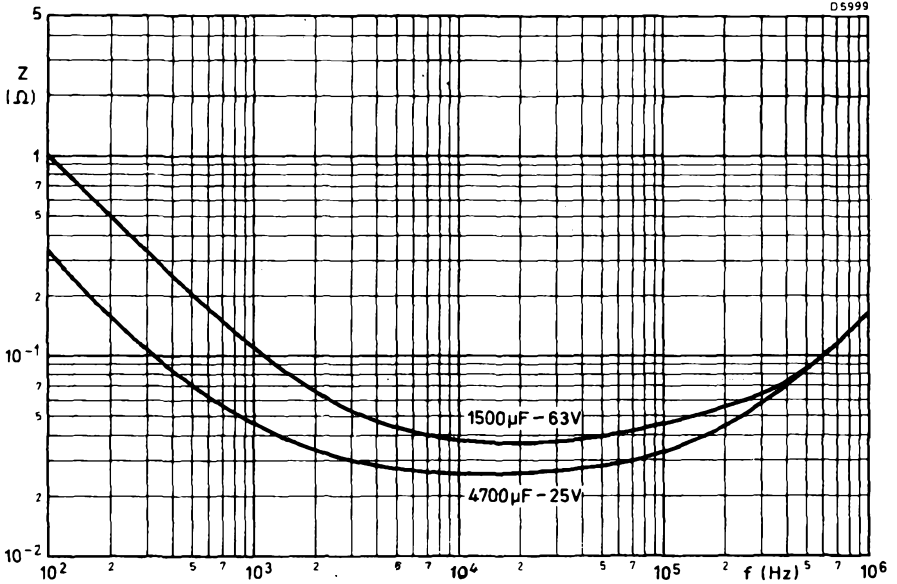

Typical impedance plotted against frequency. $T_{amb} = 20^\circ C$

Can size 7

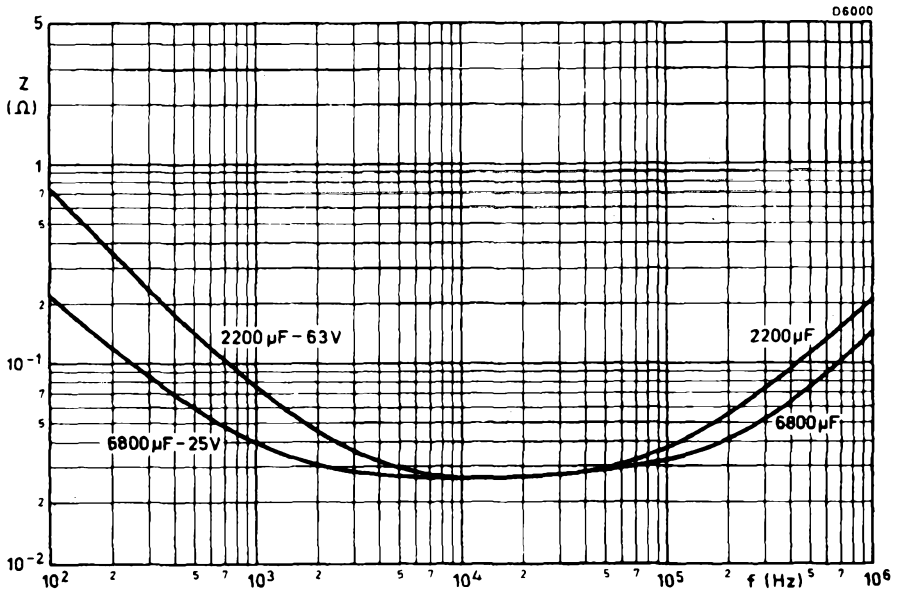

Typical impedance plotted against frequency. $T_{amb} = 20^\circ C$

Can size 8



D6001a

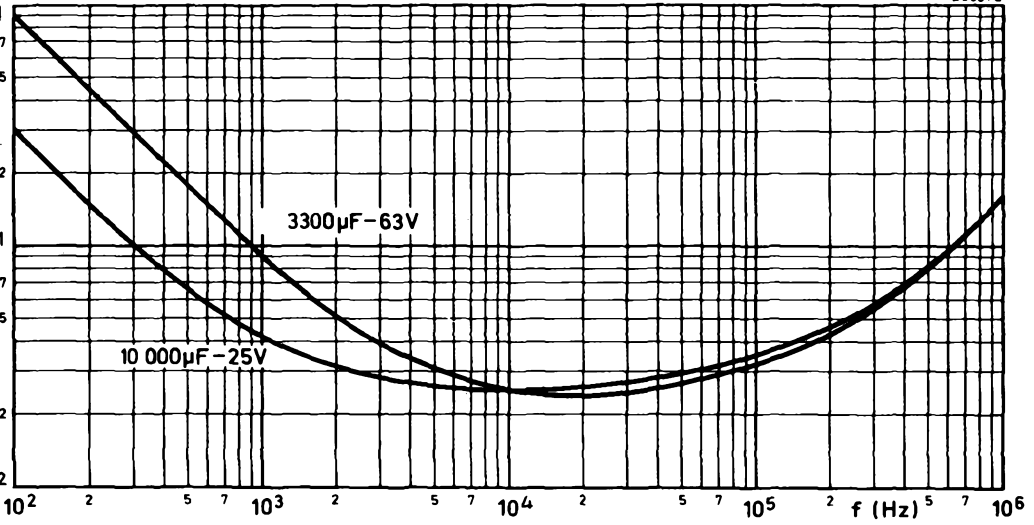

Typical impedance plotted against frequency. $T_{\text{amb}} = 20^\circ\text{C}$

Can size 9

D6002a

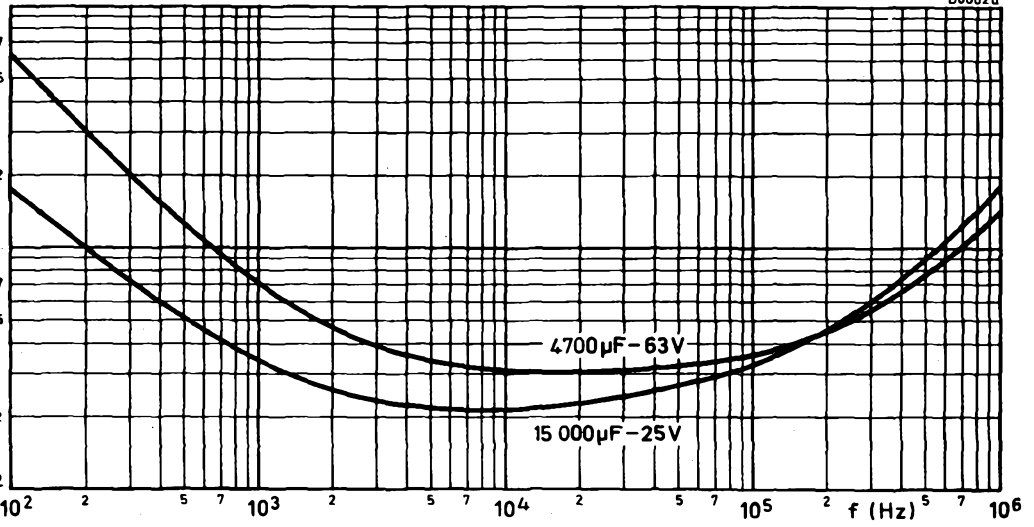

Typical impedance plotted against frequency. $T_{\text{amb}} = 20^\circ\text{C}$.

Can size 10



ALUMINIUM ELECTROLYTIC CAPACITORS

Large, long life, computer grade

**106
107
Series**

For industrial and professional use where large capacitance values, long life and high reliability are required. The 106 series is especially suitable for SMPS applications, where low ESR and ESL values are required.

QUICK REFERENCE DATA

Capacitance range (E6 Series)	1500 to 150 000	μ F
Capacitance tolerance	-10 to +50	%
Rated voltage range	6.3 to 100	V
Climatic category (IEC 68) 106 Series	40/085/56	
	107 Series	25/085/56
	IEC 384-4 long life grade	

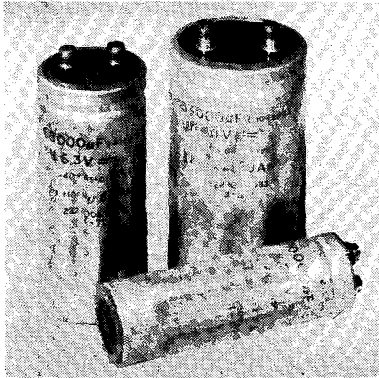

ELECTROLYTIC

Impregnated into high purity grade paper tissue.

CASING

Aluminium can sealed by a plastic disc and rubber ring, insulated by a plastic sleeve.

TERMINATIONS

Terminal posts fitted with 5 mm screws and washers.

TYPE NUMBER DESIGNATION

6.3 to 63 V versions

106 Series

100 V version

107 Series

APPROVAL

(106 Series) P.O. specification D2543, type No. 4513A

Mullard

SPECIAL FEATURES

Manufactured using the technique of multiple anode and cathode cold welded connections, resulting in low impedance and inductance values. In the event of excess internal pressure occurring, this will be released by a valve type vent without affecting the normal operation of the capacitor. The vent will operate when the internal pressure exceeds the external pressure by approximately one atmosphere (10^5 Pa). Typical life is greater than 5000 hours at 85 °C, 80 000 hrs at 40 °C or 15 years at 25 °C.

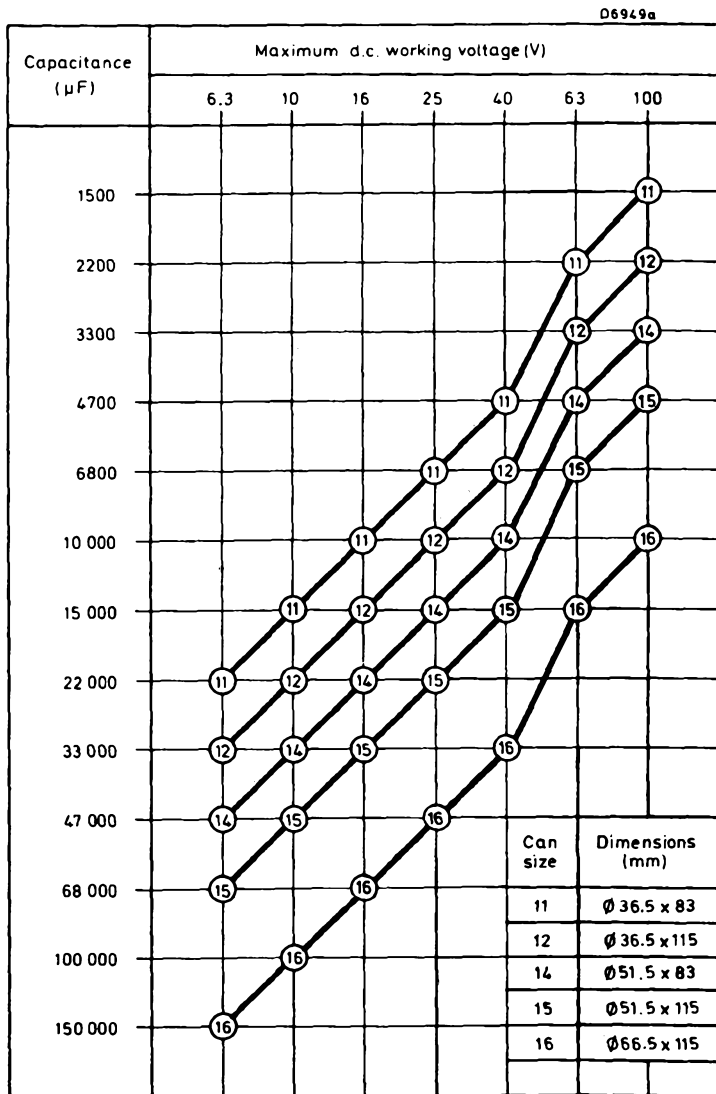

Mullard

**ALUMINIUM
ELECTROLYTIC CAPACITORS**
Large, long life, computer grade

**106
107
Series**

DIMENSIONS (millimetres)

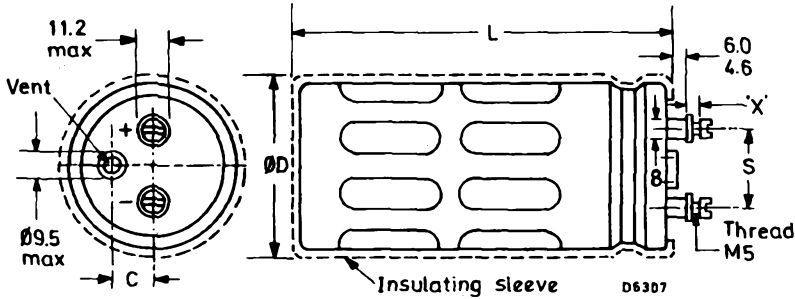

Table 1

Dimensions in millimetres					Can size	Typical weight (g)
L	D	S		C		
		min.	max.			
83	36.5	14.9	15.1	8.4	11	105
115	36.5	14.9	15.1	8.4	12	140
83	51.5	21.9	22.1	14.3	14	200
115	51.5	21.9	22.1	14.3	15	280
115	66.5	30.9	31.1	19.0	16	480

The maximum permissible torque which may be applied to the termination screws at various heights ('X' in the drawing above), is given in the table below: -

Table 2

Dimension 'X' (millimetres)	2	4	6
Max. permissible torque (newton metres)	1.5	1	0.5

ELECTRICAL DATA

Unless otherwise stated, all characteristics apply at an ambient temperature of $20 \pm 5^\circ\text{C}$, a frequency of 100 Hz, an atmospheric pressure of 10^5 Pa (1000 mbars) and a relative humidity of 75% maximum.

Rated voltage (notes 1 and 2)	Capacitance (-10 to $\pm 50\%$)	Can size	Max. leakage current (note 4)	Max. permissible ripple current $T_{amb} = 85^\circ\text{C}$ (note 6)	ESR	$\tan \delta$	H. F. impedance ($f = 20$ kHz)		Type number
(V)	(μF)		(mA)	(A)	($\text{m}\Omega$)		(m Ω)		
					typ.	max.	typ.	max.	
6.3	22 000	11	0.9	5	13.0	0.32	8.5	13.0	106 33223
	33 000	12	1.3	7.9	8.5	0.32	7.0	10.5	106 33333
	47 000	14	1.8	9.4	6.5	0.35	5.5	8.0	106 33473
	68 000	15	2.6	13.2	4.5	0.35	4.0	6.0	106 33683
	150 000	16	5.7	21.3	2.5	0.45	3.5	5.5	106 33154
10	15 000	11	0.9	5.3	14.0	0.23	8.5	13.0	106 34153
	22 000	12	1.4	7.5	9.5	0.23	7.0	10.5	106 34223
	33 000	14	2.0	9.1	7.0	0.25	5.5	8.0	106 34333
	47 000	15	2.9	12.8	5.0	0.25	4.0	6.0	106 34473
	100 000	16	6.0	20.5	2.5	0.27	3.5	5.5	106 34104
16	10 000	11	1.0	5.0	16.0	0.16	8.5	13.0	106 35103
	15 000	12	1.5	7.1	10.5	0.16	7.0	10.5	106 35153
	22 000	14	2.2	8.6	8.0	0.18	5.5	8.0	106 35223
	33 000	15	3.2	12.4	5.0	0.18	4.0	6.0	106 35333
	68 000	16	6.6	19.7	2.5	0.19	3.5	5.5	106 35683
25	6 800	11	1.1	4.7	18.0	0.12	8.5	13.0	106 36682
	10 000	12	1.5	6.7	12.0	0.12	7.0	10.5	106 36103
	15 000	14	2.3	8.2	8.5	0.13	5.5	8.0	106 36153
	22 000	15	3.3	11.6	6.0	0.13	4.0	6.0	106 36223
	47 000	16	7.1	18.7	3.0	0.14	3.5	5.5	106 36473
40	4 700	11	1.2	4.3	21.0	0.10	11.5	17.0	106 37472
	6 800	12	1.7	6.0	14.5	0.10	8.5	13.0	106 37682
	10 000	14	2.4	7.4	10.5	0.10	6.0	9.0	106 37103
	15 000	15	3.6	10.6	7.0	0.10	4.5	7.0	106 37153
	33 000	16	8.0	17.6	3.5	0.11	3.5	5.5	106 37333
63	2 200	11	0.9	3.6	30.0	0.065	11.5	17.0	106 38222
	3 300	12	1.3	5.2	20.0	0.065	8.5	13.0	106 38332
	4 700	14	1.8	6.3	14.5	0.070	6.0	9.0	106 38472
	6 800	15	2.6	8.8	10.0	0.070	4.5	7.0	106 38682
	15 000	16	5.7	14.8	5.0	0.075	3.5	5.5	106 38153
100	1 500	11	0.9	3.1	270	0.40	200	300	107 30152
	2 200	12	1.4	4.5	180	0.40	130	200	107 30222
	3 300	14	2.0	5.4	120	0.40	90	140	107 30332
	4 700	15	2.9	7.7	80	0.40	60	90	107 30472
	10 000	16	6.0	12.6	40	0.40	40	60	107 30103

ALUMINIUM ELECTROLYTIC CAPACITORS

Large, long life, computer grade

106
107
Series

Notes

1. Rated voltage is the sum of the direct voltage plus the peak ripple voltage. The peak ripple voltage relates to the maximum ripple current at 85 °C.
2. A surge voltage may be applied for a maximum of 1 minute per hour. The rated voltage plus surge voltage equals the maximum permissible voltage as shown in the table below:

Parameter	Voltage (V)						
	6.3	10	16	25	40	63	100
Rated voltage at $T_{amb} \leq 85 \text{ }^\circ\text{C}$ (UR)	6.3	10	16	25	40	63	100
Max. permissible voltage at $T_{amb} \leq 40 \text{ }^\circ\text{C}$	6.9	11	17	27	44	69	110
Max. permissible surge voltage at $T_{amb} > 40 \text{ }^\circ\text{C}$	7.20	11.5	18.4	28.7	46.0	72.4	115

3. A reverse voltage of 1 V max. may be applied at the maximum temperature for a maximum of 1 hour.
4. Maximum leakage current is measured at 20 °C, 5 minutes after the application of the full rated voltage.
5. For ripple current ratings at other frequencies, the multiplying factor shown on the graph (last page) should be applied.
6. The maximum permissible ripple current

at 100 Hz and $T_{amb} = 85 \text{ }^\circ\text{C}$	see table on page 4
$T_{amb} = 80 \text{ }^\circ\text{C}$	1.4 × value stated on page 4
$T_{amb} = 75 \text{ }^\circ\text{C}$	1.7 × value stated on page 4*
$T_{amb} = 65 \text{ }^\circ\text{C}$	2.2 × value stated on page 4*

TYPICAL INDUCTANCE

Case size 11 and 12	12 nH
14 and 15	15 nH
16	18 nH

EQUIVALENT SERIES RESISTANCE (ESR) = $\frac{\tan \delta}{\omega C}$

This can be calculated from measurements at any frequency and ambient temperature.

INSULATION TEST VOLTAGE (d. c.)

Measured between insulating sleeve and terminations 1000 V

*With a maximum of 30 A.

MOUNTING

The capacitors may be mounted vertically with terminals uppermost, or horizontally with vent uppermost. When a number of capacitors are connected to form a capacitor bank, the distance from one capacitor to another must not be less than 15 mm when no derating of ripple current and/or temperature is applied.

Suitable mounting clips from the Mullard range (see data sheet MOUNTING CLIPS) are given in the table below: -

Can size	Clip type number
11	DT2401
12	DT2401
14	DT2254
15	DT2254
16	DT2400

MARKING

The capacitors are marked with: -

Capacitance and tolerance

Maximum permissible ripple current

Rated voltage

Type number

Category temperature range

ORDERING PROCEDURE

The capacitors should be ordered by their type number, as shown in the table.

Example: A 33 000 μ F 10 V rated capacitor should be ordered by quoting the type number 106 34333.

NOTE

Non-solid electrolyte capacitors may contain chemicals which can be regarded as hazardous if incorrectly handled. Caution is necessary should the outer case be fractured.

ALUMINIUM ELECTROLYTIC CAPACITORS

Large, long life, computer grade

**106
107
Series**

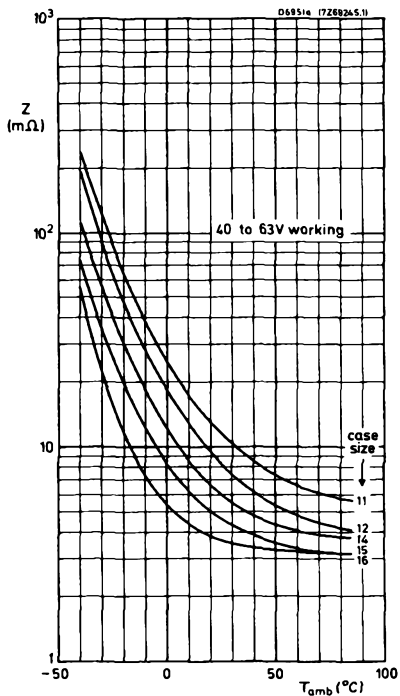
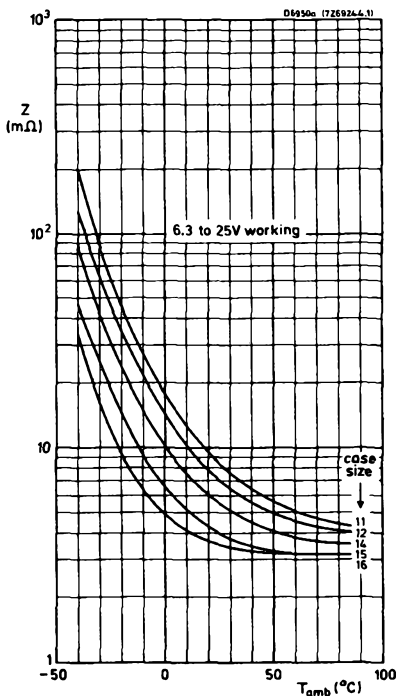

Typical impedance as a function of temperature at 20 kHz

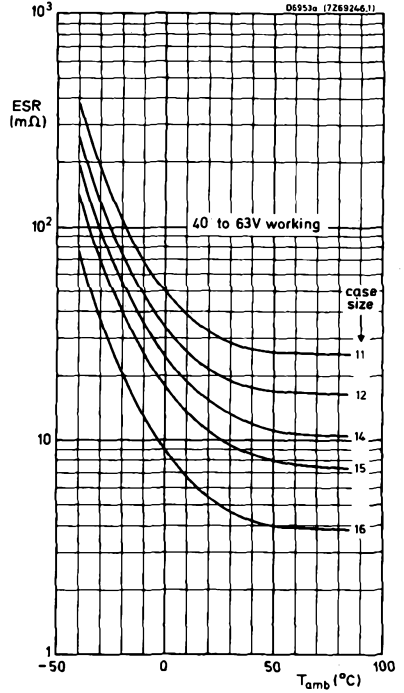
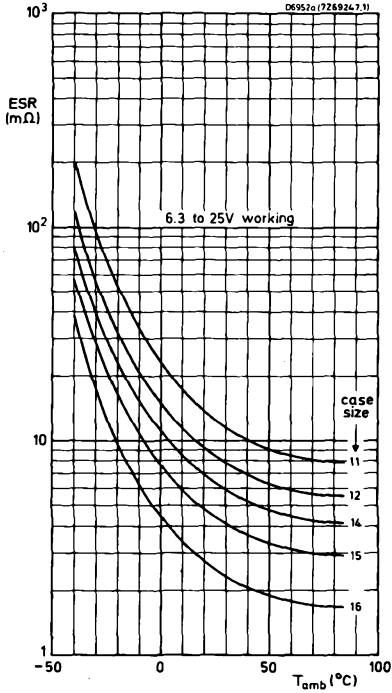

Typical ESR as a function of temperature at 100 Hz

**ALUMINIUM
ELECTROLYTIC CAPACITORS**
Large, long life, computer grade

**106
107
Series**

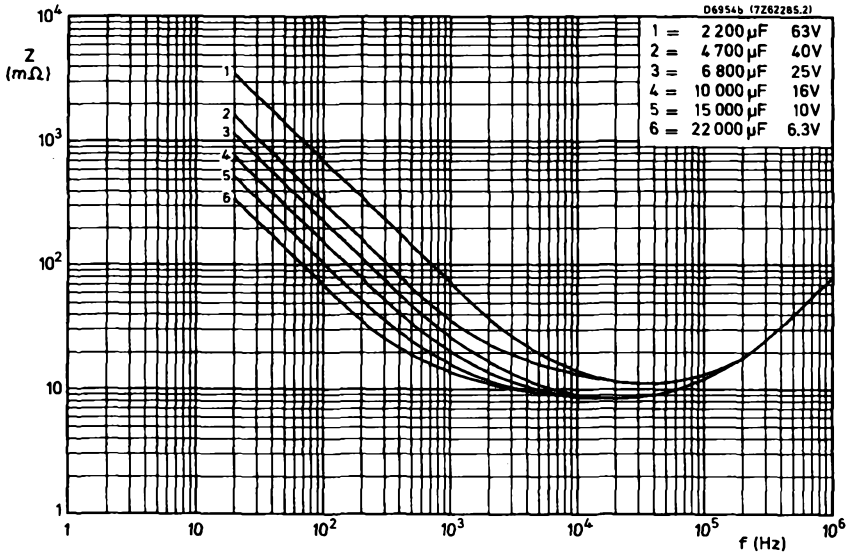

Typical impedance plotted against frequency at $T_{amb} = 20^{\circ}\text{C}$, can size 11

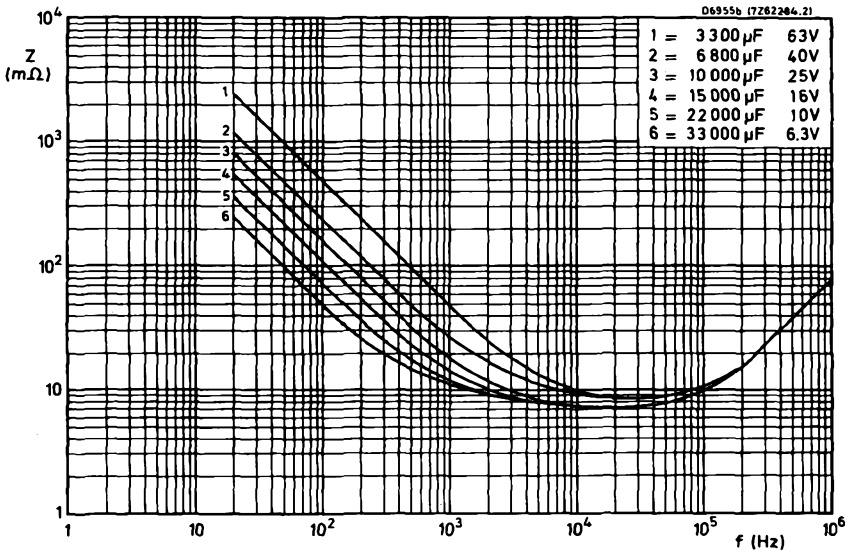

Typical impedance plotted against frequency at $T_{amb} = 20^{\circ}\text{C}$, can size 12

Mullard

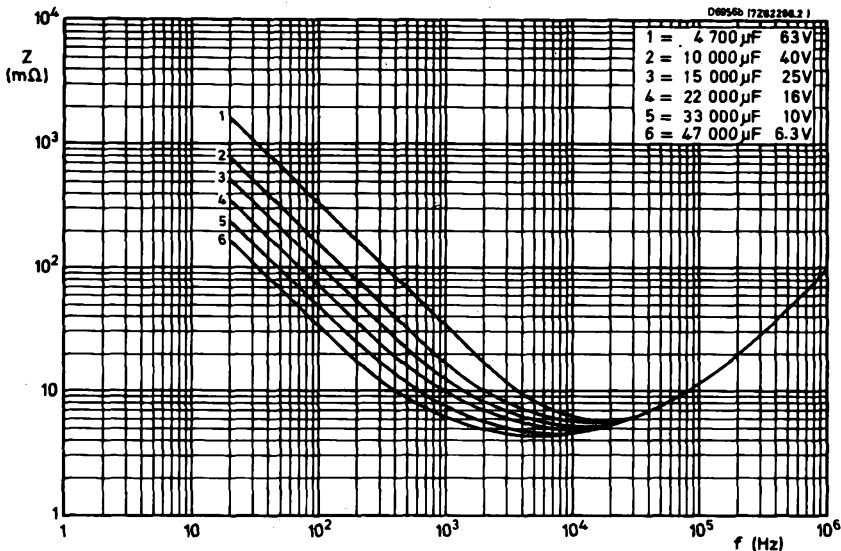

Typical impedance plotted against frequency at $T_{\text{amb}} = 20^\circ\text{C}$, can size 14

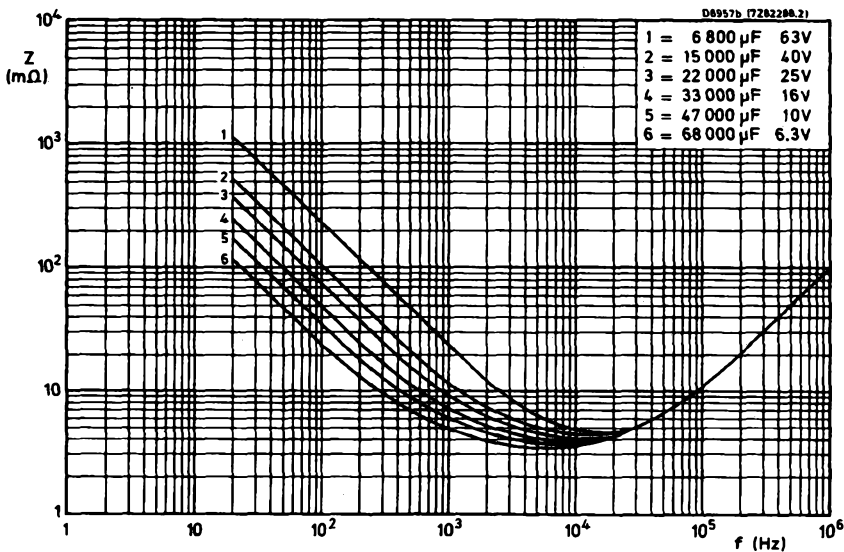

Typical impedance plotted against frequency at $T_{\text{amb}} = 20^\circ\text{C}$, can size 15

**ALUMINIUM
ELECTROLYTIC CAPACITORS**
Large, long life, computer grade

**106
107
Series**

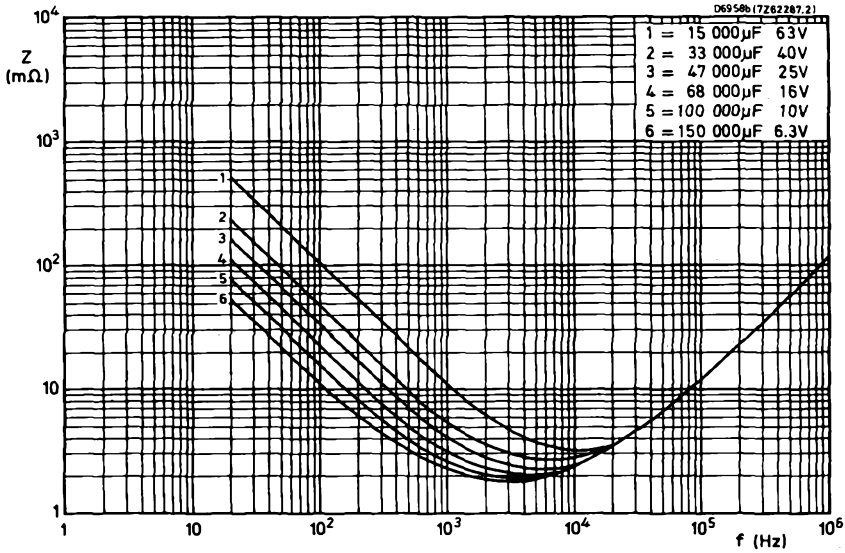

Typical impedance plotted against frequency at $T_{amb} = 20^{\circ}C$, can size 16

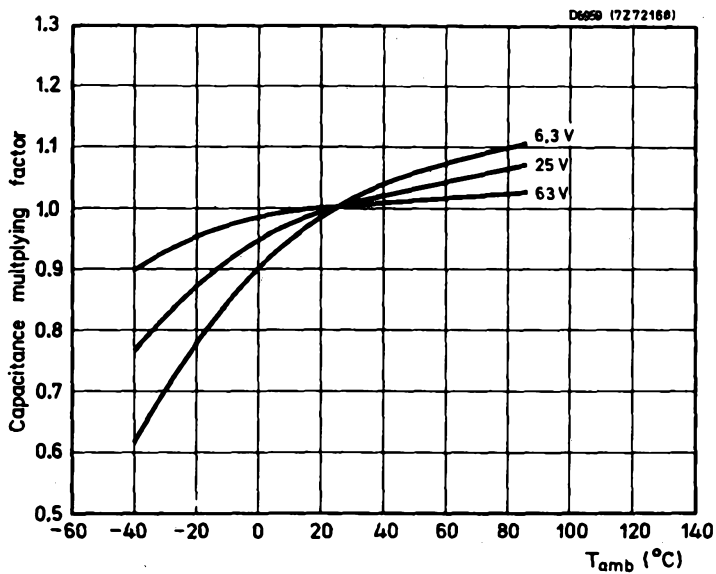

Typical capacitance as a function of ambient temperature

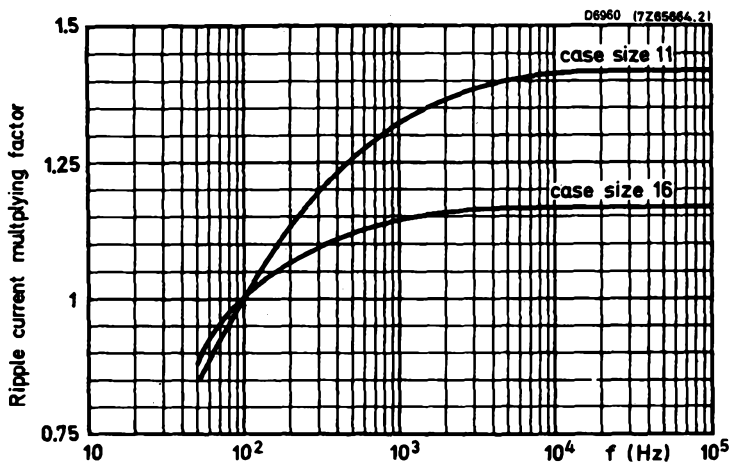

Ripple current as a function of frequency

ALUMINIUM ELECTROLYTIC CAPACITORS small, long life, axial leads — insulated

For professional applications in coupling, decoupling and smoothing where long life and high stability together with small size are required.

QUICK REFERENCE DATA

Capacitance range (E6 Series)	2.2 to 2200 μF
Capacitance tolerance	-10 to +50 %
Rated voltage range	6.3 to 63 V
Climatic category (IEC 68)	40/085/56 (IEC 384-4 long life grade)

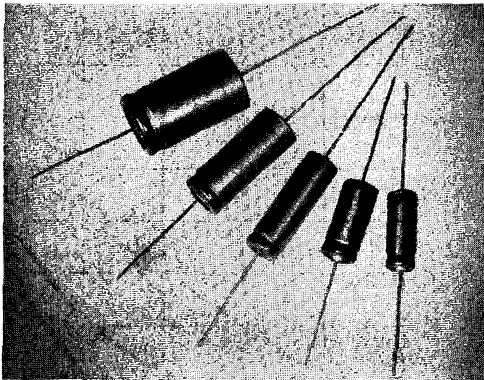

ELECTROLYTE

Impregnated into high purity grade paper.

CASING

Aluminium can sealed by a plastic disc and insulated by a plastic sleeve.

TERMINATIONS

Axial leads of tinned copper wire 0.8 mm diameter.

APPROVAL SPECIFICATIONS

Post Office D2541 (Provisional)

SPECIAL FEATURES

The capacitors utilise advanced technology and etched aluminium foil combined with welded construction to achieve high capacitance values, coupled with small size and high stability with long life. Typical life is greater than 10 000 hours at 85 °C, or greater than 160 000 hours at 40 °C. Guaranteed life is 5 000 hours at 85 °C with rated d.c. voltage applied.



QUICK SELECTION CHART

D6267a (846)

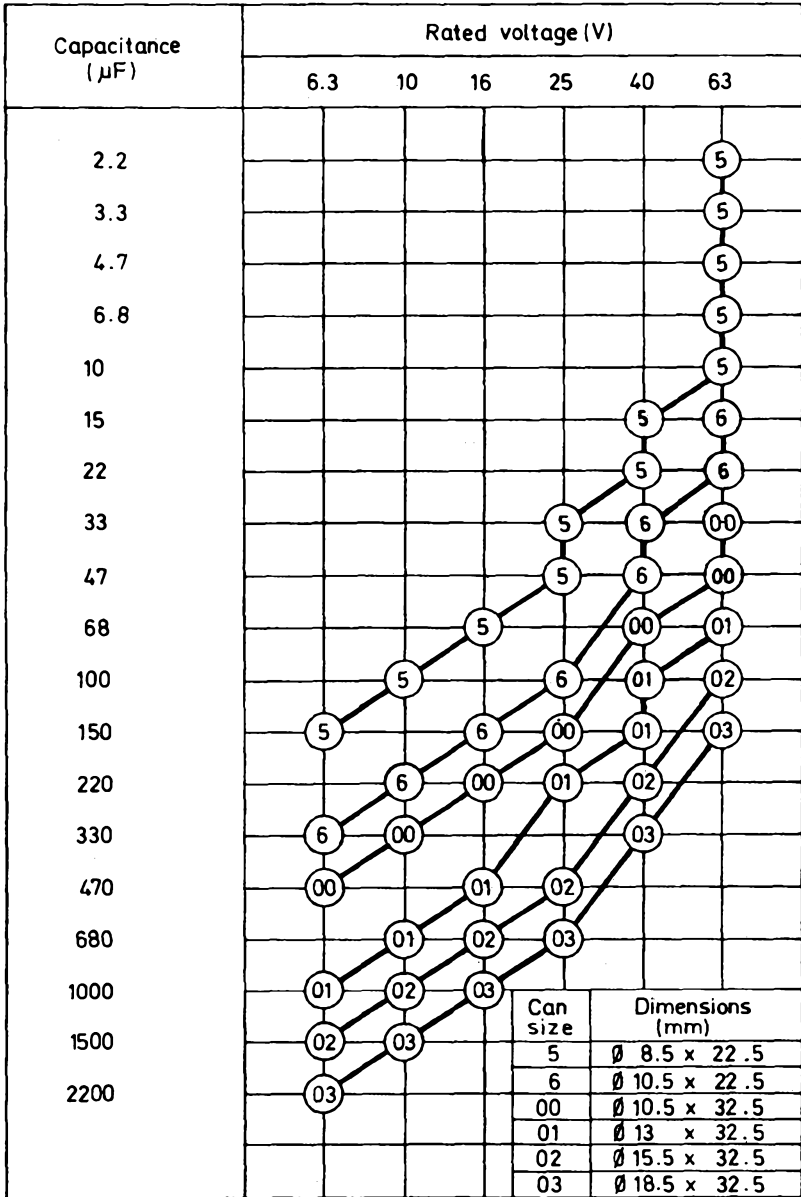

MECHANICAL DATA

Dimensions in mm

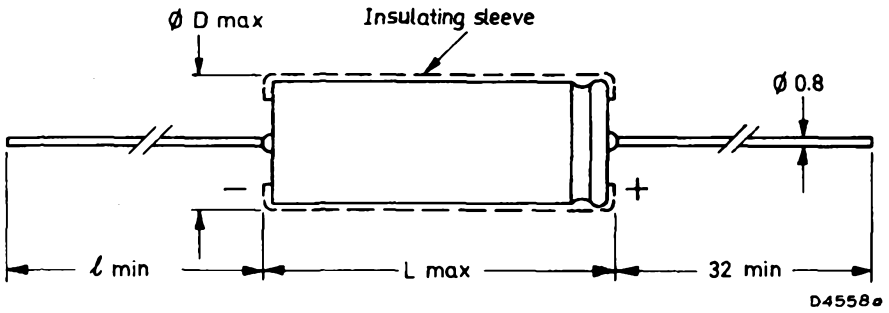

L max.	D max.	l min.	can size	typical weight (g)
22.5	8.5	32	5	1.8
22.5	10.5	32	6	2.5
32.5	10.5	54	00	4.3
32.5	13	54	01	6.6
32.5	15.5	54	02	8.5
32.5	18.5	54	03	11.2



ELECTRICAL DATA

Unless otherwise stated, all characteristics apply at an ambient temperature of 20 ± 5 °C, a frequency of 100 Hz, an atmospheric pressure of 10^5 Pa (1000 mbars) and a relative humidity of 75% maximum.

rated voltage (see notes 1 and 2) (V)	capacitance (-10 to +50%) (μ F)	can size	max. leakage current (see note 3) (μ A)	max. permissible ripple current (see note 4) (mA)	max. tangent of loss angle ($\tan \delta$)	max. h.f. impedance ($f = 100$ kHz) (Ω)	max. effective series resistance (Ω)	type number
6.3	150	5	10	130	0.20	1.60	2.12	108 33151
	330	6	17	220	0.20	0.84	0.97	108 33331
	470	00	22	325	0.20	0.42	0.68	108 33471
	1000	01	42	470	0.20	0.30	0.32	108 33102
	1500	02	60	630	0.20	0.22	0.21	108 33152
	2200	03	85	920	0.20	0.19	0.14	108 33222
10	100	5	10	120	0.15	1.60	2.39	108 34101
	220	6	17	205	0.15	0.84	1.09	108 34221
	330	00	24	325	0.15	0.42	0.72	108 34331
	680	01	45	470	0.15	0.30	0.35	108 34681
	1000	02	65	630	0.15	0.22	0.24	108 34102
	1500	03	95	920	0.15	0.19	0.16	108 34152
16	68	5	11	110	0.12	1.60	2.81	108 35689
	150	6	18	190	0.12	0.84	1.27	108 35151
	220	00	25	270	0.12	0.42	0.87	108 35221
	470	01	50	360	0.12	0.30	0.41	108 35471
	680	02	70	500	0.12	0.22	0.28	108 35681
	1000	03	100	650	0.12	0.19	0.19	108 35102
25	33	5	8	85	0.10	1.60	4.83	108 36339
	47	5	11	100	0.10	1.60	3.39	108 36479
	100	6	19	170	0.10	0.84	1.59	108 36101
	150	00	26	270	0.10	0.42	1.06	108 36151
	220	01	37	360	0.10	0.30	0.72	108 36221
	470	02	75	500	0.10	0.22	0.34	108 36471
	680	03	105	650	0.10	0.19	0.23	108 36681
40	15	5	6	65	0.08	1.60	8.49	108 37159
	22	5	9	80	0.08	1.60	5.79	108 37229
	33	6	12	110	0.08	0.84	3.86	108 37339
	47	6	15	130	0.08	0.84	2.71	108 37479
	68	00	20	195	0.08	0.42	1.87	108 37689
	100	01	28	245	0.08	0.30	1.27	108 37101
	150	01	40	280	0.08	0.30	0.85	108 37151
	220	02	55	360	0.08	0.22	0.58	108 37221
	330	03	85	495	0.08	0.19	0.39	108 37331



ELECTRICAL DATA (continued)

rated voltage (see notes 1 and 2) (V)	capacitance (-10 to +50%) (μF)	can size	max. leakage current (see note 3) (μA)	max. permissible ripple current (see note 4) (mA)	max. tangent of loss angle ($\tan \delta$)	max. h. f. impedance ($f = 100 \text{ kHz}$) (Ω)	max. effective series resistance (Ω)	type number
63	2.2	5	1.5	25	0.08	1.60	57.90	108 38228
	3.3	5	2	30	0.08	1.60	38.60	108 38338
	4.7	5	3	35	0.08	1.60	27.10	108 38478
	6.8	5	4	45	0.08	1.60	18.73	108 38688
	10	5	6	50	0.08	1.60	12.74	108 38109
	15	6	10	75	0.08	0.84	8.49	108 38159
	22	6	12	90	0.08	0.84	5.79	108 38229
	33	00	17	125	0.08	0.42	3.86	108 38339
	47	00	22	150	0.08	0.42	2.71	108 38479
	68	01	30	195	0.08	0.30	1.87	108 38689
	100	02	42	275	0.08	0.22	1.27	108 38101
	150	03	60	355	0.08	0.19	0.85	108 38151

Notes

1. Rated voltage is the sum of the direct voltage plus the peak ripple voltage. The peak ripple voltage relates to the maximum ripple current at 85 °C. The capacitors may be operated on an alternating voltage (without a direct voltage present), up to the value shown in the table below:

	voltage (V)					
rated voltage (U_R)	6.3	10	16	25	40	63
r.m.s. voltage	0.63	1	1	1	1	1

2. A surge voltage may be applied for a maximum of 1 minute per hour. The rated voltage plus surge voltage equals the maximum permissible voltage as shown in the table below:

	voltage (V)					
rated voltage (U_R)	6.3	10	16	25	40	63
maximum permissible voltage at $T_{\text{amb}} \leq 50 \text{ }^\circ\text{C}$	7.9	12.7	20.2	31.7	50.6	79.8
maximum permissible voltage at $T_{\text{amb}} > 50 \text{ }^\circ\text{C}$	7.2	11.5	18.4	28.8	46	72.5



Notes (continued)

3. Maximum leakage current is measured at 20 °C, 5 minutes after the application of the full rated voltage; during continuous operation at 20 °C the typical leakage current will be approximately 20% of the value given in the table.
4. Maximum ripple current is measured at 85 °C. At ≤ 65 °C ambient, the rating may be increased by a factor of 2.2, at 75 °C ambient the rating may be increased by a factor of 1.7.

OPERATIONAL DATA

Equivalent series resistance (ESR = $\frac{\tan \delta}{\omega C}$)

This can be calculated from measurements at any frequency and ambient temperature.

Insulation test voltage (d.c.)

measured between insulating sleeve and both leads 1000 V

Climatic category (IEC Publication 68)

40/085/56 (IEC384-4 long life grade).

Soldering conditions

250 °C max. for 5 seconds max.

MOUNTING

The capacitors may be mounted in any position.

MARKING

The capacitors are marked with:

Capacitance

Rated voltage

Date code

Series number (108)

Polarity indication

ORDERING PROCEDURE

The capacitors should be ordered by their type number, as shown in the table.

Example: A 680 μ F, 16 V rated capacitor should be ordered by quoting the type number 108 35681.

Note:

Non-solid electrolyte capacitors may contain chemicals which can be regarded as hazardous if incorrectly handled. Caution is necessary should the outer case be fractured.





Mullard

January 1980

7

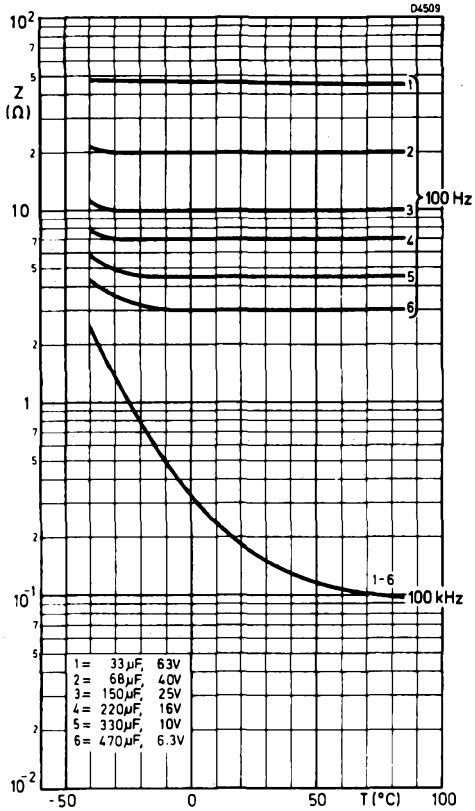

Impedance plotted against temperature with frequency as a parameter. Can size 00

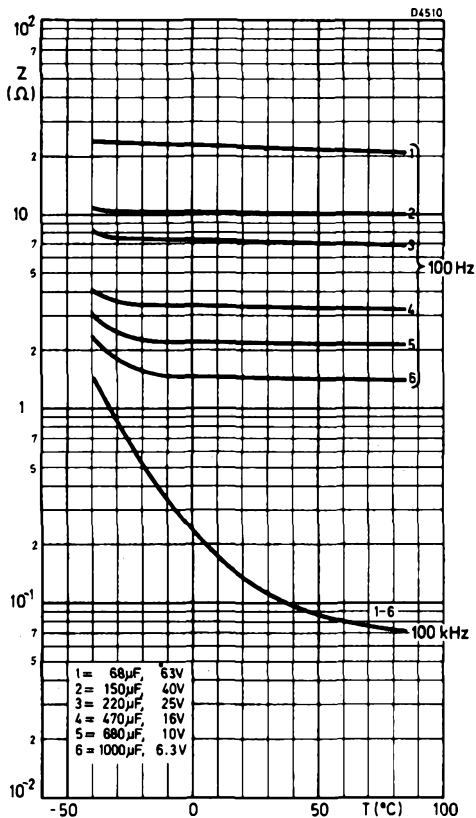

Impedance plotted against temperature with frequency as a parameter. Can size O1

Mullard

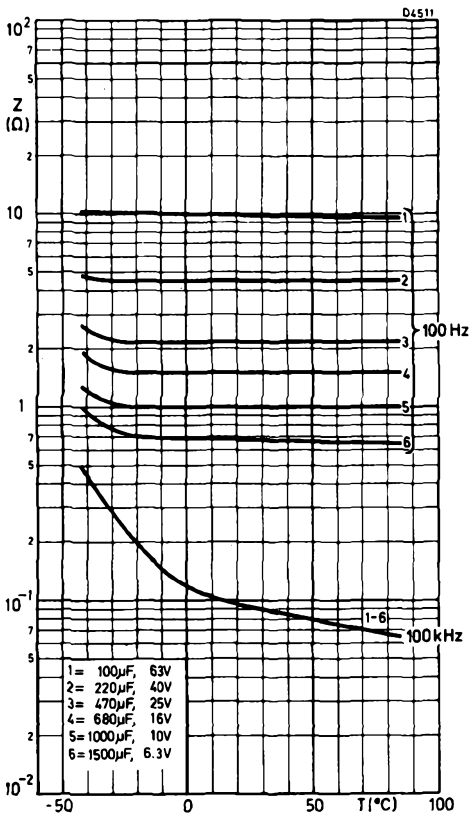

Impedance plotted against temperature with frequency as a parameter.

Can size 02





Mullard

January 1980

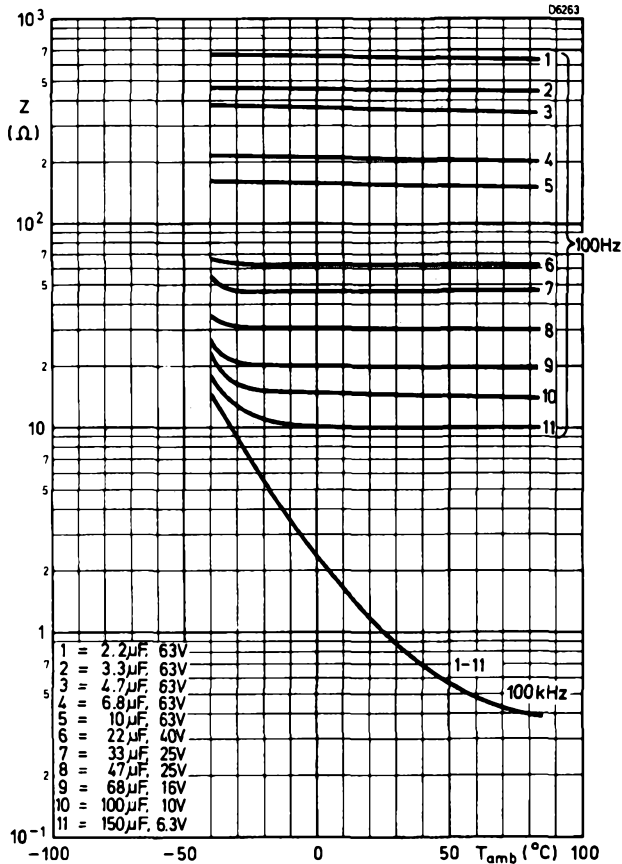

Impedance plotted against temperature with frequency as a parameter.
Can size 5

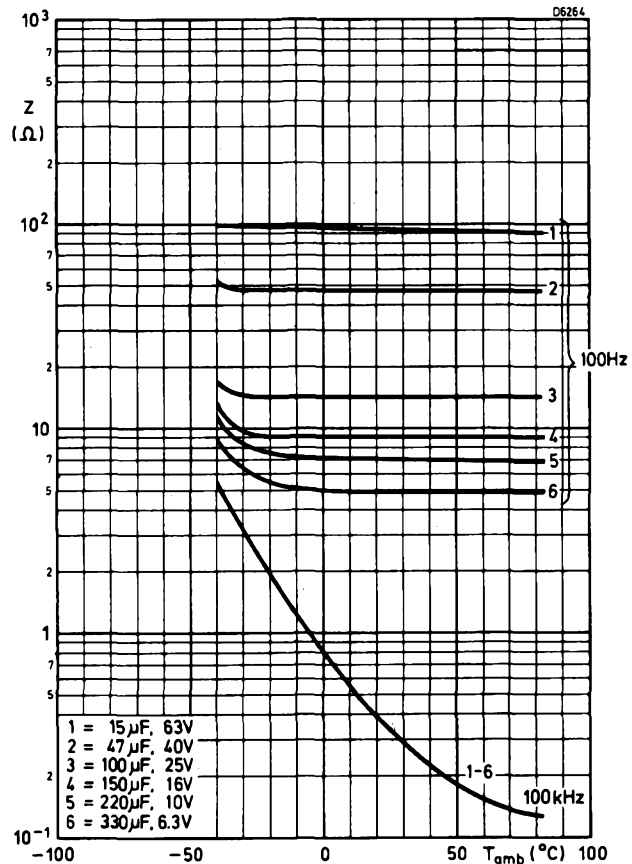

Impedance plotted against temperature with frequency as a parameter.
Can size 6

Aluminium electrolytic capacitors

108 Series

108 Series

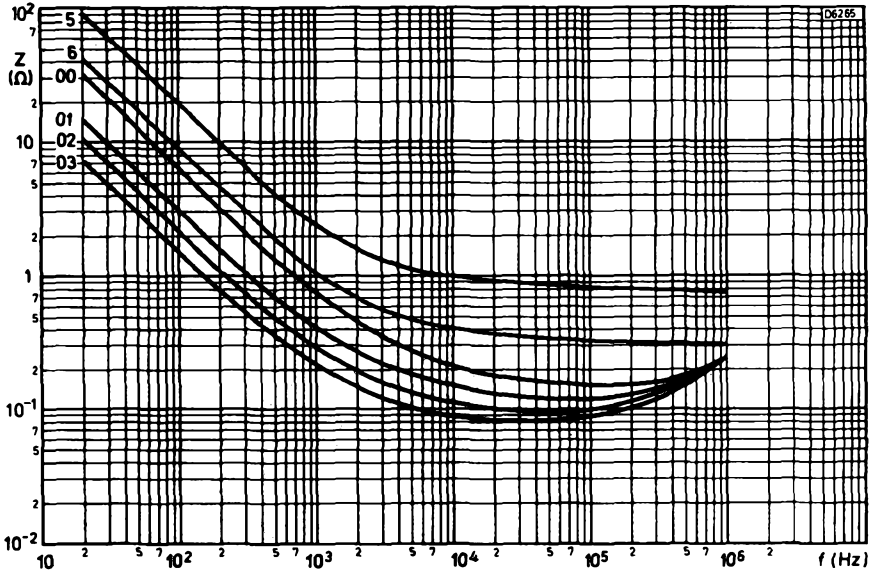

Typical impedance plotted against frequency for 16 V working capacitors, $T_{amb} = 20^\circ\text{C}$
Can sizes 00, 01, 02, 03, 5 and 6.

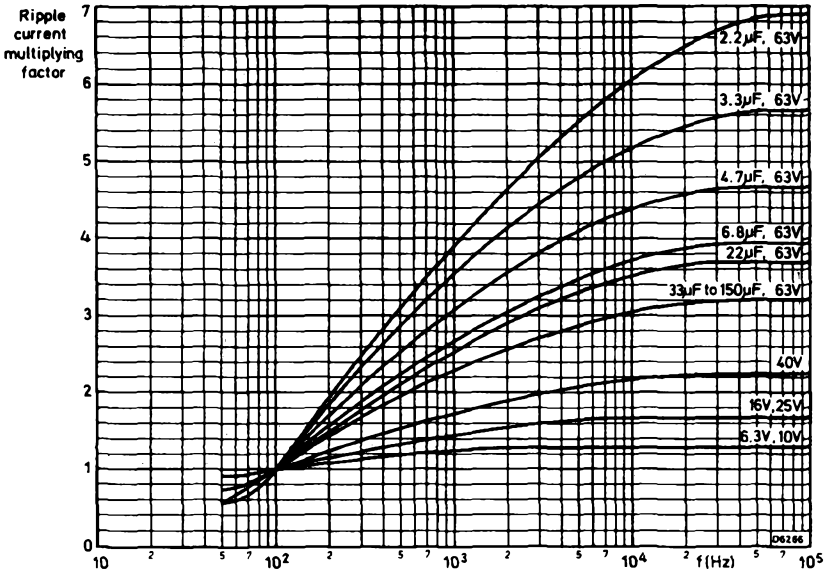

Typical ripple current multiplying factor plotted against frequency



ALUMINIUM ELECTROLYTIC CAPACITORS

- Large type with screw terminals
- High voltage
- Long life
- Industrial applications

QUICK REFERENCE DATA

Nominal capacitance range (E6 series)	150 to 4700 μ F
Tolerance on nominal capacitance	-10 to +30%
Rated voltage range, U_R	250 to 385 V
Category temperature range	-40 to +85 $^{\circ}$ C
Endurance test at 85 $^{\circ}$ C	2000 h
Basic specification	IEC 384-4 long life grade
Climatic category, IEC68	40/085/56

APPLICATION

These capacitors have extremely low impedance and inductance values and high resistance to shock and vibration which render them very suitable for applications such as:
switched-mode power supplies,
power supplies in digital equipment,
energy storage in pulse systems,
filters in measuring and control apparatus

DESCRIPTION

The low values of impedance and inductance are achieved by a special construction with multiple internal anode and cathode connections. The high resistance to shock and vibration is achieved by the longitudinal rills and special internal construction. The capacitors are completely cold-welded and charge/discharge proof. The aluminium cases are fully insulated and sealed by a synthetic disc with a vent. The capacitors are delivered with screws and washers.

C_{nom} (μ F)	U_R (V)	
	250	385
150		10
220		11
330	10	12a
470	11	14
680	12a	15a
1000	14	16a
1500	15a	16a
2200	16a	17
3300	16a	
4700	17	

case size	nom. dimensions (mm)
10	ϕ 35 x 60
11	ϕ 35 x 80
12a	ϕ 35 x 105
14	ϕ 50 x 80
15a	ϕ 50 x 105
16a	ϕ 65 x 105
17	ϕ 75 x 105



MECHANICAL DATA

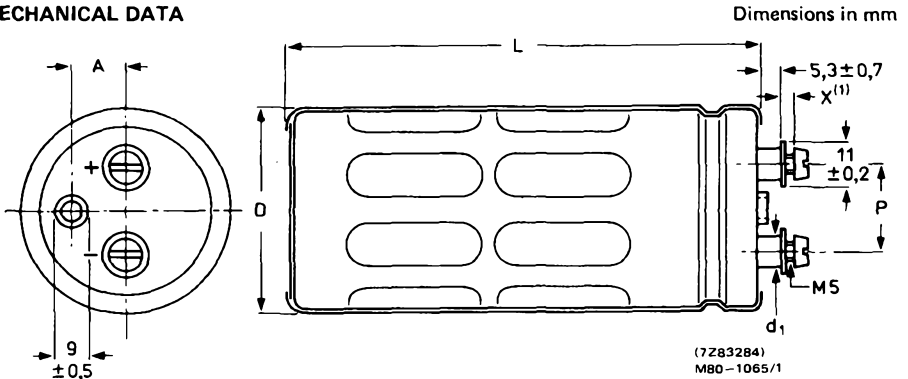

Fig.1 See Table 1 for dimensions D, L, P, A, d₁, d₂, and l.

(1) Maximum permissible torque which may be applied to the termination screws at various heights (dimension x in drawing):

x	max. permissible torque (Nm)
2	1.5
4	1.0
6	0.5

Table 1

case size	D + 1.5	L + 3	P ± 0.1	d ₁ ± 0.2	d ₂ x
10	35	60	13.0	8	M8 x 12
11	35	80	13.0	8	M8 x 12
12a	35	105	13.0	8	M8 x 12
14	50	80	22.0	8	M12 x 16
15a	50	105	22.0	8	M12 x 16
16a	65	105	28.5	11	M12 x 16
17	75	105	32.0	11	M12 x 16

Marking

The capacitors are marked with: rated capacitance, tolerance on rated capacitance, rated voltage, temperature range and IEC type, maximum r.m.s. ripple current at T_{amb} = 70 °C and 20 kHz, catalogue number, date code (year/month), name of manufacturer.



Mounting

The capacitor may be mounted upright or lying down, with or without mounting clamp. To ensure good working of the vent, this device should be on the upper side when the capacitor is mounted lying down. When a number of capacitors are connected to form a capacitor bank, the proximity to one another must not be less than 15 mm when no derating of ripple current and/or temperature is applied. (See also Mounting accessories)

Minimum atmospheric pressure: 8.5 kPa

ELECTRICAL DATA

Unless otherwise specified, all electrical values in Table 2 apply at an ambient temperature of 20 °C, a frequency of 100 Hz, an atmospheric pressure of 860 to 1060 mbar, and a relative humidity of 45 to 75%.

Capacitance

Nominal capacitance values at 100 Hz and $T_{amb} = 20\text{ °C}$ see Table 2
Tolerance on nominal capacitance at 100 Hz -10 to +30%

Voltage

Rated voltage = max. permissible voltage
at < 50 °C 1.1 U_R
at 50 °C up to 85 °C U_R

Ripple voltage

Maximum permissible a.c. voltage providing the following three conditions are met:

- maximum positive voltage on anode (d.c. + peak a.c.) is:
- maximum positive voltage on cathode (reverse voltage) is:
- maximum ripple current is not exceeded

< 50 °C	50 °C up to 85 °C
1.1 U_R	U_R
1 V	

Surge voltage

Maximum permissible voltage for short periods (see also Tests and requirements)

< 50 °C	50 °C up to 85 °C
1.2 U_R	1.15 U_R ($U_R \leq 250\text{ V}$) 1.05 U_R ($U_R = 375\text{ V}$)

Reverse voltage

Maximum d.c. voltage applied in the reverse polarity at the maximum category temperature for short periods 2 V

Ripple current

Maximum permissible r.m.s. ripple current
at 100 Hz and $T_{amb} = 85\text{ °C}$ see Table 2
at 20 kHz and $T_{amb} = 70\text{ °C}$ see Table 2

Multiplying factor versus frequency and versus temperature for calculation of maximum ripple current see Tables 3 and 4



Ripple current (continued)

Non-sinusoidal ripple currents have to be analysed into a number of sinusoidal currents and the following requirements shall then be satisfied:

$$\sum_n \frac{I_n^2}{r_n} \leq I_{r \max}^2$$

$I_{r \max}$ = maximum ripple current at 100 Hz and applicable ambient temperature

I_n = ripple current at a certain frequency

$\sqrt{r_n}$ = multiplying factor at same frequency

Note

The ripple currents are not applicable if the maximum permissible ripple voltage is exceeded. In that case the ripple voltage is decisive.

Table 2

U_R	nom. cap.	1) max. r.m.s. ripple current (A)		1) max. leakage current at U_R after 5 min. mA	1) ESR at 100 Hz typ. m Ω	1) Tan δ max.	case size	catalogue number U_R 115 -
		$T_{amb} = 85^\circ\text{C}$ 100 Hz	$T_{amb} = 70^\circ\text{C}$ 20 kHz					
V	μF							
250	330	1.2	2.9	0.50	480	0.15	10	13331
	470	1.7	4.1	0.71	340	0.15	11	13471
	680	2.3	5.5	1.02	235	0.15	12a	13681
	1000	2.8	6.7	1.50	160	0.15	14	13102
	1500	4.2	10.1	2.25	105	0.15	15a	13152
	2200	5.9	14.2	3.30	72	0.15	16a	13222
	3300	7.2	17.3	4.95	48	0.15	16a	13332
	4700	9.4	22.6	7.05	34	0.15	17	13472
385	150	0.8	1.9	0.34	560	0.10	10	18151
	220	1.1	2.6	0.50	400	0.10	11	18221
	330	1.5	3.6	0.75	260	0.10	12a	18331
	470	1.8	4.3	1.06	180	0.10	14	18471
	680	2.7	6.6	1.53	120	0.10	15a	18681
	1000	3.9	9.2	2.25	82	0.10	16a	18102
	1500	4.7	11.3	3.38	55	0.10	16a	18152
	2200	6.0	14.4	4.95	40	0.10	17	18222

1) See also corresponding paragraph



Table 3

ambient temperature °C	multiplying factor of max. ripple current versus temperature
85	1.0
80	1.4
75	1.7
70	2.0
65	2.2
60	2.4
55	2.6
50	2.8
45	3.0
≤ 40	3.2

Table 4

frequency Hz	multiplier at maximum I_r versus frequency
50	0.90
100	1.00
200	1.10
400	1.15
1000	1.19
≥ 2000	1.20

Charge and discharge current

The capacitors may be charged from a source without internal resistance and they may be discharged by short-circuiting. If the capacitors are charged and discharged continuously at a rate of several times per minute, the charge and discharge currents have to be considered as ripple currents flowing through the capacitor. The r.m.s. value of these currents should be determined and the value thus found must not exceed the applicable limit. (See also Tests and requirements).

Leakage current

Maximum leakage current 5 min. after application of the rated voltage at $T_{amb} = 20\text{ °C}$

see Table 2 (0.006 CU + 4 μ A)

Leakage current after 15 min at U_R at 20 °C
85 °C

0.125 x value stated in Table 2

0.625 x value stated in Table 2

If owing to prolonged storage and/or storage at an excessive temperature the leakage current is too high, application of the rated voltage for some hours will cause the leakage current to fall to a value lower than specified in Table 2.

Tan δ (dissipation factor)

Tan δ at 100 Hz, and $T_{amb} = 20\text{ °C}$, measured by means of a four-terminal circuit (Thomson circuit)

see Table 2

Impedance

Impedance at 20 kHz and $T_{amb} = 20\text{ °C}$ measured by means of a four-terminal circuit (Thomson circuit)

see Table 2

Equivalent series resistance (ESR) at 100 Hz and $T_{amb} = 20\text{ °C}$ see Table 2

Inductance (ESL)

case size	typical inductance
10,11,12a	13 nH
14,15a	16 nH
16a	19 nH
17	20 nH



OPERATIONAL DATA

Category temperature range for rated voltage -40 to +85 °C

Life expectancy

Typical lifetime at $T_{amb} = 85\text{ °C}$ > 5000 h
 40 °C > 100 000 h

For minimum values see Table 5

Failure rate

at rated voltage, $T_{amb} = 40\text{ °C}$ and with confidence level 60%

catastrophic < 10^{-7}
 catastrophic + degradation < 3×10^{-7}

PACKING

50 pieces per box (case size 10, 11, 12a, 14, 15a)

25 pieces per box (case size 16a, 17)

Table 5

ambient temperature °C	guaranteed lifetime hours
85	2000
80	3100
75	4800
70	7500
65	12 000
60	18 000
55	27 000
50	42 000
45	65 000
40	100 000

Tests and requirements

The tests and requirements will be according to IEC 384-4 for long life grade capacitors.



MOUNTING ACCESSORIES

Dimensions in mm

Clamps

To facilitate vertical mounting, a series of rigid clamps made of cadmium-plated steel are available. They can easily be slid over the capacitor and then fixed to it with a nut and bolt. They are provided with two or three mounting lugs. Four types are available, one for each case diameter of the capacitor range. They are delivered without nuts or bolts.

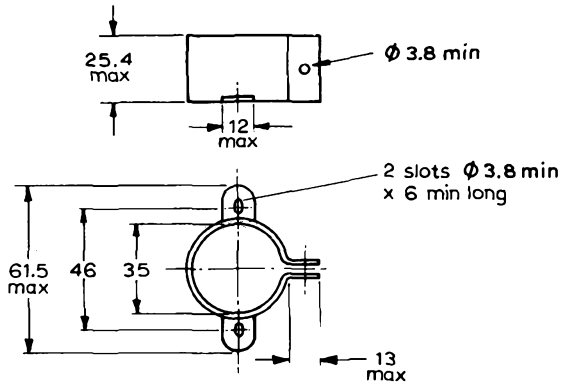

Material :- 0.9 mm (20 s.w.g.) mild steel
cadmium plated

Fig.2 Clamp for case diameter of 35 mm
Type No. DT2401

MOUNTING ACCESSORIES (continued)

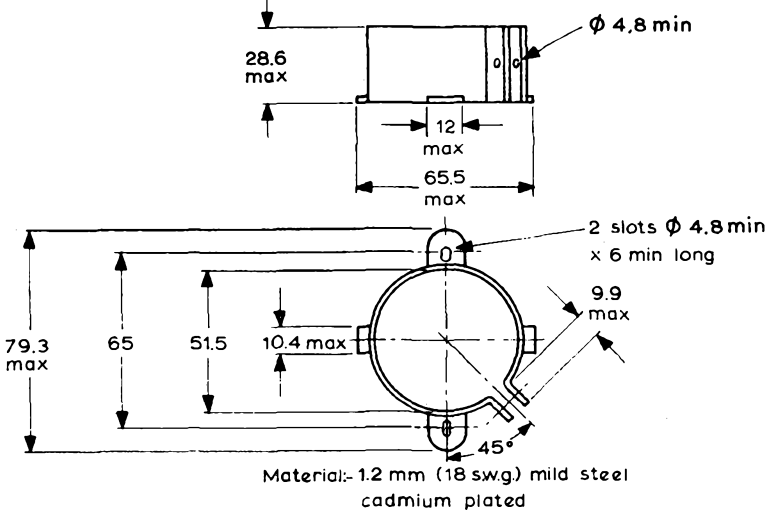

Fig.3 Clamp for case diameter of 50 mm
Type No. DT2254

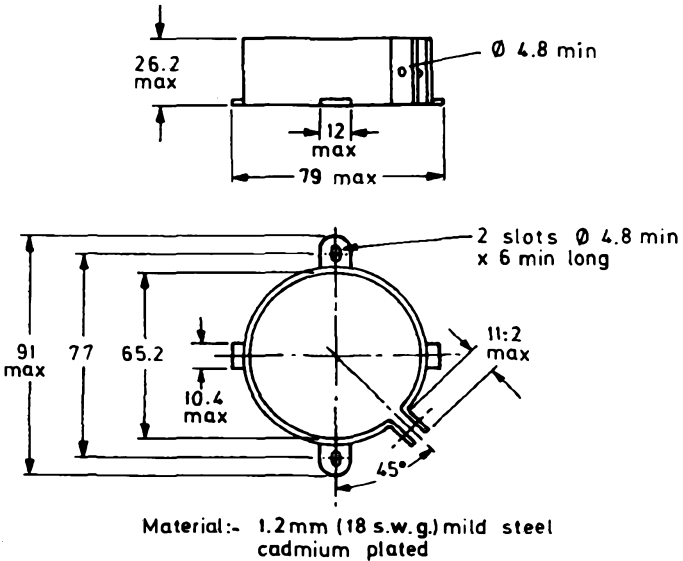

Fig.4 Clamp for case diameter of 65 mm
Type No. DT2400



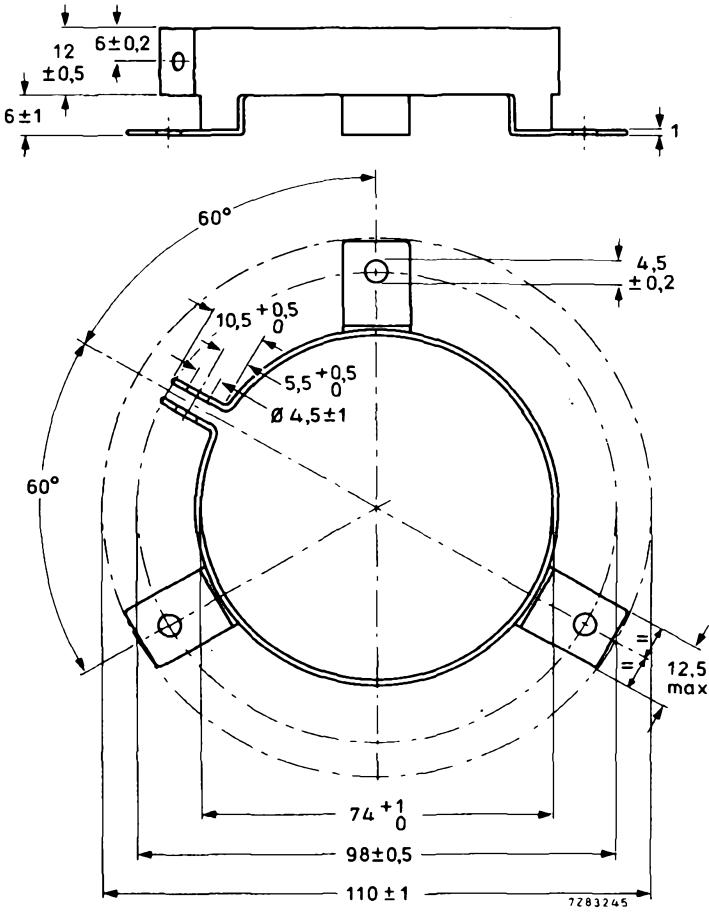

Fig.5 Clamp for case diameter of 75 mm
Catalogue number: 4322 043 12990



SOLID ALUMINIUM ELECTROLYTIC CAPACITORS

Small, long life, axial leads-insulated



QUICK REFERENCE DATA

For use in low voltage circuits, in professional and military applications, where long life and high stability over a wide temperature range are of major importance.

Capacitance range (E6 Series)	2. 2 to 330	μF
Capacitance tolerance	± 20	%
Rated voltage range (R5 Series)	6. 3 to 40	V
Climatic category (IEC 68) at rated voltage (U_R)	55/125/56	

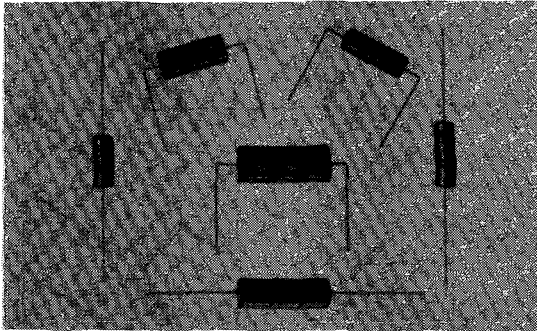

ELECTROLYTE

Semiconducting manganese dioxide on a glass fibre carrier.

CASING

Aluminium can, sealed by a ceramic disc and insulated with a plastic sleeve.

TERMINATIONS

Axial leads of tinned copper wire 0.8 mm diameter.

SPECIAL FEATURES

These capacitors utilise advanced technology to achieve long life, high stability, high ripple current rating and a low temperature dependence. The capacitors are not subject to a limitation on charge or discharge currents and they will function in circuits where voltage reversal may occur.

☼ Products approved to NEN CECC 30 302-001, available on request.



Mullard

October 1980

1

QUICK SELECTION CHART

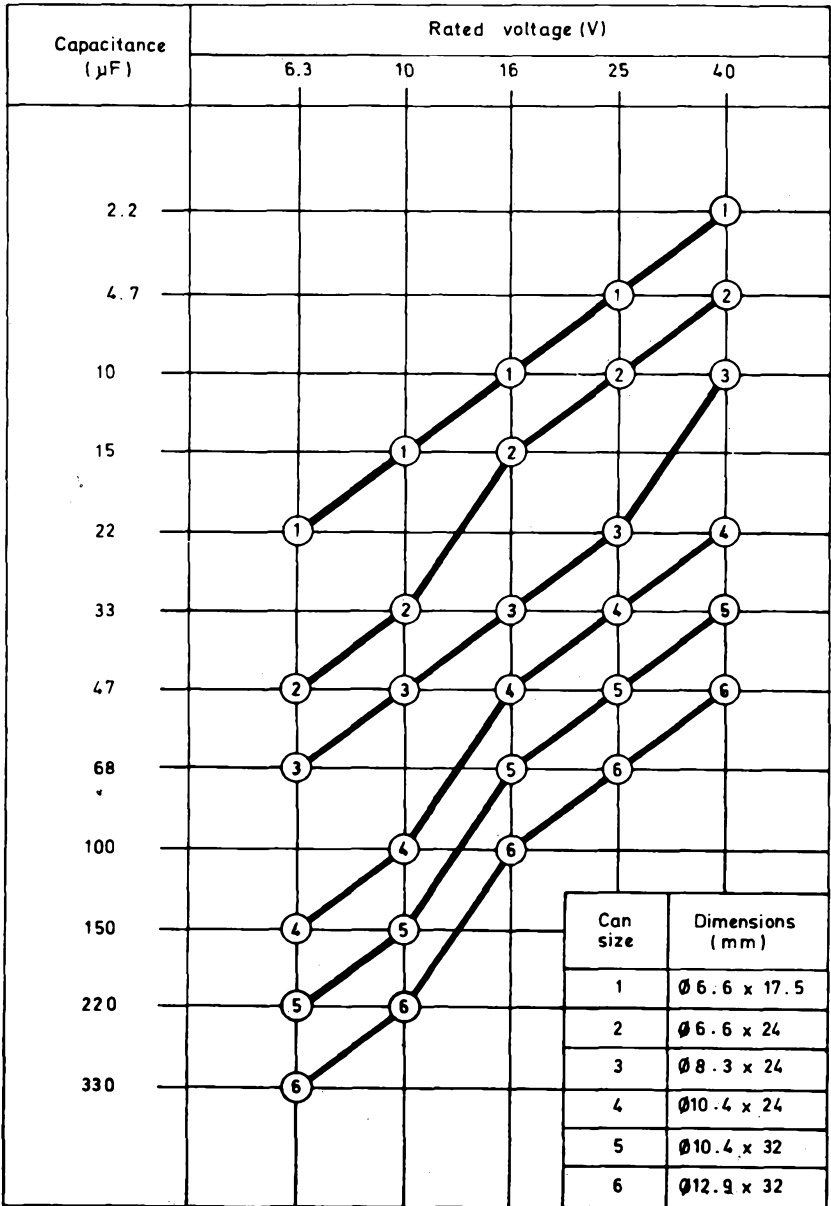

DIMENSIONS (millimetres)

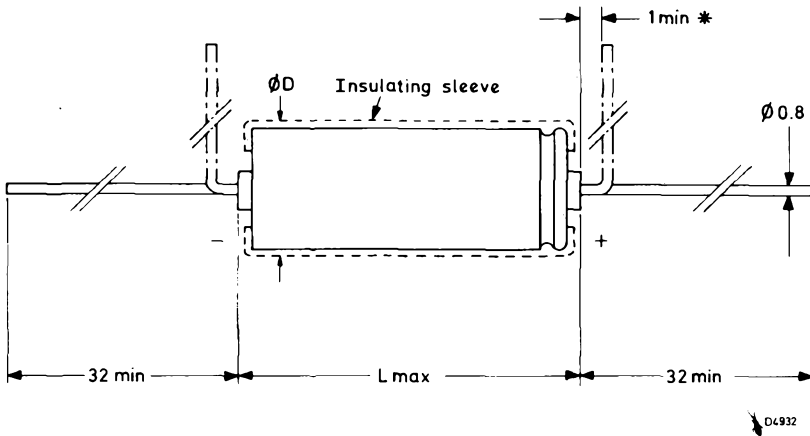

*It is recommended not to bend leads closer to the capacitor body than 1mm

L max.	D max.	Can size	Typical weight g
17.5	6.6	1	1.2
24	6.6	2	1.6
24	8.3	3	2.4
24	10.4	4	3.3
32	10.4	5	4.5
32	12.9	6	6.3



→ ELECTRICAL DATA

Unless otherwise stated, all characteristics apply at an ambient temperature of $20 \pm 5^\circ\text{C}$, a frequency of 100Hz, an atmospheric pressure of 10^5Pa (1000mbars) and a relative humidity of 75% maximum.

Rated voltage (note 1, 2 and 3)	Capacitance ($\pm 20\%$)	Can size	Max. leakage current (note 4)	Max. permissible ripple current at 85 to 125°C (note 5)	Max. tangent of loss angle	Typ. ESR (note 6)	Max. h. f. impedance ($f = 100\text{kHz}$)	Type number
(V)	(μF)		(μA)	(mA)	($\tan \delta$)	(Ω)	(Ω)	
6.3	22	1	12.5	45	0.18	6.51	2.5	121 13229
	47	2	25	75	0.18	3.05	1.25	121 13479
	68	3	40	102	0.18	2.34	0.75	121 13689
	150	4	70	170	0.18	0.95	0.5	121 13151
	220	5	125	240	0.18	0.80	0.4	121 13221
	330	6	150	335	0.18	0.53	0.4	121 13331
10	15	1	15	40	0.16	7.43	2.5	121 14159
	33	2	30	67	0.16	3.86	1.25	121 14339
	47	3	50	87	0.16	2.71	0.75	121 14479
	100	4	80	145	0.16	1.59	0.5	121 14101
	150	5	150	215	0.16	1.17	0.4	121 14151
	220	6	200	287	0.16	0.58	0.4	121 14221
16	10	1	20	35	0.14	9.55	2.5	121 15109
	15	2	40	47	0.14	5.31	1.25	121 15159
	33	3	75	97	0.14	2.89	0.75	121 15339
	47	4	100	107	0.14	1.69	0.5	121 15479
	68	5	175	150	0.14	1.64	0.4	121 15689
	100	6	250	205	0.14	0.95	0.4	121 15101
25	4.7	1	20	22	0.14	16.93	5	121 16478
	10	2	40	40	0.14	11.14	2.5	121 16109
	22	3	75	70	0.14	5.06	1.5	121 16229
	33	4	100	90	0.14	3.86	1	121 16339
	47	5	175	127	0.14	2.56	0.8	121 16479
	68	6	250	170	0.14	1.87	0.5	121 16689
40	2.2	1	20	20	0.12	28.94	5	121 17228
	4.7	2	40	32	0.12	16.93	2.5	121 17478
	10	3	75	52	0.12	9.55	1.5	121 17109
	22	4	100	87	0.12	6.51	1	121 17229
	33	5	175	122	0.12	4.34	0.8	121 17339
	47	6	250	162	0.12	2.37	0.5	121 17479



NOTES

1. Rated voltage is the sum of the direct voltage plus the peak ripple voltage. The peak ripple voltage relates to the maximum ripple current at 85°C. For temperatures above 85°C, a voltage derating of one step must be applied as shown in the table below: -

		Voltage (V)				
Rated voltage (U_R)	at $T_{amb} \leq 85^\circ\text{C}$	6.3	10	16	25	40
	at $T_{amb} > 85^\circ\text{C}$	4	6.3	10	16	25

2. A surge voltage may be applied for a maximum of 1 minute per hour. The rated voltage plus surge voltage equals the maximum permissible voltage as shown in the table below: -

		Voltage (V)				
Rated voltage (U_R) at $T_{amb} \leq 85^\circ\text{C}$		6.3	10	16	25	40
Maximum permissible voltage at $T_{amb} \leq 85^\circ\text{C}$		7.3	11.5	18.5	29	46
Maximum permissible voltage at $T_{amb} > 85^\circ\text{C}$		5.6	7.5	11.5	18.5	29

3. The maximum permissible reverse voltage without d. c. voltage present is shown in the table below: -

		Voltage (V)				
Rated voltage (U_R) at $T_{amb} \leq 85^\circ\text{C}$		6.3	10	16	25	40
Reverse voltage at $T_{amb} \leq 85^\circ\text{C}$		0.95	1.5	2.5	3.75	6
Reverse voltage at $T_{amb} > 85^\circ\text{C}$		0.6	0.95	1.5	2.5	3.75

4. Maximum leakage current is measured at 20°C, 5 minutes after the application of the full rated voltage; at 25°C the typical leakage current will be approximately 40% of the value given in the table.
5. Rated ripple current at $>85^\circ\text{C}$ is dependent on the ripple voltage, frequency and dissipation of heat. At $\leq 70^\circ\text{C}$ ambient, the rating may be increased by a factor of two. At frequencies other than 100Hz, see graph on last page. ←
6. Equivalent series resistance (ESR) = $\frac{\tan \delta}{\omega C}$. This can be calculated from measurements at any frequency and ambient temperature.



Minimum insulation resistance measured between insulating sleeve and both leads at an applied voltage of 100V	100	MΩ
Insulation test voltage (d. c.) measured between insulating sleeve and both leads	1000	V
Minimum storage temperature	-80	°C
Climatic category (IEC Publication 68) full rated voltage (U_R)	55/085/56	
0.63 U_R	55/125/56	

SOLDERING CONDITIONS 250°C max. for 5 seconds max.

MOUNTING

The capacitors may be mounted in any position.

MARKING

The capacitors are marked with: -

Capacitance

Rated voltage and maximum temperature

Derated voltage and maximum temperature

Type number

Polarity indication

ORDERING PROCEDURE

The capacitors should be ordered by their type number, as shown in the table.

Example: - A 33μF, 16V rated capacitor should be ordered by quoting the type number 121 15339.



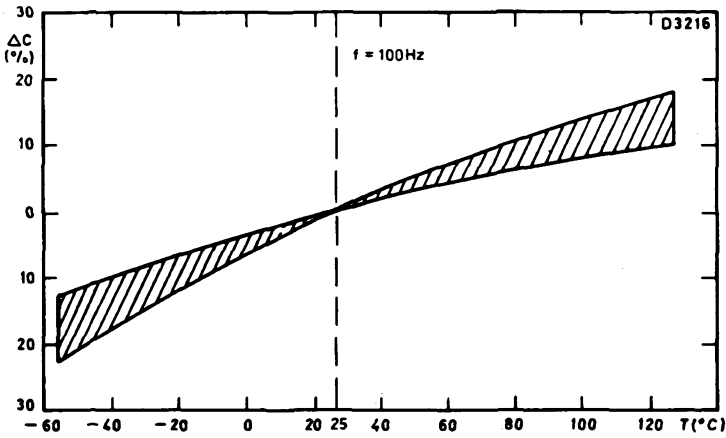

CAPACITANCE CHANGE AS A FUNCTION OF TEMPERATURE

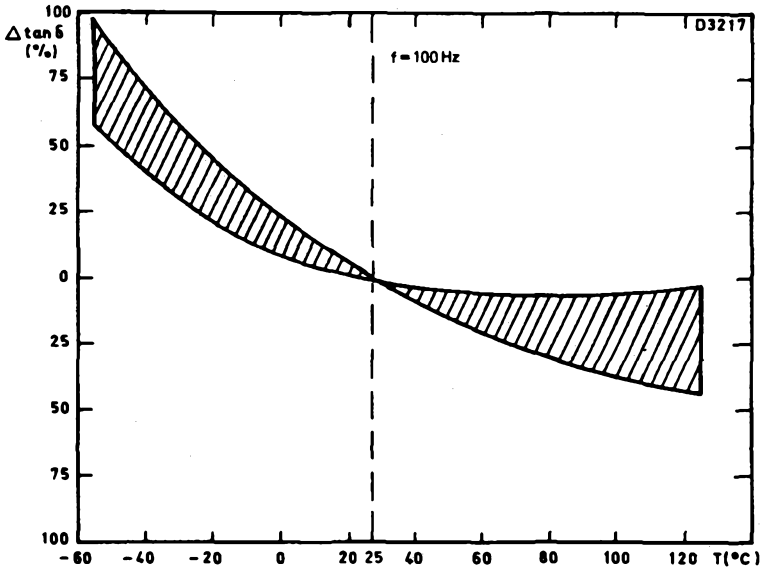

DISSIPATION FACTOR CHANGE AS A FUNCTION OF TEMPERATURE



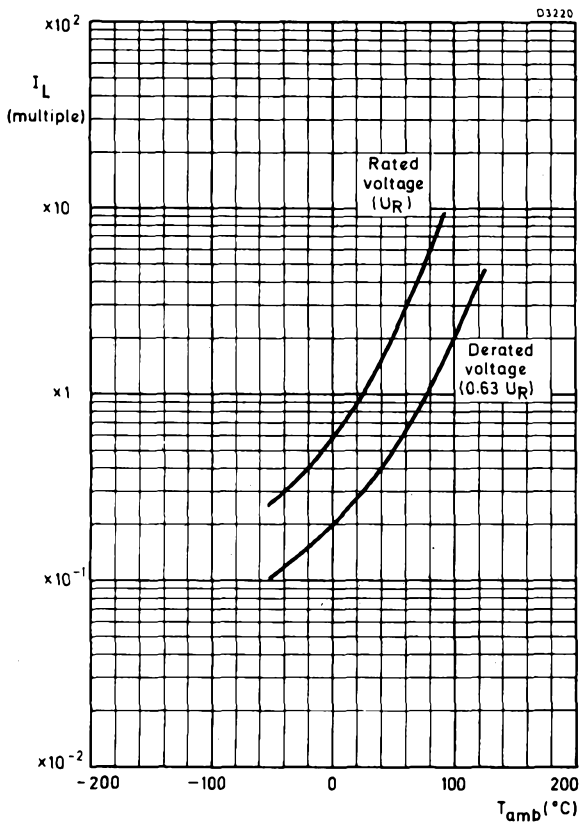

MULTIPLE OF LEAKAGE CURRENT
 $(I_L \text{ for } T_{amb} = 20^{\circ}\text{C})$ PLOTTED AGAINST
 AMBIENT TEMPERATURE



D3221

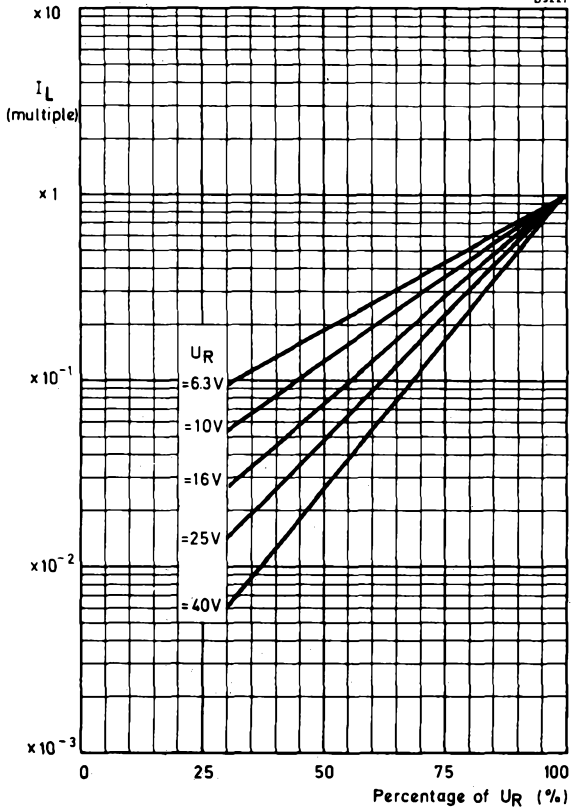

MULTIPLE OF LEAKAGE CURRENT
 (I_L for $T_{amb} = 20^{\circ}C$) PLOTTED AGAINST
 PERCENTAGE OF RATED VOLTAGE APPLIED



Mullard

October 1980

03222

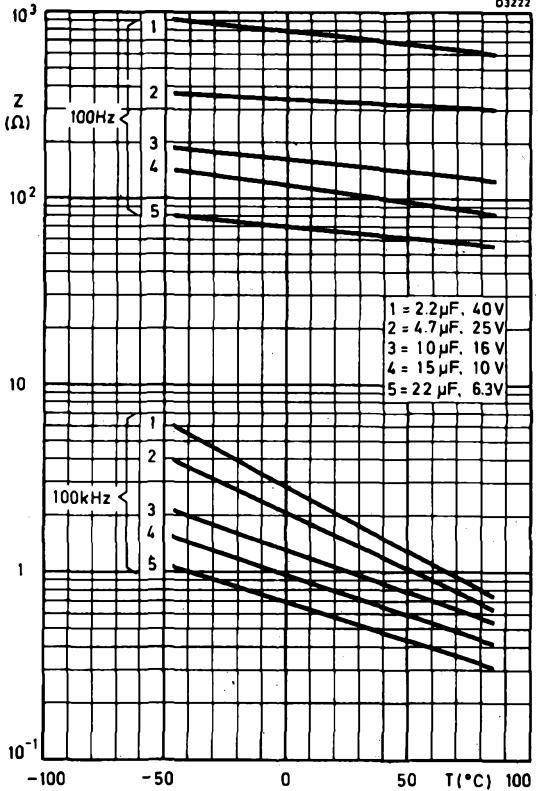

IMPEDANCE PLOTTED AGAINST TEMPERATURE
WITH FREQUENCY AS PARAMETER
CAN SIZE 1

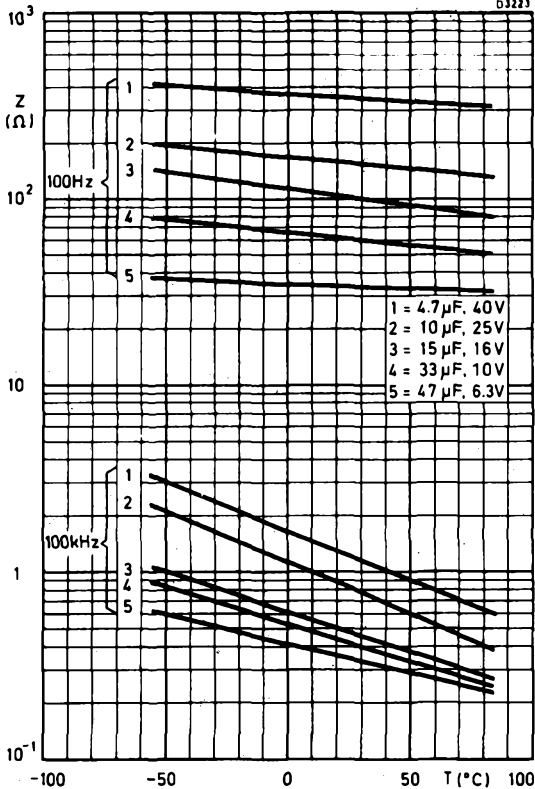

IMPEDANCE PLOTTED AGAINST TEMPERATURE
 WITH FREQUENCY AS PARAMETER
 CAN SIZE 2

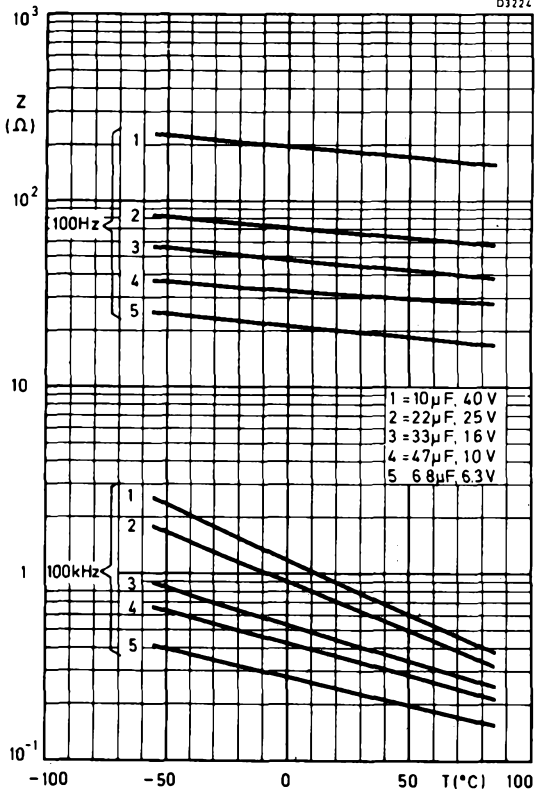

IMPEDANCE PLOTTED AGAINST TEMPERATURE
WITH FREQUENCY AS PARAMETER
CAN SIZE 3



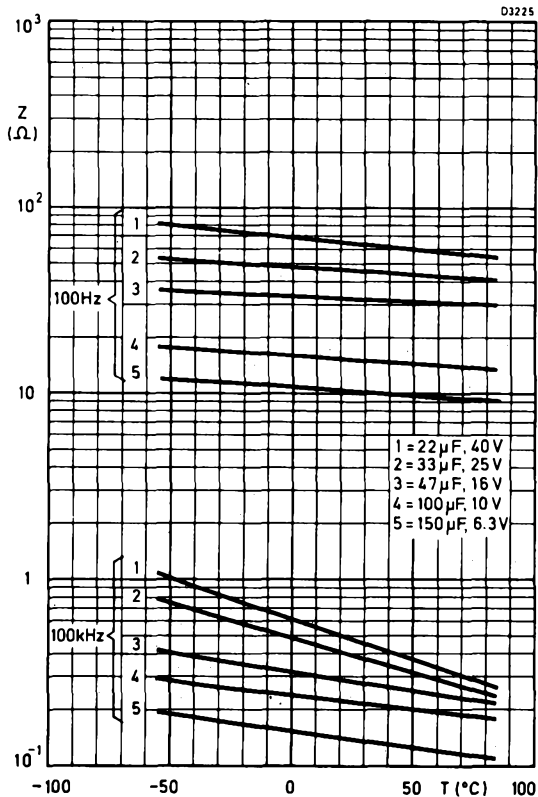

IMPEDANCE PLOTTED AGAINST TEMPERATURE
WITH FREQUENCY AS PARAMETER
CAN SIZE 4



Mullard

October 1980

11

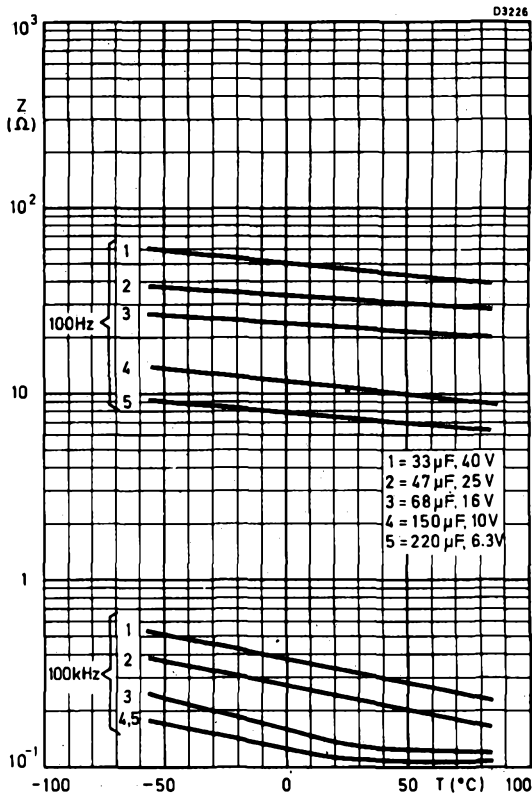

IMPEDANCE PLOTTED AGAINST TEMPERATURE
WITH FREQUENCY AS PARAMETER
CAN SIZE 5

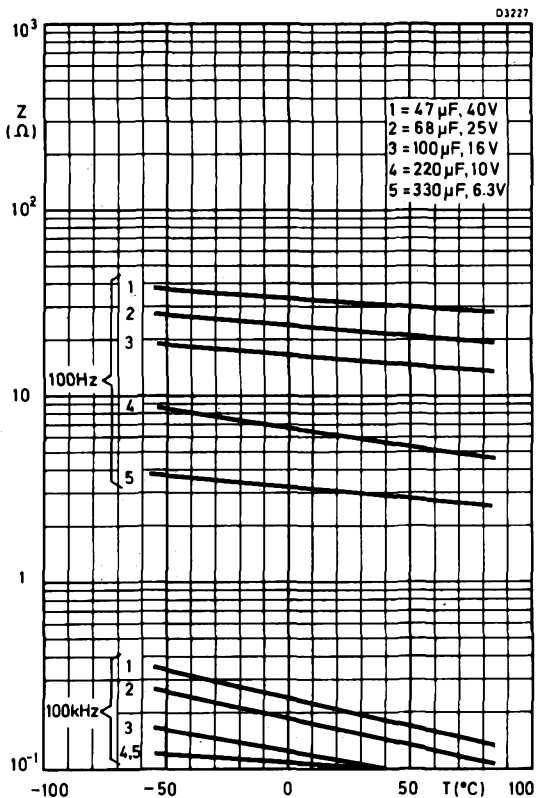

IMPEDANCE PLOTTED AGAINST TEMPERATURE
WITH FREQUENCY AS PARAMETER
CAN SIZE 6

D 1218a

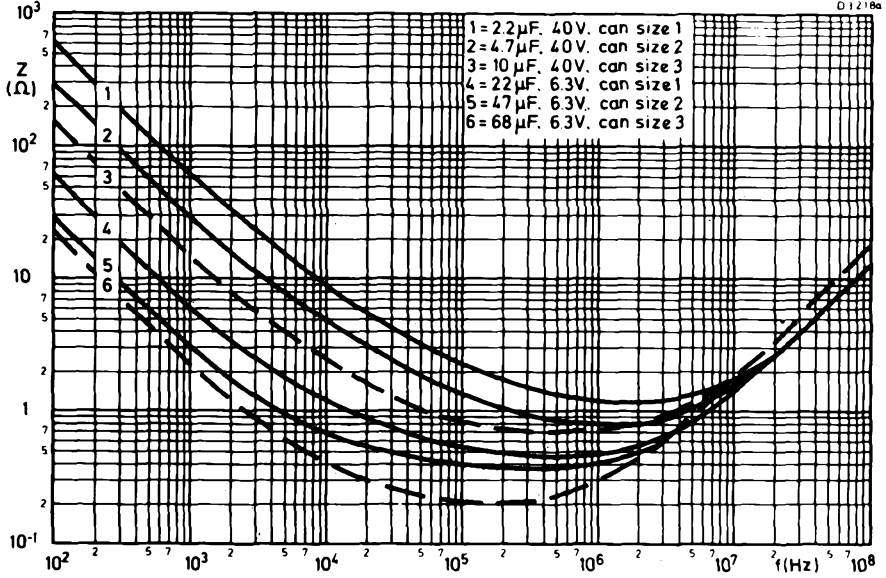

IMPEDANCE PLOTTED AGAINST FREQUENCY AT $T_{amb} = 20^{\circ}\text{C}$
(CAN SIZES 1, 2 AND 3)

D 3219a

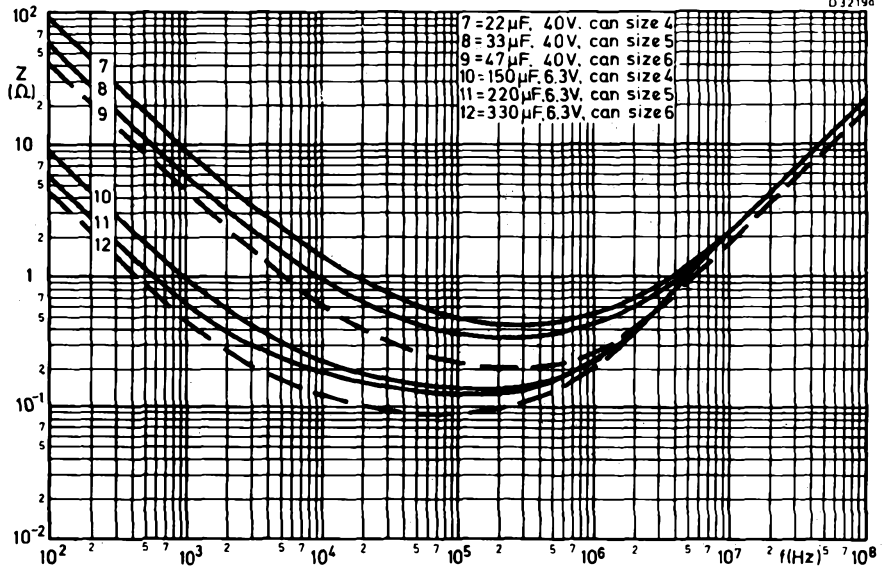

IMPEDANCE PLOTTED AGAINST FREQUENCY AT $T_{amb} = 20^{\circ}\text{C}$
(CAN SIZES 4, 5 AND 6)



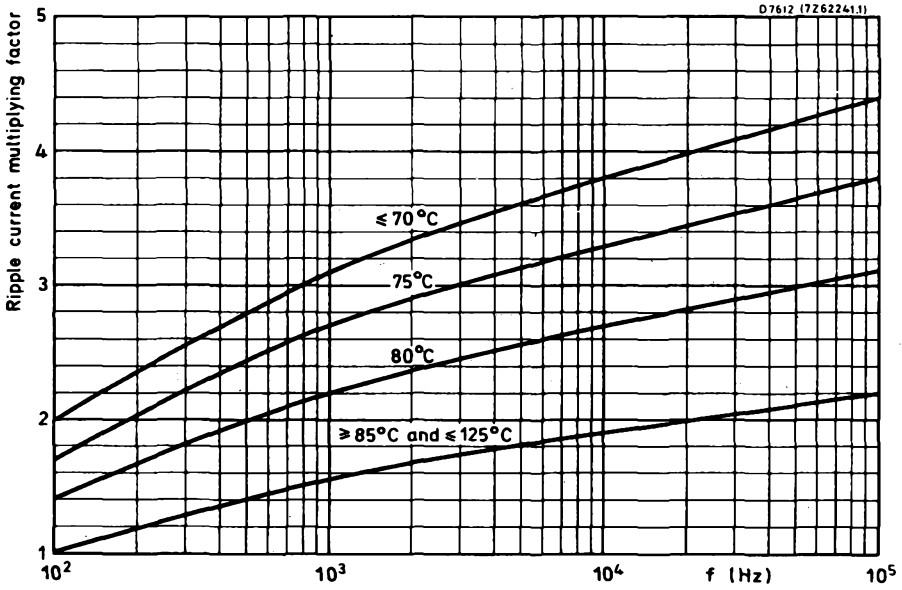

TYPICAL RIPPLE CURRENT MULTIPLYING FACTOR
PLOTTED AGAINST FREQUENCY



SOLID ALUMINIUM CAPACITORS



- Miniature type
- Single ended
- Resin dipped
- Long life
- General and industrial applications

QUICK REFERENCE DATA

Nominal capacitance range (E6 series)
Tolerance on nominal capacitance

0,1 to 68 μ F
-20 to + 40%
(\pm 20% on request)

Rated voltage range, U_R (R5 series)
Category temperature range
Endurance test

6,3 to 40 V
-55 to + 125 $^{\circ}$ C

at 85 $^{\circ}$ C
at 125 $^{\circ}$ C
Basic specification
Climatic category, IEC 68

5000 h
2000 h
IEC 384-4, long-life grade
55/125/56

Selection chart for $C_{nom} - U_R$ and relevant case sizes.

C_{nom} μ F	U_R (V)				
	6,3	10	16	25	40 *
0,1					1
0,15					1
0,22					1
0,33					1
0,47					2
0,68				1	2
1				1	3
1,5				1	4
2,2			1	2	
3,3			1	2	
4,7		1	2	3	
6,8		1	2	4	
10	1	2	3		
15	2	2	4		
22	2	3			
33	3	4			
47	4				
68	4				

case size	maximum dimensions (mm)
1	12,5 x 8 x 3,5
2	12,5 x 8 x 4,5
3	12,5 x 8 x 5
4	12,5 x 8 x 6

* Up to 85 $^{\circ}$ C, from 85 to 125 $^{\circ}$ C this value is 25 V.

Products approved to NEN CECC 30 302-002, available on request.



APPLICATION

Especially for filtering, smoothing, coupling and decoupling purposes in general and industrial applications. These capacitors utilize advanced technology to achieve long life, high reliability, high stability and low temperature dependence.

The capacitors have a very low and stable leakage current, small dimensions and a fixed pitch of 5 mm.

DESCRIPTION

This capacitor is of a construction with a highly etched aluminium plate anode, aluminium oxide as a dielectric and a solid cathode. The capacitor is coated with an orange synthetic resin. The terminal wires are brought out on one side.

MECHANICAL DATA

Dimensions in mm

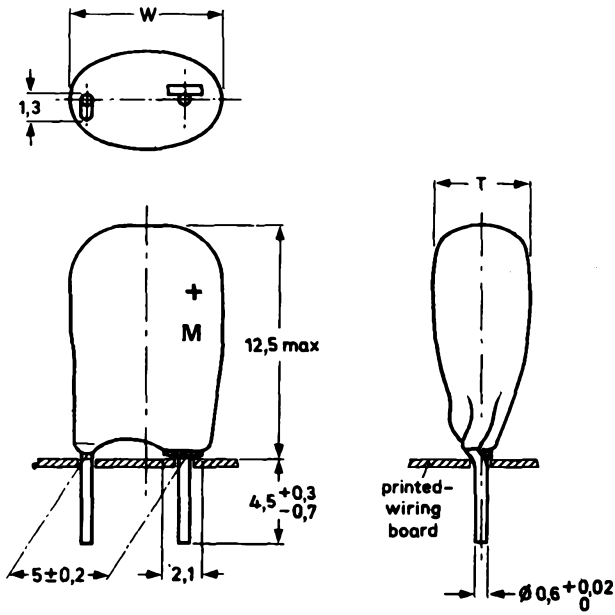

7280430.4

Fig.1 See Table 1 for dimensions T and W.



Table 1

case size	T _{max}	W _{max}
1	3,5	8
2	4,5	8
3	5	8
4	6	8

Note: A kink in the cathode wire avoids solder wetting problems of the lacquer dipped leads. The lacquer is so applied that it cannot pass beyond the centre of the kink, thus ensuring a clean surface of the part of the lead in the printed-wiring board hole. (Also suitable for use in plated-through holes.)

Marking

Stamped on the capacitor are: nominal capacitance, rated voltage, "+" signs to identify the anode terminal

Mounting

When bending, cutting or straightening the leads, ensure that the capacitor body is relieved of stress.

ORDERING PROCEDURE

The capacitors should be ordered by their type number as shown in table 2.

Example: A 3.3 μ F, 25 V rated capacitor should be ordered by quoting the number 122 56338



ELECTRICAL DATA

Unless otherwise specified all electrical values in Table 2 apply at an ambient temperature of 20 to 25 °C, a frequency of 100 Hz, an atmospheric pressure of 930 to 1060 mbar and a relative humidity of 45 to 75%.

Table 2

U_R V	nom. cap. μF	max r.m.s. ripple current at 1 kHz, $T_{amb} = 85\text{ }^\circ C$ mA *	max leakage current at U_R after 5 min μA *	max $\tan \delta$ *	case size	catalogue number
6,3	10	60	3	0,15	1	122 53109
	15	70	5	0,15	2	53159
	22	90	7	0,15	2	53229
	33	110	11	0,15	3	53339
	47	140	15	0,15	4	53479
	68	180	22	0,15	4	53689
10	4,7	40	3	0,15	1	54478
	6,8	50	4	0,15	1	54688
	10	60	5	0,15	2	54109
	15	75	8	0,15	2	54159
	22	95	11	0,15	3	54229
	33	125	17	0,15	4	54339
16	2,2	35	2	0,10	1	55228
	3,3	40	3	0,10	1	55338
	4,7	50	4	0,10	2	55478
	6,8	60	6	0,10	2	55688
	10	80	8	0,10	3	55109
	15	100	12	0,10	4	55159
25	0,68	20	2	0,10	1	56687
	1,0	25	2	0,10	1	56108
	1,5	30	2	0,10	1	56158
	2,2	35	3	0,10	2	56228
	3,3	45	4	0,10	2	56338
	4,7	55	6	0,10	3	56478
40**	6,8	70	9	0,10	4	56688
	0,1	7,5	2	0,10	1	57107
	0,15	10	2	0,10	1	57157
	0,22	12,5	2	0,10	1	57227
	0,33	15	2	0,10	1	57337
	0,47	17,5	2	0,10	2	57477
	0,68	20	2	0,10	2	57687
	1,0	25	2	0,10	3	57108
	1,5	30	3	0,10	4	57158

* See also corresponding paragraph.

** Up to 85 °C; from 85 to 125 °C this value is 25 V.



Capacitance

Nominal capacitance values at 100 Hz and $T_{amb} = 25\text{ }^{\circ}\text{C}$

see Table 2

Tolerance on nominal capacitance at 100 Hz

-20 to +40%; $\pm 20\%$ on request

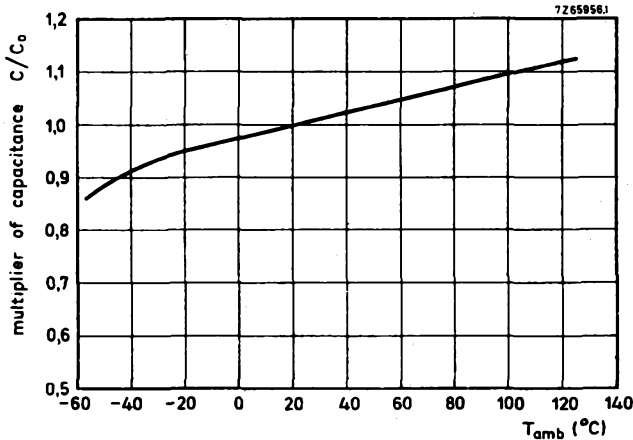

Fig. 2 Typical capacitance as a function of temperature; C_0 = capacitance at $25\text{ }^{\circ}\text{C}$, 100 Hz.

Voltage

Rated voltage = max permissible voltage at $\leq 85\text{ }^{\circ}\text{C}$

see Table 2, U_R

Derated voltage = max permissible voltage at $> 85\text{ }^{\circ}\text{C}$ up to $+125\text{ }^{\circ}\text{C}$

$0,63 \times U_R$ for 40 V version,
 U_R for other versions

Surge voltage = max permissible voltage for short periods (see also Tests and requirements)

$1,15 \times U_R$

Ripple voltage * = max permissible a.c. voltage providing the following conditions are met:

- a) if a.c. + d.c. voltage is applied:
 - max (d.c. + peak a.c.) voltage
 - max peak a.c. voltage
- b) if only a.c. voltage is applied:
 - max peak a.c. voltage

$\leq U_R$
 \leq applied d.c. voltage $+0,3 U_R$

$\leq 0,8 U_R$

Reverse voltage = max d.c. voltage applied in the reverse polarity at the maximum category temperature for short periods (see also Tests and requirements)

$0,30 \times U_R$

* Ripple voltages are not applicable if the maximum permissible ripple current is exceeded. In that case the ripple current is decisive.



Ripple current *

The maximum permissible r.m.s. ripple current at 1 kHz and 85 °C (I_{r0}) is given in Table 2. The values in this table are based upon the maximum permissible heat dissipation, which is the dominating limiting factor at frequencies above 1 kHz. From 1 kHz onwards the maximum permissible ripple current can be found from the formula: $I_r \max = \alpha \cdot I_{r0}$; α is given in Fig.3. In this graph the curves below 1 kHz are omitted, because at these frequencies the ripple voltage (see under Voltage) is the dominating limiting factor. For frequencies below 1 kHz $I_r \max$ can be calculated from the formula:

$$I_r \max = \frac{1}{2} \pi \sqrt{2} \cdot 10^{-3} (U_R + 0,3 U_R) \cdot f \cdot C \text{ mA,}$$

in which: U_R is rated voltage in V, f is frequency in Hz, C is minimum capacitance ($0,8 C_{nom}$) in μF .

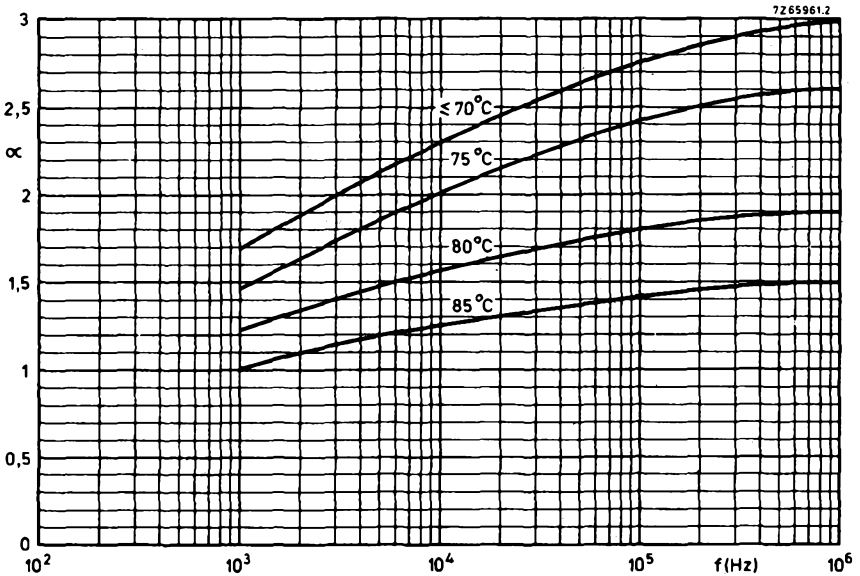

Fig.3 Multiplying factor α as a function of frequency.

Charge and discharge current

The capacitors may be charged from a source without internal resistance and they may be discharged by short-circuiting. If the capacitors are charged and discharged continuously at a rate of several times per minute, the charge and discharge currents have to be considered as ripple currents flowing through the capacitor. The r.m.s. value of these currents should be determined and the value thus found must not exceed the applicable limit.

* Ripple currents are not applicable if the maximum permissible ripple voltage is exceeded. In that case the ripple voltage is decisive.



Leakage current

Maximum leakage current 5 min. after application of the rated voltage, at $T_{amb} = 25\text{ }^{\circ}\text{C}$

see Table 2 (0,05 CU or 2 μA whichever is greater)

Leakage current during continuous operation at U_R
at 25 $^{\circ}\text{C}$
at 85 $^{\circ}\text{C}$

approx. 0,02 x value stated in Table 2
approx. 0,1 x value stated in Table 2

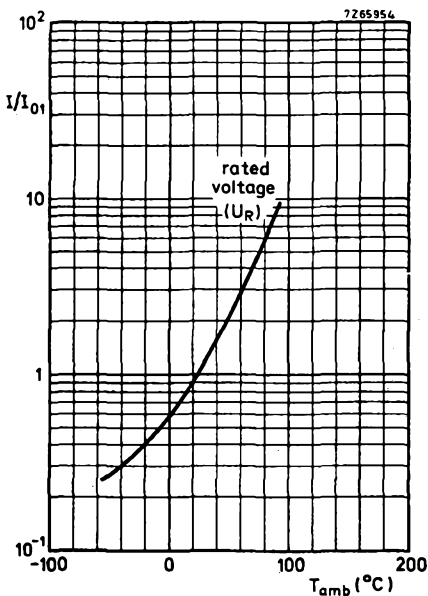

Fig. 4 Multiplier I/I_{01} as a function of temperature; I_{01} = leakage current during continuous operation at U_R , $T_{amb} = 25\text{ }^{\circ}\text{C}$.

Tan δ (dissipation factor)

Tan δ at 100 Hz and $T_{amb} = 25\text{ }^{\circ}\text{C}$, measured by means of a four-terminal circuit (Thomson circuit)

see Table 2



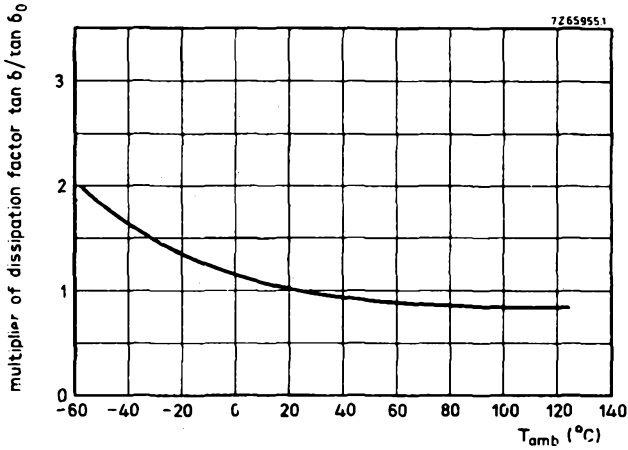

Fig.5 Multiplier of dissipation factor as a function of temperature; $\tan \delta_0$ = dissipation factor at 25 °C 100 Hz.

Impedance

Impedance at 100 kHz and $T_{amb} = 25$ °C, measured by means of a four-terminal circuit (Thomson circuit)

see Table 2

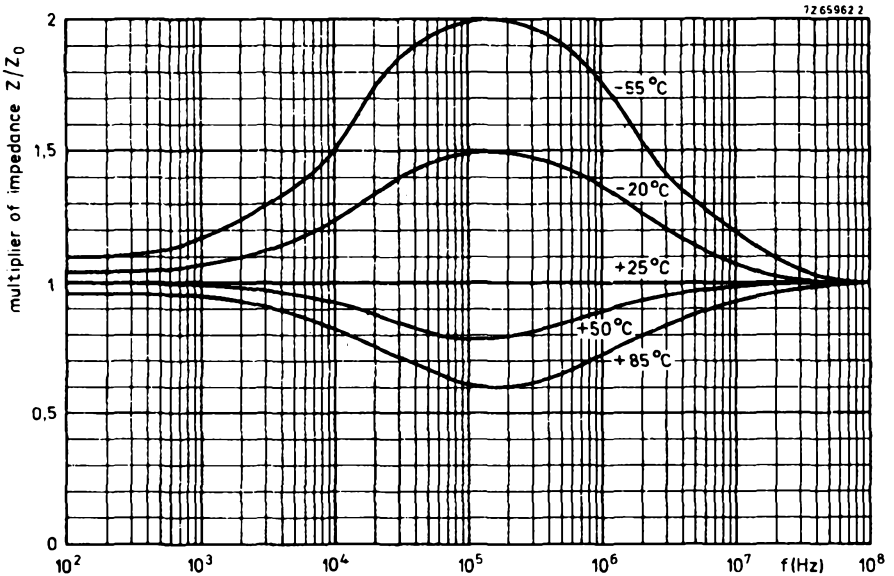

Fig.6 Multiplier of impedance Z/Z_0 as a function of frequency at different temperatures; Z_0 = impedance initial value at 25 °C.



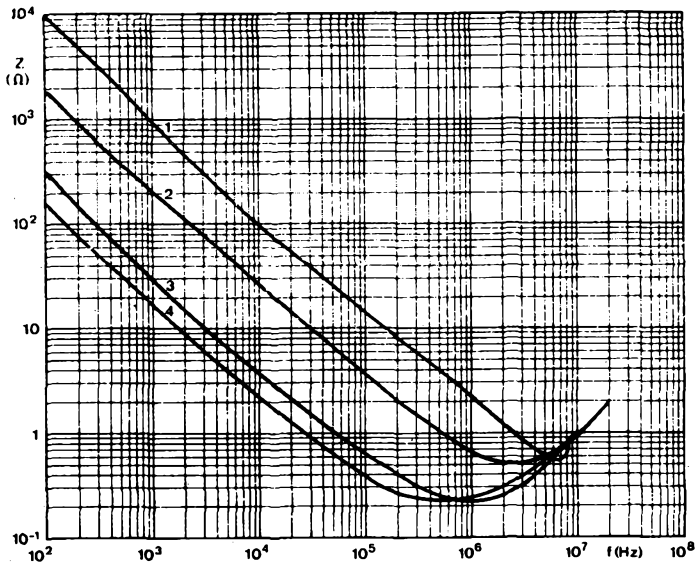

Fig. 7 Typical impedance as a function of frequency at 25 °C, case size 1. Curve 1 = 0,15 μ F, 40 V; curve 2 = 0,68 μ F, 25 V; curve 3 = 4,7 μ F, 10 V; curve 4 = 10 μ F, 6,3 V.

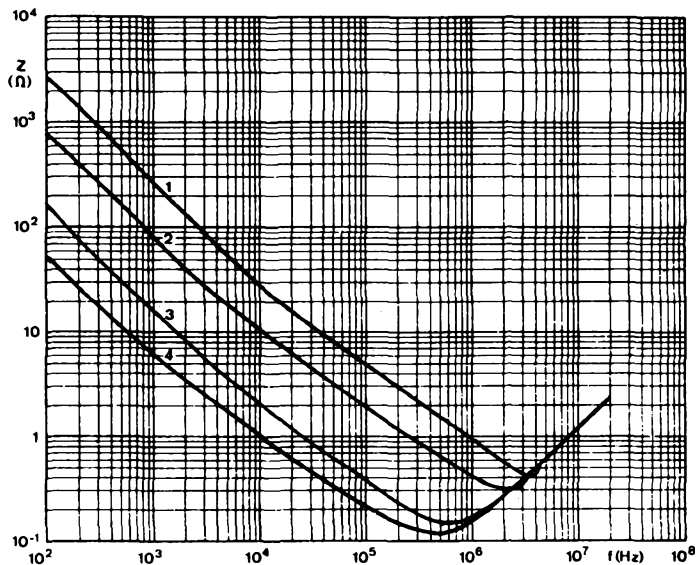

Fig. 8 Typical impedance as a function of frequency at 25 °C; case size 2. Curve 1 = 0,47 μ F, 40 V; curve 2 = 2,2 μ F, 25 V; curve 3 = 10 μ F, 10 V; curve 4 = 22 μ F, 6,3 V.



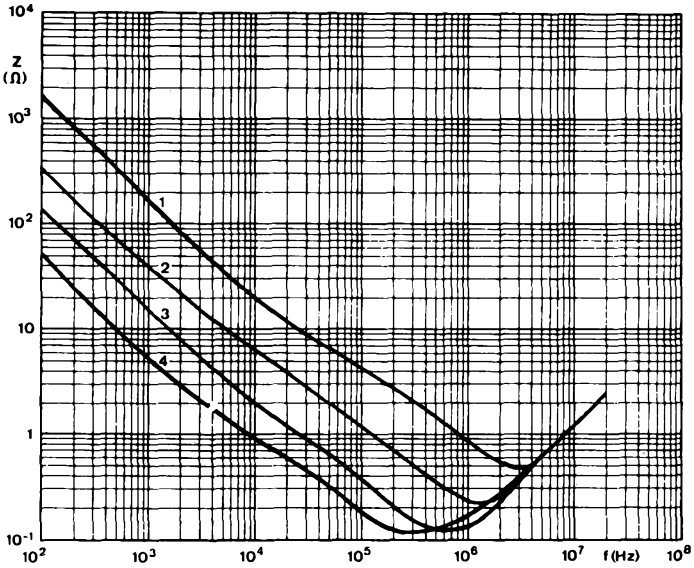

Fig.9 Typical impedance as a function of frequency at 25 °C; case size 3. Curve 1 = 1 μ F, 40 V; curve 2 = 4,7 μ F, 25 V; curve 3 = 10 μ F, 16 V; curve 4 = 33 μ F, 6,3 V.

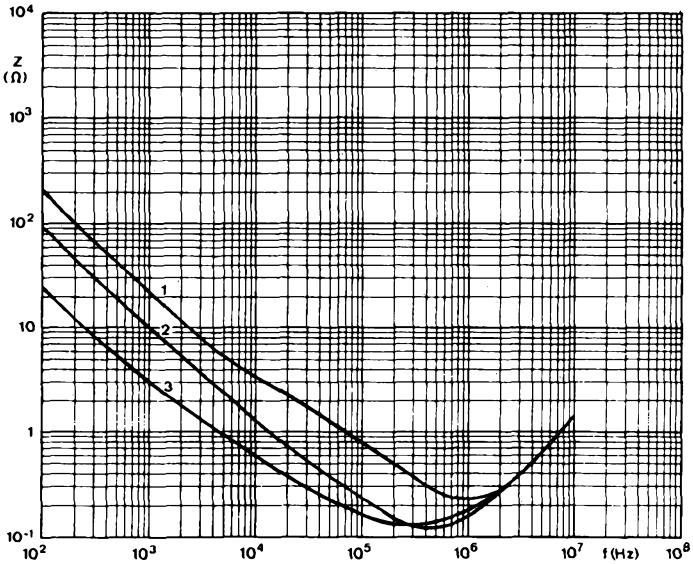

Fig.10 Typical impedance as a function of frequency at 25 °C; case size 4. Curve 1 = 6,8 μ F, 25 V; curve 2 = 15 μ F, 16 V; curve 3 = 68 μ F, 6,3 V.



Equivalent series resistance (ESR) at 100 Hz

$$ESR = \frac{\tan \delta}{\omega C}$$

Tan δ and C at 100 Hz

see Table 2

OPERATIONAL DATA

Category temperature range

for rated voltage

-55 to +85 °C

for derated voltage

-55 to +125 °C

PACKING

1000 pieces per box: 200 pieces per plastic bag, 5 bags per box.



VARIABLE CAPACITORS

E

FILM DIELECTRIC TRIMMERS

For use on printed wiring boards in radio and television equipment.

QUICK REFERENCE DATA

Maximum capacitance	5.5, 10, 15, 20, 22, 27, 40, 65, 80, 100, 120 pF
Rated voltage (d.c.)	250 V
Climatic category (IEC 68)	40/070/21, 40/085/21.

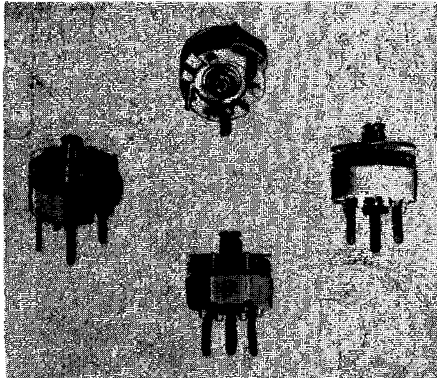

DIELECTRIC

Polypropylene film.

BODY MATERIAL

Mineral filled polypropylene housing

TERMINATIONS

Solder tags suitable for use with 2.54 mm (0.1 in) grid printed wiring boards with 1.3 mm holes.

SPECIAL FEATURES

The capacitors are sturdily constructed on a plastic frame and the dielectric is so arranged to support the vanes, thus giving a very high degree of stability. The plastic materials employed in the assembly are resistant against most of the usual cleaning agents.

Top adjustment is by means of a screwdriver slot in the centre spindle. Bottom adjustment can be achieved using the projecting ridge on the lower surface of the spindle.

Trimmers with horizontal adjustment can be supplied to special order.



DIMENSIONS (millimetres) 808 23xxx Series (5.0 mm)

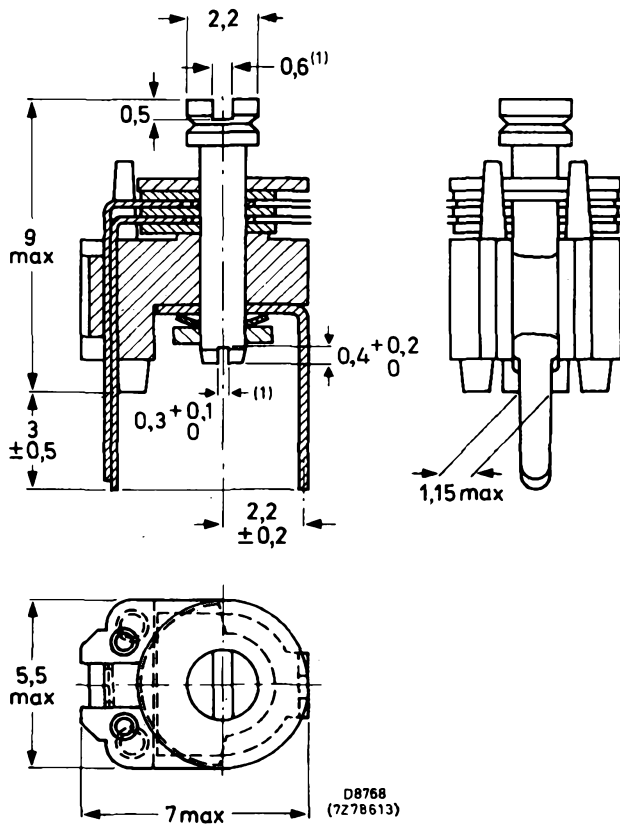

Fig.1



TECHNICAL DATA 808 23xxx Series

Unless otherwise specified, all characteristics apply at an ambient temperature of 20 ± 5 °C, atmospheric pressure of 10^5 Pa (1000 mbars), and a relative humidity of 75% maximum.

	Conditions	808 23109	808 23159	808 23209
Capacitance swing	—	≤ 3 to ≥ 10 pF	≤ 2 to ≥ 15 pF	≤ 2 to ≥ 20 pF
Body colour	—	yellow	blue	green
Temperature coefficient	20 to 70 °C	$(-200 \pm 300) \times 10^{-6}/^{\circ}\text{C}$	$(-50 \pm 200) \times 10^{-6}/^{\circ}\text{C}$	$(-50 \pm 200) \times 10^{-6}/^{\circ}\text{C}$
Rated voltage (d.c.)	—	250 V	250 V	250 V
Insulation resistance	—	$> 10\,000$ M Ω	$> 10\,000$ M Ω	$> 10\,000$ M Ω
Tangent of loss angle (tan δ)	f = 1 MHz f = 100 MHz	$\leq 10 \times 10^{-4}$ $\leq 25 \times 10^{-4}$	$\leq 10 \times 10^{-4}$ $\leq 25 \times 10^{-4}$	$\leq 10 \times 10^{-4}$ $\leq 25 \times 10^{-4}$
Contact resistance	—	≤ 10 m Ω	≤ 10 m Ω	≤ 10 m Ω
Typical self resonance	Set at C max.	> 500 MHz	> 500 MHz	> 500 MHz
Effective angle of rotation	—	180°	180°	180°
Operating torque	—	< 15 Nmm	< 15 Nmm	< 15 Nmm
Test voltage (d.c.)	Applied for 1 minute	500 V	500 V	500 V
Weight	—	0.45 g	0.45 g	0.45 g
Climatic category (IEC 68)	—	40/070/21	40/070/21	40/070/21



DIMENSIONS (millimetres) 808 11xxx Series (7.5 mm)

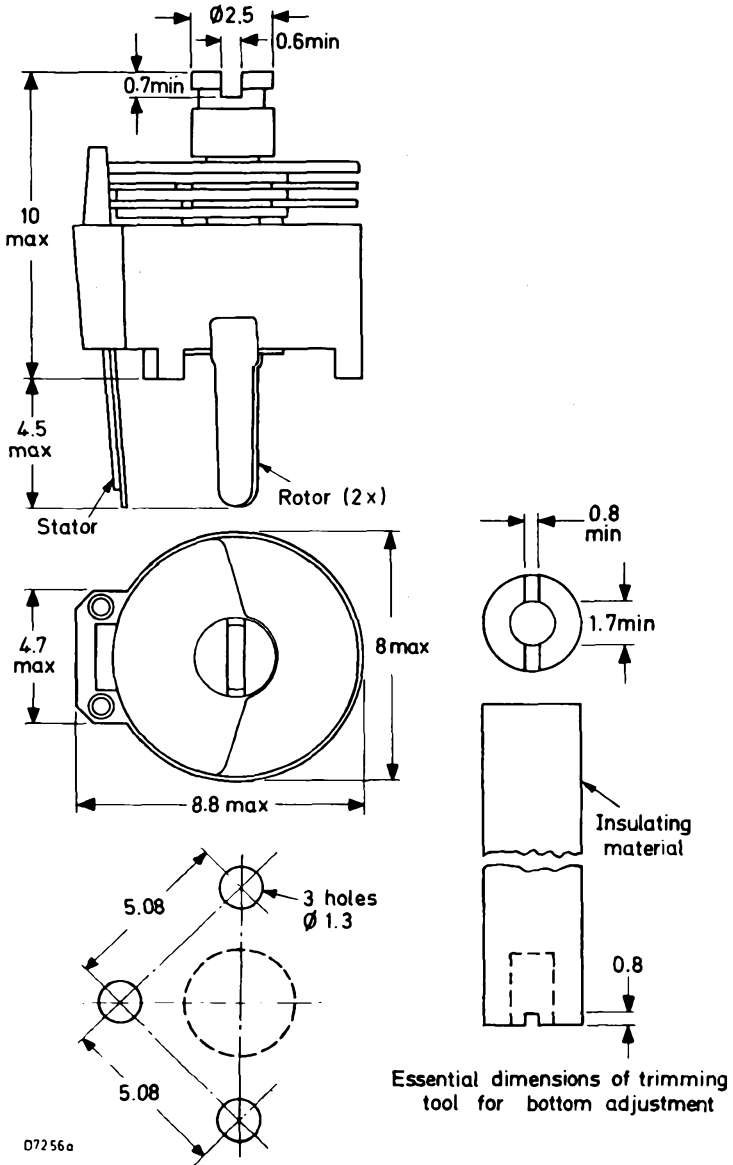

Fig.2



TECHNICAL DATA 808 1xxxx Series

Unless otherwise specified, all characteristics apply at an ambient temperature of $20 \pm 5^\circ\text{C}$, atmospheric pressure of 10^5 Pa (1000 mbars), and a relative humidity of 75% maximum.

	Conditions	808 11558	808 11109	808 11159	808 11229	808 11279	808 11409
Capacitance swing	—	$< 1.4 \text{ to } \geq 5.5 \text{ pF}$	$< 2 \text{ to } \geq 10 \text{ pF}$	$< 2 \text{ to } \geq 15 \text{ pF}$	$< 2 \text{ to } \geq 22 \text{ pF}$	$< 2 \text{ to } \geq 27 \text{ pF}$	$< 3 \text{ to } \geq 40 \text{ pF}$
Body colour	—	grey	yellow	blue	green	red	violet
Temperature coefficient	20 to 70°C	$(-750 \pm 300) \times 10^{-6}/^\circ\text{C}$	$(-200 \pm 300) \times 10^{-6}/^\circ\text{C}$	$(-200 \pm 300) \times 10^{-6}/^\circ\text{C}$	$(-350 \pm 250) \times 10^{-6}/^\circ\text{C}$	$(-250 \pm 300) \times 10^{-6}/^\circ\text{C}$	$(-250 \pm 300) \times 10^{-6}/^\circ\text{C}$
Rated voltage (d.c.)	—	250 V	250 V	250 V	250 V	250 V	250 V
Insulation resistance	—	$> 10\,000 \text{ M}\Omega$	$> 10\,000 \text{ M}\Omega$	$> 10\,000 \text{ M}\Omega$	$> 10\,000 \text{ M}\Omega$	$> 10\,000 \text{ M}\Omega$	$> 10\,000 \text{ M}\Omega$
Tangent of loss angle ($\tan \delta$)	$f = 1 \text{ MHz}$	$\leq 10 \times 10^{-4}$	$\leq 10 \times 10^{-4}$	$\leq 10 \times 10^{-4}$	$\leq 10 \times 10^{-4}$	$\leq 50 \times 10^{-4}$	$\leq 50 \times 10^{-4}$
	$f = 100 \text{ MHz}$	$\leq 25 \times 10^{-4}$	$\leq 25 \times 10^{-4}$	$\leq 25 \times 10^{-4}$	$\leq 25 \times 10^{-4}$	—	—
Contact resistance	—	$\leq 10 \text{ m}\Omega$	$\leq 10 \text{ m}\Omega$	$\leq 10 \text{ m}\Omega$	$\leq 10 \text{ m}\Omega$	$\leq 10 \text{ m}\Omega$	$\leq 10 \text{ m}\Omega$
Minimum self resonance	Set at C max.	850 MHz	400 MHz	450 MHz	350 MHz	350 MHz	300 MHz
Climatic category (IEC 68)	—	40/085/21	40/070/21	40/070/21	40/070/21	40/085/21	40/085/21
Effective angle of rotation	—	180°	180°	180°	180°	180°	180°
Operating torque	—	$< 15 \text{ Nmm}$	$< 15 \text{ Nmm}$	$< 15 \text{ Nmm}$	$< 15 \text{ Nmm}$	$< 15 \text{ Nmm}$	$< 15 \text{ Nmm}$
Test voltage (d.c.)	Applied for 1 minute	500 V	500 V	500 V	500 V	500 V	500 V
Weight	—	0.8 g	0.8 g	0.8 g	0.8 g	0.8 g	0.8 g

DIMENSIONS (millimetres) 808 32xxx Series (10.0 mm)

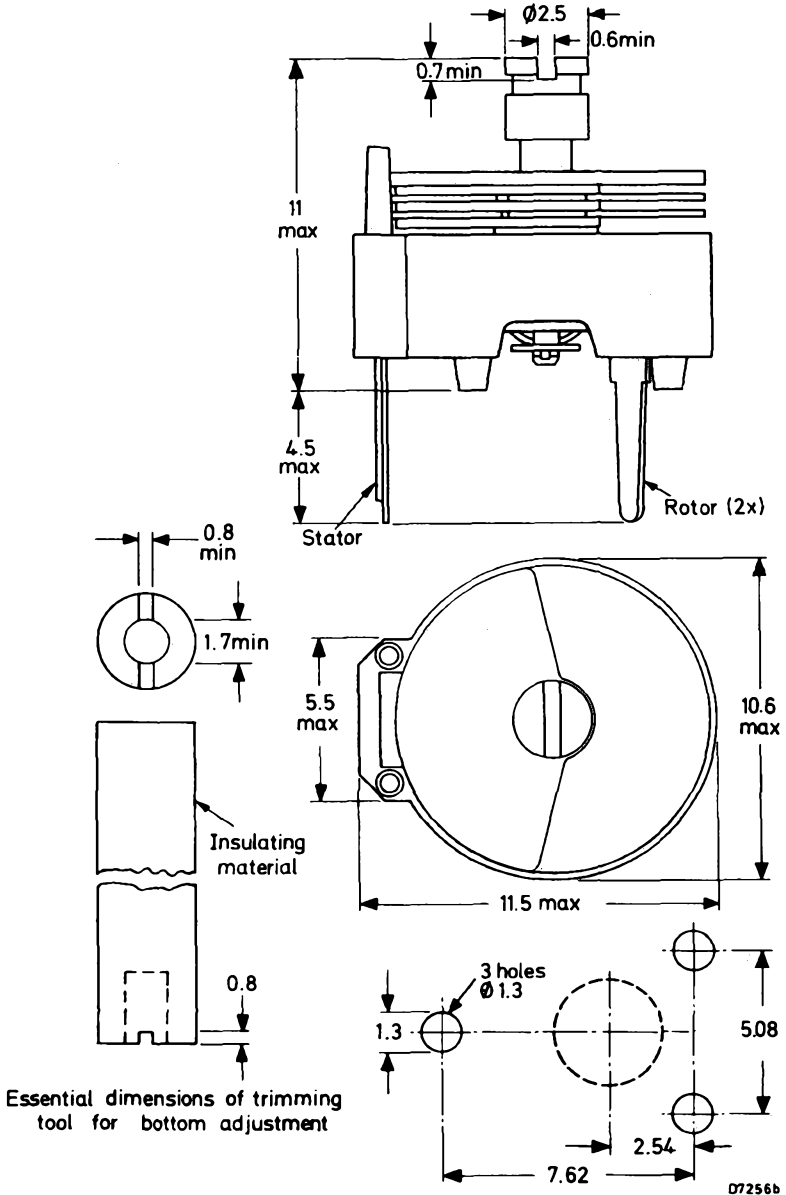

Fig.3



TECHNICAL DATA 808 32xxx Series

Unless otherwise specified, all characteristics apply at an ambient temperature of 20 ± 5 °C, atmospheric pressure of 10^5 Pa (1000 mbars), and a relative humidity of 75% maximum.

	Conditions	808 32409	808 32659	808 32809	808 32101
Capacitance swing	—	≤ 5.5 to ≥ 40 pF	≤ 5.5 to ≥ 65 pF	≤ 6.0 to ≥ 80 pF	≤ 6.0 to ≥ 100 pF
Body colour	—	grey	yellow	red	violet
Temperature coefficient	20 to 70 °C	$(-150 \pm 350) \times 10^{-6}/^{\circ}\text{C}$	$(-200 \pm 300) \times 10^{-6}/^{\circ}\text{C}$	$(-100 \pm 300) \times 10^{-6}/^{\circ}\text{C}$	$(-100 \pm 300) \times 10^{-6}/^{\circ}\text{C}$
Rated voltage (d.c.)	—	250 V	250 V	250 V	250 V
Insulation resistance	—	$> 10\,000$ M Ω	$> 10\,000$ M Ω	$> 10\,000$ M Ω	$> 10\,000$ M Ω
Tangent of loss angle (tan δ)	f = 1 MHz f = 100 MHz	$\leq 10 \times 10^{-4}$ $\leq 25 \times 10^{-4}$	$\leq 10 \times 10^{-4}$ $\leq 25 \times 10^{-4}$	$\leq 50 \times 10^{-4}$ —	$\leq 50 \times 10^{-4}$ —
Contact resistance	—	≤ 10 M Ω	≤ 10 m Ω	≤ 10 m Ω	≤ 10 m Ω
Typical self resonance	Set at C max.	> 200 MHz	> 200 MHz	> 170 MHz	> 150 MHz
Effective angle of rotation	—	180°	180°	180°	180°
Operating torque	—	< 15 Nmm	< 15 Nmm	< 15 Nmm	< 15 Nmm
Test voltage (d.c.)	Applied for 1 minute	500 V	500 V	500 V	500 V
Weight	—	1.3 g	1.3 g	1.3 g	1.3 g
Climatic category (IEC 68)	—	40/070/21	40/070/21	40/085/21	40/085/21



DIMENSIONS (millimetres) 808 41xxx Series (13.5 mm)

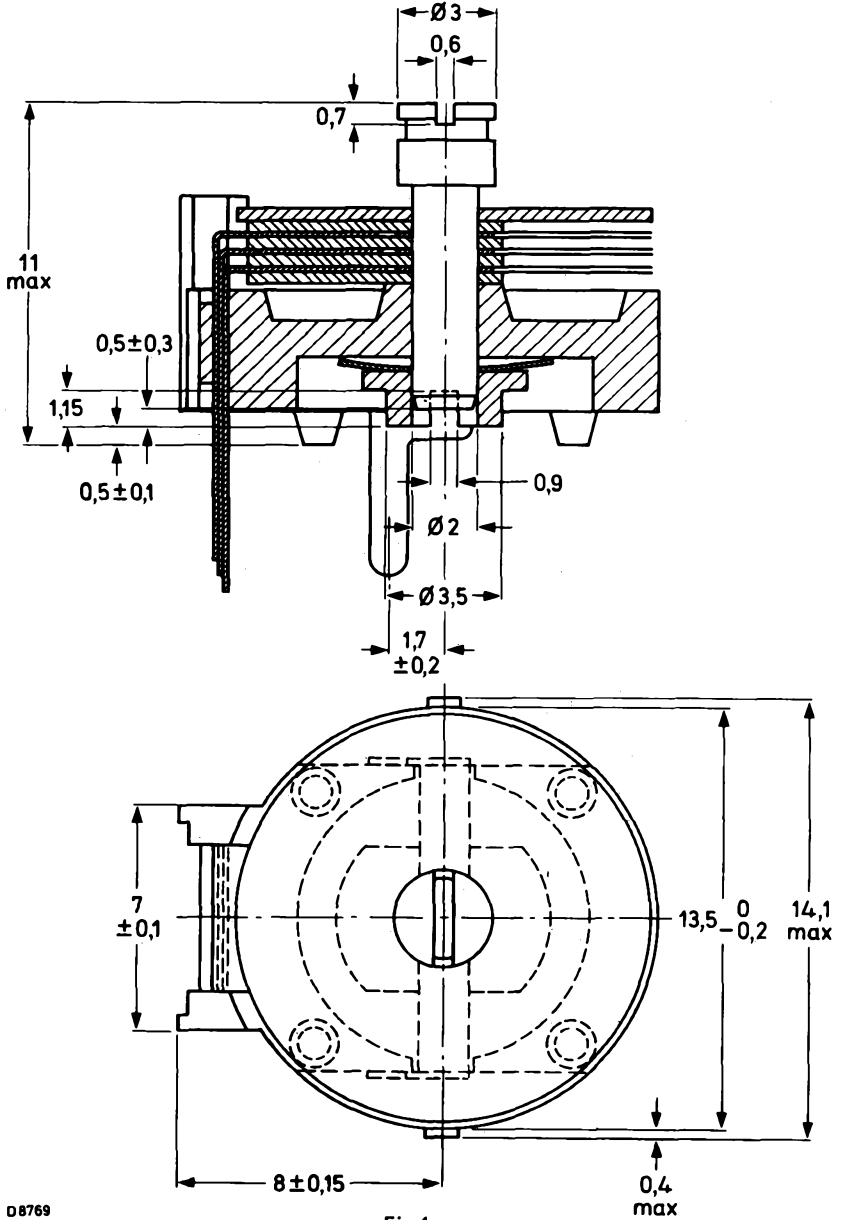

D8769

Fig.4



TECHNICAL DATA 808 41xxx Series

Unless otherwise specified, all characteristics apply at an ambient temperature of 20 ± 5 °C, atmospheric pressure of 10^5 Pa (1000 mbars), and a relative humidity of 75% maximum.

	Conditions	808 41121
Capacitance swing	—	≤ 11 to ≥ 120 pF
Body colour	—	green
Temperature coefficient	20 to 70 °C	$(0 \pm 200) \times 10^{-6}/^{\circ}\text{C}$
Rated voltage (d.c.)	—	150 V
Insulation resistance	—	$> 10\,000$ M Ω
Tangent of loss angle (tan δ)	f = 1 MHz	$\leq 50 \times 10^{-4}$
Contact resistance	—	≤ 10 m Ω
Typical self resonance	Set at C max.	> 150 MHz
Effective angle of rotation	—	180°
Operating torque	—	< 35 Nmm
Test voltage (d.c.)	Applied for 1 minute	500 V
Weight	—	2.0 g
Climatic category (IEC 68)	—	40/070/21



**FILM DIELECTRIC
TRIMMERS**
Miniature, insulated

809 05
Series

←
QUICK REFERENCE DATA

For use in miniaturised measuring and telecommunication equipment, especially where high temperatures occur and a low temperature coefficient is important, for example, for fine adjustment of h. f. tuned circuits.

Maximum capacitance	3.5, 10 and 18	pF
Rated voltage (d. c.)	300	V
Climatic category (IEC 68)	40/125/21	

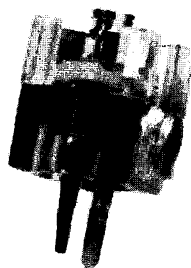
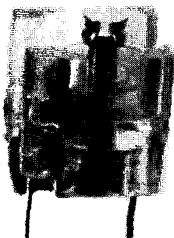
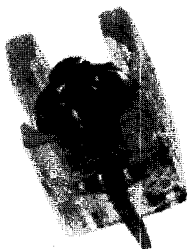

POO2

DIELECTRIC

3.5 and 10 pF trimmers

p. t. f. e. film

18 pF trimmer

p. t. f. e. and Kapton 'sandwich' film

VANE MATERIAL

Brass vanes, rotor and stator.

BODY MATERIAL

Polysulphone housing.

TERMINATIONS

Solder tags suitable for use with 2.54 mm (0.1 in) grid printed wiring boards with 1.3 mm holes.

SPECIAL FEATURES

The dielectric is so arranged that it supports the vanes to give accuracy and robustness in use; this combined with rigidly controlled production and inspection techniques produces a reliable and very stable component.

Mullard

DIMENSIONS (millimetres) AND TYPE NUMBERS

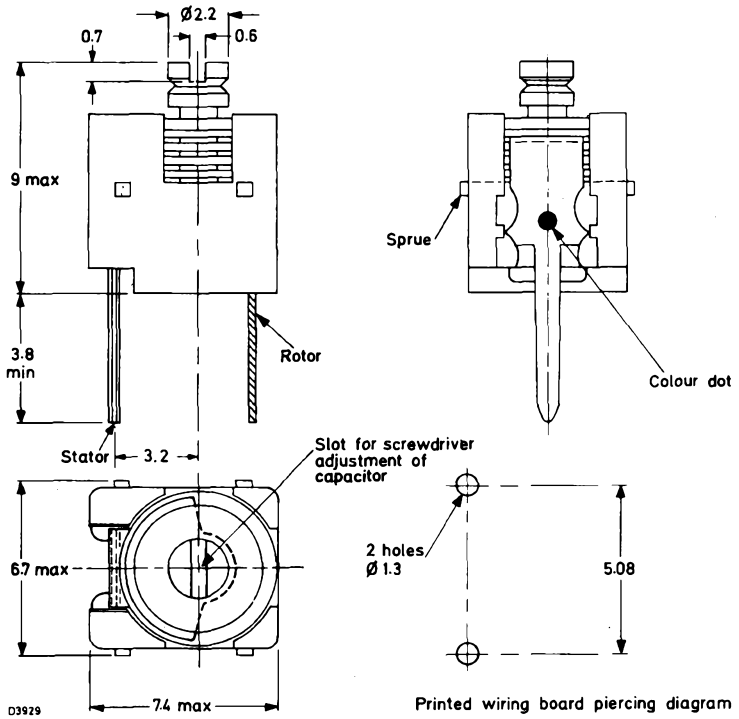

Capacitance swing	Type number
1 to 3.5pF	809 05001
1.8 to 10pF	809 05002
2 to 18pF	809 05003

**FILM DIELECTRIC
TRIMMERS**
Miniature, insulated

809 05
Series

TECHNICAL DATA

Unless otherwise specified, all characteristics apply at an ambient temperature of $20 \pm 5^{\circ}\text{C}$, atmospheric pressure of 10^5Pa (1000mbars), and a relative humidity of 75% maximum.

	Conditions	809 05001	809 05002	809 05003
Capacitance swing	-	<1 to >3.5pF	<1.8 to >10pF	<2 to >18pF
Colour code	-	orange	white	red
Temperature coefficient	20 to 70°C	$(-250 \pm 150) \times 10^{-6}$ per degC	$(-300 \pm 75) \times 10^{-6}$ per degC	$(-350 \pm 75) \times 10^{-6}$ per degC
	-40 to $+20^{\circ}\text{C}$	$(-50 \pm 200)^* \times 10^{-6}$ per degC	$(-100 \pm 200)^* \times 10^{-6}$ per degC	$(-100 \pm 200)^* \times 10^{-6}$ per degC
Rated voltage (d. c.)	-	300V	300V	300V
Insulation resistance	Between rotor and stator	>10 000M Ω	>10 000M Ω	>10 000M Ω
Tangent of loss angle (tan δ)	f = 1MHz	$<10 \times 10^{-4}$	$<10 \times 10^{-4}$	$<25 \times 10^{-4}$
	f = 100MHz	$<20 \times 10^{-4}$	$<20 \times 10^{-4}$	$<40 \times 10^{-4}$
Parallel damping	f = 1.5MHz	>10M Ω	>10M Ω	>10M Ω
Contact resistance	-	<5m Ω	<5m Ω	<5m Ω
Maximum dissipation	Set at 70% of C_{max} , f = 175MHz, temperature rise of 100°C	0.75W	0.75W	0.75W
Typical self resonance	Set at C_{max}	>850MHz	>580MHz	>360MHz
Climatic category (IEC 68)	-	40/125/21	40/125/21	40/125/21

*Tentative data

TECHNICAL DATA (Contd.)

	Conditions	809 05001	809 05002	809 05003
Effective angle of rotation	—	180°	180°	180°
Operating torque	—	<15 Nmm	<20 Nmm	<20 Nmm
Axial load	—	<2N	<2N	<2N
Test voltage (d. c.)	Applied for 1 minute	600 V	600 V	600 V
Weight (approx.)	—	0.7 g	0.7 g	0.7 g

SOLDERING CONDITIONS

For printed wiring board applications

5 seconds max. at 240°C max.

- Care should be taken to prevent the ingress of soldering flux into the rotor/stator assembly

MARKING

The capacitors are marked with colour code shown in table.

ORDERING PROCEDURE

The capacitors should be ordered by quoting their type number as shown in the table.

Example: A capacitor having a swing from 1.8 to 10 pF should be ordered by quoting the type number 809 05002.

**FILM DIELECTRIC
TRIMMERS**
Small, insulated

809 07
Series

QUICK REFERENCE DATA

For use in miniaturised measuring and telecommunication equipment, especially where high temperatures occur and a low temperature coefficient is important, for example, for fine adjustment of h. f. tuned circuits.

Maximum capacitance	40, 60, 80 and 100	pF
Rated voltage (d. c.)	200	V
Climatic category (IEC 68)	40/125/21	

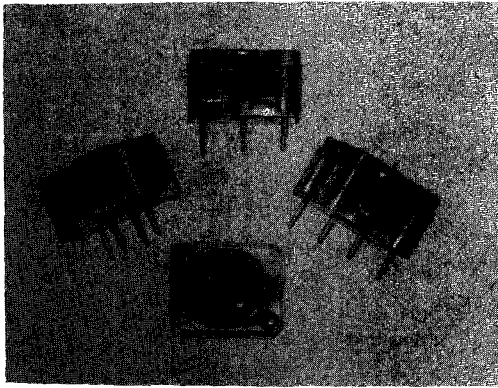

DIELECTRIC

P. T. F. E. film or p. t. f. e. and Kapton ' sandwich ' film.

VANE MATERIAL

Brass vanes, rotor and stator.

BODY MATERIAL

Polysulphone housing.

TERMINATIONS

Solder tags suitable for use with 2.54 mm (0.1 in) grid printed wiring boards with 1.3 mm holes.

SPECIAL FEATURES

The dielectric is so arranged that it supports the vanes to give accuracy and robustness in use; this combined with rigidly controlled production and inspection techniques produces a reliable and very stable component.

→ DIMENSIONS (millimetres) AND TYPE NUMBERS

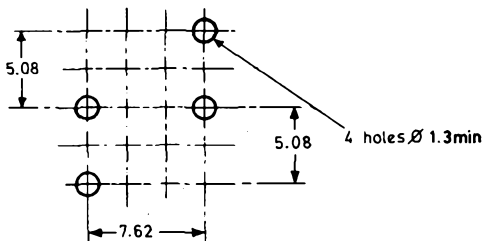
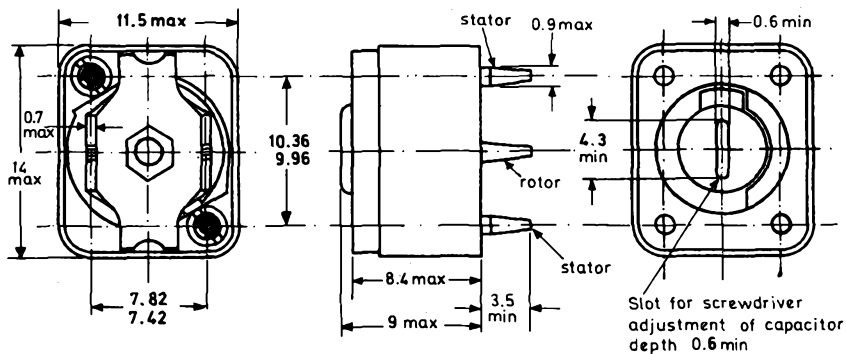

Printed wiring board piercing diagram

D1269

Capacitance swing	Type number
4 to 40pF	809 07008
5 to 60pF	809 07011
6 to 80pF	809 07013
7 to 100pF	809 07015

**FILM DIELECTRIC
TRIMMERS**
Small, insulated

809 07
Series

TECHNICAL DATA

Unless otherwise specified, all characteristics apply at an ambient temperature of $20 \pm 5^\circ\text{C}$, atmospheric pressure of 10^5Pa (1000mbars) and a relative humidity of 75% maximum.

	Conditions	809 07008	809 07011	809 07013	809 07015
Capacitance swing	—	<4 to >40pF	<5 to >60pF	<6 to >80pF	<7 to >100pF
Colour code		Yellow	Blue	Grey	White
Temperature coefficient	20 to 70°C	$(0 \pm 200) \times 10^{-6}$ per deg C	$(0 \pm 200) \times 10^{-6}$ per deg C	$(0 \pm 200) \times 10^{-6}$ per deg C	$(0 \pm 200) \times 10^{-6}$ per deg C
Rated voltage (d. c.)	—	200 V	200 V	200 V	200 V
Insulation resistance	Between rotor and stator	>10 000 M Ω	>10 000 M Ω	>10 000M Ω	>10 000 M Ω
Tangent of loss angle (tan δ)	f = 1 MHz	$<10 \times 10^{-4}$	$<10 \times 10^{-4}$	$<10 \times 10^{-4}$	$<10 \times 10^{-4}$
	f = 100 MHz	$<17 \times 10^{-4}$	$<25 \times 10^{-4}$	$<25 \times 10^{-4}$	$<25 \times 10^{-4}$
Parallel damping	f = 1.5 MHz	>10 M Ω	>10 M Ω	>10 M Ω	>10 M Ω
Contact resistance	—	<5 m Ω	<5 m Ω	<5 m Ω	<5 m Ω
Maximum dissipation	Set at 70% of C_{max} f = 175 MHz temperature rise of 45°C	1 W	1 W	1 W	1 W
Climatic category (IEC 68)	—	40/125/21	40/125/21	40/125/21	40/125/21

TECHNICAL DATA (Contd.)

	Conditions	809 07008	809 07011	809 07013	809 07015
Effective angle of rotation	—	180°	180°	180°	180°
Operating torque	—	<35 Nmm	<35 Nmm	<35 Nmm	<35 Nmm
Axial load	—	<2 N	<2 N	<2 N	<2 N
Test voltage (d. c.)	Applied for 1 minute	400 V	400 V	400 V	400 V
Weight (approx.)	—	2.3 g	2.3 g	2.3 g	2.3 g

SOLDERING CONDITION

For printed wiring board applications

5 seconds max. at 240 °C max.

→ Care should be taken to prevent ingress of soldering flux into the rotor/stator assembly.

MARKING

The capacitors may be marked with capacitance value, followed by the letter ' E' , or by a colour spot on the cover plate as shown on page 3.

ORDERING PROCEDURE

The capacitors should be ordered by quoting their type number as shown in the table.

Example: A capacitor having a swing from 5 to 60 pF should be ordered by quoting the type number 809 07011.

FILM DIELECTRIC TRIMMERS

Small, insulated

809 08

Series

QUICK REFERENCE DATA

For general purpose applications and in tuned circuits of electronic equipment.

Maximum capacitance	40 and 60	pF	←
Rated voltage (d. c.)	300	V	
Climatic category (IEC 68)	40/125/21		

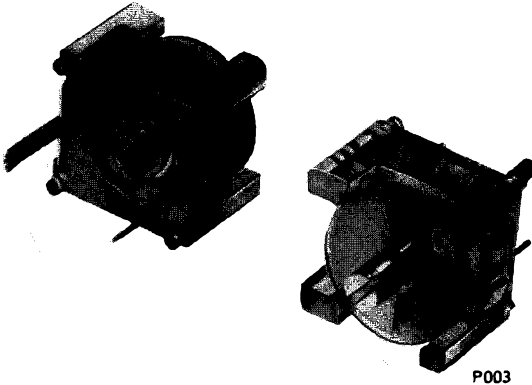

DIELECTRIC

Teflon film.

VANE MATERIAL

Brass vanes, rotor and stator.

BODY MATERIAL

Polysulphone housing.

TERMINATIONS

Solder tags suitable for use with 2.54mm (0.1 in) grid printed wiring boards with 1.3 mm ← holes.

SPECIAL FEATURES

The dielectric is so arranged that it supports the vanes to give accuracy and robustness in use; this combined with rigidly controlled production and inspection techniques produces a reliable and very stable component. The capacitors can be adjusted from both sides by means of a screwdriver.

Mullard

DIMENSIONS (millimetres) AND TYPE NUMBERS

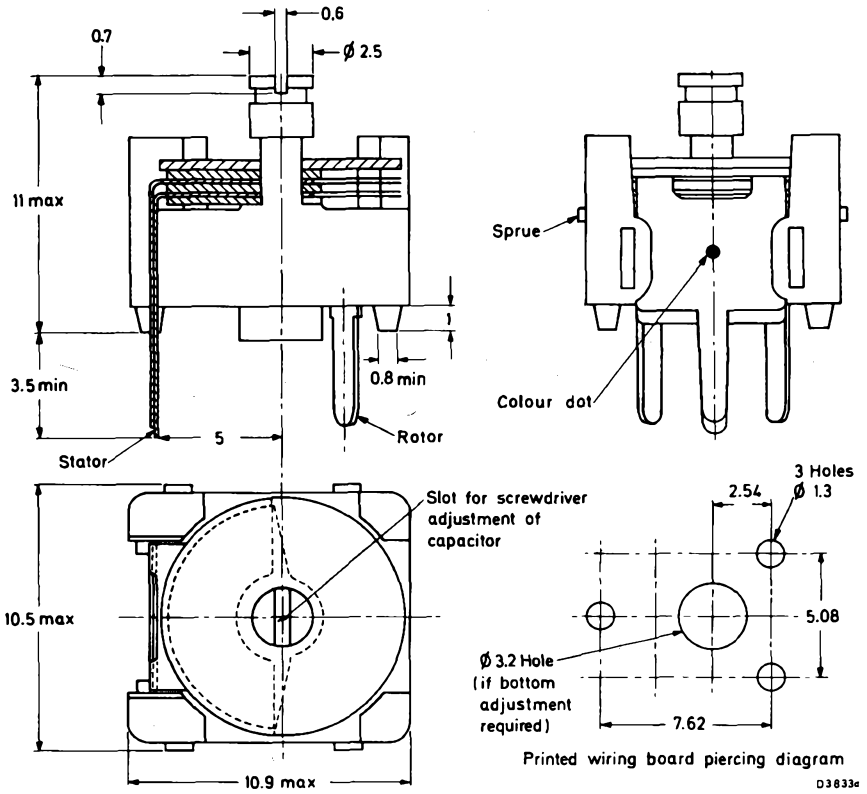

Capacitance swing	Type number
4 to 40 pF	809 08002
5 to 60 pF	809 08003

→

**FILM DIELECTRIC
TRIMMERS**
Small, insulated

809 08
Series

TECHNICAL DATA

Unless otherwise specified, all characteristics apply at an ambient temperature of $20 \pm 5^\circ\text{C}$, atmospheric pressure of 10^5Pa (1000 mbars), and a relative humidity of 75% maximum.

	Conditions	809 08002	809 08003
Capacitance swing	—	<4 to >40 pF	<5 to >60 pF
Colour code	—	yellow	blue
Temperature coefficient	—	$(-250 \pm 150) \times 10^{-6}$ per degC	$(-250 \pm 150) \times 10^{-6}$ per degC
Rated voltage (d. c.)	—	300 V	300 V
Insulation resistance	Between rotor and stator	>10 000 M Ω	>10 000 M Ω
Tangent of loss angle (tan δ)	f = 1 MHz	<25 $\times 10^{-4}$	<35 $\times 10^{-4}$
	f = 100 MHz	<25 $\times 10^{-4}$	<35 $\times 10^{-4}$
Parallel damping	f = 1.5 MHz	>10 M Ω	>10 M Ω
Contact resistance	—	<5 m Ω	<5 m Ω
Maximum dissipation	Set at 70% of C_{max} , f = 175 MHz, temperature rise of 100 $^\circ\text{C}$	1.5 W	1.5 W
Typical self resonance	Set at C_{max}	>170 MHz	>150 MHz
Climatic category (IEC 68)	—	40/125/21	40/125/21

TECHNICAL DATA (Contd.)

	Conditions	809 08002	809 08003
Effective angle of rotation	—	180°	180°
Operating torque	—	<25 Nmm	<25 Nmm
Axial load	—	<2 N	<2 N
Test voltage (d. c.)	Applied for 1 minute	600 V	600 V
Weight (approx.)	—	1.6 g	1.6 g

SOLDERING CONDITIONS

For printed wiring board applications

5 seconds max. at 240 °C max.

→ Care should be taken to prevent ingress of soldering flux into the rotor/stator assembly.

MARKING

The capacitors are marked with colour code shown in table.

ORDERING PROCEDURE

The capacitors should be ordered by quoting their type number as shown in the table.

Example: A capacitor having a swing from 4 to 40 pF should be ordered by quoting the type number 809 08002.

**FILM DIELECTRIC
TRIMMERS**
Small, insulated

809 09
Series

QUICK REFERENCE DATA

For use in measuring and telecommunication equipment, especially where high temperatures occur and a low temperature coefficient is important, for example, for fine adjustment of h.f. tuned circuits.

Maximum capacitance	5.5, 9 and 18	pF
Rated voltage (d. c.)	300	V
Climatic category (IEC 68)	40/125/21	

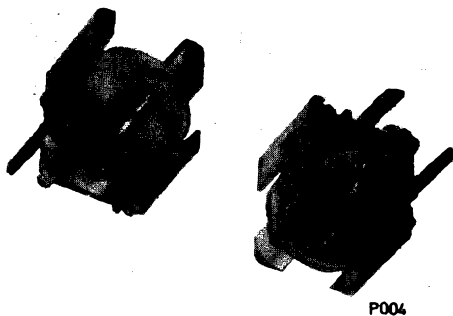

DIELECTRIC

P. T. F. E. film.

VANE MATERIAL

Brass vanes, rotor and stator.

BODY MATERIAL

Polysulphone housing.

TERMINATIONS

Solder tags suitable for use with 2.54mm (0.1in) grid printed wiring boards with 1.3mm holes.

SPECIAL FEATURES

The dielectric is so arranged that it supports the vanes to give accuracy and robustness in use; this combined with rigidly controlled production and inspection techniques produces a reliable and very stable component. The capacitors can be adjusted from both sides by means of a screwdriver.

Mullard

→ DIMENSIONS (millimetres) AND TYPE NUMBERS

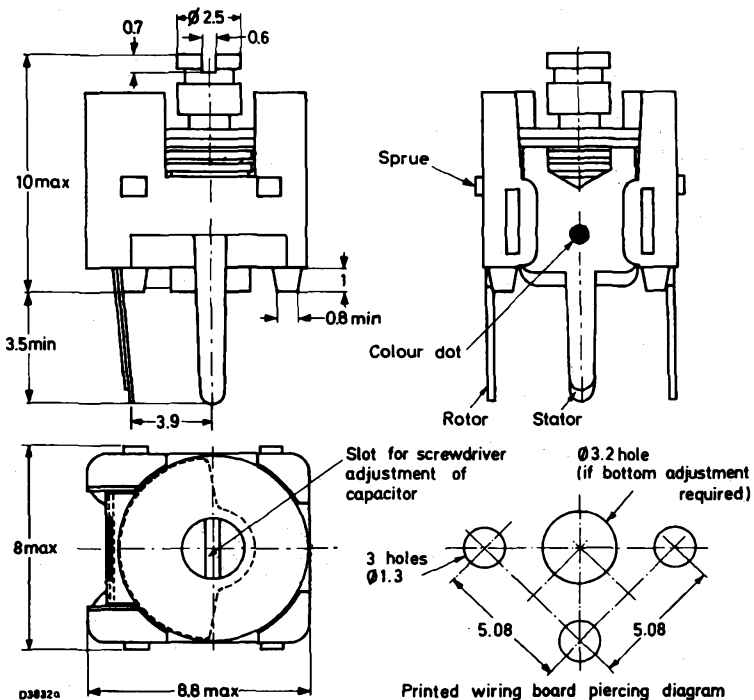

Capacitance swing	Type number
1.4 to 5.5 pF	809 09001
2 to 9 pF	809 09002
2 to 18 pF	809 09003

FILM DIELECTRIC TRIMMERS

Small, insulated

809 09

Series

TECHNICAL DATA

Unless otherwise specified, all characteristics apply at an ambient temperature of $20 \pm 5^\circ\text{C}$, atmospheric pressure of 10^5Pa (1000mbar), and a relative humidity of 75% maximum.

	Conditions	809 09001	809 09002	809 09003
Capacitance swing	—	<1.4 to >5.5pF	<2 to >9pF	<2 to >18pF
Colour code	—	green	white	red
Temperature coefficient	20 to 70°C	$(-250 \pm 150) \times 10^{-6}$ per degC	$(-250 \pm 150) \times 10^{-6}$ per degC	$(-250 \pm 150) \times 10^{-6}$ per degC
	-40 to $+20^\circ\text{C}$	$(-100 \pm 200)^* \times 10^{-6}$ per degC	$(-100 \pm 200)^* \times 10^{-6}$ per degC	$(-100 \pm 200)^* \times 10^{-6}$ per degC
Rated voltage (d. c.)	—	300V	300V	300V
Insulation resistance	Between rotor and stator	>10 000M Ω	>10 000M Ω	>10 000M Ω
Tangent of loss angle (tan δ)	f = 1MHz	$<10 \times 10^{-4}$	$<10 \times 10^{-4}$	$<10 \times 10^{-4}$
	f = 100MHz	$<15 \times 10^{-4}$	$<15 \times 10^{-4}$	$<15 \times 10^{-4}$
Parallel damping	f = 1.5MHz	>10M Ω	>10M Ω	>10M Ω
Contact resistance	—	<5m Ω	<5m Ω	<5m Ω
Maximum dissipation	Set at 70% of C_{max} , f = 175MHz, temperature rise of 100°C	1W	1W	1W
Typical self resonance	Set at C_{max}	>860MHz	>660MHz	>420MHz
Climatic category (IEC 68)	—	40/125/21	40/125/21	40/125/21

*Tentative data

Mullard

TECHNICAL DATA (Contd.)

	Conditions	809 09001	809 09002	809 09003
Effective angle of rotation	—	180°	180°	180°
Operating torque	—	<15Nmm	<20Nmm	<20Nmm
Axial load	—	<2N	<2N	<2N
Test voltage (d. c.)	Applied for 1 minute	600V	600V	600V
Weight (approx.)	—	0. 8g	0. 8g	0. 9g

SOLDERING CONDITIONS

For printed wiring board applications

5 seconds max. at 240°C max.

Care should be taken to prevent ingress of soldering flux into the rotor/stator assembly.

MARKING

The capacitors are marked with colour code shown in table.

ORDERING PROCEDURE

The capacitors should be ordered by quoting their type number as shown in the table.

Example: A capacitor having a swing from 2 to 9 pF should be ordered by quoting the type number 809 09002.

LINEAR RESISTORS

F

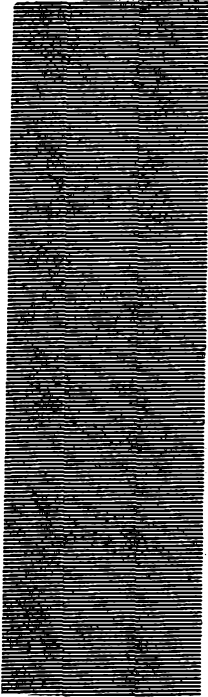

F

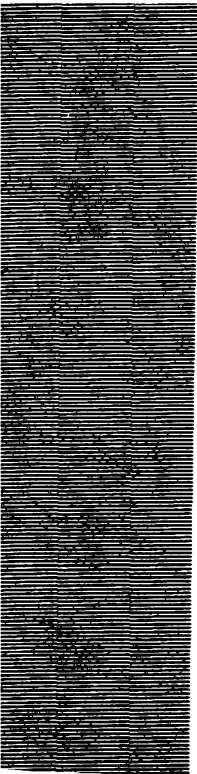

FIXED LINEAR RESISTORS

BANDOLIERS AND PACKAGING SPECIFICATION

This data sheet should be read in conjunction with the relevant resistor data sheet.

GENERAL

Mullard linear resistors are supplied in bandoliers to facilitate automatic handling by either crop-and-form processing or by fully automatic insertion.

The specification covers:

- (1) Bandoliers: -general requirements, -dimensions.
- (2) Packaging of bandoliers: -box packing, -drum packing.

BANDOLIERS

General

Resistor leads are held between one 5 mm wide adhesive tape and one 6 mm wide plain tape in such a manner that the dimensions shown in Fig. 1 are maintained during normal handling, such as shipping and machine loading. The adhesive tape is positioned within the width of the plain tape. No metal staples or clips are used for joining the tapes. No more than 4 layers of tape are used, and joints are in accordance with Fig. 2. Resistor leads do not protrude beyond the outer edges of the tapes. A maximum of one resistor per 1000 may be missing, and the leads are free from kinks. The bandolier tapes are marked at intervals of 100 pieces.

Dimensions (millimetres)

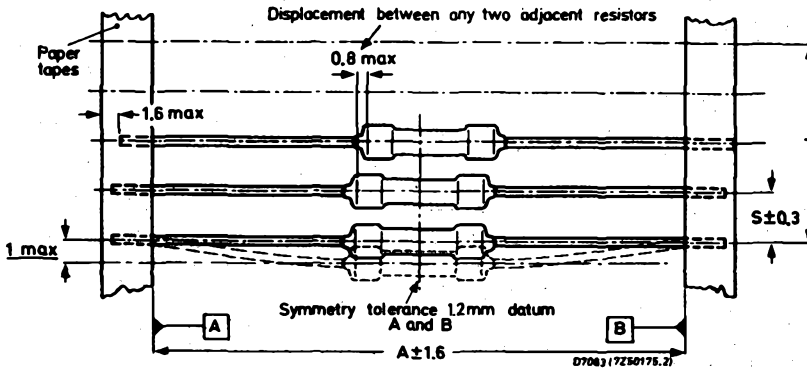

Style	A	S	T for n number of resistors	
			n < 50	n = 50 to 100
CR16, CR25, CR37, MR25, MR30, PR37, VR37	52.4	5.0	$5(n-1) \pm 2$	$5(n-1) \pm 4$
PR52, VR68	66.7	10.0	$10(n-1) \pm 2$	$10(n-1) \pm 4$

Fig. 1

Mullard

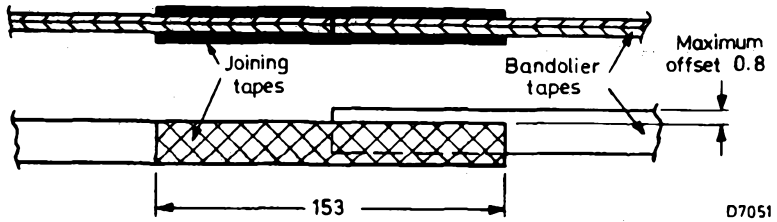

D7051

Fig. 2

PACKAGING OF BANDOLIERS

General

Bandoliered resistors may be packed in boxes (Fig. 3), or on drums (Fig. 4). The method of packing is specified on the individual data sheets.

Box packing

Bandoliers are folded as shown diagrammatically on the sketch below, and packed in units of 1000 resistors.

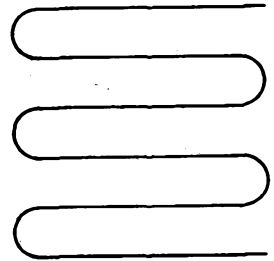
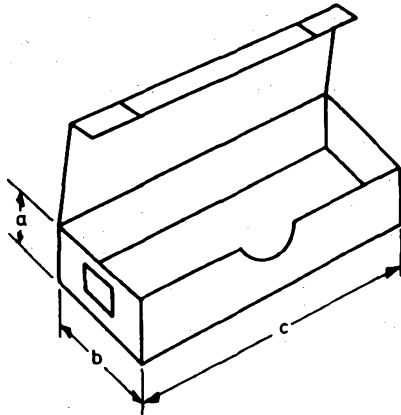

D7052

Approximate outside box dimensions (millimetres)
(for guidance only)

Style	a	b	c	Style	a	b	c
CR16	25	75	160	PR37	60	85 or 100	265
CR25	30	85	265	PR52	95	100	265
CR37	60	85	265	VR37	60	85	265
MR25	25	80 or 100	265	VR68	120	90	525
MR30	35	80 or 105	265				

Fig. 3

FIXED LINEAR RESISTORS

BANDOLIERING AND PACKAGING SPECIFICATION

Drum packing

The drums have been specially designed for automatic handling machines, and are packed in boxes as shown in Fig. 5. Drums are supplied with 5000 resistors only.

All dimensions shown below are in millimetres, approximate, and for guidance only.

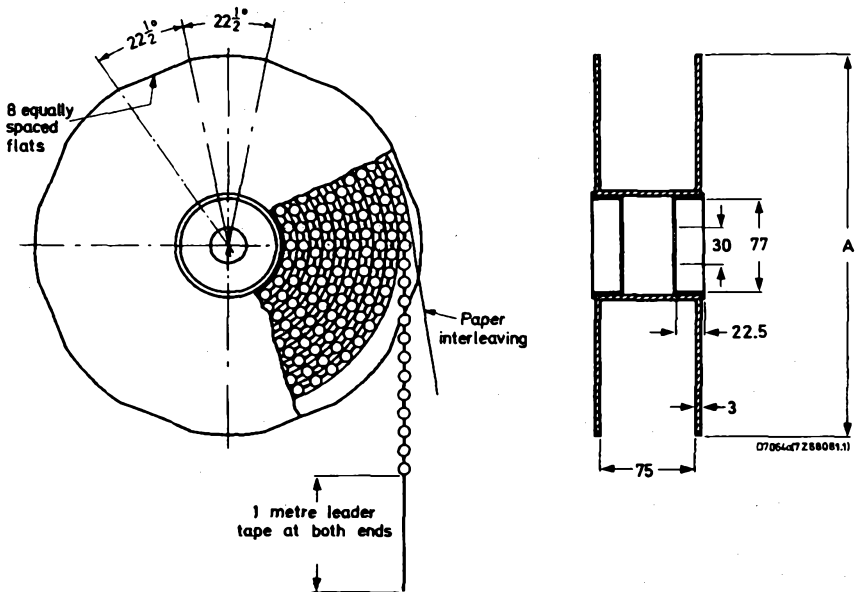

Dimension 'A': 305 mm for CR25 and MR25
356 mm for CR37 and MR30

Material: Drum flanges: -grey cardboard 2 kg/m²
Drum core: -grey cardboard, spirally wound
Interleaving paper: -Kraft paper 70 g/m²

Fig. 4

All dimensions shown below are in millimetres, approximate, and for guidance only.

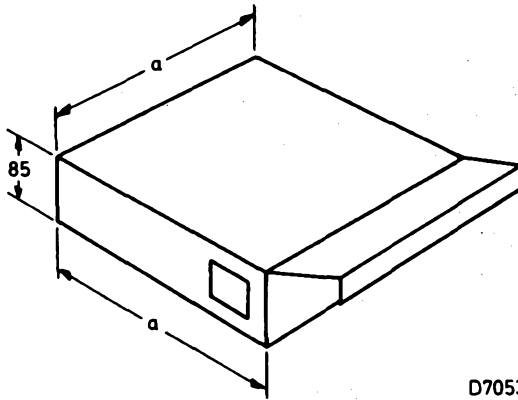

D7053

Dimension 'a': 310 mm for CR25 and MR25
365 mm for CR37 and MR30

Fig. 5

MARKING

Drums and boxes are marked as follows:

Style of resistor, e.g. CR25

Quantity

Nominal resistance value and tolerance

Date in code form

Mullard 12 digit code number

CARBON FILM RESISTORS

QUICK REFERENCE DATA

Style	CR16	CR25	CR37
Resistance range			
±5% tolerance	10 Ω to 220 kΩ	1 Ω to 1 MΩ	1Ω to 1 MΩ
±10% tolerance	270 kΩ to 1 MΩ		
Preferred value series	E12	E24	E24
Maximum power dissipation at 70 °C	0.2 W	0.33 W	0.5 W
Climatic category (IEC 68)	55/155/56	55/155/56	55/155/56

DIMENSIONS (millimetres)

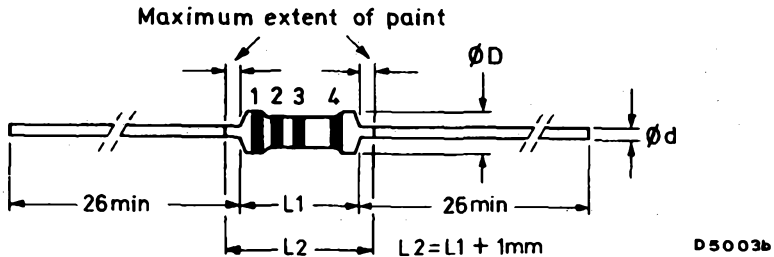

Fig.1

Type	ϕD max.	L_1 max.	ϕd nom.
CR16	1.6	4.5	0.5
CR25	2.5	6.8	0.6
CR37	3.7	10	0.7

The length L_1 is measured by inserting the leads into holes in two parallel gauge plates and moving these plates together until the resistor is held without deformation. The holes in the gauge plates for the leads are $\phi 0.8\text{ mm}$ for CR16 and $\phi 1.0\text{ mm}$ for CR25 and CR37.

GENERAL

These resistors are manufactured by depositing a homogeneous film of pure carbon on to a ceramic rod (for resistance values $< 10\ \Omega$ an electroless nickel film is used. The final resistance value is obtained by cutting a helical groove in the film. Contact caps with tinned copper leads are then pressed on to the end of the body. Finally, the resistors are coated with several layers of tan coloured insulation lacquer and colour coded. For values above $1\ \text{M}\Omega$ the VR25 and/or VR37 range is used.

GENERAL (Continued)

Resistors are the most extensively used of electronic components and therefore their reliability is of the greatest importance. In a given circuit the reliability depends on the quality of the resistors, the operating conditions and the environmental circumstances. Improper selection for these conditions is a main cause of resistor failure. In order to assist the circuit designer in selecting the correct resistor, a new method of specifying the power rating has been evolved linking this with stability and ambient temperature conditions. (See nomogram)

COLOUR CODING

The resistance and tolerance are indicated by four colour bands as follows:-

- Band 1 = 1st sig. figure
- Band 2 = 2nd sig. figure
- Band 3 = Multiplier
- Band 4 = Tolerance

The significance of the colours is in accordance with the standard resistor colour coding, as in B.S. 1852: 1967.

LEADS

The leads are manufactured from tinned copper wire.

RESISTANCE RANGE

CR16 resistors \pm 5% tolerance selection	10 Ω to 220 k Ω	E12 series*
CR16 resistors \pm 10% tolerance selection	270 k Ω to 1 M Ω	E12 series*
CR25 resistors \pm 5% tolerance selection	1 Ω to 1 M Ω	E24 series*
CR37 resistors \pm 5% tolerance selection	1 Ω to 1 M Ω	E24 series*

*To B.S. 2488: 1966

TEMPERATURE COEFFICIENT OF RESISTANCE

see page 7

LIMITING ELEMENT VOLTAGE

This is the maximum voltage (d.c. or r.m.s.) that may be continuously applied to the resistor provided that the maximum power dissipation is not exceeded.

CR16	150	V
CR25	250	V
CR37	350	V

ISOLATION VOLTAGE

This is the maximum voltage (peak) that may be applied under continuous operating conditions, between the resistor leads and an external conductor touching the body of the resistor.

CR16	210	V
CR25	350	V
CR37	500	V



STABILITY

The stability of a given resistor depends upon the dissipated power and ambient temperature. High powers may be dissipated at low ambient temperatures, whilst lower dissipation results in improved stability. With a knowledge of the relationship between ambient temperature, power dissipation and stability, the circuit designer is able to select the most suitable resistor for his application. MULLARD has developed a nomogram which shows the interdependence of the three variables and was evolved as follows:—

Power dissipation in a resistor causes an increase in the temperature of its body. The temperature rise is governed by the laws of heat conduction, convection and radiation and will show a maximum in the middle of the resistor body if it is of symmetrical construction. Theory and experiment have shown that for the temperature range where radiation plays only a minor part (this is the normal operating temperature range of film resistors), the maximum temperature rise ΔT is proportional to the power dissipated, or

$$\Delta T = AP \text{ ----- (1)}$$

The constant A gives the temperature rise in the middle of the resistor body per watt of power, and can be interpreted as a heat resistance with the dimensions of degrees C per watt. This heat resistance is a function of the dimensions of the resistor, the conductivity of the materials used and, to a lesser degree, the method of mounting it.

The sum of the temperature rise and ambient temperature is the maximum temperature T_{\max} (hot spot temperature) of the resistor.

$$\Delta T + T_{\text{amb}} = T_{\max} \text{ ----- (2)}$$

The stability of a film resistor under load is primarily determined by its hot spot temperature and the materials used in its construction. The previous common practice has been to characterise a resistor by its rated power dissipation (watts) at a particular ambient temperature associated with a derating curve showing permissible dissipations at other temperatures.

In the MULLARD system, the relationship for several variables is in the form of a nomogram for a certain heat resistance. Since the construction is the same for all resistance values, the heat resistance is a function of body dimensions. The dissipation is expressed as a function of hot spot temperature, with ambient temperature as a parameter. From equations (1) and (2) it follows that:—

$$P = \frac{T_{\max} - T_{\text{amb}}}{A}$$

If P is plotted against T_{\max} for a constant value of A, parallel straight lines are obtained for different values of T_{amb} .

The stability $\Delta R/R$ of a resistor can be determined experimentally, after 1000 hours of operation for instance, as a function of hot spot temperature. Combination of the graphs of P and $\Delta R/R$ plotted against T_{\max} produces a nomogram from which the values of several variables may be determined for a resistor of a given style operating under a range of working conditions.



NOTES ON THE NOMOGRAM (see opposite page)

1. The nomogram should not be extended beyond the maximum allowable hot-spot temperature of 155 °C
2. The maximum voltage rating of the resistors has not been allowed for in the nomogram.
3. For periods of continuous operation other than 1000 hours, the stability is proportional to the square root of the time ratio, e.g., after 2000 hours:—

$$\text{Stability} = (\text{Stability after 1000 hours}) \times \sqrt{\frac{2000}{1000}}$$

4. The stability lines gives a maximum value of $\Delta R/R$. There is a 95% probability that actual values of $\Delta R/R$ will be less than these.

POWER RATING

The maximum power which may be dissipated at 70 °C ambient irrespective of stability is:—

CR16	0.2	W
CR25	0.33	W
CR37	0.5	W

IEC Publication 115 (Recommendations for fixed non-wirewound resistors. Type 1) uses the conventional method of rating a resistor, by a 'rated dissipation' at 70 °C coupled to a fixed maximum permissible drift. In the MULLARD nomogram system, however, the rated dissipation at 70 °C is no longer specified. Stability is dependent on working conditions and hot spot temperatures. Figure 2 gives a comparison between the two systems and indicates the permissible dissipation at 70 °C for a maximum drift of 1.5% after a 1000 hours, within the limits of hot spot temperature (max. 155 °C) and limiting voltages for CR16, CR25 and CR37.

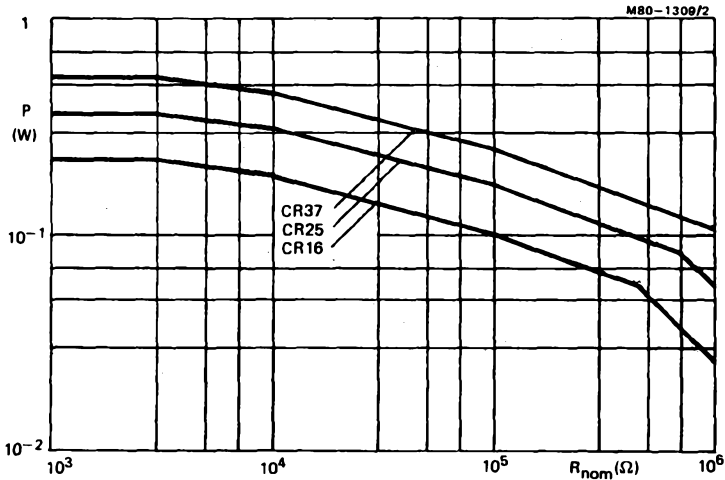

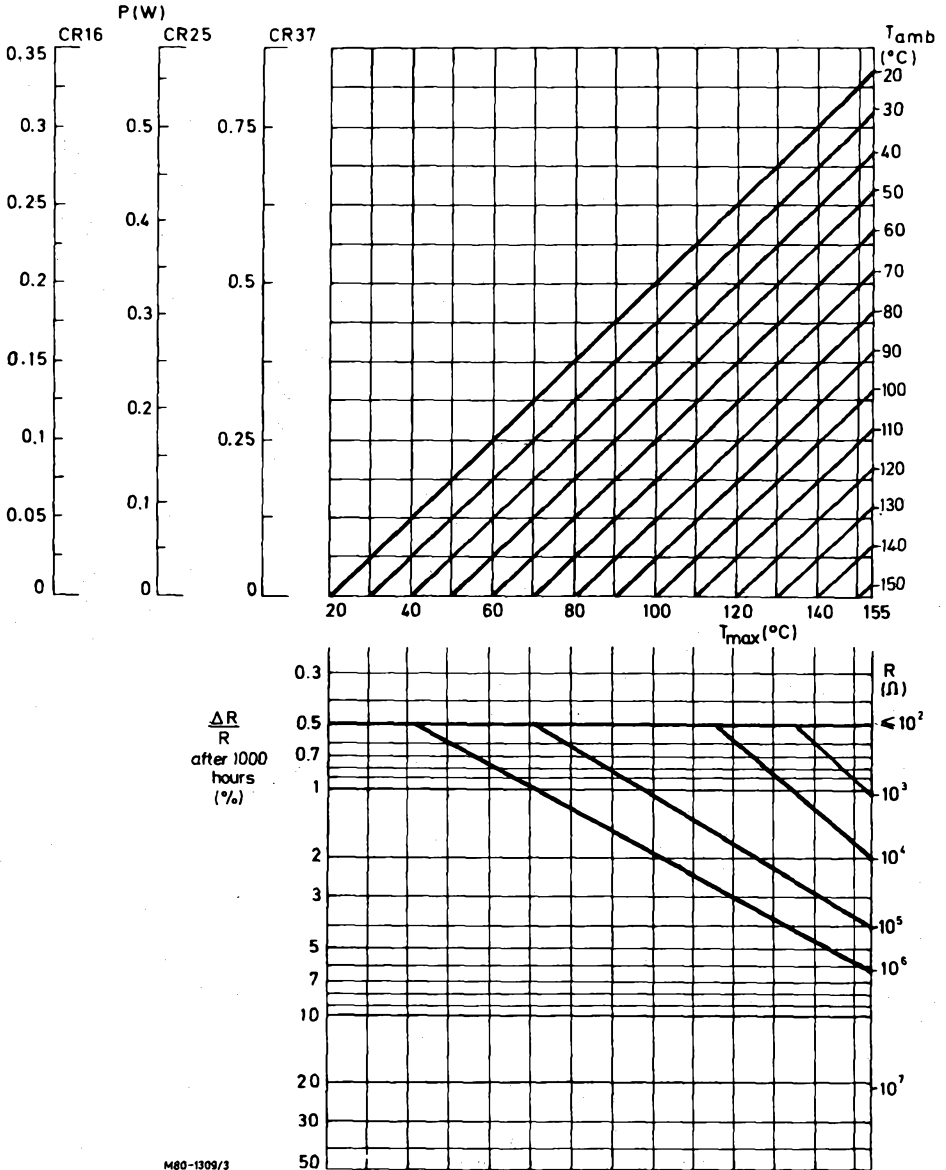

Fig.3

Performance nomogram for CR16, CR25 and CR37 showing the relationship between power dissipation (P), ambient temperature (T_{amb}), hot-spot temperature (T_{max}) and stability ($\Delta R/R$) for 1000 hours.



CR16
CR25
CR37

WORKED EXAMPLES OF THE NOMOGRAM

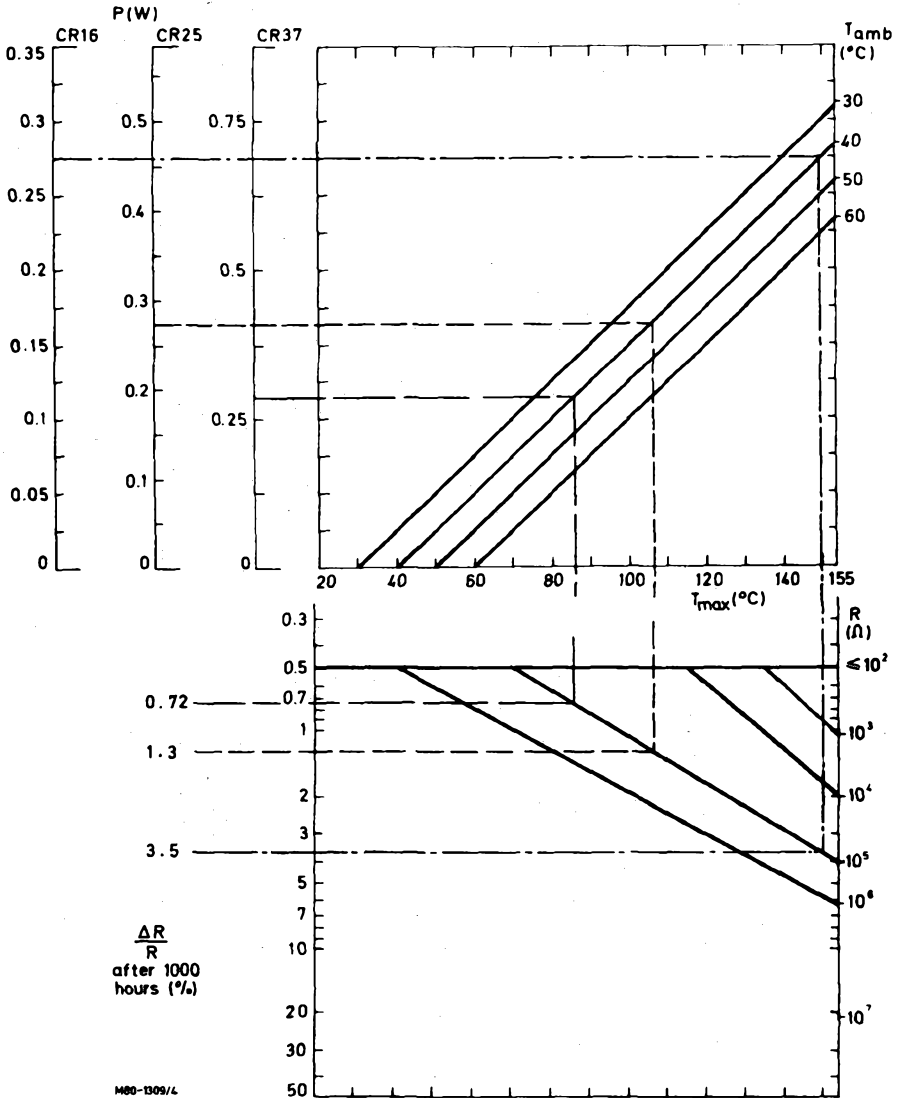

Fig.4

A 100 k Ω resistor, dissipation 0.275 W, operating in an ambient temperature of 40 °C is required. Under these conditions CR16 will have a hot spot temperature of 150 °C with a stability of 3.5% (construction ———), the CR25 will have a hot spot temperature of 107 °C with a stability of 1.3% (construction - - - -) and the CR37 will have a hot spot temperature of 86 °C with a stability of 0.72% (construction - - -).



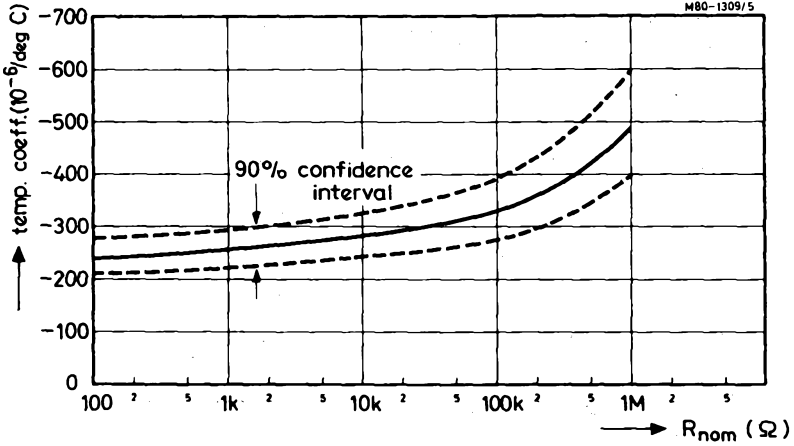

Fig.5 Temperature coefficient as a function of the resistance value

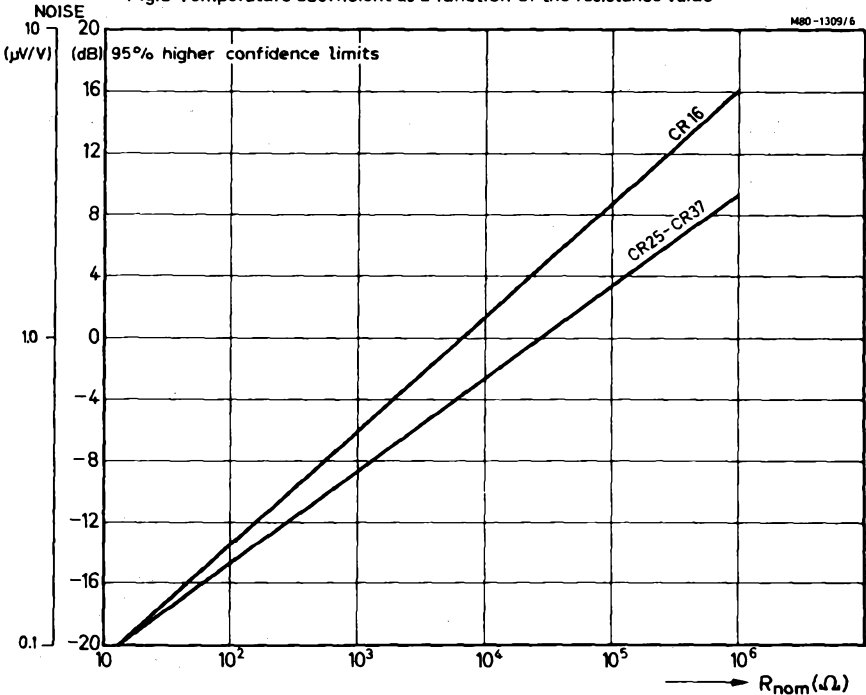

Fig.6 Noise as a function of the resistance value



HIGH FREQUENCY PERFORMANCE

The performance of a resistor at high frequencies is influenced both by its construction and by several external factors, such as length of leads, stray capacitance and the measuring apparatus. These external factors must be considered when measurements are made.

The following table gives typical values of $\frac{|Z|}{R_{nom}}$, and phase angle, ϕ , when the resistor is mounted as shown in Fig.1, using a Boonton Radio Corporation RX-meter, type 250 A.

shown in Fig.1, using a Boonton Radio Corporation RX-meter, type 250 A.

$\frac{|Z|}{R_{nom}}$ is the ratio of resultant reactance, at 250 MHz, to the nominal resistance.

R_{nom} (Ω)	CR16		CR25		CR37	
	$\frac{ Z }{R_{nom}}$	ϕ°	$\frac{ Z }{R_{nom}}$	ϕ°	$\frac{ Z }{R_{nom}}$	ϕ°
10	3.47	70	2.97	70	2.35	61
22	1.72	52	1.61	51	1.43	45
56	1.11	31	1.07	28	1.02	26
100	1.03	23	1.02	22	1.02	17
220	0.99	10	0.99	9	1	6
560	0.98	0	0.97	-5	0.94	-16
1000	0.96	-9	0.92	-15	0.88	-15
2200	0.84	-32	0.82	-35	0.69	-47
5600	0.50	-60	0.41	-66	0.35	-69

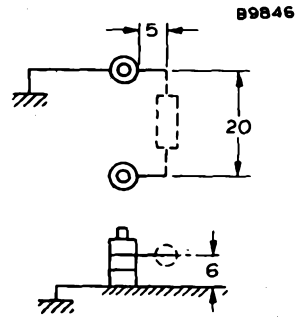

Fig.7
Measuring arrangements



PACKING

Resistors are supplied on a continuous tape (bandolier) conforming to Fig.8

CR25 and CR37 are packed either in boxes of 1000 pieces or on to drums of 5000 pieces.

CR16 are packed in boxes of 100 pieces only.

The bandoliers and drums are suitable for use on either crop and form or fully automated component insertion equipment.

The boxes and drums are marked with

1. Style of resistor
2. Packing quantity
3. Resistor values and tolerances
4. Date in code form
5. Mullard code of 12 digits

A full specification covering bandoliering and packaging is available.

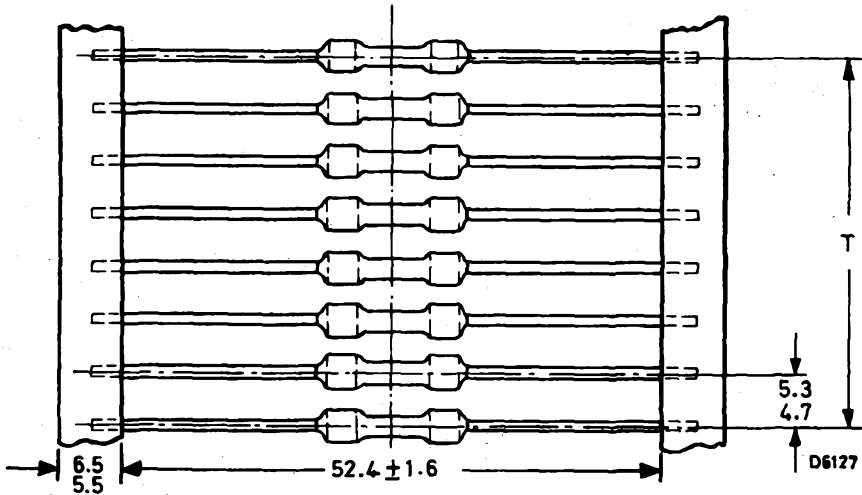

Fig.8

For 'n' < 50 pieces

$$T = 5(n - 1) \pm 2$$

For 'n' between 50 and 100 pieces

$$T = 5(n - 1) \pm 4$$

where 'n' = the number of resistors

All dimensions in millimetres



ORDERING PROCEDURE

CR25 and CR37 resistors are supplied in multiples of 1000 pieces packed in boxes or in multiples of 5000 pieces packed on to drums. CR16 resistors are supplied in boxes of 1000 pieces only. When ordering, the following information is required.

1. Quantity
2. Style of resistor e.g. CR16, CR25 or CR37
3. Packing. Drum packing (for CR25 or CR37) is indicated by adding DRM to the end of the type designation, i.e. CR25-XXX-X-DRM.
4. Resistance value and tolerance

For example

- (a) 2000 pieces of CR16 resistors $1200 \Omega \pm 5\%$ are ordered as 2000 resistors CR16-1K2-5.
- (b) 10 000 pieces of CR25 resistors, drum packed, $5.6 \Omega \pm 5\%$ are ordered as 10 000 resistors CR25-5R6-5-DRM.

TESTS AND REQUIREMENTS

Where applicable these resistors are tested to IEC Publication 115-1 (Recommendations for fixed non-wirewound resistors. Type 1) category 55/155/56, and IEC Publication 68 (Basic environmental testing procedures).

These tests are summarised in the table below.

Due to the MULLARD nomogram, to determine power rating and stability, certain deviations from the IEC Publications are necessary.

The test programme is as follows:—

IEC 115-1 clause	IEC68 test method	Test	Procedure	Requirements
18	Ua	a. Tensile all samples	0.4 mm: load 5N (0.5 kg); 10 s 0.6 mm } load 10 N (1 kg); 10 s 0.7 mm }	no damage ΔR max. 0.5% or 0.5 Ω if greater
	Ub	b. Bending half number of samples	0.4 mm load 2.5 N (0.25 kg); 4 x 90° 0.6 mm } load 5 N (0.5 kg); 4 x 90° 0.7 mm }	
	Uc	c. Torsion other half number of samples	2 x 360° in opposite directions	
19	T	Soldering	solderability: 2 s 230 °C 0.5% activated flux thermal shock: 3 s 350 °C 6 mm from body	good tinning, no damage ΔR max. 0.5% or 0.5 Ω if greater



IEC 115-1 clause	IEC68 test method	Test	Procedure	Requirements
20	Na	Rapid change of temperature	3 hours at -55°C 3 hours at $+155^{\circ}\text{C}$ 5 cycles	ΔR max. 0.5% or $0.5\ \Omega$
22	Fc	Vibration	Frequency: 10 to 500 Hz: displacement 1.5 mm or acceleration 10 g: three directions: total 6 h	no damage ΔR max. 0.5% or $0.5\ \Omega$
21	Eb	Bumping	3 x 1500 bumps in three directions: 40 g	no damage ΔR max. 0.5% or $0.5\ \Omega$
23		Climatic sequence		
23.2	Ba	Dry heat	16 hours 155°C	
23.3	D	Damp heat (accel) 1st cycle	24 hrs: 55°C : 95 to 100% R.H.	
23.4	Aa	Cold	2 hours: 55°C	
23.5	M	Low air pressure	1 hour: 85 mbar: 15 to 35°C	
23.6	D	Damp heat (accel) remaining cycles	5 days: 55°C : 95 to 100% R.H.	R_{ins} : min. 1000 M Ω ΔR max. 1.5% for $R \leq 220\ \text{k}\Omega$ 3% for $R > 220\ \text{k}\Omega$
24.2	Ca	Damp heat (Steady state)	56 days: 40°C : 90 to 95% R.H. 5 V _{d.c.} on half the number of specimens but the dissipation should not exceed 1% of the value indicated by Fig.2	R_{ins} : min. 1000 M Ω ΔR max: 1.5% for $R \leq 220\ \text{k}\Omega$ max: 3% for $R > 220\ \text{k}\Omega$



IEC 115-1 clause	IEC 68 test method	Test	Procedure	Requirements
26.2	-	Endurance	1000 hours: 70°C: dissipation taken from Fig. 2	ΔR max: 1.5%
11	-	Temperature coefficient	between -55°C and +155°C	see fig. 5
→ 10	-	Voltage proof on insulation	a. c. peak voltage = 1.4 × isolation voltage applied for 1 minute	No breakdown
14	-	Noise	IEC publication 195	see fig. 6
9	-	Insulation resistance		min. 10 ⁴ MΩ
15	-	Short time overload	room temperature, dissipation 6.25 × value taken from Fig. 2 (voltage not more than 2 × limiting voltage) 10 cycles, 4 seconds on, 45 seconds off	ΔR max. 1%
13	-	Voltage coefficient		< 5 × 10 ⁻⁶ /V



METAL FILM RESISTORS

QUICK REFERENCE DATA

Resistance range	10 Ω to 100 k Ω E24 and E96 series
Resistance tolerance	$\pm 1, \pm 2\%$
Temperature coefficient	$\pm 50, \pm 100 \cdot 10^{-6}/K^*$
Absolute max. dissipation at $T_{amb} = 70 \text{ }^\circ\text{C}^*$	0.25 W
Basic specification	IEC 115-1
Climatic category (IEC 68)	55/155/56
Stability after:	
climatic tests	$\Delta R/R$ max. 0.5% + 0.05 Ω
soldering	$\Delta R/R$ max. 0.1%
short time overload	$\Delta R/R$ max. 0.25% + 0.05 Ω

*This is the dissipation at $T_{amb} = 70 \text{ }^\circ\text{C}$ which causes the max. permissible hot-spot temperature of 175 $^\circ\text{C}$ to occur, irrespective of the resistance drift provoked by this condition.

APPLICATION

These resistors have been developed for applications in which precision, stability, and a low temperature coefficient are required e.g. in computers, telecommunication equipment, measuring apparatus, etc.

DESCRIPTION

A homogenous film of nickel-chromium is vacuum-deposited on a high grade ceramic body. Contact caps of special alloy are then pressed on to the ends of the resistor body, and the tinned electrolytic copper connecting wires are welded to the caps.

As a rule the required resistor value is not obtained directly by deposition of the film; helixing, that is cutting a helical groove in the metal film, is also needed.

The resistors are protected by four or more layers of a green lacquer that are resistant against the commonly used cleaning solvents.

* $\pm 50, \pm 100 \text{ ppm}/^\circ\text{C}$



MECHANICAL DATA

Dimensions in mm

Outlines

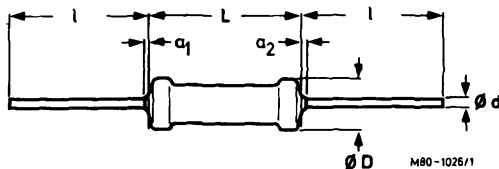

Fig.1

Table 1

D_{max}	L_{max}	$a_1 + a_2$	1	d
1.6	4.0	≤ 1	28 ± 2	0.5

The length of the body is measured by inserting the leads into the holes of two identical gauge plates and by moving these plates parallel to each other until the resistor body is clamped without deformation. (See IEC publication 294)

Diameter of hole in gauge plate 0.8 mm

Mass (per 100 pieces) 8 g

Mounting

The resistors are suitable for processing on automatic insertion equipment and cutting and bending machines. Furthermore the resistors can be mounted without any problem directly against double-sided printed circuit boards.



Marking

The nominal resistance value and the tolerance are marked on these resistors by means of four or five coloured bands according to IEC publication 62 'Colour code for fixed resistors' (see also BS1 1852 - 1967).

for E96 series



colour	significant figures	multiplier	tolerance
black	0	1 x	
brown	1	10 x	± 1%
red	2	100 x	± 2%
orange	3	1000 x	
yellow	4	10 000 x	
green	5		
blue	6		
violet	7		
grey	8		
white	9		
silver			
gold			

for E24 series



ELECTRICAL DATA**Standard values of rated resistance and tolerance**

Standard values of rated resistance (nominal resistance) are taken from the E24 series for resistors with a tolerance of $\pm 1\%$ and $\pm 2\%$, and from the E96 series for resistors with a tolerance of $\pm 1\%$.

Table 2, standard range

style	resistance range	tol. $\pm \%$	series	temperature coefficient $\times 10^{-6}/K$	limiting voltage (r.m.s.) V^{**}
MR16	10 Ω – 100 k Ω	1	E24/E96	50*	150
	10 Ω – 100 k Ω	2	E24	100	150
MR16 on reel	10 Ω – 100 k Ω	1	E24/E96	50*	150
	10 Ω – 100 k Ω	2	E24	100	150

* $100 \times 10^{-6}/K$ below 50 Ω

** Limiting voltage (element and insulation). This is the maximum voltage that may be applied continuously to the resistor element (see IEC publication 115-1). This voltage is also the maximum voltage that may be applied continuously to the insulation of the resistor.



TESTS AND REQUIREMENTS

Essentially all tests are carried out according to the schedule of IEC publication 115-1. This means: rated temperature range -55 to $+155$ °C; damp heat (long term) 56 days (see IEC Publication 115-2 clause 4.1.). The tests are carried out along the lines of IEC publication 68, 'Recommended basic climatic and mechanical robustness testing procedure for electronic components'.

In Table 3 the tests and requirements are listed with reference to the relevant clauses of IEC publications 115-1 and 68; a short description of test procedure is also given. In some instances deviations from the IEC specifications were necessary for our method of specifying.

Table 3

IEC 115-1 clause	IEC 68 test method	test	procedure	requirements
18	Ua	Robustness of terminations Tensile all samples	load 5 N, 10 s	number of failures < 10 ppm
	Ub	Bending half number of samples	load 2.5 N, 4 x 90°	no damage ΔR max. 0.1% or 0.1 Ω
	Uc	Torsion other half number of samples	3 x 360° in opposite directions	
19	T	Soldering	solderability: 2 s 230 °C, flux 600 thermal shock: 3 s 350 °C, 6 mm from body	good tinning, no damage ΔR max. 0.1%
20	Na	Rapid change of temperature	3 h - 55 °C/ 3 h + 155 °C, 5 cycles	ΔR max. 0.1% or 0.1 Ω
22	Fc	Vibration	frequency 10-500 Hz displacement 1.5 mm or acceleration 10 g, three directions; total 6 h	no damage ΔR max. 0.1% or 0.1 Ω
21	Eb	Bump	3 x 1500 bumps in three directions, 40 g	no damage ΔR max. 0.1% or 0.1 Ω



IEC 115-1 clause	IEC 68 test method	test	procedure	requirements
23		Climatic sequence		
23.2	Ba	Dry heat	16 h, 155 °C	
23.3	D	Damp heat (accel.) 1st cycle	24 h; 55 °C; 95-100% R.H.	
23.4	Aa	Cold	2 h; -55 °C	
23.5	M	Low air pressure	1 h; 8.5 kPa; 15-35 °C	
23.6	D	Damp heat (accel.) remaining cycles	5 days; 55 °C; 95-100% R.H.	R_{ins} min. 1000 M Ω ΔR max. 0.5% + 0.05 Ω
24.4	Ca	Damp heat (long term exposure)	56 days; 40 °C; 90-95% R.H. dissipation \leq 1.25 mW	R_{ins} min. 1000 M Ω ΔR max. 1.0% + 0.05 Ω
26.2	-	Endurance	1000 h; 70 °C; dissipation 0.125 W	ΔR max.: 0.5%
11	-	Temperature coefficient	between -55 °C and + 155 °C	\leq 50, \leq 100 x 10 ⁻⁶ /K see Table 2
13	-	Voltage proof	2 x limiting voltage (a.c.)	no breakdown
14	-	Noise	IEC publication 195	to be established
9	-	Insulation resistance		min. 10 ⁴ M Ω



STANDARD PACKAGING

number per box

bandolier	bandolier reeled
1000	5000

Configuration of bandolier

Dimensions in mm

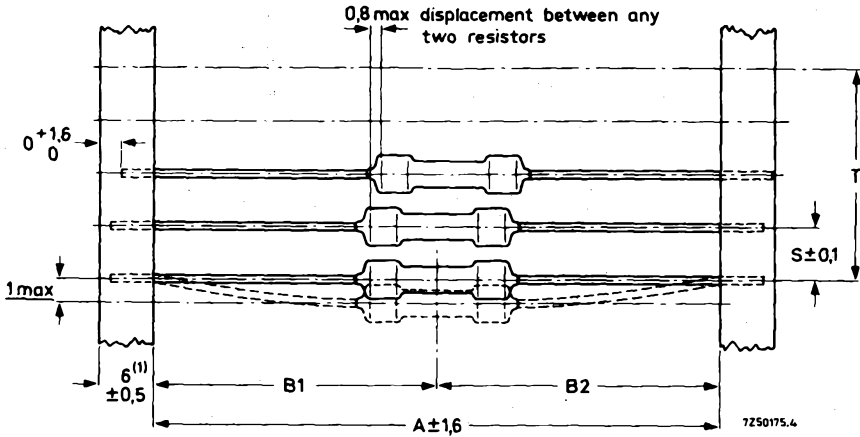

Fig.2

Table 4

A	B1 - B2 \pm max.	S (spacing)	T (max. deviation of spacing)
52.4	1.2	5	2 mm for 10 spacings 1.5 mm for 5 spacings



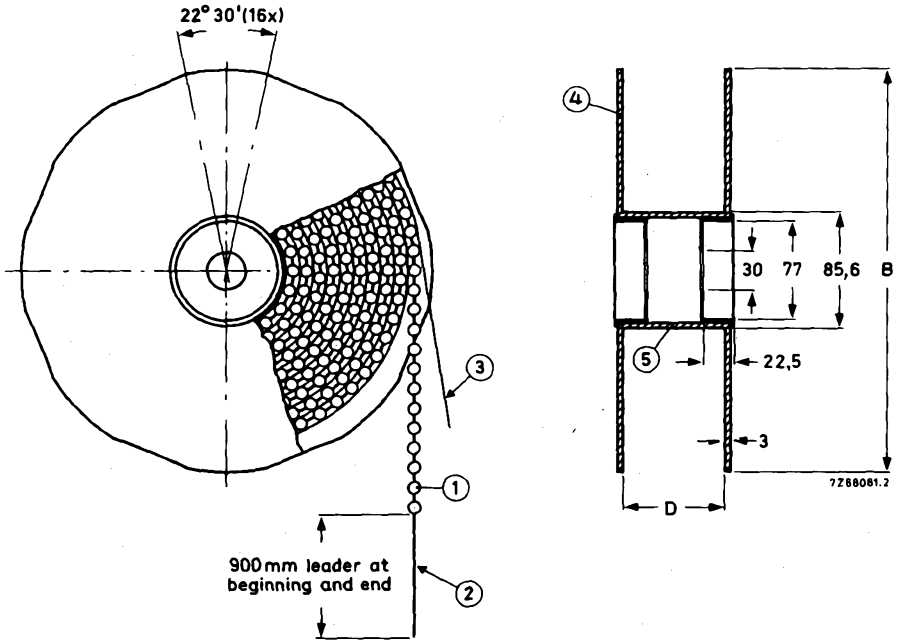

Fig.3 Reel dimensions (mm)
B = 305; D = 75

ORDERING PROCEDURE

MR16 resistors are supplied in multiples of 1000 pieces packed in boxes or in multiples of 5000 pieces packed on to drums (reels)

When ordering, the following information is required.

1. Quantity
2. Style of resistor e.g. MR16
3. Packing. Drum packing is indicated by adding DRM to the end of the type designation i.e. MR16-xxx-x-DRM.
4. Resistance and tolerance

For example

(a) 2000 pieces of MR16 resistors 1200 Ω ± 1% are ordered as 2000 resistors MR16-1K2-1.
and

(b) 10 000 pieces of MR16 resistors, drum packed, 56 Ω ± 2% are ordered as 10 000 resistors MR16-56R-2-DRM





METAL FILM RESISTORS, GENERAL PURPOSE

QUICK REFERENCE DATA

Style	MR25	MR30 and MR308
Resistance range		
± 1% tolerance E96 and E24 series	4.99 Ω to 681 kΩ	4.99 Ω to 1 MΩ
± 2% tolerance E24 series	5.1 Ω to 680 kΩ	5.1 Ω to 1 MΩ
Temperature coefficient		
± 1% tolerance*	50 ppm/°C	50 ppm/°C
± 2% tolerance	100 ppm/°C	100 ppm/°C
Maximum power dissipation at 70 °C	0.4 W	0.5 W
Climatic category	55/155/56	55/155/56

* Below 49.9 Ω; temperature coefficient is 100 ppm/°C

MECHANICAL DATA

Dimensions in mm

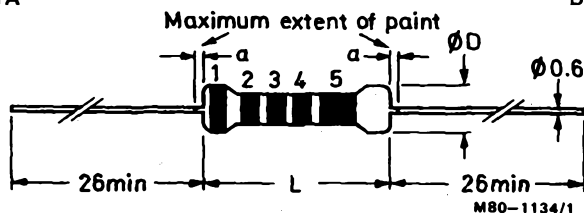

Style	L	D	a	d
MR25	6.5 max.	2.5 max.	1 max.	0.6
MR30	10 max.	3 max.	1 max.	0.6
MR308	10 max.	3 max.	1 max.	0.8

The length (L) is measured by inserting the leads into holes in two parallel gauge plates, and moving these plates together until the resistor is held without deformation. The holes in the gauge plates are ϕ 1.0 mm for MR25, MR30, and 1.2 mm for MR308.

GENERAL

Mullard metal film resistors are manufactured by depositing a homogeneous film of nickel/chromium onto a high-grade ceramic body. Contact is made with the metal film by pressed-on metal caps. The required value of resistance is obtained by cutting a helical track through the metal film. Manufacture is completed by welding solder coated copper leads to the end caps and applying multiple coats of protective green lacquer and colour code bands. The lacquer and colour code bands are proof against all normally used cleaning and defluxing processes.

The MR30 and MR308 are identical in all respects except lead diameter.

The MR308 with 0.8 mm lead diameter has been introduced specifically to meet the requirements of BS CECC 40 101-019 styles EZ and EX and British Post Office specification D245C Resistor 91E.



COLOUR CODING

The resistance and tolerance are indicated by either five colour bands ($\pm 1\%$ tolerance) or four colour bands ($\pm 2\%$ tolerance). The first band is situated on the enlarged end diameter. The last band is wider than the others.

The significance of the bands is as follows:

5 colour bands	4 colour bands
Band 1 = 1st sig. figure	Band 1 = 1st sig. figure
Band 2 = 2nd sig. figure	Band 2 = 2nd sig. figure
Band 3 = 3rd sig. figure	Band 3 = Multiplier
Band 4 = Multiplier	Space
Band 5 = Tolerance; brown ($\pm 1\%$)	Band 5 = Tolerance; red ($\pm 2\%$)

The significance of the colours is in accordance with the standard resistor colour coding, as in BS 1852: 1967

RESISTANCE RANGE

MR25 resistors	1% tolerance selection	4.99 Ω to 681 k Ω	E96 series*
MR25 resistors	2% tolerance selection	5.1 Ω to 680 k Ω	E24 series*
MR30 resistors	1% tolerance selection	4.99 Ω to 1 M Ω	E96 series*
MR308 resistors			
MR30 resistors	2% tolerance selection	5.1 Ω to 1 M Ω	E24 series*
MR308 resistors			

*To BS 2488: 1966

TEMPERATURE COEFFICIENT OF RESISTANCE

MR25 resistors			
MR30 resistors	2% tolerance selection		± 100 ppm/ $^{\circ}\text{C}$
MR308 resistors			
MR25 resistors			
MR30 resistors	1% tolerance selection values below 49.9 Ω		± 100 ppm/ $^{\circ}\text{C}$
MR308 resistors			
MR25 resistors			
MR30 resistors	1% tolerance selection values of 49.9 Ω and above		± 50 ppm/ $^{\circ}\text{C}$
MR308 resistors			

LIMITING ELEMENT VOLTAGE

This is the maximum voltage (d.c. or r.m.s.) that may be continuously applied to the resistor, provided that the maximum power dissipation (see nomogram) is not exceeded.

MR25	250	V
MR30 and MR308	350	V

ISOLATION VOLTAGE

This is the maximum voltage (d.c. or peak) that may be applied under continuous operating conditions between the resistor leads and an external conductor touching the body of the resistor.

MR25	350	V
MR30 and MR308	500	V

NOISE

Less than 0.25 $\mu\text{V/V}$ for values less than 100 k Ω

Less than 0.5 $\mu\text{V/V}$ for values greater than 100 k Ω



STABILITY

The stability of a film resistor under load is primarily determined by its hot-spot temperature and the materials used in its construction. The previous common practice has been to characterise a resistor by its power dissipation, or wattage rating at a particular ambient temperature, associated with a derating curve showing permissible dissipations at other temperatures.

Mullard have developed a nomogram which shows the relationship between power dissipation, ambient temperature, and stability. With this knowledge the circuit engineer is able to assess the performance of a resistor under working conditions and to select the type most suitable for his application.

This nomogram is given in Fig.2 and its use illustrated in Fig.3. In using the nomogram the following precautions should be observed.

1. The nomogram should not be extended beyond the maximum allowable hot-spot temperature of 175 °C.
2. The maximum voltage rating of the resistors has not been allowed for in the nomogram.
3. For periods of continuous operation other than 1000 hours, the stability is proportional to the square root of the time ratio, e.g. after 2000 hours:

$$\text{Stability} = (\text{Stability after 1000 hours}) \times \sqrt{\frac{2000}{1000}}$$

4. The stability lines give a maximum value of $\Delta R/R$. There is a 95% probability that actual values of $\Delta R/R$ will be less than these.

APPROVALS

CECC approval has been granted to the MR25, MR30 and MR308 resistors under the CECC harmonized scheme against the following specifications:

CECC

40 000	Generic specification: Fixed resistors
40 100	Sectional specification: Fixed low power non-wirewound resistors
40 101 - 002	Detailed specification for fixed low power non-wirewound resistors Stability $\pm (1\% + 0.05 \Omega)$
40 101 - 008	Detailed specification for fixed low power non-wirewound resistors Stability $\pm (.5\% + 0.05 \Omega)$
40 101 - 009	Detailed specification for fixed low power non-wirewound resistors Stability $\pm (2\% + 0.1 \Omega)$
40 101 - 019	Detailed specification for fixed low power non-wirewound resistors Stability $\pm (2\% + 0.1 \Omega)$ at upper rating; $(1\% + 0.1 \Omega)$ at lower rating

Details of the approved ranges, tolerances and temperature coefficients are given in Table 1.

BRITISH POST OFFICE

MR25 are approved to specification D2452 Issue C Resistor 91F

MR308 are approved to specification D2452 Issue C Resistor 91E



NOMOGRAM

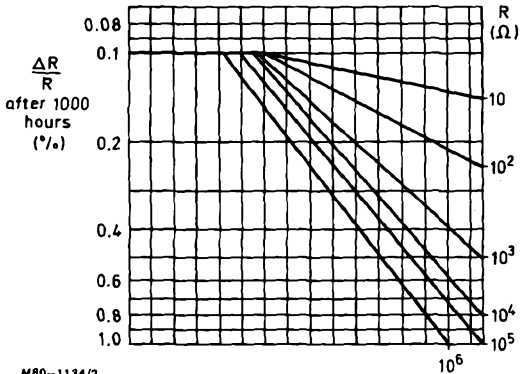
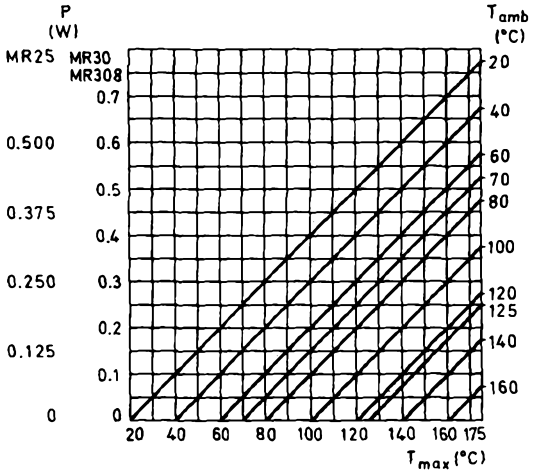

M80-1134/2

Fig.2



WORKED EXAMPLES

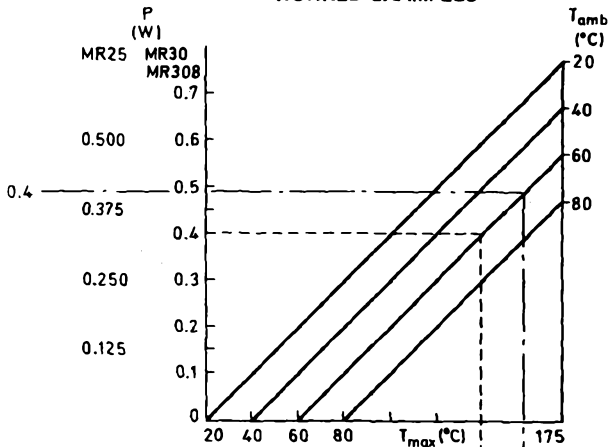

MR25
MR30
MR308

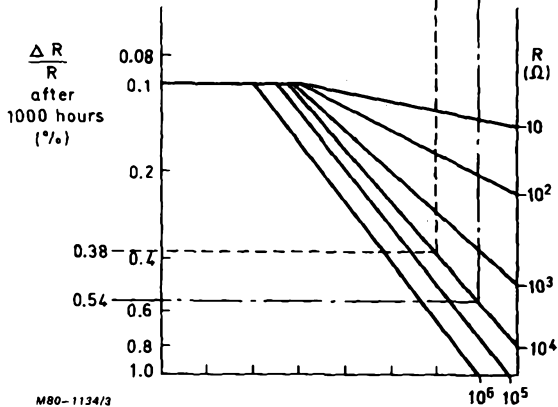

M80-1134/3

Fig.3

Fig.2 Performance nomogram for MR25, MR30 and MR308 showing the relationship between power dissipation (P), ambient temperature (T_{amb}), hot-spot temperature (T_{max}), and stability $\Delta R/R$ for 1000 hours.

Fig.3 A 10 k Ω resistor, dissipation 0.4 W, operating in an ambient temperature of 60 $^{\circ}\text{C}$ is required. Under these conditions MR25 will have a stability of 0.54% (Construction ---), and the MR30 a stability of 0.38% (Construction ---).

PACKING

All resistors are supplied bandoliered to the outline dimensions in Fig.4. Resistors are packed in boxes of 1000 pieces or on drums of 5000. The bandoliers, boxes and drums are all suitable for crop and form or fully automatic assembly operations. A full packaging specification is available.

Boxes and drums are marked with:

- 1. The resistor style MR25, MR30, or MR308
- 2. Nominal resistance and tolerance
- 3. Quantity
- 4. Date code
- 5. Mullard 12 digit code

Resistors released under CECC quality surveillance are supplied marked and sealed in accordance with the CECC requirements.

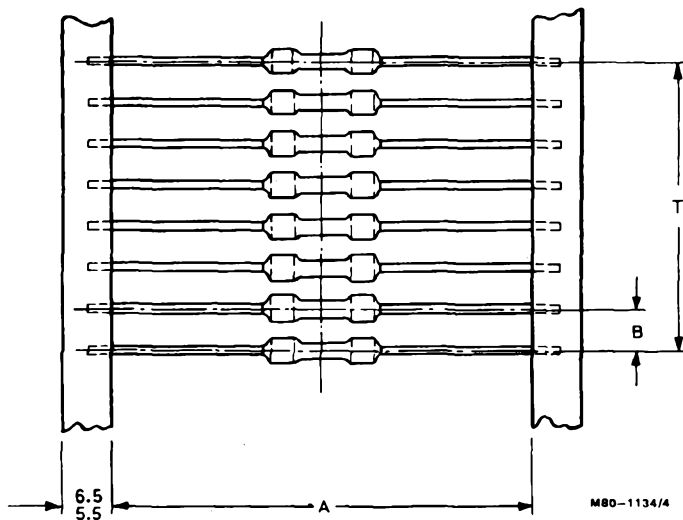

Fig.4

For 'n' < 50 pieces	$T = 5(n - 1) \pm 2$	where 'n' = the number of resistors
For 'n' between 50 and 100 pieces	$T = 5(n - 1) \pm 4$	



Table 1 CECC APPROVALS OF MULLARD METAL FILM RESISTORS

mullard type	approved resistance range	resistance tolerance %	CECC specification	style	power rating (W)	specification requirements	
						stability $\frac{\Delta R}{R}$ %/1000 hrs	temperature coefficient $\times 10^{-6}/^{\circ}\text{C}$
MR25	4.99 Ω to 301 k Ω	1	40101 - 008	BK*	0.125	0.5	100
	49.9 Ω to 301 k Ω	1	40101 - 008	BY	0.125	0.5	50
	4.99 Ω to 301 k Ω	1	40101 - 002	BK*	0.125	1.0	100
	49.9 Ω to 301 k Ω	1	40101 - 002	BY	0.125	1.0	50
	5.1 Ω to 300 k Ω	2	40101 - 009	BB	0.25	2.0	100
	4.99 Ω to 301 k Ω	1 and 2	40101 - 019	FZ	0.063 0.250	1.0 2.0	100
	4.99 Ω to 301 k Ω	1 and 2	40101 - 019	FX [†]	0.063 0.250	1.0 2.0	250
MR30	4.99 Ω to 1 M Ω	1	40101 - 008	CK*	0.25	0.5	100
	49.9 Ω to 1 M Ω	1	40101 - 008	CY	0.25	0.5	50
	4.99 Ω to 1 M Ω	1	40101 - 002	CK*	0.25	1.0	100
	4.99 Ω to 1 M Ω	1	40101 - 002	CY	0.25	1.0	50
	5.1 Ω to 1 M Ω	2	40101 - 009	CB	0.25	2.0	100
MR308	4.99 Ω to 1 M Ω	1 and 2	40101 - 019	EZ	0.125 0.500	1.0 2.0	100
	4.99 Ω to 1 M Ω	1 and 2	40101 - 019	EX [†]	0.125 0.500	1.0 2.0	250

* In these styles, values of 49.9 Ω and higher will be supplied in styles BY and CY (temperature coefficient $50 \times 10^{-6}/^{\circ}\text{C}$) only

† In these styles, resistors are supplied in styles FZ and EZ (temperature $100 \times 10^{-6}/^{\circ}\text{C}$) only.



POWER METAL FILM RESISTORS

QUICK REFERENCE DATA

Style	PR37	PR52
Resistance range	10 Ω to 10 k Ω	10 Ω to 27 k Ω
Resistance tolerance	$\pm 5\%$	$\pm 5\%$
Preferred value series	E12	E12
Maximum power dissipation at $T_{amb} = 70\text{ }^{\circ}\text{C}$	1.6 W	2.5 W
Climatic category	55/200/56	55/200/56

MECHANICAL DATA

Dimensions in mm

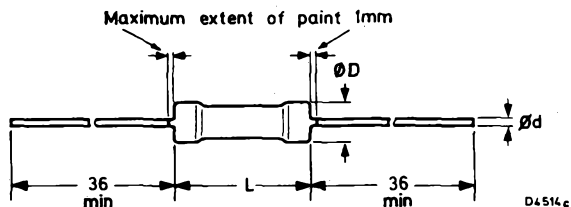

Style	L max.	D max.	d
PR37	10	3.7	0.6
PR52	16.7	5.2	0.6

The length (L) is measured by inserting the leads into 1 mm diameter holes in two parallel gauge plates, and moving these plates together until the resistor is held without deformation.

GENERAL

The resistive element consists of a chromium-nickel film deposited onto a ceramic body. End caps with solder coated connecting wires are fitted to the ends of the resistor. The final resistance value is obtained by cutting a helical track through the metal film. The resistor is protected by a high temperature silicone lacquer.



PROTECTION

The resistors are coated with a red high temperature silicone based lacquer. This lacquer is for protective purposes in handling and transit only. It does not provide electrical isolation and it may be removed by cleaning solvents.

MARKING

Each resistor has its value and tolerance printed on it. The letters R and K signify ohms and thousands respectively. For example:

27R ± 5% means 27 Ω ± 5%

2K2 ± 5% means 2200 Ω ± 5%

MOUNTING

At maximum dissipation the hot spot temperature of the resistors may rise to 300 °C. They must, therefore, be mounted stress free to allow for thermal expansion over this temperature range. Due clearance must be allowed between the resistor and thermally sensitive components. Fig.1 shows the rise of resistors hot spot temperature against dissipated power.

ELECTRICAL DATA

Resistance range

PR37 Series 10 to 10 k Ω

PR52 Series 10 to 27 k Ω

Resistance tolerance ± 5 %

Preferred number series (BS2488; 1966) E12

Maximum temperature coefficient of resistance 500 -10⁶ .K

Maximum power dissipation at T_{amb} = 70 °C

PR37 Series 1.6 W

PR52 Series 2.5 W

Maximum body temperature at maximum dissipation and T_{amb} = 70 °C 300 °C

Stability; typical ΔR after 1000 hours at maximum dissipation and T_{amb} = 70 °C 2.5 %

VOLTAGE PROOF

The resistors are not insulated

FLAMMABILITY

The resistors are made entirely of non-flammable materials. Under overload conditions they will open-circuit without burning.



ORDERING PROCEDURE

When ordering these resistors, the following information is required:-

1. Quantity
2. Style of resistor (PR37 or PR52)
3. Resistance value using the R.K.M. code.
R = units (x 1), K = kilo (x 1000), M = mega (x 1 000 000)

For example:

25 000 pieces of a PR52 resistor 3300 Ω , are ordered as 25 000 resistors PR52-3K3.

GRAPHS

$$\Delta T = T_{\text{body}} - T_{\text{amb}}$$

$$T_{\text{body max}} = 300 \text{ } ^\circ\text{C}$$

Fig.1 may be used to determine the maximum permissible dissipation at any ambient temperature above 40 $^\circ\text{C}$. Conversely, it may be used to determine ΔT for any power dissipation.

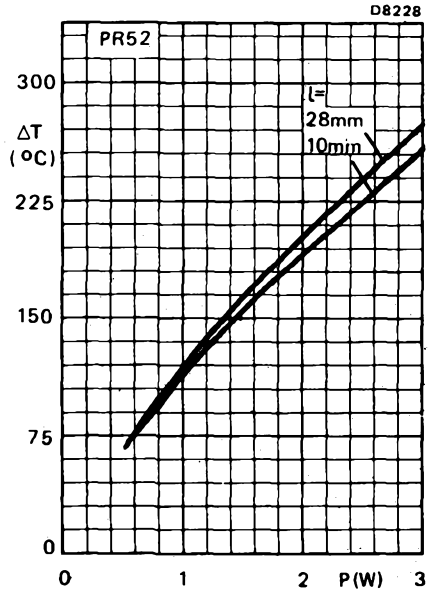
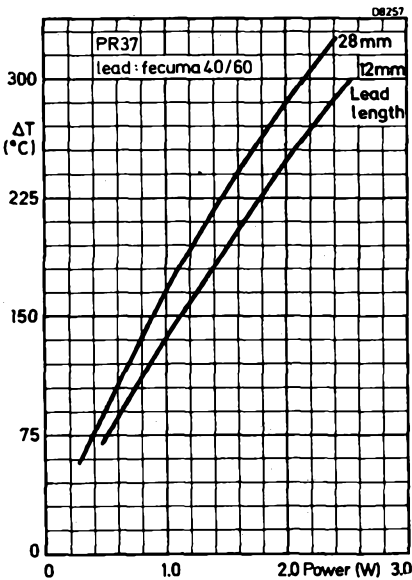

Fig.1

Rise in body temperature (hot spot) as a function of dissipated power for two lead lengths



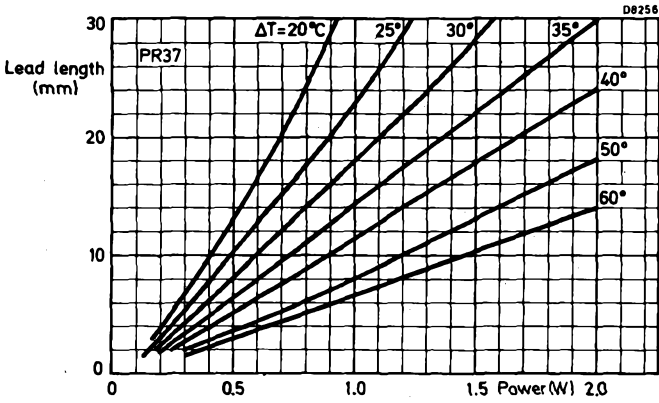

Fig.2

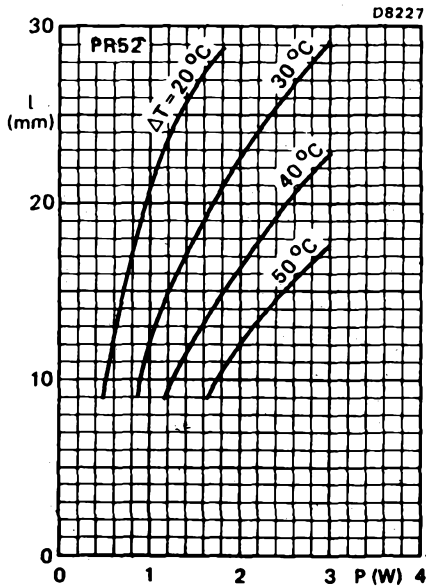

Fig.3

Lead length plotted against dissipation power with ΔT as a parameter. (ΔT = soldering spot $^\circ\text{C}$)



STANDARD FILM RESISTOR

QUICK REFERENCE DATA

Style	SFR25	
Resistance range	1 Ω to 1.0 M Ω	
Resistance tolerance	± 5	%
Preferred values series	E24	
Maximum power dissipation at $T_{amb} = 70^{\circ}\text{C}$	0.33	W
Climatic category (IEC 68)	55/155/56	

DIMENSIONS (millimetres)

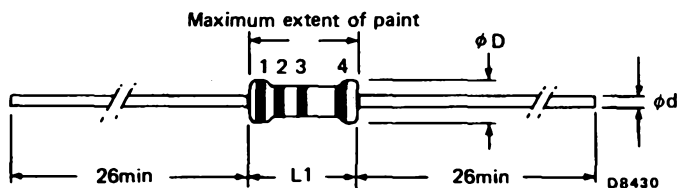

Type	ϕD max.	L1 max.	ϕd nom.
SFR25	2.5	7.0	0.6

The length L1 is the maximum clean lead to clean lead body length of the resistor. It is measured by inserting the leads into the holes $\phi 1$ mm of two identical gauge plates and by moving these plates parallel to each other until the resistor body is clamped without deformation (see IEC publication 294).

GENERAL

These resistors are manufactured by depositing a homogeneous film of nickel-chromium on to a high grade ceramic rod. (For values less than 10 Ω an electroless-deposited nickel-phosphor film is used). Contact caps are pressed on to the rods and a helical groove cut through the film to give the required resistance value. Connecting wires of lead-tin coated electrolytic copper are welded to the end caps. Finally the resistors are coated with multiple layers of light green insulating lacquer for electrical, mechanical and climatological protection. This lacquer is applied so that the end faces of the end caps and connecting leads remain clean. By this means a well defined body length and clean lead to clean lead length are obtained.



MOUNTING

These resistors are suitable for automatic insertion and processing in cut and form machines. The controlled overall length of 7.0 mm is suitable for insertion on a 10.16 mm (0.4") pitch. They may be mounted against double sided print boards. The lacquer is resistant to all commonly used solvents recommended for cleaning printed wiring boards.

COLOUR CODING

The resistance value and tolerance are indicated by four colour bands as follows:-

Bands 1 and 2	= 1st and 2nd significant figures
Band 3	= Multiplier
Band 4	= Tolerance

The significance of the colours is in accordance with the standard resistor colour code (BS1852: 1967)

LEADS

Lead-tin coated copper wire.

RESISTANCE RANGE

1 Ω to 1 M Ω \pm 5% tolerance

E24 Series*

*To BS2488: 1966

TEMPERATURE COEFFICIENT

The temperature coefficient of resistance is less than 250 ppm/ $^{\circ}$ C

LIMITING ELEMENT VOLTAGE

This is the maximum voltage (d.c. or r.m.s.) that may be applied to the resistor provided that the maximum dissipation is not exceeded.

SFR25	250	V
-------	-----	---

ISOLATION VOLTAGE

This is the maximum voltage (d.c. or peak a.c.) that may be applied under continuous operating conditions between the resistor leads and an external conductor touching the body of the resistor.

SFR25	350	V
-------	-----	---

VOLTAGE PROOF

This is the r.m.s. test voltage applied for 1 minute without breakdown between the resistor leads and an external conductor touching the body of the resistor.

SFR25	500	V
-------	-----	---

NOISE

Less than 0.1 μ V/V



PACKING

Resistors are supplied on a continuous tape (bandolier) conforming to Fig.2. SFR25 resistors are packed either in boxes of 1000 pieces or on to drums of 5000 pieces.

The bandoliers and drums are suitable for use on either crop and form or fully automated component insertion equipment.

The boxes and drums are marked with

1. Style of resistor
2. Packing quantity
3. Resistor value and tolerance
4. Date in code form
5. Mullard code of 12 digits

A full specification covering bandoliering and packaging is available.

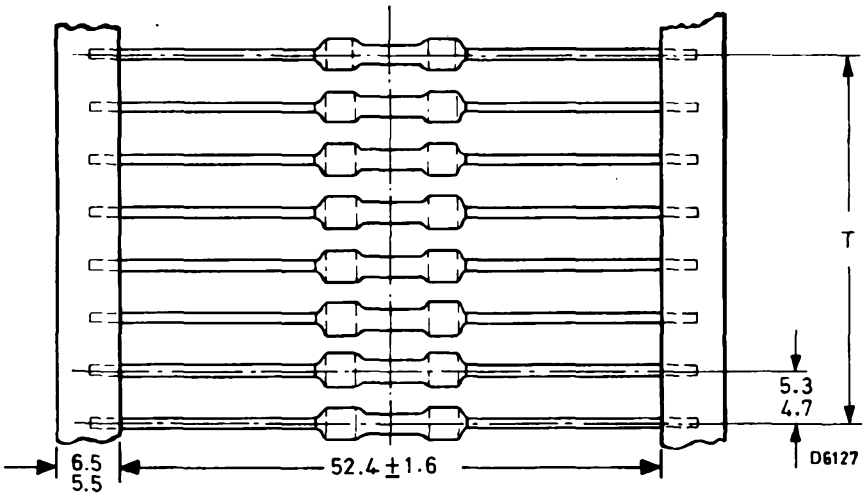

Fig.2

For 'n' < 5 pieces

$$T = 5(n-1) \pm 1.5$$

For 'n' between 5 and 10 pieces

$$T = 5(n-1) \pm 2$$

where 'n' = the number of resistors

All dimensions in millimetres



ORDERING PROCEDURE

SFR25 resistors are supplied in multiples of 1000 pieces packed in boxes or in multiples of 5000 pieces packed on to drums.

When ordering, the following information is required.

1. Quantity
2. Style of resistor e.g. SFR25
3. Resistance value and tolerance.
4. Packing. Drum packing is indicated by adding DRM to the end of the type designation, i.e. SFR25-XXX-X-DRM.

For example

- (a) 2000 pieces of SFR25 resistors $1200 \Omega \pm 5\%$ are ordered as 2000 resistors SFR25-1K2-5.
- (b) 10 000 pieces of SFR25 resistors, drum packed, $5.6 \Omega \pm 5\%$ are ordered as 10 000 resistors SFR25-5R6-5-DRM.



TESTS AND REQUIREMENTS

Where applicable these resistors are tested to IEC Publication 115-1 (Recommendations for fixed non-wirewound resistors, Type 1) category 55/155/56, and IEC Publication 68 (Basic environmental testing procedures).

These tests are summarised in the table below.

IEC 115-1 clause	IEC 68 test method	Test	Procedure	Requirements
18	Ua Ub Uc	Robustness of terminations a. Tensile all samples b. Bending half number of samples c. Torsion other half number of samples	0.6 mm load 10 N (1 kg): 10 s 0.6 mm load 5 N (0.5 kg); 4 x 90° 3 x 360° in opposite directions	No. of failures < 10 ppm ΔR max. 0.25% + 0.05 Ω
19	T	Soldering	solderability: 2 s 230 °C 0.5% activated flux thermal shock: 3 s 350 °C 6 mm from body	good tinning, no damage ΔR max. 0.25% + 0.05 Ω
20	Na	Rapid change of temperature	½ hour at -55 °C ½ hour at +155 °C 5 cycles	ΔR max. 0.25% + 0.05 Ω
22	Fc	Vibration	Frequency: 10 to 500 Hz: displacement 1.5 mm or acceleration 10 g: three directions: total 6 h	no damage ΔR max. 0.25% + 0.05 Ω
21	Eb	Bumping	3 x 1500 bumps in three directions: 40 g	no damage ΔR max. 0.25% + 0.05 Ω



IEC 115-1 clause	IEC 68 test method	Test	Procedure	Requirements
23	—	Climatic sequence		
23.2	Ba	Dry heat	16 hours 155 °C	
23.3	D	Damp heat (accel) 1st cycle	24 hrs: 55 °C: 95 to 100% R.H.	
23.4	Aa	Cold	2 hours: -55 °C	
23.5	M	Low air pressure	1 hour: 85 mbar: 15 to 35 °C	
23.6	D	Damp heat (accel) remaining cycles	5 days: 55 °C: 95 to 100% R.H.	R_{ins} : min. 1000 M Ω ΔR max. 1.0% + 0.05 Ω
24.2	Ca	Damp heat (steady state)	56 days: 40 °C: 90 to 95% R.H. Dissipation 0.01 x P _{nom}	R_{ins} : min. 1000 M Ω ΔR max. 1.0% + 0.05 Ω
26.2	—	Endurance	1000 hours: 70 °C: P _{nom} or V _{max} .	ΔR max. 1.0% + 0.05 Ω
11	—	Temperature coefficient	between -55 °C and +155 °C	≤ 250 ppm
10	—	Voltage proof on insulation	500 V _{rms} applied for 1 min.	No breakdown
14	—	Noise	IEC publication 195	≤ 0.1 mV/V
9	—	Insulation resistance		min. 10 ⁴ M Ω
15	—	Short time overload	room temperature, dissipation 6.25 x P _{nom} (voltage not more than 2 x limiting voltage) 10 cycles, 5 seconds on, 45 seconds off	ΔR max. 0.25% + 0.05 Ω



METAL GLAZE RESISTORS

high ohmic

QUICK REFERENCE DATA

Style	VR25	VR37	VR68	
Resistance range	1 to 10	1 to 33	1 to 68	MΩ
Resistance tolerance	± 5%	± 5	± 5	%
Preferred value series	E12	E12	E12	
Maximum power dissipation at $T_{amb} = 70\text{ }^{\circ}\text{C}$	0.25	0.5	1	W
Limiting voltage (r.m.s.)	1150	2500	7000	V
Limiting voltage (d.c.)	1600	3500	10 000	V
Climatic category (IEC 68)	55/155/56	55/155/56	55/155/56	

MECHANICAL DATA

Dimensions in mm

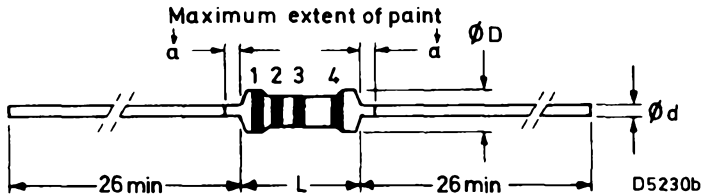

Fig.1

Style	L max.	$\varnothing D$ max.	a max.	$\varnothing d$ nom.
VR25	6.8	2.5	1.0	0.6
VR37	10	3.7	1.0	0.7
VR68	18	6.8	1.2	0.8

The length L is measured by inserting the leads into holes in two parallel gauge plates and moving these plates together until the resistor is held without deformation. The holes in the gauge plates for the leads are $\varnothing 1$ mm for VR25 and VR37, and $\varnothing 1.2$ mm for VR68.



APPLICATION

Developed for applications where high resistance values, high stability and reliability are required. Also suitable for use at high voltages.

GENERAL

The resistors consist of a metal glaze deposited on a high grade ceramic body. The ends of the resistor body are fitted with metal end caps to which solder coated electrolytic copper leads are welded. The final resistance value is obtained by cutting a helical track through the metal glaze. The resistor is protected by multiple coats of insulating lacquer, the final coat being light blue.

COLOUR CODING

The resistance value and tolerance are indicated by four colour bands as follows:—

Bands 1 and 2	= 1st and 2nd significant figures
Band 3	= Multiplier
Band 4	= Tolerance

The significance of the colours of bands 1 to 3 is in accordance with the standard resistor colour code (BS1852: 1967).

The fourth tolerance band is yellow and indicates a tolerance of $\pm 5\%$.

The positioning of the bands with respect to the resistor body is shown in Fig.1.

ELECTRICAL DATA

	VR25	VR37	VR68	
Resistance range	1 to 10	1 to 33	1 to 68	M Ω
Resistance tolerance	± 5	± 5	± 5	%
Preferred number Series (BS2488: 1966)	E12	E12	E12	
Temperature coefficient of resistance	± 200	± 200	± 200	$10^{-6}/K$
Limiting voltage (r.m.s.) see note 1)	1150	2500	7000	V
Limiting voltage (d.c.) (see note 1)	1600	3500	10 000	V
Voltage proof (see note 2)	700	700	700	V
Maximum power dissipation at $T_{amb} = 70^{\circ}C$	0.25	0.5	1	W
Maximum body temperature at rated dissipation and $T_{amb} = 70^{\circ}C$	155	155	155	$^{\circ}C$
Maximum noise	5	< 0.5	< 0.5	$\mu V/V$
Stability: typical ΔR after 1000 hours at maximum dissipation and $T_{amb} = 70^{\circ}C$	< 0.5	< 0.5	< 1	%

NOTES

1. This is the maximum r.m.s. or d.c. voltage that may be applied to the resistor, provided that the power dissipation is not exceeded (see also Fig.3).
2. This is the maximum voltage that may be applied for 1 minute between the resistor leads and an external conductor touching the body of the resistor.



PACKING

Resistors are supplied on a continuous tape (bandolier) of 1000 pieces, with dividing marks at intervals of 100 pieces.

The bandoliers are packed in boxes marked as follows:—

1. Style of resistor VR25 VR37 or VR68
2. Quantity
3. Nominal resistance value
4. Date in code form
5. Mullard code number of 12 digits

The basic dimensions of the bandolier are given below. A full specification covering bandoliering and drum packing is available.

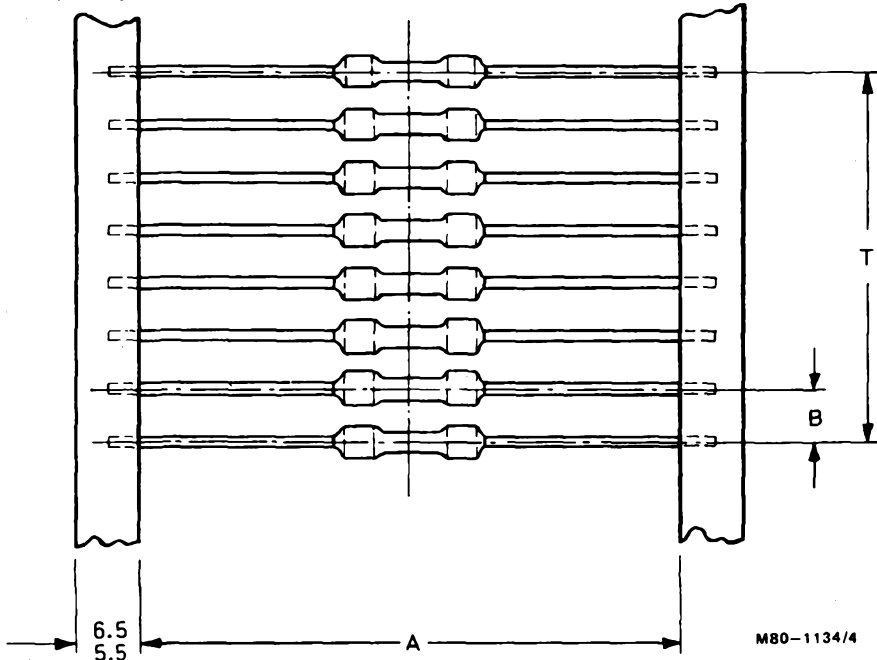

Fig.2

Style	A	B
VR25 and VR37	54.0/50.8	5.3/4.7
VR68	68.3/65.1	10.3/9.7

For 'n' < 50 pieces

$$T = [5(n - 1)] \pm 2 \text{ for VR25 and VR37}$$

$$T = [10(n - 1)] \pm 2 \text{ for VR68}$$

For 'n' 50 to 100 pieces

$$T = [5(n - 1)] \pm 4 \text{ for VR25 and VR37}$$

$$T = [10(n - 1)] \pm 4 \text{ for VR68}$$

where 'n' = the number of resistors

All dimensions in mm



ORDERING PROCEDURE

When ordering resistors, the following information is required:—

1. Quantity
2. Style of resistor (VR25, VR37 or VR68)
3. Resistance value using the R.K.M. code

R = units (x1), K = kilo (x1000), M = mega (x1000 000)

For example:

25 000 pieces of a VR37 resistor, 3.3 MΩ are ordered as 25 000 resistors V R37-3M3.

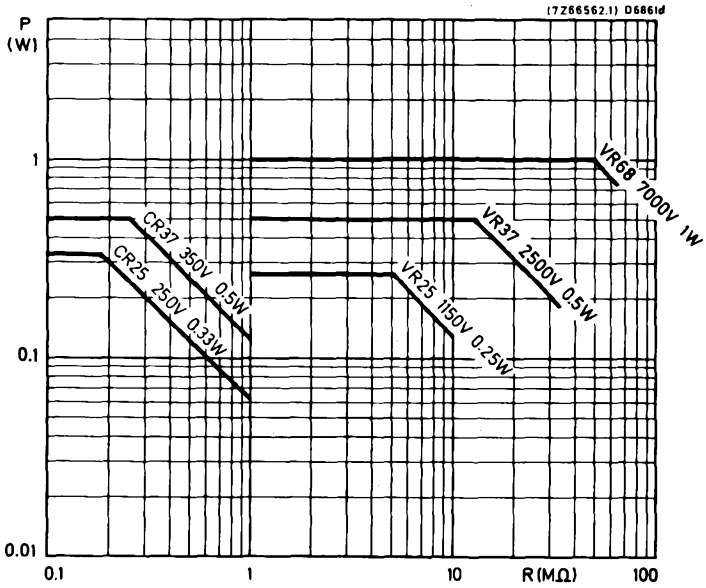

Fig.3

The relationship between resistance value and maximum power dissipation or maximum voltage rating of the VR and CR series of resistors.



NEGATIVE TEMPERATURE COEFFICIENT THERMISTORS



G





G



N. T. C. thermistors are supplied in packages marked with either the Mullard VA number or a 12 digit number. A data summary and conversion list is available.

Additionally, both numbers appear on each data sheet.

INTRODUCTION

Negative Temperature Coefficient (N. T. C.) thermistors are resistors which have a high negative temperature coefficient of resistance. They are prepared from oxides of the iron group of transition elements such as Cr, Mn, Fe, Co, Ni. These oxides have a high resistivity in the pure state, but can be transformed into semiconducting materials by the addition of small amounts of ions having a different valency. Examples are:

- (a) Iron oxide Fe_2O_3 , where a small part of the Fe^{3+} ions are replaced by Ti^{4+} ions. These Ti^{4+} ions are compensated by an equal amount of Fe^{2+} ions in order to maintain electro-neutrality. At low temperatures the extra electrons of the Fe^{2+} ions are situated on Fe ions next to the Ti^{4+} ions, but at higher temperatures they are gradually loosened from these sites and contribute to the conductivity. In this example, an electron or n-type semiconducting material is obtained.
- (b) Nickel oxide NiO , or cobalt oxide CoO , with partial substitution of Ni^{2+} ions or Co^{2+} ions by Li^{1+} ions. These Li^{1+} ions are compensated by an equal amount of Ni^{3+} ions or Co^{3+} ions. At low temperatures the electron holes of the trivalent ions are situated near the lithium ions and are free to move through the crystals at higher temperatures. In this example, a positively charged particle is the mobile charge carrier, therefore a p-type semiconducting material is obtained.

Stabilising oxides are sometimes added to obtain better reproducibility and stability of the characteristics. The choice of composition depends entirely on the temperature coefficient and required resistance.

The manufacturing process is similar to that used in the ceramic industry. After intensive mixing and the addition of a plastic binder, the material is shaped into the appropriate forms by extruding for rods, and pressing for discs. The parts are then sintered at high temperatures. Electrical contacts are made using silver paste, vacuum deposition or metal spraying techniques.

Miniature n.t.c. thermistors are made by sintering a bead of the semiconducting oxide between two parallel platinum alloy wires. This sintering process shrinks the bead on to the wires, thus forming a reliable contact. For most applications the miniature n.t.c. thermistors are enclosed in glass envelopes of various forms, to give protection against corrosive fluids. Where the highest thermal sensitivity is required the unprotected bead can be used.

ELECTRICAL PROPERTIES

Resistance versus temperature characteristic

The relationship between resistance and temperature for an n.t.c. thermistor can be approximated to:

$$R = Ae^{B/T} \tag{1}$$

- where, R = resistance in ohms
 T = absolute temperature in kelvin
 e = the base of natural logarithms (e = 2.718)
 A and B = constants for a given thermistor
 (the letter 'β' is sometimes used as an alternative symbol for B)

This equation is illustrated in fig. 1

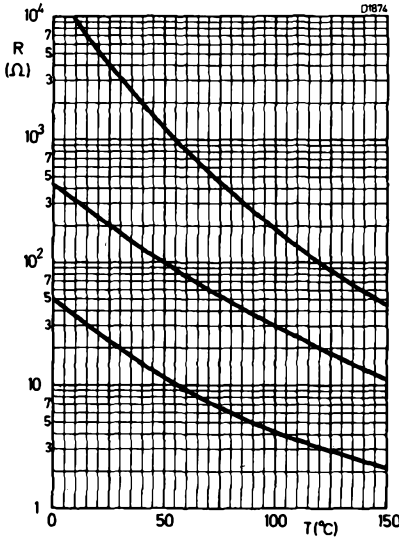

Fig. 1
 Resistance as a function of temperature
 for three different values of A and B

For a given n.t.c. thermistor the value of B may be found by measuring R at two absolute temperatures T_1 and T_2 , giving:

$$R_1 = Ae^{B/T_1} \text{ and } R_2 = Ae^{B/T_2}$$

by division

$$\frac{R_1}{R_2} = e^{(B/T_1 - B/T_2)}$$

taking logarithms

$$B = \frac{1}{\log_{10} e} \cdot \frac{\log_{10} R_1 - \log_{10} R_2}{1/T_1 - 1/T_2} \text{ kelvin } \tag{2}$$

simplified

$$B = 2.303 \frac{T_1 T_2}{T_2 - T_1} \cdot \log_{10} \frac{R_1}{R_2} \text{ kelvin} \quad (3)$$

For different material compositions, the constant B has values between 2000 and 5500K. In practice, B is not a true constant, since minor deviations occur at high temperatures.

Equation (2) may be rearranged to give:

$$\log_{10} R_1 = \log_{10} R_2 + B \left(\frac{T_2 - T_1}{T_1 \cdot T_2} \right) \log_{10} e \quad (4)$$

Equation (4) may be used to find the resistance of a thermistor at any temperature within its working range, given the resistance at a known temperature and its B-factor.

The graphs figs. 2 and 3, may also be used to find the resistance R_T at a temperature $T^\circ\text{C}$ using the resistance at 25°C (R_{25}) and B-factor given in the appropriate data sheets.

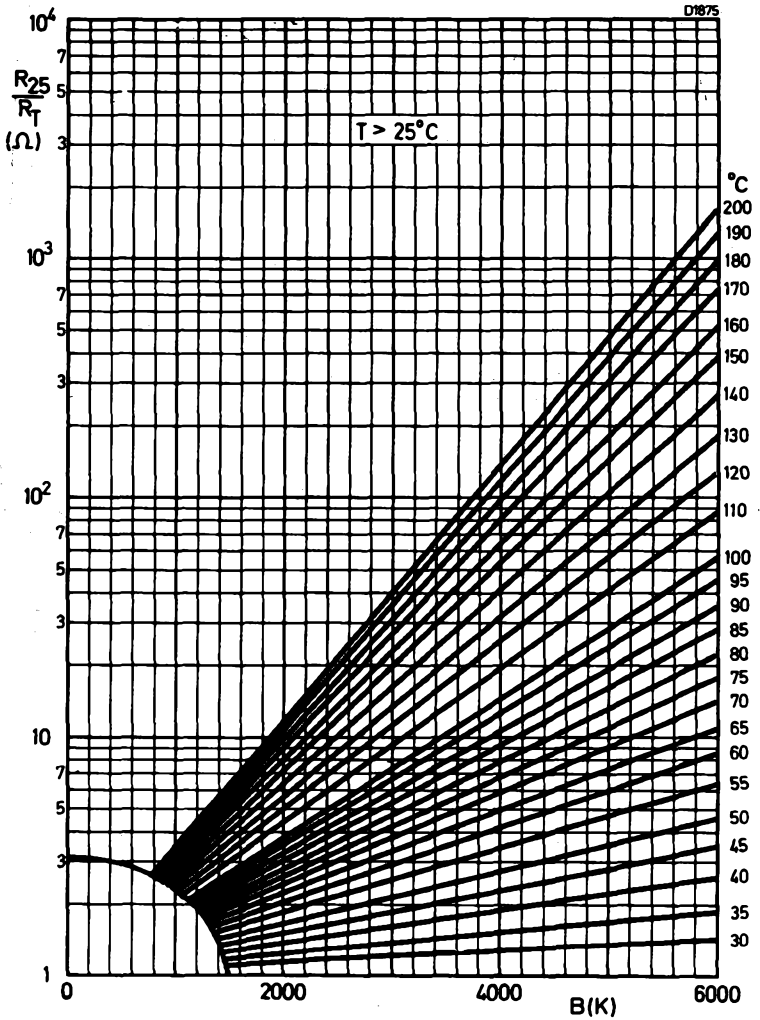

Fig. 2
 R_{25}/R_T as a function of B with temperature as a parameter

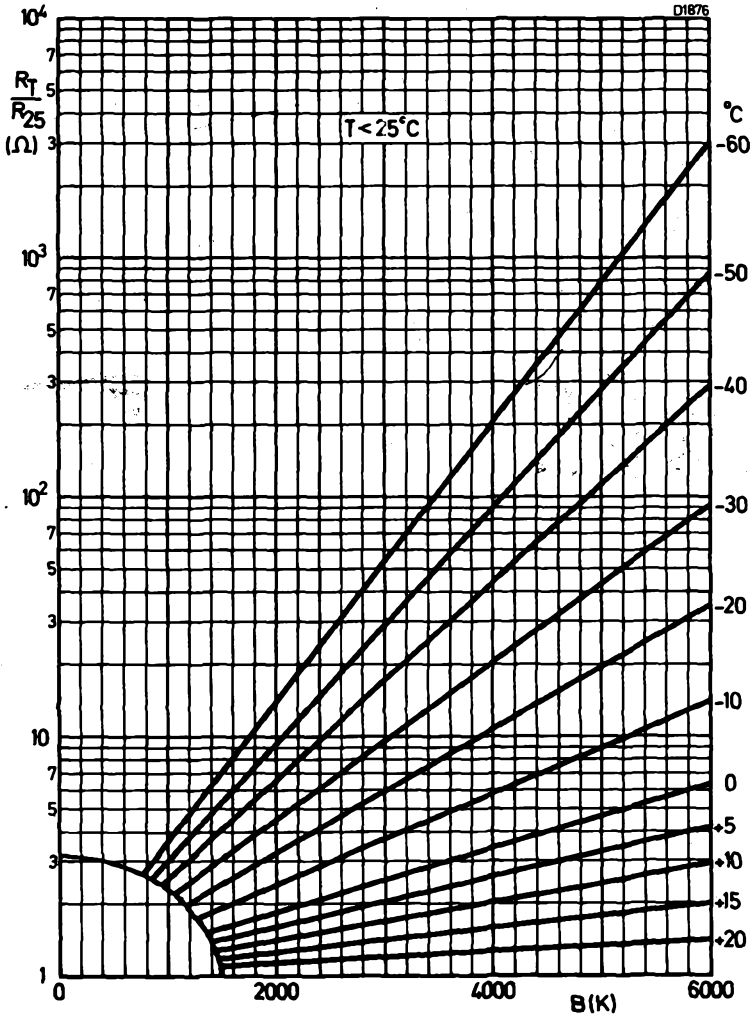

Fig. 3
 R_T/R_{25} as a function of B with temperature as a parameter

From equation (1) the temperature coefficient of resistance α can be derived as follows:

$$\alpha = \frac{1}{R} \cdot \frac{dR}{dT} = - \frac{B}{T^2} \quad (5)$$

At 25°C, α lies between -2.4 and -6.8% per deg. It should be noted that α varies as the inverse square of the absolute temperature.

Voltage versus current characteristic

A typical relationship between current and voltage drop across an n.t.c. thermistor is shown in fig. 4. This static characteristic, plotted on a log-log scale, was measured at a constant ambient temperature and the readings were taken after thermal equilibrium was achieved.

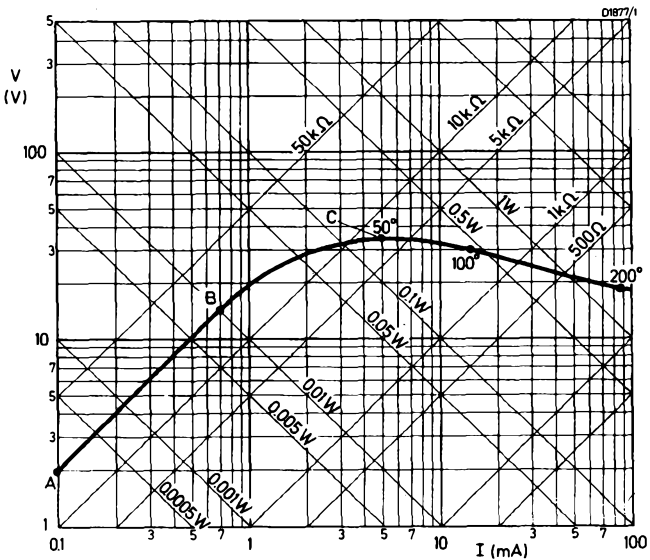

Fig. 4

At low levels, the power input to the thermistor is inadequate to cause a rise in temperature above ambient. Therefore, its resistance remains constant and the relationship between voltage and current is linear (fig. 4, A to B). Beyond this linear portion the power input is sufficient to heat the thermistor, causing its resistance to progressively fall. At a certain value of current, the voltage drop across the thermistor reaches a maximum value (fig. 4, C) and decreases as the current increases still further.

Assuming:

- (a) a constant temperature throughout the body of the thermistor,
- (b) the heat transfer to be proportional to the difference between the thermistor and its surroundings (true for low temperatures only),
- (c) the resistance as defined by equation (1),

the following may be written:

$$\log_e R = \log_e A + \frac{B}{T} \quad (6)$$

at thermal equilibrium

$$V \cdot I = D (T - T_{amb}) \quad (7)$$

where T_{amb} = ambient temperature

D = dissipation constant, i.e. the power needed to raise the temperature by 1°C.

From equations (7) and (6)

$$\log_e V + \log_e I = \log_e D + \log_e (T - T_{amb}) \quad (8)$$

$$\log_e V - \log_e I = \log_e A + \frac{B}{T} \quad (9)$$

combining

$$\log_e V = \frac{1}{2} \log_e AD + \frac{1}{2} \log_e (T - T_{amb}) + \frac{B}{2T}$$

This expression has a maximum or minimum as a function of T if

$$\frac{d(\log_e V)}{dT} = 0$$

then

$$\frac{1}{2(T - T_{amb})} - \frac{B}{2T^2} = 0$$

which is only true for those values of T which satisfy the equation

$$T^2 - BT + BT_{amb} = 0$$

The temperature at which the voltage is a maximum, T_v , is given by

$$T_v = \frac{1}{2}B \pm \sqrt{\frac{1}{4}B^2 - BT_{amb}} \quad \text{kelvin}$$

(The value with the negative sign gives the temperature corresponding to the maximum value of the voltage.) For practical values of B, T_v lies between 318K (45°C) and 358K (85°C).

From the above, which is valid for static conditions, it follows that the temperature corresponding to the maximum voltage is dependent on the B-value, not on the actual resistance value.

Thermal time constant

If the temperature of the thermistor is uniform during cooling, the following equation is valid for cooling in the time interval dt

$$-HdT = D(T - T_{amb}) dt \quad (10)$$

in which H is the heat capacity of the thermistor in joules per degree C.

From equation (10), when the thermistor cools from T_2 to T_1 ,

$$(T_1 - T_{amb}) = (T_2 - T_{amb}) e^{-t/\tau}$$

The value $\tau = H/D$ is termed the thermal time constant. The thermal time constant is defined as the time required for a thermistor to change by 63.2% of the total change between its initial and final body temperatures, when subjected to a step function change in temperature under zero power conditions.

Tolerances on R_{25} and B

In published data the values of R_{25} and B are specified with certain tolerances. The tolerance on R_{25} is normally $\pm 20\%$ and in most cases, the tolerance on the B -value is $\pm 5\%$. Due to the tolerance on B , the deviation from a nominal resistance/temperature curve, at temperatures other than 25°C , can be greater than that specified at 25°C . Fig. 5 illustrates this for an n.t.c. thermistor with an R_{25} of $1\text{k}\Omega$.

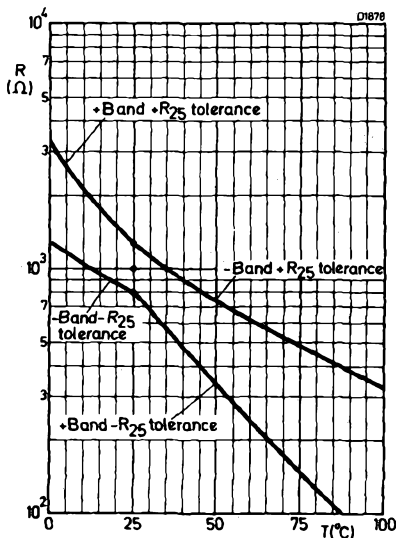

Fig. 5
The influence of the B -value tolerance

Although the resistance value will always lie between these curves, it can be seen that they represent 'worst case' conditions which seldom occur in practice.

Choice of type

When an n.t.c. thermistor has to be selected for a certain purpose, the following questions have to be considered:

1. What is the resistance, temperature range and temperature coefficient required?
2. What is the power to be dissipated?
3. What is the thermal time constant required?
4. Which slope is best suited for the purpose?

Whenever it is impossible to find an n.t.c. thermistor to fulfil all requirements, it is often possible to adapt the values of other circuit components, or to use a combination of series and parallel resistors to permit the use of a standard type.

Suppose, for compensation purposes, a thermistor is wanted with a resistance value of 50Ω at 30°C and 10Ω at 100°C . A standard type having this characteristic is not available. The problem may, however, be solved by using a standard thermistor and two linear resistors. If a disc type with an R_{25} of 130Ω is used in a series and parallel arrangement with two linear resistors of 6.04Ω and 95.3Ω (these two resistance values are taken from E96 series) as illustrated in fig. 6, the resistance of the combination at 30°C and 100°C will meet the requirements. Fig. 7 shows the new resistance versus temperature graph, together with that of the thermistor.

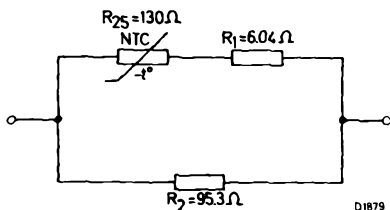

Fig. 6

Use of resistors in series and parallel to modify the n.t.c. thermistor characteristics

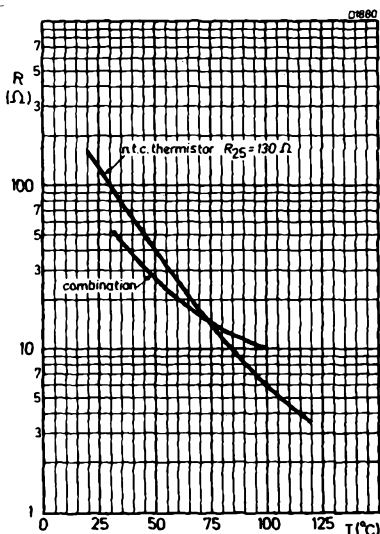

Fig. 7

Resistance as a function of temperature in a circuit as in fig. 6

It should be remembered that the temperature coefficient of the combination will always be lower than that of the n.t.c. thermistor alone. This is clearly illustrated in fig. 8, where the change in the resistance/temperature graph is shown for different values of series or parallel resistor.

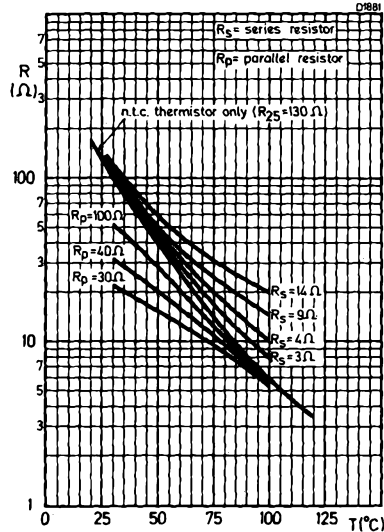

Fig. 8
Resistance as a function of temperature of a thermistor with $R_{25} = 130\Omega$, in series or parallel with various resistors

APPLICATIONS

The applications of n.t.c. thermistors may be classified into three main groups :-

1. Applications where advantage is taken of the temperature dependency of the thermistor, i.e. where the resistance is a function of temperature.

This group has two subsections :

 - (a) where the temperature of the thermistor is determined solely by the ambient medium
 - (b) where the temperature of the thermistor is determined partially by the ambient medium and partially by the dissipation of the thermistor itself.
2. Applications which make use of the thermal inertia of the thermistor; in this case the temperature is considered to be a parameter, and resistance is a function of time.
3. Applications which take advantage of the high negative temperature coefficient of resistance of these thermistors. This group includes those applications which use the negative slope of the "voltage equals a function of current" characteristic.

Application examples

1. Temperature measurement and control in industrial, domestic and medical thermometers and thermostats. The thermistor is usually used in one arm of a bridge circuit. The output from the bridge, after amplification if necessary, is either displayed on a meter, or used to control the heating or refrigerating circuits.
2. The measurement of cooling water and oil temperatures in vehicles in which the thermistor is used in series with an indicating instrument.
3. Liquid flow measurement and gas pressure measurement in low pressure systems. The rate of heat loss from a thermistor operating at a temperature above ambient is used to determine flow rate or gas pressure.
4. Compensation of the positive temperature coefficient of copper wire in television scanning coils, meters and similar windings. Any increase in resistance of the copper due to temperature increases is offset by a reduction in resistance of the thermistor.
5. The protection of series connected valve heaters, silicon diodes and switches against switching surges, by using the thermal inertia of n.t.c. thermistors. The initial high resistance of the cold thermistor limits the current to a safe value. As the thermistor heats up its resistance falls and the current increases to its working value.
6. Delay circuits to retard the operation of relays, small contactors and motors. Again, the thermal inertia of the thermistor is used to limit the initial current and allow a slow build-up to working level.
7. Gain compensation in amplifiers. Thermistors may be included in feedback networks to compensate for the variation in gain of amplifiers.
8. Compensation of transistor characteristics against temperature changes. Thermistors used as part of the bias network maintain circuit parameters within design limits.

Notes

In all applications the following precautions must be observed:

- (a) Do not use thermistors in parallel to obtain higher dissipation. Variations within the published tolerances will result in unequal current sharing, and hence unequal heating.
- (b) Do not use unprotected thermistors in conducting, corrosive, oxidising or reducing fluids.
- (c) For temperature measurement applications, the dissipation level must be kept very low to avoid self-heating of the thermistor which would give inaccurate results. The dissipation constant is an indication of the maximum permissible dissipation for accurate temperature measurement.

DEFINITIONS

Zero power resistance

The resistance value of a thermistor measured at a specified temperature T with a power input to the thermistor sufficiently low so that any further decrease in power will result in not more than $\pm 0.1\%$ change in resistance.

Rated zero power resistance (R_{25})

This is the nominal value at the standard reference temperature of 25°C , unless otherwise specified.

B-value

An index of the temperature sensitivity derived from the formula previously given in equation (3):

$$B = 2.303 \left(\frac{T_1 \cdot T_2}{T_2 - T_1} \right) \cdot \log_{10} \frac{R_1}{R_2} \text{ K}$$

where B = a constant in K

R_1 = resistance in ohms at T_1

R_2 = resistance in ohms at T_2

When calculated from measurements made at $T_1 = 298\text{K}$ (25°C) and $T_2 = 358\text{K}$ (85°C) the constant is written as $B_{\frac{25}{85}}$.

Note: The letter ' β ' is sometimes used as an alternative symbol for B.

Operating temperature category at zero power

The upper and lower category temperatures at zero power are the maximum and minimum ambient temperatures at which the thermistor can be continuously operated.

Maximum power rating

The maximum power which may be continuously dissipated in still air at 25°C ambient, unless otherwise specified.

Dissipation factor (δ)

The ratio (in milliwatts per degree C) of a change in power dissipation of a thermistor to the resultant body temperature change, at a specified ambient temperature.

Thermal time constant (τ)

The time required for a thermistor to change 63.2% of the total difference between its initial and final body temperatures, when subjected to a step function change in temperature under zero power conditions.

Resistance/temperature characteristic

The relationship between the zero power resistance of a thermistor and its body temperature.

Voltage/current characteristic

The relationship (in still air at 25°C) between the voltage developed across the thermistor and the applied steady-state current.

MEASUREMENT OF N.T.C. THERMISTOR CHARACTERISTICS

The following are precautions which must be taken when measuring n.t.c. thermistors:

1. Do not make measurements in air, this can give inaccurate results. Measurements should be made in a suitable non-conductive, non-corrosive liquid.
2. The thermostat used should have an accuracy of at least 0.1°C and measurement should be taken as close to the thermistor as possible. The liquid should be agitated.
3. Time should be allowed for equilibrium to be reached, between the thermistor and its surrounding medium, this can be greater than 1 minute for some types.
4. The measuring voltage should be kept as low as possible to avoid self heating effects, particularly when measuring miniature types. Less than 0.5V is recommended.
5. When a mercury thermometer is used for high temperature measurement, it is recommended that stem correction be applied.

N.T.C. THERMISTORS

Disc and rod types

Type No.	Code No. 2322. . .	R ₂₅ (Ω)	B-value (K)	Max. power rating (W) at 25 °C	Shape	See composite data sheet commencing with:
VA1033	610 11408	4	2800	1	Disc	VA1033
VA1034	610 11509	50	3300	1	Disc	VA1033
VA1038	610 11132	1300	5450	1	Disc	VA1033
VA1039	610 11501	500	5200	1	Disc	VA1033
VA1040	610 11131	130	4600	1	Disc	VA1033
VA1053	610 11808	8	2900	1	Disc	VA1033
VA1055S	635 01153	15 000	3600	0.6	Rod	VA1055S
VA1056S	635 01473	47 000	3925	0.6	Rod	VA1055S
VA1066S	635 01472	4700	3300	0.6	Rod	VA1055S
VA1067S	635 01154	150 000	4075	0.6	Rod	VA1055S
VA1074	610 11608	6	2825	1	Disc	VA1033
VA1086	610 11228	2.2	2675	1	Disc	VA1033
VA1096	642 11151	150	3280	0.6	Disc	VA1096
VA1097	642 11471	470	3520	0.6	Disc	VA1096
VA1098	642 11152	1500	3775	0.6	Disc	VA1096
VA1100	610 11159	15	3125	1	Disc	VA1033
VA1104	644 90005	15	3350	See note	Disc	VA1104
VA1106	642 11222	2200	3915	0.6	Disc	VA1096
VA1108	642 12153	15 000	4375	0.6	Disc	VA1096
VA1109	642 12472	4700	4200	0.6	Disc	VA1096
VA1111	642 12333	33 000	4250	0.6	Disc	VA1096
VA1112	642 12223	22 000	4200	0.6	Disc	VA1096
	610 11118	1.1	2650	1	Disc	2322-610 Series
	610 12109	10	2950	1	Disc	2322-610 Series ←
	610 11339	33	3250	1	Disc	2322-610 Series ←

Note:- Maximum current (rms) at 55 °C for VA1104 is 2.2 A

Plastic encapsulated

Code No. 2322. . .	R (kΩ)	B-value (K)	Shape
640 90004	R ₂₅ = 12; R ₁₀₀ = 0.95	3750	'Two-point' type ←
640 90005	R ₁₀₀ = 16.7; R ₂₀₀ = 1.12	4300	
640 90013	R _{.30} = 50 kΩ; R _{.10} = 15 kΩ	4000	
640 90015	R _{.10} = 15 kΩ; R ₂₅ = 2.7 kΩ	4000	



SUMMARY

Miniature bead types

Type No.	Code No. 2322. . .	R ₂₅ (Ω)	B-value (K)	Shape
VA3100	634 11102	1 000	2375	Plain bead
VA3102	634 11222	2 200	2600	
VA3104	634 11472	4 700	3725	
VA3106	634 11103	10 000	3875	
VA3108	634 11223	22 000	3850	
VA3110	634 11473	47 000	3850	
VA3112	634 11104	100 000	3800	
VA3114	634 11224	220 000	3920	
VA3116	634 11474	470 000	4030	
VA3200	634 21102	1 000	2375	Gas-filled glass encapsulated bead
VA3202	634 21222	2 200	2600	
VA3204	634 21472	4 700	3725	
VA3206	634 21103	10 000	3875	
VA3208	634 21223	22 000	3850	
VA3210	634 21473	47 000	3850	
VA3212	634 21104	100 000	3800	
VA3214	634 21224	220 000	3920	
VA3216	634 21474	470 000	4030	
VA3400	627 21102	1 000	2375	Glass dipped bead
VA3402	627 21222	2 200	2600	
VA3404	627 21472	4 700	3725	
VA3406	627 21103	10 000	3875	
VA3410	627 21473	47 000	3850	
VA3412	627 21104	100 000	3800	
VA3414	627 21224	220 000	3920	
VA3700	627 11102	1 000	2375	Thermometer type
VA3702	627 11222	2 200	2600	
VA3704	627 11472	4 700	3725	
VA3706	627 11103	10 000	3875	
VA3708	627 11223	22 000	3850	
VA3710	627 11473	47 000	3850	
VA3712	627 11104	100 000	3800	
VA3714	627 11224	220 000	3920	
VA3716	627 11474	470 000	4030	



NEGATIVE TEMPERATURE COEFFICIENT THERMISTORS

(2322 610 Series)

VA1033 VA1053
VA1034 VA1074
VA1038 VA1086
VA1039 VA1100
VA1040



This data sheet should be read in conjunction with
NEGATIVE TEMPERATURE COEFFICIENT THERMISTORS - INTRODUCTORY NOTES

APPLICATION

General purpose applications, including temperature measurement and circuit compensation.

Additional similar thermistors are detailed in the data sheet 2322 610 Series.

DIMENSIONS (millimetres)

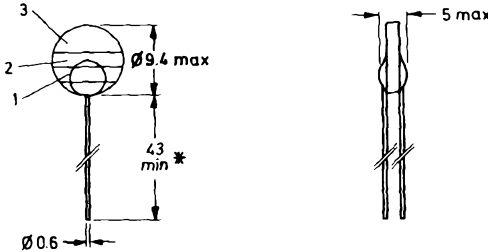

D3464

ELECTRICAL DATA

Rated zero power resistance (R ₂₅) ±20%	B-value (B _{25/85}) ±5%	Colour bands			Code No.	Type No.
		1	2	3		
2.2 Ω	2675K	red	red	gold	2322 610 11228	VA1086
4 Ω	2800K	yellow	black	gold	2322 610 11408	VA1033
6 Ω	2825K	blue	black	gold	2322 610 11608	VA1074
8 Ω	2900K	grey	black	gold	2322 610 11808	VA1053
15 Ω	3125K	brown	green	black	2322 610 11159	VA1100
50 Ω	3300K	green	black	black	2322 610 11509	VA1034
130 Ω	4600K	brown	orange	brown	2322 610 11131	VA1040
500 Ω	5200K	green	black	brown	2322 610 11501	VA1039
1300 Ω	5450K	brown	orange	red	2322 610 11132	VA1038

Maximum power rating at	1	W
Operating temperature category at zero power at maximum power	-25 to +125	°C
	0 to +55	°C
Dissipation factor (δ) (approx.)	10	mW/K (mW/°C)
Thermal time constant (τ) (approx.)	60	s

VA1110 has been replaced by 2322 610 12109

Mullard

COLOUR CODING

Three coloured bands on the body identify the types in this series.

ORDERING PROCEDURE

The thermistors should be ordered by the type or code number quoted in the table. They may be supplied in packs marked with either the type or code number.

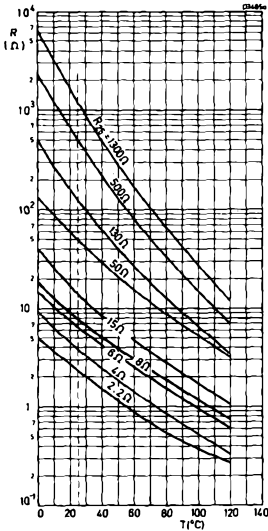

Resistance/temperature characteristics

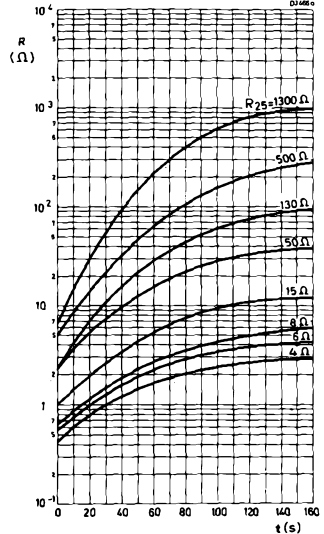

Cooling characteristics

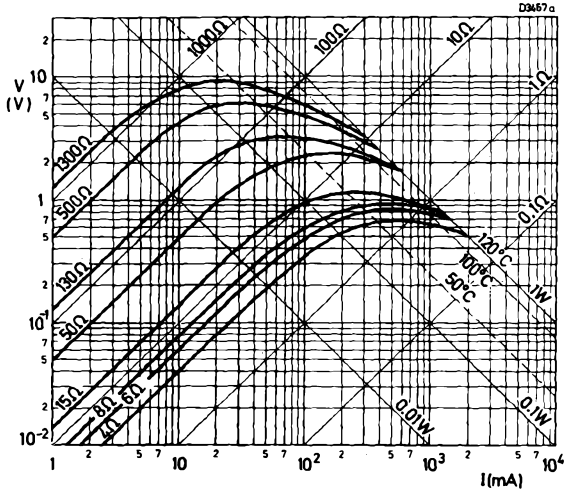

Voltage/current characteristics

Mullard

NEGATIVE TEMPERATURE COEFFICIENT THERMISTORS

(2322 635 Series)

VA1055S VA1066S
VA1056S VA1067S

This data should be read in conjunction with
NEGATIVE TEMPERATURE COEFFICIENT THERMISTORS - INTRODUCTORY NOTES

APPLICATION

General purpose applications, including temperature measurement and circuit compensation.

DIMENSIONS (millimetres)

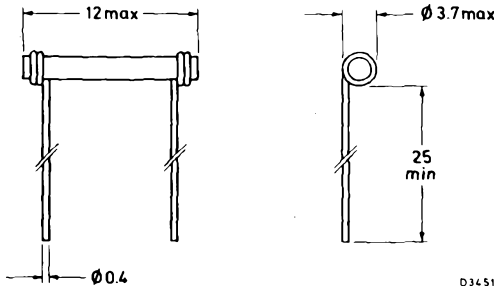

ELECTRICAL DATA

Rated zero power resistance (R_{25}) $\pm 20\%$	B-value ($B_{\frac{25}{85}}$) $\pm 5\%$	Colour coding	Code No.	Type No.
4 700 Ω	3300K	orange	2322 635 01472	VA1066S
15 000 Ω	3600K	green	2322 635 01153	VA1055S
47 000 Ω	3925K	blue	2322 635 01473	VA1056S
150 000 Ω	4075K	white	2322 635 01154	VA1067S

Maximum power rating	0.6	W
Operating temperature category at zero power	-25 to +150	$^{\circ}\text{C}$
at maximum power	0 to +55	$^{\circ}\text{C}$
Dissipation factor (δ) (approx.)	5.0	mW/K ($\text{mW}/^{\circ}\text{C}$)
Thermal time constant (τ) (approx.)	30	s

COLOUR CODING

A colour spot on the body identifies the types in this series.

ORDERING PROCEDURE

The thermistors should be ordered by the type or code number quoted in the table above. They may be supplied in packs marked with either the type or code number.

Mullard

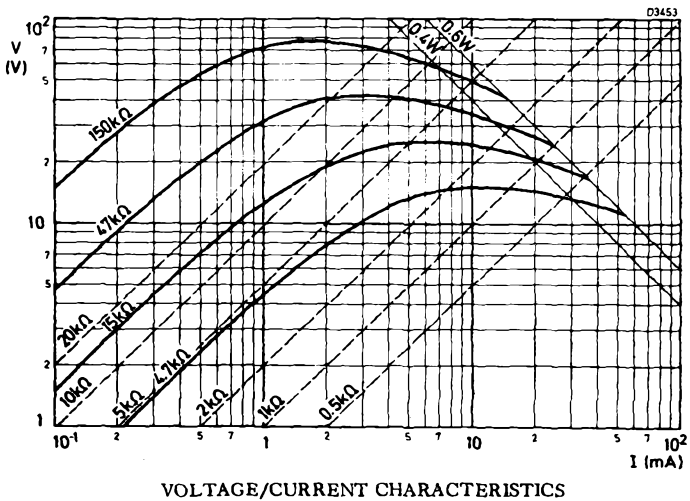
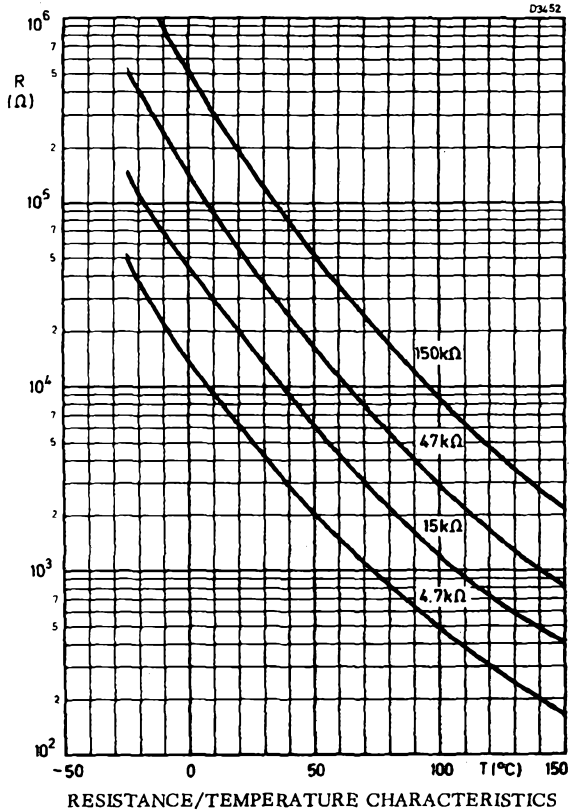

NEGATIVE TEMPERATURE COEFFICIENT THERMISTORS

(2322 642 Series)

VA1096 VA1108
VA1097 VA1109
VA1098 VA1111
VA1106 VA1112

This data sheet should be read in conjunction with
NEGATIVE TEMPERATURE COEFFICIENT THERMISTORS - INTRODUCTORY NOTES

APPLICATION

General purpose applications, including temperature measurement and circuit compensation.

DIMENSIONS (millimetres)

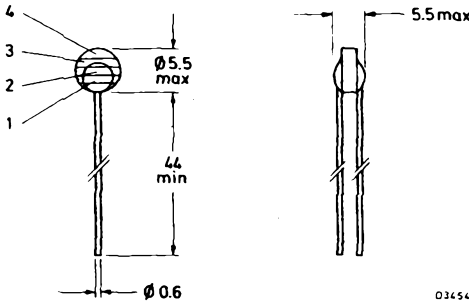

03154

ELECTRICAL DATA

Rated zero power resistance (R ₂₅)	B-value (B ₈₅ ²⁵)	Dissipation factor (δ) mW/degC	Colour bands			Code No.	Type No.
			1	2	3		
150Ω±20%	3280K	8	brown	green	brown	2322 642 11151	VA1096
470Ω±20%	3520K	8	yellow	violet	brown	2322 642 11471	VA1097
1500Ω±20%	3775K	8	brown	green	red	2322 642 11152	VA1098
2200Ω±20%	3915K	8	red	red	red	2322 642 11222	VA1106
4700Ω±10%	4200K	8	yellow	violet	red	2322 642 12472	VA1109
15 000Ω±10%	4375K	8.5	brown	green	orange	2322 642 12153	VA1108
22 000Ω±10%	4200K	8.5	red	red	orange	2322 642 12223	VA1112
33 000Ω±10%	4250K	8.5	orange	orange	orange	2322 642 12333	VA1111

Maximum power rating	0.5	W
Operating temperature category at zero power	-25 to +125	°C
at maximum power	0 to +55	°C
Dissipation factor (δ) (approx.)	8.5	mW/K (mW/°C)
Thermal time constant (τ) (approx.)	25	s

ORDERING PROCEDURE

Three coloured bands on the body identify the types in this series. Where applicable, the ±10% tolerance on R₂₅ value is marked with an additional fourth band in silver. The identification lacquer does not provide electrical insulation.

Mullard

ORDERING PROCEDURE

The thermistors should be ordered by the type or code number quoted in the table. They may be supplied in packs marked with either type or code number.

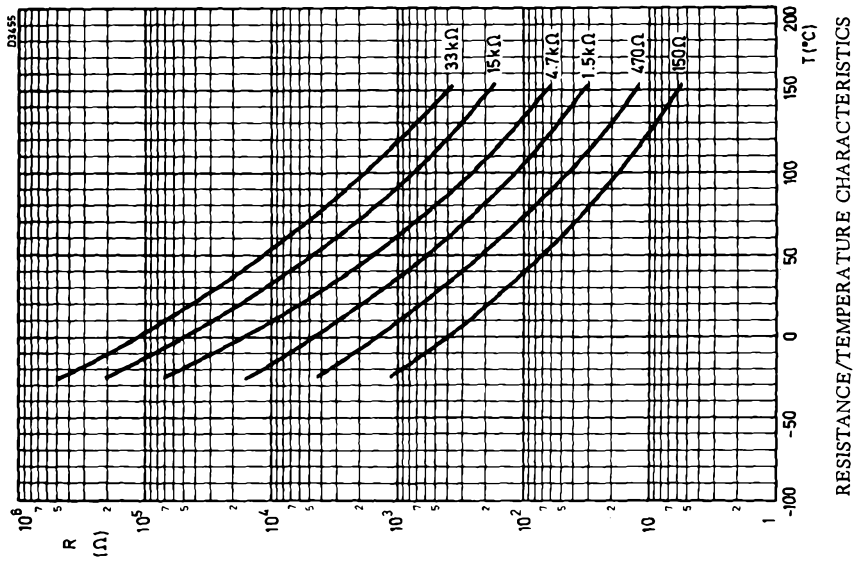
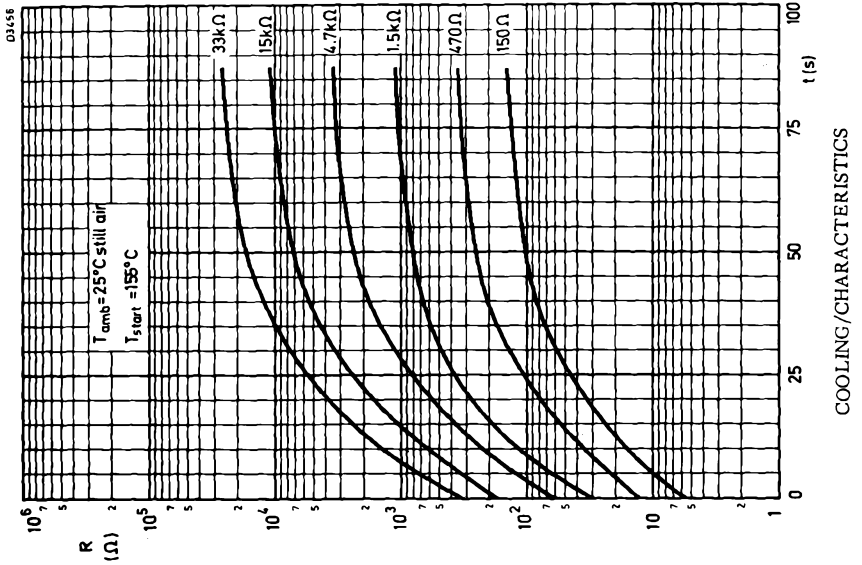

Mullard

**NEGATIVE TEMPERATURE
COEFFICIENT THERMISTORS**
(2322 642 Series)

**VA1096 VA1108
VA1097 VA1109
VA1098 VA1111
VA1106 VA1112**

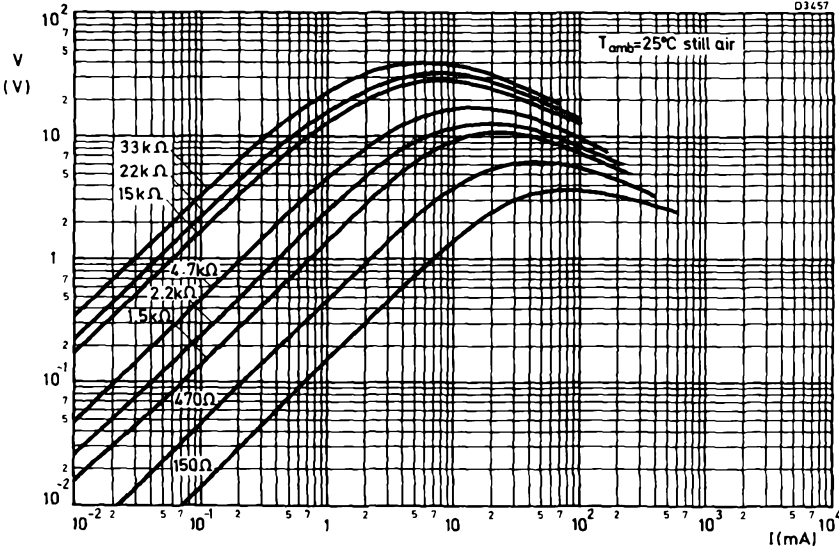

VOLTAGE/CURRENT CHARACTERISTICS

TESTS AND REQUIREMENTS

According to IEC68 recommendations, unless otherwise specified.

Tests	IEC 68 test method only	Duration	Requirements	
			$\Delta R/R(\%)$	$\Delta B/B(\%)$
Storage at +25°C	Ha	1000h	±3	±1
Dry heat at +125°C	B	1000h	±5	±2
Thermal shock -25 to +125°C	Na	5 cycles	±3	±2
Damp heat at +40°C	Ca	1000h	±5	±3
Max. dissipation at T _{amb} = +55°C		1000h	±5	±2
Robustness of terminations tensile strength 10N bending 5N	U Ua Ub	10s 2 times	Leads should neither come loose nor break	
Soldering solderability at 230 ±10°C	T para 3. 2. 3	3 to 4s	Leads must be solderable with solder containing resin flux, initially, and after six months storage	
resistance to heat at 230 ±10°C	para 3. 2. 4	3 to 4s	±2	±2

NEGATIVE TEMPERATURE COEFFICIENT THERMISTORS

(2322 644 90005)

VA1104

This data sheet should be read in conjunction with
NEGATIVE TEMPERATURE COEFFICIENT THERMISTORS - INTRODUCTORY NOTES

APPLICATION

For diode and switch protection in colour television receivers.

DIMENSIONS (millimetres)

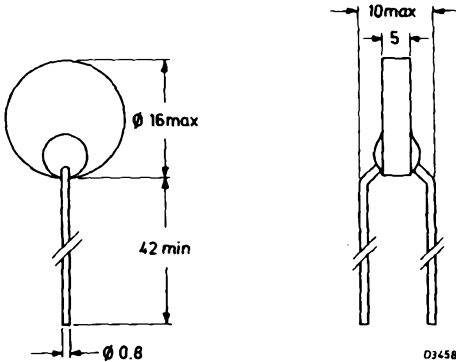

ELECTRICAL DATA

Rated zero power resistance (R_{25})	B-value ($B \frac{25}{85}$) (approx.)	Code No.	Type No.
min. 15Ω	3350K	2322 644 90005	VA1104

Maximum current (r. m. s.) at $T_{amb} = 55^{\circ}\text{C}$	2.2	A
Maximum resistance at $T_{amb} = 25^{\circ}\text{C}, I_{r. m. s.} = 2.2\text{A max.}$	1	Ω
Operating temperature category at zero power	-25 to +155	$^{\circ}\text{C}$
at maximum power	0 to +55	$^{\circ}\text{C}$
Dissipation factor (δ) approx.	17	mW/degC
Thermal time constant (τ) approx.	148	s
Maximum repetitive peak voltage (50 to 60Hz)	380	V

Mullard

MOUNTING

The thermistor should be mounted to allow free circulation of air around it, and at least 10mm from a printing-wiring board.

ORDERING PROCEDURE

The thermistor should be ordered by the type or code number quoted in the table. They may be supplied in packs marked with either type or code number.

TESTS AND REQUIREMENTS

Tests	IEC68 test method only	Duration	Requirements $\Delta R/R_{25}(\%)$
Cold at -25°C	A	1000h	± 10
Storage at $+25^{\circ}\text{C}$	Ha	1000h	± 10
Dry heat $+155^{\circ}\text{C}$	B	1000h	± 20
Thermal shock -25 to $+155^{\circ}\text{C}$	Na	5 cycles	± 20
Damp heat at $+40^{\circ}\text{C}$	Ca	1000h	± 15
Maximum current at $T_{\text{amb}} = +25^{\circ}\text{C}$		1000h	± 20
Cycling			
quick		250 cycles 5s on/5s off	± 20
slow		2000 cycles 1 min on/9 min off	± 20
Robustness of terminations	U		Leads should neither come loose nor break
tensile strength 20N	Ua	10s	
bending 10N	Ub	2 times	
Soldering	T		Leads must be solderable with solder containing resin flux, initially, and after six months storage
solderability at $230 \pm 10^{\circ}\text{C}$	para 3. 2. 3	3 to 4s	
resistance to heat at $230 \pm 10^{\circ}\text{C}$	para 3. 2. 4	3 to 4s	± 2

Mullard

VA1104 Page 3

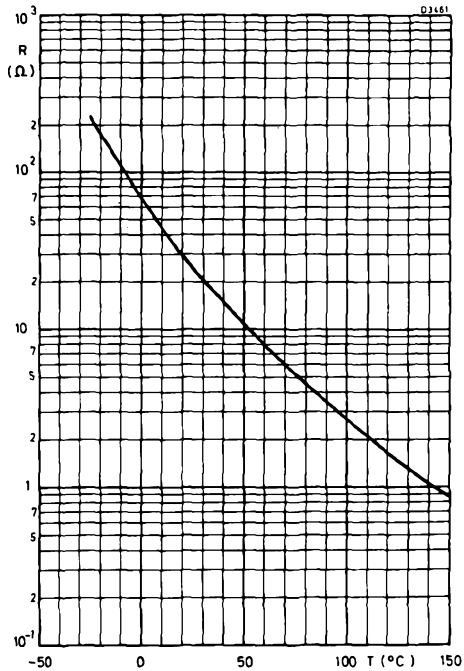

RESISTANCE/TEMPERATURE CHARACTERISTIC

NEGATIVE TEMPERATURE COEFFICIENT THERMISTOR

(2322 644 90005)

VA1104

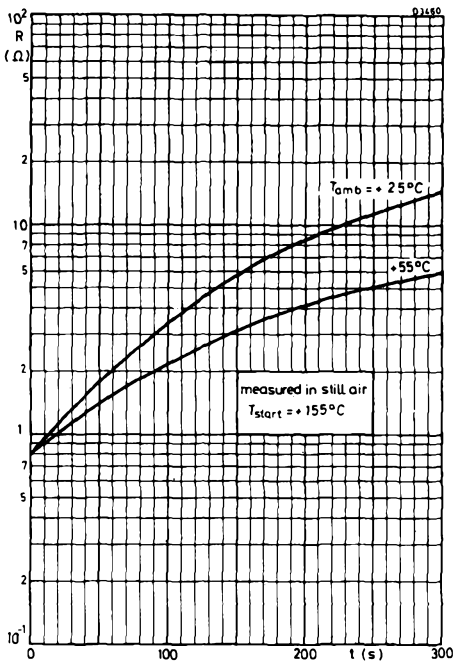

COOLING CHARACTERISTICS

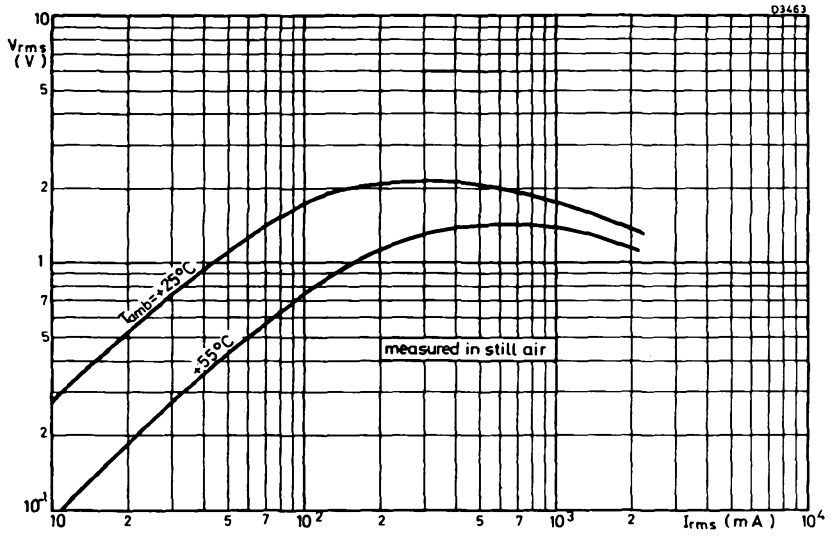

VOLTAGE/CURRENT CHARACTERISTICS

NEGATIVE TEMPERATURE COEFFICIENT THERMISTORS

(2322 634 and 2322 627 Series)

VA3100 VA3400
VA3200 VA3700
Series

This data sheet should be read in conjunction with
NEGATIVE TEMPERATURE COEFFICIENT THERMISTORS - INTRODUCTORY NOTES

INTRODUCTION

Miniature bead thermistors are available as plain beads, and in three types of glass encapsulation, as follows: -

Description	Code No.	Type No.
Plain bead with radial leads	2322 634 11...	VA3100 Series
Bead mounted in a gas filled encapsulation with axial leads	2322 634 21...	VA3200 Series
Glass dipped bead with radial leads	2322 627 21...	VA3400 Series
Thermometer type, with the bead sealed into the tip of a glass tube	2322 627 11...	VA3700 Series

ORDERING PROCEDURE

The thermistors should be ordered by the type or code number quoted in the tables over-leaf. They may be supplied in packs marked with either the type or code number.

Mullard

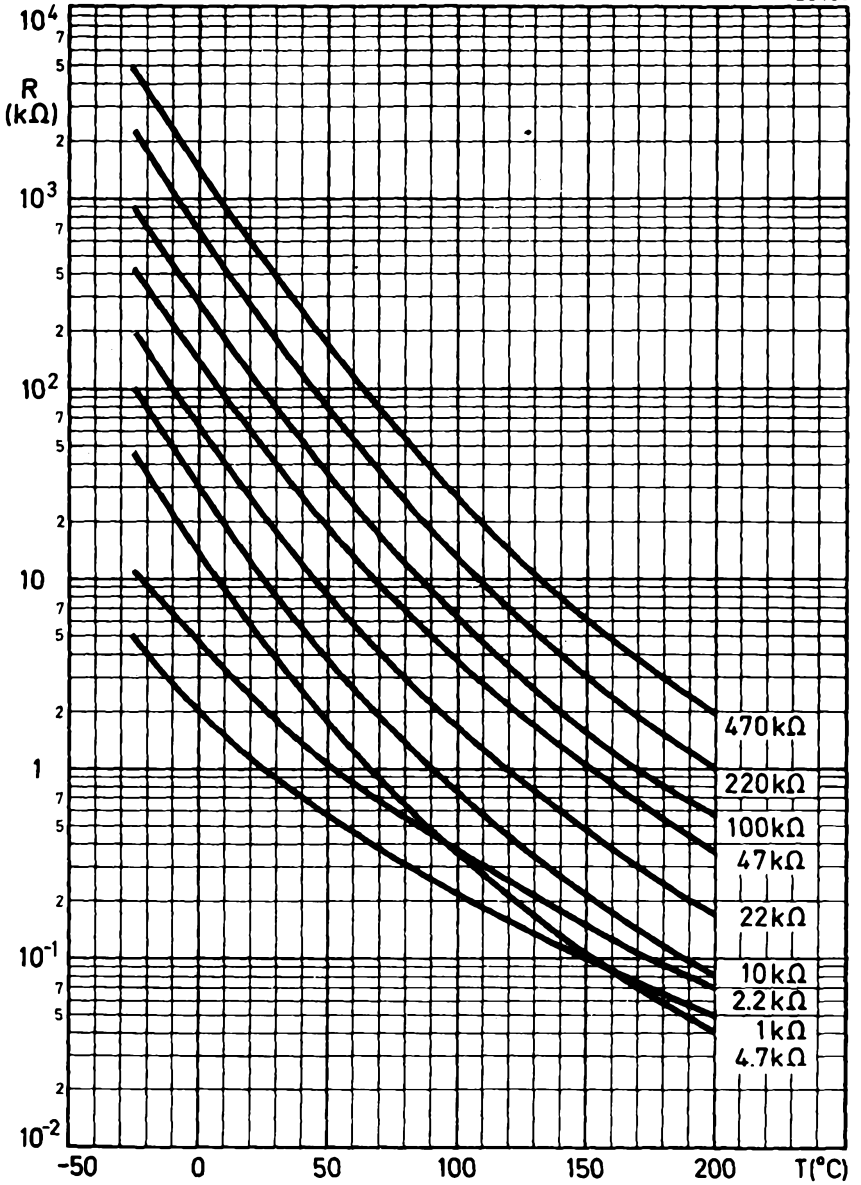

RESISTANCE/TEMPERATURE CHARACTERISTICS
FOR VA3100, VA3200, VA3400, VA3700 SERIES

**NEGATIVE TEMPERATURE
COEFFICIENT THERMISTORS**
(2322 634 and 2322 627 Series)

**VA3100 VA3400
VA3200 VA3700**
Series

VA3100 SERIES (2322 634 11... Series)

APPLICATION

Plain bead for use where very small size and high thermal sensitivity are desired.

DIMENSIONS (millimetres)

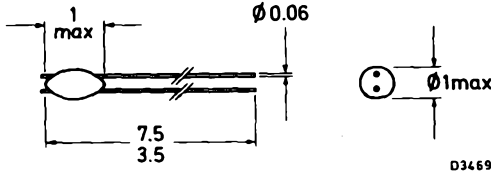

Leads: - Platinum - iridium alloy *

ELECTRICAL DATA



Rated zero power resistance (R_{25}) $\pm 20\%$	B-value ($B \frac{25}{85}$) $\pm 5\%$	Code No.	Type No.
1 000 Ω	2375K	2322 634 11102	VA3100
2 200 Ω	2600K	2322 634 11222	VA3102
4 700 Ω	3725K	2322 634 11472	VA3104
10 000 Ω	3875K	2322 634 11103	VA3106
22 000 Ω	3850K	2322 634 11223	VA3108
47 000 Ω	3850K	2322 634 11473	VA3110
100 000 Ω	3800K	2322 634 11104	VA3112
220 000 Ω	3920K	2322 634 11224	VA3114
470 000 Ω	4030K	2322 634 11474	VA3116

Maximum power rating at	60	mW
Dissipation factor (δ) (approx.)	0.1	mW/K (mW/ $^{\circ}$ C)
Operating temperature range, at zero power	-25 to +200	$^{\circ}$ C
at maximum power	0 to +55	$^{\circ}$ C
Stability, ΔR_{25} , after 1000 hours at T_{max} .	<3	%

* NOTE This material cannot be soldered but must be welded or mechanically clamped.

VA3200 SERIES (2322 634 21...Series)

APPLICATION

Double ended glass type used to compensate for small power changes in electronic circuits.

DIMENSIONS (millimetres)

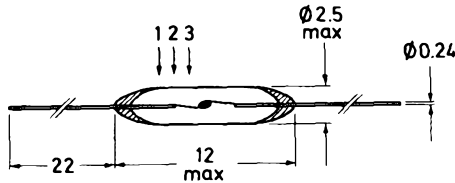

D3470

→ ELECTRICAL DATA

Rated zero power resistance (R_{25}) $\pm 20\%$	B-value ($B \frac{25}{85}$) $\pm 5\%$	Colour coding			Code No.	Type No.
		1	2	3		
1 000 Ω	2375K	brown	black	red	2322 634 21102	VA3200
2 200 Ω	2600K	red	red	red	2322 634 21222	VA3202
4 700 Ω	3725K	yellow	violet	red	2322 634 21472	VA3204
10 000 Ω	3875K	brown	black	orange	2322 634 21103	VA3206
22 000 Ω	3850K	red	red	orange	2322 634 21223	VA3208
47 000 Ω	3850K	yellow	violet	orange	2322 634 21473	VA3210
100 000 Ω	3800K	brown	black	yellow	2322 634 21104	VA3212
220 000 Ω	3920K	red	red	yellow	2322 634 21224	VA3214
470 000 Ω	4030K	yellow	violet	yellow	2322 634 21474	VA3216

Maximum power rating	60	mW
Dissipation factor (δ) (approx.)	0.4	mW/K (mW/°C)
Thermal time constant (τ) (approx.)	9	s
Operating temperature range, at zero power	-25 to +200	°C
at max. power	0 to +55	°C
Stability, ΔR_{25} , after 1000 hours at T_{max} .	<1	%

COLOUR CODING

The colour code on the body identifies the thermistors in this series.

**NEGATIVE TEMPERATURE
COEFFICIENT THERMISTORS**
(2322 634 and 2322 627 Series)

**VA3100 VA3400
VA3200 VA3700**
Series

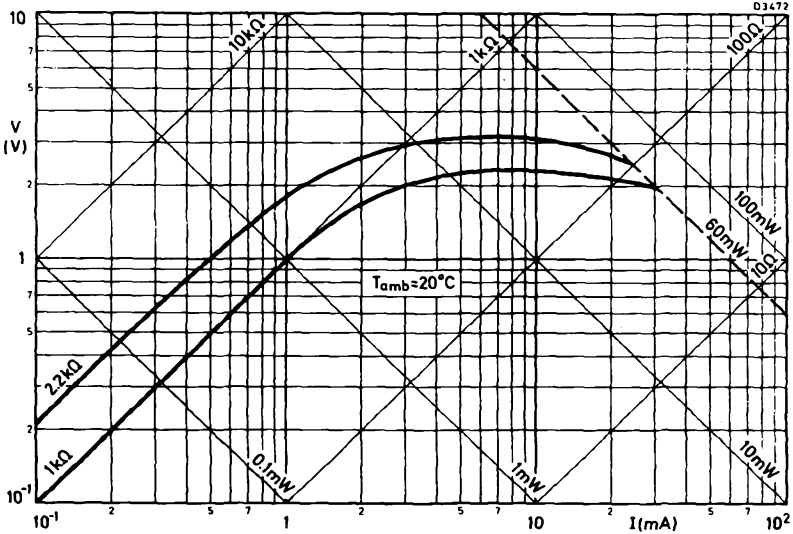
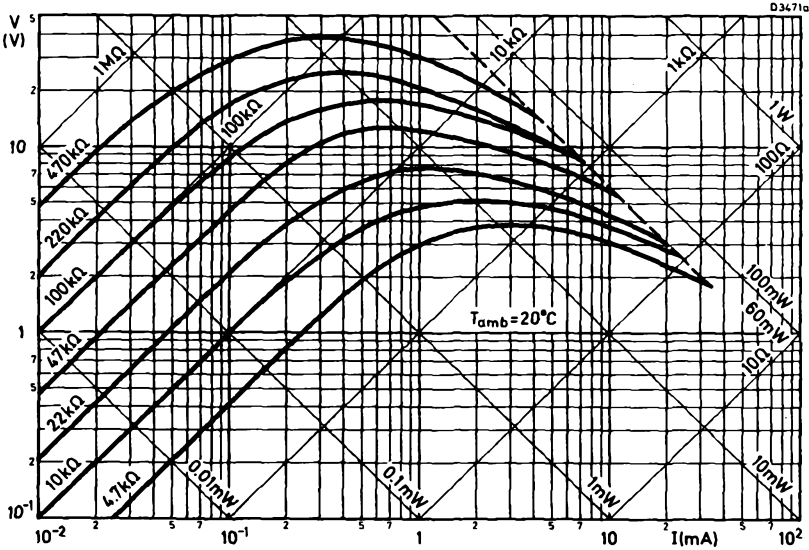

VOLTAGE/CURRENT CHARACTERISTICS
FOR VA3200 SERIES ONLY

VA3400 SERIES (2322 627 21... Series)

APPLICATION

Glass dipped bead type for use where small size is desired in temperature measurement and control applications.

DIMENSIONS (millimetres)

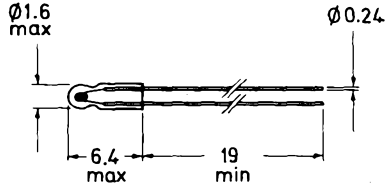

D3473a

→ ELECTRICAL DATA

Rated zero power resistance (R_{25}) $\pm 20\%$	B-value ($B \frac{25}{85}$)	Code No.	Type No.
1 000 Ω	2375K $\pm 10\%$	2322 627 21102	VA3400
2 200 Ω	2600K $\pm 10\%$	2322 627 21222	VA3402
4 700 Ω	3725K $\pm 5\%$	2322 627 21472	VA3404
10 000 Ω	3875K $\pm 5\%$	2322 627 21103	VA3406
47 000 Ω	3850K $\pm 5\%$	2322 627 21473	VA3410
100 000 Ω	3800K $\pm 5\%$	2322 627 21104	VA3412
220 000 Ω	3920K $\pm 5\%$	2322 627 21224	VA3414

Maximum power rating	100	mW
Dissipation factor (δ) (approx.)	0.7	mW/K (mW/ $^{\circ}$ C)
Thermal time constant (τ) (approx.)	10	s
Operating temperature range, at zero power	-25 to +200	$^{\circ}$ C
at max. power	0 to +55	$^{\circ}$ C
Stability, ΔR_{25} , after 1000 hours at T_{max} .	<3	%

NEGATIVE TEMPERATURE COEFFICIENT THERMISTORS

(2322 634 and 2322 627 Series)

VA3100 VA3400
VA3200 VA3700
Series

VA3700 SERIES (2322 627 11... Series)

APPLICATION

Thermometer type for use in measurement and control of temperature.

DIMENSIONS (millimetres)

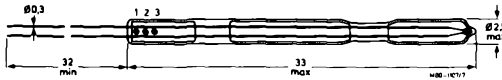

ELECTRICAL DATA

Rated zero power resistance (R_{25}) $\pm 20\%$	B-value ($B \frac{25}{85}$) $\pm 5\%$	Colour coding			Code No.	Type No.
		1	2	3		
1 000 Ω	2375K	brown	black	red	2322 627 11102	VA3700
2 200 Ω	2600K	red	red	red	2322 627 11222	VA3702
4 700 Ω	3725K	yellow	violet	red	2322 627 11472	VA3704
10 000 Ω	3875K	brown	black	orange	2322 627 11103	VA3706
22 000 Ω	3850K	red	red	orange	2322 627 11223	VA3708
47 000 Ω	3850K	yellow	violet	orange	2322 627 11473	VA3710
100 000 Ω	3800K	brown	black	yellow	2322 627 11104	VA3712
220 000 Ω	3920K	red	red	yellow	2322 627 11224	VA3714
470 000 Ω	4030K	yellow	violet	yellow	2322 627 11474	VA3716

Maximum power rating	100	mW
Dissipation factor (δ) (approx.)	0.7	mW/K (mW/°C)
Thermal time constant (τ) (approx.)	14	s
Operating temperature range, at zero power	-25 to +200	°C
at max. power	0 to +55	°C
Stability, ΔR_{25} , after 1000 hours at T_{max} .	<3	%

COLOUR CODING

The colour code on the body identifies the thermistors in this series.

Mullard

N.T.C. THERMISTOR disc

QUICK REFERENCE DATA

Resistance value at + 25 °C (R_{25})		1.1, 10 and 33 Ω
$B_{25/85}$ -value		2600, 2950 and 3250 \pm 5% K
Maximum power dissipation ($T_{amb} = 25$ °C)		1 W
Dissipation factor (δ)	approx.	10 mW/°C
Thermal time constant (τ)	approx.	60 s
Operating temperature range		
at zero power		- 25 to + 125 °C
at maximum power		0 to + 55 °C

APPLICATIONS

General purpose applications including temperature measurement and circuit compensation. Other similar thermistors are detailed in the VA1033 etc. data sheets.

COLOUR CODING

Three colour bands on the body identify the resistance at 25 °C and hence the types in the series. A tolerance of \pm 10% is indicated by an additional silver band at the top of the component. The identification lacquer does not provide electrical insulation.

ORDERING PROCEDURE

The thermistors should be ordered by the type number quoted in the table.

Notes

1. This data sheet should be read in conjunction with NEGATIVE TEMPERATURE COEFFICIENT THERMISTORS - INTRODUCTORY NOTES.
2. The 2322 610 11118 is electrically equivalent to and replaces the VA1037.
The 2322 610 12109 is electrically equivalent to and replaces the VA1110.
The 2322 610 11339 is electrically equivalent to and replaces the VA1077.



MECHANICAL DATA

Dimensions in mm

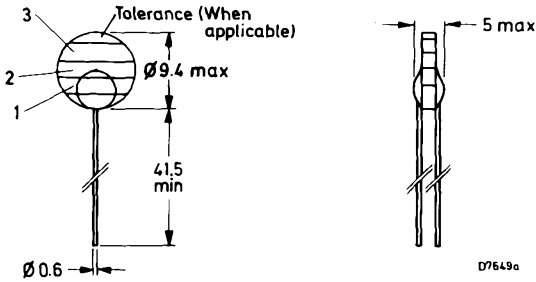

ELECTRICAL DATA

rated zero power resistance (R ₂₅) Ω	B-value (B ²⁵ / ₈₅) ± 5% K	colour bands			type number
		1	2	3	
1.1 ± 20%	2600	brown	brown	gold	2322 610 11118
10 ± 10%	2950	brown	black	black	2322 610 12109
33 ± 20%	3250	orange	orange	black	2322 610 11339

10% is indicated by an additional silver band at the top of the component.

Maximum power rating at	1 W
Operating temperature range at zero power	- 25 to + 125 °C
at maximum power	0 to + 55 °C
Dissipation factor (δ)	approx. 10 mW/K (mW/°C)
Thermal time constant (τ)	approx. 60 s



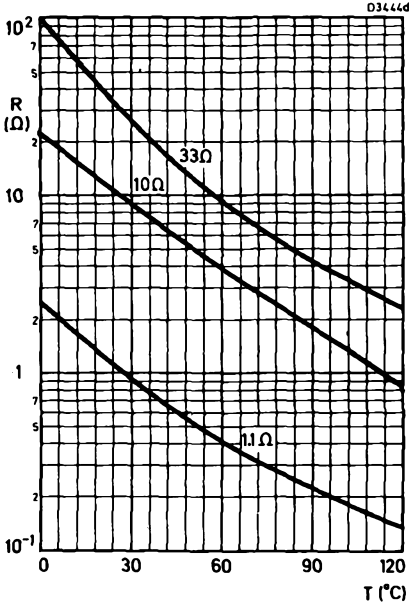

Resistance/temperature characteristics

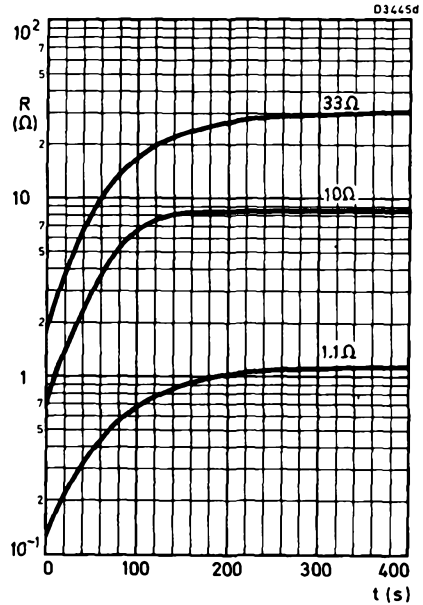

Cooling characteristics

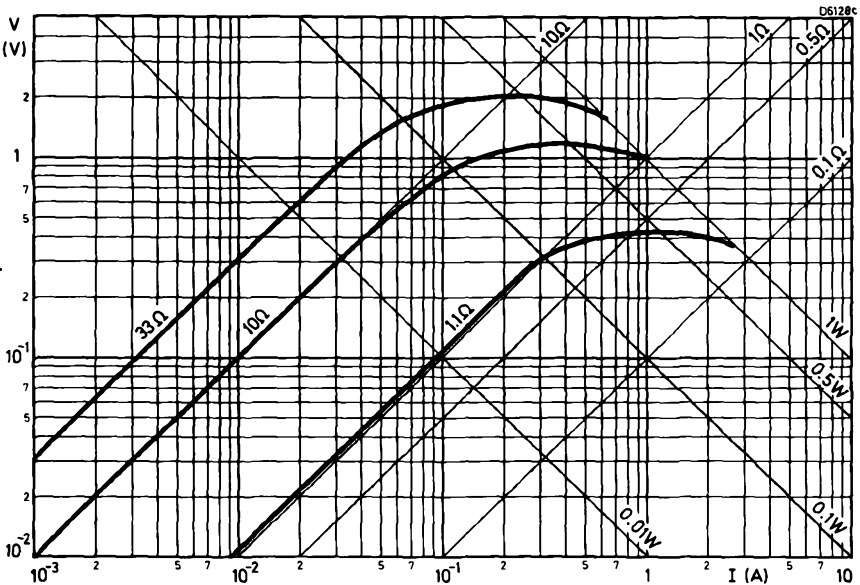

Voltage/current characteristics



NEGATIVE TEMPERATURE COEFFICIENT THERMISTORS

2322 640 90004
90005
90013
90015

This data sheet should be read in conjunction with
NEGATIVE TEMPERATURE COEFFICIENT THERMISTORS - INTRODUCTORY NOTES

QUICK REFERENCE DATA				
	90013	90015	90004	90005
Temperature range	-30 to -10 °C	-10 to +25 °C	25 to 100 °C	100 to 200 °C
Resistance at -30 °C	50 kΩ	-	-	-
-20 °C	27 kΩ	-	-	-
-10 °C	15 kΩ	15 kΩ	-	-
25 °C	-	2.7 kΩ	12 kΩ ± 7%	-
100 °C	-	-	0.95 kΩ ± 5%	16.7 kΩ ± 7%
200 °C	-	-	-	1.12 kΩ ± 7%

APPLICATION

Four types of 'two-point n.t.c. thermistors' have been developed, each matched to a range of temperatures and having its resistance value and tolerance specified at least at two points, one of which is close to the upper and one close to the lower limit of its temperature range. The temperature ranges are: -10 to -30 °C for temperature control of deep freezers; -10 to +25 °C for refrigerators, room temperature and industrial process control; 25 to 100 °C for hot water control and 100 to 200 °C for boilers, hot air and industrial process control. Their plastic encapsulation ensures that the thermistor element is fully protected from environmental conditions and is electrically isolated. The 640 90013 and 90015 replace the 640 90002 and 90003 which were previously available in this range.

DIMENSIONS (millimetres)

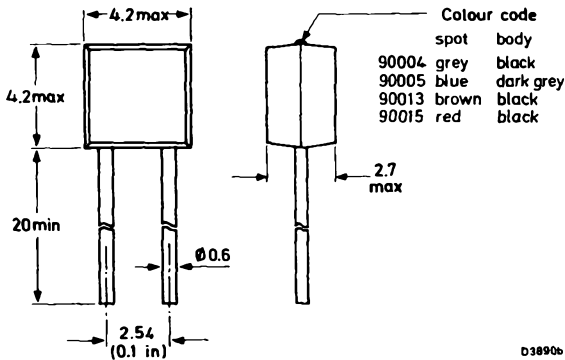

Mullard

ELECTRICAL DATA

	2322 640 90013	2322 640 90015	2322 640 90004	2322 640 90005
Temperature range	-30 to -10 °C	-10 to +25 °C	25 to 100 °C	100 to 200 °C
Resistance at $-30\text{ °C} \pm 1,5\text{ °C}$ } $-20\text{ °C} \pm 1,5\text{ °C}$ } $-10\text{ °C} \pm 1,5\text{ °C}$ } $25\text{ °C} \pm 1,5\text{ °C}$ } 25 °C } 100 °C } 200 °C } Note 1 Note 2	50 k Ω 27 k Ω 15 k Ω - - - -	- - 15 k Ω 2.7 k Ω - - -	- - - - 12 k Ω + 7% 0.95 k Ω \pm 5% -	- - - - - 16.7 k Ω \pm 7% 1.12 k Ω \pm 7%
B-value (B $\frac{25}{85}$)	4000 K	4000 K	3750 K	4300 K
Maximum dissipation in air	0.25 W	0.25 W	0.25 W	0.25 W
Dissipation factor (δ) air (Note 3) heatsink (Note 4)	6.7 mW/°C 16 mW/°C	6.7 mW/°C 16 mW/°C	7 mW/°C 19 mW/°C	7 mW/°C 17.5 mW/°C
Thermal time constant (τ) air (Note 1) heatsink (Note 4)	17 s 6 s	17 s 6 s	19 s 10 s	19 s 12 s
Operating temperature category zero power maximum power	-55 to +85 °C -55 to +55 °C	-55 to +85 °C -55 to +55 °C	-10 to +125 °C 0 to +55 °C	-25 to +200 °C 0 to +55 °C
Voltage proof (r. m. s.) terminals to heatsink (Note 3)	350 V	350 V	350 V	350 V
Minimum insulation resistance, terminals to heatsink measured at d. c. voltage of 100 V	100 M Ω	100 M Ω	100 M Ω	100 M Ω

NEGATIVE TEMPERATURE COEFFICIENT THERMISTORS

2322 640 90004
90005
90013
90015

NOTES

1. The 2322 640 90013 and 90015 are defined in terms of a fixed resistance value and tolerated temperature. The resistance value given in the electrical data will be obtained within the tolerance on temperature, e.g., the 2322 640 90013 will have a resistance value of 50 k Ω between the limits of -31,5 and -28,5 $^{\circ}$ C.
2. The 2322 640 90004 and 90005 are defined in terms of a fixed temperature and tolerated resistance value. At the temperature given in the electrical data, the resistance will be within the tolerance quoted, e.g., the 2322 640 90004 at 25 $^{\circ}$ C will have a resistance value within 12 k $\Omega \pm 7\%$.
3. Measurements made in still air.
4. Measurements made in still air when the specimen is mounted on a square heatsink 100 \times 100 \times 1,5 mm.

MOUNTING

By clip for surface mounting or self supporting by its own leads for air temperature measurement.

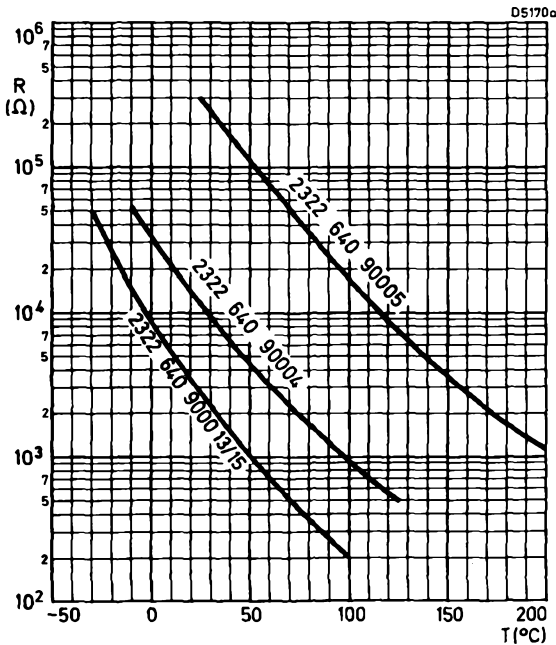

Resistance/temperature characteristics of 2322 640 90004/5/13/15

Mullard

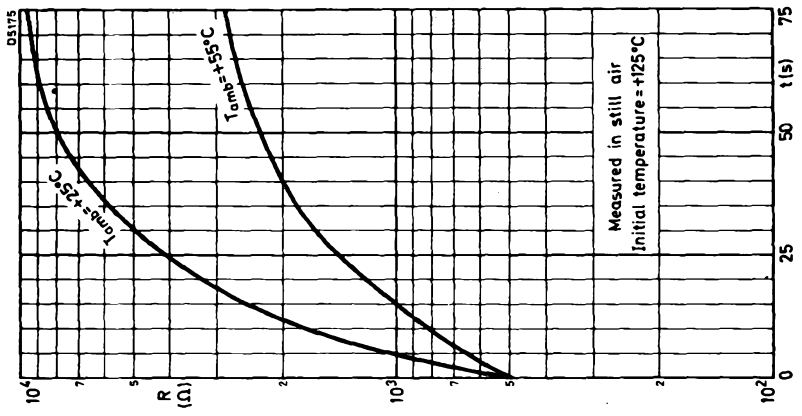
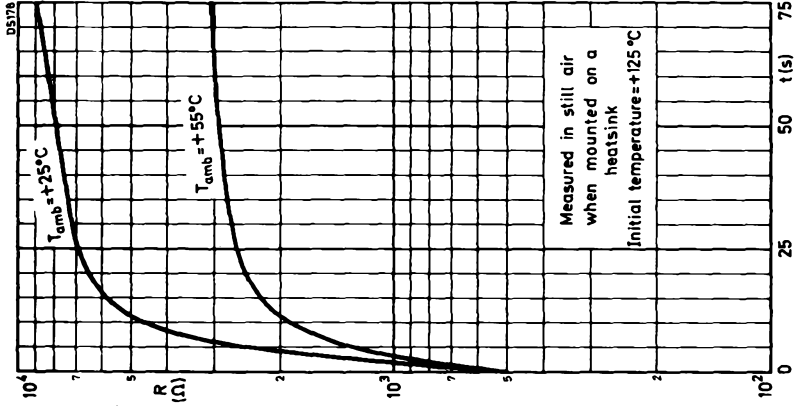

Cooling characteristics of 2322 640 90004

**NEGATIVE TEMPERATURE
COEFFICIENT THERMISTORS**

**2322 640 90004
90005
90013
90015**

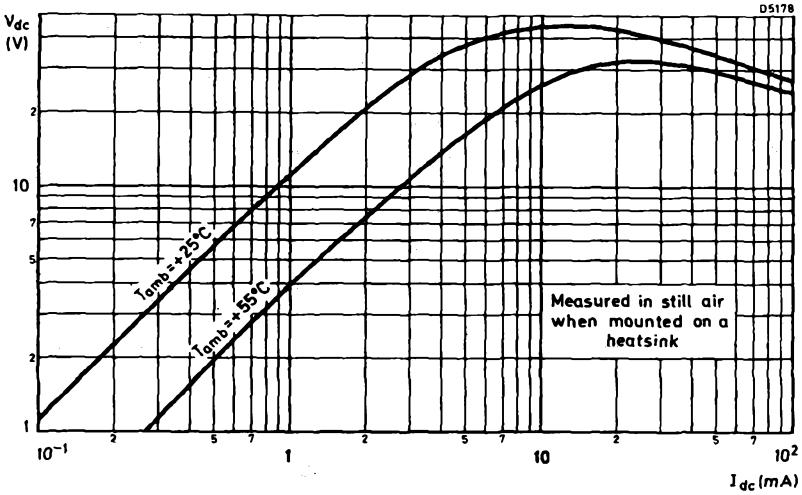
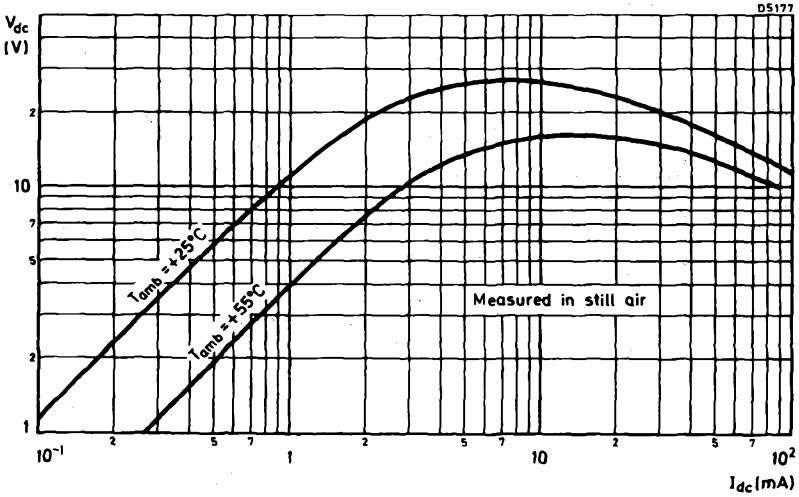

Voltage/current characteristics of 2322 640 90004

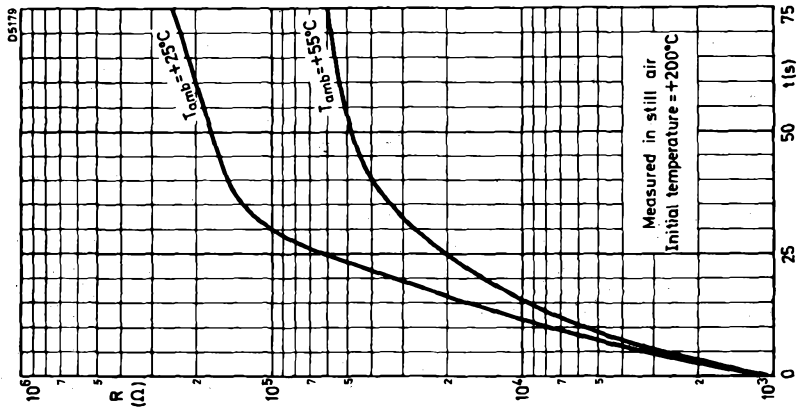
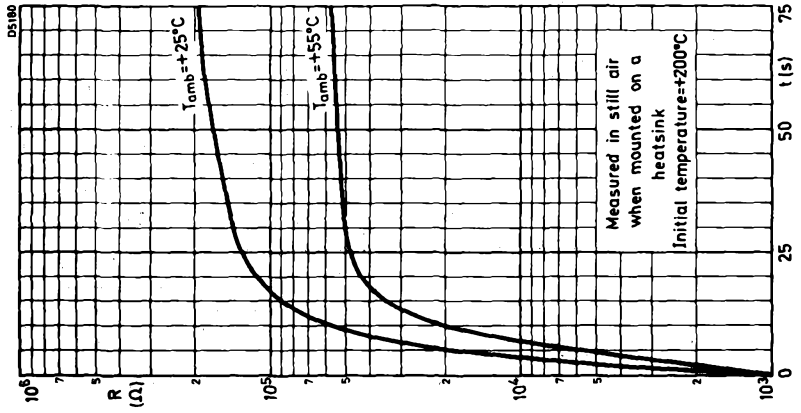

Cooling characteristics of 2322 640 90005

**NEGATIVE TEMPERATURE
COEFFICIENT THERMISTORS**

**2322 640 90004
90005
90013
90015**

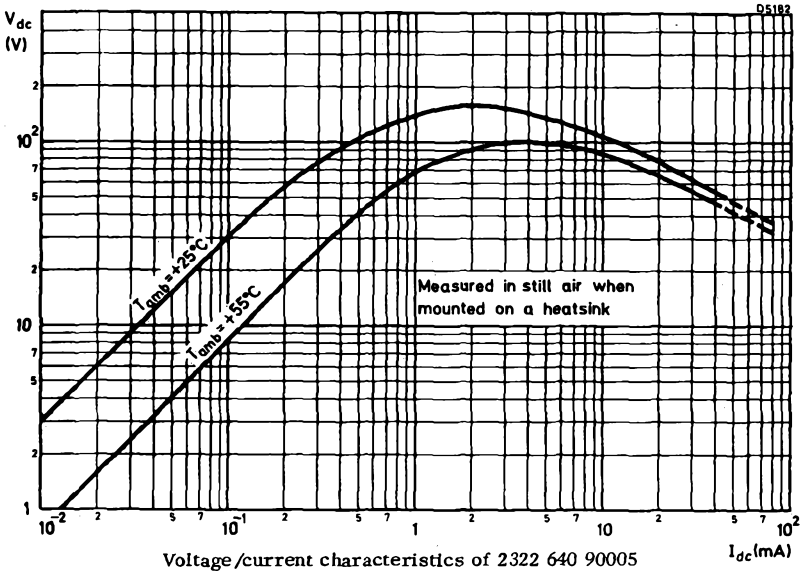
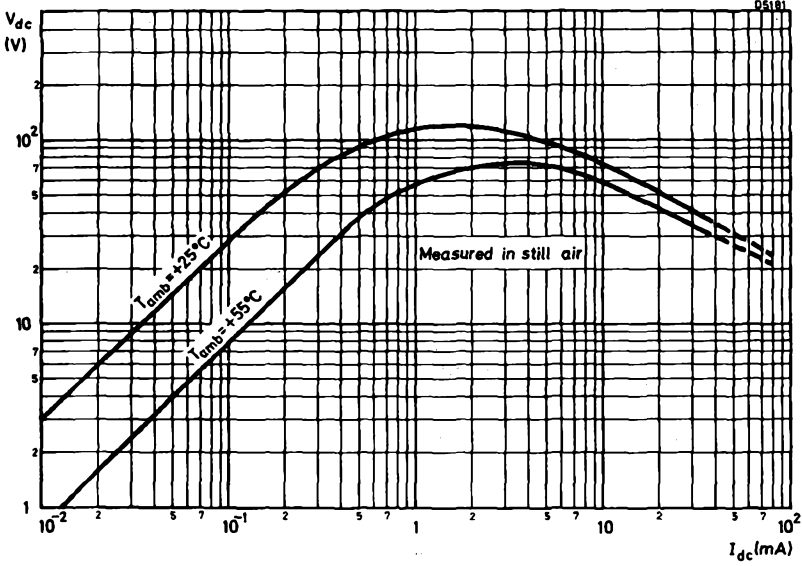

Mullard

POSITIVE TEMPERATURE COEFFICIENT THERMISTORS

H

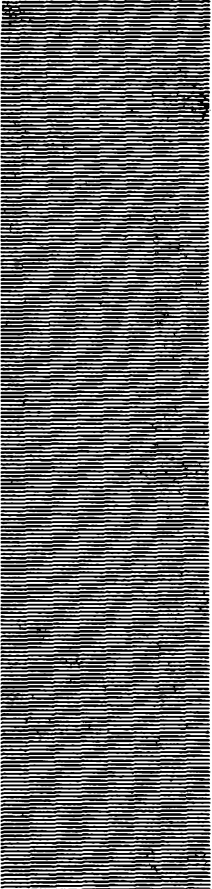

H

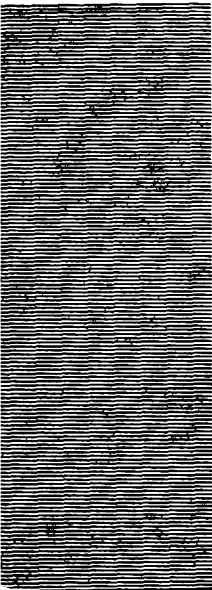

P. T. C. thermistors are supplied in packages marked with either the Mullard E or VA number, or a 12 digit number. A data summary and conversion list is available.

Additionally, both numbers appear on each data sheet.

INTRODUCTION

Positive Temperature Coefficient (P. T. C.) thermistors are resistors which have a high positive temperature coefficient of resistance over a specified temperature range. They differ from n. t. c. thermistors in several aspects, for example: -

- (1) The temperature coefficient of a p. t. c. thermistor is only positive over a limited temperature range; outside this range the coefficient is either zero or negative.
- (2) The absolute value of the temperature coefficient of a p. t. c. thermistor is normally higher than that for an n. t. c. thermistor.

P. T. C. thermistors are prepared from BaTiO_3 , or solid solutions of BaTiO_3 and SrTiO_3 . Ions of a different valency are introduced to produce extra electrons on the Ti-ions. The two methods of achieving this are either the substitution of trivalent ions (such as La^{3+} or Bi^{3+}) for Ba, or substitution of pentavalent ions (such as Sb^{5+} or Nb^{5+}) for Ti.

If carefully prepared in the absence of oxygen, these constituents produce a semiconducting material with a weak negative temperature coefficient of resistance. The p. t. c. effect, obtained by firing these constituents in oxygen, is caused by the penetration of oxygen along the pores and crystal boundaries during the cooling part of the firing process. The oxygen atoms thus absorbed attract electrons from a thin zone of the semiconducting crystals. Electrical potential barriers are formed in these zones, consisting of a negative surface charge and, on both sides of this, a positive space charge due to the presence of the now uncompensated foreign ions. These barriers cause the extra resistance of the p. t. c. thermistor.

The manufacturing process is similar to that used in the ceramic industry. After intensive mixing, and the addition of a plastic binder, the material is shaped into the appropriate forms. The parts are then sintered at high temperatures. Electrical contacts are made using silver paste, vacuum deposition or metal spraying techniques.

ELECTRICAL PROPERTIES

Resistance/temperature characteristics

The relationship between resistance and temperature for a p. t. c. thermistor is difficult to express in a compact form due to the complex nature of the characteristic. Fig. 1 compares the resistance/temperature curves for p. t. c. and n. t. c. thermistors. It clearly indicates the three modes of temperature dependency of the resistance of a p. t. c. thermistor.

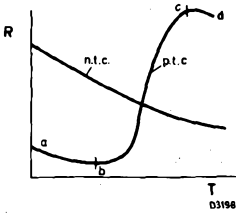

Fig. 1 Resistance/temperature characteristics of p. t. c. and n. t. c. thermistors

P. T. C. thermistors have a zero or negative temperature coefficient of resistance at low temperatures (ab), a high positive coefficient over mid-range temperatures (bc), and a zero or negative coefficient at higher temperatures (cd).

Over the mid-range of temperatures the resistance/temperature relationship can be approximated to:

$$R_T = A + Ce^{BT}, \text{ where } T_1 < T < T_2 \dots\dots (1)$$

where, R_T = resistance at a temperature T, in ohms

T = temperature in kelvin

T_1 = lower temperature limit for formula

T_2 = upper temperature limit for formula

A, B and C = constants for the thermistor.

From equation 1 by differentiation, the temperature coefficient (α) can be shown as:

$$\alpha = \frac{1}{R} \cdot \frac{dR}{dT} = \frac{BCe^{BT}}{A + Ce^{BT}} \dots\dots (2)$$

$$\alpha = 100B\% \text{ per deg C, where } R_T \gg A$$

In practice, however, it seldom occurs that the resistance/temperature characteristic can be described by the above, or any other, simple formula. Therefore, calculations must be based on graphical methods. The switch temperature T_S has been introduced as a practical indication of the temperature at which the p. t. c. thermistor starts to have a usable positive temperature coefficient of resistance. T_S is defined as the higher of two temperatures at which the resistance of the p. t. c. thermistor is twice its minimum value.

Voltage/current characteristic

The voltage/current characteristic of a p.t.c. thermistor depends on the resistance/temperature characteristic, on the ambient temperature, and the dissipation constant. The voltage/current characteristic follows a straight line (Ohm's law) when the power dissipated is insufficient to heat the thermistor above ambient temperature. When self heating causes a rise in body temperature above T_S , there is a corresponding decrease in the current. Figure 2 illustrates the voltage/current characteristic of a p.t.c. thermistor at several different ambient temperatures.

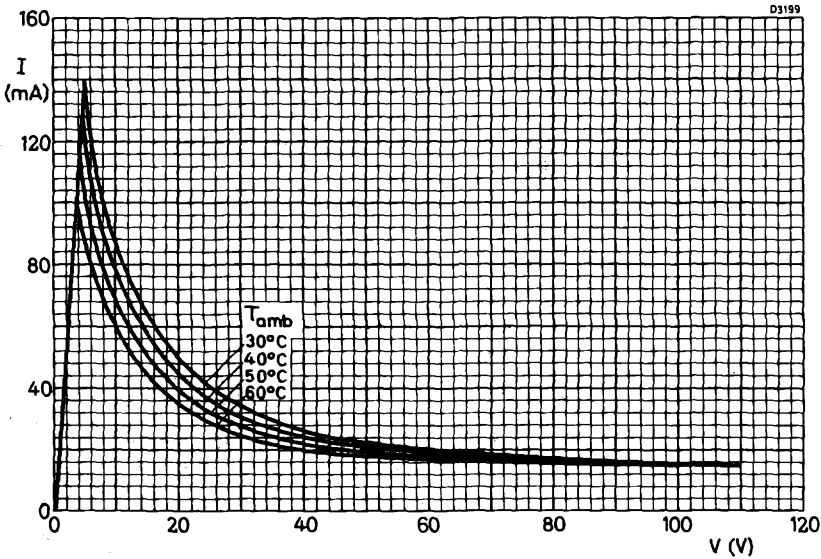

Fig. 2
Voltage/current characteristic at different ambient temperatures

In fig. 2 the characteristic has been plotted on a linear scale; in practice a logarithmic scale is more often used as shown in fig. 3, to which dissipation and resistance parameters are added.

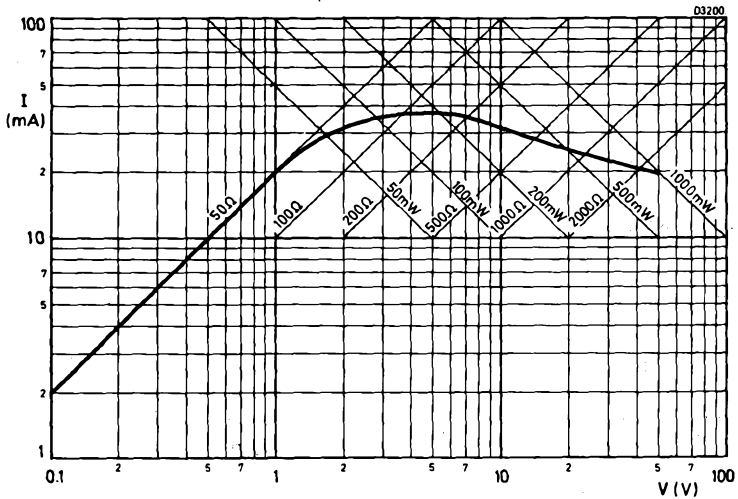

Fig. 3
Voltage/current characteristic of a typical p. t. c. thermistor with
dissipation and resistance as parameters

Figures 2 and 3 show that p. t. c. thermistors exhibit a certain degree of voltage dependency at the higher voltages. It is for this reason that the voltage/current characteristic is difficult to calculate from the resistance/temperature curve and the dissipation constant. It is, however, possible to calculate the peak of the voltage/current characteristic to reasonable accuracy, if the resistance/temperature characteristic and the dissipation constant are known.

In any resistor, power consumption is given by $W = I^2 R$ or $W = DT$ where D = dissipation constant and T = temperature rise.

$$\text{For small changes in power } \Delta W = 2IR\Delta I + I^2\Delta R \quad \dots\dots (3)$$

$$\text{or } \Delta W = D\Delta T \quad \dots\dots (4)$$

At the peak of the voltage/current characteristic of a p. t. c. thermistor a small change in the voltage will not produce a change in the current, therefore $\Delta I = 0$. If we use the subscript 'p' to denote values at the peak of the voltage/current characteristic, equations 3 and 4 may be rewritten as:

$$\Delta W_p = I_p^2 \Delta R_p \quad \dots\dots (5)$$

$$\Delta W_p = D\Delta T_p \quad \dots\dots (6)$$

Combining equations 5 and 6,

$$D\Delta T_p = I_p^2 \Delta R_p$$

or

$$\frac{\Delta T_p}{\Delta R_p} = \frac{I_p^2}{D} \dots\dots (7)$$

A value for $\frac{\Delta T_p}{\Delta R_p}$ can be simply found by a graphical method, from the resistance/temperature characteristic plotted on to a linear scale, as follows: -

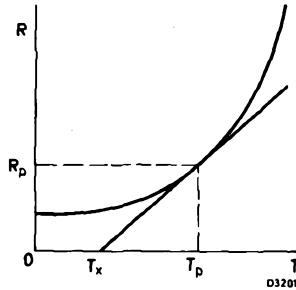

Fig. 4
Part of the resistance/temperature characteristic of a p. t. c. thermistor on a linear scale

In figure 4, the tangent to the curve at point R_p, T_p intersects the temperature ordinate at T_x , therefore: -

$$\frac{\Delta T_p}{\Delta R_p} = \frac{T_p - T_x}{R_p} \dots\dots (8)$$

Combining equations 7 and 8

$$T_p - T_x = \frac{I_p^2 \cdot R_p}{D} \dots\dots (9)$$

But,

$$\frac{I_p^2 \cdot R_p}{D} = \frac{W_p}{D} = T_p - T_{amb}$$

Therefore,

$$T_p - T_x = T_p - T_{amb}$$

$$T_x = T_{amb}$$

Thus, the tangent to the curve, of the temperature/resistance characteristic (plotted on a linear scale) at point R_p, T_p , intersects the temperature ordinate at T_{amb} .

Equation 8 may therefore be written as: -

$$\frac{\Delta T_p}{\Delta R_p} = \frac{T_p - T_{amb}}{R_p} \quad \dots\dots (10)$$

Combining equations 7 and 10,

$$\frac{I_p^2}{D} = \frac{T_p - T_{amb}}{R_p}$$

or

$$I_p = \sqrt{\frac{D(T_p - T_{amb})}{R_p}} \quad \dots\dots (11)$$

Summarising, the method of finding the peak value of current, at a known ambient temperature for a given p. t. c. thermistor is as follows: -

- (1) Replot the resistance/temperature characteristic curve (given in the data sheet) on to a linear scale.
- (2) Construct a tangent to the resultant curve, such that it passes through T_{amb} .
- (3) Read off the values of R_p and T_p and substitute, together with the value for D (given in the data sheet), into equation 11.

P. T. C. thermistors in series with a load

Due to the non-linearity of the voltage/current characteristic, it can be shown that three working points are possible when a load is connected in series with a p.t.c. thermistor (fig. 5).

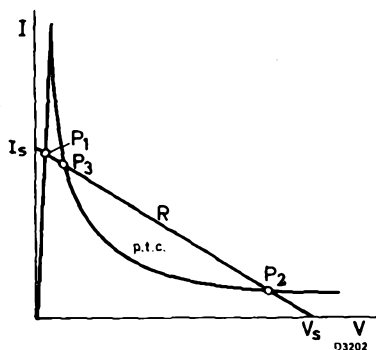

Fig. 5

A p.t.c. thermistor in series with a load showing the possible working points

The characteristic of a resistive load (R) is a straight line, which intersects the voltage axis at V_s (the supply voltage) and the current axis at I_s ($I_s = \frac{V_s}{R}$). P_1 and P_2 are stable working points, P_3 is an unstable working point.

When the voltage V_s is applied to the series combination of p.t.c. thermistor and resistor equilibrium will be reached at P_1 , a point having a relatively high current. P_2 can only be reached when the peak of the voltage/current characteristic of the p.t.c. thermistor lies below the load line of the resistor. This may occur when: -

- (1) V_s increases (figure 6)
- (2) the ambient temperature increases (figure 7)
- (3) the load resistance decreases (figure 8).

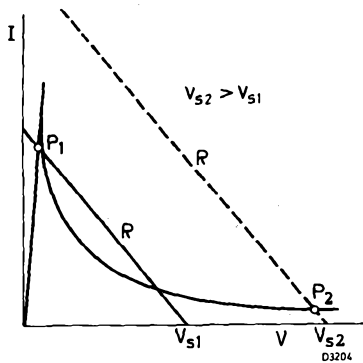

Fig. 6
The influence of supply voltage on
a p. t. c. thermistor/resistor
combination

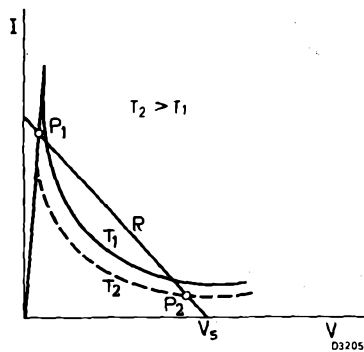

Fig. 8
The influence of ambient temperature
on a p. t. c. thermistor/resistor
combination

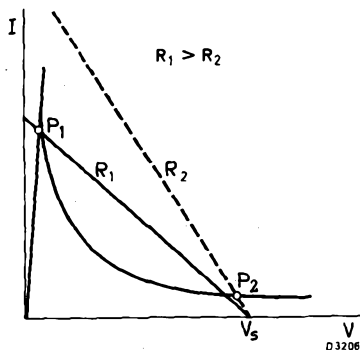

Fig. 8
The influence of load resistance
on a p. t. c. thermistor/resistor
combination

Current versus time characteristic

If a p. t. c. thermistor is connected in series with a resistor of such a value that the peak of the voltage/current characteristic lies under the resistance load line (fig. 8), the p. t. c. thermistor will heat up until its resistance value causes the stable working point P_2 to be reached (fig. 8). The time taken to reach point P_2 depends on:

- (1) the value of the resistor; the greater the value the longer the time taken (fig. 9)
- (2) the applied voltage; the higher the voltage the shorter the time taken (fig. 6)
- (3) the ambient temperature; the higher the ambient temperature the less time taken.

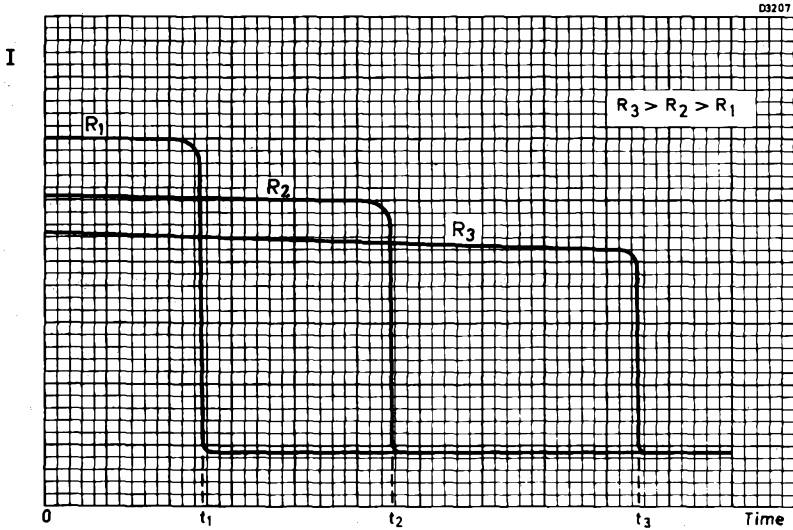

Fig. 9
The influence of resistance value on the current/time characteristic
of a p.t.c. thermistor/resistor combination

Voltage dependency

P. T. C. thermistors exhibit a certain degree of voltage dependency at higher voltages. The equivalent circuit of a normal p. t. c. thermistor is an ideal p. t. c. thermistor having no voltage dependency, in parallel with an ideal voltage dependent resistor (v. d. r.) conforming to $V \propto I^\beta$. Figure 10 shows the voltage/current characteristic of a normal p. t. c. thermistor compared with these "ideal" components. These have been plotted on a log scale and the p. t. c. thermistor curves represent measurements made under pulse conditions.

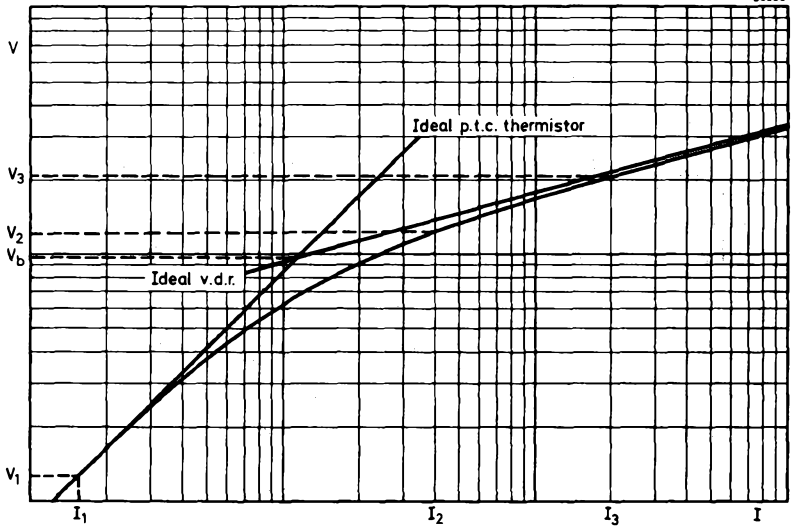

Fig. 10

Comparison of a normal p. t. c. thermistor to ideal components

It can be seen that the normal p. t. c. thermistor curve coincides with the ideal p. t. c. thermistor curve at low voltages where the characteristic follows a linear law, and with the ideal v. d. r. curve at high voltages where voltage dependency becomes effective. The two aspects of the voltage dependency of a p. t. c. thermistor are:

Balance voltage (V_b). The voltage at the intersection of the ideal p. t. c. thermistor and the ideal v. d. r. characteristic curves (see figure 10) is the balance voltage at which point the current through both ideal components is equal. Where applicable, balance voltage is given in data at a specified ambient temperature.

Voltage dependency (β). The voltage dependency of a p. t. c. thermistor can be calculated from:

$$\beta = \frac{\log V_3 - \log V_2}{\log (I_3 R - V_3) - \log (I_2 R - V_2)} \quad \dots\dots (12)$$

where,

V_2 = a pulse voltage greater than V_b

V_3 = a pulse voltage greater than V_2

I_2 = the current at V_2

I_3 = the current at V_3

$R = \frac{V_1}{I_1}$, measured at $V_1 < 1.5V$ d.c.

The voltage dependency (β) is temperature dependent; when specified it must be related to a specified temperature.

Thermal time constant

When a p.t.c. thermistor cools from a high to a low body temperature, with a constant ambient temperature and under zero power conditions, the expression for heat dissipated over time interval dt is as follows:

$$-HdT = D(T - T_{amb}) dt \quad \dots\dots (13)$$

where,

H = heat capacity in joules per deg. C

D = dissipation in watts per deg. C

Rearrangement of equation 13 gives:

$$\frac{-HdT}{(T - T_{amb})} = Ddt \quad \dots\dots (14)$$

In order to obtain the total time taken for a thermistor to cool from T_1 to T_2 equation 14 must be integrated to give:

$$H \left[\log_e \frac{(T_1 - T_{amb})}{(T_2 - T_{amb})} \right] = Dt$$

where,

$$\text{Thermal time constant } \frac{H}{D} = t \left[\log_e \frac{(T_1 - T_{amb})}{(T_2 - T_{amb})} \right]^{-1} \quad \dots\dots (15)$$

The thermal time constant quoted in the data is the time taken for a thermistor to change 63.2% of the difference between an initial body temperature and a final lower body temperature when subjected to an instantaneous temperature change at zero power conditions.

Tolerances

The data and tolerances published for p. t. c. thermistors vary according to the type of device, and its primary application.

It is usual to define the resistance and tolerance at 25°C, and at a higher temperature. As a guide the switch temperature (see page 2) is also given. The tolerance on switch temperature is usually a few degrees centigrade.

When p. t. c. thermistors are used as protection devices against over heating, for example in electric motors, the high temperature characteristics are closely defined, whereas wider tolerances are allowed on the relatively unimportant characteristics at 25°C. For current limiting purposes, for example in degaussing colour television receivers, current and voltage are specified at the appropriate ambient temperature.

APPLICATIONS

The applications of p. t. c. thermistors may be classified into two main groups:

1. Applications where the temperature of the thermistor is determined by the ambient medium.
2. Applications where the temperature of the thermistor is determined by the power dissipated in it.

Application examples

- (a) Temperature measurement and control. In these applications the p. t. c. thermistors are operated at a low power level to avoid self heating. Changes in ambient temperature cause changes in resistance which are monitored by a suitable circuit and used to regulate the heating or cooling source. P. T. C. thermistors in the windings of electric motors or transformers will sense over heating and a control circuit is used either to initiate a warning or to interrupt the supply. Similar applications exist in washing machines, boilers and fire alarms.
- (b) Current limitation, over voltage and short circuit protection. A p. t. c. thermistor may be included in a supply or signal line so that, under normal conditions, it remains in its low resistance state. Any increase in current will cause the thermistor to heat up and its resistance to increase, thus limiting the current flowing through it.
- (c) Delay circuits in conjunction with relays, coils, etc. The p. t. c. thermistor is used in series with the relay. Its initial low resistance gradually increases so that the voltage across the relay falls, and it becomes de-energised. Similarly in a colour television receiver, a p. t. c. thermistor is used in series with the degaussing coils in conjunction with a voltage dependent resistor.
- (d) For spark suppression across switch contacts. When the contacts open, the low resistance of the p. t. c. thermistor connected across the contacts absorbs the energy of the spark.
- (e) Liquid level indication. A p. t. c. thermistor immersed in a liquid will be subjected to a greater cooling influence, and therefore have a lower resistance than one in air.
- (f) A p. t. c. thermistor may be used in the bias network of a transistor circuit to turn it off should the temperature exceed a safe limit.

NOTES

In all applications the following precautions must be observed:

- (a) Do not use thermistors in series to obtain higher dissipations, or to enable the use of higher working voltages.
- (b) Care should be taken that the maximum voltage is not exceeded, especially in the high resistance condition.
- (c) Unprotected thermistors should not be used in conducting, corrosive, oxidising or reducing fluids.

DEFINITIONS

Zero power resistance (R_T)

The resistance value of a thermistor measured at a specified temperature T , with a power input to the thermistor sufficiently low so that any further decrease in power will result in not more than $\pm 0.1\%$ change in resistance. R_T is usually measured at a d. c. voltage of 1.5V or less.

Rated zero power resistance (R_{25})

This is the nominal value at the standard reference temperature of 25°C unless otherwise specified.

Switch temperature (T_s)

This is the higher of two temperatures at which the resistance of the thermistor is twice its minimum value.

Operating temperature category at zero power

The upper and lower category temperatures at zero power are the maximum and minimum ambient temperatures at which the thermistor can be continuously operated.

Dissipation factor (δ)

The ratio (in milliwatts per degree C) of a change in power dissipation of a thermistor to the resultant body temperature change, at a specified ambient temperature.

Thermal time constant (τ)

The time required for a thermistor to change 63.2% of the total difference between its initial and final body temperature, when subjected to a step function change in temperature under zero power conditions.

Temperature coefficient (α)

The ratio (in % per degree C) at a specified ambient temperature, of the change in the resistance at zero dissipation with temperature, to the resistance of the thermistor at zero dissipation.

Resistance/temperature characteristic

The relationship between the zero power resistance of a thermistor, and the body temperature.

Voltage/current characteristic

The relationship (in still air at a specified ambient temperature) between the voltage developed across the thermistor, and the steady state current.

MEASUREMENT OF P. T. C. THERMISTOR CHARACTERISTICS

The following are precautions which must be taken when measuring p. t. c. thermistors:

1. Do not make measurements in air; this can give inaccurate results. Measurements should be made in a suitable non-conductive, non-corrosive liquid such as a silicone oil.
2. The thermostat used should have an accuracy of at least 0.1°C ; the thermometer should be as close to the thermistor as possible, and the liquid should be agitated.
3. Time should be allowed for equilibrium to be reached between the thermistor and its surrounding medium; this can be greater than a minute for some types.
4. The measuring voltage should be 1.5V or less to avoid self heating effects.
5. When a mercury thermometer is used for high temperature measurement, it is necessary to apply stem correction to the indicated temperature.

POSITIVE TEMPERATURE COEFFICIENT THERMISTORS

SUMMARY

Type No.	Code No.	Resistance at 25°C (Ω)	Switch/reference temperature (°C)	Max. voltage (V)	Application
E220ZZ/01	2322 661 91005	50	+25	40	General purpose
E220ZZ/02	2322 661 91004	30	+45	50	
E220ZZ/03	2322 661 91002	50	+80	50	
E220ZZ/04	2322 661 91003	40	+110	50	
VA8650	2322 662 93037	80	+75	265*	Degaussing circuits in television receivers
	2322 662 98003	30+8	+75	265	Dual type for degaussing
	2322 662 98009	40+ 1k to 6k	-	265	Dual type for degaussing
	2322 663 93004	30	+105	265*	Overload protection

*These devices must be used with a current limiting resistor.

**POSITIVE TEMPERATURE
COEFFICIENT THERMISTORS**
(2322 661 Series)

**E220ZZ/01
to E220ZZ/04**

This data sheet should be read in conjunction with
POSITIVE TEMPERATURE COEFFICIENT THERMISTORS - INTRODUCTORY NOTES

APPLICATION

General purpose applications

DIMENSIONS (millimetres)

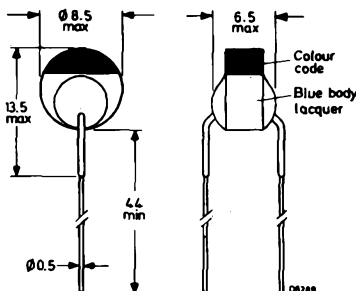

Type No.	Code No.	Colour band
E220ZZ/01	2322 661 91005	red
E220ZZ/02	2322 661 91004	orange
E220ZZ/03	2322 661 91002	yellow
E220ZZ/04	2322 661 91003	green

ELECTRICAL DATA

Resistance/temperature characteristics

Type No.	Switch temperature (T _g)	Resistance at T _{amb}					
		25°C	40°C	60°C	90°C	100°C	130°C
E220ZZ/01	25°C	50Ω ± 15Ω	-	-	-	3000 to 20 000Ω	-
E220ZZ/02	45°C	30Ω ± 15Ω	<90Ω	-	-	>10 000Ω	-
E220ZZ/03	80°C	50Ω ± 15Ω	-	<100Ω	-	>1000Ω	-
E220ZZ/04	110°C	40Ω ± 15Ω	-	-	<80Ω	-	>10 000Ω

Mullard

ELECTRICAL DATA (Contd.)

	E220 ZZ/			
	01	02	03	04
Operating temperature category at zero power		-10 to +125		°C
at maximum voltage		0 to +55		°C
Temperature coefficient (α)	9	16	18	75 %/degC
Dissipation factor (δ)	6	8.5	8.5	8.5 mW/degC
Thermal time constant (τ)	40	50	50	50 s
Maximum voltage (d. c.)	40	50	50	50 V
Balance voltage (V_b)	25	65	110	25 V
→ Voltage dependency (β)	0.35	0.25	0.48	0.28

→ COLOUR CODING

The body is coated with blue lacquer, and a colour band on top of the thermistor identifies the types in this series.

ORDERING PROCEDURE

The thermistors should be ordered by the type or code number quoted in the table. They may be supplied in packs marked with either the type or code number.

TESTS AND REQUIREMENTS

Tests	IEC test method only	Duration	Requirements $\Delta R/R(\%)$
Cold at -10°C	A	1000h	± 3
Storage at $+25^\circ\text{C}$	Ha	1000h	± 3
Dry heat $+125^\circ\text{C}$	B	1000h	± 5
Thermal shock -10 to $+125^\circ\text{C}$	Na	5 cycles	± 3
Damp heat at $+40^\circ\text{C}$	Ca	1000h	± 5
Dissipation at V_{max} and $T_{\text{amb}} = +55^\circ\text{C}$		1000h	± 5
Cycle test at V_{max} and $T_{\text{amb}} = 0^\circ\text{C}$		1000h 1 min on/ 9 min off	± 10
Robustness of terminations tensile strength 10N bending 5N	U Ua Ub	10s 2 times	Leads should neither come loose nor break
Soldering solderability at $230 \pm 10^\circ\text{C}$	T para. 3.2.3	3 to 4s	Leads must be solderable with solder containing resin flux, initially, and after six months storage
resistance to heat at $350 \pm 10^\circ\text{C}$	para 3.2.4	3 to 4s	± 2

Mullard

E220Z/01-Page 3

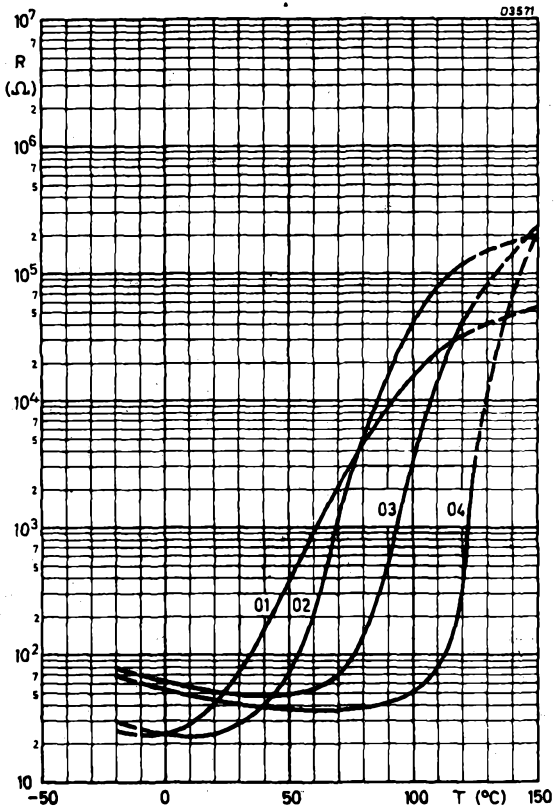

RESISTANCE/TEMPERATURE CHARACTERISTICS

**POSITIVE TEMPERATURE
COEFFICIENT THERMISTORS**
(2322 661 Series)

**E220ZZ/01
to E220ZZ/04**

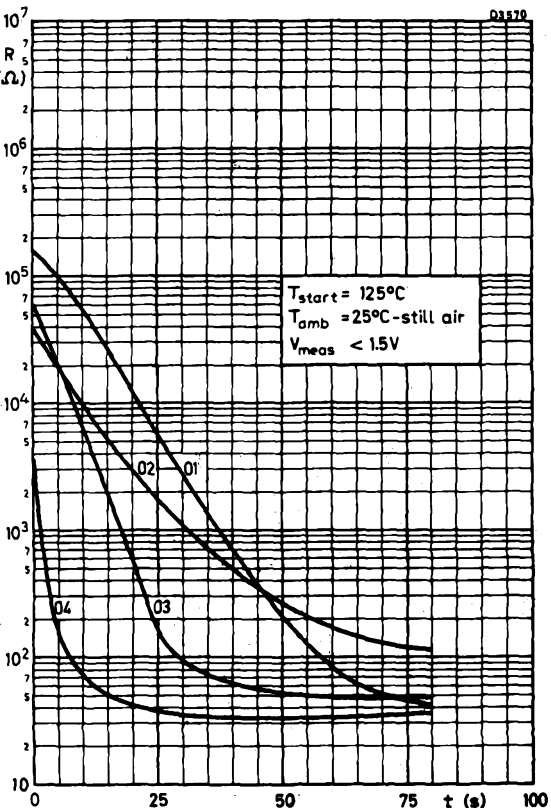

COOLING CHARACTERISTICS

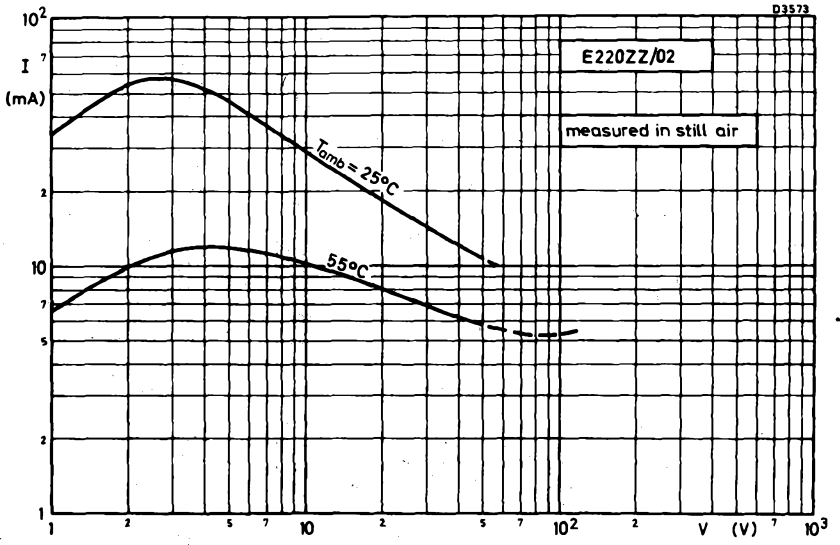
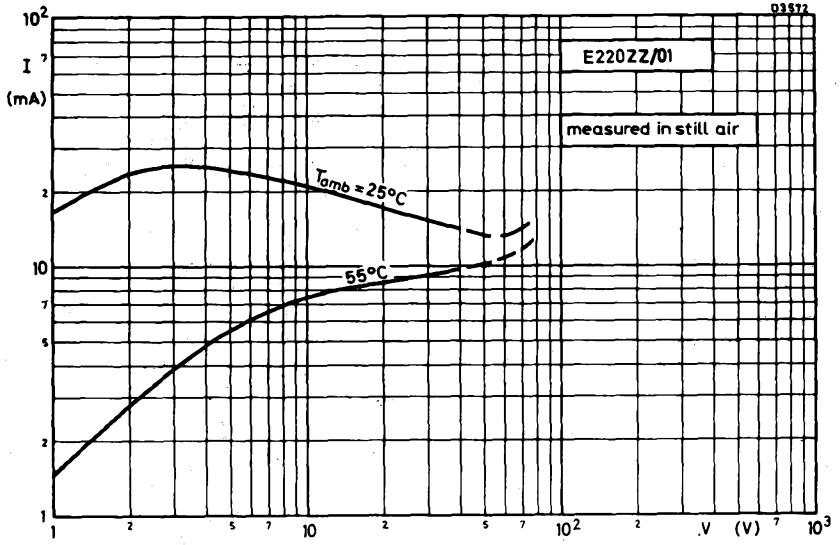

VOLTAGE/CURRENT CHARACTERISTICS

**POSITIVE TEMPERATURE
COEFFICIENT THERMISTORS**
(2322 661 Series)

**E220ZZ/01
to E220ZZ/04**

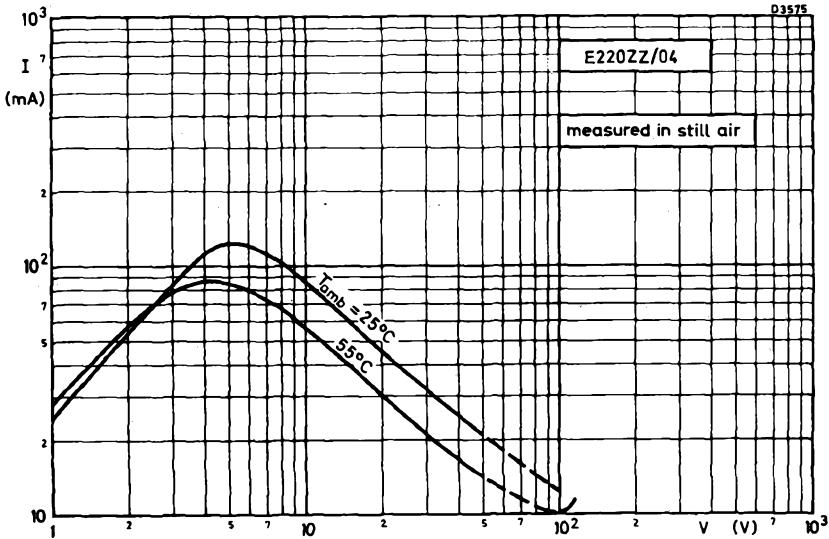
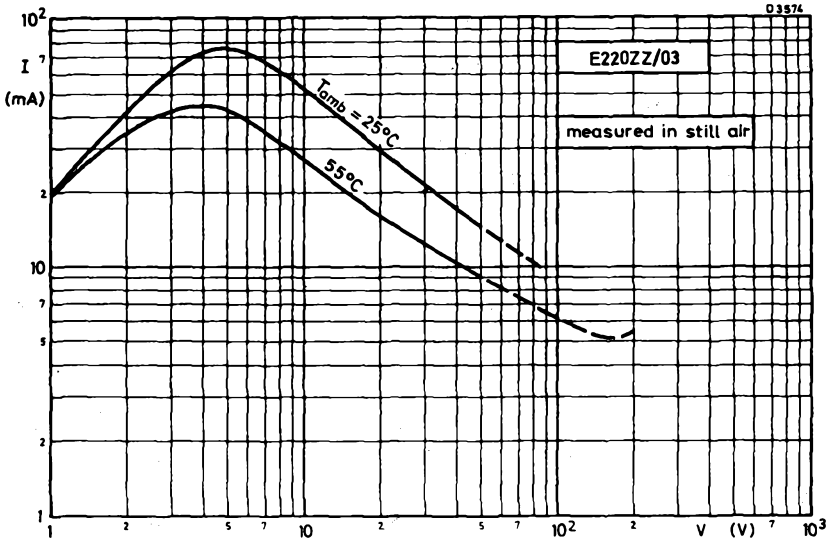

VOLTAGE/CURRENT CHARACTERISTICS

POSITIVE TEMPERATURE COEFFICIENT THERMISTOR

(2322 662 93037)

VA8650

This data sheet should be read in conjunction with
POSITIVE TEMPERATURE COEFFICIENT THERMISTORS - INTRODUCTORY NOTES

APPLICATION

For use in degaussing circuits in colour television receivers.

DIMENSIONS (millimetres)

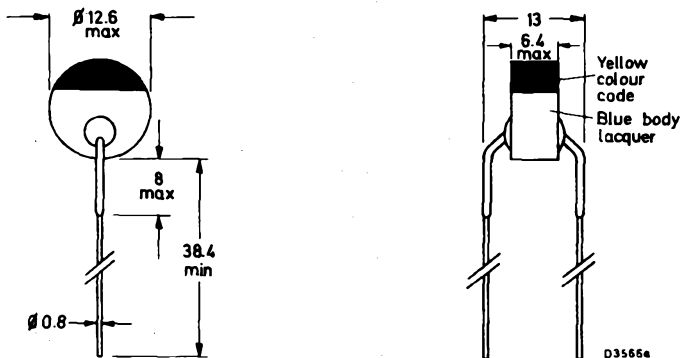

Type No.	Code No.	Colour code
VA 8650	2322 662 93037	yellow

ELECTRICAL DATA

Rated zero power resistance (R_{25})		80 \pm 20%	Ω
Resistance at $T_{amb} = 75^{\circ}\text{C}$		<220	Ω
$T_{amb} = 155^{\circ}\text{C}$, and 380V pulsed		>45 000	Ω
Switch temperature (T_{θ})	approx.	+75	$^{\circ}\text{C}$
Operating temperature category at zero power		-25 to \pm 155	$^{\circ}\text{C}$
at maximum voltage		0 to \pm 60	$^{\circ}\text{C}$
Dissipation constant (δ)	approx.	21	mW/degC
Thermal time constant (τ)	approx.	105	s
Temperature coefficient (α)	approx.	+23	%/degC
R.M.S. voltage at $T_{max} = 60^{\circ}\text{C}$ (in series with 82 Ω \pm 5% resistor)	max.	265	V
Minimum series resistance value		82 \pm 5%	Ω
Balance voltage, d.c., (V_b)	approx.	180	V
Voltage dependency at +155 $^{\circ}\text{C}$	approx.	0.28	

Mullard

MOUNTING

The thermistor should be mounted to allow free circulation of air around it, and at least 10mm from the printed-wiring board.

COLOUR CODING

The thermistor is coated with a blue protective lacquer and a yellow colour code.

ORDERING PROCEDURE

The thermistor should be ordered by the type or code number quoted in the table. They may be supplied in packs marked with either the type or code number.

TESTS AND REQUIREMENTS

Tests	IEC68 test method only	Duration	Requirements $\Delta R/R(\%)$	
			at +25°C	at +150°C
Cold at -25°C	A	1000h	±7.5	±12
Storage at +25°C	Ha	1000h	±5	±12
Dry heat at +155°C	B	1000h	±10	±12
Thermal shock -25 to +155°C	Na	5 cycles	±7.5	±12
Damp heat at +40°C	Ca	1000h	±10	±12
Dissipation at r. m. s voltage = 265V, and $T_{amb} = +60°C$		1000h	±10	±12
Cycle test at r. m. s voltage = 265V, $T_{amb} = 0°C$		100 cycles	±10	±12
$T_{amb} = +25°C$ (see note)		2000 cycles	±7.5	±12
Robustness of terminations	U			
tensile strength 20N	Ua	10s	Leads should neither come loose nor break	
bending 10N	Ub	2 times		
Soldering	T			
solderability at 230 ±10°C	para 3. 2. 3	3 to 4s	Leads must be solderable with solder containing resin flux, initially, and after six months storage	
resistance to heat at 350 ±10°C	para 3. 2. 4	3 to 4s		

Note: Cycle: 1 minute on, 9 minutes off. Series resistor: 82Ω ±5%.

POSITIVE TEMPERATURE COEFFICIENT THERMISTOR

(2322 662 93037)

VA8650

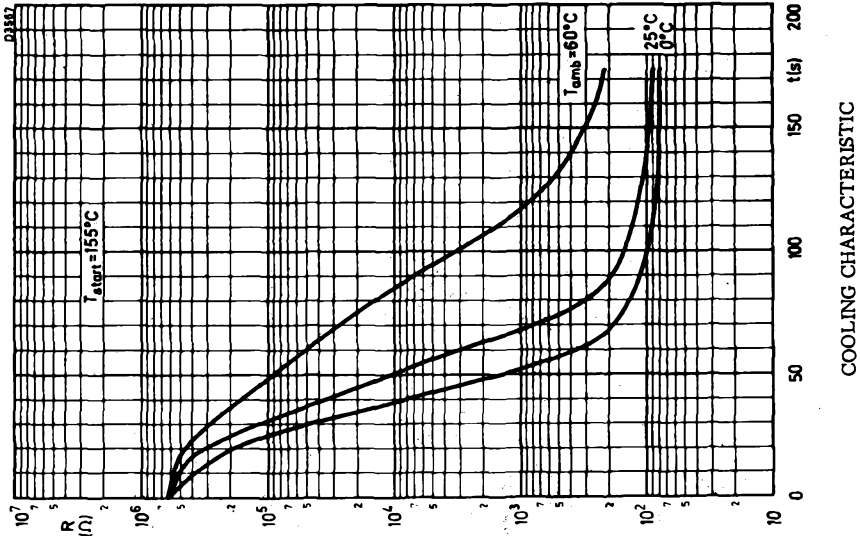

COOLING CHARACTERISTIC

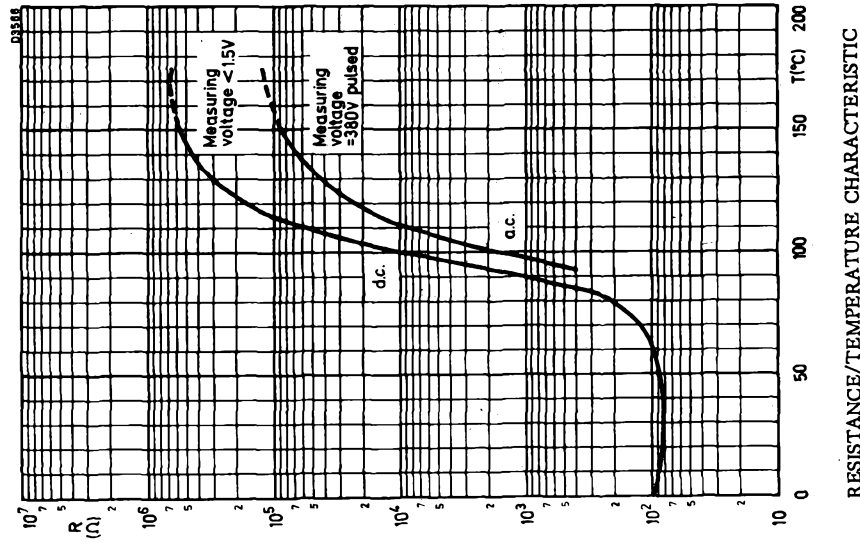

RESISTANCE/TEMPERATURE CHARACTERISTIC

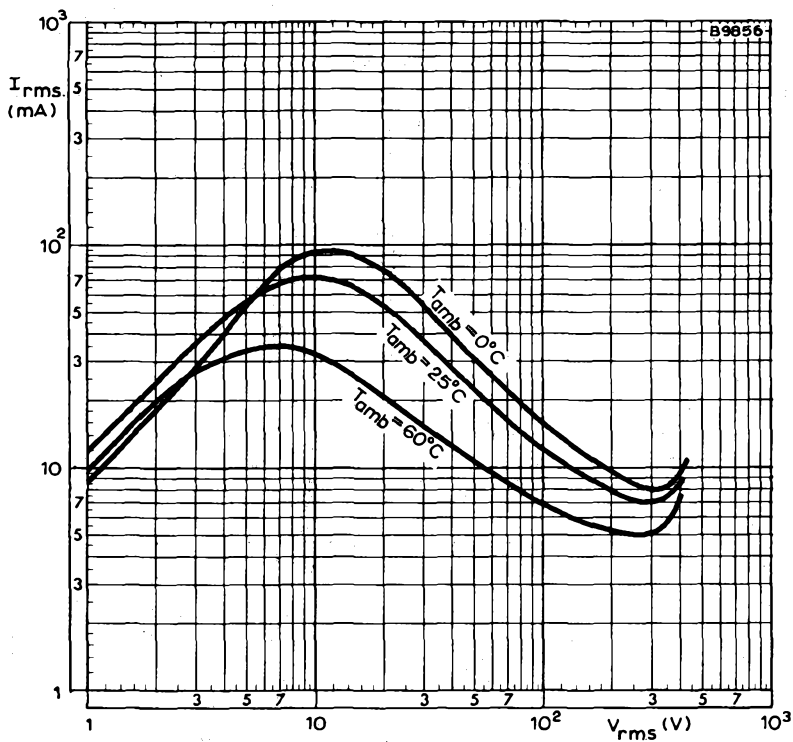

VOLTAGE/CURRENT CHARACTERISTICS

DUAL POSITIVE TEMPERATURE COEFFICIENT THERMISTOR

for degaussing

2322 662 98003

This data sheet should be read in conjunction with
POSITIVE TEMPERATURE COEFFICIENT THERMISTORS - INTRODUCTORY NOTES

DIMENSIONS (millimetres)

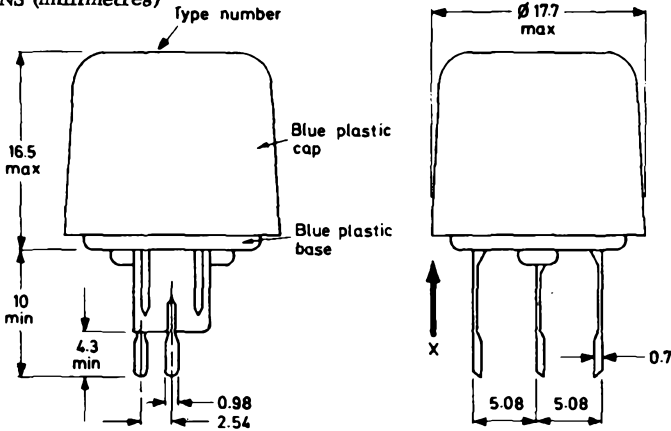

The tags A, B and C should be connected as shown in the application circuit

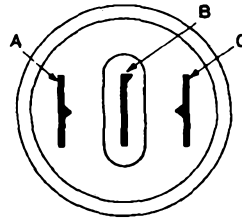

D3926c

MOUNTING

The thermistor can be soldered directly on to a printed-wiring board.

APPLICATION CIRCUIT

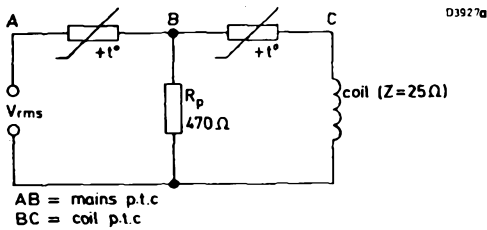

R_p must be able to withstand a peak power of 25W for 300ms

Fig. 1

Mullard

ELECTRICAL DATA

Maximum voltage (rms) (see note 1)		265	V
Inrush current (peak) through the coil (see note 2)	min.	5	A
Idle current (peak) through the coil (see note 2)			
after 5s	max.	70	mA
after 30s	max.	5	mA
after 3 minutes	max.	2	mA
Resistance at 25°C (see note 3)			
of mains p. t. c.	approx.	30	Ω
of coil p. t. c.	approx.	8	Ω
Resistance at $T_{amb} = 175^{\circ}\text{C}$ and 345V pulsed of mains p. t. c.	min.	35	kΩ
Resistance at $T_{amb} = 155^{\circ}\text{C}$ of coil p. t. c.	min.	20	kΩ
Switch temperature of mains and coil p. t. c.	approx.	75	°C
Temperature coefficient of mains and coil p. t. c.	approx.	25	%/degC
Dissipation factor (δ) (see note 1)	approx.	13.5	mW/degC
Thermal time constant (τ) (see note 1)	approx.	200	s
Operating temperature range			
at zero power		-25 to +155	°C
at maximum voltage		0 to +60	°C

NOTES

1. Measurements made with the thermistor soldered on printed-wiring board in still air.
- 2. Measured at 220V (rms) in circuit of fig. 1 with the coil replaced by an ohmic resistor of 25Ω.
3. Measured at <1.5V (d. c.) to avoid internal heating.

→ HOUSING

The thermistors are housed in a blue non-flammable plastic moulding.

DUAL POSITIVE TEMPERATURE COEFFICIENT THERMISTOR 2322 662 98003

for degaussing

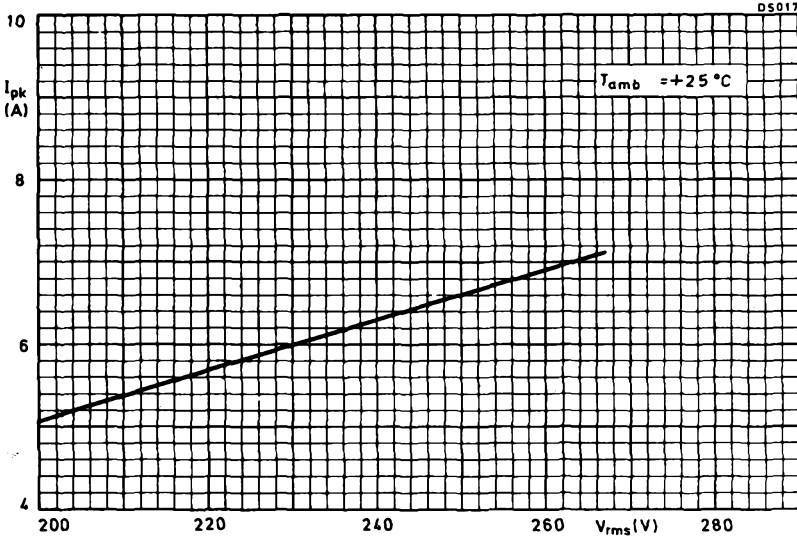

INRUSH PEAK CURRENT THROUGH THE COIL/VOLTAGE CHARACTERISTIC

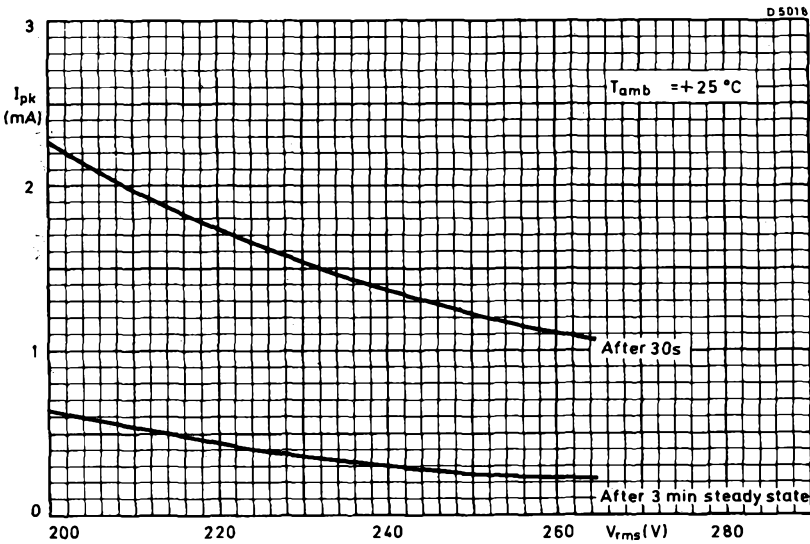

IDLE PEAK CURRENT THROUGH THE COIL/VOLTAGE CHARACTERISTIC

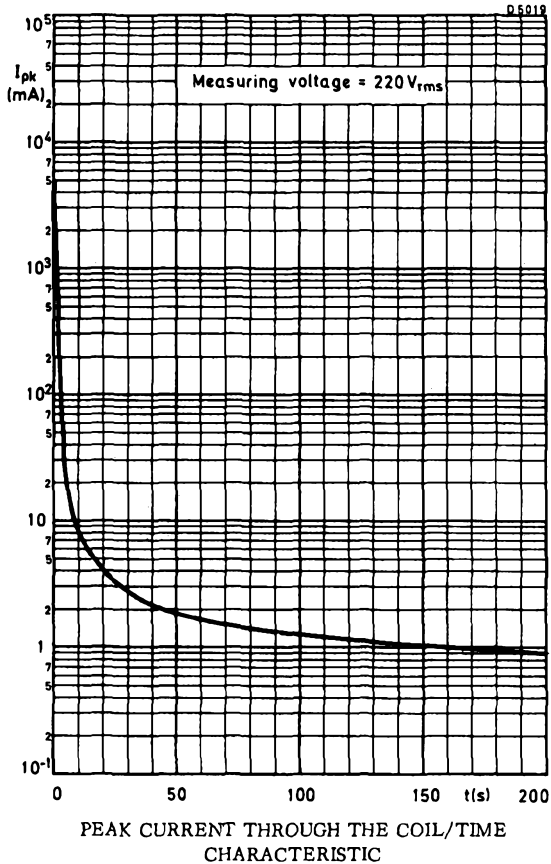

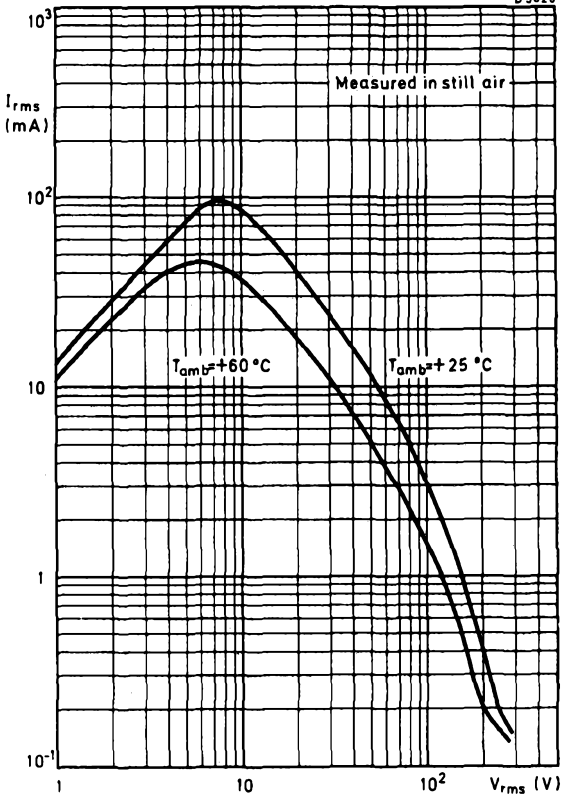

STATIC CURRENT THROUGH THE
COIL/VOLTAGE CHARACTERISTICS

DUAL POSITIVE TEMPERATURE COEFFICIENT THERMISTOR 2322 662 98009

for degaussing (parallel-series)

This data sheet should be read in conjunction with
 POSITIVE TEMPERATURE COEFFICIENT THERMISTORS - INTRODUCTORY NOTES

DIMENSIONS (millimetres)

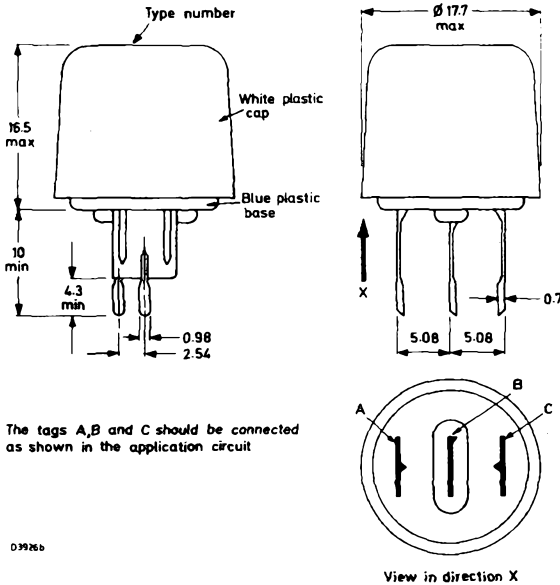

MOUNTING

The thermistor can be soldered directly on to a printed-wiring board.

APPLICATION CIRCUIT

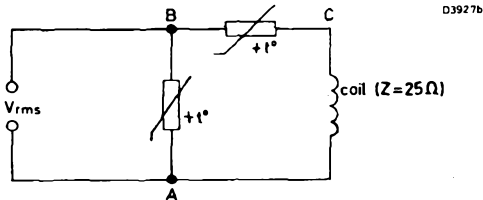

Fig. 1

GENERAL

The dual PTC consists of two disc PTC thermistors clamped between spring contacts. This assembly ensures a good thermal contact between both discs, which is essential for the function of this device. The thermistor is enclosed in a plastic housing of which the cap is white and the base blue. The three connecting pins are arranged to fit a printed-wiring board with an 0.1 inch grid.

The parallel PTC thermistor is connected across the supply, the series PTC thermistor is connected in series with the degaussing coil. The series PTC would not by itself lower the current to 2 mA, but would stabilize the current above this value. By applying further heat to the series PTC, its resistance will increase to the point where the coil current is limited to 2 mA. This extra heat is provided by the parallel PTC.

ELECTRICAL DATA

Maximum voltage (r. m. s.) (note 1)		265	V
Inrush current (peak) through the coil (note 2)	min.	5	A
Idle current (peak) through the coil (note 2)	after 5 s	max.	70 mA
	after 30 s	max.	5 mA
	after 3 minutes	max.	2 mA
Resistance at +25 °C, R_s R_p		approx.	40 Ω
			1000 to 6000 Ω
Operating temperature range	at zero power		-25 to +125 °C
	at maximum voltage		0 to +60 °C

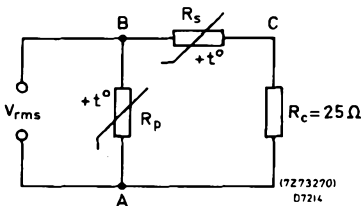

Fig. 2

Measuring circuit

R_p = parallel PTC

R_s = series PTC

R_c = replaces the degaussing coil ($Z = 25 \Omega$)

NOTES

- Measurements made with the thermistor soldered on printed-wiring boards in still air.
- Measured at 220 V (r. m. s.) in circuit of Fig. 1 with the coil replaced by an ohmic resistor of 25 Ω .

HOUSING

The thermistors are housed in a non-flammable plastic moulding.

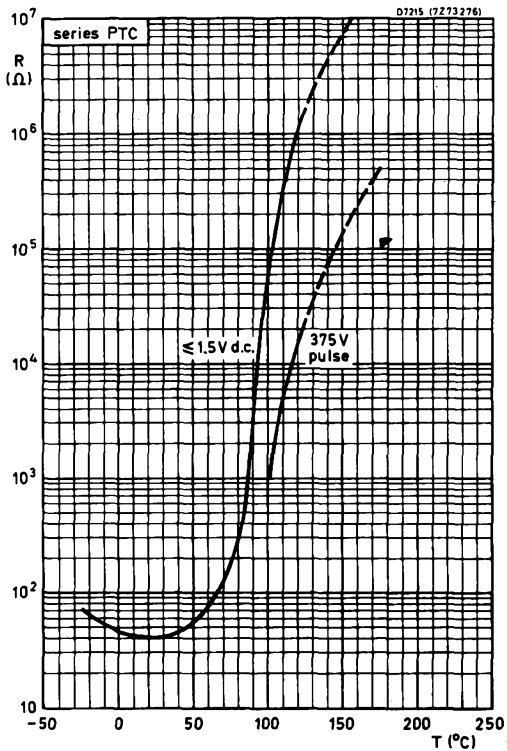

Fig. 3

Typical resistance versus temperature characteristics of the series PTC

**DUAL POSITIVE TEMPERATURE
COEFFICIENT THERMISTOR
for degaussing (parallel-series)
2322 662 98009**

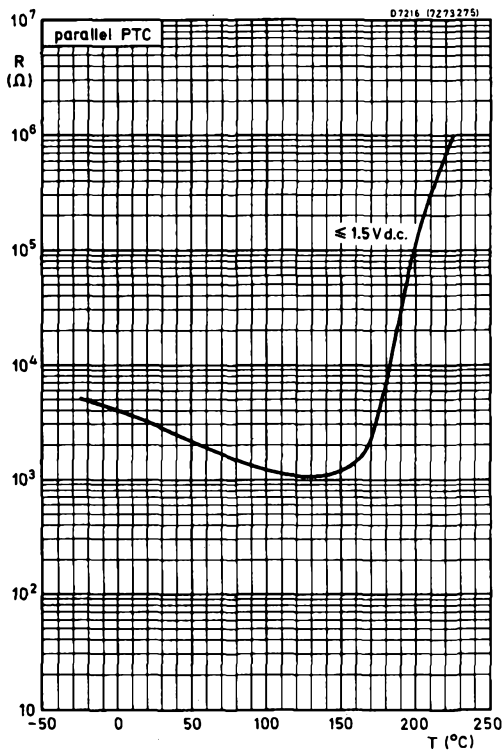

Fig. 4

Typical resistance versus temperature characteristics of the parallel PTC

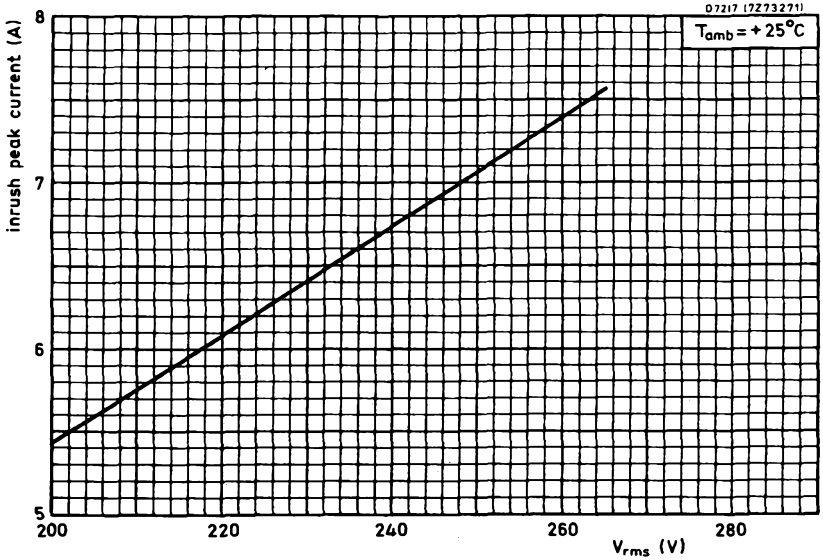

Fig. 5. Typical inrush peak current versus voltage characteristic

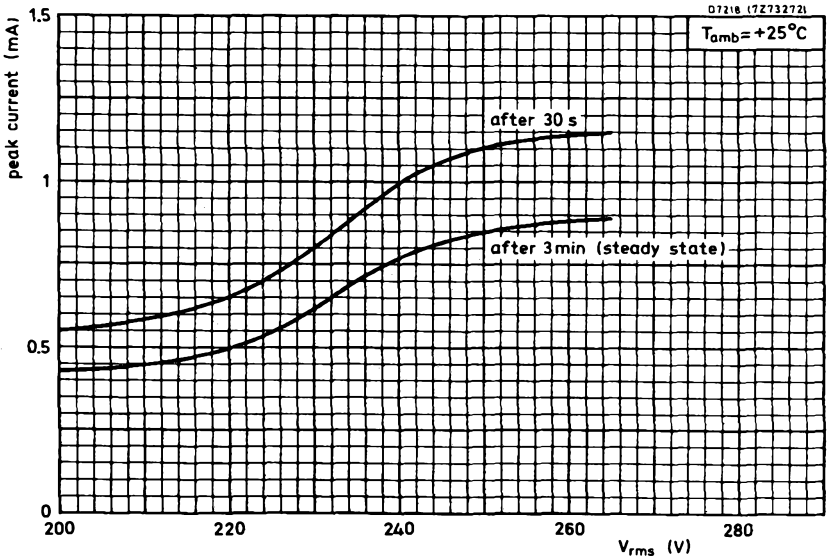

Fig. 6. Typical peak current versus voltage characteristics.

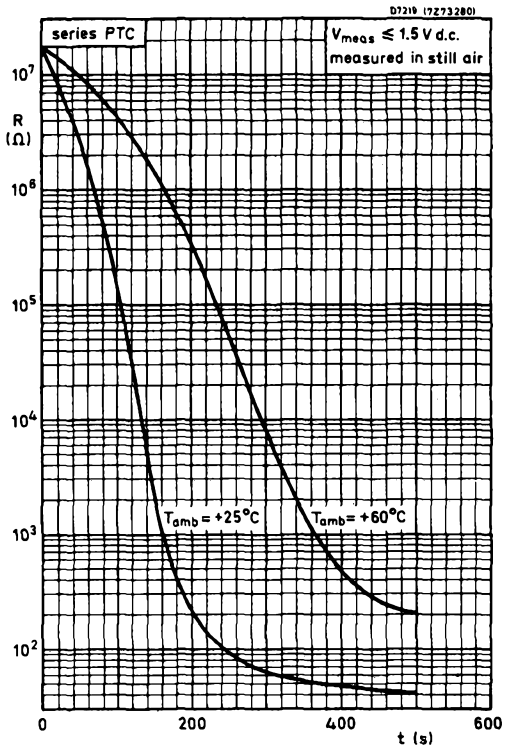

Fig. 7

Typical resistance versus cooling time characteristics of series PTC (cooling off after stationary operation at 220 V).

**DUAL POSITIVE TEMPERATURE
COEFFICIENT THERMISTOR
for degaussing (parallel-series)
2322 662 98009**

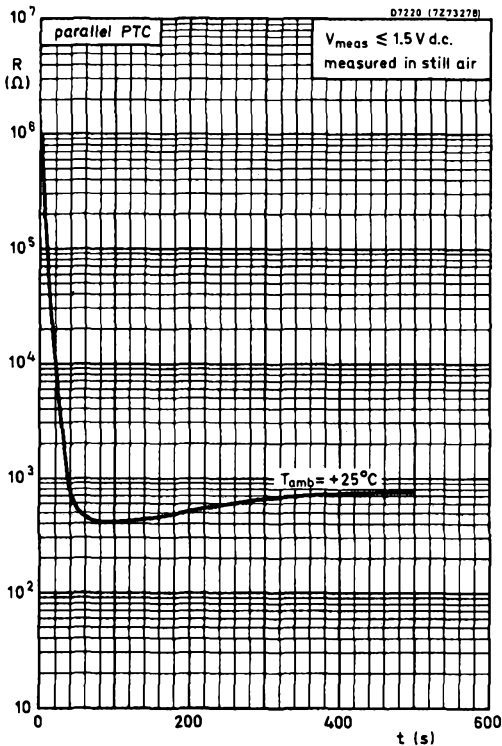

Fig. 8

Typical resistance versus cooling time characteristic of parallel PTC (cooling off after stationary operation at 220 V).

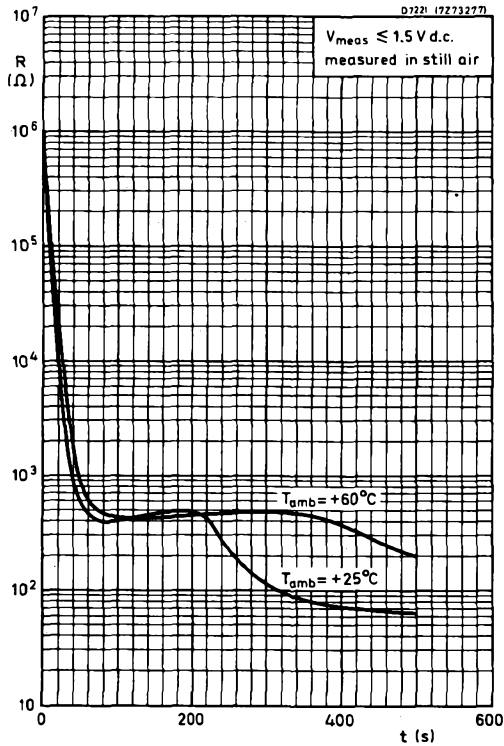

Fig. 9

Typical resistance of circuit versus cooling time characteristics (cooling off after stationary operation at 220 V).

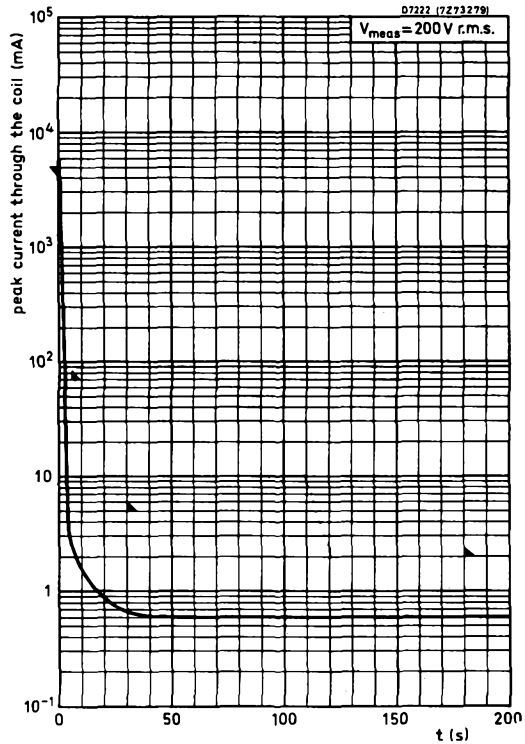

Fig. 10

Typical peak current through the coil versus time characteristic. Peak current limits are indicated by ▲

POSITIVE TEMPERATURE COEFFICIENT THERMISTOR for overload protection

2322 663 93004

Introduction

P. T. C. thermistors exhibit a large positive temperature coefficient of resistance over a restricted temperature range. The increase of resistance may be caused by an increase in ambient temperature or by self heating due to increased power dissipation within the component.

The P. T. C. thermistor can therefore be used as a current limiting device to protect transformers and motors against overload or to limit the current that may be taken from a supply. The type detailed in this data sheet has been specially developed to protect the isolating transformer in shaver outlet sockets. Under normal operating conditions it remains in its low resistance state, but, if overloaded, the P. T. C. thermistor 'switches' to its high resistance state, thus limiting the current to a safe value. It may be used in similar applications when it is desired to limit the current to less than 200 mA.

P. T. C. thermistors are manufactured from a polycrystalline ceramic material in the form of a disc with metallized flat faces to which connecting leads are attached.

MECHANICAL DATA

Dimensions in mm

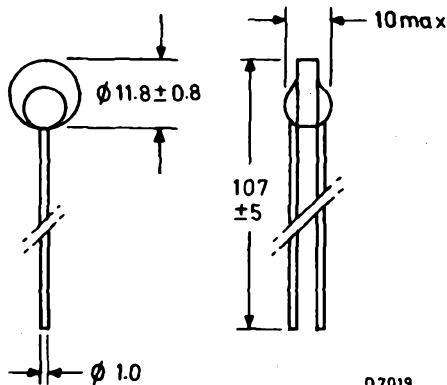

D7019

Mullard

Specification

Resistance at 25 °C measured at $V \leq 1.5$ V d.c.	approx.	30	Ω
Resistance at 105 °C measured at $V \leq 1.5$ V d.c.	<	100	Ω
Resistance at 200 °C measured at 375 V pulsed	>	25	k Ω
Maximum working voltage with minimum series resistance of 470 Ω		265	V
Switch temperature		105	°C

In Fig. 1.

- (a) with $R_x = 1720 \Omega$, a current of 140 mA and $T_{amb} = 36 \text{ }^\circ\text{C}$, the p.t.c. thermistor shall not switch.
- (b) with $R_x = 1200 \Omega$, a current of 200 mA and $T_{amb} = 25 \text{ }^\circ\text{C}$, the p.t.c. thermistor shall switch and after 5 mins. (max.) the current shall be less than 40 mA.

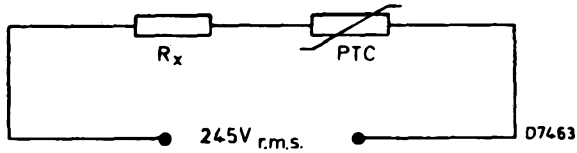
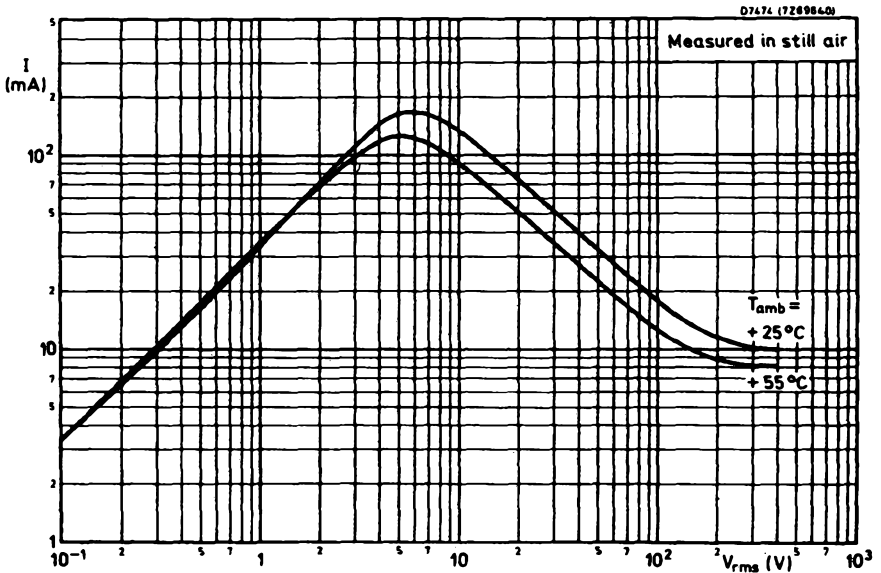

Fig. 1



Typical voltage/current characteristics

**POSITIVE TEMPERATURE
COEFFICIENT THERMISTOR**
for overload protection

2322 663 93004

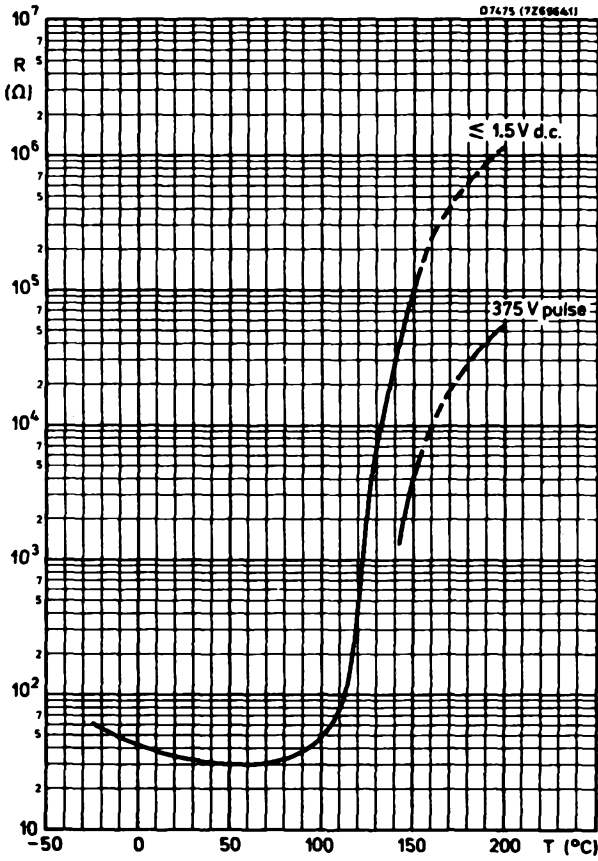

Typical resistance/temperature characteristics

Mullard

VOLTAGE DEPENDENT RESISTORS

J

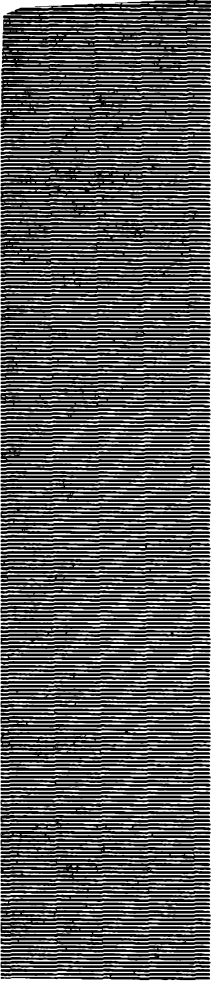

J

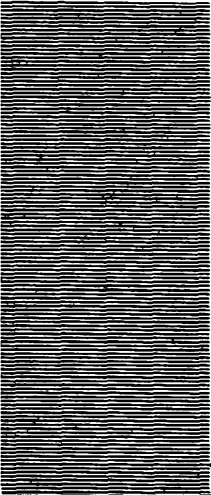

Voltage dependent resistors are supplied in packages marked with either the Mullard E number or a 12 digit number. A data summary and conversion list is available. Additionally, both numbers appear on each data sheet.

INTRODUCTION

Voltage Dependent Resistors (VDR's) are resistors which exhibit a high degree of non-linearity between resistance value and applied voltage. They are prepared from either silicon carbide or zinc oxide. Their voltage dependency results from the large number of crystal contacts forming a complicated network of series and parallel resistors. The manufacturing process is similar to that used in the ceramics industry. The basic raw materials having the required electrical and physical properties are mixed with a ceramic binder and the resulting material is pressed into discs, or extruded into rods. After a period of drying, they are sintered at a high temperature. The firing time and temperature have an important influence on the electrical characteristics. Electrical contacts of copper or zinc are metallized onto the contact surfaces. Leads are soldered on, and the VDR's are lacquered and impregnated.

ELECTRICAL PROPERTIES

D. C. conditions

The relationship between voltage and current for a VDR can be approximated to:

$$V = CI^\beta \quad (1)$$

where, V = voltage in V

I = currents in A

C and β = constants for a given VDR.

This equation is illustrated in fig. 1.

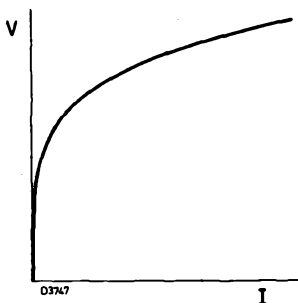

Fig. 1 Voltage/current characteristic of a VDR on linear scales

This relationship may also be expressed as :

$$\log V = \log C + \beta \cdot \log I \quad (2)$$

which is a straight line for not too small values of current, and where β is the slope of the line. Fig. 2 illustrates this.

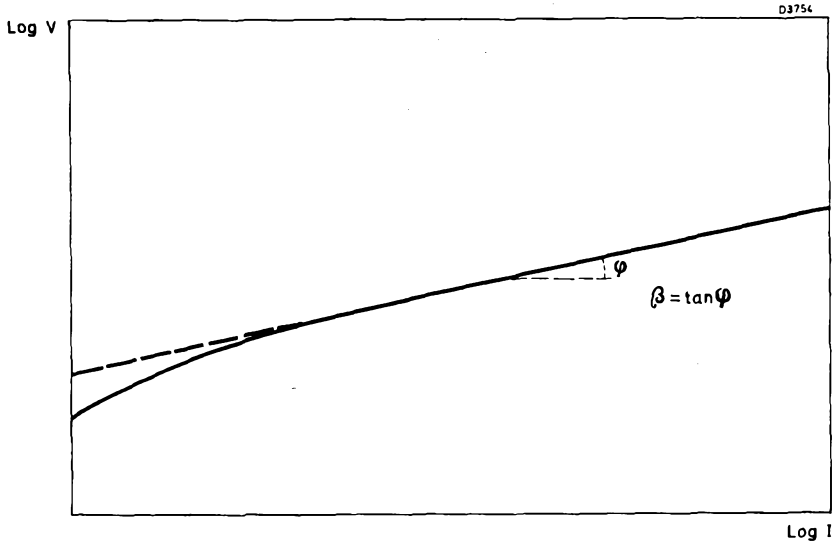

Fig. 2
Voltage/current characteristic of a VDR on logarithmic scales

For a given VDR, the values of C and β may be determined by measuring three points on its characteristic; only when these three points, plotted using logarithmic scales, lie on a straight line, can extrapolation to higher values of voltage and current be permitted.

Equation (1) may also be written as :

$$I = kV^\alpha \quad (3)$$

where, $\alpha = \frac{1}{\beta}$

and $k = \frac{1}{C^{1/\beta}}$

VDR's do not have a polar effect, i. e. , when the voltage polarity is reversed, the current changes in direction, but not in magnitude. Equations (1) and (2) are only valid for absolute values of voltage and current; this may be of importance in a. c. calculations.

To avoid lengthy calculations, equation (1) has been converted into a nomogram (fig. 3), which gives the corresponding values of voltage and current for any given silicone carbide VDR. When a straight line is drawn between the voltage and current points for a VDR, and produced to intersect the β -line, all other straight lines radiating from that point will give values of voltage and current that apply to the given VDR, e. g. , for a VDR having

a current of 10mA at 100V, and a $\beta = 0.20$, it can be seen from the nomogram that values of 70V and 1.6mA also apply to this VDR. The power dissipation of 0.11W can also be found from the nomogram.

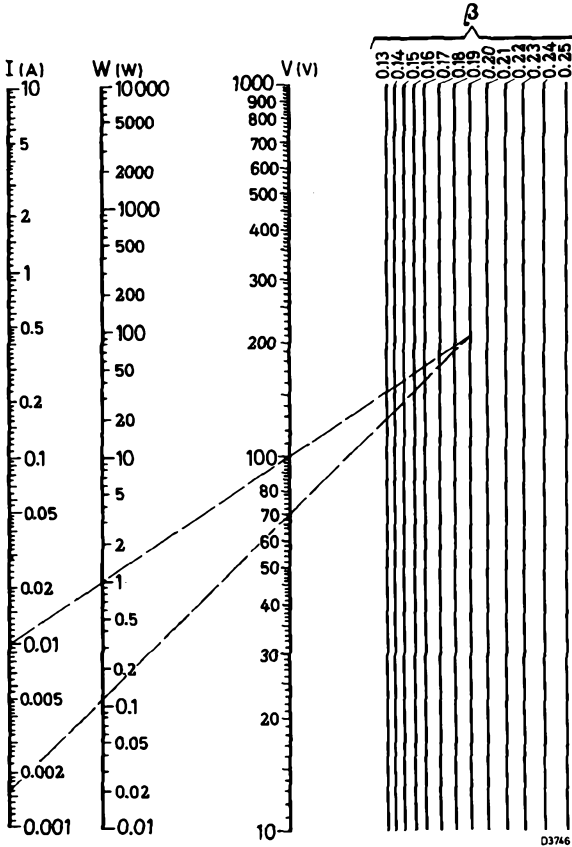

Fig. 3
Nomogram giving the relation between voltage, current, power dissipation and β -value of any silicon carbide VDR.

Although the nomogram is used in most cases, it is sometimes more convenient to use a graphical method, for example, when the voltage drop across a VDR in series with a resistor has to be determined. In this case, the load line for the series resistor is drawn on the VDR voltage/current characteristic. This load line will intersect the VDR curve at a point which gives the voltage across the VDR. In fig. 4 the characteristics of a series of VDR's are drawn on linear scales. The load line intersects each VDR curve at one point which gives the voltage drop across the VDR in series with the load.

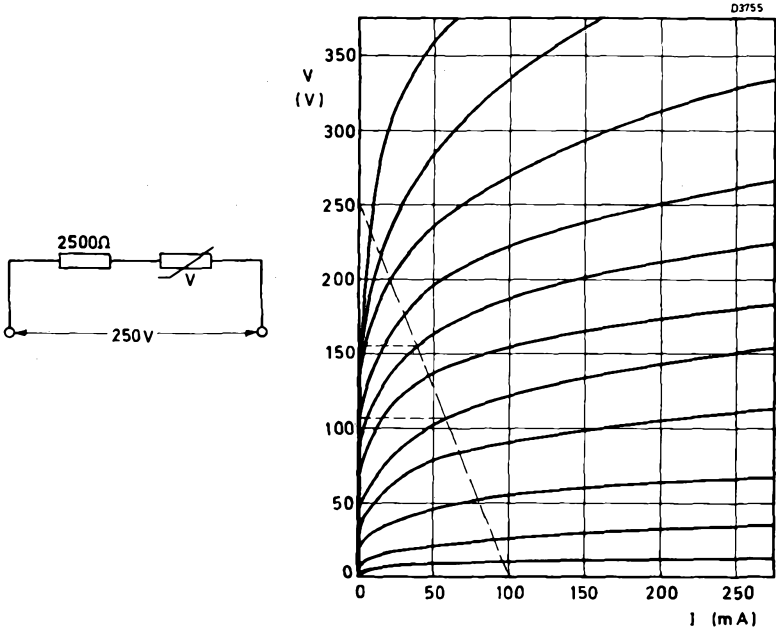

Fig. 4
 Typical voltage/current characteristics with a load
 line for a series load

Practical values

The C- and β -values of a VDR depend on the composition of the material, and on the methods used in manufacture; furthermore, the C-value depends on the shape and dimensions of the VDR. Practical values of β range between 0.14 and 0.40 for silicon carbide and approx. 0.030 for zinc oxide. It is inherent to the material properties that the β -value of a VDR with a low C-value will always be higher than that of a VDR with a high C-value. As the method of manufacture compels a minimum thickness, and the C-value is almost independent of surface area, the latter has, for practical reasons, a limited minimum value.

From equation (1) it is possible to specify the electrical characteristics of a VDR by giving its C - and β -value. The advantage of this is that only two parameters are used. The disadvantage is, however, that due to the tolerance on the β -values, the spread in voltages at low currents in the working area, becomes very large.

In published data the C -value, the applied voltage for a current of 1A, the β -value and the slope of the characteristic, are given as approximate values for information. The component is defined closer to its working point by means of a current of 1, 10 or 100mA, and a voltage and tolerance.

For zinc oxide VDR's, the voltage limits at 1mA and 1A are given together with maximum a.c. and d.c. working voltages.

VDR's in series

For a VDR, we can write equation (1):

$$V = CI^\beta$$

When n of these VDR's are connected in series and a voltage n times the original is applied, the current will remain the same. Consequently for n VDR's in series we can write:

$$nV = C' I^\beta \quad (4)$$

From equations (1) and (4), it follows that:

$$C' = nC \quad (5)$$

Hence the C -value can be increased, for a particular application, by connecting VDR's in series.

VDR's in parallel

For a VDR, we can again write equation (1):

$$V = CI^\beta$$

When n of these VDR's are connected in parallel, with the same voltage applied, the current in each VDR will remain the same. The total current will be nI . Thus for n VDR's in parallel, we can write:

$$V = C'' (nI)^\beta \quad (6)$$

From equations (1) and (6), it follows that:

$$C'' = \frac{C}{n^\beta} \quad (7)$$

Hence, it can be seen from equation (7) that for VDR's having β -values in the range 0.14 to 0.40, the C -value will decrease very little by the parallel connection of several VDR's, e.g., if $\beta = 0.20$, 32 VDR's would need to be connected in parallel to achieve a 50% reduction in C -value. In parallel circuits all VDR's should have approximately equal C - and β -values, otherwise the current sharing will depend on the voltage across the circuit. VDR's must not be connected in parallel to obtain higher power dissipation.

Resistance value

From Ohm's law, the resistance of a VDR is given by:

$$R = \frac{V}{I} = \frac{CI^\beta}{I} = \frac{C}{I^{1-\beta}} \quad (8)$$

or using $I = kV^\alpha$

$$R = \frac{V}{I} = \frac{V}{kV^\alpha} = \frac{1}{kV^{\alpha-1}} \quad (9)$$

From these equations, it is evident that the resistance value of VDR is not constant, but depends on the values of voltage and current.

Power dissipation

The power dissipated in a VDR is given by:

$$W = V \cdot I$$

but since

$$I = kV^\alpha$$

then

$$W = kV^\alpha \cdot V = kV^{\alpha+1} \quad (10)$$

For a β -value of 0.20, $\alpha = 5$, since $\alpha = \frac{1}{\beta}$, then the power dissipated is proportional to the 6th power of the voltage; hence a voltage increase of only 12% will double the power in the VDR. Thus it is necessary to ensure that the voltage does not rise above a value such that the maximum permissible dissipation is exceeded. This is important since VDR's have a negative temperature coefficient, which means that at higher dissipation the temperature will rise, thus causing the resistance to decrease, and the dissipation to increase still further.

Temperature coefficient

No account has been taken of temperature effects. The β -value is practically independent of temperature. The C-value has an appreciable negative temperature coefficient. To a good approximation we can write:

$$C_\Theta = C_0 (1 + a\Theta) \quad (11)$$

where C_Θ = C-value of the VDR at $\Theta^\circ\text{C}$

C_0 = C-value of the VDR at 0°C

a = temperature coefficient

For silicon carbide types the value of 'a' lies between -0.0010 and -0.0018. Thus for circuits where the current is constant, the temperature coefficient of voltage lies between -0.10 and -0.18% per degree C, and for circuits where the voltage is constant the temperature coefficient of current lies between +0.4 and +0.8 per degree C, depending on β -value.

A. C. Conditions

When used in a. c. circuits, care must be taken to avoid excessive power dissipation. If a sinusoidal voltage is applied to a VDR its non-linear voltage/current characteristic will cause the current to be non-sinusoidal containing odd harmonics. Similarly, if the current is sinusoidal, the voltage across the VDR will be non-sinusoidal. In all cases the power dissipated will be higher than that calculated for equivalent d. c. conditions. For silicon carbide VDR's fig. 9 shows the power to be some 2 to 3 times higher for an r. m. s. voltage than that for an equivalent d. c. voltage. Calculation of the a. c. current, voltage and power conditions in silicon carbide VDR's can be carried out using the following sections. For zinc oxide types, the data gives nominal r. m. s. and crest working for each type.

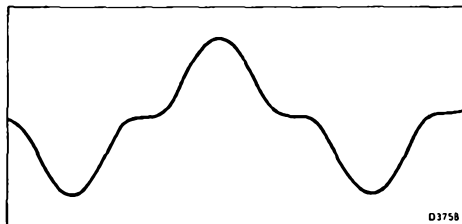

Fig. 5 Current as a function of time, when a sinusoidal voltage is applied to a VDR

(a) Sinusoidal voltage

R. M. S. value of current

The value of the r. m. s. current is given by:

$$I_{r.m.s.} = \sqrt{\frac{1}{T} \int_0^T I^2 dt}$$

where, T = the periodic time of the sinusoidal voltage.

Since the instantaneous relationship between voltage and current is given by $I = kV^\alpha$, and $V = v \sin \omega t$ in which $v = V_{r.m.s.} \sqrt{2}$, it follows that, by substitution:

$$I_{r.m.s.} = kV_{r.m.s.}^\alpha \sqrt{2} \sqrt{\frac{2}{T} \int_0^{T/2} (\sin \omega t)^{2\alpha} dt}$$

A d. c. voltage of $V = V_{r.m.s.}$ would cause a d. c. current in the VDR such that

$$I = kV_{r.m.s.}^\alpha$$

If the ratio of $I_{r.m.s.}$ to I equals r , then

$$r = \sqrt{2} \sqrt{\frac{2}{T} \int_0^{T/2} (\sin \omega t)^{2\alpha} dt} \quad (12)$$

This relationship between r and α , is illustrated in fig. 6 for various values of $\alpha = 1/\beta$.

Fig. 6 Relation between the currents caused by a d. c. voltage V , and an a. c. voltage $V_{r.m.s.} = V$

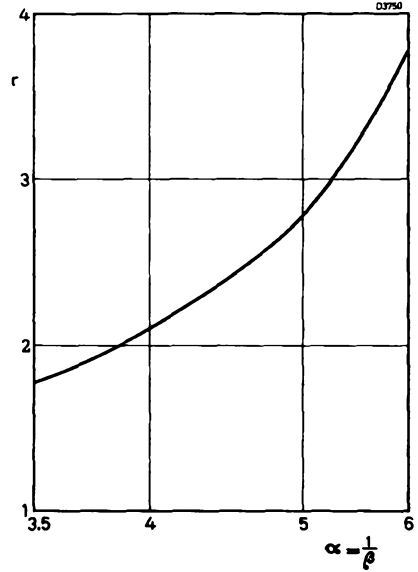

Mean value of the current in a VDR during half a cycle

The mean value is defined as:

$$I_m = \frac{2}{T} \int_0^{T/2} I dt$$

Substituting $I = kV^\alpha$, and $V = v \sin \omega t$, where $v = V_{r.m.s.} \sqrt{2}$, it follows that:

$$I_m = \frac{2kV_{r.m.s.}^\alpha 2^{\alpha/2}}{T} \int_0^{T/2} (\sin \omega t)^\alpha dt$$

A. d. c. voltage of $V = V_{r.m.s.}$ would cause a d. c. current in the VDR such that:

$$I = kV_{r.m.s.}^\alpha$$

If the ratio of I_m to I equals m , then:

$$m = \frac{2^{(\alpha+2)/2}}{T} \int_0^{T/2} (\sin \omega t)^\alpha dt \quad (13)$$

Fig. 8 Factor f by which the mean current value must be multiplied to obtain the r.m.s. current

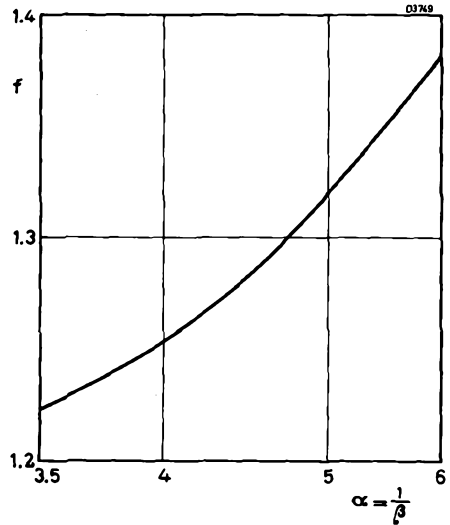

Power dissipation

The a. c. power dissipation for a sinusoidal voltage is given by:

$$W_{\text{a.c.}} = \frac{2}{T} \int_0^{T/2} kV^{\alpha+1} dt$$

Substituting $V = v \sin \omega t$, where $v = V_{\text{r.m.s.}} \sqrt{2}$, we have:

$$W_{\text{a.c.}} = \frac{2kV_{\text{r.m.s.}}^{\alpha+1}}{T} \int_0^{T/2} 2^{(\alpha+1)/2} (\sin \omega t)^{\alpha+1} dt$$

The power for a d. c. voltage of $V = V_{\text{r.m.s.}}$ is:

$$W = kV_{\text{r.m.s.}}^{\alpha+1}$$

The quotient of these two values is given by:

$$p = \frac{W_{\text{a.c.}}}{W} = \frac{2^{(\alpha+3)/2}}{T} \int_0^{T/2} (\sin \omega t)^{\alpha+1} dt \quad (14)$$

The value of p as a function of $\alpha = 1/\beta$ is shown in fig. 9

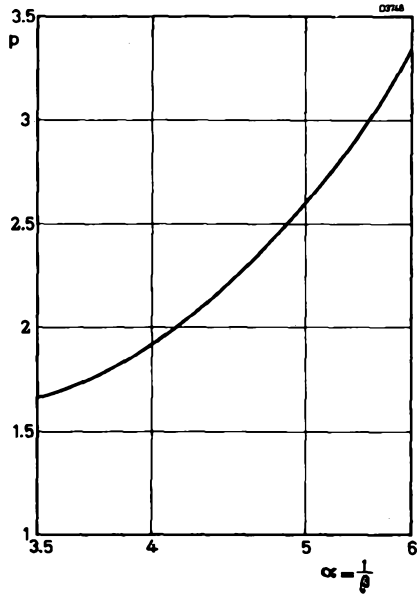

Fig. 9 Relation between the power dissipation caused by a d. c. voltage V and an a. c. voltage $V_{r.m.s.} = V$

(b) Sinusoidal current

R. M. S. value of voltage

The value of the r. m. s. voltage is given by:

$$V_{r.m.s.} = \sqrt{\frac{1}{T} \int_0^T V^2 dt}$$

The relation between voltage and current is given by:

$$V = CI^\beta$$

where $I = i \sin \omega t$, in which $i = I_{\text{r.m.s.}} \sqrt{2}$, it follows that by substitution:

$$V_{\text{r.m.s.}} = CI_{\text{r.m.s.}}^{\beta} \cdot 2^{\beta/2} \sqrt{\frac{2}{T}} \int_0^{T/2} (\sin \omega t)^{2\beta} dt$$

The voltage drop across a VDR when it carries a current $I = I_{\text{r.m.s.}}$ is given by:

$$V = CI_{\text{r.m.s.}}^{\beta}$$

The relation $n = V_{\text{r.m.s.}}/V$ is given by:

$$n = \frac{2^{\beta/2} \sqrt{\frac{2}{T}} \int_0^{T/2} (\sin \omega t)^{2\beta} dt}{CI_{\text{r.m.s.}}^{\beta}} \quad (15)$$

The values of n against β are plotted in fig. 10

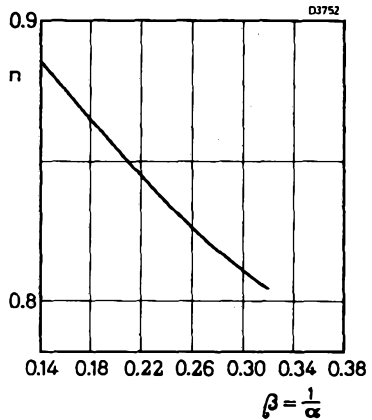

Fig. 10 Relation between the voltage caused by a d. c. current I and an a. c. current $I_{\text{r.m.s.}} = I$

Power dissipation

For a sinusoidal current, the power dissipation is given by:

$$W_{\text{a.c.}} = \frac{2}{T} \int_0^{T/2} V \cdot I dt$$

Since $V = CI^{\beta}$, and $I = i \sin \omega t$, where $i = I_{\text{r.m.s.}} \sqrt{2}$, we have:

$$W_{\text{a.c.}} = \frac{2CI_{\text{r.m.s.}}^{\beta+1}}{T} \int_0^{T/2} (\sin \omega t)^{\beta+1} dt$$

For a direct current $I = I_{\text{r.m.s.}}$ the dissipated power is:

$$W = CI_{\text{r.m.s.}}^{\beta+1}$$

Then the relation $q = W_{\text{a.c.}}/W$ is given by:

$$q = \frac{2^{(\beta+3)/2}}{T} \int_0^{T/2} (\sin \omega t)^{\beta+1} dt \quad (16)$$

Fig. 11 shows values of q as a function of β .

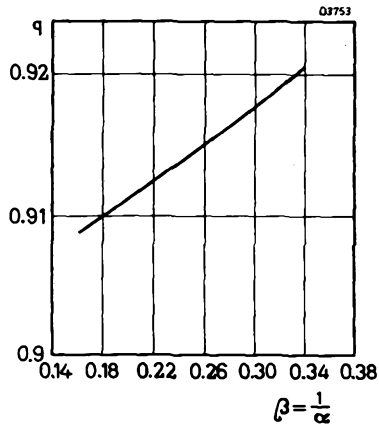

Fig. 11 Relation between the power dissipation caused by a d. c. current I and an a. c. current $I_{\text{r.m.s.}} = I$

From this graph it is clear that the variation in β -value has little influence on the power dissipation provided the current and peak voltage are constant. In practice, neither a sinusoidal voltage nor a sinusoidal current will generally occur. A sinusoidal voltage will, however, occur if an inductance is shunted with a VDR for spark suppression of contacts. Fig. 9 gives the factor depending on β -value, by which the d. c. power dissipation must be multiplied to obtain the a. c. value. If a linear resistor is connected in series with a VDR, the shape of the oscillogram will gradually deviate from that shown in fig. 5. If the resistance value is very large compared to that of the VDR, the current will take a sinusoidal form.

(c) Harmonics of the alternating current

The curve shown in fig. 5 can be evaluated into a Fourier series. In this way the ratio of the relative strengths between the first, the third, and the fifth harmonics can be found. Harmonics of the seventh and higher orders are very small, and of no practical importance. Fig. 12 shows the relative strengths of these harmonics as a function of $\alpha = 1/\beta$.

Fig. 12 Relative strengths of the harmonics

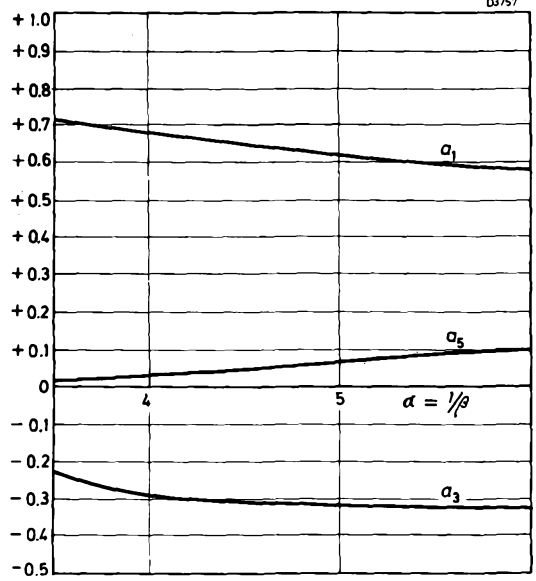

(d) High frequency alternating current

At low frequencies, the small capacitance of the VDR does not affect the voltage dependency. At high frequencies, however, this parallel capacitance may not be neglected for, at low voltages and currents, it may even determine the impedance of the VDR. At high voltages, the influence of the capacitance is less because the resistance across which the capacitance is shunted has decreased. In h. f. circuits this effect occurs as an apparent decrease in β , and the voltage/current characteristic on logarithmic scales is no longer a straight line, as shown in fig. 13, for silicon carbide types. A nominal capacitance value is given in the data for zinc oxide types.

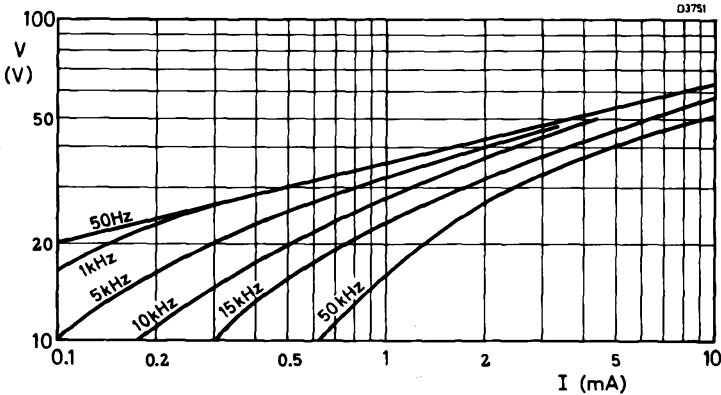

Fig. 13
Voltage/current characteristic for different frequencies

(e) Permissible dissipation

The temperature which a VDR will reach under operating conditions, is determined by the dissipated power, the thermal conductivity of the material, the nature of the surrounding medium, and the ambient temperature. As stated previously, the dissipation increases rapidly with increasing voltage.

The cooling per degree C, though increasing slightly with temperature, depends mainly on the total surface area of the VDR; it can be improved by forced ventilation. The permissible temperature of a VDR is generally limited by secondary effects, such as contact and insulation problems. For lacquered VDR's it is about 120°C.

For incidental surges, for which it may be assumed that they occur for a short time that no heat is conducted to the surrounding medium, the rise in temperature is defined by the energy in the surge, the mass of the VDR, and its heat capacity. A temperature rise of 100°C is caused by a surge of 60Ws/g. Thus for a VDR having a weight of 1g, the load may be 60W for a duration of 1s, or 6W for a duration 10s, i.e., the shorter the time, the higher the permissible load during that time, but this is limited by the material properties, which are liable to change at too high current densities, by voltage breakdown occurring between the silicon carbide crystal interfaces. The maximum current density for a VDR should be limited to 10mA/mm² for high C-values, and 5mA/mm² for low C-values.

A maximum non-repetitive peak energy rating is given in the data for zinc oxide VDR's.

Tolerances (silicon carbide VDR's)

In published data, VDR's are specified with a tolerance on the reference voltage, and a spread on β -value. From fig. 14 it can be seen that the spread on β -value can cause the tolerance on the voltage to increase for values of current other than the specified current at which the VDR is measured; this voltage is usually measured at 1, 10, or 100mA. Where voltage measurements at the specified current result in the rated dissipation of the VDR being exceeded, then pulsed conditions are used.

The C-values quoted are for a current of 1A, although the VDR may not be capable of conducting such a current, in which case the C-values are derived from measurements made at lower currents.

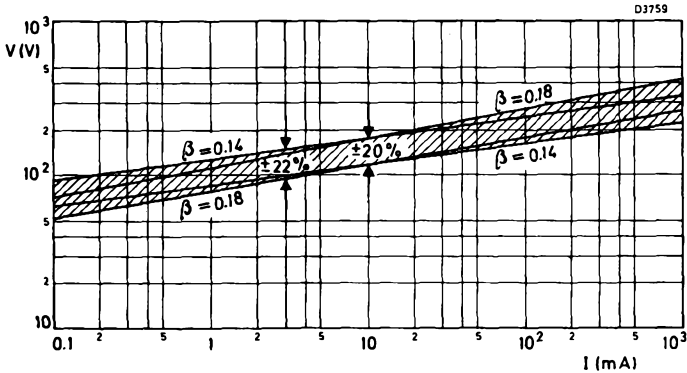

Fig. 14
The influence of the spread of β -value on the
voltage/current characteristic

Choice of type

The voltage/current characteristic will indicate which type of VDR is suitable for a particular application, and the power to be dissipated will indicate the dimensions. It is important that the maximum ratings are not exceeded, since a too high current density will change the material properties, and excessive power dissipation will cause the maximum temperature to be exceeded; this will adversely effect the soldering of the leads.

APPLICATIONS

The applications of VDR's may be classified into two main groups:

1. Applications where the voltage limiting property of the VDR is used.
2. Applications where the VDR is used for the rectification of asymmetric pulses.

Application examples

- (a) For contact protection and spark suppression for relays. When the contacts open, the energy stored in the inductance of the relay is dissipated in the VDR, and the voltage across the contacts is limited to a safe value.
- (b) Protection of small battery motors. Sparking brush contacts limit the commutator life and also cause interference. A VDR in parallel with each rotor winding prevents sparking, eliminates interference, and increases the commutator life.
- (c) Use in television receiver circuits for peak voltage limitation, oscillation damping, rectification to obtain a negative voltage for stabilising the picture width, and the e. h. t. against supply voltage variations, and against ageing of tubes.
- (d) Stabilization of voltage supplies.
- (e) The protection of semiconductors from transient surges on the supply lines.

NOTES

In all applications the following precautions must be observed:

- (a) VDR's must not be connected in parallel to obtain higher power dissipation.
- (b) Care should be taken to ensure that the maximum ratings are not exceeded.
- (c) VDR's should not be used in conducting, corrosive, oxidising or reducing fluids.

DEFINITIONS

C-value

The C-value is equal to the applied voltage for a current of 1A. Where the VDR is not capable of conducting 1A, the C-value is derived from measurements made at lower currents.

β -value

This is the index in the voltage/current relationship $V = CI^\beta$. It is equal to the slope of the voltage/current characteristic when this is plotted using logarithmic scales; α , the reciprocal of β is sometimes used in calculations.

Operating temperature category at zero power

The upper and lower category temperatures at zero power are the maximum and minimum ambient temperatures at which the VDR can be continuously operated.

Operating temperature category at maximum power

The upper and lower category temperatures at maximum power are the maximum and minimum ambient temperatures at which the VDR can be continuously operated.

Reference voltage and reference current

The co-ordinates of a point on the voltage/current characteristic. This point is in the working range of the VDR and is used to define the properties and for quality control.

Maximum power rating

The maximum power which can be dissipated at a specified temperature in still air.

Temperature coefficient (α)

The ratio (in % per degree C) of the change in voltage with temperature, to the voltage.

Voltage/current characteristic

The relationship between the voltage and current for a VDR.

MEASUREMENT OF VDR CHARACTERISTICS

The following are precautions which must be taken when measuring VDRs:

1. Use only d. c. voltages.
2. Keep the measuring time as short as possible. This will avoid self-heating effects.
3. When the voltage and current of a VDR are such that the dissipation is exceeded, measurements must be made using pulses of 10ms duration.
4. The β -value, which is dependent on both voltage and current, is measured between 0.3I and 3I for discs, and I and 10I for rods, where I is the current at which the VDR is specified:

$$\text{then } \beta = \log V_2/V_1$$

where V_2 = voltage at 3I or 10I

and V_1 = voltage at 0.3I or I

Silicon Carbide Types

Type No.	Code No.	Voltage (V) at I Ref	Reference Current (mA) I Ref	β Value	Shape
E299DD/P116	2322 552 01161	8	100	.25 to .4	Disc
E299DD/P118	2322 552 01181	10	100	.25 to .4	
E299DD/P120	2322 552 01201	12	100	.25 to .4	
E299DD/P216	2322 552 02161	8	10	.25 to .4	
E299DD/P218	2322 552 02181	10	10	.25 to .4	
E299DD/P220	2322 552 02201	12	10	.25 to .4	
E299DD/P222	2322 552 02221	15	10	.25 to .4	
E299DD/P224	2322 552 02241	18	10	.21 to .35	
E299DD/P226	2322 552 02261	22	10	.21 to .35	
E299DD/P228	2322 552 02281	27	10	.21 to .35	
E299DD/P230	2322 552 02301	33	10	.18 to .25	
E299DD/P232	2322 552 02321	39	10	.18 to .25	
E299DD/P234	2322 552 02341	47	10	.18 to .25	
E299DD/P236	2322 552 02361	56	10	.18 to .25	
E299DD/P238	2322 552 02381	68	10	.18 to .25	
E299DD/P336	2322 552 03361	56	1	.14 to .23	
E299DD/P338	2322 552 03381	68	1	.14 to .23	
E299DD/P340	2322 552 03401	82	1	.14 to .21	
E299DD/P342	2322 552 03421	100	1	.14 to .21	
E299DD/P344	2322 552 03441	120	1	.14 to .21	
E299DD/P346	2322 552 03461	150	1	.14 to .21	
E299DD/P348	2322 552 03481	180	1	.14 to .21	
E299DD/P350	2322 552 03501	220	1	.14 to .21	
E299DD/P352	2322 552 03521	270	1	.14 to .21	
E299DD/P354	2322 552 03541	330	1	.14 to .21	



Code No. 2322 594	Min. Volts at 1 mA	Max. Volts at 1 A	Shape
18202	82	140	Disc
11012	100	170	
11512	150	255	
11912	190	325	
12212	220	375	
13312	330	560	
13512	350	595	
13912	390	665	
14712	470	800	
16212	620	1055	
16812	680	1160	

Code No 2322 594	R.m.s. working voltage (V_{rms})	Clamping voltage max. at 100 A (V)	Shape
76002	60	220	Disc
77502	75	260	
79502	95	330	
71312	130	440	
71512	150	510	
71712	175	570	
72312	230	760	
72512	250	820	
72712	275	900	
73012	300	980	
74212	420	1410	
74612	460	1550	



**VOLTAGE DEPENDENT
RESISTORS**
(2322 552 Series)

E299DD
Series

This data sheet should be read in conjunction with
VOLTAGE DEPENDENT RESISTORS - INTRODUCTORY NOTES

APPLICATION

For use in television receivers and other electronic and electrical equipment.

DIMENSIONS (millimetres)

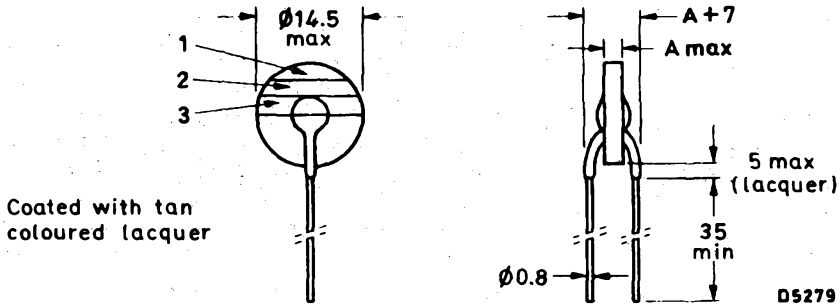

Coated with tan
coloured lacquer

ELECTRICAL DATA

Reference current (mA)	Reference voltage (V)
100	8 to 12
10	8 to 68
1	56 to 330

Tolerance on reference voltage	± 20	%
Maximum dissipation ($T_{amb} = 40^{\circ}\text{C}$)	800	mW
Asymmetry	<2	%
Temperature range		
at zero power	-25 to +125	$^{\circ}\text{C}$
at maximum power	0 to +55	$^{\circ}\text{C}$
Soldering	max. 240°C for 4s max.	

Mullard

Reference current (mA)	Reference voltage (V)	C (approx.)	β	Dimension A max. (mm)	Colour bands			Code No. 2322 552	Type No. E299DD/...
					1	2	3		
100	8	14	0.25 to 0.40	5	brown	brown	blue	01161	/P116
100	10	18	0.25 to 0.40	5	brown	brown	grey	01181	/P118
100	12	21	0.25 to 0.40	5	brown	red	black	01201	/P120
10	8	25	0.25 to 0.40	5	red	brown	blue	02161	/P216
10	10	32	0.25 to 0.40	5	red	brown	grey	02181	/P218
10	12	40	0.25 to 0.40	5	red	red	black	02201	/P220
10	15	48	0.25 to 0.40	5	red	red	red	02221	/P222
10	18	57	0.21 to 0.35	5	red	red	yellow	02241	/P224
10	22	60	0.21 to 0.35	5	red	red	blue	02261	/P226
10	27	70	0.21 to 0.35	5	red	red	grey	02281	/P228
10	33	85	0.18 to 0.25	5	red	orange	black	02301	/P230
10	39	100	0.18 to 0.25	5	red	orange	red	02321	/P232
10	47	130	0.18 to 0.25	5	red	orange	yellow	02341	/P234
10	56	150	0.18 to 0.25	5	red	orange	blue	02361	/P236
10	68	180	0.18 to 0.25	5	red	orange	grey	02381	/P238
1	56	190	0.14 to 0.23	5	orange	orange	blue	03361	/P336
1	68	230	0.14 to 0.23	5	orange	orange	grey	03381	/P338
1	82	300	0.14 to 0.21	5	orange	yellow	black	03401	/P340
1	100	350	0.14 to 0.21	5.5	orange	yellow	red	03421	/P342
1	120	400	0.14 to 0.21	6	orange	yellow	yellow	03441	/P344
1	150	500	0.14 to 0.21	6.5	orange	yellow	blue	03461	/P346
1	180	600	0.14 to 0.21	7	orange	yellow	grey	03481	/P348
1	220	750	0.14 to 0.21	7.5	orange	green	black	03501	/P350
1	270	900	0.14 to 0.21	8	orange	green	red	03521	/P352
1	330	1100	0.14 to 0.21	9	orange	green	yellow	03541	/P354

VOLTAGE DEPENDENT RESISTORS

(2322 552 Series)

E299DD Series

ORDERING PROCEDURE

The resistors should be ordered by their type or code number. They may be supplied in packs marked either with the type or code number.

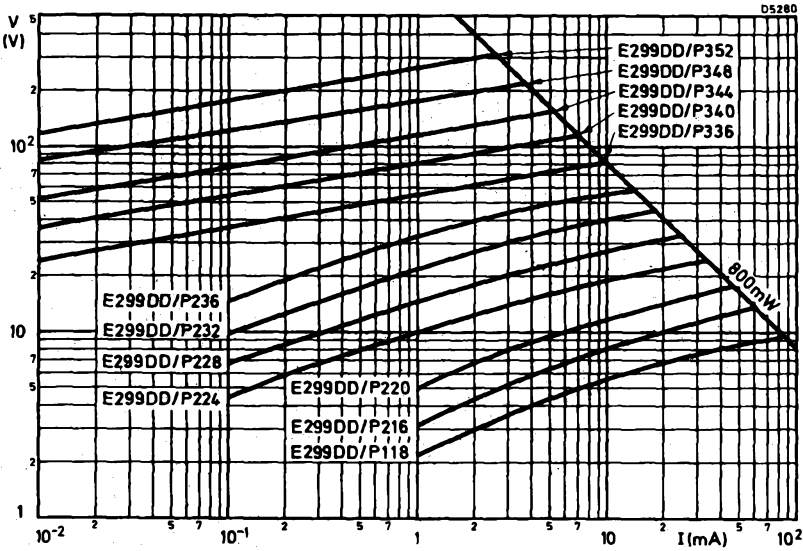

VOLTAGE/CURRENT CHARACTERISTICS

ZINC OXIDE VOLTAGE DEPENDENT RESISTOR

2322 594 1

This data sheet should be read in conjunction with
VOLTAGE DEPENDENT RESISTORS - INTRODUCTORY NOTES

QUICK REFERENCE DATA

Minimum voltage at $I_{peak} = 1 \text{ mA}$	82 to 680	V
Maximum voltage at $I_{peak} = 1 \text{ A}$	140 to 1160	V
β between 1 mA and 1 A	typ. 0.030	
Nominal r. m. s. working voltage	50 to 425	V
Max. non repetitive peak energy	3 to 6	J
Operating temperature range		
at zero power	-25 to +115	°C
at max. voltage	-25 to +85	°C

APPLICATION

For general use in contact protection, spark suppression, and particularly the suppression of voltage transients occurring on the a. c. mains supply.

DESCRIPTION

This type consists of a disc of low β material, which is provided with two solid tinned copper wires. The item is white base lacquered, but not insulated.

MECHANICAL DATA

Dimensions in mm

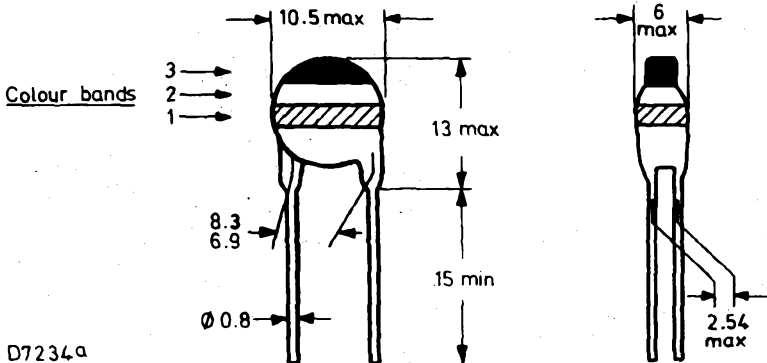

Mullard

→ ELECTRICAL DATA

Unless otherwise specified all electrical values apply at an ambient temperature of +25 °C.

β between 1 mA and 10 mA	typ.	0.030	
Voltage ratio between 1 mA and 10 mA	typ.	1.07	
Temperature coefficient at 1 mA between +25 and +85 °C	typ.	0.065	%/°C
Max. average power dissipation (averaged over 1 s)		100	mW
Max. non-repetitive pulse energy (see table 1)		3 to 6	J
Max. pulse current		500	A
Operating temperature range			
at zero power		-25 to +115	°C
at maximum r. m. s. working voltage		-25 to +85	°C

→ PULSE RATING

The maximum pulse energy (in joules) that may be dissipated by the VDR is shown in table 1 as a function of the permissible number of pulses during life. If, however, the frequency of the transient pulses exceed 1 Hz, the energy contained in the pulses must be restricted so that, the maximum average power applied to the VDR does not exceed the specified limits.

Table 1.

Type No. 2322 594. . . .	max. transient energy (Joules)			
	1 pulse	10 ² pulses	10 ⁴ pulses	10 ⁶ pulses
18202	3	1.8	0.30	0.0026
11012	3.5	2.1	0.37	0.0042
11512	4	2.3	0.44	0.0057
11912	4.5	2.6	0.51	0.0073
12212	5	2.8	0.58	0.0087
12712	5	2.8	0.58	0.0087
13312	5.5	3.1	0.65	0.0104
13512	6	3.4	0.72	0.0120
13912	6	3.4	0.72	0.0120
14712	6	3.4	0.72	0.0120
16212	6	3.4	0.72	0.0120
16812	6	3.4	0.72	0.0120

Table 2

minimum voltage at 1 mA peak 1) 2)	maximum voltage at 1 A peak 1) 3)	nominal r.m.s. working voltage 4)	maximum d.c. working voltage at $T_{amb} = +85\text{ }^{\circ}\text{C}$ 5)	maximum crest working voltage 4)	capacitance at 10 kHz 6)	colour code (see also Fig.1)			type number 2322 594 . . .
						1	2	3	
(V)	(V)	(V)	(V)	(V)	(pF)				
82	140	50	70	75	1325	grey	red	black	18202
100	170	60	85	95	1065	brown	black	brown	11012
150	255	95	135	150	800	brown	green	brown	11512
190	325	120	170	185	575	brown	white	brown	11912
220	375	135	190	210	535	red	red	brown	12212
270	460	165	235	255	395	red	violet	brown	12712
330	560	205	290	320	360	orange	orange	brown	13312
350	595	220	310	340	340	orange	green	brown	13512
390	665	245	345	380	300	orange	white	brown	13912
470	800	295	415	455	210	yellow	violet	brown	14712
620	1055	390	550	605	175	blue	red	brown	16212
680	1160	425	600	660	160	blue	grey	brown	16812

- 1) Measurement made without internal heating
- 2) Pulse time 10 ms
- 3) Rectangular pulse; pulse time between 0.5 and 1 ms.
- 4) Sinusoidal voltage assumed as normal input condition. The maximum allowed voltage is the nominal voltage +10%. If a non-sinusoidal input is present, the peak voltage should be used for type selection.
- 5) The d. c. working voltage is the average value of the applied working voltage. For ambient temperatures higher than 85 °C the maximum values must be derated as indicated in Fig. 2.
- 6) Measured without polarization. Test voltage \leq 250 mV. ↑

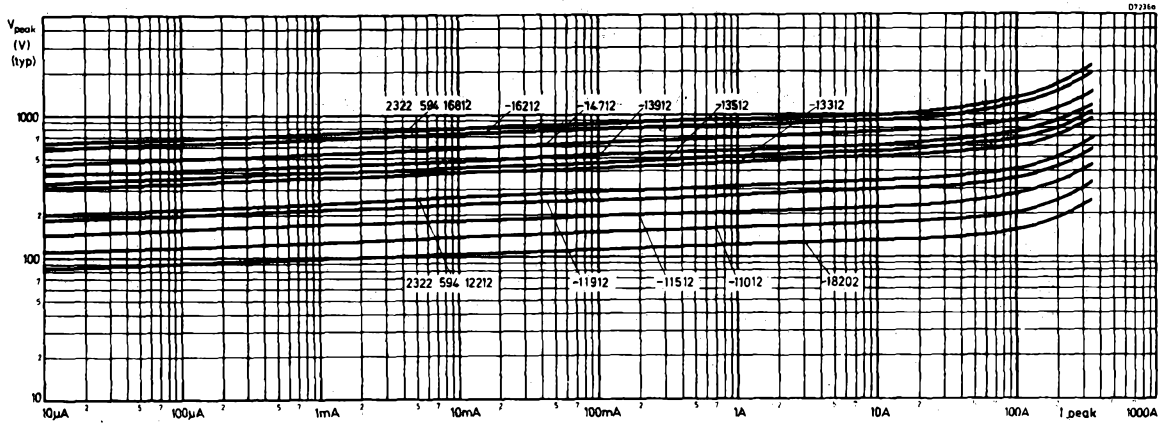

Fig. 1
Typical voltage versus current characteristic

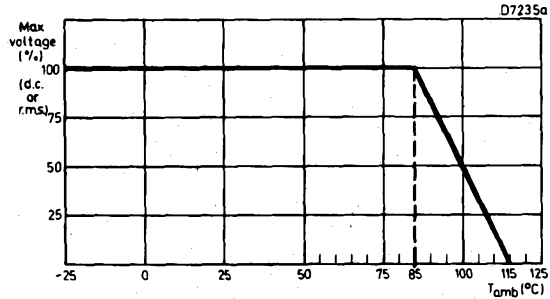

Fig. 2
Maximum d.c. voltage versus ambient temperature characteristic

VOLTAGE DEPENDENT RESISTORS

zinc oxide disc

QUICK REFERENCE DATA

Maximum a.c. voltage (r.m.s.)	60 to 460 V
Maximum d.c. voltage	85 to 615 V
Maximum non-repetitive transient energy	3 to 24 J
Operating temperature range	
at zero power	-40 to +125 °C
at maximum power	-40 to +85 °C

APPLICATION

Suppression of voltage transient, contact protection, spark suppression.

DESCRIPTION

The VDRs consist of a disc of low- β material, which is provided with two solid tinned copper wires. They are white lacquered, but not insulated.

MECHANICAL DATA

Dimensions in mm

Outlines

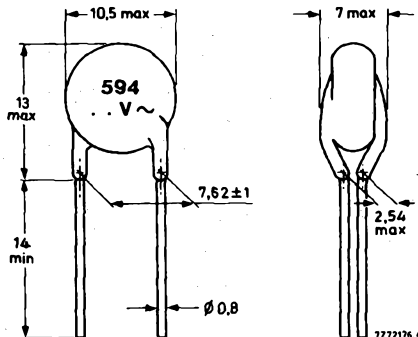

Fig.1



Marking

The resistors are marked with their serial number and the maximum r.m.s. working voltage (see Fig.1 and Table 1).

Mass

1 g approx.

Mounting

In any position by soldering

Robustness of terminations

Tensile strength 10 N

Bending 5 N

Soldering

Solderability max. 240 °C, max. 4 s

Resistance to heat max. 265 °C, max. 11 s

Inflammability

Self-extinguishing

ELECTRICAL DATA

Unless otherwise specified all electrical values apply at an ambient temperature of $+23 \pm 1$ °C

Thermal resistance, body to air	approx.	65	K/W
Temperature coefficient at 1 mA, measured between +25 and +85 °C	approx.	-0.065	%/K
Maximum average dissipation (including transients)		300	mW
Maximum impulse current (8/20 μ s)*		500	A
Operating temperature range			
at zero power		-40 to +125	°C
at maximum power		-40 to +85	°C
Climatic category		40/125/56	

See further Table 1

* This current is determined by the width T_2 (see Fig.4) and the number of impulses expected during the life of the component. Fig.5 gives the derating for different numbers of impulses. Resulting energy can be calculated with the equation: $E = K \cdot V_p \cdot I_p \cdot T_2$.



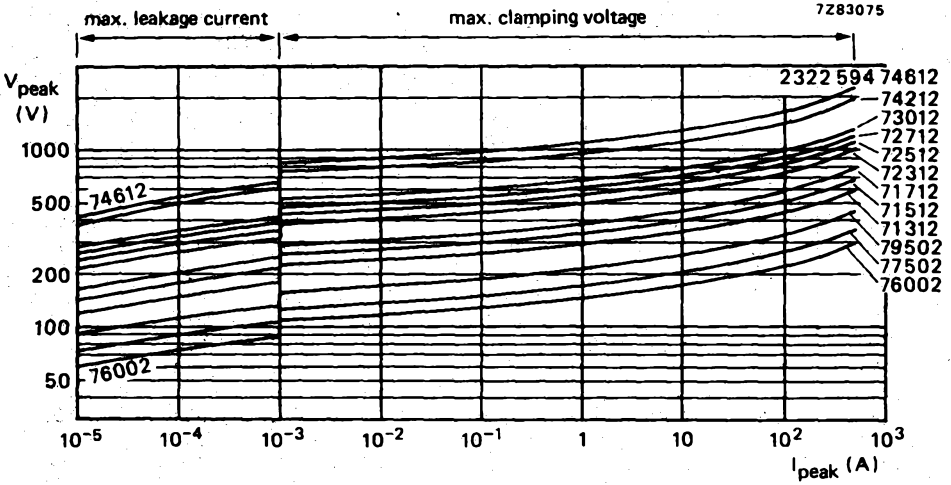

Fig.2 V/I characteristics



Table 1 VDRs with catalogue number 2322 594

suffix of catalogue number	MAXIMUM RATINGS				CHARACTERISTICS			
	r.m.s. working voltage (note 2)	d.c. working voltage	transient energy		varistor voltage (note 1)		maximum clamping voltage at 100 A	typical capacitance at 10 kHz
			8/20 μ s (note 3)	10/1000 μ s (note 4)	min.	max.		
	V	V	J	J	V	V	V	pF
76002	60	85	3,0	2,3	90	110	220	420
77502	75	100	3,5	2,8	108	132	260	350
79502	95	125	4,5	3,5	135	165	330	310
71312	130	170	6,5	4,8	185	225	440	280
71512	150	200	7,5	5,5	216	264	510	180
71712	175	225	9	6,2	243	297	570	170
72312	230	300	11	8,0	324	396	760	140
72512	250	320	12	8,8	351	429	820	130
72712	275	350	14	9,5	387	473	900	130
73012	300	385	15	10,5	423	517	980	110
74212	420	560	20	15	612	748	1410	90
74612	460	615	24	16	675	825	1550	90

Notes

1. Voltage at a current of 1 mA, impulse time 10 ms.
2. Sinusoidal voltage assumed as normal operating condition. If a non-sinusoidal voltage is present, the crest voltage x 0,707 should be used for type selection.
3. A current wave of 8 / 20 μ s (defined in IEC 60-2 section six) is used as a standard for impulse current and clamping voltage ratings. The transient energy is given for one impulse applied during the life of the component.
4. High energy surges are generally of longer duration. The max. energy for 1 impulse 10 / 1000 μ s is given as a reference for long duration impulses. This impulse can be characterized by peak current I_p and impulse width T_2 (virtual time to half I_p value following IEC 60-2 section six), see Fig. 4. If V_p is the clamping voltage corresponding to I_p , the energy absorbed in the VDR is determined by equation $E = K \cdot V_p \cdot I_p \cdot T_2$; K depends on T_1 is 8 to 10 μ s: for $T_2 = 20 \mu$ s K = 1; for 50 μ s 1,2; for 100 μ s 1,3; for 1000 μ s 1,4.



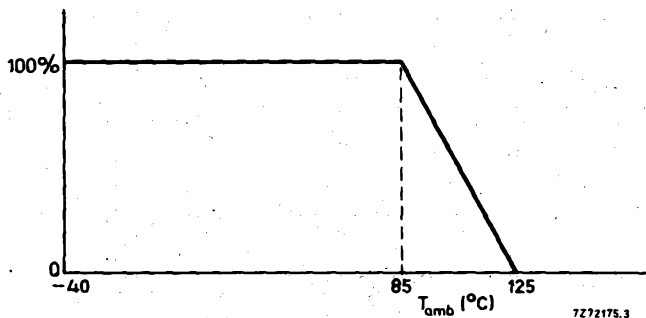

Fig. 3 Derating of max. d.c. and r.m.s. working voltage with temperature.

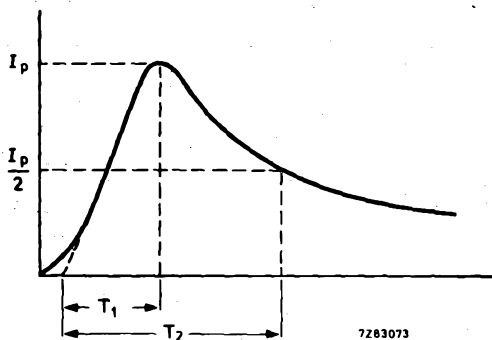

Fig. 4



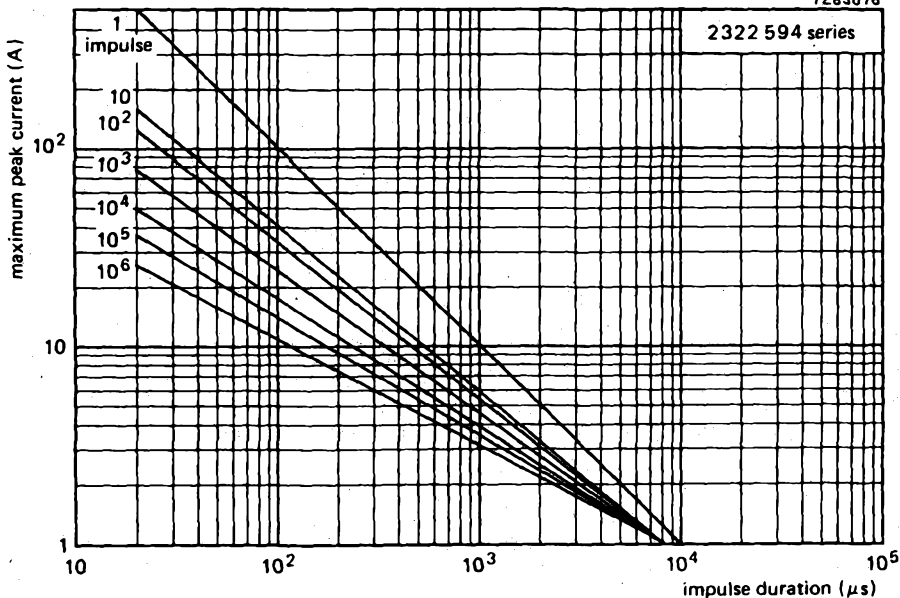

Fig. 5 Max. applicable transient current as a function of impulse duration.



TESTS AND REQUIREMENTS

According to IEC 68 recommendations unless otherwise specified.

test	test method	duration	$\Delta V/V$ (%) at $I_{peak} = 1 \text{ mA}$
Cold at $-40 \text{ }^\circ\text{C}$	A	1000 h	± 3
Storage at $+25 \text{ }^\circ\text{C}$	H	1000 h	± 3
Dry heat at $+125 \text{ }^\circ\text{C}$	B	1000 h	± 5
Rapid change of temperature	Na	5 cycles	± 5
Damp heat at $+40 \text{ }^\circ\text{C}$	C	56 days	± 5
Climatic sequence	(note 2)		± 5
Pulse tests			
High current transients at $+25 \text{ }^\circ\text{C}$	(notes 1, 7, 9)	10 pulses 8 / 20 μs	± 5
Long duration transients	(notes 1, 8, 9)	10 pulses 10 / 1000 μs	± 5
Electrical endurance at $+85 \text{ }^\circ\text{C}$			
Maximum r.m.s. voltage	(note 6)	1000 h	± 5
Maximum d.c. voltage	(notes 1, 6)	1000 h	± 5
Robustness of terminations			
Tensile strength	Ua	10 s	(note 3)
Bending	Ub	2 times	(note 3)
Soldering			
Solderability	T		
Resistance to heat	par. 3.2.3.	3 to 4 s	(note 4)
Impact	Tb	10 to 11 s	± 5
Free fall	E		
	Ed	2 falls	(note 5)

Notes

- For d.c. measurements the measuring current must have the same polarity as the load current.
- CECC 42000 issue 1 1978, par. 4. 16. Damp heat cycle test replaced by damp heat steady state for 24 h.
- Leads should neither come loose nor break.
- Leads must be solderable initially and after 6 months storage with solder containing resin flux.
- Neither electrical nor visual defects.
- CECC 42000 par. 4. 20.
- One impulse/min, all impulses same polarity, 2322 594 series $I_p = 165 \text{ A}$.
- One impulse/min, all impulses same polarity, 2322 594 series $I_p = 6 \text{ A}$.
- Impulse shape acc. to IEC 60-2 section six "Tests with impulse currents".

QUALITY LEVEL

Sampling and data evaluation for quality level in accordance with MIL-STD-105D.

- A.Q.L. 0,25%, Inoperatives
- A.Q.L. 1%, Electrical
- A.Q.L. 1,5%, Mechanical

PACKING

250 pieces per box (cardboard).



INDEX

INDEX TO BOOK 3 PART 1

CAPACITORS, RESISTORS

Type No.	Section	Type No.	Section	Type No.	Section
C281 Series	A	VA1112	G	630 Series	C
CR16, CR25, CR37	F	VA3100 Series	G	632/642 Series	C
E220ZZ/01 to 04	H	VA3200 Series	G	660 Series	C
E299DD Series	J	VA3400 Series	G	808 Series	E
Mounting clips	D	VA3700 Series	G	809/05 Series	E
MR16	F	VA8650	H	809/07 Series	E
MR25, MR30, MR308	F	VR25, VR37, VR68	F	809/08 Series	E
PR37, PR52	F	015/016 Series	D	809/09 Series	E
SFR25	F	032 Series	D	851 to 856 Series	C
VA1033	G	033 Series	D	2322 594 1. . . .	J
VA1034	G	034 Series	D	2322 594 7. . . .	J
VA1038	G	040 Series	D	2322 610 11118	G
VA1039	G	041/042 Series	D	2322 610 12109	G
VA1040	G	050 Series	D	2322 610 11339	G
VA1053	G	052 Series	D	2322 640 90004	G
VA1055S	G	071 Series	D	2322 640 90005	G
VA1056S	G	106/107 Series	D	2322 640 90013	G
VA1066S	G	108 Series	D	2322 640 90015	G
VA1067S	G	115 Series	D	2322 662 98003	H
VA1074	G	121 Series	D	2322 662 98009	H
VA1086	G	122 Series	D	2322 663 98004	H
VA1096	G	330 Series	B		
VA1097	G	344 Series	A		
VA1098	G	347 Series	B		
VA1100	G	352 Series	A		
VA1104	G	357 Series	B		
VA1106	G	358 Series	A		
VA1108	G	424, 425, 426, 427 Series	B		
VA1109	G	456, 457 Series	B		
VA1111	G	629 Series	C		

The following data sheets have been withdrawn:

- 105 Series
- C296 Series
- E298 Series

CAPACITORS, RESISTORS

CONTENTS



**SELECTION GUIDE
PREFERRED NUMBER SERIES**



A METALLISED FILM CAPACITORS



B FILM/FOIL CAPACITORS



C CERAMIC CAPACITORS



D ELECTROLYTIC CAPACITORS



E VARIABLE CAPACITORS



F LINEAR RESISTORS



**G NEGATIVE TEMPERATURE
COEFFICIENT THERMISTORS**



**H POSITIVE TEMPERATURE
COEFFICIENT THERMISTORS**



J VOLTAGE DEPENDENT RESISTORS



INDEX

Mullard Limited
Mullard House, Torrington Place, London WC1E 7HD
