

PHILIPS TECHNICAL LIBRARY

Series of books  
on  
**ELECTRONIC VALVES**

BOOK II

In this series of books on electronic valves there will appear:

- Book I Ir. J. Deketh: *Fundamentals of radio valve technique* (570 pages).
- Book II *Data and circuits of receiver and amplifier valves*, containing the valves brought out in the years 1933/39 (400 pages).
- Book III *Data and circuits of receiver and amplifier valves* (1st supplement), containing the valves of the years 1940/41.
- Book III<sup>A</sup> *Data and circuits of receiver and amplifier valves* (2nd supplement), containing the valves of the post-war years 1945/1950.
- Book IV Dr. B. G. Dammers, J. Haantjes, J. Otte, Ir. H. van Suchtelen: *Applications of electronic valves in radio sets and amplifiers* (Chapters I-V) (460 pages).
- Book V *Applications of electronic valves in radio sets and amplifiers* (Chapters VI-IX).
- Book VI *Applications of electronic valves in radio sets and amplifiers* (Chapters X-XIV).
- Book VII Ir. P. J. Heyboer: *Transmitting valves* (350 pages).

# DATA AND CIRCUITS

OF

## RECEIVER AND AMPLIFIER VALVES

This book contains a survey, together with descriptions and data, of modern receiving, amplifying and rectifying valves, as well as of electronic tubes for other purposes (current stabilizers and regulators, etc.), their uses and application. Tables are also provided of other types of receiving valves, cathode-ray tubes and special valves. A large number of receiver circuits are further included, as well as descriptions of the latest measuring instruments for laboratories, workshops and testing stations, all as at 1st January 1940.

**1949**

PUBLISHED BY  
N.V. PHILIPS' GLOEILAMPENFABRIEKEN (PHILIPS INDUSTRIES)  
EINDHOVEN, NETHERLANDS  
Technical & Scientific Literature Department

Translated by:  
G. DUCLOUX — SUTTON (ENGLAND)

The information and circuit diagrams given in this book do not imply freedom  
from patents rights.

Printed in the Netherlands.



51267

The Laboratories of the Philips Factories at Eindhoven

Copyright 1940. N.V. Philips Gloeilampenfabrieken, Eindhoven, (Holland).

All reproduction, translation and adaptation rights reserved in all countries.

## PREFACE TO THE ENGLISH EDITION

In the Dutch, French and German languages we have published a series of books under the title of "Data and Circuits of Modern Receiving and Amplifying Valves".

The object was to enable the consumers of our valves to get a clear and conveniently arranged survey of all data and characteristics of the valves produced by us.

Not long after it appeared that these books met, and still meet, such a long-felt want that we felt no longer justified in restricting ourselves to these three editions and therefore, we decided in favour of an English edition of the whole series, so that also the English speaking consumer may be able to get an insight into this matter.

The series consists of three books containing the data and characteristics of all receiving, amplifying, rectifying and regulating valves produced by us since 1933—1950. **Thus a complete documentation is supplied regardless whether any particular types are still produced or available in all countries.**

The first book, titled "Data and Circuits of Receiving and Amplifying Valves" is published as *Book II* of the series of books on Electronic Valves—part of Philips' Technical and Scientific Library.

Besides the receiving, amplifying, rectifying and regulating valves produced from 1933—1939, it contains a great many descriptions of circuiting diagrams showing how the various valves can be used, as well as the Philips measuring instruments for laboratories and workshops.

The second book with the same title is published as *Book III* of the series on Electronic Valves and is set on the same lines as Book II. It contains the data of the key-valves brought out in 1940—1941 and has 220 pages with 267 figures.

During the enemy occupation (1942—1944) no new types of valves were placed on the market, though research in our laboratories for further development was not suspended.

On the contrary an entirely new series of valves, the Rimlock Valves, were designed of which several series and types have now been placed on the market.

The description and characteristics of these new valves are to be found in the third book of the same title "Data and Circuits", 2nd supplement, it is *Book III.A* of the series on Electronic Valves. Its size is 6" × 9"—appr. 350 pages with many illustrations. (In preparation.)

It contains the Receiving and Amplifying Valves brought out in the years 1945—1950 and the principal group discussed are the Rimlock Valves.

Great attention has been paid to the application of these valves by means of a great many circuiting diagrams of apparatus in which they are employed, while the latest measuring apparatus for workshops and laboratories are again dealt with.

It is our intention that in the future this series will be continued as and when new types of valves are placed on the market. These new books will be published as *Book III.B*, *Book III.C*, etc.

## INTRODUCTION

Book I in this series deals with the fundamentals of radio valve technology. The present publication, Book II, contains more or less comprehensive descriptions of a large number of receiving and amplifying valves suitable for use on all types of current. It also furnishes full technical data and characteristics of the latest Philips receiving, amplifying and rectifying valves, current regulators and stabilizers and, further, in tabular form, details of other types of receiving and rectifying valves, electronic tubes as cathode-ray tubes, photoelectric cells, etc., which, although not immediately concerned with radio reception, are nevertheless of great importance in that sphere, e.g. for television, measurement by means of electronic indicators, or for special equipment.

The present work bears a special relation to the reception of radio telephony. In general, the valve descriptions are as brief as possible, but here and there it has been found unavoidable to enlarge upon the newer principles, for example, the question of secondary emission in the case of the secondary emission valve EEP 1. The principal data of each valve are given for the purposes of their application and, where necessary, circuit diagrams are included. Of the complete data and characteristics as measured in respect of every valve type, only the more important factors are published: primarily in view of the limitations set on the size of the book and, secondly, in order not to destroy the picture as a whole. In this way A.C. valves, A.C./D.C. types, battery and amplifying valves, are all dealt with in turn. Complete circuit diagrams illustrating the uses of these valves will be found in the final chapters, which contain comprehensive receiver circuits with their descriptions; all the circuits illustrated have been amply tried out in practice. A number of circuits for gramophone amplifiers have also been included as falling within the same category, whilst in the closing chapters short descriptions are given of Philips measuring instruments, as employed in the development and testing of receivers equipped with Philips valves. These instruments are not only extremely useful for servicing purposes but are indispensable in any well-equipped laboratory.

The opening chapters of this work contain general hints on the uses of receiving valves and electronic tubes of great value to the constructor and,

if undesirable connections or faulty applications of the valves are to be avoided, the reader would do well to peruse the instructions carefully; only in this way can ultimate disappointment be prevented.

This book is of interest to all who are concerned with radio receivers in general, with associated equipment or electronic tubes. It has been written for the designer, service dealer, amateur and student, and the material contained in the following pages may be regarded as the outcome of countless measurements and much practical experience in the use of radio valves. Moreover, the information given is furnished by the cooperation of a very large number of experts in the factories and laboratories of the Philips organization. It will be of great value both to the practical enthusiast and to the more theoretically-minded technician.



# INDEX

## INTRODUCTION

### CONTENTS

General Instructions for the correct use of Philips Valves . . . . .	Page	1
Explanatory Notes on the General Instructions for the use of Philips Valves in Radio receivers, Amplifiers, and on the maximum ratings . . . . .	..	3
The use of Philips Cathode-Ray Tubes . . . . .	..	6
Type numbering of Philips Valves . . . . .	..	8
Type numbering of Receiving, Amplifying and Rectifying valves . . . . .	..	8
Type numbering of Cathode-Ray Tubes . . . . .	..	9
Symbols and their meanings . . . . .	..	11

### A. C. VALVES

"Miniwatt" receiving valves in the "E" series . . . . .	Page	14
Triple diode EAB 1 . . . . .	..	20
Double-diode with separate cathodes EB 4 . . . . .	..	22
Double-diode triode EBC 3 . . . . .	..	24
Double-diode variable-mu pentode EBF 2 . . . . .	..	28
Double-diode output pentode EBL 1 . . . . .	..	34
Triode-hexode ECH 3 . . . . .	..	36
Secondary-emission valve EEP 1 (EE 1) . . . . .	..	51
Variable-mu R.F. pentode EF 5 . . . . .	..	61
Pentode EF 6 . . . . .	..	67
Low-noise variable-mu R.F. pentode EF 8 . . . . .	..	74
Variable-mu R.F. pentode EF 9 . . . . .	..	81
A.F. Amplifier and electronic indicator EFM 1 . . . . .	..	86
Heptode EH 2 . . . . .	..	92
Octode EK 2 . . . . .	..	98
Octode EK 3 . . . . .	..	106
Output pentode EL 2 . . . . .	..	112
Output pentode EL 3 . . . . .	..	118
Output pentode EL 5 . . . . .	..	124
Output pentode EL 6 . . . . .	..	128
Double output pentode ELL 1 . . . . .	..	134
Electronic indicator EM 1 . . . . .	..	137
Electronic indicator C/EM 2 . . . . .	..	139
Dual-sensitivity electronic indicator EM 4 . . . . .	..	144
Rectifying valve EZ 2 . . . . .	..	151
Rectifying valve EZ 4 . . . . .	..	153
Rectifying valve AZ 1 . . . . .	..	155
Rectifying valve AZ 4 . . . . .	..	157

### A.C./D.C. VALVES

Valves for A.C./D.C. Receivers . . . . .	Page	160
Double-diode output pentode CBL 1 . . . . .	..	162
Octode CK 3 . . . . .	..	166
Output pentode CL 4 . . . . .	..	172
Output pentode CL 6 . . . . .	..	175
Rectifying valve CY 1 . . . . .	..	183
Rectifying valve and voltage doubler CY 2 . . . . .	..	185

## 2 V BATTERY VALVES

Indirectly-heated double-diode KB 2 . . . . .	Page 188
Double-diode triode KBC 1 . . . . .	.. 189
Triode KC 1 . . . . .	.. 192
Triode KC 3 . . . . .	.. 194
Triode KC 4 . . . . .	.. 196
Triode-hexode KCH 1 . . . . .	.. 198
Class B output valve KDD 1 . . . . .	.. 206
Variable-mu R.F. pentode KF 3 . . . . .	.. 210
R.F. pentode KF 4 . . . . .	.. 213
Hexode KH 1 . . . . .	.. 217
Octode KK 2 . . . . .	.. 221
Output pentode KL 4 . . . . .	.. 225
Output pentode KL 5 . . . . .	.. 229

## POWER OUTPUT VALVES AND MICROPHONE PRE-AMPLIFIER PENTODE

Philips output valves . . . . .	Page 234
Triode 4641 . . . . .	.. 236
Pentode 4654 . . . . .	.. 239
Triode 4683 . . . . .	.. 244
Pentode 4689 . . . . .	.. 247
Pentode 4694 . . . . .	.. 249
Pentode 4699 . . . . .	.. 251
Pentode EL 51 . . . . .	.. 257
Pentode F 443 N . . . . .	.. 260
Microphone pre-amplifier pentode CF 50 . . . . .	.. 265

## RECTIFYING VALVES FOR AMPLIFIERS

Rectifying valves for amplifiers . . . . .	Page 270
Full-wave gas-filled rectifying valve AX 1 . . . . .	.. 272
Full-wave gas-filled rectifying valve AX 50 . . . . .	.. 274
Operating data for the Pentode EF 9 when used as resistance-coupled A.F. amplifier with A.G.C. . . . .	.. 276

## CURRENT REGULATORS AND STABILIZERS

Barretters C1, C2, C3, C8, C9, C10, C12 . . . . .	Page 278
Stabilizers 4357, 4687, 7475, 13201, 100 E 1 . . . . .	.. 285

## TABLES OF DATA REGARDING OTHER "MINIWATT" RE- CEIVING AND RECTIFYING VALVES, PHILIPS CATHODE-RAY TUBES, PHOTOELECTRIC CELLS, THERMO-COUPLES, GAS- FILLED TRIODES FOR SAW-TOOTH VOLTAGE GENERATORS AND SPECIAL TUBES

A.C./D.C. valves with side contact (P) base . . . . .	Page 290
Philips amplifying valves for special purposes . . . . .	.. 292
Philips neon indicator tube . . . . .	.. 292
Philips thermo-couples . . . . .	.. 292
Philips barretters . . . . .	.. 293
6.3 V metal and glass valves with 8-pin base . . . . .	.. 294

4 V directly-heated A.C. valves with side contact (P) base . . . . .	Page 296
4 V A.C. valves with pin-base (pre-amplifying stages) . . . . .	.. 298
4 V A.C. valves with pin-base (output stages) . . . . .	.. 300
180 mA D.C. valves . . . . .	.. 300
Battery valves with pin-base . . . . .	.. 302
Philips gas-filled triodes for time base . . . . .	.. 302
Philips power output valves . . . . .	.. 304
Philips amplifying and detector valves for television receivers . . . . .	.. 304
Philips high-vacuum cathode-ray tubes for oscillographs . . . . .	.. 306
Philips high-vacuum cathode-ray tubes for television receivers . . . . .	.. 306
Philips rectifying valves for receivers, amplifiers and cathode-ray tubes . . . . .	.. 308
Philips photoelectric cells . . . . .	.. 309
Base connections of "Miniwatt" receiving, output and rectifying valves . . . . .	.. 310
Base connections of Philips cathode-ray tubes, television and receiving valves, photoelectric cells, stabilizers, gas-filled triodes and special amplifying valves . . . . .	.. 312
Power, voltage and current as functions of the unit dB . . . . .	.. 314

### CIRCUITS OF A.C. RECEIVERS

I. 9-Valve superheterodyne receiver; balanced output stage . . . . .	Page 316
II. 8-Valve superheterodyne receiver; 18 W output . . . . .	.. 322
III. 8-Valve superheterodyne receiver; 9 W output . . . . .	.. 326
IV. 6-Valve superheterodyne receiver . . . . .	.. 330
V. 6-Valve superheterodyne receiver . . . . .	.. 334
VI. 5-Valve superheterodyne receiver . . . . .	.. 337
VII. 4-Valve superheterodyne receiver . . . . .	.. 340
VIII. 3-Valve receiver for local stations . . . . .	.. 343

### CIRCUITS FOR A.C./D.C. RECEIVERS

IX. 7-Valve superheterodyne receiver for 220 V mains . . . . .	Page 346
X. 5-Valve superheterodyne receiver for 110 V mains . . . . .	.. 348
XI. 5-Valve superheterodyne receiver for 110 V mains . . . . .	.. 351
XII. 4-Valve receiver for local stations . . . . .	.. 354

### CIRCUITS FOR BATTERY RECEIVERS

XIII. 6-Valve superheterodyne receiver . . . . .	Page 356
XIV. 6-Valve superheterodyne receiver . . . . .	.. 362
XV. 6-Valve superheterodyne receiver . . . . .	.. 364
XVI. 4-Valve superheterodyne receiver . . . . .	.. 366
XVII. 4-Valve superheterodyne receiver . . . . .	.. 369
XVIII. 4-Valve 2-circuit cascade receiver . . . . .	.. 373
XIX. 3-Valve 2-circuit cascade receiver . . . . .	.. 375
XX. 2-Valve receiver for local stations . . . . .	.. 376

### CIRCUITS FOR SMALL GRAMOPHONE AMPLIFIERS

XXI. 25 W Gramophone amplifier for A.C. mains . . . . .	Page 378
XXII. 15 W Gramophone amplifier for A.C. mains . . . . .	.. 380
XXIII. 6 W Gramophone amplifier for 220 V. mains A.C./D.C. . . . .	.. 382
XXIV. 2 W Gramophone amplifier for 110 V. mains A.C./D.C. . . . .	.. 384

**PHILIPS MEASURING INSTRUMENTS FOR THE LABORATORIES,  
WORKSHOPS AND TEST STATIONS**

Philips Valve Tester "Cartomatic I" GM 7629 . . . . .	Page 386
Philips Universal Measuring Bridge "Philoscop" GM 4140 . . . . .	.. 389
Philips Cathode-Ray Oscillograph GM 3152 . . . . .	.. 391
Philips Cathode-Ray Oscillograph GM 3155 . . . . .	.. 393
Philips Electronic Switch GM 4196 . . . . .	.. 395
Philips Service Oscillator GM 2882 . . . . .	.. 398
Philips Frequency Modulator GM 2881 . . . . .	.. 400
Philips A.F. Signal Generator GM 2307 . . . . .	.. 402
Philips Heterodyne Wavemeter GM 3110 . . . . .	.. 404
 Survey of Philips Valves . . . . .	 .. 408

# General Instructions for the correct use of Philips Valves

From the point of view of the heater supply, valves can be divided into three groups, viz:

- 1) those whose application is based on the heater voltage, that is to say, with heaters connected in parallel to a source of supply such as a transformer or battery (e.g., 4 V A.C. valves or 2 V battery valves);
- 2) those whose application is based on the heater current, the heaters being connected to the source in series (e.g., 180 mA D.C. valves or valves used exclusively for A.C./D.C.);
- 3) valves which can be selected according to their heater voltage *or* to their heater current, i.e. those suitable for parallel and series connection (e.g., 6.3 V valves used both for A.C. parallel supply and for A.C./D.C. series supply).

In case 1) where the heater voltage is the guiding factor, the data and characteristics refer to the specified value of the heater voltage. In case 2) where the basic consideration is the heater current, all the data apply to the specified value of the heater current. It should be noted that in case 1) the average value of the heater current should be taken into account and in case 2) the average value of the voltage.

For valves which are suitable both for series and for parallel operation the data given in the tables refer to the use of the valve not only at the specified heater voltage but also at the indicated current.

## THE VALVE DATA

Properties such as the mutual conductance, internal resistance, etc., are given with respect to a certain value of the anode current, which is in each case such that optimum results will be ensured under normal conditions. Since the anode current should be regarded as the guiding factor, the grid voltage values given must be taken to be average values. All total values are the outcome of measurements at the working voltages and currents as specified and they should be looked upon as averages obtained from tests on a very large number of valves. Unless otherwise stated, data concerning pentodes having separately connected suppressor grid may be considered as having been obtained with this suppressor grid connected to the cathode. All voltages are given with respect to the cathode. In the case of battery valves, voltages are quoted with respect to the negative end of the filament, whilst the other data refer to the grid bias indicated.

## MAXIMUM RATINGS

The maximum values of voltage, current, load, etc., for the mains voltage on which the receiver is to operate, should in no circumstance be exceeded. When designing the receiver it is essential to take steps to avoid voltage variations that may be occasioned by changes in signal strength or differences in the tolerances of the components. Allowance is made for the possibility that the anode voltage of pentodes — at the nominal mains voltage — may increase at most 5% above the specified maximum values as a result of variations in signal strength in the receiver.

In the given values of current, voltage and power, allowance has further been made for mains voltage variations of +10% to -10%. If even greater variations are anticipated it is recommended that the working voltages with respect to the normal mains voltage be placed at a correspondingly lower level. The heater voltage supplied by the appropriate transformer must never exceed +5% or -5% of the indicated maximum value. In connection with these tolerances the actual average of the mains voltage must be taken into consideration.

Valves for car-radio receivers are constructed for feeding from car batteries (lead accumulators), and battery valves for both accumulators and dry batteries (the valves

in the "D" series) may also be fed in series through a high-tension unit working from the mains. The tolerances of the series resistors in D.C. or A.C./D.C. receivers should meet the requirement that the heater current, at the actual average mains voltage, does not exceed  $\pm 3\%$ . If instead of a fixed resistor a barretter is employed limits of  $\pm 5\%$  may be allowed in view of the compensating action of these tubes. In some valves employed for A.F. amplification the maximum permissible sensitivity is given for 50 mW output power from the final valve, in view of possible microphony; the minimum permissible alternating grid voltage to produce an output of 50 mW from that valve must be taken into account. From this value it is possible to calculate the maximum permissible amplification obtainable without risk of microphony.

The above-mentioned values merely indicate an order of size and they refer to normal receivers fitted with loudspeakers of average sensitivity. With pentodes having a separate external connection for the suppressor grid, when controlling the internal resistance by means of this grid, care should be taken that the maximum screen load is not exceeded. For each valve a maximum value is given in respect of the resistance between *grid* and *cathode* and in many cases more than one value, e.g., with respect to both automatic and fixed grid bias. This resistance consists of the various resistance elements between grid and cathode in the circuit, such as the grid leak, smoothing resistance (as in the case of automatic gain control) and cathode (bias) resistance. It is preferable to select a value below the maximum permissible resistance; only in extreme cases should this maximum cathode-grid resistance value be permitted.

The resistance of a diode without negative delay voltage may be estimated at 10,000 ohms. If it is not possible to earth the cathodes directly this should always be done through a capacitor sufficiently large to handle the frequencies of the alternating voltages present.

To avoid interference there must be neither A.F. nor R.F. voltages between the cathode and the heater, or chassis. In the case of A.F. negative feed-back part of the cathode resistor in A.F. amplifying valves need not necessarily be decoupled by a capacitor (at most 50 ohms). With output valves it is not essential to decouple the cathode resistor at all.

The maximum permissible voltage between cathode and heater, unless otherwise stated, in every case refers to the D.C. voltage, or the peak alternating voltage at mains frequency. R.F. and A.F. voltages between cathode and heater must be avoided to prevent interference.

To prevent spluttering effects from indirectly-heated rectifying valves a sufficiently high ohmic resistance of the mains transformer must be ensured; the lowest satisfactory value of this resistance is  $R_t = R_s + u^2 R_p$ , this being dependent upon the first smoothing capacitor. If this value is not obtained a resistor  $R$  is to be included in each anode circuit, the combined value of these being such that  $R_{t_{min}} = R + R_s + u^2 R_p$ . In this formula  $R_s$  is the resistance of the secondary winding of the transformer to be used with single- anode rectifying valves, or the resistance of half the secondary winding in the case of full-wave rectification. Valves must never be mounted upside down, i.e. base upwards. Horizontal mounting may be resorted to if no better arrangement is possible. Directly-heated rectifying valves should be so mounted that the anode faces are vertical, that is to say, the plane in which the filaments are suspended should be vertical. In car-radio sets the following valve types should be used exclusively: EBC3, EF9, EK 2, EL 2, ELL 1, EM 4, EZ 2, FZ 1, EBC 11, ECH 11, EDD 11, EF 11, EZ 11. Receivers fitted with pentode output valves frequently have a switch for cutting out the built-in loudspeaker, but if the secondary side of the speaker transformer is thus open-circuited without the extension speaker being connected the screen grid of the output valve may be very heavily overloaded. Care should therefore be taken to prevent this.

# Explanatory Notes

## on the General Instructions for the use of Philips valves in radio receivers and amplifiers and on the maximum ratings.

### 1. Maximum voltage on an electrode in the cold condition

By "voltage in cold condition" is meant the potential existing at an electrode of the cold valve. Generally speaking, when a receiver is switched on the anode and heater voltages are applied simultaneously, but if the valves are of the indirectly-heated type and the rectifier for the anode supply is directly-heated the electrodes of the receiving valve receive the full direct voltage almost immediately after switching on. The cathodes of the indirectly-heated valves are then still cold and cannot emit, so that the rectifier section of the receiver is not fully loaded, if loading is not provided by means of potential dividers; consequently the voltages on the electrodes become very much higher than is the case under normal working conditions. In order to avoid flash-over, the maximum voltage in respect of the cold condition as specified must not be exceeded.

In variable- $\mu$  pentodes to which A.G.C. is applied the anode and screen current are practically nil, and voltage losses in smoothing circuits or in the dropping resistance of potential dividers are therefore also very low; the electrode potentials are then higher than in the uncontrolled condition, and in such cases these potentials should roughly approximate the maximum voltage in the cold condition.

### 2. Maximum constant loading of electrodes

By this is meant the average power in watts consumed by an electrode. This load determines the temperature of the electrode and can be obtained from the current flowing in that electrode, with no signal at the grid, multiplied by the relative D.C. voltage. The currents passing to the electrodes and the voltage present there should always be such that the maximum constant load on the electrode is never exceeded, even for a very short period. In output valves the average screen-grid current increases on full load and, for correct operation, a maximum constant load (dissipation) is quoted for the screen, with no signal on the grid, whilst the given maximum constant load for maximum modulation is a measure of whether the screen is overloaded or not.

### 3. Screen current variations in pentodes

Since the values given relate to a particular anode current, limit-values are frequently indicated for pentodes, between which the screen-grid current may vary when the anode current is in accordance with the published data. These maximum values make it possible to ascertain beforehand by how much the power of a valve varies from or exceeds the specified limit in any given circuit.

### 4. Maximum cathode current

The maximum cathode current is indicated in respect of every valve type and must in no case be exceeded; otherwise the cathode will sustain damage. The cathode current is made up of the currents passing through the various electrodes and may be checked best by means of a milli- or micro-ammeter in the cathode circuit.

### 5. Limit values at which grid current occurs

A value of grid bias is specified for each valve type, at which grid current will positively not occur, having due regard to the tolerances of the valve. The maximum permissible grid current at the maximum rating of the grid bias is taken to be  $+0.3 \mu\text{A}$ .

## 6. Maximum resistance between grid and cathode

There is almost always some risk of primary grid emission, especially in valves which tend to become very hot. This emission is caused by the deposition of small portions of the emissive substance upon the grid, thermal emission taking place when the grid becomes hot. Since the grid then emits electrons (negative charges) it becomes less negative, whilst high resistance between the grid and cathode prevents the occurrence of sufficient current to compensate the remaining positive charge. The reduced negative charge on the grid causes the anode current to rise and the valve then overloads, with the result that the grid emission is further increased. Ultimately the valve will work with practically no grid bias and the anode current accordingly rises to such a level that in a very short time the components of the valve become overheated and produce gases. Due to ionisation of these gases the heater, or the cathode, is bombarded with positive ions and their emission is reduced.

In order that these injurious processes may be avoided, in each case a maximum value is given for the total permissible resistance between grid and cathode. In R.F. valves this value is higher than in output valves, in view of the fact that the latter carry heavier currents and operate at higher temperatures.

The effects of grid emission are to a certain extent compensated by the use of automatic grid bias, obtained by including a resistor in the cathode or negative filament circuit; any increase in anode current then produces a corresponding increase in the bias which in turn reduces the anode current again. In view of this, two values are frequently given for the maximum grid-to-cathode resistance, one with respect to automatic bias and one for fixed bias. In the latter case the maximum resistance value is the lesser.

For high-mutual-conductance pentodes the maximum value of the grid-cathode resistor is given only with respect to operation with automatic grid bias. A so-called semi-automatic bias, provided for instance by the voltage drop across a resistor in the negative H.T. line of the receiver, may be employed in all cases where the cathode current of the output valve is in excess of 50 % of the total current passing through the resistor producing the voltage drop. The maximum value of the grid-cathode resistor  $R_{g_1k}$ , for automatic bias, is then reduced according to the equation:

$$\frac{\text{Cathode current of output valve}}{\text{Total current in resistor producing voltage drop}} \times R_{g_1k}$$

It is always better to work on the lowest possible grid-cathode resistance and not to adhere to the maximum value quoted.

## 7. Maximum voltage between heater and cathode

Since the insulation between the heater and the cathode consists of a very thin layer of aluminium oxide and this is naturally capable of withstanding only small variations in voltage, a maximum voltage value is stated with respect to each valve type; since D.C. voltage variations might tend to cause electrolysis, this maximum value in each case takes into account both the D.C. voltage and the effective value of the alternating voltage.

With indirectly-heated valves the secondary side of the heater transformer is frequently earthed, whilst the cathode is at a certain potential with respect to earth depending on the circuit employed. Now in A.C./D.C. receivers certain types of valve will produce high potentials between heater and cathode, seeing that the former is connected in series with the mains, whereas the cathodes themselves are usually at a potential that does not differ very much from that of the chassis. In such cases due consideration must be given to the maximum permissible voltage between heater and cathode.

## 8. Maximum resistance between heater and cathode

If a resistor is included between the heater and the cathode of an indirectly-heated



valve, for instance to provide automatic grid bias, this resistor must be limited to a definite value, as prescribed for each valve type. Due to the potential difference between heater and cathode, leak currents occur between the two, across the insulation. If the value of the resistor is too high the operating point of the valve is changed and fluctuates along the characteristic in accordance with the irregularities in the leak current. The working of the valve is then no longer uniform and, moreover, the insulation is more heavily loaded and suffers in consequence.

Should components in the cathode-chassis circuit be insufficiently decoupled, alternating voltages at the frequency of the signal on the grid will occur across those components and thus also between the cathode and the heater; as a result of the accompanying modifications in the heater-cathode insulation, interfering frequencies are introduced which manifest themselves as a crackle in the loudspeaker. Cathodes should therefore always be decoupled with sufficiently high capacitances.

In circuits including negative feed-back across a part of the bias resistor, or, in the case of output valves, across the whole of it, the decoupling capacitor is frequently dispensed with; since the A.F. alternating voltages between cathode and earth are relatively small, such circuits will not necessarily give any trouble from the point of view of hum and crackle.

# Hints on the use of Philips cathode-ray tubes

The following suggestions will be found very useful in the operation of cathode ray-tubes

## MOUNTING

Cathode-ray tubes should be mounted preferably in an earthed metal housing, sheet iron 1 mm in thickness being very suitable for this purpose. This is necessary to counteract interference caused by magnetic fields; also to protect the tube from mechanical damage and to offer protection against the very high voltages involved.

Precautions should be taken to see that the housing is quite free from magnetism. All parts having a high voltage should be adequately shielded, so that they cannot be touched, and the use of a safety switch in conjunction with any closures giving access to such parts is to be recommended. The positive side of the supply section must be earthed, as this renders dangerous voltages less accessible. It should be remembered, for instance, that as a result of the breakdown of a capacitor, or an incorrect connection, certain components not normally at a high voltage may be rendered dangerously "live". The mains voltage should therefore always be switched off before anything in the circuit is touched, and capacitors should be duly discharged by shorting them.

Earthing of the 2nd or 3rd anode results in the heater transformer (or battery if such is used) being at a high voltage below earth, and due allowance must be made for this in regard to the insulation.

From the above points it follows that the tube socket needs to be of the highest quality insulating material and that the spacing between the contact sockets, springs and the chassis must be very carefully determined.

## DEFLECTION

When electrostatic deflection is employed the deflector plates not in use must be earthed, and if one or more of these plates are connected through a capacitor it is advisable also to earth them through a 5-megohm resistor to avoid static charges on the plates.

## CENTERING THE IMAGE

If the image should not be in the centre of the screen this can be remedied in the following way:

### *a) Electrostatic deflection*

An auxiliary voltage may be applied between the deflector plates and the main anode, but as an eccentric spot is in most cases produced by an interfering magnetic field an opposing field will also correct the error.

### *b) Electromagnetic deflection.*

Improvement can be made by passing a direct current through the deflector coils. This can also be resorted to if and when a part of the screen becomes burnt, for by this means it is possible to change the location of the image.

## BRIGHTNESS OF THE IMAGE

The brightness of the image is dependent upon the intensity of the electron stream passing from the cathode to the screen. Control may be by means of the grid voltage. A certain degree of brightness is obtained at a high anode voltage with high grid bias, but also at a lower anode potential and correspondingly lower grid voltage; in the first instance, however, a smaller light spot (finer line) is produced.

## DEFINITION

Effective smoothing of the rectified high tension is essential; generally speaking, the ripple should not exceed 1 % of the anode voltage.

### a) *Electrostatic focusing.*

The definition is governed by the ratio between the potentials on the main and auxiliary anodes, the normal ratio being stated for each separate type of tube. Definition is adjusted by varying the voltage on the auxiliary anode.

### b) *Electromagnetic focusing.*

The definition of the spot can also be controlled by varying the flow of current in the focusing coil. The smaller the distance from the coil to the screen, the lower the required current for sharp definition.

## SENSITIVITY

### a) *Electrostatic deflection.*

The sensitivity of the deflector plates is inversely proportional to the anode voltage; at the maximum permissible anode potential, sensitivity is the lowest. At the same time, under such conditions, the tube is the least sensitive to interference from external electromagnetic fields.

The use of a symmetrical circuit often makes it necessary to connect the deflector plates through a capacitor of 0.1 to 1  $\mu\text{F}$  and to earth them across a resistor. The value of this resistor should be as low as possible to ensure that the potential produced on the plates by the secondary electron stream from the screen is not increased to the extent where it will have a retroactive effect on the voltage under investigation. It is true that a low value of the resistance will represent a load on the applied voltage, but as long as the internal resistance of the source of potential is also slight, this load will have no perceptible effect.

### b) *Electromagnetic deflection.*

With electro-magnetic deflection, the sensitivity is inversely proportional to the square root of the applied voltage. The above remarks with regard to the anode voltage also apply here.

## NOTES

- 1) In no circumstances should the grid be given a positive potential with respect to the cathode.
- 2) Care should be taken to see that the light spot does not remain stationary on the screen, as this causes burning of the latter.
- 3) It is advisable to apply the time voltage (sinusoidal or sawtooth voltage from the time base) to those deflector plates which are the most remote from the cathode ( $D_2$  and  $D_2'$ ). Sensitivity is at its lowest at these plates, whilst the load produced by secondary electrons from the screen is greatest. In these circumstances the other pair of deflectors have the best characteristics for the voltage under investigation.

## CONNECTIONS TO THE BASE

A tolerance of about 10 % has been allowed for in the mounting of the base, with respect to the deflector plates. It should be borne in mind, further, that the cathode is connected to one end of the filament, for which reason the cathode connection in the feed section should be connected to that point. If this is not done, the cathode will be at an undesired potential of 4 V A.C. (or 6.3 V as the case may be) with respect to the grid and this may in turn possibly cause intensity modulation.

## Type-numbering of Philips valves

### Receiving, amplifying and rectifying valves

Originally, the type numbers of the valves consisted of a capital letter and a number of 3 or 4 figures. The letter indicated the heater current in accordance with the following:

A	=	heater current of 0.06 to 0.10 A
B	=	.. .. 0.10 to 0.20 A
C	=	.. .. 0.20 to 0.40 A
D	=	.. .. 0.40 to 0.70 A
E	=	.. .. 0.70 to 1.25 A
F	=	.. .. 1.25 A or higher.

The first figure, or, in the case of 4 figures, the first two gave the value of the heater voltage; the two final figures represented the gain factor at the working point as applicable to triodes, but for valves having more than one grid the meanings were as follows:

- 41, 51, etc. tetrodes with space-charge grid (double-grid valves)
- 42, 52, etc. R.F. screen-grid valves
- 43, 53, etc. output pentodes
- 44, 54, etc. binodes
- 45, 55, etc. variable-mu R.F. tetrodes
- 46, 56, etc. R.F. pentodes
- 47, 57, etc. variable-mu R.F. pentodes
- 48, 58, etc. mixer hexodes
- 49, 59, etc. variable-mu hexodes.

For instance, the E 499 is a triode of which the heater current lies between 0.70 and 1.25 A (in actual fact it is 1.0 A), with a heater voltage of 4 V and a gain factor of 99. It was subsequently found impossible, however, to designate all valve types by this method and in 1934 a new system was introduced which sufficiently typifies all the newer kinds of valve.

The type number of recent Philips receiving valves comprises a number of capital letters and a numeral, the latter following directly after the letters. Of the latter, the first shows the series to which the valve belongs, whilst the second indicates the type of valve. In the case of composite valves various letters are employed instead of the second letter, one for each individual system contained within the valve. A numeral then follows, this being a serial number which is so selected that one and the same valve type in any of the various series (with the exception of the initial letter) will bear the same type number.

Barretters (iron-hydrogen tubes) are given only one letter, to represent the series, followed by a numeral.

The following table indicates the meaning of the different letters employed

First letter: Valve series	Second and subse- quent letters: Valve type	Figure: Serial number
A = 4 V A.C. series B = 180 mA D.C. series C = 200 mA A.C./D.C. series D = max. 1.4 V battery series E = 6.3 V A.C. and car-radio series F = 13 V car-radio series H = 4 V battery series K = 2 V battery series U = 100 mA A.C./D.C. series V = 50 mA A.C./D.C. series	A = diode B = double diode C = triode, except output valves D = output triode E = tetrode F = R.F. pentode amplifier H = hexode or heptode K = octode L = output pentode M = electronic indicator X = full-wave gasfilled rectifying valve Y = half-wave high vacuum rectifying valve Z = full-wave high vacuum rectifying valve	On the introduction of a new valve type in a given kind, the next following free number is used.

### Examples

One of the later Philips valves is the EF 9; E shows the heater voltage to be 6.3 V; F indicates that it is an R.F. pentode (or R.F. amplifier). The figure 9 is a grade number.

The ABC 1 furnishes another example; the letter A tells us that it is a 4 V A.C. valve; B and C point to a combination of double-diode and triode. The same valve, but having a heater current of 200 mA for series supply in A.C./D.C. receivers, is known as the CBC 1. The EAB 1 is a triple-diode in the 6.3 V series, that is, a combination of diode (A) and double-diode (B). The KDD 1 is a 2 V valve for battery operation (K), consisting of two output triodes (D). Barretters in the 200 mA A.C./D.C. series are known as the C 1, C 2, C 3 and so on.

### NOTE

Many special types not included in the standard range are given in a different form of code; for instance, the 4641 and 4654 amplifying valves and many others. In future, however, all new special valves will be distinguished in accordance with the letter-numeral code, with numerals commencing at 50.

### Type numbering of cathode-ray tubes

Cathode-ray tubes are coded in the same way as receiving valves, by means of letters and numerals, but the first letter now indicates the method of deflection of the cathode

ray, i.e. electrostatic or electromagnetic. A second letter is added to give the colour of the light spot on the screen and subsequent numbers indicate the approximate diameter of the screen in centimetres. A numeral, separated from the rest by a stroke, is used as serial number and, besides serving to distinguish the different models, indicates whether the tube is of a later type. For example, Type No. DG 16—1 shows that the tube is the first model of a particular type having double electrostatic deflection, green fluorescent screen and a diameter of 16 cm.

The following table gives the meanings of the letters and numerals employed.

First letter	Second letter	Numeral preceding the stroke	Numeral following the stroke
Method of deflection of the ray	Colour of spot or characteristics of the screen	Diameter of screen in cm	Serial number
<p>D == Double electrostatic deflection.</p> <p>S == Electrostatic deflection, but only in one direction. (Deflection in the other direction may be electro-magnetic).</p> <p>M == Magnetic deflection in both directions.</p>	<p>B = blue</p> <p>G = green</p> <p>N = persistent</p> <p>R = long persistent</p> <p>S = sepia</p> <p>W = white</p>	<p>7 == effective screen dia. 7 cm.</p> <p>9 == effective screen dia. 9 cm.</p>	<p>When a particular tube is introduced in a new model it is given the next consecutive number. The first model is No. 1, then follows No. 2, etc.</p>

# Symbols and their meanings

## 1. Designation of electrodes

Anode . . . . .	<i>a</i>
Anode of diode . . . . .	<i>d</i>
In double or multi-diodes. . . . .	<i>d<sub>1</sub>, d<sub>2</sub>, etc.</i>
The figure indicates the location of the diode with respect to the cathode lead-in. Diode <i>d<sub>1</sub></i> is thus the one nearest the pinch. If there is only one diode anode the figure is omitted	
Heater (filament) . . . . .	<i>f</i>
Grid . . . . .	<i>g</i>
In valves with more than one grid: <i>g<sub>1</sub>, g<sub>2</sub></i> , and so on. The figure indicates the location of the grid with respect to the cathode ( <i>g<sub>1</sub></i> is thus nearest the cathode). If only one grid is provided the figure is omitted.	
Indirectly-heated cathode . . . . .	<i>k</i>
Metallizing . . . . .	<i>m</i>
Internal screen in the valve . . . . .	<i>s</i>
Fluorescent screen in electronic indicator. . . . .	<i>l</i>
Deflector plate of cathode-ray tube . . . . .	<i>D</i>
To indicate equivalent electrodes, "ticks" are employed, e.g. . . . .	<i>a, a', a''</i>
In secondary-emission valves the primary cathode is designated as <i>k<sub>1</sub></i> and the secondary cathode as <i>k<sub>2</sub></i> .	

## 2. Designation of valve system

In combination valves the electrodes of the separate units in the valve are symbolized as follows:

in a diode. . . . .	<i>D</i>
in a triode . . . . .	<i>T</i>
in a tetrode . . . . .	<i>Q</i>
in a pentode . . . . .	<i>P</i>
in a hexode . . . . .	<i>H</i>
in an octode . . . . .	<i>O</i>
in a rectifying valve . . . . .	<i>R</i>

## 3. Designation of currents, voltages, capacitances etc.

### Voltage (V)

Anode voltage . . . . .	<i>V<sub>a</sub></i>
Anode voltage in cold condition, or at <i>I<sub>a</sub> = 0</i> . . . . .	<i>V<sub>a0</sub></i>
Diode voltage . . . . .	<i>V<sub>d</sub></i>
If more than one diode: <i>V<sub>d1</sub>, V<sub>d2</sub></i> etc.	
Heater voltage. . . . .	<i>V<sub>f</sub></i>
Voltage between heater and cathode . . . . .	<i>V<sub>fk</sub></i>
Grid voltage (bias) . . . . .	<i>V<sub>g</sub></i>
If more than one grid: <i>V<sub>g1</sub>, V<sub>g2</sub></i> , etc.	
Effective value of grid alternating voltage . . . . .	<i>V<sub>g eff</sub></i>
Grid voltage in cold condition, or at <i>I<sub>a</sub> = 0</i> . . . . .	<i>V<sub>g0</sub></i>
Alternating input signal voltage . . . . .	<i>V<sub>i</sub></i> or <i>V<sub>i eff</sub></i>
Alternating output voltage . . . . .	<i>V<sub>o</sub></i> or <i>V<sub>o eff</sub></i>
Supply or battery voltage . . . . .	<i>V</i>

### Current (I)

Anode current . . . . .	$I_a$
Anode current without signal (balanced stages or oscillator valves) . . . . .	$I_{a0}$
Anode current at max. modulation . . . . .	$I_{a \max}$
Diode current . . . . .	$I_d$
If more than one diode: $I_{d1}, I_{d2},$ etc.	
Heater current . . . . .	$I_f$
Grid current . . . . .	$I_g$
If more than one grid: $I_{g1}, I_{g2},$ etc.	
Cathode current ( $I_a + I_{g1} + I_{g2},$ etc.) . . . . .	$I_k$

### Power (W)

Anode dissipation . . . . .	$W_a$
Grid dissipation . . . . .	$W_g$
If more than one grid: $W_{g1}, W_{g2},$ etc.	
Output power . . . . .	$W_o$

### Capacitance (C)

Anode to all other electrodes . . . . .	$C_a$
Grid to all other electrodes . . . . .	$C_g$
If more than one grid: $C'_{g1}, C'_{g2},$ etc.	
Anode to grid 1 . . . . .	$C_{a:1}$
Grid 1 to grid 3 . . . . .	$C'_{g1:3}$
Grid 1 to grid 4 . . . . .	$C'_{g1:4}$
Grid 2 to grid 4 . . . . .	$C'_{g2:4}$
Diode anode $d_1$ to $d_2$ . . . . .	$C_{d1d2}$
Cathode to diode anode $d_1$ . . . . .	$C_{d1k}$
Grid to cathode . . . . .	$C_{gk}$
Anode to cathode . . . . .	$C_{ak}$
Anode to grid 4 . . . . .	$C_{a:4}$

### Resistance (R)

External resistor in anode circuit . . . . .	$R_a$
Cathode resistor . . . . .	$R_k$
External resistance between heater and cathode . . . . .	$R_{fk}$
External resistance in grid circuit . . . . .	$R_{gk}$
If more than one grid: $R_{g1k}, R_{g2k},$ etc.	
Internal resistance (anode) . . . . .	$R_i$

### Gain factor

Gain factor (control grid in respect of anode) . . . . .	$\mu$
Gain factor with respect to screen grid . . . . .	$\mu_{g1:2}$
The voltage gain of a valve in a given circuit is obtained from the quotient of the output voltage and the input voltage ( $V_o/V_i$ ).	

### Mutual conductance

Mutual conductance . . . . .	$S$
Mutual conductance at point of oscillation . . . . .	$S_o$
Conversion conductance . . . . .	$S_c$

### Efficiency

Efficiency . . . . .	$\eta$
----------------------	--------

### Sensitivity

Sensitivity of cathode-ray tubes . . . . .	$A$
--	-----

### Wavelength

Wavelength . . . . .	
----------------------	--



**A. C. valves**

## “Miniwatt” receiving valves

### Series E

The “E” series of “Miniwatt” valves comprises a range of valves nearly all of which are of small dimensions; the heaters consume only a very small amount of power. They guarantee the best reception in A.C. receivers, A.C./D.C. sets and car radio.

#### **Low current consumption**

One of the outstanding features of the Miniwatt valve is the extremely small current consumption; in all of these valves, with the exception of the “four-channel” octode, the consumption is only 1.26 W, which, in an indirectly-heated valve of such power, is exceptionally low.

#### **Improved cathode**

The warming-up period is very much shorter than usual, being about 10 seconds. The thermal radiation is only slight, and the efficiency very high. Modern methods of construction have resulted in a much improved cathode insulation.

#### **Small dimensions**

The extremely low current consumption is an outcome of the reduced length of the cathode. Moreover, the short cathode does not tend to buckle and the other electrodes can be mounted more closely around it than was formerly the case. The physical dimensions of the valve are accordingly much smaller than usual.

#### **Very slight background noise**

The small dimensions have contributed towards robustness of structure and high stability. Background noise, attributable formerly to mechanical causes, has thus been eliminated. The interference level in Miniwatt E-type valves is very low in contrast with other types.

#### **Reliability**

When the valves in this series are used trouble-free and reliable performance of the receiver is assured.

#### **Short-wave reception**

Miniwatt valves are particularly suitable for short-wave reception. The triode-hexode and 4-channel octode are outstanding for their much reduced frequency-drift and induction effect. The R.F. pentodes have high input and output damping values and only very slight retroaction from anode to grid.

#### **Compact chassis design**

The low wattage of these valves necessitates only a small bulb and the spacing of the valves on the chassis, or between them and other components

normally susceptible to heat, can therefore be quite small; the reduced dimensions of the valves may thus be employed to the best advantage.

### The complete series

EAB 1	— Triple diode with common cathode serving the three diodes	1.26 W cathode
EB 4	— Double-diode with separate cathodes	1.26 W cathode
EBC 3	— Double-diode triode having a gain factor of 30	1.26 W cathode
EBF 2	— Double-diode and I.F. amplifier pentode; variable-mu and sliding screen voltage	1.26 W cathode
EBL 1	— Double-diode output pentode. The pentode is of very high mutual conductance	8.5 W cathode
ECH 3	— Triode-hexode for use as frequency-changer in all-wave receivers; variable-mu, low current consumption and small dimensions	1.26 W cathode
EEP 1 (EE 1)	— Secondary-emission valve for driving balanced output stages without driver transformer	3.8 W cathode
EF 5	— R.F. pentode; variable-mu and excellent characteristics from the point of view of freedom from cross-modulation	1.26 W cathode
EF 6	— R.F. and A.F. amplifier pentode; fixed mutual conductance	1.26 W cathode
EF 8	— Noise-free R.F. variable-mu amplifier valve	1.26 W cathode
EF 9	— Variable-mu R.F. pentode with sliding screen voltage	1.26 W cathode
EFM 1	— Variable-mu A.F. amplifier pentode with sliding screen voltage; combined with electronic indicator	1.26 W cathode
EH 2	— Heptode for use as modulator valve in short-wave receivers or as R.F. and I.F. amplifier	1.26 W cathode
EK 2	— Low-consumption octode for mixing stages in receivers in which no control is applied to the frequency-changer in the short-wave range; also for car radio	1.26 W cathode
EK 3	— Four-channel octode for use in receiver mixing stages when high-grade performance is also required in the short-wave range	3.8 W cathode
EL 2	— Normal slope output pentode with low current consumption, especially for car radio	1.26 W cathode
EL 3	— 9 W output pentode; high mutual conductance	5.7 W cathode
EL 5	— 18 W output pentode; high mutual conductance	8.5 W cathode
EL 6	— Very steep slope 18 W pentode, to deliver maximum output at the same signal input as the EL 3	7.5 W cathode

ELL 1	— Double output pentode for balanced output stages in car radio	2.8 W cathode
EM 1	— High-vacuum electronic indicator with built-in amplifier triode	1.26 W cathode
C/EM 2	— High-vacuum electronic indicator combined with amplifier triode which can also be used for other purposes	1.26 W cathode
EM 4	— High-vacuum electronic indicator with two triode amplifiers, providing two different sensitivity values for accurate tuning on strong and weak signals	1.26 W cathode
EZ 2	— Small indirectly-heated full-wave rectifying valve for car radio	2.5 W cathode
EZ 4	— Indirectly-heated full-wave rectifying valve for high-power receivers	5.7 W cathode

This series further includes the following directly-heated rectifying valves with 4 V heater voltage and fitted with side contacts (P-type base):

AZ 1	— Directly-heated full-wave rectifying valve for receivers of medium power
AZ 4	— Directly-heated full-wave rectifying valve for receivers with high current consumption

The 1.26 W-cathode valves take a current of 200 mA at a heater voltage of 6.3 V and they can also be used in A.C./D.C. receivers. These valves are equally serviceable in conjunction with the triode-hexode ECH 3, or with the 4-channel octode for A.C./D.C. operation, or again, with the CK 3 and different A.C./D.C. output and rectifying valves.

For A.C./D.C. receivers the following valves are available:

EAB 1	— Triple diode	6.3 V heater
EB 4	— Double diode with separate cathodes	6.3 V heater
EBC 3	— Double-diode triode	6.3 V heater
EBF 2	— Double-diode and I.F. pentode	6.3 V heater
ECH 3	— Triode-hexode	6.3 V heater
EF 6	— R.F. or A.F. pentode	6.3 V heater
EF 8	— Noise-free R.F. amplifier (200 V mains only)	6.3 V heater
EF 9	— Variable-mu R.F. or I.F. pentode	6.3 V heater
EFM 1	— L.F. amplifier pentode and electronic indicator (200 V mains only)	6.3 V heater
EH 2	— Mixer heptode and R.F. or I.F. amplifier	6.3 V heater
EK 2	— Mixer octode	6.3 V heater
EM 1	— Electronic indicator	6.3 V heater
C/EM 2	— Electronic indicator	6.3 V heater

EM 4	— Electronic indicator	6.3 V heater
CBL 1	— Double-diode output pentode	44 V heater
CK 3	— Four-channel octode	19 V heater
CL 4	— 9 W output pentode (200 V mains only)	33 V heater
CL 6	— 9 W output pentode (100 and 200 V)	35 V heater
CY 1	— Half-wave rectifying valve 80 mA	20 V heater
CY 2	— Half-wave rectifying valve and voltage-doubler	30 V heater

The following valves are recommended for car radio (6.3 V):  
EBC 3, EF 9, EK 2, EL 2, ELL 1, EM 4 and EZ 2.

## **New types of construction, resulting in fresh characteristics**

For the latest developments in receiver design the E-type valves have numerous improvements and new characteristics to offer.

In some of the valves the electron-bunching principle has been adopted to meet the problem of the demand for a low-noise R.F. valve and variable-mu frequency-changer for short-wave reception. The octode EK 3 for A.C. and the CK 3 for A.C./D.C. sets work on the 4-channel electron stream principle and the sharp separation of the streams or channels for oscillation and modulation purposes has eliminated mutual interference of these functions with all its drawbacks.

Another solution to the problem of frequency changing is provided by the ECH 3, a triode-hexode with combined oscillator triode. This valve has excellent characteristics for radio receivers which are required to give really good reception on all wave-bands; it permits of control of the mutual conductance, even on the short-wave range, without the disadvantage of any frequency drift.

A further innovation is the self-adjusting or sliding screen voltage in the R.F. and A.F. pentodes. Until recently pentodes worked on a fixed screen voltage, in other words, on a fixed characteristic; any increase in the grid bias, for the purpose of reducing the gain, resulted in a shifting of the working point along the  $I_a/V_{g_1}$  curve, but with the sliding screen voltage every value of grid bias introduces a different characteristic, thus providing interesting new properties.

Amongst others, the R.F. pentode EF 9 and the I.F. pentode combined with two diodes, the EBF 2, are designed on this principle.

A very special type of valve is to be found in the secondary-emission valve EEP 1, which functions on the electron-bunching principle; the introduction of secondary emission provides in the anode and secondary-emission circuits two alternating voltages of exactly opposite phase, and this valve will drive a balanced-output circuit without the use of the usual driver transformer.

Among electronic indicators the EM 4 with its dual sensitivity is worthy of special mention. By means of this indicator it is possible to tune the receiver with just the same degree of accuracy on weak as on strong signals. The EFM 1 is another interesting development, being a combination of A.F. amplifier pentode and electronic indicator. The pentode section of this valve is of the variable-mu type and also incorporates the sliding screen voltage; the voltage variations produced in the screen grid resistor by changes in the grid bias are employed to operate the built-in electronic indicator.

In conjunction with the double diode and I.F. pentode EBF 2, described in these pages, the EFM 1 provides us with an excellent 4-valve superhet. receiver embodying all the latest features including the electronic indicator, negative feed-back, etc.

The double diode EB 4 with its separated cathodes presents countless opportunities in the design of special circuits. The triple diode EAB 1 was specially designed for use in 3-diode circuits and its introduction has resulted

in a considerable reduction of distortion in the diode stage of high-quality receivers.

The EBL 1, a double-diode pentode with high mutual conductance permits of the design of very simple superhet. receivers employing only three valves. With a view to high-fidelity reproduction of music much attention has been paid to the question of output valves, and various steep-slope types are now available. The output valve EL 6, an 18 W pentode of unusually high mutual conductance, requires roughly the same signal input for full modulation as the 9 W pentode EL 3.

For car radio an output valve has been developed that consists of two complete output-valve units in a common envelope; in a balanced circuit the ELL 1, as it is designated, will deliver a maximum output of 4.5 W with a very small current consumption.

A new valve for A.C./D.C. receivers is the EL 6, a steep-slope output pentode for interchangeable mains operation, and a similar valve is to be designed for a screen voltage of 100 V, to provide adequate output power on 110/127 V mains. This latter valve will replace the earlier model, the CL 2.

# EAB 1 Triple diode

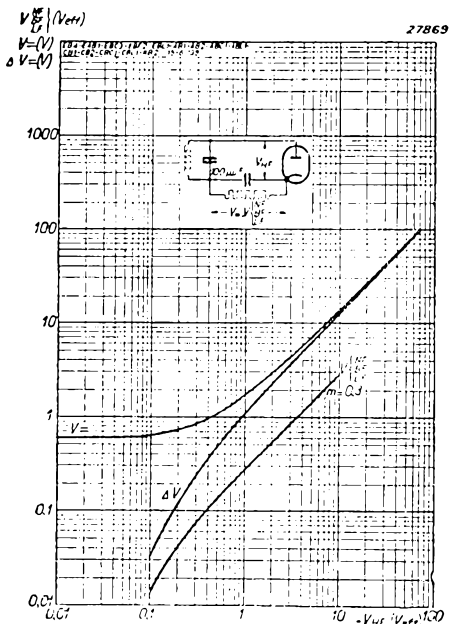

Fig. 3

Direct voltage  $V$  and direct voltage curve ( $\Delta V$ ) between the terminals of the grid leak connected to one of the diodes of the EAB1, as a function of the unmodulated R.F. voltage.  
 L.F. voltage VLF between the terminals of the grid leak as a function of the R.F. voltage modulated to a depth of 30% ( $m = 30\%$ ). These characteristics apply to grid leaks of from 0.1 to 1 megohm.

The triple diode EAB 1 consists of three diodes arranged about a common, horizontally mounted, cathode, having been especially developed for 3-diode circuits. The object of this type of circuit is to eliminate distortion and other unpleasant effects arising from the use of delayed automatic gain control and it involves an arrangement employing three diodes, one of which serves as detector and one for the A.G.C., whilst the third is used for the delaying effect. With a view to suppressing hum, the detector diode, which is shown as  $d_1$  in the diagram of base connections, Fig. 2, is mounted farthest from the heater. The diode nearest to the filament and marked  $d_2$  in the diagram has a very low capacitance with respect to the detector diode, this being less than  $0.08 \mu\text{F}$ . Since the A.G.C. diode, for many reasons, is usually connected to the

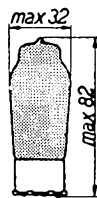

Fig. 1 Dimensions in mm.

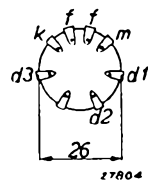
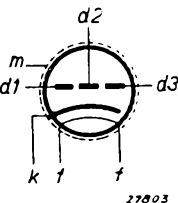

Fig. 2 Arrangement of electrodes and base connections.

primary circuit of the preceding band-filter, the amount of capacitance between this diode and the detector diode is extremely important. As the reader is doubtless aware, this capacitance acts as a coupling between the two band-filter circuits and tends to have an adverse effect on the selectivity. It is for this reason that diode  $d_1$  is employed for the A.G.C. Diode  $d_2$ , located between  $d_1$  and  $d_3$ , is then available for other purposes, in particular to provide the delaying effect for the A.G.C. as employed in this type of circuit.

### Heater ratings

Heating: indirect, A.C. or D.C., series or parallel supply.

Heater voltage . . . . .	$V_f = 6.3 \text{ V}$
Heater current . . . . .	$I_f = 0.200 \text{ A}$

### Capacitances

Diodes $d_1 - d_2$ . . . . .	$C_{d1d2} < 0.65 \mu\text{F}$
Diodes $d_1 - d_3$ . . . . .	$C_{d1d3} < 0.68 \mu\text{F}$
Diodes $d_2 - d_3$ . . . . .	$C_{d2d3} < 0.4 \mu\text{F}$
Diode $d_1 - \text{cathode}$ . . . . .	$C_{d1k} = 1.5 \mu\text{F}$
Diode $d_2 - \text{cathode}$ . . . . .	$C_{d2k} = 1.35 \mu\text{F}$
Diode $d_3 - \text{cathode}$ . . . . .	$C_{d3k} = 2.2 \mu\text{F}$



**Maximum ratings**

Voltage on $d_1$ (peak value) . . . . .	$V_{d1}$	= max. 200 V
Voltage on $d_2$ (peak value) . . . . .	$V_{d2}$	= max. 200 V
Voltage on $d_3$ (peak value) . . . . .	$V_{d3}$	= max. 200 V
Direct current to $d_1$ . . . . .	$I_{d1}$	= max. 0.8 mA
Direct current to $d_2$ . . . . .	$I_{d2}$	= max. 0.8 mA
Direct current to $d_3$ . . . . .	$I_{d3}$	= max. 0.8 mA
External resistance between filament and cathode	$R_{fk}$	= max. 20,000 ohms
Potential difference between filament and cathode (D.C. voltage or effective value of alternating voltage) . . . . .	$V_{fk}$	= max. 100 V
Voltage on diode at diode current start . . . . .	$\left. \begin{array}{l} (I_{d1} = + 0.3 \mu\text{A}) V_{d1} \\ (I_{d2} = + 0.3 \mu\text{A}) V_{d2} \\ (I_{d3} = + 0.3 \mu\text{A}) V_{d3} \end{array} \right\}$	= max. -1.3 V

# EB 4 Double diode with separate cathodes

The double diode EB 4 embodies two separate and adjacent cathodes with an anode around each, the two complete units being screened from each other. The screen is connected to a separate contact and can thus be very simply maintained at zero potential; it effectively prevents any stray electrons from passing from one unit to the other. This separation of the cathodes offers numerous advantages and greatly extends the range of application of this type of valve. A considerable reduction in the capacitance normally occurring between the anodes prevents any unwanted capacitance between the relative circuits. The two diode units are exactly similar and it is immaterial which of the two is employed for detection purposes.

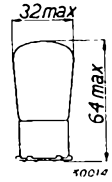

Fig. 1 Dimensions in mm.

## Heater ratings

Heating: indirect, by A.C. or D.C.; series or parallel supply.

Heater voltage . . . . .  $V_f = 6.3 \text{ V}$

Heater current . . . . .  $I_f = 0.200 \text{ A}$

## Capacitances

$C_{d1d2} < 0.2 \mu\mu\text{F}$

$C_{d1k} = 1.2 \mu\mu\text{F}$

$C_{d2k} = 1.2 \mu\mu\text{F}$

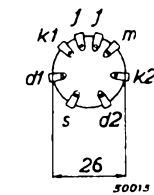
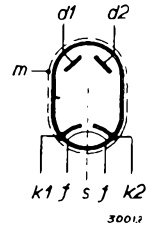

Fig. 2 Arrangement of electrodes and base connections.

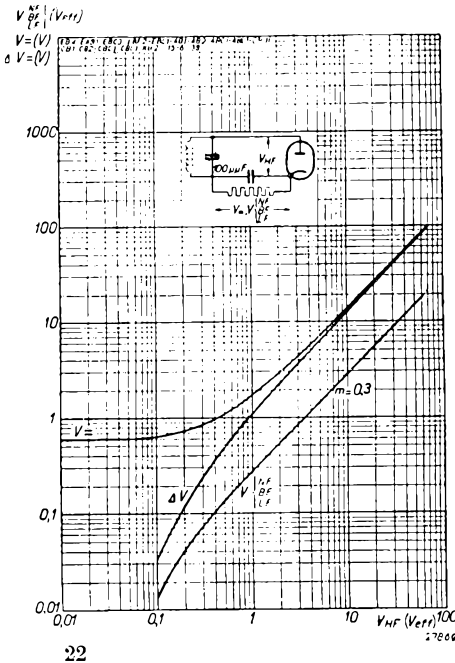

Fig. 3

Direct voltage  $V$  and direct voltage curve ( $\Delta V$ ) between the terminals of the grid leak connected to one of the diodes of the EB 4, as a function of the unmodulated R.F. voltage.

A.F. voltage  $V_{LF}$  between the terminals of the grid leak as a function of the R.F. voltage modulated to a depth of 30% ( $m = 30\%$ ) These characteristics apply to grid leaks of from 0.1. to 1 megohm.

## MAXIMUM RATINGS

Voltage on diode $d_1$ (peak value) . . . . .	$V_{d1}$	= max. 200 V.
Voltage on diode $d_2$ (peak value) . . . . .	$V_{d2}$	= max. 200 V.
Direct current to diode $d_1$ . . . . .	$I_{d1}$	= max. 0.8 mA.
Direct current to diode $d_2$ . . . . .	$I_{d2}$	= max. 0.8 mA.
External resistance between cathode $k_1$ and filament (direct current, or effective value of alternating voltage) . . . . .	$R_{fk1}$	= max. 0.02 M ohm.
Potential difference between cathode $k_1$ and filament (D.C. voltage or effective value of A.C. voltage)	$V_{fk1}$	= max. 75 V.
Potential difference between cathode $k_2$ and filament (D.C. voltage or effective value of A.C. voltage)	$V_{fk2}$	= max. 75 V.
Potential difference between the two cathodes (D.C. voltage, or peak value of alternating voltage, or D.C. voltage + peak value of alternating voltage)	$V_{k1k2}$	= max. 150 V.
Voltage on diode at diode cur- rent start . . . . .	$V_{d1}$	= max. -1.3 V.
	$V_{d2}$	= max. -1.3 V.

( $I_{d1} = + 0.3 \mu A$ )  
( $I_{d2} = + 0.3 \mu A$ )

# EBC 3 Double-diode triode

The double-diode triode EBC 3 comprises a triode in combination with a double-diode unit, in a common envelope. These two systems are served by a single cathode.

The diode section may be employed for detection and delayed automatic gain control and the triode for A.F. amplification or for other purposes. The A.F. amplification, which may effected by means of resistance coupling, is about 20 times and this is ample for most purposes. Both the diodes have their own separate external connections and the grid connection of the triode is at the top of the valve.

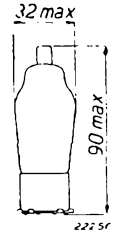

Fig. 1 Dimensions in mm.

## HEATER RATINGS

Heating: indirect, by A.C. or D.C.; series or parallel supply.

Heater voltage . . . . .  $V_f = 6.3$  V

Heater current . . . . .  $I_f = 0.200$  A

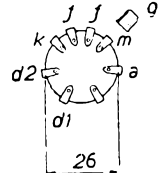
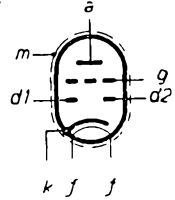

Fig. 2 Arrangement of electrodes and base connections.

## CAPACITANCES

- $C_{kd1} = 1.9 \mu\mu\text{F}$
- $C_{kd2} = 2.5 \mu\mu\text{F}$
- $C_{ad2} < 0.5 \mu\mu\text{F}$
- $C_{gd1} < 0.005 \mu\mu\text{F}$
- $C_{gd2} < 0.005 \mu\mu\text{F}$
- $C_{gf} < 0.002 \mu\mu\text{F}$

- $C_{gg} = 1.3 \mu\mu\text{F}$
- $C_{ak} = 3 \mu\mu\text{F}$
- $C_{gk} = 2.9 \mu\mu\text{F}$
- $C_{(d1+d2)g} < 0.006 \mu\mu\text{F}$
- $C_{(d1+d2)a} < 1 \mu\mu\text{F}$

## OPERATING DATA

Triode section:

Anode voltage . . . . .	$V_a =$	100 V	200 V	275 V
Grid bias . . . . .	$V_g =$	-2.1 V	-4.3 V	-6.25 V
Anode current . . . . .	$I_a =$	2 mA	4 mA	5 mA
Amplification factor . . . . .	$\mu =$	30	30	30
Mutual conductance . . . . .	$S =$	1.6 mA/V	2.0 mA/V	2.0 mA/V
Internal resistance . . . . .	$R_i =$	19,000 ohms	15,000 ohms	15,000 ohms

## MAXIMUM RATINGS

Triode section:

- $V_{ao} =$  max. 550 V
- $V_a =$  max. 300 V
- $W_a =$  max. 1.5 W
- $I_k =$  max. 10 mA
- $V_g$  ( $I_g = +0.3 \mu\text{A}$ ) = max. -1.3 V
- $R_{gk}$  (automatic) = max. 3 M ohms
- $R_{gk}$  (fixed) = max. 1 M ohm
- $V_{fk} =$  max. 75 V<sup>1)</sup>
- $R_{fk} =$  max. 20,000 ohms

Diode section:

- $V_{d1}$  (peak value) = max. 200 V
- $I_{d1}$  (D.C. value) = max. 0.8 mA
- $V_{d2}$  (peak value) = max. 200 V
- $I_{d2}$  (D.C. value) = max. 0.8 mA

<sup>1)</sup> Direct voltage or effective value of alternating voltage.

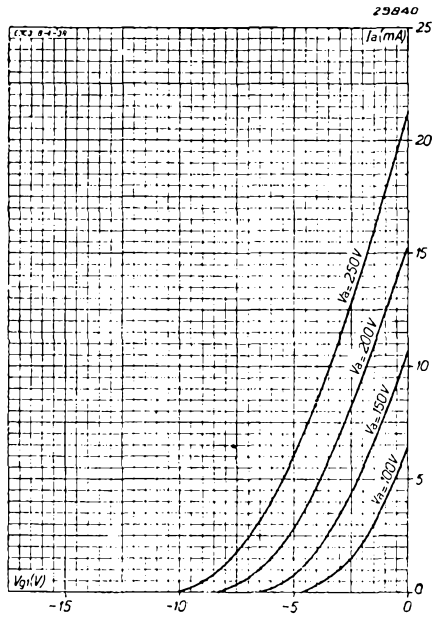

Fig. 3  
Anode current as a function of the grid bias at different anode voltages.

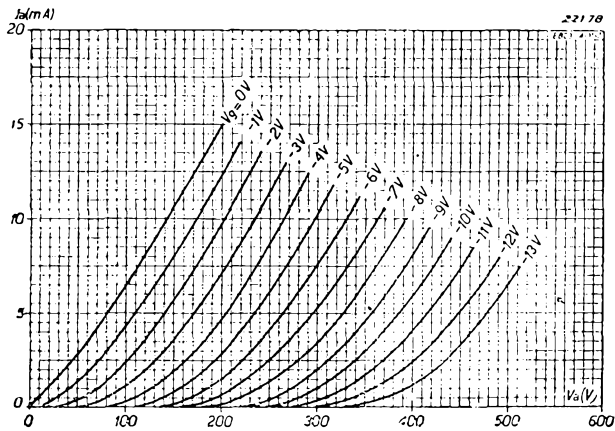

Fig. 4  
Anode current as a function of the anode voltage at different values of grid bias.

The triode can also be employed as oscillator in conjunction with the variable- $\mu$  frequency-changer heptode EH 2. To avoid feedback from the triode to the diodes, these two units are screened from each other, the screen being connected to the cathode. The metallizing is provided with a separate contact in the valve base.

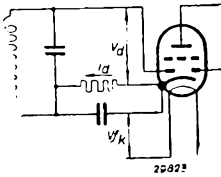

Fig. 5  
Definition of  $V_d$  and  $I_d$

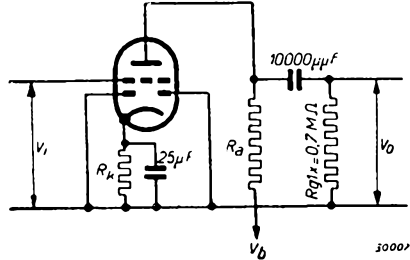

Fig. 6  
Circuit upon which the measurements given in the table are based.

The diode shown as  $d_2$  in the diagram of base connections (Fig. 2) should preferably be employed for detection. The other diode ( $d_1$ ) can then serve for other purposes such as delayed automatic gain control. The curves relating to the rise in direct voltage ( $\Delta V$ ) across the grid leak, as a function of the unmodulated R.F. signal voltage, as well as that with respect to the increase in the A.F. voltage ( $V_{LF}$ ) at one of the diodes with a grid leak of 0.5 M ohm, are the same as for the EB 4 (see Fig. 3, p. 22).

EBC 3 employed as A.F. amplifier, resistance-coupled to different output valves

Supply voltage	Anode coupling resistor	Anode current	Cathode resistor	Voltage gain	When used with the EL 2 as output valve $V_a = V_{g_2} = 250 \text{ V}$		When used with the EL 3 or EL 6 as output valve $V_a = V_{g_2} = 250$		When used with the EL 5 as output valve $V_a = 250 \text{ V}$ $V_{g_2} = 275 \text{ V}$		When used with the AD 1 as output valve $V_a = 250 \text{ V}$		Remarks	
					Alternating output voltage $V_o$ $V_{eff}$	Total distortion in the pre-amplifier $d_{tot}$ %	Alternating output voltage $V_o$ $V_{eff}$	Total distortion in pre-amplifier $d_{tot}$ %	Alternating output voltage $V_o$ $V_{eff}$	Total distortion in pre-amplifier $d_{tot}$ %	Alternating output voltage $V_o$ $V_{eff}$	Total distortion in pre-amplifier $d_{tot}$ %		
300	0.2	0.9	4,000	26	11.2	< 1	3.7	< 1	8.5	< 1	31	1.8	For receivers with heaters fed in parallel	
250	0.2	0.75	4,000	26	11.2	< 1	3.7	< 1	8.5	< 1	31	2.2		
300	0.1	1.5	2,500	25	11.2	< 1	3.7	< 1	8.5	< 1	31	2.0		
250	0.1	1.3	2,500	25	11.2	< 1	3.7	< 1	8.5	< 1	31	2.6		
300	0.05	2.3	2,000	22	11.2	< 1	3.7	< 1	8.5	< 1	31	2.0		
250	0.05	1.8	2,000	22	11.2	< 1	3.7	< 1	8.5	< 1	31	2.6		
					When used with the CL 1 as output valve		When used with the CL 2 as output valve		When used with the CL 4 as output valve		When used with the EL 2 as output valve			
200 <sup>1)</sup>	0.2	0.35	12,500	22	9.6	1.7	10	1.8	5.0	1.0	8.5	1.6		For receivers with heaters fed in series
150 <sup>1)</sup>	0.2	0.25	12,500	21	—	—	10	2.7	4.0	1.0	6.5	1.7		
100 <sup>1)</sup>	0.2	0.20	12,500	19	—	—	10	4.6	2.4	1.0	—	—		
200 <sup>1)</sup>	0.1	0.55	8,000	21	9.6	2.1	10	2.3	5.0	1.2	8.5	1.8		
150 <sup>1)</sup>	0.1	0.45	8,000	20	—	—	10	3.0	4.0	1.2	6.5	1.8		
100 <sup>1)</sup>	0.1	0.30	8,000	18	—	—	10	4.9	2.4	1.2	—	—		
200 <sup>1)</sup>	0.05	0.8	6,000	19	9.6	3.0	10	3.2	5.0	1.5	8.5	2.6		
150 <sup>1)</sup>	0.05	0.6	6,000	18	—	—	10	4.3	4.0	1.6	6.5	3.0		
100 <sup>1)</sup>	0.05	0.4	6,000	17	—	—	10	7.0	2.4	1.6	—	—		

<sup>1)</sup> also anode voltage of the output valve.

# EBF 2 Double-diode variable-mu pentode

This valve combines a pentode with two diodes, built round a common cathode. The pentode section has variable characteristics, sliding screen voltage having been adopted with a view to the use of the valve as an I.F. amplifier; the anode current is accordingly low and the mutual conductance relatively high, but, since the cathode, which also serves the two diodes, is able to dissipate only 1.26 W, the slope is somewhat less than that of the EF 9. Without control (at  $-2$  V bias), the mutual conductance of the EBF 2 is 1.8 mA/V, which provides ample I.F. amplification.

The diode section is separated from the pentode by a very effective system of screening, to prevent any unwanted interaction between the two units. This combination of double diodes with an I.F. amplifier is very useful in all cases where an A.F. valve without diode is used, for example the EF 6, with or without feed-back.

The EBF 2 is particularly suitable for use in conjunction with the A.F. amplifier and electronic indicator EFM 1.

The latter arrangement permits of the design of a very simple receiver in which two valves do the work of I.F. amplifier and detector, at the same time producing the control voltage for automatic gain control, with A.F. amplification and electronic tuning indication.

Since both diodes are supplied by the same cathode as the pentode and, because the diode for the A.G.C. is delayed by the cathode potential of this valve, the delay voltage is limited, without the use of any special circuits, to the value of grid bias required by the pentode in the uncontrolled condition.

By using special circuits it is possible to obtain a higher delay voltage for the A.G.C., but this merely tends to render the latter less effective.



Fig. 1 Dimensions in mm.

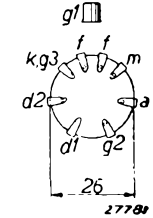
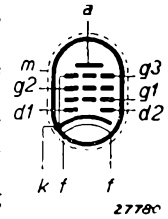

Fig. 2 Arrangement of electrodes and base connections.

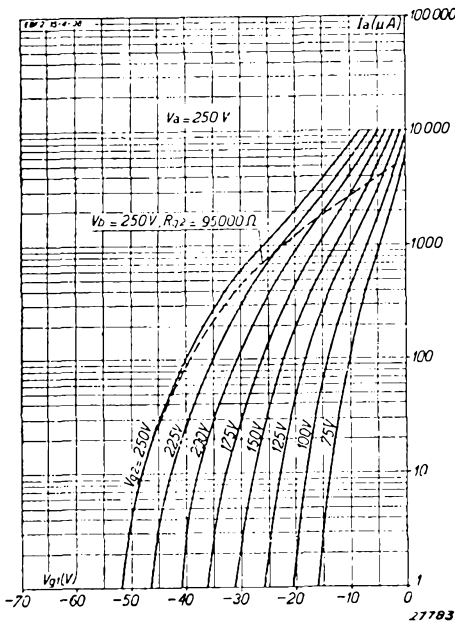

Fig. 3  $I_a/V_{g1}$  characteristic of the EBF 2, with  $V_{g2}$  as parameter. The broken line shows the anode current of the controlled valve with a screen series resistor of 95000 ohms and a supply voltage of 250 V.



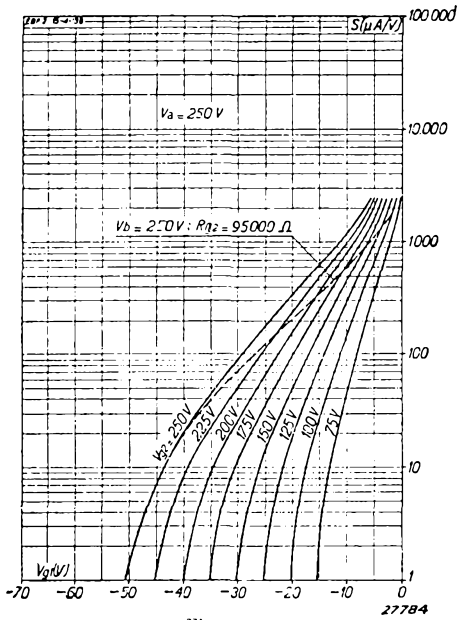

Fig. 4  
 $S/V_{g1}$  characteristic of the EBF 2, with  $V_{g1}$  as parameter. The broken line gives the slope of the controlled valve with a screen series resistor of 95,000 ohms and a supply voltage of 250 V.

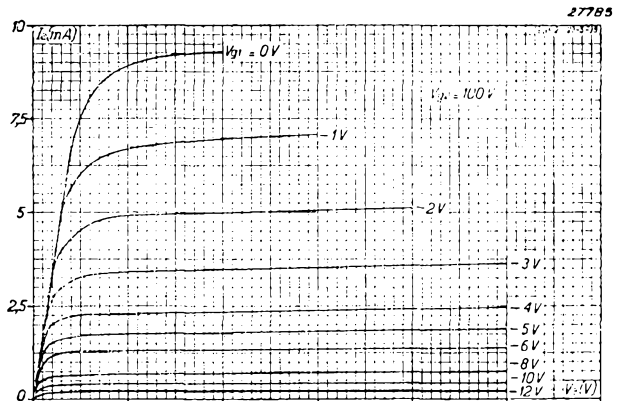

Fig. 5  
 Anode current as a function of the anode voltage at different values of grid bias and with a fixed screen potential of 100 V.

**HEATER RATINGS**

Heating: indirect, on A.C. or D.C.; series or parallel supply.

Heater voltage . . . . .	$V_f = 6.3 \text{ V}$
Heater current . . . . .	$I_f = 0.200 \text{ A}$

**CAPACITANCES**

$C_{ag1} < 0.002 \mu\mu\text{F}$	$C_{(d1+d2)g1} < 0.001 \mu\mu\text{F}$	$C_{d2a} < 0.25 \mu\mu\text{F}$
$C_{g1} = 4.4 \mu\mu\text{F}$	$C_{d1k} = 3 \mu\mu\text{F}$	$C_{(d1+d2)a} < 0.4 \mu\mu\text{F}$
$C_a = 8.6 \mu\mu\text{F}$	$C_{d2k} = 3 \mu\mu\text{F}$	$C_{g1f} < 0.01 \mu\mu\text{F}$
$C_{d1g1} < 0.0005 \mu\mu\text{F}$	$C_{d1d2} < 0.3 \mu\mu\text{F}$	
$C_{d2g1} < 0.0005 \mu\mu\text{F}$	$C_{d1a} < 0.3 \mu\mu\text{F}$	

**OPERATING DATA: pentode section employed as I.F. amplifier**

**250 V**

Anode voltage . . . . .	$V_a = 250 \text{ V}$
Screen-grid series resistor (at 250 V) . . . . .	$R_{g2} = 95,000 \text{ ohms}$
Cathode (bias) resistor . . . . .	$R_k = 300 \text{ ohms}$
Grid bias . . . . .	$V_{g1} = -2 \text{ V}^1)$ <span style="float:right">-38 V<sup>2)</sup></span>
Screen voltage . . . . .	$V_{g2} = 100 \text{ V}$ <span style="float:right">250 V</span>
Anode current . . . . .	$I_a = 5 \text{ mA}$ <span style="float:right">—</span>
Screen current . . . . .	$I_{g2} = 1.6 \text{ mA}$ <span style="float:right">—</span>
Mutual conductance . . . . .	$S = 1800 \mu\text{A/V}$ <span style="float:right">18 <math>\mu\text{A/V}</math></span>
Internal resistance . . . . .	$R_i = 1.3 \text{ M ohms}$ <span style="float:right">&gt; 10 M ohms</span>

**200 V**

Anode voltage . . . . .	$V_a = 200 \text{ V}$
Screen-grid series resistor (at 200 V) . . . . .	$R_{g2} = 60,000 \text{ ohms}$
Cathode resistor . . . . .	$R_k = 300 \text{ ohms}$
Grid bias . . . . .	$V_{g1} = -2 \text{ V}^1)$ <span style="float:right">-32.5 V<sup>2)</sup></span>
Screen voltage . . . . .	$V_{g2} = 100 \text{ V}$ <span style="float:right">200 V</span>
Anode current . . . . .	$I_a = 5 \text{ mA}$ <span style="float:right">—</span>
Screen current . . . . .	$I_{g2} = 1.6 \text{ mA}$ <span style="float:right">—</span>
Mutual conductance . . . . .	$S = 1800 \mu\text{A/V}$ <span style="float:right">18 <math>\mu\text{A/V}</math></span>
Internal resistance . . . . .	$R_i = 1 \text{ M ohm}$ <span style="float:right">&gt; 10 M ohms</span>

**100 V**

Anode voltage . . . . .	$V_a = 100 \text{ V}$
Screen-grid voltage . . . . .	$V_{g2} = 100 \text{ V}$
Cathode resistor . . . . .	$R_k = 300 \text{ ohms}$
Grid bias . . . . .	$V_{g1} = -2 \text{ V}^1)$ <span style="float:right">-16.5 V<sup>2)</sup></span>
Anode current . . . . .	$I_a = 5 \text{ mA}$ <span style="float:right">—</span>
Screen current . . . . .	$I_{g2} = 1.6 \text{ mA}$ <span style="float:right">—</span>
Mutual conductance . . . . .	$S = 1800 \mu\text{A/V}$ <span style="float:right">18 <math>\mu\text{A/V}</math></span>
Internal resistance . . . . .	$R_i = 0.4 \text{ M ohm}$ <span style="float:right">&gt; 10 M ohms</span>

<sup>1)</sup> valve not controlled.

<sup>2)</sup> Mutual conductance controlled to 1 : 100 and to limit of control.

**MAXIMUM RATINGS**

**a) Pentode section**

Anode voltage in cold condition . . . . .	$V_{a0}$	= max. 550 V
Anode voltage . . . . .	$V_a$	= max. 300 V
Anode dissipation . . . . .	$W_a$	= max. 1.5 W
Screen-grid voltage in cold condition . . . . .	$V_{g20}$	= max. 550 V
Screen voltage at $I_a = 5$ mA . . . . .	$V_{g2}$	= max. 125 V
Screen voltage at $I_a < 2$ mA . . . . .	$V_{g2}$	= max. 300 V
Screen-grid dissipation . . . . .	$W_{g2}$	= max. 0.3 W
Cathode current . . . . .	$I_k$	= 10 mA
Grid voltage at grid current start ( $I_{g1} = + 0.3 \mu A$ )	$V_{g1}$	= max. -1.3 V
Resistance between grid and cathode . . . . .	$R_{g1k}$	= max. 3 Mohms
Resistance between filament and cathode . . . . .	$R_{fk}$	= max. 20,000 ohms
Voltage between filament and cathode (direct voltage or effective value of alternating voltage) . . . . .	$V_{fk}$	= max. 100 V

**b) Diode section**

Voltage on diode $d_1$ (peak value) . . . . .	$V_{d1}$	= max. 200 V
Voltage on diode $d_2$ (peak value) . . . . .	$V_{d2}$	= max. 200 V
Direct current to diode $d_1$ . . . . .	$I_{d1}$	= max. 0.8 mA
Direct current to diode $d_2$ . . . . .	$I_{d2}$	= max. 0.8 mA
Voltage on diode at diode current start ( $I_{d1} = + 0.3 \mu A$ )	$V_{d1}$	= max. -1.3 V
Voltage on diode at diode current start ( $I_{d2} = + 0.3 \mu A$ )	$V_{d2}$	= max. -1.3 V

**APPLICATIONS**

The EBF 2 is used mainly in I.F. stages with the two diodes serving as detector and for automatic gain control. The data and characteristics apply both to A.C. receivers operating on mains of about 250 V and A.C./D.C. sets on mains of approximately 200 or 100 volts. At mains voltages other than 250 or 200 V, the required screen potential can be calculated from the screen current of 1.6 mA and the potential difference between the supply voltage and the screen voltage of 100 V.

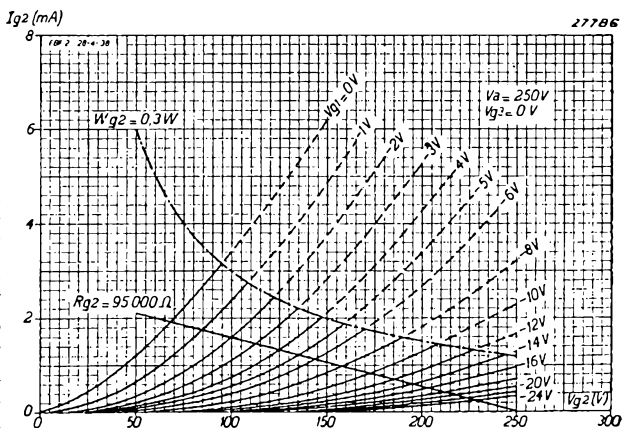

Fig. 6

Screen current as a function of the screen voltage at different values of grid bias. The curves apply roughly to all anode voltages between 100 and 250 V. The diagram also includes the limit line for the maximum continuous load on the screen and the resistance line with respect to a series resistor  $R_{g2} = 95,000$  ohms, at 250 V supply voltage

The characteristics in Figs 3, 4, 7 and 8 relating to  $I_a$  and  $S$  will then be no longer fully applicable; at 100 V supply voltage the sliding-screen-potential principle is not valid and the screen must be maintained at 100 V. The modulation distortion curve is then certainly less satisfactory, but the valve is none the less quite effective as a normal A.F. amplifier, following a diode detector. If a potential divider is used instead of a series resistor, careful adjustment of the resistance values will produce a more or less steep mutual conductance curve; the modulation distortion curve is then somewhat modified. The bias resistor should be decoupled with an electrolytic capacitor of about 25  $\mu$ F; if this is not done, the rectification, due to the curvature of the  $I_a/V_{g1}$  charac-

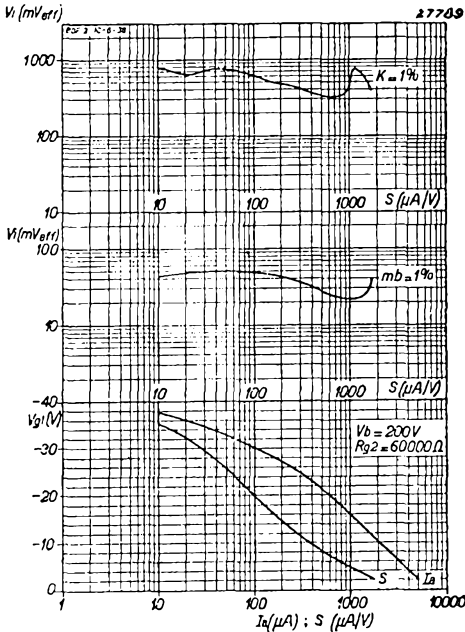

Fig. 8

Upper diagram. Effective alternating grid voltage as a function of the mutual conductance with 1% cross modulation, with a screen series resistor of 60,000 ohms and a supply voltage of 200 V.

Centre diagram. Effective alternating grid voltage as a function of the mutual conductance with 1% modulation hum.

Lower diagram. Mutual conductance  $S$  and anode current  $I_a$  as a function of the grid bias.

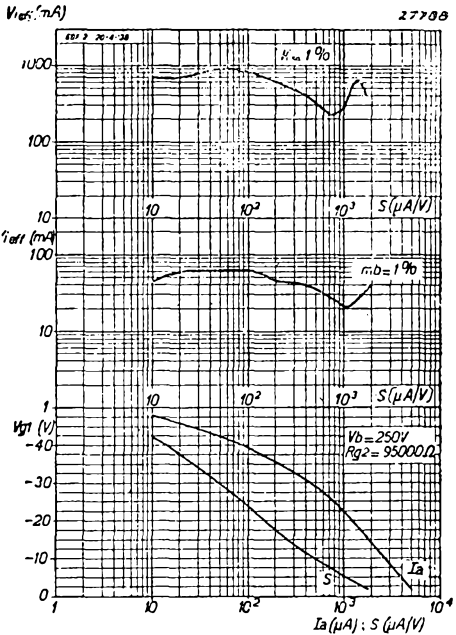

Fig. 7

Upper diagram. Effective alternating grid voltage as a function of the mutual conductance, with 1% cross modulation, a screen-grid series resistor of 95,000 ohms and a supply voltage of 250 V.

Centre diagram. Effective alternating grid voltage as a function of the mutual conductance, with 1% modulation hum.

Lower diagram. Mutual conductance  $S$  and anode current  $I_a$  as a function of the grid bias.

teristic, produces an A.F. voltage which, when the volume control is turned down, would be applied to the grid of the A.F. amplifier valve. This involves a residual signal and makes it impossible to render the receiver mute.

Diode  $d_2$  is preferably used for detection and diode  $d_1$  as rectifier for the A.G.C. In the circuit diagram of Fig. 10 the A.G.C. diode receives its delay voltage from the cathode potential of the EBF 2. To ensure optimum amplification in the uncontrolled condition this voltage should always be kept as low as possible (according to the data it is about 2 V), whereby the A.F. amplification should be such that the strength of the signal on the A.G.C. diode is below the threshold of the delay, with a fully driven output valve.

At the same time, a lower A.F. gain may

be desired, or it may be impossible to obtain the high amplification referred to above, so that special steps have to be taken to provide a higher delay voltage for the A.C.C. if the latter is not to be operative on signals which are insufficient to drive the output valve fully. For the characteristics of the diode section, reference should be made to the relative curves for the EAB 1 and EB 4, which apply also to these valves.

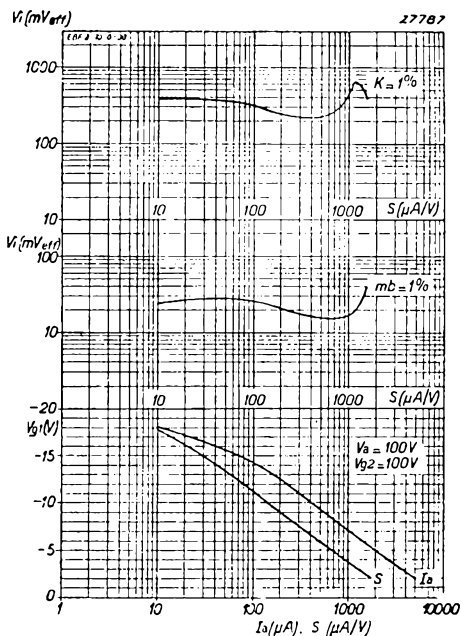

Fig. 9

Upper diagram. Effective alternating grid voltage as a function of the mutual conductance with 1% cross modulation, at  $V_a = 100V$ ;  $V_{g2} = 100V$  (fixed screen potential).  
 Centre diagram. Effective alternating grid voltage as a function of the mutual conductance with 1% modulation hum.  
 Lower diagram. Mutual conductance  $S$  and anode current  $I_a$  as a function of the grid bias.

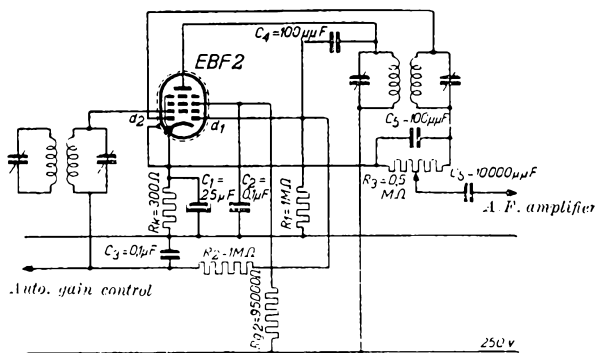

Fig. 10

Circuit diagram showing the EBF 2 employed as I.F. amplifier. Diode  $d_2$  is used for detection and diode  $d_1$  as rectifier for the A.G.C.

# EBL 1 Double-diode output pentode

The EBL 1 is a combination of double-diode and steep-slope, 9 W output pentode, in one envelope and sharing a common cathode. The characteristics of the pentode unit place this valve among the high-mutual-conductance pentodes and it may be used in the construction of very low-priced receivers, for instance of the super-heterodyne type, having a limited number of valves and which, without a stage of A.F. amplification, will nevertheless give a reasonably high output.

The two diodes are mounted below the pentode section opposite to the cathode, in such a way that the two anodes, which are not completely semi-cylindrical, are located at the same height on the mount; the diodes are therefore electrically identical. A screen separates the diode section from the pentode unit and, to prevent the grid of the latter from being affected in any way by the diodes, the grid connection is brought out at the top of the envelope.

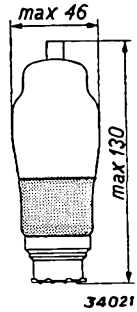

Fig. 1  
Dimensions in mm

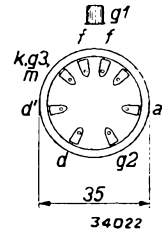
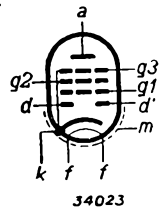

Fig. 2  
Arrangement of electrodes and base connections.

## HEATER RATINGS

Heating: indirect, A.C. or D.C., parallel supply.

Heater voltage . . . . .  $V_f = 6.3 \text{ V}$

Heater current . . . . .  $I_f = 1.18 \text{ A}$

## CAPACITANCES

$C_{ag1} < 0.8 \mu\mu\text{F}$

$C_{d2g1} < 0.08 \mu\mu\text{F}$

$C_{d1a} < 0.2 \mu\mu\text{F}$

$C_{d1k} = 3.5 \mu\mu\text{F}$

$C_{d2a} < 0.2 \mu\mu\text{F}$

$C_{d2k} = 3.5 \mu\mu\text{F}$

$C_{d1g1} < 0.08 \mu\mu\text{F}$

$C_{d1d2} < 0.25 \mu\mu\text{F}$

## OPERATING DATA

Anode voltage . . . . .	$V_a$	= 250 V
Screen-grid voltage . . . . .	$V_{g2}$	= 250 V
Cathode resistor . . . . .	$R_k$	= 150 ohms
Grid bias. . . . .	$V_{g1}$	= -6 V
Anode current . . . . .	$I_a$	= 36 mA
Screen current . . . . .	$I_{g3}$	= 4 mA
Mutual conductance at the working point. . . . .	$S$	= 9 mA/V
Internal resistance . . . . .	$R_i$	= 50,000 ohms
Load resistor . . . . .	$R_a$	= 7,000 ohms
Output with 10% distortion. . . . .	$W_o$	= 4.5 W
Alternating grid voltage for $W_o = 4.5 \text{ W}$ . . . . .	$V_i$	= 4.2 $V_{eff}$
Sensitivity ( $W_o = 50 \text{ mW}$ ). . . . .	$V_i$	= 0.35 $V_{eff}$

**MAXIMUM RATINGS**

Pentode section:

$V_{ao}$ = max. 550 V	$W_{g2}$ ( $V_i = 0$ )	= max. 1.2 W
$V_c$ = max. 250 V	$W_{g2}$ ( $W_o = \text{max.}$ )	= max. 2.5 W
$W_a$ = max. 9 W	$V_{g1}$ ( $I_{g1} = + 0.3 \mu\text{A}$ )	= max. -1.3 V
$I_k$ = max. 55 mA	$R_{g1k}$	= max. 1 M ohm
$V_{g2o}$ = max. 550 V	$R_{fk}$	= max. 5,000 ohms
$V_{g2}$ = max. 260 V	$V_{fk}$	= max. 50 V <sup>1)</sup>

Diode section:

Voltage on diode (peak value)	$V_d = V_{d'}$	= max. 200 V
Diode current	$I_d = I_{d'}$	= max. 0.8 mA
(direct current through the grid leak)		
Voltage on diode at diode current start ( $I_d = + 0.3 \mu\text{A}$ )	$V_d$	= max. -1.3 V
Voltage on diode at diode current start ( $I_{d'} = + 0.3 \mu\text{A}$ )	$V_{d'}$	= max. -1.3 V

1) Direct voltage or effective value of alternating voltage.

The curves relating to the increase in the direct voltage ( $\Delta V$ ) across the grid leak, as a function of the unmodulated R.F. voltage, as well as for the A.F. voltage ( $V_{LF}$ ) across the grid leak as plotted against the 30 % modulated R.F. voltage on one of the diodes (0.5 M ohm grid leak) are the same as for the EB 4.

Grid bias must be obtained by means of a cathode resistor only; semi-automatic bias may be employed provided that the cathode current is more than 50 % of the total current passing through the biasing resistor. Leads to the valve connections should be as short as possible and it is essential to include a resistor of about 1000 ohms in the control-grid lead.

A stage of audio-frequency amplification between one of the diodes as detector and the output valve may possibly give rise to hum and oscillation, for which reason the gain between that diode and the pentode should not exceed a factor of 15; this may be obtained by using the EBC 3 as pre-amplifier with slight negative feed-back.

The characteristics of the EL 3 relating to output power, having regard to the voltage drop across the output transformer, apply also to the EBL 1.

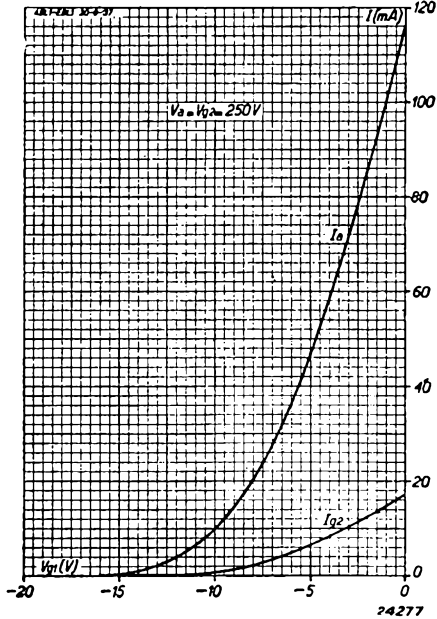

Fig. 3  
Anode current and screen-grid current as a function of the grid bias at  $V_a = V_{g2} = 250$  V.

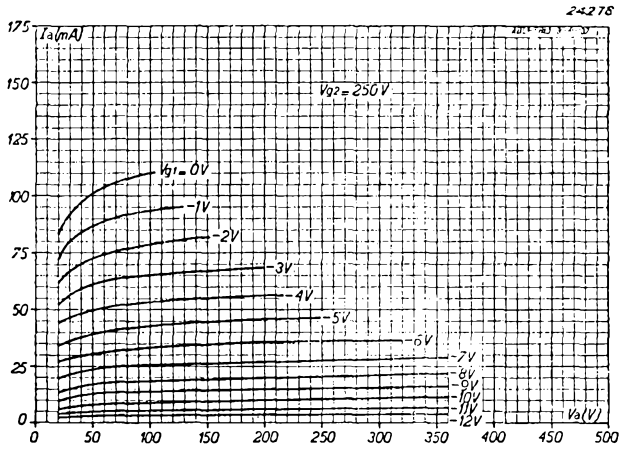

Fig. 4  
 Anode current as a function of the anode voltage at  $V_{g2} = 250V$  and at different values of grid bias.

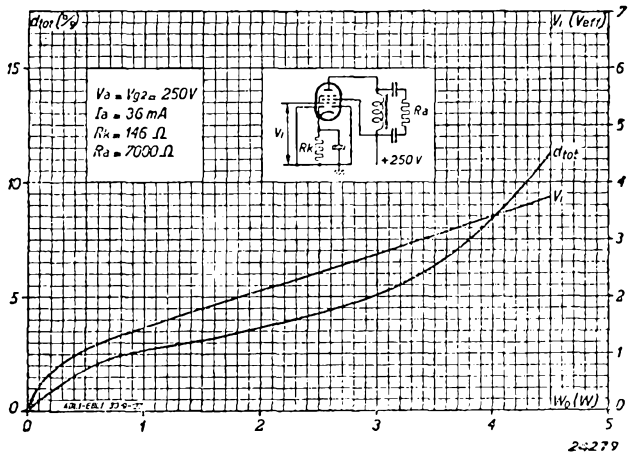

Fig. 5  
 Alternating grid voltage ( $V_i$ ) and total distortion  $d_{tot}$  as a function of the output power of the EBL1 used as a Class A output valve



# ECH 3 Triode hexode

The ECH 3 is a variable- $\mu$  frequency-changer, constructed on the principle of the triode-hexode and thus consisting of a hexode — the frequency-changer proper — and a triode to function as oscillator. Both units are mounted round a common cathode, of which the heater power is 1.26 W. The heater current at 6.3 V is 200 mA, which makes the valve suitable for A.C. receivers with their heaters in parallel, as well as for A.C./D.C. sets with the heaters in series, in a 200 mA circuit. The first grid of the hexode is wound with varying pitch; this grid carries the R.F. signal and the control voltage for the automatic gain control. Grids 2 and 4 are screen grids, whilst grid 3 is connected directly to the control grid of the triode section and therefore carries the alternating oscillator voltage.

Although the heater current of this valve is only small, very high conversion amplification is possible; on 250 V anode and 100 V screen, it is  $650 \mu\text{A/V}$ , without control, the internal resistance being 1.3 M ohms.

The ECH 3 is eminently suitable for short-wave reception with controlled mutual conductance, without too much frequency drift; the drift is very slight when occasioned by mains voltage fluctuations. If the tuned oscillator circuit is connected to the anode, with the feedback coil in the grid circuit, the frequency drift arising from mains fluctuations of 10% will be less than 1 kc/s at 15 m; at this wavelength, with a tuning capacitance of  $50 \mu\mu\text{F}$  in the oscillator circuit and full control applied to the grid, the drift is less than 2 kc/s. The relatively low input and output capacitances of this valve are also favourable features from the aspect of short-wave work.

Due to the hexode principle employed in this valve, there is no electronic coupling between the oscillator grid (grid 3) and the

R.F. grid (grid 1). Grid 3,

however, has a certain capacitance with respect to grid 1, so that on very short waves (13 m) an alternating voltage of about 0.5 V exists at the grid, although this has very little effect on the conversion conductance. Because of the high mutual conductance of the hexode unit and the rapid decrease in the slope in respect of the first grid when the negative voltage on grid 3 (see Fig. 21) is increased, it is possible to obtain very high conversion conductance in the uncontrolled condition; moreover, the alternating oscillator voltage need be only very small. The effective alternating oscillator voltage for

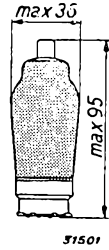
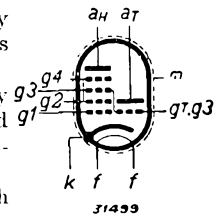

Fig. 1  
Dimensions in mm.



51499

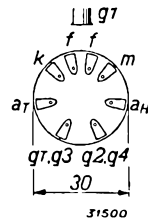

Fig. 2  
Arrangement of electrodes and base connections.

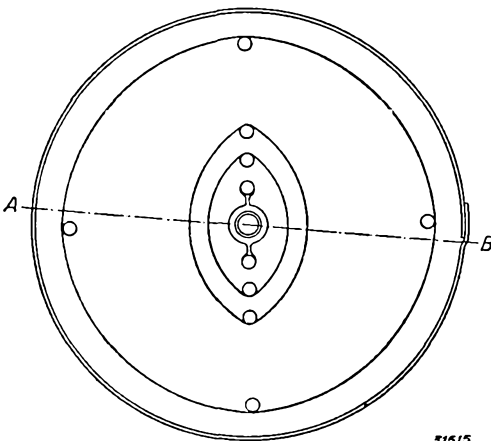

Fig. 3

Cross-section of the system of electrodes in the hexode unit.

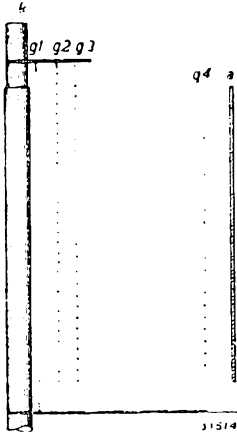

Fig. 4  
Vertical cross-section through the system of electrodes of the hexode (see A-B, Fig.3).

good results is only 8 V, which can be developed in the triode section of the valve without any difficulty by means of standard coils.

However, at lower oscillator voltages the conversion conductance is still quite high, being about  $580 \mu A/V$  at 5 V (see Fig. 9), so that satisfactory conversion amplification is also possible on short waves. At very much higher oscillator voltages than 8 V the conversion conductance deviates only slightly from the optimum value; the conductance, and also the amplification, therefore, vary only to a small degree as a result of wide fluctuations in the oscillator voltage within the wave-range. The value of 8 V (200  $\mu A$  passing through the grid leak of 50,000 ohms) gives a satisfactory compromise between background noise, whistles and the desired conversion conductance.

With a view to the control and prevention of cross-modulation, the ECH 3 is designed for potential-divider feeding of the screen grid. Although from the aspect of economy a screen series resistor would take less current, this involves one great disadvantage in that the potential of the screen in that case increases to such an extent with rises in the control voltage that it approaches that of the anode. At higher screen-grid voltages, however, secondary electrons emitted by the anode are attracted by the screen grid, with the result that the internal resistance

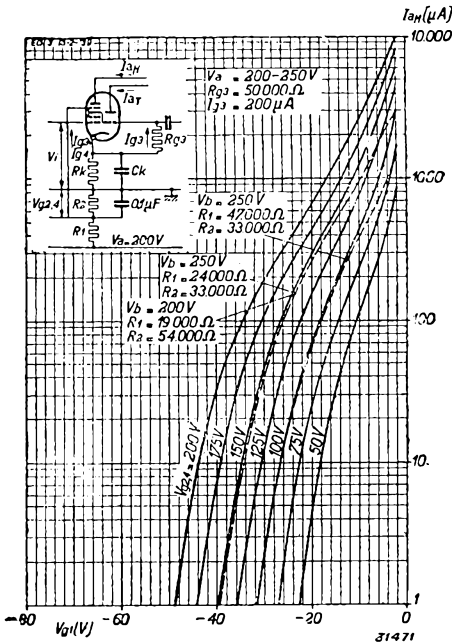

Fig. 5  
Anode current of the hexode unit as a function of the grid bias, at different screen potentials, with an anode voltage of 200 to 250 V.

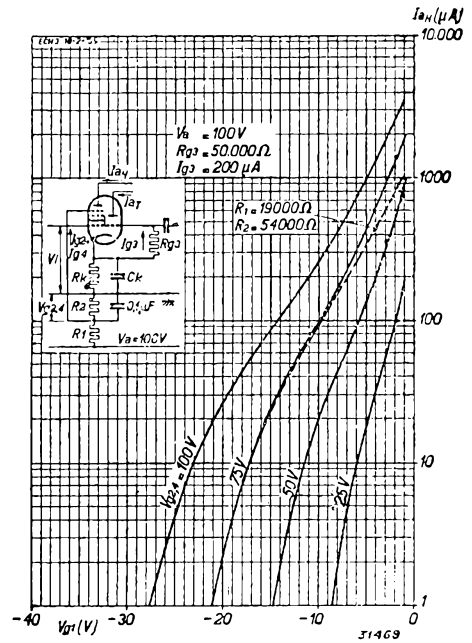

Fig. 6  
Anode current of the hexode unit as a function of the grid bias, at different screen potentials, with an anode voltage of 100 V.

is greatly reduced. Consequently, when the control is in operation the selectivity of the band-pass filter in the anode circuit also suffers. A correct choice of resistances for the potential-divider network will place a limit on the increase in screen voltage and thus avoid any alteration in the internal resistance of the valve; the control on the amplification can also be made to operate more slowly or rapidly by a judicious arrangement of the values of the resistances in this network.

Adjustment of the conversion conductance may be fairly rapid, and the characteristics with regard to cross-modulation are very good throughout the whole range of control (see Figs 15 to 20).

**HEATER RATINGS**

Heating: indirect, A.C. or D.C., series or parallel supply.

Heater voltage . . . . .  $V_f = 6.3 \text{ V}$   
 Heater current . . . . .  $I_f = 0.200 \text{ A}$

**CAPACITANCES**

a) Hexode section

$C_{g1} = 4.9 \mu\mu\text{F}$   
 $C_a = 9.0 \mu\mu\text{F}$   
 $C_{gq1} < 0.003 \mu\mu\text{F}$   
 $C_{qf} < 0.001 \mu\mu\text{F}$

b) triode section

$C_g = 8.8 \mu\mu\text{F}$   
 $C_a = 4.4 \mu\mu\text{F}$   
 $C_{ag} = 1.4 \mu\mu\text{F}$

c) between hexode and triode

$C_{qTg1H} < 0.3 \mu\mu\text{F}$

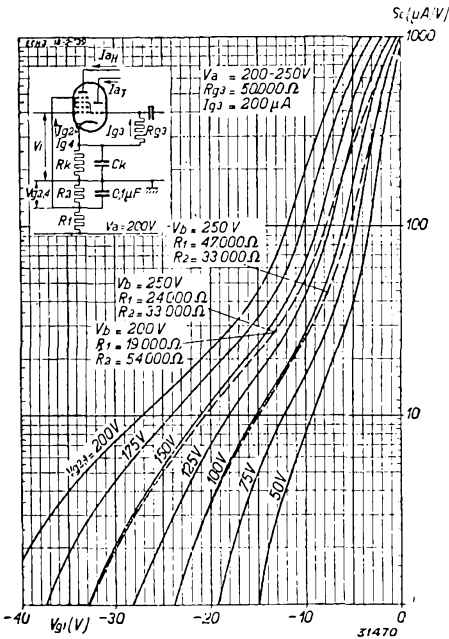

Fig. 7

Conversion conductance  $S_c$  as a function of the grid bias  $V_{g1}$  at different screen-grid voltages and for an anode voltage of 200–250 V.

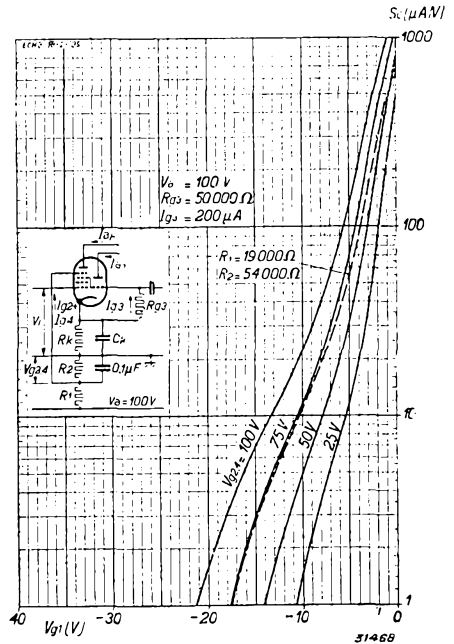

Fig. 8

Conversion conductance  $S_c$  as a function of the grid bias  $V_{g1}$  at different screen voltages and for an anode voltage of 100 V.

**OPERATING DATA (hexode section employed as frequency-changer)**

a) FIXED SCREEN VOLTAGE

Anode voltage	$V_a$	200 V	250 V
Screen-grid voltage	$V_{g2,4}$	100 V	100 V
Cathode resistor	$R_k$	215 ohms	215 ohms
Oscillator-grid leak	$R_{g3}$	50,000 ohms	50,000 ohms
Oscillator-grid current	$I_{g3}$	200 $\mu$ A	200 $\mu$ A
Grid bias (grid 1)	$V_{g1}$	-2 V <sup>1)</sup> -17 V <sup>2)</sup> -23 V <sup>3)</sup>	-2 V <sup>2)</sup> -17 V <sup>2)</sup> -23 V <sup>3)</sup>
Anode current	$I_a$	3 mA	3 mA
Screen-grid current	$I_{g2} + I_{g4}$	3 mA	3 mA
Conversion conductance	$S_c$	650 $\mu$ A/V	650 $\mu$ A/V
Internal resistance	$R_i$	0.9	1.3

1) Without control    2) Conversion conductance reduced to one-hundredth of uncontrolled value  
 3) Extreme limit of control

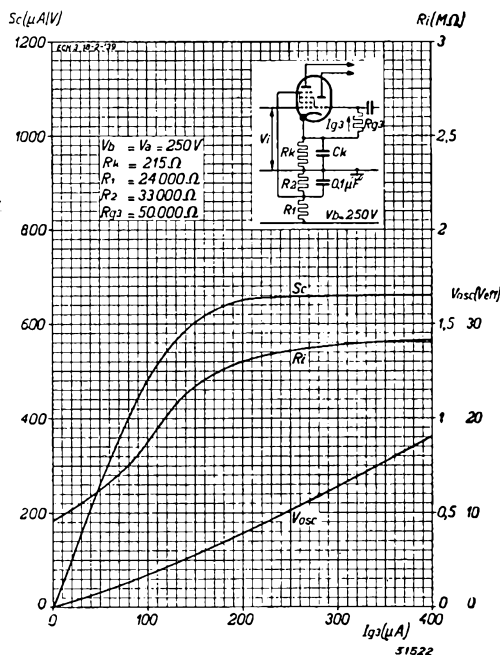
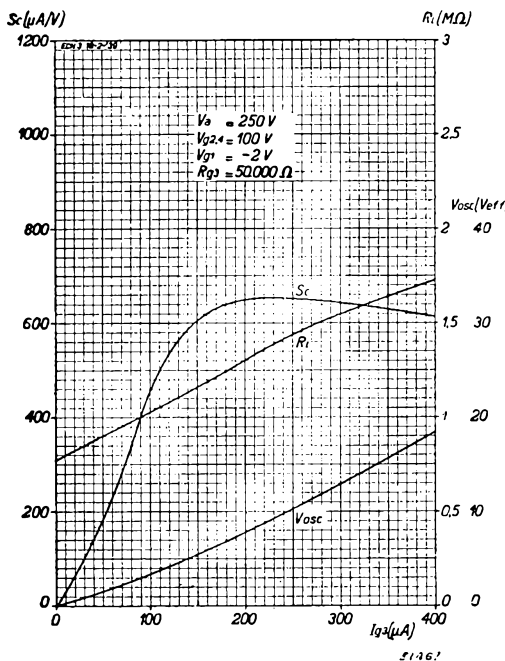

b) SCREEN FED FROM A POTENTIAL DIVIDER (normal operation) (current passing through the potential divider itself: 3 mA).

Supply or anode voltage	$V_b = V_a =$	250 V
Resistance of potential divider	(see Fig. 28) $R_1$	24,000 ohms
Resistance of potential divider	(see Fig. 28) $R_2$	33,000 ohms
Cathode resistor	$R_k$	215 ohms
Oscillator grid leak	$R_{g3}$	50,000 ohms
Grid bias (grid 1)	$V_{g1}$	-2 V <sup>1)</sup> -23.5 V <sup>2)</sup> -31 V <sup>3)</sup>
Screen-grid voltage	$V_{g2,A}$	100 V --- 145 V
Anode current	$I_a$	3 mA --- ---
Screen-grid current	$I_{g2} + I_{g3}$	3 mA --- ---
Conversion conductance	$S_c$	650 $\mu A/V$ 6.5 $\mu A/V$ 1.5 $\mu A/V$
Internal resistance	$R_i$	1.3 M ohms > 3 M ohms > 4 M ohms

1) Without control    2) Conversion conductance reduced to one-hundredth of uncontrolled value  
 3) Extreme limit of control

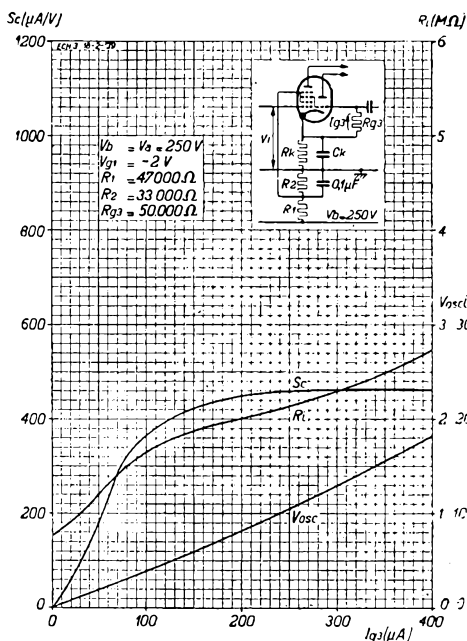

Fig. 11

Conversion conductance  $S_c$ , internal resistance  $R_i$  and alternating oscillator voltage  $V_{osc}$  as a function of the oscillator-grid current  $I_{g2}$  at  $V_a = 250$  V,  $R_{g3} = 50,000$  ohms and with screen fed from a potential divider of  $47,000 \pm 33,000$  ohms (noise-free operation).

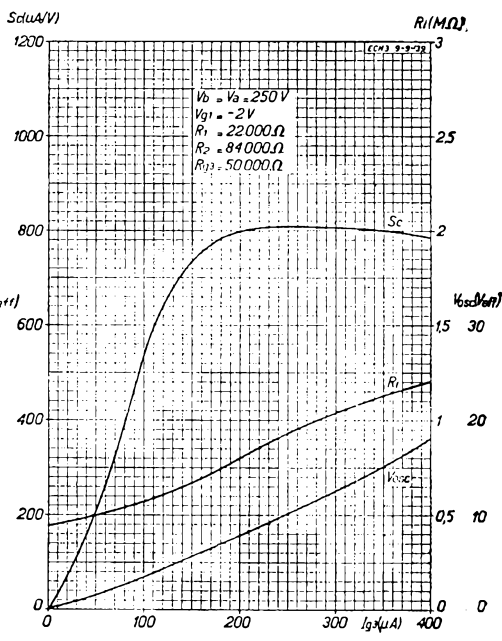

Fig. 12

Conversion conductance  $S_c$ , internal resistance  $R_i$  and alternating oscillator voltage  $V_{osc}$  as a function of the oscillator-grid current  $I_{g3}$ , at  $V_a = 250$  V,  $R_{g3} = 50,000$  ohms and with screen fed from a potential divider of  $22,000 \pm 84,000$  ohms (optimum setting from the point of view of freedom from cross-modulation).

c) ARRANGEMENT FOR LEAST POSSIBLE BACKGROUND NOISE; SCREEN GRID FED FROM A POTENTIAL DIVIDER (current passing through the potential divider itself: 2.1 mA).

Supply or anode voltage	$V_b = V_a =$	$=$	250 V
Resistance of the potential divider	(see Fig. 28) $R_1 =$	$=$	47,000 ohms
Resistance of the potential divider	(see Fig. 28) $R_2 =$	$=$	33,000 ohms
Cathode resistor	$R_k =$	$=$	310 ohms
Oscillator-grid leak	$R_{g3} =$	$=$	50,000 ohms
Oscillator-grid current	$I_{g3} =$	$=$	200 $\mu$ A
Grid bias (grid 1)	$V_{g1} =$	$=$	-2 V <sup>1)</sup> -19 V <sup>2)</sup> -23 V <sup>3)</sup>
Screen-grid voltage	$V_{g2,4} =$	$=$	70 V    —    100 V
Anode current	$I_a =$	$=$	1.5 mA    —    —
Screen current	$I_{g2} + I_{g4} =$	$=$	1.6 mA    —    —
Conversion conductance	$S_c =$	$=$	450 $\mu$ A/V    4.5 $\mu$ A/V    1.5 $\mu$ A/V
Internal resistance	$R_i =$	$=$	2 M ohms    > 5 M ohms    > 6 M ohms

1) Without control    2) Conversion conductance reduced to one-hundredth of uncontrolled value.  
 Extreme limit of control

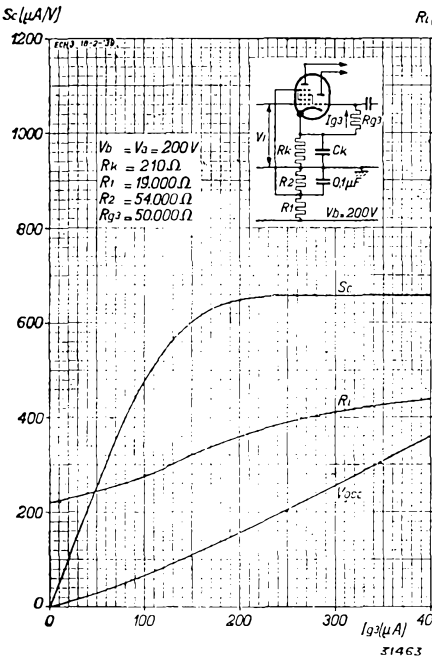

Fig. 13  
 Conversion conductance  $S_c$ , internal resistance  $R_i$  and alternating oscillator voltage  $V_{osc}$  as a function of the oscillator grid current  $I_{g3}$ , at  $V_a = 200$  V,  $R_{g3} = 50,000$  ohms and with screen fed from a potential divider of  $19,000 + 54,000$  ohms (for receivers with switch for A.C. or D.C.).

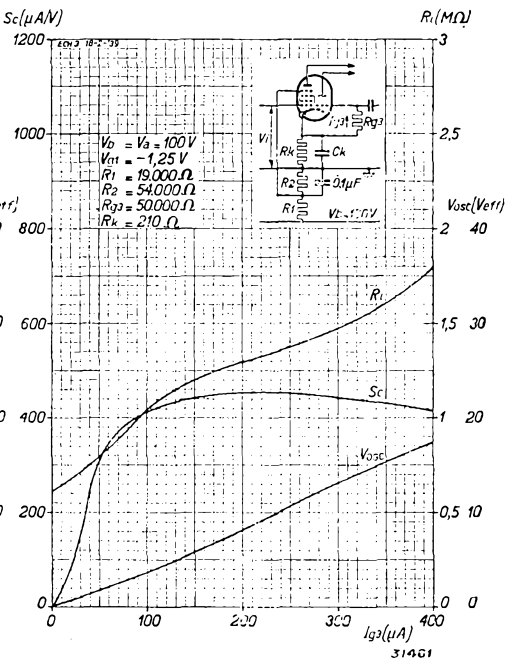

Fig. 14  
 Conversion conductance  $S_c$ , internal resistance  $R_i$  and alternating oscillator voltage  $V_{osc}$  as a function of the oscillator grid current  $I_{g3}$ , at  $V_a = 100$  V,  $R_{g3} = 50,000$  ohms and with screen fed from a potential divider of  $19,000 + 54,000$  ohms (for receivers with switch for A.C. or D.C.).

d) OPTIMUM SETTING FROM THE POINT OF VIEW OF CROSS-MODULATION; SCREEN GRID FED FROM A POTENTIAL DIVIDER (current passing through the potential divider itself 1.5 mA).

Supply or anode voltage $V_b = V_a =$	250 V		
Resistance of the potential divider (see Fig. 28) . . . $R_1 =$	22.000 ohms		
Resistance of the potential divider (see Fig. 28) . . . $R_2 =$	84.000 ohms		
Cathode resistor . . . . . $R_k =$	165 ohms		
Oscillator-grid leak . . . . . $R_{g3} =$	50.000 ohms		
Oscillator-grid current . . . . . $I_{g3} =$	200 $\mu$ A		
Grid bias (grid 1) . . . . . $V_{g1} =$	-2 V <sup>1)</sup>	-28.5 V <sup>2)</sup>	-40 V <sup>3)</sup>
Screen-grid voltage . . . . . $V_{g2,1} =$	125 V	—	200 V
Anode current . . . . . $I_a =$	4.5 mA	—	—
Screen-grid current . . . . . $I_{g2} + I_{g1} =$	4.3 mA	—	—
Conversion conductance . . . . . $S_c =$	800 $\mu$ A/V	8 $\mu$ A/V	1.5 $\mu$ A/V
Internal resistance . . . . . $R_i =$	0.8 M ohm	< 0.8 M ohm	< 1.1 M ohms

1) Without control    2) Conversion conductance reduced to one-hundredth of uncontrolled value.  
 3) Extreme limit of control

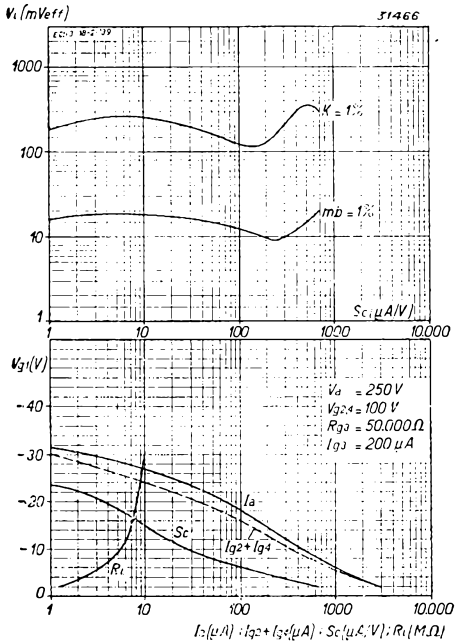

Fig. 15

At  $V_a = 250$  V and with fixed screen-grid voltage of 100 V:

Upper diagram. Permissible R.F. voltage at 1% cross-modulation ( $K = 1\%$ ) and permissible alternating voltage of the interfering signal on the grid, with 1% modulation hum ( $mb = 1\%$ ), as a function of the conversion conductance.

Lower diagram. Anode current  $I_a$ , screen-grid current  $I_{g2} + I_{g1}$ , conversion conductance  $S_c$  and internal resistance  $R_i$  as a function of the bias on grid 1.

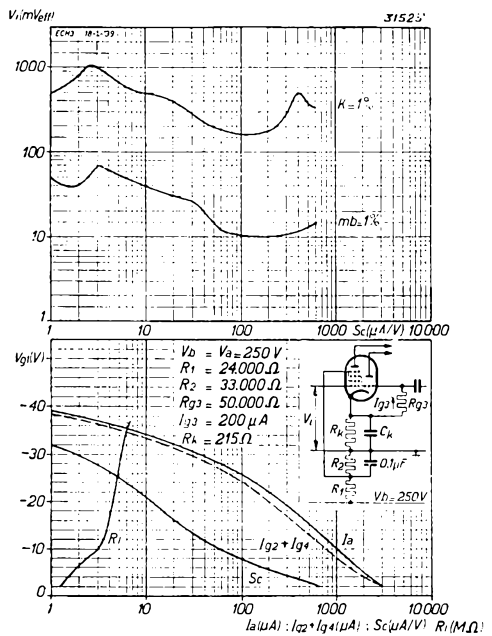

Fig. 16

At  $V_a = 250$  V and with screen fed from a potential divider of 24,000 + 33,000 ohms (normal setting):

Upper diagram. Permissible R.F. voltage at 1% cross-modulation ( $K = 1\%$ ) and permissible alternating voltage of the interfering signal on the grid at 1% modulation hum ( $mb = 1\%$ ), as a function of the conversion conductance.

Lower diagram. Anode current  $I_a$ , screen-grid current  $I_{g2} + I_{g1}$ , conversion conductance  $S_c$  and internal resistance  $R_i$  as a function of the bias on grid 1.

### ECH 3

e) FOR A.C./D.C. RECEIVERS; SCREEN GRID FED FROM A POTENTIAL DIVIDER (current passing through the potential divider itself: at  $V_b = 200$  V, 1.85 mA, at  $V_b = 100$  V, 1 mA).

Supply or anode voltage						
$V_b = V_a =$	100 V			200 V		
Resistance of potential divider (see Fig. 28) $R_1 =$	19,000 ohms			19,000 ohms		
Resistance of potential divider (see Fig. 28) $R_2 =$	54,000 ohms			54,000 ohms		
Cathode resistor						
$R_k =$	210 ohms			210 ohms		
Oscillator-grid leak						
$R_{g3} =$	50,000 ohms			50,000 ohms		
Oscillator-grid current						
$I_{g3} =$	200 $\mu$ A			200 $\mu$ A		
Bias on grid 1						
$V_{g1} =$	-1.25 V <sup>1)</sup>	-13.5 V <sup>2)</sup>	-16.5 V <sup>3)</sup>	-2 V <sup>1)</sup>	-23.5 V <sup>2)</sup>	-31 V <sup>3)</sup>
Screen voltage						
$V_{g2,4} =$	55 V	—	75 V	100 V	—	145 V
Anode current						
$I_a =$	1 mA	—	—	3 mA	—	—
Screen current						
$I_{g2} + I_{g4} =$	1.4 mA	—	—	3 mA	—	—
Conversion conductance						
$S_c =$	450 $\mu$ A/V	4.5 $\mu$ A/V	1.5 $\mu$ A/V	650 $\mu$ A/V	6.5 $\mu$ A/V	1.5 $\mu$ A/V
Internal resistance						
$R_i =$	1.3	> 4	> 5	0.9	> 2	> 2.5
	M ohms	M ohms	M ohms	M ohms	M ohms	M ohms

1) Without control. 2) Conversion conductance reduced to one-hundredth of uncontrolled value.  
3) Extreme limit of control

#### OPERATING DATA: Triode section employed as oscillator

Supply voltage . . . . .	$V_b =$	100 V	150 V	250 V
Anode load resistor . . . . .	$R_a =$	—	—	45,000 ohms
Anode current under oscillation ( $R_g = 50,000$ ohms, $I_g = 200 \mu$ A). . . . .	$I_a =$	3.3 mA	8 mA	3.3 mA
Anode current at commencement of oscillation ( $V_{osc} = 0$ ) . . . . .	$I_a =$	10 mA	18 mA	6.3 mA
Mutual conductance at commencement of oscillation ( $V_{osc} = 0$ ) . . . . .	$S_o =$	2.8 mA/V	3.8 mA/V	2.8 mA/V
Amplification factor ( $V_g = 0$ V; $V_{osc} =$ 0 V). . . . .	$\mu =$	24	24	24



**MAXIMUM RATINGS for the hexode section**

Anode voltage in cold condition . . . . .	$V_{a0} = \text{max. } 550 \text{ V}$
Anode voltage . . . . .	$V_a = \text{max. } 300 \text{ V}$
Anode dissipation . . . . .	$W_a = \text{max. } 1.2 \text{ W}$
Screen voltage in cold condition . . . . .	$V_{g20} = \text{max. } 550 \text{ V}$
Screen voltage ( $I_a = 4.5 \text{ mA}$ ) . . . . .	$V_{g2} = \text{max. } 125 \text{ V}$
Screen voltage ( $I_a < 0.5 \text{ mA}$ ) . . . . .	$V_{g2} = \text{max. } 200 \text{ V}$
Screen dissipation . . . . .	$W_{g2} = \text{max. } 0.6 \text{ W}$
Grid voltage at grid current start ( $I_{g1} = + 0.3 \mu\text{A}$ ) . . . . .	$V_{g1} = \text{max. } -1.3 \text{ V}$
Grid voltage at grid current start ( $I_{g3} = + 0.3 \mu\text{A}$ ) . . . . .	$V_{g3} = \text{max. } -1.3 \text{ V}$
Cathode current . . . . .	$I_k = \text{max. } 15 \text{ mA}$
External resistance in circuit, grid 1 . . . . .	$R_{g1k} = \text{max. } 3 \text{ M ohms}$
External resistance in circuit, grid 3 . . . . .	$R_{g3k} = \text{max. } 100,000 \text{ ohms}$
External resistance between heater and cathode . . . . .	$R_{fk} = \text{max. } 20,000 \text{ ohms}$
Voltage between heater and cathode (direct voltage or effective value of alternating voltage) . . . . .	$V_{fk} = \text{max. } 100 \text{ V}$

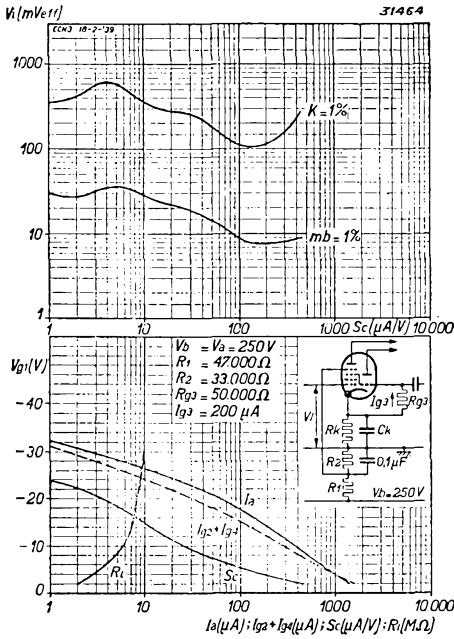

Fig. 17

At  $V_a = 250 \text{ V}$ , with screen fed from a potential divider of 47,000 + 33,000 ohms (noise-free setting).

Upper diagram. Permissible R.F. voltage with 1% cross-modulation ( $K = 1\%$ ) and permissible alternating voltage of the interfering signal on the grid with 1% modulation hum ( $mb = 1\%$ ), as a function of the conversion conductance.

Lower diagram. Anode current  $I_a$ , screen current  $I_{g2} + I_{g4}$ , conversion conductance  $Sc$  and internal resistance  $Ri$  as a function of the bias on grid 1.

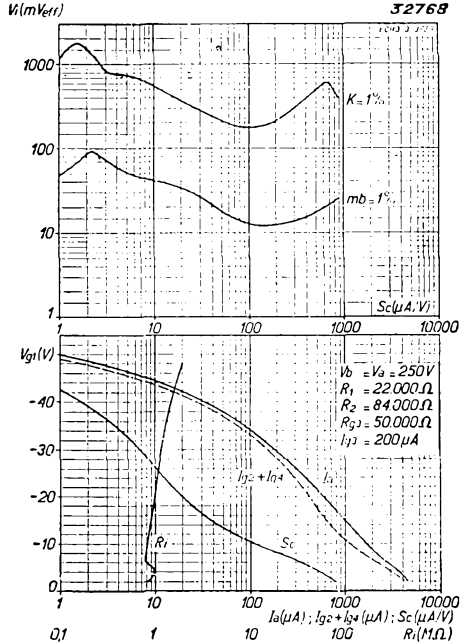

Fig. 18

At  $V_a = 250 \text{ V}$  with screen fed from a potential divider of 22,000 + 84,000 ohms (for freedom from appreciable cross-modulation).

Upper diagram. Permissible R.F. voltage with 1% cross-modulation ( $K = 1\%$ ) and permissible alternating voltage of the interfering signal on the grid with 1% modulation hum ( $mb = 1\%$ ), as a function of the conversion conductance.

Lower diagram. Anode current  $I_a$ , screen current  $I_{g2} + I_{g4}$ , conversion conductance  $Sc$  and internal resistance  $Ri$  as a function of the bias on grid 1.

**MAXIMUM RATINGS for the triode section**

- Anode voltage in cold condition . . . . .  $V_{a0}$  = max. 550 V
- Anode voltage . . . . .  $V_a$  = max. 150 V
- Anode dissipation . . . . .  $W_a$  = max. 1.5 W
- Grid voltage at grid current start ( $I_g = +0.3 \mu A$ )  $V_{g1}$  = max. -1.3 V
- External resistance in the grid circuit . . . . .  $R_{gk}$  = max. 100,000 ohms

The triode oscillates very freely, owing to its high mutual conductance, and, since it is also brought into oscillation easily, the reaction can with advantage be fairly loose. A grid leak of 50,000 ohms is recommended and a grid capacitor of  $50 \mu\mu F$  is satisfactory; these values can be maintained on all wave-ranges.

In order to limit possible frequency drift and "pulling" of the oscillator tuning by the R.F. circuit, it is advisable to incorporate the tuned oscillator circuit in the anode circuit of the triode section. If the tuned circuit is connected to the grid circuit, the frequency drift is about twice as much as in the former case. The alternating voltage at the oscillator frequency occurring in the input circuit due to the capacitance  $C_{g1g3}$

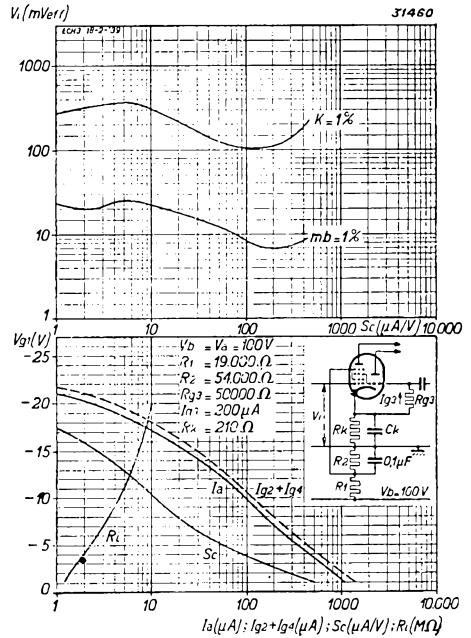
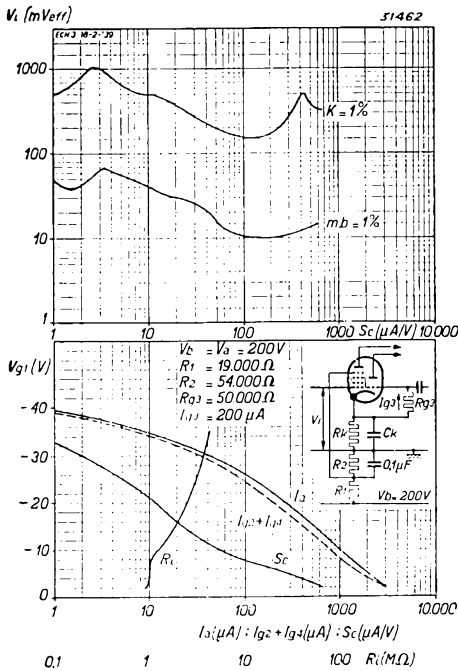

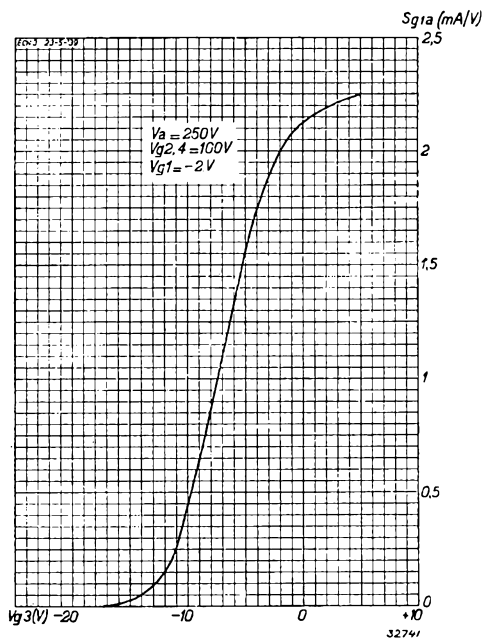

Fig. 21  
Grid-current slope  $S_{g1a}$  as a function of the grid bias.

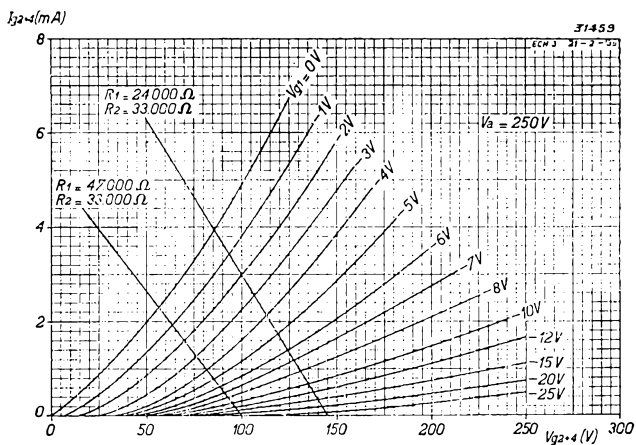

Fig. 22  
Screen-grid current  $I_{g2} + I_{g4}$  as a function of the screen voltage  $V_{g2+4}$  at various values of grid bias  $V_{g1}$ .

augments or decreases the conversion conductance according as the oscillator frequency is higher or lower than the input frequency, and it is therefore advisable, on the short wave ranges, to employ a higher oscillator frequency than the input frequency. Fig. 28 shows the theoretical circuit diagram of the ECH 3 employed as frequency-changer. The oscillator circuit may be parallel-fed in the usual manner, in which case the resistor in series with the anode should be about 30,000 ohms with a supply voltage  $V_b = 250$  V; the coupling capacitor should be between 50 and 500  $\mu\mu\text{F}$ .

In order to keep the alternating oscillator voltage constant in the medium and long wave ranges it is important to connect the reaction coil by means of a padding capacitor; the oscillator-grid current on the medium and long waves will then be 200-300-200  $\mu\text{A}$ , whilst on short waves the oscillator voltage can be stabilized by a resistor of 75 ohms in series with the reaction coil. This resistor, in conjunction with the input capacitance of the triode, has a damping effect which closely follows any increase in the frequency.

In A.C./D.C. receivers the circuit arrangement described above can be employed on a 250 V supply, provided that the feed voltage of the valve is not too low (say not less than 200 V). On a supply voltage of 100 V the anode potential is too low, in view of the fact that the anode of the triode has to be fed through a 30,000 ohm resistor; if a lower value were used for this purpose the oscillator circuit would be damped too much and, moreover, the padding curve would be unsatisfactory (greater fluctuations in the oscillator frequency, due to detuning of the oscillator circuit by the feed resistor). Since, generally speaking, the requirements of A.C./D.C. receivers working on lower voltage mains are not so stringent as otherwise, in such cases the oscillator circuit can be included in the grid circuit. In receivers designed for switching over either to A.C. or to D.C. and which are suitable for both 220 and 110 V mains, it is simpler to leave the tuned oscillator circuit in the anode feed circuit and to use the normal feed resistor for the parallel feed, also on low voltage. Naturally, there will then be a considerably lower oscillator voltage on 110 V mains than on 220 V. Different values of resistance in the potential divider for the screen feed of the hexode

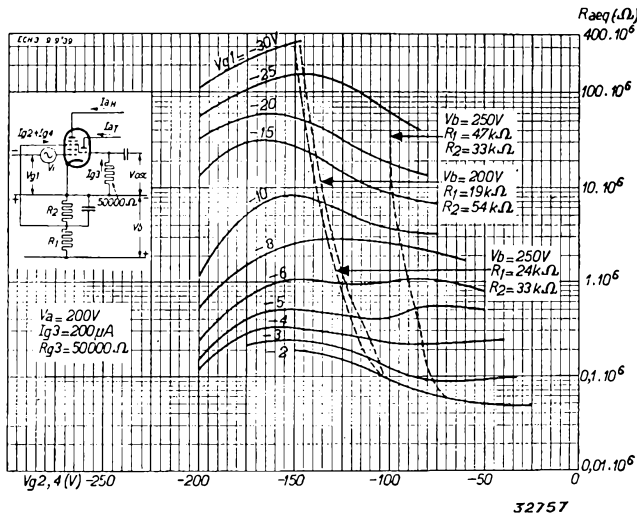

Fig. 23  
Equivalent noise resistance  $R_{eq}$  as a function of the screen-grid voltage  $V_{g2,4}$  at different values of grid bias  $V_{g1}$ .

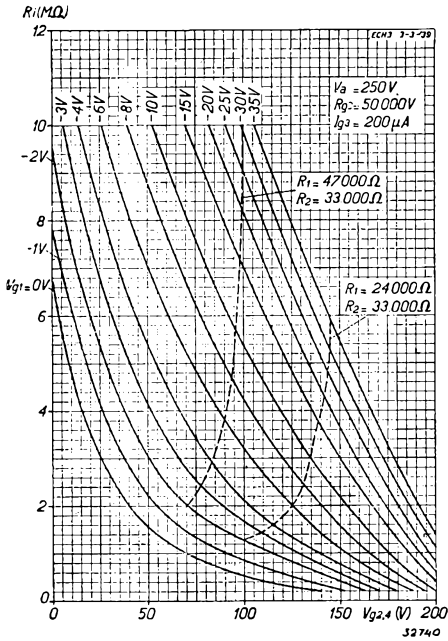

Fig. 24

Internal resistance  $R_i$  as a function of the screen-grid voltage  $V_{g_{2,4}}$  at different values of grid bias  $V_{g_1}$ , with  $V_a = 250$  V.

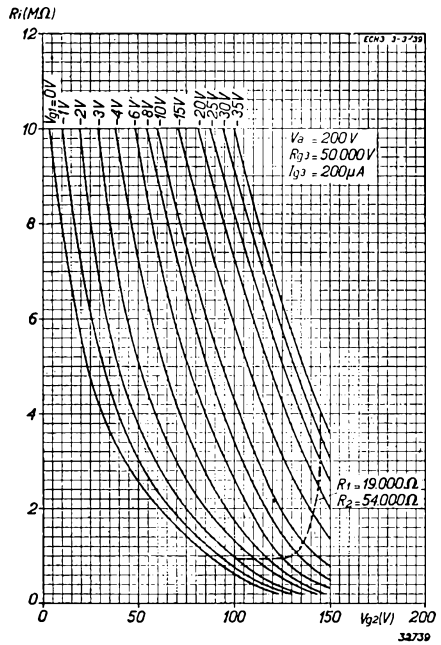

Fig. 25

Internal resistance  $R_i$  as a function of the screen-grid voltage  $V_{g_{2,4}}$  at different values of grid bias  $V_{g_1}$ , with  $V_a = 200$  V.

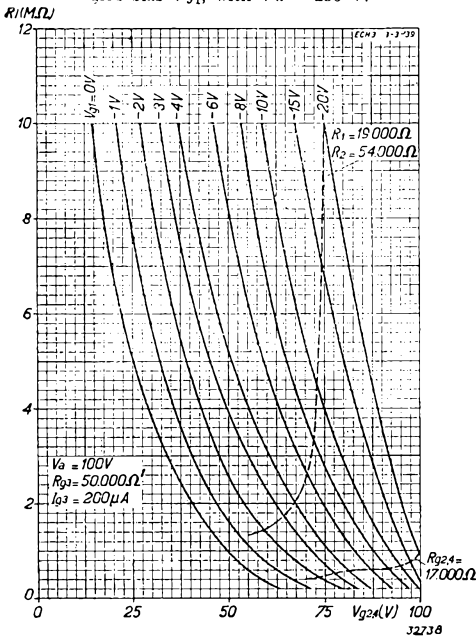

Fig. 26

Internal resistance  $R_i$  as a function of the screen-grid voltage  $V_{g_{2,4}}$  at different values of grid bias  $V_{g_1}$ , with  $V_a = 100$  V.

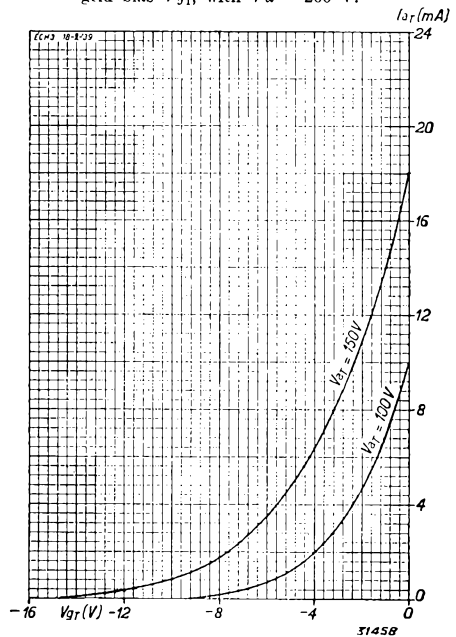

Fig. 27

Anode current of the triode section  $I_{aT}$  at  $V'aT = 150$  and  $100$  V.



# EEP 1 (EE 1) Secondary-emission valve

The EEP 1 is an amplifier with secondary-emission cathode. Although originally designed for wide-band amplification in television receivers, it is now recommended for use exclusively as a driver valve for radio receivers and amplifiers with a balanced output stage. The use of this valve not only saves the expense of the transformer normally required to produce the two alternating voltages of opposite phase, but it also provides a very high degree of amplification. In amplifiers especially, this tends to reduce the total number of valves required and also allows the use of negative feed-back, without losing too much of the gain.

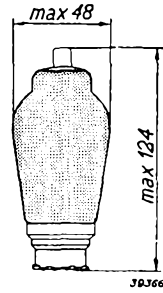

Fig. 1  
Dimensions in mm.

## Secondary emission and construction of the valve

When electrons strike a metal surface at a certain velocity a small number of them are thrown back, whilst the majority of them penetrate the superficial layer and there liberate electrons from the local atoms. Due to the impact of the primary electrons on the metallic surface, considerable velocity is imparted to the liberated electrons and if their direction of movement is favourable they are able to leave the surface. These electrons liberated from the surface of the metal by the primary electrons are known as secondary electrons. The capacity for emitting secondary electrons is expressed by the "secondary-emission factor"  $\delta$ , which is the average number of secondary electrons liberated by the primaries. The number of secondary electrons and the path which they follow depend on the

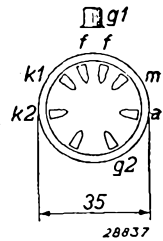
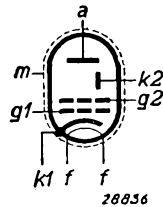

Fig. 2  
Arrangement of electrodes and base connections.

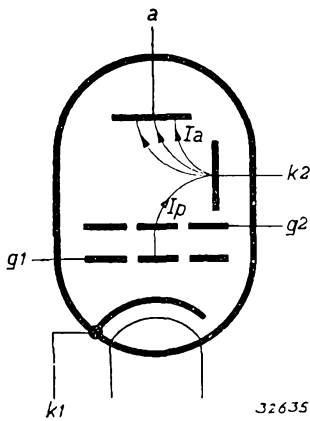

Fig. 3  
Diagram of the system employed in the secondary-emission valve. Primary electrons, leaving the cathode  $k_1$ , are deflected towards the secondary-emission cathode  $k_2$  and the secondary electrons liberated from the latter pass to the anode. The direction followed by the electrons is shown by means of arrows and it is just the opposite to that of the stream in an ordinary receiving valve.

construction of the valve, on the potential at the various electrodes and on the physical properties of the bombarded surface. A nickel surface, for instance, gives a secondary emission factor of only 0.94 at a potential difference of 150 V, so the number of secondaries will not be greater than the number of primaries; in other words there will be no multiplication of electrons.

The latter can take place only when the factor is greater than 1. Fig 3 shows the principle of the secondary-emission valve, and its action as applicable to the EEP 1 is briefly as follows. Electrons are drawn away from a primary, indirectly-heated cathode by a secondary-emission cathode at a positive potential (150 V). A screen and grid are mounted between the cathode proper and the secondary cathode and each electron reaching the latter liberates a large number of secondary electrons from it, these being attracted by the anode which is at a high potential (250 V).

It will be clear that every variation in the current flowing to the secondary-emission cathode, atten-

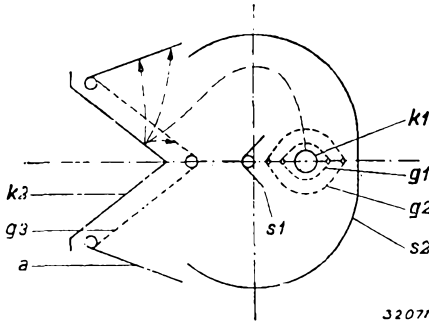

Fig. 4

Cross-section through secondary-emission valve, showing the path of the primary electrons and also that of the secondary electrons liberated from the cathode  $k_2$ .

- $k_1$  = primary cathode
- $g_1$  = control grid
- $g_2$  = screen grid (150 V)
- $s_1$  = screen for protection of secondary cathode (0 V) from deposits caused by evaporation of the cathode
- $s_2$  = deflector screen (0 V)
- $k_2$  = secondary-emission cathode (150 V)
- $a + g_2$  = anode (250 V).

1.6, the mutual conductance in that case being  $\delta^{0.6}$  times greater. Suppose that  $\delta = 5$ , then  $\delta^{0.6}$  will be 2.6.

If the primary cathode (indirectly-heated, with oxide layer) and the secondary-emission area were provided inside the valve without any precautions to avoid this, the secondary emission area would in time become covered with a deposit of material produced by evaporation of the cathode (e.g., barium and barium oxide) and the stability of the secondary emission would thus be seriously affected; the use of an electron-optical device, coupled with a careful arrangement of the paths for the electron streams, however, prevents the deposition of any material on the secondary cathode. In the EEP 1 this difficulty, namely the tendency of the primary cathode to produce deposits, is overcome by employing an electron deflector. It is assumed that the molecules liberated from the primary cathode move virtually in a

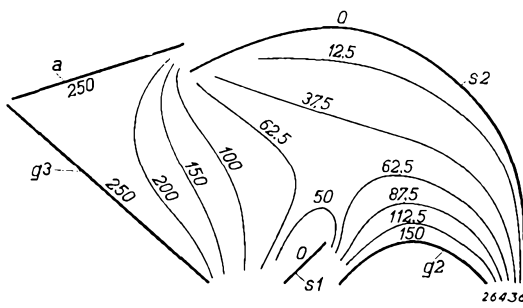

Fig. 5

Equipotential areas in the secondary-emission valve. For design-  
ation of the electrodes see Fig. 4.

straight line and an appropriate arrangement of the electrodes in the valve makes the secondary-emission cathode accessible to electrons from the primary cathode, but not to material thrown off by this cathode. The action of the secondary-emission valve can best be explained in relation to Fig. 4<sup>1)</sup>, which shows a section through the system of electrodes in the EEP 1. The primary cathode  $k_1$  (indirectly-heated oxide cathode), the control grid  $g_1$ , concentric with

\* The diagram shows the construction of the original model of the EEP 1, but in later models the anode plate  $a$  is omitted to ensure satisfactory operation of the valve as a pre-amplifier and phase-inverter in balanced output stages, thus leaving only the anode-“grid”  $g_2$  as virtual anode.



the latter, and the screen grid  $g_2$  (at a potential of about 150 V with respect to  $k_1$ ) together constitute the first three electrodes of a normal screen-grid valve;  $k_2$  is the secondary-emission cathode, which is usually also given a potential of 150 V. Between the system of three electrodes already mentioned and the secondary cathode a screen plate  $s_1$  is provided to prevent the deposition of material from the primary cathode upon the secondary; this screen is connected internally to the cathode. A second screen  $s_2$  is fitted about the electrode system, this being also at cathode potential and suitably shaped for correct deflection of the electrons. Finally, the valve contains an anode-grid  $g_3$ , stretched parallel to the emission cathode and connected to the anode plates  $a$ . The shape of the screen  $s_2$  is such that the field produced between the primary and secondary cathodes causes the electrons to follow curved paths around the screen  $s_1$  towards the secondary cathode  $k_2$  (see Fig. 4). Fig 5 shows the equipotential areas in one half of the valve. Between the screen grid  $g_2$  and the secondary cathode the electrons travel through two concentrating fields, deflection taking place in the low-potential area formed by screen  $s_2$ , and Fig. 5 clearly illustrates the so-called focusing arrangement. An electron arriving at the secondary-emission cathode liberates a number of secondary electrons (sec. emission factor  $\delta = 5$ ) which are collected by the anode-grid  $g_3$ , mounted at about 1.5 mm distance from it and operating at a voltage of some 100 V higher than that of the secondary cathode.

It is worthy of note that the electrons released from the secondary cathode set up a negative current to this cathode; whereas normally the external current flows towards the positive electrode, the current in this case passes away from the secondary cathode and follows a path through the source of voltage to the primary cathode. Simultaneously, however, the positive current flows to the secondary cathode, so that the emission current must be diminished by the value of this primary current.

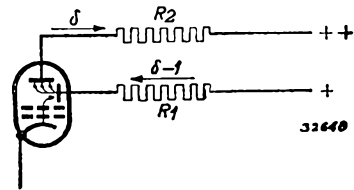

Fig. 6  
Schematic arrangement showing the action of the secondary-emission valve employed as driver valve. The arrows indicate the direction followed by the electrons. The normal current flow is in the opposite direction to that of the arrows.

*The secondary-emission valve as pre-amplifier in balanced output stages without transformer.*

When balanced output stages are driven by means of the secondary-emission valve EEP 1,

use is made of the fact that the secondary-emission current (in a positive sense) passes externally to the anode and is taken away at the secondary cathode. It must then be remembered that the current from the latter cathode is reduced to the extent of the primary electrons flowing in the opposite direction. The phases of the currents passing to the two electrodes are therefore  $180^\circ$  opposed and, if these currents be passed to or from the electrodes across resistors, voltages will be obtained which will also be  $180^\circ$  out of phase (see also Fig. 6).

These two alternating voltages of opposite phase may be applied through coupling capacitors with grid leaks to the grids of two output valves in a balanced circuit, and the values of the resistors in both anode and secondary-cathode circuit should naturally be such that the two opposed alternating voltages are exactly equal.

As already stated, the action of the valve depends upon the fact that for every electron reaching the secondary cathode  $\delta$  electrons arrive at the anode; the number of electrons at the secondary cathode is therefore augmented by  $(\delta-1)$  electrons passing through  $R_1$ <sup>1)</sup> to the secondary cathode, whilst  $\delta$  electrons leave the anode through  $R_2$  in respect of these.

<sup>1)</sup> In Fig. 16  $R_1$  is made up of  $R_2$  and  $R_3$  in parallel.

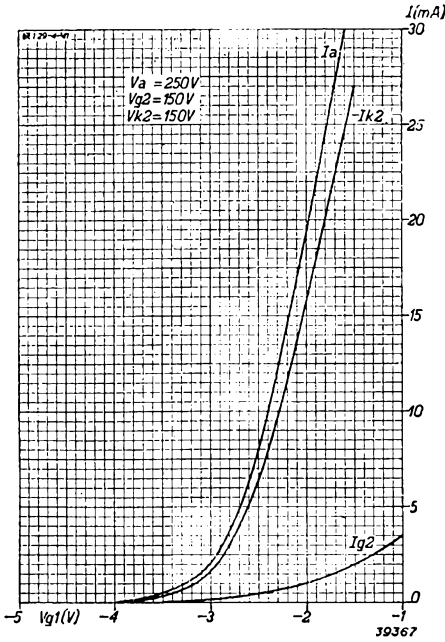

Fig. 7  
Anode current, screen-grid current and secondary-cathode current as a function of the grid bias.

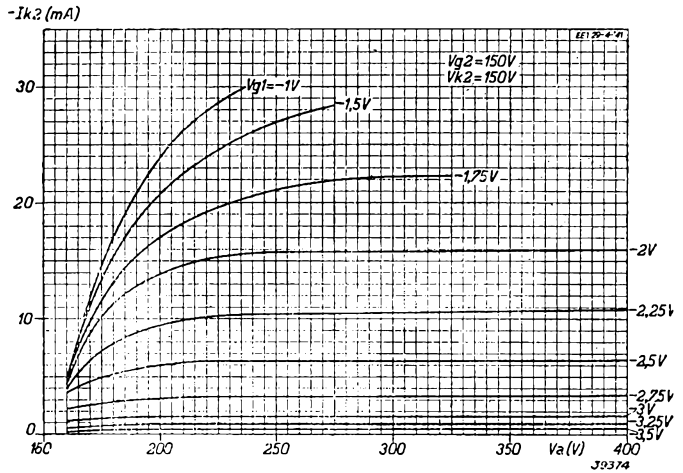

Fig. 8  
Anode current plotted against anode voltage at different values of grid bias.

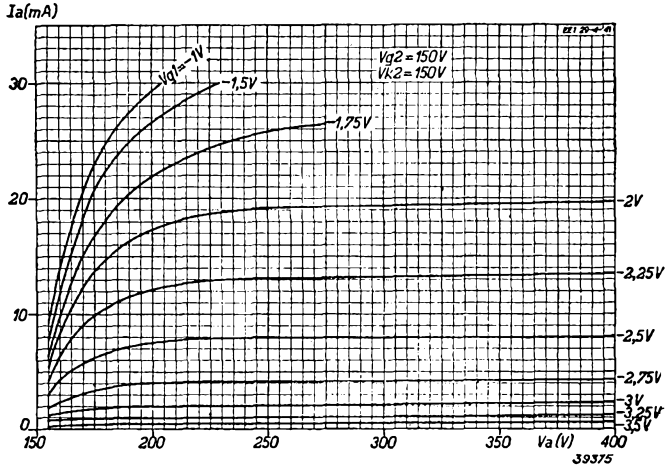

Fig. 9  
Secondary-emission cathode current as a function of the anode voltage, for different values of grid bias.

If the effect of the secondary cathode on the anode current is ignored, equal voltages will depend on the following expression:

$$(\delta - 1) R_1 = \delta R_2, \text{ or } R_2 = \frac{\delta - 1}{\delta} R_1$$

In practice  $R_2$  will have to be slightly less than this value, in view of the fact that the alternating voltage at the secondary cathode also contributes to the anode current. Fig. 16 shows the theoretical circuit diagram of the EEP 1 driving a balanced output circuit. Since the factor  $\delta$  is governed by the negative potential of the grid of the EEP 1, a method of stabilizing the grid bias is employed; the cathode is given a potential of about 23 V positive with respect to the earth line or negative H.T. line, whilst the first grid and screen grid are fed from a potential divider. In this way the first grid receives a positive potential of about 20 V.

Negative feed-back may be included in the cathode circuit as shown in Fig. 17. A potential divider,  $R_9, R_8$ , is connected across the loudspeaker; resistor  $R_8$  is simultaneously included in the cathode circuit of the EEP 1 and the speech voltage across  $R_8$  therefore occurs between the cathode and the grid of this valve. The sum of the resistances of  $R_7$  and  $R_8$  should correspond to the value of the cathode resistor as specified for this valve (the value of  $R_7$  in Fig. 16; see also the following data).

**HEATER RATINGS**

Heating: indirect, A.C. or D.C. parallel supply.

Heater voltage . . . . .	$V_f = 6.3 \text{ V}$
Heater current . . . . .	$I_f = 0.6 \text{ A}$

**CAPACITANCES**

$$C_{ag1} < 0.006 \mu\mu\text{F} \qquad C_{g1k2} < 0.001 \mu\mu\text{F}$$

**STATIC RATINGS**

Anode voltage . . . . .	$V_a = 250 \text{ V}$
Screen-grid voltage . . . . .	$V_{g2} = 150 \text{ V}$
Secondary-cathode voltage . . . . .	$V_{k2} = 150 \text{ V}$
Grid bias . . . . .	$V_{g1} = -2.5 \text{ V}$
Anode current . . . . .	$I_a = 8 \text{ mA}$
Screen-grid current . . . . .	$I_{g2} = 0.45 \text{ mA}$
Current to secondary cathode . . . . .	$I_{k2} = -6.5 \text{ mA}$
Mutual conductance . . . . .	$S = 17 \text{ mA/V}$
Internal resistance . . . . .	$R_i = 50,000 \text{ ohms}$

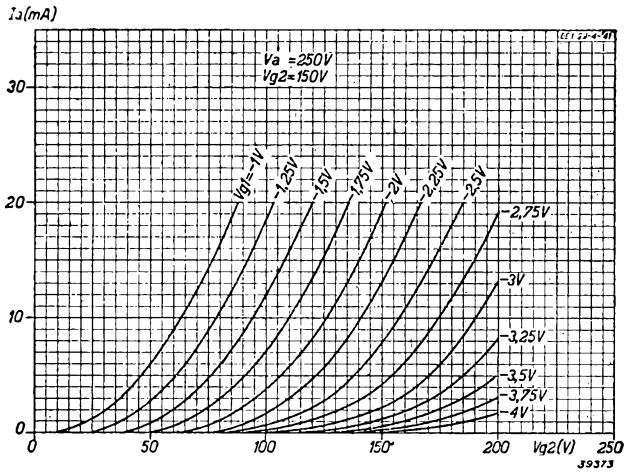

Fig. 10  
Anode current as a function of the screen-grid voltage, for different values of grid bias.

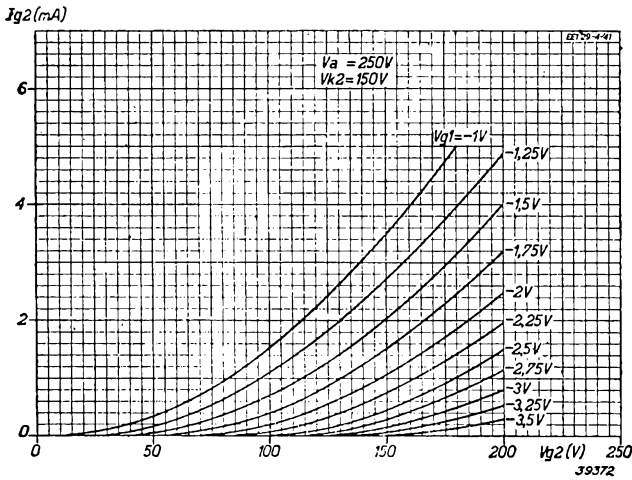

Fig. 11  
Screen-grid current as a function of the screen voltage for different values of grid bias.

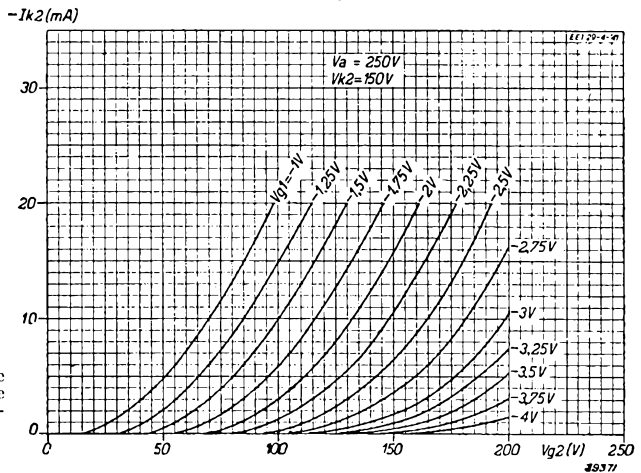
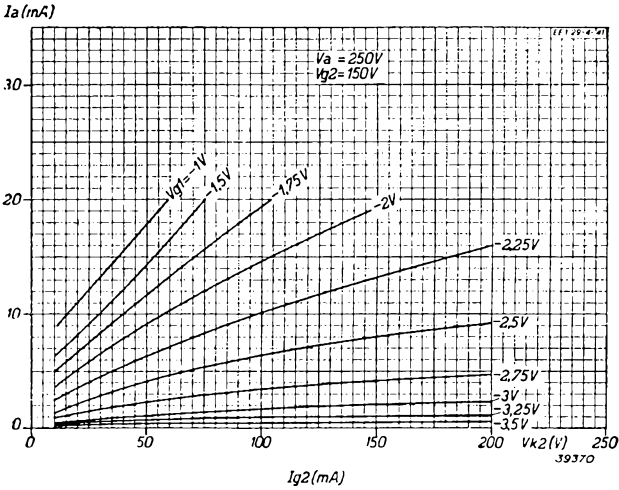

Fig. 12  
Secondary-emission cathode current as a function of the screen-grid voltage, for different values of grid bias.



Anode current as a function of the secondary cathode potential at different values of grid bias.

г. 14  
Screen-grid current as a function of the secondary cathode voltage at different values of grid bias.

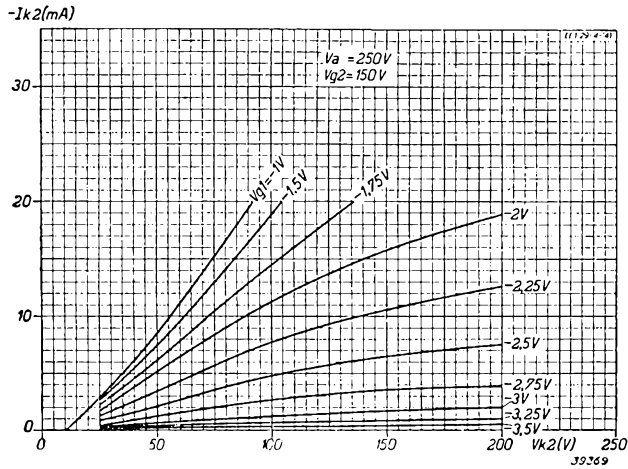
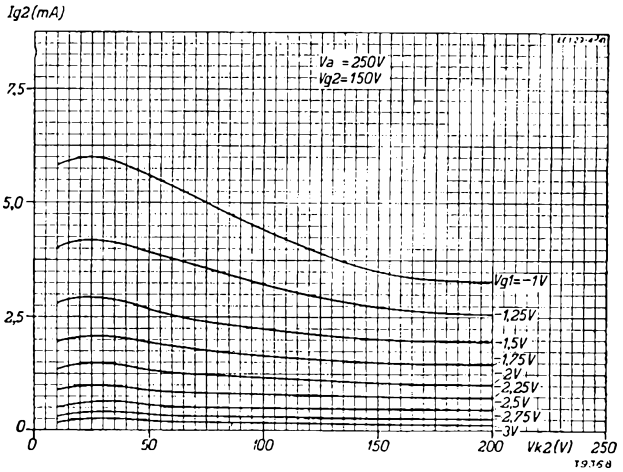

Fig. 15  
Current flowing to the secondary cathode as a function of the potential of that cathode, for different values of grid bias.

## EEP 1 (EE 1)

### OPERATING DATA: EEP 1 employed as pre-amplifier and phase-inverter in balanced output stages

(For resistance, current and voltage references see circuit, Fig. 16)

Supply voltage . . . . .	$V_b =$	400 V	500 V
Resistor . . . . .	$R_1 =$	26,000 ohms	26,000 ohms
Resistor . . . . .	$R_2 =$	208,000 ohms	208,000 ohms
Resistor . . . . .	$R_3 =$	29,000 ohms	29,000 ohms
Resistor . . . . .	$R_4 =$	85,000 ohms	105,000 ohms
Resistor . . . . .	$R_5 =$	30,000 ohms	30,000 ohms
Resistor . . . . .	$R_6 =$	9,000 ohms	9,000 ohms
Cathode resistor . . . . .	$R_7 =$	6,900 ohms	6,000 ohms
Alternating output voltage per grid in output stage . . . . .	$V_o =$	10 30	10 30 $V_{eff}$
Alternating input voltage . . . . .	$V_i =$	34 114	31 96 $mV_{eff}$
Gain between grid of EEP 1 and grid of output stage . . . . .	$V_o/V_i =$	300 265	325 315
Total distortion . . . . .	$d_{tot} =$	1.4 4.6	0.9 3.2 %

### MAXIMUM RATINGS

Anode voltage in cold condition . . . . .	$V_{a0} =$	max. 700 V
Anode voltage . . . . .	$V_a =$	max. 400 V
Anode dissipation . . . . .	$W_a =$	max. 2 W
Screen-grid voltage in cold condition . . . . .	$V_{g20} =$	max. 400 V
Screen-grid voltage . . . . .	$V_{g2} =$	max. 150 V
Screen-grid dissipation . . . . .	$W_{g2} =$	max. 0.1 W
Voltage on sec. emission cathode in cold condition . . . . .	$V_{k20} =$	max. 400 V
Voltage on sec. emission cathode . . . . .	$V_{k2} =$	max. 200 V
Dissipation of sec. cathode . . . . .	$W_{k2} =$	max. 2 W
Primary-cathode current . . . . .	$I_{k1} =$	max. 10 mA
Grid voltage at grid current start ( $I_{g1} = + 0.3 \mu A$ ) . . . . .	$V_{g1} =$	max. -1.3 V
Resistance between grid and cathode . . . . .	$R_{g1k} =$	max. 0.7 M ohm
Resistance between filament and cathode . . . . .	$R_{fk} =$	max. 20,000 ohms
Voltage between filament and cathode (direct voltage or effective value of alternating voltage) . . . . .	$V_{fk} =$	max. 50 V

### APPLICATIONS

In connection with the foregoing the following points should also be noted. The EEP 1 must be allowed to work only with automatic grid bias; normally the bias is obtained from a resistor connected to the cathode and the value of this resistor should be such that the potential difference corresponds exactly to the required bias. The working point A will then lie just on the point of intersection of the line OA with the characteristic (see Fig. 18). A slight displacement of the curve would, in the case of normal valves, produce only a small increase or decrease in the anode current. In the EEP 1, however, a very much greater variation in anode current results and, since the normal cathode resistor is of a fairly low value and offers only a small degree of compensation, special precautions have to be taken. Better automatic control of the cathode current is possible if the slope of the line OA in Fig. 18 is reduced and this effect can be obtained by using a higher resistance, due to the fact that the slope of the line in question is determined by the quotient of the cathode potential and the cathode

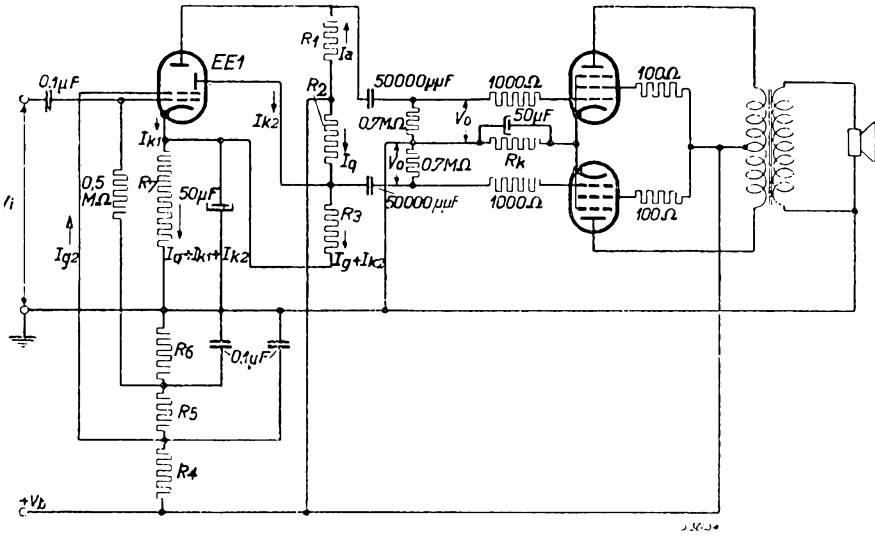

Fig. 16

Theoretical circuit diagram showing the EEP 1 used as driver valve without negative feed-back. The values of resistors  $R_1$  to  $R_7$  may be obtained from the operating data.

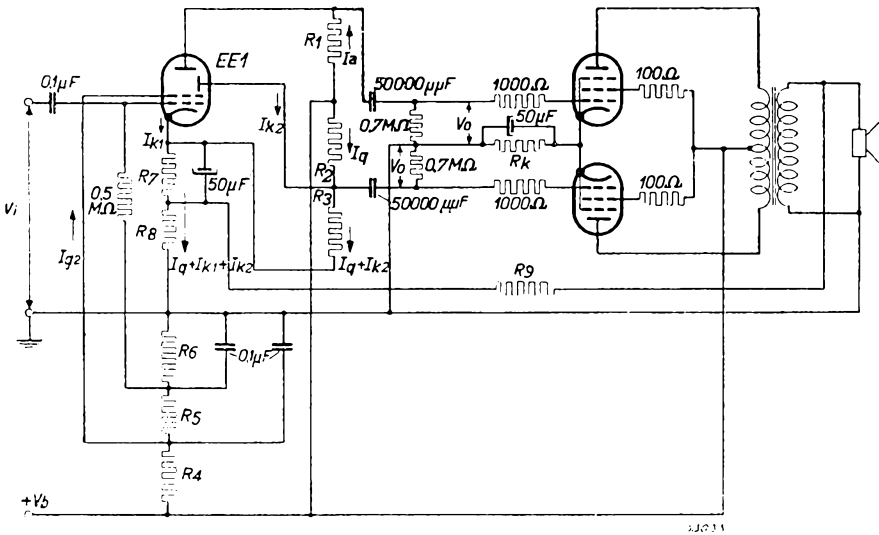

Fig. 17

The EEP 1 employed as driver, with negative feed-back. The circuit is the same as that of Fig. 16, with the exception of  $R_7$  and  $R_8$ , of which the values depend on the required feedback; the sum of the values of  $R_7$  and  $R_8$  should correspond to the value of resistor  $R_2$  in Fig. 16.

## EEP 1 (EE 1)

current. This, however, would make the grid bias too high, so that a positive potential has to be applied to the grid. In Fig. 18 this potential is represented by OB. From the point B the new line is drawn and the total grid bias as a function of the cathode current is then restored. It will be seen that the cathode current, regulated in this manner and indicated by the point of intersection with the curve, does not vary to any extent from the average value.

When the EEP 1 is employed as driver valve in a balanced circuit it is recommended that a supply voltage  $V_b$  of not less than 275 V be employed; otherwise the results will not be satisfactory.

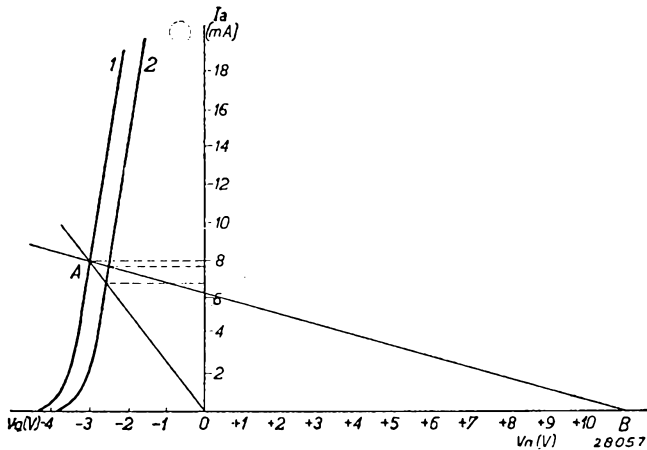

Fig. 18  
Simplified diagram showing the effect of the cathode resistor on the constancy of the cathode current. The automatic control of the current is better according as the resistance line becomes flatter.



## EF 5 Variable MU R.F. pentode

The EF 5 is a variable- $\mu$  R. F. or I.F. pentode. Special care has been devoted in the design of this valve to the greatest possible reduction in cross-modulation and modulation hum. At a screen-grid voltage of 100 V the anode current of the EF 5 is 8 mA, when the mutual conductance is 1.7 mA/V, the control range being from  $-3$  to  $-46.5$  V. The control range is capable of modification by means of the screen voltage; at lower screen potentials, for the same grid bias, the mutual conductance drops sharply, but the cross-modulation conditions are then not so very good. With a screen voltage of 85 V the control range extends from  $-2$  to  $-39$  V only. Obviously, a lower screen potential will result in a lower screen current as well as a lower anode current and it is thus possible to reduce the bias at the working point from  $-3$  to  $-2$  V to increase the slope; the working value of the mutual conductance is then 1.85 mA/V.

With 60 V screen potential the conductance is still further reduced, to  $-2/-29$  V.

The very greatly diminished modulation hum in this valve is of first importance in A.C./D.C. receivers, where alternating voltages at mains frequency can easily occur between heater and grid. The EF 5 is notable for its low inter-electrode capacitances and high internal resistance; excellent results are obtained on the short-wave range. Although on short waves the circuit magnification is usually only fair, the excellent properties of the EF 5 make it possible to achieve extremely good amplification in this range. On short waves, too, the mutual conductance is the same as on the other ranges (e.g. 200 m). The high impedance of anode and grid with respect to earth in the 12 to 60 metre band, as compared with the impedance values of practical tuned circuits, enables the EF 5 to produce in that range amplification values equal to the product of mutual conductance and

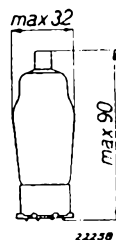

Fig. 1  
Dimensions in mm.

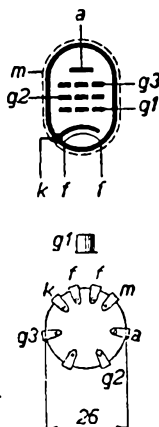

Fig. 2  
Arrangement of  
electrodes and  
base connections.

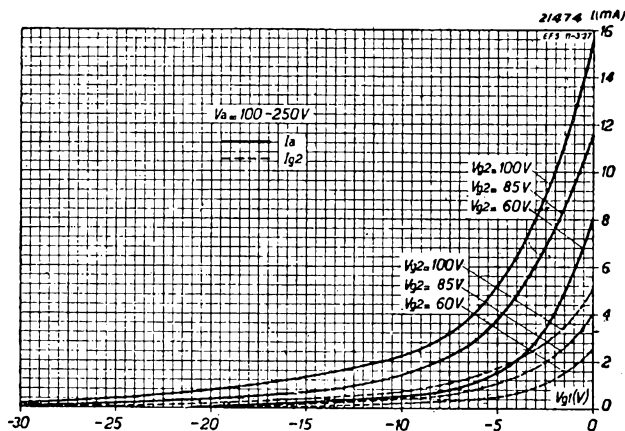
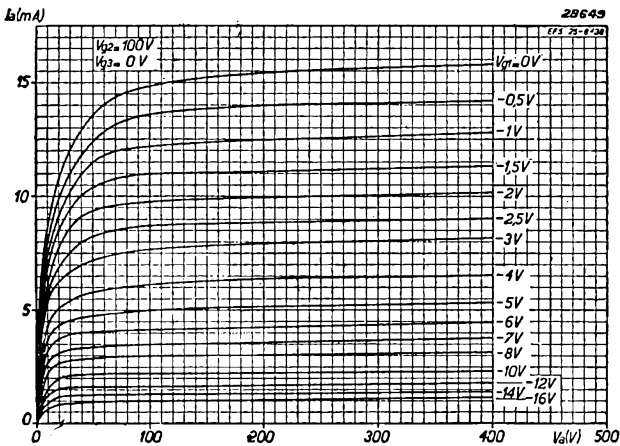
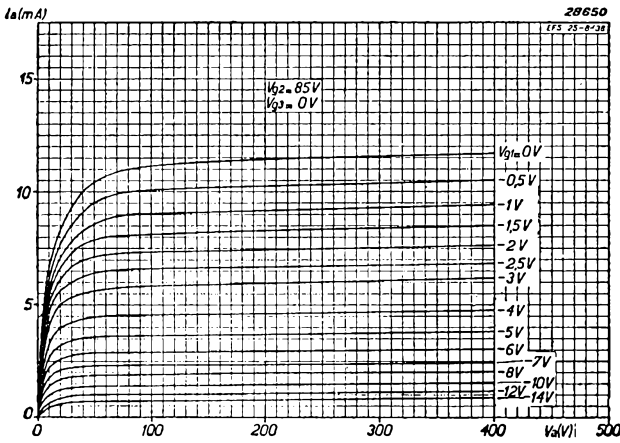
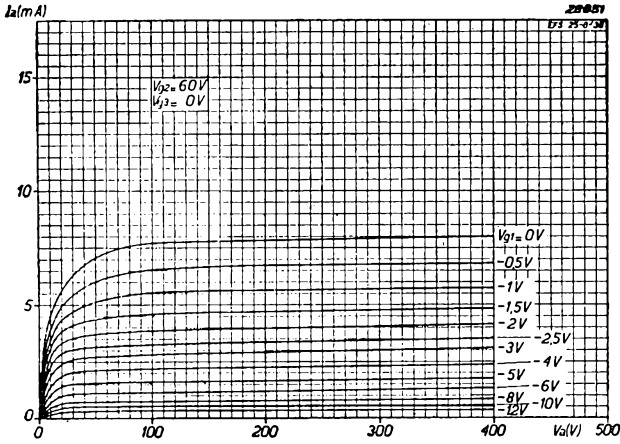

Fig. 3  
Anode current and screen current as a function of the grid bias, for different values of screen potential, at 250 V anode. The curves also apply as an approximation to anode voltages of 100-250 V.

impedance. On the short-wave bands the (feed-back) impedance, which takes the place of the anode-to-grid capacitance on the long waves, is unusually high and there is therefore no risk of parasitic oscillation, even with the maximum permissible amount of gain.

A factor contributing in no small degree towards the high properties of this valve is the use of side contacts (P-type



base). The suppressor grid and metallizing, each with their own individual contacts, can be connected direct to earth to give the best possible results with short-wave reception.

Fig. 4  
Anode current as a function of the anode voltage, for different values of screen potential and grid bias.

**HEATER RATINGS**

Heating: indirect, A.C. or D.C., series or parallel supply

Heater voltage . . . . .  $V_f = 6.3 \text{ V}$

Heater current . . . . .  $I_f = 0.200 \text{ A}$

**CAPACITANCES**

$C_{ag1} < 0.003 \mu\mu\text{F}$

$C_{g1} = 5.4 \mu\mu\text{F}$

$C_a = 6.9 \mu\mu\text{F}$

**OPERATING DATA: valve employed as R.F. or I.F. amplifier**

Anode voltage										
$V_a$ (V)	100			200				250		
Screen-grid voltage										
$V_{g2}$ (V)	100			100				100		
Suppressor-grid voltage										
$V_{g3}$ (V)	0			0				0		
Cathode resistor										
$R_k$ (ohms)	170			180				180		
Grid bias										
$V_{g1}$ (V)	-2.85 <sup>1)</sup>	-34 <sup>2)</sup>	-46.5 <sup>3)</sup>	-2.95 <sup>1)</sup>	-34 <sup>2)</sup>	-46.5 <sup>3)</sup>	-3 <sup>1)</sup>	-34 <sup>2)</sup>	-46.5 <sup>3)</sup>	
Anode current										
$I_a$ (A)	8	—	—	8	—	—	8	—	—	
Screen current										
$I_{g2}$ (mA)	2.6	—	—	2.6	—	—	2.6	—	—	
Mutual conductance										
$S$ ( $\mu\text{A/V}$ )	1700	17	2	1700	17	2	1700	17	2	
Amplification factor										
$\mu$	500	—	—	1600	—	—	2000	—	—	
Internal resistance										
$R_i$ (M ohms)	0.3	> 10	> 10	0.95	> 10	> 10	1.2	> 10	> 10	

Anode voltage										
$V_a$ (V)	100			200				250		
Screen-grid voltage										
$V_{g2}$ (V)	85			85				85		
Suppressor-grid voltage										
$V_{g3}$ (V)	0			0				0		
Cathode resistor										
$R_k$ (ohms)	190			195				200		
Grid bias										
$V_{g1}$ (V)	-1.9 <sup>1)</sup>	-29 <sup>2)</sup>	-39 <sup>3)</sup>	-1.95 <sup>1)</sup>	-29 <sup>2)</sup>	-39 <sup>3)</sup>	-2 <sup>1)</sup>	-29 <sup>2)</sup>	-39 <sup>3)</sup>	
Anode current										
$I_a$ (mA)	7.5	—	—	7.5	—	—	7.5	—	—	
Screen current										
$I_{g2}$ (mA)	2.45	—	—	2.45	—	—	2.45	—	—	
Mutual conductance										
$S$ ( $\mu\text{A/V}$ )	1850	18	2	1850	18	2	1850	18	2	
Amplification factor										
$\mu$	550	—	—	1750	—	—	2200	—	—	
Internal resistance										
$R_i$ (M ohms)	0.3	> 10	> 10	0.95	> 10	> 10	1.2	> 10	> 10	

Anode voltage									
$V_a$ (V)	100			300			250		
Screen-grid voltage									
$V_{g2}$ (V)	60			60			60		
Suppressor-grid voltage									
$V_{g3}$ (V)	0			0			0		
Cathode resistor									
$R_k$ (ohms)	360			370			380		
Grid bias									
$V_{g1}$ (V)	-1.9 <sup>1)</sup>	-2.2 <sup>2)</sup>	-2.9 <sup>3)</sup>	-2.95 <sup>1)</sup>	-2.2 <sup>2)</sup>	-2.9 <sup>3)</sup>	-2 <sup>1)</sup>	-2.2 <sup>2)</sup>	2.9 <sup>3)</sup>
Anode current									
$I_a$ (mA)	4	—	—	4	—	—	4	—	—
Screen-grid current									
$I_{g2}$ (mA)	1.3	—	—	1.3	—	—	1.3	—	—
Mutual conductance									
$S$ ( $\mu A/V$ )	1400	14	2	1400	14	2	1400	14	2
Amplification factor									
$\mu$	1200	—	—	1900	—	—	2000	—	—
Internal resistance									
$R_i$ (M ohms)	0.85	> 10	> 10	1.35	> 10	> 10	1.4	> 10	> 10

<sup>1)</sup> Without control  
<sup>2)</sup> Mutual conductance reduced to one-hundredth of uncontrolled value.  
<sup>3)</sup> Extreme limit of control.

**MAXIMUM RATINGS**

$V_{a0}$	= max. 550 V
$V_a$	= max. 250 V
$W_a$	= max. 2 W
$V_{g20}$	= max. 400 V
$V_{g2}$	= max. 125 V
$W_{g2}$	= max. 0.4 W
$I_k$	= max. 15 mA
$V_{g1}$ ( $I_{g1} = +0.3 \mu A$ )	= max. —1.3 V
$R_{g1}$	= max. 2.5 M ohms
$R_{fk}$	= max. 20,000 ohms
$V_{fk}$	= max. 100 V <sup>1)</sup>

<sup>1)</sup> Direct voltage or effective value of alternating voltage.

Due to the curvature of the characteristic, the uses of the EF 5 are restricted to R.F. and I.F. amplification. It can be employed as amplifier with either automatic or manual control. It is preferable to feed the screen through a potential divider; in many cases it would be found when using a series resistor that the screen voltage would become too high on full control and that the amplification control would be far too tardy.

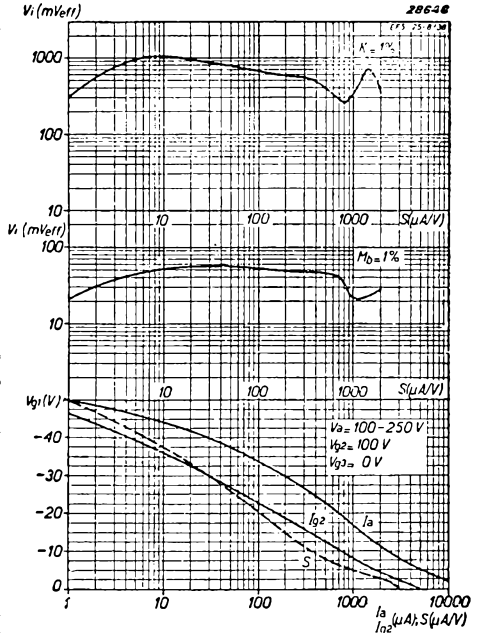

Fig. 5  
 At 100-250 V anode and 100 V screen;  
 Upper diagram. Alternating grid voltage as a function of the mutual conductance, with 1 % cross modulation.  
 Centre diagram. Alternating grid voltage as a function of the mutual conductance, with 1 % modulation hum.  
 Lower diagram. Mutual conductance  $S$ , anode current  $I_a$  and screen current  $I_{g2}$  as a function of the voltage on the first grid.

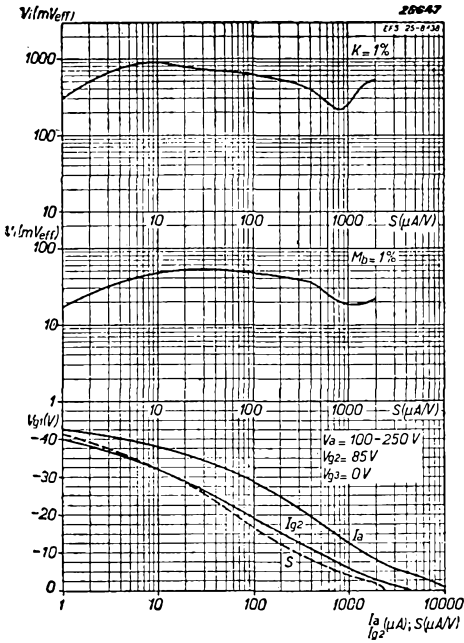

Fig. 6  
At 100-250 V anode and 85 V screen;  
Upper diagram. Effective alternating grid voltage as a function of the mutual conductance, with 1% cross modulation.  
Centre diagram. Effective alternating grid voltage as a function of the mutual conductance, with 1% modulation hum.  
Lower diagram. Mutual conductance  $S$ , anode current  $I_a$  and screen current  $I_{g2}$  as a function of the grid bias.

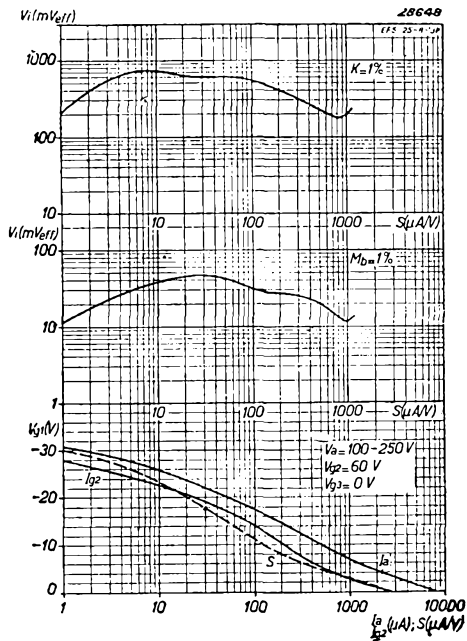

Fig. 7  
At 100-250 V anode and 60 V screen:  
Upper diagram. Effective alternating grid voltage as a function of the mutual conductance, with 1% cross-modulation.  
Centre diagram. Effective alternating grid voltage as a function of the mutual conductance, with 1% modulation hum.  
Lower diagram. Mutual conductance  $S$ , anode current  $I_a$  and screen current  $I_{g2}$  as a function of the grid bias.

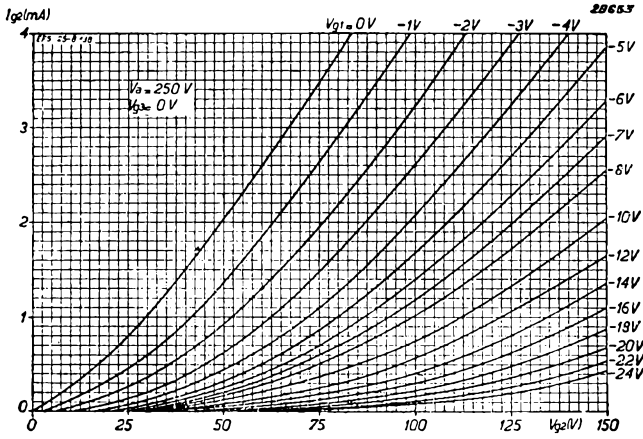

Fig. 8  
Screen-grid current as a function of the screen voltage, for different values of grid bias.

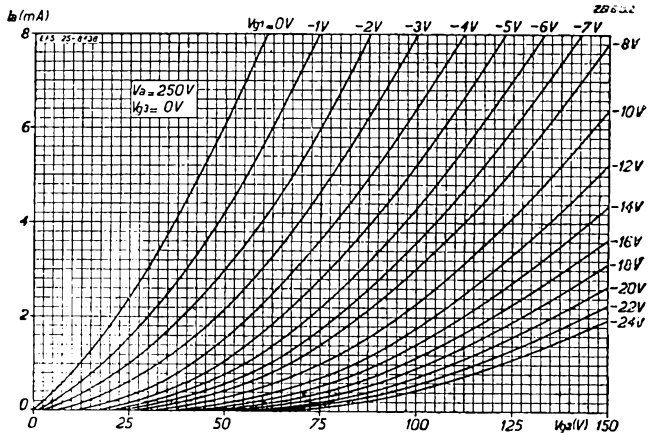

Fig. 9  
Anode current as a function of the screen-grid voltage, for different values of grid bias.

# EF 6 Pentode

This valve is particularly suitable for A.F. amplification and either anode-bend or grid detection. The EF 6 works only on a fixed bias and therefore finds no application in practice as an R.F. or I.F. amplifier. The degree of A.F. amplification, however, is very high indeed, the ultimate signal voltage on the anode being so great that practically distortionless modulation is possible in any kind of output stage. Used as a grid detector, this valve has many advantages when good reception of local stations is required.

It is also a very useful valve in special circuits, for instance as an amplifier for the control voltage in an automatic gain control circuit and so on. The EF 6 will also give very good results on the short-wave ranges, where the mutual conductance is the same as in the broadcast wave-bands.

As the R.F. impedance of anode and grid in the 12 to 60 m range, with respect to the impedance of normal tuned circuits, is extremely high, the gain obtainable from this valve is equal to the product of mutual conductance and impedance. In the short-wave range, the impedance, which replaces the anode-to-grid capacitance on long waves (anode feed-back), is also very high, so that the maximum permissible amplification may be obtained without risk of parasitic oscillation.

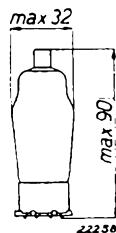

Fig. 1 Dimensions in mm.

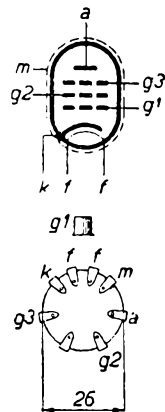

Fig. 2 Arrangement of electrodes and base connections.

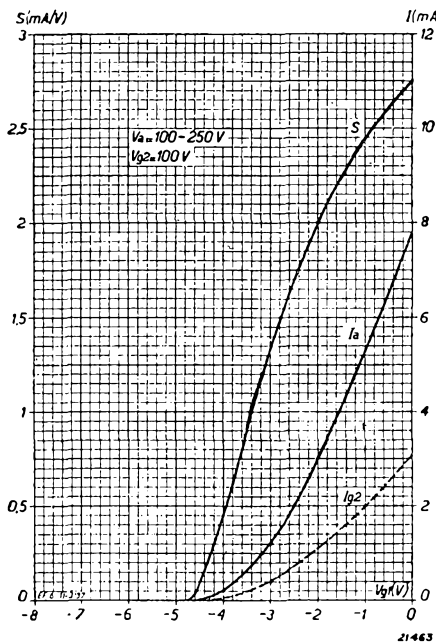

Fig. 3

Anode current, screen-grid current and mutual conductance as a function of the grid bias at  $V_{g2} = 100$  V. The curves also apply as an approximation at all anode voltages from 100 V upwards.

In part, the excellent short-wave qualities of the EF 6 are due to the use of the P-type side-contact base and separate suppressor-grid connection. Cross-modulation and modulation hum are both very slight indeed, especially at the maximum permissible screen-grid voltage and, for this reason, the valve gives good results in A.C./D.C. receivers; in view of the high alternating voltages occurring between the heater and earth, and induced on the grid, in this type of receiver it is important that modulation hum should be as low as possible.

### HEATER RATINGS

Heating, indirect, A.C. or D.C., parallel supply.

Heater voltage . . . . .  $V_f = 6.3$  V

Heater current . . . . .  $I_f = 0.200$  A

### CAPACITANCES

$C_{ag1} < 0.003 \mu\mu\text{F}$

$C_{g1} = 5.2 \mu\mu\text{F}$

$C_a = 6.9 \mu\mu\text{F}$

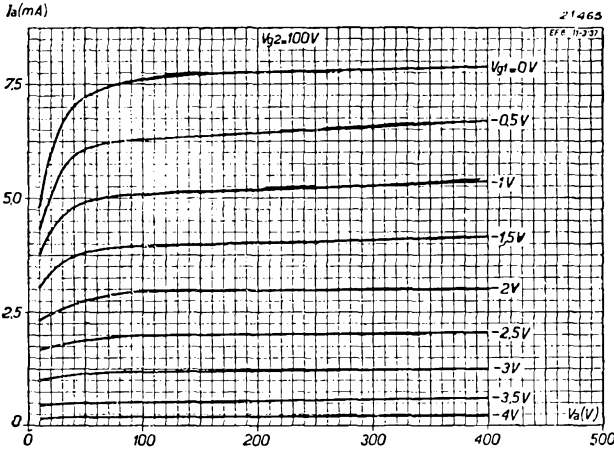

Fig. 4  
Anode current as a function of the anode voltage at  $V_{g2} = 100$  V, for different values of grid bias.

**OPERATING DATA**

Anode voltage . . . . .	$V_a =$	100 V	200 V	250 V
Screen-grid voltage . . . . .	$V_{g2} =$	100 V	100 V	100 V
Suppressor-grid voltage . . . . .	$V_{g3} =$	0 V	0 V	0 V
Grid bias . . . . .	$V_{g1} =$	-2 V	-2 V	-2 V
Anode current . . . . .	$I_a =$	3 mA	3 mA	3 mA
Screen grid current . . . . .	$I_{g2} =$	0.8 mA	0.8 mA	0.8 mA
Amplification factor . . . . .	$\mu =$	1800	3600	4500
Mutual conductance . . . . .	$S =$	1.8 mA/V	1.8 mA/V	1.8 mA/V
Internal resistance . . . . .	$R_i =$	1.0 M ohm	2.0 M ohms	2.5 M ohms

**MAXIMUM RATINGS**

$V_{a0}$ . . . . .	$\approx$ max. 550 V
$V_a$ . . . . .	$\approx$ max. 300 V
$W_a$ . . . . .	$\approx$ max. 1 W
$V_{g20}$ . . . . .	$\approx$ max. 550 V
$V_{g2}$ . . . . .	$\approx$ max. 125 V
$W_{g2}$ . . . . .	$\approx$ max. 0.3 W
$I_k$ . . . . .	$\approx$ max. 6 mA
$V_{g1}$ ( $I_{g1} = + 0.3 \mu A$ ) . . . . .	$\approx$ max. -1.3 V
$R_{g1k}$ (auto. grid bias) . . . . .	$\approx$ max. 1.5 M ohms
$R_{g1k}$ (fixed bias) . . . . .	$\approx$ max. 1 M ohm
$R_{fk}$ . . . . .	$\approx$ max. 20,000 ohms
$V_{fk}$ . . . . .	$\approx$ max. 75 V <sup>1)</sup>

<sup>1)</sup> Direct voltage or effective value of alternating voltage.



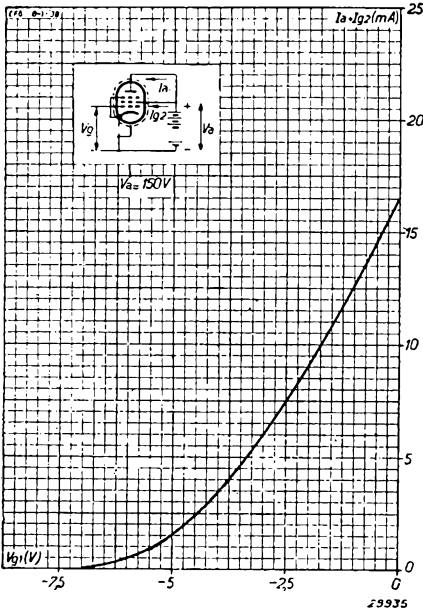

Fig. 5  
EF 6 employed as triode. Anode current as a function of the grid bias for  $V_a = 150$  V.

The valve is metallized and no additional screening is necessary, but the separate base contact to which the metallizing is connected internally must be effectively connected to the chassis. In special circuits the cathode is negative with respect to the chassis, the metallizing should be connected to the cathode. The suppressor grid also has its own separate base contact for direct connection to earth.

Care must be taken when using the EF 6 as detector or A.F. amplifier in A.C./D.C. receivers, however, to see that the heater of the valve, in the heater circuit, is connected as closely as possible to the chassis end, in order to avoid hum.

1) GRID DETECTOR WITH RESISTANCE COUPLING

For grid detection it is advisable to feed the screen from a resistor and not from a potential divider, since in that case the grid swing will increase with signal strength. In A.C./D.C. receivers for use on 110 V mains the EF 6 is not generally satisfactory, as the output

voltage is usually insufficient to load the output valve fully at low modulation depths. Table I gives the results to be obtained with the EF 6 when employed as grid detector.

2) A.F. AMPLIFIER WITH RESISTANCE COUPLING

The EF 6 is eminently suitable for A. F. amplification since it provides considerable gain with only very moderate distortion; the screen should preferably be fed through a resistor, for which a suitable value is indicated in tables II and III.

The A.F. signal applied to the grid must not be too strong, as this tends towards microphony when the loudspeaker used is of a sensitive type. This valve can be used only in circuits having not more than one stage of A.F. amplification and must therefore in every case be followed immediately by the output valve.

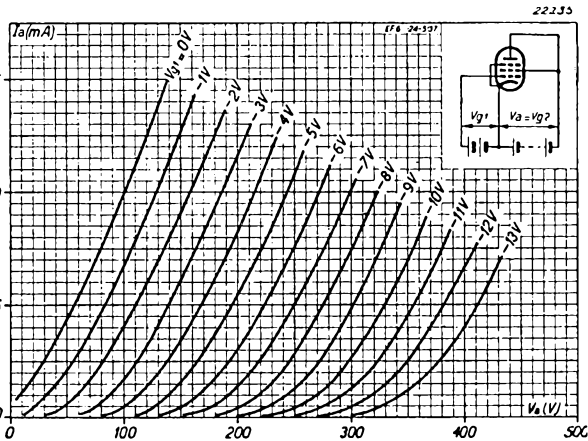
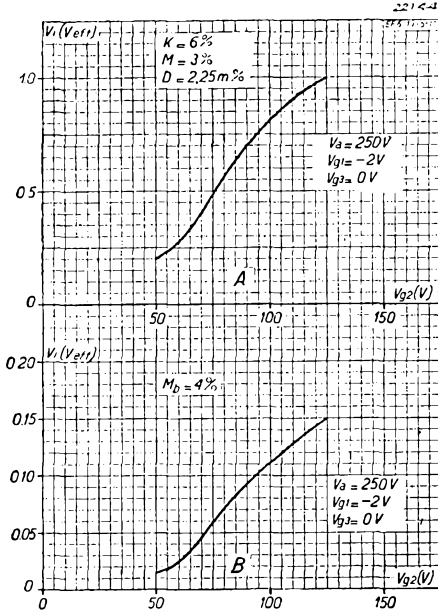

Fig. 6  
EF 6 employed as triode. Anode current as a function of the anode voltage, for different values of grid bias.



Generally speaking, the A.F. sensitivity at the grid of the EF 6 should not be less than 5 mV.

Fig. 7  
Curve A: Effective alternating grid voltage as a function of the screen-grid voltage of the EF 6, with 6% cross-modulation (3% increase in modulation depth + 2.25 m% modulation distortion,  $m$  = modulation depth). 6% cross-modulation corresponds to 0.5% third harmonic.  
Curve B: Effective value of the alternating grid voltage as a function of the screen-grid voltage with 4% modulation hum (corresponding to 1% second harmonic).

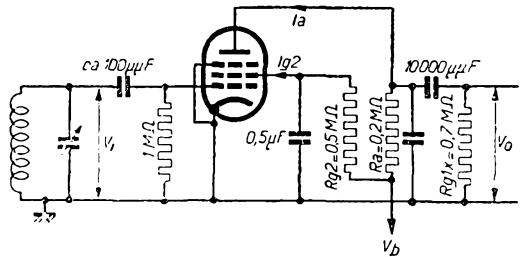

Fig. 8  
Circuit diagram of the EF 6 employed as grid detector with resistance coupling.

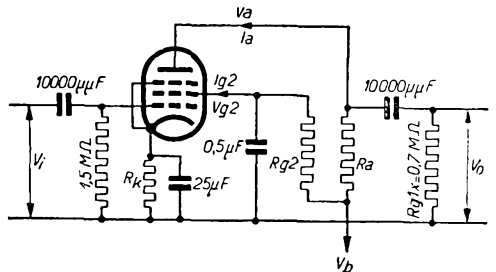

Fig. 9  
Circuit diagram of the EF 6 employed as A. F. amplifier with resistance coupling.

**TABLE I**  
 EF 6 employed as grid detector with resistance coupling in A.C. receivers.

Heaters fed in parallel in A.C. receivers; detector grid leak = 1 megohm; grid capacitor = 100 $\mu\mu$ F. Grid leak of next (output) valve $Rg_{1,e} = 0.7$ megohm. Modulation depth $m = 0.3$ (30%). Screen fed through series resistor; $Ia$ and $Ig_2$ measured without signal.																	
Supply voltage	Anode Coupling res.	Anode current	Screen-grid series resistor	Screen current	Max. alternating output	Used with EL 2 as next (output) valve. $V_a = V_{g_2} = 250$ V				Used with EL 3 as next (output) valve. $V_a = V_{g_2} = 250$ V				Used with EL 5 as next (output) valve. $V_a = 250$ V; $V_{g_2} = 275$ V			
						For 50 mW output		For full excitation		For 50 mW output		For full excitation		For 50 mW output		For full excitation	
						Output volts $V_o$ (V <sub>eff</sub> )	Input volts $V_i$ (mV <sub>eff</sub> )	Output volts $V_o$ (V <sub>eff</sub> )	Input volts $V_i$ (V <sub>eff</sub> )	Output volts $V_o$ (V <sub>eff</sub> )	Input volts $V_i$ (mV <sub>eff</sub> )	Output volts $V_o$ (V <sub>eff</sub> )	Input volts $V_i$ (V <sub>eff</sub> )	Output volts $V_o$ (V <sub>eff</sub> )	Input volts $V_i$ (mV <sub>eff</sub> )	Output volts $V_o$ (V <sub>eff</sub> )	Input volts $V_i$ (V <sub>eff</sub> )
$V_b$ (V)	$R_a$ (M ohm)	$I_a$ (mA)	$R_{g_2}$ (M ohm)	$I_{g_2}$ (mA)	$V_{omax}^1$ (V <sub>eff</sub> )												
300	0.2	1.35	0.6	0.45	19	0.9	63	11.2	0.35	0.33	35	3.7	0.14	0.5	43	8.5	0.27
300	0.2	1.15	0.8	0.35	17	0.9	58	11.2	0.35	0.33	33	3.7	0.13	0.5	41	8.5	0.26
300	0.2	1.0	1.0	0.30	15	0.9	58	11.2	0.42	0.33	33	3.7	0.14	0.5	41	8.5	0.28
250	0.2	1.15	0.6	0.35	16	0.9	60	11.2	0.35	0.33	33	3.7	0.14	0.5	40	8.5	0.27
250	0.2	0.95	0.8	0.28	14	0.9	60	11.2	0.35	0.33	33	3.7	0.13	0.5	40	8.5	0.26
250	0.2	0.8	1.0	0.23	11.5	0.9	65	11.2	0.42	0.33	33	3.7	0.14	0.5	40	8.5	0.28
300	0.1	2.6	0.3	0.85	23	0.9	58	11.2	0.43	0.33	38	3.7	0.14	0.5	50	8.5	0.35
300	0.1	2.2	0.4	0.65	20	0.9	58	11.2	0.43	0.33	38	3.7	0.14	0.5	50	8.5	0.35
300	0.1	1.8	0.5	0.55	17	0.9	58	11.2	0.48	0.33	38	3.7	0.15	0.5	50	8.5	0.35
250	0.1	2.1	0.3	0.7	19	0.9	70	11.2	0.43	0.33	38	3.7	0.14	0.5	50	8.5	0.35
250	0.1	1.8	0.4	0.55	16	0.9	70	11.2	0.43	0.33	38	3.7	0.14	0.5	50	8.5	0.35
250	0.1	1.5	0.5	0.45	14	0.9	70	11.2	0.48	0.33	38	3.7	0.15	0.5	50	8.5	0.35
300	0.05	4.6	0.15	1.5	24	0.9	77	11.2	0.6	0.33	44	3.7	0.25	0.5	56	8.5	0.45
300	0.05	3.9	0.2	1.2	20	0.9	77	11.2	0.6	0.33	44	3.7	0.25	0.5	56	8.5	0.45
300	0.05	2.9	0.3	0.9	15	0.9	79	11.2	0.7	0.33	46	3.7	0.25	0.5	59	8.5	0.60
250	0.05	3.7	0.15	1.3	18	0.9	80	11.2	0.6	0.33	42	3.7	0.25	0.5	55	8.5	0.45
250	0.05	3.1	0.2	1.0	16	0.9	80	11.2	0.6	0.33	42	3.7	0.25	0.5	55	8.5	0.45
250	0.05	2.4	0.3	0.65	12	0.9	84	11.2	0.7	0.33	45	3.7	0.25	0.5	60	8.5	0.60

<sup>1)</sup> In these values for the alternating output the distortion in the detector is less than 5%.

TABLE II

The EF 6 as resistance-coupled A.F. amplifier in A.C. mains receivers

For use in A.C. mains receivers with heaters in parallel; grid leak of the following (output) valve $R_{g_{1e}} = 0.7$ megohm; cathode decoupling capacitor = $50 \mu\text{F}$ . Screen grid fed through a resistor; $I_a$ and $I_{g_2}$ measured without signal.														
Supply voltage	Anode coupling resistor	Anode current	Screen-grid series resistor	Screen-grid current	Cathode resistor	Voltage gain	Used with EL 3 as output valve $V_a = V_{g_2} = 250 \text{ V}$		Used with EL 5 as output valve $V_a = 250 \text{ V};$ $V_{g_2} = 275 \text{ V}$		Used with EL 2 as output valve $V_a = V_{g_2} = 250 \text{ V}$		Used with AD 1 as output valve $V_a = 250 \text{ V}$	
							Output voltage	Total distortion	Output voltage	Total distortion	Output voltage	Total distortion	Output voltage	Total distortion
$V_b$ (V)	$R_a$ (megohm)	$I_a$ (mA)	$R_{g_2}$ (megohm)	$I_{g_2}$ (mA)	$R_k$ (ohms)	$\frac{V_o}{V_i}$	$V_o^1$ (Veff)	$dtot^2$ (%)	$V_o^1$ (Veff)	$dtot^2$ (%)	$V_o^1$ (Veff)	$dtot^2$ (%)	$V_o^1$ (Veff)	$dtot^2$ (%)
300	0.3	0.7	0.8	0.25	4,000	175	3.7	< 1.0	8.5	1.0	11.2	1.4	31	4.4
250	0.3	0.6	0.8	0.20	4,000	165	3.7	< 1.0	8.5	1.6	11.2	2.2	31	5.0
300	0.2	1.1	0.4	0.40	3,000	150	3.7	< 1.0	8.5	1.0	11.2	< 1.0	31	2.7
250	0.2	0.9	0.4	0.35	3,000	140	3.7	< 1.0	8.5	1.3	11.2	1.8	31	2.4
300	0.1	1.9	0.25	0.65	1,600	115	3.7	< 1.0	8.5	1.0	11.2	1.0	31	2.0
250	0.1	1.6	0.25	0.30	1,600	110	3.7	< 1.0	8.5	1.0	11.2	1.0	31	2.7

1) For the A.F. amplifier with fully loaded output valve.

2) In the A.F. amplifier with fully loaded output valve.

TABLE III

The EF 6 used as resistance-coupled A. F. amplifier in A.C./D.C. mains receivers

Used in A.C./D.C. receivers with heaters in series (heater current 200 mA); grid leak of the next (output) valve  $R_{g_{1,2}} = 0.7$  megohm. Cathode decoupling capacitor =  $50 \mu F$ ; screen fed through a resistor.  $I_a$  and  $I_{g_2}$  measured without signal.

Supply voltage	Anode coupling resistor	Anode current	Screen-grid series resistor	Screen current	Cathode resistor	Voltage gain	Used with CL 1 as output valve $V_a = V_{g_2} =$ supply voltage		Used with CL 2 as output valve $V_a =$ supply voltage; $V_{g_2} = 100$ V		Used with CL 4 as output valve $V_a = V_{g_2} =$ supply voltage	
							Output voltage $V_o$ 1) (V <sub>eff</sub> )	Total distortion $dtot$ 2) (%)	Output voltage $V_o$ 1) (V <sub>eff</sub> )	Total distortion $dtot$ 2) (%)	Output voltage $V_o$ 1) (V <sub>eff</sub> )	Total distortion $dtot$ 2) (%)
$\Gamma_b$ (V)	$R_a$ (Mohm)	$I_a$ (mA)	$R_{g_2}$ (M ohm)	$I_{g_2}$ (mA)	$R_k$ (ohm)	$\frac{V_o}{V_i}$						
200	0.3	0.45	0.6	0.17	6,400	130	9.6	2.8	10	3.0	5.0	1.8
150	0.3	0.35	0.6	0.13	6,400	120	—	—	10	2.5	4.0	1.3
100	0.3	0.22	0.6	0.08	6,400	105	—	—	10	3.5	2.4	< 1.0
200	0.2	0.60	0.4	0.23	5,000	115	9.6	2.0	10	2.1	5.0	1.0
150	0.2	0.45	0.4	0.17	5,000	110	—	—	10	2.6	4.0	0.9
100	0.2	0.30	0.4	0.12	5,000	100	—	—	10	4.2	2.4	0.9
200	0.1	1.2	0.2	0.4	3,000	95	9.6	1.5	10	1.6	5.0	< 1.0
150	0.1	0.85	0.2	0.3	3,000	90	—	—	10	2.1	4.0	1.1
100	0.1	0.60	0.2	0.2	3,000	85	—	—	10	3.3	2.4	< 1.0

1) For the A.F. amplifier with fully loaded output valve.

2) In the A.F. amplifier with fully loaded output valve.

# EF 8 Low-noise variable-MU R.F. amplifier pentode

The EF 8 is a variable-mu R.F. amplifier the chief feature of which is its very low noise factor. As the noise produced in screen-grid and pentode valves is caused mainly by the distribution of the current between the screen and the anode — from which point of view a low screen current is advantageous — efforts have been made in the design of this valve to keep this current as low as possible. In principle, the construction of the EF 8 is similar to the conventional pentode, embodying control, screen and suppressor grids, but between the control grid and screen of this valve an additional grid has been introduced, wound with exactly the same pitch as the screen and normally connected to the cathode. The turns of this extra grid are situated exactly opposite those of the screen grid and this auxiliary electrode repels and bunches the electrons on their way towards the anode, the bunches thus passing just between the turns of the screen grid. In this way, the number of electrons actually arriving on the screen is very much smaller than when the auxiliary grid is not used. Fig. 3 illustrates the paths of the electrons through the different grids.

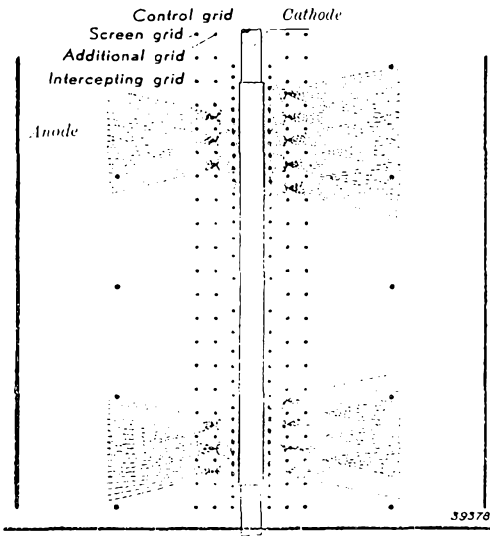

Fig. 3

Paths of the electrons from the cathode to the space between screen grid and anode. The second grid together with the third form a focusing device the actual focus of which lies roughly in front of grid 2. In this way the electrons are passed through the meshes of the third grid, resulting in a very low current to this grid.

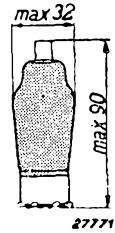

Fig. 1  
Dimensions in mm

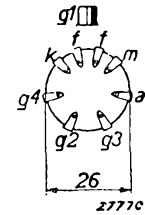
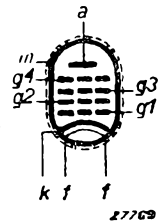

Fig. 2  
Arrangement of electrodes and base connections.

The purpose of grid 3 is to draw from the cathode a sufficient number of electrons through the two grids (grids 1 and 2) with their low potential and this can take place only if the conductance of  $g_3$  through  $g_2$  is high enough, which means a wide pitch for grids 2 and 3. For the same reason it is necessary to increase the screen voltage, which in the EF 8 is 250 V instead of the usual 100 V. One drawback of this arrangement is that the dimensions of the various grids must be such as to permit the anode to exert sufficient attraction through the grids  $g_1$ ,  $g_3$  and  $g_2$ .

In consequence, the anode-to-grid capacitance is higher than usual in

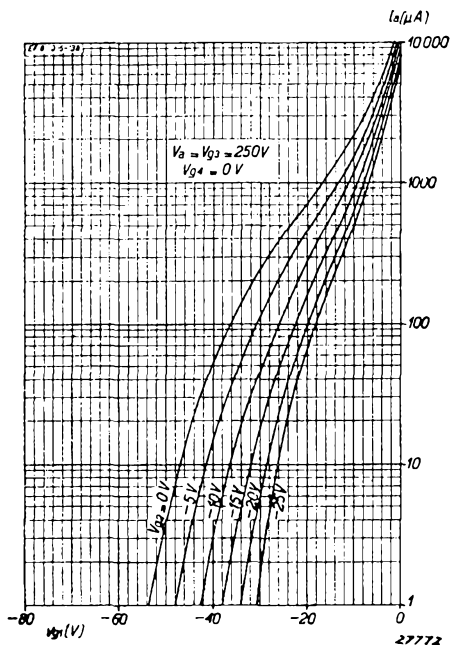

Fig. 4

Anode current as a function of the grid voltage, for different values of the bias on grid 2.

including background noises, an R.F. pre-amplifier is employed.

The use of the EF 8 as R.F. amplifier ensures excellent characteristics from the point of view of the suppression of cross-modulation. The valve is generally provided with automatic gain control and its high performance should therefore be maintained especially on very strong signals, that is, with the full control applied to the valve. A very satisfactory cross-modulation curve is obtained on an anode current of 8 mA in the uncontrolled condition and the special design of the valve ensures that background noise, for which this high anode current would otherwise be an adverse factor, is kept at an extremely low level.

In connection with these features, the screen current has been effectively reduced to 0.2 mA.

a pentode such as the EF 5 or EF 9, being max. 0.007  $\mu\mu\text{F}$ , as against 0.003  $\mu\mu\text{F}$  in the case of the EF 5. The impedance is therefore also lower, viz. 0.45 megohm. However, as the EF 8 finds practical application only as an R.F. amplifier, that is, as the input valve in a receiver, the higher  $C_{ag1}$  and lower impedance do not in themselves form an objection. In the short-wave range the circuit impedances are in any case on the low side, whilst in the normal broadcast bands the opportunities for amplification by means of this valve would, usually, not be fully utilized, since the signal input to the frequency-changer would then be too great.

Amplification is greatest behind the input valve of the receiver, but it is much less in the following stages and the latter therefore contribute in a very much smaller degree towards the general background noise. Usually the input valve is a frequency-changer and, as is generally known, this type of valve is fairly noisy, for which reason, in high-performance receivers where many different precautions are taken to suppress interference,

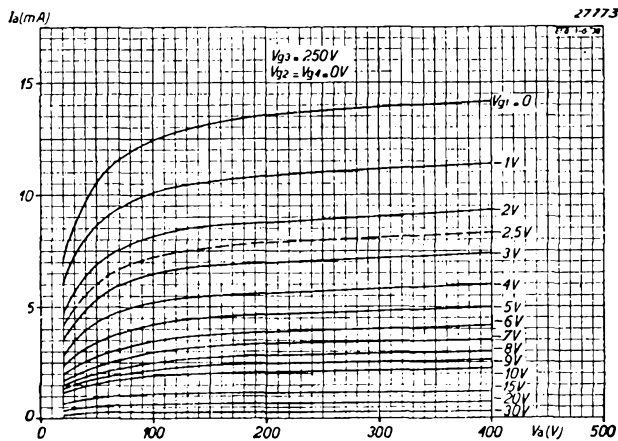

Fig. 5

Anode current as a function of the anode voltage, for various values of the bias on grid 1; grid 2 is connected to the cathode.

# EF 8

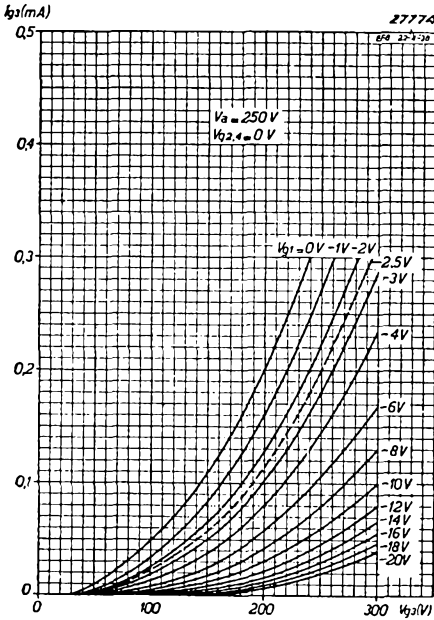

Fig. 6  
Screen-grid current as a function of the screen voltage, for different values of grid bias; grid 2 connected to cathode.

EF 8, of  $\sqrt{\frac{25,000}{13,000}} \cong 1.4$  times.

At the low-frequency end of the short-wave range, say at 50 m, the impedance of the circuit is usually much lower, being of the order of 3,000 ohms, and here the advantages of the EF 8 come more to the fore, since the total noise resistance, using that valve, becomes 6,000 ohms, as against 18,000 ohms in the case of the EF 5. This yields an improvement factor, with respect

to freedom from noise, of  $\sqrt{\frac{18,000}{6,000}} = 1.73$

On the other hand, in the medium- and long-wave ranges circuit impedances are much higher, being in the region of 100,000 ohms, and the preponderance of the noise, both with the EF 8 and the EF 5, is due to the circuit and not to the valve; the EF 8 then generally gives the better results. If, for any reason, the circuit impedances in these ranges are also comparatively low, the EF 8 will still ensure greater success.

In order to avoid an excessive signal

in contrast with which that of the EF 5 is 2.6 mA and, due to this low current, the equivalent noise resistance does not exceed 3,200 ohms.

The corresponding value in the EF 5 is 15,000 ohms, which means that the EF 8 is five times better from the aspect of freedom from background noise.

At the same time, the valve, as such, is not the only source of noise; the circuits and resistors connected to the grid are also contributory factors and ultimate improvement in the signal-to-noise ratio is obtained more especially in certain particular cases. For example, if the impedance of the tuned circuit connected to the grid is, say, 10,000 ohms at 15 m, the arrangement may be regarded thus, that the noise in the first stage is produced by a resistance of  $10,000 + 3,000 = 13,000$  ohms; with the EF 5, the total noise resistance would be  $10,000 + 15,000 = 25,000$  ohms. Now the noise voltage of a resistance is proportional to the root of the resistance value, and this shows an improvement, in the case of

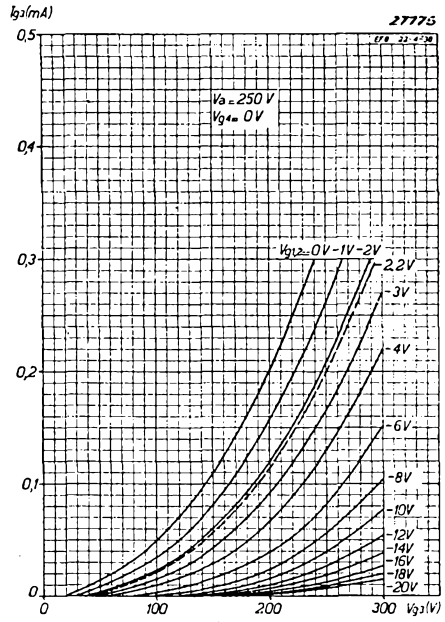

Fig. 7  
Screen-grid current as a function of the screen voltage, for different values of grid bias; grid 2 connected to the bias of grid 1.



voltage being applied to the frequency-changer of a receiver employing R.F. amplification, the latter should not be too high, a factor of about 10 being quite sufficient. When "noisy" valves are used successive amplification should be suppressed somewhat to limit the noise, and this can be effected by taking a tapping from the second R.F. circuit. Conversely, if the valve is not noisy the amplification preceding the valve may be reduced so that also the R.F. valve will have weaker signals to handle, this being better from the point of view of reducing cross-modulation and modulation distortion. The signal on the R.F. valve is reduced by connecting the grid to a tapping in the circuit and this has the effect of considerably lessening the background noise.

The noise resistance of the EF 8 increases

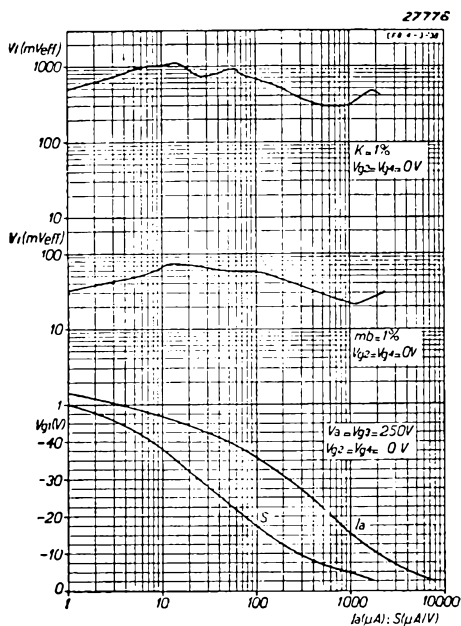

Fig. 8

Upper diagram. Effective alternating grid voltage as a function of the mutual conductance, with 1 % cross-modulation. Grid 2 connected to cathode.

Centre diagram. Effective alternating grid voltage as a function of the mutual conductance, with 1 % modulation hum.

Lower diagram. Mutual conductance  $S$  and anode current  $I_a$  as a function of the grid bias.

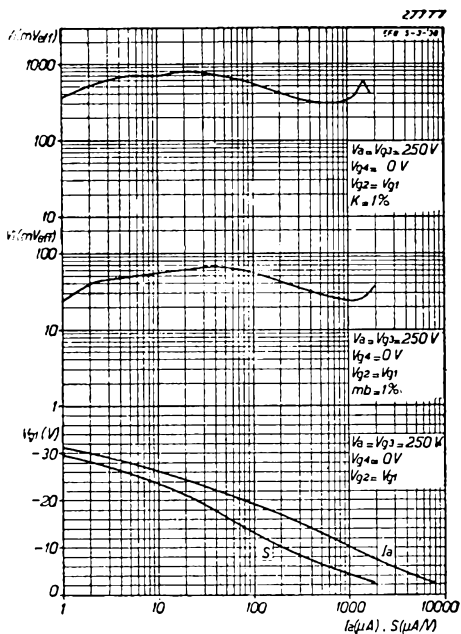

Fig. 9

Upper diagram. Effective alternating grid voltage as a function of the mutual conductance, with 1 % cross-modulation; grid 2 connected to control voltage on grid 1.

Centre diagram. Effective alternating grid voltage as a function of the mutual conductance, with 1 % modulation hum.

Lower diagram. Mutual conductance  $S$  and anode current  $I_a$  as a function of the grid bias.

according as the grid becomes more negative, but as a higher control voltage from the A.G.C. corresponds to a stronger signal the ratio of signal to noise is nevertheless improved.

On short waves the impedance values of the EF 8 are very good and ensure satisfactory amplification in this range: as the H.F. resistance between anode and grid, to earth, as compared with that of the ordinary practical circuit is quite high, amplification values can be obtained from the EF 8 in the short-wave range equal to the product of anode impedance and mutual conductance.

Grid 2 may be either connected direct to the cathode or it may be included with grid 1 in the automatic gain control circuit. In the latter case the control is more pronounced, but the cross-modulation curve is then not so good as when grid 1 is connected to the cathode: it is

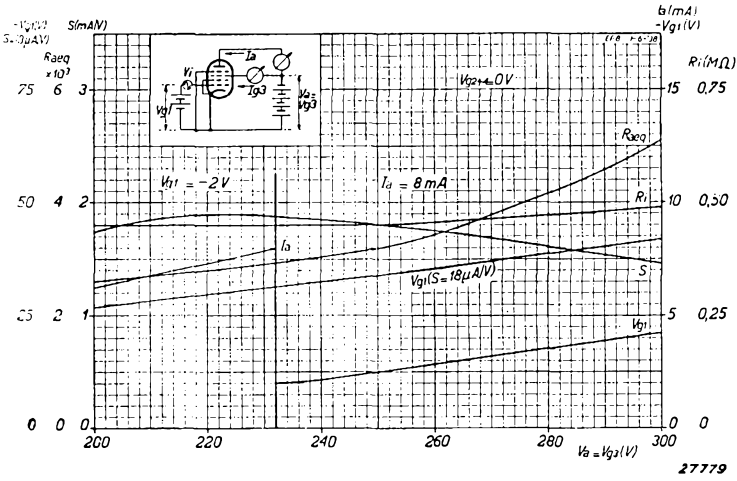

Fig. 10

Characteristics relating to various data as a function of the anode and screen-grid voltages; grid 2 connected to cathode. Left-hand side of the vertical line: at  $V_{g1} = -2$  V; right-hand side: at  $I_a = 8$  mA.

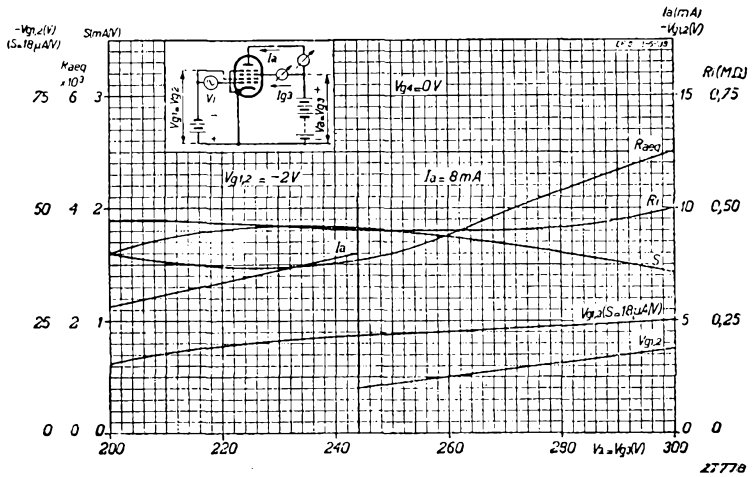
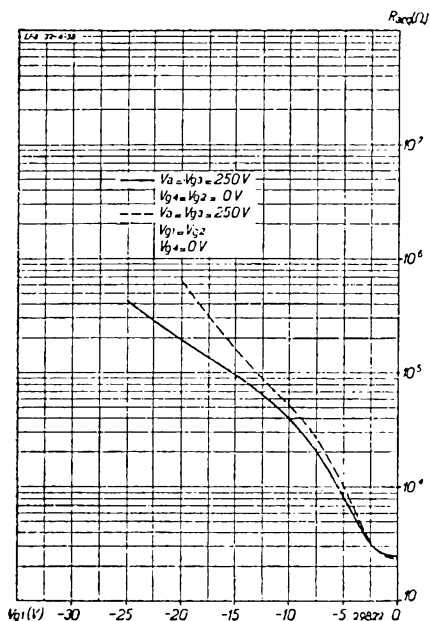

Fig. 11.

Characteristics relating to various data as a function of the anode and screen voltages. Grid 2 connected to control voltage on grid 1. Left-hand side of vertical line:  $V_{g1} = V_{g2} = -2$  V. Right-hand side:  $I_a = 8$  mA.



thus possible by means of the EF 8 to design A.G.C. circuits giving more, or less, control as required.

**HEATER RATINGS**

Heating: indirect, A.C. or D.C.; series or parallel supply.

Heater voltage . . . . .  $V_f = 6.3 V$   
 Heater current . . . . .  $I_a = 0.200 A$

**CAPACITANCES**

$C_{ag1} < 0.007 \mu\mu F$   
 $C_{g1} = 4.6 \mu\mu F$   
 $C_a = 7.8 \mu\mu F$

Fig. 12  
 Equivalent noise resistance as a function of the grid bias. The broken line refers to the case where grid 2 is connected to the control voltage on grid 1; the full line is for the grid connected to cathode.

**OPERATING DATA: EF 8 employed as R.F. amplifier**

( $g_2$  and  $g_4$  connected to cathode).

Anode voltage . . . . .	$V_a = 250 V$		
Voltage on grid 2 . . . . .	$V_{g2} = 0 V$		
Screen-grid voltage . . . . .	$V_{g3} = 250 V$		
Voltage on grid 4 . . . . .	$V_{g4} = 0 V$		
Cathode resistor . . . . .	$R_k = 305 \text{ ohms}$		
Grid bias . . . . .	$V_{g1} = -2.5 V^1)$	$-34 V^2)$	$-50 V^3)$
Anode current . . . . .	$I_a = 8 \text{ mA}$	—	—
Screen-grid current . . . . .	$I_{g3} = 0.2 \text{ mA}$	—	—
Mutual conductance . . . . .	$S = 1,800 \mu A/V$	$18 \mu A/V$	$1 \mu A/V$
Internal resistance . . . . .	$R_i = 0.45$	$> 10$	$> 10 \text{ M ohms}$
Equivalent noise resistance . . . . .	$R_{eq} = 3,200 \text{ ohms}$	—	—

**OPERATING DATA: EF 8 employed as R.F. amplifier**

( $g_2$  connected to control voltage on grid 1;  $g_4$  connected to cathode).

Anode voltage . . . . .	$V_a = 250 V$		
Screen-grid voltage . . . . .	$V_{g3} = 250 V$		
Voltage on grid 4 . . . . .	$V_{g4} = 0 V$		
Cathode resistor . . . . .	$R_k = 265 \text{ ohms}$		
Grid bias (grids 1 and 2) $V_{g1} = V_{g2} = -2.2 V^1)$		$-22 V^2)$	$-28 V^3)$
Anode current . . . . .	$I_a = 8 \text{ mA}$	—	—
Screen-grid current . . . . .	$I_{g3} = 0.2 \text{ mA}$	—	—
Mutual conductance . . . . .	$S = 1,800 \mu A/V$	$18 \mu A/V$	$2.5 \mu A/V$
Internal resistance . . . . .	$R_i = 0.45$	$> 10$	$> 10 \text{ M ohms}$
Equivalent noise resistance . . . . .	$R_{eq} = 3,200 \text{ ohms}$	—	—

<sup>1)</sup> Without control

<sup>2)</sup> Mutual conductance reduced to one - hundredth of uncontrolled value

<sup>3)</sup> Extreme limit of control.

MAXIMUM RATINGS

Anode voltage in cold condition . . . . .	$V_{a0} = \text{max. } 550 \text{ V}$
Anode voltage . . . . .	$V_a = \text{max. } 300 \text{ V}$
Anode dissipation . . . . .	$W_a = \text{max. } 2.5 \text{ W}$
Screen voltage in cold condition . . . . .	$V_{g30} = \text{max. } 550 \text{ V}$
Screen voltage . . . . .	$V_{g3} = \text{max. } 300 \text{ V}$
Screen dissipation . . . . .	$W_{g3} = \text{max. } 0.08 \text{ W}$
Cathode current . . . . .	$I_k = \text{max. } 12 \text{ mA}$
Grid voltage at grid current start ( $I_{g1} = +0.3 \mu\text{A}$ )	$V_{g1} = \text{max. } -1.3 \text{ V}$
Grid voltage at grid current start ( $I_{g2} = +0.3 \mu\text{A}$ )	$V_{g2} = \text{max. } -1.3 \text{ V}$
Resistance between grid 1 and cathode . . . . .	$R_{g1k} = \text{max. } 3 \text{ M ohms}$
Resistance between grid 2 and cathode . . . . .	$R_{g2k} = \text{max. } 3 \text{ M ohms}$
Resistance between filament and cathode . . . . .	$R_{fk} = \text{max. } 20,000 \text{ ohms}$
Voltage between filament and cathode (direct voltage or effective value of alternating voltage) . . . . .	$V_{fk} = \text{max. } 100 \text{ V}$

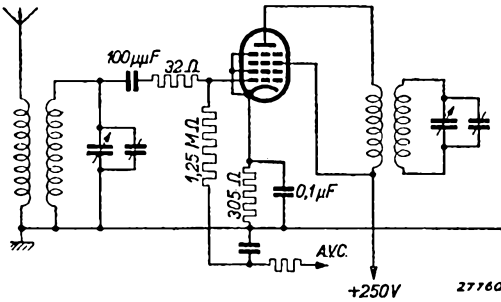

Fig. 13  
Circuit diagram of the EF 8 used as R.F. amplifier in a superhetro receiver with A.G.C. on grid 1 only.

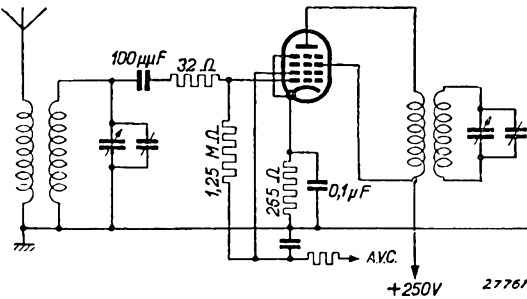

Fig. 14  
As Fig. 13 but with A.G.C. on grids 1 and 2.

APPLICATIONS

The application of this valve is restricted to the first R.F. stage of a receiver. With respect to background noise it has outstanding properties in the short-wave range, as well as on medium and long waves. The very good cross-modulation characteristic, inter alia, is of considerable importance. Grid 3 may be connected direct or, better still, via a resistor of low value with decoupling capacitor, to the H.T. line. At voltages higher than 250 V it is necessary to increase the grid bias in order to avoid overstepping the scheduled maximum anode dissipation; this has the effect of reducing slightly the mutual conductance. Figs 10 and 11 give some useful data for this valve, at different values of anode and screen grid voltages.

# EF 9 Variable-MU R.F. pentode

This is an R.F. or I.F. variable-mu pentode that can also be used as a resistance-coupled A.F. amplifier, with or without control of the amount of gain (A.G.C. operating also on the A.F. stage). The design of this valve differs from that of the EF 5 in that in place of a fixed screen potential the latter is made to vary on an increasing bias. Instead of taking the screen voltage from a potential divider the screen may be fed via a resistor. Without control the screen potential is adjusted, by means of the voltage drop across this resistor, to about 100 V. Due to the application of gain control the screen current drops and therefore also the potential difference across

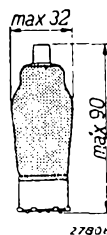

Fig. 1  
Dimensions in mm.

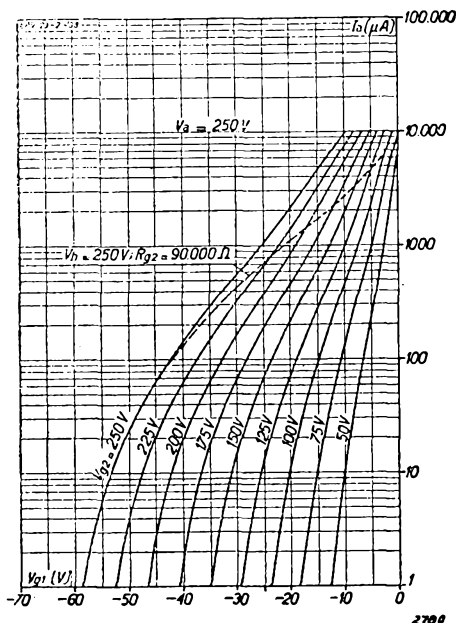

Fig. 3  
 $I_a/V_{g1}$  characteristics using  $V_{g2}$  as parameter. The broken line shows the anode current with control applied to the valve, with the screen fed through a resistance of 90,000 ohms from a supply voltage of 250 V.

characteristic is displaced to the left and, if the curve has a short "tail" when the valve is in the uncontrolled condition, this will steadily increase in size as the screen voltage rises: the logarithmic  $I_a/V_{g1}$  characteristics with respect to different screen potentials shown in Fig. 3 will confirm this fact. Arising from these circumstances it may be said that, although the  $I_a/V_{g1}$  characteristic for the uncontrolled valve has only a short tail, the cross-modulation properties during the time that control is applied are considerably better than if the screen voltage were constant.

On a supply voltage of 250 V the screen-grid series resistor must be 90,000 ohms in order to obtain 100 V on the screen without control. As there is a different screen voltage for

the resistor; the screen voltage thus rises again until, under full control, it approaches the value of the supply voltage. This varying voltage on the screen is referred to as "self-adjusting" or "sliding" screen voltage. The advantage of using a screen-grid series resistor is to be found in the fact that, assuming roughly equal cross-modulation conditions, the anode current without control is lower and the mutual conductance higher than in a valve with fixed screen voltage. For example, the anode current of the EF 9, at  $-2.5$  V and 100 V screen, in the uncontrolled condition is 6 mA and the mutual conductance 2.2 mA/V, whereas in the case of the EF 5, at  $V_{g1} = -3$  V and  $V_{g2} = 100$  V, the anode current is 8 mA and the mutual conductance 1.7 mA/V.

When the screen voltage rises the  $I_a/V_{g1}$  characteristic is displaced to the left and, if the curve has a short "tail" when the valve is in the uncontrolled condition, this will steadily increase in size as the screen voltage rises: the logarithmic  $I_a/V_{g1}$  characteristics with respect to different screen potentials shown in Fig. 3 will confirm this fact. Arising from these circumstances it may be said that, although the  $I_a/V_{g1}$  characteristic for the uncontrolled valve has only a short tail, the cross-modulation properties during the time that control is applied are considerably better than if the screen voltage were constant.

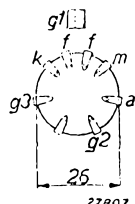
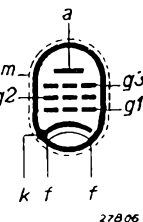

Fig. 2  
Arrangement of electrodes and base connections.

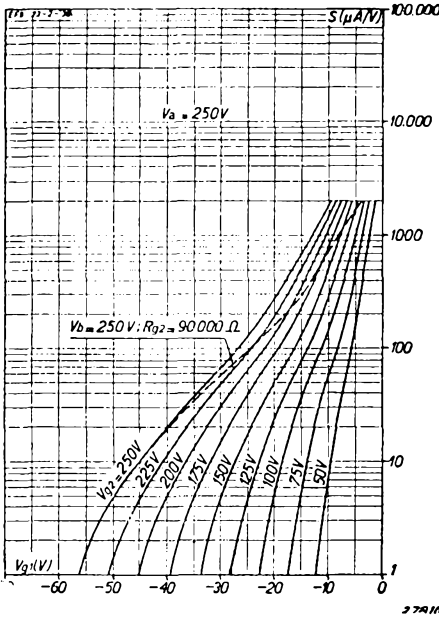

Fig. 4  
Mutual conductance as a function of the grid bias, with  $V_{g2}$  as parameter. The broken line represents the mutual conductance of the valve when under control, with a screen-grid series resistor of 90,000 ohms and a supply voltage of 250 V.

every value of the grid bias, the anode current plotted against grid bias is shown by a broken line. An alternating grid voltage does not affect the screen voltage, since the screen is decoupled with a capacitor and in this case the anode current varies in accordance with the  $I_a/V_{g1}$  characteristic relating to the appropriate grid bias.

According to Fig. 3, the screen voltage at 12.5 V bias is 175 V, so that at this bias value the  $I_a/V_{g1}$  characteristic refers to  $V_{g2} = 175$  V.

On other supply voltages the screen-grid resistor must be adjusted accordingly and the control curve is thereby slightly modified; for instance on a 200 V supply (as in A.C./D.C. sets) 60,000 ohms will be required to produce 110 V screen voltage without control. The anode voltage will then fall rather more rapidly. On a supply of 100 V, however, the sliding screen voltage no longer functions and

the valve has therefore to be used with a fixed screen potential. In this case the  $I_a/V_{g1}$  characteristic for  $V_{g2} = 100$  V shown in Fig. 3 applies. If a potential divider is used for feeding the screen it is possible to obtain a more rapid controlling effect than with fixed screen potential

by a judicious arrangement of the resistance values in the network, but it should be borne in mind that the cross-modulation characteristic is then not quite so good. By means of the  $I_{g2}/V_{g2}$  curves in Fig. 10 the various values can be determined for each particular case in advance.

A suitable choice of control curve will also guarantee excellent modulation-hum characteristics, this being of especial importance when dealing with A.C./D.C. mains receivers.

A special feature of the EF 9 is the very low interelectrode capacitance; the anode-to-grid capacitance is less than  $0.002 \mu\text{F}$  and the valve therefore gives very good results

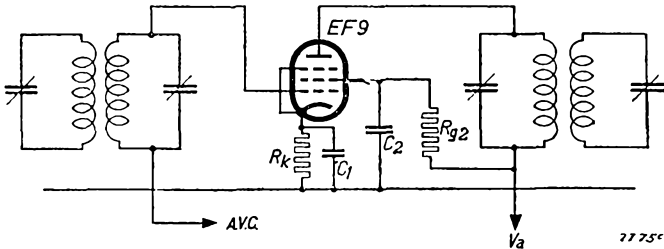

Fig. 5  
Theoretical circuit diagram of an I.F. valve employing the principle of the "sliding" screen voltage.

27012

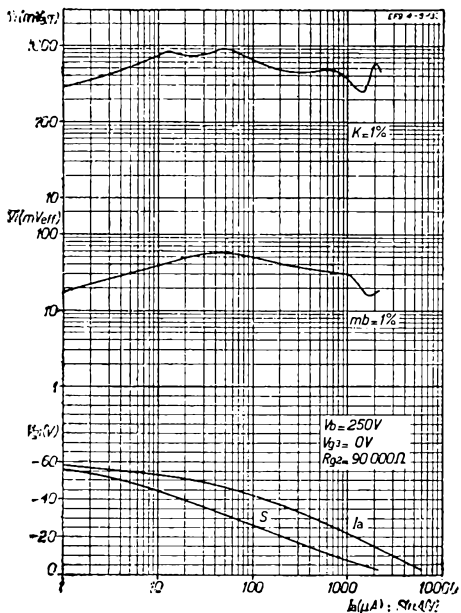

Fig. 6

Upper diagram. Effective alternating grid voltage as a function of the mutual conductance, with 1 % cross-modulation; screen fed via a resistor of 90,000 ohms from 250 V supply.  
 Centre diagram. Effective alternating grid voltage as a function of the mutual conductance, with 1 % modulation hum.  
 Lower diagram. Mutual conductance  $S$  and anode current  $I_a$  as a function of the grid bias.

27012

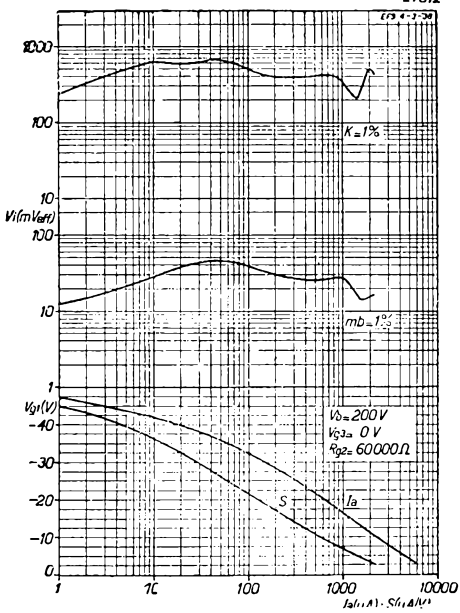

Fig. 7

Upper diagram. Effective alternating grid voltage as a function of the mutual conductance with 1 % cross-modulation; screen grid fed via a resistor of 60,000 ohms from a 200 V supply.  
 Centre diagram. Effective alternating grid voltage as a function of the mutual conductance, with 1 % modulation hum.  
 Lower diagram. Mutual conductance  $S$  and anode current  $I_a$  as a function of the grid bias.

in the short-wave range. Although in this range the magnification of the circuits is usually only fair, the EF 9 will ensure a high degree of amplification.

As already mentioned, the EF 9 can also be employed as a resistance-coupled A.F. amplifier; by applying a control voltage to the grid the amplifier may be so regulated that the performance of the A.G.C. of the receiver is enhanced by the A.F. stage. The relevant data will be found in the table on page 276.

**HEATER RATINGS**

Heating: indirect, A.C. or D.C., series or parallel supply.

Heater voltage . . . . .  $V_f = 6.3 V$   
 Heater current . . . . .  $I_f = 0.200 A$

**CAPACITANCES**

$C_{ag1} < 0.002 \mu\mu F$   
 $C_{g1} = 5.5 \mu\mu F$   
 $C_a = 7.2 \mu\mu F$

Fig. 8

Upper diagram. Effective alternating grid voltage as a function of the mutual conductance with 1% cross-modulation, at  $V_a = 100$  V,  $V_{g2} = 100$  V (fixed).  
 Centre diagram. Effective alternating grid voltage as a function of the mutual conductance with 1% modulation hum.  
 Lower diagram. Mutual conductance  $S$  and anode current  $I_a$  as a function of the grid bias.

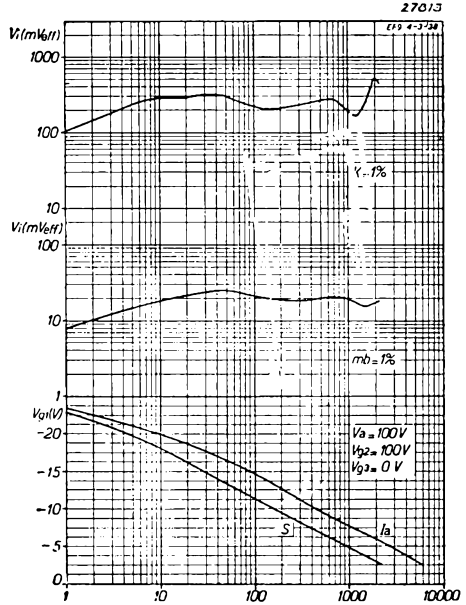

**OPERATING DATA: EF 9 used as R.F. or I.F. amplifier**

Anode voltage . . . . .	$V_a = 250$ V		
Suppressor grid voltage . . . . .	$V_{g3} = 0$ V		
Screen-grid series resistor . . . . .	$R_{g2} = 90,000$ ohms		
Cathode resistor . . . . .	$R_k = 325$ ohms		
Grid bias . . . . .	$V_{g1} = -2.5$ V <sup>1)</sup>	$-39$ V <sup>2)</sup>	$-49$ V <sup>3)</sup>
Screen voltage . . . . .	$V_{g2} = 100$ V	—	250 V
Anode current . . . . .	$I_a = 6$ mA	—	—
Screen current . . . . .	$I_{g2} = 1.7$ mA	—	—
Mutual conductance . . . . .	$S = 2,200$	22	4.5 $\mu$ A/V
Internal resistance . . . . .	$R_i = 1.25$	$> 10$	$> 10$ M ohms
Anode voltage . . . . .	$V_a = 200$ V		
Suppressor grid voltage . . . . .	$V_{g3} = 0$ V		
Screen-grid series resistor . . . . .	$R_{g2} = 60,000$ ohms		
Cathode resistor . . . . .	$R_k = 325$ ohms		
Grid bias . . . . .	$V_{g1} = -2.5$ V <sup>1)</sup>	$-32$ V <sup>2)</sup>	$-39$ V <sup>3)</sup>
Screen voltage . . . . .	$V_{g2} = 100$ V	—	200 V
Anode current . . . . .	$I_a = 6$ mA	—	—
Screen current . . . . .	$I_{g2} = 1.7$ mA	—	—
Mutual conductance . . . . .	$S = 2,200$	22	5.5 $\mu$ A/V
Internal resistance . . . . .	$R_i = 0.9$	$> 10$	$> 10$ M ohms
Anode voltage . . . . .	$V_a = 100$ V		
Suppressor-grid voltage . . . . .	$V_{g3} = 0$ V		
Screen-grid voltage . . . . .	$V_{g2} = 100$ V		
Cathode resistor . . . . .	$R_k = 325$ ohms		
Grid bias . . . . .	$V_{g1} = -2.5$ V <sup>1)</sup>	$-16$ V <sup>2)</sup>	$-19$ V <sup>3)</sup>
Anode current . . . . .	$I_a = 6$ mA	—	—
Screen current . . . . .	$I_{g2} = 1.7$ mA	—	—
Mutual conductance . . . . .	$S = 2,200$	22	7 $\mu$ A/V
Internal resistance . . . . .	$R_i = 0.4$	$> 10$	$> 10$ M ohms

<sup>1)</sup> Without control. <sup>2)</sup> Mutual conductance reduced to one-hundredth of uncontrolled value. <sup>3)</sup> Extreme limit of control range.



Fig. 9

Anode current as a function of the anode voltage at different values of the grid bias, with a fixed screen voltage of 100 V.

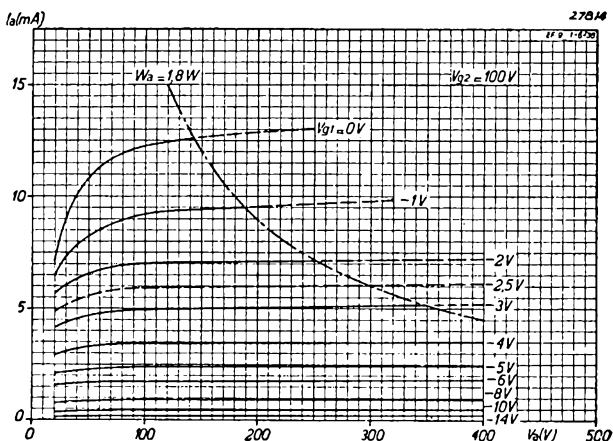

**MAXIMUM RATINGS**

Anode voltage in cold condition . . . . .	$V_{a0}$	= max. 550 V
Anode voltage . . . . .	$V_a$	= max. 300 V
Anode dissipation . . . . .	$W_a$	= max. 2 W
Screen voltage in cold condition . . . . .	$V_{g20}$	= max. 550 V
Screen voltage at $I_a = 6$ mA . . . . .	$V_{g2}$	= max. 125 V
Screen voltage at $I_a = 3$ mA . . . . .	$V_{g2}$	= max. 300 V
Screen-grid dissipation . . . . .	$W_{g2}$	= max. 0.3 W
Cathode current . . . . .	$I_k$	= max. 10 mA
Grid voltage at grid current start ( $I_{g1} = +0.3 \mu A$ )	$V_{g1}$	= max. $-1.3$ V
Resistance between grid and cathode . . . . .	$R_{g1k}$	= max. 3 M ohms
Resistance between filament and cathode . . . . .	$R_{fk}$	= max. 20,000 ohms
Voltage between filament and cathode (direct voltage or effective value of alternating voltage) . . . . .	$V_{fk}$	= max. 100 V

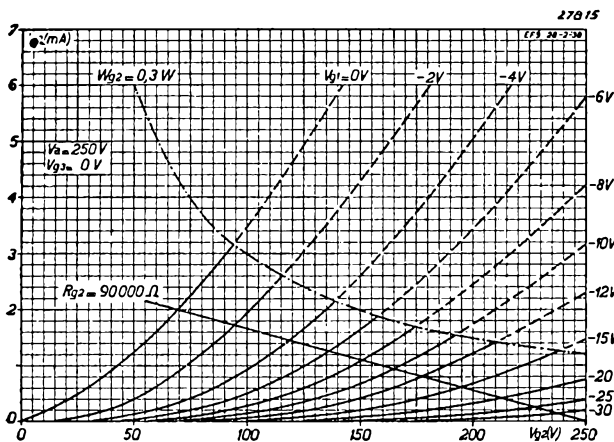

Fig. 10

Screen current as a function of the screen voltage at different values of the grid bias. These curves also apply as an approximation to anode voltages between 100 and 250 V.

For data referring to the use of the valve as a resistance-coupled A. F. amplifier see Table on p. (272).

The EF 9 is used as amplifier valve with manually or automatically controlled amplification. The heating-up time is shorter than usual and the cathode insulation is rated to carry 100 V direct voltage or effective value of the alternating voltage; this value should not be exceeded.

# EFM 1 A.F. Amplifier and electronic indicator

The EFM 1 combines a variable-mu A.F. amplifier pentode with an electronic indicator, the former being the lower of the two assemblies in the envelope; a conical fluorescent screen, of the type used in the EM 1, is mounted above the pentode unit, so as to be visible at the top of the envelope. The cathode extends into the space formed by the fluorescent screen and is screened off, so that the light emitted by the cathode will not be visible; this screen is supported on two rods, arranged in such a manner that they are invisible from the outside. Between the cathode and the screen, a grid and two deflectors are mounted; the grid is wound without backbones and is supported only at the ends. A space charge thus occurs in front of the grid and this promotes a more uniform flow of electrons to the fluorescent screen. Further, on very weak signals, when the fluorescing areas are only small, the electron stream is thus confined to a relatively small working area of the screen. The two deflector rods are connected to the screen grid of the pentode unit and two fluorescent spots appear on the screen.

The pentode section is designed on the sliding screen-voltage principle, the screen, therefore, being fed through a resistor. When the A.G.C. voltage is applied to the grid the screen current drops and the voltage on the screen, and therefore also on the deflectors, increases. The fluorescent screen being connected directly to the supply voltage, the difference between the potential of the deflector electrodes and that of the fluorescent screen decreases, as also the deflecting effect of the two electrodes, in consequence of which the

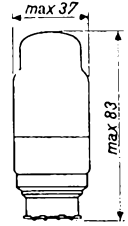

Fig. 1  
Dimensions in mm.

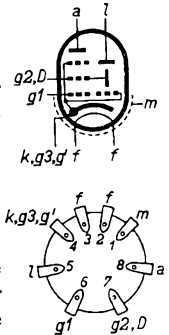

Fig. 2  
Arrangement of electrodes and base connections.

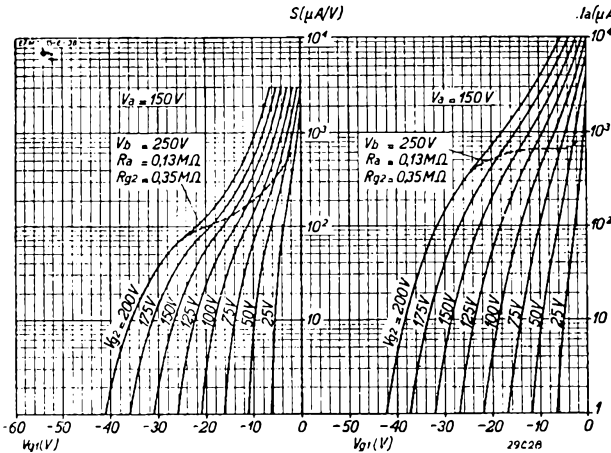

Fig. 3

*Right-hand diagram.* Anode current as a function of the grid bias, with screen voltage as parameter. These curves relate to an anode voltage of 150 V. The broken line represents the dynamic characteristic at  $V_b = 250$  V,  $R_{g2} = 0.35$  M Ohm and  $R_a = 0.13$  M Ohm.

*Left-hand diagram.* Mutual conductance as a function of the grid bias, with screen voltage as parameter. These curves are in respect of an anode voltage of 150 V. The broken line refers to the mutual conductance as a function of the grid bias, using a screen-grid resistor of 0.35 M Ohm and an anode resistor of 0.13 M Ohm, both on a 250 V supply.

fluorescent areas are increased and the dark sections decreased in size. As the screen grid is decoupled by a capacitor, it is possible simultaneously to apply A.F. voltages to the grid, without affecting the size of the luminous sectors. The anode circuit may be resistance-coupled to the next valve for further amplification of the A.F. signal.

To produce the desired indication of the correct receiver tuning, the direct voltage from the detector diode, or the A.G.C. control vol-

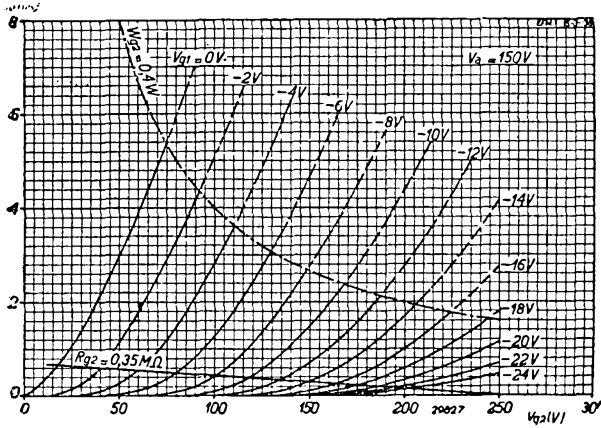

Fig. 4  
Screen-grid current as a function of the screen voltage, with grid bias as parameter: resistance-line for  $R_{g2} = 350,000$  ohms.

amplifier, and a pentode of this type must necessarily meet the requirement that distortion shall remain low throughout the whole range of control. The pentode part of the EFM 1 is designed to give an amplification factor of about 60 with an anode resistor of 130,000 ohms and a screen series resistor of 350,000 ohms, with -2 V grid bias. By increasing the bias from -2 to -20 V the amplification is reduced from 60 to roughly 13, giving a control of 1: 4.5, and this extra amount of control can be put to good use where effective automatic gain control is required.

The above variation in grid bias just corresponds to the full deflection of the fluorescent bands and the construction of the screen grid is such as to ensure a constant anode current over the whole of the range. The amount of distortion is therefore also fairly constant and, at the same time, well within the ordinary practical limits. In order to suppress distortion, a fairly high control voltage is needed for the amplifier section of the valve, so that per degree of deflection in the indicator a greater voltage variation must be established on the grid of the EFM 1 than is the case with, say, the tuning indicator EM 1.

The use of the combined amplifier — indicator makes it possible to reduce the total number of valves required for many different types of radio receiver, without dispensing with electronic indication, or reducing the sensitivity. As this valve is necessarily a compromise, however, it must not be expected that it will give results in every way comparable

tage is applied to the grid. When a strong signal arrives at the diode the grid of the EFM 1 is rendered strongly negative and the amplification is reduced, which means, of course, that the A.F. amplification stage is included in the A.G.C.

This combination of electronic indicator and A.F. pentode thus virtually automatically furnishes a variable- $\mu$  A.F.

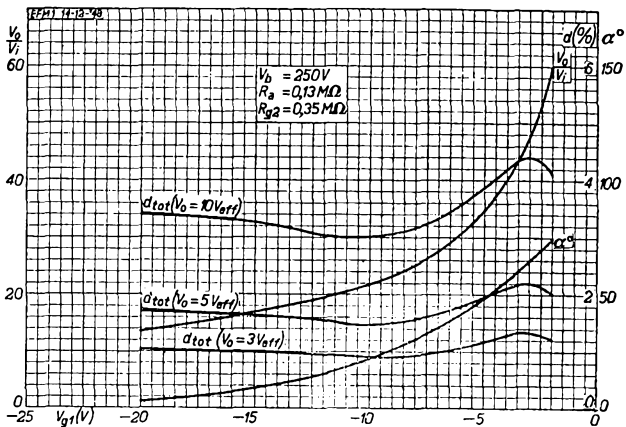

Fig. 5  
Distortion as a function of the grid bias, with alternating output voltage as parameter, at  $R_{g2} = 350,000$  ohms,  $R_a = 130,000$  ohms and  $V_b = 250$  V; also shadow angle  $\alpha$  as a function of the grid bias.

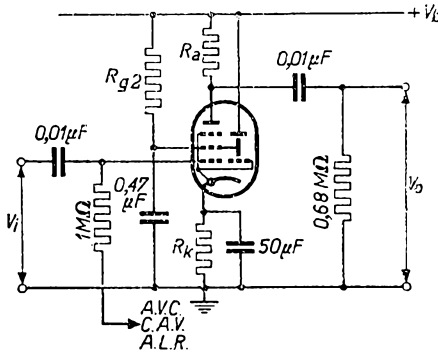

Fig. 6  
Circuit diagram illustrating the symbols used in the relevant data.

with those of an A.F. amplifier with separate indicator. The EFM 1 has no diodes for detection and will therefore be frequently used in conjunction with the double-diode I.F. pentode EBF 2; it can also be employed successfully with a separate diode such as the EAB 1 or EB 4.

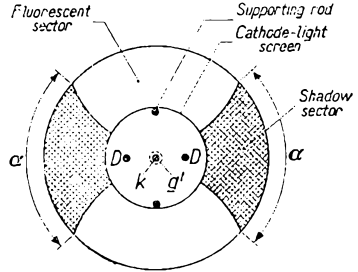

Fig. 7  
Sketch of the fluorescent screen, showing the light and dark sectors.

**HEATER RATINGS**

Heating: indirect, A.C. or D.C., series or parallel supply.

Heater voltage . . . . .	$V_f = 6.3 \text{ V}$
Heater current . . . . .	$I_f = 0.200 \text{ A}$

**OPERATING DATA**

Supply and fluorescent screen voltage . . . . .	$V_b = V_l =$	250 V
Anode resistor . . . . .	$R_a =$	130,000 ohms
Screen-grid series resistor . . . . .	$R_{g2} =$	350,000 ohms
Cathode resistor . . . . .	$R_k =$	980 ohms
Grid bias in uncontrolled condition . . . . .	$V_{g1} =$	-2 V
Grid bias with full control . . . . .	$V_{g1} =$	-20 V
Anode current . . . . .	$I_a =$	0.8 mA 0.5 mA
Screen-grid current . . . . .	$I_{g2} =$	0.6 mA 0.2 mA
Current on fluor. screen . . . . .	$I_l =$	0.65 mA 0.8 mA
Screen-grid voltage . . . . .	$V_{g2} =$	40 V 180 V
Anode voltage . . . . .	$V_a =$	146 V 185 V
Voltage gain . . . . .	$V_o/V_k =$	60 13
Distortion at 5V (eff) A.C. anode . . . . .	$d_{tot} =$	2% 1.7%
Shadow angle of single sector, measured at edge of screen . . . . .	$\alpha$	> 70° < 5°

**MAXIMUM RATINGS**

Anode voltage in cold condition . . . . .	$V_{a0} = \text{max. } 550 \text{ V}$
Anode voltage . . . . .	$V_a = \text{max. } 300 \text{ V}$

Anode dissipation . . . . .	$W_a$	= max. 0.4 W
Screen-grid voltage in cold condition . . . . .	$V_{g20}$	= max. 550 V
Screen-grid voltage . . . . .	$V_{g2}$	= max. 300 V
Screen-grid dissipation . . . . .	$W_{g2}$	= max. 0.4 W
Voltage on fluorescent screen in cold condition . . . . .	$V_{l0}$	= max. 550 V
Voltage on fluorescent screen . . . . .	$V_l$	= max. 300 V
Voltage on fluorescent screen . . . . .	$V_l$	= min. 200 V
Cathode current . . . . .	$I_k$	= max. 5 mA
Grid voltage at grid current start ( $I_{g1} = +0.3 \mu A$ )	$V_{g1}$	= max. -1.3 V
Screen-grid current under same conditions . . . . .	$I_{g2}$	= min. 0.53 mA
Resistance between grid and cathode . . . . .	$R_{g1k}$	= max. 3 M ohms
Resistance between filament and cathode . . . . .	$R_{fk}$	= max. 20,000 ohms
Voltage between filament and cathode (direct voltage or effective value of A.C. voltage) . . . . .	$V_{fk}$	= max. 100 V

**APPLICATIONS**

The EFM 1 can be used only as an A.F. amplifier combined with an electronic indicator, and Fig. 8 shows the theoretical circuit of the valve in conjunction with a preceding, detector, valve. The R.F. signal from the diode resistor  $R_1$  is fed through a capacitor to the grid of the EFM 1 and the negative D.C. voltage across the grid leak is fed from A, by way of resistors  $R_2$  and  $R_3$ , also to this grid. Resistor  $R_2$  and capacitor  $C_1$  make up a smoothing filter for the A.F. voltage occurring across the diode resistor, to ensure that only direct voltage reaches the grid of the EFM 1 along this path.  $R_3$  is the grid leak.

The negative D.C. voltage for the control of the EFM 1 is usually taken from the detector diode; it can be derived also from the A.G.C. diode, but in the case of delayed automatic gain control the cathode-ray indication, on signals of the strength less than that of the delay voltage, will then not function.

In view of possible microphony, the A. F. sensitivity at the grid of the EFM 1 should not be too great and care should be taken when mounting the valve itself that no trouble can occur through acoustic vibration. If a steep-slope output valve such as the EL 3 is used in the next stage, it is advisable to reduce the sensitivity by applying sufficient negative feed-back. To prevent hum, the direct voltage applied to the anode coupling resistor must in every case be smoothed by an R.C. filter, but no allowance has been made for this filter in the data and characteristics, since these will depend on each individual case and will also differ according to the supply voltage employed. Practical applications of the EFM 1 are confined to two possibilities. One is the improvement of the A.G.C. of a receiver, by virtue of the fact that the control voltage applied to the grid is also operative on the EFM 1. As already stated, the A.F. gain in the case of a high-mutual-conductance output valve may be reduced by means of negative feed-back; if the cathode capacitor of the EL 3 be omitted, the negative feed-back factor will be about  $2\frac{1}{2}$ , but this does not represent a sufficient reduction in the sensitivity and the only alternatives are to use a higher value of cathode resistor

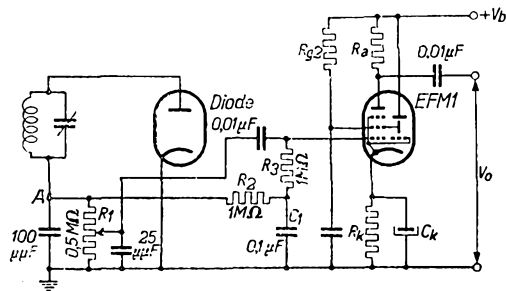

Fig. 8  
Circuit diagram showing EFM 1 used as variable A. F. amplifier and electronic indicator, following a diode-detector stage.

for the output valve, or to reduce the gain of the EFM 1 in the uncontrolled condition. To ensure the proper amount of grid bias the grid of the EL 3 should, in the first instance, be connected to a tapping on the cathode resistor; a value of 500 ohms for the latter gives a feed-back factor of about  $4\frac{1}{2}$  and will ensure sufficient reduction in the sensitivity. Naturally, however, this amount of feed-back is obtained at the expense of the optimum output power; with a resistor of  $R_k = 500$  ohms, the maximum obtainable output is not more than about 3.3 W and for this reason preference is usually given to a reduction in the amplification of the EFM 1. This can also be achieved by using a higher value for the cathode resistor, but it will result in a smaller variation in the shadow angle of the indicator (see also Fig. 5). A cathode resistor of, say, 2,000 ohms provides a bias of about  $-4$  V; the corresponding amplification factor is then 40 instead of 60 and the range of deflection of the indicator is thereby reduced from  $5-75^\circ$  to  $5-65^\circ$ .

Another method consists in the use of a lower anode coupling resistor than the value of 130,000 ohms suggested; a smoothing resistor is then connected in series with it to bring the value up to 130,000 ohms, or the appropriate higher value in the case of higher supply voltages.

One result of the limited feed-back when using high-mutual-conductance output valves (EL 5 or EL 6) is that the A.F. sensitivity is still quite high. As the reader will be aware, the strength of the I.F. signal to be applied to the detector diode and, therefore, also the delay voltage for the A.G.C. is determined by the amount of A.F. gain. When the A.F. sensitivity is high it is not necessary to have a large signal strength at the detector and this leaves only small voltages available for controlling the EFM 1; this means, in effect, that the dark sectors will be reduced only on very weak signals, or that the electronic indicator will be relatively insensitive.

A still greater reduction in the A.F. sensitivity than by means of simple feed-back in a steep-slope output valve may be obtained by means of a valve having low A.F. sensitivity, such as the triode AD 1, in which case the sensitivity of the indicator will be greatly improved.

Notwithstanding the higher alternating output voltage of the EFM 1 necessary to load fully the AD 1, the distortion is extremely slight; on an average, the distortion from the combination of EFM 1 + AD 1 is less than in the AD 1 alone, this being due to the compensation of the second harmonics.

The second course open in the application of the EFM 1 consists in shifting the point of equilibrium of the sensitivity of the indicator unit in such a way that it will contribute less towards the A.G.C. In this case a higher D.C. voltage is required at the detector and therefore also a stronger I.F. signal, with less A.F. amplification; the latter may be reduced by means of strong negative feed-back. Since negative feed-back produced by the omission of the cathode capacitor from the output valve results in a considerable loss of output power, it is necessary to feed back from the loudspeaker to the grid of the EFM 1. Voltage feed-back to the EFM 1 has the advantage that the A.F. gain can be reduced at will by increasing the amount of coupling, whilst, further, the internal resistance of the output stage is reduced instead of increased, as in the case of current-coupling by omission of the cathode capacitor. In this way it is possible to include in the feed-back circuit components which are dependent on the frequency, so as to improve the frequency characteristic.

The object of this voltage feed-back, then, is to stabilize the amount of gain, but a great part of the A.F. gain control is thereby lost. On a strong carrier wave the EFM 1 can be fully controlled, in which case the amplification is lower and the negative feed-back weaker; there is also less distortion.

## COMBINATION OF EFM 1 and EBF 2

When the EFM 1 is used as L.F. amplifier the EBF 2 will often be selected to serve as I.F. amplifier and detector, and this arrangement opens two possibilities:

1) EFM 1 as A.F. amplifier with weak negative feed-back on the output valve; the electronic indicator is then more or less insensitive.

2) EFM 1 as A.F. amplifier with strong feed-back from the loudspeaker to this valve. It has already been mentioned that the A.F. gain must be on the low side if a good tuning indication is to be obtained; in this case the delay voltage should be somewhat

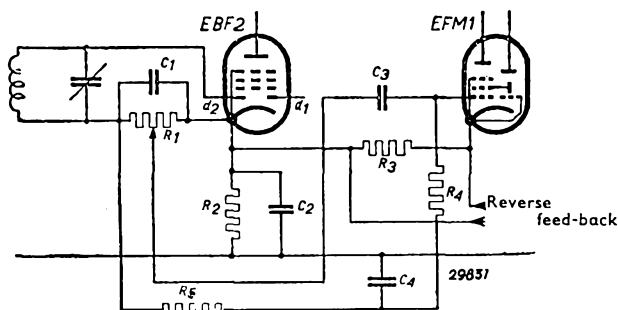

Fig. 9

Circuit diagram showing the EFM 1 used in conjunction with the EBF 2 with negative feed-back to the former.

higher (5 to 6 V). The most suitable circuit is shown in the diagram of Fig. 9; the cathode voltage of the EBF 2 is 5–6 V and the cathode of the EFM 1 is connected to that of the EBF 2 through a resistor  $R_3$  the voltage drop of which supplies the grid bias for the EFM 1. This resistor is not capacitively decoupled and it serves also as part of the potential divider for the negative feed-back.

When the EFM 1 is employed with negative feed-back the delay voltage from the A.G.C. must be higher than the normal cathode voltage of the EBF 2 (2 V), firstly in order to load fully the output valve and secondly so as not to limit the operation of the electronic indicator on weak signals. For, if the A.G.C. comes into operation before the output valve is fully loaded the direct voltage on the detector, for the same signal, is restricted and the sensitivity of the indicator reduced. A delay of 5 to 6 V is in most cases sufficient.

One complication to be taken into account is as follows. If efforts are directed towards less A.F. amplification, not by means of negative feed-back, but by using an output stage of lower sensitivity (e.g., the AD 1), the increased control on the EFM 1 will mean that the total A.F. gain on increasing signal strengths will again be reduced. In consequence, a very much stronger signal is needed at the detector to load fully the output valve on strong incoming signals than would be the case if the A.F. control were compensated by the negative feed-back, i.e., the delay voltage of the A.G.C. should be higher than the value suggested, and this in turn introduces still greater obstacles in the control of the EBF 2. It will therefore be appreciated that the use of negative feed-back is much to be preferred in reducing the A.F. gain subsequent to the detector stage.

# EH 2 Heptode

This pentagrid valve can be employed very successfully on very short wavelengths as a controlled modulator in conjunction with a separate oscillator, and also as R.F. or I.F. amplifier with limited control range.

The action of this valve is similar to that of a hexode in that, when used as modulator, the input signal is applied to the first grid and the oscillator signal to the third. The 2nd and 4th grids are screen grids having their own separate contacts on the base of the valve. The fifth grid which, regarded superficially, constitutes the main point of difference with the earlier type of hexode, is a suppressor grid, whose purpose is to improve the internal resistance and to ensure satisfactory performance when the valve is used in A.C./D.C. receivers with 100 V on the anode.

When the EH 2 is employed as frequency-changer a separate oscillator has many advantages; a triode such as the EBC 3 has an initial mutual conductance (at  $V_g = 0$ ,  $S = 3.0 \text{ mA/V}$ ) that will guarantee stability of oscillation also in the short-wave range. A variable-mu modulator valve should meet the following requirements:

- 1) Conversion conductance should be sufficiently high.
- 2) Required oscillator voltage should be as low as possible.
- 3) Currents due to transit-time must not occur.



Fig. 1 Dimensions in mm

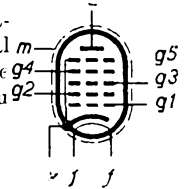

Fig. 2 Arrangement of electrodes and base connections.

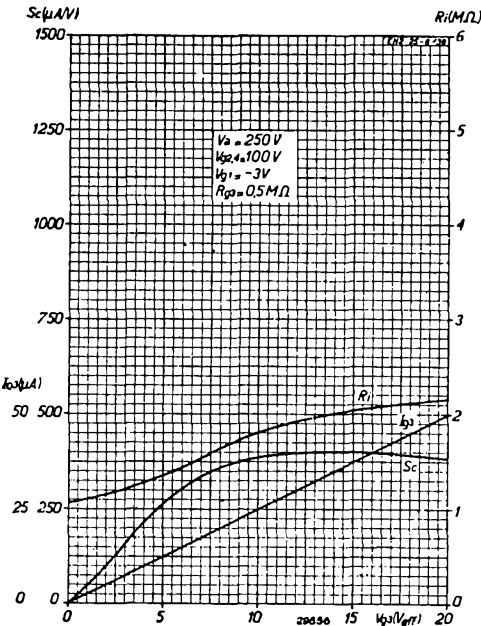

Fig. 3 Conversion conductance, internal resistance and oscillator-grid current as a function of the oscillator voltage on grid 3, at 250 V anode, 100 V screen and -3 V bias on grid 1.

- 4) Parallel input impedance should remain as high as possible, down to the very shortest wavelengths.
- 5) A satisfactory compromise between the least possible background noise, narrow range of bias for full control of the valve and also least possible cross-modulation.
- 6) Negligible frequency drift arising from the automatic gain control or from mains voltage variations.
- 7) Least possible coupling between input and oscillator circuits (inductive effect).



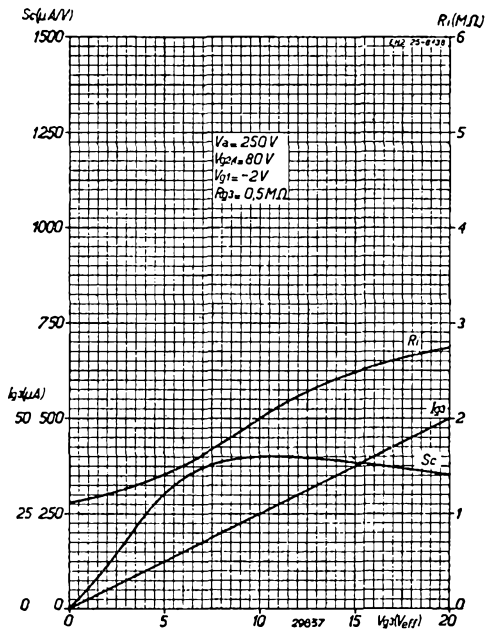

Fig. 4 Conversion conductance, internal resistance and oscillator current as a function of the oscillator voltage on grid 3, with 250 V anode, 80 V screen and -2 V bias on grid 2.

1) In the EH 2 the required conversion conductance is ensured by the high conductance of the 1st grid with respect to the anode current (when using this valve as a straight amplifier and at  $V_{g3} = 0$ ). This conductance is 1.8 mA/V.

2) With regard to the required oscillator voltage, the characteristic of the conductance of the first grid in relation to the anode current, as a function of the voltage on the 3rd grid, is the deciding factor. The more steeply this characteristic drops when the bias on the 3rd grid ( $V_{g3}$ ) is increased, the lower the peak oscillator voltage on the grid. Due to the particular construction of the first grid, this conductance is so high that when grids 2 and 4 are given a potential of 100 V the oscillator voltage necessary for the normal conversion conductance is approximately 14 V, which can be supplied by any ordinary oscillator. Figs 3 and 4 reproduce the

conversion conductance as a function of the oscillator voltage and these figures show that the values at very much lower oscillator voltages are still quite reasonable. This is important for short-wave reception.

3) The question of transit time current has also been satisfactorily dealt with. The electrons encounter a certain amount of delay in the field between grids 2 and 3, but at very high frequencies some of them, as a result of the alternating field produced by the oscillator voltage on grid 3, acquire so much kinetic energy that, despite the negative bias on grid 1,

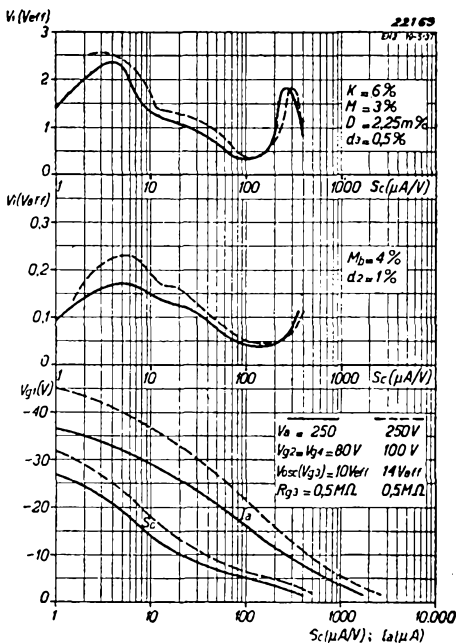

Fig. 5 Upper diagram. EH 2 used as a frequency changer. Alternating input voltage as a function of the conversion conductance as controlled by the bias on grid 1, with 6 % cross-modulation. Centre diagram. Alternating input voltage as a function of the conversion conductance as controlled by the bias on grid 1, with 4 % modulation hum. Lower diagram. Conversion conductance and anode current as a function of the bias on grid 1

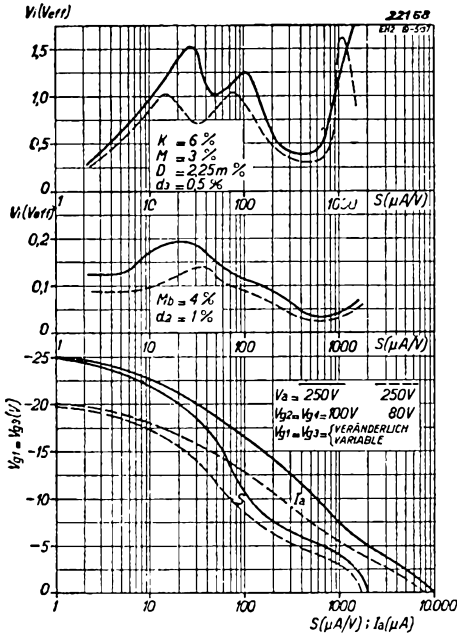

Fig. 6

EH 2 used as an R.F. or I.F. amplifier.  
Upper diagram. Alternating input voltage as a function of the mutual conductance when controlled by a similar bias on grids 1 and 3, with 6% cross-modulation.  
Centre diagram. Alternating input voltage as a function of the mutual conductance when controlled by the bias on grids 1 and 3, with 4% modulation hum.  
Lower diagram. Mutual conductance and anode current as a function of the bias on grids 1 and 3.

to mains voltage fluctuations that may be regarded as extremely slight. The drift arising from variations in the mutual conductance is also very small, since this is caused by differences in the capacitance of grid 3 which in themselves are negligible.

7) The heptode EH 2 will not produce any electrical coupling effects between oscillator and input grids, because grid 3 in no way influences the electrons in the neighbourhood of grid 1:

Fig. 7

Anode current as a function of the voltage on grid 1. EH 2 used as a frequency-changer.

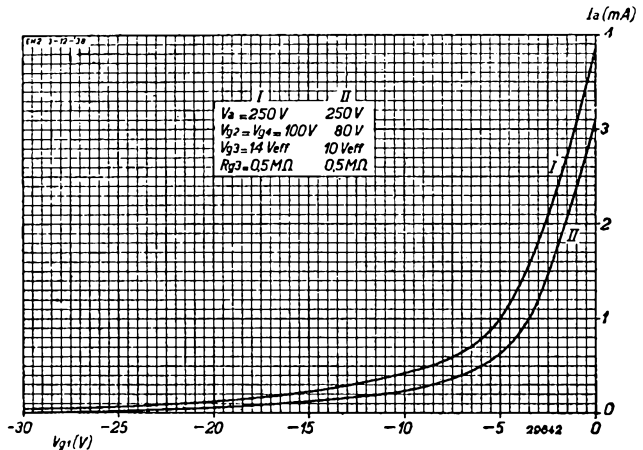

they return in the direction of this grid: this will take place when the period of the alternating field corresponds in order of size to that of the transit time required by the electron between these grids. This transit time is reduced by making the space between grids 3 and 2 small, but normally this procedure has an adverse effect on other properties of a heptode and in this respect the EH 2 represents the best possible compromise.

4) The parallel input impedance in the short-wave range shows a considerable improvement over other types, by reason of the very small spacing of  $g_1 - k$  and  $g_2 - g_1$ . At 15 metres and on a signal frequency of 500 kc/s above the oscillator frequency ( $f_{osc} = f_i + 500$  kc/s) the following values of input impedance and capacitance were obtained by actual measurement:

$$R_{input} = 30,000 \text{ ohms}$$

$$C_{input} = 6.3 \mu\mu F$$

5) In the development of the EH 2 every effort has been made to keep the noise factor as low as possible, whether the valve be used as frequency-changer or as R.F. amplifier. As will be seen from Figs 5 and 6, the alternating input voltage with 6% cross-modulation, when under the effect of control, is in either case less than  $0.3 V_{eff}$ .

6) When used with a separate oscillator valve, the valve has a frequency drift due

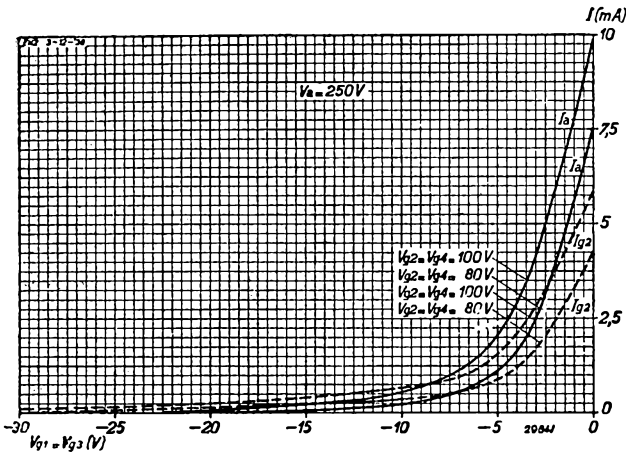

Fig. 8  
Anode and screen-grid current as a function of the voltage on grids 1 and 3 when using the EH 2 as R.F. or I.F. amplifier.

there is therefore no negative capacitance between grids 1 and 3. The normal capacitance exists between the electrodes mutually, this being about  $0.2 \mu\mu F$ , which on very short waves does result in retroaction from the oscillator voltage to the

input circuit, although if the oscillator frequency is taken higher than the input frequency this will not affect the performance of the valve.

**HEATER RATINGS**

Heating: indirect, A.C. or D.C., series or parallel supply.

Heater voltage . . . . .	$V_f = 6.3 V$
Heater current . . . . .	$I_f = 0.200 A.$

**CAPACITANCES**

$C_{ag1}$	$< 0.0015 \mu\mu F$
$C_{g1}$	$= 5 \mu\mu F$
$C_u$	$= 11 \mu\mu F$
$C_{g1g3}$	$= 0.2 \mu\mu F$

**OPERATING DATA: EH 2 used as frequency-changer**

Anode voltage . . . . .	$V_a = 250$	250 V
Screen-grid voltage . . . . .	$V_{g2,3} = 100$	80 V
Grid leak, oscillator . . . . .	$R_{g3} = 0.5$	0.5 M ohm
Oscillator voltage, grid 3 . . . . .	$V_{osc} = 14$	10 $V_{eff}$
Cathode resistor . . . . .	$R_k = 530$	380 ohms
Grid bias . . . . .	$V_{g1} = -3 \quad -25$	$-2 \quad -20 V$
Anode current . . . . .	$I_a = 1.85$	1.8 mA
Screen current . . . . .	$I_{g2} + I_{g3} = 3.8$	3.5 mA
Conversion conductance . . . . .	$S_c = 400$	$< 10 \quad 400 \quad < 10 \mu A/V$
Internal resistance . . . . .	$R_i = 2$	$> 10 \quad 2 \quad > 10 M ohms$

**OPERATING DATA: EH 2 used as R.F. or I.F. amplifier**

Anode voltage . . . . .	$V_a = 250$	250 V
Screen-grid voltage . . . . .	$V_{g2} = V_{g3} = 100$	80 V
Cathode resistor . . . . .	$R_k = 430$	310 ohms
Grid bias . . . . .	$V_{g1} = V_{g3} = -3 \quad -25$	$-2 \quad -20 V$
Anode current . . . . .	$I_a = 4.2$	4 mA
Screen current . . . . .	$I_{g2} + I_{g3} = 2.8$	2.5 mA
Mutual conductance . . . . .	$S = 1400$	$< 2 \quad 1400 \quad < 2 \mu A/V$
Internal resistance . . . . .	$R_i = 1$	$> 10 \quad 1 \quad > 10 M ohms$

**MAXIMUM RATINGS**

$V_{a0}$	= max. 550 V	$V_{g1}$ ( $I_{g1} = \pm 0.3 \mu A$ )	= max. -1.3 V
$V_a$	= max. 250 V	$V_{g3}$ ( $I_{g3} = \pm 0.3 \mu A$ )	= max. -1.3 V
$W_a$	= max. 1.5 W	$R_{g1} = R_{g3}$	= max. 2.5 M ohms
$V_{g20} = V_{g40}$	= max. 400 V	$I_k$	= max. 10 mA
$V_{g2} = V_{g4}$	= max. 125 V	$R_{fk}$	= max. 5,000 ohms
$W_{g2} = W_{g4}$	= max. 0.5 W	$V_{fk}$	= max. 100 V <sup>1)</sup>

**APPLICATIONS**

**A) R.F. OR I.F. AMPLIFIER WITH VARIABLE SLOPE**

A potential divider should be given preference for feeding the screen grids (grids 2 and 4) and the slope is best controlled by applying the same control voltage to both grids 1 and 3; if the latter grid is controlled by an attenuator (potential divider) giving a lower voltage, the control range is increased, but as the cross-modulation characteristic is identical in both instances this arrangement offers no advantages.

The metallizing of the envelope is connected to a separate contact on the base of the valve and, generally speaking, this should be carried. The usual care must be taken with respect to the screening of the leads and the arrangement of the wiring, and the supply lines should be decoupled by means of filters. Fig. 9 shows the circuit diagram of this valve employed as a variable-mu I.F. amplifier.

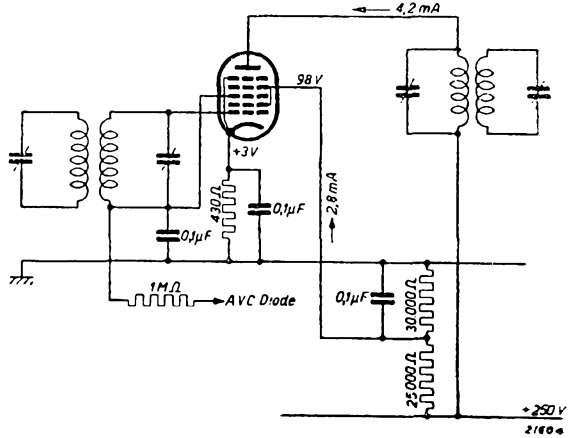

Fig. 9  
Circuit diagram of the EH 2 used as an I.F. amplifier, with the same control voltage applied to grids 1 and 3.

**B) VARIABLE-MU MODULATOR**

Fig. 10 shows the circuit of the EH 2 used as a modulator, with the EBC 3 as oscillator, although the EF 6, connected as a triode, can also be employed for this purpose. This circuit will give satisfactory results at wavelengths of 5 m; it is preferable to couple the tuned oscillator circuit to the anode of the oscillator valve. The oscillator is coupled to grid 3 of the heptode EH 2 through a capacitor of 20 to 50 μμF, the latter being the best value for "all-wave" reception.

For wavelengths of 5 to 12 metres the oscillator coil may be made from about 4½ turns of wire on an inside diameter of approximately 10 mm, not too closely wound and without an iron core. Tinned copper wire must not be used for this purpose and the leads from the coils to the tuning capacitor should be as short as possible. The coupling coil may also consist of 4½ turns of silk-covered wire about 0.1 mm in diameter, wound directly on the anode-circuit coil. A resistor of 40 ohms in series with the grid of the oscillator will prevent over-oscillation at the lower end of the wave-range.

<sup>1)</sup> direct voltage or effective value of the alternating voltage.

When the EF 6 is used as oscillator the oscillator voltage will be somewhat higher and, in the short-wave range, in contrast with octodes such as the EK 2. the oscillator frequency should be higher than the input frequency, as is usual on the medium and long waves. The other coupling, established by the capacitance between  $g_1$  and  $g_3$ , then provides a voltage across the input circuit of the same frequency as the oscillator, and the phase of this voltage is such that it tends to augment the conversion amplification. In the uncontrolled condition the bias on grid 1 should be  $-2$  V with 80 V on screens 2 and 4, or  $-3$  V with 100 V on the screens. The control voltage from the A.G.C. is in this case applied only to the first grid. The two screens (2 and 4) should be fed from a generously proportioned potential divider.

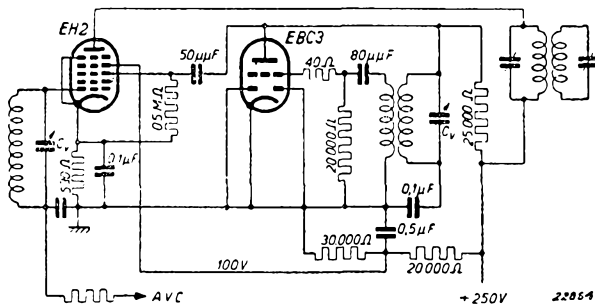

Fig. 10  
Circuit diagram of the EH 2 used as frequency-changer with the EBC 3 as oscillator

# EK 2 Octode

The EK 2 is a six-grid frequency-changer, employing the principle of electronic mixing; the small dimensions and particular internal construction of this valve provide the following advantages:

- 1) The electronic coupling effect met with especially on short waves is for the greater part counteracted by a capacitor between the first and fourth grids, the object of this capacitor being to compensate, with a positive capacitance, the apparent negative capacitance produced by electronic coupling.
- 2) Small dimensions and narrow spacing of the electrodes practically eliminates transit-time effects in the range of very short waves.
- 3) The parallel input resistance between control grid and cathode is very high, even on the very short waves, and its effect on the amplification may therefore be ignored.
- 4) Background noise, which is proportional to the root of the anode current divided by the mutual conductance, is only very slight.
- 5) The performance of the valve from the point of view of absence of whistles is extremely good.

6) Interference due to cross-modulation or modulation-distortion when control is applied to the valve is a minimum.

7) The internal resistance is more than 1 megohm and permits the use of very good quality I. F. circuits, giving a high degree of gain.

8) Microphony is so slight that it may be ignored in the design of a receiver.

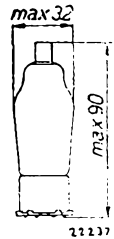

Fig. 1  
Dimensions in mm.

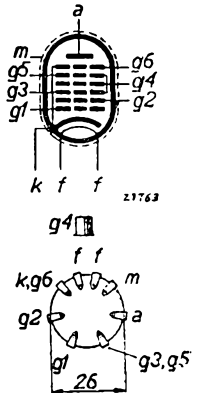

Fig. 2  
Arrangement of electrodes and base connections.

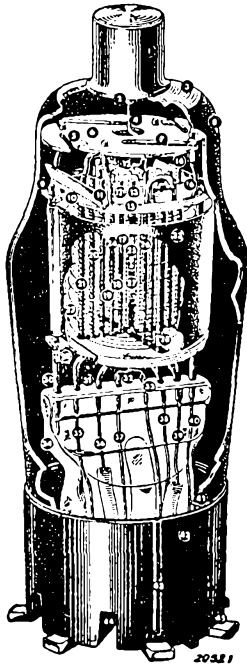

Fig. 3  
Construction of the new octode EK 2. The capacitor for the compensation of inductive effect is shown at 12.

## HEATER RATINGS

Heating: indirect; A.C. or D.C., series or parallel supply.  
 Heater voltage . . . . .  $V_f = 6.3$  V  
 Heater current . . . . .  $I_f = 0.200$  A

## CAPACITANCES

- |            |                         |            |                         |
|------------|-------------------------|------------|-------------------------|
| $C_{ag4}$  | $< 0.07 \mu\mu\text{F}$ | $C_{g2}$   | $= 4.5 \mu\mu\text{F}$  |
| $C_a$      | $= 10 \mu\mu\text{F}$   | $C_{g2g4}$ | $< 0.25 \mu\mu\text{F}$ |
| $C_{g1}$   | $= 6.0 \mu\mu\text{F}$  | $C_{g4}$   | $= 8.8 \mu\mu\text{F}$  |
| $C_{g1g4}$ | $= 1.1 \mu\mu\text{F}$  |            |                         |

## OPERATING DATA (for medium- and long-wave operation)

Anode voltage						
$V_a =$	100 V					200—250 V
Screen-grid voltage						
$V_{g3,5} =$	50 V					50 V
Oscillator-anode voltage						
$V_{g2} =$	100 V					200 V
Oscillator grid leak						
$R_{g1} =$	50,000 ohms					50,000 ohms
Oscillator voltage, grid 1						
$V_{osc} =$	9 $V_{eff}$					15 $V_{eff}$
Oscillator grid current						
$I_{g1} =$	200 $\mu A$					300 $\mu A$
Cathode resistor						
$R_k =$	570 ohms					490 ohms
Bias, grid 4						
$V_{g4} =$	-2 V <sup>1)</sup>	-15 V <sup>2)</sup>	-20 V <sup>3)</sup>	-2 V <sup>1)</sup>	-15 V <sup>2)</sup>	-20 V <sup>3)</sup>
Anode current						
$I_a =$	1 mA	—	—	1 mA	—	—
Screen-grid current						
$I_{g3} + I_{g5} =$	1 mA	—	—	1.1 mA	—	—
Oscillator-anode current						
$I_{g2} =$	1.5 mA	—	—	2.5 mA	—	—
Conversion conductance						
$S_c =$	550	5.5	2	550	5.5	2 $\mu A/V$
Internal resistance						
$R_i =$	1.2	> 10	> 10	2	> 10	> 10 M ohms
Conductance, grid 1 with respect to grid 2 ( $V_{osc} = 0$ )						
$S_{g1/g2} =$	0.3 mA/V	—	—	0.4 mA/V	—	—
Direct current, oscillator anode at commencement of oscillation ( $V_{osc} = 0$ )						
$I_{g2} =$	3.2 mA	—	—	5.5 mA	—	—

1) Without control

2) Conductance reduced to one-hundredth of uncontrolled value

3) Extreme limit of control

OPERATING DATA (for reception on all wavelengths) <sup>1)</sup>

Anode voltage	$V_a$	=	100 V		200—250 V
Screen-grid voltage	$V_{g3,5}$	=	80 V		80 V
Oscillator-anode voltage	$V_{g2}$	=	100 V		200 V
Oscillator grid leak	$R_{g1}$	=	16,000 ohms		50,000 ohms
Oscillator voltage, grid 1	$V_{osc}$	=	6 $V_{eff}$		9 $V_{eff}$
Oscillator grid current	$I_{g1}$	=	300 $\mu A$		200 $\mu A$
Cathode resistor	$R_k$	=	395 ohms		525 ohms
Bias, grid 4	$V_{g4}$	=	$-3 V^1)$ $-26 V^2)$ $-40 V^3)$ $-4 V^1)$ $-26 V^2)$ $-40 V^3)$		
Anode current	$I_a$	=	2.5 mA	—	1.7 mA
Screen-grid current	$I_{g3} + I_{g5}$	=	2.8 mA	—	1.3 mA
Oscillator-anode current	$I_{g2}$	=	2.3 mA	—	4 mA
Conversion conductance	$S_c$	=	550 $\mu A/V$	5.5	1
Internal resistance	$R_i$	=	0.65	> 10	> 10
Conductance grid 1 with respect to grid 2 ( $V_{osc} = 0$ )	$S_{g1g2}$	=	0.35	—	0.9
Direct current, oscillator anode at commencement of oscillation ( $V_{osc} = 0$ )	$I_{g2}$	=	4 mA	—	9 mA

<sup>1)</sup> Without control   <sup>2)</sup> Conductance reduced to one-hundredth of uncontrolled value   <sup>3)</sup> Extreme limit of control   <sup>4)</sup> In view of the possibility of frequency drift, the valve should not be controlled in the short-wave range.

MAXIMUM RATINGS

$V_{a0}$	= max. 550 V	$W_{g2}$	= max. 1.3 W
$V_a$	= max. 250 V	$I_k$	= max. 12 mA
$W_a$	= max. 1.0 W	$V_{g4}$ ( $I_{g4} = \pm 0.3 \mu A$ )	= max. -1.3 V
$V_{g3,50}$	= max. 550 V	$R_{g4k}$	= max. 2.5 M ohms
$V_{g3,5}$	= max. 125 V	$R_{g1k}$	= max. 100,000 ohms
$W_{g3,5}$	= max. 0.3 W	$R_{jk}$	= max. 5,000 ohms
$V_{g20}$	= max. 550 V	$V_{fk}$	= max. 100 V <sup>1)</sup>
$V_{g2}$	= max. 225 V		

<sup>1)</sup> Direct voltage or effective value of alternating voltage.



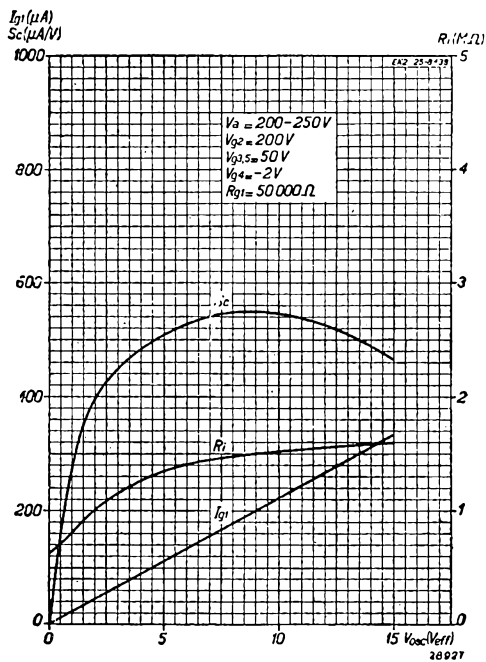

Fig. 4  
Conversion conductance  $S_c$ , internal resistance  $R_i$  and oscillator-grid current  $I_{g1}$  as a function of the oscillator voltage, with  $V_{g_2} = 200$  V and  $V_{g_{2,5}} = 50$  V.

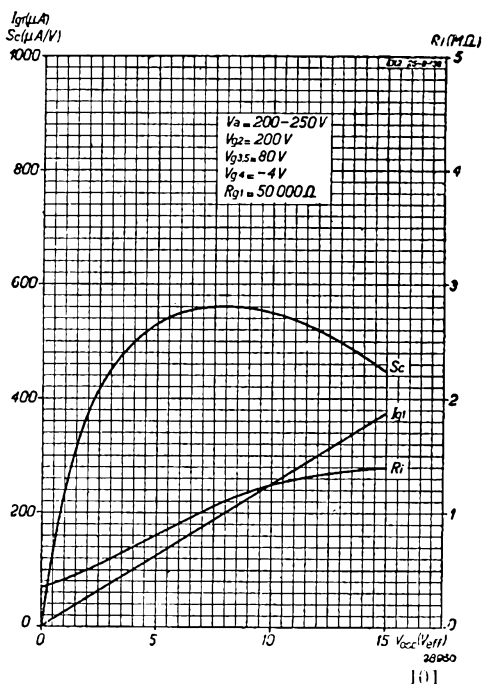

Fig. 5  
Conversion conductance  $S_c$ , internal resistance  $R_i$  and oscillator-grid current  $I_{g1}$  as a function of the oscillator voltage, with  $V_{g_2} = 200$  V and  $V_{g_{2,5}} = 80$  V.

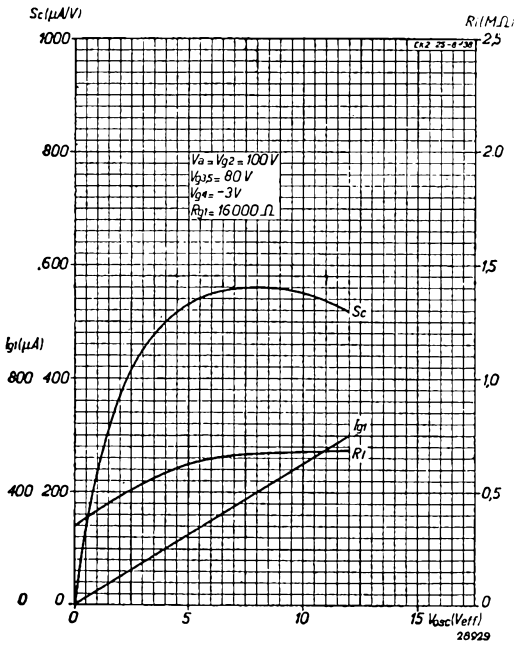

Fig. 6  
Conversion conductance  $S_c$ , internal resistance  $R_i$  and oscillator-grid current  $I_{g1}$  as a function of the oscillator voltage, with  $V_{g2} = 100 V$  and  $V_{g3,5} = 80 V$ .

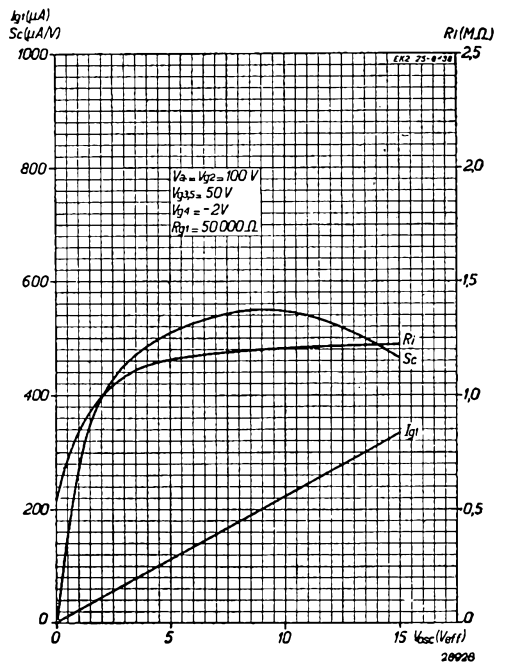

Fig. 7  
Conversion conductance  $S_c$ , internal resistance  $R_i$  and oscillator-grid current  $I_{g1}$  as a function of the oscillator voltage, with  $V_{g2} = 100 V$  and  $V_{g3,5} = 50 V$ .

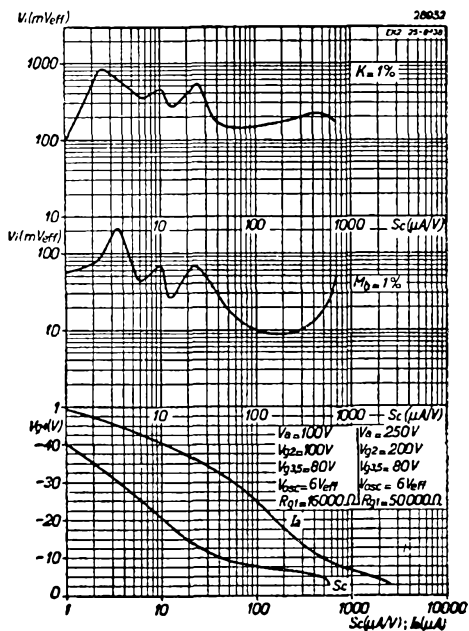

Fig. 8

Upper diagram. Alternating input voltage as a function of the conversion conductance controlled by the bias on grid 4, with 1% cross-modulation.

Centre diagram. Alternating input voltage as a function of the conversion conductance controlled by the bias on grid 4, with 1% modulation hum.

Lower diagram. Anode current and conversion conductance as a function of the bias on grid 4.

The supply for the various electrodes should be derived preferably from a high-value potential-divider network, although, naturally, it is also possible to apply the voltages through series resistors of sufficiently high value. As the oscillator unit functions just as easily without bias (i.e.  $V_{g1} = 0$ ), the grid leak of the EK 2 can be connected directly to the cathode. A value of 15  $V_{eff}$  for the oscillator voltage guarantees efficient working with very little back-ground noise and, in the medium- and long-wave ranges, this value can usually be attained without any difficulty. It is possible, however, that the reaction at 600 metres may need to be so tight that at 200 metres the oscillator voltage would be twice as much and this may tend to cause periodical interruption of the oscillation (squegging).

This effect was formerly met with in simple types of receiver with reaction, manifesting itself as a troublesome variation in reception, or else a host of whistles when the set was being tuned to certain stations, this being actually due to very rapid cessation and re-commencement of the oscillation. Squegging may be prevented by, inter alia, reducing the number of turns on the reaction coil; the oscillator voltage at the upper end of the wave-range will then certainly be slightly lower than normal, but from the characteristic of the conversion conductance as a function of the oscillator voltage (Fig. 4) it will be seen that at about 9 or 10  $V_{eff}$  the slope is even better than at 15  $V_{eff}$ . In order to stabilize the oscillator voltage throughout the whole range a damping resistor is frequently connected in parallel with the coupling coil.

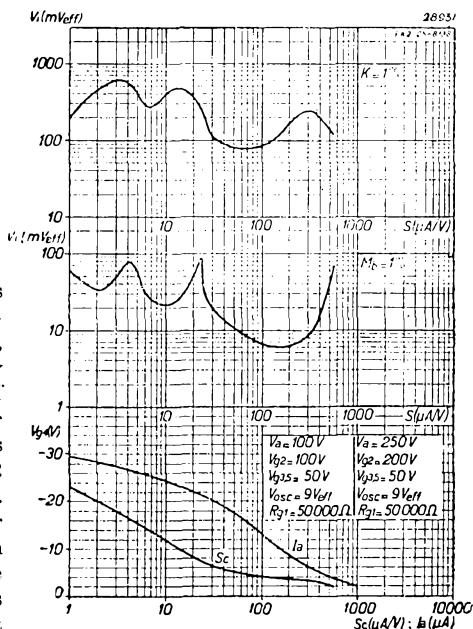

Fig. 9

Upper diagram. Alternating input voltage as a function of the conversion conductance controlled by the bias on grid 4, with 1% cross-modulation.

Centre diagram. Alternating input voltage as a function of the conversion conductance with 1% modulation hum.

Lower diagram. Anode current and conversion conductance as a function of the bias on grid 4.

Another remedy is to employ lower values of grid capacitor and leak for the oscillator section of the valve and this gives excellent results in the short-wave range; satisfactory values are about  $50 \mu\mu\text{F}$  for the grid capacitor and 50,000 ohms for the leak. Since  $50 \mu\mu\text{F}$  is really too low for good long-wave reception (a value of about 200 to 1000  $\mu\mu\text{F}$  is usually preferred), the value of the grid leak may be reduced in all-wave receivers, instead of using a smaller capacitor, e.g., 10,000 or 16,000 ohms (see also data relevant to the latter value).

At the same time this resistor must not be in parallel with the oscillator circuit, as this damps the latter too much; Fig. 11 illustrates the proper arrangement, whilst Fig. 12 shows a circuit in which a lower value of grid leak is employed with the padding capacitor serving also as grid capacitor; this again results in less damping of the oscillator circuit. If the value of the padding capacitor  $C_p$  is too low, however, damping will still occur and in "all-wave" receivers the circuit depicted in Fig. 13 is recommended.

Here a grid leak of 50,000 ohms is used for the broadcast range and 10,000 ohms for the short waves. If a padding capacitor  $C_p$  is also to be included on short waves

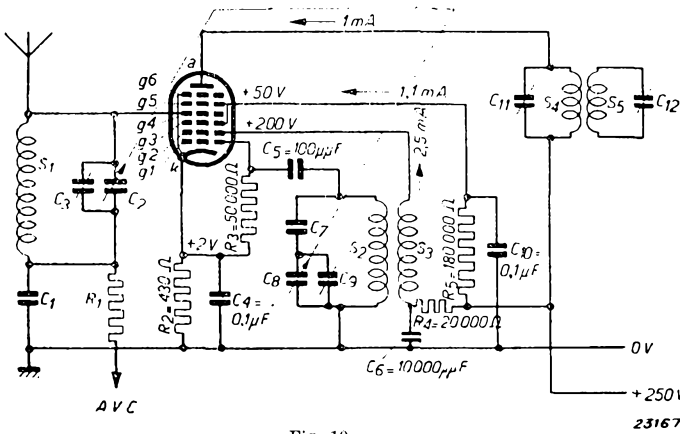

Fig. 10  
Circuit diagram showing the application of the EK 2.

this will generally be of a high value, to provide adequate earthing of the circuit.

In the short-wave range it is not so simple to obtain a sufficiently high oscillator voltage, and the following values are recommended:

- $V_{g2} = 200 \text{ V}$
- $V_{g3,5} = 80 \text{ V}$

This generally provides an oscillator voltage of 5 to  $6 V_{\text{eff}}$ , but if the

magnification of the circuits is very good this potential will be higher. It is not good practice to aim at producing extra high voltages for short-wave reception, as the tuned input circuit of the octode will then tend to oscillate; an oscillator voltage of 5 to  $6 V_{\text{eff}}$  is quite good and the valve can best be made to operate on this value.

Frequency drift is especially troublesome in the short-wave range; whilst theoretically almost negligible in the broadcast bands, this factor must certainly be taken into account in short-wave operation. Drift due to mains voltage fluctuations is so slight as to make no difference on short-waves; at a wavelength of 13 metres it is only 5 kc/s. On the other hand, frequency drift in the 13—50 m band caused by variations in the bias on the

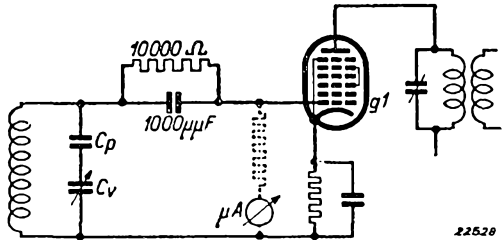

Fig. 11  
Circuit employing a low value of grid leak (10,000 ohms). The method of measuring the amplitude of the oscillator voltage by means of the grid current is also shown.

fourth grid is so great that control must not be applied in that range. If, despite this fact, control is to be employed, it is essential to use a separate triode as oscillator, although it is much better to omit the control from the mixing valve and precede the octode by a variable-mu R.F. amplifier pentode, applying the control to that valve. Without this R.F. amplifier the sensitivity in the short-wave range is not very high and it is therefore sufficient to control the I.F. valve only.

Since suppression of the image-frequency in short-wave reception (due to the lower magnification of the R.F. circuits in that range) is more difficult than in the broadcast wave-bands, it is advisable in receivers for short-wave reception to employ a high intermediate frequency (450—475 kc/s), which is, moreover, advantageous in suppressing electronic coupling. At lower intermediate frequencies it

is good practice, in order to simplify balancing of the circuits, to detune the input stage by about 500 kc/s at the lower end of the wave-range, i.e., to increase the difference between the oscillator and input frequencies by 500 kc/s. This has practically no effect on the sensitivity, but it does facilitate the trimming. In the broadcast range the oscillator frequency should be higher than that of the input, or it will not be found possible to cover the whole of the range, but on short waves, in view of electronic coupling, the situation should be reversed.

The inclusion of a small compensating capacitor definitely reduces the inductive effect but does not entirely eliminate it, since too much compensation causes the input circuit to oscillate. In the 13—50 m band the padding capacitor is often omitted, the difference in frequency being obtained from differences in the self-inductance and trimming capacitor; the oscillator frequency can therefore be lower than the input frequency also in this range.

The tuned oscillator circuit must be coupled to the first grid and the reaction coil to the second (oscillator anode). The EK 2 may also be used successfully as a self-oscillating mixer valve in the 5—13 m wave-band, but this range cannot be fully covered without the use of switches. The oscillator can be maintained in oscillation only over a small part of this range, for instance from 6 to 8 metres, but for that matter it would be difficult to include the whole range of from 5 to 15 m on a single scale. Fig. 14 shows the construction of a coil suitable for use between 6 and 8 metres and, for the rest, extreme accuracy and simplicity of controls are essential features.

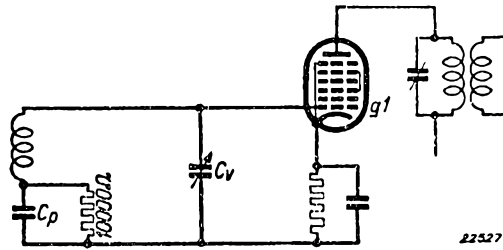

Fig. 12  
Circuit for low value of grid leak, with padding capacitor in series with the coil.

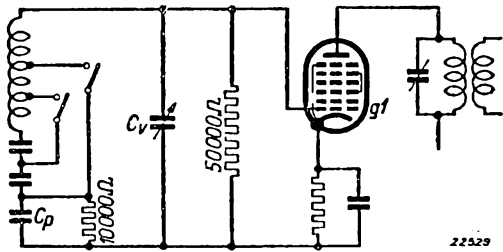

Fig. 13  
Diagram of oscillator circuit with low-value grid leak, and low-value padding capacitor for medium and long-wave reception.

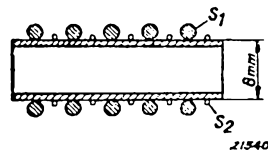

Fig. 14  
Oscillator coil for use on very short waves (6 to 8 metres). S<sub>1</sub> = 5 turns of 2 mm bare copper wire (not tinned). S<sub>2</sub> = 5 turns of 0.1–0.2 mm enamelled copper wire.

# EK 3 Octode

The EK 3 is an octode frequency-changer the characteristics of which show a considerable improvement over those of the EK 2; certain forms of interference are here reduced to a minimum by means of electronic bunching.

This valve gives an equally high conversion amplification in the short-wave band and in the ordinary broadcast ranges. In comparison with other frequency-changers the EK 3 offers many advantages. The principle of electronic bunching makes it possible to separate the oscillator unit from the mixing section as completely as though two separate valves were involved. Four electron bunches are formed, two for generating the oscillation and two for the mixing, and the two functions are to such an extent independent of each other that interaction is practically impossible. Fig. 3 shows a cross-section through the system of electrodes, together with the different electron streams. The advantages of this 4-channel system are as follows:

- 1) Frequency drift caused by mains voltage fluctuations, or variation of the bias on grid 4, is extremely slight.
- 2) Constant oscillator slope on very short wavelengths.

The almost perfect screening of the oscillator section of the EK 3 means that electrons returned to the 4th grid as a result of the control have no effect whatever on the space charge and slope of the oscillator unit; frequency drift arising from control on the valve is thus avoided and the EK 3 can therefore be included in the A.G.C., even on the short-wave range.

This screening of the oscillator unit is accompanied by the following advantages:

- a) the space charge between grid 1 and the cathode, and between grids 2 and 1, does not vary when the bias on grid 4 is altered.
- b) The mutual conductance of grid 1 with respect to grid 2 is not affected by the bias on grid 4.

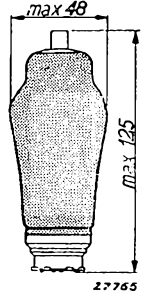

Fig. 1  
Dimensions in mm.

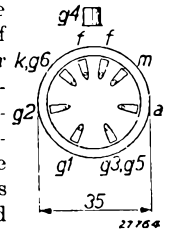
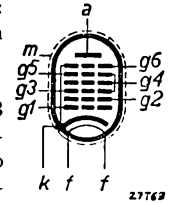

Fig. 2  
Arrangement of electrodes and base connections.

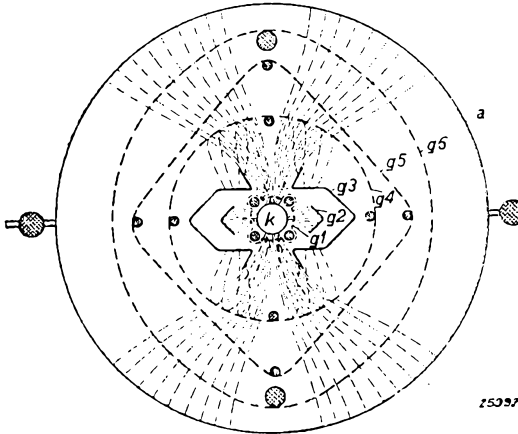

Fig. 3

Cross-section of the system of electrodes in the EK 3, showing the electron streams. The two bunches to left and right serve to generate the oscillation. The oscillator voltage thus occurs on grid 1 and the two streams flowing upwards and downwards are modulated by this voltage. The oscillator section is surrounded by a screen having in it two slots through which the bunches of electrons are directed; this screen is maintained at a positive potential and functions as a third octode grid. Electrons leaving the oscillator section are deflected to a certain extent before they reach the 4th grid. Any electrons that may be repelled back cannot re-enter the oscillator section but return to the screen surrounding the oscillator.

c) The mutual conductance of grid 4 with respect to grid 2 may be entirely ignored. Interference due to undesired coupling between the input circuit and the oscillator is thus avoided; coupling of this kind will often set up an oscillation in the input circuit of the valve as well as relaxation oscillations caused by frequency drift.

The oscillator anode consists of two V-shaped plates and the electron streams directed towards these are held by them. variations in the direct voltage on grid  $g_3$  being prevented from influencing the oscillator unit in any way. The short path of the electrons from the cathode to the auxiliary anode plates ensures very short transit-times in the oscillator section; this effect is so pronounced that the oscillator conductance corresponds to the statically measured slope, even at very short wavelengths.

The static conductance of grid 1 with respect to grid 2 is extremely high, being 4 mA/V at the threshold of oscillation, for which reason the coupling of the components in the oscillatory circuit may be fairly loose; the valve capacitances then only play a very small part in the detuning of the oscillator frequency. Measures have been taken in the design of the valve to reduce the inductive effect (electronic coupling between grids 1 and 4) and the amount of interference met with under this head is

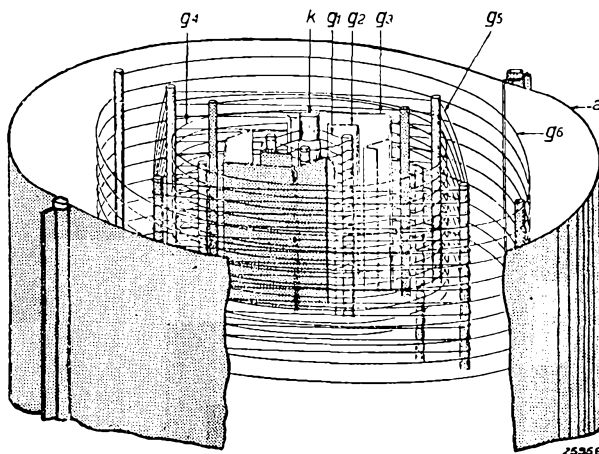

Fig. 4  
Details of construction of the 4-channel octode.

extremely small. A capacitor in series with a resistor is connected between grids 1 and 4, the function of the resistor being to make the phase angle of the alternating voltage, as applied to grid 4 through the capacitor, exactly equal to that of the induced voltage arising from the transit time of the electrons passing from grid 1 to grid 4; the conversion amplification at the lower end of the different wave-

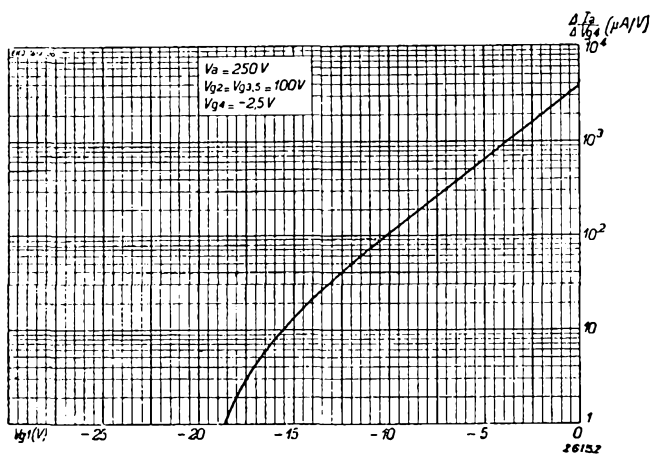

Fig. 5  
Conversion of the 4th grid as a function of the direct voltage on grid 1

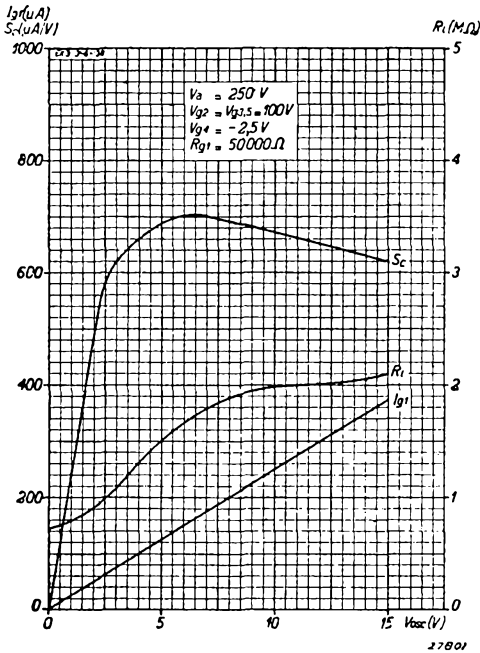

Fig. 6

Internal resistance, conversion conductance and oscillator-grid current as a function of the oscillator voltage when a grid leak of 50,000 ohms is used.

ance curve and the amplification of the sidebands is not uniform; the resultant asymmetry tends to cause considerable distortion in the detector.

In the EK 3 such capacitive variations are very small, namely only 0.2  $\mu\mu F$ , and the consequent detuning effect is only slight, in any case within the limits for the normal broadcast bands.

If a better cross-modulation characteristic is required it should be noted that the conductance of the EK 3 drops less sharply when a control voltage is applied to the 4th grid.

The high conductance of the oscillator unit and increased conversion conductance necessitate a high power cathode and the heater current is accordingly well above 200 mA, being actually 0.6 A; this valve cannot therefore be used in A.C./D.C. receivers, for which purpose a special valve with a 200 mA filament for series operation has been developed.

ranges is hardly influenced at all by the effect in question.

The input impedance of the EK 3 in the short-wave bands is very high in comparison with the impedance of the normal receiver circuit, and its effect on the amplification may therefore be ignored. At a wavelength of 14 metres the impedance is about 60,000 ohms. The input capacitance is different for every value of control voltage applied to the grid, because variations are produced in the density of the space charge in front of the grid and these variations tend to detune the circuit coupled to the grid and reduce the sensitivity of the receiver. Furthermore, the R.F. signal in this case does not occur at the centre of the reson-

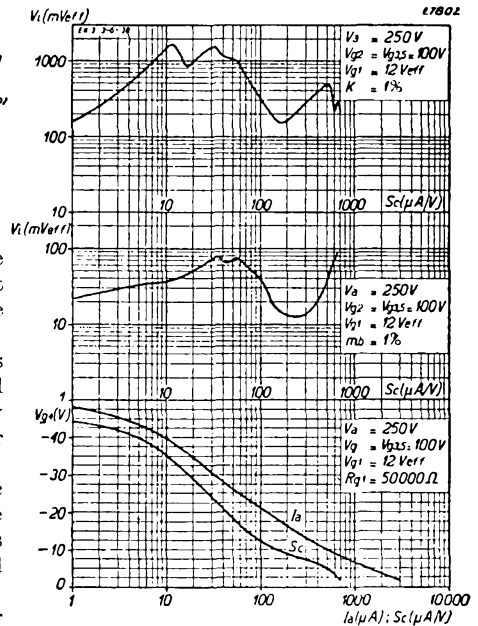

Fig. 7

Upper diagram. Alternating input voltage as a function of the conversion conductance controlled by the bias on grid 4, with 1% cross-modulation.

Centre diagram. Alternating input voltage as a function of the conversion conductance controlled by the bias on grid 4, with 1% modulation hum.

Lower diagram. Anode current and conversion conductance as a function of the bias on grid 4.



## HEATER RATINGS

Heating: indirect, A.C., parallel supply.

Heater voltage . . . . .	$V_f = 6.3 \text{ V}$
Heater current . . . . .	$I_f = 0.6 \text{ A}$

## CAPACITANCES

$C_{ag4} < 0.07 \mu\mu\text{F}$	$C_{g1g4} = 1.1 \mu\mu\text{F}$
$C_a = 16.5 \mu\mu\text{F}$	$C_{g2} = 8.6 \mu\mu\text{F}$
$C_{g1} = 14 \mu\mu\text{F}$	$C_{g3} = 15.2 \mu\mu\text{F}$

## OPERATING DATA: EK 3 employed as a frequency-changer for "all-wave" reception

Anode voltage . . . . .	$V_a = 250 \text{ V}$		
Screen-grid voltage . . . . .	$V_{g3,5} = 100 \text{ V}$		
Oscillator-anode voltage . . . . .	$V_{g2} = 100 \text{ V}$		
Oscillator grid leak . . . . .	$R_{g1} = 50,000 \text{ ohms}$		
Oscillatory voltage, grid 1 . . . . .	$V_{osc} = 12 \text{ V}_{eff}$		
Oscillator-grid current . . . . .	$I_{g1} = 300 \mu\text{A}$		
Cathode resistor . . . . .	$R_k = 190 \text{ ohms}$		
Bias, grid 4 . . . . .	$V_{g4} = -2.5 \text{ V}^1) -38 \text{ V}^2) -42 \text{ V}^3)$		
Anode current . . . . .	$I_a = 2.5 \text{ mA}$	—	—
Screen-grid current . . . . .	$I_{g3,5} = 5.5 \text{ mA}$	—	—
Oscillator-anode current . . . . .	$I_{g2} = 5 \text{ mA}$	—	—
Conversion conductance . . . . .	$S_c = 650$	6.5	3 $\mu\text{A/V}$
Internal resistance . . . . .	$R_i = 2$	$> 10$	$> 10 \text{ M ohms}$
Mutual conductance, grid 1 with respect to grid 2 ( $V_{osc} = 0$ ) . . . . .	$S_{g1g2} = 4 \text{ mA/V}$	—	—
Direct current, oscillator anode at threshold of oscillation ( $V_{osc} = 0$ ) . . . . .	$I_{g2} = 18 \text{ mA}$	—	—

1) Without control

2) Conversion conductance reduced to one-hundredth of uncontrolled value

3) Extreme limit of control

## MAXIMUM RATINGS

Anode voltage in cold condition . . . . .	$V_{a0}$	$= \text{max. } 550 \text{ V}$
Anode voltage . . . . .	$V_a$	$= \text{max. } 300 \text{ V}$
Anode dissipation . . . . .	$W_a$	$= \text{max. } 1 \text{ W}$
Screen voltage in cold condition . . . . .	$V_{g3,50}$	$= \text{max. } 550 \text{ V}$
Screen voltage . . . . .	$V_{g3,5}$	$= \text{max. } 150 \text{ V}$
Screen dissipation . . . . .	$W_{g3,5}$	$= \text{max. } 1 \text{ W}$
Oscill. anode voltage in cold condition . . . . .	$V_{g20}$	$= \text{max. } 550 \text{ V}$
Oscill. anode voltage . . . . .	$V_{g2}$	$= \text{max. } 150 \text{ V}$
Oscill. anode dissipation . . . . .	$W_{g2}$	$= \text{max. } 1 \text{ W}$
Cathode current . . . . .	$I_k$	$= \text{max. } 23 \text{ mA}$
Grid voltage at grid current start ( $I_{g1} = +0.3 \mu\text{A}$ ) . . . . .	$V_{g1}$	$= \text{max. } -1.3 \text{ V}$
Resistance in circuit of grid 4 . . . . .	$R_{g4k}$	$= \text{max. } 3 \text{ M ohms}$
Resistance in circuit of grid 1 . . . . .	$R_{g1k}$	$= \text{max. } 100,000 \text{ ohms}$
Resistance between filament and cathode . . . . .	$R_{fk}$	$= \text{max. } 20,000 \text{ ohms}$
Voltage between filament and cathode (direct voltage or effective value of alternating voltage) . . . . .	$V_{fk}$	$= \text{max. } 50 \text{ V}$

Because of the steep slope of the oscillator section it is not a difficult matter to establish and maintain the oscillation; the grid leak can therefore be connected to the cathode. The triode unit also oscillates readily and the reaction may with advantage be fairly loose; over-oscillation or squegging will then not occur. A grid leak of 50,000 ohms with a grid capacitor of 50  $\mu\mu\text{F}$  is recommended and will serve for all wavelengths.

In the EK 3 the inductive effect is counteracted by a form of compensation between grids 1 and 4, to which end it is necessary for the oscillator voltage at the lower end of the short-wave range to be 12 V (effective), (300  $\mu\text{A}$  grid current passes through the 50,000 ohm grid leak). On other wavelengths the oscillator voltage will, of course, be different and the compensation not quite so complete, but outside the short-wave range the inductive effect is so slight that it may otherwise be ignored.

The principle of electron bunching ensures that frequency drift is kept as low as possible; only the potential of the 3rd grid has any effect on the capacitance of the first, but this is to be expected, as the former surrounds the latter. If frequency drift

is to be minimized the voltage on the screen ( $V_{g3,5}$ ) must be stabilized by means of a potential divider passing a fairly considerable current; for practical purposes, however, there is a limit to this stabilization of the screen voltage. A useful method of eliminating any residual frequency drift consists in coupling the oscillator circuit to the anode circuit of the triode. Capacitive variations in the 1st grid then have less effect upon the tuning, provided that the reaction is not too tight, since the grid capacitance is induced in the oscillator circuit by way of this coil. This demonstrates clearly the importance of the high mutual

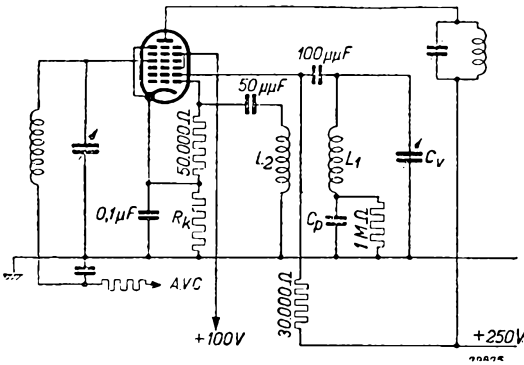

Fig. 8  
Circuit diagram showing the oscillatory circuit in the oscillator-anode circuit of the EK3, with the anode fed through a resistor of 30,000 ohms. The oscillator circuit is not accessible to the direct voltage.

conductance of this valve, since the coupling may be made extremely loose.

The circuit to be recommended from the point of view of frequency drift is that shown in Fig. 8, in which the oscillator circuit is not coupled directly to the anode circuit but by means of a capacitor of 100  $\mu\mu\text{F}$ . In this way the direct voltage of 100 V does not reach the plates of the tuning capacitor. The circuit is a simple one, but it has the drawback that it is damped by the feed resistor of 30,000 ohms, whereas damping of this circuit is the very thing to be avoided, since:

- 1) the coupling in the short-wave range should preferably be as loose as possible to avoid frequency drift;
- 2) on long waves extra damping is often provided in series with the padding capacitor on medium waves, expressly to prevent parasitic oscillation. In the great majority of cases the circuit depicted in Fig. 8 will present no difficulties.

If a padding capacitor  $C_p$  is connected in series with the oscillator coil (on the medium and long wave ranges), this should actually be by-passed by a high value resistor, to prevent a direct voltage from occurring across the tuning capacitor  $C_v$ .

Another method of feeding the oscillator anode is shown in Fig. 9, where the voltage is applied through the oscillator coil; the padding capacitor then serves simultane-

ously to block the voltage from the variable capacitor  $C_v$ . This circuit also has a disadvantage, in that extra contacts are required on the wave-change switch for connection to the padding capacitor  $C_p$ ; on the other hand, the damping of the oscillator circuit is not so heavy as in the circuit in Fig. 8. The latter, in which 5 turns of wire are used for the reaction coil, grids 3 and 5 being fed through a resistor, has given an actual measured frequency-drift value of only 4.5 kc/s at 15 m, this measurement being taken with control applied to the 4th grid, of from  $-2$  to  $-20$  V, in other words, under extremely adverse conditions. When the voltage for the screen  $V_{\mu 3,5}$  is taken from a potential divider the frequency drift is even less.

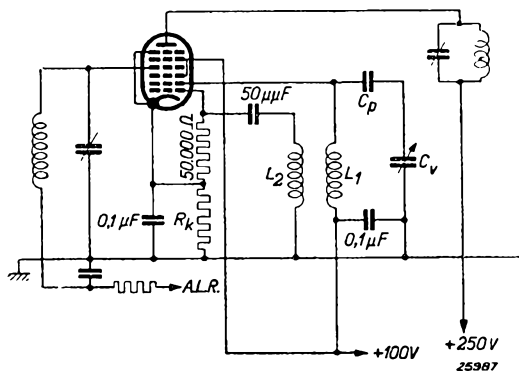

Fig. 9

Circuit diagram of oscillatory circuit in the oscillator-anode circuit, this anode being fed through the coil. The padding capacitor also serves to isolate the variable capacitor  $C_v$  from the direct voltage.

# EL 2 Output pentode

The EL 2 is an indirectly-heated, 8 W output pentode for use in car-radio receivers; the low heater-power consumption makes this valve very suitable for this purpose. With an anode and screen potential of 250 V, the mutual conductance is 2.8 mA/V at the working point. The cathode attains its full working temperature in a very short time, namely 18 seconds. The control-grid connection is at the top of the envelope.

## HEATER RATINGS

Heating: Indirect by battery current; series or parallel supply.  
 Heater voltage . . . . .  $V_f = 6.3$  V  
 Heater current . . . . .  $I_f = 0.2$  A

## CAPACITANCES

Anode to grid 1 . . . . .  $C_{ag1} < 0.6 \mu\text{F}$

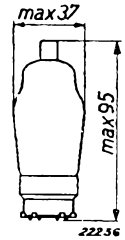

Fig. 1  
Dimensions in mm.

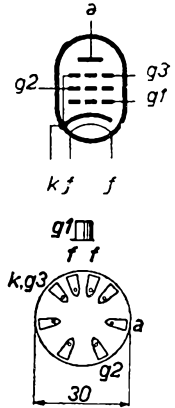

Fig. 2  
Arrangement of electrodes and base connections.

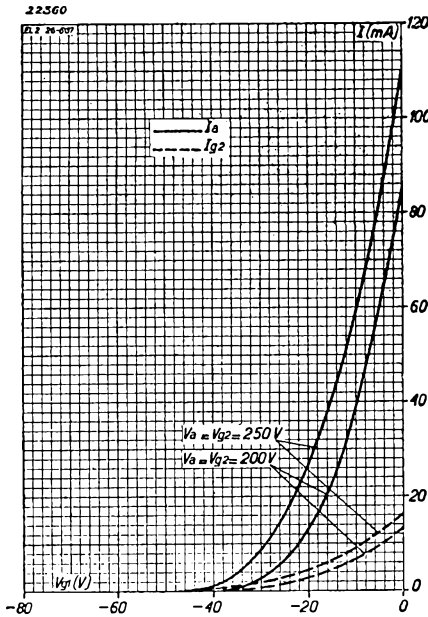

Fig. 3  
Anode and screen current as functions of the grid bias for equal anode and screen voltages of 200 V and 250 V.

**OPERATING DATA: EL 2 used as Class A output valve (single valve)**

Anode voltage . . . . .	$V_a$	= 200 V	250 V
Screen-grid voltage . . . . .	$V_{g2}$	= 200 V	250 V
Cathode resistor . . . . .	$R_k$	= 480 ohms	485 ohms
Grid bias . . . . .	$V_{g1}$	= -14 V	-18 V
Anode current . . . . .	$I_a$	= 25 mA	32 mA
Screen-grid current . . . . .	$I_{g2}$	= 4 mA	5 mA
Mutual conductance . . . . .	$S$	= 3 mA/V	2.8 mA/V
Internal resistance . . . . .	$R_i$	= 70,000 ohms	70,000 ohms
Load resistor . . . . .	$R_a$	= 8,000 ohms	8,000 ohms
Output with 10% distortion . . . . .	$W_o$	= 2.3 W	3.6 W
Alternating grid voltage with 10% distortion . . . . .	$V_i$	= 8.5 $V_{eff}$	10 $V_{eff}$
Alternating grid voltage for 50 mW output . . . . .	$V_i$	= 1 $V_{eff}$	0.9 $V_{eff}$

**OPERATING DATA: EL 2 used as output valve in balanced circuit (2 valves)**

	Automatic grid bias	
Anode voltage . . . . .	$V_a$	= 200 V    250 V
Screen-grid voltage . . . . .	$V_{g2}$	= 200 V    250 V
Common cathode resistor . . . . .	$R_k$	= 320 ohms    305 ohms
Anode current (without signal) . . . . .	$I_{a0}$	= 2 × 21 mA    2 × 27.5 mA
Anode current at full modulation . . . . .	$I_{amax}$	= 2 × 24.5 mA    2 × 32.5 mA
Screen current (without signal) . . . . .	$I_{g20}$	= 3.5 mA    2 × 4.5 mA
Screen current at full modulation . . . . .	$I_{g2max}$	= 2 × 6 mA    2 × 8 mA
Load resistor between the two anodes . . . . .	$R_{aa}$	= 9,000 ohms    8,000 ohms
Output power . . . . .	$W_{omat}$	= 5 W    8 W
Total distortion at full modulation . . . . .	$d_{tot}$	= 1.5%    1.4%
Alternating grid voltage at full modulation . . . . .	$V_i$	= 14 $V_{eff}$ 17 $V_{eff}$

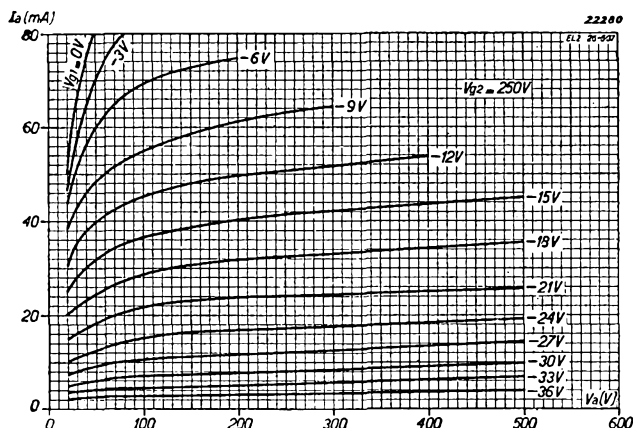

Fig. 4  
Anode current as a function of the anode voltage with  $V_{g1}$  as parameter, at  $V_{g2} = 250$  V.

# EL 2

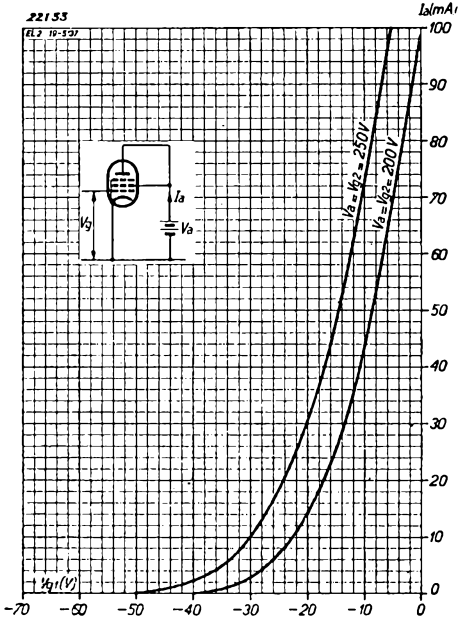

Fig. 5

EL 2 used as triode. Anode current as a function of the grid bias at  $V_a = 200$  and  $250$  V.

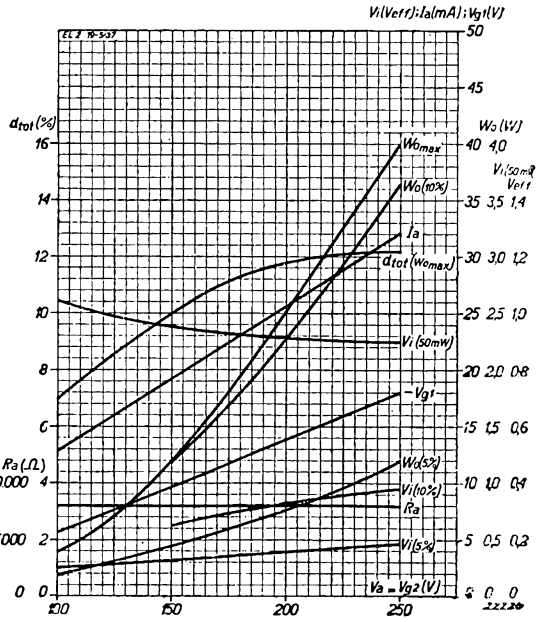

Fig. 6

EL 2 used as triode. Anode current as a function of the anode voltage for different values of grid bias.

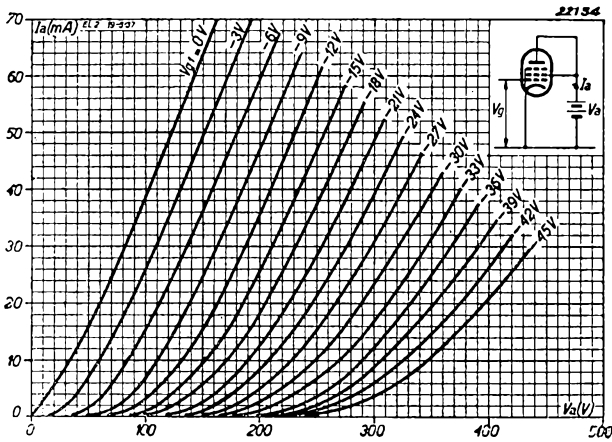

Fig. 7

Various data as function of anode and screen voltage of the EL 2.

**OPERATING DATA: EL 2 used as triode (grid 2 connected to anode)**

Anode and screen-grid voltage . . . . .	$V_a = 250$ V	250 V
Grid bias . . . . .	$V_{g1} = -27$ V	-20 V
Anode current . . . . .	$I_a = 15$ mA	30 mA
Mutual conductance . . . . .	$S = 1.7$ mA/V	2.6 mA/V
Internal resistance . . . . .	$R_i = 4,100$ ohms	3,100 ohms
Amplification factor . . . . .	$\mu = 7$	S

**MAXIMUM RATINGS**

Anode voltage in cold condition . . . . .	$V_{a0} = \text{max. } 550$ V
Anode voltage . . . . .	$V_a = \text{max. } 250$ V
Anode dissipation . . . . .	$W_a = \text{max. } 8$ W
Screen-grid voltage in cold condition . . . . .	$V_{g20} = \text{max. } 550$ V
Screen-grid voltage . . . . .	$V_{g2} = \text{max. } 250$ V
Screen-grid dissipation . . . . .	$W_{g2} = \text{max. } 1.6$ W
Cathode current . . . . .	$I_k = \text{max. } 45$ mA
Grid voltage at grid current start ( $I_{g1} = \pm 0.3 \mu\text{A}$ ) . . . . .	$V_{g1} = \text{max. } -1.3$ V
Resistance between grid and cathode with automatic bias . . . . .	$R_{g1k} = \text{max. } 1$ M ohm
Resistance between grid and cathode with fixed bias . . . . .	$R_{g1k} = \text{max. } 0.6$ M ohm
Resistance between filament and cathode . . . . .	$R_{fk} = \text{max. } 5,000$ ohm
Voltage between filament and cathode (direct voltage or effective value of alternating voltage) . . . . .	$V_{fk} = \text{max. } 50$ V

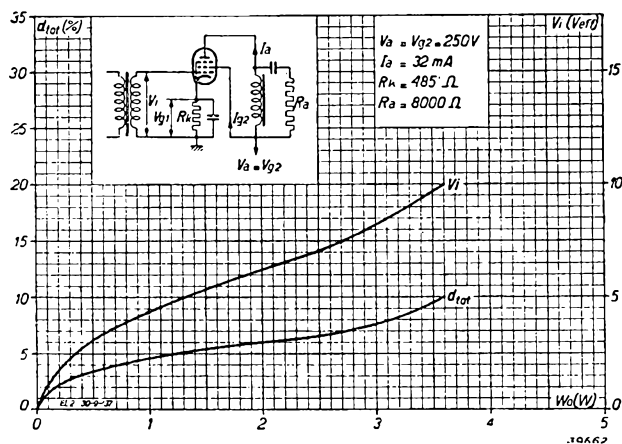

Fig. 8  
Alternating grid voltage and total distortion as a function of the output power. EL 2 used as single output valve, with  $V_a = V_{g2} = 250$  V.

This valve can be used in a single or balanced output stage in car radio sets. For 12 V batteries the heaters of two of these valves can be connected in series, or, alternatively, one EL 2 may be placed in series with another valve in the same series, for example the EBC 3 or EF 6. The cathode must be decoupled with respect to the earth line through a capacitor of at least 2  $\mu\text{F}$ , but an even higher capacitor of 25 or 50  $\mu\text{F}$  is better. When used in balanced output circuits (two

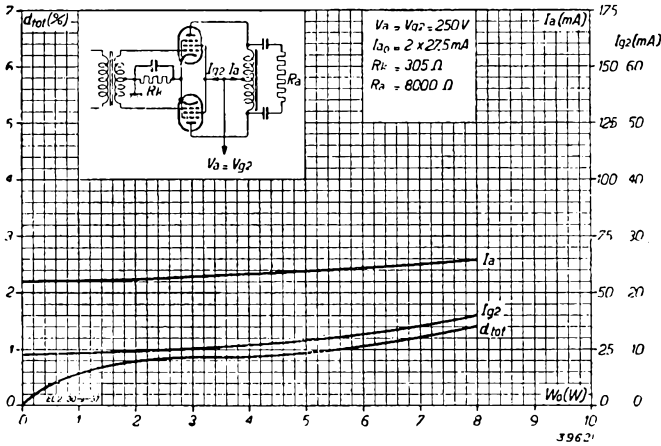

Fig. 9

Anode current, screen current and total distortion as a function of the output power for two EL 2 valves in a balanced circuit, with automatic grid bias, with  $V_a = V_{g2} = 250 V$ .

valves), the bias should preferably be automatic and the EBC 3 or EL 2, connected as triode, may be employed as driver. Bearing in mind the cost of the driver transformer and the required reproduction of low audio frequencies, the designer will find a transformation ratio of 1 : (2 + 2) quite suitable, but if the EL 2 is used, connected as triode, the ratio may be somewhat higher.

Tables I and II furnish particulars of the EL 2 for the single output valve, allowing for the voltage drop across the output transformer; the values for output power refer to the effective power at the output side of the valve and in this case the transformer losses should be deducted.

Tables I and II furnish particulars of the EL 2 for the single output valve, allowing for the voltage drop across the output transformer; the values for output power refer to the effective power at the output side of the valve and in this case the transformer losses should be deducted.

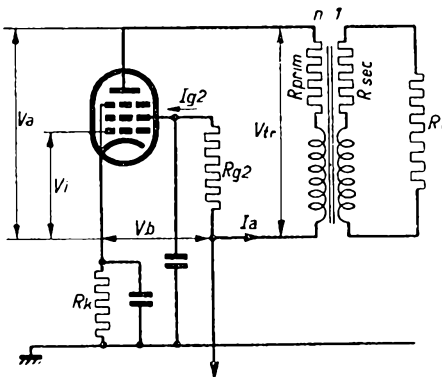

Fig. 10

Circuit diagram of the EL 2 as employed for the measurements the results of which are given in Table I. Loading resistance

$$R_a = R_{prim} + n^2 R_{sec} + n^2 R_l = R_{tr} + n^2 R_l$$

Output power

$$W_o = ia^2 (R_{prim} + n^2 R_{sec} + n^2 R_l) = ia^2 (R_{tr} + n^2 R_l) = ia^2 R_a$$

Direct voltage on the anode =  $V_a = V_b - I_a R_{prim}$

Power loss in output transformer =

$$ia^2 (R_{prim} + n^2 R_{sec}) = ia^2 R_{tr} = W_o \frac{R_{tr}}{R_a}$$

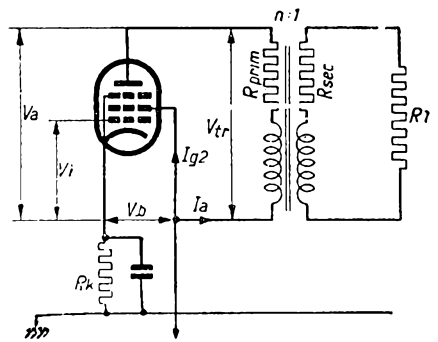

Fig. 11

Circuit diagram of the EL 2 as used for the measurements the results of which are given in Table II. For the symbols and formulae employed see text, Fig. 10



TABLE I

EL 2. Output power and alternating voltage across grid leak as a function of the voltage drop across the output transformer, at an anode voltage of 250 V.

$$I_a = 32 \text{ mA}$$

Anode voltage $V_a$ (V)	Supply voltage $V_b$ (V)	Screen resistor $R_{g_2}$ (ohm)	Voltage drop in output transf. $V_{tr}$ (V)	With 10 % distortion			At 5 % distortion			Power loss in output transformer $\frac{W_{tr}}{W_o} 100 \%$
				Anode load resistor $R_a$ (ohm)	Alternating grid voltage $V_i$ (V <sub>eff</sub> )	Output power $W_o$ (W)	Anode load resistor $R_a$ (ohm)	Alternating grid voltage $V_i$ (V <sub>eff</sub> )	Output power $W_o$ (W)	
250	250	0	0	8,000	9.4	3.65	8,000	4.7	1.3	—
250	260	1,600	10	8,000	9.4	3.5	8,000	4.5	1.1	8
250	270	3,300	20	8,000	9.3	3.3	8,000	4.4	1.1	16
250	280	4,900	30	8,000	9.0	3.2	8,000	4.4	1.1	24
250	300	8,400	50	8,000	8.5	2.95	8,000	4.3	1.0	40

TABLE II

EL 2. Output power and peak alternating grid voltage as a function of the voltage drop across the output transformer at 250 V supply and screen voltages.

$$I_a = 32 \text{ mA}$$

Anode voltage $V_a$ (V)	Supply voltage $V_b$ (V)	Screen voltage $V_{g_2}$ (V)	Voltage drop in output transf. $V_{tr}$ (V)	With 10 % distortion			At 5 % distortion			Power loss in output transformer $\frac{W_{tr}}{W_o} 100 \%$
				Anode load resistor $R_a$ (ohm)	Alternating grid voltage $V_i$ (V <sub>eff</sub> )	Output power $W_o$ (W)	Anode load resistor $R_a$ (ohm)	Alternating grid voltage $V_i$ (V <sub>eff</sub> )	Output power $W_o$ (W)	
250	250	250	0	8,000	9.4	3.65	8,000	4.7	1.3	—
250	250	250	10	7,500	9.6	3.55	7,500	4.7	1.2	8
250	250	250	20	7,000	9.6	3.35	7,000	4.7	1.1	18
250	250	250	30	7,000	9.5	3.15	7,000	5.2	1.3	27
250	250	250	50	6,000	9.8	2.9	6,000	5.1	1.1	52

Note: In calculating the power loss due to the resistance of the output transformer windings, it was assumed that the losses in primary and secondary windings were equal.

# EL 3 Output pentode

This is a high-mutual-conductance, indirectly-heated 9 W output pentode which, owing to its accuracy of construction, is capable of delivering 4.5 W with 10 % distortion (i.e., efficiency 50 %). The mutual conductance is 9 mA/V and the valve lends itself well to reception incorporating A.F. feed-back; the grid input signal for full modulation is 4.2 V. In balanced output stages it is possible to obtain an output of 8.2 W at  $V_a = V_{g_2} = 250$  V, in which case the distortion is 3.1 % whilst the input signal need only be 6.7 V (per half of the secondary winding of the driver transformer). At a screen potential of 265 V, with 250 V applied to the anode and allowing for a voltage drop of 15 V in the output transformer, an output power of 9 W is developed, with 6.8 % distortion, on a grid input of 5.6 V (effective). The special construction of the cathode imparts to this valve its very high mutual conductance with a comparatively low heater power; at the heater voltage of 6.3 V the current is only 0.9 A.

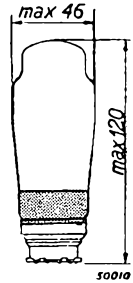

Fig. 1  
Dimensions in mm

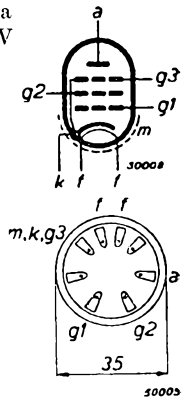

Fig. 2  
Arrangement of electrodes and base connections.

### HEATER RATINGS

Heating: indirect, A.C. or D.C. parallel supply.  
 Heater voltage . . . . .  $V_f = 6.3$  V  
 Heater current . . . . .  $I_f = 0.9$  A

### CAPACITANCES

Anode-to-grid . . . . .  $C_{ag1} = < 0.8 \mu\text{F}$

### OPERATING DATA: EL 3 employed as single output valve

Anode voltage . . . . .	$V_a$	= 250 V
Screen-grid voltage . . . . .	$V_{g_2}$	= 250 V
Grid bias . . . . .	$V_{g_1}$	= -6 V
Cathode resistor . . . . .	$R_k$	= 150 ohms
Anode current . . . . .	$I_a$	= 36 mA
Screen-grid current . . . . .	$I_{g_2}$	= 4 mA
Mutual conductance . . . . .	$S$	= 9 mA/V
Internal resistance . . . . .	$R_i$	= 50,000 ohms
Load resistor . . . . .	$R_u$	= 7,000 ohms
Output power with 10 % distortion . . . . .	$W_o$	= 4.5 W
Alternating grid voltage at $W_o = 4.5$ W . . . . .	$V_i$	= 4.2 $V_{eff}$
Sensitivity ( $W_o = 50$ mW). . . . .	$V_i$	= 0.33 $V_{eff}$
Amplification factor; grid 2 with respect to grid 1. . . . .	$\mu_{g_2g_1}$	= 23

**OPERATING DATA: EL 3 used in balanced output stage (2 valves)**  
(automatic grid bias)

Anode voltage . . . . .	$V_a$	= 250 V	250 V
Screen-grid voltage . . . . .	$V_{g2}$	= 250 V	250 V
Cathode resistor . . . . .	$R_k$	= 140 ohms	190 ohms <sup>1)</sup>
Anode current (without signal) . . . . .	$I_{a0}$	= $2 \times 24$ mA	$2 \times 31$ mA
Anode current at max. modulation . . . . .	$I_{a \max}$	= $2 \times 28.5$ mA	$2 \times 34$ mA
Screen current (without signal) . . . . .	$I_{g20}$	= $2 \times 2.8$ mA	$2 \times 3.6$ mA
Screen current at max. modulation . . . . .	$I_{g2 \max}$	= $2 \times 4.6$ mA	$2 \times 5.8$ mA
Load resistor between anodes . . . . .	$R_{aa}$	= 10,000 ohms	10,000 ohms
Output power . . . . .	$W_o$	= 8.2 W	9 W
Distortion . . . . .	$d_{\text{tot}}$	= 3.1 %	6.8 %
Alternating input voltage (per grid) . . . . .	$V_i$	= 6.7 $V_{\text{eff}}$	5.6 $V_{\text{eff}}$

<sup>1)</sup> separate cathode resistor per valve.

**OPERATING DATA: EL 3 employed as triode (Grid 2 connected to anode)**

Anode voltage . . . . .	$V_a$	= 250 V
Grid bias . . . . .	$V_{g1}$	= -8.5 V
Cathode resistor . . . . .	$R_k$	= 425 ohms
Anode current . . . . .	$I_a$	= 20 mA
Amplification factor . . . . .	$\mu$	= 20
Mutual conductance . . . . .	$S$	= 6.5 mA/V
Internal resistance . . . . .	$R_i$	= 3,000 ohms
Load resistor . . . . .	$R_a$	= 7,000 ohms
Output power with 5 % distortion . . . . .	$W_o$	= 1.1 W
Alternating grid voltage . . . . .	$V_i$	= 5.9 $V_{\text{eff}}$
Sensitivity ( $W_o = 50$ mW) . . . . .	$V_i$	= 1.1 $V_{\text{eff}}$

**MAXIMUM RATINGS**

Anode voltage in cold condition . . . . .	$V_{an}$	= max. 550 V
Anode voltage . . . . .	$V_a$	= max. 250 V
Anode dissipation . . . . .	$W_a$	= max. 9 W
Screen-grid voltage in cold condition . . . . .	$V_{g20}$	= max. 550 V
Screen voltage . . . . .	$V_{g2}$	= max. 275 V
Screen dissipation ( $V_i = 0$ ) . . . . .	$W_{g2}$	= max. 1.2 W
Screen dissipation ( $W_o = \text{max.}$ ) . . . . .	$W_{g2}$	= max. 2.5 W
Cathode current . . . . .	$I_k$	= max. 55 mA
Grid voltage at grid current start ( $I_{g1} = \pm 0.3 \mu\text{A}$ ) . . . . .	$V_{g1}$	= max. -1.3 V
External resistance between grid and cathode . . . . .	$R_{g1k}$	= max. 1 M ohm
External resistance between filament and cathode . . . . .	$R_{fk}$	= max. 5,000 ohms
Voltage between filament and cathode (D.C. voltage or effective value of alternating voltage) . . . . .	$V_{fk}$	= max. 50 V

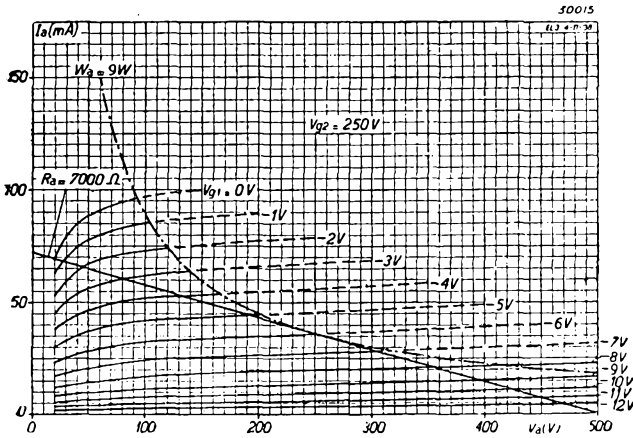

Fig. 3  
Anode current as a function of the anode voltage at different values of grid bias, at  $V_{g2} = 250$  V

As there is normally a voltage drop across the output transformer, it is necessary to allow for this in determining the supply voltage if the maximum output is to be obtained from the valve. Usually, the screen grid is connected directly to the supply line and, in order to ensure maximum anode voltage (250 V), the screen potential should be slightly higher, this being limited to 275 V maximum (see maximum ratings). Fig. 7 gives a number of useful data as plotted against

the screen voltage within a range of 250—275 V and these curves furnish the main operating data with respect to any voltage drop of from 0 to 25 V in the output transformer.

Fig. 8 supplies additional data as a function of the screen voltage for the case where the receiver supply is less than 250 V and the anode potential is less than the screen voltage by 15 V (equal to the voltage drop across the output transformer).

Grid bias may be of the automatic type only (cathode resistor); semi-automatic bias is permissible provided that the cathode current of the EL 3 exceeds 50 % of the total current flowing through the biasing resistor. The maximum value for the grid leak, as shown in the maximum ratings, should then be reduced in accordance with the formula: (cathode current of output valve/total current in the resistance)  $\times R_{g1k}$ . Furthermore, the fact must be taken into account that the current of any valves controlled by A.G.C. will affect the bias on the output valve, so that, if A.G.C. is to be employed, the bias may be too low and the anode current therefore too high. In the design of a receiver it is essential to take the high mutual conductance into consideration, as it may otherwise give rise to feed-back and parasitic oscillation. Leads to the valve holders must be as short as possible and a resistor of 1,000 ohms in the control-grid lead is in many cases necessary.

When this valve is to be used in balanced output circuits the following should also be borne in mind. If the standing anode current is more than 25 mA a separate resistor must be used for each valve; differences in the anode currents might be the cause of overloading, due to the fact that one valve carrying a high current would receive too little bias from another with too low a current. It is advisable to watch this point in all cases where the removal of one of the valves would cause damage to another. The data supplied in respect of this valve when used as a triode give a clear idea of its performance as a pre-amplifier in balanced output circuits.

To prevent oscillation it is advisable not to connect the screen directly to the anode but to interpose a resistor of 100 ohms, without any decoupling; for the rest, the same precautions must be taken as for a pentode, such as short leads, etc. The EL 3 coupled as a triode will also give good results when employed as a driver valve in balanced output stages operating with grid current.

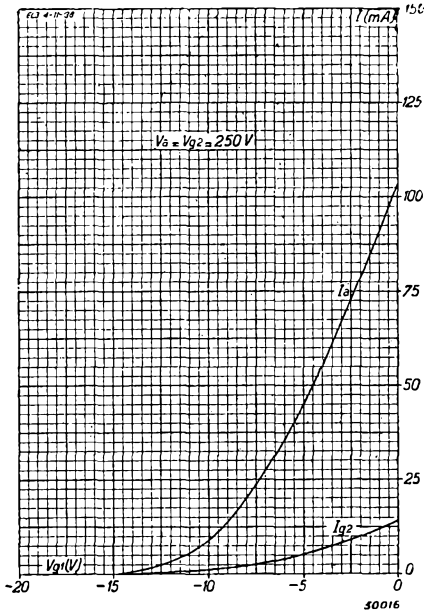

Fig. 4  
Anode and screen-grid current as a function of the grid bias at  $V_a = V_{g2} = 250\text{ V}$ .

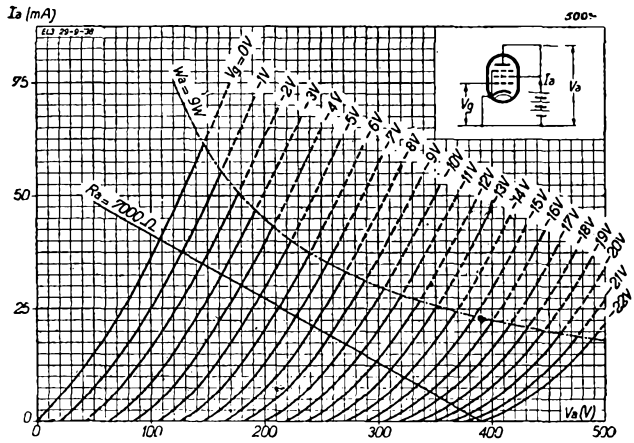

Fig. 5  
Anode and screen-grid current as a function of the anode voltage, with  $V_g$  as parameter. EL 3 used as a triode.

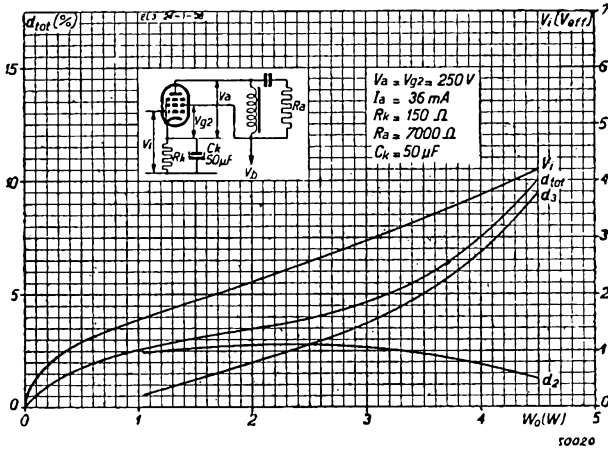

Fig. 6  
 Total distortion, 2nd and 3rd harmonic distortion and alternating grid voltage as a function of the output power. EL 3 used as single-output valve with automatic bias ( $V_a = V_{g2} = 250\text{ V}$ ).

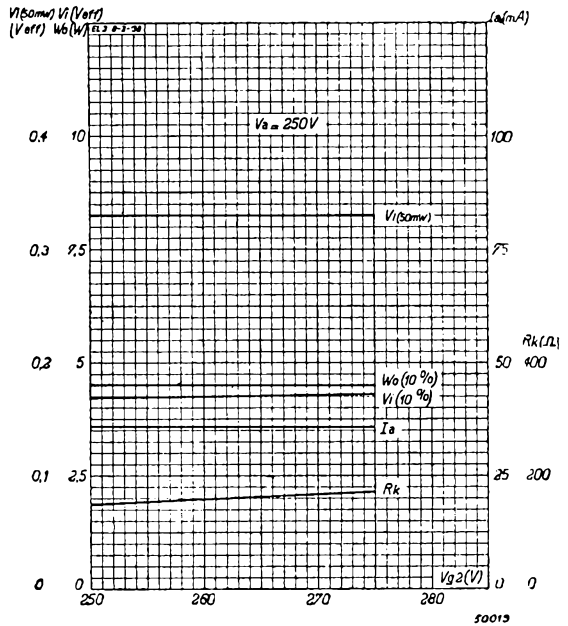

Fig. 7  
 Output power with 10% distortion . . .  $W_o(10\%)$   
 Alternating grid voltage . . .  $V_i(10\%)$   
 Sensitivity . . . . .  $V_i(50\text{ mW})$   
 Cathode resistor . . . . .  $R_k$   
 Anode current . . . . .  $I_a$

as a function of the screen-grid voltage (in the range 250–275 V), at constant anode voltage ( $V_a = 250\text{ V}$ )

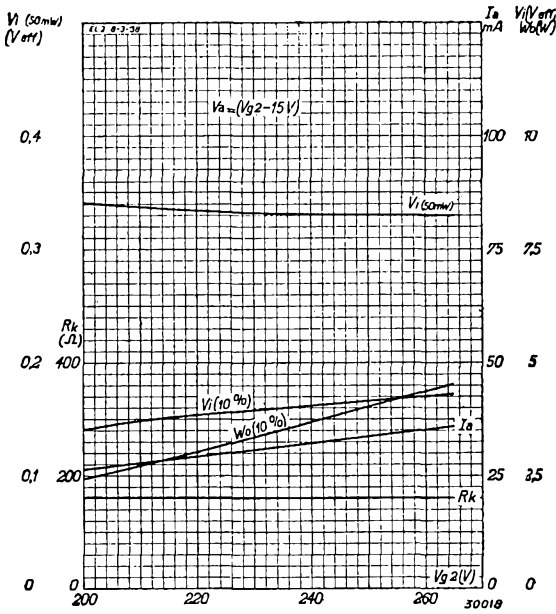

Fig. 8

Output power with 10 % distortion . . .  $W_o$  (10 %)  
 Alternating grid voltage . . .  $V_i$  (10 %)  
 Sensitivity . . . . .  $V_i$  (50 mW)  
 Cathode resistor . . . . .  $R_k$   
 Anode current . . . . .  $I_a$

as a function of the screen-grid voltage (in the range 200–265 V) and at an anode voltage of 15 V less than the screen potential.

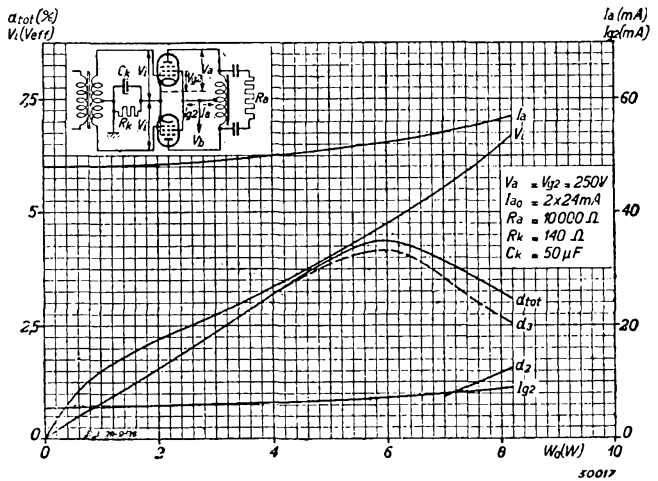

Fig. 9

Anode current  $I_a$ , screen current  $I_{g2}$ , total distortion, 2nd and 3rd harmonic distortion and alternating grid voltage  $V_i$  as functions of the output power  $W_o$ , for 2 EL 3 valves in a balanced circuit, with  $V_a = V_{g2} = 250$  V.

# EL 5 Output Pentode

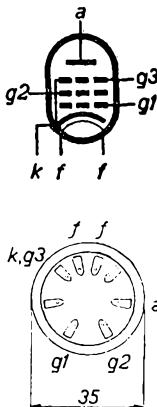

Fig. 2  
Arrangement of electrodes and base connections.

The EL 5 is a steep-slope, 18 W output pentode. Using this valve it is possible to obtain greater output power than with two 9 W pentodes in a balanced circuit. Linear and non-linear distortion are considerably reduced by applying A. F. feedback.

Two of these 18 W pentodes in a balanced circuit will deliver an effective output of 20 W, in which case contrast expansion can be successfully employed. The particular form and dimensions of the 3rd grid ensure a very satisfactory upper bend in the dynamic characteristic. At full excitation it is possible for the anode voltage to drop to very low values, with the result that the distortion at 9 W output is extremely low, being 10% when automatic bias is employed; at lower output powers the amount of 3rd harmonic distortion is very slight indeed. All the advantages of a triode are thus obtained, without its disadvantages, viz. that the output power with a given amount of distortion drops sharply when a loading resistance higher than the normal is used.

As the valve may be used with a screen voltage of 275 V this, in conjunction with an anode voltage of 250 V, will allow for a drop of about 25 V in the output transformer.

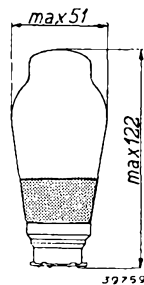

Fig. 1  
Dimensions in mm.

## HEATER RATINGS

Heating: indirect by A.C., parallel supply.  
 Heater voltage . . . . .  $V_f = 6.3$  V  
 Heater current . . . . .  $I_f = 1.3$  A

## CAPACITANCES

Anode-grid  $C_{ag1} < 0.8 \mu\mu\text{F}$

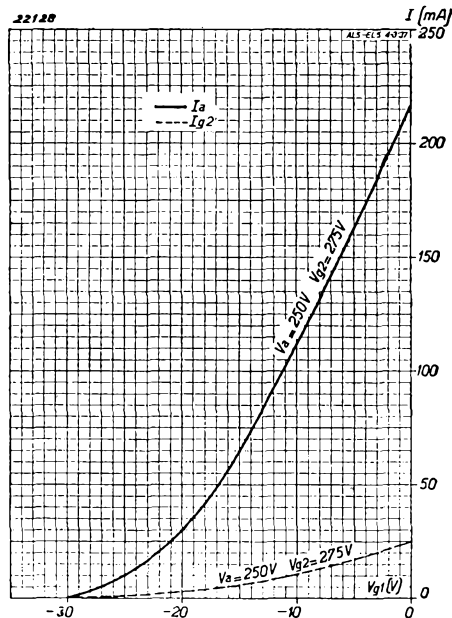

Fig. 3  
Anode current and screen current as a function of the grid bias, at  $V_a = 250$  V,  $V_{g_2} = 275$  V.



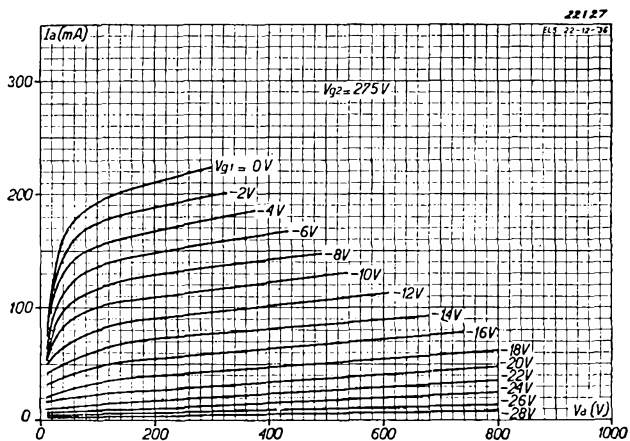

Fig. 4  
Anode current as a function of the anode voltage at  $V_{g2} = 275$  V, for different values of grid bias.

#### OPERATING DATA: EL 5 used as normal output valve (single valve)

Anode voltage . . . . .	$V_a = 250$ V
Screen-grid voltage . . . . .	$V_{g2} = 275$ V
Cathode resistor . . . . .	$R_k = 175$ ohms
Grid bias . . . . .	$V_{g1} = -14$ V
Anode current . . . . .	$I_a = 72$ mA
Screen current . . . . .	$I_{g2} = 7$ mA
Mutual conductance . . . . .	$S = 8.5$ mA/V
Internal resistance . . . . .	$R_i = 22,000$ ohms
Load resistor . . . . .	$R_a = 3,500$ ohms
Output power ( $d_{tot} = 10\%$ ) . . . . .	$W_a = 8.8$ W
Alternating input voltage with $10\%$ dist. . . . .	$V_i = 9.1$ V <sub>eff</sub>
Sensitivity ( $W_o = 50$ mW) . . . . .	$V_i = 0.5$ V <sub>eff</sub>

#### EL 5 in a balanced output circuit (two valves), with automatic bias

Anode voltage . . . . .	$V_a = 250$ V
Screen-grid voltage . . . . .	$V_{g2} = 275$ V
Cathode resistor . . . . .	$R_k = 120$ ohms
Anode current (without signal) . . . . .	$I_{a0} = 2 \times 58$ mA
Anode current at max. modulation . . . . .	$I_{a\ max} = 2 \times 65$ mA
Screen current (without signal) . . . . .	$I_{g20} = 2 \times 6.25$ mA
Screen current at max. modulation . . . . .	$I_{g2\ max} = 2 \times 10.5$ mA
Load resistor between anodes . . . . .	$R_{aa} = 4,500$ ohms
Output power ( $I_{g1} = +0.3$ $\mu$ A) . . . . .	$W_o = 19.5$ W
Total distortion ( $I_{g1} = +0.3$ $\mu$ A) . . . . .	$d_{tot} = 5.1\%$
Alternating input voltage ( $I_{g1} = +0.3$ $\mu$ A) . . . . .	$V_i = 12.5$ V <sub>eff</sub>

#### MAXIMUM RATINGS

$V_{a0} = \text{max. } 550$ V	$I_k = \text{max. } 90$ mA
$V_a = \text{max. } 250$ V	$V_{g1}$ ( $I_{g1} = +0.3$ $\mu$ A) = max. $-1.3$ V
$W_a = \text{max. } 18$ W	$R_{g1k}$ (auto. bias) = max. $0.7$ M ohm
$V_{g20} = \text{max. } 550$ V	$R_{fk} = \text{max. } 5,000$ ohms
$V_{g2} = \text{max. } 275$ V	$V_{fk} = \text{max. } 50$ V
$W_{g2} = \text{max. } 3$ W	

A. Single output Amplifier

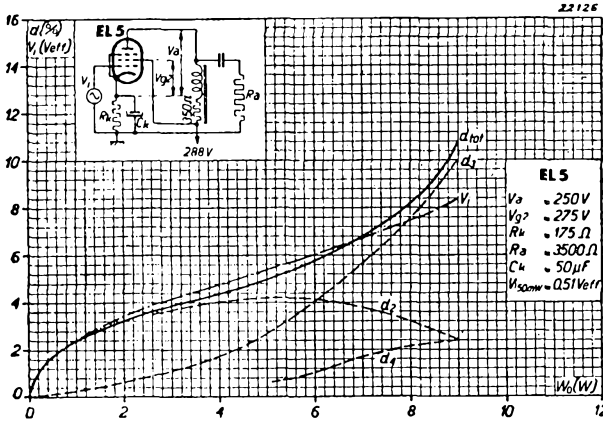

Fig. 5  
Alternating grid voltage, total distortion and distortion constituents, as functions of the output power; EL 5 used normal output valve with appropriate anode voltage, 3,500 ohms load resistor and decoupled bias resistor.

Generally speaking, it is not advisable to couple the EL 5 directly to a diode. Figures 5 and 6 indicate the alternating grid input and distortion at  $V_a = 250$  V,  $V_{g2} = 275$  V and  $R_k = 175$  ohms, corresponding to an anode current of 72 mA, as a function of the output power; Fig. 5 relates to a loading resistance of 3,500 ohms and Fig. 6 to 2,500 ohms. From these curves it is evident that when a load of 2,500 ohms is used the 3rd harmonic component is much smaller than in the case of

the 3,500 ohms load, so that in all instances where this would be an important factor the smaller load deserves preference.

The suggested pre-amplifier for use with the EL 5 is the EL 6 or EBC 3. When the EL 6 is employed in conjunction with the EL 5 the distortion curve is almost identical to that of the EL 5 alone. With the combination EBC 3 + EL 5 the distortion curve, at a lower output than three-quarters of the maximum, is about 10 % lower, this low distortion figure being due to partial compensation of the 2nd harmonic in the EL 5 by that of the EBC 3. Owing to its high mutual conductance, the EL 5 is eminently suited to the application of negative A.F. feed-back for reduction of distortion. When feed-back is applied, using a factor of about 10, the result is as shown in Fig. 7, in which the EF 6 is represented as pre-amplifier, with the feed-back applied to both valves.

B. Balanced output Stages (2 Valves)

If greater output, or less distortion, is desired, two EL 5 valves can with advantage be coupled in a balanced circuit. With an anode voltage of 250 V and

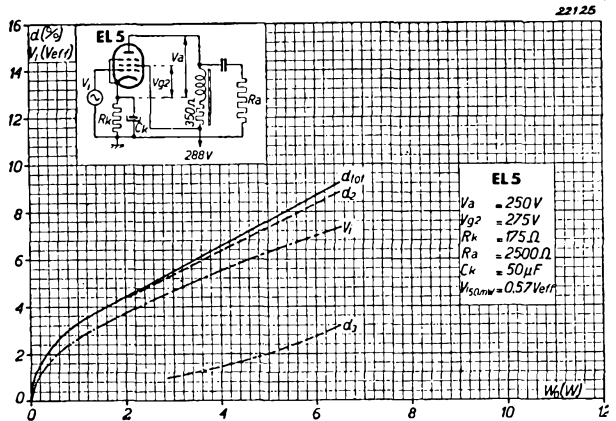

Fig. 6  
Relation between alternating grid voltage, total distortion, distortion components and output power of the EL 5, with normal anode voltage, 2,500 ohms load resistor and decoupled bias resistor.

screen voltage of 275 V, the common cathode resistor should be 120 ohms and distortion can be kept down by decoupling this resistor with a high capacitor (25 or 50  $\mu$ F). The full line in Fig. 8 represents the distortion obtained with this arrangement, with a load resistor of 4,500 ohms (between anodes), as a function of the output power. The distortion is due to 3rd harmonic only.

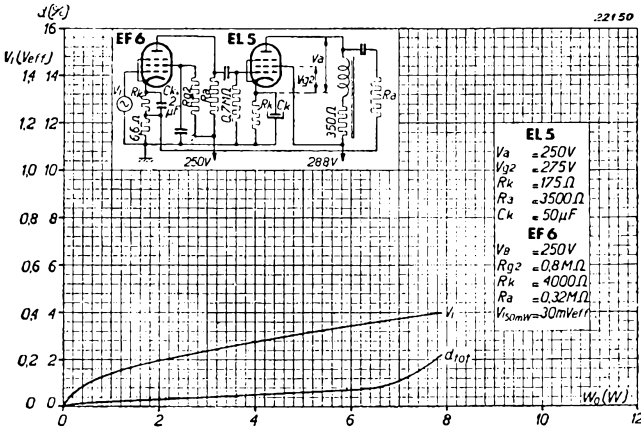

Fig. 7  
Relation between alternating grid voltage  $V_i$ , total distortion  $d_{101}$  and output power; EL 5 with pre-amplifier EF 6 and negative feedback applied to the latter.

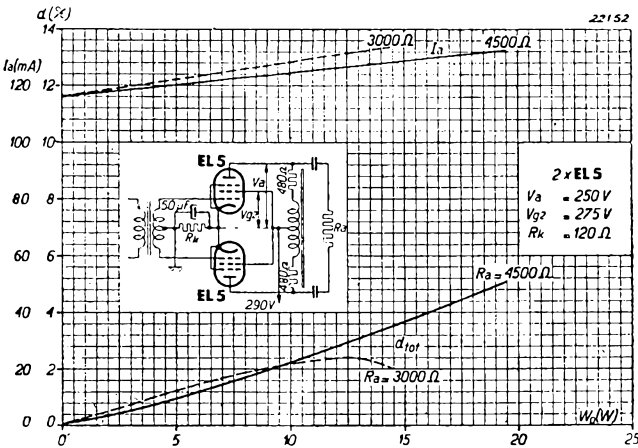

Fig. 8  
Anode current and total distortion as a function of the output power; two EL 5 valves in balanced output stage without grid current, employing normal anode voltage and load resistor of 3,000 ohms or 4,500 ohms between anodes.

# EL 6 Output Pentode

This is another 18 W, indirectly-heated, high conductance output pentode, the need for which arose from a demand for a "larger" output valve which, fully excited, would take about the same grid input as the EL 3. The advantage of this valve is that receivers having a 9 W or 18 W output stage, apart from the rectifier, may be developed along exactly the same lines. At the working point the EL 6 has the unusually high mutual conductance of 14.5 mA/V. With 10 % distortion the maximum obtainable output is 8 W. The peak alternating grid voltage for this output is only 4.8 V<sub>(eff)</sub> whilst the sensitivity (for 50 mW output) is 0.3 V<sub>(eff)</sub>.

The valve can also figure in balanced output stages, although the output obtainable is then not so high as in the case of two EL 5 type valves. On the other hand, the EL 6 has the advantage of a higher mutual conductance. The optimum output power is 14.5 W with 2.2 % distortion at an alternating grid voltage of 7.3 V<sub>(eff)</sub> per grid. Taking into account an average voltage drop of 15 V across the output transformer, the output at  $V_a = 250$  V with  $V_{g2} = 265$  V is somewhat higher, viz. 16 W, with 1.4 % distortion with a grid input of 8.5 V<sub>(eff)</sub>. The maximum distortion is roughly 3 %, which occurs at approximately 10 W output.

The very high mutual conductance is due to the special construction of the cathode, with its relatively low heater power: at 6.3 V the current consumed is 1.2 A.

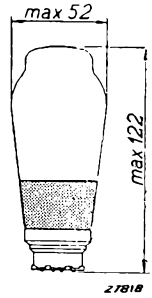

Fig. 1  
Dimensions in mm.

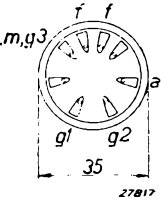
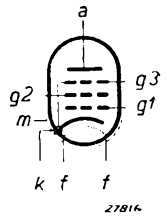

Fig. 2  
Arrangement of electrodes and base connections.

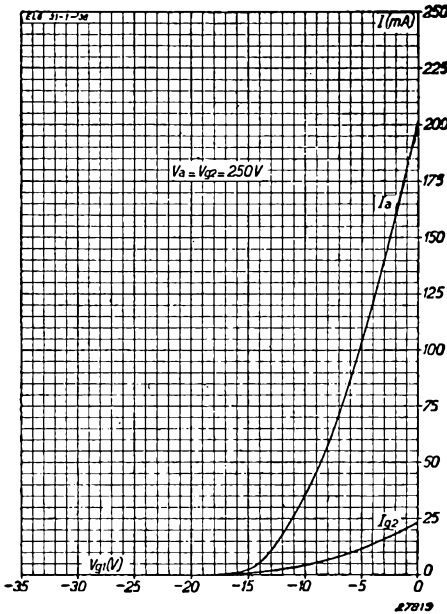

Fig. 3  
Anode and screen current as a function of the grid bias, at  $V_a = V_{g_s} = 250$  V.

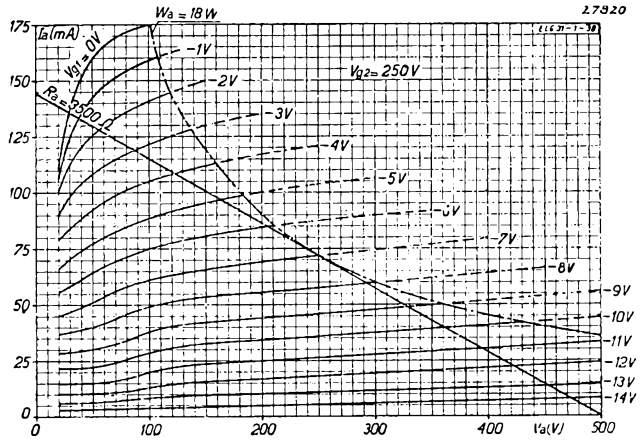

Fig. 4  
Anode current as a function of the anode voltage at  $V_{g2} = 250$  V with  $V_{g1}$  as parameter.

**HEATER RATINGS**

Heating: indirect by A.C., parallel supply.

Heater voltage . . . . .  $V_f = 6.3$  V  
 Heater current . . . . .  $I_f = 1.2$  A

**CAPACITANCES**

Anode-grid . . . . .  $C_{ag1} < 0.7 \mu\text{F}$

**OPERATING DATA: EL 6 used as a normal output valve (single valve)**

Anode voltage . . . . .	$V_{a1} = 250$ V
Screen-grid voltage . . . . .	$V_{g2} = 250$ V
Grid bias . . . . .	$V_{g1} = -7$ V
Cathode resistor . . . . .	$R_k = 90$ ohms
Anode current . . . . .	$I_{a1} = 72$ mA
Screen-grid current . . . . .	$I_{g2} = 8.0$ mA
Mutual conductance . . . . .	$S = 14.5$ mA/V
Internal resistance . . . . .	$R_i = 20,000$ ohms
Load resistor . . . . .	$R_{L1} = 3,500$ ohms
Output power with 10 % distortion . . . . .	$W_o = 8$ W
Alternating input voltage for $W_o = 8$ W . . . . .	$V_i = 4.8$ V <sub>eff</sub>
Sensitivity ( $W_o = 50$ mW) . . . . .	$V_i = 0.3$ V <sub>eff</sub>
Amplification factor, screen with respect to grid 1 . . . . .	$\mu_{g2g1} = 20$

**OPERATING DATA: EL 6 used as an output valve in balanced circuits (two valves) with automatic grid bias.**

Anode voltage . . . . .	$V_a$	= 250 V	250 V
Screen-grid voltage . . . . .	$V_{g2}$	= 250 V	265 V
Cathode resistor . . . . .	$R_k$	= 90 ohms	97 ohms
Anode current (without signal) . . . . .	$I_{a0}$	= $2 \times 45$	$2 \times 45$ mA
Anode current at max. modulation . . . . .	$I_{a \max}$	= $2 \times 53$	$2 \times 54$ mA
Screen current (without signal) . . . . .	$I_{g20}$	= $2 \times 5.1$	$2 \times 5.1$ mA
Screen current at max. modulation . . . . .	$I_{g2 \max}$	= $2 \times 8.5$	$2 \times 9.9$ mA
Load resistor between anodes . . . . .	$R_{aa}$	= 5,000 ohms	5,000 ohms
Output power . . . . .	$W_o$	= 14.5 W	16 W
Distortion . . . . .	$d_{tot}$	= 2.2 %	1.7 %
Alternating grid voltage per grid . . . . .	$V_i$	= 7.3 $V_{eff}$	8.2 $V_{eff}$

**MAXIMUM RATINGS**

Anode voltage in cold condition . . . . .	$V_{a0}$	= max. 550 V
Anode voltage . . . . .	$V_a$	= max. 250 V
Anode dissipation . . . . .	$W_a$	= max. 18 W
Screen voltage in cold condition . . . . .	$V_{g20}$	= max. 550 V
Screen voltage . . . . .	$V_{g2}$	= max. 275 V
Screen dissipation ( $V_i = 0$ ) . . . . .	$W_{g2}$	= max. 2 W
Screen dissipation ( $W_o = \max.$ ) . . . . .	$W_{g2}$	= max. 3 W
Cathode current . . . . .	$I_k$	= max. 90 mA
Grid voltage at grid current start ( $I_{g1} = + 0.3 \mu A$ ) . . . . .	$V_{g1}$	= max. -1.3 V
External resistance between grid and cathode . . . . .	$R_{g1k}$	= max. 0.7 M ohm
External resistance between heater and cathode . . . . .	$R_{fk}$	= max. 5,000 ohms
Voltage between heater and cathode (D.C. voltage or effective value of alternating voltage) . . . . .	$V_{fk}$	= max. 50 V

Fig. 6 gives a number of useful data plotted against the screen voltage in the range 250—275 V. With an anode voltage of 250 V by means of these characteristics any voltage drop in the output transformer from 0 to 25 V can be taken into account in investigating the operation of the valve. Dynamic characteristics of the EL 6 as a function of the screen voltage, in the case of receivers in which the available anode voltage is less than 250 V and whereby the anode voltage is less than that of the screen by 15 V, are given in Fig. 8. Allowance is made for an average voltage drop of 15 V across the output transformer.

In the case of Class A and A/B amplification the grid bias must be automatic (cathode resistor); semi-automatic bias may be employed so long as the cathode current of the EL 6 is in excess of 50 % of the total current flowing through the biasing resistor. The maximum value of the grid leak, as indicated in the Maximum Ratings should then be reduced in accordance with the following:

$$\frac{\text{Cathode current of the output valve}}{\text{Total current passing through the resistor producing the voltage drop}} \geq R_{g1k}$$

It should be noted, further, that the current of those valves to which automatic gain control is applied will affect the bias on the output valve, so that when the control voltage rises the bias quickly becomes too low and the anode current too high. The high mutual conductance of this valve should be taken into consideration in the design of receiver circuits, in view of the resultant tendency towards R.F. feedback and oscillation. Leads to the valve contacts should therefore be as short as possible, and a resistor of about 1,000 ohms in the grid lead is indispensable.

For the use of the valve in balanced circuits employing automatic bias the necessary data will be found in Figs 8 and 9: the former gives the distortion and alternating grid voltage at  $V_a = 250$  V and  $V_{g2} = 250$  V, whilst Fig. 9 shows various data, such as the biasing resistor, output power, etc. as functions of the screen voltage when the anode current is  $2 \times 24$  mA with a constant voltage of 250 V on the anode. Using the curves it is possible for the designer to obtain the appropriate operating conditions with respect to almost any voltage drop across the output transformer. In balanced output stages care should be taken, if the anode current (without signal) is more than 45 mA per valve, to see that each valve has its own biasing resistor. This precaution is advisable in all cases where a possibility exists that one of the valves may be removed while the set is in operation, as this will otherwise result inevitably in damage to the other valve.

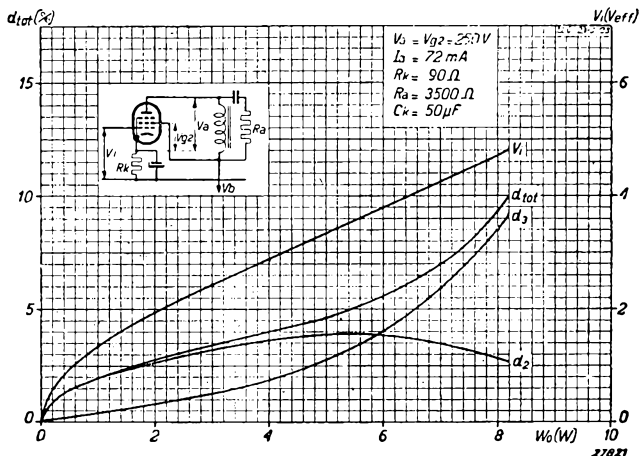

Fig. 5  
Total distortion, and 2nd and 3rd harmonic distortion; EL 6 used as normal output pentode with auto. bias and decoupling capacitor in the cathode circuit ( $V_a = V_{g2} = 250$  V).



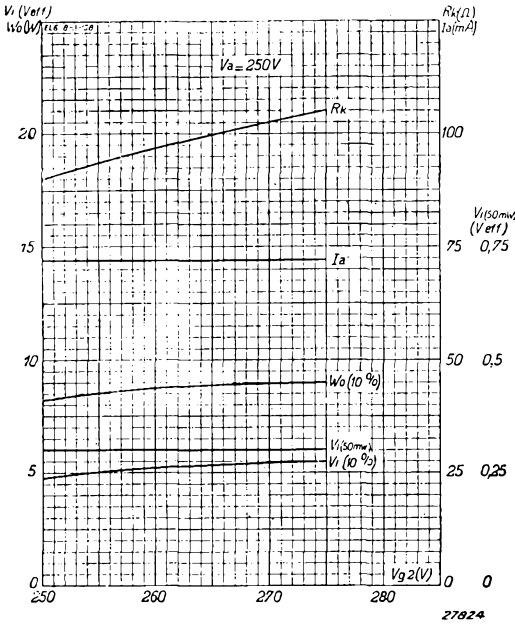

Fig. 6

Output power with 10 % distortion . . .	$W_o$ (10 %)	} as functions of the screen voltage (in the range 250–275 V) with a constant anode voltage ( $V_a = 250$ V).
Alternating grid voltage at 10 % distortion . . . . .	$V_i$ (10 %)	
Sensitivity . . . . .	$V_i$ (50 mW)	
Cathode resistor . . . . .	$R_k$	
Anode current . . . . .	$I_a$	

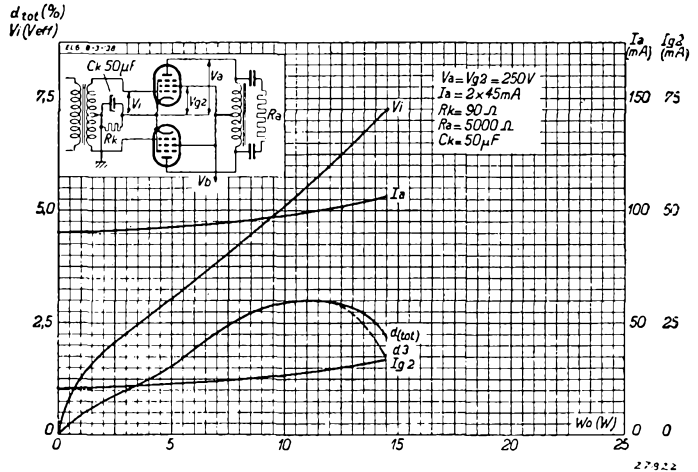

Fig. 7

Total anode current  $I_a$ , total screen current  $I_{g2}$ , total distortion  $d_{tot}$ , 3rd harmonic distortion and alternating grid voltage per grid  $V_i$ , as functions of the output power  $W_o$  when using two EL 6 valves in a balanced circuit with  $V_a = V_{g2} = 250$  V.



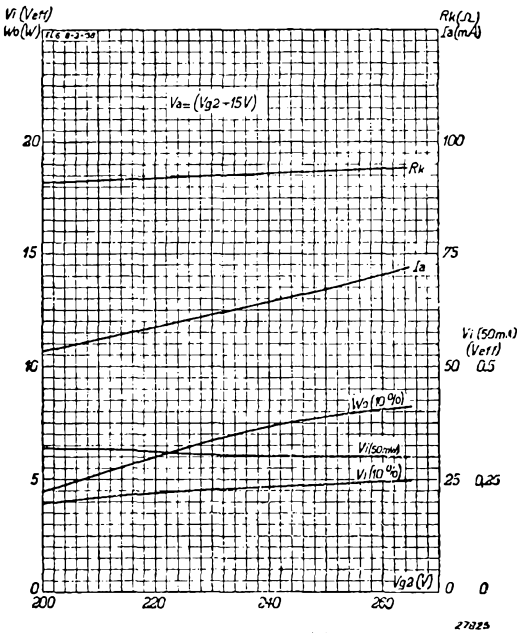

Fig. 8

Output power with 10 % distortion . . .  $W_o$  (10 %)  
 Alternating grid voltage with 10 % distortion . . .  $V_i$  (10 %)  
 Sensitivity . . .  $V_i$  (50 mW)  
 Cathode resistor . . .  $R_k$   
 Anode current . . .  $I_a$

as functions of the screen-grid voltage (in the range 200–265 V) where the voltage of the anode is 15 V lower than that of the screen.

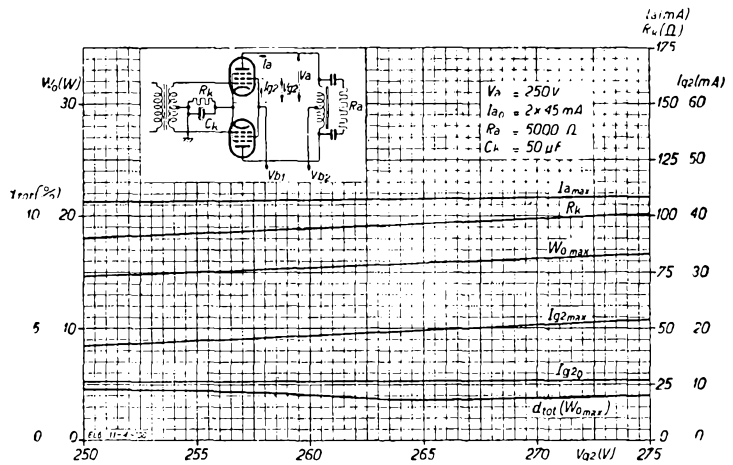

Fig. 9

Output power at max. modulation . . .  $W_{o\text{max}}$   
 Total distortion . . .  $dtot$  ( $W_{o\text{max}}$ )  
 Anode current at max. modulation . . .  $I_{a0\text{max}}$   
 Screen current (without signal) . . .  $I_{g20}$   
 Cathode resistor ( $I_{a0} = 45 \text{ mA}$  per valve)  $R_k$

as functions of the screen-grid voltage (in the range 250–275 V), at constant anode voltage ( $V_a = 250 \text{ V}$ )

# ELL 1 Double Output Pentode

This valve was specially designed for car radio receivers and consists of two output pentode units enclosed in a single envelope, each unit having an anode dissipation of 4.5 W. From the point of view of its operation from the car battery, both the heater and the anode current have been kept as low as possible; in consequence, the mutual conductance of each unit individually is not so very high, viz. 1.7 mA/V. The two valve units have been housed in a common bulb for use in balanced circuits, in order that the power supplied to the anode shall be utilized to the best possible advantage; with 3.5% distortion, the output power is 4.5 W.

The two cathodes, screen grids and suppressors are inter-connected within the valve.

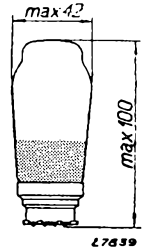

Fig. 1  
Dimensions in mm.

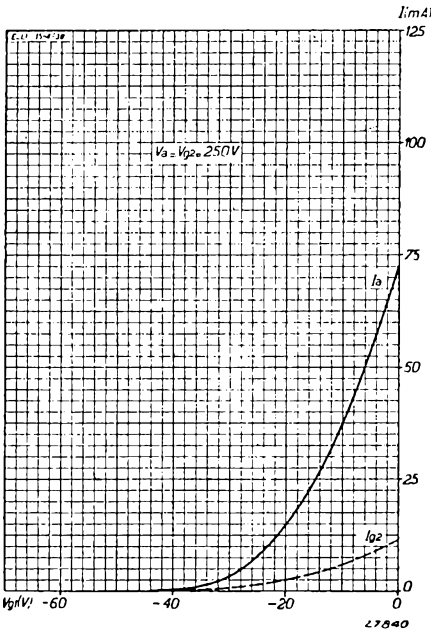

Fig. 3  
Anode and screen-grid currents of a single pentode unit of the ELL 1 as a function of the grid bias, at  $V_a = V_{q2} = 250$  V.

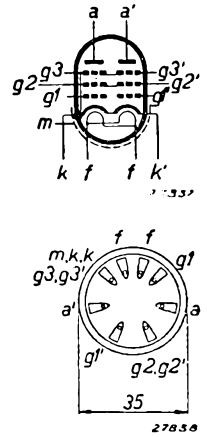

Fig. 2  
Arrangement of electrodes and base connections.

## HEATER RATINGS

Heating: indirect by battery current, rectified A.C. or D.C.; parallel supply.

Heater voltage . . . . .  $V_f = 6.3$  V

Heater current . . . . .  $I_f = 0.45$  A

## CAPACITANCES

Anode-grid system 1 . . . . .  $C_{ag1} < 1.3 \mu\mu\text{F}$

Anode-grid system 2 . . . . .  $C_{a'g1'} < 1.3 \mu\mu\text{F}$

## STATIC RATINGS (PER SYSTEM)

Anode voltage . . . . .	$V_a$	$\approx$ 250 V
Screen-grid voltage . . . . .	$V_{g2}$	$\approx$ 250 V
Grid bias . . . . .	$V_{g1}$	$\approx$ -19.5 V
Anode current . . . . .	$I_a$	$\approx$ 15 mA
Screen-grid current . . . . .	$I_{g2}$	$\approx$ 2.5 mA
Mutual conductance . . . . .	$S$	$\approx$ 1.7 mA/V
Internal resistance . . . . .	$R_i$	$\approx$ 110,000 ohms

## OPERATING DATA FOR BALANCED CIRCUIT

Anode voltage . . . . .	$V_a$	$\approx$ 250 V
Screen-grid voltage . . . . .	$V_{g2}$	$\approx$ 250 V
Common cathode resistor . . . . .	$R_k$	$\approx$ 560 ohms
Grid bias . . . . .	$V_{g1}$	$\approx$ -19.5 V
Anode current (without signal) . . . . .	$I_{a0}$	$\approx$ $2 \times 15$ mA
Anode current at max. modulation . . . . .	$I_{a \text{ max}}$	$\approx$ $2 \times 17$ mA
Screen current (without signal) . . . . .	$I_{g20}$	$\approx$ $2 \times 2.5$ mA
Screen current at max. modulation . . . . .	$I_{g2 \text{ max}}$	$\approx$ $2 \times 5$ mA
Load resistor between anodes . . . . .	$R_{aa}$	$\approx$ 16,000 ohms
Output power . . . . .	$W_o$	$\approx$ 4.5 W
Total distortion . . . . .	$d_{\text{tot}}$	$\approx$ 3.5 %
Alternating input voltage per grid . . . . .	$V_i$	$\approx$ 19 V <sub>eff</sub>

## MAXIMUM RATINGS

Anode voltage in cold condition . . . . .	$V_{a0}$	$\approx$ max. 550 V
Anode voltage . . . . .	$V_a$	$\approx$ max. 250 V
Anode dissipation (per system) . . . . .	$W_a$	$\approx$ max. 4.5 W
Screen-grid voltage in cold condition . . . . .	$V_{g20}$	$\approx$ max. 550 V
Screen-grid voltage . . . . .	$V_{g2}$	$\approx$ max. 275 V
Screen dissipation per system ( $V_i = 0$ ) . . . . .	$W_{g2}$	$\approx$ max. 0.7 W
Screen-grid dissipation per system ( $W_a = \text{max.}$ ) . . . . .	$W_{g2}$	$\approx$ max. 1.5 W
Cathode current per system . . . . .	$I_k$	$\approx$ max. 30 mA
Grid voltage at grid current start ( $I_{g1} = + 0.3 \mu\text{A}$ ) . . . . .	$V_{g1}$	$\approx$ max. -1.3 V
External resistance between heater and cathode . . . . .	$R_{fk}$	$\approx$ max. 5,000 ohms
Voltage between heater and cathode . . . . .	$V_{fk}$	$\approx$ max. 50 V

The data and characteristics given with respect to this valve refer only to a resistance-free source of voltage; in general, car radios are driven by the car battery by means of a vibrator and the latter, together with the transformer and anti-static circuit, have a fairly high resistance which will somewhat reduce the maximum obtainable output power; the internal resistance, therefore, should be as low as possible. In the case of an internal resistance in the supply unit of, say, 1,600 ohms, with the pre-amplifier valves taking 20 mA, the following values will furnish an output of 4.75 W, with 3 % distortion:

Internal resistance of the anode-feed source . . . . .	$R_b$	$\approx$ 1,600 ohms
Current consumption of amplifying valves . . . . .	$I_q$	$\approx$ 20 mA
Anode voltage . . . . .	$V_a$	$\approx$ 250 V
Screen voltage . . . . .	$V_{g2}$	$\approx$ 250 V
Cathode resistor . . . . .	$R_k$	$\approx$ 600 ohms
Anode current (without signal) . . . . .	$I_{a0}$	$\approx$ $2 \times 15$ mA
Anode current at max. modulation . . . . .	$I_{a \text{ max}}$	$\approx$ $2 \times 16.5$ mA

# ELL 1

Screen current (without signal) . . . . .	$I_{y20}$	= $2 \times 2.5$ mA
Screen current at max. modulation . . . . .	$I_{y2 \max}$	= $2 \times 4.7$ mA
Load resistor between anodes . . . . .	$R_{aa}'$	= 16,000 ohms
Output power . . . . .	$W_o$	= 4.75 W
Distortion . . . . .	$d_{tot}$	= 3 %
Alternating input voltage, per grid . . . . .	$V_i$	= 18 $V_{eff}$

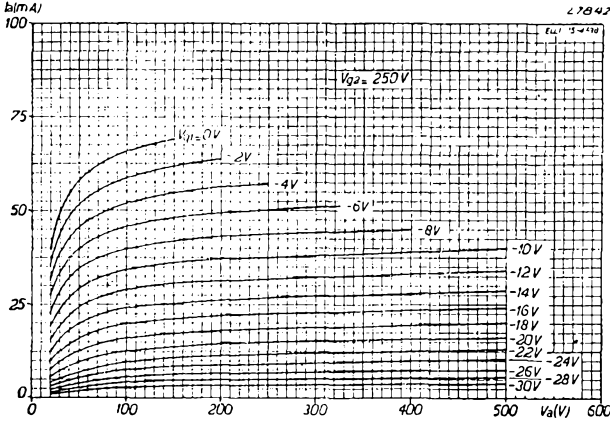

Fig. 4  
Anode current of one pentode unit of the ELL 1 as a function of the anode voltage for different values of grid bias, at  $V_{g2} = 250$  V.

The output obtainable in respect of other values may be estimated from the above figures.

The maximum anode voltage is 250 V, which on an average car battery voltage of 6.3 V must definitely not be exceeded; actually the use of car batteries may give rise to considerably greater overloads than are usually met with in the case of mains operation, since, when the battery is charging, voltages of 8 to 9 V may occur, with consequent detriment to the life of

the valves. With automatic bias, however, over-voltages on the anode and screen grid of 20 % are permissible. The maximum screen voltage of this valve being 275 V, the voltage drop across the output transformer is allowed for, and there is no necessity for a reduction in anode voltage.

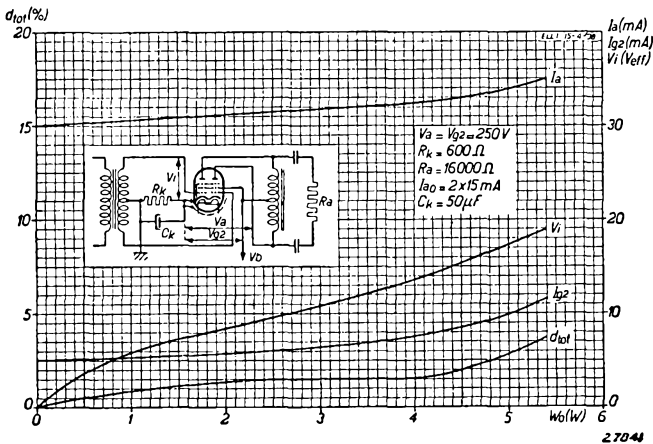

Fig. 5  
Total distortion  $d_{tot}$ , alternating grid voltage  $V_i$ , total anode current  $I_a$  and total screen current  $I_{g2}$ , as functions of the output power of the ELL 1 when used in a balanced output stage with automatic grid bias.

# EM 1 Electronic indicator

The electronic indicator EM 1 is designed on the lines of a high vacuum tube and is thus able to react without the slightest lag. It consists essentially of the virtual indicator itself, comprising a cathode, anode (screen or target) and four deflection plates. The anode is conical in shape and is coated on the inside with a fluorescent substance, the glow of this fluorescent screen, caused by the electrons striking it, being visible from the end of the valve. Between the cathode and this screen there are four deflection plates, mounted radially, which, as their name implies, exert a deflecting effect upon the electrons passing to the screen. In this way the screen, which is connected directly to the positive high-tension line of the receiver, gives rise to four bands of shadow of variable width.

In a normal receiver circuit the tuning to the desired transmitting station is set to give maximum width of the lighted sectors.

The lower part of the electronic indicator consists of a triode which amplifies the variable control voltage from the automatic gain control circuit, and the anode of this triode is connected internally to the deflection plates and externally, through a resistor of 2 megohms, to the positive side of the H.T. supply.

The variable control voltage on the grid produces variations in potential at the anode and therefore also on the deflector plates, thus varying the width of the sectors of light.

The EM 1 can be used equally well in 6.3 V A.C. receivers, car-radio sets and A.C./D.C. models with their heaters fed in series. Since the direct voltage on the fluorescent screen must not drop below 200 V, however, the use of this tube in A.C./D.C. sets is limited to those working on 220 V D.C. without voltage doubling, A.C. 220 V mains, and 110 V A.C. mains with voltage doubling.



Fig. 1  
Dimensions in mm.

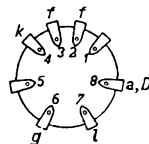
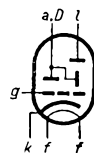

Fig. 2  
Arrangement of  
electrodes and  
base connections.

## HEATER RATINGS

Heating: indirect by A.C. or D.C., series or parallel supply.

Heater voltage . . . . .  $V_f = 6.3$  V

Heater current . . . . .  $I_f = 0.200$  A

## OPERATING DATA

Supply voltage . . . . .	$V_b = 200$ V	250 V
Anode series resistor . . . . .	$R_a = 2$ M ohms	2 M ohms
Grid bias for smallest angle of light sector . . . . .	$V_g = 0$ V	0 V
Grid bias for largest angle of light sector . . . . .	$V_g = -4$ V	-5 V
Anode current at $V_g = 0$ V . . . . .	$I_a = 75$ $\mu$ A	95 $\mu$ A
Anode current at $V_g = -4$ V or $-5$ V . . . . .	$I_a = 20$ $\mu$ A	21 $\mu$ A
Screen current at $V_g = 0$ V . . . . .	$I_l = 0.13$ mA	0.13 mA
Screen current at $V_g = -4$ V or $-5$ V . . . . .	$I_l = 0.14$ mA	0.14 mA
Angle of light at the edge of the screen, measured		
at $V_g = 0$ V . . . . .	$\beta = 20^\circ$	$16^\circ$
Angle of light at the edge of the screen, measured		
at $V_g = -4$ and $-5$ V . . . . .	$\beta = 90^\circ$	$90^\circ$

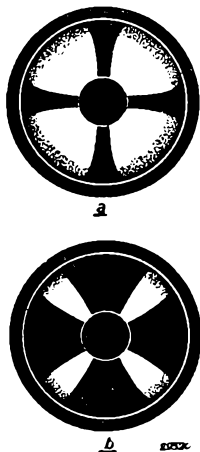

Fig. 4  
 a. Width of light sectors on the fluorescent screen with a high bias on the grid of the triode section.  
 b. The same on a low grid bias.

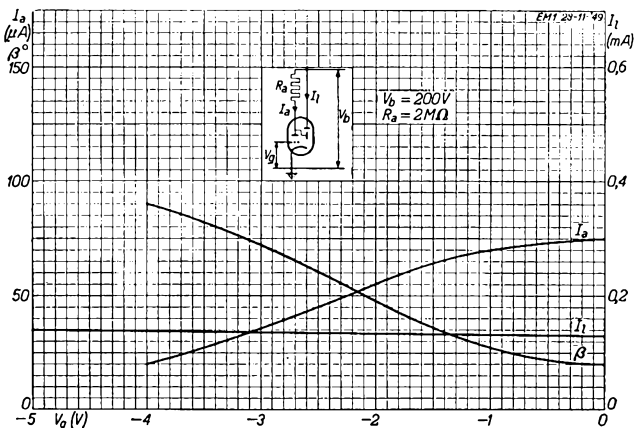

Fig. 3  
 Anode current of the triode section,  $I_a$ , current on fluorescent screen  $I_1$ , and light angle  $\beta$  measured at the edge of the screen, as functions of the grid bias, at  $V_b = 200$  V.

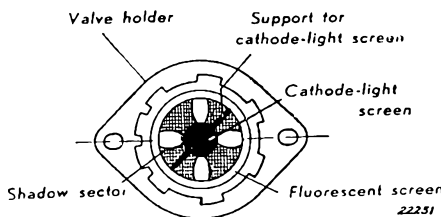

Fig. 5  
 Top view of the indicator in the holder. The support for the cathode-light screen indicates the position of the cross.

**MAXIMUM RATINGS**

- $V_{a0}$  = max. 550 V
- $V_a$  = max. 250 V
- $V_{l0}$  = max. 550 V
- $V_l$  = max. 250 V <sup>1)</sup>
- $R_{fk}$  = max. 5,000 ohms
- $R_{gk}$  = max. 2.5 M ohms
- $V_{fk}$  = max. 100 V <sup>2)</sup>

<sup>1)</sup> Allowing for 10 % over-voltage of the mains.  
<sup>2)</sup> Direct voltage or effective value of alternating voltage.

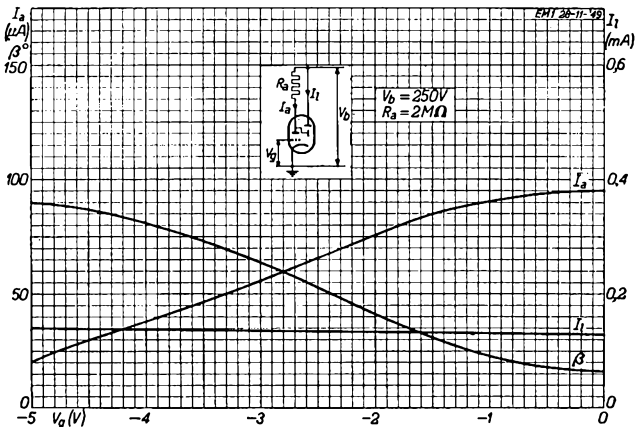

Fig. 6  
 Anode current of the triode section  $I_a$ , current on fluorescent screen  $I_1$ , and light angle  $\beta$  measured at the edge of the screen as functions of the grid bias, at  $V_b = 250$  V.

## C/EM 2 Electronic indicator

The Philips C/EM 2 is an indicator for accurately tuning the receiver to the required station. It works on the same principle as the EM 1, being a high-vacuum valve, with conical screen which is viewed from above. Two fan-shaped fluorescent patterns are formed on the screen and the width of these sectors varies with the tuning.

The difference between this tube and the EM 1 is that instead of four deflector plates only two are provided, whilst there is an extra grid between the anode and the fluorescent screen. As in the EM 1, moreover, the indicator comprises two sections, combined in a single envelope. The lower part of the tube is a triode with a high amplification factor and serves to amplify the direct voltages obtained from the automatic gain control circuit. In the upper portion of the valve a grid is mounted between the conical fluorescent screen and the cathode, by means of two rods. The supporting rods of the triode-anode protrude into the virtual indicator section and lie in the same plane as the grid supports; there are therefore two ways in which electrons from the cathode to the anode (fluorescent screen) can be controlled, viz.

1) by utilizing the deflecting effect of the two triode-anode supports, which serve the same purpose as the four deflector plates in the EM 1 and react upon the width of the light sectors; simultaneously an intensity variation occurs when the voltage on the triode anode falls;

2) the light strength of the fluorescence is controlled by the application of different potentials to the grid of the indicator; in other words, this controls the brilliance, which can ultimately be made to disappear altogether. At the same time, due to the deflecting action of the grid supports, the angles of the sectors can be varied; this means that the indication can be obtained in various ways:

a) The tuning can be rendered visible by coupling the grid of the triode section to the A.G.C. circuit; the anode supports, projecting into the indicator, then receive a higher or lower voltage due to the variable voltage drop across a series resistor as in the case of the EM 1; the electrons on their way to the anode are thus deflected to a greater or lesser degree.

b) Alternatively, the voltage on the grid of the indicator itself may be varied, for instance by connecting it to the screen-grid circuit of a controlled R.F. or I.F. valve, leaving the triode section available for other purposes, such as the suppression of interference due to crackle, or the amplification of the A.G.C. voltage.

c) Tuning can be made visible by means of a combination of the two above-mentioned arrangements. It is possible to obtain an effect whereby the light sectors on the fluorescent screen are very small and of low intensity when the receiver is not tuned to a station. As the tuning approaches the carrier-wave frequency the intensity increases until the area of the light sectors, and their intensity, are at a maximum (the screen is then saturated), after which, on a strong carrier wave, a maximum width of about  $150^\circ$  may be reached.

Tuning is thus facilitated by the variations in the intensity as well as by the changes in the width of the light sectors, especially on weak signals.

As in the EM 1, the cathode is provided with a screen cap to avoid unpleasant effects caused by the light emitted by the cathode.

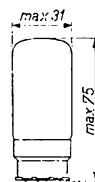

Fig. 1  
Dimensions in mm.

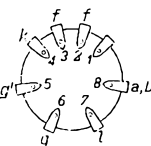
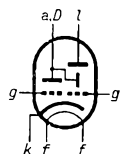

Fig. 2  
Arrangement of electrodes and base connections.

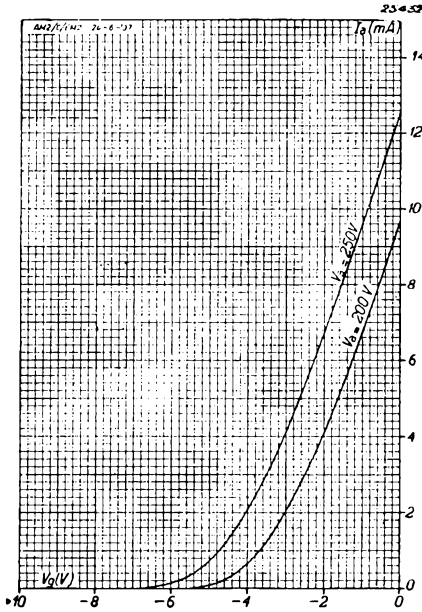

Fig. 3  
Triode section of the C/EM 2. Anode current as a function of the grid bias at  $V_a = 200$  V and 250 V.

The C/EM 2 can be used in A.C. sets as well as car radio receivers, and A.C./D.C. sets with series heater supply. Since the direct voltage on the fluorescent screen must never be less than 200 V, the use of this tube in the latter type of receiver is restricted to those working on 220 V D.C. without voltage doubling, A.C. 220 V mains, and 110 V A.C. with voltage doubling.

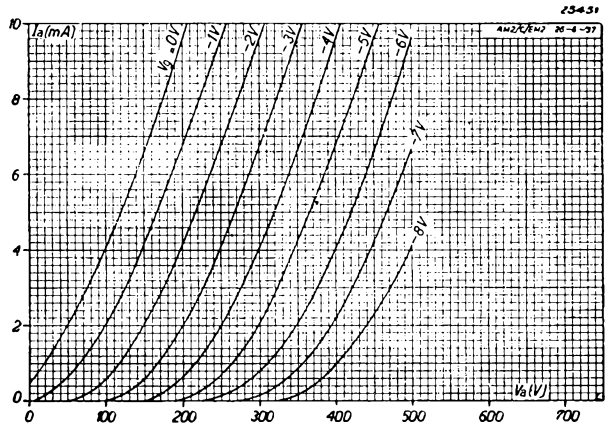

Fig. 4  
Triode section of the C/EM 2. Anode current as a function of the anode voltage for various values of grid bias, reproduced on a large anode-current scale.



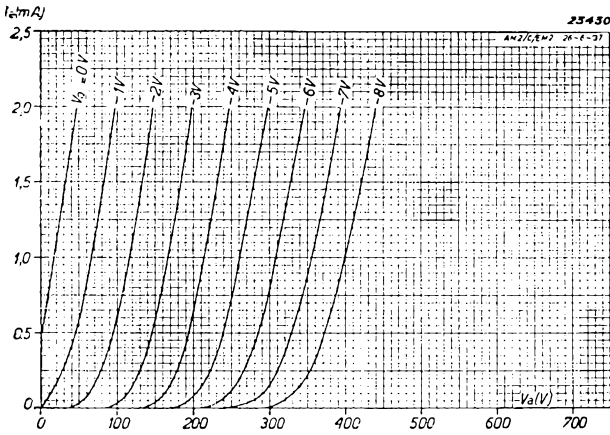

Fig. 5

Triode section of the C/EM 2. Anode current as a function of the anode voltage for various values of grid bias, reproduced on a small anode-current scale.

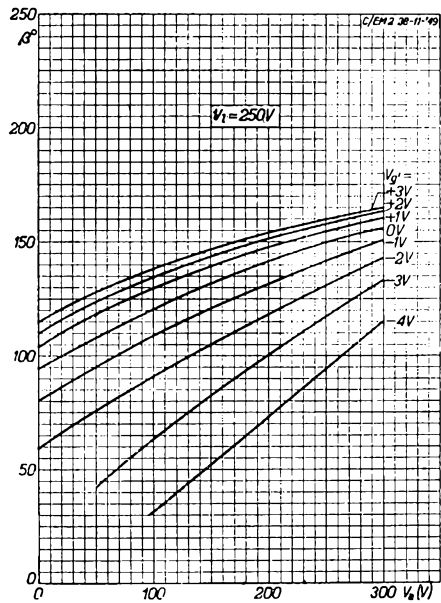

Fig. 6

Light sector angle  $\beta$  of the fluorescent screen as a function of the anode voltage  $V_a$  of the triode section, with the grid bias  $V_g$  of the indicator section as parameter. The broken lines on the curve indicate the range in which the light sectors decrease in size. Voltage  $V_1$  on the screen constant at 250 V.

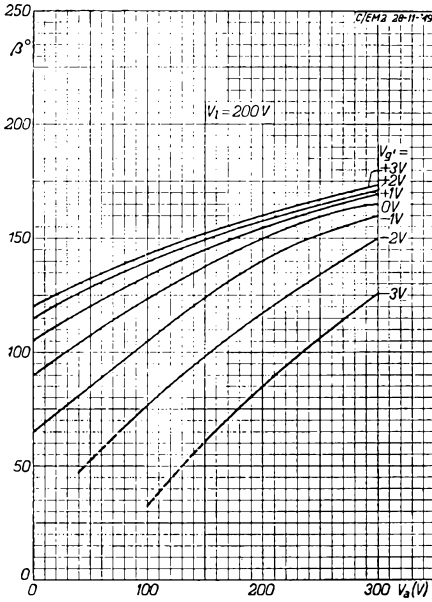

Fig. 7  
Light angle  $\beta$  of the fluorescent screen as a function of the voltage  $V_a$  on the triode anode and deflector rods, with the voltage  $V_{g'}$  on the grid of the indicator section as parameter. The broken lines in the curves indicate the range in which the intensity of the light decreases. Voltage  $V_1$  on the screen constant at 200 V.

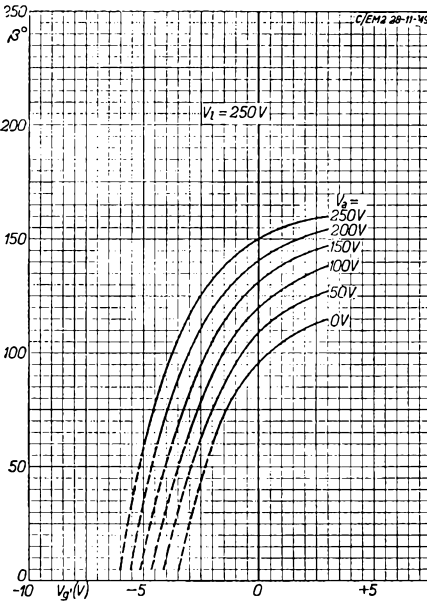

Fig. 8  
Light angle  $\beta$  of the fluorescent screen as a function of the voltage  $V_{g'}$  on the grid of the indicator section, with the voltage  $V_a$  on the anode of the triode as parameter. Voltage  $V_1$  on the fluorescent screen constant at 250 V.

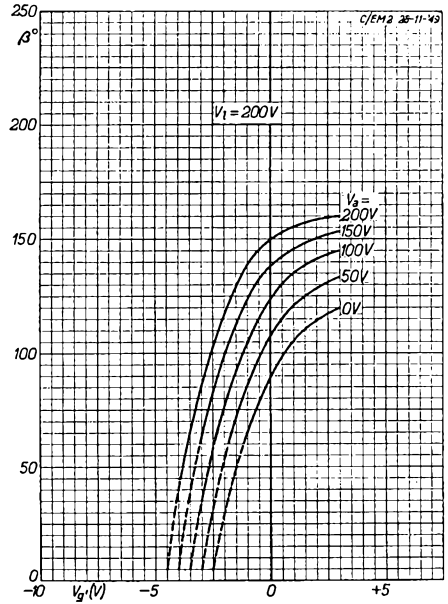

Fig. 9  
Light angle  $\beta$  of the fluorescent screen as a function of the voltage  $V_{g'}$  on the grid of the indicator section, with the voltage  $V_a$  on the anode of the triode as parameter. Voltage  $V_1$  on the fluorescent screen constant at 200 V.

**HEATER RATINGS**

Heating: indirect by A.C. or D.C., series or parallel supply.

Heater voltage . . . . .	$V_f = 6.3 \text{ V}$
Heater current . . . . .	$I_f = 0.200 \text{ A}$

**OPERATING DATA: Triode section**

Anode voltage . . . . .	$V_a = 200 \text{ V}$	250 V
Grid voltage . . . . .	$V_g = -2.5$	-3.5 V
Anode current . . . . .	$I_a = 3 \text{ mA}$	3 mA
Mutual conductance . . . . .	$S = 2 \text{ mA/V}$	2 mA/V
Amplification factor . . . . .	$\mu = 50$	50
Internal resistance . . . . .	$R_i = 25,000 \text{ ohms}$	25,000 ohms

**OPERATING DATA: Indicator section**

Voltage on fluorescent screen . . .  $V_l = 250 \text{ V}$

1. Indicator grid voltage  $V_{g'}$  variable.

Angle of fluorescent sector . . . $\beta = 5^\circ$	150°	160°
Voltage on anode of triode . . . $V_a = 250$	250	250 V
Voltage on grid of indicator . . . $V_{g'} = -6$	0	+3 V

2. Voltage on anode of triode  $V_a$  variable.

Angle of fluorescent sector . . . $\beta =$	95°	150°
Voltage on indicator grid . . . $V_{g'} =$	0	0 V
Voltage on triode anode . . . $V_a =$	0	250 V

Voltage on fluorescent screen . . .  $V_l = 200 \text{ V}$

1. Indicator grid voltage  $V_{g'}$  variable.

Angle of fluorescent sector . . . $\beta = 5^\circ$	150°	160°
Voltage on anode of triode . . . $V_a = 200$	200	200 V
Voltage on grid of indicator . . . $V_{g'} = -4.5$	0	+3 V

2. Voltage on anode of triode  $V_a$  variable

Angle of fluorescent sector . . . $\beta =$	90°	150°
Voltage on indicator grid . . . $V_{g'} =$	0	0 V
Voltage on triode anode . . . $V_a =$	0	200 V

**MAXIMUM RATINGS**

$V_{ao}$	= max. 550 V
$V_a$	= max. 300 V
$W_a$	= max. 1.5 W
$V_{lo}$	= max. 550 V
$V_l$	= max. 250 V
$V_l$	= min. 150 V
$I_l$	= max. 1 mA
$I_k$	= max. 12 mA
$V_g$ ( $I_g = \pm 0.3 \mu\text{A}$ )	= max. -1.3 V
$V_{g'}$ ( $I_{g'} = \pm 0.3 \mu\text{A}$ )	= max. -1 V
$R_{gk}$	= max. 2.5 M ohms
$R_{g'k}$	= max. 2.5 M ohms
$R_{fk}$	= max. 20,000 ohms
$V_{fk}$	= max. 125 V <sup>1)</sup>

<sup>1)</sup> Direct voltage or effective value of alternating voltage.

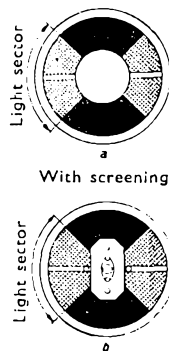

Without screening

Fig. 10  
Definition of the light angle  $\beta$ . Top view of electronic indicator,  
a. with cathode light screened.  
b. with cathode light not screened.

# EM 4 Dual-sensitivity electronic indicator

The EM 4 is a dual-sensitivity electronic indicator valve which enables weak and strong signals to be tuned in with equal ease and accuracy. It is hardly possible to distinguish this tube from the EM 1 as regards appearance; it works on the same principle and also has the conical fluorescent screen, upon which shadow sectors are produced by deflection of the electron streams, these sectors being variable in width. Here, too, the screen is observed from the top of the valve. Instead of 4 fluorescent sectors, this tube gives only two and, therefore, also two shadow zones; in the case of the EM 4 tuning is effected by means of the shadow sectors rather than by the light. The shadow sectors do not vary in size to an equal extent when the set is being tuned; one sector is very much more sensitive than the other, that is to say, the angular variation takes place more rapidly.

The development of this tube was prompted by the following considerations: in circuits employing the EM 1 it was often found difficult to obtain a satisfactory indication on weak signals as well as on strong ones, so that, if a sensitive indication is essential on weak signals as well, there is no alternative but to feed the grid of the EM 1 directly with the direct voltage from the load resistor of the receiving diode or, at any rate, to reduce this voltage only slightly by means of a potential divider. On strong signals, however, such a high voltage occurs on the grid of the indicator that the fluorescent sectors cover the whole of the screen long before the centre of the resonance curve is reached.

On the other hand, if preference is given to a good, clearly visible indication on strong transmitters, a suitable tapping being provided on the potential divider for this purpose, there will be hardly any indication at all on the weaker stations; the direct voltage variations at the grid during tuning are so small that the movement at the edges of the fluorescent zones is barely visible.

In view of the above, a satisfactory indication on both weak and strong signals can virtually be obtained only by using two indicators, one being connected direct and the other across a potential divider, to the load resistor of the receiving diode, but a better solution consists in connecting the two indicators to the load resistor

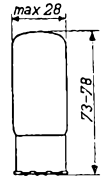

Fig. 1  
Dimensions in mm.

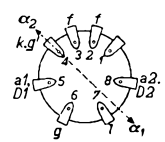
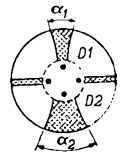
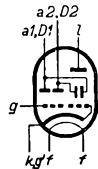

Fig. 2  
Arrangement of electrodes and base connections.

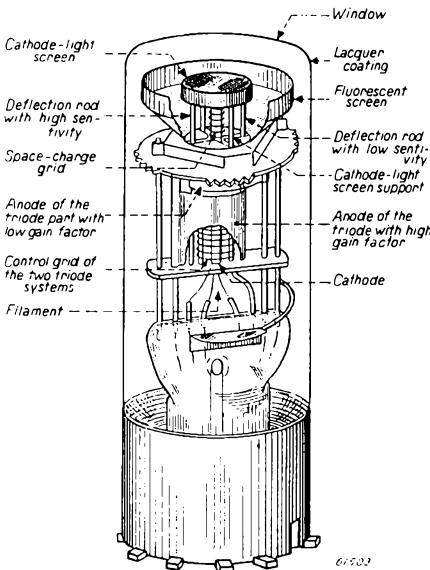

Fig. 3  
Construction of Philips Electronic Indicator EM 4.

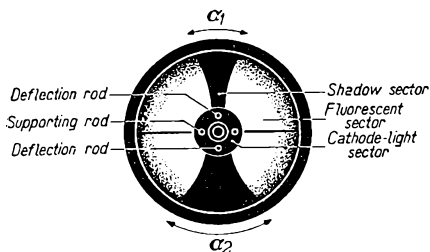

Fig. 4  
Arrangement of the components in the indicator section of the EM 4.

qualities of both high and low sensitivity.

Hence the EM 4, which may be regarded as a combination of two electronic indicators of different sensitivity, was developed; the construction, however, is almost as simple as that of the EM 1. The two units have a common fluorescent screen and cathode, one half of the screen serving each of the units.

The construction is as shown in Fig. 3: the conical fluorescent screen is at the top of the tube and the extremity of the cathode projects into it. Between the cathode and the screen, taking the components in order from the centre outwards, there is a space-charge grid, connected to the cathode, and two diametrically opposed deflector rods. The top end of the cathode is screened with a small cap to counteract the unpleasant effect of the light emitted by the cathode. This cap rests on two rods mounted vertically on the fluorescent screen, in contrast with the EM 1, which has an oblique rod. The two rods are fitted on a bar lying at  $90^\circ$  to them (see Fig. 4) and are at the same potential as the screen.

The amplifier section of the tube is at the lower end and consists of two triodes, of different amplification factors, mounted one above the other around the cathode; they are served by a common grid, but the latter is wound at a different pitch for each triode unit. The two anodes are electrically isolated from each other; the upper one, this being the smaller, is that of the high-amplification-factor triode. Each anode is connected to one of the deflector rods of the indicator unit and has its own separate contact on the base of the tube.

In the circuit (see Fig. 9) these anodes are connected across 1 megohm resistors to the positive H.T. line of the receiver; the fluorescent screen is at the same potential.

The two triodes are controlled simultaneously by the bias on the grid (control voltage from the detector diode) and they function as voltage amplifiers; variations in the bias are equivalent to a voltage drop across the anode resistors and therefore produce a variation in the width of the shadow sector behind the deflector rods.

The high-sensitivity triode unit produces a greater variation in the shadow angle behind the relative deflector rod than the other section, for a given grid voltage; in this tube the shadow angle for 0 V

in the same manner, e.g. one of the indicators being very sensitive and the other of low sensitivity.

By sensitivity, in the case of an electronic indicator, is meant the angular variation in the fluorescent and shadow sectors for one volt variation in grid voltage. The use of two valves for indicating purposes, due to the high cost and extra space required, would be out of the question, however, even in the highest class types of receiver and the need, therefore, is for a valve that will embrace the

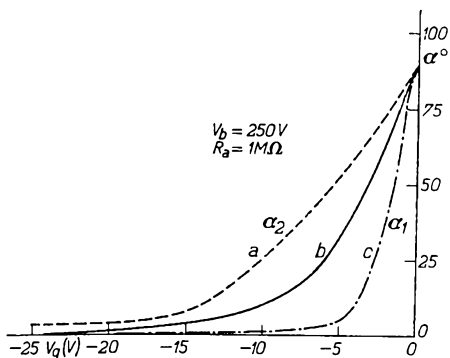

Fig. 5  
Various characteristics of the shadow angle plotted against grid voltage:  
a. Characteristic of the less sensitive unit of the EM 4.  
b. Characteristic of a valve with variable pitch grid.  
c. Characteristic of the more sensitive unit of the EM 4.

grid potential (and 250 V supply), is  $90^\circ$ . With  $-5$  V on the grid the shadow angle of the high sensitivity deflector rod is  $5^\circ$  whereas the less sensitive rod does not give this shadow angle until  $-16$  V is reached.

Fig. 6 shows the characteristics of the sections of the valve, which clearly demonstrate the action of the indicator. The two sensitivities of the EM 4 are thus obtained by the use of two amplifier triodes having different amplification factors. Originally, a solution to the problem of obtaining a clear indication for both weak and strong signals was sought in a special form of characteristic in the amplifier part of the triode, for instance by employing a grid of varying pitch, so that the  $I_a/V_g$  characteristic would have a long "tail", but characteristics of this type do not give good results, as will be seen from Fig. 5, in which curve (b) represents the shadow angle as a function of the grid voltage of a tube of this kind. At small grid voltages the mutual conductance is relatively high, giving fairly good sensitivity on weak signals, but not nearly so high as in curve (c) in the figure, which refers to the more sensitive section of the EM 4.

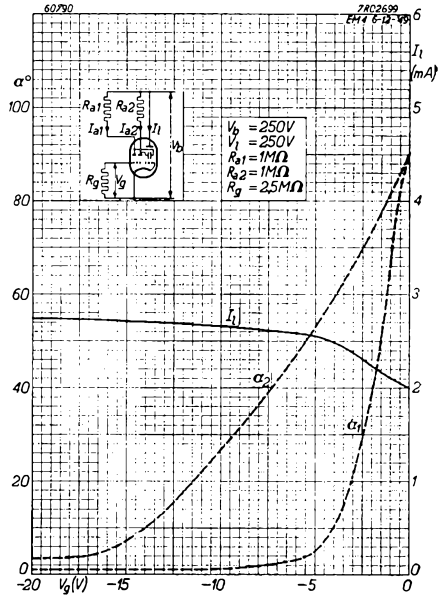
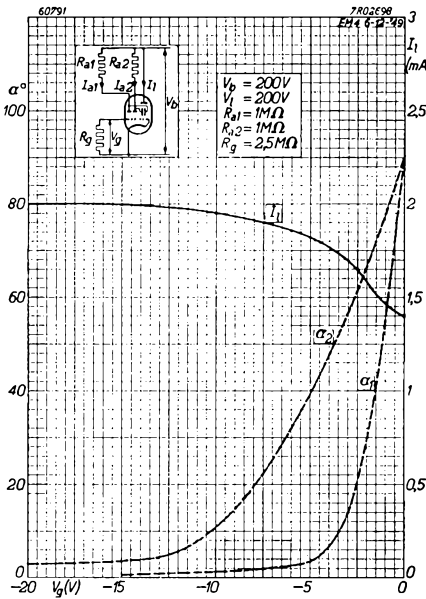

Fig. 6  
Shadow angles  $\alpha_1$  and  $\alpha_2$  measured at the edge of the screen, and screen current  $I_1$  as functions of the grid voltage on a supply of 250 V.



At high values of grid potential the tube operates on the tail of the curve and the mutual conductance is low, with correspondingly low sensitivity of the indicator. From Fig. 5 it will be noticed, however, that even on strong signals the indicator is anything but satisfactory; assuming a direct voltage of  $-10$  to  $-15$  V during tuning, curve (a) gives an angular variation of  $18^\circ$  and curve (b) only  $6^\circ$ . The indication obtained on strong signals is thus not sensitive enough when the indication for weak signals is good; valves made with varying pitch do, in actual fact, yield curves as shown in *b*, which means that such tubes are satisfactory only on weak signals. For a really good indication for both weak and strong signals the only solution is a tube of

Fig. 7  
Shadow angles  $\alpha_1$  and  $\alpha_2$  measured at the edge of the screen, and screen current  $I_1$  as functions of the grid potential on a supply of 200 V.

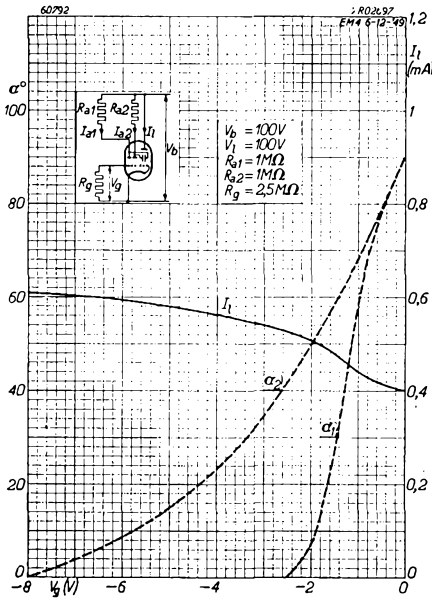

Fig. 8  
Shadow angles  $\alpha_1$  and  $\alpha_2$  measured at the edge of the screen, and screen current  $I_f$  as functions of the grid potential

the type of the EM 4 with its dual sensitivity ranges.

It should be noted that the EM 4 has only two fluorescent zones instead of the four in the EM 1. In the first place this ensures greater angular variation in each of the individual sectors; secondly, experience has shown that the average listener finds it easier to tune with only two sectors than with four. When there are four fluorescent sectors the layman invariably tries to obtain a symmetrical pattern on the screen, with correspondingly faulty tuning. With only two shadow sectors there is less to occupy the eye and there is not so much tendency towards inaccurate tuning. Due to the presence of the two rods supporting the cathode-light screen, the fluorescent areas are divided by two thin lines of shadow. Fig. 6 shows that at  $-16$  V and  $-5$  V the characteristic commences to flatten out; small lines of shadow remain over, due to the fact that the deflector rods absorb a certain amount of current which in turn produces a voltage drop across the coupling resistor, this preventing the rods from exceeding a certain positive

potential. It is on account of this fact that the fluorescent areas cannot overlap each other. Fig. 4 depicts diagrammatically the arrangement of the electrodes and supporting rods in the indicator section of the EM 4.

At the upper end the bulb is moulded to a special shape, being, as it were, depressed to a concave surface, in order that the edge of the glass, which is lacquered, may form a dark background before the actual "window" of the tube. In this way the contrast between the fluorescence and the dark background is accentuated and very slight variations in the light and shadow during tuning are rendered more easily perceptible.

Heater ratings have been chosen for this tube that will render it suitable for parallel feeding on 6.3 V as well as series feeding in 200 mA circuits. Needless to say in A.C./D.C. receivers operating on 110 V the brilliance of the fluorescent sectors is less than when the applied screen voltage is 250 V.

## HEATER RATINGS

Heating: indirect by A.C. or D.C., series or parallel supply.

Heater voltage . . . . .  $V_f = 6.3$  V  
Heater current . . . . .  $I_f = 0.200$  A

## OPERATING DATA: EM 4 used as tuning indicator

Voltage supply to screen and anode circuits. . . . .	$V_b$	= 100 V	200 V	250 V
Anode series resistor for the high-sensitivity section. . . . .	$R_{a1}$	= 1 M ohm	1 M ohm	1 M ohm
Anode series resistor for the low-sensitivity section . . . . .	$R_{a2}$	= 1 M ohm	1 M ohm	1 M ohm
Screen current at $V_g = 0$ V . . . . .	$I_l$	= 0.2 mA	0.55 mA	0.75 mA
Grid voltage for a shadow angle of $90^\circ$ in the high-sensitivity section . . . . .	$V_g (\gamma_1 = 90^\circ)$	= 0 V	0 V	0 V
Grid voltage for a shadow angle of $90^\circ$ in the low-sensitivity section . . . . .	$V_g (\alpha_2 = 90^\circ)$	= 0 V	0 V	0 V
Grid voltage for a shadow angle of $0^\circ$ in the high-sensitivity section . . . . .	$V_g (\alpha_1 = 0^\circ)$	= -2.5 V	—	—
Grid voltage for a shadow angle of $0^\circ$ in the low-sensitivity section . . . . .	$V_g (\alpha_2 = 0^\circ)$	= -8 V	—	—
Grid voltage for a shadow angle of $5^\circ$ in the high-sensitivity section . . . . .	$V_g (\alpha_1 = 5^\circ)$	= —	-4.2 V	-5 V
Grid voltage for a shadow angle of $5^\circ$ in the low-sensitivity section . . . . .	$V_g (\alpha_2 = 5^\circ)$	= —	-12.5 V	-16 V

$\alpha_1$  = shadow angle with respect to deflector rod  $D_1$ , measured at the edge of the screen.

$\alpha_2$  = the same with respect to deflector rod  $D_2$ .

## MAXIMUM RATINGS

$V_{a10}$ . . . . .	= max. 550 V	$V_l$ . . . . .	= max. 275 V
$V_{a1}$ . . . . .	= max. 275 V	$V_g (I_g = + 0.3 \mu A)$	= max. -1.3 V
$V_{a20}$ . . . . .	= max. 550 V	$R_{gk}$ . . . . .	= max. 3 M ohms
$V_{a2}$ . . . . .	= max. 275 V	$R_{fk}$ . . . . .	= max. 20,000 ohms
$V_{l0}$ . . . . .	= max. 550 V	$V_{fk}$ . . . . .	= max. 100 V <sup>1)</sup>

<sup>1)</sup> Direct voltage or effective value of alternating voltage

## APPLICATIONS

The EM 4 can be used in all A.C. or A.C./D.C. receivers incorporating diode rectification, so long as the signal strength at the diode detector is sufficiently great (superheterodynes). The electronic indicator should for preference be connected to the diode load resistor; connection to the A.G.C. diode in the case of delayed control has the disadvantage that the indicator will not then function on signals which are below the delay level. Since the more sensitive side of the EM 4 is otherwise designed to permit of exact tuning on weak signals and will do so even when the signal is below the delay level, it is advisable to connect the grid of the EM 4 directly to the detector diode. In this way, moreover, the control voltage rises more quickly during tuning, because the signal voltage at the diode is taken from the second tuned circuit in the I.F. band-pass filter, whilst the signal voltage for the A.G.C. diode is usually derived from the first tuned circuit.

The apparent sensitivity is thus greater at the detector diode than at the A.G.C. diode. Fig. 9 is a typical example of a superhet receiver circuit incorporating the EM 4.





receivers operating on a supply of 100 V and, as the less-sensitive part is then much more sensitive than normally on 250 V, approximating more closely the characteristic of the EM 1 at 250 V, this section of the indicator will give a much more satisfactory range of deflection on average signal strengths.

In A.C./D.C. receivers operating on 100 V it is also possible to short the two anodes of the triode and feed them through a common resistor of 1 megohm, and the

Fig. 10  
**Full line.** Shadow angles  $\alpha_1$  and  $\alpha_2$  measured at the edge of the screen, as a function of the grid potential on 100 V supply, with no resistor connected in series with the grid.  
**Chain-dot line.** The same with a resistor of 1 megohm connected to the grid.  
**Dotted line.** The same with a resistor of 2.5 megohms in series with grid.  
 As from  $-1.2$  V, the three curves coincide.

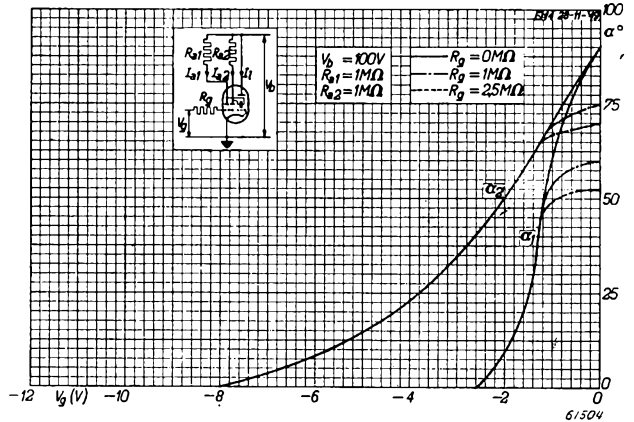

characteristics in Fig. 11 show the working conditions under this arrangement, which ensures a marked variation in the shadow angles following upon voltage variations on the grid, even at potentials below the control level. The curve of the shadow angle plotted against the control voltage now lies roughly between that of the more sensitive section of the EM 4 and that of the low sensitivity side on a supply of 250 V. In Fig. 11 the shadow angle refers to a grid resistor of 2.5 megohms; at lower values of the control voltage it is true that the bend in the curve caused by grid current is plainly to be seen, but this bend is nevertheless not nearly so marked as in the characteristic shown in Fig. 10. At a grid potential of 0 V the mutual conductance is higher, from which it follows that the indicator sensitivity is greater. This arrangement will give a maximum shadow angle of about 70°, which

is quite sufficient for all tuning purposes; both the shadow angles of the EM 4 are then the same, as is also the angular variation in the two sectors.

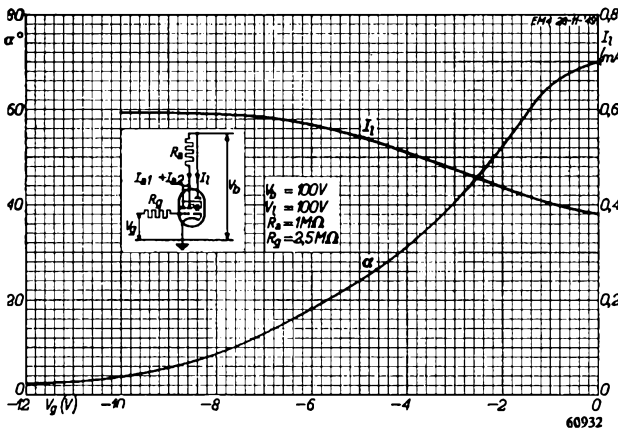

Fig. 11  
 Shadow angle  $\alpha$  of the two sectors, and screen current  $I_1$  as functions of the grid voltage on 100 V supply, with the two anodes interconnected and fed through a resistor of 1 megohm. A resistor of 2.5 megohms is connected to the grid.

# EZ 2 Rectifying valve

The EZ 2 is an indirectly-heated full-wave rectifying valve, specially designed for car radio receivers. The heater is fed from the car battery at 6.3 V and for this reason the heater-current consumption has been kept as low as possible. The optimum D.C. output is sufficient to operate a normal car radio receiver, not including energizing current for a loudspeaker.

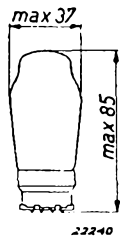

Fig. 1  
Dimensions in mm.

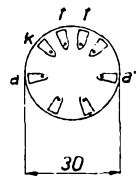

Fig. 2  
Arrangement of electrodes and base connections.

## HEATER RATINGS

Heating: indirect by A.C. or D.C.

Heater voltage . . . . .	$V_f = 6.3 \text{ V}$
Heater current . . . . .	$I_f = 0.4 \text{ A}$

## MAXIMUM RATINGS

Voltage on no-load, across the secondary winding of the power transformer . . . . .	$V_{tr} = \text{max. } 2 \times 350 \text{ V}_{\text{eff}}$
D.C. output . . . . .	$I_o = \text{max. } 60 \text{ mA}$
Voltage between heater and cathode (absolute peak value) . . . . .	$V_{fk} = \text{max. } 500 \text{ V}$
Internal resistance of the power transformer (per anode) . . . . .	$R_t = \text{min. } 600 \text{ ohms}$
Capacitance of first smoothing capacitor at $V_{tr} = 2 \times 350 \text{ V}_{\text{eff}}$ . . . . .	$C = \text{max. } 16 \mu\text{F}$
Capacitance of first smoothing capacitor at $V_{tr} = 2 \times 300 \text{ V}_{\text{eff}}$ . . . . .	$C = \text{max. } 32 \mu\text{F}$

As rectifying valve in a car radio receiver, the direct voltage with a superimposed ripple voltage between the filament — which is connected to the car chassis through the battery — and the cathode which is taken directly to the positive H.T. side of the first smoothing capacitor must be accepted as such.

At such time as the rectifying valve is not loaded a potential occurs between these components equal to the peak value of the voltage applied to the valve. The maximum permissible voltage between heater and cathode is 500 V, i.e. the maximum peak value of the alternating anode voltage, whilst the optimum value of the direct current delivered is 60 mA, this being an absolute value, applicable also to alternating voltages of  $2 \times 300 \text{ V}_{(\text{eff})}$

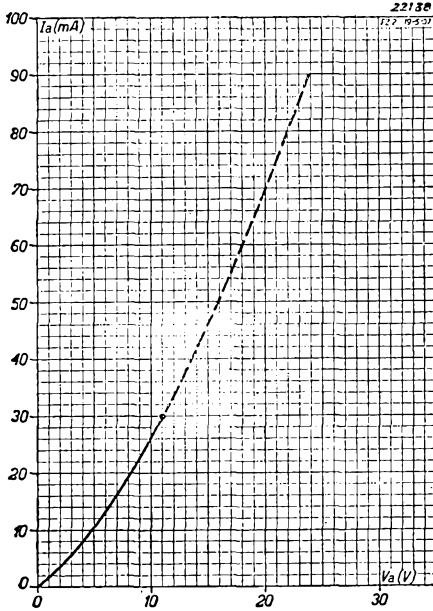

Fig. 3  
Current per anode as a function of the applied voltage.

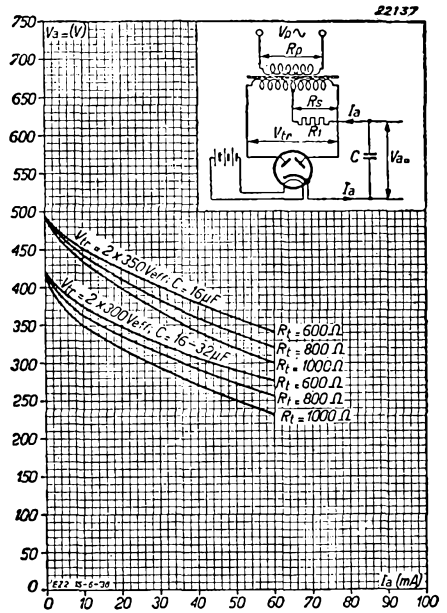

Fig. 4  
Loading curves for the rectifying valve EZ 2, for voltages of  $2 \times 300$  and  $2 \times 350$  V on no load, across the secondary winding of the power transformer, and with respect to different values of the internal resistance of the rectifier circuit. The input capacitance is at most  $16 \mu\text{F}$  on  $2 \times 350$  V, or  $32 \mu\text{F}$  on  $2 \times 300$  V. If the internal resistance of the power transformer is less than the minimum of 600 ohms, it must be increased to that value by means of an extra resistor  $R_1$  in series with the half-secondary.

$R_t = I_s + R_1 + n^2 R_p$   
 $R_p$  = resistance of primary winding.  
 $I_s$  = resistance of half secondary winding.  
 $n$  = transformer ratio; prim. winding/sec. half-winding.  
 $R_1$  = additional resistance when total resistance is too low.

## EZ 4 Rectifying valve

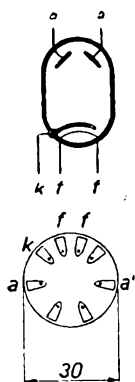

Fig. 2  
Arrangement of  
electrodes and  
base connections.

The EZ 4 is an indirectly-heated full-wave rectifying valve for use in high-power receivers and small amplifiers. With the two anodes shorted the valve can be used as a half-wave rectifying valve, and two valves connected in this manner provide a full-wave circuit that will give a high voltage with considerable power. The optimum power thus delivered is twice the value that can be obtained from a single EZ 4, the two valves giving 350 mA with  $2 \times 400$  V A.C. across the secondary winding of the power transformer.

The dimensions of this valve are unusually small; notwithstanding the low current consumption, the output is, relatively speaking, exceptionally high.



Fig. 1  
Dimensions in mm.

### HEATER RATINGS

Heating: indirect by A.C.

Heater voltage . . . . .	$V_f = 6.3$ V
Heater current . . . . .	$I_f = 0.9$ A

### MAXIMUM RATINGS

Voltage, on no load, across the secondary winding of the power transformer . . . . .	$V_{tr} = \text{max. } 2 \times 400$ V <sub>eff</sub>
D.C. output . . . . .	$I_o = \text{max. } 175$ mA
Voltage between heater and cathode . . . . .	$V_{fk} = 0$ V <sup>1)</sup>
Internal resistance of the power transformer, at $V_{tr} = 2 \times 300$ V <sub>eff</sub> (per anode) . . . . .	$R_t = \text{min. } 200$ ohms
Internal resistance of the power transformer, at $V_{tr} = 2 \times 350$ V <sub>eff</sub> (per anode) . . . . .	$R_t = \text{min. } 250$ ohms
Internal resistance of the power transformer, at $V_{tr} = 2 \times 400$ V <sub>eff</sub> (per anode). . . . .	$R_t = \text{min. } 300$ ohms
Capacitance of the first smoothing capacitor at $V_{tr} = 2 \times 350$ V <sub>eff</sub> and $2 \times 400$ V <sub>eff</sub> . . . . .	$C = \text{max. } 16$ μF
Capacitance of the first smoothing capacitor at $V_{tr} = 2 \times 300$ V <sub>eff</sub> . . . . .	$C = \text{max. } 32$ μF

<sup>1)</sup> The cathode must in every case be connected to one side of the heater.

The heater of the valve must not be included in the heater circuit of the receiving valves, but a separate winding should be provided in the power transformer; the cathode should be connected directly to one end of the heater. Of the smoothing capacitors, the first may be increased in value from 16 to 32 μF, provided the A.C. voltage is reduced to  $2 \times 300$  V<sub>eff</sub>. Owing to the very low internal resistance of this rectifying valve, not much heat is developed and it is therefore not necessary to take any special precautions in the design of the receiver or the mounting of the valve to ensure ventilation.

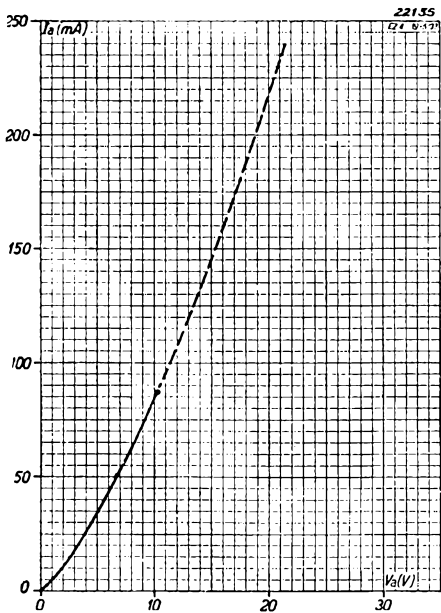

Fig. 3  
Current per anode, plotted against the applied direct voltage.

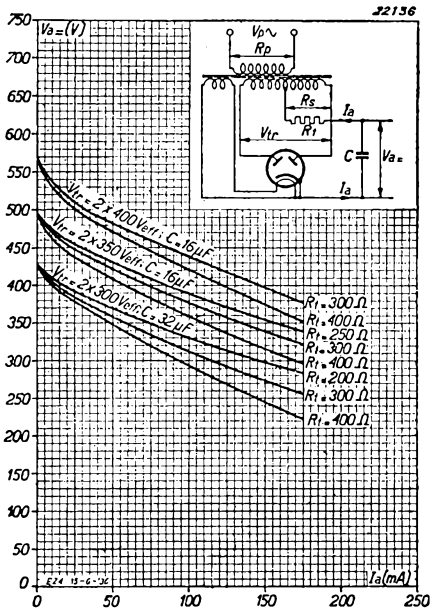

Fig. 4  
Loading characteristics of the rectifying valve EZ 4, for voltages of  $2 \times 300$ ,  $2 \times 350$  and  $2 \times 400$  V(eff) across the secondary winding of the power transformer, for different values of the internal resistance of the transformer. The input capacitance C of the filter is at most  $32 \mu\text{F}$  on  $2 \times 300$  V(eff), or  $16 \mu\text{F}$  with  $2 \times 350$  and  $2 \times 400$  V(eff). If the internal resistance of the transformer is less than the minimum value it must be raised to this minimum by means of an extra resistor  $R_i$  in series with the half-winding of the secondary.

$R_i = R_s + R_1 + n^2 R_p$   
 $R_p$  = resistance of primary winding  
 $R_s$  = resistance of the half-secondary winding  
 $n$  = transformer ratio; primary winding/half-secondary winding.  
 $R_1$  = extra resistance when total resistance is too low.

# AZ 1 Rectifying valve

This is a directly-heated, full-wave rectifying valve for medium-power receivers operating on normal working voltages.

## FILAMENT RATINGS

Heating: direct by A.C.

Filament voltage. . . . .  $V_f = 4 \text{ V}$

Filament current. . . . .  $I_f = 1.1 \text{ A}$

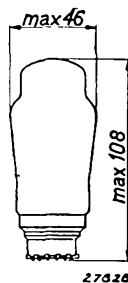
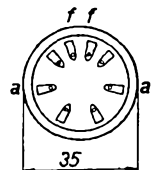
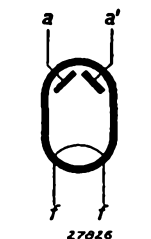

Fig. 1  
Dimensions in mm.



27027

Fig. 2  
Arrangement of  
electrodes and  
base connections.

## MAXIMUM RATINGS

Voltage, on no load, at the secondary winding of

the power transformer. . . . .  $V_{tr} = 2 \times 500 \text{ V}_{\text{eff}}$

D.C. output on  $V_{tr} = 2 \times 500 \text{ V}_{\text{eff}}$ . . . . .  $I_o = \text{max. } 60 \text{ mA}$

D.C. output on  $V_{tr} = 2 \times 400 \text{ V}_{\text{eff}}$ . . . . .  $I_o = \text{max. } 75 \text{ mA}$

D.C. output on  $V_{tr} = 2 \times 300 \text{ V}_{\text{eff}}$ . . . . .  $I_o = \text{max. } 100 \text{ mA}$

Capacitance of the first smoothing capacitor. . . . .  $C = \text{max. } 60 \mu\text{F}$

If the valve is to be mounted horizontally, it should be located so that the filament lies in the vertical plane.

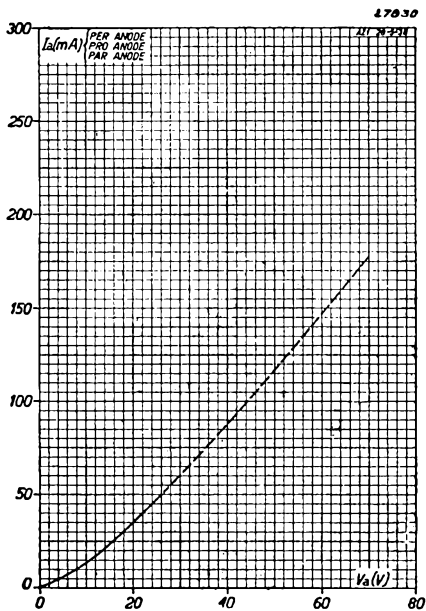

Fig. 3  
Current per anode, as a function of the applied direct voltage.

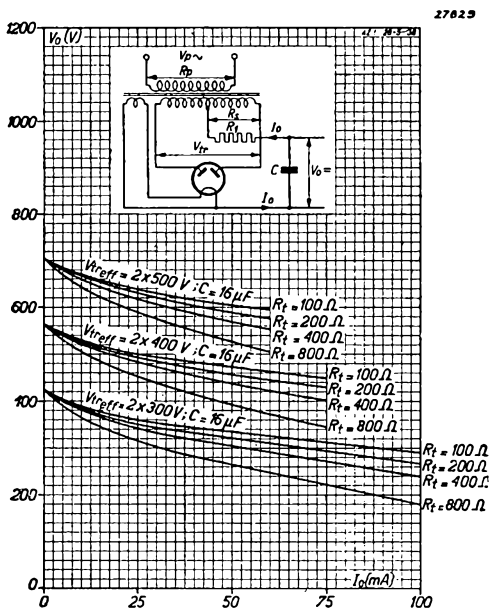

Fig. 4  
Loading characteristics relating to different transformer voltages, on no load, for different values of the internal resistance of the transformer ( $R_t = R_s + n^2 R_p + R_r$ )



# AZ 4 Rectifying valve

The AZ 4 is a directly-heated full-wave rectifying valve for receivers consuming a heavy current.

## FILAMENT RATINGS

Heating: direct, A.C.

Filament voltage. . . . .  $V_f = 4.0$  V

Filament current. . . . .  $I_f = 2.3$  A

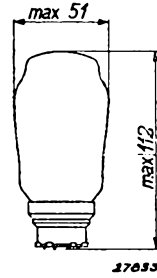

Fig. 1  
Dimensions in mm.

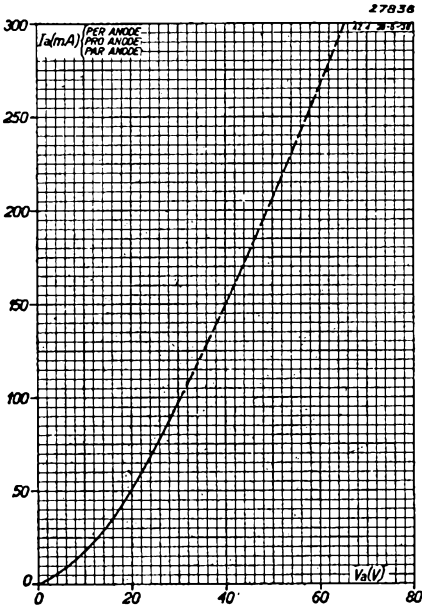

Fig. 3  
Current per anode, as a function of the applied direct voltage.

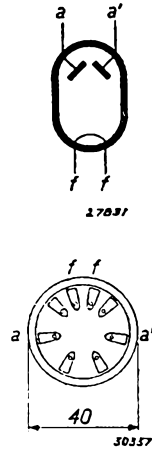

Fig. 2  
Arrangement of base connections and electrodes.

## MAXIMUM RATINGS

Voltage, on no load, across the secondary winding

of the power transformer . . . . .  $V_{tr} = \text{max. } 2 \times 500$  V<sub>eff</sub>

D.C. output with  $V_{tr} = 2 \times 500$  V<sub>eff</sub> . . . . .  $I_o = \text{max. } 120$  mA

D.C. output with  $V_{tr} = 2 \times 400$  V<sub>eff</sub> . . . . .  $I_o = \text{max. } 150$  mA

D.C. output with  $V_{tr} = 2 \times 300$  V<sub>eff</sub> . . . . .  $I_o = \text{max. } 200$  mA

Capacitance of the first smoothing capacitor. . . . .  $C = \text{max. } 60$   $\mu$ F

For medium-power amplifier equipment two AZ 4 valves each working as a half-wave rectifying valve (anodes connected in parallel) may be used in a full-wave rectifier circuit.

If the valve is to be mounted horizontally it should be located so that the filament lies in the vertical plane.

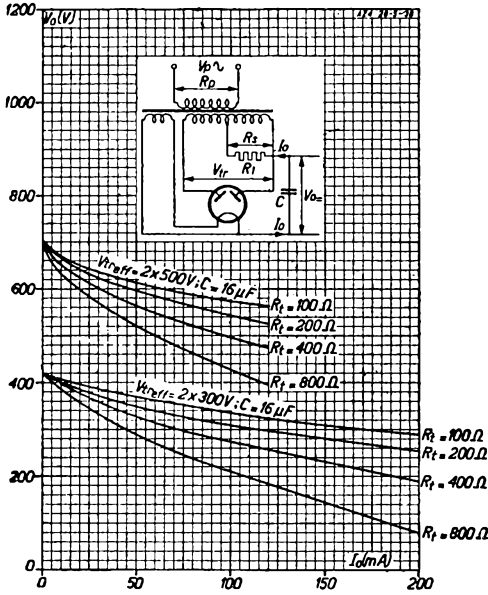

Fig. 4  
Loading characteristics for transformer voltages, on no load, of  $V_{tr} = 2 \times 300 \text{ V}$  and  $2 \times 500 \text{ V}$  and with respect to different values of the internal resistance of the transformer ( $R_t = R_s + n^2 R_p + R_l$ ).

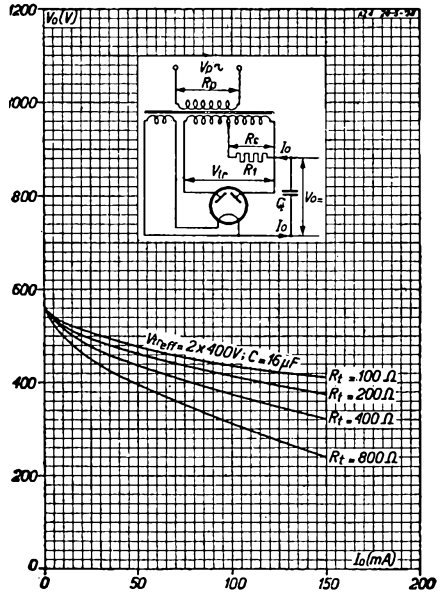

Fig. 5  
Loading characteristics relating to  $V_{tr} = 2 \times 400 \text{ V}$ , for different values of the internal resistance of the transformer ( $R_t = R_s + n^2 R_p + R_l$ ).

**Valves for A.C./D.C. receivers**

## Valves for A.C./D.C. receivers

Valves for operating on both alternating and direct current are referred to briefly as A.C./D.C. valves. A full range of Philips valves is available for such receivers, all working on a heater current of 200 mA, which represents quite a low current consumption in the heater circuit. The original series of A.C./D.C. valves comprised the following:

Type No.	Type of valve	Heater voltage
CB 2	Double diode . . . . .	13 V
CBC 1	Double-diode-triode . . . . .	13 V
CC 2	Triode . . . . .	13 V
CF 3	Variable- $\mu$ pentode . . . . .	13 V
CF 7	Pentode . . . . .	13 V
CH 1	Hexode . . . . .	13 V
CK 1	Octode . . . . .	13 V
CL 1	5 W output pentode (also for car radio) . . . . .	13 V
CL 2	8 W output pentode . . . . .	24 V
CL 4	Steep-slope 9 W output pentode . . . . .	33 V
CY 1	Half-wave rectifying valve . . . . .	20 V
CY 2	Half-wave rectifying valve and voltage doubler . . . . .	30 V

This range has now been completed by the addition of a 4-channel octode, the CK 3, a double-diode pentode CBL 1 and a steep-slope output pentode for low mains supplies, the CL 6.

Of the modern "Miniwatt", E-type valves, quite a number are also suitable for A.C./D.C. receivers, namely those whose current consumption is 200 mA at 6.3 V; these valves can be connected with their heaters in series with any other specific A.C./D.C. valves and comprise the so-called pre-amplifiers, such as R.F. pentodes, frequency-changers and A.F. amplifiers; output valves and rectifying valves in general require more heater power than 1.26 W and their current consumption is therefore more than 200 mA. They are, of course, not suitable for series feeding. In the design of A.C./D.C. receivers, incorporating the red "E"-type valves, a choice must be made from among the valves in the existing range as far as output and rectifying valves are concerned. For the mixer stage the triode-hexode ECH 3 is recommended.

In order to complete the range of A.C./D.C. valves, using the 1.26 W, E-types, the following should also be added.

Type No.	Type of valve	Heater voltage
CBL 1	Double-diode output pentode . . . . .	44 V
CK 3	4-channel octode . . . . .	19 V
CL 4	Steep-slope output pentode . . . . .	33 V
CL 6	Steep-slope output pentode for 100 V supply	35 V
CY 1	Half-wave rectifying valve. . . . .	20 V
CY 2	Half-wave rectifying valve and voltage doubler . . . . .	30 V

In the following pages the data and characteristics of the 200 mA valves are given; the red pre-amplifier valves (E-type) have already been fully described in the foregoing.

# CBL 1 Double-diode output pentode

The CBL 1 is a combination of double-diode and steep-slope pentode for A.C./D.C. receivers, both units being housed in a common envelope; the cathode is also common to both.

The pentode unit is comparable with the high-mutual-conductance output pentode CL 4.

In view of the considerable heater power required, the heater voltage, with a current of 200 mA, is 44 V. The two diodes are mounted below the pentode section, on each side of the cathode, with the anodes, which are almost semi-cylindrical in shape, level with each other; the diodes are, therefore, electrically identical. Further, the diode unit is separated from the pentode section by a screen and, to ensure that the grid of the pentode cannot be affected in any way by the diodes, and also to prevent hum, the control-grid connection is taken out to a top cap on the envelope.

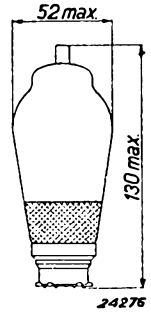

Fig. 1  
Dimensions in mm.

## HEATER RATINGS

Heating: indirect by A.C. or D.C., series supply.

Heater voltage . . . . .  $V_f = 44 \text{ V}$

Heater current . . . . .  $I_f = 0.200 \text{ A}$

## CAPACITANCES

$C_{ag1} < 1.0 \mu\text{F}$                        $C_{d'f} < 0.5 \mu\text{F}$

$C_{d'u} < 0.2 \mu\text{F}$                        $C_{df} < 1 \mu\text{F}$

$C_{da} < 0.4 \mu\text{F}$                        $C_{d'k} = 3.5 \mu\text{F}$

$C_{d'g1} < 0.15 \mu\text{F}$                        $C_{dk} = 3.6 \mu\text{F}$

$C_{dg1} < 0.15 \mu\text{F}$                        $C_{d'a} < 0.25 \mu\text{F}$

## OPERATING DATA

Anode voltage . . . . .	$V_a$	= 200 V
Screen-grid voltage . . . . .	$V_{g2}$	= 200 V
Cathode resistor . . . . .	$R_k$	= 170 ohms
Grid bias . . . . .	$V_{g1}$	= -8.5 V
Anode current . . . . .	$I_a$	= 45 mA
Screen-grid current . . . . .	$I_{g2}$	= 6 mA
Mutual conductance . . . . .	$S$	= 8 mA/V
Internal resistance . . . . .	$R_i$	= 40,000 ohms
Load resistor . . . . .	$R_a$	= 4,500 ohms
Output power with 10% distortion . . . . .	$W_o$	= 4 W
Alternating input voltage for 4 W output . . . . .	$V_i$	= 5 $V_{\text{eff}}$
Sensitivity ( $W_o = 50 \text{ mW}$ ) . . . . .	$V_i$	= 0.5 $V_{\text{eff}}$

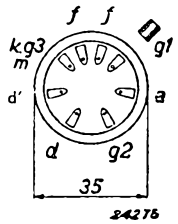
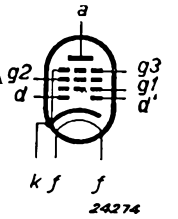

Fig. 2  
Arrangement of electrodes and base connections

**MAXIMUM RATINGS**

Pentode section:

$V_{a0}$	= max. 550 V
$V_a$	= max. 250 V
$W_a$	= max. 9 W
$V_{g20}$	= max. 550 V
$V_{g2}$	= max. 250 V
$W_{g2} (V_i = 0)$	= max. 1.2 W
$W_{g2} (W_o = \text{max})$	= max. 2 W
$I_k$	= max. 70 mA
$V_{g1} (I_{g1} = +0.3 \mu\text{A})$	= max. -1.3 V
$R_{g1k}$	= max. 1 M ohm
$R_{fk}$	= max. 5,000 ohms
$V_{fk}$	= max. 175 V <sup>1)</sup>

<sup>1)</sup> Direct voltage or effective value of alternating voltage

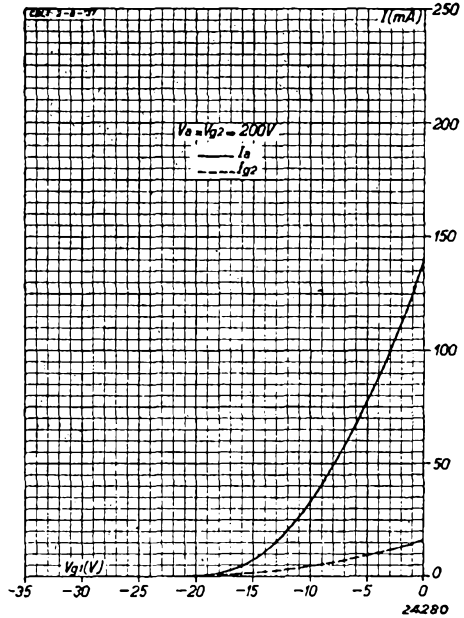

Fig. 3  
Anode and screen current as a function of the grid bias at  $V_a = V_{g2} = 200$  V.

Diode section:

Voltage on anode of diode	$V_d = V_d'$	= max. 200 V
Diode current	$I_d = I_d'$	= max. 0.8 mA
Diode voltage at diode current start ( $I_d = I_d' = +0.3 \mu\text{A}$ )	$V_d = V_d' =$	= max. -1.3 V

The characteristics relating to the increase in the voltage ( $\Delta V$ ) across the grid leak, as plotted against the unmodulated R.F. voltage, and for the A.F. voltage  $V_{LF}$  across the grid leak as a function of the 30% modulated R.F. voltage applied to one of the diodes, are exactly the same as those of the EB 4, so for these data the reader is referred to the last-mentioned valve.

Grid bias must be provided only by means of a cathode resistor; semi-automatic bias is also permissible, but the cathode current of the valve must then be definitely in excess of 50% of the total current passing through the resistor producing the voltage drop.

In general, the capacitance of the decoupling capacitor should be at least 2  $\mu\text{F}$ , but for better reproduction of the lower audio frequencies an electrolytic capacitor of 25 to 50  $\mu\text{F}$  capacitance is better. Leads to the valve contacts should be kept as short as possible and a resistor of about 1000 ohms in the control-grid lead will often be found necessary.

It should be observed that any A.F. amplification between the detector diode and the pentode section of the valve may possibly give rise to trouble due to hum or microphony. Any such amplification should therefore not exceed at most 15 times.

Tables I and II provide an idea of the power delivered, having regard to the voltage drop across the output transformer. The theoretical circuit diagrams employed to obtain the values given in these tables are depicted in the figures relating to the EL 2 valve.

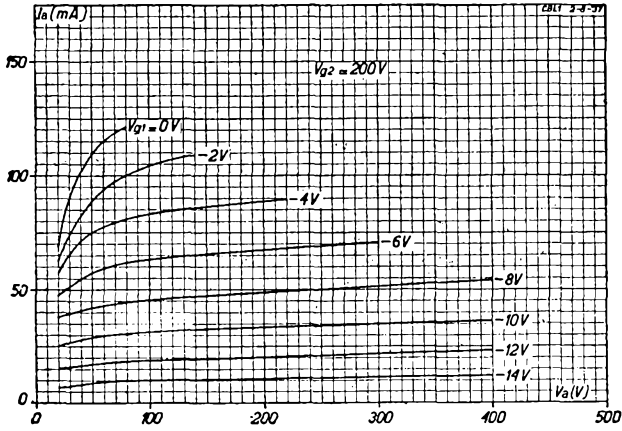

Fig. 4  
Anode current as a function of the anode voltage at  $V_{g2} = 200$  V,  
for different values of grid bias.

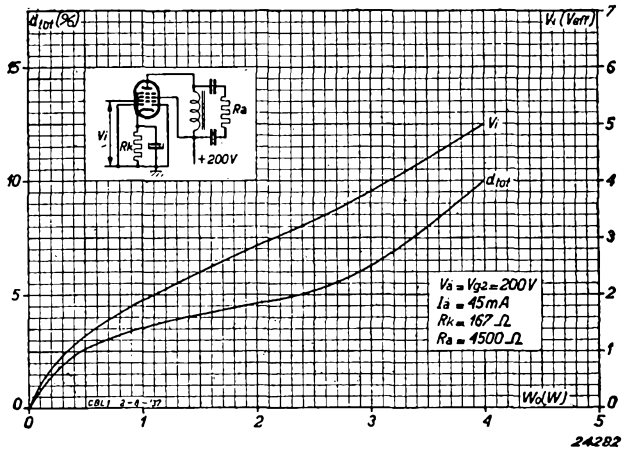

Fig. 5  
Alternating grid voltage and total distortion as functions of the  
output power.



TABLE I

Output power and grid input voltage as functions of the voltage drop in the output transformer, on an effective anode voltage of 200 V D.C.

$$I_a = 45 \text{ mA}$$

Effective D.C. volts on the anode	Supply voltage	Screen-grid series resistor	Voltage drop across output transf.	With 10 % distortion			With 5 % distortion			Loss in power in output transf. $\frac{W_{tr} \times 100}{W_o}$ (%)
				Ext. anode res.	Alt. grid volts	Output power	Ext. anode res.	Alt. grid volts	Output power	
				$R_a$ (ohm)	$V_i (V_{eff})$	$W_o (W)$	$R_a$ (ohm)	$V_i (V_{eff})$	$W_o (W)$	
$V_a (V)$	$V_b (V)$	$R_{g_2}$ (ohm)	$V_{tr} (V)$	$R_a$ (ohm)	$V_i (V_{eff})$	$W_o (W)$	$R_a$ (ohm)	$V_i (V_{eff})$	$W_o (W)$	
200	200	0	0	4,500	4.4	4.0	4,500	2.7	2.1	—
200	210	1,800	10	4,500	4.3	3.7	4,500	2.5	1.8	10
200	220	3,400	20	4,500	4.25	3.6	4,500	2.4	1.6	20
200	230	5,000	30	4,500	4.2	3.5	4,500	2.3	1.5	30
200	250	8,500	50	4,500	4.1	3.3	4,500	2.3	1.5	50

TABLE II

Output power and grid input voltage as functions of the voltage drop in the output transformer when the screen and supply voltage = 200 V.

$$I_a = 45 \text{ mA}$$

Effective D.C. volts on the anode	Supply voltage	Screen-grid voltage	Voltage drop across output transf.	With 10 % distortion			With 5 % distortion			Loss in power in output transf. $\frac{W_{tr} \times 100}{W_o}$ (%)
				Ext. anode res.	Alt. grid volts	Output power	Ext. anode res.	Alt. grid volts	Output power	
				$R_a$ (ohm)	$V_i (V_{eff})$	$W_o (W)$	$R_a$ (ohm)	$V_i (V_{eff})$	$W_o (W)$	
$V_a (V)$	$V_b (V)$	$V_{g_2} (V)$	$V_{tr} (V)$	$R_a$ (ohm)	$V_i (V_{eff})$	$W_o (W)$	$R_a$ (ohm)	$V_i (V_{eff})$	$W_o (W)$	
200	200	200	0	4,500	4.4	4.0	4,500	2.7	2.1	0
190	200	200	10	4,200	4.4	3.5	4,200	2.5	1.85	11
180	200	200	20	4,000	4.3	3.4	4,000	2.6	1.75	22
170	200	200	30	3,800	4.3	2.9	3,800	2.7	1.65	35
150	200	200	50	3,350	4.2	2.6	3,350	2.9	1.65	66

Note: The loss of power due to the resistance of the output transformer is calculated on the assumption that  $R_{prim} = n^2 R_{sec}$ .

# CK 3 Octode

This is an octode of the 4-channel type; with the exception of the heater ratings it is similar to the EK 3, for A.C./D.C. receivers. With a view to its use on 100 V mains, the sixth grid has been modified slightly, but the data as given for the EK 3 also apply to this valve, which offers the same advantages with respect to frequency drift, induction effect, conversion conductance, cross-modulation, oscillator slope, etc.

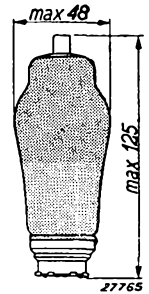

Fig. 1  
Dimensions in mm

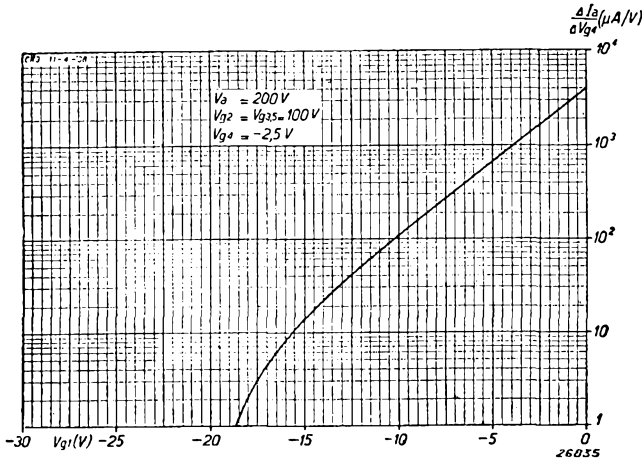

Fig. 3  
Conductance of the 4th grid as a function of the direct voltage on grid 1.

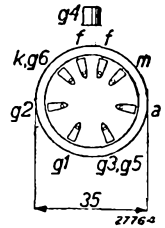
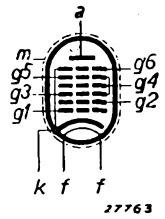

Fig. 2  
Arrangement of electrodes and base connections.

### HEATER RATINGS

Heating: indirect, A.C. or D.C., series supply.

Heater voltage . . . . .  $V_f = 19 \text{ V}$

Heater current . . . . .  $I_f = 0.200 \text{ A}$

### CAPACITANCES

$C_{ag4} < 0.1 \mu\mu\text{F}$

$C_{g1g4} = 1.1 \mu\mu\text{F}$

$C_a = 16.5 \mu\mu\text{F}$

$C_{g2} = 8.6 \mu\mu\text{F}$

$C_{g1} = 14 \mu\mu\text{F}$

$C_{g4} = 15.2 \mu\mu\text{F}$

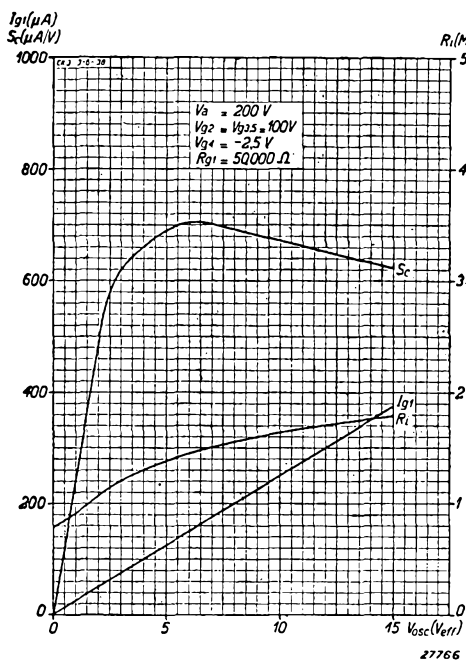

Fig. 4

Internal resistance, conversion conductance and oscillator-grid current as functions of the oscillator voltage, for a grid leak of 50,000 ohms, with  $V_a = 200$  V.

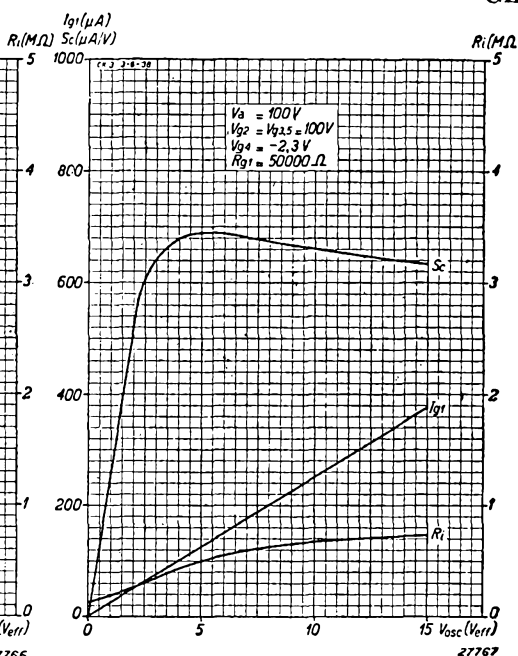

Fig. 5

Internal resistance, conversion conductance and oscillator-grid current as functions of the oscillator voltage, for a grid leak of 50,000 ohms, with  $V_a = 100$  V.

**OPERATING DATA: CK 3 used as frequency-changer  
200 V**

Anode voltage . . . . .	$V_a$	=	200 V		
Screen-grid voltage . . . . .	$V_{g3,5}$	=	100 V		
Oscillator-anode voltage . . . . .	$V_{g2}$	=	100 V		
Grid leak, oscillator . . . . .	$R_{g1}$	=	50,000 ohms		
Alternating oscillator voltage, grid 1 . . . . .	$V_{g1(osc)}$	=	12 V <sub>eff</sub>		
Oscillator-grid current . . . . .	$I_{g1}$	=	300 μA		
Cathode resistor . . . . .	$R_k$	=	190 ohms		
Bias, grid 4 . . . . .	$V_{g4}$	=	-2.5 V <sup>1)</sup>	-38 V <sup>2)</sup>	-42 V <sup>3)</sup>
Anode current . . . . .	$I_a$	=	2.5 mA	—	—
Screen-grid current . . . . .	$I_{g3} + I_{g5}$	=	5.5 mA	—	—
Oscillator-anode current . . . . .	$I_{g2}$	=	5 mA	—	—
Conversion conductance . . . . .	$S_c$	=	650	6.5	3 μA/V
Internal resistance . . . . .	$R_i$	=	1.7	> 10	> 10 M ohms
Conductance: grid 1 with respect to grid 2 ( $V_{osc} = 0$ )	$S_{g1g2}$	=	4 mA/V	—	—
Oscillator-anode current at threshold of oscillation ( $V_{osc} = 0$ ) . . . . .	$I_{g2}$	=	18 mA	—	—

1) Without control.

2) Conductance reduced to one-hundredth of uncontrolled value.

3) Limit of control.

100 V

Anode voltage . . . . .	$V_a$	=	100 V	
Screen-grid voltage . . . . .	$V_{g2,5}$	=	100 V	
Oscillator-anode voltage . . . . .	$V_{g2}$	=	100 V	
Oscillator grid leak . . . . .	$R_{g1}$	=	50,000 ohms	
Alternating oscillator voltage, grid 1 . . . . .	$V_{g1(osc)}$	=	12 V <sub>eff</sub>	
Oscillator-grid current . . . . .	$I_{g1}$	=	300 $\mu$ A	
Cathode resistor . . . . .	$R_k$	=	175 ohms	
Bias, grid 4 . . . . .	$V_{g4}$	=	-2.3 V <sup>1)</sup>	-38 V <sup>2)</sup> -42 V <sup>3)</sup>
Anode current . . . . .	$I_a$	=	2.5 mA	---
Screen-grid current . . . . .	$I_{g3} + I_{g5}$	=	5.5 mA	---
Oscillator-anode current . . . . .	$I_{g2}$	=	5 mA	---
Conversion conductance . . . . .	$S_c$	=	650	6.5 3 $\mu$ A/V
Internal resistance . . . . .	$R_i$	=	0.7	> 10 > 10 M ohms
Conductance, grid 1 with re- spect to grid 2 ( $V_{osc} = 0$ )	$S_{g1g2}$	=	4 mA/V	---
Oscillator-anode current at threshold of oscillation ( $V_{osc} = 0$ ) . . . . .	$I_{g2}$	=	18 mA	---

1) Without control.  
 2) Conductance reduced to one-hundredth of uncontrolled value.  
 3) Limit of control.

MAXIMUM RATINGS

Anode voltage in cold condition . . . . .	$V_{a0}$	=	max. 550 V
Anode voltage . . . . .	$V_a$	=	max. 300 V
Anode dissipation . . . . .	$W_a$	=	max. 1 W
Screen voltage in cold condition . . . . .	$V_{g3,50}$	=	max. 550 V
Screen voltage . . . . .	$V_{g3,5}$	=	max. 150 V
Screen dissipation . . . . .	$W_{g3,5}$	=	max. 1 W
Oscillator-anode voltage, cold . . . . .	$V_{g20}$	=	max. 550 V
Oscillator-anode voltage . . . . .	$V_{g2}$	=	max. 150 V
Oscillator-anode dissipation . . . . .	$W_{g2}$	=	max. 1 W
Cathode current . . . . .	$I_k$	=	max. 23 mA
Grid voltage at grid current start ( $I_{g4} = +0.3 \mu$ A)	$V_{g4}$	=	max. -1.3 V
External resistance between grid 4 and cathode . . . . .	$R_{g4k}$	=	max. 3 M ohms
External resistance between grid 1 and cathode . . . . .	$R_{g1k}$	=	max. 100,000 ohms
External resistance between heater and cathode . . . . .	$R_{fk}$	=	max. 20,000 ohms
Voltage between heater and cathode (direct voltage or effective value of alternating voltage) . . . . .	$V_{fk}$	=	max. 100 V

The frequency drift in this octode will be at its minimum when the tuned oscillator circuit is coupled to the oscillator anode; the coupling coil is then connected to the control grid and Fig. 7 shows the method of arranging the feeds. The direct voltage is applied to the oscillator anode across a resistor of 30,000 ohms.

The direct voltage on the oscillator anode must be 100 V; on 110 V mains this is of the same order as the supply voltage and the series resistor should then actually be much less than 30,000 ohms, but this, again, is not feasible since the oscillator circuit is damped by this resistor and either the oscillator voltage in the short and medium ranges would then be too small, or it would not be possible to maintain it. An alternative method is to use the CK 3 in the other type of circuit, shown in Fig. 8, although a drawback to this arrangement is that extra contacts have to be provided in the wave-change switch for changing over the padding capacitor  $C_p$ .

However, Fig. 9 offers a better solution that can be quite serviceable on a high intermediate frequency, provided that the padding capacitance is kept fairly small. In the long-wave range, for instance, this capacitance is of the order of 200  $\mu\mu\text{F}$ , but this is insufficient for by-passing the feed resistor of 5,000 ohms and would produce too much damping of the oscillator circuit; in the other wave ranges, in which  $C_p$  is of a higher value, this does not apply to such an extent, so that the type of circuit shown in Fig. 7 may be used for the long-wave range and that of Fig. 9 for the other ranges; the combined circuit is shown in Fig. 10. On long waves, when switches  $S_1$  and  $S_2$  are open, the circuit closely resembles that of Fig. 7, although the feed is not applied at the extreme "top" of the circuit. The oscillator circuit is thus fairly heavily damped by the resistor of 5,000 ohms, but on long waves it is not a difficult matter to obtain a sufficiently tight coupling.

On the medium waves, with  $S_1$  closed, the circuit is as shown in Fig. 9; the padding capacitor is large enough, as is also the case for the short waves.

If it is necessary to isolate the tuning capacitor from the D.C. supply of 100 V, a fixed capacitor of fairly high capacitance is placed in series with it, although this is superfluous if the tuned oscillator circuit is connected to the first grid. The frequency drift due to control of the

voltage on the 4th grid is then somewhat more, but this must be accepted if control on the valve is essential.

It should be noted that no account has been taken of the 100 V D.C. occurring on the contacts of the wave-change switch and in many instances this will not be acceptable in view of prevailing safety precautions. High-capacitance isolating capacitors then have to be included, but if this is considered too costly the only alternative is to connect the tuned oscillator circuit to the first grid.

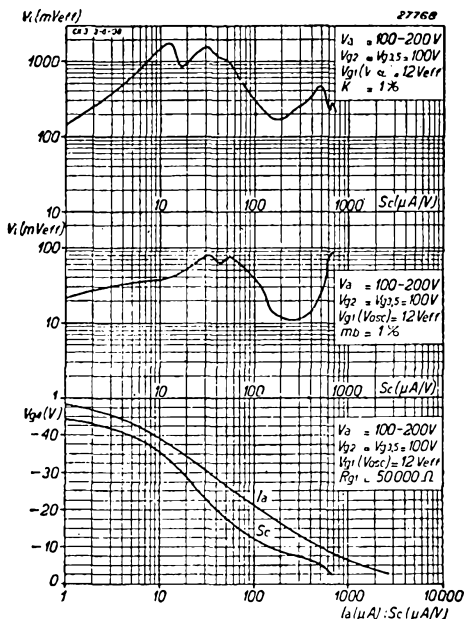

Fig. 6

Upper diagram. Input signal as a function of the conversion conductance as controlled by the bias on the 4th grid, with 1% cross-modulation. (Conductance and voltage on logarithmic scale)

Centre diagram. Input signal as a function of the conversion conductance as controlled by the bias on the 4th grid, with 1% modulation hum. (Conductance and voltage on logarithmic scale)

Lower diagram. Conversion conductance and anode current (logarithmic scale) as a function of the bias on grid 4 (on linear scale).

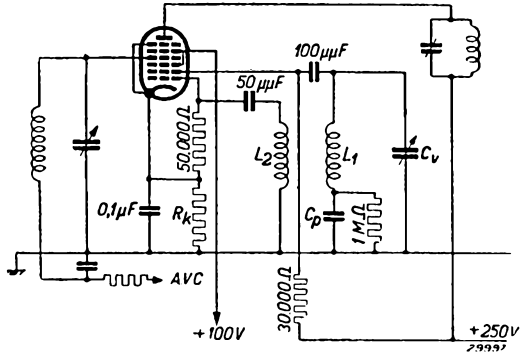

Fig. 7  
Oscillator anode fed through a resistor of 30,000 ohms. This circuit is not suitable for the CK 3 when used on 100 V supply.

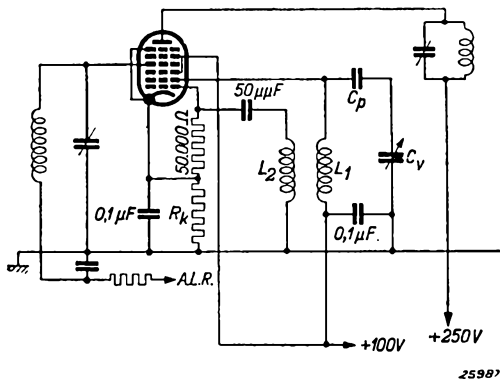

Fig. 8  
Oscillator anode fed through the tuning coil. This arrangement is suitable for 100 V supply but has the disadvantage that the padding capacitors for the different wave ranges have to be switched.

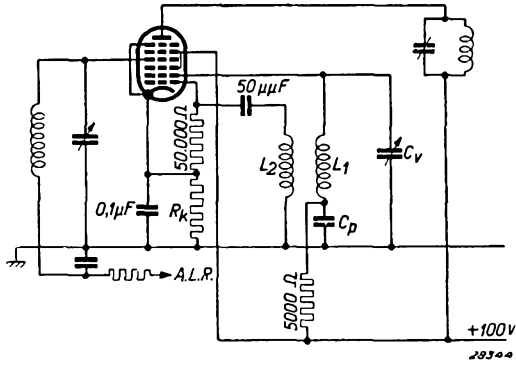

Fig. 9  
Oscillator anode fed through the tuning coil using a series resistor of 5,000 ohms.

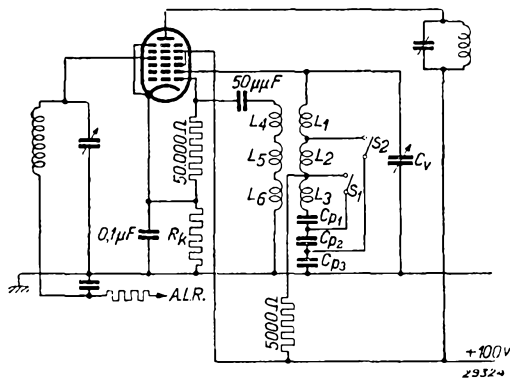

Fig. 10  
Combination of circuits of Figs 7 and 9

# CL 4 Output pentode

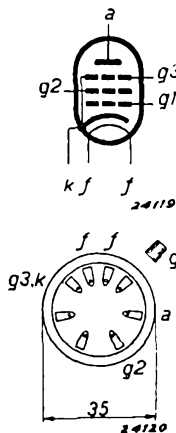

Fig. 2  
Arrangement of electrodes and base connections.

The CL 4 is an indirectly-heated 9 W output pentode of high mutual conductance, especially for use in A.C./D.C. receivers; it lends itself admirably to the construction of simple types of receivers. As the mutual conductance, as stated, is very high, the heater power is also on the high side; the current with 33 V is 200 mA.

The CL 4 may be employed either as a Class A amplifier or in balanced output circuits, and in the latter instance will deliver 8 W with 1.5 % distortion; with a potential of 250 V on both anode and screen, as much as 13.5 W can be obtained from this valve with 5.7 % distortion (the anode-to-anode load is 6,000 ohms). The cathode biasing resistor must then be 175 ohms and the alternating grid voltage 12.5  $V_{\text{eff}}$ , per grid.



Fig. 1  
Dimensions in mm.

## HEATER RATINGS

Heating: indirect, by A.C. or D.C., series supply.

Heater voltage . . . . .	$V_f = 33 \text{ V}$
Heater current . . . . .	$I_f = 0.200 \text{ A}$

## CAPACITANCES

Anode-grid . . . . .	$C_{ag1} < 1 \mu\mu\text{F}$
----------------------	------------------------------

## OPERATING DATA: CL 4 used as single output valve

Anode voltage . . . . .	$V_a$	$\approx 200 \text{ V}$
Screen-grid voltage . . . . .	$V_{g2}$	$\approx 200 \text{ V}$
Cathode resistor. . . . .	$R_k$	$\approx 170 \text{ ohms}$
Grid bias. . . . .	$V_{g1}$	$\approx -8.5 \text{ V}$
Anode current . . . . .	$I_a$	$\approx 45 \text{ mA}$
Screen-grid current . . . . .	$I_{g2}$	$\approx 6 \text{ mA}$
Mutual conductance . . . . .	$S$	$\approx 8 \text{ mA/V}$
Internal resistance . . . . .	$R_i$	$\approx 35,000 \text{ ohms}$
Load resistor . . . . .	$R_a$	$\approx 4,500 \text{ ohms}$
Output power with 10 % distortion . . . . .	$W_o$	$\approx 4 \text{ W}$
Alternating input voltage . . . . .	$V_i$	$\approx 5 \text{ V}_{\text{eff}}$
Sensitivity ( $W_o = 50 \text{ mW}$ ) . . . . .	$V_i$	$\approx 0.5 \text{ V}_{\text{eff}}$

## OPERATING DATA: CL 4 used in balanced stage (2 valves)

Anode voltage . . . . .	$V_a$	$\approx 200 \text{ V}$
Screen-grid voltage . . . . .	$V_{g2}$	$\approx 200 \text{ V}$
Cathode resistor. . . . .	$R_k$	$\approx 135 \text{ ohms}$
Anode current (without signal) . . . . .	$I_{a0}$	$\approx 2 \times 33 \text{ mA}$
Anode current at max. modulation . . . . .	$I_{amax}$	$\approx 2 \times 40 \text{ mA}$
Screen-grid current (without signal) . . . . .	$I_{g20}$	$\approx 2 \times 3.5 \text{ mA}$
Screen-grid current at max. modulation . . . . .	$I_{g2max}$	$\approx 2 \times 6 \text{ mA}$
Load resistor, anode-to-anode . . . . .	$R_{aa}$	$\approx 4,500 \text{ ohms}$
Output power at max. modulation . . . . .	$W_o$	$\approx 8 \text{ W}$
Total distortion at max. modulation . . . . .	$d_{tot}$	$\approx 1.5 \%$



## MAXIMUM RATINGS

$V_{a0}$	= max. 400 V
$V_a$	= max. 250 V
$W_a$	= max. 9 W
$V_{g20}$	= max. 400 V
$V_{g2}$	= max. 250 V
$W_{g2}$	= max. 2 W
$I_k$	= max. 70 mA
$V_{g1}(I_{g1} = +0.3\mu\text{A})$	= max. -1.3 V
$R_{g1k}$	= max. 1 M ohm
$R_{fk}$	= max. 5,000 ohms
$V_{fk}$	= max. 125 V <sup>1)</sup>

<sup>1)</sup> Direct voltage or effective value of alternating voltage.

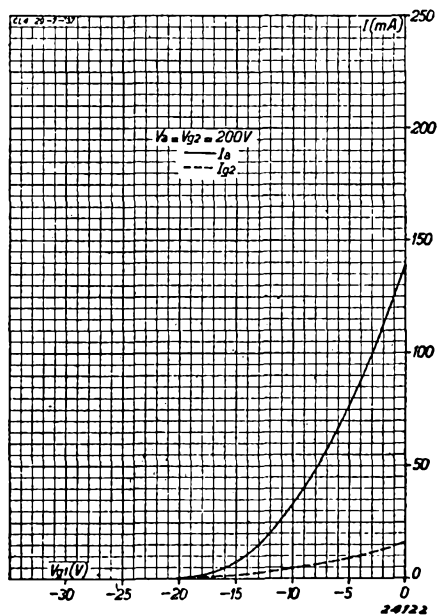

Fig. 3  
Anode current as a function of the grid bias at  
 $V_a = V_{g2} = 200\text{ V}$ .

Grid bias is to be obtained only by means of a cathode resistor; semi-automatic bias may be employed provided that the cathode current of the valve is more than 50 % of the current passing through the resistor producing the voltage drop. The decoupling capacitor should, generally speaking, be  $2\ \mu\text{F}$ , but for better reproduction of the lower tones it is better to use an electrolytic capacitor of 25 to  $50\ \mu\text{F}$ .

Leads to the valve contacts must be kept as short as possible, whilst a resistor of about 100 ohms in the control grid circuit is often desirable. Tables I and II relating to the CBL 1 also apply to this valve; they provide details of the output power, having regard to the voltage drop in the output transformer. The circuits employed for the measurements given in these tables are reproduced in the text relating to the EL 2.

In balanced output circuits employing two type CL 4 valves, a suitable pre-amplifier is the EBC 3, the EF 6 connected as triode, or the CL 4, also connected as triode. A satisfactory ratio for the coupling transformer is 1 : (2 + 2) for the EBC 3 and EF 6 (as triode), or 1 : (3 + 3) for the CL 4 (as triode).

The CL 4 is also very useful in A.C./D.C. receivers employing negative feed-back to reduce distortion and to improve the frequency-response curve of the amplifier.

Fig. 4  
Anode current as a function of the anode voltage at  $V_{g2} = 200$  V, for different values of grid bias.

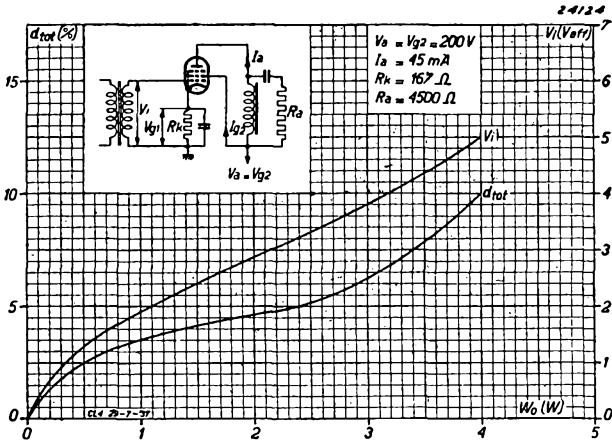
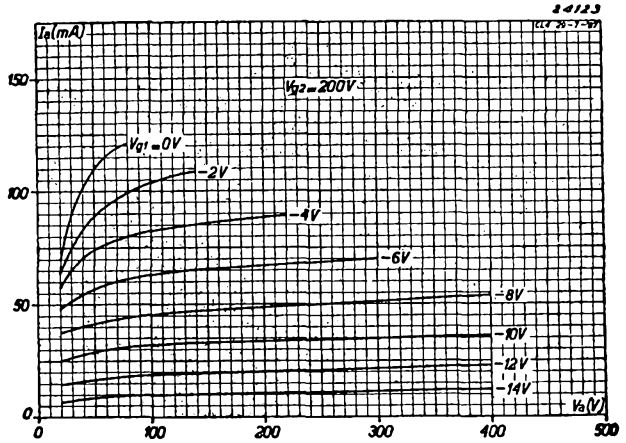
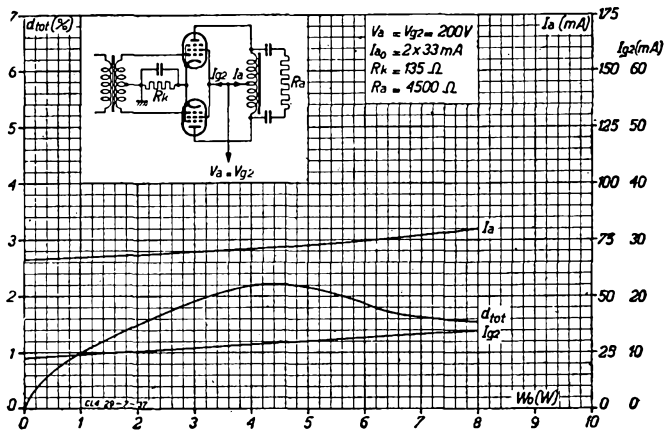

Fig. 5  
Alternating grid voltage and total distortion as functions of the output power of the CL 4 when used as a single output valve.

Fig. 6  
Anode current, screen current and total distortion as functions of the output power for two CL 4 valves in a balanced output stage.



# CL 6 Output pentode

The CL 6 is a highly sensitive output pentode designed for use in A.C./D.C. receivers operating on low-voltage mains. In such cases the screen voltage needs to be about 100 V, this being the reason why the CL 6, as well as the CL 2, has been designed on that basis. With  $V_a = V_{g2} = 100$  V, the anode current is 50 mA, which gives the CL 6 an output of 5 W. The mutual conductance is then 8.5 mA/V and, when properly matched, the valve delivers 2.1 W with 10 % distortion. The alternating grid voltage under these conditions is 5.6  $V_{(eff)}$ , the sensitivity being 0.62  $V_{(eff)}$ .

The high mutual conductance of this valve is an advantage in that, in receivers designed to use the CL 4 as pre-amplifier valve, the CL 6 can also be employed without any modification to the circuit. In A.C./D.C. receivers for use on low-voltage mains, another advantage of the steep-slope pentode is that, owing to the high conductance, the alternating grid voltage is very much lower than in an average output valve. As the bias is produced by means of a cathode resistor, or by the voltage drop across a resistor in the negative H.T. line, and therefore reduces the amount of anode voltage available for the output valve, it is obviously an advantage to ensure that the grid bias takes the smallest possible proportion of the direct voltage available.

The necessary bias for the CL 6 is -8.3 V, with  $V_a = V_{g2} = 100$  V, as against -15 V in the case of the CL 2. The CL 6 thus ensures a voltage which is 6.7 V higher, this being a not inconsiderable difference, on low-voltage mains.

A.C./D.C. receivers are often designed for switching over from high to low-voltage mains and vice versa, and in view of this the possibility of using an anode potential of 200 or 250 V has also been taken into account in the design of the valve; at the higher anode voltages it can be used as a 9 W output valve. The screen potential must in no case exceed 125 V and should, therefore, always be applied through a resistor or potential divider. For A.C./D.C. sets operating only on high-voltage mains it is more economical to use the CL 4. With 200 V on the anode and 100 V on the screen, the mutual conductance is

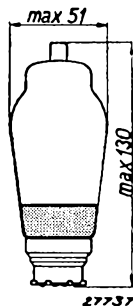

Fig. 1 Dimensions in mm.

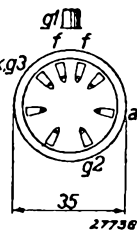
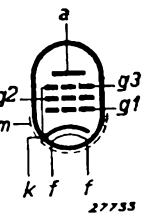

Fig. 2 Arrangement of electrodes and base connections.

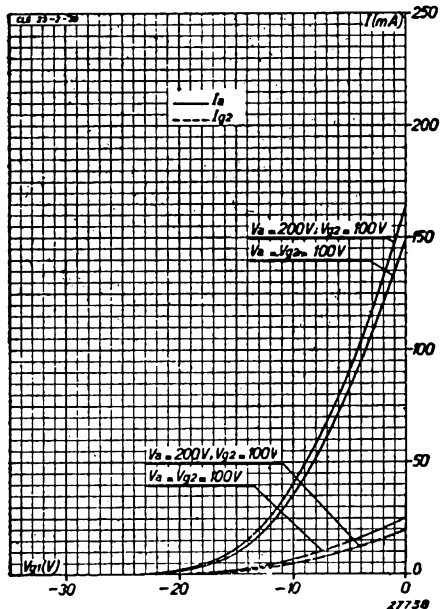

Fig. 3 Anode current and screen current as functions of the grid bias, with  $V_{g2} = 100$  V and  $V_a = 100$  and 200 V.

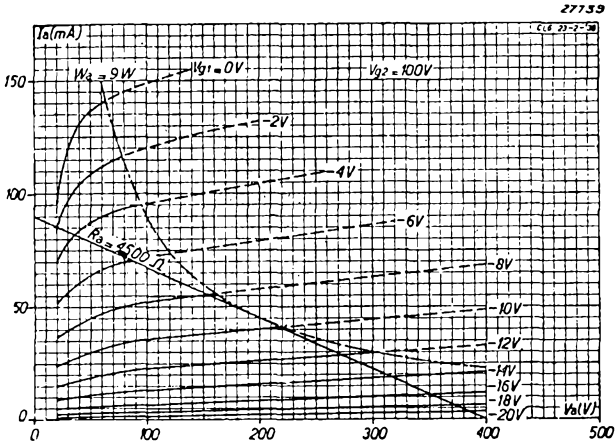

Fig. 4  
Anode current as a function of the anode voltage at  $V_{g2} = 100$  V, with grid bias as parameter.

is usual to connect a resistor in series with the screen.

The bias resistor for a working voltage of 100 V, is 140 ohms, from which it follows that the resistance in series with the screen, on 200 V, should be 27,000 ohms, this giving an output of 2.6 W with 8 % distortion. In order to obtain a higher output, A.C./D.C. sets intended for use on low voltages are frequently provided with a balanced output stage, in which case the CL 6 delivers 4 W with 5 % distortion, on  $V_a = V_{g2} = 100$  V; the alternating grid voltage is 6.7 V<sub>(eff)</sub> per grid. In small portable amplifiers for operation on all mains voltages the CL 6 in a balanced output stage is very useful in view of its suitability for switching over from high mains to low and vice versa. On anode voltages of 200 and 250 V the power is quite considerable, this being another feature in its favour in small amplifiers. A balanced circuit with 125 V on the screens and 200 V on the anodes will deliver a maximum of 12 W with 1.8 % distortion, whilst with an anode voltage of 250, 13.5 W with 6.3 % distortion can be obtained.

The grid connection of this valve is placed at the top of the envelope in order to keep hum at a minimum.

8 mA/V, in which case the valve is similar to the CL 4. The output power with 10 % distortion is 4 W, the alternating grid voltage being 5.6 V<sub>(eff)</sub>. As receivers designed for switching to either high or low-voltage mains generally give some trouble in the switching of the biasing (cathode) resistor, the same resistor is employed on a working voltage of 200 as on 100 V.

With a view to ensuring a low current, in order to obtain the least possible voltage drop in the rectifier smoothing circuit, it

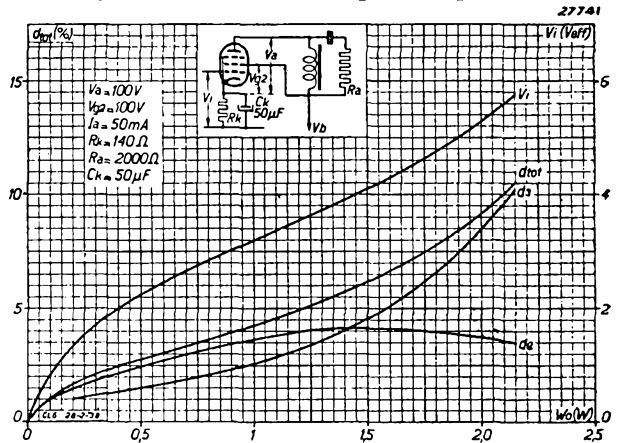

Fig. 5  
Total distortion, 2nd and 3rd harmonic distortion and alternating grid voltage of the CL 6 when used as single output valve with automatic bias.  $V_a = V_{g2} = 100$  V.

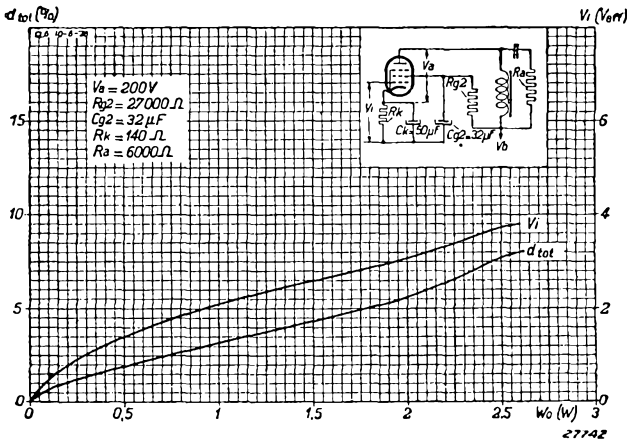

Fig. 6  
 Total distortion and alternating grid voltage; CL 6 used as single output valve with automatic bias.  $V_a = 300 V$ ,  $R_{g2} = 27,000$  ohms.

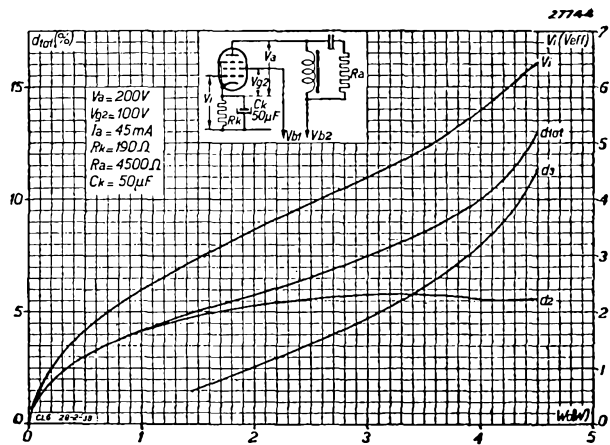

Fig. 7  
 Total distortion, 2nd and 3rd harmonic distortion and alternating grid voltage; CL 6 used as single output valve with automatic bias.  $V_a = 200 V$ ,  $V_{g2} = 100 V$ .

**HEATER RATINGS**

Heating: indirect by A.C. or D.C., series supply.

Heater voltage . . . . .	$V_f = 35 \text{ V}$
Heater current . . . . .	$I_f = 0.200 \text{ A}$

**CAPACITANCES**

Anode-grid . . . . .	$C_{ag1} < 0.5 \mu\text{F}$
----------------------	-----------------------------

**OPERATING DATA: CL 6 used as single output valve**

Anode voltage . . . . .	$V_a = 100 \text{ V}$	200 V	200 V
Screen-grid voltage . . . . .	$V_{g2} = 100 \text{ V}$	—	100 V
Screen series resistor . . . . .	$R_{g2} = \text{—}$	27,000 ohms	—
Screen decoupling capacitor . . . . .	$C_{g2} = \text{—}$	32 $\mu\text{F}$	—
Cathode resistor. . . . .	$R_k = 140 \text{ ohms}$	140 ohms	190 ohms
Grid bias. . . . .	$V_{g1} = -8.3 \text{ V}$	—	-9.5 V
Anode current . . . . .	$I_a = 50 \text{ mA}$	45 mA	45 mA
Screen-grid current . . . . .	$I_{g2} = 9 \text{ mA}$	4.5 mA	5.5 mA
Mutual conductance . . . . .	$S = 8.5 \text{ mA/V}$	—	8 mA/V
Internal resistance . . . . .	$R_i = 12,000 \text{ ohms}$	—	22,000 ohms
Load resistor . . . . .	$R_u = 2,000 \text{ ohms}$	6,000 ohms	4,500 ohms
Output power . . . . .	$W_o = 2.1 \text{ W}$	2.6 W	4 W
Distortion . . . . .	$d_{tot} = 10 \%$	8 %	10 %
Alternating grid voltage . . . . .	$V_i = 5.6 \text{ V}_{\text{eff}}$	3.8 $\text{V}_{\text{eff}}$	5.6 $\text{V}_{\text{eff}}$
Sensitivity ( $W_o = 50 \text{ mW}$ ) . . . . .	$V_i = 0.62 \text{ V}_{\text{eff}}$	0.42 $\text{V}_{\text{eff}}$	0.47 $\text{V}_{\text{eff}}$
Amplification factor: grid 2 with respect to grid 1 . . . . .	$\mu_{g2g1} = 7.0$	—	6.5

**OPERATING DATA: CL 6 used in balanced stage (2 valves)**

Anode voltage . . . . .	$V_a = 100 \text{ V}$	200 V	200 V	250 V
Screen-grid voltage . . . . .	$V_{g2} = 100 \text{ V}$	—	125 V	125 V
Common screen series resistor	$R_{g2} = \text{—}$	10,000 ohms	—	—
Cathode resistor, per valve	$R_k = 190 \text{ ohms}$	190 ohms	250 ohms	365 ohms
Anode current ( $V_i = 0 \text{ V}$ )	$I_{a0} = 2 \times 42$	$2 \times 45$	$2 \times 45$	$2 \times 36 \text{ mA}$
Anode current at max. modulation	$I_{a \text{ max}} = 2 \times 42$	$2 \times 40$	$2 \times 51$	$2 \times 43 \text{ mA}$
Screen current ( $V_i = 0 \text{ V}$ )	$I_{g20} = 2 \times 7.5$	$2 \times 5.2$	$2 \times 5$	$2 \times 4.1 \text{ mA}$
Screen current at max. modulation	$I_{g2 \text{ max}} = 2 \times 12.5$	$2 \times 6.2$	$2 \times 11.7$	$2 \times 12.5 \text{ mA}$
Load resistor between anodes	$R_{aa} = 3,000$	6,000	4,400	7,000 ohms
Output power . . . . .	$W_o = 4 \text{ W}$	6.8 W	12.1 W	13.5 W
Distortion at max. modulation	$d_{tot} = 5.6 \%$	3.5 %	1.8 %	6.3 %
Alternating input voltage, per grid	$V_i = 6.7 \text{ V}_{\text{eff}}$	5.9 $\text{V}_{\text{eff}}$	11 $\text{V}_{\text{eff}}$	13.7 $\text{V}_{\text{eff}}$

**MAXIMUM RATINGS**

Anode voltage in cold condition . . . . .	$V_{a0}$	= max. 550 V
Anode voltage . . . . .	$V_a$	= max. 250 V
Anode dissipation . . . . .	$W_a$	= max. 9 W
Screen-grid voltage in cold condition . . . . .	$V_{g20}$	= max. 550 V
Screen-grid voltage . . . . .	$V_{g2}$	= max. 125 V
Screen dissipation ( $W_o = \text{max.}$ ) . . . . .	$W_{g2}$	= max. 1.5 W
Screen dissipation ( $V_i = 0 \text{ V}$ ) . . . . .	$W_{g2}$	= max. 1.0 W
Cathode current . . . . .	$I_k$	= max. 70 mA
Grid voltage at grid current start ( $I_{g1} = + 0.3 \mu\text{A}$ )	$V_{g1}$	= max. $-1.3 \text{ V}$
External resistance between grid and cathode . . . . .	$R_{g1k}$	= max. 1 M ohm
External resistance between heater and cathode . . . . .	$R_{fk}$	= max. 5,000 ohms
Peak value of voltage between heater and cathode . . . . .	$V_{fk}$	= max. 175 V

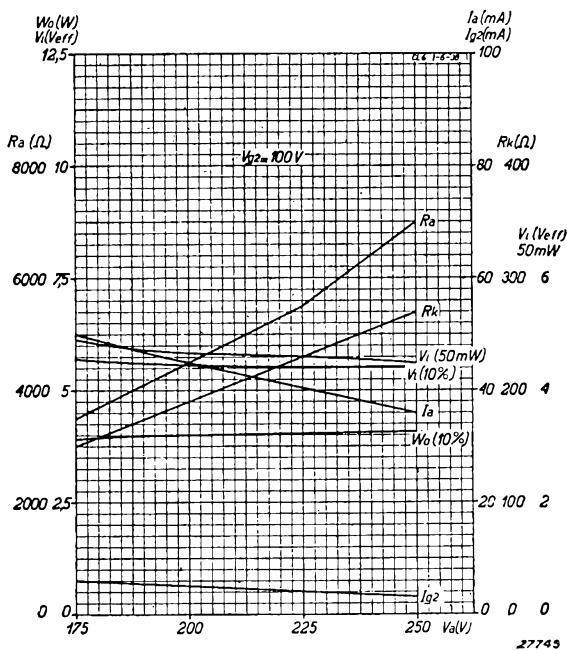

Fig. 8

Output power with 10 % distortion . . . . .	$W_o$ (10 %)	} as functions of the anode voltage (within the range 175 to 250 V), for operation at $W_a = 9 \text{ W}$ , with constant screen voltage $V_{g1} = 100 \text{ V}$ .
Alternating grid voltage at 10 % distortion . . . . .	$V_i$ (10 %)	
Sensitivity . . . . .	$V_i$ (50 mW)	
Cathode resistor . . . . .	$R_k$	
Anode current . . . . .	$I_a$	
Screen-grid current . . . . .	$I_{g2}$	
Load resistor . . . . .	$R_a$	

CL 6

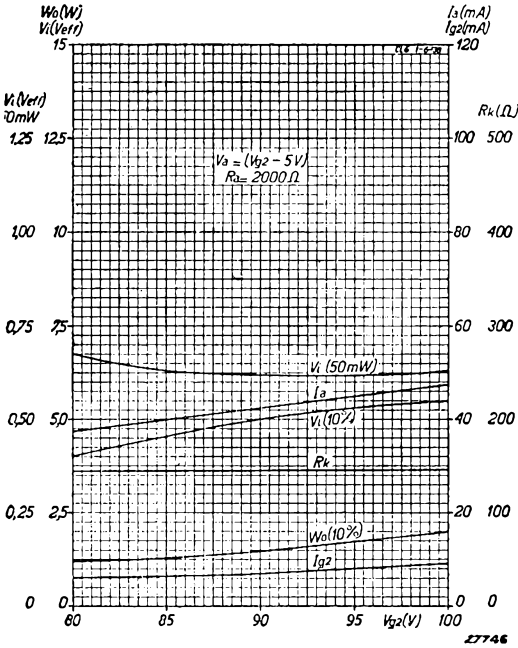

Fig. 9

Output power with 10 % distortion . . . . .	$W_0(10\%)$	} as functions of the screen voltage (in the range 80 to 100 V), with an anode voltage 5 V lower than that of the screen.
Alternating grid voltage at 10 % distortion . . . . .	$V_i(10\%)$	
Sensitivity . . . . .	$V_i(50 mW)$	
Cathode resistor . . . . .	$R_k$	
Anode current . . . . .	$I_a$	
Screen current . . . . .	$I_{g2}$	

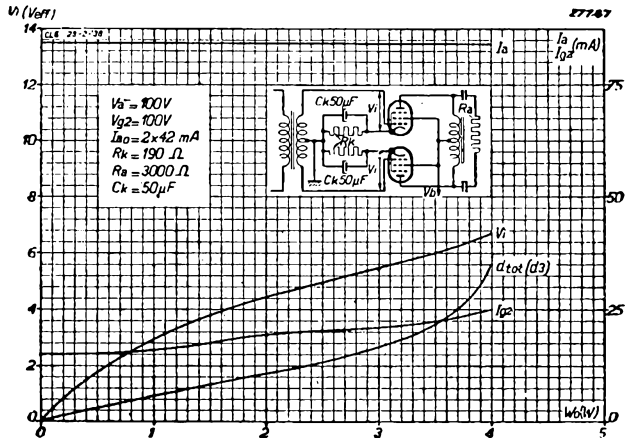

Fig. 10

Anode current  $I_a$ , screen current  $I_{g2}$ , total distortion  $dtot (= d_3)$  and alternating grid voltage  $V_i$  as functions of the output power  $W_0$  for two type CL 6 valves in a balanced circuit with  $V_a = V_{g2} = 100 V$ .



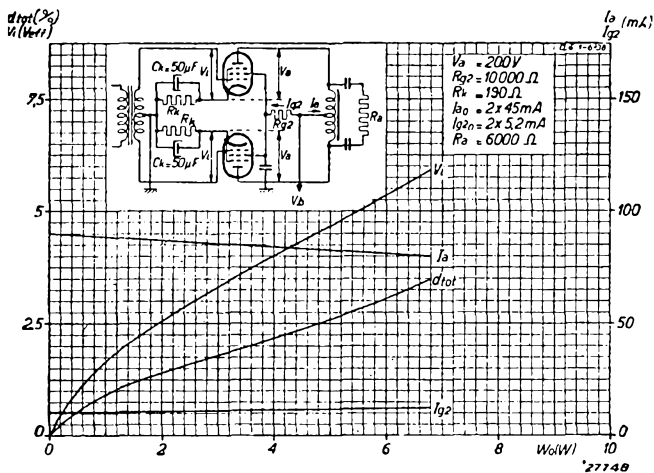

Fig. 11

Anode current  $I_a$ , screen current  $I_{g2}$ , total distortion  $d_{Tot}$  and alternating grid voltage  $V_i$  as functions of the output power of the CL 6 in a balanced circuit with  $V_a = 200$  V, using the same cathode resistor as for  $V_a = V_{g2} = 100$  V.

In order to show the performance of the CL 6 at other working voltages than those given in the standard data, various values have been included in the curves of Figs. 8 and 9, not only as functions of the anode voltage at a constant screen-grid potential with continuous anode dissipation, with respect to higher feed voltages, but also as plotted against  $V_{g2}$  in the case of an anode voltage which is 5 V lower than that of the screen. In the latter instance an average voltage drop of 5 V in the

output transformer has been taken into account.

Grid bias must be obtained by means of a cathode resistor only (auto. bias); semi-automatic bias is permissible only when the cathode current of the CL 6 is in excess of 50 % of the total current passing through the resistor that produces the voltage drop; the maximum value for the grid leak, as shown in the Maximum Ratings, must then be reduced in accordance with the following:

Cathode current of the output valve

Total current passing through resistor producing the voltage drop  $\times R_{g1k}$ .

In this case, moreover, it must be remembered that the current in those valves which are subjected to control will affect the bias of the output valve; in other words, when the control is operating, the bias very quickly becomes too low and the anode current of the output valve too high.

The high mutual conductance of the valve must also be considered in the design of the receiver, as it may otherwise result in R.F. feed-back and oscillation. Leads to the valve contacts must be kept as short as possible, and a resistor of about 1,000 ohms in the control-grid lead is recommended. With 100 V on the anode, the optimum value of the load resistance is 2,000 ohms; with 200 V anode, 4,500 ohms. In A.C./D.C. receivers for both high and low-voltage mains operation a switch must be provided in the output transformer circuit that will ensure the best possible matching conditions on different anode voltages.

CL 6

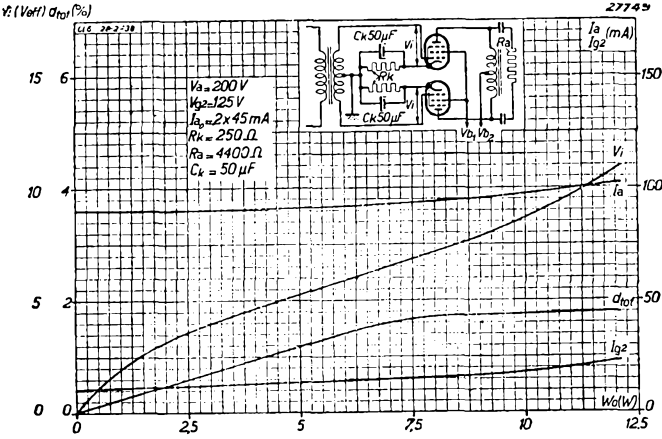

Fig. 12  
 Anode current  $I_a$ , screen-grid current  $I_{g2}$ , total distortion  $d_{tot}$  and alternating grid voltage  $V_1$ , as functions of the output power  $W_o$  for two CL 6 valves in a balanced circuit with  $V_a = 200\text{ V}$ , and  $V_{g2} = 125\text{ V}$ .

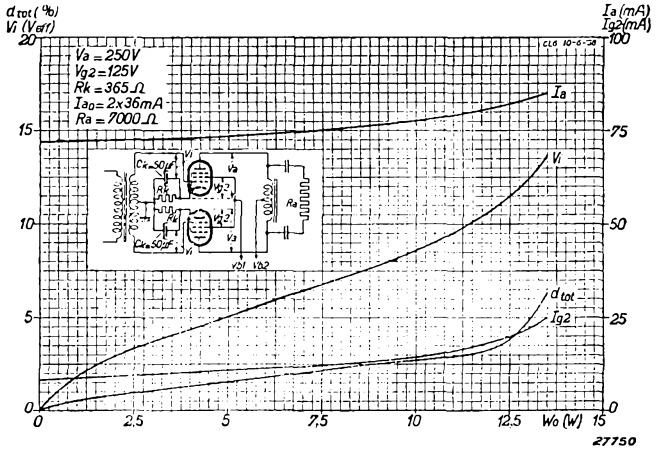

Fig. 13  
 Anode current  $I_a$ , screen current  $I_{g2}$ , total distortion  $d_{tot}$  and alternating grid voltage  $V_1$  as functions of the output power for two type CL 6 valves in a balanced circuit with  $V_a = 250\text{ V}$ , and  $V_{g2} = 125\text{ V}$ .

# CY 1 Rectifying valve

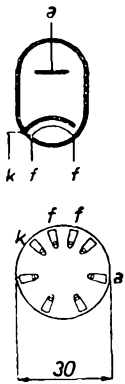

Fig. 2  
Arrangement of  
electrodes and  
base connections.

Philips CY 1 is a half-wave rectifying valve taking a heater current of 200 mA at 20 volts. The internal resistance is very low and the anode current therefore produces only a very slight decrease in the voltage. In the applications of the CY 1, it is well to bear in mind that the peak voltage between filament and cathode must not exceed 450 V; on high mains voltages, when large-capacitance smoothing capacitors are used, a resistor should be included in the anode circuit to safeguard the valve. The minimum value of this resistor will be found in the following table:

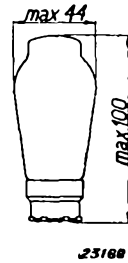

Fig. 1  
Dimensions in mm

Mains voltage	Smoothing capacitor	Series resistor
Max. 250 V	32 $\mu$ F	Min. 125 ohms
	16 $\mu$ F	Min. 75 ohms
	8 $\mu$ F	0 ohms
Max. 170 V	32 $\mu$ F	Min. 75 ohms
	16 $\mu$ F	Min. 30 ohms
	8 $\mu$ F	0 ohms
Max. 127 V	32 $\mu$ F	0 ohms
	16 $\mu$ F	0 ohms
	8 $\mu$ F	0 ohms

## HEATER RATINGS

Heating: indirect, A.C. or D.C., series supply.

Heater voltage . . . . .  $V_f = 20$  V

Heater current . . . . .  $I_f = 0.200$  A

## MAXIMUM RATINGS

Anode voltage, A.C.

$$V_i = \text{max. } 250 \text{ V}_{\text{(eff)}}$$

Direct current  $I_o = \text{max. } 80$  mA

Voltage between heater and cathode . . .  $V_{fk} = \text{max. } 450$  V

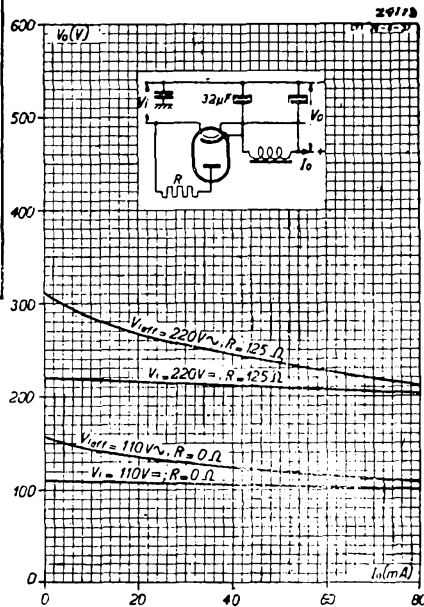
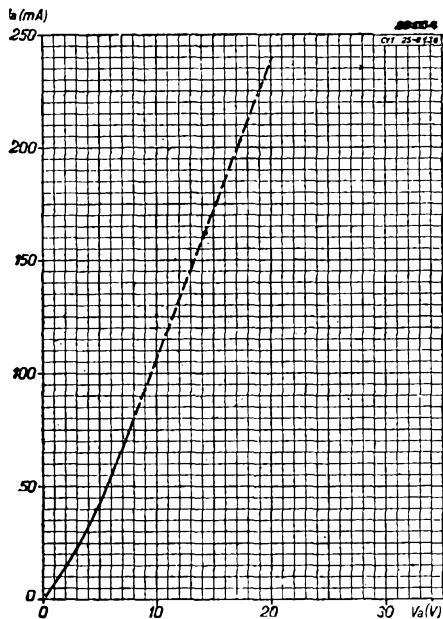

Fig. 3  
Loading characteristics of the CY 1.

CY 1/CY 2



CY 1

Fig. 4  
Anode current as a function of the applied voltage.

CY 2

Fig. 5  
Anode current as a function of the applied direct voltage, per anode.

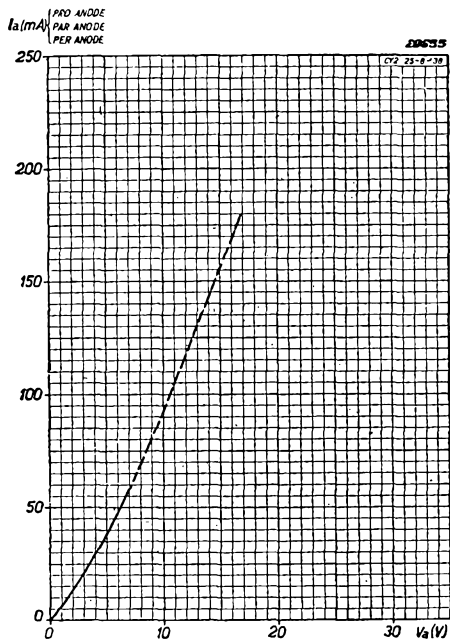

## CY 2 Rectifying valve and voltage doubler

The CY 2 has a split cathode and two anodes and can be used either as a half-wave rectifying valve (see fig. 3) or as a voltage doubler. In the former case the valve will deliver 120 mA, whilst as voltage doubler it gives a maximum of 60 mA at roughly twice the voltage when used as rectifying valve.

It should be noted that the peak voltage between cathode and filament must in no case exceed 450 V and, on high-voltage mains, with large smoothing capacitors, a protecting resistor should be included in the anode circuit; minimum values for this resistor are given in the table below.

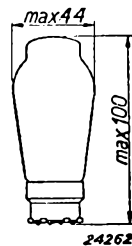

Fig. 1  
Dimensions in mm.

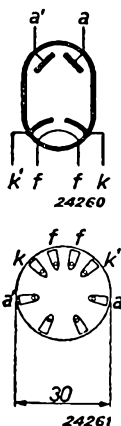

Fig. 2  
Arrangement of  
electrodes and  
base connections.

Mains voltage	Smoothing capacitor	Series resistor
Max. 250 V	32 $\mu\text{F}$	Min. 125 ohms
	16 $\mu\text{F}$	Min. 75 ohms
	8 $\mu\text{F}$	0 ohms
Max. 170 V	64 $\mu\text{F}$	Min. 75 ohms
	16 $\mu\text{F}$	Min. 30 ohms
	8 $\mu\text{F}$	0 ohms
Max. 127 V	32 $\mu\text{F}$	0 ohms
	16 $\mu\text{F}$	0 ohms
	8 $\mu\text{F}$	0 ohms

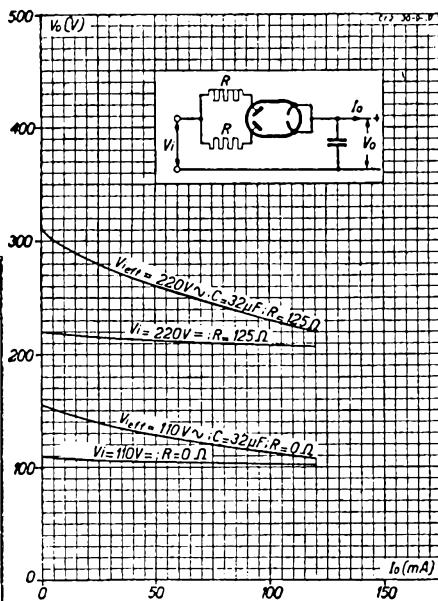

Fig. 3  
Loading characteristics of the CY 2 employed as  
half-wave rectifying valve.

CY 2

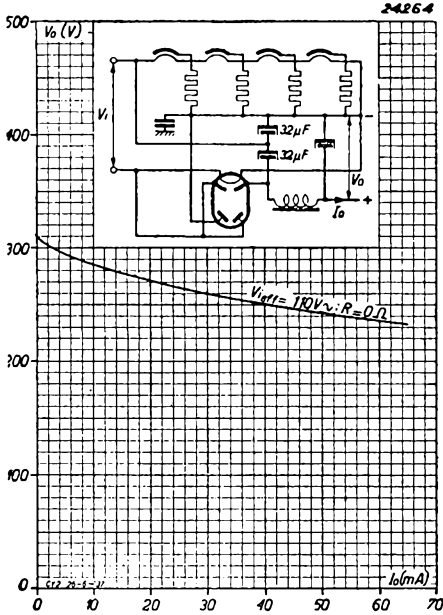

Fig. 4  
Loading characteristic of the CY 2 used as a voltage doubler. This curve also applies to both voltage-doubling circuits

**HEATER RATINGS**

Heating: indirect by A.C. or D.C., series supply.

Heater voltage . . . . .  $V_f = 30 \text{ V}$   
 Heater current . . . . .  $I_f = 0.200 \text{ A}$

**MAXIMUM RATINGS**

- 1) As half-wave rectifying valve.
  - Alternating anode voltage . . . . .  $V_i = \text{max. } 250 \text{ V}_{(\text{eff})}$
  - Direct current . . . . .  $I_o = \text{max. } 120 \text{ mA}$
- 2) As voltage doubler
  - Alternating anode voltage . . . . .  $V_i = \text{max. } 127 \text{ V}_{(\text{eff})}$
  - Direct current . . . . .  $I_o = \text{max. } 60 \text{ mA}$
  - Voltage between heater and cathode (peak value) . . . . .  $V_{fk} = \text{max. } 450 \text{ V}$

## **2 V Battery valves**

# KB 2 Indirectly-heated double-diode

The KB 2 is an indirectly-heated double-diode valve for battery receivers. The current consumption is very low indeed, being only about 95 mA on 2 V.

As the cathode is indirectly heated, sets in which this valve is used may be equipped with delayed automatic gain control; the delay may be regulated as desired by applying a positive potential from the H. T. battery to the cathode. The KB 2 can be employed as a detector preceding a stage of A.F. amplification using a valve such as the KF 4, or a driver, e.g. the KC 3, or it can be coupled directly to a pentode output valve.

The strong signals which in the latter case would inevitably occur on the KB 2 can be quite easily handled by this diode.

The capacitance between the two diodes has been kept as low as possible, as this is of importance when the second anode is used for the delayed A.G.C., and is accordingly connected to the primary side of the preceding band-pass filter. The characteristics of the D.C. voltage gain ( $\Delta V$ ) across the load resistor as a function of the unmodulated R.F. signal, as well as that of the A.F. voltage ( $V_{LF}$ ) across the resistor of 0.5 megohm as plotted against the 30% modulated R.F. voltage on one of the diodes, are identical with those relating to the EB 4, to which reference may be made for details.

### HEATER RATINGS

Heating: indirect by battery, parallel supply.

Heater voltage . . . . .  $V_f = 2.0 \text{ V}$

Heater current . . . . .  $I_f = 0.095 \text{ A}$

### CAPACITANCES

$C_{d_1 d_2} < 0.25 \mu\mu\text{F}$

$C_{k d_1} = 2.1 \mu\mu\text{F}$

$C_{k d_2} = 1.7 \mu\mu\text{F}$

### MAXIMUM RATINGS

Voltage on diode (peak value) . . . . .  $V_{d_1} = V_{d_2} = \text{max. } 125 \text{ V}$

Diode current . . . . .  $I_{d_1} = I_{d_2} = \text{max. } 0.5 \text{ mA}$

Voltage between heater and cathode . . . . .  $V_{fk} = \text{max. } 50 \text{ V}$

External resistance between heater and cathode . . . . .  $R_{fk} = \text{max. } 20,000 \text{ ohms}$



Fig. 1  
Dimensions in mm.

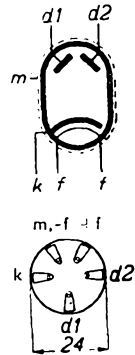

Fig. 2  
Arrangement of electrodes and base connections.



# KBC 1 Double-diode triode

The KBC 1 is a directly-heated double-diode triode. This combination of triode with two diodes promotes a considerable saving in filament current, this being a matter of some importance in battery receivers.

This valve can be employed to advantage in "straight" circuits or in superheterodyne receivers; the triode unit may be used also as a driver in conjunction with the Class B output amplifier KDD 1, or as pre-amplifier for the output pentode KL 4.

The diode located at the negative end of the filament should be used as detector and the other diode, at the positive end, for the delayed A.G.C. In Fig. 2, the diode situated at the end of the filament marked  $f_1$  is shown as  $d_1$  and the other, at the extremity  $f_2$ , as  $d_2$ . If the filament extremity  $f_1$  is positive, diode  $d_2$  is employed as detector; otherwise weak signals are not properly rectified. The loading resistor on the diode should preferably be connected to the positive, not to the negative, end of the filament, as this gives a better detection characteristic.

The second diode is approximately 2 V negative with respect to the positive extremity of the filament, thus providing a similar amount of delay voltage; if a greater delay is desired, this can be obtained by the use of a special circuit (see Chapter XXV). The diode unit is separated from the triode section by a screen, which effectively prevents any coupling between the two.

## FILAMENT RATINGS

Heating: direct, by battery; parallel supply.

Filament voltage. . . . .  $V_f = 2$  V

Filament current. . . . .  $I_f = 0.115$  A

## CAPACITANCES

Diode section: $C_{d1} = 2.7 \mu\mu\text{F}$	Triode section: $C_{ag} = 3.1 \mu\mu\text{F}$
$C_{d2} = 2.5 \mu\mu\text{F}$	$C_u = 6.5 \mu\mu\text{F}$
$C_{d1d2} < 0.5 \mu\mu\text{F}$	$C_g = 3.0 \mu\mu\text{F}$
$C_{d1g} < 0.003 \mu\mu\text{F}$	
$C_{d2g} < 0.003 \mu\mu\text{F}$	

## STATIC DATA OF THE TRIODE SECTION

Anode voltage . . . . .	$V_a = 90$	135 V
Grid bias. . . . .	$V_g = -3.4$	-4.5 V
Anode current . . . . .	$I_a = 1$	2.5 mA
Amplification factor . . . . .	$\mu = 16$	16
Mutual conductance . . . . .	$S = 0.7$	1 mA/V
Internal resistance . . . . .	$R_i = 23,000$	16,000 ohms

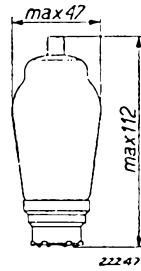

Fig. 1  
Dimensions in mm

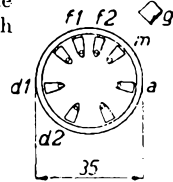
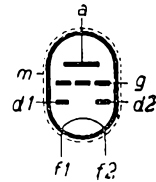

Fig. 2  
Arrangement of electrodes and base connections

# KBC 1

## MAXIMUM RATINGS

Triode section:	$V_a$	= max. 150 V
	$W_a$	= max. 0.6 W
	$I_k$	= max. 6 mA
	$V_g (I_g = + 0.3 \mu A)$	= max. -0.2 V
	$R_g$	= max. 3 Mohms
Diode section:		
Voltage on diode (peak value)	$V_{d1} = V_{d2}$	= max. 125 V
Diode current	$I_{d1} = I_{d2}$	= max. 0.2 mA
Diode voltage at diode current start	$(I_{d2} = + 0.3 \mu A) V_{d2}$	= max. -0.4 V

When the triode section is to be employed as a resistance-coupled A.F. amplifier, the necessary data may be obtained from the following table:

**TABLE**  
KBC 1 used as a resistance-coupled A.F. amplifier

Battery voltage	Coupling resistor	Anode current	Grid bias	Output voltage	Distor-tion	Stage gain
$V_a$ (V)	$R_a$ (M ohm)	$I_a$ (mA)	$V_g$ (V)	$V_o$ ( $V_{eff}$ )	$d$ (%)	$\frac{V_o}{V_i}$
135	0.2	0.35	-2.0	5 8	0.7 1.2	12.5
90	0.2	0.19	-2.0	3 5	0.8 1.3	11
135	0.1	0.69	-2.0	5 8	0.7 1.2	12
90	0.1	0.36	-2.0	3 5	0.8 1.3	11
135	0.05	1.25	-2.0	5 8	0.8 1.3	11
90	0.05	0.60	-2.0	3 5	1.0 1.6	10

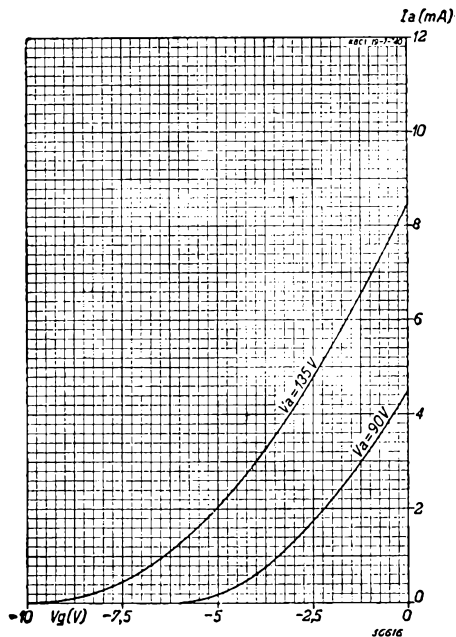

Fig. 3  
 $I_a/V_g$  characteristics for the triode section of the KBC 1.

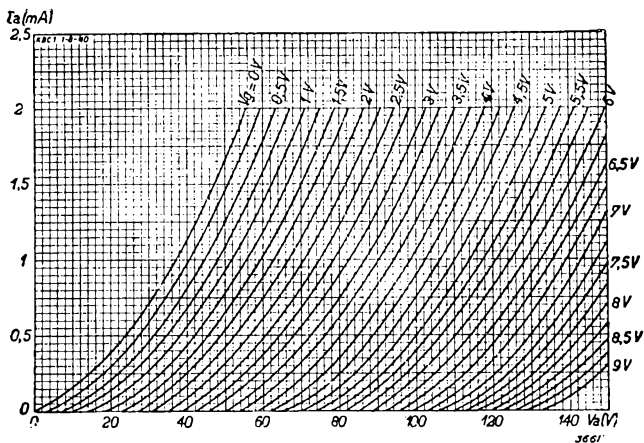

Fig. 4  
 Anode current of the triode section of the KBC 1 as a function of the anode voltage with grid bias as parameter.

# KC 1 Triode

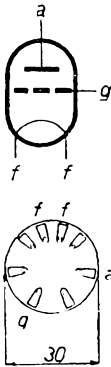

Fig. 2  
Arrangement of electrodes and base connections.

This triode is useful as an A.F. amplifier valve, anode-bend detector, or oscillator in battery receivers. Its use as a grid detector is not recommended, since the maximum alternating output voltage is then usually insufficient for the output stage. In the case of A.F. amplification, care must be taken that the A.F. gain following the grid of this valve is not made too great, as this is liable to set up microphony.



Fig. 1  
Dimensions in mm.

## FILAMENT RATINGS

Heating: direct by battery; parallel supply.

Filament voltage . . . . .	$V_f = 2.0 \text{ V}$
Filament current . . . . .	$I_f = 0.065 \text{ A}$

## CAPACITANCES

$C_{ag} = 3.5 \mu\mu\text{F}$
$C'_{a} = 2.0 \mu\mu\text{F}$
$C'_g = 3.0 \mu\mu\text{F}$

## STATIC DATA

Anode voltage	$V_a = 90 \text{ V}$	135 V
Anode current	$I_a = 0.3 \text{ mA}$	1.2 mA
Grid bias	$V_g = -1.5 \text{ V}$	-1.5 V
Internal resistance	$R_i = 60,000 \text{ ohms}$	40,000 ohms
Amplification factor	$\mu = 25$	25

## MAXIMUM RATINGS

$V_a$	= max. 150 V
$W_a$	= max. 0.5 W
$I_k$	= max. 4 mA
$V_g$ ( $I_g = \pm 0.3 \mu\text{A}$ )	= max. -0.2 V
$R_{gf}$	= max. 3 M ohms

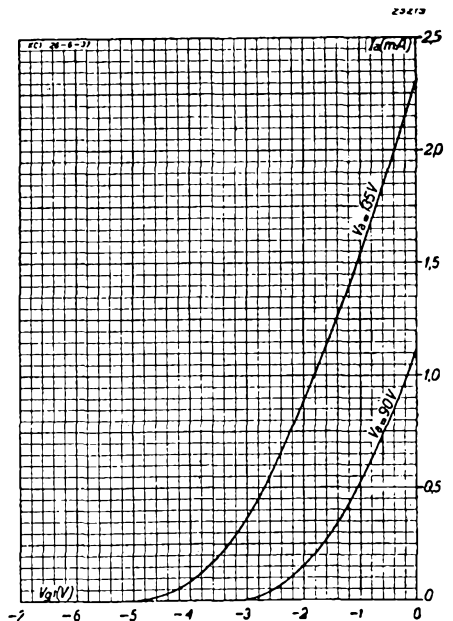

Fig. 3  
Anode current as a function of the grid bias, with  $V_a = 90 \text{ V}$  and  $135 \text{ V}$ .

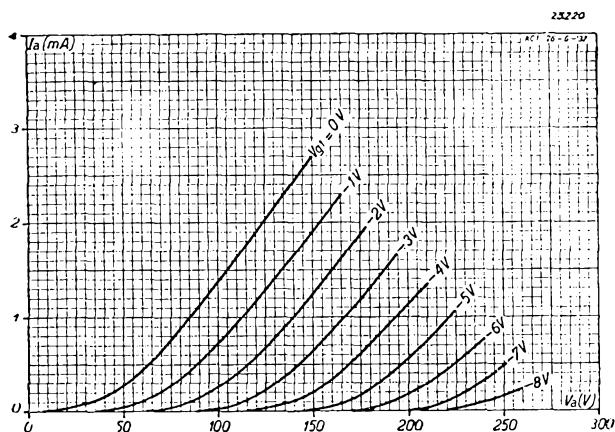

Fig. 4  
Anode current as a function of the anode voltage with grid bias as parameter.

TABLE  
KC 1 used as a resistance-coupled A.F. amplifier

Battery voltage $V_b$ (V)	Coupling resistor $R_a$ (megohms)	Anode current $I_a$ (mA)	Grid bias $V_g$ (V)	For an alternating output voltage of 7 Veff		For an alternating output voltage of 10 Veff	
				Gain	Distortion	Gain	Distortion
				$\frac{V_o}{V_i}$	$d_{tot}$ (%)	$\frac{V_o}{V_i}$	$d_{tot}$ (%)
90	0.32	0.08	-1.5	14.6	2.7	—	—
90	0.32	0.13	-0.75	16.7	1.6	—	—
135	0.32	0.18	-1.5	—	—	19	1.0
135	0.32	0.23	-0.75	—	—	20	0.8
90	0.2	0.11	-1.5	14.3	4	—	—
90	0.2	0.17	-0.75	16.2	1.5	—	—
135	0.2	0.26	-1.5	—	—	18	1.0
135	0.2	0.32	-0.75	—	—	18.5	0.8

# KC 3 Triode

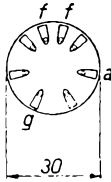

Fig. 2  
Arrangement of electrodes and base connections.

This triode is a driver valve for Class B output stages in which the grid of the output valve passes a certain amount of current. In view of the high power required for the excitation of a Class B output circuit in which grid current flows, the filament consumption is on the high side.

The KC 3 should be employed only in conjunction with the Class B output valve KDD 1, using a driver transformer having a ratio of 2 : (1 + 1). The sensitivity of the combination of KC 3 and KDD 1 valves is so high that the KF 4, connected as A.F. amplifier or detector, may precede it only when operating below its maximum amplification; otherwise the receiver becomes microphonic.

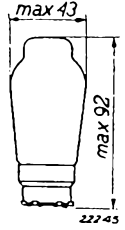

Fig. 1  
Dimensions in mm

## FILAMENT RATINGS

Heating: direct by battery; parallel supply.  
 Filament voltage. . . . .  $V_f = 2.0$  V  
 Filament current . . . . .  $I_f = 0.21$  A

## CAPACITANCES

$C_{mj} = \text{max. } 6.3 \mu\mu\text{F}$

## STATIC DATA

Anode voltage . . . . .	$V_a = 90$	135 V
Grid bias . . . . .	$V_g = -1.6$	-2.8 V
Anode current . . . . .	$I_a = 2$	3 mA
Mutual conductance . . . . .	$S = 2.2$	2.5 mA/V
Internal resistance . . . . .	$R_i = 14,000$	12,000 ohms
Amplification factor . . . . .	$\mu = 25$	25

## MAXIMUM RATINGS

$V_a$	= max. 150 V
$W_a$	= max. 1 W
$I_k$	= max. 7 mA
$V_{gf}$ ( $I_{gf} = + 0.3 \mu\text{A}$ )	= max. -0.4 V
$R_{yf}$	= max. 3 M ohms

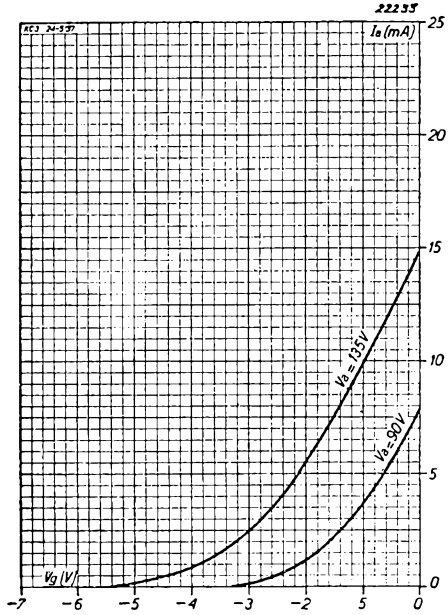

Fig. 3  
Anode current as a function of the grid bias.

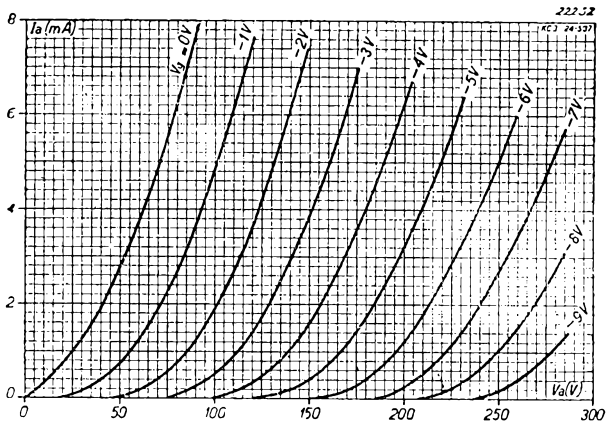

Fig. 4  
Anode current as a function of the anode voltage for different values of grid bias.

# KC 4 Triode

The triode KC 4 can be used either as oscillator valve for the frequency-changer KH 1, or as A.F. amplifier. In the last-mentioned case the total A.F. gain, as from the grid of the valve, should not be too high, as this may result in microphony.

## FILAMENT RATINGS

Heating: direct by battery; parallel supply.

Filament voltage . . . . .  $V_f = 2.0$  V

Filament current . . . . .  $I_f = 0.1$  A

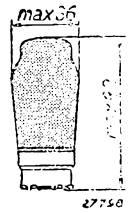

Fig. 1  
Dimensions in mm

## CAPACITANCES

$C_{ag} = 2.9 \mu\mu\text{F}$

$C_{gf} = 2.1 \mu\mu\text{F}$

$C_{af} = 5 \mu\mu\text{F}$

## STATIC DATA

Anode voltage	$V_a = 90$	135 V
Grid bias	$V_g = -1.5$	-1.5 V
Anode current	$I_a = 0.5$	2.2 mA
Amplification factor	$\mu = 30$	30
Internal resistance	$R_i = 37,500$	21,500 ohms
Mutual conductance	$S = 0.8$	1.4 mA/V

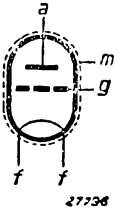

27798

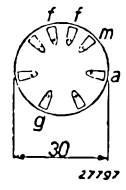

27797

Fig. 2  
Arrangement of electrodes and base connections

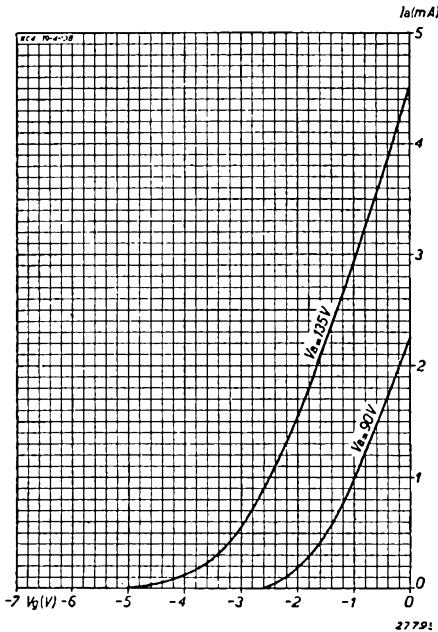

Fig. 3  
Anode current as a function of the grid bias, with  $V_a = 90$  and 135 V.



OPERATING DATA: KC 4 used as resistance-coupled A.F. amplifier

Battery voltage $V_b$ (V)	Coupling resistor (M ohms)	Grid bias $V_{g1}$ (V)	Anode current $I_a$ (mA)	Stage gain $\frac{V_o}{V_i}$	For valve KL 1		For valve KL 2		For valve KL 4	
					$V_a = V_b$		$V_a = V_b$		$V_a = V_b$	
					$V_o$ (Veff)	$d_{tot}$ (%)	$V_o$ (Veff)	$d_{tot}$ (%)	$V_o$ (Veff)	$d_{tot}$ (%)
135	0.2	-1.5	0.32	21.5	4.2	< 1	8	1.2	5	< 1
90	0.2	-1.5	0.15	18.5	3	1.5	5	2.3	3.3	1
135	0.1	-1.5	0.52	20	4.2	< 1	8	1.3	5	< 1
90	0.1	-1.5	0.23	16.5	3	1.7	5	2.9	3.3	1.1
135	0.05	-1.5	0.8	17.5	4.2	< 1	8	1.6	5	< 1
90	0.05	-1.5	0.32	13.5	3	2.8	5	4	3.3	1.5

MAXIMUM RATINGS

- Anode voltage . . . . .  $V_a = \text{max. } 150 \text{ V}$
- Anode dissipation . . . . .  $W_a = \text{max. } 0.5 \text{ W}$
- Cathode current . . . . .  $I_k = \text{max. } 5 \text{ mA}$
- Grid voltage at grid current start . . . . .  $(I_g = +0.3 \mu\text{A}) V_{g1} = \text{max. } -0.2 \text{ V}$
- External resistance between grid and filament . . . . .  $R_{gf} = \text{max } 3 \text{ M ohms}$

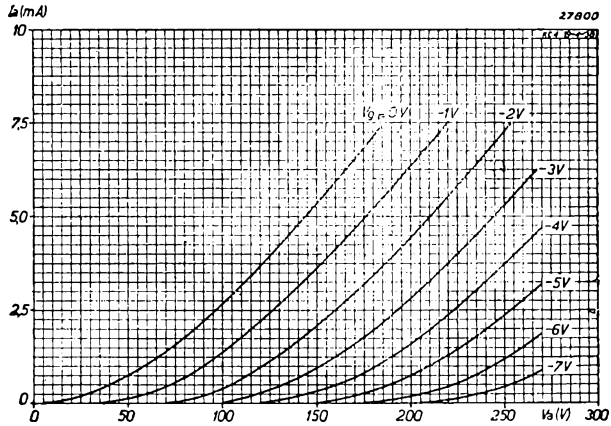

Fig. 4  
Anode current as a function of the anode voltage for various values of grid bias.

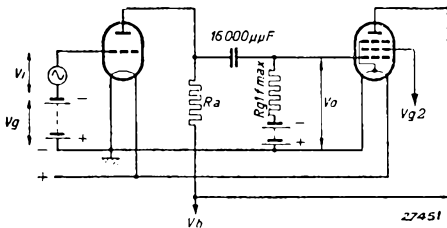

Fig. 5  
Theoretical diagram of circuit employing resistance-coupled amplification and illustrating the symbols used in the data.

# KCH 1 Triode-hexode

The KCH 1 is a frequency-changer for battery superheterodyne receivers. It consists of a combination of hexode for mixing the input signal with the signal generated by the oscillator, and a triode for use as the latter.

Every effort has been made in the development of this valve to attain the highest possible conversion conductance, with a low filament current consumption. The main object was to produce a mixer valve for battery receivers that would give a reliable performance on short waves and also permit of automatic gain control on that wave range, with a minimum of interference due to frequency drift and so on.

Because of the rapid control required in battery receivers, great care has been taken to ensure good characteristics from the aspect of cross-modulation. A variation in the grid bias of from  $-0.5$  to  $-17$  V, with an anode potential of 135 V and "sliding" screen voltage, is sufficient to reduce the conversion conductance to one-hundredth. Without control the conversion conductance is  $325 \mu\text{A}/\text{V}$ . The screen-grid voltage of the hexode section of the KCH 1 may be arranged so as to be self-adjusting; this saves the current that would otherwise pass through the potential divider and operates the valve as economically as possible. On a battery voltage of 135 V, with a resistor of 67,000 ohms in series with the screen, the total load on the anode battery is only 5 mA. With a fixed screen potential, control of the conversion conductance is considerably more rapid, but the cross-modulation characteristics are not so favourable.

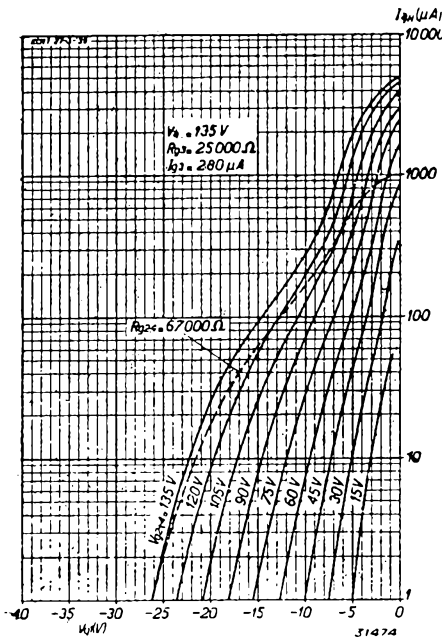

Fig. 3

Anode current of the hexode unit as a function of the grid bias, with the screen-grid voltage as parameter. The broken lines show the anode current in the case of the controlled valve, with the screen fed from the 135 V battery through a resistor of 67,000 ohms.

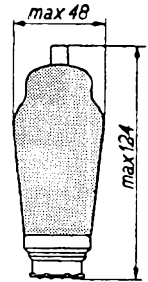

Fig. 1  
Dimensions in mm.

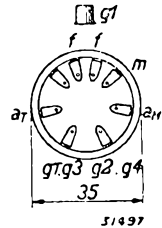
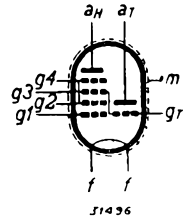

Fig. 2  
Arrangement of electrodes and base connections.

the potential divider and operates the valve as economically as possible. On a battery voltage of 135 V, with a resistor of 67,000 ohms in series with the screen, the total load on the anode battery is only 5 mA. With a fixed screen potential, control of the conversion conductance is considerably more rapid, but the cross-modulation characteristics are not so favourable.

Further, when the valve is operated on a fixed screen voltage the internal resistance during the control period, even on a low battery voltage, increases rapidly, whereas if a screen series resistor is used the internal resistance commences to decrease. This is explained by the fact that the screen voltage, when self-adjusting, closely approaches the same value as the anode voltage when control is applied; due to secondary emission the internal resistance drops, until the anode voltage has decreased so far in response to

the control that the internal resistance again rises. The curve relating to the internal resistance of the valve when under control, as a function of the grid bias, shows a decrease at  $-5$  V. At  $V_a = 135$  V and  $R_{g2,4} = 67,000$  ohms, the internal resistance diminishes to 0.5 megohm, whilst on  $V_a = 90$  V and  $V_{g2,4} = 29,000$  ohms the minimum is 0.1 megohm. Although a value of 0.5 megohm is still quite serviceable, 0.1 megohm must be regarded as too low, as the selectivity of the associated I.F. circuit is then reduced too much. On a low battery voltage, therefore, a fixed screen voltage will normally be preferred, or alternatively, potential-divider feed; the latter need take only a very small amount of current, viz. 0.5—1 mA.

Much attention has been given to the oscillator section of this valve to ensure reliable oscillation when the valve is to be used in conjunction with ordinary standard coils and circuits. Every effort has also been made to procure the highest possible conductance in the triode section at the threshold of oscillation; this is 1.3 mA/V at an anode potential of 70 V, and constant oscillation is thus guaranteed.

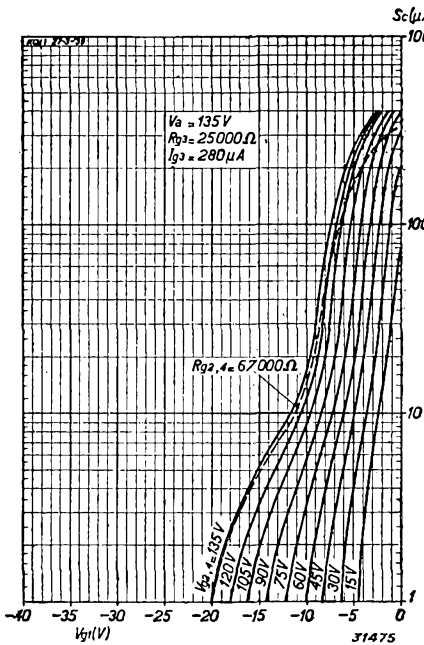

Fig. 4 Conversion conductance as a function of the grid bias, with the screen voltage as parameter. The broken line refers to the conductance when control is applied to the valve, with the screen fed from the 135 V battery through a resistor of 67,000 ohms.

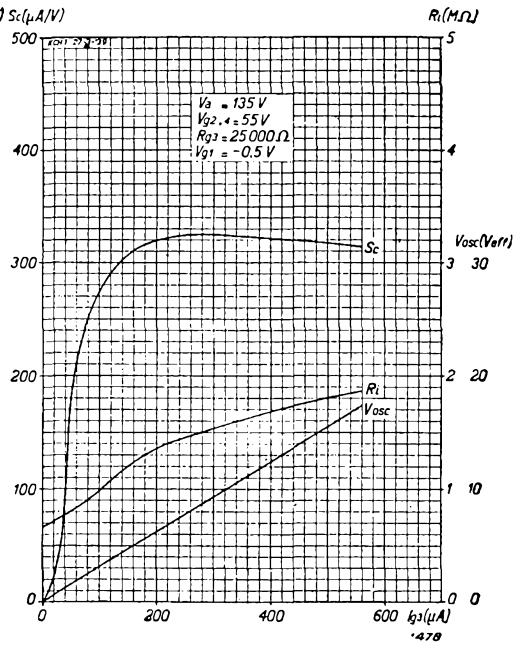

Fig. 5 Conversion conductance  $S_c$ , internal resistance  $R_i$  and effective oscillator voltage  $V_{osc}$  as functions of the oscillator-grid current  $I_{g3}$  (grid leak of oscillator,  $R_{g3} = 25,000$  ohms), at  $V_a = 135$  V and a fixed screen voltage of 55 V.

**FILAMENT RATINGS**

Heating: direct by battery; parallel supply.

Filament voltage . . . . .  $V_f = 2.0$  V

Filament current . . . . .  $I_f = 0.18$  A

**CAPACITANCES**

a. Hexode section.

$$C_{g1} = 7 \mu\mu\text{F}$$

$$C_a = 16 \mu\mu\text{F}$$

$$C_{ag1} < 0.05 \mu\mu\text{F}$$

b. Triode section.

$$C_{gf} = 13.5 \mu\mu\text{F}$$

$$C_{af} = 3.6 \mu\mu\text{F}$$

$$C_{ag} = 3.5 \mu\mu\text{F}$$

Between hexode and triode.

$$C_{gTg1H} < 0.4 \mu\mu\text{F}$$

**OPERATING DATA: Hexode section**

a) FIXED SCREEN-GRID VOLTAGE

Anode voltage . . . . .	$V_a =$	90 V			135 V		
Screen-grid voltage . . . . .	$V_{g2,4} =$	55 V			55 V		
Grid leak . . . . .	$R_{g3} =$	25,000 ohms			25,000 ohms		
Oscillator-grid current . . . . .	$I_{g3} =$	280 $\mu\text{A}$			280 $\mu\text{A}$		
Grid bias . . . . .	$V_{g1} =$	-0.5 <sup>1)</sup> -8 <sup>2)</sup> -9.5 <sup>3)</sup>			-0.5 <sup>1)</sup> -8 <sup>2)</sup> -9.5 <sup>3)</sup>		
Anode current . . . . .	$I_a =$	1 mA	—	—	1 mA		
Screen current . . . . .	$I_{g2,4} =$	1.2 mA	—	—	1.2 mA		
Conversion conductance . . . . .	$S_c =$	320	3	1	325	3	1 $\mu\text{A/V}$
Internal resistance . . . . .	$R_i =$	0.7	> 4	> 5	1.5	> 10	> 10 M ohms

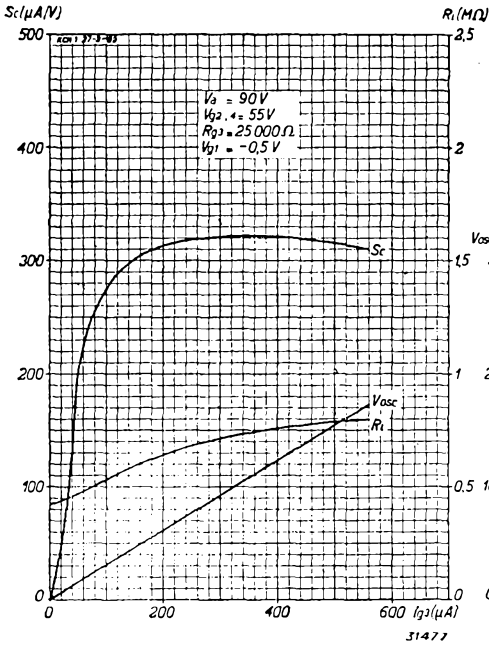

Fig. 6

Conversion conductance  $S_c$ , internal resistance  $R_i$  and effective oscillator voltage  $V_{osc}$  as functions of the oscillator-grid current  $I_{g3}$  (oscillator grid leak  $R_{g3} = 25,000$  ohms), with  $V_a = 90$  V and fixed screen voltage of 55 V.



Fig. 7

Conversion conductance  $S_c$ , internal resistance  $R_i$  and effective oscillator voltage  $V_{osc}$  as functions of the oscillator-grid current  $I_{g3}$  (oscillator grid leak  $R_{g3} = 25,000$  ohms), with  $V_a = 135$  V and screen fed from 135 V battery through a resistor of 67,000 ohms.

b) WITH SCREEN SERIES RESISTOR

Anode voltage . . . $V_a =$	90 V	135 V
Screen series resistor . . . $R_{g2,4} =$	29,000 ohms	67,000 ohms
Grid leak . . . $R_{g3} =$	25,000 ohms	25,000 ohms
Oscillator grid current . . . $I_{g3} =$	280 $\mu$ A	280 $\mu$ A
Grid bias . . . $V_{g1} =$	-0.5 <sup>1)</sup> -12 <sup>2)</sup> -15 <sup>3)</sup>	-0.5 <sup>1)</sup> -17 <sup>2)</sup> -20 V <sup>3)</sup>
Screen-grid voltage . . . $V_{g2,4} =$	55 — 90	55 — 135 V
Anode current . . . $I_a =$	1 — —	1 — — mA
Screen-grid current . . . $I_{g2,g4} =$	1.2 — —	1.2 — — mA
Conversion conductance . . . $S_c =$	320 3 1	325 3 1 $\mu$ A/V
Internal resistance . . . $R_i =$	0.7 <sup>4)</sup> > 0.9 > 1	1.5 <sup>5)</sup> > 1 > 1.5 M ohms

For footnotes see next page.

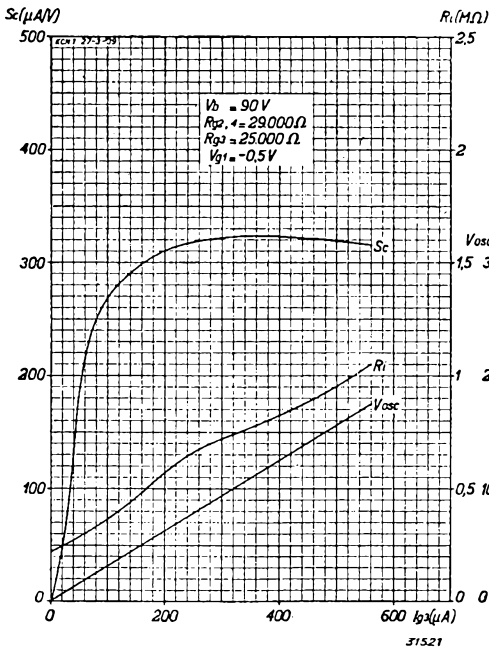

Fig. 8 Conversion conductance  $S_c$ , internal resistance  $R_i$  and effective oscillator voltage  $V_{osc}$  as functions of the oscillator-grid current  $I_{g3}$  (oscillator grid leak  $R_{g3} = 25,000$  ohms), with  $V_a = 90$  V and screen fed from 90 V battery through a resistor of 29,000 ohms.

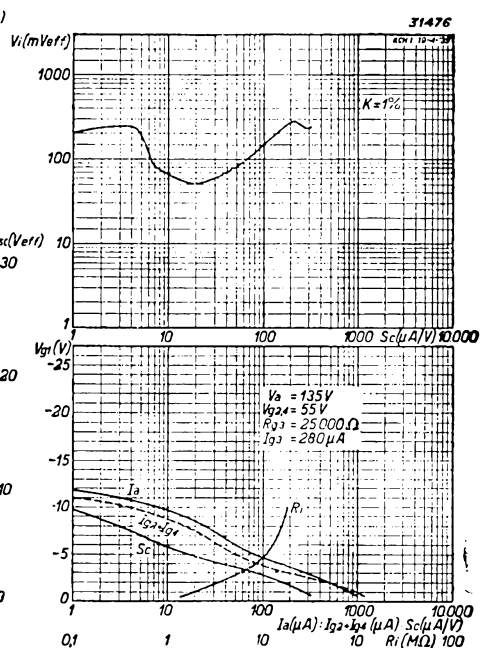

Fig. 9 With 135 V anode voltage and fixed screen voltage 55 V; Upper diagram. Alternating grid voltage of interfering signal (effective value) as a function of the conversion conductance, with 1 % cross-modulation. Lower diagram. Conversion conductance  $S_c$ , anode current  $I_a$ , screen current  $I_{g2} + I_{g4}$  and internal resistance  $R_i$  as functions of the grid bias  $V_{g1}$ .

c) SCREEN FED FROM A POTENTIAL DIVIDER

Anode voltage . . . . .	$V_a =$	90 V		90 V	
Potential divider resistor . . . . .	$R_1$ <sup>6)</sup> =	16,000 ohms		22,000 ohms	
Potential divider resistor . . . . .	$R_2$ <sup>6)</sup> =	55,000 ohms		110,000 ohms	
Potentiometer current . . . . .	$I_p =$	1 mA		0.5 mA	
Grid leak . . . . .	$R_{g3} =$	25,000 ohms		25,000 ohms	
Oscillator-grid current . . . . .	$I_{g3} =$	280 $\mu$ A		280 $\mu$ A	
Grid bias . . . . .	$V_{g1} =$	-0.5 <sup>1)</sup>	-9.5 <sup>2)</sup>	-11 V <sup>3)</sup>	-0.5 <sup>1)</sup> -10 <sup>2)</sup> -12 <sup>3)</sup> V
Screen-grid voltage . . . . .	$V_{g2,1} =$	55	—	70 V	55 — 75 V
Anode current . . . . .	$I_a =$	1	—	— mA	1 — — mA
Screen current . . . . .	$I_{g2,g1} =$	1.2	—	— mA	1.2 — — mA
Conversion conductance . . . . .	$S_c =$	320	3	1	325 3 1 $\mu$ A/V
Internal resistance . . . . .	$R_i =$	0.7	> 2	> 3	0.7 > 1.5 > 2.5 M ohms

1) Without control  
 2) Conversion conductance controlled to 1 : 100  
 3) Limit of control  
 4) With a grid bias of -5 V the internal resistance is approx. 0.1 megohm  
 5) With a grid bias of -6 V the internal resistance is approx. 0.4 megohm  
 6) See circuit diagram, Fig. 16.

OPERATING DATA: triode section used as oscillator

Anode voltage . . . . .	$V_a =$	70	—	— V
Battery voltage . . . . .	$V_b =$	—	90	135 V
Anode series resistor . . . . .	$R_a =$	—	22,000	22,000 ohms
Anode current with $I_g = 280 \mu$ A and $R_{g1} = 25,000$ ohms . . . . .	$I_a =$	3	2	3 mA
Anode current ( $V_g = 0, I_g = 0$ ) . . . . .	$I_a =$	2.4	—	— mA
Mutual conductance at threshold of oscillation ( $V_g = 0, I_g = 0$ ) . . . . .	$S_o =$	1.3	1.1	1.3 mA/V
Amplification factor, with $V_g = 0, I_g = 0$	$\mu =$	28	28	28

MAXIMUM RATINGS: Hexode section

Anode voltage . . . . .	$V_a =$	max. 135 V
Anode dissipation . . . . .	$W_a =$	max. 1.5 W
Screen-grid voltage without control on the valve ( $I_a = 1$ mA) . . . . .	$V_{g2,1} =$	max. 60 V
Screen voltage, valve under control ( $I_a < 0.2$ mA) . . . . .	$V_{g2,4} =$	max. 135 V
Screen-grid dissipation . . . . .	$W_{g2,4} =$	max. 1 W
Cathode current . . . . .	$I_k =$	max. 8 mA
External resistance between control grid and cathode . . . . .	$R_{g1k} =$	max. 3 M ohms
Grid voltage at grid current start ( $I_{g1} = + 0.3 \mu$ A)	$V_{g1} =$	max. -0.2 V

**MAXIMUM RATINGS: Triode section**

Anode voltage . . . . .	$V_a$	= max. 80 V
Anode dissipation . . . . .	$W_a$	= max. 0.5 W
Grid voltage at grid current start ( $I_{g2} = + 0.3 \mu A$ )	$V_{g1}$	= max. - 0.2 V
External resistance between grid and cathode . . .	$R_{gk}$	= max. 50,000 ohms

**APPLICATIONS**

A few further remarks may be added to the above. In order to limit frequency drift as much as possible, the oscillator circuit should be connected to the anode of the triode unit of the KCH 1; the reaction coil is therefore connected to the grid. At a wavelength of 15 metres, the drift will then be 3 kc/s with a grid voltage variation of from -2 to -15 V, which means that this valve is quite suitable for automatic gain control in the short-wave range. For the medium and long waves, the "bottom" end of the reaction coil should be connected to the "top" of the padding capacitor; the inductive coupling will then be assisted by the capacitive reaction through the

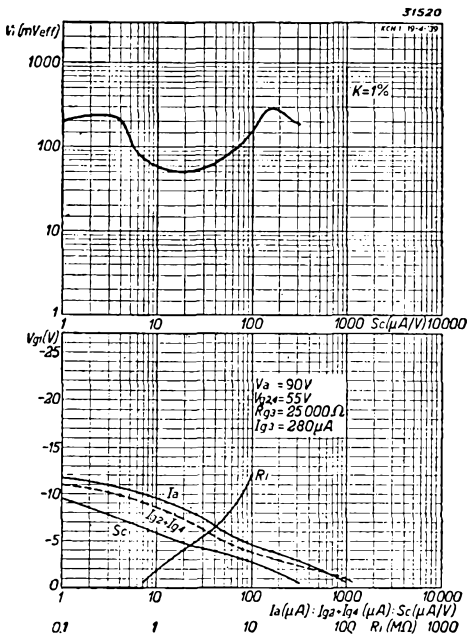

Fig. 10

With 90 V anode voltage and fixed-screen voltage of 55 V:

*Upper diagram.* Alternating grid voltage of the interfering signal (effective value) as a function of the conversion conductance, with 1 % cross-modulation.

*Lower diagram.* Conversion conductance  $S_c$ , anode current  $I_a$ , screen-grid current  $I_{g2} + I_{g4}$  and internal resistance  $R_i$ , as functions of the grid bias  $V_{g1}$ .

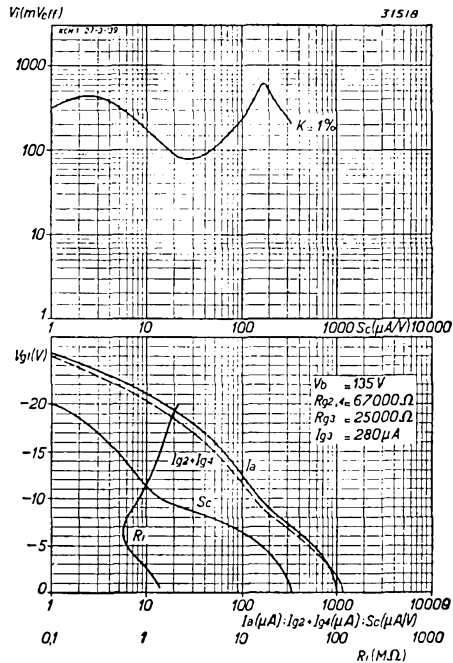

Fig. 11

With 135 V anode voltage and screen fed through a resistor of 67,000 ohms from a 135 V battery:

*Upper diagram.* Alternating grid voltage of the interfering signal (effective value) as a function of the conversion conductance with 1 % cross-modulation.

*Lower diagram.* Conversion conductance  $S_c$ , anode current  $I_a$ , screen-grid current  $I_{g2} + I_{g4}$ , and internal resistance  $R_i$  as functions of the grid bias  $V_{g1}$ .

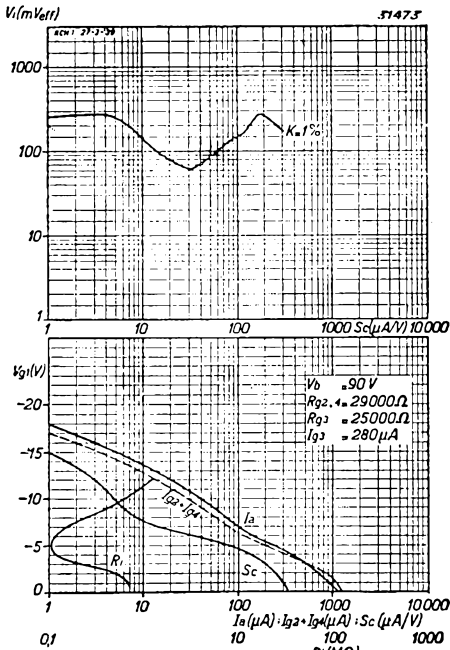

Fig. 12  
With 90 V anode voltage and screen fed through a resistor of 29,000 ohms from a 90 V battery: Upper diagram. Alternating grid voltage of the interfering signal (effective value) as a function of the conversion conductance, with 1 % cross-modulation. Lower diagram. Conversion conductance  $Sc$ , anode current  $I_a$ , screen-grid current  $I_{g2} + I_{g4}$  and internal resistance  $R_i$  as functions of the grid bias  $V_{g1}$ .

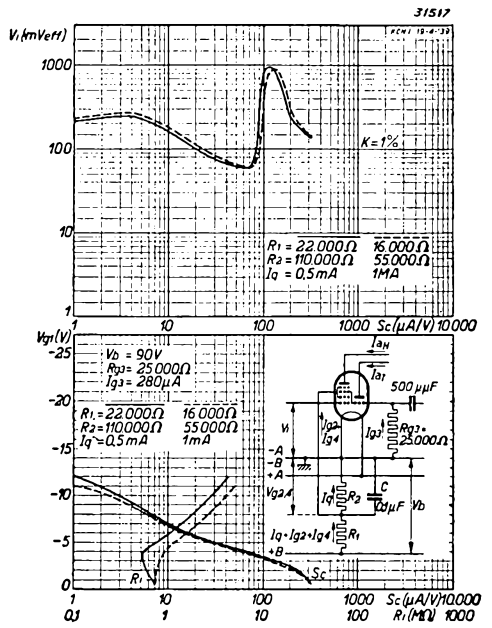

Fig. 13  
With 90 V anode voltage and screen fed from a potential divider carrying a current of 0.5 mA (full line), or 1 mA (broken line): Upper diagram. Alternating grid voltage of interfering signal (effective value), as a function of the conversion conductance, with 1 % cross-modulation. Lower diagram. Conversion conductance  $Sc$ , and internal resistance  $R_i$ , as functions of the grid bias  $V_{g1}$ .

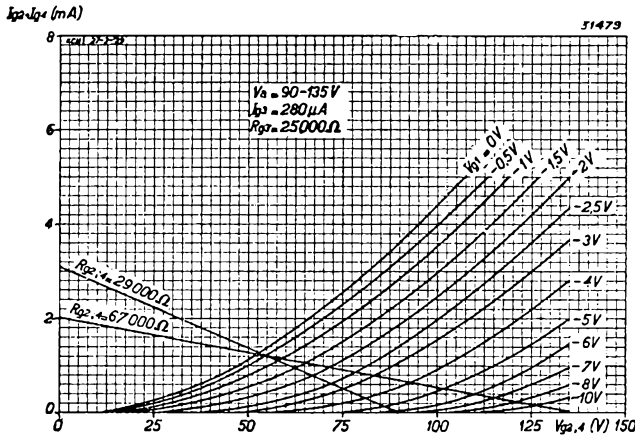

Fig. 14  
Screen-grid current  $I_{g2} + I_{g4}$  as a function of the screen voltage  $V_{g2,4}$  with grid bias  $V_{g1}$  as parameter. The resistance lines for  $R_{g2,4} = 67,000$  ohms for a battery voltage of 135 V, and for  $V_{g2,4}$  with reference to a 90 V battery are also given.



latter. This ensures more uniform oscillation throughout the whole wave-range. For short waves a padding capacitor is not usually employed. A grid capacitor of some 50 to 70  $\mu\text{F}$  will give reliable oscillation on long waves, with very little frequency drift on the short waves. A value of 25,000 ohms is recommended for the grid-leak resistor as this will prevent over-oscillation and will at the same time not damp the oscillator circuit too heavily. When a 135 V battery is used, it is advisable to feed the anode through a resistor of 22,000 ohms; this resistor is in parallel with the oscillator circuit for the high frequencies, thus slightly damping the circuit. Fig. 16 shows the circuit diagram of the KCH 1 when used on a 90 V or 135 V battery. If on a 90 V battery supply the resistor in series with the anode is any lower than 7,000 ohms, the damping of the oscillator circuit is considerably increased, but, on the other hand, if the 22,000 ohms resistor is used, the conductance at the threshold of oscillation will be reduced. With the last mentioned value, however, oscillation is more reliable, which is, of course, the more preferable result. To avoid any possibility of parasitic oscillation, a small resistor of 30 to 50 ohms can be included in the first grid circuit.

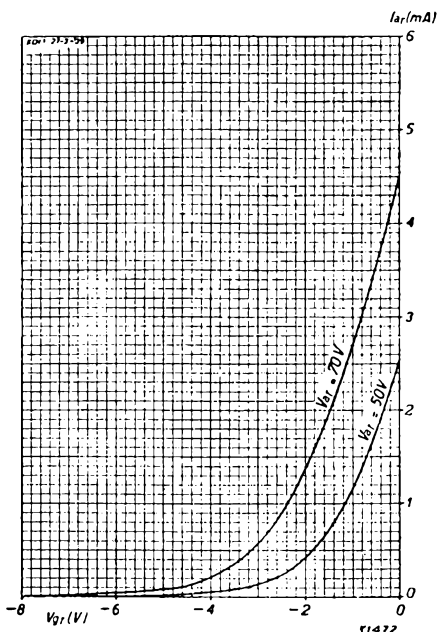

Fig. 15  
Anode current of the triode section,  $I_{aT}$ , as a function of the grid bias  $V_{gT}$ , with  $V_{bT} = 50$  and  $70$  V.

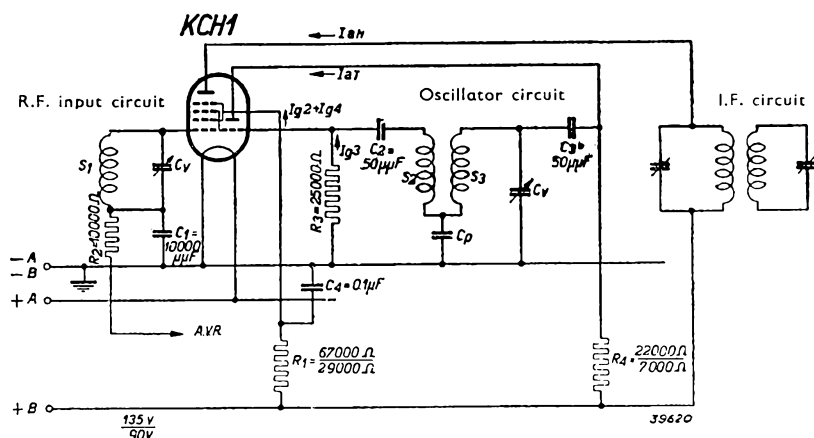

Fig. 16  
Circuit diagram showing the KCH 1 employed as a frequency-changer in a battery receiver operated from a 135 V or 90 V battery.

# KDD 1 Class B output valve

The KDD 1 is, in effect, two triodes housed in a single envelope; it is intended for use in Class B output circuits operating with grid current and, in conjunction with a suitable driver valve, it will deliver 2.2 W without too much drain on the H.T. battery. The valve is of a type that requires no grid bias; without bias, grid current flows during almost the whole of the cycle of grid signal, thus avoiding any sudden surges of grid current in the secondary winding of the transformer, which would produce severe distortion of a very unpleasant character by reason of the clearly audible higher harmonics.

When there is no signal on the grid the anode current is extremely low, being only about 3 mA for the two anodes together, on 135 V; the current becomes appreciable only when the signal is applied. Consumption of anode current is roughly proportional to the alternating grid voltage, which means that a considerable saving may be effected, since the average current is much less than with maximum excitation. It is also possible to relieve the drain on the H.T. battery somewhat by turning down the receiver volume control to a low level. With a signal present on the grid, grid current flows in both of the triodes, and the driver valve must be capable of supplying the input required to load the valve fully.

The construction of the grid is such that grid current is limited to a minimum, whilst ensuring the greatest economy and sensitivity in the driver stage.

A suitable driver transformer, of ratio 2 : (1 + 1), should be used with the KDD 1 and the optimum matching impedance between anodes will in this case be 10,000 ohms.

## FILAMENT RATINGS

Heating: direct by battery; parallel supply.

Filament voltage. . . . .  $V_f = 2.0$  V

Filament current. . . . .  $I_f = 0.22$  A

## OPERATING DATA

Anode voltage . . . . .	$V_a$	= 90 V	135 V
Grid voltage . . . . .	$V_g$	= 0	0 V
Anode current (without signal) . . . . .	$I_{a0}$	= $2 \times 0.8$	$2 \times 1.5$ mA
Anode current at max. modulation . . . . .	$I_{a\max}$	= $2 \times 8.5$	$2 \times 14$ mA
Output power at max. modulation . . . . .	$W_a$	= 0.72 <sup>1)</sup>	2.0 W <sup>1)</sup>
Load resistor between anodes . . . . .	$R_{aa}$	= 10,000	10,000 ohms
Alternating grid voltage of the driver valve . . . . .	$V_i$	= 1.5 <sup>1)</sup>	1.9 $V_{\text{eff}}$ <sup>1)</sup>
Total distortion . . . . .	$d_{\text{tot}}$	= 6 <sup>1)</sup>	10 % <sup>1)</sup>

<sup>1)</sup> Measured with KC 3 as driver; transformation ratio 2 : (1 + 1).

## MAXIMUM RATINGS PER SYSTEM

Anode voltage . . . . .	$V_a$	= max. 150 V
Anode dissipation ( $V_i = 0$ ) . . . . .	$W_a$	= max. 0.35 W
Anode dissipation ( $W_o = \text{max.}$ ) . . . . .	$W_a$	= max. 1.5 W
Direct current per anode (average value) . . . . .	$I_a$	= max. 20 mA

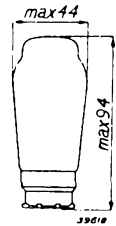

Fig. 1  
Dimensions in mm

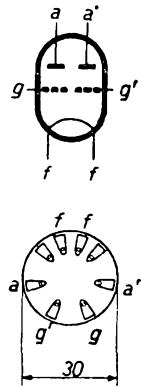

Fig. 2  
Arrangement of electrodes and base connections.

TABLE  
VALVES KC 3 + KDD 1

Ratio of driver transformer prim. wdg. $\frac{1}{2}$ sec. wdg.	$\frac{5}{3} = \frac{1.67}{1}$					$\frac{2}{1}$					$\frac{7}{3} = \frac{2.33}{1}$				
	5,000	7,500	10,000	15,000	20,000	5,000	7,500	10,000	15,000	20,000	5,000	7,500	10,000	15,000	20,000
Load resistor between anodes (ohms) $R_{aa}$															
Max. output power (limited by grid current of KC 3) (W)	1.8	2.2	2.2	2.2	1.9	1.6	2.0	2.2	2.1	1.8	1.5	1.8	2.0	2.0	1.8
Distortion with that output (%)	10	11	13	19	22	7.2	8.2	10	15	20	5	5.7	8.0	13	18
Combined anode current of both anodes with that output (mA)	35	32	32	24	20	33	30	28	23	19	31	29	27	22	19
Alternating grid voltage $V_i$ for 50 mW output (sensitivity) ( $V_{eff}$ )	0.31	0.26	0.22	0.19	0.17	0.35	0.29	0.25	0.22	0.20	0.39	0.32	0.29	0.25	0.22

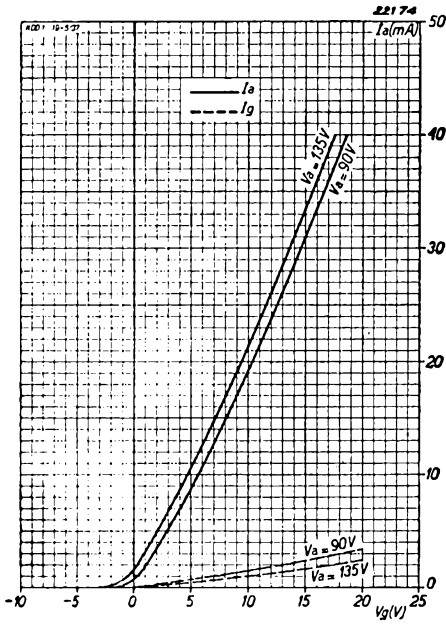

Fig. 3  
Anode current and grid current as functions of the grid voltage.

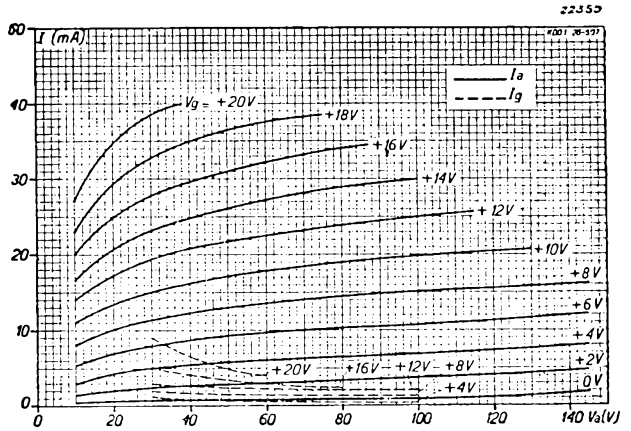

Fig. 4  
Anode current and grid current as functions of the anode voltage, with grid voltage as parameter.

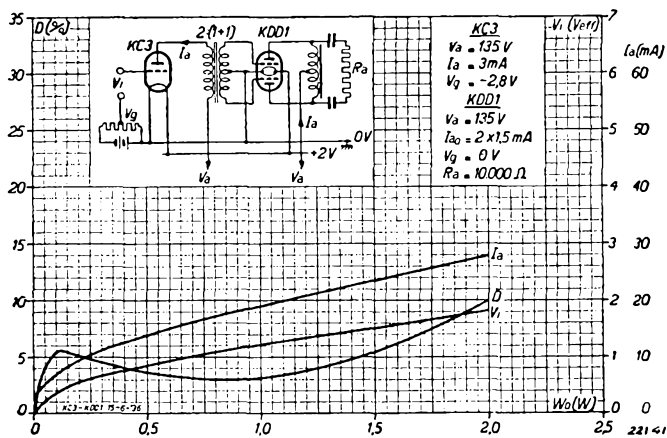

Fig. 5  
 Anode current, alternating grid voltage and total distortion  $d_{tot}$  as functions of the output power of the KDD 1 for an anode voltage of 135 V, using the KC 3 as driver valve.

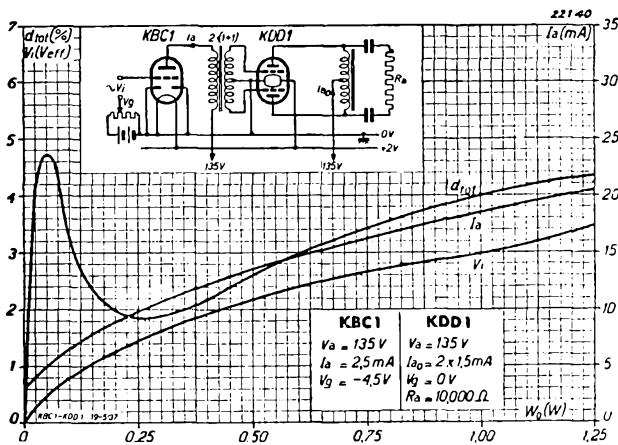

Fig. 6  
 Anode current, alternating grid voltage and total distortion  $d_{tot}$  as functions of the output power of the KDD 1 for an anode voltage of 135 V, using the KBC 1 as driver valve.

# KF 3 Variable-MU R.F. pentode

The KF 3, a variable-mu R.F. pentode, offers excellent cross-modulation characteristics throughout the whole range of control on the valve. At the normal working point the anode current is very low; only a small control potential will completely quench the valve. These rapid control characteristics are of great importance in superhet. battery receivers that include a short-wave range and, although it is not generally advisable to apply control on that range, effective A.G.C. can nevertheless be obtained in the case of the KF 3. This valve can be used only for R.F. and I.F. amplification; when employed in the former capacity it gives very good results also on short waves; not only are the low capacitances subject to very little variation when control is applied, but the input and output damping resistances are high and retroaction from the anode extremely slight. On short waves, especially, it is advisable to earth both the metallizing and the suppressor grid by means of the shortest possible (low inductive) leads.

### FILAMENT RATINGS

Heating: direct by battery; parallel supply.

Filament voltage. . . . .  $V_f = 2\text{ V}$

Filament current. . . . .  $I_f = 0.045\text{ A}$

### CAPACITANCES

$C_{app1} < 0.006\ \mu\mu\text{F}$

$C_{g1} = 6.2\ \mu\mu\text{F}$

$C_u = 5.2\ \mu\mu\text{F}$

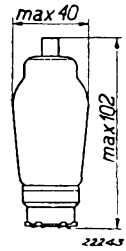

Fig. 1  
Dimensions in mm.

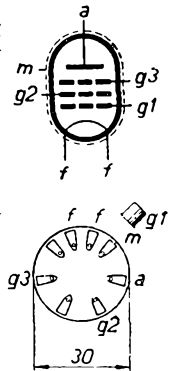

Fig. 2  
Arrangement of electrodes and base connections.

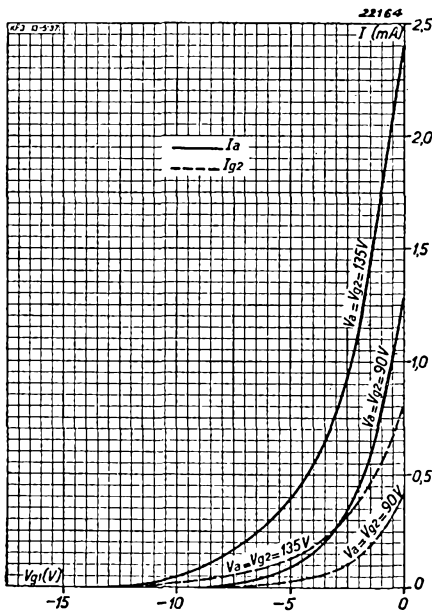

Fig. 3  
Anode and screen-grid current as functions of the grid bias.

**OPERATING DATA**

Anode voltage . . . . .	$V_a$	=	90		135 V
Screen-grid voltage . . .	$V_{g2}$	=	90		135 V
Suppressor grid voltage.	$V_{g3}$	=	0		0 V
Grid bias . . . . .	$V_{g1}$	=	$\overbrace{-0.5 \quad -9}$		$\overbrace{-0.5 \quad -13.5}$ V
Anode current . . . . .	$I_a$	=	1	—	2 mA
Screen-grid current . . .	$I_{g2}$	=	0.2	—	0.6 mA
Amplification factor . . .	$\mu$	=	1000	—	850
Mutual conductance . . .	$S$	=	500	5	650 $\mu\text{A/V}$
Internal resistance . . .	$R_i$	=	2	$> 10$	1.3 $> 10$ M ohms

**MAXIMUM RATINGS**

$V_a$	= max. 135 V	$V_{g2}$	= max. 135 V
$W_a$	= max. 0.5 W	$W_{g2}$	= max. 0.2 W
$I_k$	= max. 5 mA	$R_{g1}$	= max. 3 M ohms
$V_{g1}$ ( $I_{g1} = \pm 0.3 \mu\text{A}$ ) = max. —0.2 V			

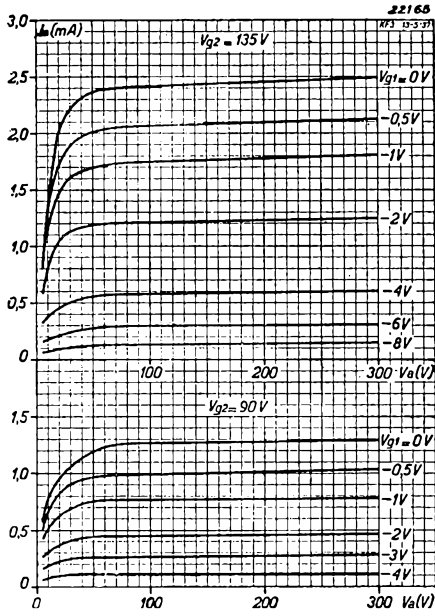

Fig. 4  
Anode current as a function of the anode voltage, with grid bias as parameter.

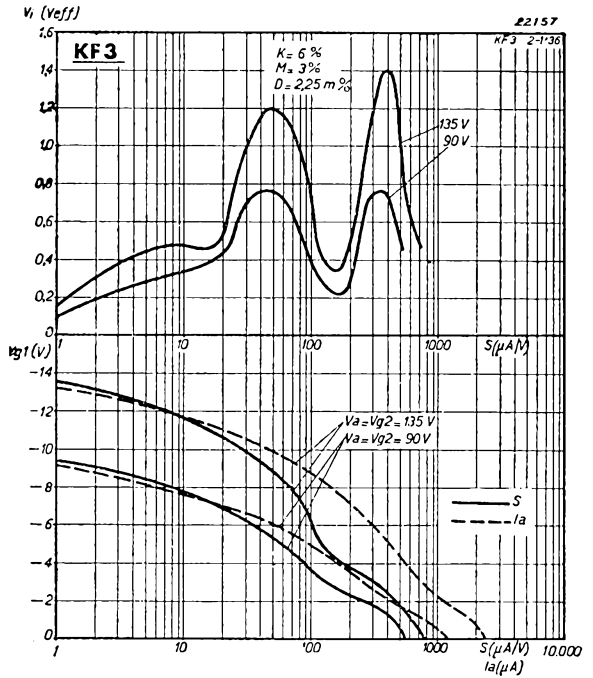

Fig. 5  
Upper diagram. Max. permissible effective value of alternating grid voltage with 6 % cross-modulation (0.5 % 3rd harmonic) as a function of the mutual conductance.  
Lower diagram. Mutual conductance and anode current as functions of the grid bias.



# KF 4 R.F. pentode

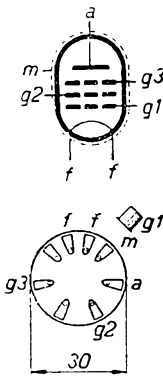

Fig. 2  
Arrangement of  
base connections  
and electrodes.

The R.F. pentode KF 4 has no control characteristic; it can be employed for R.F. or I.F. amplification, anode-bend or grid detection, and as resistance-coupled A.F. amplifier.

When used for the last-mentioned function it should follow the indirectly-heated double-diode KB 2 for driving a Class A output stage using the pentode KL 4 or, with the necessary driver transformer, a Class B stage comprising two valves of the latter type.

The KF 4 gives excellent results on short waves; this is mainly due to the use of the P-type base with which it is fitted, and a separate contact for the suppressor grid connection. In the design of this valve output capacitances have been kept as low as possible.

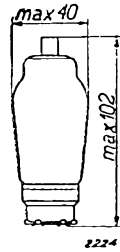

Fig. 1  
Dimensions in mm.

## FILAMENT RATINGS

Heating: direct by battery; parallel supply.

Filament voltage. . . . .  $V_f = 2.0 \text{ V}$

Filament current. . . . .  $I_f = 0.065 \text{ A}$

## CAPACITANCES

$$C_{ag1} < 0.008 \mu\mu\text{F}$$

$$C_{g1} = 6.0 \mu\mu\text{F}$$

$$C_u = 5.0 \mu\mu\text{F}$$

## MAXIMUM RATINGS

$$V_a = \text{max. } 135 \text{ V}$$

$$W_a = \text{max. } 0.5 \text{ W}$$

$$V_{g2} = \text{max. } 135 \text{ V}$$

$$W_{g2} = \text{max. } 0.25 \text{ W}$$

$$I_k = \text{max. } 5 \text{ mA}$$

$$V_{g1} (I_{g1} = +0.3 \mu\text{A}) = \text{max. } -0.2 \text{ V}$$

$$R_{g1k} = \text{max. } 3 \text{ M ohms}$$

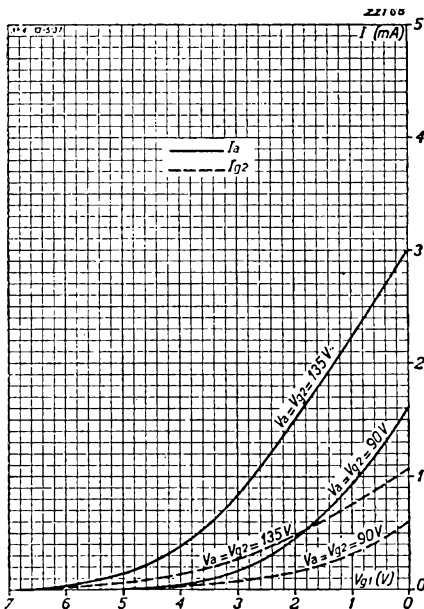

Fig. 3  
Anode and screen-grid current as functions of  
the grid bias.

STATIC DATA

Anode voltage . . . . .	$V_a = 90 \text{ V}$	135 V
Screen-grid voltage . . . . .	$V_{g2} = 90 \text{ V}$	135 V
Suppressor-grid voltage . . . . .	$V_{g3} = 0$	0 V
Grid bias . . . . .	$V_{g1} = -0.5 \text{ V}$	-0.5 V
Anode current . . . . .	$I_a = 1.2 \text{ mA}$	2.6 mA
Screen-grid current . . . . .	$I_{g2} = 0.4 \text{ mA}$	1.0 mA
Amplification factor . . . . .	$\mu = 800$	700
Mutual conductance . . . . .	$S = 0.7 \text{ mA/V}$	0.8 mA/V
Internal resistance . . . . .	$R_i = 0.9 \text{ M ohms}$	0.8 M ohms

TABLE I

KF 4 used as grid detector with resistance coupling (connected as pentode); grid leak of following valve = 1 megohm.

Battery voltage $V_b$ (V)	Coupling resistor $R_a$ (M ohm)	Anode current $I_a$ (mA)	Screen-series resistor $R_{g2}$ (M ohm)	Screen-grid current $I_{g2}$ (mA)	Detector amplification; modulation depth 30 %		Alternating output voltage; modulation depth 30 %	
					Altern. output voltage $V_o$ (V <sub>eff</sub> )	Stage gain	Altern. output voltage $V_o$ (V <sub>eff</sub> )	Altern. grid voltage $V_i$ (V <sub>eff</sub> )
135	0.32	0.37	0.64	0.15	2	6.6	4.8	0.64
90	0.32	0.24	0.5	0.11	2	4.8	2.6	0.56
135	0.10	1.05	0.5	0.16	2	7.3	6.4	1.0
90	0.04	2.1	0.032	1.05	2	4.4	5.1	1.6
135	0.10	0.71	0.10	0.41	2	4.9	4.5	1.0
90	0.04	1.5	0.016	0.75	2	3.9	3.8	1.1

TABLE II

KF 4 used as grid detector with reaction and resistance coupling (connected as triode).

Battery voltage $V_b$ (V)	Coupling resistor $R_a$ (Ohms)	Anode current $I_a$ (mA)	Detector amplification at $m = 0.3$		Alternating output voltage at $m = 0.3$			Alternating output voltage at $m = 0.1$		
			Altern. output volts $V_o$ (V <sub>eff</sub> )	Stage gain	Altern. output volts $V_o$ (V <sub>eff</sub> )	Altern. grid volts $V_i$ (V <sub>eff</sub> )	Distortion %	Altern. output volts $V_o$ (V <sub>eff</sub> )	Altern. grid volts $V_i$ (V <sub>eff</sub> )	Distortion %
135	20,000	2.6	0.5	1.9	2.2 <sup>1)</sup>	1.1	2	0.85	1.5	0.9
135	40,000	1.8	0.5	2.2	2.2 <sup>1)</sup>	1.0	3.6	0.86	1.5	2
90	20,000	1.5	0.5	1.6	1.4 <sup>2)</sup>	0.95	5 <sup>3)</sup>	—	—	—
90	40,000	1.1	0.5	2.0	1.4 <sup>2)</sup>	0.8	4	—	—	—

<sup>1)</sup> Max. excitation of the stage KC 3 + KDD 1 at  $V_a = 135 \text{ V}$  is reached at an alternating grid voltage of 2.2V(<sub>eff</sub>)

<sup>2)</sup> Max. excitation of the stage KC 3 + KDD 1 at  $V_a = 90 \text{ V}$  is reached at an alternating grid voltage of 1.4 V(<sub>eff</sub>).

<sup>3)</sup> Maximum alternating output voltage.

TABLE III

KF 4 used as A.F. amplifier (connected as pentode). Grid leak of following valve  
1 megohm.

Battery voltage $V_b$ (V)	Coupling resistor $R_a$ (Mohm)	Anode current $I_a$ (mA)	Screen series resistor $R_{g_2}$ (M ohm)	Screen-grid current $I_{g_2}$ (mA)	Grid bias $V_{g_1}$ (V)	With an alternating output voltage of 10 $V_{eff}$ :		With an alternating output voltage of 14 $V_{eff}$ :	
						Gain factor	Distortion $d$ (%)	Gain factor	Distortion $d$ (%)
135	0.32	0.30	0.64	0.11	-1.5	72	0.5	72	0.7
90	0.32	0.18	0.4	0.10	-1.5	52	1.5	52	1.8
135	0.20	0.41	0.4	0.15	-1.5	62	0.8	62	1.0
90	0.20	0.24	0.25	0.10	-1.5	48	1.2	48	1.9
135	0.10	0.64	0.2	0.23	-1.5	47	0.9	47	1.6
90	0.10	0.50	0.05	0.20	-1.5	37	0.9	37	1.8

TABLE IV

KF 4 used as A.F amplifier (connected as triode). Grid leak of the following valve  
1 megohm.

Battery voltage $V_b$ (V)	Coupling resistor $R_a$ (M ohm)	Anode current $I_a$ (mA)	Grid bias $V_{g_1}$ (V)	With an alternating output voltage of 7 $V_{eff}$ : <sup>1)</sup>			With an alternating output voltage of 10 $V_{eff}$ : <sup>2)</sup>		
				Altern. grid volts $V_i$ ( $V_{eff}$ )	Stage gain	Distortion $d$ (%)	Altern. grid volts $V_i$ ( $V_{eff}$ )	Stage gain	Distortion $d$ (%)
135	0.32	0.25	-1.5	0.39	18	0.8	0.56	18	0.8
135	0.32	0.15	-3.0	0.43	16.2	1.5	0.62	16.2	2.8
90	0.32	0.13	-1.5	0.43	16.2	2	—	—	—
90	0.32	0.05	-3.0	0.62	11.5	10	—	—	—
135	0.20	0.35	-1.5	0.39	18	0.8	0.56	18	0.8
135	0.20	0.21	-3.0	0.45	16	1.7	0.63	16	3.0
90	0.20	0.17	-1.5	0.43	16.2	2	—	—	—
90	0.20	0.07	-3.0	0.65	10.5	13	—	—	—
135	0.10	0.56	-1.5	0.42	16.6	0.8	0.60	16.6	1.0
135	0.10	0.33	-3.0	0.48	14.5	2.4	0.70	14.5	4.0
90	0.10	0.28	-1.5	0.48	14.5	1.5	—	—	—
90	0.10	0.09	-3.0	0.76	9.5	18	—	—	—

<sup>1)</sup> Max. excitation of the KL 2 at  $V_a = V_{g_2} = 90$  V is reached at an alternating input of 7  $V_{eff}$ .

Max. excitation of the KL 4 at  $V_a = V_{g_2} = 90$  V is reached at an alternating input of 2  $V_{eff}$ .

<sup>2)</sup> Max. excitation of the KL 2 at  $V_a = V_{g_2} = 135$  V is reached at an alternating input of 10  $V_{eff}$ .

Max. excitation of the KL 4 at  $V_a = V_{g_2} = 135$  V is reached at an alternating input of 3.5  $V_{eff}$ .

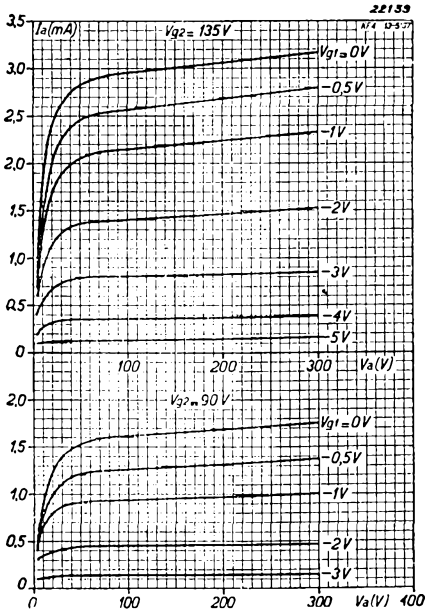

Fig. 4  
Anode current as a function of the anode voltage, with grid bias as parameter, at  $V_{g2} = 90$  V and 135 V.

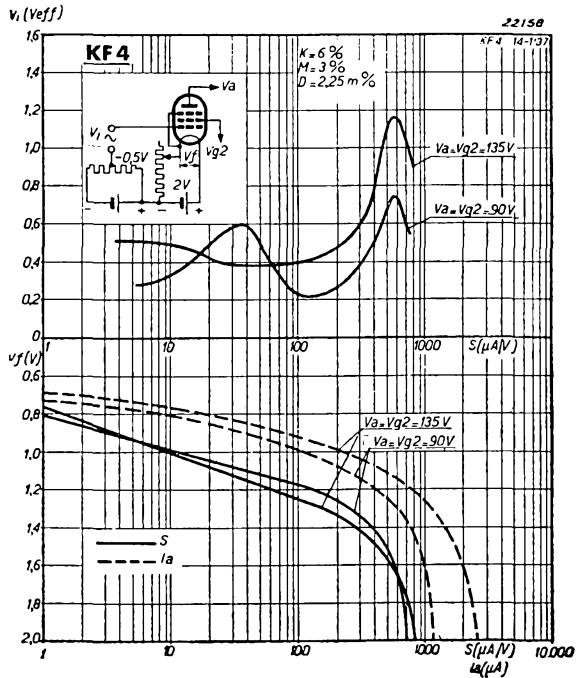

Fig. 5  
Upper diagram. Maximum permissible effective value of the alternating grid voltage with 6% cross-modulation (0.5% 3rd harmonic), as a function of the mutual conductance controlled by varying the filament voltage.  
Lower diagram. Mutual conductance and anode current as functions of the filament voltage.

# KH 1 Hexode

This battery hexode can be utilized for three different purposes, viz:

1) As a frequency-changer with a separate oscillator valve, such as the KC 4 which is specially designed for the purpose. The R.F. signal is applied to the first grid and the oscillator signal to the third grid. The screens, grids two and four, are given a positive potential of 60 V. The pitch of the first grid is such that A.G.C. can be employed, with excellent cross-modulation characteristics; the conversion conductance, for a battery valve, is very high, being 450  $\mu\text{A/V}$ .

2) As an R.F. vari-mu pentode in R.F. and I.F. amplifiers. The second and third grids are again given a potential of 60 V, whilst the fourth grid serves as suppressor and is accordingly earthed, this arrangement giving high mutual conductance (1.4 mA/V) with a low battery current (2.95 mA).

3) As a variable-mu R.F. tetrode in R.F. or I.F. amplifiers. The second and fourth grids are joined and supplied with 60 V and the third grid is earthed. In this case the mutual conductance is slightly higher than when the valve is used as a pentode (1.5 mA/V), and the anode current somewhat lower (2.8 mA); the control, however, is less rapid and the internal resistance is lower.

## FILAMENT RATINGS

Heating: direct by battery; parallel supply.

Filament voltage. . . . .  $V_f = 2.0 \text{ V}$

Filament current. . . . .  $I_f = 0.135 \text{ A}$

## CAPACITANCES

$C_{g1} = 7.8 \mu\text{F}$

$C_{g1g3} = 0.17 \mu\text{F}$

$C_{g3} = 12.5 \mu\text{F}$

$C_{ag1} = < 0.002 \mu\text{F}$

$C_a = 16.3 \mu\text{F}$



Fig. 1 Dimensions in mm.

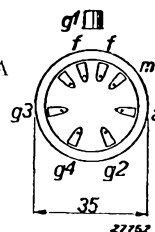
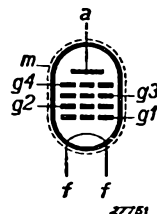

Fig. 2 Arrangement of electrodes and base connections.

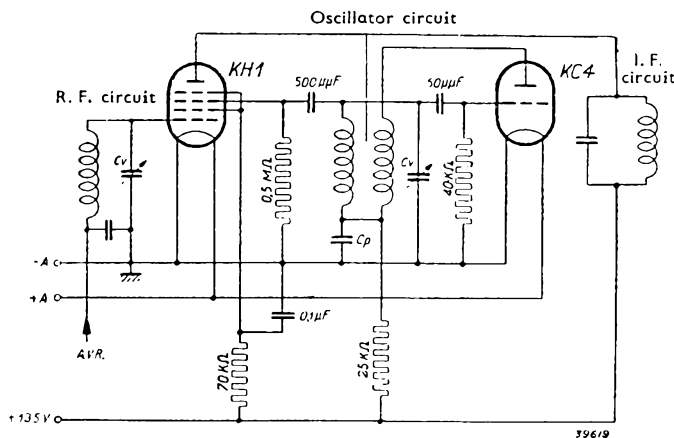

Fig. 3 Circuit diagram showing the KH 1 used as a frequency-changer.

# KH 1

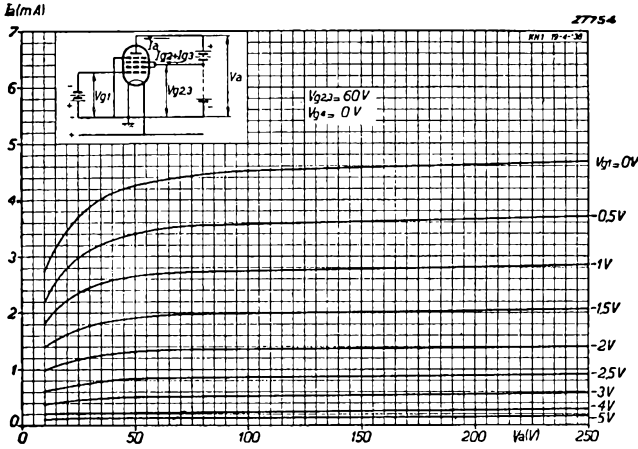

Fig. 4  
 $I_a/V_a$  characteristics of the KH 1 used as a pentode.

## OPERATING DATA: KH 1 employed as a frequency-changer

Anode voltage . . . . .	$V_a = 135 \text{ V}$		
Voltage on grid 2 . . . . .	$V_{g2} = 60 \text{ V}$		
Voltage on grid 4 . . . . .	$V_{g4} = 60 \text{ V}$		
Grid leak, grid 3 . . . . .	$R_{g3} = 0.5 \text{ M ohm}$		
Oscillator voltage, grid 3 . . . . .	$V_{osc} = 10 \text{ V}_{eff}$		
Grid bias . . . . .	$V_{g1} = -1.5 \text{ V}^1)$	$-8 \text{ V}^2)$	$-9.5 \text{ V}^3)$
Anode current . . . . .	$I_a = 1 \text{ mA}$	—	—
Screen-grid current . . . . .	$I_{g2} \div I_{g4} = 1.1 \text{ mA}$	—	—
Conversion conductance . . . . .	$S_c = 450 \mu\text{A/V}$	$4.5 \mu\text{A/V}$	$1 \mu\text{A/V}$
Internal resistance . . . . .	$R_i = 1 \text{ M ohm}$	$> 10 \text{ M ohms}$	$> 10 \text{ M ohms}$

<sup>1)</sup> Without control. <sup>2)</sup> Conductance controlled to 1 : 100. <sup>3)</sup> Limit of control.

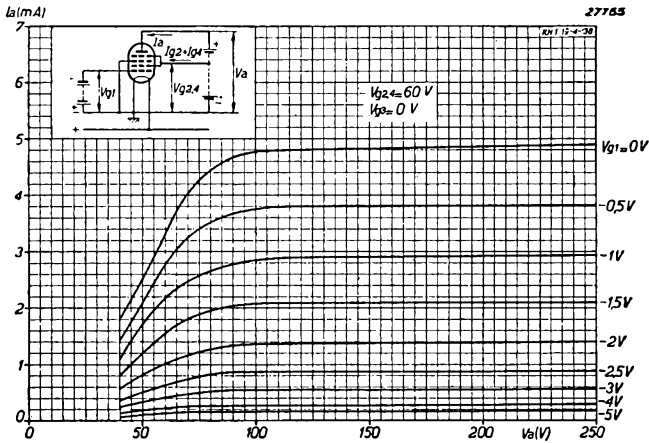

Fig. 5  
 $I_a/V_a$  characteristics of the KH 1 used as tetrode.

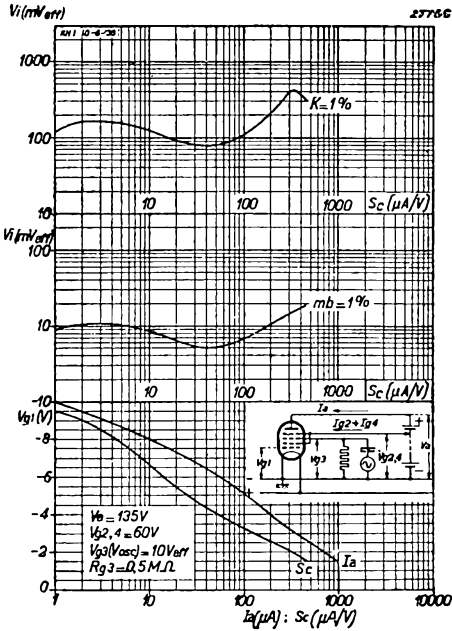

Fig. 6

KH 1 as a frequency-changer.

Upper diagram. Effective value of the alternating grid voltage as a function of the conversion conductance, with 1% cross-modulation.

Centre diagram. Effective value of the alternating grid voltage as a function of the conversion conductance, with 1% modulation hum.

Lower diagram. Conversion conductance  $S_c$  and anode current  $I_a$  as functions of the grid bias.

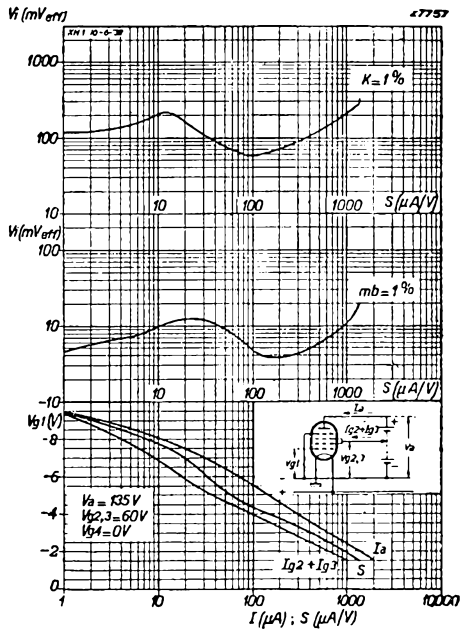

Fig. 7

KH 1 as a pentode.

Upper diagram. Effective value of the alternating grid voltage as a function of the mutual conductance, with 1% cross-modulation.

Centre diagram. Effective value of the alternating grid voltage as a function of the mutual conductance, with 1% modulation hum.

Lower diagram. Mutual conductance  $S$ , screen-grid current  $I_{g2} + I_{g3}$ , and anode current  $I_a$  as functions of the grid bias.

**OPERATING DATA: KH 1 connected as a pentode (R.F. or I.F. amplifier)**

Anode voltage . . . . .	$V_a = 135 V$		
Voltage on grid 2 . . . . .	$V_{g2} = 60 V$		
Voltage on grid 3 . . . . .	$V_{g3} = 60 V$		
Voltage on grid 4 . . . . .	$V_{g4} = 0 V$		
Grid bias . . . . .	$V_{g1} = -1.5 V^1)$	$-7.5 V^2)$	$-9.3 V^3)$
Anode current . . . . .	$I_a = 2 \text{ mA}$	—	—
Screen-grid current . . . . .	$I_{g2} + I_{g3} = 0.95 \text{ mA}$	—	—
Mutual conductance . . . . .	$S = 1,400 \mu\text{A/V}$	$14 \mu\text{A/V}$	$1 \mu\text{A/V}$
Internal resistance . . . . .	$R_i = 1.3 \text{ M ohms}$	$> 10 \text{ M ohms}$	$> 10 \text{ M ohms}$

**OPERATING DATA: KH 1 connected as a tetrode (R.F. or I.F. amplifier)**

Anode voltage . . . . .	$V_a = 135 V$		
Voltage on grid 2 . . . . .	$V_{g2} = 60 V$		
Voltage on grid 3 . . . . .	$V_{g3} = 0 V$		
Voltage on grid 4 . . . . .	$V_{g4} = 60 V$		
Grid bias . . . . .	$V_{g1} = -1.5 V^1)$	$-8.5 V^2)$	$-11 V^3)$
Anode current . . . . .	$I_a = 2.1 \text{ mA}$	—	—
Screen-grid current . . . . .	$I_{g2} + I_{g4} = 0.7 \text{ mA}$	—	—
Mutual conductance . . . . .	$S = 1,500 \mu\text{A/V}$	$15 \mu\text{A/V}$	$1 \mu\text{A/V}$
Internal resistance . . . . .	$R_i = 0.7 \text{ M ohm}$	$> 10 \text{ M ohms}$	$> 10 \text{ M ohms}$

<sup>1)</sup> Without control. <sup>2)</sup> Conductance controlled to 1 : 100. <sup>3)</sup> Limit of control.

**MAXIMUM RATINGS**

Anode voltage . . . . .	$V_{a}$	= max. 150 V
Anode dissipation . . . . .	$W_{a}$	= max. 0.4 W
Voltage, grid 2 . . . . .	$V_{g2}$	= max. 60 V
Dissipation, grid 2 . . . . .	$W_{g2}$	= max. 0.1 W
Voltage, grid 3 . . . . .	$V_{g3}$	= max. 60 V
Dissipation, grid 3 . . . . .	$W_{g3}$	= max. 0.1 W
Voltage, grid 4 . . . . .	$V_{g4}$	= max. 60 V
Dissipation, grid 4 . . . . .	$W_{g4}$	= max. 0.1 W
Grid voltage at grid current start . . . . .	$(I_{g1} = + 0.3 \mu A)$ $(I_{g3} = + 0.3 \mu A)$	$V_{g1} =$ max. $-0.2$ V $V_{g3} =$ max. $-0.2$ V
Cathode current . . . . .	$I_k$	= max. 10 mA
External resistance between grid 1 and cathode. . . . .	$R_{g1k}$	= max. 1 M ohm
External resistance between grid 3 and cathode . . . . .	$R_{g3k}$	= max. 1 M ohm

**TOLERANCES ON SCREEN-GRID CURRENT**

- a) valve used as a frequency-changer ( $V_a = 135$  V,  $V_{g2} = V_{g4} = 60$  V,  $V_{g3} = 10$  V<sub>eff</sub>,  $V_{g1} = -1.5$  V).  
 $I_{g2} + I_{g4} =$  max. 1.45 mA  
 $I_{g2} + I_{g4} =$  min. 0.75 mA
- b) valve used as a pentode ( $V_a = 135$  V,  $V_{g2} = V_{g3} = 60$  V,  $V_{g4} = 0$ ,  $V_{g1} = -1.5$  V).  
 $I_{g2} + I_{g3} =$  max. 1.3 mA  
 $I_{g2} + I_{g3} =$  min. 0.7 mA
- c) valve used as a tetrode ( $V_a = 135$  V,  $V_{g2} = V_{g4} = 60$  V,  $V_{g3} = 0$  V,  $V_{g1} = -1.5$  V).  
 $I_{g2} + I_{g4} =$  max. 0.9 mA  
 $I_{g2} + I_{g4} =$  min. 0.5 mA

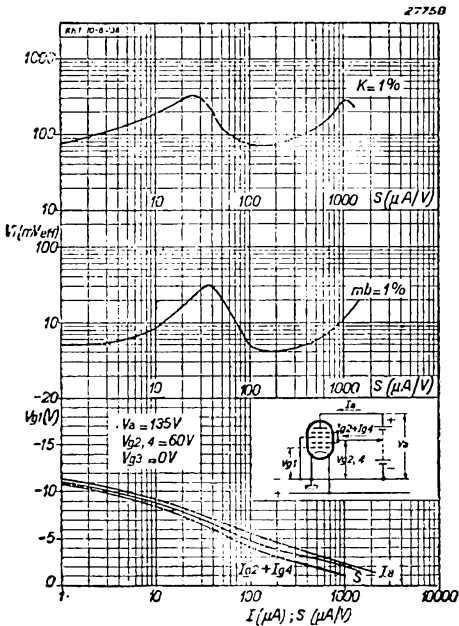

Fig. 8  
 KH 1 used as a tetrode:  
 Upper diagram. Effective value of the alternating grid voltage as a function of the mutual conductance, with 1 % cross-modulation.  
 Centre diagram. Effective value of the alternating grid voltage as a function of the mutual conductance, with 1 % modulation hum.  
 Lower diagram. Mutual conductance  $S$ , screen-grid current  $I_{g2} + I_{g4}$ , and anode current  $I_a$  as functions of the grid bias.



# KK 2 Octode

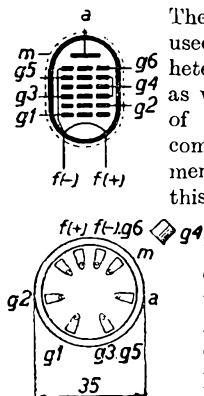

Fig. 2  
Arrangement of electrodes and base connections.

The KK 2 is a directly-heated octode that can be used as a frequency-changer in battery superheterodyne receivers for medium and long waves as well as short-wave reception. This combination of oscillator and mixer valve, operating on a common anode current and sharing a single filament, this being an important factor in the design of battery sets. The filament current is only 0.13 A, with a total cathode current of 3.5 mA on medium and long waves and 4.3 mA on the short-wave range.

A superheterodyne receiver based on the use of the KK 2 will always be a reliable and fool-proof proposition. For a battery valve, the conversion conductance and internal resistance are both very high, ensuring a high degree of conversion amplification; further, automatic gain control may be applied with success. A grid voltage variation of only  $-12\text{ V}$  is sufficient to reduce the conversion conductance from its maximum value to  $0.002\text{ mA/V}$ .



Fig. 1  
Dimensions in mm.

## FILAMENT RATINGS

Heating: direct by battery; parallel supply.

Filament voltage . . .  $V_f = 2.0\text{ V}$

Filament current . . .  $I_f = 0.13\text{ A}$

## CAPACITANCES

$C_{g1} = 6.4\ \mu\text{F}$        $C_{g3g4} < 0.2\ \mu\text{F}$

$C_{g4} = 10\ \mu\text{F}$        $C_{g2g4} < 0.4\ \mu\text{F}$

$C_a = 14\ \mu\text{F}$        $C_{ag3} < 0.07\ \mu\text{F}$

$C_{g2} = 8\ \mu\text{F}$

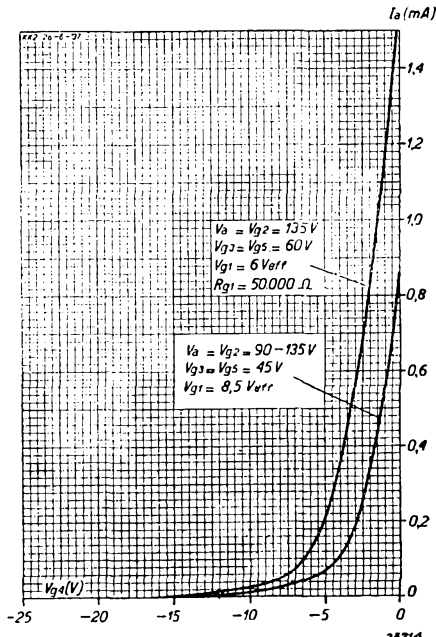

Fig. 3  
Anode current as a function of the grid bias, at  $V_{g3,5} = 45\text{ V}$  and  $60\text{ V}$ .

**OPERATING DATA**

**1. FOR MEDIUM AND LONG WAVE RECEPTION**

Anode voltage . . . . .	$V_a$	= 90	135 V
Oscillator-anode voltage . . . . .	$V_{g2}$	= 90	135 V
Screen-grid voltage . . . . .	$V_{g3,5}$	= 45	45 V
Grid bias (without oscillation) . . . . .	$V_{g1}$	= 0	0 V
Oscillator voltage on control grid . . . . .	$V_{osc}$	= 8.5	8.5 $V_{eff}$
Grid leak (control grid) . . . . .	$R_{g1}$	= 50,000	50,000 ohms
Bias, grid 4 . . . . .	$V_{g4}$	= -0.5	-0.5 V
Anode current ( $V_{g4} = -0.5$ V) . . . . .	$I_a$	= 0.7	0.7 mA
Oscillator-anode current . . . . .	$I_{g2}$	= 1.6	2.2 mA
Screen-grid current . . . . .	$I_{g3,5}$	= 1.0	1.0 mA
Conversion conductance (at $V_{g4} = -0.5$ V) $S_c$		= 0.27	0.27 mA/V
Conversion conductance (at $V_{g4} = -11$ V) $S_c$		< 0.0027	0.0027 mA/V
Internal resistance (at $V_{g4} = -0.5$ V) $R_i$		= 2	2.5 M ohms
Internal resistance (at $V_{g4} = -11$ V) $R_i$		> 10	> 10 M ohms

**2. FOR SHORT WAVE RECEPTION**

Anode voltage . . . . .	$V_a$	=	135 V
Oscillator-anode voltage . . . . .	$V_{g2}$	=	135 V
Screen-grid voltage . . . . .	$V_{g3,5}$	=	60 V
Control-grid bias (without oscillation) . . . . .	$V_{g1}$	=	0 V
Oscillator voltage at control grid . . . . .	$V_{osc}$	=	6 $V_{eff}$
Control grid leak . . . . .	$R_{g1}$	=	50,000 ohms
Bias, grid 4 . . . . .	$V_{g4}$	=	-1.5      -15 V
Anode current . . . . .	$I_a$	=	1.0 mA      —
Oscillator-anode current . . . . .	$I_{g2}$	=	3.0 mA      —
Screen-grid current . . . . .	$I_{g3,5}$	=	1.4 mA      —
Conversion conductance . . . . .	$S_c$	=	0.3      0.003 mA/V
Internal resistance . . . . .	$R_i$	=	1.7      > 10 M ohms

**MAXIMUM RATINGS**

$V_a$	= max. 135 V	$W_{g2}$	= max. 0.6 W
$W_a$	= max. 0.5 W	$I_k$	= max. 10 mA
$V_{g3,5}$	= max. 100 V	$V_{g4}$ ( $I_{g4} = \div 0.3 \mu A$ )	= max. -0.2 V
$W_{g3,5}$	= max. 0.4 W	$R_{gsk}$	= max. 3 M ohms
$V_{g2}$	= max. 135 V	$R_{g1k}$	= max. 0.1 M ohm

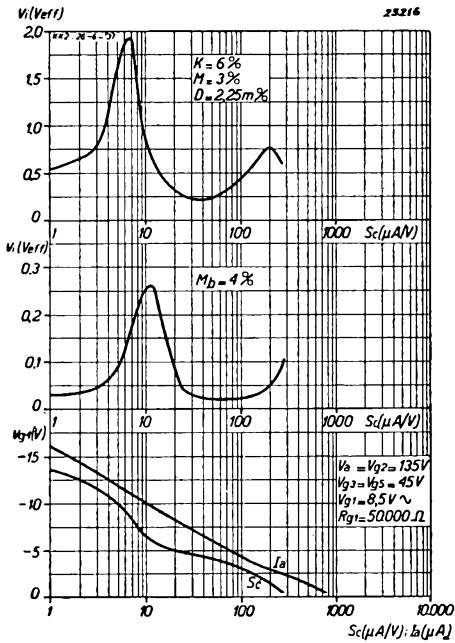

Fig. 4

Upper diagram. Alternating input voltage as a function of the conversion conductance (as controlled by the potential on the 4th grid), with 6 % cross-modulation (0.5 % 3rd harmonic), at  $V_{g_{3,5}} = 45$  V. Centre diagram. Alternating input voltage as a function of the conversion conductance (as controlled by the potential on the 4th grid), with 4 % modulation hum, at  $V_{g_{3,5}} = 45$  V. Lower diagram. Conversion conductance and anode current as functions of the bias on the 4th grid, at  $V_{g_{3,5}} = 45$  V.

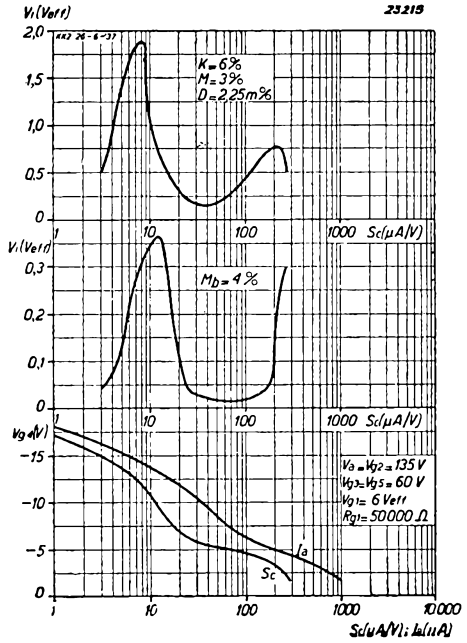

Fig. 5

Upper diagram. Alternating input voltage as a function of the conversion conductance (as controlled by the voltage on grid 4), with 6 % cross-modulation (0.5 % 3rd harmonic), at  $V_{g_{3,5}} = 60$  V. Centre diagram. Alternating input voltage as a function of the conversion conductance (as controlled by the voltage on the 4th grid) with 4 % modulation hum, at  $V_{g_{3,5}} = 60$  V. Lower diagram. Conversion conductance and anode current as functions of the grid bias (4th grid), at  $V_{g_{3,5}} = 60$  V.

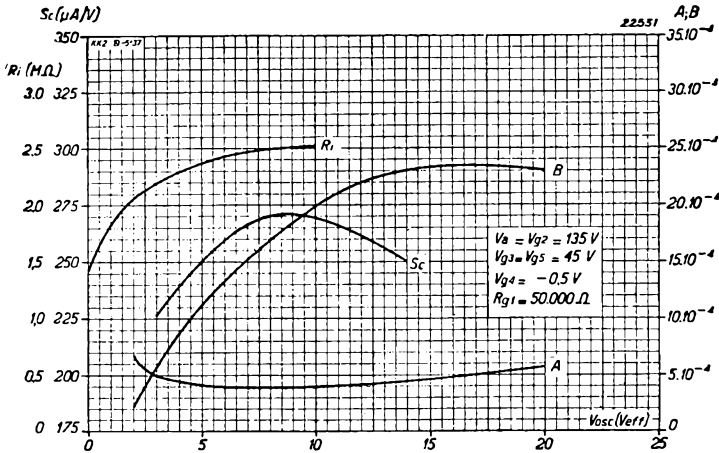

Fig. 6

Conversion conductance, internal resistance, factor A (governing the strength of the background noise) and factor B (strength of whistles) as functions of the oscillator voltage of the KK 2 when used on medium and long waves.

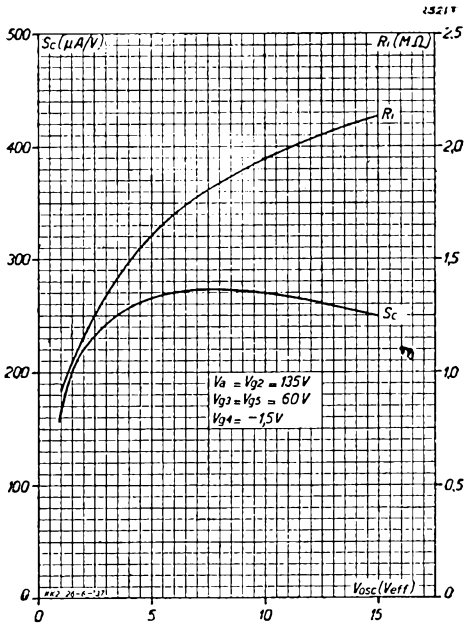

Fig. 7  
Conversion conductance and internal resistance as functions of the oscillator voltage of the KK 2 when used on short waves.

APPLICATIONS

In connection with the applications of the valve, the following points should be taken into consideration. The coupling of the oscillator circuit must be tighter than is normally the case with A.C. valves, and should be so adjusted that the current passing through the grid leak  $R_2$  is about  $100 \mu A$  (see Fig. 8); in the short-wave range the average grid current is approximately  $60 \mu A$ .

For the last-mentioned wave-range tighter coupling may be obtained by employing the circuit shown in Fig. 9 in which the inductive coupling is enhanced by capacitive coupling. The value of capacitor  $C_3$  should be about  $2,500 \mu\mu F$ .

Again, for short-wave work, improved results may be obtained in certain circumstances by selecting an oscillator frequency which is lower than that of the input. The conductance in the medium and long wave ranges may be varied by applying the control voltage to the 4th grid, but on short waves frequency drift precludes any alteration in the voltage on the 4th grid.

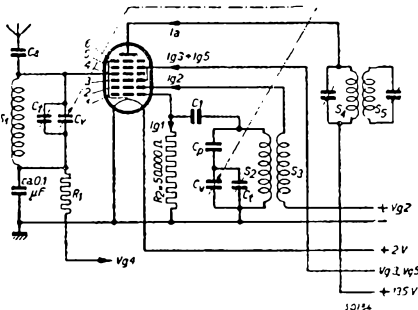

Fig. 8  
Theoretical circuit of the KK 2 as used on medium and long waves.

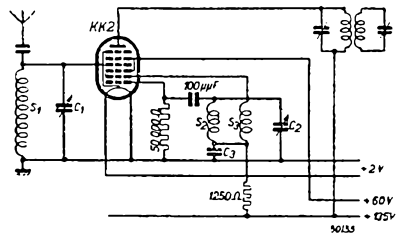

Fig. 9  
The KK 2 in a short-wave circuit

# KL 4 Output pentode

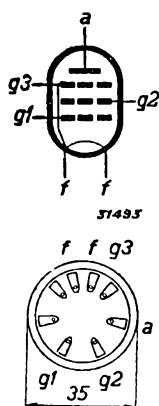

Fig. 2  
Arrangement of electrodes and base connections.

The KL 4 is an output valve using a relatively small filament current (0.15 A). The sensitivity is very high, only a small input voltage being required for full excitation; with 135 V on anode and screen the KL 4 will deliver 0.47 W, with 11.2 % distortion. This valve is suitable for use only in balanced output stages operating without grid current; the quality of reproduction is then excellent and the output obtainable at the above-mentioned anode and screen voltage is approximately 0.8 W.

### FILAMENT RATINGS

Heating: direct by battery; parallel supply.

Filament voltage. . . . .	$V_f = 2.0 \text{ V}$
Filament current. . . . .	$I_f = 0.150 \text{ A}$

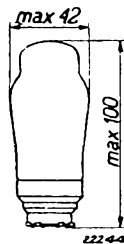

Fig. 1  
Dimensions in mm.

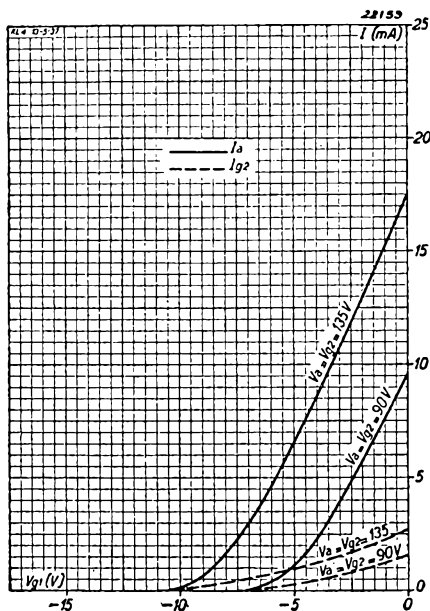

Fig. 3  
Anode and screen-grid current as functions of the grid bias, with  $V_a = V_{g_2} = 135$  and  $90 \text{ V}$ .

### OPERATING DATA

Anode voltage	$V_a = 90$	135 V
Screen-grid voltage	$V_{g_2} = 90$	135 V
Grid bias	$V_{g_1} = -2.6$	-5 V
Anode current	$I_a = 4.7$	7 mA
Screen-grid current	$I_{g_2} = 0.8$	1.1 mA
Mutual conductance	$S = 1.8$	2.1 mA/V
Internal resistance	$R_i = 150,000$	130,000 ohms
Load resistor	$R_a = 19,000$	19,000 ohms
Output power (10 % dist)	$W_o = 0.16$	0.44 W
Alternating input voltage	$V_i = 1.9$	3.3 V <sub>eff</sub>

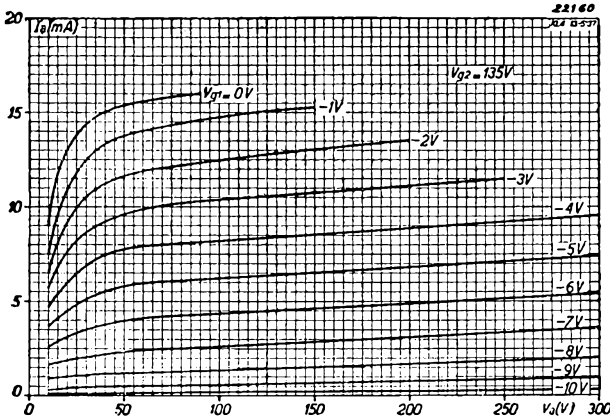

Fig. 4  
Anode current as a function of the anode voltage, with grid bias as parameter, at a screen voltage of 135 V.

**MAXIMUM RATINGS**

$V_a$	= max. 135 V	$W_{g2} (W_o = \text{max})$	= max. 0.30 W
$W_a$	= max. 1 W	$I_k$	= max. 10 mA
$V_{g2}$	= max. 135 V	$R_{g1}$	= max. 1 M ohm
$W_{g2} (V_i = 0)$	= max. 0.15 W	$V_{g1} (I_{g1} = + 0.3 \mu A)$	= max. -0.2 V

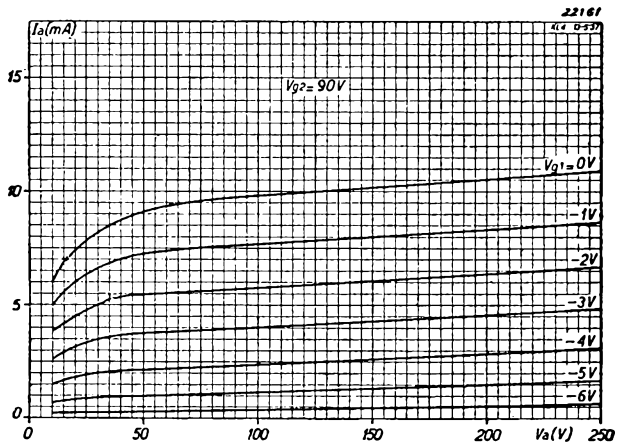

Fig. 5  
Anode current as a function of the anode voltage, with grid bias as parameter, for a screen voltage of 90 V.

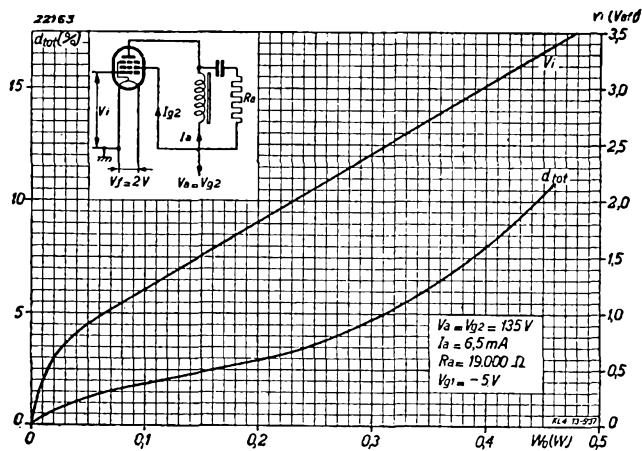

Fig. 6  
 Alternating grid voltage  $V_i$  and total distortion of the KL 4 as functions of the output power, on  $V_a = V_{g2} = 135V$ .

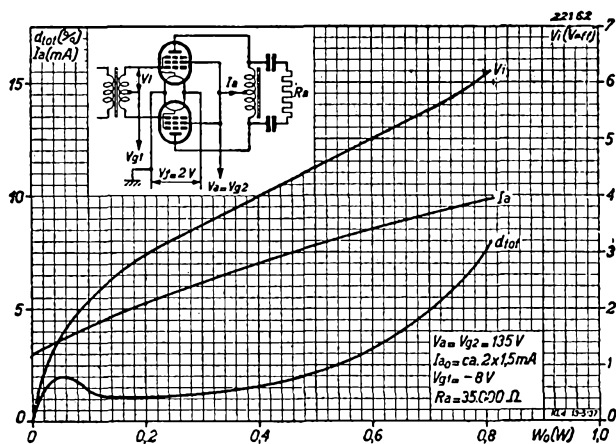

Fig. 7  
 Alternating grid voltage  $V_i$ , total distortion and combined anode current of the output power of two KL 4 valves in a balanced circuit operating without grid current ( $V_a = V_{g2} = 135V$ ).

Fig. 8  
Alternating grid voltage  $V_i$  and total distortion of the KL 4 as functions of the output power with  $V_a = V_{g2} = 90$  V.

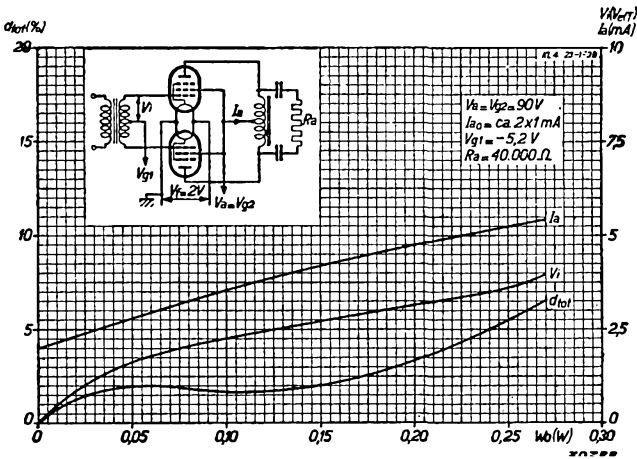
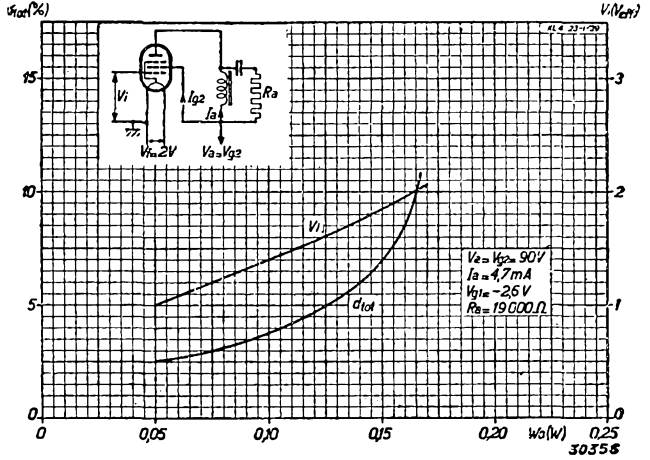

Fig. 9  
Alternating grid voltage  $V_i$ , total distortion and combined anode current as functions of the output power of two KL 4 valves in a balanced circuit operating without grid current ( $V_a = V_{g2} = 90$  V).



# KL 5 Output pentode

This is a directly-heated output valve for 2 V battery receivers, delivering a reasonably high output on a very low current consumption; with 135 V on the anode, passing a current of 8.5 mA, the output is 0.52 W with 10% distortion.

In this valve an improvement has been introduced in the form of mica dampers on the filament, which greatly reduce any tendency towards microphony; in this respect, too, therefore, the KL 5 is an extremely reliable valve. Two of these valves in a balanced circuit will deliver an output which for battery receivers is quite high, with relatively little distortion. The low filament consumption in such circuits is another important feature; with an anode potential of 135 V, two KL 5 valves will give slightly more than 1 W, with about 7% distortion, the combined filament current being only 0.2 A. The sensitivity is such that the valve can be fully excited with any normal A.F. valve, or with a pentode functioning as grid detector.

## FILAMENT RATINGS

Heating: direct by battery; parallel supply.

Filament voltage. . . . .  $V_f = 2.0$  V

Filament current. . . . .  $I_f = 0.1$  A

## CAPACITANCES

Anode-grid . . . . .  $C_{ag1} < 0.6 \mu\text{pF}$

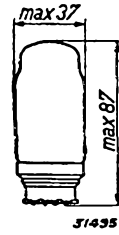

Fig. 1  
Dimensions in mm.

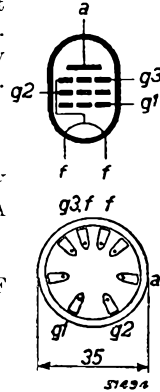

Fig. 2  
Arrangement of electrodes and base connections.

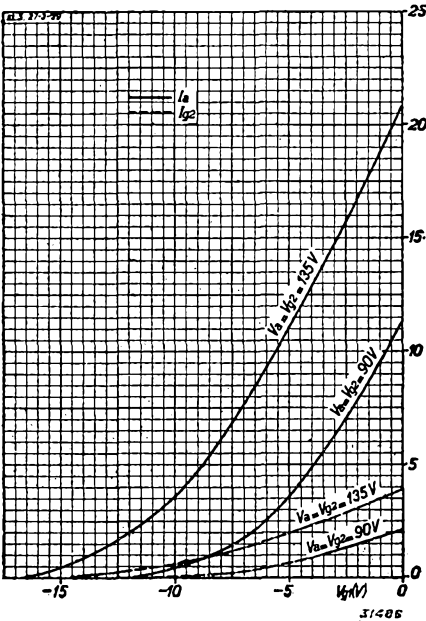

Fig. 3  
Anode and screen-grid current as functions of the grid bias, with  $V_a = V_{g3} = 135$  and 90 V.

**OPERATING DATA: KL 5 used as a single output valve**

Anode voltage . . . . .	$V_a$	= 90 V	135 V
Screen-grid voltage . . . . .	$V_{g2}$	= 90 V	135 V
Grid bias. . . . .	$V_{g1}$	= -4 V	-6.5 V
Anode current . . . . .	$I_a$	= 4.8 mA	8.5 mA
Screen-grid current . . . . .	$I_{g2}$	= 0.9 mA	1.5 mA
Mutual conductance . . . . .	$S$	= 1.4 mA/V	1.7 mA/V
Internal resistance . . . . .	$R_i$	= 180,000 ohms	135,000 ohms
Load resistor . . . . .	$R_u$	= 19,000 ohms	16,000 ohms
Output power (10% distortion) . . . . .	$W_o$	= 0.2 W	0.53 W
Alternating grid voltage (10% distortion). . . . .	$V_i$	= 2.6 $V_{eff}$	4.8 $V_{eff}$
Sensitivity ( $W_o = 50$ mW). . . . .	$V_i$	= 0.7 $V_{eff}$	0.8 $V_{eff}$

**OPERATING DATA: KL 5 used in a balanced output stage (2 valves)**

Anode voltage . . . . .	$V_a$	= 90 V	135 V
Screen-grid voltage . . . . .	$V_{g2}$	= 90 V	135 V
Grid bias. . . . .	$V_{g1}$	= -8.5 V	-12 V
Anode current (without signal). . . . .	$I_{a0}$	= 2 × 1 mA	2 × 2 mA
Anode current at max. modulation . . . . .	$I_{a\ max}$	= 2 × 3.6 mA	2 × 6.25 mA
Screen-grid current (without signal). . . . .	$I_{g20}$	= 2 × 0.1 mA	2 × 0.35 mA
Screen-grid current at max. modulation . . . . .	$I_{g2\ max}$	= 2 × 1.0 mA	2 × 2.4 mA
Load resistor between anodes . . . . .	$R_{uu}$	= 25,000 ohms	25,000 ohms
Output power at max. modulation . . . . .	$W_o$	= 3.5 W	1.05 W
Alternating grid voltage at maximum modulation . . . . .	$V_i$	= 6.5 $V_{eff}$	8.7 $V_{eff}$
Total distortion at maximum modulation . . . . .	$d_{tot}$	= 3.8%	7%

**MAXIMUM RATINGS**

Anode voltage . . . . .	$V_a$	= max. 200 V
Anode dissipation . . . . .	$W_a$	= max. 2.0 W
Screen-grid voltage . . . . .	$V_{g2}$	= max. 200 V
Screen-grid dissipation ( $V_i = 0$ V) . . . . .	$W_{g2}$	= max. 0.5 W
Screen-grid dissipation ( $W_o = \max.$ ) . . . . .	$W_{g2}$	= max. 1.0 W
Cathode current . . . . .	$I_k$	= max. 12 mA
Grid voltage at grid current start . . . . .	$(I_{g1} = + 0.3 \mu A) V_{g1}$	= max. -0.2 V
External resistance between grid and cathode . . . . .	$R_{g1k}$	= max. 1 M ohm

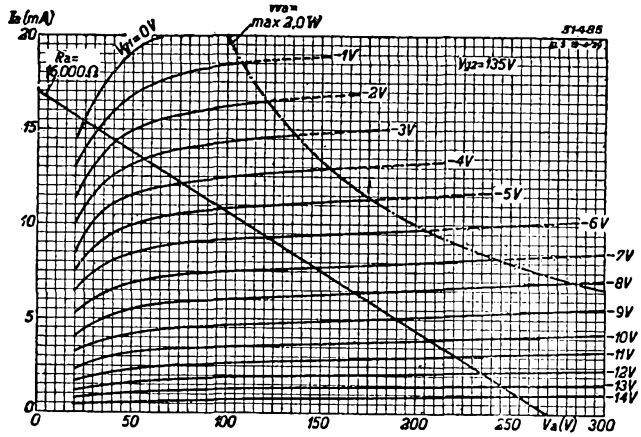

Fig. 4  
Anode current as a function of the anode voltage, with grid bias as parameter, for a screen voltage of 135 V.

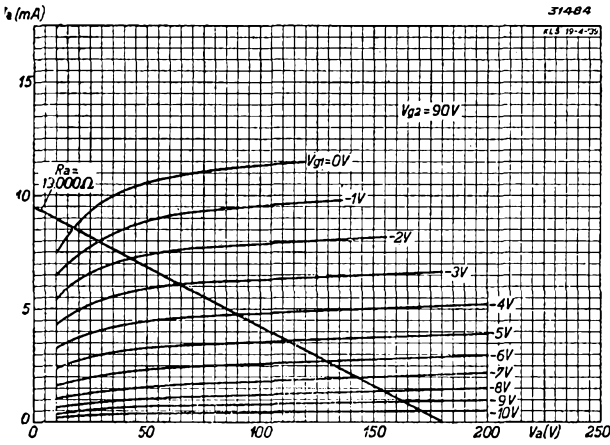

Fig. 5  
Anode current as a function of the anode voltage, with grid bias as parameter, for a screen voltage of 90 V.

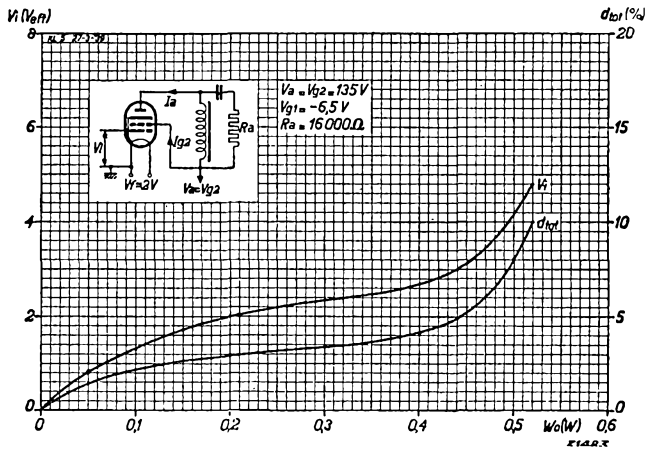

Fig. 6  
Alternating grid voltage  $V_i$  and total distortion  $d_{tot}$  of the KL 5 as functions of the output power ( $V_a = V_{g2} = 135V$ ).

Fig. 7  
 Alternating grid voltage  $V_i$ , total distortion  $d_{tot}$ , combined anode current  $I_a$  and combined screen-grid current  $I_{g2}$  as functions of the output power, for two KL 5 valves in a Class B output circuit without grid current ( $V_a = V_{g2} = 135$  V).

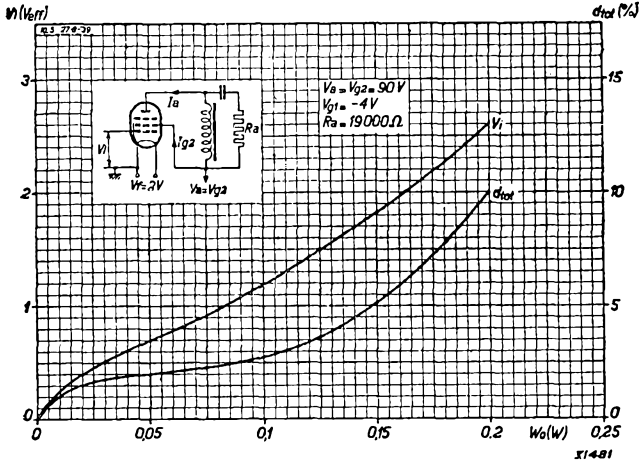
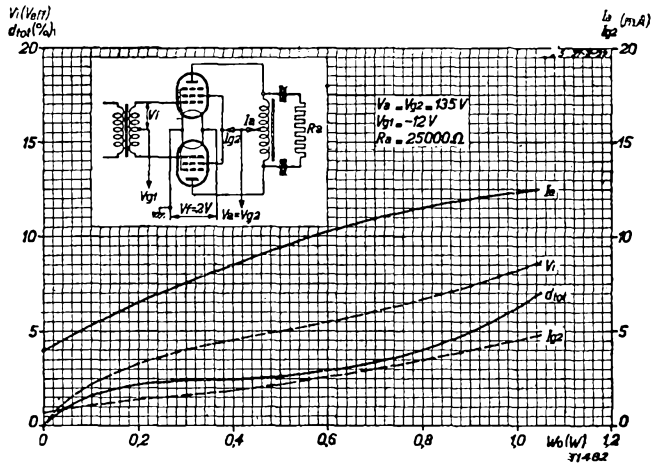
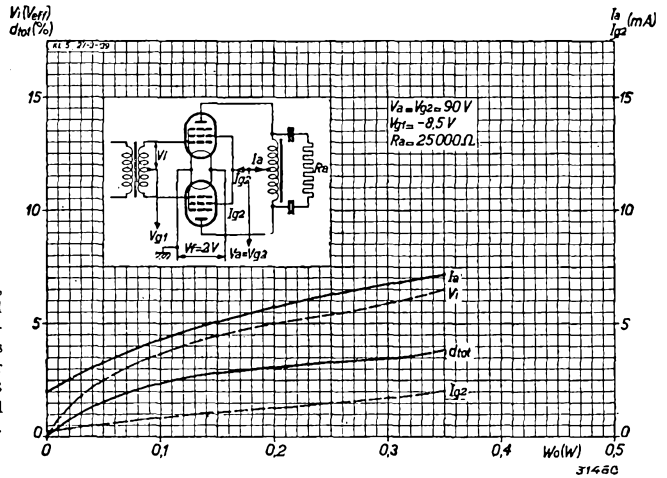

Fig. 8  
 Alternating grid voltage  $V_i$  and total distortion  $d_{tot}$  of the KL 5 as functions of the output power.  $V_a = V_{g2} = 90$  V.

Fig. 9  
 Alternating grid voltage  $V_i$ , total distortion  $d_{tot}$ , combined anode current  $I_a$  and combined screen-grid current  $I_{g2}$  as functions of the output power of two KL 5 valves in a Class B output circuit without grid current.  $V_a = V_{g2} = 90$  V.



**Power output valves**  
**and**  
**Microphone pre-amplifier pentode**

## Power output valves

In the following, details are given of a number of directly and indirectly-heated power output valves for use in small, medium and large amplifier equipment. Some of these valves, when employed in a balanced output stage, are capable of delivering up to 55 or even 133 W. The mutual conductance of all these types is very high, necessitating only a low grid input to load them fully.

The valves concerned are the following:

- 4641 directly-heated 25 W triode;  $V_a = \text{max. } 1,500 \text{ V}$ ,  $V_f = 4 \text{ V}$ .
- 4654 indirectly-heated 18 W pentode;  $V_a = \text{max. } 600 \text{ V}$ ,  
 $V_{g2} = \text{max. } 425 \text{ V}$ ,  $V_f = 6.3 \text{ V}$ .
- 4683 directly-heated 15 W triode;  $V_a = \text{max. } 350 \text{ V}$ ,  $V_f = 4 \text{ V}$ .
- 4689 indirectly-heated steep-slope 18 W pentode;  $V_a = \text{max. } 375 \text{ V}$ ,  
 $V_{g2} = \text{max. } 275 \text{ V}$ ,  $V_f = 6.3 \text{ V}$ .
- 4694 indirectly-heated steep-slope 9 W pentode;  $V_a = \text{max. } 400 \text{ V}$ ,  
 $V_{g2} = \text{max. } 425 \text{ V}$ ,  $V_f = 6.3 \text{ V}$ .
- 4699 indirectly-heated steep-slope 18 W pentode;  $V_a = \text{max. } 425 \text{ V}$ ,  
 $V_{g2} = \text{max. } 425 \text{ V}$ ,  $V_f = 6.3 \text{ V}$ .
- EL 51 indirectly-heated steep-slope 45 W pentode;  $V_a = \text{max. } 750 \text{ V}$ ,  
 $V_{g2} = \text{max. } 750 \text{ V}$ ,  $V_f = 6.3 \text{ V}$ .
- F 443 N directly-heated 25 W pentode;  $V_a = \text{max. } 550 \text{ V}$ ,  
 $V_{g2} = \text{max. } 300 \text{ V}$ .  $V_f = 4 \text{ V}$ .

Besides these, Philips are marketing ranges of smaller and also considerably larger valves, particulars of which will be gladly given on application.

With the exception of types 4641 and F443 N, the amplifier valves in question are all fitted with the P-type, or side-contact, base. The small dimensions of these valves permit the design of small, compact amplifiers of outstanding efficiency, delivering high power with only slight distortion. The ranges include low and high power triodes for low-impedance output stages, as well as normal and steep-slope pentodes for high-impedance stages. The high working voltages of the new steep-slope pentodes, amongst other features, make it possible to design highly sensitive amplifiers incorporating a minimum number of valves.

The data reproduced in the following pages relate only to valves in output stages operating without grid current; if a valve is run in the grid-current zone it is certainly possible to obtain higher efficiency and therefore a greater output from it, but on the other hand there is serious, audible distortion, arising from the alternating flow and cessation of the grid current. For high-fidelity reproduction, such as may be expected from a good amplifier, Class B circuits involving grid current are not recommended.

This does not imply that the valves are not suitable for that purpose, however, and particulars will be furnished on request.

# 4641 Triode

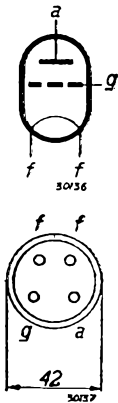

Fig. 2  
Arrangement of electrodes and base connections.

The triode, type 4641, is a directly-heated 25 W valve intended mainly for use in balanced output stages, being equally satisfactory in Class AB or Class B circuits. In the latter instance the effective output is 68 W. In view of the anode voltage this valve is fitted with the 4-pin base, whilst special precautions have been taken in the design to prevent flash-over within the valve.

### FILAMENT RATINGS

Heating: direct by A.C.; parallel supply.  
 Filament voltage . . . . .  $V_f = 4 \text{ V}$   
 Filament current . . . . .  $I_f = 2.1 \text{ A}$

### CAPACITANCES

Anode-grid . . . . .  $C_{ag} = 7 \mu\text{tF}$

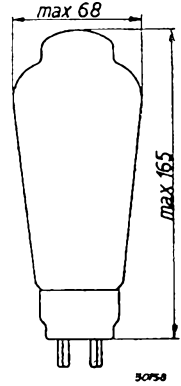

Fig. 1  
Dimensions in mm.

### OPERATING DATA

		Class B output with fixed grid bias (2 valves)	Class AB output with auto. grid bias (2 valves)	Class B output with fixed grid bias (2 valves)
Anode voltage . . . . .	$V_a \text{ (V)}$	1,000	1,000	1,500
Common cathode resistor for auto. grid bias . . . .	$R_k \text{ (ohms)}$	—	1,700	—
Fixed grid bias . . . . .	$V_g \text{ (V)}$	—93	—	—144
Anode current ( $V_i = 0 \text{ V}$ )	$I_{ao} \text{ (mA)}$	$2 \times 10$	$2 \times 25$	$2 \times 10$
Anode current at maximum modulation . . . . .	$I_{a \text{ max}} \text{ (mA)}$	$2 \times 45$	$2 \times 28$	$2 \times 41$
Load resistor (between anodes) . . . .	$R_{aa} \text{ (ohms)}$	20,000	35,000	40,000
Output power . . . . .	$W_o \text{ (W)}$	41	29	68
Alternating grid voltage (per grid) at maximum modulation . . . . .	$V_i \text{ (V}_{eff})$	65	58	105
Distortion at max. modu- lation . . . . .	$d_{tot} \text{ (\%)}_o$	2.35	4.5	1.9



**STATIC DATA**

Anode voltage . . . . .	$V_a = 1,000 \text{ V}$	1,500 V
Grid bias . . . . .	$V_g = -85 \text{ V}$	-140 V
Anode current . . . . .	$I_a = 25 \text{ mA}$	15 mA
Mutual conductance . . . . .	$S = 3 \text{ mA/V}$	2 mA/V
Internal resistance . . . . .	$R_i = 3,400 \text{ ohms}$	4,600 ohms

**MAXIMUM RATINGS**

$V_{a0}$	= max. 3,000 V
$V_a$	= max. 1,500 V
$W_a$	= max. 25 W
$V_g$ ( $J_g = + 0.3 \mu\text{A}$ )	= max. -2 V
$I_k$	= max. 60 mA
$R_{gk}$ (auto bias)	= max. 0.3 M ohm
$R_{gk}$ (fixed bias)	= max. 0.1 M ohm

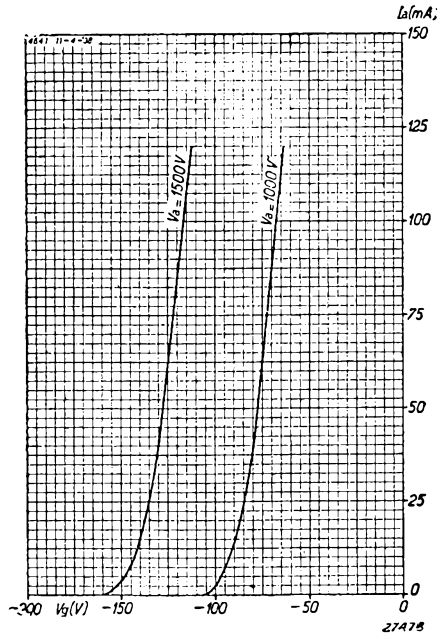

Fig. 3  
Anode current as a function of the grid bias with  $V_a = 1,000$  and  $1,500 \text{ V}$ .

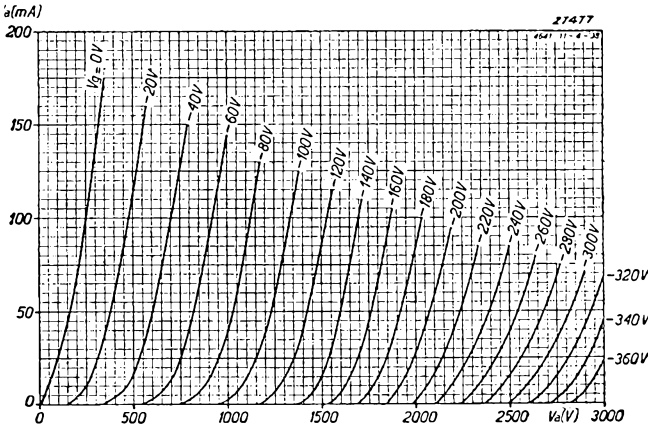

Fig. 4  
Anode current as a function of the anode voltage for different values of grid bias.

Fig. 5  
Total distortion, alternating grid voltage and total anode current as functions of the output power of two 4641 valves in a Class AB output circuit with automatic bias.  $V_a = 1,000$  V.

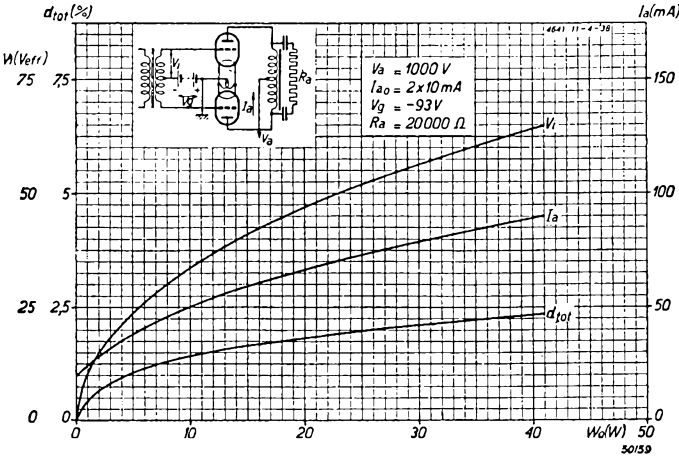
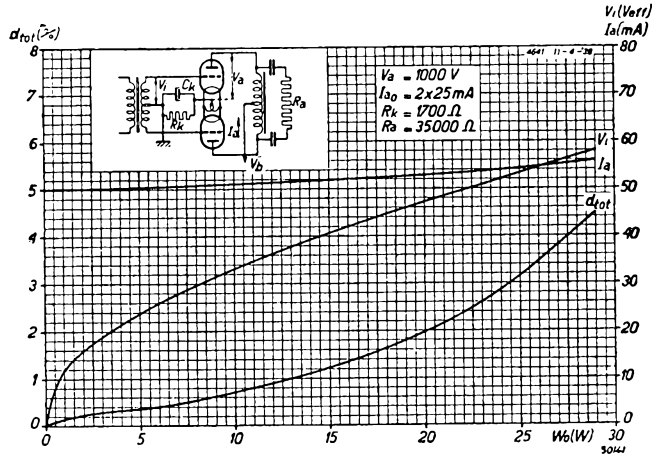
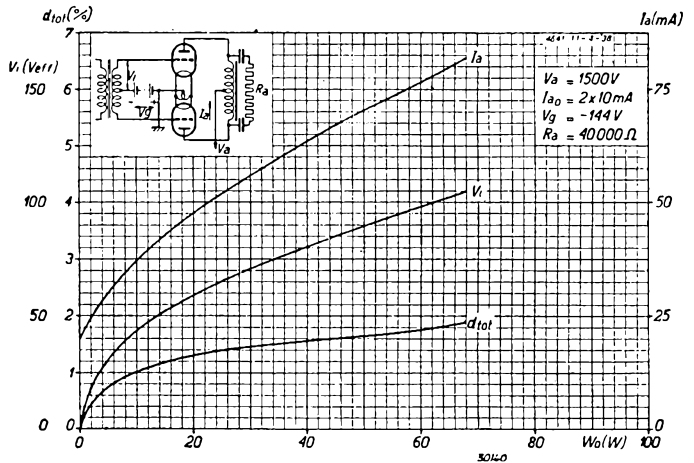

Fig. 6  
Total distortion, alternating grid voltage per grid and total anode current as functions of the output power of two 4641 valves in a Class B output circuit with fixed bias.  $V_a = 1,000$  V.

Fig. 7  
Total distortion, alternating grid voltage per grid and total anode current as functions of the output power of two 4641 valves in a Class B output circuit, with fixed bias.  $V_a = 1,500$  V.



# 4654 Pentode

The 4654 is an indirectly-heated steep-slope 18 W output valve for a maximum anode voltage of 600 and maximum screen-grid voltage of 425. In view of the high anode voltage involved and the relatively small dimensions of the valve, the anode connection is located at the top of the envelope; high voltages in the pinch are thus avoided. The suppressor grid is connected to a separate contact on the base, making the valve also suitable for amateur transmission work; with the screen and suppressor grids joined, the valve can be employed as an electron-coupled master oscillator, in which case the top cap ensures a conveniently short connection between the anode and oscillator circuits.

The 4654 lends itself well to the following purposes in amateur transmitters:

- 1) modulator in Class A, AB or B circuits,
- 2) electron-coupled master oscillator,
- 3) R.F. amplifier or frequency-multiplier in intermediate stages (Class C),
- 4) class C output amplifier in telegraphy transmitters,
- 5) output valve for telephony (Class C), with modulation on both anode and screen grid.

It can be used as transmitter valve at all wavelengths from 50 m, for which purpose a single valve, in a Class C amplifier, will deliver

a carrier-wave output power of 36 W, at 67% efficiency, excluding circuit losses (anode voltage 600 V, screen voltage 200 V, and grid bias -60 V).

The valve is eminently suitable for simultaneous modulation of both anode and screen, in which case it should once more operate on an anode voltage of 600 V, a screen voltage of 200 V and a grid bias of -60 V, the output then being 24 W (less circuit losses). Complete details will gladly be furnished on request.

As an amplifier valve the 4654 has various possibilities, both in amplifiers and modulator stages.

With a fixed bias, a supply voltage of  $V_b = 425$  V, an anode voltage of  $V_a = 400$  V and a common screen series resistor of  $R_{g2} = 500$  ohms, an output of 48 W can be obtained without exceeding the maximum anode dissipation of 18 W.

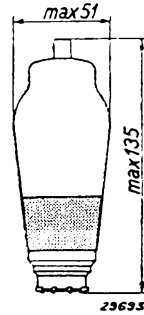

Fig. 1  
Dimensions in mm.

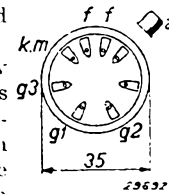
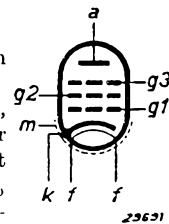

Fig. 2  
Arrangement of electrodes and base connections.

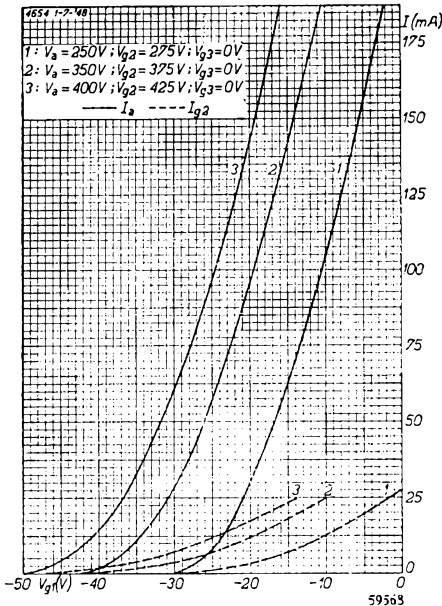

Fig. 3  
Anode and screen current of the 4654 as functions of the grid bias, for various values of anode and screen potential.

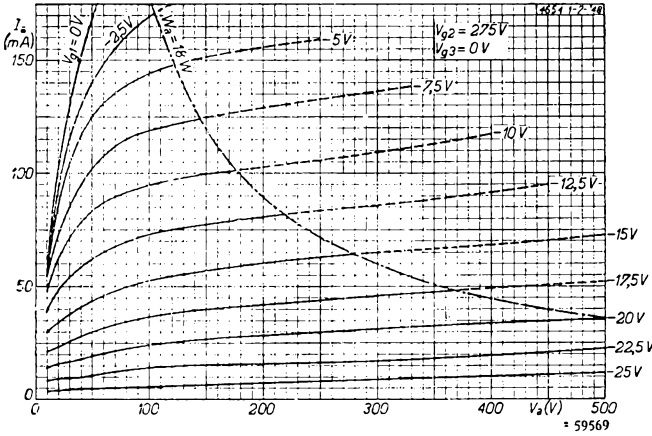

Fig. 4  
Anode current as a function of the anode voltage for various values of grid bias.  $V_{g_2} = 275$  V.

**HEATER RATINGS**

Heating: indirect by A.C., parallel supply.

Heater voltage  $V_f = 6.3$  V  
Heater current  $I_f = 1.35$  A

**CAPACITANCES**

Anode-grid  $C_{ag1} < 0.8 \mu\text{F}$

**OPERATING DATA**

The 4654 used as single output valve in class A

Anode voltage . . . . .	$V_a = 250$ V
Suppressor-grid voltage . . . . .	$V_{g_3} = 0$ V
Screen-grid voltage . . . . .	$V_{g_2} = 275$ V
Cathode resistor . . . . .	$R_k = 175$ ohms
Anode current . . . . .	$I_a = 72$ mA
Screen-grid current . . . . .	$I_{g_2} = 8$ mA
Mutual conductance . . . . .	$S = 8.5$ mA/V
Amplification factor; screen with respect to control grid . . . . .	$\mu_{g_2}^1 = 11$ —
Internal resistance . . . . .	$R_i = 22,000$ ohms
Load resistor . . . . .	$R_a = 3,500$ ohms
Alternating input voltage ( $I_{g_1} = + 0.3 \mu\text{A}$ ) . . . . .	$V_i = 11.5$ V <sub>eff</sub>
Power output ( $I_{g_1} = + 0.3 \mu\text{A}$ ) . . . . .	$W_o = 9.2$ W
Total distortion ( $I_{g_1} = + 0.3 \mu\text{A}$ ) . . . . .	$d_{tot} = 11.4$ %
Alternating input voltage ( $W_o = 50$ mW) . . . . .	$V_i = 0.5$ V <sub>eff</sub>

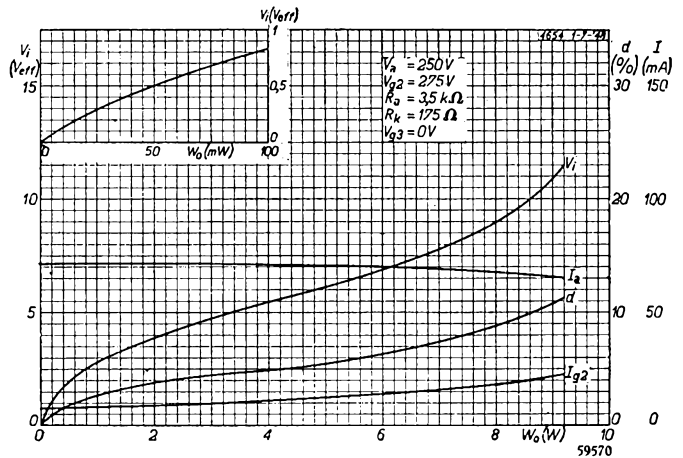

Fig. 5  
Total distortion, anode and screen-grid current and alternating input voltage as functions of the output power; the 4654 used as single output valve class A with  $V_a = 250$  V and  $V_{g_2} = 275$  V.

The 4654 used in class B output stage with fixed grid bias (two valves)

Load resistor between anodes . . . . .	$R_{aa} = 5,000$	5,000	ohms
Common screen-grid series resistor	$R_{g2} = 500$	500	ohms
Grid bias . . . . .	$V_{g1} = -38$	-32	V
Suppressor-grid voltage . . . . .	$V_{g3} = 0$	0	V

Alternating input

voltage . . . . .	$V_i =$	0	26.5	26.5	0	22.4	22.4	$V_{eff}$
Supply voltage . . . . .	$V_b =$	425	425	400	375	375	350	V
Anode voltage . . . . .	$V_a =$	420	400	375	370	350	325	V
Anode current . . . . .	$I_a =$	$2 \times 20$	$2 \times 93$	$2 \times 81.5$	$2 \times 20$	$2 \times 79$	$2 \times 70$	mA
Screen-grid current . . . . .	$I_{g2} =$	$2 \times 2.2$	$2 \times 21$	$2 \times 18$	$2 \times 2.2$	$2 \times 17$	$2 \times 15$	mA
Power output . . . . .	$W_o =$	0	48	39	0	35	29	W
Total distortion . . . . .	$d_{tot} =$	—	2.5	4.2	—	2.5	4.0	%

The 4654 used in class AB output stage with auto. grid bias (two valves)

Supply voltage . . . . .	$V_b =$	425	375	V
Load resistor between anodes . . . . .	$R_{aa} =$	6,500	5,000	ohms
Common screen-grid series resistor	$R_{g2} =$	2,000	500	ohms
Common cathode resistor . . . . .	$R_k =$	265	195	ohms
Suppressor-grid voltage . . . . .	$V_{g3} =$	0	0	V

Alternating input voltage . . . . .	$V_i =$	0	27	0	22.5	$V_{eff}$
Anode voltage . . . . .	$V_a + V_{Rk} =$	405	400	355	350	V
Anode current . . . . .	$I_a =$	$2 \times 46.5$	$2 \times 60$	$2 \times 53$	$2 \times 66.5$	mA
Screen-grid current . . . . .	$I_{g2} =$	$2 \times 5.4$	$2 \times 13$	$2 \times 6.5$	$2 \times 15.5$	mA
Power output . . . . .	$W_o =$	0	27.5	0	26	W
Total distortion . . . . .	$d_{tot} =$	—	5	—	3.5	%

The 4654 used in triode connection as single output valve class A (screen-grid connected to anode)

Supply voltage . . . . .	$V_b = 375$ V	Anode current . . . . .	$I_a = 50$ mA
Suppressor-grid voltage . . . . .	$V_{g3} = 0$ V	Alternating input voltage . . . . .	$V_i = 17.5$ $V_{eff}$
Cathode resistor . . . . .	$R_k = 470$ ohms	Power output . . . . .	$W_o = 4.5$ W
Load resistor . . . . .	$R_a = 3,000$ ohms	Total distortion . . . . .	$d_{tot} = 9$ %

The 4654 used in triode connection in class AB output stage with auto. grid bias (two valves)

Supply voltage . . . . .	$V_b =$	400	V
Load resistor between anodes . . . . .	$R_{aa} =$	5,500	ohms
Suppressor-grid voltage . . . . .	$V_{g3} =$	0	V
Common cathode resistor . . . . .	$R_k =$	280	ohms
Alternating input voltage . . . . .	$V_i =$	0	21 $V_{eff}$
Anode current . . . . .	$I_a =$	$2 \times 50$	$2 \times 56$ ohms
Power output . . . . .	$W_o =$	0	13 W
Total distortion . . . . .	$d_{tot} =$	—	1 %

**MAXIMUM RATINGS**

$V_{a0}$	= max. 1,200 V	$I_k$	= max. 120 mA
$V_a$	= max. 600 V	$V_{g1}$ ( $I_{g1} = + 0.3 \mu A$ )	= max. -1.3 V
$W_a$	= max. 18 W	$R_{g1}$ (auto. bias)	= max. 0.7 M ohm
$V_{g20}$	= max. 1,000 V	$R_{g1}$ (fixed bias)	= max. 0.5 M ohm
$V_{g2}$	= max. 425 V	$V_{fk}$	= max. 50 V
$W_{g2}$ ( $V_i = 0$ )	= max. 3 W	$R_{fk}$	= max. 20,000 ohms
$W_{g2}$ ( $W_o = \text{max.}$ )	= max. 10 W		

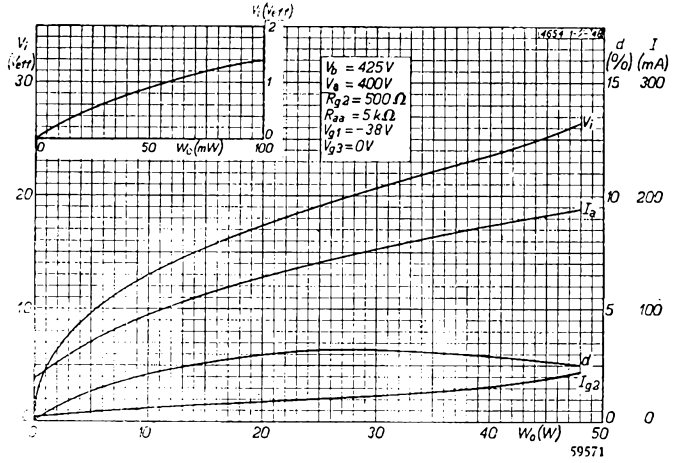

Fig. 6  
Total distortion, anode and screen-grid current and alternating input voltage as functions of the output power; 2 valves 4654 used in class B output stage with fixed grid bias.  $V_b = 425 V$ .

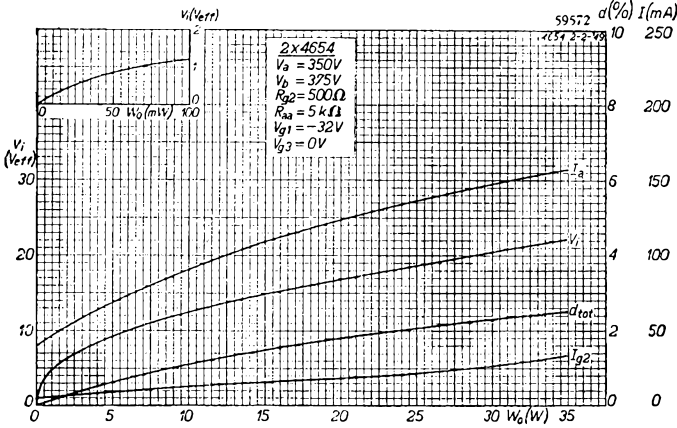

Fig. 7  
Total distortion, anode and screen-grid current and alternating input voltage as functions of the output power; 2 valves 4654 used in class B output stage with fixed grid bias.  $V_b = 375 V$ .

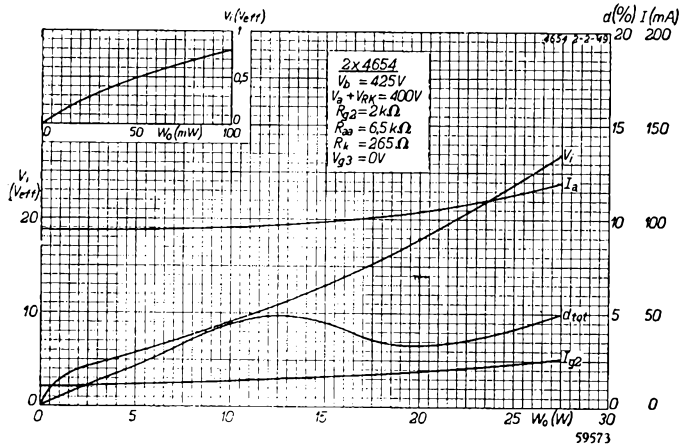

Fig. 8  
Total distortion, anode and screen-grid current and alternating input voltage as functions of the output power; 2 valves 4654 used in class AB output stage with auto. grid bias.  $V_b = 425 V$ .

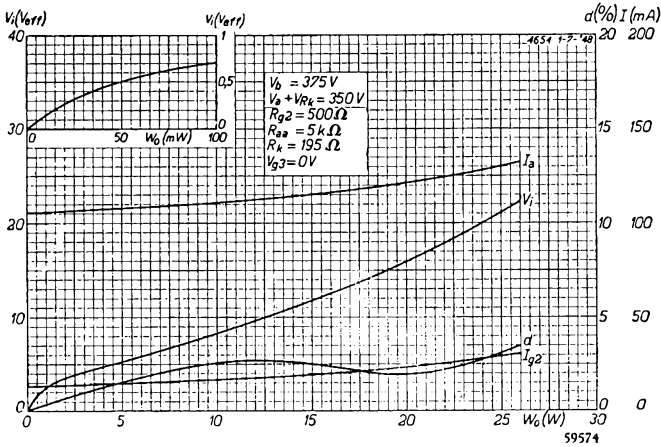

Fig. 9  
Total distortion, anode and screen-grid current and alternating input voltage as functions of the output power; 2 valves 4654 used in class AB output stage with auto. grid bias,  $V_b = 375 V$

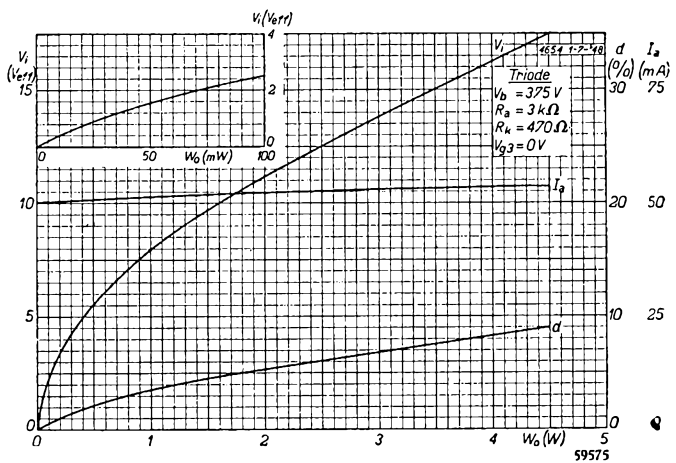

Fig. 10  
Total distortion, anode current and alternating input voltage as functions of the output power; the 4654 used as single output valve in triode connection (screen-grid connected to anode) class A with  $V_b = 375 V$ .

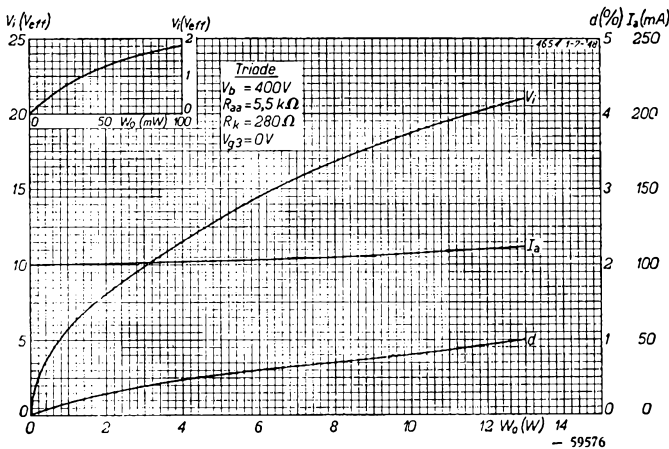
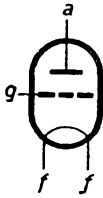
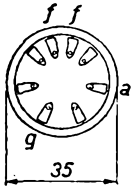

Fig. 11  
Total distortion, anode current and alternating input voltage as functions of the output power; 2 valves 4654 in triode connection (screen-grid connected to anode) used in class A B output stage with  $V_b = 400 V$

# 4683 Triode



23364



23365

Fig. 2  
Arrangement of electrodes and base connections.

The 4683 is a directly-heated power triode having an anode dissipation of 15 W.

### FILAMENT RATINGS

Heating: direct, A.C., parallel supply.

Filament voltage . . . . .  $V_f = 4 \text{ V}$

Filament current . . . . .  $I_f = 0.95 \text{ A}$

### CAPACITANCES

Anode-grid . . . . .  $C_{ag} < 20 \mu\mu\text{F}$

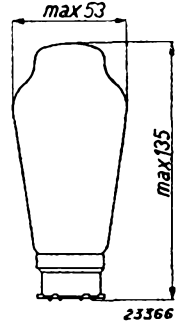

23366

Fig. 1  
Dimensions in mm.

## OPERATING DATA

		Class AB output with auto. grid bias. (2 valves)	Class B output with fixed grid bias. (2 valves)
Anode voltage . . . . .	$V_a =$	350 V	350 V
Common cathode resistor for auto- matic bias . . . . .	$R_k =$	850 ohms	—
Fixed grid bias . . . . .	$V_g =$	—	—75 V
Anode current (without signal) . .	$I_{a0} =$	$2 \times 43 \text{ mA}$	$2 \times 35 \text{ mA}$
Anode current at max. modulation	$I_{a \text{ max}} =$	$2 \times 46 \text{ mA}$	$2 \times 70 \text{ mA}$
Load resistor (between anodes) . .	$R_{aa} =$	8,000 ohms	5,000 ohms
Output power . . . . .	$W_o =$	15.6 W	20 W
Alternating grid voltage (per grid) at max. modulation . . . . .	$V_i =$	51 $V_{eff}$	49 $V_{eff}$
Distortion at max. modulation . .	$d_{tot} =$	2.3 %	2.1 %

### MAXIMUM RATINGS per valve

- $V_{a0}$  = max. 600 V
- $V_a$  = max. 350 V
- $W_a$  = max. 15 W
- $V_g$  ( $I_g = + 0.3 \mu\text{A}$ ) = max. —2 V

- $I_k$  = max. 90 mA
- $R_{gk}$  (auto. bias) = max. 0.7 M ohm
- $R_{gk}$  (fixed bias) = max. 0.3 M ohm



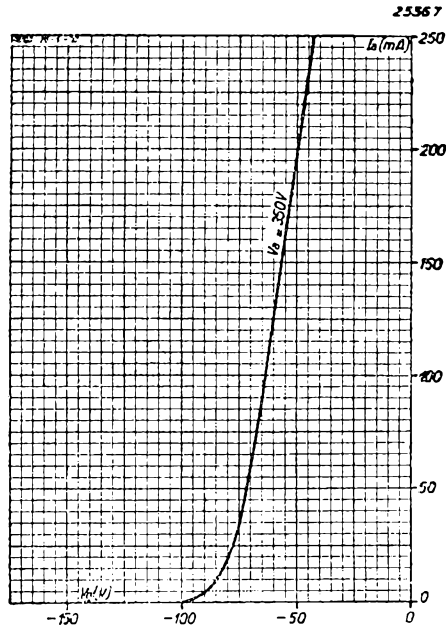

Fig. 3  
Anode current as a function of the grid bias,  
with  $V_a = 350$  V.

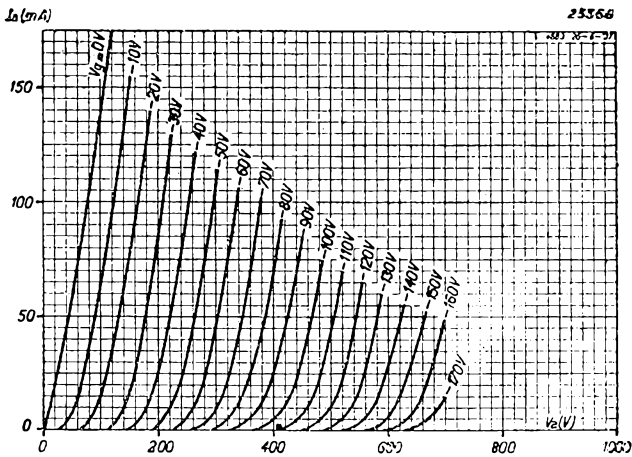

Fig. 4  
Anode current as a function of the anode voltage for different values  
of grid bias.

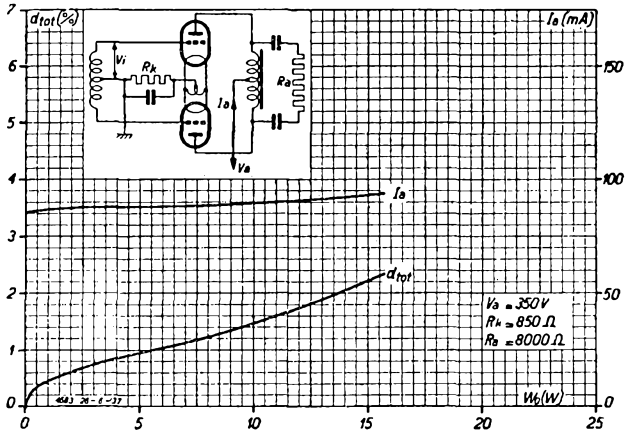

Fig. 5  
Total distortion and total anode current as functions of the output power; 2 valves 4683 in a balanced circuit with automatic grid bias.

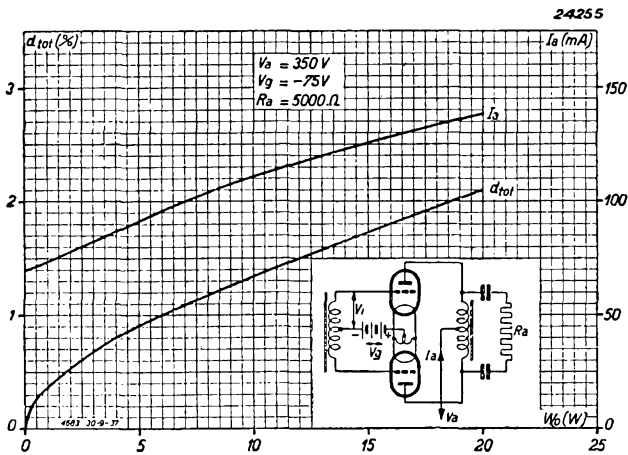

Fig. 6  
Total distortion and total anode current as functions of the output power; 2 valves 4683 in a balanced circuit with fixed bias.

# 4689 Pentode

This is an indirectly-heated steep-slope 18 W output valve using a maximum anode potential of 375 V. Two of these valves in a balanced circuit will deliver a combined output of nearly 29 W and, due to the high mutual conductance, an output stage of this type will operate on a very moderate grid input; any ordinary A.F. amplifier valve is therefore sufficient to excite fully the output stage. In view of the high mutual conductance, it is advisable to employ automatic grid bias; the published data relate to a constant screen potential of 275 V. Should a potential divider be used for the feed in order to reduce the screen voltage to 250 V, the screen voltage will fall on an increasing input signal, if the current passing through the potential divider is not sufficiently high; in consequence, the grid swing is reduced and, with it, the output. It is therefore recommended in all cases where such losses of power are undesirable, that the screen voltage be kept constant by means of stabilizer tubes, e.g. type 4687; this also has the advantage that the main voltage will not decrease as much as it is likely to do without stabilization.

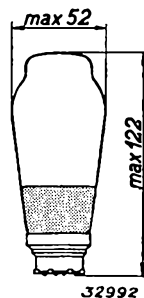

Fig. 1  
Dimensions in mm.

## HEATER RATINGS

Heating: indirect by A.C. or D.C.; parallel supply.

Heater voltage . . . . .  $V_f = 6.3$  V  
 Heater current . . . . .  $I_f = 1.35$  V

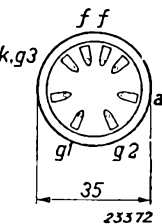
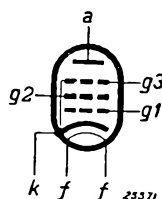

Fig. 2  
Arrangement of electrodes and base connections.

## CAPACITANCES

Anode-grid  
 $C_{ag1} < 0.8 \mu\text{F}$

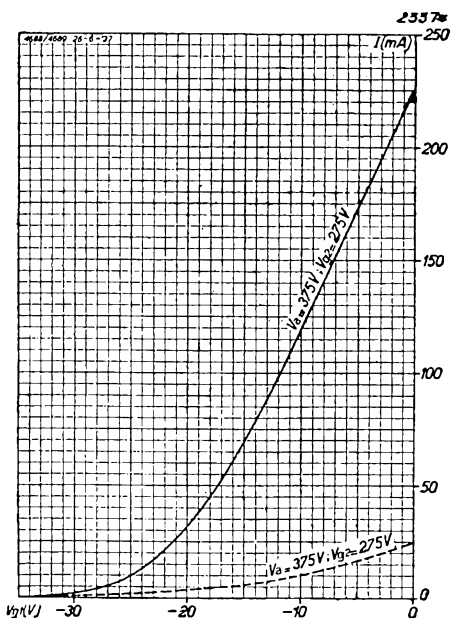

Fig. 3  
Anode and screen-grid current of the 4689 as functions of the grid bias.  $V_a = 375$  V,  $V_{g_2} = 275$  V.

OPERATING DATA

		Class AB output with auto. grid bias (2 valves)
Anode voltage . . . . .	$V_a =$	375 V
Screen-grid voltage . . . . .	$V_{g2} =$	275 V
Common cathode resistor . . . . .	$R_k =$	165 ohms
Anode current (without signal) . . . . .	$I_{a0} =$	$2 \times 48$ mA
Anode current at max. modulation . . . . .	$I_{a \text{ max}} =$	$2 \times 62$ mA
Screen-grid current (without signal) . . . . .	$I_{g20} =$	$2 \times 5$ mA
Screen-grid current at max. modulation . . . . .	$I_{g2 \text{ max}} =$	$2 \times 9$ mA
Load resistor (between anodes) . . . . .	$R_{aa} =$	6,500 ohms
Output power . . . . .	$W_o =$	28.5 W
Alternating grid voltage (per grid) . . . . .	$V_i =$	16 $V_{eff}$
Distortion at maximum output . . . . .	$d_{tot} =$	2.25 %

MAXIMUM RATINGS per valve

- $V_{a0} =$  max. 600 V
- $V_a =$  max. 375 V
- $W_a =$  max. 18 W
- $V_{g20} =$  max. 600 V
- $V_{g2} =$  max. 275 V
- $W_{g2} (V_i = 0) =$  max. 2 W
- $W_{g2} (W_o = \text{max.}) =$  max. 3.5 W
- $I_k =$  max. 90 mA
- $V_{g1} (I_{g1} = + 0.3 \mu A) =$  max. -1.3 V
- $R_{g1k} =$  max. 0.7 M ohm
- $R_{fk} =$  max. 5,000 ohms
- $V_{fk} =$  max. 50 V

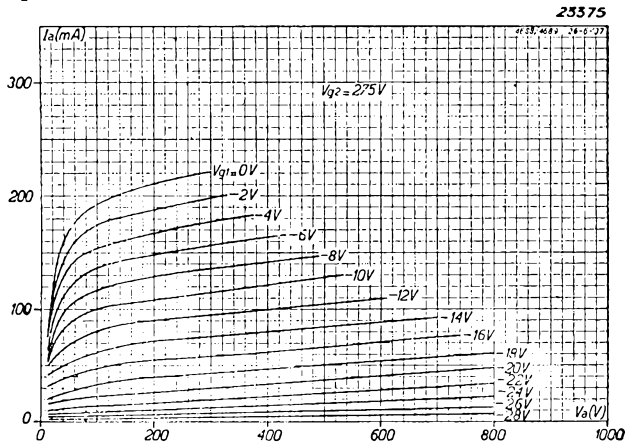

Fig. 4  
Anode current of the 4689 as a function of the anode voltage for different values of grid bias.  $V_{g2} = 275$  V.

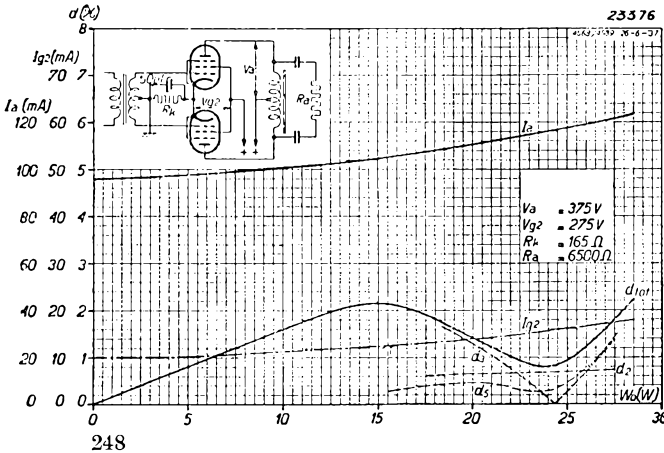

Fig. 5  
Total distortion, total anode and screen-grid current as functions of the output power; two valves 4689 in a Class B output circuit with automatic grid bias.

# 4694 Pentode

The 4694 is an indirectly-heated steep-slope 9 W pentode. In balanced stages the available output is 12 to 13 W, which makes the valve very attractive for use in 10 W amplifiers. The maximum anode voltage is 400 V, that is to say 400 V on the anode and 425 V on the screen; the latter potential is thus slightly higher than that of the anode, so that allowance may be made for the voltage drop occurring across the output transformer. It is not necessary to feed the screen from a potential divider and the losses inherent in this type of feed are thus avoided, whilst the output is not reduced by decreases in the screen voltage at max. modulation. The relatively high working voltages of this valve make it possible to employ pre-amplification stages of very high sensitivity. Moreover, due to the high mutual conductance the alternating grid voltage is extremely low; grid bias, therefore, must be of the automatic type.

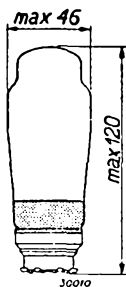

Fig. 1  
Dimensions in mm.

## HEATER RATINGS

Heating: indirect, A.C.; parallel supply.

Heater voltage . . . . .  $V_f = 6.3$  V  
 Heater current . . . . .  $I_f = 0.9$  A

## CAPACITANCES

Anode-grid . . . . .  $C_{ag1} < 0.8 \mu\mu\text{F}$

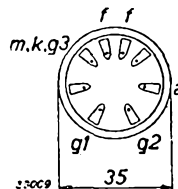
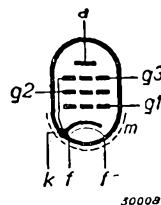
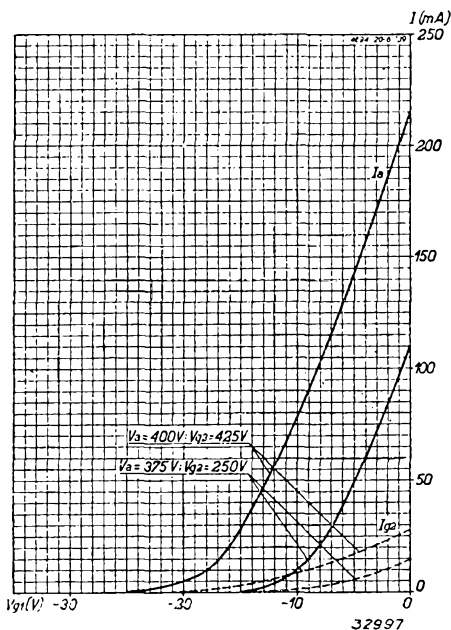

Fig. 2  
Arrangement of electrodes and base connections.



## STATIC DATA

Anode voltage . . . . .  $V_a = 400$  V  
 Screen-grid voltage  $V_{g2} = 425$  V  
 Grid bias . . . . .  $V_{g1} = -15.6$  V  
 Anode current . . . . .  $I_a = 22$  mA  
 Screen-grid current  $I_{g2} = 2.8$  mA  
 Mutual conductance  $S = 7$  mA/V  
 Internal resistance  $R_i = 75,000$  ohms

Fig. 3  
Anode and screen-grid current of the 4694 as functions of the grid bias, with respect to different anode and screen voltages.

OPERATING DATA

		Class AB output with auto. bias (2 valves)
Anode voltage . . . . .	$V_a =$	400 V
Screen-grid voltage . . . . .	$V_{g2} =$	425 V
Common cathode resistor . . . . .	$R_k =$	315 ohms
Anode current (without signal) . . . . .	$I_{a0} =$	$2 \times 22$ mA
Anode current at max. modulation . . . . .	$I_{a \text{ max}} =$	$2 \times 25$ mA
Screen current (without signal) . . . . .	$I_{g20} =$	$2 \times 2.8$ mA
Screen current at max. modulation . . . . .	$I_{g2 \text{ max}} =$	$2 \times 6.2$ mA
Load resistor (between anodes) . . . . .	$R_{aa} =$	20,000 ohms
Power output . . . . .	$W_o =$	13 W
Alternating grid voltage . . . . .	$V_i =$	9 V <sub>eff</sub>
Distortion at maximum modulation . . . . .	$d_{tot} =$	5 %

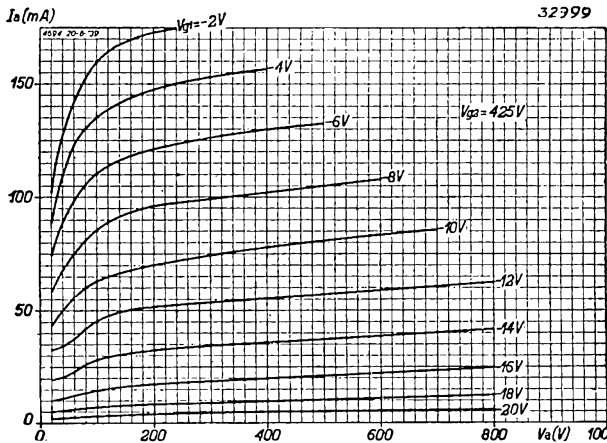

Fig. 4  
Anode current as a function of the anode voltage for various values of grid bias.  $V_{g2} = 425$  V.

MAXIMUM RATINGS per valve

- $V_{a0} =$  max. 650 V
- $V_a =$  max. 400 V
- $W_a =$  max. 9 W
- $V_{g20} =$  max. 650 V
- $V_{g2} =$  max. 425 V
- $W_{g2} (V_i = 0) =$  max. 1.3 W
- $W_{g2} (W_o = \text{max.}) =$  max. 2.7 W
- $I_k =$  max. 55 mA
- $V_{g1} (I_{g1} = + 0.3 \mu\text{A}) =$  max. -1.3 V
- $R_{g1k} =$  max. 1 M ohm
- $R_{fk} =$  max. 5,000 ohms
- $V_{fk} =$  max. 50 V

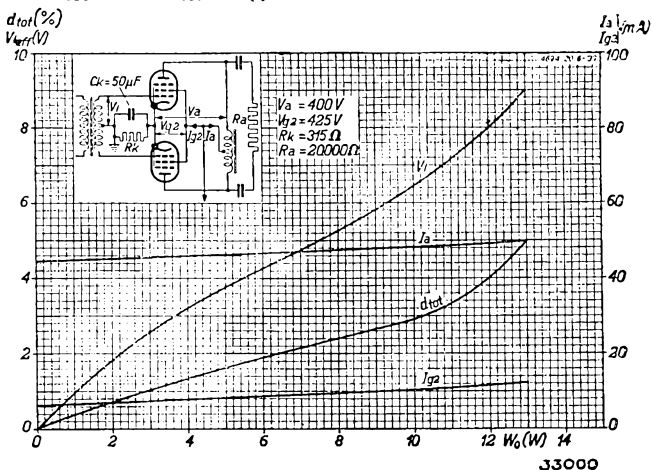

Fig. 5  
Total distortion, total anode and screen-grid current and alternating grid voltage, per grid, as functions of the output power. 2 valves 4694 in a Class AB output stage with auto. bias.

# 4699 Pentode

This pentode is an indirectly-heated 18 W output valve of extremely high mutual conductance, for A.C. heater-supply. It was designed especially for small amplifiers with Class AB output stages. In view of the high mutual conductance the valve is extremely useful for supersensitive amplifiers. For two 4699 used in class AB output stage with automatic grid bias an alternating input voltage of 17 V<sub>eff</sub> is sufficient to obtain a power output of 29 W. Older types of amplifying valves such as the 4689 are supplied with an anode voltage of 375 V, with 275 V screen; owing to the necessity for feeding the screen from a potential divider for this type of valve, there is a considerable drop in output at maximum modulation as the current passing through the potential divider is not high enough. When the grid signal increases, the screen current also rises, so that when a high resistance potential divider is used the screen voltage and grid swing are reduced. In practice the decrease in output due to this potential divider is 10 to 20 %.

The maximum anode and screen voltages of the 4699 are such that the latter may be fed direct, without the use of any potential divider, and the advantages of equal anode and screen potentials may be listed as follows:

a) Less costly circuit, since two fairly high-wattage resistors and a smoothing capacitor are then unnecessary.

b) Lower current consumption, in view of the absence of the potential divider.

c) No reduction in output at maximum modulation, such as exists when the screen is fed from a potential divider.

The 4699 gives good results on both high and low voltages ( $V_b = 450$  V and  $V_b = 375$  V respectively); in the latter instance it is possible to economise in the supply section of the amplifier, whilst in the other case the stages of pre-amplification may be made more sensitive.

For a valve with such high mutual conductance the 4699 has an unusually low heater consumption (about 6.3 W), this being due mainly to the special form of the cathode.

## HEATER RATINGS

Heating: indirect by A.C.; parallel supply.  
 Heater voltage. . . . .  $V_f = 6.3$  V  
 Heater current. . . . .  $I_f = 1.0$  A

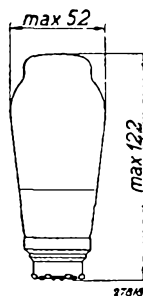

Fig. 1 Dimensions in mm.

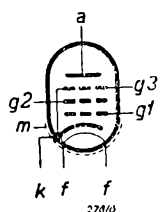

Fig. 2 Arrangement of electrodes and base connections.

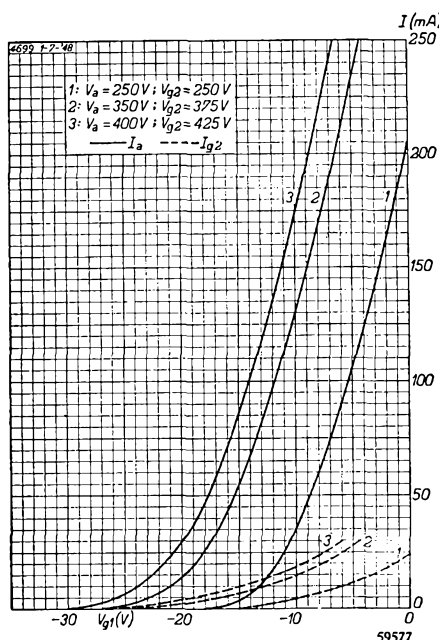

Fig. 3 Anode and screen current of the 4699 as functions of the grid bias for various values of anode and screen potential.

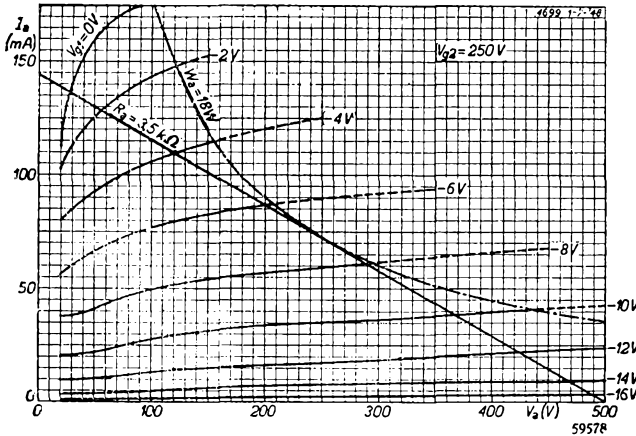

Fig. 4  
Anode current as a function of the anode voltage for various values of grid bias with  $V_{g2} = 250$  V.

**CAPACITANCES**

Anode-grid . . . . .  $C_{ag1} < 0.7 \mu\mu F$

**OPERATING DATA**

The 4699 used as single output valve in class A

Anode voltage . . . . .	$V_a = 250$ V
Screen-grid voltage . . . . .	$V_{g2} = 250$ V
Cathode resistor . . . . .	$R_k = 90$ ohms
Anode current . . . . .	$I_a = 72$ mA
Screen-grid current . . . . .	$I_{g2} = 8$ mA
Mutual conductance . . . . .	$S = 14.5$ mA/V
Amplification factor; screen with respect to control grid . . . . .	$\mu_{g2g1} = 20$ —
Internal resistance . . . . .	$R_i = 20,000$ ohms
Load resistor . . . . .	$R_a = 3,500$ ohms
Alternating input voltage ( $I_{g1} = + 0.3 \mu A$ ) . . . . .	$V_i = 5.3$ V <sub>eff</sub>
Power output ( $I_{g1} = + 0.3 \mu A$ ) . . . . .	$W_o = 8$ W
Total distortion ( $I_{g1} = + 0.3 \mu A$ ) . . . . .	$d_{tot} = 10$ %
Alternating input voltage ( $W_o = 50$ mW) . . . . .	$V_i = 0.3$ V <sub>eff</sub>

The 4699 used in class AB output stage with auto. grid bias (two valves)

Supply voltage . . . . .	$V_b = 425$	$375$	$375$	$V$
Load resistor between anodes . . . . .	$R_{aa} = 8,000$	$6,000$	$ohms$	
Common screen-grid series resistor . . . . .	$R_{g2} = 2,200$	$700$	$ohms$	
Cathode resistor . . . . .	$R_k = 170$	$125$	$ohms$	
Alternating input voltage . . . . .	$V_i = 0$	$17$	$0$	$14$ V <sub>eff</sub>
Anode voltage . . . . .	$V_a + V_{Rk} = 405$	$400$	$355$	$350$ V
Anode current . . . . .	$I_a = 2 \times 46$	$2 \times 58$	$2 \times 52$	$2 \times 64$ mA
Screen-grid current . . . . .	$I_{g2} = 2 \times 5$	$2 \times 14.5$	$2 \times 6.5$	$2 \times 16.5$ mA
Power output . . . . .	$W_o = 0$	$29$	$0$	$27.5$ W
Total distortion . . . . .	$d_{tot} =$ —	$5$	$—$	$4$ %

The 4699 used in triode connection as single output valve class A (screen-grid connected to anode)

Supply voltage . . . . .	$V_b = 375$ V	Alternating input	
Cathode resistor . . . . .	$R_k = 300$ ohms	voltage . . . . .	$V_i = 11$ V <sub>eff</sub>
Load resistor . . . . .	$R_a = 4,000$ ohms	Power output . . . . .	$W_o = 4.5$ W
Anode current . . . . .	$I_a = 50$ mA	Total distortion . . . . .	$d_{tot} = 9$ %



The 4699 used in triode connection in class AB output stage with auto. grid bias (two valves)

Supply voltage . . . . .	$V_b =$	400	V
Load resistor between anodes . . . . .	$R_{aa} =$	5,500	ohms
Common cathode resistor . . . . .	$R_k =$	175	ohms
Alternating input voltage . . . . .	$V_i =$	0	13.5 $V_{eff}$
Anode current . . . . .	$I_a =$	$2 \times 48$	$2 \times 54$ mA
Power output . . . . .	$W_o =$	0	13 W
Total distortion . . . . .	$d_{tot} =$	—	1.5 %

#### MAXIMUM RATINGS

Anode voltage in cold condition . . . . .	$V_{ao} = \text{max.}$	800 V
Anode voltage . . . . .	$V_a = \text{max.}$	425 V
Anode dissipation . . . . .	$W_a = \text{max.}$	18 W
Screen-grid voltage in cold condition . . . . .	$V_{g2o} = \text{max.}$	650 V
Screen-grid voltage . . . . .	$V_{g2} = \text{max.}$	425 V
Screen dissipation without signal . . . . .	$W_{g2} = \text{max.}$	2 W
Screen dissipation at max. modulation . . . . .	$W_{g2} = \text{max.}$	5 W
Cathode current . . . . .	$I_k = \text{max.}$	90 mA
Grid voltage at grid current start ( $I_{g1} = +0.3 \mu A$ ) . . . . .	$V_{g1} = \text{max.}$	-1.3 V
External resistance between grid and cathode (auto. bias) . . . . .	$R_{g1} = \text{max.}$	0.7 M ohm
External resistance between grid and cathode (fixed bias) . . . . .	$R_{g1} = \text{max.}$	0.5 M ohm
External resistance between heater and cathode . . . . .	$R_{fk} = \text{max.}$	20,000 ohms
Voltage between heater and cathode . . . . .	$V_{fk} = \text{max.}$	50 V

The 4699 is operated with automatic grid bias; semi-automatic bias may be employed, provided that the cathode current in the output stage constitutes more than 50 % of the total current flowing in the resistor producing the bias. The value of  $R_{g1}$  must then be reduced in accordance with the following:

$$\frac{\text{Cathode current of output valve}}{\text{Total current passing through resistor producing the voltage drop}} \times R_{g1}$$

Due to the high mutual conductance, a stopper resistor of about 1,000 ohms is included in the grid lead to prevent oscillation.

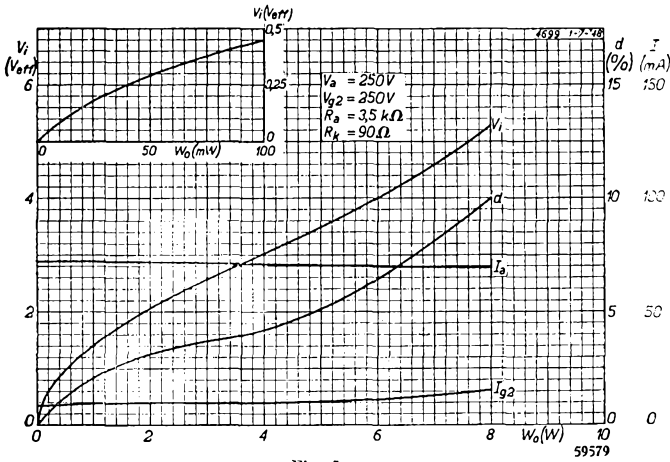

Fig. 5  
 Total distortion, anode and screen-grid current and alternating input voltage as functions of the output power; the 4699 used as single output valve class A with  $V_a = 250V$  and  $V_{g2} = 250V$ .

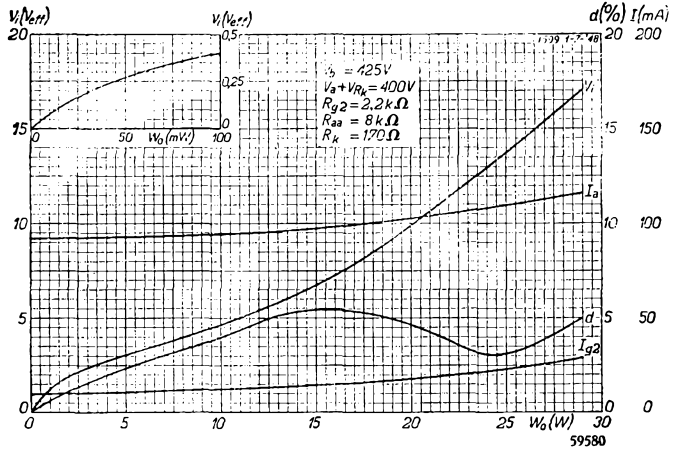

Fig. 6  
 Total distortion, anode and screen-grid current and alternating input voltage as functions of the output power; 2 valves 4699 used in class AB output stage with auto. grid bias,  $V_b = 425V$ .

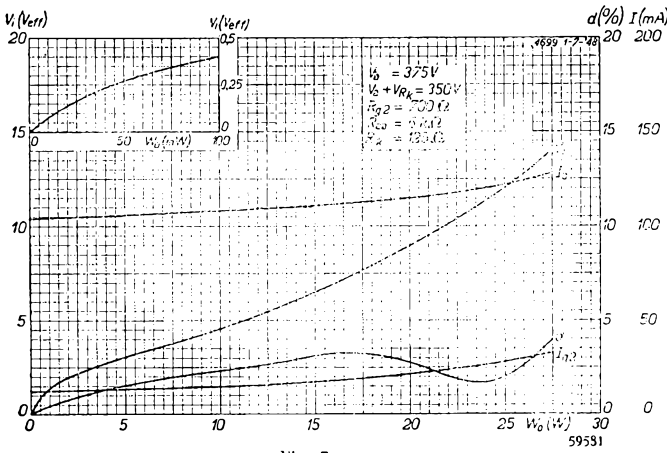

Fig. 7  
 Total distortion, anode and screen-grid current and alternating input voltage as functions of the output power; 2 valves 4699 used in class AB output stage with auto. grid bias,  $V_b = 375\text{ V}$

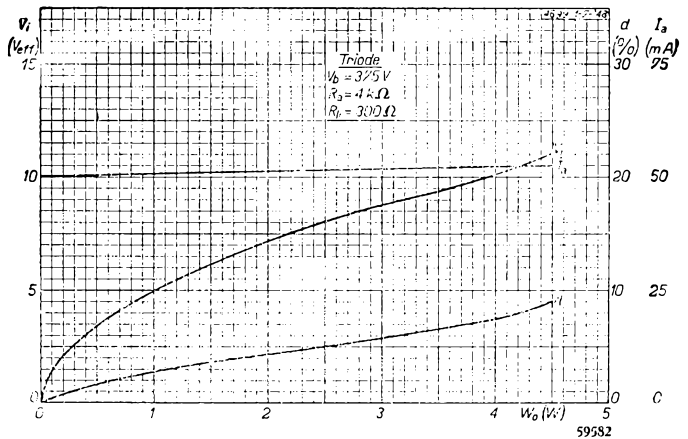

Fig. 8  
 Total distortion, anode current and alternating input voltage as functions of the output power; the 4699 used as single output valve in triode connection (screen-grid connected to anode) class A with  $V_b = 375\text{ V}$ .

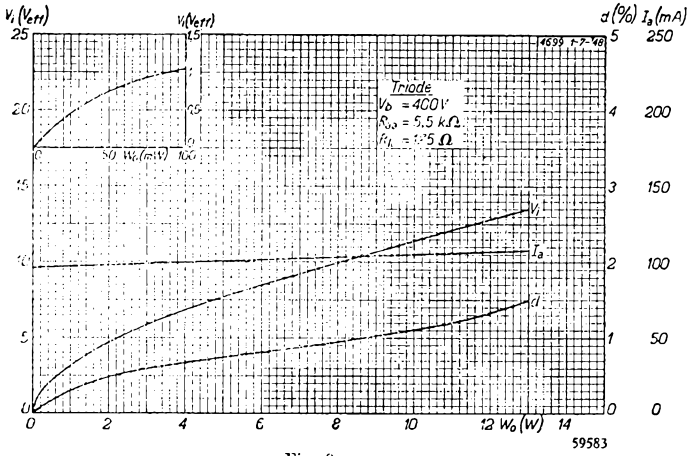

Fig. 9  
 Total distortion, anode current and alternating input voltage as functions of the output valve; 2 valves 4654 in triode connection (screen-grid connected to anode) used in class AB output stage with  $V_b = 400 V$ .

# EL 51 Pentode

The EL 51 is a 45 W pentode for use in large amplifier equipment. Two of these valves in a balanced circuit with an anode and screen potential of 750 V will deliver an output of 140 W. A 68 W electric lamp must be connected in series with the screen grids to prevent the screen-grid being overloaded. The fact that the screen carries the same potential as the anode affords many possibilities in connection with the application of this valve, since the screen can be fed directly from the high-tension line, without necessitating the use of a potential divider carrying a high current. The grid input for maximum modulation is quite small on account of the high mutual conductance; the heater consumption is, nevertheless, relatively low, being 12 W.

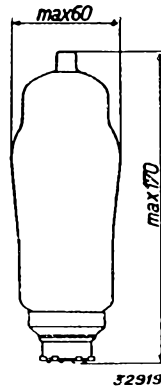

Fig. 1  
Dimensions in mm.

## HEATER RATINGS

Heating: indirect by A.C. or D.C.; parallel supply.

Heater voltage . . . . .	$V_f = 6.3$ V
Heater current . . . . .	$I_f = 1.9$ A

## CAPACITANCES

Anode-grid . . . . .	$C_{ag1} < 1.5$ $\mu$ tF
----------------------	--------------------------

## STATIC RATINGS

Anode voltage . . . . .	$V_a =$	500	750	V
Screen-grid voltage . . . . .	$V_{g2} =$	500	750	V <sup>1)</sup>
Grid bias . . . . .	$V_{g1} =$	-20	-37.5	V
Anode current . . . . .	$I_a =$	87	60	mA
Screen-grid current . . . . .	$I_{g2} =$	13	10	mA
Mutual conductance . . . . .	$S =$	11	8	mA/V
Amplification factor; screen with				
respect to control grid . . . . .	$\mu_{g2g1} =$	16,500	16,500	—
Internal resistance . . . . .	$R_i =$	33,000	50,000	ohms

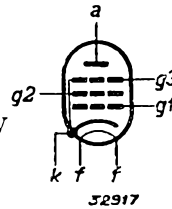

## OPERATING DATA

The EL 51 used in class B output stage with fixed grid bias (two valves)

Anode voltage . . . . .	$V_a =$	750	V
Screen-grid voltage . . . . .	$V_{g2} =$	750	V <sup>1)</sup>
Grid bias . . . . .	$V_{g1} =$	-40	V
Load resistor between anodes . . . . .	$R_{aa} =$	6,000	ohms/k.g3
Alternating input voltage . . . . .	$V_i =$	0	28.5 $V_{eff}$
Anode current . . . . .	$I_a =$	$2 \times 40$	$2 \times 145$ mA
Screen-grid current . . . . .	$I_{g2} =$	$2 \times 7.5$	$2 \times 30$ mA
Power output . . . . .	$W_o =$	0	140 W
Total distortion . . . . .	$d_{tot} =$	—	5 %

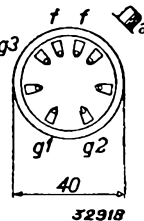

Fig. 2  
Arrangement of electrodes and base connections.

<sup>1)</sup> A resistor of 1,000 ohms should be included in series with the common screen-grid lead, or, better still, a special electric lamp (550 V, 68 W).

The EL 51 used in class AB output stage with auto. grid bias (two valves)

Anode voltage . . . . .	$V_a =$	500	V
Screen-grid voltage . . . . .	$V_{g2} =$	500	V
Common cathode resistor . . . . .	$R_k =$	100	ohms
Load resistor between anodes . . . . .	$R_{aa} =$	4,800	ohms
Alternating input voltage . . . . .	$V_i =$	0	19 $V_{eff}$
Anode current . . . . .	$I_a =$	$2 \times 87$	$2 \times 110$ mA
Screen-grid current . . . . .	$I_{g2} =$	$2 \times 13$	$2 \times 23$ mA
Power output . . . . .	$W_o =$	0	67.5 W
Total distortion . . . . .	$d_{tot} =$	—	5 %

MAXIMUM RATINGS

$V_{a0}$	= max.	1,500 V	$I_k$	= max.	200 mA
$V_a$	= max.	750 V	$V_{g1}$ ( $I_{g1} = +0.3 \mu A$ )	= max.	-1.3 V
$W_a$	= max.	45 W	$R_{g1}$ (fixed bias)	= max.	0.35 M ohm
$V_{g20}$	= max.	1,500 V	$R_{g1}$ (auto. bias)	= max.	0.7 M ohm
$V_{g2}$	= max.	750 V	$V_{fk}$	= max.	50 V
$W_{g2}$ ( $V_i = 0$ )	= max.	7 W	$R_{fk}$	= max.	20,000 ohms
$W_{g2}$ ( $W_o = \text{max.}$ )	= max.	25 W			

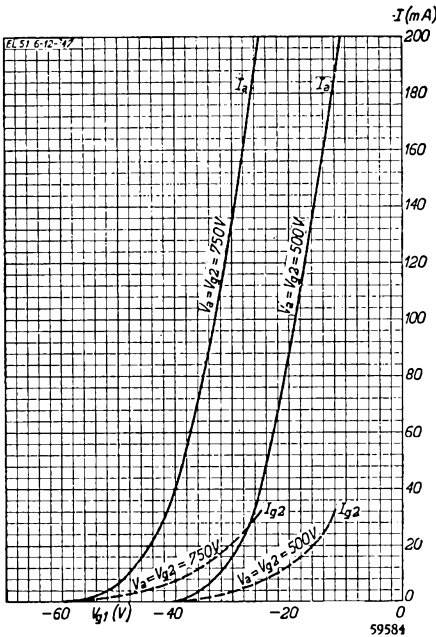

Fig. 3  
Anode and screen current of the EL 51 as functions of the grid bias, for various values of anode and screen potential.

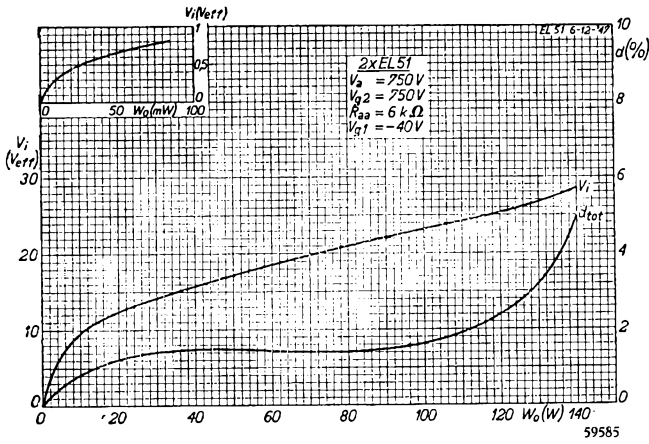

Fig. 4  
Total distortion and alternating input voltage as functions of the output power; 2 valves EL 51 used in class B output stage with fixed grid bias,  $V_a = V_{g2} = 750$  V.

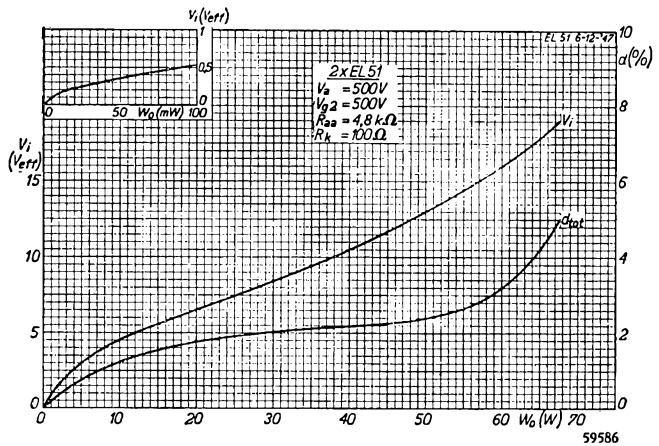

Fig. 5  
Total distortion and alternating input voltage as functions of the output power; 2 valves EL 51 used in class AB output stage with auto. grid bias,  $V_a = V_{g2} = 500$  V.

# F 443 N Pentode

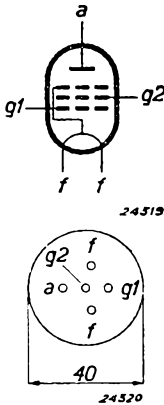

Fig. 2  
Arrangement of  
electrodes and  
base connections.

This is a directly-heated 25 W output pentode, fitted with a 5-pin base and suitable for a maximum anode potential of 550 V; the maximum screen voltage is 300 V.

On an anode voltage of 300 V the same potential may be applied to the screen, thus avoiding the necessity for potential divider feeding, possibly with voltage stabilization. In balanced circuits, however, the maximum output power is then considerably lower than in the case of operation with an anode voltage of 550 V and a screen voltage of 250 V; a Class AB output stage employing two of these valves at the last-mentioned rating and with automatic bias will yield 41 W with 4.3 % distortion.

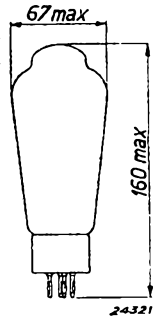

Fig. 1  
Dimensions in mm.

## FILAMENT RATINGS

Heating: direct, A.C., parallel supply.

Filament voltage. . . . .  $V_f = 4 \text{ V}$   
 Filament current. . . . .  $I_f = 2 \text{ A}$

## CAPACITANCES

$$C_{ag1} < 3 \mu\text{F}$$

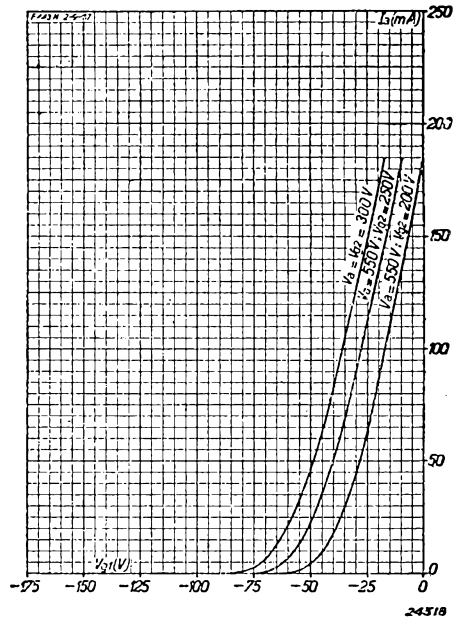

Fig. 3  
Anode current as a function of the grid bias, with  $V_a = 550 \text{ V}$ ,  $V_{g2} = 250 \text{ V}$ ;  $V_a = 550 \text{ V}$ ,  $V_{g2} = 200 \text{ V}$  and  $V_a = V_{g2} = 300 \text{ V}$ .



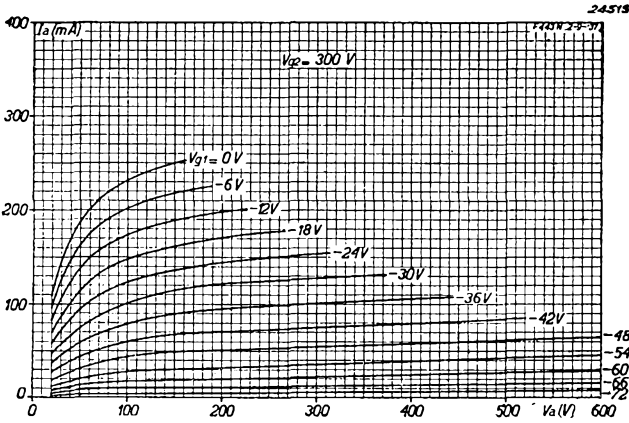

Fig. 4  
Anode current as a function of the anode voltage for different values of grid bias.  $V_{g2} = 300$  V.

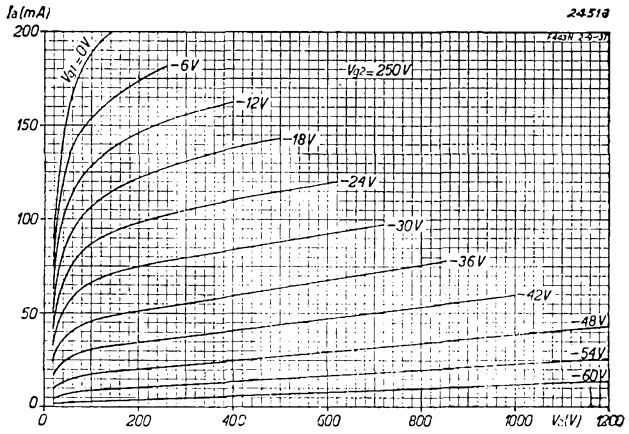

Fig. 5  
Anode current as a function of the anode voltage for different values of grid bias.  $V_{g2} = 250$  V.

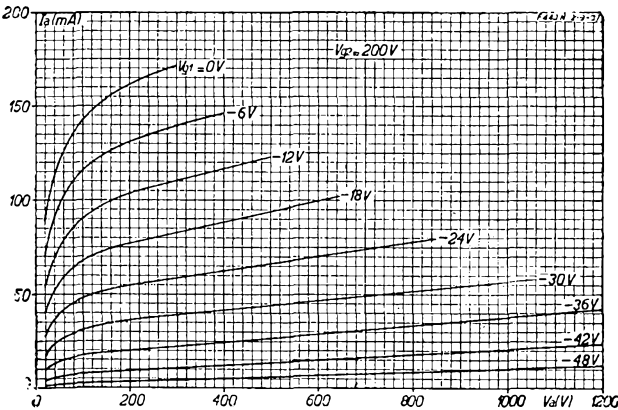

Fig. 6  
Anode current as a function of the anode voltage for different values of grid bias.  $V_{g2} = 200$  V.

OPERATING DATA

		Single amplifier (Class A)	Single amplifier (Class A)	Class AB output with auto. bias (two valves)	Class AB output with fixed bias (two valves)	Class AB output with auto. bias (two valves)
Anode voltage . . . . .	$V_a$ (V)	550	300	50	300	300
Screen voltage . . . . .	$V_{g2}$ (V)	200	300	250	300	300
Fixed grid bias . . . . .	$V_{g1}$ (V)	-30	-40	—	-63	—
Common cathode resistor for auto. bias . . . . .	$R_k$ (ohms)	647	455	445	—	330
Anode current (without signal) . . . . .	$I_{a0}$ (mA)	45	83	$2 \times 45$	$2 \times 15$	$2 \times 64$
Anode current at max. modulation . . . . .	$I_a$ max (mA)	—	—	$2 \times 53$	$2 \times 72.5$	$2 \times 72.5$
Screen current (without signal) . . . . .	$I_{g2}$ (mA)	1.4	4.6	$2 \times 0.8$	$2 \times 0.4$	$2 \times 2.0$
Screen current at max. modulation . . . . .	$I_{g2}$ max (mA)	—	—	$2 \times 7.4$	$2 \times 14.3$	$2 \times 11.9$
Mutual conductance . . . . .	$S$ (mA/V)	3.2	3.9	—	—	—
Internal resistance . . . . .	$R_i$ (ohms)	30,000	20,000	—	—	—
Load resistor (between anodes) . . . . .	$R_{aa}$ (ohms)	12,000	3,600	12,000	4,500	4,000
Power output . . . . .	$W_o$ (W)	12	10.3	41	26.5	24
Distortion at max. output . . . . .	$d_{tot}$ (%)	10	10	4.3	4.5	2.9
Alternating grid voltage at max. modulation . . . . .	$V_i$ (V <sub>eff</sub> )	15.5	20	37	46	39

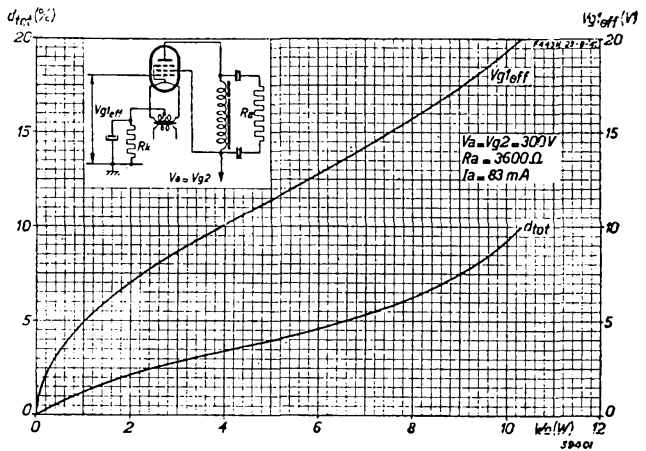

Fig. 7  
Total distortion and alternating grid voltage as functions of the output power with  $V_a = V_{g2} = 300$  V. F 443 N used as a single output valve.

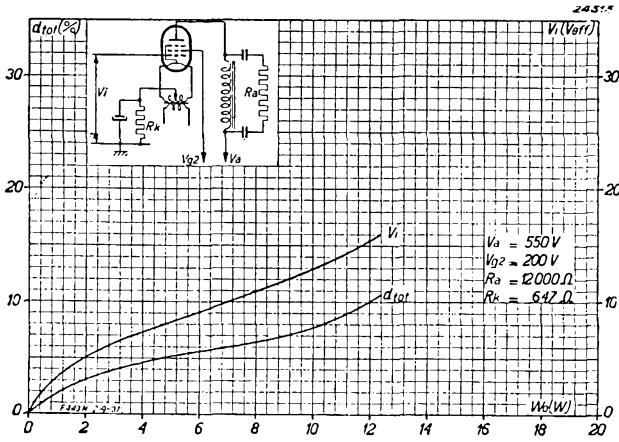

Fig. 8  
 Total distortion and alternating grid voltage as functions of the output power, with  $V_a = 550 V$  and  $V_{g2} = 200 V$ . F 443 N used as a single output valve.

**MAXIMUM RATINGS**

$V_{a0}$	= max. 900 V	$I_k$	= max. 100 mA
$V_a$	= max. 550 V	$V_{g1}$ ( $I_{g1} = + 0.3 \mu A$ )	= max. -2 V
$W_a$	= max. 25 W	$R_{g1k}$ (auto. bias)	= max. 0.3 M ohm
$V_{g20}$	= max. 500 V	$R_{g1k}$ (fixed bias)	= max. 0.1 M ohm
$V_{g2}$	= max. 300 V		
$W_{g2}$ ( $V_i = 0$ )	= max. 1.5 W		
$W_{g2}$ ( $W_o = \text{max}$ )	= max. 4.3 W		

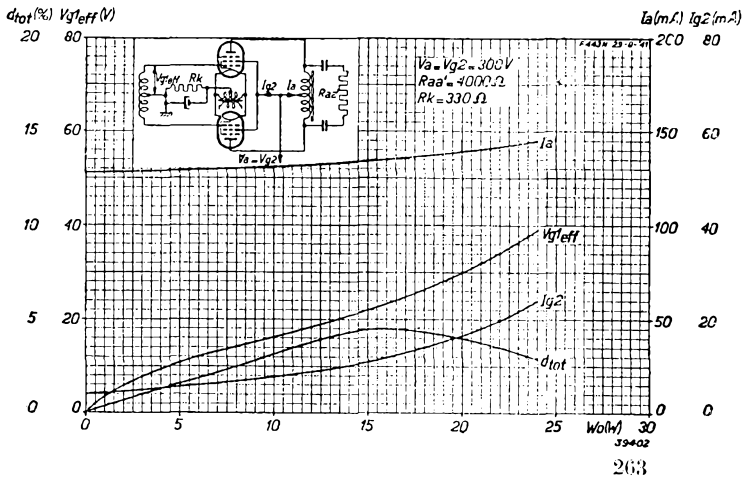

Fig. 9  
 Total distortion, total anode and screen-grid current and alternating grid voltage as functions of the output power. Two F 443 N valves in a balanced output stage with automatic bias.  $V_a = V_{g2} = 300 V$ .

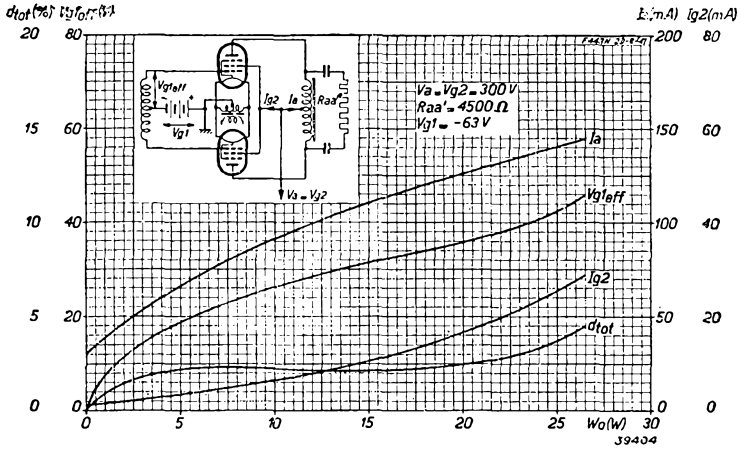

Fig. 10  
Total distortion, total anode and screen-grid current and alternating grid voltage as functions of the output power. Two F 443 N valves in a balanced output stage with fixed bias.  $V_a = V_{g2} = 300\text{ V}$ .

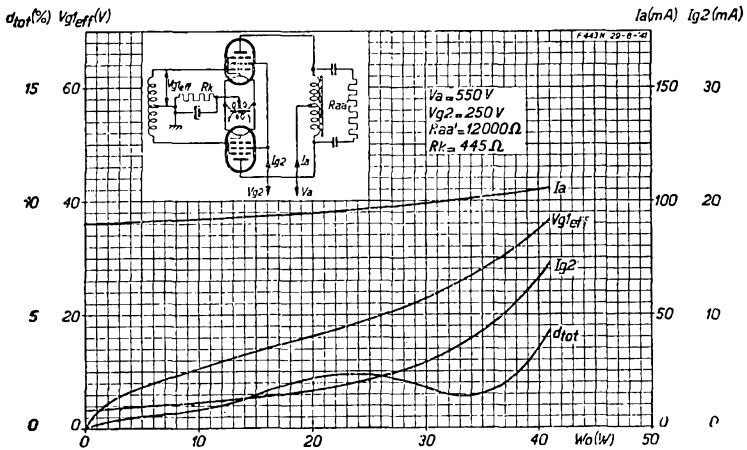

Fig. 11  
Total distortion, total anode and screen-grid current, and alternating grid voltage as functions of the output power. Two F 443 N valves in a balanced output stage with automatic bias.  $V_a = 550\text{ V}$ ,  $V_{g2} = 250\text{ V}$ .

# CF 50 Microphone pre amplifier pentode

The CF 50 was specially designed for the amplification of very low voltages. Hum, background noise and microphony have all been reduced to a minimum and the principal application of the valve is as a pre-amplifier in crystal or ribbon-microphone equipment.

This valve is capable of being operated to give a stage gain of about 300, producing an effective alternating output voltage of 3 V with less than 1% distortion or, if required, a gain factor of between 395 and 45 with distortion less than 0.4% and an output voltage of 0.1  $V_{eff}$ . This versatility of the valve may be ascribed to the fact that the input signals in this case are extremely small.

Details of the operating possibilities of this valve are set out in Tables I and II.

In view of the fact that the valve is specially intended for the amplification of very small signals, extra care must be taken to prevent hum, since otherwise the level of the hum will quickly approach that of the input signal itself. For this latter reason the valve is equipped with a bifilar filament, in consequence of which the external magnetic field is very weak; as this field is proportional to the strength of the current, the heater current has been kept as low as possible, namely 200 mA, so that, in effect, there is hardly any external field at all. To ensure sufficient emission from the cathode on this current it has been necessary to employ a heater voltage of 30 V. The ultimate result is that, using a grid impedance of 0.5 megohm, the voltage on the grid corresponding to the hum on both grid and anode is less than 1  $\mu V$ . Taking into consideration the fact that the voltage delivered by the microphone is of the order of 1 mV, it may be claimed that the ripple level is very low indeed. In a cathode resistor without a decoupling capacitor the induced ripple voltage will be about 20  $\mu V$ .

The equivalent noise resistance of the CF 50 is 2,500 ohms, which corresponds to an effective value of 0.7  $\mu V$  for the noise voltage on the grid at a bandwidth of 10,000 c/s and this, compared with the voltages applied to the grid, is also extremely low. In fact, the equivalent noise resistance gives the impression of being unnecessarily low in com-

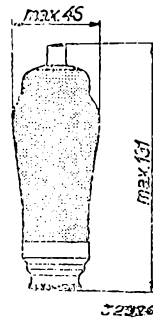

Fig. 1  
Dimensions in mm.

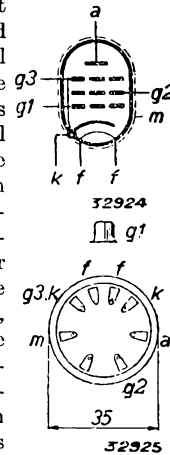

Fig. 2  
Arrangement of electrodes and base connections.

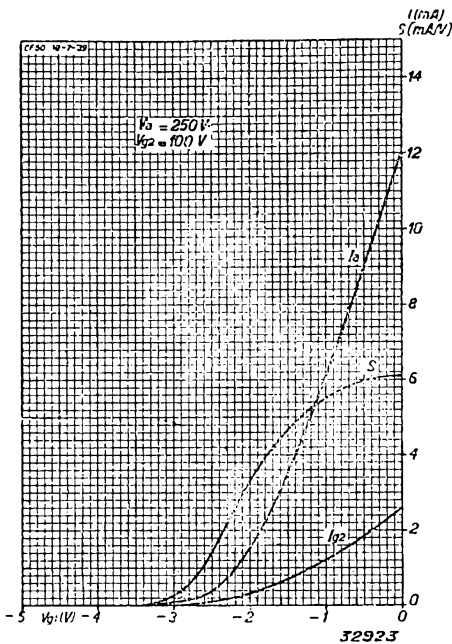

Fig. 3  
Anode current  $I_a$ , screen-grid current  $I_{g2}$  and mutual conductance  $S$  as functions of the grid bias  $V_{g1}$  with  $V_a = 250$  V and  $V_{g2} = 100$  V.

parison with the customary value of the grid leak, but it should be remembered that crystal microphones have a markedly capacitive character, due to which fact the noise resistance of the microphone, for the greater part of the frequency range, is considerably lower than the matching resistance based on the response over a relatively small range of low frequencies. The low value of the equivalent noise resistance of the CF 50 is a result of the high mutual conductance with a low anode current ( $S = 3.3 \text{ mA/V}$ ,  $I_a = 1.5 \text{ mA}$ ).

Finally it may be noted that microphony is eliminated as far as possible by the use of special double mica supports for the system of electrodes; on the whole, then, the CF 50 is an excellent valve for the pre-amplification stage of the more sensitive type

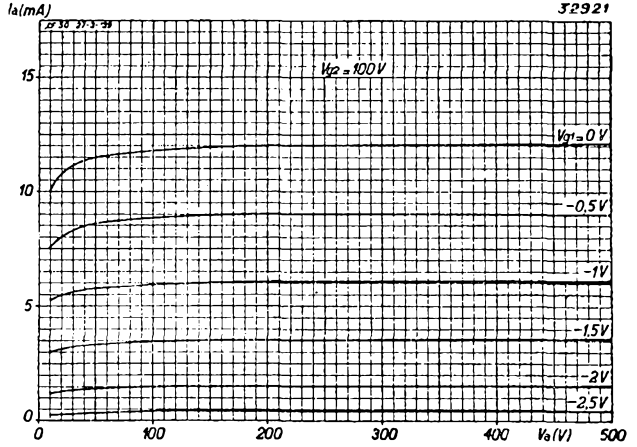

Fig. 4  
Anode current as a function of the anode voltage for different values of grid bias, at a screen potential of 100 V.

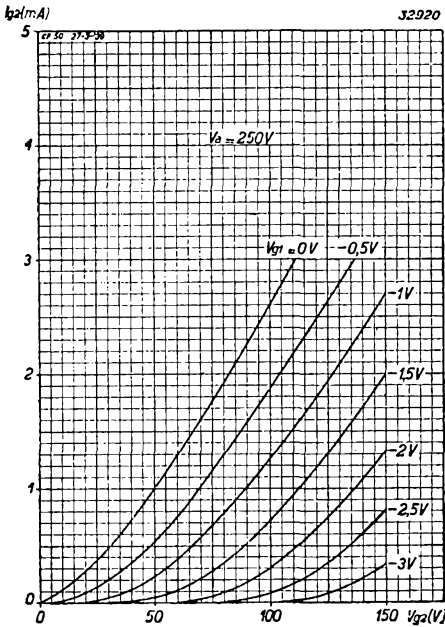

Fig. 5  
Screen-grid current as a function of the screen voltage for different values of grid bias, with 250 V anode voltage.

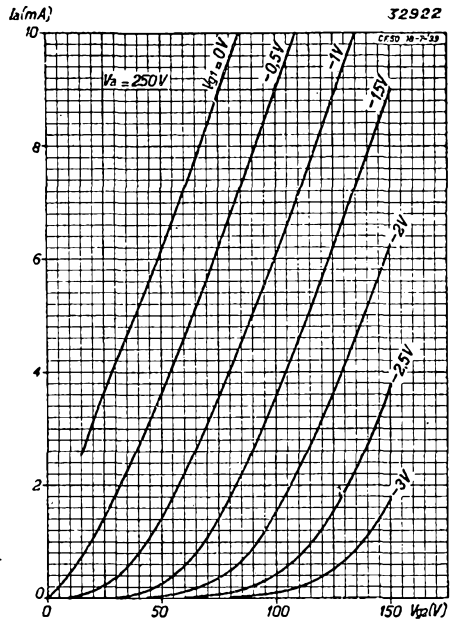

Fig. 6  
Anode current as a function of the screen voltage for different values of grid bias, with 250 V anode voltage.

of amplifier, more especially on account of the low noise resistance in cases where the voltage to be amplified comes from a source of which the noise resistance is also comparatively low.

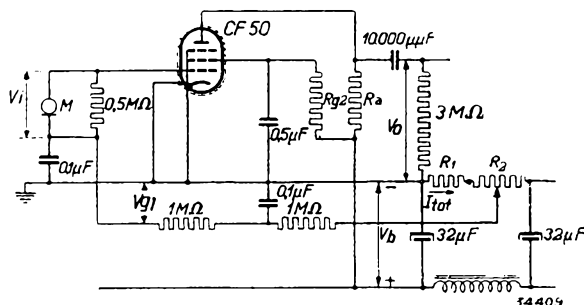

Fig. 7  
Circuit diagram showing the CF 50 used as a microphone pre-amplifier.

**HEATER RATINGS**

Heating: indirect, A.C. or D.C., series or parallel supply.  
Heater voltage  $V_f = 30$  V.  
Heater current  $I_f = 0.200$  A.

**CAPACITANCES**

$C_{ag1} < 0.03 \mu\mu F$   
 $C_{g1} = 13 \mu\mu F$   
 $C_a = 14.5 \mu\mu F$

**STATIC RATINGS**

Anode voltage . . . . .	$V_a = 100$ V	250 V
Screen-grid voltage . . . . .	$V_{g2} = 100$ V	100 V
Grid bias. . . . .	$V_{g1} = -2$ V	-2 V
Anode current . . . . .	$I_a = 1.5$ mA	1.5 mA
Screen-grid current . . . . .	$I_{g2} = 0.3$ mA	0.3 mA
Mutual conductance . . . . .	$S = 3.3$ mA/V	3.3 mA/V
Internal resistance . . . . .	$R_i = 2$ M ohms	2.5 M ohms
Amplification factor; screen with respect to control grid . . . . .	$\mu_{g2/1} = 45$	45
Equivalent noise resistance in the frequency range 50 to 10,000 c/s . . . . .	$R_{eq} = -$	2,500 ohms

**TABLE I**

**OPERATING DATA: CF 50 used as resistance-coupled A.F. amplifier without gain control (see Fig. 7)**

Supply voltage	Anode resistor	Screen-grid series resistor	Cathode resistor	Anode current	Screen current	Voltage gain	Output voltage	Total distortion
$V_b$ (V)	$R_a$ (M ohm)	$R_{g2}$ (M ohm)	$R_k$ (ohms)	$I_a$ (mA)	$I_{g2}$ (mA)	$V_o/V_i$	$V_o$ (V <sub>eff</sub> )	$d_{tot}$ (%)
250	0.3	0.9	2,000	0.7	0.18	315	3	< 1
200	0.3	0.8	3,000	0.5	0.15	260	3	< 1
100	0.3	0.4	7,000	0.2	0.07	150	3	< 1
250	0.2	0.7	1,800	0.9	0.22	295	3	< 1
200	0.2	0.64	2,000	0.7	0.18	245	3	< 1
100	0.2	0.32	5,000	0.3	0.09	145	3	< 1
250	0.1	0.64	1,800	0.9	0.22	280	3	< 1
200	0.1	0.56	2,200	0.7	0.19	230	3	< 1
100	0.1	0.28	5,000	0.3	0.09	140	3	< 1

**TABLE II**  
**OPERATING DATA: CF 50 used as a resistance-coupled A.F. amplifier with control of the amplification (see Fig. 7)**

Supply voltage $V_b$ (V)	Anode resistor $R_a$ (M ohm)	Screen-grid series resistor $R_{g_2}$ (M ohm)	Grid bias $V_{g_1}$ (V)	Anode current $I_a$ (mA)	Screen-grid current $I_{g_2}$ (mA)	Voltage gain $V_o/V_i$	Output voltage $V_o$ (V <sub>eff</sub> )	Total distortion $d_{tot}$ (%)
450	0.3	1.0	-2	1.4	0.38	395	0.1	0.2
450	0.3	1.0	-6	0.72	0.18	260	0.1	0.2
450	0.3	1.0	-10	0.22	0.06	90	0.1	0.2
450	0.3	1.0	-11	0.11	0.04	45	0.1	0.4
450	0.3	1.0	-12	0.04	0.02	7	0.1	3
450	0.2	0.8	-2	1.78	0.44	350	0.1	< 0.2
450	0.2	0.8	-6	0.94	0.23	230	0.1	< 0.2
450	0.2	0.8	-10	0.18	0.05	45	0.1	< 0.2
450	0.2	0.8	-11	0.08	0.02	20	0.1	0.4
450	0.2	0.8	-12	0.03	0.01	3	0.1	3
450	0.1	0.5	-2	2.8	0.64	245	0.1	< 0.2
450	0.1	0.5	-6	1.5	0.33	180	0.1	< 0.2
450	0.1	0.5	-10	0.25	0.05	38	0.1	0.3
450	0.1	0.5	-11	0.09	0.02	15	0.1	1.1
450	0.1	0.5	-12	0.03	0.01	3	0.1	5

**MAXIMUM RATINGS**

- Anode voltage in cold condition . . . . .  $V_{a0}$  = max. 550 V
- Anode voltage . . . . .  $V_a$  = max. 250 V
- Anode dissipation . . . . .  $W_a$  = max. 1 W
- Screen voltage in cold condition . . . . .  $V_{g20}$  = max. 550 V
- Screen voltage at  $I_a = 1.5$  mA . . . . .  $V_{g2}$  = max. 125 V
- Screen voltage at  $I_a < 0.25$  mA . . . . .  $V_{g2}$  = max. 450 V
- Screen dissipation . . . . .  $W_{g2}$  = max. 0.5 W
- Cathode current . . . . .  $I_k$  = max. 10 mA
- Grid voltage at grid current start ( $I_{g1} = + 0.3 \mu A$ )  $V_{g1}$  = max. -1.3 V
- External resistance between control grid and cathode  $R_{g1k}$  = max. 3 M ohms
- External resistance between heater and cathode . . .  $R_{fk}$  = 20,000 ohms
- Voltage between heater and cathode . . . . .  $V_{fk}$  = max. 100 V



# **Rectifying valves for amplifiers**

# Rectifying valves for amplifiers

In general, the current and voltage required for an amplifier need to be higher than in the case of radio receivers, and the rectifiers employed, therefore, have to be capable of supplying more power. It is also important that the voltage delivered by the rectifier should remain as constant as possible in spite of wide fluctuations in the load in view of the fact that the output stages of amplifiers are usually of the balanced type as, in that case, the current varies more or less, according to whether a Class B or Class AB circuit is employed.

A low internal resistance of the rectifier is therefore a necessity, which means that the power transformer and choke should be generously proportioned, whilst the internal resistance of the rectifying valve itself should also be low. As is generally known, the internal resistance of gas-filled rectifying valves is very low indeed, since the voltage drop within the valve is constant at almost any value of the current; this voltage drop is actually equal to the arc voltage of the gas-filling, that is, about 13 V.

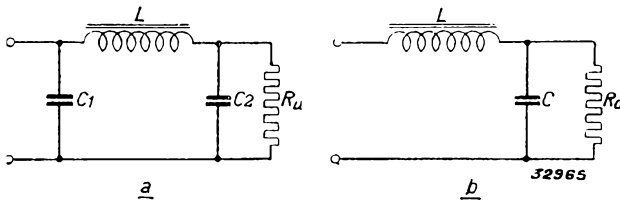

Fig. 1  
 a) Smoothing circuit commencing with a capacitor.  
 b) Smoothing circuit in which the first element is a choke.

Uniformity of the voltage on varying loads can be further increased by placing a choke of sufficiently high inductance first in the sequence of the smoothing circuit, instead of a capacitor. The direct voltage obtainable from a given alternating voltage is then certainly slightly lower, but it is at the

same time much less dependent on the load. The low internal resistance of the rectifier circuit therefore only comes into its own when the first element in the smoothing circuit is the choke; if a capacitor occupies this position the average value of the direct voltage with a low current rises almost to the peak value of the alternating voltage on the transformer, so that the direct voltage output is actually more dependent on the current delivered than might be concluded from the low internal resistance of the transformer and rectifying valve. The same thing applies when the smoothing circuit commences with a choke of insufficient inductance, only in this case it is due to the smoothing capacitor following the choke; the inductance of the choke must therefore exceed a certain minimum value which can be found very simply by means of the following formula:

$$L > \frac{R_a}{1000},$$

where  $L$  is the inductance of the choke in Henries and  $R_a$  the resistance of the external load in ohms ( $R_a = \frac{\text{direct voltage}}{\text{current delivered}}$ ).

It follows, then, that the choke must be larger according as the current delivered is less. The loading characteristics of gas-filled rectifying valves show that the voltage varies only very slightly as a result of very wide fluctuations in the current; at low values of the current the voltage does rise rather rapidly, but this is explained by the presence of the smoothing capacitor at the output side of the choke.

In a smoothing circuit commencing with a capacitor the internal resistance of the transformer should not be merely as low as possible, as the current surge passing through the valve during the time that the capacitor is charging then becomes too

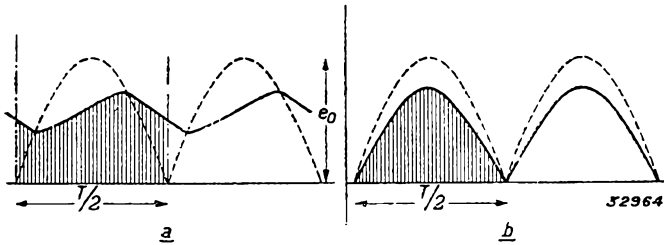

Fig. 2

- a) Direct voltage across the reservoir condenser in a full-wave rectifier circuit.  
 b) Direct voltage across the load resistance when no smoothing circuit or reservoir condenser is used.

In both figures the alternating transformer voltage is shown by a broken line. When the hatched areas in the two figures a) and b) are equal, the average direct voltage in both cases will also be equal.

the first-mentioned valve delivers 125 mA and the second 250 mA, D.C. The AX 1 is therefore suitable for amplifiers of which the output stage consists of two 4683 or 4694 valves, whilst the AX 50 will operate an amplifier using two 4654 valves (at 425 V) or 4699 valves (at 425 V); for larger amplifiers, half-wave gas-filled rectifying valves are supplied in the transmitting range, e.g., the DCG 1/150 or the DCG 4/4000. Details will be furnished on application.

great; when the choke is the first element in the circuit this does not apply.

For smaller amplifier equipment Philips are now supplying their AX 1 and AX 50, both of which are designed for use with a transformer giving a maximum of  $2 \times$  500 V on no load;

# AX 1 Full-wave gas-filled rectifying valve

The AX 1 is a full-wave gas-filled rectifying valve for use in the smaller class of amplifiers.

## FILAMENT RATINGS

Heating: direct, by A.C.  
 Filament voltage. . . . .  $V_f = 4.0$  V  
 Filament current. . . . .  $I_f = 2.4$  A

## MAXIMUM RATINGS

Secondary (A.C.) voltage of the power transformer on no load. . . . .  $V_{tr} = \text{max. } 2 \times 500$  V<sub>eff</sub>  
 D.C. output . . . . .  $I_o = \text{max. } 125$  mA  
 Voltage drop in the valve . . . . .  $V_{arc} = \text{max. } 15$  V

Capacitance of the capacitor across the input of the smoothing circuit . . .  $C = \text{max. } 64$   $\mu$ F  
 When a capacitor is connected across the input of the smoothing circuit:

The ohmic resistance in the D.C. circuit, with  $C = 64$   $\mu$ F . . . . .  $R_t = \text{min. } 200$  ohms  
 The ohmic resistance in the D.C. circuit, with  $C = 32$   $\mu$ F . . . . .  $R_t = \text{min. } 150$  ohms  
 The ohmic resistance in the D.C. circuit, with  $C = 10$   $\mu$ F . . . . .  $R_t = \text{min. } 100$  ohms

## KEY TO SYMBOLS

The ohmic resistance  $R_t$  in the D.C. circuit, when the smoothing circuit commences with a capacitor, constitutes the ohmic resistance of the secondary winding of the transformer together with that of the transformer primary, i.e.  $R_t = R_s + n^2 R_p$ . If the first component of the smoothing circuit is a choke, however, this resistance value must be augmented to the extent of the ohmic resistance of that choke:

$R_t = R_f + R_s + n^2 R_p$ . The voltage delivered may be calculated from the expression:  $V_o = 0.45 V_{tr} - I_o R_t - V_{arc}$ , in which  $V_{tr}$  is the effective alternating voltage of the secondary winding of the transformer, for example  $V_{tr} = 2 \times 500$  V. The inductance of the choke should be at least equal to  $\frac{R_a}{1,000}$  or  $\frac{V_o}{V_i}$  ( $V_o$  in volts and  $I_o$  in mA),

where  $I_o$  is taken to be the lowest value occurring; in an amplifier having two output valves in a balanced output stage, this will be the current flowing in the amplifier without excitation. From this it will be seen that with a 12-henry choke, the characteristics begin to flatten out only at  $I_o = 30$  mA approx. At lower current values the loading curves rise steeply, owing to the effect of the smoothing capacitor. A choke having a higher inductance will produce straight characteristics down to lower current values, for instances 42 henries — 10 mA.

Fig. 4 shows the loading characteristics of the AX 1 used in a circuit in which a capacitor is the first smoothing element, and comparison of these with the corresponding curves for a high vacuum valve such as the AZ 4 shows clearly that the former are

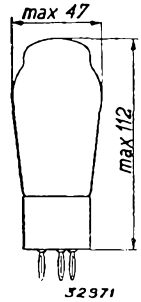

Fig. 1. Dimensions in mm.

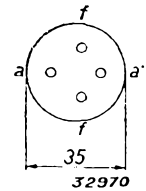

Fig. 2. Arrangement of electrodes and base connections

very much flatter with a low value of the internal resistance  $R_i$ ; also that the direct voltage is higher for the same alternating input. The direct voltages obtained from a smoothing circuit in which a capacitor is the first component are, further, higher than those in a circuit containing a choke as the first smoothing element.

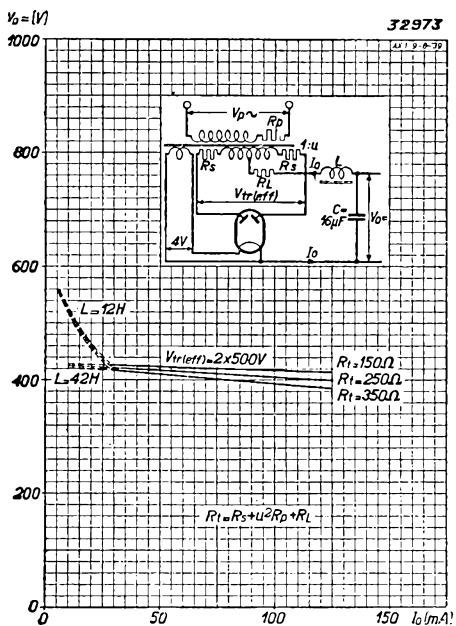

Fig. 3 Loading curves (D.C. voltage as a function of the current delivered) for various values of the resistance  $R_t = (R_L + R_s + n^2 R_p)$ , in a smoothing circuit commencing with a choke. The voltages at lower current values with a choke of 12 or 42 henries are shown by broken lines.

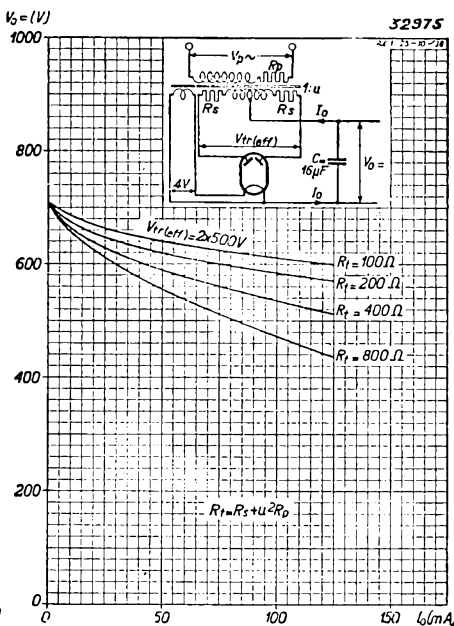

Fig. 4 Loading curves (D.C. voltage as a function of the delivered current) for various values of the total resistance  $R_t = (R_s + n^2 R_p)$ , in a smoothing circuit commencing with a capacitor.

# AX 50 Full-wave gas-filled rectifying valve

The AX 50 is a full-wave gas-filled rectifying valve for use in fairly large amplifier equipment.

## FILAMENT RATINGS

Heating: direct by A.C.

Heater voltage . . . . .  $V_f = 4$  V  
 Heater current . . . . .  $I_f = 3.75$  A

## MAXIMUM RATINGS

Secondary (A.C) voltage of the power transformer on no load. . . . .  $V_{tr} = \text{max. } 2 \times 500$  V<sub>eff</sub>  
 D.C. output . . . . .  $I_o = \text{max. } 250$  mA  
 Voltage drop in the valve . . . . .  $V_{acc} = \text{max. } 15$  V

Permissible capacitance of capacitor across input of the smoothing circuit:  $C = \text{max. } 64$   $\mu$ F

When a capacitor is connected across the smoothing circuit:

The ohmic resistance in the D.C. circuit, with  $C = 64$   $\mu$ F . . . . .  $R_t = \text{min. } 200$  ohms  
 with  $C = 32$   $\mu$ F . . . . .  $R_t = \text{min. } 150$  ohms  
 with  $C = 16$   $\mu$ F . . . . .  $R_t = \text{min. } 100$  ohms

For the correct operation of this valve reference should be made to the notes on the AX 1.

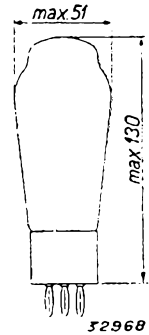

Fig. 1  
Dimensions in mm.

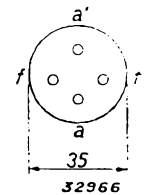
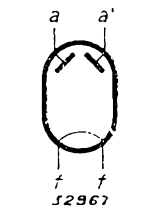

Fig. 2  
Arrangement of base connections and electrodes.

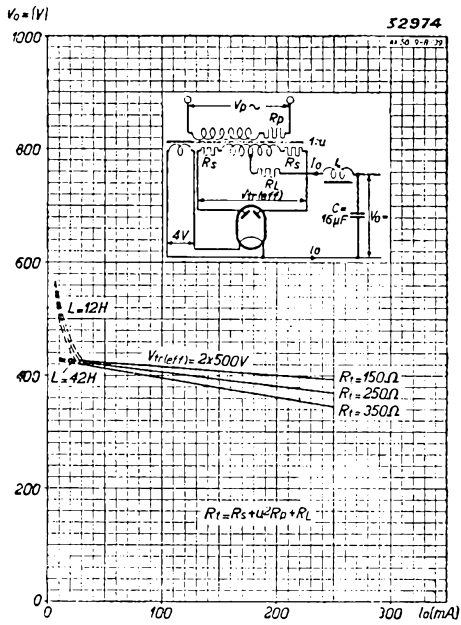

Fig. 3

Loading curves (direct voltage as a function of the output current) with respect to different values of the total resistance  $R_L = (R_L + I_Ls + u^2 R_p)$  in a smoothing circuit in which a choke is the first component. The voltage curves relating to lower values of current for chokes of 12 and 42 H are shown by the broken lines.

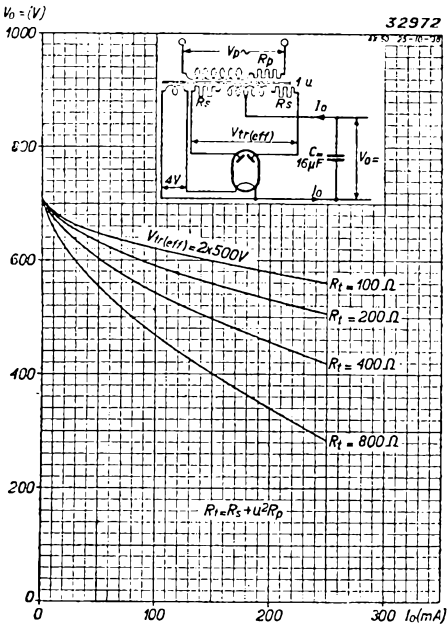

Fig. 4

Loading curves (direct voltage as a function of the output current) for different values of the total resistance  $R_L = R_L + I_Ls + u^2 R_p$  in a smoothing circuit in which the first component is a capacitor.

**OPERATING DATA: EF 9 used as resistance-coupled A.F. amplifier with controlled amplification**

(in amplifiers or A.C. receivers)

Supply voltage	Anode coupling res.	Screen series res.	Cathode res.	Control voltage on control grid	Anode current	Screen current	Alternating input volts	Alternating output volts	Voltage gain	Total distortion.
$V_b$ (V)	$R_a$ (M ohm)	$R_{g_2}$ (M ohm)	$R_k$ (ohm)	$V R$ (V)	$I_a$ (mA)	$I_{g_2}$ (mA)	$V_i$ (Veff)	$V_o$ (Veff)	$\frac{V_o}{V_i}$	$d_{tot}$ (%)
250	0.2	0.8	1,750	0	0.87	0.26	0.028	3	106	0.8
250	0.2	0.8	1,750	-5	0.69	0.21	0.075	3	40	0.8
250	0.2	0.8	1,750	-10	0.55	0.17	0.13	3	23	1.1
250	0.2	0.8	1,750	-18	0.37	0.11	0.27	3	11.6	1.5
250	0.2	0.8	1,750	-25	0.17	0.05	0.45	3	6.7	2.7
250	0.2	0.8	1,750	0	0.87	0.26	0.047	5	106	2.4
250	0.2	0.8	1,750	-5	0.69	0.21	0.125	5	40	2.4
250	0.2	0.8	1,750	-10	0.55	0.17	0.22	5	23	1.9
250	0.2	0.8	1,750	-18	0.37	0.11	0.42	5	11.6	2.4
250	0.2	0.8	1,750	-25	0.17	0.05	0.75	5	6.7	4.4
250	0.2	0.8	1,750	0	0.87	0.26	0.094	10	106	2.7
250	0.2	0.8	1,750	-5	0.69	0.21	0.25	10	40	2.7
250	0.2	0.8	1,750	-10	0.55	0.17	0.43	10	23	3.7
250	0.2	0.8	1,750	-18	0.37	0.11	0.86	10	11.6	4.8
250	0.2	0.8	1,750	-25	0.17	0.05	1.46	10	6.7	8.8
250	0.1	0.4	1,000	0	1.6	0.45	0.035	3	85	0.8
250	0.1	0.4	1,000	-5	1.22	0.36	0.083	3	36	0.8
250	0.1	0.4	1,000	-10	0.92	0.28	0.15	3	20	1.2
250	0.1	0.4	1,000	-18	0.57	0.18	0.33	3	9.2	1.8
250	0.1	0.4	1,000	-25	0.36	0.11	0.55	3	5.5	2.8
250	0.1	0.4	1,000	0	1.6	0.45	0.059	5	85	1.3
250	0.1	0.4	1,000	-5	1.22	0.36	0.14	5	36	1.4
250	0.1	0.4	1,000	-10	0.92	0.28	0.25	5	20	2.1
250	0.1	0.4	1,000	-18	0.57	0.18	0.55	5	9.2	3.1
250	0.1	0.4	1,000	-25	0.36	0.11	0.91	5	5.5	4.8
250	0.1	0.4	1,000	0	1.6	0.45	0.118	10	85	2.5
250	0.1	0.4	1,000	-5	1.22	0.36	0.28	10	36	2.7
250	0.1	0.4	1,000	-50	0.92	0.28	0.49	10	20	4.1
250	0.1	0.4	1,000	-18	0.57	0.18	1.08	10	9.2	6.1
250	0.1	0.4	1,000	-25	0.36	0.11	1.83	10	5.5	9.5

*Note.* The values for the voltage gain relate to cases where the grid leak of the next valve is 0.7 megohm. The control voltage on the grid must not be interchanged with the grid bias, which consists of the control voltage augmented by the voltage drop across the cathode resistor.



# **Current regulators and stabilizers**

# Current regulator tubes (Barretters)

When the heaters of the receiving and rectifying valves in a receiver are connected in series, fluctuations in the mains voltage will produce under- and over-heating of the filaments very much more quickly than when the heaters are arranged in parallel. The reason for this is that, primarily, there is usually a resistor in series with the heaters, to reduce the supply voltage to the sum of the heater voltages. When the mains voltage rises, the current increases, as does also the resistance of the heaters, so that the current does not increase as quickly as the voltage; the resistor included in the heater circuit does not show an appreciable increase in value, however, seeing that, owing to the presence of this resistor, the increase in the total resistance is less than if the heater circuit consisted of heaters only. In A.C./D.C. receivers the heaters, with the resistor in series with them, are therefore subjected to a heavier strain than the heaters of A.C. sets which are usually connected in parallel, and it is a very much better procedure in such cases to employ a current regulator tube, or barretter, in series with the heaters instead of a resistor.

These barretters comprise an iron wire suspended in a bulb containing hydrogen, and they possess the particular feature that the resistance of the iron wire increases to such an extent on an increasing voltage that the current remains practically constant. In certain cases the current will even tend to diminish, but this applies only to a certain range of voltages.

When one of these tubes is included in the heater circuit of a receiver, the heater current, within certain voltage limits, is maintained at a constant level, this being all to the good for the valves from the point of view of their life. The use of a barretter is particularly important in A.C./D.C. receivers since, due to under-heating, the internal resistance of the rectifying valve and consequently also the voltage loss in the latter increase very considerably; the anode voltage, which will have dropped as a result of the decrease in the mains voltages, is thus further reduced.

The voltage range within which the heater current is kept constant is in certain circumstances so wide that the heater circuit of the receiver can be connected directly to mains voltages of very different values, e.g., 220 and 170 V.

A factor to be taken into account is the current surge occurring when the receiver is switched on, the valves being in the cold condition; if this surge is too great, the life of the barretter will be endangered and it is therefore usual to include a resistor in series with the tube, to limit the surge. Taking the simplest case, this resistor might consist of the heaters of the receiving valves themselves, whose resistance value in the cold condition is about  $\frac{1}{7}$ th to  $\frac{1}{10}$ th of the value when hot. In this connection, Philips quote for their barretters both the maximum voltage that may occur in the tube when the set is switched on, and the minimum total heater voltage of the receiving valves with which the tube is in series.

The minimum total heater current of the valves thus represents the minimum resistance which must be in series with the barretter when

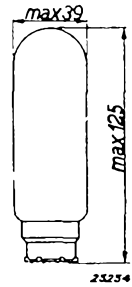

Fig. 1  
Dimensions of  
barretters C 1, C 3  
and C 8 in mm.

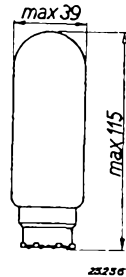

Fig. 2  
Dimensions of  
barretters C 2, C 9  
and C 10 in mm.

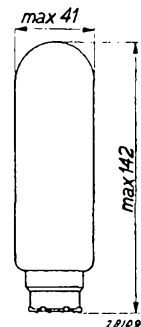

Fig. 3  
Dimensions of  
the barretter C 12  
in mm.

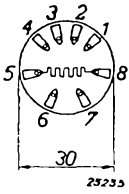

Fig. 4  
Base connections of  
the C 1 and C 2.

the "cold" receiver is switched on. In the case of the C 1, for instance, the minimum total heater voltage of the receiving valves in the working condition must be 52 V; the resistance of the hot valves is then  $\frac{52}{0.2} = 260$  ohms and in the cold condition about  $\frac{1}{7} \times 260 = 37$  ohms. In this instance the mains voltage must not exceed 250 V. At lower mains voltages the surge is smaller, which fact can be taken into account. If the sum of the heater voltages of the particular valves used is less than the minimum total heater voltage it may be advisable to include a small resistance in series with the valves, to augment the resistance of the latter in the cold condition.

Any pilot lamp in series with the valve heaters is especially likely to suffer as a result of surges; the ordinary pilot lamp is normally quite useless for this type of receiver, as it burns out too quickly, and special lamps have to be employed. The current surge on the pilot lamps will always be greatest when a receiver, fitted with a large number of valves, is operated on a low mains voltage and may even reach seven times the amount of current consumed under normal working conditions. Less stringent requirements are placed upon the pilot lamp when a current regulator such as the C 1 or C 2 is employed.

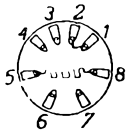

Fig. 5  
Base connections of  
the C 3 and C 8. Contacts 1 and 2 are connected together so that A.C./D.C. receivers can be switched for high voltage mains.

In order to eliminate the surge entirely, barretters have been designed incorporating a built-in resistor apart from the resistance wire; the value of this limiting resistor at, say, 20° (i.e. when cold) will be 2,000 ohms and when hot (300°) 100 ohms. When the receiver is switched on the resistance consists mainly of the limiter resistor (2,000 ohms), the electrical energy being there converted to heat. The time required to raise this resistor to its "hot" temperature is sufficient also for the wire in the barretter to heat up, so that, by the time the value of the limiter has reached its lowest resistance the barretter is able to absorb the whole of the surplus voltage arising from the fact that the more tardy cathodes of the receiving valves are by then not sufficiently hot. The pilot lamp is then not overloaded when the receiver is switched on, and an ordinary 200 mA lamp may be used.

The presence of a limiting resistor has the effect of reducing slightly the range of control of the barretter, but not to such an extent as to impair the practical uses of these tubes, and Figs 9 and 10 illustrate the action of the barretter with built-in resistor, in limiting the surge.

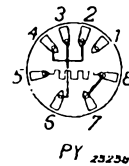
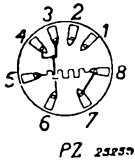

Fig. 6  
Base connections of  
the C 10. Contacts 2, 3, 4 and 6, as well as 7 and 8 are shorted so that A.C./D.C. receivers may be switched for operation on low voltage mains.

When D.C. receivers are operated on different mains voltages, it is usually sufficient to change the resistor in series with the valve heaters; the resistors in the cathode, screen-grid and anode circuits need not be changed as these are generally of such a value that the valves will be operating at their specified voltages when used on 220 V mains. On a lower voltage, however, of say 110 V, the screen resistors are no longer of the correct value and the receiver would be operating on lower voltages than those which would give the best results.

In A.C./D.C. receivers this simple solution is not applicable, since many A.C. mains are of lower voltage (127 V) and it is necessary to ensure that the set will work properly when operated on these as well. In order to obtain satisfactory performance and output when

# Barretters



**Fig. 7**  
Base connections of the C 9. Contacts 3, 4, and 6, also 7 and 8 are shorted to enable A.C./D.C. receivers to be adapted for low mains voltages.

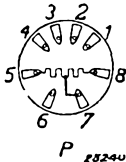

**Fig. 8**  
Base connections of the C 12. For high mains voltages contacts 5 and 8 are used; for low voltages contacts 5 and 7, i.e., switching should be provided between 7 and 8.

Barretter C 2 with PY base is known as the C 10, and with PZ base as the C 9. There is also a tube having two different

changing over to lower voltage mains, it is necessary not only to change the barretter in the heater circuit but also to short-circuit some of the resistors in the anode and screen circuits, and readjust the matching of the speaker transformer; fig. 11 shows how these changes may be made. Here, all the screens are fed from a common resistor  $R_1$ , to reduce the potential to 100 V with high voltage mains; further, a resistor  $R_2$  is placed in series with the screen grid of the output valve to lower the already reduced voltage to 75 V for the CL 2, or 83 V for the CL 6. It is not necessary to modify the value of the cathode resistors. When the receiver is to be used on low mains voltages both the resistors  $R_1$  and  $R_2$  are short-circuited; resistor  $R_3$ , which serves to protect the rectifying valve when the set is working on high voltage, is also shorted on low voltage in order that full use may be made of the available potential. The matching impedance is usually changed by altering the anode voltage (for the CL 6,  $V_a = 100$  V,  $R_a = 2,000$  ohms, or  $V_a = 200$  V,  $R_a = 4,500$  ohms) and provision must therefore also be made for changing the ratio of the output transformer.

By suitably linking up certain contacts on the base of the barretter which would otherwise not be used, all the resistors in question can be short-circuited and the output transformer suitably strapped, simultaneously. Barretters for high voltages are supplied with a shorting link between contacts 1 and 2, the base in this case being known as type PX (Fig. 5); the base for low mains barretters is the PY (Fig. 6) and that in which the connection to contact 2 is omitted is type PZ (Fig. 7).

For high mains voltages Philips also supply a barretter without a limiting-resistor fitted with a P-type base having no shorting links. Another, similar type for low voltages is also supplied. These are the C 1 (high voltage) and C 2 (low voltage).

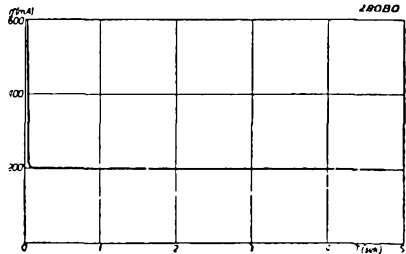

**Fig. 9**  
Heater current as a function of time after switching on a receiver, the valve heaters being in series with a barretter without a limiting resistor.

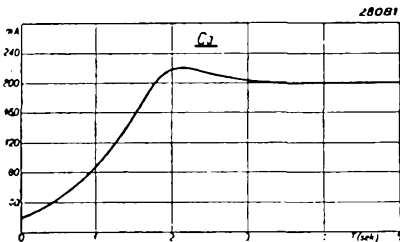

**Fig. 10**  
Heater current as a function of time, after switching on a receiver of which the valve heaters are in series with a barretter fitted with a limiting resistor.

internal resistance wires, one having the properties of the C 1 and the other those of the C 2 and, needless to say, this tube has no shorted contacts on the base. As the regulating range of barretters with limiting resistor is slightly smaller than otherwise, several of these tubes are required in order to cover all possible mains voltages. However, with a view to limiting the number

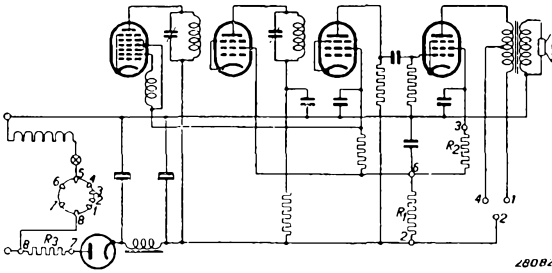

Fig. 11

Circuit diagram showing method of switching A.C./D.C. receivers from 220 V to 110 or 127 V mains, using barretters for high and low voltages. The numbers of the different points in the diagram correspond to those indicated on the base of the barretter.

200 mA Barretters

	Without resistor to limit the surge						With limiting resistor
	C 1	C 2	C 8	C 9	C 10	C 12	C 3
Controlled current . . .	0.200	0.200	0.200	0.200	0.200	0.200	0.200 A
Control range. . .	80-200	35-100	80-200	35-100	35-100	80-200	100-200V
Maximum working voltage. . .	200	100	200	100	100	35-100	200 V
Max. voltage across barretter on switching on the receiver . . . . .	250 <sup>1)</sup>	160 <sup>2)</sup>	250 <sup>1)</sup>	160 <sup>2)</sup>	160 <sup>2)</sup>	250 <sup>1)</sup> 160 <sup>2)</sup>	250 V <sup>1)</sup>
Dimensions. . .	Fig. 1	Fig. 2	Fig. 3	Fig. 2	Fig. 2	Fig. 3	Fig. 1
Base. . . . .	P 30	P 30	P 30 X	P 30 Z	P 30 Y	P 30	P 30 X
Base connections	Fig. 4	Fig. 4	Fig. 5	Fig. 7	Fig. 6	Fig. 8	Fig. 5
Curves. . . . .	Fig. 12	Fig. 13	Fig. 15	Fig. 16	Fig. 17	Fig. 18	Fig. 14

<sup>1)</sup> The total heater voltage of the receiving valves connected in series with the barretter must be at least 52 V.

<sup>2)</sup> The total heater voltage of the receiving valves connected in series with the barretter must be at least 74 V.

The rectangles shown in dotted lines in the following characteristics indicate the tolerances on the current as regulated by the barretters and the voltage limits on the range of control.

# Barretters

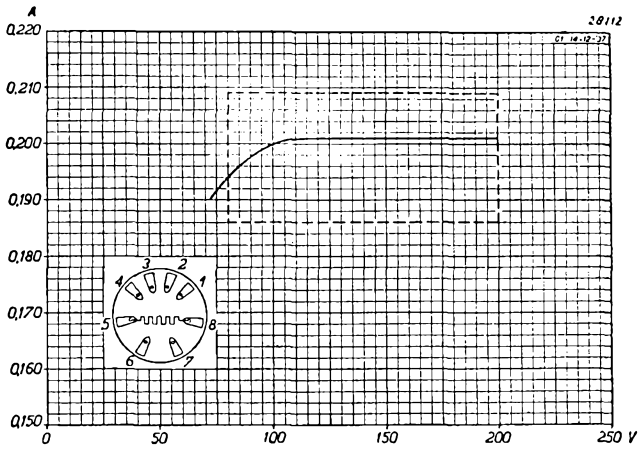

Fig. 12  
Current as a function of the voltage across the C 1

Fig. 13  
Current as a function of the voltage across the C 2.

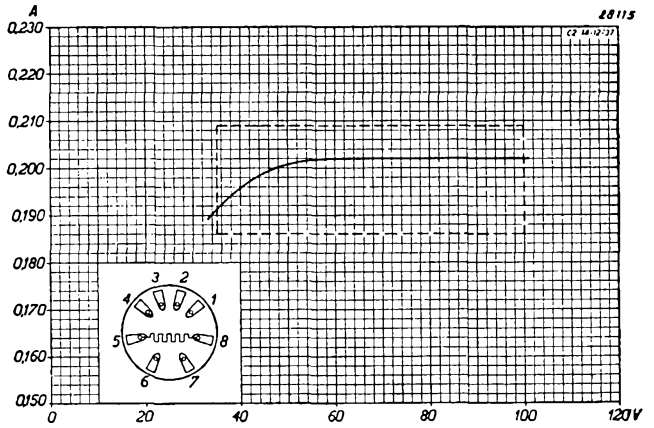
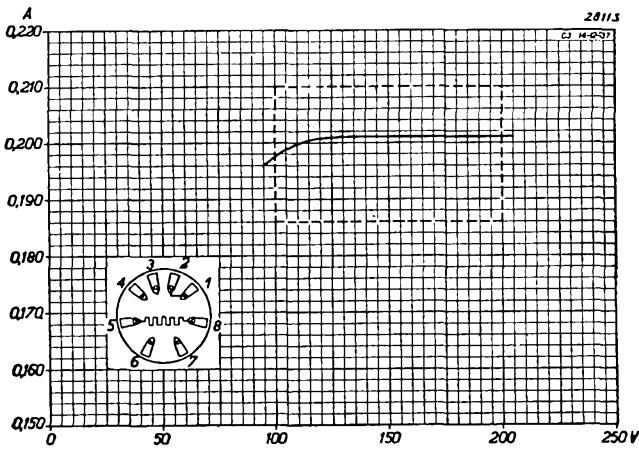

Fig. 14  
Current as a function of the voltage across the C 3.



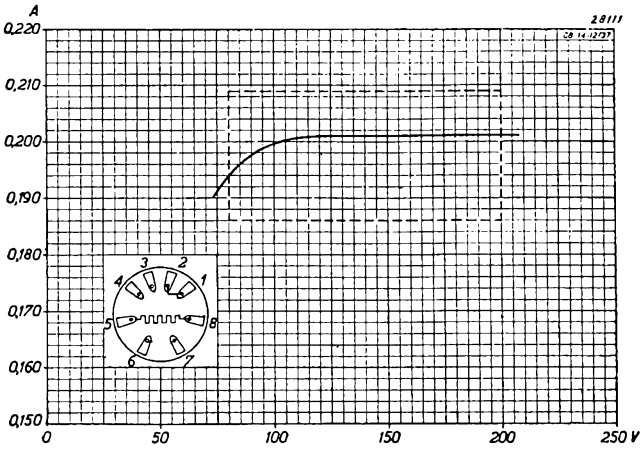

Fig. 15  
Current as a function of  
the voltage across the C 8.

Fig. 16  
Current as a function of  
the voltage across the C 9.

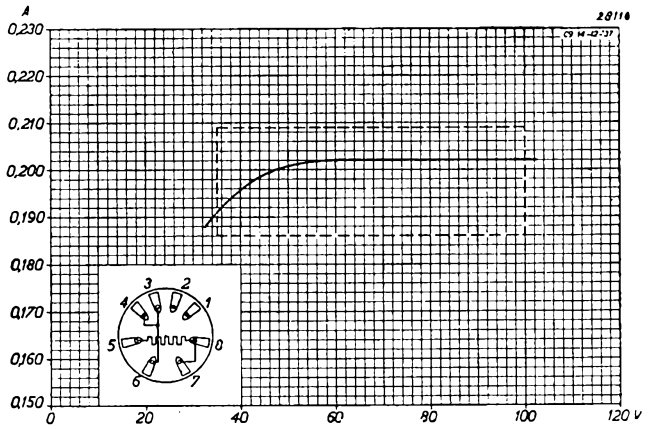
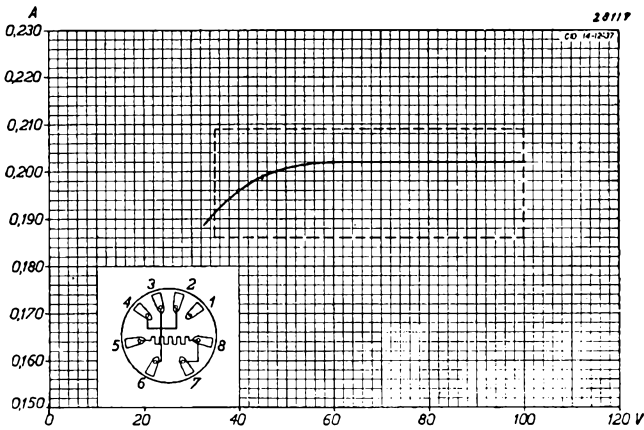

Fig. 17  
Current as a function of  
the voltage across the C 10.



# Barretters

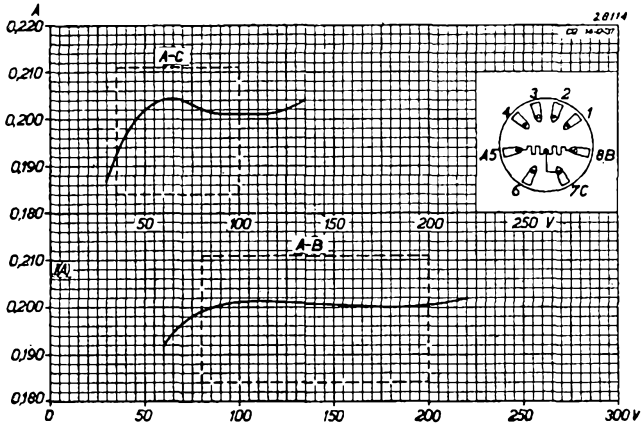

Fig. 18

*Upper diagram.* Current as a function of the voltage across the section A-C of the resistance wire of the tube C 12.  
*Lower diagram.* Current as a function of the voltage across the section A-B of the resistance wire of the tube C 12.



# Stabilizing tubes

Stabilizers are used in all cases where it is necessary to keep the voltage in a receiver or component thereof as constant as possible, so that the latter may be sufficiently independent of the current consumption and of fluctuations in the applied mains or battery voltage; in this way the fixed grid bias of an amplifier or measuring instrument may be stabilized.

The neon stabilizer tube depends for its action on the fact that the current flowing through it rises rapidly as the voltage is increased. When the voltage is applied to the tube through a resistor, the rise in current produces a corresponding increase in the voltage drop across that resistor, thus partly neutralizing the increase in potential; in many instances the internal resistance of the voltage source is sufficient to provide a stabilizing effect, in which case the resistor may be dispensed with.

Fluctuating loads produce voltage variations in the series resistor, which in turn are compensated by variations in current in the neon tube. To ensure effective stabilization, small voltage variations on the tube must occasion the greatest possible variations in current, and the ratio of the voltage increase to the corresponding current increase in the tube is known as the A.C. resistance. The latter should be as low as possible, being actually about 250 ohms in the case of the tube type 4687, so a voltage increase of 2.5 V on the tube will produce an increase in the current of 10 mA. The D.C. resistance indicates the relationship between the current through and the voltage across the tube.



Fig. 1  
Arrangement of electrodes in a neon stabilizer tube.

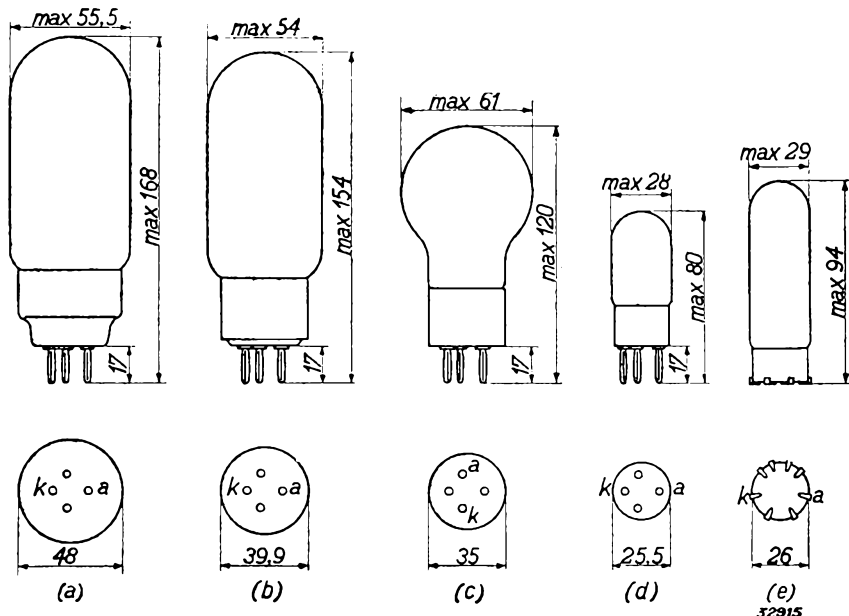

Fig. 2  
Dimensions in mm. and base connections of the various Philips Neon Stabilizers.  
a) Type 100 E 1      c) Type 4357      e) Type 4687  
b) Type 13201      d) Type 7475

## Stabilizers

The 4687, with 90 V, will pass a current of 20 mA and the D.C. resistance is therefore 4,500 ohms.

A neon tube has to be "started up" by an "ignition" voltage, which is in every case higher than the normal working voltage, and precautions must be taken to ensure that when the switch is closed the receiver does not take so much current that the voltage drop across the series resistor prevents the tube from igniting. The "quenching" voltage must also be borne in mind; at a given voltage, which is somewhat lower than the working voltage, the discharge is quenched and re-ignition will take place only when the load has decreased to the extent where the voltage on the tube is once more equal to the ignition voltage. When the tube has been quenched, therefore, there will be a period during which no stabilization takes place.

A rectifier provided with one of these stabilizers may be looked upon as a source of voltage of very low internal resistance, since the voltage at the terminals of the stabilizer is independent of the load and remains practically constant. It follows, then, that a stabilized rectifier will tend to reduce R.F. or A.F. coupling through the medium of the internal resistance. Further, the neon tube improves the smoothing

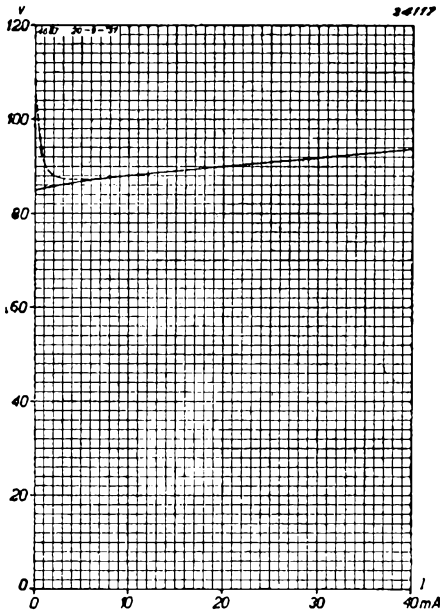

Fig. 3  
Voltage-current curve of the 4687.

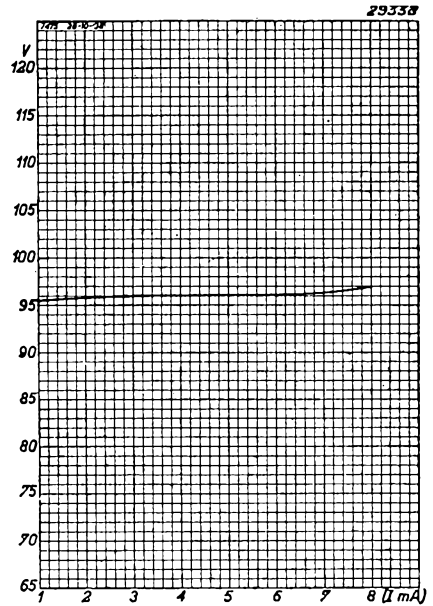

Fig. 4  
Voltage-current curve of the 7475.

of the rectified voltage, because voltage variations arising from the ripple are also stabilized.

Admittedly, the A.C. resistance of the neon tube increases with the frequency, but at normal mains frequencies it will not deviate to any great extent from the published value.

If the voltage to be stabilized is very much higher than the tube voltage a number of tubes may be connected in series with each other, in which case, however, at least one of them must be shunted by a fairly high resistor, say 0.1 megohm; otherwise the tubes will not ignite (see Fig. 8).

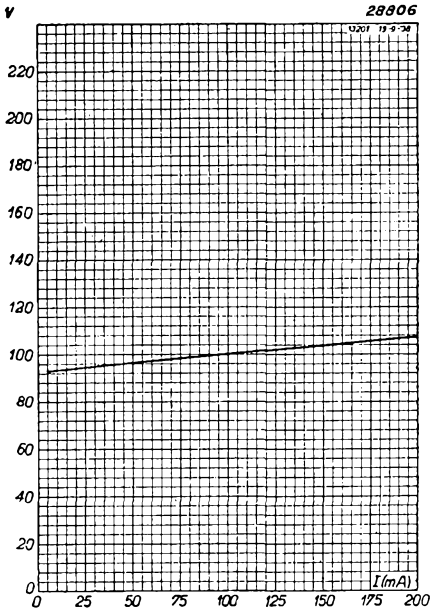

Fig. 5  
Voltage-current characteristic of the 13201.

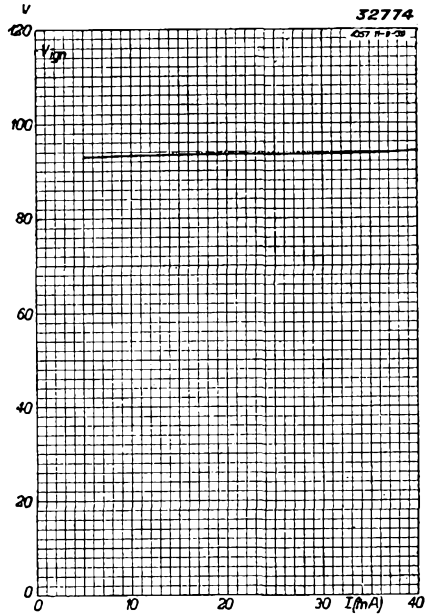

Fig. 6  
Voltage-current characteristic of the 4357.

It should be noted here that neon tubes are used for stabilizing D.C. voltages only; further, these tubes must never be connected in parallel to stabilize heavy currents. Owing to the unavoidable circumstance that the ignition voltage varies between one tube and another, the tube having the lowest ignition voltage would start up first

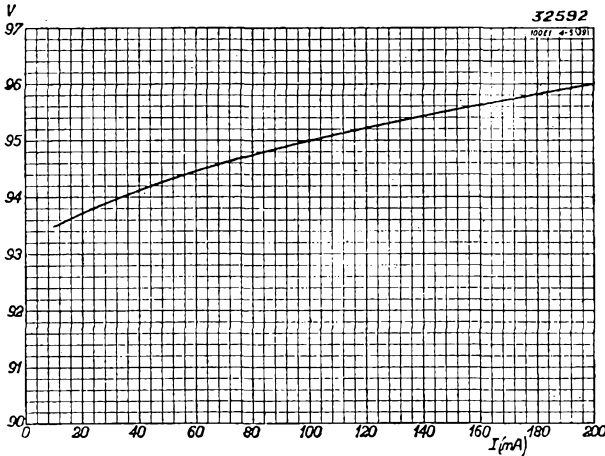

Fig. 7  
Voltage-current characteristic of the 100 E 1.

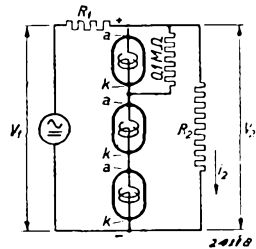

Fig. 8  
Three neon tubes connected in series to stabilize approximately 270 V. The output circuit is represented by the resistor  $R_2$ , passing a current  $I_2$  at a voltage  $V_2$ .  $V_1$  is the D.C. voltage source with superimposed alternating voltage (voltage fluctuations), and  $R_1$  is the internal or series resistance of the voltage source. A resistor of 0.1 megohm is connected across one of the tubes to enable ignition to take place.

## Stabilizers

and immediately consume current, thus reducing the voltage across the other tubes in parallel with it, which would thus have no further chance of ignition.

Philips make five different types of neon voltage stabilizers suitable for use in large or small equipment and the working values of these tubes have been so selected as to provide a tube for almost any conceivable project. The general data are as given in the following table:

### DETAILS OF PHILIPS STABILIZING TUBES

Type	Dim. and Base connections	Base	Operating voltage at stated quiescent current (V)	Maximum starting voltage (V)	Quiescent current <sup>1)</sup> (mA)	Upper current limit for stabilization (mA)	Lower current limit for stabilization (mA)	Max. A.C. resistance (ohms)
4357	Fig. 2c	A 35	85—100	125	20	40	10	75
4687	Fig. 2c	P 26	85—100	115	20	40	10	250
7475	Fig. 2d	A 25.5	90—110	140	4	8	1	700
13201	Fig. 2b	A 48	90—110	140	100	200	15	90
100 E 1	Fig. 2a	A 40	90—105	140	125	200	50	30

<sup>1)</sup> To ensure a reasonable life, the specific average value for the current passing through the tube should not be exceeded.

Philips neon stabilizers are “burned” or screened first on A.C. and then on D.C.; it is recommended that the negative pole of the voltage source be connected to the electrode indicated as cathode and the positive pole to the anode.

# Tables

of data regarding other "Miniwatt" Receiving and  
Rectifying Valves, Philips Cathode-Ray Tubes,  
Photo-electric Cells, Thermo-couples  
and special tubes.

AC/DC VALVES WITH SIDE

Type	Class (application in parenthesis)	Max. dim.  mm	Base (connec- tions in paren- thesis)	Heater ratings			Anode volts  Va V	Anode cur- rent  Ia mA	Grid bias  Vg <sub>1</sub> V
				Heat- ing	Heater volts  V	Heater cur- rent  A			
CB1	Double-diode (13)	89 × 30	V22 (67)	indir.	13	0.200	—	—	—
CB2	Double-diode (13)	85 × 29	V24 (66)	indir.	13	0.200	—	—	—
CBC1	Double-diode triode (9)	100 × 37	P30 (30)	indir.	13	0.200	200	4.0	—5.5
							100	2.0	—2.5
							Vb=200 <sup>1)</sup>	0.39	—
							Vb=200 <sup>1)</sup>	0.20	—
CC2	Triode (3, 6, 10, 11)	100 × 37	P30 (28)	indir.	13	0.200	200	6	—4
							100	2	—2.5
CF2	R.F. vari-mu pentode (1, 2)	109 × 42	P30 (41)	indir.	13	0.200	200	4.5 —	—2 —22
							100	4.5 —	—2 —22
CF3	R.F. vari-mu pentode (1, 2)	106 × 43	P30 (41)	indir.	13	0.200	200	8.0 —	—3 —55
							100	8.0 —	—3 —55
CF7	R.F. pentode (1, 2, 7, 8, 11)	106 × 43	P30 (41)	indir.	13	0.200	200	3	—2
							100	3	—2
							Vb=200 <sup>1)</sup>	0.98	—
							Vb=100 <sup>1)</sup>	0.50	—
CK1	Octode (4)	116 × 46	P35 (48)	indir.	13	0.200	200	1.6 —	—11 <sup>9)</sup>
							100	1.6 —	—11 <sup>9)</sup>
CL2 <sup>4)</sup>	Output pentode (12)	123 × 46	P35 (36)	indir.	24	0.200	200	40	—19
							200	40	—11
							100	50	—15

KEY TO THE FIGURES REPRESENTING THE APPLICATION  
IN THE "CLASS" COLUMN

- 1 = R.F. amplifier
- 2 = I.F. amplifier
- 3 = Oscillator
- 4 = Frequency changer (oscillator modulator)
- 5 = Modulator
- 6 = Grid det. with transf. coupling
- 7 = Grid det. with resistance coupling
- 8 = Anode det. with resistance coupling

- 9 = Diode det. with A.F. amplification
- 10 = A.F. amplifier with transf. coupling
- 11 = A.F. amplifier with resistance coupling
- 12 = Output amplifier
- 13 = Diode detector
- 14 = Electronic Indicator
- 15 = Balanced output amplifier without grid current
- 16 = Balancee output amplifier with grid current

CONTACT (P) BASE

Cathode res. (appr.)	Screen-grid volts	Screen-grid current	Grid 3 (and 5) volts	Grid 4 volts	Mut. cond.	Amplification factor	Intern. res.	Extern. anode res. or optim. matching res.	Max. output power with 10% dist.	Altern. grid voltage for max. output	Max. anode diss.	Anode to grid capac.	Type
Rk ohms	Vg <sub>2</sub> V	Ig <sub>2</sub> mA	Vg <sub>3</sub> (±) V	Vg <sub>4</sub> V	S μA/V	μ	Ri ohms	Ra ohms	Wo W	Vi Veff	Wa W	Cag <sub>1</sub> μμF	
—	—	—	—	—	—	—	—	—	—	—	—	—	CB1
—	—	—	—	—	—	—	—	—	—	—	—	—	CB2
—	—	—	—	—	2,000	27	13,500	—	—	—	—	—	CBC1
—	—	—	—	—	1,800	27	15,000	—	—	—	—	—	
12,500	—	—	—	—	—	$\frac{V_o}{V_i} = 18^2$	—	$0.2 \times 10^6$	—	—	1.5	—	
12,500	—	—	—	—	—	$\frac{V_o}{V_i} = 17^2$	—	$0.2 \times 10^6$	—	—	—	—	CC2
—	—	—	—	—	2,500	30	12,000	—	—	—	2	1.7	
—	—	—	—	—	1,800	30	16,000	—	—	—	—	—	CF2
340	100	1.4	0	—	$\frac{2,200}{<2}$	—	$\frac{1.4 \times 10^6}{>10^7}$	—	—	—	1.5	<0.003	
340	100	1.4	0	—	$\frac{2,200}{<2}$	—	$\frac{0.4 \times 10^6}{>10^7}$	—	—	—	—	—	CF3
285	100	2.6	0	—	$\frac{1,800}{<2}$	—	$\frac{0.9 \times 10^6}{>10^7}$	—	—	—	2	<0.003	
285	100	2.6	0	—	$\frac{1,800}{<2}$	—	$\frac{0.25 \times 10^6}{>10^7}$	—	—	—	—	—	CF7
490	100	1.1	0	—	2,100	4,000	$2.0 \times 10^6$	—	—	—	—	—	
490	100	1.1	0	—	2,100	1,500	$0.7 \times 10^6$	—	—	—	—	—	
4000	Rg <sub>2</sub> = 0.25 M Ohm	0.30	0	—	—	$\frac{V_o}{V_i} = 135^2$	—	$0.2 \times 10^6$	—	—	1	<0.003	
4000	Rg <sub>2</sub> = 0.25 M Ohm	0.15	0	—	—	$\frac{V_o}{V_i} = 110^2$	—	$0.2 \times 10^6$	—	—	—	—	CK1
—	90	$\frac{2^2}{—}$	70	$\frac{-1.5}{-25}$	$\frac{600^2}{<2}$	—	$\frac{1.5 \times 10^6}{>10^7}$	—	—	—	0.5	<0.06*	
—	90	$\frac{2^2}{—}$	70	$\frac{-1.5}{-25}$	$\frac{550^2}{<2}$	—	$\frac{1.0 \times 10^6}{>10^7}$	—	—	—	—	—	CL2 †)
420	100	5	—	—	3,100	—	23,000	5,000	3.0	8.8	—	—	
247	75	4.5	—	—	3,700	—	19,000	5,000	2.5	6.9	8	<1.5	
258	100	8	—	—	3,800	—	16,000	2,000	1.7	9.4	—	—	

1) H.T. supply voltage. Details in this column referred to resistance-coupled A.F. amplification.

2) Stage gain (alternating anode volts/alternating grid volts).

3) Screen series resistor.

4) Suitable only for series-heater supply

5) Conversion conductance.

6) Negative volts provided by grid leak of 50,000 ohms during oscillation, with a grid current of 190 μA (Vosc = 8.5 Veff).

7) Screen current Ig<sub>3</sub> + Ig<sub>2</sub> = 3.8 mA.

8) Capacitance between anode and grid 4.

For base connections see pp. 310-313.

### THERMO-COUPLES

Type	Approx. 12 mV EMF at a heater current of: mA	Indication varies proportionally with the square of the heater current and is accurate to 2 % up to: mA	Max. current through heater wire	Short over- load current through heater wire	Resistance of heater wire (approx.)	Resistance of thermo- couple (approx.)
			mA	mA	ohms	ohms
TH 1	10	5	15	20	75	5.5
TH 2	20	10	30	40	23	3.0
TH 3	40	20	75	100	7.3	3.0
TH 4	100	50	150	200	2.2	3.0
TH 5	200	100	300	350	1.1	3.0

F = Connections of  
heater wire

+E = thermo-couple  
pos. pole

E = thermo-couple  
neg. pole



### NEON INDICATOR TUBE

Type	Diam. exclud. pins	Base (connec- tions in parenthesis)	Ignition volts on aux. anode	Working volts on main anode	Main anode current with cathode fully lighted	Aux. anode current
	mm		V <sub>a2</sub> V	V <sub>a1</sub> V	I <sub>a1</sub> mA	I <sub>a2</sub> μA
4662	98 × 13	small 4-pin (XXII)	165—190	150—170	2	40—50

### AMPLIFYING VALVES FOR

Type	Application	Maximum dimensions without pins mm	Base (connections in parenthesis)	Heater ratings		
				Heat- ing	Heater volts V	Heater current A
4060	Electrometer triode	142 × 58	H 35 (XVII)	dir.	0.7	0.7
E1C (4671)	Triode for U.S.W. receivers (Button valve)	35 × 30	without base (XVIII)	indir.	6.3	0.15
E1F (4672)	Pentode for U.S.W. receivers (Button valve)	48 × 30	without base (XIX)	indir.	6.3	0.15
4673	Pentode for measuring instruments	121 × 47	P 30 (XIII)	indir.	4.0	1.35
4674	Diode for measuring instruments	35 × 30	without base (XX)	indir.	6.3	0.15
E2F (4695)	Vari-mu pentode for U.S.W. (Button valve)	48 × 30	without base (XIX)	indir.	6.3	0.15
C408	Triode for valve voltmeters and other measuring instruments	94 <sup>1)</sup> × 48	A 35 (XVI)	dir.	4.0	0.25

<sup>1)</sup> Without top cap.

<sup>2)</sup> Max. peak A.C. voltage.

For base connections



## BARRETTERS

	Type	Max. dim. <sup>1)</sup> mm	Base (Connections in parenthesis)	Voltage control range	Max. voltage	Current	Admissible voltage when switching on V
				V	V	mA	V
For indirectly- heated D.C. valves.	<b>1926</b>	119 × 35	A32 (7)	8—26	—	180	120 <sup>2)</sup>
	<b>1927</b>	120 × 40.5	A35 (7)	40—120	—	180	150 <sup>2)</sup>
	<b>1928</b>	120 × 40.5	A35 (7)	80—240	—	180	240 <sup>2)</sup>
For directly- heated D.C. valves	<b>1904</b>	92 × 39	A32 (7)	30—80	—	100	—
	<b>1911</b>	93 × 39	A32 (7)	30—80	—	150	—
	<b>1915</b>	115 × 38	A32 (7)	50—70	—	240	—
	<b>1920</b>	115 × 38	A32 (7)	50—70	—	250	—
For indir. heated valves	<b>1941</b>	140 × 50	A35 (7)	80—200	200	300	—
	<b>1949</b>	95 × 38	A35 (7)	25—75	90	300	—
	<b>1910</b>	92 × 35	H32 (16)	5—15	—	1400	—

<sup>1)</sup> Without pins.

<sup>2)</sup> The total heater voltage of the receiving valves in series with the barretter must be at least 94 V.

## SPECIAL PURPOSES

Anode volts V <sub>a</sub> V	Anode current I <sub>a</sub> mA	Grid bias V <sub>g1</sub> V	Screen volts V <sub>g2</sub> V	Volts grid 3 V <sub>g3</sub> V	Screen current I <sub>g2</sub> mA	Mut. cond. S mA/V	Ampli- fication factor μ	Int. res. Ri ohms	Cur- rent 1st grid I <sub>g1</sub> μA	Anode to grid cap. C <sub>ag1</sub> pF	Grid cap. C <sub>g1</sub> pF	Anode cap. C <sub>a</sub> pF	Type
4	—	—2.5	—	—	—	0.028	approx. 0.5	—	<10 <sup>-11</sup>	—	—	—	4060
180	4.5	—5	—	—	—	2.0	25	12,500	—	1.4	1.0 <sup>3)</sup>	0.6 <sup>4)</sup>	E1C (4671)
250	2.0	—3	100	0	0.7	1.4	2,100	1.5 × 10 <sup>6</sup>	—	<0.007	3.0	3.4	E1F (4672)
250	8.0	—2.5	200	0	1.5	5.0	>7,500	>1.5 × 10 <sup>6</sup>	—	<0.012	9.6	7.3	4673
180 <sup>5)</sup>	0.8 <sup>3)</sup>	—	—	—	—	—	—	—	—	—	1.15 <sup>4)</sup>	—	4674
250	6.7 —	—3 —46	100	0	2.7 —	1.7 0.002	1,000 —	0.6 × 10 <sup>6</sup> >10 <sup>6</sup>	—	<0.007	2.7	3.3	E2F (4695)
150	14	—7	—	—	—	2.7	8	3,000	—	—	—	—	C408

<sup>2)</sup> Max. D.C. through grid leak.

<sup>4)</sup> Anode/cathode capacitance.

<sup>5)</sup> Grid/cathode capacitance.

see pages 310-313.

### 6.3 VOLT METAL AND GLASS VALVES

Type	Class (application in parenthesis)	Max. dim. without pins  mm	Base (connec- tions in paren- thesis)	Heater ratings			Anode volts  Va V	Anode current  Ia mA	Grid bias  Vg <sub>1</sub> V
				Heat- ing	Heater volts V	Heater current A			
<b>EB11</b>	Double-diode with 2 sep. cathodes (13)	43.5 × 43.5	Y8A43.5 (71)	indir.	6.3	0,200	—	—	—
<b>EBC11</b>	Double-diode triode (9)	37.5 × 43.5	Y8A43.5 (72)	indir.	6.3	0,200	250	5	-8
							100	2	-3.2
							V <sub>b</sub> = 250 <sup>1)</sup>	0.75	—
<b>EBF11</b>	Double-diode and I.F. pentode (2, 13)	37.5 × 43.5	Y8A43.5 (76)	indir.	6.3	0,200	250	5	-2,0 -41
							100	5	-2,0 -16
<b>ECH11</b>	Triode-hexode (4)	37.5 × 43.5	Y8A43.5 (78)	indir.	6.3	0,200	V <sub>b</sub> = 250 <sup>4)</sup>	15.5 3.3	0 -10 <sup>5)</sup>
							250 <sup>6)</sup>	2.3	-2 -12 <sup>7)</sup>
							200 <sup>8)</sup>	2.3	-2 -12 <sup>9)</sup>
<b>ECL11</b>	Triode and output tetrode (11, 12)	110 × 46	Y8A35 (77)	indir.	6.3	1.0	250 <sup>11)</sup>	2.0	-2.5
							250 <sup>12)</sup>	36	-6
<b>EDD11</b>	Double output triode (16)	43.5 × 43.5	Y8A43.5 (80)	indir.	6.3	0.4	250	2 × 3.5 2 × 17.5	-6.3
<b>EF11</b>	R.F. vari-mu pentode (1, 2)	37.5 × 43.5	Y8A43.5 (73)	indir.	6.3	0,200	250	6	-2 -45
							100	6	-2 -18
<b>EF12</b>	R.F. pentode (1, 2, 7, 8, 11)	37.5 × 43.5	Y8A43.5 (73)	indir.	6.3	0,200	250	3	-2
							V <sub>b</sub> = 250 <sup>4)</sup>	0.9	—
<b>EF13</b>	Low-noise R.F. pentode (1)	37.5 × 43.5	Y8A43.5 (74)	indir.	6.3	0,200	250	4.5	-2 -17
<b>EFM11</b>	A.F. ampl. pentode and electronic indicator (11, 14)	76 × 37	Y8A35 (79)	indir.	6.3	0,200	V <sub>b</sub> = V <sub>L</sub> = 250 <sup>1)</sup>	1	-1.5 -20
<b>EL11N</b>	Steep-slope output pentode (12, 15)	110 × 46	Y8A35 (75)	indir.	6.3	0.9	250	36	-6
							250 <sup>20)</sup>	2 × 24 2 × 28.5	—
<b>EL12</b>	Steep-slope output pentode (12)	110 × 51	Y8A35 (75)	indir.	6.3	1.2	250	72	-7
<b>EM11</b>	Dual sensitivity electronic indic. (14)	76 × 37	Y8A35	indir.	6.3	0,200	V <sub>b</sub> = V <sub>L</sub> = 250	—	0 -5
							—	0 -16	

<sup>1)</sup> H.T. supply voltage. The data in this column refer to resistance-coupled L.F. amplification.

<sup>2)</sup> Stage gain (alternating anode volts divided by alternating grid volts).

<sup>3)</sup> Screen-grid series resistor.

<sup>4)</sup> Data for the triode section when used as oscillator; H.T. voltage applied through anode resistor of 30,000 ohms.

<sup>5)</sup> Negative voltage obtained during oscillation, for a grid current of 200 μA, with a grid leak of 50,000 ohms (V<sub>osc</sub> = 8 Veff).

<sup>6)</sup> Data for the hexode section.

<sup>7)</sup> With fixed screen voltage. When the screens g<sub>2</sub> and g<sub>1</sub> are fed through a resistor of 50,000 ohms, a bias of -18.5 V is required for reducing the mutual conductance to one-hundredth of the uncontrolled value.

<sup>8)</sup> I<sub>g2</sub> + I<sub>g1</sub>.

<sup>9)</sup> Conversion conductance.

<sup>10)</sup> With fixed screen voltage. When the screens g<sub>2</sub> and g<sub>1</sub> are fed through a resistor of 50,000 ohms, a bias of -17.6 V is required for reducing the mutual conductance to one-hundredth of the uncontrolled value.

WITH 8-PIN BASE

Cathode res. (appr.)	Screen volts	Screen current	Volts grid 3 (and 5)	Volts grid 4	Mut. cond.	Amplification factor	Int. res.	Ext. anode res. or opt. match. res.	Max. output power with 10% dist.	Alt. grid volts for max. output power	Max. anode diss.	Anode to grid cap.	Type
Rk ohms	V <sub>g2</sub> V	I <sub>g2</sub> mA	V <sub>g3(5)</sub> V	V <sub>g4</sub> V	S $\mu$ A/V	$\mu$	Ri ohms	Ra ohms	W <sub>o</sub> W	V <sub>i</sub> Veff	Wa W	Cap, $\mu$ /f <sup>2</sup>	
—	—	—	—	—	—	—	—	—	—	—	—	—	EB11
1,600	—	—	—	—	2,200	25	11,500	—	—	—	1.5	—	EBC11
1,600	—	—	—	—	1,800	25	14,000	—	—				
5,000	—	—	—	—	—	$\frac{V_o}{V_i} = 18^2$ )	—	200,000	—				
300	R <sub>g2</sub> = <sup>3)</sup> 85,000 ohms	1.8	—	—	1,800	18	$2.0 \times 10^6 > 10^7$	—	—	—	1.5	<0.002	EBF11
300	100	1.8	—	—	1,800	18	$0.5 \times 10^6 > 10^7$	—	—	—	1.0	<1.5	ECH11
—	—	—	—	—	2,800	20	—	—	—				
220	100	3 <sup>4)</sup>	-10 <sup>5)</sup>	100	650 <sup>6)</sup> 6.5	—	$1.4 \times 10^6 > 10^7$	—	—	—			
250	100	3 <sup>4)</sup>	-10 <sup>5)</sup>	100	650 <sup>6)</sup> 6.5	—	$0.7 \times 10^6 > 10^7$	—	—	—	1.5	<0.001	ECL11
—	—	—	—	—	2,000	70	—	—	—	—	0.5	—	ECL11
—	250	4	—	—	9,000	—	25,000	7,000	3.5	4.2	9	—	
—	—	—	—	—	—	—	—	16,000 <sup>12)</sup>	5.5 <sup>14)</sup>	—	2 × 3	—	EDD11
250	R <sub>g2</sub> = <sup>3)</sup> 75,000 ohms	2.0	—	—	2,200	22	$2.0 \times 10^6 > 10^7$	—	—	—	2	<0.002	EF11
250	100	2.0	—	—	2,200	22	$0.45 \times 10^6 > 10^7$	—	—	—			
500	100	1.0	—	—	2,100	—	$>1.5 \times 10^6$	—	—	—			
1,600	R <sub>g2</sub> = <sup>3)</sup> 0.5 M Ohm	0.37	—	—	—	—	$\frac{V_o}{V_i} = 181$ )	—	200,000	—	1.5	<0.002	EF12
400	100	0.6	—	—	2,300	23	$>0.5 \times 10^6 > 10^7$	—	—	—	2	<0.005	EF13
650	R <sub>g2</sub> = <sup>3)</sup> 350,000 ohms	0.65	—	—	—	—	$\frac{V_o}{V_i} = 80$ ) $\frac{V_o}{V_i} = 80$ )	—	110,000 <sup>15)</sup>	—	0.4	—	EFM11
150 <sup>17)</sup>	250 <sup>18)</sup>	4	—	—	9,000	—	50,000	7,000	4.5	4.2	9	<0.8	EL11N
140 <sup>19)</sup>	250 <sup>18)</sup>	2 × 2.8 2 × 4.6	—	—	—	—	—	10,000 <sup>12)</sup>	0 8.2 <sup>21)</sup>	0 6.7 <sup>22)</sup>			
90 <sup>17)</sup>	250 <sup>18)</sup>	8	—	—	15,000	—	25,000	3,500	8	4.5	18	<0.7	EL12
—	—	I <sub>l</sub> =0.35	—	—	—	—	$\alpha_1 = 75^\circ$	R <sub>l1</sub> = 1.5 × 10 <sup>6)</sup>	—	—	—	—	EM11
—	—	I <sub>l</sub> =0.35	—	—	—	—	$\alpha_2 = 80^\circ$ $\alpha_3 = 5^\circ$	R <sub>l2</sub> = 1.0 × 10 <sup>6)</sup>	—	—			

<sup>11)</sup> Data for the triode section.

<sup>12)</sup> Data for the tetrode section. Valve to be used with auto. bias only. To avoid parasitic oscillation a control-grid stopper of about 1,000 ohms (without decoupling) must be used.

<sup>13)</sup> From anode to anode.

<sup>14)</sup> Measured with EBC 11 as driver valve (Va = 250 V, Rk = 1,600 ohms), transf. ratio n = 3 : (1 + 1). Alternating grid voltage on grid of EBC 11, Vi = 4.5 Veff.

<sup>15)</sup> Light-angle measured at edge of screen.

<sup>16)</sup> Extra resistor of 20,000 ohms with decoupling capacitor, in series with anode-load resistor.

<sup>17)</sup> Valve to be used only with auto. bias.

<sup>18)</sup> To avoid parasitic oscillation a grid stopper of about 1,000 ohms without decoupling must be used.

<sup>19)</sup> Common cathode resistor.

<sup>20)</sup> For 2 valves in balanced circuit.

<sup>21)</sup> With 3.1% distortion.

<sup>22)</sup> Alternating grid voltage per grid.

4 VOLT DIRECTLY-HEATED A.C. VALVES

Type	Class (application in parenthesis)	Max. dim.  mm	Base (connections in parenthesis) <sup>1)</sup>	Heater ratings			Anode volts  Va V	Anode current  Ia mA	Grid bias  Vg <sub>1</sub> V
				Heat- ing	Heater volts  V	Heater current  A			
AB2	Double-diode (13)	85 × 29	V24 (66)	indir.	4.0	0.65	—	—	—
ABC1	Double-diode triode (9)	100 × 37	P30 (30)	indir.	4.0	0.65	250	4.0	app.—7.0
ABL1	Double-diode and steep- slope pentode (13, 12)	130 × 46	P35 (39)	indir.	4.0	2.4	250	36	Rk = 150 ohms <sup>4)</sup>
AC2	Triode (3, 11)	100 × 37	P30 (28)	indir.	4.0	0.65	250	6.0	app.—5.5
AD1	Output triode (12)	135 × 58	P35 (25)	dir.	4.0	0.95	250	60	—45
				dir.	4.0	0.95	250	2 × 60 2 × 62.5	Rk = 375 ohms <sup>4)</sup>
AF3	R.F. vari-mu pentode (1, 2)	106 × 43	P30 (41)	indir.	4.0	0.65	250	8.0	app.—3.0 —55
AF7	R.F. pentode (1, 2, 7, 8, 11)	106 × 43	P30 (41)	indir.	4.0	0.65	250	3.0	app.—2.0
AH1	Vari-mu hexode (1, 2, 5)	110 × 46	P35 (44)	indir.	4.0	0.65	250	1.7 <sup>6)</sup> <0.015	app.—2.0 —24
				indir.	4.0	0.65	250	3.0 <0.015	app.—2.0 —20
AK2	Octode (4)	117 × 47	P35 (48)	indir.	4.0	0.65	250	1.6 <0.015	app.—11 <sup>2)</sup>
AL1	Output pentode (12)	115 × 51	P35 (33)	dir.	4.0	1.1	250	36	app.—15
AL2	Output pentode (12, 15)	117 × 47	P35 (36)	indir.	4.0	1.0	250	36	app.—25
				indir.	4.0	1.0	250	2 × 33 2 × 41	Rk = 350 ohms <sup>4)</sup>
AL4	Steep-slope output pentode (12, 15)	115 × 46	P35 (35)	indir.	4.0	1.75	250	36	Rk = 150 ohms <sup>4)</sup>
AL5	Steep-slope output pentode (12, 15)	117 × 51	P35 (35)	indir.	4.0	2.0	250	72	—14
				indir.	4.0	2.0	250	2 × 58 2 × 65	Rk = 120 ohms <sup>4)</sup>
AM1	Electronic indicator (14)	75 × 28	P26 (51)	indir.	4.0	0.3	Vb = V <sub>l</sub> = 250 <sup>13)</sup>	0.095 0.021	0 <sup>16)</sup> —5 <sup>17)</sup>
AM2	Electronic indicator (14)	75 × 31	P30 (52)	indir.	4.0	0.32	250 <sup>18)</sup>	—	—
							250 <sup>18)</sup>	—	—
							250 <sup>18)</sup>	—	—
							0 <sup>18)</sup>	—	—
							250 <sup>19)</sup>	3	—3.5

- <sup>1)</sup> The numeral after the letter indicates the greatest diameter of the base.
- <sup>2)</sup> To be used only with self-bias. With this value of cathode resistor the bias is about — 6 V.
- <sup>3)</sup> With 5 % distortion.
- <sup>4)</sup> Common cathode resistor.
- <sup>5)</sup> With 1.3 % distortion.
- <sup>6)</sup> The data in the horizontal line refer to oscillation conditions with Vosc = 9 Veff.
- <sup>7)</sup> Ig<sub>2</sub> + Ig<sub>1</sub>.
- <sup>8)</sup> Conversion conductance.
- <sup>9)</sup> Negative voltage obtained during oscillation with a grid current of 190 μA passing through a grid leak of 50,000 ohms (Vosc = 8.5 Veff). This includes the grid bias produced by the cathode resistor.

WITH SIDE CONTACT (P) BASE

Screen voltage	Screen current	Volts grid 3 (and 5)	Volts grid 4	Mut. cond.	Amplification factor	Normal int. res.	Ext. anode res. or opt. match. res.	Max. output power with 10% dist.	Alt. grid volts for max. output power	Max. anode diss.	Anode to grid cap.	Type
$V_{g_2}$ V	$I_{g_2}$ mA	$V_{g_3(s)}$ V	$V_{g_4}$ V	S mA/V	$\mu$	Ri ohms	Ra ohms	Wo W	Vi Veff	Wa W	Cag <sub>1</sub> μμF	
—	—	—	—	—	—	—	—	—	—	—	—	AB2
—	—	—	—	2.0	27	13,500	—	—	—	1.5	—	ABC1
250	4	—	—	0.0	—	50,000	7,000	4.5	4.2	9	—	ABL1
—	—	—	—	2.5	30	12,000	—	—	—	2.0	1.7	AC2
—	—	—	—	—	4	670	2,300	4.2 <sup>9)</sup>	30	15	—	AD1
—	—	—	—	—	—	—	4,000	0 9.2 <sup>9)</sup>	—	—	—	
100	2.6	0	—	1.8 <0.002	2,200	1.2 × 10 <sup>9</sup> >10 <sup>7</sup>	—	—	—	2.0	<0.003	AF3
100	1.1	0	—	2.1	4,000	2.0 × 10 <sup>9</sup>	—	—	—	1.0	<0.003	AF7
80	2.6 <sup>7)</sup>	—12 or Rg <sub>3</sub> = 0.5 M Ohm	80	0.55 <sup>8)</sup> 0.002	—	2.0 × 10 <sup>9</sup> >10 <sup>7</sup>	—	—	—	1.5	<0.003	AH1
80	1.1 <sup>7)</sup>	app. -2.0 -20	80	1.5 <0.002	—	2.0 × 10 <sup>9</sup> >10 <sup>7</sup>	—	—	—	—	—	
90	2.0 <sup>10)</sup>	70	app. -1.5 -25	0.6 <sup>9)</sup> <0.002	—	1.6 × 10 <sup>9</sup> >10 <sup>7</sup>	—	—	—	0.5	<0.06 <sup>11)</sup>	AK2
250	6.8	—	—	2.8	—	43,000	7,000	3.1	9.7	9	—	AL1
250	5	—	—	2.6	—	60,000	7,000	3.8	14	9	—	AL2
250	2 × 3.5 2 × 7	—	—	—	—	—	6,600	0 11.5 <sup>12)</sup>	—	—	—	
250	5	—	—	9.5	—	50,000	7,000	4.3	3.6	9	—	AL4
275	7	—	—	8.5	—	22,000	3,500	8.8	9.1	18	—	AL5
275	2 × 6.25 2 × 10.5	—	—	—	—	—	4,500	0 19.5 <sup>12)</sup>	—	—	—	
—	I/ = 0.13 I/ = 0.14	—	—	—	—	—	2.0 × 10 <sup>6</sup>	—	—	—	—	AM1
Vl = 250	—	Vg' = +3	β = 160 <sup>9)</sup>	—	—	—	—	—	—	—	—	AM2
Vl = 250	—	Vg' = 0	β = 150 <sup>9)</sup>	—	—	—	—	—	—	—	—	
Vl = 250	—	Vg' = -6	β = 5 <sup>20)</sup>	—	—	—	—	—	—	—	—	
Vl = 250	—	Vg' = 0	β = 150 <sup>9)</sup>	—	—	—	—	—	—	—	—	
Vl = 250	—	Vg' = 0	β = 95 <sup>20)</sup>	—	—	—	—	—	—	—	—	
—	—	—	—	2.0	50	25,000	—	—	—	—	—	—

<sup>10)</sup> Screen-grid current I<sub>g3</sub> + I<sub>g5</sub> = 3.8 mA.

<sup>11)</sup> Capacitance between anode and grid 4.

<sup>12)</sup> With 3% distortion.

<sup>13)</sup> With 5.1% distortion.

<sup>14)</sup> Electronic tuning indicator.

<sup>15)</sup> H.T. supply voltage.

<sup>16)</sup> At this voltage the fluorescent screen shows light sectors of 16° (measured at edge of screen).

<sup>17)</sup> At this voltage the fluorescent screen shows light sectors of 90° (measured at edge of screen).

<sup>18)</sup> Voltage on the triode anode.

<sup>19)</sup> Typical characteristics of the triode section.

<sup>20)</sup> Light-angle measured at edge of screen.

“Class” column see page 290; for base connections see pp. 310-313.

4 VOLT A.C. VALVES (FOR PRE-AMPLIFYING STAGES)

Type	Class (application in parenthesis)	Max. dim. <sup>1)</sup>  mm	Base (connec- tions in paren- thesis) <sup>2)</sup>	Heater ratings			Anode volts  V <sub>a</sub> V	Anode current  I <sub>a</sub> mA	Grid bias  V <sub>g1</sub> V
				Heat- ing	Heater volts  V	Heater current  A			
AB1	Double-diode (13)	91 × 29	O24 (22)	indir.	4.0	0.65	—	—	—
ACH1	Triode-hexode (4)	130 × 50	C35 (14)	indir.	4.0	1.0	300	2.5 0.01	app.—2.0 —20
							150	5.0	—
AF2	R.F. vari-mu pentode (1, 2, 5)	138 × 51	O35 (24)	indir.	4.0	1.1	200	4.25 0.015	app.—2.0 —22
AK1	Octode (4)	119 × 47	C35 (13)	indir.	4.0	0.65	200	1.6 <0.015	app.—11 <sup>4)</sup>
E409	Triode (3)	91 × 46	O35 (18)	indir.	4.0	1.0	200	12	app.—16
E424N	Triode (3, 6, 7, 10, 11)	100 × 46	O35 (18)	indir.	4.0	1.0	200	6.0	app.—3.5
E438	Triode (7, 8, 11)	93 × 48	O35 (18)	indir.	4.0	1.0	200	0.3 0.1	app.—2.5 app.—2.5
E442	Tetrode (1, 2)	112 × 47	O35 (23)	indir.	4.0	1.0	200	1.5	app.—1.3
E442S	Tetrode (1, 2, 8, 11)	120 × 51	O35 (23)	indir.	4.0	1.0	200	4.0	app.—2.0
E444	Binode (diode-tetrode) (9)	130 × 51	B35 (8)	indir.	4.0	1.1	200	0.35 0.9	app.—2.3 app.—2.3
E444S	Binode (diode-tetrode) (9)	115 × 46	O35 (21)	indir.	4.0	1.0	200	6.0	app.—3.5
E445	R.F. vari-mu tetrode (1, 5, 7)	127 × 51	O35 (23)	indir.	4.0	1.1	200	6.0 0.01	app.—2.0 —40
E446	R.F. pentode (1, 2, 5, 7, 8, 11)	138 × 51	O35 (24)	indir.	4.0	1.1	200	3.0	app.—2.0
E447	R.F. vari-mu pentode (1, 2, 5)	138 × 51	O35 (24)	indir.	4.0	1.1	200	4.5 0.01	app.—2.0 —50
E448	Hexode	130 × 50	C35 (12)	indir.	4.0	1.2	200	4.0	app.—1.5
E449	Vari-mu hexode (1, 2)	130 × 50	C35 (12)	indir.	4.0	1.2	200	3.0	app.—2 —15
E452T	R.F. tetrode (1, 2, 7, 8, 11)	128 × 51	O35 (23)	indir.	4.0	1.0	200	3.0	app.—2.0
E455	R.F. vari-mu tetrode (1, 2)	127 × 51	O35 (23)	indir.	4.0	1.0	200	3.0 0.01	app.—1.5 —40
E499	Triode (7,8, 11)	101 × 46	O35 (18)	indir.	4.0	1.0	200	0.2 0.08	app.—1.6 app.—1.6

<sup>1)</sup> Without pins.

<sup>2)</sup> The figure placed after the capital letter indicates the maximum diameter of the base.

<sup>3)</sup> Across a resistor of 20,000 ohms.

<sup>4)</sup> Conversion conductance.

<sup>5)</sup> Capacitance between grid 1 and grid 3.

<sup>6)</sup> Neg. voltage passing through grid leak of 50,000 ohms with a current of 190 μA, during oscillation. (Vosc = 8 Veff).

For the meanings of the figures representing the applications in the

WITH PIN BASE

Screen Voltage $V_{g_2}$ V	Screen current $I_{g_2}$ mA	Volts grid 3 (and 5) $V_{g_3(5)}$ V	Volts grid 4 $V_{g_4}$ V	Max. slope ( $V_{g_1} = 0$ V) Smax. mA/V	Mut. cond. S mA/V	Amplification factor $\mu$	Norm. int. res. Ri ohms	Ext. anode res. or opt. match. Ra ohms	Max. output power with 10% dist. Wo W	Max. anode diss. Wa W	Anode to grid cap. Cag1 $\mu\mu\text{F}$	Type
—	—	—	—	—	—	—	—	—	—	—	—	AB1
70	—	Vosc = 15 V <sup>9)</sup>	70	—	0.75 <sup>4)</sup> <0.002	—	$0.8 \times 10^6$ > $10^7$	—	—	1.5	<0.5 <sup>5)</sup>	ACH1
—	—	—	—	2.0	—	13	—	—	—	1.0	—	AF2
100	1.8	—	—	3.2	2.5 <0.002	3,500	$1.4 \times 10^6$ > $10^7$	—	—	1.5	<0.006	AK1
90	2.0 <sup>7)</sup>	70	app. -1.5 -25	—	0.6 <sup>4)</sup> <0.002	—	$1.5 \times 10^6$ > $10^7$	—	—	0.5	0.06 <sup>8)</sup>	E409
—	—	—	—	4.0	1.3	9	7,000	—	—	3.0	4	E424N
—	—	—	—	3.5	2.4	30	12,500	—	—	1.5	2	E438
—	—	—	—	1.5	—	38	120,000 400,000	$0.3 \times 10^6$ $1.0 \times 10^6$	—	1.5	3	E442
100	0.6	—	—	1.2	0.9	700	800,000	—	—	1.0	0.005	E442S
60	0.5	—	—	1.1	1.0	400	400,000	—	—	1.0	0.02	E444
33 45	—	—	—	3.0	—	1,00 800	$0.3 \times 10^6$ $1.0 \times 10^6$	$0.3 \times 10^6$ $0.1 \times 10^6$	—	1.0	—	E444S
—	—	—	—	2.5	2.0	30	15,000	—	—	2.3	—	E445
100	0.8	—	—	1.2	1.0 0.005	300	300,000 > $10^7$	—	—	1.5	0.003	E446
100	1.2	—	—	3.5	2.3	5,000	$2.2 \times 10^6$	—	—	1.0	0.006	E447
100	1.9 —	—	—	3.5	2.3 <0.002	2,300	$1.0 \times 10^6$ > $10^7$	—	—	1.5	0.006	E448
100	8.5 <sup>9)</sup>	200	—3 <sup>10)</sup>	—	0.5S <sup>11)</sup>	—	$0.15 \times 10^6$	—	—	1.0	—	E449
80	—	app. —2 -7	80	3.0	2 <0.001	—	$0.45 \times 10^6$ $50 \times 10^6$	—	—	1.0	0.002	E452T
100	0.7	—	—	3.0	2.0	900	450,000	—	—	1.0	0.003	E455
100	0.8 —	—	—	3.0	2.0 0.005	700	350,000 > $10^7$	—	—	1.0	0.003	E499
—	—	—	—	4.0	—	99	100,000 330,000	$0.3 \times 10^6$ $1.0 \times 10^6$	—	1.5	1.5	

This voltage includes the grid bias produced by the cathode resistor.

7) Screen current  $I_{g_3} + I_{g_5} = 3.8$  mA.

8) Cap. between anode and grid 4.

9) Current to 3rd grid.

10) Vosc = 6.3 Veff.

11) Conversion conductance at Vosc = 6.3 Veff.

“Class” column see page 290; for base connections see pages 310-313.

4 VOLT A.C. OUTPUT VALVES

Type	Class (Application in parenthesis)	Max. dim. <sup>1)</sup>	Base (Connections in paren- thesis)	Heater ratings			Anode volts Va V	Anode current Ia mA	Grid bias Vg <sub>1</sub> V
				Heat- ing	Heater volts V	Heater current A			
E453	Pentode (12)	105 × 51	B35 (9)	indir.	4.0	1.1	250	24	app.—15
E463	Pentode (12)	110 × 55	B35 (9)	indir.	4.0	1.35	250	36	app.—22
B409	Triode (12)	91 × 46	A32 (1)	dir.	4.0	0.15	250	12	app.—16
B443	Pentode (12)	92 × 51	O35 (20)	dir.	4.0	0.15	250	12	app.—10
B443S	Pentode (12)	92 × 51	O35 (20)	dir.	4.0	0.15	250	12	app.—12
C443	Pentode (12)	92 × 51	O35 (20)	dir.	4.0	0.25	300	20	app.—25
C443N	Pentode (12)	89 × 51	O35 (20)	dir.	4.0	0.25	300	20	app.—42
E443H	Pentode (12)	123 × 55	O35 (20)	dir.	4.0	1.1	250	36	app.—15

<sup>1)</sup> Without pins.

<sup>2)</sup> With 5 % distortion.

180 mA D.C.

Type	Class (Application in parenthesis)	Max. dim. <sup>1)</sup>	Base (Connections in paren- thesis)	Heater ratings			Anode volts Va V	Anode current Ia mA	Grid bias Vg <sub>1</sub> V
				Heat- ing	Heater volts V	Heater current A			
B2006	Output triode (12)	105 × 51	O35 (17)	indir.	20	0.130	200	15	app.—15
B2038	Triode (3, 6, 7, 10, 11)	105 × 51	O35 (18)	indir.	20	0.180	200	6.0	app.—3.0
B2043	Output pentode (12)	105 × 51	B35 (9)	indir.	20	0.150	200	20	app.—18
B2044	Binode (diode-tetrode) (9)	130 × 51	B35 (8)	indir.	20	0.180	200	0.29 0.76	app.—3.2 app.—4.0
B2044S	Binode (diode-triode) (9)	108 × 46	O35 (21)	indir.	20	0.180	200	6.0	app.—3.0
B2045	Vari-mu tetrode (1, 2, 5)	120 × 51	O35 (23)	indir.	20	0.180	200	4.0 0.01	app.—2.0 —4.0
B2046	R.F. pentode (1, 2, 5, 7, 8, 11)	138 × 51	O35 (24)	indir.	20	0.180	200	3.0	app.—2.0
B2047	R.F. vari-mu pentode (1, 2, 5)	138 × 51	O35 (24)	indir.	20	0.180	200	4.0	app.—2.0
B2048	Mixer hexode (4)	130 × 50	C35 (12)	indir.	20	0.180	200	3.0	app.—1.5
B2049	Vari-mu hexode (1, 2)	130 × 50	C35 (12)	indir.	20	0.180	200	3	app.—2 —8
B2052T	R.F. tetrode (1, 2, 5, 7, 8, 11)	127 × 51	O35 (23)	indir.	20	0.180	200	3.0	app.—2.0
B2099	Triode (11)	101 × 46	O35 (18)	indir.	20	0.180	200	0.08 0.2	app.—1.6 app.—1.6

<sup>1)</sup> Without pins.

<sup>2)</sup> Current third grid.

<sup>3)</sup> Vosc = 6.3 Veff.



WITH PIN BASE

Screen-grid volts $V_{g_2}$ V	Screen current $I_{g_2}$ mA	Volts grid 3 (and 5) $V_{g_3(-)}$ V	Volts grid 4 $V_{g_4}$ V	Mut. cond. S mA/V	Amplification factor $\mu$	Int. res. Ri ohms	Ext. anode res. or opt. match. Ra ohms	Max. output power at 10% dist. Wo W	Altern. grid volts for max. output Vi Veff	Max. anode diss. Wa W	Anode to grid capac. Cag <sub>1</sub> $\mu\mu\text{F}$	Type
250	10	—	—	2.5	175	70,000	11,000	2.9	8	6	—	E453
250	3.2	—	—	2.7	100	37,000	8,000	4.1	12.3	9	—	E463
—	—	—	—	1.8	9	5,000	12,000	0.65 <sup>2)</sup>	12	3	—	B409
150	2.4	—	—	1.3	60	45,000	20,000	1.35	12.1	3	—	B443
80	2.0	—	—	1.6	100	60,000	22,000	1.12	6.8	3	—	B443S
200	4.5	—	—	1.7	60	35,000	15,000	2.8	16	6	—	C443
200	0.4	—	—	1.5	37	25,000	15,000	3.0	20	6	—	C443N
250	6.8	—	—	3	130	43,000	7,000	3.1	9.7	9	—	E443H

VALVES

Screen-grid volts $V_{g_2}$ V	Screen current $I_{g_2}$ mA	Volts grid 3 (and 5) $V_{g_3(-)}$ V	Volts grid 4 $V_{g_4}$ V	Max. mut. cond. S max. mA/V	Mut. cond. at working point S mA/V	Amplification factor $\mu$	Int. res. Ri ohms	Ext. anode res. or opt. match. Ra ohms	Max. output power at 10% dist. Wo W	Max. anode diss. Wa W	Anode to grid capac. Cag <sub>1</sub> $\mu\mu\text{F}$	Type
—	—	—	—	2.5	1.6	6	4,000	16,000	0.21 <sup>2)</sup>	5	—	B2006
—	—	—	—	3.5	2.3	33	14,000	—	—	1.5	—	B2038
200	8	—	—	2.5	1.7	70	40,000	10,000	1.7	5	—	B2043
40 60	—	—	—	2.8	—	700 600	$2.4 \times 10^6$ $1.2 \times 10^6$	$0.32 \times 10^6$ $0.1 \times 10^6$	—	1.0	0.003	B2044
—	—	—	—	2.0	1.8	30	16,000	—	—	1.5	—	B2044S
60	0.9	—	—	1.2	1.0 0.005	400	$0.4 \times 10^6$ $>10^6$	—	—	1.0	0.004	B2045
100	1.1	—	—	3.5	2.2	5000	$2.2 \times 10^6$	—	—	1.0	$<0.006$	B2046
100	1.8	—	—	3.0	2.0 $<0.002$	200	$1.1 \times 10^6$ $>10^7$	—	—	1.5	$<0.006$	B2047
120	8.5 <sup>2)</sup>	200	$-3^2)$	—	0.58 <sup>2)</sup>	—	$0.15 \times 10^6$	—	—	1.0	—	B2048
80	—	app.— <sup>2)</sup> —8	80	2	1.5 $<0.002$	—	$0.45 \times 10^6$ $>50 \times 10^6$	—	—	1.0	$<0.002$	B2049
100	0.2	—	—	3.0	2.0	900	$0.45 \times 10^6$	—	—	1.0	0.003	B2052T
—	—	—	—	3.0	—	99	330,000 100,000	$0.32 \times 10^6$ $1 \times 10^6$	—	1.5	1.5	B2099

<sup>1)</sup> Conversion conductance at  $V_{osc} = 6.3$  Veff.

<sup>2)</sup> At 5% distortion.

"Class" column see page 290; for base connections see pages 310-313.

## BATTERY VALVES

Type	Class (application in parenthesis)	Max. dim. <sup>2)</sup>  mm	Base (Connections in parenthesis)	Filament ratings			Anode volts  Va V	Anode current  Ia mA	Grid bias  Vg <sub>1</sub> V
				Fil.	Fil. volts V	Fil. current A			
<b>B217</b>	Triode (3, 6, 10)	81 × 41	A32 (1)	dir.	2.0	0.1	150	3	app.—4.5
<b>B228</b>	Triode (7, 11)	81 × 41	A32 (1)	dir.	2.0	0.1	150	2.0	app.—2.0
<b>B240</b>	Double-triode (16)	96 × 47	C35 (10)	dir.	2.0	0.2	150	2 × 15 <sup>4)</sup>	0
<b>C243N</b>	Output pentode (12)	89 × 51	O35 (20)	dir.	2.0	0.2	150	9.5	app.—4.5
<b>KF1</b>	R.F. pentode (1, 2, 7, 8, 11)	118 × 47	C35 (11)	dir.	2.0	0.2	135	3.0	0
							90	1.1	0
<b>KF2</b>	R.F. vari-mu pentode (1, 2)	118 × 47	C35 (11)	dir.	2.0	0.2	135	3.0	0
							90	1.4	0
<b>A409</b>	Triode (3, 6, 10)	83 × 42	A32 (1)	dir.	4.0	0.065	150	3.5	app.—9.0
<b>A415</b>	Triode (3, 6, 10)	83 × 42	A32 (1)	dir.	4.0	0.085	150	4.0	app.—4.5
<b>A425</b>	Triode (7, 8, 11)	83 × 42	A32 (1)	dir.	4.0	0.065	200	0.25 0.1	app.—2.5 app.—2.5
<b>A441N</b>	Double-grid valve (4)	92 × 46	A35b (4)	dir.	4.0	0.08	100	4.0	0 <sup>4)</sup>
<b>B405</b>	Triode (12)	91 × 46	A32 (1)	dir.	4.0	0.15	150	11	app.—18
<b>B406</b>	Triode (12)	91 × 46	A32 (1)	dir.	4.0	0.1	150	8	app.—15
<b>B409</b>	Triode (12)	91 × 46	A32 (1)	dir.	4.0	0.15	250	12	app.—16
<b>B424</b>	Triode (3, 6, 10)	92 × 46	A35 (1)	dir.	4.0	0.100	200	6.0	app.—3
<b>B438</b>	Triode (7, 8, 11)	78 × 35	A35 (1)	dir.	4.0	0.100	200	0.25 0.05	app.—2.5 app.—2.5
<b>B442</b>	Tetrode (1, 2)	108 × 46	A35 (3)	dir.	4.0	0.100	200	4.5	app.—1.0
<b>B443</b>	Output pentode (12)	92 × 51	O36 (20)	dir.	4.0	0.150	250	12	app.—19

<sup>1)</sup> Anode current without signal.

<sup>2)</sup> From anode to anode.

<sup>3)</sup> At Va = 120 V.

<sup>4)</sup> Volts on control grid.

## GAS-FILLED TRIODES

Type	Filling	Max. dim.  mm	Base (Connections in parenthesis)	Ind. heated		Capacitances		
				Heater voltage	Heater current	Anode to grid C <sub>ag</sub>	Anode to cathode C <sub>ak</sub>	Grid to cathode C <sub>gk</sub>
				V	A	μμF	μμF	μμF
<b>4686</b>	Argon	99 × 37	P30 (XIV)	4.0	app. 1.2	2.7	3.1	3.4
<b>EC50</b>	Helium	108 × 43	P35 (XV)	6.3	app. 1.3	2.3	4.2	6.7

<sup>1)</sup> The striking surge must be limited by means of a resistor in the cathode or anode circuit.

The value of this resistor is determined by the max. voltage across the capacitor.

<sup>2)</sup> To determine the max. grid current it should be remembered that during ignition the grid, anode and cathode are all roughly at the same potential; the tube may therefore be regarded as a diode in the circuit.

WITH PIN BASE

Screen volts $V_{g_2}$ V	Screen current $I_{g_2}$ mA	Volts grid 3 (and 5) $V_{g_3(s)}$ V	Volts grid 4 $V_{g_4}$ V	Max. mut. cond. S max. mA/V	Mut. cond. at working point S mA/V	Amplification factor $\mu$	Normal Int. res. Ri ohms	Ext. anode res. or opt. match. Ra ohms	Max. output with 10% dist. Wo W	Max. anode diss. Wa W	Anode to grid cap. Cag, $\mu\mu\text{F}$	Type
—	—	—	—	1.4	1.3	17	13,000	—	—	0.9	5.5	B217
—	—	—	—	1.3	1.2	28	23,000	—	—	0.75	5.5	B228
—	—	—	—	—	—	—	—	14,000 <sup>2)</sup>	1.3 <sup>3)</sup>	—	—	B240
150	2.2	—	—	—	2.4	—	75,000	15,000	0.58	1.5	—	C243N
135	1.0	0	—	1.8	1.8	1,600	$0.9 \times 10^6$	—	—	0.8	<0.01	KF1
90	—	0	—	—	1.0	1,500	$1.5 \times 10^6$	—	—	—	—	
135	1.0	0	—	1.3	1.3 <0.002	1,400	$1.1 \times 10^6$ > $10^7$	—	—	0.8	<0.01	KF2
90	—	0	—	—	0.8 <0.002	1,500	$1.9 \times 10^6$ > $10^7$	—	—	—	—	
—	—	—	—	1.2	0.9	9	10,000	—	—	—	4	A409
—	—	—	—	2.0	1.5	15	10,000	—	—	—	4.5	A415
—	—	—	—	1.2	—	25	80,000 250,000	$0.32 \times 10^6$ $1.0 \times 10^6$	—	—	3	A425
4.0 <sup>4)</sup>	—	—	—	—	0.3 <sup>4)</sup> 1.0 <sup>5)</sup>	—	—	—	—	—	—	A441N
—	—	—	—	2.0	1.6	5	3,000	—	—	—	—	B405
—	—	—	—	1.4	1.3	6	4,500	—	—	—	—	B406
—	—	—	—	2.0	1.8	9	5,000	12,000	0.65 <sup>6)</sup>	3	—	B409
—	—	—	—	3.0	2.5	24	9,000	—	—	—	4	B424
—	—	—	—	2.0	—	38	170,000 400,000	$0.32 \times 10^6$ $1.0 \times 10^6$	—	—	4	B438
100	—	—	—	1.2	0.9	350	$0.4 \times 10^6$	—	—	—	<0.005	B442
150	—	—	—	—	1.3	—	45,000	20,000	1.35	3	—	B443

<sup>5)</sup> Potential of space-charge grid.

<sup>6)</sup> Conductance of control grid.

<sup>7)</sup> Conductance of space-charge grid.

<sup>8)</sup> Without pins.

<sup>9)</sup> With 5% distortion

FOR TIME BASE

Arc (quench) volts V	Max. peak volts between grid and anode V	Max. peak volts anode-cathode V	Max. peak anode current mA	Max. average current during oscillation mA <sup>1)</sup>	Max. peak grid current mA <sup>2)</sup>	Max. volts between heater and cathode V <sup>3)</sup>	Ratio: ign. volts to grid volts	Max. obtainable frequency c/s	Type
app. 17	350	300	300	3	1.4	100	20	app. 50,000	4686
app. 33	1,500	1,000	750	10	1.4	100	35	app. 150,000	EC50

The resistors (without decoupling) determine the current passing to the grid. If this is too high a resistor must be included in the grid circuit.

<sup>1)</sup> The cathode must always be positive with respect to the filament.

“Class” column see page 290; for base connections see pages 310-313.

POWER OUTPUT

Type	Class	Max. dim. <sup>1)</sup> mm	Base (Connections in parenthesis)	Heater ratings			Applications	Anode volts V <sub>a</sub> V	Screen volts V <sub>g2</sub> V	Anode current without signal I <sub>a0</sub> mA
				Heat-ing	Heater volts V	Heater current A				
E406N	Triode	130 × 51	A35 (1)	dir.	4.0	1.0	Class A, 1 valve	500	—	24
							Class B, 2 valves	500	—	2 × 20
							Class AB, 2 valves	500	—	2 × 24
E408N	Triode	125 × 51	A35 (1)	dir.	4.0	1.0	Class A, 1 valve	400	—	30
							Class AB, 2 valves	400	—	2 × 20
							Class AB, 2 valves	400	—	2 × 30
E443N	Pentode	110 × 57	O40 (20)	dir.	4.0	1.1	Class A, 1 valve	400	200	30
							Class AB, 2 valves	400	200 <sup>4)</sup>	2 × 23
E451	Double-grid output valve	123 × 55	O35 (19)	dir.	4.0	1.1	Class A, 1 valve	250	—	22
							Class B, 2 valves	300	—	2 × 6
							Class AB, 2 valves	400	—	2 × 8.5
E707	Triode	188 × 52	W42 (69)	dir.	7.2	1.1	Class A, 1 valve	800	—	35
							Class AB, 2 valves	800	—	2 × 30
							Class AB, 2 valves	800	—	2 × 40
F410	Triode	145 × 61	A40 (1)	dir.	4.0	2.0	Class A, 1 valve	550	—	45
							Class AB, 2 valves	550	—	2 × 20
							Class AB, 2 valves	550	—	2 × 45

<sup>1)</sup> Without pins.

<sup>2)</sup> Anode and grid 2 shorted; as driver valve.

<sup>3)</sup> Grids 1 and 2 shorted; operation with grid current.

<sup>4)</sup> Load resistor for optimum output. Roughly twice this value is recommended when used as driver valve for Class B output stages operating with grid current.

AMPLIFYING AND DETECTOR VALVES FOR

Type	Class and application	Max. dim. over pins mm	Base (Connections in parenthesis)	Heater ratings		
				Heat-ing	Heater volts V	Heater current A
EA50	Single diode	69 × 12	without base (XXI)	indir.	6.3	0.15
EE50	Secondary-emission valve for amplification of very wide modulation bands.	77 × 37	T9A (XII)	indir.	6.3	0.3
EF50	Steep-slope pentode for amplification of very wide modulation bands.	77 × 37	T9A (XII)	indir.	6.3	0.3

<sup>1)</sup> Peak value of alternating voltage.

<sup>2)</sup> Max. direct current through grid leak.

<sup>3)</sup> Capacitance between diode-anode and cathode.

For base connections

## VALVES

Anode current at max. mod.	Screen current without signal	Screen current at max. mod.	Neg. grid volts with fixed bias $V_{g1}$ V	(Common) cathode res.	Normal mut. cond.	Int. res.	Anode matching res. (between anodes)	Max. output power	Total dist.	Alt. grid volts	Max. anode diss.	Anode to grid cap.	Type
$I_a$ max. mA	$I_{g2}$ mA	$I_{g2}$ max mA	$V_{g1}$ V	Rk Ohms	S mA/V	Ri ohms	Ra ohms	Womax W	dtot %	$V_i$ Veff	Wa W	$C_{ag}$ $\mu\mu F^b$	
—	—	—	-68	—	3.0	2,000	11,500	5.3	5	45	12	—	E406N
2 × 38	—	—	-70	—	—	—	12,000	15	1.4	43	12	—	
2 × 27	—	—	—	1400	—	—	16,000	13	3.3	52	12	—	
—	—	—	-36	—	2.7	3,000	6,000	2.6	5	—	12	12	E408N
2 × 28	—	—	-40	—	—	—	12,000	7	0.56	0.28	12		
2 × 32	—	—	—	600	—	—	10,000	7	0.62	26.5	12		
—	5.2	—	-40	—	1.8	55,000	13,500	5.4	10	20.2	12	—	E443N
2 × 28	2 × 4.3	2 × 10	—	720	—	—	17,500	14	4.1	35	12		
—	—	—	-33 <sup>3)</sup>	—	2.4	2,400	6,400 <sup>4)</sup>	1.25	5	—	10	—	E451
2 × 48	—	—	0 <sup>3)</sup>	—	—	—	6,000	16	8.4 <sup>5)</sup>	—	—		
2 × 56	—	—	0 <sup>3)</sup>	—	—	—	6,000	22.4	5.4 <sup>5)</sup>	—	—		
—	—	—	-90	—	2.3	3,000	11,000	9	5	60	32	—	E707
2 × 59	—	—	-92	—	—	—	10,000	30	1.1	60	32		
2 × 44	—	—	—	1100	—	—	15,000	25	1.1	63	32		
—	—	—	-36	—	4.0	2,500	7,000	5.9	5	24.5	25	—	F410
2 × 40	—	—	-43	—	—	—	10,000	14.6	1.08	28	25		
2 × 48	—	—	—	400	—	—	10,000	14.4	0.86	25	25		

<sup>3)</sup> Measured with E 451 as driver ( $V_a = 250$  V,  $V_{g1} = -33$  V) and a driver transformer of 2.5 : (1 + 1).

<sup>5)</sup> Screen voltage in balanced output stages can be stabilized as much as possible with a series of stabilizer tubes. Type 4087 is excellent for this purpose.

## TELEVISION RECEIVERS

Anode volts	Screen-grid volts	Volts on sec. emiss. cath.	Grid bias	Volts grid 3	Anode current	Screen current	Current on sec. emiss. cath.	Mut. cond.	Int. res.	Anode to grid cap. (cold)	Grid cap. (cold)	Anode cap. (cold)	Type
$V_a$ V	$V_{g2}$ V	$V_{k2}$ V	$V_{g1}$ V	$V_{g3}$ V	$I_a$ mA	$I_{g2}$ mA	$I_{k2}$ mA	S $\mu A/V$	Ri ohms	$C_{ag1}$ $\mu\mu F^b$	$C_{g1}$ $\mu\mu F$	$C_a$ $\mu\mu F$	
200 <sup>4)</sup>	—	—	—	—	0.8 <sup>2)</sup>	—	—	—	—	—	—	2.1 <sup>3)</sup>	EA50
250	250	150	-3 <sup>4)</sup>	—	10	0.6	-8	14	$0.25 \times 10^6$	<0.003	7.7	7.7	EE50
250	250	—	-2	0 -54	10	3	—	6.5 0.45	$1.0 \times 10^6$	<0.003	7.3	5.3	EF50

<sup>4)</sup> Self-bias only must be employed. To compensate variations in anode current the cathode resistor should be larger than strictly necessary for the bias. The grid is then connected to a suitable positive potential to produce the correct bias.

see pages 310-313.

PHILIPS HIGH-VACUUM CATHODE-RAY

Type	Description	Deflection	Colour or characteristics of screen	Dia. of screen (max.) mm	Length without pins (max.) mm	Length without pins (min.) mm	Base Connections	Heater ratings			Max. volts on 3rd anode V <sub>a,max</sub>
								Heating	Heater volts V	Heater current A	
DG3-1	C.R. tube for oscilloscopes	Double electrostatic Pair of plates D <sub>2</sub> D <sub>2</sub> ' asymmetrical <sup>12)</sup>	green	38	125	119	I	indir.	6.3	0.63	—
DG7-1 <sup>7)</sup>	C.R. tube for oscilloscopes	Double electrostatic symmetrical	green	71	163	151	II	indir.	4.0	1.0	—
DG7-2 <sup>8)</sup>	C.R. tube for oscilloscopes	Double electrostatic Pair of plates D <sub>2</sub> D <sub>2</sub> ' asymmetrical <sup>12)</sup>	green	71	163	151	III	indir.	4.0	1.0	—
DG9-3 <sup>9)</sup>	C.R. tube for oscilloscopes	Double electrostatic Pair of plates D <sub>2</sub> D <sub>2</sub> ' asymmetrical <sup>12)</sup>	green	98	327	312	IV	indir.	4.0	1.0	—
DG16-1 <sup>10)</sup>	C.R. tube for oscilloscopes	Double electrostatic symmetrical	green	167	440	415	V	indir.	4.0	1.0	—
DG16-2 <sup>11)</sup>	C.R. tube for oscilloscopes	Double electrostatic symmetrical	green	167	450	425	VI	indir.	4.0	1.0	—

- <sup>1)</sup> Adjust deflection.      <sup>3)</sup> Of deflector plates at screen end.      <sup>5)</sup> At the cathode end.  
<sup>2)</sup> Of deflector plates at cathode end.      <sup>4)</sup> With respect to all other electrodes.      <sup>6)</sup> At the screen end.  
<sup>7)</sup> This tube can also be supplied with blue (DB 7—1) or with persistent screen (DN 7—1).  
<sup>8)</sup> This tube can also be supplied with blue (DB 7—2) or with persistent screen (DN 7—2).  
<sup>9)</sup> This tube can also be supplied with blue (DB 9—3) or with persistent screen (DN 9—3).  
<sup>10)</sup> This tube can also be supplied with blue (DB 16—1) or with persistent screen (DN 16—1).

PHILIPS HIGH-VACUUM CATHODE-RAY

Type	Description	Deflection	Colour of screen	Dia. of screen (max.) mm	Length without pins (max.) mm	Length without pins (min.) mm	Base Connections	Heater ratings		
								Heating	Heater volts V	Heater current A
MW22-1	C.R. tube for television receivers.	Double magnetic	white	223	360	352	IX	indir.	4.0	approx. 1.0
MW22-5	C.R. tube for television receivers.	Double magnetic	white	231	376	368	IX	indir.	6.3	approx. 0.65
MW31-6	C.R. tube for television receivers.	Double magnetic	white	308	465	455	IX	indir.	6.3	approx. 0.65
MW39-3	C.R. tube for television receivers.	Double magnetic	white	392	580	570	X	indir.	6.3	approx. 0.65
MS11-1	Projection tube for television receivers.	Double magnetic	sepia	114	354	341	X	indir.	4.0	approx. 1.0

- <sup>1)</sup> In relation to all other electrodes.  
<sup>2)</sup> The number of ampere-turns required for the magnetic concentration amounts to about 550—750 when a coil without iron casing is used.

For base connections see

## TUBES FOR OSCILLOGRAPHS

Max. volts on 2nd anode $V_{a2}$ V	Max. volts on 1st anode $V_{a1}$ V	Max. grid bias for visual cut-off $V_g$ V	Operating data						4) Grid capacitance $C_g$ $\mu\mu F$	5) Cap. of deflector plates $CD_1D_1'$ $\mu\mu F$	6) Cap. of deflector plates $CD_2D_2'$ $\mu\mu F$	Type
			Volts 2nd anode $V_{a2}$ V	Volts 1st anode $V_{a1}$ V <sup>1)</sup>	Grid bias $V_g$ V	2) Sensitivity $N_1$ mm/V	3) Sensitivity $N_2$ mm/V	Grid volts $V_g$ V				
500	150	-35	500	approx. 130	Grid voltage must be adjusted to give the desired brightness of the spot. The maximum screen loading of 5 mW/cm <sup>2</sup> for the DG 3-1 to DG 9-3, and 10 mW/cm <sup>2</sup> for the DG 16-1 and DG 16-2 must never be exceeded.	0.1	0.08	7.0	1.75	2.0	DG3-1	
			250	approx. 60		0.20	0.16					
800	350	-30	800	150—350		0.22	0.14	7	0.7	0.85	DG7-1 <sup>7)</sup>	
			500	approx. 140		0.35	0.24					
800	350	-30	800	150—350		0.22	0.14	7	0.65	2.5	DG7-2 <sup>8)</sup>	
			500	approx. 140		0.35	0.24					
1,200	500	-40	1,000	200—400		0.40	0.31	8	1.1	1.4	DG9-3 <sup>9)</sup>	
2,000	600	-40	2,000	350—500		0.25	0.17	9.5	1.2	2	DG16-1 <sup>10)</sup>	
			1,000	approx. 175-200		0.50	0.35					
2,000	600	-40	2,000	350—500		0.25	0.17	7.3	2.1	2.7	DG16-2 <sup>11)</sup>	
			1,000	approx. 175-250		0.50	0.35					

<sup>1)</sup> This tube can also be supplied with blue (DB 16—2) or with persistent screen (DN 16—2).

<sup>2)</sup> An asymmetrical pair of plates  $D_2D_2'$  permits of asymmetrical control when using a simple time-base generator or amplifier. The plate  $D_2$  may then be connected to the asymmetrical time base or to the output voltage of the amplifier.

## TUBES FOR TELEVISION RECEIVERS

Max. volts on 2nd anode $V_{a2,max}$ V	Max. volts on 1st anode $V_{a1,max}$ V	Max. average current of 2nd anode $I_{a2,max}$ $\mu A$	Max. grid bias for visual cut-off $V_{g,max}$ V	Operating data						Grid cap. <sup>1)</sup> $C_g$ $\mu\mu F$	Type
				Volts on 3rd anode $V_{a3}$ V	Volts 2nd anode $V_{a2}$ V	Volts 1st anode $V_{a1}$ V	Grid volts $V_g$ V	Sensitivity $N$ <sup>4)</sup>			
5,000	250	100	-100	— <sup>2)</sup>	5,000	250	Grid voltage must be adjusted to give the desired brightness of the spot. The maximum screen load of 10 mW/cm <sup>2</sup> must never be exceeded.	0.09	13	MW22-1	
7,000	250	100	-200	— <sup>2)</sup>	7,000	250		0.076	12	MW22-5	
7,000	250	100	-200	— <sup>2)</sup>	7,000	250		0.106	12	MW31-6	
6,000	250	100	-100	— <sup>2)</sup>	6,000	250		0.13	13	MW39-3	
25,000	500	2,000	-150	— <sup>2)</sup>	25,000	500		0.034	10	MS11-1	

<sup>2)</sup> The number of ampere-turns required for the magnetic concentration amounts to about 750 when a coil with iron casing is used.  $V_{a2} = 20$  kV; air gap 9 mm at a distance of 85 mm from the transition of the neck to the conical part of the tube.

<sup>4)</sup> Expressed in cm deflection per cm coil width per gauss of mean field strength.

## RECTIFYING VALVES FOR RECEIVERS, POWER AMPLIFIERS AND CATHODE-RAY OSCILLOGRAPHS

		Type	Max. dim. <sup>1)</sup> mm	Base (Connections in parenthesis)	Heater Ratings			Anode ratings		Max. input cap. of the filter μF	Min. tot. resist. in anode circuit per anode <sup>2)</sup> Rt (ohms)
					Heat- ing	Heater volts V	Heater current approx. A	Max. effective A.C. volts V	Max. rectified current mA		
For A.C. receivers.	Full-wave High vacuum	506	110 × 48	A35 (6)	dir.	4.0	1.0	2 × 300	75	32	—
		506K	92 × 47	A35 (6)	dir.	4.0	1.0	2 × 300	75	32	—
		1561	125 × 51	A35 (6)	dir.	4.0	2.0	2 × 500 2 × 300	120 160	32	—
		1801	92 × 47	A35 (6)	dir.	4.0	1.0	2 × 250	30	32	—
		1805	110 × 48	A35 (6)	dir.	4.0	1.0	2 × 500 2 × 300	60 100	32	—
		1815	113 × 53	A40 (6)	dir.	4.0	2.5	2 × 500 2 × 300	180	32	—
		1817	123 × 53	A40 (6)	dir.	4.0	4.0	2 × 350 2 × 250	300 300	32	—
		1831	118 × 56	A35 (6)	dir.	4.0	1.0	2 × 700	60	32	—
		AZ11N	92 × 41	Y8A35 (S1)	dir.	4.0	1.1	2 × 500 2 × 300	60 100	60	—
		AZ12	105 × 51	Y8A35 (S1)	dir.	4.0	2.3	2 × 500 2 × 300	120 200	32	—
	EZ12	88 × 37	Y8A35 (S3)	indir.	6.3	0.85	2 × 500 2 × 400	100 125	32 32	300 300	
	Half-wave High vac.	1802	100 × 32	H35 (15)	dir.	4.0	0.4	250	30	32	—
		1803	100 × 52	H35 (15)	dir.	4.0	0.6	500	30	32	—
1832		145 × 60	H35 (15)	dir.	4.0	1.3	700	120	32	—	
Car radio	Full-wave High vac.	EZ11	43.5 × 43.5	Y8A43.5 (S2)	indir.	6.3	0.29	2 × 250	60	60	600
		FZ1	91 × 37	P30 (59)	indir.	13	0.25	2 × 250	50	32	600
For ampli- and television receivers.	Half-wave High vac.	4646	145 × 60	W42 (68)	dir.	4.0	1.3	1,000	75	12	200
For oscilloscopes and television reception.	Half-wave High vacuum	1875	137 × 49	P35 (56)	dir.	4.0	2.3	5,000	5	0.5	10,000
		1876	97 × 52	P35 (55)	dir.	4.0	0.3	850	5	0.5	—
		1877	113 × 44	A35 (5)	indir.	4.0	0.65	5,000	3	0.5	20,000
		1878	154 × 53	Edison (70)	indir.	4.0	0.7	10,500	2	—	—
	gas-filled	1018	—	—	dir.	1.8	1.8	16	200	—	—

<sup>1)</sup> Without pins. <sup>2)</sup>  $R_t = R_s + n^2 R_p$  ( $R_s$  = resistance of half transf. sec.;  $R_p$  = prim. resistance;  $n$  = transf. ratio; (half sec. divided by prim.). If no transformer is available, a corresponding resistance must be connected in series with each anode. <sup>3)</sup> Rectifying valve for battery chargers.

For base connections see



### PHOTO-ELECTRIC CELLS

Type	Description	Max. dim. without pins num	Base (Connections in parenthesis)	Anode cath. capac. Cak $\mu\mu\text{F}$	Normal anode volts Va V	Sensitivity N $(\mu\text{A}/\text{lm}^{-1})$	Max. anode volts Va V	Max. anode current Ia $\mu\text{A}$	Min. load resist. megohm
3512	High-vacuum with caesium cathode	120 × 58	A (XXVI)	3	100	20	500	5	—
3530	Gas-filled, with caesium cathode	59 × 18	(XXVII)	3	100	150	100	7.5	1
3533	Gas-filled, with caesium cathode	62 × 28	XXVIII	3.4	100	150	100	7.5	1
3534	Gas-filled, with caesium cathode	87.5 × 30	(XXIX)	5	90	150	90	7.5	1
3541	Gas-filled, with caesium cathode	62 × 28	XXVIII	3.4	100	150	100	7.5	1

<sup>1)</sup> Measured with tungsten filament lamp. The temperature of the tungsten filament is 2600° K and the luminous flux, measured statically, is 0.1 lumen for type 3512, for the others 0.025 lumen

BASE CONNECTIONS OF PHILIPS "MINIWATT" RECEIVING,

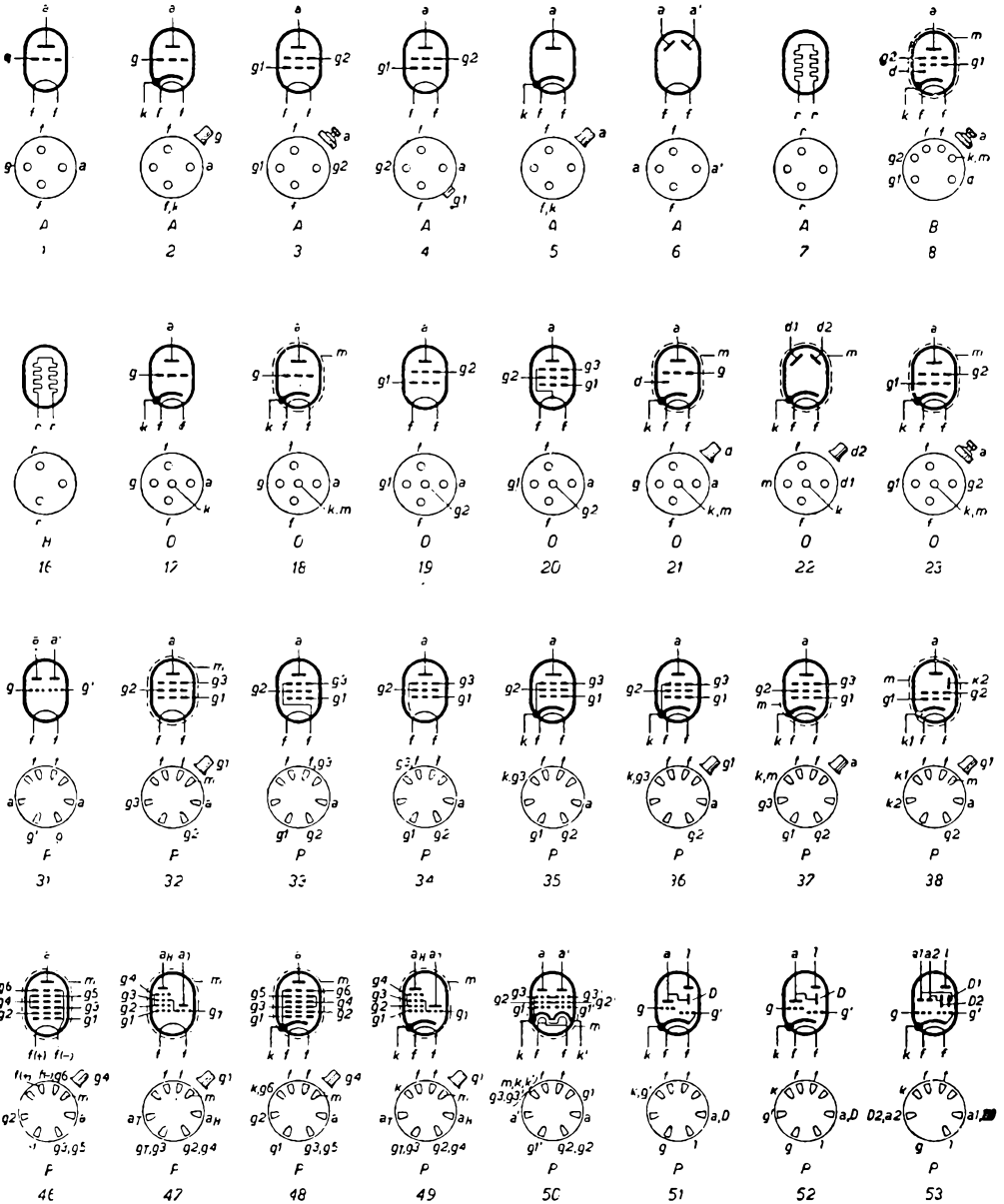

\*) Connection for metallizing on the EL 12 only.

In the column "Base" for the valve concerned the capital letter indicates the type of base and the following numeral the diameter of the base in mm. The figure

# OUTPUT AND RECTIFYING VALVES

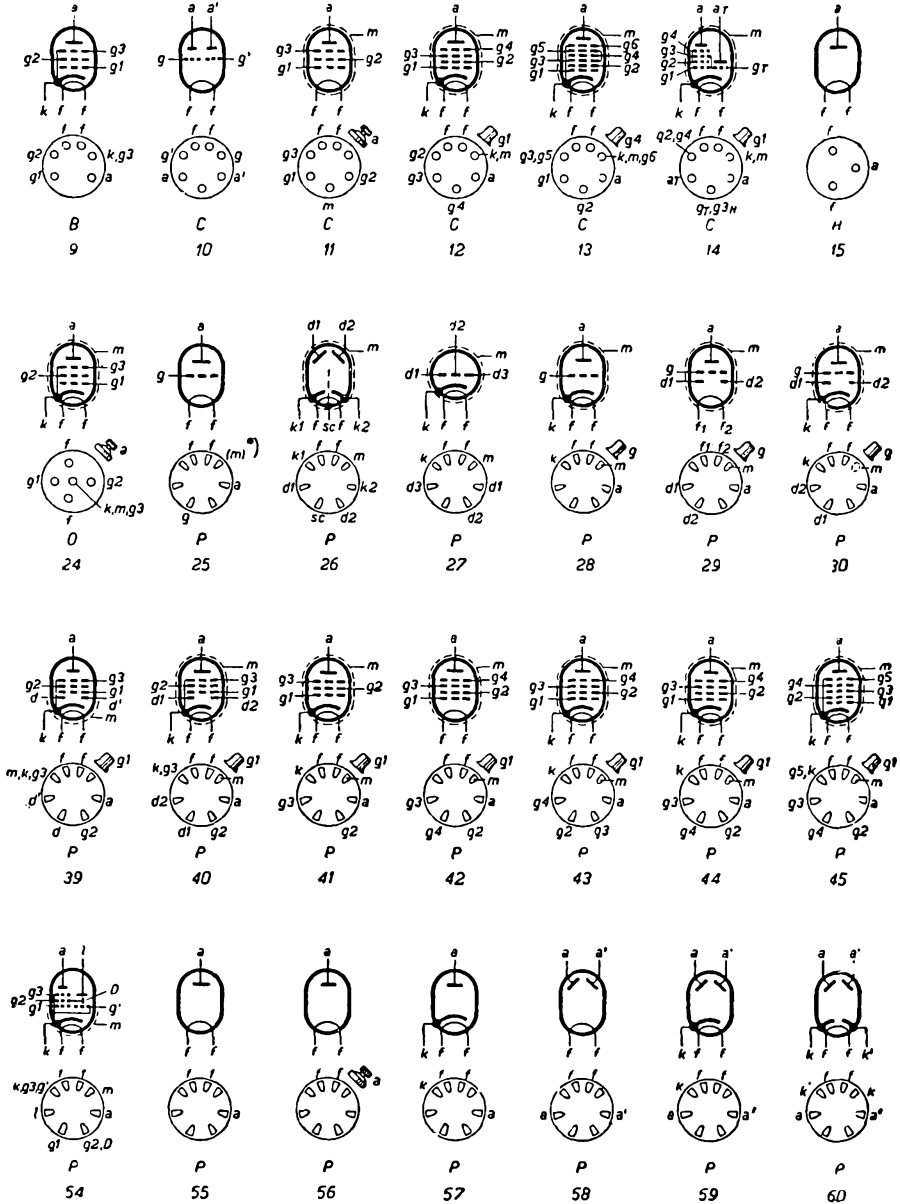

shown in parenthesis is the number of the sketch above, giving the connections of the base. In each case the theoretical valve diagram is also given and in the different figures the base is represented as viewed against the pins or contacts. Top-cap connections are shown in diagram.



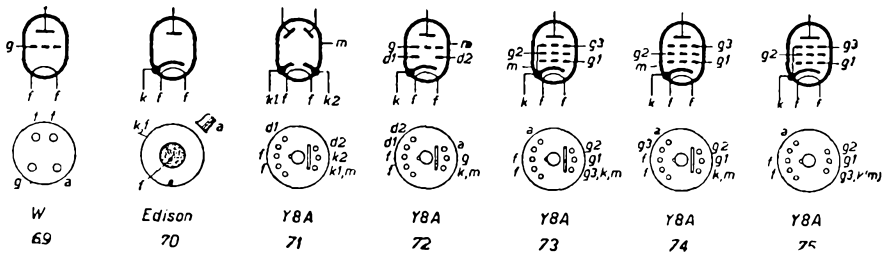

TELEVISION AND RADIO RECEIVING VALVES, STABILIZERS, AND SPECIAL AMPLIFYING VALVES

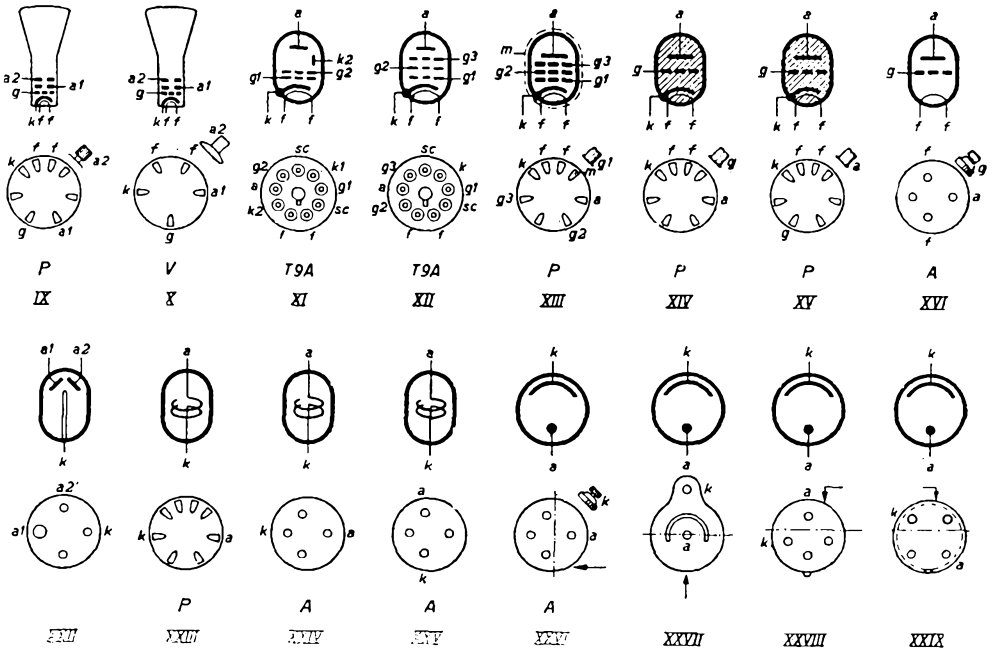



# **Circuits of A. C. Receivers**

## I. 9-Valve superheterodyne receiver with balanced output stage

*Valves used:* EF 8, ECH 3, EF 9, EAB 1, EEP 1,  $2 \times$  EL 6, AZ 4, EM 4.

This is a design for a high-class receiver of unusually high sensitivity, having an output stage that will give ample power. On long and medium waves the sensitivity is  $0.7 \mu\text{V}$ ; the receiver has 4 wave-ranges, two of which are for short-wave reception, as follows:

Long waves	830—2080 m
Medium waves	200—560 m
Short waves I	36—90 m
Short waves II	15—37.5 m.

The R.F. input stage includes a "silentode" valve EF 8 and the noise level is accordingly extremely low. Delayed automatic gain control using the triple-diode principle is provided, and the stage of A.F. amplification employs the secondary-emission valve EEP 1 for driving the balanced output stage, consisting of two 18 W pentodes EL 6.

The bandwidth can be adjusted to either of two settings by varying the coupling between the circuits of the first I.F. transformer, and as a tuning indicator the dual-sensitivity electronic indicator EM 4 is used. The R.F. circuits are based on the use of a variable capacitor of 20—500  $\mu\mu\text{F}$ , the "zero" capacitance of the medium-wave range having been assessed as 50  $\mu\mu\text{F}$  and that of the long-wave range at 70  $\mu\mu\text{F}$  (wiring, trimmers, etc.). On medium waves the capacitive variation is accordingly 70 to 550  $\mu\mu\text{F}$  and in the long-wave range 90 to 570  $\mu\mu\text{F}$ ; using R.F. coils of inductance 160  $\mu\text{H}$ , the former range therefore covers 200 to 560 m, whilst on long waves R.F. coils of inductance 2,150  $\mu\text{H}$  give a range of 830 to 2,080 metres.

It is not possible to state accurately the self-inductance of the short-wave coils, since the inductance of the wiring affects the ultimate value; the total inductance of both the coil and the wiring is therefore adjusted to the required value in the receiver, and this is done with a small copper plate adjusted at a certain distance from the coil by means of a screw, the latter being locked with solder when the adjustment has been completed. Inductance values of 4 and 0.7  $\mu\text{H}$  provide ranges of 36 to 90 and 15 to 37.5 m respectively. The coupling between the aerial and R.F. circuits is inductive, and for this reason the inductances for the medium- and long-wave ranges are trimmed to the correct values with the aerial coil short-circuited. The increase in the inductance when the short-circuit is removed is then a measure of whether the coupling between aerial and tuning coil is sufficient to provide the necessary voltage gain. The coils are so proportioned as to give a voltage gain factor of the same value on all wave-ranges; when the short-circuit is removed from the aerial coil the inductance of the medium-wave tuning coil increases by 3% and that of the long-wave coil by 7%. Selection of the required wave-range is effected by switching the coils; this is preferable to the method, often followed, of short-circuiting certain sections of the coils, although the latter procedure does certainly entail fewer contacts on the switch. Shorted sections of coils tend to introduce various kinds of interference (erratic tuning, undesirable coupling, etc.). Coupling between the 2nd R.F. circuit and the anode circuit of the R.F. valve is inductive and, as this coupling must be as tight as possible, coils S 9 and S11, S10 and S12 are wound together on the same formers; the method of ensuring sufficiently tight coupling in the case of the short-wave coils S13/S14 and S15/S16 may be seen from the diagrams of the coils.

Due to the high signal-to-noise ratio of the "silentode" EF 8, the noise level is exceptionally low, this being an important factor in short-wave reception; in the medium and long-wave ranges the amplification of this valve is attenuated by employing capacitive tappings in the 1st and 2nd R.F. circuits so as to limit the grid input voltage to the frequency-changer; in this way overloading is avoided and whistling tones are suppressed. The capacitive tapping in the first R.F. circuit also limits the signal input



to the EF 8, thus improving the cross-modulation characteristics and, due to the very low noise level of this valve, the signal-to-noise ratio is thereby not adversely affected.

The lower voltage gain and R.F. amplification in this circuit are obtained by coupling the EF 8 and ECH 3 to their input circuits through the low capacitances C6 and C16, but in the short-wave range the R.F. amplification is used to the full, a capacitor of 100  $\mu\mu\text{F}$  being then connected in parallel with C6, whilst C16 is short-circuited.

Extra smoothing is provided in the form of a choke with an electrolytic capacitor, for the R.F. valve, frequency-changer, I.F. valve and A.F. pre-amplifier, to suppress modulation hum and direct ripple. Since the frequency-changer in this circuit is not provided with automatic gain control and there is therefore no risk of frequency drift, the oscillator circuit is coupled to the grid of the triode unit of the ECH 3. As is also the case with the R.F. circuits, the wave-range of the oscillator is changed by switching between the coils, the advantage of this being that the coils are then quite independent of each other; the effects sometimes occurring with series-connected coils, such as jumping of the frequency in stages, are also avoided. In the first range a resistor of 16,000 ohms is connected across the oscillator circuit to ensure

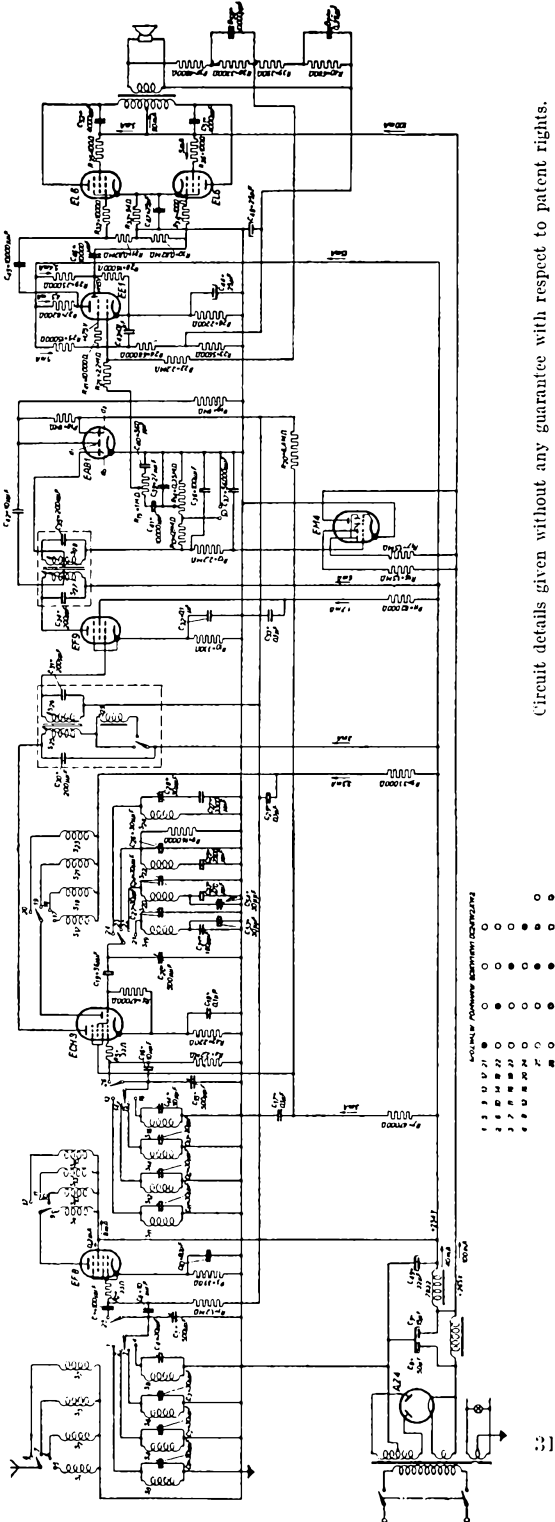

(Circuit details given without any guarantee with respect to patent rights.)

the greatest possible stability of the oscillator voltage; the padding capacitor for the long- and medium-wave ranges consists of a fixed capacitance with a trimmer in parallel, for accurate adjustment.

The frequency-changer is the ECH 3; the oscillator voltage on the 3rd grid of the hexode part of this valve and on the control grid of the triode unit should be about 8 V<sub>eff</sub>, with 200  $\mu$ A passing through the leak R6 of the last mentioned valve.

To suppress any tendency towards parasitic oscillation, a 33 ohm resistor is included in the lead to the hexode unit; the anode voltage of the triode part, as well as that of grids 2 and 4 of the hexode are derived directly from the supply line through series resistors, as the mixer is not controlled by the A.G.C. As already stated, the feed to the mixer valve is smoothed twice, but even without this the modulation hum becomes only slightly troublesome when very powerful transmissions are being received.

The I.F. is 470 kc/s and the quality of the I.F. transformers,  $r/L$ , is equal to  $15,000 \frac{\text{ohms.}}{\text{H}}$ .

To align the circuits the self-inductance is varied by rotating the iron cores. The capacitance of the capacitors is fixed, at 200  $\mu$ F; adding to this 20  $\mu$ F for coil and wiring capacitances and taking into account losses in the primary circuit due to the internal resistance of the frequency-changer, the average circuit impedance of the first I.F. transformer will be 2,750,000 ohms; with a conversion conductance of 0.65 mA/V this will produce a conversion gain factor of 90. The coupling between the circuits of the first I.F. transformer is variable from "critical" to "super-critical", a small coil being connected in series with the primary side; the coupling between this coil and the secondary side is such that when the coil is switched into the circuit an increased coupling, and therefore a wider bandwidth, is obtained. The detuning effect produced by the introduction of this coil does not greatly alter the resonance curve as a whole, displacement of the peak being only about 1 kc/s.

For one-tenth of the response at resonance the amount of detuning in the "wide" bandwidth setting is 6.5 kc/s and in the "narrow" 3.8 kc/s. The circuits of the 2nd I.F. transformer are damped by two diodes, together with the internal resistance of the I.F. valve; the diode valve EAB 1 serves as detector and also provides the A.G.C., with diode  $d_3$  as detector. Diode  $d_1$  is connected to the primary side of the last I.F. transformer. No delay voltage is applied to the latter diode and the distortion that would otherwise occur is thus avoided.

The delay voltage for the A.G.C. is furnished by diode  $d_2$ ; as long as this diode is positive (due to its connection to  $R_{20}$ ), current flows through it and there is no control on the R.F. and I.F. valves, but immediately  $d_1$  becomes sufficiently negative to check the flow of current the A.G.C. comes into operation. Diodes  $d_1$  and  $d_3$  are connected to tapings on the I.F. coil in order to keep the damping effects of these diodes upon the I.F. circuits as low as possible.

A resistor,  $R_{13}$ , is placed in series with the volume control  $R_{14}$  for the purpose of reducing the difference between the A.C. and D.C. loading of the diode circuit, for, if this is not used, the difference is too great, because the tone control  $R_{15}$  is in parallel with  $R_{14}$  so far as A.C. is concerned (with the volume control turned to maximum). As is known, this would cause demodulation of the I.F. signal and also place a limit on the modulation depth that can be handled by the diode without distortion. This effect is almost entirely eliminated by the resistor  $R_{13}$ ; signals of maximum modulation depth 75 % can be received and, although the sensitivity of the receiver is reduced to the extent of 22 % by this resistor, this can hardly be regarded as a disadvantage, as the sensitivity is in any case ample.

The A.F. voltage is derived from the potentiometer  $R_{14}$  and passes by way of capacitor  $C_{41}$  to the tone-control potential divider  $R_{15}$ . The latter includes a capacitor  $C_{40}$ , the signal being taken from potential divider  $R_{15}$  across a resistor of 2.2 megohms ( $R_{21}$ ) to the grid of the EEP 1; the purpose of  $R_{21}$  is to render the feed-back, which

is applied to the grid across another resistor of 2.2 megohms ( $R_{22}$ ), independent of the setting of  $R_{15}$  and  $R_{14}$ .

The secondary-emission valve EEP 1 functions as a combined pre-amplifier and phase-inverter, the A.F. voltages being supplied in anti-phase from the anode and auxiliary cathode. Although the conductances of the anode and the cathode in question are practically equal, the resistor  $R_{29}$  has a higher value than  $R_{27}$  since the impedance in the auxiliary cathode circuit consists not only of  $R_{29}$  but also of the parallel-connected resistors  $R_{29}$  and  $R_{28}$  (so far as A.C. is concerned). The screen grid and auxiliary cathode are fed by means of potential dividers, in order to minimize D.C. voltage variations as much as possible. Grid bias is derived from the difference between the cathode voltage and a positive feed-back potential, the latter being necessary because the voltage drop across  $R_{26}$  is greater than the required bias; the variations in current between

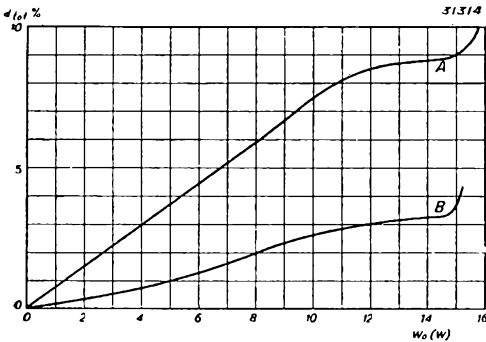

Fig. 1

Curve A. Total distortion as a function of the output power  $W_o$  of the whole A.F. section of the receiver, without negative feed-back.  
Curve B. The same, but with negative feed-back.

and screen-grid leads, again to check parasitic oscillation, and these valves deliver 14 W with 3.5 % distortion at maximum excitation. The matching impedance between the anodes is 5,000 ohms. Fig. 1 shows the total distortion with and without negative feed-back, as a function of the output power.

Through the potential-divider circuit, consisting of the resistors  $R_{37}$ ,  $R_{38}$ ,  $R_{39}$  and  $R_{40}$ , part of the voice-coil voltage is applied through the resistor  $R_{22}$  to the grid of the EEP 1; capacitors are connected in parallel with  $R_{34}$  and  $R_{40}$ , their values being such that the feed-back is attenuated on the high and low frequencies, thus giving a very uniform response at all frequencies.

The frequency response of the A.F. section of the receiver is shown in Fig. 2 and relates to

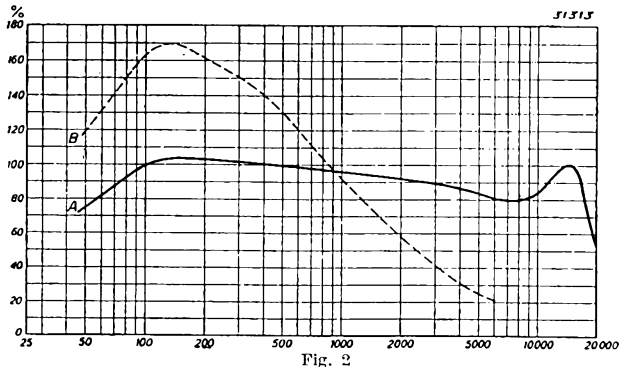

Fig. 2

Curve A. Frequency response with tone control rotated in clockwise direction.  
Curve B. Frequency response with tone control rotated in anticlockwise direction.

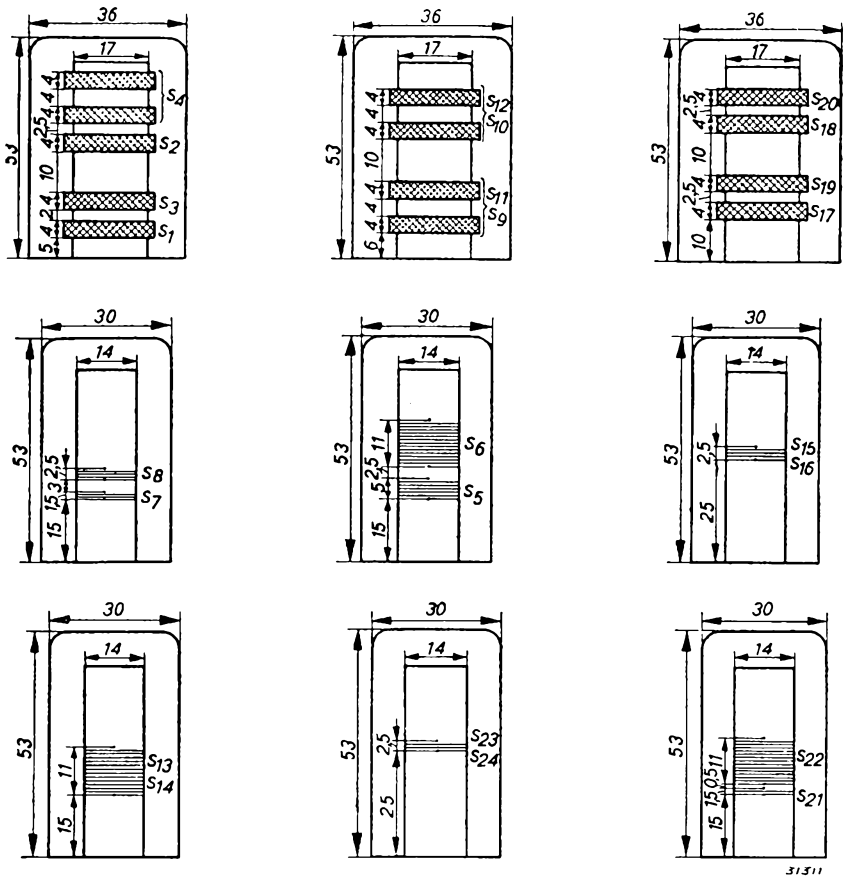

Fig. 3  
R.F. and oscillator coils used in the 9-valve superheterodyne receiver.

both maximum and minimum setting of the tone control; the amount of negative feed-back equals a factor of 7.

Tuning indication is given by means of the electronic indicator EM 4, to the grid of which is applied the negative voltage produced across the grid leak of the detector diode; the A.F. voltages across this resistor are filtered out by  $R_{13}$  and  $C_{37}$ . Each of the anodes of the two triodes contained in the EM 4 is connected to a separate deflector rod within the valve.

As the gain factors of the two triodes of the EM 4 are not the same, a clear indication is obtained on weak as well as on strong signals.

The rectifying valve is the AZ 4 and the smoothing circuit consists of a double electrolytic capacitor of  $50 + 15 \mu\text{F}$  with an 8-henry choke; the voltage for the earlier valves is smoothed again by means of another 8-henry choke and  $32 \mu\text{F}$  electrolytic capacitor and the extra cost of this additional filter is justified when set against the saving effected by the valves. The voltage across the capacitor  $C_9$  should be 265 V and a transformer is used of which the no-load secondary voltage is about  $2 \times 300$  V; the total current consumed is approximately 140 mA.

## Technical data

### 1. Sensitivity (for 50 mW output) on the medium- and long-wave ranges.

at the diode	0.3 $V_{(eff)}$	I.F. stage gain: 145 Conversion gain factor: 90 R.F. stage gain: 15 Voltage gain factor: 2.5
at the I.F. valve	2.1 $mV_{(eff)}$	
at the freq. changer	24 $\mu V_{(eff)}$	
at the R.F. valve	1.6 $\mu V_{(eff)}$	
at the aerial	0.7 $\mu V_{(eff)}$	

### 2. Selectivity

“Narrow” bandwidth

Attenuation on detuning	+ 3.8 and — 3.8 kc/s	1 : 10
“ ” “ ”	+ 7 and — 7 “ ”	1 : 100
“ ” “ ”	+ 12 and — 12 “ ”	1 : 1,000

“Wide” bandwidth

Attenuation on detuning	+ 6.5 and — 6.5 kc/s	1 : 10
“ ” “ ”	+ 10 and — 10 “ ”	1 : 100
“ ” “ ”	+ 15 and — 15 “ ”	1 : 1,000

### 3. Automatic gain control curve:

1 ×	normal input voltage	corresponds to	1 ×	normal output voltage
5 ×	“ ” “ ”	“ ”	5 ×	“ ” “ ”
10 ×	“ ” “ ”	“ ”	10 ×	“ ” “ ”
100 ×	“ ” “ ”	“ ”	25 ×	“ ” “ ”
1,000 ×	“ ” “ ”	“ ”	35 ×	“ ” “ ”
10,000 ×	“ ” “ ”	“ ”	50 ×	“ ” “ ”

TABLE OF COILS

Coil	Num-ber of turns	Self-inductance	Type of winding	Dia. of former	Dia. of wire mm	Type of wire	Dia. of can
S1	700	—	wave	17	0.1	Enamel	36
S2	190	—	“	17	0.1	“	36
S3	320	2,150 $\mu H$	“	17	0.1	“	36
S4	2 × 60	160 $\mu H$	“	17	15 × 0.05	Litz	36
S5	40	—	layer	14	0.1	Enamel	30
S6	20	(S5 shorted) 4 $\mu H$	“	14	0.5	“	30
S7	13	—	“	14	0.1	“	30
S8	5½	(S7 shorted) 0.9 $\mu H$	“	14	0.5	“	30
S9	2 × 208	—	wave	17	0.1	d.s.c.	36
S10	2 × 60	—	“	17	0.1	“	36
S11	2 × 208	2,150 $\mu H$	“	17	0.1	“	36
S12	2 × 60	160 $\mu H$	“	17	15 × 0.05	Litz	36
S13	20	—	layer	14	0.1	d.s.c.	30
S14	20	4 $\mu H$	“	14	0.5	Enamel	30
S15	5½	—	“	14	0.1	d.s.c.	30
S16	5½	0.9 $\mu H$	“	14	0.5	Enamel	30
S17	40	—	wave	17	0.1	“	36
S18	35	—	“	17	0.1	“	36
S19	118	320 $\mu H$	“	17	0.1	“	36
S20	59	75 $\mu H$	“	17	0.1	“	36
S21	17	—	layer	14	0.1	“	30
S22	19.5	—	“	14	0.5	“	30
S23	4	—	“	14	0.1	d.s.c.	30
S24	5	—	“	14	0.5	Enamel	30

## II. 8-Valve superheterodyne receiver for 18 W output

*Valves used:* "Minivatt" EF 8, ECH 3, EF 9, EAB 1, EF 9, EL 6, AZ 4, EM 1.

This is a very sensitive, high-quality receiver with 4 wave-ranges (two for short-wave reception), and a low noise-level input stage; it differs from the receiver described under section I in that the output stage is arranged on simpler lines, whilst A.F. amplification and tuning indication are obtained in a different manner. Sensitivity on the long and medium wave-ranges is  $1 \mu\text{V}$ , the different ranges being as follows:

Long waves	829—2,000 m
Medium waves	200— 559 m
Short waves I	36— 90 m
Short waves II	15— 37.5 m.

Delayed A.G.C. is provided by the triple diode EAB 1 and the control is applied to the R.F. and I.F. valves only, that is to say, the frequency-changer ECH 3 is not included. The A.F. section works with strong negative feed-back for the reduction of distortion and to improve the frequency response of the A.F. amplifier.

As this receiver differs from the 9-valve circuit only in the design of the A.F. section, reference may be made to the description of that receiver for the R.F., mixer, I.F. and detector stages.

The A.F. amplifying valve is the EF 9, the A.F. signal being taken from the volume control  $R_{17}$ , through capacitor  $C_{33}$  to the grid of this valve. As output valve, the steep-slope 18 W pentode EL 6 is used, with small stopper resistors in the control- and screen-grid leads to suppress parasitic oscillation; the cathode resistor of this valve is decoupled with a  $50 \mu\text{F}$  dry electrolytic capacitor. Negative feed-back is applied to the A.F. amplifier; the speech voltage occurs across the potential divider  $R_{33}, 34, 35$  and  $36$ , and the attenuated voltage is fed back to the control grid. Capacitors are connected in parallel with  $R_{34}$  and  $R_{35}$ , of a suitable value to reduce the amount of feed-back on high and low frequencies and thus ensure uniform response throughout the whole A.F. range (see Fig. 1, curve a; full line). For comparative purposes the frequency curve showing the performance without feed-back is also given. The capacitor  $C_{40}$  may be switched out of the circuit in order to reduce amplification

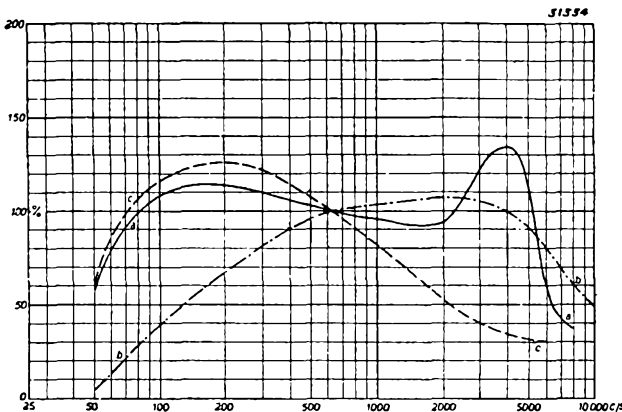

Fig. 1

- Curve a. Frequency response with capacitor  $C_{54}$  in circuit.  
 Curve b. Frequency response without feed-back.  
 Curve c. Frequency response with capacitor  $C_{54}$  out of circuit.

of the high frequencies, and the switch therefore functions as a tone control (curve c).

The resistors  $R_{28}$  and  $R_{29}$  together form a potential divider for both the A.F. voltage on the diode-load resistor and the feed-back voltage, and if these resistors are of equal value the amplification and the feed-back will be reduced by one half.

Visual tuning is provided by the electronic indicator EM 1, for which purpose part of

the negative voltage from the detector-diode anode is taken across a potential divider  $R_{18}-R_{19}$  to the grid. The voltage from a gramophone pick-up is applied to the volume control  $R_{17}$  and a resistor,  $R_{16}$ , of 56,000 ohms is placed in series with the latter so that the detector diode of the EAB 1 will not be in parallel with the pick-up. The rectifying valve is the AZ 4 and the smoothing comprises two electrolytic capacitors of  $32 \mu\text{F}$  (320 V) and a choke of 8 H. The voltage across capacitor  $C_{56}$  should be 270 V, when the total current consumed will be approximately 112 mA.

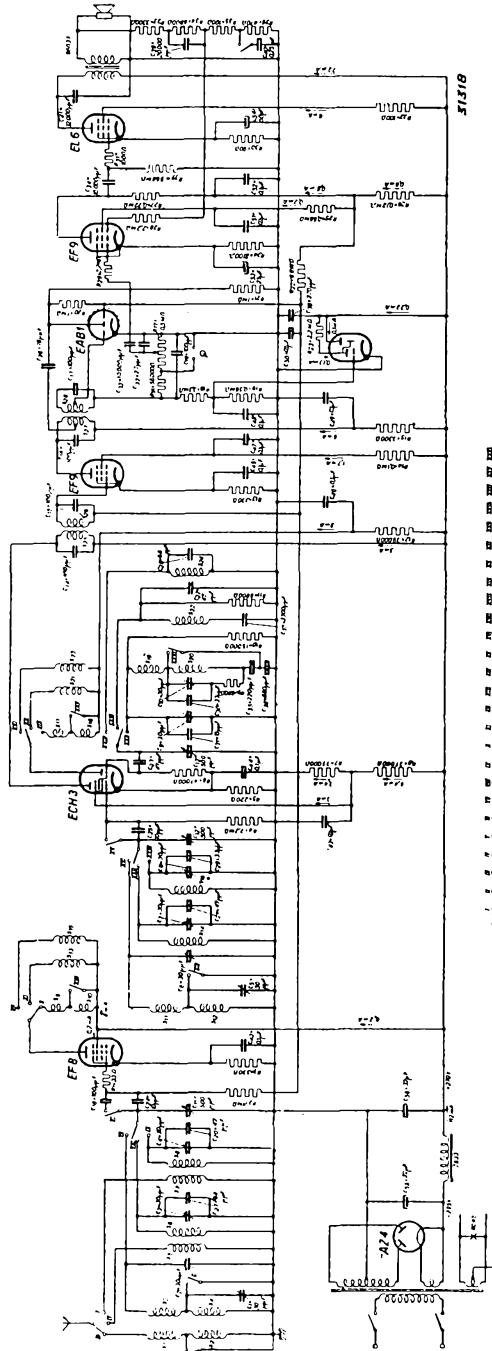

(circuit given without any guarantees in respect of patent rights.)

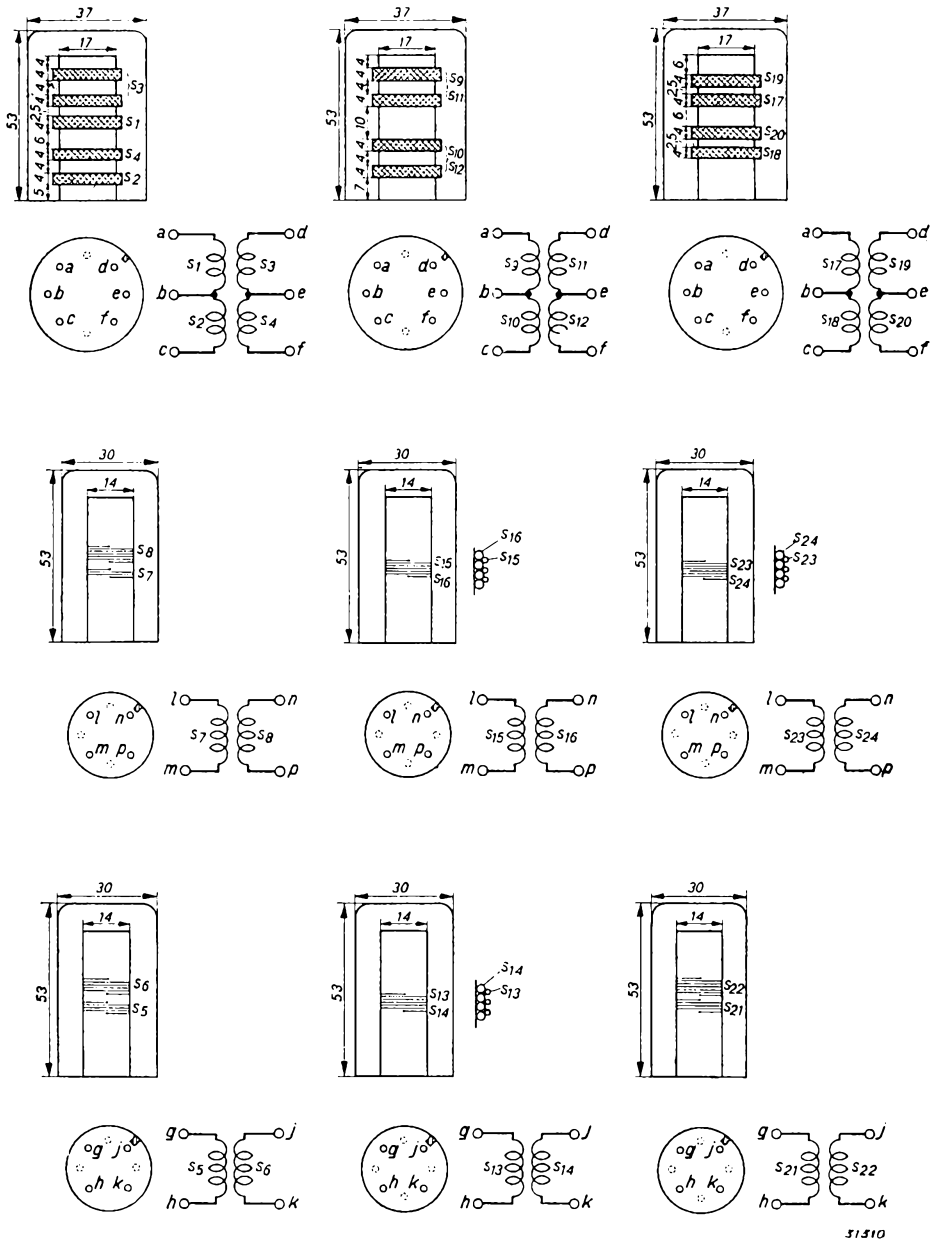

Fig. 2  
Coils employed in the 8-valve receiver.  
For the I.F. coils see Fig. 1 on page 324.



**TECHNICAL DATA**

1. *Sensitivity* (for 50 mW output) on the medium- and long-wave ranges.

at the diode	0.35 V <sub>(eff)</sub>	} I.F. stage gain 100 } Conversion gain factor 100 } R.F. stage gain 16 } Voltage gain factor 2.5
at the I.F. valve	3.5 mV <sub>(eff)</sub>	
at the freq. changer	35 μA <sub>(eff)</sub>	
at the R.F. valve	2 μV <sub>(eff)</sub>	
at the aerial	1 μV <sub>(eff)</sub>	

2. *Selectivity*

Attenuation on detuning	+ 4.5 and - 4.5 kc/s:	1 : 10
" " "	+ 8 and - 8 "	1 : 100
" " "	+ 13 and - 13 "	1 : 1,000

3. *Automatic gain control curve*

1 × normal input voltage	corresponds to	1 × normal output voltage
5 × " " "	" " "	5 × " " "
10 × " " "	" " "	10 × " " "
100 × " " "	" " "	25 × " " "
1,000 × " " "	" " "	35 × " " "
10,000 × " " "	" " "	50 × " " "

**TABLE OF COILS**

Coil	Number of turns	Self-inductance	Type of winding	Dia. of former	Dia. of wire mm	Type of wire	Dia. of can
S1	180	—	wave	17	0.1	Enamel	37
S2	680	—	"	17	0.1	"	37
S3	2 × 58	S1, 2 and 4 shorted = 160 μH	"	17	15 × 0.05	Litz	37
S4	306	S3 + S4 = 2,150 μH (S1 + S2 shorted in series)	"	17	0.1	Enamel	37
S5	40	—	layer	14	0.1	"	30
S6	20	(S5 shorted) 4 μH	"	14	0.5	"	30
S7	13	—	"	14	0.1	"	30
S8	5.5	(S7 shorted) 0.9 μH	"	14	0.5	"	30
S9	2 × 56	—	wave	17	0.1	d.s.c.	37
S10	2 × 205	—	"	17	0.1	"	37
S11	2 × 56	(S12 shorted) 160 μH	"	17	0.1	"	37
S12	2 × 205	(S11 + S12) = 2,150 μH	"	17	0.1	"	37
S13	20	—	layer	14	0.1	"	30
S14	20	(S13 shorted) 4 μH	"	14	0.5	Enamel	30
S15	5.5	—	"	14	0.1	d.s.c.	30
S16	5.5	0.9 μH	"	14	0.5	Enamel	30
S17	35	—	wave	17	0.1	"	37
S18	40	—	"	17	0.1	"	37
S19	56	(S20 shorted) 75 μH	"	17	0.1	"	37
S20	102	S19 + S20 = 320 μH	"	17	0.1	"	37
S21	17	—	layer	14	0.1	"	30
S22	19.5	—	"	14	0.5	"	30
S23	4	—	"	14	0.1	"	30
S24	5	—	"	14	0.5	"	30
S25)	2 × 130	—	wave	With 7 mm iron core	5 × 0.07	Litz	—
S26)							
S27)							
S28)							

### III. 8-Valve superheterodyne receiver for 9 W output

*Valves used:* "Miniwatt" EF 8, EK 3, EF 9, EAB 1, EF 6, EL 3, AZ 1, EM 1.

The following is a description of a highly sensitive 4-range receiver having an input stage with a very low noise level and a sensitivity of  $1 \mu\text{V}$  on the medium- and long-wave ranges. There are two short-wave bands, and the different ranges are as follows:

Long waves	829—2,120	m
Medium waves	200— 559	m
Short waves I	36— 90	m
Short waves II	15— 37.5	m

The receiver incorporates automatic gain control, with the EAB 1 in a triple-diode circuit, and use is also made of strong negative feed-back to minimize distortion and ensure uniform frequency response over the whole of the A.F. range; by means of a switch, a tone control can be included in the feed-back circuit if required. Visual tuning is included, this being provided by the EM 1, which is connected to the detector diode.

The silentode EF 8 is employed for the R.F. stage to ensure a low noise level. In the short-wave ranges the full amplification of this valve is utilized, but on medium and long waves the gain is reduced by capacitors  $C_{49}$  and  $C_{53}$ , so as not to overload the grid of the EK 3.

Only one tuned circuit precedes the R.F. stage in all the four wave-ranges; the R.F. medium- and long-wave coils are wound on a common former, whereas the coils for the two short-wave ranges are quite separate. The self-inductance is  $160 \mu\text{H}$  on the medium and  $2,150 \mu\text{H}$  on the long-wave range; for the short-wave ranges the minimum capacitance is brought up to about  $70 \mu\mu\text{F}$  by means of fixed capacitors which, although somewhat reducing the range, greatly improve the accuracy of tuning, especially at the lower end of the range. The inductances for the two short-wave bands are respectively  $4$  and  $0.9 \mu\text{H}$ , but as wiring inductances also have to be considered the coils are corrected to the required values in the receiver; this may be done by means of a small copper plate with screw, which is moved in and out of the field of the coil, being locked in its final position with solder.

The R.F. circuits are coupled inductively to the aerial; for the correction of the inductance of the medium-wave coils, the two coils S1 and S2 should be short-circuited, whilst the inductance of the long-wave coils is trimmed with these two coils shorted in series. Since the short-wave coils are corrected in the receiver itself, the effect of the aerial coils is naturally included in the inductance of the tuning coil.

A single tuned circuit is included between the R.F. and mixer valves for all the wave-bands.

The 2nd R.F. circuit is inductively coupled to the R.F. valve and, as this coupling has to be as tight as possible, coils S9 and S11, S10 and S12 are wound together: the method of winding the short-wave coils S13/S14 and S15/S16 that will ensure sufficiently tight coupling is shown in the diagrams of the coils.

The frequency-changer is the EK 3 and, as both the R.F. and I.F. valves are included in the automatic gain control system, the EK 3 is not controlled. The oscillator circuit is coupled to the first grid of the EK 3, since there is no risk of frequency drift, and the medium- and long-wave oscillator coils, moreover, are wound on the same formers. Padding capacitors are placed in series with the coils and they are also included in the switching; further, to increase uniformity of the oscillator voltage, resistors are connected in parallel with the oscillator circuits on the medium- and long-wave as well as the first short-wave ranges. The trimmers for the medium and long waves are augmented by fixed capacitors, but no trimmers are used in the short-wave oscillator circuits, because the existing capacitance can be sufficiently accurately corrected by means of the fixed capacitors.



A resistor  $R_{11}$  is placed in series with the long-wave trimmer to prevent any possible oscillation at undesired frequencies. The I.F. valve is the EF 9, the screen of which is fed across a resistor. The intermediate frequency is 470 kc/s and the inductance of the I.F. coils, which are fitted with iron cores, is about 1 mH; the I.F. circuits are trimmed by varying the self-inductance, this being effected by rotating the iron cores.

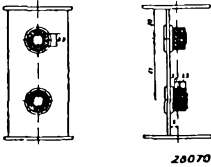
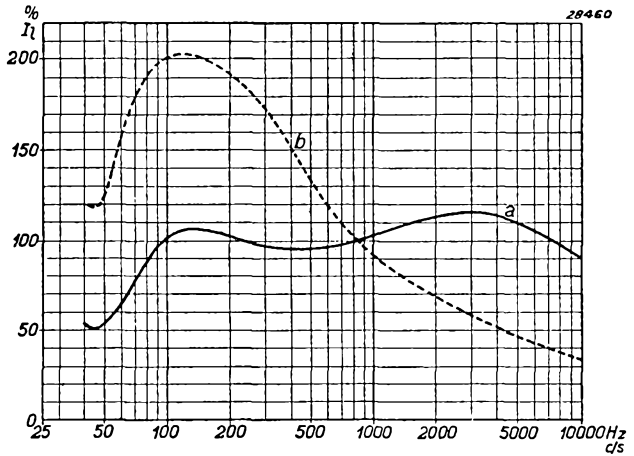

Fig. 1  
I.F. coil.

Diode  $d_3$  of the 3-diode valve EAB 1 is employed as detector, with diode  $d_1$  for the A.G.C., this being connected to the primary circuit of the last I.F. transformer. The delay voltage of the A.G.C. is supplied by diode  $d_2$  and so long as the latter is positive (across  $R_{25}$ ) it will carry a current and the R.F. and I.F. valves will be uncontrolled. Diodes  $d_3$  and  $d_1$  are connected to tappings on the I.F. coils in order that losses produced by these diodes may be kept as low as possible.

The A.F. voltage across the volume control  $R_{16}$  is applied through a capacitor  $C_{36}$  to the grid of the A.F. valve EF 6 and a resistor  $R_{30}$  is employed to render the A.F. characteristic sufficiently straight. A potential divider R 23, 24, 30 and 31 is placed across the output, the values of these resistors being so chosen that they will combine to provide the correct grid bias for the EF 6; a part of the speech voltage is simultaneously fed back to the cathode of the EF 6, and the resistors  $R_{23}$  and  $R_{30}$  are by-passed by capacitors of a suitable value to reduce the amount of feed-back at the high and low frequencies, thus ensuring uniform reproduction over the whole of the A.F. range. Capacitor  $C_{40}$  is provided with a switch for purposes of tone control, the amplification of high frequencies being considerably reduced when this switch is opened.



In regard to this receiver circuit it may be said,

further, that a resistor of 200 ohms, without decoupling capacitor, is included in the cathode circuit of the EF 6; under certain circumstances this arrangement might give rise to hum, but if this should be considered a drawback the connections of the ECH 3 in circuit IV may be used in preference, though then the sensitivity is slightly lower. A resistor  $R_{15}$  is connected in series with the volume control; otherwise the diode  $d_3$  would be in parallel with the pick-up sockets.

The rectifying valve used is the AZ 1, and smoothing is by means of an 8 H choke; the total amount of direct current delivered is 73 mA.

## TECHNICAL DATA

### 1. Sensitivity (for 50 mW output) on the medium- and long-wave ranges:

at the diode	0.55 V <sub>eff</sub>	} I.F. stage gain 114 } Conversion gain factor 90 } R.F. stage gain 16 } Voltage gain factor 2.5
at the I.F. valve	4.8 mV <sub>eff</sub>	
at the mixer valve	40 μV <sub>eff</sub>	
at the R.F. valve	2.5 μV <sub>eff</sub>	
at the aerial	1 μV <sub>eff</sub>	

### 2. Selectivity

Attenuation on detuning	+ 3.5 and - 3.5 kc/s	1 : 10
" " "	+ 5.5 and - 5.5 "	1 : 100
" " "	+ 7.5 and - 7.5 "	1 : 1,000

### 3. Automatic gain control curve

1 ×	normal input voltage	corresponds to	1 ×	normal output voltage
5 ×	" " "	" " "	5 ×	" " "
10 ×	" " "	" " "	10 ×	" " "
100 ×	" " "	" " "	25 ×	" " "
1,000 ×	" " "	" " "	35 ×	" " "
10,000 ×	" " "	" " "	50 ×	" " "

TABLE OF COILS

Coil	Number of turns	Self-inductance	Type of winding	Dia. of former	Dia. of wire mm	Type of wire	Dia. of can
S1	180	—	wave	17	0.1	Enamel	37
S2	680	—	"	17	0.1	"	37
S3	2×58	(S1, S2 and S4 shorted) = 160 μH	"	17	15×0.05	Litz	37
S4	306	S3 + S4 = 2,150 μH (S1 + S2 shorted in series)	"	17	0.1	Enamel	37
S5	40	—	layer	14	0.1	"	30
S6	20	(S5 shorted) 4 μH	"	14	0.1	"	30
S7	13	—	"	14	0.1	"	30
S8	5.5	(S7 shorted) 0.9 μH	"	14	0.5	"	30
S9	2×56	—	wave	17	0.1	d.s.c.	37
S10	2×205	—	"	17	0.1	"	37
S11	2×56	(S12 shorted) 160 μH	"	17	0.1	"	37
S12	2×205	S11 + S12 = 2,150 μH	"	17	0.1	"	37
S13	20	—	layer	14	0.1	"	30
S14	20	(S13 shorted) 4 μH	"	14	0.5	Enamel	30
S15	5.5	—	"	14	0.1	d.s.c.	30
S16	5.5	(S15 shorted) 0.9 μH	"	14	0.5	Enamel	30
S17	35	—	wave	17	0.1	"	37
S18	40	—	"	17	0.1	"	37
S19	56	(S20 shorted) 75 μH	"	17	0.1	"	37
S20	102	S19 + S20 = 320 μH	"	17	0.1	"	37
S21	17	—	layer	14	0.1	"	30
S22	19.5	(S21 shorted) 4 μH	"	14	0.5	"	30
S23	4	—	"	14	0.1	"	30
S24	5	(S23 shorted) 0.9 μH	"	14	0.5	"	30
S25							
S26	2×130	—	wave	with 7 mm iron core	5×0.07	Litz	—
S27							
S28							

#### IV. 6-Valve superheterodyne receiver

*Valves used:* "Miniwatt" ECH 3, EF 9, EBC 3, EL 3N, AZ 1, EM 1.

This receiver circuit, which has a sensitivity of  $16 \mu\text{V}$  on the medium- and long-wave ranges, has three ranges, viz:

Long waves	830—2,000 m
Medium waves	200— 547 m
Short waves	15— 48 m.

Delayed automatic gain control is provided. The double-diode EBC 3 is employed as detector, resistance-coupled amplifier and also to provide the delay voltage for the A.G.C. The steep-slope 9 W pentode EL 3N is used as output valve. The A.F. circuit includes negative feed-back derived from a part of the speech voltage, which is applied to the grid of the EBC 3, whilst the frequency-response curve is further improved by employing components in the feed-back circuit which are dependent of the frequency. The EM 1, coupled to the detector diode, provides visual tuning. On medium and long waves an R.F. band-pass filter with capacitive coupling is employed; the circuit calculations are based on the use of a variable capacitor of capacity 20 to  $500 \mu\mu\text{F}$ , the minimum-capacitance on the medium- and long-wave ranges, including wiring, trimmers, etc., being 50 and  $70 \mu\mu\text{F}$  respectively.

Taking into consideration the capacitance of the band-pass filter coupling capacitor, connected in series with the tuning capacitor, the capacitive variation for the medium-wave band is 70 to  $527 \mu\mu\text{F}$  and on long waves 90 to  $521 \mu\mu\text{F}$ . With coils of  $160 \mu\text{H}$ , the first mentioned range covers 200 to 547 m, whilst coils of  $2,150 \mu\text{H}$  give 829 to 2,000 m for the long waves. For short-wave reception only one R.F. circuit is provided, and the inductance of the short-wave coil is about  $1.3 \mu\text{H}$ . On medium and long waves the coupling between the aerial and the first R.F. circuit is both capacitive and inductive, so that a constant voltage gain factor of 3 is obtained throughout the whole range; in the short-wave band the coupling is purely inductive. For the adjustment of the self-inductance of the first R.F. coil the aerial coil is short-circuited and, as coil  $S_3$  is shorted on medium waves, trimming of the inductance for this range is carried out with the two coils  $S_2$  and  $S_3$  shorted; the long-wave range is trimmed with coils  $S_2$  and  $S_3$  shorted in series. The inductance of the short-wave coil is adjusted in the receiver by means of a small copper cylinder which is pushed into the coil and screwed in position when the correct value is obtained, and in this case the effect of the aerial coil on the inductance of the tuning coil is, of course, taken into account. In order to keep frequency drift at a minimum, the oscillator circuit is connected to the anode of the triode section of the ECH 3 and the amount of drift is, in fact, so small that the frequency-changer can be included in the A.G.C. system on short waves as well.

The three oscillator coils are wound on a common former (Fig. 1). The padding capacitors are arranged in series with the coils and are included in the coil switching. Constant oscillation throughout the wave ranges is ensured by connecting the lower end of the series-connected reaction coils to the upper end of the two padding capacitors also in series. The anode potential for the oscillator unit of the valve is applied through a resistor  $R_{10}$ , with capacitor  $C_{18}$  to block the direct voltage from the oscillator circuit (parallel supply).

The medium-wave padding capacitor should be about  $530 \mu\mu\text{F}$  and the long-wave capacitor about  $170 \mu\mu\text{F}$ , the latter value being obtained by connecting  $250 \mu\mu\text{F}$  in series with the medium-wave padding capacitor; the ultimate values of these capacitors will depend on the minimum-capacitance of the respective circuits.

Capacitor  $C_{17}$  has a value of about  $50 \mu\mu\text{F}$ , which ensures reliable oscillation on long waves whilst guaranteeing the least possible amount of frequency drift on the short-wave range. The voltage for the 2nd and 4th grids of the ECH 3 is obtained



ing the full voltage for the control.

The A.F. voltage is tapped from the volume control  $R_{15}$  and is taken through  $C_{33}$  to the potential divider  $R_{16}$ , which serves as tone control; the effective tone-control circuit actually consists of  $R_{16}$  and  $C_{35}$  and the voltage is passed from the potential divider  $R_{16}$  through  $R_{17}$  to the grid of the EBC 3. The last-named resistor is included to prevent the feed-back voltage, occurring across the resistor  $R_{16}$  (also 2 megohms) on the grid of the valve, from varying with the setting of  $R_{15}$  and  $R_{16}$ .

To ensure satisfactory reproduction of the low frequencies, the cathode resistor of the EBC 3 is decoupled by an electrolytic capacitor  $C_{36}$  of 25  $\mu$ F.

The output valve is the steep-slope pentode EL 3 N, the control-grid and screen-grid circuits of which include small stopper resistors to suppress parasitic oscillation. A part of the speech voltage is tapped from the potential divider  $R_{29-30-31-32}$  and is applied to the grid of the EBC 3 through a resistor  $R_{18}$ , the feed-back factor being about 4. Capacitors are connected in parallel with  $R_{30}$  and  $R_{32}$ , of suitable values to reduce the amount of feed-back on the high and low frequencies, thus ensuring uniform response over the whole A.F. range.

The EM 1 provides visual tuning indication, part of the negative potential on the detector diode being taken to the grid of this valve across the potential divider  $R_{14}-R_{19}$ ; the cathode of the electronic indicator is connected to that of the I.F. valve, since, if it were earthed, the grid of the EM 1 would become positive on weak signals (cathode voltage of the EBC 3), in

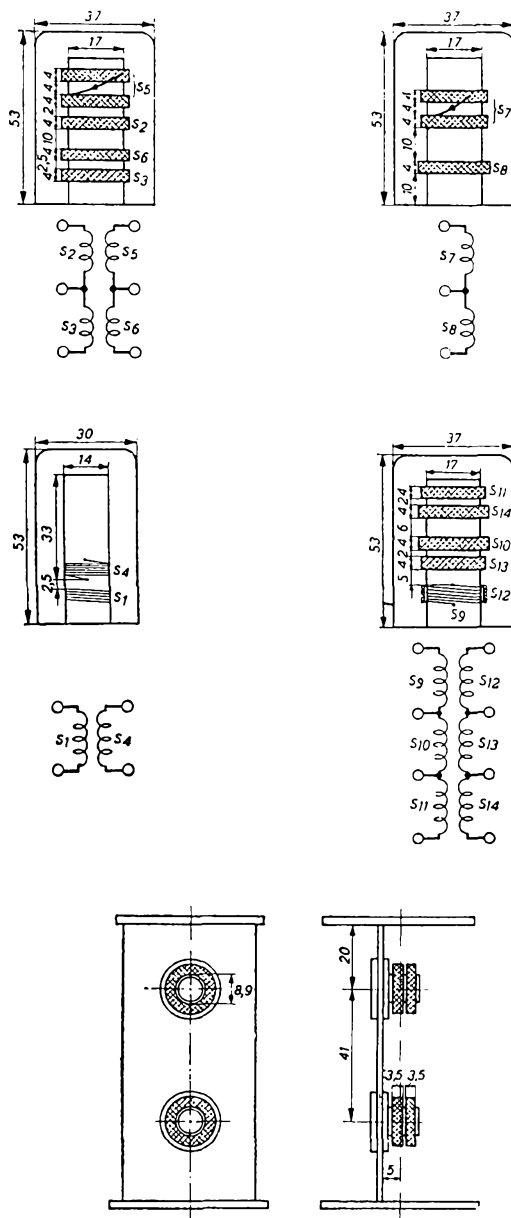

Fig. 1  
Coils employed in the 6-valve receiver.



consequence of which no indication would appear. Since control is applied to the EF 9, the cathode potential of this valve falls when the signals are strong; the deflection on the screen of the indicator on strong signals is therefore smaller in proportion, and a good indication is thus ensured when the more powerful transmissions are being received.

The rectifier is the AZ 1 and the smoothing circuit consists of two electrolytic capacitors of 32  $\mu$ F (320 V) with an 8 H choke. The voltage across capacitor C 43 should be 264 V, so that the transformer should deliver a no-load secondary voltage of  $2 \times 300$  V. The total consumption is about 60 mA.

### TECHNICAL DATA

- Sensitivity* (for an output of 50 mW) on the medium- and long-wave ranges.
 

at the diode	0.5 V <sub>(eff)</sub>	{	I.F. stage gain: 100
at the I.F. valve	5 mV <sub>(eff)</sub>		
at the mixer valve	50 $\mu$ V <sub>(eff)</sub>		
at the aerial	16 $\mu$ V <sub>(eff)</sub>		
			Conversion gain factor: 100
			Voltage gain factor: 3

### 2. *Selectivity*

Attenuation on detuning + 4.5 and — 4.5 kc/s: 1 : 10  
 " " " + 8 and — 8 " 1 : 100  
 " " " + 13 and — 13 " 1 : 1,000

### 3. *Automatic gain control curve*

1 $\times$	normal input voltage	corresponds to	1 $\times$	normal output voltage
5 $\times$	" " "	" " "	5 $\times$	" " "
10 $\times$	" " "	" " "	8 $\times$	" " "
100 $\times$	" " "	" " "	18 $\times$	" " "
1,000 $\times$	" " "	" " "	30 $\times$	" " "
10,000 $\times$	" " "	" " "	42 $\times$	" " "

TABLE OF COILS

Coil	Number of turns	Self-inductance	Type of winding	Dia. of former	Dia. of wire mm	Type of wire
S1	13	—	layer	14	0.1	Enamel
S2	180	—	wave	17	0.1	"
S3	680	—	"	17	0.1	"
S4	13	—	layer	14	1	"
S5	2 $\times$ 58	(S2, S3 and S6 shorted) 160 $\mu$ H	wave	17	15 $\times$ 0.05	Litz
S6	310	S5 + S6 (S2 + S3 shorted in series) = 2,150 $\mu$ H	"	17	0.1	Enamel
S7	2 $\times$ 57	(S8 shorted) 160 $\mu$ H	"	17	15 $\times$ 0.05	Litz
S8	294	S7 + S8 = 2,150 $\mu$ H	"	17	0.1	Enamel
S9	7	—	layer	17	0.5	"
S10	54	S9 + S10 (S11 shorted) = 75 $\mu$ H	wave	17	0.1	"
S11	99	S9 + S10 + S11 = 320 $\mu$ H	"	17	0.1	"
S12	6	—	layer	17	0.1	"
S13	35	—	wave	17	0.1	"
S14	40	—	"	17	0.1	"
S15						
S16	2 $\times$ 130	—	"	7 mm iron core.	5 $\times$ 0.07	Litz
S17						
S18						

## V. 6-Valve superheterodyne receiver

*Valves used:* "Miniwatt" EK 3, EF 9, EBC 3, EL 3, AZ 1, EM 1.

This type of receiver falls within the "average" price class and it has a sensitivity of 16  $\mu\text{V}$ .

The three wave-ranges employed are as follows:

Long waves	S30—2,000 m
Medium waves	200— 547 m
Short waves	15— 48 m.

Delayed automatic gain control is provided. The double-diode EBC 3 functions as detector and A.F. amplifier and also furnishes the control voltage for the A.G.C. An EL 3, steep-slope 9 W pentode, is used in the output stage, whilst in the A.F. section a part of the speech voltage is fed back to the grid of the EBC 3; the components of the negative feed-back circuit are all independent of frequency, this being necessary to ensure a satisfactory response curve. To give visual-tuning indication the EM 1 is coupled to the detector diode. In the medium- and long-wave ranges a capacitively-coupled R.F. band-pass filter is used; the self-inductance of the medium-wave R.F. coils is 160  $\mu\text{H}$  and that of the long-wave coils 2,150  $\mu\text{H}$ . On short waves only one R.F. circuit is provided, the inductance of the coil being about 1.3  $\mu\text{H}$ . For the medium- and long-wave bands the first tuned circuit is coupled to the aerial both inductively and capacitively, giving a voltage gain factor of 3; the short-wave aerial coupling is purely inductive.

For trimming the medium-wave inductances the two coils  $S_2$  and  $S_3$  are short-circuited; for the long waves these coils are shorted in series. The short-wave coil is usually trimmed in the receiver.

Frequency drift is limited as much as possible by coupling the oscillator circuit to the 2nd grid of the frequency-changer valve EK 3, and this valve is also included in the A.G.C. system. The three oscillator coils are wound on a common former. The padding capacitors are connected in series with the coils and are included in the coil switching; resistors are included in parallel with the short- and medium-wave coils to stabilize the oscillator voltage. An isolating capacitor  $C_{17}$  is employed to avoid having a "live" variable capacitor (parallel feed). The capacitance of the medium-wave padding capacitor is about 670  $\mu\mu\text{F}$  and that of the long-wave capacitor about 195  $\mu\mu\text{F}$ , the latter value being obtained by connecting 275  $\mu\mu\text{F}$  in series with the medium-wave capacitor;  $C_{29}$  is an isolating capacitor which has little or no effect on the values of the padding capacitor. To prevent parasitic oscillation stopper resistors are included in the anode and 4th-grid circuits.

The intermediate frequency is 470 kc/s and the I.F. coils, which are fitted with iron cores, have an inductance value of 1 mH. The I.F. circuits are trimmed by rotating the iron cores, thus varying the self-inductance of the coils.

The I.F. valve EF 9 operates on the sliding-screen-voltage principle. The two diodes of the EBC 3 are connected to tappings on the I.F. coil in order to reduce losses in the I.F. circuits as much as possible; the cathode potential of the EBC 3 is used as delay voltage for the A.G.C., the control voltage being applied to the relevant valves across a potential divider  $R_{22}$ ,  $R_{23}$ , and it should be noted that the resultant control curve is not too straight.



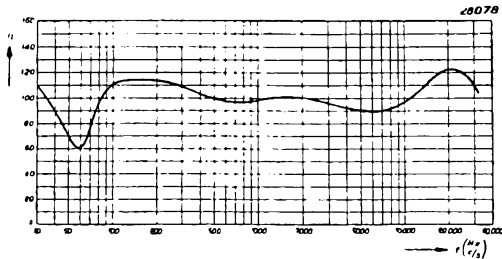

Fig. 1  
Frequency-response curve for circuit including negative feedback.

A tone control is included in the A.F. section, comprising  $R_{16}$  and  $C_{35}$ , and to ensure sufficient low-note response the cathode is decoupled by an electrolytic capacitor of  $25 \mu\text{F}$ . The negative feedback amounts to a factor of 4. Capacitors are placed in parallel with  $R_{50}$  and  $R_{32}$ , of suitable values to reduce the amount of feedback at high and low frequencies with a view to improving the response curve.

A switch  $S$  may be added, if required, to cut out the negative feedback on short-wave reception, which will increase the sensitivity.

The rectifier is the AZ 1; the smoothing choke should have an inductance of 8 H. The total amount of current consumed is approx 70 mA.

### TECHNICAL DATA

1. *Sensitivity* (for 50 mW output) on the medium- and long-wave ranges.

at the diode	$0.5 \mu\text{V}_{(\text{eff})}$	} } } }	I.F. stage gain: 100	
at the I.F. valve	$6 \text{ mV}_{(\text{eff})}$			
at the mixer valve	$50 \mu\text{V}_{(\text{eff})}$			Conversion gain factor: 100
at the aerial	$16 \mu\text{V}_{(\text{eff})}$			Voltage gain factor: 3

2. *Selectivity*

Attenuation on detuning	+	4.5	and	-	4.5	kc/s:	1 :	10
"	"	"	"	"	"	"	1 :	100
"	"	"	"	"	"	"	1 :	1,000

3. *Automatic gain control curve*

1 ×	normal input voltage	corresponds to	1 ×	normal output voltage
5 ×	"	"	5 ×	"
10 ×	"	"	8 ×	"
100 ×	"	"	18 ×	"
1,000 ×	"	"	30 ×	"
10,000 ×	"	"	42 ×	"

### TABLE OF COILS

See Circuit IV.

The coils used for Circuits IV and V are identical.

## VI. 5-Valve superheterodyne receiver

Valves used: "Miniwatt" EK 3, EBF 2, EFM 1, EL 3, AZ 1.

In this receiver the combined A.F. amplifier and electronic indicator EFM 1 is used, with negative feed-back from the speech coil. The sensitivity at the aerial as well as in the medium- and long-wave bands is  $16 \mu\text{V}$  and there are three wave bands, viz:

Long waves	830—2,000 m
Medium waves	200— 547 m
Short waves	15— 48 m.

The R.F., I.F. and oscillator coils are identical with those employed in Circuits IV and V for the 6-valve receivers, the only difference between the two last-named circuits and the present receiver being in the I.F. valve and the design of the A.F. section: the I.F. valve is the pentode unit in the EBF 2, which operates with sliding screen voltage. For detection and automatic gain control the two diodes in the other section of the valve are employed; these are connected to tapplings on the I.F. coils in order to reduce I.F. circuit losses. Both the EK 3 and the EBF 2 are included in the A.G.C. system and the cathode voltage of the last-mentioned valve also serves as delay voltage for the control.  $R_{12}$  is the load resistor for this diode; since the required delay voltage is in excess of the grid bias needed by the pentode unit only a part of the cathode potential is applied to the EBF 2, through a potential divider formed by R 12, 13, 14 and 15, which means that only a portion of the delay voltage is applied to the I.F. valve, across  $R_{12}$ . Further, part of the positive cathode potential of the EBF 2 is applied via the potential divider R 12—15 to the 4th grid of the EK 3, for which reason the biasing resistor is rather larger than usual.

The A.F. signal is passed from the volume control  $R_{17}$  across the tone control ( $R_{18}$ — $C_{31}$ ) to the grid of the EFM 1; a resistor,  $R_{31}$ , of 50,000 ohms is connected in series with

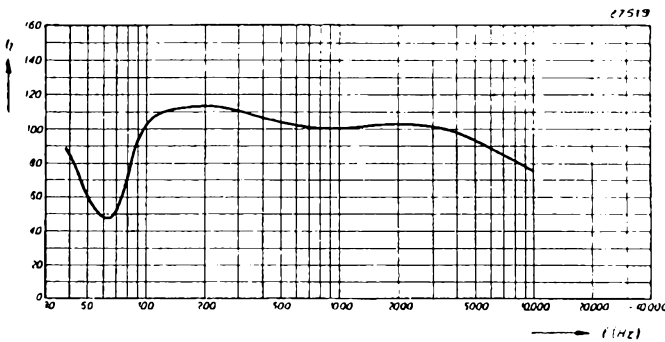

Fig. 1. Frequency-response curve

the volume control; otherwise the detector diode would be in parallel with the pick-up when the set is used for gramophone reproduction, and this would produce considerable distortion.

A portion of the speech voltage is tapped from the potential divider  $R_{29}$ ,  $R_{30}$ ,  $R_{23}$ ,  $R_{22}$  for feed-

back to the cathode of the EFM 1, and this is sufficient to give a feed-back factor of about 4. Capacitors are connected in parallel with  $R_{30}$  and  $R_{22}$ , the values of these being such that the amount of negative feed-back is reduced at high and low frequencies: the response is thus rendered more uniform on all frequencies.

In this circuit a resistor is connected to the cathode of the EFM 1, without a decoupling capacitor, and in certain circumstances this may give rise to hum; in this event, and if better performance is required, the circuit of the EBC 3 in diagram IV may be preferred, although the sensitivity will then be slightly less.

The negative potential occurring across the potential divider  $R_{17}$  is applied through a filter consisting of  $R_{19}$  and  $C_{36}$  to the "earth" end of the grid leak of the EFM 1 for the purpose of providing tuning indication.

The rectifying valve is the AZ 1 and the smoothing choke should have an inductance of 8 H. The total amount of current used is about 71 mA.



**TECHNICAL DATA**

1. *Sensitivity* (for 50 mW output) in the medium- and long-wave bands.

at the diode	0.5 V	I.F. stage gain: 100 Conversion gain factor: 100 Voltage gain factor: 3
at the I.F. valve	5 mV	
at the mixer valve (octode)	50 $\mu$ V	
at the aerial	16 $\mu$ V	

2. *Selectivity*

Attenuation on detuning	+ 4.5 and - 4.5 kc/s	1 : 10
" " "	+ 8 and - 8 " "	1 : 100
" " "	+ 13 and - 13 " "	1 : 1,000

3. *Automatic gain control curve*

1 $\times$	normal input voltage	corresponds to	1 $\times$	normal output voltage
5 $\times$	" " "	" " "	5 $\times$	" " "
10 $\times$	" " "	" " "	8 $\times$	" " "
100 $\times$	" " "	" " "	18 $\times$	" " "
1,000 $\times$	" " "	" " "	30 $\times$	" " "
10,000 $\times$	" " "	" " "	42 $\times$	" " "

**TABLE OF COILS**

Coil	Number of turns	Self-inductance	Type of winding	Dia. of former	Dia. of wire mm	Type of wire
S1	13	—	layer	14	0.1	Enamel
S2	180	—	wave	17	0.1	"
S3	680	—	"	17	0.1	"
S4	12	—	layer	14	1	"
S5	2 $\times$ 58	(S2, S3 and S6 shorted) 160 $\mu$ H	wave	17	15 $\times$ 0.05	Litz
S6	310	S5 + S6 (S2 + S3 shorted in series) = 2,150 $\mu$ H	"	17	0.1	Enamel
S7	2 $\times$ 57	(S8 shorted) 160 $\mu$ H	"	17	15 $\times$ 0.05	Litz
S8	294	S7 + S8 = 2,150 $\mu$ H	"	17	0.1	Enamel
S9	7	—	layer	17	0.5	"
S10	54	S9 + S10 (S11 shorted) = 75 $\mu$ H	wave	17	0.1	Enamel
S11	99	S9 + S10 + S11 = 320 $\mu$ H	"	17	0.1	"
S12	7	—	layer	17	0.1	"
S13	35	—	wave	17	0.1	"
S14	40	—	"	17	0.1	"
S15	2 $\times$ 130	—	"	8.9	5 $\times$ 0.07	Litz
S16				with		
S17				7 mm		
S18				iron core		

## VII. 4-Valve superheterodyne receiver

*Valves used:* "Miniwatt" EK 3, EF 9, EBL 1, AZ 1.

The following is a description of a small, low-priced receiver which, notwithstanding the small number of valves employed, has very outstanding properties. Sensitivity on the medium- and long-wave bands is  $45 \mu\text{V}$  and there are three bands, viz:

Long waves	830—2,000 m
Medium waves	200— 546 m
Short waves	15— 48 m.

In this receiver the R.F., I.F. and oscillator coils are the same as those employed in Circuit V; the difference between these two receivers is that only one valve is used in place of two others, namely the EBL 1 instead of the EBC 3 and EL 3, in consequence of which the A.F. gain is much less. Further, there is no negative feed-back or visual tuning indicator.

For detection and A.G.C. the two diodes of the EBL 1 are employed, delay voltage for the A.G.C. being derived from the cathode voltage of this valve and, as the delay voltage needs to be higher than the grid bias on the output valve, an extra resistor is connected in series with the self-biasing resistor. The control voltage is applied to the appropriate valves via a potential divider  $R_{21}$  and  $R_{22}$ .

To ensure satisfactory low-note response the bias resistor of the EBL 1 is decoupled with a  $50 \mu\text{F}$  electrolytic capacitor. The tone-control circuit consists of a capacitor of  $50,000 \mu\mu\text{F}$  in series with a  $50,000$  ohm resistor across the primary side of the output transformer.

As the amplification of the output valve is not sufficient for gramophone reproduction, the I.F. valve in this case operates as A.F. amplifier; the resistor  $R_{14}$ , which on radio reception decouples the anode voltage, functions as load resistor for record playing. The rectifier section is similar to that of the 6-valve receiver and the total current is about  $70 \text{ mA}$ .

### TECHINCAL DATA

#### 1. Sensitivity (for $50 \text{ mW}$ output) on medium and long waves:

at the diode	$1.4 \text{ V}$	}	I.F. stage gain: 100		
at the I.F. valve	$14 \text{ mV}$				
at the mixer valve (octode)	$140 \mu\text{V}$			}	Conversion gain factor: 100
at the aerial	$45 \mu\text{V}$				

#### 2. Selectivity

Attenuation on detuning	+ 4.5 and — 4.5 kc/s:	1 :	10
" " "	+ 8 and — 8 "	1 :	100
" " "	+ 13 and — 13 "	1 :	1,000

#### 3. Automatic gain control curve

1 $\times$	normal input voltage	corresponds to	1 $\times$	normal output voltage
5 $\times$	" " "	" " "	5 $\times$	" " "
10 $\times$	" " "	" " "	8 $\times$	" " "
100 $\times$	" " "	" " "	18 $\times$	" " "
1,000 $\times$	" " "	" " "	30 $\times$	" " "
10,000 $\times$	" " "	" " "	42 $\times$	" " "





TABLE OF COILS

Coil	Number of turns	Self-inductance	Type of winding	Dia. of former	Dia. of wire mm	Type of wire
S1	13	—	layer	14	0.1	Enamel
S2	180	—	wave	17	0.1	„
S3	680	—	„	17	0.1	„
S4	12	—	layer	14	1	„
S5	2×58	(S2, S3 and S6 shorted) 160 μH	wave	17	15×0.05	Litz
S6	310	S5 + S6 (S2 + S3 shorted in series) = 2,150 μH	„	17	0.1	Enamel
S7	2×57	(S8 shorted) = 160 μH	„	17	15×0.05	Litz
S8	294	S7 + S8 = 2,150 μH	„	17	0.1	Enamel
S9	7	—	layer	17	0.5	„
S10	54	S9 + S10 (S11 shorted) = 75 μH	wave	17	0.1	„
S11	99	S9 + S10 + S11 = 320 μH	„	17	0.1	„
S12	7	—	layer	17	0.1	„
S13	35	—	wave	17	0.1	„
S14	40	—	„	17	0.1	„
S15	2×130	—	„	8.9	5×0.07	Litz
S16				with		
S17				7 mm		
S18				iron core		

### VIII. 3-Valve receiver for local stations

Valves used: "Miniwatt" EF 6, EL 3, AZ 1.

This single-circuit receiver has three wave-bands, viz:

- Long waves 770—2,000 m
- Medium waves 200— 550 m
- Short waves 15— 63 m.

It comprises a grid detector with output stage and rectifier; tuning is but little affected by the aerial and the station dial may be calibrated.

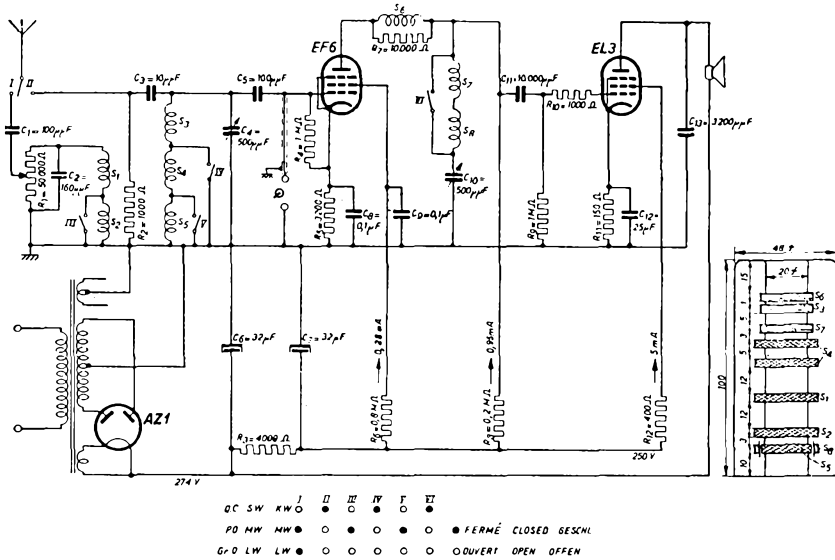

SCHALTUNGSBEISPIEL OHNE PATENTBLIGO UNSERERSEITS  
 EXEMPLE D'UN SCHEMA DE MONTAGE DONNE SANS GARANTIE EN REGARD DE DROITS DE BREVETS D'INVENTION  
 SPECIMEN OF CIRCUIT DIAGRAM WITHOUT ANY GUARANTEE AS TO PATENTRIGHTS  
 23244  
 Circuit diagram.

In the medium- and long-wave bands the aerial coupling is inductive (switch I closed); the self-inductances of the aerial coils  $S_1$  and  $S_2$  are such that their resonant frequencies lie below the lowest frequency in the wave band concerned (e.g., at 700 and 2,200 m). The two aerial coils have a potential divider of 5,000 ohms in parallel with them, the aerial being connected to the slider, by which means the input signal, and simultaneously the volume, can be adjusted as desired.

In the short-wave band (switch II closed) the aerial coupling is capacitive. All the coils are wound on a common former and tuning is by means of a variable capacitor of maximum capacity 500  $\mu\mu\text{F}$ . Care must be taken to employ a drive having a sufficiently high ratio reduction gear to facilitate tuning on short waves.

The coils are operated by a switch that should have the lowest possible capacitance, and if the mains switch is combined with the coil switch the former must be carefully screened to avoid induced ripple on the grid of the detector; for the same reason all leads at mains potential should be properly screened.

The reaction coupling is inductive and can be controlled by a variable capacitor of at most 500  $\mu\mu\text{F}$ . The anode resistor of 0.2 megohm is not connected direct to

the anode but to the junction of the short and medium-wave reaction coils; in this way the input circuit of the output valve is not in parallel with the short-wave coupling coil when the receiver is operating on short waves and the reaction control functions without difficulty over the whole range. To prevent over-oscillation, this coupling coil has a 10,000 ohms resistor in parallel with it. On medium and long waves the coupling is normal, the small short-wave coil  $S_6$  having practically no effect on reception.

In order to suppress parasitic oscillation on very short wavelengths the grid lead to the output valve EL 3 is made from a 1,000 ohm spiraled resistor, whilst a resistor of 400 ohms is included in the lead to the screen grid. The cathode of the EF 6 is connected to a 3,200 ohm resistor ( $R_5$ ) with a 0.1  $\mu$ F decoupling capacitor  $C_8$  to raise it above earth potential, thus providing the necessary bias for A.F. amplification when the set is used for gramophone reproduction. When the pick-up is connected to the set the grid will be at earth potential, owing to the low internal resistance of the pick-up itself, in which case  $R_4$  ceases to function.

As regards assembly of the chassis, it is essential to fit a screen between the detector and output valves; moreover, the pick-up sockets should not be too close to the loudspeaker sockets, since the high amplification produced by the two valves may otherwise give rise to A.F. feed-back.

The AZ 1 is employed as rectifier, and the smoothing circuit consists of two electrolytic capacitors of 32  $\mu$ F each and a resistor of 4,000 ohms. The no-load voltage from the power transformer should be  $2 \times 240$  V. The total current used is about 42 mA.

TABLE OF COILS

Coil	Number of turns	Type of winding	Diameter of former	Diameter of wire mm	Type of wire
S1	175	wave	20 mm	15 $\times$ 0.05	R.F. Litz
S2	580	"		0.1	Enamelled
S3	6	layer		0.8	d.s.c.
S4	2 $\times$ 48	wave		15 $\times$ 0.05	R.F. Litz
S5	258	"		0.1	Enamelled
S6	7	layer		0.3	"
S7	8	"		0.1	"
S8	35	"		0.1	"

Diameter of can = 48 mm.

**Circuits**  
for A.C./D.C. receivers

## IX. 7-Valve superheterodyne receiver for 220 V mains

*Valves used:* "Miniwatt" CK 3, EF 9, EBC 3, CL 4, CY 1, EM 1, C 1.

Apart from the supply section and the valves employed, this receiver circuit is identical with the 6-valve receiver, Circuit V. The wavebands and coils are the same, as also the main features of the circuit; sensitivity is 16  $\mu$ V. The wave ranges are as follows:

Long waves	830—2,000 m
Medium waves	200— 547 m
Short waves	15— 48 m.

### *Connection of heaters*

The valve heaters and the pilot lamp are all in series with a barretter, type C 1, and the sequence of the heaters is so arranged that ripple from the mains is kept as low as possible; the heater of the EBC 3 is accordingly earthed.

### *Anode voltage*

The rectifier is the CY 1. Since one side of the mains is applied directly to the chassis, capacitors are included in the aerial, earth and gramophone connections. The chassis as such must therefore never be earthed and has to be mounted in the cabinet in such a way that it cannot be touched when live. For the smoothing circuit two electrolytic capacitors of 32  $\mu$ F (320 V) and an 8 H choke are used. The total amount of current consumed is about 77 mA.

## TECHNICAL DATA

### 1. *Sensitivity* (for an output of 50 mW) on the medium- and long-wave bands:

at the diode	0.5 V <sub>(eff)</sub>	I.F. stage gain: 100 Conversion gain factor: 100 Voltage gain factor: 3
at the I.F. valve	5 mV <sub>(eff)</sub>	
at the mixer valve (octode)	50 $\mu$ V <sub>(eff)</sub>	
at the aerial	16 $\mu$ V <sub>(eff)</sub>	

### 2. *Selectivity*

Attenuation on detuning	+ 4.5 and — 4.5 kc's	1 : 10
" " "	+ 8 and — 8 " "	1 : 100
" " "	+ 13 and — 13 " "	1 : 1,000

### 3. *Automatic gain control curve*

1 $\times$	normal input voltage	corresponds to	1 $\times$	normal output voltage
5 $\times$	" " " "	" " "	5 $\times$	" " "
10 $\times$	" " " "	" " "	8 $\times$	" " "
100 $\times$	" " " "	" " "	18 $\times$	" " "
1,000 $\times$	" " " "	" " "	30 $\times$	" " "
10,000 $\times$	" " " "	" " "	42 $\times$	" " "

## TABLE OF COILS

For details of the coils in this receiver reference may be made to Circuit IV.

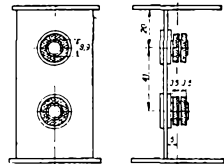
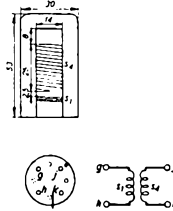
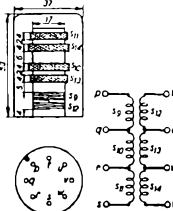
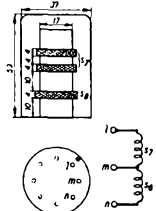
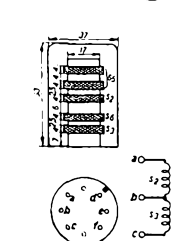
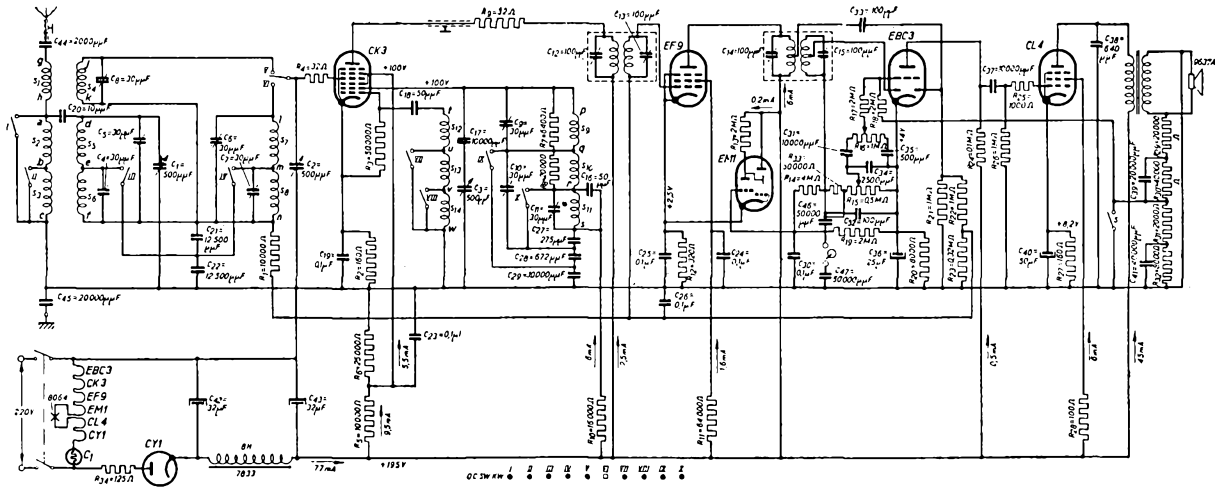

DC SW KW 1 2 3 4 5 6 7 8 9 10 11 12 13 14 15 16 17 18 19 20 21 22 23 24 25 26 27 28 29 30 31 32 33 34 35 36 37 38 39 40 41 42 43 44 45 46 47 48 49 50 51 52 53 54 55 56 57 58 59 60 61 62 63 64 65 66 67 68 69 70 71 72 73 74 75 76 77 78 79 80 81 82 83 84 85 86 87 88 89 90 91 92 93 94 95 96 97 98 99 100 101 102 103 104 105 106 107 108 109 110 111 112 113 114 115 116 117 118 119 120 121 122 123 124 125 126 127 128 129 130 131 132 133 134 135 136 137 138 139 140 141 142 143 144 145 146 147 148 149 150 151 152 153 154 155 156 157 158 159 160 161 162 163 164 165 166 167 168 169 170 171 172 173 174 175 176 177 178 179 180 181 182 183 184 185 186 187 188 189 190 191 192 193 194 195 196 197 198 199 200 201 202 203 204 205 206 207 208 209 210 211 212 213 214 215 216 217 218 219 220 221 222 223 224 225 226 227 228 229 230 231 232 233 234 235 236 237 238 239 240 241 242 243 244 245 246 247 248 249 250 251 252 253 254 255 256 257 258 259 260 261 262 263 264 265 266 267 268 269 270 271 272 273 274 275 276 277 278 279 280 281 282 283 284 285 286 287 288 289 290 291 292 293 294 295 296 297 298 299 300 301 302 303 304 305 306 307 308 309 310 311 312 313 314 315 316 317 318 319 320 321 322 323 324 325 326 327 328 329 330 331 332 333 334 335 336 337 338 339 340 341 342 343 344 345 346 347 348 349 350 351 352 353 354 355 356 357 358 359 360 361 362 363 364 365 366 367 368 369 370 371 372 373 374 375 376 377 378 379 380 381 382 383 384 385 386 387 388 389 390 391 392 393 394 395 396 397 398 399 400 401 402 403 404 405 406 407 408 409 410 411 412 413 414 415 416 417 418 419 420 421 422 423 424 425 426 427 428 429 430 431 432 433 434 435 436 437 438 439 440 441 442 443 444 445 446 447 448 449 450 451 452 453 454 455 456 457 458 459 460 461 462 463 464 465 466 467 468 469 470 471 472 473 474 475 476 477 478 479 480 481 482 483 484 485 486 487 488 489 490 491 492 493 494 495 496 497 498 499 500 501 502 503 504 505 506 507 508 509 510 511 512 513 514 515 516 517 518 519 520 521 522 523 524 525 526 527 528 529 530 531 532 533 534 535 536 537 538 539 540 541 542 543 544 545 546 547 548 549 550 551 552 553 554 555 556 557 558 559 560 561 562 563 564 565 566 567 568 569 570 571 572 573 574 575 576 577 578 579 580 581 582 583 584 585 586 587 588 589 590 591 592 593 594 595 596 597 598 599 600 601 602 603 604 605 606 607 608 609 610 611 612 613 614 615 616 617 618 619 620 621 622 623 624 625 626 627 628 629 630 631 632 633 634 635 636 637 638 639 640 641 642 643 644 645 646 647 648 649 650 651 652 653 654 655 656 657 658 659 660 661 662 663 664 665 666 667 668 669 670 671 672 673 674 675 676 677 678 679 680 681 682 683 684 685 686 687 688 689 690 691 692 693 694 695 696 697 698 699 700 701 702 703 704 705 706 707 708 709 710 711 712 713 714 715 716 717 718 719 720 721 722 723 724 725 726 727 728 729 730 731 732 733 734 735 736 737 738 739 740 741 742 743 744 745 746 747 748 749 750 751 752 753 754 755 756 757 758 759 760 761 762 763 764 765 766 767 768 769 770 771 772 773 774 775 776 777 778 779 780 781 782 783 784 785 786 787 788 789 790 791 792 793 794 795 796 797 798 799 800 801 802 803 804 805 806 807 808 809 810 811 812 813 814 815 816 817 818 819 820 821 822 823 824 825 826 827 828 829 830 831 832 833 834 835 836 837 838 839 840 841 842 843 844 845 846 847 848 849 850 851 852 853 854 855 856 857 858 859 860 861 862 863 864 865 866 867 868 869 870 871 872 873 874 875 876 877 878 879 880 881 882 883 884 885 886 887 888 889 890 891 892 893 894 895 896 897 898 899 900 901 902 903 904 905 906 907 908 909 910 911 912 913 914 915 916 917 918 919 920 921 922 923 924 925 926 927 928 929 930 931 932 933 934 935 936 937 938 939 940 941 942 943 944 945 946 947 948 949 950 951 952 953 954 955 956 957 958 959 960 961 962 963 964 965 966 967 968 969 970 971 972 973 974 975 976 977 978 979 980 981 982 983 984 985 986 987 988 989 990 991 992 993 994 995 996 997 998 999 1000

Circuit given without any guarantees with respect to patent rights.

## X. 5-Valve superheterodyne receiver for 110 V mains

*Valves used:* "Miniwatt" CK 3, EF 9, EBC 3, CL 6, CY 1.

In principle this circuit is the same as Circuit IX for a 7-valve receiver. As the operating voltage is 110 V, however, the mixer valve is connected in a different manner, and no tuning indication is provided. The power section is also different. The receiver has a sensitivity of about 18  $\mu$ V.

The output valve is the CL 6, which, in spite of the low anode voltage available, delivers a relatively large amount of power. The receiver employs the same coils as those used in the 220 V model, and the wavebands are:

Long waves	830—2,000 m
Medium waves	200— 547 m
Short waves	15— 48 m.

For the R.F. circuits reference may be made to the description of the 6-valve A.C. Circuit (IV).

To minimize frequency drift, the oscillator circuit is connected to the second grid of the octode CK 3, which is included in the A.G.C. system on all wave bands.

The three oscillator coils are wound on a common former. Padding capacitors are in series with the coils and are included in the coil switching. Owing to the fact that the available anode voltage is low, the resistor  $R_4$  should not exceed 5,000 ohms and this resistor is placed between  $S_{10}$  and  $S_{11}$  in order to avoid the circuit losses that would occur if the arrangement in Circuit IX was employed. Apart from inductive reaction, capacitive coupling is also provided, the lower end of the coupling coil being connected to the padding capacitor.

As the tuning capacitor would otherwise be live, an insulating capacitor  $C_{30}$  is fitted. The values of the padding capacitors are about 525  $\mu\mu$ F for the medium waveband and about 165  $\mu\mu$ F for long waves, the latter value being obtained by connecting a capacitor of 220  $\mu\mu$ F in series with the medium-wave padding capacitor.  $C_{29}$  is an insulating capacitor, which in no way affects the padding.

The intermediate frequency is 470 kc/s and the I.F. coils are the same as those used for Circuit VI; in the present circuit, however, the I.F. valve has a fixed screen voltage. A tone control is included in the anode circuit of the output valve and consists of a capacitor of 0.1  $\mu$ F with a 50,000 ohms variable resistor in series with it. The rectifying valve is the CY 1; the smoothing choke should be of 8 H. The total current consumed is about 69 mA. In this circuit the valve heaters are in series with the pilot lamp and a resistor of 12.5 ohms (0.5 W), the sequence of the heaters being so arranged that mains ripple is kept as low as possible.





## TECHNICAL DATA

### 1. Sensitivity (50 mW output) on the medium and long wavebands:

at the diode	0.5 V <sub>(eff)</sub>	} I.F. stage gain: 100 } Conversion gain factor: 100 } Voltage gain factor: 3
at the I.F. valve	5 mV <sub>(eff)</sub>	
at the mixer valve (octode)	50 μV <sub>(eff)</sub>	
at the aerial	18 μV <sub>(eff)</sub>	

### 2. Selectivity

Attenuation on detuning	+ 4.5 and - 4.5 kc/s:	1 : 10
" " "	+ 8 and - 8 "	1 : 100
" " "	+ 13 and - 13 "	1 : 1,000

### 3. Automatic gain control curve:

1 × normal input voltage	corresponds to	1 × normal output voltage
5 × " " " "	" " " "	5 × " " "
10 × " " " "	" " " "	18 × " " "
100 × " " " "	" " " "	30 × " " "
1,000 × " " " "	" " " "	42 × " " "

TABLE OF COILS

Coil	Number of turns	Self-inductance	Type of winding	Dia. of former (mm)	Dia. of wire (mm)	Type of wire
S1	13	—	close	14	0.1	Enamel
S2	180	—	wave	17	0.1	"
S3	680	—	"	17	0.1	"
S4	12	—	close	14	1	"
S5	2 × 58	(S2, S3 and S6 shorted) 160 μH	wave	17	15 × 0.05	Litz
S6	310	S5 + S6 (S2 + S3 shorted in series) = 2,150 μH	"	17	0.1	Enamel
S7	2 × 57	(S8 shorted) 160 μH	"	17	15 × 0.05	Litz
S8	294	S7 + S8 = 2,150 μH	"	17	0.1	Enamel
S9	7	—	close	17	0.5	"
S10	54	S9 + S10 (S11 shorted) = 75 μH	wave	17	0.1	"
S11	99	S9 + S10 + S11 = 320 μH	"	17	0.1	"
S12	7	—	close	17	0.1	"
S13	35	—	wave	17	0.1	"
S14	40	—	"	17	0.1	"
S15 } S16 } S17 } S18 }	2 × 130	—	"	8.9 with 7 mm iron core	5 × 0.07	Litz

## XI. 5-Valve superheterodyne receiver for 110 V mains

*Valves used:* "Miniwatt" ECH 3, EF 9, EBC 3, CL 6, CY 1.

This receiver circuit is similar to Circuit X, also for a 5-valve receiver, but instead of the frequency-changer CK 3 the triode-hexode ECH 3 is used. The sensitivity,  $18 \mu\text{V}$ , is the same.

The three wavebands are:

Long waves	830—2,000 m
Medium waves	200— 547 m
Short waves	15— 48 m.

For details of the R.F. circuits reference may be made to the description of the 6-valve A.C. receiver, Circuit IV. The oscillator circuit is connected to the grid of the triode section of the ECH 3 and, although this arrangement produces rather more frequency drift than when the circuit is coupled to the anode, it is preferable, as it simplifies the feeding of the triode anode; the coupling coil is connected directly to the source of anode voltage, and the voltage drop which a series resistor would entail, is thereby avoided. At the same time, the amount of frequency drift is still within the necessary limits, so that the mixer valve ECH 3 can be included in the A.G.C. system on short as well as other wavebands.

The oscillator coils are also identical with those described in Circuit IV, and the padding capacitors are again placed in series with the coils and included in the coil switching; to prevent parasitic oscillation on the long-wave band, switch VII is closed when operating in this range. The grid capacitor  $C_{12}$  is  $56 \mu\mu\text{F}$ , this value ensuring reliable oscillation on long waves and a minimum of frequency drift on the short-wave band. Small stopper resistors are included in the leads to the first and third grids of the hexode unit of the valve, to suppress parasitic oscillation.

The oscillator voltage on the third grid of the hexode (and grid of the triode) should be approximately  $8 V_{(\text{eff})}$ , with  $200 \mu\text{A}$  passing through  $R_3$ . The I.F. is 470 kc/s and the I.F. coils are the same as in Circuit IV; the I.F. valve operates on a fixed screen potential.

For detection, A.F. amplification, and also to provide the control voltage for the A.G.C., the double-diode triode EBC 3 is used.

The L.F. voltage is taken from the volume control  $R_{12}$ , via resistor  $R_{21}$  and capacitor  $C'_{25}$  to the grid of the EBC 3,  $R_{21}$  being necessary to prevent R.F. voltages from entering the A.F. section. The control grid and screen grid of the output valve CL 6 are also provided with stopper resistors. The tone control, across the primary side of the output transformer, consists of a capacitor of  $0.1 \mu\text{F}$  in series with a 50,000 ohm variable resistor.

When a pick-up is used with the receiver the voltage from the former is applied to the volume control  $R_{12}$  through capacitors  $C'_{19}$  and  $C'_{20}$ , and a resistor  $R_5$  of 56,000 ohms is placed in series with the volume control to avoid the detector diode being across the pick-up.

The rectifying valve is the CY 1 and the smoothing choke should be of 8 H. The total current consumed is about 66 mA.

For sketches and table of coils see Circuit IV.



**TECHNICAL DATA**

1. *Sensitivity* (for 50 mW output) on the medium and long wavebands:

at the diode	0.5 V <sub>(eff)</sub>	$\left. \begin{array}{l} \{ \\ \} \\ \{ \\ \} \end{array} \right\} \begin{array}{l} \text{I.F. stage gain: 100} \\ \text{Conversion gain factor: 100} \\ \text{Voltage gain factor: 3} \end{array}$
at the I.F. valve	5 mV <sub>(eff)</sub>	
at the mixer valve (octode)	50 $\mu$ V <sub>(eff)</sub>	
at the aerial	18 $\mu$ V <sub>(eff)</sub>	

2. *Selectivity*

Attenuation on detuning	+ 4.5 and — 4.5	kc/s: 1 : 10
"    "    "	+ 8 and — 8	"    1 : 100
"    "    "	+ 13 and — 13	"    1 : 1,000

3. *Automatic gain control curve:*

1 × normal input voltage	corresponds to	1 × normal output voltage
5 × " " "	" " "	5 × " " "
10 × " " "	" " "	18 × " " "
100 × " " "	" " "	30 × " " "
1,000 × " " "	" " "	42 × " " "

## XII. 4-Valve receiver for reception of local stations

Valves used: "Miniwatt" EF 6, CL 4, CY 1, C 1.

This small, "straight" receiver for A.C./D.C. mains operation has three wavebands and is similar to the A.C. model, Circuit VIII, with the exception of the heater-supply and high-tension circuits. The heating circuit is as shown in the diagram. When the half-wave rectifying valve CY 1 is fitted, the receiver is suitable for A.C. and D.C. mains of 220—250 V, but details of a voltage-doubling arrangement employing the full-wave rectifying valve CY 2 are also given; in this case the receiver will also operate on 110—127 V A.C. mains when the points marked "110 V" in the diagram are short-circuited. With the points "220 V" shorted, the circuit is the same as for the CY 1 and the set can be run on A.C. and D.C. 220—250 V supplies. Where the voltage-doubling circuit is employed, that is, on 110—127 V A.C. mains, the barretter C 1 is replaced by a resistor of 175 ohms (10 W) or, if no pilot lamp is to be fitted, it is advisable to use the C 2 instead of this resistor.

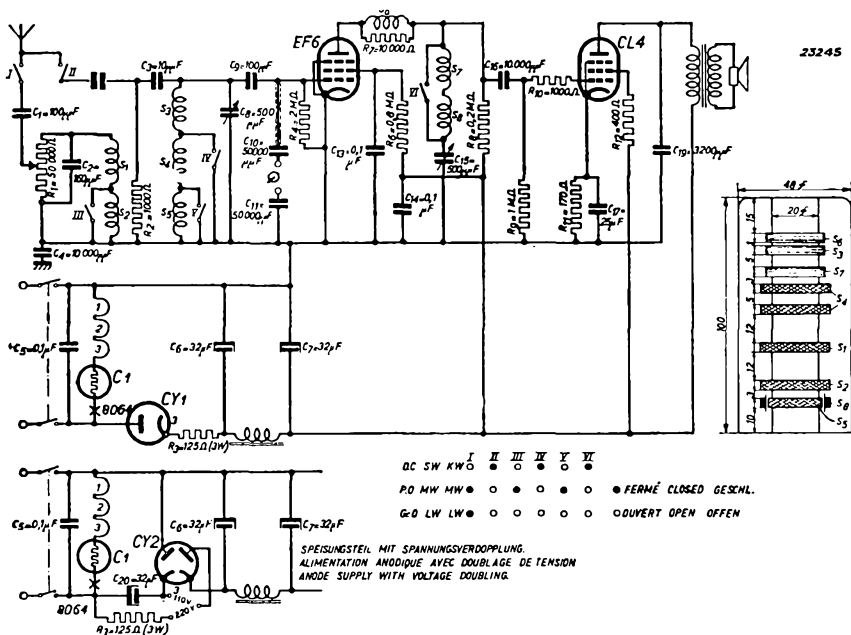

Circuit given without any guarantees in respect of patent rights.

As one side of the mains is connected to the chassis, capacitors are placed in series with the aerial, earth and pick-up connections<sup>1)</sup>; the chassis must therefore never be earthed and, moreover, should be mounted in the cabinet in such a manner that it cannot be touched without breaking the mains connection.

For gramophone reproduction the EF 6 operates without any biasing resistor or decoupling capacitor, since the pick-up is insulated from the mains by capacitors  $C_{10}$  and  $C_{11}$  and will not earth the grid; it is therefore not possible to apply bias to the grid of the EF 6.

The anode voltage is smoothed by two electrolytic capacitors of 32  $\mu$ F (320 V) and an 8 H choke. For details of the coils see page 344.

<sup>1)</sup> In this circuit the capacitor (10,000  $\mu$ F) in series with switch II has been omitted in error.

**CIRCUITS**  
**for battery receivers**

### XIII. 6-Valve superheterodyne receiver

*Valves used:* "Miniwatt" KF 3, KK 2, KF 4, KB 2, KC 3, KDD 1.

This circuit possesses excellent characteristics, being equipped with an R.F. pre-amplifier and a balanced output stage delivering 2 W. The wavebands covered are as follows:

Long waves 875—2,110 m  
Medium waves 200— 569 m  
Short waves 17— 51 m.

#### *Batteries*

- 1) H.T. battery 135 V
- 2) Grid-bias battery 3 V
- 3) Accumulator 2 V.

For the grid bias part of the voltage from the H.T. battery may be tapped, instead of using a separate battery.

#### *Current consumption*

The filament current is 0.77 A: when the set is used for gramophone reproduction the KF 3, KK 2 and KB 2 are switched off and the filament current is then only 0.5 A. Without an aerial input signal the H.T. current is about 12 mA, whilst with maximum excitation of the output valve the consumption is roughly 36 mA. When the set is used as a gramophone amplifier the anode current without a signal is 8 mA and with full excitation 32 mA.

#### *Coils, capacitors and circuits*

The medium-wave R.F. coils have a self-inductance of 160  $\mu\text{H}$  and the long-wave coils 2,150  $\mu\text{H}$ ; the inductance of the short-wave coils is adjusted to approximately 1.3  $\mu\text{H}$  in the receiver.

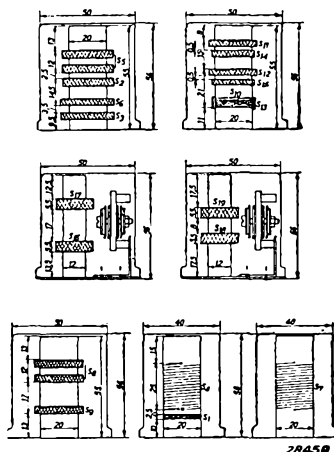

Fig. 1  
Sketches of the coils used.

The R.F. coils are wound on a 20 mm diameter former, the wire used for the medium waveband being  $15 \times 0.05$  Litz, whilst for the long waves enamelled copper wire of 0.1 mm is employed. The short-wave coils are wound on separate formers with 1 mm enamelled wire. The numbers of turns on the coils for the first and second R.F. circuits





are not the same, as the self-inductance values should be similar under varying conditions. The first coil is inductively coupled to the aerial and trimming in the medium- and long-wave bands is carried out with the two coils  $S_1$  and  $S_2$  short-circuited; in both ranges the voltage gain amounts to a factor of about 5. The second R.F. coil is connected directly to the anode circuit of the R.F. valve, which means that the anode voltage occurs across the plates of the tuning capacitor, and if the latter is not suitable for this purpose an insulating capacitor of sufficiently high capacitance must be used.

Stray capacitance between the R.F. circuits should be kept as low as possible. On the medium waveband an oscillator coil of  $128 \mu\text{H}$  is used and on long waves a coil of  $987 \mu\text{H}$ , the long-wave padding capacitor being shorted simultaneously with the coil. Resistor  $R_{19}$  is a damping resistor for the suppression of parasitic oscillation. The short-wave oscillator coil is wound on the same former as the medium and long-wave oscillator coils. Padding capacitor values are approximately  $2,500 \mu\mu\text{F}$  for the medium waves and  $700 \mu\mu\text{F}$  for the long waves, the latter value being obtained by connecting about  $1,000 \mu\mu\text{F}$  in series with the medium-wave capacitor; the padding capacitor  $C_{38}$  in the short-wave oscillator circuit also serves to provide capacitive reaction.

The wave-change switch should be so arranged that when the receiver is switched from the long to the medium-wave band, the tuning coil  $S_{12}$  cannot be shorted in advance of the coupling coil  $S_{15}$ .

The intermediate frequency is  $125 \text{ kc/s}$  and the self-inductance of the I.F. coils is about  $17.5 \text{ mH}$ , tuning to  $125 \text{ kc/s}$  being affected by variable capacitors of approximately  $140 \mu\mu\text{F}$ . Coupling between the two circuits is critical in the case of both the I.F. transformers and, since the two circuits of the second of these transformers are damped by the double-diode KB 2, the coupling between these two coils has to be tighter than in the first transformer; this explains why the spacing of the coils in the first transformer is  $17 \text{ mm}$  and that of the second  $8 \text{ mm}$ .

Calculating from the aerial to the control grid of the octode, the gain to be obtained in this receiver amounts to a factor of about one hundred on both medium and long-wave bands. Normally such a high gain would not be practicable in view of the higher harmonics of the signal frequency, which would produce too much interference in the form of whistles, but due to the high sensitivity of the circuit and the very flat A.G.C. characteristic the conductance of the R.F. valve is reduced by such a high grid bias on reception of practically all the stations concerned that the maximum R.F. gain is seldom obtained. However, on very weak stations which hardly come into consideration for general reception, when the R.F. amplification is at its highest faint whistles will be audible.

### *Valves*

The R.F. valve has  $80 \text{ V}$  applied to both anode and screen, the total current passing through the valve thus being only  $0.8 \text{ mA}$ ; a resistor,  $R_{15}$ , of  $64,000 \text{ ohms}$  is used to reduce the battery voltage to the required  $80 \text{ V}$ .

The R.F. voltage is transformed into an I.F. voltage by the octode KK 2, the current consumption of which on the medium and long-wave bands is only  $3.3 \text{ mA}$ . A potential of only  $45 \text{ V}$  is therefore applied to grids 3 and 5. To ensure reliable oscillation on the short-wave band, the voltage on these grids has to be increased to  $60 \text{ V}$  on that band and the current consumption is then  $4.3 \text{ mA}$ . In order to dispense with the switch necessitated by this arrangement, it is possible, however, to run the octode with  $60 \text{ V}$  on the 3rd and 5th grids on medium and long waves as well, but the current consumption is then naturally higher.

Automatic gain control is applied to the octode in the medium and long-wave ranges whereas on short waves a fixed potential of  $-1.5 \text{ V}$  is applied to grid 4; this potential

is used as the minimum grid bias for the octode on the medium and long-wave bands, as well as for the R.F. and I.F. amplifying valves. A lower bias can of course be used to increase sensitivity, but the anode current will then be somewhat higher.

The R.F. pentode KF 4 serves as I.F. amplifier, taking a total current of 2.3 mA with a grid bias of  $-1.5$  V; this valve is not included in the A.G.C. system. The intermediate frequency is rectified by one of the diodes of the KB 2, the other diode being employed for A.G.C. purposes. The cathode of the KB 2 is connected to a tapping on the H.T. battery and the load resistor of the A.G.C. diode is at a potential of  $-1.5$  V, so that the controlled valves also receive this bias when the control is not in operation. Consequently, the A.G.C. diode is held at a certain threshold potential which delays the control. If a voltage of 12 V (+ B 2 in the circuit diagram) is applied to the cathode of the double-diode, the control will commence working, roughly speaking, when the output valve is fully excited, assuming a signal modulated to 30%. Owing to the strong signals occurring on the diode, the control characteristic, as from the threshold point, is extremely flat.

To drive the Class B output stage the triode KC 3 is used, this valve taking a current of 2.5 mA on a grid bias of  $-3$  V. Two resistors,  $R_6$  and  $R_7$ , each of 100 ohms, are connected across the bias battery; the latter therefore has to deliver a current of

$\frac{3}{200} \cdot 10^3 = 15$  mA, so that when the anode current falls the grid bias is also reduced, thus preventing the KC 3 from operating on the curved part of the characteristic, with consequent serious distortion. The accumulator switch should be of the double-pole type as shown in the circuit, to break the grid-bias current when the set is switched off.

The resistors  $R_6$  and  $R_7$  serve also as a potential divider for the bias to be applied to the other valves.

Current from the bias battery—as also the anode current—flows in the lead marked —B, but in the opposite direction, and a milliammeter used for measuring the anode current of the receiver must not therefore be connected in that lead, but in the lead marked +B 1.

The different leads connected to the grid of the driver valve KC 3 must be as short as possible, to avoid A.F. oscillation; should they be at all lengthy, they should be screened and the screening adequately earthed. The driver transformer should have a ratio of 2 : (1 + 1); if this is any higher the maximum obtainable output is less, whilst if it is smaller the distortion is increased. Care should be taken, further, to ensure that the inductance of the primary winding is high enough to guarantee satisfactory low-note response. The correct number of turns for the primary is 2,500, with  $2 \times 1,250$  turns on the secondary and a cross-sectional area of the iron core of 2.5 cm<sup>2</sup>. The primary inductance is 14 H at 50 c/s, with a primary direct current of 2.5 mA.

The output valve KDD 1 comprises two matched, high-gain triodes, the anode current, of which without a grid input signal or bias, is extremely low, being only 3 mA for the two triodes together; as soon as a signal is received at the grid, the current rises, reaching 28 mA at the maximum output of 2.2 W. Practically speaking, therefore, this valve constitutes an appreciable load on the H.T. battery only when signals are being received and not in the intervals between signals.

The output transformer should be designed to give a matching resistance of 10,000 ohms between the anodes of the output valve and, to suppress any tendency towards accentuated treble response, capacitors of 5,000  $\mu\mu\text{F}$  are connected across the primary windings. Capacitor  $C_{37}$ , which in conjunction with the variable resistor  $R_{17}$  is placed across the whole primary winding, serves as a tone control. Resistor  $R_{17}$  should be at least 0.1 megohm; otherwise too much of the power delivered by the KDD 1 will be absorbed.

The amplification of the KC 3 is not sufficient for gramophone reproduction and the I.F. valve KF 4 is therefore used alternatively as an A.F. amplifying valve. Resistor  $R_9$ , which decouples the anode voltage on radio reception, functions as a load resistor for gram. reproduction, whilst  $C_{23}$  is a decoupling capacitor on radio and a blocking capacitor on gram.

As the leads to the pick-up sockets are usually fairly long, they should be screened. The signal from the pick-up is applied to the grid of the KF 4; capacitor  $C_{19}$ , of 200  $\mu\mu\text{F}$ , provides a sufficiently high impedance to the A.F. voltages to prevent the pick-up from being shorted by the coil  $S_{17}$ , and this capacitor is also large enough to allow the I.F. voltage present during radio reception to pass without attenuation to the grid of the KF 4, so that it is not necessary to employ a separate switch. It is essential, however, when changing back from gramophone to radio reception, to remove the pick-up plugs from the set, although if it is found preferable to leave them connected a separate switch can be provided to break the connection.

On gramophone reproduction the KF 4 receives no bias, since the pick-up is connected to the chassis, in consequence of which the gain, and also the anode current of this valve, will be slightly higher.

### TECHNICAL DATA

#### 1. Sensitivity (for 50 mW output) on the medium and long-wave bands:

I.F. signal:			
at the diode	0.9 V <sub>(eff)</sub>	}	I.F. stage gain: 30
at the grid of the I.F. valve	30 mV <sub>(eff)</sub>		
R.F. signal:			
at 4th grid of octode	1 mV <sub>(eff)</sub>	}	Conversion gain factor: 30
at the grid of the R.F. valve	50 $\mu\text{V}$ <sub>(eff)</sub>		
at the aerial	10 $\mu\text{V}$ <sub>(eff)</sub>		
			R.F. stage gain: 20
			Voltage gain factor: 5.

#### 2. Selectivity

Attenuation on detuning	+	4.5	and	—	4.5	kc/s:	1 :	10
"	"	"	+	"	8	and	—	8
"	"	"	+	"	13	and	—	13
								"
								1 : 1,000

#### 3. Automatic gain control curve: (+B 2 = 12 V).

The following points are taken from the control characteristic.

1	×	normal input voltage	corresponds to	1	×	normal output voltage
5	×	"	"	5	×	"
10	×	"	"	9	×	"
100	×	"	"	14	×	"
1,000	×	"	"	20	×	"
10,000	×	"	"	25	×	"

TABLE OF COILS

Coil	Number of turns	Self-inductance	Dia. of wire (mm)	Type of wire
S1	13	Approx. 8 $\mu$ H	0.1	Enamelled
S2	160	Approx. 800 $\mu$ H	0.1	"
S3	570	S2 + S3 = appr. 10.5 mH	0.1	"
S4	10	Approx. 1.3 $\mu$ H *)	1	"
S5	2 $\times$ 49	160 $\mu$ H *)	15 $\times$ 0.05	Litz
S6	263	S5 + S6 = 2,150 $\mu$ H *)	0.1	Enamelled
S7	9	approx. 1.3 $\mu$ H	1	"
S8	2 $\times$ 48	160 $\mu$ H	15 $\times$ 0.05	Litz
S9	249	S8 + S9 = 2,150 $\mu$ H	0.1	Enamelled
S10	6	approx. 1.3 $\mu$ H	0.5	"
S11	67	128 $\mu$ H	0.1	"
S12	165	S11 + S12 = 987 $\mu$ H	0.1	"
S13	6	—	0.1	"
S14	40	—	0.1	"
S15	67	—	0.1	"
S16	1,080	approx. 17.5 $\mu$ H	0.1	"
S17				
S18				
S19				

\*) measured with shorted coupling coil.

#### XIV. 6-Valve superheterodyne receiver

*Valves used:* "Miniwatt" KF 3, KK 2, KF 3, KBC 1, 2 × KL 4.

This is a modified version of Circuit XIII for a 6-valve battery receiver; in place of the double-triode KDD 1 in the output stage, two output pentodes KL 4 are used in Class B. The maximum output delivered is slightly lower, but the quality of reproduction is better, owing to the absence of grid current in the output stage.

The KBC 1 is used as driver, the anodes of this valve being employed for detection and delayed A.G.C. respectively. A 7.5 V grid-bias battery is required for the output stage.

Delay for the A.G.C. system is obtained from the potential divider, consisting of  $R_{18}$ ,  $R_{16}$  and  $R_{17}$  and connected between the negative side of the G.B. battery and L.T. positive. As the diode anode used for the A.G.C. is located near the positive

end of the filament, the delay is about  $\frac{1.3}{2.3} (7.5 + 2) = 5.4$  V.

Obviously the potential divider  $R_{16}$ - $R_{17}$  reduces the control voltage somewhat, but the A.G.C. is nevertheless sufficiently effective. As the A.F. sensitivity of this circuit is higher than that of the receiver employing the KDD 1, the variations in the alternating voltages in the anode circuit of the I.F. valve are not so great and this valve can be included in the A.G.C. circuit; it is thus possible to use the KF 3 instead of the KF 4. In view of the fact that the R.F. valve is also controlled, it is not necessary to control the frequency-changer and the inevitable frequency drift is avoided. The A.F. sensitivity is adequate for record playing and in this case the I.F. valve need not function as pre-amplifier for that purpose.

For data regarding the tuned circuits, reference may be made to the receiver incorporating the KDD 1.

A driver transformer with a ratio of 1 : (1.5 + 1.5) is used in the output stage.



### **XV. 6-Valve superheterodyne receiver**

*Valves used:* "Miniwatt" KF 3, KK 2, KF 3, KB 2, KF 4, KL 4.

This circuit differs from Circuit XIV in the arrangement of the output, detector and A.F. amplifier stages; only one pentode KL 4 is used instead of two in Class B, with the KF 4 as resistance-coupled pre-amplifying valve.



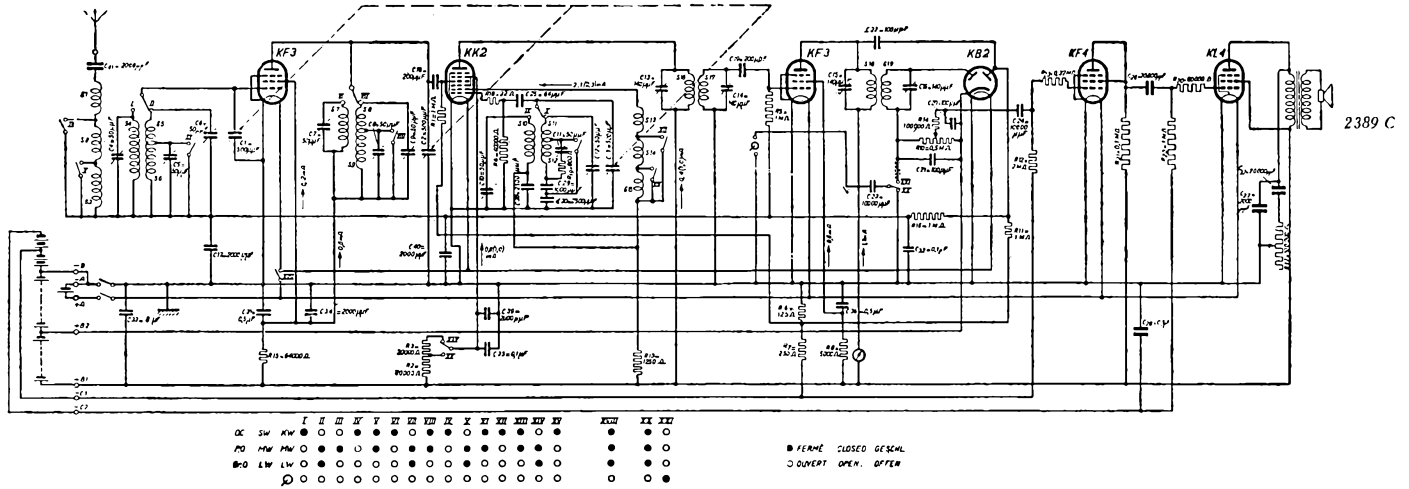

Circuit given without any guarantees with respect to patent rights.

## XVI. 4-Valve superheterodyne receiver

Valves used: "Miniwatt" KK 2, KF 3, KBC 1, KL 4.

This is an extremely simple receiver without an R.F. stage, the sensitivity being, therefore, relatively low. The three wavebands covered are as follows:

Long waves	875—2,100 m
Medium waves	200— 559 m
Short waves	17— 51 m.

### Batteries

- 1) H.T. battery 135 V
- 2) Grid-bias battery 7.5 V
- 3) Accumulator 2 V.

Instead of a separate grid-bias battery, a tapping on the H.T. battery may be used.

### Coils, capacitors and circuits

In the medium and long-wave bands the frequency-changer is preceded by a band-pass filter, but on short waves this gives place to a single tuned circuit. The self-inductance values of the R.F. coils are  $160 \mu\text{H}$  for the medium-wave band and  $2,150 \mu\text{H}$  for the long waves; the inductance of the short-wave coil is adjusted to about  $1.3 \mu\text{H}$  in the receiver. The R.F. coils are wound on a former 20 mm in diameter, with Litz wire  $15 \times 0.05 \text{ mm}$  for the medium-wave range and 0.1 mm enamelled copper wire for the long waves; the short-wave coil is separate.

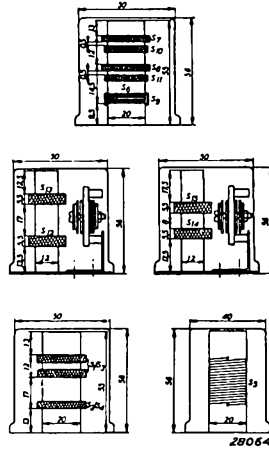

Fig. 1  
Sketches of the coils.

In the medium-wave band the oscillator-coil inductance is  $128 \mu\text{H}$  and in the long-wave range  $987 \mu\text{H}$ , the padding capacitor for the latter waveband being switched simultaneously with the coil.  $R_4$  is a damping resistor for suppressing parasitic oscillation. The short-wave oscillator coil is wound on the same former as the other oscillator coils. Padding capacitor values should be approximately  $2,500 \mu\text{F}$  for the medium-wave band and about  $700 \mu\text{F}$  for the long waves, the latter value being obtained by connecting roughly  $1,000 \mu\text{F}$  in series with the medium-wave padding capacitor.

$C_{13}$  fulfils a double function in serving also to establish capacitive coupling. The wave-change switch should be so arranged that when the receiver is switched from the long-wave to the medium band, there is no chance of shorting-out the tuning



coil  $S_8$  in advance of the coupling coil  $S_{11}$ . The intermediate frequency is 125 kc/s and the inductance of the I.F. coils is about 17.5 mH, the I.F. being adjusted to 125 kc/s by means of variable capacitors of capacitance about 170  $\mu\mu\text{F}$ ; the coupling between the circuits of both I.F. transformers is critical. The secondary side of the 2nd I.F. transformer is damped by the detector diode and the coupling of the two coils of this transformer should therefore be tighter than in the first transformer; hence the spacing of 17 mm between the coils in the first and only 8 mm in the second I.F. transformer.

#### Valves

The mixer valve is the KK 2, grids 3 and 5 of which are at a voltage of only 45 V on the medium and long-wave bands; on short waves this is increased to 60 V. On the former wavebands the octode is included in the automatic gain control circuit, but for short-wave operation a fixed bias of  $-1.5$  V is applied to grid 4.

The KF 3 is used as the I.F. valve and is controlled by the A.G.C.; the intermediate-frequency signal is rectified by the parallel-connected diodes of the KBC 1.

The A.G.C. is not delayed, the control voltage being derived from the load resistor in the detector circuit; a negative potential exists across this resistor even in the absence of a signal, so that it is not necessary to provide a separate bias for the KK 2 and KF 3 valves. The output valve KL 4 is resistance-coupled to the triode section of the KBC 1.

TABLE OF COILS

Coil	Number of turns	Self-inductance	Type of winding	Dia. of former (mm)	Dia. of wire (mm)	Type of wire
S1	2 × 48	160 $\mu\text{H}$ <sup>1)</sup>	wave	20	15 × 0.05	Litz
S2	249	S1 + S2 = 2,150 $\mu\text{H}$	"	20	0.1	Enamel
S3	2 × 48	160 $\mu\text{H}$ <sup>2)</sup>	"	20	15 × 0.05	Litz
S4	249	S3 + S4 = 2,150 $\mu\text{H}$	"	20	0.1	Enamel
S5	9	approx. 1.3 $\mu\text{H}$	close	20	1	"
S6	6	approx. 1.3 $\mu\text{H}$	"	20	0.5	"
S7	67	128 $\mu\text{H}$ <sup>3)</sup>	wave	20	0.1	"
S8	165	S7 + S8 = 987 $\mu\text{H}$	"	20	0.1	"
S9	6	—	close	—	0.1	"
S10	40	—	wave	20	0.1	"
S11	67	—	"	20	0.1	"
S12	1,080	approx. 17.5 mH	"	12	0.1	"
S13						
S14						
S15						

<sup>1)</sup> S2 shorted.

<sup>2)</sup> S4 shorted.

<sup>3)</sup> S8 shorted.

## XVII. 4-Valve superheterodyne receiver

*Valves used:* "Miniwatt": KCH 1, KF 3, KBC 1, KL 5.

This is a simple battery superhet. of relatively low sensitivity, namely 180  $\mu\text{V}$  on the medium- and long-wave bands. It has three ranges, viz:

Long waves	830—2,000 m
Medium waves	200— 547 m
Short waves	15— 48 m.

Automatic gain control is applied to the frequency-changer and I.F. valve on all the wavebands.

### *Batteries*

- 1) H.T. battery 120 V.
- 2) Accumulator 2 V.

The A.F. and output valves are self-biased by means of resistors.

### *Coils, capacitors and circuits*

On the medium- and long-wave ranges the mixer valve is preceded by a capacitively-coupled band-pass filter. The variable capacitor is of 20 to 500  $\mu\mu\text{F}$  and, taking into account a minimum capacitance on the medium and long-wave bands of 50 and 70  $\mu\mu\text{F}$  respectively (trimmers, wiring, etc.) and also the capacitance of the band-pass filter coupling capacitor which is in series with the tuning capacitor, the capacitive variation on the medium-wave band is 70 to 527  $\mu\mu\text{F}$  and on long waves 90 to 521  $\mu\mu\text{F}$ . R.F. coils of inductance 160  $\mu\text{H}$  and 2,150  $\mu\text{H}$  then give a medium-wave band of 199.5—547 m and a long-wave band of 829—2,000 m respectively.

On short waves a single R.F. circuit only is employed; the inductance of the short-wave coil is about 1.3  $\mu\text{H}$ .

The tuned R.F. circuit, on medium and long waves, is coupled to the aerial both inductively and capacitively, giving a fairly constant voltage gain factor of 3 throughout the ranges; on short waves the aerial coupling is purely inductive.

To minimize frequency drift, the oscillator circuit is connected to the anode of the triode part of the KCH 1, thus permitting the mixer valve to be controlled also on the short-wave band.

The medium and long-wave oscillator coils are wound on the same former (see Fig. 1) and the padding capacitors are in series with the coils; on the medium and long-wave bands, moreover, the "lower" end of the coupling coil is connected to the "upper" end of the padding capacitor to ensure a more uniform oscillator voltage over the whole of the wave-range.

No padding capacitor is fitted on the short-wave band.

The anode feed is applied through a resistor  $R_4$ , the voltage being blocked from the oscillator circuit by capacitor  $C_{13}$  (parallel feed). On the medium-wave band the value of the padding capacitor should be about 538  $\mu\mu\text{F}$  and on long waves approximately 180  $\mu\mu\text{F}$ , but the ultimate values depend on the minimum capacitance of the circuits. The grid capacitor  $C_{12}$  is 56  $\mu\mu\text{F}$ , this giving reliable oscillation on the long-wave band, with a minimum of frequency drift on short waves.

The intermediate frequency is 470 kc/s. Iron-cored coils are fitted in the I.F. circuits and the quality of these circuits is accordingly very high; the inductance of the coils is about 1 mH and the value of the capacitors in the I.F. circuit should be 100  $\mu\mu\text{F}$ ; these capacitors should be of the best low-loss type if the required quality of the circuit is to be attained. These circuits are trimmed by means of iron cores, which are rotated to vary the self-inductance.

## Valves

The frequency-changer is the triode-hexode KCH 1, the 2nd and 4th grids of which are fed through the resistor  $R_2$  to suppress frequency drift.

To avoid possible parasitic oscillation a stopper resistor  $R_{15}$  is connected to the 1st grid of this valve. The oscillator voltage on the 3rd grid of the hexode section (and grid of the triode) should be  $8 V_{(eff)}$ , with  $180 \mu A$  passing through  $R_3$ .

The KF 3 is used as the I.F. valve, the screen being fed through a resistor; this valve is controlled by the A.G.C. For detection and A.G.C., the two diodes of the KBC 1 are employed, each of these diodes being connected to a tapping on the I.F. coils to reduce circuit losses. Delay for the A.G.C. is established in the first place by the fact that the diode anode used for this purpose is located near the positive end of the filament and, secondly, by the negative potential applied to this diode anode and obtained from the potential-divider  $R_8, R_9, R_{10}$ . The valves controlled by the A.G.C. also receive their respective bias from this potential divider when the control is not operating. It is true that only one half of the available control voltage is obtained across  $R_8-R_9$ , but this is quite sufficient to ensure a reasonably straight control characteristic.

The A.F. voltage is applied to the grid of the KBC 1 through the volume control  $R_7$ , and capacitor  $C_{24}$ . The output valve is the KL 5, which operates on a filament current of only 0.1 A; with 120 V on anode and screen, this valve will deliver an output of 0.38 W. The total current to be supplied by the H.T. battery is approximately 14 mA.

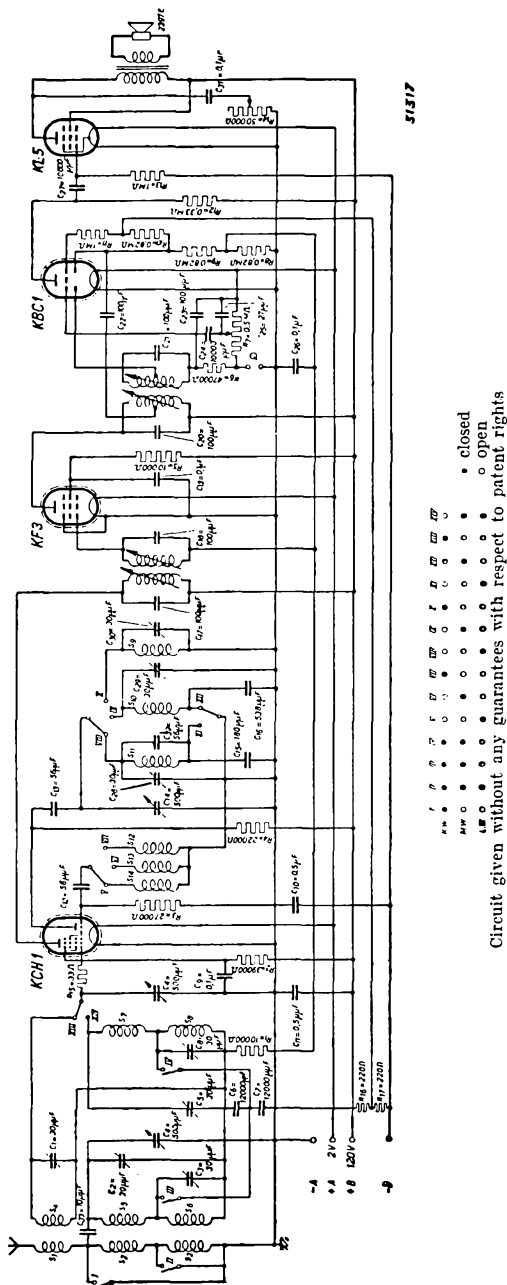

Circuit given without any guarantees with respect to patent rights

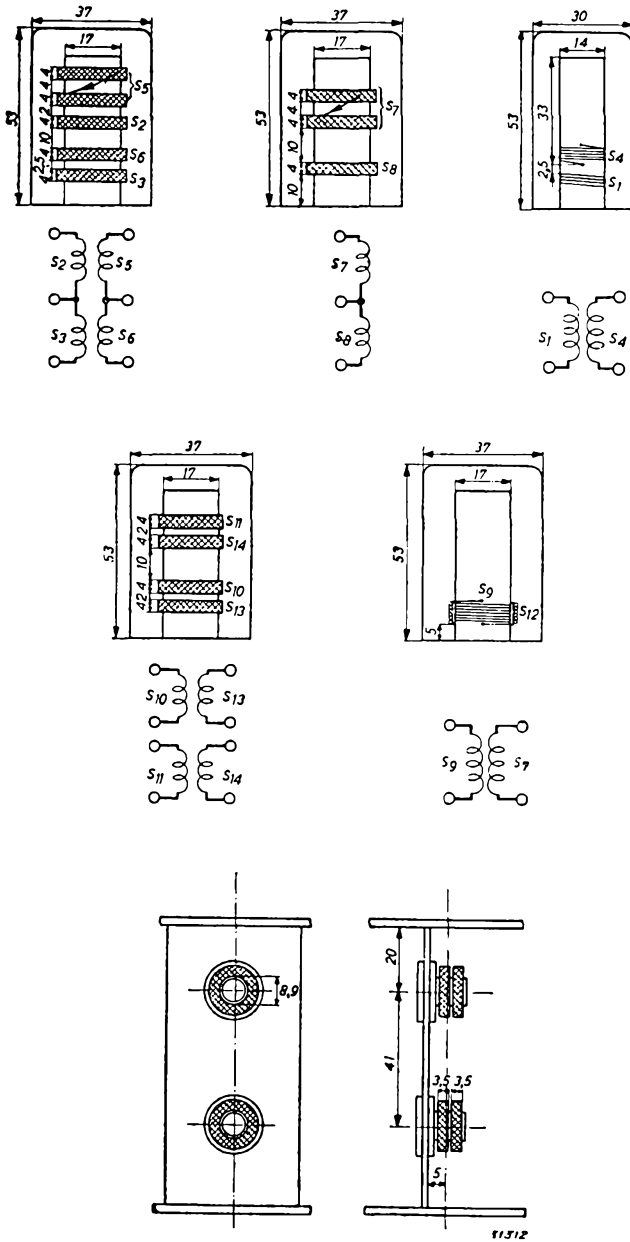

Fig. 1  
 Sketches of the coils used in the 4-valve receiver.

## TECHNICAL DATA

### 1. Sensitivity (for 50 mW output) in the medium and long-wave bands:

at the diode	0.6 V <sub>(eff)</sub>	} I.F. stage gain: 30 Conversion gain factor: 40 Voltage gain factor: 3
at the I.F. valve	20 mV <sub>(eff)</sub>	
at the mixer valve	500 μV <sub>(eff)</sub>	
at the aerial	180 μV <sub>(eff)</sub>	

### 2. Selectivity

Attenuation on detuning	+ 4.5 and — 4.5 kc/s:	1 : 10
" " "	+ 8 and — 8 " "	1 : 100
" " "	+ 13 and — 13 " "	1 : 1,000

### 3. Automatic gain control curve

1 × normal input voltage	corresponds to	1 × normal output voltage
5 × .. .. .	.. .. .	3 × .. .. .
10 × .. .. .	.. .. .	4 × .. .. .
100 × .. .. .	.. .. .	8 × .. .. .
1,000 × .. .. .	.. .. .	16 × .. .. .

TABLE OF COILS

Coil	Number of turns	Self-inductance	Type of winding	Dia. of former (mm)	Dia. of wire (mm)	Type of wire
S1	13	—	close	14	0.1	Enamel
S2	180	—	wave	17	0.1	"
S3	680	—	"	17	0.1	"
S4	13	approx. 1.3 μH	close	14	1	"
S5	2 × 58	160 μH <sup>1)</sup>	wave	17	15 × 0.05	Litz
S6	310	S5 + S6 = 2,150 μH <sup>2)</sup>	"	17	0.1	Enamel
S7	2 × 57	160 μH <sup>2)</sup>	"	17	15 × 0.05	Litz
S8	294	S7 + S8 = 2,150 μH <sup>3)</sup>	"	17	0.1	Enamel
S9	7	approx. 1.3 μH	close	17	0.5	"
S10	59	75 μH	wave	17	0.1	"
S11	118	320 μH	"	17	0.1	"
S12	7	—	close	17	0.1	"
S13	35	—	wave	17	0.1	"
S14	40	—	"	17	0.1	"
S15 } S16 } S17 } S18 }	2 × 130	—	"	Iron core 7 mm	5 × 0.07	Litz

<sup>1)</sup> S2, S3 and S6 shorted.

<sup>2)</sup> S2 + S3 shorted in series

<sup>3)</sup> S8 shorted.



### XVIII. 4-Valve, 2-circuit cascade receiver

Valves used: "Miniwatt" KF 4, KF 4, 2 × KL 4.

This is a simple receiver circuit employing an R.F. stage and grid detector with reaction. The three wavebands are as follows:

- Long waves 805—2,080 m
- Medium waves 199— 558 m
- Short waves 15— 50 m.

Needless to say, the requirements to be imposed on a receiver of this type must not be too severe; if the set is to be used in the vicinity of a local transmitter it will be necessary to include a wavetrap in the aerial.

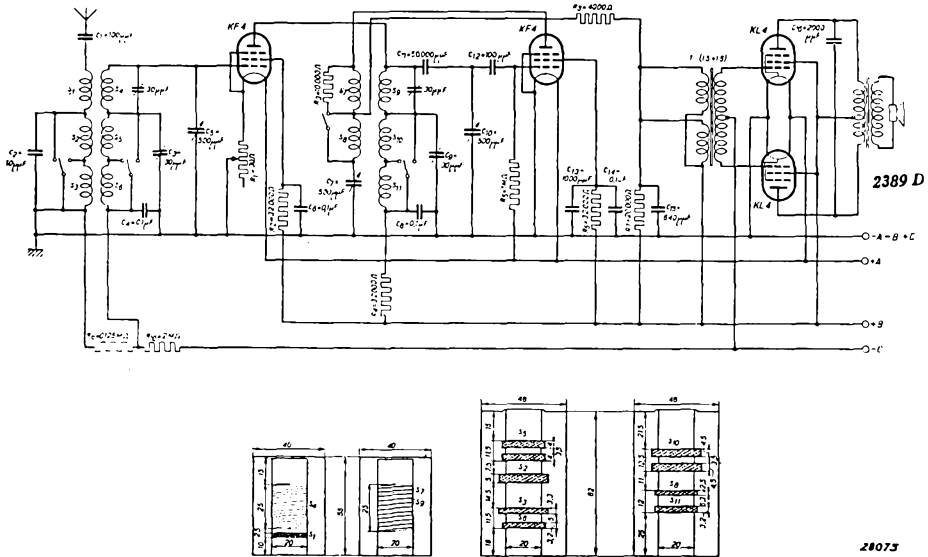

Circuit given without any guarantees with respect to patent rights.

28075

Inductive coupling of the aerial is adopted in order to provide uniform sensitivity throughout the wavebands and to minimize the effect of the aerial upon the losses and tuning of the circuit.

Capacitors of 20 to 500  $\mu\text{F}$ , in conjunction with a self-inductance of 160  $\mu\text{H}$ , will give a medium waveband of 199 to 558 m, and with 2,150  $\mu\text{H}$  a long-wave range of 805—2,050 m. The inductance values of the aerial coils  $S_2$  and  $S_3$  are 800 and 10,750  $\mu\text{H}$  respectively. As the wiring affects the short-wave inductances, it is not possible to give an exact figure for that waveband, but the number of turns indicated in the Table of Coils will give roughly the required range; the inductance values may be corrected in the receiver by adjusting the spacing of the turns on the coils.

The R.F. valve is the KF 4 and the volume is controlled by varying the filament current of this valve, which, moreover, operates on a fixed grid bias of  $-1.5$  V. In the second circuit the same self-inductances are employed as in the first, although the numbers of turns are slightly fewer, since there are no coupling coils in this circuit. The same coupling coil serves both the medium and long-wave bands.

Pentode KF 4 is used as grid detector and the output stage is coupled to it by a driver transformer of ratio 1 : (1.5 + 1.5).

As shown in the circuit diagram, the winding of the latter is in two equal sections, with the two primary windings in parallel. This ensures a symmetrical arrangement, with equal capacitances of the windings on the grids of the valves. A resistor of 20,000 ohms is connected across the primary side of the transformer, to ensure uniform frequency response. The grid bias for the output valve should be adjusted so as to give a total combined current on the two output valves of about 3 mA, with no signal. Sensitivity depends on the setting of the reaction control, but averages about 400  $\mu$ V.

TABLE OF COILS

Coil	Number of turns	Self-inductance	Type of winding	Dia. of former (mm)	Dia. of wire (mm)	Type of wire
S1	13	—	close	20	0.1	Enamel
S2	175	approx. 800 $\mu$ H	wave	20	15 $\times$ 0.05	Litz
S3	580	approx. 10,750 $\mu$ H	„	20	0.1	Enamel
S4	9	—	close	20	1	„
S5	2 $\times$ 48	160 $\mu$ H <sup>1)</sup>	wave	20	15 $\times$ 0.05	Litz
S6	258	S5 + S6 = 2,150 $\mu$ H <sup>2)</sup>	„	20	0.1	Enamel
S7	9	—	close	20	0.15	„
S8	28	—	wave	20	0.1	„
S9	8	—	close	20	1	„
S10	2 $\times$ 47	160 $\mu$ H <sup>3)</sup>	wave	20	15 $\times$ 0.05	Litz
S11	250	S10 + S11 = 2,150 $\mu$ H	„	20	0.1	Enamel

<sup>1)</sup> S2, S3 and S6 shorted.

<sup>2)</sup> S2 and S3 shorted in series.

<sup>3)</sup> S11 shorted.



## XX. 2-Valve receiver for local stations

Valves used: "Miniwatt" KF 4, KL 4.

This simple little circuit is intended for the reception of local transmitters only. It has three wavebands, viz:

Long waves: approx. 900—2,000 m

Medium waves: „ 200— 550 m

Short waves: „ 15— 50 m.

The KF 4, as grid detector, is followed by a resistance-coupled output pentode KL 4.

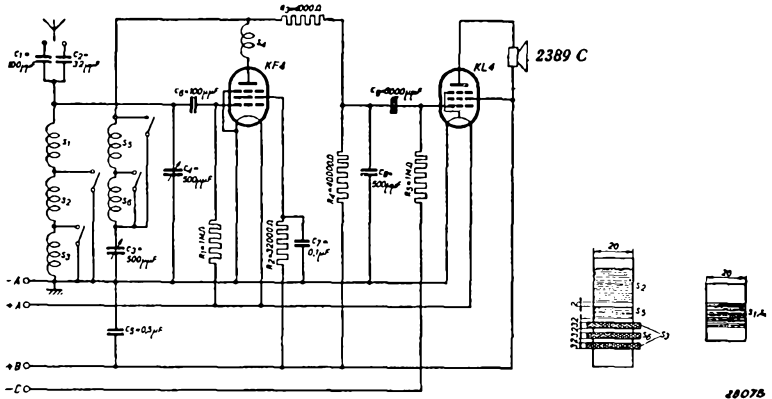

Circuit.

TABLE OF COILS

Coil	Number of turns	Type of winding	Diameter of former (mm)	Diameter of wire (mm)	Type of wire
S1	8	close	20	0.5	Enamelled
S2	108	„	20	0.15	„
S3	2 × 132	wave	20	0.15	„
S4	11	close	20	0.15	„
S5	60	„	20	0.1	„
S6	80	wave	20	0.1	„

# **CIRCUITS**

**for small gramophone amplifiers**



choke should be as large as possible, say 30 H, with a D.C. resistance of 180 ohms. A lamp is connected in parallel with the heaters of the valves to serve as a signal light. With a view to the acoustic properties of the amplifier, the loudspeaker is not mounted on the amplifier chassis and, in order to avoid the possibility of damage to the output valves when the speaker lead is disconnected from the amplifier sockets, a 4-pole jack should be used; two of the contacts are for the speaker itself and the other two make the connection between points A and B, so that when the plug is withdrawn the mains connection is simultaneously opened.

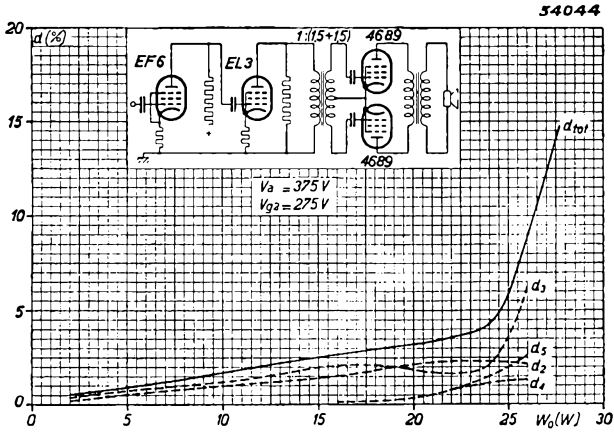

Total distortion, 2nd, 3rd, 4th and 5th harmonic distortion, as functions of the power measured at the loudspeaker.

## XXII. 15-W gramophone amplifier for A.C. mains operation

Valves used: "Miniwatt" AF 7, AL 4, 2 × 4683, AZ 1, 1815.

The output stage of this amplifier comprises two 15 W triodes type 4683 in Class B, with fixed bias; the second pre-amplifying valve is the AL 4, connected as a triode and coupled to the output stage by a driver transformer having a ratio of 1 : (1.5 + 1.5). The AF 7 is used as first pre-amplifying valve, with a volume control in the grid circuit and a tone control in the anode circuit.

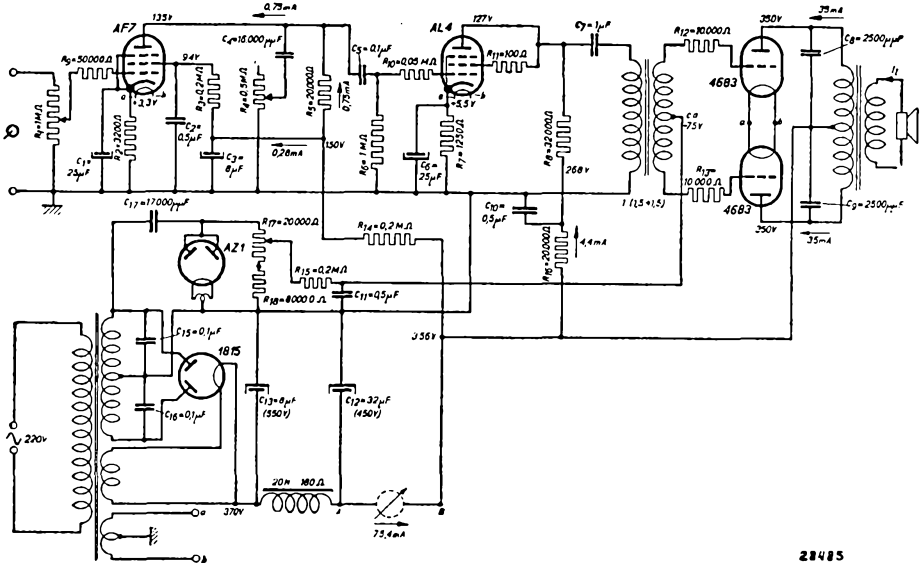

28485

Circuit given without any guarantees with respect to patent rights.

The output triodes 4683 are given a fixed bias, since the optimum output power with automatic bias would be about 4.5 W less; the required bias is about  $-75$  V, this being supplied by another rectifying valve, the AZ 1, connected for half-wave rectification and operating on one half of the secondary winding of the power transformer. Together with the internal resistance of the AZ 1, capacitor  $C_{17}$  forms a potential divider which reduces the voltage across the secondary winding to the required level of 75 V D.C., and the voltage can be further adjusted by means of  $R_{17}$ , of 20,000 ohms. With 350 V on the anode and  $V_{g1} = -75$  V, the internal resistance of the 4683 is about 800 ohms, which means that the anode current is to a great extent dependent on variations in the anode voltage, i.e. about 1.3 mA per volt anode-voltage variation for each valve. It is therefore always advisable to adjust the bias on the output valves so that the total current consumed by the amplifier, with no signal, will be about 75–80 mA, as measured with the milliammeter connected across points A and B. The resistor  $R_{15}$ , of 0.2 megohm, and capacitor  $C_{11}$ , of 0.5  $\mu$ F, are for smoothing the grid bias. The driver transformer, the ratio of which, as stated, is 1 : (1.5 + 1.5), is so connected that it does not carry any current.

The value of capacitor  $C_7$  is 1  $\mu$ F, this being a suitable value to favour the bass response. The first pre-amplifying valve is the AF 7, with the volume control  $R_1$  of



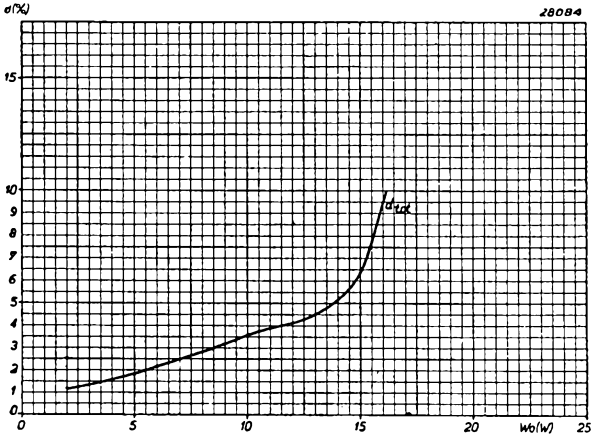

Fig. 1  
Distortion in the output stage of the amplifier as a function of the power, measured at the loudspeaker

1 megohm in the grid circuit; a tone control, consisting of a potential divider  $R_4$  (0.5 megohm) and capacitor  $C_4$  (16,000  $\mu\mu\text{F}$ ), is connected across the anode circuit. The value of the coupling resistor of the AF 7 has been so selected that an alternating voltage of  $0.15 V_{\text{eff}}$  applied to the input terminals of the amplifier will fully load the output valves.

For the valve feeds, the full-wave rectifying valve 1815 is used, with an electrolytic capacitor  $C_{13}$  of 8  $\mu\text{F}$  (550 V), a choke of 20 H (180 ohms) and a second electrolytic capacitor  $C_{12}$  of 32  $\mu\text{F}$  (450 V) for the smoothing. Anode voltages for the two pre-amplifying valves AF 7 and AL 4 are smoothed separately by filters  $R_{14} = 0.2$  megohm,  $C_3 = 8 \mu\text{F}$  and  $R_{16} = 20,000$  ohms,  $C_{10} = 0.5 \mu\text{F}$ .

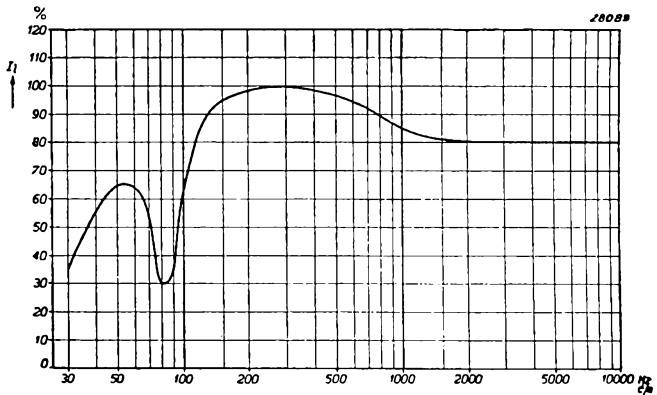
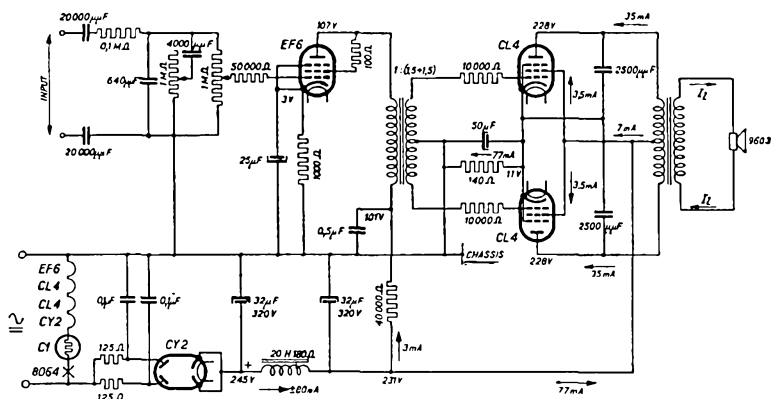

Fig. 2  
Frequency response of the amplifier.

### XXIII. 6-Watt gramophone amplifier for 220 V A.C./D.C. mains

Valves used: "Miniwatt" EF 6, 2 × CL 4, CY 2, C 1.

This 220 V A.C./D.C. amplifier circuit is of simple design, employing only three amplifying valves, viz. the pentode EF 6 and two output pentodes CL 4; the first of these is the pre-amplifier, connected as triode, with a resistor of 100 ohms between the anode and the screen grid to suppress parasitic oscillation. The volume and tone controls are both in the grid circuit of this valve, the former consisting of a logarithmic potential divider of 1 megohm and the latter a logarithmic potential divider with a 4,000  $\mu\text{F}$  capacitor. A filter is also included in the input circuit, comprising a resistor of 0.1 megohm and 640  $\mu\text{F}$  capacitor, for the purpose of flattening out



28076

SCHEMATIC DRAWING WITHOUT PATENT RIGHTS OR UNREGISTERED.  
 EXEMPLE D'UN SCHEMA DE MONTAGE DONNE SANS GARANTIE EN REGARD DE DROITS DE BREVETS D'INVENTION  
 SPECIMEN OF CIRCUIT DIAGRAM WITHOUT ANY GUARANTEES AS TO PATENT RIGHTS

Circuit given without any guarantees in respect to patent rights.

the frequency response characteristic, which is fairly straight up to 7,000 c/s. The output stage, comprising two output pentodes operating in Class A/B, is coupled to the EF 6 by a driver transformer the ratio of which is 1 : (1.5 + 1.5).

The valve heaters are connected in series, as shown in the circuit diagram, i.e. from the chassis end, the EF 6, the two CL 4 valves, rectifying valve CY 2, barretter C 1 and a signal lamp 8064; this sequence will ensure the least possible amount of hum. Resistors of 125 ohms are connected to the anodes of the CY 2 to protect the rectifying valve, and smoothing is provided by two electrolytic capacitors of 32  $\mu\text{F}$  (320 V), with a choke of 20 H (180 ohms). The anode voltage of the pre-amplifying valve EF 6 is further smoothed by a resistor of 40,000 ohms with a 0.5  $\mu\text{F}$  decoupling capacitor. The effective output as measured at the loudspeaker is 6.2 W with 5 % distortion on an input of about 0.27  $V_{\text{eff}}$  to the amplifier.

The input terminals of the amplifier are connected through capacitors of 20,000  $\mu\text{F}$ , and as they are therefore isolated from the mains they can be safely handled. On the other hand, the chassis is at mains potential and should for the sake of safety be mounted in a suitable cabinet. It is advisable to locate the input terminals as far as possible from the speaker terminals.

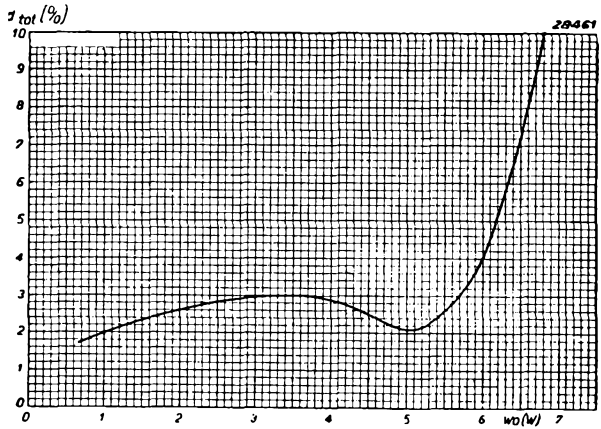

Fig. 1  
Distortion in the output stage of the amplifier as a function of the output power measured at the loudspeaker.

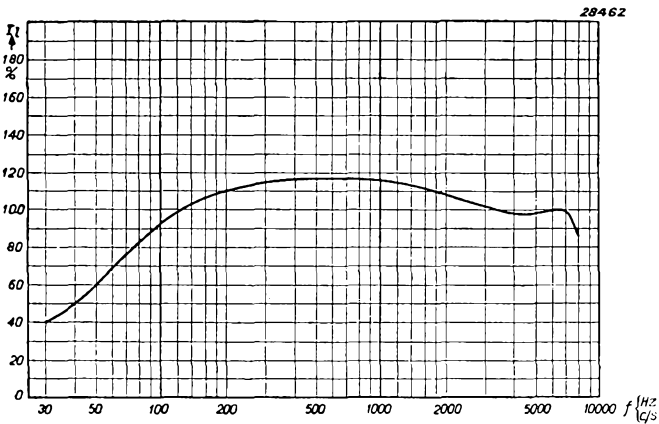
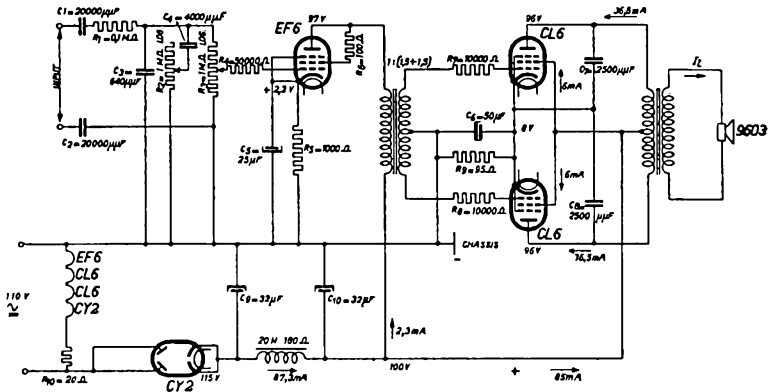

Fig. 2  
Frequency response characteristic of the amplifier.  
A.F. current passing through the loudspeaker as a function of the frequency.

## XXIV. 2-Watt gramophone amplifier for 110 V A.C./D.C. mains

Valves used: "Miniwatt" EF 6, 2 × CL 6, CY 2.

This circuit is for 110 V A.C. or D.C. mains operation. Owing to the fact that the anode voltage of the output stage is lower, the optimum output is not so great as in the case of Circuit XXIII. The output stage comprises two CL 6 valves in a balanced circuit.



Circuit given without any guarantees with respect to patent rights.

The pentode EL 6, connected as a triode, serves as pre-amplifying valve; to conserve voltage, the anode voltage of this valve is not separately smoothed, but this does not result in any noticeable hum.

The 125 ohm resistors in series with the anodes of the rectifying valve in Circuit XXIII are omitted here, in view of the lower voltage. Otherwise, the frequency-response curve is the same as that of Circuit XXIII and the output power measured on a mains supply of 110 V is shown against the distortion in Fig. 1.

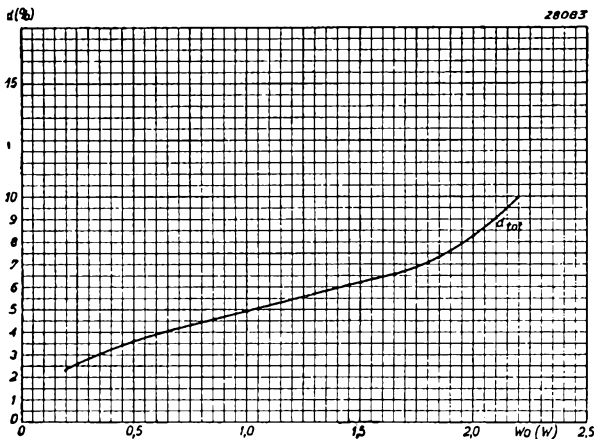

Fig. 1  
Distortion in the output stage as a function of the power as measured at the loudspeaker.

Fig. 1. The power at the loudspeaker is 2.2 W with 10 % distortion, the input required to produce this being about 0.27 V<sub>eff</sub>. The matching resistance in the output stage, measured between anodes, is 3,000 ohms.

The common biasing resistor for the output valves should be 95 ohms and this can be made up by using one 1 W, 100 ohm resistor and one 0.5 W, 2,000 ohm resistor in parallel. In place of the baretter in the previous circuit, a resistor of 20 ohms, 1 W, is employed,

**Philips measuring instruments  
for  
laboratories, workshops and test stations**

# Philips Valve Tester "Cartomatic I" GM 7629

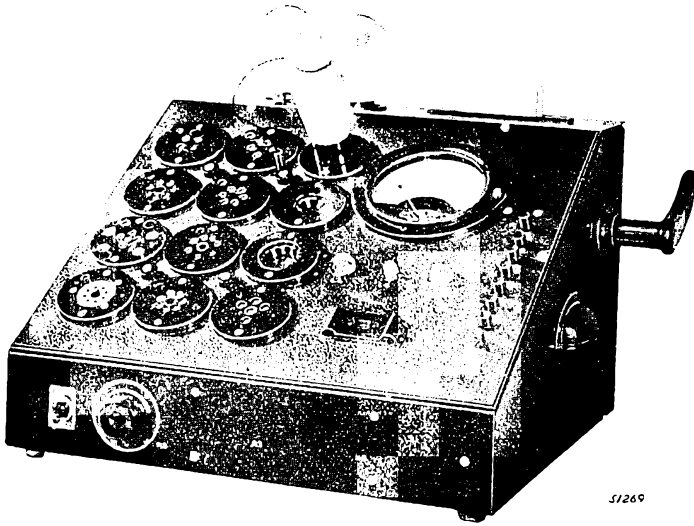

Fig. 1  
Philips Valve Tester "Cartomatic I" type GM 7629.

Philips Valve Tester GM 7629 is a service instrument capable of performing all the usual tests on radio valves, as well as current, voltage, capacitance and resistance measurements.

All the settings of the instrument are effected automatically by means of a contact box having 140 contacts (see Fig. 2) and suitably perforated cards (Fig.3).

Only those contacts which are

opposite to the perforations can be closed, and the correct strappings for the currents and voltages required for the measurement are therefore automatically established. Measurement is extremely simple, quick and reliable, and the required cards are supplied with each unit.

The 140 conical, silver-plated contact pins are disposed opposite solid silver contact plates which are automatically maintained in a bright condition by the friction set up by the closing of the contact box. The latter also contains a safety contact, by means of which the mains circuit is closed only when the card has been correctly inserted.

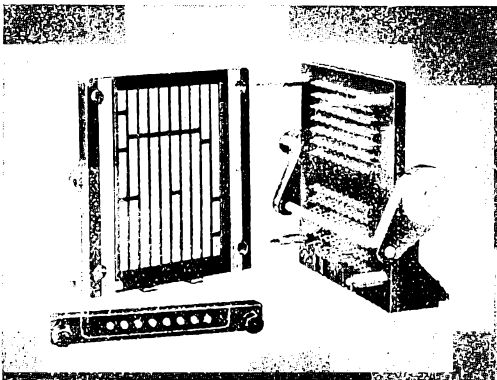

Fig. 2  
Contact box with 140 contacts.

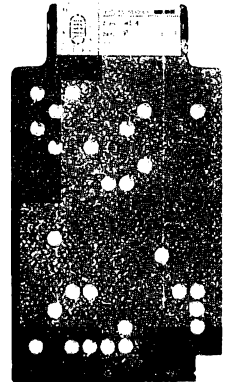

Fig. 3  
Perforated card

The unit is equipped with 12 different types of valve-holders to accommodate almost every current type of valve base, British, Continental and American.

A particularly sensitive milliammeter is fitted, capable of giving full deflection on 0.5 mA, all the moving parts being of extremely light construction. The scale, which can be quickly read, is 80 mm in length, with an overall diameter of 105 mm, and the instrument is protected by a rectifier connected in parallel with it; a choke is included in series with this rectifier in order that the measurement of pulsating direct voltages may not be affected. For the measurement of the emission of all types of valves a special circuit is provided, whereby the limit at which a valve may be regarded as being no longer serviceable is in every case at the same point on the scale; if the pointer does not deflect beyond this point, in the red area on the scale; the valve emission is inadequate. It is therefore not necessary to work with tables of the limits at which different valves are considered to have lost their emission, thus effecting a considerable saving of time and trouble.

### VALVE MEASURING

By operating in succession the eight switch buttons on the right-hand side of the panel, the requisite card having been duly inserted in the contact box and the latter closed, or not, a valve may be tested very quickly under the following headings:

1. Broken filament
2. Shorting electrodes
3. Contact between metallizing and relative pin.
4. Insulation between electrodes of "hot" valve.
5. Adequate emission
6. Mutual conductance
7. Open-circuited leads to the electrodes.

### RANGES FOR D.C. MEASUREMENTS

Range	Internal resistance	Current consumption
10 —500 V	500,000 ohms	1 mA
2 —100 V	100,000 ohms	1 mA
1 — 50 V	100,000 ohms	0.5 mA
0.2— 10 V	20,000 ohms	0.5 mA

### RANGES FOR A.C. MEASUREMENTS

Range	Internal resistance	Current consumption
50—500 V	500,000 ohms	1 mA
10—100 V	100,000 ohms	1 mA
5— 25 V	25,000 ohms	1 mA
1— 5 V	5,000 ohms	1 mA

### RANGES FOR D.C. MEASUREMENTS

Range	Voltage drop
20 —1,000 mA	0.1—0.25 V
10 — 500 mA	0.1—0.25 V
2 — 100 mA	0.1—0.25 V
0.5— 25 mA	0.1—0.25 V
0.1— 5 mA	0.1—0.25 V

### RANGES FOR A.C. MEASUREMENTS

Range	Voltage drop
100—1,000 mA	5 V
100— 500 mA	5 V
10— 100 mA	5 V
5— 25 mA	5 V

### RANGES FOR RESISTANCE MEASUREMENTS

50,000 ohms — 5 megohms  
10,000 ohms — 500,000 ohms  
1,000 ohms — 50,000 ohms  
20 ohms — 4,000 ohms  
1 ohm — 200 ohms

### RANGES FOR CAPACITANCE MEASUREMENTS

10 — 200  $\mu\text{F}$   
1 — 20  $\mu\text{F}$   
0.1 — 2  $\mu\text{F}$   
0.03 — 0.5  $\mu\text{F}$   
1,000 — 30,000  $\mu\mu\text{F}$

### MEASUREMENT OF ALTERNATING OUTPUT VOLTAGES

For the measurement of the alternating output voltage of a receiver, three cards are provided, for ranges of 25, 100 and 500 V.

### SHORT-CIRCUIT TEST

For detecting the presence of a short circuit, a neon tube is provided, which lights up when the test leads are shorted.

### POTENTIOMETER FOR MAINS VOLTAGE

The unit is fitted with a potentiometer for the accurate adjustment of the mains supply, to ensure that all the tests are carried out at the correct potentials.

### VALVES

AX 1 Full-wave rectifying valve for the anode feed.  
1823 or 506 K Full-wave rectifying valve for the grid bias.  
2  $\times$  4357 Neon stabilizers for control- and screen-grid voltages.  
8041 Signal lamp to indicate broken filament.  
9512 Neon tube for short-circuit test.

### MAINS CONNECTION

The unit incorporates a tapping switch for use on all the mains supplies from 100 to 250 V, 50—100 c/s.

### DIMENSIONS

Width 49 cm  
Depth 40 cm  
Height 28 cm

### WEIGHT

Complete: 20 kg nett.



# Philips Universal Measuring Bridge "Philoscop" GM 4140

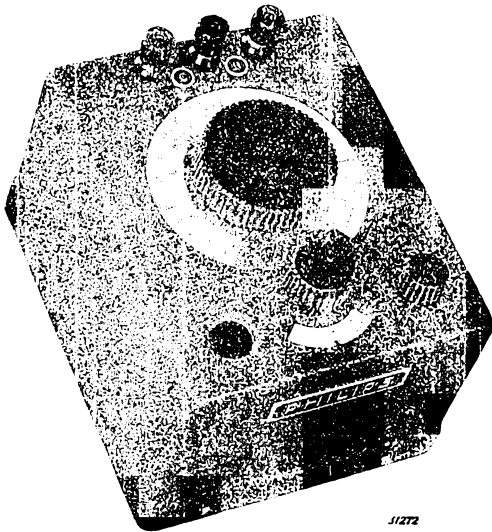

Fig. 1

Philips universal measuring bridge "Philoscop" GM 4140.

This is a new and very practical instrument for measurements of resistance and capacitance, which excels by reason of its small dimensions, light weight, low test voltage, extra high sensitivity, reliability and simplicity in operation. The entirely new principle of the bridge circuit enables the unit to be employed for the most divergent purposes.

The "Philoscop" is adapted for feeding from all available A.C. mains voltages from 100 to 250 V and operated on frequencies between 40 and 10,000 c/s; no batteries are required.

It is especially important when carrying out measurements on chemical solutions (electrolytes, etc.) that the instrument used can be fed with high-frequency current. The test voltage, obtained by transforming the feed voltage, is

only 1 V, which means that low resistance values and high capacitances can be measured without difficulty; low value resistances otherwise quickly run a risk of being overloaded. The finely calibrated range of measurement is particularly wide, including as it does capacitances of  $1 \mu\mu\text{F}$  to  $10 \mu\text{F}$  and resistances of 0.1 megohm to 10 megohms, whilst by means of separate standard inductances it is also possible to measure self-inductances. The range, furthermore, can be extended to some hundreds of microfarads or megohms.

The zero-indicator is not the usual type of pointer instrument but is a Philips electronic indicator EM 1, the action of which is not subject to any lag and which is, moreover, parallax-free; this indicator contains a triode as amplifying valve, and the high sensitivity thus obtained is further augmented by a pre-amplifier stage with a pentode valve. A direct reading of all results is obtained from a single scale, accurate to within 2%, which eliminates the old and cumbersome method of working with calibration curves. Zero-calibration is effected by means of the instrument itself. The "Philoscop" will be found an indispensable instrument in many kinds of laboratories and factory production departments.

## TECHNICAL DATA

*Ranges, using the built-in standard resistances and capacitances:*

<i>Resistances:</i>	0.1 ohm	—	10 ohms
	10 ohms	—	1,000 ohms
	1,000 ohms	—	0.1 megohm
	0.1 M ohm	—	10 megohms
<i>Capacitances:</i>	10 $\mu\mu\text{F}$	—	1,000 $\mu\mu\text{F}$
	1,000 $\mu\mu\text{F}$	—	0.1 $\mu\text{F}$
	0.1 $\mu\mu\text{F}$	—	10 $\mu\text{F}$

Capacitances between  $1 \mu\mu\text{F}$  and  $10 \mu\mu\text{F}$  can also be measured accurately, and the ranges may be further extended to some hundreds of  $\mu\text{F}$  and megohms by using separate standard resistances and capacitances.

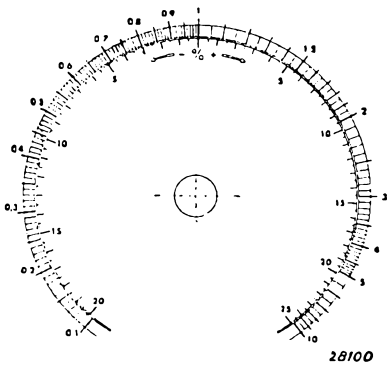

Fig. 1  
Calibration of the scale.

*Continuously variable sensitivity.* Owing to the fact that the sensitivity is continuously variable, approximate measurements may be made in quick succession at low sensitivity, whilst more accurate readings may be taken with the sensitivity at its maximum.

*Zero indication without inertia or parallax.* The electronic indicator functions without the slightest lag and is quite free from the effects of parallax, allowing quick and accurate readings.

*A. C. Supply.* The unit is suitable for use on all lighting mains between 100 and 250 V, and for all sources of alternating current at frequencies of 40–10,000 c/s.

*D. C. Supply.* If the bridge is to be used on direct-current mains, one of the following auxiliary instruments will also be required:

“Vibraphil” vibratory converter Type 7710 for 110 V D.C., or

“Vibraphil” vibratory converter Type 7711 for 220 V D.C.

For use on a 6 V car battery, the “Vibraphil” vibratory converter Type GM 4226 is employed.

*1000 c/s supply.* For the measurement of electrolytes, the bridge is fed with a voltage of frequency 1,000 c/s, e.g. as supplied by the A.F. oscillator GM 4260, instead of the normal 50 c/s test voltage.

*Mains voltage fluctuations.* The bridge is not affected by variations in the mains voltage.

*Insensitivity to mechanical vibration.* Although the electronic indicator is extremely sensitive electrically, it is unaffected by the usually unavoidable jarring and vibration occurring in everyday use.

*Consumption.* On 220 V mains supplies the consumption of power is only 11 W.

*Dimensions.* The dimensions are quite small, viz: length 17.5 cm, width 13.5 cm, height 13 cm.

*Weight.* The weight, including valves, is 2.9 kg.

*Valves.* EM 1 — Electronic indicator

EF 6 — Amplifier pentode

AB 2 — Full-wave rectifying valve

*Self-inductances.* These can also be measured, by means of separate standard inductances.

*Low test voltage.* The voltage on the bridge is not more than 1 V, A.C.

*Accuracy of measurement.* The degree of accuracy in all ranges is 2%, but when separate standard resistances and capacitances are employed the accuracy may be increased at least to 0.1%.

*Single scale.* All results are read from one and the same scale.

*Calibration by means of the instrument itself.* By setting the switch to the “Calibrating” position, it is possible at all times to check the correctness or otherwise of the zero adjustment.



Fig. 2  
Electronic indicator.

# Philips Cathode Ray Oscillograph GM 3152

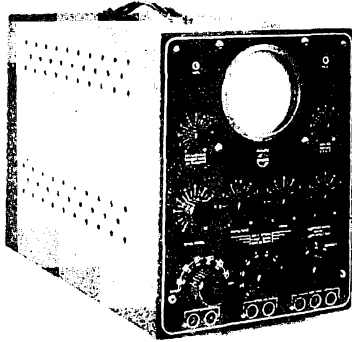

Fig. 1  
Philips Cathode Ray Oscillograph GM 3152.

Philips portable cathode ray oscillograph GM 3152 is housed in a robust metal case (see Fig. 1), containing all the essential elements, viz. Philips high-vacuum C.R. tube with 95 mm screen, time base, variable frequency between 2 and 150,000 c/s, a 2-stage amplifier having a range of 10 to 1,000,000 c/s, and a supply unit.

Owing to its relatively light weight and small dimensions this precision instrument is an extremely handy and easily portable piece of equipment. Its applications are so extensive that, in conjunction with simple transducers, it is also suitable for the measurement of

mechanical, thermal and optical phenomena.

## PHILIPS CATHODE RAY TUBE

The cathode ray tube contained in this unit has a screen diameter of 95 mm and, apart from the electron-optical system, comprises two pairs of perpendicularly opposed deflector plates. The following tubes may be employed in this unit:

- DN 9-3 (long persistent)
- DG 9-3 (green fluorescence)
- DB 9-3 (blue fluorescence)

## TIME BASE

The time base includes three high-vacuum pentodes, and the frequency of the linear base is continuously variable between 2 and 150,000 c/s. For the adjustment of the frequency a 10-way switch with potential divider for vernier reading is provided. A single-impulse time base is also included.

## STATIONARY IMAGES

For stationary images, the time base can be synchronized as required with the frequency on test, the mains, or any other externally applied frequency.

## AMPLIFIER

The built-in linear amplifier consists of a pre-amplifier with a balanced output stage; the anode voltage for the former stage is stabilized by means of a Philips 7475 neon tube. Fig. 2 depicts the frequency characteristic of the amplifier, from which it will

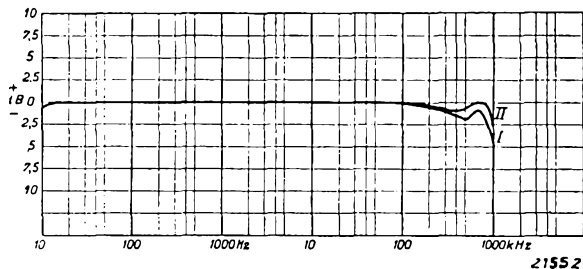

Fig. 2  
Frequency characteristic of the amplifier.

be seen that the amplification between 10 and 1,000,000 c/s is linear to within  $\pm 2$  dB. The overall gain, which exceeds a factor of 1,600, is adjustable in three stages by means of the sensitivity switch and is further continuously variable.

*Sensitivity of the oscillograph.* The total sensitivity is 6 mV<sub>eff</sub> per cm image height; without amplification the sensitivity is 10 V<sub>eff</sub> per cm.

*Input impedance.* The normal input impedance, using the sensitivity switch, is 10,000 ohms, and the maximum permissible voltage is 45 V.

*High input impedance.* When the sensitivity switch is not operating the input impedance is 1 megohm and the input capacitance 20  $\mu$ F.

#### ULTRA SHORT WAVES.

For the measurement of ultra short waves, for example 60 Mc/s (5 metres), there is at the rear of the unit a terminal plate which is in direct contact with the deflector plates. In this way all long leads and stray capacitances are eliminated.

#### SUPPRESSION OF THE CATHODE RAY

Fitted on the terminal plate on the back panel is a switch for suppressing the cathode ray; by applying 45 V D.C. to the unit and reversing the switch it is possible to suppress the ray for a certain period, thus facilitating certain kinds of observation or photographic recording.

#### MAINS CONNECTION

The unit has a voltage tapping switch covering all normal mains voltages, viz. 110 V, 125 V, 145 V, 200 V, 220 V and 245 V, 40—100 c/s. Adjacent to this switch, two fuse-holders are fitted to accommodate 1-A fuses. The unit can be used on D.C. mains in conjunction with Philips "Vibraphil" vibratory converter Type 7710 for 110—145 V, or Type 7711 for 220—245 V, D.C.

*Consumption.* The total consumption of power is approximately 100 W.

#### SUPPLY SECTION

This oscillograph contains two rectifiers, namely one for the anode feeds of the six amplifier pentodes and time base, and one for the C.R. tube. For the smoothing of this potential, of about 1,000 V, Philips "Microlyte" capacitors, connected in series, are employed, these ensuring high capacitance and effective smoothing.

The whole of the feed section is screened from the rest of the unit by a steel screening plate.

#### VALVES:

There are in all 10 valves, viz:

- 1 C.R. tube DN 9-3 (long persistent), or  
DG 9-3 (green screen), or  
DB 9-3 (blue screen)

*Amplifier*            1 amplifier pentode 4673 for the input stage  
                         2 amplifier pentodes 4673 in balanced circuit.

*Time base*            1 charging pentode 4673  
                         1 discharging pentode (9 W) AL 4  
                         1 modulator and synchronizing pentode 4673

*Supply section*      1 high-voltage rectifying valve 1876  
                         1 full-wave rectifying valve AZ 1  
                         1 neon tube for stabilization, type 7475.

**WEIGHT:**            The weight, complete, is about 19 kg.

**DIMENSIONS:**    Length 42 cm  
                         Width 22.5 cm  
                         Height 29 cm

# Philips Cathode Ray Oscillograph GM 3155

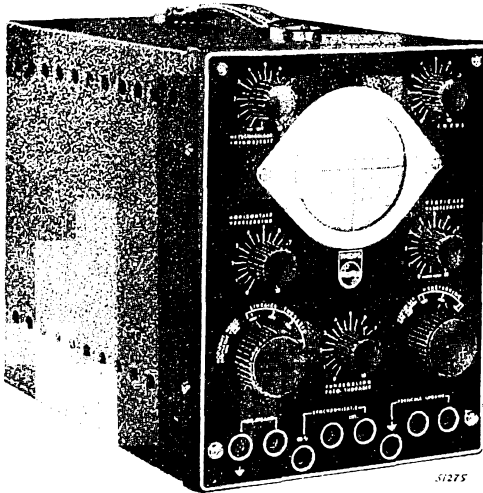

Fig. 1  
Philips Cathode Ray Oscillograph GM 3155.

This portable cathode ray oscillograph was designed for the rapid qualitative measurement of periodic electrical phenomena. The auxiliary apparatus contained in the unit makes it possible to carry out numerous types of measurement without the aid of additional equipment, and the circuits are sufficiently universal to permit of investigations into mechanical, magnetic and other phenomena when used in conjunction with simple transducers.

Measurements of heavy currents can likewise be effected, e.g. the two built-in amplifiers can be employed for phase measurement. Screws are provided at each side of the fluorescent screen for attachment of a transparent scale or camera stand.

In conjunction with Philips Service Oscillator GM 2880 or GM 2882 and Philips Frequency Modulator GM 2881, this cathode ray oscilloscope is eminently suitable for the rapid servicing of radio receivers, R.F. amplifiers and so on; the tuning curve of a receiver can be traced directly from the fluorescent screen of the C.R. tube and, further, the selectivity can be measured with sufficient accuracy for all practical purposes.

## CONSTRUCTION AND CIRCUITS

The oscillograph is housed in a sprung metal case and comprises the following main units: Philips high-vacuum C.R. tube (70 mm screen), time-base with frequency variable between 20 and 20,000 c/s, two single-stage amplifiers, one for the horizontal and one for the vertical deflection and having a range of 25—100,000 c/s. Special facilities are provided for modulation of the ray. The feed section consists of 2 separate rectifiers. All the controls are clearly marked and calibrated.

### PHILIPS C.R. TUBE DN 7-2

The Philips high-vacuum C. R. tube DN 7—2 fitted in this unit has a 70 mm screen; the deflector plates are in two pairs, perpendicular to each other.

### TIME BASE

The built-in time base includes a charging pentode 4673 and a gas-filled discharging triode 4690; the linear time-base frequency is variable between 20 and 20,000 c/s, the different ranges being controlled by switches. Throughout the whole frequency range the amplitude of the time-base is variable from about 2 to 5 cm.

### SYNCHRONIZED TRACE

For stationary images the time-base may be synchronized with either the frequency under investigation or an externally applied voltage or, again, with the mains frequency.

### AMPLIFIERS

The two amplifiers contained in the unit, for the horizontal and vertical deflection, are each equipped with a pentode 4673.

## FREQUENCY RANGE

The linear frequency range of the two amplifiers is 25—100,000 c/s, and with the feed-back in circuit the linearity is within  $\pm 1$  dB.

## TEST SENSITIVITY

The maximum sensitivity of the amplifier for perpendicular deflection is 125 mV<sub>eff</sub> per cm overall height of the trace, with the feed-back switched off; with the latter fully applied the sensitivity is 830 mV<sub>eff</sub> per cm and when partially applied 350 mV<sub>eff</sub> per cm.

Without amplification the sensitivity is 17 V<sub>eff</sub> per cm and that of the amplifier for the horizontal deflection, which works with feed-back in every case, is about 30 % less than that of the vertical amplifier with feed-back switched on.

## INPUT RESISTANCE

When the potential divider for controlling the sensitivity is in use the input resistance of the vertical amplifier is 10,000 ohms; the maximum permissible voltage is 45 V. With the potential divider turned fully anticlockwise ("off" position) the input resistance is 1 megohm and the maximum voltage 150 V.

## MODULATION OF THE RAY

Terminals are provided at the rear of the unit for the purpose of modulating the ray with an external alternating voltage.

## MAINS CONNECTION

A tapping switch is provided so that the unit may be used on 110 V, 125 V, 145 V, 200 V, 220 V or 245 V, 40—100 c/s mains, and the necessary fuses are fitted. The oscillograph can be used on D.C. mains in conjunction with a "Vibraphil" vibratory converter Type 7710 (110—145 V), or Type 7711 (220—245 V mains).

## CONSUMPTION

The total consumption is about 40 W.

## VALVES

There are in all 6 valves:

1 high-vacuum cathode ray tube	DN 7-2
1 R.F. amplifier pentode (vertical deflection)	4673
1 R.F. amplifier pentode (horiz. defl.)	4673
1 gas-filled discharging triode	4690
2 half-wave rectifying valves	1876

## WEIGHT

The total weight is approx. 7.7 kg.

## DIMENSIONS

Height	22 cm
Width	17 cm
Depth	24 cm (without knobs)

# Philips Electronic Switch GM 4196

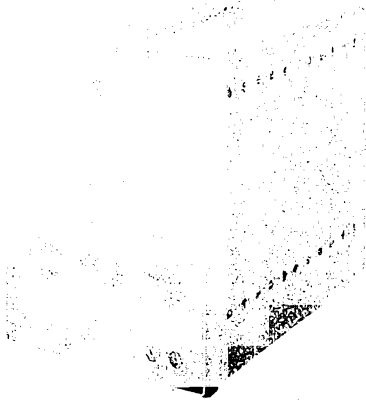

Fig. 1  
Philips Electronic Switch GM 4196.

The electronic switch is used as auxiliary equipment with a cathode ray oscillograph. By means of this unit two different electrical phenomena can be observed simultaneously and independently on the fluorescent screen of the C.R. tube, thus greatly extending the field of application of the latter. The electronic switch depends for its action on the fact that it enables the two electrical phenomena to be reproduced alternately, at a very high frequency. Since the fluorescent coating on the screen gives a certain amount of persistence, whilst the human eye, on the other hand, exhibits a certain lag, the two oscillograms are "seen" simultaneously. The switching, which takes place at about 10,000 per second, is produced by high-vacuum valves; hence the term

"electronic switch". Using this instrument, it is possible to adjust two images to a common zero line on the screen or, if required, to separate lines, one above the other, without modification of the phasing; it is thus possible to observe in detail the amplitude, wave form, frequency ratio and phase displacement of any two given voltages. The electronic switch GM 4196 was designed especially for use with the cathode ray oscilloscope GM 3152 and its practical performance has already earned for it a very great deal of interest. By means of this unit it is possible with only one oscillograph to carry out investigations which would normally require two such instruments; the features which this unit offers will make it a welcome addition to the equipment of any laboratory.

## OUTSTANDING FEATURES

The more important features of Philips Electronic Switch GM 4196, when used with Philips Cathode Ray Oscillograph, are as follows:

1. Two voltages or currents may be oscillographed at the same time but quite independently.
2. The two oscillograms may be adjusted as desired to a single zero line, or two separate lines.
3. The phasing of the two phenomena remains unaffected.
4. The two signals may be amplified separately.
5. The frequency of switching is about 10,000 c/s, giving an image of excellent quality.
6. Due to the use of a carefully adjusted compensating circuit, the switching voltage is very nearly rectangular, resulting in a very clear image.
7. Only high-vacuum valves are used in this unit; it does include any mechanical devices.

## WORKING PRINCIPLE

The working of the instrument is as follows: two separate high-vacuum valves are alternately switched on and off with the aid of a multivibrator delivering a voltage the frequency of which is about 10,000 c/s. In this way the oscillogram is built up from very small elements, traced at the frequency of 10,000 per second, giving the impression that the trace consists of a full line. This applies to all phenomena of a frequency above 400 or 500 c/s.

The electronic switch is fully equipped for use on lighting mains of all A.C. voltages, being quickly strapped to suit any local voltage.

## TECHNICAL DATA

### *Amplifiers I and II*

Each of the applied signals can be amplified separately, within a frequency range having its lower limit at about 25 c/s, the upper limit being determined by the frequency of the multivibrator, which is approximately 10,000 c/s; a fundamental frequency of 500 c/s can therefore be oscillographed with perfectly clear definition.

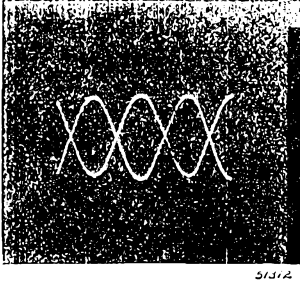

Fig. 2  
The electronic switch enables two characteristics to be observed as flowing lines.

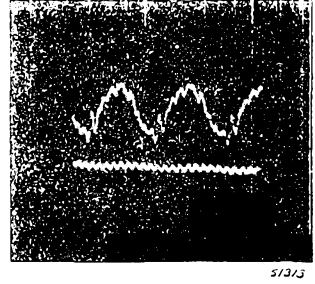

Fig. 3  
The large amplitude makes it possible to reproduce the mechanical vibration of an electric motor; the vibration of small amplitude is that of a normal frequency of 500 c/s.

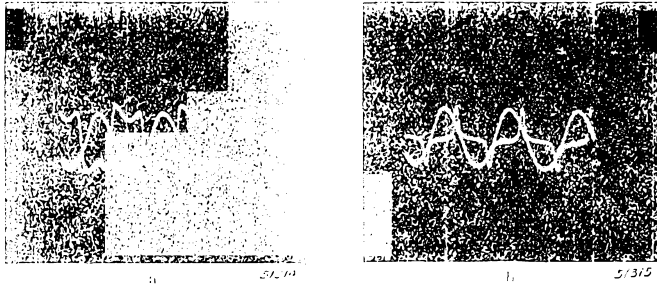

Fig. 4  
The sinusoidal curve illustrates the primary voltage of the transformer; the flattened curve in a is that of the secondary voltage and the sharply peaked curves in b the primary current. In both cases the 3rd harmonic is very marked



Each amplifier has two sets of input sockets, one for the low voltage, of minimum  $0.1 V_{eff}$  to maximum  $75 V_{eff}$ , having an input impedance of 50,000 ohms, and one for minimum  $2 V_{eff}$  to maximum  $300 V_{eff}$  with an input impedance of 1 megohm. One of the input sockets is in each case earthed.

#### *Multivibrator*

The built-in multivibrator delivers a voltage of rectangular wave form, of about 10,000 c/s. The switching impulses, which in many well-known circuits produce interference, have been here reduced to a negligible minimum, as will be seen from the oscillogram, Figs. 2 and 4.

#### *Variable zero-line*

A common zero-line or two separate lines can be obtained as desired by means of a potential divider.

#### *Connection to oscillograph*

The electronic switch has two sockets for connection to the oscillograph, one being earthed.

#### *Mains connection*

The instrument is intended for use on A.C. mains; a red signal lamp lights up as soon as the mains switch is closed. This unit can be adapted for all mains supply voltage between 100 and 250 V, 40–60 c/s, by means of a tapping switch. The consumption of power is approximately 30 W at 220 V.

#### *Valves*

- 2 R.F. pentodes EF 6
- 2 9-W pentodes EL 3
- 1 rectifying valve EZ 3
- 1 signal lamp 8045 D-07.

#### *Weight and dimensions*

- Weight: approx. 5.5 kg
- Dimensions:
- Length 25 cm (over the knobs 27 cm)
- Width 23 cm
- Height 27 cm

## Philips Service Oscillator GM 2882

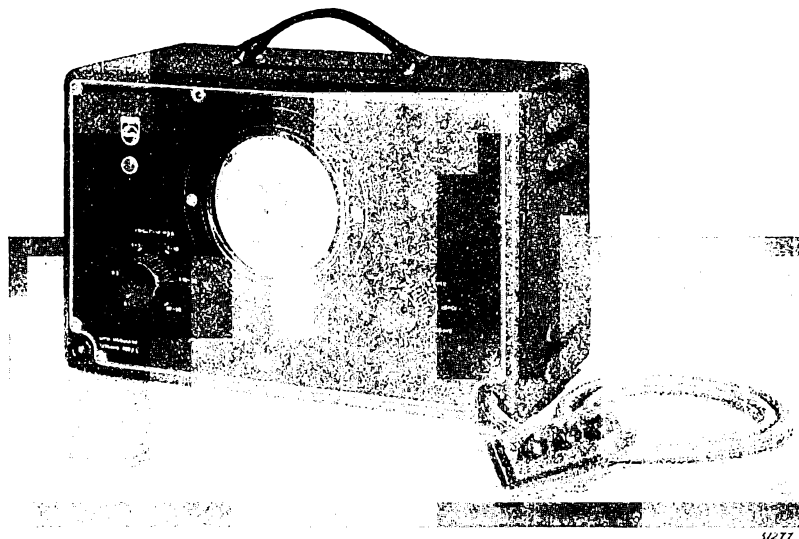

The practical build, the new type of circuit employed, and specially designed components of the Philips Service Oscillator GM 2882 give this instrument many advantages over earlier types. It is extremely simple in operation.

1. The number of controls has been reduced to a minimum.
2. The frequency is read from the scale direct in kc/s or Mc/s.
3. A direct indication of the input voltage is shown on the attenuator.

The power consumption, physical dimensions and weight have all been reduced as far as possible for this type of unit, making it an extremely practical service oscillator for the calibration of station dials, trimming of circuits and checking sensitivity, A.G.C. and automatic tuning.

The entire frequency range is divided into 6 bands and the output voltage is continuously variable between  $1 \mu\text{V}$  and 100 mV. For selectivity measurements, moreover, an attenuator, calibrated in steps of 1 : 10, is combined with a dummy aerial at the end of the cable. The signal can be modulated to a depth of 30 % by the built-in 400 c/s oscillator, or an external frequency can be employed for modulation to a depth of 80 %.

Every possible measure has been taken to ensure the highest possible stability of the frequency; the design of the oscillator coils and their switching aims at the shortest possible connections in each waveband. The coils are mounted on a disc which is rotated by the control knob to six different positions, introducing a fresh coil at each setting; in this way the same short leads to the variable capacitor and oscillator valve are employed in each case, so that neither mechanical nor electrical effects can disturb the stability of the frequency.

The oscillator coils themselves are so constructed that they have a negative temperature coefficient, to compensate the positive coefficient of the variable capacitor; temperature stability of the oscillator circuit is therefore very good. The oscillator valve is the steep-slope pentode EF 50 which was specially developed for operating on very high

frequencies, and accordingly the oscillator frequency is to a very high degree independent of any fluctuations in the mains voltage.

Moreover, the frequency is not affected by the setting of the attenuator, whilst frequency modulation is obviated by the use of a special circuit consisting of a separating stage between the oscillator valve and the attenuator; the modulation, therefore, is practically undistorted, even at very high frequencies.

The frequency scale gives readings which are accurate to within 1 %, this being usually ample for the trimming of radio-receiver circuits; an ingenious type of potentiometer, operated by a single knob, controls the attenuator, thus reducing the total number of controls on the unit to four, these being as follows:

1. wave-range control
2. tuning
3. attenuator
4. on-off and modulator switch.

#### TECHNICAL DATA

*Frequency ranges.* 1) 100— 300 kc/s,            3) 1— 3 Mc/s,            5) 10—30 Mc/s,  
2) 300—1,000 kc/s,            4) 3—10 Mc/s,            6) 30—60 Mc/s.

*R. F. Voltage.* The maximum obtainable R.F. voltage is 100 mV.

*Attenuator.* The attenuator controls the signal continuously, down to  $< 1 \mu\text{V}$ . An attenuator 1 : 10 is also included with the dummy aerial.

*Modulation.* Internal modulation of 400 c/s (mod. depth 30 %); external modulation up to 10,000 c/s (mod. depth up to 80 %).

*A. F. Voltage.* The A. F. voltage for internal modulation may be tapped from the connecting socket for the external modulation; this voltage is 1.5 V at 400 c/s.

*Calibrated scale.* Calibration of the scale is in kc/s and Mc/s, to within a tolerance of 1 %, giving a high degree of accuracy in reading.

*Constant frequency.* It is of the greatest importance that the frequency should be as constant as possible; the frequency is constant to within 0.02 % for voltage variations of 10 % and to within 0.1 % with an increase in temperature of 10 %, so that the accuracy of the scale is superior to all these factors.

Frequency modulation is negligible.

*Valves.* Oscillator valve EF 50  
Modulator valve EF 50

A.F. oscillator valve EF 6  
Rectifying valve EZ 2  
Signal lamp 8060-00.

#### *Mains voltage.*

The service oscillator is suitable for use on all A.C. mains, viz. 110 V, 125 V, 145 V, 200 V and 245 V  $\pm 10\%$ , 50-100 c/s. The unit is fully mains-operated.

#### *Consumption.*

18 W

#### *Dimensions.*

Width 33.3 cm

Height 22 cm

Depth 16.5 cm

#### *Weight.*

8.5 kg

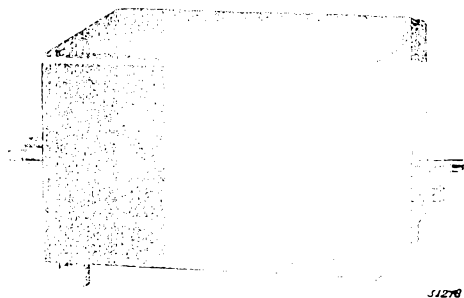

## Philips Frequency Modulator GM 2881

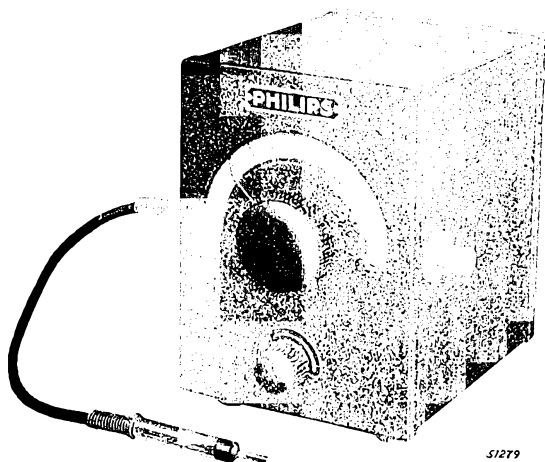

Fig. 1  
Philips Frequency Modulator GM 2881.

Philips Frequency Modulator GM 2881 is used for the purpose of visually testing the tuning curves of radio receivers and R.F. amplifiers; it should be employed preferably in conjunction with Philips Service Oscillator GM 2882 and the small Cathode Ray Oscillograph GM 3155, although, naturally, the larger oscillograph GM 3152 will also serve this purpose.

### OUTSTANDING FEATURES

This frequency modulator has the following features to offer:

1. The tuning curve and the output amplitude are rendered directly visible in combination with each other; any deviations in the form of the tuning curves are immediately observed.
2. Simple readings and operation, rapid control of the tuning curve on wide or narrow bandwidth (variable bandwidth).
3. Direct reading of bandwidth in kc/s; range of measurement up to about 25 kc/s.
4. Adjustment of tuning curve in accordance with a standard characteristic.
5. Effects of trimming upon the tuning curve are immediately visible.
6. When the R.F. voltage and A.F. voltage immediately after detection are oscillographed, the effect of the detection on the tuning curve can be determined.
7. The frequency scale of the oscillogram can be matched with the form of the tuning curve (bandwidth).

### CIRCUIT

The modulator contains two octodes CK 1 which serve respectively as mixer valve and frequency modulator and, further, a full-wave rectifying valve AZ 1. In principle the working of the instrument in conjunction with Service Oscillator GM 2882 and the oscillograph is as follows. The service oscillator delivers a certain R.F. signal  $f_2$  and the frequency modulator another signal  $f_1$  of 4,000 kc/s (maximum tolerance  $\pm 1.5\%$ ): suppose that the frequency of the required R.F. signal, to which the receiver is tuned, is  $f_0$ , then the frequency of the service oscillator will be adjusted to  $f_1 - f_2 = f_0 =$  R.F. tuning of the receiver.

### FREQUENCY MODULATION

The time-base voltage of the cathode ray oscillograph is employed for frequency modulation, this saw-tooth voltage being used to modulate the R.F. test signal between 25 kc/s above and below the mean frequency (varying impedance of the octode).

### SELECTIVITY CURVES

The amplifier in the cathode ray oscillograph GM 3152 has a linear frequency characteristic of 10—1,000,000 c/s, enabling both the tuning curve of the R.F. signal and

that of the A.F. signal to be reproduced (to ascertain the effect of the detector); the oscillograph GM 3155, the two amplifiers of which have a linear characteristic of 25—100,000 c/s, permit of inspecting the tuning curve only with the A.F. signal, although this is quite sufficient for most service purposes.

#### **WIDTH OF TUNING CURVE**

The frequency  $f_1$  (4,000 kc/s) of the oscillator in the modulator unit is variable through a range of about  $\pm 25$  kc/s, the scale being generously proportioned and clearly calibrated in kc/s. When the control is rotated from the "off" position in the direction "+", or — 25 kc/s, the tuning curve moves from left to right on the screen, so that the bandwidth can be read directly in kc/s at any desired point on the curve, with an accuracy that is quite ample for all practical purposes. The height of the oscillogram is directly proportional to the R.F. or A.F. signal of the receiver under test.

#### **CONNECTIONS**

Sockets for connection of the frequency modulator to the service oscillator GM 2882 are provided on the left-hand side of the metal case. On the right is an R.F. cable with dummy aerial.

#### **VALVES**

Oscillator and mixer valve: octode CK 1

Frequency-modulator valve: octode CK 1

Full-wave rectifying valve AZ 1.

#### **MAINS CONNECTIONS**

The unit is fitted with a tapping switch for voltages of 110 V, 125 V, 145 V, 200 V, 220 V and 245 V.

#### **CONSUMPTION**

Approx. 20 W.

#### **WEIGHT**

The total weight, including valves, is about 4.4 kg.

#### **DIMENSIONS**

Depth (with knobs)	23 cm
Depth (without knobs)	20 cm
Height	20 cm
Width	15 cm

# Philips A. F. Signal Generator GM 2307

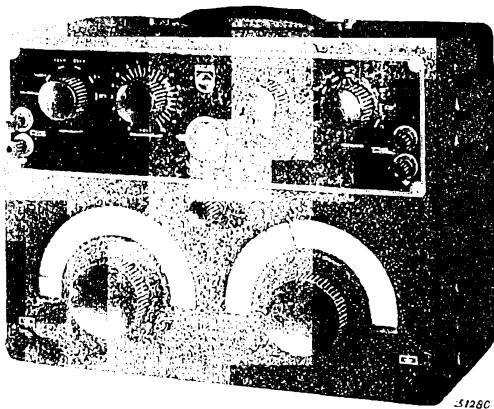

Fig. 1  
Philips A.F. signal generator GM 2307.

Philips A.F. signal generator GM 2307 furnishes a very constant alternating voltage of a variable amplitude, so that it is suitable for all measurements falling within the range of 30—16,000 c/s.

The test frequency is produced by filtering out and amplifying the beat frequency obtained from two R.F. oscillators, preset to different frequencies. The frequency of the A.F. signal is of course the difference between the two R.F. frequencies.

## OUTSTANDING FEATURES

1. High accuracy of scales.
2. Wide frequency range.
3. Constant output voltage throughout the range.
4. During warming up, very little change in frequency and amplitude of the signal.
5. Practically no effects of mains voltage fluctuations.
6. High output voltage, with balanced output stage if required, also when the attenuator is in use.
7. Output can be matched to four different load impedances.
8. Good sinusoidal wave form; very weak harmonics.
9. Very low ripple voltage.
10. The zero point of the A.F. beat frequency can be accurately adjusted by means of the electronic indicator.

## TECHNICAL DATA

*Frequency range.* The right-hand frequency control covers a range of 0—1,000 c/s and the left-hand control 0—15,000 c/s; the readings of the two controls are additive and the maximum frequency (with both controls at maximum) is therefore 16,000 c/s.

*Frequency variation during warming-up period.* After 10 minutes from the time the unit is switched on, the difference in frequency for the next three hours is less than 20 c/s, after which there is no further variation at all.

*Setting and accuracy of frequency scales.* With both scales set to zero the frequency is adjusted to the zero point with the aid of an electronic indicator, after which adjustment the scale tolerance is  $\pm 1\%$  from 200 to 16,000 c/s; between 30 and 200 c/s the maximum deviation is 2 c/s.

*Frequency curve.* The deviation in the linearity of the curve is less than  $\pm 2.5\%$  between 30 and 16,000 c/s, this applying to all settings of the matching switch.

*Matching.* The output of the instrument can be matched to the following loads by means of a switch:

- |   |  |
|---|--|
| 1. Attenuator in circuit <sup>1)</sup>        | 4. Output resistance 250 ohms <sup>2)</sup>  |
| 2. Output resistance 1,000 ohms <sup>2)</sup> | 5. Output resistance 5 ohms <sup>2)</sup>  |
| 3. Output resistance 500 ohms <sup>2)</sup>   | 6. Maximum voltage approx. 50 V; output resistance approx. 25,000 ohms <sup>3)</sup> . |

*Attenuator.* The built-in attenuator has 8 settings, giving a total attenuation of 1 : 10,000; these correspond to  $1.3 \times 10^{-1}$ ,  $10^{-1}$ ,  $3 \times 10^{-2}$ ,  $10^{-2}$ ,  $3 \times 10^{-3}$ ,  $10^{-3}$ ,  $3 \times 10^{-4}$ ,  $10^{-4}$  times the input voltage and represent approximately 10 dB per stage. Normally the input voltage of the attenuator is 0–15 V, and this can be measured with a valve voltmeter, e.g. Philips R.F. Triode Voltmeter GM 4151, or Philips Thermionic Voltmeter GM 4132, connected to the left-hand terminals. The loading resistance between the output (R. H.) terminals should be 25,000 ohms or more; a separate switch is provided whereby the output may be rendered symmetrical, or not, with respect to earth. The voltage across the output terminals then remains unaltered, any difference being less than 2%. At the "asymmetrical" setting the lower terminal is automatically earthed.

Once the output voltage of the attenuator has been carefully adjusted, the attenuated voltage, at the various settings, does not deviate by more than 1% from the nominal value.

*Maximum output power and distortion.* With the load correctly matched the maximum output power at settings 2 to 5 of the matching control is normally 200 mW, but, should such be required for special purposes, the maximum available output can be increased to 1 W or reduced to 100 mW by means of a screw at the rear of the unit. The distortion then varies in accordance with the following:

Frequency	Distortion at		
	100 mW	225 mW	1 W
30—200 c/s	0.5 %	1 %	2.5 %
200—16,000 c/s	0.25 %	0.5 %	1.5 %

When the voltage control is set to its maximum the ripple voltage, for an output of 15 V, is less than 0.5–1%.

*Calibration of the voltage control.* The voltage occurring across the left-hand terminals with respect to settings 1 and 2 of the matching switch may be read from the graduations on  $R_1$ . The maximum voltage is adjusted to 15  $V_{eff}$  but is variable between 10 V and 32 V by means of the screw at the back of the case. This voltage is unaffected by variations in the mains voltage or the temperature, but for very accurate measurements it is essential to measure the voltage.

*Supply.* A voltage tapping plate is provided at the rear of the generator, by means of which the unit may be made suitable for use on mains of 110, 125, 145, 200 or 245 V, 40–100 c/s as required. The consumption is approximately 40 W. Variations in output voltage due to fluctuations in the mains supplies amount to less than 2%.

*Use with vibrator-converter.* The signal generator may be employed on D.C. mains when used in conjunction with Philips "Vibraphil" vibratory converter Type 7710 (110–145 V) or Type 7711 (200–245 V).

<i>Valves.</i>	Triode-hexode	ECH 3	Pentode	EL 3
	Pentode	EF 6	Rectifying valve	EZ 2
	A.F. pentode-electronic indic.	EFM 1	Neon stabilizer	150 A 1.

*Weight and dimensions.* Weight: approx. 12 kg  
 Width: 34 cm  
 Height: 25.5 cm  
 Depth: 20 cm (incl. knobs).

<sup>1)</sup> The unit is provided with a switch by means of which the output can be made symmetrical with respect to earth, or not, as desired. <sup>2)</sup> The lower terminal may be earthed, as required, by means of a switch. <sup>3)</sup> The lower terminal must then be earthed through the earthing switch.

# Philips Heterodyne Wavemeter GM 3110

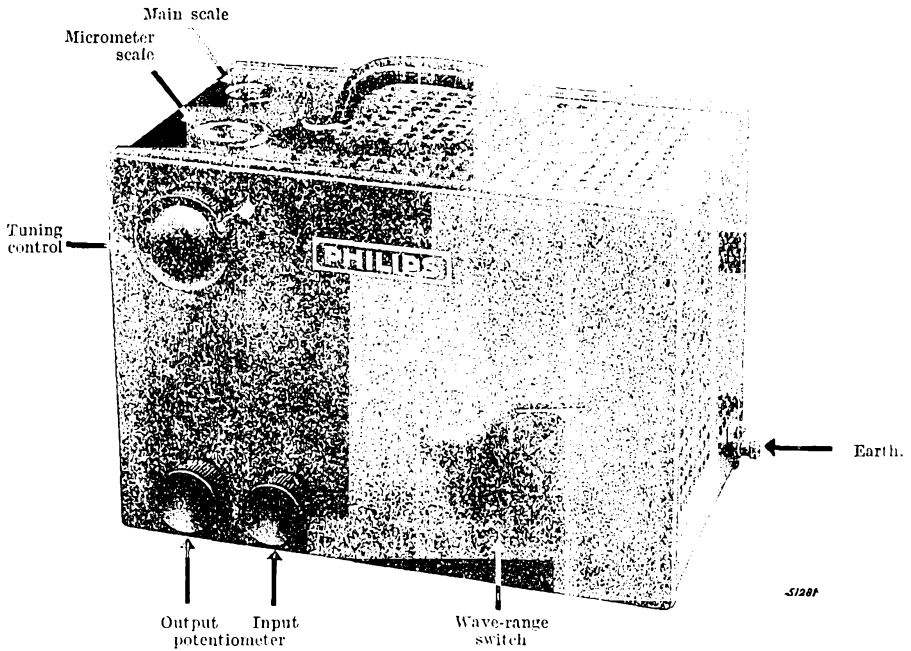

Fig. 1  
Philips heterodyne wavemeter GM 3110.

By means of the Philips Heterodyne Wavemeter frequency measurements over a very wide wave-range may be carried out with a high degree of accuracy; for this purpose the heterodyne principle is preferable to any other.

The built-in precision capacitor is equipped with a micrometer drive which enables tuning to be effected with the greatest possible accuracy.

The six wavelength ranges extend over the following frequencies:

Position 1:	5—	16 Mc/s
„ 2:	2—	5 „
„ 3:	600—2,000	kc/s
„ 4:	200—	600 „
„ 5:	90—	200 „
„ 6:	40—	90 „

A special circuit ensures that the 2nd, 3rd and even the 4th harmonics are strong enough to permit of all frequency measurements occurring in normal practice, up to 60 Mc/s (5 m).

The wavebands are so arranged that they overlap each other, but a separate oscillator coil covers each range, these coils being mounted on a rotary disc and fitted with screening cans. Each coil, moreover, is operated by a reliable system of switching and the advantage of this arrangement is that it is not necessary to carry loose coils; the time entailed in changing the coils each time is therefore saved.

Broadly speaking, the wavemeter consists of an R.F. oscillator of very high accuracy and stability, the latter factor being due to the use of a special oscillator circuit in which the anode voltage is stabilized by means of a neon tube. A further advantage of this arrangement is that the frequency is unaffected by variations in the mains voltage.



Each component of the wavemeter, down to the very smallest, has been selected for its particular purpose only after the most searching technical investigation, thus ensuring a reliable and easily operated measuring instrument of practical and rugged construction.

Measurement is almost completely independent of external influences such as fluctuations in temperature, etc. during normal use.

A dull silver-plated scale having 7 graduations is mounted on the capacitor spindle, and the drum of the micrometer drive is accurately calibrated in 100ths and half 100ths, giving a scale of 1,400 divisions for each wave range. The length of the scale, apart from the unusually small amount of mechanical backlash, which is less than 0.2 of a division, is another important factor; the diameter of the micrometer drum is 50 mm, and, the total length of the scale being about 110 cm, the readings can be taken with ease and precision. The accuracy of calibration of the wavemeter itself is in excess of 0.2 %.

An attenuator is included in the unit, by means of which the R.F. signal can be controlled as required from minimum to maximum; this attenuator consists of an input and an output potentiometer, so arranged that the R.F. signal is attenuated first by the former and then by the latter.

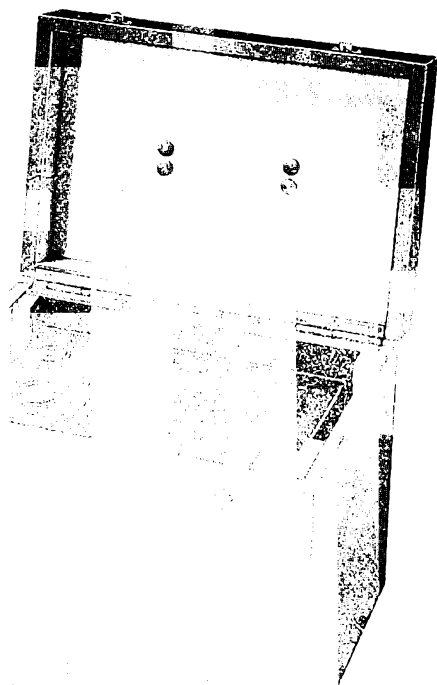

Fig. 2  
Carrying case for the wavemeter

#### DIMENSIONS

Wavemeter including control knobs:

26 × 19 × 24 cm.

Dimensions of carrying case:

33 × 22.5 × 27 cm

#### WEIGHT

Wavemeter GM 3110: 6.75 kg  
complete with  
carrying case: 10.5 kg

#### VALVES

6F 7 pentode oscillator valve  
1801 full-wave rectifying valve  
7475 neon tube for voltage  
stabilization.

It is important that the frequency should remain as constant as possible, even when the signal strength is increased from minimum to maximum, and tests have proved that variations in the frequency amount to less than 0.1 %, which may be regarded as more than satisfactory for all normal purposes. As stated, fluctuations in mains voltage have little or no effect on the frequency, these being counteracted by a frequency stabilizer with neon tube; the frequency is constant to within 0.25 % on mains variations of 10 %.

Wavemeter type GM 3111 can be supplied to order, this unit being provided with extra terminals for external modulation; it can therefore be used with or without modulation and in the latter instance normal calibration curves of the usual degree of accuracy are employed.

The wavemeter GM 3110 as supplied is suitable for use on mains supplies of nominal voltage 127 and 220 V, 50 c/s, but other models may be obtained to order. The amount of power consumed by these units is not more than 11 W approx.

Each wavemeter is supplied in a felt-lined carrying case with handle and nickel-plated fittings; the unit is small and light and thus can be easily carried about.

*Supply.* As mentioned above, wavemeter GM 3110 is used on A.C. mains of 127 and 250 V, 50 c/s, but it can also be employed on D.C. supplies in conjunction with Philips "Vibraphil" vibratory converter Type 7710 (110—145 V), or Type 7711 (220—245 V). With the Vibraphil converter GM 4226 the wavemeter can also be used on a 6 V accumulator.

SURVEY OF

Type	Page		Type	Page		Type	Page	
100 E1	285		4683	244		B 405	302	
506	308		4686	302		B 406	302	
506 K	308		4687	285		B 409	300,302	
1018	308		4689	247		B 424	302	
1561	308		4694	249		B 438	302	
1801	308		4695	292		B 442	302	
1802	308		4699	251		B 443	300,302	
1803	308		7475	285		B 443S	300	
1805	308		13201	285		B 2006	300	
1815	308		A 409	302		B 2038	300	
1817	308		A 415	302		R 2043	300	
1831	308		A 425	302		B 2044	300	
1832	308		A 441N	302		B 2044S	300	
1875	308		A 442 <sup>1)</sup>	—		B 2045	300	
1876	308		AB 1	298		B 2046	300	
1877	308		AB 2	296		B 2047	300	
1878	308		ABC 1	296		B 2048	300	
1904	293		ABL 1	296		B 2049	300	
1910	293		AC 2	296		B 2052T	300	
1911	293		ACH 1	298		B 2099	300	
1915	293		AD 1	296		C 1	278	
1920	293		AF 2	298		C 2	278	
1926	293		AF 3	296		C 3	278	
1927	293		AF 7	296		C 8	278	
1928	293		AH 1	296		C 9	278	
1941	293		AK 1	298		C 10	278	
1949	293		AK 2	296		C 12	278	
3512	309		AL 1	296		C 243N	302	
3530	309		AL 2	296		C 408	292	
3533	309		AL 4	296		C 443	300	
3534	309		AL 5	296		C 443N	300	
3541	309		AM 1	296		CB 1	290	
4060	292		AM 2	296		CB 2	290	
4357	285		AX 1	272		CBC 1	290	
4641	236		AX 50	274		CBL 1	162	
4646	308		AZ 1	155		CC 2	290	
4654	239		AZ 4	157		C/EM 2	139	
4662	292		AZ 11N	308		CF 1 <sup>2)</sup>	—	
4671	292		AZ 12	308		CF 2	290	
4672	292		B 217	302		CF 3	290	
4673	292		B 228	302		CF 7	290	
4674	292		B 240	302		CF 50	265	

<sup>1)</sup> This valve should be replaced by B 442.

<sup>2)</sup> This valve should be replaced by CF 7.

PHILIPS VALVES

Type	Page		Type	Page		Type	Page	
CK 1	290		E 451	304		EL 51	257	
CK 3	166		E 452T	298		ELL 1	134	
CL 2	290		E 453	300		EM 1	137	
CL 4	172		E 455	298		EM 4	144	
CL 6	175		E 463	300		EM 11	294	
CY 1	183		E 499	298		EZ 2	151	
CY 2	185		E 707	304		EZ 4	153	
DB 7-1	306		EA 50	304		EZ 11	308	
DB 7-2	306		EAB 1	20		EZ 12	308	
DB 9-3	306		EB 4	22		F 410	304	
DB 16-1	306		EB 11	294		F 443N	260	
DB 16-2	306		EBC 3	24		FZ 1	308	
DG 3-1	306		EBC 11	294		KB 2	188	
DG 7-1	306		EBF 2	28		KBC 1	189	
DG 7-2	306		EBF 11	294		KC 1	192	
DG 9-3	306		EBL 1	34		KC 3	194	
DG 16-1	306		EC 50	302		KC 4	196	
DG 16-2	306		ECH 3	37		KCH 1	198	
DN 7-1	306		ECH 11	294		KDD 1	206	
DN 7-2	306		ECL 11	294		KF 1	302	
DN 9-3	306		EDD 11	294		KF 2	302	
DN 16-1	306		EEP 1	51		KF 3	210	
DN 16-2	306		EE 50	304		KF 4	213	
E 1C	292		EF 5	61		KH 1	217	
E 1F	292		EF 6	67		KK 2	221	
E 2F	292		EF 8	74		KL 4	225	
E 406N	304		EF 9	81, 276		KL 5	229	
E 408N	304		EF 11	294		MS 11-1	306	
E 409	298		EF 12	294		MW 22-1	306	
E 424N	298		EF 13	294		MW 22-5	306	
E 438	298		EF 50	304		MW 31-6	306	
E 442	298		EFM 1	86		MW 39-3	306	
E 442S	298		EFM 11	294		TH 1	292	
E 443H	300		EH 2	92		TH 2	292	
E 443N	304		EK 2	98		TH 3	292	
E 444	298		EK 3	106		TH 4	292	
E 444S	298		EL 2	112		TH 5	292	
E 445	298		EL 3	118				
E 446	298		EL 5	124				
E 447	298		EL 6	128				
E 448	298		EL 11N	294				
E 449	298		EL 12	294				