

BELL SYSTEM PRACTICES
Transmission Engineering and Data
Vacuum Tube Data

SECTION AB46.031
Issue 1, July 1941
A T & T Co Standard

Western Electric

101D Vacuum Tube (Dome)

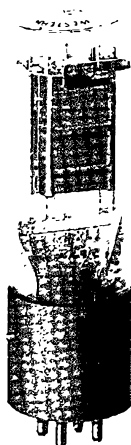

Classification—Low-Power, Filamentary Triode

This tube replaces the D-86326 tube and has been assigned the old code number 101D. It includes an improved filament, a new mechanical design using transverse mica supports and is mounted in a dome type bulb. The electrical characteristics are essentially the same as for the D-86326 tube.

Applications—Voice frequency and carrier-frequency amplifier for telephone repeater equipment and other applications where small power outputs are required.

Modulator and demodulator in carrier-systems.

Oscillator in voice and carrier frequency applications.

Dimensions and Connections—Figures 1 and 2 show the outline diagrams of the tube and base, giving the dimensions and the arrangement of the electrode connections to the base terminals.

Base and Mounting—This vacuum tube employs a medium, four-pin bayonet type base having special contact metal at the ends of the pins. It is suitable for use in a Western Electric 100L, 100R, or similar type socket, preferably provided with contact-metal contacts.

The tube may be mounted in either a vertical or horizontal position. If mounted in a horizontal position the plane of the filament, which is indicated in Figure 2, should be vertical. To assure adequate ventilation the tubes should be mounted with not less than 2⁵/₈ inches between centers when two or more tubes are used.

Average Direct Interelectrode Capacitances

Grid to Plate	6.4 $\mu\mu\text{f}$
Grid to Filament	4.4 $\mu\mu\text{f}$
Plate to Filament	2.9 $\mu\mu\text{f}$

These values are for a based tube without socket.

Filament Rating

Filament Current	1.0 ampere, d.c.
Nominal filament voltage	4.5 volts

The filament of this tube is designed to operate on a current basis and should be operated at as near the rated current as practicable.

The filament resistance of this tube increases slightly during the first 2000 hours of operation. The voltage given above is the nominal value after this resistance change has stabilized.

Characteristics—Figure 3 shows typical curves of plate current as a function of grid voltage for several values of plate voltage. The grid and plate voltages are measured from the negative end of the filament. Figures 4, 5 and 6 show corresponding amplification factor, plate resistance and transconductance characteristics respectively. Figure 7 shows plate current as a function of plate voltage for several values of grid voltage.

Operating Conditions and Output—Figure 3 shows the range of permissible operating plate and grid voltages included within the area ABCD. A number of recommended and maximum operating conditions and the corresponding values of amplification factor, plate resistance, transconductance and performance data are given in the table.

Recommended conditions or others of no greater severity should be selected in preference to maximum conditions wherever possible. The life of the tube at maximum operating conditions will be shorter than at less severe conditions.

The performance data shown include the fundamental power output in milliwatts and the second and third harmonic levels in db below the fundamental for values of load resistance equal to the plate resistance and for a load resistance of 12000 ohms. The peak value of the sinusoidal input voltage E_{gm} , which gives the indicated output P_m , and harmonic levels F_{2m} , and F_{3m} , in each case is numerically equal to the grid bias. For a smaller input voltage E_g , the approximate levels may be computed from the following relations:

$$P = P_m \left(\frac{E_g}{E_{gm}} \right)^2$$

$$F_2 = F_{2m} + 20 \log_{10} \frac{E_{gm}}{E_g}$$

$$F_3 = F_{3m} + 40 \log_{10} \frac{E_{gm}}{E_g}$$

Microphonic Noise

For a plate voltage of 130 volts, a grid bias of -9 volts, and a load resistance of 100,000 ohms, the mean microphonic output level of this tube, measured in a laboratory reference test set is 32 db below 1 volt. The range of levels of individual tubes extends from 20 to 40 db below 1 volt. Since microphonic noise output depends on the type and intensity of the mechanical disturbance which produces it, the values given here are useful chiefly for comparison with the levels of other types of tubes which have been tested in the same way.

		TABLE								
	Plate Voltage	Grid Bias	Plate Current	Amplification Factor	Plate Resistance	Transconductance	Load Resistance	Power Output	Second Harmonic	Third Harmonic
	Volts	Volts	Milli-amperes		Ohms	Micro-mhos	Ohms	Milli-watts	db	db
Recommended Operating Conditions	100	-4	8.1	6.2	5700	1090	5700 12000	14 12	38 45	61 73
	130	-12	4.7	6.2	6800	900	6800 12000	91 89	22 28	35 44
	130	-9	7.7	6.2	5800	1070	5800 12000	65 58	31 37	48 57
	130	-6	11.2	6.2	5100	1220	5100 12000	34 29	38 45	60 68
	160	-16	5.6	6.1	6500	940	6500 12000	172 161	20 27	32 40
	160	-12	9.9	6.2	5300	1170	5300 12000	121 108	29 37	46 56
	Maximum Operating Conditions	160	-10	12.5	6.2	4900	1270	4900 12000	93 79	33 41
190		-20	6.4	6.1	6200	990	6200 12000	263 250	19 26	30 37
190		-18	8.7	6.2	5600	1100	5600 12000	248 224	23 31	35 46
190		-16	11.0	6.2	5100	1210	5100 12000	223 187	26 35	42 54

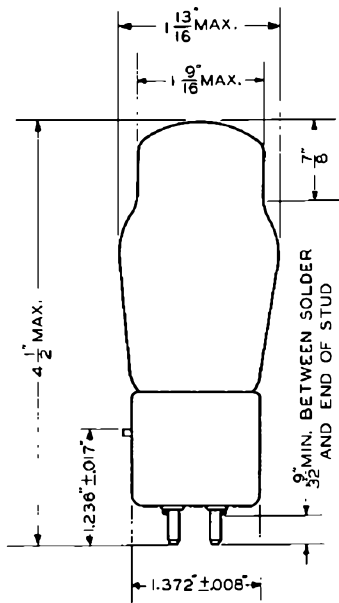

FIG. 1

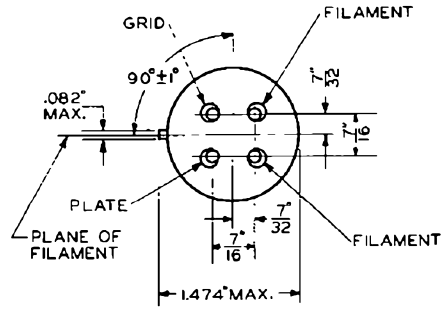

FIG. 2

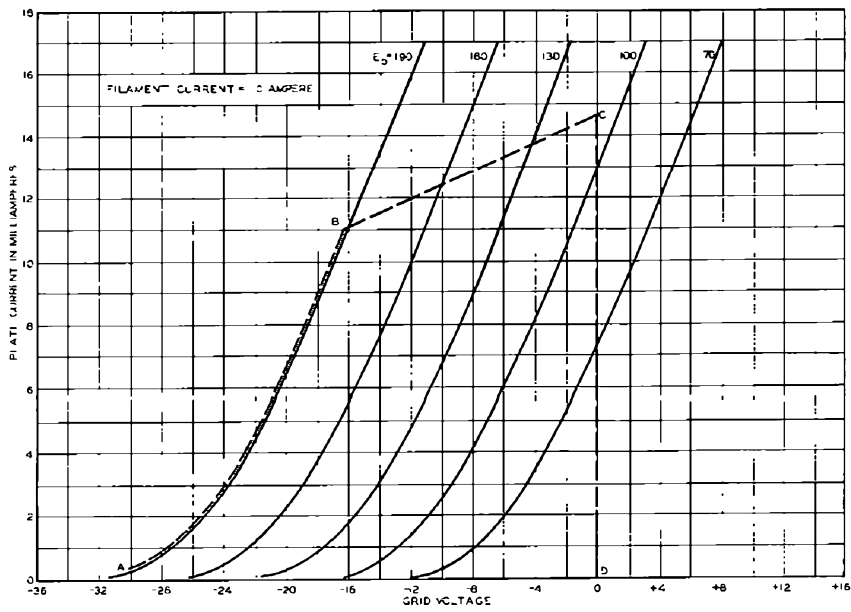

FIG. 3

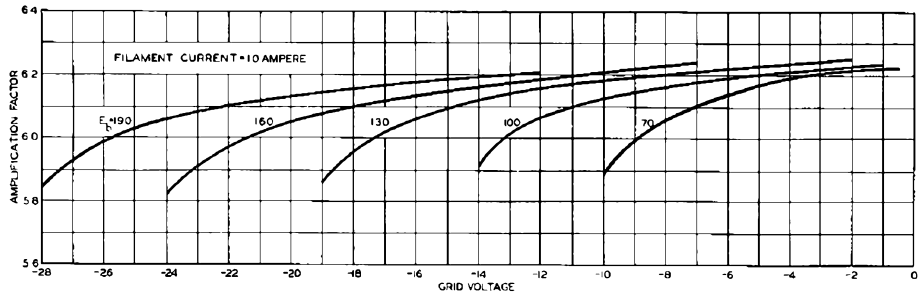

FIG. 4

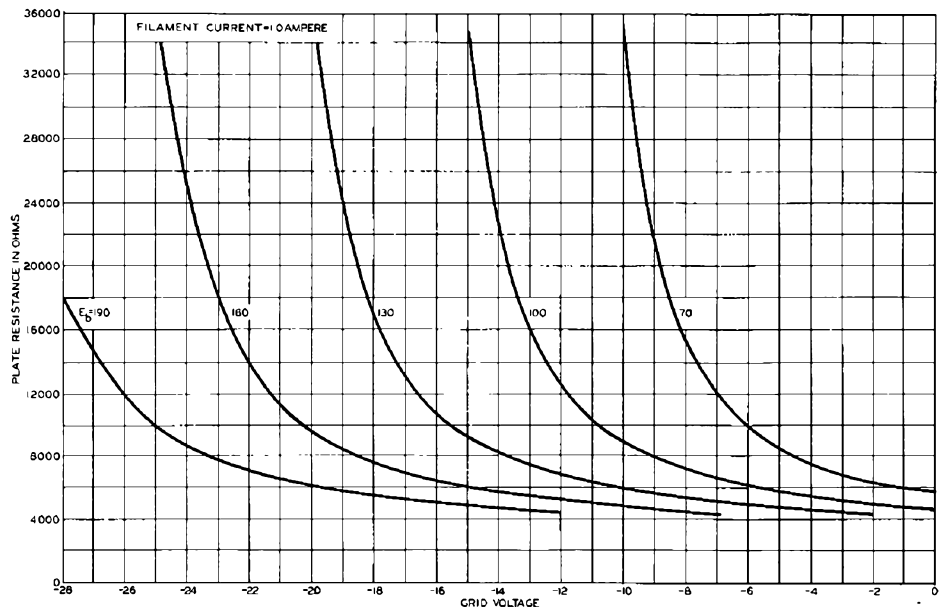

FIG. 5

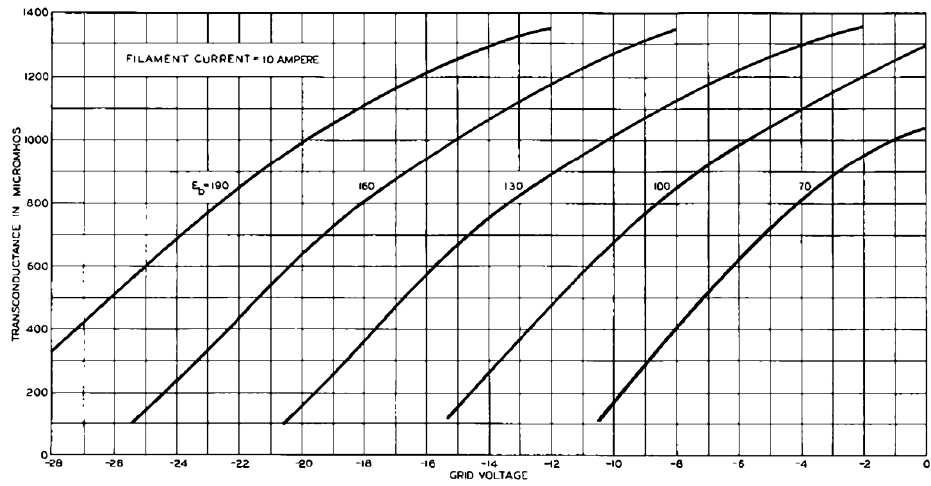

FIG. 6

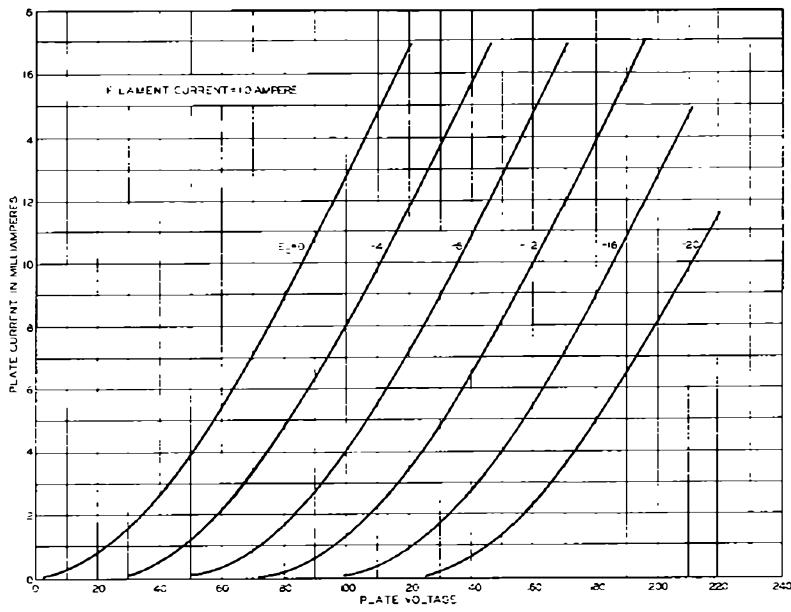
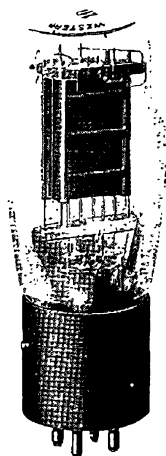

FIG. 7

Western Electric

101F Vacuum Tube (Dome)



Classification—Low-power, filamentary triode

This tube replaces the old design 101F tube. It includes an improved filament, a new mechanical design using transverse mica supports and is mounted in a dome type bulb. The electrical characteristics are practically identical with the previous 101F tube. Due to the improved insulation between elements, it is suitable for use in place of the 101J tube.

Applications—Voice frequency and carrier-frequency amplifier for telephone repeater equipment and other applications where small power outputs are required.

Modulator and demodulator in carrier-systems.

Oscillator in voice and carrier frequency applications.

Dimensions and Connections—The outline diagrams of the tube and base, giving the dimensions and the arrangement of the electrode connections to the base terminals are shown in Figures 1 and 2.

Base and Mounting—This vacuum tube employs a four-pin bayonet type base having special contact at the ends of the pins. It is suitable for use in a Western Electric 100L, 100R, or similar type socket, preferably provided with contact-metal contacts.

The tube may be mounted in either a vertical or horizontal position. If mounted in a horizontal position the plane of the filament, which is indicated in Figure 2, should be vertical. To assure adequate ventilation the tubes should be mounted with not less than $2\frac{5}{8}$ inches between centers when two or more tubes are used.

Average Direct Interelectrode Capacitances

Grid to plate	5.9 $\mu\mu\text{f}$
Grid to filament	4.2 $\mu\mu\text{f}$
Plate to filament	2.7 $\mu\mu\text{f}$

These values are for a based tube without socket.

Filament Rating

Filament current	0.50 ampere, d.c.
Nominal filament voltage	4.15 volts

The filament of this tube is designed to operate on a current basis and should be operated at as near the rated current as practicable.

The filament resistance of this tube increases slightly during the first 2000 hours of operation. The voltage given above is the nominal value after this resistance change has stabilized.

Characteristics—Typical curves showing plate current as a function of grid voltage for several values of plate voltage are shown in Figure 3. The grid and plate voltages are measured from the negative end of the filament. Corresponding amplification factor, plate resistance and transconductance characteristics are given in Figures 4, 5 and 6 respectively. Plate current as a function of plate voltage for several values of grid voltage is shown in Figure 7.

Operating Conditions and Output—Permissible operating plate and grid voltages are included within the area, ABCD in Figure 3. A number of recommended and maximum operating conditions and the corresponding values of amplification factor, plate resistance and performance data are given in the table below. Recommended conditions or others of no greater severity should be selected in preference to maximum conditions wherever possible. The life of the tube at maximum operating conditions may be shorter than at less severe conditions.

The performance data shown includes the fundamental power output in milliwatts and the second and third harmonic levels in db below the fundamental for values of load resistance equal to the plate resistance and for a load resistance of 12000 ohms. The peak value of the sinusoidal input voltage E_{gm} , which gives the indicated output P_m , and harmonic levels F_{2m} and F_{3m} , in each case is numerically equal to the grid bias. For a smaller input voltage E_g , the approximate levels may be computed from the following relations:

$$P = P_m \left(\frac{E_g}{E_{gm}} \right)^2$$

$$F_2 = F_{2m} + 20 \log_{10} \frac{E_{gm}}{E_g}$$

$$F_3 = F_{3m} + 40 \log_{10} \frac{E_{gm}}{E_g}$$

Microphonic Noise

For a plate voltage of 130 volts, a grid bias of -8 volts, and a load resistance of 100,000 ohms, the mean microphonic output level of this tube, measured in a laboratory reference test set is 30 db below 1 volt. The range of levels of individual tubes extends from 20 to 40 db below 1 volt. Since microphonic noise output depends on the type and intensity of the mechanical disturbance which produces it, the values given here are useful chiefly for comparison with the levels of other types of tubes which have been tested in the same way.

TABLE

	<u>Plate Voltage</u> Volts	<u>Grid Bias</u> Volts	<u>Plate Current</u> Milli-amperes	<u>Amplification Factor</u>	<u>Plate Resistance</u> Ohms	<u>Load Resistance</u> Ohms	<u>Power Output</u> Milli-watts	<u>Second Harmonic</u> db	<u>Third Harmonic</u> db
Recommended Operating Conditions	100	-4	6.2	6.5	5900	5900	15	35	60
						12000	13	42	65
	130	-10	4.8	6.5	6600	6600	79	24	38
						12000	75	30	46
	130	-8	6.8	6.5	5800	5800	60	30	48
						12000	53	37	60
130	-4	11.7	6.6	4700	4700	18	41	70	
					12000	15	50	75	
160	-14	5.4	6.5	6300	6300	155	21	32	
					12000	145	27	41	
160	-10	10.0	6.5	5000	5000	100	30	48	
					12000	90	40	60	
Maximum Operating Conditions	160	-8	12.5	6.5	4600	4600	70	34	55
						12000	65	44	70
	190	-18	6.1	6.5	6100	6100	250	19	30
						12000	245	26	39
190	-16	8.4	6.5	5300	5300	240	23	40	
					12000	220	32	48	
190	-14	10.9	6.5	4900	4900	205	27	43	
					12000	180	37	55	

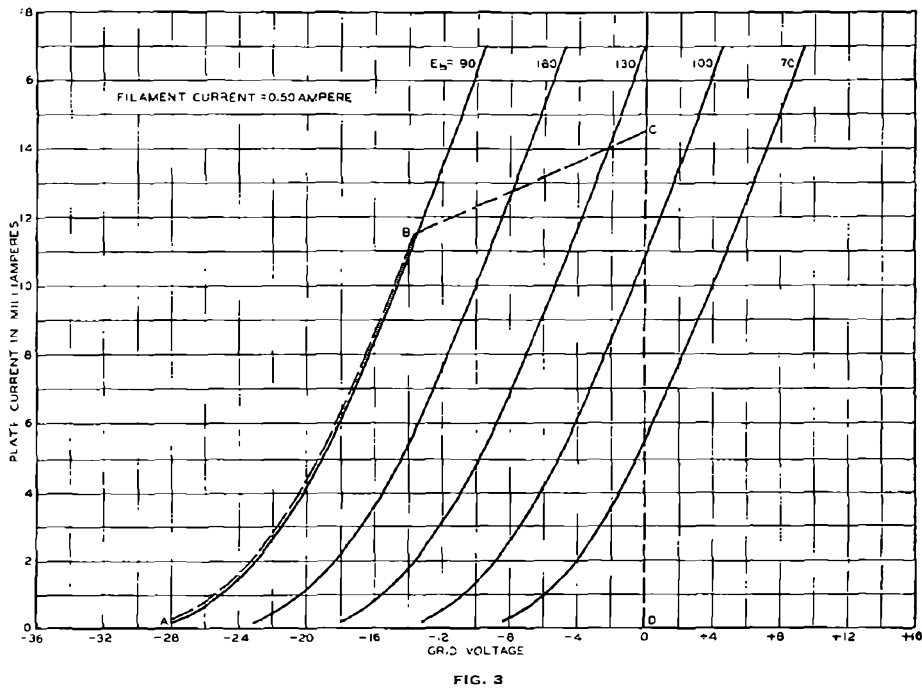
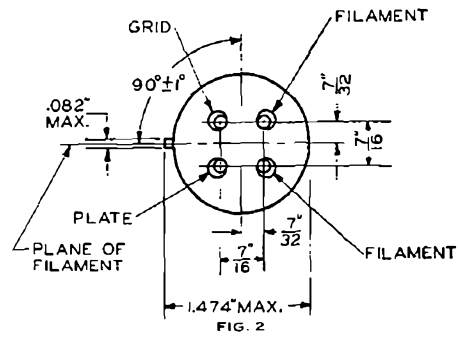
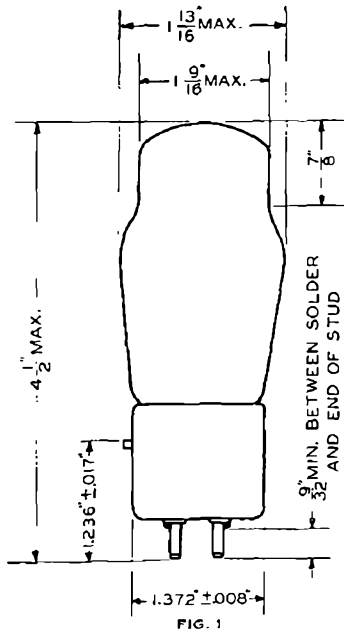

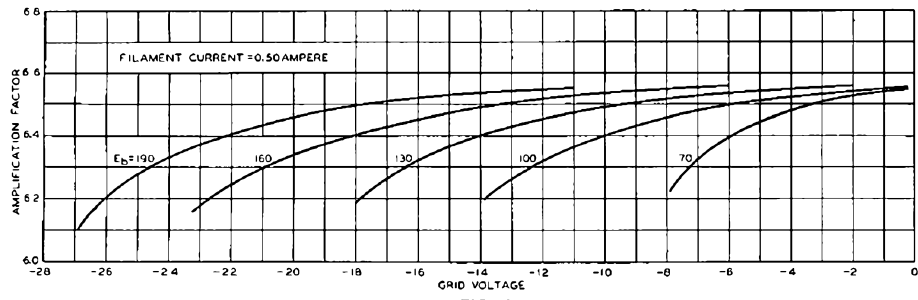

FIG. 4

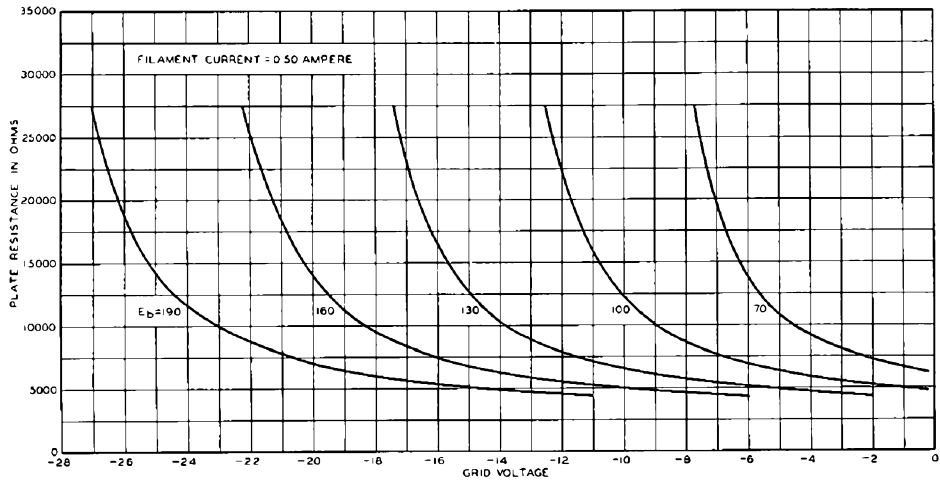

FIG. 5

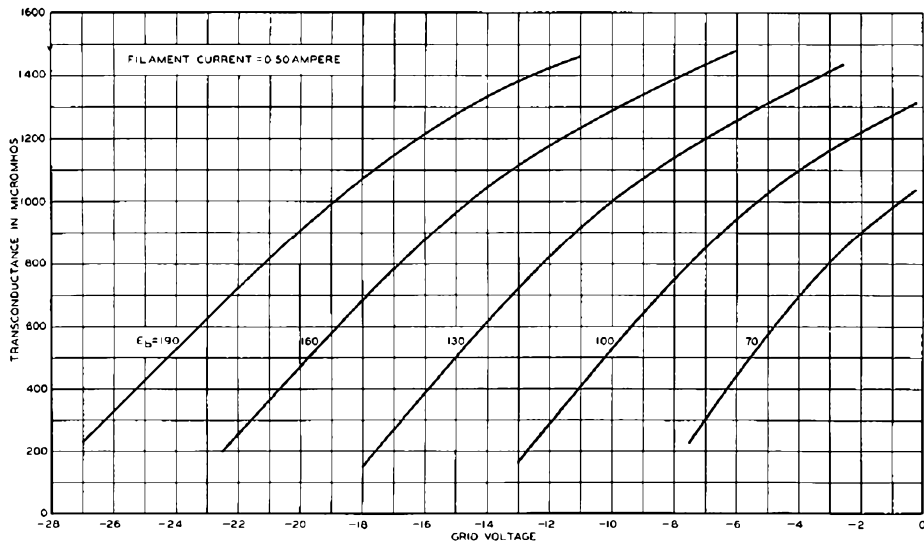
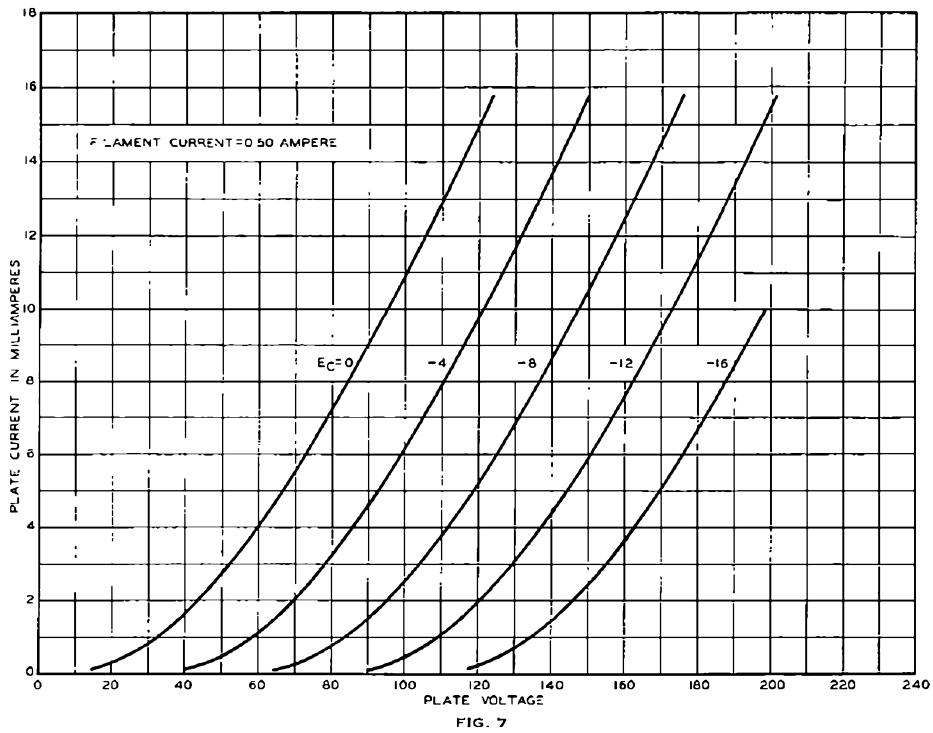
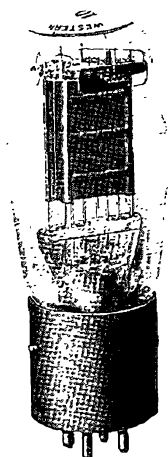

FIG. 6



Western Electric

101FA Vacuum Tube



Classification—Low-power, filamentary triode

This tube is similar to the 101F (dome) tube except for modifications in the characteristics to obtain higher gain.

Applications—Voice-frequency repeaters and other telephone equipment requiring higher gain than can be obtained from the 101F tube.

Dimensions and Connections—The outline diagrams of the tube and base, giving the dimensions and the arrangement of the electrode connections to the base terminals are shown in Figures 1 and 2.

Base and Mounting—This vacuum tube employs a four-pin bayonet type base having special contact metal at the ends of the pins. It is suitable for use in a Western Electric 100L, 100R, or similar type socket, preferably provided with contact-metal contacts.

The tube may be mounted in either a vertical or horizontal position. If mounted in a horizontal position the plane of the filament, which is indicated in Figure 2, should be vertical. To assure adequate ventilation the tubes should be mounted with not less than $2\frac{5}{8}$ inches between centers when two or more tubes are used.

Average Direct Interelectrode Capacitances

Grid to plate	5.1 $\mu\mu\text{f}$
Grid to filament	4.9 $\mu\mu\text{f}$
Plate to filament	2.7 $\mu\mu\text{f}$

These values are for a based tube without socket.

Filament Rating

Filament current.....	0.50 ampere, d.c.
Nominal filament voltage.....	4.15 volts

The filament of this tube is designed to operate on a current basis and should be operated at as near the rated current as practicable.

The filament resistance of this tube increases slightly during the first 2000 hours of operation. The voltage given above is the nominal value after this resistance change has stabilized.

Characteristics—Typical curves showing plate current as a function of grid voltage for several values of plate voltage are shown in Figure 3. The grid and plate voltages are measured from the negative end of the filament. Corresponding amplification factor, plate resistance and transconductance characteristics are given in Figures 4, 5 and 6 respectively. Plate current as a function of plate voltage for several values of grid voltage is shown in Figure 7.

Operating Conditions and Output—Permissible operating plate and grid voltages are included within the area, ABCD in Figure 3. A number of recommended and maximum operating conditions and the corresponding values of amplification factor, plate resistance and performance data are given in the table below. Recommended conditions or others of no greater severity should be selected in preference to maximum conditions wherever possible. The life of the tube at maximum operating conditions may be shorter than at less severe conditions.

The performance data shown includes the fundamental power output in milliwatts and the second and third harmonic levels in db below the fundamental for values of load resistance equal to the plate resistance and for a load resistance of 12000 ohms. The peak value of the sinusoidal input voltage E_{gm} , which gives the indicated output P_m , and harmonic levels F_{2m} and F_{3m} , in each case is numerically equal to the grid bias. For a smaller input voltage E_g , the approximate levels may be computed from the following relations:

$$P = P_m \left(\frac{E_g}{E_{gm}} \right)^2$$

$$F_2 = F_{2m} + 20 \log_{10} \frac{E_{gm}}{E_g}$$

$$F_3 = F_{3m} + 40 \log_{10} \frac{E_{gm}}{E_g}$$

Microphonic Noise

For a plate voltage of 130 volts, a grid bias of -8 volts, and a load resistance of 100,000 ohms, the mean microphonic output level of this tube, measured in a laboratory reference test set is 30 db below 1 volt. The range of levels of individual tubes extends from 20 to 40 db below 1 volt. Since microphonic noise output depends on the type and intensity of the mechanical disturbance which produces it, the values given here are useful chiefly for comparison with the levels of other types of tubes which have been tested in the same way.

TABLE

	<u>Plate Voltage</u> Volts	<u>Grid Bias</u> Volts	<u>Plate Current</u> Milli-amperes	<u>Amplification Factor</u>	<u>Plate Resistance</u> Ohms	<u>Load Resistance</u> Ohms	<u>Power Output</u> Milli-watts	<u>Second Harmonic</u> db	<u>Third Harmonic</u> db
Recommended Operating Conditions	100	-4	5.3	9.0	5400	5400	30	28	47
						12000	25	33	55
	130	-8	4.4	8.9	6100	6100	94	20	34
						12000	91	26	43
	130	-6	7.5	9.0	4900	4900	72	26	44
						12000	63	34	55
130	-4	11.6	9.2	4200	4200	39	34	55	
					12000	30	43	70	
160	-10	6.6	8.9	5400	5400	170	21	35	
					12000	150	28	45	
Maximum Operating Conditions	160	-8	10.4	9.1	4500	4500	140	26	43
						12000	115	35	55
	190	-14	5.6	8.8	5800	5800	285	16	29
12000						260	22	34	
	190	-12	9.0	9.0	4800	4800	275	20	34
						12000	255	29	46

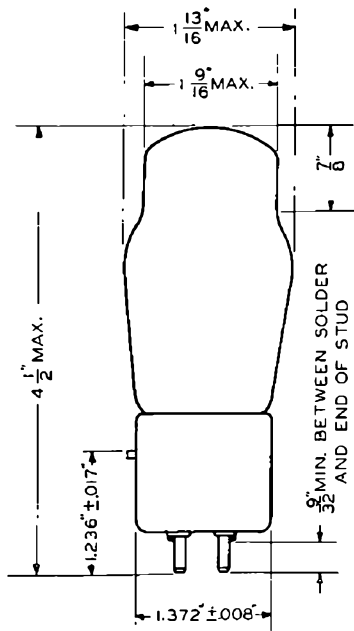

FIG. 1

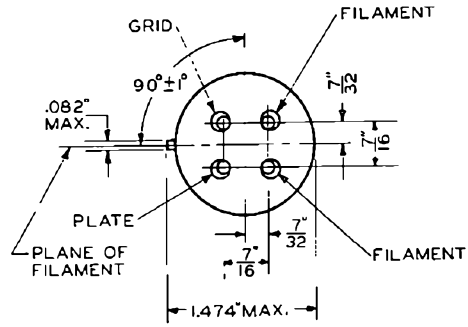

FIG. 2

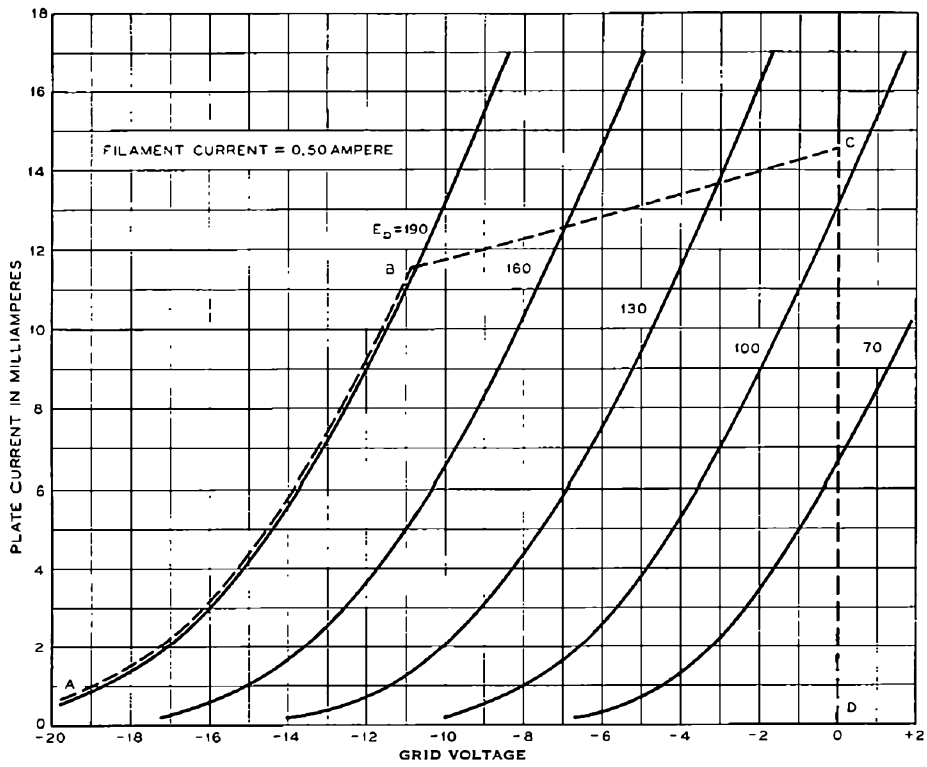

FIG. 3

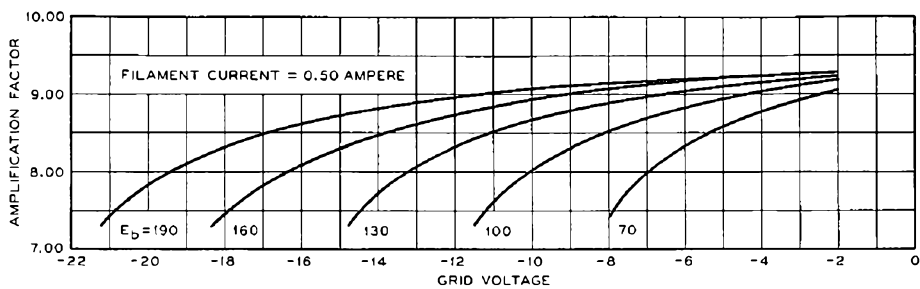

FIG. 4

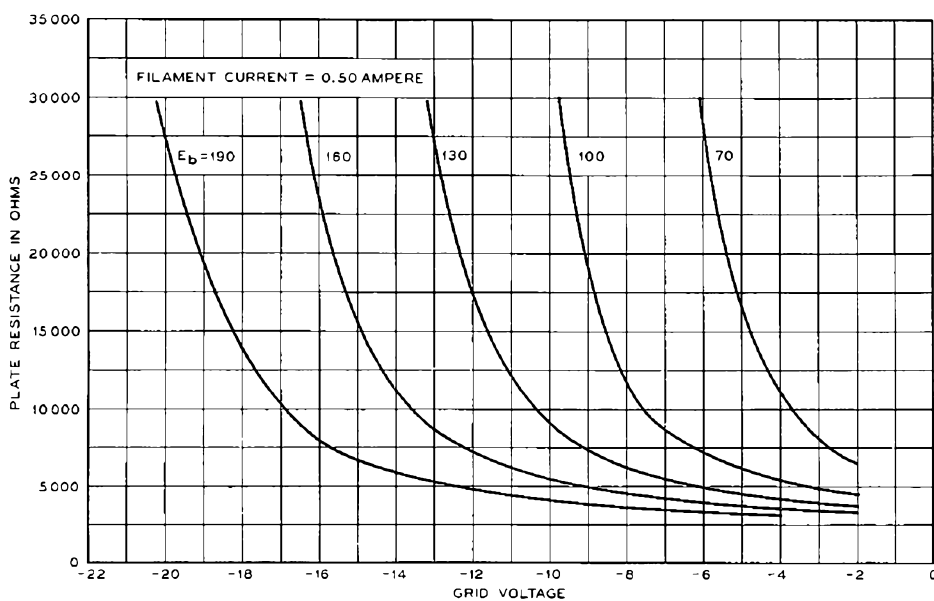

FIG. 5

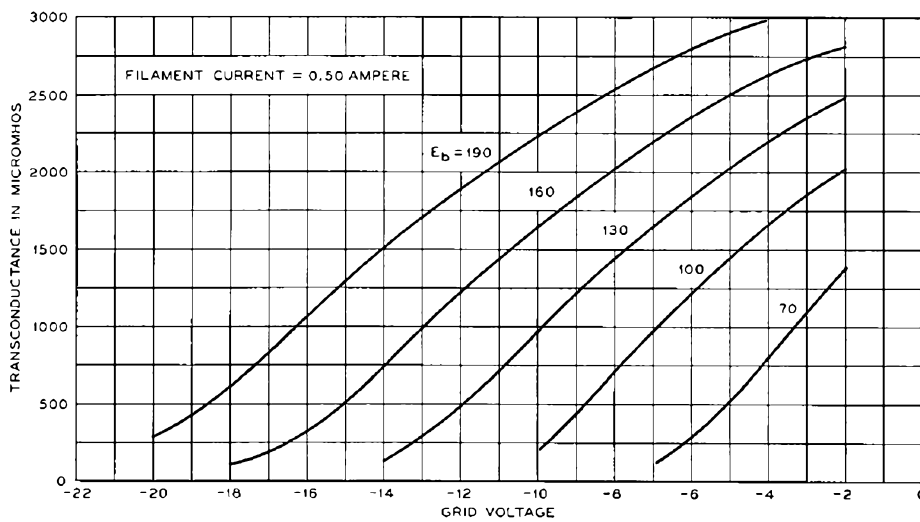

FIG. 6

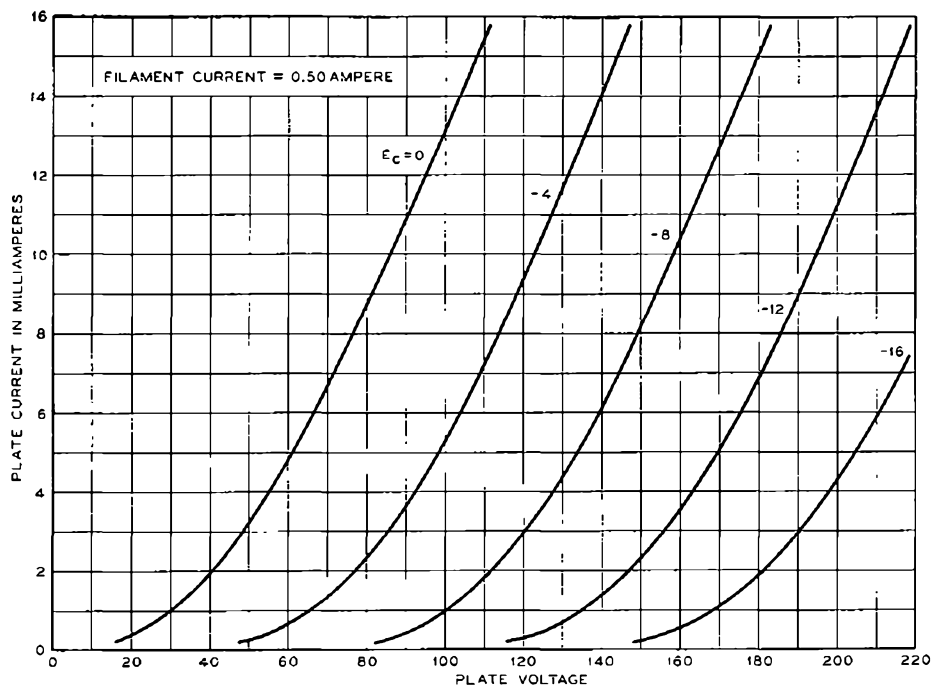

FIG. 7

1-K-39-5340
PRINTED IN U.S.A.

A development of Bell Telephone Laboratories, Incorporated,
the research laboratories of the American Telephone and Tele-
graph Company and the Western Electric Company

V. T. DATA SHEET 101FA
ISSUE 1

Western Electric

101J Vacuum Tube

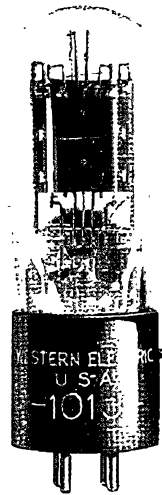

Classification—Low-power filamentary triode

The 101J tube is similar in characteristics to the 101F, but is contained in a pear-shaped bulb and has higher insulation between elements.

Applications

Modulator and demodulator in carrier systems.

Voice-frequency and carrier-frequency amplifier for telephone repeater equipment and other applications where small power outputs are required.

Dimensions—Dimensions, outline diagrams of the tube and base, and the arrangement of the electrode connections to the base terminals are shown in Figures 1 and 2.

Base—Four-pin, bayonet type, having special contact metal at the ends of the contact pins.

Socket—Four-contact, bayonet-slot type, preferably provided with contact-metal contacts, such as the Western Electric 100L for front of panel mounting or 100R for rear of panel mounting.

Mounting Positions—Either vertical or horizontal. If mounted in a horizontal position, the plane of the filament, which is indicated in Figure 2, should be vertical.

Average Direct Interelectrode Capacitances

	<u>A</u>	<u>B</u>	<u>C</u>
Grid to plate, $\mu\mu\text{f.}$	6.5	6.1	6.2
Grid to filament, $\mu\mu\text{f.}$	4.2	4.9	5.3
Plate to filament, $\mu\mu\text{f.}$	1.7	3.7	4.1

Column A—Based tube without socket.

Column B—Tube alone when measured in 100L socket mounted on metal plate; socket and mounting plate connected to filament.

Column C—Tube alone when measured in 100R socket mounted in metal plate; socket and mounting plate connected to filament.

Filament Rating

Filament current	0.50 ampere, d.c.
Nominal filament voltage	4.15 volts

The filament of this tube is designed to operate on a current basis and should be operated at a current not appreciably exceeding the rated value.

Characteristics and Operating Conditions—Plate-current characteristics of a typical 101J tube are shown in Figure 3 as functions of grid bias. Permissible operating grid and plate voltages are included within the area ABCD. The grid and plate voltages are measured to the negative end of the filament. Corresponding amplification-factor, plate-resistance, and transconductance characteristics are given in Figures 4, 5, and 6, respectively. Plate-current characteristics are given as functions of plate voltage in Figure 7.

A number of recommended and maximum operating conditions and the corresponding values of amplification factor and plate resistance are given in the table on page 3. Recommended conditions or others of no greater severity should be selected in preference to maximum conditions wherever possible. The life of the tube at maximum operating conditions may be shorter than at the recommended conditions.

Power Output and Distortion—The fundamental power output in milliwatts, and the second and third harmonic levels in db below the fundamental, corresponding to the recommended and maximum operating conditions, are given in the latter part of the table for values of load resistance, R , both equal to and double the value of the plate resistance, r_p . The peak value of the sinusoidal input voltage, E_{gm} , which gives the indicated power output, P_m , and harmonic levels, F_{2m} and F_{3m} , in each case, is numerically equal to the grid bias. For a smaller input voltage, E_g , the approximate levels may be computed from the following relations:

$$P = P_m \left(\frac{E_g}{E_{gm}} \right)^2$$

$$F_2 = F_{2m} + 20 \log_{10} \frac{E_{gm}}{E_g}$$

$$F_3 = F_{3m} + 40 \log_{10} \frac{E_{gm}}{E_g}$$

Microphonic Noise—With a plate voltage of 130 volts, a grid bias of -8 volts, and a load resistance of 100,000 ohms, the mean microphonic noise output level of the 101J tube, measured in a laboratory reference test set, is 26 db below 1 volt. The range of levels of individual tubes extends from 14 to 34 db below 1 volt. Since microphonic noise output depends on the type and intensity of the mechanical disturbance which produces it, the values given here are useful chiefly for comparison with the levels of other types of tubes which have been tested in the same way.

Table

	Plate VOLT- age Volts	Grid Bias Volts	Plate Cur- rent Milli- amperes	Amplifi- cation Factor	Plate Resis- tance Ohms	OUTPUT					
						$R = r_p$			$R = 2r_p$		
						Power Output Milli- watts	Second Har- monic db	Third Har- monic db	Power Output Milli- watts	Second Har- monic db	Third Har- monic db
Recommended	100	-4	6.3	6.6	5,750	16	32	55	14	38	65
Operating Conditions	130	-10	4.8	6.5	6,500	80	22	36	75	28	46
	130	-8	7.0	6.5	5,600	62	26	46	55	33	55
	130	-4	11.9	6.6	4,800	20	37	60	18	43	65
	160	-14	5.4	6.5	6,500	170	20	32	160	26	42
	160	-10	10.0	6.6	5,000	120	28	47	110	34	55
Maximum	190	-18	6.2	6.5	6,100	275	17	29	255	24	37
Operating Conditions	190	-16	8.4	6.5	5,450	270	22	35	250	28	45
	190	-14	10.9	6.6	5,000	250	25	43	215	31	50

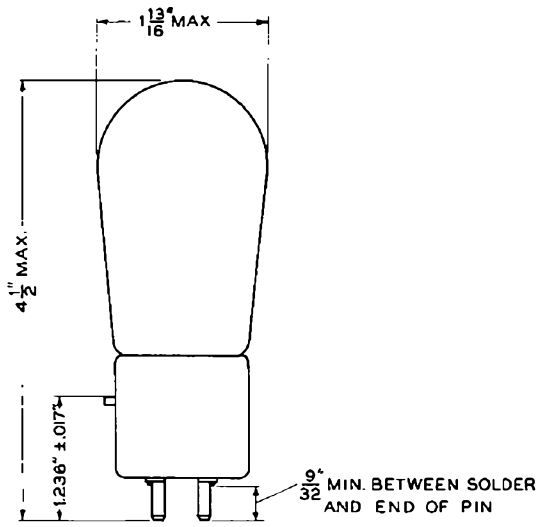

FIG. 1

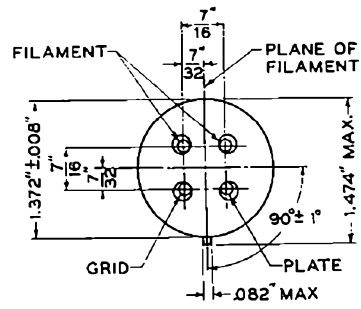

FIG. 2

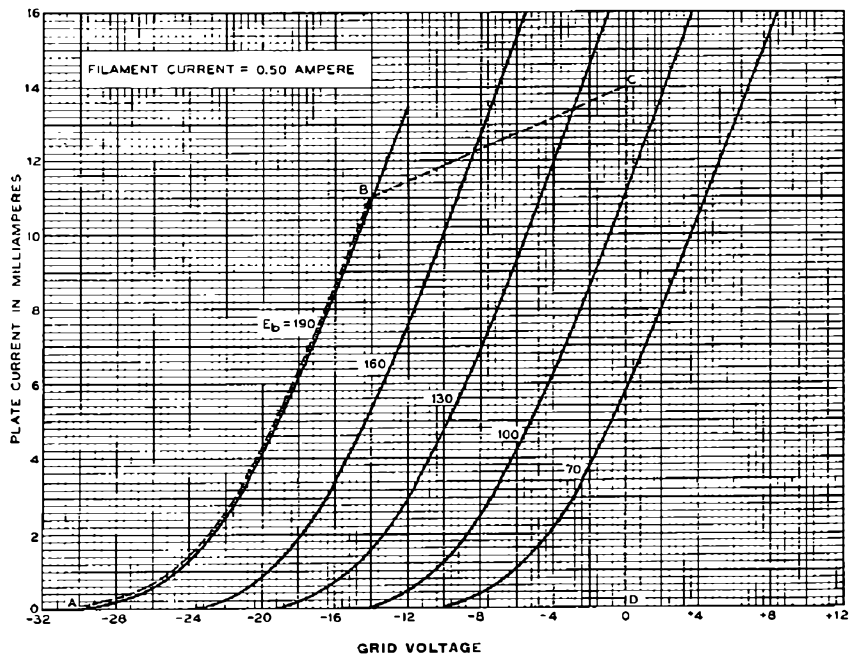

FIG. 3

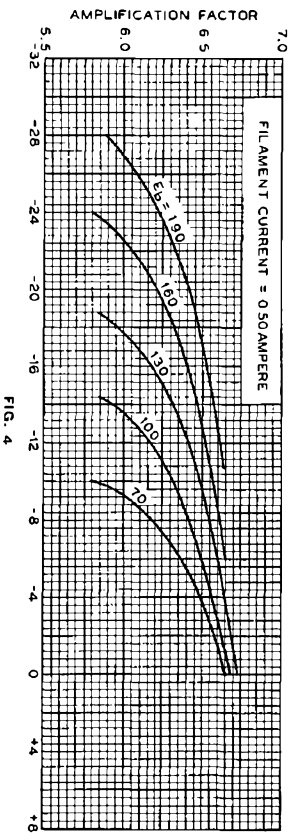

FIG. 4

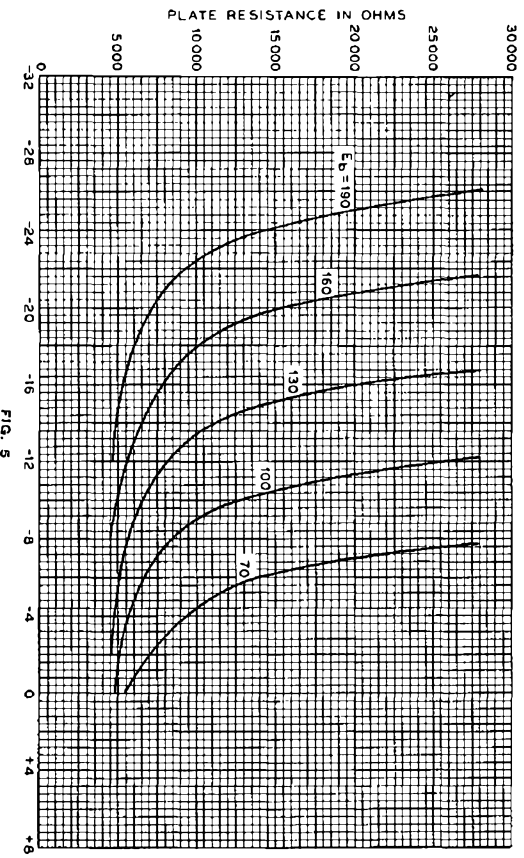

FIG. 5

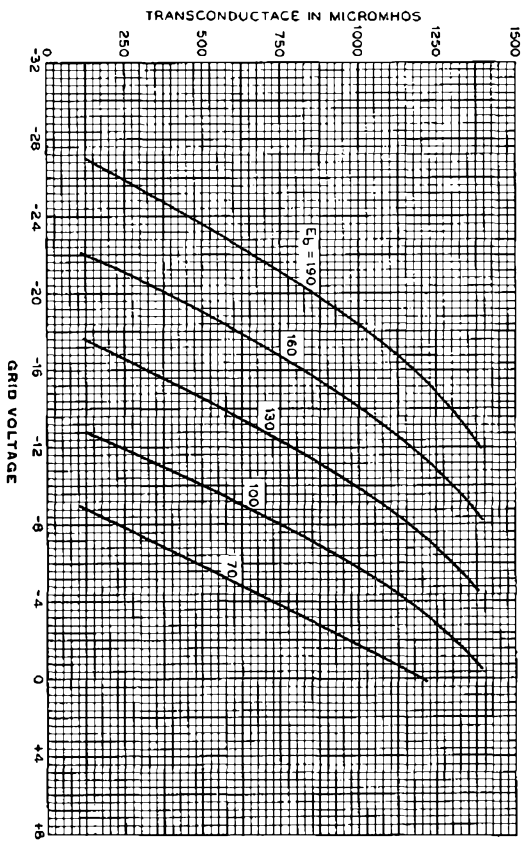

FIG. 6

[5]

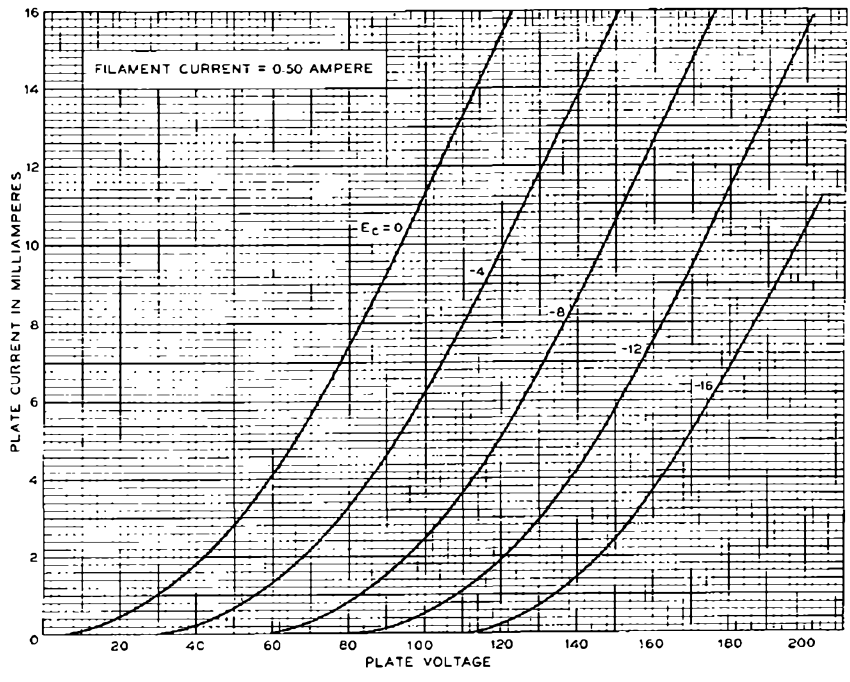

FIG. 7

101L



TRIODE
AUDIO-FREQUENCY AMPLIFIER

Western Electric

DESCRIPTION

The 101L is a filamentary type triode. It is designed for use as an audio-frequency amplifier or modulator.

CHARACTERISTICS

Filament Current	250 milliamperes
Maximum Plate Voltage	180 volts
Amplification Factor	6.5

101L
TRIODE

GENERAL CHARACTERISTICS**ELECTRICAL DATA**

Filament Current	250 milliamperes
Filament Voltage, Nominal*	4.15 volts
Direct Interelectrode Capacitances	without external shield
Grid to Plate	6.0 uuf
Input	3.9 uuf
Output	2.8 uuf

MECHANICAL DATA

Cathode	Coated Filament
Base	Medium 4-pin type with bayonet pin
Mounting Position	Preferably vertical; if horizontal, pins #1 and #2 must lie in same vertical plane

Dimensions and pin connections shown in outline drawing on Page 5

MAXIMUM RATINGS, Design-Center Values

Plate Voltage	180 volts
Plate Dissipation	2.0 watts
Plate Current	15 milliamperes

TYPICAL OPERATING CONDITIONS AND CHARACTERISTICS—CLASS A₁ AMPLIFIER

Filament Current, D-C	250	250 milliamperes
Plate Voltage	130	160 volts
Grid Voltage	-8	-10 volts
Peak A-F Grid Voltage	8	10 volts
Plate Current	6.8	10.2 milliamperes
Transconductance	1080	1240 micromhos
Amplification Factor	6.5	6.5
Plate Resistance	6000	5200 ohms
Load Resistance	6000	5200 ohms
Maximum Signal Power Output	60	100 milliwatts
Total Harmonic Distortion Less Than	3.4	3.2 per cent

* The filament resistance of this tube increases slightly during the first year of operating life. The voltage given above is the nominal value after the filament resistance has stabilized.

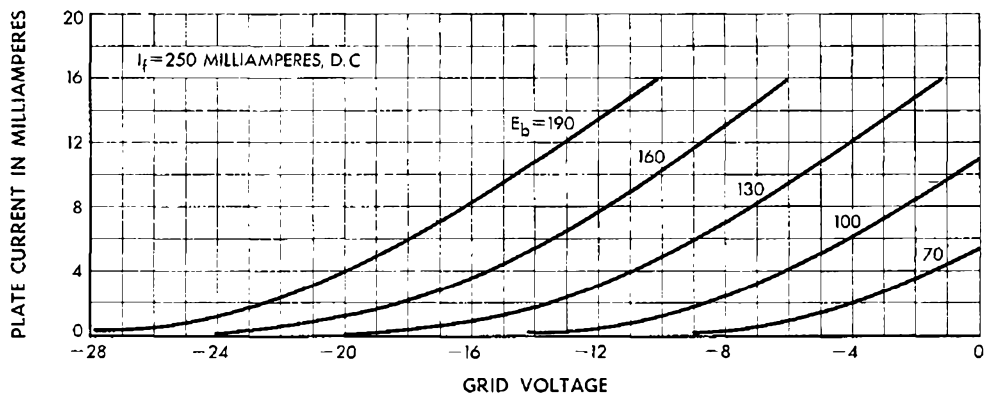
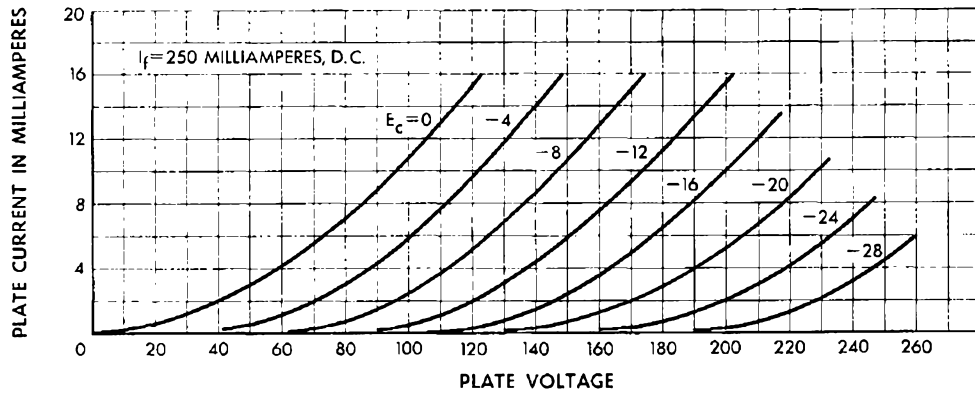

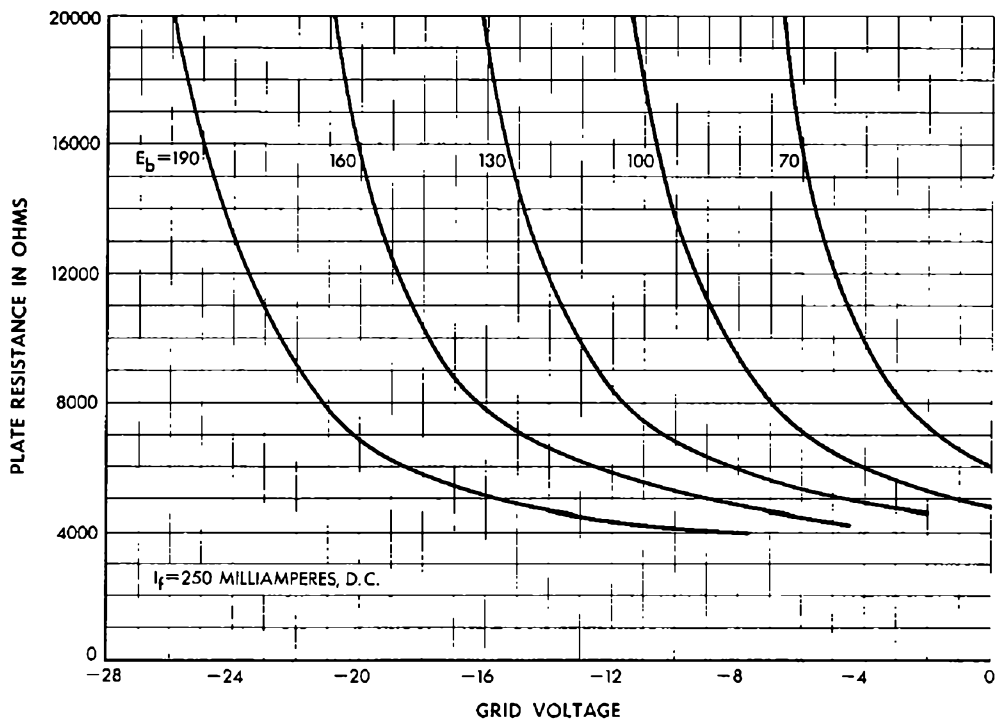
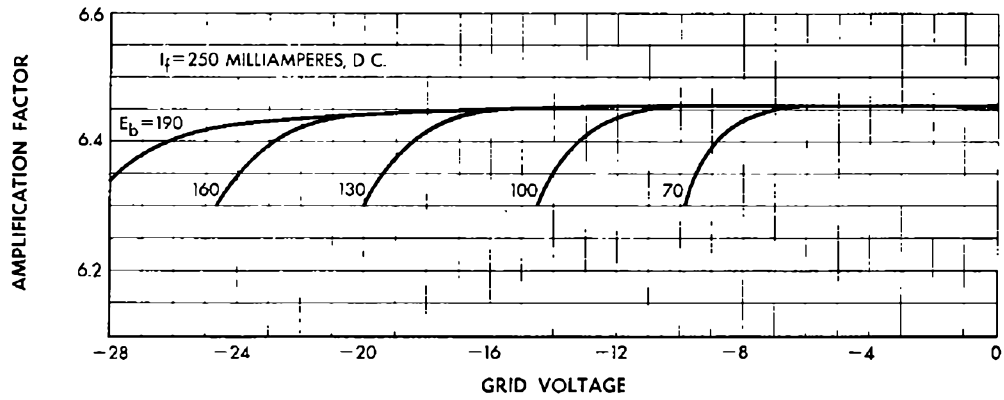

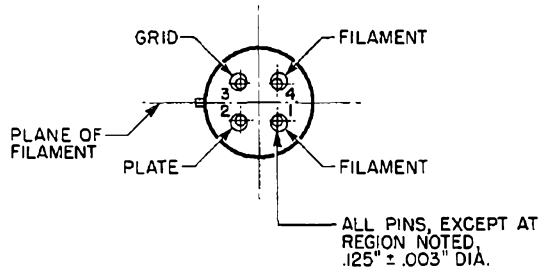
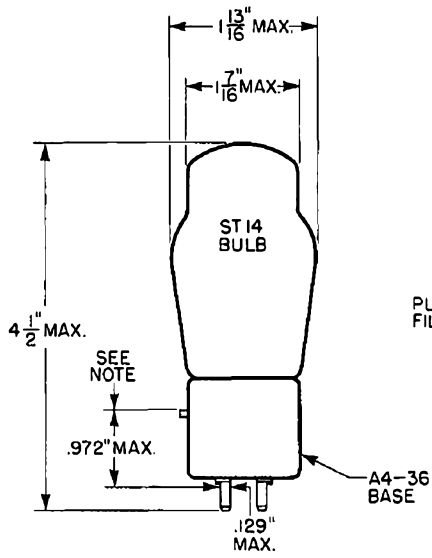
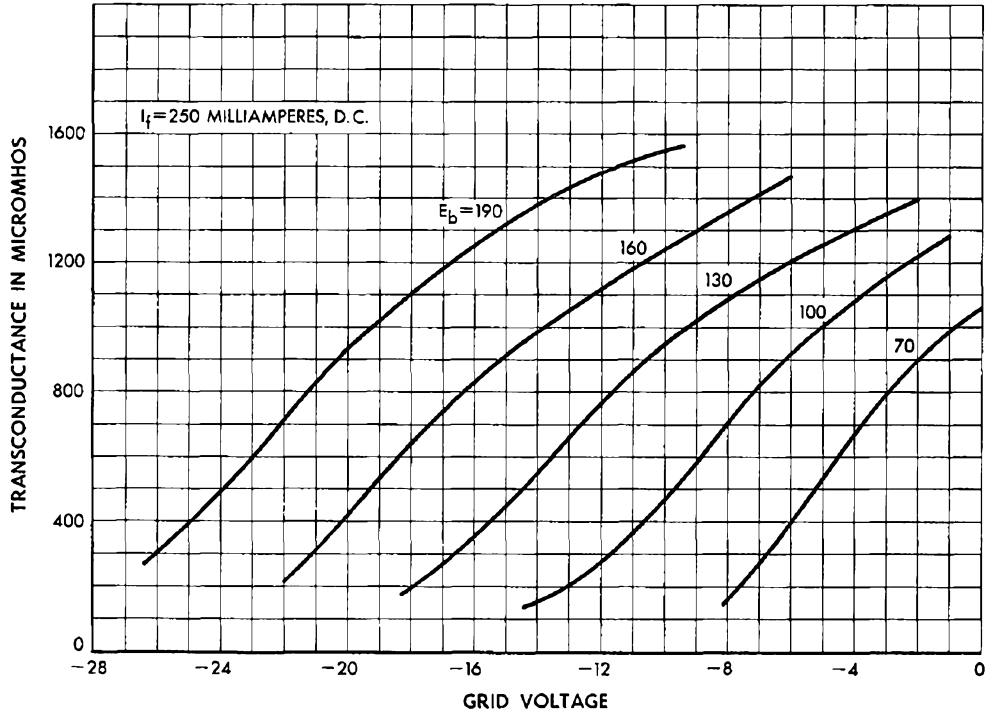

NOTE:
THIS DIMENSION APPLIES FROM THE TOP OF THE BAYONET PIN, TO A POINT ON THE STUD WHERE THE DIAMETER OF THE STUD PLUS SOLDER DOES NOT EXCEED $.129$ MAX.

101M



TRIODE
AUDIO-FREQUENCY AMPLIFIER

Western Electric

DESCRIPTION

The 101M is a filamentary type triode. It is designed for use as an audio-frequency amplifier or modulator. This tube is intended for use in equipment where quick filament heating is required. Better thermionic life will be obtained by using other types of the 101 series of tubes when filament heating time is not a factor.

CHARACTERISTICS

Filament Current	250 milliamperes
Maximum Plate Voltage	180 volts
Amplification Factor	6.5

101M
TRIODE

GENERAL CHARACTERISTICS**ELECTRICAL DATA**

Filament Current	250 milliamperes
Filament Voltage, Nominal*	3.75 volts
Direct Interelectrode Capacitances	without external shield
Grid to Plate	6.0 uuf
Input	3.9 uuf
Output	2.8 uuf

MECHANICAL DATA

Cathode	Coated Filament
Base	Medium 4-pin type with bayonet pin
Mounting Position	Preferably vertical; if horizontal, pins #1 and #2 must lie in same vertical plane

Dimensions and pin connections shown in outline drawing on Page 5

MAXIMUM RATINGS, Design-Center Values

Plate Voltage	180 volts
Plate Dissipation	2.0 watts
Plate Current	15 milliamperes

TYPICAL OPERATING CONDITIONS AND CHARACTERISTICS—CLASS A₁ AMPLIFIER

Filament Current, D-C	250	250 milliamperes
Plate Voltage	130	160 volts
Grid Voltage	-8	-10 volts
Peak A-F Grid Voltage	8	10 volts
Plate Current	6.8	10.2 milliamperes
Transconductance	1080	1240 micromhos
Amplification Factor	6.5	6.5
Plate Resistance	6000	5200 ohms
Load Resistance	6000	5200 ohms
Maximum Signal Power Output	60	100 milliwatts
Total Harmonic Distortion	3.4	3.2 per cent

* The filament resistance of this tube increases slightly during the first year of operating life. The voltage given above is the nominal value after the filament resistance has stabilized.

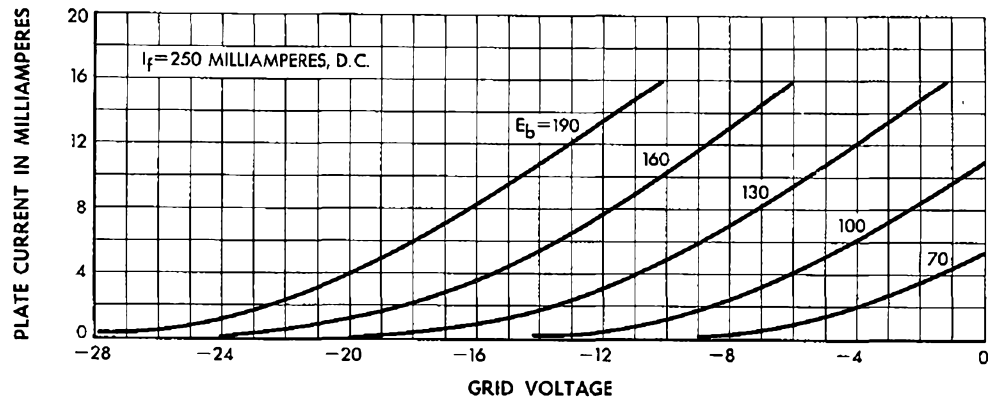
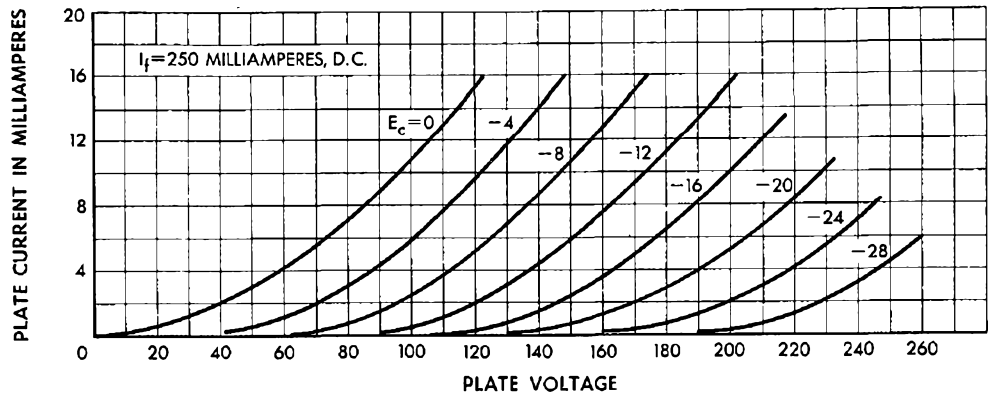

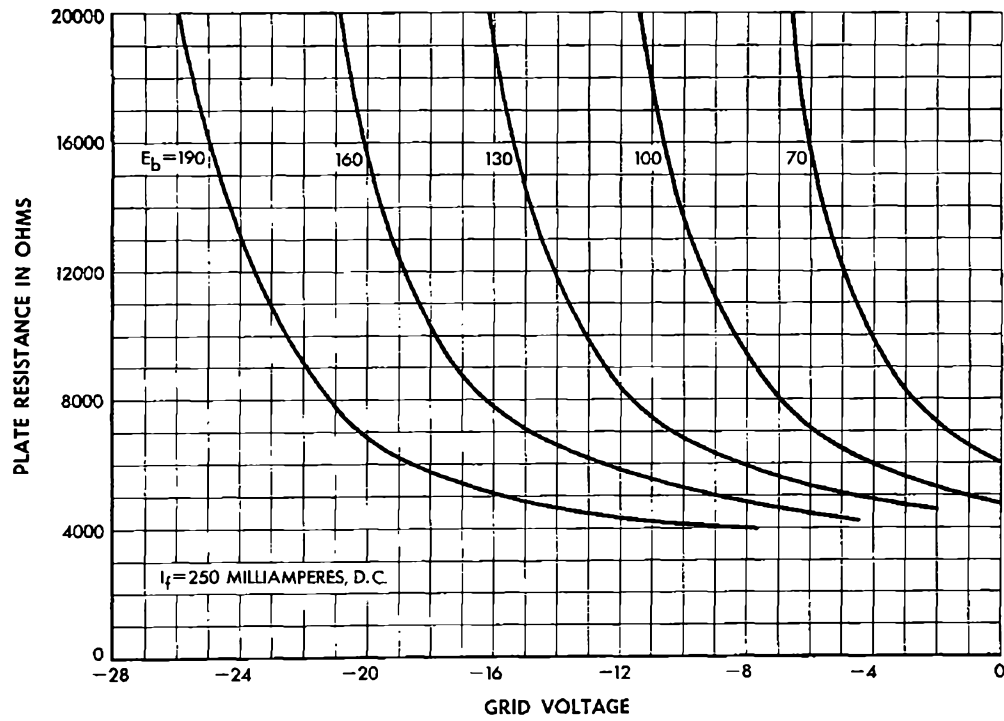
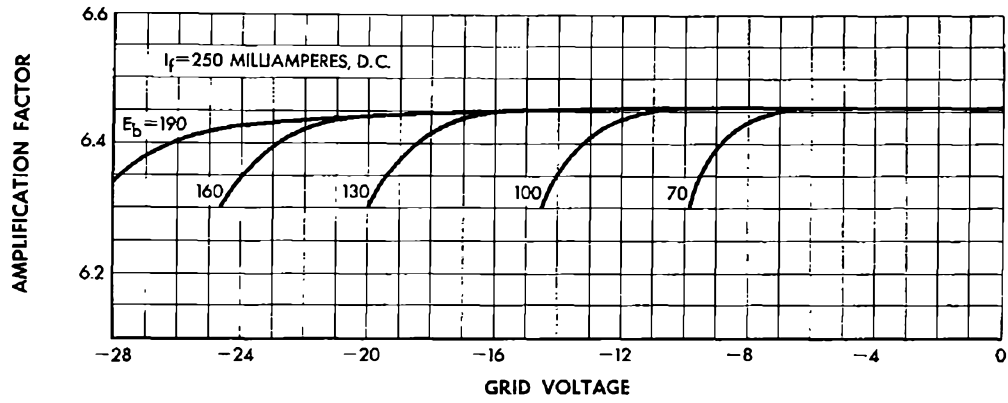

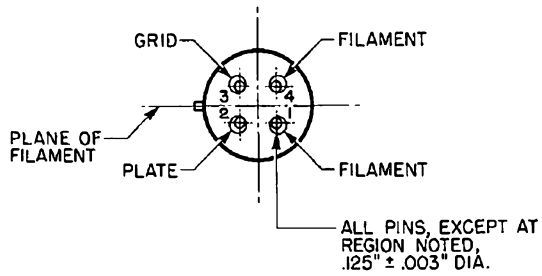
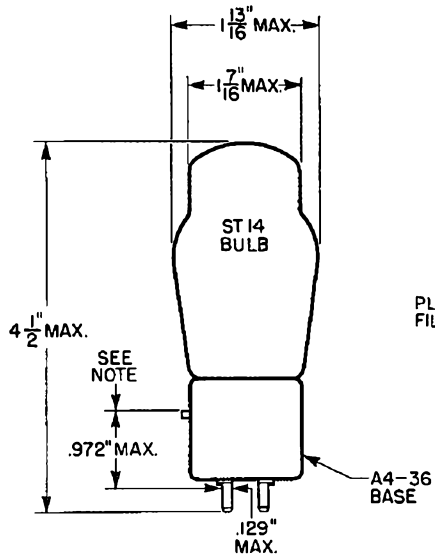
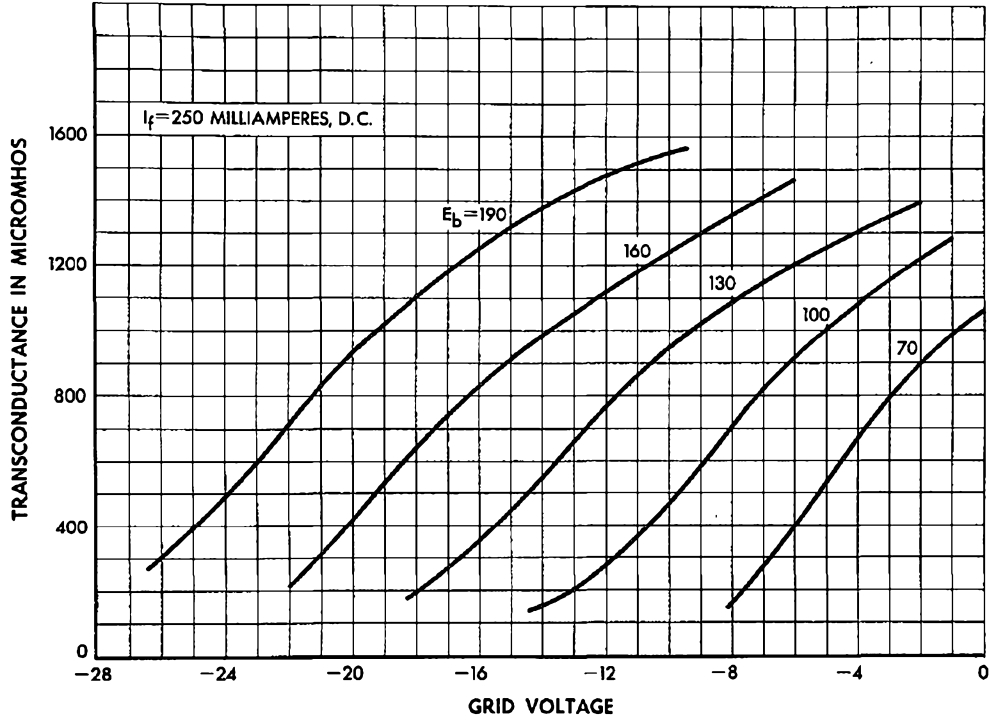

NOTE:
THIS DIMENSION APPLIES FROM THE TOP OF THE BAYONET PIN, TO A POINT ON THE STUD WHERE THE DIAMETER OF THE STUD PLUS SOLDER DOES NOT EXCEED .129" MAX.

102D



TRIODE
AUDIO-FREQUENCY AMPLIFIER

Western Electric

DESCRIPTION

The 102D is a filamentary type triode. It is designed for use as an audio-frequency voltage amplifier or modulator.

CHARACTERISTICS

Filament Current	1.0 ampere
Maximum Plate Voltage	180 volts
Amplification Factor	30

102D
TRIODE

GENERAL CHARACTERISTICS**ELECTRICAL DATA**

Filament Current	1.0 ampere
Filament Voltage, Nominal*	2.1 volts
Direct Interelectrode Capacitances	without external shield
Grid to Plate	5.4 uuf
Input	4.1 uuf
Output	2.6 uuf

MECHANICAL DATA

Cathode	Coated Filament
Base	Medium 4-pin type with bayonet pin
Mounting Position	Preferably vertical; if horizontal, pins #1 and #2 must lie in same vertical plane

Dimensions and pin connections shown in outline drawing on Page 5

MAXIMUM RATINGS, Design-Center Values

Plate Voltage	180 volts
Plate Dissipation	0.5 watt
Plate Current	7.5 milliamperes

TYPICAL OPERATING CONDITIONS AND CHARACTERISTICS—CLASS A₁ AMPLIFIER

Filament Current, D-C	1.0	1.0 ampere
Plate Voltage	130	160 volts
Grid Voltage	-1.5	-2.0 volts
Peak A-F Grid Voltage	1.5	2.0 volts
Plate Current	0.65	0.87 milliampere
Transconductance	500	560 micromhos
Amplification Factor	29.9	29.9
Plate Resistance	60000	53500 ohms
Load Resistance	300000	300000 ohms
Maximum-Signal Voltage Output	29	37 peak volts
Total Harmonic Distortion Less Than	1.0	1.0 per cent

* The filament resistance of this tube increases slightly during the first year of operating life. The voltage given above is the nominal value after the filament resistance has stabilized.

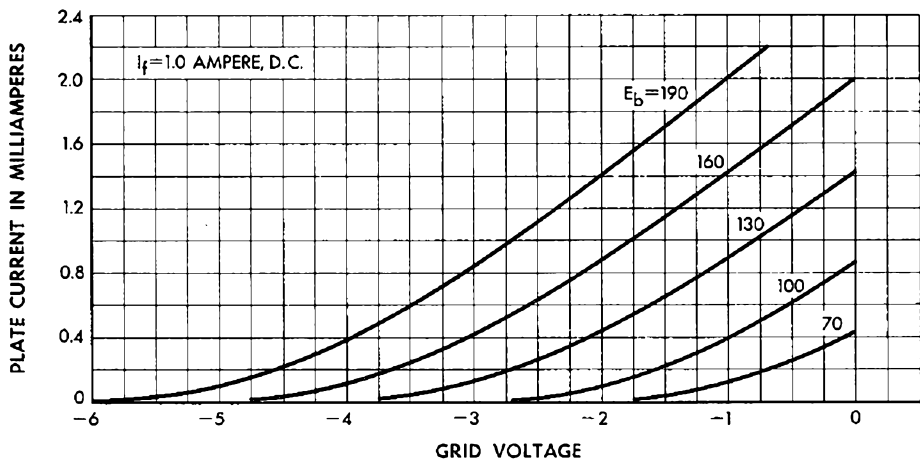
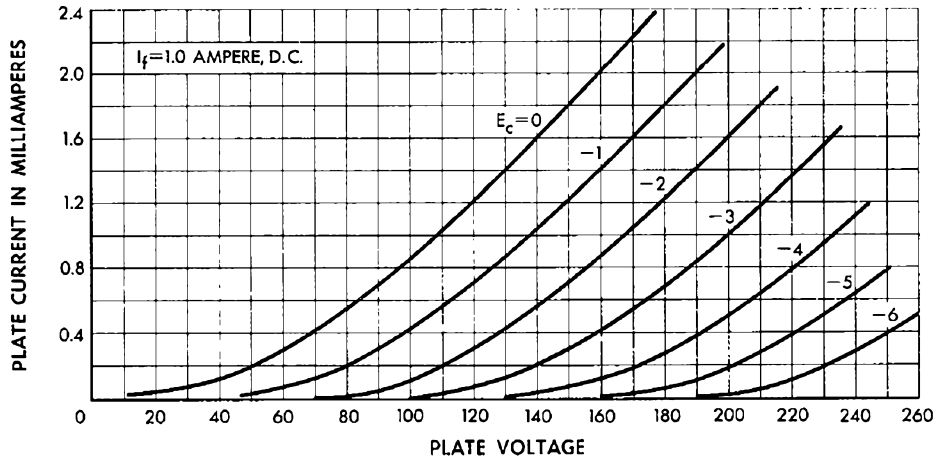

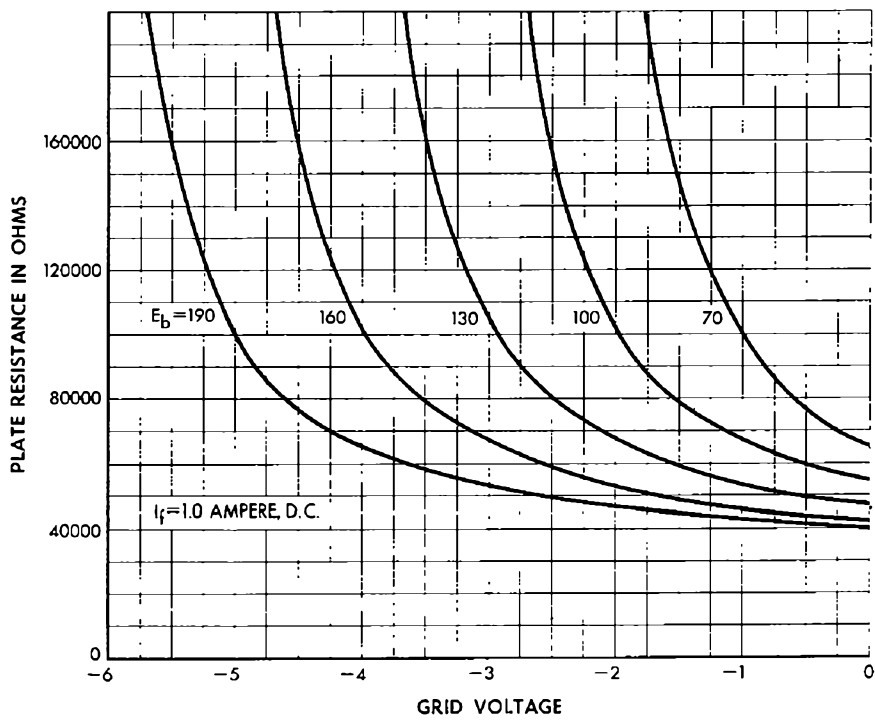
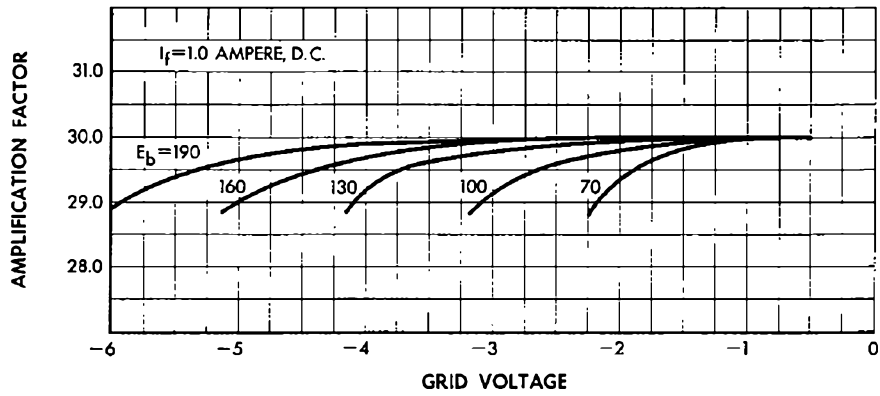

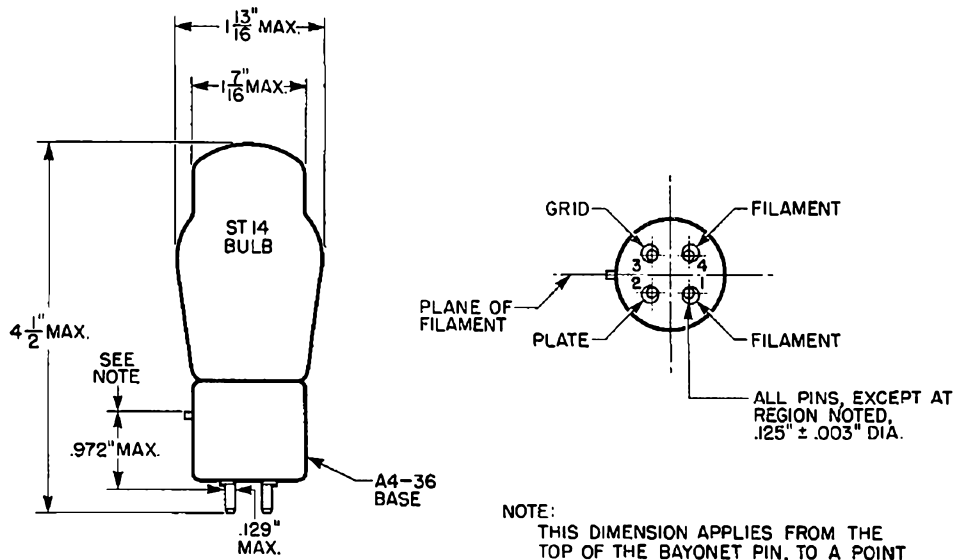
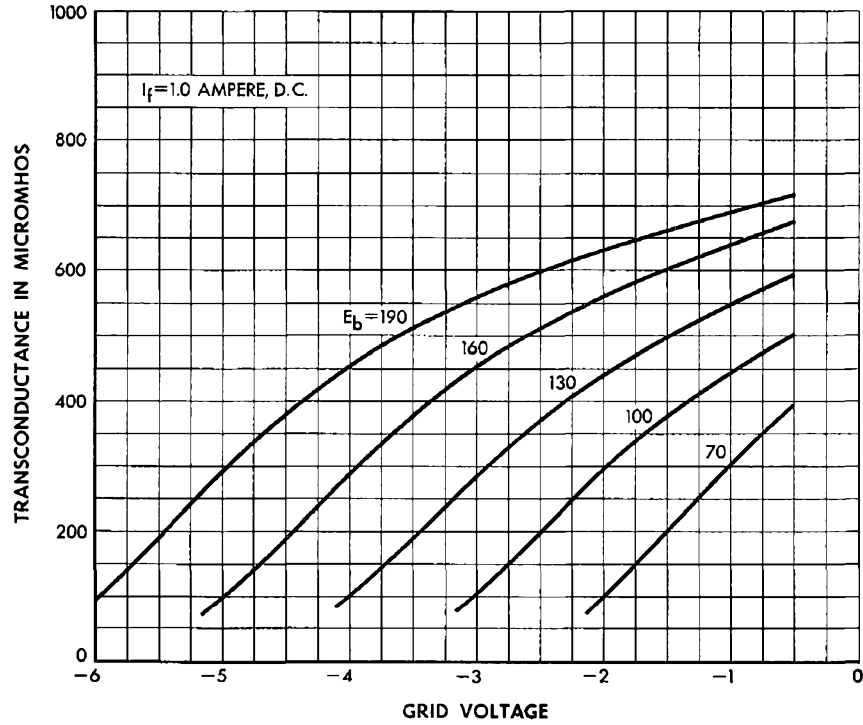

NOTE:
THIS DIMENSION APPLIES FROM THE TOP OF THE BAYONET PIN, TO A POINT ON THE STUD WHERE THE DIAMETER OF THE STUD PLUS SOLDER DOES NOT EXCEED .129 MAX.

Western Electric

102F Vacuum Tube (Dome)



Classifications—Filamentary, voltage amplifier triode

This tube is a redesign of the 102F tube. It includes an improved filament, a new mechanical design using transverse mica supports and is mounted in a dome type bulb. The electrical characteristics are practically identical with the previous 102F tube which it supersedes.

Applications—Voltage amplifier for voice-frequency telephone repeaters and carrier-frequency telegraph equipment.

Detector or modulator.

Dimensions and Connections—The outline diagrams of the tube and base, giving the dimensions and the arrangement of the electrode connections to the base terminals are shown in Figures 1 and 2.

Base and Mounting—This vacuum tube employs a medium, four-pin bayonet type base having special contact metal at the ends of the pins. It is suitable for use in a Western Electric 100L, 100R, or similar type socket, preferably provided with contact-metal contacts.

The tube may be mounted in either a vertical or horizontal position. If mounted in a horizontal position the plane of the filament, which is indicated in Figure 2, should be vertical. To assure adequate ventilation the tubes should be mounted with not less than $2\frac{3}{8}$ inches between centers when two or more tubes are used.

Average Direct Interelectrode Capacitances

Grid to plate	5.1 $\mu\mu\text{f}$
Grid to filament	4.0 $\mu\mu\text{f}$
Plate to filament	2.3 $\mu\mu\text{f}$

These values are for a based tube without socket.

Filament Rating

Filament current	0.50 ampere, d.c.
Nominal filament voltage	2.1 volts

The filament of this tube is designed to operate on a current basis and should be operated at as near the rated current as practicable.

The filament resistance of this tube increases slightly during the first 2000 hours of operation. The voltage given above is the nominal value after the resistance has stabilized.

Characteristics—Typical curves showing plate current as a function of grid voltage for several values of plate voltage are shown in Figure 3. The grid and plate voltages are measured from the negative end of the filament. Corresponding amplification factor, plate resistance and transconductance characteristics are given in Figures 4, 5 and 6 respectively. Plate current as a function of plate voltage for several values of grid voltage is shown in Figure 7.

Operating Conditions and Output—Permissible operating plate and grid voltages are included within the area, ABCD in Figure 3. A number of recommended and maximum operating conditions and the corresponding values of amplification factor, plate resistance, transconductance and performance data are given in the table below. Recommended conditions or others of no greater severity should be selected in preference to maximum conditions wherever possible. The life of the tube at maximum operating conditions may be shorter than at less severe conditions.

The performance data shown include the fundamental output voltage in peak volts and the second and third harmonic levels in db below the fundamental for values of load resistance equal to the plate resistance and for load resistances of 100,000 and 300,000 ohms. The peak value of the sinusoidal input voltage E_{gm} , which gives the indicated output E_{pm} , and harmonic levels F_{2m} and F_{3m} , in each case is numerically equal to the grid bias. For a smaller input voltage E_g , the approximate levels may be computed from the following relations:

$$E_p = E_{pm} \frac{E_g}{E_{gm}}$$

$$F_2 = F_{2m} + 20 \log_{10} \frac{E_{gm}}{E_g}$$

$$F_3 = F_{3m} + 40 \log_{10} \frac{E_{gm}}{E_g}$$

Microphonic Noise

For a plate voltage of 130 volts, a grid bias of -1.5 volts and a load resistance of 100,000 ohms, the mean microphonic output level of this tube, measured in a laboratory reference test set is 33 db below 1 volt. The range of levels of individual tubes extends from 25 to 41 db below 1 volt. Since microphonic noise output depends on the type and intensity of the mechanical disturbance which produces it, the values given here are useful chiefly for comparison with the levels of other types of tubes which have been tested in the same way.

TABLE									
Plate Voltage	Grid Bias	Plate Current	Amplification Factor	Plate Resistance	Trans-conductance	Load Resistance	Output Voltage	Second Harmonic	Third Harmonic
Volts	Volts	Milli-amperes		Ohms	Micro-mhos	Ohms	Peak Volts	db	db
130	-2.0	0.60	30.9	58,000	530	58,000	28	23	39
						100,000	37	28	45
						300,000	49	39	55
130	-1.5	0.85	31.0	50,000	620	50,000	22	30	48
						100,000	30	37	55
						300,000	38	49	65
130	-1.0	1.15	31.0	44,000	700	44,000	14	36	55
						100,000	20	44	60
						300,000	25	56	65
160	-3.0	0.55	30.9	60,000	520	60,000	42	19	33
						100,000	53	23	38
						300,000	71	35	50
160	-2.0	1.15	31.0	45,000	690	45,000	29	30	48
						100,000	39	37	55
						300,000	49	50	65
*160	-1.0	1.85	31.0	39,000	800	39,000	15	41	60
						100,000	21	51	65
						300,000	25	60	65
*190	-3.0	1.15	30.9	45,000	690	45,000	45	26	40
						100,000	62	35	50
						300,000	75	46	60
*190	-2.0	1.85	31.0	39,000	800	39,000	30	35	55
						100,000	41	44	60
						300,000	50	55	65

*Maximum operating conditions.

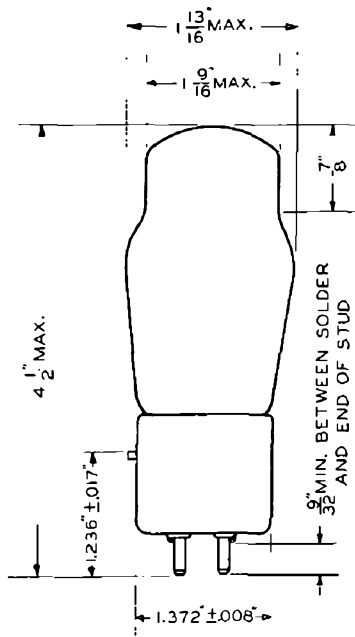

FIG. 1

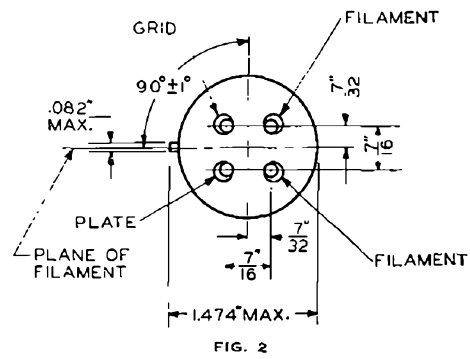

FIG. 2

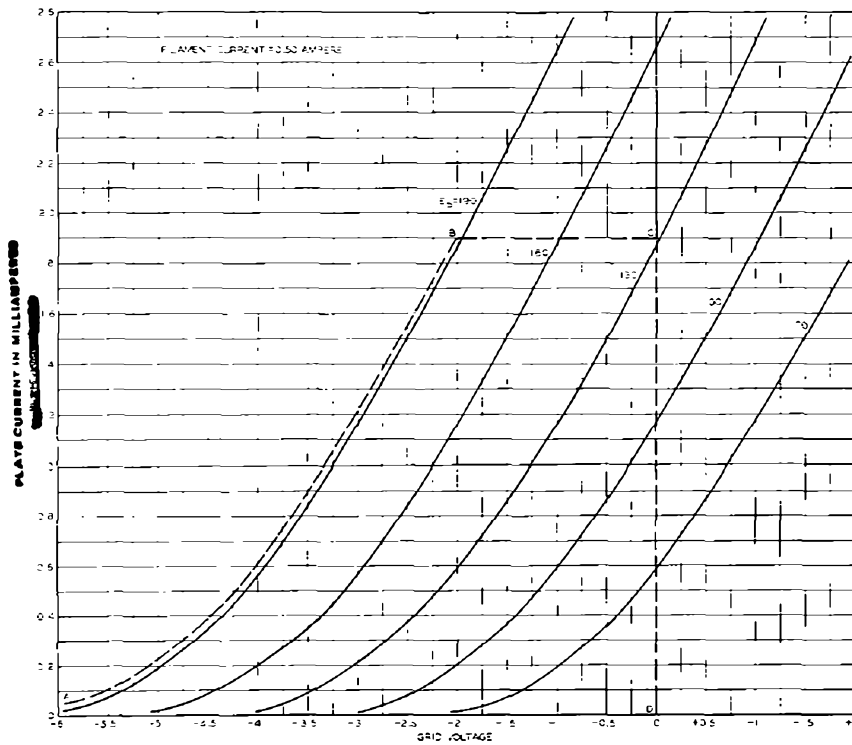
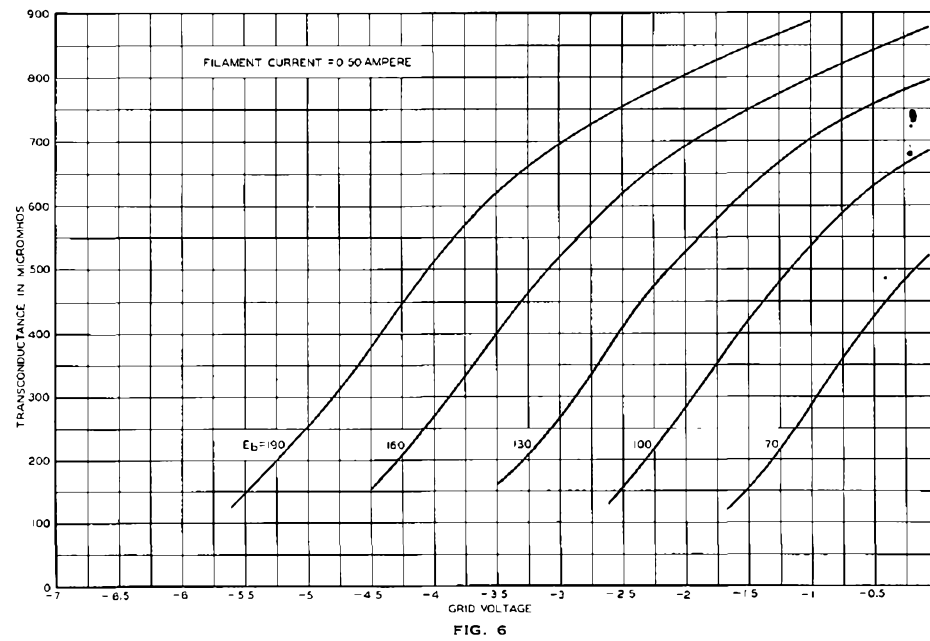
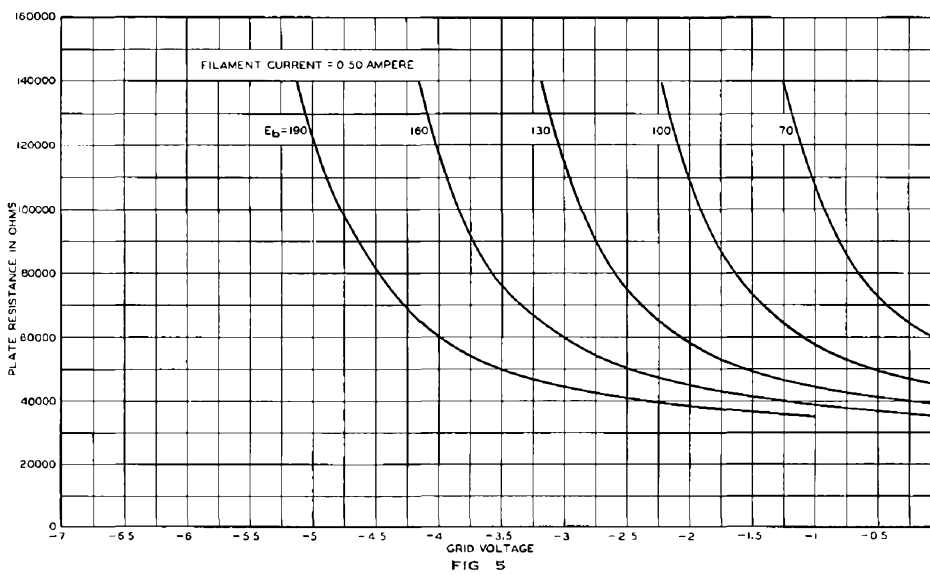
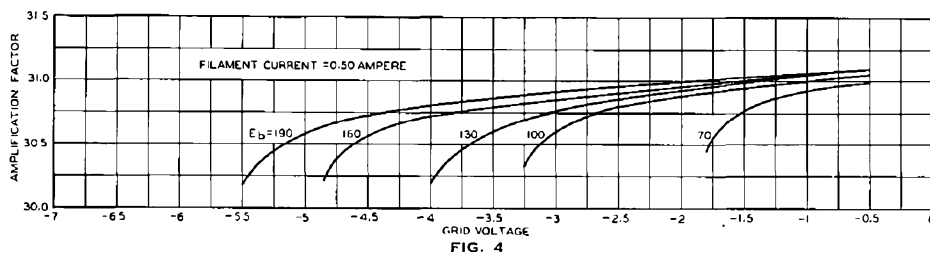

FIG. 3



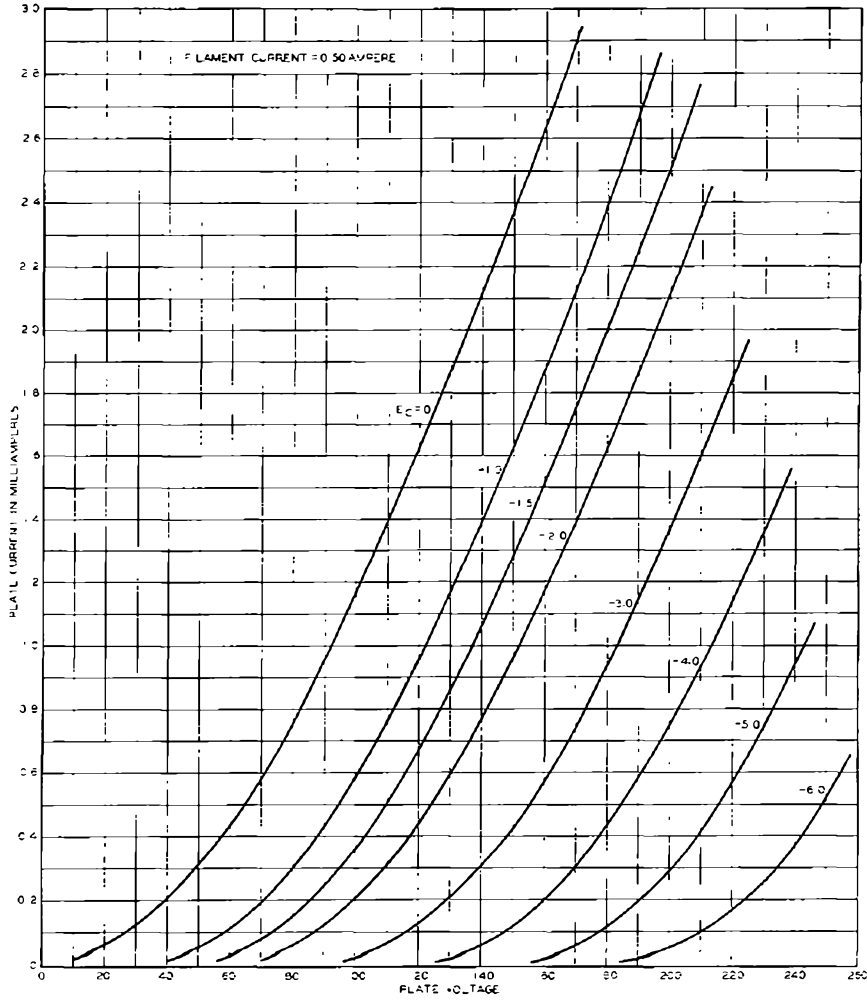
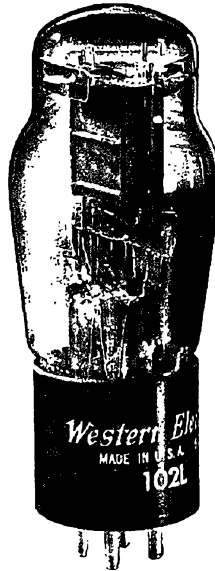

FIG. 7

102L



TRIODE
AUDIO-FREQUENCY AMPLIFIER

Western Electric

DESCRIPTION

The 102L is a filamentary type triode. It is designed for use as an audio-frequency voltage amplifier or modulator.

CHARACTERISTICS

Filament Current	250 milliamperes
Maximum Plate Voltage	180 volts
Amplification Factor	30

102L
TRIODE

GENERAL CHARACTERISTICS**ELECTRICAL DATA**

Filament Current	250 milliamperes
Filament Voltage, Nominal*	2.1 volts
Direct Interelectrode Capacitances	without external shield
Grid to Plate	5.0 uuf
Input	3.8 uuf
Output	2.4 uuf

MECHANICAL DATA

Cathode	Coated Filament
Base	Medium 4-pin type with bayonet pin
Mounting Position	Preferably vertical; if horizontal, pins #1 and #2 must lie in same vertical plane

Dimensions and pin connections shown in outline drawing on Page 5

MAXIMUM RATINGS, Design-Center Values

Plate Voltage	180 volts
Plate Dissipation	0.5 watt
Plate Current	7.5 milliamperes

TYPICAL OPERATING CONDITIONS AND CHARACTERISTICS—CLASS A₁ AMPLIFIER

Filament Current, D-C	250	250 milliamperes
Plate Voltage	130	160 volts
Grid Voltage	-1.5	-2.0 volts
Peak A-F Grid Voltage	1.5	2.0 volts
Plate Current	0.85	1.2 milliamperes
Transconductance	650	800 micromhos
Amplification Factor	30.2	30.2
Plate Resistance	46000	39000 ohms
Load Resistance	300000	300000 ohms
Maximum-Signal Voltage Output	34	44 peak volts
Total Harmonic Distortion Less Than	1.0	1.0 per cent

* The filament resistance of this tube increases slightly during the first year of operating life. The voltage given above is the nominal value after the filament resistance has stabilized.

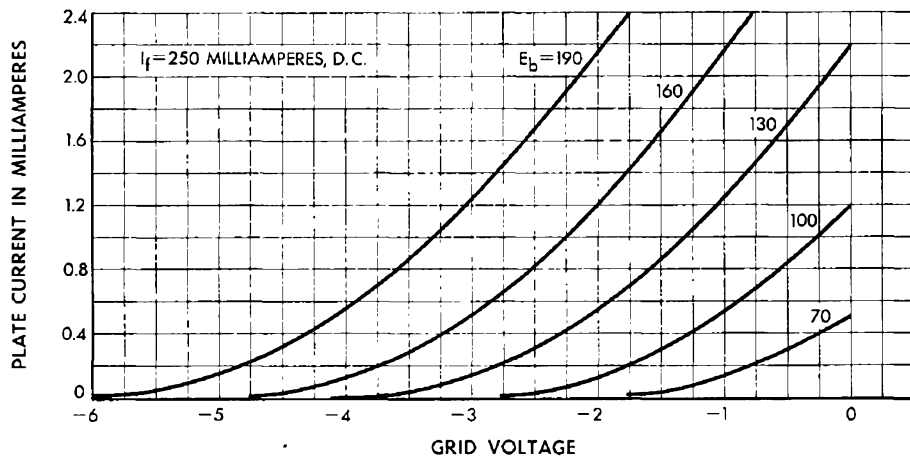
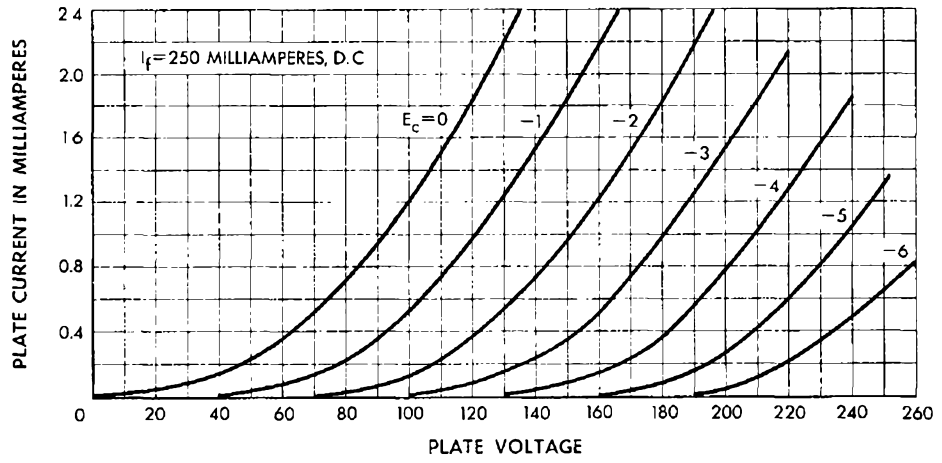

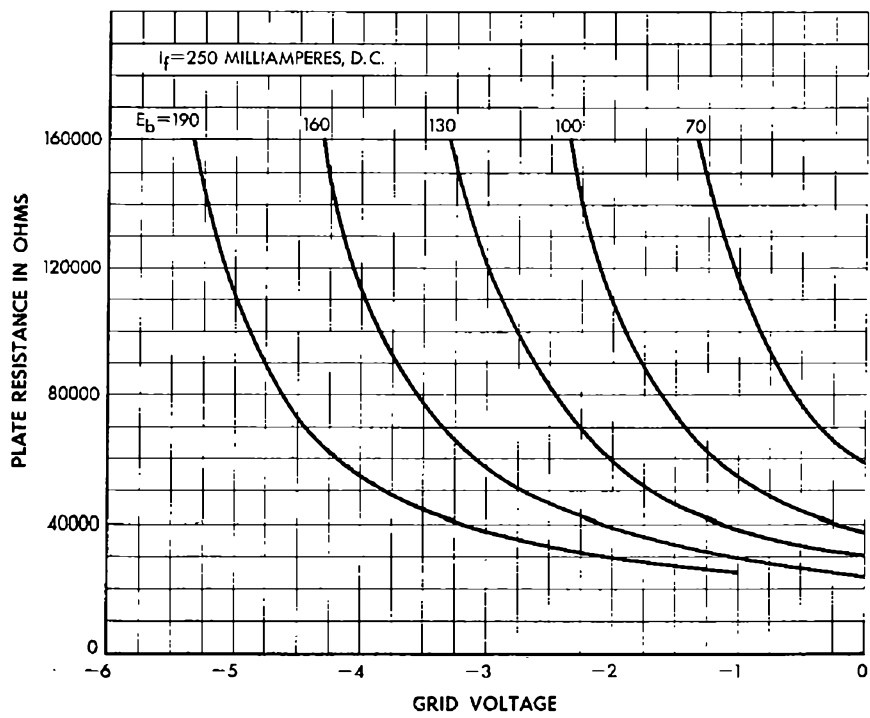
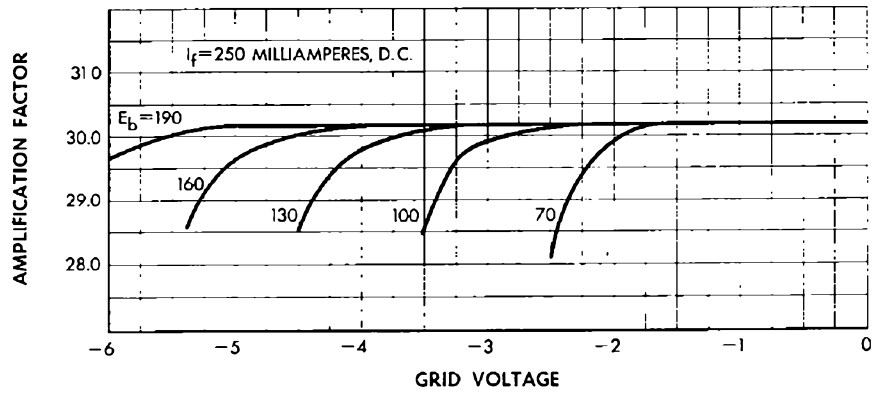

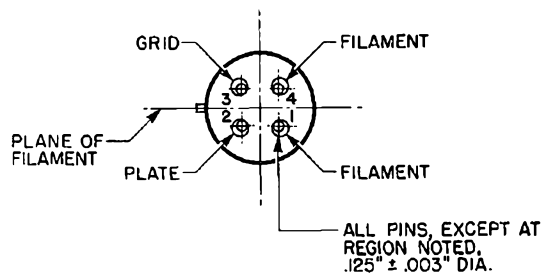
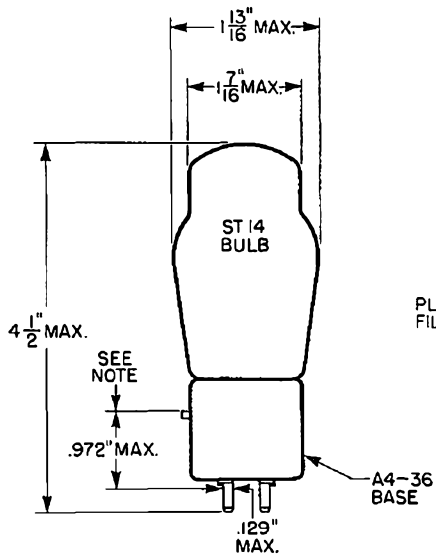
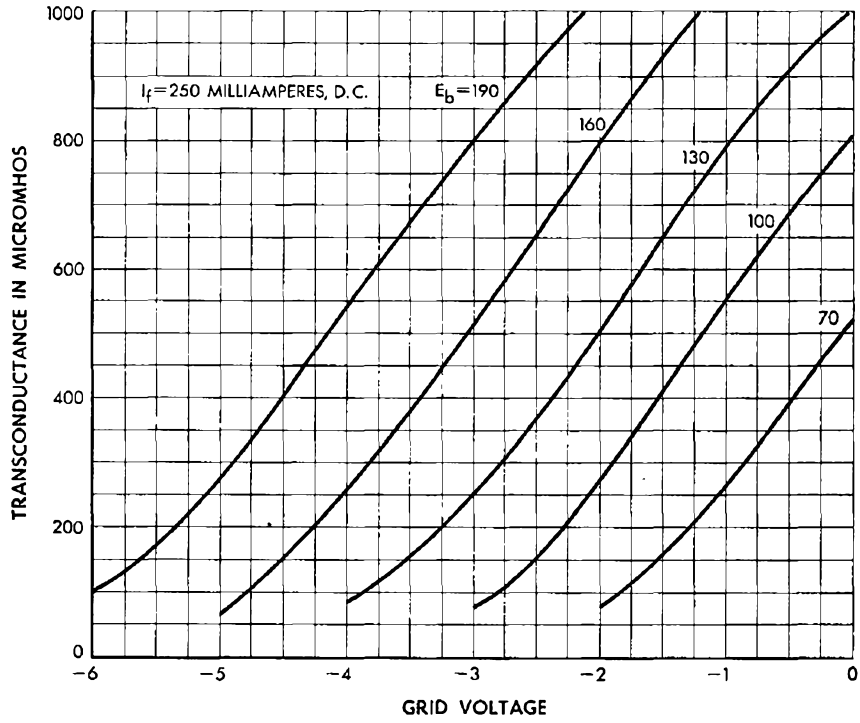

NOTE:
THIS DIMENSION APPLIES FROM THE TOP OF THE BAYONET PIN, TO A POINT ON THE STUD WHERE THE DIAMETER OF THE STUD PLUS SOLDER DOES NOT EXCEED .129 MAX.

BELL SYSTEM PRACTICES
Transmission Engineering and Data
Vacuum Tube Data

SECTION AB46.035
April 1941 Issue 1
A T & T Co Standard

Western Electric

104D Vacuum Tube (Dome)

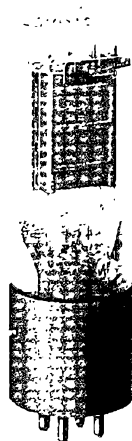

Classification—Filamentary, power amplifier triode

This tube replaces the D-86327 tube and has been assigned the old code number 104D. It includes an improved filament, a new mechanical design using transverse mica supports and is mounted in a dome type bulb. The electrical characteristics are essentially the same as for the D-86327 tube.

Applications—Voice frequency and carrier frequency amplifier for telephone repeater equipment requiring greater power outputs than can be obtained from the 101D or 101F type tubes.

Volume limiter in carrier telephone equipment.

Amplifier in various testing apparatus.

Dimensions and Connections—The outline diagrams of the tube and base, giving the dimensions and the arrangement of the electrode connections to the base terminals are shown in Figures 1 and 2.

Base and Mounting—This vacuum tube employs a medium, four-pin bayonet type base having special contact metal at the ends of the pins. It is suitable for use in a Western Electric 100L, 100R or similar type socket, preferably provided with contact-metal contacts.

The tube may be mounted in either a vertical or horizontal position. If mounted in a horizontal position the plane of the filament, which is indicated in Figure 2, should be vertical. To assure adequate ventilation the tubes should be mounted with not less than $2\frac{5}{8}$ inches between centers when two or more tubes are used.

Average Direct Interelectrode Capacitances

Grid to plate.	4.9 $\mu\mu\text{f.}$
Grid to filament.	4.1 $\mu\mu\text{f.}$
Plate to filament.	3.4 $\mu\mu\text{f.}$

These values are for a based tube without socket.

Filament Rating

Filament current.	1.00 ampere, d.c. .
Nominal filament voltage.	4.5 volts

The filament of this tube is designed to operate on a current basis and should be operated as near to the rated current as practicable.

The filament resistance of this tube increases slightly during the first 2000 hours of operation. The voltage given above is the nominal value after the resistance has stabilized.

Characteristics—Typical curves showing plate current as a function of grid voltage for several values of plate voltage are shown in Figure 3. The grid and plate voltages are measured from the negative end of the filament. Corresponding amplification factor, plate resistance and transconductance characteristics are given in Figures 4, 5 and 6 respectively. Plate current as a function of plate voltage for several values of grid voltage is shown in Figure 7.

Operating Conditions and Output—Permissible operating plate and grid voltages are included within the area, ABCD in Figure 3. A number of recommended and maximum operating conditions and the corresponding values of amplification factor, plate resistance, transconductance, and performance data are given in the table.

Recommended conditions or others of no greater severity should be selected in preference to maximum conditions wherever possible. The life of the tube at maximum operating conditions will be shorter than at less severe conditions.

The performance data shown includes the fundamental power output in milliwatts and the second and third harmonic levels in db below the fundamental for values of load resistance equal to the plate resistance and for a load resistance of 5000 ohms. The peak value of sinusoidal input voltage E_{gm} , which gives the indicated output P_m , and harmonic levels F_{2m} and F_{3m} , in each case is numerically equal to the grid bias. For a smaller input voltage E_g , the approximate levels may be computed from the following relations:

$$P = P_m \left(\frac{E_g}{E_{gm}} \right)^2$$

$$F_2 = F_{2m} + 20 \log_{10} \frac{E_{gm}}{E_g}$$

$$F_3 = F_{3m} + 40 \log_{10} \frac{E_{gm}}{E_g}$$

Microphonic Noise

For a plate voltage of 130 volts, a grid bias of -20 volts, and a load resistance of 100,000 ohms, the mean microphonic output level of this tube, measured in a laboratory reference test set is 31 db below 1 volt. The range of levels of individual tubes extends from 20 to 40 db below 1 volt. Since microphonic noise output depends on the type and intensity of the mechanical disturbance which produces it, the values given here are useful chiefly for comparison with the levels of other types of tubes which have been tested in the same way.

TABLE

	<u>Plate VOLT- age</u>	<u>Grid Bias</u>	<u>Plate Cur- rent</u>	<u>Ampli- fication Factor</u>	<u>Plate Resist- ance</u>	<u>Trans- conduct- ance</u>	<u>Load Resist- ance</u>	<u>Power Out- put</u>	<u>Second Har- monic</u>	<u>Thrd Har- monic</u>
	Volts	Volts	Milli- amperes		Ohms	Micro- mhos	Ohms	Milli- watts	db	db
Recom- mended Operat- ing Condi- tions	100	-20	12.5	2.4	2700	890	2700 5000	110 100	23 28	50 65
	100	-10	22.5	2.6	2200	1160	2200 5000	38 32	34 38	60 65
	130	-30	14.5	2.3	2600	900	2600 5000	250 225	22 25	47 75
	130	-20	25.0	2.5	2100	1180	2100 5000	150 125	28 32	48 58
	130	-10	37.0	2.6	1800	1430	1800 5000	45 36	38 44	65 70
	160	-45	13.0	2.3	2900	810	2900 5000	475 445	18 21	37 49
	160	-35	21.5	2.4	2300	1040	2300 5000	390 340	22 27	47 70
Maximum Operat- ing Condi- tions	160	-25	33.0	2.5	1900	1300	1900 5000	250 210	28 33	49 53
	190	-55	15.5	2.3	2800	810	2800 5000	735 700	18 22	36 48
	190	-45	24.5	2.4	2200	1070	2200 5000	650 565	22 26	45 65

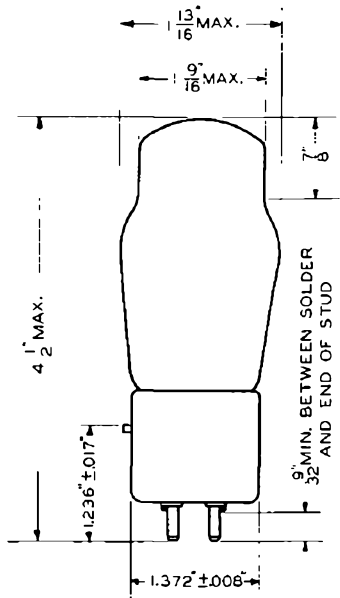
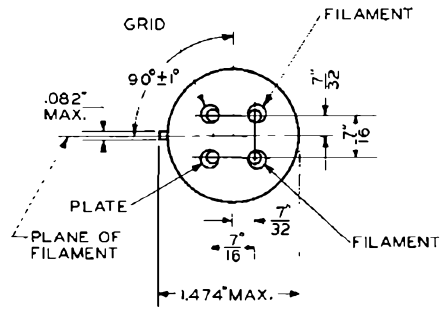

FIG. 1



BOTTOM VIEW
FIG. 2

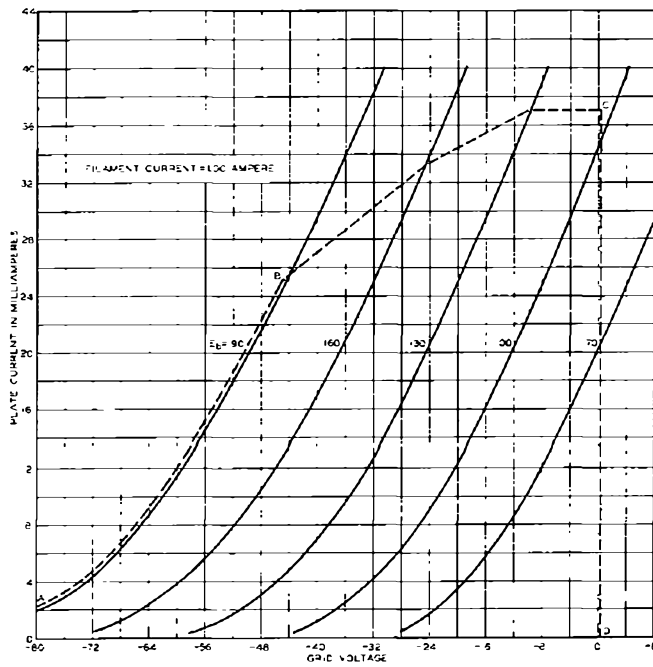

FIG. 3

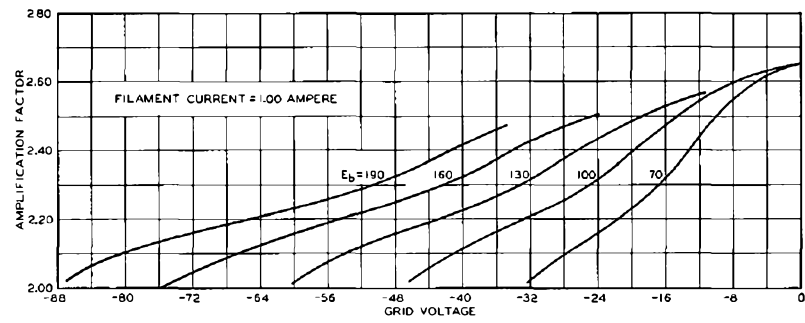

FIG. 4

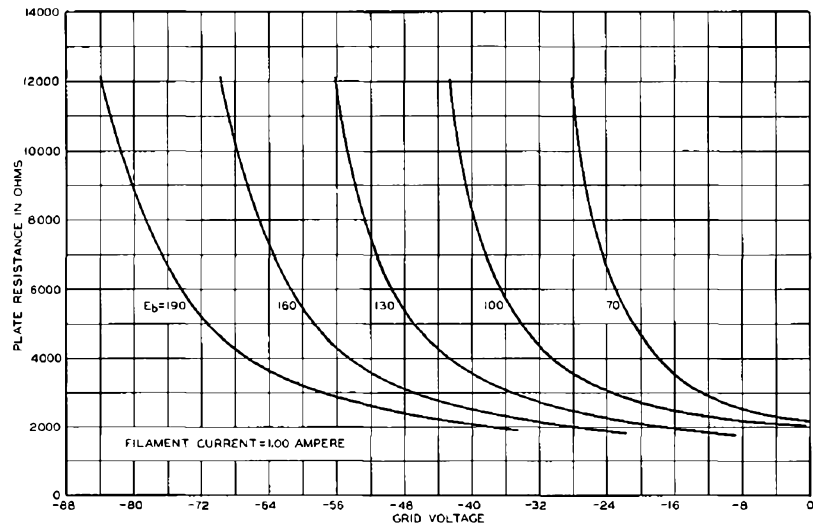

FIG. 5

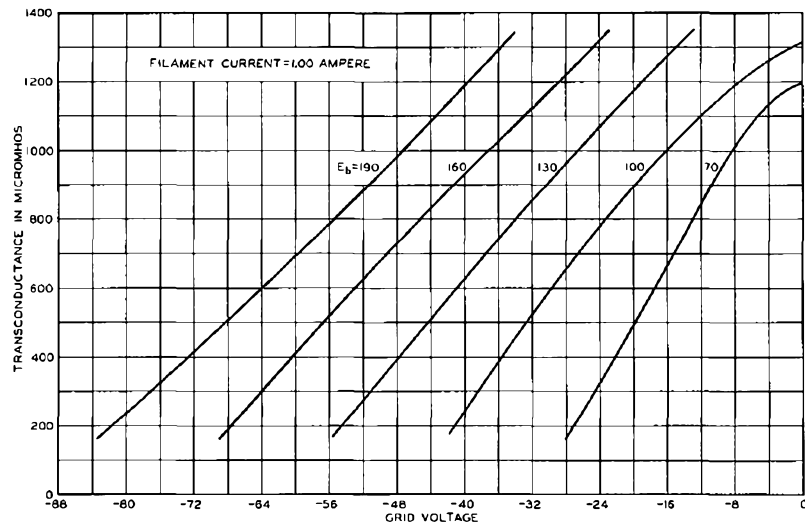

FIG. 6

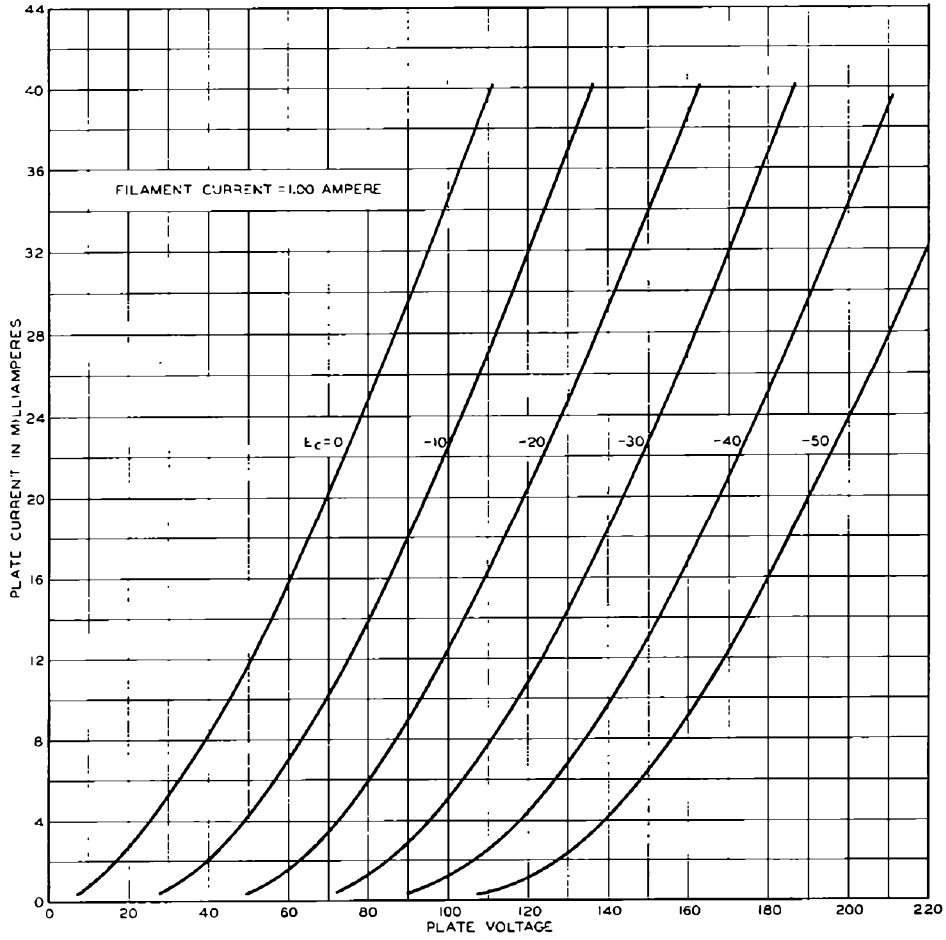
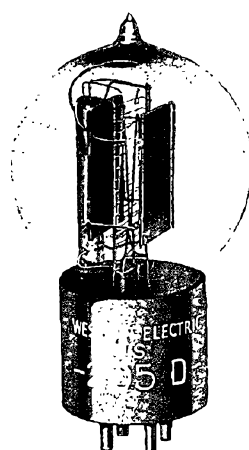

FIG. 7

*Western Electric***205D Vacuum Tube**

Classification—Moderate power, filamentary triode

Applications

Audio-frequency amplifier or modulator where power outputs of approximately 1 watt or less are required.

Radio-frequency power amplifier.

Oscillator.

Dimensions—Dimensions, outline diagrams of the tube and base, and the arrangement of the electrode connections to the base terminals are shown in Figures 1 and 2.

Base—Medium, four-pin, bayonet type with the bayonet pin offset.

Socket—Four-contact, bayonet-slot type, such as the Western Electric 100M for front of panel mounting or 115B for rear of panel mounting.

Mounting Positions—Either vertical or horizontal. If mounted in a horizontal position, the plane of the filament, which is indicated in Figure 2, should be vertical.

Average Direct Interelectrode Capacitances

	<u>A</u>	<u>B</u>	<u>C</u>
Grid to plate, $\mu\mu\text{f.}$	4.8	4.3	4.3
Grid to filament, $\mu\mu\text{f.}$	5.2	6.4	6.9
Plate to filament, $\mu\mu\text{f.}$	3.3	5.2	5.5

Column A—Based tube without socket.

Column B—Tube alone when measured in 100M socket mounted on metal plate; socket and mounting plate connected to filament.

Column C—Tube alone when measured in 115B socket mounted in metal plate; socket and mounting plate connected to filament.

Filament—Oxide-coated

Filament voltage.	4.5 volts, a.c. or d.c.
Nominal filament current	1.6 amperes

The filament of this tube is designed to operate on a voltage basis and should be operated at as near the rated voltage as is practicable. When alternating-current filament supply is used, the grid and plate returns should be connected to a center tap on the secondary of the filament transformer.

Characteristics—Plate current characteristics of a typical 205D tube are shown in Figure 3 as functions of grid voltage for several values of plate voltage. Corresponding amplification factor, plate resistance, and transconductance characteristics are given in Figures 4, 5 and 6, respectively. Plate current characteristics as functions of plate voltage for several values of grid voltage are shown in Figure 7. These characteristics are for direct-current filament supply with the grid and plate voltages measured from the negative end of the filament. When alternating-current filament supply is used, the same characteristics are applicable if 2.6 is added to the numerical value of each grid bias.

Microphonic Noise—With a plate voltage of 350 volts, a grid bias of -22.5 volts, and a load resistance of 100,000 ohms, the mean microphonic noise output level of the 205D tube measured in a laboratory reference test set is 25 decibels below 1 volt. The range of levels of individual tubes extends from 16 to 33 decibels below 1 volt. Since microphonic noise depends on the type and intensity of the mechanical disturbance which produces it, the values given here are useful chiefly for comparison with the levels of other tubes which have been tested in the same way.

Limiting Conditions for Safe Operation

	<u>Class A</u> <u>Amp.</u>	<u>*Class B</u> <u>R-F</u> <u>Amp.</u>	<u>Class C</u> <u>R-F Amp.</u> <u>or Osc.</u>	<u>*Class C</u> <u>R-F Amp.</u> <u>Plate</u> <u>Modulated</u>
Maximum direct plate voltage	400	400	400	350 volts
Maximum direct plate current	50	35	50	40 milliamperes
Maximum plate dissipation	14	14	14	10 watts
Maximum direct grid current	—	10	10	10 milliamperes

*Carrier conditions for use with modulation factors up to 1.0.

Operating Conditions and Output

Class A—Amplifier or Modulator

Permissible operating grid and plate voltages for Class A operation are included within the area, ABCD, in Figure 3. Amplification factor, plate resistance, transconductance, and performance data are given in Table I for a number of typical operating conditions represented by selected points within this area. A less severe operating condition should be selected in preference to a maximum operating condition wherever possible. The life of the tube at maximum conditions may be shorter than at less severe conditions.

The performance data include the fundamental power output in milliwatts and the levels of the second and third harmonics in decibels below the fundamental for values of load resistance, R , equal to one, two, and in some cases three times the plate resistance, r_p . The peak value of the sinusoidal input voltage, E_{gm} , which gives the indicated power output, P_m , and harmonic levels, F_{2m} and F_{3m} , in each case, is numerically equal to the grid bias. For a smaller input voltage, E_g , the output and harmonic levels are given approximately by the following relations:

$$P = P_m \left(\frac{E_g}{E_{gm}} \right)^2$$

$$F_2 = F_{2m} + 20 \log_{10} \frac{E_{gm}}{E_g}$$

$$F_3 = F_{3m} + 40 \log_{10} \frac{E_{gm}}{E_g}$$

TABLE I

Plate Voltage	Grid Bias	Plate Current	Amplification Factor	Plate Resistance	Trans-conductance	Input Voltage	Load Resistance	Power Output	Second Harmonic	Third Harmonic
Volts	Volts	Milli-amperes		Ohms r_p	Micro-mhos	Peak Volts	R	Milli-watts	db	db
200	- 6	22.5	7.4	4000	1840	6	$R = r_p$	60	35	65
							$R = 2r_p$	55	40	70
250	- 22	9	6.9	6000	1160	22	$R = r_p$	500	18	33
							$R = 2r_p$	450	22	40
							$R = 3r_p$	380	26	47
250	- 15	19	7.2	4350	1670	15	$R = r_p$	310	26	45
							$R = 2r_p$	280	30	55
250	- 10	27.5	7.4	3800	1950	10	$R = r_p$	180	33	60
							$R = 2r_p$	160	38	65
250	- 5	37.5	7.5	3500	2150	5	$R = r_p$	50	40	70
							$R = 2r_p$	45	43	70
300	- 30	8	6.7	6700	1000	30	$R = r_p$	800	15	28
							$R = 2r_p$	720	20	35
							$R = 3r_p$	600	24	42
300	- 24	15.5	7.1	4800	1460	24	$R = r_p$	750	20	36
							$R = 2r_p$	670	25	45
300	- 18	25	7.3	4000	1830	18	$R = r_p$	540	27	46
							$R = 2r_p$	480	31	55
350	- 22.5	29	7.3	3800	1940	22.5	$R = r_p$	875	26	44
							$R = 2r_p$	800	30	50
375	- 30	22	7.1	4300	1660	30	$R = r_p$	1300	20	36
							$R = 2r_p$	1200	26	45
*300	- 10	41	7.4	3350	2220	10	$R = r_p$	200	37	65
							$R = 2r_p$	180	41	70
*350	- 20	34	7.3	3600	2060	20	$R = r_p$	750	28	50
							$R = 2r_p$	675	32	55
*375	- 24	32	7.3	3650	1990	24	$R = r_p$	1000	26	44
							$R = 2r_p$	900	30	55
*400	- 29	30	7.2	3800	1890	29	$R = r_p$	1400	23	39
							$R = 2r_p$	1300	28	48

*Maximum operating conditions.

Class B—Amplifier

Radio-telephone applications, particularly the amplification of a modulated carrier wave with a minimum of distortion. Typical carrier conditions for use with modulation factors up to 1.0 are shown in Table II.

TABLE II

Direct Plate Voltage	Grid Bias	Direct Plate Current	Driving Voltage		Power Output		Effective Load Resistance	Peak Driving Power
			Carrier	A-F Peak	Carrier	A-F Peak		
Volts	Volts	Milli-amperes	Peak Volts	Volts	Watts	Watts	Ohms	Watts
350	-48	28	69	138	2.5	10	3100	1
400	-56	28	73	146	3.0	12	3700	1

Class C—Amplifier or Oscillator

Radio-telegraph or other continuous wave applications. Typical operating conditions are shown in Table III.

TABLE III

Direct Plate Voltage	Grid Bias	Direct Plate Current	Driving Voltage	Power Output	Effective Load Resistance	Driving Power
Volts	Volts	Milli-amperes	Peak Volts	Watts	Ohms	Watts
350	-96	45	186	8.3	3750	1.3
400	-112	45	202	10.0	4500	1.5

Class C—Amplifier—Plate modulated

Radio-telephone applications. Typical carrier conditions for use with modulation factors up to 1.0 are shown in Table IV.

TABLE IV

Direct Plate Voltage	Grid Bias	Direct Plate Current	Driving Voltage	Power Output	Effective Load Resistance	Driving Power
Volts	Volts	Milli-amperes	Peak Volts	Watts	Ohms	Watts
300	-120	35	205	6.0	4000	1.3
350	-144	35	229	7.1	5000	1.7

High Frequency Ratings

If the 205D tube is to be used at frequencies higher than 15 megacycles, the plate voltage and plate dissipation ratings given above should be reduced to avoid excessive high-frequency currents, excessive heating due to dielectric losses, and consequent injury to the tube. At the limiting frequency of 30 megacycles, the maximum ratings should be as follows:

- Maximum plate voltage 300 volts
- Maximum plate dissipation 10 watts
- Maximum r-f grid current 3 amperes

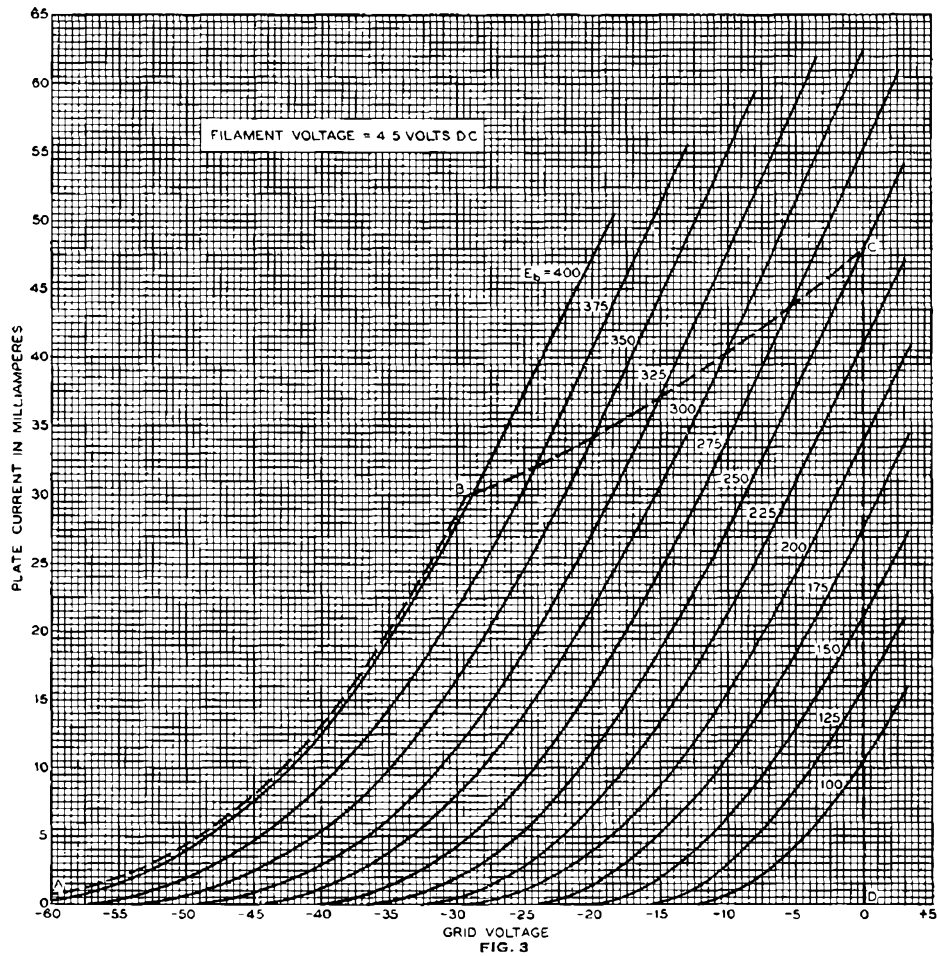
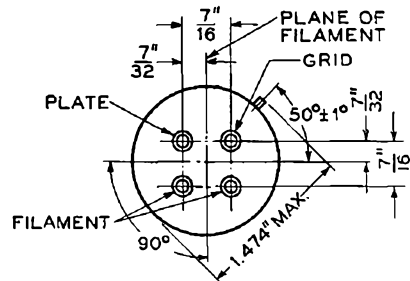
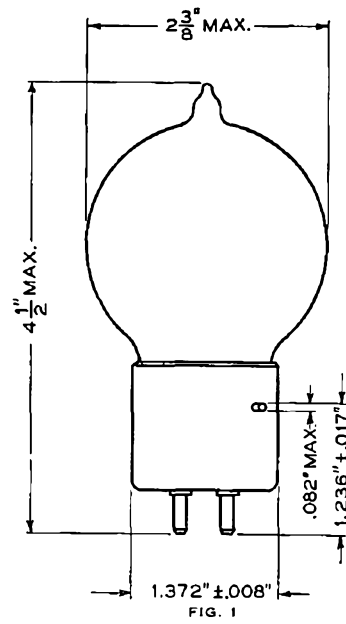

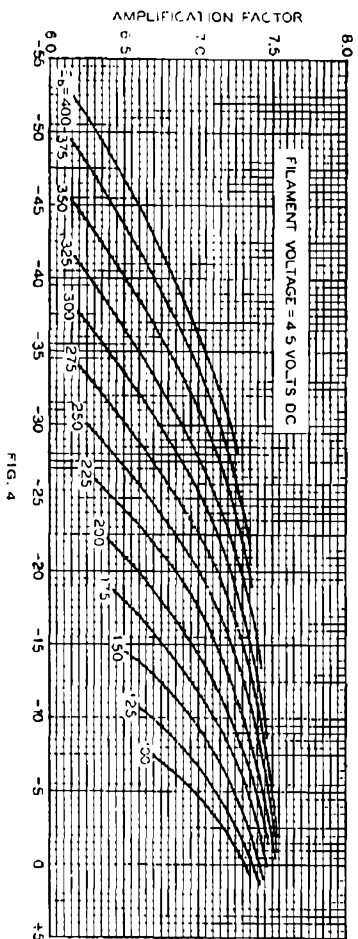

FIG. 4

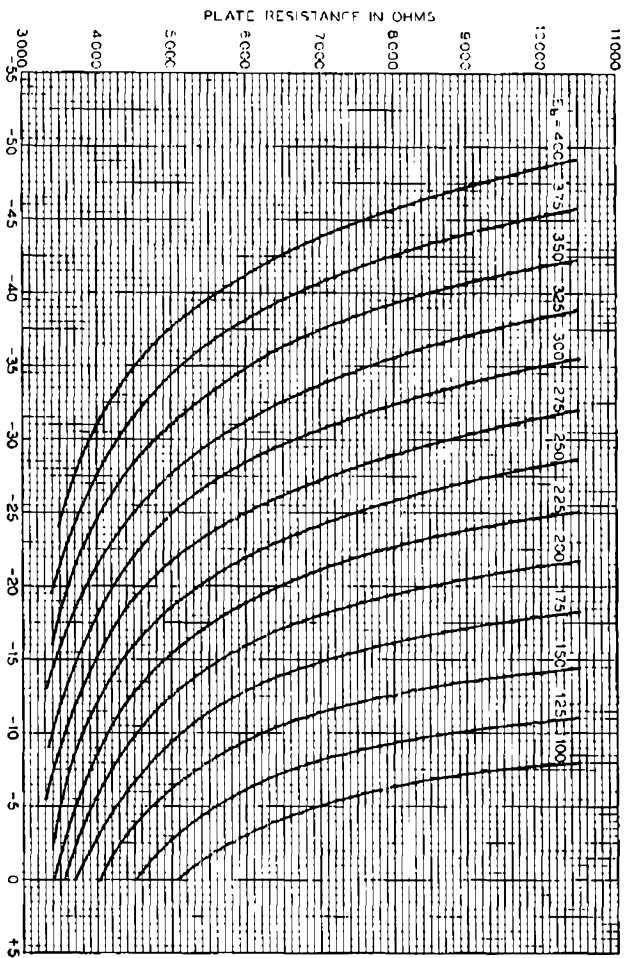

FIG. 5

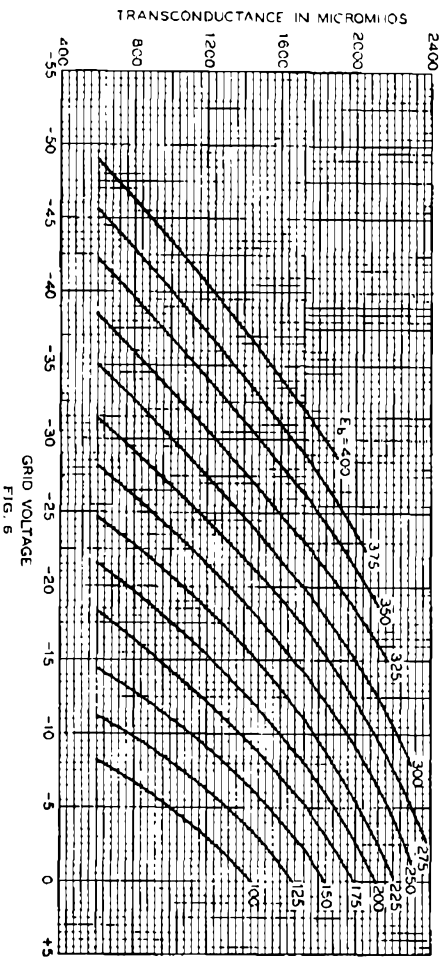

FIG. 6

[6]

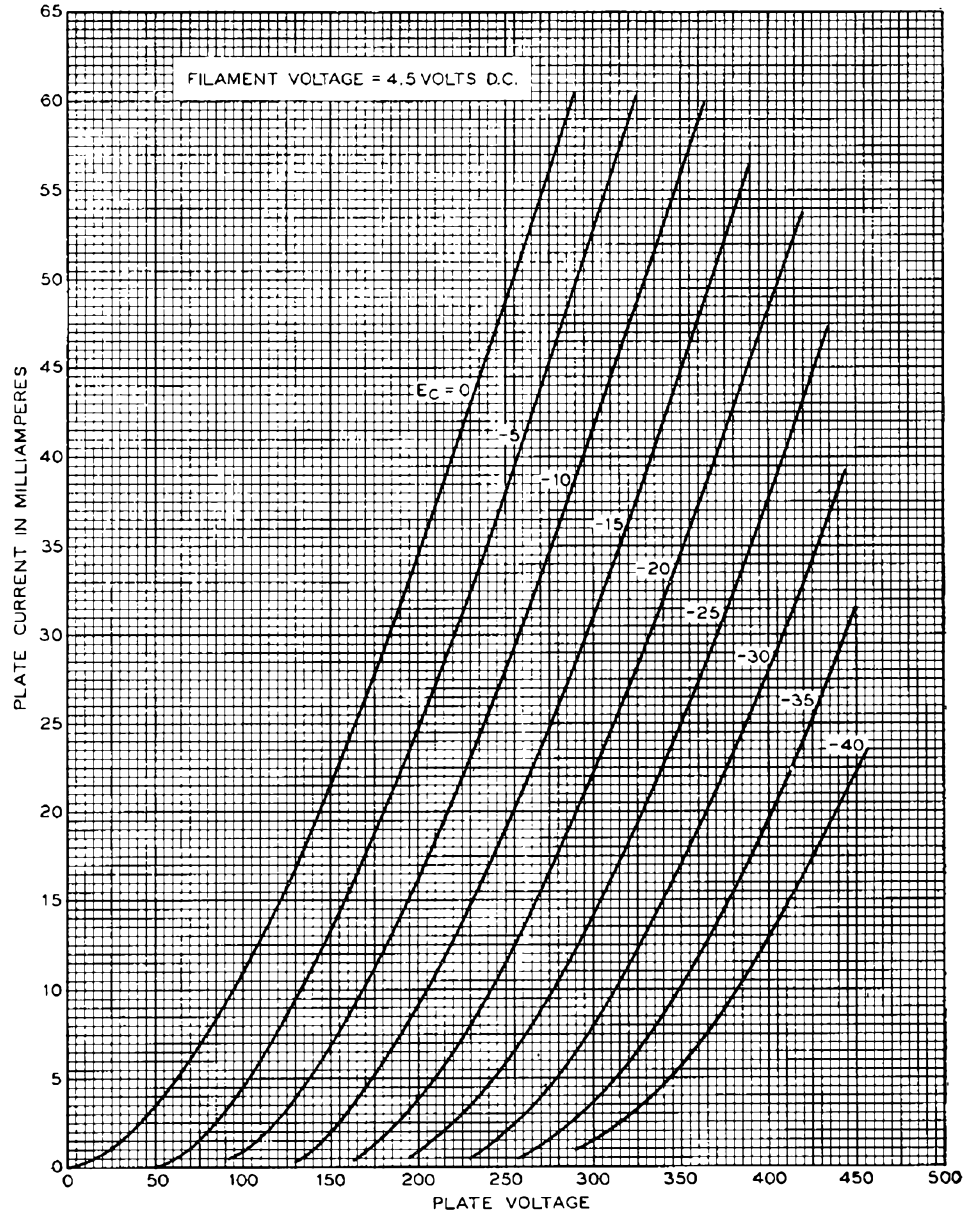

FIG. 7

1-C-36-55C
 PRINTED IN U.S.A.

A development of Bell Telephone Laboratories, Incorporated,
 the research laboratories of the American Telephone and Tele-
 graph Company, and the Western Electric Company

V. T. DATA SHEET 205D
 ISSUE 1

Western Electric

205E Vacuum Tube

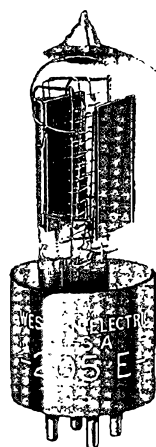

Classification—Moderate power, filamentary triode

The 205E tube is similar to the 205D tube except that special precautions have been taken in the 205E tube to minimize sputter noise in the tube and contact noise between the contact pins and the socket.

Applications

Audio-frequency amplifier or modulator where power outputs of approximately 1 watt or less are required.

Radio-frequency power amplifier.

Oscillator.

Dimensions—Dimensions, outline diagrams of the tube and base, and the arrangement of the electrode connections to the base terminals are shown in Figures 1 and 2.

Base—Medium, four-pin, bayonet type having special contact metal at the ends of the contact pins. The bayonet pin is offset.

Socket—Four-contact, bayonet-slot type, preferably provided with contact-metal contacts, such as the Western Electric 100M for front of panel mounting or 116A for rear of panel mounting.

Mounting Positions—Either vertical or horizontal. If mounted in a horizontal position, the plane of the filament, which is indicated in Figure 2, should be vertical.

Average Direct Interelectrode Capacitances

	<u>A</u>	<u>B</u>	<u>C</u>
Grid to plate, $\mu\text{f.}$	4.8	4.3	4.3
Grid to filament, $\mu\text{f.}$	5.2	6.4	6.9
Plate to filament, $\mu\text{f.}$	3.3	5.2	5.5

Column A—Based tube without socket.

Column B—Tube alone when measured in 100M socket mounted on metal plate; socket and mounting plate connected to filament.

Column C—Tube alone when measured in 116A socket mounted in metal plate; socket and mounting plate connected to filament.

Filament—Oxide-coated

Filament voltage.	4.5 volts, a.c. or d.c.
Nominal filament current	1.6 amperes

The filament of this tube is designed to operate on a voltage basis and should be operated at as near the rated voltage as is practicable. When alternating-current filament supply is used, the grid and plate returns should be connected to a center tap on the secondary of the filament transformer.

Characteristics—Plate current characteristics of a typical 205E tube are shown in Figure 3 as functions of grid voltage for several values of plate voltage. Corresponding amplification factor, plate resistance, and transconductance characteristics are given in Figures 4, 5, and 6, respectively. Plate current characteristics as functions of plate voltage for several values of grid voltage are shown in Figure 7. These characteristics are for direct-current filament supply with the grid and plate voltages measured from the negative end of the filament. When alternating-current filament supply is used, the same characteristics are applicable if 2.6 is added to the numerical value of each grid bias.

Microphonic Noise—With a plate voltage of 350 volts, a grid bias of -22.5 volts, and a load resistance of 100,000 ohms, the mean microphonic noise output level of 205E tube measured in a laboratory reference test set is 25 decibels below 1 volt. The range of levels of individual tubes extends from 16 to 33 decibels below 1 volt. Since microphonic noise depends on the type and intensity of the mechanical disturbance which produces it, the values given here are useful chiefly for comparison with the levels of other tubes which have been tested in the same way.

Sputter Noise—A particularly disagreeable type of noise, characterized by an unmusical crackling or sputtering sound, occurs in many vacuum tubes, sometimes as a result of slight mechanical agitation. The sputter noise spectrum covers a wide band and may be of appreciable intensity even at radio frequencies. Such noise is usually due either to discontinuously variable insulation leaks

between electrodes or to intermittent contacts involving conducting members such as filament supports which, at times of no contact, are insulated from other parts of the tube. Special precautions have been taken in the design of the 205E tube to eliminate this type of noise.

Limiting Conditions for Safe Operation

	Class A Amp.	*Class B R-F Amp.	Class C R-F Amp. or Osc.	*Class C R-F Amp. Plate Modulated
Maximum direct plate voltage	400	400	400	350 volts
Maximum direct plate current	50	35	50	40 milliamperes
Maximum plate dissipation	14	14	14	10 watts
Maximum direct grid current	—	10	10	10 milliamperes

*Carrier conditions for use with modulation factors up to 1.0.

Operating Conditions and Output

Class A—Amplifier or Modulator

Permissible operating grid and plate voltage for Class A operation are included within the area, ABCD, in Figure 3. Amplification factor, plate resistance, transconductance, and performance data are given in Table I for a number of typical operating conditions represented by selected points within this area. A less severe operating condition should be selected in preference to a maximum operating condition wherever possible. The life of the tube at maximum operating conditions may be shorter than at less severe conditions.

The performance data include the fundamental power output in milliwatts and the levels of the second and third harmonics in decibels below the fundamental for values of load resistance, R , equal to one, two, and in some cases three times the plate resistance, r_p . The peak value of the sinusoidal input voltage, E_{gm} , which gives the indicated power output, P_m , and harmonic levels, F_{2m} and F_{3m} , in each case, is numerically equal to the grid bias. For a smaller input voltage, E_g , the output and harmonic levels are given approximately by the following relations:

$$P = P_m \left(\frac{E_g}{E_{gm}} \right)^2$$

$$F_2 = F_{2m} + 20 \log_{10} \frac{E_{gm}}{E_g}$$

$$F_3 = F_{3m} + 40 \log_{10} \frac{E_{gm}}{E_g}$$

TABLE I

Plate Voltage	Grid Bias	Plate Current	Amplification Factor	Plate Resistance	Trans-conductance	Input Voltage	Load Resistance	Power Output	Second Harmonic	Third Harmonic
Volts	Volts	Milli-amperes		Ohms r_p	Micro-mhos	Peak Volts	R	Milli-watts	db	db
200	- 6	22.5	7.4	4000	1840	6	$R = r_p$	60	35	65
							$R = 2r_p$	55	40	70
250	-22	9	6.9	6000	1160	22	$R = r_p$	500	18	33
							$R = 2r_p$	450	22	40
							$R = 3r_p$	380	26	47
250	- 15	19	7.2	4350	1670	15	$R = r_p$	310	26	45
							$R = 2r_p$	280	30	55
250	- 10	27.5	7.4	3800	1950	10	$R = r_p$	180	33	60
							$R = 2r_p$	160	38	65
250	- 5	37.5	7.5	3500	2150	5	$R = r_p$	50	40	70
							$R = 2r_p$	45	43	70
300	-30	8	6.7	6700	1000	30	$R = r_p$	800	15	28
							$R = 2r_p$	720	20	35
							$R = 3r_p$	600	24	42
300	-24	15.5	7.1	4800	1460	24	$R = r_p$	750	20	36
							$R = 2r_p$	670	25	45
300	- 18	25	7.3	4000	1830	18	$R = r_p$	540	27	46
							$R = 2r_p$	480	31	55
350	-22.5	29	7.3	3800	1940	22.5	$R = r_p$	875	26	44
							$R = 2r_p$	800	30	50
375	-30	22	7.1	4300	1660	30	$R = r_p$	1300	20	36
							$R = 2r_p$	1200	26	45
*300	- 10	41	7.4	3350	2220	10	$R = r_p$	200	37	65
							$R = 2r_p$	180	41	70
*350	-20	34	7.3	3600	2060	20	$R = r_p$	750	28	50
							$R = 2r_p$	675	32	55
*375	-24	32	7.3	3650	1990	24	$R = r_p$	1000	26	44
							$R = 2r_p$	900	30	55
*400	-29	30	7.2	3800	1890	29	$R = r_p$	1400	23	39
							$R = 2r_p$	1300	28	48

*Maximum operating conditions.

Class B—Amplifier

Radio telephone applications, particularly the amplification of a modulated carrier wave with a minimum of distortion. Typical carrier conditions for use with a modulation factor up to 1.0 are shown in Table II.

TABLE II

Direct Plate Voltage	Grid Bias	Direct Plate Current	Driving Voltage		Power Output		Effective Load Resistance	Peak Driving Power
			Carrier	A-F Peak	Carrier	A-F Peak		
Volts	Volts	Milli-amperes	Peak Volts	Volts	Watts	Watts	Ohms	Watts
350	-48	28	69	138	2.5	10	3100	1
400	-56	28	73	146	3.0	12	3700	1

Class C—Amplifier or Oscillator

Radio telegraph or other continuous-wave applications. Typical operating conditions are shown in Table III.

TABLE III

Direct Plate Voltage	Grid Bias	Direct Plate Current	Driving Voltage	Power Output	Effective Load Resistance	Driving Power
Volts	Volts	Milli-amperes	Peak Volts	Watts	Ohms	Watts
350	- 96	45	186	8.3	3750	1.3
400	-112	45	202	10.0	4500	1.5

Class C—Amplifier—Plate modulated

Radio telephone applications. Typical carrier conditions for use with modulation factors up to 1.0 are shown in Table IV.

TABLE IV

Direct Plate Voltage	Grid Bias	Direct Plate Current	Driving Voltage	Power Output	Effective Load Resistance	Driving Power
Volts	Volts	Milli-amperes	Peak Volts	Watts	Ohms	Watts
300	-120	35	205	6.0	4000	1.3
350	-144	35	229	7.1	5000	1.7

High Frequency Ratings

If the 205E tube is to be used at frequencies higher than 15 megacycles, the plate voltage and plate dissipation ratings given above should be reduced to avoid excessive high-frequency currents, excessive heating due to dielectric losses, and consequent injury to the tube. At the limiting frequency of 30 megacycles, the maximum ratings should be as follows:

Maximum plate voltage.....	300 volts
Maximum plate dissipation.....	10 watts
Maximum r-f grid current.....	3 amperes

205E

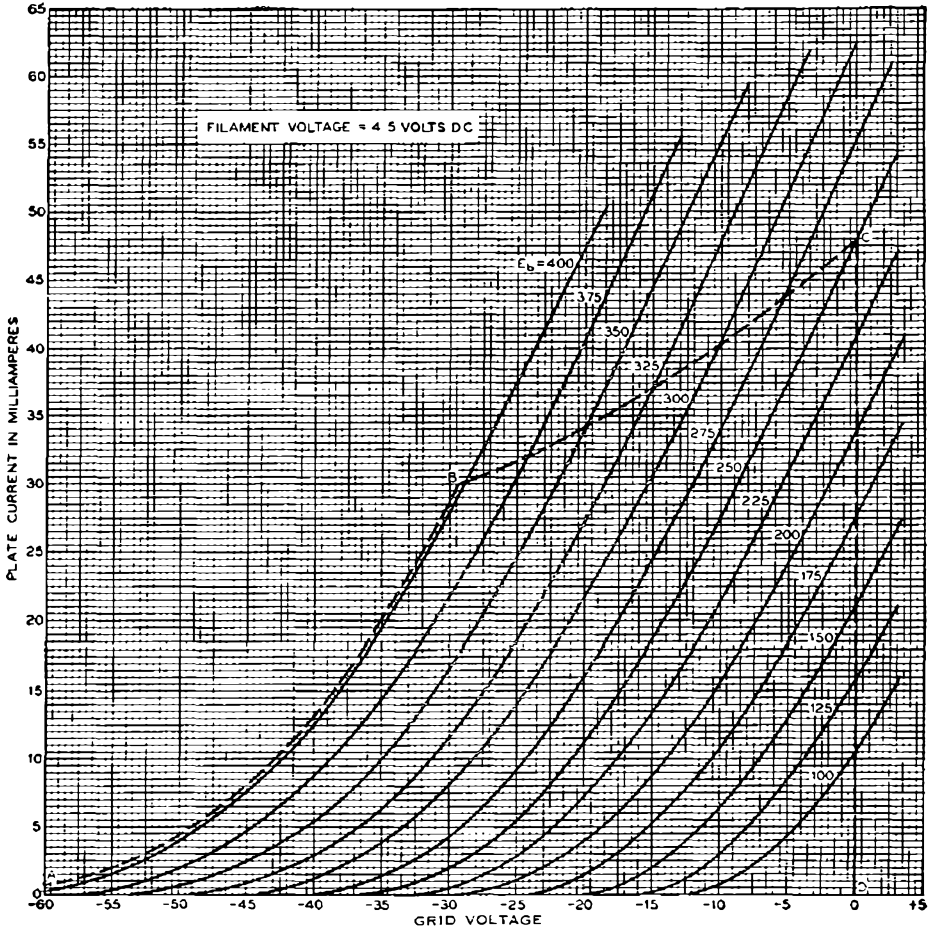
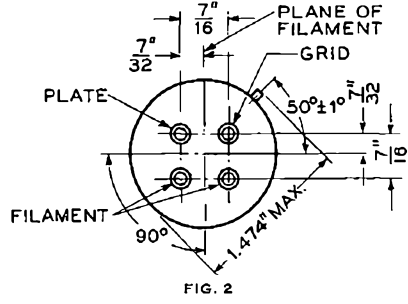
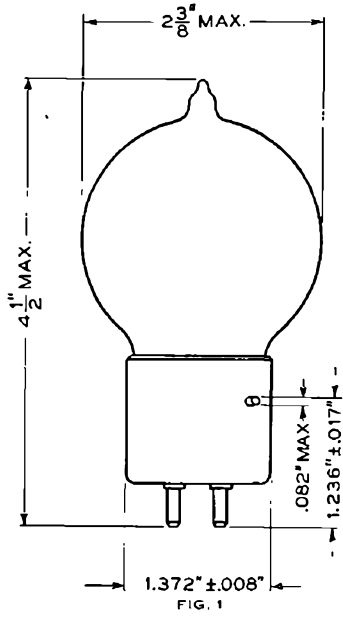

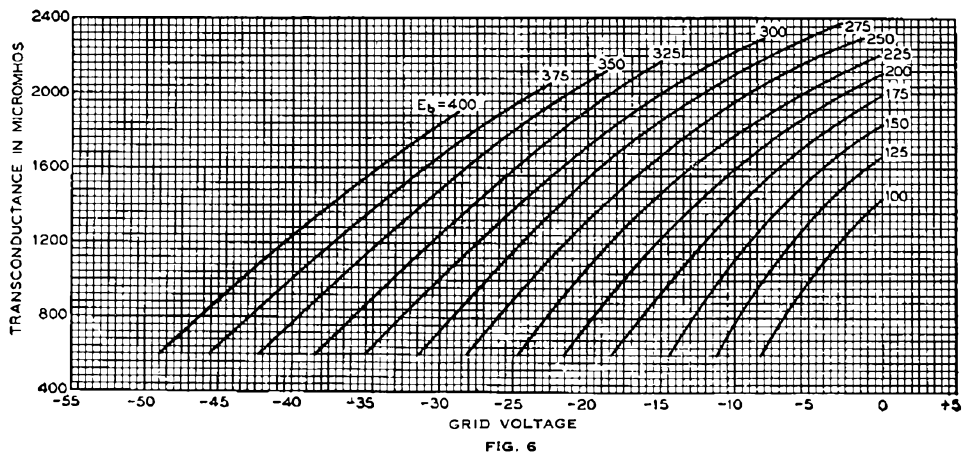
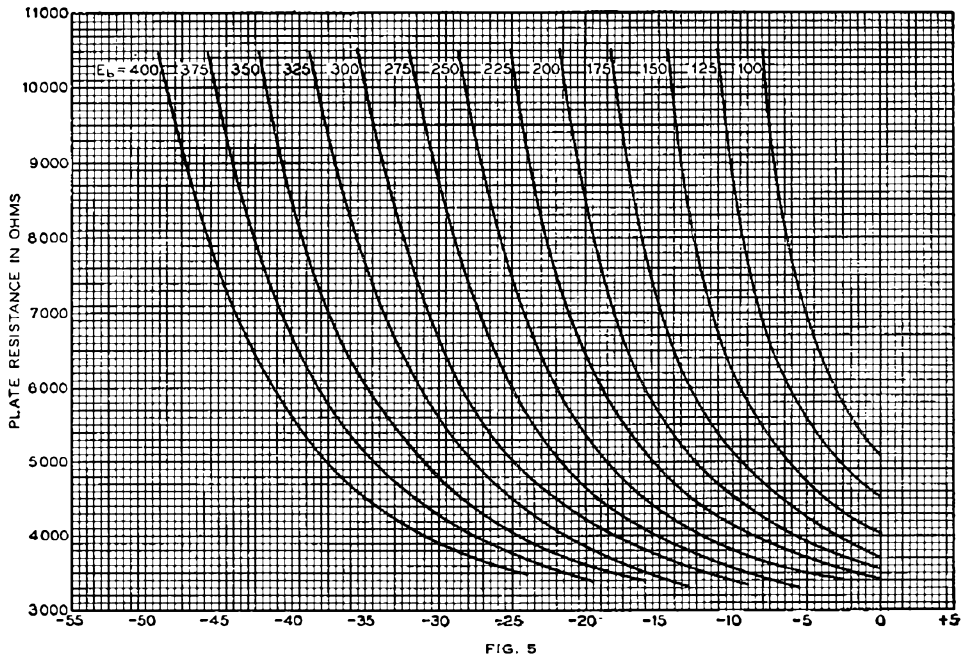
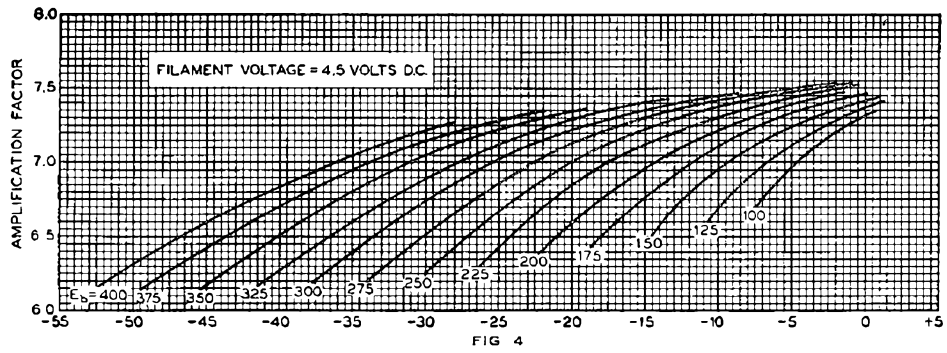

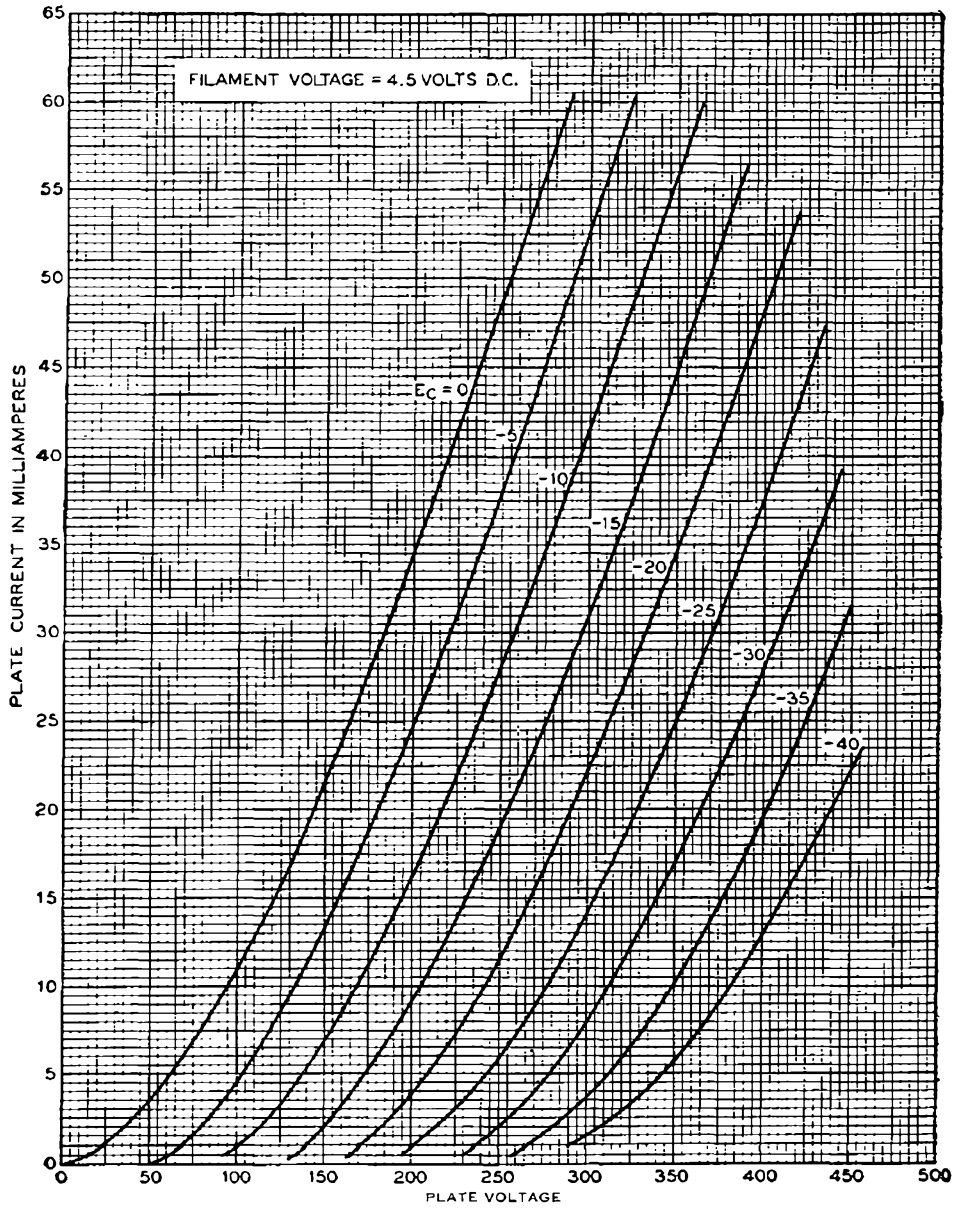

FIG. 7

1-C-36-3M
PRINTED IN U.S.A.

A development of Bell Telephone Laboratories, Incorporated,
the research laboratories of the American Telephone and Tele-
graph Company, and the Western Electric Company

V. T. DATA SHEET 205E
ISSUE 1

205F

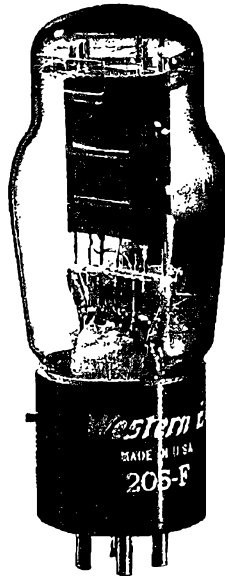

**TRIODE
POWER AMPLIFIER**

Western Electric

DESCRIPTION

The 205F is a filamentary triode designed for use as an audio-frequency power amplifier or modulator.

CHARACTERISTICS

Filament Voltage	4.5 volts
Plate Current	35 milliamperes
Power Output	880 milliwatts

$E_b = 350$ volts; $E_c = -22.5$ volts

GENERAL CHARACTERISTICS**ELECTRICAL DATA**

Filament Voltage, A-C or D-C	4.5 volts
Filament Current	1.6 amperes
Direct Interelectrode Capacitances	
Grid to Plate	5.9 uuf
Input	4.1 uuf
Output	2.2 uuf

MECHANICAL DATA

Cathode	Coated Filament
Base	Medium 4-pin, bayonet type with bayonet pin offset
Mounting Position	Preferably vertical; if horizontal, pins #1 and #2 must lie in same vertical plane

Dimensions and pin connections shown in outline drawing on Page 5

MAXIMUM RATINGS, Design-Center Values

Plate Voltage	360 volts
Plate Current	50 milliamperes
Plate Dissipation	12.5 watts

TYPICAL OPERATING CONDITIONS AND CHARACTERISTICS

Filament Voltage, A-C	4.5	4.5	4.5	4.5 volts
Plate Voltage	250	300	350	350 volts
Grid Voltage*	-22	-18	-22.5	-22.5 volts
Peak A-F Signal Voltage	22	18	22.5	22.5 volts
Zero Signal Plate Current	11.5	30	35	35 milliamperes
Maximum Signal Plate Current	12	30.5	36	36 milliamperes
Transconductance	1350	1880	1950	1950 micromhos
Plate Resistance	5300	3800	3700	3700 ohms
Load Resistance	12000	8000	4000	8000 ohms
Amplification Factor	7.2	7.2	7.2	7.2
Maximum Signal Power Output	550	450	880	760 milliwatts
Total Harmonic Distortion	4.6	1.6	2.8	1.4 per cent

*If the filament is operated on D.C., the characteristics will be approximately the same if the grid voltage, measured from the negative filament, is decreased by 2.3 volts.

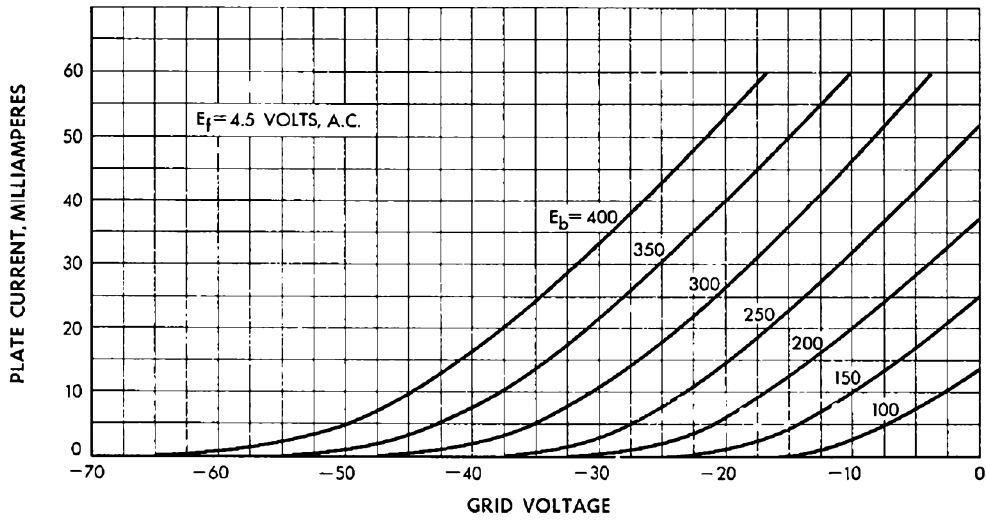
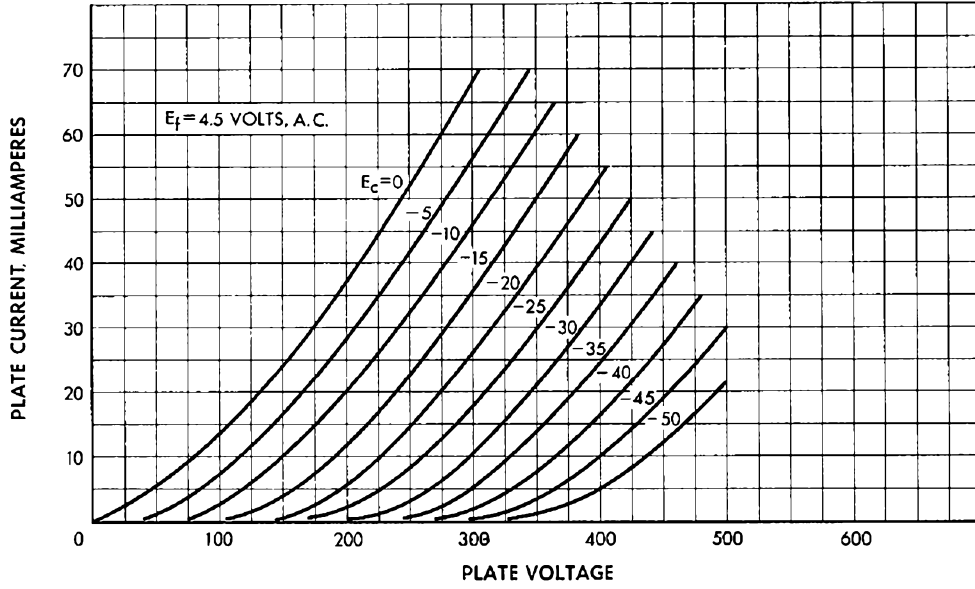

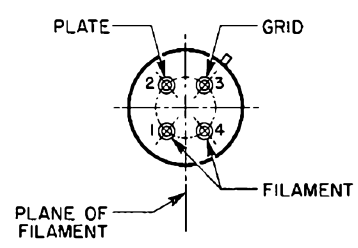
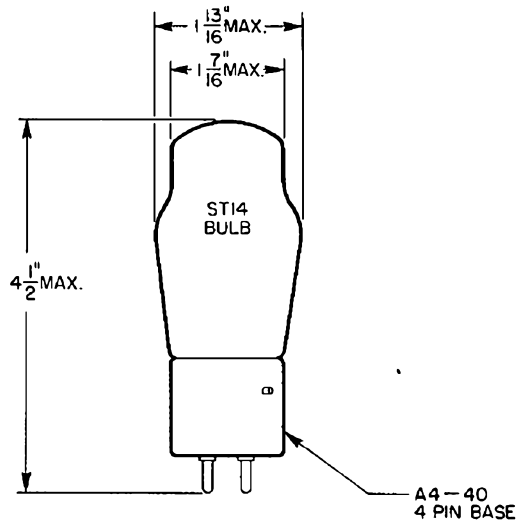
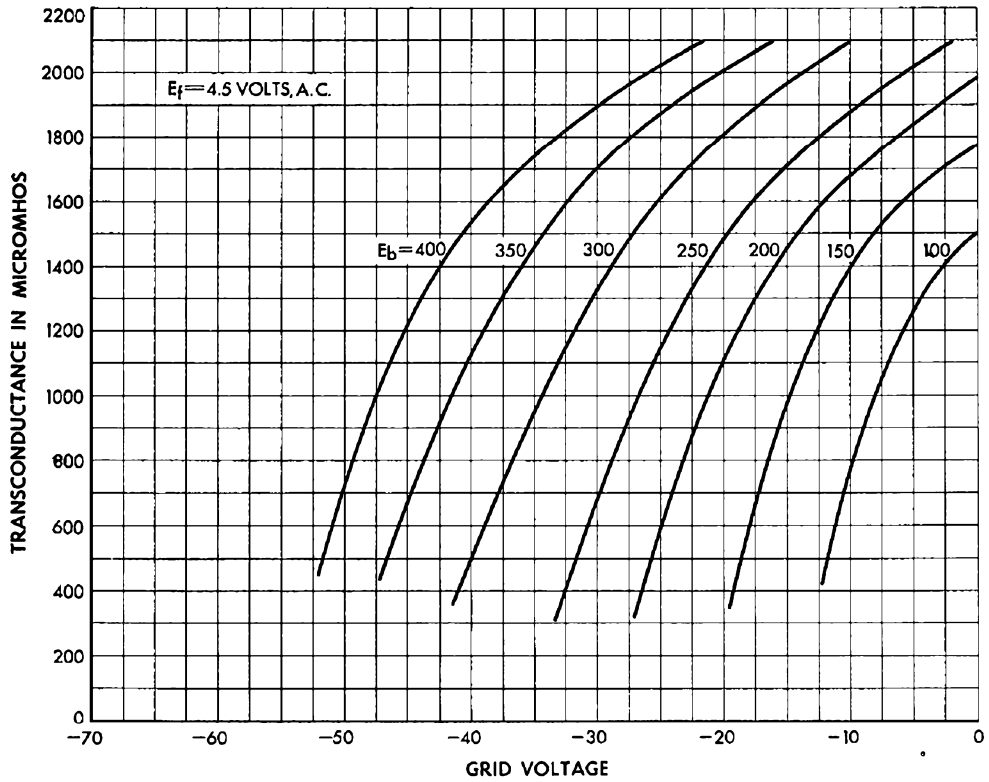

ELECTRON TUBE DATA SHEET
 FILE: GENERAL PURPOSE SECTION
 12-48

212E Vacuum Tube

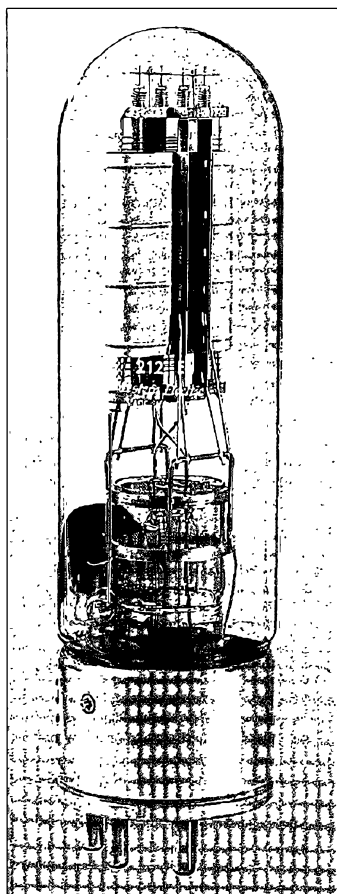

Classification—Filamentary Air-cooled Triode

May be used as an audio-frequency amplifier or modulator, or as a radio-frequency oscillator or amplifier

Mounting

Large four-pin bayonet base for use in a W E 113A or similar socket, for either vertical or horizontal mounting. If mounted horizontally the plane of the filament, which is indicated in Figure 2, should be vertical.

Filament

Thoriated tungsten
Filament voltage 14 volts
Nominal filament current ... 6 amperes
Average thermionic emission 4 amperes

Average Direct Interelectrode

Capacitances

Plate to grid 18.8 $\mu\mu\text{f}$
Grid to filament 14.9 $\mu\mu\text{f}$
Plate to filament 8.6 $\mu\mu\text{f}$

Characteristics

Performance data given below are based upon a typical set of conditions. Variations can be expected with different circuits and tubes. Figures 3 and 4 give the static characteristics of a typical tube plotted against grid and plate voltages.

Average Characteristics at 2000 volts direct plate potential and minus 90 volts grid bias
Amplification factor 16
Plate resistance 1900 ohms
Grid to plate transconductance 8500 micromhos

Each 212E vacuum tube falls within one of four impedance classes and is stamped accordingly. These classifications are #1, #2, #3 and #4, and are in no way a gradation of quality, but are to facilitate parallel operation in the ordinary system using a common rectified supply. Where more than one tube is used, those of the same or adjacent classes should be employed so that the load may be evenly distributed. When only a single tube is used no one of the classes has any advantage over the other. Tubes may be ordered according to impedance classification at an extra charge.

With a plate voltage of 1500 volts, a grid bias of -60 volts and a filament voltage of 14, the plate current will be as follows for each impedance class

- # 1 110-129 milliamperes, inclusive
- # 2 130-148 milliamperes, inclusive
- # 3 149-167 milliamperes, inclusive
- # 4 168-185 milliamperes, inclusive

Operating Precautions

Mechanical—Figures 1 and 2 show the overall dimensions and basing arrangements for the tube.

The tubes should not be subjected to mechanical shock or excessive vibration. Mechanical vibration may cause breakage of the thoriated tungsten filaments.

A free circulation of air must be provided to insure adequate cooling of the glass during operation.

Electrical

Overload protection should always be provided for the plate circuit. A suitable fuse or circuit breaker should remove the plate voltage if the plate current exceeds 350 milliamperes. Although the tube is sufficiently rugged to withstand momentary overloads, a prolonged overload caused by inefficient adjustment of the circuit, may damage the tube. When adjusting a new circuit, reduced plate voltage or a series resistance of 1000 to 5000 ohms in the plate circuit should be used until it is operating properly.

The filament should always be operated at the rated voltage, measured at the tube terminals. A 5% decrease in filament voltage reduces the thermionic emission approximately 25%. Either direct or alternating current may be used for heating the filament. If direct current is used, the plate and grid circuit returns should be connected to the negative filament terminal. If alternating current is used, the circuit returns should be connected to the center tap of the filament heating transformer winding or to the center tap of a resistor placed between the filament terminals. A resistance of 30 to 40 ohms of ten watt rating is suitable.

In cases where severe and prolonged overload has temporarily impaired the electronic emission of the filament, the activity may be restored by operating the filament, with the plate grid voltages off, 30% above normal voltage for 10 minutes followed by a longer period at normal voltage.

212E Vacuum Tube

Operation

Maximum Ratings		
Max direct plate voltage	3000	volts
Max direct plate current	350	milli amperes
Max plate dissipation	275	watts
Max direct grid current	75	milli amperes
Max r-f grid current	5	amperes
Max frequency for the above ratings	1.5	megahertz
Max plate voltage for upper frequency limit of 4.5 MHz	1000	volts
Max plate voltage for frequencies between 1.5 and 4.5 MHz in proportion		

The above are maximum ratings which do not apply simultaneously but depend on the type of service as specified below.

Class A Audio Amplifier or Modulator

Direct plate voltage	1500	1250	volts
Grid bias	-57	-40	volts
Direct plate current	170	200	milli amperes
Plate dissipation	250	250	watts
Load impedance	5000	3000	ohms
Undistorted output	50	40	watts

Grid Bias Modulator

Direct plate voltage	3000	volts
Grid bias	-260	volts
Plate dissipation	175	watts
Load impedance	8000	ohms
Peak power output	200	watts

Class B Audio Amplifier or Modulator for balanced 2 tube circuit

Direct plate voltage	2000	1500	volts
Grid bias	-105	-75	volts
Direct plate current per tube (no drive)	40	50	milli amperes
Max drive	300	300	milli amperes
Plate dissipation	250	250	watts
Load (res. plate-to-plate)	8000	5900	ohms
Load (res. per tube)	2000	1475	ohms
Approx. max. output	650	500	watts
Recommended power for driving stage	50	50	watts

Class B Radio-Frequency Amplifier

Direct plate voltage	2000	1500	volts
Direct plate current	300	300	milli amperes
Plate dissipation	275	275	watts
Grid bias	-120	-90	volts
Approx. carrier watts for use with 100% modulation	200	150	watts

Class C Radio-Frequency Oscillator or Power Amplifier—Unmodulated

Direct plate voltage	2000	1500	volts
Direct plate current	300	300	milli amperes
Grid bias	-185 to -250	-150 to -200	volts
Nominal power output	400	300	watts

Class C Radio-Frequency Amplifier—Plate Modulated

Direct plate voltage	1500	1000	volts
Direct plate current	300	300	milli amperes
Grid bias	-200	-125	volts
Max direct grid current	75	75	milli amperes
Nominal carrier power output for use with 100% modulation	300	200	watts

Dimensions

Dimensions and outline diagrams are shown in Figures 1 and 2. The overall dimensions are:

Maximum overall length	13.5"
Maximum diameter	3.5"

Audio Amplifier or Modulator

Class A—Peak grid drive equal to or less than the grid bias.

Grid bias may be obtained from the drop across a resistance in the plate current return or from a rectified supply.

Plate dissipation allowable for this type of service is generally lower than is safe for other uses since the energy is dissipated in the plate in smaller areas due to relatively high voltage drop in the tube.

The plate dissipation is equal to the plate voltage multiplied by the normal plate current. Performance data are based upon the use of a resistance load. Undistorted output is calculated on the basis of 5% second harmonic distortion.

Class B—Grid bias practically at cut-off and grid driving voltage higher than the bias.

Two tubes may be used in a balanced circuit. An adequate driving stage and an input transformer with good regulation must be used so that the grid current drawing during positive grid swings does not produce appreciable distortion. The output transformer must transform the load impedance to the proper value for the tubes used. The power output obtainable will be determined by the quality of the transformer used and the amount of distortion which can be tolerated. The grid bias must be held constant and therefore cannot be obtained by grid leak or series resistor methods. A rectified d.c. supply or other source having good regulation is necessary.

The power required of a modulator for complete modulation of a Class C amplifier is one-half the direct power input to the plates of the Class C amplifier.

212E Vacuum Tube

Radio-Frequency Oscillator or Power Amplifier

Class B—Radio Frequency Amplifier
 The Class B radio-frequency amplifier is used to amplify a modulated radio-frequency carrier wave without appreciable distortion. It operates similarly to the Class B audio amplifier except that a single tube may be used, the tuned output circuit serving to preserve the wave shape. The push-pull circuit, however, eliminates the even order harmonics and thus increases the efficiency slightly.

Class C—Radio-Frequency Oscillator or Power Amplifier—Grid bias below cut-off Unmodulated
 This type of operation is suitable for telegraphy, or the production of a continuous flow of radio-frequency power for purposes other than communication.

Plate Modulated
 This type of operation is for use when the modulating voltage is superimposed on the plate supply voltage and to obtain good quality the output power should vary as the square of the plate voltage. For complete or 100% modulation, the plate voltage varies from zero to twice the applied direct value during a cycle of the audio frequency. With no modulation applied, the plate voltage is, of course, the direct value and the carrier power output is one-fourth of the peak power output under 100% modulation. In this case, since the plate voltage varies with modulation, the direct value must be rated lower than for other types of operation.

High Frequency Ratings

The frequency limits specified under maximum ratings are based on the tube being used as an oscillator. The tube may be used at full rating up to 1.5 megaHertz. When operating at higher frequencies, the dielectric losses, charging currents and lead in heating are increased greatly. The plate voltage and hence plate dissipation must be reduced to values specified for the upper frequency limit and for frequencies between these two limits the plate voltage should be proportionately reduced.

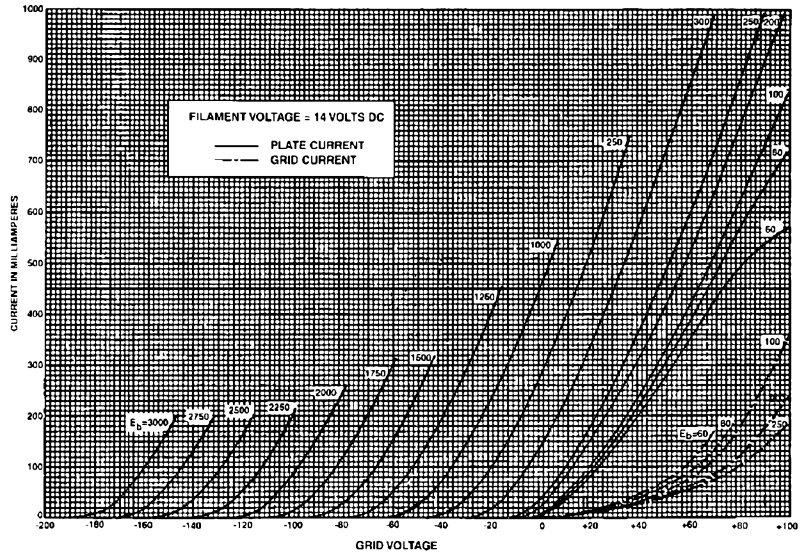

FIG. 3

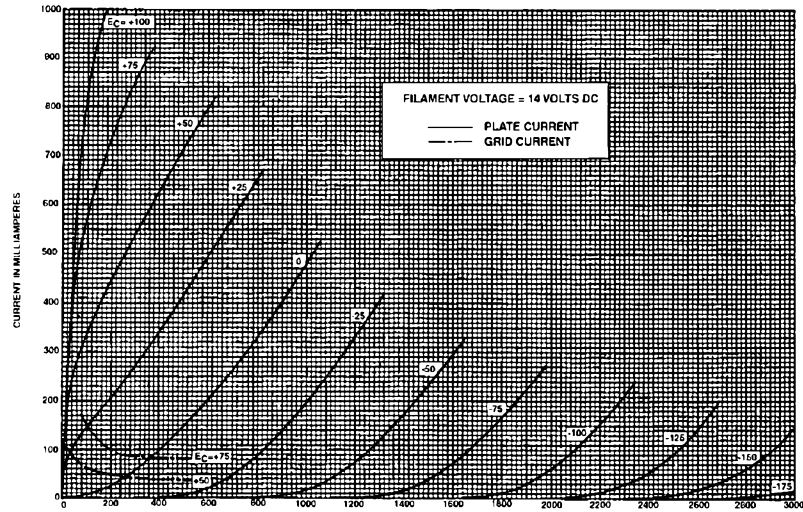
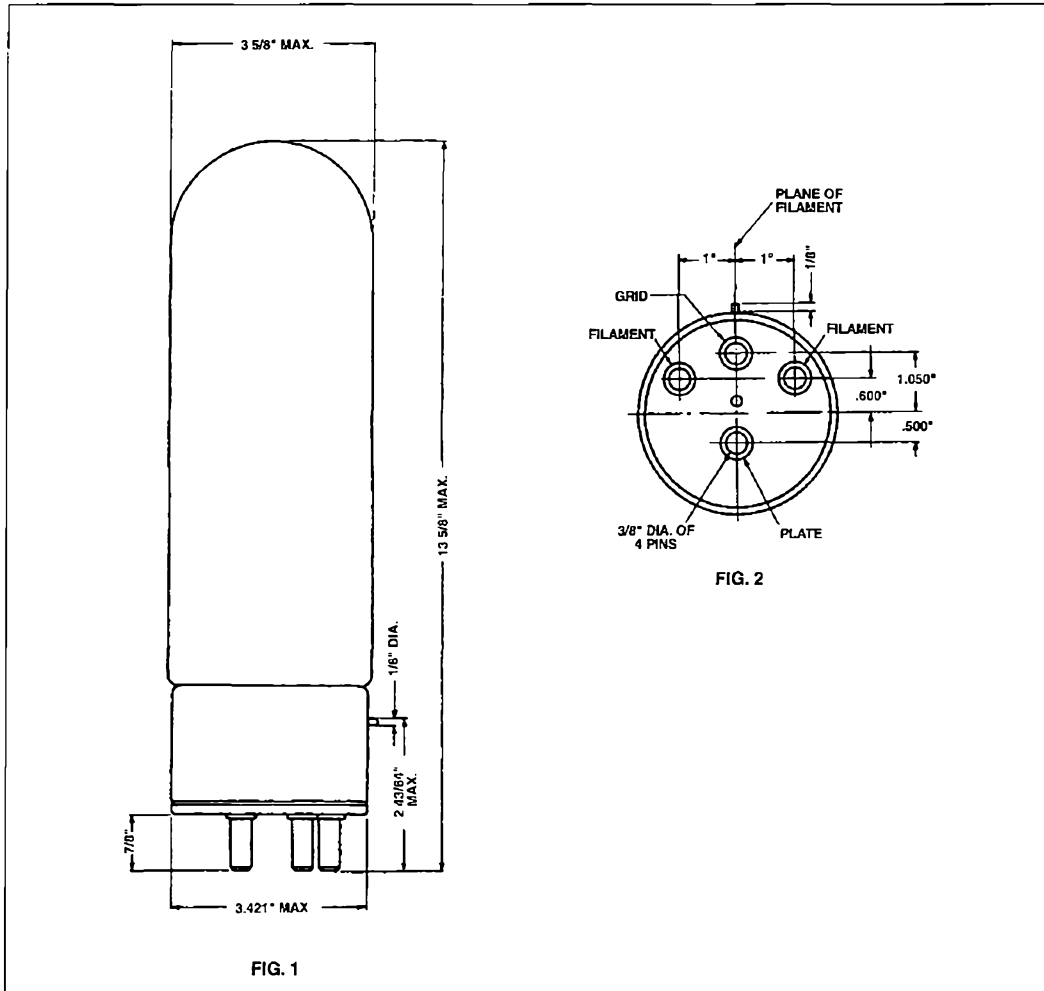

FIG. 4



Ordering Information

(Order by Code and Comcode)

Electron Tubes

Code	Description	Comcode
212E	Air Cooled Triode	N/A

Western Electric High Fidelity products are marketed worldwide exclusively by Westrex Corporation

Western Electric electron tubes are manufactured in the U.S.A. Developments of AT&T Bell Telephone Laboratories, incorporated research laboratories of AT&T

Western Electric[®]
High Fidelity

For more information please contact: your Western Electric Sales Representative

Westrex Corporation
AT&T Promenade II
1230 Peachtree Street
Suite 3750
Atlanta, Georgia 30309-3575
404-874-4400 • 404-874-4415 Facsimile

Western Electric is a trademark of AT&T licensed to Westrex Corporation, independent of AT&T. Westrex is a trademark of Westrex Company, Limited formerly Western Electric Company, Limited

Westrex Corp. reserves the right to make changes to the products described in this document in the interest of improving internal design, operational function and/or reliability. Westrex Corp. does not assume any liability, which may occur due to use or application of the products, or circuit layouts as described herein.

Copyright © 1968 Westrex Corp. All Rights Reserved
Printed in U.S.A.

Western Electric

215A Vacuum Tube

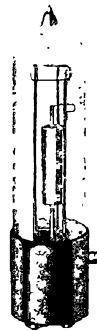

Classification—Small, filamentary triode

Important features of the 215A tube are its small size and low filament power consumption.

Applications

Audio-frequency and intermediate-frequency amplifier

Detector

Oscillator

Dimensions—Dimensions, outline diagrams of the tube and base, and the arrangement of the electrode connections to the base terminals are shown in Figures 1 and 2.

Base—Small, four-terminal, bayonet base having silver contacts.

Socket—Four-contact, bayonet-slot type preferably provided with contact-metal contacts, such as the Western Electric 125B socket.

Mounting Positions—The 215A tube may be mounted in any position.

Average Direct Interelectrode Capacitances

Grid to plate.....	2.6 $\mu\mu\text{f.}$
Grid to filament.....	1.6 $\mu\mu\text{f.}$
Plate to filament.....	1.2 $\mu\mu\text{f.}$

Filament Rating

Filament current.....	0.25 ampere, d.c.
Nominal filament voltage.....	1.0 volt

The filament of this tube is designed to operate on a current basis and should be operated at as near the rated current as is practicable.

Characteristics—Plate current characteristics of a typical 215A tube are shown in Figure 3 as functions of grid voltage for several values of plate voltage. Corresponding amplification factor, plate resistance, and transconductance characteristics are given in Figures 4, 5 and 6, respectively. Plate current characteristics as functions of plate voltage are shown in Figure 7 for several values of grid voltage. The grid and plate voltages for all of these characteristics are measured from the negative end of the filament.

Operating Conditions and Output—Permissible operating conditions are included within the area, ABCD, in Figure 3. Amplification factor, plate resistance, transconductance, and performance data are given in the table on page 3 for a number of typical amplifier operating conditions represented by selected points within this area. Typical detector operating conditions for both plate current and grid current detection are also listed in the table. The less severe operating conditions should be selected in preference to maximum operating conditions wherever possible. The life of the tube at maximum conditions may be shorter than at less severe conditions.

The performance data include the fundamental power or voltage output and the second and third harmonic levels for the indicated values of load resistance and input voltage. The fundamental output is given in terms of the power, P_m , in milliwatts for values of load resistance, R , equal to and double the value of the plate resistance, r_p , and in terms of the voltage, E_{pm} , in peak volts for values of load resistance five times the plate resistance. The second and third harmonic levels, F_{2m} and F_{3m} , are given in decibels below the fundamental in each case. The peak value of the sinusoidal input voltage, E_{gm} , is numerically equal to the grid bias for each operating condition. For a smaller input voltage, E_g , the output and harmonic levels, except for the lowest values of third harmonic, are given approximately by the following relations:

$$P = P_m \left(\frac{E_g}{E_{gm}} \right)^2$$

$$E_p = E_{pm} \frac{E_g}{E_{gm}}$$

$$F_2 = F_{2m} + 20 \log_{10} \frac{E_{gm}}{E_g}$$

$$F_3 = F_{3m} + 40 \log_{10} \frac{E_{gm}}{E_g}$$

The level of the third harmonic in the 215A tube is usually low and may differ widely in individual tubes. The values given in the table are for a typical tube.

TABLE

Plate Voltage	Grid Bias	Plate Current	Amplification Factor	Plate Resistance	Transconductance	Input Voltage	Load Resistance	Power Output	Voltage Output	Second Harmonic	Third Harmonic
Volts	Volts	Milli-amperes		Ohms r_p	Micro-mhos	Peak Volts	R	Milli-watts	Peak Volts	db	db
45.0	-3.0	1.0	5.7	16500	340	3.0	$R = r_p$	2.2	14.0	29	50
							$R = 2r_p$	1.9		34	60
							$R = 5r_p$			39	65
45.0	-1.5	1.6	5.8	14500	400	1.5	$R = r_p$	0.60	7.2	40	65
							$R = 2r_p$	0.55		45	70
							$R = 5r_p$			49	70
60.0	-3.0	2.0	5.7	13500	420	3.0	$R = r_p$	2.9	14.5	35	60
							$R = 2r_p$	2.6		40	65
							$R = 5r_p$			45	70
67.5	-6.0	1.4	5.6	15500	360	6.0	$R = r_p$	9.4	28.5	25	45
							$R = 2r_p$	8.3		30	50
							$R = 5r_p$			35	60
67.5	-4.5	2.0	5.7	14000	410	4.5	$R = r_p$	6.0	22.0	31	50
							$R = 2r_p$	5.5		36	60
							$R = 5r_p$			40	70
*67.5	-4.0	2.2	5.7	13500	420	4.0	$R = r_p$	5.0	19.5	34	55
							$R = 2r_p$	4.5		38	60
							$R = 5r_p$			43	70
*90.0	-8.0	2.2	5.6	14000	400	8.0	$R = r_p$	18	40.0	26	45
							$R = 2r_p$	16		31	55
							$R = 5r_p$			37	65
*100.0	-10.0	2.1	5.6	14500	390	10.0	$R = r_p$	26	47.0	24	35
							$R = 2r_p$	23		29	40
							$R = 5r_p$			36	40
22.5	-4.0	0.01	}	Plate current detection.							
45.0	-9.0	0.01									
67.5	-14.0	0.01									
22.5	+1.0	1.0	}	Grid current detection. Grid bias usually obtained by connecting grid return to positive end of filament.							
*45.0	+1.0	2.6									

*Maximum operating conditions

Microphonic Noise—With a plate voltage of 60 volts, a grid bias of -3 volts, and a load resistance of 100,000 ohms, the mean microphonic noise output level of the 215A tube, measured in a laboratory reference test set, is 27 decibels below 1 volt. The range of levels of individual tubes extends from 12 to 42 decibels. Since microphonic noise depends on the type and intensity of the mechanical disturbance which produces it, the values given here are useful chiefly for comparison with the levels of other tubes which have been tested in the same way.

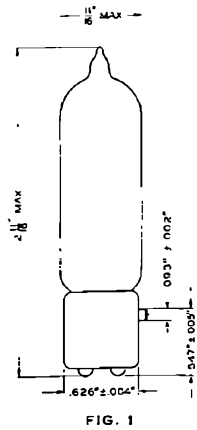

FIG. 1

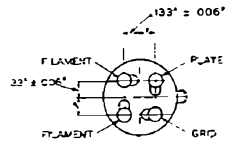

FIG. 2

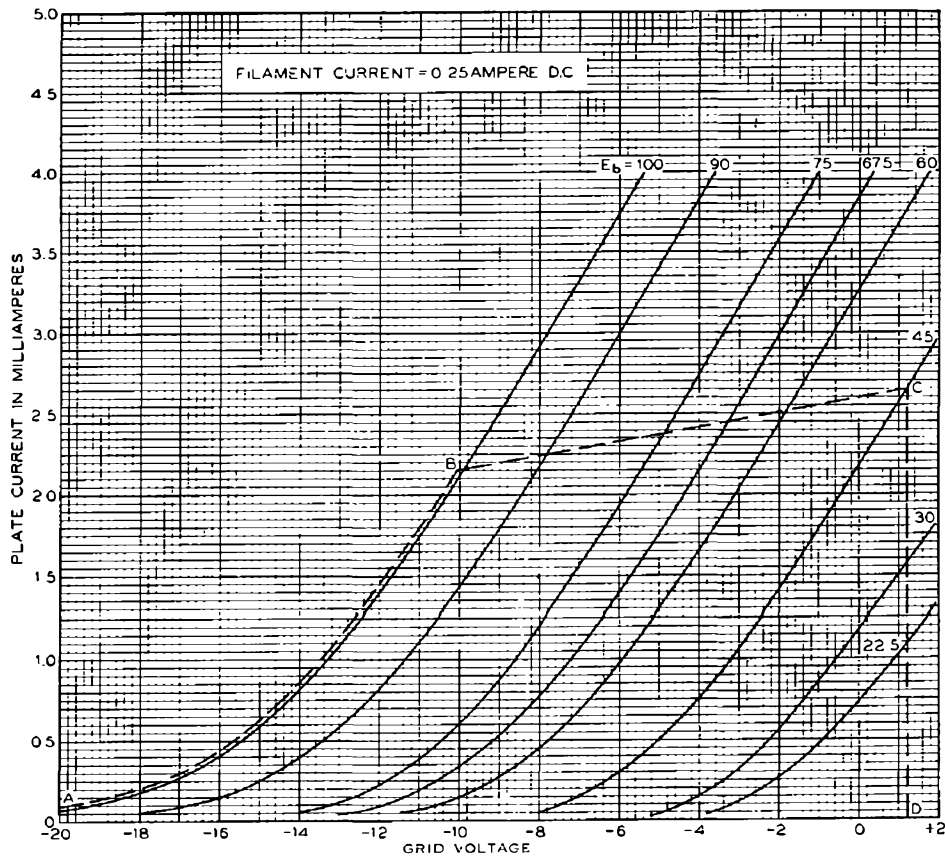

FIG. 3

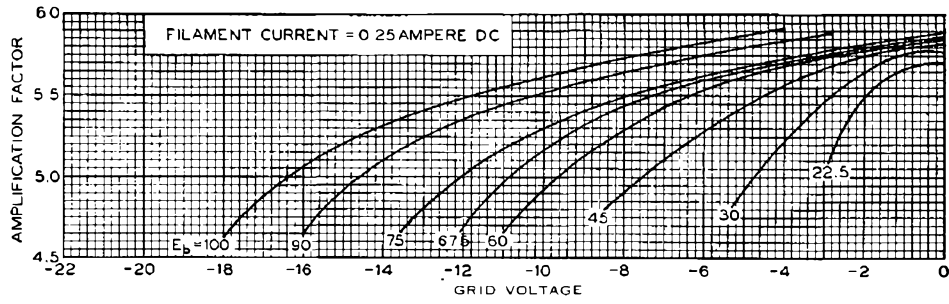

FIG. 4

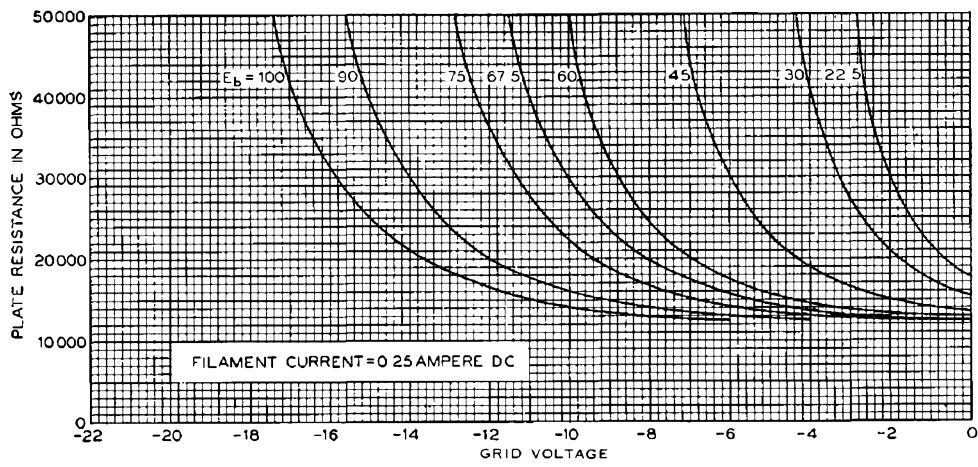

FIG. 5

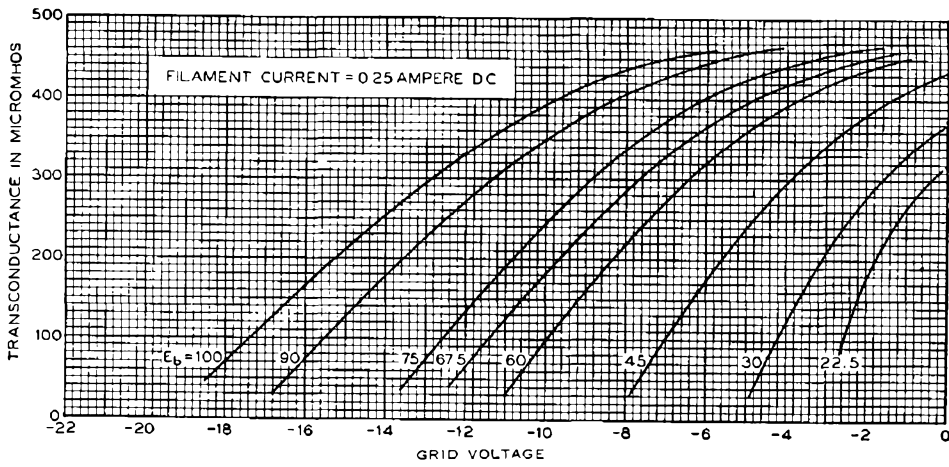

FIG. 6

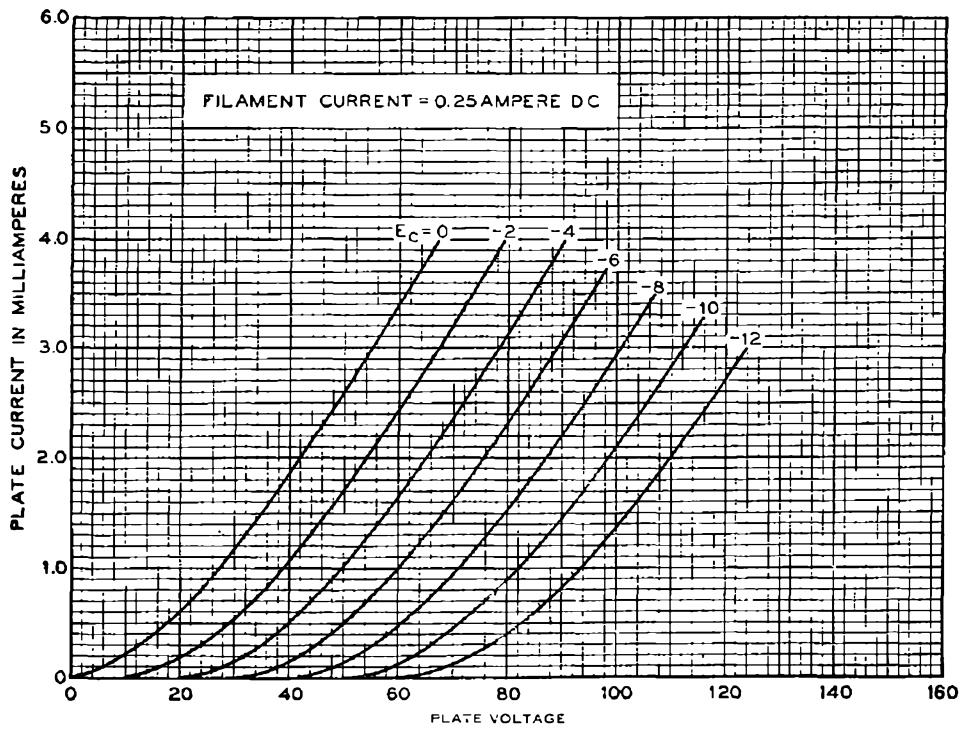
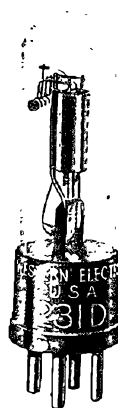

FIG. 7

Western Electric

231D Vacuum Tube



Classification—Small, filamentary triode

An important feature of the 231D tube is its low filament power consumption.

Applications

Audio-frequency and intermediate-frequency amplifier.

Detector.

Oscillator.

Dimensions—Outline diagrams showing dimensions of the tube and base, and the arrangement of the electrode connections to the base terminals are given in Figures 1 and 2.

Base—Small, four-pin, thrust type.

Socket—Standard four-contact type such as the Western Electric 143B socket.

Mounting Positions—Either vertical or horizontal. If mounted in a horizontal position the plane of the filament, which is indicated in Figure 2, should be vertical.

Average Direct Interelectrode Capacitances

Grid to plate	3.6 $\mu\mu\text{f.}$
Grid to filament	2.5 $\mu\mu\text{f.}$
Plate to filament	2.5 $\mu\mu\text{f.}$

Filament Rating

Filament current	0.060 ampere, d.c.
Nominal filament voltage	3.1 volts

The filament of this tube is designed to operate on a current basis and should be operated at as near the rated current as is practicable.

Characteristics—Plate current characteristics of a typical 231D tube are shown in Figure 3 as functions of grid voltage for several values of plate voltage. The grid and plate voltages are measured from the negative end of the filament. Corresponding amplification factor, plate resistance, and transconductance characteristics are given in Figures 4, 5 and 6, respectively. Plate current characteristics as functions of plate voltage are shown in Figure 7 for several values of grid voltage.

Operating Conditions and Output—Permissible operating plate and grid voltages are included within the area, ABCD, in Figure 3. Amplification factor, plate resistance, transconductance, and performance data are given in the table on page 3 for a number of typical operating conditions represented by selected points within this area. The less severe operating conditions should be selected in preference to maximum operating conditions wherever possible. The life of the tube at maximum conditions may be shorter than at less severe conditions.

The performance data include the fundamental power or voltage output and the second and third harmonic levels for the indicated values of load resistance. The fundamental output is given in terms of the power, P_m , in milliwatts for values of load resistance, R , equal to and double the value of the plate resistance, r_p , and in terms of the voltage, $E_{p,m}$, in peak volts for values of load resistance five times the plate resistance. The second and third harmonic levels, F_{2m} and F_{3m} , are given in decibels below the fundamental in each case. The peak value of the sinusoidal input voltage, E_{gm} , is numerically equal to the grid bias for each operating condition. For a smaller input voltage, E_g , the fundamental power and voltage output and the harmonic levels are given approximately by the following relations:

$$P = P_m \left(\frac{E_g}{E_{gm}} \right)^2$$

$$E_p = E_{p,m} \frac{E_g}{E_{gm}}$$

$$F_2 = F_{2m} + 20 \log_{10} \frac{E_{gm}}{E_g}$$

$$F_3 = F_{3m} + 40 \log_{10} \frac{E_{gm}}{E_g}$$

TABLE

Plate Voltage	Grid Bias	Plate Current	Amplification Factor	Plate Resistance	Transconductance	Input Voltage	Load Resistance	Power Output	Voltage Output	Second Harmonic	Third Harmonic
Volts	Volts	Milli-amperes		Ohms r_p	Micro-mhos	Peak Volts	R	Milli-watts	Peak Volts	db	db
67.5	-3.0	.93	8.5	22500	380	3.0	$R = r_p$	3.0		29	50
							$R = 2r_p$	2.5		36	60
							$R = 5r_p$		20	47	70
67.5	-1.5	1.55	8.5	18300	460	1.5	$R = r_p$	1.0		39	70
							$R = 2r_p$	0.9		46	80
90.0	-5.0	1.15	8.5	20700	410	5.0	$R = r_p$	10		26	43
							$R = 2r_p$	9		33	50
							$R = 5r_p$		35	42	65
90.0	-3.0	2.10	8.4	16300	510	3.0	$R = r_p$	4.5		36	60
							$R = 2r_p$	4.0		42	70
							$R = 5r_p$		22	50	75
112.5	-8.0	1.00	8.5	22200	390	8.0	$R = r_p$	23		21	34
							$R = 2r_p$	20		27	42
							$R = 5r_p$		55	38	60
112.5	-6.0	1.90	8.4	17200	490	6.0	$R = r_p$	17		29	45
							$R = 2r_p$	15		35	55
							$R = 5r_p$		42	44	70
135.0	-11.5	0.70	8.5	27000	320	11.5	$R = r_p$	45		17	28
							$R = 2r_p$	40		23	34
							$R = 5r_p$		76	33	47
135.0	-10.0	1.25	8.5	20300	420	10.0	$R = r_p$	40		21	32
							$R = 2r_p$	35		28	41
							$R = 5r_p$		67	37	55
135.0	-8.5	1.95	8.5	17200	490	8.5	$R = r_p$	35		26	40
							$R = 2r_p$	30		33	50
							$R = 5r_p$		57	42	65
*90.0	-1.5	2.90	8.4	14500	580	1.5	$R = r_p$	1.2		46	75
							$R = 2r_p$	1.0		50	85
*112.5	-4.5	2.65	8.4	15000	560	4.5	$R = r_p$	10		34	55
							$R = 2r_p$	9		40	65
							$R = 5r_p$		30	50	70
*135.0	-7.5	2.50	8.4	15600	540	7.5	$R = r_p$	27		29	47
							$R = 2r_p$	24		36	55
							$R = 5r_p$		48	45	70

*Maximum operating conditions.

Microphonic Noise—With a plate voltage of 90 volts, a grid bias of -3 volts, and a load resistance of 100,000 ohms, the mean mic ophonic noise output level of the 231D tube, measured in a laboratory reference test set, is 16 decibels below 1 volt. The range of levels of individual tubes extends from 2 to 28 decibels. Since microphonic noise depends on the type and intensity of the mechanical disturbance which produces it, the values given here are useful chiefly for comparison with the levels of other tubes which have been tested in the same way.

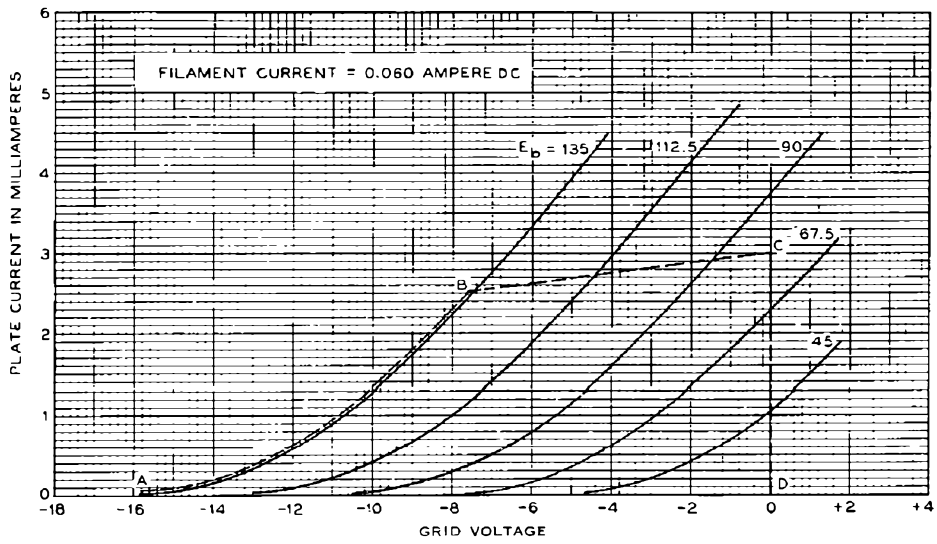
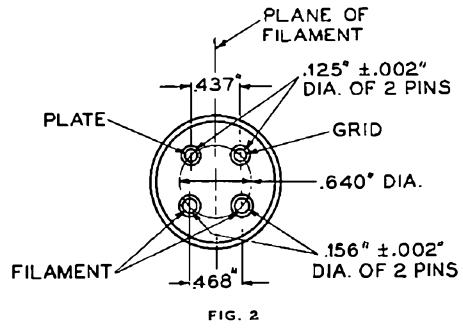
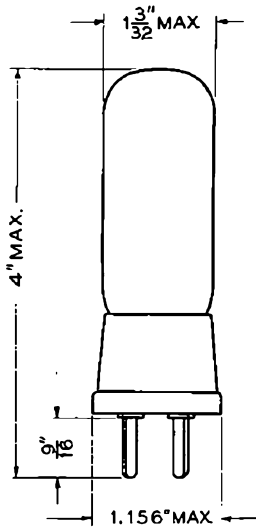

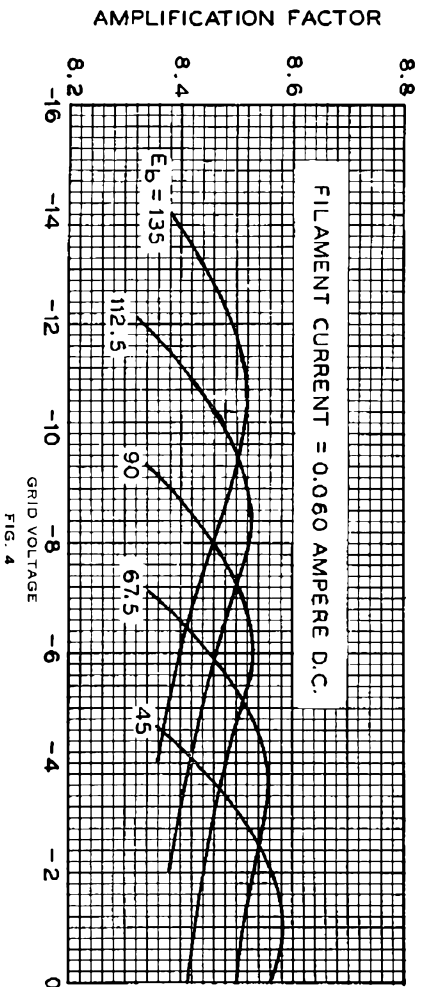

FIG. 4

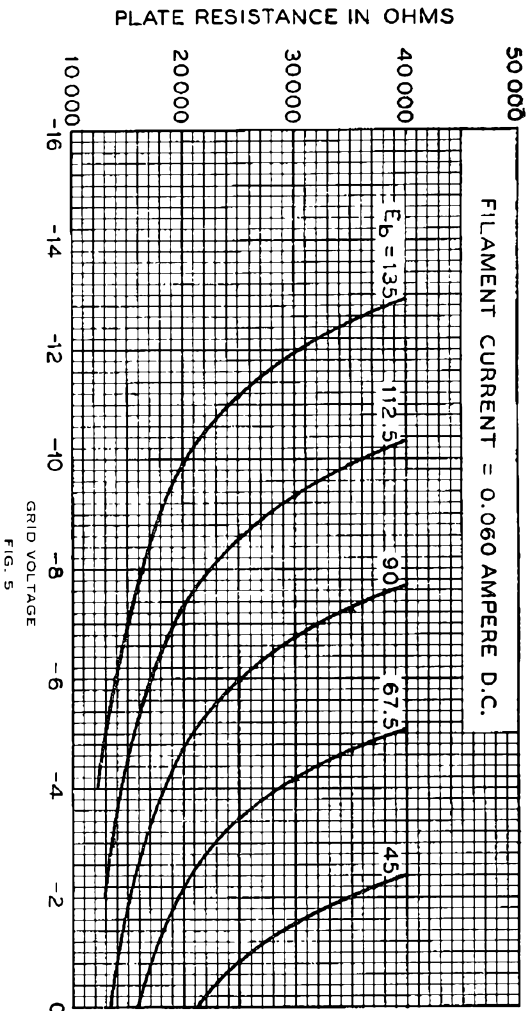

FIG. 5

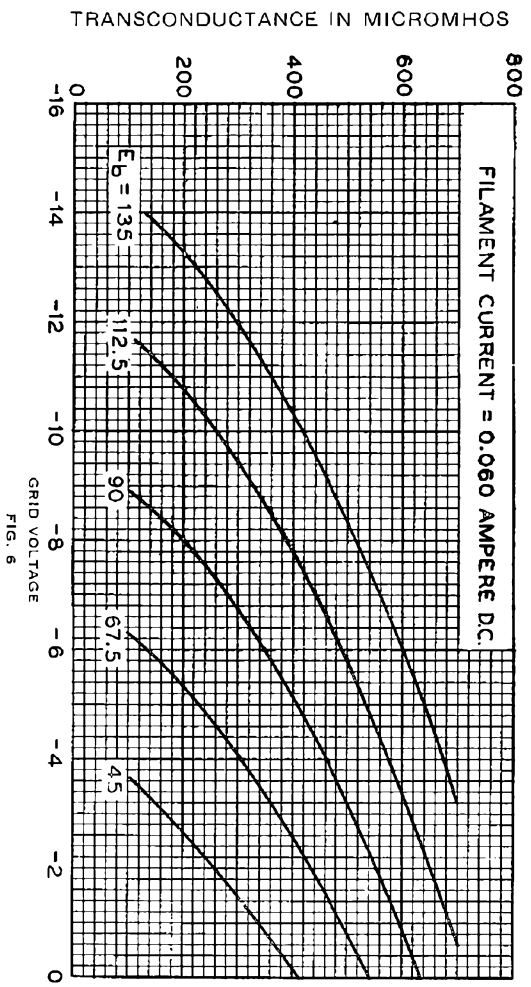

FIG. 6

[5]

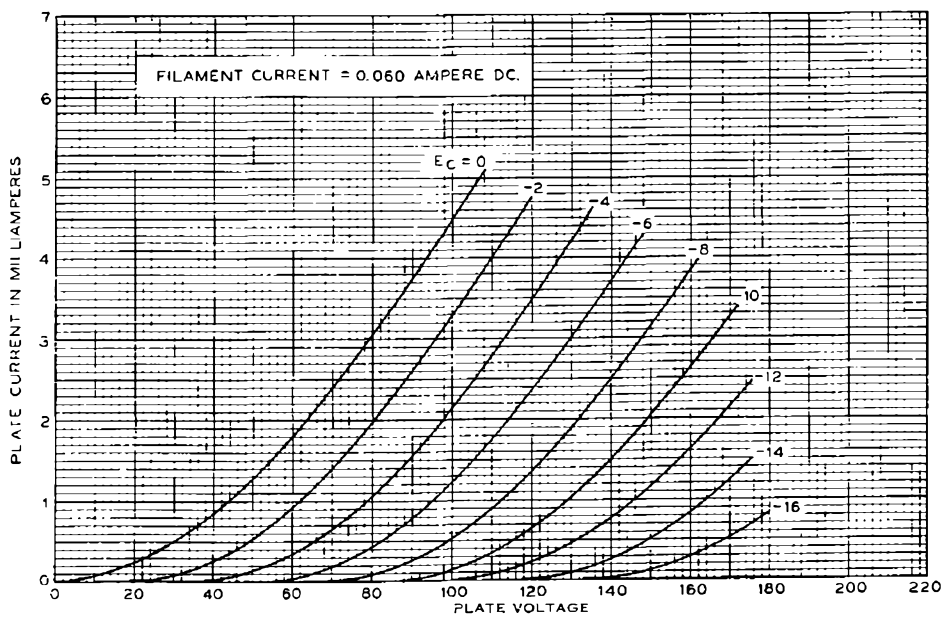
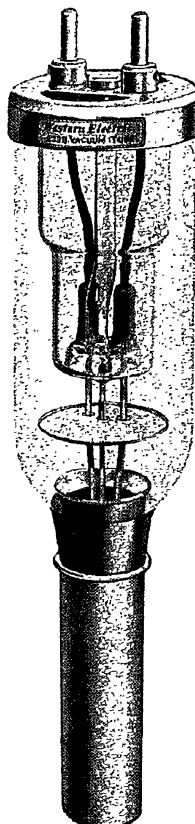

FIG. 7

Western Electric

233B Vacuum Tube



Classification—Half wave, high voltage, water-cooled rectifier

Designed to supply direct current from an alternating current supply. This tube entirely replaces the 233A tube.

Dimensions—Figure 1 shows the dimensions and outline diagrams. The overall dimensions are:

Maximum overall length.....	20 $\frac{7}{8}$ "
Diameter of bulb.....	4 $\frac{1}{8}$ "

Mounting—This vacuum tube should be mounted only in a vertical position with the anode end down in a Western Electric socket made in accordance with ESR-611038, Details 1 and 2 or the equivalent.

Filament—Tungsten

Filament voltage.....	21.5 volts, a.c.
Nominal filament current.....	41 amperes
Average thermionic emission.....	7 amperes

Characteristics and Operating Condition

Maximum peak inverse voltage.....	50,000 volts
Maximum peak plate current.....	5 amperes

The maximum permissible peak plate current (5 amperes) is a limitation on the instantaneous value that the tube can carry safely in the direction in which it is designed to conduct and should not be exceeded. The maximum rectified load current is not fixed but will depend upon the wave form required by the load and filter circuit.

The maximum permissible peak inverse voltage (50,000 volts) is a limitation on the instantaneous value that the tube can stand safely in the opposite direction to that in which it is designed to conduct. If it is exceeded, an arc-back may result which will injure the tube. The maximum direct potential available is not fixed but will depend upon the type of circuit used.

233B vacuum tubes may be operated in parallel if some provision is made to insure a proper division of the load current. Resistors in the heating circuit of each filament may be used for this purpose.

Operating Precautions

Mechanical—Figure 1 shows the overall dimensions and basing arrangement for the tube.

The tubes should not be subjected to mechanical shock or excessive vibration. Mechanical vibration may cause breakage of the tungsten filament. Care should always be used in handling the tube to avoid scratches on the glass envelope as these may develop into cracks which result in leaks.

A free circulation of air must be provided to insure adequate cooling of the glass during operation.

The cooling water should be of sufficient purity to retard the tendency to form scale on the anode. Formation of scale would have the effect of insulating the anode from the water and the ineffective cooling of the anode would result in failure of the tube. It is therefore recommended that distilled water be used in the cooling system.

The temperature of the water and rate of flow should be such that there is no tendency for the water to boil, as indicated by a hissing sound, under maximum dissipation. In general, the outlet water temperature should not exceed 75° C. and the rate of flow should be not less than 1 gallon per minute. The minimum length of water column which can be used to insulate the plate from the water supply, which is usually grounded, will depend upon the resistivity of the water used and the leakage current that can be tolerated. This length should not be less than 15 feet. The cooling connections must always be made so that the water flows in at the center port of the tube socket.

The number of water coils required will depend upon the type of circuit in which the tubes are used. For example in Circuit B, although there are four tubes used, only two cooling coils are required since two of the anodes are permanently at ground potential. On the other hand the corresponding filament circuits reach peak alternating potential above ground and must be insulated accordingly.

Provision should be made in the circuit to safeguard against filament and plate voltages being applied until cooling water is circulating at the proper rate and temperatures, and for immediate cut-off of filament and plate voltages if the circulating rate falls below the allowed minimum or the temperature exceeds the allowable maximum. A momentary interruption of the water circulation during operation of the tube may cause immediate failure.

Electrical—Overload protection should always be provided for the plate circuit. Although the tube is sufficiently rugged to withstand momentary overloads, a prolonged overload caused by inefficient adjustment of the circuit, may damage the tube.

Some provision should be made to limit the initial filament current when the filament is cold, to a value of approximately 90 amperes. This may be done by inserting additional resistance or reactance in the filament circuit when voltage is first applied or by using a transformer having sufficiently high reactance.

Figure 2 shows the impedance characteristic and the effect of lowering the filament voltage of a typical tube, and Figure 3 shows the resistance characteristic of the filament.

Typical Rectifier Circuits—This vacuum tube may be used in any conventional rectifier circuit subject to its current and voltage limitations. Typical circuits are shown below. The approximate direct output current and voltage for each type of rectifier circuit where tubes are operated at maximum permissible plate current and inverse voltage are given in the table. The values listed below are average values of the pulsating current and voltage for an unfiltered circuit.

TABLE

Circuit Designation	Number of Tubes	Load Potential in Volts	Load Current in Amperes
A	2	15,000	3
B	4	30,000	3
C	6	45,000	5
D	6	20,000	8.5

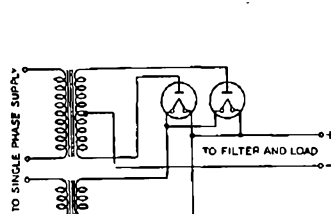

SINGLE PHASE, DOUBLE HALF-WAVE
CIRCUIT A

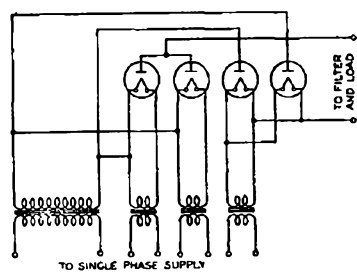

SINGLE PHASE, DOUBLE HALF-WAVE,
4 TUBE SERIES CIRCUIT
CIRCUIT B

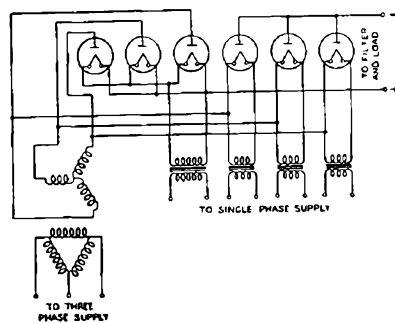

THREE PHASE, 6 TUBE SERIES "Y" CIRCUIT
CIRCUIT C

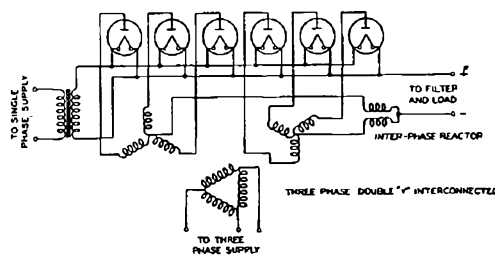

THREE PHASE, "Y" CIRCUIT
CIRCUIT D

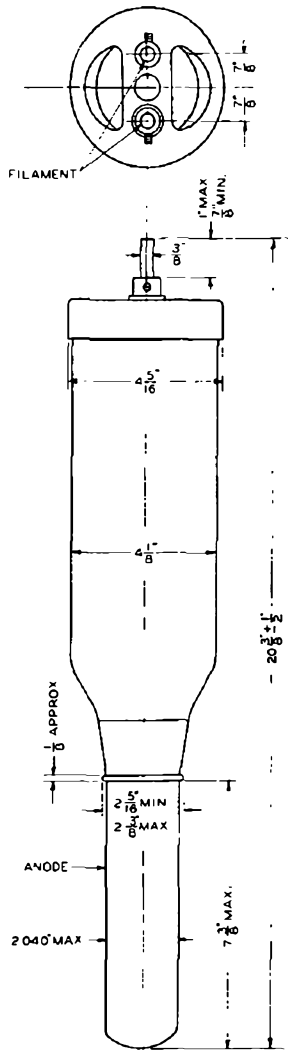

FIG. 1

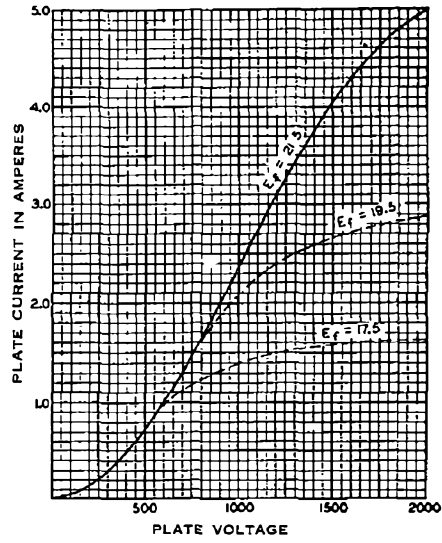

FIG. 2

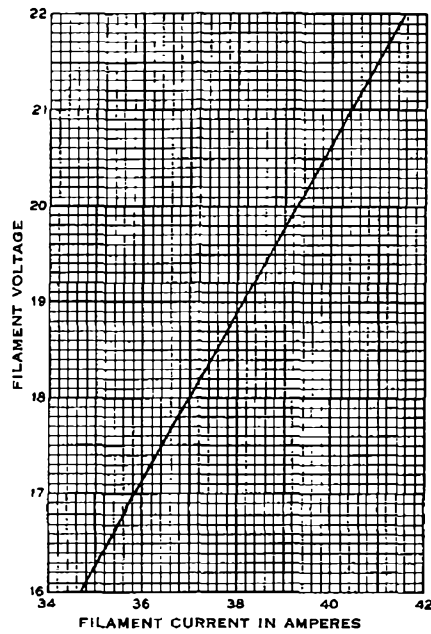
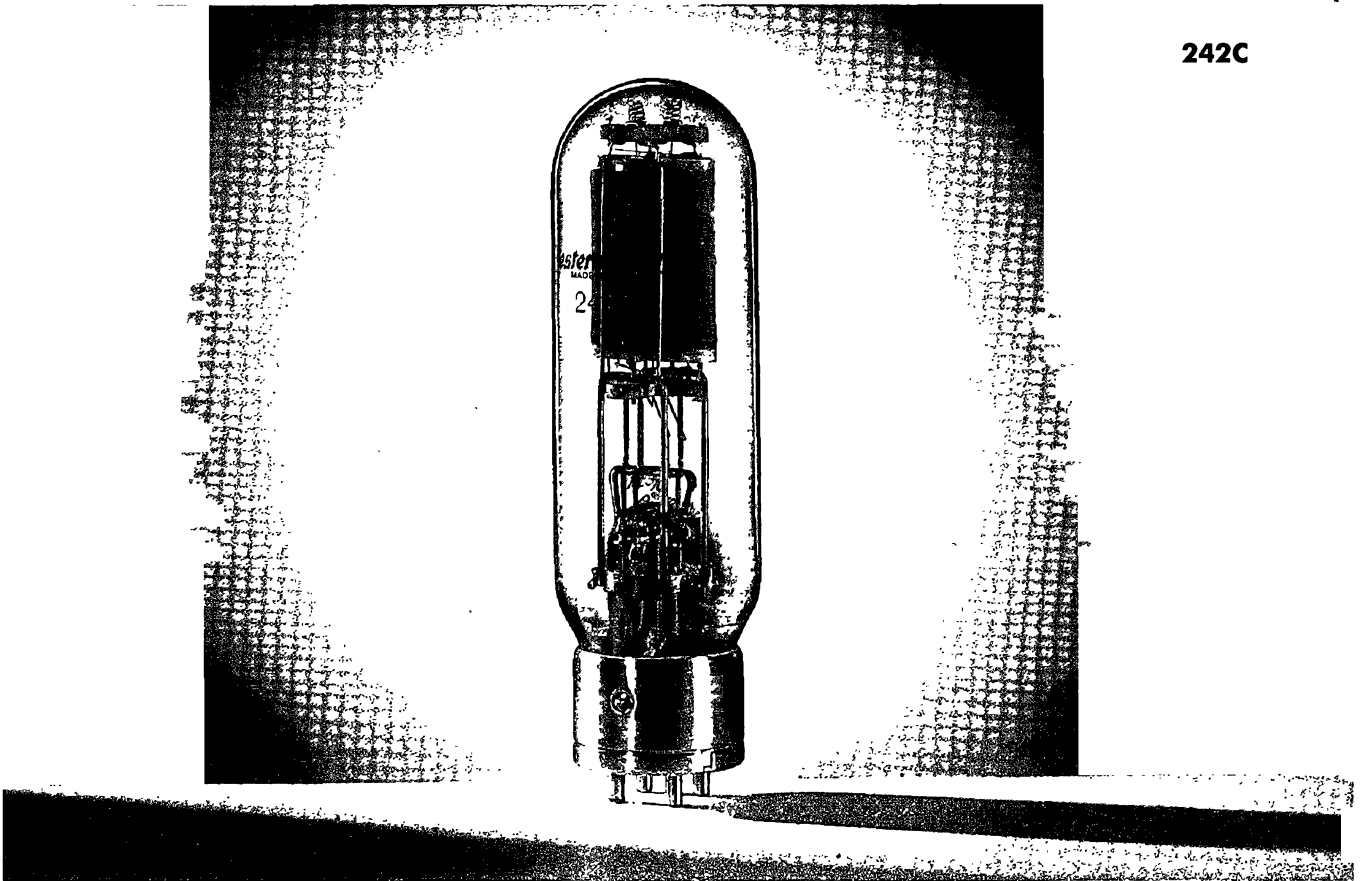

FIG. 3

242C



**TRIODE
AMPLIFIER, OSCILLATOR OR MODULATOR**

Western Electric

DESCRIPTION

The 242C is a three-electrode tube designed for use as a radio-frequency amplifier or oscillator, audio-frequency amplifier or modulator. The anode is capable of dissipating 100 watts and

the cooling is accomplished by radiation. The tube is capable of operating up to 6 megacycles at maximum ratings and up to 30 megacycles at reduced ratings. The cathode is a thoriated tungsten filament.

MAXIMUM RATINGS

D-C Plate Voltage	1250 volts
D-C Plate Current	150 milliamperes
Continuous Plate Dissipation	100 watts
D-C Grid Current	50 milliamperes

ELECTRON TUBE DATA SHEET
FILE: TRANSMITTING SECTION
4-48



GENERAL CHARACTERISTICS

ELECTRICAL DATA

	Min.	Bogey	Max.	
Filament Voltage	9.5	10.0	10.5	volts
Filament Current at Bogey Voltage	3.1	3.25	3.4	amperes
Amplification Factor				
Conditions: $E_b = 1250$ volts, $I_b = 68$ milliamperes	11	12.5	14	
Interelectrode Capacitances				
Grid-Plate	11.4	13.0	14.6	uuf
Grid-Filament	4.8	6.1	7.1	uuf
Plate-Filament	3.2	4.7	5.9	uuf
Maximum Usable Cathode Current ¹				1.3 amperes

MECHANICAL DATA

Mounting Position	Vertical, or horizontal with plane of filament vertical
Type of Cooling	Radiation
Net Weight, Approximate	8 ounces

MAXIMUM RATINGS AND TYPICAL OPERATING CONDITIONS

AUDIO-FREQUENCY POWER AMPLIFIER AND MODULATOR — CLASS A₁

MAXIMUM RATINGS, Absolute Values

	CCS
D-C Plate Voltage	1250 volts
D-C Grid Voltage	-80 volts
Plate Input	85 watts
Plate Dissipation	85 watts

TYPICAL OPERATION

	CCS	CCS
D-C Plate Voltage	1000	1250 volts
D-C Grid Voltage	-47	-70 volts
Peak A-F Grid Voltage	47	70 volts
D-C Plate Current	85	68 milliamperes
Load Resistance	7000	9000 ohms
Total Harmonic Distortion	5	5 per cent
Power Output	12.5	22 watts

1. Represents maximum usable cathode current for tube as plate current plus grid current for any condition of operation.

AUDIO-FREQUENCY POWER AMPLIFIER AND MODULATOR - CLASS B**MAXIMUM RATINGS, Absolute Values**

	CCS
D-C Plate Voltage	1250 volts
Maximum Signal D-C Plate Current ²	150 milliamperes
Maximum Signal Plate Input ²	188 watts
Plate Dissipation ²	100 watts

TYPICAL OPERATION

Unless otherwise specified values are for 2 tubes

	CCS	CCS
D-C Plate Voltage	1000	1250 volts
D-C Grid Voltage	-70	-90 volts
Peak A-F Grid-to-Grid Voltage	312	336 volts
Zero Signal D-C Plate Current	16	20 milliamperes
Maximum Signal D-C Plate Current	300	300 milliamperes
Effective Load Resistance (plate-to-plate)	6000	7600 ohms
Maximum Signal Driving Power, Approximate	5.5	5.0 watts
Maximum Signal Power Output, Approximate	165	200 watts

RADIO-FREQUENCY POWER AMPLIFIER - CLASS B

Carrier conditions per tube for use with a maximum modulation factor of 1.0

MAXIMUM RATINGS, Absolute Values

	CCS
D-C Plate Voltage	1250 volts
D-C Plate Current	150 milliamperes
Plate Input	150 watts
Plate Dissipation	100 watts

TYPICAL OPERATION

	CCS	CCS
D-C Plate Voltage	1000	1250 volts
D-C Grid Voltage	-72	-95 volts
Peak R-F Grid Voltage	141	133 volts
D-C Plate Current	150	120 milliamperes
Plate Tank Impedance	1680	2680 ohms
D-C Grid Current, Approximate	4	1 milliamperes
Driving Power, Approximate ³	20	10 watts
Power Output, Approximate	50	50 watts

2. Averaged over any audio-frequency cycle of sine wave form.

3. At crest of audio-frequency cycle with modulation factor at 1.0.

PLATE-MODULATED RADIO-FREQUENCY POWER AMPLIFIER — CLASS C TELEPHONY

Carrier conditions per tube for use with a maximum modulation factor of 1.0

MAXIMUM RATINGS, Absolute Values		CCS	
D-C Plate Voltage		1000	volts
D-C Grid Voltage		-400	volts
D-C Plate Current		150	milliamperes
D-C Grid Current		50	milliamperes
Plate Input		150	watts
Plate Dissipation		67	watts
TYPICAL OPERATION		CCS	CCS
D-C Plate Voltage		750	1000 volts
D-C Grid Voltage		-200	-260 volts
Peak R-F Grid Voltage		357	410 volts
D-C Plate Current		150	150 milliamperes
Plate Tank Impedance		2180	3270 ohms
D-C Grid Current, Approximate		38	30 milliamperes
Driving Power, Approximate		13	12 watts
Power Output, Approximate		72	100 watts

RADIO-FREQUENCY POWER AMPLIFIER AND OSCILLATOR — CLASS C TELEGRAPHY

Key-down conditions per tube without amplitude modulation⁴

MAXIMUM RATINGS, Absolute Values		CCS	
D-C Plate Voltage		1250	volts
D-C Grid Voltage		-400	volts
D-C Plate Current		150	milliamperes
D-C Grid Current		50	milliamperes
Plate Input		188	watts
Plate Dissipation		100	watts
TYPICAL OPERATION		CCS	CCS
D-C Plate Voltage		1000	1250 volts
D-C Grid Voltage		-175	-225 volts
Peak R-F Grid Voltage		305	355 volts
D-C Plate Current		150	150 milliamperes
Plate Tank Impedance		3080	3820 ohms
D-C Grid Current, Approximate		16	12 milliamperes
Driving Power, Approximate		5	5 watts
Power Output, Approximate		100	130 watts

Maximum ratings apply up to 6 megacycles. The tube may be operated at higher frequencies provided the maximum values of plate voltage and power input are reduced

according to the tabulation below (other maximum ratings are the same as shown above). Special attention should be given to adequate ventilation of the bulb at these frequencies.

Frequency	6	15	30 megacycles
Percentage of Maximum Rated Plate Voltage and Plate Input			
Class B	100	85	70 per cent
Class C Plate Modulated	100	75	50 per cent
Class C Unmodulated	100	75	50 per cent

4. Modulation essentially negative may be used if the positive peak of the envelope does not exceed 115 per cent of the carrier conditions.

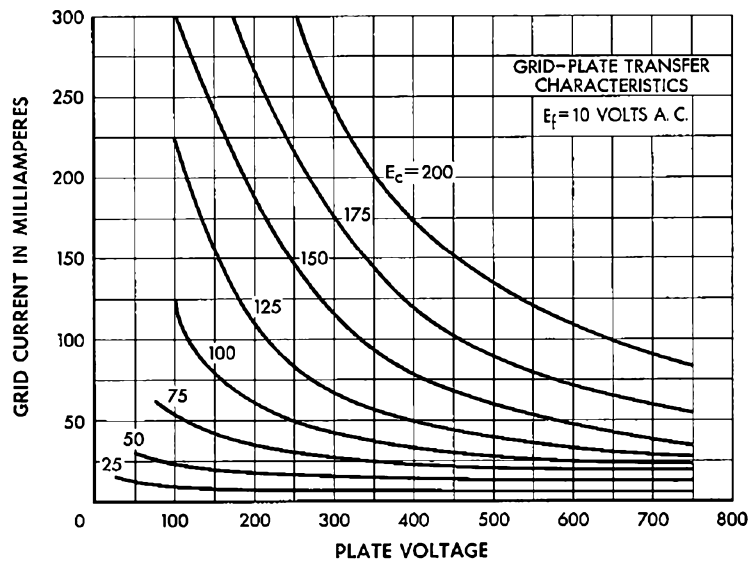
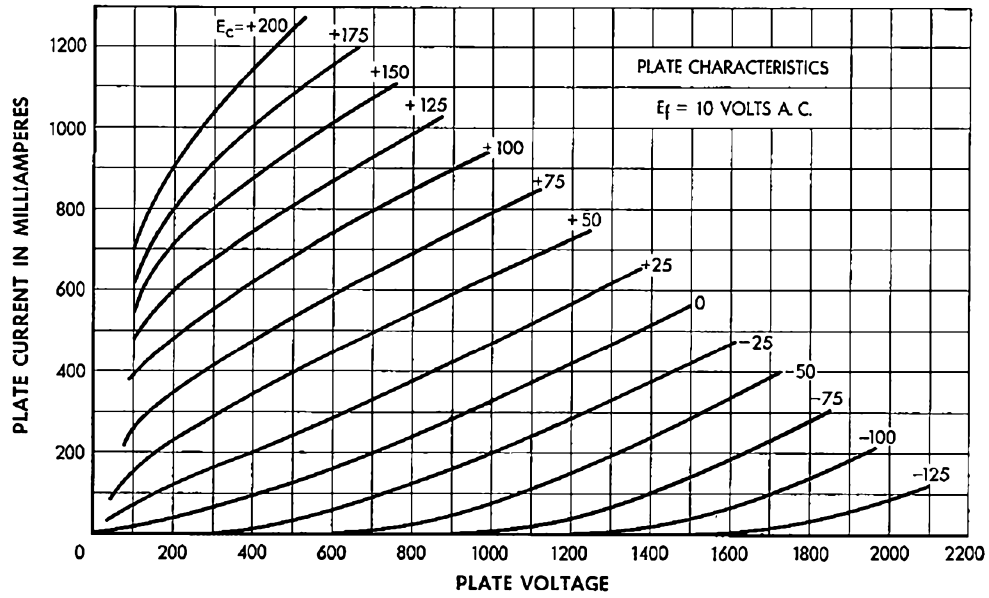

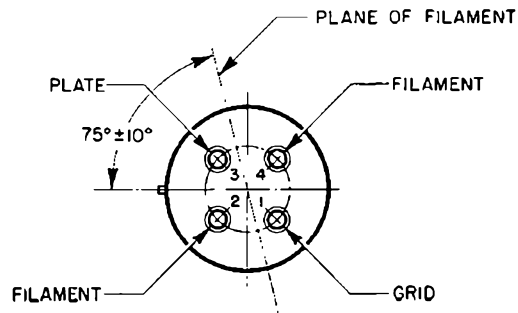
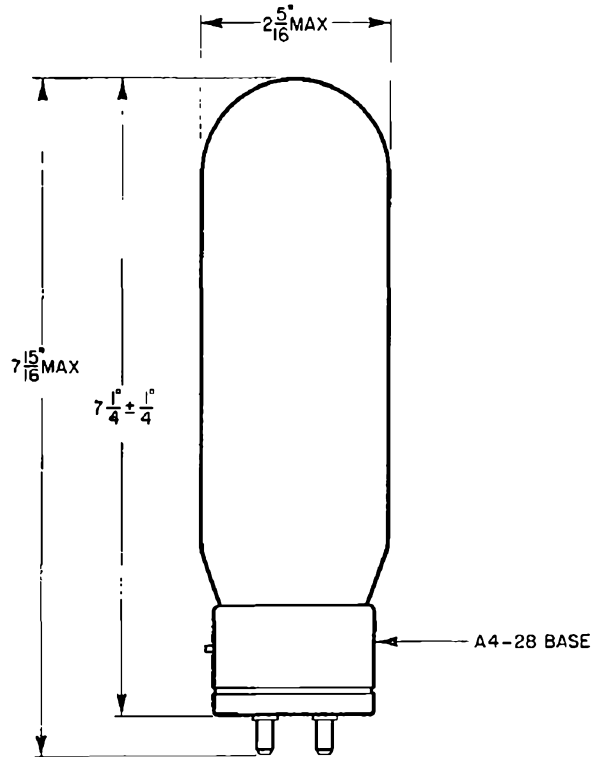

Western Electric

A development of Bell Telephone Laboratories, the research laboratories of the American Telephone and Telegraph Company and the Western Electric Company.

Western Electric

244A Vacuum Tube



Classification—Low-power triode with indirectly heated cathode

For most applications, the heater element of the 244A tube may be operated on alternating current.

Applications

- Audio-frequency voltage amplifier.
- Audio-frequency power amplifier where small amounts of power are required.
- Oscillator.

Dimensions—Dimensions, outline diagrams of the tube and base, and the arrangement of the electrode connections to the base terminals are shown in Figures 1 and 2.

Base—Medium, five-pin type with bayonet pin.

Socket—Standard, five-contact type, such as the Western Electric 141A socket.

Mounting Positions—The 244A tube may be mounted in any position.

Average Direct Interelectrode Capacitances

	A	B
Grid to plate, $\mu\mu\text{f.}$	3.3	3.2
Grid to heater and cathode, $\mu\mu\text{f.}$	3.1	3.3
Plate to heater and cathode, $\mu\mu\text{f.}$	2.8	3.2

Column A—Based tube without socket.

Column B—Tube alone when measured in 141A socket mounted in metal plate; mounting plate connected to heater and cathode.

Heater Rating

Heater voltage	2.0 volts, a.c. or d.c.
Nominal heater current	1.6 amperes

The heater element of this tube is designed to operate on a voltage basis and should be operated at as near the rated voltage as is practicable.

Cathode Connection—When the heater is operated on alternating current, a reduction of hum in the tube may usually be obtained by connecting the cathode to a center tap on the secondary of the heater transformer or to the center point of a suitable resistance connected across the heater terminals. If voltage must be applied between the heater and cathode, it should be kept as low as possible and should not exceed 90 volts.

Characteristics—Plate current characteristics of a typical 244A tube are shown in Figure 3 as functions of grid bias for several values of plate voltage. Corresponding amplification factor, plate resistance, and transconductance characteristics are given in Figures 4, 5, and 6, respectively. Plate current characteristics are shown as functions of plate voltage for several values of grid bias in Figure 7.

Operating Conditions and Output—Permissible operating plate and grid voltages are included within the area, ABCD, in Figure 3. Amplification factor, plate resistance, transconductance, and performance data are given in the table on page 3 for a number of typical operating conditions represented by selected points within this area. The less severe operating conditions should be selected in preference to maximum operating conditions wherever possible. The life of the tube at maximum conditions may be shorter than at less severe conditions.

The performance data include the fundamental power output in milliwatts and the second and third harmonic levels in decibels below the fundamental for values of the load resistance, R , equal to one, two, three, or five times the plate resistance, r_p . The peak value of the sinusoidal input, E_{gm} , which gives the indicated power output, P_m , and harmonic levels, F_{2m} and F_{3m} , in each case, is numerically equal to the grid bias. For a smaller input, E_g , the output and harmonic levels, except for very low third harmonic levels, are given approximately by the following relations:

$$P = P_m \left(\frac{E_g}{E_{gm}} \right)^2$$

$$F_2 = F_{2m} + 20 \log_{10} \frac{E_{gm}}{E_g}$$

$$F_3 = F_{3m} + 40 \log_{10} \frac{E_{gm}}{E_g}$$

The level of the third harmonic in the 244A tube is usually low and may differ widely in individual tubes. The values given in the table are for a typical tube.

Microphonic and Sputter Noise—With a plate voltage of 135 volts, a grid bias of -6 volts, and a load resistance of 100,000 ohms, the mean microphonic noise output level of the 244A tube, measured in a laboratory reference test set, is 32 decibels below 1 volt. The range of levels of individual tubes extends from 24 to 43 decibels below 1 volt. Since microphonic noise depends on the type and intensity of the mechanical disturbance which produces it, the values given here are useful chiefly for comparison with the levels of other tubes which have been tested in the same way.

Improvements in the design of the 244A tube have practically eliminated both the disagreeable sputtering sounds and the isolated microphonic noise impulses which sometimes occur spontaneously at random intervals in tubes of this general type. When the tube is shielded from external microphonic noise impulses, it is quiet in operation and can be used for the audio-frequency amplification of exceptionally low level signals.

Plate Voltage	Grid Bias	Plate Current	Amplification Factor	Plate Resistance	Trans-conductance	Input Voltage	Load Resistance	Power Output	Second Harmonic	Third Harmonic
Volts	Volts	Milli-amperes		Ohms r_p	Micro-mhos	Peak Volts	R	Milli-watts	db	db
90	- 6	1.9	9.5	15100	630	6	$R = r_p$	32	21	50
							$R = 2r_p$	29	25	45
90	- 4	3.3	10.1	11800	850	4	$R = r_p$	20	25	55
							$R = 2r_p$	17	28	50
120	- 8	2.6	9.5	13600	700	8	$R = r_p$	58	21	50
							$R = 2r_p$	51	25	50
							$R = 3r_p$	46	27	50
120	- 6	4.1	9.9	11200	890	6	$R = r_p$	43	24	50
							$R = 2r_p$	39	27	50
120	- 4	6.1	10.4	9500	1090	4	$R = r_p$	24	27	65
							$R = 2r_p$	22	30	60
135	-10	2.4	9.3	14600	640	10	$R = r_p$	84	19	35
							$R = 2r_p$	75	23	45
							$R = 3r_p$	63	26	50
135	- 8	3.8	9.7	11800	820	8	$R = r_p$	69	22	45
							$R = 2r_p$	60	26	50
135	- 6	5.5	10.1	10000	1010	6	$R = r_p$	49	25	50
							$R = 2r_p$	43	28	50
150	-12	2.1	9.1	15800	580	12	$R = 2r_p$	98	22	40
							$R = 3r_p$	86	25	45
150	-10	3.4	9.5	12500	760	10	$R = r_p$	100	21	50
							$R = 2r_p$	89	25	45
							$R = 3r_p$	76	27	45
150	- 8	5.1	9.8	10600	930	8	$R = r_p$	80	23	50
							$R = 2r_p$	70	27	50
*135	- 4	7.7	10.5	8800	1200	4	$R = r_p$	26	28	65
							$R = 2r_p$	24	31	70
*150	- 6	7.1	10.2	9200	1110	6	$R = r_p$	54	26	50
							$R = 2r_p$	47	29	50
*180	-16	1.8	8.9	17800	500	16	$R = 3r_p$	128	23	45
							$R = 5r_p$	104	27	50
*180	-14	2.9	9.2	14000	660	14	$R = 2r_p$	150	22	45
							$R = 3r_p$	130	25	50
*180	-12	4.4	9.5	11600	820	12	$R = r_p$	153	20	45
							$R = 2r_p$	136	24	50
*180	-10	6.2	9.8	10000	980	10	$R = r_p$	128	23	50
							$R = 2r_p$	112	26	45

*Maximum operating conditions.

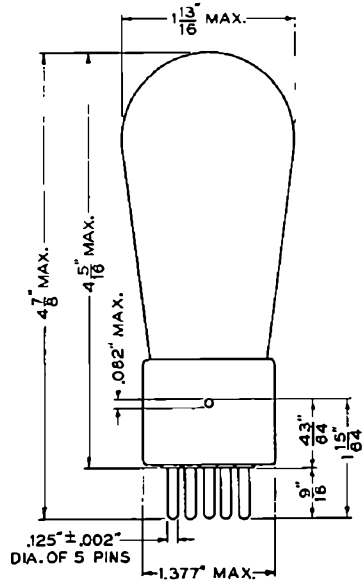

FIG. 1

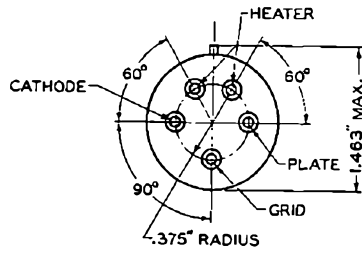

FIG. 2

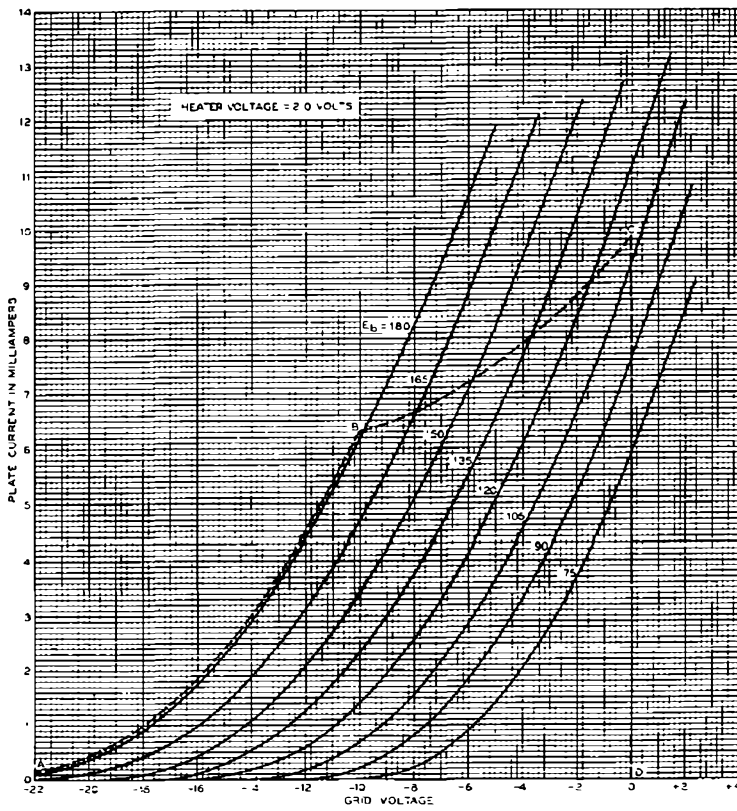

FIG. 3

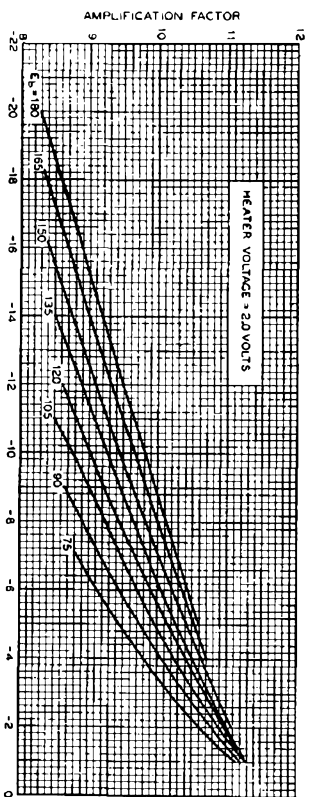

FIG. 4

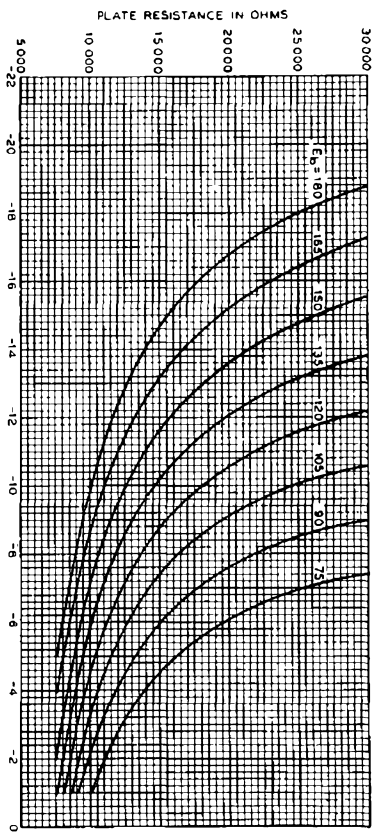

FIG. 5

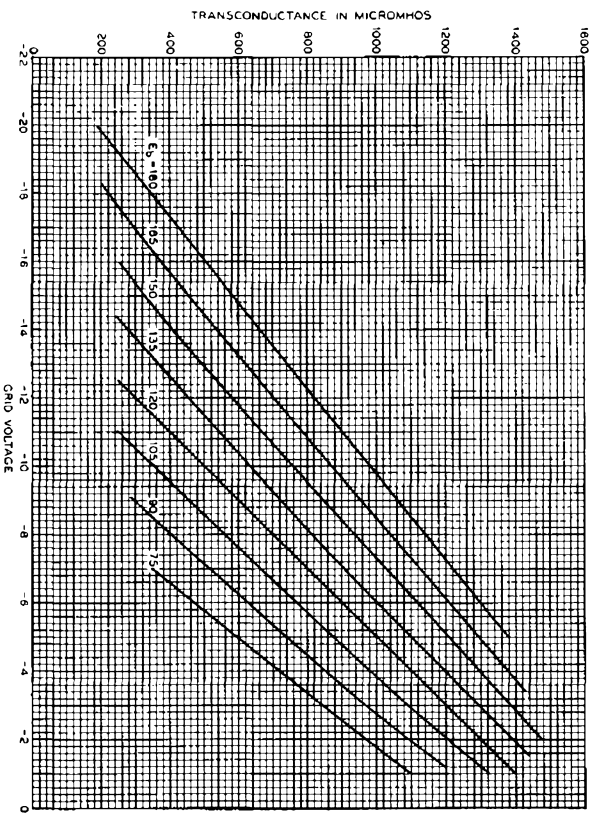

FIG. 6

[5]

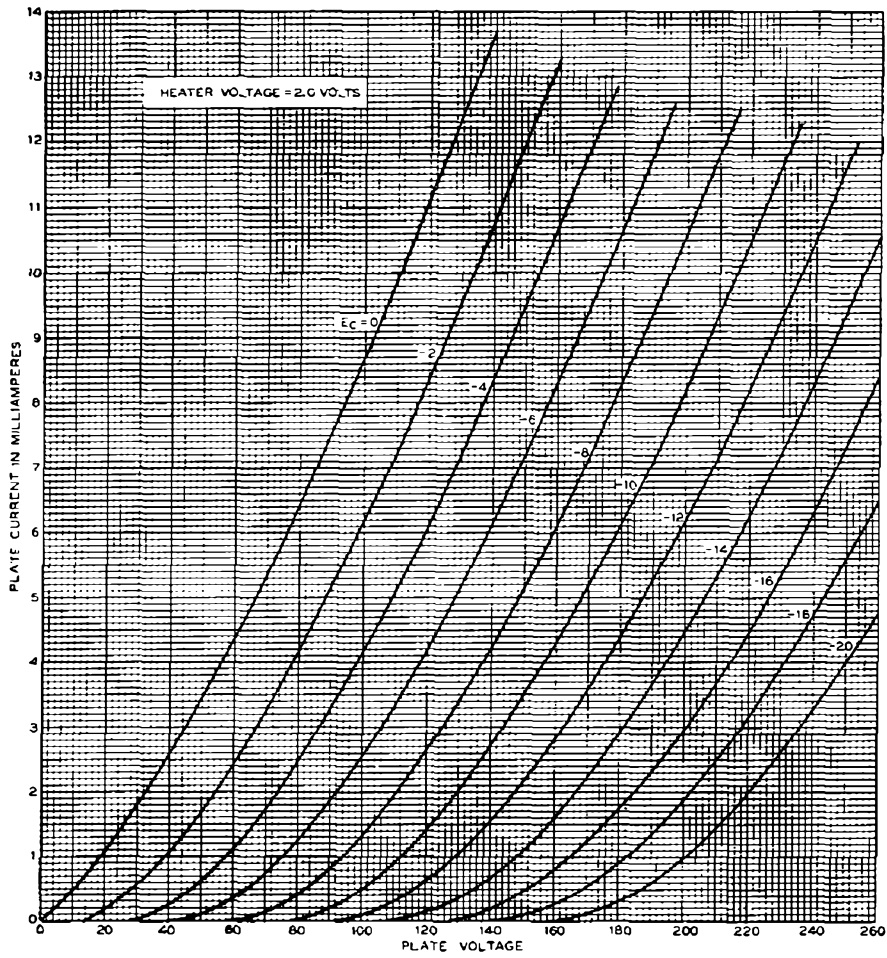
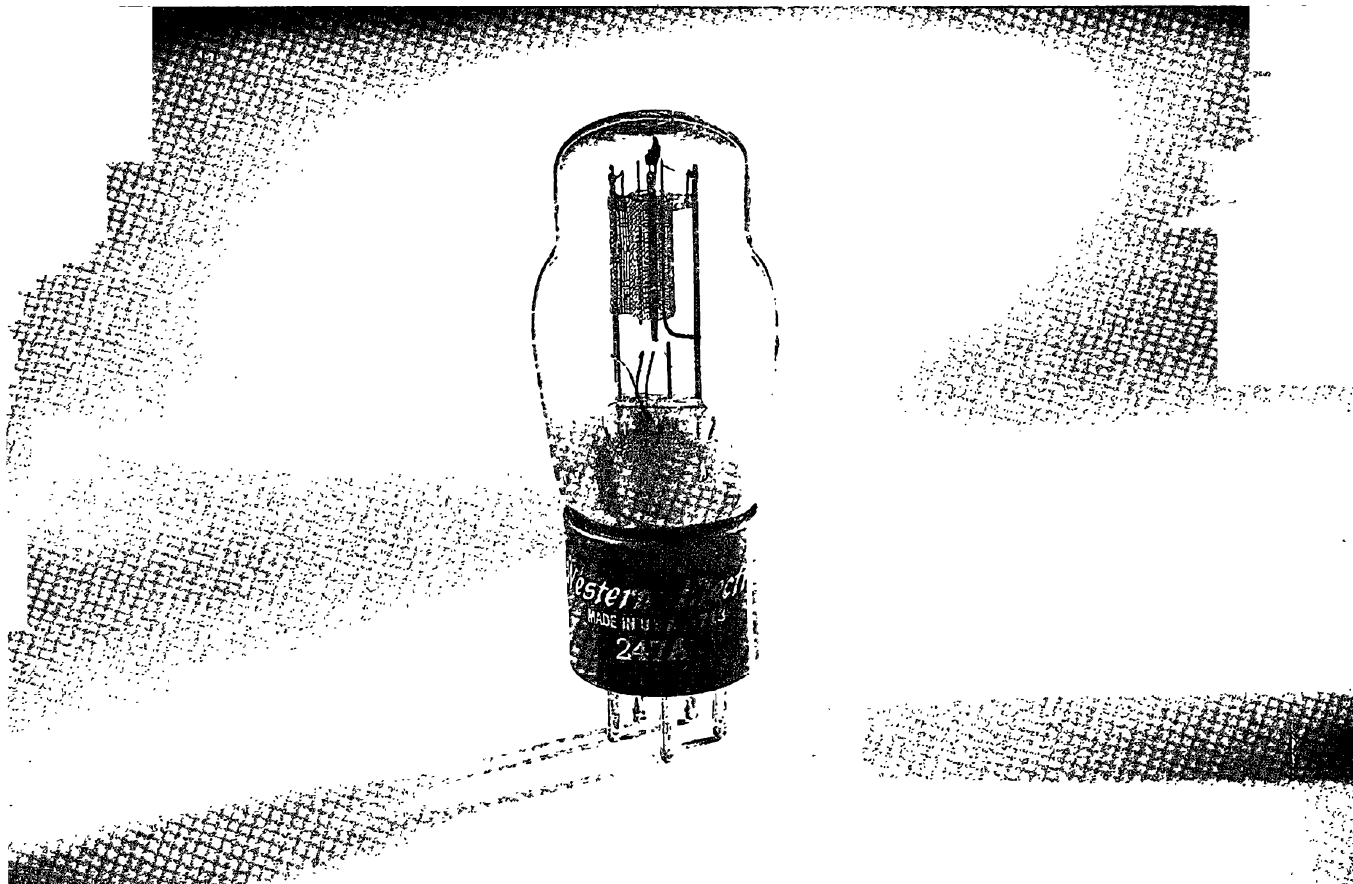

FIG. 7



**TRIODE
AUDIO-FREQUENCY AMPLIFIER**

Western Electric

DESCRIPTION

The 247A is a low power triode having an indirectly heated cathode. It is designed for use in audio-frequency amplifier, oscillator, and detector circuits.

CHARACTERISTICS

Heater Voltage	2.0 volts
Maximum Plate Voltage	180 volts
Amplification Factor	15

GENERAL CHARACTERISTICS

ELECTRICAL DATA

Heater Voltage, A-C or D-C	2.0 volts
Heater Current	1.6 amperes
Direct Interelectrode Capacitances (without external shield)	
Grid to Plate	3.1 uuf
Input	2.9 uuf
Output	2.2 uuf

MECHANICAL DATA

Cathode	Coated Unipotential
Bulb	ST 14
Base	Medium 5-pin
Mounting Position	Any
Dimensions and pin connections shown in outline drawing on Page 4	

MAXIMUM RATINGS, Design-Center Values

Plate Voltage	180 volts
Plate Dissipation	2.0 watts
Plate Current	10.0 milliamperes
Heater-Cathode Voltage	100 volts

TYPICAL OPERATING CONDITIONS AND CHARACTERISTICS—CLASS A₁ AMPLIFIER

Plate Voltage	120	135	150	180	volts
Grid Voltage	-6.0	-4.5	-6	-7	volts
Peak A-F Grid Voltage	6.0	4.5	6	7	volts
Plate Current	1.3	3.2	2.8	3.6	milliamperes
Transconductance	600	940	850	940	micromhos
Amplification Factor	14.2	15.2	14.8	14.9	
Plate Resistance	23500	16000	17400	15700	ohms
Load Resistance	120000	80000	87000	78500	ohms
Maximum Signal Power Output	22	21	32	49	milliwatts
Total Harmonic Distortion	4.5	2	2.5	3	percent

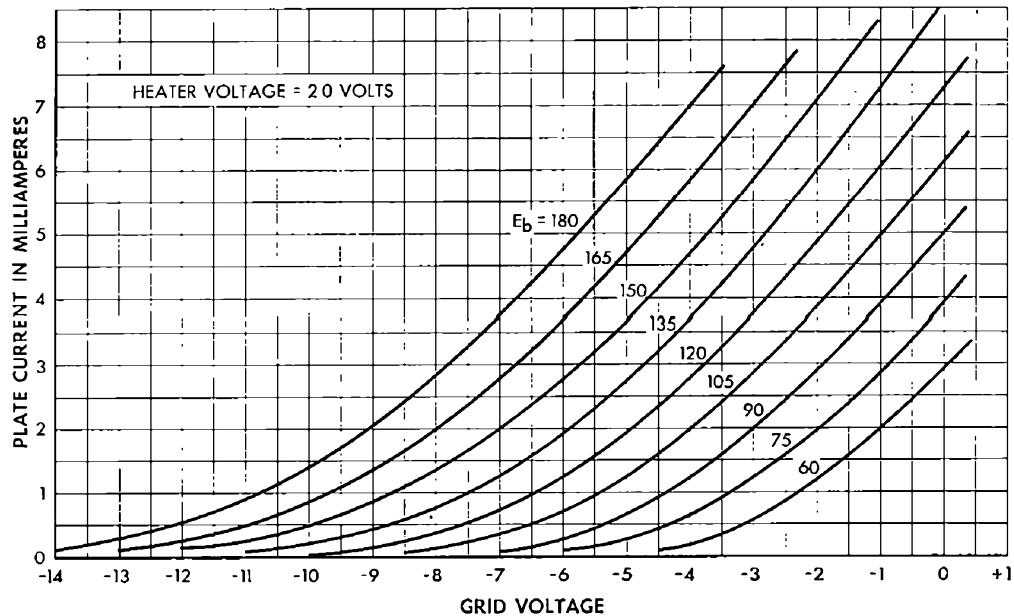

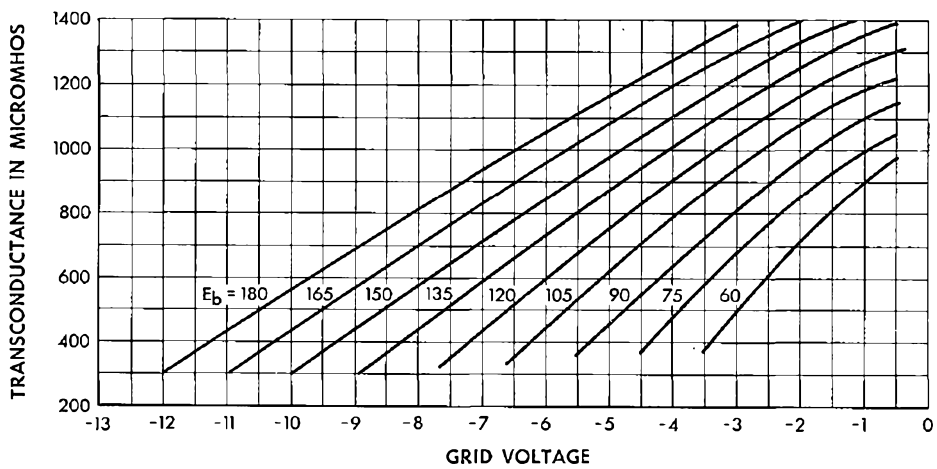
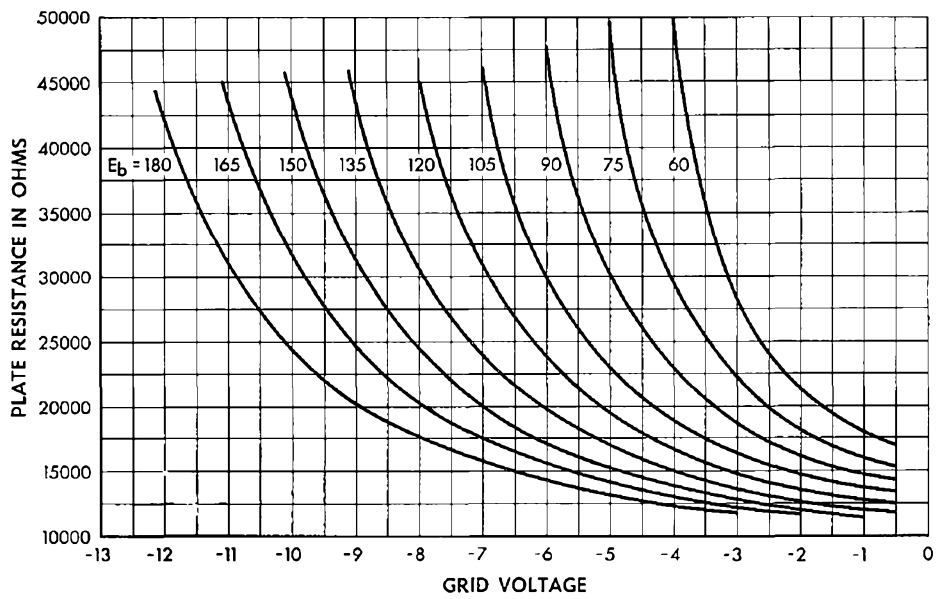
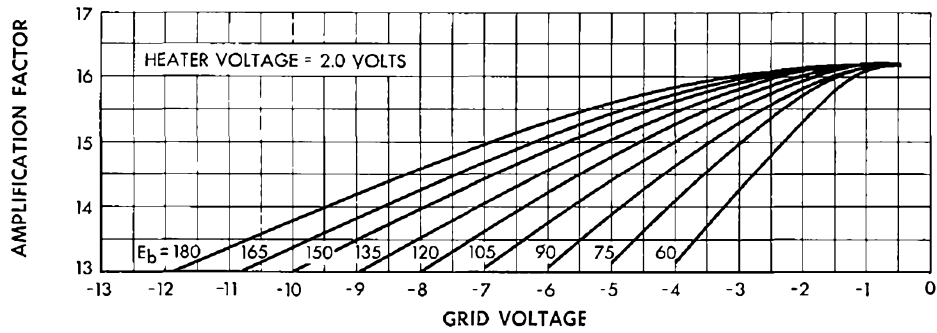

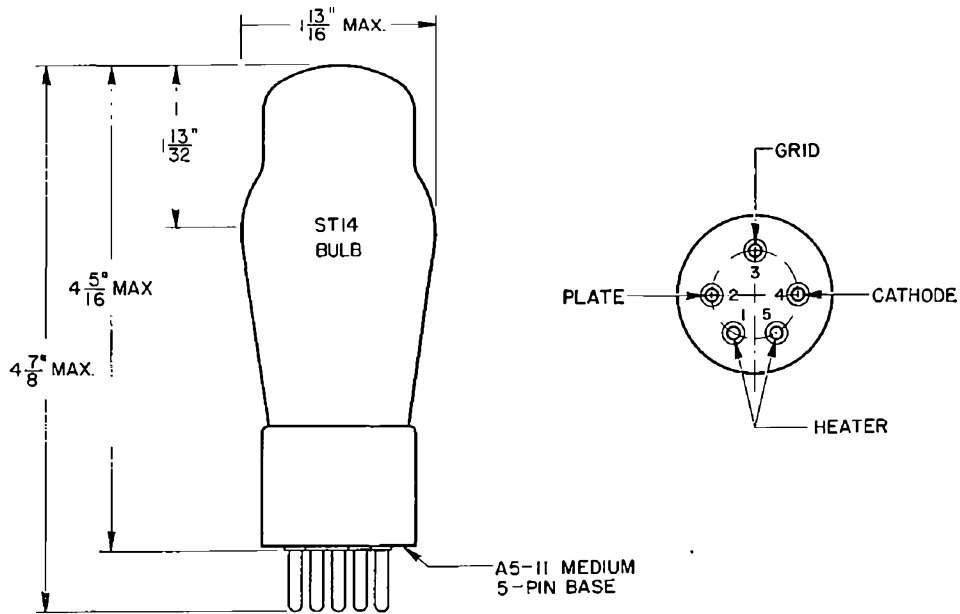
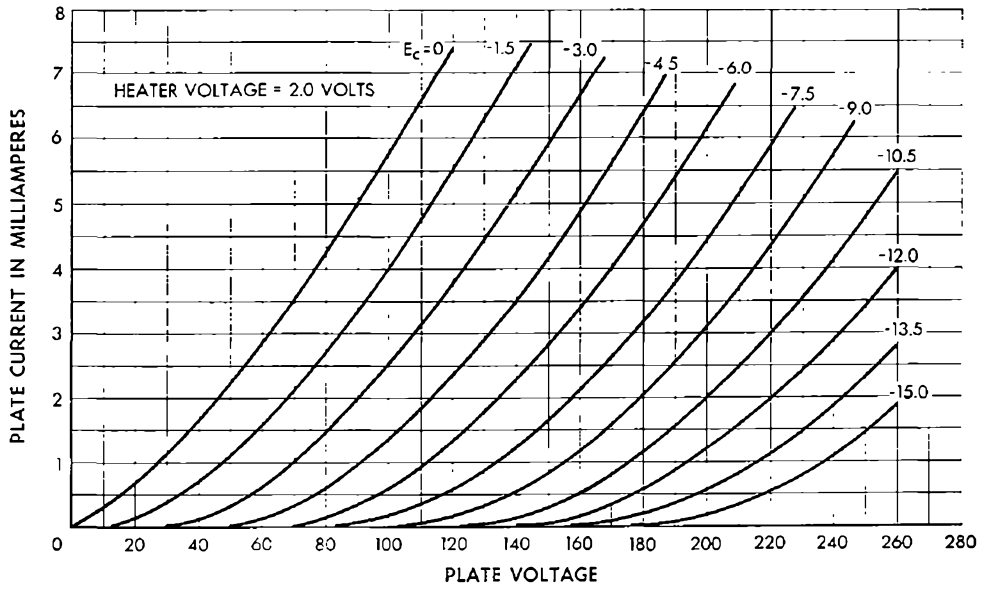

Western Electric

A development of Bell Telephone Laboratories, the research laboratories of the American Telephone and Telegraph Company and the Western Electric Company

ELECTRON TUBE DATA SHEET
WESTERN ELECTRIC 249B ELECTRON TUBE



DESCRIPTION

The 249B is a mercury-vapor diode for use in high voltage rectifier circuits. The latest gettering techniques and materials are employed in this tube to insure greater service life.

MAXIMUM RATINGS

Peak Anode Voltage	7500 volts
Average Cathode Current	0.64 ampere

FILE: RECTIFIER SECTION
ISSUE 3, 4-52

249B

MAXIMUM RATINGS, ABSOLUTE VALUES

Peak Inverse Anode Voltage	7500 volts
Cathode Current	
Peak	2.5 amperes
Average	0.64 ampere
Surge (maximum duration 0.1 second)	25 amperes
Averaging Time	5 seconds
Condensed Mercury Temperature	+20 to +70 centigrade

ELECTRICAL DATA

	<u>Min.</u>	<u>Bogey</u>	<u>Max.</u>
Filament Voltage	2.37	2.5	2.62 volts
Filament Current at 2.5 volts	----	7.5	8.25 amperes
Filament Heating Time Required ¹	15	---	---- seconds
Anode Voltage Drop	----	15	---- volts
Critical Anode Voltage	----	---	50 volts

MECHANICAL DATA

Type of Cooling	Convection
Equilibrium Condensed Mercury Temperature Rise Above Ambient, Approximate	
At Full Load	20 centigrade
At No Load	16 centigrade
Mounting Position ²	Vertical, Base end down
Net Weight, Approximate	3 ounces

1. Mercury may become deposited on the tube elements in shipment, storage or handling. When using the tube for the first time, or after handling, a filament heating period of 15 to 30 minutes should be allowed to properly distribute the mercury.
2. Sufficient clearance should be allowed around the tube to insure free air circulation.

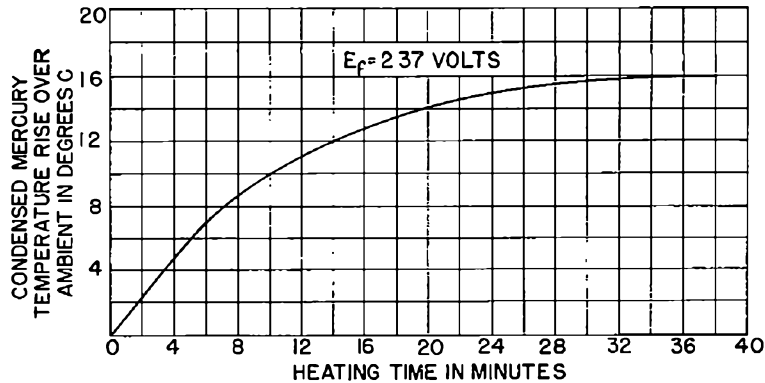

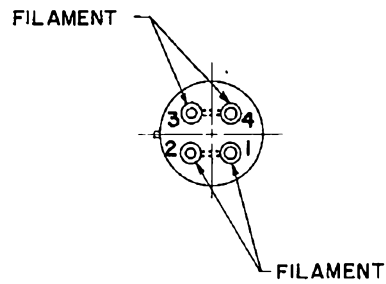
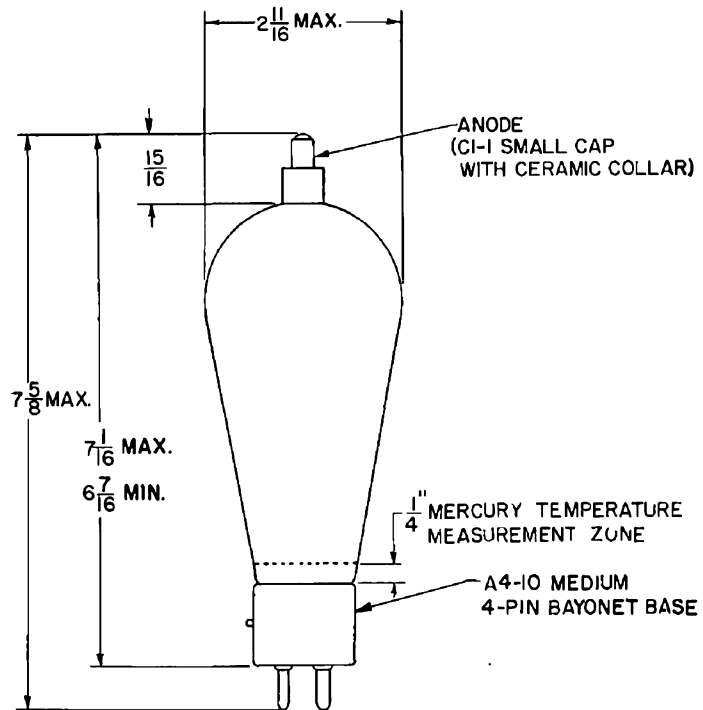

A development of Bell Telephone Laboratories, the research laboratories of the American Telephone and Telegraph Company and the Western Electric Company.

ELECTRON TUBE DATA SHEET
WESTERN ELECTRIC 249C ELECTRON TUBE



DESCRIPTION

The 249C is a mercury-vapor diode for use in high voltage rectifier circuits. The latest gettering techniques and materials are employed in this tube to insure greater service life.

MAXIMUM RATINGS

Peak Anode Voltage	7500 volts
Average Cathode Current	0.64 ampere

FILE: RECTIFIER SECTION
ISSUE 1, 4-52

249C

MAXIMUM RATINGS, ABSOLUTE VALUES

Peak Inverse Anode Voltage	7500 volts
Cathode Current	
Peak	2.5 amperes
Average	0.64 ampere
Surge (maximum duration 0.1 second)	25 amperes
Averaging Time	5 seconds
Condensed Mercury Temperature Limits	+20 to +70 centigrade

ELECTRICAL DATA

	<u>Min.</u>	<u>Bozey</u>	<u>Max.</u>
Filament Voltage	2.37	2.5	2.62 volts
Filament Current at 2.5 volts	----	7.5	8.25 amperes
Filament Heating Time Required ¹	15	---	---- seconds
Anode Voltage Drop	----	15	---- volts
Critical Anode Voltage	----	---	50 volts

MECHANICAL DATA

Type of Cooling	Convection
Equilibrium Condensed Mercury Temperature	
Rise Above Ambient, Approximate	
At Full Load	20 centigrade
At No Load	16 centigrade
Mounting Position ²	Vertical, base end down
Net Weight, Approximate	3 ounces

1. Mercury may become deposited on the tube elements in shipment, storage or handling. When using the tube for the first time, or after handling, a filament heating period of 15 to 30 minutes should be allowed to properly distribute the mercury.
2. Sufficient clearance should be allowed around the tube to insure free air circulation.

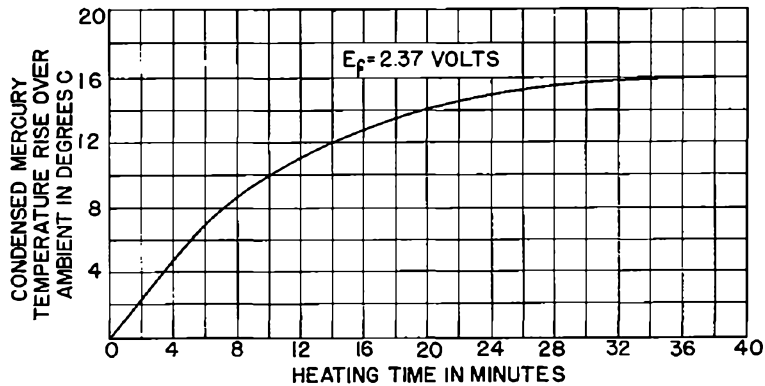

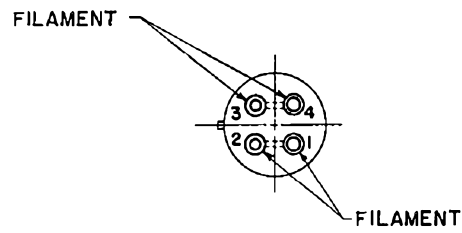
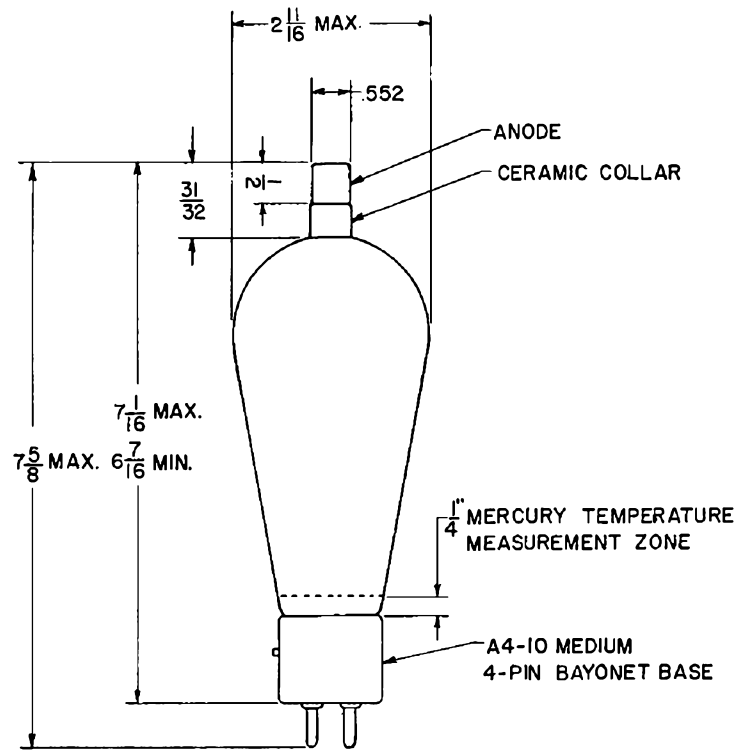

A development of Bell Telephone Laboratories, the research laboratories of the American Telephone and Telegraph Company and the Western Electric Company.

253A

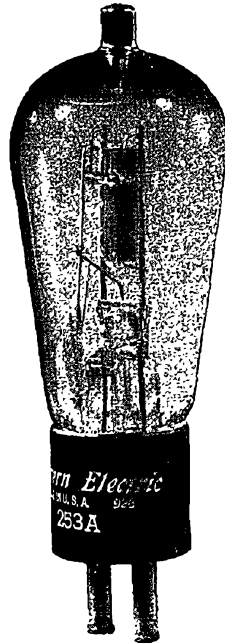

ONLY

RECTIFIER
HALF-WAVE, MERCURY-VAPOR

Western Electric

DESCRIPTION

The 253A is a half-wave mercury-vapor rectifier tube for use in high voltage rectifier circuits.

MAXIMUM RATINGS

Peak Inverse Anode Voltage	3500 volts
Average Cathode Current	0.25 ampere

ELECTRON TUBE DATA SHEET
FILE: RECTIFIER TUBE SECTION

© American Telephone and Telegraph Company 1963

253A
RECTIFIER

MAXIMUM RATINGS, Absolute Values

Peak Inverse Anode Voltage	3500 volts
Cathode Current	
Peak	1 ampere
Average	0.25 ampere
Surge (Maximum duration 0.1 second)	10 amperes
Averaging Time	5 seconds
Frequency	150 cycles/sec.
Condensed Mercury Temperature Limits	20 to 70 centigrade

ELECTRICAL DATA

	Min.	Bogey	Max.
Filament Voltage	2.38	2.5	2.62 volts
Filament Current at 2.5 Volts		3.0	3.3 amperes
Cathode Heating Time, Required	10		seconds
Anode Voltage Drop		15	volts
Critical Anode Voltage			50 volts

MECHANICAL DATA

Net Weight, Approximate	3 ounces
Equilibrium Condensed Mercury Temperature Rise Over Ambient	
At Full Load (Approximate)	19 centigrade
At No Load (Approximate)	15 centigrade
Cooling	convection

Mounting This tube should be mounted in a vertical position only with the base end down. Sufficient clearance should be maintained around the tube to insure free air circulation.

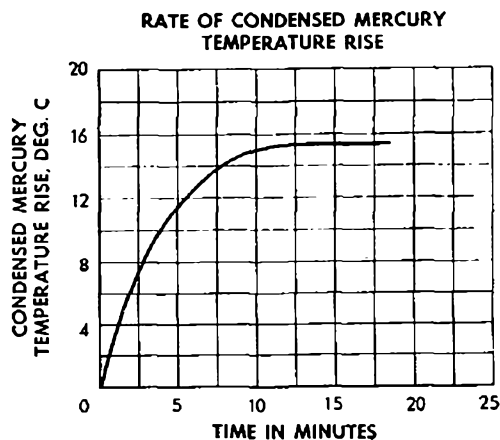

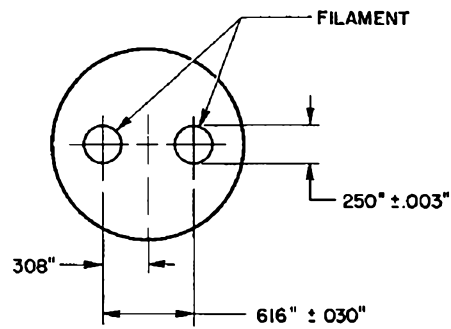
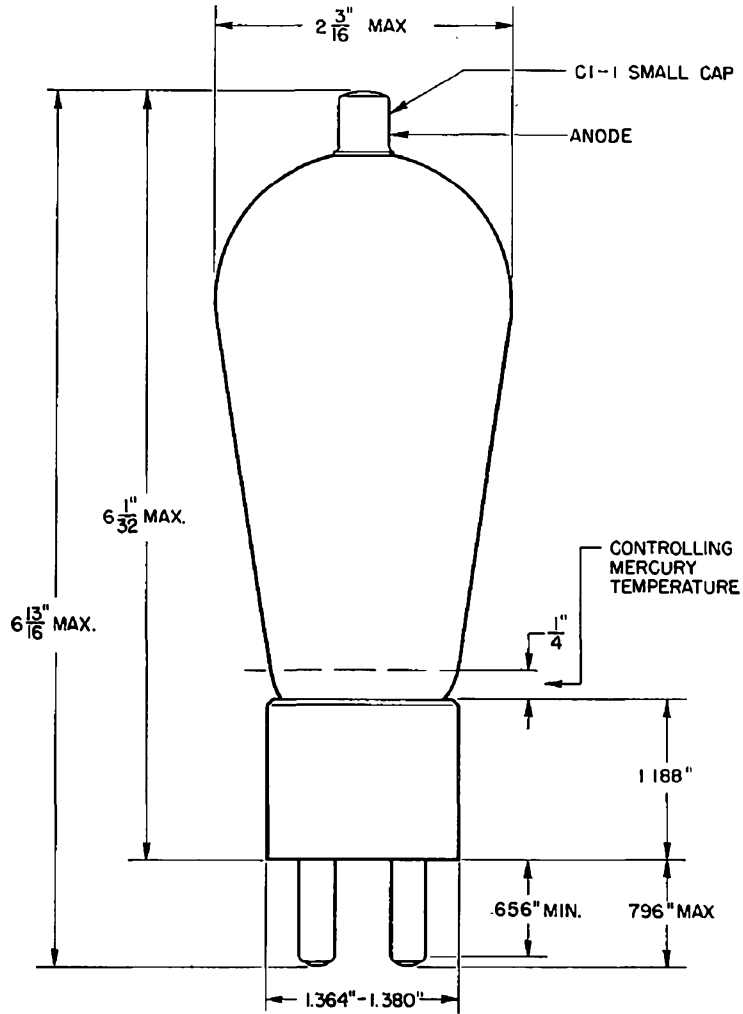

Western Electric

257A Vacuum Tube

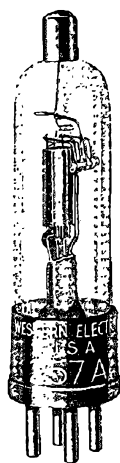

Classification—Small, filamentary triode

The 257A tube is similar to the 231D tube except that the grid terminal of the 257A tube is at the top of the bulb. An important feature of the 257A tube is its low filament power consumption.

Applications

- Audio-frequency and intermediate-frequency amplifier.
- Detector.
- Oscillator.

Dimensions—Outline diagrams showing dimensions of the tube and base, and the arrangement of the electrode connections to the base terminals are given in Figures 1 and 2.

Base—Small, four-pin, thrust base. Small metal cap grid terminal at the top of the bulb. One base contact pin is unconnected.

Socket—Standard four-contact type such as the Western Electric 143B socket.

Mountings Positions—Either vertical or horizontal. If mounted in a horizontal position the plane of the filament, which is indicated in Figure 2, should be vertical.

Average Direct Interelectrode Capacitances

Grid to plate	3.0 $\mu\mu\text{f.}$
Grid to filament	1.8 $\mu\mu\text{f.}$
Plate to filament	2.3 $\mu\mu\text{f.}$

Filament Rating

Filament current	0.060 ampere, d.c.
Nominal filament voltage	3.1 volts

The filament of this tube is designed to operate on a current basis and should be operated at as near the rated current as is practicable.

Characteristics—Plate current characteristics of a typical 257A tube are shown in Figure 3 as functions of grid voltage for several values of plate voltage. The grid and plate voltages are measured from the negative end of the filament. Corresponding amplification factor, plate resistance, and transconductance characteristics are given in Figures 4, 5 and 6, respectively. Plate current characteristics as functions of plate voltage are shown in Figure 7 for several values of grid voltage.

Operating Conditions and Output—Permissible operating plate and grid voltages are included within the area, ABCD, in Figure 3. Amplification factor, plate resistance, transconductance, and performance data are given in the table on page 3 for a number of typical operating conditions represented by selected points within this area. The less severe operating conditions should be selected in preference to maximum operating conditions wherever possible. The life of the tube at maximum conditions may be shorter than at less severe conditions.

The performance data include the fundamental power or voltage output and the second and third harmonic levels for the indicated values of load resistance. The fundamental output is given in terms of the power, P_m , in milliwatts for values of load resistance, R , equal to and double the value of the plate resistance, r_p , and in terms of the voltage, E_{pm} , in peak volts for values of load resistance five times the plate resistance. The second and third harmonic levels, F_{2m} and F_{3m} , are given in decibels below the fundamental in each case. The peak value of the sinusoidal input voltage, E_{gm} , is numerically equal to the grid bias for each operating condition. For a smaller input voltage, E_g , the fundamental power and voltage output and the harmonic levels are given approximately by the following relations:

$$P = P_m \left(\frac{E_g}{E_{gm}} \right)^2$$

$$E_p = E_{pm} \frac{E_g}{E_{gm}}$$

$$F_2 = F_{2m} + 20 \log_{10} \frac{E_{gm}}{E_g}$$

$$F_3 = F_{3m} + 40 \log_{10} \frac{E_{gm}}{E_g}$$

TABLE

Plate Voltage	Grid Bias	Plate Current	Amplification Factor	Plate Resistance	Trans-conductance	Input Voltage	Load Resistance	Power Output	Voltage Output	Second Harmonic	Third Harmonic
Volts	Volts	Milli-amperes		Ohms r_p	Micro-mhos	Peak Volts	R	Milli-watts	Peak Volts	db	db
67.5	-3.0	.93	8.5	22500	380	3.0	$R = r_p$	3.0		29	50
							$R = 2r_p$	2.5		36	60
							$R = 5r_p$		20	47	70
67.5	-1.5	1.55	8.5	18300	460	1.5	$R = r_p$	1.0		39	70
							$R = 2r_p$	0.9		46	80
90.0	-5.0	1.15	8.5	20700	410	5.0	$R = r_p$	10		26	48
							$R = 2r_p$	9		33	50
							$R = 5r_p$		35	42	65
90.0	-3.0	2.10	8.4	16300	510	3.0	$R = r_p$	4.5		36	60
							$R = 2r_p$	4.0		42	70
							$R = 5r_p$		22	50	75
112.5	-8.0	1.00	8.5	22200	390	8.0	$R = r_p$	23		21	34
							$R = 2r_p$	20		27	42
							$R = 5r_p$		55	38	60
112.5	-6.0	1.90	8.4	17200	490	6.0	$R = r_p$	17		29	45
							$R = 2r_p$	15		35	55
							$R = 5r_p$		42	44	70
135.0	-11.5	0.70	8.5	27000	320	11.5	$R = r_p$	45		17	28
							$R = 2r_p$	50		23	34
							$R = 5r_p$		76	33	47
135.0	-10.0	1.25	8.5	20300	420	10.0	$R = r_p$	40		21	32
							$R = 2r_p$	35		28	41
							$R = 5r_p$		67	37	55
135.0	-8.5	1.95	8.5	17200	490	8.5	$R = r_p$	35		26	40
							$R = 2r_p$	30		33	50
							$R = 5r_p$		57	42	65
*90.0	-1.5	2.90	8.4	14500	580	1.5	$R = r_p$	1.2		46	75
							$R = 2r_p$	1.0		50	85
*112.5	-4.5	2.65	8.4	15000	560	4.5	$R = r_p$	10		34	55
							$R = 2r_p$	9		40	65
							$R = 5r_p$		30	50	70
*135.0	-7.5	2.50	8.4	15600	540	7.5	$R = r_p$	27		29	47
							$R = 2r_p$	24		36	55
							$R = 5r_p$		48	45	70

*Maximum operating conditions.

Microphonic Noise—With a plate voltage of 90 volts, a grid bias of -3 volts, and a load resistance of 100,000 ohms, the mean microphonic noise output level of the 257A tube measured in a laboratory reference test set, is 22 decibels below 1 volt. The range of levels of individual tubes extends from 12 to 36 decibels. Since microphonic noise depends on the type and intensity of the mechanical disturbance which produces it, the values given here are useful chiefly for comparison with the levels of other tubes which have been tested in the same way.

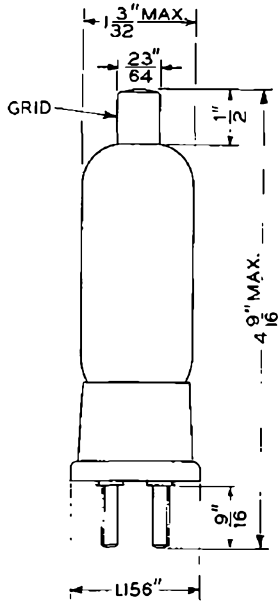

FIG. 1

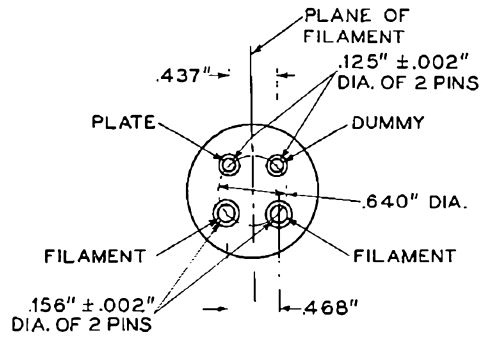

FIG. 2

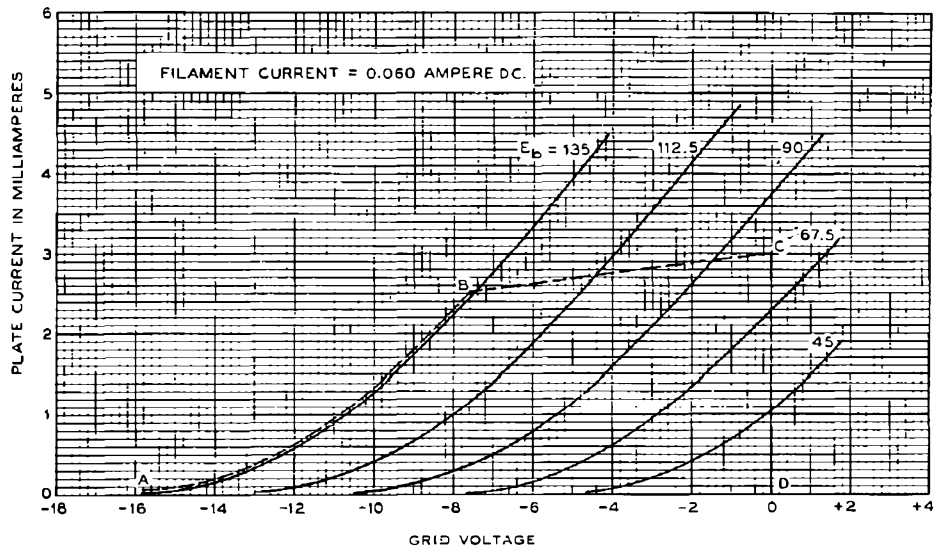

FIG. 3

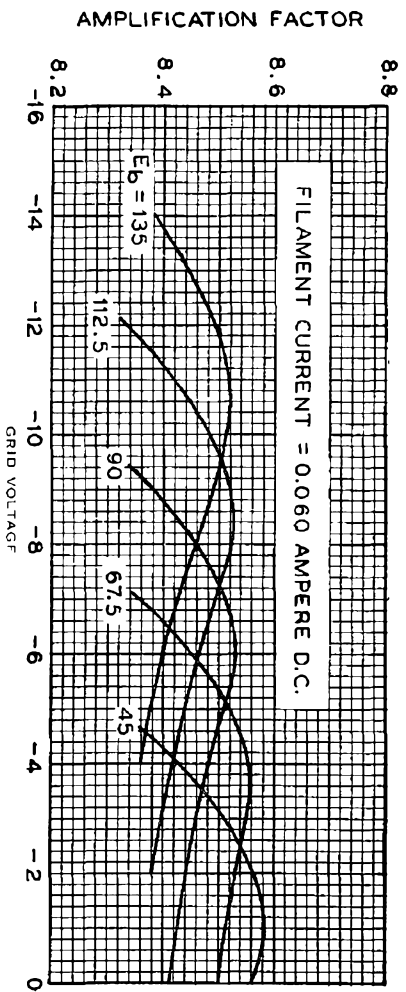

FIG. 4

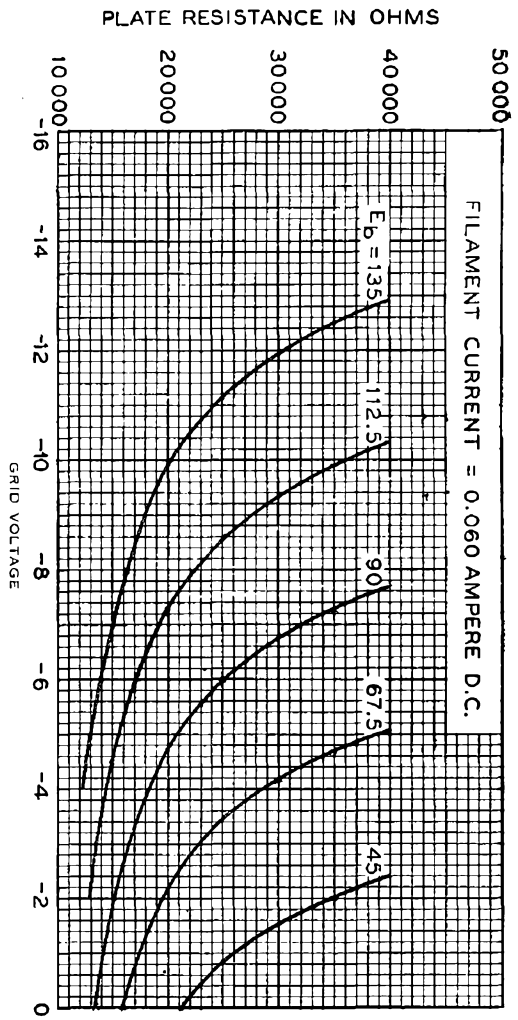

FIG. 5

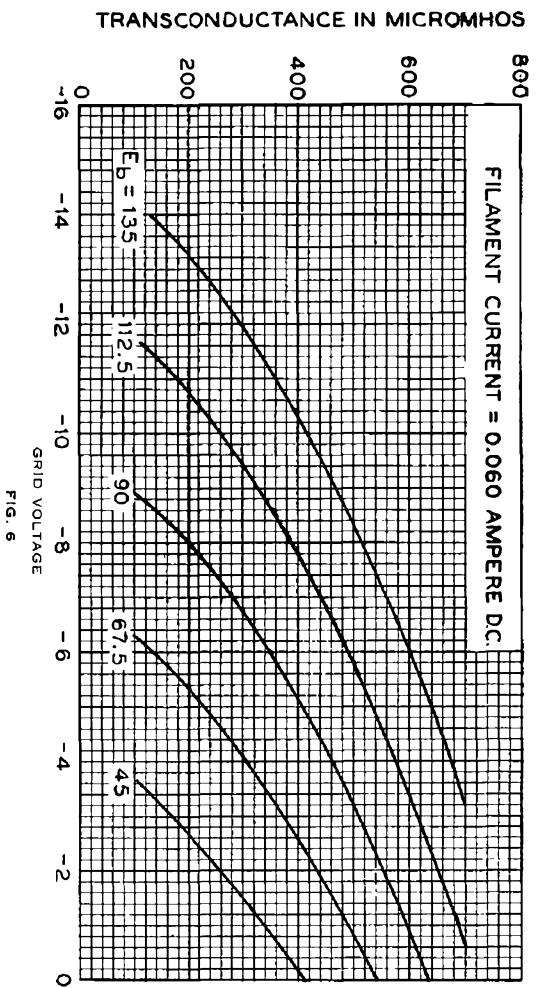

FIG. 6

[5]

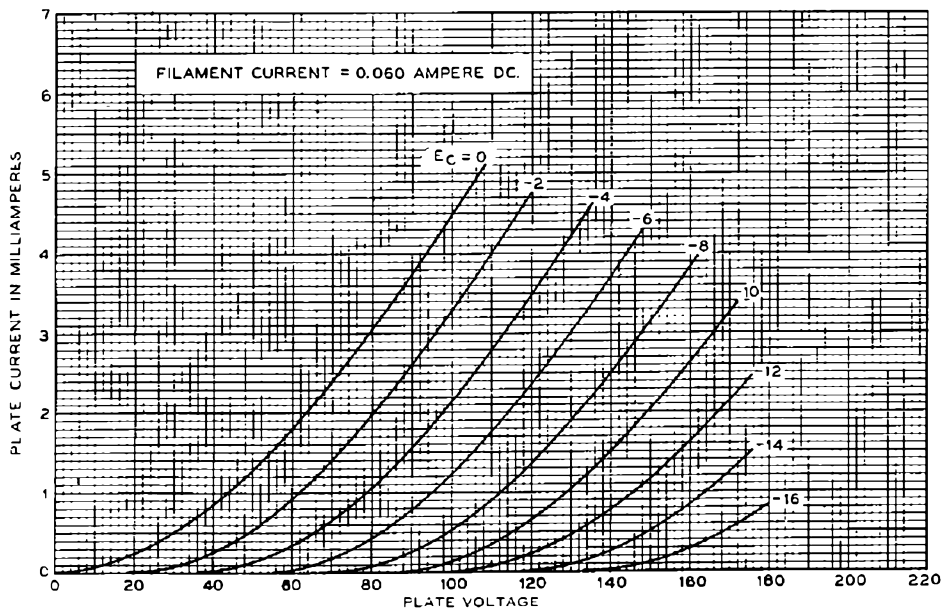

FIG. 7

1.C.36-28C
PRINTED IN U.S.A.

A development of Bell Telephone Laboratories, Incorporated,
the research laboratories of the American Telephone and Tele-
graph Company, and the Western Electric Company

V. T. DATA SHEET 257A
ISSUE 1

ELECTRON TUBE DATA SHEET
WESTERN ELECTRIC 258B ELECTRON TUBE

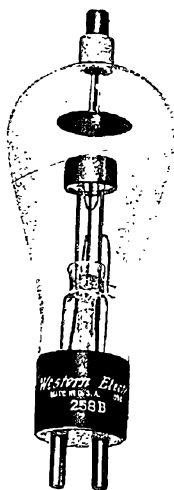

ONLY

DESCRIPTION

The 258B is a mercury-vapor diode for use in high voltage rectifier circuits. The latest gettering techniques and materials are employed in this tube to insure greater service life.

MAXIMUM RATINGS

Peak Anode Voltage	7500 volts
Average Cathode Current	0.64 ampere

FILE: RECTIFIER SECTION

MAXIMUM RATINGS, ABSOLUTE VALUES

Peak Inverse Anode Voltage	7500 volts
Cathode Current	
Peak	2.5 amperes
Average	0.64 amperes
Surge (maximum duration 0.1 second)	25 amperes
Averaging Time	5 seconds
Condensed Mercury Temperature Limits	+20 to +70 centigrade

ELECTRICAL DATA

	<u>Min.</u>	<u>Bogey</u>	<u>Max.</u>
Filament Voltage	2.37	2.5	2.62 volts
Filament Current at 2.5 volts	----	7.5	8.25 amperes
Filament Heating Time Required ¹	15	---	--- seconds
Anode Voltage Drop	----	15	---- volts
Critical Anode Voltage	----	---	50 volts

MECHANICAL DATA

Type of Cooling	Convection
Equilibrium Condensed Mercury Temperature Rise Above Ambient, Approximate	
At Full Load	20 centigrade
At No Load	16 centigrade
Mounting Position ²	Vertical, base end down
Net Weight, Approximate	3 ounces

1. Mercury may become deposited on the tube elements in shipment, storage or handling. When using the tube for the first time, or after handling, a filament heating period of 15 to 30 minutes should be allowed to properly distribute the mercury.
2. Sufficient clearance should be allowed around the tube to insure free air circulation.

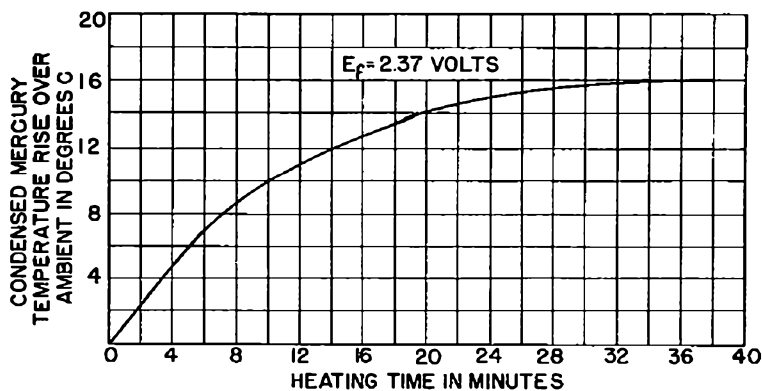

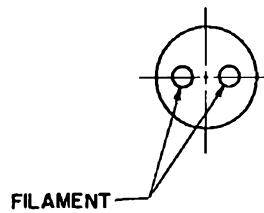
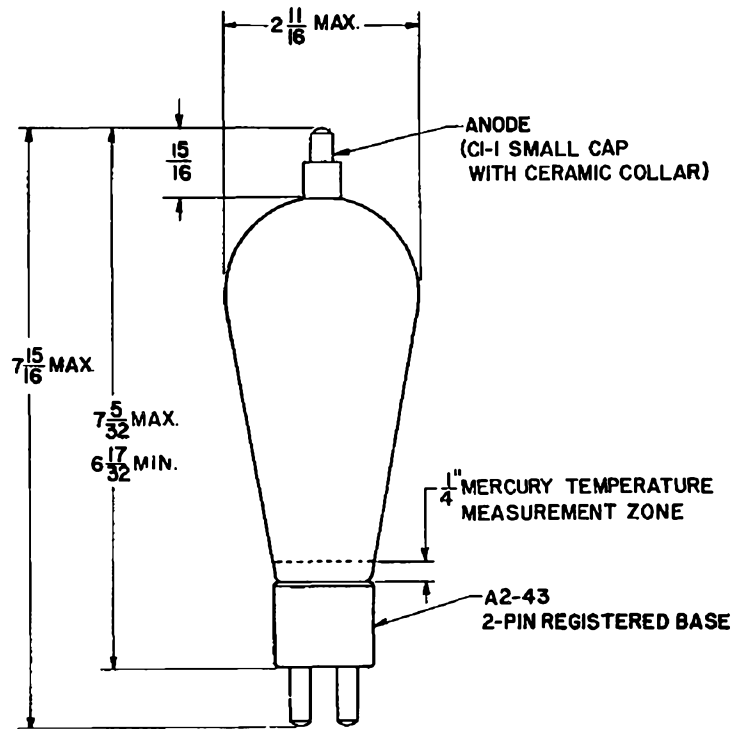

A development of Bell Telephone Laboratories, the research laboratories of the American Telephone and Telegraph Company and the Western Electric Company.

PRINTED IN U.S.A.

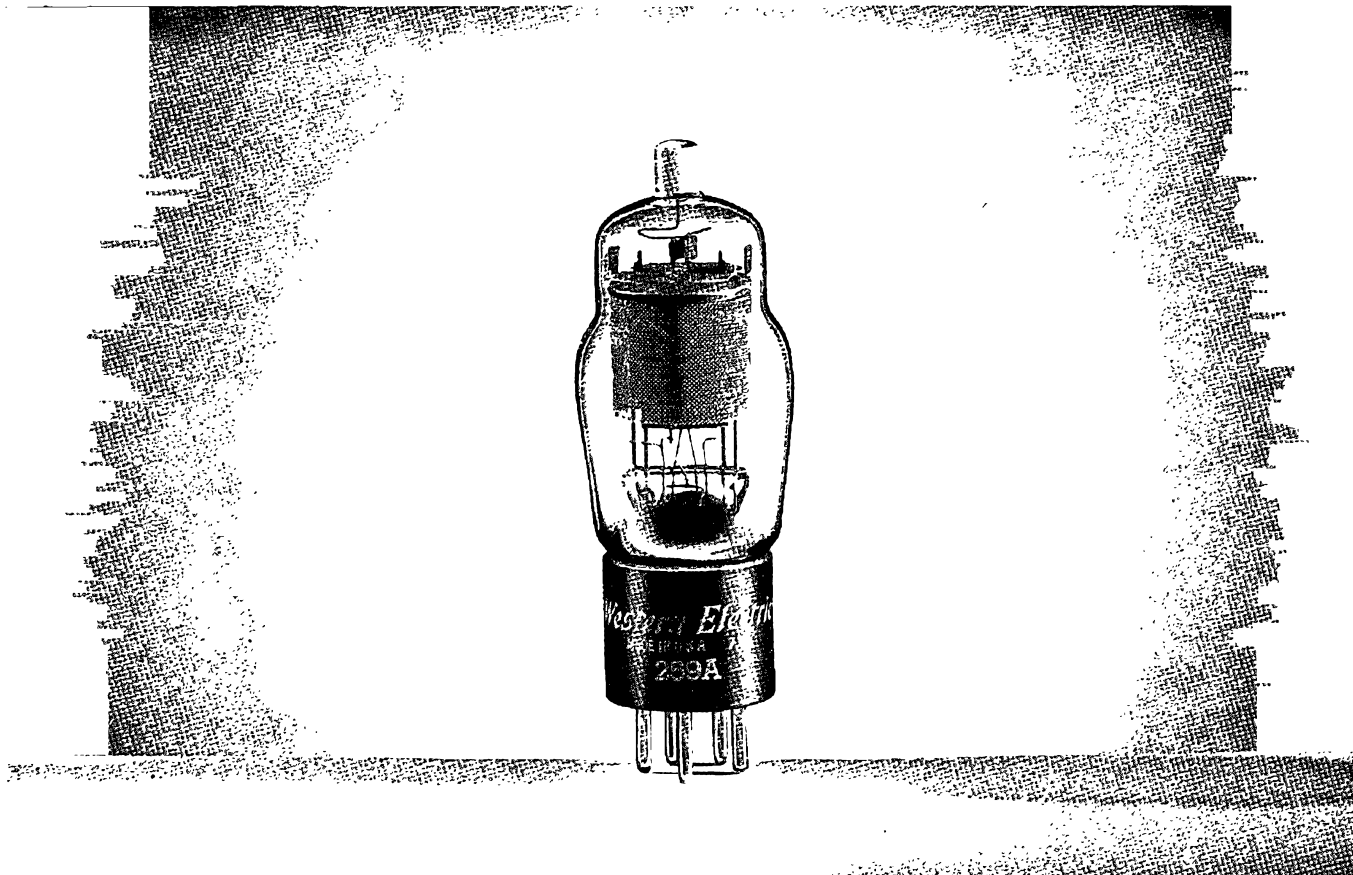

TETRODE

Western Electric

DESCRIPTION

The 259A is a tetrode having an indirectly heated cathode. It is designed for use as a radio-frequency voltage amplifier. It may also be used as a detector or audio-frequency voltage amplifier.

CHARACTERISTICS

Heater Voltage	2.0 volts
Plate Current	} $E_b = 180$ volts; $E_c = 75$ volts; {	6.0 milliamperes
Transconductance		} $E_{c1} = -1.5$ volts {



GENERAL CHARACTERISTICS

ELECTRICAL DATA

Heater Voltage, A-C or D-C		2.0 volts
Heater Current		1.60 amperes
Direct Interelectrode Capacitances	without external shield	with external shield (RMA #312)
Grid to Plate (maximum)	0.017	*0.007 uuf
Input	6.0	*7.3 uuf
Output	12.5	*13.0 uuf

MECHANICAL DATA

Cathode	Coated unipotential
Bulb	ST14
Base	Medium 5-pin, with bayonet pin
Mounting Position	Any
Dimensions and pin connections shown in outline drawing on Page 7	

MAXIMUM RATINGS, Design-Center Values

Plate Voltage	250 volts
Screen Grid Voltage	90 volts
Plate Dissipation	2.0 watts
Screen Grid Dissipation	0.4 watt
Cathode Current	10 milliamperes
Heater-Cathode Voltage	100 volts

TYPICAL OPERATING CONDITIONS AND CHARACTERISTICS

Plate Voltage	135	180	180 volts
Screen Grid Voltage	75	75	90 volts
Control Grid Voltage	-1.5	-1.5	-1.5 volts
Plate Current	5.8	6.0	8.3 milliamperes
Screen Grid Current	2.1	2.0	2.8 milliamperes
Plate Resistance	0.32	0.52	0.35 megohm
Transconductance	1440	1490	1670 micromhos
Control Grid Voltage, Approximate, for 10 Microamperes Plate Current	-9.5	-9.5	-12 volts

*With external shield (RMA #312) connected to cathode pin.

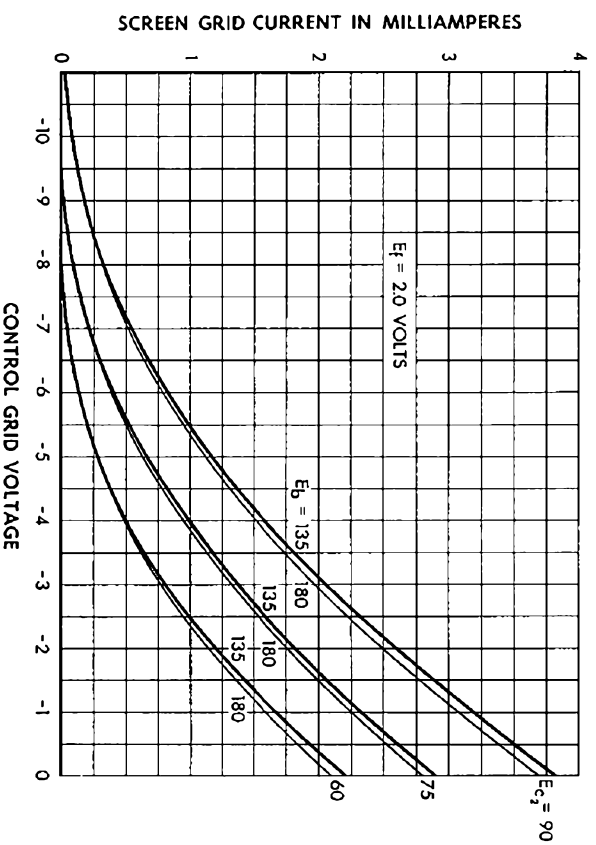
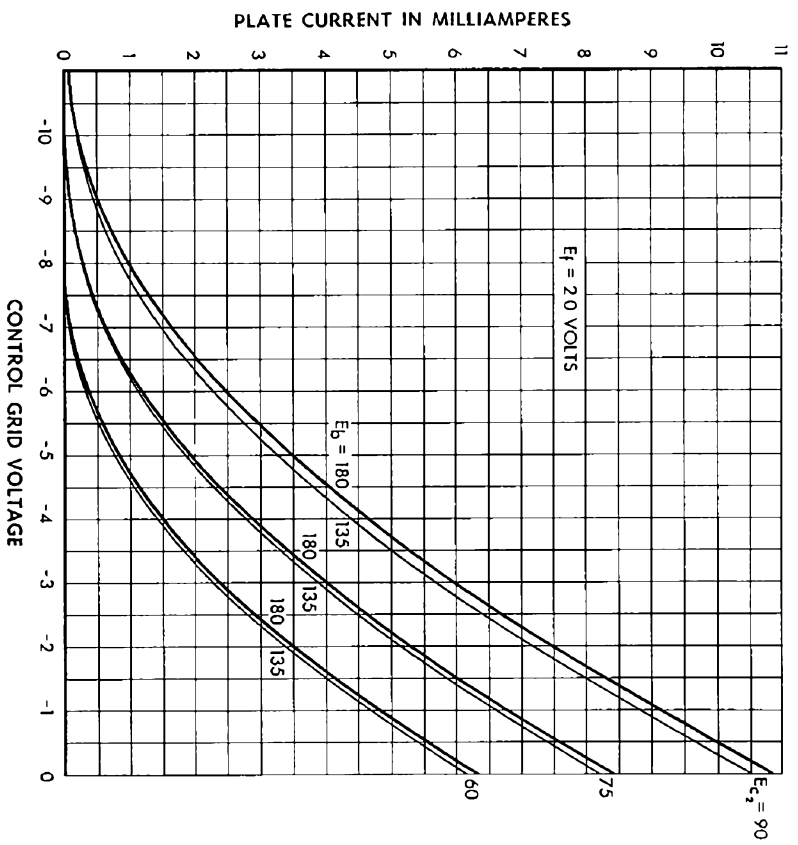

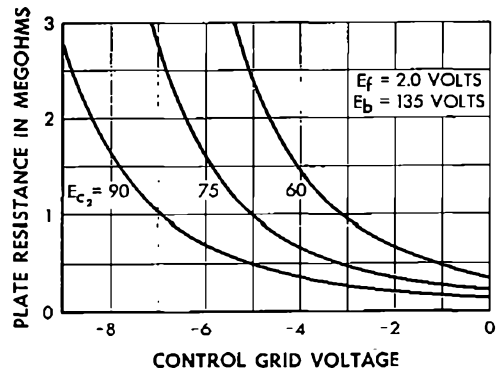
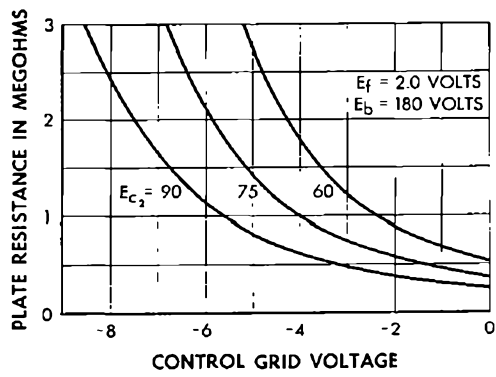
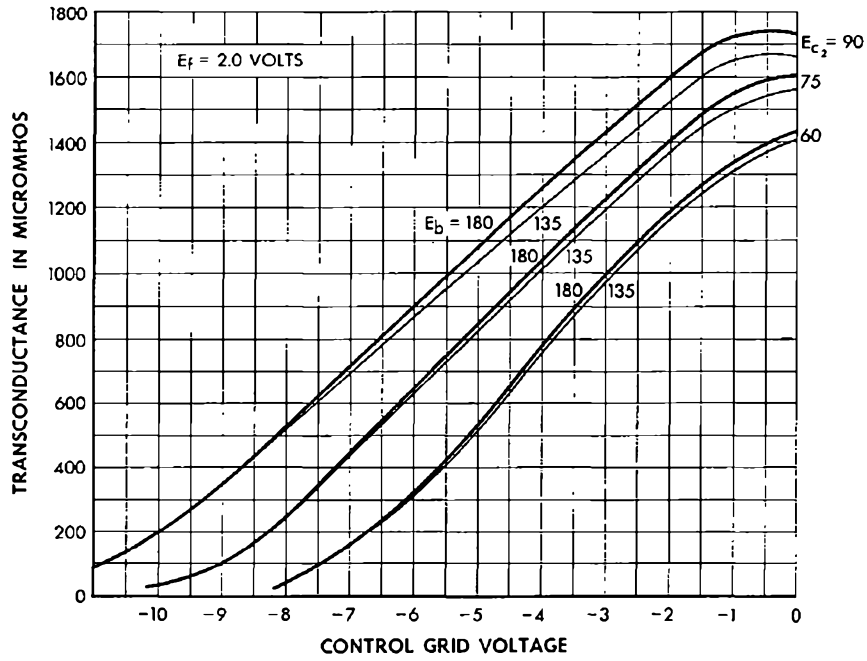

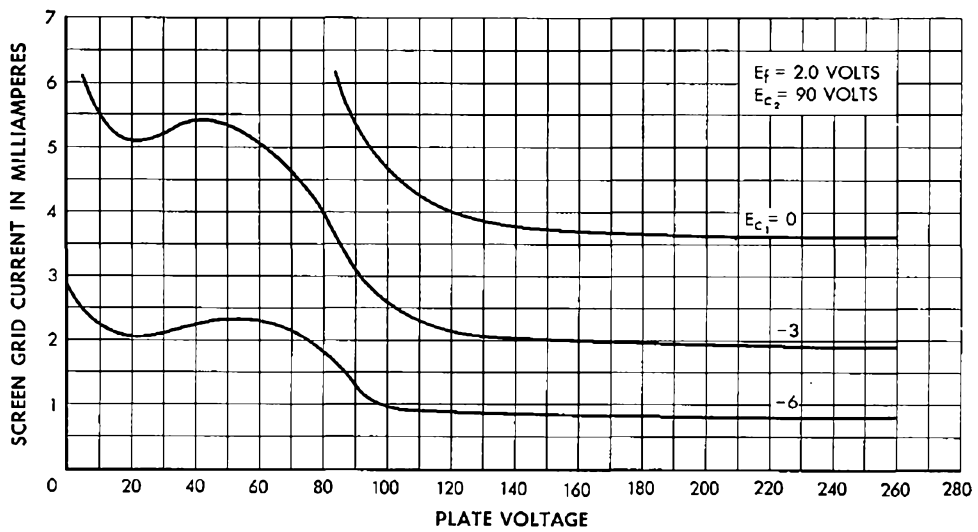
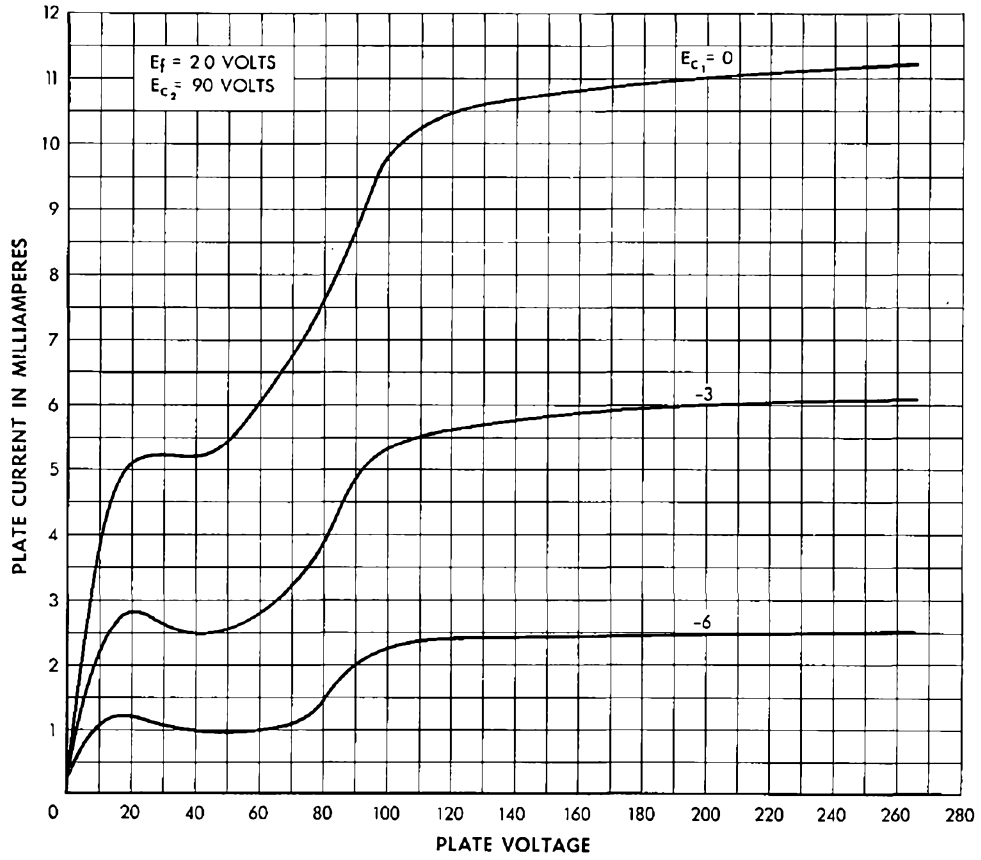

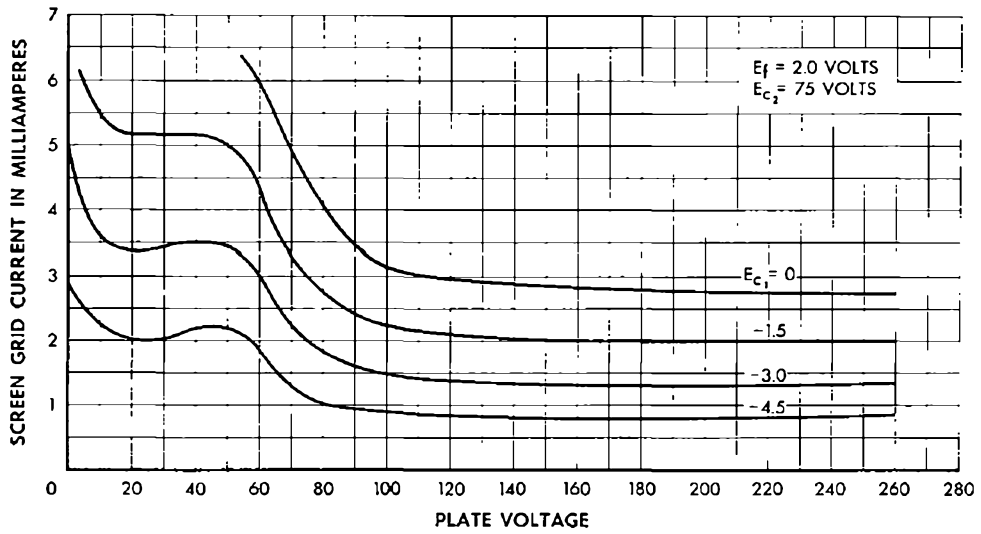
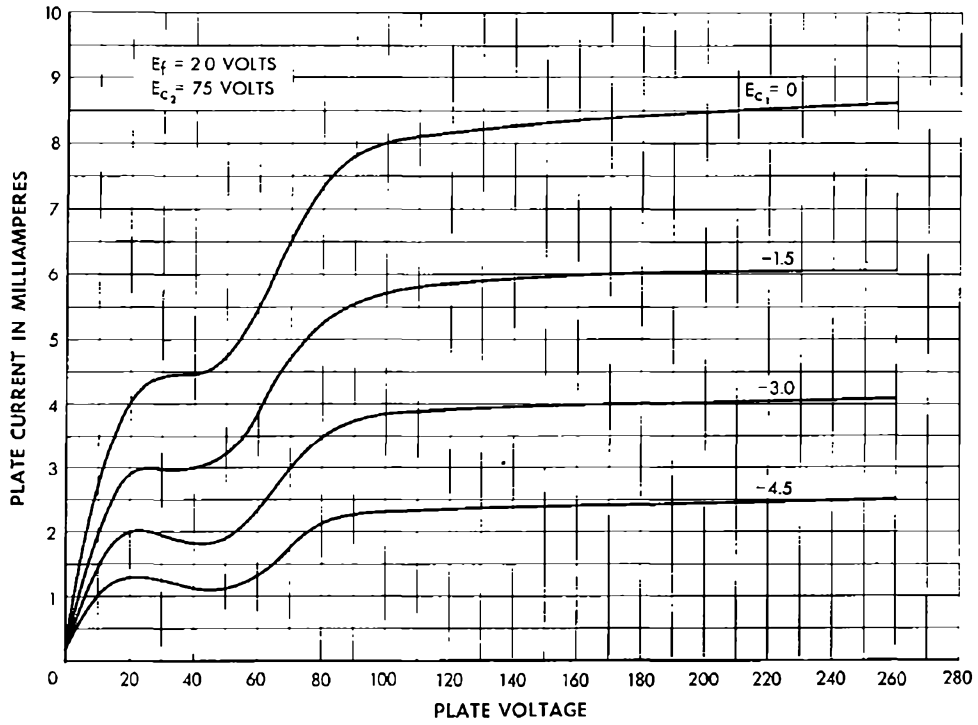

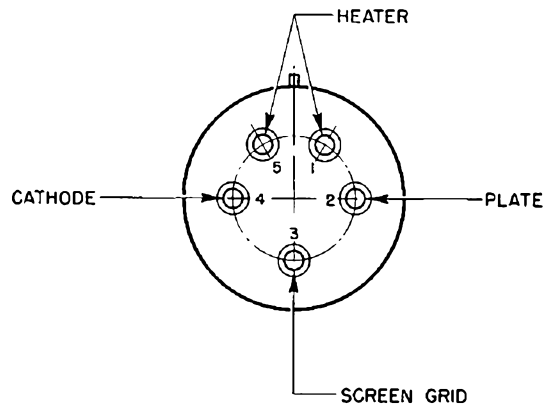
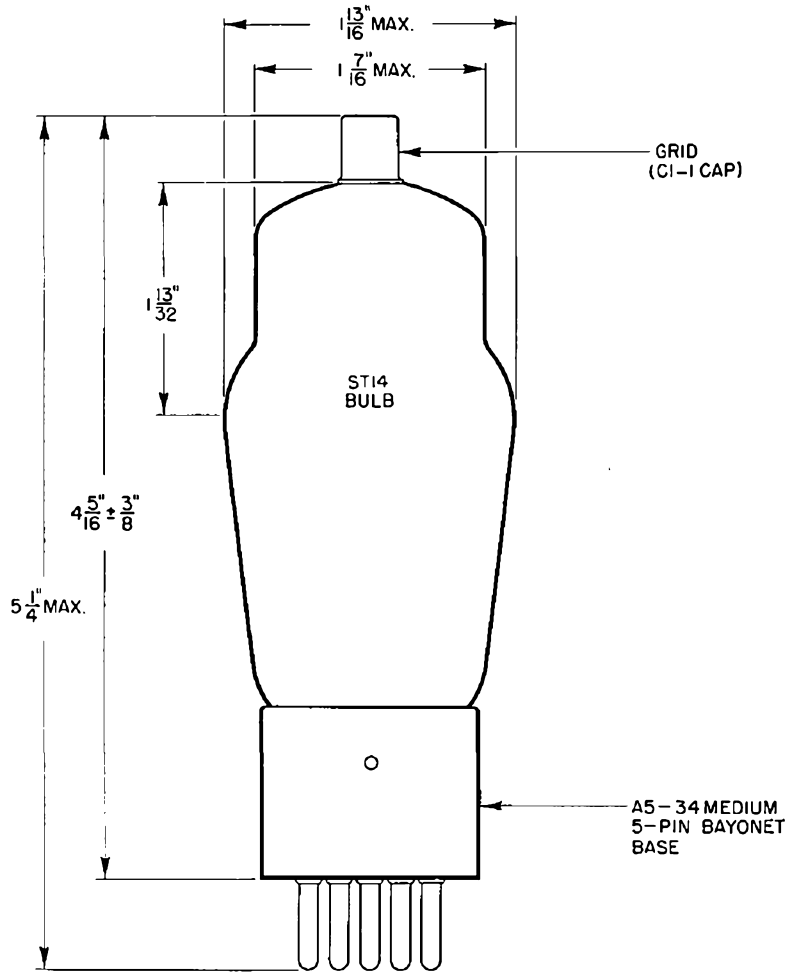

Western Electric

262A Vacuum Tube

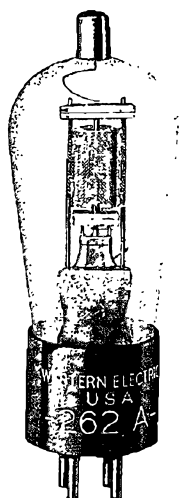

Classification—Low-power triode with indirectly-heated cathode

The 262A tube is designed to minimize hum produced by alternating current operation of the heater, and to minimize microphonic noise.

Application—Audio-frequency amplifier where alternating current is used for heating the cathode and exceptionally low tube noise is required

Dimensions—Dimensions, outline diagrams of the tube and base, and the arrangement of electrode connections to the base terminals are shown in Figures 1 and 2.

Base—Medium, four-pin thrust type having silver-plated pins. Small metal cap grid terminal at the top of the bulb.

Socket—Standard, four-contact type, preferably provided with silver-plated contacts such, as the Western Electric 143B socket.

Mounting Positions—The 262A tube may be mounted in any position.

Average Direct Interelectrode Capacitances

Grid to plate	1.9 $\mu\mu\text{f}$.
Grid to cathode and heater	1.8 $\mu\mu\text{f}$.
Plate to cathode and heater	4.0 $\mu\mu\text{f}$.

Heater Rating

Heater voltage	10.0 volts, a.c. or d.c.
Nominal heater current	0.32 ampere

The heater element of this tube is designed to operate on a voltage basis and should be operated at as near the rated voltage as is practicable.

Cathode Connection—Preferably direct to the mid-point of the heater transformer winding or to the mid-point of a low resistance connected across the heater terminals, where alternating heater voltage is used. This connection usually reduces the hum produced in the tube. Where voltage must be applied between the heater and cathode, it should be kept as low as possible and should not exceed 90 volts.

Characteristics—Plate current characteristics of a typical 262A tube are shown in Figure 3 as functions of grid voltage for several values of plate voltage. Corresponding amplification factor, plate resistance and transconductance characteristics are given in Figures 4, 5, and 6, respectively. Plate current characteristics are given as functions of plate voltage for several values of grid voltage in Figure 7.

Operating Conditions and Output—Permissible operating plate and grid voltages are included within the area, ABCD, in Figure 3. A number of recommended and maximum operating conditions represented by selected points within this area and the corresponding values of amplification factor, plate resistance and transconductance are given in the table on page 4. Recommended conditions or others of no greater severity should be selected in preference to maximum conditions wherever possible. The life of the tube at maximum conditions may be shorter than at the recommended conditions.

In the latter part of the table are given the fundamental power output, P_m , in milliwatts, the fundamental voltage output, E_{pm} , in peak volts, and the second and third harmonic levels, F_{2m} and F_{3m} , in db below the fundamental, corresponding to each of the recommended and maximum operating conditions for the indicated values of load resistance, R . The fundamental output is given in terms of power for values of load resistance equal to and double the value of the plate resistance, r_p , and in terms of voltage for values of load resistance five times the plate resistance.

The peak value of the sinusoidal input voltage, E_{gm} , in each case is numerically equal to the grid biasing voltage. For a smaller input voltage, E_g , the fundamental power and voltage output and the harmonic levels are given approximately by the following relations:

$$P = P_m \left(\frac{E_g}{E_{gm}} \right)^2$$

$$E_p = E_{pm} \frac{E_g}{E_{gm}}$$

$$F_2 = F_{2m} + 20 \log_{10} \frac{E_{gm}}{E_g}$$

$$F_3 = F_{3m} + 40 \log_{10} \frac{E_{gm}}{E_g}$$

Hum—The disturbance produced in the plate circuit of an indirectly heated cathode type tube by alternating current operation of the heater has two main frequency components. One is of the same frequency as the alternating heater voltage. The other, often larger in magnitude, is of double this frequency. With a plate voltage of 135 volts, a grid bias of -4.5 volts, a load resistance equal to the plate resistance of the tube, and with the cathode connected to the mid-point of the heater circuit, the mean hum output level of the 262A tube at the supply frequency is 110 db below 1 milliamperere. The range of levels of individual tubes extends from 95 to 125 db below 1 milliamperere. At double the supply frequency, the mean level is 111 db below 1 milliamperere, and the range of levels of individual tubes extends from 104 to 118 db below 1 milliamperere.

The 262A tube has high insulation resistance and low capacitance between the grid and the heater. When reasonable care is exercised to keep the insulation leakage and capacitance small between the grid and heater leads in the external wiring, a resistance of 2 megohms may be used in the grid circuit without materially affecting the hum level.

Microphonic Noise—With a plate voltage of 135 volts, a grid bias of -4.5 volts and a load resistance of 100,000 ohms, the mean microphonic noise output level of the 262A tube measured in a laboratory reference test set is 50 db below 1 volt. The range of levels of individual tubes extends from 38 to 62 db below 1 volt. Since microphonic noise depends on the type and intensity of the mechanical disturbance which produces it, the values given here are useful chiefly for comparison with the levels of other tubes which have been tested in the same way.

Fluctuation Noise—An irreducible minimum of noise in a vacuum tube is produced by uncontrollable, minute fluctuations in the rate of flow of electrons to the anode. With a plate voltage of 135 volts, a grid bias of -4.5 volts, and a load resistance of 100,000 ohms, the mean equivalent fluctuation noise input of the 262A tube for the audio-frequency range from 40 to 10,600 cycles is 112.4 db below 1 volt. Individual 262A tubes may differ from this value by as much as 5 db. By reducing the plate voltage to 36 volts and the grid bias to -1 volt, the mean fluctuation noise level may be reduced by about 7.5 db, without seriously affecting the voltage amplification. The equivalent noise input voltage is equal to the measured output voltage divided by the voltage amplification of the tube in the measuring circuit.

TABLE

	Plate VOLT- age Volts	Grid Bias Volts	Plate Cur- rent Milli- amperes	Ampli- fication Factor	Plate Resis- tance Ohms r_p	Trans- con- duc- tance Micro- mhos	Load Resis- tance R	Power Out- put Milli- watts	Volt- age Out- put Peak Volts	Sec- ond Har- monic db	Third Har- monic db
Recom- mended Operat- ing Condi- tions	90	-4.0	0.9	14.3	23800	600	$R = r_p$	17	—	21	42
							$R = 2r_p$	15	—	23	55
							$R = 5r_p$	—	50	30	55
	90	-3.0	1.6	15.0	18500	810	$R = r_p$	13	—	23	55
							$R = 2r_p$	12	—	27	60
							$R = 5r_p$	—	40	32	55
	90	-2.0	2.5	15.6	15700	990	$R = r_p$	8	—	28	55
							$R = 2r_p$	7	—	31	60
							$R = 5r_p$	—	30	36	70
	112.5	-4.5	1.6	14.7	19100	770	$R = r_p$	30	—	20	47
							$R = 2r_p$	25	—	25	65
							$R = 5r_p$	—	67	30	55
	112.5	-3.0	2.9	15.5	15000	1030	$R = r_p$	17	—	26	60
							$R = 2r_p$	15	—	30	70
							$R = 5r_p$	—	40	33	60
	*135	-7.5	0.7	13.7	29000	470	$R = 5r_p$	—	95	25	50
	135	-6.0	1.6	14.4	19600	730	$R = r_p$	45	—	19	42
							$R = 2r_p$	40	—	23	55
$R = 5r_p$							—	75	29	50	
135	-4.5	2.8	15.1	15400	980	$R = r_p$	35	—	23	60	
						$R = 2r_p$	30	—	27	60	
						$R = 5r_p$	—	60	31	55	
*157.5	-8.0	1.4	14.0	22000	640	$R = 5r_p$	—	100	26	50	
157.5	-7.0	2.0	14.5	18200	800	$R = r_p$	65	—	18	42	
						$R = 2r_p$	60	—	23	55	
						$R = 5r_p$	—	90	29	50	
Maxi- mum Operat- ing Condi- tions	112.5	-2.0	4.0	16.0	13400	1190	$R = r_p$	9	—	31	55
							$R = 2r_p$	8	—	34	60
							$R = 5r_p$	—	30	38	65
	135	-3.5	3.8	15.6	13700	1140	$R = r_p$	25	—	26	55
							$R = 2r_p$	20	—	30	70
							$R = 5r_p$	—	47	33	70
	157.5	-5.5	3.3	15.1	14800	1020	$R = r_p$	55	—	22	55
							$R = 2r_p$	50	—	27	60
							$R = 5r_p$	—	70	31	50
	*180	-10.5	0.9	13.6	28800	470	$R = 5r_p$	—	130	23	42
	*180	-9.0	1.7	14.1	20200	700	$R = 5r_p$	—	110	27	50
	180	-7.5	2.8	14.7	16200	910	$R = r_p$	90	—	20	46
$R = 2r_p$							80	—	24	60	
$R = 5r_p$							—	95	30	50	

*Operating conditions applicable primarily for voltage amplification.

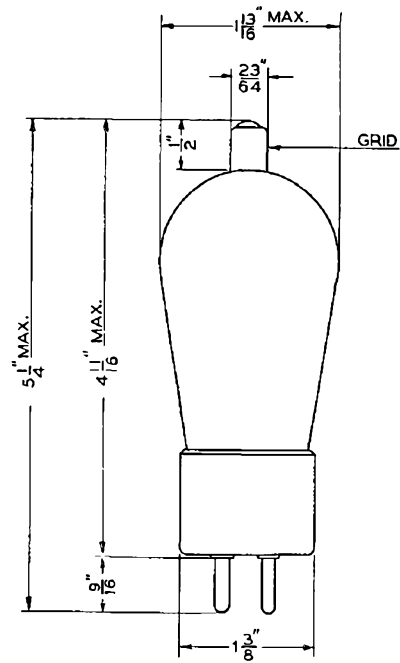

FIG. 1

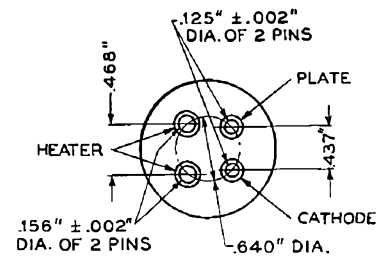

FIG. 2

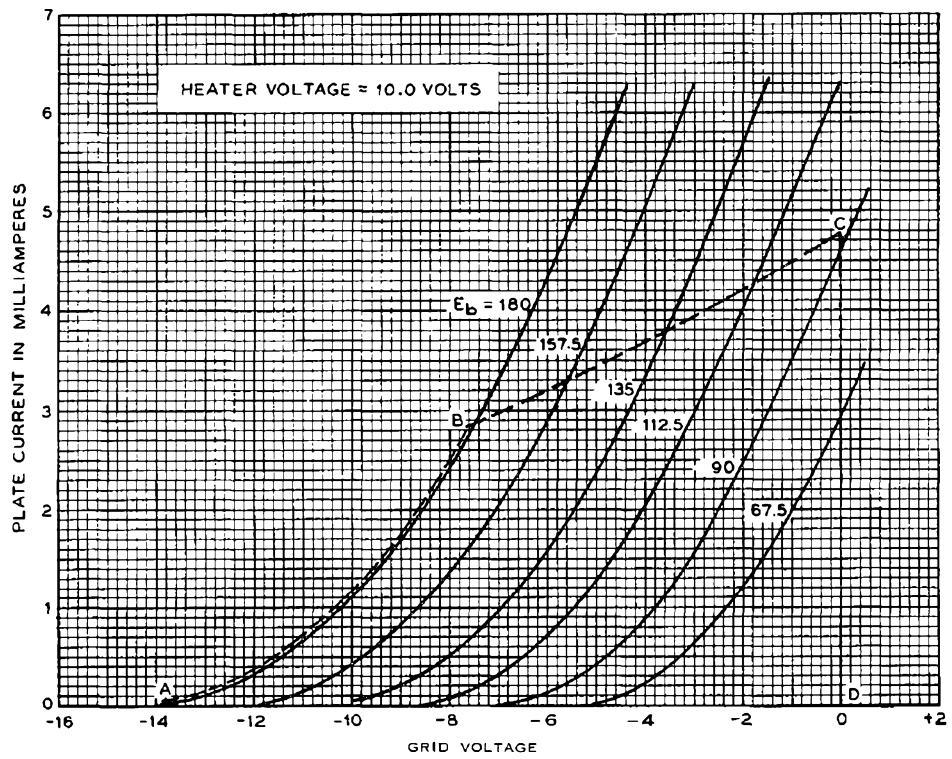

FIG. 3

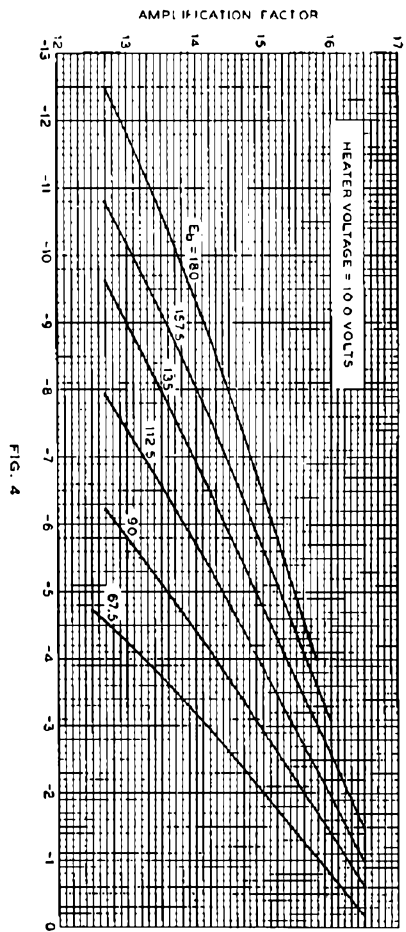

FIG. 4

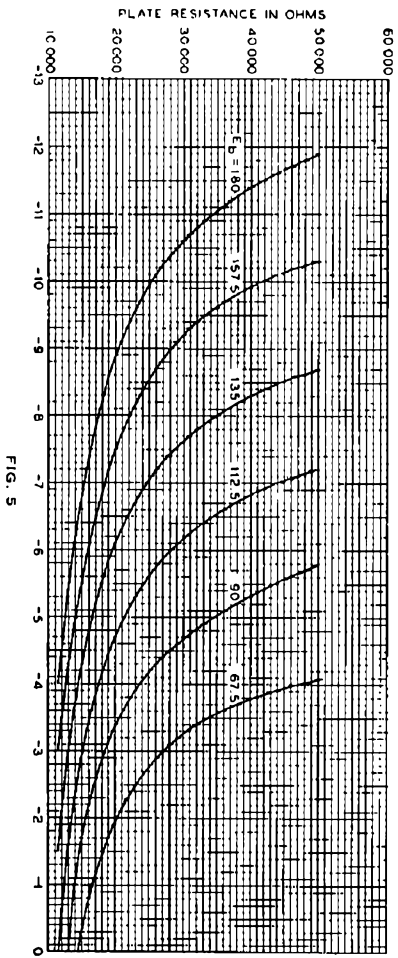

FIG. 5

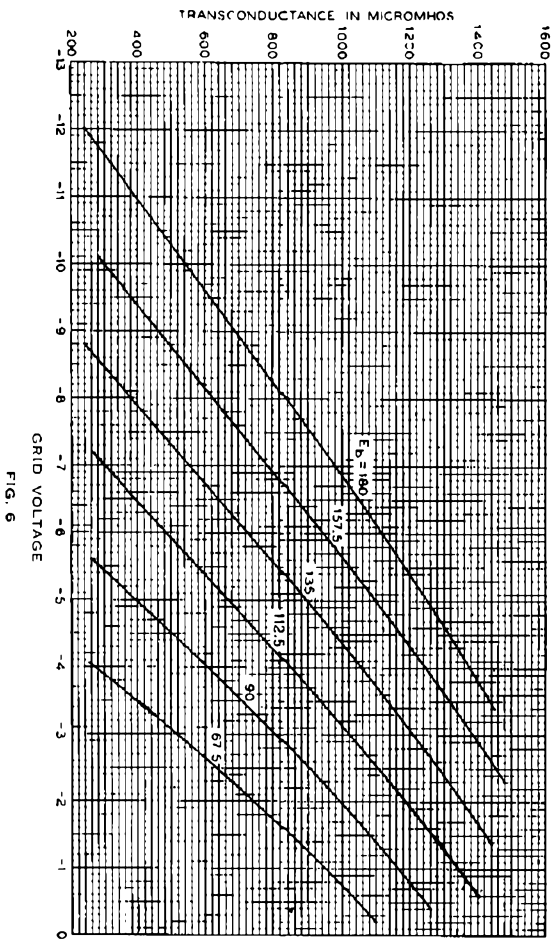

FIG. 6

[6]

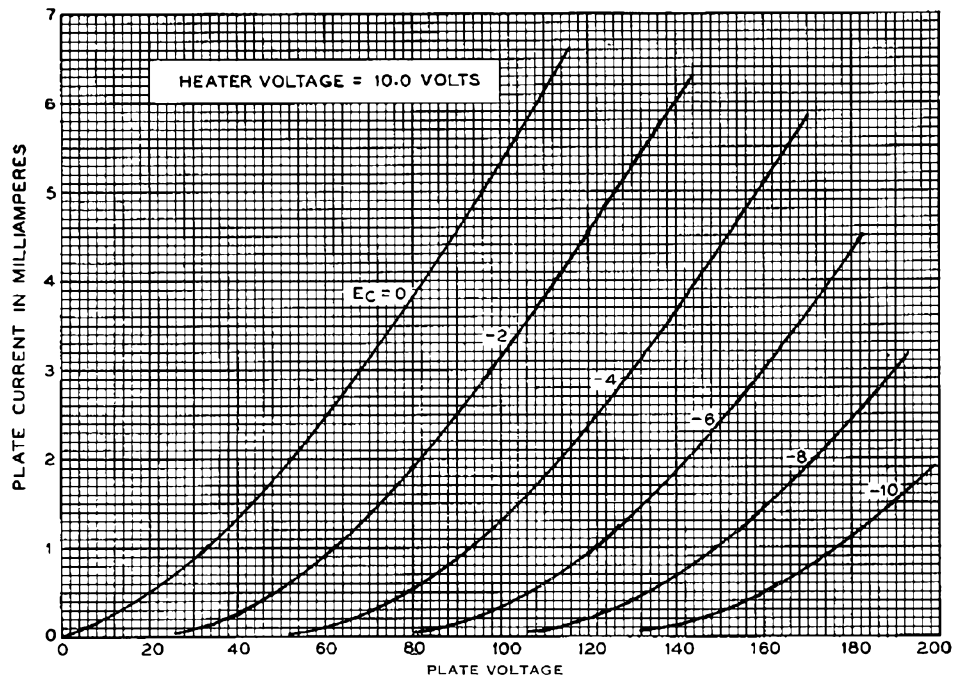
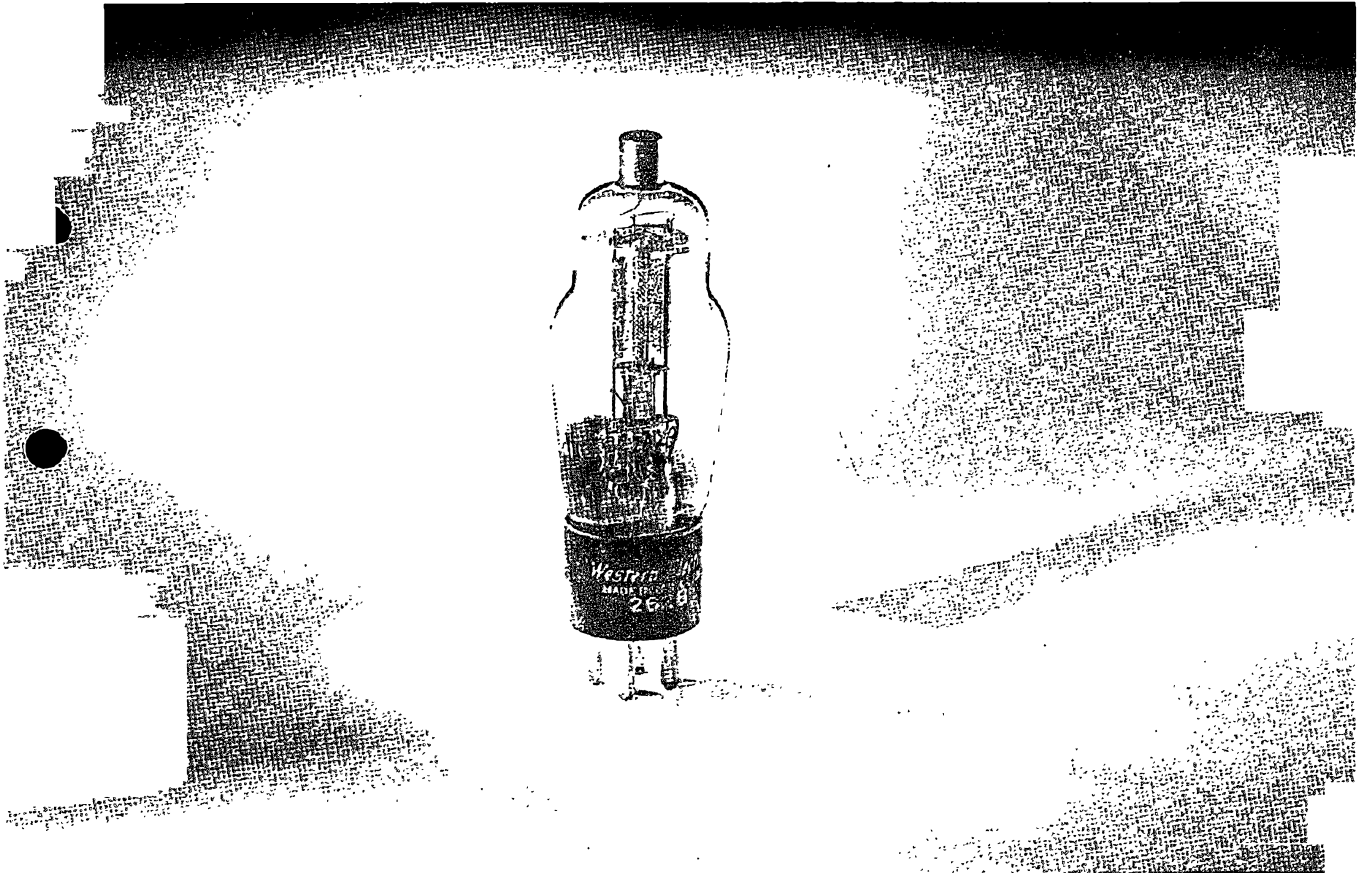

FIG. 7



**TRIODE
AUDIO-FREQUENCY AMPLIFIER**

Western Electric

DESCRIPTION

The 262B is a triode designed for use as an audio-frequency amplifier where exceptionally low tube noise is required. Special design features minimize both the microphonic noise and the hum produced by a.c. operation of the heater.

CHARACTERISTICS

Heater Voltage	10 volts
Maximum Plate Voltage	180 volts
Amplification Factor	15

GENERAL CHARACTERISTICS**ELECTRICAL DATA**

Heater Voltage, A-C or D-C	10 volts
Heater Current	320 milliamperes
Direct Interelectrode Capacitances (without external shield)	
Grid to Plate	1.9 uuf
Input	2.4 uuf
Output	3.8 uuf

MECHANICAL DATA

Cathode	Coated Unipotential
Bulb	ST 12
Base	Small 4-pin
Mounting Position	Any
Dimensions and pin connections shown in outline drawing on Page 5	

MAXIMUM RATINGS, Design-Center Values

Plate Voltage	180 volts
Plate Dissipation	2.0 watts
Plate Current	10.0 milliamperes
Heater-Cathode Voltage	30 volts

TYPICAL OPERATING CONDITIONS AND CHARACTERISTICS—CLASS A₁ AMPLIFIER

Plate Voltage	120	135	160	180 volts
Grid Voltage	-6.0	-4.5	-6.0	-7.5 volts
Peak A-F Grid Voltage	6.0	4.5	6.0	7.5 volts
Plate Current	1.0	3.0	3.0	2.8 milliamperes
Transconductance	560	890	880	840 micromhos
Amplification Factor	14.8	15.4	15.5	15.3
Plate Resistance	26600	17300	17700	18300 ohms
Load Resistance	100000	100000	100000	100000 ohms
Maximum Signal Power Output	24	18	31	48 milliwatts
Total Harmonic Distortion	4	2.5	3	3 percent

HUM

Under typical operating conditions, and with the cathode of the tube connected to the mid-point of the heater circuit, the equivalent hum voltage in the grid circuit will be less than 12 microvolts at the supply frequency and less than 5.0 microvolts at double the

supply frequency.

If the insulation leakage and capacitance between the external grid and heater connections are kept reasonably low, a resistance of 2 megohms may be used in the grid circuit without materially affecting the hum level.

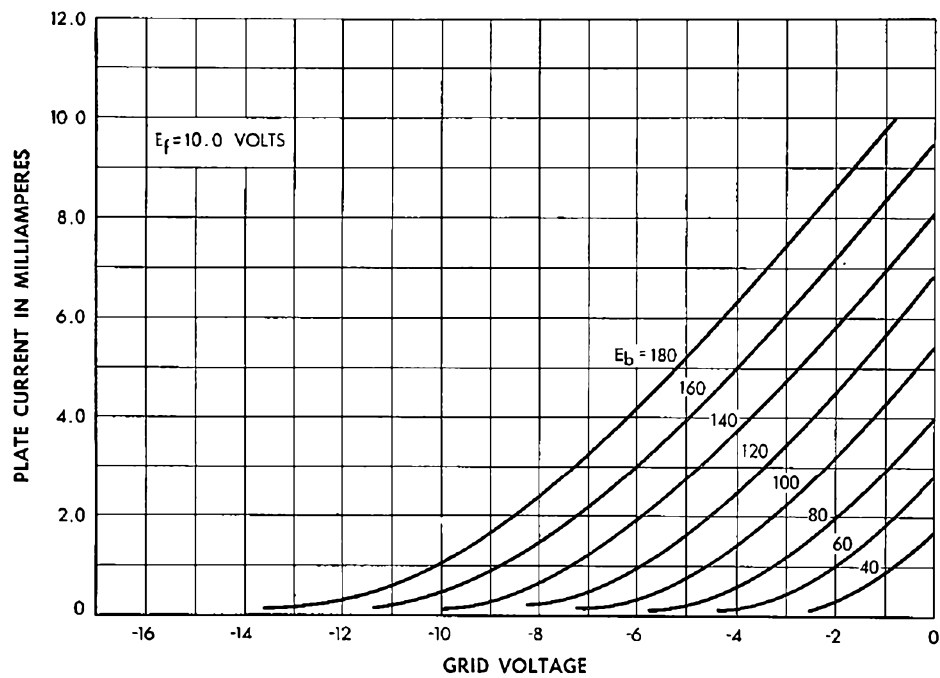
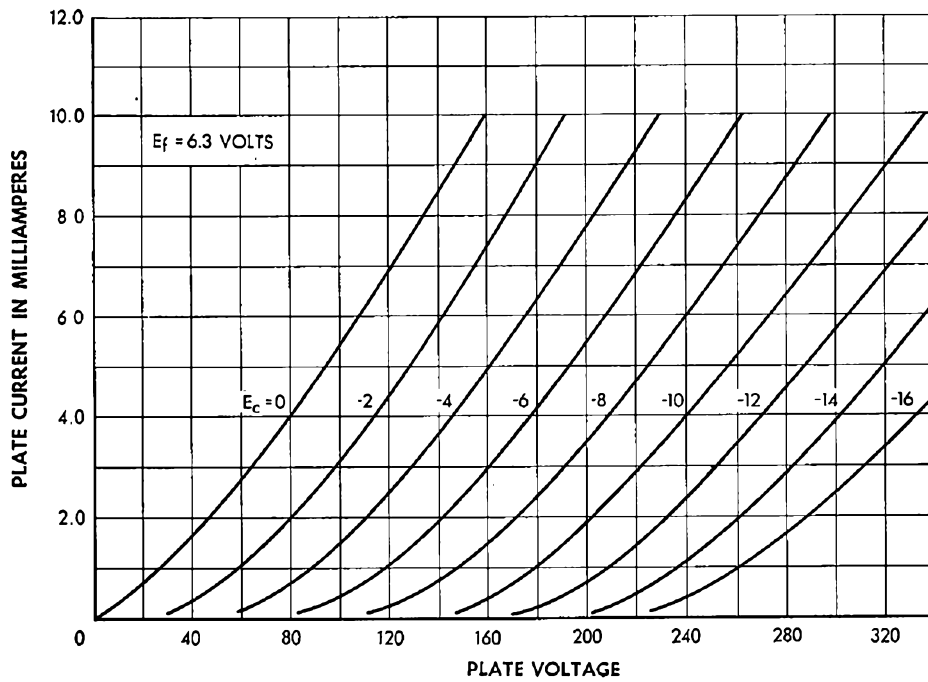

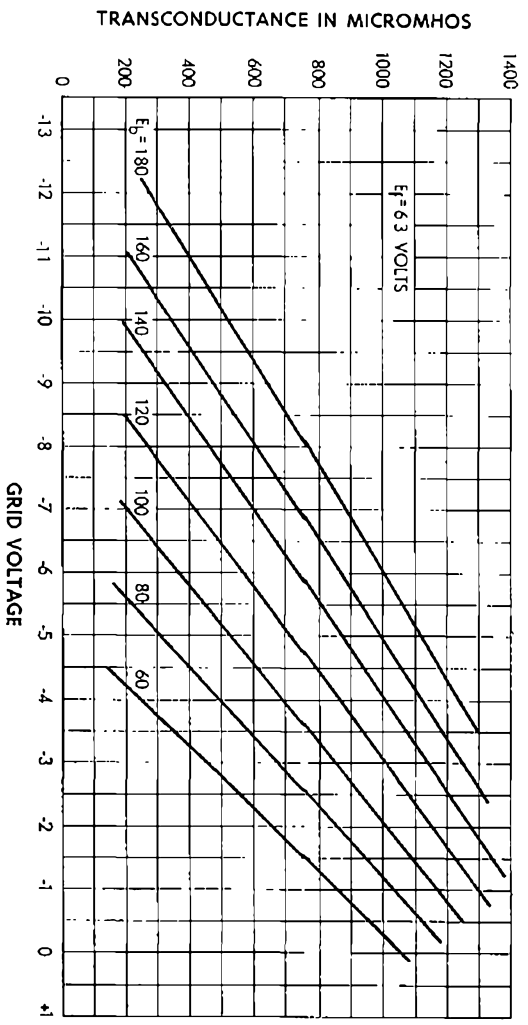
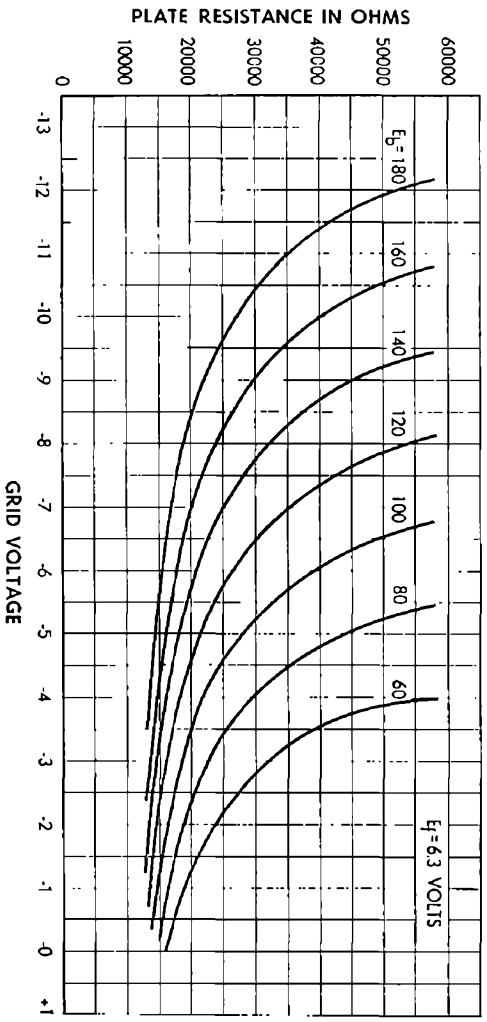
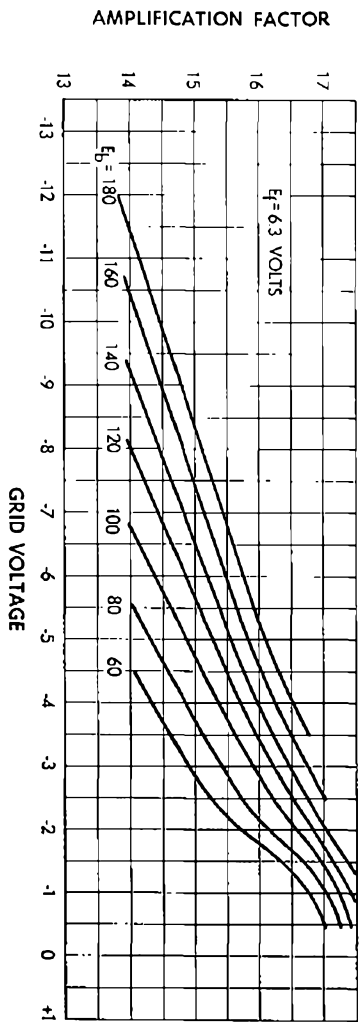

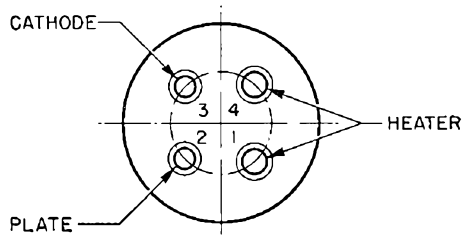
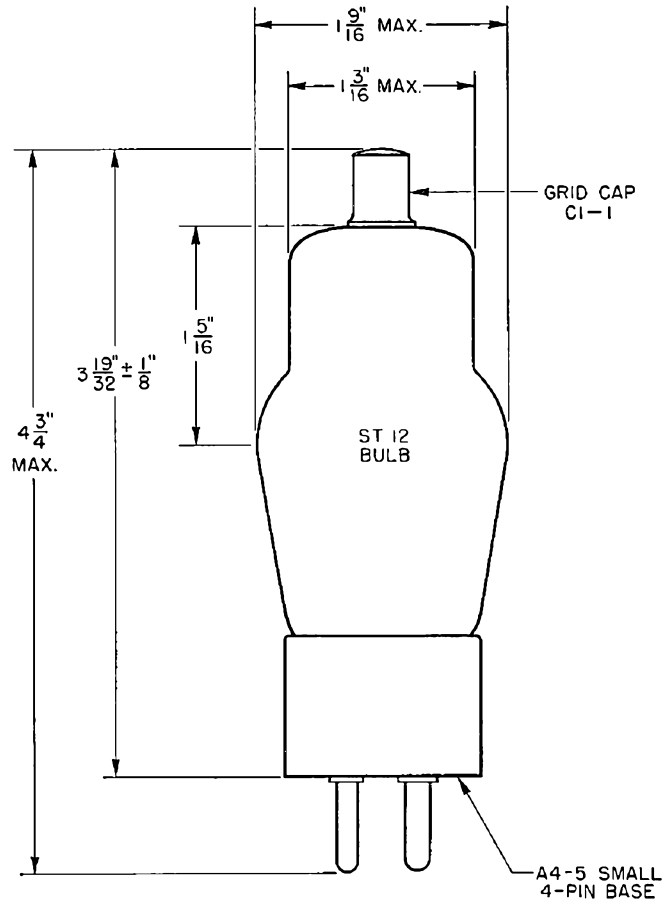

264C

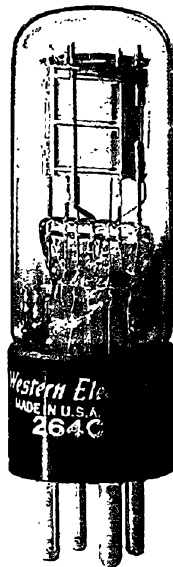

TRIODE
AUDIO-FREQUENCY AMPLIFIER

Western Electric

DESCRIPTION

The 264C is a filamentary type triode designed for use as an audio-frequency amplifier in applications requiring low tube noise or high input resistance.

CHARACTERISTICS

Filament Voltage	1.5 volts
Maximum Plate Voltage	135 volts
Amplification Factor	7.2

264C
TRIODE

GENERAL CHARACTERISTICS

ELECTRICAL DATA

Filament Voltage	1.5 volts
Filament Current	300 milliamperes
Direct Interelectrode Capacitances (without external shield)	
Grid to Plate	4.9 uuf
Input	3.0 uuf
Output	2.6 uuf

MECHANICAL DATA

Cathode	Coated Filament
Bulb	T9
Base	Small 4-pin
Mounting Position	Any

Dimensions and pin connections shown in outline drawing on Page 4

MAXIMUM RATINGS, Design-Center Values

Plate Voltage	135 volts
Plate Current	3.5 milliamperes

TYPICAL OPERATING CONDITIONS AND CHARACTERISTICS — CLASS A₁ AMPLIFIER

Plate Voltage	60	100 volts
Grid Voltage	-2	-8 volts
Peak A-F Grid Voltage	2	8 volts
Plate Current	2.35	2.10 milliamperes
Transconductance	620	580 micromhos
Amplification Factor	7.3	7.2
Plate Resistance	11700	12400 ohms
Load Resistance	23400	24800 ohms
Maximum Signal Power Output	2.1	30 milliwatts
Total Harmonic Distortion Less Than	1	3 per cent

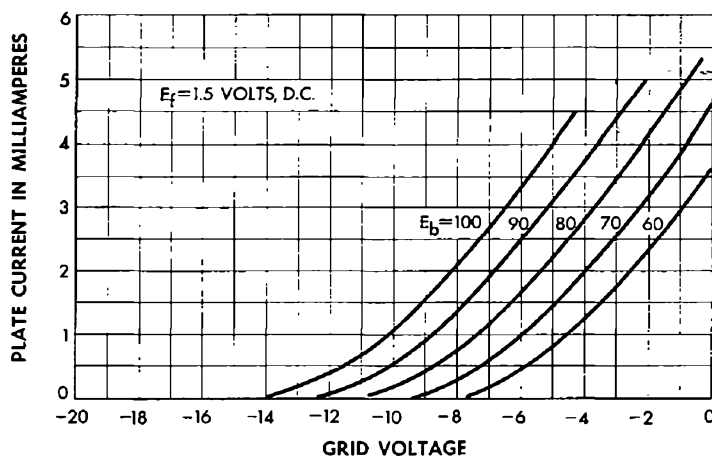

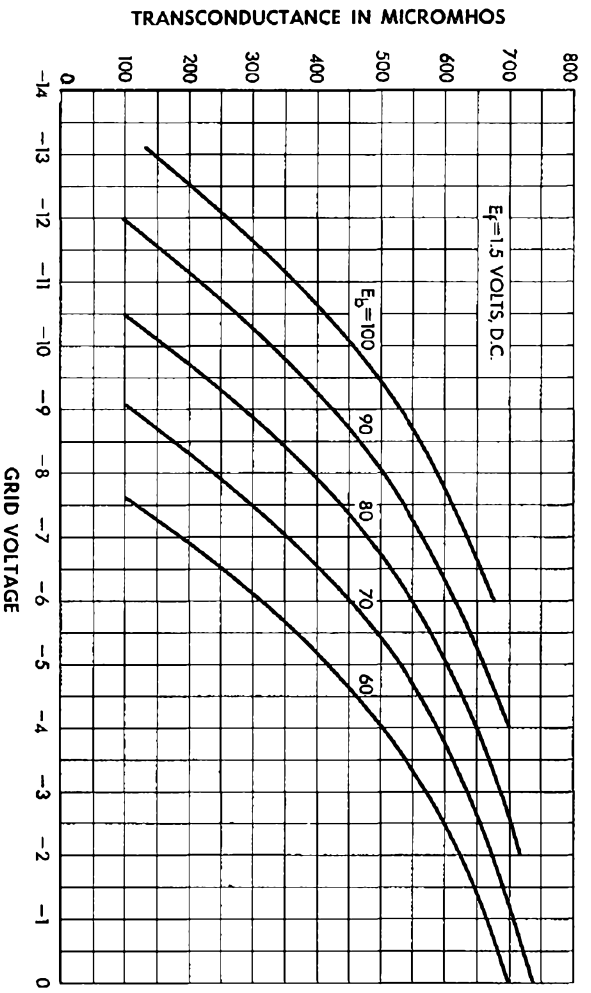
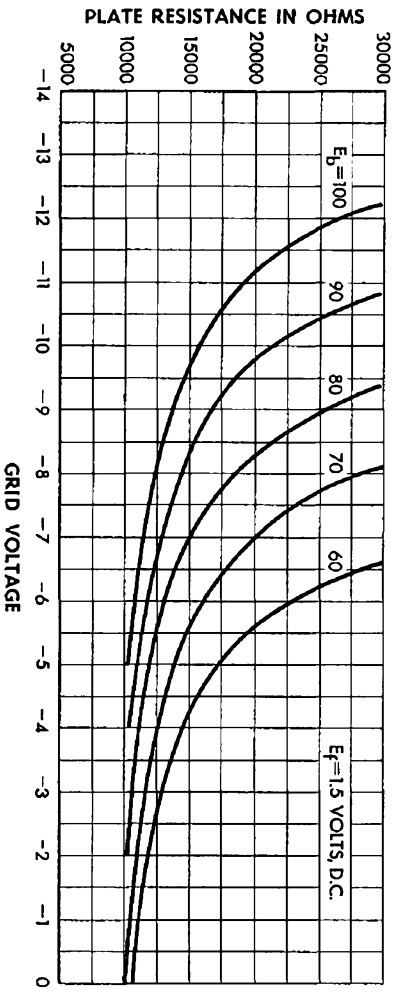
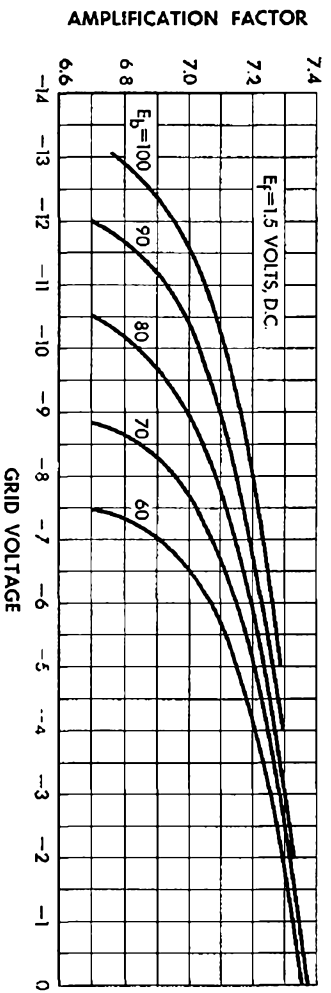

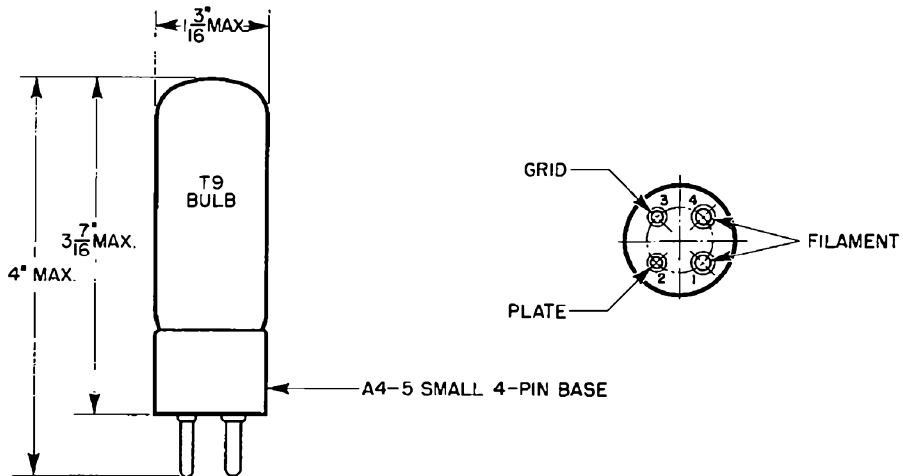
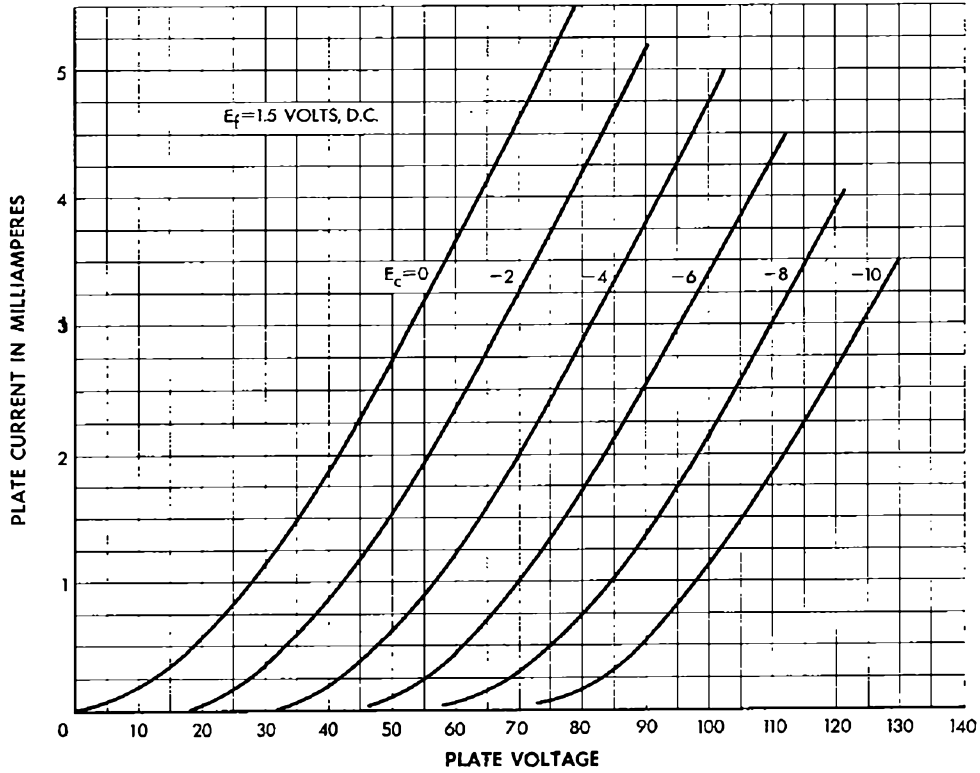

Western Electric

A development of Bell Telephone Laboratories, the research laboratories of the American Telephone and Telegraph Company and the Western Electric Company.

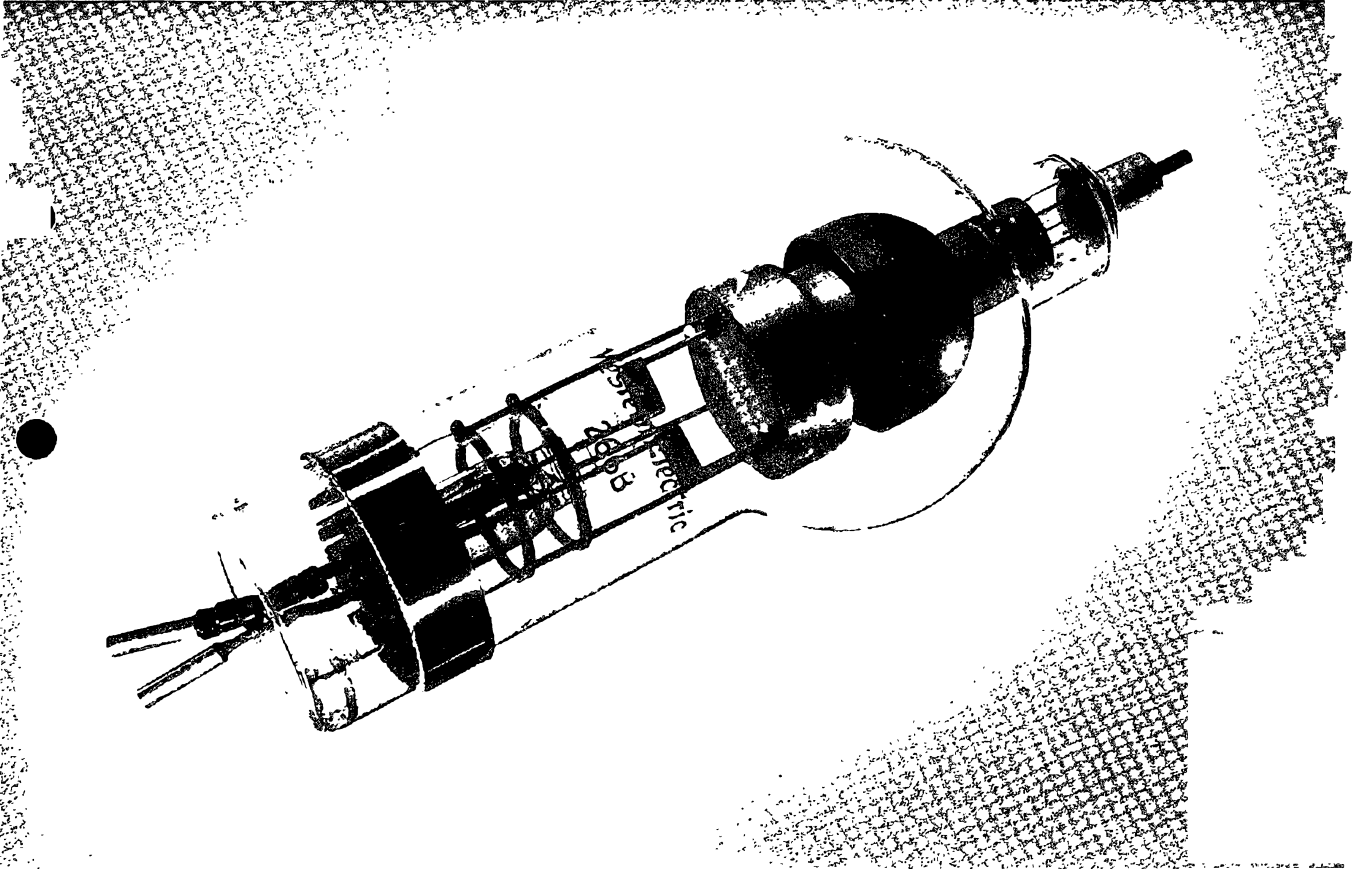

RECTIFIER
HALF-WAVE, MERCURY-VAPOR

Western Electric

DESCRIPTION

The 266B is a half-wave, mercury-vapor rectifier tube for use in high-voltage rectifier circuits.

MAXIMUM RATINGS

Peak Inverse Anode Voltage	22000 volts
Average Cathode Current (Quadrature Operation)	10 amperes

MAXIMUM RATINGS, ABSOLUTE VALUES

Peak Inverse Anode Voltage for		
Condensed Mercury Temperature 20 to 40 C		22000 volts
Condensed Mercury Temperature 20 to 50 C		12500 volts
Cathode Current		
Peak		
In-phase Operation		20 amperes
Quadrature Operation		40 amperes
Average		
In-phase Operation		5 amperes
Quadrature Operation		10 amperes
Surge (maximum duration 0.2 second)		200 amperes
Averaging Time		60 seconds
Frequency		150 cycles/sec.

ELECTRICAL DATA	Min.	Bogey	Max.
Filament Voltage	4.75	5.0	5.25 volts
Filament Current at 5.0 Volts	42	46 amperes
Cathode Heating Time, Required	300 seconds
Anode Voltage Drop	15 volts
Critical Anode Voltage	100 volts

MECHANICAL DATA

Net Weight, Approximate	4¼ pounds
Equilibrium Condensed Mercury Temperature Rise	
At Full Load, Approximate	18 centigrade
At No Load, Approximate	15 centigrade

Cooling The condensed mercury temperature should be held within the range specified for the maximum peak inverse anode voltage appropriate to the application. If forced-air cooling is necessary, a flow of 6 cubic feet per minute from a 1-inch nozzle directed at the zone of mercury temperature control just below the support collar ordinarily will be adequate.

Mounting This tube has a collar at the filament end of the tube by which it is supported when mounted. It should be mounted in a vertical position only, with the filament end down. Connections to the anode and filament terminals should be flexible. Sufficient clearance should be maintained around the tube to insure free air circulation.

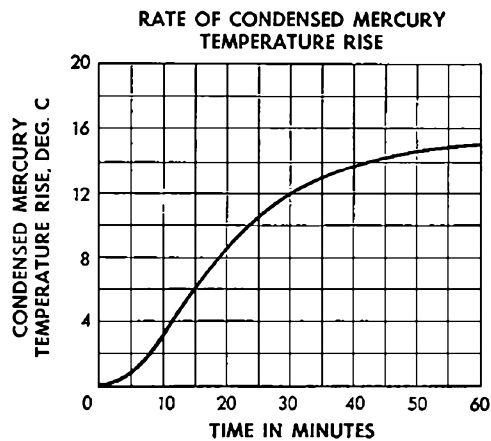

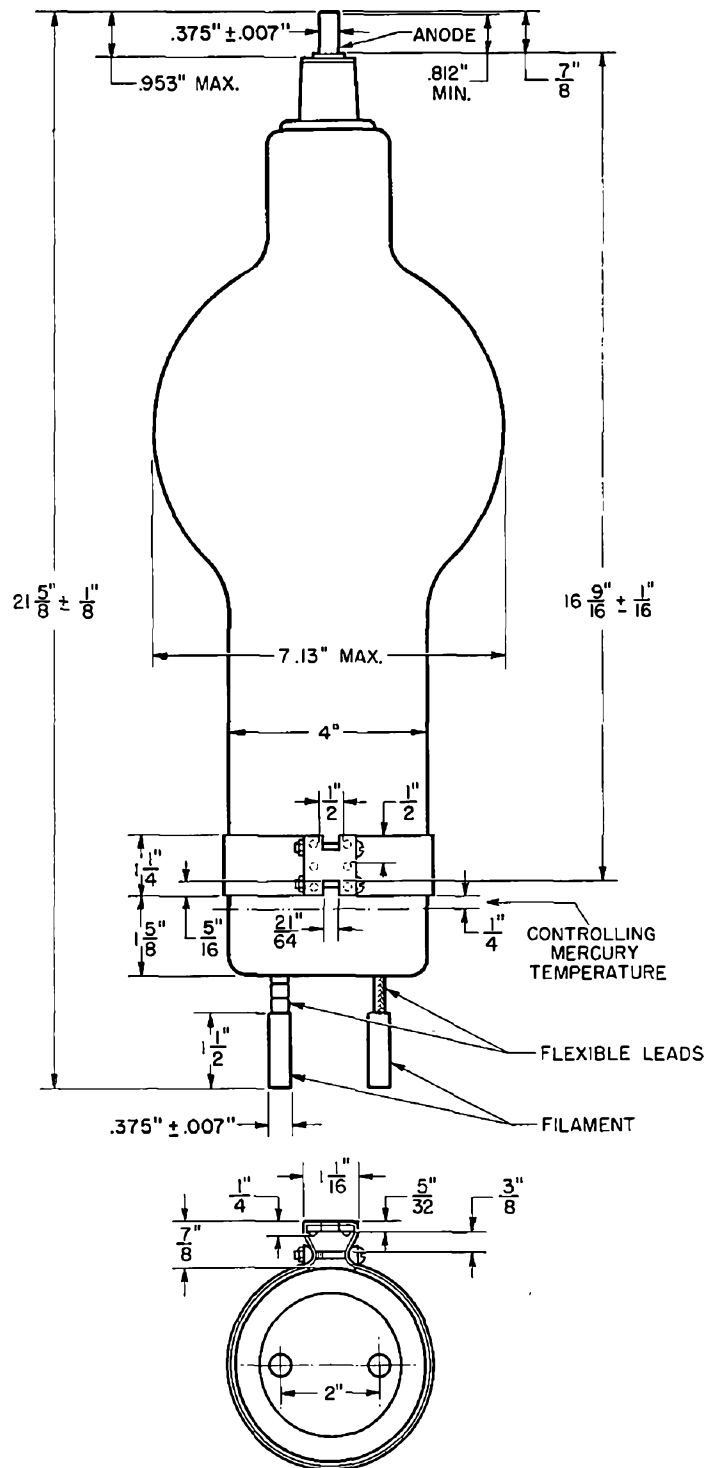

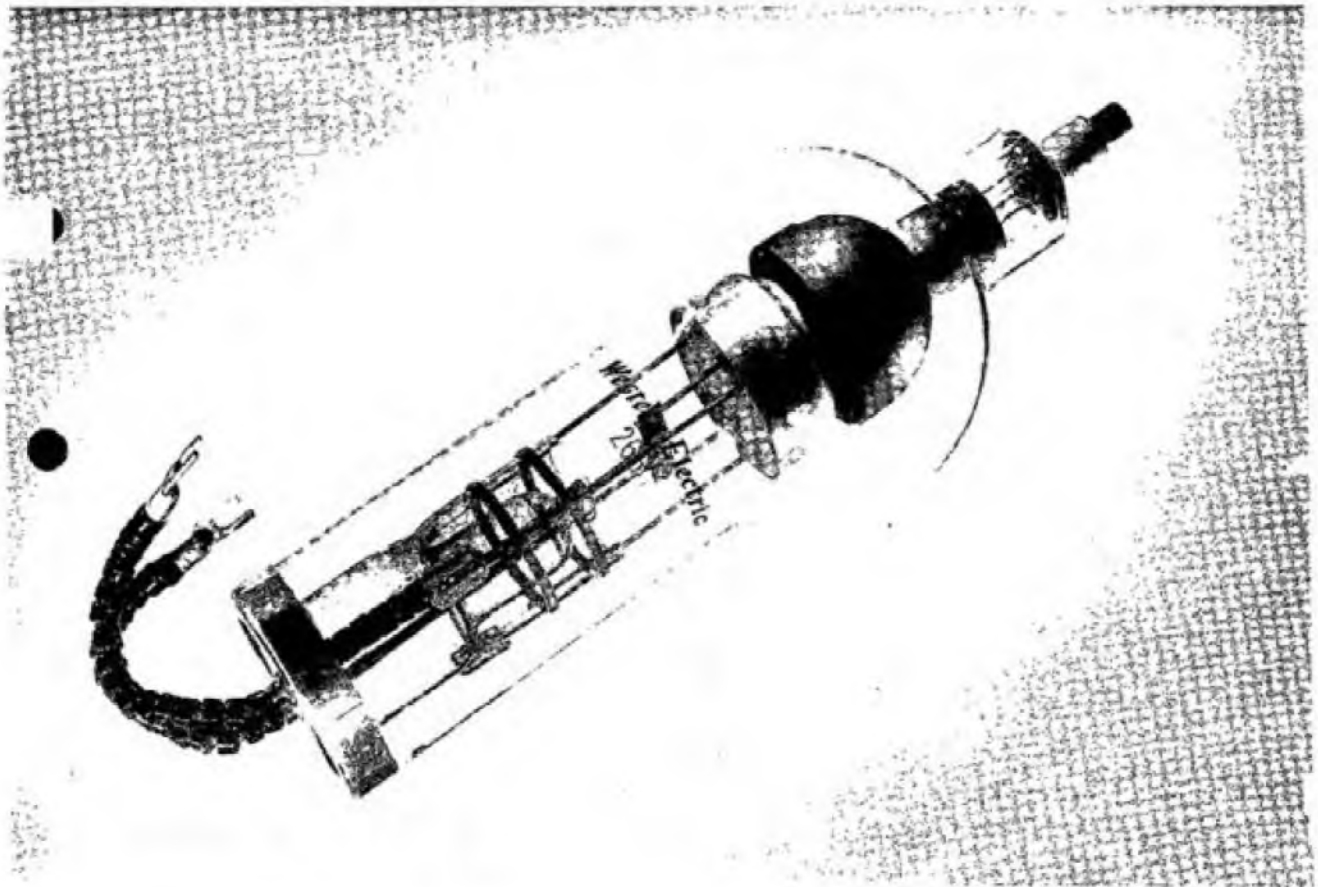

RECTIFIER
HALF-WAVE, MERCURY-VAPOR

Western Electric

DESCRIPTION

The 266C is a half-wave, mercury-vapor rectifier tube for use in high-voltage rectifier circuits.

MAXIMUM RATINGS

Peak Inverse Anode Voltage	22000 volts
Average Cathode Current (Quadrature Operation)	10 amperes

MAXIMUM RATINGS, ABSOLUTE VALUES

Peak Inverse Anode Voltage for		
Condensed Mercury Temperature 20 to 40 C		22000 volts
Condensed Mercury Temperature 20 to 50 C		12500 volts
Cathode Current		
Peak		
In-phase Operation		20 amperes
Quadrature Operation		40 amperes
Average		
In-phase Operation		5 amperes
Quadrature Operation		10 amperes
Surge (maximum duration 0.2 second)		200 amperes
Averaging Time		60 seconds
Frequency		150 cycles sec.

ELECTRICAL DATA

	Min.	Bogey	Max.
Filament Voltage	4.75	5.0	5.25 volts
Filament Current at 5.0 Volts	42	46 amperes
Cathode Heating Time, Required	300 seconds
Anode Voltage Drop	15 volts
Critical Anode Voltage	100 volts

MECHANICAL DATA

Net Weight, Approximate		4¼ pounds
Equilibrium Condensed Mercury Temperature Rise		
At Full Load, Approximate		18 centigrade
At No Load, Approximate		15 centigrade
Cooling	The condensed mercury temperature should be held within the range specified for the maximum peak inverse anode voltage appropriate to the application. If forced-air cooling is necessary, a flow of 6 cubic feet per minute from a 1-inch nozzle directed at the zone of mercury temperature control just above the top of the base ordinarily will be adequate.	
Mounting	This tube should be mounted in a vertical position only, with the filament end down. The connection to the anode terminal should be flexible. Sufficient clearance should be maintained around the tube to insure free air circulation.	

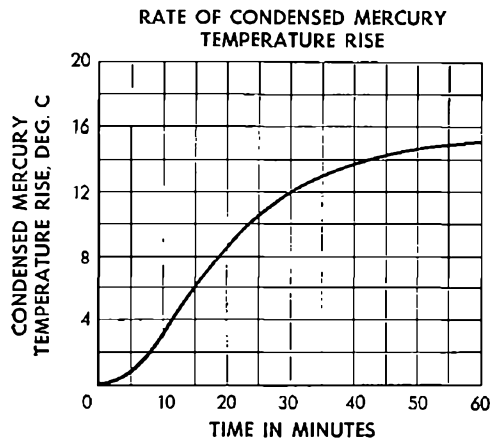

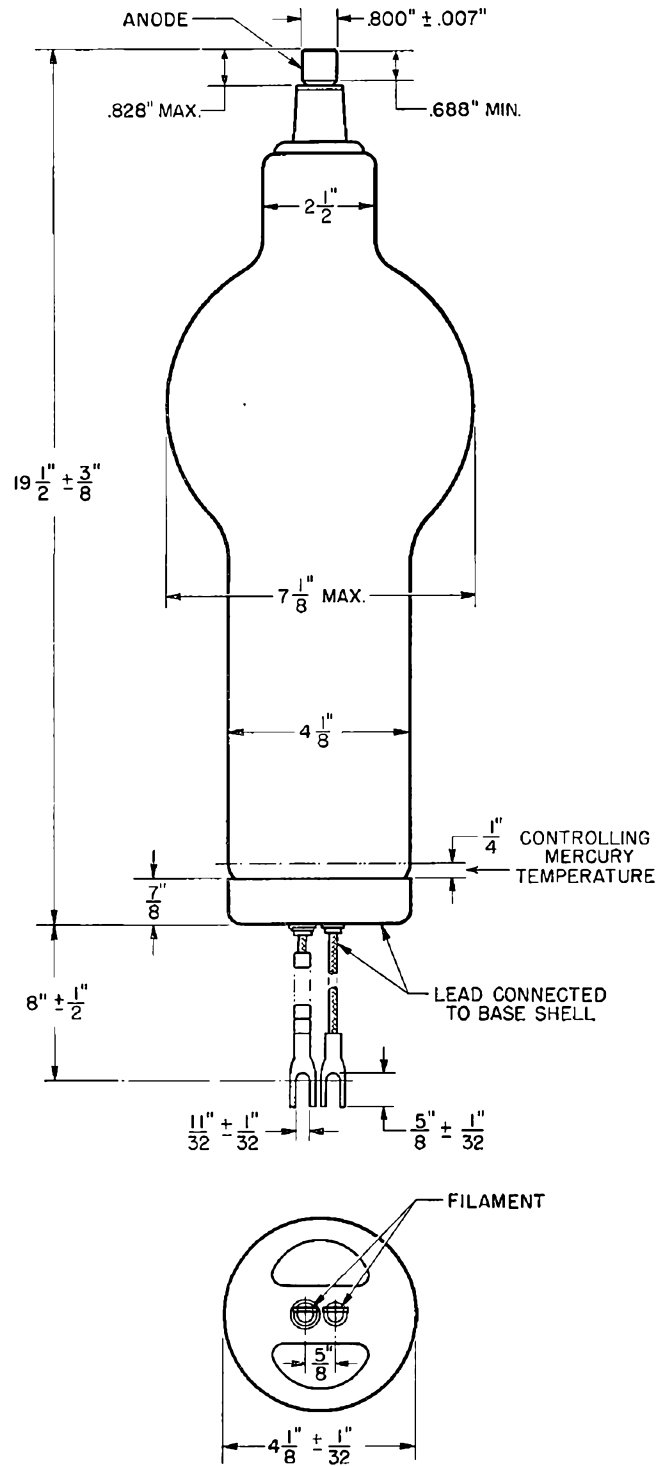

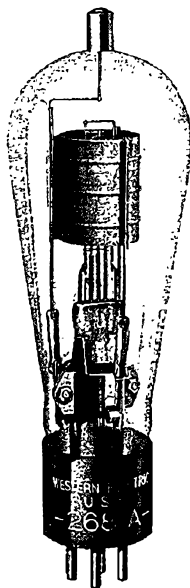
*Western Electric***268A Vacuum Tube****Classification—Filamentary air-cooled triode**

May be used as an audio-frequency amplifier or as a radio-frequency amplifier, modulator or oscillator.

Dimensions—Dimensions and outline diagrams are shown in Figures 1 and 2. The overall dimensions are:

Maximum overall length.....	6 $\frac{15}{16}$ "
Maximum diameter.....	2 $\frac{7}{16}$ "

Mounting—Four-pin bayonet base for use in a W.E. 143B or similar socket. The anode terminal is located at the top of the bulb.

Filament—Thoriated tungsten

Filament voltage.....	5.0 volts, a.c. or d.c.
Nominal filament current.....	3.25 amperes
Average thermionic emission.....	0.60 ampere

Average Direct Interelectrode Capacitances

Plate to grid	2.3 μmf
Grid to filament	5.4 μmf
Plate to filament	1.1 μmf

Characteristics—Performance data given below are based upon a typical set of conditions. Variations can be expected with different circuits and tubes.

Figures 3 and 4 give the static characteristics of a typical tube plotted against grid and plate voltages.

Average Characteristics at maximum direct plate voltage and dissipation Class A ($E_b = 750$ volts, $I_b = 25$ milliamperes)

Amplification factor	5
Plate resistance	6250 ohms
Grid to plate transconductance	800 micromhos

Operation**Maximum Ratings**

Max. direct plate voltage	750 volts
Max. direct plate current	60 milliamperes
Max. plate dissipation	25 watts
Max. direct grid current	10 milliamperes
Max. r-f grid current	3 amperes
Max. frequency for the above ratings	30 megacycles
Max. plate voltage for upper frequency limit of 60 Mc	400 volts
Max. plate voltage for frequencies between 30 and 60 Mc in proportion	

Class A Audio Amplifier or Modulator

Direct plate voltage	750	500 volts
Grid bias	-100	-37 volts
Direct plate current	25	40 milliamperes
Load impedance	18000	5000 ohms
Undistorted output	4.0	1.0 watts

Class B Audio Amplifier or Modulator for Balanced 2 Tube Circuit

Direct plate voltage	750	500 volts
Grid bias	-120	-70 volts
Direct plate current per tube		
No drive	12	12 milliamperes
Max. drive	60	60 milliamperes
Plate dissipation	20	15 watts
Load resistance plate-to-plate	11200	7400 ohms
Load resistance per tube	2800	1850 ohms
Approximate maximum output—2 tubes	50	33 watts
Recommended power for driving stage	5	5 watts

Class B Radio-Frequency Amplifier

Direct plate voltage	750	500 volts
Direct plate current for carrier conditions	50	60 milliamperes
Grid bias	-165	-105 volts
Approximate carrier watts for use with 100% modulation	12.5	10 watts

Class C Radio-Frequency Oscillator or Power Amplifier—Unmodulated

Direct plate voltage	750	500 volts
Direct plate current	60	60 milliamperes
Grid bias	-255 to -340	-165 to -220 volts
Nominal power output	30	20 watts
Plate dissipation	15	10 watts

Class C Radio-Frequency Amplifier—Plate Modulated

Direct plate voltage	500	350 volts
Direct plate current	60	60 milliamperes
Grid bias	-220	-160 volts
Max. direct grid current	10	10 milliamperes
Nominal carrier power output for use with 100% modulation	20	14 watts

Operating Precautions

Mechanical—Figures 1 and 2 show the overall dimensions and basing arrangement for the tube.

The tubes should not be subjected to mechanical shock or excessive vibration. Mechanical vibration may cause breakage of the thoriated tungsten filaments.

A free circulation of air must be provided to insure adequate cooling of the glass during operation.

Electrical—Overload protection should always be provided for the plate circuit. A suitable fuse or circuit breaker should remove the plate voltage if the plate current exceeds 75 milliamperes. Although the tube is sufficiently rugged to withstand momentary overloads, a prolonged overload caused by inefficient adjustment of the circuit, may damage the tube. When adjusting a new circuit, reduced plate voltage or a series resistance of 1000 to 5000 ohms in the plate circuit should be used until it is operating properly.

The filament should always be operated at the rated voltage measured at the tube terminals. A 5% decrease in filament voltage reduces the thermionic emission approximately 25%. Either direct or alternating current may be used for heating the filament. If direct current is used, the plate and grid circuit returns should be connected to the negative filament terminal. If alternating current is used, the circuit returns should be connected to the center tap of the filament heating transformer winding or to the center tap of a resistor placed between the filament terminals. A resistance of 20 to 30 ohms of three watt rating is suitable.

In cases where severe and prolonged overload has temporarily impaired the electronic emission of the filament, the activity may be restored by operating the filament, with the plate and grid voltages off, 30% above normal voltage for 10 minutes followed by a longer period at normal voltage.

Audio Amplifier or Modulator

Class A—Peak grid drive equal to or less than the grid bias.

Grid bias may be obtained from the drop across a resistance in the plate current return or from a battery or rectifier supply.

Plate dissipation allowable for this type of service is generally lower than is safe for other uses since the energy is dissipated in the plate in smaller areas due to relatively high voltage drop in the tube.

The plate dissipation is equal to the plate voltage multiplied by the normal plate current. Performance data are based upon the use of a resistance load. Undistorted output is calculated on the basis of 5% second harmonic distortion.

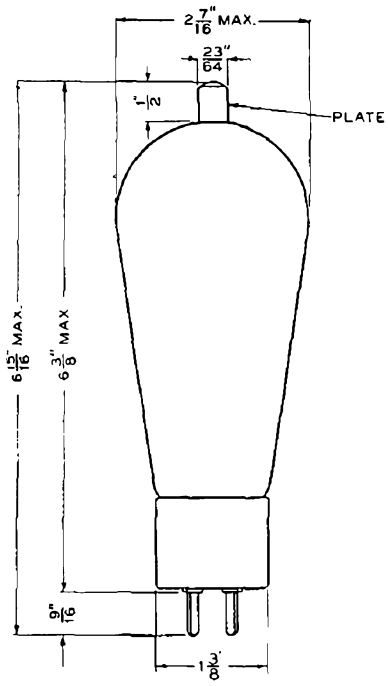

FIG. 1

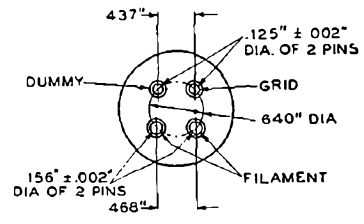

FIG. 2

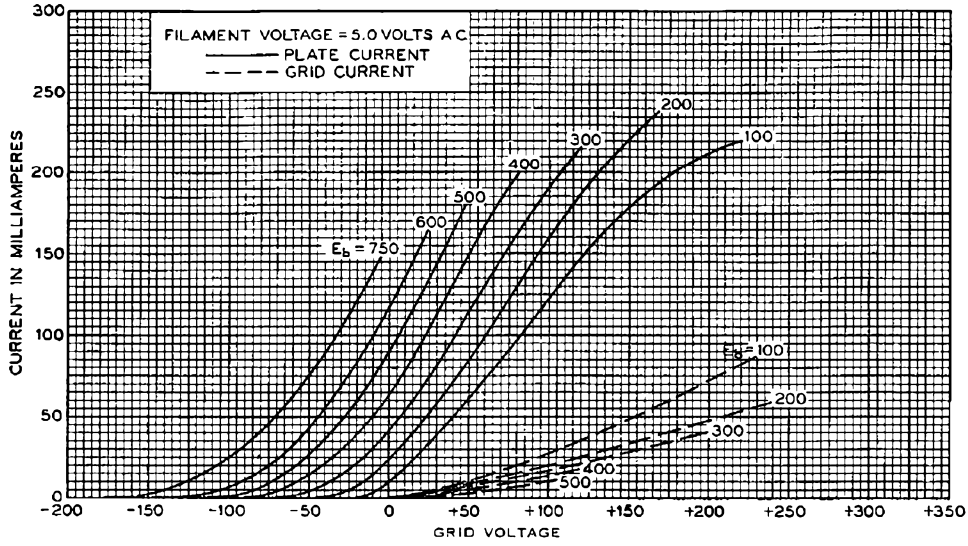

FIG. 3

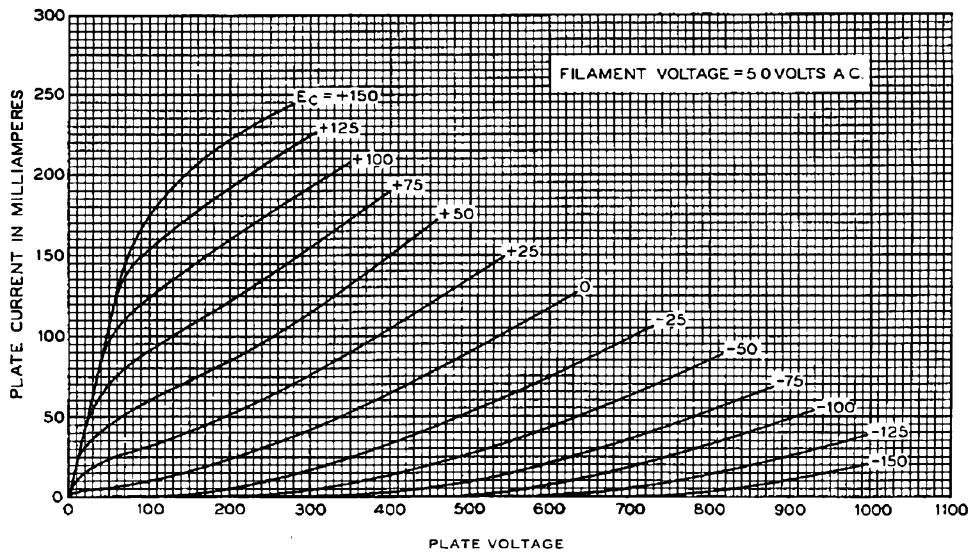
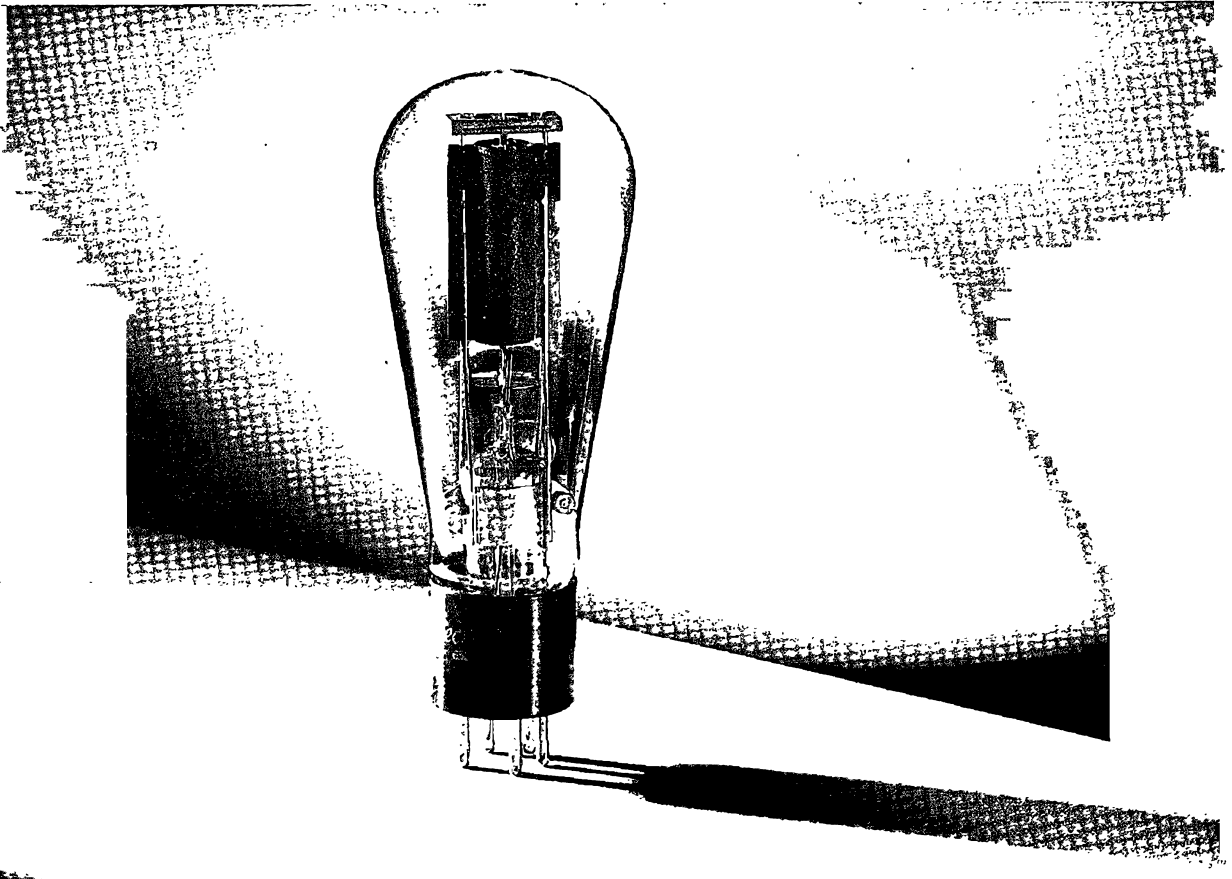

FIG. 4

1-D-36-28C
PRINTED IN U.S.A.

A development of Bell Telephone Laboratories, Incorporated,
the research laboratories of the American Telephone and Tele-
graph Company, and the Western Electric Company

V. T. DATA SHEET 268A
ISSUE 1



**TRIODE
POWER AMPLIFIER**

Western Electric

DESCRIPTION

The 271A is a power amplifier triode having an indirectly heated cathode. It is designed for use in amplifier, modulator, or oscillator circuits for both audio and radio frequencies.

CHARACTERISTICS

Heater Voltage	5.0 volts
Maximum Plate Voltage	450 volts
Power Output	3.0 watts

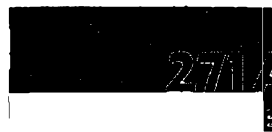

GENERAL CHARACTERISTICS**ELECTRICAL DATA**

Heater Voltage, A-C or D-C	5.0 volts
Heater Current	2.0 amperes
Direct Interelectrode Capacitances (without external shield)	
Grid to Plate	4.2 uuf
Input	6.7 uuf
Output	3.1 uuf

MECHANICAL DATA

Cathode	Coated Unipotential
Bulb	S19
Base	Medium 5-pin
Mounting Position	Any
Dimensions and pin connections shown in outline drawing on Page 5	

MAXIMUM RATINGS, Design-Center Values

Plate Voltage	450 volts
Plate Dissipation	27 watts
Plate Current	60 milliamperes
Heater-Cathode Voltage	100 volts

TYPICAL OPERATING CONDITIONS AND CHARACTERISTICS -- CLASS A₁ AMPLIFIER

Plate Voltage	300	350	400	450 volts
Grid Voltage	-25	-25	-30	-30 volts
Peak A-F Grid Voltage	25	25	30	30 volts
Plate Current	19.5	34.5	37.5	57.5 milliamperes
Transconductance	2250	2930	2920	3480 micromhos
Amplification Factor	8.2	8.4	8.3	8.5
Plate Resistance	3650	2850	2830	2450 ohms
Load Resistance	14600	5700	6000	4900 ohms
Maximum Signal Power Output	0.9	1.7	2.4	3.1 watts
Total Harmonic Distortion	4.5	6	6	3.1 per cent

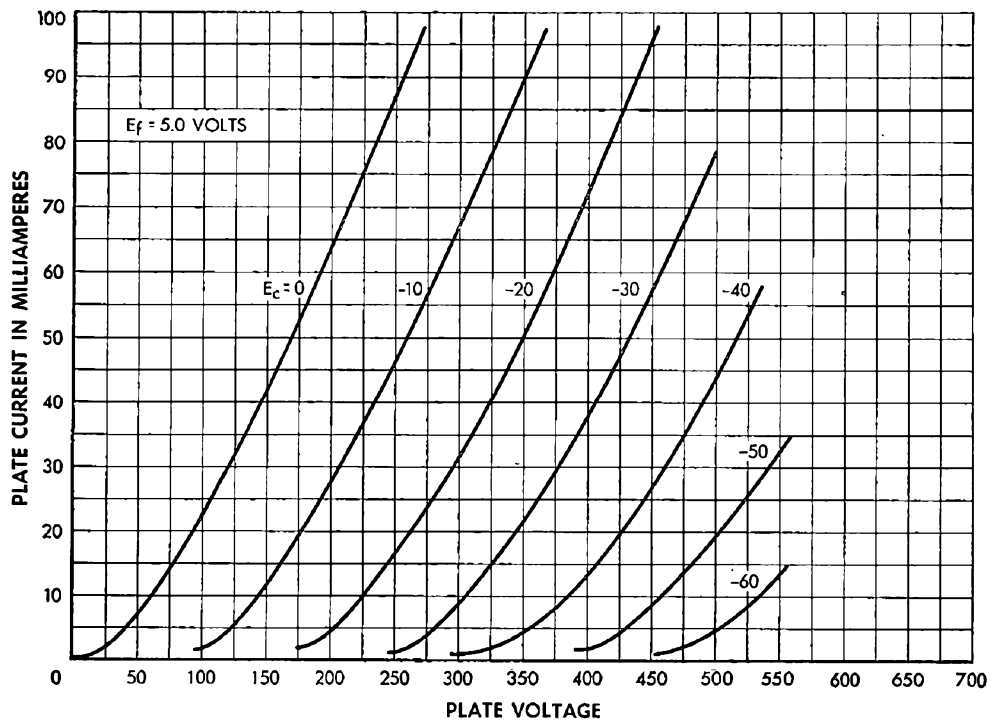
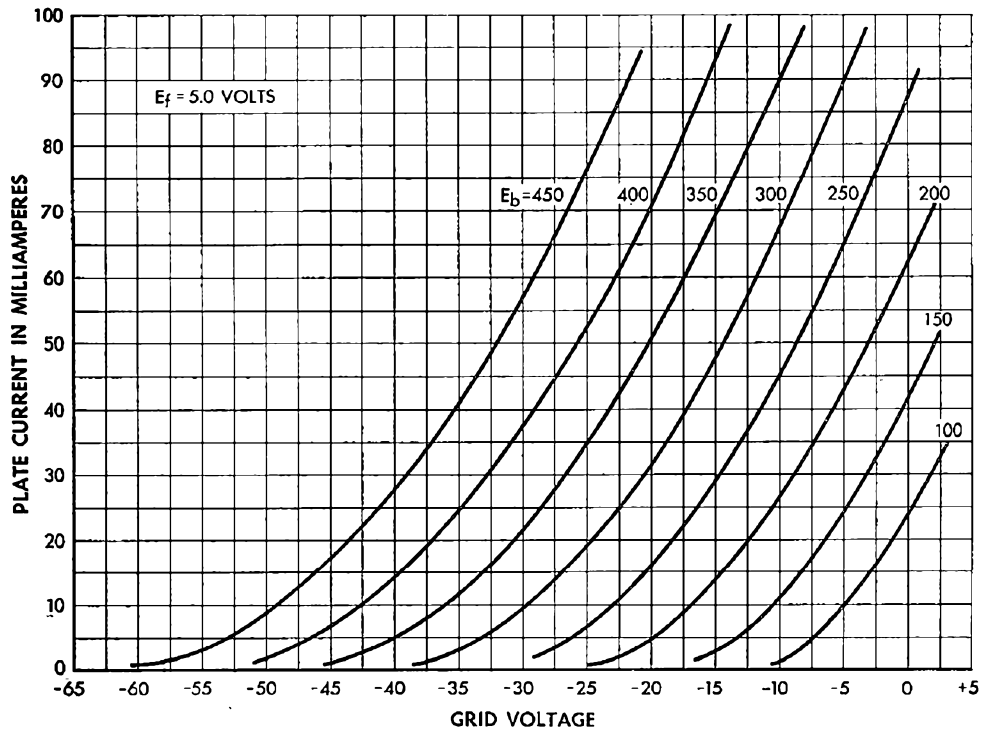

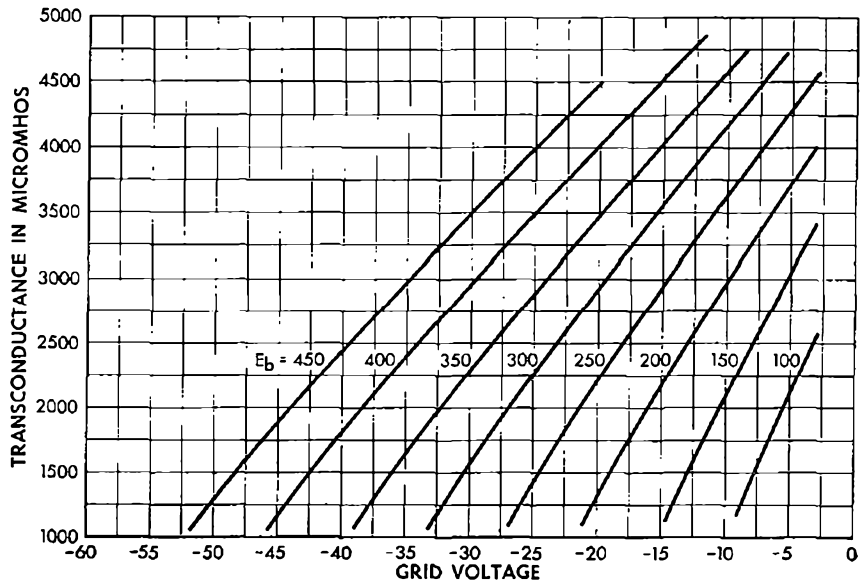
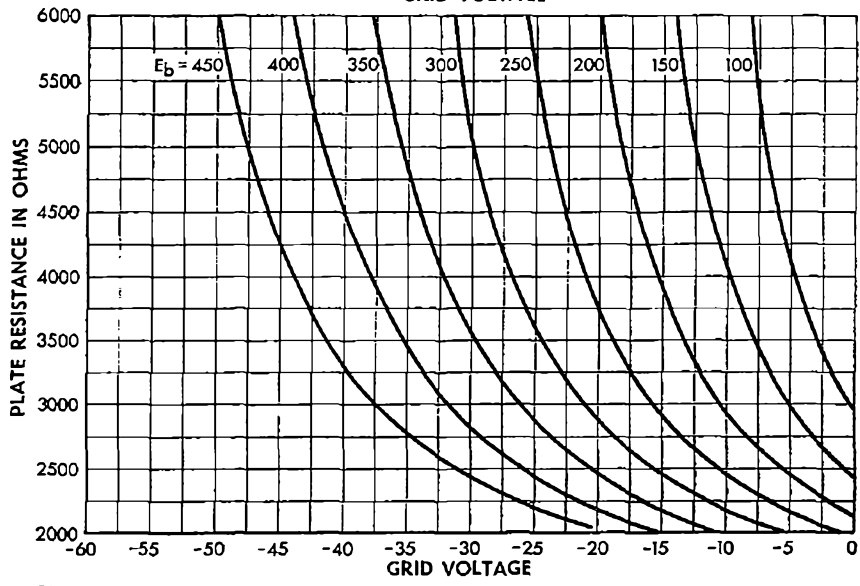
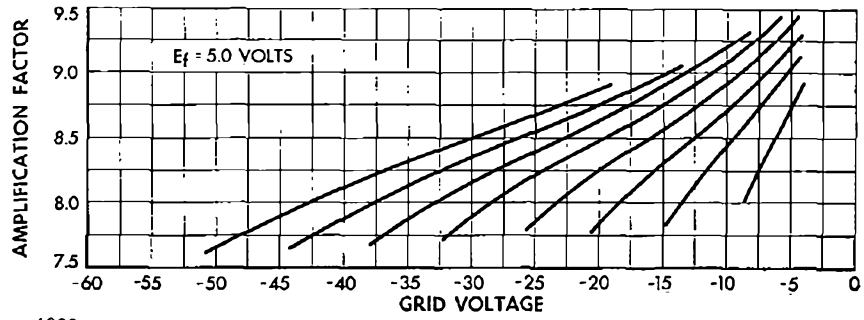

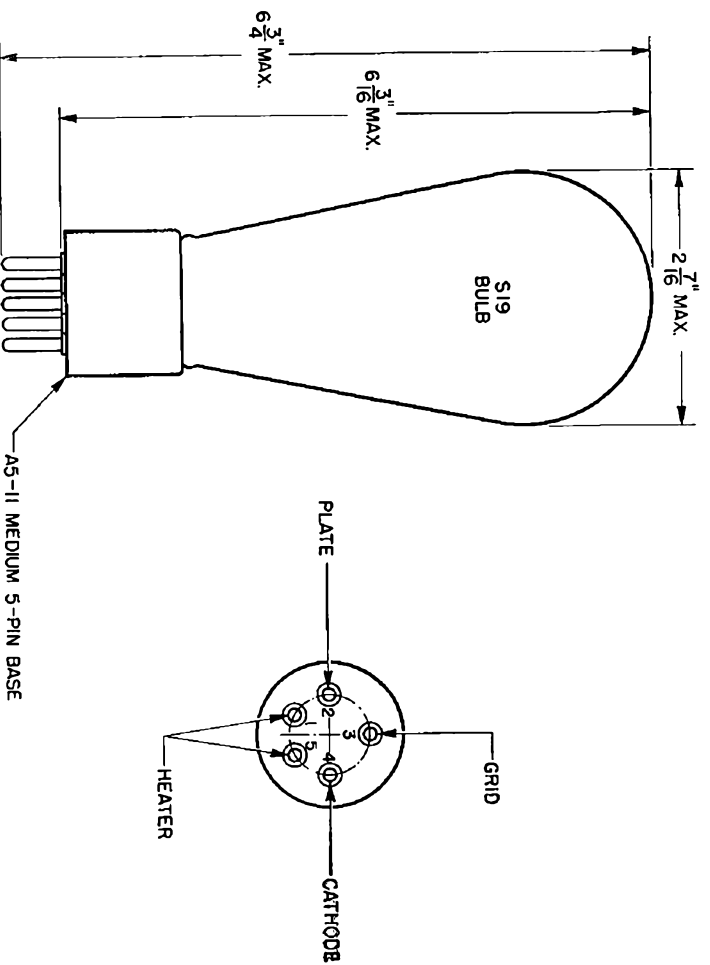
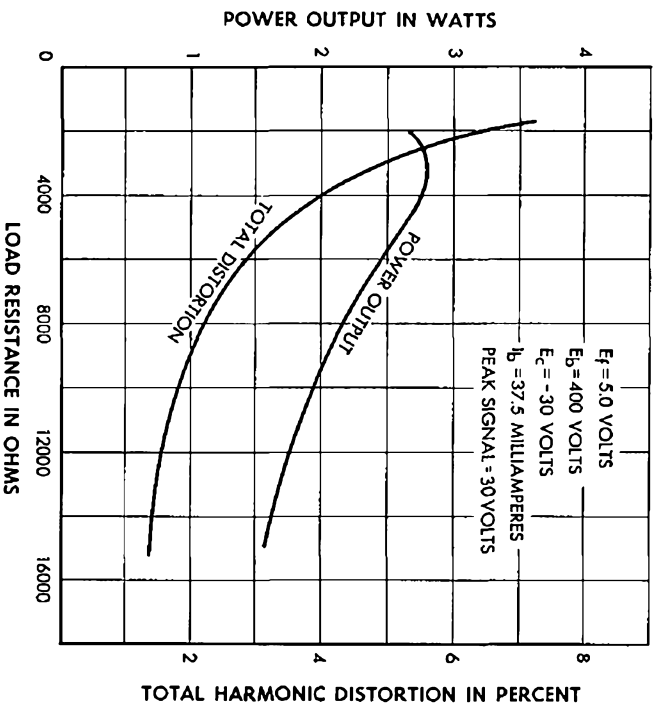

ELECTRON TUBE DATA SHEET
 FILE: GENERAL PURPOSE SECTION
 12-47

272A

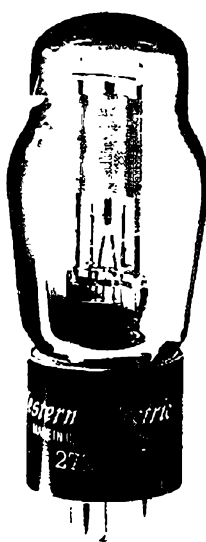

**TRIODE
LOW POWER AMPLIFIER**

Western Electric

DESCRIPTION

The 272A is a triode having an indirectly heated cathode. It is designed for use as a radio-frequency antenna-coupling amplifier, low-power audio-frequency amplifier, detector or modulator.

CHARACTERISTICS

Heater Voltage	10.0 volts
Maximum Plate Voltage	180 volts
Amplification Factor	.60

272A
TRIODE

GENERAL CHARACTERISTICS**ELECTRICAL DATA**

Heater Voltage, A-C or D-C	10.0 volts
Heater Current	320 milliamperes
Direct Interelectrode Capacitances (without external shield)	
Grid to Plate	2.8 uuf
Input	3.1 uuf
Output	2.5 uuf

MECHANICAL DATA

Cathode	Coated unipotential
Bulb	ST14
Base	Medium 5-pin, with bayonet pin
Mounting Position	Any
Dimensions and pin connections shown in outline drawing on Page 5	

MAXIMUM RATINGS, Design-Center Values

Plate Voltage	180 volts
Plate Dissipation	2.0 watts
Plate Current	12.0 milliamperes
Heater-Cathode Voltage	100 volts

TYPICAL OPERATING CONDITIONS AND CHARACTERISTICS — CLASS A₁ AMPLIFIER

Plate Voltage	100	120	160	180 volts
Grid Voltage	-7	-10	-17	-21 volts
Peak A-F Grid Voltage	7	10	17	21 volts
Plate Current	6.6	6.7	6.6	6.2 milliamperes
Transconductance	950	910	820	760 micromhos
Amplification Factor	6.0	5.8	5.6	5.5
Plate Resistance	6300	6400	6800	7200 ohms
Load Resistance	12600	12800	13600	14400 ohms
Maximum Signal Power Output	30	60	150	210 milliwatts
Total Harmonic Distortion	4.0	5.0	6.3	8.0 per cent

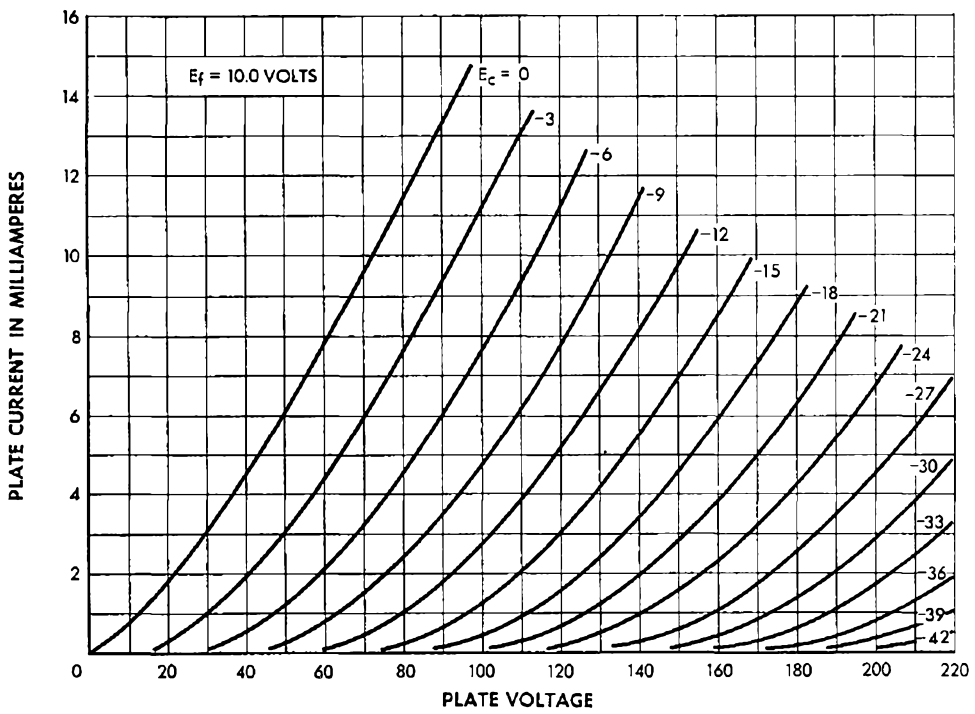
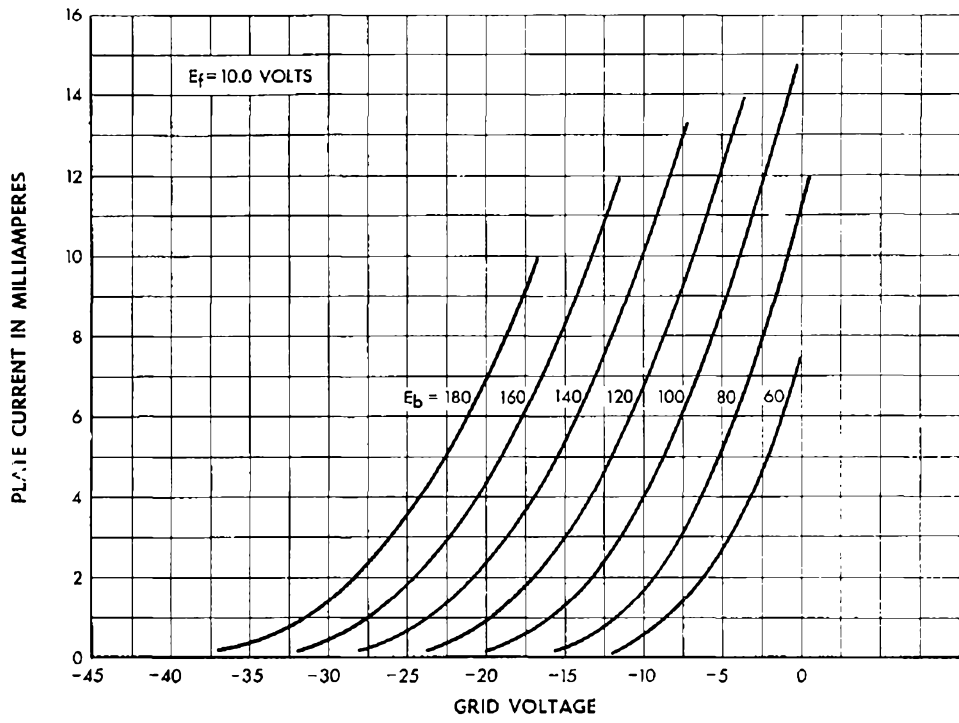

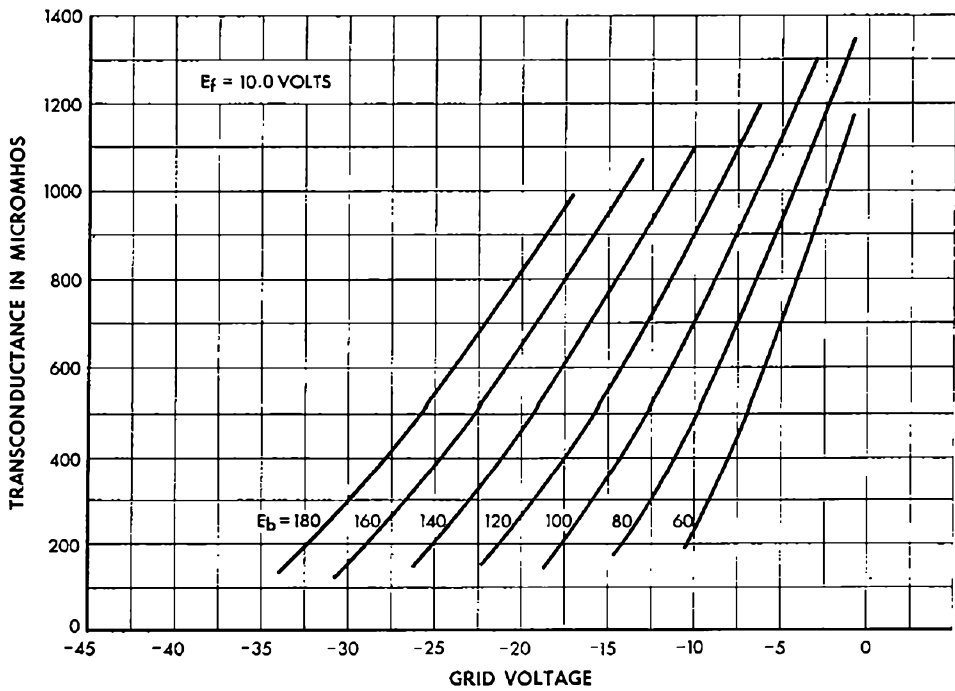
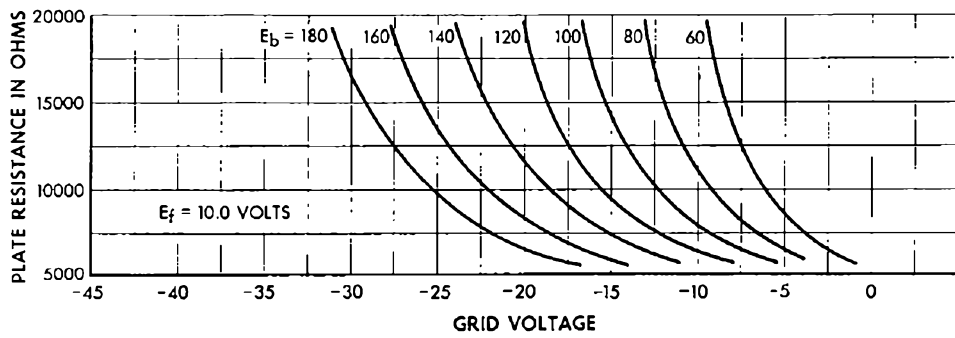
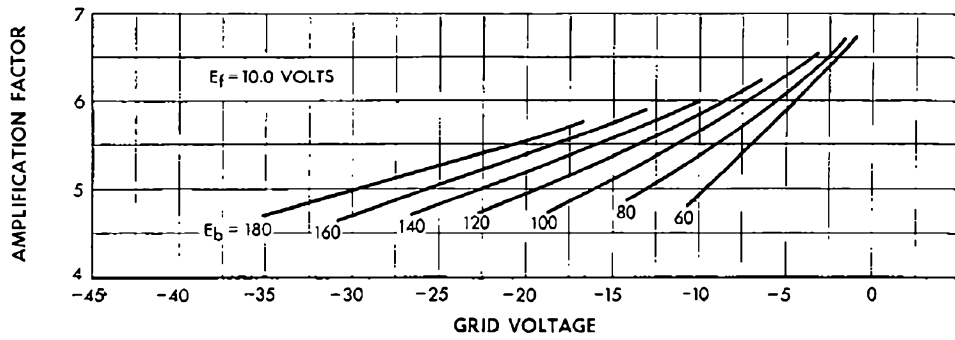

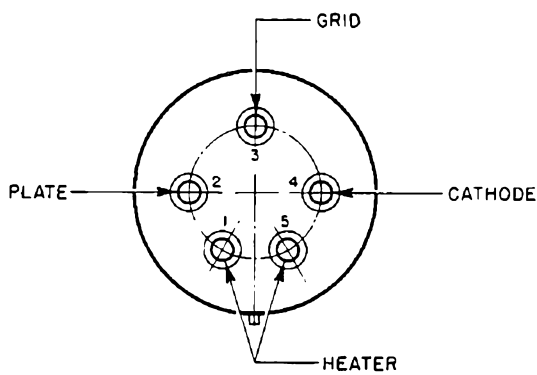
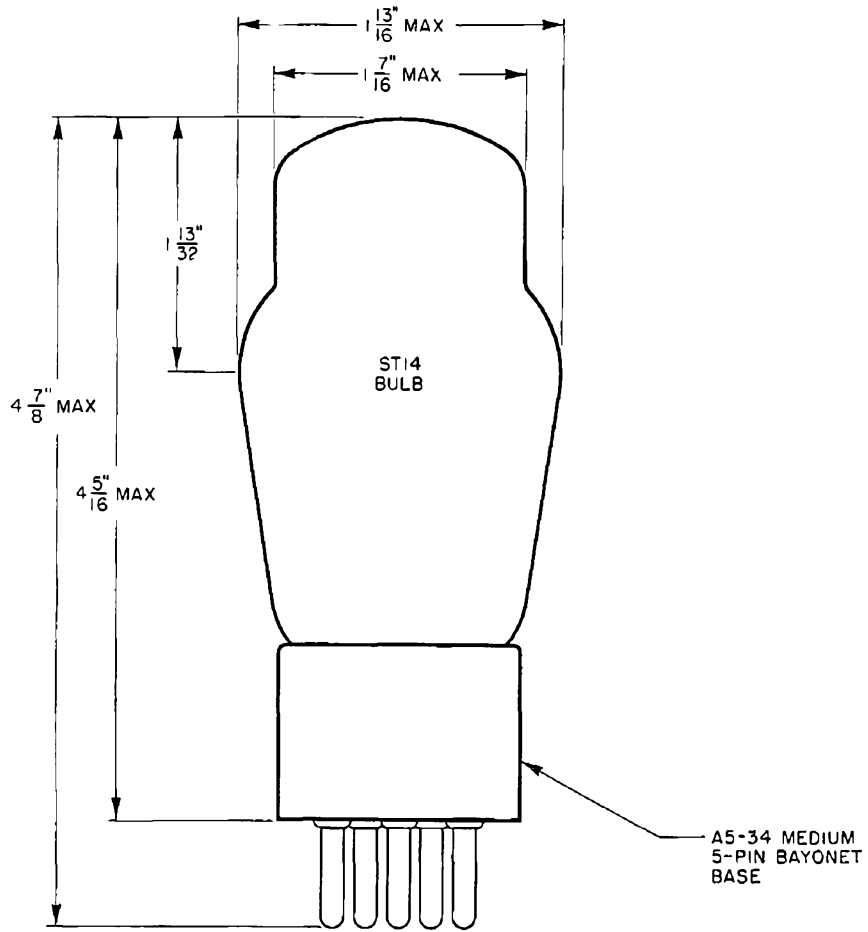

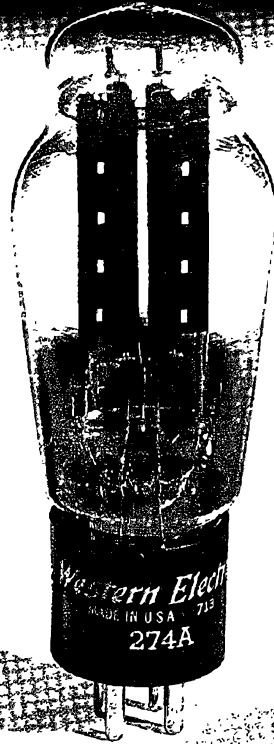

RECTIFIER
FULL-WAVE, HIGH VACUUM

Western Electric

DESCRIPTION

The 274A is a filamentary full-wave rectifier designed to supply direct current from an alternating current source.

CHARACTERISTICS

Filament Voltage	5.0 volts
Maximum Plate Voltage (RMS) per Plate	660 volts
Maximum D-C Output Current	225 milliamperes

GENERAL CHARACTERISTICS**ELECTRICAL DATA**

Filament Voltage	5.0 volts
Filament Current	2.0 amperes

MECHANICAL DATA

Cathode	Coated filament
Bulb	ST16
Base	Medium 4-pin
Mounting Position	Preferably vertical; if horizontal, pins #1 and #4 should be in horizontal plane

Dimensions and pin connections shown in outline drawing on Page 4

MAXIMUM RATINGS, Design-Center Values

Peak Inverse Voltage	1500 volts
Peak Plate Current per Plate	675 milliamperes
Peak Transient Plate Current per Plate	2.5 amperes

With Choke-Input Filter:

A-C Plate Voltage per Plate (RMS)	660 volts
D-C Output Current	225 milliamperes
Minimum Input-Choke Inductance	3 henrys

With Condenser-Input Filter:

A-C Plate Voltage per Plate (RMS)	450 volts
D-C Output Current	160 milliamperes
Minimum Total Effective Plate-Supply Impedance per Plate	100 ohms

TYPICAL OPERATING CONDITIONS**With Choke-Input Filter:**

A-C Plate Voltage per Plate (RMS)	550 volts
D-C Output Current	160 milliamperes
D-C Output Voltage, Approximate, at Input to Filter	430 volts
Filter Input Choke	5 henrys

With Condenser-Input Filter:

A-C Plate Voltage per Plate (RMS)	450 volts
D-C Output Current	140 milliamperes
D-C Output Voltage, Approximate, at Input to Filter	475 volts
Total Effective Plate-Supply Impedance per Plate	180 ohms
Filter Input Condenser	4 microfarads

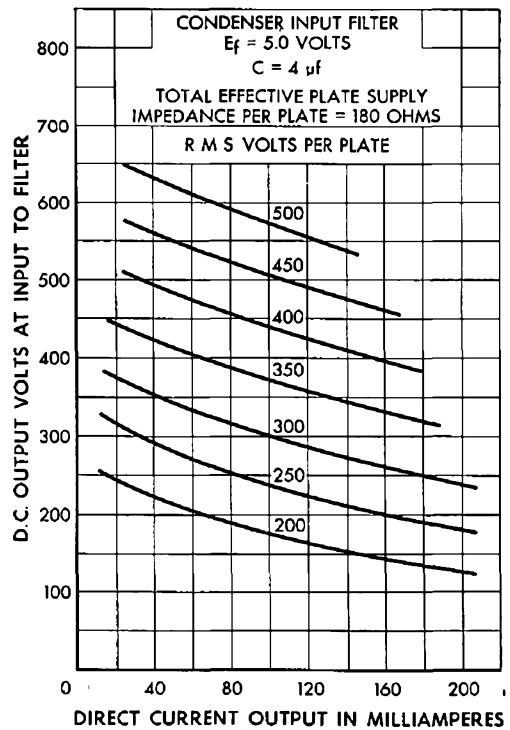
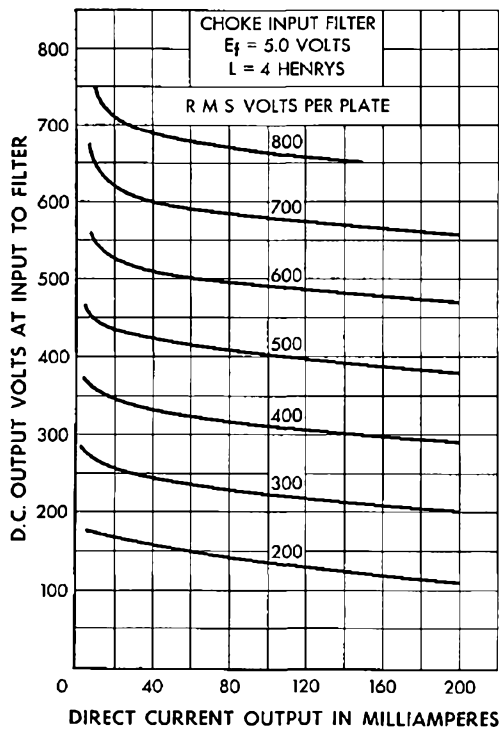
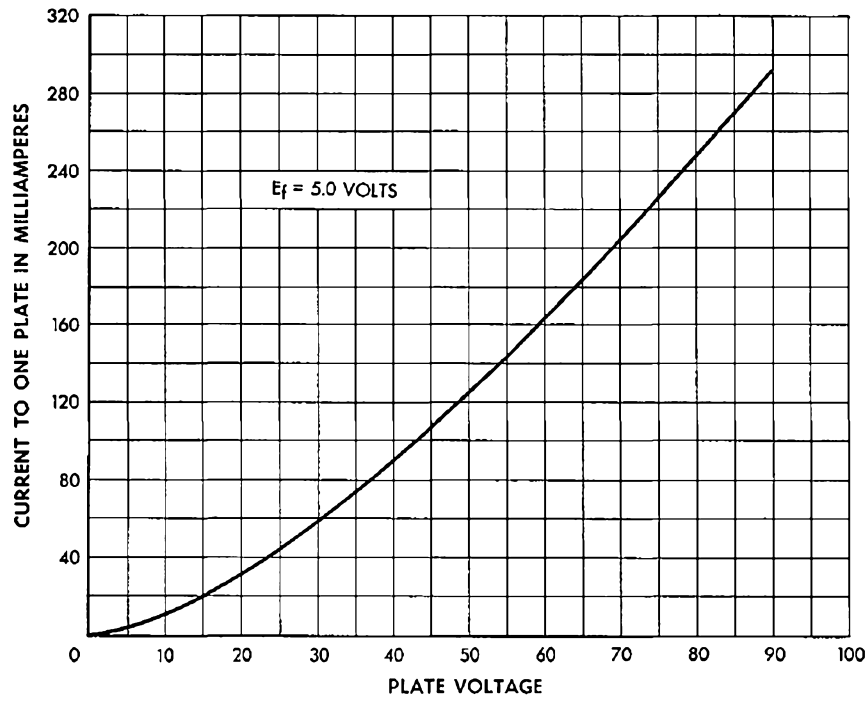

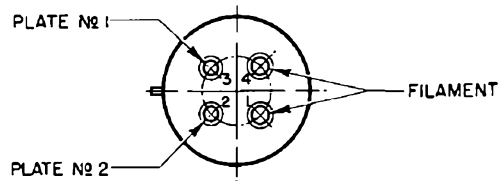
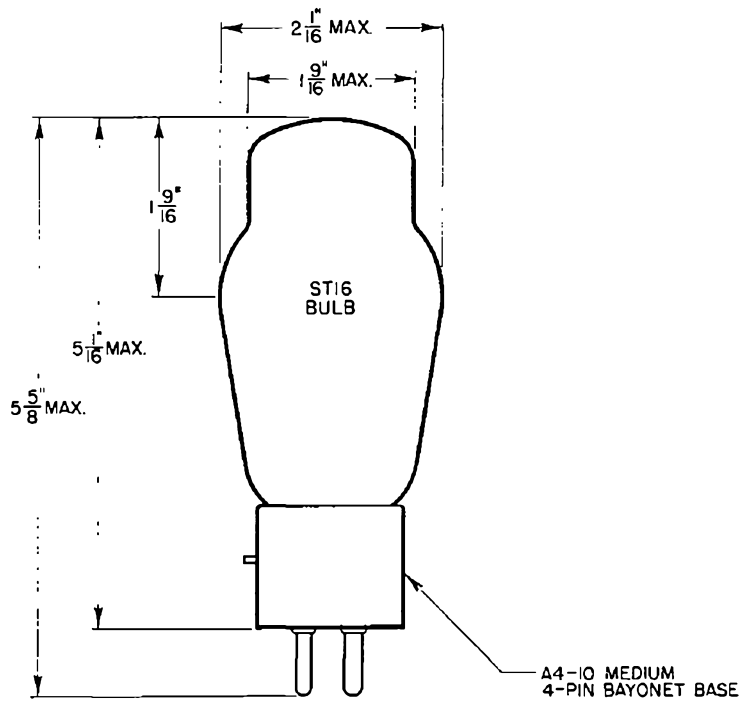

Western Electric

A development of Bell Telephone Laboratories, the research laboratories of the American Telephone and Telegraph Company and the Western Electric Company

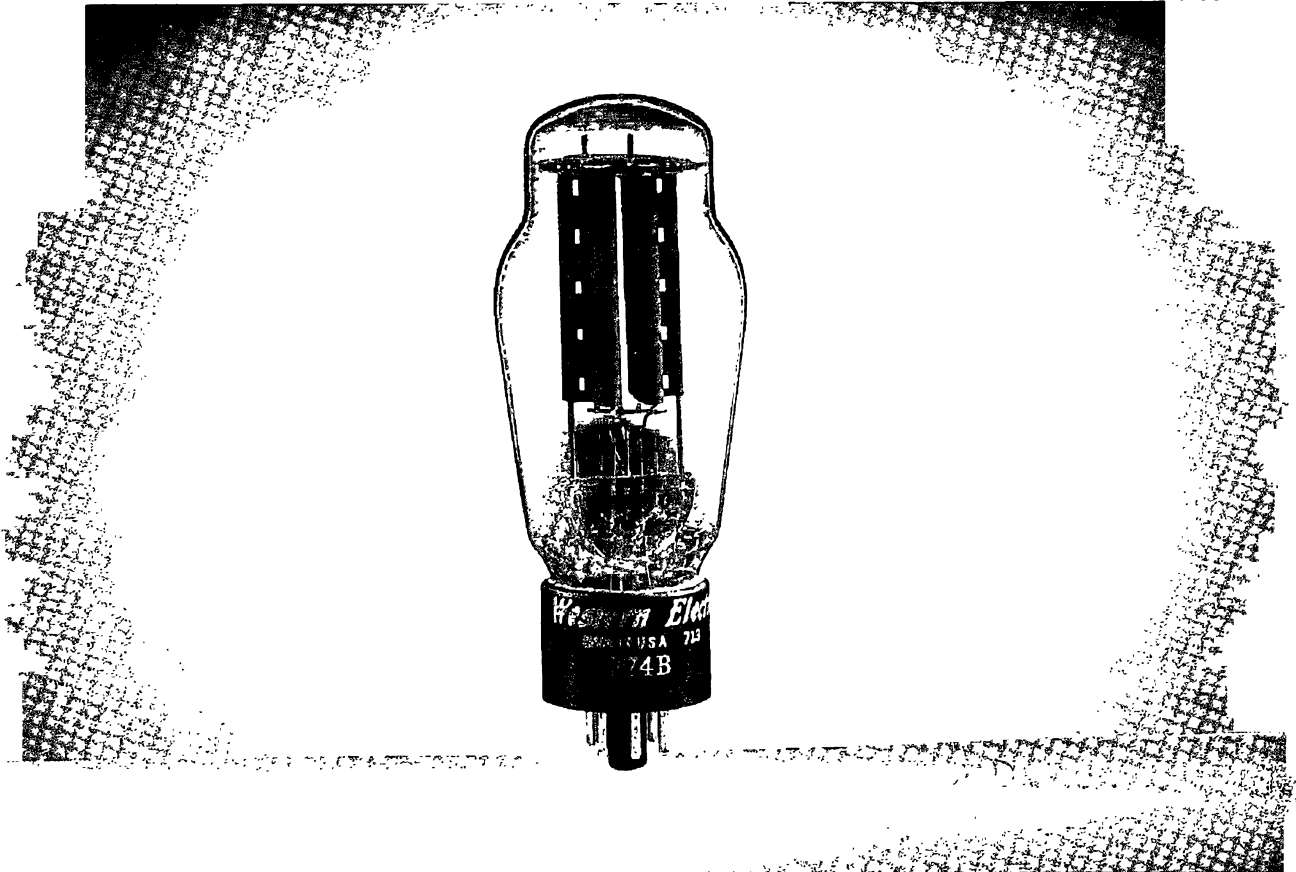

RECTIFIER
FULL-WAVE, HIGH VACUUM

Western Electric

DESCRIPTION

The 274B is a filamentary, octal based, full-wave rectifier designed to supply direct current from an alternating current source.

CHARACTERISTICS

Filament Voltage	5.0 volts
Maximum Plate Voltage (RMS) per Plate	660 volts
Maximum D-C Output Current	225 milliamperes

GENERAL CHARACTERISTICS**ELECTRICAL DATA**

Filament Voltage	5.0 volts
Filament Current	2.0 amperes

MECHANICAL DATA

Cathode	Coated filament
Bulb	ST16
Base	Medium 5-pin, octal
Mounting Position	Preferably vertical; if horizontal, pins #1 and #4 should be in vertical plane
Dimensions and pin connections shown in outline drawing on Page 4	

MAXIMUM RATINGS, Design-Center Values

Peak Inverse Voltage	1500 volts
Peak Plate Current per Plate	675 milliamperes
Peak Transient Plate Current per Plate	2.5 amperes

With Choke-Input Filter:

A-C Plate Voltage per Plate (RMS)	660 volts
D-C Output Current	225 milliamperes
Minimum Input-Choke Inductance	3 henrys

With Condenser-Input Filter:

A-C Plate Voltage per Plate (RMS)	450 volts
D-C Output Current	160 milliamperes
Minimum Total Effective Plate-Supply Impedance per Plate	100 ohms

TYPICAL OPERATING CONDITIONS**With Choke-Input Filter:**

A-C Plate Voltage per Plate (RMS)	550 volts
D-C Output Current	160 milliamperes
D-C Output Voltage, Approximate, at Input to Filter	430 volts
Filter Input Choke	5 henrys

With Condenser-Input Filter:

A-C Plate Voltage per Plate (RMS)	450 volts
D-C Output Current	140 milliamperes
D-C Output Voltage, Approximate, at Input to Filter	475 volts
Total Effective Plate-Supply Impedance per Plate	180 ohms
Filter Input Condenser	4 microfarads

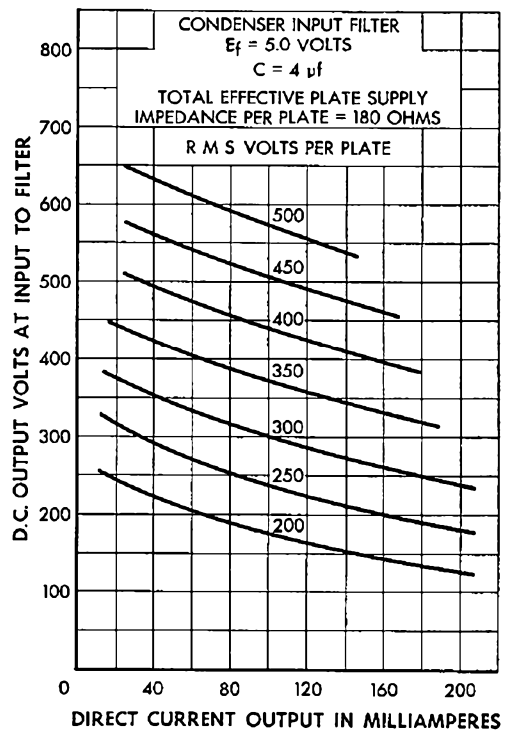
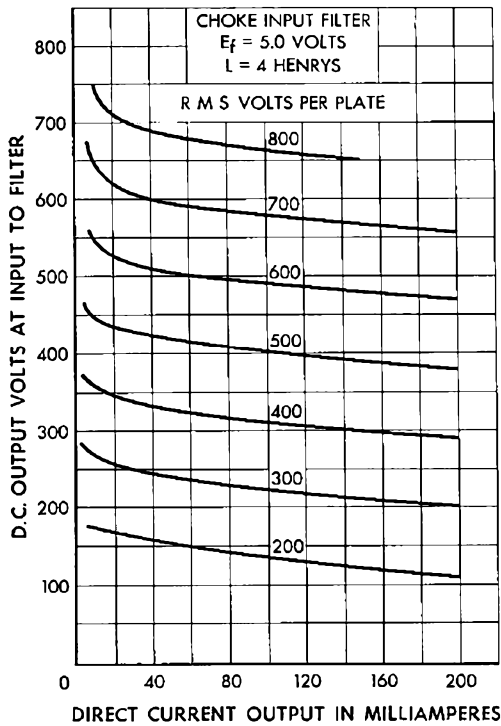
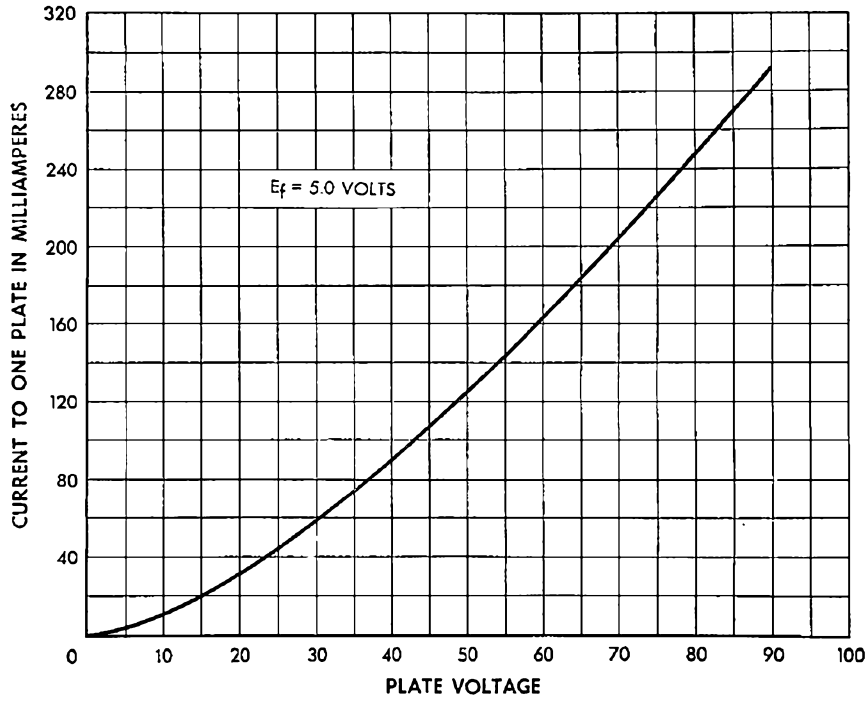

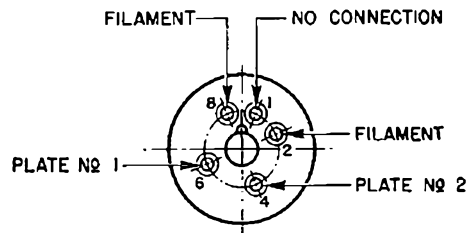
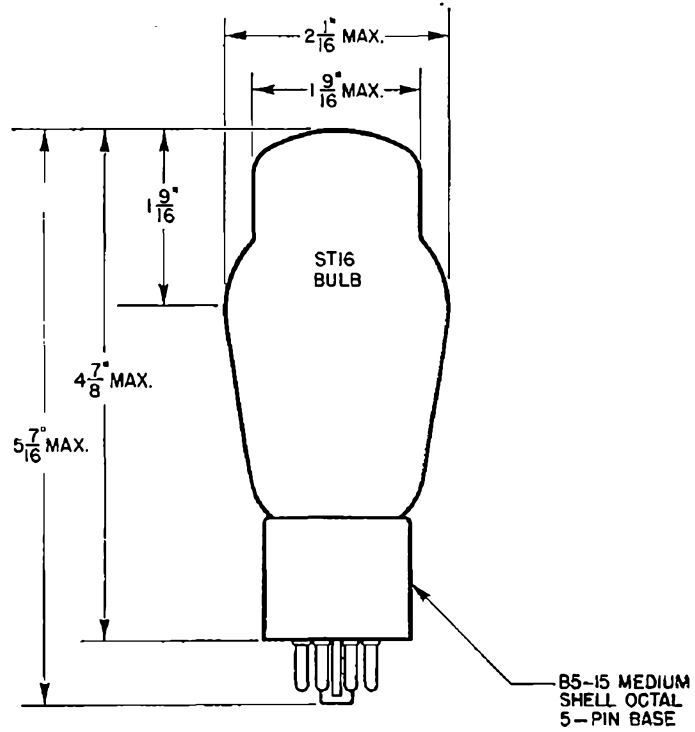

Western Electric

A development of Bell Telephone Laboratories, the research laboratories of the American Telephone and Telegraph Company and the Western Electric Company.

284D

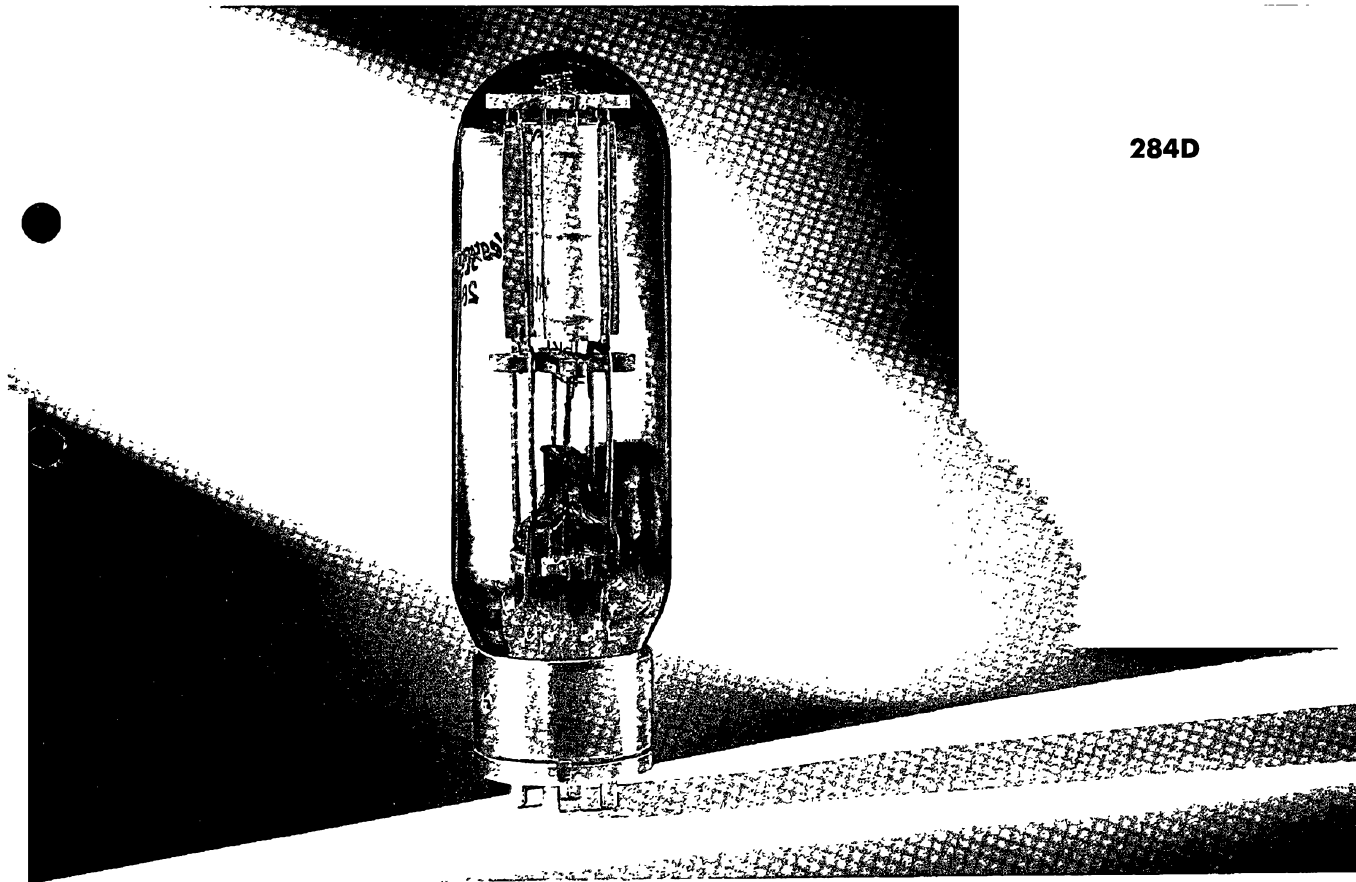

**TRIODE
 AMPLIFIER, OSCILLATOR OR MODULATOR**

Western Electric

DESCRIPTION

The 284D is a three-electrode tube designed for use as an audio-frequency amplifier and modulator. It may also be used as a radio-frequency amplifier or oscillator. The anode is capable of dis-

sipating 100 watts and cooling is accomplished by radiation. The cathode is a thoriated tungsten filament. Maximum ratings apply up to 6 megacycles.

MAXIMUM RATINGS

D-C Plate Voltage	1250 volts
D-C Plate Current	150 milliamperes
Continuous Plate Dissipation	100 watts
D-C Grid Current	100 milliamperes

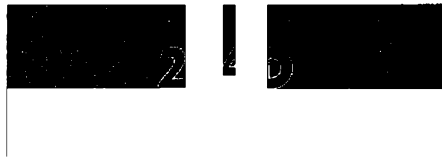

GENERAL CHARACTERISTICS**ELECTRICAL DATA**

	Min.	Bogey	Max.
Filament Voltage	9.5	10.0	10.5 volts
Filament Current at Bogey Voltage	3.1	3.25	3.4 amperes
Amplification Factor			
Conditions: $E_c = 1250$ volts, $I_b = 64$ milliamperes	4.3	4.8	5.3
Interelectrode Capacitances			
Grid-Plate	7.6	8.6	9.6 uuf
Grid-Filament	4.5	5.4	6.3 uuf
Plate-Filament	4.1	5.5	6.9 uuf

MECHANICAL DATA

Mounting Position	Vertical or horizontal with plane of filament vertical
Net Weight, Approximate	6.5 ounces

MAXIMUM RATINGS AND TYPICAL OPERATING CONDITIONS**AUDIO-FREQUENCY POWER AMPLIFIER AND MODULATOR—CLASS A₁****MAXIMUM RATINGS, Absolute Values**

	CCS
D-C Plate Voltage	1250 volts
D-C Grid Voltage	−240 volts
Plate Input	85 watts
Plate Dissipation	85 watts

TYPICAL OPERATION

	CCS	CCS	CCS
D-C Plate Voltage	750	1000	1250 volts
D-C Grid Voltage	−100	−160	−215 volts
Peak A-F Grid Voltage	100	160	215 volts
D-C Plate Current	110	83	68 milliamperes
Load Resistance	8000	8500	12000 ohms
Total Harmonic Distortion	2.4	3.6	4.4 per cent
Power Output	11.0	24.4	31.0 watts

AUDIO-FREQUENCY POWER AMPLIFIER AND MODULATOR—CLASS B**MAXIMUM RATINGS, Absolute Values**

	CCS
D-C Plate Voltage	1250 volts
Signal D-C Plate Current ¹	150 milliamperes
Signal Plate Input ¹	188 watts
Plate Dissipation ¹	100 watts

TYPICAL OPERATION

Unless otherwise specified, values are for 2 tubes	CCS	CCS
D-C Plate Voltage	1000	1250 volts
D-C Grid Voltage	-200	-250 volts
Peak A-F Grid-to-Grid Voltage	530	720 volts
Zero Signal D-C Plate Current	20	25 milliamperes
Maximum Signal D-C Plate Current	250	300 milliamperes
Effective Load Resistance, Plate-to-Plate	7700	7200 ohms
Maximum Signal Driving Power, Approximate	3.5	2 watts
Maximum Signal Power Output, Approximate	150	200 watts

RADIO-FREQUENCY POWER AMPLIFIER AND OSCILLATOR—CLASS C TELEGRAPHYKey-down conditions per tube without amplitude modulation²**MAXIMUM RATINGS, Absolute Values**

	CCS
D-C Plate Voltage	1250 volts
D-C Grid Voltage	-550 volts
D-C Plate Current	150 milliamperes
D-C Grid Current	100 milliamperes
Plate Input	188 watts
Plate Dissipation	100 watts

TYPICAL OPERATION

	CCS	CCS
D-C Plate Voltage	1000	1250 volts
D-C Grid Voltage	-245	-300 volts
Peak R-F Grid Voltage	385	445 volts
D-C Plate Current	150	150 milliamperes
D-C Grid Current, Approximate	18	16 milliamperes
Driving Power, Approximate	6.5	7.5 watts
Power Output, Approximate	115	140 watts

Maximum ratings apply up to 6 megacycles. The tube may be operated at higher frequencies provided maximum values of plate voltage and power input are reduced according to the tabulation below (other

maximum ratings are the same as shown above). Special attention should be given to adequate ventilation of the bulb at these frequencies.

Frequency	6	15	30 megacycles
Percentage of Maximum Rated Plate Voltage and Plate Input			
Class B	100	85	70 per cent
Class C Unmodulated	100	75	50 per cent

1. Averaged over any audio-frequency cycle of sine wave form.

2. Modulation essentially negative may be used if the positive peak of the envelope does not exceed 115 per cent of the carrier conditions.

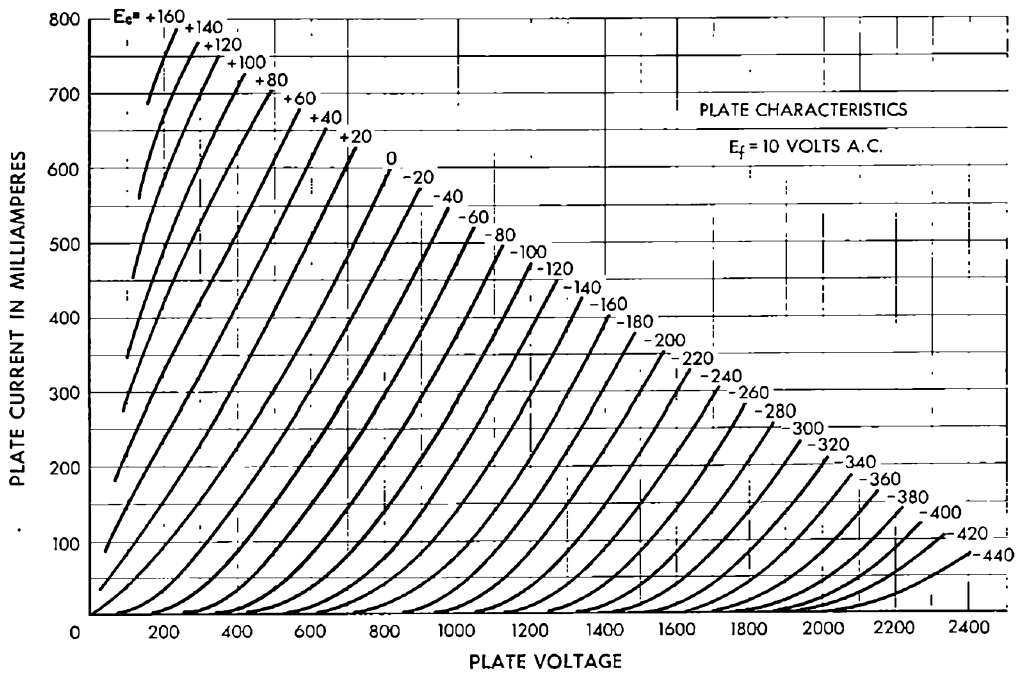
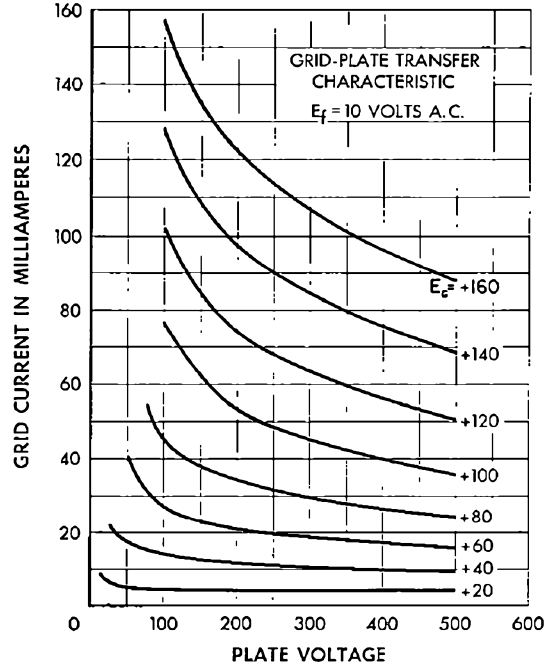

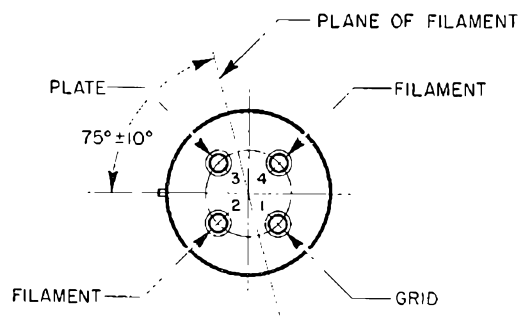
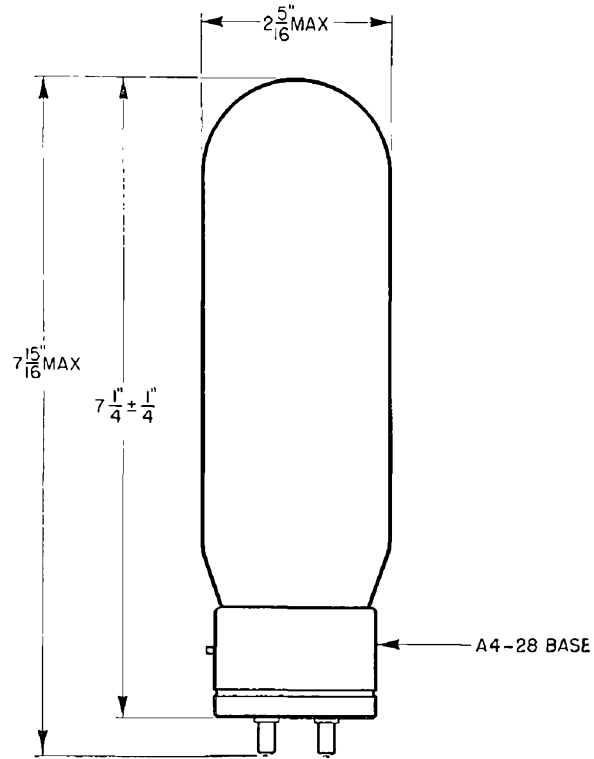

ELECTRON TUBE DATA SHEET
WESTERN ELECTRIC 287A ELECTRON TUBE

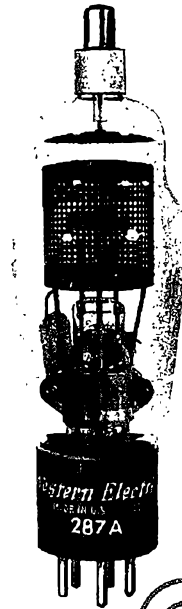

ONLY

DESCRIPTION

The 287A is a three-electrode mercury-vapor thyatron with a negative control characteristic. This tube is designed for regulated or controlled rectifiers.

MAXIMUM RATINGS

Peak Anode Voltage	1250	2500 volts
Average Cathode Current	1.5	0.64 amperes

FILE: THYRATRON SECTION

MAXIMUM RATINGS, Absolute Values

Peak Anode Voltage		
Inverse	1250	2500 volts
Forward	1250	2500 volts
Cathode Current		
Peak	6.0	2.5 amperes
Average	1.5	0.64 amperes
Surge (maximum duration 0.1 second)	60	25 amperes
Averaging Time	5	5 seconds
Negative Grid Voltage		
Before Conduction	500	500 volts
During Conduction	10	10 volts
Positive Grid Current, Average		
(averaging time = one cycle)010	.010 ampere
Condensed Mercury Temperature Limits	+ 30 to +80 centigrade	

ELECTRICAL DATA

	Min.	Bogey	Max.
Filament Voltage	2.37	2.5	2.62 volts
Filament Current at 2.5 volts	---	7.0	7.75 amperes
Filament Heating Time Required	15	---	seconds
Anode to Grid Capacitance	---	1.8	uuf.
Grid to Filament Capacitance	---	5.0	uuf.
Deionization Time, Approximate ¹			
E _{bb} =2500 volts; I _b =2.5 amperes:			
E _{cc} =-18 volts; THg=80C; Rg=20000 ohms	---	1000	microseconds
Ionization Time, Approximate ²			
E _{bb} =100 volts; THg=40C; Grid C _{ver} voltage=5 volts	---	150	microseconds
E _{bb} =100 volts; THg=80C; Grid C _{ver} voltage=25 volts	---	1	microsecond
Anode Voltage Drop	---	15	volts
Critical Grid Current at 220 Anode Volts	---	---	5 microamperes

MECHANICAL DATA

Type of Cooling	Convection
Equilibrium Condensed Mercury Temperature	
Rise Above Ambient, Approximate	
At Full Load	30 centigrade
At No Load	20 centigrade
Mounting Position	Vertical-base down
Net Weight, Approximate	3 ounces
Dimensions and pin connections shown in outline drawing on Page 4.	

1. Deionization time decreases with an increase in negative grid voltage or with a decrease in (a) condensed mercury temperature (THg), (b) grid resistance or (c) anode current immediately preceding the end of conduction.
2. Ionization time decreases with an increase in (a) anode voltage, (b) condensed mercury temperature (THg) or (c) grid overvoltage. Grid overvoltage is defined as the magnitude by which the applied voltage exceeds, in a positive direction, the critical grid voltage value. Critical grid voltage is the instantaneous value of grid voltage at the time when anode current starts to flow.

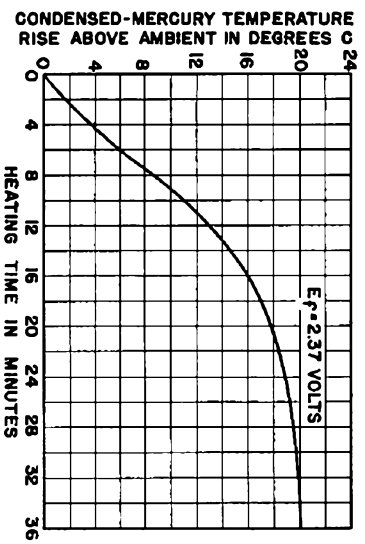
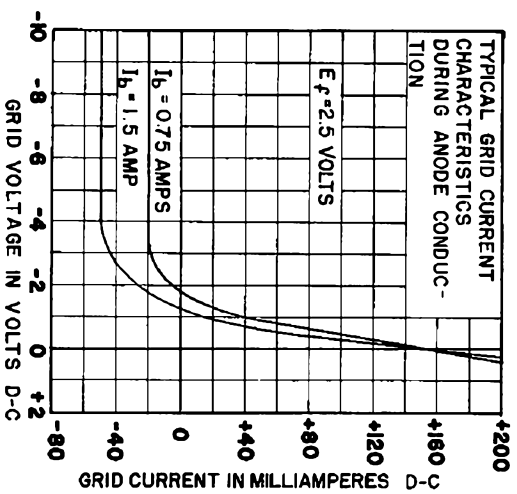
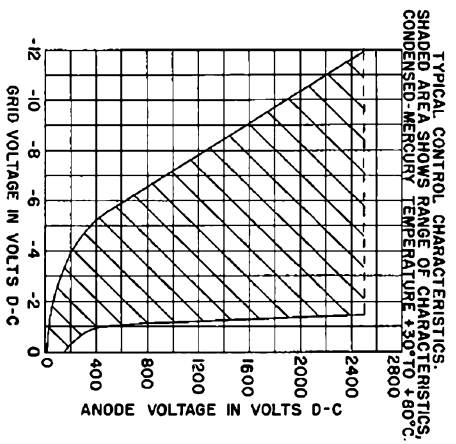

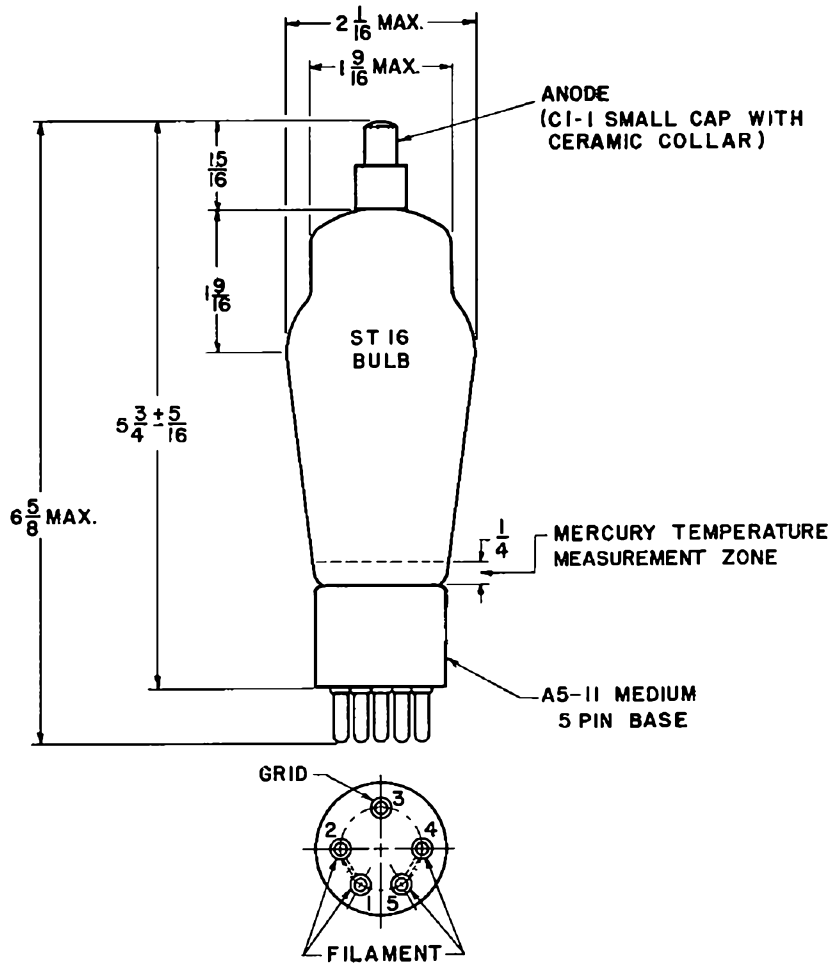

A development of Bell Telephone Laboratories, the research laboratories of the American Telephone and Telegraph Company and the Western Electric Company.

PRINTED IN U.S.A.

293A

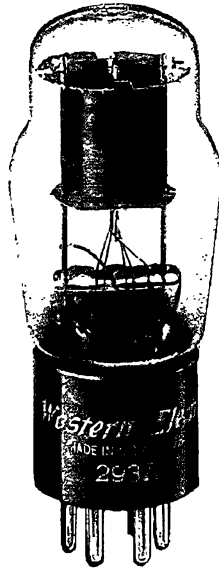

**PENTODE
POWER AMPLIFIER**

Western Electric

DESCRIPTION

The 293A is a suppressor grid, power pentode having an indirectly heated cathode. It is designed for use as an audio-frequency power amplifier in Class A₁ service.

CHARACTERISTICS

Heater Voltage		10.0 volts
Plate Current		15.8 milliamperes
Transconductance	} $E_b = E_{c2} = 180$ volts; $E_{c1} = -18$ volts; $E_{c3} = 0$ }	1175 micromhos
Power Output		1.2 watts

GENERAL CHARACTERISTICS

ELECTRICAL DATA

Heater Voltage, A-C or D-C	10.0 volts
Heater Current	320 milliamperes
Direct Interelectrode Capacitances (without external shield)	
Grid to Plate	0.66 uuf
Input	6.2 uuf
Output	6.5 uuf

MECHANICAL DATA

Cathode	Coated Unipotential
Bulb	ST14
Base	Medium 6-pin
Mounting Position	Any
Dimensions and pin connections shown in outline drawing on Page 6	

MAXIMUM RATINGS, Design-Center Values

Plate Voltage	250 volts
Screen Grid Voltage	200 volts
Plate Dissipation	5 watts
Screen Grid Dissipation	1 watt
Cathode Current	30 milliamperes
Heater-Cathode Voltage	150 volts

TYPICAL OPERATING CONDITIONS AND CHARACTERISTICS

SINGLE TUBE AMPLIFIER – CLASS A₁

Plate Voltage	135	180	250 volts
Screen Grid Voltage	135	180	200 volts
Control Grid Voltage	-12	-18	-18 volts
Peak A-F Grid Voltage	12	18	18 volts
Zero Signal Plate Current	12.5	15.8	21.5 milliamperes
Maximum Signal Plate Current	13.5	17.0	23.5 milliamperes
Zero Signal Screen Grid Current	1.9	2.7	3.5 milliamperes
Maximum Signal Screen Grid Current	3.2	5.2	5.6 milliamperes
Transconductance	1140	1175	1340 micromhos
Plate Resistance	95000	100000	100000 ohms
Load Resistance	11000	11500	12000 ohms
Maximum Signal Power Output	0.6	1.3	2.1 watts
Total Harmonic Distortion	9.7	11	10 per cent

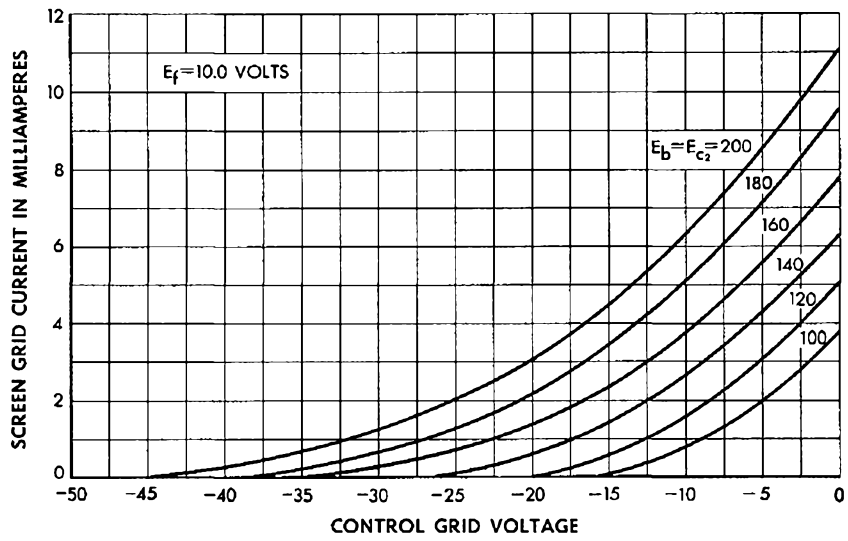
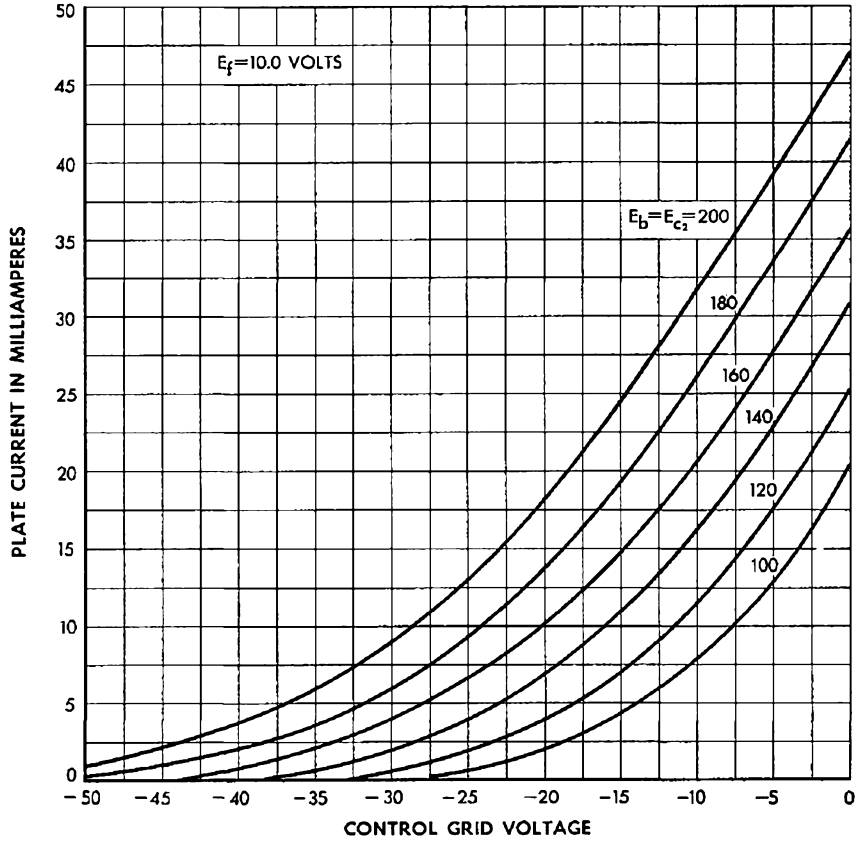

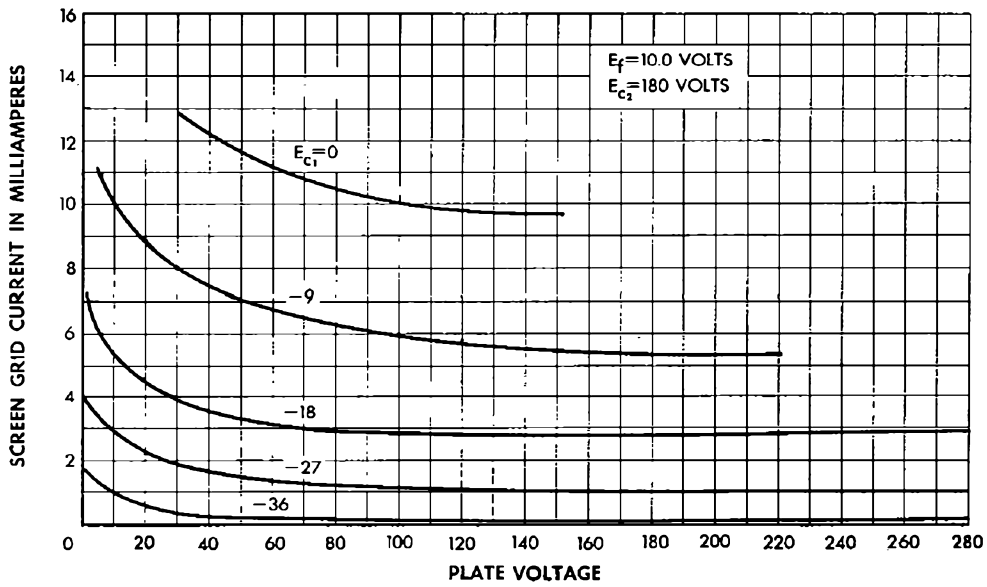
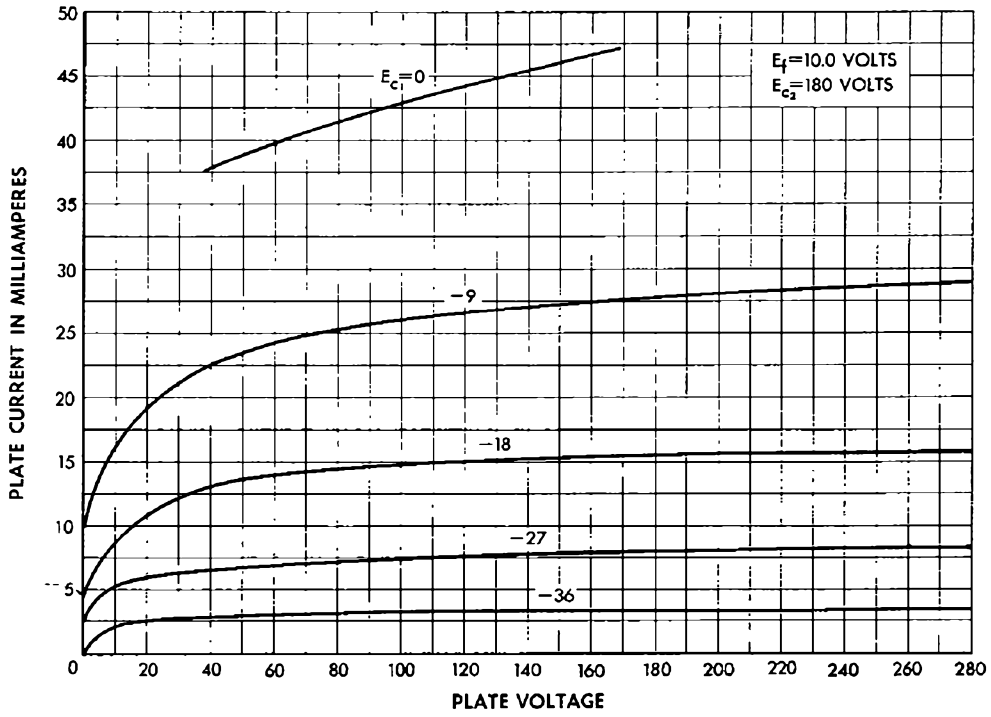

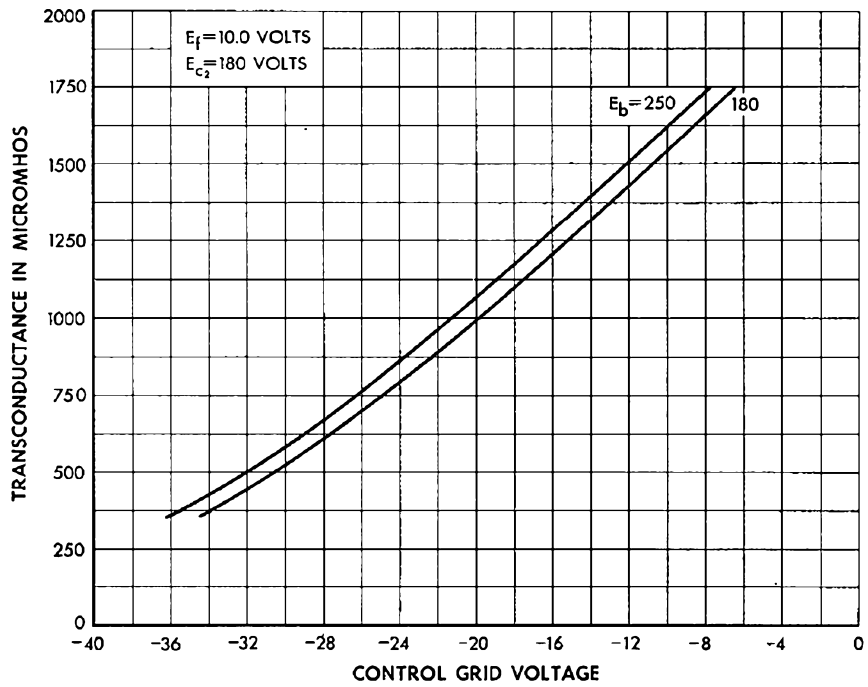
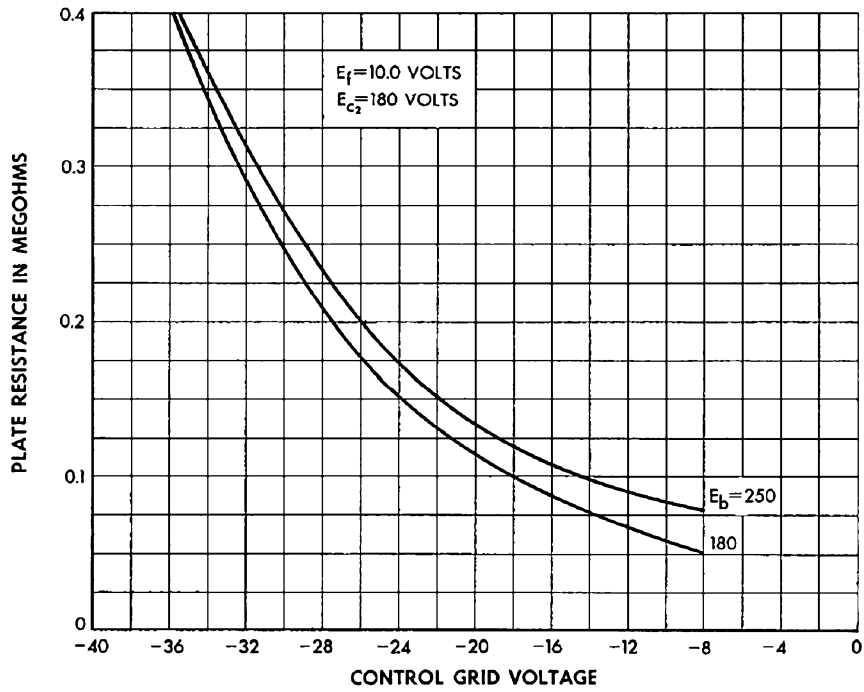

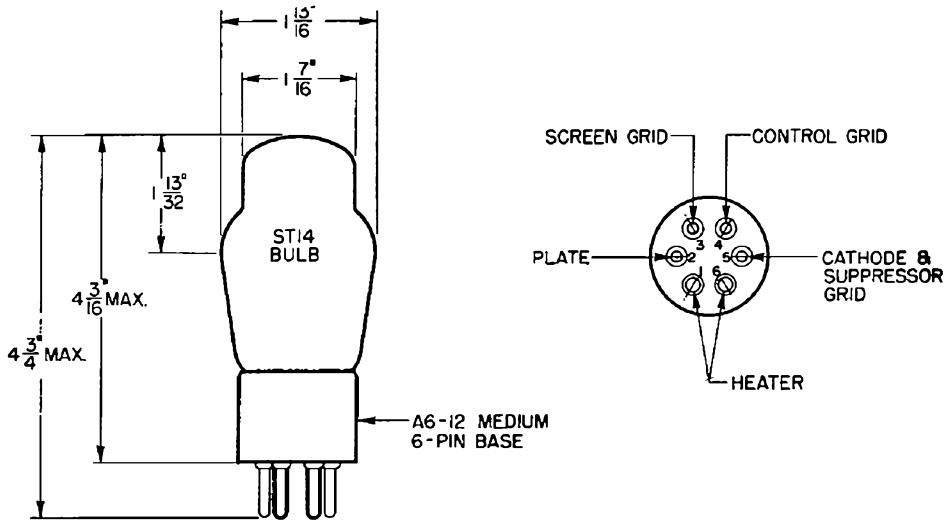
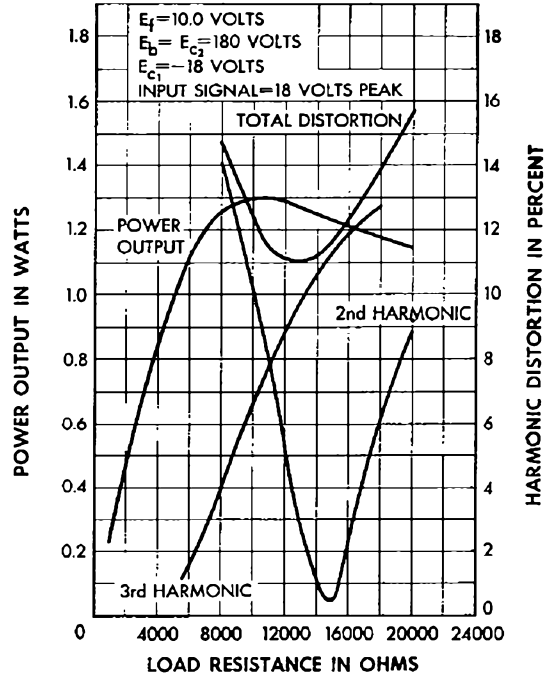

Western Electric

A development of Bell Telephone Laboratories, the research laboratories of the American Telephone and Telegraph Company and the Western Electric Company.

Western Electric

297A

297A Vacuum Tube



Classification—Three element, argon filled, filamentary thyatron

This tube is a rectifier of low internal impedance in which the starting of the conduction cycle may be controlled by the grid. It is intended for use in special circuits as a relay or trigger-action device. A few of its other possible uses are: as a controlled-frequency oscillator giving a square wave-form, as a voltmeter or volume level-indicator, or as a source of sweep-voltage for a linear time axis.

Dimensions—The dimensions and outline diagrams are given in Figures 1 and 2. The overall dimensions are:

Maximum length.....	4"
Diameter.....	1 $\frac{3}{16}$ "

Mounting—This vacuum tube employs a standard four-pin thrust type base suitable for use in a Western Electric 143B or similar socket. The arrangement of electrode connections to the base terminals is shown in Figure 2.

The tube may be mounted in either a vertical or horizontal position, although the vertical position is preferable. If mounted in a horizontal position the plane of the filament, which is indicated in Figure 2, should be vertical.

Filament Rating

Filament voltage.....	1.75 volts
Nominal filament current.....	0.350 ampere
Required filament heating time.....	2 seconds

FILE: Thyatron Section

The filament of this tube is designed to operate on a voltage basis. The voltage should be maintained to within 5% of its rated value (1.75 volts). Operation of the filament above the upper limit will definitely reduce the life of the tube, while a decrease below the lower limit may cause immediate failure.

Sufficient time should always be allowed for the cathode temperature to reach its normal operating value before anode current is drawn. If filament transformers with good regulation are used this time is 2 seconds. Failure to allow sufficient time may result in immediate failure. If instantaneous anode currents less than 10 milliamperes are desired with anode voltages less than 50 volts, anode current may be drawn simultaneously with the application of filament voltage; but approximately 2 seconds will be required for the anode current to reach its final value.

Operating Conditions

Approximate tube voltage drop	20 volts
Maximum instantaneous anode current	60 milliamperes
Maximum average anode current	10 milliamperes
Maximum time of averaging anode current	0.5 second
Maximum peak voltage between anode and grid	250 volts
Maximum instantaneous grid current	10 milliamperes
Operating ambient temperature range	-20° to +50° C.
Nominal deionization time	100 microseconds

The characteristics of the 297A tube are such that, for any given positive anode potential, there is a critical grid potential. If the grid is held more negative than this value and the tube is non-conducting, the anode current will remain zero. If it is made less negative, the tube becomes conducting, and the anode current assumes a value determined by the applied anode potential and the impedance in the anode circuit. When the tube is conducting, the tube voltage drop is practically independent of the value of both the anode current and the grid potential. To extinguish the discharge and reestablish control by the grid, the anode potential must be reduced to zero or made negative for a period at least as long as the deionization time (100 microseconds).

A typical curve relating the critical grid potential to the anode potential is shown in Figure 3. This characteristic may vary from tube to tube and during the life of a given tube.

The maximum anode current is specified in terms of an instantaneous value (60 milliamperes) and an average value (10 milliamperes), with a maximum period of averaging of 0.5 second. These are maximum limitations and should not be exceeded.

Sufficient resistance must always be included in the grid circuit to limit the negative grid potential to 10 volts when anode current is flowing. Failure to observe this precaution will result in short tube life.

Typical Circuits

The tube may be used in a variety of circuits. Two general types are common. One use of the tube is to produce a saw-toothed, current wave. The circuit for this application is shown in Figure 4. The resistance R should, ordinarily, be at least 100,000 ohms, and the product RC (C in farads) approximately equal to the desired fundamental period.

The second general use for the tube is as a relay. In this application the anode may be supplied from either alternating or direct current. When supplied from direct current, the circuit, Figure 5, possesses a "lock-in" feature, since the anode potential must be removed momentarily in order to restore the tube to the non-conducting condition. When supplied from alternating current, the circuit possesses no "lock-in" feature, but the average anode current may be controlled by the relative phase of grid and anode potentials. The schematic circuit for this application is shown in Figure 6. Figure 7 is a simplified circuit employing a photoelectric cell in place of the resistance,

R, used in the phase shifting device in Figure 6. The photoelectric cell, however, is equivalent to a variable resistance in the sense that the current passed will depend upon the amount of light falling on it. In circuits Figures 6 and 7 alternating current may be used for the filament supply.

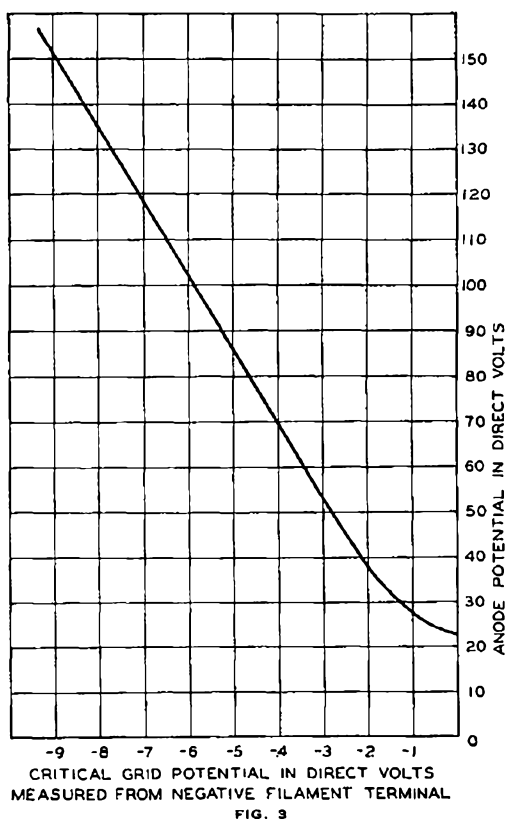
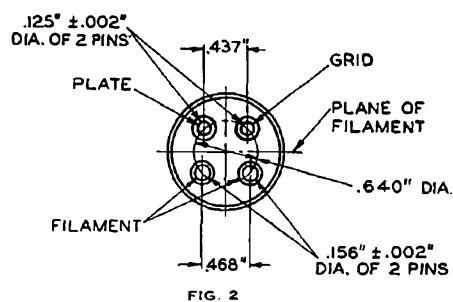
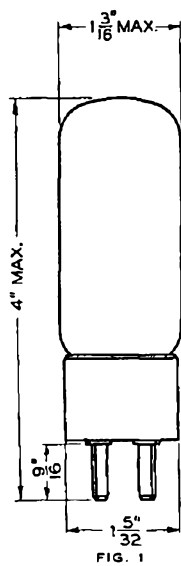

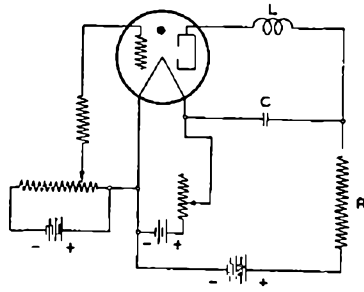

FIG. 4

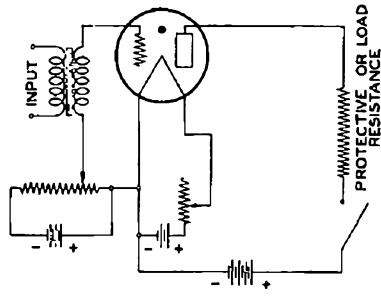

FIG. 5

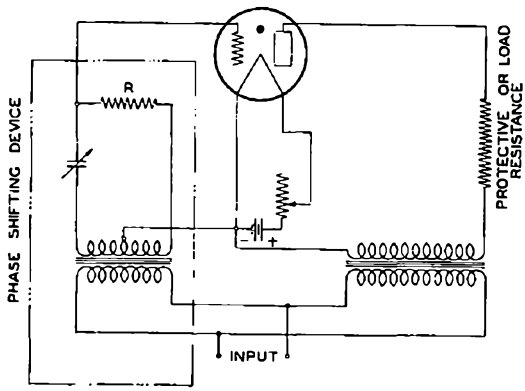

FIG. 6

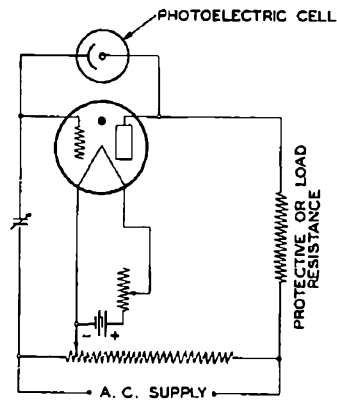
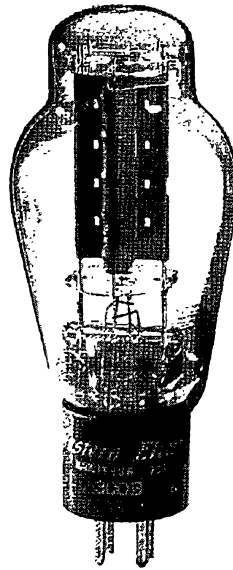

FIG. 7

A development of Bell Telephone Laboratories, Incorporated,
 the research laboratories of the American Telephone and Tele-
 graph Company and the Western Electric Company

300B



**TRIODE
POWER AMPLIFIER**

Western Electric

DESCRIPTION

The 300B is a filamentary type triode designed for use as an audio-frequency power amplifier.

CHARACTERISTICS

Filament Voltage	5.0 volts
Plate Current	60 milliamperes
Power Output	8 watts

$E_0 = 350$ volts; $E_c = -74$ volts

300B
TRIODE

GENERAL CHARACTERISTICS**ELECTRICAL DATA**

Filament Voltage, A-C or D-C	5.0 volts
Filament Current	1.2 amperes
Direct Interelectrode Capacitances	
Grid to Plate	15 uuf
Input	8.5 uuf
Output	4.1 uuf

MECHANICAL DATA

Cathode	Coated Filament
Base	Medium 4-pin with skew bayonet pin
Mounting Position	Preferably vertical; if horizontal, pins #1 and #2 must be in same vertical plane

Dimensions and pin connections shown in outline drawing on Page 6

MAXIMUM RATINGS, Design-Center Values

Plate Voltage	400 volts
Plate Current	100 milliamperes
Plate Dissipation	36 watts

Maximum Grid Circuit Resistance for

Fixed Bias	0.05 megohm
Self Bias	0.25 megohm

TYPICAL OPERATING CONDITIONS AND CHARACTERISTICS**SINGLE TUBE AMPLIFIER - CLASS A₁**

Filament Voltage, A-C	5.0	5.0 volts
Plate Voltage	300	350 volts
Grid Voltage	-61	-74 volts
Peak A-F Signal Voltage	61	74 volts
Zero Signal Plate Current	62	60 milliamperes
Maximum Signal Plate Current	74	77 milliamperes
Transconductance	5300	5000 micromhos
Plate Resistance	740	790 ohms
Load Resistance	3000	4000 ohms
Amplification Factor	3.9	3.9
Maximum Signal Power Output	6	7 watts
Total Harmonic Distortion	5	5 per cent

PUSH-PULL AMPLIFIER - CLASS A₁

Unless otherwise specified, values are for 2 tubes

Filament Voltage, A-C	5.0	5.0 volts
Plate Voltage	300	350 volts
Grid Voltage*	-61	-67.5 volts
Peak A-F Grid-to-Grid Voltage	122	135 volts
Zero Signal Plate Current	100	170 milliamperes
Maximum Signal Plate Current	150	200 milliamperes
Effective Load Resistance (Plate-to-Plate)	4000	4000 ohms
Maximum Signal Power Output	10	20 watts
Total Harmonic Distortion	4.5	2 per cent

*If the filament is operated on D.C., the characteristics will be approximately the same if the grid voltage, measured from the negative filament, is decreased by 2.5 volts.

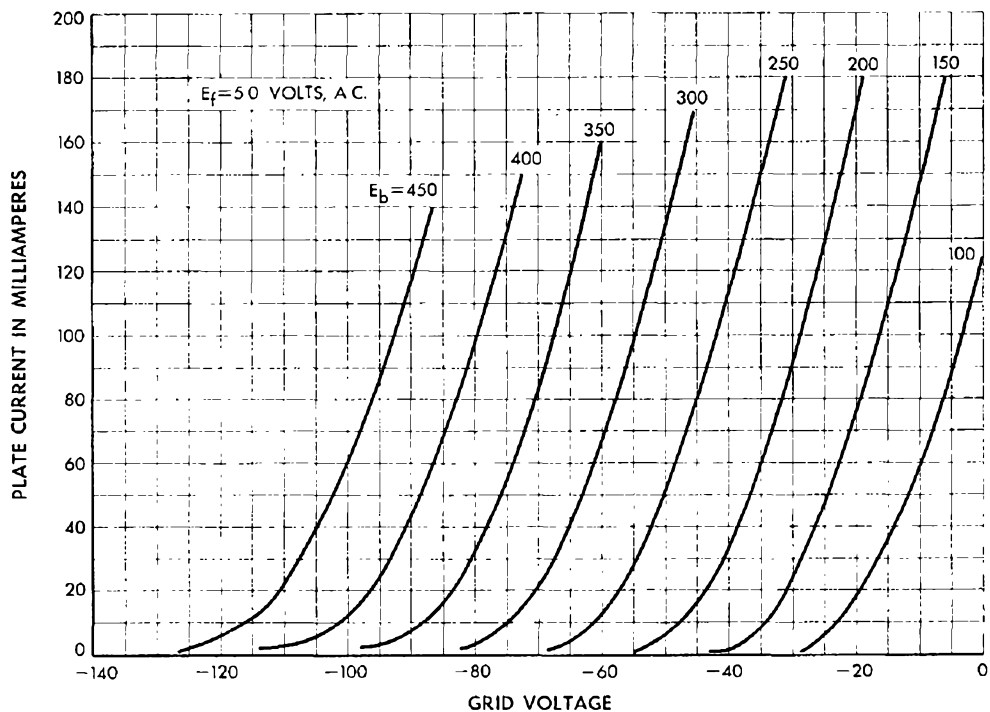
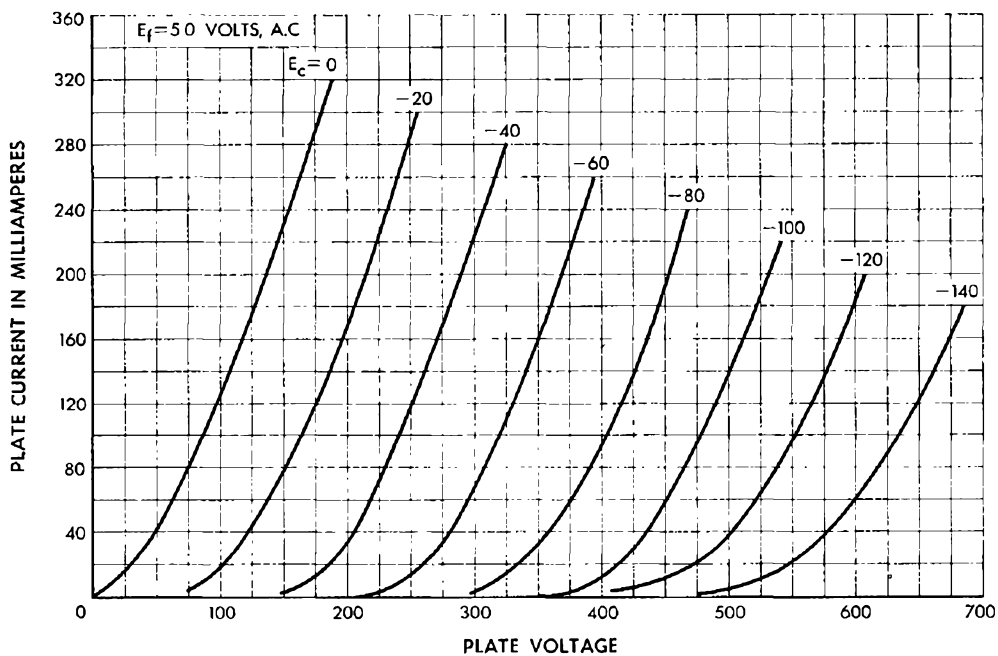

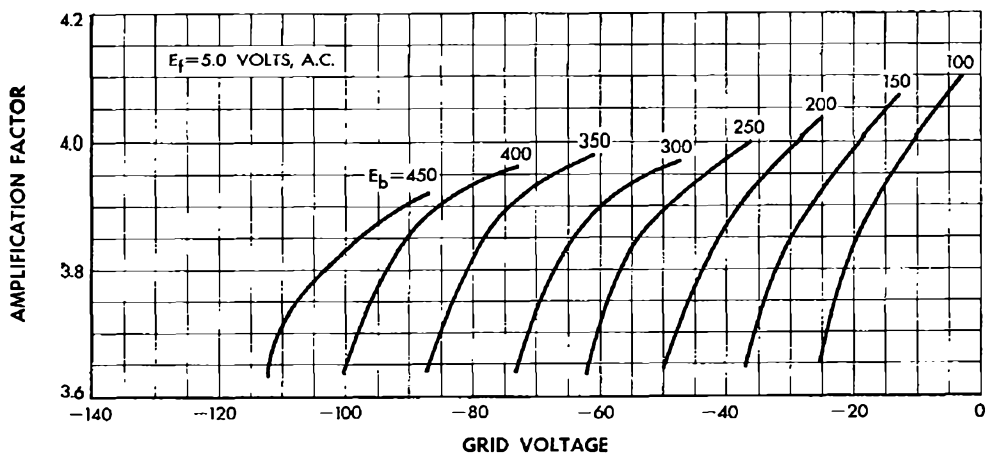
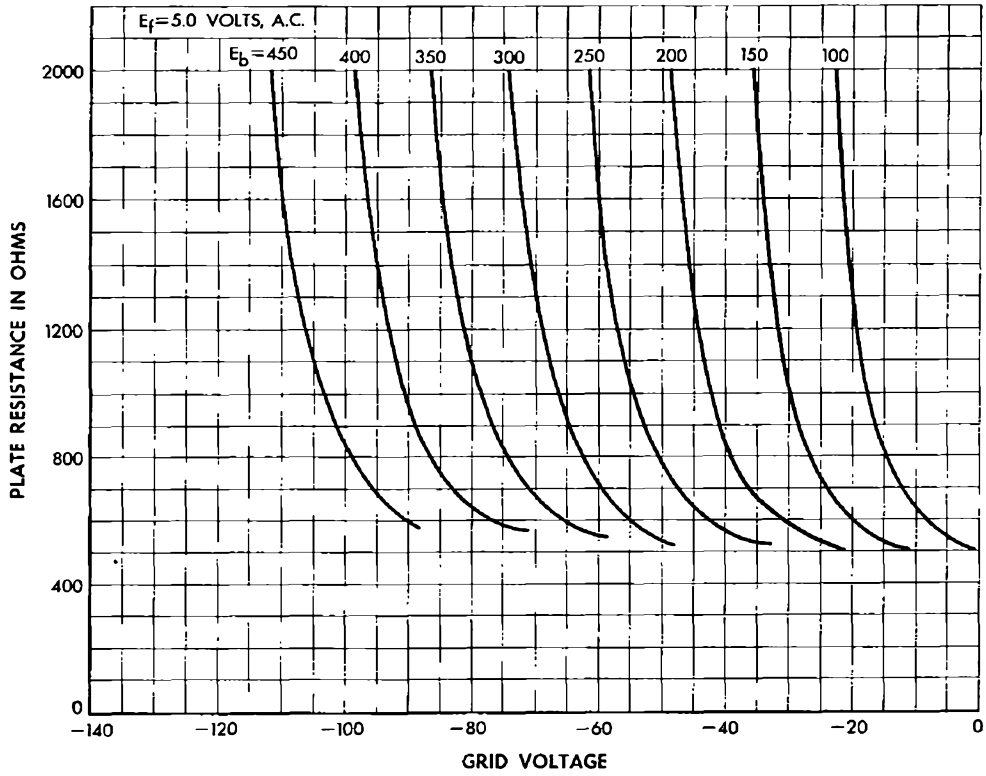

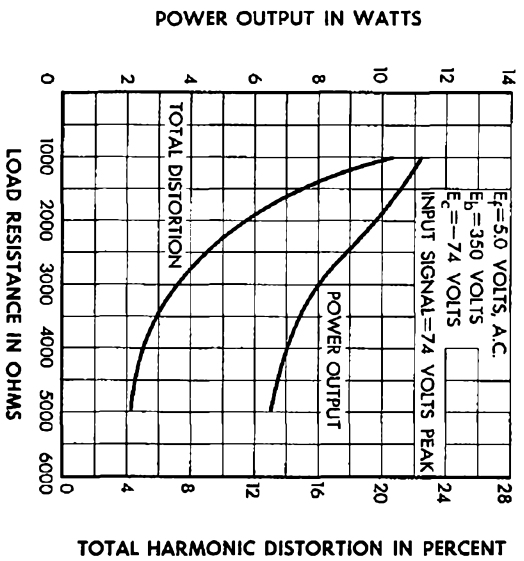
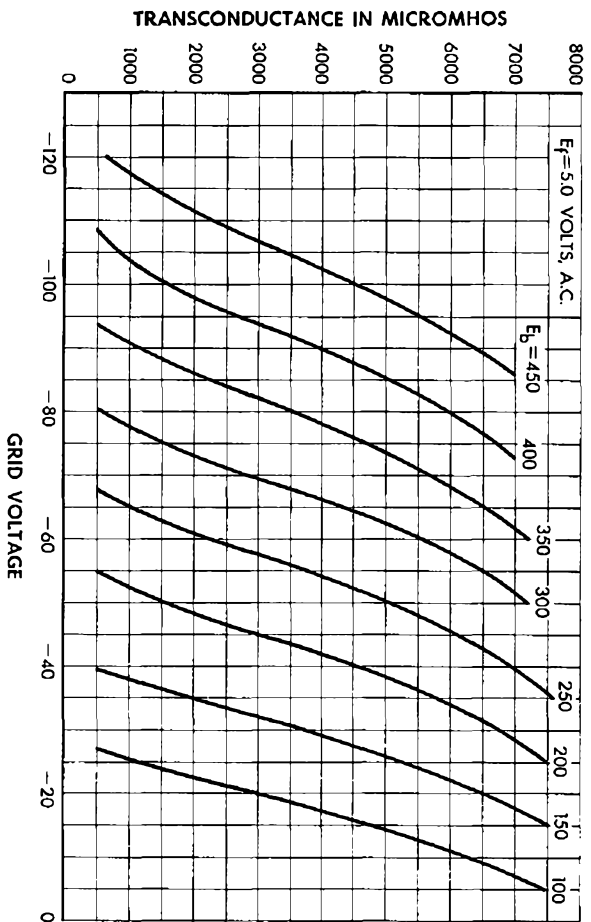

ELECTRON TUBE DATA SHEET
 FILE: GENERAL PURPOSE SECTION
 5-49

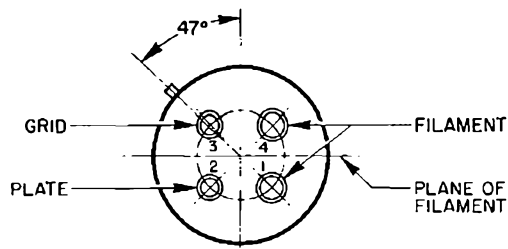
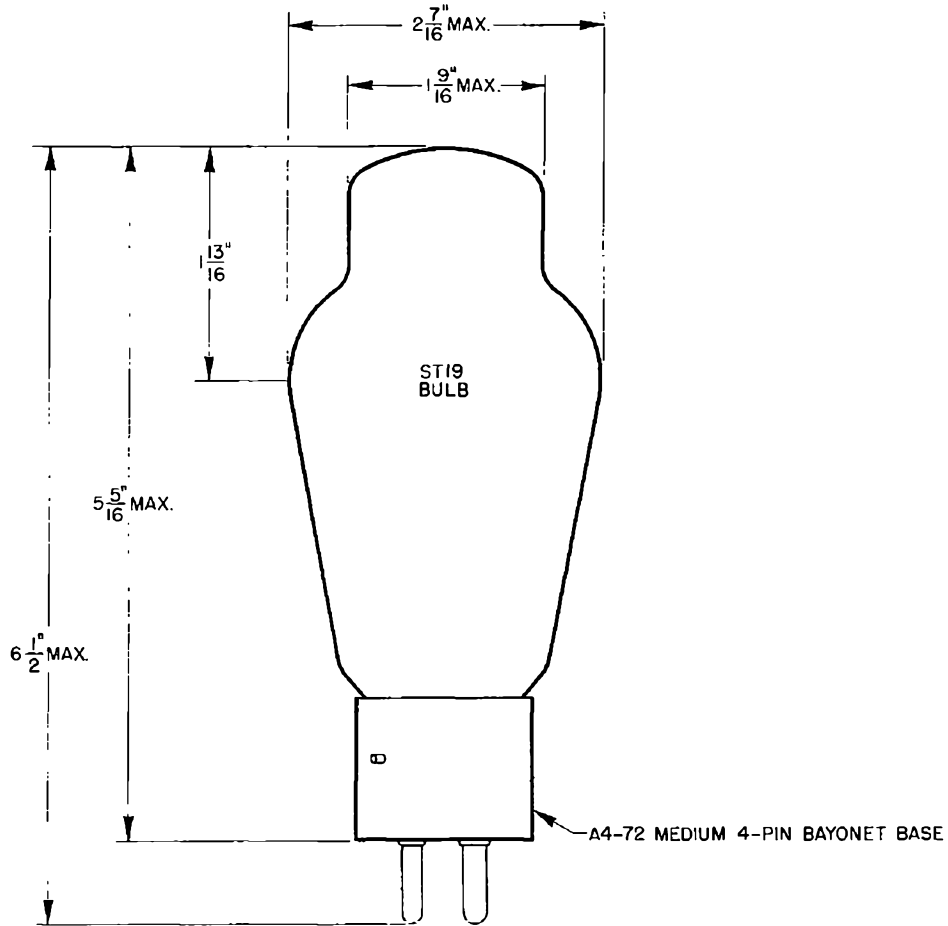

Western Electric

A development of Bell Telephone Laboratories, the research laboratories of the American Telephone and Telegraph Company and the Western Electric Company.

Western Electric

301A Vacuum Tube

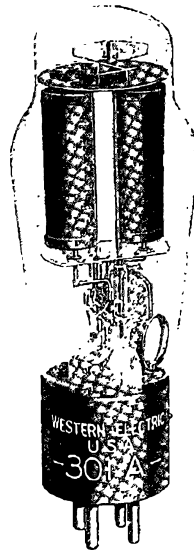

Classification—Full wave, thermionic, mercury vapor rectifier

The 301A vacuum tube is designed to supply direct current from an alternating-current supply.

Dimensions—The dimensions and outline diagrams are given in Figures 1 and 2. The overall dimensions are:

Maximum length.....	6½"
Maximum diameter.....	2¼"

Mounting—The 301A employs a standard 4 pin thrust type base suitable for use in a Western Electric 143B or similar socket. Base dimensions and the arrangement of electrode connections to the base terminals are shown in Figs. 1 and 2.

The tube should be mounted in a vertical position with the base end down. There should be a free circulation of air around the tube. No object should touch the glass bulb.

Filament Rating

Filament voltage.....	5.0 volts
Nominal filament current.....	3.0 amperes

The filament of this tube is designed to operate on a voltage basis from an alternating-current supply. The voltage should be maintained to within 5% of its rated value (5.0 volts). Operation

301A

of the filament at a voltage above the upper limit will definitely reduce the life of the tube while a decrease in voltage below the lower limit may cause immediate failure.

Sufficient time must always be allowed for the filament temperature to reach its normal operating value before the anode potential is applied. If filament circuits with good regulation are used, this time is 30 seconds. If the tube is operated at ambient temperatures below 20° C., a longer period of time is required for the purpose of bringing the mercury vapor pressure to a satisfactory operating value. The minimum filament warming time as a function of ambient temperature is shown in figure 3.

For proper distribution of the mercury a period of 10 to 15 minutes filament warming time should be allowed when the tube is used for the first time or if it has been reinserted in the apparatus after having been removed.

Characteristics and Operating Conditions

Approximate anode-cathode potential drop	10 volts
Maximum peak plate current	1.0 ampere
Maximum peak potential between electrodes	1800 volts
Maximum operating ambient temperature range	0 to 50° C
Recommended operating ambient temperature range	10 to 40° C

The anode-cathode potential drop is substantially independent of the plate current. The exact value varies from tube to tube and during the life of a given tube. Within the specified ambient temperature range and plate current range, it may vary from 5 to 25 volts.

The anode-cathode drop as a function of temperature is shown on fig. 4 for a typical 301A tube after reaching temperature equilibrium and when passing the rated plate current.

The maximum permissible peak plate current (1.0 ampere) is a limitation on the instantaneous value that the tube can carry safely in the direction in which it is designed to conduct and should not be exceeded. The maximum direct load current is not fixed but will depend upon the wave form required by the load and filter circuit.

The maximum permissible peak potential between electrodes (1800 volts) is a limitation on the instantaneous value that the tube can stand safely. If it is exceeded, an arc-back may result which will injure the tube. The maximum direct potential available is not fixed but will depend upon the type of circuit used.

301A vacuum tubes may be operated in parallel if some provision is made to insure a proper division of the load current. Current dividing reactors or ballasting resistors in series with each anode, may be used for this purpose. The size of the reactors or resistors depends upon the circuit design.

In most cases the termination of the useful life of the 301A tube is due to the loss of filament activity. This causes the tube to fail by arcing between the electrodes. Failures of this kind should be safeguarded by proper fuse protection to prevent injury to other tubes in the circuit and to the auxiliary equipment.

Typical Rectifier Circuits—The 301A vacuum tube may be used in any standard high vacuum rectifier circuit subject to its current, voltage and temperature limitations. Typical circuits are shown below. The approximate direct output current and voltage for each type of rectifier circuit where tubes are operated at maximum permissible plate current and inverse voltage are given in Table 1. The values listed are average values of the pulsating current and voltage for an unfiltered circuit.

Table 1

Circuit Designation	Phase Supply	Number Tubes	Load Potential in Volts	Load Current in Amperes
A	1	1	550	0.6
B	1	2	550	1.2
C	1	2	1100	0.6
D	3	3	800	1.6
E	3	3	700	1.8
F	1	3	1100	0.6

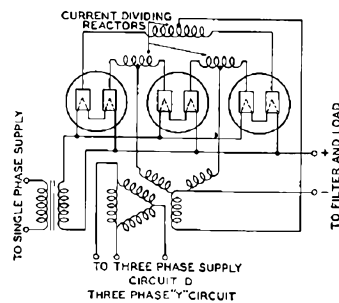
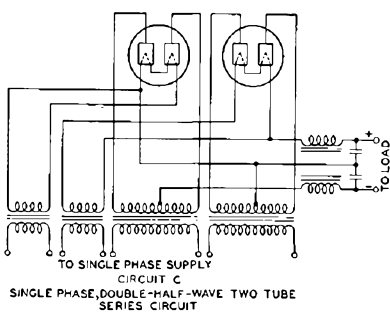
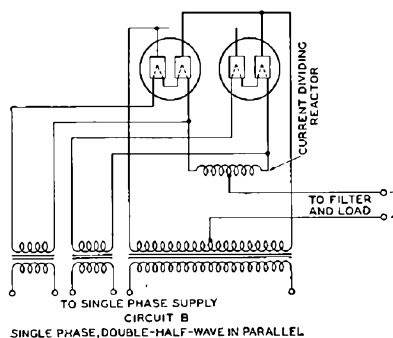
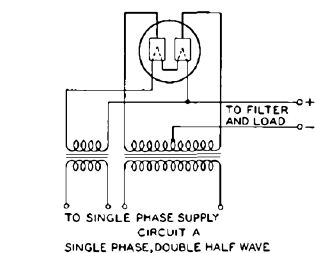

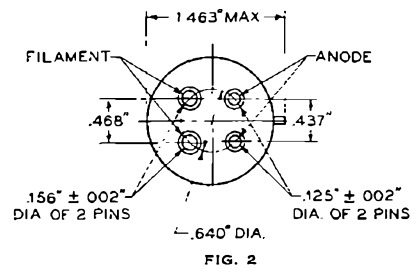
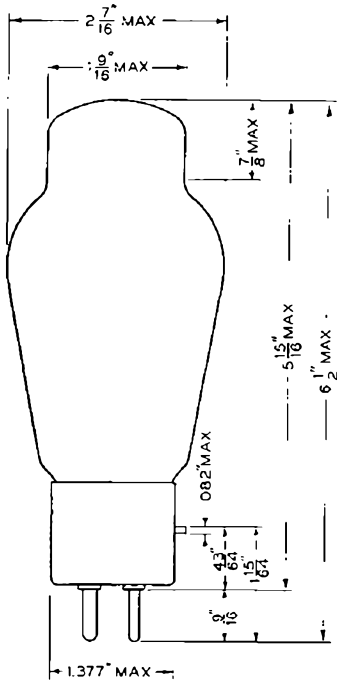
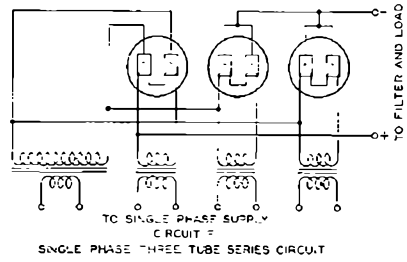
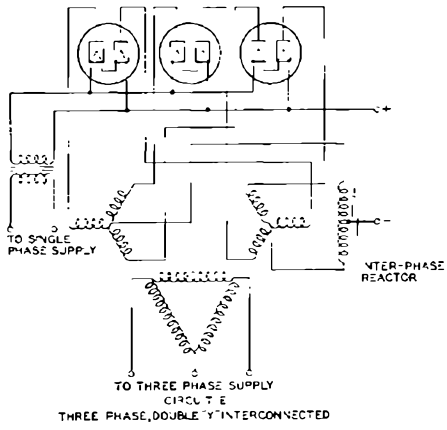

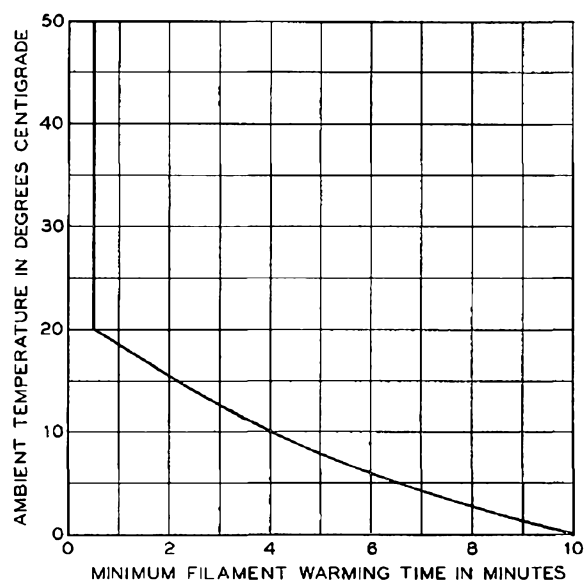

FIG. 3

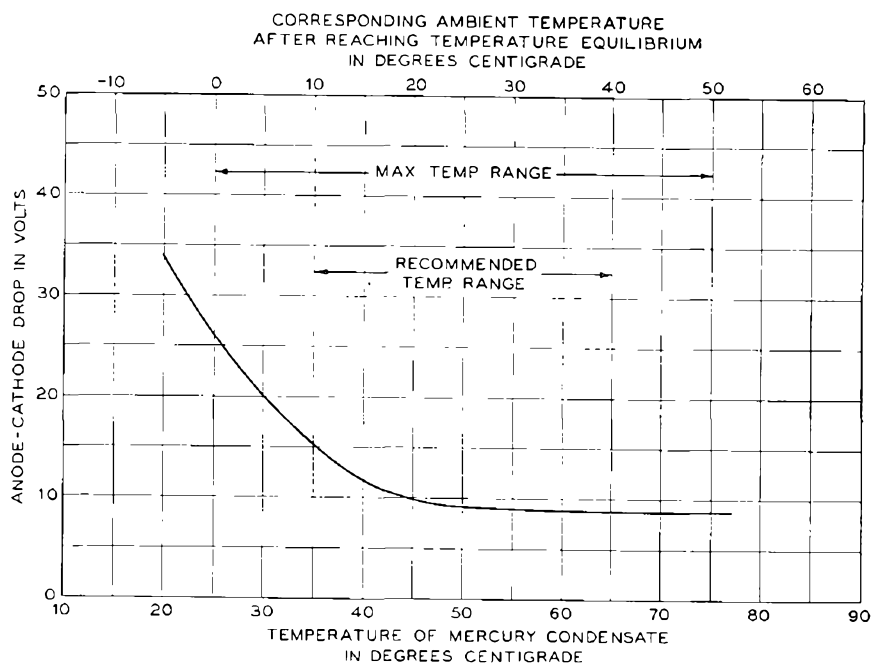

FIG. 4