

how to identify & resolve

Radio-TV Interference Problems

Prepared by the Federal Communications Commission

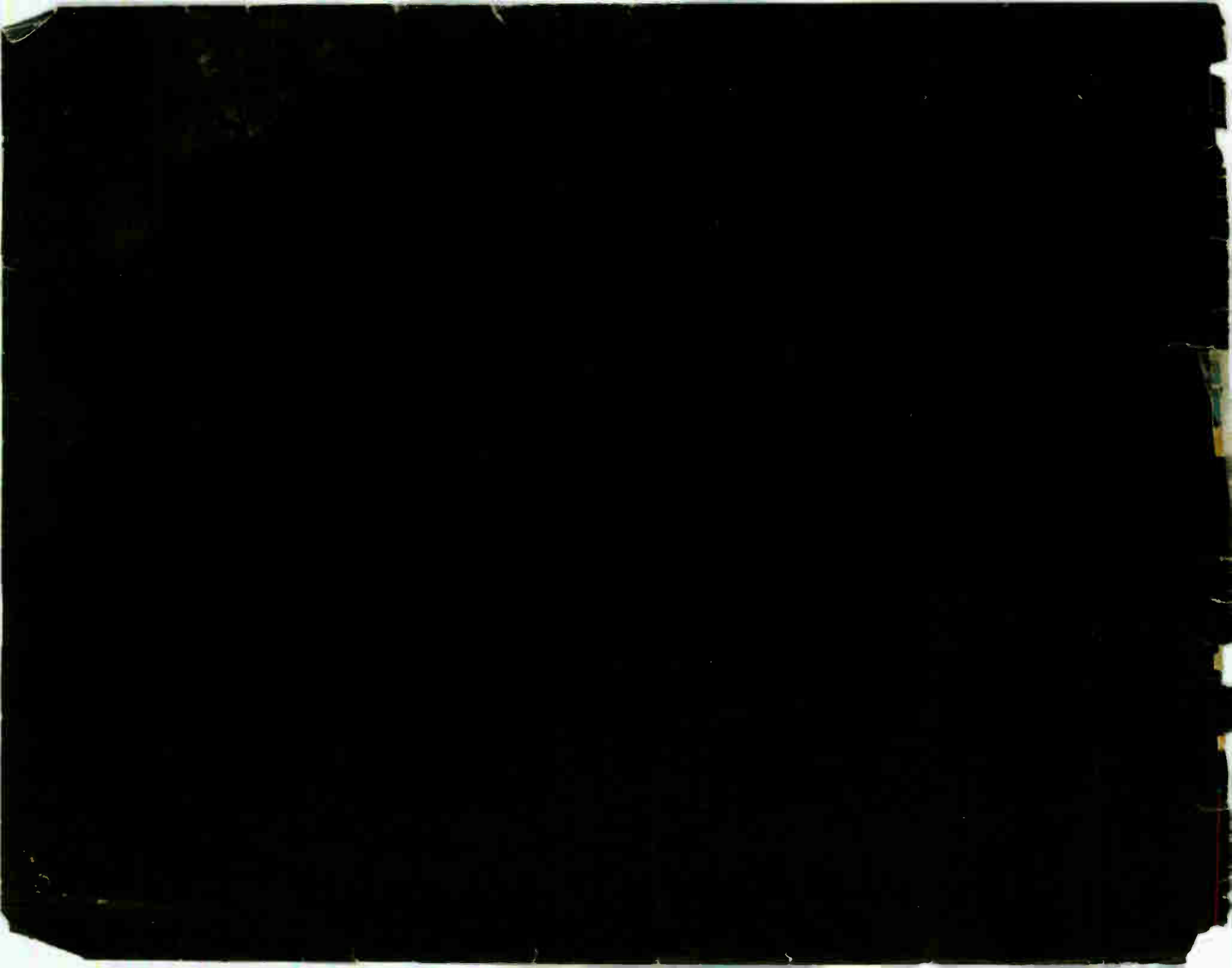

how to identify & resolve

Radio-TV Interference Problems

Prepared by the staff of the
Field Operations Bureau
Federal Communications Commission

First Edition
May, 1977



Readers are invited to submit comments and suggestions to:

Federal Communications Commission
File 1410-C
1919 M Street, NW.
Washington, D.C. 20554

Introduction

During the past few years tremendous advances have been made in the field of radio and television communications. Communications by radio and television from any point on the earth, and sometimes from points beyond the earth, have now become commonplace. In recent years, the growth of two-way radio, permitting personal communications from motor vehicles and homes, has been explosive.

These advances in communication technology are not without problems. The radio frequency spectrum is becoming crowded and interference problems, due to lack of compatibility between the different radio systems, are becoming widespread. This is evidenced by the thousands of complaints of interference to home electronic entertainment equipment (television, stereo, electronic organ, telephone, tape recorder and other audio equipment) received by the Federal Communications Commission (FCC) each year.

Most of these interference problems can be traced to one or more of the following factors:

1. Characteristics of the receiving system, e.g., television receiver or antenna systems design and installation.

2. Environment of the receiving system, e.g., distance from television transmitter and intervening terrain or presence of nearby radio transmitter.

3. Characteristics of radio frequency generating devices, e.g., Citizens Band (CB) radio transmitter or other radio transmitters.

4. Practices of radio transmitter operator, e.g., CB user operating an illegal overpower transmitter or amplifier.

The control of some of the above factors is within the jurisdiction of the Federal Communications Commission. For example, the Commission has technical standards for radio transmitting devices such as CB transmitters; these technical standards were strengthened by the Commission, effective January 1, 1977. Also, the Commission has rules concerning the way in which radio transmitters are operated.

Obviously, control of some of the above factors is *not* within the jurisdiction of the Commission. The quality of the television signal received at your home is one such factor, because such quality is most often influenced by the distance you live from the television station and the intervening terrain. Also, the Commission has no standards for the design and installation of television

receivers and associated antenna systems. As you will find in this bulletin, many interference problems can be corrected by modification and improvement of the television receiving systems.

The purpose of this bulletin is to help you identify and resolve interference problems which you can correct. By reading this bulletin, you will discover that identifying and resolving interference can be an interesting challenge. You will not only be doing your own detective work in locating the source, but you also will be resolving the problem by following the suggestions contained in the "Home Remedies" section.

Because most interference complaints concern television reception, you will find the first section of this bulletin devoted to television interference. If the interference is to your audio equipment (stereo, telephone, AM/FM radio), simply skip to the section of this bulletin which deals with audio interference.

As you begin to identify the type of interference you are experiencing, keep in mind that not only must your equipment be able to receive and amplify the desired signal, but it also must reject all unwanted signals and noise. This means that, even if the equipment allegedly causing the interference is being properly operated, it is still possible to experience interference.

If you have followed the home remedies suggested, and the interference continues, you may want to contact your service representative for assistance. When you contact your service representative, we suggest that you provide that person with a copy of the Service Representative Section of this bulletin. This section has been designed specifically for a technician's use. There is also a section directed to the radio operator which you may wish to show to the operator of the radio transmitter that is allegedly causing you interference.

If you find, after following the guidelines for resolving interference that are provided in this bulletin, that you still are experiencing interference problems, you may want to contact one of the Sources for Assistance listed in Appendix A.

We hope this bulletin will serve as a useful tool in helping you to resolve your interference problem.

CAUTION: To avoid the possibility of a shock hazard, fire, or violation of your equipment warranty, any INTERNAL modifications of your equipment should be done ONLY by a qualified service representative.

Contents

IDENTIFYING INTERFERENCE TO TELEVISION	1
Radio Transmitter Interference	1
Electrical Interference	2
FM Interference	3
Co-Channel Television Interference	4
HOME REMEDIES FOR TELEVISION INTERFERENCE	5
Radio Transmitter Interference	5
Electrical Interference	7
FM Interference	8
IDENTIFICATION OF AUDIO INTERFERENCE	9
HOME REMEDIES FOR AUDIO INTERFERENCE	9
TECHNICAL INFORMATION FOR SERVICE REPRESENTATIVE	10
Radio Transmitter Interference	10
Electrical Interference	12
FM Interference	12
Audio Interference	13
RADIO TRANSMITTER OPERATOR GUIDELINES	18
Radio Transmitter Interference	18
Audio Interference	19
APPENDIX A	21
Sources for Assistance	21
Associations	21
Manufacturers	21
Dealers	27
FCC District Offices	28
Additional Information Requested from Complainants	30

Identifying Interference to Television



NORMAL PICTURE

Use this normal picture for comparison with the other pictures shown on this page.

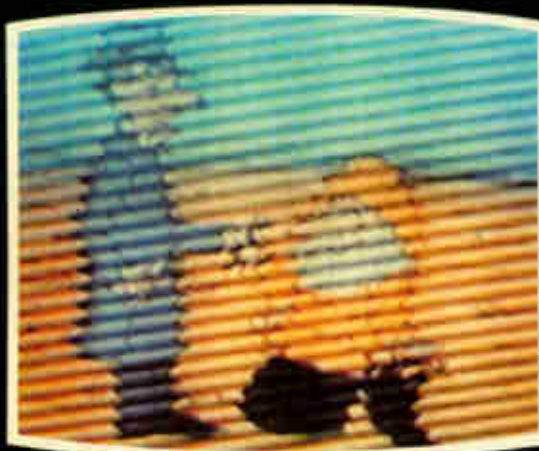

RADIO TRANSMITTER INTERFERENCE

This is what your picture looks like when it is picking up the transmission of CB, Amateur, Police or other radio transmitters. It will normally affect VHF channels only. You may notice that the interference pattern changes or moves as the radio transmitter operator talks.

Steps you or the service representative can take to eliminate the interference begin on page 5. Refer to that page if you have identified this as being the type of interference you are receiving.

Do not confuse this interference with Horizontal Control Problem.

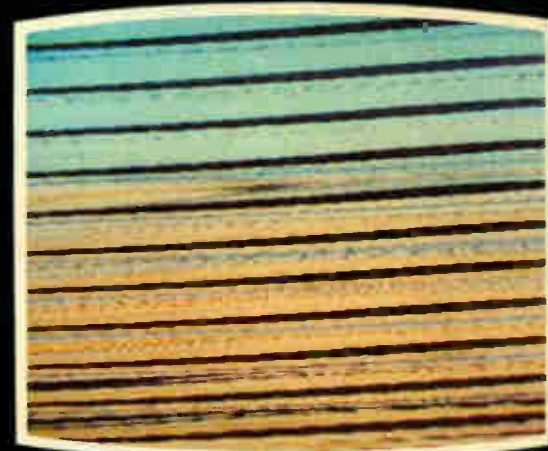

HORIZONTAL CONTROL PROBLEM

When your set requires adjustment of the horizontal hold control or replacement of a bad tube or component, the above pattern will appear on your TV picture. The sound, if affected, may contain a high pitch tone.

To eliminate, simply adjust your horizontal hold control or call your service representative to replace the bad tube or component.



NORMAL PICTURE

Use this normal picture for comparison with other pictures shown on this page.



ELECTRICAL INTERFERENCE

This is what your television picture looks like when your set is reacting to any of the following devices operated in or near your home. *Hair dryers - electric shavers - mixers - blenders - power saws - vehicle ignition systems - and other similar devices.* When this type of interference is occurring, you may also hear a sizzling or buzzing sound along with the sound of the TV program.

Methods used to locate the offending device, and ways to correct the problem begin on page 7. Refer to that page if you have identified this as being the type of interference you are receiving.

Do not confuse this interference with Poor TV Signal.



POOR TV SIGNAL

This is the type of television picture you will be receiving if you are far away from the TV transmitter site or if there is a building or mountain between you and the TV station. Defective antenna, improper antenna orientation, or disconnected or broken lead-in wire may also cause this problem. The sound of your TV usually will not be affected unless the TV signal is extremely weak.

You can improve the quality of the signal by installing a higher antenna; using a directional antenna; a signal amplifier; or repairing the lead-in wire.

Check with your TV sales and service representative on antenna systems available.

3



NORMAL PICTURE

Use this normal picture for comparison with the other pictures shown on this page.



FM INTERFERENCE

Interference from a nearby FM broadcast station will cause this type pattern to appear on your TV screen. Although it normally will affect TV Channel 6 only, one additional channel in the Channel 2-13 series may occasionally be affected. It sometimes affects both the picture and sound of your set.

Note that the interference pattern may change or vary with the sound of the FM broadcast station program, NOT the sound of the TV program.

Techniques to eliminate this interference are discussed on page 8. Please refer to that page if you have identified this as being the type of interference you are receiving.

Do not confuse this interference with Fine Tuning Problem.



FINE TUNING PROBLEM

This is the type of pattern which will appear on your screen if the fine tuner of the TV set is not properly adjusted. Although it looks similar to FM interference, you will note that the pattern changes with the sound of the TV program.

Readjust the fine tuning control of the TV set to eliminate the problem.



NORMAL PICTURE

Use this normal picture for comparison with the other pictures shown on this page.



CO-CHANNEL INTERFERENCE

This is the type of pattern which will appear on your screen when your set is simultaneously receiving two TV signals. Note that the two images are different, as though one picture has been placed on top of the other.

Co-Channel interference is due to either atmospheric conditions or the location of your home in relation to the location of the TV stations. If the problem is from atmospheric conditions, little can be done to correct the problem. However, the problem is usually temporary. If it is caused by the location of your home in relation to the location of the TV stations, use of a highly directional antenna may help to eliminate the problem.

Do not confuse this interference with Ghosting.



GHOSTING

This is the type of picture you will see when 1) the TV signal is reflected, or 2) the TV antenna or antenna lead-in wire are in poor condition.

When "Ghosting" occurs, it means the TV signal is being reflected off a mountain, building or other man-made structure, with the signals being sent over different paths to your TV set and arriving at slightly different times. With "Ghosting", note that the two images are the same.

Rotation of your TV antenna to a new position, or installation of shielded lead-in wire may resolve this problem. If rotation of the antenna does not resolve the problem, have a service representative check the condition and/or placement of the antenna and antenna lead-in wire.

5 Home Remedies for TV Interference

HOME REMEDIES FOR RESOLVING RADIO TRANSMITTER INTERFERENCE

Installing A High-Pass Filter

There are no set procedures for eliminating television interference—it is a matter of eliminating the most likely sources of interference a step at a time. The first step is to install an inexpensive high-pass filter on the back of your TV set. In making this installation, follow these procedures:

1. Determine the type of antenna wire that is connected to your TV set. There are two possibilities:

Coaxial Cable—a round lead-in wire which requires a filter “impedance” of 75 ohms. (See Figure 1a.)

Twin Lead Wire—a flat wire which requires a filter “impedance” of 300 ohms. (See Figure 1b.)

2. Purchase the filter which matches the type of antenna wire coming from your set. The “impedance” information mentioned above will be on the filter label. DO NOT use a combination of twin-lead and coaxial cable without proper matching transformers (often called baluns). Filters are available in most stores that sell or repair television sets. Figure 2 provides a small example of what high-pass filters look like.

3. Carefully read the instructions that are provided with the filter. You will be installing the filter on the back of your TV set, as near to the antenna terminal as possible. The antenna terminal and the filter terminal will look like either Figure 1a or 1b depending upon the type of wire you are using—coaxial or twin lead.

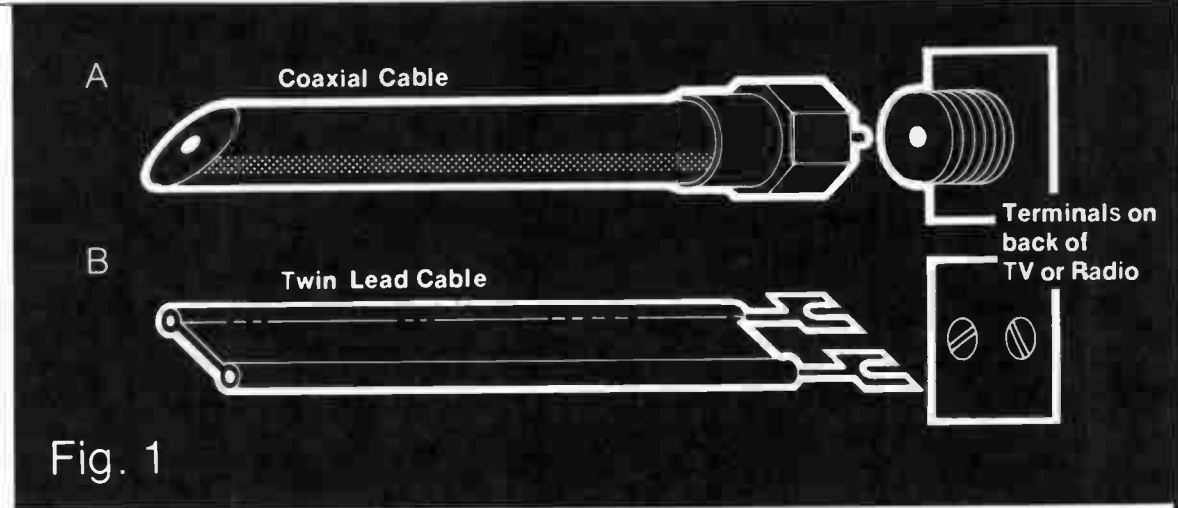

Fig. 1

4. If you are on a cable system, you may still install the filter at the antenna terminal. However, if the interference continues, contact the cable company repair service for assistance. DO NOT attempt to modify the cable system yourself.

5. The following information on installing the filter should answer any additional questions you may have.

a. Disconnect the antenna wire (twin-lead or coaxial) from the television set antenna terminals.

b. Connect the wire from the antenna to the input terminals of the filter.

c. For twin-lead wire, connect a very short (1" to 2") “jumper” wire from the antenna input terminals of the set to the filter (see Figure 3). For coaxial cable, it will be necessary to obtain a jumper cable that has the proper connectors already installed. (This can be purchased at the time you buy the coaxial filter.)

d. Be sure that in the case of **TWIN-LEAD WIRE**, the actual wires are making

Fig. 2



Montage of Filters

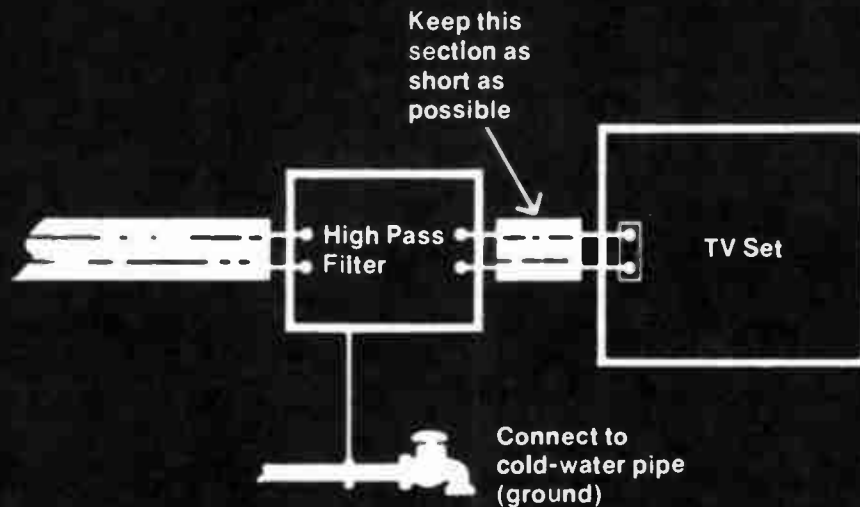
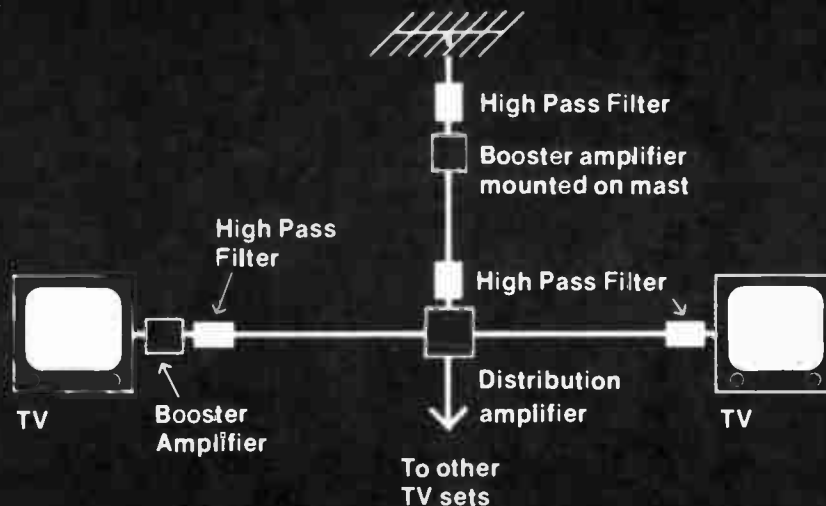

Fig. 3

Fig. 4



contact with the terminals. For **COAXIAL CABLE**, be sure the connector plugs are properly installed on the coaxial cable.

e. If you have an amplifier in your antenna system, you should have a filter installed ahead of the amplifier and another filter ahead of the TV receiver input terminals (see Figure 4). If the amplifier is located close to the receiver, then install the filter before the amplifier only.

Note: BOOSTER amplifiers usually are located near the back of the TV set; MAST MOUNTED (Outdoor) amplifiers are usually located on the antenna; and DISTRIBUTION amplifiers are usually located somewhere in the distribution system. If a distribution amplifier is in your antenna system, then be sure to trace the entire length of the antenna system, because amplifiers are usually in out-of-the-way places (for example—clothes closets, basements, etc.)

f. The connecting wires between the filter and amplifier, and between the amplifier and antenna terminal, should be as short as possible.

g. The instructions provided with the filter you bought may call for a ground connection. The wire should be as short as possible and connected between the high-pass filter ground terminal and a metallic cold water pipe or a ground rod. Use bell wire for this connection (see Figure 3). Bell wire can be obtained from most variety stores.

h. If installation of the filter at the TV antenna terminals does not entirely eliminate the interference, you should then contact your service representative to install a high-pass filter inside the TV set at the tuner

input terminals. INTERNAL modifications to your set should be done ONLY by a service representative. Information to assist your service representative is contained in the Technical Information for Service Representatives section.

Home Remedies for Resolving Electrical Interference

Electrical interference is caused by two sources:

1. Vehicle ignition systems,
2. Electrical devices.

The first step in attempting to resolve electrical interference problems is to locate the source of interference.

Interference from Vehicle Ignition System

1. Ignition interference sounds like a "popping" noise in the sound system of your TV that rises in intensity; the "pops" occur closer and closer together as the speed of the engine speeds up. This can be caused by any vehicle ignition system, such as gasoline operated lawn mowers, snowmobiles, automobiles, etc.

2. If the interference is to television receivers, you may hear the same popping noise in the sound and also see "dancing dots" in the picture of the set. You may only see the interference, and not hear the "popping" noise in the sound.

3. If your own vehicle is causing interference, you may wish to install a commercially manufactured kit in your vehicle to reduce the ignition noise. Other remedial measures include relocating your antenna, raising the antenna, and using shielded lead-in antenna wire.

Interference from Electrical Devices

1. Any one or more of the following electrical devices may be causing the interference you are experiencing on your television set or AM/FM radio:

Electric razor, Vacuum cleaner, Fan, Drill, Electric blankets, Bake ovens, Fluorescent lights, Arc lights, Light dimmer controls, Relays, Static from machinery, Lightning arrestors, Adding machine, Cash register, Circuit breakers, Ultra-violet lamps, Germicidal lamps, Defective wiring, Loose fuse, Arc welder, Switch contacts (such as on dishwashers and other home appliances), Refrigerator, Water pump, Sewing machine, Light blinkers (including Christmas tree light blinker), Electric heating pads, Aquarium warmers, Neon signs, Door bell circuits/transformers, Toys (such as electric trains), Sign flashers, Antifriction bearings, Printing press static eliminators, Calculator, Insulators, Incandescent lamp (new or old), Sun lamps, Electrical pole (ground wire cut or poor contact), Loose electrical connection, Electric fence unit, Furnace controls, Power company transformers, Smoke precipitators.

2. In attempting to locate the specific device causing the interference, consider the following suggestions:

a. If you have a portable radio that is affected by the interference, use the radio as a detection device to assist in locating the source of interference. With the portable radio, move from room to room and determine in which room the interference appears to be the loudest. Then look for one of the devices listed above and unplug it to see if the interference disappears. If several devices listed

above are in the room, unplug them, one at a time, until the interference disappears.

b. If a portable radio is not affected, you can go to the main fuse or circuit breaker box in your home, remove one fuse at a time, or shut off one breaker at a time, and see if the interference goes away.

c. If it does not go away when the first fuse or circuit breaker is off, replace the fuse or turn the circuit breaker back on and continue on until the interference does disappear. When the circuit that supplies the power to the TV or radio is turned off, it will be necessary to plug that device into some other circuit to determine if the interference is being generated by a device in the same room as your TV or radio.

d. When the interference disappears with a fuse removed or circuit breaker off, you should go to the room supplied by that circuit and look for any of the devices listed above. If any of the listed devices are found in the room, replace the fuse or turn the circuit breaker back on. Then unplug the device suspected of causing the interference. If several devices are in the room, unplug them, one at a time.

3. If you are unable to locate within your own home the device that is causing the problem, the interference may be coming from a device located in your neighbor's home. With the cooperation of your neighbor, follow the same procedures described above.

4. If your investigation leads you to suspect that a power line or power company equipment is the source of interference, you should contact the power company to assist you in resolving the problem.

5. Short duration interference, such as that from electric drills and saws, may be very costly to attempt to eliminate; you may just want to "live with it."

6. To *resolve* electrical interference, modifications must be made to the interfering device. This should only be done by a qualified service representative. Information for your service representative is contained in the Technical Information for Service Representatives section.

Home Remedies for Resolving FM Interference

The installation of an inexpensive FM band rejection filter is the first step to take in resolving FM interference. In making this installation, follow these procedures:

1. Determine the type of antenna wire you have connected to your TV set. There are two possibilities:

Coaxial Cable—a round lead-in wire which requires a filter "impedance" of 75 ohms (see Figure 1a).

Twin Lead Wire—a flat wire which requires a filter "impedance" of 300 ohms (see Figure 1b).

2. Purchase the appropriate filter, according to the type of antenna wire you have. The "impedance" information mentioned above will be on the filter label. DO NOT use a combination of twin-lead and coaxial cable without proper matching transformers (often called baluns). Filters are available in most stores that sell or repair television sets.

3. Carefully read the instructions that are provided with the filter. You will be installing the filter on the back of your TV set, as near to the antenna terminal as possible. The antenna terminal and the filter terminal will look

like either Figure 1a or 1b depending upon the type of wire you are using—coaxial cable or twin-lead wire.

4. If you are on a cable system, you may still install the same FM band rejection filter at the antenna terminal. However, if the interference continues, contact the cable company repair service for assistance. DO NOT attempt to modify the cable system yourself.

5. The following information on installing the filter should answer any additional questions you may have.

a. Disconnect the antenna wire (twin-lead or coaxial) from the television set antenna terminals.

b. Connect the wire from the antenna to the input terminals of the filter.

c. For twin-lead wire, connect a very short (1" to 2") "jumper" wire from the antenna input terminals of the set to the filter (see Figure 3). For coaxial cable, it will be necessary to obtain a jumper cable that has the proper connectors already installed.

d. Be sure that in the case of TWIN LEAD WIRE, the actual wires are making contact with the terminals. For COAXIAL CABLE, be sure the connector plugs are properly installed on the coaxial cable.

e. If you have an amplifier in your antenna system, you should have a filter installed before the amplifier and another filter ahead of the TV receiver input terminals (see Figure 4). If the amplifier is located close to the receiver, then install the filter before the amplifier only.

Note: BOOSTER amplifiers usually are located near the back of the TV set; MAST MOUNTED (outdoor) amplifiers are usually located on the antenna; and DISTRIBUTION amplifiers are usually located somewhere in

the distribution system. If a distribution amplifier is in your antenna system, then be sure to trace the entire length of the antenna system, because amplifiers are usually in out-of-the-way places (for example—clothes closets, basements, etc.)

f. The connecting wires between the filter and amplifier, and between the amplifier and antenna terminal, should be as short as possible.

g. The instructions provided with the filter you bought may call for a ground connection. The wire should be as short as possible and connected between the FM band rejection filter ground terminal and a metallic cold water pipe or a ground rod. Use bell wire for this connection (see Figure 3). Bell wire can be obtained from most variety stores.

h. If the filter does not entirely eliminate the interference, you should call your service representative. The Technical Information for Service Representatives Section is provided to assist the service representative.

9 Audio Interference

Identification of Audio Interference

Interference to audio devices, such as tape recorders, record players, electronic organs, telephones, hi-fi amplifiers, etc., is caused when the equipment responds to the transmission of a nearby radio transmitter.

Audio interference (often called audio rectification) may also affect the sound (audio) portion of your TV and AM/FM radio.

When this type of interference is occurring, you will hear the voice transmissions of the radio transmitter and/or the volume level of the audio device you are using may decrease.

If you have determined that this is the type of interference you are receiving, refer to the following Home Remedies section for suggested methods for eliminating audio interference.

Home Remedies for Resolving Audio Interference

Audio interference is a condition that usually requires internal modification of your equipment. For safety reasons, it is recommended that any modifications be made by a qualified service representative.

Due to the complexity of resolving interference to an electronic organ, again, servicing should be done only by an experienced service representative. More detailed information should be obtained from the equipment manufacturer.

For telephone interference, contact your local telephone company. They can install a 1542A or similar inductor in the telephone instrument to resolve the problem. The information provided in this bulletin applies primarily to privately-owned equipment and should not be applied to equipment owned by the telephone company. Bell System personnel can obtain additional data in Section 500-150-100 of the "Bell System Practices—Plant Series" manual.

For all other audio devices, you may wish to take the following steps before calling your service representative.

1. Replace UNSHIELDED wire between the amplifier and speakers with SHIELDED wire.
2. Ground the affected equipment to a metallic cold water pipe or ground rod. A ground connection can be made with a short piece of "bell wire" which can be obtained at most variety stores. DO NOT ground "AC-DC" type devices. Normally devices which may safely be grounded will provide a grounding terminal. If no terminal is provided, then you should consult a qualified service representative for advice.

3. If the interference is not eliminated after taking these steps you must call a qualified service representative. The Technical Information for Service Representatives section is provided to assist your service representative in resolving the problem. You may also wish to discuss the matter with the operator of the radio transmitter, sharing the information in the Radio Operator Guidelines section of this bulletin.

Technical Information for Service Representatives

Resolving Radio Transmitter Interference

There are no set procedures for eliminating television interference—it is a matter of eliminating the most likely sources of interference a step at a time. You may be required to take several steps before the interference problem is resolved. Once you have installed the filter called for, or made the adjustment that you were instructed to do, leave the modifications in place and proceed to the next step.

To begin, check to see if a high-pass filter has been installed on the TV set at the antenna terminals. If not, read the Home Remedy information beginning on page 5. If the interference is still present after the installation of a high-pass filter proceed with the following steps.

Check Radio Transmitter

1. Contact the operator of the radio transmitter identified as the source and, with his/her cooperation, determine if the transmitter is operating properly. You may also wish to share the Radio Operator Guidelines section of this bulletin with the operator. Areas of concern should be:

a. Is the transmitter properly grounded? (This means a good radio frequency (RF) ground. A single piece of wire to a ground rod may be an open circuit to RF.)

b. Are harmonics and/or spurious emissions present?

c. Is the transmitter cabinet radiating energy?

2. If the transmitter is not grounded, connect the chassis to a good earth ground

with large diameter wire or copper strap. This should assist in eliminating radiation of energy from the cabinet.

3. Next, install a low-pass filter on the transmitter antenna circuit to see if any difference occurs in the interference pattern. If a change occurs, the interference is probably caused by harmonics and/or spurious emissions from the transmitter. If no change occurs in the interference pattern, it is probably being generated at some point in the TV reception system.

Check TV Reception System

1. Conduct a visual inspection of the TV antenna, lead-in wire, and lightning arrestors. This may reveal a source of trouble. Corroded connections or deteriorated lead-in wire could be at fault and should be repaired.

2. Assuming no faulty conditions are found, or if found, they are corrected, and the interference is still present, look for an amplifier in the line. Amplifiers are highly susceptible to radio frequency (RF) energy.

Note: BOOSTER amplifiers usually are located near the back of the TV set; MAST MOUNTED (outdoor) amplifiers are usually located on the antenna; and DISTRIBUTION amplifiers are usually located somewhere in the distribution system. If a distribution amplifier is in the antenna system, then be sure to trace the entire length of the antenna system, because amplifiers are usually in out-of-the-way places (for example—closets, basements, etc.).

3. If an amplifier is in the system, remove it from the circuit. If you find that this eliminates the interference, reconnect the amplifier, but protect the amplifier by a) grounding,

b) enclosing it in a metallic rf-proof housing and grounding the housing, or c) installing a high-pass filter at the input to the amplifier. If one filter improves the condition, but does not entirely eliminate the interference, install two filters in series.

4. If no amplifier is utilized, or the interference still persists after following one or all of the above steps, check the TV receiver system.

Check TV Receiver System

1. An AC power line RF filter should be installed to determine if the RF from the transmitter is entering the TV via the power cord. (A line filter may be either purchased or one may be constructed by following the schematic in Figure 5.)

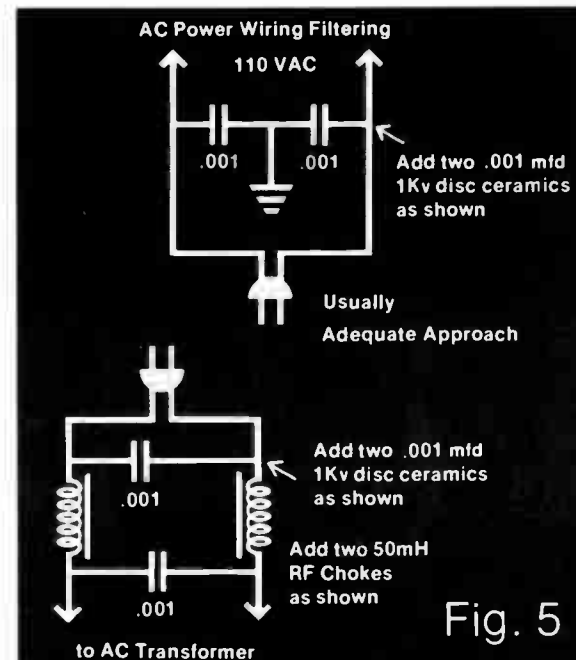

Fig. 5

2. If no change is found with the power line filter installed, and the antenna disconnected, then the set itself is responding to the RF energy.

3. The most likely internal circuit in the set to be affected by a radio transmitter is the tuner. Disconnect the antenna input lead inside the set directly at the tuner. If the interference is eliminated, then install a high-pass filter at the tuner.

4. If the interference is still present after installing the filter at the tuner, it will be necessary to refer to service data for the set and check each stage of the set for undesired response.

CB Interference to TV Channel 2

1. Second harmonic interference from a CB transmitter to Channel 2 television may exist even though the transmitter meets FCC specifications for harmonic radiation. In such cases, a tuned filter across the antenna terminals of the television should help. The filter may be an inductor and capacitor in series as in Figure 6. The filter should be tuned for minimum interference.

2. A second method is to put an open circuit, quarter-wave, tuned stub across the antenna terminals. The stub should be made of the same type of wire as the antenna input terminals of the television. The initial stub length should be 37" for RG-59/U coax; and 48" for 300 ohm twin lead.

3. After connecting the stub, cut the unterminated end of the stub off in 1/8" to 1/4" sections until the interference is eliminated. Refer to Figure 7. For harmonics falling on other TV channels, such as channel 5, 6, or

9, the length of the stub may be appropriately shortened according to the following formula.

$$\text{Length in inches} = \frac{2952V}{f}$$

where V = Velocity factor of line
and f = frequency in megahertz

Amateur Interference to TV Channel 2

1. One additional type of interference from a nearby transmitter is unique to the amateur 6 meter band—50-54 MHz. Since 6 meters is immediately adjacent to Channel 2 television (54-60 MHz), interference to Channel 2 may occur.

2. In most cases, installation of an open circuit, quarterwave, tuned stub at the antenna terminals of the television set should be effective. It should be connected as shown in Figure 7.

3. If RG-59/U is used as the TV lead-in wire, the initial length of the stub should be 42". If 300 ohm twin lead is used, the initial length should be 53".

4. After the stub is attached to the television, begin cutting off the unterminated end of the stub 1/8" to 1/4" at a time until the interference is eliminated. If the interference is reduced, but not eliminated by this method, add a second stub directly to the input terminals of the tuner. The theoretical final length of the stub should be:

$$\text{Length in inches} = \frac{2952V}{f}$$

Where V = Velocity factor of line
and f = frequency in megahertz

5. If the interference continues, share the information in the Radio Operator Guidelines section with the operator of the radio transmitter.

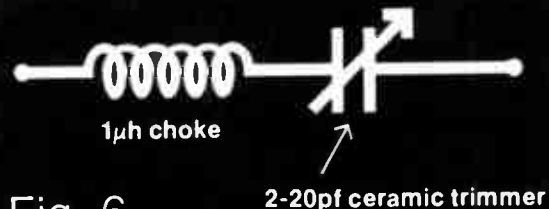

Fig. 6

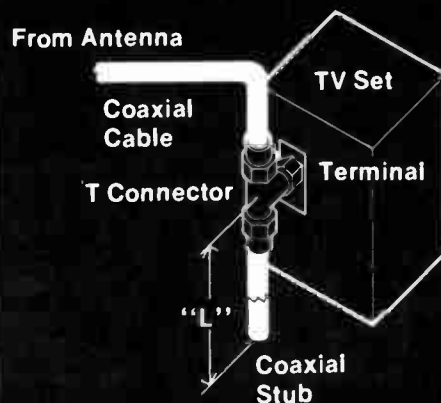
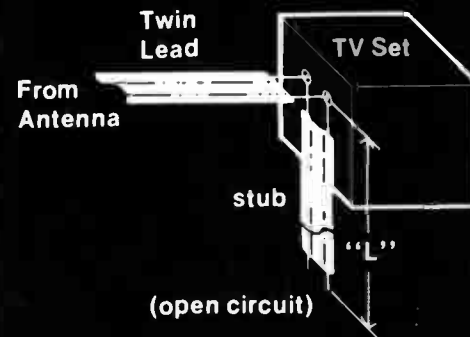

Fig. 7

Resolving Electrical Interference

1. Please read through the procedures outlined in the Home Remedies section, beginning on page 7, before proceeding. If the steps in the previous section have been taken, you should now know the source of the interference.

2. Before proceeding with the following steps to modify the device located as the source of interference, you should check the local electrical codes to determine if the device may be modified, and whether a licensed electrician must modify the device.

Caution: All bypassing of devices with capacitors should be done with extreme care to insure that the capacitors do not short out the AC line. Dangerous voltages exist which can cause electrocution if mishandled. Also, avoid power wiring which can cause the full AC line voltage to appear on the case of the device.

3. Since interference from an electric drill or saw may be of short duration, we suggest no modifications be made to the device. Mainly because it may be very difficult and time-consuming to modify the device. If, however, interference is of long duration, and you wish to take on this task, proceed as follows:

a. Interference from a drill or saw is actually caused by arcing between the brushes and commutator. The interference then is transmitted through the power cord. Bypassing each side of the line to ground with a capacitor, and each side to the other may be helpful. Also bypass the switch. Figure 8 shows the schematic involved. The bypassing should be internal to the device in question.

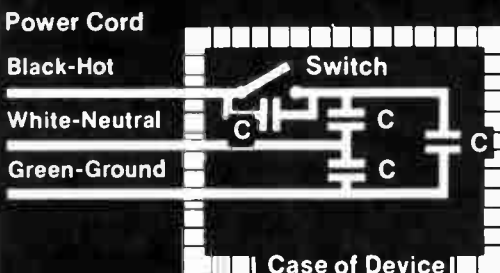

Fig. 8 C = .001 mfd., disc ceramic



Fig. 9

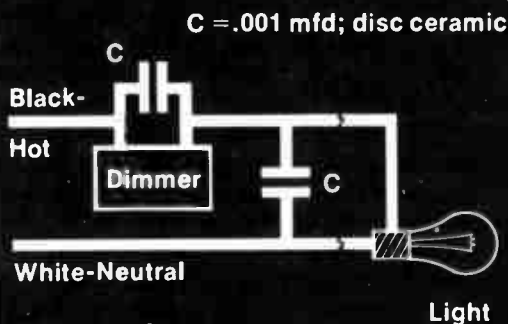

Fig. 10

4. Electric blankets, fish tank heaters, and other thermostatically controlled appliances, with worn and pitted contacts, cause interference because of contact arcing of the breaker points. This can be eliminated by bypassing the contacts with a .001 mfd capacitor or replacing the worn or pitted contacts. (See Figure 9.)

5. Defective devices such as doorbell transformers should be replaced.

6. Dimmer switches that utilize an SCR or triac can produce tremendous interference and it is very difficult to eliminate. This is due to the approximate square wave output that is produced by the switching at the SCR or triac. However, bypassing in a manner shown in Figure 10 may be helpful.

7. Since resolving electrical interference has to proceed on a case-by-case basis, you should always consider adequately bypassing any component of the circuit that arcs or distorts the AC sine wave with ceramic condensers.

Resolving FM Interference

There are no set procedures for eliminating FM interference—it is a matter of eliminating the most likely sources of interference a step at a time. You may be required to take several steps before the interference problem is resolved. Once you have installed the filter called for, or made the adjustment that you were instructed to do, leave the modifications in place and proceed to the next step.

1. To begin, check to see if an FM band rejection filter has been installed on the TV set at the antenna terminals. If not, read the Home Remedies section of this bulletin, beginning on page 8.

2. If the installation of an FM band rejection filter is not effective, then a tuned stub

trap should be constructed (see example in Figure 11). The trap should be placed on and parallel to the lead-in and tuned for minimum interference. Then slide the trap along the line to further reduce interference. Finally, tape the trap to the lead-in in the most effective position.

3. Another type of stub, called an open circuit quarter-wave type, can be made from the same type of wire as the antenna lead-in wire (see Figure 12). The initial length of the stub should be 24" for RG-59/U coaxial cable or 29" for 300 ohm twin-lead wire. For other cables, the initial length can be determined by the general formula:

Length in inches = (35) (Velocity factor of line)

Note: If "F" type tee connectors are not available, you may use BNC type connectors.

4. If connecting the stub to the antenna terminals is not completely effective, connect a second stub of the same length directly to the input terminals of the tuner, inside the television set. This should eliminate the interference.

Resolving Audio Interference

1. Audio interference is defined as reception of radio frequency (RF) energy by an

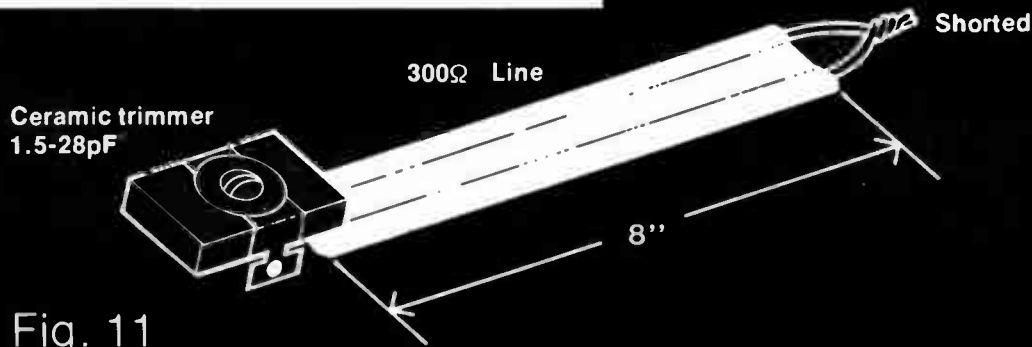

Fig. 11

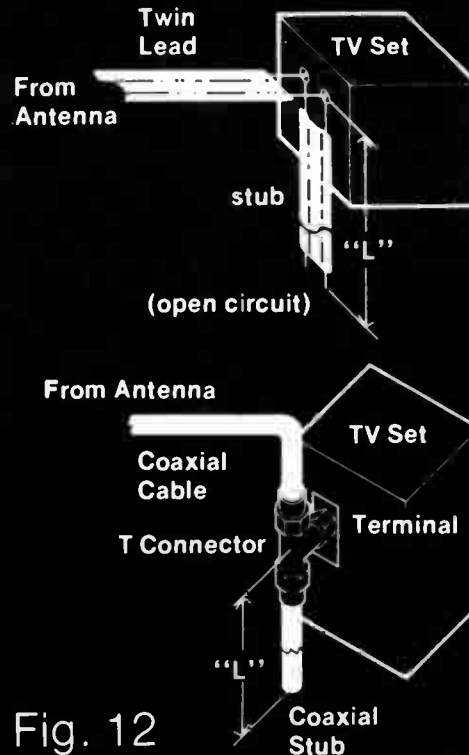

Fig. 12

audio amplifier. The RF energy is then rectified, or more properly "detected", by an electron tube, transistor, diode, poor solder joint or ground, or integrated circuit. The detected signal is then treated identically as a normal audio signal appearing at the amplifier input terminals. The effects of audio interference vary with the type of modulation employed by the transmitter. The following chart shows expected effects:

AM—The voice or music will be heard as any normal audio signal applied to the amplifier. The voice or music may be extremely loud and slightly distorted.

SSB—Single Sideband—The voice will sound practically unintelligible and garbled.

FM—Usually no sound will be heard; however, a decrease in the volume of the amplifier will be noted when the radio transmitter is on. Clicks may be heard when a two-way radio transmitter is keyed and unkeyed. A "frying" noise (such as bacon sizzling) may also be heard.

TV—Audio rectification of a TV signal will sound like a buzz. The buzz will change its sound as the television picture changes.

2. In attempting to isolate where in the audio chain the rectification is taking place, check to determine if the volume control has any effect on the interference. If the volume of the interfering signal changes with a change in the volume control, then the rectification is occurring BEFORE the volume control. If the volume control has minimal or no effect, the rectification is occurring AFTER the volume control. You should next proceed to the appropriate set of solutions. If the solutions described below do not resolve the audio interference problem, contact the manu-

facturer of the audio device for further assistance.

Rectification Before the Volume Control

1. A multiple input audio amplifier may be susceptible to audio interference on only one or some of the available inputs. Generally, low-level, high-impedance inputs, such as those in turn-tables, cartridges, tape heads, or microphones, are the most susceptible. If, for example, the only input affected is from a turn-table, then disconnect the turn-table cartridge from the amplifier at the input terminals of the amplifier.

2. If the interference is eliminated, then the cartridge, or wire between the cartridge and amplifier, is sensing the **RF**. Proper grounding, connections, shielding, and **RF** bypassing are the keys to solving audio rectification. Often, a "process of elimination" approach must be used.

Grounding

1. All grounding should be to a good earth ground such as a metallic cold water pipe or 8' ground rod. Ground leads should be as short as possible. Remember, a DC ground may appear as an open circuit to **RF** energy. Ground leads should be of as large a diameter wire as practicable. Finally, grounding of the chassis, shields of speaker leads, and other external connections should be made to a common point to avoid ground loops. (Ground loops are circuits that form a DC ground, but contain **RF** circulating currents.) Figure 15 shows the correct and incorrect methods of grounding components.

Caution: Some equipment chassis are at line voltage potential and cannot be con-

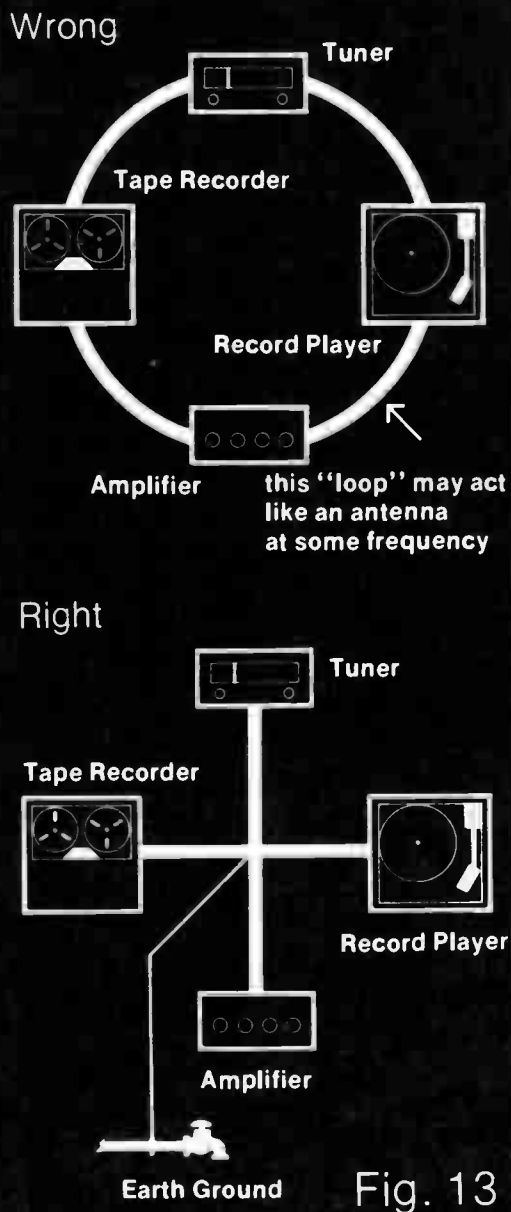

nected directly to ground. In these circumstances, a ceramic capacitor of 0.001 mfd at 1Kv should be placed in the ground lead. This capacitor appears as a short to **RF**, but an open circuit to AC.

Shielding

1. All speaker leads from audio equipment should be made of two conductor shielded wires. The shield should be grounded only at the amplifier end, and should not be used as an audio conductor. The two internal wires should be connected to the speaker.

Power Line Filter

1. **RF** may be entering the audio device through the AC power line. Several power line filters are commercially available. If necessary, a power line filter like the one shown in Figure 5 may be constructed, placing the filter as close as possible to the point where the AC cord enters the amplifier.

Poor Electrical Connections

1. Occasionally, poor solder connections or old electrolytic capacitors may be the cause of the audio rectification problem. If tests to this point have failed, try resoldering all connections in the amplifier and replacing electrolytic capacitors. Before actually replacing the electrolytic capacitor, try paralleling the capacitor with another one of like value. This should reveal the presence of a bad capacitor.

Rectification After the Volume Control

1. When the volume control is in its minimum position, and the interference is still heard, then an **RF** filter is required in the audio amplifier. It is extremely important that

the filter does not affect the audio response of the amplifier.

Tube Type Equipment

1. Interference in tube type equipment can be avoided by connecting an RF choke (ranging in value from 2 millihenry to 5 millihenry) in the upper end of the cathode circuit as shown in Figure 14.

2. The choke coil must NOT be bypassed by a capacitor because the DC resistance of such coil is generally quite low and the bias voltage is not greatly affected. However, if the DC resistance does affect the bias voltage, the value of the bias resistor may be decreased to compensate for the DC resistance of the choke.

3. A grid-stopping or "swamping" resistor can also be employed. A resistor, ranging in value from 1 k to 75 k ohms, can be connected in series with the grid as shown in Figure 15.

4. Capacitors, **RF** chokes and resistors can be used in combinations to make filters to eliminate the interference. For circuits such as those shown in Figure 16, use a choke of 2 to 6 microhenries and a capacitor of about 10 picofarads. A combination RF filter is shown in Figure 17 with the recommended values.

Transistor Equipment

1. Interference in transistor equipment can usually be eliminated with the use of a shunt capacitor as shown in Figure 18. A resistor/capacitor combination can be used as shown in Figure 19. It is important that the filter network does not affect the biasing of the transistor or the frequency response of the amplifier.

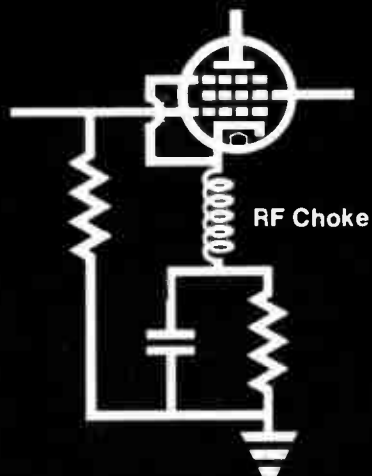

Fig. 14

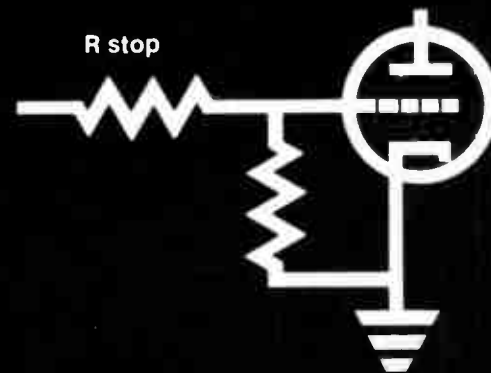

Fig. 15

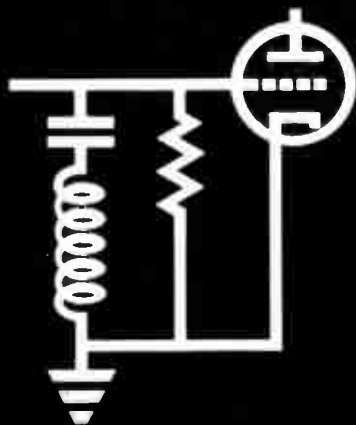
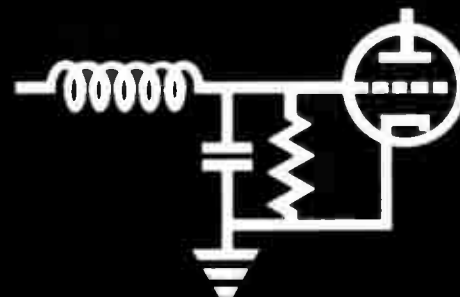

Fig. 16



A combination RC filter is shown in Figure 17 with the recommended values.



Fig. 17

2. The values of the capacitors used are not critical, but there are some pitfalls to look out for in using capacitors. For example, ceramic caps are best, whereas paper caps do not work at radio frequencies.

3. Leads should be kept as short as possible. Grounds should be made directly to the emitter and not to the chassis or other grounds, since they may have more **RF** than the signal lead. If the signal increases, then a ground loop has been created, and the inductor method should be tried.

4. In areas of high **RF** energy, the inductor approach is more effective than the shunt capacitor. An **RF** choke can be used in series with the input and output leads of the amplifier stage since the **RF** can enter a stage through either. This method and the values are shown in Figure 20.

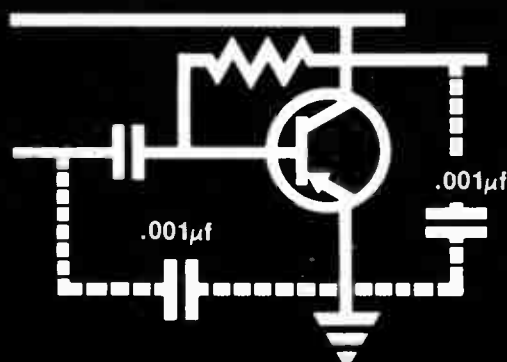

Fig. 18

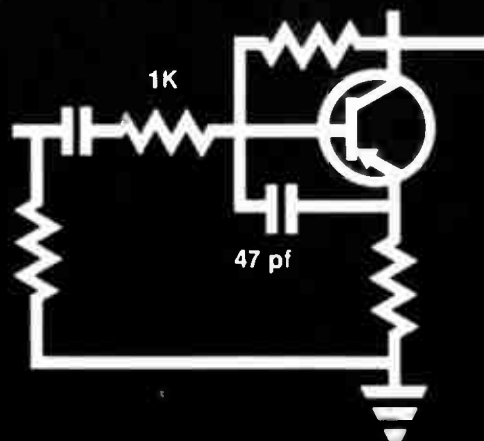
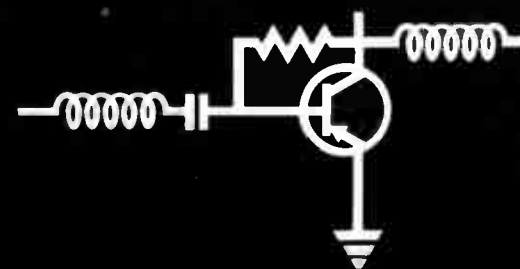

Fig. 19



1.5 mHy-up to 20 MHz
500 μ Hy- 20 to 50 MHz
100 μ Hy-50 to 500 MHz

Fig. 20

Electronic Organs

1. Organ circuits can be isolated by the use of the Swell Pedal, band box volume, or tabs (draw bars). By adjusting each one of these different controls, the effect on the interference can be noted. If the volume of the interference changes, the RF is being detected by the amplifier at a point before that particular control. If the volume of the interference does not change, then the interference is being detected after that control.

2. Using this method, the point at which the RF is entering the organ can be determined, and the appropriate filter, as described above, can be inserted into the circuit.

Telephones

1. Telephone RF interference can be eliminated by the use of a 1542A or similar inductor. This inductor must be installed inside the phone and not at the baseboard. To install the inductor inside the phone, the corners of the plastic container will have to be removed. If the phone is too small for the inductor, such as the "Princess" telephone, then a pair of 2.5 MH chokes (75 ma or higher) must be installed inside the phone, one on each side of the line and as close to the 211A equalizing network as possible.

Note: The information provided here applies primarily to privately owned equipment and should not be applied to equipment owned by the telephone company. Telephone company owned equipment should be modified only by telephone company personnel. Bell System personnel can obtain additional data in Section 500-150-100 of the "Bell System Practices—Plant Series" manual.

References

1. *The Audio Cyclopedia* by Howard M. Tremline, Howard W. Sams and Co., Inc.
2. *Radio Handbook* by William I. Orr, Editors and Engineers, Ltd.
3. *The Radio Amateur's Handbook* by American Radio Relay League.
4. *Thomas Tech-Flash*, Thomas Organ Co., Sepulveda, California.
5. "Filtering RF Interference in Audio Equipment", by R. S. MacCollister from *Journal of the Audio Engineering Society*, April 1968, Pages 210, 212, 214.
6. *Stopping Telephone Interference* by Irvin M. Hoff, QST, March 1968, Pages 46-47.

Resolution of Interference for Radio Transmitter Operators

Although some interference problems can be attributed to television receivers, such problems can also be traced to CB radio transmitters. Therefore, upon receipt of an interference complaint from your neighbor(s), you should take all steps possible to insure that your radio transmitter is not causing the interference. Voluntary installation of a low-pass filter, or other steps as outlined below, may eliminate the interference, and may prevent you from receiving an order from the Commission to implement these measures. You are not, however, required to service or add filtering to the complainant's television, and should not take any such action without the full cooperation of your neighbors.

You are cautioned that the use of an amateur transceiver on the Citizens Band is illegal. Further, the use of external **RF** power amplifiers with CB transceivers is illegal. Both actions may subject you to Commission actions or criminal penalties.

Generally, transmitter equipment that is commercially manufactured and type-accepted by the Commission has precautions built into the set to reduce harmonic radiation. Harmonics are radiations that are multiples of the operating frequency. However, you should follow the steps outlined below to insure that your radio equipment is operating properly.

1. If television interference is occurring, note which channels are affected.

a. Lower harmonics of CB generally affect TV Channels 2, 5, 6, and 9. Therefore, if one or more of these channels are affected,

your transmitter is probably radiating harmonics.

b. If all TV channels are affected, the problem is more likely to be in the TV receiver.

2. If the interference is caused by harmonics, a spectrum analyzer, a calibrated field intensity meter, or frequency selective voltmeter, can be used to accurately measure harmonic and spurious radiations from your transmitter. If any lead-in devices, such as standing wave ratio (SWR) meters are used, measurements should be made with the in-line device both installed and removed. This may help identify the interference and lead you to the source. These are complex measurements and should normally be made only by experienced technicians.

3. If it appears that your transmitter is at fault, you should first make sure the chassis of the set is secured to the metal case of the radio by tightening the screws holding the chassis and case together. Then assure that the case of the transmitter is grounded to a good earth ground (metallic cold water pipe or 8 foot ground rod). Solid conductor wire of at least #10 gauge or copper ribbon should be used as a ground lead. The lead should be as short as possible.

4. By installing one or more low-pass filters in the transmitter antenna lead, you will reduce the chances of unnecessary harmonic radiation. A low-pass filter allows frequencies up to 30 or 50 megahertz (MHz), depending on brand, to pass through unattenuated to the antenna while effectively shorting out harmonic radiation. To make this test, connect the equipment as in Figure 21 and take a power reading. If only an SWR Bridge is available, calibrate it in the forward direction to the

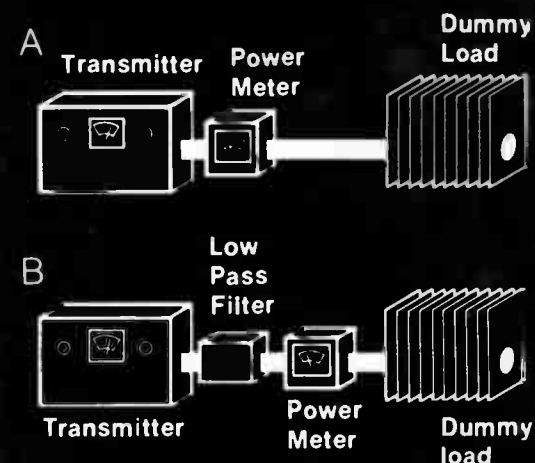

Fig. 21

calibrate line in the meter. Then insert the low-pass filter and make another power measurement. **DO NOT** retune the transmitter.

5. If you notice a decrease in output power on a power meter, operating to a properly matched load, with the low-pass filter installed, this is an indication that harmonic content may be present. Even though the meter reading may be lower with the filter installed, it does not mean that the transmitter absolutely has harmonic radiation. Slight detuning of the transmitter by the filter may cause a lower indication.

6. At amateur power levels, corroded metal connections in the area of the transmitting antenna may act like diodes and generate harmonics which may radiate. This type of problem can be found by vibrating suspected offenders such as galvanized downspouts, metal fences, clothes lines, etc., while view-

ing the affected television set. Sudden changes in the interference pattern which correspond to the vibration should be noted. This test requires an observer at the TV receiver, someone to "shake" suspicious metal objects in the area, and another person to key (but NOT modulate) the transmitter involved.

7. Finally, some transmitters may actually be radiating harmonic and spurious energy from their cabinet or through the power lines. Try operating the transmitter into a shielded dummy load. If the interference is still present, then cabinet or power line radiation is indicated. A power line filter should be installed. Several types are commercially available. For low power transmitters, the filter in Figure 5 may be used.

8. Continued interference with the power line filter installed points toward cabinet radiation. An earth ground should eliminate cabinet radiation.

9. Local Television Interference (TVI) Committees dedicated to resolving CB-TV problems are now being established. For assistance in locating a TVI Committee in your area, contact: International CB Radio Operators Association (CBA), P.O. Box 1020, Roanoke, Va., 24005.

Resolution of Interference for Amateur Transmitter Operators

1. If you have a linear amplifier on your amateur transmitting equipment, use two low-pass filters. One filter should be installed between the actual transmitter (exciter) and the input to the linear amplifier. (This prevents harmonics generated in the exciter from reaching the linear amplifier.) The second filter should be installed at the output of

the linear amplifier to reduce harmonic and spurious content.

2. One unique interference problem to TV Channel 2 is from an amateur transmitter operating on the 6 meter band. This is due to the close proximity of the frequencies involved. You may wish to follow the procedures outlined in the Technical Information for Service Representatives section, page 11, to eliminate this type interference. You are not, however, required to service or add filtering to the complainant's television, and should not take any such action without the full cooperation of your neighbor.

3. Local Television Interference (TVI) Committees are available to assist you in resolving interference problems. Contact the nearest FCC district office (see addresses beginning on page 28) or the American Radio Relay League, Newington, Connecticut, for assistance in locating a TVI committee in your area.

Radio Transmitter Operator Guidelines for Resolving Audio Interference

Although audio interference (often called audio rectification) is usually resolved by modification of the affected device, you as a radio operator can take certain steps to reduce the possibility of audio rectification by eliminating circulating radio frequency (RF) currents in grounds and metal objects in the area.

1. Your radio transmitting equipment should be effectively grounded to a metallic cold water pipe or a ground rod driven into the ground at least 8 feet. The ground lead must be at least #10 wire or copper ribbon. The greater the surface area of the ground lead,

the more effective it will be. Also, the ground lead should be as short as possible.

2. You are reminded that you are licensed to use only the amount of power necessary to establish communications. Operating with excessive power is likely to cause audio interference problems.

3. If you need assistance in performing the above modifications to your equipment, you can contact the dealer or manufacturer representatives. Also, an FCC-licensed service representative may be able to assist you.

Notes

20

21 Appendix A

Sources for Assistance in Resolving Television Interference

If you have followed the instructions outlined in this bulletin, and the problem still exists, you may want to contact one of the sources listed below for assistance and further information.

When contacting these people, please forward with your request the information requested on page 30.

In most cases, the addresses listed for associations and manufacturers are for national headquarters. Once your inquiry is received, it will be sent to the local representative for response.

The assistance of FCC district office staff is also available to you (addresses on page 28). If you have taken all the steps suggested in this bulletin, and the problem still exists, there may be something unique to your interference problem. By furnishing the information requested on page 30 to your nearest FCC district office, an FCC staff member may be able to determine what additional steps are needed to resolve your interference problem.

Associations

**Director of Consumer Affairs
Electronic Industries Association (EIA)
2001 Eye Street, NW.
Washington, D.C. 20006
Telephone: 202 457-4900**

Manufacturer Service Representatives

(The information contained in this listing has been supplied by the American Radio Relay League (ARRL), Newington, Connecticut.)

Institutional Listing

Admiral

*Admiral Group
Rockwell International Corp.
1701 East Woodfield Road
Schaumburg, IL 60172*

Primary Products Distributed and Remarks:

RFI complaints are usually handled by the local Admiral dealer service technician. National Service personnel are available to assist the technician when needed. Admiral maintains its own staff of technical representatives who travel in the field and may be called upon to assist the dealer technician with difficult problems including RFI. Admiral provides technicians with various instruction bulletins dealing with RF interference suppression. RFI complaints should be referred to the local Admiral dealer. If front end overload or cross modulation occurs in areas of extremely high level of transmitter radiation, the National Services Division has suitable traps available at no charge to the customer:

*National Service Division
Box 2845
Bloomington, IL 60701*

Akai

*Akai America, Ltd.
2139 E. Del Amo Blvd.
Compton, CA 90220*

Primary Products Distributed and Remarks:

Akai products include audio tape recorders, video tape recorder, AM/FM receivers, speaker systems and related accessory products. Inquiries related to RFI should be addressed to:

*Akai America, Ltd.
Customer Service Dept.
2139 E. Del Amo Blvd.
Compton, CA 90229*

Upon receipt of these inquiries, we will investigate the situation, and to our utmost try to resolve the customer's problems.

Allen Organ Company

Macungie, PA 16162

Primary Products Distributed and Remarks:

Electronic Organs. When a complaint is received via the dealer, Allen Organ Co. sends the dealer an informational service bulletin on RFI and sufficient components to cover all amplifiers in the affected instrument. This service is offered at no cost to the customer. Refer RFI problems to the local Allen dealer.

Altec Lansing

*Sound Products Division
1515 S. Manchester Avenue
Anaheim, CA 92803*

Primary Products Distributed and Remarks

Customer RFI problems are referred to the local authorized Altec Warranty stations located nationwide and denoted by an information card furnished with each piece of equipment. Unusual situations are, at the option of the warranty station, referred to:

*Altec Customer Service
1515 W. Katella Avenue
Anaheim, CA 92803*

Or:

*Engineering Department
1515 S. Manchester Avenue
Anaheim, CA 92803
Attention: Chief Engineer, Electronics*

Arvin Industries, Inc.

*15th Street
Columbus, Indiana 47201*

Primary Products Distributed and Remarks

Radios—8 Track Players

Customer problems involving RFI should be referred to the Manager of Field Service.

Audio Research Corporation

2843 Twenty-Sixth Avenue, S.
Minneapolis, Minnesota 55406

**Primary Products
Distributed and Remarks**

Amplifiers—Pre-Amplifiers + Accessories

In the event of an RFI problem, customer may write to:

Chief Engineer
Audio Research Corp.
Box 6003
Minneapolis, MN 55406

Baldwin Piano & Organ Company

1801 Gilbert Avenue
Cincinnati, Ohio 45202

**Primary Products
Distributed and Remarks**

Electronic Organs

RFI complaints are usually handled by the local Baldwin service technician. Factory personnel are available to assist the technician when needed. Baldwin maintains its own staff of technical representatives who travel in the field and may be called upon to assist the dealer technician with difficult problems, including RFI. Baldwin provides technicians with a detailed instruction bulletin entitled "Hints on Suppressing RF Interference".

RFI complaints should be referred to the local Baldwin dealer.

Benjamin Electronic Sound Company

790 Park Avenue
Huntington, NY 11743

**Primary Products
Distributed and Remarks**

Manufacturers and distributors of ELAC Miracord record changers, Concord AM/FM receivers and CEC manual turntables.

RFI problems should be directed to the Service Manager in Huntington. Price of required modifications will depend upon equipment warranty status.

Capehart Corporation

5th Street
Norwich, Connecticut 06360

**Primary Products
Distributed and Remarks**

Stereo Console Phonographs and Radios

Capehart Corp. asks that if an RFI problem develops in their product, the customer refer the matter to the attention of the General Manager.

Conn Organ Corporation

1101 East Beardsley Ave.
Elkhart, Indiana 46514

**Primary Products
Distributed and Remarks**

Electronic Organs

RFI complaints should be referred to the local Conn dealer, whether equipment is in or out of warranty. Factory assistance is available to the dealer if he is unable to correct the problem.

RFI problems encountered within term of instrument warranty are usually corrected by the selling dealer without cost to the organ owner.

Curtis Mathes Manufacturing Co.

P. O. Box 151
Athens, Texas 75751

**Primary Products
Distributed and Remarks**

Color TV; Stereo (100% solid state) in portable, consol, and combination configurations.

Customer complaints involving RFI should first be resolved at the retail dealer level. If not satisfied, then complaint should be made in writing to the Consumer Relations Department, giving all details of problem, along with model, serial number, date of sale, dealer, and service history. Each complaint will be handled individually.

Dumont

(See Capehart Corporation)

Dynaco-Dynakit Division of Tyco Laboratories

Coles Road
P. O. Box 88
Blackwood, New Jersey 08012

**Primary Products
Distributed and Remarks**

Amplifiers, Pre-Amplifiers, Tuners, Integrated Amplifiers, and Kits.

Inquiries related to RFI involving Dynaco products should be addressed to the Customer Service Department.

Dynaco has available for owners of Dynakits an excellent information sheet on solving RFI problems.

Elpa Marketing Industries, Inc.

Thorens Building
New Hyde Park, N. Y. 11040

**Primary Products
Distributed and Remarks**

Thorens turntables, Reel-to-Reel tape recorders.

Complaints are handled with respect to parts and labor on an individual basis. Necessary modifications for RFI are made on a no-charge basis, parts and labor, during the term of instrument warranty. Beyond warranty, modification parts are available free of charge. Customer then pays for labor involved in the installation of the parts.

Emerson Quiet Kool Company

16th & Coles Streets
Jersey City, New Jersey 07302

**Primary Products
Distributed and Remarks**

Televisions, Radios and Recorders.

Customer should refer RFI problems or inquiries related to Emerson or Dumont products to the National Service Manager for special handling.

Fisher Corporation

21314 Lassen Street
Chatsworth, CA 91311

**Primary Products
Distributed and Remarks**

Fisher Corp. asks that RFI problems involving Fisher products be handled by reference to one of the following:

1. Request assistance from the local selling dealer;
2. Request assistance from the local Fisher Authorized Service Station (a list is packed with every Fisher unit);
3. Contact Fisher Service Coordination Group.

Fisher's Service Coordination Group maintains close communications with Fisher Authorized Service Stations and engineering departments, and works under the supervision of the National Service Manager.

Garrard Plessey Consumer Products

100 Commercial Street
Plainview, L.I., New York 11803

**Primary Products
Distributed and Remarks**

Garrard Single Play and Multiple Play Automatic Turntables.

Garrard advises the consumer on methods which may eliminate RFI. In unique cases where the suggestions are ineffective, customer should refer the RFI problem to the Assistant Service Manager. Any RFI problems which are referred to Garrard are always handled on a no-charge basis.

General Electric Company

Television Business Department
College Blvd.
Portsmouth, VA 23705

**Primary Products
Distributed and Remarks**

GE Television Receivers.

RFI problems should be referred to the nearest GE Customer Care Service Operation. If GE Customer Care Service is unable to correct the RFI, the customer should refer the problem to the Television Business Dept., Attention: Manager, Product Service.

GE Radios, Record Players and other Audio Products. All RFI problems involving audio products should be referred to:

Manager, Customer Services,
Audio Electronics Department
Electronics Park
Syracuse, New York 13201

Gulbransen

A Division of CBS, Inc.
8501 West Higgins Road
Chicago, Illinois 60631

**Primary Products
Distributed and Remarks**

Electronic Organs.

Gulbransen cooperates with dealers and customers in offering suggested RFI solutions. Gulbransen does not reimburse the consumer for servicing. However, when extreme cases are encountered due to proximity of the transmitter and relative power, the dealer may sometimes absorb the cost of servicing RFI problems.

Customers should refer RFI problems to the local dealer. Inquiries may be directed to the Customer Service Supervisor.

Hammond Organ Company

11700 Copenhagen Court
Franklin Park, Illinois 60131

**Primary Products
Distributed and Remarks**

Organs.

Hammond maintains a staff of Technical Service Representatives who become directly involved in RFI cases that the dealer's service personnel are unable to solve. Hammond states that the services of engineering and technical field service departments under its control are provided to consumer and dealer alike without charge, whether or not a product is within warranty.

RFI problems should be referred to the local Hammond dealer.

The Hammond Technical Service Department asks that it be informed of any unique interference problem involving the Hammond instrument.

Harman-Kardon, Inc.

Subsidiary of Jervis Corp.
55 Ames Court
Plainview, New York 11803

**Primary Products
Distributed and Remarks**

Receivers, Amplifiers, Turntables, AM/FM Tuners, Preamps, Record Players, Tape Recorders.

Customers should refer RFI problems to the Manager of Customer Service.

Customer RFI problems are handled on an individual basis. If local, the customer is invited to bring the affected set into the plan. Non-local customers are referred to the nearest warranty station. Corrective action is provided at no cost to the customer.

Heath Schlumberger Company

Benton Harbor, MI 49022

**Primary Products
Distributed and Remarks**

AM/FM Radio, Television, Audio Systems (Kits), Transmitter Kits.

Heath Company suggests that for fastest service on matters related to RFI, regardless of the product involved, customers may now reach the Technical Consultation Department by either writing directly to that department or by using a new direct line telephone system to the department (616) 982-3302. DO NOT write to an individual.

Hitachi Sales Corporation of America

401 W. Artesia Boulevard
Compton, California 90220

**Primary Products
Distributed and Remarks**

Televisions, Radios, Tape Products.

Customers with RFI problems should contact the service manager of the nearest regional office:

Western Regional Office
401 W. Artesia Blvd.
Compton, CA 90220

Mid-Eastern Regional Office
1400 Morse Avenue
Elk Grove Village, IL 60007

Mid-Western Regional Office
World Trade Center, 183
2050 Stemmons Freeway
Dallas, Texas 75207

J.C. Penny Company, Inc.

1301 Avenue of the Americas
New York, New York 10019

**Primary Products
Distributed and Remarks**

J.C. Penny Company asks that customers with RFI problems contact their nearest J.C. Penny store for personal assistance.

JVC America, Inc.

50-35 56th Road
Maspeth, New York 11378

**Primary Products
Distributed and Remarks**

Amplifiers, Tuners, Receivers, Televisions.

Inquiries related to RFI involving JVC products may be referred to the office of the Chief Engineer.

Kenwood Electronics, Inc.
15777 South Broadway
Gardena, California 90248

Primary Products
Distributed and Remarks

Receivers, Tuners, Amplifiers, Turntables.

Kenwood asks that customers with RFI problems take the affected unit to an authorized service center where adjustments will be made at no cost to the customer if the product is properly registered with Kenwood and within warrantee. It is suggested that prior authorization for the return be obtained from Kenwood.

KLH Research and Development Corporation
30 Cross Street
Cambridge, Mass. 02139

Primary Products
Distributed and Remarks

Radio Receivers, Turntables, Music Systems.

KLH initially provides the customer with a listing of suggested steps for isolating and correcting RFI. If self-help does not resolve the problem, the customer may write to the Manager, Customer Service for authorization to return the affected unit to the factory. Return can then be made through contact with the nearest KLH factory authorized service station.

KLH absorbs the cost of service for units returned to the factory for any RFI problem. Customer bears the responsibility for shipping the unit to and from the repairing service station.

Lafayette Radio Electronics Corporation
111 Jericho Turnpike
Syosset, L.I., New York 11791

Primary Products
Distributed and Remarks

AM/FM radio, Home Entertainment Audio Products. Customers should refer RFI problems involving Lafayette products to the local dealer. If the dealer cannot alleviate the problem, the customer may contact the Vice President, Engineering.

Magnavox Consumer Electronics Company
1700 Magnavox Way
Fort Wayne, Indiana 46804

Primary Products
Distributed and Remarks

Televisions, Multi-Channel Receivers, Record Changers.

Customers should direct RFI problems involving Magnavox products to the nearest of the nine Magnavox service offices.

Pacific Division
1360 San Mateo Avenue
So. San Francisco, CA 94080

Los Angeles Division
2645 Maricopa Street
Torrance, CA 90503

Southwestern Division
8813 John Carpenter Highway
Dallas, Texas 75247

Great Plains Division
7510 Frontage Road
Skokie, Illinois 60076

Great Lakes Division
24092 Detroit Road
Westlake, Ohio 44145

Southeastern Division
1898 Leland Drive
Marietta, Georgia 30062

Northeastern Division
607 North Avenue, Door 17
Wakefield, Mass. 01880

New York Division
161 East Union Avenue
East Rutherford, N.J. 07073

Mid-Atlantic Division
2201 Route 38, Suite 750
Cherry Hill, N.J. 08034

MGA Mitsubishi Electric Corporation
Melco Sales, Inc.
3030 East Victoria Street
Compton, California 90221

Primary Products
Distributed and Remarks

Melco Sales, Inc. is the sales and service representative for the Mitsubishi Electric Corporation.

RFI reports from the field, beyond the dealers capability to resolve, in which Melco Sales becomes involved, are handled on an individual basis. All attempts will be

made to give customer satisfaction.

Melco Sales suggests that requests for assistance be addressed to its Compton, CA address, or the Service Department may be contacted by telephone on a toll free number (800) 421-1132. Ask for the National Service Manager.

Midland International Corporation
Consumer Products Division
P. O. Box 1903
Kansas City, Missouri 64141

Primary Products
Distributed and Remarks

Portable Black and White and Color Television Receivers.

Midland asks that, should any RFI problems be encountered with the Midland product, individuals should write the General Services Manager or call (816) 842-0511.

Montgomery Ward
Corporate Offices
535 West Chicago Avenue
P. O. Box 8339
Chicago, Illinois 60680

Primary Products
Distributed and Remarks

Televisions, Radios, Audio Products.

Service for RFI should be obtained from the nearest Montgomery Ward location. If service is not obtainable locally, customer may write to the Customer Service Product Manager at the Corporate Offices. The Montgomery Ward field service organization can call upon factory and corporate engineering talent for assistance with difficult RFI problems.

Morantz
(See Superscope)

Nikko Electric Corporation of America
16270 Raymer Street
Van Nuys, CA 91406

Primary Products
Distributed and Remarks

Stereo receivers, Tuners and Amplifiers, Combination Preamp, Main amp pairs.

For information and assistance with any Nikko Electric products, inquiries should be made to the Service Department, Attention: National Service Manager.

Norlin Music, Inc.
737 North Cicero Avenue
Lincolnwood, Illinois 60646

**Primary Products
Distributed and Remarks**

Lowrey Electronic Organs

Norlin offers local service organizations technical help in treating RFI through the Norlin Service Manager.

Customers should refer RFI problems to the local Lowrey dealer.

North American Phillips Corporation
100 E. 42nd Street
New York, New York 10017

**Primary Products
Distributed and Remarks**

Each RFI situation is handled individually by the Service Manager of the particular division whose product is involved. Inquiries related to RFI should be addressed to the proper division of North American Phillips Corporation.

Nutone Division

Scovill Housing Products Group
Madison & Red Bank Roads
Cincinnati, Ohio 45227

**Primary Products
Distributed and Remarks**

Radios, Intercoms, AM radios.

Refer RFI problems to Consumer Relations Department for handling.

Panasonic Company
Division of Matsushita Electric
Corporation of America
50 Meadowlands Parkway
Secaucus, New Jersey 07094

**Primary Products
Distributed and Remarks**

When instances of RFI occur, the customer should contact Panasonic in Secaucus.

Customers should provide model number, serial number and information concerning the problem. Upon review, the customer will be contacted advising them where to return their unit for corrective repair. Panasonic will absorb both parts and labor costs in these instances.

Philco (Television)
(See GTE Sylvania)

Quasar Electronics Corporation
9401 West Grand Avenue
Franklin Park, Illinois 60131
Attention: Consumer Relations Manager

**Primary Products
Distributed and Remarks**

For a high-pass filter, consumer should write Quasar and should include model and serial number of the receiver, frequency of the interference signal (if known), and whether sound or picture, or both, are affected. The Quasar distributor serving the local area should be contacted relative to any other interference problem that is unique to Quasar products.

Radio Shack
National Headquarters
2617 West Seventh Street
Fort Worth, Texas 76107

**Primary Products
Distributed and Remarks**

AM/FM Radios, Home Entertainment Audio Products.

Customers who encounter unique interference problems involving Radio Shack audio products may write to the Product Development Manager or the National Quality Control Manager.

RCA Consumer Electronics
600 N. Sherman Drive
Indianapolis, Indiana 46201

**Primary Products
Distributed and Remarks**

RFI problems involving both television and audio products may be referred to RCA Consumer Electronics 1-455.

Requests for filters should include model and serial number of the equipment. Filter installation charges will be the customer's responsibility.

Rodgers Organ Company
1300 N. East 25th Avenue
Hillsboro, Oregon 97223

**Primary Products
Distributed and Remarks**

RFI problems involving the Rodgers Organ may be referred to Custom Organ Test Dept.

Sansui Electronics Corporation
201 East 42nd Street
New York, New York 10017

**Primary Products
Distributed and Remarks**

RFI problems should be directed to the attention of the Vice President, 201 Communications Inc. (212) 867-3325.

201 Communications, Inc. is the advertising and public relations agency representing Sansui. They will direct the customer to the appropriate Sansui Service Center. They state that all Sansui products are carefully checked prior to final engineering commitments for susceptibility to RFI. Units are often taken to high RF level areas such as New York City to determine any design flaws.

Sanyo Electric, Inc.
Electronics Division
1200 W. Artesia Blvd.
Compton, CA 90220

**Primary Products
Distributed and Remarks**

In the event an RFI problem should occur, the customer is requested to take the set to the nearest Sanyo Authorized Repair Station.

Transportation to and from the shop is the responsibility of the customer. Should the shop not alleviate the problem, either the customer or the shop should contact the Field Service Manager in Compton (213) 537-5830.

Schober Organ Corporation
43 West 61st Street
New York, New York 10023

**Primary Products
Distributed and Remarks**

Organ Kits.

Customers with RFI problems are supplied with the necessary parts, free of charge, to correct the trouble.

Schober Organ Corp. also assists customers in location of the offending stages in the organ.

Refer RFI problems to the Development Engineer.

H. H. Scott, Inc.

111 Powder Mill Road
Maynard, Mass. 01754

**Primary Products
Distributed and Remarks**

Manufacturer and Importer of AM/FM Tuners-Receivers and Stereo Amplifiers used in Hi-Fi Systems.

Manufacturer offers simple instruction sheet to aid customers in resolving problems involving RF pickup. The information includes suggestions about suitable equipment grounding, power line bypassing, and hints and suggestions on how to determine where RF is entering the equipment.

Refer RFI problems to the Engineering Dept.

Scientific Audio Electronics, Inc.

P. O. Box 60271 Terminal Annex
Los Angeles, CA 90060

**Primary Products
Distributed and Remarks**

Refer all RFI inquiries to the attention of the National Marketing Manager.

Sears Roebuck & Company

BSC-41-03
Sears Tower
Chicago, Illinois 60684

**Primary Products
Distributed and Remarks**

Televisions, Radios, Audio Products.

Sears asks that customers with an RFI problem involving a Sears product contact the nearest Sears Service Department for assistance.

Sharp Electronics Corporation

10 Keystone Place
Box 588
Paramus, N.J. 07652

**Primary Products
Distributed and Remarks**

Manufacturer of Television and Radio Receivers.

Sharp Electronics will, with proof of purchase, supply

to any TV owner who complains of interference, a Drake TV-300 high-pass filter at no charge. Audio rectification problems are handled on an individual basis by the service department. Refer all Sharp Electronics RFI problems to the Service Department.

Sherwood Electronic Laboratories, Inc.

4300 N. California Avenue
Chicago, Illinois 60618

**Primary Products
Distributed and Remarks**

Receivers, Amplifiers, Tuners.

Customers with interference problems should contact the Service Laboratory Manager.

Sony Corporation

(See Superscope)

Consumer Audio Tape Products Only.

Shure Brothers, Inc.

222 Hartrey Avenue
Evanston, Illinois 60204

**Primary Products
Distributed and Remarks**

Microphones and Electronic Components.

Manufacturer recommends the use of balanced line, low impedance microphones, cables. If the RFI problem persists after taking this step, the consumer should contact Shure Brothers with specifics so that they may be able to help solve the problem. Refer RFI problems to Customer Service Manager.

Superscope Corporate Offices

20525 Nordhoff Street
Chatsworth, CA 91311

**Primary Products
Distributed and Remarks**

Superscope/Marantz AM/FM receivers, tuners, amplifiers, tape recorders, record players, and audio systems.

Sony consumer audio tape products.

In the event of special RFI cases, resulting from extremely high RF fields, contact the Technical Services Department at Superscope Corporate Offices.

Modifications necessary to resolve such RFI problems are provided customers on an individual basis.

GTE Sylvania, Inc.

Entertainment Products Group
Group Headquarters
700 Ellicott Street
Batavia, N.Y. 14020

**Primary Products
Distributed and Remarks**

Televisions, AM/FM Tuners, Radios, Amplifiers.

Consumers should first contact the dealer. Factory Field Service and Field Engineering personnel work together to solve many of the TVI and Audio Rectification problems. The dealers are in touch with the manufacturer's services that will help resolve the problem. RFI problems are handled on an individual basis.

Sylvania has available for their technicians an excellent pictorial TVI training manual titled, "Diagnosis, Identification and Elimination" of TVI.

Tanberg of America, Inc.

Labriola Court
Armonk, New York 10504

**Primary Products
Distributed and Remarks**

Recorders.

When RFI occurs in Tanberg products, the manufacturer suggests that the unit be returned to them. "We will do any modification possible to eliminate the RFI."

Prior authorization should be obtained from the Technical Manager prior to return of the unit.

Tenna Corporation

19201 Cranwood Parkway
Cleveland, Ohio 44128

**Primary Products
Distributed and Remarks**

Tenna Corp. has not produced home entertainment equipment within the past two years, but will be glad to help out all past customers if a problem arises with RFI. Will install a circuit change at no cost except postage and handling. All unique RFI problems may be referred to the National Service Manager.

Thomas Organ Company

7310 North Lehigh Avenue
Chicago, Illinois 60648

**Primary Products
Distributed and Remarks**

Electronic Organs.

Refer RFI complaints to the dealer. RFI is usually resolved at this level. If the manufacturer's field service is made aware of a consumer complaint regarding RFI, the field service will contact the seller and advise that person on how to eliminate the problem. Should that fail, "we continue to pursue the problem utilizing our own people."

Thomas has six field service engineers. In the event of a call for assistance, an engineer personally contacts the consumer by telephone, makes an appointment to visit the home of the consumer to correct the RFI condition, with or without the dealer's technician. "We do not charge the consumer for this service."

Toshiba America, Inc.
41-06 DeLong Street
Flushing, N.Y. 11355

**Primary Products
Distributed and Remarks**

Televisions, Radios, Tape Products, Amplifiers, Tuners, Receivers.

Customers should contact the nearest Regional Office Service Manager for obtaining assistance in resolving RFI problems.

Eastern Regional Office
41-06 DeLong Street
Flushing, N.Y. 11355

Southwest Regional Office
3225 E. Carpenter Freeway
Irving, Texas 75062

Western Regional Office
19515 S. Vermont Avenue
Torrance, CA 90502

U.S. Pioneer Electronics Corp.
75 Oxford Drive
Moonachie, N.J. 07074

**Primary Products
Distributed and Remarks**

Consumers should contact the nearest Regional Service Manager. Pioneer makes available to their technicians an excellent service manual titled, "Hi-Fi I Countermeasures."

Eastern Regional Office
75 Oxford Drive
Moonachie, N.J. 07074

Midwest Regional Office
1500 Greenleaf Avenue
Elk Grove Village, Illinois

Western Regional Office
13300 South Estrella Avenue
Gardena, California

Yamaha International Corporation
6600 Orangethorpe Avenue
Buena Park, CA 90622

**Primary Products
Distributed and Remarks**

Electronic Organs

Yamaha organization attempts to cure each RFI problem on an individual basis. Yamaha supplies all necessary technical information at no charge. If interference is due to design error, Yamaha takes steps at its own expense to remedy the problem.

Refer RFI problems to the local dealer. The dealers are kept well informed and current on RFI countermeasures.

Zenith Radio Corporation
11000 Seymour Avenue
Franklin Park, IL 60131

**Primary Products
Distributed and Remarks**

Televisions, Radios, Audio Systems.

Zenith gives consideration to handling and providing relief for RFI problems on a case-by-case basis. RFI problems should be referred to the Service Division. RFI referrals should include model and serial number of the affected product.

Customers with a unique, difficult RFI problem may direct a letter to the National Service Manager.

Dealers

You may want to go back to the dealer from whom you bought your television set or audio device, and discuss with that person possible solutions to your interference problem.

For Amateur Operators

Your local Television Interference (TVI) Committee, composed of amateurs who live in your area, may be of assistance in resolving interference problems. Addresses for these committees can be obtained from the nearest FCC district office (addresses on page 28).

For Citizens Band Operators

Local Television Interference (TVI) Committees dedicated to resolving Citizens Band interference problems are new. However, you can contact the International CB Radio Operators Association (CBA), Box 10-2, Roanoke, Va. 24005, for assistance in locating a committee in your area.

Addresses of FCC District Offices

Listed below are the addresses and telephone numbers of the FCC district offices. This list is alphabetical by state, and also includes offices in Puerto Rico and the District of Columbia (Washington, D.C.).

You are reminded that the information requested on page 30 of this bulletin will be required in order that a staff member may analyze your interference problem. Please forward this information by mail.

ALASKA, Anchorage
U.S. Post Office Building Room G63
4th & G Street, P.O. Box 644
Anchorage, Alaska 99510
Phone: Area Code 907 265-5201

CALIFORNIA, Los Angeles
3711 Long Beach Blvd.
Suite 501
Long Beach, California 90807
Phone: Area Code 213 426-4451

CALIFORNIA, San Diego
Fox Theatre Building
1245 Seventh Avenue
San Diego, California 92101
Phone: Area Code 714 293-5460

CALIFORNIA, San Francisco
323A Customhouse
555 Battery Street
San Francisco, California 94111
Phone: Area Code 415 556-7700

COLORADO, Denver
Suite 2925 Executive Tower
1405 Curtis Street
Denver, Colorado 80202
Phone: Area Code 303 837-4054

**DISTRICT OF COLUMBIA
(WASHINGTON, D.C.)**

1919 M Street N.W. Room 411
Washington, D.C. 20554
Phone: Area Code 202 632-8834

FLORIDA, Miami
919 Federal Building
51 S.W. First Avenue
Miami, Florida 33130
Phone: Area Code 305 350-5541

FLORIDA, Tampa
Barnett Office Bldg., Rm 809
1000 Ashley Drive
Tampa, Florida 33602
Phone: Area Code 813 228-2872

GEORGIA, Atlanta
Room 440, Massell Bldg.
1365 Peachtree St. N.E.
Atlanta, Georgia 30309
Phone: Area Code 404 881-3084

GEORGIA, Savannah
238 Federal Office Bldg. and Courthouse
125 Bull Street, P.O. Box 8004
Savannah, Georgia 31402
Phone: Area Code 912 232-4321 ext. 320

HAWAII, Honolulu
502 Federal Building
P.O. Box 1021
335 Merchant Street
Honolulu, Hawaii 96808
Phone: Area Code 808 546-5640

ILLINOIS, Chicago
3935 Federal Building
230 South Dearborn Street
Chicago, Illinois 60604
Phone: Area Code 312 353-0195

LOUISIANA, New Orleans
829 F. Edward Hebert Federal Bldg.
600 South Street
New Orleans, Louisiana 70130
Phone: Area Code 504 589-2094

MARYLAND, Baltimore
George M. Fallon Federal Building
Room 823 31 Hopkins Plaza
Baltimore, Maryland 21201
Phone: Area Code 301 962-2728

MASSACHUSETTS, Boston
1600 Customhouse
165 State Street
Boston, Massachusetts 02109
Phone: Area Code 617 223-6609

MICHIGAN, Detroit
1054 Federal Building
231 W. Lafayette Street
Detroit, Michigan 48226
Phone: Area Code 313 226-6078

MINNESOTA, St. Paul
691 Federal Building
316 N. Robert Street
St. Paul, Minnesota 55101
Phone: Area Code 612 725-7810

MISSOURI, Kansas City
1703 Federal Building
601 East 12th Street
Kansas City, Missouri 64106
Phone: Area Code 816 374-6155

NEW YORK, Buffalo
1307 Federal Building
111 W. Huron Street at Delaware Ave.
Buffalo, New York 14202
Phone: Area Code 716 842-3216

NEW YORK, New York
201 Varick St.
New York, New York 10014
Phone: Area Code 212 620-3437

OREGON, Portland
1782 Federal Office Bldg.
1220 S.W. 3rd Avenue.
Portland, Oregon 97204
Phone: Area Code 503 221-3098

PENNSYLVANIA, Philadelphia
11425 James A. Byrne Federal Courthouse
601 Market Street
Philadelphia, Pennsylvania 19106
Phone: Area Code 215 597-4411

PUERTO RICO, San Juan
U.S. Post Office and Courthouse
Room 323 P.O. Box 2987
San Juan, Puerto Rico 00903
Phone: Area Code 809 753-4567

TEXAS, Beaumont
Room 323, Federal Building
300 Willow Street
Beaumont, Texas 77701
Phone: Area Code 713 838-0271

TEXAS, Dallas
Earle Cabell Federal Bldg.
Room 13E7, 1100 Commerce Street
Dallas, Texas 75242
Phone: Area Code 214 749-1719

TEXAS, Houston
5636 Federal Building
515 Rusk Avenue
Houston, Texas 77002
Phone: Area Code 713 226-5624

VIRGINIA, Norfolk
Military Circle
870 North Military Highway
Norfolk, Virginia 23502
Phone: Area Code 804 461-6472

WASHINGTON, Seattle
3256 Federal Bldg.
915 Second Avenue
Seattle, Washington 98174
Phone: Area Code 206 442-7653

In requesting assistance from the association, manufacturer, dealer, or FCC district office, the following information will be helpful in analyzing your problem.

_____ Date

1. Your name: _____

Address: _____

Phone Number: _____

2. If known, radio transmitter operator's:

Name: _____

Address: _____

Call Sign: _____

Hours of Operation: _____

3. Type of interference identified:

- Radio Transmitter Electrical
 Co-Channel FM
 Audio

4. a. TV Channels affected: _____

b. AM/FM Frequencies affected: _____

5. If you are experiencing either FM or Co-Channel interference, estimate the distance of the interfering station from the location of your home: _____ (miles).

6. Were suggested home remedies made?

- Yes No

Please explain (be specific): _____

7. a. Was service representative called:

- Yes No

b. If yes, were suggested modifications made? Yes No

Please explain (be specific): _____

8. a. If a radio transmitter is involved, was the operator contacted? Yes No

b. If yes, what was the result of that conversation? _____

c. Were suggested transmitter modifications made? Yes No

Please explain (be specific): _____

9. At what time of day does the interference usually occur and how long does it last?

10. Give Make, Model Number, and the Year Purchased, of your TV or AM/FM receiver. _____

11. Was the level of interference affected in any way by the modifications suggested in this bulletin? Yes No

Comments: _____

12. Describe fully the sound or noise made by the interference and, if the TV picture is affected, please provide a drawing of what the interference pattern looks like. (Use separate sheet.)

13. a. Are any of your neighbors experiencing the same type of interference?

- Yes No

If yes, on a separate sheet, indicate their names, addresses, and type equipment receiving the interference; TV, AM/FM radio, electronic organ, etc.

b. Was the information provided in this bulletin shared with your neighbors?

- Yes No

If yes, please explain what modifications were made to their equipment and if the modifications eliminated or reduced the level of interference. (Use separate sheet if necessary.)

31

14. Give any other pertinent information which you feel will assist us in analyzing your interference problem: _____

PLEASE LEAVE THE FOLLOWING
SPACE BLANK

(For use by association, manufacturer,
dealer, or FCC district office.)

Notes

Notes

For sale by the Superintendent of Documents
U.S. Government Printing Office
Washington, D.C. 20402
Stock No. 004-000-00345-4