

September/October 1977  
\$1.50

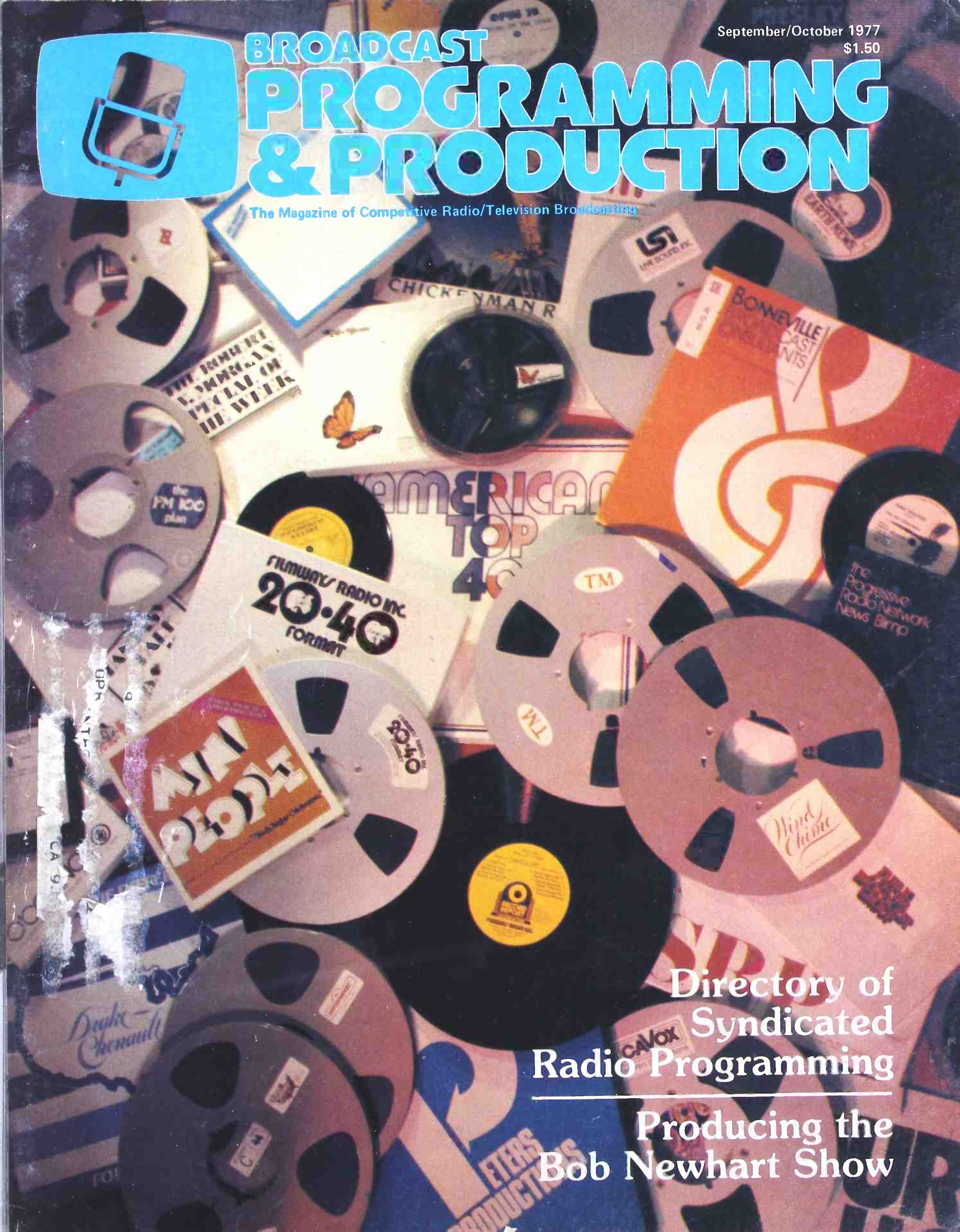

# BROADCAST PROGRAMMING & PRODUCTION

The Magazine of Competitive Radio/Television Broadcasting



Directory of  
Syndicated  
Radio Programming

Producing the  
Bob Newhart Show

# Introducing the Newvicon™ color camera from the people who invented the Newvicon tube.

Up to now, there were just two kinds of color studio cameras. The kind you wanted. And the kind you could afford. But now there's Panasonic's new color studio camera and control unit, the WV-2150. At around \$6,500 (not including lens), it gives you the professional results you want at a price you can afford.

First there's Panasonic's Newvicon tube and all the sensitivity that goes along with it. All you need is 200 footcandles of standard illumination at  $f/2.8$ . And with a flip of the 6 dB gain switch, only 25 footcandles is required at  $f/2.0$ . There's also a S/N ratio of 46 dB with standard illumination. As well as a stable

color picture that's sharp and clear. With a maximum of resolution. And a minimum of blooming and burn-in.

The 2150 also includes automatic pedestal circuitry. Automatic color level contours for both high and low light levels. Horizontal and vertical aperture correction circuits. As well as new dynamic focusing circuitry for sharp, even focus over the entire tube.

The camera control unit features a flip-down front panel for easy access to all critical controls and adjustments. What's more, all printed circuit boards can be removed from the front. Also included is a self-contained subcarrier phase shifter with coarse and fine phase adjustments.

For less stringent requirements, take a look at the WV-2310. Panasonic's new lightweight color studio camera. At around \$4,250

(not including lens), it comes complete with two vidicon tubes. A 3" viewfinder. And its own professional-type camera control unit.



So, if the color studio camera you've wanted hasn't been the one you've been able to afford, look again. At Panasonic.

For more information, write: Panasonic Company, Video Systems Division, One Panasonic Way, Secaucus, N.J. 07094. In Canada, contact Panasonic Video Systems Department, 40 Ronson Drive, Rexdale, Ontario M9W 1B5.

**Panasonic**  
just slightly ahead of our time.



Want more details? Circle No. 1 on Product Info. Card.

# Contents

**GARY KLEINMAN**  
Editor / Co-publisher

Consulting Editors:

**DON ELLIOT**

**PETER BUTT**

**MICHAEL CARRUTHERS**

**MARK BRAGG**

**D. KEITH LARKIN**

Operations Manager

**V.L. GAFFNEY**

Business Manager

**LARRY DOUGLAS**

Circulation Manager

**DON AULD**

Production Coordinator

**JOSEPH LAUX**

Production Assistant

**PETER NEUHAUS**

Reader Service Manager

**MARTIN GALLAY**

Publisher

## ADVERTISING OFFICES:

### West Coast

Broadcast Programming & Production,  
1850 N. Whitley Avenue, Suite 220,  
P.O. Box 2449, Hollywood, CA 90028.  
(213) 467-1111. Contact: Gary Klein-  
man, Martin Gallay, Steven Gallay.

### Midwest

The Patis Group, 4761 West Touhy  
Avenue, Lincolnwood, IL. Telephone:  
(312) 679-1100. Contact: Joseph J.  
Brennan.

### East Coast

R.H. Hammond Associates, P.O. Box  
277, Sparta, NJ 07871. Telephone:  
(201) 729-5666; In New York City,  
(212) 986-0711. Contact: Bob Ham-  
mond, Louise Wallace.

"Broadcast Programming & Production"  
is published bi-monthly (every other  
month) by Recording & Broadcasting  
Publications, 1850 N. Whitley Ave.,  
Suite 220, Hollywood, CA 90028, and  
is sent to qualified recipients. Sub-  
scription rates: \$7.00 per year United  
States; \$8.50 per year Foreign; \$13.00  
Airmail. Material appearing in "BP&P"  
may not be reproduced without the  
written permission of the Publisher.  
"Broadcast Programming & Production"  
is not responsible for any claim made  
by any person based upon the publica-  
tion by "Broadcast Programming & Pro-  
duction" of material submitted for  
publication.

Controlled Circulation postage paid at  
Los Angeles, California.

Postmaster: Send form 3579 for ad-  
dress correction to:

**BROADCAST PROGRAMMING  
& PRODUCTION**  
P.O. BOX 2449  
HOLLYWOOD, CA 90028  
(213) 467-1111

MORE BASICS OF  
COMPETITIVE PRODUCTION 6 *Don Elliot*

GETTING "SET"  
FOR TV NEWS  
*What role does a news  
set play in the presentation  
and ratings of a newscast?* 18 *Mark Bragg*

Q&A:  
CBS NEWS'  
DAN RATHER 22 *Arlen Peters*

DIRECTORY OF SYNDICATED  
RADIO PROGRAMMING 26

PRODUCING THE  
BOB NEWHART SHOW 41 *Michael Carruthers*

CREATIVE PROGRAMMING  
WITH AUTOMATION 48 *JoAnn Roe Burkhart*

Market Memoranda:  
RADIO PROMOTIONS 55 *Gary Kleinman*

Letters 4  
New Products & Services 71  
"Broadcast Buffoonery" 79  
Classified 81

## INDEX OF ADVERTISERS

Ampex . . . . .	12 - 13	Master Broadcast Services . . . . .	36
Audio Marketing . . . . .	20	MCI . . . . .	7
Audio Sellers . . . . .	49	Memphis Avionics . . . . .	77
Bonneville Broadcast Consultants . . . . .	34, 35, 50, 51	Micro-Trak . . . . .	54
BPI . . . . .	38	Music Director Programming Service . . . . .	82
Cavox Stereo Productions . . . . .	15, 32, 53, 62, 74, 79	Music Masters . . . . .	30
Century 21 Productions & Programming . . . . .	69	Musicworks . . . . .	63
CNB Studios . . . . .	81	Mutual Broadcasting System . . . . .	5
Command Productions . . . . .	82	National Leukemia Bdcst. Council . . . . .	23
Concept Productions . . . . .	30	O'Connor Creative Services . . . . .	39
DeWolf Music Library . . . . .	82	Opamp Labs . . . . .	81
Don Elliot Creative Services . . . . .	82	Orange County Electronics . . . . .	8
Fame Game . . . . .	30	Pacific Recorders & Engineering . . . . .	57
Fidelipac . . . . .	53	Panasonic . . . . .	2, 42, 43
Filmways Radio Inc. . . . .	40, 64, 65, 68	Programming and Production Assoc. . . . .	15
FM 100 Plan . . . . .	55	Radio Arts . . . . .	27
Good Music Co. . . . .	52	Record Report . . . . .	40, 68
Greater Media Inc. . . . .	31	Russco Electronics . . . . .	59
Harris . . . . .	17	Shure Bros. . . . .	19
Harrison . . . . .	82, 83	SMC . . . . .	32
IGM . . . . .	61	Summit Productions . . . . .	66
Innovation Organization . . . . .	81, 82	Sundance Organization . . . . .	73
Inovonics . . . . .	71	Swingin' Years . . . . .	62
Kala Music . . . . .	67	Taber Engineering . . . . .	25
Krishane Enterprises . . . . .	82	TM Productions . . . . .	28, 29
Live Sound Inc. . . . .	60	UREI . . . . .	4
		Thomas J. Valentino Inc. . . . .	77
		Watermark Inc. . . . .	37
		Westlake Audio . . . . .	84
		Windchime Communications . . . . .	33

# Pure Parametric Pleasure

## Check Our Specs:

Controls: Large, easy to adjust  
Operator Ease: Pure pleasure  
Performance: Incredible  
Quality: UREI, of course  
Price: Unbelievable\*

UREI's Model 545 is a pure parametric equalizer. From 15 Hz to 20 kHz, all parameters are continuously variable including two end cut filters. Boosts and cuts are truly reciprocal. Its a super tool for creative and corrective equalization. We do have a complete data sheet that we will be happy to send you, but you'll really have to try it to believe it . . . so pick one up from your UREI dealer.

\*under \$400.00

**UREI**  
QUALITY  
OF COURSE



8460 San Fernando Road, Sun Valley, California 91352 (213) 767-1000  
Exclusive export agent: Gotham Export Corporation, New York

Want more details? Circle No. 2 on Product Info. Card.



---

from: **Bobby Ocean**  
Promotion Coordinator  
KHJ/am Radio  
Hollywood, CA

I want you to know how much I enjoy the Face-To-Face interview in your July/August issue of *Broadcast Programming & Production* with Dave Hull and Danny Dark on commercial voice-overs.

I say "enjoy" in the present tense on purpose. The appreciation is still here . . . it is not in the past tense.

I'm sure that the answers to the questions you asked of Danny and Dave will continue to be of tremendous value to all of us participating in the broadcasting field. I came away from reading the article with a sense of ". . . If I only knew then what I know now . . .".

You're sailing a great course.

---

from: **Don Blaisdell**  
Operations Manager  
KWAT Radio  
Watertown, SD

Let me take this opportunity to tell you how much I've enjoyed *Broadcast Programming & Production*. I'm relatively new to radio having come into the business five years ago from sales organization. Your articles and interviews all have something I can drop into my memory banks for later use. I only wish it came out monthly! Keep up the great work . . . this business can use some guidance.

---

Letters to the Editor  
Should be Addressed to:

Editor,  
Broadcast Programming  
& Production  
P.O. Box 2449  
Hollywood, CA 90028

**OF ALL THE RADIO NETWORKS...**

# **Mutual Is No. 1 \***

**\* In News...**

Whether you want only a minute an hour for minimum interruption or enough to satisfy an all news format, Mutual News is totally flexible...totally excellent...totally money-making for you! Mutual offers 1 to 5 minutes of News on the hour and the half-hour...plus 1½ to 4 minutes of Progressive News every hour at :55. Designed to fit your format! Reported by renowned newsmen.

**\* In Sports...**

...plus Mutual's "Wide Weekend of Sports" hosted by Jack Gregson and featuring live-from-the-scene reports more than 37 times each weekend. Nothing compares to it in network radio. And football (NFL, Notre Dame, NCAA and six major bowl games)...golf (all the great tournaments)...basketball(NBA and NCAA)...and much more brought to you play-by-play by expert sportscasters like Al Wester, Lindsey Nelson, Tony Roberts, Pat Sheridan and Sam Huff. Mutual Sports. Flexible. Diversified. Unbeatable.

**\* In New Concepts...**

Names like...Jack Anderson...David Frost...Curt Gowdy...Fred Robbins...Sydney Omarr...Jeffrey St. John...Elmer Dapron...report on Mutual's 2½-minute Mini-Features, a new concept in network programming, covering beats that stretch from the White House and Capitol Hill to Hollywood and interviews with show business stars, to reports on what the consumer will find in the neighborhood grocery or supermarket. Mutual's Mini-Features fit any format. And they're easy to sell!

Mutual is the new look in networking. It is a totally computerized, automated operation...and soon to come (1978) is satellite distribution of network programming to Mutual affiliates with 15 khz stereo quality. Mutual now has more than 765 affiliate radio stations...from the largest markets to the smallest. It is the radio network of tomorrow...the money-making answer for your programming. Come by and let us tell you about Mutual's "tailored affiliation" that will fit your station as if it were made for it. Because it is.

**During the NRBA Convention see Mutual's Western Union satellite demonstration in Exhibit Booth 116-117 and visit Mutual's Hospitality Suite 1629. Come see us!**



**mutual broadcasting system**

THE WORLD'S LARGEST RADIO NETWORK

Washington D.C. World Headquarters

1755 South Jefferson Davis Highway, Arlington, Virginia 22202, (703) 685-2000

# More Basics of Competitive Production

by Don Elliot

Whether or not you've got a head for what's behind the panel of a console shouldn't determine your production abilities or limitations. In other words, you shouldn't be boxed in by the lack of a first ticket preventing you from learning flexibility and signal paths in your production room.

In past BP&P articles, I have tried to present some very basic production techniques that some of us have forgotten, and that oddly enough, a lot of people never learned.

In most of the arts, the *idea* is often the central object and target of the creative mind, and is conceived first, before the artist sets to work. The how-to is the secondary problem to surmount. I feel that in *production*, learning new techniques in themselves often spark new ideas that were subconsciously eliminated by the originator previously if he didn't know how to express them. Consequently, I hope when you read on . . . something will strike you for immediate application . . . "Hey . . . so that's how they did such-and-such . . ." or . . . "If I'd known that before, I could have saved hours and made it sound better!"

Here then, are a few additional tips that might be applicable to your needs and hopefully will be a springboard for you to add even further tricks.

## LOOPS

Everybody's heard of a tape-loop, but do you know how to properly build one?

When a situation calls for repeating a music background with a continuous rhythm pattern (or anything), build an endless loop. Late model Scully and Ampex tape decks come equipped with an edit switch. Early models will require holding up

### Tape loop.



the right-hand tension arm with masking tape to defeat the auto-shut-off switch. Isolate the sound you want and mark the beginning (or front end) of the tape with a grease pencil. At the back end of the passage, mark the appropriate beat or spot where you want the edit to rhythmically fall, bearing in mind that the shorter the loop, the sooner it repeats, and the more noticeable that point will be if it consists of a bad edit. The tape is then cut at the marks (on a splicing block) and spliced together. The shortest loop which can be made, of course, is one which hugs the periphery of the head cover, roller, and tape guide area. If an extremely long loop is desired, you can use your imagination and expand it by hanging the tape over the edge of the Ampex with an empty take-up reel used as a weight. I've even run tape down a hallway, threading it around door knobs and through coffee cup handles! Just make it sound right first, and then worry about where to hang it!

## TWO-TRACK SEL-SYNC

A lot of newer tape machines' full capabilities are rarely tapped. Consider the mono AM station's two-track machine with sel-sync that gets used on one channel only for mono tapes recorded on both channels, and the sum dubbed onto a mono cartridge. Or the similar problem in a stereo station: the two-track that's never used in production with sel-sync because the result would be a mono spot — so what? Do it once in a while. Sel-sync lets you *listen* on the record head and electronically assemble-edit spots without making physical splices. Neat, because you can overlap and if you blow a take, you've only blown that one section. That means you only have to re-do that one section until you get it just right.

To get the full benefit from sel-sync, if your board doesn't provide a monitor for it, get at least a headphone box wired to the output of the tape machine itself, ahead of the console for three reasons: 1) If you bring the pot up into the board, you'll have feedback; 2) If you use an audition or cue channel, it will be muted by the mike switch unless you can over-ride the mute feature; and, 3) You can use this function to "A-B" (compare input with output). By leaving the tape machine on input, you'll hear what the

board is feeding the machine; by switching to play, you'll instantly be able to check what's on the tape itself. If it doesn't sound the same, it's time for re-editing, alignment, or other maintenance.

Using sel-sync is simple. Lay down the first section of the spot on Channel 1. Rewind the tape and play it in the "sync" position through your sync monitor, with Channel 2 switched to input so you can hear what you're going to add in sync with what's already recorded. You can punch the record switch early, anytime, because switching the first channel to sync automatically puts it into "safe". When you hear the end of the first section on the first track, drop in the next element onto Channel 2, which is already recording. In this way, you can overlap the new material if you wish, or drop in new material *anywhere*. You can carry on indefinitely, alternating tracks. Then you combine the two and mix them down to a mono master or cartridge. This is especially handy for re-assembling loose and sloppy agency piggybacks. Mixing down will require bringing in each track on a separate pot on the board so you may need to re-patch or even re-wire to get the final result. Start with clean tape (either virgin or bulk-erased), otherwise you'll run into difficulties when you combine the channels in mixing down — stray sounds from previously recorded materials may still be on portions of the tape that weren't recorded over on both channels.

## DONUTS

### I. Pre-produced Spot

A fast way to do donuts is to listen to the donut bed in sync on Channel 1, as you are recording the voice track on Channel 2.

### Wrapping capstan with splicing tape for quick and easy vari-speed control.

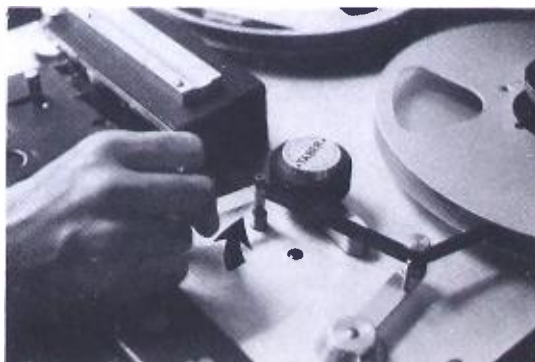

# FEEDBACK

READ SOME LETTERS TO MCI REGARDING THE REMARKABLE JH-110A SERIES OF TAPE RECORDERS

I thought you may be interested in learning of some of the benefits this company has derived since we changed to MCI JH-110 tape recorders.

As you know, both stations are heavily automated. Several times during the day and night we are required to record spots from the NBC Network. One of the first "tricks" our production staff learned was to record the network on two recorders. At the beginning of spot No. 1, they punch the reset button of recorder No. 1; at the beginning of spot No. 2, they punch the reset button of recorder No. 2. Then, at their leisure, they punch the RTZ button on both recorders, and there are the two spots already cued.

The cue facility allows us tighter "drop-ins" on beginning and end tags, and in compiling programs generally.

The calibrate/variable play and record level controls, and variable speed, are useful in that we have to process tapes received and from many different sources. The 3-speed capability also allows us to high-speed these dubs—saving valuable time.

Apart from the tremendous improvement in recorded quality (we were able to align the recorders to better than factory specifications) since installing the recorders we have not had one case of stretched or broken tape.

We have been able to design and build relatively simple units to interface with the control logic to enable us to—for example—pre-time record start and multi-recorder start and stop.

In closing, might I just say that original alignment and installation was very quick and simple, and maintenance has been virtually negligible.

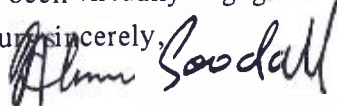
Yours sincerely,  

H. Graeme Goodall,  
WVCG-WYOR, Coral Gables, Florida

It's been nearly a year since I purchased an MCI JH-110, and it's been a year of pleasure! I am (at least I consider myself to be) one of the best production persons in the country, and your machine puts all the others to shame!!!

I must tell you that I bought my machine by chance. I was not satisfied with our Ampex and ITC's, and Scully just couldn't handle it. I read a tiny ad in the trades and called your chief engineer for details on performance. Never having seen nor heard of your machine before, I

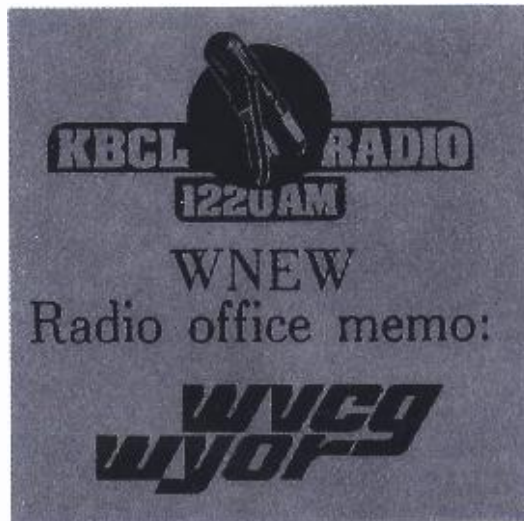

was impressed with his recommendations and therefore purchased one.

I have found several uses which were not listed in the Manual, and it seems we discover new ways to use the machine every week—and we do some pretty complicated production!

I assure you that when the money and the opportunity (and in that order) arises, I will purchase a 4-track and perhaps another 2-track and, hopefully, have you add a few more production aids which I feel could be of great value to our production load.

Again, I am totally satisfied with my MCI JH-110. It's a shame everyone has not had the good fortune to work with one.

Very truly yours,  

Larry Ryan, General Manager,  
KBCL, Shreveport, Louisiana

After using the MCI for a couple of weeks I'm greatly impressed by its improvements over traditional tape machines and its innovative features.

The machine is incredibly quiet—one reason being its motor does not idle but engages only during the play mode. Undoubtedly this feature will give the machine far greater mechanical life than its counterparts.

The machine's constant-tension transport feature is a plus in news situations where a mixture of small and large reels are used.

One of the more remarkable features is the machine's ability to time tape. At present, completed 60-minute shows are

Professional Recording Equipment



timed by running them through a conventional recorder at 15 IPS and the elapsed time doubled for an accurate reading of 7½ IPS programming. This MCI machine actually times the programming while in the fast-forward mode—reducing a 30-minute job to a 3- or 4-minute job and greatly reducing machine tie-up time.

Though the advantages of 2-deck electronic editing are obvious and ultimately the best state-of-the-art engineering for news producers, the MCI "tape return" feature by itself is quite helpful. I reset the mechanism while dubbing cassette material to reel-to-reel for quick and accurate recall of key segments.

The time saved in hunting material is valuable, but perhaps more importantly this is the first tape machine I have ever encountered that actually "assists" the operator. All other machines are neutral in their attitude to the job—they'll go when the right button is pressed, stop when another is pressed . . . but THIS machine actually is *positive*. It's a great device—too many engineers ignore the human engineering factor. These people have explored it and created a machine with a valuable accessory.

Other benefits: the machine is extremely easy to thread—and the proximity of the reels to the actual operating deck is an advantage over the Electro Sound transport system which is raised and creates the possibility of tape fall.

The machine is incredibly quick-starting, even at 15 IPS, which is the speed I most often use. I have often started the transport in mid-sentence on the air, where on other machines I have had to edit leader into the tape to account for slow-start wow.

The manual velocity control is another device which gives quick access to material on tape. I can audition material at variable speeds from a slow crawl to the speed of fast forward—slip into reverse direction with a minimum of mechanical effort—and locate key segments at three to five times the speed of conventional decks.

*I intend to chain this demonstrator model to the wall when its test period is over. Congratulations to its manufacturer and designer for creating a machine with the human factor in mind.*



Mike Linder,  
WNEW Radio, New York

4007 NE 6th AVENUE / FORT LAUDERDALE, FLA. 33334 USA / (305) 566-2853 / TELEX 51-4362 MCI FT L

Want more details? Circle No. 4 on Product Info. Card.

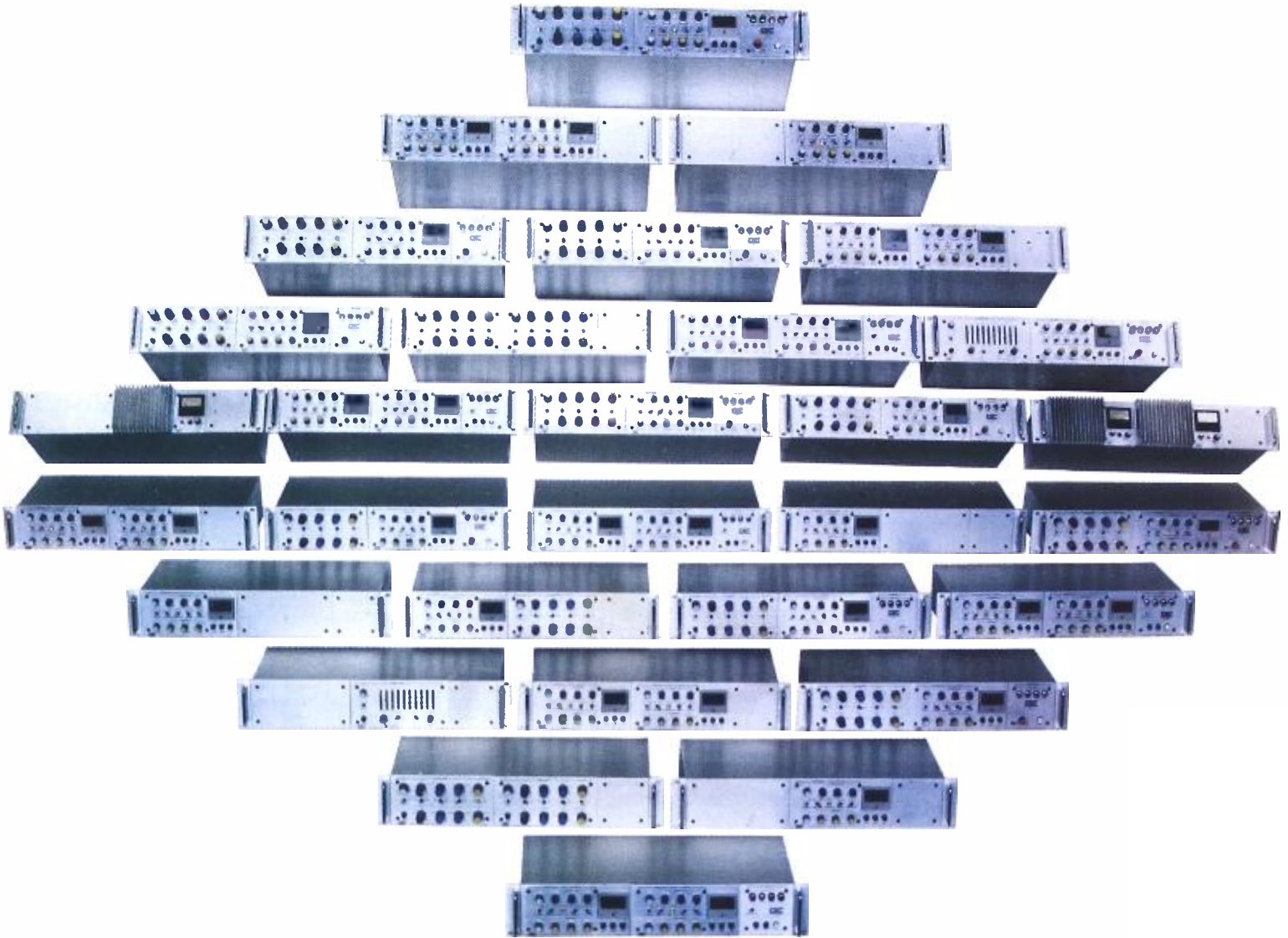
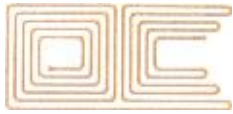

audio

ORANGE COUNTY is audio. Quality audio. Controlled audio. Professional audio. Clean audio.

In the 100th year of recorded sound, ORANGE COUNTY is proud to present its fourth generation of audio processing and audio monitoring equipment.

The ORANGE COUNTY VS-1 Stressor. The CLX-S-FM Stereo Processor. The CLX Com-

pressor/Limiter/Expander. The SEQ Parametric Equalizer. The GEQ Graphic Equalizer. The 200 Series Amplifiers. The BETA II Motional Feedback Monitor.

Allow us to send you our all new catalogue and the reasons more broadcasters and studios rely on ORANGE COUNTY. Or contact your nearest professional audio or broadcast equipment dealer.

**SEE US AT BOOTH 123 AT NRBA, OCT. 9-12 NEW ORLEANS HILTON**

The Orange County Electronics Corporation Ltd.  
1125 Empress St. Winnipeg, Manitoba R3E 3H1 (204) 775-8151



USE THIS CARD FOR MORE FACTS ON ITEMS SEEN IN THIS ISSUE

Name \_\_\_\_\_  
 Title \_\_\_\_\_  
 Station/Company \_\_\_\_\_  
 Address \_\_\_\_\_  Office  Home  
 City \_\_\_\_\_ State \_\_\_\_\_ Zip \_\_\_\_\_

**PLEASE CHECK APPROPRIATE CATEGORY:**

RADIO:  AM  FM  Stereo  Live  Automated *Format:* \_\_\_\_\_  
 Manufacturer  Syndicator  Production Co.  Other: \_\_\_\_\_  
 TELEVISION:  VHF  UHF  
 Manufacturer  Syndicator  Production Co.  Other: \_\_\_\_\_  
 Your Comments: \_\_\_\_\_

**SEND INFORMATION ON ITEMS CIRCLED BELOW:**

1	2	3	4	5	6	7	8	9	10	11	12	13	14	15	16	17	18	19	20
21	22	23	24	25	26	27	28	29	30	31	32	33	34	35	36	37	38	39	40
41	42	43	44	45	46	47	48	49	50	51	52	53	54	55	56	57	58	59	60
61	62	63	64	65	66	67	68	69	70	71	72	73	74	75	76	77	78	79	80
81	82	83	84	85	86	87	88	89	90	91	92	93	94	95	96	97	98	99	100
101	102	103	104	105	106	107	108	109	110	111	112	113	114	115	116	117	118	119	120

Use this card up to 6 months after issue date.



The author: Don Elliot is operations manager at KIIS AM-FM, Los Angeles, and a regular contributor to "BP&P."

phase with. Of course, this is only for mono material; and it is just honing down things a bit further. But it really helps in cleaning up the act!

**REMOTE CONTROL**

I don't know how anybody can live without remote controls on most or all of the machines. A really handy function to have is a master start switch that sets everything in the room that's armed into motion all at once. Tape 1, 2, 3, Turntable, Cart, etc., all start simultaneously with one switch. This helps in putting together spots which involve many different elements that have to start all at once... a task that is sometimes impossible with only two hands.

Individual remotes don't have to be the brand-name box that the manufacturer sells with the machine (or as an optional accessory). You can buy several microphones with what it would cost to

**VARI-SPEED CONTROL**

A very make-shift pitch change can be afforded by simply using a capstan wrap (actually wrapping tape around the capstan). Splicing tape is the best to use. You can easily raise the pitch a half, whole, or even two tones of the music scale by trial and error. If you want to slow something down by the same amount, leave the tape on the capstan and record. Remove the wrap and playback. The material was recorded faster and of course will now playback slower. Very handy to match musical pitches in a segue for a super smooth end result.

Going a little more advanced — if you can obtain an electronic device called a "harmonizer", you can restore the original pitch of your material while altering its length (and vice-versa). You can now shrink or stretch a spot's length without changing the pitch of the voice or music. We're all too familiar with trying to speed up a voice with it ending up sounding like Donald Duck. That won't happen with a harmonizer device.

suggested easy accessibility to the playback head of at least one of your machines for out-of-house tapes that come in out of azimuth. An additional aid is to take one channel of a two-track machine, and "Y-it" to both channels of the board. That way, there's no other channel for it to be out of

**SPLICE FINDER —  
RAPID Q APPLICATION**

If all your cartridges have been properly and reliably cued past the splice, you have created an advantageous situation you probably weren't even aware of: cheap rapid-cue!

With a splice-finder in the air studio for the jock, he can now preview song intros, run-through spots, and in short, take advantage of all that rapid-cue offers. Just drop the cart into the finder, and run it high-speed until it cues up. Re-cycle it in an actual cart machine to find the real cue tone, which

Figures 1, 2, and 3. Wiring diagrams for remote switch for Ampex and Scully tape decks.

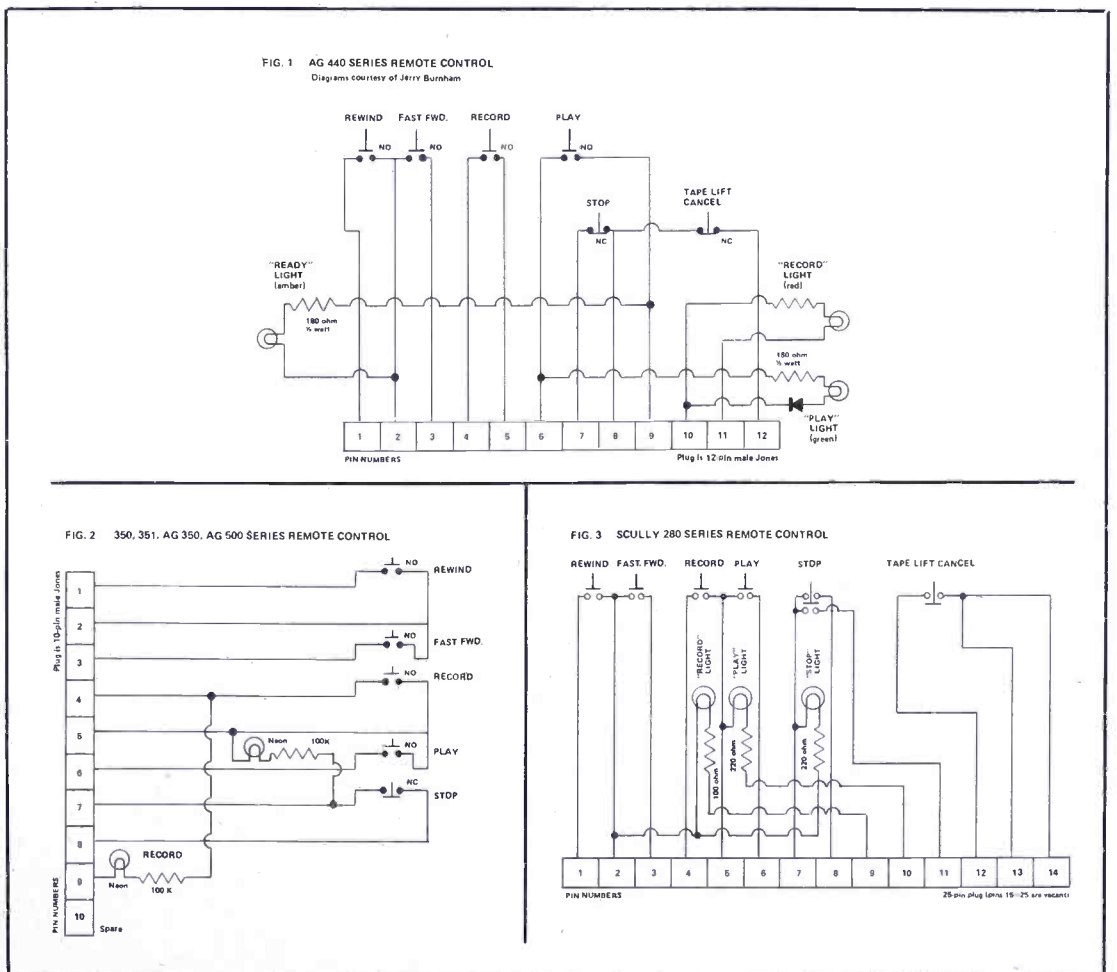



# The best audio recorder in the world.

Buy an Ampex ATR-100 for your studio, and you'll have the finest audio recorder ever offered for sale. Use it for monaural, two-channel and four-channel work, and you'll produce recordings (and playbacks) that simply cannot be matched by any other machine.

The fully servoed transport with automatic tension control and dynamic braking nails down tape speed for unprecedented timing accuracy. By eliminating the pinch roller and employing a unique tape path design, Ampex found a way to greatly extend tape life and reduce transient stresses. Spin the capstan, and both reels follow suit. Try to start the transport with the tape loose, and nothing happens. Kick out the power cord during fast rewind, and the machine slows gradually to a programmed stop.

The lift-out control panel has LED indicators for status on every channel, and control is a matter of touching calculator-like buttons. Search-to-cue arms at a touch and stops on a dime. You even get a choice of 60 or 120 ips shuttle speed under capstan control plus a superfast rewind speed.

Mechanical features of the ATR-100 are important, but don't overlook audio performance. Many specs are a full order of magnitude better than anything else on the market, and *every* performance measurement is the world standard. ATR-100 is what Ampex knows about sound recording.

Get the complete story on this ultimate performance recorder by requesting a free brochure on the ATR-100. The best audio recorder in the world.



## AMPEX

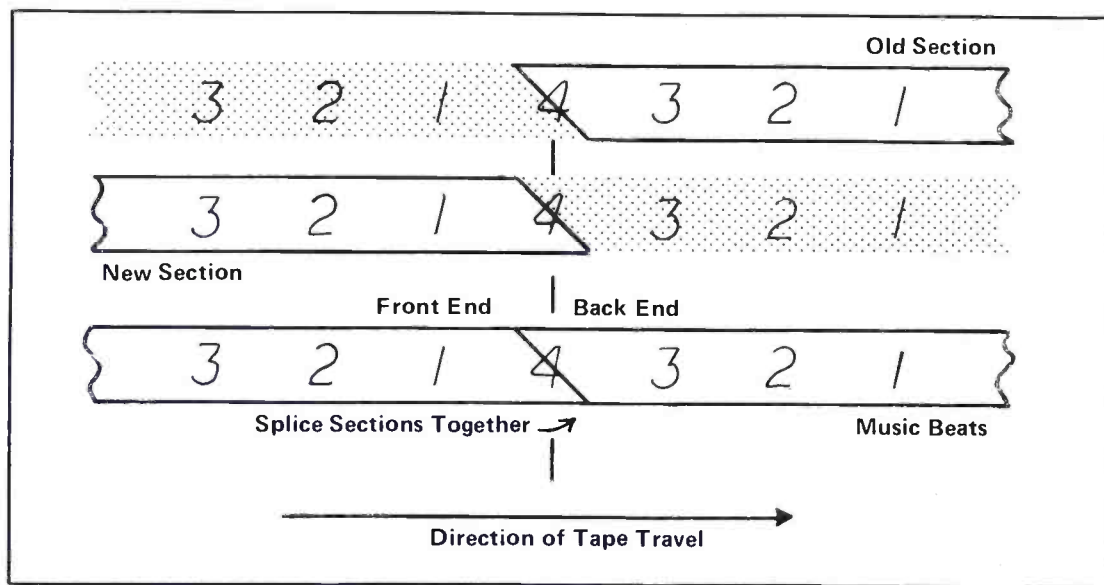

Figure 4. Assembly editing requires splices to be made on the proper beats (see text).

is highly professional, it isn't fast.

### VOICE OR MUSIC FIRST?

**Voice First:** If you are combo-ing the spot (voicing yourself), doing the voice track separately affords you the luxury of mixing on speakers instead of having to hear your mix in headphones. Also, you can change the music bed later, edit, or do updates more readily if you have an isolated voice track. The disadvantage is that it is not as flexible as "live" voicing because you can't "phrase" to the beat of the music bed.

**Music First:** If you are going to build the music track first, say for an l.p. spot, then the copy must fit in the backgrounds you're providing. This is probably the ideal way, but it doesn't always come to you with carte blanche on a silver platter. Quite often, an l.p. spot is written by someone in an ad agency who may have never even heard the l.p.! So if they won't give you some flexibility with the spot, they're only killing themselves. It is most convenient to at least have a happy working relationship with the agency or client to a degree, that allows you the "OK" to re-work their phrasing to time-out to music or to make the copy natural and "radio-enough" to sell without sounding like newspaper copy.

**Both First:** In a high percentage of cases, both first (my favorite) — assembly edit in sections with music changes or transitions, and 'live' announcer over: you need an ability to phrase to the beat and to the best edit point for the upcoming event to be edited to. This is an essential aptitude here, and it will mark the difference between a polished or un-polished piece. If you can "feel" the talk-up to a vocal without a timer, or hopefully, can count to 4, if you know what I mean (if you were in the High School Band you will), then you can do it. In other words, if the front end of the piece you're editing to starts with a pick-up note (on, say, the 4th beat), then you'd better edit it to the 4th beat of the back end of the piece you're coming out of (and voicing over — so you've got to know where to get out without hearing the new piece in your headphones). Of course, you have to preview the materials to get the edit points in your mind.

Let's again use an l.p. spot as an example. You're approximately two songs

remote a couple of decks that way. For 50 cents per switch, you can make a push-button panel with all the machines appearing on it individually.

### LIMITER USE AND ABUSE

If you have a limiter in production, it is advantageous to be able to switch it in and out quickly, or at least have patch-ability. Balance it out right with tones so that the levels will be the same at the input to the tape machines whether the limiter is switched in or out.

As a general rule, it is a good idea to only process the product through the limiter once, whether it's in your final mix to your master, or in dubbing to cart.

Secondary and tertiary use of tones for cue purposes:

At stations where music is on cart, holding in the secondary cue tone for the last 30-45 seconds of the record provides a tone which can light an additional cue light in front of the jock for a "record ending" warning. At KIIS, we went whole hog on this idea... mounting not a neon panel lamp... but a pair of truck tail-lights on the console so that you'll be warned even if you're across the room filing carts or taking transmitter readings. Additionally, the "On

Air" light outside the door can be two-colored... Red for "On Air", and Yellow for an air warning. This is in case the jock is in the hall... or someone is about to enter the studio just seconds prior to the jock's stop set... which could distract him. This cue light is also used on the end of spots to confirm the label's outcue. Additionally, you might use the tertiary cue tone to flash another colored light for *live tags* or *donut cues*.

### ASSEMBLE METHODS

An extremely time consuming and somewhat primitive method for complex production without a multi-track recorder is to arrange the voice track on one tape machine with leader at the head. Assemble *in order* the music and sound effects on a second (and third, if you have it) machine. Now, by simultaneously starting all machines from a pre-marked point on the leader of each, it is now possible to move any element in relation to each other: voice tracks, sound effects, or music beds, by adding or subtracting the appropriate amount of leader by timing and trial and error. It also gives you independent control of the level of each piece, just like a multi-track machine, but... you'd better bring your lunch because even though the result

Figure 5. Making a simple microphone pop filter/wind screen.

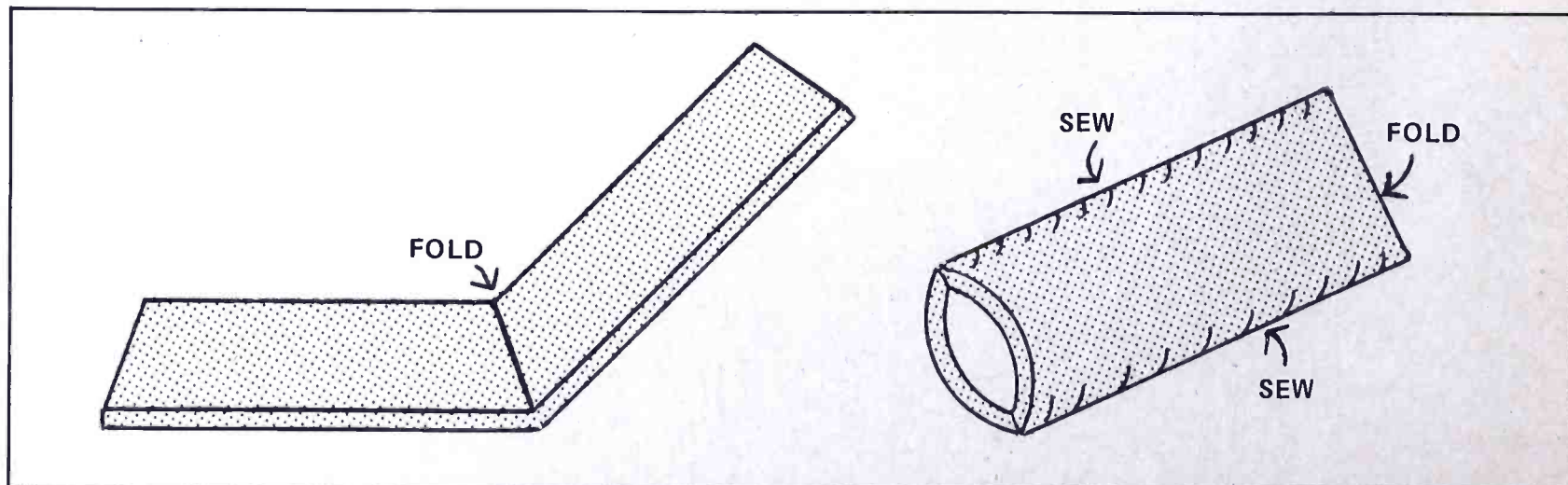

into the spot, and maybe around one-half way through . . . but the advantages of the assemble-edit method bring along another molehill to overcome: overall length. Since you are assembly-editing in sections, it is difficult in the planning stages to nail it down to the magic :30 or :60 on the nose.

So, at this point, do a 'preview edit' for yourself. Play through the first half with your timer running and the voice track cued-up to the remainder of the spot where it would pick up at the half-way point, or read it live if you're doing it that way. Then if your voice track ends up at, say, :54, it simply means that you have :06 of music needed to fill in the next transition.

Assembly-editing with an existing voice track does lend itself to this technique because it is possible to move the voice track slightly when you punch it up with respect to the track. You might even space it with leader or cut breaths if it doesn't injure interpretation. Learn to homogenize all the techniques and blend them when you need them at a moment's notice, depending on the situation at hand.

### THE DUBBING STAGE

1. Clean up the intro of the spot — there could be noise, wow, or scratch. The most efficient way is with white paper leader. Plastic is a static generator.

2. If you can't dub to cart tight without wowing either because of an inadequacy of

the machine or you don't have a consistent knack, then try this secondary method and use whichever is best for you: If you're at 15 ips, back-cue the start of the sound to the erase head. If at 7½ ips, then back-cue just to the record head. Start the reel-to-reel first (in playback), and then start (in record mode) the cart machine like it was the second syllable of a word — "ka-lunk, 1 - 2" kind of feel. Practice for the right feel. If you roll another reel-to-reel on record at the same time you are dubbing to cart, you'll have a master that's of the same generation as the cartridge itself, eliminating the need to master from the cart, or to master on reel and dub another generation down by the time you get to cart.

Of course, if it is a piece of complex production, you are already dubbing from a master.

If you need two duplicate carts of the same spot (say you simulcast or maybe make a set for remotes or a transmitter location), you can cut production time in half by starting and feeding two cart machines simultaneously from one run of the master.

3. If the material you are dubbing was furnished on a reel with a small hub, re-spool it onto a reel with a large NAB hub. Keep a couple of empties around like this for this purpose. The machines work better with the tensions that the NAB hub reels provide, and it will help starting on speed



**8 powerful formats for automated or live radio.**  
**Complete Library Service • Mono or Stereo**  
 CaVox Stereo Productions, 502 S. Isis, Inglewood, CA 90301  
 Call Bob Mayfield collect at (213) 776-6933  
 NRBA Suite 1823

Want more details?  
 Circle No. 8 on Product Info. Card.

and won't cause an off-speed, slowing-down condition at the end of the reel.

4. If this tension problem is a big "bugaboo", play with the tension switches on the later-model tape decks that feature such switches. Optimize tensions per the maintenance manual. It might take some doing or assistance from an engineer. If he doesn't have the tools, some sporting goods supply houses have fishing scales you can hook a string to and wrap around the reels where the tape would normally thread. This gives you the capability of measuring the tension to obtain the proper settings.

The pressure roller is critical, too. It should be set at 5 pounds pullaway pressure on most Ampex decks. Check your manual, though, for your particular model.

### COVERING BAD TRANSITIONS OR EDITS

Isolate a cymbal from an l.p. sound effects record. Preferably not a cymbal with

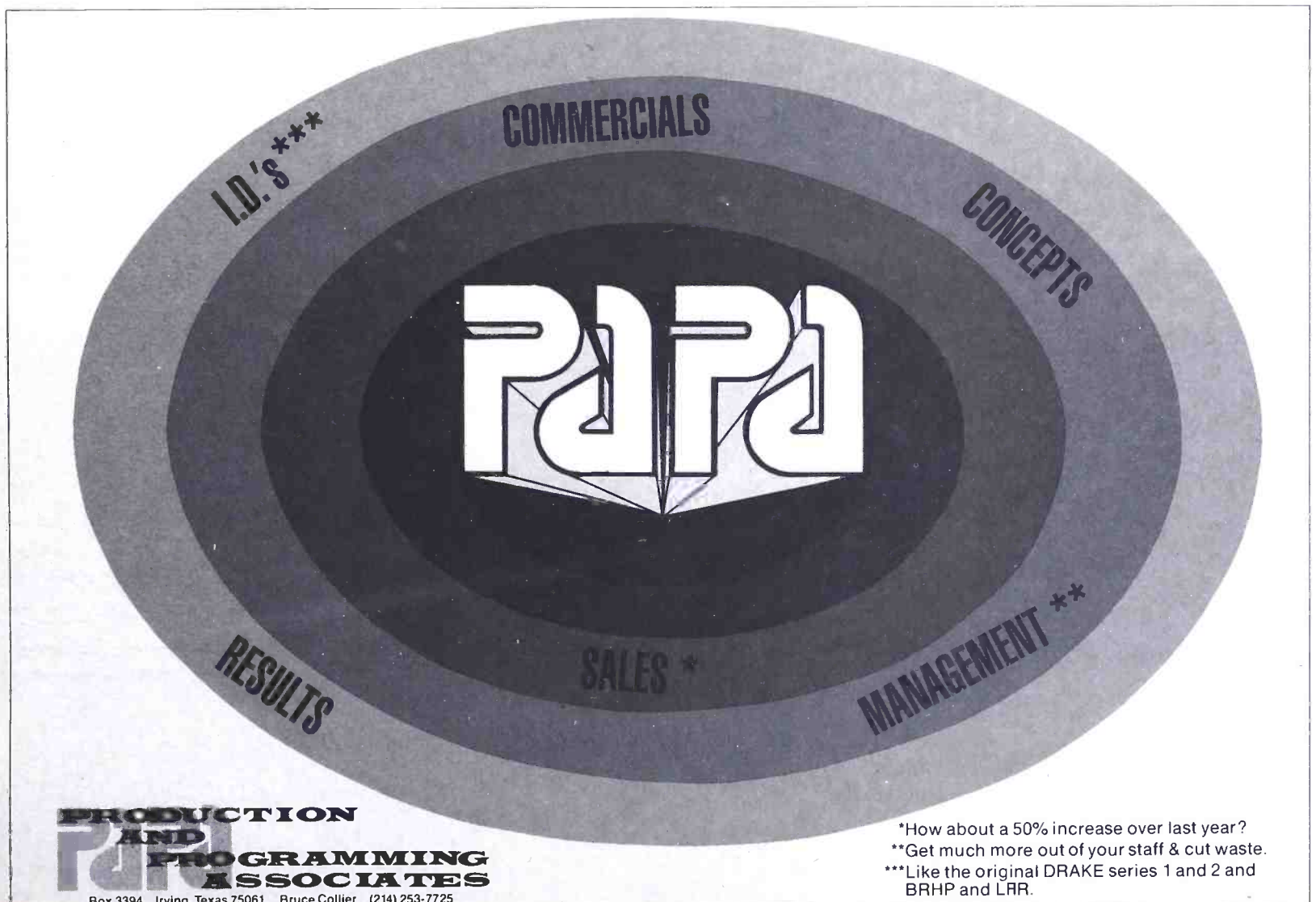

**PRODUCTION AND PROGRAMMING ASSOCIATES**  
 Box 3394 Irving, Texas 75061 Bruce Collier (214) 253-7725

\*How about a 50% increase over last year?  
 \*\*Get much more out of your staff & cut waste.  
 \*\*\*Like the original DRAKE series 1 and 2 and BRHP and LRR.

Want more details? Circle No. 7 on Product Info. Card.

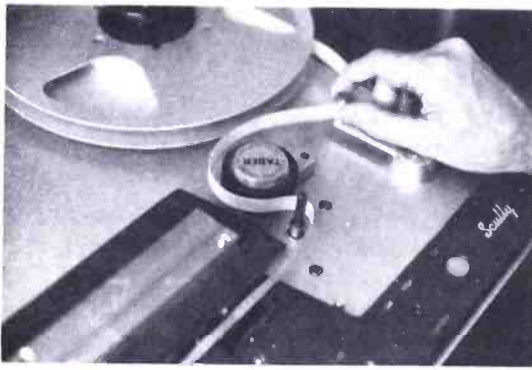

Threading technique to make a reel-to-reel machine run backwards.

an impact, but rather, one with a rising crescendo. Use it by overdubbing it onto another track covering a bad edit or segue that doesn't work. If you only have a two-track machine, and you've run out of tracks, you can still do it by re-dubbing to another machine, taking one generation loss, or go direct to cart, adding the cymbal at the right time in the process.

Search for other sounds that accomplish the same thing. It is a good effect in itself and isn't necessarily a "hide-it" technique.

Another method of doctoring a music edit that seems to drop out from abruptness, is to intensify the reverb momentarily at that point (that is, spring chamber reverb . . . not tape slap-back echo). It makes the source sound as though it ended live, rather than being clipped off, and if you have that source on a separate track, you can make the reverb overlap and segue over the next track by simply sending only *that* track to the reverb input (or "reverb send"). Return it to *center* if you're producing in stereo.

### MIKE POP FILTER/WINDSCREEN

Making your own pop filters and

windscreens is simple. Low density polyurethane fabric is available in sheets ( $\frac{1}{8}$  to  $\frac{1}{4}$  inch thick) that you can cut with scissors, and it's easy to sew. Simply tailor the measurements to the particular microphone, then sew the edges together, turn it inside-out, and pull it over the mike. This is an acceptable, acoustically transparent device that will save you \$10 and up . . . along with the wind and pop noises.

### RUNNING A REEL-TO-REEL MACHINE BACKWARDS

You can make most tape machines run backwards without any modification whatsoever, by threading the tape as illustrated.

Anytime your production calls for something running backwards, it is now possible with this method. If you're using backwards elements to enhance something, the level you mix it at will greatly understate or over-produce the effect . . . so keep it believable.

### BACKTIMING

To time-out a voice track, or anything else to the music bed before a vocal, where you are already locked in to using an existing voice or sound on tape, thread the machine as above (for playing backwards) after you have cued the music track to the vocal, or point where you want to hit after the voice track (you will be playing the music backwards from this point). Start the voice track at the beginning, simultaneously with the backwards music track, and when the voice gets to the end or cue-word (it helps if you've leadered it), stop both machines. With a grease pencil, make a temporary "music" mark here on the music track. This is where you'll hit the beginning of the voice track when you mix. If you weren't lucky

enough to have this point be on a spliceable beat, back-up further until you find the proper edit beat, and still start the voice track when you get to the music mark.

### BULK ERASE TECHNIQUE

How many times have you watched someone "scrub" a cart over a bulk eraser only to pop it into a machine and hear that aggravating "whomp, whomp" from the low frequency that got introduced onto the tape as the previous material got erased?

Here's a faster method that's cleaner, too . . . if you have the type of bulk eraser as shown in the photo.

Cue the cartridge to the splice (as usual). Start the eraser with the cart several feet from it. With a slow 3-second operation, push the cartridge across the top, flip it over counter-clockwise (upside-down) after you have entirely passed over the top, and pull it slowly back in another 3-second stroke. Turn the eraser off at a safe distance again. Advance the cart in the machine just an inch or so (simply start-stop it quickly and repeat the erase procedure). This helps eliminate any residual signal from tape positioning in the cart.

This method consistently removes noise to practically virgin tape level, and is faster once you get into a routine rhythm with it.

The creative person reminds himself that there isn't any "book" out there somewhere . . . there really aren't any rules once you hike up to that certain plateau of professionalism. The key is having the tools, aptitude, and an open mind since, quite often, more ideas happen once you sit down in the production room.

It's been my intent here to show you a few more ideas without talking "too hip for the room." Sometimes you have to go back to basics. I hope that with minimal time and equipment, you'll be able to achieve blue chip results for your creative efforts.

**Cartridge bulk-erasing technique:** Start eraser with cart several feet away. With a slow, 3-second operation, push cart across top, flip it counter-clockwise, and pull it slowly back in another 3 second stroke. Turn eraser off when cart is again a safe distance away.

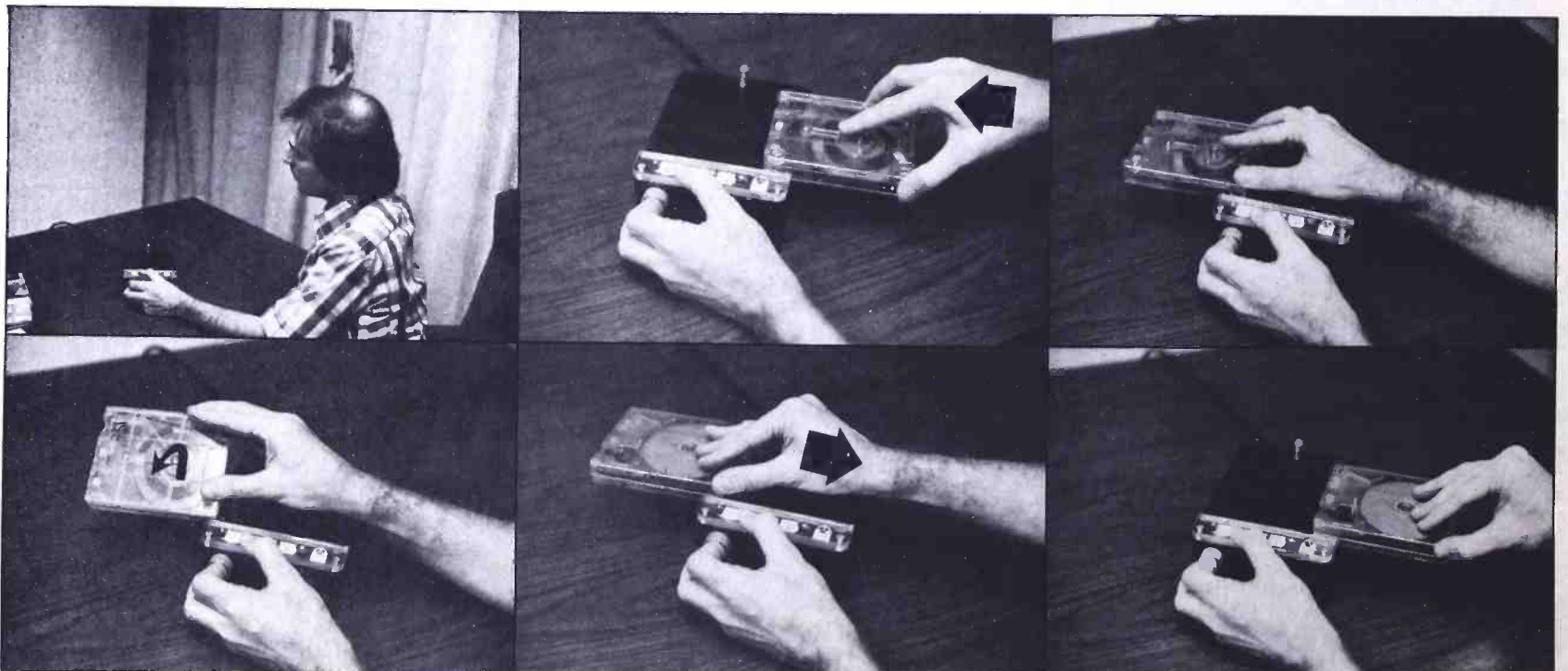

# A Harris Automation System Customer Says It All...

**W Q F L**

**RON TIETSORT**  
MANAGER

5500 E. RIVERSIDE BLVD. • ROCKFORD, ILLINOIS 61111  
PHONE: 815/654-1200

Attn: President, Broadcast Products Division, Harris Corp.  
P. O. Box 290  
Quincy, Illinois 62301

Dear Sir:

We have had the System 90 on the premises since April 21 and since learning how to use it effectively, we have enjoyed working with it immensely.

Being a religious station with many taped programs, we have one of the most difficult formats in the industry; this is one of the main reasons we chose the System 90. All the other companies that presented automation systems to us had such rigid programming that we would have had to compromise our format at every turn.

In the three months since April we have changed programming instructions completely 3 times cutting the number of events used in the main format from 80 to 24, for a seven day period. We have reduced the number of time corrections needed from 54 to 18. We can change instructions completely for all this in less than 5 minutes using the TI ASR 733 terminal. In fact it takes longer to dream up new programming ideas than to program them! This System 90 is marvelous! We've never had so much fun doing our work and it is turning some of our staff into computer nuts! And its reliability is beyond belief.

On July 18 we had a very violent electrical storm during which a nearly direct lightning strike knocked us off the air for over an hour. The only damage that the system incurred was a shorted LDR in the back of the audio switcher. No memory loss, no burned components, no lost time on the clock.

What else can I say? We're excited about the System 90!

Enthusiastically,

*Wayne Cook*

Wayne Cook, Chief Engineer

"Leading the Way to Christ..."  
CHRISTIAN RADIO  
100.9 FM • 24 HOUR STEREO  
QUEST FOR LIFE, INC.

handles difficult  
format with no  
problems

most flexible  
system

programming  
instructions  
changed quickly,  
easily

excellent  
reliability

so are we...  
contact us for  
more information

For the whole story, contact  
Harris Corporation  
Broadcast Products Division  
Quincy, Illinois 62301



**HARRIS**  
COMMUNICATIONS AND  
INFORMATION HANDLING

# Getting "Set" for TV News

---

**What role does a news set play in the presentation and ratings of a newscast?**

by Mark Bragg

The following account of events regarding a major market television station's newscast is true. It really did happen. However, no identification is given to protect the innocent.

It was late 1975.

The ratings were absolutely awful. Management stood by watching helplessly while share points dropped away like dying mosquitoes in a "No Pest" commercial. When the subject of news broadcasts would come up during agency calls, the station account executives would fidget in their seats, fumble with their ties, bite their lips and finally end up sitting on their hands while trying to explain how hard it was to find news to report, what with Watergate and all.

Finally, in what would become the second to last straw, old, old *Lucy* reruns on a competing station edged out the early news to make it the least watched program in the

history of the station, if not in all the history of television. In the gospel according to Nielsen, no one was watching the news and seven people were badmouthing the broadcast. That was the last straw.

Management quickly replaced all the talent, most of whom went on to better success at competing stations. But management also found another scapegoat. It was the set. After trying just about everything else, management ludicrously decided the set was the culprit . . . responsible for driving away the viewers. The set had to go. In this one instance, the set was replaced through massive reconstruction of the station's entire physical plant at a cost some insiders put at nearly seven hundred thousand dollars! At this station, the entire news broadcasts have been redesigned by a new management team, but the ratings are still lousy.

The truth is, a news set isn't nearly as important to success as it seems to be when a station is failing. It's just one of the elements, deserving time, artistic attention, creativity and money . . . and there is almost never enough of any of them when they're needed. The best time, therefore, to be thinking about a new news set is when the old one is working just fine.

If the budget permits, it is probably more advantageous to utilize the service of an experienced set designer in creating the environment in which you present your news.

Too often, a news set consists of an orange cyc with dayglo green letters that scream SIX O'CLOCK REPORT at the viewer as he runs to the bathroom. Electronic advances also mitigate against

the possible success of someone designing a set who is not caught up on all the latest equipment and techniques available.

The missing element in most local set design today is . . . design. There are so few trained set designers outside of the networks and O&O's that it's a wonder any designing gets done at all. While the reasons for that may be obvious (declining amounts of local production, smaller budgets, etc.), the results are equally obvious. You need only compare your local news set to the network news sets. After all, your viewers are making the comparison, too.

The viewability, credibility and saleability of network news broadcasts are based on how professional those folks and their environments look. So they look good. While you probably cannot afford to look as good as they do, you can read the advice that follows and give it your best shot. The advice comes from one of those set designers whose work you may have admired or even envied: Lou Dorfsman, Senior Vice-President and Creative Director for Advertising and Design for the CBS Broadcast Group. It is preceded by some general guidelines from a variety of sources, including the Mitchell Group and television news consultants.

## **SIMPLICITY**

On the small outdoor sign that is the only indicator of the existence of the most exclusive hair salon in Beverly Hills, there is a barely visible inscription that reads, "Simplicity is the essence of good taste." According to the professionals, that sign should be preceded by the phrase "In video . . ." and hung on the wall of every news set in



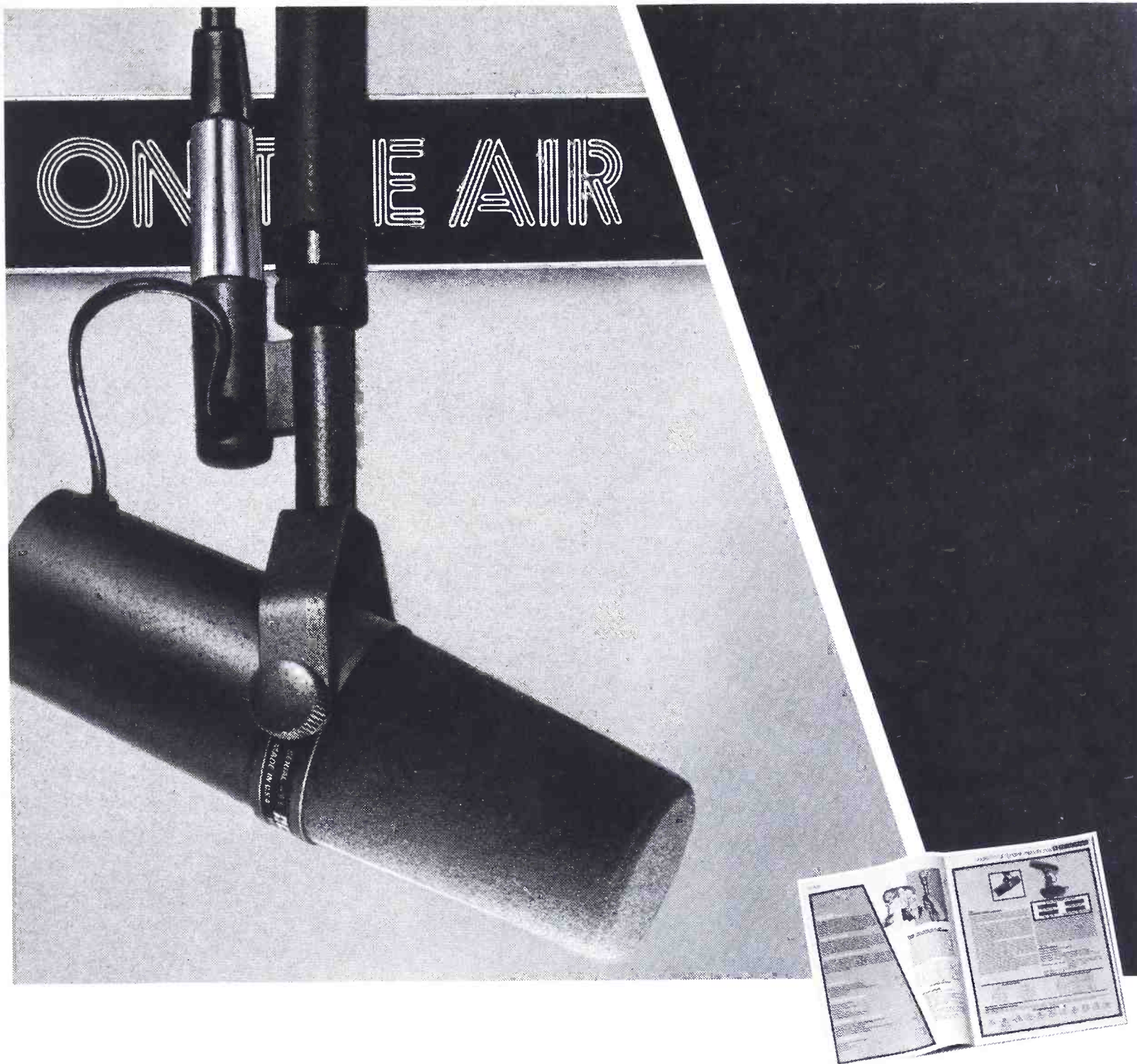

## Station Master.

You can virtually drive coast-to-coast without leaving the sound of a radio station using a Shure microphone. In fact, you'll encounter almost as many different models of Shure microphones as you will states.

Case in point: the Shure SM7. It features a wide-range, ultra-smooth frequency response with show 'n' tell switches that allow the user to select any of four microphone response curves: (1) flat response; (2) presence boost; (3) bass rolloff; and (4) presence boost with bass rolloff.

The SM7 also uses an innovative "air suspension" integral shock mount for super-isolation against mechanical and shock noise.

Ask your Shure dealer for a demonstration of the show 'n' tell SM7. It's one Shure "show" worth telling everybody about.

Shure Brothers Inc.  
222 Hartrey Ave., Evanston, IL 60204  
In Canada:  
A. C. Simmonds & Sons Limited

### TECHNICORNER

The Shure SM7 is a unidirectional dynamic microphone with a 40 to 16,000 Hz frequency response. Noise reduction systems cut mechanical noises, breath "pop," wind, and electromagnetic hum. "Add-on" filter devices are unnecessary. The SM7's integral foam wind/"pop" filter reduces even difficult close-up breath sounds. Impedance is rated at 150 ohms for microphone inputs rated from 19 to 300 ohms. Output level: -57 dB (0 dB = 1 milliwatt per 10 microbars); open circuit voltage: -79 dB (0 dB = 1 volt per microbar).

 **SHURE**®

MANUFACTURERS OF HIGH FIDELITY COMPONENTS, MICROPHONES, SOUND SYSTEMS AND RELATED CIRCUITRY.

Want more details? Circle No. 10 on Product Info. Card.

BP&P 19

the country.

Anyone who spent time in the service will remember the acronym, "KISS". It stands for "Keep It Simple Stupid". On a television news set it means the less there is that can go wrong, the less there is that will go wrong. It also means the viewer will be paying more attention to content than to possible distractions. There should be a logical reason (from the viewer standpoint) for everything on the news set.

Some other key points:

1. News sets generally should be designed around the station's anchor people. The design should fit the people who are using it. Obviously, a short anchorman or woman will not look good behind a podium designed for a tall newscaster. Attention should be paid to proportions of the individuals as well as the overall representation. If the station changes anchor people, re-examine the news set to see if the new people really fit.

2. The set design should also fit the format. If the flow of the format is swimming against the current of the set, viewers may get tired and sink to the depths of watching a competitor. It must be as easy for the viewer to follow a camera angle change as it is for the director to direct it. If camera operators have trouble getting their shots or on-camera personnel have trouble getting to their positions, viewers will have little trouble getting to their channel selectors to move on.

3. A clean set is basic and essential. Avoid designs that distract news watchers. Clutter, geometrics, props of various descriptions and cosmetic effects all tend to be merely distractions.

4. A set design should take into consideration different ways to maximize use of people other than the anchor(s) on the set. Many news formats are making increasing use of on-camera, in studio visits by newsmakers. If it is difficult to accommodate them in a natural looking and comfortable seating arrangement, the opportunity may be lost. The set may also need to accommodate on-camera visits by reporters who normally work in the field.

5. In addition to being simple and adaptable, a new news set should be able to be modified and changed without major reconstruction. It is often difficult to tell if a set will work in day-to-day operation unless it's been tried for a shakedown period.

### THE NEWSROOM SET

Probably the first thing one should do when contemplating a *Newsroom* set is to forget everything they've ever learned about set design. The Newsroom set, after all, really isn't a set. It is the actual newsroom. And while it has many advantages of credibility, fascination, and viewer interest, the Newsroom set also has more pitfalls than Tarzan ever fell into, and they're full of sharpened bamboo sticks.

If you've seen a major market Newsroom

set, you have seen those kinds of sets at their best and worst because virtually all of them are still being used as vehicles for some experimentation. Here is some of what's been learned about their use.

1. Props that appear to be genuine articles (not to appear as props), must be kept away from the anchor desks. Clutter on the desks may make it look lived in, but the anchor desks must not look disorganized.

2. Monitors are both the angels and the devils of any Newsroom set. While it looks very technical and fascinating to many viewers to see multiple sets monitoring different pictures, it's only good for a wide, establishing shot coming into or out of breaks from the actual news delivery. Movement on the set (especially movement of pictures on monitors) during the news delivery is totally distracting to the viewer and eventually becomes an irritant. There should be NO movement behind the anchors while they are on camera. This generally requires the use of a blank wall or cyc and careful planning of camera angles.

3. Because it is a working environment as well as a news set, writers, editors, secretaries and other daytime personnel must be sensitized to the on-air requirements of the newsroom. Once camera angles are established and tested, simply changing the angle of a picture as it sits on a desk in the background can cause a light reflection which can cause seizures in the booth.

Those are some general suggestions about do's and don'ts and they apply to almost every news operation. While they may seem obvious to someone who knows practical news set design, there doesn't appear to be an overabundance of those folks around.

But what does a real professional have to say about his own set? Clearly there is more than one professional set designer in all of American television. However, we have chosen the following man for a variety of reasons.

As Senior Vice-President and Creative Director for Advertising and Design for the CBS Broadcast Group, Lou Dorfsman has more experience than almost anyone in the business. He also has earned more recognition from his colleagues than most. It includes 13 gold medals and 22 awards of distinction for design from the New York Art Directors Club... a very stylish group. In his 31 years at CBS, Dorfsman has witnessed the genesis of television, has participated in much of its development, and has led many of its design advances.

In the captions to the accompanying photographs, Lou Dorfsman describes why he designed the WCBS-TV news set as he did. In what seems to be a rather typical kind of quiet understatement, Dorfsman appeals for greater professionalism on the local station level. He reminds news directors and general managers that "... designers can positively effect the atmosphere in which the news is presented."

## AH'S NEW 6 IN 2 OUT PRODUCTION MIXER



A&H's S6-2 is designed for economical broadcast and disco mixing. It has linear faders throughout; stereo main out; 2 stereo phono and 2 stereo tape inputs; 2 mic.; and a "ducking" circuit for voiceovers. Specs available from the dealers listed or A&H's USA representative...

### audiomarketing Ltd.

142 Hamilton Ave., Stamford, CT 06902 TEL: 203 359 2315 TELEX: 99 6519

Alpha Electronics, Takoma Park, MD  
Associated Audio, Sacramento, CA  
Audio Consultants, Nashville, TN  
Audiotechniques, Stamford, CT  
Brandybrook, Derby, CT

Ford Audio, Oklahoma City, OK  
Fred Locke Professional, Berlin, CT  
Hun Sound, San Rafael, CA  
Janco Pro. Sound, San Diego, CA  
Taber Mfg. & Eng., San Leandro, CA

SEE US IN ROOM 10E AT THE AES CONVENTION.

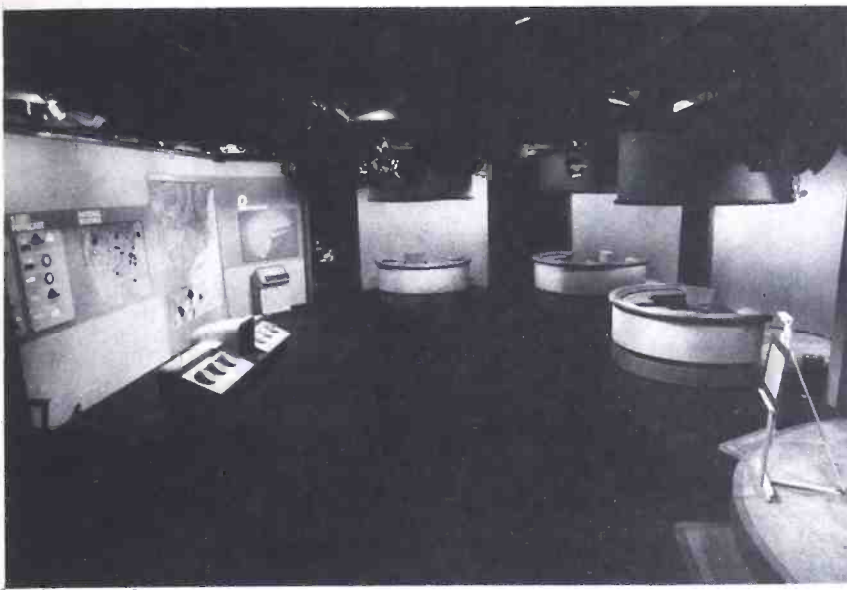

An overall view of the WCBS-TV news set without people or cameras. Some of the features of the set include a clear, unobstructed working floor space for cameras and technical people. Cameras can move past each other and shoot past each other with ease in order to give the TD a variety of options. The easel for studio art cards is sitting on the platform designed for live interviews. It can be moved to other positions when the set is in use. One of the most unique features of the set is its flexibility. It is used on both 6 and 11 o'clock news broadcasts. Designer Lou Dorfsman wanted to give the set the capability of looking either slightly or substantially different for each broadcast so the different modules are each built on casters allowing them to be moved around easily.



Although it doesn't show, the set gives a warm feeling to the viewer. It's accomplished with a color scheme of coordinated Earth tones of tans and browns. Carpeting is a rich, chocolate brown. That color scheme carries from module to module and includes the interview area at the lower right. While there is extensive use of chroma key effects, the backgrounds of each of the modules is light tan right up until a moment before the key is used. At the appropriate moment, the background is flooded with blue light. Blue and green colored lighting avoids the necessity of garish backgrounds.

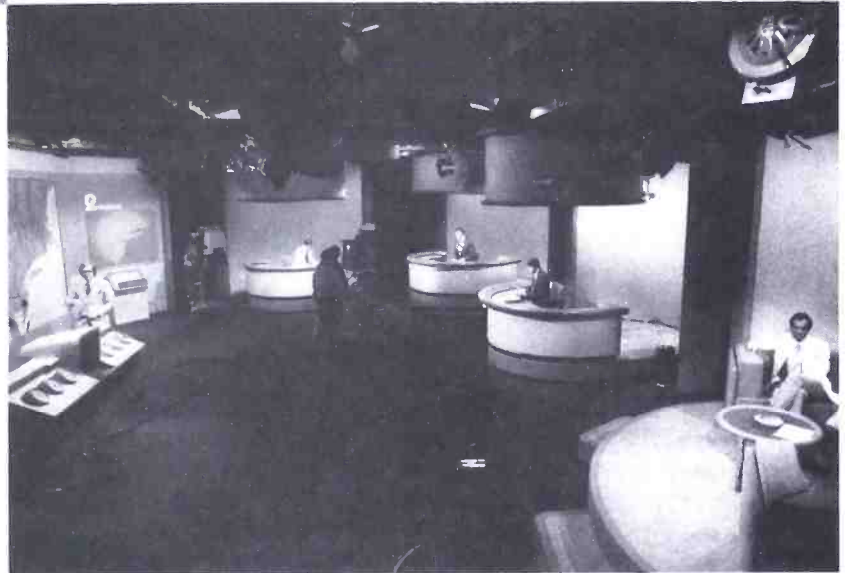

Proportions are paramount. In the module positions, Jim Jensen is the senior anchorman and also happens to be larger than Anchorman Rolland Smith. Jensen's position in the center of the three modules is somewhat elevated. It tends to lend greater authority to the reporter in the elevated position. While it is not imperative that there be a uniform, some coordination of clothing is helpful to the overall appearance.



Weather has a scientific and technical credibility all its own (except, of course, when the prediction is in error). The set uses this credibility by giving the viewer direct access to a greater than usual variety of weather instruments including the center mounted radar screen. Letters on the forecast board are designed around the same type font that's used for supering. Supers are of the same design character, executed on plexiglas and simply stuck to the map. The set was designed to be a completely integrated and unified system from opening graphics to closing credits.

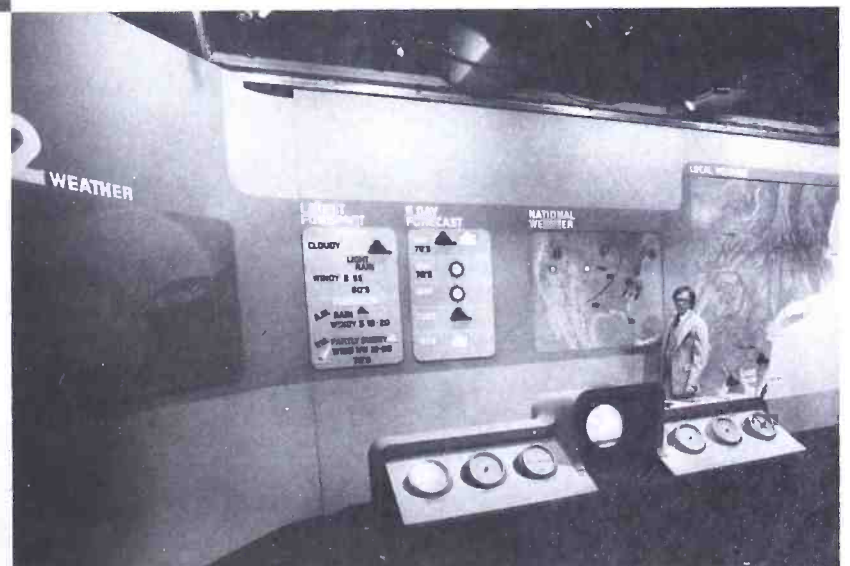

# Q&A:

## CBS News' Dan Rather

by Arlen Peters

Dan Rather is perpetual motion. On this particular day, he had flown in early from New York (one of those red eye flights), done a few interviews on his book "The Camera Never Blinks," and was now dashing into the Hollywood Brown Derby for this interview. It was noon and he had only twenty-five minutes to spare before rushing across the street to do the Merv Griffin Show, after which he was to do the Dinah Shore Show, then hop on a plane to be back in New York the following day for a special breakfast tribute to William Paley of CBS.

But for Rather it was all in a day's work. He looked none the worse for wear, still wearing makeup from his earlier TV appearances and with a dark blue pin striped

suit. For all intents and purposes he could have been a lawyer taking his case to court.

Amidst the rustling of silverware and the clatter of dishes, we settled into a corner booth and talked about his career in news and the state of news today.

*BP&P: You're a rare person who can say his career actually started in a 250-watt radio station.*

**Dan Rather:** That's the old joke, isn't it? I started out in the radio business in what you'd call a tea kettle. Two-hundred-fifty watts is the lowest wattage allowed by the FCC, you know, and this was a commercial station, not a college station. It was a three room shack in Huntsville, Texas. The signal was so poor we sold advertising time in a town fifteen miles away and they couldn't

even hear the station after six o'clock at night. Good old Kay Sam.

*BP&P: Kay Sam?*

**Dan Rather:** KSAM, those were the call letters. Owned by Pastor Ted Lott, a Baptist minister. I was hired at .40¢ an hour to keep the station on the air weekends. I always wanted to be a newspaper man, never thinking much about broadcasting. My first stumble was KSAM. You see, I couldn't spell well enough for newspaper work.

*BP&P: How did you get into television work?*

**Dan Rather:** My biggest break was going to work for KHOU, a CBS affiliate in Houston. I was the news director and also the anchorman on the 6 p.m. and 11 p.m. news. A man named Calvin Jones was the program manager and he gave me free rein as to what to do with our news coverage. That was 1960, 1961.

*BP&P: What was your competition like in Houston at the time?*

**Rather:** Tough. I remember the NBC affiliate was Channel 2. Head of their news staff was a man named Ray Miller who knew his business. The ABC affiliate, Channel 13, had good people working there but inadequate equipment.

*BP&P: What was your news philosophy then?*

**Rather:** Good, solid, live local coverage. There are so many stations, even today, who don't seem to learn that important point. The stations that pull big ratings are the ones that are able to get on top of a big story fast, stay right on top of it and leave after all the other stations.

*BP&P: Did you have any particular "big" stories you covered there?*

CBS Newsmen, Dan Rather.



**SHIRLEY JONES**  
**AND**  
**THE NATIONAL LEUKEMIA BROADCAST COUNCIL**  
**PROUDLY SALUTE**

**WOR\* New York WMAL\* Washington D.C. WIP\* Philadelphia**

and 71 other outstanding radio stations who have raised over \$1,500,000  
to fight Leukemia through research!

Leukemia is the number one child killing disease  
that kills even more adults than children.

We can find a cure for this dread disease  
faster if your radio station will join  
in the ANNUAL FIGHT LEUKEMIA DAY BROADCAST

**Please contact us now!**

**NLBC (National Leukemia Broadcast Council)**  
15233 Ventura Blvd., Sherman Oaks, CA 91403

- Phone Collect: (213) 990-0733 Jon Ross, Managing Director
- Shirley Jones, National Chairwoman, Leukemia Radiothon

**\* WOR, WMAL, WIP raised more than \$223,000 in less than 24 hours on February 26, 1977**

The following radio stations have raised over 1.5 million dollars:

*California:* KNEW, KLAC, KGIL, KFWB, KWKW, KFI, KGBS, KFMB, *Colorado:* KLZ, *Connecticut:* WCKQ, WMMM, WDJF, WINF, *Delaware:* WILM, *Washington D.C.:* WMAL, *Florida:* WQBA, WPBR, WEAT, WWRN, *Illinois:* WMAQ, *Kansas:* KFH, KXXX, WIBW, KJCK, KLWN, KSCB, KMKF, KAKE, KOAM, KSKG, *Kentucky:* WAVE, *Massachusetts:* WNCR, WCOP, WHDH, *Missouri:* KMBZ, KMOX, *New York:* WOR, WGR, WBEN, WNDR, WLFJ, WINR, WCMF, WVOR, WAXC, WNYR, WEZO, WPTR, *Ohio:* WHIO, WJW, *Pennsylvania:* WIP, WMLP, WFEC, WEEP, *Rhode Island:* WHIM, *Texas:* KDOK, KIKM, KWKC, KITE, KVLK, KPRC, *Virginia:* WTID, WFOG, WQRK, WNOR, WEOO, WMBG, WGH, WTAR, WKLK, WZAM, WCPK, WVEC, *Wisconsin:* WISN

**Rather:** The biggest, for me, because it led to a network job with CBS. It was September of 1961 and there was a storm brewing, a weather storm. Hurricane Carla. We first got reports of a storm on Tuesday. Calvin Jones didn't think much of it, but I suggested we watch it closely, especially over the upcoming weekend. Because we had such a small staff, extensive weekend coverage was almost impossible, but Cal agreed. I talked the station manager into taking a mobile unit to Galveston at a cost of about \$2,000 to better cover what I felt would be a massive news story. Carla struck on Monday, killing 12 people. The weather bureau credited us with keeping that total down because of all of our advance warnings to the public.

**BP&P:** *How did your minute staff hold up under all of this?*

**Rather:** We had ten people working and by Monday we had worked 72 hours straight. We ran out of food, ate mostly candy bars, lost our picture a couple of times but we did our duty. It was a hell of a reporting job.

**BP&P:** *And you then went with CBS?*

**Rather:** Well, they monitored our coverage very closely. There was a hint, even during the end of our coverage, that the people in New York were impressed with our coverage. They offered me a job and I turned it down, which most of my close friends couldn't believe. I was happy, having turned the news into a winner in Houston and didn't want to leave. Three months went by and CBS called again, this time with a better offer and I couldn't turn it down.

**BP&P:** *What was the move like, from Houston to CBS in New York?*

**Rather:** It was a cataclysmic event in my life. We had two small children and my wife and I had lived in Texas just about all of our lives. Then came the traveling. My first year I was home 35 days the whole year, the second year I was home 41 days. But I was fascinated by what I was doing, like being plunged into graduate school.

**BP&P:** *And what did you think of your new colleagues?*

**Rather:** Needless to say, I was in awe of them. Take Charles Collingwood. My first day at CBS I had the chance to meet him, even took his script to do my own audition. I wasn't used to using a prompter, so I looked over the script — I believe in talking things through — then I did this four-and-a-half minute newscast. It went well, too.

**BP&P:** *Do you recall your first day on the job?*

**Rather:** Pretty well. It was the first of March, 1962 and I was immediately thrust into a major news story. A plane that had taken off from New York had crashed and when the crew went running out to get the story, I asked to go along. I wound up doing the radio reports, with Dave Dugan covering the

TV coverage. Since there were no phones nearby, I went running off to the highway, flagged down a passing phone company van, explained my story to the phone man, and he climbed the nearest pole and hooked up a phone. I did hourly reports from then on.

**BP&P:** *Sounds chaotic.*

**Rather:** That's the name of the game. Broadcast journalism is chaotic, whether it be TV or radio, especially when you're on a big story. Most people don't understand how much and how often a line reporter on a TV network is flying by the seat of his pants. The reality of it all is being put down in yet another tank town where a riot is already underway, you get there at two in the afternoon and have to feed something at 4:30 or 5:00 p.m. to New York. There's a pell mell deadline on every story that's kind of addicting, yet exciting. But you also must remember that one mistake on a major news story could kill you professionally, which means you're on the line every day.

**BP&P:** *I take it since you're still functioning as one of the top newsmen in the business, you haven't made too many mistakes?*

**Rather:** Everybody makes mistakes, but not the kind you mean. My heart almost stopped a few times.

**BP&P:** *When?*

**Rather:** The biggest story I've ever covered, a once-in-a-lifetime searing experience was the assassination of President Kennedy. On November 22, 1963 I was the new chief of the CBS bureau in New Orleans. CBS decided they wanted to do a sidebar story on the ninety-eighth birthday of former vice president John Nance Garner, so I was in Dallas doing it. After I finished the piece I discovered that the last film drop on the route of the President's motorcade was uncovered because we were short a man on the staff. So I covered it.

**BP&P:** *Then you saw the actual shooting?*

**Rather:** Not really. The motorcade was a little late. Then I saw a police car go by moving like hell, taking the wrong turnoff and I thought I saw the presidential limousine but I didn't see the president. Something was wrong. I started running back to our station in Dallas, KRLD, and saw police swarming about and warning the crowd, some of whom were lying on the ground, not to panic. At the station I monitored the police radio and caught a reference to Parkland Hospital. I immediately called there and got an operator who confirmed the fact the president had been shot. She switched me to a doctor who verified the fact and told me that he understood he was dead. Now if you've covered enough police beats you know you tread very gently with information like this.

**BP&P:** *In the chaos of the moment, were*

*you able to confirm your information?*

**Rather:** I knew I had to make a second call and check this out. I made a second call to the hospital, getting an operator who was clearly very busy. She told me everyone was tied up, but there were two Catholic fathers in the hall. I asked if one would speak to me and after some mumbled conversations, a man's voice came on the phone. I asked if he could confirm whether the president was dead. Very matter of factly he told me the president had been shot and was dead. At this moment, the very first press bulletin's were making the wires, the fact that there was a shooting. And I had information that said the president was dead.

**BP&P:** *Could you release this right away?*

**Rather:** I called CBS New York and wrestled around with this. All I had were the words of a doctor and a father at the hospital. Two of my editors went with the bulletin 17 minutes ahead of anyone. Those were the 17 longest minutes of my career. We were hung out there and if, by chance, I was wrong, if anything was wrong with the story I had given them, I knew that I'd be selling shoes in Smithville, Texas, the next day. But the competitive pressure is enormous at a tragic time like that.

**BP&P:** *I understand that during those dark days in Dallas you came up with something new in the way of television reporting.*

**Rather:** As they say, necessity is the mother of invention. When Jack Ruby shot Lee Harvey Oswald, we were all stunned again. Things happened so fast we weren't sure what had happened. We did know that we had the shooting on film and I was wondering whether we could run it in slow motion, like the slo-mo used in football games.

**BP&P:** *It sounds like you were improvising like crazy.*

**Rather:** TV news during this period and anytime really is full of improvising. Slo-mo had never been used before in news but we all wanted to clearly show that it was Ruby who shot Oswald and that the police weren't kidding anybody. It was a spur of the moment decision shared between our technician in Dallas, myself and Don Hewitt, our producer in New York. That was an idea that worked.

**BP&P:** *And others didn't work?*

**Rather:** It's hard to bat 1,000 every time. I remember someone saying to me there's a stripper in Tyler, Texas, who thinks she saw Jack Ruby and Oswald together at the same place and time and I said go and get her and bring her into the studio. We interviewed her live and it turned out she was mistaken. It happens all the time.

**BP&P:** *Are you saying that there's a lot of inaccurate reporting on television?*

**Rather:** Not at all. I'm saying that everyone is human and as hard as you try you can't

always have perfection. The pressures that you have are hard for the viewing audience to perceive. It's not "what am I going to look like", but "what am I going to say." It's got to be right, fair and accurate, not how your hair is combed or what your suit looks like. I'm constantly astonished by how many people believe that a network reporter's day is consumed by thoughts of what his agent thinks, how he looks on camera and memorizing his script. You just have to get the story, get it right and fast. Either this crushes you or you say put me down anywhere in the world and I'll get a story for you.

*BP&P: And you've been almost everywhere.*

**Rather:** True. I've had the luck of being at the right place at the right time. First it was hurricane Carla, then the assassination. By the time I was thirty, I never figured I'd have a story as big as that again. But then came Watergate. And scattered around were things like covering the Viet Nam war, the Mississippi riots.

*BP&P: What you're saying is that you were never a pretty face just sitting at some anchor desk in a studio.*

**Rather:** No, I've always liked to be out in the field covering things as they happen. After the Watergate affair, CBS felt it would be better for me to have a change, so they put me with CBS Reports. Then came "60 Minutes" and "Who's Who". But I'm still on the run.

*BP&P: Just how much running?*

**Rather:** I figure I work about 110 hours a week. In one ten day period, my secretary figured I had 42 different flights on my expense account. In 15 years at CBS I've spent three in planes.

*BP&P: Do you consider yourself a TV news star?*

**Rather:** In a matter of speaking, yes. But it's still hard work. When they paid Barbara Walters all that money it made me think what it was going to do to the news profession. What was it going to do to my paycheck? A lot is related to luck. Barbara was at the right place at the right time. I give credit to her and her agent. She created a competitive market.

*BP&P: Yes, but is that good?*

**Rather:** Well, it might lead to what is known in the industry as a "quick fix". That means if your ratings are in trouble just go across town and hire the other station's anchorman. In that case, the salary is nothing more than an attention getter, a box office hype. If Paul Newman decided to chuck movies tomorrow and get into news, I'd hate to co-anchor with him.

*BP&P: You mention ratings in news. Do you think too much emphasis is put on them?*

**Rather:** To a certain extent, yes. There was a time when, if you came on as a news director of a station in a major market, you needed a few years to turn ratings around. Now you've got three, maybe four months to turn it around before the pink slips start flying.

*BP&P: Is too much emphasis put on the cosmetics of news, like sets?*

**Rather:** A TV critic once suggested we try the entertainment aspects of news. The questions would be do you spend your money on a fancy set or a couple of great cameramen? Should you have fancy intros or slick news vans? In too many newsrooms and stations across the country, management is going for the set, the intro or the news "star". If it's a fad or a trend, I think we should start worrying.

*BP&P: What about anchorpeople?*

**Rather:** A good journalist doesn't become part of the story he's covering. A newsman does not make news. It's offensive to me to think of the reporter as a pop media star.

*BP&P: In your mind, what makes a good anchorperson?*

**Rather:** To me, the key is believability. Cronkite, Reasoner, Severeid, Chancellor, Wallace, Brinkley. All of them are different, but the thing they have in common is believability. I've heard of some stations

bringing actors in to read the news. It didn't work. Now take Walter Cronkite. If Walter came into a local newsroom today and applied for an anchorman position, management would think 'He's got to be kidding'. Maybe a news director or a station manager, but on the air, never. What made Walter a star on the network wasn't physical appearance, but inner integrity.

*BP&P: What's your overall impression of TV news?*

**Rather:** Television is a copycat medium. If it works in one place, they're going to try it in another place. Just think about it — any night of the week the networks are working with generally the same bulk of news. The viewer can switch channels anytime he wants and see basically the same stories covered. What it comes down to is a quality easily named, but hard to define: believability, charisma, personality and warmth.

*BP&P: Have you been happy with your career?*

**Rather:** Happy and lucky. Like I said before, I was addicted to journalism before I came to CBS and after being at the network I was consumed by it. Reporters really have it good but you have to love what you're doing. Covering news by television is still so new. It's not in its infancy anymore, but it's in its early adolescence and we're all still learning.

Change  
Sound to  
Silence  
with a



## TABERASER

This rugged, heavy duty bulk tape eraser wipes sound from all magnetic tapes, cartridges, cassettes and magnetic film stock; handling up to 2".

It erases with minimum residual noise because the field automatically diminishes at the end of each 30-second cycle.

A thermal control and blower keeps the unit below 71° C.

Priced at only \$395.00.

For the distributor in your area — Call or write:

**TABER** Manufacturing & Engineering Company  
2081 Edison Ave. • San Leandro, Ca. 94577 • (415) 635-3831

# Directory of Syndicated Radio Programming

Syndicated radio programming is available in a wide variety of forms . . . from one-time specials, to daily or weekly features, to total automation programming. Availability of programs ranges from a cash purchase to time barter . . . for all types of formats from rock, to country, to classical, R&B, religious, and so on. Some programming is designed to be a profit-making sales tool for the local broadcaster, while others serve only the purpose of enhancing a station's programming. The kinds of syndicated programming suppliers are as varied as the products: from part-time business ventures of local disc jockeys, to multi-million dollar entertainment corporations.

The radio syndication field is growing, and becoming more stable every step of the way. It is true that, as in any competitive marketplace, some syndicators have not been able to survive. Yet others have built a firm foundation in radio broadcasting, successfully achieving high ratings results in even the most competitive of markets.

Each radio station has its own policy regarding the airing of syndicated programming. Some prefer to locally generate all of their own programming, specifically tailoring every element to their station and local situation. Yet others are joining the growing list of stations who are finding advantages to airing syndicated products: exclusively presenting programs to their listeners that, in many cases, are not economically feasible to produce on a local level.

The following is a complete, up-to-date directory of syndicated radio programming available. The first group of listings covers syndicated radio shows, features, and specials, followed by radio automation formats.

The listings are comprised of information carefully gathered from

comprehensive questionnaires supplied to each syndicator by *BP&P*. We think you'll find this to be the most complete, in-depth directory of syndicated radio programming in print, and help you in selecting the right programming for your needs.

## Radio Programs

**Advertisers Broadcasting Company**  
1700 Broadway  
New York, NY 10019  
(212) 757-3560

**Contact: Sholom Rubinstein or Ruth Beckerman**

**Program: "The Joey Adams Show"**

Announcer: Oscar Rose. Program length: 45 minutes. Frequency: Monday through Friday. Description: Joey Adams is a Toastmaster, comedian, author, world traveler, and talks to people from all walks of life . . . is known as "the Ambassador of good will". Also does programs with live performers, singers, entertainers, musicians. Available on cash basis. Minimum contract: 13 weeks. Program supplied on tape.

**Air Crafts, Ltd.**  
P. O. Box 68  
Woodbridge, NJ 07095  
(201) 634-0388

**Contact: Ted Pastuszak, Jr.**

**Program: "Rock & Roll Illustrated"**

Announcer: Michael Vee. Program Length: 15 minutes, weekly. Program description: Each week spotlights a different artist or notable period in rock history. Also reports on important new artists, releases, and trends in rock. Available on cash basis; price range: \$15.00 to \$50.00 per week, depending on market size. Three minutes of commercial airtime per program; 13-week minimum contract. Designed for rock and pop music formats; promotional materials available from syndicator; program supplied on mono or stereo tape which must be returned to syndicator. One play permitted per program (additional plays at extra cost).

**Program: "15 Big Ones"**

Announcer: Mr. Ted (Michaels). Program description: pop music quiz show. Listeners questioned on famous recordings after hearing portions of them. This, along with other tests encompasses fifteen hits per show. Additional information same as above.

**Alcare Communications, Inc.,**  
P. O. Box 361  
Wayne, PA 19087  
(215) 687-5767  
**Contact: Jordan Schwartz, Frank Beazley**

**Program: "One Moment Please"**

Announcer: Mort Crim. Program length: approx. 60-seconds, daily. Program description: Upbeat daily commentaries on the world's happenings. Available on cash basis or time barter on request. Cash price dependent on market size; 13-week minimum contract. Designed for all formats; promotional materials available. Program supplied on tape, which must be returned after use; unlimited broadcasts permitted.

**Program: "Update: Where Are They Now?"**

Announcer: Mort Crim. Program length: approx. 2½-

minutes, daily. Program description: Nostalgia — famous personalities from America's past and what they are doing today. Two commercial airtime per program; all other information same as above.

**Program: "What An Idea"**

Announcer: Gene Crane. Program length: approx. 45-seconds, daily. Program description: Light, up-tempo ideas to make life work better. All other information same as above.

**American Foundation for the Blind**  
15 West 16th Street  
New York, NY 10011  
(212) 924-0420

**Contact: Arthur Zigouras or Joel Saltzman**

**Program: "Talking About Blindness"**

Announcer: Ken Kliban and various celebrities. Program length: :10, :30, :60 seconds. Frequency: total of 20 spots. Program description: Celebrities featured in informational spots about blindness and attitudes toward the blind. Free information offered in each spot by writing to box number. Available free of charge; designed for all formats. Available on mono discs for unlimited airplay.

**Program: "Working in the Sighted World, Vol. IV"**

Announcer: Ken Kliban. Program length: Ten programs at 4:30 each. Program description: Actualities of blind persons in different professions. Amusing and thought-provoking. Voice-over and format music. Available free of charge; designed for all formats. Available on mono discs for unlimited airplay.

**American Lutheran Church/  
United Methodist Church**  
1568 Eustis Street  
St. Paul, MN 55108  
(612) 645-9173  
**Contact: Ms. Carol Birkland/Promotion**

**Program: "Scan"**

Announcer: Hal Dragseth. Program length: 1/2-hour, weekly. Program description: Contemporary rock/progressive/album cuts/with interviews in a stream of consciousness style. Topics: poverty, alcoholism, aging. No hard-sell style. Public service/religious. Available free for sustaining use. Designed for contemporary rock/AOR/progressive formats. Promotional materials available. Program supplied on mono or stereo tape; tapes must be returned after use (postage is pre-paid). Unlimited broadcasts permitted. Program won Gabriel Award in 1976 for outstanding nationally produced radio program in youth-oriented category. Certificate of Merit (2nd prize) in educational/informational category.

**Program: "Church World News"**

Announcers: Dave Moore, Dean Montgomery. Program length: 15 minutes, weekly. Program description: News of all church bodies (Catholic/Protestant/Orthodox/Judiasm). Nationally and internationally oriented stories and movie reviews in regular news broadcast format. Available free for sustaining use. Designed for MOR/farm/beautiful music/religious/talk formats. Promotional materials available. Supplied on mono tape; tapes must be returned after use (postage is pre-paid). Unlimited broadcasts permitted.

**American Radio Archives**  
Box 3022  
San Rafael, CA 94902  
(415) 453-3356  
**Contact: Victor Hall**

**Programs: "Old Radio Shows"**

Program length: varies. Description: Original recordings of many old radio dramas, mysteries, serials, etc. Available on

Directory listings were compiled from information supplied by syndicators. "Broadcast Programming & Production" shall not be responsible for any errors or omissions.





# When We Deliver Your RADIO ARTS FORMAT "We've Only Just Begun"

## Technical Quality

"Confidence in the technical quality of syndicated programming is important at WGSA. THE ENTERTAINERS tapes meet our high standards exceptionally well."

WGSA—Ephrata, Pennsylvania

## Music Consistency & Control

"The consistent sound of THE ENTERTAINERS has led to consistent audience and sales growth."

WTAG—Worcester, Massachusetts

## Format Salability

"Since signing THE ENTERTAINERS format, positive audience reaction, ratings, and sales revenues have all increased."

KMJ—Fresno, California

## Creative Excellence

"We think EASY COUNTRY is the greatest country sound in America . . . and so do our listeners. Over 300 letters attest to the format's creative excellence."

WSUE—Sault Ste. Marie, Michigan

## Sound That Is Alive

"The heartbeat at WXKE comes from the live and friendly sound of THE ENTERTAINERS."

WXKE—Ft. Wayne, Indiana

## Continuing & Reliable Service

"The continuous in-touch service from Radio Arts, insures a consistent smoothness between the EASY COUNTRY format and our air personalities."

KLRA—Little Rock, Arkansas

**If You're Interested in a Program Service That Serves, Send For Your Demo Today!**

"The Entertainers"  Reel  Cassette  "Easy Country"  Reel  Cassette

Name \_\_\_\_\_ Title \_\_\_\_\_

Station \_\_\_\_\_ Present Format \_\_\_\_\_

Address \_\_\_\_\_ City \_\_\_\_\_

State \_\_\_\_\_ Zip \_\_\_\_\_ Telephone \_\_\_\_\_



For further information call collect to Phillip Koener, Radio Arts' General Sales Manager.

## Radio Arts, Inc.

Suite 104, 210 North Pass Avenue, Burbank, California 91505 (213) 841-0225

The  
Production  
Source.

SM

The result of a major, nationwide survey  
among production directors:

# TM introduces The Production Source. The only music and sound effects library you'll ever need.

The Production Source is the most needed, most comprehensive music and sound effects library in the industry today. It's totally new and dedicated to you, the serious production man. The Production Source is bigger, richer, a masterpiece more complete by far than anything else available.

When TM mailed a 34-point production questionnaire to more than 2,000 production directors nationwide, the response was overwhelming. We asked you what you wanted, and the Production Source is the result. It's the ultimate production library.

**For production music and sound effects, you won't need any other source.**

It starts with eight discs of sound effects, and twenty-two full discs of music in every conceivable style, length, and tempo. And you get another disc of music every single month.

The Production Source also includes a monthly audio newsletter containing production ideas and discussions, plus samples from other Production Source stations. It's the source for audience and sales promotion ideas, the latest styles and techniques of production.

The Production Source. The first complete production library designed by and for production professionals.

- Your source for the most comprehensive production music ever: commercial-length and random-length tracks, production pads, instrumental drop-ins, stagers, intros, tags, and more.

- Makes your production — and your station — sound great.
- Your source for good sounding, good selling spec spots.
- Categorized and simple to use.
- Marks the end of the time-consuming search for good production music; the end of the improper-length hassle.
- Your source of production — exclusively, in your market.

Return the coupon or call right now for a demo. Area code 214 - 634-8511, collect. Jerry Atchley has details on how easy it is to become The Production Source in your market.

Yes, I want to hear the biggest, most professional production music and sound effects library available. Please send a demo right away.

NAME \_\_\_\_\_

STATION \_\_\_\_\_

TITLE \_\_\_\_\_

ADDRESS \_\_\_\_\_  
\_\_\_\_\_  
\_\_\_\_\_

PHONE \_\_\_\_\_

DATE \_\_\_\_\_

# TM

TM Productions, Inc.

1349 Regal Row  
Dallas, Texas 75247  
214-634-8511

Want more details? Circle No. 15 on Product Info. Card.

AUTOMATION PROGRAMMING THAT SOUNDS

**"LIVE"**

THE DIFFERENCE IS LIKE

**NITE & DAY**



CONTEMPORARY M.O.R.  
SOFT ROCK • ALBUM ROCK  
**CONCEPT PRODUCTIONS**

P.O. BOX 41406 • Sacramento, CA 95841  
Phone (916) 782-7754 • Dick Wagner

Want more details? Circle No. 16 on Product Info. Card.

cash basis or time barter. 13-week minimum contract; programs supplied on tape.

**Toby Arnold & Associates, Inc.**  
4255 LBJ-Two Summers Square  
Suite 156  
Dallas, TX 75234  
(214) 661-8201  
Contact: Toby Arnold

Program: "Opus 77"

Announcer: Larry McKay. Program length: 8-hour one-time special. Program description: Countdown and playback of the top 100 hits of 1977, featuring over 50 interviews with the stars who made them happen. Special promos, jingles, and production package included. Available on cash basis; \$325 to \$550 for package. 12 commercial avails per hour (96 total). Annual exclusive contract. Designed for rock, adult contemporary, and MOR formats; promotional materials available; provided on stereo discs, unlimited broadcasts permitted.

Program: "Backspin"

Announcer: Charlie Van Dyke. Program length: 5 minutes daily. Program description: Audio almanac looking back at off-beat news and information from past 20 years of rock, coupled with playback of a number one song from the day in history. Available on cash basis; \$3.00 to \$7.00 per day, depending on market size. Two commercial avails per program (:60 and :30). 13-week minimum contract. Designed for rock, oldies, and adult contemporary formats. Promotional materials available; custom voice tracks, jingles, production music, promos. Program supplied on stereo tape; unlimited broadcasts permitted.

Program: "Southwest Conference Sidelights"

Announcer: Bill Mercer. Program length: 10 minutes weekly. Program description: Interviews with coaches of conference colleges, football, basketball, and all sports. Available on time barter. National sponsor, Dodge. One sponsor commercial per program; one local avail per program; 13-week minimum contract. Designed for all formats, custom voice tracks, theme, and jingles available. Provided on mono disc, unlimited broadcasts permitted.

**Audio Stimulation**  
6430 Sunset Boulevard

**Hollywood, CA 90028**  
(213) 466-9561

Program: "The Wolfman Jack Show"

**Barrett & Gorin**  
32 Fremont Road  
N. Tarrytown, NY 10591  
(914) 631-2617  
Contact: Cliff Barrett

Program: "The People-Oriented Package"

Announcers: A dozen former NBC correspondents. Program length: 90 seconds. Frequency: 50 programs per week. Program description: News drop-ins. People oriented features. Available on cash basis; \$95 to \$225 per week, depending on market size; 13-week minimum contract. Designed for news, talk, and MOR formats. Programs customized for each station. Programs supplied on tape which must be returned after use; unlimited broadcasts permitted. Designed for sales and programming tools.

**Bonneville Productions**  
130 Social Hall Avenue  
Salt Lake City, UT 84111  
(801) 237-2400

Contact: Ron Anderson

Program: "Christmas and Then Some"

Four hour one-time special featuring specially selected seasonal music interspersed with attention-grabbing actualities and vignettes about every aspect of Christmas. Some funny; some moving. Top entertainment for all ages 12-plus. Price depends on market size. Four two minute commercial breaks per hour. Designed for contemporary, MOR or rock formats, and can be customized for each station. Program supplied on tape which must be returned after use. One broadcast permitted. Demo tape is available.

Program: "Today's Family"

Announcer: Dr. Elliott Landau. Length: 2 minutes, five times weekly (once daily). Landau is well-known author and professor of child development, discussing problems facing the modern family. Offers practical advice on parenting with wit and charm. Price dependent on market size. One commercial avail per program. Minimum contract: 13-weeks. Designed for MOR formats. Program supplied on tape which

must be returned after use. One broadcast permitted. Demo tape available.

Program: "Music and the Spoken Word"

Announcer: J. Spencer Kinard. Length: 29 minutes, one time weekly. Description: Temple Square in Salt Lake City, Utah, is the home of the weekly live broadcast of "Music and the Spoken Word", featuring the Mormon Tabernacle Choir with J. Spencer Kinard as narrator. The famed choir has sung sacred hymns and the great choral works of the masters for more than 125 years. Broadcast is framed best within MOR formats. Provided on tape which must be returned after use. One weekly broadcast permitted. Program is public service available at no charge to stations.

Program: "You and Your World"

Length: 15 minutes, weekly. Description: A unique radio experience. In 15 minute segments, the program zeros in on the significant challenges each of us faces in achieving successful living. And what is more gives helpful hints and meaningful direction for everyone on the path to happiness. Mono only tapes must be returned after use. One weekly broadcast permitted. Public service programming available at no cost to stations.

**Casino Loot Productions**  
232 — 8th Street  
Brooklyn, NY 11215  
(212) 768-1587

Contact: Frank Cotolo or Rose Blair

Program: "Idiotorials"

Announcer: Mike Solace. Program length: 60 seconds. Frequency: daily. Program description: Zany misinterpreted opinions on topical in-the-news themes. Comic views from absurd newsman character who prepares material with little or no time spent with deep thought! Available on cash basis. Price range: \$227.50 to \$617.50 per run of 13 weeks. Compatible with contemporary, top 40, MOR, and country & western formats. Promotional materials available; print ads, custom promos, or commercials upon request. Program supplied on tape which must be returned to syndicator. All 65 programs are delivered in one shipment, and station is entitled to unlimited use of shows.

Program: "Dead Air"

Announcers: Thom Savino and Frank Cotolo. Program length: 30 minutes. Frequency: weekly. Program description: Situation comedy geared toward 18-30 year olds featuring regular characters, social satire, and general mayhem. Available on cash basis. Price range: \$260 to \$360. Five commercial avails per program. Minimum contract 26 weeks (13 episodes played twice each.) Designed for progressive FM formats. Promotional materials available; print ads, custom promos, and spots on request. Programs supplied on tape which must be returned to syndicator. 13 programs delivered per shipment.

**C. C. Productions**  
511 Morris Street  
Grand Rapids, MI 49503  
(616) 453-7680

Contact: Christopher Conn

Program: "Bass Akwards: Crumentator Extraordinaire"

Announcer: Christopher Conn. Length: 90 seconds, daily. Program Description: Humorous reports of fictitious news stories, reported in the voice and style of ABC commentator Paul Harvey. Undated. Available on cash basis; 1/2 times highest one-time rate per day; also available on time barter. One commercial avail per program. 13-week minimum contract (65 programs). Designed for all formats except beautiful music. Extra charge for customizing program. Supplied on tape which must be returned after use. One broadcast only permitted.

**Century 21 Productions & Programming, Inc.**  
2825 Valley View Lane, Suite 221  
Dallas, TX 75234  
(800) 527-3262 or (214) 243-6721  
Contact: Tom McIntyre or Dave Scott

Program: "The Electric Disco"

Length: 3-4 hours, weekly. Program Description: Disco hits (current, recurrent, and oldies) for dance special. Available on cash basis, \$25 per week. Designed for contemporary formats; customized for each station. Promotional materials available. Supplied on mono or stereo tape. Unlimited broadcasts permitted.

Program: "Epic Of The 70's"

Announcer: Larry McKay. Length: 6 hours. Program Description: One-time special covering the number one hits of the 70's with exclusive interview with the stars. Available on cash basis; \$200 to \$400 for package, depending on market size. Twelve commercial avails per hour. Designed for rock and top 40 formats; customized for each station; jingles, promos, artwork included. Supplied on stereo or mono disc or tape (also automation tapes). Unlimited broadcasts permitted.

**The Chicago Radio Syndicate, Inc.**  
Two East Oak Street  
Chicago, IL 60611  
(312) 944-7724

Contact: Sandy Orkin, Ursula Wosik

Programs: "Chickenman", "Tooth Fairy", "Mini People", "You Had To Be There", "Ace Trucking Company", "The Masked Minuteman".  
Lengths: 2-1/2 minutes, 52 weeks of programming. Program Description: 2-1/2-minute comedy vignettes, 65 episodes in 13 weeks. Available on cash basis with price dependent on market size. One or two commercial avails per program, 13 week minimum contracts. Designed for all formats. Programs supplied on tape which must be returned after use; unlimited broadcasts of programs permitted.

**WHAT MADE OVER 10,000 RADIO LISTENERS FAMOUS FROM COAST TO COAST?**

... and brought fortune to 150 stations and their sponsors ...

**Fame Game**  
the sparkling musical comedy radio contest

Pick your FAME GAME month and 60 of your listeners and Mr. Sponsorperson will hear their names SUNG with YOUR STATIONS CALL LETTERS!

CALL COLLECT  
OR WRITE FOR  
FREE DEMO:

Mr. Jim Hogg (216) 771-1720  
Music Masters, Inc. 1730 E. 24th Street  
Cleveland, Ohio 44114

Want more details? Circle No. 17 on Product Info. Card.

# Wind Chime

## **MellowMusic™ is the original. So why settle for a copy?**

When Tom McKay left KNX/FM to form Windchime Communications, he knew he had a good format.

But Dick Penn, GM at KBBC, Phoenix, says it's not just good...it's "UNBELIEVABLE!"

*"Never have I seen such a rapid turn-around in any radio station since I've been in the business...Sales are distinctly up...The response on the street and in the mail has been genuinely impressive."*

*"Our growth 25-34 has been most impressive and from a sales point, the even spread between 18-24 and 25-34 enables us to attract new blue chippers like Valley National Bank, Western Savings and Estes Homes."*

John Bayliss, President of Combined Communications, says:

*"I think it is...the best sounding 'mellow' (format) in the country."*

Even Steve Marshall, National Programming Consultant for KNX/FM and the CBS/FM Group, says:

*"If you have the opportunity to avail yourself of Tom McKay's professional services, I could not recommend him strongly enough."*

Robert Nelson, VP & GM, KNX/FM, adds:

*"They have the best version of 'The Mellow Sound™' in syndication and have been quite successful with it in several major markets."*

Call or write for a demo. It's a dub of the original...not a copy.

Please send me a demo and contact me

Name \_\_\_\_\_ Title \_\_\_\_\_  
Station \_\_\_\_\_ Address \_\_\_\_\_

Area Code \_\_\_\_\_ Telephone \_\_\_\_\_

BE SURE TO VISIT US AT THE N.R.B.A. Booth 121 Suite 1329



Windchime Communications Inc., 15300 Ventura Blvd./  
Suite 220/Sherman Oaks, CA 91403/Tel. (213) 986-0618



**8 powerful formats for automated or live radio.**  
**Complete Library Service • Mono or Stereo**  
 CaVox Stereo Productions, 502 S. Isis, Inglewood, CA 90301  
 Call Bob Mayfield collect at (213) 776-6933  
 NRBA Suite 1823

*Want more details?*  
**Circle No. 8 on Product Info. Card.**

**Program: "Jamboree U.S.A."**  
 Length: Two hours, weekly. Program Description: Live performance by popular country stars recorded each Saturday night at the Capitol Music Hall in Wheeling, West Virginia. Available on a cash basis with price dependent on market size. Ten commercial avails per hour. 13 week minimum contract. Program is customized for each station. Program supplied on tape which must be returned after use. One play permitted per week, designed for country formats.

**Program: "Six Hour Radio Special — Elvis"**  
 Length: 6 hours. Program Description: One-time special highlighting Elvis Presley's music, influence on other artists, and his impact on American music. Available on cash basis with price dependent on market size. Eight minutes of commercial avails per hour. Designed for all formats; customized for each station. Program supplied on tape which must be returned after use.

**Cinema/Sound, Ltd.**  
**311 West 75th Street**  
**New York, NY 10023**  
**(212) 799-4800**

**Contact: Barbara Stones, Joan Franklin**

**Program: "The Crowdaddy Rock Review"**  
 Announcer: Pete Fornatelle. Length: One hour, weekly. Program Description: Entertainment package on pop culture, modeled after Crowdaddy Magazine. Self-contained segments with superstar interviews, music reviews, rising stars, comedy nonsense, news, and music. Available on time barter. Sponsor: Discwasher, Inc. Two sponsor commercials per program; six local avails; 52-week minimum contract with option to cancel after 13 weeks. Designed for progressive, top 40, rock, MOR, and contemporary formats. Program supplied on stereo tape which must be returned after use. Unlimited use for 14-day period. Stations get advantage of full page advertisements in Crowdaddy Magazine.

**Program: "Film Music"**

Announcer: David Raskin. Length: One hour, weekly. Program Description: Original soundtrack recording plus interviews with noted composers of movie classics and contemporary favorites. Conversation mixed in a thoughtful blend of music and anecdotes. Available on time barter; supplied on mono tape. Additional information same as above.

**Program: "Concert Stage"**

Announcer: Leonard Marcus, Phyllis Curtin. Length: One hour, weekly. Program Description: Co-hosts interview a famous guest in the world of classical music. Presents informal conversation and the finest classical recordings. Available on time barter. Designed for classical, talk, information formats. Supplied on stereo tape. Additional information same as above.

**Program: "Heywood Hale Brown"**

Announcer: Heywood Hale Brown. Length: One hour, weekly. Program Description: Book review program with author/celebrity interviews by popular TV personality, actor, commentator, Woody Brown. Available on time barter. Designed for all formats. Supplied on mono tape. Additional information same as above.

**Program: "Hank Spann's Boogie"**

Announcer: Hank Spann. Length: One hour, weekly. Program Description: Entertainment package on black culture featuring disco hits of the week, album artist of the week, live interview with a major artist, and a historical flashback highlighted by a song. Available on time barter (sponsor not listed). Designed for R&B, black formats. Supplied on stereo tape. Additional information same as above.

**Program: "Country Music Magazine Show"**

Announcer: Lee Arnold. Length: One hour, weekly. Program Description: Entertainment package on country music featuring a live interview with a major artist, album of the week, comedy, and short feature segments. Available on time barter (sponsor not listed). Designed for country formats. Stations listed as part of full page advertising support in Country Music Magazine. Additional information same as above.

**Program: "The Law On Trial"**

Announcer: Henry Rothblatt. Length: 1/2-hour, one to five times a week. Program Description: Legal experts analyze notorious crimes and the law. Available on time barter (sponsor not listed). One sponsor commercial per program, 3 local avails. Designed for all formats. Supplied on mono tape. Program supplied on tape which must be returned to syndicator after use. Unlimited plays permitted.

**Program: "Health Line"**

Announcer: Dr. Elizabeth Whelan. Length: 1/2-hour, one to five times per week. Program Description: Interviews with leading doctors and nutritionists on topics such as food fads, fallacies, diet, heart disease, and smoking. Additional

information same as above.

**Program: "Here's What's New"**

Announcer: Ken Gilmore. Length: 5 minutes of 1/2-hour, daily or weekly. Program Description: Ken Gilmore, executive director of Popular Science, gives human dimension to the new products that will affect the way we live. Additional information same as above.

**Program: "The Mighty Memory Quiz"**

Announcer: Garry Moore. Length: 7 minutes, daily. Program Description: Editors of New York Times conduct memory quiz based on history. Additional information same as above. 90-minute, weekly version available on cash basis \$12 to \$75 per week, depending on market size. Ten commercial avails per program.

**Program: "1977 to 78 Year End Special"**

Announcers: Garry Moore, Tony Randall, Kevin McCarthy. Length: 5 hours, one-time special. Program Description: News and entertainment wrap-up. Available on time barter (no sponsor listed). 40 commercial avails. Designed for all formats. Supplied on mono disc; unlimited use permitted. Program can be stripped.

**Creative Media Consultants, Inc.**  
**Box 3146**  
**Walnut Creek, CA 94598**  
**(415) 938-4444**  
**Contact: John Hawkins**

**Program: "John Hawkins Goldmine"**

Announcer: John Hawkins. Length: 1 hour, weekly (can be played in segments). Program Description: Exploration of relationships between classical performances and performers of past and present; placing music, interviews, comedy cuts, and actualities together in juxtaposition. Available on cash basis with price dependent on market size; 13 week minimum contract. Designed for adult formats, customized for each station. Promotional materials available. Supplied on mono/stereo tape which must be returned after use. Tapes sometimes bicycled. Unlimited play during week of show.

**Program: "Hitmakers"**

Announcers: John Hawkins, Ron Hall, Steve Rood. Length: 5 minutes. Program Description: Artist biography or background information on classic hit record, often including interview, segued into the hit. Two commercial avails per program. Additional information same as above.

**D.I.R. Broadcasting Corp.**  
**445 Park Avenue**  
**New York, NY 10022**  
**(212) 371-6850**  
**Contact: Alan H. Steinberg**

**Program: "The King Biscuit Flower Hour"**

# INVESTIGATE

**You're searching for superior broadcast equipment**

You're looking for a digital programmer multi-function operator keyboard and display unit that permits selection of any desired action such as entry, display, etc. and then directs that action to the unit in question, such as keyboard, memory, teletype, data tape, data terminal, or cassette deck.

You're looking for an entry error-proof system which permits fast preparation of special program formats.

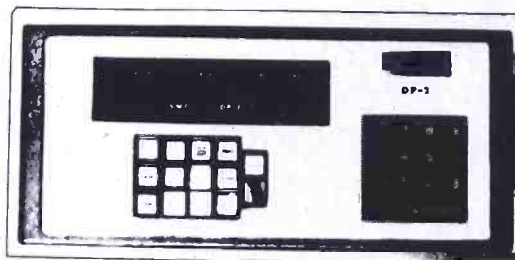

## DISCOVER the SMC DP-2 Digital Programmer

... which features the qualities mentioned plus a whole lot more. We'd like the opportunity to show you all the advantages of our DP-2



1005 West Washington Street  
 Bloomington, Illinois 61701  
 Phone 309-829-6373  
 TWX 510-352-2506

**Stop by our Booths (81-82-83) at the  
NRBA**

**New Orleans Hilton • October 9-10-11-12**

MEET: Pete Charlton . . . . Bob Popke . . . . Joe Toher . . . . Steve Sampson

## DECIDE

We'll back up your decision with over 30 years of quality equipment & service to the broadcasting field.

Our contributions can best be evaluated by the long list of premier equipment presented to broadcasting—the invention of computer assisted programming; new developments in cartridge recorders and players; the famous Carousel, the preferred multiple cartridge player for stations both large and small; the finest in logging equipment, just to name a few.

We are continually at work improving the state of the art.

# Magic Music<sup>SM</sup> programming works. George can prove it!

WMGX FM, Stereo 93  
477 Congress Street  
Portland, Maine 04101  
Telephone (207) 774-4661

**wmgx**

July 15, 1977

Mr. Philip H. Roberts  
General Manager  
Greater Media Services  
197 Highway 18  
East Brunswick NJ 08816

Dear Phil:

In over 10 years of broadcasting, I have never seen such rapid market acceptance by listeners and advertisers as with Magic Music programming. Instinctively, I knew that this programming was going to have great impact in the market, nevertheless, to experience such phenomenal growth is amazing.

Sales acceptance has been on a par with audience acceptance -- excellent! Lots of station "love letters" and great advertising results. I speak for all of those involved with WMGX when I tell you that you have one incredible product -- we're proud to be the first syndicated user of this great new programming service.

Sincerely,

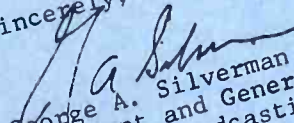
  
George A. Silverman  
President and General Manager  
Sunshine Broadcasting, WMGX Radio

Sunshine Broadcasting Inc.  
60,000 Watts

Hear the music. See the proof.  
Suite 1829, New Orleans Hilton,  
at the NRBA.

Thank you, George, for adding the latest chapter to the Magic Music story of proven performance.

As we've said, our original soft, contemporary vocal music programming continues to be the only one offering proven audience growth, proven audience quality, proven local and national sales success and proven bottom-line results.

Interested? Call Phil Roberts at (201) 247-6161. He'll show you why the first is still the best. And he'll prove it.



**GREATER  
MEDIA, INC.**

Turnpike Plaza  
197 Highway 18  
East Brunswick, NJ 08816  
(201) 247-6161

SM: Magic alone, and in combination with other terms, such as Magic Music, Magic Radio, Magic [dial position], etc. are the exclusive Service Marks of Greater Media, Inc.

**John Doremus, Inc.**  
875 N. Michigan Avenue  
Chicago, IL 60611  
(312) 664-8944

Program: "The John Doremus Show"  
Announcer: John Doremus. Length: 55 minutes, daily or weekly. Program Description: MOR/Easy Listening Music/Talk show, available in 5 to 30 programs per week. Based on variations of a theme, such as name, countries, etc. Each show consists of 4 segments during the 55 minutes. Available on cash basis, with price dependent on market size. Eleven commercial avails per program; 13-week minimum contract. Designed for MOR/easy listening formats. ID's, station promos, news and weather intros included. Supplied on mono or stereo tape which must be returned after use. One broadcast permitted per program.

**Drake-Chenault Enterprises, Inc.**  
8399 Topanga Canyon Blvd.  
Suite 300  
Canoga Park, CA 91304  
(213) 883-7400  
Call Toll Free (800) 423-5084  
(except California, Alaska, Hawaii)

Program: "Golden Years of Country"  
Announcer: Bob Kingsley. Length: 16 hours, one-time special; program can be stripped. Program Description: Highlights the artists and their music in a year per hour form, covering 1955 through 1970. Available on cash basis. 10 minutes of commercial avails per hour; 26-week minimum contract — unlimited use. Designed for country formats. Promotional materials available from syndicator. Program supplied on mono or stereo tapes and discs.

Program: "Top 100 Of The 60's"  
Announcer: Robert W. Morgan. Length: 12 hours, one-time special. Program Description: A count-down of the 100 best songs of the 60's decade including interviews with artists and news events. Fast-paced and best used on weekends as minimum six-hour block each day. Available on cash basis. Additional information same as above, except designed for contemporary formats and supplied on stereo or mono tape.

Program: "The History Of Rock & Roll"  
Program Description: A brand new edition of this award winning classic is now in production. Release date has not been announced. No other information available as of press date.

Program: "Golden Years of Rock"  
Announcer: Robert W. Morgan. Length: 17 hours, one-time special; can be stripped. Program Description: Highlights the artists and their music in a year per hour form, covering 1956 through 1972. Available on a cash basis. Ten minutes of commercial avails per hour. 26-week minimum contract with unlimited use. Designed for contemporary formats, Program supplied on mono or stereo tape which must be returned after use.

Program: "Elvis: A 3-Hour Special"  
Announcer: Bill Drake. Length: 3 hours, one-time special. Program Description: A timeless memorial to the "King of Rock and Roll", produced and originally aired coast-to-coast the weekend after Elvis died. Contains his music and comments as well as comments from Pat Boone, Glen Campbell, and others. Available on cash basis. 8 minutes of commercial avails per hour. Designed for all formats. Program supplied on stereo or mono tape which must be returned after use.

#### Earth News Radio

32234 Pacific Coast Highway  
Malibu, CA 90265  
(213) 457-2547

Contact: Jim Brown

Program: "Earth News"  
Announcer: Lew Irwin. Length: 3 minutes, 45 seconds. Frequency: 2 features per day, 7 days per week. Program Description: News for youth. Available for time barter. National sponsor: Clairol. One 60 sponsor commercial per program. 52-week minimum contract. Designed for rock formats; program customized for each station. Provided on disc. Unlimited broadcasts permitted.

Program: "Hot News"  
Announcer: Sally. Length: 3 minutes, 45 seconds. Frequency: one show per day, 7 days per week. Program Description: Firesign Theatre, twice a week doing topical satire. Len Chandler with musical commentary once each week, plus other reports for youth. Available for time barter. Sponsored by Noxema. One 60second sponsor commercial per program. Designed for rock formats, customized for each station. Provided on disc. Unlimited broadcasts permitted.

**Earth News Service**  
210 California Street  
San Francisco, CA 94111  
(415) 362-3045

Contact: Bill Haniford

Program: "Daily Planet"

**The Electric Weenie**  
660 N. Mashta Drive  
Key Biscayne, FL 33149  
(305) 361-1600

Contact: Tom Adams

Program: "The Tom Adams Show"  
Announcer: Tom Adams. Length: 3 hours for Saturday and Sunday (3 hours each day). Program Description: Humor, one-liners, comment on current events in humorous editorial style, on cassette or reel-to-reel, station plays the records, commercials, news weather and times. Available on cash basis, price range \$100 to \$400 per week, depending on market size. 10-18 commercial avails per program. 26-week minimum contract. Designed for top 40, C&W, MOR formats; program is initially customized for each station. Program supplied on tape which must be returned to syndicator after use. Unlimited broadcasts permitted.

**Filmways Radio, Inc.**  
1610 N. Cahuenga Boulevard  
Hollywood, CA 90028  
(213) 462-6421

Contact: Mary White; Gary Standard

Program: "Record Report"  
Announcer: Charlie Tuna. Length: 3½ minutes. Frequency: Daily (10x per week). Program Description: News of the world of pop music featuring actualities of top hit artists. Short, fast-paced delivery. Many stations using for news or "other" credit. Available for time barter. Sponsor: Warner-Lambert (Certs, Trident, etc.). One sponsor commercial per program; one local avail per program rerun; 13-week minimum contract. Designed for contemporary formats; weekly and custom promos included. Program supplied on mono disc. Two plays per program permitted.

Program: "Country Concert"  
Announcer: Chris Lane. Length: 60 minutes. Frequency: Weekly. Program Description: Live-on-tape radio concert direct from Hollywood's "Palomino" night spot, plus other

locations. Major stars perform before live audience of country music fans. Available on cash basis; with price dependent on market size. Ten commercial avails per program; 52-week minimum contract. Designed for country formats; custom and weekly promos included. Program supplied on stereo disc; one play permitted per program.

**Gordon/Casady, Inc.**  
Box 3157  
Beverly Hills, CA 90212

Program: "The Dr. Demento Show"

**Infomax**  
Box 3022  
San Rafael, CA 94902  
(415) 453-3356

Contact: Victor Hall

Program: "Infomax Christmas Package Show"  
Length: Varies. Frequency: Annually. Program Description: Original old radio shows from holiday seasons of late 30's to early 50's. Available on cash basis; \$100 to \$180 per annual package. Designed for all formats. Program supplied on tape which must be returned to syndicator after use. One broadcast permitted per program.

**Inner-View, Inc.**  
8913 W. Olympic Blvd., Suite 201  
Beverly Hills, CA 90211  
(213) 652-3984

Contact: Lynnsey Guerrero

Program: "Inner-View"  
Announcers: Jim Ladd, Elliot Mintz. Length: 60 minutes, weekly. Program Description: The Inner-View program features an in-depth look into the lives of today's most popular and influential rock artists through their own words and music. The format is 60% music and 40% talk/interview. Available for time barter. Rotating sponsors (MCA, Captiol, Atlantic Records, and Datsun). Six national sponsor commercials per program; 3 local avails per program. 13-week minimum contract. Designed for rock formats; promotional materials available. Program supplied on stereo discs which must be returned after use. Unlimited broadcasts permitted.

**Keystone Broadcasting System, Inc.**  
527 Madison Avenue  
New York, NY 10022  
(212) 355-3720

Contact: Nicholas Gordon

Program: "The Herb Jepko Nitecap Program"  
Announcer: Herb Jepko. Length: 12 Midnight to 5:00 a.m., Monday through Saturday, annually. Program Description: The country's only national midnight to dawn telephone call-in program which is on in all time zones on a specially tailored network of radio stations. Americans working in all-night occupations comprise bulk of audience.

**Krishane Enterprises, Inc.**  
4601 Willis Avenue, Suite 309  
Sherman Oaks, CA 91403  
(213) 981-8255

Contact: Kris Erik Stevens

Program: "The American Disco Network"  
Announcer: Kris Erik Stevens. Length: 30 minutes, Monday through Friday. Program Description: A non-stop disco music program with on-going features designed to attract

# Soft Rock

Mellow music  
for the 18 to 34 lifestyle.



274 County Road ■ Tenafly, N.J. 07670 ■ 201-567-8800

A Division of Bonneville International Corporation



listener interest — disco radio news, artist interviews, telephone calls to major disco clubs around the country. Available on cash basis; price dependent on market size. Four commercial avails per program; 13-week minimum contract. Designed for rock, MOR, and R&B formats. Customized for each station. Program supplied on stereo tape.

**Program: "Love Is The Message"**

Announcer: Various. Length: 30 seconds, daily. Program Description: Thirty-second thoughts of life, love and everyday living. Words and music of wisdom worth a million emotions and year's worth of love. Available on cash basis; price dependent on market size; 52-week minimum contract (260 programs). Designed for gentle rock and MOR formats. Program supplied on stereo tape. Unlimited broadcasts permitted.

**Program: "Rock Reflections"**

Announcer: Jim Pewter. Length: 30 minutes, Monday through Friday. Program Description: The greatest hits of the 50's and 60's with inside info and fun facts. Guest recording stars and special nostalgic program concepts like 'Roots of Rock', 'Surfin' Summer', 'British Invasion', and more. Available on cash basis; price dependent on market size. 13-week minimum contract. Designed for oldies and top 40 formats. Program supplied on tape.

**Media International**

Box 624, Wall Street Station  
New York, NY 10005  
(212) 339-3450  
Contact: Kevin Collins

**Program: "Superhit Countdown"**

Announcer: Don K. Reed (WCBS-FM, New York). Length: 7 hours. Frequency: One-time special. Program Description: Countdown of the top 100 hits of rock and roll, from 1955 through 1977. Includes exclusive interviews with the artists that recorded the hits. Available on cash basis; price dependent on market size. Number of commercial avails: 84. Designed for top 40, oldies, and contemporary formats. Program supplied on tape.

**Charles Michelson, Inc.**  
9350 Wilshire Boulevard  
Beverly Hills, CA 90212  
(213) 278-4546

Contact: Albert A. Altmark

Programs: "The Shadow", "Fibber McGee & Molly", "The Green Hornet", "Gunsmoke", "Dragnet", "Gangbusters", "The Lone Ranger", "Tarzan", "The Best of Sherlock Holmes", "The Hidden Truth", "The Clock", "The Sealed Book", "Suspense"

Announcers: Original network stars. Length: All programs 30 minutes. Program Description: Original network series. Available on cash basis; \$10 to \$125 per week, depending on market size. Up to 5 minutes of commercial avails per half-hour; 26-week minimum contract for each program. Designed for all formats; posters, synopsis, newspaper slicks, albums available as promotional materials. Programs provided on mono tape, which must be returned after use. One play permitted per program. All programs above are ordered individually.

**Robert Michelson, Inc.**

127 West 26th Street  
New York, NY 10001  
(212) 243-2702  
Contact: Robert Michelson

**Program: "National Lampoon True Facts Radio Series"**

Announcer: Various. Length: 2½-minutes daily. Program Description: Hilarious little known incidents that actually occur. Programs read by celebrities and enhanced in the Lampoon manner with sound effects. Available for time barter. 5 commercial minutes available for local sale per week. Designed for album rock formats. Program supplied on tape. Two plays per program permitted.

**Program: "The Daily Planet"**

Announcer: David McQueen. Length: 3½-minutes. Frequency: 12 programs per week. Program Description: Innovative public affairs and news series currently broadcast in over 185 markets. Available for time barter. 12 commercial avails per week. Designed for AOR FM formats. Program supplied on disc.

**Program: "The Marvel Comics Radio Series"**

Announcer: Various. Length: 5 minutes daily. Program Description: Highly produced radio show featuring Stan Lee as narrator with repertoire company bringing to life on radio the adventures of The Fantastic Four. Show supplied with effects. Available on cash basis; price dependent on market size; 13-week minimum contract. Designed for AOR FM formats; promotional materials available — posters, ad mats, etc. Program supplied on disc. Two plays per program permitted.

**More Music Programming, Inc.**

5315 Laurel Canyon Blvd., Suite 200  
No. Hollywood, CA 91607  
(213) 985-3300  
Contact: Jay Dunn

**Program: "A Chronology of American Music"**

Announcer: Jay Stevens. Length: 31 hours. Program Description: One-time special chronological count-down of all the national number one hits, beginning with July 1955 to the present. Available on cash basis; \$600 to \$1,500, depending on market size. 12 commercial avails per hour. In California available for time barter. Sponsor: Warehouse Record Stores. Two sponsor commercials and 10 local avails per hour. Designed for rock and oldies formats; custom intros, ID's, and breakers available. Supplied on mono and stereo discs and tape, which must be returned after use. Some tapes/discs bicycled. Number of plays permitted varies with contract.

**Music Masters, Inc.**

1730 East 24th Street  
Cleveland, OH 44114  
(216) 771-1720  
Contact: Jim Hogg

**Program: "The New Fame Game"**

Frequency: Daily. Program Description: Eight week radio promotion contest where listeners hear names sung, and call to claim instant t-shirt prize, eligible for grand prize week of fame, customized name jingles. Available on cash basis; \$1,000 to \$7,500 per 8-week run; price is dependent on market size. Eight commercial adjacencies daily. Designed for top 40, MOR, contemporary, country & western formats. Program customized for each station: call letters, sponsor's name sung in winning name jingles; promotional materials available. Thirty customized/non-customized music, 50 comedy promos, 70 t-shirts, photos. Supplied on mono tape. One play per 60-week period.

**Mutual Broadcasting System, Inc.**

1755 S. Jefferson Davis Highway  
Arlington, VA 22202  
(703) 685-2048

**Program: "Nixon: For The Record"**

Announcer: David Frost. Program Description: Fifth and final in a series of interviews by David Frost with former President Richard Nixon. Available on cash basis: \$50 to \$500, depending on market size.

**McLendon Programming Services**

1917 Elm Street  
Dallas, TX 75201  
(214) 651-1010  
Contact: Charlie Van

**Program: "Fantasy Park II"**

Length: 48 hours. Program Description: One-time special creating a make-believe rock concert. 58 of the hottest superstars perform.

**Narwood Productions, Inc.**

40 East 49th Street  
New York, NY 10017  
(212) 755-3320  
Contact: Ted LeVan

**Program: "Country Corner"**

Announcer: Lee Arnold. Length: One hour, weekly. Program Description: Award-winning DJ, Lee Arnold, interviews the top-name country music artists and features their music. Available on cash basis; 10 commercial avails per program; 13-week minimum contract. Designed for country formats. Promotional materials available: customized promos, press releases; photos; sales aids. Program supplied on stereo and mono tape which must be returned after use. One play permitted per program.

**New Realities Magazine**

Box 26289  
San Francisco, CA 94126  
(415) 776-2600  
Contact: Victor Hall

**Program: "New Realities Radio Show"**

Announcer: Victor Hall. Length: 2 minutes. Frequency: 40 shows in package, may be used anytime. Program Description: Up-beat news format. Non-sensational treatment of articles from "Psychic" and "New Realities" magazine — all aspects of psychic phenomena, holistic health, consciousness, lifestyle, transformation. Available for time barter. (Programs free in exchange for 15 second credit mention.) One optional cutaway commercial available within body of each program; 40 program minimum contract. Designed for all formats. Programs provided on mono tape. Unlimited broadcasts permitted. Stations pay one-time duplication charge of \$15.00.

**Nightingale-Conant Corporation**

6677 North Lincoln Avenue  
Chicago, IL 60645  
(312) 478-0050

Contact: Bryant Gillespie, Barbara Vidmar

**Program: "Our Changing World"**

Announcer: Earl Nightingale. Length: One minute or five minutes, daily, five days per week. Program Description: "The personal research of the man who reads everything" and serves it up everyday to improve the understanding . . . and so the lives . . . of his listeners." Format: customized billboard, commentary, closing tag. Available on cash basis; \$15 to \$125 per week, depending on market size; three commercial avails per program; 52-week minimum contract. Designed for all formats. Promotional materials available: on-air, TV slides, newspaper mats, PR films, books, give-away scripts. Program supplied on mono discs; discs must

# CONTEMPORARY MOR!

Today's music on target with  
the 18 to 49 audience.



274 County Road ■ Tenafly, N.J. 07670 ■ 201-567-8800

A Division of Bonneville International Corporation

# The wiser you get the better we look.

## SIX KEYS TO SOUND SUCCESS

1. 200 hour base library
2. 36 hour Christmas package
3. Additional Holiday music
4. Weekly tape schedule
5. Custom ID's
6. Competitive success stories and competitive rates

# Beautiful Music



For further information  
and a demonstration reel,  
write or call us, collect.

**Master Broadcast Services, Inc.**

P.O. Box 61, Morrisville, Penna. 19067  
Telephone: (215) 295-0413

NRBA Suite No. 829

be returned after use. Unlimited broadcasts permitted.

**The North American Broadcasting Corporation**  
Box 507, 8850 Bohemian Highway  
Monte Rio, CA 95462  
Contact: Richard Tenney

Program: Various.

Program Description: Light music, variety, serious music, talks, features, drama, and educational. All programs free of charge; programs may not be interrupted by commercials, nor may programs be sponsored in any form. No contract, station ships blank tape for duplication; duplicated in mono or stereo. Unlimited broadcasts permitted, except for certain programs containing restricted works. NABC is an all-volunteer, free program interchange, whose members consist of educational and cultural broadcasters.

**O'Connor Creative Services, Inc.**  
Box 8888  
Universal City, CA 91608  
(213) 769-3500 or (800) 423-2694

Program: "The Beatles — From Liverpool To Legend"

Length: 15 hour special. Program Description: Words and music documentary on the most important group in the history of contemporary music. Available on cash basis, \$300 to \$3,000, depending on market size. Ten minutes commercial avails per hour. Designed for all contemporary formats; promotional materials available. Supplied on stereo disc which must be returned after use. Fee provides one-year unlimited use.

Program: "The RKO Superstars"

Length: 1 hour. Program Description: Series of 12 programs covering the words and music of the top names in contemporary music, hosted by your local personality. Cash price: \$300 to \$3,000 for one year unlimited use, depending on market size. Fourteen commercial minutes available per hour. Designed for contemporary formats. Supplied on mono tape which must be returned after use.

Program: "Nat King Cole — Biography In Song"

Length: 8 hours. Program Description: One-time special words and music profile of one of the most listened to superstars in the world of music. Cash price: \$200 to \$1,200, depending on market size, for one year unlimited use. Ten commercial avails per hour. Designed for MOR, easy listening formats. Supplied on stereo disc which must be returned after use.

Program: "Charlie Tuna Christmas Party"

Length: 3 hours. Program Description: One-time special. 3 hour Christmas party featuring Christmas stories, phone bits to North Pole, Santa interviews, music. Cash price: \$95 to \$500, depending on market size, for unlimited use. Up to 15 commercial avails per hour. Designed for contemporary formats. Supplied on stereo tape.

Program: "Elton John Christmas Special"

Length: 2 hours. Program Description: One-time special. Elton John's thoughts on Christmas, along with his music. Cash price: \$25 to \$150, depending on market size. Twenty commercial avails for special. Designed for all formats. Supplied on stereo disc which must be returned after use.

Program: "Frank Sinatra — Biography In Song"

Length: 8 hours. Program Description: One-time special words and music profile. Cash price: \$200 to \$1,200 for one year license, depending on market size. Eleven commercial avails per hour. Designed for MOR, easy listening formats. Supplied on stereo disc which must be returned after use.

Program: "Halloween Horrorthon"

Announcer: John Carradine. Length: 5 — 21 minute shows. Program Description: Annual package, dramatic productions of well-known "scary" literary works. Cash price: \$95 to \$500 for annual package, depending on market size. Eight commercial avails per program. Supplied on stereo tape.

Program: "The New Bob & Ray Comedy Collection"

Length: Various, daily. Program Description: Sketches and vignettes featuring Bob & Ray's famous characters. Cash price: \$9 to \$95 per week, depending on market size; 52-week minimum contract. Supplied on mono tape. Unlimited broadcasts permitted.

Program: "The Story Lady"

Program Description: Daily feature. 260 fractured fairy tales for adults who refuse to grow up. Cash price: \$9 to \$95 per week, depending on market size. One commercial avail per program; 26-week minimum contract. Supplied on mono disc. Unlimited broadcasts permitted.

Program: "Superfun"

Length: Various. Frequency: Daily. Program Description: A comedy library — over 600 grabbers and gigglers. Cash price: \$10 to \$105 depending on market size; 52-week minimum contract. Supplied on mono tape. Unlimited broadcasts permitted.

Program: "All My Problems"

Frequency: Daily. Program Description: A soap opera spoof. Cash price: \$149 to \$599 per year, depending on market size. One commercial avail per program; 52-week minimum contract. Supplied on mono tape. Unlimited broadcasts permitted.

Program: "Traditions"

Announcer: Art Linkletter. Length: 1 minute, daily. Program Description: A program dealing with the traditions of our most cherished religions, social and festive occasions. Available on cash basis with price dependent on market size. One commercial avail per program. Supplied on mono tape. Unlimited broadcasts permitted.

Program: "You're The Judge"

Announcer: Ralph Story. Length: 90 seconds, daily. Program Description: Actual legal cases related with warmth and humor. Listeners have a chance to guess the verdict. Cash price: \$8 to \$80 per week, depending on market size. One

# On behalf of these great radio stations, we'd like to thank the awards committee of Billboard's 1977 International Radio Programming Forum for awarding **BEST SYNDICATED SERIES** to **AMERICAN TOP 40.**

*Casey Kasen*

<b>ALABAMA</b> Birmingham WSGN Carrilton WAQT Enterprise WKMX Gadsden WGSV Guntersville WGSV Huntsville WAAY Marion WJAM Mobile WABB (AM) WABB (FM) Montgomery WHHY WHHY (FM)	Bainbridge Carrollton Columbus Dalton Eastman Gainesville Griffin Metter Milledgeville Ocala Rome WROM (FM) WROM (FM) WVGA Valdosta WVLD West Point WRLO Waycross WAYX	<b>WAZA</b> WPP1 WCGQ WTT1 WUFF WFOX WKEU WHCG WXLX WSIZ WROM (FM) WVGA WVLD WRLO WAYX	Baton Rouge Houma Lafayette Lake Charles Leesville Monroe Natchitoches New Orleans Shreveport Ville Platte	<b>WIBR</b> KJIN KTDY KLOU KLLA KMLB KNWD WNOE KEEL KVPI (FM) KVPI (FM)	Great Falls Helena <b>NEBRASKA</b> Alliance Grand Island Lincoln Omaha North Platte <b>NEVADA</b> Carson City Las Vegas Winnemucca <b>NEW HAMPSHIRE</b> Franklin Hanover Portsmouth <b>NEW JERSEY</b> Millville/Vineland <b>NEW MEXICO</b> Albuquerque Farmington Gallup Santa Fe Clovis <b>NEW YORK</b> Buffalo Corning Fulton Gloversville Ithaca Jamestown New York City Olean Plattsburg Potsdam Riverhead Rochester Seneca Falls Troy Utica <b>NORTH CAROLINA</b> Asheboro Asheville Brevard Burlington Charlotte Clinton Elizabeth City Fairmont Fayetteville Forest City Greensboro Hickory Jacksonville Laurinburg Lenoir Raleigh Rockingham Sanford Wilmington Wilson Winston-Salem <b>NORTH DAKOTA</b> Bismarck Fargo Grand Forks Wahpeton <b>OHIO</b> Bellefontaine Cambridge Canton Cincinnati	<b>KDDI</b> KCAP <b>KCOW</b> KRGI KLMS KGOR KODY <b>KXBC</b> KPTL KFMS KWNA <b>WFTN</b> WDCR WHEB WHEB (FM) <b>WMVB</b> WMVB (FM) <b>KOEO</b> KRAZ KYVA KYVF KTQM <b>WYSL</b> WPHD WBCA WKFM WENT WICB WICB (FM) WKSX WPXI WYMS WYR WYR WYR WYR <b>WRCN</b> (FM) WBBF WBSW WBSW (FM) WTRY WTLB WTLB (FM) <b>WZOO</b> WISE WPNE WBBB WBT WCLN WCNC WFMD WQSM WBBO WYNG WHKY WXOR WLNC WJRI WKIX WLWL WFJA WWSL WVDT WAIR <b>KFYR</b> XVOX KNOX KBMW <b>WTOO</b> WTOO (FM) WILE WILE (FM) WHBC WHBC (FM) WSAI	Cleveland Columbus Mansfield Marion Newark Ottawa Springfield Toledo <b>OKLAHOMA</b> Ardmore Bartlesville Henryetta Tulsa <b>BEND</b> Bend Coos Bay Eugene Klamath Falls Medford Pendleton Portland Newport <b>PENNSYLVANIA</b> Alltoona Allentown Bedford Clarion Clearfield Erie Harrisburg Hanover Honesdale Latrobe Lykens New Castle Pittsburgh Pottsville State College Waynesboro Wilkes-Barre Williamsport York <b>SOUTH CAROLINA</b> Aiken Barnwell Camden Charleston Chester Columbia Florence Georgetown Greenville Greenwood Sumter <b>SOUTH DAKOTA</b> Aberdeen Mitchell Winner Rapid City <b>CHATTANOOGA</b> Chattanooga Columbia Cookeville Cowan Etowah Johnson City Knoxville Murfreesboro Nashville Dneida Union City <b>TEXAS</b> Abilene Austin Beaumont Bellville Brownwood Bryan Corpus Christi Crockett El Paso Fort Worth Houston Kerrville Killeen Laredo Lufkin McAllen Monahans Ozona San Angelo <b>KVSO</b> KWON KHEN KELI <b>KBND</b> KWYB KBDF KAGO KYJC KTIX KGVW KNPT <b>WVAM</b> WKAP WAYC WWCH WCPA WCCK WKBO WYCR WAEN WQTV WQIN WKST WPEZ WPAM WRSC WEEO WILK WILQ WYCR <b>WLOW</b> WBWA WPUB WTMA WGCD WCOS WJMX WGBM W00K WCBS WDXY <b>KABR</b> KMII KWYR-FM KTOO <b>WDEF</b> WKRM WHUB WHUB (FM) WZYX WCPH WETB WNBX WNGS WBYO WBNT WBNT (FM) WENK <b>KRBC</b> KHF1 KAYC KACO KBVO KTAM KZFM KIVY KIVY (FM)	El Paso Fort Worth Kerrville Laredo Lufkin McAllen Monahans Ozona San Angelo <b>TYLER</b> Tyler Victoria Waco <b>UTAH</b> Cedar City Delta Logan St. George Salt Lake City <b>VERMONT</b> Rutland <b>VIRGINIA</b> Appomattox Big Stone Gap Charlottesville Collinsville Norfolk Pulaski Richmond Roanoke Staunton Tappahannock Winchester <b>VIRGIN ISLANDS</b> Christiansted/ St. Croix <b>WASHINGTON</b> Bellingham Olympia Seattle Spokane Wenatchee Yakima <b>WEST VIRGINIA</b> Beckley Charleston Huntington Keyser Morgantown Parkersburg Pineville Ronceverte <b>WISCONSIN</b> Eau Claire Green Bay La Crosse Racine Two Rivers <b>WYOMING</b> Gillette Kemmerer Rock Springs Torrington <b>PAGO PAGO</b> Pago Pago	<b>KELP</b> KFJZ KRLY KERV KIXS KIXS (FM) KOYE KLUF KRIO KVKM KRCT KIXY KIXY (FM) KTSA KIKM KIKM (FM) KTYL KWAC <b>KBRE</b> KDLT KVVU KDXU KCPX <b>WVSYB</b> WTTX WLSO WLSO (FM) WINA WVIC WGH WPUB WPUB (FM) WFR WTON WRAR WRAR (FM) WINC <b>WSTX</b> KPUG KGY KJR KJRB KWWW KMWX <b>WNNR</b> WXIT WKEE WKEE (FM) WKL WCLG WCLG (FM) WPAR WWYP WRON <b>WOKL</b> WNFL WIZM WRKR WOTC WOTC (FM) <b>KOLL</b> KMER KRKK KGOS <b>WVUV</b>	<b>AUSTRALIA</b> Adelaide, S.A. SAK Albany, W.A. 6VA Alice Springs, N.T. 8HA Armidale, NSW 2AD Brisbane, Qld. 4KQ Dubbo, NSW 2DU Cairns, Qld. 4CA Geraldton, W.A. 6GE Grafton, NSW 2GF Griffith, NSW 2RG Gosford, NSW 2GO Gunnedah, NSW 2MO Kalgoorlie, W.A. 6KG Lancelton, Tas. 7LA Melbourne, Vic. 3DB Merredin, W.A. 6MD Murray Bridge 5MU Murray Valley, S.A. 5RM Nambour, Qld. 4NA Newcastle, NSW 2KO Northam, W.A. 6AM Perth, W.A. 6PM Port Augusta, S.A. 5AU Rockhampton, Qld. 4RO Sydney, NSW 2TW Tamworth, NSW 2RE Taree, NSW 4AY Townsville, Qld. 2WL Warrambool, Vic. 3YB <b>CANADA</b> Prince Alberta, Sask. CKBI <b>COSTA RICA</b> San Jose Radio Top 12 <b>GUATEMALA</b> Guatemala City Radio Exclusiva <b>HONG KONG</b> Hong Kong Commercial Radio <b>INDONESIA</b> Bandung Radio Lelidya Denpasar, Bali Yudha Radio Jakarta Keayaan Malang K.D.S.8 Medan Sumatra Alnora Palembang, Sumatra Erita Semarang Radio Merca Surabaya Radio Merdeka Yogyakarta Retjo Java <b>IRAN</b> Beckley Radio N.I.R.T. Tehran <b>JAPAN</b> Yokohama/ Tokyo Radio Kanto <b>NETHERLAND ANTILLES</b> Orangestad, Aruba Voz di Aruba PJA 10 <b>NEW ZEALAND</b> Auckland Radio Hauraki Christchurch Radio Avon 3XA Dunedin Radio Otago Hamilton Radio Waikato Wellington Radio 2ZM Whakatane Radio 1XX <b>PHILIPPINES</b> Quezon City OZRJ <b>SINGAPORE</b> Singapore Rediffusion <b>TRINIDAD</b> Port-of-Spain Radio 610
--	--	---	---	--	---	--	---	---	--	---

... and the more than 400 stations in the American Forces Radio Network.

Watermark • 10700 Ventura Blvd. • No. Hollywood, CA 91604 213/980-9490

makers of  
**American Country Countdown • The Elvis Presley Story**  
**Mansion of Mystery • The Robert W. Morgan Special of the Week**

Want more details? Circle No. 24 on Product Info. Card.

# MUSIC IS BPI

## formats for automation

Programmed by the industry's leading professionals. Some are announced by broadcast superstars, top-rated in major markets. All of them, announced and unannounced, have proved themselves to be audience builders at station after station all over the country. Check the formats you want to hear and send this entire ad to BPI. We'll send you audition tapes immediately.

- MOR
- Adult Contemporary
- Bright 'n Beautiful
- Easy Listening
- Rock-AOR
- Rock Gold
- Country
- Spectrum
- Concert Overtures & Encores
- Classical

- Announced
- Unannounced
- Full-Time Programming
- Part-Time Programming

# BPI

**Broadcast Programming International, Inc.**

Pacific National Bank Building  
Bellevue, WA 98004  
Toll Free 1-800-426-9082

Name \_\_\_\_\_  
Title \_\_\_\_\_  
Station \_\_\_\_\_  
Address \_\_\_\_\_  
City \_\_\_\_\_  
State \_\_\_\_\_ Zip \_\_\_\_\_  
Phone \_\_\_\_\_

Want more details?

Circle No. 25 on Product Info. Card.

commercial avail per program; 13-week minimum contract. Promotional materials available. Program supplied on mono tape. Unlimited broadcasts permitted.

**Program: "Candid Comments"**  
Announcer: Geoff Edwards. Length: 2 minutes, daily. Program Description: Celebrities tell it like it is. Cash price: \$8 to \$80 per week, depending on market size. One commercial avail per program; 13-week minimum contract. Promotional materials available. Program supplied on mono tape. Unlimited broadcasts permitted.

**Program: "Beauty Spot"**  
Length: 2 minutes, daily. Program Description: Common sense ideas for personal care and grooming. Additional information same as above.

**Program: "Sound Ideas"**  
Length: 2 minutes, daily. Program Description: Helps listeners make sense out of sound, whether it be CB, stereo, cassette, quad, etc. Additional information same as above.

**Program: "The Edge of Science"**  
Length: 2 minutes, daily. Program Description: Factual reports on scientific phenomena. Additional information same as above.

**Program: "Rip Off"**  
Announcer: Martin Milner. Length: 2 minutes, daily. Program Description: Covers every con, swindle and fraud known to man. Cash price: \$9 to \$95 per week, depending on market size. Additional information same as above.

**Program: "You and Your Money"**  
Announcer: Elliot Janeway. Length: 2 minutes, daily. Program Description: America's foremost economist presents topical daily commentary on money matters. Additional information same as above.

**Program: "Earl Butz Commentary"**  
Announcer: Earl Butz. Length: 3 minutes, daily. Program Description: Commentary on agricultural matters as they relate to both rural and urban listeners. Programs written and voiced by former Secretary of Agriculture. Cash price: \$15 to \$150 per week, depending on market size. Two commercial avails per program; 13-week contract minimum. Supplied on mono disc. One play permitted.

**Program: "William E. Simon Report"**  
Length: 3½ minutes, daily. Program Description: Former U.S. Secretary of Treasury discusses broad range of topical subjects from energy to economy to foreign affairs. Cash price: \$10 to \$105 per week, depending on market size. Two commercial avails per program; 13-week minimum contract. Supplied on mono tape. Unlimited broadcasts permitted.

**Program: "Profiles In Greatness"**  
Announcer: Efrem Zimbalist, Jr. Length: 3½ minutes, daily. Program Description: Captures the greatness of 260 of the most exceptional people in the history of mankind. Additional information same as above.

**Program: "Kids Say The Darndest Things"**  
Announcer: Art Linkletter. Length: 3½ minutes, daily. Program Description: Art interviews kids with hilarious results. Cash price: \$14.50 to \$145 per week, depending on market size; 26-week minimum contract. Additional information same as above.

**Program: "Ronald Reagan Commentary"**  
Length: 3½ minutes, daily. Program Description: Conservative commentary. Cash price: \$16 to \$160 per week, depending on market size. Supplied on mono disc. Additional information same as above.

**Program: "Dialogues"**  
Length: 25 minutes, weekly. Program Description: 30% contemporary music mixed with carefully planned narration, each program addresses one concrete human problem. Cash price: \$8 to \$36 per week, depending on market size. Five commercial avails per program; 26-week minimum contract. Supplied on stereo tape. Unlimited broadcasts permitted. Qualifies as educational programming that can be credited toward your "all other" FCC commitment.

**Orbit Radio-Video**  
P.O. Box 1644  
Louisville, KY 40201  
(502) 584-5535  
Contact: Stephen A. Cisler

**Program: "Make Believe Ballroom"**  
Announcer: Various. Length: 60 minutes. Frequency: Daily, five times per week. Program Description: The big bands of nostalgia time. Mythical ballroom remotes with four bands in four segments for each program. Brief music intros, crowd noises, ballads to rumbas, sweet and swing, instrumentals and vocals with big band back-up. Available on cash basis: \$30 to \$100 per week, depending on market size. Ten commercial avails per program; 13-week minimum contract. Designed for MOR, variety, and easy listening formats. Promotional materials available. Programs supplied on tape, which must be returned or bicycled after use. Two broadcasts per program permitted.

**Program: "Magic Carpet"**  
Program Description: The music of the world plus magazine features from many lands. A music show to introduce the likeable music of other countries, and human interest news or comments on what their people are doing. Not a folk music, political, or tourist propaganda show. Music is light, melodious, and original to the artists or countries featured. Additional information same as above.

**Program: "Golden Greats of Music"**  
Length: 30 minutes. Frequency: 3 times weekly. Program Description: Each show salutes one music star of old — reports on what they are doing now, highlights of their career. Stars are from all phases of music — popular, jazz, vocal, classical, country. No rock or soul. Some stars covered include Patti Page, Bing Crosby, Nat King Cole, Mario Lanza, Gene Autry, etc. Available on cash basis; \$18 to \$60 per week, depending on market size. Four commercial avails per program. Additional information same as above.

**Orr Production Services, Inc.**  
60 East 42nd Street  
New York, NY 10017  
(212) 687-7975  
Contact: Lorraine Orr

**Program: "Good Living"**  
Announcer: Lorraine Orr. Length: 2 minutes, daily. Program Description: Interviews, homemaking, travel, health, etc. Program available free of charge. Open and close available for local sale. Designed for use in talk programs; promotional materials available. Supplied on disc. Unlimited broadcasts permitted.

**Program: "Campus Radio Voice"**  
Announcer: Bill Connors. Length: 3½-minutes daily. Program Description: Interviews and features designed for college men and women. Additional information same as above.

**Program: "Feliz Dia Con Maria"**  
Announcer: Mina Korn. Length: 3½-minutes, daily. Program Description: Spanish features on child care, health, decorating, government, benefits, foods, etc. Additional information same as above.

**Parkway Productions, Inc.**  
7979 Old Georgetown Road  
Washington, DC 20014  
(301) 657-9808

**The PH Factor**  
6255 Sunset Blvd., Suite 1006  
Hollywood, CA 90028  
(213) 467-5111  
Contact: Chet Miller

**Program: "Words 'n Music"**  
Announcer: Dave Prince. Length: one-hour program, plus five minute features. Frequency: Weekly. Program Description: Package of 13 superstar specials featuring the music and interviews of Barry Manilow, The Eagles, Hall & Oates, Helen Reddy, The Bee Gees, and others. Plus, 65 five minute features. Available on cash basis; price dependent on market size. Up to 15 commercial avails. Also available on barter basis. 13-week minimum contract. Designed for rock and contemporary MOR formats; promos available. Supplied on stereo tape, which must be returned after use. Unlimited broadcasts permitted during contract.

**Program: "Alex Karras Sports Show"**  
Announcer: Alex Karras. Length: 3½-minutes, five times weekly. Program Description: Each show is written by Ted Green of the L.A. Times. Alex Karras brings his own special brand of humor to each report, along with guest stars. Available on cash basis or time barter; cash price dependent on market size. One or two commercial avails per program. Barter sponsor: Datsun. Two sponsor commercials per program; local avails on program re-runs. 26-week minimum contract. Designed for all formats; promos available. Supplied on stereo tape which must be returned after use. Unlimited broadcasts permitted during each week.

**Ponek-Fisher Associates**  
300 Poplar Street, Suite 5  
Mill Valley, CA 94941  
(415) 383-9020

**Program: "Seeds"**  
Length: 30 minutes. Frequency: Weekly. Program Description: Features music and interviews dealing with artists' formative years. Artists include Elvin Bishop, Heart, Jefferson Starship, Bob Seger, Steve Miller, Pablo Cruise, Alice Cooper, Doobie Brothers, etc. Available for time barter.

**Progressive Radio Network**  
Box 172  
Bronx, NY 10451  
(212) 585-2717  
Contact: Bill Quinn

**Program: "News Blimps"**  
Length: 3 minutes, 12 shows per week. Program Description: Densely produced features satisfying FCC requirements for news and/or P.A. Investigations of current topics from technology, consumerism, environment, urban problems, arts, etc. Available on cash basis; \$30 to \$90 per week, depending on market size. Four week minimum contract. Designed for rock formats; promotional materials available. Supplied on stereo or mono tape which must be returned at end of contract period. Unlimited broadcasts permitted.

**Program: "Sound Advice"**  
Length: 2:30, daily. Program Description: Tells listeners about audio and hi-fi equipment. Helps average consumer understand stereo. Delivery is friendly, low-key, with sound effects and other production elements. Available on cash basis; \$500 to \$3,500 per 13-weeks, depending on market size. 13-week minimum contract. Designed for rock formats; promotional materials available. Supplied on stereo tape, which must be returned after use. Unlimited broadcasts permitted.

**Public Affairs Broadcast Group**  
P.O. Box 48911  
Los Angeles, CA 90048  
(213) 550-7151  
Contact: Mark Bragg, Robert McKane

**Program: "In Depth" and "In Brief"**  
Announcer: Mark Bragg. Length: 2 half-hour documentaries and 7 one minute features per week. Program Description: Programs are produced around the commonly ascertained community needs of our subscribing member stations. They are designed to be aired at better times than simple talk shows because of their production values. Features are designed for multiple daypart use. All programs have printed

performance records accompanying. Available on cash basis: \$15 to \$50 per week depending on station rate card. Four commercial avails per half-hour, one commercial avail per minute feature; 26-week minimum contract. Designed for all formats. Programs customized for each station. Promotional materials available. Programs supplied on mono cassette. Tapes must be returned after use. Unlimited broadcasts permitted in assigned week.

**Program: "Plant Lady", "Consumer Chronicles", "For Your Good Health", "Pets and People"**

**Announcer:** Various. **Length:** 1 minute, daily. **Program Description:** Designed for specific types of retail sponsors while fitting one or more categories of license-related programming. Available on cash basis: \$8 to \$35 per week, depending on station rate card. One commercial avail per program; 26-week minimum contract. Programs customized for each station. Promotional materials available. Programs supplied on tape which must be returned after use. Four plays per program permitted.

**Program: "From A to Z" (replaces 'Galaxy File')**  
**Announcer:** David Bodie. **Length:** 1 minute. **Frequency:** Twice daily. **Program Description:** New developments in science, psychology, and space. Available on cash basis: \$12 to \$40 per week, depending on station rate card. Designed for all formats. Additional information the same as above, except two plays per program permitted.

**Purcell Productions, Inc.**

**300 West 55th Street  
New York, NY 10019  
(212) 757-5300**

**Contact: Don Purcell**

**Program: "Do-It-Yourself"**  
**Length:** 60 or 30 seconds. **Frequency:** 130 programs, optional rotational schedule. **Program Description:** Valuable suggestions and how-to-do-it type for homemaker, directed at both men and women. Designed for building supply, hardware, or paint dealer sponsorship. Available on cash basis: \$20 to \$40 per month, depending on market size. One commercial avail per program; 52-week minimum contract. Designed for all formats. Programs can be customized for either station or client. 60-second programs supplied on mono tape; 30-second programs supplied on mono disc. Unlimited program play permitted during year. Program available outside U.S. and Canada from: Grace Gibson, Radio Productions Pty., Ltd., 77 Pacific Highway, North Sydney, Australia 2060.

**Program: "Car Care"**  
**Program Description:** A traffic-time feature, designed for the car dealer or auto service organization. Co-written by Dave Lachenbruch of TV Digest and antique car collector, and Harold Rusten, syndicated newspaper columnist. Additional information the same as above.

**Program: "Sports Special"**

**Program Description:** Strong traffic-time feature with wide listener and advertiser appeal. Sports vignettes of yesteryear compiled by Milt Shapiro, noted sportswriter and author of "The Jackie Robinson Story". Additional information the same as above.

**Program: "Health Hints"**

**Program Description:** A family program of valuable and timely medical information, scripted by Ted Stoll of Medical World News. Designed for sponsorship by drug stores or drug products. Additional information the same as above.

**Program: "Kitchen Korner"**

**Program Description:** A program featuring unusual quickie recipes and kitchen tips. Designed for food products and supermarket chain sponsorship. Additional information the same as above.

**Program: "The Great Outdoors"**

**Program Description:** Milt Shapiro, editor of "Gunsport" magazine has written this series of outdoor features covering facts and figures for the outdoorsman. Designed for sporting goods products and dealers. Additional information the same as above.

**Program: "Camera Club"**

**Program Description:** A non-technical series of picture-taking tips for the serious shutterbug and casual snapshooter alike. Written in easy-to-understand language by Charles Sinclair, consultant for Kodak Company. Designed for camera shops, processors, or manufacturers. Additional information the same as above.

**Radioland Productions, Inc.**

**25 Ledge Road  
Gloucester, MA 01930  
Contact: Todd W. Kaiser**

**Program: "Fibber McGee & Molly and the Good Old Days of Radio"**

**Announcers:** Jim Jordan, Hal Peary, Gale Gordon, Larry Thor. **Length:** 45 minutes. **Program Description:** Package of 7 shows featuring Fibber McGee talking about oldtime radio programs. Includes guest appearances. Available on cash basis: \$18 to \$52.50 per show, depending on market size. Ten commercial avails per program. Supplied on mono tape.

**Program: "A Christmas Carol, starring Orson Welles and Lionel Barrymore"**

**Length:** 55 minutes, one-time special. **Program Description:** Classic broadcast of traditional Christmas show, taken from Christmas Eve, 1939. Available on time barter.

**Program: "The Memory Bank"**

**Length:** 3 minutes, daily. **Program Description:** Brief comment on popular oldtime radio shows. Available on cash

basis; 13-week minimum contract. Two commercial avails per program.

**Radio Programs, Inc.  
2773 E. Horseshow Drive  
Las Vegas, NV 89120  
(702) 451-4273**

**Contact: William G. Mors**

**Program: "Accent"**

**Announcer:** Guests. **Length:** 3 hours weekly. **Program Description:** Designed for weekend play. Music from country to classics, plus interviews with various stars, special records, in magazine-type format. Available on cash basis: price, five times highest 1-time station spot rate weekly. Thirty-six commercial avails per program; 26-week minimum contract. Designed for MOR/talk/beautiful music stations. Program provided on stereo tape or disc. At end of 26 weeks, unlimited airplay permitted.

**Rock Around The World  
6255 Sunset Blvd., Suite 716  
Los Angeles, CA 90028  
(213) 464-7481**

**Contact: Danny Lipman, Eddie Kritzer**

**Program: "Rock Around The World"**

**Announcer:** Chuck Marshall. **Length:** 60 to 90 minutes, weekly. **Program Description:** Interviews and live concerts of rock stars from around the world. Available for time barter; various sponsors. Five national sponsor commercials per program; five local avails per program; 13-week minimum contract. Designed for rock formats. Promotional materials available: Monthly newspaper ads and promo spots. Program provided on disc. Unlimited broadcasts permitted.

**Alan Sands Productions**

**565 Fifth Avenue  
New York, NY 10017  
(212) 697-6135**

**Program: "Miracle Gardening Tips"**

**Announcer:** S. Baker. **Length:** 45 seconds, 10 features weekly. **Program Description:** Tips on indoor and outdoor gardening suitable for both home owners with a garden, or apartment dwellers who keep potted plants. Available on cash basis: \$5 to \$10 per week, depending on market size. One commercial avail per program; 13-week minimum contract. Designed for all formats. Programs supplied on tape. Tapes must be returned after use. Unlimited broadcasts permitted.

**Program: "Your Guide to Good Health"**

**Announcer:** L. Coleman. **Program Description:** Discussion of health topics of interest to the general public. Additional information the same as above.

# LOOK TO O'CONNOR



**RONALD REAGAN**— Former California Governor presents an alternative look at the vital issues facing America. 5 minutes daily.



**ELIOT JANEWAY'S "You and Your Money"**. Valuable advice on money matters from America's foremost personal economist. 2 minutes daily.



**ART LINKLETTER** with "Kids Say the Darndest Things". The fascinating show that captures the priceless humor of children. 5 minutes daily.

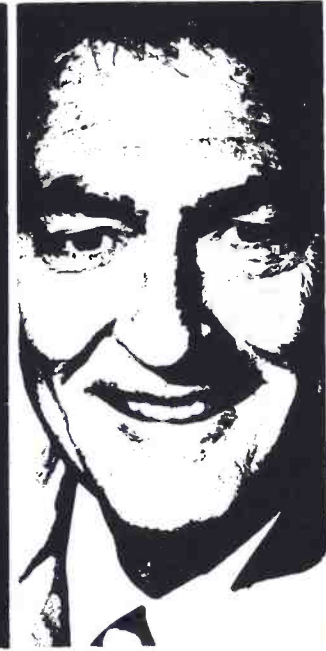

**"YOU'RE THE JUDGE"** with Ralph Story. An informative feature that lets your listeners "judge" actual court cases. 2 minutes daily.



**RIP OFF** with Martin Milner. Consumer and criminal cons, swindles and frauds are the subject of this fascinating feature. 2 minutes daily.

# FOR RADIO FEATURES

Call for your audition cassette  
TOLL-FREE 800-423-2694

 O'CONNOR

O'CONNOR CREATIVE SERVICES  
Box 8888, Universal City, CA. 91608  
Phone (213) 769-3500

# Record Report Hooks Charlie Tuna!

Charlie Tuna, top-rated morning man on KHJ, Los Angeles, joins "Record Report" as its new national host.



"Record Report" begins its third year of reporting the exclusive, inside news of what's going on with the superstars of pop music in a 3½ minute, twice-daily newscast. Now heard on over 185 leading U.S. radio stations.

Charlie Tuna gets hooked on "Record Report." So will your listeners and advertisers. Call Mary White and catch "Record Report" exclusively for your station, free of charge!



**FILMWAYS/RADIO INC.**

1610 N. Cahuenga Blvd.  
Hollywood, CA 90028  
(213) 462-6421

↑ Want more details?  
Circle No. 27 on Product Info. Card.

Program: "Boating Tips"  
Announcer: W. McKeown. Program Description: A comprehensive series that discusses 260 boating situations — both sailing and motorized — from safety to seasickness, racing and boat care. Additional information the same as above.

Program: "Your Home Handyman"  
Announcer: B. Gladstone. Program Description: In simple language, discusses time-saving and money-saving tips on home repairs for the home owner and apartment dweller. Additional information the same as above.

Program: "Minute Tips on Your Child and You"  
Announcer: Celia Dayton. Program Description: Covers many different problems of baby and child care. Additional information the same as above.

**Signal Productions, Inc.**  
6233 Selma Avenue  
Hollywood, CA 90028  
(213) 463-4173  
Contact: Ken Veth

Program: "Point of Law"  
Announcer: Jack Moyles. Length: 3¼ minutes, daily. Program Description: Three times winner of Freedoms Foundation award. Sets forth important legal cases and decisions in challenging, interesting, entertaining manner. Available on cash basis, with price depending on market size. 13-week minimum contract. Designed for all formats. Some promotional materials available from syndicator. Programs supplied on tape. Tapes must be returned after use. Two plays permitted per program.

Program: "Doctor's House Call"  
Announcer: Dr. James Rogers Fox, M.D., plus guests. Length: 3¼ minutes. Program Description: 640 medical subjects discussed in authoritative non-technical terms that laymen can understand and enjoy. Designed for sponsorship by pharmacies, insurance companies, etc. Additional information the same as above.

Program: "The Passing Parade"  
Announcer: John Doremus. Length: 3¼ minutes. Program Description: Entertaining, story-telling program featuring true stories from the realm of romance, adventure, mystery and science. Additional information the same as above.

Program: "World of Travel"  
Announcer: Dr. John Furbay. Length: 3¼ minutes, daily. Program Description: Travel program which takes listeners on thrilling visits to domestic and international places of special interest, discussing customs and traditions. Designed for sponsorship with travel agents, oil companies, service stations, financial institutions, auto dealers, etc. Additional information the same as above.

Program: "American Mosaic"  
Announcer: Don Burgess. Length: 2¼ minutes, including commercial, daily. Program Description: Program setting forth contributions to America's heritage and culture by various immigrant stocks. Additional information the same as above.

Program: "Good Ideas"  
Announcer: Jerry Verbel. Length: 1 minute, daily. Program Description: Series of good ideas for modern living narrated in a bright, breezy format. Helpful ideas for home, school or work. Designed for sponsorship by banks, insurance companies, etc. Additional information the same as above.

**Simcom International, Inc.**  
1900 Avenue of the Stars, Suite 1000  
Los Angeles, CA 90067  
(213) 552-2284  
Contact: George Krieger, Rick Melchior

Program: "The Cook's Survival Kit"  
Announcer: Stacie Hunt. Length: 90 seconds. Frequency: 5X per week, Monday through Friday. Program Description: A consumer cooking show designed to save time, money, and effort in and around the kitchen with unusual tips, hints, etc. Available exclusively to one station per market. Show to be aired between 10:00 a.m. and 3:00 p.m. Available time barter (free). Sponsor: Spice Islands. One :30 sponsor commercial with :60 local avail. Minimum contract 26-weeks. Designed for all formats and customized for each station. Two plays required per program. Programs supplied on tape. Currently on the air on 75 stations in U.S. and Canada.

**Starborne Productions Corp.**  
P.O. Box 8260  
Van Nuys, CA 91409  
(213) 789-5293  
Contact: Jim Schlichting

Program: "Frank Chacksfield and His Orchestra"  
Length: 20 minutes per month. Program Description: Current and recent hits for easy listening stations, recorded in London for U.S. radio play only. Available on cash basis with price depending on market size. Minimum contract one month. Promotional materials available. Program supplied on tape or disc in stereo. Tapes and discs must be returned to syndicator. Unlimited broadcasts permitted.

**The Starr Studios, Inc.**  
7011 N. Jan Mar Drive  
Dallas, TX 75230  
(214) 691-8846  
Contact: Carole or Dick Starr

See listing for Toby Arnold & Associates, Inc.

**Summit Productions**  
6605 Ampere Avenue  
No. Hollywood, CA 91606  
(213) 762-5544  
Contact: Derith Hansen, Carrol Potter

Program: "The ESP Phenomena"  
Announcer: Sonny Melendrez. Length: 3½ minute features. Program Description: Celebrities, psychics, and parapsychologists commenting on fascinating events they have witnessed of a psychic nature. Interlaced with pop music pertaining to each subject. Winner of last year's award for excellence in programming from Billboard magazine. Available on cash basis: \$125 to \$600 for entire series; price is depending on market size. 150-290 commercial avails for series; 13-week minimum contract. Designed for rock, MOR, R&B, and talk formats. Program customized on request. Program supplied on mono or stereo disc, which must be returned after airplay. Unlimited airplay permitted for length of contract.

Program: "Sentimental Journey"  
Announcer: Pete Moss. Length: 13 one hour shows or 10 minute sets, daily or weekly. Program Description: Carefully selected combinations of music, events, and actualities of the twenties through the fifties, produced in 65 balanced sets. Available on cash basis; price depending on market size. 130 to 360 commercial avails for package; 13-week minimum contract. Designed for MOR and beautiful music formats. Program customized on request. Promotional materials available. Supplied on stereo or mono discs which must be returned after use. Two plays permitted per program during contract period.

Program: "Women"  
Length: 60 seconds, daily, five days per week. Program Description: Vignettes on famous and infamous women throughout history. Designed for all formats. Programs customized for each station.

Program: "The American Disco Network"  
See Krishane Enterprises, Inc., listing.

Program: "The Cook's Survival Kit"  
See Simcom International, Inc., listing.

**Bud Sunkel Time**  
927 N. Griffin Street  
Danville, IL 61832

Program: "Bud Sunkel Time"  
Length: 15 or 30 minutes, daily. Program Description: A radio visit on a one-to-one basis. Covers subjects from A to Z. Informal chat and philosophy. Available on cash basis: \$5 per program (5 per week); 2 — :20 and 2 — :60 commercial avails per program. One week minimum contract. Designed for MOR, country, news, talk, and gospel formats. Programs customized for each station. Promotional materials available. Supplied on mono tape. Tapes must be returned after use. Two plays per program permitted.

**Syndicast Northwest**  
North Pacific Building, Suite 303  
Portland, OR 97208  
(503) 225-0509

Program: "Soul Control U.S.A."  
Announcer: Roy Jay. Length: 90 minutes, weekly. Program Description: Weekly countdown of the nation's top 20 R&B hits with commentary. Available on time barter basis. Three commercial avails per program. Designed for R&B formats. Program supplied on stereo tape. Tapes must be returned or bicycled. Two broadcasts per program permitted.

Program: "Roy Jay's Review"  
Announcer: Roy Jay. Length: 60 minutes, monthly. Program Description: Program debuting new R&B releases. Additional information the same as above.

**Syndication Corporation**  
1635 S. Division  
Grand Rapids, Mich. 49507  
(616) 243-6837  
Contact: Bob Thompson



**8 powerful formats for automated or live radio.**  
Complete Library Service • Mono or Stereo

Call (213) 776-6933  
CaVox Stereo Productions, 502 S. Isis, Inglewood, CA 90301

See Us at NRBA, Suite 1823, New Orleans Hilton Hotel.

**Directory continued**  
on page 60



# Producing the Bob Newhart Show

by Michael Carruthers

The position of Executive Producer, and sometime Writer and/or Director of *The Bob Newhart Show*, is more than a full-time job in itself. Nevertheless, you'll find Executive Producer Michael Zinberg's name on the credits of just about every MTM show on the air. His energetic proficiency on the stage and in the offices of the Bob Newhart Show seems to be the rule rather than the exception.

Zinberg never revealed the source of the energy, but the proficiency comes from having worked with some very successful people. He worked for two years as a production assistant for Talent Associates, a television production company responsible for such shows as *Get Smart*, *The Governor and J.J.*, *The Good Guys*, as well as several pilots. On the staff at Talent Associates were such familiar names as Jim Brooks, Alan Burns, Jay Sandrich and David Davis. In 1971, Zinberg left the company to work as Assistant Producer on the James Garner series, *Nichols*, while Davis left to work on *The Mary Tyler Moore Show*, along with Brooks and Burns. Although *Nichols* was only in production for a year, Zinberg feels it gave him the opportunity to associate with and learn from some real professionals.

Frank Pierson, the Producer of the *Nichols* series, later went on to write and direct *A Star Is Born*, and write *Dog Day Afternoon*, winning an Academy Award for the latter. Pierson's Executive Producer, Meta Rosenberg, produced *Skin Game*, and is still associated with James Garner on *The Rockford Files*. All-in-all, not bad company to keep.

When *Nichols* was cancelled, David Davis asked Zinberg to come to work on a new pilot that CBS had just bought . . .

something called *The Bob Newhart Show*. Davis was leaving his position with *The Mary Tyler Moore Show*, Zinberg picked up those additional duties, and ended up as its Associate Producer, along with the *Newhart* show.

Although it was sort of a complicated chain of events, Zinberg recalls the early MTM days as being a lot of fun, and a great learning experience. "There were probably only a dozen guys here in the executive offices," says Michael, "so it was a small, family-type company. Then, after the second season of the *Newhart* show, we had two new shows on the air . . . *Rhoda*, and Paul Sands' *Friends and Lovers*. The company started to grow. We all chose the way we wanted to pursue our careers . . . I decided I wanted to direct, so I stayed with the *Newhart* show." Zinberg says the opportunity to make career decisions like that doesn't happen too often. "It would have been very easy for them to say no . . . you're too young to direct. Or Bob (Newhart) could have said he didn't see me as a director. I could have been stopped at any point. But this group of people will let you do anything you want to. They'll also let you fall on your face! You make your own decision as to whether or not you can do a job. That philosophy comes from Grant Tinker (MTM head). That's the kind of company he wanted . . . so that's the kind he created." Michael is now in his sixth year with MTM Enterprises and *The Bob Newhart Show*, and has moved from Associate Producer, to Producer, to Executive Producer in this, the show's final season.

The origins of the *Newhart* show go back to when Bob Newhart's and Mary Tyler Moore's manager, Arthur Price, gave up his

management career (except for managing Bob and Mary) to form MTM Enterprises with Grant Tinker. Soon after *The Mary Tyler Moore Show* debuted on CBS, Newhart was asked if he would like to do a series for the company. Newhart had turned down several series offers in the past, feeling that none of them were exactly right for him. However, having observed Mary's show, and feeling it was, "well-produced and had class and style to it . . ." Newhart reacted favorably when MTM approached him.

After Newhart's favorable reaction evolved into a deal, the concepts of the series went through several evolutions. In the original discussions of developing the characters, their occupations, and situations in which the characters would revolve around, Bob was going to be a psychologist living in a condominium with his wife. The stories would then be divided between problems at the office, and

The "Newhart" cast celebrates the filming of the 100th episode. While 1978 is the final season for "The Bob Newhart Show," Newhart will do one special per year for CBS, and is contracted for another regular series beginning in 1981.



# Why Panasonic's Series 9000™

## We started with an annealed aluminum die-cast chassis.

Up to now selecting the right VCR deck or system left you with one major problem: To get the features you wanted, you had to pay a small fortune. Now there's Panasonic's new generation VCR. Series 9000. Two standard-performance decks. Two high-performance decks. And a high-performance, direct-drive editing system. Each with the kind of features and performance you may not find even in the most expensive 3/4" decks.

Like an annealed aluminum die-cast chassis. For better stability of alignment, greater strength and long-term durability. Like individually removable cabinet panels on the outside. And low-density circuit boards on the inside. There's also a new jam-proof gear tape loading system. Less jitter. A high S/N ratio of 45 dB. And more.

For those who want a meaningful alternative in standard VCR performance, Panasonic offers the NV-9100 player. And the NV-9300 player/recorder

with VHF and UHF tuners. Both decks include high resolution: 330 lines mono and 240 lines color. A VTR/TV antenna switch. An optional RF modulator. And just about everything else you need for the kind of picture you want.

There are also two high-performance, direct-drive decks. The NV-9200 player/recorder and the NV-9500 editing recorder. The NV-9200 gives you outstanding performance at a very affordable price. Because it gives you a direct-drive video head cylinder. Patented HPF video heads. Chroma level adjustments. As well as the capstan servo system.

The results: Highly stable color and black and white pictures with less jitter. High resolution: 330 lines mono and 250 lines color. And dubs that look more like masters than copies. But whether you use it as a high-quality master recorder, a CCTV studio deck or a dubbing deck, the NV-9200 will give you the performance you expect at a price you don't.

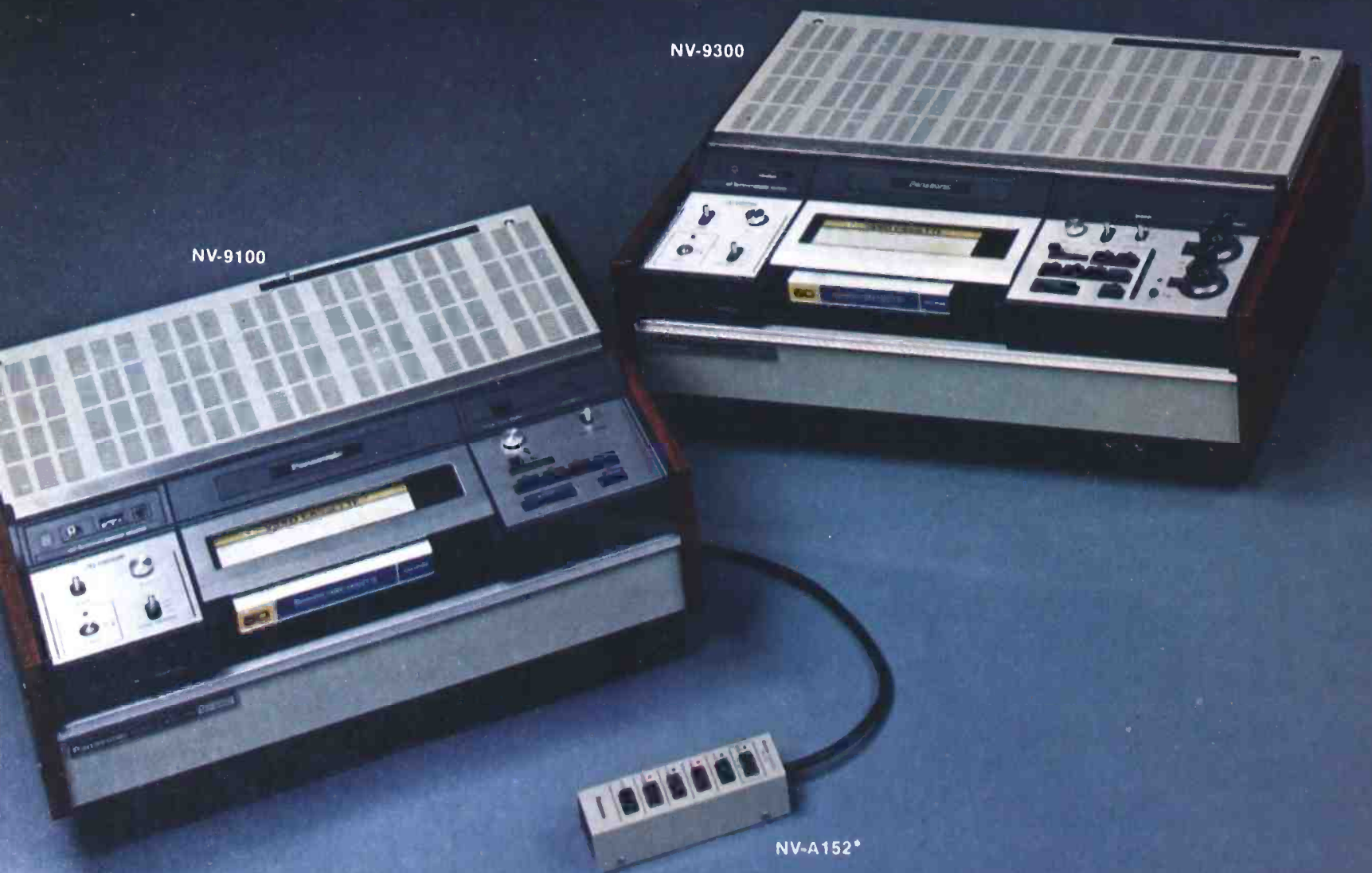



# should be your next 3/4" VCR.

**We finished with a direct-drive editing system for under \$10,000.**

With the NV-9500 editing recorder, you also get frame-by-frame insert and assembly edits that are crisp and clear. Without tear, roll or loss of chroma information. And with its two independently selectable audio channels, you can also edit audio without affecting video.

But perhaps the best part about the NV-9200 and the NV-9500 is what goes between them—the NV-A950 editing controller. With its five-minute memory for entry and exit points of video and audio inserts, the NV-A950 will let you perform insert and assembly edits automatically. What's more, at a complete system price of under \$10,000 you can also achieve considerable savings over comparable editing systems.

And for complete 3/4" mobility, Panasonic also offers the NV-9400 portable VCR, as well as the WV-2210 portable color camera. Both are compact, lightweight and operate on rechargeable

Panaloid™ batteries.

But the best way to be convinced about our new VCR's is to see them in action. Ask your Panasonic dealer for a demonstration. He'll show you how to get the 3/4" VCR system you want at a price you can afford. Series 9000 by Panasonic.

For more information write: Panasonic Company, Video Systems Division, One Panasonic Way, Secaucus, N.J. 07094. In Canada, contact Panasonic Video Systems Department, 40 Ronson Drive, Rexdale, Ontario M9W 1B5.

\*Optional remote control for all Series 9000 decks shown below.

All cabinetry is simulated wood.

## Panasonic®

just slightly ahead of our time.





Michael Zinberg is Executive Producer of "The Bob Newhart Show." Zinberg has written and directed several "Newhart" episodes, and has worked on many other MTM shows, such as "Mary Tyler Moore," "The Tony Randall Show," "We've Got Each Other," "The Betty White Show," and "Rhoda."

problems at home. The condominium concept was dropped, because it was felt that a majority of the viewers wouldn't know enough about condominiums to get any humor out of it. The character, Jerry, was originally another psychologist who, as Newhart describes, "... was a little wild-eyed ... he was always into hot tubs, nude encounter groups, and that sort of thing. That didn't seem to test well, so we made him a dentist on the same floor with me." The other regular characters were added, the pilot shot, and eventually sold.

Filming the Newhart show is a four-day project each week the show is in production. In other words, from the time the cast first assembles with scripts to begin rehearsal, to the time the show is filmed in front of a live audience, four days have elapsed. Other situation comedies of this type usually involve a five-day production

Mark Tinker, Associate Producer, worked for KNXT-TV, Los Angeles, before joining Lorimar Productions as a production assistant on "The Waltons." At MTM for the past two years, Mark has served as Associate Producer for the "Newhart" show, "Three For the Road," and several MTM pilots. He recently produced the Mary Tyler Moore retrospective with Michael Zinberg which was seen on the Emmy Awards show.

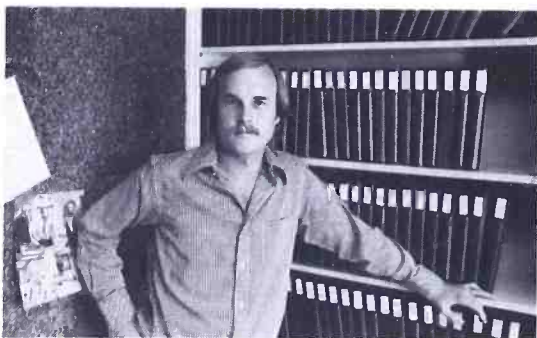

schedule to allow more rehearsal time, but Newhart prefers four days so the material doesn't become stale. Newhart comments, "I don't like a five-day week because I get down on the material ... and then I lose faith in it."

### Production Schedule

Michael Zinberg explains the sequence of events in a typical four-day production week:

*Day 1:* "We read at nine-thirty on the first day, which usually takes about an hour. We rehearse and stage the entire show ... the writers come down and see the first three scenes before lunch, and the last three scenes after lunch. Then the writers (along with Zinberg, Producers Glen and Les Charles, Associate Producer Mark Tinker, Story Editor Lloyd Garver, and Creative Consultant Dick Martin) do the *big re-write*. We take everything that's not working in the script and try to improve it. We're usually here very late that night."

*Day 2:* "The next morning, the actors come in to a new script. We rehearse all morning, then sometime around two o'clock, we do a complete run-through of the show in sequence. We then come back upstairs and do what we hope will be a light polish on the script."

*Day 3:* "The third day, we start at nine-thirty in the morning blocking the cameras to the scenes, using stand-ins. We then bring the actors back and run the scenes with the proper blocking and camera choreography."

*Day 4:* "The fourth day, the actors come in about noon. We rehearse each scene two or three times with cameras until around four o'clock. We then do a total run-through of the show in wardrobe, with all effects working. We take a break for about an hour-and-a-half, then shoot the show in front of the audience at about seven o'clock."

The show's regular cast has adapted to the four-day week, as well as the constant re-write. However, it has made some directors pretty nervous. According to Bob Newhart, "Some directors we've had got pretty nervous because they never knew what they were going to get. But it's the only way I can work." Newhart also notes that it makes some of the guest actors uneasy as well. "... We advise the actors not to lock anything in until the third night, because it's being changed all the time. We had one actor who was *Broadway-trained* and used to a lot of rehearsal. At the end of the first day, we all said, *fine ... see you tomorrow*, and he said, *well ... when do we sit down and talk about our roles and our characters?* But we just don't do that. The hardest part is learning the lines ... there's no short-cut to learning them, because we don't use any aids (cue cards). And in addition to just knowing it, it's gotta be funny ... that's what the whole show is all about."

### Scripts

Although the show employs writers and

*re-writers*, everyone involved contributes ideas for script changes to end up with the best possible material. It's not uncommon for considerable script changes to take place just prior to the actual filming on the fourth day. While last-minute overhauls may make the cast and crew uneasy, the original writer of the script rests well. There is a policy at MTM that, regardless of the amount of changes made on the original script, the writer who submitted it always receives solo credit. According to Zinberg it doesn't always work that way with other production companies. "... If you submit a script, and the producer or story editor does a re-write, you can submit the script for arbitration. Some members of the Writer's Guild will read both versions of the script and decide who should get the credit. In addition to the screen credit getting chopped up, the residuals get chopped up. In the past there have been cases of story editors and producers taking perfectly good material and re-writing it ... then taking money even though the script was fine to begin with." Jim Brooks and Alan Burns had been victimized by this practice in the past, so when they went on to MTM, they developed a policy whereby a script will never be arbitrated. No matter how many changes had to be made, the writer of record always gets full credit. Zinberg added, "In the history of this company, I can tell you that some of the scripts have been shot word-for-word with what the writer brought in. And on some of them, the only original thing left was the writer's name. The average script ends up sixty to seventy per cent of what the writer originally brought in."

As in past years, many of the original scripts are being generated from within MTM enterprises. The shows Producers, Glen and Les Charles, have written several episodes for this season, as has Lloyd Garver, the show's Story Editor. Plus, this year, almost every episode will be directed by someone already working on the show ... either Michael Zinberg, Dick Martin (formerly of Rowan & Martin), or Peter Bonerz (actor who plays Dentist Jerry Robinson).

Zinberg credits the development of the characters largely to the actors who portray them. "Newhart is his own character," says Michael. "He knows that character better than anyone else ... Suzanne (Pleshette)

"The Bob Newhart Show" is filmed before a live audience on a sound stage at CBS Studio Center, Studio City, California.





Michael Zinberg, Executive Producer, confers with "Newhart" staff members between scenes. While most situation comedies are on a five-day production schedule, "Newhart" works on a four-day schedule, to keep the material from becoming stale.

has worked very hard at defining a character out of Emily Hartley. The first couple of years there was no character. Now, as a result of her defining the character, it's a little tricky for us to write for her because she's the best judge of what works, and what doesn't. Bill Daily's character (airline pilot Howard Borden) is positive laughs, and so is Marcia Wallace's (Carol, Dr. Hartley's secretary). Peter Bonerz' character (Dentist Jerry) is the one character I've been disappointed in. It's certainly not Peter's fault... because he can act anything we give him. It's just that we have not developed that character in the writing. This season, although it's our last, we are trying to expand that character."

### Lighting

The *Bob Newhart Show* is filmed before a live audience on a sound stage at the CBS Studio Center in Studio City, California. Normally, lighting for shows of this kind is very flat from very high. The flat lighting, which Zinberg describes as, "basically throwing a sheet of light across the stage," combined with highlighting to prevent camera shadows, provides what Michael considers, "... a very washed-out look. Our cinematographer is willing to take more chances than most cinematographers... in moving the set through peaks and valleys in terms of lighting. Occasionally, we've had an actor walk into the dark because he's missed a spot... but on the other hand, the show's look is much better... more real." To correctly set the lights, the cinematographer watches the rehearsals. He notes the locations of the actors in the scenes, and when the run-throughs have ended, he re-positions the lights accordingly, using stand-ins.

### Audio Problems

For Michael Zinberg, the biggest technical problem is the audio. First of all, everything must be miked from above using omni-directional microphones. Floor mikes won't work, because cameras would run over them. Wireless mikes on the actors won't work because there are too many wardrobe changes between scenes. Another problem is that the audio console

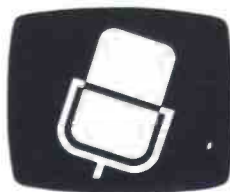

# BROADCAST PROGRAMMING & PRODUCTION

## BOOKS BOOKS BOOKS

**DIMENSIONS OF BROADCAST EDITORIALIZING** by Edd Rouff. How to establish an editorial policy, how to develop and write forceful and effective editorials (and how to present them), and how to avoid legal complications resulting from violations of the FCC "Fairness" rules. 204 p. Order No. 697 Hardbound \$8.95

**RADIO PROGRAM IDEABOOK** by Hal Fisher. All the programming ideas you need to build and hold an audience. A virtual thesaurus of ideas on radio showmanship loaded with suggestions to help push ratings to the top. 256 p. Order No. 268 Hardbound \$12.95

**RADIO PRODUCTION TECHNIQUES** by Jay Hoffer. Covers every phase of radio production from announcements to over all station "sound"—special emphasis on sales and production expertise. 196 p., illustrated. Order No. 661 Hardbound \$12.95

**VIDEOTAPE PRODUCTION AND COMMUNICATION TECHNIQUES**, by J.L. Efrein. A complete text on the production of video recording for effective communications. How to put professional techniques to work. 256 p. Order No. 541 Hardbound \$12.95

**JOURNALIST'S NOTEBOOK OF LIVE RADIO-TV NEWS** by Phillip Keirstead. Covers the techniques of gathering, processing, writing, and broadcasting live news, using the latest ENG equipment. Contains special sections on laws relating to journalism, documentaries, and editorials. 252 p. Order No. 819 Hardbound \$12.95

**TELEVISION NEWS HANDBOOK** by David Dary. A complete guide to TV news department operation, including how to gather, write, produce and present TV news. 256 p. Order No. 567 Hardbound \$9.95

**RADIO NEWS HANDBOOK** by David Dary. Ideas to improve and enhance newscasts. Provides a solid grounding in radio news basics, mechanics, and style, plus necessary details on the workings of a radio newsroom. 192 p. Order No. 216 Hardbound \$7.95

**THE MINI-DOCUMENTARY—Serializing TV News**, by Stanley Field. Keys to successful presentation of serial documentaries, based on interviews with producers, cameramen, editors, and soundmen with hands-on experience with the mini-documentary. 252 p. Order No. 797 Hardbound \$12.95

**HOW TO WRITE NEWS FOR BROADCAST & PRINT MEDIA** by David Dary. A complete handbook on journalism in both print and broadcast fields. 192 p. Order No. 643 Hardbound \$9.95

**GUIDELINES FOR NEWS REPORTERS** by Sol Robinson. Covers what is required of a broadcast journalist, the problems and solutions. 192 p., illustrated. Order No. 516 Hardbound \$9.95

**GUIDE TO PROFESSIONAL RADIO & TV NEWSCASTING** by Robert C. Siller. A practical, self-study guide for those who want to get ahead in broadcast journalism. 224 p. Order No. 535 Hardbound \$9.95

**THE POWER TECHNIQUE FOR RADIO-TV COPYWRITING** by Neil Terrell. How to write broadcast copy that gets results, copy that will sell products and services. Presents actual samples from the files of leading pros. Analyzes advertising copy that will motivate people to buy. 224 p. Order No. 518 Hardbound \$9.95

**PROFESSIONAL BROADCAST WRITER'S HANDBOOK** by Stanley Field. Covers all forms of writing—drama, documentary, children's, and religious programming, news, and commercial copy—for both radio and TV. Order No. 635 Hardbound \$14.95

**PROMOTIONAL & ADVERTISING COPYWRITER'S HANDBOOK** by Thomas F. Ris. A copywriting text-workbook. Contains 18 assignments in preparing copy for papers, magazines, billboards, direct mail, radio, and television. 128 p. Order No. 579 Leatherette \$7.95

**HANDBOOK OF MULTICHANNEL RECORDING** by F. Alton Everest. Covers everything to know about making the highest quality tape recordings, including modern techniques in dubbing, special effects, mixing, reverb, echo, and synthesis. Recommended for all broadcast recording applications. Order No. 781 Hardbound \$10.95

**HOW TO PREPARE A PRODUCTION BUDGET FOR FILM AND VIDEOTAPE** by Sylvia Allen Costa. A complete guide to determining the finances needed for any video tape or film production, from TV commercials to feature length productions. 196 p. Order No. 845 Hardbound \$12.95

**THE COMPLETE HANDBOOK OF VIDEO CASSETTE RECORDERS** by Harry Kybett. Covers all aspects of videocassette machines. Order No. 811 Hardbound \$9.95

**TV LIGHTING HANDBOOK** by J.A. Carroll and R.E. Sherriffs. All aspects of television lighting, from position, intensity, camera relationships, subjects, color, graphics, special effects, background lighting, and remote telecasts. 226 p., illustrated. Order No. 793 Hardbound \$12.95

**HOW TO SELL RADIO ADVERTISING** by Si Willing. The sales call—how to use available sales tools to the best advantage, and how to deal with competition. You'll learn ways to sidestep objections, how to recognize the "opportune moment," and how to convert a "No" to a "Yes." 320 p., illustrated. Order No. 511 Hardbound \$12.95

**HANDBOOK OF RADIO PUBLICITY & PROMOTION** by Jack Macdonald. A virtual promotion encyclopedia of over 1500 on-air promo themes adaptable to any format. Over 350 contests, stunts, station and personality promos. Order No. 213 3-ring binder \$29.95

**RADIO PROMOTION HANDBOOK** by William Peck. Jam-packed with hundreds of ideas, and complete with scores of factual examples to spark hot new ways of promoting a station, both on the air and off. 256 p., illustrated. Order No. 267 Comb-bound \$9.95

**ANATOMY OF LOCAL RADIO-TV COPY** by William Peck. Over-the-shoulder course in creative copywriting by one of the best admen in the business, who gives practical instruction on every step of the copywriting process. Order No. 890 Leatherette \$5.95

**RADIO ADVERTISING—HOW TO WRITE AND SELL IT** by Sol Robinson. Practical ap-

proach to radio advertising sales—new and useful methods which the time salesman (and writer) can use to obtain better results for himself, the station, and sponsor. 228 p. Order No. 565 Hardbound \$12.95

**RADIO STATION SALES PROMOTIONS** by Jack Macdonald. A compendium of creative selling ideas designed exclusively for radio stations. Covers sales-producing ideas in 43 categories, from air conditioners to washing machines. 72p. Order No. 214 Comb-bound \$10.00

**A COMMON SENSE GUIDE TO PROFESSIONAL ADVERTISING** by Arthur W. Lavidge. Practical, how-to guide that shows how successful advertising is created—from copy and design to TV commercials. 304 p., illustrated. Order No. 612 Hardbound \$9.95

**BROADCAST STATION OPERATING GUIDE** by Sol Robinson. Guidelines for station operation—from starting a new facility to making a profit, from programming to accounting. This comprehensive reference deals with the specifics of day-to-day operation. 256 p. Order No. 467 Hardbound \$12.95

**MODERN RADIO BROADCASTING: Management & Operation in Small to Medium Markets**, by R.H. Coddington. Management, production, engineering, or operations, this encyclopedia covers the "nuts and bolts" of radio operation. Order No. 482 Hardbound \$12.95

**AM-FM BROADCAST STATION PLANNING GUIDE** by Harry Etkin. A comprehensive guide to planning, building, and operating a radio broadcast facility. 192 p. Order No. 500 Leatherette \$12.95

**MANAGING TODAY'S RADIO STATION** by Jay Hoffer. Covers expected return on investment, budgeting and projections, audience ratings, advertising, automation, double-billing, unionism, preventive maintenance, format control, station image, news, community involvement, editorials, sports, copywriting, air talent, salesmen, rate cards, competition, merchandising, collections, etc. 288 p. Order No. 461 Hardbound \$12.95

**THE BUSINESS OF RADIO BROADCASTING** by Edd Rouff. How to operate a station as a profitable business and serve the public interest as well. 400 p., illustrated. Order No. 587 Hardbound \$12.95

**MODERN RADIO PROGRAMMING** by J. Raleigh Gaines. Every aspect of radio programming, from format layout to selecting DJs—is detailed in this comprehensive and authoritative work, which is equally applicable to rock, country, religious, classical, or all-talk stations. Order No. 623 Hardbound \$9.95

BP&P BOOKS / P.O. Box 2449  
Hollywood, CA 90028

Please send me the books indicated below:

Book Number:	Price:
_____	\$ _____
_____	\$ _____
_____	\$ _____
_____	\$ _____
_____	\$ _____

Total Enclosed \$ \_\_\_\_\_

(Full remittance must be included with your order — no billing. California residents add 6% sales tax — Foreign orders must be in U.S. dollars, and must include \$1.00 extra per book).

Name \_\_\_\_\_

Address \_\_\_\_\_

City \_\_\_\_\_ State \_\_\_\_\_ Zip \_\_\_\_\_



Zinberg (left) and Dick Martin (formerly of Rowan & Martin). This season, Dick Martin was hired as a creative consultant for "The Bob Newhart Show."

on the sound stage is removed to another stage, and brought back in time for the following week. Since the board is not always there, advance audio preparation is not possible, and in addition, the board's weekly installation requires complete re-patching. "Re-patching the board," says Zinberg, "with seventy or eighty different connections into different mike lines, really changes the property of the sound. Consequently, the show sounds one way one week, and different the next week. Since you can't get a fix on any particular audio qualities of any particular show, the sound has to be re-equalized every week."

Occasionally it is necessary to loop a scene in whole or in part, either because the microphone levels were not properly maintained, or an actor was off-mike. However, rather than loop on a looping stage, the actors go back to the actual set,

"The Bob Newhart Show" sets were designed to allow maximum usage of floor space on the sound stage. Several walls are pivoted and on wheels, which can be swung in either direction to reveal one of two complete sets. The left side of this photo shows the reception area in full. Notice how the center wall has turned Dr. Hartley's office into a closet.



and record the lines wild, without any loop control at all. In doing it that way, the producers feel they can re-create the mood and pace of the scene.

Mark Tinker, Associate Producer, is responsible for dubbing the shows each week on the dubbing stage. There, all the elements of the audio (dialog, effects, and music) are enhanced, equalized, and mixed in sync with the film. "The sound cutters," explains Tinker, "go through the show and make as many tracks as they have to so all the units combine together . . . all the tracks are running on however many machines it takes." The track capability of the equipment is sophisticated enough that, should an error be made, they can simply pick up where the mistake was made. "Ten or twelve years ago," notes Mark, ". . . you had one pass at a reel, and if you screwed up, you had to go back and start again. I can't imagine doing it that way, because we're going back and forth all the time. If we get a laugh we don't like, or an effect is too loud, we go back and do it (that one part) again."

The finished audio master is then made into an optical track which is applied to the film to produce the answer print. Tinker then views the answer print to check the color correction, opticals (fades, dissolves, etc.), and any other potential problems. The next step is the delivery of the show to the network.

#### Laugh Tracks

In the editorial process, as elements are taken out or tightened up, the audio track of the original studio audience reactions tends to start "bouncing", or become "chopped off". In the past, a common solution to audience reaction track problems was the use of what is typically called a *McKenzie machine*. It is a system of pre-taped applause and laughs, whereby each reaction can be called upon by the machine's operator. There are many *McKenzies* still in use, but MTM uses a new system developed

by a company called *Northridge Electronics*. Zinberg describes it as a more advanced and controllable system of audience reactions, ranging from one person laughing to an entire crowd applauding, pre-recorded on an array of cassettes. Michael felt that the *McKenzie* was too limited for their purpose. "It really only has ten laughs . . . they all sounded the same. I know one of the editors who worked on *Ozzie & Harriet*. That show only had one laugh . . . it was on a reel. That was the state-of-the-art in those days."

#### Editing

Naturally, all of the film editing must be completed before anyone can worry about the audio. The show is normally filmed on a Friday, and first reviewed the following Monday. Similar to the majority of the film situation comedies, the Newhart show is a *three-camera film show* (each of the three cameras simultaneously shoots every scene from different floor positions). The film is initially assembled for viewing on a three-headed Movieola in the order the scenes were shot (which is always in show sequence for the benefit of the studio audience). Upon viewing, the producers and director make editing decisions with the film editor, who then cuts together the chosen segments shot from each of the three cameras. The result is viewed, at which point secondary editing decisions are made. "If the show runs long," says Mark Tinker, "we have to lift things out. Sometimes it's very difficult . . . other times it falls right out because there are some jokes that didn't work, or there is exposition we don't need. Then once all the editing is done, it goes to the dubbing stage to begin the dubbing process."

#### Color Correction

Finally, before the video is matched up with the audio to make the answer print, the color in each segment of film is computer-analyzed and corrected. Since the color has a tendency to vary from camera-to-camera, the computer analyzes the color densities of each segment and assigns an arbitrary measurement. As each film segment passes through, continuing measurements are made and correlating adjustments are made on the optical printer. The end result is a balanced final print, with matching hues and contrast from segment-to-segment. The entire process, from the first day of rehearsal, to color correction, is four-to-five weeks.

#### Film . . . or Videotape?

In the past, all MTM productions have been three-camera film shows. But beginning this season, two MTM shows, *We've Got Each Other* and *The Betty White Show*, will utilize videotape, a medium seemingly becoming more and more popular with sitcoms. Each of the mediums has its own advantages and disadvantages, but Michael Zinberg prefers film. "I like film because to me, film

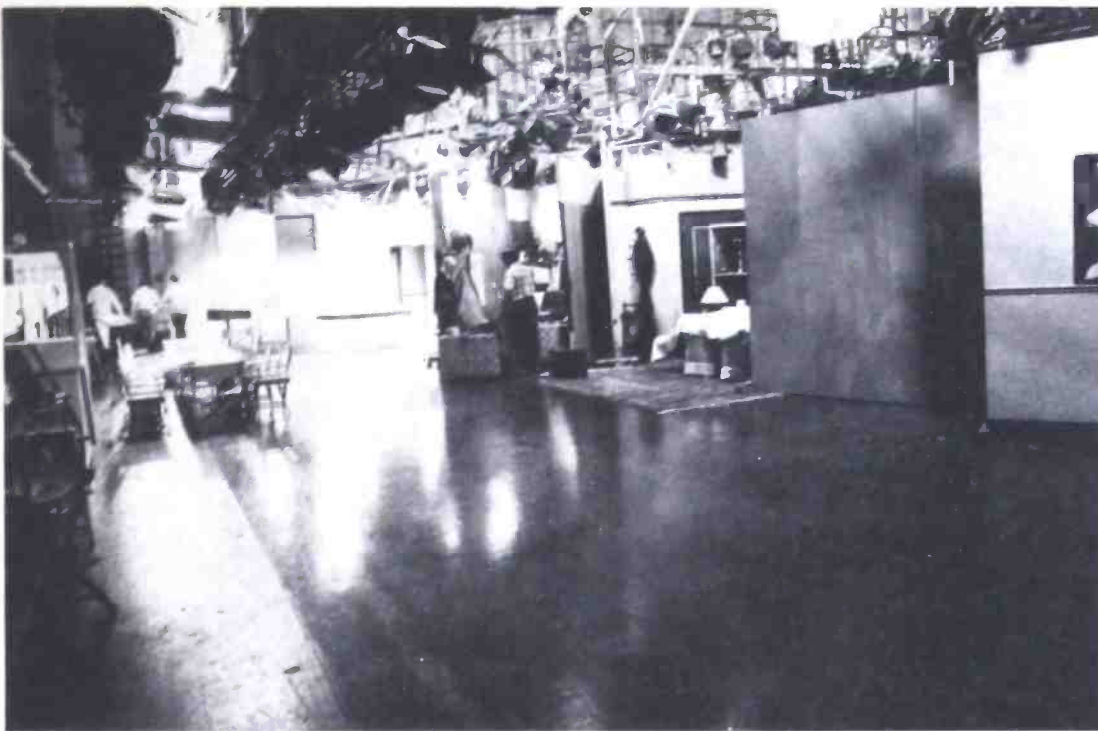

Lighting the "Newhart" set consists of flat lighting from very high — "... basically throwing a sheet of light across the stage ... combined with high lighting to prevent camera shadows."

creates a life of its own, while tape suggests entertainment. Mary's show for example ... you really believed that Mary, Lou, Ted, and Murray could be found at WJM in Minneapolis. They created a life of their own. Archie and Edith Bunker, although they're marvelous, you just don't associate them with reality. You can somehow separate them and say they are characters. Because of the history of film as the great

While many new situation comedies are being produced on videotape, Newhart's Executive Producer, Michael Zinberg, says he prefers film. "... To me, film creates a life of its own. Because of the history of film as the great escape for audience, you go to a theater and ... you are enveloped in a whole different world. I think tape is one step removed from that ... (tape) is acknowledged entertainment. Film represents a real world feeling."



escape for audience ... you go to a theatre and sit there and experience for two hours what it's like to be possessed by the devil ... or what it's like to drive in the French Grand Prix. You are enveloped in a whole different world, and I think tape is one step removed from that. I think it (tape) is acknowledged entertainment."

Although Michael isn't sure if people have gone to New York to find Archie, they have gone to Minneapolis to find Mary Tyler Moore. When the MTM crew went back to Minneapolis to film additional stock footage of the city for transition material, the lady who owned the house that Mary Richards supposedly lived in, refused to let them film anymore exterior shots of the house. Since the show began, she claims people constantly bang on her door asking if Mary Richards is home!

When the crew was in Chicago filming footage for the main titles of The Newhart Show, people on the street were relating to Bob as Dr. Hartley. Because there is the use of stock footage of the location, and the use of different real-life settings like restaurants, hotels, etc., Zinberg feels that film represents more of a real world feeling.

As mentioned previously, the current season will be the final one for *The Bob Newhart Show*. Yet, it will return in syndicated re-runs next fall. Bob Newhart is leaving the series for various reasons, but most importantly, he says, "... you get so involved in the business that you have no judgements about it. If you're in this business, you need to know something about it, and you almost don't have the time. So I just want to stand back and take a look at it ... and see where it's going ... and where I fit into it."

Although the series is ending, Newhart's television appearances won't be. He will be doing a special each year for CBS, and has a contract for another regular series beginning in 1981. However, as Bob Newhart correctly noted, "... this will be a pretty hard one to follow."

## "PRODUCT INFORMATION CARDS" Bring You More Facts Fast!

**PRODUCT INFORMATION CARD**  
Free Card For More Facts On Advertised Products

Please send me additional information on items circled below

Category	101	107	113	119	125	131	137	143	149	155	161	167
Live	102	108	114	120	126	132	138	144	150	156	162	168
Automated	103	109	115	121	127	133	139	145	151	157	163	169
Syndicator	104	110	116	122	128	134	140	146	152	158	164	170
	105	111	117	123	129	135	141	147	153	159	165	171
	106	112	118	124	130	136	142	148	154	160	166	172

Was this copy addressed to you personally?  
Yes  No  Paid Subscriber

Name: BILL JOHNSON  
Title: GENERAL MANAGER  
Station/Company: KTSM  
Address: 4338 OAK ST.  
City: GREENVILLE  
Zip: 15391

Home  Station

Issue Date: 12/7

Categories in this issue were put to you? (In order of preference)  
MARKET RESEARCH  
ADVERTISING PROMOTION

Want more details on products and services seen in this issue of BP&P? Simply tear out the enclosed "PRODUCT INFORMATION CARD," and circle the numbers that correspond to those found at the bottom of the advertisement or editorial item in which you are interested. Then mail it, postage-free, and more information will be rushed to you—at no cost or obligation!

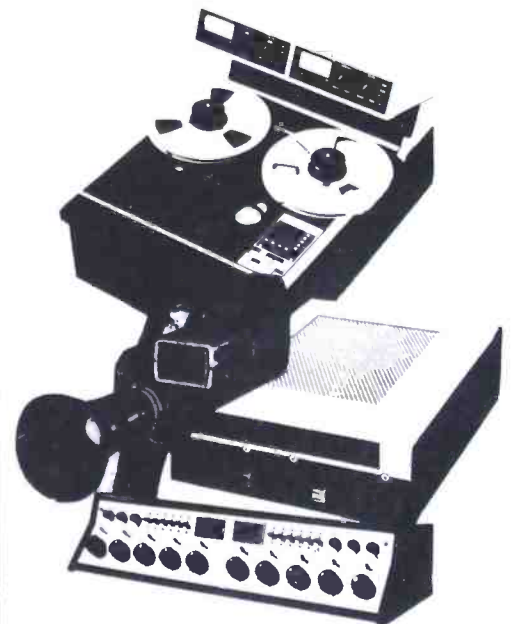

# Creative Programming with Automation

by JoAnn Roe Burkhart  
IGM

"Television has been taping its shows for years now, but nobody cares; in fact, by, taping, elements are presented *right*, no mistakes, no unforeseen problems. So why should we in radio feel that we have to be live to sound alive and vibrant. Even emotion is enhanced because of the ability to study beforehand the cause and effect of your voice tracking."

... This was Pat O'Day talking, once a staunch opponent of automation, but now firmly convinced that — properly and creatively programmed — automation can be an answer to consistency of sound for format.

Paul Drew, Vice President of Programming for RKO, is of the same mind, saying recently,

WDZQ, Decatur, Illinois.

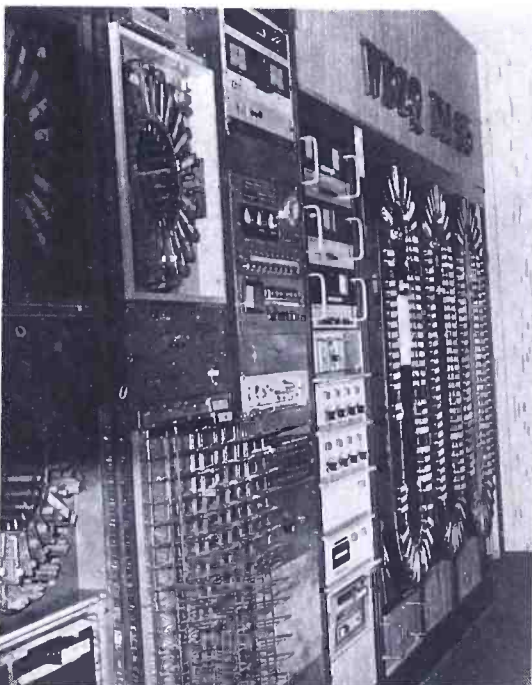

"I welcome with open arms to radio broadcasting the era of computers and equipment that will provide radio with something it has never had, which is a production that is consistent — and I don't mean a lack of spontaneity. It's just that radio in the past ten or fifteen years has become a *business* for a lot of corporations, and a company is in business to make money. There's no live TV today except for news and sports events and a few local shows. Everything is on videotape or film. As a programmer, I want to know that what I have created is presented just that way, because my job is on the line as a programmer if it isn't!"

Still another automation user, Steve Bellingier of WDZQ, Decatur, Illinois, facetiously pointed out that "live" spelled backwards is "evil."

It's true that for hours at a time a live radio station's reputation is hanging out there, resting on the words and snap judgement of one person. A jock's blunder at the mike reflects on the image of the whole station.

The key word mentioned by top programmers using automation is "creative," the difference between dead and live sound from the machinery. Creativeness runs the gamut from sheer camp to seriously researched programs that can be put on the air only (or at least most conveniently) with automation, and include format, news and public service announcements. The common goal of any station is to reach out and hold a loyal group of listeners who look forward each day to laughing, learning and arguing with the station DJ's, as well as listening to music.

Basic to all the latent creativeness in

most DJ's and programmers is the ability to utilize the many features provided in an automation system. Programmed without imagination or incorrectly from an electronic aspect, an automated station can sound robot-like or dissonant. Evolution takes place in radio, not just in equipment, but in personnel. It is a real problem for some non-technical station personnel to approach creative programming with automation. A natural progression in radio is from DJ to programmer, and depending on the size of station, to Ops Manager or General Manager. Meanwhile, because considerable technical knowledge is required to keep a station running, the station engineer usually starts and remains as just that. When management considers purchasing equipment, the engineer naturally is consulted. So a typical situation in many small to medium size stations, even large markets, is that non-technical DJ's or Program Directors are suddenly faced with a sophisticated automation system purchased by the Business Manager and Engineer, then told, well, there it is, now "go" with it. Facing all that shiny hardware, viewed by some as mysterious and malevolent, a few creative people throw up their hands and quit.

What more enlightened management and Program Directors say, however, is that automation enables them to fully utilize truly top people, making it *possible* to really afford the salaries of such talent. Instead of laying off DJ's, the equipment frees them to be better than ever. It's really not all that creative to sit and spin records and press buttons to actuate commercials, juggling the myriads of details, during an entire broadcast day.

Probably the most common remark

# The demos with a difference are here!

Music Explo and The Money Machine. You can listen to library demos all day long and you'll NEVER hear one like ours. In fact, we INVITE you to listen to our competition. (And you know we wouldn't say that unless we are absolutely secure in the knowledge that we have the most dynamic product on the market today.) Listen and compare . . . and we think you'll agree. We DO have the demos with the difference. Which means we have the PRODUCT with the difference. Ask anyone from our participating stations in San Francisco, to Chicago, to Boston to tell you their success stories.

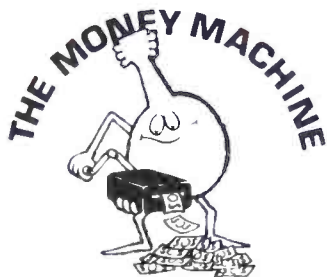

"I know The Money Machine can 1) upgrade and give you a pride about the quality of your station you might not have had until now. And 2) I know your production and sales staff will like The Money Machine because the music doesn't all sound the same. Like we said, there's no sound like it on the market.

And aside from the initial mailing of a complete, reference catalog; 230 music beds; there are 13 flexible, ready-made campaigns (each with country, MOR and contemporary versions), with more mixing capabilities than you'll probably ever need or use.

I know radio's an ever-changing business. It could be your format, your sales manager, your program director, or brand new equipment that requires new people and new sounds to carry it off.

But I also know one thing that HASN'T changed. Your responsibility to your advertisers to give them your best at all times. To be their idea center in consistently developing unique advertising approaches that keep up with THEIR changing needs.

The Money Machine GIVES you this ammunition. This quality . . . to keep their product moving. And when your CLIENT makes money, YOU make money. A good business should be just as simple as that. And with a good sales/production library like The Money Machine . . . it is! (I only wish I had had The Money Machine when I was there!)"

Jerry K. Williams  
President, Money Machine

"The same holds true for Music Explo. Literally an explosion of 400 music beds with a "today" sound that nobody else has. A sound that can only be obtained when each individual piece of music is composed, conducted, and produced where the talent is. And today . . . that talent's right here in Nashville, Tennessee.

But not only is Music Explo singular in its production, it's written in convenient 60 and 30 second lengths. Music just waiting to enhance any client's TV or radio image.

But Music Explo ISN'T for rent. (You read right — it's not for rent.) NOW, for the first time ever, you can BUY OUTRIGHT this incredible music package. Yours to use again and again, forever and ever. Accompanied by an attractive, comprehensive reference catalog, it also comes with a 6 month guarantee good for replacement of any albums damaged in shipment, or scratched by over-use.

Think of it. 400 pieces of contemporary music. Music to add to, to round out, or even to begin an exclusive library nobody else in your area will have. (These same exclusivity rights apply to The Money Machine as well.)

And if I've heard it once, I've heard it 1000 times (and I ought to know, because I've said it myself), "you can never have too many music beds!"

Music Explo. Exclusivity: a quality, unique sound."

Replace, enhance, or add potential profit to an already existing library, with The Money Machine and/or Music Explo. And getting your demos with a difference is as easy as 1, 2, 3.

- 1) Write us at P.O. Box 23355 c/o The Money Machine — Nashville, Tennessee 37202, or
- 2) Call us at our toll-free number 1-800-251-2058, or
- 3) If you're coming to the NRBA, look for us in booth # 27, and Suite 1347.

In Canada, dial:  
(416) 486-6150, Toronto;  
(604) 688-0458, Vancouver.

## No matter how you find us . . . you'll be glad you did !

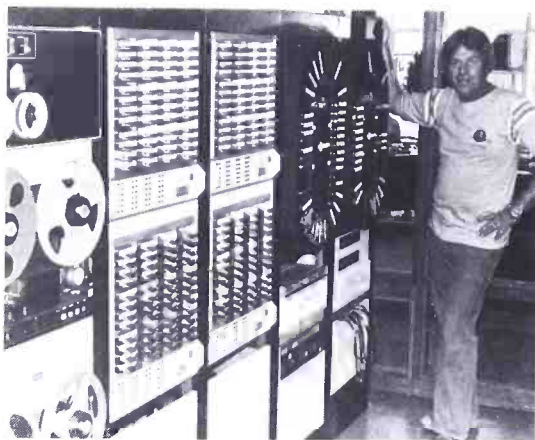

Pat O'Day, KYYX, Seattle, Washington.

made by programmers after using automation systems for a time is that it enables them to pin down the "overall sound" they've been striving for. This might be compared to the rehearsal of a live drama production on stage on Broadway until each actor has his lines just right on opening night.

Bellinger has said that, if you believe in automation, it will work; if you don't, it will be bad. The biggest factor in making automation work is the increasing proliferation of cartridges and cart-handlers. The development of instant random access multi-cartridge handling devices provided a particular impetus for programming with cartridges. In 1976 Chicago's Station WNIS-FM, which carried straight news, sports, and information services, decided to go with a music format under new call letters WKQX. The executive committee laid down certain criteria that it felt would make QX a success in its highly competitive area. When asked what he needed to "win," the Program Director decided on an all-cartridge format because of the infinite choices for music selection, then searched for an automation system that would fill the switching needs.

An unusual configuration consisting of a huge bank of ten Instacarts was selected, because this equipment gave the programming department no constraints whatever in varying the play list and other elements. Before it went on air, WKQX carted over 1,500 pieces of music, and is working toward a cart library of 3,000 to 4,000 selections. The shortest turn-around is four to five hours. Working around a sound aimed at album oriented rock with no editing, the station used two long-play turntables to play the cuts onto tapes for the carts.

Voice tracks for WKQX are originated in-house and can be made within a short time of airing. Each personality produces a six-hour show just as if he were on air live, and such tapes are made no more than two days in advance of air time — usually the same day and within a few hours of airing. The talent includes Mitch Michaels, Lorna Osmond Bob Hyman, and Bob Pittman, who is also the Program Director. Each personality is able to cut his six-hour show in less than an hour, choosing his own music from a controlled music list that has proper rotation built in. The station engineers work with the talent and coordinate the voice tracks with the cartridges, pre-recorded commercials, PSA's, ID's, etc., by using the programming brain for the automation (the RAM) and away it goes. When WKQX went on the air January 1st with its new format, the first ARB started six days later. By the time of the next ratings the station came out as No. 1 in the 18-24 year old male and female demographic.

John Bailie, Manager of Technical Operations, says that tremendous creativeness and research went into the music selection. Meticulous attention was paid to carting of music with the right air chain, utilizing an Optimod 8000 and a Burwin dynamic noise filtering system, and maintaining the proper stereo phasing. An

innovation at WKQX is that Pam Backey, Coordinator of Operations, programs a custom cassette with a two-day programming load (which can be fed into the system in 1-1/2-minutes). The cassette is then given to the Station Engineer, who puts it onto a decoder to place the data into the automation brain. The encoder is a simple microprocessor-controlled, ten-key device no more complicated than an adding machine. An advantage of this interim step is that the entire program can be double-checked before entering into the automation system, because the encoder includes a display for read-back.

Of course, one of the most important facets of creating a total program comes from a "sixth-sense" feeling of where to put the cue tone, or switching tone, on the voice track. Under terrific pressure conducive to errors and ulcers, the DJ or his engineer working under live radio twist dials and push buttons to fade in, dissolve, talk over, double or triple. Conversely, using automation, the programmer sits relaxed in his studio coordinating the voice tracks with the music list and other elements, experimenting until he gets his particular sound just right. Probably no aspect of programming with automation is as wide open for creativeness as this individualistic meshing of the presentation. Even the position of the station call letters comes in for scrutiny. Bob Pittman, Program Manager of WKQX, says that he wants the call letters to be prominent and get attention, so he puts them on immediately coming out of a music selection, or the last thing coming out of a commercial. Coming out of music tends to be a time when the listener is focused strongly, and coming out of a commercial — or just before the next music selection starts — is when a listener's possibly lagging attention is picking up again.

Pittman feels that, because his station

# Just Beautiful Music

Mass appeal  
with  
proven  
performance.



274 County Road ■ Tenafly, N.J. 07670 ■ 201-567-8800

A Division of Bonneville International Corporation



has to carry a lot of commercials and programs which build the community image, the music programming has to be very tight to keep the music listener from tuning out. This means tight rotation with only hit records, and heavy repetition of the changeable Top 40, which is worked into but does not totally dominate the AOR overall format.

At the O'Day Broadcasting Corporation's station KYYX (96 Kicks) studios in Seattle, Robin Mitchell alone directs the placement of cue tones on the carts. The station is totally automated with a computer-controlled IGM 750 for on air and an IGM 770 off air solely to work out music lists and program mixes for syndication purposes. Mitchell works with taped voice tracks from five different DJ's, including Pat O'Day himself, a principal of the broadcasting corporation, and on air personality as well.

An odd thing about KYYX's voice tracking is that two of the jocks are in Honolulu making the cuts — Lan Roberts and Bruce Brown. The programming department at KYYX in Seattle makes up a pre-log on the 770, then sends it via special air delivery to Hawaii every few days, along with newspaper articles, special promotional literature, and other local data, to guide the distant jocks in making pertinent voice tracks for Seattle listeners. KORL in Honolulu uses a similar pre-log which contains a proper, carefully selected music mix for guidance in cutting its total format, too. Roberts and Brown — and sometimes Pat O'Day, who bounces back and forth across the Pacific — cut the voice tracks onto a reel-to-reel tape and ship it back to KYYX. Then Mitchell fine tunes the program format, sometimes placing the cue tones back a short distance from the end of the cart to provide a talkover . . . a segue to a commercial . . . or whatever seems right to him. He can put together a six-hour show in

this manner in an hour or less, including air-checking for errors.

Conversely, some station owners using automation think that too much time is consumed by programmers in trying to make a station sound live. WSRF's Tom Judge maintains that listeners don't care whether the voices they hear are live or not:

"It's a stigma that exists only in our own heads sometimes," he says. "When we automated our station completely, not one telephone call came in to say 'I hate automation.'"

However, Judge did agree that "if you know where to place the tone, that's the thing." In his opinion, programming is a *feeling* and only a person that has that ability within him should be allowed to do cue tones, segue records, etc. "Leave it clean and leave it alone" is his motto. His contention is that the real reason for automation is to use high-priced personnel more effectively and creatively.

There's that word again — *creatively*, using people power for creativeness and letting the machines carry out the details. While listeners to WEEI-FM, Boston, are enjoying a selection by Elton John, the jocks and technicians might be reviewing the news wires, updating the weather, or cutting voice tracks for the following day. In making up each day's format, Program Manager Clark F. Smidt first calls up a list of music in the categories he wants — for instance, he might ask the system to give him a list of 25 selections by a male vocalist, none longer than three minutes, all between the dates of 1974 and 1977, plus 10 instrumentals and 20 of the Top 40 hits. Within minutes a computer readout appears, and Smidt decides on the sequencing. Following a pre-log which includes all elements of the day or segment's program, commercials, ID's, etc., he simply enters his music decision by event and cartridge number, works out the cue or switching tones to suit, and air-checks the



Jim Parsons, CHNL, Kamloops, British Columbia.

program. The list of music cartridges goes to a technician, who places the proper carts into the slots of the Instacart by number. Both computer directions and cartridges can be changed up to a few minutes before air time. WEEI calls its 770 a "human error reduction machine," and more affectionately, "Big Herm."

For Steve Bellinger's Decatur, Illinois operation automation provides originality, not so much in the programming, as in the unique handling of the format. Using four big 78-cart Go-Carts WDZQ simply sequences an all-cart format in numerical order BUT loads the machines in a manner that provides a daily change. Ignoring the numbers on the cartridge slots, the station gives each cartridge — music, commercials, or whatever — its own particular number with taped-on labels. At midnight on Monday, for example, cartridges will be loaded into the machines starting with cartridge No. 1; on Tuesday the starting point is No. 21, on Wednesday No. 42 . . . thus the entire format rotates into a different time of day on a preplanned advancement basis. The chief reason for this unusual arrangement is ultra-simplicity of operation and subsequent dollar savings in handling.

# Traditional M.O.R.

Great artists  
and songs for  
the 25 to 49  
audience.



274 County Road ■ Tenafly, N.J. 07670 ■ 201-567-8800

A Division of Bonneville International Corporation

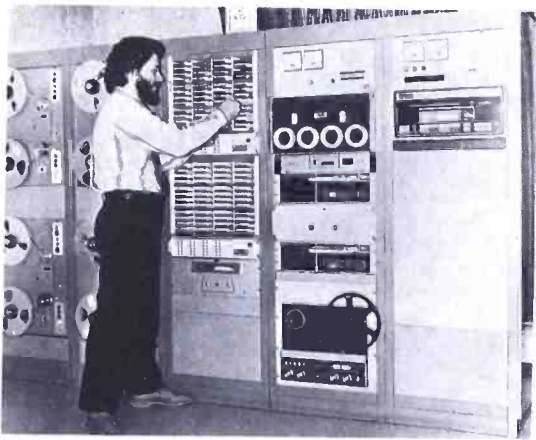

Ken Flynn, KKLV, Anchorage, Alaska.

Bellinger's staff sells all commercials at the same very low rate, whether aired at prime time or at 2:00 A.M., and the advancement formula provides a variable time of airing. With the Program Director largely freed from operational details, he has time to dream up new programs that will be placed on cartridges as PSA's, special news programs, etc. Bellinger's contention, indeed, is that there isn't anything you do live that you couldn't do better on tape, because you can rehearse it before airing it. One of Bellinger's more imaginative and dramatic public service programs was not exactly an aired program . . . but the frequent announcement during the hours of 12 midnight and 6:00 A.M. that persons with

problems could call the station for counseling. At WZDQ pastors took turns manning telephone lines, with the understanding that no specific religion was to be stressed (to avoid conflicts in the community), but anyone wishing to consult that pastor later on could do so, of course. During the first two weeks that the crisis line was on the air the counselors averted two suicides!

In addition to the usual problems of music mix Canadian stations have to program in an additional item — 30% of all music played must be Canadian-produced. Situated in a medium-sized market, Station CHNL, Kamloops, B.C., manages to achieve partial automation with careful planning, using only a Marc VII manual remote control assist with a paper tape attachment, one Instacart, 2 ITC 3-stacks for commercials (the DJ's keep reloading), turntables and two Ampex 440's. The paper tape is programmed to govern all the sources, if required, and runs the station from 1:00 to 5:00 A.M. untended, also feeding three satellite stations through B.C. Tel Microwave in the surrounding towns of Merritt, Princeton, and Clearwater. To achieve the program mix, Music Director Jeff Bourhas, consulting with Station Manager Dan McAllister, makes up the music list weekly, listing the title, artist, time, intro, A or B record (time of day, up or down tempo), C record (Canadian). Current

music is entirely on cartridges in a multi-cart handling system, four selections of 9 cartridges each plus those additional selections that CHNL itself deems to be the most popular 10 or 12, rounding out the 48-cart capacity. The stacks are rotated every three hours, taking care to achieve the overall bright, up tempo sound the station strives for. Up dates on the cartridges involve only an average of seven carts a week.

The gold is programmed on reel or turntable by Bourhas simultaneously with the 48 selections on cartridge and, if Bourhas chooses, he can include more Canadian selections in the gold and allow time for more current selections on cartridge, because the Top 40 usually (but not always) comes from the United States. Station CHNL has its own "sound" that it strives for and music is not selected strictly from the lists but from the joint opinion of the pertinent staff. Prospects are selected from the Billboard and RPM (Canadian) lists, new selections sent by record services, or even absolutely unknown Canadian-produced selections now and then. After listening to selections two or three times a week, the programming personnel rate them: A — a definite hit, B — I think it will be a hit, C — sounds good but is a question mark. "We may play a record never heard anywhere else, if it happens to sound good to us," says Bourhas.

The station remains very personality-oriented and uses the Marc VII as a manual assist for switching to the different pieces of equipment as programmed shown on a CRT, giving the personality a chance to plan ahead. Talent includes Wayne Sheridan, a "crazy" morning man who uses considerable local color material, Jeff Bourhas, and Dan McAllister, the Station Manager. CHNL also accepts the Jack Webster Show from Vancouver (CBC Network), a very provocative open-line show. During the night hours on reel-to-reel the station uses the Jim French Show, alternating it with current play lists, so that only part of the show is used at any given time.

On Sunday mornings from 6:00 to 10:00 A.M., often a dull time on some stations, there's a surprisingly broad audience due to imaginative programming by Bob Egby, formerly with BBC overseas. He tapes about ten interviews a week with diverse people ranging from a woman on the Mother's March to a young unwed mother or an unemployed logger, a pilot for a local charter airline, a Forest Ranger., The tapes are edited into short segments three to five minutes long and interspersed throughout the four-hour period. Egby ties in his music with the interviews; for instance, if he aired the interview with a pilot, he might schedule "Magnificent Men In Their Flying Machine," before or after it. Using these same interviews, Egby produces a 30-minute show for Sunday night airing as a documentary. As Kamloops is on the edge

## WHAT DO ALL THESE PROGRAMMING EXPERTS HAVE IN COMMON?



**ONE THING!** They all came to The Good Music Company for the greatest collection of custom produced instrumental and vocal beautiful music. Shouldn't you?

Contact: Tom Fenno, The Good Music Company, 3518 Cahuenga West, Suite 305, Hollywood, California 90068 / (213) 851-7777



of a semi-wilderness abounding with interesting history, it's natural that some of the lore would find its way onto his programs, like the tales of pioneer Overlanders, the history of the Pacific Western Airlines which serves Kamloops, or colorful homestead stories from the North Thompson River area.

For use in several of its stations across Canada, and other outside purchasers, Moffat Broadcasting Corporation developed its own random assist device to control the music mix and program elements. The DJ may choose his music from a list which appears on a CRT fed by a computer, which always keeps the proper rotation and includes the Canadian content, mood, etc.

Some jocks fear that with automation, they will be summarily fired, but the strange thing is that often the staff increases. This was the case in WILY, Centralia, Illinois, population 15,000, where the staff has doubled since installing automation. The station simply is doing more business. According to Sam Hassan, General Manager, small stations like his tend to hire young men with no experience as DJ's, because they work cheap, which he thinks is a mistake. Small stations have to cater to everyone's tastes, and usually a MOR format is best. That young DJ usually knows rock and talks rock best, not MOR. Therefore, Hassan prefers to use a syndicated format on his system with the voice tracks already cut. WILY has to please his community and the total programming concept is "EOP," event-oriented programming, going to the grass roots. The station has sent crews to tape band concerts of the local high school and later play it on their station. It has taped the commencement exercises and interviewed graduating seniors. According to Hassan, when such programs are aired, almost everyone in town is glued to the radio because *their kids* are being featured.

... That's what it all boils down to in programming with automation ... let the automation take care of the housekeeping details and free the personnel to create programs pertinent to their particular area.

As Bill Garcia of WXLO-FM, New York, puts it, the format is just an extension of the Program Director's personality, and should soar completely free of restraint.

Let's look at some of the original programs conceived across the nation, all of them placed on tape and used in automation systems of some manufacture. Station KGMI, Bellingham, Washington, airs live a one-hour interview program called "Impact," hosted by Haines Fay, every weekday. Taped for replay during evening prime time, "Impact" has received about thirty-five awards of excellence. Guests include absolutely anyone of interest that comes through town — even a man who advocated not paying income taxes to the IRS — and also prosaic groups from Rotary Club or Kiwanis plugging some local festival,

The first half-hour is spent interviewing the subject(s) and the second half-hour the phone lines are open so that listeners may ask questions of the interviewees. The taped program is placed on the automation system for airing at 6:00 P.M.

While running a very tight Top 40 play list, WXLO-FM, New York, keeps its listeners on their toes by asking such leading questions as "Do you think the President has reduced inflation?" or "Do you think New York will come out of its financial woes?" The comments made by persons calling in are taped during the day, then aired in one-minute segments off and on. Denise Richardson has put together an interview show that is syndicated within the RKO stations, with guests such as Walter Cronkite or Barbara Walters. She or others in the station often interview artists such as Barbra Steisand, including excerpts within the total programming. On cartridge it's easy to insert any such edited material within moments.

"It's easy to become apathetic in New York," observes Bill, "but we're against any form of negativism about the city we serve. We move toward more local programming and an upbeat feeling about our big town." WXLO uses short PSA's twice an hour to maintain an attitude of *local interest*.

Carrying this attitude of personalizing even the mundane tasks of radio, using carts to do it, Bob Hamilton of KRTH, Los



8 powerful formats for automated or live radio.

Complete Library Service • Mono or Stereo

CaVox Stereo Productions, 502 S. Isis, Inglewood, CA 90301

Call Bob Mayfield collect at (213) 776-6933

NRBA Suite 1823

Want more details?

Circle No. 8 on Product Info. Card.

Angeles, another RKO station, even personalizes the time and temperature announcements.

In Boston's WROR, Les Garland, in cooperation with the Police Department, prepares a cartridge listing the license plates of hot cars. This is played off and on, especially during prime drive time hours, so that listeners become involved in watching for the stolen vehicles.

KNX-FM, Los Angeles, is another station that uses its commitment of public affairs programming to more closely relate to its listeners. Out of its weekly commitment of five hours, thirty-five minutes, it produces four-and-a-half-hours locally, taking the remainder from the CBS network of which it is a member. A feature called *Sixty Seconds* takes excerpts from the total public affairs concerns, edits several into one-minute vignettes and airs them periodically all week.

The news at KHAR-KKLV,

NOW  
6dB Greater Output  
with **HOT TAPE**  
exclusively from



Cartridge tape quality equal to that of the finest professional reel-to-reel mastering types ... HOT TAPE—High Output Transfer Tape—delivers up to 6dB greater output over types used in most broadcast cartridges to date. That means: dramatically reduced tape hiss ... greater headroom for less audibility of audio system white noise components ... increased signal saturation for decreased IM and other distortions. But, MOST IMPORTANT, you get studio perfect reproduction of music and commercial spots.

Hot Tape is available to special order in all factory loaded Fidelipac Cartridges or in bulk for reloading. For details, contact your Fidelipac distributor today or



**FIDELIPAC**

109 Gaither Drive • Mt. Laurel, NJ 08057 • (609) 235-3511

® Trademark

See Us NRBA Booth 114

Want more details? Circle No. 34 on Product Info. Card.

BP&P 53



Carl Hanson, KNX-FM, Los Angeles.

Anchorage, is prepared off and on all day as it comes in, placed on cartridge for use in their automation system. Updates are made up to minutes before air time, and the total tape is used during the night hours when there is seldom anything new happening. If there is a fast-breaking news item, the night man can overpower the automation and announce it, for manual operation of the system is provided for. As part of its morning news and talk show, hosted by Fern Chandonnet, there is an air traffic advisory originating from a Cessna 172 high over Anchorage — not unusual, except that one would hardly expect distant Anchorage to have a traffic problem. With 180,000 people and a relatively few main arteries, the teeming city does find the service useful. In the tradition of Robert Service, famous Alaskan poet, KHAR has its own bard, Ruben Gaines, the official poet laureate of Alaska, who tapes Alaskana for airing under the title of "Conversations."

News Director Christopher Ames, of KNX-FM, Los Angeles, believes that, for inclusion in its news, any story must be pertinent for the Los Angelenos who listen. This regional theory is becoming more and more prevalent in stations all across the

country — a yardstick of local relevance before using certain news.

At KYYX, Seattle, the news is taped in a conversational manner, programmed into the over-all tempo of the station under the control of Robin Mitchell. Instead of a pompous "The Forest Service announces a fire out of control in Cub Creek," the item might read, "Hey, there's a bad fire out in Okanogan this morning, etc. . . ." Bearing out the often-repeated reason for automating, O'Day has hired who he feels is one of the top newsmen in the country — Steve Nicholl. Not satisfied with the front page news, Nicholl gets in and digs for details. According to Mitchell, if there was an item about a new secret weapon that the Soviets had developed, Nicholl probably would get on the phone and tape an interview with a top U.S. scientist, asking his opinion about the significance of the matter.

The station's PSA's include some imaginative ideas, both in content and presentation. To enliven a series on career guidance, KYYX DJ's interview proprietors, clerks, actors, or businessmen in Seattle to get firsthand insight on why a person works at his particular job, exactly what he does, what the problems are. The material is edited into short, stimulating vignettes no more than two minutes long and aired during prime time. The term "skid row" originated in Seattle, named for the teeming area that existed near the "skid road," a sort of log roller down the steep hills of Seattle, and inhabited by loggers, sailors, and other transients bent on recreation. To glean material for a program, "Who's On First?" (as First Avenue is the "skid row" section) programmers from KYYX interviewed people on the street, looking for stories from the vagrants that tend to hang out there. There's an amazing wealth of stories. Some rheumy-eyed persons turn out to have college degrees, to have been

corporation executives; others are brand new immigrants living in this area, the cheapest part of town, because they're unemployed. The program tends to make the entire city more sensitive to the problems of diverse people.

A particularly Northwest subject that has captivated Robin Mitchell is the story of the legendary Sasquatch, "Big Foot," whose stronghold is supposedly the Cascade Mountains. He tends to take the legend seriously, after taping numerous people who claim to have seen the creature. Mitchell is also exploring interesting Indian legends, which abound among Northwest tribes.

It should be emphasized that all the programs mentioned are not long, ponderous discussions but are usually encapsulized for short, snappy, thought-provoking breaks in a music format.

A conclusion that comes into focus, when one reviews the types of programming produced by users of automation, is that great emphasis is made on regionalizing or localizing the programming of stations. At first glance, it might appear that, in using syndicated formats, computer-controlled automation systems, and other "fancy machinery," all the stations in the country would begin to sound alike. The opposite view emerges, because only by freeing themselves of the chains of total live operation, can the creative station personnel use time effectively and begin to relate to the community to which they broadcast. The limits of ingenious programming are bounded only by the curiosity and legwork of the station's employees, by the electronic and technical know-how of in-house personnel. Furthermore, on tape cartridge, the accumulation of knowledge gained in preparing programs is easily stored for use another day.

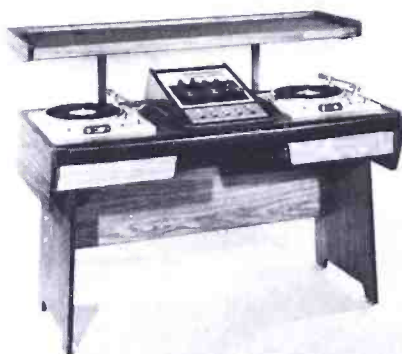

SYSTEM D STUDIO COMPACT

## TOOLS OF THE TRADE

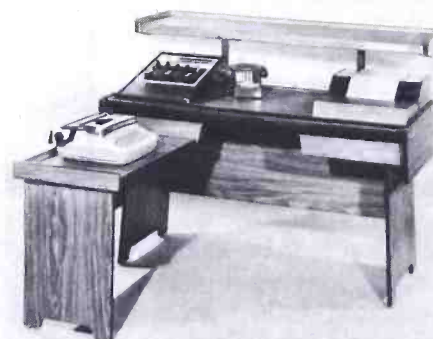

SYSTEM D NEWSDESK

The Master Wood Carver uses tools of the finest steel. The Industrial Model Maker uses the best machine tools. Rembrandt was fussy about his paint brushes. Micro-Trak's 'D Systems' are the *tools of the trade* for today's audio and news production professionals. Whether your installation is live air, or building money-making spots, Micro Trak has a 'D System' to give you knife edge performance.

Contact your local Micro-Trak dealer or call our Marketing Department at (413) 536-3551.

**MICRO-TRAK CORPORATION**  
620 RACE ST., HOLYOKE, MASSACHUSETTS 01040



# Radio Promotions



by Gary Kleinman

The definition of the term "promotion" varies from radio station to radio station. For some it merely means simple contests and giveaways. To others it means lavish, expensive campaigns. Still others find some combination of those two extremes. The amount of promotion a station does is usually directly related to the format of a station, it's competitive situation, the size market it's in, and its budget. Following is a brief look at how four stations in different programming and market situations "promote".

## KSVN — Ogden, Utah

There are six commercial stations licensed to the city of Ogden, so although not a large market, the competition for audience is strong. Bruce Holland Operations Director of KSVN, a daytime country station, feels that promotion is necessary to attract and hold an audience. "Country music fans are one of the most loyal groups of people in the world and they'll be around whether you run a contest or not . . . but I think a contest will help you hold your listener and help you get new ones."

Holland believes that as much as a good contest will help you, a bad contest will hurt you. "If you don't follow through you're defeating the whole purpose of the thing." To prevent the problem of sloppy contests becoming an issue, KSVN has a procedure to insure a good contest from beginning to end. "When we find a contest we like," says

WBZ, Boston, ran a bumper sticker contest in which the grand prize was more lavish than most: a new Cadillac Seville. Afternoon personality, Dave Maynard, is shown with the Cadillac winner, Phil McPhail.



Holland, "we hold a few meetings with the sales staff to see if it's feasible and also to see if we might put a sales package together with the contest." Bruce says that as soon as they've decided to go ahead with the contest, they begin preliminary on-the-air promotion. Once a target date is set, either Bruce or another member of the staff puts the contest together and works out all the details. Then, according to Bruce, "we get together in the production room and actually go through it as it would be on the air . . . that way the guys know what they're doing, nobody screws up on the air and it seems to run much smoother."

KSVN runs a contest about once a month. Bruce Holland says, "when we get ready to wind up one contest we like to have the next one ready to go. We usually wait four or five days to let the last contest quiet down before we start promoting the next one."

One of the most successful promotions that station has run is the *Dial A Letter* contest, where listeners get a chance to guess what letter the station's jingle will stop on . . . the K, the S, the V or the N. They call in and make their guess on the air. Then the disc jockey plays the jingle (on one of several lengthy carts) and they win a prize if they guess correctly. Another successful promotion was the *Giant Easter Bunny* contest. Several large Easter bunnies were displayed at various retail locations in Ogden. People would then go into the various stores to register for a drawing to win the Easter bunny on display. On the day the bunnies were given away, it was announced on the air that Bruce Holland would be going to the various locations at specified times. Bruce went live on the air via telephone with the winner's name, and says Bruce, "Fifty percent of the time the winners were already there and the other fifty percent were there within ten minutes."

KSVN does other types of promotions including remote broadcasts and some simple album giveaway contests. However, it is the monthly contests which are well designed and executed that Bruce is most proud of. The listener response to the various promotions has been excellent and, in fact, "sometimes the listeners get a little frustrated and ask 'when are you going to run this or that contest again?'" Although

they usually repeat successful contests, that's the kind of frustration KSVN can live with.

## WBZ — Boston, Massachusetts

Promotions at WBZ are as complicated as their programming. So in order to better understand the promotions, a description of the programming day is in order. From 5:30 to 9:00 a.m. is Carl de Suze and The Morning Team (consisting of news, weather, sports and traffic people). Although there is music, the morning show is information oriented. From 4:00 to 6:00 p.m. is Dave Maynard and The Afternoon Team. Again, it is an information oriented program only with a little more emphasis on music. Middays are handled by Bob Raleigh from 9:00 a.m. to 2:00 p.m., and Dave Maynard (without the Team) from 2:00 to 4:00 p.m. The music on WBZ is adult contemporary and the music is the main emphasis during middays. From 6:00 p.m. to 5:30 a.m. the station is all talk.

WBZ has several on-going promotions, according to Doranne Jung, Advertising and Sales Promotion Manager for the station. "One of our on-going promotions is

WBZ's slogan is "We Hear You." WBZ continually conducts promotions, because they are, ". . . a community station . . . we believe that because our listeners listen to us, we should give them something in return."



Test The Team, where we cross promote our morning and afternoon teams." When Dave Maynard came on the air in mid-1976, it was decided to cross promote the morning and afternoon teams by having the afternoon guys challenge the morning guys to a test of general knowledge. "We asked listeners to send in questions," says Doranne, "and each team would attempt to answer four questions a day. The first team to answer one hundred and three questions (WBZ is 103 AM) won. Then there was a second and third challenge."

Research showed that there was a great deal of interest in the promotion, especially in the questions, so they continued and

expanded the promotion. The station asked people at various Boston area businesses to enter the "test". For example, there might be a team from Blue Cross in the morning and a team from a life insurance company in the afternoon. WBZ would install a simple remote hookup at those businesses and then the teams would be asked questions by the personality on the air. At the end of the week the team which had answered the most questions correctly would win.

Another lengthy promotion, explains Doranne, "is the one called *Night and Day*. We are pitting the daytime people (Carl, Bob, and Dave), against the nighttime talk show hosts (Guy Mainella, Paul Benzaquin,



WBZ's remote van.

and Larry Glick) . . . what we have are questions from management asked once per day per show." Listeners send in post cards with the name of their favorite personality and if that post card is picked, the listener is called on the air and both the personality and the listener try to figure out the answer. The first team of guys to reach one hundred and three points wins.

Earlier this year WBZ ran a "typical" bumper sticker contest (if your car is spotted with a bumper sticker you win a prize and are registered for the grand prize), except that the grand prize was more lavish than most . . . a new Cadillac Seville. "I think because we gave away the Seville rather than something less," notes Doranne, "it gave the promotion a real lift."

Another successful promotion held earlier this year is described by Doranne Jung as "the first comprehensive health education campaign ever broadcast in the country." The promotion was called *BZ Living*, and ran for ninety-nine days from February 22 through May 21. It revolved around "seven basic rules of health . . . it involved the entire radio station from newscasts to talk shows . . . we had pre-recorded, fifteen second messages every hour before the news. Then, every day, each personality would get a script containing information on the 'health topic' of the day. We also wrote and produced a twenty-eight page wall calendar to go along with the on-air product."

While these lengthy promotions were going on earlier this year, there were other short term promotions going on as well. The *Mother and Child Reunion* contest offered to reunite the most deserving mother and child anywhere in the world. Says Doranne, "we ended up sending a woman home to Budapest — to visit her dying mother — who just got there in time. It was a very sad story, but on the other hand a very happy story." For Father's Day WBZ had the *Glad Dad* contest where listeners were asked to write in what they would like to give their dad for Father's Day. The station picked a dozen winners and supplied the gifts including a recliner, a flying lesson, and the reuniting of a family with their father who was in Virginia working.

WBZ has too many promotions to describe in detail . . . they have a softball team that plays for charity, a remote van; the list is almost endless. Why does WBZ do

## THE SYSTEMS APPROACH

...at last, AGC/Processing and Peak Control in the proper packages.

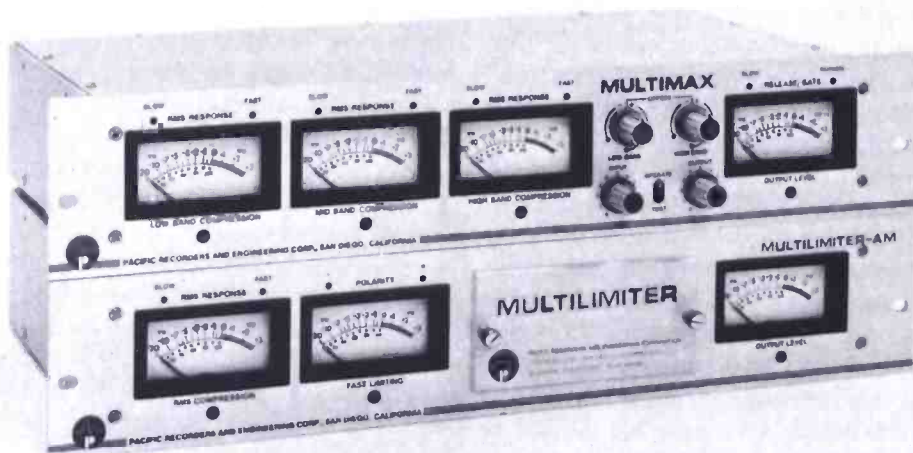

**MULTIMAX**—the AGC/Processor with exceptional input headroom, low noise, and low distortion.

Multimax is the 3 band processor which employs unique energy based, open-loop compressors as the active gain control elements. A special gated release circuit insures smooth gain control and band tracking performance. Separate cross-over frequencies are designed for AM and FM bandwidths.

**MULTILIMITER**—the limiter that features an input "gain riding" compressor, a variable compression ratio fast limiter and a ultra fast peak control limiter which provides modulation protection without relying on clippers.

**The Multimax, Multilimiter "package" concept puts your processor and limiter where they belong...in separate boxes. Multimax and Multilimiter are available for AM or FM application.**

Call, write or telex today...



PACIFIC RECORDERS AND ENGINEERING CORPORATION  
11100 ROSELLE ST., SAN DIEGO, CALIFORNIA 92121  
TELEPHONE (714) 453-3255 TELEX 695008

# MAKE YOUR MOVE TO the **FM 100** plan



Chicago #1 UP	Los Angeles UP	Hartford UP	Boston UP	Orlando UP	Seattle UP	Detroit UP
St. Louis UP	Phoenix UP	Atlanta UP	Indianapolis UP	Milwaukee UP	New Orleans UP	Chicago #2 UP
Honolulu UP	Chattanooga UP	Portland UP	Nashville UP	Rochester UP	Oklahoma City UP	Sacramento UP
Tucson UP	Grand Rapids UP	Omaha UP	YOUR STATION UP	Knoxville #1 Again	Allentown UP	Greenville-Spartanburg UP
Santa Barbara UP	Quad Cities UP	Albuquerque UP	Manchester UP	El Paso UP	Ft. Wayne UP	Lexington #2 Again
Lincoln UP	Ashville UP	Lansing UP	Pompano Beach UP	Evansville UP	Greenville UP	Madison UP
YOUR STATION UP	Ft. Atkinson UP	Ashtabula UP	Peoria UP	Jackson UP	Savannah UP	Saginaw UP

Over **90%** of our rated stations are **UP** again!\*

The FM 100 Plan can help you get the **JUMP** on your competition . . . with solid **#1** positions across the board!

Join the move to America's **HOTTEST** music service . . . we'll soon be programming over **100** stations!

## NOW 3 WINNING FORMATS! (All with the SECRET to long listening)



Call for Demo Tapes and Complete A.R.B. Report

the **FM 100** plan

875 N. MICHIGAN AVE.  
SUITE 3112  
CHICAGO, IL 60611

Call:

*Darrel Peters*  
Darrel Peters  
(312) 440-3123

Be Our Guest!  
NRBA Convention  
Oct. 9-12  
New Orleans Hilton  
Suite 1043

\*ARB April/May '77, MSA, TSA, 18+, Avg. ¼ Hr. and/or total listeners compared with April/May '76 or latest rating available.

Want more details? Circle No. 37 on Product Info. Card.



Doug Matthews, General Manager, KASK, Las Cruces, New Mexico says promoting the radio station is not the sole reason for running promotions. "... A promotion done right can be a good income producer."

all this promotion? Doranne says, "Our slogan is 'We Hear You.' WBZ is an institution in New England, as we say on the air, 'the Spirit of New England.' We are a community station and we believe that because our listeners listen to us, we should give them something in return. So there is interaction between us. We feel responsible."

#### KASK — Las Cruces, New Mexico

Promoting the radio station is not the sole reason for running promotions at KASK. General Manager Doug Matthews says, "a promotion done right can be a good income producer." Although the station does not have a large promotion budget, the promotions they do have usually pay for themselves, and then some.

Probably the most successful promotion the station has run was their *Safe Contest*. The station contracted with an insurance company to insure against the safe being opened in a one month period. The policy was for a \$2,000 payoff, and only cost KASK \$200. The safe was then transported around to four different sponsor locations during the course of the month and listeners were invited to try and open it. If they could they

KASK, Las Cruces, New Mexico, recently conducted a "safe cracking" contest, and was able to give away a \$2,000 cash prize, while only having to come up with \$200 themselves: they contracted with an insurance company to insure against the safe being opened in a one-month period. KASK listener, Bill Principe (shown in photo), was the \$2,000 winner.



would receive \$2,000 in two dollar bills.

The rules of the contest were that each person had three minutes (they used an egg timer) to attempt to open the safe using no mechanical devices. There were clues given on the air for all of the numbers in the combination except one. Just prior to the end of the month a computer programmer at New Mexico State University opened the safe. He had used the computer to figure several combinations and then tried them until one worked. Although the insurance company had to pay off, Doug says, "they'd be happy to do it again, and they probably will someday." Because the station sold participations in the contest and spot packages to go with it, KASK ended up making money on a fairly complicated promotion.

Insuring such a contest like KASK did is not unusual says Doug. "Almost any insurance company has 'special risk' categories... it's special risk like insuring it won't rain on the day of the company picnic. I'm sure any insurance agent would have knowledge and access to such companies."

Recently KASK had a *Golden Garbage Can Contest* where people wrote in saying why they felt they deserved a golden garbage can. "Not only was it golden," says Doug, "it was monogrammed!... That promotion cost us about ten dollars, (eight for the garbage can, two for gold spray paint) but it got excellent response and created a lot of talk in the community."

KASK is very promotion-minded and Doug feels promotion is essential in any kind of competitive situation. KASK is a good argument against the theory that you need a lot of money to do good promotion. In fact, good promotions can make you a lot of money.

#### WHBQ — Memphis, Tennessee

As all the other RKO rock stations are very promotion conscious, so is WHBQ. There are contests and promotions going on all the time, and Assistant Promotions Director, Mable Springfield, is responsible for coordinating all of it. Mable says the philosophy behind all the promotion is that, "we believe people like to get involved in radio, so with our promotions, we try to get them involved... they have to do something, or remember something or say something, or maybe even sing something."

Some of the promotions WHBQ has been involved with recently include the *Hot Dog Skateboard Festival* where participants demonstrated their ability to perform stunts on skateboards. The event was held at a large shopping mall in Memphis and was co-sponsored by the mall, Pepsi-Cola, and WHBQ. The winner of the contest received cash prizes, gift certificates, a skateboard, and a supply of Pepsi.

On July 4, 1977, the station sponsored a Fourth of July spectacular using a computerized laser light show. *Futuristic Fourth*, as it was called, projected lights on a giant outdoor screen. Accompanying the



WHBQ, Memphis, recently conducted "The Deep Treasure Chest" contest, in conjunction with the motion picture, "The Deep." The chest was on display at a local record store. Listeners would call in to win keys in hopes of opening the chest and receiving cash prizes.

lights was a visual and musical history of the country.

In conjunction with a local record store and the movie, *The Deep*, WHBQ had *The Deep Treasure Chest* promotion. The disc jockey would say, "I'll take the tenth call," and give that person one of one-hundred-forty keys to the treasure chest which was on display at the record store and full of money and prizes. Then, on a specified day, everyone with a key came out to the record store to try and open the chest. Only one of the keys would fit the lock.

In as many promotions as possible, WHBQ uses the River City Angels, who are three local girls a la Charlie's Angels. "Our big promotion this whole summer," says Mable, "has been the *WHBQ Summer Fun Patrol*. The Q Angels rode around in the van everyday giving away t-shirts, records, and prizes to people listening to WHBQ."

In addition to coordinating the listener-oriented promotions, Mable recently put together a promotion for advertising agencies. To illustrate the station's success in the recent ratings, "all of our promotional sheets said, 'The Memphis Pie, How Big A Piece Do You Want?' Then instead of using lines and graphs to compare our station with the others, we just drew a big pie and cut pieces to illustrate how big a share each station had. In each case our piece was the biggest." Mable then put a little media kit together and had the Angels deliver it to all

WHBQ crew and Atlantic Records promoters kicking off recent "Foreigner" release, "Cold As Ice."





**The Memphis Pie  
How big a piece do you want?**

Total Audience 12+

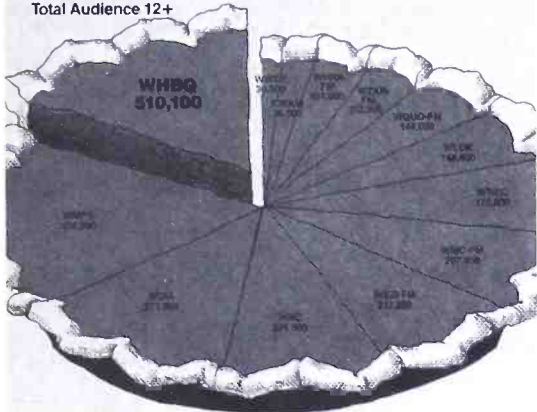

**56~WHBQ**

Has 510,100 total different listeners.  
First in Memphis and the Mid-South  
TEENS — 145,100  
18-49 — 311,100  
50+ — 53,900

In addition to coordinating listener-oriented promotions, WHBQ recently put together a promotion for advertising agencies, illustrating the station's ratings success.

the agency people along with an apple pie. Similar to WBZ, WHBQ has a lot of promotions going on all the time. When asked about the difficulty in consistently coming up with new contests, Mable responded, "At some stations I've been associated with, it seems that the creative people are the ones who have to come up with all the ideas and coordinate them . . . here at WHBQ the whole station is involved. Everybody is constantly thinking of something we can do. Even the people in bookkeeping and accounting. Sometimes it makes my job easy because someone else will come up with a great idea and all I have to do is put it all together . . . but it also keeps me thinking because I can't let them out-think me . . ."

A live performance by WHBQ's morning air personality, Rick Dees, of "Disco Duck" fame.



audio \* Stereo  
**MIXERS**  
**AMPLIFIERS!**  
⇒ turntables  
**PRE-AMPS**  
**RUGGED**

RUSSCO engineers design the broadcast equipment that works for you—Solid state stereo and mono 5-channel audio mixers, amplifiers and preamps, the finest turntables and precision tone arms. Using modern, trouble-free technology and RUSSCO-RUGGED construction, we bring you products you can really depend on. There's just no other name to consider for Top Quality and Economy!



• Write us for our brochures

**RUSSCO**

**ELECTRONICS INCORPORATED**

1070 BROOKHAVEN, CLOVIS, CALIF. 93612 Ph. (209) 299-2167

your  
**BEST BUY**

Want more details? Circle No. 38 on Product Info. Card.

# Directory of Syndicated Radio Programming (continued from page 40)

Program: "Hang Glider Traffic Reports"  
Announcer: Character voices. Length: :60 or less, daily.  
Program Description: 13 weeks of simulated traffic reports, customized to local format, building street names and call letters. Available on cash basis: \$480 to \$3,000 for 13-week package, depending on market size. One commercial avail per program, 13-week minimum contract. Promotional materials available. Program supplied on mono tape which must be returned after airplay. Unlimited broadcasts permitted.

Swingin' Years  
P.O. Box Z  
Tarzana, CA 91356  
(213) 999-1937  
Contact: Chuck Cecil

Program: "Swingin' Years"  
Announcer: Chuck Cecil. Length: 3 hours, weekly. Program Description: Big bands of 1935-1955 with interviews, air checks, theme songs. On air in Los Angeles since 1956. Available with automation tones. Available on cash basis: \$30 to \$90 per week. Six commercial avails per hour (18 total per program); 13-week minimum contract. Designed for all formats. Promotional materials available: On-air announcements and print ads. Program supplied on mono or stereo tape, one play permitted per program.

Program: "Big Band Count-Down"  
Announcer: Chuck Cecil. Length: 1 hour, weekly. Program Description: Ten most popular records in America on day of broadcast, in one of the years between 1935-1955. Each week spotlights a different year. Available on cash basis: \$10 to \$30 per week. Six commercial avails per program; 13-week minimum contract. Designed for all formats. Programs customized for each station. Promotional materials available: On-air announcements. Additional information the same as above.

Program: "Glenn Miller: Memory Maker"

Announcer: Chuck Cecil. Length: 12-hour one-time special. Program Description: Chronological display of Miller's music from 1926 to 1944. Interviews with 29 musicians, singers, arrangers who made records and memories with Glenn Miller. Available on cash basis: \$125 to \$450 for special. Six commercial avails per hour (72 total). 30-day minimum contract (unless "Swingin' Years" subscriber). Additional information the same as above.

William B. Tanner Company  
2714 Union Avenue Extd.  
Memphis, TN 38112  
(901) 320-4340  
Contact: Keith Lee, Kurt Alexander

Program: "The History of Country Music"  
Announcer: Hugh Cherry. Length: 40 hours, one-time special. Program Description: History of country music, can be presented in segments, hourly, or as special. Available on cash basis or time barter — cash price \$780 to \$2,500, depending on market size (minimum \$65 per month plus trade). Eighteen minutes of commercial avails per hour. Designed for country formats. Programs customized for each station. Supplied on mono tape which must be returned at end of contract. Unlimited broadcasts permitted.

Program: "Golden Reflection"  
Length: 24 hours. Program Description: One-time special, adult contemporary to rock. Available on cash basis or time barter. Cash price \$1,000 to \$5,000, depending on market size. Eighteen minutes commercial avails per hour, barter arrangement varies; 1 year minimum contract. Unlimited plays permitted within contract time.

TM Productions, Inc.  
1349 Regal Row  
Dallas, TX 75247  
(214) 634-8511  
Contact: Jim Conlee

Program: "The Evolution of Rock: The Music That Made the World Turn 'Round"  
Length: 64 hours. Frequency: Flexible — 23 chapters (chapter one is four hours, all others three hours). Program Description: Traces the story of rock, for the first time in chronological order. Interviews and rare recordings. Available on cash basis with price depending on market size. 10-12 minutes of commercial avails per hour (total of 640-768 minutes in all). Minimum contract one year. Designed for rock, oldie, and MOR formats. Promotional materials available: over 100 live promo scripts, assortment of pre-recorded promos, suggested press releases. Supplied on mono disc which must be returned to syndicator. Station is entitled to two plays of program per contract.

TRAV  
Television, Radio, & Audio-Visuals Agency of the  
Presbyterian Church in the U.S.  
341 Ponce de Leon Avenue, N.E.  
Atlanta, GA 30308  
(404) 873-1531  
Contact: Bill Huie

Program: "What's It All About?"  
Announcer: Bill Huie. Length: 5 minutes, weekly. Program Description: Current hit records along with interviews with the recording artist are woven together by narrator Huie into a vignette that ends with a theological or philosophical perspective on the records or artist comments. Available free for public service broadcast. Designed for rock and AOR formats. Promotional materials available: custom promo spots, t-shirts, buttons, newspaper mats. Program supplied on stereo disc. Unlimited broadcasts permitted.

Program: "Women of Faith"  
Announcer: Dana Ivey. Length: 4:30 (series of 49 programs). Program Description: Historical dramas on outstanding women of American history. Designed for all formats. Program supplied on mono discs. Additional information the same as above.

Program: "The Protestant Hour"  
Announcer: Various. Length: 29:30, weekly. Program Description: Traditional religious programming including sermons and choirs from four denominations, Presbyterian, Methodist, Lutheran and Episcopal. Now in its 32nd year of continuous broadcast. Available free for public service broadcast to one AM and one FM station per market. Designed for all formats. Promotional materials available: posters and promo materials mailed to churches each quarter. Program provided on mono tape. One play permitted.

University of Chicago  
Office of Radio & Television  
1307 East 60th Street  
Chicago, IL 60637  
(312) 753-4371  
Contact: Robert Heitsch

Program: "From the Midway"  
Announcer: Robert H. Heitsch. Length: 58:40 weekly. Program Description: 15-year old series is for public affairs broadcast. Program features lectures and discussions of national relevance. Available on cash basis: \$3 per week; 13-week minimum contract. Designed for all formats. Provided on mono tape. Tapes must be returned after use. Pre-paid address labels are included. Unlimited broadcasts permitted.

Program: "Conversations at Chicago"  
Announcer: Milton Rosenberg. Length: 29:20 weekly. Program Description: Thought-provoking discussions of nationally relevant topics are featured on this 9 year old series produced by the University of Chicago for public affairs broadcast. Available on cash basis: \$2 per week; 13-week minimum contract. Provided on mono tape. Tapes must be returned after use. Pre-paid labels included. Unlimited broadcasts permitted.

## Is it Live?...or is it "Big Country?"

After five successful years on the air, thousands of loyal "Big Country" listeners still don't know they're listening to automated radio stations. Chances are, even you, the professional broadcaster, wouldn't be able to tell.

"Big Country" is the only radio automation format that has accomplished the task of sounding totally live. Four major-market personalities provide you with all the country hits, and new voice track tapes for every day of the year. The jock's comments are always new... they never repeat. And the music is strategically rotated and updated. Never before has a radio format been able to deliver the live personality and identity possible with "Big Country."

The format is customized for your market, and compatible with automated and semi-automated situations.

The audience/sponsor appeal of a live, local personality and music station, along with the control and economy of automation, is only available with "Big Country." If you're still not convinced, wait until you've heard our ratings success stories. Give us a call.



**LIVE SOUND, INC.**

6362 Hollywood Blvd., 4th Floor  
Hollywood, CA 90028  
(213) 462-3351



Bob Morgan  
3-8 pm

Chris Lane  
10am-3 pm

Chuck Roberts  
8 pm-11 pm

# It's BASIC

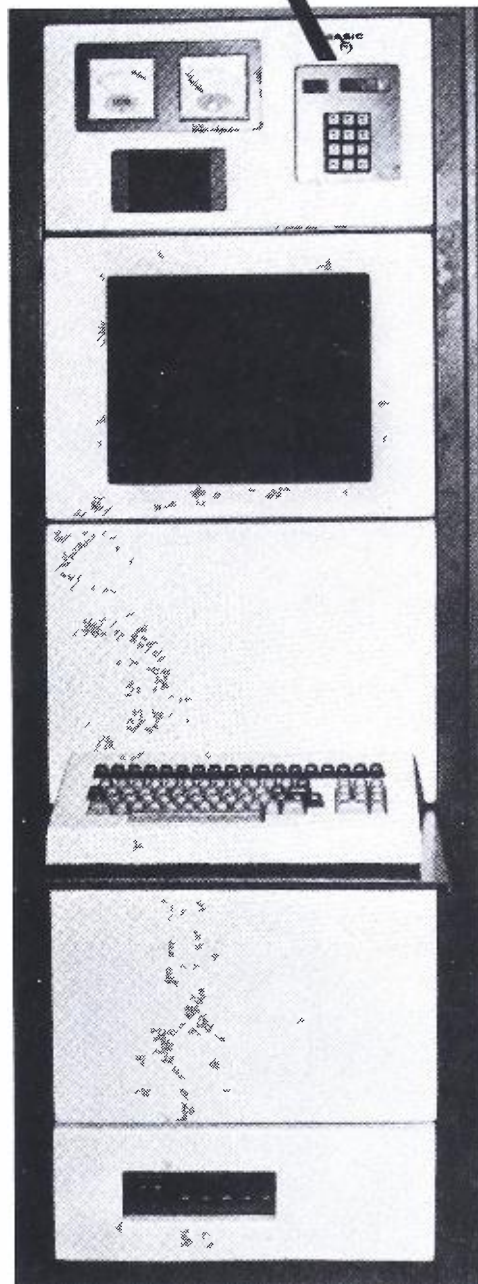

**BASIC**  
**A**  
**BASIC**  
**B**

We asked broadcasters all over the country what they wanted most in an audio control system. They told us and we built it. We call it BASIC.

Everybody wants a system that talks English... not computerese. BASIC will find the next station ID if you ask it to "find the next station ID." Just like that. You can insert your programming commands in broadcast language phrases.

Everybody wants a system that will perform all important functions (not everyone agreed on what was important and what wasn't). Nevertheless, BASIC performs all of the functions all IGM systems ever have... and more.

**...the only  
audio control  
system  
that talks  
your language  
...ENGLISH!**

## IGM

A Division of NTI  
4041 Home Road  
Bellingham, WA 98225  
206-733-4567

Everybody wants a system that handles thousands of events. BASIC A employs RAM (Random Access Memory) to store 4000 events, expandable to 8000 in 2000 increments. BASIC B employs "floppy discs" to store eight days of up to 6000 events each day plus 8000 events common to all days.

Everybody said "those big systems cost too much. Produce one that we all can afford." So we did. We call it BASIC... and it's the finest thing IGM ever did.

---

**See Basic  
at  
NRBA  
BOOTH 119-120**

---



**8 powerful formats for automated or live radio.**

**Complete Library Service • Mono or Stereo**

CaVox Stereo Productions, 502 S. Isis, Inglewood, CA 90301

Call Bob Mayfield collect at (213) 776-6933

NRBA Suite 1823

Want more details?

Circle No. 8 on Product Info. Card.

Vogue Music, Inc.

100 Wilshire Boulevard, Suite 700

Santa Monica, CA 90401

(213) 871-0911

Contact: Dean Kay

(In Canada: Mark Altman, Morning Music, Ltd., 1343

Matheson Blvd., W., Mississauga, Ontario L4W 1R1  
(416) 625-2676)

Program: "Bob McDill — You Know Him By His Music"

Announcer: Mac Curtis. Length: 52:30 Frequency: One-time special. Program Description: Talk units containing interviews mixed with complete hit tunes performed by Crystal Gayle, Don Williams, Mickey Gilley, Dave & Sugar, Bobby Bare, Jerry Lee Lewis, etc. Available free of charge. 7½-minutes of commercial avails for local sale. Designed for country music stations. Available on stereo disc for unlimited play.

**Watermark, Inc.**  
10700 Ventura Boulevard  
No. Hollywood, CA 91604  
(213) 980-0490

Program: "American Top 40"

Announcer: Casey Kasem. Length: 3 hours weekly. Program Description: Current news and information about the records in each week's top 40 as reported by Billboard magazine. The chart is presented in its entirety, from #40 to #1. Historical record data is also presented for perspective. 3 "special" countdowns are included in the package annually. Available on cash basis: \$50 to \$500 per week, depending on

market size. Thirty-three minutes of commercial avails per program; 13-week minimum contract. Designed for contemporary and MOR formats. Promotional materials available from syndicator. Program supplied on stereo discs.

Program: "American Country Countdown"

Announcer: Don Bowman. Length: 3 hours weekly. Program Description: Carefully researched information and the biggest national country hits, played in order from #40 to #1, with statistics reported by Billboard magazine. Included in the package, 3 "specials" per year, including "The Top 100 Country Hits", and the American Heritage Series with programs such as "Songs of the American West". Available on cash basis: \$50 to \$500 per week, depending on market size. Thirty-six minutes of commercial avails per program; 13-week minimum contract. Designed for country and MOR formats. Promotional materials available. Supplied on stereo discs.

Program: "Special of the Week"

Announcer: Robert W. Morgan. Length: one hour. Frequency: Weekly, in two 13-week flights per year. Program Description: One-hour dramatic events with the superstars playing the lead roles themselves. Each show is theatrically scored with the star act's own music. The programs go well beyond the interview level to present an intimate profile of the stars. Available on both cash basis and time barter. Cash price: \$650 to \$2,500 per 13-week flight, depending on market size. Ten minutes of commercial avails per program on cash basis. Barter sponsor: Toyota of America. Two sponsor commercials per program plus additional "promo spots" in prior week. Eight commercial avails for local sale on barter arrangement; 13-week minimum contract. Designed for contemporary and MOR formats. Promotional materials available. Program supplied on stereo discs which must be returned to syndicator.

Program: "The Elvis Presley Story: A Final Tribute"

Announcer: Wink Martindale. Length: 13 hours, one-time special programmed according to station preference. Program Description: A documentary on the most spectacular figure in the history of rock and roll. Originally produced in 1971, the program was updated and augmented in 1975. Now, this third edition, released for broadcast on Labor Day weekend, 1977, has been assembled by producer Ron Jacobs and writer Jerry Hopkins from hundreds of interviews assembled over the years. Available on cash basis: \$600 to \$5,000 for package, depending on market size. Nine minutes of commercial avails per hour — 117 minutes total. All licenses expire January 18, 1978. Designed for all formats. Promotional materials available. Program supplied on stereo discs which must be returned to syndicator.

**Westwood One**  
10960 Wilshire Boulevard  
Los Angeles, CA 90024  
(213) 479-7713  
Contact: Norm Pattiz

Program: "Star Trak"

Announcer: Candy Tusken. Length: 90 seconds. Frequency: Twice daily. Program Description: Record industry news and interview features, supplied to stations weekly. Available on cash basis, depending on market size. Available for time barter with one national spot with one local avail per program. Minimum contract 13-weeks. Designed for rock formats. Promos, ID's, and tags available. Program supplied on disc. Unlimited broadcasts permitted.

Program: "National Album Countdown"

Announcer: Humble Harve. Length: 3 hours, weekly. Program Description: Countdown of Record World magazine's top 30 albums of the week. Contains interviews, retail reports, plus special features. Available on cash basis, with price depending on market size. Fourteen commercial avails per program, 13-week minimum contract. Designed for rock formats. Custom promos, ID's, tags, and sales information available. Supplied on stereo tape. Unlimited airplay permitted per week.

Program: "Sound of Motown"

Announcer: Jerry Lang. Length: 24 one-hour specials. Program Description: Contains all the hits of Motown from 1959 to 1977, plus interviews with the Motown artists who made it happen. Available on cash basis with price dependent on market size. Twelve minutes of commercial avails per program; one year minimum contract. Designed for rock and R&B formats. Promotional materials available: artist promos, ad slicks, sales information. Supplied on stereo discs, which must be returned to syndicator. Unlimited broadcasts permitted.

Program: "In Hollywood"

Announcer: Darcel Howell. Length: 90 seconds, twice daily. Program Description: Black entertainment news features and interviews. Available on time barter with one minute local avail per program; 13-week minimum contract. Designed for R&B and Black formats. Promos, custom ID's and tags available. Program supplied on mono tape which must be returned to syndicator. Unlimited broadcasts permitted.

# cut a rug...

with Chuck Cecil and his SWINGIN' YEARS programs!

We're not just bumpin' our gums, chums ... that hep cat's cookin' with gas ... on the front burner. Just slip into your zoot suit ... the one with the drape shape and the reet pleat ... dirty up those saddle shoes ... warm up the model A ... and reap the rewards of nostalgia!

Chuck spins America's most memorable records of the 30's ... 40's ... and 50's ... on three great syndicated radio shows:

"Big Band Count-Down"

(1 hour a week)

"Swingin' Years"

(3 hours a week)

"Glenn Miller: Memory Maker"

(12 hour special)

So hubba-hubba all you jitterbugs. Swing along with the jive and swoon tunes in mono or stereo.

For scam to scan, contact:  
SWINGIN' YEARS  
P.O. Box "Z"  
Tarzana, California  
91356



## Radio Formats

**Bonneville Broadcast Consultants**  
274 County Road  
Tenafly, NJ 07670  
(201) 567-8800  
Contact: Loring Fisher, Dick Drury

Format: "Just Beautiful Music"  
Category: Beautiful Music. Description: An easy listening

Want more details? Circle No. 41 on Product Info. Card.

format of familiar instrumental and vocal selections designed for long term listening. Available un-announced. Compatible with live, automated, and semi-automated situations. Price range: \$500 to \$4,000 per month, depending on market size. 1 year minimum contract. Required equipment: Four reel-to-reel machines, three single play cart decks, carousel or audiophile. Updates received monthly. Programming supplied on 10½ reels, 7½ ips stereo. Duplicated high speed. Tapes must be returned after use. Time clocks, jingles, voice ID's, and consultation on programming, engineering, internal operations, and promotion available.

**Format: "Contemporary MOR"**

**Category:** Middle of the road. **Description:** A foreground music structure designed to attract the 18-49 year old listener. Familiar MOR hits of the past, mixed with arrangements of current and recent MOR hits. Update reels received monthly and weekly; all additional information same as above.

**Format: "Soft Rock"**

**Category:** Contemporary soft rock. **Description:** Current hits, solid gold and album cuts and selections from the most popular albums. Designed to reach young adults 18-34. Price range: \$600 to \$2,500 per month. All additional information same as above.

**Format: "Traditional MOR"**

**Category:** Easy listening — good music. **Description:** A conservative middle of the road structure, consisting of familiar instrumental and vocal selections. A bright and mature format designed as an alternative AM or FM format. Price range: \$500 to \$2,000 per month. All additional information same as above.

**Broadcast Music Service**

1947 Hillhurst  
Los Angeles, CA 90027  
(213) 666-4270

Contact: Jerry Sybilrud, Doug Cramer

Formats: Beautiful music, Classical, Rock, County and MOR.

All formats are un-announced, except classical which is available back-announced or un-announced. Price range: \$232 to \$435 per month; 1 year minimum contract. Required equipment: Reel-to-reel machines handling 10½" or 14" reels, 7½ ips or 3¾ ips. Six thousand hours of programming in basic library. 9-24 hours of updates provided monthly. Available in stereo or mono. Duplicated 8:1. Three month tape deposit required.

**Broadcast Programming International (BPI)**

Pacific National Bank Building  
360 Bellevue Square  
Bellevue, WA 98004  
(206) 454-5010

or Toll Free (800) 426-9082

Contact: Kemper Freeman, Jr., Jon Holiday, Skip Piper

**Format: "Country Living"**

**Category:** Country. **Description:** Modern country music with personable DJ's — Chris Lane, Bob Jackson, and Don Harris. Top country standards and new country hits by artists like Charlie Rich, Dolly Parton, Waylon Jennings, Tammy Wynette, etc. Local copy cut by personalities can create localized sound. Available back and front announced. Compatible with automated, semi-automated, and live situations. Price range: \$750 to \$2,000 per month, depending on market size. 1 year minimum contract. Required equipment: Two reel-to-reel, 1 multiple cart playback, 2 single cart playbacks, sequencer. 80 reels in library, consisting of 1,500 titles; 3 new reels every ten days; 12 library exchange monthly. Exchange keeps library up-to-date, new releases provide current hits. Entire library is renewed every 7 months. Programming supplied on 10½" or 14" reels, 3¾ or 7½ ips, stereo or mono. Duplicated 16:1. Tapes must be returned after use. Tape deposit required. Ten minutes of local copy, ID's, promos, jingles, consultation and analysis at no extra charge. Slight charge for time-announce. Partial format packages available.

**Format: "MOR"**

**Category:** Contemporary MOR. **Description:** Features personalities of Larry Nelson, Jim French, and Lee Smith. Targeted at 18-49 listeners. Music is carefully researched and programmed, including artists like Tony Orlando & Dawn, Gordon Lightfoot, Chicago, Captain & Tennille, etc. Local copy localizes sound. Required equipment: 3 reel-to-reel, 1 multiple cart playback, 2 single cart playbacks, sequencer. 80 reels in library, consisting of 1,400 titles; 12 library reel exchanges, 6 new release reels, and 2 recurrent reels per month. All additional information same as above.

**Format: "Adult Contemporary"**

**Category:** Contemporary. **Description:** Upbeat, contemporary format including the best of today's popular music . . . such as Barry Manilow, Carole King, Neil Diamond, and America. Carefully programmed to provide flexibility and control. Music may be voice tracked or can stand on its own as unannounced format. Price range: \$500 to \$2,000 per month, depending on market size. 40 reels in library, consisting of 1,400 titles. 10 update reels per month. All additional information same as above.

**Format: "Album Oriented Rock" (AOR)**

**Category:** AOR. **Description:** Targeted at 18-35 listeners with carefully selected music by artists like Elton John, Carly Simon, The Eagles, Steely Dan. The 3-reel configuration (up-tempo, mellow, new release) may be varied to produce mellow rock, free-form, or progressive rock for overall station sound or daypart. Available un-announced. New releases announced or un-announced. 40 reels in library, consisting of 1,000 titles; 6 update reels per month. All additional information same as above.

**Format: "Bright 'n Beautiful"**

# PUT US ON AND TAKE OFF

FOUR TAPED FORMATS FOR YOUR  
AUTOMATED OR SEMI-AUTOMATED AM OR FM

## Alive Country

This is a personality format featuring 3 major market DJ's ready to go on the air for you with a Modern Country Format. Bill Robinson, Gary Havens & Lee Shannon will localize for your station so that if you didn't know they weren't there, you'd swear they were!

## Casual Country

An exciting new concept blending Country Music's easy sounding vocalists, cross over artists, and "beautiful" country flavored recordings. This format has an identifiable "class" image. This is a fully back announced format, and a new sound your listener will love . . . and they'll love telling their friends about it too.

## Real M.O.R.

Here is that "all-over-the-road" format that so many stations have been looking for, and unable to find . . . until now. This is the ideal answer for presenting a broad based adult image to your listeners. Yes, this is a totally back announced service too.

## canned pop

Now you can get a soft rock format that is back announced by a real person, instead of some "verb-less robot." An extensive re-current & oldie pop library, plus all the current hits tailored to give your station a mature "non-screaming" approach to an 18 to 34 audience.

CALL MUSICWORKS PRESIDENT BILL ROBINSON  
FOR MORE DETAILS.

317+291-9400 (COLLECT) OR WRITE

THE  
MUSICWORKS  
INC.

6238 LAPAS TR. • INDPLS. IN 46268

Want more details? Circle No. 42 on Product Info. Card.

# BIGGER.

Let four of the biggest names in Country radio come to your town with up to 24 hours of new, professional programming every day—localized and customized.

Stunning in its impact, simple to program. And competitive in price with old-fashioned formats.

For information on this exciting new concept in broadcast automation, write or call John Price or Steve Epstein collect — now.



## FILMWAYS RADIO INC.

1610 N. Cahuenga Blvd., Hollywood, CA 90028  
(213) 462-6421

*Want more details? Circle No. 43 on Product Info. Card.*

See us at the NRBA Show  
New Orleans Hilton,  
October 9-12.

# BETTER.

The Filmways Radio "20•40" adult contemporary format is better than "beautiful," and more successful than "soft."

It's an honest mix of familiar music and real people.

Hear adult contemporary better from Filmways. Write, or call John Price or Steve Epstein collect - now.

## 20•40 FORMAT

NOW PLAYING,  
KEZR,  
SAN JOSE/  
SAN FRANCISCO

### FILMWAYS RADIO INC.

1610 N. Cahuenga Blvd., Hollywood, CA 90028  
(213) 462-6421

*Want more details? Circle No. 44 on Product Info. Card.*

See us at the NRBA Show  
New Orleans Hilton,  
October 9-12.

Category: Beautiful music. Description: A bright, up-tempo approach is combined with slower beautiful music to successfully reach 25-49 year olds with the sounds of Mantovani, Andre Kostelanetz, Ferrante & Teicher, etc. Selections are grouped by tempo so custom music blends can be created. Available un-announced. 80 reels in library, consisting of 2,000 titles, 8 update reels per month. All additional information same as above.

**Format: "Announced Easy Listening"**

Category: Easy listening. Description: All time standards are blended with beautiful arrangements of today's hits. Features personalities of Bob Concie and Del King. Target audience is 25-plus, with music by such artists as Ray Coniff, Anne Murray, Andy Williams, Carpenters, etc. 3-reel configuration and local copy creates custom local sound. Available front and back announced (mixed). Price range: \$600 to \$2,000 per month, depending on market size. 80 reels in library, consisting of 2,000 titles; 10 update reels per month. All additional information same as above.

**Format: "Easy Listening"**

Category: Easy listening. Description: Blend of favorite standards, current hits, and covers by artists like Bert Kaempfert, Paul Mauriat, Roger Whittaker, and Ronnie Aldrich, for a 25-plus audience. Available un-announced. Price range: \$500 to \$2,000 per month, depending on market size. All additional information same as above.

**Format: "Spectrum"**

Category: Seven categories to create your own format. Description: Good music in seven categories, including pop instrumentals, orchestra, pop vocals, light classics, etc. Can be mixed and matched to produce a variety of custom formats from traditional MOR to light classic. Available un-announced. Price range: \$400 to \$2,000 per month, depending on market size. 80 reels in library, consisting of 2,000 titles. 4 update reels per month. All additional information same as above.

**Format: "Concert Overtures & Encores"**

Category: Classical. Description: Showcase of most familiar short classic works. Highly recognizable classical selections are complemented by other well-known melodies, by such orchestras as the Boston Pops, New York Philharmonic, London Symphony, Mantovani, etc. Available back-announced by Bob Concie. Price range: \$225 to \$1,000 per month. Required equipment: Varies, depending on specific format plan; 40 reels in library, consisting of 600 titles; 4 update reels per month. All additional information same as above.

**Format: "Black Gold"**

Category: Oldies plus current hits. Description: Combines the familiarity of oldies with the freshness of current hits. With a 4-reel configuration, the format offers maximum control and flexibility. The gold library is programmed by tempo to allow for dayparting and specific market adjustments. Available un-announced. Price range: \$500 to \$2,000 per month, depending on market size. Required equipment: 4 reel-to-reel, 1 multiple cart playback, 2 single cart playbacks, sequencer. 40 reels in library, consisting of 1,000 titles; 8 update reels per month. All additional information same as above.

**Cavox Stereo Productions**

502 S. Isis  
Inglewood, CA 90301  
(213) 776-6933

Contact: Lee Tate, Bob Mayfield

Formats: "Standard Pop", "Easy Listening", "Contemporary MOR", "Conservative Tempo", "Good Music", "Beautiful Music", "Adult MOR Contemporary", "Cavox County".

Method of announcing: Un-announced. Designed for live, automated, and semi-automated situations. Price range: \$170 to \$365 per month; 1 year minimum contract. Required

equipment: 2 reel-to-reel machines minimum. 60-90 hours of programming in library, consisting of up to 2,000 titles; 9-15 hours of updates received monthly. Programming supplied on 10" and 14" reels, 7 1/2 ips, stereo and mono; duplicated high speed at 60 ips. Tapes must be returned at end of contract. Two months payment required in advance. PSA's and promos available at no extra charge.

**Century 21 Productions & Programming, Inc.**

2825 Valley View Lane  
Dallas, TX 75234  
(800) 527-3262 or (214) 243-6721

Contact: Tom McIntyre, Dave Scott

**Format: "The Z Format"**

Category: Contemporary. Description: Custom-tailored format with 14 basic music categories available. The proper music blend can be achieved for each station's audience and competitive situation. Spans the entire contemporary spectrum from soft adult contemporary, through several shades of top 40 to album-oriented-rock and disco. Announcers alternate in 3-hour shifts. Method of announcing varies. Designed for automated or partial-live stations. Price range: \$300 to \$1,500 per month, depending on market size and services supplied. Minimum contract varies. Required equipment: 3 or 4 reel-to-reel decks, carousel or single-play cart machines for jingles, localized announcements, weather, etc. 80 reels in library consisting of 700 titles; 15 update reels supplied monthly (4 per week). Programming supplied on 10 1/2 reels, 7 1/2 ips, stereo or mono. Promotions, contests, consultation, sales presentation available at no extra charge. Time clock available for \$250 to \$650.

**Format: "Super Country"**

Category: Country. Description: New format featuring modern country hits with currents, recurrences, and oldies. Progressive country emphasis also available for dayparted use. Format is flexible for local needs. Will accommodate from none to 18 commercial minutes per hour. Price range: \$300 to \$1,200 per month, depending on market size. 30 reels in library, consisting of 500 titles; 7 update reels per month. No extra charge for time clock. All additional information same as above.

**Format: "E-Z Format"**

Category: Contemporary MOR. Description: 100% familiar adult music primarily featuring smooth hit songs by the name artists. Separate categories for current easy hits, recurrences, oldies in original versions and image series of mellow music (includes album cuts and some cover versions of familiar songs in non-rock versions.) Flexible to match market needs. Price range: \$300 to \$1,200 per month, depending on market size. 50 reels in library consisting of 800 titles; 7 update reels supplied per month. No extra charge for time clock. All additional information same as above.

**Churchill Productions**

1130 E. Missouri, Suite 800  
Phoenix, AZ 85014  
(602) 264-3331

Contact: Mike Churchill

**Format: "Beautiful Music"**

Description: A service of matched-flow quarter hours on hour length reels. Supplied un-announced, compatible with automation, semi-automated, and live situations. Price range: \$800 to \$3,000 per month, depending on market size. 2 year minimum contract. Required equipment: 3 reel-to-reel tape decks. 150 reels in basic library, supplied on 10" reels, 7 1/2 ips, stereo. Tapes must be returned after use. Station ID, themes, consultation, available at no extra charge.

**The CnB Studios**

3415 Beresford Avenue  
Belmont, CA 94002

(415) 592-6149

Contact: Bud or Carole Thompson

**Format: "Promat 'C' and Promat 'B'"**

Category: Beautiful music. Description: Promat "C" is contemporary, plush music of the 60's and 70's. Promat "B" is beautiful yesteryear music of the 30's, 40's, and 50's. The two formats can be used alone or intermixed to create either a beautiful music format or an easy listening format. Can be customized. Available un-announced. Price depends on reel size and configuration. Verbal contract allowed, depending on station's desires. Required equipment: 2 reel-to-reel decks minimum; over 300 hours of programming in library. Programming supplied on 10 1/2" reels and 14" reels, 7 1/2 and 3 3/4 ips, mono and stereo. Duplicated one-to-one. Consultation included in service.

**Format: "Promat 'P'"**

Category: Beautiful music, MOR. Description: A potpourri of hard-to-find sounds such as C&W instrumentals, Night Touch, Sunday Music Theatre, Big Band, etc. All additional information same as above.

**Format: "Promat 'N'"**

Category: Big band sounds. Description: Nostalgic vintage sounds of the 78 rpm era. All additional information same as above.

**Concept Productions**

1145 Coloma Way  
Roseville, CA 95678  
(916) 782-7754

Contact: Dick Wagner

**Format: "Concept 1, Contemporary MOR"**

Description: Carefully balanced blend of popular vocal and instrumental MOR hits of wide listener appeal, targeted at 25-49 adults. Format features five San Francisco Bay area announcers, each with a daily show for live sound. Custom production done for each station weekly. Music is easily customized and dayparted. Available front and back-announced. Price range: \$500 to \$2,000 per month, depending on market size. 1 year minimum contract. Required equipment: Standard automation system, four reel-to-reel decks, one or two single-play cart decks, 2 cassette decks and multiple cart decks to suit spot load. 40 reels in library, consisting of 1,000 titles; 12 updates per month (shipped weekly), consisting of current hits, oldies, and recurrences. Programming supplied on 10 1/2" reels, 7 1/2 ips, stereo, duplicated one-to-one. Tapes must be returned after use. PSA's, promos, contests, promotions, and weekly consultation included at no extra charge. Time clock available at slight charge.

**Format: "Concept 2, Soft Rock"**

Description: Similar to format above, except targeted at 18-34 audience, and features carefully balanced blend of soft rock hits of today and yesterday. Involves five personalities for live sounding result. Compatible with automated, semi-automated, and live situations. All additional information same as above.

**Format: "Concept 3, Album Rock"**

Description: Similar to above, except aimed at 15-30 year old audience. A carefully planned blend of rock and progressive hits of the past and present. Involves five personalities for live sound. All additional information same as above.

**Creative Media Consultants, Inc.**

Box 3146  
Walnut Creek, CA 94598  
(415) 938-4444

Contact: John Hawkins

Formats: "Contemporary", "Adult Contemporary", "Middle-years MOR", "Beautiful Music", "Disco Rock"

**SUMMIT PRODUCTIONS  
PROUDLY PRESENTS THE BEST OF**

**THE PAST**

**SENTIMENTAL  
JOURNEY**

with  
Pete Moss

A 13 week collection of the music, people and events of the Roaring Twenties thru the Fabulous Fifties.

**THE PRESENT**

**THE AMERICAN  
DISCO NETWORK**

with  
Kris Erik Stevens

A weekly series of hard hitting disco music, celebrity interviews and surveys of the disco scene across the country.

**THE FUTURE**

**The  
ESP  
Phenomena**

with  
Sonny Melendrez

The award winning collage of 26 3 1/2 minutes episodes that take a scientific and entertaining look at extra sensory phenomena.

I'm interested in demos on:

- \_\_\_\_\_ Sentimental Journey
- \_\_\_\_\_ The American Disco Network
- \_\_\_\_\_ The ESP Phenomena

Name \_\_\_\_\_ Title \_\_\_\_\_

Station \_\_\_\_\_ Format \_\_\_\_\_

Street Address \_\_\_\_\_

City \_\_\_\_\_ State \_\_\_\_\_ Zip \_\_\_\_\_

Telephone \_\_\_\_\_

**SUMMIT PRODUCTIONS**  
6605 Ampere Avenue  
North Hollywood, CA 91606  
(213) 762-5544



Formats available back-announced or un-announced. Designed for automated, semi-automated, and live situations. Price range: \$200 per month and up, depending on market size. 1 year minimum contract. Can run on automation system or four separate machines. Programming supplied on 7 1/2" or 10" reels, 7 1/2 ips, stereo and mono, duplicated one-to-one. Time clocks, PSA's, promos, contests, t-shirts, copy service, consultation available. Formats may be intermixed to create custom sound or dayparting.

**Drake-Chenault Enterprises, Inc.**  
**8399 Topanga Canyon Blvd., Suite 300**  
**Canoga Park, CA 91304**  
**(213) 883-7400**  
**Call Toll Free (800) 423-5084**  
*(except California, Alaska, Hawaii)*

**Format: "Contempo 300"**  
**Category:** Soft contemporary. **Description:** Format geared for the 18-49 demographic, featuring The Beatles, Barry Manilow, Paul Simon, Neil Diamond, Carole King... all hit artists and songs. Available in AM and FM configurations, custom designed to meet station's marketing objectives. **Method of announcing:** Limited and varies. **Price range:** \$500 to \$5,000 per month, plus reel charges, depending on market size. 2 year minimum contract. **Required equipment:** 4 reel-to-reels, multiple-spot cartridge playbacks, (carousels, audiofiles, etc.), 2 or 3 single play units, time announce and control unit or "brain". 30 reels in library consisting of 700 titles; updates received weekly, consisting of currents, recurrences, base library. **Programming supplied on 10 1/2" reels, 7 1/2 ips, stereo and mono; duplicated one-to-one; all reels shipped at \$10 each. Programming aids included at no extra charge: time announce, custom jingles, custom promos, image lines, consultations, promotion, sales manuals and news letters. All Drake-Chenault formats use an exclusive computer rotation for each station, guaranteeing proper music mix and balance.**

**Format: "Great American Country"**  
**Category:** Modern country. **Description:** Format is heard on over 70 stations. Flexibility options allow the stations to use only oldies since 1970 or the entire library consisting of hit country music back to the 1950's. Designed for AM and FM use. Commercial availabilities can vary. Artists include Johnny Cash, Sonny James, Charley Pride, Glen Campbell, Dolly Parton, Conway Twitty, Loretta Lynn, etc. **Target demographic:** 18-plus. **Method of announcing:** Back or front, some un-announced. All additional information same as above.

**Format: "XT-40"**  
**Category:** Contemporary rock. **Description:** The music is directed toward sophisticated rock and away from MOR or 'bubble gum'. Oldies go back to the mid 60's with current music shipped weekly. Available in a high energy approach or a mellow rock style. Artists include Supertramp, Fleetwood Mac, Electric Light Orchestra, Heart, James Taylor, CSN&Y. Album cut option also available. **Target demographic:** 18-34. **Method of announcing:** Limited and varies. All additional information same as above.

**Format: "AOR-100"**  
**Category:** Album-oriented-rock. **Description:** A pop, wide appeal FM album rock format geared for markets needing a sophisticated edge over top 40 or progressive rock competition. Reaches the 15-30 year old demographics, mixed men and women. Complete guidance for effectively using local one-liners, PSA's to give the station a definitive 'feel'. **Method of announcing:** Limited. All additional information same as above.

**Format: "SuperSoul"**  
**Category:** Black. **Description:** A modern, more music approach to black radio. It is highly flexible concentrating on today's black hits, oldies, and new album tracks. Variations include high energy AM or a more laid-back design for FM. **Demographics** are 12-34 and not limited to only black listeners. **Method of announcing:** Varies. All additional information same as above.

**Format: "Beautiful Music"**  
**Category:** Beautiful music. **Description:** Beautiful music format eliminating repetition, formatting to reach target demographics and offering complete title control. Flexibility allows the format to be tailored to meet specific market objectives including smaller market needs for more commercial availability. **Demographics** appeal 18-plus. **Format** is un-announced. Designed for automated or live situations. All additional information same as above.

**Format: "DC-MOR"**  
**Category:** Middle of the road. **Description:** Returns to easy listening music by established vocalists — Frank Sinatra, Peggy Lee, Johnny Mathis; choral groups such as Johnny Mann Singers, Ray Coniff Singers, Sandpipers, etc., and instrumental arrangements of standards, as well as 'covers' of today's music. Designed to compliment the busy, highly involved AM operation. **Format** is un-announced. Designed for automated or live situations. All additional information same as above.

**Filmways Radio, Inc.**  
**1610 N. Cahuenga Boulevard**  
**Hollywood, CA 90028**  
**(213) 462-6421**  
**Contact: John Price, Steve Epstein**

**Format: "20/40"**  
**Category:** Adult contemporary. **Description:** Adult contemporary music presented in segments. Up to 6 stop sets per hour. Music for adults 20 to 40 years eliminates heavy metal and teen tunes. Emphasis on familiarity. Two air hosts (Rodger Layng, Caron Allen) each do daily show. Segments are back-announced, currents are front-announced. Compatible with automated, semi-automated, and live situations. **Price range:** \$650 to \$2,000 monthly, depending on market size. 1 year minimum contract. **Required equipment:** 2 to 4 reel-to-reel decks, 6-24 cart trays for currents, a few trays for local voice tracks. Operates on

virtually any system. 40 reels in library, consisting of 1,200-1,600 titles; 3 update reels (2 library, 1 current) provided weekly. Programming supplied on 10 1/2" reels, 7 1/2 ips, stereo or mono. Duplicated one-to-one. Tapes must be returned after use. Custom time checks, unlimited copy service, local voice tracks, consultation (management, sales, promotion, and engineering) included.

**Format: "The Filmways Radio Country Format"**  
**Category:** Country. **Description:** Voice-tracked "live" country format that is 70% current and 30% gold. Four Los Angeles air personalities (including Harry Newman, Gene Price, and Ron Martin) each provide 5-hour daily programs through voice tracks plus custom copy service. **Method of announcing:** Voice tracked. **Price range:** \$800 to \$3,000 per month, depending on market size. **Required equipment:** 3 reel-to-reel decks, 48 current hit trays (1 Instacart, 2 carousels, etc.), 2 cartridge playbacks, time announcer. 50 reels in library, consisting of 1,548 titles; 7 voice track, current, and gold update reels provided weekly. All additional information same as above.

**The FM 100 Plan**  
**875 N. Michigan Avenue, Suite 3112**  
**Chicago, IL 60611**  
**(312) 440-3123**  
**Contact: Darrel Peters**

**Format: "The FM 100 Plan"**  
**Categories:** Beautiful Music, Beautiful Country, and Bright & Beautiful MOR (3 formats). **Description:** For automated, semi-automated, or live stations (combined random-select and match flow). **Formats** are un-announced. **Price range:** \$500 to \$3,000 per month, depending on market size. 3 year minimum contract. 4-20 update reels provided each month. **Programming supplied on 10" reels, 7 1/2 ips stereo, duplicated 2:1. Programming aids included at no extra charge: promos, ads, TV spots, bus signs, billboards, extra charge only for aids involving announcing services. Engineering, promotion, and sales consultation available at no extra charge.**

**The Good Music Company**  
**3518 Cahuenga West, Suite 305**  
**Hollywood, CA 90068**  
**(213) 851-7777**  
**Contact: Tom Fenno, Ed Yelin**

**Description:** Company provides original-produced music for beautiful music stations.

**Gospel Music Service**  
**P.O. Box 178225**  
**San Diego, CA 92117**  
**(714) 299-2236**  
**Contact: Bill Gruber**

**Format: "The Music of New Wine"**  
**Category:** Contemporary gospel (for commercial market). **Description:** Average of 17 cuts per hour with a total of six minute commercial avails. **Format** is for 24-hour automation using jingles, disc jockeys, and is flexible for news, local promos, etc. **Music selection** is strictly mellow contemporary. **Method of announcing:** back-announced, front-announced, and un-announced. Designed primarily for automated stations. **Price range:** \$600 to \$900 per month, depending on market size. 1 year minimum contract. (Flexible) **Required equipment:** At least 4 reel-to-reel decks and two cart decks. 30 reels in basic library, consisting of 500 titles; 6 update reels per month. **Programming supplied on NAB reels, 7 1/2 ips stereo. Tapes** must be returned after use. **Programming aids** available: time clocks, jingles, promo units.

**Greater Media Services, Inc.**  
**Turnpike Plaza Bldg., 197 Highway 19**  
**East Brunswick, NJ 08816**  
**(201) 247-6161**  
**Contact: Phillip H. Roberts**

**Format: "Magic Music"**  
**Category:** Soft contemporary. **Description:** Four music sets of four songs each per hour. Four stopsets of maximum 2 units per hour. For use with live announcers. **Price range:** \$800 to \$4,000 per month, depending on market size. 2 year minimum contract. **Required equipment:** 3 stereo decks, 3 stereo cart playbacks, 3 mono cart playbacks, 680 reels in library; 1 current update reel supplied weekly. **Supplied on 7 1/2" reels, 15 ips stereo; duplicated one-to-one. Marketing and consultation services** provided.

**HG Productions**  
**Box 2049**  
**Scottsdale, AZ 85252**  
**Contact: Howard Greenlee**

**The Innovation Organization**  
**Box 3133**  
**No. Hollywood, CA 91609**  
**(213) 882-0177**  
**Contact: Ron Lewis**

**Format: "Rockin' Easy"**  
**Category:** Easy rock, contemporary MOR. **Description:** The best selling soft rock/MOR LP's and singles targeted at 18-34 audience. Songs are clustered in double and triple sets. **Produced** back-announced or un-announced. Compatible with automated, semi-automated, and live situations. **Price range:** \$250 to \$600 per month, depending on market size and services provided. 1 year minimum contract, (with cancellation possible after six months). **Required equipment:** 3 or 4 reel-to-reel machines, cart machines depend on station's requirements for ID's, jingles, spots, and

**KalaMusic** works...

sounds great... gains audience...

builds profits... IN MARKETS

JUST LIKE YOURS!



Williams, Arizona	Frederick, Maryland
Punta Gorda, Florida	New Iberia, Louisiana
Roanoke, Virginia	Huntington, West Virginia
Kalamazoo, Michigan	West Palm Beach, Florida

These are markets just like yours. Markets where most of the revenue is retail, and where competition for those dollars, and for listeners is fierce. In these markets, and in several others, **KalaMusic** has proven itself in the ratings books, and on the bottom line.

**KalaMusic's** unique blend of "up-front" Beautiful Music, our flexible program consultation service, and our sales and promotion aids are ready to go to work for you.

To learn more about **KalaMusic** call Bill Wertz or Stephen Trivers at (616) 345-7121

or see us in

**KalaMusic**  
 Suite 334, ISB Building  
 Kalamazoo, Michigan 49006

**SUITE 1529**  
**at the NRBA.**

time track. 60 reels in library, consisting of 1,000 titles; 1 update reel provided weekly. Programming supplied on 10 1/2" reels, 7 1/2 ips, stereo, duplicated one-to-one. Tapes must be returned at end of contract. ID's, PSA's, promos, promotion, sales ideas, and consultation included; slight charge for custom jingles and time clock.

**Kala Music**  
**Service of Fairfield Broadcasting Co.**  
 Suite 334  
 Industrial State Bank Building  
 151 S. Rose Street  
 Kalamazoo, MI 49006  
 (616) 345-7121

Format: "KalaMusic"  
 Category: Beautiful music. Description: Programming supplied on half-hour tapes, each reel consisting of two half-hour segments and two fill records. Consists of familiar music performed by the world's greatest artists in carefully constructed quarter-hour segments. Designed as an upfront programming service, as opposed to background programming. Available un-announced; compatible with automated, semi-automated, and live situations. Price range: \$450 to \$1,100 per month, depending on market size. 1 year minimum contract. Minimum of 2 reel-to-reel machines required. 600 reels in library, consisting of 6,015 titles; updates received monthly. Programming supplied on 10" reels, 7 1/2 ips, stereo, duplicated one-to-one. Tapes must be returned after use. Tape deposit required. Consultation included.

# Record Report Hooks Charlie Tuna!

Charlie Tuna, top-rated morning man on KHJ, Los Angeles, joins "Record Report" as its new national host.



"Record Report" begins its third year of reporting the exclusive, inside news of what's going on with the superstars of pop music in a 3 1/2 minute, twice-daily newscast. Now heard on over 185 leading U.S. radio stations.

Charlie Tuna gets hooked on "Record Report." So will your listeners and advertisers. Call Mary White and catch "Record Report" exclusively for your station, free of charge!



**FILMWAYS/RADIO INC.**

1610 N. Cahuenga Blvd.  
 Hollywood, CA 90028  
 (213) 462-6421

Want more details?  
 Circle No. 27 on Product Info. Card.

**Live Sound, Inc.**  
 6363 Hollywood Boulevard  
 Los Angeles, CA 90028  
 (213) 462-3351  
 Contact: A. F. Peterson

Format: "Big Country"  
 Category: Country. Description: Modern country music voice-tracked by five top Los Angeles area disc jockeys who do new shows for every day of the year. Features Jason McCall, Chris Lane, Bob Morgan, and Chuck Roberts. Method of announcing: voice tracked. Price range: \$500 to \$1,500 per month, depending on market size. 1 year minimum contract. Required equipment: 3 reel-to-reel machines, 48 random access capability for music (on cart); plus cart capability for spots, program aids, and jingles. 30 reels in library, consisting of 900 titles; 7 voice-track and 1 current music reel updates per week; 1 oldies update reel per month. Programming supplied on 7 and 10" reels, 7 1/2 ips, stereo; duplicated high speed, 60:1. Promos and non-commercial voice tracks provided free for local copy. Format installation and on-going consultation included. Slight charge for time tapes.

**Mar-Wal, Inc**  
 2813 Hartwood  
 Ft. Worth, TX 76109  
 (817) 927-5694  
 Contact: Wally Blanton

Format: "Mar-Wal Sterling Series"  
 Category: Beautiful music/easy listening. Description: Basically beautiful, but includes smooth contemporary instrumentals and vocals. Program grid prevents exact sequence repeats in specific time periods for up to 200 days. 25 Hz. tone between each selection for complete flexibility. Method of announcing: adaptable to any situation, live or automated. Price range: \$200 to \$2,000 per month, depending on market size. 1 year minimum contract. Required equipment: 2 reel-to-reel (preferable 3). 110 reels in library, consisting of 2,000 titles; minimum of 2 updates per month, consisting of new titles plus new or different arrangements. Format includes optional all-vocal tapes by contemporary artists. Programming supplied on 10 1/2" reels, 7 1/2 ips, high-speed duplication 8:1 ratio. Consultation included at no extra charge. All tapes programmed in day and night segments. Exclusive market area guarantee. 30-day free trial at no obligation.

**Master Broadcast Services**  
 P.O. Box 61  
 Morrisville, PA 19067  
 (215) 295-0413  
 Contact: Jason Taylor, Gary Walker

Format: "Master Service 1"  
 Category: Bright easy listening/beautiful music. Description: Beautiful music done in matched-flow segments. Content is bright and includes discreet use of 'cover-hit' artists. Weekly tape schedule included. Custom ID's. 36-hour Christmas package. Format is un-announced; designed for automated or un-automated situations. Price range: \$550 to \$2,500 per month, depending on market size. 2 year minimum contract. Required equipment: 3 reel-to-reel plus 2 carousels, plus 3 single-play cartridge machines. 204 hours of programming is in library, consisting of over 3,000 titles; 80 updates per year, received monthly, consisting of average of 60% new material. Programming supplied on 10 1/2" reels, 7 1/2 ips, stereo. Tapes must be returned after use. Charge for broken tapes only. ID's and time clocks available at extra charge. Technical and sales consultation at no extra charge.

**More Music Programming, Inc.**  
 5315 Laurel Canyon Blvd., Suite 200  
 No. Hollywood, CA 91607  
 (213) 985-3300  
 Contact: Jay Dunn

Format: "The Great Hits"  
 Category: Pop/rock. Description: Five formats in one. Runs the spectrum of soft rock to top 40 to all oldies. Music mix determined by station's needs. Total flexibility. No commercial minimums or limits. Available announced or un-announced; automation system required (can run on as few as 2 reel-to-reel decks). Price range: \$250 to \$1,200 per month, depending on market size. 1 year minimum contract. 40-60 reels in library, consisting of 900 to 1,200 titles; library and recurrent update reels supplied monthly; current update reel supplied weekly. Supplied on 10 1/2" reels, 7 1/2 ips, stereo; duplicated one-to-one; current reels must be returned after use. Non-commercial production and consultation provided free. Slight charge for time clocks and custom jingles.

**Morning Music (USA), Inc.**  
 P.O. Box 12647  
 Nashville, TN 37212  
 (416) 625-2676  
 Contact: Mark Altman

Format: "Beautiful Music — MOR"  
 Description: Easy listening instrumentals produced in Germany and Austria. Uptempo, mellow, and ethnic variety. Mostly unfamiliar titles. Designed for semi-automated situations. Supplied un-announced. \$40 per 10 discs.

**The Music Director Programming Service**  
 P.O. Box 103  
 Indian Orchard, MA 01151  
 (413) 783-4626  
 Contact: Budd Clain

Format: "Oldies on Tape — 1955 thru 1976"  
 Category: MOR, Adult Contemporary, Top 40. Description: Oldies tape library consists of 417 oldies from 1955 through 1976. A basic library of the top records from the past 21 years. Programming is un-announced; designed for

automated, semi-automated, and live situations. Available on outright purchase basis — entire series in mono priced \$269; in stereo is \$305. 29 reels in library, consisting of 417 titles; 2 update reels available each year. Programming supplied on 7" reels, 7 1/2 ips.

Format: "Christmas Hits on Tape"  
 Description: Nearly 100 Christmas songs for Christmas programming. Rates available on request. All additional information same as above.

Format: "Damn Good Programmers"  
 Description: Series of MOR/good music recordings. Rates on request. All additional information same as above.

**The Musicworks, Inc.**  
 6238 LaPas Trail  
 Indianapolis, IN 46260  
 (317) 291-9400  
 Contact: Bill Robinson, Jim Potter

Format: "Alive Country"  
 Category: Country. Description: Personality-oriented format featuring three hosts: Bill Robinson, Less Shannon, and Gary Havens. Station can purchase one, two, or three personalities, depending on programming needs. Music mix ranges from artists such as Merle Haggard and Conway Twitty to Lynn Anderson, Ray Price, Waylon Jennings, and Emmylou Harris. Produced back and front announced; compatible with automated and semi-automation situation. Price range: \$300 to \$1,900 per month, depending on market size and services supplied. No minimum contract. Required equipment: At least 3 reel-to-reel machines. Comprehensive library of classics provided, as well as hit-tape updates; programming supplied on 10 1/2" reels, 7 1/2 ips, stereo or mono; duplicated one-to-one. Tapes are recycled after a period of time. Tape deposit required. Clocks (both generic and custom), spot production, copy service, and consultation available (some free, some at slight charge).

Format: "Canned Pop"  
 Category: Contemporary soft rock. Description: Targeted at 18-34 audience. Consists of oldies (top soft rock hits of early 60's to 1974), re-currents, and current soft rock hits. Produced back-announced. Price range: \$250 to \$950 per month, all additional information same as above.

Format: "Casual Country"  
 Category: Beautiful country. Description: Smooth blending of country's top easy sounding vocalists, cross-over artists, and country flavored instrumentals. Designed as an alternative to traditional country and beautiful music. Price range: \$200 to \$2,000 per month. Requires at least 2 reel-to-reel machines. All other information same as above.

Format: "Real MOR"  
 Category: Traditional MOR. Description: Designed to present a blend of familiar music by solo vocalists, group vocals, and instrumental groups having adult appeal. Consists of standards, recent popular music (cross-over country hits that have MOR appeal to bands, orchestras, singers, and groups). Produced back-announced. Price range: \$200 to \$2,000 per month. All additional information same as above.

**Orbit Radio-Video**  
 P.O. Box 1644  
 Louisville, KY 40201  
 (502) 584-5535  
 Contact: Stephen A. Cisler

Format: "Golden Greats"  
 Category: Variety in easy listening music for nostalgia. Description: The best of popular music of the past 50 years, omitting rock and soul types. Includes both instrumental and vocal, male, female, groups, et al. Programmed for continuous running or for use as inserts or change of pace in other programming formats. Format produced back-announced; compatible with automated, semi-automated, and live situations. Price range: \$250 to \$1,000 per month, depending on market size. 6 month minimum contract. Required equipment: Reel-to-reel on one or multiple machines. 250 reels in basic library, consisting of 3,000 to 5,000 titles; 2 updates supplied per month consisting of new material. Programming supplied on 7" or 10 1/2" reels, 7 1/2 ips, mono or stereo; duplicated high speed 2:1. Tapes must be returned after use. Tapes are bicycled after inspection. Tape deposit required, and tape charge FOB Louisville. Promo spots and consultation available at no extra charge.

**Peters Productions, Inc.**  
 8228 Mercury Court  
 San Diego, CA 92111  
 (714) 565-8511  
 Contact: Edward J. Peters

Format: "Music — Just for the Two of Us"  
 Category: Beautiful music. Description: A precise blending of contemporary and standard titles with a base of total familiarity. Four separate format blends allow tailoring for market competitive factors. Music is programmed in four 12-minute sweeps per hour with 4 stopsets. Recommended commercial limitation is 8 minutes per hour. Depending on format blend selected, vocals are programmed at rate of 4 to 8 per hour. Available un-announced. Price is dependent on market size. 1 year minimum contract. Required equipment: 4 reel-to-reel, 2 carousels, 3 single-play cartridge machines. Updates received monthly; programming supplied on 10" reels, 7 1/2 ips, stereo or mono; duplicated one-to-one. Tapes must be returned after use. Tape deposit required. All voice work, sales and promo aids, and consultation provided at no extra charge.

Format: "The Great Ones"  
 Category: MOR. Description: Two separate formats designed for traditional or contemporary MOR stations. Available announced or un-announced. Designed for automated or live situations. Required equipment: 4 reel-to-reel, 4 carousels, 3 single-play cart machines. All additional information same as above.

Format: "The Love Rock"

Category: Contemporary rock. Description: Precision programming of today's top hits, albums, and demographically gridded oldies, targeted to the 18-24 audience. Required equipment: 3 reel-to-reel machines, 4 carousels, 4 single-play cart machines. All additional information same as above.

**Radio Arts, Inc.**  
210 N. Pass Avenue, Suite 104  
Burbank, CA 91505  
(213) 841-0225  
Contact: Larry Vanderveen

Format: "The Entertainers"

Category: MOR. Description: Format based on a three-part blend of modern MOR, standard MOR, and country crossover. Stations utilize solo vocal, group vocal, and current reels, plus instrumental or recurrent reels. Music programmed on a random select basis and is designed to have maximum flexibility while retaining strong format identity. Produced back, front, and un-announced; compatible with automated, semi-automated, and live situations. Price range: \$450 to \$3,500 per month, depending on market size. 2 year minimum contract. Required equipment: At least 4 decks equipped with 25 Hz. tone sensors. Number of carousels and cart machines flexible, depending on station needs. 52 reels in library consisting of 2,000 titles; 18 update reels provided monthly; programming supplied on 10 1/2" reels, 7 1/2 ips, stereo. Duplicated one-to-one. Jingles, customized promos, time clocks, voicing service, promotional materials, sales aids, and consultation included.

Format: "Easy Country"

Category: Country. Description: Library divided into modern and traditional segments and is designed to appeal to the mainstream country listener and to attract formerly non-country audience. In addition to basic library, format utilizes a current series and optional recurrent series. Design of format allows for emphasis on modern or traditional elements. Random selection process creates flexibility in programming. 50 reels in library consisting of 1,500 titles. 12 update reels received monthly. All additional information same as above.

**Radio Programming/Management**  
25140 Lasher, Suite 232  
Southfield, MI 48034  
(313) 358-1040

**Radio Programs, Inc.**  
2773 E. Horseshoe Drive  
Las Vegas, NV 89120  
(702) 451-4273  
Contact: William G. Mors

Formats: "No. 1 Country", "No. 1 Easy Listening", "Blue Denim", "Blue Velvet"

Categories: Country, MOR, adult, contemporary, beautiful music. Description: Categories derived from latest charts as well as programming any music which is compatible to category considering lyrics and musical reflection of the listed category, regardless of chart position or artist. Format is left up to the station who syndicator feels is more aware of the particular needs of its market. Front-announce, back-announce, and un-announced available. Designed for automated, semi-automated, and live situations. Price range: \$35 per reel, no announcer, to \$600 per month for full service. Compatible with any equipment or automation system. Updates supplied monthly; programming supplied on 10" reels, 7 1/2 ips, stereo. Time tapes, consultation, fill tapes, Christmas tapes, promos, PSA's, available at no extra charge. Promotional items on 'at cost' basis. Syndicator limits number of accounts to 20 at all times.

**Sacred Sounds**  
11635 Richmond Street  
Riverside, CA 92505  
(714) 785-4567  
Contact: Lee McIntyre

Format: "Sacred Sounds of Praise/Vocal"

Category: Traditional religious. Description: Traditional hymns and songs sung by outstanding soloists and groups such as Sixteen Singing Men, Haven of Rest, Free Spirit, Hale and Wilder, Norma Zimmer, George Beverly Shea. Each tape balanced for flow, including tempo, mood, group vs. solo, etc., for maximum flexibility. Produced un-announced or back-announced. Compatible with automated or live situations. Price range: \$14 to \$72 per month, depending on size of library purchased. No minimum contract. Required equipment: Works best with 3 or 4 reel-to-reel machines (format is non-structured). 50 reels in library consisting of 1,500 titles; up to 3 update reels supplied each month. Programming supplied on 7 or 10 1/2 inch reels, 7 1/2 ips, stereo or mono. Duplicated one-to-one. \$170 to \$1,032 tape deposit required.

Format: "Sacred Sounds of Praise/Instrumental"

Category: Traditional religious. Description: Slightly more contemporary version of vocal format listed above. All additional information same as above.

Format: "Sacred Gospel Sounds"

Category: Religious. Description: Wide range of gospel artists such as Gaither Trio, Walt Mills, Speers, Lanny Wolfe, Rambos, etc. 60 reels in library consisting of 1,800 titles; up to 4 update reels provided monthly, or as desired. \$170 to \$1,032 tape deposit required. All additional information same as above.

Format: "Sacred Sounds of Today"

Category: Religious MOR. Description: Slightly up-tempo MOR format of modern religious music performed by such artists as Truth, Evie Tornquist, Paul Johnson, Rick Powell Singers, Dallas Holm, Honeytree, etc. All additional information same as above.

Format: "Sacred Sound of Tomorrow"

Category: Religious gospel rock. Description: Contemporary, up-beat music with a message to reach the younger audience. Includes Gary Paxton, Sammy Hall, Second Chapter of Acts, Love Song, and others. 26 reels in library, consisting of 780 titles; up to 3 update reels supplied monthly. \$170 to \$560. Tape deposit required. All additional information same as above.

**Schulke Radio Productions, Ltd.**  
3001 Hadley Road  
South Plainfield, NJ 07080  
(201) 753-0444  
Contact: Jim Schulke, Dave MacFee

Format: "Schulke Format"

Category: Beautiful music. Description: Music programmed in 12 to 14 minute matched-flow segments. Produced un-announced; compatible with automated semi-automated, and live situations. Required equipment. Minimum of 2 tape decks and 4 cart machines. Compatible with all types of automation systems. Programming supplied on 10" reels, 7 1/2 ips, stereo. ID's, promotion, and consultation provided.

**Southcott Productions**  
16661 Ventura Blvd., Suite 309  
Encino, CA 91436  
(213) 368-4938  
Contact: Chuck Southcott

Format: "This is Music"

Category: Adult MOR/bright instrumentals. Description: 50% vocal and 50% instrumental. Can be dayparted by an up to 71% emphasis on vocals in certain time periods, and up to 71% instrumental in opposite time periods. Features standard MOR performers, along with current performers with adult appeal. Instrumentals are typically brighter than those heard on beautiful music formats. Designed as alternative to rock-based contemporary MOR and beautiful music formats. Target demographic 25-plus. Method of announcing: Front and back announced, separately tracked. Compatible for live or automated station. Price range \$340 to \$2,000 per month, depending on market size. 1 year minimum contract. Required equipment: 3 or 4 reel-to-reel machines, 2 carousels, and 2 single-play cartridge machines. 48-72 reels to start in basic library, consisting of a minimum of 1,344 titles; 4 update reels provided monthly, consisting of one new library reel in each of four categories \$10 deposit per basic library reel. Time announce, news back-time available at extra charge; all other services provided at no extra cost, including promos, jingles, copy service, consultation, and rotation charts. All masters dbx-encoded.

**The Starr Studios, Inc.**  
7011 N. Jan Mar Drive  
Dallas, TX 75230  
(214) 691-8846  
Contact: Dick or Carole Starr

Format: "Your Kind of Country"

Category: Country. Description: Contemporary country format with daypart programming capability, feature elements, flexible stopset, and special emphasis groupings. 6 stopsets per hour (12 minutes spot time), may be altered for local needs. Music rotation includes currents, recurrences, and gold categories. Package includes promotions, jingles, and on-going consultancy. Method of announcing. Back and front-announced; compatible with automated and semi-automated situations. Price range: \$600 to \$1,800 per month, depending on market size. 1 year minimum contract. Required equipment: 4 reel-to-reel machines, 3 single-play cart machines, sequential brain, commercial spot sources as needed. 100-plus reels in basic library, consisting of 1,500 titles; 4 update reels per month (shipped weekly), consisting of 2 currents, 1 gold, 1 recurrent; programming supplied on 10" reels, 7 1/2 ips, stereo or mono; duplicated one-to-one. Tape deposit included in contract. \$15 charge if reel must be replaced. Time announce, custom PSA's, promos, and jingles available free or at extra charge, depending on contract. Monthly promotions and aircheck consultation at no extra charge.

**Studio West**  
3901 Westerly Place  
Newport Beach, CA 92807  
(714) 637-8349  
Contact: Jim Meeker

**William B. Tanner Company**  
2714 Union Avenue Extd.  
Memphis, TN 38112  
(901) 320-4340  
Contact: Keith Lee, Kurt Alexander

Format: "Pacific Green"

Category: Beautiful music. Description: Available un-announced. Price range: \$400 to \$1,800 per month, depending on market size. 2 year minimum contract. Required equipment: 4 reel-to-reels preferable (will run on 3), other equipment depends on station's desires, walk-away, billing, etc. 96 reels in library consisting of 2,880 titles. 4 update reels monthly consisting of music and songs from different categories; computer reel rotation schedules. Programming supplied on 10 1/2" metal reels, stereo, 7 1/2 ips; duplicated high speed (3:1). Tape deposit required. Tapes must be returned at end of contract. ID's, time announce, and wild carts available at no extra charge; consultation, production libraries, sales aids, and custom rotations available at minimal charge.

Format: "Bright Blue — 100, 200, 300"

Category: MOR (3 different formats). Description: Traditional MOR music categories. Format based on individual station requirements, with computer reel rotations. Available back-announced; compatible with

## THE Z FORMAT BEATS 'EM ALL

Of all radio stations airing a syndicated programming service, the highest rated FM in the nation uses Century 21's Z FORMAT!

KTDY's 26.5% share makes them number one in total persons 12+ in the Lafayette, LA MSA, Monday-Sunday, 6 AM-Midnight.

Their Z FORMAT programming also gives KTDY the highest share of any automated FM surveyed in Arbitron's 164-market estimates this year!

Ron Gomez's KTDY wins number one honors in every major demographic, including 12+, 18+, 18-34 and 18-49 for men, women and adults, metro and total survey areas.

The secret is in the programming service: Century 21's contemporary Z FORMAT. It provides more flexibility, more music updates, more voices, more localization, and more help to make it happen.

You get more out of it because Century 21 puts more into it. Arbitron ratings prove it!

Whether you want rock, MOR or country, find out what Century 21 has that others don't have. Call Century 21 now at (800) 527-3262, or return the product information card for the whole story.

**century21**

PRODUCTIONS & PROGRAMMING, INC.

2825 Valley View Lane / Suite 221 / Dallas, Texas 75234

TOLL FREE (800) 527-3262

Want more details?

Circle No. 47 on Product Info. Card.

# Subscribe to



Receive your own personal subscription to BP&P, and start a useful reference library of radio and television production techniques, programming concepts and market profiles, audio, video, equipment, services, promotion, automation, syndication, and more. A complete information source on successful broadcasting.

Check or Money Order must be included with your subscription order (sorry, no billing). Your subscription will begin with the next-published issue (we cannot start with back issues). Since BP&P is published six times per year, please allow ample time to receive your first issue. Clip coupon below and mail to: Broadcast Programming & Production, Subscriptions / P.O. Box 2449 / Hollywood, CA 90028.

BP&P / P.O. Box 2449 / Hollywood, CA 90028

Start my personal subscription to



**UNITED STATES:**

- 3 Years (18 issues) \$18  
 2 Years (12 issues) \$13  
 1 Year (6 issues) \$7  
 1 Year via Air Mail \$13

**FOREIGN: (U.S. Dollars)**

- 1 Year (6 issues) \$8.50  
 1 Year via Air Mail \$24.00

I have enclosed \$ \_\_\_\_\_

Name	Title
Station/Company	<input type="checkbox"/> New <input type="checkbox"/> Renewal
Address	<input type="checkbox"/> Home <input type="checkbox"/> Office
City	State/Province/Country Zip

automated, semi-automated, and live situations. Price range: \$400 to \$1,800 per month, depending on market size. 2 year minimum contract. Minimum of 35 reels in library consisting of 1,100 titles; 7 update reels received (weekly and monthly), consisting of currents, recurrences, and library. All additional information same as above.

**Format: "Red Satin Rock"**

Description: Two different formats in rock categories. All additional information same as above.

**Format: "Tanner Country"**

Description: Country format. All additional information same as above.

**TM Programming, Inc.**

1349 Regal Row

Dallas, TX 75247

(214) 634-8511

Contact: Ron Nickell

**Format: "Beautiful Music 1000-C"**

Category: Beautiful music. Description: Custom to market. Produced un-announced; compatible with all live or automated situations. Price range: \$700 to \$5,000 per month, depending on market size. 2 year minimum contract. Required equipment: At least 3 decks, 2-track stereo, 10 1/2" reels, 3 single-play cart decks and commercial playback unit (carousel, Instacart, etc.) 110 reels in library, consisting of 3,000 titles; minimum of 48 update reels per year (3 or 4 month, min.). Programming supplied on 10 1/2" reels, 7 1/2 ips, stereo; duplicated 6:1. Tapes must be returned after use. Programming aids and consultation included; extra charge for time clocks only.

**Format: "Stereo Rock"**

Category: Mainstream rock. Description: Custom to market. Produced back-announced on current and album cuts only. Compatible with automated and live situations. Required equipment: Modern brain, 4 reel-to-reels, 3 single-play cart machines, carousels. 58 reels in library, consisting of 1,200 titles; 6 update reels provided monthly. All additional information same as above.

**Format: "TM Country 4000-C"**

Category: Modern country. Description: Custom to market. Required equipment: At least 3 reel-to-reels. 45-plus reels in library; 6 update reels per month, shipped weekly. All additional information same as above.

**Format: "Beautiful Rock 5000-X"**

Category: Mellow or soft rock. Description: Custom to market. Produced back, front, and un-announced. 68 reels in library; 8 update reels per month, shipped weekly. All additional information same as above.

**Twelve Oaks Productions**

Box 4917

Thousand Oaks, CA 91359

(805) 497-3022

Contact: Toby Fisher

**Format: "Inspirational Format"**

Description: Inspirational format featuring top contemporary/MOR selections.

**United Tapes of America**

Box 1193

Grand Junction, CO 81501

(303) 242-0405

Contact: Steve Schmidt

**Format: "Bouquet"**

Description: Easy listening. 170 reels available.

**Format: "Dayparts"**

Description: Easy listening. 30 reels available with 900 selections.

**Format: "Sounds of the 70's"**

Description: Adult contemporary MOR, 36 reels available with 900 selections.

**Format: "Contemporary"**

Description: Current hits and oldies; 90 reels available with 2,700 selections.

All services can be customized for specific station needs. Formats available un-announced but custom announcing available. Designed for automated, semi-automated, and live situations. Price range: \$120 to \$375 per month. 1 year minimum contract (month-by-month available at extra charge). Required equipment: Minimum of 2 reel-to-reel machines plus multiple cartridge unit. Updates supplied bi-weekly or monthly; programming supplied on 10" reels, 7 1/2 ips or 3 3/4 ips, stereo or two-track mono; duplicated one-to-one. Time announce, jingles, commercial production, custom promos, and ID's available at extra charge.

**Windchime Communications, Inc.**

15300 Ventura Boulevard

Sherman Oaks, CA 91403

(213) 986-0618

**Format: "Mellowmusic"**

Category: Adult contemporary. Description: Syndicated version of the successful KNX-FM mellow music format. Programmed by Tom McKay (4 years Associate Program Director of KNX-FM). Features best contemporary music in an adult atmosphere. Skews to adults 25-34, high socioeconomic profile. Method of announcing: back and front announced; designed for automated, semi-automated and live stations. Price range: \$450 to \$6,000 per month, depending on market size. 2 year minimum contract. Required equipment: 3 reel-to-reel machines (prefer 4), Instacarts, 3-4 carts for time checks, drop-ins, etc. 2,000 titles in basic library; updates provided weekly and monthly; programming supplied on 10" reels, 7 1/2 ips, stereo; duplicated one-to-one. Time clocks available at no extra charge. Promos, local spots, jingles, graphics and consultation available at no extra cost.

# NEW PRODUCTS & SERVICES

## BEUCART MACHINES NOW USED FOR REMOTE SPORTS BROADCASTING

All over the country hundreds of independent AM, FM and collegiate radio stations broadcast local high school, college, and semi-professional athletic events to their audiences. And all of them have a problem in properly cueing back from the remote broadcast location to the station for pre-recorded advertisements and other spots. Usually, a disc jockey or engineer, only half conscious of the game in progress, is responsible for cueing carts back at the station, and the frequency with which split-second cues are missed is a notorious fact of life in the trade. The ideal solution is, of course, to cue up these pre-recorded spots right from the press box.

The basic problem in doing non-live spots remotely is the fact that no piece of equipment exists to conveniently do this job. Instead, the sportscaster, often as not by himself, has to haul a heavy, clumsy cartridge tape player up into the press box with him, along with a portable amplifier, a stack of pre-recorded carts, and all his other paraphernalia.

"What's really needed," according to Connecticut's WELI Radio/WTNH Television personality, Dick Galliette, "is a simple, briefcase-sized amplifier and cartridge reproducer combination which would operate on either 120 VAC/60 Hz power or battery. Armed with such a piece of equipment, remote sportscasts would



really be a breeze to produce."

While such a piece of equipment is still at the drawing board stage, the Beucart Division of UMC Electronics Company has come up with a portable version of its compact Type 10 Beucart radio cartridge tape player which is much more convenient for remote operation. Equipped with a carrying handle, this relatively light weight, 20 lb. machine measures 4 1/8" x 5 3/4" x 15 3/4" and is suitable for all A-sized carts.

"Last season, for instance," says Galliette, "we broadcast Yale football games over the Yale Football Network." The games were broadcast live over WELI Radio in New Haven, WNAB in Bridgeport, WNLK-FM in Norwalk, and WOWW in Waterbury. "Since football time-outs are one minute, it's easy to run a string of spots over into the next play, which makes for sloppy broadcasting. Sometimes you also seem to end up with some fractional seconds of dead time while the engineer is cueing up back at the station.

"But with the portable Beucart player, we find that we can 'cheat' by chopping plays a bit short to allow us a full 60-seconds of non-playing time. After all, an experienced sportscaster can easily tell when a ball carrier is about to go out of bounds, stopping the clock, before the whistle blows. These two techniques, chopping plays and remote spots, give the sportscaster plenty of breathing room and allow much tighter programming of non-live material."

Since the Yale Football Network consisted of only four stations in 1976, a separate telephone line was run to each of them. Should more stations be involved, or should some of them be outside the local area, the live broadcast would go to one station where it would be relayed on by telephone to the others. Since the signal travels with electronic speed and no appreciable time delay is involved, the signal can be transmitted to a relatively distant station by relaying it through two or three intermediate stations which are also broadcasting the material.

"The market for remote broadcast equipment," concludes Galliette, "is enormous and wide open since so many non-network, independent broadcasters are involved. Remote broadcasting is really the only way to go."

**REMOTE BROADCASTING  
BEUCART DIVISION  
U.M.C. ELECTRONICS CO.  
460 SACKETT POINT ROAD  
NORTH HAVEN, CT 06473  
PHONE: (203) 288-7731**

*Want more details?*

*Circle No. 48 on Product Info. Card.*

## MUTUAL ADDS MORE "MINI-FEATURES" TO ITS NEW CONCEPT IN NETWORK PROGRAMMING

The Mutual Broadcasting System has expanded its recent offering of popular 2 1/2-minute mini-features by adding two more

programs to its current schedule of seven.

Each program contains 90-seconds of commentary, entertainment, or information and a 60-second commercial announcement and is offered on a swap-exchange basis. The first broadcast of each 2 1/2-minute program by stations includes the 90-seconds of program content and a 60-second network commercial. Stations may then repeat each program as often as desired, replacing network commercial with a local announcement. The new daily programs are "Astrology Today" with Sydney Omar, predictions and dynamic reports on the world of astrology; and "Consumer's Buyer Guide", authoritative information that helps the audience make important consumer decisions.

**MUTUAL BROADCASTING SYSTEM  
1755 S. JEFFERSON DAVIS HWY.  
ARLINGTON, VA 22202  
PHONE: (703) 685-2048**

*Want more details?*

*Circle No. 49 on Product Info. Card.*

## COMPACT HIGH RESOLUTION COLOR MONITOR AVAILABLE FROM CONRAC

A high resolution 13V color monitor designed for size-limited signal evaluation applications in broadcasting and teleproduction is available in production quantities from Conrac.

The compact unit, which can be

## Turn on a better idea

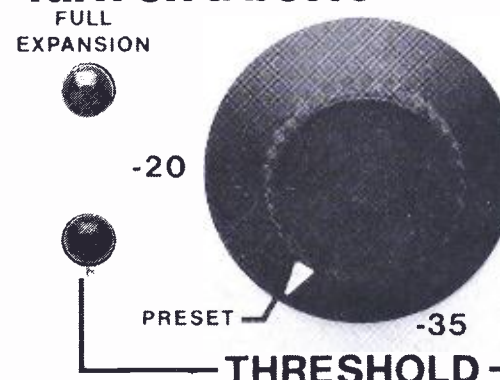

Program-controlled filter suppresses residual background noise in audio reproduction systems. Selectable low frequency, high frequency, or wideband suppression modes.

**Inovonics'  
DYNEX Noise  
Suppressor**

Model 241 - \$280

**Inovonics Inc.**

503-B Vandell Way  
Campbell, CA 95008  
(408) 374-8300



*Want more details?*

*Circle No. 50 on Product Info. Card.*



mounted over VTR consoles, offers excellent colorimetry and long-term stability. Called the Model 5722, it is compatible with VTR instrumentation/monitor bridges. The monitor also has a cabinet configuration as an option for portable teleproduction use.

The Model 5722 features a 13V high resolution Colormatch shadow mask CRT which allows critical signal evaluation. The unit includes preset controls for contrast, brightness, chroma, phase and aperture; horizontal and vertical delay switches; a horizontal AFC time-constant switch; and phase linear aperture correction.

**CONRAC CORPORATION**  
600 N. RIMSDALE AVENUE  
COVINA, CA 91722  
PHONE: (213) 966-3511

*Want more details?*  
Circle No. 51 on Product Info. Card.

### CETEC/SPARTA LITERATURE AVAILABLE

New full-color literature describing the latest broadcast (radio and TV) audio consoles made by Cetec Sparta is available now from Cetec Broadcast Group.

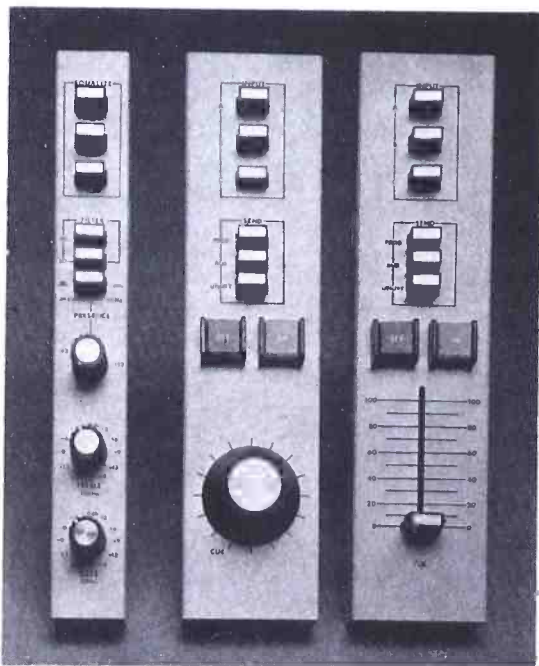

Labeled simply "Cetec Sparta Audio Equipment/1", the 12-page booklet is devoted to the Centurion Series and 3000-Series consoles. "Audio Equipment/2" is also available and describes other console lines, studio and remote broadcast furniture made by Cetec Sparta, speakers and related studio equipment.

**CETEC BROADCAST GROUP**  
75 CASTILLIAN DRIVE

GOLETA, CA 93017  
PHONE: (805) 968-1561

*Want more details?*  
Circle No. 52 on Product Info. Card.

### JAM RELEASES TWO NEW JINGLE SERIES

"Positron" is the latest rock series, produced for WABC. The package features short, but not sterile, jingles which showcase the call letters and a sell line (such as "The Best Music" and "Music Radio"). Many of the cuts feature electronic effects in the tracks, which give the jingles a unique sound.

"The WSM Package" was designed for that station's adult-contemporary format. The series offers a variety of logo cuts in different tempos. It also includes personality cuts specially designed for each day-part. The series provides several fully orchestrated :60 beds for promos or talkovers.

**JAM PRODUCTIONS**  
4631 INSURANCE LANE  
DALLAS, TX 75205  
PHONE: (214) 526-7080

*Want more details?*  
Circle No. 53 on Product Info. Card.

### 3M COMPANY INTRODUCES NEW PRODUCTION SWITCHER

A low-cost production switcher featuring versatile reliable switching has been introduced by 3M Company's Mincom Division.

The Model 812 Production Switcher is capable of 12 effects which are selected by knob control. Included are such popular patterns as circle, diamond, upper left corner and square diagonal. A joystick positioner, when activated, allows positioning of five effects. Effects can be further enhanced by built-in softwipe and spotlight controls.

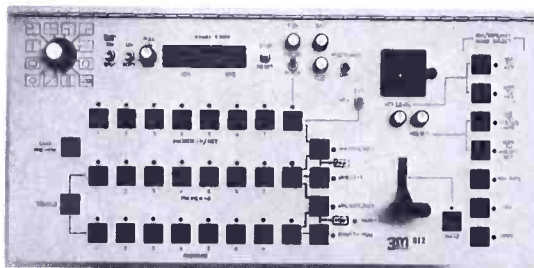

The unit has eight video inputs. The first seven are loop-through with built-in 75 ohm terminating switches. The eighth is selectable to either internal colorizer or internal color black generator signal.

The 812 features a 3-buss configuration: Program, Preview A and Preview B. To assure a quality video output, a non-sync warning indicator alerts the operator to non-mixable video inputs.

A preset control allows for mix-to-preset-wipe and wipe-to-preset-mix operations. An Auto Mix/Wipe button automatically mixes or wipes to the new input. Price: \$3,995.00.

**3M COMPANY**  
DEPARTMENT MN7-34

P.O. BOX 33600, 3M CENTER  
ST. PAUL, MINN. 55133  
PHONE: (612) 733-9853

*Want more details?*  
Circle No. 54 on Product Info. Card.

### NEW SHURE ACOUSTIC COUPLER SIMPLIFIES FEEDING RECORDED MATERIAL THROUGH TELEPHONE

Shure Brothers, Inc., has announced a new telephone acoustic coupler with features that greatly improve transmission quality and the ease of feeding recorded material into a telephone for remote broadcasting.



Called the Shure 50AC, the coupler may be strapped to any telephone in seconds. Connect it to a cassette tape recorder, flip the "play" switch and the recorded material is automatically fed into the phone.

There is no need to tie into the telephone wiring system or to remove the telephone mouthpiece. The 50AC completely covers the telephone mouthpiece. There is no background noise, no loss in intelligibility and the unit has no induction coils. The 50AC may also be driven by the Shure SM82 Line Level Microphone, making an ideal "emergency" remote broadcast package.

A lever built into the 50AC also allows adding live commentary without interrupting the transmission of a taped interview or message. In addition, the 50AC may be used as a microphone by speaking directly into the unit while its "mini-plug" is connected to the mike input of a recorder. A 300 to 3,000 Hz "tailored" frequency response approximates the response of the telephone.

The entire unit, including coupler, voiceover lever, attachment strap, cable and miniature phone plug, weighs 112 grams (3.95 oz.). User net price is \$28.50.

**SHURE BROTHERS, INC.**  
222 HARTREY AVENUE  
EVANSTON, IL 60204  
PHONE: (312) 679-4020

*Want more details?*  
Circle No. 55 on Product Info. Card.

### "SEEDS" OFF TO SMOOTH START

Fifteen stations have already signed up for "Seeds", a new 30-minute weekly syndication featuring music and interviews dealing with artists' formative years. The taped program is expected to debut the week of September 25th with Elvin Bishop and Heart. Jefferson Starship, Bob Seger,

Steve Miller, Pablo Cruise, Alice Cooper, Grateful Dead, Sammy Hagar and the Doobie Brothers are among the artists scheduled in the first ten shows. "Seeds" is available by barter in rated markets.

**PONEK-FISHER ASSOCIATES**  
**300 POPLAR STREET, SUITE 5**  
**MILL VALLEY, CA 94941**  
**PHONE: (415) 383-9020**

*Want more details?*

*Circle No. 56 on Product Info. Card.*

**NEW CP/NEWSLITE 12V/100W LIGHTING SYSTEM AVAILABLE FROM CINEMA PRODUCTS**

Cinema Products Corporation announces the availability of the new, lightweight CP/NewsLite 12V/100W lighting system — ideal for use with the new, faster film stocks (Eastman VNF 7250 and Fujicolor RT400, both rated at 400 ASA) in most television newsgathering, documentary, and similar applications.

The entire ultra-lightweight lighting system consists of a focusing CP/NewsLite, a 100-watt/12 Volt 3400°K "Quartz" lamp, and a CP 12V battery (with built-in charger).

Designed to be top-mounted on CP-16, CP-16R and other 16mm cameras, the rugged focusing CP/NewsLite weighs only 19 oz. (with cable and connector), and is priced at \$85.00 (less lamp). The CP/NewsLite also features a convenient integral handle and a detachable yoke.

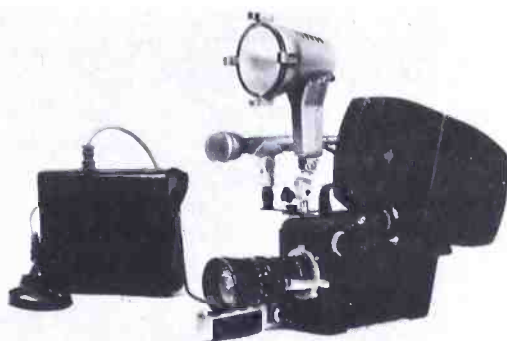

The CP 12V battery (with built-in charger) weighs approximately 6 lbs., and recharges overnight. It is priced at \$275.00. (A black leather case and shoulder strap is included.)

**CINEMA PRODUCTS CORPORATION**  
**2037 GRANVILLE AVENUE**  
**LOS ANGELES, CA 90025**  
**PHONE: (213) 478-0711**

**ENGLISH COMMAND CONTROL SYSTEM**

Absolutely a new concept at IGM is that "It's Basic." Basic is a system control which uses English commands, virtually eliminating coding of information, event number or other alpha-numeric encoded data. Working with Intel and utilizing the latest microprocessor computer-based technology, IGM engineers designed Basic systems A and B to perform more tasks than most existing systems — yet for

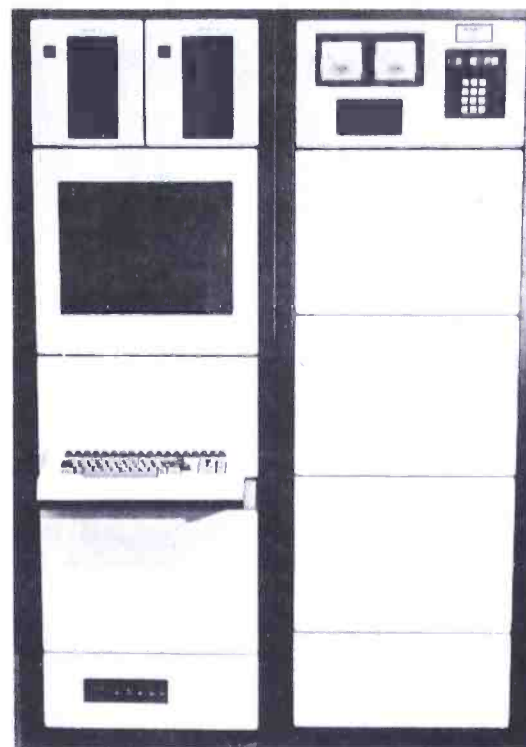

dramatically reduced costs, only ¼ the cost of some systems, even those of IGM.

Basic A is programmed, controlled and monitored from a single black and white enclosure rack, using a standard keyboard with 18 special function keys. It can handle 16 sources, expandable in increments of 16. Capacity of the static RAM memory system is 4,000 schedule entries, expandable to 8,000 in increments of 2,000. Programmable

**OKAY,  
 YOU ASKED  
 FOR IT  
 AND GRANDSON  
 HAS IT**

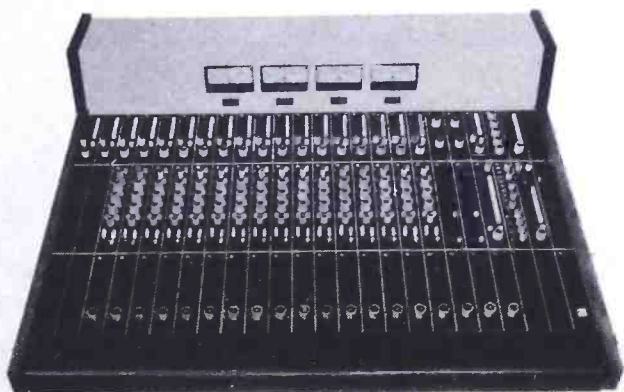

"It" is more. That's what broadcasters have been asking for in production consoles. Flexibility. Capability. And totally unique Grandson has it all.

There is nothing else like it anywhere!

**Equalization** at each input position. Don't laugh. If you don't think it's needed, that's because you haven't tried it. EQ is only the most useful, creative tool in audio. And Grandson's EQ is something special. One major network has bought a bunch. That's special.

**Monitoring and foldback flexibility** to let you and the talent have separate monitor mixes! And changes of monitor mode at the push of a single button. Here's the key to fast, creative production.

**Internal patch point**, after mic preamp before fader, brought out to permit inserting special devices. How about plugging in a limiter just ahead of the pot for the screamer, or mic swallower. Think that would be neat? So do we. Grandson will let you do it!

Four reasons Grandson was selected by ABC-TV, Hughes Sports Network and WWL in the Superdome. There are more. None accidental. Because you said it's needed.

Grandson is "it." A totally unique approach. Want more details? Write or phone today.

 **auditronics, inc.**  
 3750 Old Getwell Rd. Memphis, Tn. 38118  
 The closer you look, the better we look.

audio fade control for each source with unlimited real-time switching abilities is standard. English print-out logging is standard. Basic B stores memory on floppy disks for up to 6,000 schedule entries per day with 8,000 format or subroutine entries common to all days and offers color CRT.

**I G M**  
**4041 HOME ROAD**  
**BELLINGHAM, WA 98225**  
**PHONE: (206) 733-4567**

*Want more details?*  
*Circle No. 58 on Product Info. Card.*

### INSPIRATIONAL AUTOMATION FORMAT

Twelve Oaks Productions announces the availability of their new Inspirational Automation Format. The programming features top selections in the contemporary/MOR vein from one of the fastest growing segments of today's music industry.

Headed by Toby Foster, Paul Stilwell, and Mike Trout; Twelve Oaks is offering a complete dayparted music programming service with voice announce by Gary McCartie of KBRT/KBIG in Los Angeles, and Mike Trout; custom program aids by Thurl Ravenscroft (known by millions as "Tony The Tiger"); feature length specials by Brian Bastien of KFWB and Group W Broadcasting; technical consultancy, Time Carts, PSA's, commercials, and ID jingles.

**TWELVE OAKS PRODUCTIONS**  
**BOX 4917**  
**THOUSAND OAKS, CA 91359**  
**PHONE: (805) 497-3022**

*Want more details?*  
*Circle No. 59 on Product Info. Card.*

### TELEMATION INTRODUCES TMM- 205 MULTIPLEXER

The TMM-205 Multiplexer accepts up to three projector inputs and can accommodate 8mm, 16mm, and 35mm film projectors for operation with a color or monochrome camera. Transitions between optical sources occur in approximately 0.5 of a second and are bounce-free. The entire mechanism is designed to eliminate acceleration and shock loading forces. A fiberglass cover protects the optical assembly from dust and prevents extraneous light from entering the

camera lens. A local control panel permits selection of Film 1, Film 2, and slide, and contains the master AC switch and fuse. All equipment is connected to a shelf or pedestal with a three-point adjustable mount, making the system installation and optical alignment of the TMM-205 simple and permanent.

List price for the TMM-205 Multiplexer is \$995.00.

**TELEMATION, INC.**  
**P.O. BOX 15068**  
**SALT LAKE CITY, UT 84115**  
**PHONE: (801) 972-8000**

*Want more details?*  
*Circle No. 60 on Product Info. Card.*

### PORTABLE REMOTE PICK-UP TRANSMITTER RPU-1103

McMartin Industries has engineered a new Portable Remote Pick-Up Transmitter, the RPU-1103 to meet and exceed all the new FCC requirements. The unit is a 3 watt, 150 mHz solid state, dual frequency transmitter. The RPU-1103 comes complete with a rechargeable nicad battery which will provide eight to ten hours of on the job reporting at a 30% duty cycle.



This is the perfect unit for on the scene reporting of news or sports actualities. Total weight including battery is only six pounds and with the included shoulder strap is one of the most convenient remote pick-up transmitters available today. Standard equipment includes a whip antenna which can be replaced with the lower profile rubber duck type antenna. Two frequency operation is achieved with a front panel switch when the optional second channel frequency element is installed. Two high quality audio inputs are provided. One is a mike input with 25 dB of compression along with an LED indicator to display proper operation. Also a line input is provided for use of a portable tape recorder or cassette player which when combined with the talk over feature of the push-to-talk button on

the microphone allows for production in the field.

The unit is designed for broadcast quality type microphones and the input jack is provided so that any available microphone can be used. With typical distortion of 1% and audio response of less than 1 dB from 50 to 7,500 Hz with 75 microsecond pre-emphasis the unit provides broadcast quality from remote locations of news and sports as it happens.

**McMARTIN INDUSTRIES, INC.**  
**4500 SOUTH 76TH STREET**  
**OMAHA, NB 68127**  
**PHONE: (402) 331-2000**

*Want more details?*  
*Circle No. 61 on Product Info. Card.*

### BEAUTIFUL MUSIC JINGLES FROM EYE

Eye, Inc., of Hollywood, California, has announced the release of "Beautiful Musicreations".

The jingle package, originally built for WPAT-AM/FM in New York City, is now also on the air over WJR-FM, Detroit, WLAK, Chicago, and WSRS-FM in New England.

The production contains twenty-five cuts and is available in full stereo.

**EYE, INC.**  
**3518 CAHUENGA WEST, SUITE 305**  
**HOLLYWOOD, CA 90068**  
**PHONE: (213) 851-6377**

*Want more details?*  
*Circle No. 62 on Product Info. Card.*

### NEW HIGH-PERFORMANCE CASSETTE VIDEO TAPE USING BERIDOX COATING INTRODUCED BY FUJI

A high-performance Beridox tape for 3/4" U-Matic video cassettes has been introduced by the Magnetic Tape Division, Fuji Photo Film U.S.A. The new tape, Fuji Beridox KCS is available in 20-minute lengths as KCS-20 and 10-minute lengths as KCS-10.

Designed for critical applications in ENG, Fuji Beridox tape uses an exclusive formulation of berthollide iron oxide, providing the advantages of chromium

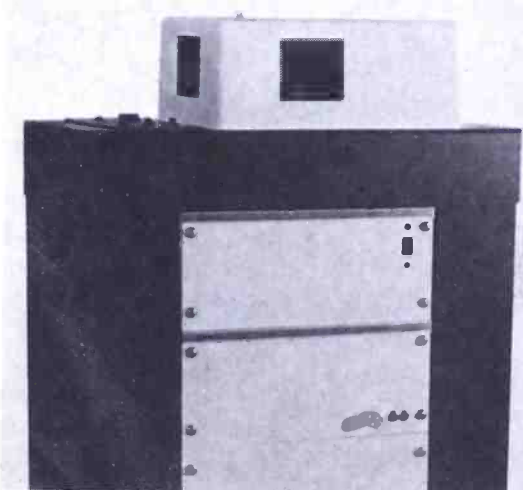



USE THIS CARD FOR MORE FACTS ON ITEMS SEEN IN THIS ISSUE

Name \_\_\_\_\_  
 Title \_\_\_\_\_  
 Station/Company \_\_\_\_\_  
 Address \_\_\_\_\_  Office  Home  
 City \_\_\_\_\_ State    Zip

PLEASE CHECK APPROPRIATE CATEGORY:

RADIO:  AM  FM  Stereo  Live  Automated *Format:* \_\_\_\_\_  
 Manufacturer  Syndicator  Production Co.  Other: \_\_\_\_\_  
 TELEVISION:  VHF  UHF  
 Manufacturer  Syndicator  Production Co.  Other: \_\_\_\_\_  
 Your Comments: \_\_\_\_\_

SEND INFORMATION ON ITEMS CIRCLED BELOW:

- |     |     |     |     |     |     |     |     |     |     |     |     |     |     |     |     |     |     |     |     |
|-----|-----|-----|-----|-----|-----|-----|-----|-----|-----|-----|-----|-----|-----|-----|-----|-----|-----|-----|-----|
| 1   | 2   | 3   | 4   | 5   | 6   | 7   | 8   | 9   | 10  | 11  | 12  | 13  | 14  | 15  | 16  | 17  | 18  | 19  | 20  |
| 21  | 22  | 23  | 24  | 25  | 26  | 27  | 28  | 29  | 30  | 31  | 32  | 33  | 34  | 35  | 36  | 37  | 38  | 39  | 40  |
| 41  | 42  | 43  | 44  | 45  | 46  | 47  | 48  | 49  | 50  | 51  | 52  | 53  | 54  | 55  | 56  | 57  | 58  | 59  | 60  |
| 61  | 62  | 63  | 64  | 65  | 66  | 67  | 68  | 69  | 70  | 71  | 72  | 73  | 74  | 75  | 76  | 77  | 78  | 79  | 80  |
| 81  | 82  | 83  | 84  | 85  | 86  | 87  | 88  | 89  | 90  | 91  | 92  | 93  | 94  | 95  | 96  | 97  | 98  | 99  | 100 |
| 101 | 102 | 103 | 104 | 105 | 106 | 107 | 108 | 109 | 110 | 111 | 112 | 113 | 114 | 115 | 116 | 117 | 118 | 119 | 120 |

Use this card up to 6 months after issue date.

throughout, and includes automatic start and fade for fast, economical tape program production.



Features contained in the attractive 17 $\frac{3}{8}$ " x 15 $\frac{3}{8}$ " x 3 $\frac{1}{2}$ " console include two stereo RIAA inputs; two stereo tape inputs; two microphone inputs; equalization on all inputs; broadcast cue; stereo output plus stereo monitor output. It also utilizes a digital switching system for start/stop control of turntables or tape machines.

Economically priced at under \$1,100, the versatile S6-2 is in reach of even the smallest broadcast facilities. An automatic "ducking" circuit for voice-overs is standard, a feature perfect for all broadcast studios.

**AUDIO MARKETING, LTD.**  
 142 HAMILTON AVENUE  
 STAMFORD, CT 06902  
 PHONE: (203) 359-2312

Want more details?  
 Circle No. 64 on Product Info. Card.

**ELECTRO-VOICE INTRODUCES  
 MINIATURE LAVALIER WITH TWO-**

Incorporating the 25-inch Trinitron picture tube (measured diagonally), the PVM-2550 has the largest screen-size of any color video monitor Sony has ever offered in the United States. With external synchronization capability, the dual input color unit is designed for professional use.

The PVM-2550 employs a specially designed color picture tube with a Beam Scanning Velocity Modulation System. This technological innovation dramatically improves resolution, providing a dynamically sharp picture over the entire screen area. The new modulation system also suppresses white color distortion and eliminates "snow" noise.

By offering a level of visual quality in a large format that formerly was only available in small monitors, the PVM-2550 is particularly suitable for those applications where the audience may be large and the picture quality must be high. The monitor also offers flexibility as a display device for video use at trade shows, point of purchase displays or whenever any large size displays are required.

**SONY CORPORATION**  
 9 WEST 57TH STREET  
 NEW YORK, NY 10019

Want more details?  
 Circle No. 66 on Product Info. Card.

**AIR CRAFTS LIMITED LAUNCHES  
 TWO WEEKLY ROCK SERIES**

AirCrafts Limited announces a special offer for broadcasters who wish to get acquainted with their two new weekly series, "Rock & Roll Illustrated" and "15 Big Ones".

Both popular music programs are fifteen minutes in length and allow up to

## Weather Radar

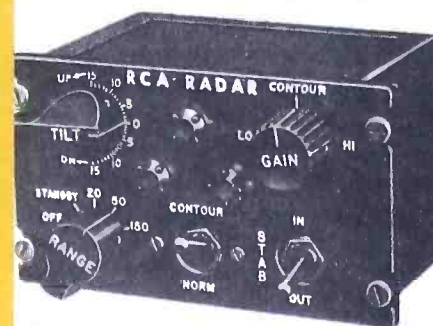

We have a limited number of used RCA AVQ-10 Weather Radar Systems at a fraction of new cost. These systems are overhauled by an FAA approved repair station and are guaranteed for 90 days. Repair service and exchange units also available.

## MEMPHIS AVIONICS

P.O. Box 30272 - International Airport  
 781 Premier Cv. - Memphis, TN. 38130  
 Phone (901) 362-8600 - Telex 53-3254

Want more details?  
 Circle No. 67 on Product Info. Card.

minutes for commercials per show. Programs in these series are supplied on tape, and available in both stereo and mono. Minimum contract length for either series is thirteen weeks.

"Rock & Roll Illustrated" is hosted by Michael Vee, and is billed as "the Rock magazine for radio." Each weekly show focuses on a different artist, or a notable time period in Rock, and features programs that are extensively researched in terms of proper track selection and information, assuring overall subject accuracy. In addition, a number of shows in this series spotlight important new artists and releases, and reports on upcoming trends in this popular music.

"15 Big Ones" is a unique program that is designed to test the listener's knowledge of Rock & Roll in a most appealing way. Mr. Ted, the series' host, presents the listener with a collection of brief passages of music, culled from hit recordings. The audience is then asked to identify the performers, song titles, years of their release, etc. Following the commercial break, the answers are

*Production Music*

**Contemporary Music for  
 Spots & Programming**

Write for Free Catalogs—  
**Thomas J. Valentino, Inc.**

151 W. 46 St., New York 10036 (212) 246-4675

*Sound Effects*

Want more details?  
 Circle No. 68 on Product Info. Card.

audio fade control for each source with unlimited real-time switching abilities standard. English print-out logging standard. Basic B stores memory on floppy disks for up to 6,000 schedule entries per day with 8,000 format or subroutine entries common to all days and offers color CF

**I G M**

**4041 HOME ROAD  
BELLINGHAM, WA 98225  
PHONE: (206) 733-4567**

*Want more details?  
Circle No. 58 on Product Info. Card.*

**INSPIRATIONAL AUTOMATION  
FORMAT**

Twelve Oaks Productions announce the availability of their new Inspiration Automation Format. The program features top selections in the contemporary/MOR vein from one of the fastest growing segments of today's music industry.

Headed by Toby Foster, Paul Stilwell and Mike Trout; Twelve Oaks is offering complete dayparted music programming service with voice announce by Gary McCartie of KBRT/KBIG in Los Angeles and Mike Trout; custom program aids Thurl Ravenscroft (known by millions as "Tony The Tiger"); feature length specials by Brian Bastien of KFWB and Group W Broadcasting; technical consultancy, Time Carts, PSA's, commercials, and ID jingles.

**TWELVE OAKS PRODUCTIONS  
BOX 4917  
THOUSAND OAKS, CA 91359  
PHONE: (805) 497-3022**

*Want more details?  
Circle No. 59 on Product Info. Card.*

**TELEMATION INTRODUCES TMM-205 MULTIPLEXER**

The TMM-205 Multiplexer accepts up to three projector inputs and can accommodate 8mm, 16mm, and 35mm film projectors for operation with a color or monochrome camera. Transitions between optical sources occur in approximately 0.5 of a second and are bounce-free. The entire mechanism is designed to eliminate acceleration and shock loading forces. A fiberglass cover protects the optical assembly from dust and prevents extraneous light from entering the

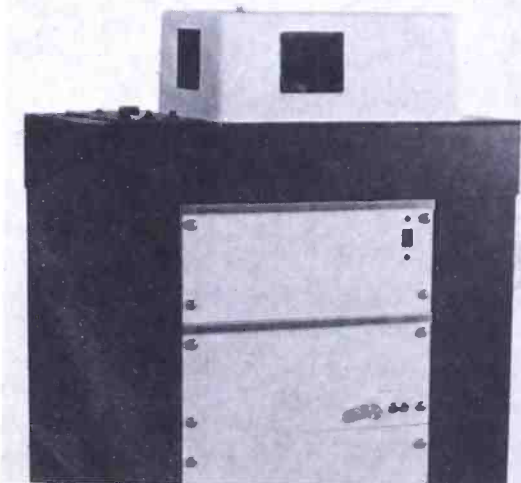

This is the perfect unit for on the scene reporting of news or sports actualities. Total weight including battery is only six pounds and with the included shoulder strap is one of the most convenient remote pick-up transmitters available today. Standard equipment includes a whip antenna which can be replaced with the lower profile rubber duck type antenna. Two frequency operation is achieved with a front panel switch when the optional second channel frequency element is installed. Two high quality audio inputs are provided. One is a mike input with 25 dB of compression along with an LED indicator to display proper operation. Also a line input is provided for use of a portable tape recorder or cassette player which when combined with the talk over feature of the push-to-talk button on

**EYE, INC.  
3518 CAHUENGA WEST, SUITE 305  
HOLLYWOOD, CA 90068  
PHONE: (213) 851-6377**

*Want more details?  
Circle No. 62 on Product Info. Card.*

**NEW HIGH-PERFORMANCE  
CASSETTE VIDEO TAPE USING  
BERIDOX COATING INTRODUCED  
BY FUJI**

A high-performance Beridox tape for 3/4" U-Matic video cassettes has been introduced by the Magnetic Tape Division, Fuji Photo Film U.S.A. The new tape, Fuji Beridox KCS is available in 20-minute lengths as KCS-20 and 10-minute lengths as KCS-10.

Designed for critical applications in ENG, Fuji Beridox tape uses an exclusive formulation of berthollide iron oxide, providing the advantages of chromium



**FIRST CLASS  
Permit  
No. 59188  
Los Angeles, CA**

**BUSINESS REPLY MAIL**

No Postage Stamp Necessary if Mailed in the United States

Postage will be paid by:



**Broadcast  
Programming  
& Production**

**Box 24694  
Los Angeles, CA 90024**

*Above Address for Product Information Cards Only*

dioxide and iron oxide coatings without their disadvantages.

The new Fuji tape offers higher sensitivity, greater output, wide-frequency response and an improved signal-to-noise ratio, resulting in higher resolution and a clearer image.

Beridox tapes also offer improved color, greater resistance to wear, longer head life and improved stop motion performance.

In addition to improving the tape, Fuji has improved the U-Matic cassette, providing improved leader tape and even more rigid quality control than before, including tighter mechanical tolerances.

**FUJI PHOTO FILM, U.S.A.**  
350 FIFTH AVENUE  
NEW YORK, NY 10001  
PHONE: (212) 736-3335

*Want more details?*

*Circle No. 63 on Product Info. Card.*

### ALLEN & HEATH INTRODUCES NEW S6-2 MIXER

Allen & Heath's exclusive U.S. distributor, Audio Marketing, Ltd., is now offering A&H's new S6-2 mixer. The S6-2 has been designed specifically for radio and TV applications. It utilizes linear faders throughout, and includes automatic start and fade for fast, economical tape program production.



Features contained in the attractive 17 $\frac{3}{8}$ " x 15 $\frac{3}{8}$ " x 3 $\frac{1}{2}$ " console include two stereo RIAA inputs; two stereo tape inputs; two microphone inputs; equalization on all inputs; broadcast cue; stereo output plus stereo monitor output. It also utilizes a digital switching system for start/stop control of turntables or tape machines.

Economically priced at under \$1,100, the versatile S6-2 is in reach of even the smallest broadcast facilities. An automatic "ducking" circuit for voice-overs is standard, a feature perfect for all broadcast studios.

**AUDIO MARKETING, LTD.**  
142 HAMILTON AVENUE  
STAMFORD, CT 06902  
PHONE: (203) 359-2312

*Want more details?*

*Circle No. 64 on Product Info. Card.*

### ELECTRO-VOICE INTRODUCES MINIATURE LAVALIER WITH TWO-

### YEAR UNCONDITIONAL WARRANTY

Electro-Voice of Buchanan, Michigan, has introduced the first professional condenser tie clasp microphone to be covered by the company's two-year unconditional warranty.

According to the company, the CO90 microphone which measures just 3/8" in diameter and 7/8" in length is ideal for on-camera use. The CO90 is supplied with a tie bar mount; windscreen, storage pouch and six feet of cable which connect the microphone to its belt clip battery/transformer housing. A similar model, the CO90E can be powered directly from wireless transmitters. Frequency response is 40—15,000 Hz with an output level of -57 dB into a low-impedance input.

**ELECTRO-VOICE**  
600 CECIL STREET  
BUCHANAN, MICH 49107  
PHONE: (616) 695-6831

*Want more details?*

*Circle No. 65 on Product Info. Card.*

### SONY INTRODUCES THE PVM-2550, THE LARGEST COLOR VIDEO MONITOR THE COMPANY HAS EVER OFFERED IN THE U.S.

Incorporating the 25-inch Trinitron picture tube (measured diagonally), the PVM-2550 has the largest screen-size of any color video monitor Sony has ever offered in the United States. With external synchronization capability, the dual input color unit is designed for professional use.

The PVM-2550 employs a specially designed color picture tube with a Beam Scanning Velocity Modulation System. This technological innovation dramatically improves resolution, providing a dynamically sharp picture over the entire screen area. The new modulation system also suppresses white color distortion and eliminates "snow" noise.

By offering a level of visual quality in a large format that formerly was only available in small monitors, the PVM-2550 is particularly suitable for those applications where the audience may be large and the picture quality must be high. The monitor also offers flexibility as a display device for video use at trade shows, point of purchase displays or whenever any large size displays are required.

**SONY CORPORATION**  
9 WEST 57TH STREET  
NEW YORK, NY 10019

*Want more details?*

*Circle No. 66 on Product Info. Card.*

### AIR CRAFTS LIMITED LAUNCHES TWO WEEKLY ROCK SERIES

AirCrafts Limited announces a special offer for broadcasters who wish to get acquainted with their two new weekly series, "Rock & Roll Illustrated" and "15 Big Ones".

Both popular music programs are fifteen minutes in length and allow up to

## Weather Radar



We have a limited number of used RCA AVQ-10 Weather Radar Systems at a fraction of new cost. These systems are overhauled by an FAA approved repair station and are guaranteed for 90 days. Repair service and exchange units also available.

## MEMPHIS AVIONICS

P.O. Box 30272 - International Airport  
3781 Premier Cv. - Memphis, TN. 38130  
Phone (901) 362-8600 - Telex 53-3254

*Want more details?*

*Circle No. 67 on Product Info. Card.*

three minutes for commercials per show. Programs in these series are supplied on tape, and available in both stereo and mono. The minimum contract length for either series is thirteen weeks.

"Rock & Roll Illustrated" is hosted by Michael Vee, and is billed as "the Rock magazine for radio." Each weekly show focuses on a different artist, or a notable time period in Rock, and features programs that are extensively researched in terms of proper track selection and information, assuring overall subject accuracy. In addition, a number of shows in this series spotlight important new artists and releases, and reports on upcoming trends in this popular music.

"15 Big Ones" is a unique program that is designed to test the listener's knowledge of Rock & Roll in a most appealing way. Mr. Ted, the series' host, presents the listener with a collection of brief passages of music, culled from hit recordings. The audience is then asked to identify the performers, song titles, years of their release, etc. Following the commercial break, the answers are

*Production Music*

**Contemporary Music for  
Spots & Programming**

*Write for Free Catalogs—*

**Thomas J. Valentino, Inc.**

151 W. 46 St., New York 10036 (212) 246-4675

*Sound Effects*

*Want more details?*

*Circle No. 68 on Product Info. Card.*

given, and a new test is introduced. In all, the listeners are quizzed on fifteen hit records in fifteen minutes. Hence the series title.

Both series are fully described in the new Presentation Package. Included are full length pilots (which can be aired) for both series, logs, complete purchasing information and all other related material. This new package is available free to interested broadcasters until the supply is exhausted.

The costs for airing these series are based on the individual station's rates, and the broadcaster is asked to include a copy of his current rate card when requesting the Presentation Package, so price quotes can be sent with the material.

**AIR CRAFTS LIMITED, INC.**  
**P. O. BOX 68**  
**WOODBIDGE, NJ 07095**  
**PHONE: (201) 634-0388**

*Want more details?*  
*Circle No. 69 on Product Info. Card.*

### NEW AUDIO/VIDEO TAPE SYNCHRONIZER

EECO's new, microprocessor-based MQS-100 series synchronizing system can cue and synchronize any three mag tape transports including video, audio and mag film simultaneously. The SMPTE/EBU Edit Code, used for indexing of the tapes, need not be identical and tapes with drop-frame and non-drop-frame formats can be intermixed.

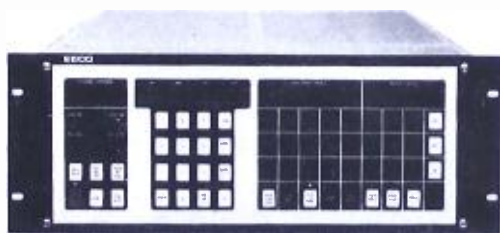

System modes include High Speed Search and Cue, follow the leader or "Chase Mode", Synchronized Play Back, Fast and Slow Re-synchronization and Roll-Back with automatic re-synchronization. Operational efficiency is demonstrated by control simplicity. One button actuates all transports to roll back, start forward and synchronize automatically.

Time code readings for all tapes can be "captured on the fly", individually or simultaneously. A plus or minus offset of any selected time increment can be preset for each slave transport. The "Chase Feature" of the MQS directs the slave transports to follow all master transport actions. This permits the operator to control cueing and synchronizing at the front panel of the master transport.

The MQS is 7" high with standard 19" wide Retma Mounting.

**EECO**  
**1441 EAST CHESTNUT**  
**SANTA ANA, CA 92701**  
**PHONE: (714) 835-6000**

*Want more details?*  
*Circle No. 70 on Product Info. Card.*

### TASCAM CONSOLE EXTENDER

An expander unit, designed specifically for use with the TEAC Tascam Series Model 5 mixer, can increase the inputs from eight to as many as 20.



The extension unit — called the Model 5EX — is equipped with eight 201 input modules. An additional four inputs are available as an optional package.

According to Ken Sacks, sales manager for the TEAC Tascam Series product line, the self-powered 5EX, when connected to the Model 5 mixer, retains all the functions of the Model 5, including four line output busses, a cue output buss, echo output buss and a solo output.

The 5EX carries a nationally advertised value of less than \$1,300.00.

**TEAC CORPORATION**  
**OF AMERICA**  
**7733 TELEGRAPH ROAD**  
**MONTEBELLO, CA 90640**  
**PHONE: (213) 726-0303**

*Want more details?*  
*Circle No. 71 on Product Info. Card.*

### NEW MUSIC LIBRARY

DeWolfe, the award-winning music library, is now offering a package of 20 LP albums containing interesting, up-to-date varied sounds of today's music world to fit the special needs of the TV/radio programmer.

DeWolfe avoids the concept that requires a broadcaster to be saddled with a commitment for one or more years involving the use of a whole music library, most of which is outdated.

The DeWolfe package can be supplemented with frequent new issues including 16 LP sound effects albums recently produced.

**DE WOLFE MUSIC LIBRARY**  
**25 WEST 45TH STREET**  
**NEW YORK, NY 10036**  
**PHONE: (212) 586-6673**

*Want more details?*  
*Circle No. 72 on Product Info. Card.*

### COLOR MONITOR CALIBRATING UNIT IS NEWEST PORTA-PATTERN TEST/ALIGNMENT PRODUCT

Telecommunications Industries, Ltd., has announced the immediate availability of a Porta-Pattern product for precise



adjustment of picture white and grey scale tracking. The new Color Monitor Grey Scale Reference Unit, packaged in a 4" x 19" x 13" case for portability, contains a ten-step grey scale transparency manufactured on special film stock which precisely matches the output of a standard 10-step signal generator. Its application is in control rooms and other technical areas to match color monitor luminance characteristics to a standard independent of transmission system distortions.

The uniform illuminating source is a lamp calibrated at 6500° Kelvin (Illuminant D). Maximum brightness is mechanically adjustable from 5 to 35 foot lamberts without affecting color temperature. Both 115 and 230 VAC models are offered.

**TELECOMMUNICATIONS**  
**INDUSTRIES**  
**6335 HOMEWOOD AVE., SUITE 204**  
**LOS ANGELES, CA 90028**  
**PHONE: (213) 461-3561**

*Want more details?*  
*Circle No. 73 on Product Info. Card.*

### NEW LITERATURE FROM 3M ON TV PRODUCTS

A new four-page brochure containing information on two television-related products from 3M — the Model 5110 color insert keyer and Model 5120 video outliner — is available free from 3M Company's Mincom Division.

The color insert keyer adds color and dimension to graphics produced by a character generator or camera. The video outliner, by offering a choice of five outline possibilities, furnishes new options for the display of alphanumeric characters and other TV graphics.

Also included in the two-color booklet are flow charts showing proper installation of the units in relation to video input and program output. In addition, detailed specifications are given for both pieces of hardware.

**3M COMPANY**  
**DEPARTMENT MN-7-37**  
**P.O. BOX 33600, 3M CENTER**  
**ST. PAUL, MINN. 55133**  
**PHONE: (612) 733-9853**

*Want more details?*  
*Circle No. 74 on Product Info. Card.*

### 60-SECOND LP — ALBUM SYNDICATED REVIEW DEBUTS

60-Second LP, a syndicated album review premiered August 15, unsponsored, on 200 radio stations. The 60-second feature, is designed to run once a day, 7:00 p.m. to midnight, lasting 60-seconds with a 30-second national adjacency. The series,

produced by former program director Jeff Craig, is provided free to all ARB stations with each format licensed exclusive per market. 60-Second LP debuted with two formats, Contemporary/MOR, with the other three expected by January 1, 1978, R&B, C&W, and MOR.

The 60-second mini features are reviewed by professional syndicators from the Los Angeles Times, Herald and Trades. These are then produced with interviews, cuts from the albums and production room notes. Some of the artists reviewed to date include: England Dan and John Ford Coley, Olivia Newton John, Alan Parsons, Doobie Brothers, James Taylor, Hall and Oates, Rita Coolidge, Driver, Heart, and Linda Ronstadt.

**60-SECOND LP**  
**6729 VARIEL AVENUE**  
**CANOGA PARK, CA 91303**  
**PHONE: (213) 703-0368**

*Want more details?*  
*Circle No. 75 on Product Info. Card.*

### LUCHT DEVELOPS COMPACT E-6 CINE PROCESSOR

A new highly compact E-6 cine processor has been developed by Lucht Engineering, Inc. Designed for installations with restricted floor space, the unit uses only 10 square feet and processes at 32 inches per minute.

The new E-6 model handles any size roll film from 16mm to full 90mm and can be operated safely by just about anyone. After a few minutes of instruction, even people who never before have used cine processors can splice all sizes of film together and run them in the fully automatic unit.

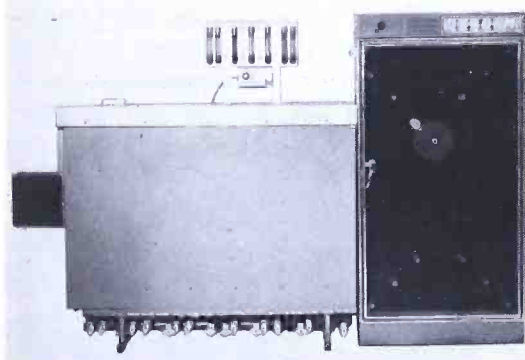

Temperature tolerance in the 5½ gallon developer system is plus or minus ¼ degree fahrenheit. A complete compliment of chemical flow meters and filters is included with the unit.

**LUCHT ENGINEERING, INC.**  
**500 WEST 79TH STREET**  
**MINNEAPOLIS, MINN 55420**  
**PHONE: (612) 884-1444**

*Want more details?*  
*Circle No. 76 on Product Info. Card.*

### NEW CATALOG FEATURES PROFESSIONAL TAPE COMPONENTS

Telex Communications, Inc., details its full line of audio tape components in an all

# Broadcast Buffoonery

by Robert W. Morgan

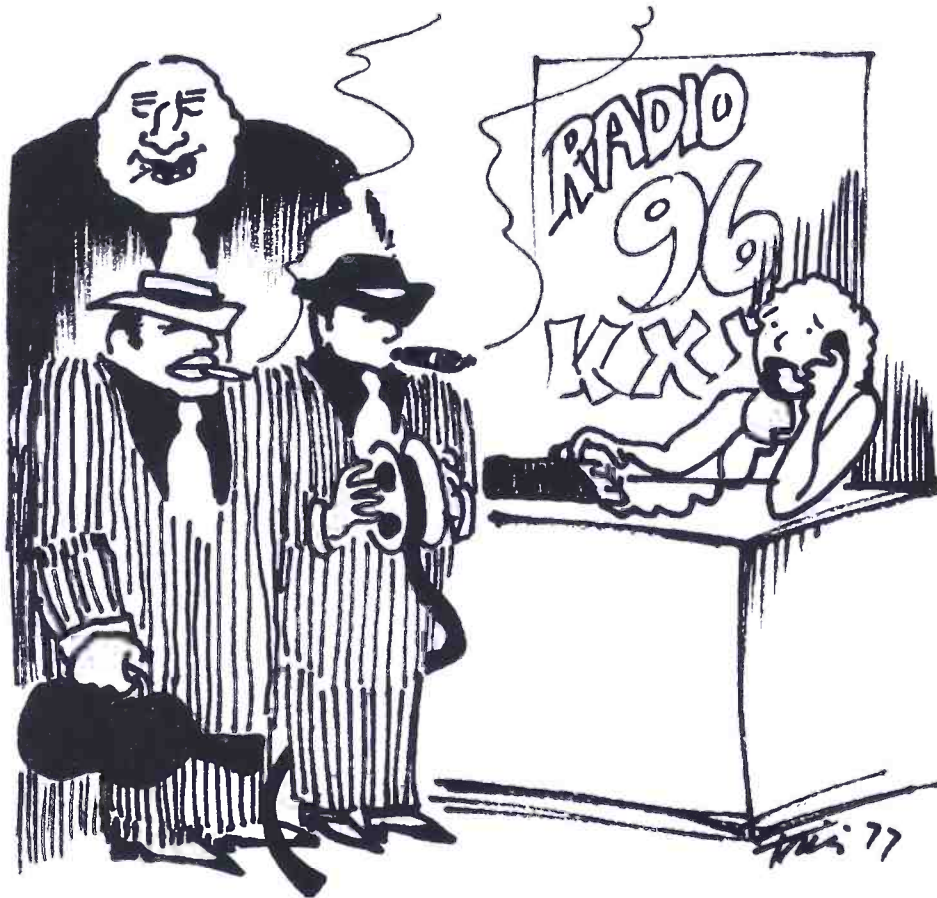

*Uh, excuse me, sir . . . but there are three guys out here who want to know if you'd like to get into . . . "syndication."*

new illustrated brochure. Included in the brochure are complete product specifications, descriptions and ordering information.

The tape components featured in the catalog provide the professional sound specialist enormous design flexibility for custom installations. The catalog features heavy duty open reel tape transports and tape cartridge transports. Endless loop NAB type magnetic tape cartridges are also shown. The company's latest solid state record/play, playback and power amplifier



**TELEX**  
**PROFESSIONAL TAPE EQUIPMENT**

for single and multi-channel systems are described in detail.

The brochure is available, free of charge, by requesting form PA2230 from:  
**PROFESSIONAL AUDIO DEPT.**  
**TELEX COMMUNICATIONS, INC.**  
**9600 ALDRICH AVENUE SOUTH**  
**MINNEAPOLIS, MN 55420**  
**PHONE: (612) 884-4051**

*Want more details?*  
*Circle No. 77 on Product Info. Card.*

### VIDEO SOURCE IDENTIFIER QSI/VSDI-8

The Video Source Identifier (VSDI) is a type of electronic tagger, designed to provide electronic identification to video sources all within a small p.c. card. The VSDI is used to tag electronic video signals in the same technique that electronic



*Want more details?*  
*Circle No. 8 on Product Info. Card.*



cabling and equipment are tagged and identified with reference designations. Within all video systems, patch panels, switchers, monitors, VTR's, etc., are physically labeled for signal source identification. These identification tags seldom change, but often times the signals routed through these video devices change. To be absolutely accurate as to video signal routing, recording and airing during fast reacting and emergency operating situations, VSID's are used to eliminate most technical operating errors.

**QSI SYSTEMS, INC.**  
**993 WATERTOWN STREET**  
**WEST NEWTON, MASS 02165**

**PHONE: (617) 969-7118**

*Want more details?*  
*Circle No. 78 on Product Info. Card.*

**PRO VIDEO UNVEILS IMAGE REPOSITIONER**

An innovative moderately priced alternative to the new digital TV compressor for use in TV special effects was introduced by the Professional Video Group.



The Model 1080 Video Image Repositioner can be used to move a window insert of the most important element of a TV scene to any desired location on the screen at a fraction of the cost of the more complex equipment. Pre-recorded videotape, film and slides as well as live video images can be repositioned anywhere on the TV screen.

**PROFESSIONAL VIDEO GROUP**  
**25 WEST 54TH STREET**  
**NEW YORK, NY 10019**  
**PHONE: (212) 246-1274**

*Want more details?*  
*Circle No. 79 on Product Info. Card.*

**ATTENTION "BP&P" READERS OUTSIDE OF U.S.A.:**

Up until now, subscriptions to "BP&P" mailed outside of the U.S.A. were available only by surface mail. By popular demand, a new foreign AIRMAIL rate has been established so that you will receive your issues much sooner:

**ONE YEAR (6 issues) \$24.00 AIRMAIL**

Your airmail subscription can be established by sending your name, address, and remittance for \$24.00 (U.S. dollars) to: BP&P foreign subscriptions / P.O. Box 2449 / Hollywood, CA 90028 USA. If you are already a subscriber, please enclose your mailing label from a recent issue of "BP&P."

**MUTUAL RADIO SYNDICATES 5TH NIXON/FROST INTERVIEW "NIXON: FOR THE RECORD"**

The Mutual Broadcasting System is syndicating the radio version of the fifth and final program in a series of interviews by David Frost with former President Richard M. Nixon. Mutual has exclusive worldwide radio rights to the program, "Nixon: For The Record" and is offering the program on tape to its 769 affiliates nationwide and many other radio stations around the world. Stations may air the program between September 4th and 16th unless there is a clearance of the television version in their market; then both must coincide.



Produced by Frost's Paradine Productions, the first four interviews with the former President Nixon drew record radio audiences through Mutual, and the station response to the fifth program has been excellent. Program fees range from \$50 to \$500 based on Market Rank.

**MUTUAL BROADCASTING SYSTEM**  
**1755 S. JEFFERSON DAVIS HWY.**  
**ARLINGTON, VA 22202**  
**PHONE: (703) 685-2048**

*Want more details?*  
*Circle No. 80 on Product Info. Card.*

**BROADCAST PROGRAMMING & PRODUCTION**

**BACK ISSUES**

The following back issues of BP&P are available for \$2.00 each. Use the order form below to order.

**A. Vol. 1 / No. 1; April / May 1975**  
 Clive Davis and Buzz Bennett on music programming - TV computer animation - Some basics of competitive production - Dallas/Ft. Worth, Texas radio.

**B. Vol. 1 / No. 2; July / August 1975**  
 Syndicated radio programming - Stereo tape machine alignment - Programming research in TV - Chicago radio.

**C. Vol. 1 / No. 3; Sept / Oct 1975**  
 Imaginative radio production - Match Game '75 - FM vs AM programming - Radio press publicity.

**D. Vol. 1 / No. 4; Nov / Dec 1975**  
 Radio comedy - Spanish language television - Which formats attract the largest audience? - Radio programming in Atlanta.

**E. Vol. 2 / No. 1; Jan / Feb 1976**  
 Why are you playing that record? - Cue tones and the "tight" automation format - TV news gathering - Notes on becoming a production pro.

**F. Vol. 2 / No. 2; March / April 1976**  
 Robert W. Morgan and Don Imus on the radio personality - More basics of competitive production - TV promotional spots - Radio program syndication, Tom Rounds.

**G. Vol. 2 / No. 3; May / June 1976**  
 Tape care for maximum performance - Electronic graphics and visual programming effects - New Orleans radio.

**H. Vol. 2 / No. 4; July / August 1976**  
 SOLD OUT

**I. Vol. 2 / No. 5; Sept / Oct 1976**  
 Gary Owens and Charlie Tuna on the radio personality - The practical radio broadcast console - Film vs. Videotape, part 1 - MOR: the table of the mysterious lost format.

**J. Vol. 2 / No. 6; Nov / Dec 1976**  
 The public affairs time bomb: how to stop the explosion - Caution: stereo can be hazardous to your mono - Film vs. videotape, part 2 - Seattle radio, part 1.

**K. Vol. 3 / No. 1; Jan / Feb 1977**  
 Seattle radio, part 2 - Music customizing - Retail television commercials - Giving your TV station a face lift.

**L. Vol. 3 / No. 2; March / April 1977**  
 3/4-inch: the videotape format of the future? - How bad weather snowballed into good programming - Surviving the AM/FM split - Market profile of Escondido, California - Automatic transmission systems: the 1934 shadow no longer lurks.

**M. Vol. 3 / No. 3; May / June 1977**  
 The mellow sound: getting a rocking share the "easy" way, part 1, Ron Nickell - The mellow sound, part 2: how four locally programmed soft rock stations are "taking it easy" - Radio station public relations - A look at local TV programming

**N. Vol. 3 / No. 4; July / August 1977**  
 All news radio - The people talk to President Carter: a television meeting - Dave Hull and Danny Dark on commercial voice-overs - Producing the network/syndicated "Gong Show" - Marathon radio telephone talk show - Television audio: the Grammy Awards.

BP&P - Back Issues  
 P.O. Box 2449  
 Hollywood, CA 90028

Please send me the back issues of BP&P circled below. I have enclosed \$2.00 for each back issue (sorry, no billing).

Amount Enclosed: \_\_\_\_\_

A B C D E F G I J K L M N

Name \_\_\_\_\_

Address \_\_\_\_\_

City \_\_\_\_\_ State \_\_\_\_\_ Zip \_\_\_\_\_



## STATION SERVICES

**DeWolfe**  
A MODERN  
MUSIC & SOUND EFFECTS LIBRARY  
SEND FOR CATALOG  
25 WEST 45, NY 10036 - 212-586-6673

Want more details?  
Circle No. 84 on Product Info. Card.

Write  
for  
**FREE**  
Catalog

CUSTOM RADIO PRODUCTION  
Contemporary ID's - Logo's - Intros.  
All Formats - Lowest Prices.

ALSO - Aircheck Tapes, Production Aids,  
Wild Tracks, DJ Comedy, Books, FCC Tests,  
Feature Programs, DJ Promos, and MORE!

**COMMAND PRODUCTIONS** BOX 26348  
(415) 332-3161 SAN FRANCISCO, CALIF. 94126

Want more details?  
Circle No. 85 on Product Info. Card.

SPREAD THE WORD!  
A WHOLE NEW SERIES OF AUDIENCE  
GRABBERS AVAILABLE ON TAPE  
True Good Music. These 271 DAMN  
GOOD PROGRAMMERS will make your  
station sound fantastic.

THE MUSIC DIRECTOR'S  
PROGRAMMING SERVICE  
Box 103  
Indian Orchard, MA 01151  
(413) 783-4626

Want more details?  
Circle No. 86 on Product Info. Card.

417 OLDIES  
on tape available to Radio Stations. Chart  
hits from 1955 thru 1976 in stereo or  
mono.

THE MUSIC DIRECTOR'S  
PROGRAMMING SERVICE  
Box 103  
Indian Orchard, MA 01151  
(413) 783-4626

Want more details?  
Circle No. 87 on Product Info. Card.

**JINGLES:  
Logo Motion**

The newest most exciting jingle package  
from Krishane Enterprises.

Contemporary custom cuts for every  
programming need.

Let your radio flow with:  
**LOGOMOTION**

**KRISHANE  
ENTERPRISES INC.**  
4601 Willis Ave. Sherman Oaks  
Calif. 91403 Phone 213/981-8255

Want more details?  
Circle No. 88 on Product Info. Card.

## DON ELLIOT

Creative Services

3330 BARHAM BLVD • HOLLYWOOD, CALIF 90068  
BOX 662 • HOLLYWOOD, CALIF 90028 • (213) 851 SPOT

### JINGLES

- 1 SPACE ROCK PACKAGE. Adult con-  
temporary, shotgun logos done with  
lasers. Declares WAR on your competi-  
tion.
- 2) Sensational new double barrell shot-  
gun package with synthesizer intro's,  
a capella end. Perfect for steaming  
out of stop sets and showcasing the  
next hit.
- 3) Moog beds for promos, contests, com-  
mercials. New package of beds, punc-  
tutators, sustained pads, and short  
stingers, all editable. Buy one time -  
yours forever.

Demos on request  
the price is right - we can be had

### JINGLES WITH YOUR SOUND

At last the perfect jingles for your Soft  
Rock sound are now available at a very  
reasonable price.

#### "TAKIN' IT EASY"

is the perfect package to identify the  
music you play. All 25 cuts plus edits are  
only \$999.00. Any 12 cuts plus edits only  
\$600.00. Fast delivery - one station per  
market. Write for a free demo on your  
station's letterhead today.



The  
Innovation  
Organization

Box 3133 N. Hollywood, CA 91609  
(213) 882-0177

Want more details?  
Circle No. 89 on Product Info. Card.

## MISCELLANEOUS

**AIRCHECKS WANTED**  
Trade or buy. Airchecks of KFVB, KRLA,  
KHJ, 1966 and earlier.  
Bob Maslen  
814 N. Ogden Dr. Los Angeles, CA 90046  
(213) 651-4619

## POSITIONS WANTED

EIGHT YEARS HONEST EXPERIENCE  
in several areas; I could fit well in many  
situations. Good voice, production,  
multi-track recording/mixdown, first class  
with light engineering and digital skills.  
Special interest in music and contemp.  
programming and automation. Some PD  
and major market air.

BOX MNF  
c/o BP&P, P.O. Box 2449  
Hollywood, CA 90028

HARRISON consoles are  
available world-wide from the  
following select organizations:

Austria, Switzerland  
and Eastern Europe:  
Studer International AG  
CH-8105 Regensdorf, Switzerland

Benelux (Belgium, The  
Netherlands and Luxembourg):  
Heijnen B. V.  
NL-6940 Gennep, Netherlands

Canada:  
Studer Revox Canada Limited  
Toronto, Ontario M4H 1E9 Canada

Denmark:  
Quali-fi A/S  
DK-2930 Klampenborg, Denmark

Far East (Except Japan):  
Studer-Revox Hong Kong Limited  
Wanchai, Hong Kong B.C.C.

Finland:  
Into OY  
Helsinki 17, Finland

France:  
Studer France  
75015 Paris, France

Germany:  
Franz Vertriebsgesellschaft mbH.  
Elektronik, Mess- und Tonstudioteknik (EMT)  
D-763 Lahr 1, West Germany

Greece:  
Electronica O. E.  
Athens 134, Greece

Italy:  
Audio Products International  
20131 Milan, Italy

Japan:  
Shindenshi Manufacturing Corp.  
Tokyo, Japan

Mexico:  
Ingenieros en Electronica Asociados S.A. de C.V.  
Mexico 10 DF

Spain:  
Neotecnica, s.a.e.  
Madrid 8, Spain

Sweden:  
ELFA Radio & Television AB  
S-171 17 Solna, Sweden

United Kingdom:  
Scenic Sounds Equipment  
London W1H 7AB, England

United States:  
Studio Supply Company  
Nashville, Tennessee 37202

Westlake Audio, Inc.  
Los Angeles, California 90048

Willi Studer America, Inc.  
Nashville, Tennessee 37203

Willi Studer America, Inc.  
Hamden, Connecticut 06517

Export Agent:  
Audio Systems International  
Los Angeles, California 90036

**Harrison**



# NOW Affordable Automation From HARRISON 2824

**Automation ready** means different things to different people. At Harrison Systems, it means that our consoles can be connected to an existing and available automation programmer with a simple multi-pin connector. Every Harrison console ever produced has this capability. Some are now being used for automated mixing.

Some manufacturers of recording consoles *claim* to be automation ready. Interface with existing programmers, however, requires additional circuitry not included in the console, or the programmer.

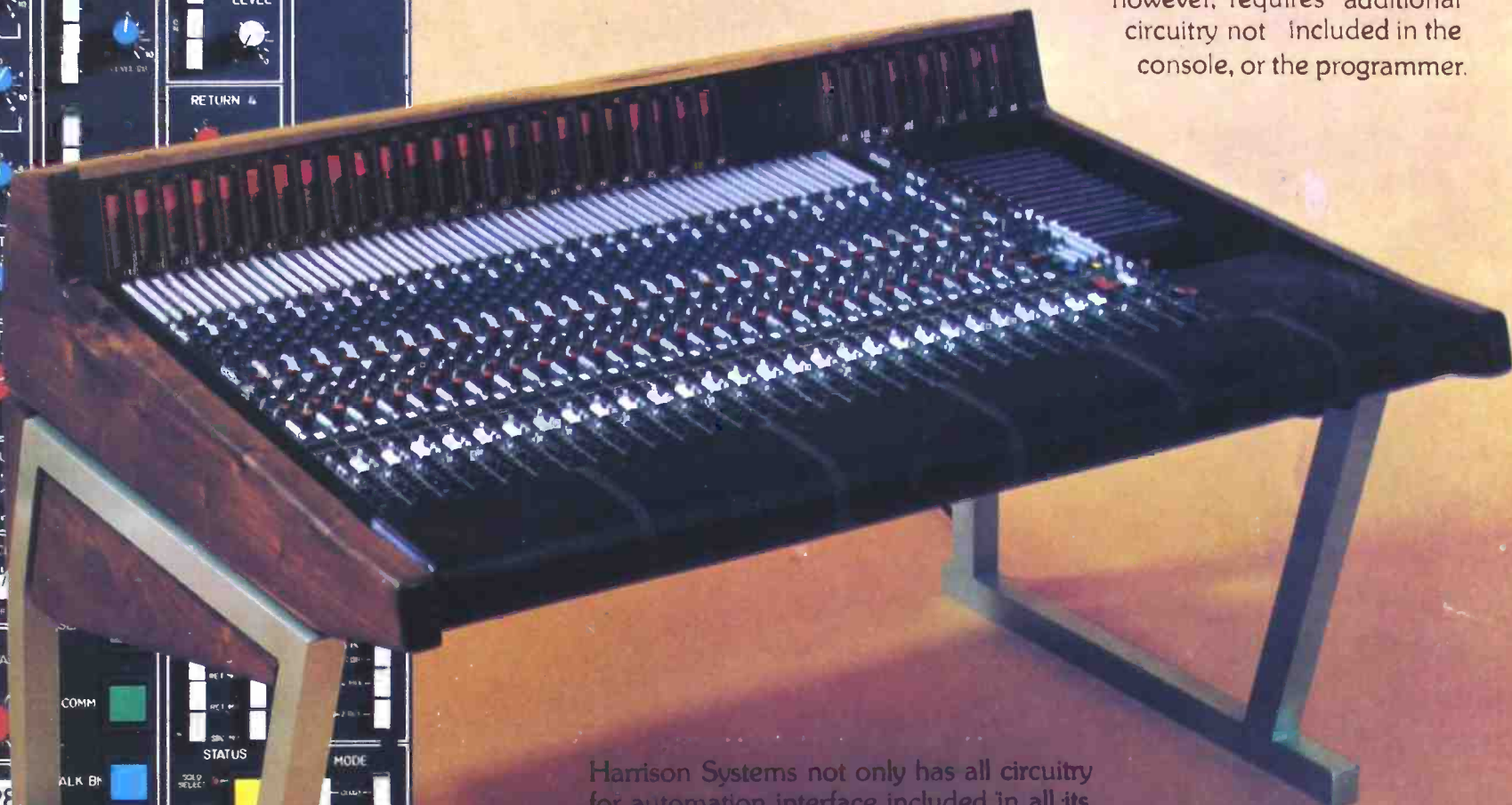

Harrison Systems not only has all circuitry for automation interface included in all its consoles, but beginning January 1977, all consoles shipped will have been interfaced and tested with an automation programmer during final test. This insures plug-in compatibility should you automate in the future.

**True Automation Readiness...**  
part of the NO COMPROMISE philosophy at

**Harrison** 

**Harrison Systems**

P.O. Box 22964

Nashville, Tenn. 37202

Tel. (615) 834-1184 Telex 555133

Want more details? Circle No. 90 on Product Info. Card.

## Looking for a professional audio product?

Westlake Audio is a lot more than a studio builder. We represent, stock, sell and service the finest professional audio products available today! Microphones, tape machines, amplifiers, speakers, consoles and more. Whatever your product need, call Westlake Audio.

### Consoles

Audiotronics • Automated Processes • Harrison • Cetec  
Allen & Heath • Yamaha

### Tape Machines

3M • Electro Sound • Otari and Nakamichi

### Synchronizers

Automated Processes • 3M • EECO

### Monitor Speakers

Westlake Audio • JBL • Gauss/Cetec

### Amplifiers

Crown • JBL • Crewin-Vega • SAE • Yamaha

### Microphones

AKG • Electro-Voice • Neumann • Sennheiser • Shure • Sony  
• Beyer • PML

### Support Equipment

Allison Research • Amber • Atlas • Auratone • Countryman • DBX  
• Dolby • Editall • Eventide Clockworks • Inovonics • Koss  
• Lang Electronics • MRL • MXR • Multi-Sync • Orban-Parasound  
• Pandora • Pultec • Sennheiser • Sony • Stephens • Superex  
• U.R.E.I. • White • EMT • Micmix

### Custom Acoustic Design and Construction

Complete Studio, Control Room and Echo Chamber Design,  
Construction, Wiring and System Interface.

Otari Electric Co. Ltd

K140  
"cardan"

K140 K14U  
"cardan" "cardan"

K140 K140  
"cardan" "cardan"

series 65k allison research, usa.

YAMAHA

Want more details?

Circle No. 57 on Product Info. Card.

from acoustic design  
to down beat...

**Westlake  
Audio**

6311 Wilshire Boulevard  
Los Angeles, California 90048  
(213) 655-0903  
Telex 698646

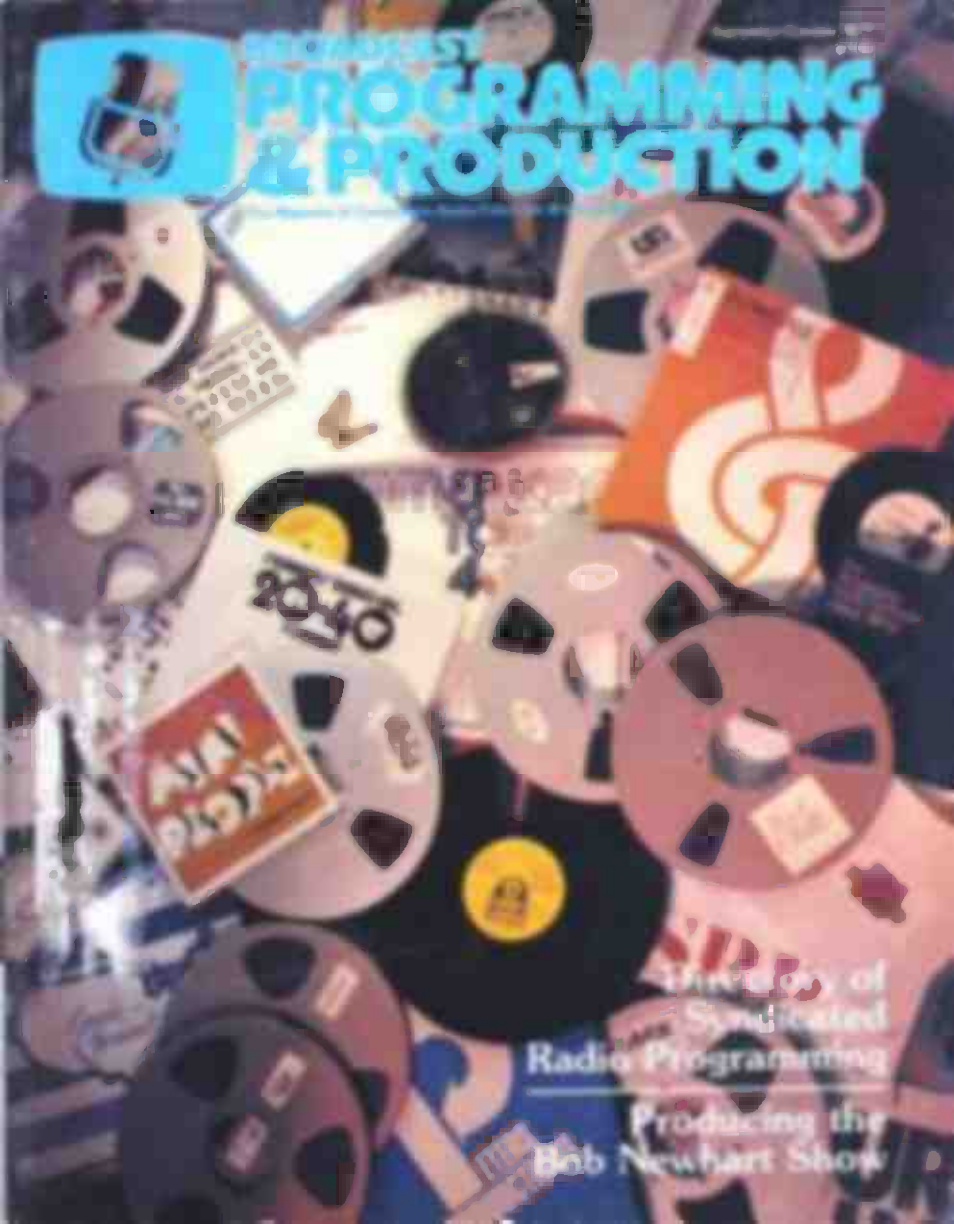

**BROADCAST  
PROGRAMMING  
& PRODUCTION**

The Key to  
Successful  
Radio Programming  
Producing the  
Bob Newhart Show