

# The TALKING MACHINE WORLD

AND  
NOVELTY  
NEWS

Published Each Month by Edward Lyman Bill at 1 Madison Avenue, New York, November 15, 1906

## Certificate of Award

1876

INTERNATIONAL EXHIBITION, U. S. CEN-  
TENNIAL COMMISSION

ESTABLISHED 1867



## Certificate of Award

1905

UNIVERSAL EXPOSITION, ST. LOUIS, MO.

“BAKED-ON”



THE TEA TRAY COMPANY of NEWARK, N. J., desires to interest its patrons and increase its already extensive business in all departments. To this end we invite you when in our vicinity to call and inspect our factory, covering several acres of ground in one of the largest manufacturing cities in the world, Newark, N. J. We began in a small way to manufacture Horns and other articles for Talking Machines, and were the first in the field in this particular branch of our business. The very great variety of standard articles that are now accepted and sold all over the world is a proof of our ability to originate and invent salable goods. The benefit of our work, we are assured, has greatly helped all users of Talking Machines, and has added to the profit of the purchasers. This is gratifying to us and has added greatly to our success, and encouraged us to continue our effort to constantly improve our very large and up-to-date manufacturing interest. We will soon place on the market other new and useful articles, and are making some improvements in those already so well known. We are sure that you will find it to your advantage and profit to carry our line of goods. Our prices are always carefully made and are in accord with the untiring effort to keep up and, if possible, improve the high standard of our goods.

A new catalogue is now in the hands of our printers, which will show some of the new patented designs that are certain to prove attractive and salable. Our object is to give these new articles to you, so that your salesmen may have something new to show their customers, and by this method increase your business among your own trade; as these new articles have considerable merit, we are confident that they will meet with success.

If you are interested kindly notify us, so that your name will be listed in our sales department and receive early attention that we may give you valuable information.

Our product is sold exclusively to the jobbing trade, and we refer all dealers to their jobber. Any dealer who is unable to obtain our goods from his regular jobber upon request will be referred to another in his territory who can supply him, or we will be glad to take up the subject direct with his regular jobber, as we are sure that we can convince him of the quality of our goods and the demand of the dealers for the same.

Yours with respect,

THE TEA TRAY COMPANY OF NEWARK, N. J.

November 10, 1906.



*Albert S. Marten*

“BAKED-ON”

# OUR MAIL BAG

for many years has brought out the fact beyond the question of a doubt that our friends and customers want us to put on the market

## A TALKING MACHINE. WE HAVE DECIDED TO DO SO

and now present for your consideration a machine with a new and improved method—a decided advance over all other known machines. It has been designed so that it will prolong the record life by sustaining with its own mechanism the weight of the diaphragm and arm: a mechanical feed device beautiful in its simplicity, ingenious, new, practical, feeds the arm across the record, and being absolutely independent thereof, all the record has to do is to play, sing, in a word *breathe* music: we have relieved the record of its hard work.

**It is no longer a common carrier of diaphragm and machine parts.**

## THE WORK OF THE CRANE

is done in this invention by other means.

It is self evident that this "record relief" enhances the durability of the record and improves its musical possibilities.

Requests for further information will receive prompt attention by the undersigned.

## IMPERIAL RECORDS A WORD OR TWO ABOUT RECORDS

The above announcement *in re* machines may be a little raw in style—we are new in machine talks—but when it comes to records, we warm right up to the subject. **In records you get us where we live.**

 **To All and Sundry: Lovers of Music, YOU** know the **IMPERIAL**—the brilliant musical disc that has delighted and entertained millions of people at home and abroad.

The name **Imperial** stamped on a record is merit enough for **YOU**.

**BUT** to those who have not yet heard this disc (there *must* be **some** people **SOMEWHERE** who have not), you should buy them.

**REASONS TWO** among many

*First:* the beauty of the Imperial is in its sweetness of tone, and in natural reproduction.

*Second:* the lasting quality of the Imperial lies in the fact that it is made of the best material—the Imperial can be played many times, yes many, many times without deterioration—we prove this every day. **So can You.**

**"L. & C. Needles," too—BEST**

# LEEDS & CATLIN CO.

53 East 11th Street

NEW YORK

LEEDS & CATLIN CO.  
53 East 11th Street, New York  
GET OFF AND MAIL TO  
Send me details of your talking machine.  
Name \_\_\_\_\_  
Address \_\_\_\_\_



# The Talking Machine World

Vol. 2. No. 11.

New York, November 15, 1906.

Price Ten Cents

## GOODWIN WAXES REMINISCENT.

The Manager of Lyon & Healy's Talking Machine Department Chats of His Early Days in the Business and the Development of the Talking Machine and Concomitant Branches.

(Special to The Talking Machine World.)  
World Office, 195 Wabash avenue,

Chicago, Ill., Nov. 10, 1906.

C. E. Goodwin, manager of the talking machine department at Lyon & Healy's, is a very busy man. He seldom has time to do more than fire the trade news of the day at you in crisp, short sentences. Consequently, when I struck him with a few minutes at his disposal and inclined to wax reminiscent, I made the most of my opportunity.

"The development of the talking machine industry in any large sense has really taken place in the last decade," remarked Mr. Goodwin. "Therefore, when I tell you that I got into the business in 1894, you can see that I can be ranked in the pioneer class so far as the selling end is concerned.

"I made my debut as a salesman for the Washington (D. C.) branch of the Columbia Phonograph Co. I still experience a job lot of thrills when I call to mind my first sale. The machine was one of the first Baby Grand graphophones put out by the Columbia people. It was a comparatively crude affair, with a small clock-work motor. You listened to the cylinder record through hearing tubes, and the price was \$100. It didn't run as well as the \$7.50 type of to-day. The purchaser, Rev. Alexander Mackay Smith, was not gifted with prophetic powers, however, and he was pleased beyond measure with his acquisition. He no doubt used it to the intense delight of his parishioners. Whether the additional popularity thus won had anything to do with it I cannot say, but the fact remains that the good man to-day occupies the important position of bishop coadjutor of the Episcopal diocese of Pennsylvania.

"I continued selling talkers in the Capitol City until 1897, when I went on the road for the Columbia's New York office under the direction of the late Merwin E. Lyle, one of the finest characters the talking machine business has ever known.

"My first road experience was really something terrific. Dealers were just beginning to take up the talking machine proposition, and traveling salesmen combined retailing with wholesaling on their journeys. I started in at Lowell and hustled for a week without making a sale of any kind. Late Saturday afternoon, however, I struck a Catholic priest, who showed some slight evidences of interest. I was desperate, and would not let him go. I sold him, but only by sacrificing my commission.

"Nowadays, when I feel like going after a new dealer with a sharp stick for cutting prices to make his first sale, I think of my own eagerness and what I did on that gloomy Saturday afternoon. I have since learned that it isn't 'a shame to take the money.'

"I am willing to take oath to the effect that more rain fell in the next fifteen days than has ever been known since. When I struck Lawrence I called on Lord & Co. One of the firm actually gave me the laugh when I mentioned my line. 'Couldn't sell a machine a year,' he said. 'We've got one under the counter that's dusty and out of order, and there's a restaurant keeper down the street who has a fine one he would sell you cheap.' Well, Lord & Co. have sold hundreds of machines since then, and I doubt if they are any prouder of the encouragement they gave me that day than I am of having sacrificed my commission to the priest at Lowell. I pegged on for another week without a sale, but in the meantime got a valuable clue from a druggist who had a

slot machine which was paying him 20 per cent. a month on his investment. Finally a clerk in a music store told me that the engineer of the electric railway power plant wanted to buy a talking machine. With a new light gleaming in my eyes I hurried to a car. At the power house I was met by a grimy individual who told me that Mr. McGinnis had just gone home. I had to walk a mile and climb a hill in the hot sun to find the house. When I got there I was met by a bulldog big enough to make a double Uncle Tom show take to its heels. McGinnis' wife made her appearance just in time to save me from total destruction. She gave me the information that her husband was not at home, and 'wouldn't be after buying any foolishness if he was.'

"I simply staggered from that door with my heavy outfit. On my way to the car line I



C. E. GOODWIN, OF LYON & HEALY, CHICAGO.

stopped at a drug store and gasped an order for vichy and ammonia. The druggist was eyeing my machine case and asked me what my line was. In 30 minutes I had taken his order for a \$60 slot machine, using for the first time my interest argument, and went back to the hotel a new man. For the next three or four months I averaged a machine a day. Then that fall the dealers began to sit up and take notice, and talkers began to come in extensively as a home proposition."

Mr. Goodwin traveled out of New York for a couple of years, and in 1899 came to Chicago to represent the Chicago branch of the Columbia Co., then under the management of George W. Lyle. One day he dropped into Lyon & Healy's to buy a carrying case for his sample horn. He got into conversation with C. N. Post, who was not very strongly disposed toward talking machines. This chat was followed by others, however, and the end of it was that Lyon & Healy established a talking machine department with Mr. Goodwin as manager. The rest of the story is quickly told. It can be summed up in the statement that the business of the department has grown from \$700 a month to half a million dollars a year in seven years.

The Schmelzer Arms Co., Kansas City, Mo., have sent out some very attractive circulars to the prominent people of that city, calling attention to their new concert rooms. Under the management of A. A. Trostle, this concern has built up a very satisfactory business at 710-720 Main street, with the Edison and Victor lines. They have three beautiful demonstrating rooms.

## "TALKER" INSTEAD OF ORCHESTRA.

A Happening in Connecticut Which Demonstrates the Musical Value of the Talking Machine—How Dealers Can Make Money.

An unique method of employing a talking machine in the place of an orchestra, was recently devised by a Connecticut man, which might prove a valuable idea to dealers in pushing the sale of their machines. The gentleman in question had invited a number of friends for a weekend party, and planned an elaborate dinner. An orchestra was engaged, but at the last minute failed to put in an appearance. One of his guests, who was the owner of a talking machine, suggested that they go to the nearest dealer and purchase one with an ample supply of grand opera records. In less than an hour a machine with a half hundred records was at the house, and placed in the musician's stand. As this had been banked with flowers so that the performers would be out of sight, the talking machine was hidden from view. It was in charge of the dealer, who was to manipulate it during the evening, and when the guests in the drawing room heard the opening strains of Strauss' "Invitation to the Waltz," they thought the orchestra had put in a tardy appearance. When they reached the dining room and learned the truth, they were both surprised and delighted, saying that it was the first time that they had ever listened to such a galaxy of vocal and instrumental stars at a banquet, and pronouncing it far better than an orchestra.

The dealer says he is looking for further engagements along the same line, and is going to notify the public that for a reasonable sum he will supply a complete outfit and his services for any occasion, believing it will be the means of making money and many sales. In the case above mentioned the orchestra would have cost considerably more than was paid for the talking machine records.

## TALKING MACHINES IN CANADA.

Discussion as to Which Firm First Handled Talking Machines as a Regular Line.

As the result of a recent argument in Canadian trade circles regarding the first concern to handle talking machines in the Dominion, that is, as a regular line, it would seem that the Nordheimer Piano & Music Co. have this distinction. The first order was placed with the National Gram-o-phone Co. for a number of Berliner machines, which line is still handled by the Nordheimer house. The first machine, a hand-power affair, submitted to the house was rejected, and it was not until the year following that a motor-operated machine was offered and was accepted.

At the present time the Nordheimer Piano & Music Co. are regular distributors for the Berliner and Victor lines.

## OLD PROVERBS RE-SET.

A dollar in the till is better than a dollar and a quarter in the hands of an uncertain debtor.

Honesty is the best policy, but with a good insurance policy on his store, the talking machine man can sleep sounder nights.

The ant may be all right for the sluggard, but the advertising man is better for the talking machine dealer who would succeed.

It is a long loan that has no returning. Keep your collections as close as possible.

The pitcher that goes often to the well is broken. So is a creditor who trusts too much.

A fool and his money are soon parted. This means that you must never let a smart traveling salesman load you with more goods than you want.

# Artistic Flower Horns

**A**SK your jobber if he carries them, if not write us, we will advise you of a jobber in your locality who does.

Remember "ARTISTIC FLOWER HORNS" are only made by us. They are the handsomest and most attractive line on the market to-day.

They are not cheap or gaudy looking.

They are made on the most approved acoustic lines.

They command their value everywhere.

Look for  
This Trade-Mark

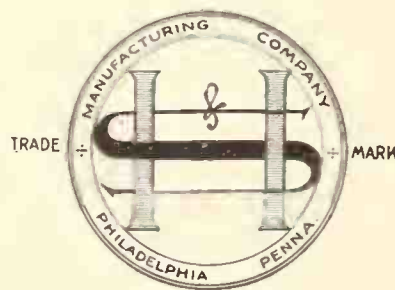

It is a  
Guarantee of Quality

Hawthorne & Sheble Mfg. Co.  
PHILADELPHIA, PA.



## EDUCATES THE PEOPLE.

A Missouri Editor Who Appreciates the Value of the Talking Machine.

A good deal of trash has been published editorially by the daily papers throughout the country regarding the Sousa article on "Canned Music," in which he pictured the evils of the talking machine as a deterrent to real musical progress. The writers of these articles evidently have never heard the perfected talking machine of to-day, nor have they heard the wonderful records which are now being made in which the human voice is reproduced with that nuance and quality which is almost lifelike.

Apparently these editorial writers have never investigated, but consider there is a great phonographic peril because Bandmaster Sousa says so, and yet Sousa was glad to use this machine as a means of popularizing his music at one time, and assumes the present attitude from a purely selfish viewpoint. There are some exceptions, however, in the matter of the daily papers, and the following editorial in the St. Joseph, Mo., News and Press, was written by a broad-minded man, who at least is willing to see the other side:

"So far from being a menace, it has done a great deal of good in the way of educating the people to appreciate music. There are many people who cannot afford to attend grand opera who have yet enjoyed the work of the greatest opera singers through this invention of Mr. Edison. They have also had an opportunity to listen to the imposing strains of Sousa's band and become familiar with instrumental music. Then, there are the families who cannot afford a piano. For them the phonograph is a means of innocent diversion. It is true that there is a great deal of trashy music extant which is frequently heard emanating from the funnel of the talking machine, but because one man prefers "Waiting at the Church" is no reason why another may not enjoy "Tannhauser." To a certain extent the good or evil that a phonograph may do rests with the man who owns and operates it. He has the opportunity to familiarize himself with classical music, and if he does not choose to do so it cannot be helped. At any rate, it is no worse than hearing him torture a mouth-organ with "Suwanee River" or wring the wailing strain of "After the Ball" from an overworked accordeon."

### WHITNEY-CURRIER CO. CONCERTS.

(Special to The Talking Machine World.)

Toledo, O., Nov. 8, 1906.

Upon the completion of their new talking machine parlors, which were recently refitted and

newly equipped, the Whitney-Currier Co. gave a series of free afternoon talking machine concerts extending throughout the entire week, and which were attended by large crowds. The concerts were offered in the nature of a house warming and were highly successful in calling the attention of the Toledo public to the firm's exceptional facilities for filling their wants in talking machines, records and supplies expeditiously and satisfactorily.

### HER VOICE PHOTOGRAPHED.

Miss Hattie Williams, the Well Known Singer of "Experience" Has Made a Number of Records Which Have Been Sent by Charles Frohman to London for the Benefit of Miss Edna May—Value of Talker in This Role.

Charles Frohman intends to have Miss Edna May sing "My Irish Rosie" in London, and has sent a "record" of Miss Hattie Williams' rendition of the song as a model for Miss May. That's why Miss Williams went down the other day to have her voice photographed by the record-making people.

When she faced this new orchestra, arranged on wooden benches, like the audience at a country circus, the singer of "Experience" grew a little nervous. She remembered that they had played recently for grand opera artists.

"We'll leave out the brass the first time," said the conductor to his men.

"No; don't do that!" protested Miss Williams. "I feel as if I hadn't any brass."

But she faced the tin cornucopia as bravely as if she were not afraid it would explode, while the orchestra faced a larger receiver near her. At the end of three bars there was a sudden stop.

"Hermann," said the conductor, "you left out three notes there!"

Hermann emerged from the three-ply coil of brass pipes which encircled his neck, and into which he had been puffing, and indignantly produced his score to show that he was innocent. The three notes were inserted. The song was then sung through without further interruption. After it was finished the record was played over. Miss Williams listened to her voice in miniature.

"It's very much like the effect you get from watching the stage through reversed opera glasses," she said.

Then she turned to read over the score of Gilea's "Adriana Lecouvreur," which Mme. Homer had been singing into the records. "I'm glad it's over!" she said.

"It's just begun," said the musical director. "We'd like to have three more records, and select the best."

So Miss Williams did it all over again several times, observing certain changes in tempo and

dynamics to get all the material in the record. And she tried hard not to look at the queer instruments, lest they should queer her singing.

"A violin with the sounding board cut away and a small tin horn in its place is uncanny," said Miss Williams. "Everything here has horns, and they look like the——"

But the orchestra struck up and drowned the last word. When it was all over, Alf. Hayman, who had arranged the matter for Mr. Frohman, took Miss Williams down to her cab.

All the members of the orchestra followed Miss Williams out and started off for Philadelphia. And Herman, he of the three missing notes, looked after Miss Williams' cab.

"I tell you what," he said, "I like those chest voices. She made a better record than Mme. Rappold or Herr Knot."

And nobody denied the statement.

### NOW SALES MANAGER FOR "3 IN ONE."

Charles E. Hunt, who for several years has been circulating among the jobbers of the country in the interests of the famous "3 in 1," has been appointed sales manager of the G. W. Cole Co., the manufacturers of "3 in 1."

Mr. Hunt's appointment as sales manager is a deserved recognition of his abilities and energies. Jobbers and dealers from Maine to Mexico know the genial Mr. "Oilright" Hunt. Even Canada has been covered by Mr. Hunt, so in assuming direction of "3 in 1" sales all over the "3 in 1" business is marvelous to even those in charge of its development. The demand for and the consumption of this oil spreads so rapidly that the "3 in 1" factory is taxed to keep up with the demand and enough surplus stock on hand to ship without delay. Up to date, however, the factory has been able to ship any reasonable quantities on even telegraphic instructions, and with the new additions and improvements now under way expect to keep pace of even Mr. Hunt's most sanguine expectations.

### PHONOGRAPH AIDS SPIRITUALISTS.

"How is the soul of a trance medium dispossessed of its body?" was the question which came up before the convention of the National Spiritualists' Association, which was held in the Y. M. C. A. auditorium, 153 LaSalle street, Chicago, Ill., week before last, when, for the first time in the history of the movement, a phonograph was used in the tests. According to the plan of operation all of the words supposed to be spoken by mediums and clairvoyants while they are under the control of spirits were recorded on phonographic records, and the instruments later repeated the sentences to the mediums after they were released from the spell.

# VICTOR SERVICE

## WHY WE CAN GIVE YOU THE BEST

We are the only Victor distributors in the East who devote an entire store to the Victor line. We have the space and facilities for carrying at all times as large and complete a stock of Victor machines and records as that carried by the factory.

We can guarantee to ship all orders the day they are received. Our shipping department is located in the very heart of the wholesale district of Boston with its numerous daily express collections covering every point in the United States; it employs a large and efficient force who give their entire time and attention to the filling of Victor orders.

We place all records in separate envelopes immediately upon receipt from the factory and deliver them in the same envelopes. Thus the retailer receives his records in the best shape to handle and in as perfect condition as when shipped from the factory.

JOBBERS and DEALERS in  
**Disc Records**

**DO YOU USE  
ENVELOPES?**

Our envelopes are used by  
75 per cent. of the largest  
jobbers.

Their superiority is proved  
by the numbers of dupli-  
cate orders we receive.

Ten different styles and  
sizes. Samples and prices  
on application.

**M. STEINERT & SONS COMPANY**

DISTRIBUTORS OF

VICTOR TALKING MACHINES—VICTROLAS, AUXETOPHONES, HERZOG FAMOUS DISC CABINETS

35-37 Arch Street

BOSTON, MASS.



## THE QUAKER CITY NEWS BUDGET.

Reasons Why October Business Was Backward—Jobbers Rushed, However, and Can't Get Stock Enough—Great Activity at Victor Plant—Penn Co. Bring Suit for Violation of Contract—Jobbers Say Development of Business Will be Great Along Commercial and Public Amusement Lines—Musical Echo Expansion—Snellenberg Opens Regular Department—Opera Records in Great Demand—The World Visits the Principal Dealers.

(Special to The Talking Machine World.)

Philadelphia, Pa., Nov. 8, 1906.

October business was more or less backward, retail dealers say; but they add that the past two weeks has seen a change for the better. Disagreeable weather, the election campaign and minor reasons were given to explain why trade was quiet during a part of October. Retailers seemed agreed that business was behind that of a year ago at a similar period. "I can't understand it," commented one dealer. "Everybody is working and trade generally seems very good."

The jobbers and wholesalers tell a different story. Almost all of them report October business to have been very good, and so far November trade is also brisk. The usual complaint, inability to get talking machines and records from manufacturers, is heard, and doubtless trade would be far more active in jobbing circles if jobbers could get goods with which to fill orders.

Inability to secure records and supplies so worked upon one jobber that he went into a poetic trance and sent the following effusion to one of the manufacturers:

"Everybody works but the factory,  
And they sit around all day,  
Always writing letters,  
'Expect to ship next day';  
Customers keep on calling,  
New stories we must tell;  
Everybody works at the factory,  
Yes, they do, like ———!"

The familiar story, "rushed night and day," quite aptly describes conditions at the plant of the Victor Talking Machine Co., Camden, N. J. All hands continue very busy and, so far as the company, with present facilities, can fill orders, it is doing so. Manufacturing facilities are being steadily enlarged, new buildings are being erected, and vigorous efforts are being made to meet the demands of the trade; which is all any one can do, it should be added.

The concrete pavements adjoining the Victor Co.'s plant on Cooper street have been finished, the grass plots are enclosed with neat iron fences, and the whole premises now look enticing and attractive. Work on the new office and laboratory building, opposite the main plant, was started the latter part of October, and already good headway has been made. Secretary A. C. Middleton, of the company, has abiding faith in reinforced concrete construction, and the "unit" system is being used in both the office building referred to and the new warehouse addition at Front and Linden streets.

At almost every place visited by The World's correspondent good words were spoken by jobbers and dealers of the horns and supplies made by the Hawthorne & Sheble Co., of this city. The horns are popular with the public and give the utmost satisfaction.

At the North Eastern Phonograph Co.'s store, Manager Silverman stated that business was improving. "We sold, we believe, the first Victor Victrola," said Mr. Silverman, "and could no doubt sell others if we could get them." The company have added to their stock of Zonophone, Victor and Edison records and machines, and are well prepared to meet fall and holiday demands.

Cheap talking machines are being used as premium gifts by a local spice and flavoring house. As the cheap instruments almost always lead the owners to purchase good talking machines, the work being done by the spice house is to be commended.

A. B. Butcher, retailer of talking machines, Broadway and Spruce street, Camden, N. J., visited New York the past month. He was accompanied by Mrs. Butcher, and they visited the Edison plant at Orange, N. J., and were shown

through the entire works. Mr. Butcher, while in New York, ordered a full line of machines and records for winter trade. He is vigorously pushing sales and building up a solid business.

Said David Keen, of the Keen Co., 132 North Eighth street: "Business is improving. We have just added a line of Columbia records; we carried a fair-sized stock, but have now enlarged it. Trade has been rather quiet, but is becoming better every day."

The amusement parlor at Ninth and Market streets is being altered and remodeled at a cost of \$4,000.

Dawson & Adams are having the building at 2618 Germantown avenue altered into an amusement parlor and will install slot machines, phonographs, etc.

The Penny Arcade at 127 North Eighth street, recently opened, has made a number of improvements and added additional phonographs and slot devices.

"Business is fair," reported the manager of the Eastern Phonograph Co., 143 N. Eighth street, owned by Futernik & Silverman. "We have put in a complete line of Victor talking machines and records. I look to see a good holiday trade—in fact, it ought to be a booming year."

The Keystone Phonograph and Camera Co., 148 North Eighth street, make a feature of handsome and attractive show window displays, and their present exhibit is very creditable. "Business is pretty fair," said Mr. Abrahams, "but it is not up to the same period a year ago." The company have added a line of Weymann musical instruments to their business, and will also handle pianos. A large stock of sheet music is also carried.

In the local courts the past month the Penn Phonograph Co. instituted suit against Ruane & Bayley as a firm, and John F. Ruane individually, for alleged violation of contract. Ruane & Bayley dissolved partnership about two months ago, and both now conduct retail talking machine stores.

Said a jobber: "Between you, me and the lamp post, do you know that I believe the talking machine business has about struck its level in Philadelphia? There's just about so much business to be done, you know, and it seems to me there are now enough jobbers and dealers to take care of it. Maybe there's too many, and if so it accounts for some of the quiet business stories you hear."

Said Benjamin Futernik, of the Philadelphia Phonograph Co., 156 North Eighth street: "We confine our business strictly to talking machine lines. Trade is going along all right, and we expect a good fall and holiday trade." Benj. Futernik is a pioneer in the business, being one of the first merchants who opened talking machine stores on Eighth street. "I suppose we made so much money when we first opened," remarked Mr. Futernik, "that others concluded it was a good field. Well, there's room for all, I guess, even if all of us do not acquire millions." The Philadelphia Co. carry complete lines of Victor, Edison and Columbia goods.

In a trade chat, one of the large jobbers made a few points as follows: "It seems to me that talking machine trade from now on will develop quite strongly along two lines—commercial and public amusement. The household trade ought to increase, of course. While not wanting to criticize the record manufacturers, it seems to me they should bring out less new pieces and go heavy on stock numbers for a while, in order to fill the demand. Dealers who sell on the installment plan at cash prices forget they are getting nothing for their tied-up money. A needleless talking machine would be a great comfort.

Daily experience proves that talking machines lead people to higher musical tastes and stimulates sales of many other musical instruments."

Getting inspiration from a street organ grinder, two Philadelphia lads mounted their "talker" on an express wagon, took to the street and were gathering in many pennies until a non-sympathetic policeman demanded their license. Will street talking machines join the piano and organ caravan?

"Boss!" said a colored man to one of the Musical Echo Co.'s sales clerks, "hav' ya got a record wid de 'de'd ma'ch ob Saul' on it?" "Yes, we have one." "Well, I wants hit. Dar's gwine for to be use foh hit if Sam Johnson doesn't quit foolin' wid my 'Liza!' And he paid for the record and disappeared.

"Our October business," reported the Wells Phonograph Co., jobbers, "was the best October business we have had since entering business. The outlook for trade is very good. We are featuring Tea Tray and H. & S. horns. The Searchlight horns are selling well. We have a very fine line of disc and cylinder record cabinets which we are exploiting carefully. Edison business, in particular, has been exceptionally big."

At H. A. Weymann & Son's, 923 Market street, Mr. Weymann said: "We have had very good business in our talking machine department, due to the fact that having the goods we have been enabled to fill orders and satisfy all demands. We have found that to get business we must have the goods on hand. Where formerly we lacked room we now have it and carry a large and complete stock of Edison and Victor goods." Mr. Weymann said trade in pianos, musical instruments, sheet music, etc., was also very satisfactory.

"Business has been improving and is better than it was," reported the Lewis Talking Machine Co., South Ninth street. "We have had good success in selling Petmecky needles—so much so that we had to take them from our display window. The outlook for business is promising, and beyond this there is little news to report."

"Business is gradually picking up," reported the Penn Phonograph Co., South Ninth street. "We now have the largest stock we ever carried; as you see we have carpenters at work on additional record racks. We occupy two large storerooms, basements, etc., and are in excellent shape to meet all trade demands." Salesman Wilson, of the Edison Co.'s forces, was a recent visitor.

At the main local office of the Columbia Phonograph Co. it was stated that business is going along in a steady, satisfactory way. The company's several retail branch stores in this city are putting out many machines and records, and the same thing is being done by the Camden, N. J., and Easton, Pa., branches.

Harry A. Matthews, C. C. Hildinger and Chas. W. Klag, of Trenton, N. J., have organized the Dream Amusement Co., and will operate an amusement parlor equipped with motion pictures, etc.

Said H. B. Rouillot, manager of the talking machine and piano player department of James Bellak's Sons: "We are doing very nicely, all things considered; of course, there's considerable competition to be met, but we are getting our share of trade." The Hardman and Harrington autotones and Hardman piano player are exploited, as well as music rolls for all players.

Said Manager Marschalk, of the Musical Echo Co., Chestnut street: "Trade with us is limited to our ability to get in goods. There's no trouble in selling—it is getting what we want that bothers us." An unusually large order was recently placed by the company with the Victor Co. The Musical Echo Co. have supplied Snellenberg's phonograph department with Victor goods. They have also supplied the wants of Fred W. Lindig, a retailer, at Louisberg, Pa. The concerts given in the company's concert hall continue to attract pleased audiences.

Inquiry shows that there has been a good demand for the Victor Co.'s records of Verdi's "Il Trovatore." One dealer alone has taken orders







for twenty complete sets of the opera records, and the indications are that the innovation will be a pleasing success.

Snellenbergs, department storeists, have opened a regular talking machine department and will exploit Victor, Edison and Columbia lines. The department is said to be a favorite one with Jos. Snellenberg and will be kept up-to-date, of course. It is under the management of John McArthur, who, while young in years, is credited with much talking machine knowledge, as well as push and energy. It is understood that heretofore Snellenberg's sold phonographs and records under a consignment arrangement, but now they will conduct a regular talking machine department, buying all goods direct from wholesalers or manufacturers.

Strawbridge & Clothier's talking machine department reports good business. Extra effective advertising, no doubt, has contributed to that end as well as the pleasing care shown all patrons by the sales force.

Increasing sales are reported by the Western Talking Machine Co., 128 South Ninth street, of which F. R. Reinick is the capable manager.

That effectively dressed display windows increase sales is proved by C. E. Gabriel, manager of the Columbia Co.'s branch store at Camden, N. J. Mr. Gabriel's window exhibits are attractive and original.

Clarence Wright, a clever Camden, N. J., youth, who has been appointed assistant mail clerk by the Victor Co., is an accomplished pianist and violinist.

"It wouldn't do to put the records of some of the political candidates on a talking machine," sagely remarked the boss packer of the Wells Phonograph Co.

Manager Ford, of the Disk Talking Machine Co., 13 North Ninth street, has had quite busy times the past month on Zonophones and records. Being a popular-priced "talker" the Zonophone is a favorite with a large number of people.

Large fireproof steel safes are found alongside of talking machines at Harris Master's store,

239 Market street, and he enjoys good business in both lines.

### VOICE TO SOUND AT OWN BIER.

Minister Makes Talking Machine Record for Use at His Funeral.

If the wishes of Rev. Daniel Bassett Leach, of Bone Gap, Ill., are complied with at his death, the unusual event of a man delivering his own benediction will come to pass. Rev. Mr. Leach, who is 89 years old, has requested that the concluding ceremony of his funeral should be the rendering on a talking machine of a benediction composed by himself. He has been a Methodist minister for more than 70 years, or since he was 18 years of age, and has been noted for the length of his prayers. He has recently had placed on a talking machine record his favorite benediction, which he is wont to deliver in a stentorian voice that can be heard two blocks away. Rev. Mr. Leach, though enfeebled physically to the extent that he has to sit at the pulpit, still preaches occasionally. Forty years ago there was not a Methodist pulpit of southern Illinois but had been occupied by him. He is the oldest superannuated clergyman in the southern Illinois conference.

### INTERESTING CHAT WITH MR. SHEBLE.

(Special to The Talking Machine World.)

Philadelphia, Pa., Nov. 8, 1906.

In a recent interview with Mr. Sheble, of the Hawthorne & Sheble Manufacturing Co., he discussed the situation regarding the infringement of their patent rights in a number of horn cranes at present on the market. Mr. Sheble said: "We believe our company were pioneers in the manufacture of horn cranes, and during the years we have been working on them, many new and attractive features have suggested themselves. Our policy is to apply for letters patent as soon as a new idea is evolved by us, and consequently we have covered many features

not at present employed in our product. The patent office have been so far back in their work as to cause us an unusual amount of delay in the issuing of some of our patents, but I am pleased to state that all of our basic patents have been allowed, and some have recently been issued that were delayed in the Patent Office for several years. We believe our patents are broad enough in their scope to thoroughly protect our ideas, and we expect shortly to take such legal steps as may be necessary against infringing articles as will establish our rights."

### PHONOGRAPH DINNERS.

Did you ever hear of a phonograph dinner? They're giving them in Chicago now with soup and fish and roasts served to the accompaniment of "talker" music and with phonographic toasts all bottled up in the form of napkin rings and laid by the side of the plates of the diners. It is only one of the many ingenious things done by ingenious Chicagoans with their talking machines, which in late years have come to serve many purposes, from storage batteries for business letters to nursemaids, crooning songs of Sleepyland to tired babes at night.

### THE BERLINER GRAM-O-PHONE CO.

The Berliner Gram-o-phone Co., of Montreal, Can., have moved their Toronto branch from Queen street to handsome and larger quarters at 264 Yonge street, that city. The branch store known as the Toronto Gram-o-phone Co. is now under the management of N. E. Winton, a capable talking machine man, formerly with Johnson's, Ltd., who succeeded F. Johnson as manager of the Gram-o-phone Co.'s store. The latter has associated himself with Grinnell Bros., Detroit, Mich.

Charles H. Mulholland, who was with the Adams Dry Goods Co. in this city, is now connected with the Shepard Company, of Providence, R. I., where he is acting as buyer for the talking machine and several other departments.

**WHEN PLACING YOUR HOLIDAY ORDERS**

**REMEMBER**

That we are exclusive **VICTOR JOBBERS**, and that we are prepared to take care of your wants in this line, be they large or small. We have three large floors and basement devoted entirely to the sale of these goods, and carry a stock which is sufficiently large to take care of all orders received, promptly.

**WE ARE THE ONLY JOBBERS IN NEW YORK CITY DEVOTING AN ENTIRE BUILDING TO THE VICTOR EXCLUSIVELY**

**NEEDLES**

**PERFECT**

**MEDIUM**

**QUIET**

**These are the brands manufactured by us. They stand for A1 QUALITY. Millions of these styles are sold by us every month to satisfied customers. ARE YOU ONE OF THEM?**

If you are not a user as yet, let us send you **SAMPLES FREE** and convince you by the quality and price that you cannot do better, whether you are a jobber or dealer. Write for full particulars.

**Place your orders promptly if you wish shipment before the Holidays.**

**AMERICAN TALKING MACHINE COMPANY**  
586 FULTON STREET, - - - BROOKLYN-N. Y. CITY

**Largest Talking Machine House in the City**



## PRACTICAL SUGGESTIONS AND COMMENTS.

### DOING AWAY WITH "ASIDE" EFFECTS.

William F. Hunt, talking machine dealer of Wanatah, Ind., writes *The World* regarding the above subject in the following vein: "In my opinion the time is ripe to do away with many of the 'aside' effects recorded in the records. By this, I mean, for instance, the whistling, clapping of hands and shouting in minstrel records, etc. I think such effects rather detract than add to the attractiveness of the reproduction. The talking machine has reached the point of perfection where it quite ably takes the place of the actual performer, and one feels as if he were really in the presence of the living artist and not a machine when listening to one of its reproductions. Would it be natural for a vaudeville artist to spring the joke and then laugh at it himself? Not quite. Well, that is just what a talking machine is made to do. If many of these effects were eliminated from the records, I believe the few who are now prejudiced against the talking machine would learn to admire it. Some of the records are certainly too noisy to be enjoyed by any one, especially when they are often repeated by an over-enthusiastic neighbor, who has a better ear for noise than music. No one objects to good, wholesome music, but when it comes to plain noise, I as well as most others will call the limit. The above mentioned effects were not so objectionable, when the talking machine was in a crude state—when it produced sounds only faintly—but since it produces them with all its natural volume it is most raking on the nervous system. Another word in regard to unnecessary effects in records are the announcements. For instance, many are now using the talking machine in church services. Is it not rather out of place to advertise a record manufacturer during church services. 'Nuf said."

### CARING FOR THE EDISON PHONOGRAPH.

In answer to a number of questions on the above subject, propounded to the editor of the *New Phonogram*, the assistant superintendent of the National Phonograph Co. has prepared the following replies, hence their reproduction here:

"In regard to the parts that need oiling in the phonograph, they are those parts which are moving, as in any other machine—the bearings of the shafts, both on top of machine and in the motor; the back rod on which the diaphragm arm slides, and the main shaft screw on which the feed nut travels.

"As to how often it needs oiling, your own judgment should determine this. As long as there is a slight amount of oil in the bearings they need not have any more. The main spring is graphited here in the factory and this should last quite a long while; as long as the main spring unwinds evenly, without any jumping, it shows that it is properly lubricated.

"In regard to your record slowing up, or rather your mandrel slowing up in the center of almost every record, this would tend to denote that there is a bind in the travel of your diaphragm arm at this point. We would judge that the trouble might be in the feed nut or the thread of the main shaft. If you would let the arm down and feed it across, holding the finger very lightly on the feed nut spring, you could feel whether there was any roughness in the thread of the main shaft. Sometimes rust accumulates in these threads and makes considerable friction at that point, which would cause your trouble. There can be no other reason for slowing up at one point every time. We think if you examine this closely you will find the trouble.

"If the humming noise in your motor is appreciable when the cabinet is closed, then there is some part which is fastened to the motor frame that touches the top part of the machine. This motor frame is suspended between spiral springs to neutralize the vibrations in the same and not transmit them to the top plate of the machine. Possibly your starting lever, when thrown over to start the machine, touches the side or end of slot through which it comes. This

would cause the trouble you speak of. Or, the crank may be touching the thimble hole in the cabinet. If neither of these two parts are causing the trouble, we would suggest that while your machine is running you take hold of motor frame with the cabinet opened up, and twist it around a little on the springs and see if this overcomes the hum. If you find that it does, then one of the screws which goes through the springs probably touches in the hole of the motor frame where it passes through. These screws, which pass through the spiral springs and which screw into the top plate of machine, should not touch any part of the motor frame casting, for if they do they will transmit all the vibrations of the motor frame casting to the top part of the machine and cause the humming noise which you speak of.

### SOMETHING OF A LEGAL NATURE.

A prominent dealer writes *The World* as follows: "Certain manufacturers are infringing on a patent which I control, and I am contemplating sending out a circular to the trade, calling attention to this fact. A friend of mine, who presumes to have some legal knowledge, tells me that I have no right to do this, but I can warn them personally, but cannot warn their customers. What do you think of it?"

Really this is a matter outside of the province of the editor, who has not graduated from a law school, but we may say that it has been held by the courts many times that a circular forbidding persons to buy articles claimed to be infringements is not a libel calling for damages or injunction if made in good faith and the circulators' patent is valid or apparently so. Parties claiming rights on a patent may publish their own claims and warn others, and if they are acting in good faith will not be restrained. It must be borne in mind, however, that excessive and derogatory language must not be used beyond what is necessary to give the proper information. Any excessive and superfluous adverse comment against an existing patent becomes a libel for which the owner of the rival patent may have redress.

### NO SCARCITY OF REPAIRERS IN WICHITA.

Eberhardt & Hays, general music dealers, Wichita, Kan., write *The Talking Machine World* as follows: "We read with interest and no little surprise the article on page 6 of the October number of *The Talking Machine World*, under the heading of 'The Scarcity of Repairers,'

written by a 'subscriber' to *The World* from Wichita. In justice to ourselves we do not care to let this pass without comment. If the writer of this inquiry will call at our place of business, he will find a well equipped repair shop, under the supervision of workmen who are competent to do anything asked for in the way of repairing any and all up-to-date talking machines. We are in the talking machine business 'for keeps,' and can furnish anything in the way of repairs for any standard talking machine. We do sometimes get hold of a premium or mail order house machine that we or nobody else can get repairs for, because they were sold with the understanding on the part of the seller, at least that they were not to be repaired, but we do not stand back for any of the modern machines, and can repair or regulate them with a guarantee on our work that it will be entirely satisfactory. If the writer of the article referred to will call at our place of business in Wichita, we will be glad to show him that we know something about talking machines and will repair or regulate his machine to his entire satisfaction."

### BEST VOICES FOR RECORDS.

A Laboratory Expert Discants on the Making of Good Records.

A well-known talking machine expert connected with the manufacturing end of the business in chatting recently about record making said: "It is a curious fact, and one which I do not wish you to lose sight of, that the best voices do not always make the best records. A bass voice in a man and a contralto in a woman as a rule are more effective than a tenor and a soprano respectively. For this reason Schumann-Heink has a better effect than Melba, while Plancon is superior to Burgstaller. However, I think there is one exception, and that is Caruso. No voice rings out better or with more realistic effect than Caruso's, and one could almost believe it was the man himself who was singing and not the record. Throaty tones are fatal, and the man or woman who sings from the back of the throat is no good for the talking machine. What is wanted is a clear, unaffected tone which will cut cleanly into the wax record and with a sharpness which while avoiding the shrill, is so distinct that every word and note comes back with the clearness of a bell."

George Ackerman, Scranton, Pa., proprietor of Phonograph Hall, has one of the largest and handsomest stores in eastern Pennsylvania.

## New England Dealers

will be interested to know that we have for six weeks past been preparing to supply their wants promptly when the Fall and Winter rush is on.

☞ We had on hand by October 1st a surplus stock of over twenty-five hundred Edison and Victor machines and over two hundred thousand Edison and Victor records. This surplus with the deliveries the factories will make us during the rush season will enable us to give dealers' orders the same attention as we would ordinarily during the Summer.

☞ *Prompt and Full Shipments on day order is received.*

☞ Send for our new list of "Live Ones" of the Edison Record List.

☞ If you are not already handling the Mega Flower Horns (plain and decorated) send for descriptive circulars and prices.

NEW ENGLAND DISTRIBUTING HEADQUARTERS

**THE EASTERN TALKING MACHINE CO.**

177 Tremont Street, Boston, Mass.

Distributors of EDISON and VICTOR MACHINES, RECORDS and ALL SUPPLIES.  
Eastern agent for HERZOG DISK and CYLINDER RECORD CABINETS :: ::



## EDISON'S GREAT ACHIEVEMENT.

A New Storage Battery Which Is to Revolutionize Industry and Transportation—The Originator of the Phonograph Adds Another Great Invention to His Credit.

Thomas A. Edison, the inventor of the phonograph, has accomplished a surprise for the world. He has worked out successfully the problem of cheap power. He promises to put on the market within six months a new storage battery which will enable every man to travel in his own private carriage at about the cost of car fare.

Without danger, without breakdowns, without cost almost, a carriage, once supplied with the new power, for \$200, will travel without repairs for fifteen years, for a hundred thousand miles, if necessary, says the wizard. He reiterates the declaration that he has invented a storage battery which will solve the problem of congested traffic in the big cities of the world as soon as he can manufacture enough of them. He is erecting two large factory buildings, now nearly completed, and is installing in them new machinery especially for the manufacture of a motor battery that will be as common a factor in the business life of the world as the telephone is now.

He says that he will be able to sell at the cost of \$10 a cell a storage battery that is almost indestructible. It will travel a hundred thousand miles before it is worn out. Twenty cells will be all that is needed for a runabout or brougham, and sixty cells will be enough for the largest and heaviest truck used. For \$200 one will be equipped with motive power that will need no renewal for fifteen years. "Now, it lies with rubber tire manufacturers to meet this commercial reduction of motive power," said Mr. Edison, gayly.

Mr. Edison, it seems, has had quite some trouble in providing the principal ingredient of the battery. Many chemicals were tried, but he considered he did not attain success until he experimented with cobalt; this being one of the rare metals, however, the matter of expense was something to be considered. Mr. Edison, therefore, set to work to find cobalt in sufficient quantities to warrant its use, and was most successful in discovering lots of it in Canada, in Wisconsin, in Oregon and in Kentucky. The next problem was to separate cobalt from the ores with which it is associated. This has been done at great expense, but within the past few months Mr. Edison has devised a plan in which to get cobalt out of the ore cheaply and within a ratio of cost already calculated for the price of each cell. He has succeeded in every respect in his experiments, according to an authority in the Times, and he now promises that a new battery will be on the market in the spring. This is not a haphazard prophecy, for he has had thousands of batteries working within the past three years so as to insure success.

According to Mr. Edison, "in fifteen years from now the horse will be a curiosity. We shall be paying 50 cents to look at him in side shows." The actual cost of recharging the new battery is a matter of a few cents per cell, the greatest achievement being in making a motive power of light weight, in compact shape, and, above all, enduring. Speed is not the purpose that Edison had in mind.

"I am a commercial inventor, strictly commercial," he said.

The popular phonograph has shown that; in fact, nearly everything Edison has ever done shows it.

A 3 per cent. quarterly dividend has just been paid to stockholders of the Texas Phonograph Co., which does a wholesale jobbing and distributing business in talking machines. It is said that nearly 300 dealers throughout Texas are supplied by this progressive Houston concern.

Everything points to a big winter trade in "tireless musicians" ("talkers").

## A BETTER SELLING PROPOSITION.

For the Dealer Is Found in Talking Machines and Supplies Than in Pianos According to Manager McConnell of Wurlitzers—Great Activity in Every Branch of This Great Business—Big Stock Kept in Hand.

(Special to The Talking Machine World.)  
Cincinnati, O., Nov. 7, 1906.

Something of an idea of the remarkable increase in the demand for talking machines throughout the entire country, but particularly through the Middle West, may be gathered by the expansion of the departments of the Rudolph Wurlitzer Co. agents in this city and vicinity for the Victor talking machines and Edison phonographs. This department was practically organized about three years ago, perhaps as an experiment, deponent sayeth not, and has now increased to a proportion of the firm's business that, considered with the piano business, averages up to almost as numerous an output, always comparing the relative difference in the price of the instruments. Mr. McConnell, who has charge of the talking machine department on the first floor, spoke of the ever increasing demand for talking machines. Much of this demand is ascribed to the new and valuable improvements made in the machines, which increases their tone and trueness to the human voice or musical instruments by doing away with the "scratch," as it is technically known. Mr. McConnell feels that the small dealer has a better selling proposition in talking machines than in the piano trade merely. He argues that to sell pianos successfully in any but the largest cities, a dealer must provide himself with several fine instruments as an initial expense, a demonstrator of no mean ability is required to prove the excellence of the piano tone and a considerable store of sheet music must be provided to fill out the programme. The first expense and the running expenses of selling the talking machines is considerably less, and these reach the taste of a greater number of people many of whom have no special skill in playing the piano, but who are still desirous of hearing good and lively music. The machines afford a greater variety of entertainment, such as band music, recitations, vocal selections and instrumental numbers. The difference in price of the pianos and the machines gives the latter a decided advantage in many a home where the question of the extra dollar is necessarily paramount.

For the Edison phonograph, Mr. McConnell says all salesmen have a special soft spot in their heart. Its educational features give it an additional and growing value. The splendid im-

provements of the Victor Victrola have made that instrument almost peerless in its reproductions of even the best qualities of voice of the great singers and artists. The great variety of entertainment provided by these instruments offers the small dealer so attractive a line that the business is steadily expanding. Mr. McConnell believes the talking machines are the instruments of the future for the great mass of the people.

The Wurlitzers keep in stock not less than 100,000 records, all of which are hermetically sealed in specially made envelopes the moment they leave the factory. This firm maintains an immense library on the third floor of their establishment, where records are kept in the most methodical and careful manner. A vast number is ordered each month for distribution.

## SOME STORE POINTS WORTH NOTING.

Just at this time of year arise three important questions to be settled by every merchant in the United States: (1) Proper fire protection. (2) Proper store lighting. (3) Suitable store fixtures.

The question of fire protection is the most important and should be looked to first. Good insurance is essential, and every store should be fitted up with a good reliable fire extinguishing system. The right kind are efficient and not very expensive. Such a system may save thousands of dollars and is always protection against fire.

Lighting is very important now, as the days are growing shorter and shorter, and the store that gets the business is the store that is well lighted. If you live in a town where there is no gas or electricity, or even if you do and want to save money, there are several safe, sure and efficient gasoline lighting systems on the market worth looking into.

Store fixtures are always an important consideration, but now that the fall openings are on, Thanksgiving next, and then Christmas, the merchant should be very careful to see that his fixtures are fitted to his store and the class of trade he caters to.

## ECHOES OF THE POLITICAL CAMPAIGN.

"The phonographs used in the New York stump speaking campaign ought to be lined with gutta percha to keep them from corroding."

This clipping is from the Columbus (O.) Times. Really! Judging from the speeches the records carried, a lining of asbestos would have proven more necessary to prevent the heated remarks from melting the wax.

## YOU HAVE WAITED FOR THIS!

AN ATTACHMENT FOR HOLDING SOFTERTONE AND MEDIUM TONE NEEDLES IN THE NEW SPRING CLAMP NEEDLE ARM OF THE VICTOR EXHIBITION SOUND BOX

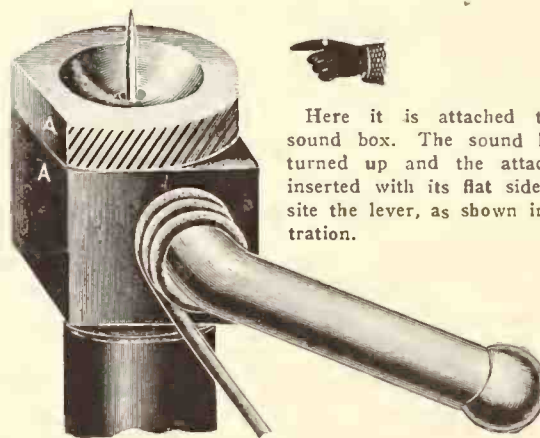

Here it is attached to the sound box. The sound box is turned up and the attachment inserted with its flat side opposite the lever, as shown in illustration.

Here is the Needle Clamp Attachment separate.



Without this attachment it is impossible to use softer and medium tone needles on the spring clamp needle arm. It is perfectly simple, easily attached, holds like a vise and is made in two sizes—for softertone and for Medium tone needles. Order as NEEDLE CLAMP ATTACHMENT and specify which needle is to be used.

Price, 25 cents each

Special prices to jobbers and dealers

**The Softertone Needle** is growing in popularity every day. The loud tone needle, of course, is a necessity to the dealer for selling machines, but it is often too loud for home use. When a customer takes a machine home he finds the softertone needle a great relief. Instead of tiring it perpetuates the use of the machine. This means record sales.

**It Costs Less** One Softertone needle will play six records. Less time is used in changing needles, and there is less wear on the records. A record will last three times as long when the softertone needle is used. We did not accept this fact until satisfied by numerous tests. You owe it to yourself to make a test if in doubt.

FOR SALE BY LYON & HEALY, CHICAGO



*The Talking Machine World,*  
*November 15, 1906.*

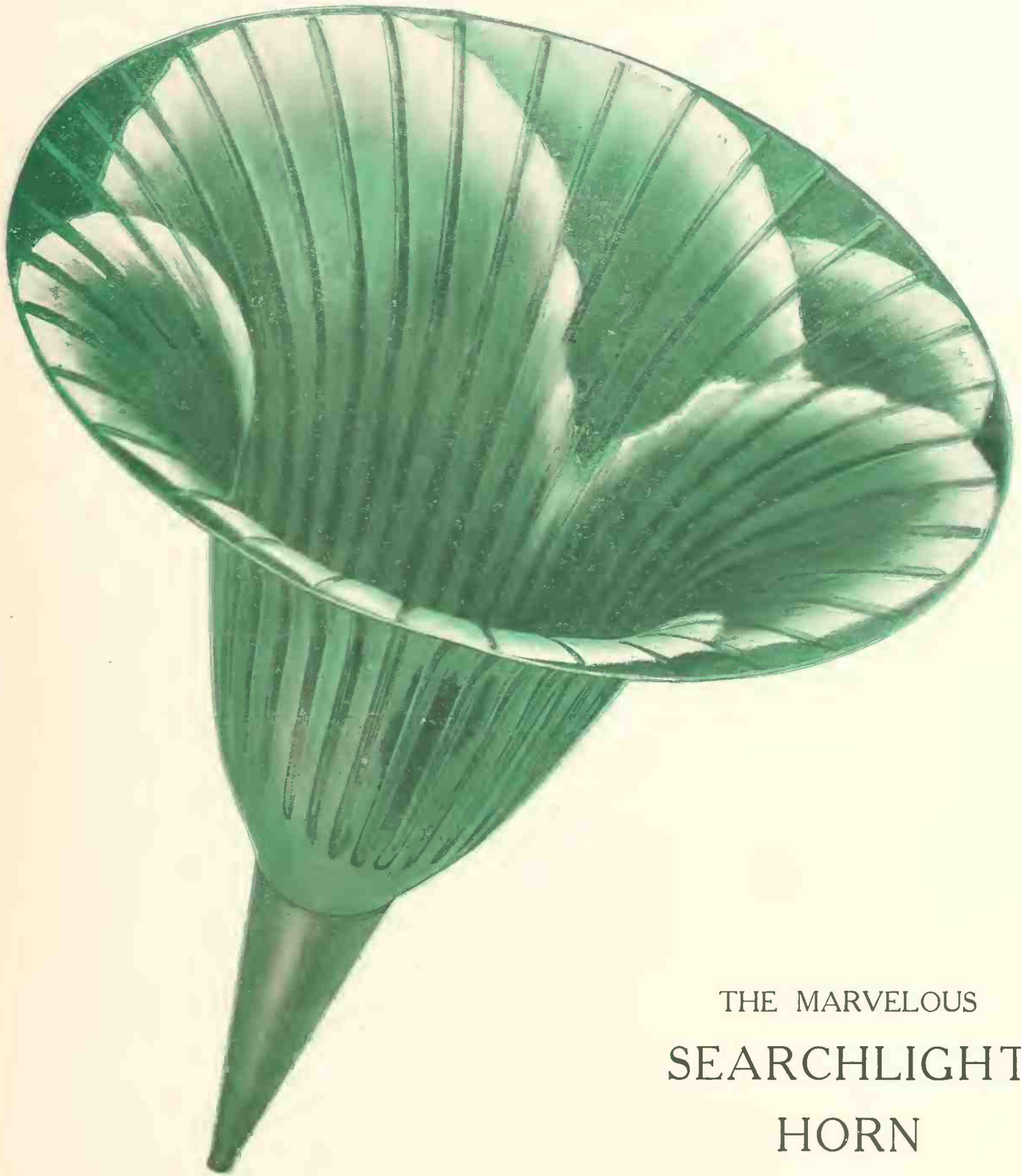

THE MARVELOUS  
SEARCHLIGHT  
HORN

Style—Green de Luxe, Decorated.  
For all cylinder and disc machines

FOR DESCRIPTION SEE OTHER SIDE

*“The Horn without a Competitor”*

THE  
SEARCHLIGHT  
HORN

MAKES  
A SOULFUL INSTRUMENT OF  
A TALKING MACHINE

REPRODUCES THE FULL STRENGTH OF THE RECORD

Sold only through Jobbers

Send to your Jobber for Samples

MANUFACTURED BY THE  
SEARCHLIGHT HORN COMPANY

753-755 Lexington Avenue

Borough of Brooklyn, New York

Distributed by

CONROY PIANO CO.,	- - - - -	St. Louis, Mo.
DOUGLAS PHONOGRAPH CO.,	- - - - -	New York
E. F. DROOP & SONS CO.,	- - - - -	{ Washington, D. C. Baltimore, Md.
HARGER & BLISH,	- - - - -	Dubuque, Iowa
J. W. JENKINS SONS MUSIC CO.,	- - - - -	Kansas City, Mo.
LYON & HEALY,	- - - - -	Chicago
MINNESOTA PHONOGRAPH CO.,	- - - - -	St. Paul, Minn.
NATIONAL AUTOMATIC FIRE ALARM CO.,	- - - - -	New Orleans, La.
POWERS & HENRY CO.,	- - - - -	Pittsburgh, Pa.
PHILLIPS & CREW CO.	- - - - -	Atlanta, Ga.
SPOKANE PHONOGRAPH CO.	- - - - -	Spokane, Wash.
SOUTHERN TALKING MACHINE CO.,	- - - - -	Dallas, Tex.
WELLS PHONOGRAPH CO.,	- - - - -	Philadelphia, Pa.
R. S. WILLIAMS & SONS CO., Ltd.	- - - - -	Toronto, Canada
RUDOLPH WURLITZER CO.,	- - - - -	Cincinnati, O.



**THE MYSTERY IS SOLVED!**

Now We Know Where the Voices of Our Broadway Song Birds Have Gone—An Amusing Skit That May Interest Mr. Sousa.

The mystery is solved! At last we know where the voices of our Broadway song birds have gone.

It's a case of *cherchez la phonograph*.

Do you know, it's really something awful the way these horrible machines have just gone and ruined the vocal cords of our Broadway songsters.

John Philip Sousa says "A bas!" with the phonograph, when it comes to dishing up grand and otherwise opera by the turn of a crank, and



THE FAIR PRIMA DONNA WILL MAKE THE MOTIONS, WHILE THE MACHINE DOES THE REST.

I guess if John Philip says "A bas" it will be "A bas"—perhaps.

We're mightily obliged to the march king for throwing light on the subject. It explains a lot of things that have brought surprises to our ears within the walls of comic opera homes. Whatever may have been the crimes of the phonographs, they're going to get it paid back to them good and plenty.

Oh, phonographs, how many crimes will be committed in thy name!

If any of our lady singers want to explain their lack of vocal powers, all they will have to do will be trump up this phonograph business.

John Philip complains that the singing into phonographs is a desecration of art. "You have these infernal machines going night and day," says the indignant musician. "We will not have a vocal cord left. They will be eliminated by a process of evolution."

And to think the phonographs have got in their deadly work already. We know now where the fair Lillian and Adele and dainty Marguerite, Hattie and George M. Washington, Jr., and—but why enumerate—just put all the pets along Broadway—have been spending all their time. Why didn't they 'fess up and let us know they'd been "eliminating their vocal cords by a process of evolution?"

That sounds almost as imposing as a doctor's certificate, and it ought to go with an audience better than the "sudden cold" business. But why worry? Things won't be much worse in the realm of comic opera than they are now. If the

Sousa diagnosis is true, the time may come when the fair singer will stand behind the phonograph and make motions while the machine does the rest.

An eminent throat specialist, who has taken issue with Mr. Sousa, adds that, anyway, we go to the opera for other things besides hearing vocal cords stretched. We are quite sure of this in musical comedy. It didn't need the phonograph excitement to bring this point to the front.

After the recent panic in the ranks of a chorus by the discovery of a coryphee who could sing, we are prepared for anything. The same discovery, however, didn't extend to the prima donna, but what matter, so long as Paris gowns are still to be exploited or beauty unadorned still holds sway with the ladies of the ensemble?

The eminent specialist insists that the beautiful scenic effects that appeal to the eye make opera a success as well as singing, so I guess our fair singers needn't be afraid. When it comes to stage pictures they know a thing or two themselves.

There's one thing, with the passing of the real prima donna there would be no disappointment in store for the audience. You couldn't very well stand for an excuse of a phonograph taking cold. Even the prince of press agents wouldn't have the nerve to spring such a yarn as that.

We haven't heard any complaint from Nordica or Schumann-Heink or Eames about their voices being eliminated per the phonograph route, but, of course, they're used to rough and tear work. You can't expect the delicate exotic voices, reared in the hot air—we should say hothouse air—of the Great White Way to stand for such phonographic strain.

Our eminent specialist might go so far as to suggest a voiceless opera, since he is willing to admit we go to the opera as much to see as to hear. When we have voiceless choruses, in direct contradiction of the old Greek laws, why



JUDGING FROM RESULTS, MANY OF OUR BROADWAY FRIENDS MUST HAVE BEEN BUSY ELIMINATING THEIR VOCAL CHORDS.

not carry American progression a little further and dish up the voiceless opera for keeps? It would be just the same, only Government inspection would insist on the right labor being used. You wouldn't really notice the difference at all, says Margaret Rohe in the New York Telegraph. It's a great proposition. We're sure the copyright office and all the eminent specialists and John Philip Sousa don't feel half as excited about it as do the Rialtoites. The nerve of the phonograph, anyway! Just think of it.

There is one thing to be considered, too. In future it looks like we would never more have the old excuse of "Understudy will go on in place of Miss Tessie Bumnote, who is suffering from laryngitis."

It will be phonographitis for her. John Philip Sousa has at least invented a new disease.

The fact that the desire for talking machines is not confined to race or creed has been amply illustrated since the opening of the Knight-Campbell Music Co.'s department in Denver, Col. Their customers range from Frenchmen to Russian Jews and Chinese, and there are records in stock that appeal especially to every clan.

During the last week of October W. O. Crew, secretary and treasurer of the Elmira (N. Y.) Arms Co., toured the northern part of the State in his automobile.

**Do You Want to Make Money, Mr. Talking Machine Dealer?**

Good, big money. The men who sent in an order for a sample line of our instruments were delighted with the results.

They found our instruments blended perfectly with the talking machine line, besides helping to make the store attractive. If you want to help out in the profits during the holiday season you can't go at it in a better way than with our specialties; your musical friends will come to you when they learn that you have the Durre violins, bows, strings, etc. They have a high standing.



We are judges of the excellence of all kinds of small goods, such as Accordeons, Mandolins, Guitars and Harmonicas, and carry a large stock, of which we offer at lesser prices, but which are superior to any on the market at the same price.

It will pay you to order a sample line at once. You will then see how profitable it is to devote a portion of your store to the exhibition and sale of small goods. Write for catalogue.

Make good money for the new year. It is easy with our help. We can tell you how and go with the business tide when it serves.

**BUEGELEISEN & JACOBSON**

113-115 University Place  
Corner 13th Street, NEW YORK

**210**

**Cylinder Records**

can be stored in this Cabinet. Has 5 Drawers provided with Iron Stops to prevent the Drawers from being pulled out too far.

**WOOD PEGS**

The only Pegs that will stand the wear. The best selling Cabinet on the Market. Size: wide, 22 in.; deep, 18 1-2 in.; high, 34 in.

No. 42 Cabinet.

**FEIGE DESK CO.,**  
2076 Genesee Ave., Saginaw, Mich., U. S. A.



# NEW TAPERING ARM ZON-O-PHONE

\$27.50, \$35.00, \$45.00, \$55.00



## THE NEW GRAND OPERA ZON-O-PHONE

The motor has triple spring, cabinet hinge top  $13\frac{1}{2} \times 13\frac{1}{2}$ , ten-inch turntable. We wish to call special attention to the new speed regulator; also the brake; as you will note when you shut off the instrument it doesn't stop with a jerk. The Grand Opera Machine is equipped with either regular horn or all brass morning-glory horn. Retails at \$55.00.

## THE CONCERT GRAND ZON-O-PHONE

The brake and speed regulator are the same as on the Grand Opera. The motor is exactly the same, except that it has two springs instead of three. The cabinet is different in design but is the same size and has the hinge top. It is equipped with the regular horn or the morning-glory horn—red, blue or green. Retails at \$45.00.



# UNIVERSAL TALKING MACHINE MFG. CO.

28 Warren Street, New York



**"TALKER" POSTAL CARDS.**

Have Not Won Any Large Degree of Favor at the Hands of the Trade or Public Although Somewhat Popular Abroad.

A little while ago great things were expected of the latest development in souvenir postal cards—those that talk their message to the receiver instead of conveying the written word—but they have not become as popular as expected.

These cards originated, like all other varieties of souvenir post cards, in Germany, but have up to the present obtained their widest vogue in France, though there are a few made and sold in England. The cards are about three times the thickness of the ordinary post card, this thickness being contributed by the disc in the center of the card on which the phonographic message is recorded. When a person wishes to send one of these remembrances home he goes to the office where the cards are sold, makes his little speech into the recording instrument, which is then transferred to the disc on the card. After the address is written on the other side the card is mailed and the recipient puts the card into a talking machine and hears the friend's voice. All this costs, in Paris, half a franc, or 10 cents.

The makers of "talkers" in New York are not particularly interested in this new device. They declare the combination of the paper on which the record is made and the sharp point of the needle used in transcribing the record is one that does not make for any lasting quality, and they have doubts as to whether in the ordinary course of mail transmission the record would not be made either partially or wholly illegible. The scheme has, they declare, no possible value commercially, hearing the same relation to a written message as an ordinary souvenir post card has to a work of art. That the spread of the pretty custom would increase the sale of talking machines does not appeal to them seriously. They believe the new cards could be turned out to sell at a profit for five cents, instead of the ten charged in France.

In England, although there are diminutive records of this kind on sale, they have not reached such a state that they can be sent through the mail without protection of some sort. There the phonograph men are particularly keen over the novelty, and declare it will be a matter of only a short time before the talking post cards will come into general use.

The Bureau of Manufactures at Washington, D. C., in one of its recent publications, stated that a Spanish firm desiring to purchase disc talking machines and records of every description manufactured in the United States would be glad to get the names and addresses of the largest dealers in New York, who are exporters of such specialties. While those interested can address the Bureau of Manufactures, stating that their letter is an answer to query No. 416, we may say that we have forwarded to this concern a copy of *The Talking Machine World*, which contains the advertisements of every live house in the United States.

The Columbia Phonograph Co., through their Chicago manager, A. D. Herriman, have leased the store at 118 West Third street, Davenport, Iowa, and will open a branch there.

**Would Make a Change**

**A Thoroughly Experienced** man wants position to manage a large talking machine enterprise. Years of successful results is my record. Do you want it? Is it worth anything to you? If you want a perfect system in your wholesale, retail, instalment, buying and selling departments, ask me for it. Correspondence strictly confidential.

**ADDRESS D**

Care of *The Talking Machine World*, New York City

**QUEER USES OF MACHINE.**

Spreading Anarchistic Doctrines in France—  
—How Discovered—Gave a Modest Violinist  
Courage to Bring His Talents Before Public.

Another of the queer uses of a talking machine is out to be revealed some time ago during work by the French police on an Anarchist case. A raid had been made on the house of a suspected Anarchist, but to the surprise and disgust of the authorities nothing more incriminating than a talking machine, some blank wax cylinders, and one containing sound vibrations were found. The latter was reproduced in the hope that something incriminating might be exposed. But it was discovered to be only a reproduction of a stump speech, and the record had evidently been badly used, for here and there irritating lapses in the piece occurred.

These did not arouse any suspicion at first, but on the record being again reproduced some time later it led a wily official to investigate what exactly were the words lacking. Securing a printed copy of the speech, he compared the two together, making a note of the missing words. The result was successful beyond his fondest hopes. The missing words proved to be nothing other than an Anarchist message of great importance, and led up to further disclosures which convicted not only the suspected man, but several of his confederates.

Another curious story connected with a talking machine is told of a Scotch violinist, who has since become famous. At that time the violinist had no idea of his real skill with the instrument and only played for the benefit of his friends. One day, however, he was persuaded to play a selection of music into a graphophone, and when the selection was reproduced a minute or two later the violinist received a pleasant surprise. Queer as it may seem, he was amazed at the beauty of his own execution, and for the first time an ambition seized him to appear in public, which shortly afterwards he did with pronounced success.

**VICTOR PUBLICITY AND THE DEALERS.**

Thoroughly believing in widespread and persistent publicity as is illustrated by large spaces in the leading magazines, trade and daily papers, the Victor Talking Machine Co. are making earnest efforts to impress the value of advertising upon their dealers and have issued a pamphlet under the title of "How to Advertise," which is illustrated with sample advertisements, showing the good and had forms and with reading matter, giving a comprehensive idea of what really constitutes good publicity and why. As an added incentive to dealers to advertise the Victor liberally in their locality the company have offered a series of prizes for best advertisements and great results are anticipated.

**MADE NEW UNIVERSAL CO. JOBBERS.**

On the 1st H. W. Macminimen returned from a trip through New York and Pennsylvania, touching the large towns only, for the Universal Talking Machine Manufacturing Co. He made a number of new jobbers. Mac has been in the business upward of thirteen years, and says he knows the "game" as well as the man who made it. H. R. Breeder is the latest addition to the company's traveling staff, starting out November 5, making his trip through Pennsylvania, and later going into New England permanently.

**C. D. SHAW IN BUSINESS FOR HIMSELF.**

In the early days Cortland D. Shaw was manager of sales of the Victor Talking Machine Co., and subsequently in charge of their premium machine department before it was cut out. Now Mr. Shaw has become a dealer, having opened a handsome store at 1061 West 52d street, Philadelphia, Pa., a fine residential district of the city, and is carrying the Victor, Edison and Zonophone lines. He is doing a fine business.

**Are you  
prepared  
for the  
holiday rush?**

The Christmas season is the time of all times when a dealer mustn't let his stock get behind. Customers can't wait indefinitely for goods you haven't in stock, and excuses and apologies don't go.

You should have everything in ship-shape for this holiday trade. It gives you more than an opportunity for present profit. It is the greatest chance in the world to cultivate new customers and an abundance of good will that means much for the future of your business.

The fact, however, still remains that no matter how careful you are in selecting goods, you're almost bound to fall short in some places and have to send a rush order to your jobber.

What if your jobber isn't equal to the emergency? Then you're in a pretty fix! You can't put the blame on the jobber—it's your fault for having such a jobber. The people look to you, not to the jobber.

You'll not find us wanting in any particular. Victor talking machines and records, trumpet horns, English needles, fibre cases and other accessories are here in large quantities and you can get whatever you want whenever you want it. All orders are shipped the same day they reach us.

Better send for a copy of our latest catalogue and keep it where you can easily refer to it.

**The Victor Distributing  
and Export Company**

77 Chambers Street New York





### THE UNIVERSITY EXTENSION

By Means of the Talking Machine Is No Longer a Dream But a Fact—It Forms One of the Features of the New Correspondence School Opened by the University of Wisconsin.

(Special to The Talking Machine World.)

Madison, Wis., Nov. 7, 1906.

One of the most important features of the new correspondence school just opened by the University of Wisconsin will be the use of talking machines. The leading professors will read their lectures into the machine, and the records will be sent to students at different points. The innovation will be first tried with German, in order to test the feasibility of accurately reproducing the pronunciation of different sounds. The new move has occasioned considerable comment. For instance, the State Journal, in an editorial, makes the following remarks on this subject:

"University extension by phonograph. What limitless possibilities are suggested in this twentieth century idea. It is bringing the university home to the people with a vengeance. It is likely to Bostonize the entire State. No longer will it be necessary for the ambitious youth of limited means to come to Madison and spend four expensive years here. All he will have to do is to invest in a phonograph, send his rolls to the professor and when they return place them in his machine, light his pipe, lean back in his chair and listen to the melodious voice of the prof. No necessity of changing his jeans or taking off his felt boots. Education can go hand in hand with production at minimum cost of time and money. Instead of the family being obliged to listen to idle gossip or the rasping, metallic strains of "My Old Man," the dinner hour can be made uplifting and profitable with a lecture on organic chemistry or the sources of Browning's inspiration. And the beauty of it is that the lecture can be repeated and again repeated till the weighty truths are sunk in the

mind to stay. Even to the professor the plan must have its attractions. If he likes to hear himself talk here is a way by which he can be gratified to his heart's content. Then, too, the music of the junior prom, of student recitals, etc., can be brought home. The next logical step will be the vitascope with its supplementary moving pictures to present the scene to the eye also. The possibilities are limitless indeed."

### FREDERICKSON-KROH CO.'S BIG LINE.

(Special to The Talking Machine World.)

Oklahoma City, Okla., Nov. 10, 1906.

One of the largest stocks of talking machines brought into the Southwest was recently placed in the new parlors prepared especially for that department in the basement of the Frederickson-Kroh Music Co.'s store at 221 Main street, this city. The company are handling both the Edison and Victor lines, including the Gold Seal records reproducing the voices of the famous grand opera singers. A series of Saturday night talking machine concerts has been instituted and they are expected to go far toward popularizing the new branch of the business.

### ENTERPRISING BROCKTON DEALER.

L. R. Porter, the progressive talking machine dealer of Brockton, Mass., had a novel window display recently in the shape of the first Victor talking machine ever made, with the world-famous Victor dog looking down the horn. The exhibit was placed on a revolving platform and the remainder of the window filled with the latest Victor machines, to which were attached the legend, "Buy a Victor, but look out for the dog." As an added attraction Mr. Porter advertised to give a sheet of music free to every visitor to his store, and also held talking machine concerts.

Mr. Porter also handles the Edison line and claims to have in stock every record in the Edison catalogue.

### LOOKS LIKE PROGRESS IN DENVER.

A Splendid Business Worked by Malcolm B. Henry for the Columbia Phonograph Co.—Carries a Complete Stock.

(Special to The Talking Machine World.)

Denver, Col., Nov. 8, 1906.

The branch of the Columbia Phonograph Co. in this city, under the management of Malcolm B. Henry, is one of the most progressive in the West, and are selling goods faster than fresh shipments can be received. The stock at this store contains 30,000 records, 16,000 of them of the disc variety, and the balance, 14,000, "X P" or cylinder records. The stock of machines of all styles averages 100. The stock is said to be one of the most complete between Kansas City and Salt Lake.

An item of interest is that Mr. Hamilton, of this branch, took a \$100 disc machine on the recent trip of the International League of Press Clubs, and it was played almost constantly throughout the journey of 1,400 miles. So pleasing did its music prove that a member of one of the clubs at the end of the trip purchased the machine, together with four dozen records.

Mr. Henry, the manager of the store, was married on October 15 to Miss Myrtle McGowan, of Decatur, Ill. He is well known to the trade, having been previously connected with the Hawthorne-Sheble Mfg. Co. and the American Record Co. He is an energetic exponent of the talker, as is evidenced by his work since he became associated with the Columbia Phonograph Co. on July 1.

C. N. Hibbard, western manager of the commercial department of the National Phonograph Co., with headquarters in Chicago, spent several days in Des Moines, Ia., recently, where he demonstrated the use of the Edison commercial phonograph in the store of Hopkins, the company's agents in that place. Mr. Hibbard succeeded in interesting a number of business men in the new system.

**The O. K.  
Horn Crane**

TO RETAIL AT

**\$1.25**

—THE—

**Universal  
Horn Crane**

TO RETAIL AT

**\$1.75**

Both styles adapted for Edison  
and Columbia Machines.

We take pleasure in announcing that broad patents have recently been allowed on our Horn Cranes.

**The Ideal Fastener Co.**

143 Liberty Street, New York





5

1000

of an inch is a small space



BUT IT IS THE SIZE OF THE GROOVES ON A DISC TALKING MACHINE RECORD IN WHICH LAY THE SOUND IMPRESSIONS. UNDER A STRONG MICROSCOPE THEY LOOK LIKE THIS

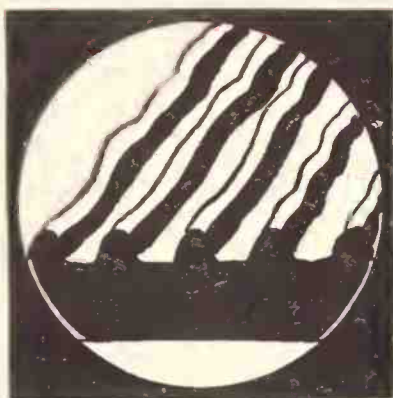

It can now be readily seen how easily these minute grooves, which are little larger than a horse hair, are filled up with dust, grease from handling, chips of steel worn from the needles and other deposits.

Therefore when these grooves become filled, they clog the sound impressions, prevent the needle from properly entering

[SEE NEXT PAGE]







the track, and destroy contact with the sound waves the result being a poor chattering reproduction, unpleasant and annoying to the listener, who condemns the record or the machine, never realizing that a dirty record is the real cause. A little *Recordite* will correct this trouble. The most dangerous enemy to the advancement of the talking machine business is a clogged record. *Recordite* will free it from this bad spot and increase your sales a big percentage.

No matter how good a machine may be, to work well it must be kept well cleaned and oiled. This is what *Recordite* does—it cleans, lubricates, preserves and polishes Disc Records, of all kinds. Every dealer should have a stock on hand especially now for the holiday trade. We want you to write, to day for our circular and *Special Introductory Offer*. Get your orders in now. *Recordite* is put up in an elegant package and will ornament the finest counter in the talking machine trade.



## Recordite Company

1905 Park Avenue

NEW YORK CITY





**TRADE NEWS FROM ST. LOUIS.**

October Trade Very Active—T. P. Clancy With Columbia Co.—Fuhri Changes in Chicago—Thiebes-Steirlin's Fine Department—Other Items of News from Sainly City.

(Special to The Talking Machine World.)

St. Louis, Mo., Nov. 10, 1906.

Talking machine trade for the month of October was very active, and showed a nice improvement over that of September, and the demand for high priced machines was particularly good. The demand for records has been most excellent, and there are complaints of shortage in both machines and records. Trade is expected to establish a new record for the winter season.

Thomas P. Clancy, who has been manager of the talking machine department of the Conroy Piano Co. for the last several years, and one of the most popular and energetic men in the talking machine business, has accepted the local managership of the Columbia Phonograph Co., and will assume his new duties about Dec. 1.

W. C. Fuhri, who has charge of the Columbia Phonograph Co.'s interest in this territory and West, will move his headquarters to Chicago, but will have charge of all the Western territory. The departure of Mr. Fuhri from this city has caused many expressions of regret, as he has established a very excellent standing here as a high class business man, and one who does business on a very lofty basis. He will leave about Dec. 1.

Manager D. S. Ramsdell, of the St. Louis Talking Machine Co., states that trade is very good, but that they are handicapped in getting goods. They are having an excellent demand for their new \$200 Victrola machines.

The Thiebes-Stierlin Music Co. have just completed a fine talking machine department on their first floor, which is in charge of S. R. Brewer. It consists of four fine booths, handsomely equipped, and constructed strictly with all the modern arrangements. Mr. Brewer is to have an assistant at an early date.

The Val A. Reis Music Co. now have their talking machine department running nicely, and they report a good volume of activity.

Marks Silverstone, president of the Silverstone Talking Machine Co., reports a nice trade and that he is doing exceptionally well with the new Victrola of the Victor Talking Machine Co.

E. B. Walthall, manager of the talking machine department of the O. K. Houck Piano Co., reports trade good, and that he has sold a number of Victrolas that are yet to arrive.

The talking machine department of the H. A. Phipps Piano Co. is now complete, and they are pushing it with good results.

Mr. Brown, of the advertising department of the Victor Talking Machine Co. at Camden, N. J., was a recent visitor here.

**WORKING OUT THE PHONOGRAPH.**

James Creelman, the well-known writer, in the course of an interesting article in Pearson's Magazine, on "The Cry for 'Brains,'" refers to Mr. Edison's connection with the development of the phonograph as follows: "One of Mr. Edison's assistants has recorded the fact that, in working out the phonograph, the inventor has spent from 15 to 20 hours a day, for six or seven months at a stretch, shouting the word 'spezia' against the wax cylinders, in his effort to have the sibilants distinctly reproduced. The intense and prolonged labor which has resulted in the new business man's phonograph can scarcely be realized. But it took immense capital and a widespread organization to place the million or more phonographs of all kinds now in use."

After establishing and selling out several talking machine concerns, Pat E. Powers now owns and manages the furniture department in one of the leading stores of Buffalo, N. Y. The traveling men passing through the city stop off and josh Pat on his change of base.

**CARUSO TELLS OF HIS SUCCESS.**

One Man Gave Him \$3,000 for Two Songs—Got \$8,000 for Making Four Records.

The great success in Berlin of Caruso, who is so popular it took a squad of police to prevent the people from mobbing him, led the great tenor to give a very interesting sketch of his early life to the local press of that city.

"Up to eighteen years of age," Caruso said, "I was in doubt whether I had a tenor or a baritone voice. I started to sing in Italian churches when I was ten years old, and then at eighteen I tired of thinking over the problem of my voice, I began to take lessons, but I quit my first teacher very soon because he could not tell me anything about the quality of my voice. Another teacher found that my voice was so thin the other fellows in the school called it a glass voice, perhaps because it broke easily.

"While I was doing military service at Rieti I used to sing while shining the buttons of my uniform. Major Mogliati heard me and made me spend leisure hours for many months studying with a teacher he procured for me."

The great tenor says he is pleased now with his lot in life, and speaks freely of his success in America, where, when engaged by a millionaire named Smith to sing two songs, he got a check for \$3,000 and got \$8,000 from a talking machine firm for four songs, which because of a percentage on the sale have already brought him \$4,000 additional in one year.

It is said that Bonci, who is also engaged to sing in New York this winter with Hammerstein, has studied much more than Caruso, and had a harder time of it. He used to walk eight miles every day from Pano to Pesaro to attend the conservatory lessons, and he did this for over four years, no matter what the weather or the season.

The German Emperor, who was present with the Empress at a recent opera performance in which Caruso appeared, sent for the great tenor and after complimenting him on his voice and

acting, gave him a beautiful scarfpin of diamonds and rubies bearing the imperial initials in jewels. The management of the Berlin opera has engaged him for the next season. Caruso sings again with the Metropolitan opera forces this season.

**SWITKY'S NEW STORE.**

Opens Handsome Establishment on 42d Street With Mrs. Switky in Charge.

Benj. Switky, the enterprising talking machine jobber, has equipped a third retail ware-room at 253 West 42d street, near Eighth avenue. In these new quarters there will be carried a full line of all talking machine supplies, and the various styles of Edison and Victor machines. In the front are two large show windows in which samples of the various lines are displayed in a very effective manner, and is due to the ingenuity of Mrs. Switky, who will have charge of this branch of the business. Mrs. Switky is thoroughly familiar with the talking machine business, a very clever saleswoman, and will demonstrate the fact that a woman can make a success in the talking machine field.

**A \$2,000,000 CORPORATION (?)**

Among the incorporations filed with the Secretary of the State at Albany on Monday last was that of the Atlantic Phonograph Co., for the purpose of manufacturing and dealing in all kinds of musical merchandise. Capital, \$2,000,000. Incorporators: Joseph L. Adrian, Peter Mannebach and C. D. R. Adrian, all of New York, and Frank C. Hamilton, Syracuse, N. Y.

**START INSTALMENT DEPARTMENT.**

An instalment department on a large scale has been installed by C. C. Mellor Co., Ltd., Pittsburg, Pa., under the supervision of Ollie Oldhansen, the talking machine manager who is so popular with the traveling men. They have recently added the Zonophone line.

**THE BLACKMAN CYLINDER RECORD TRAY**

(PATENT APPLIED FOR)

**A Record Tray and Record Label for Less Than One Cent**

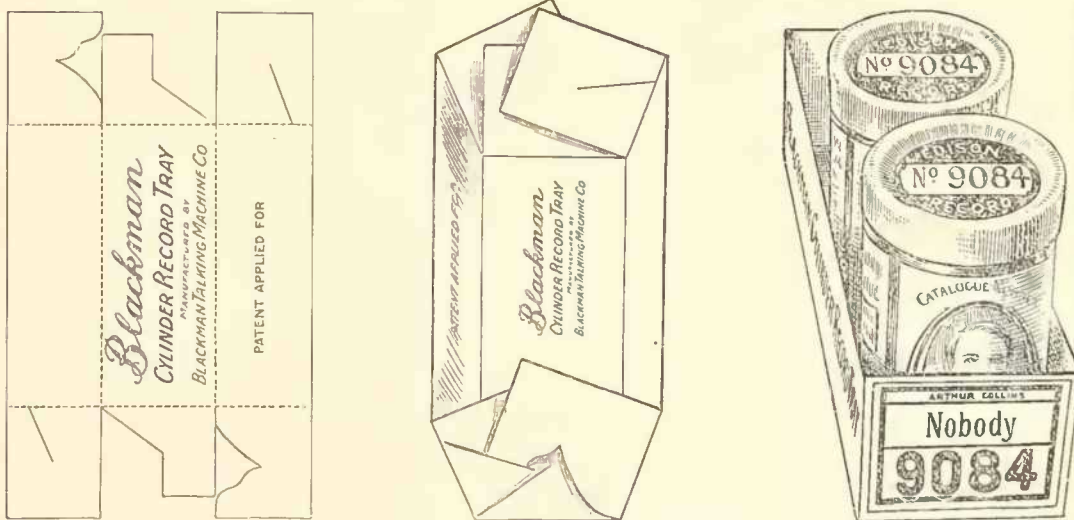

We ship them Flat and they can be FOLDED into a STRONG TRAY in a few seconds, as shown above. This tray, with the RAPKE Record LABEL, makes a HANDSOME looking stock and a SYSTEM that you can't beat. Full particulars on request.

Prices for Trays to hold				Rapke Labels with Edison numbers and names	
	RECORDS	\$5.50	PER		
2	"	6.50	"	1000	Domestic Selections No. 2 to No. 9433
3	"	7.50	"	1000	which includes Dec., 1906 - - - \$3.50
4	"	8.50	"	1000	Year's Supply Labels thereafter - 1.00
5	"	9.50	"	1000	
6	"			1000	

Smaller quantities, same rate

FREE SAMPLE of tray and labels to any Edison dealer or jobber who writes on his business letter head.

**Blackman Talking Machine Co.**

(J. NEWCOMB BLACKMAN, Prop.)

97 Chambers Street, New York City



**BEKA RECORD**

**THE BEST and CHEAPEST DISC**

**IN THE WORLD**

*The largest and most Comprehensive Repertoire which has  
ever been compiled, in*

**GERMAN**  
**ENGLISH**  
**FRENCH**  
**ITALIAN**  
**PORTUGUESE**  
**RUSSIAN**  
**AUSTRIAN**  
**HUNGARIAN**  
**DANISH**  
**SWISS**  
**DUTCH**  
**SPANISH**

**CHINESE:**  
SWATOW  
GUAKAU  
PEKINESE  
SHANSINESE  
KIANGNESE  
CANTONESE

**ARABIAN**  
**TURKISH**

**HINDUSTANEE:**  
URDU  
MARATHI  
GUJARATHI  
HINDI  
TARSI

**TAMIL**  
**MALAYIAN**

**INTERNATIONAL CATALOGUE (224 Pages) GRATIS**  
*(See description in pages 23 and 24 this issue)*

**UP-TO-DATE ADVERTISING**

**CORRESPONDENCE INVITED**

**Beka Record, G. m. b. H. Berlin, Heidelberger Str. 75-76**

**SOLE AGENT FOR GREAT BRITAIN AND COLONIES**

**O. RUHL, KIMBERLEY HOUSE, 6 and 7 REDCROSS ST., LONDON, E. C.**



# FROM OUR EUROPEAN HEADQUARTERS

69 BASINGHALL STREET, LONDON, E. C., W. LIONEL STURDY, MANAGER.

## THE TRADE IN ENGLAND.

**Business Uneven During the Past Month—Factories, However, Are Very Busy—Price Cutting Being Discouraged—Great Financial Showing by Gramophone Typewriter Ltd.—Henry Seymour, Ltd., Brings Out Novelty—Sterling Special Record Popular—Remarkable Zonophone Sales—Cromelin's Speech Noticed—Recent Business Changes—Interesting Suit—Great Beka Catalogue—Columbia Co.'s Grand Prize—Some Pathe Freres News—The Month's Happenings in Detail.**

(Special to The Talking Machine World.)

London, England, Nov. 6, 1906.

The last month has seen rather a lull in certain quarters, although it is satisfactory to observe that sales have maintained a good average generally. In some districts dealers complain that business is quiet in comparison to a few weeks ago, while others declare for increased sales. The factories are up to their eyes with orders, and the manufacturers are unable to meet the demand. In conversation with the head of one of the largest cylindrical record concerns, he said: "It is a fact that the condition to-day is far and away ahead of any previous season. The stupendous and ever-increasing shoals of orders are more than we can cope with. Our factory has been considerably enlarged, and is working every minute of the twenty-four hours, yet we cannot get in front of the demand." These words are synonymous to what other manufacturers state, so it is pretty evident there is an abnormal demand, which every dealer should secure a good share of. The labor market is still in a very unsettled state, but the country is more quiet than last month. Price-cutting is being vigorously discouraged on all sides, and altogether the talking machine industry is in a most satisfactory condition. Witness the report of the Gramophone and Typewriter, Ltd., for the year ending June 30, last. The trading result is a credit balance of £212,236. Add to this the amount brought forward from last report, £445,297, makes a grand total of £657,533. The increase is over £72,000 on the previous year. An interim dividend of 10 per cent. had already been paid on the ordinary shares, and it was now proposed to pay in addition a bonus of 10 per cent., leaving, to be car-

ried forward, £487,176. Since the company was started, they had paid altogether 90 per cent. to the original shareholders. There has been a considerable increase in the demand for the company's goods during the year, as compared with the previous year, and the directors report that such demand continues; the sales for the three months—July, August and September, 1906—being considerably in excess of the corresponding months of last year.

### Howell Bros. Great Business.

Howell Bros., the well-known factors of St. John street, Clerkenwell, report a splendid business state. At the time of my call they were busy unloading a large vanful of records. These I learned were a portion of a consignment of "Rex" records, issued by the late Lambert Co. Altogether, Mr. Howell has bought from 70,000 to 80,000, and dealers would do well to get into touch with the firm at once if they wish to secure a share of the bargains.

### How the Gramophone Sells.

Walking into the Regent street quarters of the Gramophone & Typewriter Co. the day after Caruso's appearance in Berlin, a gentleman, after listening to certain of the renowned artist's records, purchased £50 worth before he left.

### Another Unbreakable Record.

At the offices of Henry Seymour, Ltd., I saw some good specimens of what they claim to be an unwearable and unbreakable record. Unlike other attempts put upon the market, its surface is as smooth and as perfect as the genuine Edison wax records. It is made of an entirely new composition, which cannot be gouged into at present; suffice it to say that the principal ingredient is celluloid, but experiments are still being made to obtain a non-inflammable material. The tone of the record is ideal, while the surface noise is nil.

### The Sterling Special Record.

The Sterling special record has won for itself such a tremendous sale that the Russell Hunting Co. are a long way behind in the execution of their orders. Mr. Manson reports the huge factory capacity as inadequate, although working night and day. List No. 26 contains some fine selections, many of which, it is expected, will gain enormous popularity, particularly the descriptive record, entitled "Trafalgar." The Linguaphone language series of records are boom-

ing. The provincial factors are taking up and pushing the sales with marked success. I am asked to give denial to the rumor now current that this company have marketed a new cylinder machine. There is no truth in the report, outside the fact that a machine will eventually be manufactured and issued by the Russell Hunting Record Co., who have in hand the perfecting of an instrument that will be thoroughly reliable and a credit to the firm.

The Odeon and Fonotipia records are going well, and there is a notable increase in the sale of those selections, recorded under the supervision of Russell Hunting. The vast tone improvement and general power will surely win additional favor and demand for these discs.

### Will Stock Gramophone Goods.

A matter of considerable interest lies in the fact that the Edison Bell Co. have decided to stock gramophone goods. There is a good demand in the West, and the company have rightly set out to fulfil it.

### American Talking Machine Co. Catalogue.

The American Talking Machine Co. will shortly issue a new catalogue, which it is said will contain an illustration of every talking machine on the British market. The time taken in its preparation and the expense involved is sufficient justification of the company's claim that it will be absolutely the most comprehensive general catalogue of its kind.

### Remarkable Sales of Zonophone Records.

The remarkable sales achieved by the Zonophone records is a matter of comment throughout the trade, and the boom is still on. The company's representatives are busy "accepting" orders, which is rather reversing the usual method of salesmanship. Mr. Malyon, the assistant manager, gave some very interesting details respecting the popularity of his company's products. Said he; "In the first place we know the sale of our records will continue to show an increase week over week throughout the season. Why? Because we cater to the popular taste." "And that is, Mr. Malyon?" "Out of the many class of selections we list the majority are of a serio-comic nature, and therein lies the point of Zonophone popularity. Yes; our list of classical, sentimental and other class selections reach a good sale, and in our November list they are fairly represented, together with four Welsh titles. The number of ten-inch records sold is more than

# THE BEST IN THE WORLD HOWELL BROS. SOUND BOX

Adapted for Victor Taper Arm and also Direct Horn Machines

Dealer's Price \$1.50

You can afford to pay duty on this and then have a better line than any in the States.

Europe, Asia, Africa and Australia have expressed their satisfaction with our Sound Box and now we want to supply the rest of the World

**HOWELL BROS., St. John St., CLERKENWELL, LONDON**





**PATHE FRERES—LONDON**  
**PATHE FRERES—LONDON**

# PATHE'S DISC



ONCE YOU HAVE HEARD  
**PATHE'S DISC** YOU WILL  
 NEVER BUY OTHERS.

**PATHE'S DISCS** ARE PLAYED  
 WITHOUT A NEEDLE, HENCE THEIR  
 GREAT SUPERIORITY.

THE TIME FOR FANCY PRICES  
 FOR DISCS IS PAST WE GIVE YOU THE  
 GREATEST STAR ARTISTES AT ONE  
 UNIFORM PRICE, 3/- PER DISC.

THE GREAT SUPERIORITY OF THE  
**PATHE DISC** IS OBTAINED BY  
 USING A SAPHIRE POINT, THERE  
 IS NO CHANGING THE NEEDLE,  
 GIVES THE NATURAL VOICE.

**PATHE'S REPERTOIRE**  
 CONTAINS OVER 20,000  
 SELECTIONS DRAWN FROM  
 ALL PARTS OF THE WORLD.

# PATHE'S PHONOS

LONDON WAREHOUSE, 14, 16, 18, LAMBS CONDUIT STREET (W.C.)  
 LONDON RETAIL SHOWROOMS, 64, REGENT STREET, LONDON (W.)

**PATHE FRERES—LONDON**  
**PATHE FRERES—LONDON**



FROM OUR LONDON HEADQUARTERS—(Continued.)

three times that of the seven-inch, which goes to prove, in spite of the price difference, that the user appreciates best the record that will give most music."

#### Lecture on Evolution of Gramophone.

Under the auspices of the Polyglot Club, Harry Burgess entertained a large audience at the Holborn restaurant with gramophone reproductions, after first delivering a very interesting lecture on the history or evolution of the instrument. The Gramophone spoke and sang with absolute accuracy in English, French, German, Italian, Spanish and Russian. No flaw could be found in the reproduction of accent or intonation, the records being played with unimpeachable fidelity. Songs by Melba, Patti, Caruso and others were given, and were surrounded by an air of reality by the aid of limelight portraits of the artists, shown at the side of the instrument. The recital and lecture were both highly successful.

The suggestion has been made that the heads of the department of education might well give their serious consideration to making use of the Gramophone as a means of training the ear in the study of foreign languages. It is an excellent idea, and one that should be vigorously followed up by the company concerned.

#### The General Phonograph Co.

"Now, Mr. Latham, I would like you to inform The World readers of the latest events concerning the products of your company." "Yes? Well, now, the best news that occurs to me just at the moment is that we have now doubled the producing capacity of the factory, which is continuously at work night and day, turning out the White records as fast as possible. Even with our greater manufacturing facilities we cannot catch up on the orders in hand, but it will ease matters to some extent. The demand is a daily one, every post brings orders, and it is gratifying to observe that many orders are being placed by foreign and colonial dealers." My informant continued: "We are issuing many new show

cards of an original nature, both in respect to the wording and design. Letters of appreciation still reach us, and it is evident the public demand will be well maintained." A fine new list of record titles will be found in the company's advertisement.

#### Trade Conditions in North Wales.

The winter season has up to the present always been associated with the best talking machine sales, but the old order changeth in North Wales. A dealer located there has just written the General Phonograph Co. that summer is the best time for sales. He is evidently situated in a little out-of-the-way place that is practically deserted in the cold season.

#### Cromelin's Speech Much Noticed.

The complimentary dinner to Mr. Marconi in New York in celebration of his association with the Columbia Phonograph Co. and which furnished the occasion for some exceedingly interesting speeches, as noted in The World, have been much remarked here. The remarks of Mr. Cromelin, vice-president of the company, are particularly significant, forecasting, as they do, the probable future of the talking machine. The following quotation from Mr. Cromelin's speech has been specially noticed: "It is not disputed that a talking machine without a diaphragm or other medium than the air is actually possible and practicable. No needles, no friction, no noise. Be on the lookout for it, for it surely is coming. The future offers much more of a field for inventive effort and application than has been covered in the past. The surface has hardly been scratched. I have an abundant faith in the lasting quality and permanency of the talking machine enterprise. I have little faith in the permanency of the present forms of either machines or records, and I seriously believe that before the works of Marconi and his contemporaries become history, present-day talking machines and records will be looked upon as curious specimens in the evolution of the art, much

as we to-day consider the Edison tin-foil phonograph and the original Bell and Taintor treadle-gramophone."

#### Unique Acknowledgment Card.

A most unique acknowledgment of order card has been issued by the well-known and popular Charlie Howell. When on the continent our friend had his photo taken, showing, of course, the usual continental smile. This has been reproduced on the card together with a contrasting photo of his appearance when in London. One shows the man of business, the other the man of pleasure. The idea is amusing, but it is not without its value from a publicity point of view, as such little departures from the ordinary cut-and-dried business methods, tend to remind us that the firm are alive and are ready to handle another order.

#### Singophone, Ltd., Succeed Bruce & Co.

I am advised that the business hitherto carried on at 151 High Holborn under the name of David Bruce & Co. will in future be transacted by the newly registered company, Singophone, Ltd. With a capital of £5,000, the new concern will be in a position to push more vigorously the patents they control.

#### Some Specially Fine Imperial Records.

The November list of Imperial records (Cook's Athletic Co.) includes some very fine violin selections by Harold Eisenberg and Frederic Voelke. There is also listed some splendid duets by favorite singers and a French-Canadian song by F. A. Archambault. Henry Burr's "Teasing" and "Battle Cry of Freedom," which I had the pleasure of listening to, are both rendered in a clear and perfect manner, and there is a noticeable absence of all foreign noise. Messrs. Cook are working at high pressure, which says enough for splendid sales.

#### The "Beka" International Record Catalogue.

Undoubtedly the finest, most comprehensive and up-to-date record catalogue issued for some

"BY TEST"—"THE BEST"

# "WHITE" RECORDS

"WHITE" RECORDS  
 "WHITE" RECORDS  
 "WHITE" RECORDS  
 "WHITE" RECORDS

We wish to call *special* attention of *colonial* dealers to the fact that the "*White Record*" is of *British* manufacture, and the purchase of this record means the saving of duty, owing to the *preferential tariff*.

The four principal points of the "*White Record*" are sound well, wear well, look well and sell well. Quality unsurpassed, reproduction perfect. *Make a note* of these points.

"WHITE" RECORDS  
 "WHITE" RECORDS  
 "WHITE" RECORDS  
 "WHITE" RECORDS

**RETAIL PRICE, ONE SHILLING EACH**

WRITE US FOR LISTS AND FULL PARTICULARS OR FACTORS

**THE GENERAL PHONOGRAPH CO., Ltd.**

26 Euston Bldgs., Euston Road, London, N. W., England



## FROM OUR LONDON HEADQUARTERS—(Continued.)

time, is that emanating from the now famous Beka Record Co., of Berlin. The title, "International," will of itself convey to the mind some idea of the far-reaching associations this catalogue embraces. Original records have been made in all the principal European countries. The list of selections covers all tastes from classical to comic, and the whole are systematically tabulated and arranged, according to class and country, under their particular headings. I do not know how many—it would take a day or more to count—but the "titles" in this book must reach many thousands. Just think of the amount of time, trouble and expense involved in obtaining and recording all these selections, and the enormous quantities of patience required to compile such a unique catalogue as the one under review, and—well, I am rather inclined to the belief that some of us would have had enough "thinking" to last for the rest of our earthly term. And yet, there it all is, contained in this one book, which can be had by application to the company's offices in Berlin. As a last word or two, I would say that the general get-up is without a fault, the printing is good, on fine art paper, and the excellent, not to say very pertinent design on the front cover, speaks of a very clever brain among the Beka Record Co.'s members. An idea of the scope of the Beka records can be gleaned by a perusal of their advertisement on page 20 of this issue.

**Columbia Co. in Their New Quarters.**

During the past month the Columbia Phonograph Co., General, have taken up their abode in their new premises at 64-66 Oxford street, just above Tottenham Court Road, and the crowd of people always to be met at this busy point have watched, with undisguised interest, the transformation of the empty building into an attractive depot stocked with inviting goods. The advertising value of the new establishment has thus been early demonstrated. Meanwhile business has proceeded apace within. The staff have found themselves most comfortably housed, with every facility at hand for the efficient discharge of their respective duties. Every department, however, has not moved west, and, while headquarters are to be at Oxford street, the company will still utilize their city premises in Great Eastern street.

**Grand Prize for Columbia Exhibits.**

The adjudicators' awards at the Milan Exposition give grounds for congratulation to the Columbia Phonograph Co., General. The Columbia

exhibits have gained the grand prize, and the company have thus added another link to their unbroken chain of unrivaled exhibition successes. Needless to say, the Columbia people are very gratified with the triumph.

**Turning Out Disc Records.**

The Columbia Co.'s London factory is turning out disc records at a great rate. The new plant, including the necessary hydraulic presses and other costly and up-to-date machines, is quite completed, and the company are therefore thoroughly well equipped for big business. Like the "Symphonic" and "Lyric" gold moulded records, Columbia discs now come under the denomination "Made in England," and the nearness of the source of supply is a guarantee of prompt execution of orders.

**IMPORTANCE OF DRIVING BELT.**

A Good Many Machines Spoiled by an Ill-Fitting Strap—Some Pertinent Pointers by Philip Neale, the Talking Machine Expert.

(Special to The Talking Machine World.)

London, England, Nov. 3, 1906.

Philip Neale, the talking machine expert, contributes the following talk on "Driving Belts" to The World, which will doubtless interest its many readers throughout the world:

"A good many machines, and I may add some of the best, are completely spoiled by an ill-fitting strap, an uneven strap, a crooked pulley, etc. This is noticeable in records of a lady's voice. You are listening, say, to Mme. Narelle singing that beautiful song, "Silver Threads Among the Gold." You notice every few words a slight failing of her voice, the more educated you are to good singing the more you will notice it, and if you think your machine is the cause, where would you look for it, not to that innocent little piece of leather. You go at once to the motor; you fancy a wheel touches at each revolution, perhaps a faulty tooth, or the spring wants oiling; but should you happen to examine the strap you will find a bad join, a part of the strap thicker than the other, or uneven sides sometimes. If the strap is all right, you will find the little pulley which "takes up the slack" is not working freely; but whatever fault you find, that fault will be more or less noticeable in the singing, because it is directly connected with the cylinder.

You go to the phono. repairer, whether amateur or not. I will explain this little pulley.

You will notice that the outside, upon which the strap runs, is oval in shape. This is done to encourage the strap to keep to the middle and not run off, because the strap will always run to the largest part of the pulley. It also, if properly adjusted, will keep the strap running in its proper place on the cylinder and driving wheel. To remove oil from the strap, wash it in benzoline. To join a new or broken strap trim the ends and cement with mendine. Use a thin strap, especially for the Koh-i-nor type. Of course, there are other causes for flat notes in the singing, but they are more easily detected, i. e., the feed screw too tight, cylinder ditto, motion wheels uneven, feet nut not true on the thread, especially in the "Home" machine; but I will deal with these more fully in my next article, "Governors of All Machines" (illustrated), which I think will interest the Talking Machine World readers. I shall explain with illustrations how the governor of the Koh-i-nor, although, properly made, is put together wrong, always has been, and, I suppose, always will be. Take the "Gem," for instance. Why is the little pulley put on the down-hill side of the stop different to all other machines and decidedly wrong."

**PATHE FRERES ADVANCE.**

This Distinguished House Issues New Goods—New Disc Record and Machine—A New Sound Amplifying Device.

(Special to The Talking Machine World.)

London, England, Nov. 4, 1906.

Sometime back it was announced that the famous house of Pathé Frères, London, would soon place on the market entirely new goods. In the case of the forthcoming manufacture of disc records, we were promised certain improvements in the recording system that would practically cause a revolution in the trade. Then again many whispers were in the air of a special arrangement and other new departures in connection with their machines. We waited, and we were not disappointed. All promises have now been fulfilled, and to-day sees great advances, both in the new cylinder machines and tonal qualities of the records, while we have also a new departure in the shape of disc records and disc machines. Such is the general information, and in order to obtain detailed particulars I sought an interview with Mr. L. H. Courant, who courteously supplied news of much interest to The Talking Machine World. "Yes," said Mr. Cour-

**The Russell Hunting Record Co., Limited****MANUFACTURERS OF THE "STERLING" RECORD**

ARE THE LARGEST MANUFACTURERS OF RECORDS IN GREAT BRITAIN. OUTPUT 125,000 WEEKLY.

Every Sterling Master is Recorded by RUSSELL HUNTING The Originator of the "Michael Casey" Series.

WE GUARANTEE EVERY RECORD TO BE PERFECT.

**"STERLING"**

GOLD MOULDED RECORDS 25 CENTS EACH.

LIBERAL DISCOUNT FOR EXPORT.

Canadian, New Zealand and South African Importers will save Duty by Importing BRITISH MADE RECORDS.

**THE RUSSELL HUNTING RECORD CO., Limited**

81, City Road, London, E. C., England

**Electro-Mechanical Engineering Works**

211 HACKNEY ROAD, LONDON

EXPERTS FOR RECORDING, DISCS & CYLINDERS  
DUPLICATING and MOULDING

Try our London Popular Record

**PHILIP NEALE,**

PHONO. EXPERT,

5 Chalk Farm Rd. LONDON, N. W.

Talking Machines of every description repaired. Special terms to the trade. City address and price list on receipt of postal. No job too small—no job too large.

**Have You a London Representative ?**

If your goods are not represented in this market, they should be, as there is a good opening for smart American Talking Machine Accessories or Novelties. Communicate with Box 100, Talking Machine World, office, 69 Basinghall Street, London, England.

**LATEST NOVELTIES**

The "Cordock" Concert Reproducer for Puck and similar type machines. Acknowledged by experts to be the finest reproducer on the market for small Phonographs, 50 per cent. louder than any other reproducer of its kind. For volume, clearness and distinctness of tone, it stands alone unequalled. Factors should write for sample and wholesale prices, to

G. W. CORDOCK & CO.

High Street, Scunthrope, Linc's, England.





FROM OUR LONDON HEADQUARTERS—(Continued).

AN INTERESTING SUIT.

Edison Bell Co. on Suspended List—National Phonograph Co.'s Action—Judge's Extraordinary Remark on Trial of Suit.

(Special to The Talking Machine World.)

London, Eng., Nov. 7, 1906.

Described by counsel for the defense as a case containing the charms of novelty and ingenuity, was the action brought by the National Phonograph Co., Ltd., against the Edison Bell Consolidated Phonograph Co., Ltd., to recover damages for the loss of trade alleged to be due to the conduct of the defendants. It was stated that the Edison Bell Co. had been placed on the plaintiffs' blacklist, but despite this had obtained 700 of their phonographs. They were procured through the plaintiffs' agents, who acted either in ignorance or in deliberate breach of their agreements with the plaintiffs not to supply anyone on the "black" or "suspended" list. The defendants paid full trade prices for the machines, and it was not alleged that they had sold under price to the public. The grievance was that they had sold their own records with the machines, and that the plaintiffs accordingly lost a profit they would otherwise have made. It was said that the sale of records was the most profitable part of the business, and that the loss in connection with the 700 machines was £660. It was also claimed that the action of the defendants had been detrimental to the general sale of plaintiffs' machines, as people, thinking they could get them from the Edison Bell Co., would go there, and then probably buy one of the defendants' machines instead.

His Lordship, Mr. Justice Joyce, suggested that the falling off in business might be accounted for by the fact that "thousands of people may be getting tired of such nonsense."

The defendants denied that they had done anything wrong. Judgment was reserved, His Lordship remarking that it was a curious case.

LATEST ENGLISH PATENTS.

Compiled for the Talking Machine World by an Expert in London—Will Give Americans an Idea of Developments on the Other Side.

(Special to The Talking Machine World.)

London, England, Nov. 6, 1906.

The following list has been compiled exclusively for The Talking Machine World by Cassell & Co., 90 Chancery Lane, to whom inquiries relating to all patents should be made:

No. 7472. Dated March 28, 1906. Complete

patent accepted October 4, 1906. Ferdinand von Madaler and Neophone, Ltd., "Improvements in and Apparatus for Sound Reproducing Machines."

The object of this invention is to provide means whereby Edison phonograph or hill and dale cut records may be reproduced by means of a needle or fine sapphire point fitted at the edge of the diaphragm to a connecting bar as in the case of the Berliner records.

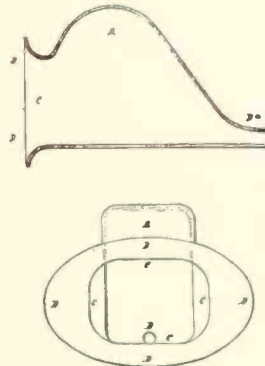

As shown, the needle or pointed sapphire is fitted by a screw l at the edge of a diaphragm to one extremity of the usual connecting bar communicating with the diaphragm. In order to accomplish the object of this invention, the face of the diaphragm is placed upwards with the needle or sapphire extending

from its edge from the lowest point of the diaphragm so that the common plane of the diaphragm and the needle is inclined at an angle of 45 degrees to the approaching track of the record when being reproduced. The diaphragm sound box e is then connected with the sound arm c by means of a short tube g provided with a plate k sliding into a grooved plate f screwed to the back of the diaphragm sound box.

No. 1531. Dated January 20, 1906. Complete patent accepted October 4, 1906. George Henry Young's "Improvements in Horns for Phonographs, Gramophones and the like."

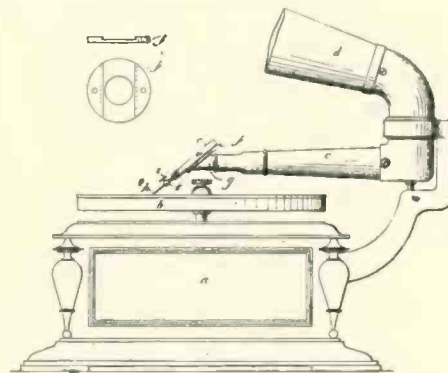

The object of this invention is to so shape the horn that space within it equivalent to the human palate or the belly of the violin is provided in which the sounds produced may be properly developed and a closer reproduction of the original in regard to quality and timbre be attained. As shown, a chamber A is formed between the

ant, "it is some time now since we took over the British interests, and although our new goods are but now ready, we have been very busy in the meanwhile, making a change here and an improvement there, until our whole organization has reached that pitch of excellence which enables us to offer a business service of the very best type." In answer to a question came the reply, "We have made arrangements to still further extend the cylinder record and machine departments, and so our facilities in this direction will be much appreciated by our phono customers; but as the trend of the times calls for flat records, and the demand is increasing each week, we decided to place both a disc record and machine upon the market. To deal with the record first, I may say it is based upon an entirely new principle of recording, whereby sweetness of tone runs all through. I myself can heartily confirm this latter statement, as each one of the records I heard were characterized by a richness of tone and complete absence of blasting or metallic sound. One peculiarity of this new recording system is that instead of commencing on the outside edge of the record each selection starts from the inner or center line. As for artists such talent as Miss Ada Crossley, Kirkby Lunn, Ben Davies, Delna Ancona, Caruso, Noté Alvaraz, etc., etc., and many others equally well known, help to provide records suitable to all tastes."

The new disc machine has a most handsome appearance, and is fitted with a specially strong motor and artistic flower horn. The sound-box is excellent, and is fitted with a sapphire pointed needle of the best quality. Details will be sent to all dealers who make application to the company (see advertisement in our column). A new sound magnifying innovation of much interest was also shown to me. It consists of a patent device attached to a peculiarly constructed speaker fitted with a sapphire point only. Connected to the reproducer is a long tube through which air is pumped by a small electric motor. The air current forces the sound waves much more strongly against the diaphragm, the increased agitation of which provides a volume of sound great enough to be heard a quarter of a mile away; and with all this powerful volume the quality of the tone is just as pure and sweet, if not better in this particular, than with an ordinary reproducer; in fact, it is absolutely lifelike and fully comes up to what the manufacturers claim. I was informed that dealers would be placed upon most advantageous terms, and full particulars will be sent on receipt of card at the company's warehouse in Lambs Conduit street London, England.

CARL LINDSTRÖM, G. m. b. H.  
BERLIN

LARGEST Continental Manufacturer of All Kinds of

TALKING MACHINES

Best Quality

Best Workmanship

Best Value

Agent for England and Colonies:

O. RÜHL, 6 and 7 Red Cross St.  
London E. C., England

To whom all inquiries should be addressed



# An Unusual Opportunity For a Small Investment

Buffalo Times—"The one weakness of the telephone as a means of communication—that it keeps no record—has been eliminated."

Washington Post—"There is no scratching sound, the words coming from the machine as clearly as from a human throat."

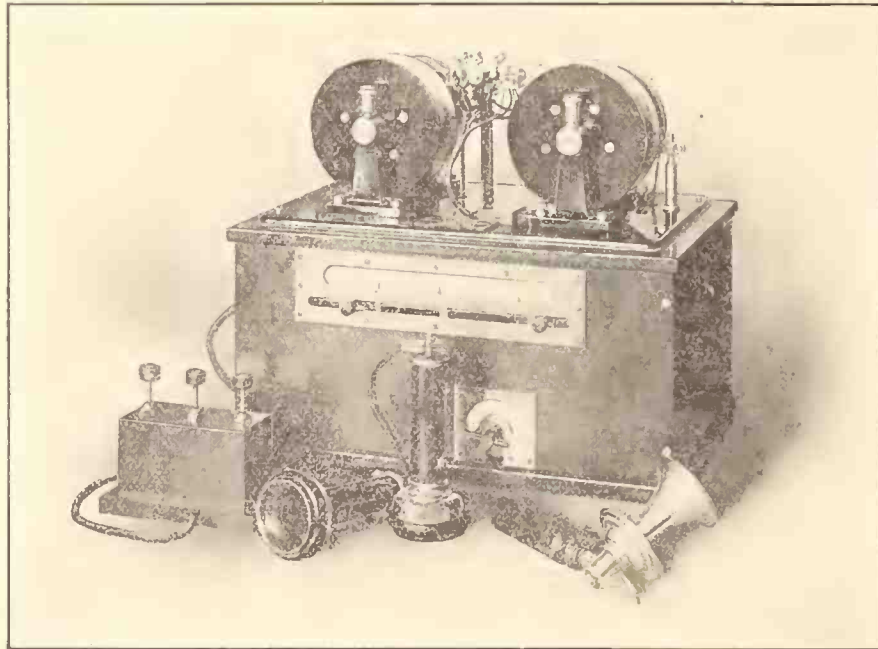

Cleveland Plain Dealer—"A thoroughly practical piece of office equipment, for which the demand has already outrun the supply."

Pittsburgh Gazette—"Promises to make as many fortunes as were made by the Mergenthaler typesetting machine."

Had you invested only \$10 in Bell Telephone stock a few years ago you could sell your interests to-day for more than \$20,000. Such opportunities for fortune-making investments occur only once or twice in a lifetime, when some great practical discovery is made which like the telephone, is susceptible of a "basic patent," securing to its owners an absolute and legitimate monopoly.

Such an opportunity is now open to the first few investors whose quick intelligence will enable them to see the vast practical usefulness of the

## Telegraphone

The general interest in this epoch-making invention has grown day by day until it is now the most earnestly discussed device in scientific and commercial circles throughout the world. This is because men realize that the practical usefulness of the TELEGRAPHONE will quickly make it a coveted thing

for every man who has a telephone,  
or owns a typewriter,  
or employs a stenographer,  
or enjoys amusement,  
or wishes to learn a foreign language,  
or is deprived of his eyesight,  
or writes letters,  
or sends telegrams.

The TELEGRAPHONE has a broader field and a greater future than the telephone, the telegraph, the typewriter, or the phonograph, because

It renders a telephone conversation as tangible and as safe as a written contract,—  
It supplements greatly both the wire telegraph and the wireless,—  
It supersedes the phonograph in the office and in the home,—  
It is not only a wonderful saver of time, but also a great convenience, and insurance against error, both for the correspondent and the typewriter.

**LARGE CLAIMS?** Yes, but you will agree that these are modest claims when you have seen this perfected machine in operation and perceived its marvelous capabilities. Every one of these claims will be demonstrated to your entire satisfaction.

The U. S. Patent Office will tell you that practically all patents issued are based upon improvements or modifications of some already known scientific or mechanical device, but that the TELEGRAPHONE is one of those rare instances of a discovery susceptible of a "basic patent," because it embodies entirely new principles of applied science. It is an application of electro-magnetism by which sound waves, even those produced by the minutest whisper or respiration, are electrically projected into the mole-

cules of steel, there to remain and be reproduced at will. There have not been a dozen basic patents of importance issued in the last quarter of a century, and without a single exception such basic patents (legitimate monopolies) have made vast fortunes for early investors.

A limited portion of the treasury stock in the American Telegraphone Company will be sold to the earliest applicants at \$10 per share. Each subscriber will be limited to a few shares, because the more investors we have, the more general will be the interest aroused in the Telegraphone. **THERE ARE NO PREFERENCE SHARES AND NO BONDS—ALL SHARES ARE ALIKE AND EACH SHARE CARRIES WITH IT THE RIGHT TO VOTE**, so that with a single share you will have every right, privilege and protection possessed by any other stockholder, and being in at the birth of a great industrial business, you can not only watch it grow, but also assist in some measure in your own community, until the TELEGRAPHONE surpasses in magnitude, as it surely will, such vast interests as the Telephone, Air-brake, Phonograph, Sewing-machine, Kodak, and many other industries which originally started in a small way, but by real merit have achieved enormous power in the commercial world.

The net proceeds of the present limited sale will be devoted entirely to manufacturing and to enlarging and equipping the plant for the manufacture and sale of the TELEGRAPHONE. The instrument has met with an immediate demand of surprising proportions—orders having already been received for a number far in excess of the factory's utmost capacity of production for many months to come.

We invite your fullest investigation. If you cannot call to see the TELEGRAPHONE in operation,

**—THEN CUT OUT THIS BLANK AND MAIL IT TO US TO-DAY—**

With your permission, we should like to mail you, entirely at our expense, an illustrated booklet describing the Telegraphone, and pointing out some of the far-reaching influences which this unique invention is already beginning to exert upon scientific, social and commercial life. *To avoid all chance of error or delay in forwarding this booklet to you, please write very plainly:*

YOUR FIRST NAME SPELLED OUT:	MIDDLE INITIAL:	YOUR LAST NAME:
MR., MRS. OR TITLE: YOUR MAIL ADDRESS (P. O. BOX, OR STREET AND NUMBER)		
YOUR RESIDENCE (CITY AND STATE):		[K 651 B R]

Our object in the free distribution of these interesting booklets is primarily to inform the public of the practical capabilities of this remarkable discovery, and so by returning this blank, with the particulars asked above, you will be placing yourself under no obligation whatever to us. In the belief that you will wish to take advantage of a most unusual opportunity to make a small, safe and very profitable investment, we will mail with the booklet full information as to how you may secure a few shares of a limited issue of treasury stock, which is about to be made.

**STERLING DEBENTURE CORPORATION.**  
36 Wall Street, New York.  
F. C. MACLEAN, Manager.



apex of the horn and the mouth thereof. This chamber approximates in width to the ordinary horn, but rises greatly into a more or less semi-circular chamber above the normal horn, the chamber developing in returning curves upon the one side of the apex B and upon the other to the mouth D of the horn. Between the chamber and the actual mouth of the horn is a throat C of somewhat lesser area and beyond this throat the horn is expanded into an elliptical mouth D. The horn is preferably made of thin glass.

**MR. LONG NOT MR. MALYON IS MANAGER.**

To the Editor Talking Machine World:

Dear Sir—I notice in your issue of September you mention my name as manager of the Zonophone Co. This is incorrect, as this post is filled by Mr. Long; will you kindly mention this in your next issue. Yours respectfully,  
T. MALYON.

**CHRISTMAS TIME.**

The Talking Machine Dealer Should Not Overlook Its Opportunities.

Are you preparing for Christmas, Mr. Dealer? There is a great deal to be done if you wish to profit by the elixir of good cheer with which the air is filled at Christmas time. It is customary at this season for the public to put on its "glad rags" and go shopping, gladness in its heart and a well-filled pocketbook in its inside pocket. And on what mission is it bent? Why the congested thoroughfares and the crowded stores? Christmas presents are being sought, and it is "up to you," Mr. Dealer, to share in the prosperity that comes of this holiday buying.

To do this you must get in touch with your customers, and convince them that talking machine records make appropriate Christmas gifts and that you have a large supply especially adapted to that purpose.

Then you should make an appeal to the general public residing in the neighborhood of your place of business, asking them to call and be convinced of the wonderful entertaining qualities of the talking machine. Announce a free concert by way of introduction; that will bring them to you; then demonstrate in the most minute detail the fact that the talking machine is positively the only instrument in existence which will give with absolute naturalness of tone every musical instrument, the voice of every well-known singer, the mighty blare of the great concert band, or the soft, delicate melody of the symphony orchestra.

The following is suggested for such an appeal, either in the form of a circular letter or an advertisement in a local paper:

Have you decided upon your Christmas gifts? Before you come to a definite conclusion regarding them, we beg to inform you that there is nothing you can select for your dear ones which will prove so satisfying during the long evenings this winter as a talking machine. You will admit, we hope, that an instrument which will bring Sousa's band, the voices of our great Opera and Concert singers, the funny sayings of Minstrels and Vaudeville artists; in fact, all the mirth melody, and oratory of the theatre into your home, is worth careful consideration, to say the least. Ah! you marvel! And well you may. But this statement is true, notwithstanding, and we will deem it a very great pleasure to demonstrate its truthfulness to your entire satisfaction if you will kindly afford us the opportunity. If you would make your home a place of entertainment, better than Club or Theatre, and at a small fraction of the expense of either, you will buy a talking machine. It is the only solution to the home enjoyment problem.  
JOHN JONES,  
No. 23 Broad Street.

An advertisement such as the above will prove effective, and when your callers arrive upon their tour of investigation into the mysteries of the talking machine, in order that they may be duly impressed not only with your goods, but with yourself as well, you must have your store tastefully decorated as befits the occasion. Let the pictures of the talent which adorn your walls be festooned with holly, and the whole establishment aglow with the good cheer of Christmas tide. Then tell them the story of the talking machine from the start to the finish, illustrate its wonderful adaptability to the many fields of amusement, and they will be enrolled upon your book of customers ere they depart from under your hospitable roof.

Here's to you, Mr. Dealer;  
I drink this toast to you:  
May Christmas find you prosperous  
With lots of work to do,  
And when the New Year comes around,  
May it bring to you so much trade  
That you will bask in Fortune's smiles,  
Your reputation made.  
—HOWARD TAYLOR MIDDLETON.

The Columbia Phonograph Co. have established a department for the exhibition and sale of their commercial Phonographs at their retail store at 872 Broadway. This move has been made necessary on account of the large demand for these machines in the uptown business section of the city. This department will be in charge of H. M. Nicholson,

**A Business Builder**

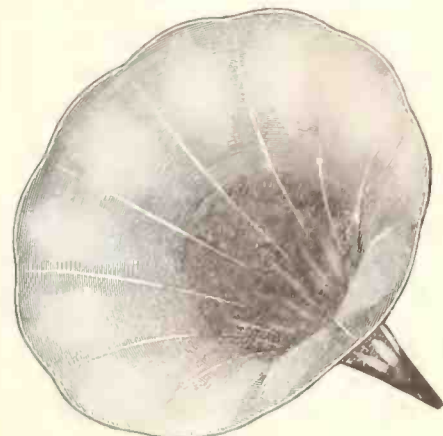

**The "MEGA"**

Have your crank customer or critic try a "Mega" in his home.

Get his views on the fibre horn later. We'll rely upon his opinion as an argument why you should demonstrate the "Mega" for your general trade.

It will pay you well to add the "Mega" to your regular line of horns. This assertion is not a matter of biased opinion, but is a fact that is vouched for by many live dealers.

**TAKE OUR WORD FOR IT.**

The "Mega" will sell more records than any other horn on the market today.

It will interest a prospective machine customer more quickly and make more machine sales than would be possible by using metal.

Your trade will get the best possible results from its equipment with the aid of the "Mega." This means that the user will be interested longer than is usually the case and naturally will result in additional record sales.

These are mutual benefits to dealer and jobber. They cannot be obtained by using metal as a medium.

There is not a dealer to-day who is not willing to increase his business. There is no one, we believe, but who would be willing to test to his own satisfaction a medium which would accomplish this result.

It's a pleasure to have the majority of your trade voluntarily express themselves well pleased and recommend a horn you have sold them.

This has been the uniform experience of all dealers who handle the "Mega."

The fact that some of your trade may have a large metal horn is not a handicap in pushing the "Mega." We have found it to be the case in the majority of instances that the owner of a machine is willing to increase his equipment if he can obtain better results. There is undoubtedly a large field for the "Mega" among the trade you have perhaps equipped with metal. This means you do not have to depend upon initial trade to demonstrate the "Mega."

Let us tell you more about our product in our literature. We shall be pleased to send it to you, if you are interested.

**A Type, Style and Price for Every Requirement.**



Makers, E. A. & A. G. SCHOETTEL,  
Broad Street, Maspeth, Queens Co., N. Y.



## A Victory Cash Register

is the main function to a successful business man.

To obtain one does not mean that you should support the monopolist's large selling force by paying an exorbitant price for a cash register. You need a machine that will account for the various business transactions and correctly register your "Cash Sales." A Victory, with a two years' guarantee, will do it. Send for Catalogue.

**Price of "Victory" \$65.00**  
**"Victory Jr." \$40.00 Less 10% for Cash**

**Easy Payments It Desired**

**H. C. MEHDEN**

Phone 3445 Columbus 145 Amsterdam Ave., New York

**JUST OUT**

## PRUDON'S STOP GAUGE

**For Phonographs.**



An attachment for repeating Records from the exact place where the piece begins. Nothing better for Dance Music.

**Home and Standard, Price 75c.**  
**Triumph, " \$1.00**

Patented Sept. 5, '05.

In ordering state if Old or New Models.  
Order through your jobber.

**L. T. PRUDON, Mir., 921 Demott St., W. Hoboken, N. J.**

## IF YOU

**Are looking for the Best in Band Instruments**



it may interest you to know that hundreds of American Musicians are patronizing

## The House of York

with eminently satisfactory results.

The above named firm manufactures nothing but the Very Best that is produced in the brass instrument line, and its productions include not only Cornets, but Trumpets, Horns, Trombones, Tenors, Baritones, Basses of all kinds, and even Drums, which the firm is now featuring with unprecedented results.

A very handsome Illustrated Catalogue of the York Instruments will be mailed free of charge to any one requesting it; also catalogues of Music for Band or Orchestra, each containing sample parts for Cornet or Violin, as the case may be. Simply write your request, with correct address, on a postal card directed to

**J. W. YORK & SONS**  
**GRAND RAPIDS, MICH.**





THE



# Victorious Columbia

Honored At The Milan Exposition With The

## GRAND PRIZE

There is no better proof of the superiority of the Columbia Disc and Cylinder machines and Records than the fact that when brought into comparison with all other talking machines expert judgment instantly recognizes their superiority.

The award of the Grand Prize at the Milan Exposition is only another evidence of the absolute superiority of the COLUMBIA and follows the custom that whenever the Columbia goods are exhibited in direct competition with all other talking machine goods, they invariably come away with flying colors.

Milan is not only the musical centre of Europe but might justly be deemed the musical centre of the world. To sing at La Scala is the ambition of every musical artist. To be accepted by the critical Milanese music loving public is a voucher for ability accepted the world over.

These facts give a value to the award of the Milan Exposition which would not obtain under any ordinary circumstances. The Grand Prize gives the Columbia Graphophone and Records a supereminence which cannot be challenged or denied.

The medal pinned on the soldier's breast does not make him a bit braver than he ever was before. It only makes public recognition of virtues already existing. In the same way the award of the Grand Prize does not make the Columbia one bit better than it ever was. It always was the first and best talking machine in the world.

The Milan award is another public recognition of the superiority which always existed.

If you don't handle Columbia goods, you don't do yourself justice and you do an injustice to your trade. They are goods that sell better than any others, goods that make lasting friends and constant customers.

Our method of dealing assures you a good profit which is always uniform. When you put in Columbia goods you can count your profits as exactly and as surely as if they were already to your credit in the Bank.

## COLUMBIA PHONOGRAPH COMPANY, Gen'l

90-92 West Broadway, New York

CREATORS OF THE TALKING MACHINE INDUSTRY      LARGEST TALKING MACHINE  
MANUFACTURERS IN THE WORLD      OWNERS OF THE FUNDAMENTAL PATENTS

GRAND PRIX, PARIS, 1900

DOUBLE GRAND PRIZE, ST. LOUIS, 1904

GRAND PRIZE, MILAN, 1906

STORES IN ALL PRINCIPAL CITIES

DEALERS EVERYWHERE





# THE Twentieth Century Columbia Record

**Half-foot Long**

IT MEASURES UP TO THE  
PUBLIC'S EXPECTATIONS

Every user of a cylinder talking machine who has heard the new Columbia half foot record wishes that his cylinder machine had a mandrel long enough to accommodate this remarkable record.

The user wants it because it affords him the first opportunity he has had to hear on one cylinder record a **COMPLETE SELECTION**.

He wants it for another reason: every record contains the choicest selections obtainable from the most famous artists of the world.

The **TWENTIETH CENTURY RECORD** marks a distinct advance in record construction.

Very naturally the informed prospective users, those who look around for the best, propose to buy **THE MACHINES THAT ARE PROVIDED WITH THE**

## **EXTRA LONG MANDREL**

accommodating both the Columbia half foot record and the standard size records of all makes.

This is especially true when the buyer finds that these Columbia machines are equipped with the best reproducers, the best recorders, the best motors and the handsomest cabinets.

We have four models equipped with the extra long mandrel: the Peerless, \$40; Sovereign, \$50; Twentieth Century Home, \$75; Twentieth Century Premier, \$100. This "Big Four" is among the Columbia prize winners at the recent Milan Exposition (see announcement on opposite page on Columbia's victory at Milan).

Your advantage in handling Twentieth Century half foot cylinder records and these famous long mandrel machines is plain and clear: **THEY GIVE YOU A CALL ON ALL OF THE TRADE WHICH NO OTHER MACHINES OR RECORDS CAN GIVE.**

In every detail of construction these goods stand alone—Unique, Perfect, Satisfying. The Twentieth Century half foot record appeals to all up-to-date dealers. We have the Twentieth Century goods. Are you a Twentieth Century dealer?

If not write your jobber to-day for Twentieth Century information, or

## **COLUMBIA PHONOGRAPH COMPANY, Gen'l**

90-92 West Broadway, New York

GRAND PRIX, PARIS, 1900

DOUBLE GRAND PRIZE, ST. LOUIS, 1904

GRAND PRIZE, MILAN, 1906

STORES IN ALL PRINCIPAL CITIES

DEALERS EVERYWHERE

THE NEW COLUMBIA  
Twentieth Century  
Gold Moulded Record,  
50c. each; \$5.00 per  
dozen.

HALF FOOT LONG



XP. Gold Moulded  
Record, 25c. each.

STANDARD LENGTH, 4  
INCHES.







# MARCONI

AND THE

# GRAPHOPHONE

The greatest inventive genius of the age, Marconi, inventor of the wireless telegraph, has joined the experimental staff of this Company. Do you understand what this means for the

## COLUMBIA

It is the biggest event in all talking machine history. When one realizes what this young wireless wizard has done in the application of electricity to new forms of telegraphy, some idea can be gained of his capacity for doing great things for the talking machine art.

By arrangements, completed with Mr. Marconi, all of his talking machine inventions will be exclusively controlled by the Columbia Company.

Something of vital interest to you may be expected because of this extraordinary addition to our staff.

👉 **Here's a tip.—Keep your eye on Columbia for something doing**

**COLUMBIA PHONOGRAPH COMPANY, Gen'l**

**NEW YORK      CHICAGO      SAN FRANCISCO      LONDON**

**Grand Prix, Paris, 1900**

**Double Grand Prize, St. Louis, 1904**  
**Grand Prize, Milan, 1906**





## TIMELY TALKS ON TIMELY TOPICS.

"Dubbing" is now talked of in the trade as if no particular offense is committed in its practice. The World has had occasion to refer before to the production and sale of these illegitimate records. There is no defense for those engaged in the manufacture of these spurious goods. On moral grounds the "dubbers" have not a leg to stand upon, and presumptively they are equally culpable in a legal sense. It must be remembered that the only case on record—Victor Talking Machine Co. against Albert T. Armstrong (American Vitaphone Co.)—was carried only as far as the United States Circuit Court, who issued a preliminary injunction, and consequently it was never tried on the merits, because of the defendant's death. In granting the enjoining order Judge Lacombe's remarks are so pertinent as to almost foreshadow what his ultimate decision would have been were further argument heard to make the injunction permanent.

Significant, indeed, are these words. Therefore "dubbers" and their allies, who glibly contend the long arm of the law is unable to reach them in restraint of their nefarious business—for such it may be truly characterized—should give heed ere it is too late. That "dubbing" on a large scale is being considered, if not actually engaged in, the trade seems cognizant of, hence The World's warning. Companies who have expended large sums of money to secure "masters" of the world's great vocal artists will not stand idly by and humbly submit, without even a protest, not to mention a battle royal, against being robbed of valuable property acquired by their enterprise and foresight. Possibly the game so far has been too insignificant to waste powder upon; but in view of possible developments, of which those directly concerned are doubtless aware, what threatens to be a wholesale launching of spurious records may be summarily checked by legal process.

The "lawyers" in the trade who speak lightly of "dubbing," and doubtless believe the manufacture of "dubbed" records is without the pale of the law, should look upon Judge Lacombe's opinion in the foregoing suit, reported in full on page 11 of The Talking Machine World, March, 1905. The "dubbers" and their defenders or apologists, as you please, should "read, ponder and inwardly digest" when reaching that portion of the decision where the judge says: "The

novel and interesting question as to whether the defendants have no right to take the discs produced by the plaintiff as records of a piece of music specially executed and reproduce from them duplicates thereof \* \* \* need not now be discussed. \* \* \* Thus they save themselves the expense of securing an execution of the musical piece by singer or orchestra." It is needless to quote farther, as this is sufficient to indicate the animus of the judicial mind.

Some time ago quite some interest was aroused among the city's theatre-goers by a machine displayed in the vaudeville houses under the title of the Immensaphone. As both the program and announcer informed the audience, the contrivance was built and operated on the principle of the phonograph. It was. Its shape reminded one of a phonograph, and it had a brass horn from which issued instrumental and vocal music. There the resemblance ended. The whole contrivance was an immense "fake," although it fulfilled its mission in entertaining the audience for a quarter of an hour or more. It may be said right here that "home" immensaphones will not make their appearance on the market in the near future, as it has not been found profitable to send the case with a brass band and vocalists out to the consumer at nothing down and a dollar a month.

Much interest is attached to the suit of the Victor Talking Machine Co. against the Keen Co., reported on another page. It is evident the courts are not taking any backward step regarding the enforcement of the principle that a patentee can control the price of his invention under any and all conditions. The defendants were selling Victor records at a price, and contended they could not be enjoined; but they were, nevertheless, and it appears they must have been advised the case would go against them, for they withdrew their appeal and permitted the final decree and permanent injunction to be entered without opposition.

C. N. Andrews, of Syracuse, N. Y., president of the Eastern Talking Machine Jobbers' Association (and by the way, what has become of the organization?), is one of the wealthiest jobbers in the business. At one time he was heavily interested in stock operations, making a fortune, but now he is greatly interested in talking machine affairs, and has been very successful.

Mr. Andrews is a man of strong individuality and force of character, combined with a natural dignity of manner which carries great weight. In addition he has the faculty of making friends, and this combination is hard to beat in any condition of life.

At one time the traveling salesmen had formed an association for "mutual benefit and protection." They were to open headquarters and maintain a place for the "gentlemen of the grip," when in New York, to be perfectly at home. It was a splendid idea, but the practical working out of the scheme has been suffered to lapse for one reason or another.

While the great plant at Orange, N. J., known far and wide as the home of the Edison phonograph, has a diversified product—four separate manufacturing companies operating—85 per cent. of the output is talking machines.

Leading jobbers have requested the manufacturers of disc records to use envelopes for the standard line the same as is done with the high-priced goods. Those broaching this matter propose to have the associations take the matter up and thereby formulate an official request, as it were, for what is spoken of as a very desirable improvement. As it is a number of jobbers are "enveloping" their discs at their own expense, but they believe the manufacturers should do this so as to have a uniform and distinctive cover that the public would learn to look upon as a guarantee of genuineness, even if an additional charge were made.

The progress in talking machine developments are so rapid that one cannot leave the trade for even a comparatively brief time and expect to keep abreast of affairs. This comment was made by a prominent manufacturer, who in engaging the services of a superintendent known for his inventive genius, remarked: "Oh, yes, the gentleman is all right in a way, but he has not kept up with the procession. You see, he was abroad for awhile, and then on his return here became engaged in another line. Well, the consequence was that when he returned to this business so much advancement had been made that he almost seemed a back number. Not but what he has natural aptitude, and all that, still he is not quite in touch, and I tell you no one can afford to lose much time experimenting these days. You have got to be right up to the mark. This is true right through, from manufacturing to jobbing and retailing. Improvements are materializing almost daily, in one way or another, and one must keep in close touch with manufacturing methods and practices in order to produce the right goods."

A student of sound, who objected greatly to the metallic ring from the horn of his phonograph, recently discovered a new way of preventing it. He took a half a dozen wooden clips, such as are used to hold paper together, and put them on the edge of the horn. He found it had the desired effect, and recommends their use to all who desire to do away with the metallic tone.

Leeds & Catlin Co.'s new feed device machine is announced as being ready for the market. This old-established company—one of the first to manufacture records—have never made a machine, and this is their introductory in that line. The company are also nearly in a position to furnish round or cylinder records, their list containing selections that will attract attention.

A tall hall (grandfather's) clock, constructed of graphophones and records, is one of the novelties in the window of the uptown branch of the Columbia Phonograph Co., at 872 Broadway. The body of the clock, containing the mechanism, is made of one of the old-style square graphophones. The face is a 12-inch record, the word Graphophone taking the place of the figures, while across the face are the two words "on time." The supports are made of X P records and the base of disc records. A 7-inch disc record forms the pendulum and the weights are made of mandrills of the X P style machines.

## WELLS PHONOGRAPH COMPANY

Wholesale Headquarters for

### Edison and Victor MACHINES, RECORDS AND SUPPLIES

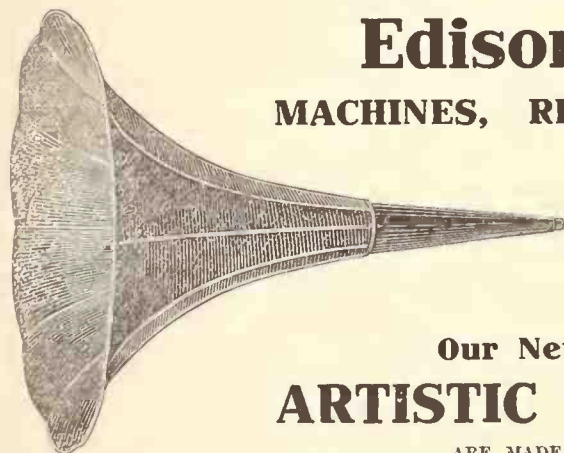

#### "Never Slip" Belt Dressing

For all Talking Machines. Positively prevents the belt from slipping. Thoroughly preserves the leather. Protects its elasticity.

RETAILS 10 CENTS

### Our New Line of H and S ARTISTIC FLOWER HORNS

ARE MADE IN THE FOLLOWING STYLES:

Brass, nickel-plated and polished outside, brilliant enamel background inside, with or without floral decoration.

Brass, polished outside, brilliant enamel background inside, with or without floral decoration.

Silk finish outside, brilliant enamel background inside, with or without floral decoration.

WRITE IMMEDIATELY FOR SPECIAL PRICES

If you want your orders filled promptly, try us

45 North 9th St., Philadelphia, Pa.



# THE PETMECKY MULTI-TONE SELF SHARPENING Talking Machine Needle

Plays loud or soft and intermediate tones with the same needle.  
Sharpens itself. Each needle plays ten records.  
Saves wear on the records.  
Makes disc machines as smooth and scratchless as cylinder machines.  
Makes worn records play without scratch.  
Helps the sale of disc machines and records.  
The only needle that has a character.  
Pays dealers a better profit than any other needle.  
The price is restricted and profits are certain.

## WHAT DEALERS THINK OF PETMECKY NEEDLES :

- The **A. Hospe Co. of Omaha, Neb.** say:—"We have tried the Petmecky needles thoroughly. Last week the writer played sixteen twelve inch red seal records with one needle and after the test the needle seemed worn but little."
- The **Unique Talking Machine Co. of Houston, Texas,** say:—"We have sold quite a few of your needles and each sale brings others. As to our opinion: we use them on all our high priced records. Did we not consider them the best we would not use them on records worth from \$3 to \$5."
- H. A. Guyon of Red Bank, N. J.,** says:—"I have done some investigating with your needles and have come to the conclusion that you have the real thing in needles. I would suggest that you retail them at 25c. per hundred. There is no use throwing a good thing away competing with the needles now on the market when none but yours will play a twelve inch record through distinctly."
- The **Huff Music Co. of Bethlehem, Pa.,** say:—"The sample needles received. We gave them immediate trial in the presence of a number of persons and the various loud and soft effects produced by the change of fronts is marvelous."
- Harry C. Lansell of Phila., Pa.,** says:—"Philadelphia is the home of the Victor and all improvements in anything pertaining to the talkers must have decided merits. Your needle, however, needs no explanation. It speaks for itself."

Write for free samples, descriptive circular and terms to dealers.

## DISTRIBUTORS TO THE TRADE :

W. H. & L. C. WOLFE,	-	Altoona, Pa.	THE O. K. HOUCK PIANO CO.,	Little Rock, Ark.
WALTER D. MOSES & CO.,	-	Richmond, Va.	THE A. HOSPE CO.,	- - Omaha, Neb.
SHERMAN CLAY & CO.,	-	Seattle, Wash.	TEXAS PHONOGRAPH CO.,	Houston, Tex.
F. M. ATWOOD,	- -	Memphis, Tenn.	THE STONE & BARRINGER CO.,	Charlotte, N. C.
THE CABLE CO.,	- -	Chicago, Ill.	KOHLER & CHASE,	Oakland and San Francisco, Cal.

**THE PETMECKY CO.,** Manufacturers  
AUSTIN, TEXAS, U. S. A.



## THE BUILDING UP OF A BUSINESS.

This Article Embodies the Varied Experiences of Several Successful Talking Machine Dealers Interviewed by the Writer Especially for The World.

The first question which must of necessity arise in the mind of the prospective talking machine dealer is where to locate. This can only be determined after a great deal of very careful investigation, for it is practically the key to the situation. If the location is good, the dealer may either succeed or fail according to his aptitude, but if the location is bad, even ability will not suffice, and the business will surely languish. It is imperative, therefore, that a good location be chosen, and in doing this there are two things to consider:

First, the store should be situated along a thoroughfare upon which people are constantly passing.

Second, the people who pass should, in the majority, be those who can afford the pleasure of a talking machine in their homes.

Then there should be something in the adornment of the show window to catch the eye of the beholder and hold it long enough for an image, hazy, perhaps, but nevertheless an image, to be stamped upon his memory and carried away with him in the form of an advertisement for the store from which it is taken.

By this time we will suppose that the site for the store has been chosen and the window decorated along the lines above described, and that the proprietor has a little time to devote to other matters. The first of these should be a catchy advertisement in a local paper. Every ward in our large cities, and every country town has its little advertising sheets distributed gratuitously, and therefore widely read. The rate charged advertisers is extremely moderate, and it will serve the needs of our friend remarkably well, for it will acquaint people with his existence, and the sooner he does that the better. It should be carefully worked up in a way that will attract attention, the following being an idea for such an advertisement:

Next time you stroll down Broad street,  
Stop in at twenty-three.  
We've something there to show you  
That you will want to see.  
We've opened up a brand new store;  
Come in and have a laugh.  
You'll simply have to, when you hear  
Our latest phonograph.  
JOHN JONES,  
Dealer in Talking Machines and Supplies,  
No. 23 Broad Street.  
We will treat you *all right all* the time.

This advertisement could be made even more attractive if accompanied by an illustration of a humorous character, for people will stop to look at a funny picture when they will allow print to pass them by unread.

How would this do?

# OUR GOODS

## WILL

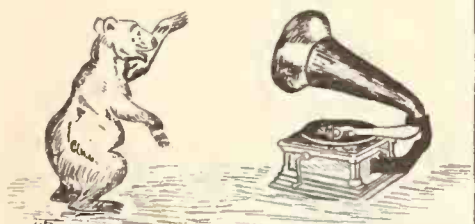

## BEAR INSPECTION!

The dealer will find that the very first insertion will bring him visitors galore, but they will come out of curiosity, and not to purchase. He should not be disheartened, however, but should treat them courteously, playing the part of genial host to the best of his ability. He must render

all selections asked for, and answer all questions, no matter how numerous, and while at first it may seem a thankless task, slowly, almost imperceptibly, there will be growing among his callers an interest in the talking machine which will eventually ripen into purchases.

We have now reached the point where the business should begin to show some returns, and from this time forward it is simply a question of hard work, viz.:

The local advertising should be kept up.

Monthly bulletins should be sent to patrons embodying, in addition to the list of new records, any little hints or ideas which may occur to him from time to time, and which he thinks will maintain the interest in him and his goods. In other words, he should prove himself a progressive dealer.

There is very little more to be said, for after the business is started, and started right, it will run smoothly and with an ever-increasing profit, provided the man at the helm has his eye open for bars and rocks, is optimistic, and steers under a full head of steam straight for the harbor of success.

HOWARD TAYLOR MIDDLETON.

Editor's Note.—There have been a number of editorialettes published in *The World* during the past few months dealing with hints to dealers which will be of assistance to the new recruit in the "talker" line at the outset of his career.

### A COLUMBIA ENTHUSIAST.

We present herewith an excellent portrait of Mervin E. Lyle, who came to this city on October 1 to take the position as assistant to J. W. Binder, chief of the executive office of the Commercial Graphophone, General, at 353 Broadway.



MERVIN E. LYLE.

Mr. Lyle is a son of the late Mervin E. Lyle, who was one of the founders of the Columbia business, and is a nephew of George W. Lyle, general manager of the Columbia Co. Mr. Lyle has made a splendid reputation for himself, and is a young man of very pleasing personality, and who will without doubt win for himself a host of friends in this city.

### REVIEW OF MARKET CONDITIONS.

With talking machine people trade has improved the past month. No great rush of business with dealers, but jobbers are in a more cheerful frame of mind, with manufacturers in the various branches swamped with orders. The large companies are doing their best to satisfy the demand for goods, but they are still woefully behind; in fact, it is not believed they will catch up on machines and records until after the first of the year.

It is needless to refer to the situation from the point of view of the "big four," as they are running capacity, increasing their factory forces and enlarging plants to cope not only with the present demand, but to provide for what they esti-

mate will be a still further development of the trade.

One of the marked features in machine sales is the astonishing orders placed for Victor Victrolas, the new hornless combination cabinet product of the Victor Talking Machine Co., who admit their inability to make deliveries as rapidly as might be wished, and possibly prayed for on the part of the jobber. The V. V. has certainly made a "ten strike," and imitations are being heard about in the open market.

### TALKING MACHINE GROWTH.

The Latest Figures Issued by the Census Bureau Are Interesting.

The Census Bureau have recently issued some figures on the development of the talking machine industry for the year 1904, as compared with 1900, the last census date. While the growth of the industry has been greatest within the past two years, yet these figures give an idea of the steady advance of this industry. In 1904 there were fourteen establishments engaged in the manufacture of talking machines with a total capital of \$8,740,618. In 1900 the number was 11, and the capital invested amounted to \$3,348,232. The number of salaried officials, clerks, etc., in 1904, was 537, whose salaries amounted to \$666,489, while in 1900 the number was 114, and their salaries amounted to \$119,145. The average number of wage earners in 1904 was 3,397, to whom was paid \$1,683,903 in wages. The wage earners in 1900 numbered 1,267, and the wages paid amounted to \$608,490. Miscellaneous expenses in 1904 amounted to \$1,653,762, and the cost of materials used to \$4,161,136. In 1900 these amounts were \$215,401 and \$827,520, respectively. The total value of the product in 1904 was \$10,237,075, while in 1900 it was only \$2,246,274.

### ORATORIA BY TALKING MACHINE.

In recent issues *The World* has referred to the production of opera through the medium of the talking machine and we have now to note another advance, namely, that on October 14 "The Messiah," Handel's immortal work, was given by means of the Gramophone to a large and enthusiastic audience at Halston Hall, Weybridge, England, and a week later another performance was given at Queens Hall. The chorus and solo work was admirably reproduced. This marks another artistic advance.

W. A. Mullen is now attached to the commercial system department of the National Phonograph Co., and assisted at the company's exhibit in the National Business Show, Madison Square Garden, New York, which closed November 3.

### COMMERCIAL GRAPHOPHONE WANTED.

WANTED—Commercial Graphophone, Spring motor or electric. "Wholesale," care of Talking Machine World, 1 Madison Avenue, New York.

### ATTENTION MANUFACTURERS!

Correspondence invited with manufacturers of automatic specialties and advertising novelties desiring Western representation. Boyd-Harrison Co., 6 and 8 Madison Street, Chicago.

### WANTED

Will pay cash for some Talk-o-Phones. Straight arm machines preferred. Must be cheap. Communicate at once with "Regular," care The Talking Machine World, 1 Madison Avenue, New York City.

### WANTED IMMEDIATELY—

A young and energetic manager for our wholesale and retail Edison and Victor Talking Machine Departments. Must be thoroughly experienced and reliable. Write at once, giving references and stating salary expected. E. H. Droop, care E. F. Droop & Sons Co., 925 Penna. Avenue, Washington, D. C.



# 4%—PAID EACH MONTH—4%

As sure as the dividends on Government bonds; six times as often and 25 times as much!

The amazing thing is the certainty of it. The more you look into it the more clearly you will see that the proposition is based on demonstrated facts.

We welcome the closest scrutiny. We urge you to dig to the bottom of every phase of this proposition before you invest. There is nothing to guess at. There is nothing to take for granted. But as surely as you do look into it, just so sure will you be that our statement of 4 per cent. each month—PAID EACH MONTH—is far below what the company will really do.

That is what surprises and delights the business men who look into this matter. The shrewder they are as investors, the better they understand what profits are now being made in certain absolutely legitimate lines, the more certain they are to take stock in

## THE MULTIPHONE, That Musical Marvel

### THE MULTIPHONE

is something new and novel. The music it makes is a revelation—rich, sweet and with a tone volume that is unapproached. There is nothing like it anywhere, nothing to compare with it, nothing to compete with it.

In construction it is a monument of simplicity. A large magazine wheel carries twenty-four phonographic records, any one of which may be reproduced at the will of the operator. A nickel starts it. It has an accurate register for recording the number of nickels taken. The power is from a spring motor. One winding is sufficient to reproduce 18 records. The public does the winding, so there is no expense for power.

In appearance striking and unique, it is the crowning triumph of music producing instruments. A massive and magnificent cabinet, standing six feet high and three feet wide, in general design like an old fashioned harpsichord, finished in antique bronze or built of genuine San Domingo solid mahogany.

The front and sides are of French beveled plate glass, exposing the mechanism to full view.

### SMALL CAPITAL

Here is a New York company (capital only \$100,000) that is doing business now, that is making money now, that is paying dividends (from its earnings) of 4 per cent. a month now.

Multiphones are being built as fast as facilities permit.

### COST AND RETURNS

\$100 will buy one share, paying \$4 monthly at least.

\$200 will buy two shares, paying \$8 monthly at least.

\$500 will buy five shares, paying \$20 monthly at least.

\$1,000 will buy ten shares, paying \$40 monthly at least.

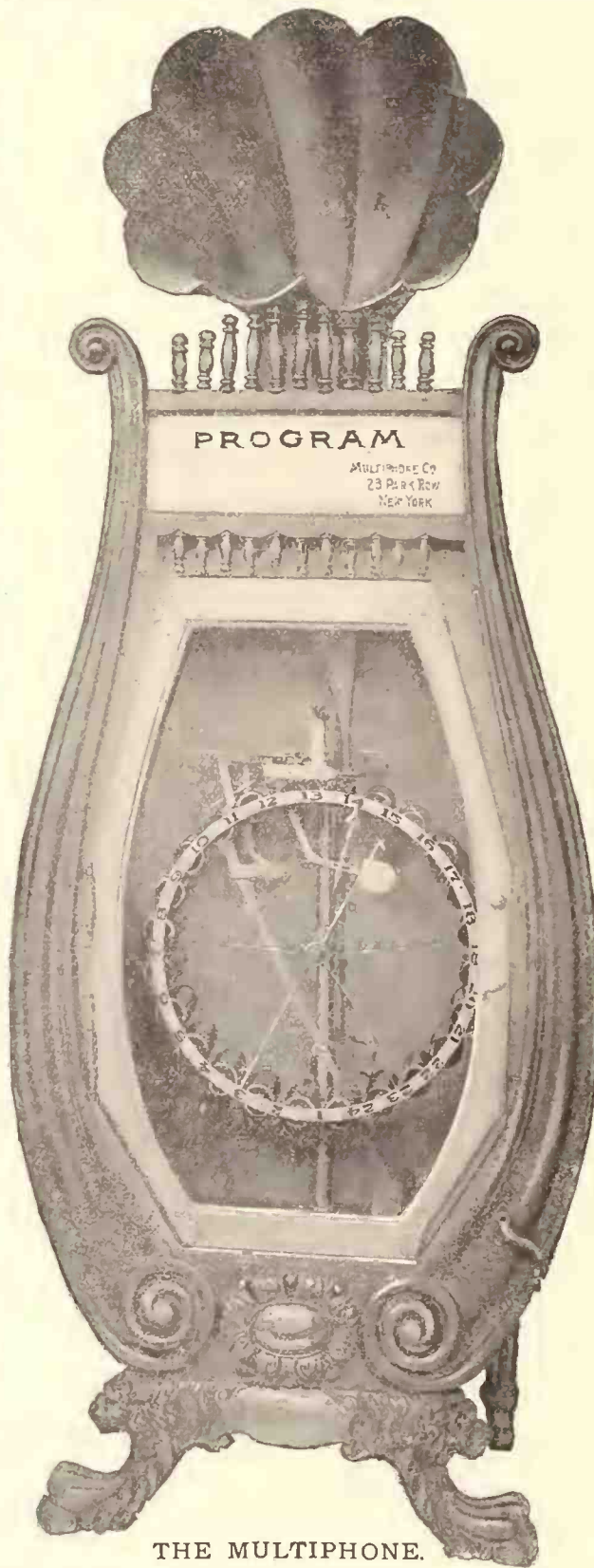

THE MULTIPHONE.

### EARNING CAPACITY

The actual average earnings of seven instruments we have had in operation as a test for about one year have been at the rate per instrument of .....\$501.00  
Per cent. for location privilege.\$100.00  
Cost of records, 2½ per cent.  
of intake..... 12.00  
Cost of attention, repairs, &c. 25.00  
————— 137.50  
Net profit for instrument per year..\$363.50

The operating profits are so large as to startle one accustomed to receive the rates usually paid for money invested.

The returns are immediate. There is no preliminary period of non-productiveness nor running expenses to absorb capital.

There is no uncertainty as to cost of production. It is definitely fixed.

Each Multiphone is valued at cost, \$250.00, and its proved net earnings are over one hundred per cent. per annum, fifty per cent. of which is paid to the investor and fifty per cent. to the company, who, by reason of this arrangement, give all services without emolument.

For every \$500 invested two additional instruments are completed and put to earning dividends.

### NO SALARIES

Practically every penny earned is available for dividends, for there are no salaries; there are no expenses; there are no leaks. You couldn't think out a cleaner, squarer, more attractive business. The patrons are pleased, the company is pleased, the public is pleased.

### LITTLE STOCK FOR SALE

Only a small amount of stock is for sale. Only a small amount will ever be for sale. Not a share of it has been sold under par—\$100. If you care to get in on the ground floor of the richest, juiciest business chance that ever came your way—look into this one. We don't want a cent from a blind-folded man—the further back you are from Missouri the better we will like it.

Checks, money orders or drafts should be made out to

## MULTIPHONE OPERATING COMPANY

TELEPHONE, 4109 CORTLANDT

23 PARK ROW, NEW YORK CITY

President, EDWIN J. SELLEY.

Secretary, WILLIAM H. PRITCHARD.

Vice-President, PETER J. COLLISON.

Treasurer, ISAAC THORMAN.

WARREN B. HUTCHINSON, Patent Attorney, 141 Broadway, N. Y.

BANKERS:  
Oriental Bank, 184 Broadway, N. Y.

COUNSELLORS:  
Rushby & Berkeley, 220 Broadway, N. Y.

PROSPECTUS FREE ON APPLICATION. SEND POSTAL FOR PARTICULARS



**KAISER'S VOICE PRESERVED.**

Prof. Scripture, Who Has Undertaken the Systematic Collection and Preservation of the Voices of the Famous Men of the World, Was Able to Secure Some Very Excellent Records of Emperor William's Voice to be Filed at Harvard University and the National Museum at Washington.

Prof. E. W. Scripture has undertaken the systematic collection and preservation of "the voices of persons of historic, literary, or linguistic importance" by means of phonetic records. The first record actually taken by him for such a permanent archive in America was that of the German Emperor, and in the November Century the professor gives the result of his study of the Emperor's voice. He says: "Through the American Ambassador, Charlemagne Tower, I applied for a record of the voice of the German Emperor, for preservation in durable material in Harvard University, the National Museum at Washington and the Library of Congress at Washington. The record is to be kept as a historical document for posterity. The phonetic archives at the institutions mentioned are to include records from such persons as will presumably have permanent historical interest for America. The importance of the undertaking can be estimated by considering the present value of voice records by Demosthenes, Shakespeare or Emperor William the Great.

"The Emperor consented, and the apparatus was set up in the palace. I asked for four records, one for each of the institutions mentioned and one for my own scientific investigations. The Emperor, however, made only two records, designating one for Harvard University and the other for the other purposes. The two records were made by a phonograph with specially selected recorders on wax cylinders. Such cylinders are of no permanent value because they are often injured by mold, and sooner or later they always crack, owing to changes in temperature."

From each original "master record" a metal

matrix was made by coating it with graphite and then galvanoplasting it. The wax master record was then removed (being destroyed in the process), leaving a mold from which "positives"—that is, copies of the original—could be cast. Durable positives were cast in a hard shellac composition and in celluloid. Some casts were also made in wax, and new metal matrices were made from these. In this manner the following material was obtained: (1) A metal matrix and positive of record No. 1, deposited in the National Museum at Washington; (2) a similar set of record No. 1, deposited in the Congressional Library at Washington; (3) a similar set of record No. 2, deposited in Harvard University; (4) a complete set for both records (a metal matrix and positive of each), which I presented to the Emperor; and (5) a reserve set of both. These are the only records of the German Emperor's voice which exist at the present time. The Emperor declaimed the beginning of the speech made by him at the unveiling of the monument of Frederick the Great near Berlin, and also an original essay.

In explaining the purpose of the collection of which the Emperor's voice is the nucleus, the professor says: "We shall never know how Shakespeare intended Hamlet to deliver his address to the players. He had his own notions concerning his plays, and undoubtedly instructed his actors by precept, correction, and example; but the voice is lost, and all we have to-day are the mere printed words. In printers' ink and metal type we have nothing but the mummy of an author's thought. How much more to us would be Longfellow's Psalm of Life, spoken by his own voice than it can ever possibly be now! What would not the world give for records of the voices of Sophocles, Cicero, Charlemagne, Luther and Washington?"

**EDISON EXCHANGE PROPOSITION.**

The record exchange proposition in effect in this country from October 1 to 6 has been universally proclaimed by the trade to be the most satisfactory of any ever promulgated by this

company. The conditions imposed were all that could be expected. They were easily understood, and compared to the large number of shipments the friction and errors were of no consequence. The number of cut out, surplus and defective records returned by many dealers was surprisingly small for each. The aggregate, however, has given the specially created "exchange department" at Orange a most busy month. Probably two-thirds of our 9,000 dealers took advantage of the exchange proposition and made shipments to Orange. All of these arrived by freight within two weeks. With the arrival of the first shipment a score or more of trucks and wagons were put into commission. Yet at one time fourteen carloads stood on the siding awaiting the trucks and wagons. For a time the local freight officials were literally "up in the air." At the factory the "exchange department" worked like beavers, checking the cases, getting them opened, taking the records out of the cartons, inspecting them and filling in the necessary blanks. It is difficult to imagine in advance the magnitude of a task of this kind. It is practically over now, and since the trade is so well satisfied we are greatly pleased, says the Edison Phonograph Monthly.

An exchange proposition similar to the above was in effect in Canada from November 1 to 6. Its general conditions were the same as in the United States, excepting that the records were returned through R. S. Williams & Sons Co., Ltd., Toronto.

**AN ENTERPRISING KANSAS HOUSE.**

The J. F. Schmelzer & Sons Arms Co., Kansas City, Mo., have fitted up an elaborate talking machine department with three separate rooms for demonstrating purposes. They are showing Victor and Edison machines and have built up an extensive trade in these lines. A unique feature of these publicity campaigns is the sending out of invitations to selected list of Kansas City residents requesting that they call and look over the stock of records. The scheme has proven very successful, resulting in a number of sales.

**WE ARE JOBBERS EXCLUSIVELY**

A distinction we wish to emphasize. Your orders, Mr. Dealer, have our first and only consideration and it's dollars to doughnuts we can give them better attention than if our interests were divided. Just bear in mind these few points: Orders are filled the day received; our goods are absolutely fresh, and have never passed through a retail department; and our immense stock, practically unlimited facilities and years of experience, enable us to give you the best possible service. If your record orders have not filled as completely as you would like, try us.

EDISON PHONOGRAPHS AND RECORDS  
TALKING MACHINE SUPPLIES

HORNS, HORN CRANES,  
CABINETS

EXCLUSIVE DISTRIBUTORS FOR NEW ENGLAND

FOR THE

**VITAK MOVING PICTURE MACHINE**

The only machine of this character selling at a popular price that accomplishes the same results as the higher priced machines, costing many times as much.

It is a most logical companion to the talking machine. Your business does not stop with the sale of the machine, as your customers are bound to come back for films, just as in the case of the records. While in no sense a toy, it is perfectly simple and can be operated by a child.

Retail price, complete, \$6.50

Retail price, films per foot, .10

Write us for circular and Dealer's price and get in line in time to get the Christmas trade.

**The Pardee-Ellenberger Co.**

96-104 STATE STREET,

NEW HAVEN, CONN.



100,000 RECORDS ALWAYS IN STOCK

JOBBER

**EDISON**  
PHONOGRAPHS  
RECORDS, ETC.

GENERAL SUPPLIES  
FOR  
CYLINDER MACHINES

**Douglas Phonograph Company**

MANUFACTURERS "PERFECTION" SUPPLIES, ETC.

RETAIL—WHOLESALE—EXPORT

Salesroom, 89 Chambers Street

Cable Address, Doughphone, N. Y.

New York

Largest Exclusive Talking Machine Jobbers in the World.

DISTRIBUTORS

**VICTOR**

TALKING MACHINES  
RECORDS, ETC.

GENERAL SUPPLIES  
FOR  
DISC MACHINES

# DOUBLE STOCK

Last season's experience taught us a lesson. We have twice the stock on hand and have never been so well prepared to fill orders. In buying from us you are sure to receive

NEW—FRESH GOODS.

*Our salesroom is at the disposal of dealers.*

*Bring your customers here, if you like.*



*If you have a customer for a high grade Cabinet or outfit—we will help you make the sale—no charge.*

We carry the complete Edison Foreign Catalogue in our usual liberal quantities.

The largest stock of Repair Parts for all types of machines.

Perfect in Manufacture and Material.

New Price List ready—you should have one.

Don't forget our Record Cabinets are the kind that last.

Worth buying if you sell on installments.





EDWARD LYMAN BILL, - Editor and Proprietor

J. B. SPILLANE, Managing Editor.

Trade Representatives: GEO. B. KELLER, F. H. THOMPSON,  
W. N. TYLER, B. BRITAIN WILSON.

Boston Office: ERNEST L. WAITT, 278A Tremont St.

Chicago Office: E. P. VAN HARLINGEN, 195-197 Wabash Ave.

TELEPHONES: Central, 414; Automatic, 8643.

Philadelphia Office: Minneapolis and St. Paul:  
W. H. PRESCOTT. A. W. SHAW.

St. Louis Office: San Francisco Office:  
CHAS. N. VAN BUREN, ALFRED METZGER, 1635 Van Ness Ave.

Cleveland Office: G. F. PRESCOTT.

London, England, Office:

69 Basinghall St., E. C. W. LIONEL STURDY, Manager.

Published the 15th of every month at 1 Madison Ave. N. Y.

SUBSCRIPTION (including postage), United States, Mexico and Canada, One Dollar per year; all other countries, \$1.25. England and her colonies, five shillings.

ADVERTISEMENTS, \$2.00 per inch, single column, per insertion. On quarterly or yearly contracts a special discount is allowed. Advertising Pages, \$60.00; special position, \$75.00.

REMITTANCES, in other than currency form, should be made payable to Edward Lyman Bill.

**IMPORTANT.**—Advertisements or changes should reach this office by the first of each month. Advertisements arriving too late for insertion in the current issue will, in the absence of instructions, be inserted in the succeeding issue.

Long Distance Telephone—Number 1745 Gramercy.  
Cable Address: "Elbill," New York.

NEW YORK, NOV. 15, 1906.

TRADE for the past month has been excellent, and as a result of the energy displayed in the manufacturing department of the industry during the summer, there is no such shortage of stock as existed last year at this time, and while the manufacturers are far behind in their orders, the jobbers do not propose to be caught napping in the same way that they were last season. They have been getting in goods for months, so that the jobbing stocks throughout the country are in fair shape to keep up with the immediate demands made upon them by retailers. Jobbers who last year were practically denuded of stock at this time, are in splendid condition to take care of the needs of their trade with promptness, and judging from the large shipments which are being made there will be a great depletion in the jobbing stocks within the next two weeks.

THERE is an increased demand for the more expensive products, and the real shortage to-day occurs in the higher priced goods. It would have seemed absurd to have predicted a few years ago that hundred-dollar talking machines could not be created fast enough to supply the demand, but such is the case to-day, and on the special products the manufacturers are rushed to the utmost and cannot keep up with their orders. The business over the country looks particularly bright, and our special reports, which cover nearly every important city in America, indicate that talking machine men are looking for an unusually brisk holiday trade. Surprisingly large shipments are being made to the Pacific Coast. The people in San Francisco are not to be daunted by a combination of earthquake and fire, and are clamoring for goods loudly and insistently, and all over the Pacific Coast talking machines are being sold in larger quantities than ever before. In the South, too, they are moving ahead more rapidly than last

year. In this section for a while the trade had been somewhat slow, but it is now showing considerable pace acceleration.

THE Middle West is a splendid talking machine territory, and the dealers there are enjoying a trade of magnificent proportions. Our reports from abroad, too, indicate an excellent business condition, and the music and piano dealers throughout England are now being won over to the talking machine. As an illustration showing the importance of this trade in England we may say that the Gramophone & Typewriter Co., Ltd., of London, last year paid a dividend of 10 per cent., a bonus of 10 per cent., and has in hand, after substantial reductions have been made for depreciation, a sum amounting to about two and one-half million dollars. When concerns of such magnitude can be built up in London, it certainly shows that the talking machine has merits which invite the investment of large capital.

THE commercial machine, too, is steadily winning its way into business popularity. At the recent business show at Madison Square Garden exhibits of the Columbia and Edison business talking machines have been in evidence, and they came in for a large share of attention from visitors, many of whom left orders to have these machines installed in their offices. The business product is as yet comparatively young, but its possibilities in this particular department are almost beyond estimate, and in a few years the commercial talking machine will be in evidence in business offices all over the world.

WE are in constant receipt of communications from advertisers who advise us of the excellent results which they are receiving through publicity in the columns of The Talking Machine World. This pleasing state of affairs is not surprising to us, because we know of the thousands of copies of this publication which go forth each month to all parts of the world. There is not a land where The World is not read, and hardly an island of the sea where it is not a welcome visitor each month. Foreign advertisers are beginning to learn that the circulation of this paper is enormous outside of the land over which Uncle Sam maintains law and order.

A TALKING MACHINE MAN, who has recently returned from India, writes: "I have been much surprised to find the position that your publication occupies in the Far East, where it is regarded as the greatest publication of its kind in the world. As far as I am able to learn, you have no competitors, and among the European manufacturers I hear nothing but the kindest words for your publication. They frankly say The World is the leader. I wish you all the success which you deserve, and that is a good deal, because you are doing much for the talking machine interests, not only in your United States, but in all other countries where talking machines are sold."

We have made for many months past a careful survey of the talking machine situation in foreign lands, and as a result we may say, without fear of contradiction, that we are sending more papers to the English-speaking countries throughout the world than any other talking machine publication, no matter where published. In Canada, India, Australia, New Zealand, South Africa and South America The

World is particularly strong, and while we are steadily gaining subscribers in Great Britain, we have not made the same advance there that we have in the British colonies, where The World is looked upon as the greatest exponent of the talking machine industry.

HERE is a communication sent us under recent date by the Petmecky Co., Austin, Tex.: "It may interest you to know that we have had replies, and have secured business from our half-page advertisement in The Talking Machine World from all parts of the United States, several from Canada and Europe, and to-day have received one from Delhi, India. We are pleased with the results of the small amount spent with you for advertising, and believe that any one with talking machine goods to sell can get pleasing results if meritorious goods are advertised in your publication."

It is easy to see why Europeans regard this publication with so much favor, and why it is so greatly sought in other countries. A comparison of The World with other publications in its line will clearly emphasize its superiority. There is behind this newspaper institution a thorough and comprehensive newspaper organization which extends to all parts of the globe, and there is no other institution that is spending the money or using the energy to produce a talking machine publication.

It is gratifying to us to see how highly The World is regarded, because it started out with the view of serving the trade interests fairly and helping to build the industry. It is with pleasure that we receive such communications as the following from Australia:

"The last World was the best, and your paper, like wine, seems to improve with age. You don't know what a blessing it is in this country to get such a wide-awake, progressive paper, which contains the news of the world. I am glad to see your English department, because it shows that your progress is of the kind which does not halt on the frontier line of the various countries."

NOW that the November elections have been settled there is every good reason why general business should show steady betterment. The last part of October trade in some lines languished somewhat, and as we approach the holiday season it should show the best kind of improvement.

Talking machine dealers, however, should not figure that trade will come their way without effort on their part. A progressive policy should be inaugurated and maintained by every talking machine man in the world. We have been receiving recently some clever forms of advertising which have originated with dealers, and it is such work which brings the talking machine effectively and intelligently before the public, and will win good business for the dealer. It is useless to think that interest in talking machines can be maintained without effort. The leading manufacturers are doing their part in the columns of the magazines of wide distribution, and this work should be supplemented by local campaigns on the part of the dealers.

THE talking machine is receiving considerable free advertising in the columns of the daily papers, owing to the wonderful advance which it has made, and the fact that it is being used in so many ways in our modern life.



# Protected HORN

Save  
Order the

We have made ample preparations to take care of delay in shipments. If you are not familiar with our own interests if you do not handle the SEARCHLIGHT.

**THE SEARCHLIGHT**

753-755 Lexington Avenue,



**Your** \_\_\_\_\_  
**GRADE!**

**It**  
**SEARCHLIGHT**

grade. We can meet all demands made upon us. No  
opposition; you should be. You are neglectful of your

**HT HORN CO.**

gh of Brooklyn, New York



## GOOD REPORTS FROM CLEVELAND TRADE.

Complaints Still Heard of Inability to Secure Goods—November Records Praised—Electric Theatres and Moving Picture Shows Springing Up Constantly—Interesting Chat With Mr. Arnold—May Co. Will Handle Full Columbia Line—Eclipse Musical Co. Improvements—Biograph Pictures to Augment Navy—Price Cutting in the Trade—The Month's News.

(Special to The Talking Machine World.)

Cleveland, O., Nov. 9, 1906.

Business generally among talking machine dealers has been fair for October, and as the season advances is perceptibly improving. Some complaint is heard of inability to procure goods from the manufacturers with that promptness desirable, owing to the large demand. This applies to the machines and accessories more recently placed on the market. The jobbers and dealers are all laying in ample stocks and making preparations for an extensive trade from now until the ushering in of the new year. The November records are accorded universal praise by both sellers and buyers, and are meeting with ready sales. They are so fetching it is simply impossible to resist purchasing.

The electric theaters, moving picture shows, panoramic and other amusement places of a similar nature are springing up constantly in the populous districts of the city. Fortunes, big or little, according to the magnitude of the undertaking, are being developed in their wake. With the addition of every year's education, every year's commercial activity and the unveiling of larger industries, it requires less and less apparently to amuse the public. This is due, perhaps, to the fact that the mind that is highest in poise needs the least in the unusual to turn the current of his thoughts. His already overloaded brain will readily grasp at some inconsequential thing as a laxative.

A large number of these miniature theaters are scattered about the city. Two on Euclid avenue cost a snug sum to fit up, and the rentals are up in the thousands, but they, as well as the others, are doing a profitable business. It really has come to the stage in this city where the man who undertakes to supply the craving of the public for a few minutes' entertainment has a sure thing. The lottery stage has been passed. With reasonable management and a good location dividends are about as sure as taxes and death.

W. J. Roberts, Jr., is doing a nice business, and securing an excellent class of trade. He anticipates a large volume of business during the next three months.

I. R. B. Arnold, proprietor of the stereopticon exchange, No. 45 Sheriff street, has been in the

stereopticon business for a number of years, and is an adept in the business. Your representative called on him a few days ago and asked him in what relation the talking machine stood as an aid to the stereopticon. In a reminiscent mood he said:

"Abraham Lincoln lived less than fifty years ago, and, strange as it may seem to us, never saw an electric light, electric street car, phonograph or telephone. Every new invention creates a demand for others. The world to-day could not dispense with appliances and conveniences that fifty years ago were not known. Not the least useful among these inventions is the talking machine. As a companion to the stereopticon it has no equal. In open air and tent work I have seen people come several blocks to hear what they supposed to be a brass band. It helps to draw an audience and interests people before the entertainment begins, and during the programme there are many things it can do, not simply to 'fill in,' but in the performance of the programme itself. An entertainment is incomplete without a few illustrated songs.

"The talking machine is a very inexpensive member of the company. It runs up no board bill at the hotel, and does not require a railroad ticket as a passenger. As the pictures are projected on the screen it does the singing much better than some member of the company can do it. Especially in connection with battle scenes, its appropriate instrumental music adds much to the efficiency of the programme. The wide-awake exhibitor will find many ways of making his talking machine the most versatile and useful member of his company. I have given over seven thousand stereopticon entertainments during the last thirty years, and since the talking machine came into use have found it to be indispensable to a first-class stereopticon entertainment."

It is the general belief that the talking machine is a medium promotive of pleasure and good feeling generally among those fortunate in the possession of one, or those who are the beneficiaries of its wonderful productions; but there are exceptions, and the disruption of a congregation in a nearby town has resulted from the giving of a picture show, accompanied by music from a talking machine. The resignation of the pastor and the starting of a new

church by the disaffected is the finale of the entertainment.

The Columbia Phonograph Co. recently closed a deal with the May Co., of this city, involving several thousand dollars. The company will carry an entire line of Columbia goods, and do a jobbing and retail business. It is also their intention to carry the Columbia goods in their entire chain of stores at New York, Cleveland, St. Louis and Denver. Mr. Stauffer, the buyer and manager of this department here, says he found it necessary because of the demand for Columbia goods to put in their line. Mr. Stauffer is working on plans to enlarge the present space given to this department to five times its present size, and when completed claims it will be the finest in the State.

The Eclipse Musical Co. have just completed several decided improvements in their demonstrating and retail departments, and now have a handsomely and conveniently arranged store. "In the past week," said T. H. Towell, manager, "we have sold several Victrolas, and have orders on file which we are unable to fill. Business generally is fairly good with us." The company have on exhibition a Victor Auxetophone, and hundreds who have called to examine and hear it pronounce it without exception the most wonderful musical instrument in existence. "It is a wonderful machine," said Mr. Towell, "and clearly demonstrates the strides the Victor Co. are making over their competitors. I predict a large sale for it, especially to that class of musically educated people whose homes will afford it ample space. We have several prospective Auxetophone purchasers."

As an inducement to encourage young men to join the United States Navy, the naval vessel Wolverine shows biograph pictures, accompanied by a talking machine, of life aboard battleships, scenes of visits to foreign lands and other alluring pictures.

Miss Ryan, in charge of the talking machine department of the Bailey Co., reported business very good, and demand improving. She stated they were selling a good many machines and lots of records, and that the November records were especially fine and selling well.

A new picture show has been started and is in successful operation at No. 5809 St. Clair avenue.

An old-timer—one of the first phonographs made by Mr. Edison—is on exhibition in the show window of W. G. Roberts, Jr. It was made in 1877, and judging from its looks, weighs 100 pounds. The machine came into the possession

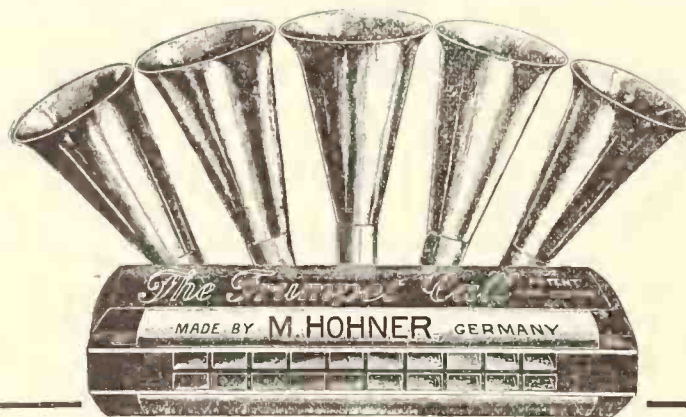

For a Powerful Organ-like Tone the New

## M. Hohner "TRUMPET CALL" Harmonica

Surpasses any mouth-organ that has ever been placed on the market.

No. 220. This instrument which has lately been offered to the trade is endowed with a phenomenal amount of tone power. The reeds are directly connected with a wooden sound-box, into which the tone passes, and finds an outlet through five Brass Trumpet Horns which protrude from the box. No Harmonica of this kind has ever been shown to the trade before, nor is there any which increases the tone so wonderfully. In the hands of an expert player this instrument can be made to sound like a church organ. In producing this instrument the house of Hohner has again shown great results from its constant effort to bring the Harmonica on the level with a high-class musical instrument. The mouth-organ has 10 double holes, 40 reeds, brass plates and is full concert.

M. HOHNER, 475 Broadway, NEW YORK

76 York Street, Toronto, Canada



of Mr. Roberts about eight years ago, when he first engaged in the talking machine business. It attracts the earnest attention of crowds who stop to examine and discuss the progenitor of the talking machine.

At the store of W. H. Buescher & Son business was reported fairly good and improving. "The prospects are," said Mr. Buescher, "that there will be the usual volume of business this season. We have sold and delivered one Auxetophone, and have secured more orders to deliver as soon as we can get the machines. There is an excellent demand for machines, and the November records are selling rapidly.

Business was stated to be rather quiet at Fiesheim & Smith's, though they are having an increasing demand and selling machines all the time. They handle the Zonophone principally, but also have a good trade in Edison phonographs.

Since installing a talking machine department the Smith & Nixon Piano Co. have been doing a very satisfactory business in this line. Mr. Ritter, in charge, said: "Trade is very encouraging. We handle the Victor and Edison machines with a complete line of records. We are getting the business into good working shape. Have sold a number of machines, and records are selling well."

The Columbia Phonograph Co. stated that business was better than it usually was in October. The company are putting in a series of booths for the different machines and records, which will greatly improve their facilities for demonstrating and more readily accommodate the increasing demand.

There seems to be considerable price cutting going on in Cleveland. It is alleged two concerns in the city are offering special inducements in the way of reduced prices on supplies, such as horns, stands, etc., in order to make a sale

of a machine. This price cutting seems to be on inexpensive machines; in fact, they are being offered as low as \$26, complete, including 12 records, machine and a large horn with support, showing the keenest kind of competition.

H. E. Jones, manager of the commercial graphophone department of the Columbia Phonograph Co., says he finds it difficult to cover all of the opportunities for business which present themselves. "The month of October," said he, "showed such an increase of business that we have been scarcely able to keep abreast of orders. During the month we sold outfits aggregating 23 commercial graphophones, with necessary supplies and equipment, to eleven of the most representative concerns in town. At present we have very promising trials in progress in the offices of six of the largest concerns in the city and vicinity, and more in immediate prospect.

Collister & Sayle sell Victor machines and records, and report business fair and demand increasing. They stated the November list of records was fine and selling well.

The Columbia Co. sold Twentieth Century graphophones to two new moving picture people this month. One to Spencer & Shaw, corner of Willson and Kinsmore street, and one to Korach & Loney, on Lorain avenue.

Mr. Evans, of the Ball-Fintze Co., Newark, O., was in the city a few days ago, calling on the trade. Mr. Evans was making the trip for Mr. Neff, whose business engagements elsewhere prevented him from coming.

Mr. Hugg, representative of the National Phonograph Co., was calling on dealers in the city October 18-19. He left with a good bundle of orders.

T. F. Murray, representing the Columbia Phonograph Co., of New York, was a recent visitor to the city. He was the recipient of hearty greetings from the talking machine men.

OUR FOREIGN CUSTOMERS.

Amount and Value of Talking Machines Shipped Abroad from the Port of New York.

(Special to The Talking Machine World.)

Washington, D. C., August 10, 1907.

Manufacturers and dealers in talking machines will doubtless be interested in the figures showing the exports of talking machines for the past five weeks from the port of New York:

OCTOBER 8.

Berlin, 244 pkgs., \$2,237; Bombay, 26 pkgs., \$489; Bradford, 27 pkgs., \$188; Bristol, 25 pkgs., \$130; Calcutta 10 pkgs., \$211; Callao, 3 pkgs., \$106; Campeche, 8 pkgs., \$160; Carthage, 5 pkgs., \$230; Colon, 4 pkgs., \$125; 5 pkgs., \$191; Glasgow, 9 pkgs., \$375; Havana, 7 pkgs., \$390; 27 pkgs., \$688; 19 pkgs., \$615; 4 pkgs., \$123; Havre, 11 pkgs., \$329; Leeds, 57 pkgs., \$1,716; Limon, 12 pkgs., \$178; Liverpool, 54 pkgs., \$1,688; 3 pkgs., \$169; 160 pkgs., \$1,205; London, 931 pkgs., \$8,889; 81 pkgs., \$7,943; 22 pkgs., \$1,094; Manchester, 109 pkgs., \$689; Melbourne, 45 pkgs., \$1,195; Milan, 47 pkgs., \$899; Para, 3 pkgs., \$165; Port Natal, 8 pkgs., \$193; Shanghai, 13 pkgs., \$644; Sheffield, 58 pkgs., \$374; St. Petersburg, 14 pkgs., \$491; Sydney, 327 pkgs., \$12,025; Tampico, 4 pkgs., \$310; Vienna, 16 pkgs., \$493; Wellington, 5 pkgs., \$100.

OCTOBER 15.

Alexandria, 19 pkgs., \$475; Berlin, 285 pkgs., \$6,163; Bombay, 4 pkgs., \$200; Brussels, 200 pkgs., \$2,000; Buenos Ayres, 32 pkgs., \$3,913; 138 pkgs., \$8,217; Calcutta 4 pkgs., \$457; Cardiff, 63 pkgs., \$712; Corinto, 2 pkgs., \$107; Glasgow, 57 pkgs., \$700; Guayaquil, 2 pkgs., \$166; Hamburg 27 pkgs., \$1,200; Havre, 10 pkgs., \$207; Havana 17 pkgs., \$231; Kingston, 2 pkgs., \$223; La Guayra, 3 pkgs., \$190; Leeds, 42 pkgs., \$275; London, 86 pkgs., \$6,953; 1,278 pkgs., \$13,398; 2 pkgs., \$134; 45 pkgs., \$2,792; Milan, 13 pkgs., \$453; Montevideo, 14 pkgs., \$1,458; Newcastle, 71 pkgs., \$446; Para, 11 pkgs.,

REGULAR AND DECORATED "MEGA" FLOWER HORNS

26"x16 1/2" — JUNIOR AND SENIOR SIZES — 32"x23"

We Control  
The "MEGA"  
in Maine  
New Hampshire  
Vermont  
Massachusetts  
and  
Rhode Island

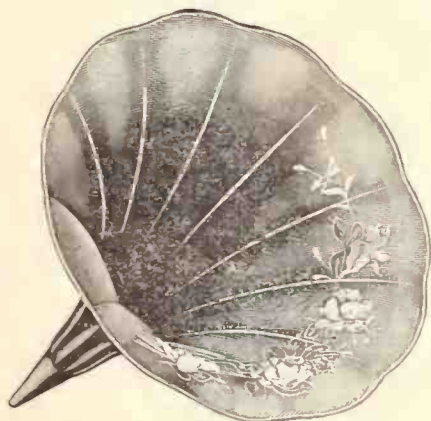

REG. FLOWER

IN 6 COLORS

DEC. FLOWER

IN 4 COLORS

Attractive Prices  
to the Dealer and  
Jobber. Send for  
descriptive sheets

NEW MODEL TEA TRAY CRANES

No. 200

No. 228

Ready for Delivery

ALL DEALERS SHOULD SEND TO US

For Our New Up-To-Date List of

"LIVE ONES" 250 BEST SELLING RECORDS ON EDISON LIST

PHOTOS OF THE TALENT

Making Victor and Edison Records. Finely Mounted. Retail 35 Cents Each. Send for List and Dealers' Prices.

New England Agents for

HERZOG DISK AND CYLINDER RECORD CABINETS

SYRACUSE WIRE RECORD RACKS

RAPKE RECORD TRAYS AND LABELS

H. & S. RECORD AND MACHINE CASES

T. T. CO. METAL FLOWER HORNS

MELLOW-TONE ATTACHMENTS

LYNN RECORD BOXES AND CASES

PLACE AUTOMATIC RECORD BRUSHES

H. & S. UNIT DISK RECORD STOCK RACKS

REPAIR PART CABINETS

Prices on Application

We have on hand the Largest and Most Complete Stock in New England of

VICTOR MACHINES AND RECORDS  
EDISON PHONOGRAPHS AND RECORDS

And All Supplies

Our Shipping Facilities are Unexcelled

"PROMPTNESS" IS OUR MOTTO

THE EASTERN TALKING MACHINE CO., 177 Tremont St., BOSTON, MASS.

Distributors of EDISON and VICTOR MACHINES, RECORDS and ALL SUPPLIES. Eastern Agent for HERZOG DISK and CYLINDER RECORD CABINETS



\$194; Rio de Janeiro, 10 pkgs., \$304; 10 pkgs., \$1,200; Savanilla, 23 pkgs., \$7,222; St. Petersburg, 20 pkgs., \$877. Sydney, 1,917 pkgs., \$20,073; Valparaiso, 22 pkgs., \$1,410; 2 pkgs., \$126; Vienna, 14 pkgs., \$498; Yokohama, 9 pkgs., \$373.

OCTOBER 22.

Berlin, 236 pkgs., \$2,556; Bombay, 3 pkgs., \$108; Bradford, 50 pkgs., \$485; Bristol, 25 pkgs., \$130; Brussels, 67 pkgs., \$815; Buenos Ayres, 5 pkgs., \$142; 86 pkgs., \$5,127; Cape Town, 13 pkgs., \$568; Cartagena, 6 pkgs., \$624; Callao, 2 pkgs., \$117; Glasgow, 1 pkg., \$602; Hamburg, 10 pkgs., \$290; Havre, 2 pkgs., \$54; Leeds, 97 pkgs., \$621; Liverpool, 250 pkgs., \$2,104; 5 pkgs., \$117; London, 1,080 pkgs., \$14,518; 4 pkgs., \$112; 99 pkgs., \$13,086; Manchester, 158 pkgs., \$937; Newcastle, 76 pkgs., \$481; Neuvas, 7 pkgs., \$100; Pernambuco, 2 pkgs., \$246; Progreso, 3 pkgs., \$122; Rio de Janeiro, 37 pkgs., \$1,897; Santiago, 10 pkgs., \$231; Sheffield, 58 pkgs., \$374; St. Petersburg, 23 pkgs., \$964; Surinam, 3 pkgs., \$239; Sydney, 199 pkgs., \$7,032; Valparaiso, 10 pkgs., \$688; Vienna, 8 pkgs., \$282; Wellington, 8 pkgs., \$180.

OCTOBER 29.

Belfast, 27 pkgs., \$178; Berlin, 240 pkgs., \$2,089; Bombay, 36 pkgs., \$1,957; Bremen, 1 pkg., \$100; Bradford 50 pkgs., \$333; Bristol, 65 pkgs., \$1,530; Brussels, 25 pkgs., \$212; Cardiff, 64 pkgs., \$1,408; Glasgow, 58 pkgs., \$861; Havana, 6 pkgs., \$122; Havre 13 pkgs., \$597; 19 pkgs., \$1,010; 2 pkgs., \$120; La Guayra, 14 pkgs., \$318; Leeds, 99 pkgs., \$1,379; Limon, 8 pkgs., \$189; Liverpool, 278 pkgs., \$1,849; London, 1,251 pkgs., \$16,153; 6 pkgs., \$450; Manchester, 224 pkgs., \$1,325; Manila, 4 pkgs., \$219; Melbourne, 15 pkgs., \$384; Milan, 8 pkgs., \$219; Newcastle, 76 pkgs., \$394; Para, 77 pkgs., \$1,518; Santa Marta, 1 pkg., \$110; St. Petersburg, 21 pkgs., \$787; 9 pkgs., \$275; Sheffield, 57 pkgs., \$365; Vera Cruz, 23 pkgs., \$805.

NOVEMBER 5.

Berlin, 235 pkgs., \$1,938; Beyrouth, 2 pkgs., \$145; Bobay, 30 pkgs., \$413; Bradford, 79 pkgs., \$511; Brussels, 27 pkgs., \$299; Buenos Ayres, 7 pkgs., \$569; Cape Town, 9 pkgs., \$295; Car-

diff, 94 pkgs., \$655; Copenhagen, 3 pkgs., \$112; Delagoa Bay, 3 pkgs., \$115; Glasgow, 29 pkgs., \$286; Havana, 7 pkgs., \$195; 29 pkgs., \$839; Havre, 15 pkgs., \$1,186; Leeds, 97 pkgs., \$562; Limon, 5 pkgs., \$100; Liverpool, 244 pkgs., \$1,758; London, 3 pkgs., \$109; 1,382 pkgs., \$15,868; 42 pkgs., \$5,342; Manaos, 4 pkgs., \$121; Manchester, 159 pkgs., \$962; Neuvas, 4 pkgs., \$258; Newcastle, 75 pkgs., \$494; Shanghai, 9 pkgs., \$3,471; Sheffield, 57 pkgs., \$362; Singapore, 3 pkgs., \$125; St. Petersburg, 26 pkgs., \$1,372; Southampton, 22 pkgs., \$713; Sydney, 914 pkgs., \$10,198; 249 pkgs., \$9,507; Valparaiso, 10 pkgs., \$136; Vera Cruz, 14 pkgs., \$517; Vienna, 19 pkgs., \$896.

LATEST EDISON OPERATIC RECORDS.

Supplementary list No. 4 of the Edison grand opera records issued by the National Phonograph Co., includes the following selections:

- B. 31—Arie. "Durch die Wälder" (Through the Forests) "Der Freischütz".....Weber  
By Alois Burgstaller, Tenor.  
Sung in German, Orchestra accompaniment.
- B. 32—Sortitia d'Amonarso, ("Amonarso's Air") "Aida".....Verdi  
By Antonio Scotti, Baritone.  
Sung in Italian, Orchestra accompaniment.
- B. 33—Balkon Scene. "Euch Lüften" ("Ye Breezes") "Lohengrin".....Wagner  
By Mme. Rappold, Soprano.  
Sung in German, Orchestra accompaniment.
- B. 34—Deserto Sulla Terra ("Alone in the World") "Il Trovatore".....Verdi  
By Romeo Berti, Tenor  
Sung in Italian, Orchestra accompaniment.
- B. 35—El mar sin playas, ("The Sea Without Shores").....Sancedo  
By Gustave Berl Resky, Baritone.  
Sung in Spanish, Orchestra accompaniment.
- B. 36—Lohengrin's Abschied, ("Lohengrin's Farewell") "Lohengrin".....Wagner  
By Andreas Dipple, Tenor.  
Sung in German, Orchestra accompaniment.
- B. 37—L'aria di Gilda, "Caro Nome" ("That Dear Name") "Rigoletto".....Verdi  
By Miss Bessie Abbott, Soprano.  
Sung in Italian, Orchestra accompaniment.
- B. 38—Siegmond's Liebeslied, (Siegmond's Love Song) "Walküre".....Wagner  
By Heinrich Knotte, Tenor.  
Sung in German, Orchestra accompaniment.
- B. 39—L'air de Stephano, (Stephano's Air) "Romeo et Juliette".....Gounod  
By Mme. Jacoby, Contralto.  
Sung in French, Orchestra accompaniment.
- B. 40—"Deo miei bolienti Spiriti" ("Fervid mad Wild My Dream of Youth") "La Traviata".....Verdi  
By Florencio Constantino, Tenor.  
Sung in Italian, Orchestra accompaniment.

SATISFY CUSTOMERS.

Bad Plan to Send Records Not Ordered if You Desire to Cultivate Trade.

One of the most discouraging things to the owner of a good talking machine is the difficulty frequently experienced in certain quarters in obtaining the records desired. After spending possibly an hour or more picking out a list of desirable records from among the thousands of titles offered in the catalogue it is not pleasant to try the records sent as filling the order and find that a ragtime duet of obscure origin has been substituted for a quartette rendering of "Asleep in the Deep" or the "Arkansas Traveler" as a violin solo be sent, instead of an operatic selection. A reasonable man will insert several extra numbers in his order to allow for possible shortage in some of the records chosen, but if it is found impossible to fill even this supplementary list the customer should be so informed and not supplied with records that are of no use to him.

We know of one instance where a customer got only five records out of a list of over two dozen that he selected, and the balance of the list was filled in with records that were directly opposite in character to the ones desired. The result was that thereafter he sent to another city for his records, thus depriving his home dealer of considerable business.

It is more important to cultivate the customer and keep his business, even although only a few records are supplied at a time than to flood him with undesirable records once and stop his patronage. The best plan of all, however, is to carry as complete a line of records as possible and fill all the order. The increased outlay will mean a greatly increased profit.

Formerly an exclusive Edison jobber, W. D. Myers, Williamsport, Pa., has put in a disc line, handling the Zonophone goods on an extensive scale.

MANUFACTURERS OF

TALKING MACHINE DISC AND CYLINDER RECORD CABINETS

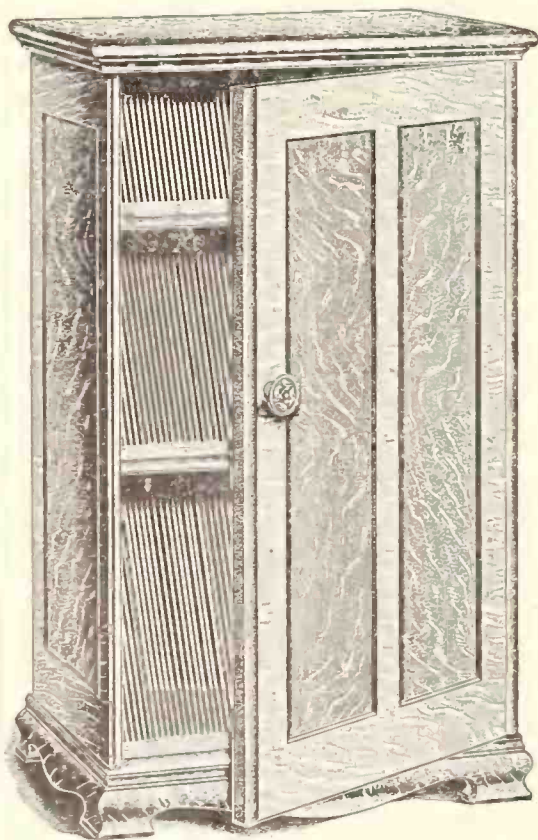

No. 705

NEW STYLES JUST OUT

Artistic and attractive in design, finished better than any other make now offered to the trade.

A sample order will convince you that our goods are the best, and our prices are the lowest.

We do not only solicit your trade, but fill all orders promptly.

New catalogue sent free.

Write for it NOW.

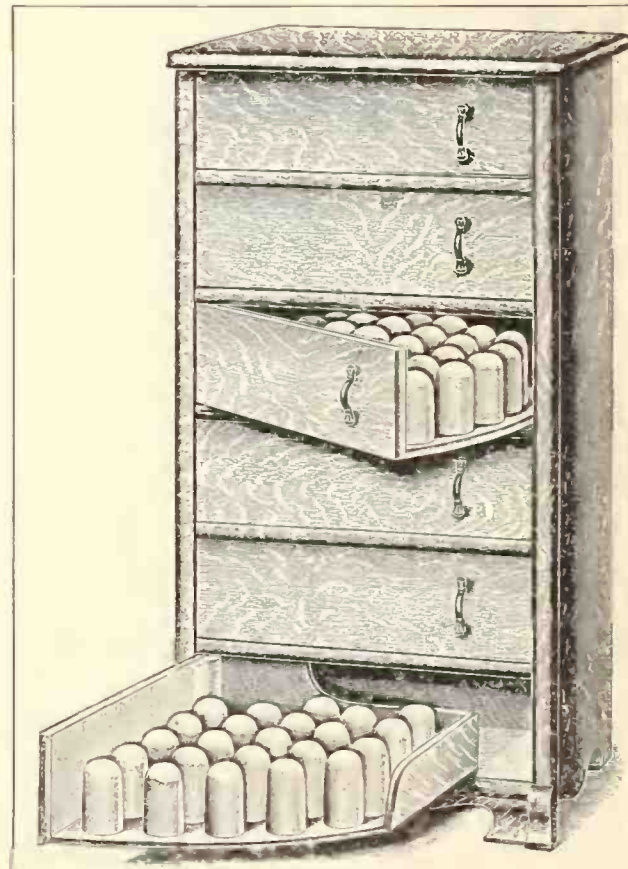

No. 710

SALTER MANUFACTURING COMPANY, 102-108 N. Oakley Ave. CHICAGO



## FINAL DECREE IN KEEN CO. CASE.

Entered in Favor of the Victor Talking Machine Co. Last Week—Some of the Points Involved in This Interesting Suit.

(Special to The Talking Machine World.)

Philadelphia, Pa., Nov. 7, 1906.

The suit of the Victor Talking Machine Co., Camden, N. J., against the Keen Co., Victor distributors of this city, has attracted attention in the trade from the special nature of the controversy, which involved a phase of selling goods contrary to the protected price principle. The Victor Co. filed their bill of complaint June 21, 1906, and on the 28th following a motion was argued for a preliminary injunction before Judge McPherson, of the United States Circuit Court, Eastern District of Pennsylvania. The complainant alleged that the Keen Co. infringed claims 5 and 35 of their Berliner patent No. 534,543. The defendant contended that because patent No. 548,623 had been decided by Judge Hazel, United States Circuit Court, Southern District of New York, to be restricted to the particular material of which the record was composed, which defendant did not use, that, therefore, the complainants had no right to claim restrictions upon the sale of records.

The enjoining order was issued, and subsequently an appeal was taken to the United States Circuit Court of Appeals, Third Circuit, argument being heard October 22. Later the Keen Co. withdrew the appeal, and Judge McPherson thereupon made the injunction permanent, entering the subjoined decree on November 5:

"Ordered, adjudged and decreed, that the letters patent in suit, No. 534,543, issued February 19, 1895, to Emile Berliner for improvement in gramophone, are good and valid in law, and that the complainants herein, the Victor Talking Machine Co. and the United States Gramophone Co., are and have been the true, lawful and exclusive owners and licensees, respectively, of the said letters patent No. 534,543 at and since the times set forth in the said bill of complaint as alleged in the said bill of complaint, and of all rights and profits granted and secured thereby, together with all rights of action existing by reason of infringement of the said letters patent; that the said defendant herein, the Keen Co., have infringed upon said letters patent by selling or causing to be sold, complainants' sound records patented under the said patent No. 534,543, forming an essential element and part of claim 35

of the said patent, for use in accordance with the method claimed in claim 5, in violation of the terms and conditions of the license under which the said sound records manufactured by the complainants were licensed to be sold and used, and in violation of the reserved rights of the complainants in the said sound records, particularly by selling the said sound records to the public at a less price than the price at which the said sound records were licensed by the complainants to be sold or used, as set forth in the notice of license attached to each of the said infringing sound records, and as set forth and alleged in the bill of complaint.

"It is further ordered adjudged and decreed that a writ of injunction issue in this cause perpetually restraining the defendant, the Keen Co., its associates, attorneys, servants, agents and workmen, and each and every of them, from directly or indirectly, selling or causing to be sold or offering for sale, or advertising for sale, or in any way disposing of talking machine sound records of complainants' manufacture forming a part of claim 35 of said letters Patent No. 534,543, in suit, and constructed to be used as a part of the combination thereof, which claim reads as follows, namely: '35. In a sound reproducing apparatus consisting of a traveling tablet having a sound record formed thereon and a reproducing stylus shaped for engagement with said record and free to be vibrated and propelled by the same, substantially as described.'

"And from selling or causing to be sold, or offering for sale, or advertising for sale, or in any way disposing of talking machine records of complainants' manufacture which are intended for use, or intended to be used with apparatus or devices which embody the method of claim 5 of said letters patent, which claim reads as follows, namely: '5. The method of reproducing sounds from a record of the same which consists in vibrating a stylus and propelling the same along the record by and in accordance with the said record, substantially as described.' Or which are intended to be operated in accordance with said method claim 5, at a less price than the price at which the same have been licensed, are licensed, or shall be licensed by the complainants, in violation of the reserved rights of the complainants, or in violation of any of the terms or conditions under which the said records are, or have been, or shall be, sold by the complainants, or in violation of any rights of the complainants whatsoever in the premises."

## MUSICAL COPYRIGHT LEAGUE.

Organized With Paul H. Cromelin as President  
—To Take Action on Pending Bill.

On October 15 the American Musical Copyright League was organized at the Hotel Astor, New York, with Paul H. Cromelin, vice-president of the Columbia Phonograph Co., general, temporary president. The only other representative present from the talking machine trade was E. F. Leeds, president of the Leeds & Catlin Co., New York. At a subsequent meeting, on the 22d ult., the organization was perfected, Mr. Cromelin being duly elected president and Mr. Leeds a member of the executive committee. The league is a combination of talking machine and perforated music roll interests. Active steps will be taken to induce the Patents Committees, by whom the new copyright bill is being considered, to incorporate in the measure a clause exempting automatic reproductions of all kinds from its provisions. A third meeting was held at the same place November 5, when addresses were made by several lawyers who had made arguments before the joint sessions of the Patents Committees of the Senate and House in June opposing the measure.

## GET MUSIC BY TELEPHONE.

Directors of Company Backing New Electrical  
Contrivance Hear It Work.

Following years of experiment by Dr. Cahill, the dynamophone, or, as some call it, the electro-phonograph, took its initial step toward commercial practicability at Martin's the evening of November 9, when the members of the New York Electric Music Co. were entertained during a banquet by selections transmitted from the machine in the company's office, at Broadway and 39th street.

Apparatus for receiving the music consists of a phonograph horn attached to the telephone receiver. Musical sounds are electrically produced from a plant of two hundred dynamos, the operator playing on a complicated keyboard. There will be a concert each evening, and subscribers will be treated to classical music played by experts. The company plans to enlarge its plant in the future, so as to afford a variety of concerts, operatic, popular, religious and classical, with any of which the subscriber can be connected according to his taste. The tone qualities of the different orchestral instruments are splendidly simulated.

## ADDRESSES BY J. W. BINDER.

J. W. Binder, manager of the Columbia commercial department, addressed the classes in salesmanship in the Y. M. C. A. rooms of Brooklyn, on Thursday evening, Oct. 11; on Friday evening, Oct. 12, he spoke before classes in salesmanship at the Twenty-third Street Y. M. C. A., and on Saturday evening at Newark, N. J. The subject of these talks was salesmanship in general with special application to the selling of commercial graphophones.

The J. Raymond Smith Co., of 2126 Sutter street, San Francisco, Cal., have a very excellent talking machine department which is proving quite successful.

The Pennsylvania Railroad Co. are arranging to place powerful talking machines in their various stations for the purpose of announcing the arrival and departure of their trains.

The Ball-Fintze Co., Newark, O., recently made affidavit that they had in stock over 163,000 records. During the winter this concern will carry over 300,000.

The Western Talking Machine Co. have removed to 41-43 North Ninth street from 128 South Ninth street, Philadelphia, Pa., where larger quarters and better facilities are secured.

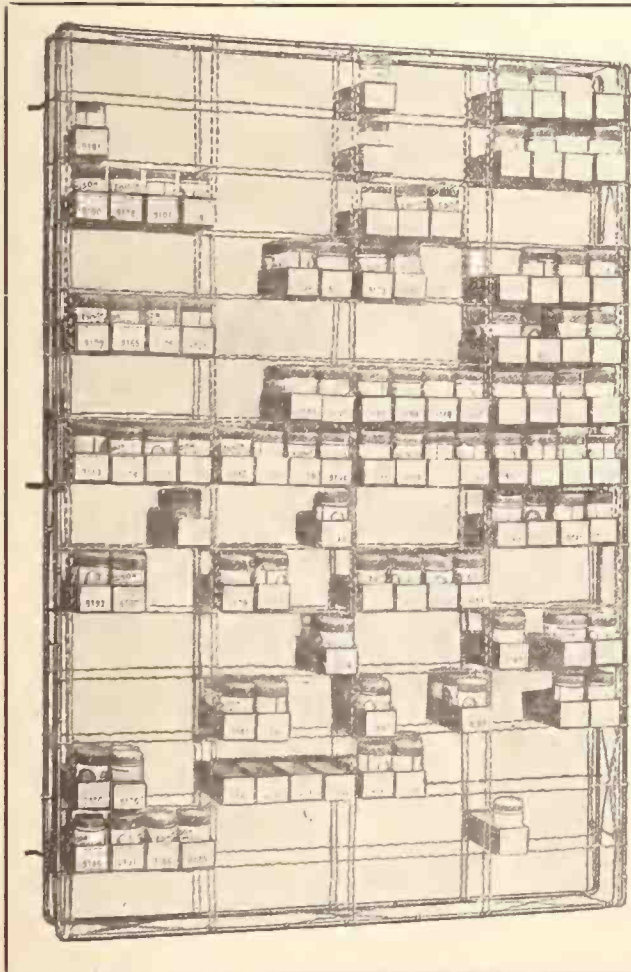

## THE SYRACUSE MULTO-RECORD RACK

A practical combination of "The Heise System" of Wire Record Racks combined with the Rapke Label System and neat pasteboard trays.

Most desirable where dealer desires to carry several records of one kind. Neat, compact, strong, durable. Admits of being fastened to wall, or back to back, or in any way designed to insure greatest economy in space.

This Size, Holding 240  
Trays, 3 Records to Tray \$15

Get Circular explaining details.

## SYRACUSE WIRE WORKS

SYRACUSE, N. Y.



## AN AID TO THE PUBLIC SPEAKER.

How the Talking Machine May be Utilized in This Connection—A Pointer for Dealers.

The public speaker, whether he be recitationist or lecturer, will find the talking machine a valuable adjunct to his work. Let us consider first the recitationist, the man who entertains audiences throughout the rural districts where the orchestra, and even the piano, is not available. Unaccompanied and without incidental effects of any kind, his voice, no matter how mellow and magnetic in quality, loses a great deal of its charm, but with a soft orchestral melody as a background, it becomes a thing of

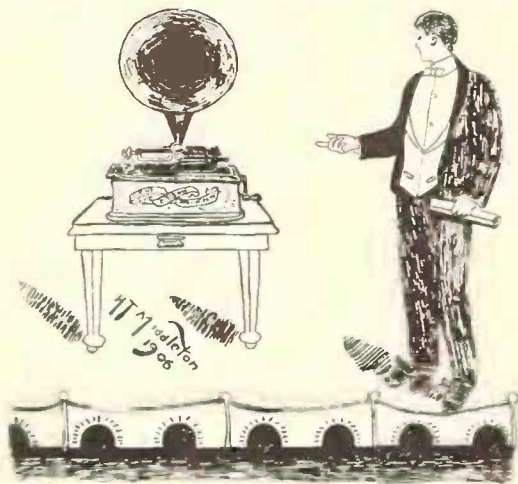

RECITATION WITH TALKER OBLIGATO.

power capable of controlling the feelings of its auditors at will.

For example, we will suppose he is reciting a poem such as "Echoes of the Past," which begins—

From a little shop in Paris  
With an ivy covered wall,  
Echoed the strains of a 'cello,  
Played by M'sieu DuVall.

Then it goes on to tell of the fast friendship which existed between the old Frenchman and his instrument, and ends in a pathetic manner as follows:

In his chair by the firelight  
Sat old M'sieu DuVall;  
By his side lay his 'cello broken:  
His hands had let it fall.

In the light from the fireplace,  
That wandered o'er his face,  
I knew a Heavenly messenger  
Had visited the place.

With a soft 'cello obligato, this poem is a thing of beauty, and without it the effect is crude and unfinished.

Of such great benefit is incidental music to the

recitationist that he has reached the point where he must have it in order that he may do justice to himself before an audience. He depends on it as much as the singer does his accompaniment, and when in some country town far removed from the facilities he craves, and is forced to work without them, his ability to entertain is reduced to a minimum.

Mr. Dealer, you have the remedy for this complaint always at hand, and you should send out circular letters at once to elocutionists in general, telling them what your machines will do for them in this line, and that they can all have the incidental effects which the theatre affords for the small fraction of the cost of one accompanist.

To the lecturer the talking machine is also invaluable. If he is lecturing on one of our greatest American poets, Longfellow, for instance, and has mentioned "The Bridge," as one of that great man's most noted and beloved creations, how fitting to have a talking machine at hand to sing in a masterly manner with orchestra accompaniment, the masterpiece above described.

It will pay you, Mr. Dealer, to get in touch with gentlemen of this profession, too.

HOWARD TAYLOR MIDDLETON.

## LANGUAGE INSTRUCTION BY 'PHONE.

In the talking machine parlors of the E. F. Droop & Sons Co., on Pennsylvania avenue, Washington, D. C., there was recently demonstrated in a very effective manner the advantages of the talking machine method of language instruction. The demonstration was in charge of Brian Dunne, of the department of languages of the International Correspondence Schools, Scranton, Pa., and aroused much interest. The predominating advantage of the phonograph method of language instruction is that the student is able to obtain the absolutely correct pronunciation of over 2,000 words in any language which are contained on the twenty-five records furnished with each separate course.

## NEWS FROM THE SOUTHLAND.

The Phillips & Crew Co., of Atlanta, Ga., have recently remodeled their building, and the talking machine department now occupies the entire second floor. Besides their prosperous retail business they are large jobbers and enjoy a trade extending along the South Atlantic seaboard. Mr. Ben Lee Crew, the general manager of the company, has the talking machine depart-

ment under his wing, and traveling men tell many stories of the warm reception he always extends to knights of the grip.

The Alexander-Elyea Co., of Atlanta, engaged in the talking machine business less than a year ago, but have already built up an excellent business. They are exclusive Victor jobbers. They recently placed a notable order for H. & S. supplies.

When the L. Grunewald Co., of New Orleans, get into their new building, which is being constructed just across the street from their former location, they will go into the talking machine business much more extensively than heretofore. Commodious quarters will be provided for the department, and several private rooms fitted up for demonstration purposes.

The National Automatic Fire Alarm Co., of New Orleans, rank among the largest of Southern jobbers. Their line consists of the Victor and Edison goods. Their retail department boasts of having sold two Auxetophones and five Victor-Victrolas in two weeks, besides taking orders for three more of the latter to be delivered as soon as the factory is able to ship them.

## NEEDLES AS AN EXCEPTION TO A RULE.

It is a common saying that "seeing is believing," but the Blackman Talking Machine Co. claim that this will not apply to their Playrite and Melotone needles, for with them it is a case of "hearing" to believe.

A neat little folder that they have issued has as a title "They play from start to finish, and work all the time." Mr. Blackman says that this reminds one of the newspaper conundrum of "black and white and read (red) all over." In coining his trade mark name, "Playrite," he also added "the name tells what they do." for the Blackman Co. claim that their Playrite needle plays a 12-inch record perfectly from start to finish, and their Melotone needle is furnished to fill the demand for a needle that will give a softer reproduction.

The needle question has been a very serious one, for the manufacturer has been making great improvements in the record, whereby a much harder surface is the result, and this has made necessary a needle that will stand wear and not become worn out when only half of the record has been played. They are so confident with the result of their Playrite needles that they are furnishing free sample packages to all dealers and jobbers upon request, and furnishing very attractive advertising matter for distribution.

## Popular Hebrew Records



WE now have ready the most complete selection of Hebrew Records ever offered. These include all of the popular numbers, and are made by the most talented Hebrew artists.

### Dealers Have Found Them to be Remarkable Sellers

Their clearness has been commented on, and many unhesitatingly pronounce them the best records made.

It is our aim to have a complete stock at all times, and twenty new numbers will be ready on the 20th of November.

Under the new management of this business the closest attention is given to dealers who have a demand for this class of records, and every dealer can be assured of the most liberal treatment, and that his orders will be promptly filled.

A splendid opportunity for first-class dealers to increase their trade is here afforded.

Send for list of latest records. It will pay you.

## The United Hebrew Record Co.

257-261 Grand Street

LOUIS ROSANSKY, Prop.

New York City

## Business Developers

SOLE IMPORTERS OF

## Low-Priced Cylinder Phonographs

IMMEDIATE DELIVERIES FROM  
NEW YORK STOCK

THE EDWIN A. DENHAM COMPANY, Inc.  
31 Barclay Street

LONDON NEW YORK BERLIN

60 YEARS'  
EXPERIENCE

# PATENTS

TRADE MARKS  
DESIGNS  
COPYRIGHTS & C.

Anyone sending a sketch and description may quickly ascertain our opinion free whether an invention is probably patentable. Communications strictly confidential. HANDBOOK on Patents sent free. Oldest agency for securing patents. Patents taken through Munn & Co. receive special notice, without charge, in the

## Scientific American.

A handsomely illustrated weekly. Largest circulation of any scientific journal. Terms, \$3 a year; four months, \$1. Sold by all newsdealers.

MUNN & Co. 361 Broadway, New York  
Branch Office, 625 F St., Washington, D. C.



**PITTSBURG REPORTS PROGRESS.**

Business Very Prosperous—Powers & Henry's New Store—Enders Opens Up—Mitchell in Charge of Commercial Graphophone Department—Other News of Interest.

(Special to The Talking Machine World.)

Pittsburg, Pa., Nov. 12, 1906.

From inquiry at the many talking machine stores throughout the city there is no doubt but that the business is in a very prosperous condition. All classes of people are buying all kinds of machines. Selling machines on time has become a very notable feature of the business here, and one which has brought great prosperity to the several dealers. There is a very large class of people, honest working people who are earning good wages throughout Pittsburg and surrounding territory, who are making wages which enable them to indulge in the luxuries and pleasures of life, and they are not slow to take advantage of their opportunities. These people are without musical education in very many cases, and living somewhat remotely from places of amusement, take to the talking machines naturally as a source of entertainment and diversion. Hundreds of machines are being daily sold to these people, very generally on time payments. It necessitates upon the part of the dealers keeping up a regular collection department. These departments are capably and ably manned, and from inquiry it is learned that comparatively few losses are sustained from transactions of this kind.

The Columbia Phonograph Co., under the management of Elmer A. McMurtry, has taken a somewhat forward step in keeping open until 9 o'clock every evening and until 10.30 on Saturday. Mr. McMurtry reports that his innovation has been very profitable up to the present. Notwithstanding that the Columbia office is on Penn avenue and not in what would be termed strictly the center of transient traffic, a great many purchasers have found their way to the Columbia store at night, and have made in very many cases handsome purchases. The opportunity for careful investigation of the machines, and without rush and hurry hearing the records available, probably promotes many sales that would not be made throughout the day.

Powers & Henry Co. report excellent business in both of their stores. They have recently opened a store in the Arcade on Fifth avenue, which is also adding to the prosperity of this enterprising concern.

W. H. Enders, well known in New York in the

talking machine business, and more recently connected with the Powers & Henry Co., has opened an establishment at 126th street for renting films.

Powers & Henry Co. have on exhibition a Victor Auxetophone, the only one in Pittsburg up to the present time. It has aroused considerable interest and excited a great deal of wonder as to what will be the next advance step in the talking machine line.

The C. C. Mellor Co., Fifth avenue, have recently added to their stock a complete line of Columbia records, both cylinders and disc, and also a complete line of the disc graphophones. They report excellent business in all of their lines of talking machines.

R. L. Mitchell had recently been put in charge of the Pittsburg territory for the sale of commercial graphophones. Mr. Mitchell was formerly a newspaper man, and more recently a publisher of a trade newspaper in this city. He reports that the effect of the business show in New York is being felt in this city in many inquiries for the new commercial graphophone. Those who saw it pronounced it absolutely perfect, and many are now waiting the opportunity to give it a thorough trial in their own offices.

**GREAT INCREASE OF SALES**

In West Virginia—Some Plain Words About Conditions—A New Snake Story.

(Special to The Talking Machine World.)

Wheeling, W. Va., Nov. 8, 1906.

When you ask the talking machine dealer, "How is business?" the invariable reply is, "Slower opening up this year than last." When a comparison of sales is made, then comes the revelation that the increase of this year's sales over last year is well worth considering. When one looks over the stocks of goods now carried by the retailers in this city, as in comparison with a year ago, then it's easy to figure out the cause of the feeling usually expressed. They merely overlook the fact that their big stock was put in so that the holiday business could be handled to the best advantage, and then have a surplus to help them carry on business without being solely at the mercy of the jobbers, who by that time will be handing out the old story of "I told you so" instead of their present promises to fill 98 to 100 per cent. of your record orders.

By the way, a new snake story was uncoiled here. A down-river West Virginian stalked into one of the prominent talking machine stores last week and asked to be shown "one of them

things what makes a noise." At the same time he offered the information that he bought and captured snakes, tamed them, then sold them for pets. He thinks the machine will be a great aid to him in the taming end of his business. If his experimenting meets with success the summer business in talkers should show a great increase. Mother will allow Mary to go out and pick blackberries if she promises to keep the phonograph playing all the time.

Both C. A. House and the J. W. Baumer Co. report good business in their talking machine departments. Bard Bros. keep pushing right along after business. The showing of machines and records made at their new Main street store would be a credit to a much larger city. They have just had the front of their building re-decorated; it makes a very striking appearance.

Manager Rogers, of the Columbia store, is well pleased with the business he is getting.

**LIPTON AND THE "TALKER."**

Hears His Own Voice While Visiting the Columbia Phonograph Co.'s Plant Last Week.

Sir Thomas Lipton heard his own voice reproduced while a guest in the factory of the Columbia Phonograph Co.'s factory at Bridgeport, Conn., on Friday, November 9. The distinguished yachtsman was a guest in that city, and in the forenoon he was taken up to the plant of that company. On the way the auto that carried him broke down and the occupants were gently lowered to the street. Fortunately no one was hurt. Arriving at the factory Sir Thomas was instructed in the art of sound reproduction and allowed to see the record-making. John J. Fisher sang for record an original song, entitled "Tommy Lipton," to the air of "Tommy Atkins." This song had been sung for the first time at a banquet given in Sir Thomas' honor the previous night. The yachtsman then spoke for a record, his theme being "How I failed to lift the America's cup." He first treated the subject humorously, told stories to illustrate his points and succeeded in spinning an interesting yarn. He said that knowledge of the sailing conditions about Sandy Hook had something to do with his defeat, but he was careful to emphasize the statement that he had been beaten fairly each time. In terminating the speech he referred to the bright prospects for a fourth race, and that he pinned his faith in the fourth leaf of the shamrock, and was confident that Shamrock IV. would be the means of taking the cup across the Atlantic. It is hoped that Sir Thomas will allow the Columbia Co. to place this record on the market, as he has a host of admirers that would be proud to own one.

**PROTECTS "PENNY ARCADES."**

Police Must Let Them Alone While Injunction Is Argued.

The question whether the "penny arcades" must obtain theatrical licenses is before Justice Mareau, of the Supreme Court. There are over forty such places in Manhattan and Brooklyn, and it has been held by the police that they must obtain licenses. Most of them have none and others are operating under showman's licenses, for which they pay \$25 a year. The police contend that they must obtain theatrical licenses, which cost \$500 a year.

Captain O'Brien has been making trouble for several of these places in Brooklyn, and Gustavas A. Rogers has obtained an injunction preventing the police from interfering while the question is before the courts.

Under the title "Powers & Henry, Agents for the Edison Phonograph Co.," some party or parties are sending out letters through Colorado for some purpose not apparently legitimate. The Powers & Henry Co. desire to warn the trade at large, particularly in the West, against communications of this kind, and they have placed the matter in the hands of the police. The letters are distinct forgeries.

**ATTENTION**

If you are interested in Talking Machine

**FLOWER HORNS**

Write us immediately for full particulars.

Our Horns are constructed from the finest sheet metal obtainable. WE GUARANTEE EVERY ONE NOT TO FADE.

*Jobbers, send for Free Sample.*

**NEWARK TINWARE AND METAL WORKS**

53-55 N. J. R. R. Ave. = = = NEWARK, N. J.



## CROMELIN REPLIES TO SOUSA.

Declares Mechanical Music Is Not a Menace  
But a Blessing.

In The World recently reference was made to the article by John Philip Sousa in last month's Appleton's Magazine on "The Menace of Mechanical Music." In the current issue of Appleton's there appears a very interesting communication in reply to Sousa's article from the pen of Paul H. Cromelin, vice-president of the Columbia Phonograph Co., in which he says:

"I have read with much interest an article under this title in the September Appleton's, written by my distinguished friend, John Philip Sousa. Having been closely identified with the development of the talking machine, I was curious to learn how many and which of our cherished institutions were menaced by the great and growing use of these mechanical reproducers of music; and after having read the catalogue set forth in the above entitled article, I confess to having breathed a sigh of relief.

"But before taking up the details, I cannot refrain from calling to mind that the mechanical reproducer of musical and other sounds has received, in the article referred to, precisely the same greeting that has been accorded to the other really great products of mechanical genius. There are not lacking, in such cases, those who see in the new device some peril to the community, and who seek to excite opposition to it, though usually, if the opposition be probed, a selfish motive may be found. One of the distinguished instances was the cotton gin, which was regarded as so serious a "menace" to those who earned a livelihood by separating cotton fiber from its seed that the inventor was stoned by the infuriated representatives of the 'menaced' industry. Now, the annual output of about ten million bales of cotton is the answer to that historic wail of unfounded apprehension.

"There are those still living who can recall the outcry against the sewing machine, and the predictions that it would deprive the poor sewing girl of her scanty wage. But notwithstanding these predictions, plausible as they appeared to be, there are to-day a score of sewing women earning, and with comparative facility, good wages by the aid of the mechanical device, where there was then one securing a pittance by plying her needle.

"But, after all, what are the existing institutions which are menaced by the talking machines and automatic piano players?

"First, it is complained that the expression or rendition of music suffers, with a threat of deterioration of the public taste and appreciation in music.

"To this assertion, a general denial can be confidently entered. No one who reflects upon the matter for a single moment will deny that the average rendition of music by the amateurs in the homes of our land is far, far below that of the mechanical music reproducer of to-day. It is just because these devices bring into our homes renditions of music of a superior quality,

to which the vast majority of our people are total strangers, that they are meeting with such universal acceptance.

"But there is much more than this. The average amateur is generally limited to one instrument, and his or her proficiency admits only of the indifferent rendition of a small number of compositions, usually of elementary character and mediocre quality. The graphophone, on the contrary, brings into the home the widest range of musical renditions, vocal and instrumental, solo and concerted, rendered, it may be, by the greatest living artists. So far, therefore, from the musical taste and appreciation of the public being menaced from this cause, it is safe to say that nothing has yet been devised by the wit of man so calculated to promote these qualities.

"But let us hasten to the next of our menaced institutions. Our author assures us that the onward march of the mechanical music maker will cause the girls of our nation to desist from the effort to make mediocre piano players of themselves, and will also diminish the use of the banjo, mandolin and guitar. Assuming for a moment the correctness of this statement, which of our readers, on hearing it, will not cheer onward the march of the mechanical music maker, and wish that it may soon accomplish its wholesome mission? What a fearful waste of time and what needless suffering have been caused by the futile but persevering attempts to make all our Mary Janes "learn the piano." And to think that now a mighty reforming agency has appeared, which will abolish from our houses and flats the horrors of scales and exercises, and will confine these tedious performances to the musical colleges, or to those who really possess the gift of musical expression!

"But I deny that the progress of the mechanical music maker will diminish individual application to the art of musical rendition. On the contrary, one important result of the present-day musical sound records is to excite an interest in music in millions of homes which otherwise have absolutely no access to really artistic musical renditions, or even access to renditions of any sort of great musical compositions. To those gifted by nature with a singing voice the opportunity of listening repeatedly to the phrasing and expression of great artists is of incalculable benefit. Already the high-class musical sound records have produced great educational results, affording to gifted persons in remote places and of slender means the extraordinary advantage of singing lessons from the greatest living artists, and a career of great utility is opened in this direction.

"The idea that any person having the natural ability and desire to sing, will permit a mechanical device to do his singing for him is laughably absurd. On the contrary, the mechanical reproduction of songs by correct methods will only stimulate him to sing the more and enable him to sing the better.

"Music and musical tone production has differed in the past from all other forms of art in that the pleasure which it afforded was but of a momentary and passing existence. We love the

pictures and paintings in our homes and in the great galleries, and delight in feasting our eyes upon the masterpieces which noted sculptors have produced. There is a certain sense of possession and security in the knowledge that, if we care to, we may cross to Dresden and linger as long as we will in silent contemplation, not to say awe approaching adoration, before Raphael's Sistine Madonna. A few steps into another room, and once again Hoffmann's wondrous masterpiece, Christ in the Temple, is ours to remain with and to behold in sweet meditation.

"But, oh! the memory of that night when Jean de Reske sang at the Metropolitan. Beautiful and sweet and blessed memory, but only a thing of memory now; and the recollections of the nightingale tones of Jenny Lind's remarkable voice! Ah, but a recollection now; a thing of the dead, dead past—gone, gone forever.

"But the talking machine will change all this, and future generations will rejoice and be able to enjoy forever the music of the great artists of to-day. Tamagno is gone, but the voice of the great Italian tenor remains and brings pleasure and instruction to thousands of homes. Our well beloved Joe Jefferson is no longer with us, but we have a precious legacy in Rip's quaint and pathetic meeting with his daughter 'Meenie,' after twenty years' sleep. The matchless and incomparable triple-tongue cornet tones of Jules Levy remain to delight and please us, although all that was mortal of the great artist lies buried in a country churchyard.

"Can we pay too great a tribute to the genius in the invention which makes it possible to bottle up this wine of music and song inexhaustible, and should we not offer up our thanks for 'The Blessing of Mechanical Music'?"

## CHANGES IN CANADA.

Monday C. H. Wilson, general sales manager of the National Phonograph Co., got back to New York from a week's trip over the border. The business of the company has expanded so rapidly in Canada that it has got beyond R. S. Williams & Sons Co., Ltd., of Toronto and Winnipeg, who were the sole Edison jobbers in the Dominion. Dealers being unable to obtain goods as quickly as desired and to facilitate shipments Mr. Wilson created the following additional jobbers: Peter Kelly, Montreal; C. Robitaille, Quebec, and W. H. Thorne & Co., St. Johns, N. B.

An immense Victor dog, as an illustrated sign, will be placed in front of Landay Bros.' new store, 440 Fifth avenue, New York. It is over five feet high, and in proportion throughout.

A. L. Irish, former president of the Talkophone Co., Toledo, O., is the executive head of the Atlantic Phonograph Co., a New York corporation, with a capital of \$2,000,000, with an office in New York City. J. L. Adrien is secretary and O. Clayton Reed his assistant. These were connected with talk-o-phone interests also.

## Rapke Horn Crane, No. 15

**S**IMPLEST and best ever produced. Will support any horn up to and including 36 inches. Is nicked throughout, and fits into small space. Weighs only 13¼ lbs. Can be attached in an instant to any Phonograph without injury to cabinet.

**RAPKE HORN  
CRANE, No. 15**

PATENTS PENDING

PRICE, . . . \$1.50

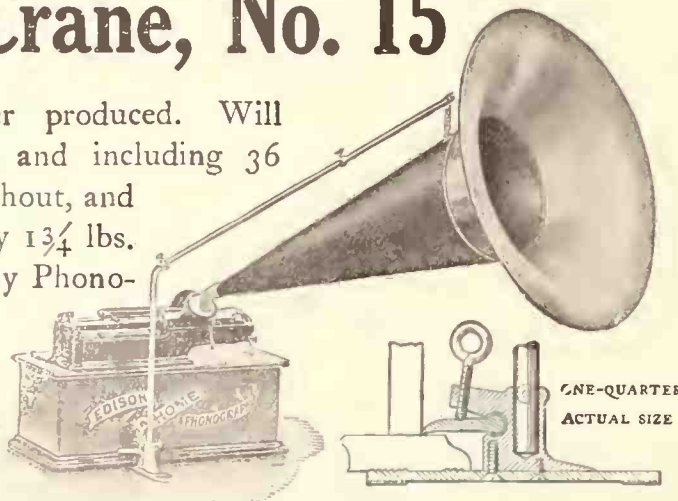

## Mr. Dealer!

are you using the RAPKE Labels for Edison and Columbia XP Records: Trays, regular and folding? If not, consult at once

## YOUR JOBBER

SAMPLES OF LABELS FREE.

As soon as you adopt this system, your profits increase. It costs you nothing to try.

If your jobber cannot supply you, write to

**VICTOR H. RAPKE, Mfr., 1661 Second Av., New York**



**TALKING MACHINE AS A TEACHER.**

Has Won an Important Place in the Musical World, According to N. J. Corey—Writes Most Illuminating Article for "The Etude."

Inventive ingenuity has accomplished so much during the past century, and the human mind has become so accustomed to a succession of marvels, that it now hardly takes notice when a new one is presented. Formerly people could scarcely believe when the various remarkable discoveries and inventions were successively announced, but now incredulity is fast becoming obsolete. Since the successful application of wireless telegraphy we are prepared to believe almost anything, even in the construction of a practicable airship, thus far the most unconquerable of problems. Who would have believed, a quarter of a century ago, that ultimately the sound of Adelina Patti's voice could be heard in every house in the land? Phonographic instruments were not unknown then, but only snarling travesties of the human voice were heard issuing from them, nothing that could for a moment attract the attention of a serious lover of good singing. Now the possibilities of the reproduction of sound have been so enormously perfected that even an expert connoisseur listening from an adjoining room to the voice of Caruso issuing from the horn of a talking machine, could be with difficulty persuaded that the great singer himself was not there.

Mechanical playing instruments have been in vogue for years, the music box having been a common means of amusement with our well-to-do grandparents, but it is only very recently that such instruments have begun to be taken seriously by professional musicians. Mechanical players for the piano and organ have become very popular. The best results are produced with the organ, its sustained and somewhat impassive tones lending themselves more readily to satisfactory effects.

To people who cannot play, yet are fond of music, a self-player attached to their pianos affords a great deal of pleasure. More than this, teachers of the history of music in many of the largest universities and conservatories are making use of self-playing instruments in order to make their students familiar with the standard orchestral works. Teachers, by making their classes familiar with these great works, prepare their minds to listen to them intelligently when interpreted by the great orchestras. Thus the self-playing instruments become a sort of preparatory school in musical listening. Unfortunately they have no individuality of interpretation, and thus far have been able to assume only a makeshift function, something to be made use of for the lack of a better; a valuable function, nevertheless, in a scheme for a musical education, for a teacher who is not a good piano player and sight reader.

The Victor talking machine, on the other hand, is no makeshift. The actual interpretation of the great singer or player is recorded and reproduced exactly as first made. It occupies a similar position in the realm of auditory that

the photographic camera does in visual phenomena. It is not correct to call it a mechanical instrument, for the sound produced is not mechanical. It is more properly an instrument for preserving sound.

Personally, I never took very kindly to any of the self-playing instruments, not even for the orchestral movements. Originally I felt similarly toward the phonographic instruments. The harsh, stridulous tones that I had heard issuing from them impressed me as inexpressibly disagreeable, so much so that when certain enthusiasts urged me to go in and hear the Caruso records, I declined, harboring at the same time a feeling of compassion for those who could enjoy such disagreeable imitations of singing. It was a year before I allowed myself to be persuaded to hear the records. It turned out to be nothing more than a repetition of the old story of the man who went to scoff. My astonishment was so great that I could hardly believe the evidence of my senses. But I was forced to confess that here was the first automatic reproducing device that I had ever heard that produced a thoroughly artistic result in the highest sense of the word. It could not be otherwise, for there were the voices of Sembrich, Eames, Plancon, Campanari and others, just as I heard them repeatedly; tonal quality and interpretation reproduced exactly.

Almost my first thought was: What a splendid opportunity for illustrative examples in teaching of musical history, an opportunity that had never before existed, even in the largest centers! I refer particularly to the history of the opera. Even in New York the number of operas that may be heard in a single season is comparatively limited, from a historical standpoint, and not every student can afford to attend all that may be given. But with the talking machine examples may be given from opera composers of all styles and periods.

Most conservatories have a course of study in the history of music, which may be copiously illustrated with instrumental selections, but very sparingly from the operatic repertoire. There may be good singers among the members of the conservatory faculty, but even with the four voices represented, soprano, alto, tenor and bass, comparatively few illustrations could be used, for each singer usually has but a few arias from the operas in his or her repertoire. From the long list of arias from the operas of Gluck, Mozart, Rossini, Bellini, Donizetti, Verdi, Meyerbeer, Weber, Wagner, Bizet, Gounod, Thomas, Saint-Saens, Massenet, Mascagni, Leoncavallo, Giordano, Puccini, etc., not enough could be given to make a comparative study possible. But in the course of study I have arranged for the Michigan Conservatory of Music, I make use of more than a hundred arias in illustration, as well as a few instrumental records.

A comprehensive musical education demands that the student not only learn about music, but that he hear the music itself, and as much of it and as often as possible. Opportunity for listening is the one great lack in the education of most students. The enterprise of the Victor Talking

Machine Co. in making a specialty of these arias from the grand operas of all schools and periods and sung by the greatest singers, makes it possible for schools and private studios, even in the most remote corners of the land, to install a course that will be invaluable to students. Singing teachers can now give demonstrations of the interpretations and vocal art of Patti, Sembrich, Plancon, Caruso, etc., in places where these artists can never be heard in person. In a course of lectures which I gave during the past summer at Chautauqua, New York, the talking machine was used in some of them, and audiences of from one to four thousand people heard with absorbed attention the records of the great singers. People from all parts of the country, who had never expected to have an opportunity to listen to so many great artists, heard Patti, Melba, Sembrich, Gadski, Eames, Schumann-Heink, Caruso, Plancon, Campanari, Scotti, etc. They heard ten arias sung by Tamagno, the greatest tenor of the past quarter century.

Two periods in musical history have heretofore been sealed books to music students, that of the Gregorian Chant and that of Palestrina. It is impossible to give any idea of the Gregorian music by means of an instrument, it is so inherently peculiar. But since the publication of a complete series of Gregorian records, made under the most authoritative auspices, the Sistine Chapel (the Pope's choir), the Augustinian Fathers and the Benedictines of St. Anselmo, pupils may now be made thoroughly familiar with what the music of this important period of musical history was. The same may be said of Palestrina. Great as is his music, enormous as was his influence upon musical composition, his music is practically obsolete, so far as opportunities for hearing it under ordinary circumstances are concerned. To play his music upon the organ even, gives but an extremely inadequate idea of it. Such involved a capella part writing needs the individual character of the various voices themselves to give its true effect. The records of this music, published by the Victor Co., were made by the Pope's choir, which lends additional interest to them.

As time goes on, and musical educators become more familiar with these fine records, I believe they will become eventually indispensable to the work of every conservatory course of instruction, for it is coming more and more to be recognized that hearing great music is more useful in developing a musical appreciation than hearing about it just as, in the study of English literature, students are now expected to read selections from the great writers, whereas formerly they only read their like and a criticism of their more important works.

The Hawthorne & Sheble Manufacturing Co., of Philadelphia, report having booked so many orders on their new line of "artistic flower horns" that their three factories will be taxed to their utmost capacity in order to turn them out. Evidently the dealers and jobbers generally are becoming alive to the fact that properly made horns of attractive design will bring their price.

**WE SOLICIT  
YOUR  
PATRONAGE**

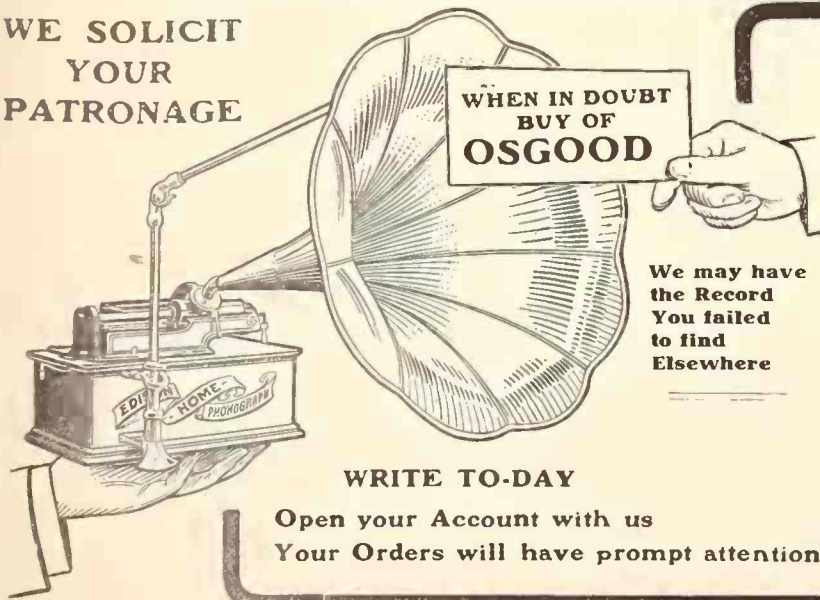

## Edison Headquarters AT OSGOOD'S

Our Complete and Comprehensive Stock include

Edison Phonographs, all styles, Complete Stock of Records, Horns, Black and Gold, all sizes. Flower Horns, new designs, Herzog Cabinets, Disc and Cylinder, Carrying Cases.

HORN STANDS AND CRANES

The Tea Tray Co. and Hawthorne and Sheble Co's Products are fully represented

Our New and Enlarged Quarters enable us to fill orders promptly

**The C. E. OSGOOD CO.** Wholesale Distributors  
744-756 Washington St., BOSTON



## COMMERCIAL TALKING MACHINES AT THE BUSINESS SHOW.

The Handsome Exhibits Made by the Columbia Phonograph Co. and National Phonograph Co. Attracted Large Crowds and Splendid Missionary Work Was Accomplished.

The National Business Show, which has been one of the leading features at the Madison Square Garden, opening October 27, brought

Durand, the manager of the Commercial Department, he being ably assisted by M. E. Elliott, district manager for New York; N. R.



NATIONAL PHONOGRAPH EXHIBIT IN FOREGROUND.

the commercial talking machine into greater prominence than ever before, the displays of both of the leading companies being extremely

Compton, district manager for Philadelphia, Pa.; G. R. Harris, district manager for Boston, Mass., and William Wadams, manager of the installa-



THE COLUMBIA PHONOGRAPH CO.'S BOOTH.

attractive, and amazing the business men with their possibilities as time and labor savers.

The display of the Edison Business Phonograph, manufactured by the National Phonograph Co., occupied a prominent position in front of the main entrance, and at once arrested the attention of the visitor. One of the unique features of this large and beautifully arranged exhibit was one of the original phonographs built by Thomas A. Edison nearly thirty years ago, placed in juxtaposition to their latest models. Pretty and expert operators demonstrated how the typewriter could receive dictation, and crowds of interested people were always in evidence. The display was in charge of Nelson C.

tion department, New York. These gentlemen were kept busy from the time the show opened in the morning until late at night explaining the workings of the Edison commercial system, and they feel that the results achieved well paid them for their trouble and expense.

The exhibit of the Columbia Phonograph's Commercial Department in spaces 88 and 89 was always crowded with visitors, who at once became interested in the workings of their product. Their 1907 model, which was recently described in *The Review*, was the cynosure for all eyes, and its extreme simplicity and portability were commented on favorably. A force of handsome young ladies operating on a number of these machines showed them in actual operation, and many of the spectators dictated letters and messages which they quickly transcribed. The exhibit was in charge of J. W. Binder, manager of the General Commercial Department, and his assistant, Mervin E. Lyle. As expert demonstrators, there were present Walter H. Bedard, manager of the Commercial Graphophone Department, of Atlanta, Ga.; Richard Faulkner, manager of the Commercial Graphophone offices, Philadelphia, Pa.; William P. Hopkins, a member of the systematizing staff of Stephen T. Williams, of the New York Life Building, New York; H. M. Nicholson, manager of the New York uptown Commercial branch; John G. Williams, New York city salesman, and F. M. McClintic, who for a number of years held the world's championship for the most accurate and rapid transcript of the Associated Press matter received by telegraph.

In conjunction with these exhibits the Telegraphone, that remarkable invention whereby speech is accurately recorded on a fine wire by electricity, came in for its share of attention. The possibilities of this instrument have not as yet been fully developed, but from what the public was able to see, they were fully convinced of its great merits, and saw for it all of the great future prophesied by its promoters. They had two machines at work, one being intended for commercial purposes and the other as an attachment to a telephone. The exhibit was in charge of Willard M. Miner, who ably demonstrated the workings of the machines, and interested many in the matter of investment in the stock, so that the company might be still further exploited, and an adequate plant established.

Both the Edison and Columbia managers made some very good sales to representative concerns during the course of the show, and have several deals in abeyance, which, when they materialize, will do much toward bringing the commercial talking machine into greater prominence.

### HUMAN SIDE OF BUSINESS SHOW.

Interesting Contribution by the Observant J. W. Binder Who Discusses Men and Things.

There was much more to the Business Show in Madison Square Garden than machines, systems, signs and electric lights. Each of these was extremely important and extremely interesting, but by no means the "whole show." In an event of this kind one must look beyond the external for the true "motif." This will be found in the individuals constituting the ever-changing throng that filled the aisles of the big show place.

## THE NEW Imperial Records

RECORDED IN EUROPE

Are Meeting With  
Marked Success **\$1.00 and \$1.50 Each**

SEND TO-DAY FOR CATALOGUE

LEEDS & CATLIN COMPANY - - New York



The machines and devices shown were interesting; the arrangement of the displays, the electric signs and the many methods used to catch and hold the attention of the spectator were interesting, but to the close observer, the human factor held the greatest element of interest. What the machines did was wonderful. Their effect upon the individuals who came to see them was much more so.

I spent the seven days of the show coming in contact with hundreds of these individuals, and out of the chaos of mental impressions left behind a few stand out.

Our exhibit—commercial graphophones—was a center of attraction. The idea of recording dictation upon a cylinder at any moment and as rapidly as one loves to talk, is still sufficiently novel to arrest the attention of even the most blasé. Hence they all come to us.

\* \* \* \*

This happened about 10 o'clock of the opening night.

There were just two of them—sweet young things who had some things still to learn.

"Oh! see that handsome man"—referring to Mr. Bedard, of Georgia—"talking into the speaking tube," piped one.

"Why, you know, Bess," answered her companion, "he's dictating letters. He talks them into the machine; they go over and wire to the girl over there, and she writes the letters."

"But why don't he dictate them to the girl at once, Bess?" queried the fair one.

I couldn't resist the temptation.

"Because," I said, as gently as possible, "his wife won't let him."

They passed on. \*

\* \* \* \*

"Might I listen to one of the machines?" Her voice was sweet and mellow as that of a full-throated robin.

"With much pleasure, madam."

"You know, my employer is talking of getting some of your machines, and I'd like to know just how they work."

"Glad to show you." This from the genial Hopkins, who was demonstrating. A letter was dictated, and she was allowed to listen to its reproduction.

"Why, that's fine," she said. "But where does the letter come out?"

It was explained to her that it was still necessary to use a typewriting machine before the letter could be written.

She breathed a sigh of relief as she moved up the aisle. Her job was safe.

\* \* \* \*

There were four of them, all prosperous business men. They came in and sat around a machine for a demonstration. Each dictated a letter, and when it came time to reproduce the last man's dictation, he listened to it and gravely remarked to his companions:

"Boys, not another highball for me to-night. I'm drunk now."

"Why, how can you tell?" queried the bunch. You can walk all right, and your talk is straight."

"That's a' right," he answered; "but you listen to the 't' in that word 'mister.' It ain't there in the machine. I'm drunk, a' right."

And he was.

\* \* \* \*

This boy was a smooth one. He came into the booth and asked if the machines would record dictation. There was a sixteen-foot sign staring him in the face which said that was what they were there for, but that made no difference.

He was given a demonstration and listened with much interest. It was, he said, the first time he had seen such a thing and it interested him greatly. He was going to look into it further. Would we kindly let him have a full set of literature?

As he was going out he turned to the machine once more and said: "Oh, I would just like to see how your speed regulator operates."

He was a decoy from a competitor's booth.

## DURAND CHATS OF BENEFITS

Which Were Derived by the Display of Commercial Phonographs at the Business Show.

"The recent Business Show in the Garden was an object lesson to the progressive business man in more ways than one," said Nelson C. Durand, manager of the commercial department of the National Phonograph Co. to The World after the close of the show; "but in the use of the phonograph as a necessary accessory to the office was the lesson strongly emphasized. Months of correspondence and talking could not convince business men of its utility like a practical demonstration given by an operator at our booth. When they realized the fact that they had an amanuensis constantly at hand, who never grew weary and made errors, and who would work overtime without a grumble, it became an easy matter to interest them. Then, too, we were able to show the stenographer how, instead of curtailing her salary, it would tend to make her more valuable. This we did by demonstrating the extra amount of work that could be produced in a given time without the labor on her part that would be required if she had to take notes instead of transcribing direct from dictation. In showing the saving we did not advance the argument that a purchaser of one of our outfits would save money on the salary, but by the added results. By doing this, we made friends with both sides. The old question of the phonograph injuring the hearing also was constantly coming up, and we were kept busy answering questions on that score. But by allowing those who advanced such theories to make a practical test with the modern ear pieces we convinced them that the phonograph would train the ear to more acute hearing than to the contrary. The show proved an ideal school for the training of our salesmen, and it was for this reason we had so many present from our out-of-town stores. One of the points developed by the show was the constantly increasing interest in time saving appliances, and employes who examined our

product did not ask 'how much labor will it save,' but 'how much of my time will I save in producing a given amount of work with my present force.' Of course, there was the omnipresent curiosity seeker, the man who knew it all and every other class that you will find in every show, but I do not think any exhibit aroused greater interest than the Edison phonograph."

## ENTERPRISING KNOXVILLE CONCERN.

The Knoxville Phonograph & Typewriter Co., of Knoxville, Tenn., have recently remodeled their establishment, and now have one of the finest stores in the South. E. J. Rogers, the proprietor, is a man of exceptional organizing ability, and travelers speak with admiration of the perfect system which prevails throughout the store. A visitor to the basement salesrooms receives a surprise. Instead of the usual blank walls he finds himself apparently gazing through windows upon moonlit gardens. The effect is produced by constructing recesses in the walls at intervals, creating a scenic background and placing electric lights out of sight, but so as to shed a gentle radiance over the "landscape." An extensive jobbing business is done in Edison, Victor and Columbia goods and American records. Mr. Rogers, it is understood, has recently embarked on the flower-strewn sea of matrimony.

## COLUMBIA STAFF CHANGES.

S. S. B. Campbell has resigned as manager of the New York office of the Columbia Phonograph Co., General, and will take a few months' vacation, going to Europe, and on his return will re-enter the company's service. J. H. Dorian, formerly of the executive offices, has been appointed manager of the New York office, and is in direct charge of all the Columbia stores in the States of New York and New Jersey. No changes have as yet been made in the Western or Chicago offices of the company, but a shift in management will be made on December 1, according to the statement given The Review by General Manager Lyle.

# The Highest Authorities say the I. C. S. Language System is of Sterling Worth —Are YOU Selling it?

The leading educators and authorities everywhere who have investigated the I. C. S. System of teaching foreign languages have pronounced it to be the most perfect in the world. Take the following endorsement from the German Embassy at Washington, for instance:

I have, with great interest, taken notice of the Language System, through the phonograph, as taught by the International Correspondence Schools, of Scranton, Pa. The pronunciation of German and the rendering of the German specimen recitations, in verse and prose, which the machine delivers, are absolutely irreproachable, and the method applied to the Grammar appears to me thorough and practical. I deem the system well adapted to further the acquisition of the German language according to its Grammar and pronunciation.

SCHELLER-STEINWARTZ,  
Imperial Councillor of Legation,  
Secretary of the Imperial German  
Embassy at Washington, D. C.

This only goes to show that the language feature of the business is well worth YOUR investigation. Another thing that proves the same fact is that dealers who have tried it have greatly increased their business thereby. We have been telling you this for some time. Probably you have meant to look it up, but have forgotten to do so.

Why not sit down and write us a postal NOW

## International Correspondence Schools

Box 918, SCRANTON, PA.



I.C.S. LANGUAGE SYSTEM

WITH  
Thomas A. Edison  
PHONOGRAPH



## WINTER OUTLOOK ENCOURAGING

In the Northwest—Our Correspondent in Minneapolis Makes Cheery Report.

(Special to The Talking Machine World.)  
Minneapolis and St. Paul, Nov. 9, 1906.

The outlook for the fall trade seems to be very encouraging, to judge from the reports for October. Not only has the trade continued good in the cities, but all throughout this section the small dealers are sending in generous orders.

"We haven't a kick coming," said L. H. Lucker, of the Minnesota Phonograph Co. "We had a splendid retail trade during October, and good-sized orders were received from all our agencies. The prospects for a heavy trade in the country this fall seem very good. We sold three Victrola machines last month, and there are several prospects in sight."

The New England Furniture Co. have transferred their Victor department from the corner section they have been occupying to another portion of the store on First avenue, which has been fitted up in an attractive style. The October trade was reported better than a year ago, especially in the line of records.

The best indication of the growth of the talking machine trade of W. J. Dyer & Bro. is the fact that they have had to enlarge the space which had been devoted to it on the ground floor, when the building was remodeled this summer. Sales during October were reported good in both Victor and Edison goods, while the demand for records is much larger than last year.

The Columbia Phonograph Co.'s branches in both towns report a better month in October than in September, and that the indications point to much greater activity from now on to the holidays, the sales tending toward the better grade.

At T. C. Hough's three stores there were indications of a good trade, and Mr. Hough reported himself as being highly satisfied with the results from the sale of Edison goods.

There were rumors afloat Saturday that Donaldson's talking machine department would be closed soon. This, however, has not been verified as yet. If the department has not proven a successful one, it must have been due to the fact that nearly all makes of instruments were carried, and the selling energy was not directed to one in particular.

Butler Bros., the large catalogue house of Chicago, will soon enter the field, their big warehouse being erected here nearing completion. It is understood they will handle the American goods.

## TRADE NOTES FROM TEXAS.

This State Proving One of the Most Profitable for Talking Machine Men—Month's Happenings in Detail.

(Special to The Talking Machine World.)  
Houston, Tex., Nov. 10, 1906.

Probably few men in the trade realize the immense proportions the talking machine business has assumed in this state in the last five years. Whether you visit the homes of our populous cities, the cotton plantations of the central and southern portions, or the ranches of the extreme West and the "Panhandle" you find talking machines everywhere. You find them sold in many little hamlets of two or three hundred population, but which form the base of supplies for a large expanse of territory.

One of the largest jobbers in this section of the country is the Texas Phonograph Co., of this city. On September 19 last President E. H. Holleman was able to declare a dividend of 14 per cent. on the company's stock. They recently added another building, furnishing them needed additional space for both the wholesale and retail branches of their business. They are large Edison jobbers, and keep a man constantly on the road.

Thomas Goggan & Bros., the great piano and organ and musical instrument house, with headquarters at Galveston and branches at Houston, Austin, San Antonio, Dallas and Waco, handle

talking machines at all their stores and do an important jobbing business from Galveston. They are exclusive Victor jobbers. William Goggan has this department of the business under his personal supervision. He recently said that when they added talking machines a year or so ago they were somewhat doubtful whether the business could be made to pay or not. He is no longer skeptical.

The H. C. Rees Optical Co., of San Antonio, Edison jobbers, report a brisk trade. They placed unusually large orders for fall shipment.

The Louis Book & Stationery Co., San Antonio, are stirring things up in that city in a retail way. They have recently opened another store and are handling Columbia, Victor and Edison goods at both stores. They are aggressive advertisers. They have recently been working the newspaper premium scheme on Columbia goods with marked success.

The Southern Talking Machine Co., of Dallas, have a large store, and sell nothing but talking machines, moving picture machines and stereopticons. During the recent State Fair at Dallas, which lasted three weeks, the company did the business of its life.

Cummings & Shepherd, of Fort Worth, Tex., sell large quantities of talking machines besides pianos and a general line of musical instruments. They are Edison jobbers. They recently shelved one entire side of their store for their retail record stock.

The Waco Talking Machine Co. is a new company recently incorporated. They are handling the Victor and Edison at retail, and have taken on the American records as jobbers. They have a nice store and are doing a good business.

At Austin the Petmecky Co. have an excellent trade on the Edison, Victor and Columbia goods, and are jobbers of American records. The company have sprung into national trade prominence as the inventors and manufacturers of the Petmecky needles, which are being handled by jobbers and dealers everywhere with signal success.

TRADE STANDARD	TRADE STANDARD	TRADE STANDARD	TRADE STANDARD	TRADE STANDARD
 <h2 style="text-align: center;">Standard Metal Mfg. Co.</h2> <p style="text-align: center;">Office and Salesroom 10 WARREN STREET, NEW YORK</p> <p style="text-align: center;">FACTORY Jefferson, Chestnut and Malvern Streets Newark, N. J.</p> <h1 style="text-align: center;">Standard Horns</h1> <p style="text-align: center;">ARE THE ONES TO HANDLE</p> <p style="text-align: center;"><b>WELL MADE      CAREFULLY FINISHED      AT RIGHT PRICES</b></p> <p style="text-align: center;">Give entire satisfaction and increase sales. No kicks</p> <p style="text-align: center;"><i>Variety to Please All. See our New Line</i></p> <p style="text-align: center;">Dull finished Horns, also extra fancy and artistic color effects on brass, and brass nickel plated Horns. All our Horns hold their colors perfectly.</p> <p style="text-align: center;"><i>Every Horn Fitted with Patent Thimble End</i></p> <h2 style="text-align: center;">Standard Horns Once Handled Always Handled</h2> <p style="text-align: center;">LET US HEAR FROM YOU</p>				
TRADE STANDARD	TRADE STANDARD	TRADE STANDARD	TRADE STANDARD	TRADE STANDARD



# FROM OUR CHICAGO HEADQUARTERS

195-197 WABASH AVENUE, E. P. VAN HARLINGEN, MANAGER.

A Progressive Chinaman—Mills Promoted—Noyes' Good Trip—Flower Horns at Western Talking Machine Co.—Some Columbia Changes—Blumberg Well Pleased—Babson Bros. Success—The "Tiz-It" Reproducer—Lyon & Healy's New Catalogue—Cal Stewart's Popular Uncle Josh Records—Talking Machine Co.'s Big Victor Sales—C. L. Hibbard Promoted—Burton Holmes Learning Languages Through the International Correspondence Schools Course—The News of the Month Interestingly Presented by Our Western Manager.

(Special to The Talking Machine World.)

Chicago, Ill., Nov. 10, 1906.

Possibly your readers would like to know something about the only Chinese talking machine dealer in Chicago. Sim Law is his name, and he is an intelligent, progressive man. He speaks excellent English, is an aggressive advertiser and energetic hustler for business. He is a subscriber to The Talking Machine World, another point in his favor.

Sim Law has been handling "lo-sing-kehe," the Chinese verbal chow-chow for talking machines, for five years. Pronounce the word quickly with a hurry-up on the "kehe" and you will get within hailing distance of the orthodox Chink way of doing it. He has a flat on the second floor of 295 South Clark street, in the heart of the Chinese district. Here are to be found Sim, his Chinese wife, a really attractive woman, and two little almond-eyed babies. The front room does double duty as a parlor and talking machine salesroom. One end of the room has been alcoved and here he has fitted up shelving for his record stock. He has constantly on hand something like three thousand Chinese

records about equally divided between disc and cylinder. Sam is always glad to demonstrate records, using \$100 machines for the purpose, and when he's absent his wife takes care of the customers. When he gets in an attractive lot of new records he gives a concert, sending out invitations to all his customers and those he thinks he can interest.

But his local trade forms only a small part of his business. He does a large mail order business, especially on records. His advertisement appears in every issue of the Chinese World, a daily published in Los Angeles, and which circulates all over the country. He also advertises in a Chinese magazine published in Shanghai, and which has a large subscription list among the subjects of the Flowery Kingdom in this country. He furthermore sends out a great many circulars, printed in Chinese, of course, together with the Chinese catalogues issued by the Victor, Edison and Columbia companies.

The Chinese are far more liberal record buyers than the Americans, according to Sim Law. Most of the records are in series of ten or twelve records, covering an entire opera or play. Consequently to buy one naturally leads to the purchase of all of the series.

He has many customers who have anywhere from three or four hundred to a thousand records, and some of them have both disc and cylinder machines in order to get everything good that is issued. Just the other day he sold a man a \$10 machine and fifty records. Pretty fair outfit for so cheap a machine. The average Chinaman, however, will buy a \$30 or \$40 machine, and a good many will not be satisfied with anything less than a \$100 talker. Mr. Law also says that the Chinese are great buyers of accessories. When they get a machine they want

everything pertaining to it—carrying cases, record cabinets, etc.

Our Chinese dealer is an enthusiast regarding the expanding market for Chinese records, and is constantly trying to induce the companies to enlarge their list. Naturally he has an advantage over the American dealers, as a Chinaman can trust a Chinaman to make selections for him and substitute intelligently. Few American dealers carry anything like a stock of Chinese records, and if they did, a mail order business would be out of the question. To them all Chink records are a monotonous combination of high squeak and irritating "tom-tom" and nothing more.

Joseph W. Mill has been made manager of the Elgin store of the Columbia Phonograph Co. He has been working as an instalment solicitor for the Chicago office, and displayed abilities which won for him promotion. He has inaugurated an aggressive advertising campaign.

Recent visitors who were at Babson Brothers were B. H. Sanford, Sheboygan Falls, Wis., and C. E. Nicodemus, Forreston, Ill., both enthusiastic Edison dealers.

T. H. Dunk, at one time in charge of the instalment department of the Talking Machine Co. before they went out of the retail business, has gone to Detroit, Mich., to take charge of the sales department of the Puritan Mfg. Co., makers of slot machines.

C. W. Noyes, secretary of the Hawthorne-Sheble Mfg. Co., and western representative of the American Record Co., returned the last of October from a month's trip through the South. He visited St. Louis, Cincinnati, Atlanta, Knoxville, Memphis, Nashville, New Orleans, Birmingham, Montgomery, all the principal Texas cities, and stopped at Mis-

## BABSON BROTHERS,

WHOLESALE

Edison Phonographs

AND RECORDS.

We desire to announce to the trade that we have secured the old quarters of the National Phonograph Co., at 304 Wabash Ave., Chicago, and G. M. NISBETT as Manager of our wholesale business.

*Complete Stock and Prompt Shipments.*

304 Wabash Avenue,

CHICAGO, ILL.



souri river points on his return. He had an excellent trip and came home with a big bunch of orders for American records and H. & S. supplies. He found the South in excellent condition, the jobbers all having a good trade and prepared for a big fall and holiday demand. Their only complaint is that they are unable to get all the goods they want.

The office of the Western Talking Machine Co. at 185 Dearborn street, has the appearance of a flower garden, owing to the display of flower horns. They have just received a fine sample line of record cabinets. Messrs. Dillbahrer & Feinberg, the proprietors, are direct factory agents for everything in the way of talking machines and supplies. They also seem bent upon springing innovations on the trade. They have established a talking machine and record exchange, and jobbers are invited to list with them their surplus stock of machines, records and supplies, which they are willing to dispose of. These special offerings appear in a monthly bulletin sent out by the Western Talking Machine & Supply Co. The current bulletin lists thousands of records and machines at attractive prices. B. Feinberg returned recently from a trip among the jobbers of the Northwest, Missouri River points and St. Louis with a fine bunch of orders. He leaves in a few days for a trip which will include Ohio, Indiana, Michigan and West Virginia. The firm are having a big demand for the Daughty horn crane, adjustable and self-locking, made by the New Jersey Sheet Metal Co.

A. W. White, who is to be the manager of the new Columbia branch at Duluth, left for his new field of labors Nov. 2, accompanied by C. F. Baer, assistant manager of the Chicago office and who went along to help him get started. The Duluth store will be at 18 Third Ave. North, in the heart of the business district, and will be opened about Nov. 15. A jobbing as well as a retail business will be done from the Duluth establishment, and a large stock will be carried. An aggressive campaign will also be inaugurated on the commercial dictation graphophone. Mr. White has been head assistant in the credit department of the Chicago Columbia headquarters, and is a well posted all 'round man.

George W. Lyle, general manager of the Columbia Phonograph Co., spent Thursday and Friday at the Chicago office, leaving Friday evening for New York. W. C. Fulri, manager of the St. Louis office, was also a visitor.

Richard Topham, recognized as a top-notch talking machine salesman, has returned from a trip through his territory—Illinois, Wisconsin and Iowa—in the interests of the Columbia Co. It was one of the best trips he has ever made, and resulted in the establishment of a number of new Columbia agents. Mr. Topham, by the way, now has a new invention in the way of an appliance for talking machines on its way through the patent office. Particulars are withheld for the present, but the new device will soon be placed on the market about the first of the year.

John Hofreiter, who sings in one of the principal Polish Catholic churches of the city, recently returned from the East, where he made twenty-five records, mostly of Polish folk songs, at the Columbia laboratory. A. V. Morrisey, wholesale city salesman for the Columbia Co., "discovered" Hofreiter, who also sings under the nom de plume of Rokcansky, and is proud of the fact.

Robert R. Smallfield, proprietor of the Smallfield Music House, Davenport, Ia., was a recent Chicago visitor. In a chat with The World he said:

"I want to advise every young man in the country who has recently started in business for himself or contemplates doing so in the near future to carry talking machines. It's the best means in the world to get a foothold in the piano business. It brings in the ready cash during the struggle period, and gets you an acquaintance you could form in no other way. When I tell you that in the three years I have been in business I have sold enough machines to put one in every tenth home in Scott County, Iowa, and

Rock Island County, Ill. (embracing the cities of Rock Island and Moline) you can form an idea of what an aid this branch of my business has been. I am about to move into a new store double the size of the old one, and half of it will be devoted to the talking machine department."

The Rudolph Wurlitzer Co., of Cincinnati, through Edward H. Uhl, its Chicago manager, has filed suit against Frederick Sheppy, trading as the Crescent Talking Machine Co., alleging infringement of the patents owned by the Wurlitzer Co., on tone regulators. Both parties to the suit claim priority of introduction of their devices, and the matter will have to be fought out in the courts. The case is set for hearing the first Monday in December.

Mr. Hawthorne, of the Hawthorne-Sheble Manufacturing Co., was in Chicago early in the month on a visit to their secretary and Western representative, C. W. Noyes.

L. L. Leeds, manager of sales of Leeds & Catlin Co., was a recent visitor on his way to the Coast. He said that business was very satisfactory, and that the Imperial opera records were receiving a warm reception by the trade.

Henry C. Brown, manager of the advertising department of the Victor Talking Machine Co., was in Chicago last month on a general trip through the Central West, familiarizing himself with Victor jobbers and dealers, and general conditions in this territory.

Lyon & Healy are now making their own disc record cabinets, and a large amount of space in their big factory fronting Union Park is devoted to that purpose.

J. Blumberg, Western manager for the Regina Co., is well pleased with the success which has attended the introduction of the new improved automatic Reginapbone in the West. This is certainly one of the most practical coin-controlled talking machines on the market. It occupies much less space than the ordinary instrument, holds six cylinder records, and has a novel and extremely valuable feature in the self-changing tune device. Mr. Blumberg also reports an excellent demand for the Sublima piano and the other well-known products of the company.

C. W. Long, the new manager of the talking machine department of the Cable Company, is

## Chicago Horn Support

### FOR EDISON PHONOGRAPHS

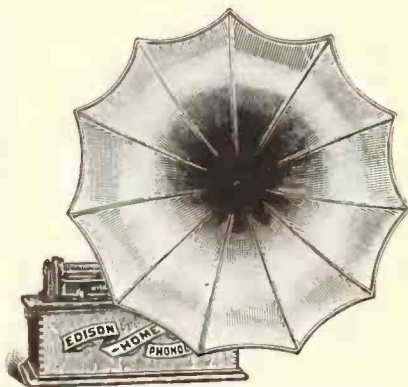

FRONT VIEW—SUPPORT INVISIBLE

The simplest, neatest and most practical Horn Support on the market. Has many advantages over other devices of this kind. Is adjustable to different size horns, holding the largest size bell horn perfectly without tipping the machine.

This support is so constructed that it comes directly under the machine and practically out of sight, leaving the top of machine perfectly clear. This support is quickly attached and detached, and folds up into a package 1 3/4 inches by 2 1/4 inches by 15 inches in length, allowing same to be packed inside of machine case. Handsomely finished in heavy nickel plate.

Ask your jobber to send you a sample. Retail price \$1.50 each.

**CHICAGO STAND CO.**  
266 Wabash Avenue, CHICAGO

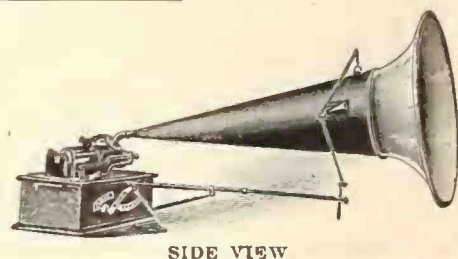

SIDE VIEW

## Record and Machine Cases

We manufacture a full line of cases for Cylinder and Disc Records, Machine Cases and Horn Cases. Carrying goods in stock, we can make prompt shipment. Our quality is the best, and prices right. Ask for our catalogue.

**CHICAGO CASE MFG. CO.**

142 and 144 W. Washington Street, Chicago, Ill.

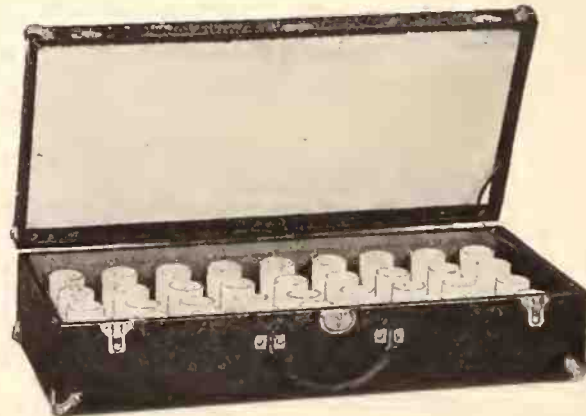
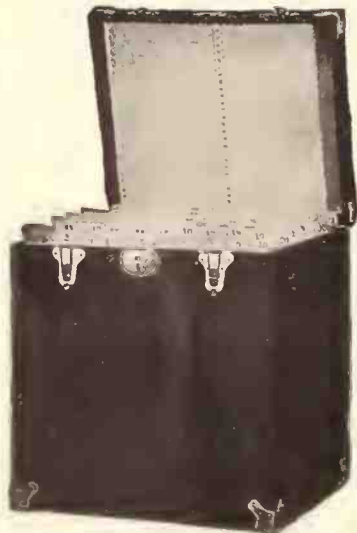



Of Interest to  
**EVERY DEALER**

in  
**TALKING MACHINES**

We are distributors of  
**EDISON PHONOGRAPHS  
RECORDS AND SUPPLIES  
COLUMBIA DISC AND  
CYLINDER GRAPHOPHONES  
RECORDS AND SUPPLIES  
RECORD CABINETS AND  
SUPPLIES FOR ALL KINDS  
OF TALKING MACHINES**

We carry a complete stock and are in a position to make **Prompt Shipments.**

All of our goods are new. No second grade or worn stock is carried in our warerooms.

**Our Monthly Specials.**

Every month we have an attractive special offer to make to Dealers.

These offers have created great interest and we want to send our announcements to every dealer.

Is **your** name on our list? If not fill out the coupon and mail it to us.

The December offer will be an exceptionally good one.

SEND THIS COUPON

**THE CABLE COMPANY**  
Chicago

Please send announcement of your December special offer, and put my name on your list.

Name .....

Street and No. ....

City .....

**THE CABLE COMPANY**  
Talking Machine Department  
**CHICAGO**

rounding out his first month in a manner which betrays the resourceful talking machine man experienced in both the wholesale and retail branches of the trade. The company are going after the dealers' business in a strong way, and are now in a position to ship orders not only completely, but within twenty-four hours of the time of receipt. Two or three travelers will be put on the road as soon as the proper men can be found. Mr. Shepherdson, a well-known man in Chicago and formerly assistant to E. C. Plume when the latter had charge of the retail department here, has been secured by Mr. Long to take charge of the instalment department.

Babson Bros. are making big success of the wholesale business—something not to be wondered at, considering the personality and equipment of the members of the firm and of G. M. Nisbett, wholesale manager. They carry an immense stock of Edison goods and a general line of supplies, and are making a strong specialty of quick shipments with a minimum percentage of "outs."

Frederick Sheppy, of the Crescent Talking Machine Co., won the pennant for selling the first Auxetophone in Chicago. He had to fairly beg it of Manager Geissler, of the Talking Machine Co. Sheppy sold it to the proprietor of a cafe down on Cottage Grove avenue, who was a bitter skeptic until he heard the machine. There's a big future before the Auxetophone in Chicago, Mr. Sheppy says, as soon as the Victor Co. are able to make deliveries. It will meet a long-felt want in many places where musicians are now employed at a cost of many times the price of an Auxetophone.

W. E. Fitch, formerly credit man for the Talking Machine Co., is now with Babson Bros., wholesale, looking after the credits and acting as Manager Nisbett's chief assistant.

John McDonald, a well-known piano dealer of Kansas City, Kan., and U. L. Means, who have stores at Sterling and Winfield, same State, have consolidated their interests under the name of the McDonald-Means Piano Co., with headquarters at Kansas City, Kan., but continuing all three stores. They will add talking machines in a retail way now, and expect to become jobbers after the first of the year.

The Crescent Talking Machine Co. report a steadily increasing trade on the Crescent tone regulator. They are not only handled extensively by jobbers in this country, but shipments have been made to Europe, Java, the Hawaiian Islands and other sections of the footstool.

Kreiling & Co., 855 North 40th avenue, Chicago, manufacture the "Tiz-it" all-metal horn connection for Edison phonographs and Columbia cylinder graphophones, having the new style lyre-shaped reproducer. The manufacturers claim that the device increases the volume of tone and makes it clearer and eliminates "blasting," while the usual soft rubber connection deadens the sound. Furthermore, the device prevents wear on the feed screw and nut, as it offers no resistance or strain laterally while the reproducer travels over the record, as when using rubber connection. Kreiling & Co. also make a speed pointer for cylinder machines which is very simple and practical.

The Chicago Case Manufacturing Co. are having the largest fall trade in their history on their line of carrying cases and record cases. Their line is remarkably complete, and the company enjoys a high reputation for quality of product.

Lyon & Healy have just issued a new illustrated and descriptive price list of "Victor and Edison supplies." Horns of different makes, cranes, carrying cases, record cases and needles are among the lines covered. Special attention is, of course, paid to the Lyon & Healy Soft-tone attachments and needles, and to the firm's special brand of Damascus needles. The firm also state that in a circular letter that they have several of each number of the Edison catalogue, except three, and expect to have those in by the time the circular reaches the trade.

Cal. Stewart, whose laughing stories have been famous to talking machine lovers since

**X The Handy Counter X**  
**RECORD RACK X**

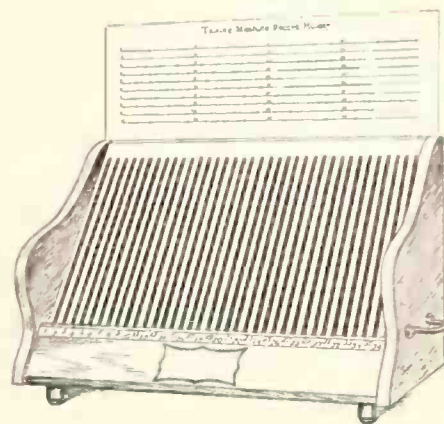

Just the thing for  
Holding new  
Monthly Records  
Beautifully Indexed  
List \$3.50

Exhibition Needles  
Our Brand  
Your Imprint on each  
envelope  
Write for sample

**Remember**  
**WE WHOLESALE EXCLUSIVELY**  
Before placing your Fall  
stock order  
Write for our accessory  
Catalogue  
We have some new ideas  
in Cabinets

Not a Machine held back  
For Retail business  
**We do no retail**  
Everything at your dis-  
position  
And, we have placed the  
Largest stock order in the  
History of our business  
We depend on your busi-  
ness only for our living

**Exclusive Victor Distributors.**



105-107-109 Madison Street,  
CHICAGO, ILL.



1897, has been in Chicago for the past three weeks, making the circuit of the outlying theaters with the Man's Broken Promise Co. He has a role built on the Uncle Josh order, and has been permitted to introduce some of his original monologues and specialties. In spite of the fact that he becomes a bit pensive when he thinks of the imitators who have broken into his peculiar field, he is the same jolly optimistic Cal. of yore. On Tuesday and Friday mornings of last week he gave a demonstration of record making at the Columbia headquarters at 88 Wabash avenue. He shot some of his standard numbers, laugh and all, into the recorder, and they were reproduced with great effect through the Twentieth Century graphophone. Before he left New York he made a new batch of Uncle Josh records at the Columbia laboratory. They include Uncle Josh's visit to the dentist, his experience with labor unions (a splendid piece of satire), the wooden wedding of Uncle Josh and Aunt Nancy, the descriptive reading for the quartette in "The Meeting of the Hen Roost Club," and a number of others. Mr. Stewart is now making records exclusively for the Columbia Co.

Joel Mossberg, who has made a number of successful records of Swedish folk songs and Swedish renditions of standard songs for the Victor Co., is a Chicagoan. He has done considerable work in light opera, is the basso of the Sixth Presbyterian Church choir, and teaches.

The big factory of the Salter Manufacturing Co., 102-108 North Oakley avenue, is busily engaged taking care of the large demand for their excellent line of record and music cabinets. The new styles, No. 705 disc and No. 710 cylinder record cabinets, are experiencing something very like a boom.

Manager A. D. Geissler, of the Talking Machine Co., reports that October sales for Victor talking machines and records exceeded the business of any month since the inception of the house. The latest member of the Talking Machine Co. force to set the wedding bells tingling is Virginus W. Moody, city sales manager, who was married the other day to Miss Ethel M. Hannah, of Dallas, Tex., at the home of the bride's parents in that city.

The Chicago Stand Co., 266 Wabash avenue, Chicago, have added a number of important firms to their list of jobbers of the Chicago Horn Support for Edison machines the past month. The device has some very distinctive points of merit, and the demand for it is growing at a rapid rate.

C. L. Hibbard, who has been district manager of the business phonograph department of the National Phonograph Co., has been promoted to the position of Western manager, a new position created with the inauguration of the broader

policy adopted by the company relative to the distribution of their commercial machines. Mr. Hibbard has just returned from a visit to headquarters, bringing his new honors with him. While in the East Mr. Hibbard will, of course, make his headquarters in Chicago, as in the past, but will travel to some extent, establishing agencies for the business phonograph. Edwin C. Barnes, who has heretofore been a member of the Chicago selling force, has been made district manager.

L. L. Lewis, manager of the language department, is proud of some of the students he has on the list. Burton Holmes, the famous lecturer, has studied German through the International Correspondence Schools' course, and is now taking Spanish through the same medium.

### THE BOYD-HARRISON CO.

Have Just Opened Up in the Automatic Musical Instrument Field and Promise to be an Influential Factor in the Trade.

(Special to The Talking Machine World.)  
World Office, 195 Wabash avenue,  
Chicago, Ill., Nov. 10, 1906.

A new concern which promises to be a strong factor in the automatic musical instrument field is the Boyd-Harrison Co., which has just been organized, and will apply for articles of incorporation in a few days. The principals are both men of experience in the talking machine and coin-controlled fields.

W. T. Boyd founded the business of the Indiana Talking Machine Co., and was its president. Later he became widely known to the trade of the country as a member of the traveling force of the Zouphone Co., and has recently been in charge of the automatic department of the Chicago house of the Rudolph Wurlitzer Co. J. W. Harrison was at one time connected with the Columbia Co. in Chicago, and was afterward manager of their Indianapolis store for two years. Returning to Chicago he took charge of the automatic electric piano department of the Cable Company, and when the talking machine department was established assumed charge of it in addition to his other duties.

The Boyd-Harrison Co. will make leaders of the Standard and Favorite electric pianos, but will also handle other automatic specialties, together with premium goods and advertising novelties. Their thorough knowledge of the coin-controlled proposition will enable them to give dealers valuable advice as to the best methods of handling this branch of their business. The company have established offices and salesrooms in the Willoughby Building, Nos. 6 and 8 Madison street, corner of Michigan avenue.

### NISBETT ENTHUSIASTIC.

Wholesale Manager of Babson Bros. Has Splendid Record in Talking Machine Field—Interesting Chat Regarding His Experiences.

(Special to The Talking Machine World.)  
World Office, 195 Wabash Ave.,  
Chicago, Ill., Nov. 10, 1906.

The talking machine has no more enthusiastic exponent than George M. Nisbett, wholesale manager for Babson Bros., of this city. He has been a material factor in the development of the business in the West, and has seen its growth from the fake class, where it was once placed by gen-



GEORGE M. NISBETT.

eral opinion, into the musical instrument art class. Like all men who are thoroughly conversant with present-day tendencies, Mr. Nisbett believes that the industry is only in the beginning of its larger development.

When Mr. Nisbett first became connected with the business in 1895, the talker was still largely a mail order proposition, and he started in with Montgomery, Ward & Co. His ability soon manifested itself, and it was not long before he was practically the head of the department. He had the title assistant manager and buyer, but in reality was the whole thing, as the nominal head had a number of other departments to look after. The intelligence and energy with which the department was conducted attracted attention, and in 1900 he became a member of the force of the National Phonograph Co., traveling

# CRESCENT TONE REGULATOR

No. 1 for VICTOR and ZONOPHONE Disc Machines,  
No. 2 for EDISON and COLUMBIA Cylinder Machines,

can be attached in ONE minute. Simple in construction. Very neat appearance, DOES NOT WEAR ON THE RECORDS; the volume of sound can be regulated WHILE THE MACHINE IS PLAYING; it does away with the annoyance of having to stop the machine and change the needle in order to get a variation in the volume of sound. With the CRESCENT TONE REGULATOR the change is instantaneous. You can also give expression to the music. The sale on this little Regulator has been phenomenal and we are now selling the largest Jobbers in the country. It is one of the best selling accessories in the talking machine line. This device is the invention of Mr. Frederick Sheppy, formerly mechanical expert with Lyon & Healy, of Chicago, and application for patent has been made by him and is now pending.

We are the sole licensees for the manufacture of the "Crescent Tone Regulator" and will protect our customers in the sale of same.

Retail price is \$1.00.

If you do not handle the Crescent send for sample and discounts.

**CRESCENT TALKING MACHINE CO.**

3749 COTTAGE GROVE AVENUE - - - CHICAGO, ILL.

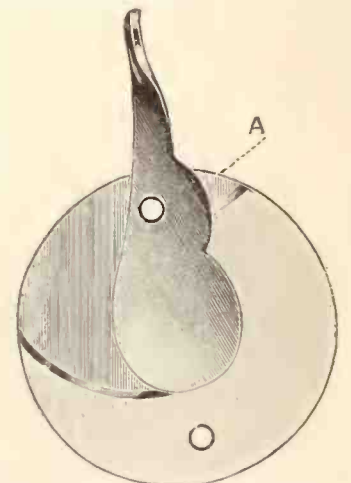
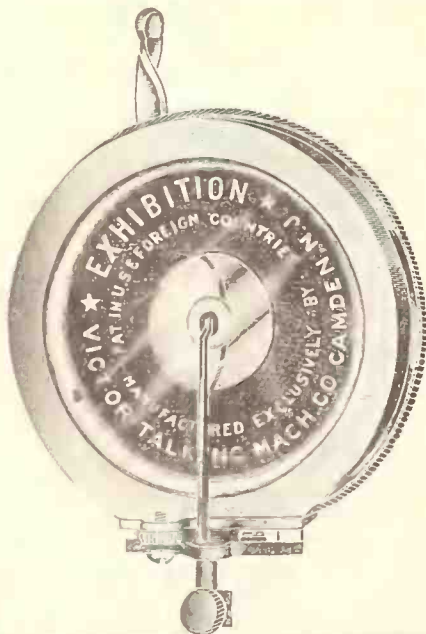



in the West and reporting to New York. In reality he started the Chicago office, as within five months it became necessary to have headquarters in Chicago, where a stock of machines and records could be carried to fill emergency orders from jobbers. When the National opened general Western offices in Chicago, Mr. Nisbett was made assistant manager, and in 1904 was promoted to the Western managership, which he retained until the company closed its offices here on June 1 of the present year. Babson Bros., who were preparing to go into the wholesale business as exclusive Edison jobbers on a large scale, were quick to snap up Mr. Nisbett and with him the old Edison offices and warerooms at 304 Wabash avenue.

During his career in the talking machine business Mr. Nisbett has done an immense amount of traveling throughout the West, and he has a fellow feeling for talking machine travelers, and, indeed, for road salesmen in general.

"I often wonder if employers as a rule realize what the men on the road have to contend with, and how little time the conscientious man has to himself," said Mr. Nisbett the other day.

"If you economize your time to the best advantage you must get up at all hours of the night to make trains; must frequently get out long before the breakfast hour at home in order to catch a dealer before the rush of the day begins, and often you find it impossible to get his attention during the day at all, and must make an appointment at night. Then no matter how late the hour, the report to the house must be made out; you get only a few hours' sleep—

sometimes none at all—before the jump to the next town.

"Not so very long ago I had an experience in a Northern Wisconsin town, which is quite typical. The conditions were not conducive to comfort. The thermometer was 18 degrees above and there was no heat in the hotel, as the boilers had been ripped out for repairs. I called on my dealer, and when I opened up found my concert machine had been smashed. Consequently I couldn't demonstrate records. The dealer suggested a way out, but it meant that I would have to wait four hours until the store closed. At six o'clock I met him, and he saw about as froze a mortal as you would want to find. We went to a saloon where there was a phonograph slot machine. We were preceded by a tall, ungainly lumberman, who made a dash for the machine and dropped in his nickel. The result pleased him so that he actually played the record a dozen times in all, spending sixty cents in the operation. We stood by reciting soul stirring poems to ourselves. Of course, we could say nothing, as the man was making money for the house. Well, we finally got hold of the machine and I demonstrated my records. It all ended satisfactorily, as the man gave me an excellent order.

"Just to show the way the business is developing from the dealer's standpoint, I have exclusive talking machine dealers come in here every day who first added talkers as a side line and finally found it advisable to drop their original business altogether and devote their entire time and energy to 'canued music,' as Mr. Sousa has so courteously termed it."

**HENRY J. HAGEN'S GREAT TRIP.**

Visited South America to Secure Records of Creole and Spanish Songs—Got Some Fine Operatic Records in Italy—Instrumentals by Leading Orchestras—Interesting Chat With This Expert Record Maker.

While Henry J. Hagen, who recently returned from a record-making tour to South America and Italy, was unusually successful, he secured a number of unique examples in voice reproduction upon which the Universal Talking Machine Manufacturing Co. may well plume themselves. Chatting informally with The World of his trip in New York the other day, Mr. Hagen, who is nothing if not modest in his manner, said:

"I was two months in Buenos Ayres, going by the way of Hamburg from New York, and my main purpose was to obtain records of the creole of Spanish songs, and many excellent reproductions were secured, remarkably few being lost. I also got some Italian operatic records, but the expense was too great, as the singers, when in South America, generally demand ridiculous fees—several times higher than when at home in Italy—therefore I had to cut them out. Then their status in the profession is exaggerated beyond all reason. For example, a tenor lyric (Henry always speaks by the card) who would stand second rate in Buenos Ayres, would be, without question, about sixth on his native heath.

**"STANDARD"  
ELECTRIC  
PIANOS**

## BIG MONEY

In Handling Automatic Musical Instruments

**FAVORITE  
ELECTRIC  
PIANOS**



NOT ONLY CAN WE SELL YOU THE VERY BEST ELECTRIC PIANOS AND OTHER AUTOMATIC MACHINES ON THE MARKET, BUT OUR LONG EXPERIENCE IN PLACING COIN-CONTROLLED MACHINES IS AT YOUR SERVICE.

**We can help you plan a winning campaign**

**STANDARD and FAVORITE ELECTRIC PIANOS** contain expression devices and other features which raise them way above the ordinary coin controlled class.

**PICTURE  
PROJECTING  
MACHINES**

**BOYD-HARRISON CO.**  
6 and 8 MADISON STREET, - - CHICAGO

**PREMIUM  
GOODS AND  
ADVERTISING  
NOVELTIES**

## WE CAN TURN YOUR SURPLUS STOCK INTO

\$ \$ \$ \$ \$ \$ \$ \$ \$ \$

List anything you want to dispose of with us. Others are doing it, WHY NOT YOU? We issue a Jobbers' Exchange Bulletin monthly. November Bulletin contains 5,356 Machines.

41,800 Records of all makes. If you failed to receive it write without delay; prices very interesting.

We are also direct factory representatives for everything pertaining to the Talking Machine business.

## Western Talking Machine & Supply Co.

DILLBAHNER & FEINBERG, Props.

185 Dearborn St.Chicago

## See That Ball?



PAT. AP'L'D FOR

# "TIZ-IT"

The New  
**ALL-METAL-BALL-AND-SOCKET-  
SWIVEL-JOINT**

## Horn Connection

Increases tone volume and quality. Stops blasting. Also makes better home-made records. Soft rubber connection deadens the sound. "TIZ-IT" makes it louder and clearer. It consists of ball and socket. Ball swivels freely in all directions. Made of brass, nickel-plated and polished.

For Edison Phonograph and Columbia Graphophone

**RETAILS AT 50 CENTS**

Regular Discount to Dealers

## KREILING & COMPANY

Inventors and Sole Manufacturers  
855 North 40th Ave., CHICAGO



"In Milano," continued Mr. Hagen, with a distinct flavor of sunny Italy in his voice, "I was very successful. Besides recording a large number of selections and choruses from all the principal operas, I obtained the full score of 'Rigoletto,' 'Aida,' 'Cavalleria Rusticana,' 'Faust' and 'La Boheme.' Up to this time the disc records of but one complete opera, that of 'Il Trovatore,' is known in this country, being put out by the Victor Talking Machine Co. So you see, it was no small undertaking to record the full musical scene of these operas. In addition I have a large collection of instrumentals from the best known orchestras and band organizations in the whole of Italy. Of course, some singers, who are bound up in contracts, were unattainable, many of them having signed exclusively with the Fonotopia Co., owned and controlled by G. Ricordi & Co., the famous music publishers. This reminds me that not a few beautiful operas not yet heard in the United States are perfectly familiar to the people of the South American countries, and made so through the talking machine.

"Am I glad to get back? Well, I should think so. People at home have no conception what the sight of the American flag is in a foreign port to the wanderer from his own fireside. It just makes your patriotic feelings boil over, and you feel like hurrahing every few minutes.

"I met Henry B. Babson, the president of the company, in Milano, and he afterward went to Paris with E. Long, the manager of our export department, you know. Mr. Babson is no stranger in Europe. He has been over a number of times. You remember when he was in China and made that big coup on records? That was the time he came back by the way of the Trans-Siberian Railroad, going through Russia. This Siberian road runs the trains only during the day, and at night everybody gets out and stops at the station, where the accommodations are far from palatial. Then the next morning the journey is resumed. South America is a great country, almost twenty-five years behind us, but is the coming part of the world."

EMERALD ISLE HAPPENINGS.

Auxetophone Attracts Great Crowds at Public Concert—Present Season Destined to Excel Any in Volume of Business—Edison Machines to Make Announcements at Railway Station—Columbia Graphophone Used Instead of Band at International Foot-ball Match—Sterling Records Popular.

(Special to The Talking Machine World.)

Belfast, Ireland, Nov. 3, 1906.

The Auxetophone still continues to attract large crowds to the Saturday evening concerts at Ulster Hall, this city; the perfect rendition of all classes of records by this "world's wonder," especially of songs by the great prima donnas Mesdames Melba and Patti, and the famous tenors, Caruso, Tamagno and Scotti, has begotten a love for "talkers" hitherto unexperienced by the wealthier section of music lovers. While the people wend their way homeward from the hall they become transfixed opposite the Edison factor's premises, to which they are drawn by the two powerful American Cooper-Hewitt Mercury vapor electric lamps used by the proprietor (Osborne) for lighting his store, and particularly by the fascinating musical programme of popular "pantomime hits," rendered by the Columbia Twentieth Century sound-magnifying graphophone. No instrument can compare with the machine referred to for outdoor concerts; hundreds have confessed that they have hurried from adjoining streets in the expectation of hearing a military band pass the City Hall, only to discover as an agreeable surprise, however, that they had been listening to a band piece on the graphophone.

"Sterling" records (one shilling) seem to be growing more popular every day. It is most interesting to watch from year to year the stock racks and shelves of an up-to-date dealer or factor, the quantities he holds of various records clearly indicating the popularity of the different brands.

Although T. Edens Osborne has been selling gramophones since autumn of 1898, he reports that this season has been absolutely phenomenal so far as the output of gramophone and zono-phone products is concerned. The Gramophone Company's yearly balance sheet has just been published, and the figures are highly gratifying; all the company's dealers in British Isles are delighted at results of the year's trading; there is probably no firm of talking machine manufacturers who are in closer touch with their dealers than the Gramophone Company; this is traceable to a widespread appreciation of their business methods, their prompt attention to orders, the courtesy displayed in their correspondence, and the kindly interest manifested by their manager, S. W. Dixon, in all dealers who loyally respect the price-maintenance agreements.

The Columbia S. M. graphophone proved an excellent substitute for a band at the international football match (Ireland versus England), contested at Cliftonville, Belfast, a couple of weeks ago. Ireland was defeated.

A talking machine enthusiast recently confessed she was so much enamored of her gramophone that she removed a partition wall and "threw two rooms into one," on account of the instrument being too loud. She could not conceal her feelings of remorse when told that the same result could have been achieved by placing a silk handkerchief in the trumpet.

One of the ticket checkers at a local railroad depot recently complained of hoarseness occasioned by having to shout so frequently, "All tickets please"; he has just arranged to make a record on an Edison Standard of these words, repeated again and again for two and one-half minutes, and hopes the railway company's manager will permit him to use the phonograph at the ticket barrier as a substitute for his own vocal efforts.

Odeon double-sided disc records are growing in demand; a large percentage of them sound loudly, clearly and sweetly on the auxetophone.

TOPHAM'S CASES

are the original and standard. Build up your trade by carrying the standard rather than the imitation.



For 72 Records

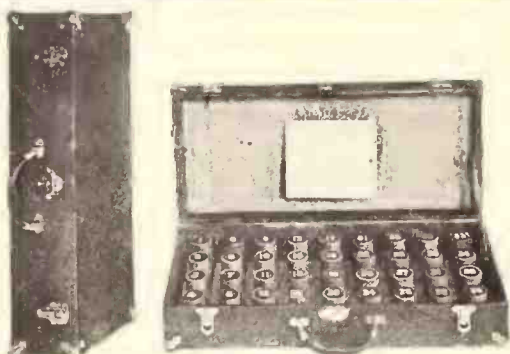

For 36 Records

These are a few styles only.

1855

Canadian Distributors  
R. S. Williams & Sons Co., Ltd.  
Toronto and Winnipeg, Canada.



Pioneer Manufacturer

Write for complete catalogue and price list.

1906

New England Distributors for Disc and Machine Cases,  
M. Steinert & Sons Co.  
Boston, Mass.



Made for Any Make and Number Machines.

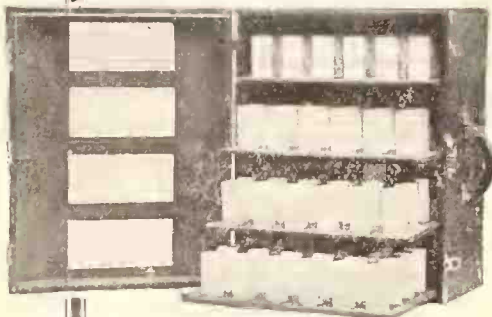

For 96 Records  
Something New and Exclusive With Us.

All our cases are made from select lumber, covered with a genuine book cloth, imitation of seal grain leather. An inside flange, which is cut from the solid wood, forming the top, thus giving strength and keeping out dust and dampness, is a point I claim exclusive to our case. Cylinders are made on especially constructed machines and are correct size and uniform diameter. By my special method of fastening in, they are absolutely secure.

JAMES S. TOPHAM  
WASHINGTON, D. C.



10 and 12 inch

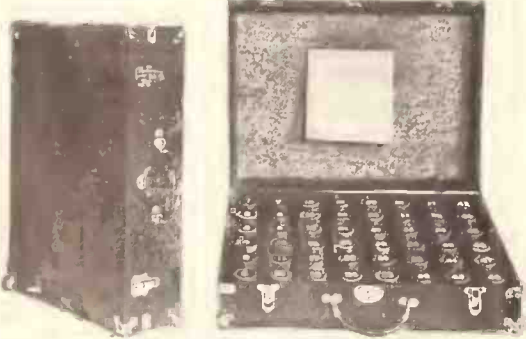

For 48 Records



TRADE NOTES FROM BOSTON.

Business Continues Satisfactory—Some Difficulty in Getting Certain Goods—Language Study at Eastern Talking Machine Co.'s Store—Read & Read's New Store—Columbia's for Skating Rinks.

(Special to the Talking Machine World.)

Boston, Mass., Nov. 9, 1906.

All the talking machine stores might well put out the sign, "Standing Room Only," business is so good this month. Both the jobbers and the retailers make the same report, and a glimpse of the number of customers on the floor proves it to be true. The chief trouble is, as it always has been, the inability to get goods from the factories, and especially now the Victor-Victrola is the thing most demanded. It can't be had for love or money.

"Crowded for room" is the cry at the Oliver Ditson store, where Manager F. W. Winkleman is pushing the Victor goods. "We could sell twenty-five Victrolas this month if we could only get them," he says. The Victor goods are the kingpins here, and Mr. Winkleman has formulated a system whereby each record is put into an envelope as soon as it is received from the factory, and remains in it until it reaches the customer's home. This saves all danger of its being scratched or marred, especially during shipment.

At the Winchell Co.'s Summer street store a number of interior changes have been made. The business office has been transferred to the balcony, leaving more room for the display of goods. This company has recently secured the agency for the entire Regina line, and will be virtually the New England headquarters of this firm. A fine business is done here on the Zonophone and on the Victor and Edison records and machines.

At Houghton & Duttons, Manager Howe reports a phenomenal business, especially during

the last three weeks when he says that he has done more business than in the three months previous. He has put in the Victor line and reports a great sale on the Edison records. A change is being made in the method of keeping records, the tray system being installed.

At the Columbia Phonograph Co., Manager Blakeborough has made a change in the location of his office, which is a marked improvement in the general appearance of the store. He reports business as particularly good, and the number of customers in the store at the time the writer called was ample verification. Mr. Blakeborough is enthusiastic over the extended use of the Columbia phonographs in the various skating rinks of the New England States, in place of orchestras. He showed the writer a number of letters from skating rink managers, indorsing the phonograph as a medium for enlivening the rink and furnishing music for skaters. The fact that it is much cheaper than an orchestra is a great factor; in fact, one rink manager, who is also the manager of an orchestra, has displaced his own musicians by an instrument. Mr. Morse, of the wholesale department of the Columbia Co., has been in Boston this week, looking over affairs at the local warerooms.

A demonstration of the advantages of the talking machine in the study of foreign languages is to be made at the Eastern Talking Machine Co.'s store this week. Victor-Victrolas are a minus quantity here also, although a large number have been ordered. General Manager Taft declares that he has never known of the time when business was generally so good as at present, and he predicts that the talking machine is to be one of the greatest factors in commercial progress.

A unique idea in window advertising was adopted recently by the Columbia Phonograph Co. The lower half of the window was covered with a white cloth, in which a peek-hole was cut, and over this was painted the words, "For Men Only." It was a sight to witness the crowd of men—almost a continuous line—who took turns

in looking through this peek-hole, only to find confronting them, inside the window, a sign which read: "November Records For Sale Here Now." It made a hit along the street.

The firm of Read & Read are preparing to remove to their new store on Essex street, opposite the big Siegel store, within a week. This will be a big improvement, as it is on the ground floor and is nice and light. Business here has increased greatly in the last month.

CURIOUS AUXETEPHONE EXPERIMENT.

A curious experiment was tried with an auxetophone in a New York wareroom recently. It is well known that when the bellows are not in operation, the tones die away and become very faint. A duet record was placed on the revolving table, and by shutting off the power at the proper moment, the effect of great distance between the singers was produced. Some of the hearers could not believe until proof was forthcoming that such was not the case, and some seemed to prefer the effect to the proper way in which the record should have been reproduced. A perfect echo effect was accomplished by using a record on which a line was repeated wholly or in part.

"Il Trovatore," Verdi's great opera, complete in twenty records, is among the latest offerings of the Victor Talking Machine Co. The records were made by the entire company of La Scala Theatre, Milan, Italy, and contain the entire opera from opening chorus to last act and finale. The new set of records has been advertised extensively and direct to the consumer, the retail price being \$21.60 per set.

J. R. Challen, inventor of the whisperphone attachment to the telephone, and an old-timer in the talking machine business, was in New York recently visiting the trade. Mr. Challen is now manager of the Philadelphia branch of Collier's Weekly.

INCREASE YOUR RECORD BUSINESS  
THE TRAY SYSTEM FILLS THE LONG-FELT WANT

Every dealer will readily see the advantages obtained by using this System of carrying records in stock. It is concise and appeals at once to the prospective customer. Every dealer using this System speaks in the highest terms of its convenience and selling power.



By actual experience sells as many records as a first-class salesman. Makes a more attractive looking stock than can be obtained by any other method.

*Sold to the trade in complete outfits, consisting of 1350 Trays and Labels for every Edison record listed in the Domestic catalogue.*



### VICTOR CO. ANNOUNCEMENT

Regarding the Recent Decision of the Court of Appeals in the Case of the Victor Talking Machine Co. Against the Talk-o-Phone Co.

Under date of October 31, the Victor Talking Machine Co., Camden, N. J., write The Talking Machine World as follows:

"We are sending herewith copy of letter sent to our various distributors, also a copy of the announcement as it appears in the coming issue of 'The Voice of the Victor.' As you will note, this letter of announcement refers to the recent decision of the Court of Appeals in the cases of the Victor Talking Machine Co. against the Leeds & Catlin Co. and the Talk-o-Phone Co."

The letter is subjoined, to wit:

"We desire to advise you that we have received a communication from our counsel, Horace Pettit, Esq., notifying us that the United States Circuit Court of Appeals, of New York, in our suits against the Talk-o-Phone Co. and against the Leeds & Catlin Co., on October 12, 1906, affirmed the decision of the court below granting preliminary injunction against each of the defendants in the above entitled cases, again sustaining our fundamental Berliner patent No. 534,543, for the combination of our disc talking machines and records, and method of operating the same, and restraining the defendants from manufacturing and selling disc records and machines in infringement of the said patent.

"You will recall that this patent had been previously sustained in our suit against the American Graphophone Co. by the United States Circuit Court of Appeals, and that the defendants in the present suits made unavailing strenuous efforts to have the patent declared invalid. We expect to at once proceed to enforce our rights by preliminary injunction against all infringers, including all manufacturers of infringing machines and records who have not taken a license from us, and dealers in such infringing goods. We have previously notified you that the Universal Talking Machine Manufacturing Co. and the American Graphophone Co. had each taken out licenses."

The announcement referred to in the company's letter above, reads as follows:

"The cases of the Victor Talking Machine Co. against the Leeds & Catlin Co. and against the Talk-o-Phone Co., on appeal from the court below granting preliminary injunction, were argued before the United States Circuit Court of Appeals of New York on October 11, 1906. Louis Hicks argued the cases on behalf of the defend-

ants, while Horace Pettit represented the Victor Co. Upon adjournment, the Court of Appeals went into consultation, and after considering the elaborate briefs filed on both sides, Judge Wallace delivered an opinion at the opening of the court on the morning of October 12, in favor of the Victor Co., affirming the decision of Judge Townsend in the court below, on all points. Counsel on behalf of the Leeds & Catlin Co. and the Talk-o-Phone Co. argued every conceivable defence, but the court, however, decided in favor of the Victor Co., affirming the lower court. In conformity with the decision of the Court of Appeals, of October 12, 1906, a decree has been entered in each of the cases, and preliminary injunction issued in conformity with the order of the Court of Appeals against each of the defendants."

Regarding the appearance of the Leeds & Catlin Co. as defendants in the above case, the company have repeatedly informed The World that their connection therewith was indirect entirely. That in the course of a business transaction they had accepted some machines from the Talk-o-Phone Co. in settlement of a debt, and were in nowise involved, excepting in this way. Therefore whenever The World has had occasion to report the above litigation as it passed from court to court, this explanation has been duly made in justice to the attitude of the Leeds & Catlin Co.

### JOHNSTON'S, LTD., MAKE ASSIGNMENT.

Johnston's, Ltd., talking machine dealers, of 191 Yonge street, Toronto, Canada, have assigned to W. L. Martin & Co. The liabilities are \$18,000, with assets nominally the same, consisting of stock about \$10,000 and book debts \$8,000. Tenders for the purchase of the stock are now being advertised for.

### HEXT CO. HAVE VICTOR AGENCY.

The Hext Music Co., Denver, Colo., have taken the Victor agency in addition to those for the Edison and Columbia lines which they previously carried and have arranged their store in such a way that each line is given a separate room for exhibition and testing purposes.

### ROUSH BUYS OUT E. G. HAYS.

The talking machine department of E. G. Hays & Co., Pittsburg, Pa., has been purchased by the Standard Talking Machine Co. Victor, Edison and Columbia lines are handled.

The Duplex Phonograph Co., Kalamazoo, Mich., have increased their capital stock from \$30,000 to \$100,000.

**PRICE LISTS AND CATALOGUES WANTED** (Trade) of all novelties in photographic materials, talking machines, records, etc.  
**RAFAEL FAVARO & CO.**  
Calle 25 de Mayo, 280  
Montevideo (Uruguay), S. America

*Playrite*  
TRADE MARK

### NEEDLES

"THE NAME TELLS WHAT THEY DO"

Best for VOLUME, TONE and LASTING QUALITY. PLAY RIGHT from START to FINISH. PRESERVE RECORDS and can be used on ANY DISK MACHINE OR RECORD. Packed in RUST PROOF packages of 100. RETAIL, 10c. per 100; 25c. 300, 75c. 1,000.

*Melotone*  
TRADE MARK

"GIVE A MELLOW TONE"

REDUCE VOLUME and DON'T SCRATCH. Each needle can be used SIX TIMES. No special attachments needed. Packed in RUST PROOF packages of 200. Price, 25c. Package.

NOTE—We furnish Jobbers and Dealers with ADVERTISING MATTER FREE. Big profit. Write for FREE SAMPLES.

Manufactured by

**BLACKMAN TALKING MACHINE CO.**  
97 Chambers Street, New York

## STEWART

You can handle banjos easily and add to your income. Talking mach. ne men will find them big sellers.



**THE BAUER CO.,** 1410 North Sixth Street, Philadelphia, Pa.

## Some Facts Worth Considering

**T**HE talking machine man frequently asks, "How can I increase my business?" The answer is easy. Place on a side line which takes but little space, which is attractive, and a standard in its particular line. Take the **Black Diamond Strings**, for instance. Steel and wound. New process. They are the finest manufactured. They are used by all of the prominent artists, and you will have a trade coming your way when it is known that you handle the "Black Diamond." Music dealers all over America, and all over the world for that matter, know full well the value of this product.

**National Musical String Co.**  
New Brunswick, N. J.

## ATTENTION

### Edison and Victor Dealers

**WE ARE KNOWN** all over Pennsylvania as the largest Edison and Victor jobbers in the State.

**WE ARE PIONEERS** in the Talking Machine business and among the first to sell both these lines and **OUR EXPERIENCE COUNTS** in YOUR FAVOR.

**IN ADDITION** to machines and records we sell supplies of all kinds. We particularly call your attention to our fine line of **CYLINDER** and **DISC CABINETS** and our **SUPER NEEDLES**.

**WRITE FOR PARTICULARS**

### PENN PHONOGRAPH COMPANY

17 South Ninth Street - - PHILADELPHIA, PA.



# Leading Jobbers of Talking Machines in America

## OLIVER DITSON COMPANY

Are the largest Eastern Distributors of  
**Victor Talking Machines and Records**

Orders from Dealers are filled more promptly, are packed better, are delivered in better condition, and filled more completely by this house than any other house in the Talking Machine business, so our customers tell us.

150 Tremont St., BOSTON, MASS.

## SAINT LOUIS TALKING MACHINE CO.

Southwestern Headquarters for  
**Victor Machines and Records**  
We are Specialists of long experience and guarantee satisfactory service  
SAINT LOUIS, MO.

## I. DAVEGA, Jr., Jobber of EDISON PHONOGRAPH and VICTOR TALKING MACHINES, RECORDS and SUPPLIES

Large Stock of CYLINDER and DISC CABINETS  
125 W. 125th St., NEW YORK  
WM. H. FREELAND, Mgr., Wholesale Dept.

## Peter Bacigalupi & Sons

SAN FRANCISCO, CAL.  
WHOLESALE 1021-23 Golden Gate Ave.  
RETAIL 1113-15 Fillmore St.

JOBBERS Edison, Zonophone  
DEALER Victor

All Kinds of Automatic Musical Instruments and Slot Machines.

## You Can Get Goods Here Edison Victor JOBBER DISTRIBUTORS

Our wholesale depot is a mile from our retail store. Records are not mailed over for retail customers and then shipped out to dealers. Dealers buying from us get brand new goods just as they come from the factory

McGREAL BROS., Milwaukee, Wis.

## HARGER & BLISH

Western Distributors for the  
**VICTOR COMPANY.**

It's worth while knowing, we never substitute a record.

If it's in the catalog we've got it.

DUBUQUE, IOWA.

## BABSON BROS.

304 WABASH AVENUE  
CHICAGO, ILL.

Special attention given DEALERS only, by G. M. NISBETT, Manager, Wholesale Department.

LARGEST STOCK OF EDISON PHONOGRAPHS AND RECORDS in the U. S.

## BENJ. SWITKY

Victor and Zonophone Distributor  
Phone 665 Gramercy 27 E. 14th St., New York City

## PITTSBURG PHONOGRAPH CO.

VICTOR JOBBER and EDISON JOBBER  
Largest and most complete stock of Talking Machines and Records in Western Pennsylvania.

## Southern California Music Co.

EVERYTHING FOR TALKING MACHINES  
**Edison and Zon-o-Phone Jobbers**  
LOS ANGELES, CAL.

## NEW ENGLAND JOBBER HEADQUARTERS EDISON AND VICTOR

Machines, Records and Supplies.  
THE EASTERN TALKING MACHINE CO.  
177 Tremont Street BOSTON, MASS.

## Minnesota Phonograph Co.

ST. PAUL MINNEAPOLIS  
37 E. 7th Street 518 Nicollet Avenue  
**Edison Phonographs and Records**  
ALL MACHINES, RECORDS AND SUPPLIES  
Write for Prices on Supplies.  
Orders filled same day as received.

## KLEIN & HEFFELMAN CO.

Canton, OHIO.  
**Edison Victor**  
MACHINES, RECORDS AND SUPPLIES  
Quickest service and most complete stock in Ohio

## Eclipse Phonograph Co., Hoboken, N. J.

Jobbers of Edison Phonographs and Records.  
Best deliveries and largest stock in New Jersey

## T. H. TOWELL, Pres. & Treas. THE ECLIPSE MUSICAL COMPANY

JOBBER OF EDISON PHONOGRAPHS,  
**VICTOR TALKING MACHINES,  
RECORDS AND SUPPLIES.**  
LARGEST STOCK, QUICKEST SERVICE. 714 Prospect Ave., Cleveland, O.

## Jacot Music Box Co.,

39 Union Sq., New York.  
Mira and Stella Music Boxes.  
Edison and Victor Machines and Records.

## JOHN F. ELLIS & CO.

WASHINGTON, D. C.  
Distributor  
**VICTOR Talking Machines and RECORDS**  
Wholesale and Retail  
Largest Stock in the South

## E. F. DROOP & SONS CO.

925 Pa. Avenue 109 N. Charles St.  
WASHINGTON, D. C. BALTIMORE, Md  
**Wholesale and Retail Distributors**

## Victor Talking Machines and Records

**SELF-PLAYING PIANOS.**  
Catalogs and Prices on Application.  
Pacific Coast Distributors  
**Sherman, Clay & Co.,** San Francisco, Los Angeles, Seattle.

PERRY B. WHITSIT L. M. WELLER

**PERRY B. WHITSIT CO.,**  
213 South High Street, Columbus, Ohio.

Edison Phonographs and Records **JOBBER** Victor Talking Machines and Records

## Edison Phonographs

**Victor Talking Machines**  
**Southern Representatives for**  
Topham's Carrying Cases; Herzog's Record Cabinets; Searchlight, H. & S. Tea Tray and Standard Metal Co.'s Horns and Supplies.

## SOL BLOOM

SOL BLOOM BUILDING  
3 E. 42d Street, New York  
**VICTOR DISTRIBUTOR  
EDISON JOBBER**

All the Latest Novelties in Talking Machines, Attachments, Supplies, Etc.

## S. B. DAVEGA,

EDISON JOBBER  
**VICTOR DISTRIBUTOR**  
Kaiser's Illuminated Signs for Edison, Victor and Columbia Records.  
32 East 14th St. New York City.

## WEYMANN & SON

WHOLESALE DISTRIBUTORS  
**EDISON Talking Machines RECORDS & Supplies VICTOR**

Place your name on our mailing list. We can interest you.

923 Market St., Philadelphia, Pa.

IF YOU'RE IN WESTERN MICHIGAN it will be money in your pocket to order

**Victor Machines and Records**  
of...  
**JULIUS A. J. FRIEDRICH**  
30-32 Canal Street, Grand Rapids, Michigan  
Our Motto: Quick Service and a Saving in Transportation Charges

Every Jobber in this country should be represented in this department. The cost is slight and the advantage is great. Be sure and have your firm in the December list.



# Leading Jobbers of Talking Machines in America

**C. B. HAYNES, EDISON JOBBER**  
 Exclusive Agency  
**RAPKE CRANES—MEGA HORNS**  
 602 EAST MAIN STREET, RICHMOND, VA.

**FINCH & HAHN,**  
 Albany, Troy, Schenectady.  
 Jobbers of Edison  
**Phonographs and Records**  
 100,000 Records  
 Complete Stock Quick Service

**Lewis Talking Machine Co.**  
 15 South 9th Street, Philadelphia, Pa.  
**Columbia Jobbers**  
 SUPPLIES OF EVERY DESCRIPTION  
 Give us a trial on your next month's Record order.

Every Jobber in this country should be represented in this department. The cost is slight and the advantage is great.  
 Be sure and have your firm in the December list.

## EXPANSION ON PACIFIC COAST.

Business Is Very Satisfactory in San Francisco  
 —Jobbers and Dealers Doing Good Work.

(Special to The Talking Machine World.)

San Francisco, Cal., Nov. 4, 1906.

The talking machine section of the city has spread beyond the confines of Fillmore street and Van Ness avenue, and encroached upon Golden Gate avenue, which connects the two thoroughfares. The new stores in this locality are brilliantly illuminated at night, and business on that street is developing rapidly. Peter Bacigalupi & Sons have their big wholesale store on Golden Gate avenue, between Laguna and Buchanan streets, and have doubled the business in both Edison and Victor goods in the last six months, and Heydenfeldt & Co., located on the same avenue, near Fillmore street, have also enjoyed a large and constantly increasing trade in the Edison and Victor lines, and also in Zon-O-Phones.

Sherman, Clay & Co., Clark Wise & Co., the Bartlett Music Co., and, in fact, all the larger concerns, are exploiting their talking machine departments on a broad scale, often devoting to it fully half of their regular advertising space. So successful has been the "talker" business with Clark, Wise & Co. that they have arranged to enlarge the department given over to this branch of the business, which is under the capable management of Richard Wise.

Byron Mauzy, who devotes his attention especially to the Victor, has plenty to keep him busy, and when he occupies his new building, will give over a large portion to that department.

The Columbia Phonograph Co., on McAllister street, are continually opening new accounts, both in and out of town, and have succeeded in placing some very large opening stocks that will mean more business in the future.

All in all, the talking machine situation in San Francisco would be hard to improve upon, and the end is not in sight, everyone handling machines and records finding that the difficulty lies in obtaining sufficient goods and a place to store them, rather than in finding purchasers.

Now that election is over, let us settle down to work.

## EDISON COMMERCIAL SYSTEMS.

Business Will be Placed in the Hands of Jobbers and Dealers Qualified to Handle It.

In its last issue The World announced the willingness of the National Phonograph Co. to place its commercial system in the hands of Edison jobbers and dealers qualified to handle the business, otherwise appointments will be made among other local firms. In calling the attention of the trade to this preference the company have since declared the following features are important: First, representatives must purchase the proper number of outfits for writing their correspondence, and for demonstration, at the special discount of 20 per cent; second, branch offices of the commercial department will send any goods to customers they may require, either for outright purchase or for trial, and assume the account so that representatives need not carry any stock; third, representatives must provide salesmen and a mechanic for repairs—the branch office of the commercial department will supply all of the repair parts; fourth, the commercial department branch office will bill the goods direct to the customer and the National Phonograph Co. will be responsible for the collection of account; fifth, on all goods installed by representatives a commission of 20 per cent, will be allowed when the customer has paid for the goods to the National Phonograph Co.

## A NEW TRAY FOR CYLINDER RECORDS.

J. Newcomb Blackman, proprietor of the Blackman Talking Machine Co., has been experimenting for several months in an effort to provide improved systems for dealers in carrying a stock of records. One of Mr. Blackman's recent improvements is a folding tray for cylinder records, which is shipped perfectly flat, but in a few seconds can be folded into a strong tray to hold records.

The Blackman Co.'s advertisement in this issue illustrates this improved tray, and it will be interesting for the dealer to know that with record label it costs less than 1 cent for the popular sizes. If the dealer will consider the handsome appearance that a stock of records presents, as well as the fact that he can immediately place his hand on any record called for,

he will realize the investment is a very economical one.

Most out-of-town dealers have hesitated about using the label and tray system because the transportation on the old style trays was so great and, in most cases, almost equal to the cost of same. This objection has been overcome, however, by the improved folding tray, which, being shipped flat, makes the cost of transportation very small and saves the dealer about one-half on the cost of the trays. Sample trays are being mailed to all dealers and jobbers upon request, and the idea has met with great favor among the trade.

## PARDELL DIAPHRAGMS IN DEMAND.

(Special to The Talking Machine World.)

New Haven, Conn., Nov. 9, 1906.

The Pardee-Ellenberger Co., of this city, are meeting with very general success with their Pardell diaphragm. Orders are coming in from jobbers and dealers all over the country, and the diaphragm has met with very gratifying results wherever it has been used.

This company claim to be the only Edison jobbers in New England whose business is exclusively devoted to wholesaling. The growth of the business has been rapid, and last spring they purchased a large building in the wholesale district of the city, allowing them ample space for a great stock of machines, records and supplies generally. One of the firm recently stated that they began as early as last June to stock up for the winter trade, and on account of their practically unlimited quarters were enabled to anticipate any reasonable demand that might be made upon them this year. They report that business has been far ahead of any previous year and the prospects for the next few months are very bright.

A. J. Pommer, president of the A. J. Pommer Music Co., of Sacramento, Cal., has recently been spending several days with the Hawthorne & Sheble Manufacturing Co., of Philadelphia, arranging for some heavy Coast shipments.

J. F. (Doc.) O'Neill is now traveling his old territory—West and Southwest—for the Victor Talking Machine Co., Camden, N. J., and is making good, of course.

# Phonograph Record Cabinets with Hornholder Attachment

PATENTED

Always in place when needed. Out of sight and folded inside of Cabinet when not in use. Larger one opens automatically and has drawer bottoms that turn on center pivot. Practical and indispensable. Prices reasonable.

MADE ONLY BY

**SYRACUSE CABINET CO., SYRACUSE, N. Y.**

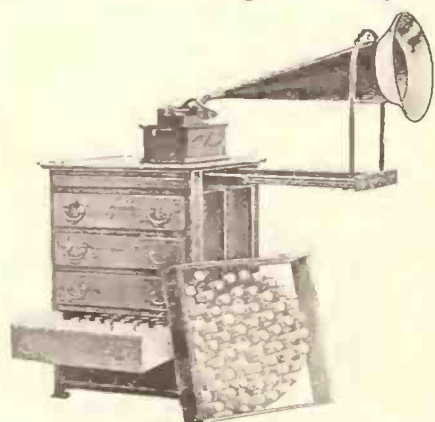

Quart. Oak, Holds 305 Records.



Plain Oak, Holds 180 Records.



**RECORD BULLETINS FOR DECEMBER, 1906.**

**NEW COLUMBIA 10-INCH DISC RECORDS.**

3504 Let It Alone (Williams and Rogers)..... Bert Williams  
 3505 Whistling Minstrel—Caprice (Andrew Her man)..... Prince's Military Band  
 3506 Serenade, "An meine Mutter"—To My Mother (G. B. Voigt)..... Biederman, Lufsky and Prince  
 3507 Sunflower Dance (Vess L. Ossman)..... Vess L. Ossman  
 3508 "Edna" Mazurka (C. A. Prince)..... Thos. Mills  
 3509 Nightingale and Thrush (H. Kling)..... Marshall P. Lufsky  
 3510 Donnybrook Fair—Two-Step (Harry Davis)..... Thomas Mills  
 3511 Ring the Bells of Heaven (Cushing and Root)..... The Columbia Quartet  
 3512 Christmas Morning at Flannigan's—De scriptive (Steve Porter)..... The Columbia Quartet  
 3513 Camp Meeting Time (E. Van Alstine)..... Collins and Harlan  
 3514 Would You Leave Your Happy Home for Me? (Harry Von Tilzer)..... Collins and Harlan  
 3515 I'm Tired of Eating in the Restaurants— Coon Song (Bert Williams)..... Bert Williams  
 3516 Abide With Me (W. H. Monk)..... Geo. Alexander  
 3517 Abraham Jefferson Washington Lee (Harry Von Tilzer)..... Arthur Collins  
 3518 Home, Sweet Home Sounds Good to Me (Harry Von Tilzer)..... Arthur Collins  
 3519 He Walked Right in, Turned Around, and He Walked Right Out Again (Max Silver)..... Boh Roberts  
 3520 Why Don't You Write When You Don't Need Money?—Coon Song (Gus Edwards)..... Boh Roberts  
 3521 In the Evening by the Moonlight, Dear Louise (Harry Von Tilzer)..... Frank C. Stanley  
 3522 Experience (Caryll and Ross)..... Miss Ada Jones  
 3523 Hottentot Love Song (Sylvio Hein)..... Miss Ada Jones  
 3524 Mira Di Acerbe Lagrime, from "Il Trova tore," Part I. (Verdi)..... Mme. Gina Ciaparelli and Taurino Parvis  
 3525 Viva from "Il Trovatore," Part II. (Verdi)..... Mme. Gina Ciaparelli and Taurino Parvis  
 3526 An Evening at Mrs. Clancy's Boarding House (Steve Porter)..... Steve Porter and Billy Murray  
 40953 Parade March of the 105th Reg. of Royal Saxon Infantry (Parade Marsch D. Kgl. Saechs. Inf. Regt. 105—Spobr)..... Columbia Orchestra  
 40980 Medley of Student Songs (Studentlieder —Potpourri)..... Columbia Orchestra  
 40998 Army March No. 7 (Armeemarsch No. 7)..... Columbia Orchestra

**NEW COLUMBIA 12-INCH DISC RECORDS.**

30035 Tonio e Nedda, from "Pagliacci" (Leon cavallo)..... David Bispham  
 30036 Kathleen Mavourneen (J. N. Croucb)..... David Bispham  
 30037 Dio Possente, from "Faust" (Gounod)..... David Bispham  
 33025 Let It Alone (Williams and Rogers)..... Bert Williams  
 33026 Lord Baltimore March (Henry Fillmore)..... Prince's Military Band  
 33027 Under Arms March (Al Hayes)..... Prince's Military Band  
 33028 Serenade "An meine Mutter"—To My Mother (G. B. Voigt)..... Biederman, Lufsky and Prince  
 33029 "Edna" Mazurka (C. A. Prince)..... Thos. Mills  
 33030 Donnybrook Fair—Two-Step (Harry Davis)..... Thomas Mills  
 33031 Record "C" Introducing "Moses Andrew Jackson, Good-bye." Sing by Arthur Col lins..... The Rambler Minstrel Company  
 33032 Ring the Bells of Heaven (Cushing and Root)..... The Columbia Quartet  
 33033 Christmas Morning at Flannigan's—De scriptive (Steve Porter)..... The Columbia Quartet  
 33034 Let the Lower Lights be Burning—Sacred (P. P. Bliss)..... Anthony and Harrison  
 33035 Over the Line—Sacred (Bradford and I'elps)..... Anthony and Harrison  
 33036 In the Sweet Bye and Bye—With bell toll ing effect (J. P. Webster)..... George Alexander  
 33037 Fare Thee Well, My Old Kentucky Home (Joe Natban)..... J. W. Myers  
 33038 She's So Much Like You, Mother (Gilbert and Ball)..... Frank C. Stanley  
 33039 I Love to Tell the Story—Sacred (W. G. Fischer)..... Charles Gordon

33040 How Can I Leave Thee (C. Cramer)..... Henry Burr  
 33041 'Tis But a Dream (Paul H. Von Moltke)..... Henry Burr  
 33042 Rosebud (Call and I'll Come to You) (Will Cobb)..... Billy Murray  
 33043 An Evening at Mrs. Clancy's Boarding House (Steve Porter)..... Steve Porter and Billy Murray  
 85086 Let It Alone (Williams and Rogers)..... Bert Williams  
 85087 Abraham Jefferson Washington Lee (Harry Von Tilzer)..... Arthur Collins  
 85088 When Tommy Atkins Marries Dolly Gray (Gus Edwards)..... Billy Murray

**ZON-O-PHONE 10-INCH RECORDS.**

600 Artist's Life Waltz..... ZON-O-PHONE CONCERT BAND.  
 601 D. M. I. March.....  
 602 Gipsy Prince—Hungarian Two-step Intermezzo.....  
 604 His Honor the Mayor—Selections.....  
 605 Little Cherub—Selections.....  
 606 Recollections from "Tanhauser"..... HAGER'S ORCHESTRA.  
 607 Ange D'Amour (Angel of Love) Waltz.....  
 608 Fordham Ram March and Two-step.....  
 609 Frühlings March.....  
 610 La Kraquette Two-step.....  
 611 Policy Pate—Characteristic Two-step.....  
 612 "You Can Have Broadway" Medley Waltz..... CORONET SOLO BY BOHUMIR KRYL, WITH ORCH. ACCOMP.  
 613 Du Du, with variations..... SONGS WITH ORCHESTRA ACCOMPANIMENT.  
 614 Ain't You Coming Back to Old New Hamp shire, Molly?..... Frank C. Stanley  
 615 And a Little Child Shall Lead Them..... B. G. Harlan  
 616 Arrah—Wanna..... Collins and Harlan  
 617 Down on the Farm..... Len Spencer and Ada Jones  
 618 Experience..... Miss Ada Jones  
 619 Good-a-Bye, John..... Len Spencer and Ada Jones  
 620 I Love the Last One Best of All..... Frank C. Stanley  
 621 Little Willie Brown..... Billy Murray  
 622 Love Me and the World is Mine..... Henry Burr  
 623 Sweet Anastasia Brady..... Billy Murray  
 624 That's What the Rose Said to Me..... Henry Burr  
 625 Yimminy Yee, I Yumped My Yob for You..... Collins and Harlan

**NEW VICTOR RECORDS.**

Number	SOUSA'S BAND.	Size
31574	Huguenots—Selection Act IV. (Benedic tion of the Poignards)..... Meyer	12
4867	Cherry—Two-Step..... Albert	10
4866	"Pennsylvania Special" March..... Inues	10
4868	Entry of the Gladiators—March.....	10
4869	Donnybrook Fair—March..... Davis	10
4870	Waiting at the Chureb—Medley Two-Step.....	10
31576	"Mlle. Modiste" Waltzes..... Herbert	12
4880	Russian Kossack (Jewish Dance)..... Ascher	10
4881	Boruch Habo, from opera "Gabriel" (Jew ish Dance)..... Friedsell	10
31575	Miss McCloud's Reel.....	12
4897	Melodie (Belgie)..... Massenot	10
31582	Berceuse from Jocelyn..... Godard	12
4871	In the Evening by the Moonlight, Dear Louise.....	10
31573	The Star of Bethlehem (Christmas Song).....	12

SONGS BY MISS ADA JONES.  
 4873 The Bullfrog and the Coon..... Nathan 10  
 4892 Marie Cahill's "Hottentot Love Song"..... 10  
 SOPRANO SOLO BY MISS FLORENCE HINKLE, WITH VIOLIN OBLIGATO.  
 4874 Believe Me if All Those Endearing Young Charms..... Moore 10  
 WHISTLING SONG BY S. H. DUDLEY.  
 4885 The Merry Whistling Parky..... 10  
 DUET BY MISS STEVENSON AND MR. STANLEY.  
 4876 The Linger Longer Girl..... Solomon 10  
 DUET BY MACDONOUGH AND BIELING.  
 4877 A Flower from Home, Sweet Home..... Schmid 10  
 DUET BY MISS JONES AND MR. MURRAY.  
 4891 You Can't Give Your Heart to Somebody Else and Still Hold Hands With Me..... 10  
 SONGS BY BILLY MURRAY.  
 4872 My Mariuccia (Take a Steamboat)..... 10  
 4883 I Don't Like Your Family..... 10  
 BILLY MURRAY AND HAYDN QUARTET.  
 4898 When Tommy Atkins Marries Dolly Gray..... 10  
 "COON" SONG BY ARTHUR COLLINS.  
 4878 Abraham Jefferson Washington Lee..... 10  
 DUET BY COLLINS AND HARLAN.  
 4879 The Songs of the Ragtime Boy..... Von Tilzer 10  
 HANDEL MINED QUARTET, UNACCOMP.  
 4875 It is Well With My Soul..... Bliss 10  
 HARRY MACDONOUGH AND HAYDN QUARTETTE.  
 31583 Somewhere in the World There's a Little Girl for Me..... Bowers 12  
 DESCRIPTIVE SPECIALTY BY BILLY GOLDEN.  
 4887 Sissereta's Visit to the North..... 10  
 SOUSA'S BAND.  
 300 Hands Across the Sea—March..... Sousa 8  
 4862 Iola—Intermezzo Two-Step..... Johnson 8  
 ARTHUR PRYOR'S BAND.  
 4841 Royal Trumpeters March..... Seltzer 8  
 4842 On the Rocky Road to Dublin..... Ephraim 8  
 CHARACTER SONG BY MISS ADA JONES.  
 4714 Waiting at the Church..... 8  
 TENOR SOLO BY BILLY MURRAY.  
 4861 Not Because Your Hair Is Curly..... Adams 8  
 PARODY BY S. H. DUDLEY.  
 4886 Swanee River Parody..... 8  
 MALE QUARTETS BY THE HAYDN QUARTET.  
 656 Carty Me Back to Old Virginia..... 8  
 4898 Glory Song ("Oh, That Will Be Glory")..... 8  
 4865 The Teacher and the Tack—(unaccomp.)..... 8  
 CHOIR RECORD BY THE TRINITY CHURCH.  
 717 Rock of Ages..... Hastings 8  
 BASS SOLO BY WILLIAM F. HOOLEY.  
 4893 Let Erin Remember the Days of Old..... Moore 8  
 BARITONE SOLOS IN SPANISH BY CARLOS CACERES, PIANO ACCOMP.  
 4888 Himno Nacional Peruano "Somos libres, seamoslo siempre"..... 10  
 4889 La Tela de Arana—Bacavola ("La Tem pestad bravi")..... Lamadrid-Nieto 10  
 4890 Un adios—Cancion..... Lora! Yrader 10  
 31577 Una Vieja—Cavatina "Un Espanol que viene"..... Camprodon-Gastañide 12  
 31578 Amor y olvido—Romanza—del Valle-Alvarez 12  
 31579 El Diablo en el Poder—Romanza..... Camprodon-Barbieri 12  
 31580 Fuegos de oro—Romanza "Yo te á maba"..... Barbieri 12  
 NORWEGIAN SOLOS BY H. E. ROSEN, PIANO ACCOMP.  
 3500 For Norge, Kjaempers fodeland..... A. Gretry 8  
 3501 Syng kun i din ungdoms vaar..... Silcher 8  
 3502 Studentersang..... Ibsen 8  
 3503 Aa Ola Ola min egjen Ongje (Gammel folkevis)..... 10  
 3504 Jeg lagde mig Saa Sildig (Gammel folke vise)..... 10  
 3505 Ja vi elsker..... Rikard Nordraak 10  
 3506 Sønner af Norge..... C. Blom 10  
 3507 Det Norske flag..... L. M. Ibsen 10  
 3508 Saeterjentens sondag..... Ole Bull 10  
 3509 Millom Bakkar og Berg ut med havet (Gam mel folkevis)..... 10  
 81084 Il Trovatore—Stride la vampa ("Fierce Flames are Soaring")..... Verdi 10  
 85104—Gloranda—Voice di donna (Angelic Voice)..... Tonchielli 12  
 85105 Martha—Esser mesto il mio cor (Softly Whispers a Voice)..... Flotow 12  
 85106 Faust—Quando a te lieta (When All Was Young)..... Gounod 12  
 ELDA CAVALIERI, SOPRANO, WITH ORCH.  
 74054 Tosca—"Vissi d'arte"..... Puccini 12  
 74055 Aida—O patria mia (My Native Land)..... Giuseppe Verdi 12

**ANOTHER NEW CYLINDER RECORD CABINET**

Only one of a "bunch" of new Cylinder Cabinets.

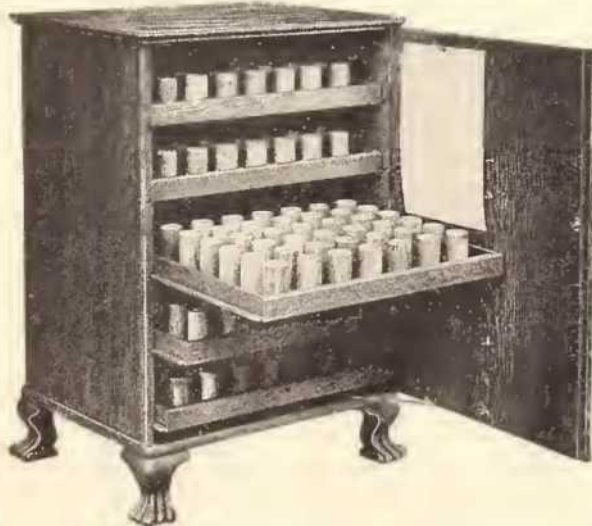

No. 503—Open.

We think it is a dandy!

Our styles, finish and prices are very attractive.

Mr. Dealer, you surely need some Udell Disk and Cylinder Record Cabinets.

FOLDER AND QUOTATION ON REQUEST

**THE UDELL WORKS, 1210 West 28th Street INDIANAPOLIS, U. S. A.**



## LIST FOR JANUARY, 1907.

Of New Edison Gold Moulded Records—  
Records Listed Below Will be Shipped in  
Time to Reach All Jobbers Before December  
27th, But They Must Not be Placed on Sale  
by Jobbers or be Reshipped to Dealers Before  
8 A. M. on December 27th.

Edison Gold Moulded Records are made only in Stand-  
ard Size. Both Standard and Concert Records may be  
ordered from this list. Order by number, not title. If  
Concert Records are wanted, give the number and  
letter C.

- 9434 The Mouse and the Clock (Whitney). Listen  
to the mouse. Edison Concert Band  
9435 Just Because (Burleigh). Harry Anthony  
9436 Gwendolyn (Hein). Comic song hit from  
Marie Cabill's "Marrying Mary". Ada Jones  
9437 Believe Me, If All Those Endearing Young  
Charms (Stevenson-Benzler). Albert Benzler  
9438 When the Flowers Bloom in Springtime (Von  
Tilzer). Harry MacDonough  
9439 Tramp! Tramp! Tramp! (Root). Male Duet  
Harlan and Stanley  
9440 I'm Getting Ready for My Mother-in-law  
(Norworth). Bob Roberts  
9441 Colonial Guard March (Bonk). A catchy  
military march. Edison Military Band  
9442 Moses Andrew Jackson, Good-bye (Snyder)  
Arthur Collins  
9443 It Is Well with My Soul (Bliss). Sacred  
quartet by mixed voices. Edison Mixed Quartet  
9444 Seems to Me I've Always Loved You (Ball)  
Irving Gillette  
9445 Hermosillo (Schuh). A characteristic Mex-  
ican dance. Edison Symphony Orchestra  
9446 Why Can't a Girl Be a Soldier? (Halle)  
W. H. Thompson  
9447 Arrah Wanna (Morse). Irish-Indian matri-  
monial venture. Collins and Harlan  
9448 Spring-Tide Revels (Harper)  
Mrs. Alice Shaw and Twiu Daughters  
9449 Ballet Music from William Tell (Rossini)  
Edison Concert Band  
9450 The Bird on Nellie's Hat (Solman). A new  
comic song. Helen Trix  
9451 When Tommy Atkins Marries Dolly Gray  
(Cobb and Edwards). Billy Murray  
9452 I Love the Last One Best of All (Hein)  
Frank C. Stanley  
9453 March—"Jose" (Blum). Xylophone solo.  
Albert Benzler  
9454 Bonnie Jean (Snyder). Byron G. Harlan  
9455 Jealous Julie (Original)  
Ada Jones and Len Spencer  
9456 When Daddy Sings the Little Ones to Sleep  
(Vogel). Edison Male Quartet  
9457 On the Rocky Road to Dublin (Ephraim).  
Irish intermezzo. Edison Military Band

## NOVEMBER LIST CONCERT RECORDS.

(Leeds & Catlin Co., New York.)

- TENOR SOLOS BY HARRY TALLY, WITH ORCH. ACCOMP.  
75255 A Little Lunch for Two. A. Von Tilzer  
75259 Carolina. John Ford  
75272 Why Don't You Try. Van Alstyne  
75273 Alice, Where Art Thou Going. Gumble  
75275 Cheer Up, Mary. Paley  
75277 Camp Meeting Time. Van Alstyne  
TENOR SOLOS BY DAN QUINN, WITH ORCH. ACCOMP.  
75256 Mr. McGuire, Esquire. Kern  
75276 My Mariuccia Tak a Steamboat, She's Gone  
Away. Piantados  
7924 Yankee Boogie. Jerome and Schwartz  
BARITONE SOLO BY FRANK C. STANLEY, WITH PIANO  
ACCOMP.  
7902 Absence Makes the Heart Grow Fonder.  
Herbert Dillea  
7922 When the Harvest Days Are Over.  
A. Von Tilzer  
BARITONE SOLO BY LEN SPENCER, BANJO ACCOMP. BY  
VESS L. OSSMAN.  
7824 You've Been a Good Old Wagon, but You've  
Done Broke Down.  
7821 Hickory Bill.  
BANJO SOLOS BY VESS L. OSSMAN, WITH PIANO ACCOMP.  
7827 Colored Major.  
7834 Tell Me Pretty Maiden. Otto Langley  
ORCHESTRA SELECTIONS.  
75280 Honor Bright—March.  
75284 Regatta—March.  
75285 High Society—March. Steele  
BAND SELECTIONS.  
75292 Sorella—March. Gallini

## NOVEMBER LIST IMPERIAL RECORDS.

(Leeds & Catlin Co., New York.)

- TENOR SOLOS BY HARRY TALLY, WITH ORCH. ACCOMP.  
45274 Won't You Come Over to My House.  
Van Alstyne  
45288 Smile on Me. Sutton  
TENOR SOLO BY HENRY BURR, WITH ORCH. ACCOMP.  
45290 Lonesome Little Maid. Solman

BARITONE SOLOS BY LEN SPENCER, BANJO ACCOMP. BY  
VESS L. OSSMAN.

- 44816 Banjo Evangelist.  
44823 The Little Old Log Cabin in the Lane.  
BARITONE SOLOS BY FRANK C. STANLEY, WITH ORCH.  
ACCOMP.  
44910 He Laid Away His Suit of Gray to Wear  
the Union Blue. Ben Yansen  
44915 My Cozy Corner Girl. John W. Bratton  
44918 She's Just a Little Different from the  
Others That I Know. Gustav Luders  
45286 Yeoman's Wedding Song. Prince Poniatowski  
45287 Walklug Home With Angeline.  
John C. Rundback  
45288 Alice Where Art Thou? J. Ascher  
45289 Kathleen Mavourneen. J. N. Crouch  
45290 A Warrior Bold. Stephen Adams  
45291 Beauty's Eyes. Paolo Tosti  
45294 In Dreamland. Walter Slaughter  
45296 Come Back to Erin. Claribel  
45299 The Miner's Dream of Home.  
Will Goodwin and L. D.  
WITH PIANO ACCOMP.  
44911 I'm Wearing My Heart Away for You.  
Chas. K. Harris  
DUET BY FRANK C. STANLEY AND HENRY BURR, WITH  
PIANO ACCOMP.  
44928 Come Along, Little Girl, Come Along.  
J. B. Mullen  
BANJO SOLOS BY VESS L. OSSMAN, WITH PIANO ACCOMP.  
44828 El Capitan. Sousa  
44826 Creole Belles. Lampe  
45282 Sunflower Dance. Ossman  
44837 Chimes—America.  
BAND SELECTIONS BY THE CONCERT BAND.  
44864 Bohemian Girl. Balfe  
44894 Stars and Stripes Forever. Sousa  
45293 El Capitan. Sousa  
45295 The Squirrel's Dance. Lauredean  
45297 Poet and Peasant—Overture. Suppe  
45298 Mikado. Sullivan  
ORCHESTRA SELECTIONS BY THE IMPERIAL ORCHESTRA.  
45261 With Sword and Lance. Starke  
45262 Overture from "Maritana". Wallace  
45263 Selection from "A Country Girl". Godfrey  
45264 Selection from "The Duchess of Dantzic".  
Godfrey  
45265 Selection from "The Cingalee". Godfrey  
45266 Tancredi—Overture. Rossini  
45267 Josie—Barn Dance. Peters  
45268 Laughing Water—Two-Step. Hager  
45269 King Cotton—March. Sousa  
45270 By the Suwanee River—American Sketch.  
Mydelton  
45271 The Peacemaker—March (Representing  
Russia, Japan and America). Alford  
45278 Salut D'Amour. Edward Elgar  
45279 The Garden of Sleep—Waltz. Bucalossi  
45281 Delicia. Frank Frantzen  
45283 Sunbeams and Shadows. R. A. Keiser

## GRAPHOPHONE IN KANSAS POLITICS.

(Special to The Talking Machine World.)

Topeka, Kan., Nov. 7, 1906.

The use of the graphophone in politics was  
tried during the campaign just closed in Miami  
County with success. Alpheus Lane, chairman  
of the Republican county central committee, was  
responsible for the use of the talking machine.  
He has been using them in country school-  
houses with great success.

## WOMEN BOTTLE CANARIES' SONGS.

A club of women on the south side of Chicago  
recently gave a unique entertainment for its  
members. A dozen of the women caught the  
voices of their canaries on the wax records and  
on a given afternoon assembled and ran all the  
records through a machine. Then there was a  
vote as to which canary should have the prize,  
a package of birdseed, for the sweetest song.  
Later others of the women had their pet dogs  
bark and after trying these records separately  
set half a dozen machines going at once, making  
a tremendous racket.

## TALKING MACHINE AT FUNERAL.

At a funeral recently held of an old resident  
of Beulah, Col., the talking machine was used  
at the services, the favorite hymns of the de-  
ceased being interpreted by the machine. The  
scene was a most impressive one, and all who  
were present were most affected.

The New Jersey  
Sheet Metal Co.

Manufacturers of

The  
DAUGHTY  
CRANE

Simplest working crane on the market

The  
KOMPAKT  
HORN

Collapsible metal flower  
horn which anyone can  
put into use in one minute

The regular line of flower  
horns manufactured by us  
is the best proposition  
on the market to-day

Write for catalogue and prices

The New Jersey  
Sheet Metal Co.

9-11 CRAWFORD ST.,  
Newark, New Jersey  
U. S. A.



Mr. Dealer:

If you want always to get  
the goods, send your orders to  
a house of exclusive  
Victor Jobbers.

STANLEY & PEARSALL,  
541 Fifth Avenue, N. Y.



**LATEST PATENTS RELATING TO TALKING MACHINES AND RECORDS**

(Specially prepared for The Talking Machine World.)  
Washington, D. C., Nov. 8, 1906.

PHONOGRAPH. William W. Rosenfield, New York. Patent No. 831,895.

This invention relates to automatic return mechanism for phonographs, and is an improvement on previous patents by same inventor.

In the drawings, Fig. 1 is a plan view of a phonograph provided with an automatic return

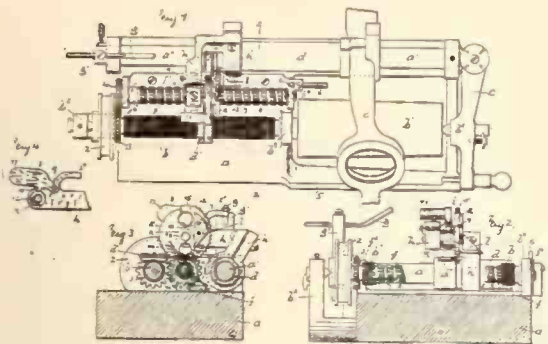

mechanism embodying the invention. Fig. 2 is an elevation of the return mechanism and parts of the phonograph with the feed shaft and the auxiliary or return feed shaft broken away so as to more clearly show other parts. Fig. 3 is a section on line x x of Fig. 1 looking toward the left. Fig. 4 is a detail view, partly in section, of parts which will be hereinafter described.

SOUND-REPRODUCING DISC RECORD. Joseph H. Milans, Washington, D. C. Patent No. 832,403.

This invention relates to improvements in sound-reproducing disc records, and has for its primary object to overcome the disadvantages inherent in the hit-and-miss idea involved in the manual application of opaque discs of the character designated to a centering pin or equivalent device carried by the rotating platform or record support now universally employed in talking machine structures and the like.

The present invention has been devised, and in its generic sense the improvements reside in the provision of instrumentalities facilitating the manual application of a normally free sound-reproducing disc record, the main body of which is opaque, to the centering device or devices on the rotary platform or disc support, it being noted that by the term "normally free" the inventor intends to differentiate discs applied and removed by the hands of the operator in contradistinction to such discs as are used in magazine machines and the like and shifted by the mechanism thereof from an inactive to an active position, or vice versa.

More specifically, the invention comprehends a disc having an opaque body portion and a centrally disposed sight opening or window, which may be in the nature of an open space or transparent disc, or both, through which the centering pin or device may be clearly seen by the operator from above the record, said transparent disc or open space, or both, as the case may be, im-

mediately surrounding an opening or openings formed to correspond with and receive the centering device or devices on the record support or platform, a highly important advantage gained by the formation of a disc record of this type, due to the provision enabling relatively constant observation of the centering device from above the record, being that said devices may be of non-circular or angular contour or separated and the receiving portions of the disc formed complementary thereto, whereby when they are brought into operative relation a positive drive of the record may be effected as compared with the friction-drive in machines now on the market, thus doing away with felt or other frictional engaging surfaces usually carried upon the upper face of the record supporting frame or platform.

To more readily impart a clear and full understanding of the invention, there are illustrated in the accompanying drawings, forming part hereof, a number of embodiments of the invention, and the novel details in the construction

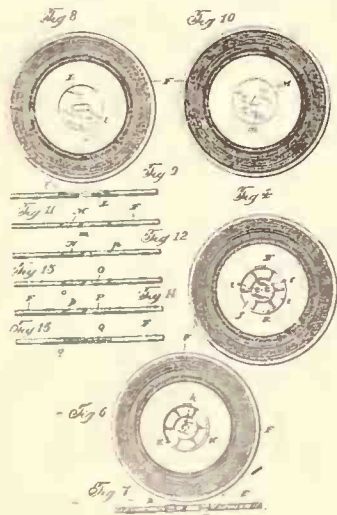

and arrangement of the several parts thereof will be apparent upon an inspection of said drawings in connection with the detailed description hereinafter contained.

In the drawings, Fig. 1 is a perspective view, somewhat fragmentary, of an ordinary graphophone, showing the manner of applying one of the improved discs thereto, the body of the disc being opaque and the centering portion thereof transparent and apertured, the centering pin on the platform adapted to enter the aperture showing through said transparent portion. Fig. 2 is a face view of the disc record of Fig. 1. Fig. 3

is a central transverse sectional view through Fig. 2. Fig. 4 is a face view of a record constituting another embodiment of the invention, and this particular form, for the purposes of the present application, the preferred embodiment of the invention is styled. Fig. 5 is a central transverse sectional view through Fig. 4. Figs. 6 and 7 are views similar to Figs. 4 and 5, of a third embodiment of the invention. Figs. 8 and 9 and Figs. 10 and 11 are similar views of still further embodiments of the invention, and Figs. 12, 13, 14 and 15 are detail sectional views illustrative of different ways of securing the transparent discs or windows to the opaque record discs.

AMPLIFYING HORN FOR TALKING MACHINES. Wilburn N. Dennison, Camden, N. J., assignor to Victor Talking Machine Co., same place. Patent No. 832,896.

This invention relates to amplifying horns for talking machines, and more especially to means for detachably mounting the horn upon the machine and for connecting sections of the horn in a readily detachable manner.

In the accompanying drawings, which illustrate one embodiment of the invention, Fig. 1 is a side elevation of the essential parts of a talking machine, having an improved amplifying horn in use in connection therewith, and Fig. 2 a

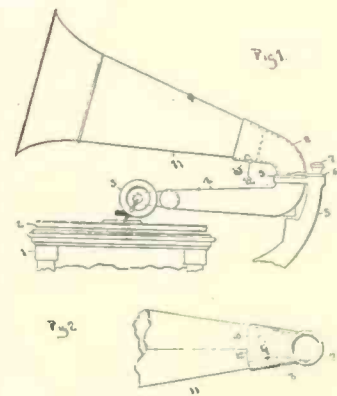

bottom plan view of the amplifying horn detached from the machine.

PRODUCTION OF PHONOGRAPHIC SOUND RECORDS. William F. Nehr, Newark, N. J., assignor to New Jersey Patent Co., West Orange, N. J. Patent No. 834,485.

This invention relates to apparatus for use in the molding of phonographic sound records, and more particularly to apparatus for carrying out a molding process described and claimed in United States letters patent No. 683,615, dated October 1, 1901, to Miller and Aylsworth, wherein a tubular mold is caused to descend into a bath of molten material, which fills the same and congeals upon its interior in a coating or layer which adheres to the same while the mold is lifted out of the bath, after which the record may be finished upon its interior surface and removed from the mold by radial contraction or shrinkage.

Heretofore in producing records according to this process it has not been possible to mold the upper end of the record to the shape desired in the finished article, the practice being to form a rough end which must afterward be removed in any suitable manner, as by a cutter or trimmer of any suitable description.

This invention has for its object the provision of means whereby such upper end may be molded into a form suitable for the finished article—that is, a surface which will present a smooth

**1907 Price List For**

**EDISON AND VICTOR SUPPLY PARTS**

**IS NOW READY**

**Have You Received Yours?**

**EDISONIA CO., Newark, N. J.**



and polished appearance and which will be free from depressions, elevations, discolorations and all forms of roughness or irregularity. With this end in view a large number of experiments

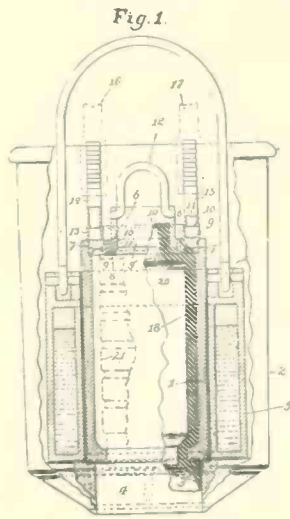

have been made to obtain a mold-cap which when placed upon a tubular coreless mold will be capable of molding the upper end of the sound record in the manner referred to for an indefinite number of operations. From these experiments it has been determined that the mold-cap should have a concave surface, the outer edge of which during the molding operation adjoins and forms a

continuation of the bore of the mold. Preferably the body of the mold should extend above at least the lower part of said concave surface, so that when the cap is removed from the mold the molded end of the record or that portion which forms the end after the reaming operation will be protected by the mold against accidental injury during the handling

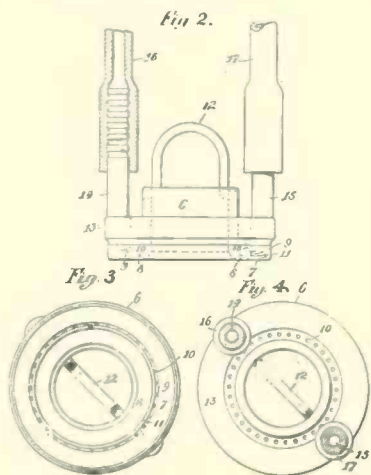

of the same prior to the removal of the finished article from the mold. It has also been determined that the said concave surface may be of such form as to entrap a portion of the air contained in the bore of the mold as the same descends into the molten material, in which case the air is permitted to escape through airholes extending through the body of the mold-cap. It has also obtained good results by providing a

second groove concentric with the first groove and separated therefrom by a partition which tapers to a comparatively sharp edge. I have also discovered that the concave surface should be perfectly smooth and highly polished and preferably nickel-plated, and also that the mold-cap should be kept cool during the molding operation, as by providing the same with a water jacket.

Reference is hereby made to the accompanying drawings, in which Fig. 1 is a vertical section showing a mold supported in a mold carrier and surrounded by a water jacket in the usual manner and provided with a cap constructed in accordance with the invention. Fig. 2 is an elevation, on an enlarged scale, of the mold-cap shown in Fig. 1. Fig. 3 is a bottom plan view of Fig. 2, and Fig. 4 is a top plan view of the same.

**SPEED INDICATOR.** Edmond Hugh Riordan, Idaho City, Idaho. Patent No. 831,079.

The invention relates to talking machines, and its object is to provide a new and improved speed indicator arranged to enable the user of the machine to quickly and conveniently adjust the speed of the motor and consequently that of the record, and to insure playing of the record piece in proper time. A practical embodiment of the invention is represented in the accompanying drawings. Fig. 1 is a perspective view of the improvement as applied to a Victor talking machine, and Fig. 2 is a sectional side elevation of the same.



**GRAMOPHONE.** Joseph Sanders, Washington, D. C. Patent No. 834,326.

This invention has reference to improvements in gramophones of the type wherein a tapering amplifying horn or a section thereof is mounted to swing over a record tablet only in a plane parallel thereto, and the object of the invention is to produce a means for mounting the sound-box whereby it may be carried by said tapering horn or horn section and have freedom of movement in a plane at right angles to the plane of movement of the said horn.

The invention consists in providing a quadrantal neck for the sound-box, which neck is pivotally yoked to the taper section, so as to move in a curved path past the smaller or free end of said horn section to bring the stylus of the sound-box in engagement with a sound record groove or to bring the sound-box over onto the horn section in position for the insertion or

removal of a stylus. To insure a sound-proof joint between the quadrantal neck or sound-box carrier and the tapering horn section, the meeting faces are curved on an arc the center of

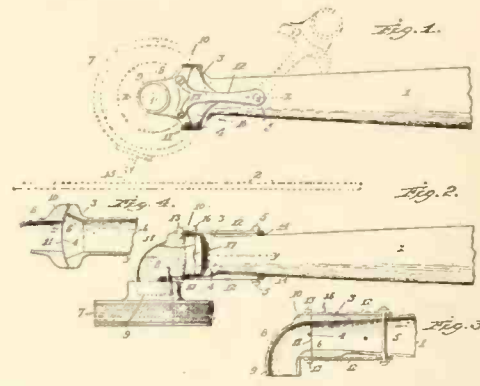

which is the pivot of the yoke joining the sound-box carrier to the horn section. Fig. 1 is a side elevation of a portion of a taper horn section and the quadrantal neck or sound-box carrier with the sound-box and a disc record tablet shown in dotted lines. Fig. 2 is a plan view of the structure shown in Fig. 1 with the sound-box shown in full lines and the record disc omitted. Fig. 3 is a section on the line x x of Fig. 1, and Fig. 4 is a section on the line y y of Fig. 2.

**PHONOGRAPH.** Ernst Sollors, Cologne, Germany. Patent No. 832,703.

The present invention relates to an adjusting device for phonographs. In phonographs, especially such as are employed for purposes of dictation, a great drawback is found to be in that when the phonograph is started or stopped the machine is not immediately connected or disconnected. The phonograph will, moreover, invariably at the moment of the disconnecting make a little further forward motion, and in like manner when it is started again there will be necessary a certain movement of the phonograph before it again possesses the speed at which the sounds through the trumpet are clearly audible. Obviously this is a very disagreeable occurrence in the reproduction of dictated matter, because by stopping and starting some words are invariably lost. By means of the stopping and starting device forming the subject of this application this drawback is overcome, inasmuch as the phonograph, when the machine is stopped, automatically moves a little backward, so that when it is started again the sounds which would otherwise be lost become audible, and under certain circumstances also the last words previously heard are repeated.

The device is preferably so arranged that the

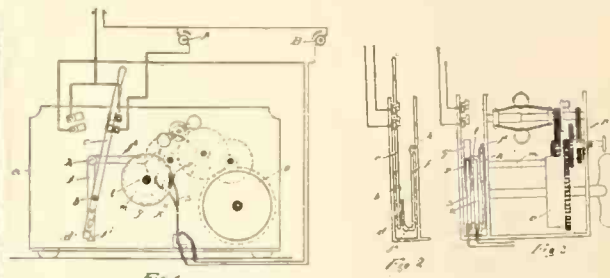

controlling lever of the driving motor of the phonograph at the moment of stoppage releases a catch acting upon the controlling device, whereupon this latter starts the second motor or reverses the original driving motor. Moreover, the stopping of the controlling device is effected either by the automatic engagement of the catch or by the running down of the controlling device itself.

Any suitable mechanism may be employed as a controlling device, and as the simplest thereof may be mentioned a clockwork mechanism which puts the second motor in operation during the working period or reverses the driving motor or drives itself directly by mechanical means. The clockwork must be arranged automatically to put itself out of gear after a given time and to stop the second motor or the reversed motor.

Reference is had to the accompanying drawings, in which a suitable device of this kind is illustrated, by way of example, in Fig. 1 in front elevation, and in Figs. 2 and 3 in side elevation.

DIAPHRAGM FOR TRANSMITTING SOUND WAVES.

MIRA MUSIC BOX

Unequaled for Sweetness Harmony and Volume of Tone

The following are some of the dealers handling the "Mira" Music Boxes:—

LYON & HEALY, Chicago, Ill.  
 SHERMAN, CLAY & CO., San Fran., Cal.  
 SHERMAN, CLAY & CO., Oakland, Cal.  
 SHERMAN, CLAY & CO., Seattle, Wash.  
 OLIVER DITSON CO., Boston, Mass.  
 J. E. DITSON & CO., Philadelphia, Pa.  
 C. H. DITSON & CO., New York.  
 JOHN WANAMAKER, New York.  
 JOHN WANAMAKER, Philadelphia, Pa.  
 MACKIE PIANO & ORGAN CO., Rochester, N. Y.  
 DENTON, COTTIER & DANIELS, Buffalo, N. Y.  
 S. HAMILTON, Pittsburg, Pa.  
 KRELL PIANO CO., Cincinnati, O.  
 CARLIN & LENOX, Indianapolis, Ind.  
 FINZER & HAMMEL, Louisville, Kentucky.  
 O. K. HOUCK PIANO CO., St. Louis, Mo.  
 A. NOSPE, Jr., Omaha, Neb.  
 S. KANN SONS & CO., Washington, D. C.

Write for Catalogue and Prices

JACOT Music Box Co.

39 Union Sq., New York



Edwin H. Molley, Morton, Pa. Patent No. 834,629.

One of the difficulties which has been met in preserving the clearness and distinctness as well as the natural tone or "timbre" of sounds transmitted by vibratory diaphragms has been due to the fact that, owing to the construction of the diaphragm, it assumes a more or less curved or arched position while vibrating under the action of the sound waves, which results in the deflection of the sound waves and their consequent interference with one another.

If the diaphragm, or that portion of it which is effective in the transmission of the sound waves, vibrates in the plane of its surface, or without curvature in the diameter of its plane, the waves will not be deflected, but will be transmitted in direct lines. While this result can and possibly has been obtained in diaphragms of special construction where the central vibratory portion has been connected with the clamping edge or outer support by separate connecting springs, such constructions are unsatisfactory not only because of their complicated and expensive construction, but also because the openings afforded

by those spring connections permit a portion of the sound waves to pass through without acting on the diaphragm. Not only are such sound waves lost, but the openings permit air currents to pass through, which affect the sound waves transmitted by the vibrations of the diaphragm.

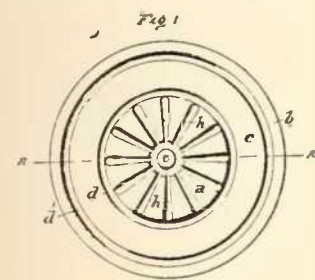

It is the object of this invention to provide a diaphragm composed of a single integral sheet without openings or attenuated portions in which the central part may vibrate under the action of the sound waves without appreciable curvature in the lines of its diameter or plane of its surface.

The diaphragm is formed of a thin sheet of strong resilient material, having its central portion united with the clamping edge by an integral, continuous and unattenuated spring portion of substantial width, so that the central portion is strengthened or stayed against curvature and the radial movements necessary to permit the vibrations are taken up in the integral uniting spring portion.

The diaphragm may be used in any instrument for transmitting sound waves, such as the reproducing and recording heads of phonographs, graphophones and gramophones, and the sound boards and tympana of musical instruments.

In the drawings, Fig. 1 is a plan view of a diaphragm embodying the invention. Fig. 2 is a transverse section of the same.

TALKING MACHINE. John C. English, Camden, N. J., assignor to Victor Talking Machine Co., same place. Patent No. 834,511.

The object of this invention is to provide such a construction in connection with talking machines or other similar sound recording and reproducing machines that the sound-box will at all times in traversing the grooves of the record be held accurately in such a position that the plane of the stylus or needle will be substantially tangent to the direction of rotation of a turn table, and, therefore, tangent to the turns of the record groove.

Heretofore in talking machines the arm which supports the reproducing mechanism has usually been pivoted upon a vertical pivot, which causes the sound-box to swing in the arc of a circle about said pivot, and as the proper line on which the sound-box and needle should move in traversing a record of the disc type is a radius or straight line toward the center of the record it is evident that the stylus of the sound-box or reproducer in such former constructions would be in a plane tangent to the record grooves at

only one point in its movement across the record. This relation between the stylus or needle and the record grooves seems to interfere somewhat with an accurate reproduction of the sounds recorded on the record, especially at the beginning and ending of the record, because the stylus bar was not actuated in a direction exactly at right angles to the place of the diaphragm.

This invention has substantially overcome this difficulty, and by its use the stylus is forced to move in substantially a straight line across the

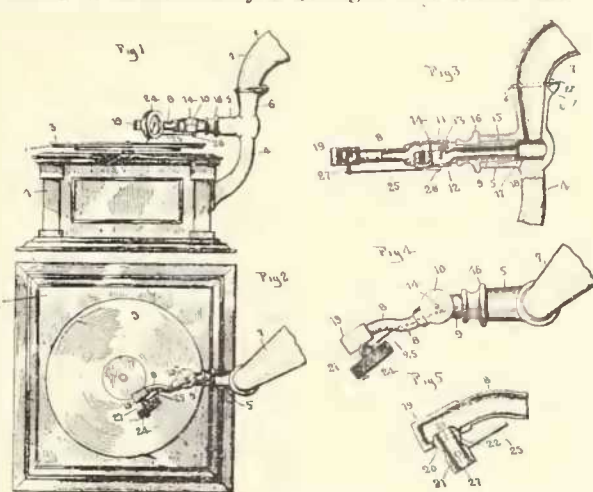

face of the record, said straight line being a radius, while at the same time the plane of the needle or stylus, as well as the sound-box diaphragm, are substantially in planes tangent to the record groove on the radius referred to.

Briefly, this invention comprises an arm for supporting the reproducing mechanism which is composed of two parts joined or pivoted together, the sound-box also being pivoted in relation to the parts of said supporting arm, and also means for connecting the sound-box with a fixed point, so that said sound-box is held accurately and firmly in its correct position while traversing the entire width of the record. Fig. 1 is a side elevation of a talking machine, showing the improved device in use in connection therewith. Fig. 2 is a plan view of the same. Fig. 3 is a longitudinal sectional view of the supporting arm detached from the other parts of the machine and showing the manner of joining the sections of said arm. Fig. 4 is a detailed plan view of the same, and Fig. 5 is a sectional view showing the manner of forming the joint between the sound-box and the supporting arm.

### VARIED MUSICAL TASTES.

Illustrated in the Orders Sent in for Records.

The great variety of musical taste shown by the public is well illustrated by a glance through the orders sent in to any one of the big com-

panies. Some want religious airs not heard since the time of the Crusaders. Others send in for a ragtime tune that, if it ever was heard in public, sank into obscurity years ago and no monument erected to it. A sample order was that received by the National Phonograph Co. for a record to be made of "Down Went McGinty," that relic of bygone days that has almost become a classic. In replying to the above the company said: "It is impossible to say what our recording department may do in the future. 'Down Went McGinty' is, however, looked upon as a 'has been,' and, unless, like roller-skating, its popularity is revived, it is not likely that we will ever make a record of it." And still they come.

### CABLE COMPANY'S BIG BUSINESS.

The Cable Company's branch in Richmond, Va., is doing a phenomenal business with the Victor machines and records, often being handicapped from the fact that new shipments cannot be received rapidly enough to fill out the depleted stocks. The extent of the business may be judged from the fact that it was found necessary recently to send in a rush order for \$6,000 worth of Victor goods, and the inability of the factory to fill it completely at such short notice caused untold inconvenience. J. G. Corley, the manager of that store, is to be congratulated upon the trade he has succeeded in building up in Richmond and vicinity, and which is continually being increased.

### THE UNIQUE TALKING MACHINE CO.

(Special to The Talking Machine World.)

Houston, Tex., Nov. 7, 1906.

The Unique Talking Machine Co., of this city, are a large and continually growing concern, who claim to carry the largest line of both cylinder and disc records of any house in Texas on the shelves at the local store. They have recently opened a branch in Galveston, the original equipment of which was 16,000 disc records and 100 machines. They are now arranging for the installation of an extensive Columbia line in that city. With that record as a beginning the future of the new branch with such a concern back of it seems to be of the brightest.

John Rawlings, Scranton, Pa., who has one of the best equipped sporting goods stores in the State, to which the talking machine department is a good second, has removed from 225 Penn avenue to one of the best sections of Wyoming avenue. Mr. Rawlings will open a talking machine and sporting goods store in Carbonale, Pa.

# You're Not the Only Dealer Who



doesn't sell "3-in-One"—but you will be, pretty soon, if you don't hurry. Are you sure you know just how good "3-in-One" is? If not, simply write us for FREE sample bottle—then try it. Then you'll know what "3-in-One" really is—the greatest oil on earth for talking machines. Then you'll sell it, as other smart dealers do—and net 50 and 100 per cent. profit—without bursting a blood vessel making sales.

"3-in-One" sells itself. The name is a household word—the oil is a household need. "3-in-One" has been lubricating, cleaning, polishing and preventing rust from Maine to California for 12 years. "3-in-One" has stood the test of time—the tests of hundreds of thousands of users. Then why labor to sell unknown, untried oils in its stead? *Cui bono?* Think it over, Mr. Dealer.

Your jobber is waiting for your trial order for "3-in-One." Will he get it? When?

**G. W. COLE COMPANY,** Sole Makers of "3-in-One"

Broadway and Liberty Street,

New York City.



## With the Makers and Sellers of Automatic Specialties

### TRADE CONDITIONS REVIEWED.

Tremendous Growth of the Arcade Business Throughout the Country—Money Being Made Rapidly—Many Advantageous Locations Yet Uncovered—Sheet Music Proving Quite a Feature—Some Side Features That Are Proving Profitable—Decorative Effects Most Essential to Win Public Notice and Appreciation—Some Valuable Pointers on Equipping Establishments.

Wherever one travels throughout the country one cannot help being impressed with the advance made in the arcade business. Someone has said that the way to become a millionaire is to discover a popular demand and then meet it at a popular price. One of the characteristics of the American people is a fondness for music. They eagerly seek it everywhere. It is a feature in theatres, churches, public meetings, fairs, battles, halls, parades, and on all occasions where people come together. Music inspires and thrills. It banishes care and lends new strength and courage to the weary. The so-called "penny vaudevilles" now being so extensively operated, are uniformly successful because they are the poor people's theatres. If they have but a cent to spend for entertainment here they can get the most for their money. If they wish to spend a greater number of pennies they will find ample opportunities for doing so.

Because the business is built on the smallest coin of the country is no reason why it should be small. On the contrary, it has most emphatically proved capable of astonishing results. Few people can buy \$5 seats at the opera, but a greater number can buy \$1 seats. Yet where one person can pay \$1 for a few hours' entertainment a thousand can afford 10 cents, and few people patronize a "penny vaudeville" without spending at least 10 cents, and it is surprisingly easy to spend 25.

All the large cities are now well represented; but there are thousands of advantageous locations as yet uncovered. Of course, the larger the city the larger the crowds that throng the thoroughfares, but a city of ten to twelve thousand will support at least one arcade and do so well, providing the manager is one who looks after details closely and pays enough attention to publicity. Attractive bill posters of various pictures and songs on the machines are great instigators of trade. A complete show, run on a series of machines side by side, connected by a sign featuring the exhibit, is a good scheme. For example, "The Broadway Quartet" on machine No. 1, we'll have, say a song; No. 2, a clog dance; No. 3, musical specialties, etc., etc.

Sheet music is now considered almost necessary in the large arcades, and justly so, for the returns from this department have always proved highly satisfactory. Another idea is a fish pond, which can easily be erected, and by placing floats on the water, each one numbered on the top with a loop or eye, the idea being to fish for one of these floats, which when caught, the number is called and a prize given according to the number attached; where this is impractical, a grab bag can be installed at a penny or nickel a grab. This idea has always proved a great one, especially among children. Some parlors have a regular printing department, where cards of all kinds can be secured at various prices, according to the class of work. Where the room can be used for this it has brought fairly good returns, but especially in small places. We would recommend the regular card printing slot machine, which, though it

only prints one style letter, pays better for the amount of the investment, and needs no attendant to do the work.

Nickelodians or moving theatres are now the rage. These, like the arcades, have grown to full bloom almost in a night. Places are now being opened that occupy entire buildings, especially constructed for their use, and rival in size and beauty some of our best vaudeville theatres. Increased admission fees from five to ten, fifteen, and even twenty cents are now growing common. The inside layout is similar to regular show houses with orchestra and balcony seats, musicians to play between scenes, etc. Some even carry the vaudeville idea to its extent and stage a number of various acts by well-known performers, for, say, forty minutes, while others are continuous performances.

Of course, to carry such a place on a paying basis a great deal of attention must be paid to publicity. The outside decorations must necessarily be showy and attractive; a white marble granite or plaster front, with a profusion of electric lights proves very effective. And during mild weather, providing your outside lobby is large enough, a fountain on which changing colored lights are thrown makes an attraction no crowd can resist. Bill posting must not be neglected, and a judicious amount of printers' ink distributed among the local papers helps to keep things moving. In such of the large places where regular theatrical performances are given, slot machines holding candy or opera glasses ought to be attached to the back of the seats. The giving of souvenirs to ladies once a week is a good plan and will make a hit. Programs printed on the back of some attractive picture in the form of a post card—something the people will retain—is a good idea, and in that way your name is unconsciously kept before them.

### ENTIRE PLAYER REPRODUCED

Through the Medium of the Talking Machine and Moving Picture Machine—Will be Taken Throughout the Country.

Entire plays given through the medium of a talking machine and moving pictures is the latest development in the march of the "talker," and affords an interesting addition to the list of wonderful things continually occurring in trade connection with these machines. It will be remembered that Charles Frohman had records made of the songs in "The Little Cherub" as they were sung in England, which style he considered correct, and had them reproduced for the benefit of the American company, but in the case of "Nurse Marjorie" the talker has played an even more important part.

A special performance of the third act of "Nurse Marjorie" was given at the Liberty Theatre, New York, recently and after it was photographed by a moving picture machine, the actors repeated their lines into a talking machine.

The pictures will be taken on tours, and as they are displayed the voices of the actors will be heard issuing from the talker, the lines fitting perfectly into their proper places in the pictures and thereby affording a finished performance. The idea on a smaller scale was successfully carried out during the recent campaign for governor of New York State, when speeches were reproduced from talking machines and made to correspond with the movements depicted in moving pictures of the candidate shown at the same time.

### MOTION PICTURE MACHINES

Are Now Utilized in Every Feasible Domain of Effort—The Perfection of the Machine Is Such That Scientific Men and Savants Are Spending Much of Their Time Following Up This Wonderful Phase of Photography.

According to Dwight L. Elmendorf, the well-known lecturer, the American public does not take the cinematograph, biograph, or motion pictures seriously, partly because of the trash which ordinarily is presented, and again because of the numerous "fakes" made to represent some real event. In Europe the attitude toward this wonderful phase of photography is entirely different, and in many instances genuine and scientific advance has been made, and this is to such an extent that scientific men and savants are spending much of their time in this fascinating pursuit.

Frequently royalty has turned to the taking of motion pictures as a pastime. The Emperor of Germany is an enthusiast; also the Sultan, who has films taken under his supervision, and has attached to his traveling court an English man as "bioscope attache." He is employed continually by the Sultan to entertain the women of the harem by showing them motion pictures of various parts of the world. The Shah of Persia is also devoted to this fascinating branch of photography.

The fact that the queen mother of the reigning King of Italy owns a bioscope will no doubt appear strange to Americans, yet it is true that in Europe many wealthy people devote a great deal of time to taking "animated" pictures.

Now that the ordinary camera has become almost universal, why should not those who can afford expensive pastimes indulge in this exceedingly attractive form of camera work and catch hits of motion here and there while on their travels to be reproduced at home for the benefit of their friends who cannot travel?

There are indeed few who have not come in contact with motion pictures as a form of amusement in one way or another. And yet this is the least important side of the subject. Enormous strides have been made in the last three years by business, manufacturing, and educational interests toward putting the bioscope to many practical uses. One illustration must suffice to show its uses to the manufacture and to schools.

There is one company in the United States manufacturing mining machinery which has made a complete bioscope record of its work. The series begins with moving pictures of mining the ore; then the transportation of the ore to the furnace, where the process of converting the ore into steel is shown; then to the works, where the steel is made into different parts.

The next series shows the manner of assembling these parts, and ends with a completed piece of machinery. The third series is devoted to the transportation of the machinery to the mine where it is to be used, and ends with the product in actual operation. The value of these films to the manufacturer is in demonstrating their machinery to prospective buyers.

Many manufacturers are employing the biograph for similar purposes, as it gives a clearer idea of their products than would be possible by ordinary photographs and catalogues. In colleges and engineering schools it is also employed to good advantage. The value to the student is apparent. He may have a good technical idea of this or any other piece of machinery; perhaps he could, with ease, demonstrate how and why the engine works, but the chances are he would be in a sorry plight were he told to assemble some huge piece of machinery. Once having seen it in actual operation by means of a



# The Caille Bros. Co.

1300 to 1340 SECOND AVENUE, DETROIT, MICHIGAN

## Over 160 Different Kinds of Slot Machines

THE LARGEST PLANT IN THE WORLD FOR THEIR MANUFACTURE

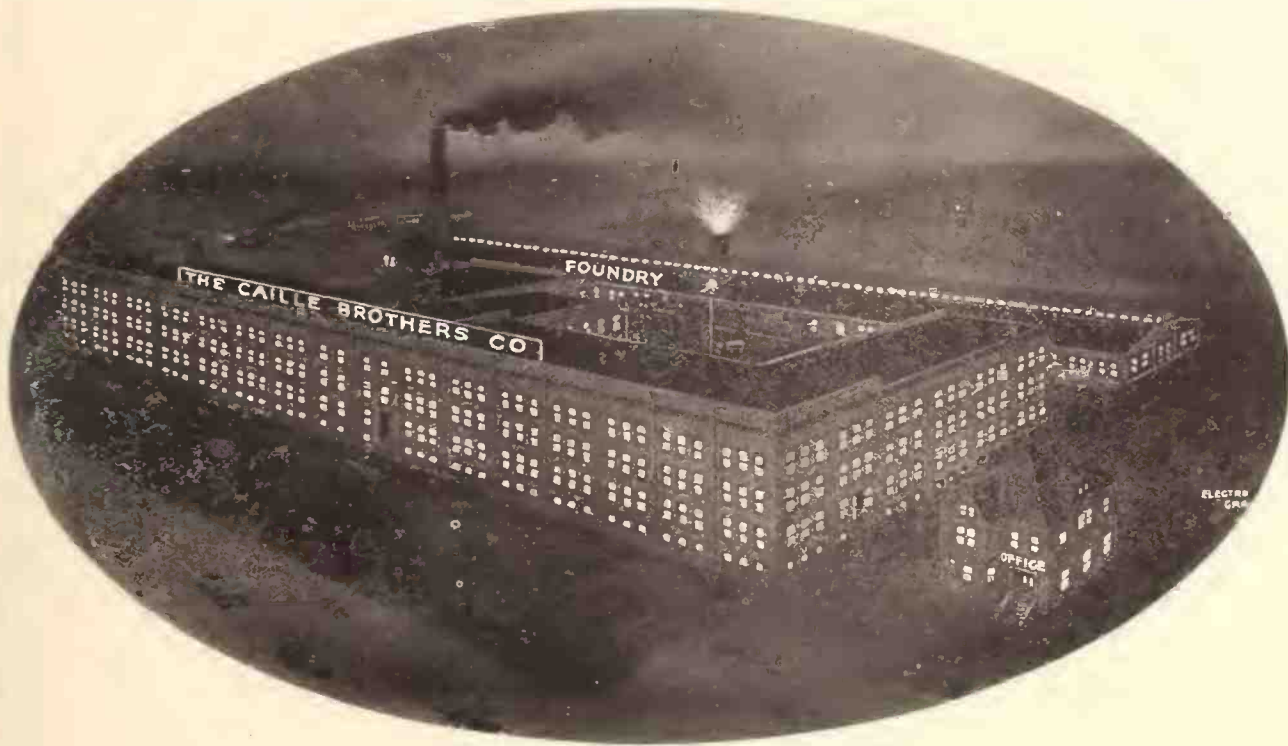

A NIGHT SCENE OF OUR PREMISES



UNCLE SAM GRIP MACHINE  
Price \$40.00

### BIG PROFIT, SMALL INVESTMENT.

We have started more men on the road to wealth than any other manufacturing concern in the world. Opportunities are better to-day than at any time. We are originators and equip complete Penny Arcades at a cost of \$600.00 and upwards. The earnings of one of these penny amusement places will often pay back the original investment in sixty days' time. We make every kind of machine from the Phonograph and Picture machine to the Novelty and Strength Testing devices. Penny arcades are paying immense profits in all cities of over eight thousand population. Machines placed on shares in public locations always pay big dividends. Our customers are making fortunes from this business. We are exclusive manufacturers of the most complete line of Slot Scales which are always popular and get the money. Big opportunities for the right men. Write for catalog and mention where you saw this advertisement.

#### WE MAKE

- Phonographs
- Picture Machines
- Slot Scales
- Fortune Tellers' Love Letter Machines
- Punchers
- Lifters
- Grip Tests
- Lung Tests
- Vending Machines
- Pulling Machines
- Pushing Machines
- Electric Machines
- Post Card Machines
- Etc., Etc.

F. S. ZIMMERMAN

5 East 14th Street, NEW YORK

THE CAILLE BROS. CO.

900 Republic Building, CHICAGO

Samples can be seen at these Salesrooms

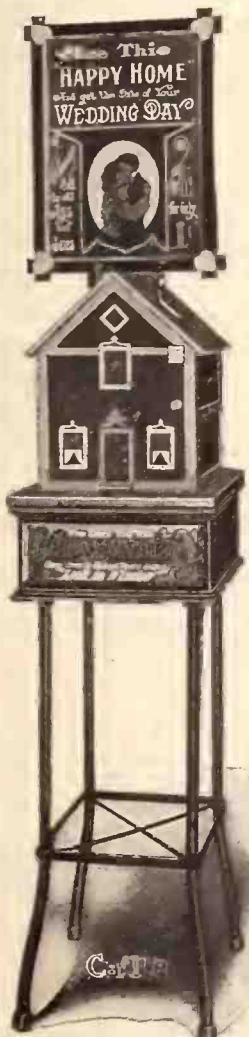

HAPPY HOME, Price \$50.00



CAILOSCOPE PICTURE MACHINE  
Price \$35.00

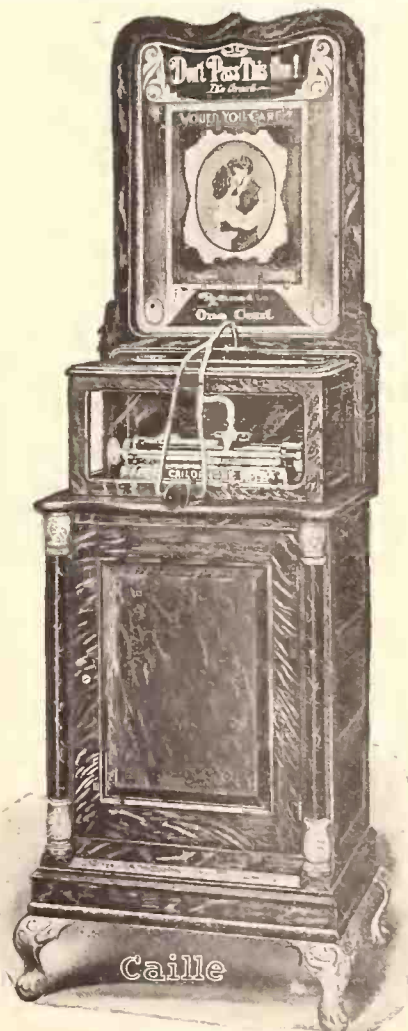

CAILOPHONE (PHONOGRAPH)  
Price \$65.00



motion picture, however, he receives the next best information—practical experience.

The scientific application of bioscopic records is unlimited. In microscopy remarkable motion pictures have been made illustrating the "unseen world." the life and habits of animals and insects, indelibly fixed upon films for future study and reference. The life history of ants and bees is beautifully illustrated by this animated photographic method. It has also been employed in eclipses, in records of surgical operations, while it is unnecessary to say that one of its most interesting applications is that of recording human life and action. In this respect Mr. Elmendorff has employed it most successfully in his lectures, to which it imparts a tremendous life and vigor that mere words could never do.

It is interesting to note that Monsieur A. Giehart, of the French Department of Correction, was in this country recently studying methods of capital punishment, France desiring to find some more humane method of putting criminals out of existence than by the guillotine. He secured many important points through the biograph. Prominent manufacturers of films in speaking the other day of the tremendous demand for moving pictures, said:

"Among all the nations of the world the Japanese are among our best customers. They are intensely keen in regard to everything that shows the interior workings of American establishments, the factory, the hotel, the store, the municipal and governmental buildings. We sent a portrayal of the Postoffice Department and that vied in popularity with the Westinghouse factories. We have even received orders for a packing house series from another country, but that is still in abeyance."

#### VENEZUELA'S TARIFF ON MACHINES.

(Special to The Talking Machine World.)

Washington, D. C., Nov. 6, 1906

Consul E. H. Plumacher, of Maracaibo, has sent to the Department of Commerce and Labor the following extract from a recent Venezuela Customs Decree which will be found of interest to manufacturers of automatic contrivances:

"Automatic scales to weigh a person by throwing into the slot a piece of money, generally a nickel, or 0.12½ bolivars, and all such kind of machines, shall be placed in the fourth class (0.75 bolivars per kilogram), but other automatic scales or machines which produce music or return the money as a game of hazard shall be placed in the fifth class of the national tariff (1.25 bolivars per kilogram)."

#### RECENT INCORPORATIONS.

Stanwix Co., amusements; capital, \$15,000. Incorporators: G. W. Hall, E. J. Watson, G. Leonard, Rochester, N. Y.

A. W. Gumpertz Amusement Co., theatres, etc., capital, \$45,000. Incorporators: Sam W. Gumpertz, No. 118 West 44th street; Ahner B.

#### PRICE REDUCED

## Burnt Leather POST CARDS

Our Burnt Leather Post Cards are the quickest selling and most profitable side line ever offered the Talking Machine trade.

TRIAL ORDER.—We will send you prepaid 100 cards (100 beautiful designs), with the name of your town stamped on each if desired, for \$3.10 cash. Retail everywhere at 10c. You make a clean profit of \$6.90.

## Risley-Bird Mfg. Co.

94 Fifth Avenue,  
New York.

Stupel, No. 1646 Park avenue; Alfred J. Wolff, No. 163 Lenox avenue, all of New York.

Pinnacle Recreation Co., Rochester, amusements; capital, \$15,000. Incorporators: William L. Hoyt, M. B. Shant, E. W. Bridges, Rochester, N. Y., and others.

Cambridge Amusement Co., Cambridge; penny arcade; capital, \$20,000. Incorporators: William T. Roop, Arlington, Mass.; treasurer, James A. Porter, No. 199 Marlboro street; clerk, Louis F. Baldwin, No. 6 Beacon street, both of Boston, Mass.

Vanity Fair Co., Boston; amusements; capital, \$600,000. President, Addison M. Thayer, Franklin, Mass.; treasurer, Walter H. Baldwin, No. 101 Tremont street, Boston, Mass.; clerk, Hugh P. McNally, No. 53 Georgia street, Roxbury, Mass.

American Amusement Co., Portland; theatres and other places of amusement; capital, \$10,000. President, J. B. Reed; treasurer, E. G. Wilson; clerk, J. H. Hill, all of Portland, Me.

Dream Amusement Co., No. 15 North Warren street, Trenton, N. J.; exhibitions, amusements, etc.; capital, \$2,000. Incorporators: Harry A. Matthews, No. 119 East Front street; Charles C. Hildinger, No. 132 South Broad street; Charles W. Klag, No. 49 Carroll street; Clinton C. Cutler, No. 217 Montgomery street, all of Trenton, N. J.

#### PERFORATED ENDLESS ROLLS

For the Style 44 Peerless Pianos Made by Roth & Engelhardt.

6104.—1, It's Nice to Have a Sweetheart, song, from "The Tonists," Gustave Kerker; 2, Cheer Up, Mary, song, Kendis and Paley; 3, I'm Crazy 'Bout It, song, G. N. Edmunds; 4, I'd Rather Be on the Outside a-Lookin' In, Tban on the Inside Lookin' Out, song, Hamill and Snyder; 5, The Bee that Gets the Honey Doesn't Hang Around the Hive, song, Rose and Helf.

6105.—1, Waltz Me Around Again, Willie, 'Round, 'Round, 'Round, song, Cobb and Shields; 2, The Bullfrog and the Coon, song, Feist and Nathan; 3, When the Flowers Bloom in Springtime, Molly Dear, waltz, H. Von Tilzer; 4, Gee, but This is a Lonesome Town, song, Billy Gaston; 5, When Her Beauty Begins to Fade, waltz, Theo. Morse.

6106.—1, Hearts and Masks, waltz, Leo Friedman; 2, Sunflower Slow Drag, Joplin and Hayden; 3, Newport Belles, march and two-step, Emil Ascher; 4, A Dream of Heaven, waltz, A. W. Bauer; 5, Lickity-Split, march and two-step, C. J. Penny.

6107.—1, Alabama Dream, ragtime cake walk, Geo. D. Barnard; 2, Swamptown Shuffle, march and two-step, H. W. Jones; 3, A Ragtime Drummer, march and cake walk, Chas. Knebler; 4, Nigger Alley, promenade de Negro, Geo. D. Andrews; 5, Somethin' Doin', a ragtime two-step, L. W. Smith.

6108.—1, Good-bye, Jennie Jones, song, L. B. O'Connor; 2, Selina, song, Reimer and Koehler; 3, I Thought My Troubles Were Over, but They'd Scarce Begun, song, from "In Abyssinia," Gray and Jones; 4, Little Willie Brown, song, from "The Little Cherub," Chas. Collins; 5, Not Because Your Hair Is Curly, song, Bob Adams.

6109.—Spanish Serenades.—1, La Paloma, C. Yradier; 2, Mandolina, Otto Langey; 3, Cubanola, H. B. Blanke; 4, Seguidilla, E. Holst; 5, La Jota, E. Holst.

6,200.—Popular Spanish Waltzes.—1, Espanita, Geo. Rosey; 2, La Susanna, Geo. Rosey; 3, Santiago, A. Corbin; 4, Serenade, Olivier Metra.

6201.—1, Marguerite, waltz, L. C. Reimer; 2, Red Domino, march and two-step, S. R. Henry; 3, The Lion and the Mouse, waltz, Theo. Bendix; 4, Antionette, march and two-step, Scott Joplin; 5, Love Is King, waltz, C. Blake.

6202.—1, Don't Go Way, Nobody, song, Cahill and P. A. G. T.; 2, Campmeetin' Time, coon song, Williams and Van Alstyne; 3, He Handed Me a Lemon, song, Bob Cole; 4, Abraham Jefferson Washington Lee (You Ain't Goin' to Pick No Fuss Out of Me), song, Sterling and Von Tilzer; 5, When Tommy Atkins Marries Dolly Gray, song, Cobb and Edwards.

6203.—1, Amazon Ritt, op. 321, "Ride of the Amazons," F. Spindler; 2, Alice, Where Art Thou? romance, J. Ascher; 3, Titania, Lefebvre Wely; 4, Dance of the Demons, galop de concert, E. Holst.

#### New Rolls for Style D Peerless Pianos.

5237.—1, Sunflower Slow Drag, Joplin and Hayden; 2, Hearts and Masks, waltz, Leo Friedman; 3, Newport Belles, march and two-step, Emil Ascher; 4, A Dream of Heaven, waltz, A. W. Bauer; 5, Lickity-Split, march and two-step, C. J. Penny.

5238.—1, Somethin' Doin', a ragtime two-step, L. W. Smith; 2, Nigger Alley, Promenade de Negro, Geo. D. Andrews; 3, A Ragtime Drummer, march and cake walk, Chas. Knebler; 4, Swamptown Shuffle, march and two-step, H. W. Jones; 5, Alabama Dream, ragtime cake walk, Geo. D. Barnard.

5239.—Class Music.—1, Elfin Mazurka, op. 23, No. 2, H. N. Bartlett; 2, Eldorado, polka de concert, H. N. Bartlett; 3, Silver Fishes, concert mazurka, Ketterer; 4, Les Sylphes, caprice valse, C. Bachman.

5240.—Classic Music.—1, Cascade de Roses, J. Ascher; 2, Monastery Bells, Wely; 3, The Flatterer (La Lisonjere), C. Chaminade; 4, Belle de Nuit, Ascher.

5241.—Classic Music.—1, Dance of the Demons, Galop de Concert, Ed. Holst; 2, Titania, Lefebvre Wely; 3, Alice, Where Art Thou? romance, Ascher; 4, Amazon Ritt, op. 321, "Ride of the Amazons," F. Spindler.

5242.—Popular Classic Waltzes.—1, Le Fete des Fleurs, Valse Elegante, Elsa Fleming; 2, Amoureuse,

Valse Tres Lente, R. Berger; 3, Rose Mousse, Valse Lente, August Bosc; 4, Valse Bleu, Alfred Margis.

5243.—1, Love Is King, waltz, C. Blake; 2, Antionette, march and two-step, Scott Joplin; 3, The Lion and the Mouse, waltz, Theo. Bendix; 4, Red Domino, march and two-step, S. R. Henry; 5, Margurite, waltz, R. C. Reimer.

5244.—1, When Tommy Atkins Marries Dolly Gray, song, Cobb and Edwards; 2, Abraham Jefferson Washington Lee (You Ain't Goin' to Pick No Fuss Out of Me), song, Sterling and Von Tilzer; 3, He Handed Me a Lemon, song, Bob Cole; 4, Campmeetin' Time, coon song, Williams and Van Alstyne; 5, Don't Go 'Way, Nobody, song, Cahill and P. A. G. T.

5245.—1, When Her Beauty Begins to Fade, waltz, Theo. Morse; 2, Gee, but This is a Lonesome Town, song, Billy Gaston; 3, When the Flowers Bloom in Springtime, Molly Dear, waltz, H. Von Tilzer; 4, The Bullfrog and the Coon, song, Feist and Nathan; 5, Waltz Me Around Again, Willie, 'Round, 'Round, 'Round, song, Cobb and Shields.

5246.—1, Not Because Your Hair Is Curly, song, Bob Adams; 2, Little Willie Brown, song, from "The Little Cherub," Chas. Collins; 3, I Thought My Troubles Were Over, but They'd Scarce Begun, song, from "In Abyssinia," Gray and Jones; 4, Selina, song, Reimers and Koehler; 5, Good-bye, Jennie Jones, song, L. B. O'Connor.

#### CAILLE BROS. CO.'S BIG LINE.

One of the most complete lines of slot machines in this industry is that carried by the Caille Bros. Co., of Detroit, Mich. Their specialties are known by every user of automatic machines for their money-making features, and are highly esteemed. Members of the trade desiring to branch out into a larger sphere of activity would do well to keep this firm in mind when contemplating anything of that kind.

#### NEW YORK VITAK CO.'S AGENTS.

The New York Vitak Co. have appointed the Pardee-Ellenberger Co., of New Haven, Conn., distributors for New England for the Vitak Moving Picture Machine and Films, and have given them the exclusive sale of these goods for that territory.

Report states that the Hawthorne & Sheble Manufacturing Co., of Philadelphia, have perfected a new illustrated song machine that embodies many new and valuable features. If such is a fact, we presume details will shortly follow, as the progressive concern's reputation for pushing is a well-known fact.

## To Talking Machine Dealers

The MUSIC TRADE REVIEW is the oldest publication in the music trade industry. It contains more than fifty pages devoted to the piano trade, musical merchandise news, music publishers' department and talking machine trade. A special technical department is a regular weekly feature of the publication. A vast amount of valuable information is contained in each issue. The REVIEW has won higher honors at the great expositions than have ever been won by any other publication in the world.

Grand Prix at the Paris Exposition, 1900  
Diploma at Pan-American Exposition, 1901  
Silver Medal Charleston Exposition, 1902  
Gold Medal St. Louis Exposition, 1904  
Gold Medal Lewis-Clark Exposition, 1905

Subscription in United States, Canada and Mexico, \$2.00 for 52 weeks. All other countries, \$4.00.

We publish the Tuner's Guide also—a cloth-bound, illustrated work of over one hundred pages. Sent postpaid to any part of the world upon receipt of one dollar.

**EDWARD LYMAN BILL**  
Publisher. 1 Madison Ave., New York



# Do You wish to make big money during the Holi- days?



The Regal Player

Have you ever figured how much nickels that keep on growing amount to? Perhaps you have.

But do you know how easily people will put nickels into a slot to hear good music like that of the

## Regal Automatic Piano

and what a goodly sum those nickels amount to in a week? Perhaps you do.

But here's another point. It isn't only what the Regal Player *takes* in; but what it *brings* in—the extra nickels, dimes and dollars that people are sure to spend while they stay in the place to listen to the music. That's what counts.

---

*The Regal*  
**Piano and Player  
Company**

890 Southern Boulevard

NEW YORK, N. Y.

Do you know, Mr. Talking Machine Dealer, that the Agency for the Regal will make you good money? You can easily handle Players with Talking Machines.

Arcades and places of public resort can be easily reached with the Regal.

Do you know the value of the Regal Agency to you?

Have you thought the subject over?

If not, it would pay you to think of it right now.

Many wise men are making money by having the REGAL AUTOMATIC PIANO to take in and bring in money for them every day. We believe if you knew how much profit there is in it you would want one, too.

### Genuine.

It is a genuine piano-player; gives the finest kind of music, loud or soft; every selection you want—popular or classic. Requires no attention; looks after itself, so to speak. Runs by pneumatic power, pumped by a small electric motor, which we supply to suit every kind of electric current.

### The very best.

It is the most musical, simplest, strongest, longest-wearing, and in every way the most satisfactory and profitable instrument ever made for supplying music to the music-loving public:

And it is a beautiful ornament anywhere you put it, and it blends perfectly with the talking machine business.

Why not make some money out of it yourself by selling it?



### HERE AND THERE IN THE TRADE.

Some of the Latest Novelties and Improvements Which Are Destined to Win More Than Ordinary Notice This Fall.

The counting of coin by hand is one of the most brain-racking, annoying and expensive items of the entire financial system. Men for ages who have been in the habit of handling large amounts, such as bankers, merchants, etc., have had this worry them every day of their life. The arcade man has now placed himself in their ranks, and is up against a stiff proposition when he comes to count his day's receipts. The habit in vogue has generally been that of weighing the coin in bulk. But this, even with the most accurate scales, has proved far from satisfactory. It remained for a man by the name of Johnson to perfect a coin counter whose accurate results have made him famous. The Johnson coin counter counts automatically any denomination of coins, or counts and wraps as rapidly as five experts could do by hand; mistakes are impossible. There is a separate head or counter for each denomination of coin, and the change from one size to another can be made instantly. Arcade men will find it a great help to them in their business.

The "multiphone" is one of the musical marvels of the age. In construction it is remarkably simple. A large magazine wheel carries twenty-four cylinder records, any one of which may be reproduced at the will of the operator. A nickel starts it. It has an accurate register for recording the number of nickels taken. The power is from a spring motor. One winding is sufficient to reproduce eighteen records. The public does the winding, so there is no expense for power. In appearance the "multiphone" is striking and unique. It is a massive cabinet, standing six feet high and three feet wide, and in general design is like an old-fashioned harpsichord, finished in antique bronze or built of San Domingo mahogany. The front and sides are French beveled plate glass, exposing the mechanism to full view. Wherever people gather or pass in numbers is the natural location for the "multiphone." In railroad stations, in ferry houses, in hotels or restaurants, in theatre lobbies, it serves the double purpose of pleasing the

eye and delighting the ear. Is it therefore any wonder that the call for these instruments, whose average yearly intake passes the \$500 mark, promises to make a new record in the business world? The machine is controlled by the Multiphone Operating Co., a New York corporation having a capital stock of \$100,000.

Another new machine which has made a remarkable record for itself since its appearance a short while ago is an automatic penny or nickel drink machine. One of its beauties is that any drink can be sold. The large five-gallon bottles which hold the liquid can be easily changed and refilled. During the summer months cider has proved the most popular beverage. This can be bought wholesale at 35 cents or less for five gallons. There are 112 glasses to that amount. One of these machines, which was placed in an arcade in Syracuse, averaged a sale of thirty gallons a day during the hot weather. This was sold at one cent a glass, so that the big profit made is apparent. The company manufacturing these machines are not selling them, but are placing them in various locations on a percentage basis. They can be used anywhere—in arcades, cafes, talking machine stores, etc.

A new and very interesting invention has just been perfected by Chas. H. Kayser, of West Orange, N. J. It consists of a motion picture machine outfit for home entertainment. The machine is very small, about the size of a cigar box, and so simple in construction that a child can operate it and show as perfect moving pictures as are shown with the regular machines used in theatres; of course, on a smaller scale, about five feet square, large enough for the home. The inventor claims he can by his system sell pictures for about three cents per foot, and in this way bring moving pictures within the reach of anybody with moderate means. The pictures are made on a fireproof paper, instead of the inflammable celluloid, now the only available material for moving pictures. Mr. Kayser has constructed another machine on the coin-in-slot principle, enabling from one to five persons at the same time to view the moving pictures, provided a coin is deposited. This machine works automatically and will be a mint for dealers.

The New York Vitak Co. are having all they

can possibly do to fill the orders that have piled in on them from their advertising campaign carried on in this paper, and if their advertisement does not appear in this issue it is not because they are not satisfied, but because they are behind in filling orders. There has been a general call for this company to turn out a higher class machine to retail at between \$25 and \$35, and from what we hear this company are bending their energies to fill this demand. Watch for something interesting to appear in their December announcement.

### A NEW ELEMENT REVEALED.

The Combination of the Talking Machine and Vitascope Is Destined to Become a Force in Political Campaigning.

In the fact that the manager of a London music hall is planning to amuse his patrons by letting them hear and see Mr. Hearst in the very act of delivering one of his speeches, that aspiring statesman's political servitors will probably find conclusive proof of their own wisdom in making this marvel possible by calling the talking machine and the vitascope into play as campaign auxiliaries. The idea was, indeed, an ingenious one, though so simple, now it has been done, the wonder is that it hasn't been done before, but there ought to be a warning in its ready acceptance as a means of filling out the programme of an evening's entertainment in a place so far away from the scene of battle.

If London takes interest in a speech so scientifically preserved and illustrated, the chances are that those whom it interests here will also have more attention for the method of presentation than for the matter presented, says the New York Times. Such a "number" would be watched attentively by anybody while it remained a novelty, but it is hardly possible that it would inspire thought on any political question, and not even imaginable that it would change a vote or strengthen a determination. The old confidence in oratory as the best way to "reach the public" is waning fast. It would not yet be safe to abandon the plan, but the real work of every campaign is probably done now through the newspapers, which have voices that carry vastly further than those of any candidate or waged spellbinder.

## Some Progressive Makers of Automatic Specialties

Do you want more Profit?

Get **THE NICKLIN** The best  
Coin Operated Piano  
in the World

This is a First-class Upright Piano—Can also be played by hand in the usual way

—Manufactured by—

**Neola Piano & Player Company**  
General Offices, 201-203 East 49th Street, New York



Coin Operated Talking Machines  
Coin Operated Illustrated Song Machines  
Coin Operated Machines of all other types

**THE ROSENFELD MFG. CO.**  
591 HUDSON STREET, N. Y. CITY

**American Mutoscope & Biograph Co.**

11 E. FOURTEENTH ST., NEW YORK

**The Mutoscope** Oldest and Best Known  
Slot Machine

"The Backbone of the Automatic Parlor Business"  
Showing Moving Pictures in their Most Attractive Form

## THE PIANOVA COMPANY,

Manufacturers of

44 AND 65 NOTE ELECTRIC PLAYERS

with or without nickel in the slot attachment

SECURE THE AGENCY NOW.

117-125 Cypress Avenue,

New York.

Every Manufacturer in this country should be represented in this department. The cost is slight and the advantage is great. Be sure and have your firm in the December list.





THAT THE  
Peerless

Coin-Operated Piano is the *best* player proposition for you.

You must sell some coin-operated pianos.

You must sell the best for the best results.

A live dealer in your town is what we want. Are you he?

Some good territory still open.

Write now.

THAT MORE  
Peerless

are sold than any other Coin-Operated pianos.

It is different from all others in many ways.

Each one of these ways is a conclusive reason why your customers will prefer to buy it.

Our new catalogue, entitled "Easy Money," sent upon request.

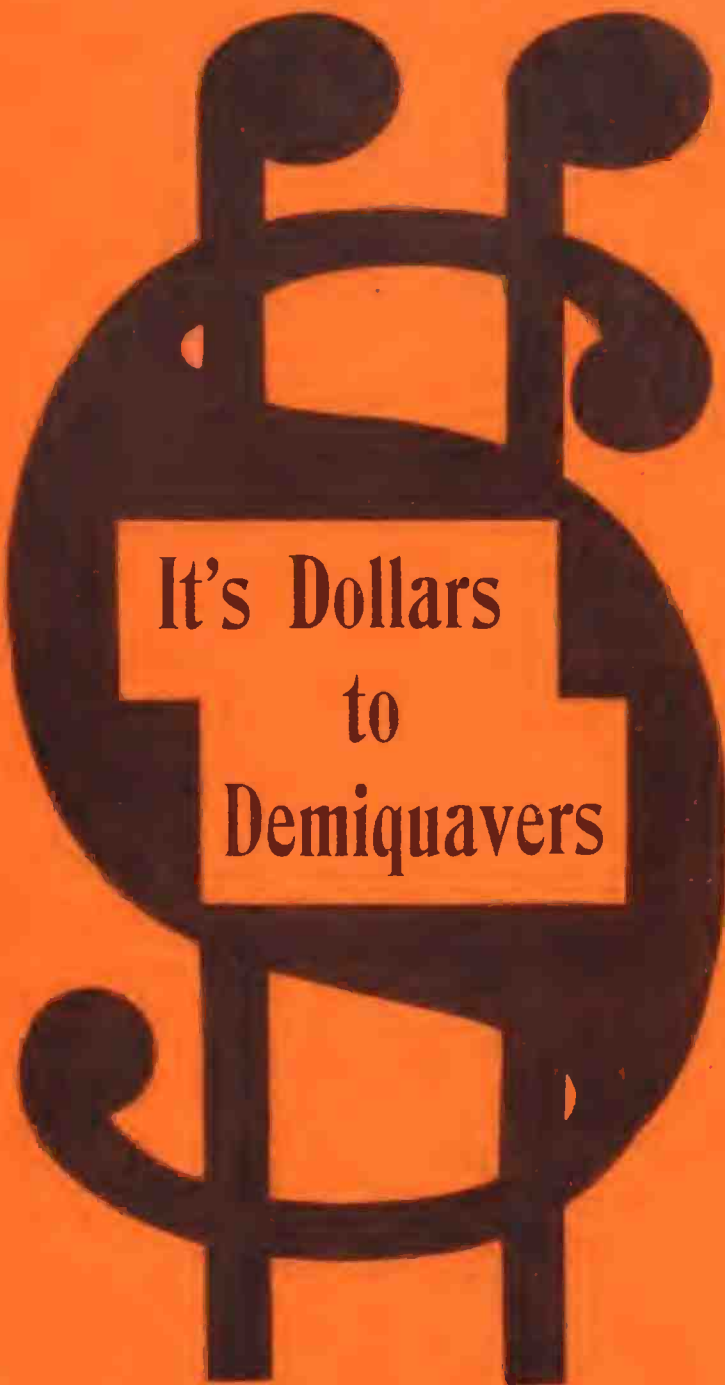

It's Dollars  
to  
Demiquavers

Highest Award—Gold Medals

Buffalo, 1901

St. Louis, 1904

Portland, 1905

**ROTH & ENGELHARDT**

*(Props. Peerless Piano Player Company)*

Windsor Arcade

Fifth Avenue

New York

Factories at St. Johnsville, N. Y.





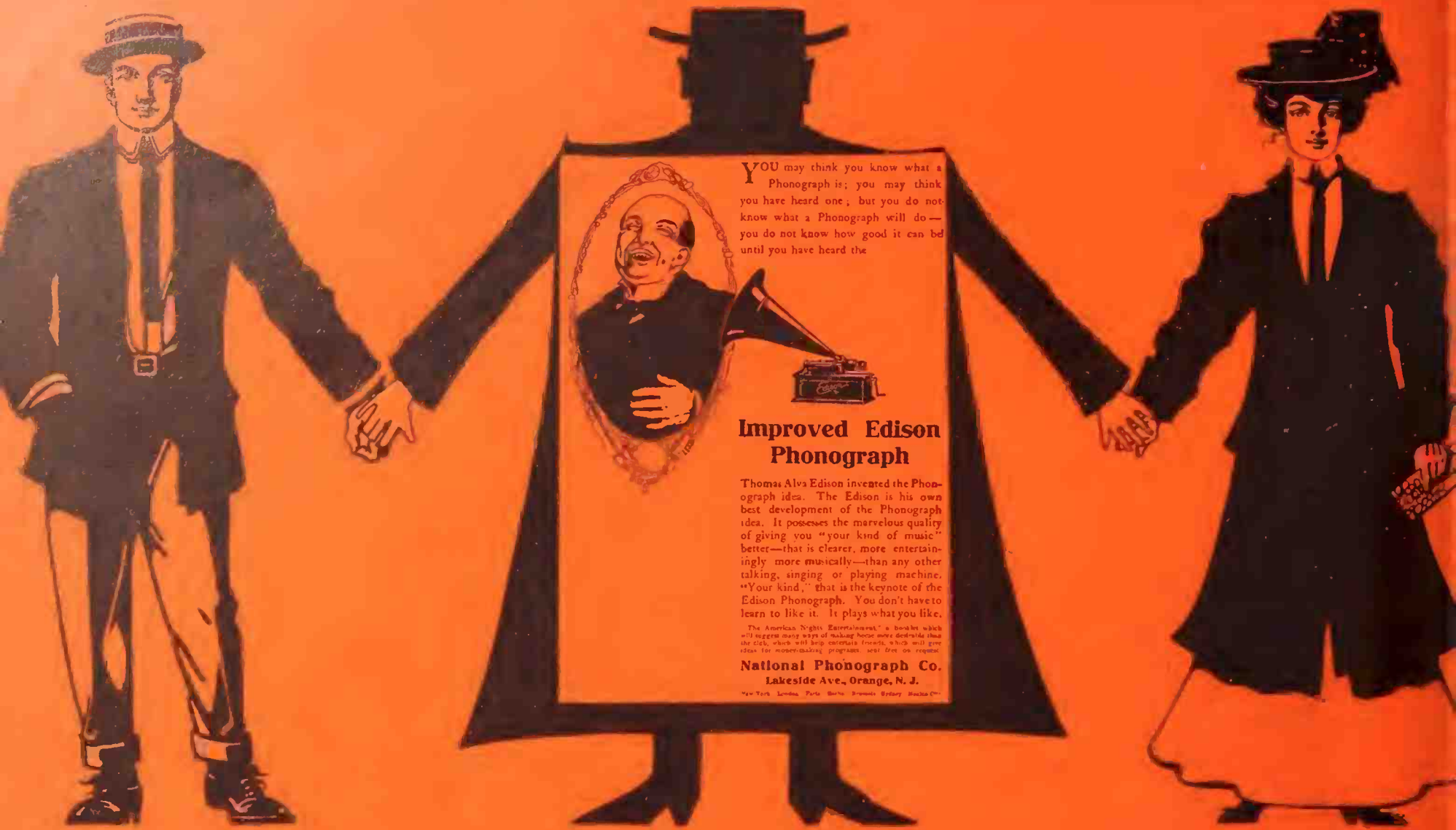

## The Edison Phonograph Advertising Brings Customers with Money to Your Door.

THE advertising brings the customers. But you must do the rest. The only way to sell an Edison Phonograph is to sell it. Believe in it, show it, talk about it, let it talk to the man who wants a Phonograph. You cannot get any benefit from Edison advertising unless you have the Phonograph.

We can do but two things, we can make the Phonograph and we can make the customers want it. Don't let the customers get to your store before the Edison does. If you do, our advertising, so far as your store is concerned, is wasted.

### National Phonograph Co.,

67 Lakeside Avenue,

Orange, N. J.