

The TALKING MACHINE WORLD

AND
NOVELTY
NEWS

Published Each Month by Edward Lyman Bill at 1 Madison Avenue, New York, May 15, 1910



The best-known trade mark in the world

"The Victor talking machine's design, 'His Master's Voice,' has become a household word, and the quaint little fox terrier at attention before the horn is familiar to more Americans than any of the world's great masterpieces."—COLLIER'S, May 22, 1909.

THE PLEASURE
DOUBLED

THE COST
REDUCED



10 inch 65c. **DOUBLE RECORD DISCS** 12 inch \$1.00

Zon-o-phone Records are pre-eminently the BEST that money, brains, and a thorough knowledge of the art of sound recording can produce.

They are justly famous for their remarkably clear, natural tones, absence of scratch and wearing quality.

The greatest care is exercised in combining the selections, each side of the disc presenting the latest and best in popular music or standard compositions.

The price appeals to the masses, the quality to the classes, making them indeed a popular record at a popular price.

A new catalogue of Hebrew Single Side Selections has just been issued. Solos by Mme. Prager, Mr. Juvelier, Master Mirsky, the boy soprano, and other eminent singers. These are undoubtedly the most perfect Hebrew records ever recorded. 10 inch, 50 cents, 12 inch, 75 cents.

Resolve yourself, Mr. Dealer, into a committee of one and investigate these claims. Consider, criticize, compare. ZON-O-PHONE RECORDS will stand the test. A trial will verify all that we say.

Universal Talking Machine Mfg. Co.

Fourth and Race Streets

Philadelphia, Pa.

Distributors of Zon-o-phone Goods:

ALABAMA

Mobile W. H. Reynolds, 167 Dauphin St.

ARKANSAS

Ft. Smith R. C. Bollinger, 704 Garrison Ave.

CALIFORNIA

San Francisco... Peter Bacigalupi & Sons, 941 Market St.

FLORIDA

Tampa Turner Music Co., 604 Franklin St.

ILLINOIS

Chicago Benj. Allen & Co., 181-141 Wabash Ave.
Chicago B. Olshansky, 515 So. Jefferson St.

IOWA

Des Moines Harger & Blish, 707 Locust St.
Dubuque Harger & Blish, Security Bldg.

KANSAS

Topeka Emahizer-Spielman Furn. Co., 517-519 Kansas Ave.

MARYLAND

Annapolis Globe House Furn. Co.
Baltimore C. S. Smith & Co., 641 W. Baltimore St.
Baltimore Louis Mazor, 1432 E. Pratt St.

MINNESOTA

St. Paul W. J. Dyer & Bro., 21-23 W. 5th St.

MICHIGAN

Detroit J. E. Schmidt, 336 Gratiot Ave.

MISSOURI

Kansas City Webb-Freyschlag Merc. Co., 620 Delaware St.
Springfield Morton Lines, 325 Boonville St.
St. Louis Knight Mercantile Co., 211 N. 12th St.
St. Louis D. K. Myers, 3389 Finney Ave.

NEW JERSEY

Hoboken Eclipse Phono. Co., 203 Washington St.

NEW YORK

Brooklyn F. W. Rous Co., 435 Fifth Ave.
Brooklyn B. G. Warner, 1218 Bedford Ave.

NORTH DAKOTA

Fargo Stone Piano Co., 614 First Ave., N.

OHIO

Akron Geo. S. Dales Co., 128 S. Main St.
Cincinnati J. E. Poorman, Jr., 689 Main St.
Cleveland The Bailey Company, Ontario St. and Prospect Ave.

PENNSYLVANIA

Allegheny H. A. Becker, 601 Ohio St.
Philadelphia... Harmonia Talking Machine Co., 1821 Arch St.
Philadelphia... H. A. Weymann & Son, 1010 Chestnut St.
Pittsburgh C. C. Mellor Co., Ltd., 319 Fifth Ave.

TEXAS

Beaumont K. B. Pierce Music Co., 608 Pearl St.

CANADA

Toronto Whaley, Royce & Co., Ltd., 158 Yonge St.
Vancouver, B.C.M. W. Waitt & Co., Ltd., 555 Granville St.
Winnipeg, Man. Whaley, Royce & Co., Ltd.
Yarmouth... Yarmouth Cycle Co.

The Talking Machine World

Vol. 6. No. 5.

New York, May 15, 1910.

Price Ten Cents

THE TALKER IN TEACHING

Proves Especially Valuable to Vocal Instructors—How One Teacher Does It—Henry D. Tovey, of University of Arkansas, Makes Some Interesting Comments Upon That Form of Instruction—Field of the Talking Machine as an Educational Factor Continually Broadening as Value Is Appreciated.

The educational value of the talking machine from a musical viewpoint has been frequently discussed in these columns. Prominent vocal teachers, who took pains some years ago to deride and belittle the talking machine, claiming that it possessed no musical or educational value whatsoever, have since been converted into enthusiastic adherents and supporters. As a necessity and help to up-to-date music teachers and educators the talking machine is now being largely employed. It is only necessary to visit the studios of some of our leading vocal instructors to comprehend how the talking machine is being utilized as an assistant in teaching style, phrasing, expression and interpretation. This is the case not only in New York, but in all the leading cities. Henry D. Tovey, of the University of Arkansas, in a recent letter said:

"In this department we use the Victor in our work. I have given concerts every two weeks with my machine, and by the third week in May we will have studied thirty-two operas and a large number of other works, solos, oratorios, etc. With the records I show pictures of the singers, have girls read the story of the operas, and the lives of the singers. I have found the year's work with this machine most helpful. I can notice greater interest in outside musical matters. While passing through the halls I often hear pupils comparing the different voices heard. I am much pleased with this phase of the work and shall continue it next year."

The foregoing illuminating communication was recently used by the Oliver Ditson Co. as the basis of a very clever advertisement. In this connection they stated: "Mr. Tovey expresses the sentiment of many of our most advanced teachers and to those who have not become familiar with the Victor talking machine we recommend a careful analysis of its possibilities. Such an analysis can be made in our reception rooms, free of cost, and educators in the arts of singing, speaking and music may learn the value of this wonderful musical instrument as a help to their teachings. Accuracy, precision and beauty of expression, such as cannot be obtained in other ways, may be listened to with great benefit to teacher and pupil alike."

We are confident that the talking machine is going to play a still greater part in the future, not merely as an educational factor in the vocal field, but will occupy a still wider sphere in disseminating musical knowledge and musical culture throughout the nation.

SOME REASONS FOR FAILURE.

Lack of Self Reliance and Courage One of the Chief Troubles of the Unsuccessful Man.

The man who failed was not trained to grasp subjects, to generalize, to make combinations. He was not self-reliant, did not depend upon his own judgment; leaned upon others, and was always seeking other people's opinion and advice. He lacked courage, energy, boldness. He was not resourceful or inventive. He could not multiply himself in others. He did not carry the air of a conqueror. He did not radiate the power of a leader.

There was no power back of his eye to make men obey him. He could not handle men. He antagonized people. He did not believe in himself. He tried to substitute "gall" for ability. He could not project himself into his lieutenants;

he wanted to do everything himself. He could not cover up his weak points. He did not know that to reveal his own weakness was fatal to the confidence of others.

MAKING RECORDS OF STORMS.

Prof. Schultz Spent Winter on Island in Sound Preparing Them for Use at Oberammergau.

(Special to The Talking Machine World.)
South Norwalk, Conn., May 3, 1910.

All winter a mysterious man has dwelt in a shack on the uttermost point of Nauvoo Island, in Long Island Sound. Whenever a storm came up he was seen scurrying about, very busy about something. Oystermen, mariners and oldest inhabitants in general speculated about him.

Now the secret is out. The mysterious man is Prof. Herman Schultz, of Newark, and he is making phonographic records of storms and thunder for use, it is said, in the Passion Play at Oberammergau this year. Prof. Schultz is reported to have rigged up gigantic phonograph records on the island, which have been digesting elemental noise for months.

MONTELIUS HOUSE EXPANDS.

Vancouver Dealers Enlarge and Improve Talking Machine Department—To Handle Band Instruments Made by York & Sons.

(Special to The Talking Machine World.)
Vancouver, B. C., April 29, 1910.

The Montelius Piano House, of this city, who, besides pianos, handle complete lines of both Edison and Victor machines and records, have recently finished a number of alterations in their talking machine department, including the installation of two more commodious record rooms and additional facilities for the storage of stock and records. The company have also recently secured the agency for British Columbia for the J. W. York & Sons band instruments. They report an excellent volume of business at both their Vancouver and Victoria stores.

SELLING METHODS COUNT.

Present Day Conditions Necessitate Close Attention to Numerous Details Besides Quality of Goods and Size of Stock.

The time has gone by when entire dependence in the matter of making and holding trade can be placed on the selling of good goods. Almost every store of any respectability nowadays sells pretty fair goods and gives pretty fair values. It is no longer a singularity to do this; no longer a sure passport to public favor.

Of course no store can be permanently successful unless it sells good goods, but we must guard ourselves against believing that good merchandise is the only requisite, because it is not.

Attractiveness of store appearance, inside and out, has become nowadays a very, very potent trade-winning factor. Probably no one thing has so much to do with the impression a store produces on its visitors—not even attentiveness and courtesy of the sales people.

Surface indications determine the judgment of the masses of buyers. They are not, in the main, discriminating judges of the merchandise, however much they may fondly cherish the delusion that they are.

But everyone, however little fitted he or she may be to accurately analyze the general character of a store's merchandise, is certainly fully capable of judging a store's general appearance.

Quality of merchandise and prices being fairly equal, the store that is attractive in fittings and arrangements will outdraw two to one the store that is rather old-fashioned and commonplace in these respects.

The store with an old-fashioned, dingy-looking

front, with old counters and fixtures, and a jumbled up, unkempt looking stock, is laboring under a heavy handicap which it will take more than good advertising to overcome.

Good advertising will not offset the effects of bad stock keeping.

Keeping the stock in apple pie order—having everything neat and orderly and scrupulously clean—is an absolute essential to forceful advertising.

Advertising can bring people into the store, but it cannot make them buy or induce them to visit the store a second time if the first visit is unsatisfactory.

OUR EXPORT AND IMPORT TRADE

Of Talking Machines for March—Exports Show Strong Gain as Compared with Last Year—Some Interesting Figures.

(Special to The Talking Machine World.)
Washington, D. C., May 9, 1910.

In the summary of exports and imports of the commerce of the United States for the month of March (the latest period for which it has been compiled), which has just been issued by the Bureau of Statistics of the Department of Commerce and Labor, the following interesting figures relating to talking machines and supplies are set forth:

The total exports of talking machines, records and supplies for March, 1910, amounted to \$361,836, as compared with \$248,128 for the same month of the previous year. The nine months' exportations of talking machines, records and supplies amounted to \$2,843,742, as against \$2,174,356 for the same period in 1909.

The total export figures for the nine months of the past three years are as follows: 1908, \$3,851,521; 1909, \$2,174,356; 1910, \$2,843,742.

The value in detail of exportations of talking machine records and supplies amounted to \$221,642 in March, 1910, as against \$248,128 for the same month of 1909, and for the nine months ending in March, 1910, they amounted to \$1,797,304, as against \$2,174,356 in 1909 and \$3,851,521 in 1908.

The value of all other parts relating to talking machines, phonographs, records and materials therefor sent abroad during March, 1910, amounted to \$140,194; the total exports for the nine months under this heading foot up \$1,046,438.

R. C. ROGERS CO.'S ENTERPRISE.

Giving a Strong Representation to the Victor and Edison Lines in Washington.

(Special to The Talking Machine World.)
Washington, D. C., May 6, 1910.

The Robt. C. Rogers Co., who recently succeeded John F. Ellis & Co., as talking machine dealers at 1313 F street, are building up an excellent business. Mr. Rogers, the head of this institution, was in the employ of the Ellis house for more than twenty-five years, and for several years previous to the incorporation of the Robt. C. Rogers Co. was in charge of the talking machine department of the Ellis firm. The Victor and Edison lines are handled, and it is intended to give these the strongest kind of representation in this city. The Rogers Co. have attractive quarters and a good organization.

WOOKEY & CO.'S NEW QUARTERS.

Wookey & Co. have recently taken possession of a large double store at 320-322 South Adams street, Peoria, Ill., where they are making a very complete display of Victor talking machines and Columbia phonographs, as well as the records made by this concern. They also handle pianos and player-pianos. They occupy over 24,600 square feet of floor space, elevator service and other modern conveniences.

THE TRADE IN MILWAUKEE.

Dealers Satisfied with Present Business Though It Might be Livelier—Visit of Metropolitan Grand Opera Co. Helps the Sale of Grand Opera Records—"New Idea" Cabinets Prove Decided Success—Some Interesting Personalities—Good Supply of Amberol Records and Attachments—Wisconsin State Talking Machine Dealers' Association Inactive—Lacks Energetic Head.

(Special to The Talking Machine World.)

Milwaukee, Wis., May 8, 1910.

Milwaukee retailers seem to be entirely satisfied with present business even though it is not as brisk as it might be. Dealers say that trade is no more quiet than it usually is at this season of the year, that, in fact, it is showing a decided improvement over a year ago. As soon as the summer resort season opens a revival is expected. The one disquieting feature of the local retail situation is the fact that collections are a little slow. While money seems to be plentiful enough, people are busily engaged in investing it in various enterprises and are allowing their accounts to wait for a time.

The wholesale trade, taken as a whole, is very satisfactory. Of course, demand is quiet in some lines as a result of the rather dull trade that country dealers are meeting with at this season of the year.

The recent appearance of the Metropolitan Grand Opera Company in a three days' engagement at the Auditorium did much to increase sales in grand opera records in the different lines. Even at the present time, a lively interest is being manifested in Red Seal records and dealers say that they are selling more high priced records than they have in months. Miss Gertrude Gannon, proprietress of the McGreal retail store, was one of the heaviest advertisers of grand opera records during the time that the Metropolitan Company was in the city. Miss Gannon arranged a most interesting Caruso window that attracted wide attention. J. H. Becker, Jr., manager of the talking machine department of the Hoeffler Mfg. Co., offered a big window display that brought him some fine sales of grand opera records. Mr. Becker's afternoon grand opera concerts were well patronized and were something of an innovation.

The "New Idea" disc cabinet, invented by William Schmidt, traveling salesman for Lawrence McGreal, and manufactured by the New Idea

Cabinet Co., of Milwaukee, is creating no end of interest among the retailers and wholesalers of the Middle West. It is expected that the new cabinet will be placed on the market by May 20. "The 'New Idea' cabinet seems to be creating even more interest in the trade than we had anticipated," said Lawrence McGreal, the leading factor in the organization of the New Idea Cabinet Co. "The interchangeable tops, designed to fit the different forms of the Victor machines are proving decidedly popular, while the practical feature offered in the sliding record files is meeting with favor. Orders are being received from all sections of the country."

Lawrence McGreal attended the meeting of the executive committee of the National Talking Machine Jobbers' Association held at Columbus, O., recently.

John E. Daly, well known talking machine dealer of Grand Rapids, Mich., was a recent Milwaukee visitor.

William P. Hope, Wisconsin and Upper Michigan representative of the National Phonograph Co., is expected to return to Milwaukee in a few weeks for a most successful trip to Winnipeg and other Canadian points.

Laurence Lucker, of the Minnesota Phonograph Co., of Minneapolis, stopped over in Milwaukee recently on his return from the East as the guest of Lawrence McGreal.

William Schmidt, traveling representative of Lawrence McGreal, is now covering southwestern and western Wisconsin, where he is meeting with a good wholesale business.

Shipments of Amberola records and machines are beginning to arrive at Milwaukee with more frequency, and the demands of dealers are being satisfied to a certain extent. The trade is well satisfied with the special offer made by the National Phonograph Co., giving ten Amberola records with the sale of attachments. Miss Gertrude Gannon, retailer, sent out more than 5,000 letters to the public advertising this offer and as a result she is meeting with a phenomenal business in the Amberola line.

Many dealers seem to believe that the Wisconsin State Talking Machine Dealers' Association is to be allowed to die a natural death. Since the association was organized, on September 21 of last year, when President Taft visited Milwaukee, and when dealers from all over the State flocked to the metropolis with two ends in view: one to help in the organization of the association and the other to see the new President, not a meeting has been held. The keen

interest which was displayed at that time by the many dealers seems to have died out completely. That there is ample need for such an association and that it would be decidedly useful has always been conceded, but for some reason the present association seems to be on its last legs.

The prime mover in effecting the organization among the dealers last fall was Lawrence McGreal and it was he who sent out letters to the dealers of the State explaining the value of an organization and calling the meeting for September 21. Since that time Mr. McGreal has retired from the retail field and is now devoting his entire attention to the jobbing business. It is highly probable that if some prominent dealer would take up the matter that new life might be instilled into the now inanimate association.

Immediately following his election, Emil Seidel Social Democratic Mayor of Milwaukee, has announced that the school buildings of the city may be used by the young people for dances on Saturday nights. This is his first step toward the betterment of the social conditions of the poorer classes, and later, he states, that he will arrange for talking machine concerts and moving picture shows in the schools. His other motive in this campaign is to do away with the vice breeding wine rooms and saloon dance halls, which are so numerous in all cities.

The talking machine and its educational value was the topic of an interesting address given recently before the Milwaukee Library Club by Lewis A. Valentine. Mr. Valentine treated the subject from all sides and angles, and the talking machine as a factor in education has risen a great deal in the opinion of the different members of the club.

Lawrence McGreal, the well known jobber, and Miss Gertrude Gannon, retailer, have sold a number of Victrolas in the different cafes and ice cream establishments in Milwaukee for the entertainment of the customers. Among the places where the Victrolas are in evidence are the "Sweet Shop," located on Wisconsin street, and La Mont's cafeteria on Third street. Concerts are given throughout the day and evening, and they are becoming very popular among the patrons of the different establishments.

J. W. BINDER LOCATES IN CHICAGO.

Becomes General Sales Manager of the C. E. Zimmerman Co.

J. W. Binder, formerly vice-president and general sales manager of the Dictaphone Co. of America, with offices at 290 Broadway, New York, has connected himself with the C. E. Zimmerman Co., Chicago, as general sales manager. The arrangement has just been completed.

The C. E. Zimmerman Co. is an advertising and sales promotion agency organized to furnish to merchants and bankers in small towns an advertising agency service of exactly the same standard as is given to the great national advertisers by the big agencies. The concern is backed by a group of the leading capitalists in Chicago, each of whom is a "headliner" in his particular business. Mr. Binder will at once organize a selling force of the highest grade, which will operate under his direction on the district office plan. This organization will be headed by ten of the strongest men obtainable who, as district managers, will organize and operate the several territories allotted to them.

Mr. Binder is well known throughout the specialty selling field as an authority on that subject. He has written and lectured on salesmanship quite extensively. His address on "Advertising and Selling" in Madison Square Garden, New York, during the last business show will be remembered by those who heard it, as one of the best ever made. His "Salesmanship" stories in "System" and other magazines have been read and enjoyed by thousands.

Chicago is to be congratulated on acquiring him as a resident and as a "doer," who will help in making her what she is destined to be—the leading city of the world.

EASTERN SERVICE IS GOOD SERVICE

It stands for prompt and careful filling of orders. Special attention to rush orders. Quick and satisfactory adjustment of claims, and the fact of our handling both

VICTOR AND EDISON

gives the additional advantage to the trade of the one source of supply, one transportation charge.

Try Our Service and No Other Will Satisfy

THE EASTERN TALKING MACHINE CO.

177 Tremont Street

BOSTON, MASS.



Go after the Victor business in your locality

Victor goods are better now than ever before, and your sales should be larger than ever.

How much larger? That depends upon you. Our business has been increasing by leaps and bounds, and unless your business shows the same kind of a growth you are not keeping pace with us.

Every Victor dealer in this land should make the most of his opportunity. His profit is just about five times our profit—for every dollar we make, you make five dollars. So you see, it is worth your while to get your shoulder to the wheel and put forth more effort.

Advertise in your local newspapers and drive home the impression created by our regular systematic magazine, newspaper and farm paper advertising. Make your window displays as frequent and attractive as you possibly can—our ready-made window displays are a big help. Give Victor concerts and invite people to your store. Send a Victor out on trial and let it prove its value.

Make use of every opportunity to push the Victor and you are sure to get all the Victor business that you should have, and to make this year the biggest and most profitable year you ever had.

Victor Talking Machine Co., Camden, N. J., U. S. A.

Berliner Gramophone Co., Montreal, Canadian Distributors.

To get best results, use only Victor Needles on Victor Records

VICTOR DISTRIBUTORS:

Albany, N. Y. Finch & Hahn.
 Altoona, Pa. W. H. & L. C. Wolfe.
 Atlanta, Ga. Elyea-Austell Co.
 Phillips & Crew Co.
 Austin, Tex. The Petmecky Supply Co.
 Baltimore, Md. Cohen & Hughes, Inc.
 E. F. Droop & Sons Co.
 H. R. Eisenbrandt Sons.
 Wm. McCallister & Son.
 Bangor, Me. M. H. Andrews.
 Birmingham, Ala. E. E. Forbes Piano Co.
 Talking Machine Co.
 Boston, Mass. Oliver Ditson Co.
 The Eastern Talking Machine Co.
 M. Steinert & Sons Co.
 Brooklyn, N. Y. American Talking Machine Co.
 Buffalo, N. Y. W. D. Andrews.
 Neal, Clark & Neal Co.
 Burlington, Vt. American Phonograph Co.
 Butte, Mont. Orton Brothers.
 Canton, O. The Klein & Heffelman Co.
 Charlotte, N. C. Stone & Barringer Co.
 Chicago, Ill. Lyon & Healy.
 The Rudolph Wurlitzer Co.
 The Talking Machine Co.
 Cincinnati, O. The Rudolph Wurlitzer Co.
 Cleveland, O. W. H. Buescher & Son.
 Collister & Sayle.
 The Eclipse Musical Co.
 Perry B. Whitsitt Co.
 Columbus, O. Perry B. Whitsitt Co.
 Denver, Colo. The Hext Music Co.
 The Knight-Campbell Music Co.
 Des Moines, Iowa. Chase & West.
 Harger & Blish, Inc.
 Detroit, Mich. Grinnell Bros.
 Dubuque, Iowa. Harger & Blish, Inc.
 Duluth, Minn. French & Bassett.

Elmira, N. Y. Elmira Arms Co.
 El Paso, Tex. W. G. Walz Co.
 Galveston, Tex. Thos. Goggan & Bros.
 Grand Rapids, Mich. J. A. J. Friedrich.
 Honolulu, T. H. Bergstrom Music Co., Ltd.
 Indianapolis, Ind. Musical Echo Co.
 Wulschner-Stewart Music Co.
 Jacksonville, Fla. Carter & Logan Brothers.
 Kansas City, Mo. J. W. Jenkins Sons Music Co.
 Schmelzer Arms Co.
 Knoxville, Tenn. Knoxville Typewriter & Phonograph Co.
 Lincoln, Neb. Ross P. Curtice Co.
 Little Rock, Ark. O. K. Houck Piano Co.
 Los Angeles, Cal. Sherman, Clay & Co.
 Louisville, Ky. Montenegro-Riehm Music Co.
 Memphis, Tenn. E. E. Forbes Piano Co.
 O. K. Houck Piano Co.
 Milwaukee, Wis. Lawrence McGreal.
 Minneapolis, Minn. Lawrence H. Luckner.
 Mobile, Ala. Wm. H. Reynolds.
 Montreal, Canada. Berliner Gramophone Co., Ltd.
 Nashville, Tenn. O. K. Houck Piano Co.
 Newark, N. J. Price Talking Machine Co.
 Newark, O. The Ball-Fintze Co.
 New Haven, Conn. Henry Horton.
 New Orleans, La. Nat'l Auto. Fire Alarm Co.
 Philip Werlein, Ltd.
 New York, N. Y. Blackman Talking Machine Co.
 Sol Bloom, Inc.
 C. Bruno & Son, Inc.
 I. Davega, Jr., Inc.
 S. B. Davega Co.
 Chas. H. Ditson & Co.
 Jacot Music Box Co.
 Landay Brothers, Inc.
 New York Talking Machine Co.
 Stanley & Pearsall.
 Benj. Swifty.

Omaha, Neb. A. Hoeppe Co.
 Nebraska Cycle Co.
 Piano Player Co.
 Peoria, Ill. Putnam-Page Co., Incorp.
 Philadelphia, Pa. Sol Bloom, Inc.
 Louis Bucha & Brother.
 J. E. Ditson & Co.
 C. J. Hepp & Son.
 Penn Phonograph Co., Inc.
 H. A. Weymann & Son, Inc.
 Pittsburg, Pa. C. C. Mellor Co., Ltd.
 Standard Talking Machine Co.
 Portland, Me. Cressey & Allen.
 Portland, Ore. Sherman, Clay & Co.
 Richmond, Va. Cable Piano Co., Inc.
 W. D. Moses & Co.
 Rochester, N. Y. The Talking Machine Co.
 Salt Lake City, Utah. Carstensen & Anson Co.
 The Consolidated Music Co.
 San Antonio, Tex. Thos. Goggan & Bros.
 San Francisco, Cal. Sherman, Clay & Co.
 Savannah, Ga. Phillips & Crew Co.
 Seattle, Wash. Sherman, Clay & Co.
 Sioux Falls, S. D. Talking Machine Exchange.
 Spokane, Wash. Eilers Piano House.
 Sherman, Clay & Co.
 St. Louis, Mo. Koerber-Brenner Music Co.
 St. Louis Talking Machine Co.
 St. Paul, Minn. W. J. Dyer & Bro.
 Koehler & Hinrichs.
 Syracuse, N. Y. W. D. Andrews.
 Toledo, O. The Hayes Music Co.
 The Whitney & Currier Co.
 Washington, D. C. E. F. Droop & Sons Co.
 Robert C. Rogers Co.

The completeness of the Columbia line and its rapidly growing popularity, together with the solid and fair policy of the Company behind that program, cannot safely be ignored either by you or your competitors.

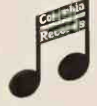

Columbia Phonograph Co., Tribune Building, New York.

TRADE ON THE PACIFIC COAST.

Retail Business Rather Dull—How Some Dealers Account for the Condition—Wholesale Trade Active—Frequent Changes Agitate—What the Pacific Phonograph Co. Are Doing—New Location for Bacigalupi—Columbia Phonograph Co. in New Quarters—Activities of the Other Houses

(Special to The Talking Machine World.)

San Francisco, Cal., May 2, 1910.

While everybody started the season with high hopes, and expectations have been more than fulfilled in the Coast territory as a whole, there is no dodging the fact that the retail talking machine business in this city just now is dull. There are exceptions in the case of certain dealers who may have some advantages in situation or management, but nearly all local houses which confine themselves to the retail department find conditions unsatisfactory. One or two are inclined to think that the enthusiasm for talking machines is subsiding, but this statement is controverted by the great activity in other quarters. The prevalent view is that the local condition is only temporary, and will pass off as the season advances.

Wholesale dealers have no complaint to make of business in general, as business in the country towns has continued on fully as large a scale as last month. There will naturally be a lull during the summer months, but it has not started yet, and there can hardly be a doubt that the fall season will be one of the best ever experienced. Coast crops are all heavy, and with prospects of a high average of prices money is moving freely in the agricultural districts.

The San Francisco trade continues to be agitated by frequent changes in the wholesale talking machine trade, but it is believed that the era of change is about over, and that the different houses will soon settle down to the usual steady pull for trade. The changes now in progress are the removal of the Columbia Phonograph Co. and the Pacific Phonograph Co. into permanent quarters.

The Pacific Phonograph Co.'s stay in the quarters first secured at the rear of Peter Bacigalupi & Sons' establishment was short. They gave up their lease almost as soon as they moved in, and are now transferring their stock to the Bass-Hueter building, 816 Mission street, which they consider one of the best locations for wholesale business in the city. The offices are still in the Stevenson street location, but will be removed in a few days. The company are now putting up the shelving and arranging the stock in the new location, the work being under the immediate supervision of A. R. Pommer and Mr. Jones. The main stock has not yet been brought over from the Oakland warehouse, but will be transferred immediately after the first of the month. Mr. Pommer says that the stock of records carried will be the second largest in the United States, the intention being to have everything in the Edison catalog always on hand. A well-tested

system of stock keeping is being installed, by which automatic indicators will give notice when the number of any records reaches the minimum, and the stock will be gone over every day. The location, on an upper floor, gives ample facilities for handling this enormous stock, with freight and passenger elevators at front and rear. In addition to the record racks, running half the length of the building, a large space in the rear will be reserved for the machines and packed stock, as well as a packing department. The latter is furnished with a power saw for boxing, and a packing bench 47 feet long. A room at the side, especially well lighted, will be fitted up for repair work, and space at the front will be reserved for offices. The entire loft is unusually well lighted for a place of that character, and Mr. Pommer believes it is the best that could be found in the city. Mr. Pommer says the wholesale business has been remarkable, in view of the numerous recent changes, and is highly optimistic regarding the future of the concern. He says there has been a wonderful demand of late for Amberolas. The company has furnished stock to a lot of new talking machine departments recently, among them being those of W. F. Denby, at Esparto, Cal.; Perry & Harper, in Oakland, Cal.; F. A. Phillips, at Round Mountain, Cal.; Chas. L. Fork, at Woodleaf, Cal.; the Weill-Nickoll Co., at Rocklin, Cal.; and Hanby's Pharmacy, on Seventh street, Oakland, Cal.

Peter Bacigalupi & Sons also expect to get into a new location before long. Mr. Bacigalupi states that the lease on his present store, 557 Market street, will soon expire, and he is endeavoring to dispose of it for the short time remaining. Mr. Bacigalupi will take a trip through the East in May, and after his return will begin to look around for a new place, preferably in the musical center of the city. With the numerous lines he is now handling in addition to talking machines, and others he expects to secure, he will require a comparatively large store.

Mr. Bacigalupi will be accompanied on his Eastern trip, about May 6, by Leon F. Douglass, vice-president of the Victor Co., who makes his home in San Rafael, Cal. Mr. Douglass finds his health greatly improved, and, it is said that he finds it very difficult to tear himself away from his suburban home.

The Columbia Phonograph Co.'s San Francisco headquarters are now at 334 Sutter street, in the Allied Arts building. The Van Ness avenue place was finally abandoned April 18, just four years since the fire. The stock is not yet in order, but Mr. Scott, the local manager, is busily at work on it, and expects to complete the job in a couple of weeks. The new quarters afford plenty of space for both stock and offices, and it is believed that the location will prove advantageous in many ways, being very close to the musical center, and accordingly convenient for visiting customers. Kohler & Chase, who have the retail business for the Columbia goods in this city, are keeping up their work in this department energetically, and are making a good record even at the local store. As they now carry the Columbia line in all their

stores in California, they are getting away with a decidedly large quantity of goods. Coast Manager W. S. Gray has just returned from a visit to the North, where he secured several new accounts. He states that the Grafonola Regent has been placed in furniture stores in every important place from Los Angeles north, the dealers everywhere taking a lively interest in it and using it to great advantage for display. Mr. Gray says the local business is looking up a little now, though rather quiet early in the month. He has spent much of his time in southern California this year, and states that conditions there are very much to his liking.

Andrew G. McCarthy, of Sherman, Clay & Co., has been giving considerable attention for the last few weeks to the promotion of the Panama-Pacific Exposition for San Francisco, but the talking machine business has not been neglected, and Mr. McCarthy reports a volume of business fully up to the former record. He expects to go East in about ten days.

GOING AFTER BUSINESS.

O. K. Houck Co. Doing a Splendid Trade in the Edison Attachment Proposition—Their Plan of Developing Business Worth Emulating.

The O. K. Houck Piano Co., Memphis, Tenn., are carrying on a great campaign in connection with the Edison special combination attachment offer. They have got out some very interesting letters bearing on this subject as well as on the latest Edison Amberol records, which must undoubtedly bring them splendid results. In connection with the special offer on the Edison attachment they have sent out return postal cards, in which their representative is invited to call with the attachment at the sender's house.

This is certainly going after business in the right way. They are not waiting for the customer to come, but are going after him. This is the kind of work which brings results and piles up business. It demonstrates that there is a live man at the head of the Houck talking machine department—a man who believes in "doing" things as well as talking about them. This is a spirit worth emulating. If every dealer would get after trade in this manner there would be little talk about dull times. Trade is oftentimes dull because dealers don't enforce plans whereby they may become busy.

Probably more than half the battle in building up a retail business consists in getting people into the store. A well-managed show window attracts trade at regular prices and if given constant attention may be made exceedingly productive. Newspaper advertising is valuable, especially when given personal care by one who understands how to tell a convincing story in print. These much used methods are good, but a suggestion discussed at several conventions recently goes a little farther in carrying out the idea that a merchant must go after the business if he wants to build up his trade on a profitable basis.

A LIVE MEMBER OF THE TRADE.

Archie Matheis, Proprietor of Talking Machine Co., Minneapolis, Has Successful Career in Jobbing and Retail Fields.

(Special to The Talking Machine World.)
Minneapolis, Minn., May 5, 1910.

Archie Matheis, proprietor of the Talking Machine Co., located at 236 Nicollet avenue, this city, is one of the men who have made a special study of the talking machine business, and who as a result of the knowledge thus gained have made a success in that field.

A few years ago Mr. Matheis joined the forces of Koehler & Hindrichs, of St. Paul, as manager



ARCHIE MATHEIS.

of a couple of their departments, and learned that the firm had a jobber's contract with the Victor Talking Machine Co., but were not doing very much with it. Mr. Matheis took hold of that department, rearranged the stock and started a lively campaign among the dealers. The success of the venture necessitated larger quarters in a very few months, whereupon the Edison line was added and proved equally successful.

Mr. Matheis then entered the retail business, and following the lines that won success for him in the jobbing business, soon built up a strong trade. His work is an excellent example of what may be accomplished by a live wire in the talking machine business.

THE NEWS FROM INDIANAPOLIS.

Various Conditions Tend to Retard Trade—Kipp-Link Co. in New Quarters—Successful Woman Manager—Columbia Activity—Playing of Talking Machines Before Cheap Theaters—Other Trade News.

(Special to The Talking Machine World.)
Indianapolis, Ind., May 6, 1910.

The talking machine business in Indianapolis has not been so good for the last month. Several conditions have entered into this. Cold weather toward the close of April caused many to replenish their coal bins. The last month also was the final time for paying the first instalment on taxes. The talking machine houses feel the effect of such conditions more than stores which sell instruments of greater price.

The Kipp-Link Co., who handle Edisons, are now transacting business in their new and commodious quarters in Massachusetts avenue, near the big Marott department store. A retail department is also conducted by the Kipp-Link Co., but, as usual, most of their attention is given to the wholesale business. The new location gives every promise of being a good one.

Miss Ada Willsey, who has charge of the new store of the Musical Echo Co., in North Pennsylvania street, which handles Victors, is the only woman in Indianapolis, so far as is known, who is in charge of a talking machine store.

She has been with the company for the last five years, and likes the business. The Musical Echo store is one of the neatest in the city. Business with this house has been good for the last month, the best demand being for the Victrola.

Manager Devine of the Columbia Phonograph Co. is greatly pleased with a record by Lina Cavalieri, which is included in the list of sample records for June. He considers it one of the finest soprano records ever made, and he predicts a good sale for it.

As an evidence that the advertising campaign which the Columbia Co. have been conducting with marked vigor for several months is beginning to bear fruit, the sale of two \$225 Grafonolas in one day is cited.

There seems to be a feeling among the jobbers that dealers generally are beginning to wake up to the fact that high-priced machines can be sold in smaller cities with less trouble and to better advantage than even the less expensive machines.

H. H. Myers, traveling representative of the Columbia Co. in Chicago, was in Indianapolis one day. J. A. Herdman, traveling representative from Cincinnati, also stopped in Indianapolis on his way South.

An ordinance is now in the Council which will prevent the playing of talking machines in front of the low-priced vaudeville houses. It might be thought on first impulse that the talking machine men would oppose this move. However, the playing of talking machines in front of the picture shows has never benefited the talking machine business very much. Machines in such places are allowed to get out of order, and old records are played over and over until the passing public get tired at the sound of a talking machine. It is evident that this is not so good for the business. And, again, the picture show field in Indianapolis is about full, and there is not a chance that there will be so many more picture shows for which the talking machine men can provide machines.

The order issued by Mayor Shank which

again permits the use of talking machines and electric pianos in the amusement resorts is proving a stimulus to the talking machine business to a certain degree. The Mayor declared that talking machines and pianos were useful in keeping the inmates of such resorts off the streets, and therefore were beneficial.

Robert Campbell, investigating officer for the Children's Aid Association, has been making an investigation of the moving picture shows in Indianapolis. He says that most of the picture shows present scenes which are instructive.

TO HANDLE "TALKERS" EXCLUSIVELY.

The W. G. Walz Co., who conduct a large establishment in El Paso, Tex., have given up their line of pianos and organs and will devote themselves exclusively in the future to developing their business in talking machines and side lines. They handle the Victor and Edison machines and records and the I. C. S. phonograph language outfits. The business is now in active charge of Harry T. and William G. Walz, Jr., W. G. Walz, the head of the business, having retired. They have a handsomely equipped store and a good organization, and are destined to make a still greater record in the talking machine line.

MME. ALDA MAKES VICTOR RECORDS.

Mme. Alda, who recently became the wife of Signor Gatti-Casazza, director of the Metropolitan Opera Co., left for Paris shortly after the close of the Chicago opera season with her husband, where she will sing with the Metropolitan Opera Co.'s forces, who will give a season of opera in the French capital. Before her departure for Europe, however, she was busily employed at the Victor laboratory making a number of records in compliance with a desire to follow the great success her "Othello" records have had. Among the most interesting records issued this season is the one by Mme. Alda and Signor Caruso.



Learn Spanish, French, German, or Italian

The I. C. S. System of Language Instruction by the phonograph method makes easy the mastering of a foreign language and appeals with compelling power to thousands. The dealer in phonographs that does not carry I. C. S. Language Outfits is neglecting a quick and sure way to increase his business. The new \$35 Language Outfit of the I. C. S. is a marvel. It represents the highest art in the teaching of languages, and embodies a method that has won the warmest praise of thousands qualified to speak authoritatively. The Spanish, French, German, and Italian Embassies at Washington, as well as the leading colleges, have cordially indorsed the I. C. S. Method of teaching languages.

The I. C. S. Language Outfit consists of an Edison Gem Phonograph made especially for language work; 14-inch brass horn; special hearing tube; recorder; reproducer; speaking tube; winding crank; camel's-hair brush; blank cylinders on which to make phonographic recitations; and 25 Conversational Records, teaching pronunciation guaranteed to be absolutely correct, with native intonation and inflection. In addition to these Conversational Records there are pamphlet Instruction Papers teaching the theory of languages. The new Outfit is the best and cheapest ever offered—the price being only \$35.

If you want to increase your business, write today for full particulars.

International Correspondence Schools
Box 918, Scranton, Pa.

a n EDISON

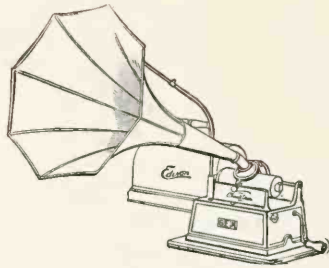

GEM

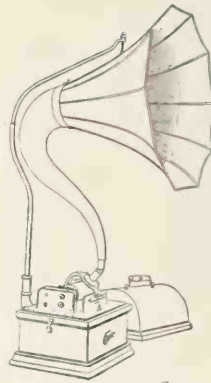

FIRESIDE

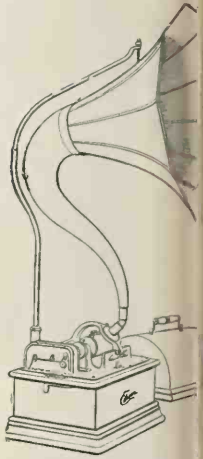

STANDARD

\$12.50

THE great range of Edison prices makes it possible for everyone to have an Edison Phonograph. But you can presume, to start with, that every customer that comes into your store is *able to purchase* an *Amberola*. Because the *Amberola* costs a good deal less than a piano, and almost everyone can and does afford a piano nowadays.

But whether it's an *Amberola*, a *Gem* or any other style of Edison that you sell, your continuous profit—*income*—is on Records. And the man who buys a *Gem* pays you just as big a profit on the Records that he buys as does the *Amberola* purchaser.

Take your profits from the

National Phonograph Company

for Everyone

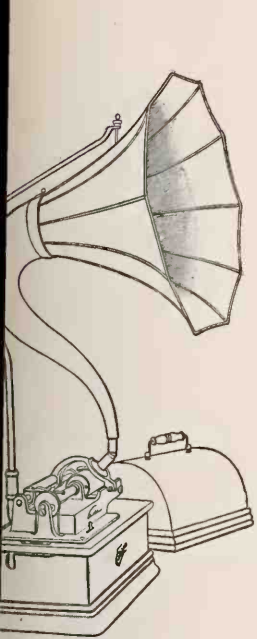

HOME

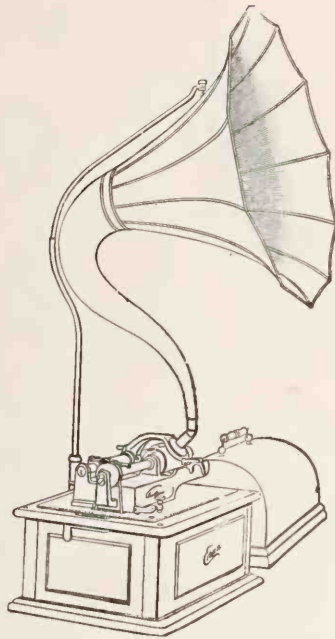

TRIUMPH



AMBEROLA

to \$200.00

EVERYBODY wants the Edison, because—it plays both Standard and Amberol Records, rendering the best music of every class from the Grand Opera arias of Slezak, Carmen Melis and other great Grand Opera stars, to the head-liners of Vaudeville, like Lauder and Stella Mayhew; because it has the permanent sapphire reproducing point that does not wear out the Records and does not wear *itself* out; because it is the only instrument upon which records can be made at home—and everyone knows that *that* is more than half the pleasure of having a sound reproducing instrument.

Instrument that everybody wants

9 Lakeside Ave., Orange, N. J.



EDWARD LYMAN BILL, - Editor and Proprietor

J. B. SPILLANE, Managing Editor.

Trade Representatives: GEO. B. KELLER, W. T. DYKES,
L. E. BOWERS, B. BRITAIN WILSON, A. J. NICKLIN,
AUGUST J. TIMPE, R. W. SIMMONS.

Boston Office: GLAD. W. HENDERSON, 180 Tremont St.

Chicago Office: E. P. VAN HARTLINGEN, 156 Wabash Ave.

Philadelphia: Minneapolis and St. Paul:

R. W. KAUFFMAN. ADOLF EDSTEN.

St. Louis: San Francisco:

CHAS. N. VAN BUREN. S. H. GRAY, 88 First St.

Cleveland: G. F. PRESCOTT.

Cincinnati: JACOB W. WALTER.

London, England, Office:

69 Basinghall St., E. C. W. LIONEL STURDY, Manager.

Published the 15th of every month at 1 Madison Ave. N. Y.

SUBSCRIPTION (including postage), United States, Mexico, One Dollar per year; all other countries, \$1.25. England and her colonies, five shillings.

ADVERTISEMENTS, \$2.00 per inch, single column, per insertion. On quarterly or yearly contracts a special discount is allowed. Advertising Pages, \$60.00; special position, \$75.00.

REMITTANCES, should be made payable to Edward Lyman Bill by check or Post Office Order.

VERY IMPORTANT.—Advertisements or changes should reach this office by the first of each month. Advertisements arriving too late for insertion in the current issue will, in the absence of instructions, be inserted in the succeeding issue.

Long Distance Telephones—Numbers 4677 and 4678 Gramercy. Cable Address: "Elbill," New York.

NEW YORK, MAY 15, 1910.

EARLY in July The National Association of Talking Machine Jobbers will convene at Atlantic City.

There will be several days given over to the discussion of business topics and it is the intention of the directors to make the Convention in all respects interesting and valuable to the talking machine jobbers of this country.

This will be the fourth annual meeting of the jobbers' organization and it must be conceded that the jobbers of America have labored faithfully to perpetuate an association along lines which should be helpful to the best interests of the talking machine trade.

It is an acknowledged fact that by organization men in all lines may help themselves materially.

Organization and agreement on a code of ethics to do away with many of the wastes which come from unkind competition and objectionable practices is a good thing.

Organization which means protection to the legitimate trade is also helpful and in many ways the talking machine men of this country may advance their own interests by standing together, and they will, without question, be inclined to rake their territory thoroughly, and there is a powerful lot of wasted territory in this country, and that question of wasted territory is a peculiar one.

WHAT should a certain territory produce in the talking machine trade according to population?

That is a question which is well worthy of discussion and the more it is discussed the clearer it will become that territory is not half worked.

There are plenty of good, thriving towns and cities in this country where good talking machine trade may be secured if the jobbers and dealers only go after it right.

It is up to the jobbers to interest bright, active, wide-awake men, to enthuse them with up-to-date ideas regarding the talking machine possibilities.

There is plenty of business to be had in this country if men only go after it—business for the jobber and business for the dealer.

It cannot be obtained by sitting down and figuring that trade will come knocking at your doors clamoring for talking machines.

It is pretty safe to bet that the man who figures on these lines will be seeking favors in the way of extensions because the business will not come to him, and he will have his stock on his hands.

The only way to get business is to go after it and not in a half-hearted manner.

Go after it with a ginger spirit and red blood in your veins and presumably you will land the trade.

THERE are thousands and thousands of people in this country who have no adequate conception of the evolution of the talking machine and its present position as an entertainer and instructor.

Now, they are the people to interest and an association, whether composed of jobbers or dealers, can forward the interests of all members if it simply injects a little trade enthusiasm into the business.

The dealers of the East have recently formed an association and it seems to be in excellent working order and is taking in new members all the time.

Now, that's the kind of work which counts and organizations which bring men of a particular trade into healthy contact will be beneficial.

They will help the manufacturing department and they will help themselves.

In fact, all will be benefited by the adoption of modern, progressive and up-to-date ideas, and there is no question but that there are some men in the talking machine trade who need some of the ginger spirit.

THERE are some jobbers who are not doing their full duty to the manufacturers and to their constituency by adhering to too conservative a policy.

They are not working their territory as they should.

They are not spending the money for developing their trade.

Now, many dealers are unacquainted with the talking machine possibilities.

They entered the business with little or no knowledge of the peculiar environment of the talking machine.

They simply looked upon it as a good thing and their very ignorance of the trade situation is holding back their own development.

Now, it is the jobber's business, because the jobber stands between the dealer and the manufacturer to aid them.

It is the jobber's business to enthuse—to educate and to train his trade and he cannot do this if he hides his business light under the bushel of indifference.

He must be up and doing.

He must exploit his product and let the talking machine men in his vicinage understand that he is in business and that he knows

the talking machine trade from A to Z and that he has got special attractive features.

THERE is a good opportunity for talking machines.
Excellent.

A widespread publicity in every line has created with the consumer new wants because advertising has brought about a change of conditions.

It has changed luxuries into necessities.

Not only is this true of the city dwellers, but the farming communities are demanding the best of everything.

The farmer must have his automobile, his player-piano and why not his talking machine?

To our minds, continuous advertising has brought about the actual demand for these things and it has helped to raise the standard of living.

It has impressed upon the people the necessity of having certain articles in their household which formerly they viewed as luxuries.

Why should not the talking machine men have their share of the increased demand?

Why has the great consuming public come to make these demands?

By education, and who has been a greater educator than the national advertiser?

Who has taught the world that progress is possible only by elevation to a higher standard of living?

The public is taking to itself the best of music and good pictures.

The public is reading more and better books than ever before in the world's history, and this means a greater consumption of paper, ink and other accessories.

The average man and woman are better dressed than ever before.

We ride in better carriages, in automobiles, and our railroad coaches are better appointed as regards the comfort of the traveling public.

WHAT has brought this all about?

Well, one great factor has been the steady hammering of the big advertisers.

They have actually compelled people to think that certain things were necessities.

Advertising has created the demand and in this connection it must be conceded that the talking machine manufacturers of this country have not lagged behind the procession in this particular.

They have been right in the front ranks and they have spent fortunes annually in acquainting the public with talking machine development.

But if the dealers and jobbers do not act in the same spirit and work along harmonious lines how can they expect to profit by this tremendous educational work which has been done through talking machine advertising all these years.

There is work—plenty of it—for everyone, and while trade conditions in parts of the country are not of the best, it is no time to sit down and view the outlook in an indifferent way.

On the contrary, it is time to be up and doing and thereby secure a fair slice of public patronage.

WHY DEALERS LOSE TRADE.

Many Retailers Sit Down and Wait About Trade Going to Large Houses and Department Stores Instead of Trying to Get the Business Themselves—No Secret in Having a Store That People Like to Visit—A Direct Talk Upon an Important and Interesting Subject.

It was Shakespeare who said, "Wise men ue'er sit and wail their loss, but cheerily seek how to redress their harms."

This will form the text for a heart-to-heart talk with some of those talking machine dealers located in what is termed "the poorer sections" of New York City, who are habitually complaining of dull trade, stating that the big stores are getting too large a share of what they should get.

It is our belief that a resident of an apartment on the east or west side of New York would just as soon buy records or machines from the dealer in his locality as to go downtown to a large single dealer or department store, if there wasn't some reason for his so doing.

And there is not only a reason, but reasons. As a matter of fact, but few of the smaller dealers take any pains to make their stores attractive or inviting. Moreover, their stock is inadequate and invariably dusty and poorly displayed.

Now, there is no excuse for this neglect, unless the dealer becomes a willing victim to that fatal disease, "dry rot."

In this case his business days are numbered, and there is an understandable justification for the complaint, "Somebody else gets the business."

In these days of keen competition any one who desires to succeed must be up and doing.

Among the elementary essentials is that the stock of talking machine records and supplies carried should be attractively displayed, kept immaculately clean, and the windows considered of advertising value.

And they cannot be of value if the glass is dirty and the stock dusty, and the whole place wears a dress of neglect.

During the past two weeks we have made it a point to visit a great many of these stores, and we must confess to a positive surprise at the conditions revealed. It is true these stores are controlled by small dealers. But they are small because of their failure to comprehend modern commercial or successful business requirements.

In the talking machine field to-day there is no excuse for dealers "creeping" along.

They are given every help by the manufacturers to work out original ideas and to build trade.

The man who neglects to study these pointers is cheating himself and cheating the company whose goods are handled, simply because he is not playing fair.

There is still a virgin retail field in New York City, right in the very center where these dealers are located, in which an immense trade may be developed.

It requires energy and originality to win out, of course, but the opportunity is there if the dealers awake to it.

New York, in many ways, is the best talking machine field in the world, but we are inclined to the belief that it is not properly worked, simply because a great many dealers are too content to straggle along at the tail end instead of at the head of the procession.

And what applies to New York applies to small dealers in all the large cities in the United States.

It is time to wake up!

WHERE ADVERTISING SHINES.

Advertising introduces the goods and paves the way for the salesman; insures for the traveler a respectful hearing when he arrives; brings orders when the salesman is not on the ground; increases the volume of the order which the sales-

man can secure in person; makes the merchant respect the firm and the salesman; cements the friendship between the house and the merchant; tells the merchant what the salesman forgets to mention; supports the salesman in his statements to the merchant, and brings about a better acquaintance and understanding between the merchant and the traveler.

TRADE IN SAINTLY CITY.

Active Business During April—Demand for Better Grade Goods—Some Recent Visitors—Visit of Opera Company Booms Record Sales—Interesting Personalities—Doings of the Various Houses.

(Special to The Talking Machine World.)
St. Louis, Mo., May 11, 1910.

The talking machine trade for the month of April has been quite active in all departments, with an exceptional good demand for high class instruments. The month's business showed a nice improvement over that for the same period in 1909.

Manager Walthall, of the Columbia Phonograph Co., reports a splendid business for April, the total being almost double that of April, 1909.

Col. F. B. T. Hollenberg, of the Hollenberg Talking Machine Co., Little Rock, Ark., spent some days here recently and was met by W. C. Fuhri, district manager of the Columbia Phonograph Co., who secured a very handsome wholesale order for his company from Mr. Hollenberg.

The visit of the Metropolitan Opera Company to St. Louis was a remarkable one, and Manager Gressing, of the St. Louis Talking Machine Co., took advantage of every opportunity the opera season afforded them in the way of an advertisement. The special Caruso Ready-Made Victor Window was installed in their show window, and elaborate signs and cards giving each singer's records were displayed around the store. The result was that quite a number of high-priced machines were sold, and the record trade was enormous.

The St. Louis Talking Machine Co. report that business is exceptionally good. The demand is mostly for the high-priced machines, both the Victrola styles leading. Miss Clara Goetz, who left this firm last year, is back again in her old position.

Visiting dealers at the St. Louis Talking Machine Co. were E. Marks, Edwardsville, Ill.; H. A. Tunehorst, Jerseyville, Ill.; J. A. Kieselhorst

and L. Davis, of the Kieselhorst Piano Co., Alton, Ill.; John Winkler, Mascoutah, Ill.; Mrs. Parks, Louisiana, Mo.; Mr. Wells, of Wells Mercantile Co., Bonne Terre, Mo.; Mr. and Mrs. Robertson, Mexico, Mo.; H. D. Tovey, Fayetteville, Ark.

A. Roos, chief accountant of the Columbia Phonograph Co., Chicago, spent several days here recently on business for the company.

W. M. Todd, who has been connected with the accounting department of the Columbia Phonograph Co., at Bridgeport, Conn., has accepted the position of accountant of the St. Louis branch of the company, and took charge April 4.

Charles Kauffmann, traveler for the local branch of the Columbia Phonograph Co., left on April 11 for a two months' trip through Northern Missouri.

The Silverstone Talking Machine Co. report their business for April to have been quite satisfactory and that they had an excellent trade on Amberolas.

Miss Sadie Rosenblatt, manager of the talking machine department of the J. H. Buettner Furniture and Carpet Co.; D. K. Myers, the well known Zonophone jobber, and The Koerber-Brenner Music Co. report that their trade for April was good in all departments.

The Thiebes Piano Co. report having had a good trade in their talking machine department in April, and that the demand for high priced instruments and records was excellent.

J. H. Allgaier, traveler for the National Phonograph Co., was a recent visitor here.

H. C. Rhodes, treasurer of the Rhodes-Burford Co., Paducah, Ky., a large dealer in Columbia phonographs at that place, spent two days here recently. Other visiting dealers were: G. E. Turpen, Flat Rock, Ill., and M. H. Phipps, Cowden, Ill.

REGARDING BUSINESS HABITS.

"Many men make the mistake of confining business habits to business hours. Do you know that it's a splendid privilege to be able to acquire business habits? A well-regulated store is a business college conducted on a practical basis. Its specialty is imbuing its men with 'business habits' and watching them acted out. In college we have a recitation. In the store we have the real thing. The professor corrects the one. The manager corrects the other. But the point is to carry this habit outside of the store. Let your trained business habits apply to home life, social life, church life, political life."

Purchase Quality Needles

BURCHARD needles naturally cost more than needles of an inferior quality, but, they have advantages which will be plain to all.



They move noiselessly over the disc and each needle can be used at least six times. You can get more out of BURCHARD needles than any other on the market. Send for a sample order of these needles and you will use no others.

MANUFACTURED IN THREE STYLES

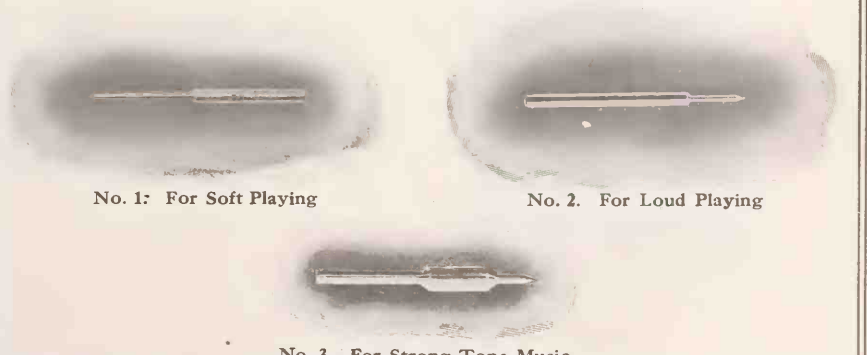

No. 1: For Soft Playing

No. 2: For Loud Playing

No. 3: For Strong Tone Music

Write for samples. We are prepared to arrange for sole sales agency in the United States. Write

F. R. REINGRUBER, SCHWABACH, BAVARIA, GERMANY



U-S Banner Model



U-S Opera Model



U-S Phonola, Model B



U-S Phonola, Model A

Write for Prices
and Particulars

Special Announcement To the

WITHIN the next few weeks formal announcement will be made to the public, through the pages of broadly circulated magazines, of the development and perfection of what is destined to be the most widely-demanded line of phonographic goods in America—the **U-S Combination Phonograph** and **U-S Everlasting**.

We say "most widely-demanded" not as a high sounding advertising expression because the very essentials which guide people in the choice of an outfit are those in which the U-S line has an actual and provable superiority—**convenience of operation, of tone-production and indestructibility of records.**

The U-S Phonograph is a **new** instrument: it is built on **new** lines; its performance is **new** to anyone accustomed to the old line phonograph. An advantage of first importance is its **Automatic-Change Reproducer Carriage**, by which with a single turn of an indicator machine is automatically and instantly adjusted to play either a two-minute or a one-minute record. In other words, the troublesome process of disconnecting the mandrel gears to change the speed, the removing of one reproducer and fastening on another, are all done away with in the

U-S Combination Phonograph

and the same result accomplished, in a **fraction of a second**, by simply a touch of the thumb and forefinger. The mechanism by which this instantaneous change is made is simple in construction, never-failing in its operation. No other phonograph in the world has this most desirable improvement.

The Motor of the U-S Machine is of a New Type, remarkable for its simple and unusual power. It is so nearly noiseless that were it not for **seeing** the revolution of the mandrel, scarcely able to tell whether the motor is running or not. Its ample reserve power, under most delicate control, gives a smooth, evenly-balanced and positive revolution of the record mandrel. As an added safeguard against the tone-destroying speed variations found in a motor, the U-S is fitted with a pulley balance wheel—another exclusive feature and **positively the only means of insuring a reproduction true to pitch.**

The Diaphragm is much larger than any here before used. This extra size, together with the fact that it is made of an unusually sensitive material, gives it marked superiority as a "voicing" instrument, particularly in bringing out fine music detail, much of which is lost in the average machine. The reproducer has a sapphire point, most carefully adjusted and rounded so as to eliminate scratching and to fit perfectly, **without friction**, in the sound hole.

Every dealer, no matter what his present stock, can order, or write a letter, and secure particulars. He only offers a phonograph line in all its complete.

See our Exhibit and hear the
of Piano Dealers and Musicians

U-S Phonograph Company

Announcement Trade

As the U-S Phonograph is of a revolutionary character among phonographs, so is U-S Everlasting Record a wide and radical departure and improvement in cylindrical nograph records.

This Record is not a Wax Record; in substance and structure it is unlike any other. It is composed of a wear-proof surface mounted upon an unbreakable cylinder base. The whole makes a record that is absolutely **Everlasting**—proof against scratching, proof against cracking by extreme heat or cold, proof against damage from careless handling or dropping; it may even be sent through the mails in its original carton, unprotected. To the dealer who suffers repeated losses through breakage, and also in view of the extra business to be received through mail delivery, this point will appeal with peculiar force.

Let us repeat: the **U-S Record absolutely will not break!** Nor can playing wear it. As a test, a record was taken from stock and played continuously for eight days (100 times), yet a microscope failed to reveal the slightest trace of wear, either upon the record or the sapphire point. It could have been played 10,000 or 100,000 times with the same result.

U-S Everlasting Records

The features we have enumerated are simply ones of **mechanical** excellence. To convey the **musical** excellence of U-S Phonographs and Records nothing short of actual hearing will suffice; and not only hearing but **rigid comparison** with any other phonograph, graphophone or talking machine you ever sold or heard.

Note the purity of tone, the fullness and roundness of volume, the brilliancy with which detail is brought out. Note the **naturalness** of the voice or instrument—the sympathy and feeling that bring you into the **presence** of that voice or instrument. All the metallic, artificial character usually noticed in a mechanical reproduction is eliminated; there is no scratching or hissing; it is **genuine music**, the kind that makes an enthusiast of the most optical listener.

As a Business Proposition we are offering merchandise and **musical possibilities** of a quality and character never before placed at the disposal of the trade. This is not a proposition of promise or claim, but of **proof and conviction**. From the very start we will prove to the world the difference between U-S Machines and Records and other machines and records. We are not going to **tell** people they are better; through actual comparative demonstrations at our dealers we are going to **show them** they are better.

In a word this is a broad, fully-perfected business plan, built on absolute merit and with limited resource behind it, **big** enough for the permanent co-operation of the biggest dealer, **sure** enough to justify the confidence of the smallest.

should fill out and mail the accompanying coupon—the wonderful U-S proposition, one that not only carries with it **increased profit**. Write to-day.

shown at the National Convention
Richmond, May 16th to 21st

Cleveland, O., U. S. A.

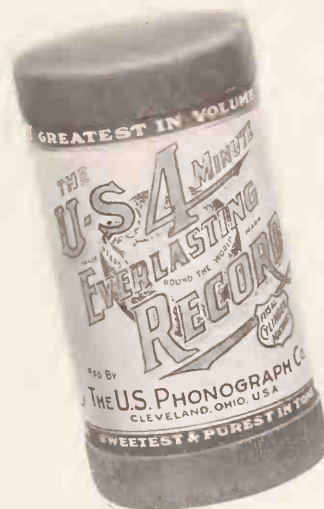

Two-Minute and
Four-Minute
Records

U-S
Phonograph Co.
1013 Oregon Ave.
CLEVELAND, O.

Gentlemen:
Please send full particulars
concerning the U-S Line of
Phonographs and Records.

Name

Address

City

State

A Columbia Grafonola sold is money made and more coming; for Grafonola buyers are the best kind of record buyers.



Columbia Phonograph Co., Tribune Building, New York.

TALKER SUCCEEDS "HURDY-GURDY."

First Machine to Succeed Hand-Organ in This Country Makes Its Appearance in Flatbush in Charge of a Son of Italy—How He Made the Innovation Pay.

Judging from present-day developments, the hand-organ man of New York and suburbs has taken a hint from his contemporary in Germany and adopted the talking machine as the successor of the time-honored "hurdy-gurdy," the talking machine having made its debut in its new field in Flatbush one day recently.

The operator would make a fine subject for an artist who wanted to picture a typical native of Sunny Italy, well along in years. With a long, drooping gray mustache he was typical of an aged Sicilian mountaineer. His clothes did not spell opulence, to be sure, but he expects that with the aid of the "talker" he will soon have enough to enable him to dress more respectably.

The talking machine was mounted on a hand-cart, such as those used by rag and waste paper gatherers. The "musician" said he got it from a man who didn't like that style of music and who abstracted the machine and a couple of dozen records from the house when his wife wasn't looking. It is a disc machine, of a well-known make, and can be heard a block away. It gives forth a really superior brand of music and nearly all of the records are operatic.

For this reason the innovation has made a hit in Flatbush, where the culture and wealth of Brooklyn is to be found in abundance.

The new style "hurdy-gurdy" attracts great attention wherever it goes and children follow it for blocks, singing and dancing. The operator has it easier than the men who grind the regular piano organs, for he does not have to keep winding it continuously. It has another advantage over the piano organ in that its repertoire is more extensive and calculated to please all tastes.

The operator explained in broken English that he used different records in different neighborhoods, having some of the popular variety to play in sections where the residents are not educated up to opera. So far, he says, he has the field to himself, but expects to encounter some opposition before long, as rival "hurdy-gurdy" men are jealous of his success with the new musical device and are anxious to follow his lead.

Most of the piano organs of the city are controlled by padrones or companies and are merely rented by the operators. It is expected that they will soon begin to put out talking machines to keep up with the march of progress. Talking machines have been in use in Europe by street musicians for some time, but the one now amusing the Flatbush section is believed to be the first one in this country.

Every extravagance, whether it be state or individual; every increase in prices, whether it be in wages, rates or commodities, comes out of the consumer. He must pay the bills.

OUR FOREIGN CUSTOMERS.

Amount and Value of Talking Machines Shipped Abroad from the Port of New York.

(Special to The Talking Machine World.)

Washington, D. C., May 2, 1910.

Manufacturers and dealers in talking machines will doubtless be interested in the figures showing the exports of talking machines for the past five weeks from the port of New York:

APRIL 13.

Adelaide, 75 pkgs., \$753; Bahia, 136 pkgs., 9,148; Berlin, 22 pkgs., \$457; Buenos Ayres, 16 pkgs., \$472; Calcutta, 4 pkgs., \$134; Cape Town, 36 pkgs., \$827; Guayaquil, 6 pkgs., \$246; Havana, 39 pkgs., \$1,833; Havre, 13 pkgs., \$290; Liverpool, 5 pkgs., \$208; Manila, 88 pkgs., \$5,186; Matanzas, 2 pkgs., \$146; Mazatlan, 8 pkgs., \$341; Port Barrios, 8 pkgs., \$207; Savanilla, 15 pkgs., \$775; Sydney, 170 pkgs., \$2,374; Tampico, 12 pkgs., \$328; Valparaiso, 2 pkgs., \$105.

APRIL 20.

Algoa Bay, 84 pkgs., \$2,479; Berlin, 34 pkgs., \$520; Brussels, 38 pkgs., \$260; Demerara, 6 pkgs., \$318; Havana, 19 pkgs., \$1,183; Iquique, 8 pkgs., \$735; Iquitos, 9 pkgs., \$616; Kingston, 14 pkgs., \$290; 3 pkgs., \$105; La Paz, 2 pkgs., \$148; Liverpool, 98 pkgs., \$2,347; London, 332 pkgs., \$7,137; 5 pkgs., \$341; Melbourne, 111 pkgs., \$2,677; Molendo, 15 pkgs., \$410; Moscow, 5 pkgs., \$200; Port Au Prince, 1 pkg., \$130; Port of Spain, 6 pkgs., \$297; Riga, 12 pkgs., \$2,100; Shanghai, 3 pkgs., \$193; Tampico, 37 pkgs., \$1,518; Vera Cruz, 63 pkgs., \$2,753.

APRIL 27.

Brussels, 3 pkgs., \$135; Buenos Ayres, 6 pkgs., \$196; Callao, 2 pkgs., \$159; Colon, 3 pkgs., \$177; Havana, 22 pkgs., \$319; Havre, 19 pkgs., \$459; London, 80 pkgs., \$2,334; 17 pkgs., \$1,853; Montevideo 22 pkgs., \$1,786; Para, 10 pkgs., \$610; St. Johns, 7 pkgs., \$120; Sydney, 437 pkgs., \$10,784; Trieste, 1 pkg., \$250; Vera Cruz, 6 pkgs., \$126.

MAY 3.

Acajutla, 4 pkgs., \$150; Berlin, 9 pkgs., \$674; Buenaventura, 2 pkgs., \$101; Buenos Ayres, 107 pkgs., \$4,955; Callao, 33 pkgs., \$610; Cienfuegos, 15 pkgs., \$235; Colon, 2 pkgs., \$170; Havana, 31 pkgs., \$2,474; London 276 pkgs., \$6,520; 9 pkgs., \$846; 23 pkgs., \$629; Manila, 13 pkgs., \$717; Moscow, 7 pkgs., \$257; Para, 3 pkgs., \$291; Puerto Plata, 6 pkgs., \$202; Rio de Janeiro, 18 pkgs., \$2,210; Santos, 10 pkgs., \$681; Savanilla, 2 pkgs., \$115; Sydney, 152 pkgs., \$5,135; Tampico, 11 pkgs., \$369; Trinidad, 16 pkgs., \$336; Valparaiso, 16 pkgs., \$348; Vera Cruz, 317 pkgs., \$6,389.

GEO. K. CHENEY TO BOSTON.

Will Assume Charge of the Laboratory of a Talking Machine Co. Recently Organized in Boston.

George K. Cheney, manager of the recording laboratory of the Sonora Phonograph Co., New York, resigned May 14, and will accept a similar

position with a new talking machine company now being organized in Boston, Mass. Mr. Cheney will be succeeded by L. Muller, formerly in charge of the Leeds & Catlin Co.'s laboratory, now wiped off the map by bankruptcy proceedings. Mr. Cheney has had great experience as a recorder and has traveled over the entire world making masters for the Universal Talking Machine Manufacturing Co., whose laboratory he had also charge of for a number of years. Mr. Cheney will enjoy a handsome salary in his new position. The World wishes him abundant success and he is deserving of it.

THE DICTOGRAPH.

A Remarkable Instrument—It Magnifies Sound Waves—Now Being Used in a Great Many Public Places in New York City.

At police headquarters and in different public offices in Manhattan there has been installed a little instrument that may play an important part in future official investigations. It is called the dictograph, and is a mechanical eavesdropper that will strike terror to the heart of the corrupt politician when he knows what it is. Politicians in search of questionable favors and wrongdoers who imagine they are pouring their confidences into the ears of a single and friendly official had better look around the official's desk before opening their hearts.

The instrument is primarily used to facilitate communication between distant rooms. It makes the faintest whisper in one room audible to a stenographer in another room. The instrument magnifies sound waves ten or twelve octaves. Borough President McAneny, who has installed the instrument in his Park Row building offices, said last week:

"Yes, it is a wonderful little thing. I touch a push button and then talk. The person in another part of the building to whom I talk hears me distinctly, though I may be five or six feet from the instrument itself. I believe any sound in my office could be heard in another room, but of course I have never used it for such a purpose and have no intention of doing so. With us it is merely a very fine line of communication, that is all."

Police Commissioner Baker has installed the instrument at headquarters, where, it was said that it is used only for conversation between officials. The dictograph has been used by Chief Wilkie in the United States Secret Service offices in Washington and many large banks have it.

NEW STORE IN MARQUETTE.

The Cable Piano Co. has shipped its entire stock of talking machines and records from its store at Marinette, Wis., to its new store at Marquette, Mich.

Joseph Thomas, a talking machine dealer and printer of Wilkesbarre, Pa., has moved to new quarters in that city.

FROM OUR EUROPEAN HEADQUARTERS

69 BASINGHALL STREET, LONDON, E. C., W. LIONEL STURDY, MANAGER.

TRADE HAPPENINGS IN LONDON.

Talking Machine Sales of Satisfactory Volume Except in Provincial Centers—Public Demanding the Better Grades of Machines and Records—Poor Goods Harm Industry—Optimistic in the Export Field—A New Home Recorder for Discs—What's in a Name?—Trade on the Continent Unsatisfactory—Phonograph for the Pope—New Artists Making Records—The Lists for the Month—Talking Machines Entertain Lepers—A New Way of Giving Away Machines—Attractive Show Windows Cause Trouble—Summary of the News from the Provinces—Happenings of the Month in London and Vicinity.

(Special to The Talking Machine World.)

London, E. C., May 10, 1910.

Apart from the depression existing in certain provincial centers, as reported elsewhere in this issue, there is no cause to complain of talking machine sales generally. True, things are quiet, but nothing out of the ordinary for this time of year. Dealers are placing fine orders for the various styles of portable disc instruments, which is sufficient index that they recognize this as a line capable of profitable handling during the outdoor season, a line, too, which may be relied upon to give extra fillip to record sales. Another point worthy of note just now in directing the dealers' policy is the steady call for "quality" goods. The cheap and unreliable stuff meets with little encouragement from a public who each month becomes more discerning, and it would certainly seem that the best course for traders to adopt is the featuring of better-class machines—Instruments calculated to give such satisfaction to the buyer that he forever will remain a steady enthusiast and a regular buyer of good records. I believe that quite half of the people who give up all interest in their instruments do so because of some mechanical defect in the motor, often the outcome of bad workmanship and material, and that is why the sale of these cheap machines does an incalculable amount of harm to this industry as a whole. It is well that dealers are becoming alive to this fact, and that in pushing the best goods they are taking care of their own interests, present and future.

Export Business Improving.

In the export field business is improving very considerably, yet much of the colonial and foreign trade which should come to England goes elsewhere, partly owing to the scant amount allowed for expenditure on energetic advertising methods and the fact that our manufacturers do not trouble to ascertain the wants and market requirements of traders located overseas. Our manufacturers do not seem to realize the splendid business possibilities in Australia, New Zealand, Canada, South Africa, India and other colonies. They are not content to let the orders go to Germany or America, but they do little or nothing to obtain a share themselves. We are told that colonial merchants are only too anxious to deal with English manufacturers, if the latter will cater to their requirements more satisfactorily. Isn't this sufficient encouragement? Can manufacturers expect to sell their products, however well made, if those products do not suit the climatic conditions and colonial ideas? Of course not. Then let them offer what is wanted and advertise that offer freely.

Numerous Visitors of Note.

During the week quite a number of distinguished visitors have been to London, and among whom may be mentioned Mr. Rosenbaum (Beka Record Co., Berlin), Emil Rink (managing director of the International Talking Machine Co. and Fonotopia, Ltd.), M. Strauss (Carl Lindstrom, Ltd.), and Mr. Wyncken (director of the Favorite Record Co., Hanover).

New Home Recording Device.

Since the passing of the old Neophone Co. (the only remaining asset of which is, or was, a first-class season from London to Brighton), disc record users have been unable to enjoy the delights of home recording. J. E. Hough, Ltd., have now come to the rescue in filling the proverbial long-felt want by a timely introduction of an ingenious device for this purpose. The recorder is only adaptable to the phonograph cut, but in view of its practicability it will no doubt exercise a big influence in further popularizing this class of disc among users of the needle-cut type.

More Trouble.

A deal of comment, not to say astonishment, was caused in the trade last month by the association of the word Gramophone in Barnett Samuel & Sons, Ltd., press announcements advertising their well-known series of Dulcephone disc machines. It appears that Barnett Samuel recently registered a trade-mark containing the words "The Dreadnought Gramophone," and it is the advertising of this which has not unnaturally been taken exception to by the Gramophone Co., Ltd. I use the phrase "not unnaturally" advisedly, because whatever may be the merits of the case it cannot be denied that up to the present the Gramophone Co. have enjoyed the use of the name exclusively and have spent thousands or pounds in making that name, in a sense, very valuable from a commercial point of view. In a circular letter to the trade the Gramophone Co. advise that an action has been commenced against Barnett Samuel, and that they intend to institute proceedings against any persons infringing the company's rights. In reply to this Barnett Samuel inform traders that "if the action is proceeded with it will be defended, and we have no anxiety as to the result. We are advised that the Gramophone Co., Ltd., have never had any exclusive right to the use of the word 'Gramophone,' and that it is open to us or anyone else to use it." And there the matter rests for the present.

New Cable to Belgium.

In addition to the new London-Paris telephone cable to be laid between Dover and Cape Grisnez shortly, preparations are being made to lay yet another telephone cable across the Channel to Belgium, in order to open out the principal center of England beyond London. There are now no less than eight telephonic services to the Continent, and this facility should weigh materially in establishing quicker communication with continental machine and record makers.

Trade Conditions on the Continent.

Discussing the continental trade situation with your correspondent, M. Strauss, of the well-known Lindstrom concern, and a recent visitor to this city, said that the talking machine business in Germany, while not entirely unsatisfactory, left a good deal to be desired. There was room for improvement, especially in the matter of prices, which were so much cut up as to leave little or no profit for progressive development. Particularly was this the case in the record field, and it is somewhat astonishing to learn that a fairly good disc record is sold there for about tenpence wholesale. Such a situation demonstrates very forcibly the need for trade protection associations, the existence and value of which in America is the envy of all business men this side. Dealing with the German copyright situation, Mr. Strauss informed me that the second reading of the copyright bill may be expected to come up before the summer vacation. While the Odeon and Gramophone companies, supported by the publishers, are asking for a monopoly clause, the rest of the manufacturers, who are supported by the composers, advocate a similar system of license stamps as obtains in France. The situation is therefore somewhat complex, but in Mr.

Strauss' opinion the French method will eventually obtain and come into force only from the date of the passing of the new act. It seems to me that that healthy competition so vital to business progress can only be kept open by giving to every record manufacturer the freedom and right to adapt any musical piece or song to reproduction mechanically upon a royalty basis, quite apart from the question of local conditions. And this view is apparently most favored in trade circles both here and abroad.

Idelia Phonograph and Edison Records for Pope.

The trade will be interested to learn that the Pope has been pleased to accept an Idelia phonograph, with a selection of Edison records, presented to him by Mr. Edison through the National Phonograph Co., Ltd. The Chevalier Bocchi, managing director of Ashton & Mitchell's Royal Agency, of Old Bond street, London, made the presentation. The Pope expressed his great pleasure with the instrument and asked to have his thanks conveyed to Mr. Edison. His holiness presented Signor Bocchi with a handsome gold medal as a souvenir of the occasion.

Signor Bocchi has given to a representative of the Pall Mall Gazette the following account of the presentation: "When I was informed that the Pope would receive me in private audience, and that he would also be most pleased to accept the phonograph which Thomas Edison desired to offer, I was pleasantly surprised. I was busy preparing the machine in his studio under the impression that I was quite alone, when I was startled at hearing a voice quite close to me. I looked up to see his holiness evidently taking a great deal of interest in my doings. For the moment I felt somewhat taken back. The Holy Father, however, has such a charming and benign manner that one is instantly put at one's ease. After hearing several records, the Pope was quite charmed, and, turning to me, said: 'It is really quite marvelous; the tone is wonderful'; while after hearing a violin record by Mr. Spalding, he remarked, 'There is no doubt the violin is the finest instrument of all!' I explained that one great advantage of this machine was that his holiness could make his own records and dictate his own correspondence, to be transcribed later on. This idea pleased him immensely and he exclaimed, 'Ah! that is an excellent idea; no one would then be able to say I had said anything but what I really did say.'"

Interesting Hire-Purchasing Decision.

A case of much interest to traders who sell talking machines and records on the hire-purchase system was that in which Shenstone & Co., pianoforte manufacturers of Leyton, sued a Mr. Freeman under the Law of Distress Amendment Act, 1908. At the Lambeth County Court Judge Emden had held that the landlord of certain premises in Southwark Bridge Road was entitled in distraining for rent to take possession of a piano which had been obtained by the tenant's wife on a hire-purchase agreement. Messrs. Shenstone appealed against that decision, and the matter being regarded as a test case, the appellants were supported by the Hire Traders' Protection Association. By the Law of Distress Amendment Act, 1908, part of the Lodgers' Goods Protection Act, 1871, is repealed, and additional protection is afforded to lodgers and others whose goods happen to be on premises where the landlord distrains for rent. The act, however, provides that it should not apply to goods belonging to husband or wife of a tenant whose rent is in arrears nor to goods included in a bill of sale, hire-purchase agreement, or settlement made by such tenant, nor to goods in the possession, order or disposition of such tenant by the consent and permission of the true owner under such circumstances that such tenant is the reputed owner thereof. Justice Darling, delivering judgment,

FROM OUR LONDON HEADQUARTERS—(Continued.)

stated that it could not be said the piano was in the possession of the tenant, Mr. Wyard. Even if it were there was no evidence that it was in his possession "by the consent and permission of the true owner." Their lordships allowed the appeal with costs, and granted leave to take the case to the Court of Appeal.

Gramophone Records by Sammarco.

The Gramophone Co. draw special attention this month to a new series of records by Signor Sammarco, who, by the way, possesses one of the finest baritone voices known in operatic circles. Effective show cards are being issued in connection with this series. The usual monthly supplementary list for May contains many gems by popular artists of the day, and it is not too much to say that if anything the recording of these records are even better than the usual excellent standard maintained by the Gramophone Co. Here is the list: "Zanetta Overture," Students' Songs (No. 3), "March Russe" and "Valse Triste," all by the Band of H. M. Coldstream Guards; "Hebrides" ("Fingal's Cave") overture, by the La Scala Symphony Orchestra; "Japanese National Anthem," by the Black Diamond Band; "Onaway, Awake, Beloved!" Evan Williams; "The Sweetest Flower That Blows," John Harrison; "Long Ago in Alcala," Thorpe Bates; "Rolling Down to Rio," Stewart Gardner; (a) "Love Is a Dream" and (b) "O That We Two," Mme. Kirkby Lunn; "Bolero-Merci dilette amiche" ("1 Vespri Sicilliana"), Miss Amy Castles; "In a Child's Small Hand," Miss Edna Thornton; "I Dreamt That I Dwelt" ("Bohemian Girl"), Miss Perceval Allen; duet. "Watchman, What of the Night?" John Harrison and Robert Radford; "Slavisch Tanze, No. 8," by the Renard Instrumental Quartet, and "Adagio Cantabile," 'cello solo by Hugo Becker. Truly, a very fine list.

T. A. Edison Contemplates Visit?

A Daily Chronicle report speaks of Mr. Edison's intention to pay a visit to this country some time next year. We have read reports of a sim-

ilar nature many times within the last year or so, but if it should turn out to be true, what a welcome awaits him! And what a fillip, too, it would give to sales of the goods which bear his name!

Cooks Athletic Co. Fail.

Cooks Athletic Co. (1907) Ltd., of Beech street, Barbican, have called a meeting of creditors. The liquidator is G. Askew. This is the firm who first handled the old Imperial records in London, but the agency was terminated after a few months.

The "Twins" list for June contains a budget of real good titles, which will certainly be in great demand, a summer trade reviver.

Beka Records in Bengal.

Another addition to the many world agencies for the Beka Record Co.'s English discs is the appointment of Sen & Sen, of 1, Chowringhee, Calcutta, as sole agents for the Province of Bengal.

Summerfeld with Favorite Co.

Following upon A. Vischer's retirement from the Favorite Record Co., this line will in future be handled by Mr. Summerfeld, a gentleman, by the way, whose experience in the offices of O. Ruhl, Ltd., well qualifies him for the position. The Favorite record has long been popular with talking machine lovers, and it is not too much to expect that Mr. Summerfeld, with the friendly aid of Mr. Ruhl, will increase the enviable reputation of his product.

Phonographs for Leper Settlement.

In the leper settlement at Kalawao, Molokai, Hawaii, says the Edison Phonograph Monthly, several Home phonographs and over 1,200 records, distributed throughout the entire reservation, afford unlimited entertainment to the inmates, especially to the young people. The records of native songs and dancers made in America by Toots Paka's Hawaiians, are, of course, in greatest demand, but the leper boys extract no end of amusement from making records of their own voices, which, says the superintendent of the

colony, are very good—low and quiet, but tuneful.

British Zonophone Co.'s Fine List.

One of the best record lists for this month is that issued by the British Zonophone Co., who offer some real good selling titles, which their dealers will appreciate to the utmost at this time of the year. A beautiful record is that of Tosti's "Good-bye," made by an instrumental trio composed of violin, flute and harp, a combination which is very popular these days. Others are (12-inch), "O Ruddier Than the Cherry" (Händel), by Harry Dearth; (10-inch), selection, "Il Trovatore," by the Black Diamonds Band; "Monte Cristo Waltz," the Peerless Orchestra; "By the Fountain," Ernest Pike; duet, "Love and War," E. Pike and S. Kirkby, and "I've Found Kelly," Billy Williams.

A New View of Price-Cutting.

At the annual general meeting of A. W. Gamage, Ltd., Mr. Gamage had something to say upon the question of price-cutting, a policy for which his firm has obtained some notoriety. He said: "The people who took exception to the company's methods were all cutters, more or less, but they did it in different ways. The company preferred to do it in a straightforward and open manner, paying full prices for the goods they purchased. Many of those who had created such a disturbance signed agreements which they broke at the first opportunity." After giving particulars in support of these statements, Mr. Gamage continued: "That afternoon a meeting was to be held having for its object not the protection of the consumer but the formation of a new society of motor traders, the object of which would be to squeeze the bonds still tighter about retailers so that they should not cut prices. The suggestion was that if a retailer did not charge the prices established by any particular manufacturer all the manufacturers of the country would refuse to supply that retailer with goods. Similar efforts had been made before, but in vain. In his view this policy of price-maintenance was im-

ROYAL APPRECIATION

of the

GRAMOPHONE



To H. M. the KING
OF ITALY



BY APPOINTMENT
To H. M. the QUEEN



To T. M. the KING and
QUEEN OF SPAIN



To H. H. the KHEDIVE
OF EGYPT



HIS MASTER'S VOICE



To H. M. the SHAH
OF PERSIA

THE GRAMOPHONE COMPANY, Ltd.
21 CITY ROAD, LONDON

15 Rue Bleue, PARIS
36 Ritterstrasse, BERLIN
56 Balmes, BARCELONA
139 Belleghatta Road, CALCUTTA

FROM OUR LONDON HEADQUARTERS—(Continued.)

moral! It had undoubtedly tended to create great business immorality. It had turned men of good principle into liars and breakers of agreements. He felt sure that the shareholders would not agree with the tactics of certain societies, because it was right that the trader, so long as he conducted his business in an honest, straightforward manner, should be left to decide for himself what profit he was content with."

This is without question a bold and specious pronouncement, but we reckon Mr. Gamage would soon change his tune if all traders took up the same attitude. Competition along these lines could only end in one way. Profits would dwindle to nothing in order that one trader might get the better of the other. Sheer philanthropy! Gamage, by the way, are still selling Imperial records at 10d. each!

Prominent Artists Make Rena Records.

It can hardly be said that the monthly supplements of Rena records suffer from a lack of variety, either in artistes or titles. This month's list of 10-inch Rena embraces three new artists, one of them Mrs. A. Stewart Holt, the lovely contralto hitherto only associated with the 12-inch records. Another is Carroll Clerk, who sings "Darling Nelly Gray" and "Daddy's Pickaninny Boy" as his introductory offerings.

Harry Ford is back again on Rena records. He sings this month two of his own unpublished songs, so that they are quite exclusive to Rena. The King of Patter Comedians, as he is billed, has made a big name for himself on Rena.

Imperial Graphophone a Success.

The Columbia Phonograph Co. announce that the Imperial graphophone in the new style is a distinct success. It may be stated that the cabinet design has been altered and now has curved sides and rounded corners. But the most striking improvement is the addition of a mahogany horn, the new Columbia Symphony horn.

Boom in Lashwood Records.

Those who participated in the boom in Lash-

wood records on the Rena list a little while back—a boom which still exists—will be interested to know that George Lashwood is touring the principal cities of the United States, taking each one by storm as he goes. He is featured as the "Vaudeville Beau Brummel" and the saner critics of the newspapers on the other side unite in declaring his receptions to surpass even Chevalier and Vesta Victoria at their best. In the States, the Columbia Co. secured him to sing for them, just as was the case over here.

The New Rena Record List.

The 12-inch Rena supplement for this month takes a somewhat novel form. It comprises four double records, and is, we are informed, somewhat in the nature of an experiment. The two band records offer "Carmen" selections in two parts, obverse and reverse of a record, and "Tannhauser" selections, also in two parts on one double record. The vocalist is Kirk Towns, the celebrated baritone of the Wiesbaden Opera, and he is represented by two records of contrasting character but of unexampled brilliance.

The Gipsy Smith Records.

Gipsy Smith, records by whom, under exclusive contract with the Columbia Phonograph Co., are just being issued in a special Rena supplement on 12-inch discs, was always a singer as well as a preacher. As far back as 1883 we find critics enlarging upon his charming vocalization. He tells how in the year in the circus of Hanley, Staffs he sang a solo. His records may without exaggeration be said to show the same felicitous treatment and depth of feeling that characterized his singing those twenty-seven years ago and that have given him so firm a grip on his crowded audiences since and now. With a full sense of the fitness of things, the Columbia Co. are issuing the series in a specially designed 12-inch album, gold-lettered and tied with ribbon.

Give Machines to Record Buyers.

In a previous issue attention was drawn to the operations of the English Record Co. in giv-

ing away a machine upon a promise to purchase fifty-two double discs at half a crown each. This is a perfectly legitimate form of competition, it must be admitted, but dealers very naturally take exception to the company's methods of trading direct by means of house to house canvassers. All would be well if only the manufacturers were to insist upon the scheme being conducted through the proper trade channels. And in this connection a somewhat similar idea inaugurated by Messrs. Lockwoods, the well-known Twin and Zonophone factors, deserves the support of traders, because it is conducted only through dealers appointed by the firm in specified districts. Messrs. Lockwoods offer embodies an agreement to purchase one Twin record at 2s. 6d. regularly per week for 48 weeks, in consideration of which a model 6 Perophone disc machine, value 4 guineas, is given upon a promise to pay at the end of that period the sum of one guinea, or four weekly payments of 5s. 3d. From the description before me the machine is a thoroughly reliable one, and is quite remarkable value for the money. This is a sensible proposition which will no doubt meet with a good reception, since it furnishes dealers with a splendid opportunity of easily combatting the competition of the English Record Co., whose free machine, by the way, is very poor value for the estimated price put upon it.

To Pay Creditors Small Percentage.

It may be of interest to those of my readers who are creditors of the defunct American Talking Machine Co. to know that the stock in trade and effects have realized a sum sufficient to pay all creditors 3s. 6d. in the pound. The trustee, G. E. Corfield, of Balfour House, Finsbury Pavement, London, will, however, pay out this sum only on condition that the creditors sign the following understanding, which is self-explanatory:

"We understand from you that Mr. Cowen, Berwick-on-Tweed, claims to be a creditor on the

Responsible Exporting Firms in America, Canada and Colonies are invited to apply for Sole Agencies

"ASPIR" Disc Records (sapphire cut) 11" and 12" double sided

*Finest Repertoire of Operas, Orchestras and Songs.
Unsurpassed for Tone and Quality.*

Manufactured by

ESTABLISSEMENTS PHONOGRAPHIQUES D'IVRY

5, RUE BOUDREAU—PARIS

(Branch of the C. G. E. — Paris. Capital frs. 18,000,000)

E. P. I. Talking Machines

complete with sound-box fitted with unwearable sapphire for playing "ASPIR" discs. :: :: ::

Best and Cheapest Machine on the Market.

Manufactured by the

ESTABLISSEMENTS PHONOGRAPHIQUES D'IVRY

5, RUE BOUDREAU. (Opera) PARIS



British Branch:— **ASPIR — LONDON.** 15, Victoria Street, London (England)

FROM OUR LONDON HEADQUARTERS—(Continued.)

above estate for about £950, which claim you are resisting. We also understand that you are legally advised not to part with the funds you have in hand until the question of Mr. Cowen's debt has been settled. If, however, you will hand over to us the dividend which is coming to us, you may take this letter as our personal undertaking to refund the amount to you should Mr. Cowen issue and serve you with a writ in relation to his claim."

Novelties in Current Beka List.

There are several interesting novelties in the current monthly Beka record list which will meet a ready demand if featured prominently by those dealers who have an eye to quick business. The records of most interest, perhaps, are those by A. D. Dobrochotof, who operates a new kind of instrument called a Balalaika, which combines a banjo, mandolin and guitar in one. Then there are another two fine records by Harry Champion, "A Member of the Force," and "Robin Redbreast." Other selections worthy of note are: Parts 1 and 2 of the Raymond overture, "On Jersey Shore, March" and "Austria March," "Russian National Hymn" and "Marseillaise," and "Rule Britannia" and "God Save the King," all by the Beka London Orchestra; "Song of Titania," from "Mignon," and "Last Rose of Summer," by Mme. Isabel Carol, and "All I Said was Ha! Ha! Ha!" and "Laughing All the Day," by Billy Whitlock. A really fine list!

A Premium on Enterprise.

Some material action has at last been taken against the police interference of traders rights in the matter of shop window displays. A meeting was held at the Holborn Restaurant recently for the purpose of considering the position in regard to the law of traders whose displays caused crowds to collect, thus obstructing the traffic. The gathering was summoned at the instance of certain trade journals in consequence of recent prosecutions of shopkeepers whose win-

dows had been too attractive in this way to the public. There was a large attendance of representatives from the leading London stores. The chairman expressed the opinion that the traders had a grievance against the police regulations which put an end to enterprise and novelty. Under present conditions if a trader arranged a display which attracted a crowd to his premises he was haled before the magistrates and penalized. If all were treated alike there would be no cause for grumbling, but places of amusement and newspaper offices, which attracted crowds, appeared to be exempt from prosecution. In these cases the police actually assisted in marshaling the crowds. Mr. Conly, legal adviser to the committee, explained that there was no defense in law where a shopkeeper occasioned an obstruction by causing a crowd to assemble outside his premises. A resolution expressing dissatisfaction with the present state of the law, and that a deputation be appointed to wait upon the commissions of police, was duly moved and carried unanimously. Gamage & Co., Catesby & Sons, and Selfridge & Co., large talking machine traders, strongly supported the resolution. It is to be hoped that the effect of this meeting will result in obtaining some concrete advantage.

Provincial News.

At the time of writing trade conditions in the provinces have shown little signs of improvement since my last report, and indeed, if anything, sales are on the downward grade. It is, however, not considered entirely unsatisfactory for the time of year, and then, too, the fortunate settlement of the great strike threatened in the coal industry has caused much rejoicing in Welsh trade circles, where talking machine prospects are much brighter in consequence. Around the Midlands business is reported to be somewhat quiet in machine sales, but Twin, Zonophone and Edison records still enjoy a pretty good demand. Disc machines of the portable type are gaining in popularity as a good summer line for dealers,

and some good orders have recently been placed with the London manufacturers.

Up Manchester way things are still somewhat unsettled. For over ten months now the cotton mill operatives have been working short time, and there seems a likelihood of further trouble arising out of the masters seeking to reduce wages 5 per cent. This would mean in the aggregate a loss to the operatives of something like £10,000 a week, and a corresponding loss to talking machine dealers, since at least 5 per cent. of this amount may be reckoned as surplus spending money. Despite such conditions, however, trade might be worse, but for all that it is significant that very little advertising is being indulged in by the Manchester factors. A trade exhibition to be held in Manchester during May will be supported by several musical instrument houses, and we are glad to learn that J. E. Hough, Ltd., makers of cylinder and disc machine records, have taken a large stand in a prominent position, with the object of stimulating trade in that city and Lancashire generally. Owing to the continuance of the coal strike, which shows no signs of settlement, business in the county of Northumberland is very depressed, and traders in talking machines are complaining bitterly of the absence of sales of any material note.

Irish ditties or melodies, we are told, are as popular north of the Tweed as they are across the Channel, so that the two special Irish songs appearing in the May list of Rena records are sure of a big demand in Bonnie Scotland.

Good Selections in Edison List.

The usual batch of good selections appear in the Edison record list for June, and are as follows: Amberol records—"Bohemian Girl Overture" (Balfe), and "Trafalgar March" (Zehle), by National Military Band; "Give It to Father" (David and Lyle), Miss Vesta Tilly; "Boss of the House" (Murphy), Jack Pleasants; "The Irish Emigrant" (Baker), Stanley Kirkby; "I Put On My Coat and Went Home" (Hargreaves),

BEKA RECORD

THE BEST DISC IN THE WORLD

The Largest and Most Comprehensive Repertoire in



German	Croatian	Siamese
English	Bohemian	Abyssinian
French	Grecian	Tamil
Italian	Arabian	Malayan
Russian	Turkish	Burmese
Polish	Chinese:	Hindustanee:
Spanish	Swatow	Urdu
Portuguese	Guakau	Marathi
Hungarian	Pekinese	Gujarathi
Dutch	Shansinese	Hindi
Danish	Kiangnanese	Tarai, and 15
Jewish	Cantonese	other dialects.
Roumanian	Japanese	

REPertoire ALWAYS UP-TO-DATE

For terms, etc., apply to

Beka Record, G.m.b.H., 75-76 Heidelberger Strasse, Berlin

Sole Agents for British India, Ceylon and Burma:
THE TALKING MACHINE & INDIAN RECORD COMPANY
15 Elphinstone Circle, FORT, BOMBAY

Sole Agent for Great Britain and Ireland:
O. RÜHL, 77 City Road, LONDON, E. C.

George Formby; "O Rest in the Lord" ("Elijah") (Mendelssohn), Miss Violet Oppenshaw; "The Fireman's Troubles" (David and Mayo), Arthur Osmond; "Can't We Take It Home with Us?" (Murray, Hilbury and Godfrey), Miss Florrie Forde; "My Old Armchair" (Scott and Williams), Billy Williams; "Dem Dear Ole Days," barn dance (Tregina), United States Marine Band; "The Garden of Roses" (Schmid), Joe Maxwell and chorus; "Larboard Watch" (Williams), Stanley and Gillette; "One More Day's Work for Jesus" (Lowry), Miss Marvin and Mr. Anthony; "Foxy Kid," cornet duet (Colburn-Ecke), Edison Concert Band; "Forgotten" (Cowles), W. H. Thompson; "My Jesus, As Thou Wilt" (Von Weber), Edison Mixed Quartet; "Moraima," Spanish caprice (Epinosa), American Standard Orchestra; "Peaches and Cream," Miss Ada Jones and Len Spencer; "Motor King March" (Frantzen), New York Military Band; "Farmyard Medley," Premier Quartet, and "Morgenblätter Waltz" (Strauss), Sousa's Band. Standard records—"Lifeguards' March" (Allier), and "The Coon's Patrol" (Lotter), by National Military Band; "The Land Where the Women Wear the Trousers" (Godfrey), Billy Williams; "Love Makes the Whole Year June" (Pether), John Roberts; "Blue Bonnets, Highland Schottische" (Balfour), Alexander Prince; "If You Should See a Little Soldier" (Castling and Murphy), Miss Florrie Forde; "I Cheered as the Boat Went Out" (Lonsdale), Arthur Osmond; "Rain, Rain, Go Away" (Mellor, Lawrence and Gifford), Stanley Kirkby; "MacPherson's Lament" (Old Scotch), J. Scott Skinner; "Father Coaxed Her In" (Murphy and Lipton), George Formby; "Salute to Washington March" (Sanford), United States Marine Band; "Underneath the Monkey Moon" (Meyer), Collins and Harlan; "What's the Matter with Father" (Williams and Van Alstyne), Billy Murray; "We Shall Meet Bye-and-Bye" (Main), Stanley and Gillette; "I've Set My Heart on You" (Le Roy), Manuel Romain; "Love's Torment Waltz" (Barthelemy and Caruso), American Standard Orchestra; "The Bulldog," college song, Peerless Quartet; and "Bachelor's Button" (Powell), Sousa's Band.

Public Wireless Service.

April 23 saw the opening of Marconi's transatlantic wireless telegraph service for public use between Europe and America. The rate is 7½d. per word.

More Record Litigation.

Some litigation has arisen over the raised edge rim on Favorite records. This is alleged to be an infringement of a gramophone record, and I understand that in consequence the Gramophone Co. have taken action against the liquidators of the firm of H. Lange's Successors, Ltd.

English Record Co. to Market Favorite Records. I hear that the English Record Co. have now



contracted arrangements with the Favorite Record Co., of Hanover, to supply the Favorite records for marketing under their hire-purchase scheme.

It Was W. Manson.

Owing to a typographical error, the name of Mr. W. Manson, in the article referring to the new Zonophone List last month was spelt incorrectly, but his friends soon had the matter right.

KLINGSOR WORKS TO MOVE.

To Occupy Much Larger Premises on Tabernacle Street—To Introduce New Record—Success of the Klingsor Products—Plans Undertaken for a Big Expansion of Business Throughout the Country.

(Special to The Talking Machine World.)

London, Eng., May 2, 1910.

A matter of more than ordinary importance this month is the information that the Klingsor works are shortly to remove from City Road to much larger premises at 22 and 24 Tabernacle street, close by, where they will continue the manufacture of the many successful Klingsor models, and, in addition, introduce a new record. In these days of strenuous competition only the best records can be expected to weather the test of time, and, recognizing this fact, the promoters of the Klingsor disc have arranged to submit to a discerning public something which, it is said, will create quite a sensation. The record is of the needle cut style, and although the price is not yet fixed, I am told that it will be such as to insure, in conjunction with quality, an immediate demand both from the traders and the talking machine public generally. Certain it is that no finer combination could be found than the Klingsor machine and Klingsor disc record, and in view of the fact that it will make its introduction under the best auspices, there seems indeed a splendid future for its commercial success. The new undertaking, too, will have the co-operation of two very powerful firms, whose names I shall be in a position to publish next month. Mr. A. Vischer, of whom there is no more popular man in the trade, is joining the organizer of this new concern, Mr. H. E. Heyder, whose conspicuous business ability and wide experience of the trade conditions in all continental countries must certainly go a long way to at once place the new Klingsor works as one of the foremost concerns in the trade. More anon.

COUNTERFEITING RECORDS.

Important Opinion Against Counterfeiting Records Handed Down by the Supreme Court of Germany.

The German Gramophone Co., of Berlin, some time ago began proceedings against two firms, one in Leipzig and another in Berlin, on the charge that these firms had copied and sold records in Germany and Russia made from original records sold by the plaintiff company. A temporary injunction prohibiting the manufacture of illegal copies of gramophone records was obtained against both defendants and suits for damages were filed. When the matter was heard on appeal by the Court of Appeals the opinion of the lower courts was confirmed in both instances.

The reasons for the decision coincided very

Don't Buy Needles That Damage Records



Bad Needles

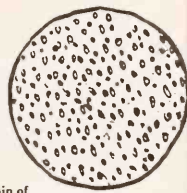

Grain of

Condor Needles

When a needle is running a record, the friction causes the polished surface of the needle to be taken off, while its interior (grain) is exposed and touches the sound waves.

Consequence:

The poorer the polishing and rougher the grain, the more the sound waves are injured!

Only *Condor Needles* are warranted to have always the highest and most perfect polish, smoothest grain. Using them means:

**Finest Reproduction,
No Ruin of Record.**

Sole Manufacturer

JOS. ZIMMERMANN

Needle and Pin Works

AACHEN, GERMANY

MR. RECORDER, do you know my **WAX "P,"**

the best existing recording material for Berliner- (Gramophone-) cut?
If not write for free sample to

CHEMISCHE
FABRIK

E. SAUERLANDT

FLURSTEDT
bei Apolda i. Th., Germany

The largest manufacturing plant in the world devoted exclusively to the manufacture of Master-Waxes for Gramophone and Phonograph

We are prepared to make every sale of the Columbia Grafonola on the basis of comparison. Once a prospective customer gets as far as comparison, its all over but the name and address on the order sheet.



Columbia Phonograph Co., Tribune Building, New York.

closely in both courts and were based on paragraphs 823 and 826 of the civil law dealing with the question of unfair competition, which recited, "Whoever intentionally and in a manner opposed to proper public policy causes damage to another, shall be liable to the latter for such damage and to make suitable compensation."

The Court of Appeals at Berlin adds further expressly that in this instance particularly the copying under the circumstances was most aggravating, the question as to whether others had done the same thing and manufactured counterfeits in a similar manner before was said to be immaterial, as the practising of a mischievous habit did not render the latter permissible in the eyes of the law.

In both instances the defendants appealed again to the Supreme Court at Leipzig (Reichsgericht) and this court has handed down a decision fully concurring with the views of the lower courts.

The business of making unlawful copies of talking machine records may now be regarded as legally prohibited at last. The disc and cylinder industry has been freed from a most serious handicap and should now make use of every opportunity as soon as it learns of any further counterfeiting, to take a most energetic stand against it. It is expected that when the new copyright law goes into effect it will contain a provision which will give further protection against making unlawful copies.—Die Sprechmaschine, Berlin, April 16, 1910.

A NOTABLE COINCIDENCE

When Wizard Edison Stumbled on Wizard Morse's Diary.

In the middle '80s Thomas A. Edison took a house in Gramercy Park, where he found himself very well situated for the leisure which he always enjoys, being by nature a reposeful man and not the grinding dynamo that people so often fancy him.

Few things suit better the mood of idleness than to poke aimlessly around an old house that has its legible traces and signs of human occupancy, and thus one day Edison found himself in the garret of the house, where some old furniture had been stored.

Opening one of the drawers he saw a flat, oblong book labeled "Daily Journal." To his great

astonishment, says the Metropolitan, this proved to be nothing less than an original diary kept by Samuel F. B. Morse, inventor of the system of telegraphy which bears his name.

The entries belonged to a brief but interesting period of his life, the year 1848, supplemented by transcripts of important correspondence dated back as far as 1843, when the electro-magnetic telegraph system was being constructed between Washington and Baltimore.

Edison put the book away carefully and took it with him when he established himself at his present country home in New Jersey. He has now placed it in the hands of the American Institute of Electrical Engineers with this comment in his accompanying letter:

"As this appears to me to be a matter of great scientific and public interest, I feel that this journal should be placed where it may be accessible to others, and I therefore take much pleasure in forwarding the same herewith and in presenting it to your institute in the hope that it may be deemed worthy of receiving a place among the mementos of the telegraphic art in your library."

That Edison himself, the great telegraph inventor of our own age, who stands next in line to Franklin and Morse as master of the electrical forces, should have chanced thus casually on such a lost relic of his predecessor is to say the least a notable coincidence.

"NEW RICHMOND IN THE FIELD."

The U. S. Phonograph Co. Makes Its Formal Debut with a Line of Machines and Records. An Important Announcement Worth Reading.

The first formal introduction of their line of machines and cylinder records is made by the U. S. Phonograph Co., Cleveland, O., on pages 12-13 of this issue of The World. It is a frank and candid statement regarding their product and doubtless the entire trade will read it carefully. The company term their machines the "U. S. Combination phonograph," and their records the "U. S. Everlasting records." Besides appealing to the trade the company will exploit their goods to the buying public through the medium of broadly circulated magazines, in which it is proposed to speak of what they say is "the development and perfection of what is

destined to be the most widely demanded line of phonographic goods in America." In explanation of this encomium it is further stated that the "U. S. line has an actual and provable superiority—convenience of operation, quality of tone production and indestructibility of records." The U. S. machine is a new instrument built on new lines and the record in substance and structure is unlike any other they report.

MAX LANDAY AT RICHMOND.

Max Landay, of Landay Bros., 400 Fifth avenue, New York, is attending the Piano Trade Exhibition in Richmond, Va., and will probably remain until it closes. Max is one good hustler and has a great many friends and customers among music dealers for his Talking Machine Supply Co. lines. This means he will write some good business, meet more new people and have a cheerful time besides.

JOHN C. BUTTON MARRIED.

John C. Button, assistant to H. A. Yerkes, manager of the Columbia Phonograph Co.'s wholesale department at headquarters, was married on May 4 in Washington, D. C., to Olive Lyle, daughter of Dr. and Mrs. Cornelius Lydecker Demarest, of that city. The ceremony took place in Calvary Baptist Church, and among the guests present were Edward D. Easton, president of the Columbia Co., uncle of the bride; Mrs. Easton, Miss Easton, M. D. Easton, Mr. Yerkes, Reginald Demarest, W. D. F. Baker, of the advertising department; C. N. Malliet and W. A. Kitchen, on the traveling staff of the Columbia Co.'s Chambers street store. The presents were numerous and handsome. Mrs. Button is also a cousin of George W. Lyle, general manager of the company, and sister of Reginald Demarest, Columbia manager at Hartford, Conn.

Following a reception at the home of the bride's parents, attended by a number of people prominent in the social and official life of the national capital, the happy couple started on a wedding trip to the coast, to be away a couple of weeks. They will be "at home" after June 1 at Arcola, N. J., the beautiful estate of President Easton, of whom Mr. Button was private secretary for several years.



Our "Elite" 9 Machines One of the Best.

FRITZ PUPPEL, G. m. b. H. BERLIN, S. O. BOUCHÉ ST. 35

Manufacturers of the cheapest and most popular

Disc Talking Machines and Phonographs

PUPPEL MACHINES INSURE BEST RESULTS

EXPORTED TO ALL COUNTRIES OF THE WORLD

Catalogues sent post free on application



Our Famous "Puck Phonograph."

TELEGRAPHIC ADDRESS: "PUCKAWO"

TRY IT!!

The only way to bring an indifferent customer back to the fold is to teach him how to use the Fibre Needle.

Just try it once and watch the result.

The whole combination is so radically different from what he has been accustomed to that his discarded machine immediately becomes a new fad.

“B. & H.” FIBRE MFG. CO.

35 W. Kinzie Street, Chicago, Ill.



SOLID WOOD (NOT VENEERED)

Mr. Dealer!

In last month's issue of this publication we offered to send the

MUSIC MASTER WOOD HORN

on approval. We were greatly surprised at the number of dealers who took advantage of the offer.

If you could see the complimentary letters we receive from these dealers, you would send at once for samples of the MUSIC MASTER on approval, and investigate our proposition.

Should your jobber be unable to supply you, write us, and we will send you a sample line of oak, mahogany or spruce disc, or cylinder horns.

If you are not entirely satisfied with the superior merits of the MUSIC MASTER, you can return them to us for credit.

SHEIP & VANDEGRIFT, Inc.

PHILADELPHIA, PA.

AUSTRALIA A GOOD MARKET

For Talking Machines and Supplies, Says Chas. Wortley—A Country of Great Possibilities.

A recent arrival at the executive offices of the Columbia Phonograph Co., general, is Charles Wortley, general manager of the Columbia business in Australia, with headquarters at Sydney. He is stopping at the Herald Square Hotel, New York, and will be here some time. Speaking of trade in that distant part of the world he said:

"Australia is one of the best countries in the world for the talking machine business. Australians are extremely fond of the machine and never seem to tire of the records. I think there are greater possibilities for the trade with us than any other part of the globe. All sorts of goods are sold in Australia, chiefly English, French and German, the latter make being chiefly cheap stuff. The cylinder record has the preference over the disc in Australia, strange

as it may seem; or rather, when one considers the popularity of the disc record in Europe and the United States. Of course, our best and most appreciated line of goods—because of their superiority over the European product—come from the States. Australians are naturally partial to anything and everything American, because, I suppose, we are nearer to you than to England. Business with us was never better, and there is every indication that it will continue."

R. CABANAS OFF TO EUROPE.

R. Cabanas, president and general manager of the Compania Fonografica Mexicana, of the City of Mexico, who is here with his bride on their wedding trip, sails for Europe Wednesday next on the "Lusitania" of the Cunard Line. He has had a very enjoyable visit at the headquarters of the Columbia Phonograph Co., general, New York, the officers showing him every possible courtesy.

THE TRADE IN BALTIMORE.

April Business of Satisfactory Volume Despite Unfavorable Weather—Dealers Well Pleased with Present Conditions and the Outlook—Cohen & Hughes Manager on the Road—What the Various Large Houses Have to Report Regarding General Business.

(Special to The Talking Machine World.)

Baltimore, Md., May 9, 1910.

Despite the extremely bad weather that prevailed during the latter part of April, there was a good business done by the talking machine people in this city. Summing up the reports of all the dealers, it is fair to say that the volume of business for the month exceeded that for the same period of 1909. This has been a source of encouragement to the experts of the trade who feel that they are in for a good spring business, while they also declare that they have every reason to believe that the summer trade will be much more active than for several years past. They express this opinion in regard to both machines and records as the activity of the past month has been in both branches of the business. Unlike the promoters of other lines of business, the men engaged here in the talking machine trade are very optimistic and are always looking on the rosy side of life.

Manager Joseph Grottendick, of the talking machine department of Cohen & Hughes music store, 315 North Howard street, has been on the road for a week or more extending the business of the firm to a number of points on the Eastern Shore of Maryland and Virginia, as well as in other sections of the State. Reports at the Cohen & Hughes store are to the effect that the firm has had a good month with the Victor and Edison machines and the records of the two concerns.

E. F. Droop & Sons' Co., who also carry a large line of Edisons and Victors, according to Manager Roberts, have been in the swim all during April, while the startoff for May has been very satisfactory. Manager Roberts contemplates an early visit to a number of the firm's customers in the State, where the trade has been showing up in good style.

At William McCallister & Sons, Baltimore street near Howard, similar bright statements concerning the trade are made. The company has been particularly busy furnishing the customers with the records of the latest popular songs. There has been a heavy raid on many of these. McCallister & Co. have a line of Victor and Edison machines.

Morris Silverstein & Co., who had been running a line of Columbia and Victor machines at 216 North Howard street, have moved from that location. Mr. Silverstein is well known in the talking machine field, having been manager for the Columbia Phonograph Co. at Louisville, Ky., and Baltimore stores before entering business on his own hook.

Sanders & Stayman have also been busy with the sales of Victrolas and Grafonolas, while the demand there for operatic and other records has been brisk.

Manager Laurie, of the Columbia Phonograph Co., and the several other houses here, make reports of a similar encouraging nature.

NEW VICTOR CONTRACT.

On May 4 the Victor Talking Machine Co., Camden, N. J., forwarded to their dealers a new contract or agreement, revised to May 1, for their signatures, which are then to be returned through the distributor with whom they have accounts. In their circular letter to the trade the company say: "There are no changes in the new contract from the old, of any importance. We have simplified the same by leaving the price list out of the contract, issuing that in separate form. By this elimination, our contract will not seem to grow obsolete so early and the price list can be readily revised and issued at intervals, when necessary."

THE COMPLETE CONVENTION PROGRAMME.

Planned to Make Every Moment of the Stay at Atlantic City Full of Interest—Time Between Business Sessions to be Given Over to the Full Enjoyment of the Pleasures of That Famous Resort—Headquarters at the Chalfonte—Every Progressive Jobber Will Be There.

Headquarters will be at the Chalfonte. Special rates have been arranged which will greatly modify the usual charges. Unusual arrangements have been made with the management of the hotel to provide every accommodation for the convenience and pleasure of the Association. Rooms, single and en suite, are reserved on one floor and adjoining each other, so that the association members will be grouped together and spared the annoyance of going from floor to floor. A certain section of the dining-room will be at the individual disposal of the association. Music, special attendants, including our own corps of waiters, bell boys and other attendants, have been proffered. With a further addition of very assured courtesy, the association members are guaranteed something very unusual.

Each member will have the entire freedom of Atlantic City and can govern his movements to suit his individual taste. The main features of the entertainment are enough to occupy the entire time, but anyone wishing to deviate in any particular, by reason of friends, acquaintances or special desires on his part, can do so ad libitum.

First Day, Tuesday, July 5th.

Personally conducted tour of the boardwalk and general features of the beach, immediately after breakfast until 11 a. m.

Bathing, 11 a. m.

Luncheon.

Association meet, 2:30 to 4:30 p. m.

Dinner, 6 p. m.

Dancing, 9 to 11 p. m., on Amusement Pier.

Old Vienna, 11 p. m. to 6 a. m.

Second Day, Wednesday, July 6th.

After breakfast, sail at the Inlet.

Bathing, 11 a. m.

Luncheon.

Association meet, 2:30 to 4:30 p. m.

Dinner, 6 p. m.

Personally conducted tour of Young's Pier and inspection of the Wireless Station. Numerous side attractions have been arranged for, allowing an assortment for selection that will meet any taste.

THORN NEEDLES PROVE POPULAR.

J. W. Jenkins & Sons Music Co. Report Encouraging Demand for That Product—Burton J. Pierce on Commercial Club Tour—Conditions in West.

(Special to The Talking Machine World.)

Kansas City, Mo., May 7, 1910.

The J. W. Jenkins Sons Music Co. are experiencing a very encouraging demand on their thorn needle. They report the receipt of orders from all parts of the United States. They have also received considerable inquiry from abroad.

Burton J. Pierce, manager of the talking machine department of the company, returned early this month from a week's trip through Northern Arkansas, Oklahoma and Eastern Kansas with the Kansas City Commercial Club. The crowd traveled in a special train and made about ninety towns in the territory named. "We found business conditions very satisfactory," said Mr. Pierce, "considering the fact that the recent cold weather has partly destroyed a large portion of the fruit and garden truck, and almost all of the country has been in need of rain, although the heavy rain we have had during the last 24 hours seems to have been general, and it will improve conditions wonderfully in the country.

"Our branch store managers in Oklahoma City, Okla., and Independence, Kan., are very hopeful for a splendid year's business. In fact, Oklahoma is booming to such an extent that they are bound to have a good year in that

10 p. m., Special Seashore Dinner with elaborate musical program.

Old Vienna follows until the wee sma' hours.

Third Day, Thursday, July 7th.

9 a. m., ball game between the Eastern and Western Jobbers at the Atlantic City Ball Park.

Bathing, 11 a. m.

Luncheon, 11 a. m.

Association Open Meeting, 2:30 p. m. Reading of special papers prepared by Association members and experts from the various talking machine factories.

5 p. m., English Afternoon Tea with light luncheon.

7:30 p. m., banquet at the Shelburne "Rose Room," specially decorated for the occasion, with elaborate menu and select musical program. Guests of honor: Emil Berliner, of Montreal; Eldridge R. Johnston, president of the Victor Co.; Leon F. Douglass, vice-president and chairman of the Board of Directors of the Victor Talking Machine Co.; Frank L. Dyer, president of the National Phonograph Co., and Edward Lyman Bill, Editor of The Talking Machine World.

Fourth Day, Friday, July 8th.

The association members will board the 9:30 a. m. train, arriving in Camden about 45 minutes later. As guests of the Victor Talking Machine Co., the association will visit the factory. After visiting this plant, luncheon will be served on the roof garden of the Hotel Bellevue-Stratford, Philadelphia. An interval will elapse before dinner, which will allow members to "see" Philadelphia. After dinner members are invited to join the representatives of the Victor Talking Machine Co. in attending a theatrical entertainment, following which supper will be provided at one of the leading cafes.

Fifth Day, Saturday, July 9th.

Specially arranged meet and visit at the Edison factory, Orange, N. J., a short run from Philadelphia. The officers and members of the Edison Co. will show the association their usual handsome attention, which will include ample provision for the entertainment and pleasure of all while in Orange.

section of a prosperous and go-ahead country.

"I traveled very extensively through the western part of Oklahoma four years ago, through what was then known as the 'short grass' country, and I passed through miles and miles of country without seeing any plowed ground. This year I went over the same territory, and, as far as the eye could reach, I could see nothing but land under cultivation, and everything seemed to be surrounded by a prosperous atmosphere. In spots, where a few years ago there was only grazing ground, I found splendid little towns. The people seem to be very progressive, and everyone of these towns claims to be the future metropolis of the Southwest.

"The talking machine is keeping pace with the business growth of the Southwest, and I found the various lines represented everywhere. Many dealers are complaining of business being slack at the present time, but are not at all alarmed, and are looking forward to a great increase in business as soon as the various crops are assured."

Robert Chanler, the famous ex-sheriff of Dutchess County, N. Y., brother of former Lieutenant-Governor Chanler, the fiance of Lena Cavalleri, the celebrated operatic singer, has a Grafonola de Luxe on which he plays only the records of her voice. Mr. Chanler is a man of means, and has provided himself with every Cavalleri record made, and during her present absence in Europe this is his mode of paying homage to his fiancee. They will be married in October, when the lady returns to this country.

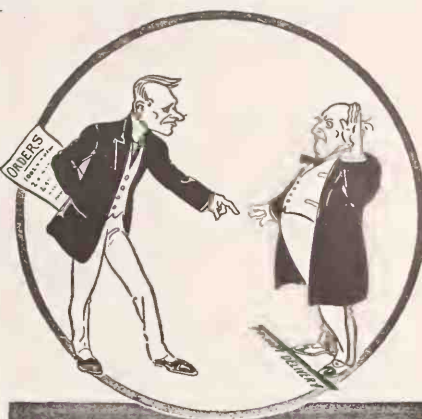

Make your jobber "toe the mark"

You can't take the proper care of your customers unless your jobber does his part by you.

If he doesn't send goods to you promptly and makes you keep your customers waiting, he is working against you, and all your efforts to please your customers and build up a larger and more profitable business will count for nothing.

You want your customers to depend on you to have what they want or to get it for them quickly. And you ought to have a jobber you can depend on. If he values your trade, he will show it by taking care of it.

Nothing slow about us in filling orders. We always have a large stock of Victors, Victor Records, Victrolas, record cabinets, horns, fibre cases, needles, extra parts and accessories of every kind right on hand, and all orders are packed and shipped the same day they reach us.

We help you best by helping you to please your customers. We know that means more money and increased trade for you—and we'll get our share of the business from you.

Good idea to give us a trial order for the things you generally have the most trouble to get. That will be a pretty good test of what you can expect from us.

Write to-day for our latest catalog and our booklet, "The Cabinet That Matches."

New York Talking Machine Co.

Successors to

Victor Distributing and Export Co.

83 Chambers Street

New York



The Columbia business in both machines and records is so far ahead of last year, that it takes three figures and a per cent. mark to express it.



Columbia Phonograph Co., Tribune Building, New York.

TIMELY TALKS ON TIMELY TOPICS

While it is true the marvelous growth of the talking machine industry was materially checked by the financial depression of the past years, the plants of the principal manufacturers have been steadily expanding. To be sure, much of the work along these lines was probably laid out before the monetary disturbance of 1907 had materialized. At any rate, at the present time none of the three big companies whose fame is world-wide, but is crowded for room capacity. It is true the advent of the high priced lines is responsible in great measure for the volume of business now booked or in sight.

The National Phonograph Co., Orange, N. J., have a group of buildings which are worth a long journey to see. A recent visit to the plant by The World revealed many improvements and enlargements of which the trade at large possibly are not aware. In the hands of Sales Manager Dolbeer this expansion, under way and to be undertaken in the near future, was made clear. The Edison works own a large tract of land where the plant is located, and it is gradually being covered by concrete buildings of massive and impressive appearance.

Only a couple of the old low frame buildings

survive, and these will in time be replaced by others of a more substantial structure. Several of the lofty new buildings will be extended in some instances fifty and a hundred feet, so as to provide for what the company feels assured will be many prosperous years. The introduction of the Amberola cabinet and Amberol records has opened up an entirely new field of activity, and for months the capacity of the plant to supply these goods has been employed. In the record-moulding department a new method of "spinning" has increased the production greatly, the process being simplified and the output running up to 600 completely finished records an hour.

The wonderful factory of the Victor Talking Machine Co., Camden, N. J., is going ahead with such rapid strides that those not actually in close touch with its affairs at first hand would scarcely realize. Where only a few years ago one modest building was sufficient to house the entire business, now stands a group of magnificent brick and concrete structures covering many acres of ground, running from the Delaware River front back a half dozen squares. The buildings are consecutively numbered, and when one notices 60 there is a real basis for astonishment.

A visitor will occupy nearly three hours in going over the Victor plant, on a steady go all the time, and then not get into everyone of the departments or loiter very long to witness some particularly interesting process or operation. The business or executive end of this celebrated company occupies one large building alone. The structures accommodating the various manufacturing departments, every one of which to the person not familiar with the work of making talking machines, records, etc., is a study. If it will be borne in mind that nearly everyone of the processes involved in the manufacture of talking machines—or, as the intelligent guide, with considerable pride, will doubtless inform his guest, the "Victor is a scientific apparatus for the reproduction of sound, not a talking machine"—and disc records were originated, developed and perfected for the work, he will be still more amazed. Such is the fact, however.

The trade are prone to take everything for granted, and comparatively few, indeed, have a conception what a splendid organization is represented by the personnel of the Victor Talking Machine Co., from President Johnson and General Manager Geissler down through the ranks to the humblest employe in the most unimportant department of the service. The affable general manager, whose consistent policy and indefatigable industry, aided by a capable corps of alert and resourceful assistants, has done so

much toward building up the present gigantic business of the Victor Co., speaks with pardonable pride of what has been accomplished. With a record of 97,000 unfilled orders for machines on the books, a demand for Victrolas running into such high figures that all records are broken, the company are literally swamped, so to speak, with business. So true is this that, as related more in detail by a special correspondent, the cabinet-making plant, designed on such a scale as was deemed sufficient to meet every requirement, is now so inadequate that a new building was recently decided upon and is now being hurried to completion that will double the capacity. The writer, who had the pleasure of witnessing the industrial activity embodied in the Victor plant, could keep right on describing at length that what is an every day operation, but lack of available space compels him to desist. In conclusion, it might be said, however, that if a dealer is ever in Philadelphia and fails to visit the Victor plant he will miss a sight long to be remembered.

The trip to South America recently concluded by Walter Stevens, manager of the export department of the National Phonograph Co., the narrative of which appears on another page, is worth a careful perusal by readers of The World. Aside from his graphic description of the points visited, manners of the people and intelligent summing up of the business methods—ceremonious to a degree—followed by our Latin-American neighbors, he gives point to the fact that the American flag is seldom seen on any vessels in these ports. The lack of banking facilities in the hands of Americans is also dwelt upon, though a movement is on foot to establish a financial institution in Rio de Janeiro. The lack of shipping and direct transportation connections with the United States is also spoken of as to be regretted. Mr. Stevens' candid opinion concerning the glorious opportunities for the American manufacturers of talking machines in South America is shared and endorsed by everyone who ever has traveled in that part of the world. Needless to say, the field is not neglected, but is being sedulously cultivated, and the companies now shipping their product to that vast market are not allowing any grass to grow under their feet.

Last week the export department of the Columbia Phonograph Co., general, issued a supplementary list of their August double-disc records for the Spanish-American countries. The bulletin includes twenty-two selections, in band, orchestral, instrumental and vocal music. The names of some well known native artists appear, among them admirable records, of which shipments were made at the same time.

The time for a man to retire from active business depends on conditions. Some men are young at seventy; others are old at fifty. The method of living, the occupation, habits, successes or failures all have their influences.

Talking Machine Dealers ATTENTION!



Here is a "hot-weather" BUSINESS STIMULATOR. BIG SALES—BIG PROFITS are within your reach if you represent us on the

ICY-HOT

bottle in your territory. Your customers are in need of the "ICY-HOT" in their homes, on their travels, when camping, automobileing, fishing and in a hundred different useful ways. A PROFITABLE SIDE LINE FOR YOU TO CARRY. The "ICY-HOT" bottle is guaranteed to keep contents either steaming hot for 24 hours or ICY cold for 72 hours. Write for our SPECIAL PROPOSITION to represent us in your city. Illustrated booklets for the asking.

THE ICY-HOT BOTTLE CO.
207 Longworth Street, CINCINNATI, OHIO

AROUND THE BOSTON TRADE.

Business Is Normal—Publicity Brings Results—Columbia Progress—Eastern Talking Machine Co.'s Progress—Steinert's Attractive Quarters—Business Active with Oliver Ditson Co.—Special Summer Service Inaugurated by the Boston Cycle and Sundry Co.—News of the Month.

(Special to The Talking Machine World.)

Boston, Mass., May 10, 1910.

"Normal" consistently sums up talking machine conditions in Boston. April, as a rule, is expected to bring a little lull in sales of every character, and, while this is true more or less this year, there was no decided break in volume. On the contrary—outside of a little lessening—business is in a good staple state. A feature of the month was the large increase in instalment business on the lower-priced machines, as goods of this character are always in active demand during the spring. This is natural, owing to the opening of summer cottages, camps and canoe clubs, which, of course, carries with it a contingent call for records and supplies. There was a fair gain in orders for the high-priced "talkers," as these have been firmly established in the mind of the public as the acme of talking machine construction—an instrument that is musical and ornamental to the fullest degree.

Dealers Advertise Liberally.

A vigorous campaign of newspaper advertising has been maintained during April by the retail distributors of talking machines. It was not uncommon to see several large-sized "ads" of different dealers appearing on the same day, and this is something that has not been witnessed for some time. Books and circulars galore have been mailed to the trade, customers and prospects, and this, with the general publicity of the home offices, ought surely to be of immense advantage in securing an excessive May business, hearing in mind the phrase that "Advertising of all kinds helps all kinds of advertising."

"Columbia Conciselets."

Here are some "Columbia Conciselets": The National Sportsman Co., of this city, have taken on the Columbia line exclusively, starting with a complete stock of machines and records.

F. E. Hightner, formerly with the Columbia Phonograph Co. in Toledo, is now connected with the Boston end, where his efforts are proving particularly successful.

George P. Donnelly, former assistant manager of the Columbia Co.'s Boston store, has been transferred to Portland, Me., with the lettering on his private office reading, "Manager." There is no doubt but that his ability and experience will stimulate an increased Columbia business in that territory.

The Household Furniture Co., of New Bedford, Mass., is another concern to secure the exclusive Columbia agency. A complete line of goods, including all the new-type machines and records, shows the confidence they have in the fast selling qualities of "Columbia's."

Arthur Erisman, the genial manager of the Boston store, reports a very satisfactory business for the past month. "Of course we experience no grand rush," remarked Mr. Erisman, "but the fact is that a seasonable business was transacted. It is very gratifying to note the activity in Columbia Grafonolas—the library table style—which we are producing in many kinds of woods. The mission oak style is proving very popular for hungalows, club rooms and summer homes, while the oak, mahogany and other finishes easily match the environs of the library, parlor or living room of the modern home."

Some of the hoys in the Columbia warerooms are wearing a pretty watch fob, with the complements of the home office. It is a reproduction in gold and black of the notes and bar which comprise the Columbia trade-mark.

"Window-decorator" Mason says he has something in mind for an artistic window display that will make passersby "stop short and notice" the merits of the Columbia line. His accomplishments in the past have been A-1, so he will

It will interest The World readers in Boston and New England to know that a larger service will be rendered the interests of the trade in that section of the country in the columns of this publication than heretofore.

We have opened World headquarters at 180 Tremont Street, Boston, Mass., with Glad. W. Henderson in charge.

Mr. Henderson, whose training in business and journalistic life especially fits him for the work before him, will devote his time and energy to furthering World interests in Boston and vicinity.

He is admirably qualified to strengthen The World lines and to render to the trade a specialized service which will be of obvious advantage.

He enters upon his managerial duties with the desire to give to the Boston and New England trade a service which will be beneficial in every way.

Editor The Talking Machine World

have to "go some to exceed his foregoing efforts.

E. T. M. "Bulletin Board" Service.

As a means of acquainting the sales force of the Eastern Talking Machine Co. regarding changes in goods, new records, local advertising and other details that are constantly arising, this company has instituted a "Bulletin Board" service. Items are tacked on this board from time to time, as they occur, and as employees are expected to read the "Board" daily they are fully

SAVE THE LIFE OF YOUR RECORDS
 BY USING **THE PLACE AUTOMATIC RECORD BRUSH**
 FOR EDISON PHONOGRAPHS AND VICTOR TALKING MACHINES.

PATENTED {September 25 and October 2, 1906 and September 10, 1907.

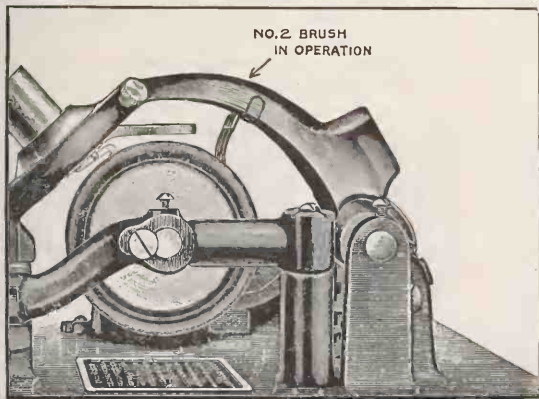

NO. 2 BRUSH IN OPERATION



No. 1



No. 2



No. 3

PRICE, 15 CENTS

CAN BE USED ON ALL PHONOGRAPHS

Removes lint and dust from record automatically. Saves Sapphire from wearing flat and prevents rasping sound. Insures a perfect playing record. It is equally as efficient when recording. It is too cheap to be without.

No. 1 fits Triumph No. 2 Standard and Home No. 3 Gem and Fireside



THE PLACE No. 10

DISK RECORD BRUSH
 FOR
VICTOR EXHIBITION SOUND BOX
 PRICE, 25 CENTS

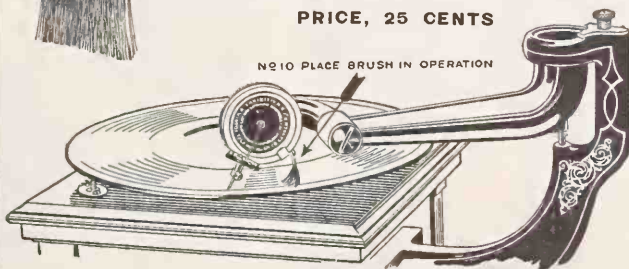

NO. 10 PLACE BRUSH IN OPERATION

PRESERVES THE LIFE OF DISK RECORDS

Automatically cleans the Record Grooves and gives the needle a clean track to run in. Insures a clear Reproduction and prevents Record getting scratchy. Makes the Needle wear better. Dust and dirt in the Record grooves wear the record out quickly and grind the Needle so it cuts the Record. SAVE THE LIFE OF YOUR RECORDS.

FREE SAMPLES will be sent upon request to any Jobber or Dealer who don't handle them. **Write Now**

DEALERS are requested to get their supply from their regular Jobber. If he will not supply you write us for the name of one who will.

MANUFACTURED BY

BLACKMAN TALKING MACHINE CO.

J. NEWCOMB BLACKMAN
 President

97 CHAMBERS STREET, NEW YORK

"The White Blackman"

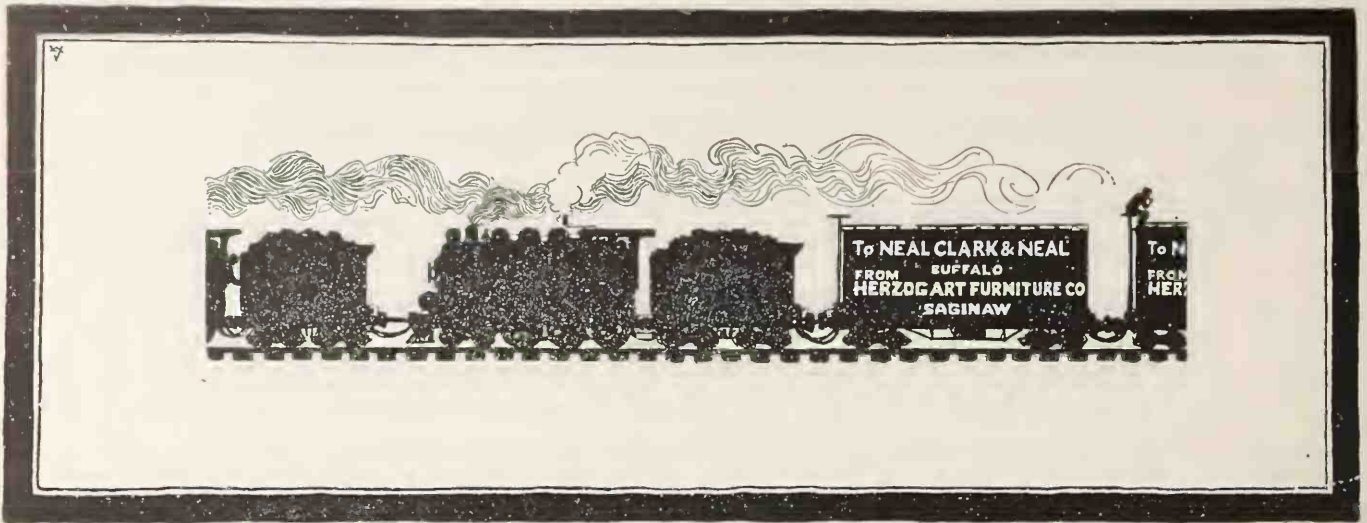

GREATEST CABINET SALE EVER KNOWN

Entire Stock of the Herzog Art Furniture Co. Closed Out to Neal, Clark & Neal Co., Buffalo.

90 Per Cent. of All Phonograph Cabinets Have Been Built by this Well-known Company

33 ¹/₃ % DISCOUNT







On this Train Load of Cabinets

if you buy any ten or more cabinets in one order. 27 1/2 per cent. discount if you buy five cabinets. 20 per cent. discount if you buy one or two cabinets as specified. All cabinets mahogany finish except No. 724 which is oak.

Buy now while we can fill your order completely. When one line is sold out we will substitute nearest style and price.

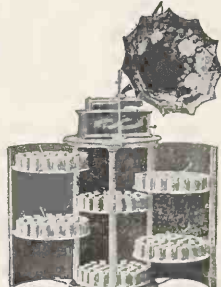
Cabinets hold following records: No. 700, 100; No. 701, 96; No. 704, 120; No. 714, 216; No. 718, 252; No. 724, 215; No. 703, 100; No. 702, 120; No. 706, 150; No. 715, 150; No. 719, 150; No. 712, 216; No. 713, 216; No. 717, 252; No. 720, 294; No. 722, 294; No. 708, 150; No. 707, 150.

							
No. 700. Dealers, \$7.25 Per 10.. 4.83 " 5.. 5.25 " 2.. 5.80	No. 703. Dealers, \$7.25 Per 10.. 4.83 " 5.. 5.25 " 2.. 5.80	No. 702. Dealers, \$8.75 Per 10.. 5.83 " 5.. 6.37 " 2.. 7.00	No. 704. Dealers, \$8.75 Per 10.. 5.83 " 5.. 6.37 " 2.. 7.00	No. 706. Dealers, \$10.00 Per 10.. 6.67 " 5.. 7.25 " 2.. 8.00	No. 708. Dealers, \$10.00 Per 10.. 6.67 " 5.. 7.25 " 2.. 8.00	No. 707. Dealers, \$13.75 Per 10.. 9.17 " 5.. 9.97 " 1.. 11.00	No. 715. Dealers, \$12.50 Per 10.. 8.33 " 5.. 9.06 " 1.. 10.00

						
No. 715. Dealers, \$17.00 Per 10.. 11.33 " 5.. 12.33 " 1.. 13.60	No. 714. Dealers, \$13.00 Per 10.. 8.67 " 5.. 9.43 " 1.. 10.40	No. 716. Dealers, \$14.00 Per 10.. 9.33 " 5.. 10.25 " 1.. 11.20	No. 724. Dealers, \$23.50 Per 5.. \$17.04 Per 10.. 15.87 " 1.. 18.80	No. 717. Dealers, \$20.75 Per 10.. 13.83 " 5.. 15.04 " 1.. 16.60	No. 718. Dealers, \$15.50 Per 10.. 10.33 " 5.. 11.24 " 1.. 12.40	No. 701. Dealers, \$5.50 Per 10.. 3.67 " 5.. 3.98 " 2.. 4.40

			
No. 720. Dealers, \$18.00 Per 10.. 12.00 " 5.. 13.05 " 1.. 14.40	No. 712. Dealers, \$12.25 Per 10.. 8.16 " 5.. 8.90 " 1.. 9.80	No. 722. Dealers, \$19.50 Per 10.. 13.00 " 5.. 14.14 " 1.. 15.60	No. 719. Dealers, \$15.00 Per 10.. 10.00 " 5.. 10.87 " 1.. 12.00

Victor and Edison Distributors
150,000 Records Always in Stock

TRY OUR IMPROVED SERVICE
WE CAN PLEASE YOU

NEAL, CLARK & NEAL COMPANY

643-645 Main Street

BUFFALO, N. Y.

632-634-636 Washington Street

versed in all the late news. It occupies a relative position of a newspaper's bulletin and the information thus obtained keeps the salesman fully apprised of transpiring events in the selling field.

Inaugurates "Special Summer Service."

Charles R. Cooper, manager of the talking machine department of the Boston Cycle and Sundry Co., Edison jobbers, reports an extensive trade, both wholesale and retail. Mr. Cooper has inaugurated a scheme for the benefit of their patrons during the coming months which is covered by the slogan, "Special Summer Service." Edison dealers will find this bureau to be of great assistance for rapid shipments of orders—one that will save dollars when it comes to a rush. Mr. Cooper feels confident that the dealers of the country will be pleased at the innovation, and he bases the theory that he practices on the ground that even a slight delay will jeopardize profits that rightfully belong to the dealer. And this "service" ought to secure some good new accounts.

John L. Gately, New England representative of the Victor Talking Machine Co., is making a "fine-tooth comb" trip of this territory, at present being in Maine.

C. E. Osgood Co.'s Handsome Window.

Picture in your mind a tent in the woods, pine trees, log fire, a little pond in the distance and a man sitting cross-legged smoking and listening to the strains of a Victor talking machine and you have the whole "plot and story" of the window display of the C. E. Osgood Co. Manager C. J. Sylvester, of the Osgood talking machine department, is the "instigator," and this reproduction of a camp scene is a most longing appeal to vacationists to hie away with a Victor. It is getting business, too, judging from the inquiries to look at a machine "like the one in

EXPERT

On manufacturing of records has a frictionless method of recording up and down groove for sale. L. J. Schramek, 416 E. 77th street, New York City.

WILL BUY

Wanted cheap disc or cylinder talking machines, suitable for premiums. Must be cheap in price. International Publishing Co., Box 903, Tucson, Arizona.

FOR SALE QUICK TO HIGHEST BIDDER

425 Columbia D. D. Records, 350 Columbia Indestructible Records. Reason for selling—have gone into another business. All new records. Terms, C. O. D. Address, "Bedgood," care Talking Machine World, 1 Madison avenue, New York City.

LIVE SALESMAN WANTED

Good live wire to sell dictaphones and manage department in a hustling city near New York. Fine opportunity for energetic salesman to make good. State compensation expected and references. Box 300, Talking Machine World, 1 Madison avenue, New York City.

FOR SALE

Our Talking Machine Business in Stockton, Cal. This is the best opportunity in California for this business. Reason for selling, we wish to devote all our time and money to the piano business. Write for particulars. McNeil & Co., Elks' Building, Stockton, Cal.

FOR SALE

FOR SALE, or will take partner; have two stores in city of 125,000 inhabitants; desirable location in Sunny South. Victor-Edison in one, and Columbia exclusive proposition in other. Practically no competition. Prefer to sell half-interest, but will sell all. Will make easy terms to right man. Address "PARTNER," care Talking Machine World, 1 Madison Ave., New York.

CHANCE TO BUY FOREIGN RECORDS

First-class German disc manufacturing company with large repertoire (particularly in Russian, Roumanian, Hungarian, Hebrew, Arabian, Chinese, etc.), wishes to contract for important quantities. Address offers, etc., BOX 500, care Talking Machine World, 1 Madison Avenue, New York City.

the window." Mr. Sylvester predicts a large May business.

Forty cents bought 50 high-priced records, including a case to carry them in, at the recent auction of unclaimed express packages held by a local company. History repeats itself; and by rigid economy some of the boys say they will be on hand at the next sale with the aforesaid amount, hoping for a repetition.

A. W. Chamberlain, assistant general manager of the Eastern Talking Machine Co., says from his observations that the ensuing months will show a brightening of trade that will be decidedly pleasing to the talking machine fraternity.

Commodious Quarters of M. Steinert & Sons.

One of the big sights of this city is the large talking machine emporium of the M. Steinert & Sons So. They occupy entirely one large building containing five stores, where every possible convenience and improvement is employed in the conduct of their business. On the first floor are numerous sound-proof booths for the use of customers, salesmen's desks and general sales headquarters. In one corner of the second floor is the private office of Manager Royer (one of the most popular "talking men" in the country). The auditing department is also located on "the second," with the remaining space devoted to a magnificent stock of records. The third floor finds a huge number of the many styles and types of Victor machines, with the fourth floor being occupied by the repair department. In the two extremes—the top and the basement—are to be seen the shipping ends and other various departments. It's a monument that testifies to the big volume of business that this company handles each year, including a gracious testimonial to Victor selling qualities.

Oliver Ditson Co. Active.

Meteor Needles, which are controlled exclusively by the Oliver Ditson Co. are meeting with marked success everywhere. The trade all over the country have ordered them in large lots, and the wide and continuous distribution of Meteor Needles is the best evidence that can possibly be cited. Manager Henry Winkleman, of the Ditson Victor department, still has the illness diagnosed as "Can't get Victrolas fast enough." The symptoms of this disease are a quickening of the pulse accompanied by a flushed face at the pleasure of booking Victrola orders, followed by a chill at the thought of losing those profits because of inability to secure the machines.

AEOLIAN ADDS TALKING MACHINES.

Reported That Great Company Will Establish Talking Machine Departments in Their Various Branch Stores and Become Victor Distributers at St. Louis—Arthur D. Geissler Swings Big Deal.

There has been a great deal of whispering in the Western trade the past week or so regarding the effecting of a large deal by which it is said the Aeolian Co. will enter the talking machine trade on a large scale, establishing Victor departments in their various branch stores and lending their immense prestige and bringing their vigorous advertising and exploitive policy to bear on the talking machine business in the various cities where they have their own retail branches.

It is learned that Herman B. Schaad, of the Aeolian Co., and Arthur D. Geissler, manager of the Talking Machine Co., of Chicago, have been in St. Louis, Indianapolis, Cincinnati and Dayton, making arrangements for the rearrangement of these stores for the establishment of Victor departments.

It would appear that to Mr. Geissler is due the credit of initiating and carrying the deal through, and it is reported that he has arranged for the sale to the Aeolian Co. of the stock and business of the St. Louis Talking Machine Co., Victor distributors to the Aeolian Co., who will remove the stock to their own store in that city. This will make the Aeolian Co. Victor distributors in that city and enable them to sell all

their branches in the leading cities from that point.

The conversion of the Aeolian Co. to the talking machine idea seems to have had its inception in the fact that when they recently bought the lease of the Bissell-Cowan Co. in Chicago for the establishment of their new branch in that city they found a well-established Victor department, which it was decided to continue as an experiment and which promised so well that Manager Tom Fletcher became an enthusiast and used his influence to the company to take up the matter along the lines indicated above.

The above report is confirmed by the Aeolian Co., who added that it would not be long before they would be Victor dealers.

The Talking Machine Co., of Salt Lake City, have filed articles of incorporation in Utah for the purpose of carrying on talking machine and music business, with a capital of \$25,000. N. W. Clayton is president; Ashton B. Snow, vice-president, and C. C. Clayton, secretary and treasurer.

SONORA

"The Instrument of Quality"

HIGHEST CLASS



Talking Machines
and Records

To be Used With Either Needle or Sapphire.



INVISIBLE HORN

for Beauty and Comfort.

TONE MODIFIER

for Variety of Tone.

AUTOMATIC STOP

for Convenience.

COVERED CASES

to Eliminate the Scratch of the Needle.

SAPPHIRE SOUNDBOXES

for Perpetual Needle.

SAPPHIRE RECORDS

for Ten-fold Wear.

Sonora Phonograph Co.

78 Reade Street, NEW YORK, N.Y.

The Columbia Grafonola means to every Columbia dealer a new class of customers and a new era of prosperity. Ask yourself if you are willing to be left out of it.



Columbia Phonograph Co., Tribune Building, New York.

JOBBERS' ASSOCIATION ACTIVE.

Work of Association Benefits Entire Trade—
Preparations for Convention at Atlantic City Under Way.

In reviewing the work of the National Association of Talking Machine Jobbers, J. Newcomb Blackman, vice-president of the association and chairman of the Press Committee, said in a chat with *The World*:

"To the chairman of the Press Committee of an association is allotted the task of letting the trade know what the association is doing. This would not seem so difficult were it not for the fact that the association desires to be modest without creating the impression that nothing has been accomplished as a result of association work.

"We cannot by any means claim that every favorable change or action taken on the subject by the manufacturer, after presentation through the association, was a direct result of its work. Let us first remember that while we may present some good suggestions to the factories it remains for them to use them, and in doing so we want them to get due credit. Experience has proved that committees representing the association have often seen matters in a different light after hearing some of the problems that confront the situation from a factory standpoint.

"On the other hand, the jobbers have been able, by reasoning, to convince the factory officials on certain points from the jobbers' standpoint which, when presented by a single individual, might not have been considered seriously.

"We jobbers don't pretend to know how to run a talking machine factory, but as the Edison and Victor companies have chosen to market their goods through us as their representatives, it is natural that we should be a little closer to certain situations than the factory. Committee meetings seem to be a continuous performance in both the Victor and Edison works. There are day sessions and night sessions, and in this way the knotty problems are unraveled. It is not human nature and customary to take the path of least resistance, and in such meetings, therefore, agree with the man higher up, perhaps at the expense of what should be the real result of the conference.

"This does not exist to such an extent in our jobbers' meetings, for we are all on an equal basis. How many times have important moves been made by officials in all lines of business when a mistake, afterward discovered, was presented in ample time, but not considered because of the position held by the one with the opinion? In these progressive days can we afford to overlook a suggestion made with best intent, though it come from a man on the low rungs of the ladder? At least the suggestion is worth some consideration.

"What we want between jobbers and the factory is confidence in each other to the fullest extent. Each ready to yield and placing ourselves in the position of the other, thus treating with as little selfishness as possible everything at issue. With this spirit the factory interest will

be ours and ours will be theirs, and the result of conferences will ripen into decisions that bespeak advancement and prosperity.

"The above is not to be construed as an evidence of lack of harmony, but for the benefit of any jobbers who doubt the importance of the Jobbers' Association and for those in the factories who might prefer fewer suggestions from the jobbers as an association. Every member of the association has been advised direct from time to time as to what the association was doing, as trade papers are not the best medium in which to give the details of association work. Rest assured, therefore, Mr. Manufacturer, that we propose to hold confidential and personal, to the parties interested, the details of our association work.

"We do desire to go on record for publication as approving the friendly receptions our committees are receiving at the hands of the factories, for it makes us think you have confidence in us and it will encourage extra effort on the part of the members of the association to have you increase it, if possible.

"The Jobbers' Association has been successful from the start and all in the trade have benefited in the results. Is there a jobber who can honestly say otherwise and should not feel obligated to support the association by his membership and the payment of dues, even though he should do nothing else. Every name on the roll of members gives strength and importance to the organization.

"The last two conventions at Atlantic City were pronounced a success, and it remains with the jobbers and manufacturers to make the coming one at the Hotel Chalfonte, July 5, 6 and 7, bigger and better than ever. J. C. Roush, of the Standard Talking Machine Co., of Pittsburg, secretary of the association, is also chairman of the Committee of Arrangements for the coming convention. Give him all the help you can to get everybody in your territory to attend the convention. Last year they talked hard times or most anything for an excuse not to come.

"This year business has certainly been better and it should take very little coaxing to be convinced that your attendance at this year's convention will be a good investment. Use Sunday, the 3d, and Monday, the 4th, to travel, if necessary, but be on hand on the 5th. The hotel rates, etc., are a duplicate of last year, and details of same can be obtained from Mr. Roush.

"In addition to the natural attractions of Atlantic City there will be an arranged program of entertainment, with ample time so that the business meetings will not interfere with the pleasure program."

Reformers will swarm at the Richmond conventions. But those who mistake the excitement and agitation of reform for the source of danger, must have overlooked all history.

Unfailing politeness will do your store more good than daily bargain sales.

If you are a dealer in the city or a life-size town where much business correspondence is carried on, we want you to investigate

The Edison Business Phonograph

the greatest business appliance of the age.

Business men everywhere now dictate their letters to the Edison Business Phonograph, because it saves at least half their time.

It also saves half the actual writing time of the typewriter operators who transcribe from the Edison Business Phonograph.

It also saves all of the time in which the stenographer is ordinarily engaged in taking shorthand notes.

It cuts the cost of letter-writing in two—and every business man will listen to that argument, if you can prove it. And you can prove it with the Edison Business Phonograph.

The whole business world is your field, the game is young and the profits are generous.

Write us for full particulars to-day.

Edison Business Phonograph Company, 207 Lakeside Avenue, Orange, N. J.

THE RICHMOND EXHIBITION.

The Talking Machine Companies Will Be Well in Evidence at the Great Exhibition Which Opens at Richmond, Va., Next Monday in Connection with the Convention of the Piano Manufacturers and Dealers to be Held in That City—Those Who Will Attend.

At the Piano Trade Exhibition, which opens at Richmond, Va., this week, remaining open from May 16 to 21, four talking machine manufacturers are making an elaborate display of their products. As stated elsewhere this marks a new era in the history of the music trade, dignified always, and generally opposed to innovations of a radical nature. At least this is the first time that the talking machine is officially recognized as a musical instrument, the entertaining qualities of which embody the most splendid and artistic of vocal and instrumental triumphs in the realms of music.

The companies who are exhibiting the latest and most perfect products of their great factories include the Columbia Phonograph Co., general, New York; National Phonograph Co., Orange, N. J.; United States Phonograph Co., Cleveland, O., and the Victor Talking Machine Co., Camden, N. J.

Booths 8 and 9 will be occupied by the Columbia Phonograph Co., in which a complete line of Grafonolas—De Luxe, Regent, Elite and Mignon—will be displayed. The Grafonola Mignon is



H. A. YERKES, COLUMBIA CO.

shown for the first time. Besides every type of machine—disc and cylinder—will be exhibited. There will be also a selection of double disc and Indestructible cylinder records. The representatives of this company present will include H. A. Yerkes, manager of the wholesale department; George P. Metzger, manager of the advertising and publicity department; T. K. Henderson, manager of the company's distributing branch in Philadelphia, Pa.; Ben Feinberg, special traveling envoy.

The National Phonograph Co. will occupy booths 23 and 24, displaying likewise a complete line of their beautiful Amberola concealed horn cabinet machines, together with a line of their regular machines, namely, the Gem, Home, Fireside, Triumph, Ideal, etc. Besides a fine lot of Amberola and Standard records will be on hand for demonstrating purposes. The gentlemen who will be present to meet the trade are F. K. Dolbeer, sales manager; "Colonel" J. W. Scott, chief of the traveling staff at large, and C. E. Goodwin, manager of salesmen.

In close proximity to the other companies in this line the United States Phonograph Co. will be found, and their goods of the cylinder type



LOUIS F. GEISSLER, VICTOR CO.

exclusively will have their initial introduction as a trade product. Four models of machines will be exhibited in connection with their new Everlasting record, of which great things have been reported in point of fine finish and clear reproduction. T. H. Towell, general manager of this company, will be in charge.

The Victor Talking Machine Co. are on spaces 27 and 28, where an elegant exhibit of this great



F. K. DOLBEER, NATIONAL PHONOGRAPH CO.

company's line will be placed. These include the wonderfully successful Victrola—all the various types and finishes, running as high as \$500 for the Vernis Martin cabinets. A complete line of their standard machines from Victor O to VI, will also be displayed, with the various horns known to the trade. In records, the famous Victrola and Red Seal and regular single and double-disc goods will be in full supply. Louis F. Geissler, general manager of the company, assisted by a competent corps of assistants from the traveling staff, will be in attendance.

E. T. M. CO. ASSOCIATES GIVE SHOW.

Provide Evening's Entertainment in the Role of Minstrel Men—An Excellent Performance—S. R. O. Sign Required Early.

(Special to The Talking Machine World.)

Boston, Mass., May 11, 1910.

The Eastern Talking Machine Company Associates gave a most enjoyable evening's entertainment in the form of a minstrel show on April 12 at the Store Reception Hall. Mr. S. H. Brown, chairman of the entertainment committee, was most ably assisted by M. L. Read, Edward Welch and W. J. Fitzgerald, and all are to be highly congratulated upon their wonderful achievements as "high-class entertainers."

From the opening to closing choruses every detail was most punctually and accurately given with a zest and zeal known only to professionals. Mr. Fitzgerald and Mr. Brown as end men proved themselves heroes of the hour, their wit and art being manifested by every word of song and speech. Fortunately for the company, no hustling theatrical manager was on hand to sign up these two artists and star them as comedians.

There was not a dull moment during the entire evening. Among those deserving special mention for their splendid performance are W. R. Anderton, a brother of the famous Walter Anderton, favorably known to both theatrical and record-buying public. Mr. Loudon rendered several beautiful seaside songs and captivated several of the ladies in the audience. His imitations of "Seaside Life" were the best ever. Mr. Fitzgerald and Mark L. Read presented a coon sketch in the olio, entitled "The Two Loony Coons," the most side-splitting 15-minute entertainment. Mr. McCourt, with three others, gave a splendid account of themselves in the darky sketch entitled "The Hen Roost Inspector Man." The quartet chords had it all over the barber shop aggregation. Others who helped to make this entertainment one of the season's hits in the talking machine business were Fred Finn, who sang "Cubanola Glide"; J. J. Spillane, who sang "I Wish I Was in Heaven Sitting Down," and B. T. Reardon, who rendered "By the Light of the Silvery Moon."

Even the "No Standing Room" sign had to be "turned to the wall," as the seating capacity, accommodating about 250, was taken up very early in the evening.

Nothing like this has ever been done before by any one talking machine house with such splendid results. Best wishes are due for their continued success.

Among those present in the audience were Mr. and Mrs. E. F. Taft, Mr. and Mrs. John L. Gately, Mrs. S. H. Brown, wife of the chairman of the committee, and a party of friends, Mr. and Mrs. S. J. Freeman, Mr. and Mrs. A. W. Chamberlain, representatives from other jobbing houses, and others.

Those who participated in the minstrel show were: G. T. Waldron, R. Levett, W. J. Fitzgerald, J. J. Spillane, M. L. Read, E. A. Welch, S. H. Brown, R. Durkee, P. H. Cohen, G. W. Reese, D. Moore, R. M. McCourt, H. P. Cadegan, A. J. Collins, A. L. Osgood, M. P. Rice, C. J. Auerback, B. F. Reardon, and F. Finn. In the center of the circle was the Victor mascot, "His Master's Voice."

J. N. BLACKMAN TO GO TO RICHMOND.

J. Newcomb Blackman, of the Backman Talking Machine Co., has planned to attend the convention of the piano dealers at Richmond, Va., this week. He will be accompanied by Mrs. Blackman and will stop off at Old Point Comfort for a short time en route.

Sol Bloom, who has one of the handsomest establishments in the country at 366 Fifth avenue, handling the Victor line exclusively, has given up the store at 40 West Thirty-fourth street, New York, consolidating the two. Mr. Bloom is said to pay \$25,000 a year rental for his Fifth avenue place.

CAVALIER



CAVALIER'S fame is known to the American public, with all its worth. In these first Cavalier records it is at its best. Every note is clear and every inflection as when rendered by the artist.

No Columbia dealer or distributor should be without it.

Reach the people who have never had a machine of any make—and have never even had a chance to hear every good-sized town in the country—people who have never even had the demonstration of a concealed-horn machine.

There is one point of trouble with the Grafonola that you may have overlooked: no musical instrument will fail to attract attention. He won't let that \$200 instrument go.

There are Grafonola prospects in your neighborhood every day of scores of purchasers—more than you can get at your dealer's door apparently with their minds and hands. One day, by mail, just the other day, contained several orders.

"One man came in this morning and he said 'Send it up.' Here is the order."

"A man I had never seen before."

"Either the advertising or the Grafonola 'Regent' in its regular mail."

You have the one biggest and best means confined to the large dealers in the country.

COLUMBIA PHONOGRAPHS

GRAFONOGRAMS

I - C O L U M B I A

de; she is probably the best-known dramatic soprano at present before the
stic reputation justly earned by vocal and histrionic talents of extraordinary
rds, offered in the June list, the art of recording the soprano voice is shown
e and musical, and as reproduced, has exactly the same tonal and dramatic
ly by the singer in our laboratory.

consider his display complete without a Grafonola.

dice prevents their owning a horn
e plenty of those people whom you
k to. In almost every section of
l States, there are a large number of
proached by *anybody* in the demon-
e of *any* make.

us importance in the sale of a Grafo-
No man who puts \$200 into a
in with a good lot of records—and
stand idle, either.



a *your* street, in *your* neighborhood. We are hear-
ly of the Grafonola 'Regent'—who step inside of the
and ready to give delivery instructions. One morning's
notes from enthusiastic Columbia dealers like these:

asked if that Grafonola in the window was the 'Regent' he had seen advertised. We told him it was, and

at the store this week and ordered a Grafonola 'Regent' without even taking the time to hear it played."

de demand is making sales of the Grafonola 'Regent' easy. We just had a customer who saw the Grafo-
ment and ordered one in mission oak with only a description to go by."

te in your town that the business has ever afforded. Columbia dealers everywhere are proving it—and it isn't by any
either. *Exclusive* Columbia dealers, especially. Ask about that. Write to the

NOGRAPH CO., Gen'l
BUILDING, NEW YORK

A - C O L U M B I A

WILL REPRESENT THE COLUMBIA COMPANY AT THE EXPOSITION AT RICHMOND.



D. FEINBERG.



THOS. K. HENDERSON.



GEO. P. METZGER.

TRADE GOOD IN PHILADELPHIA.

Marked Increase Over Last Year—National Co.'s Proposition Helps—Weymann in Ocean City—Hepe's Report—Other Items.

(Special to The Talking Machine World.)
Philadelphia, Pa., May 7, 1910.

Business in Philadelphia during the first four months of the year has been most satisfactory. Each month has shown an advance over the previous month, and a large increase over the corresponding months of 1909. There have been various elements entering into the business that have helped the dealers to create trade. Not the least interesting or productive of results have been the proposition made by the National Co. on their four-minute attachment. All firms who handle the Edison report that they have had a tremendous business on this proposition.

The Penn Phonograph Co. report that their business in April was almost double that of a year ago. Ralph Clark and Edward Smullen are both on the road for the firm at present, and T. W. Barnhill has just returned from a trip up the State, where he reports having found conditions very healthy.

H. A. Weymann & Sons are very well pleased with the outlook for May business in talking machines. They have rented the same store on the boardwalk at Ocean City they conducted last summer, and will feature this year talking machines along with their sheet music. Norbet Whitley, their road man, is up the State at present and is sending in some very nice orders for Amberolas and Victrolas, while William Doerr is looking after the New Jersey and seashore trade. Mr. Weymann says that the new Edison proposition has stimulated trade among all the dealers.

When I asked F. J. Hepe what he had to report regarding his talking machine business he said, "You may say that our retail business in April increased one hundred per cent. over the corresponding month of last year, and fully seventy-five per cent. in the wholesale department." The Heppes have opened a very fine talking machine branch at Lancaster, Pa., in the Y. M. C. A. building in that city and they have been doing very well with it.

The Columbia Phonograph Co. report an excellent business. They have been giving quite a few church concerts in various parts of the

city recently with the Gipsy Smith and other records of a similar character, which have been very popular and through which they got some very good returns. They have also been giving exhibitions of other characters, last week playing a long list of numbers of Irish composers and singers for the Knights of Columbus at their club house. At this concert they played the full list of McCormack records. Among the visitors to the Columbia were E. D. Easton, president of the company, and Mr. Dorian. The Columbia Co. have been having quite a trade among the hotel and cafe people through the State on their new disc machines.

Louis Buehn & Bro. are about to open a new place at 1115 Walnut street, devoted to Business phonographs. Fred Smith, who has had considerable experience in this part of the work, will be in charge. Edward Buehn is traveling through the Cumberland Valley at present, and is finding the business very much improved in that section.

SONORA PHONOGRAPH CO.'S CATALOG.

Their first complete catalog has been issued by the Sonora Phonograph Co., 76 Reade street, New York, in which their full line of machines and records is illustrated and described, and it will certainly interest jobbers and dealers. The Sonora, termed "the instrument of quality," is thus explained in this handy booklet:

"The Sonora phonographs with invisible horn free from metallic effects represent purest quality of tone, perfect construction, beauty and durability. All cases are covered so that the mechanism is concealed from view, and the scratch of the needle is almost imperceptible. Our motors and sound boxes are made in Switzerland, at a factory with vast facilities, backed by the experience of a century in building motors for fine mechanisms. Their construction is scientifically perfect and simple, solid and durable. In Europe, the sapphire, in connection with disc records, is superseding the needle more and more, because the same sapphire may be used indefinitely, and because sapphire records are not destroyed in playing. As the sapphire requires records with up-and-down grooves, while the needle plays those with lateral grooves, it is convenient to have a sound box which can be used with both, so that either style of record may be played. Our duplex sound box, of wonderful tone quality, provides for this."

J. C. Rousch, secretary of the National Association of Talking Machine Jobbers, is sending out some interesting literature as well as illustrated postal cards urging on jobbers the necessity of being represented at the convention to take place at Atlantic City early in July. There is no excuse for jobbers this time.

THE SENECA

☐ Here's the new disc rack equipped with board shelving.

☐ Openings are 3 inches wide, over double the width of our other disc racks.

☐ It is 46 inches wide and 51 inches high. Four shelves for 10 inch discs. One for 12 inch.

☐ Finish in bright or dull copper.

☐ Price is \$14.00, envelopes not included.

☐ "The Heise System" of wire racks is the "last word" in stock carrying systems.

ORDER NOW

SYRACUSE WIRE WORKS

R. S. Williams & Sons Co., TORONTO AND WINNIPEG
Canadian Representatives

SYRACUSE, N. Y.



THE SOUTH AMERICA OF TO-DAY.

Observations of Walter Stevens, Who Recently Visited a Number of South American Ports on the Trip of the Bluecher—The Country from a Business Man's Viewpoint—Visited Many Talking Machine Houses—A Rich Field Sadly Neglected by Business Men of the United States—Cities Full of Cultured People and Decidedly European in Sentiment—An Interesting Review of a Memorable Trip Which Makes Instructive Reading.

Primarily, Walter Stevens, manager of the export department of the National Phonograph Co., Orange, N. J., went on the cruise of the Hamburg-American liner "Bluecher" to South American ports for pleasure and recreation. That was the intention of the company when he and Mrs. Stevens were given bon voyage at the dock in Hoboken and the steamer backed out into the Hudson River on January 22 and bade farewell to American waters until she poked her nose through the Narrows again April 13. While Mr. Stevens enjoyed the voyage greatly, he could not, however, wholly set business aside, and as he is a close observer and is possessed of that valuable asset, trained judgment, what he saw, heard and thoughtfully considered cannot help but be interesting to readers of the World everywhere. When asked for a "few remarks" appertaining to his journey, he replied as follows:

"As you know, I have been into Mexico several times, but had never made the South American trip. It was an experience I shall never forget, as every moment was enjoyable and each incident worth remembering. Of course, I was supposed to be going for pleasure, but at the same time being a business man, and one especially interested in the affairs of the National Phonograph Co., particularly the development of their foreign trade in the countries visited, naturally no opportunity was lost to study conditions and visit the trade. As a matter of fact, wherever the steamer made a port of call every house handling talking machines was called

sult is the goods are made up in Germany in exact imitation of the original American article, shipped and offered in competition at so low a price that the market is lost or so demoralized a foothold is difficult to regain.

"We have ignored and neglected one of the richest chances for gaining a great and splendid trade in South America. Possibly our own domestic business has been so large that it is more indifference than absolute neglect, but an American who is really alive to the vast importance of cultivating closer trade relations with the South Americans, not only for commercial but political reasons as well, cannot but regret the poor showing we make as compared to the standing of European nations. Having made no special effort to gain the regard and confidence of the South Americans in business matters, we have only ourselves to blame, if in turn, they do not hold us in the highest esteem. It is a common saying there that an Englishman's word is his bond, but who will believe a Yankee?"

others, are overwhelmingly European in sentiment, taste and inclination. The foreign population is largely German, English, Italian, with a considerable mingling of Scotch and few Americans.

"With this mixture you may imagine what chance the Americans stand unless more aggressive and persistent efforts are made along lines that harmonize with existing conditions. This is strikingly true so far as it affects the



VIEW OF RIO DE JANEIRO, BRAZIL.

Products of the American talking machine manufacturers. There are at present tons of cheap German, French and English types of talking machines and worse records. The American manufacturers, however, are making rapid headway with their superior goods, even if they do command a higher price. In other words, there is a great and splendid future for the American-made talking machine in South America, if properly handled. I made a number of valuable connections, which I feel assured will develop into a very satisfactory volume of business for the National Phonograph Co.



BANQUET BY AMERICAN COLONY, SAO PAULO, BRAZIL.

"Undoubtedly, we will get the trade in South America, for events in recent years point that way. It will, however, take time. Inexperienced salesmen from the United States, with little, if any, knowledge of the language, and with a patronizing air, are obnoxious in every sense of the word. There are a great many bright people in these countries, people who have traveled, are experienced in business affairs, and highly cultured besides. The cities, especially Rio, Montevideo, Buenos Ayres, Valparaiso, and



VIEW OF ST. THOMAS, D. W. I.

upon. To be sure, this was incidental, but it was the means of putting me in close touch with the situation, and it was, besides, time well and profitably spent in a strictly business sense.

"South America has been not only sadly, but shamefully, neglected by the business men of the United States. It is the most wonderful market in the world, and instead of these great and magnificent countries having an influential representation of American merchants and mercantile and manufacturing interests, there are comparatively only a handful of our people in evidence. After leaving the harbor of New York I never saw an American flag in any of the South American ports, though each was crowded with shipping, until I returned, excepting the one on the tug that brought the United States Minister to Brazil out to a banquet aboard the 'Bluecher' in the harbor of Rio de Janeiro.

"There is not an American bank in any South American country. The banking business is in the hands of the Germans and English, with the Germans predominating everywhere. For example, if an invoice of goods is shipped from the United States, and a draft is drawn against documents, as is usual, it is presented to the German bank designated, and every item is not only closely scrutinized before payment, but a copy is made of the bill, in which cost prices, etc., are given in detail, and sent to Germany. The home bank passes the duplicate invoice on to some manufacturer, who is told to get busy. The re-



TOURISTS CROSSING THE ANDES.

"The party aboard the 'Bluecher' were shown every courtesy at whatever port we called. Among the passengers were men prominent in banking, manufacturing and professional circles, with a large number of seasoned globe trotters, including some who came from Europe especially to take the trip. At the same time, while probably not one of the passengers had any idea of making the trip one of business, yet many of them hoped to gain a thorough knowledge of the countries to be visited and learn what the possibilities were for doing business in the countries of South America.

"After touching at Trinidad, the first stop of importance was Para, Brazil, a city of 130,000 inhabitants, where 65 per cent. of the world's supply of crude rubber is shipped from. Tons upon tons of rubber here awaiting shipment. At Bahia the view of the harbor from the city, with a population of 265,000, is inspiring. It is built on a high bluff rising abruptly from the sea. A carnival was in progress while we were



PLAZA HOTEL, BUENOS AYRES.

Do you realize fully the difference
between "exclusive selling rights" as
granted by the Columbia Phonograph
Company and the restrictive and ar-
bitrary competitive plan of selling "One
line of goods exclusively"?



Columbia Phonograph Co., Tribune Building, New York.

there, and the costumes, lighting effects, floats and orderly behavior of the crowds occasioned favorable comment. Bahia is a famous diamond market. Santos, our next port of call, is not particularly attractive. From there we took a trip to Sao Paulo, the second largest city in Brazil, with 280,000 people. Half of the population are Italians, the remainder being German and Portuguese, with only eight or ten American families. The latter are a small but important factor and exert considerable influence.

"Our experience with exchanging American money for 'coin of the realm'—in each country

point of view. At Pocos, a fashionable beach resort of the capital, the hotel compares favorably with the best places of the kind in this country.

"Buenos Ayres, the capital of the Argentine Republic, is directly opposite Montevideo, across the La Plata river, which is only 120 miles wide at this point. It took us twelve hours to steam across. At Montevideo some of the passengers decided to leave the ship, so they would have more time in seeing Buenos Ayres, and to take the trip across the Andes to Valparaiso and Santiago, Chili. Buenos Ayres, with its population of a million and a quarter, is the Paris of South America, and its general appearance is not unlike the important cities in the United States, though the atmosphere of the place is typically European.

"The journey across the Andes, partly by rail and carriage, was an experience novel, exhilarating and decidedly enjoyable. The tunnel through the mountains was opened April 1, but too late for our trip. We climbed the mountains 10,000 feet on a cog road, and then up to the summit 3,000 feet by carriage, and it was made on a run. At the top, on the boundary line between Chili and Argentine, we passed the heroic statue of 'Christ of the Andes,' erected to commemorate the settlement of the dispute between the two countries. Cannon were melted to furnish material for this remarkable monument, and the inscription reads: 'These mountains shall crumble to dust ere Argentines and Chileans break the peace which, at the feet of Christ, the Redeemer, they have sworn to maintain.'

"We visited Santiago, the capital, a beautiful city of 400,000, with straight, wide streets and many fine buildings and beautiful parks. Valparaiso, the seaport of Chili, is the largest city on the west coast, with 150,000 population. In Chili the conductors on the trolley cars are women and the 'chambermaids' at the hotels are men. We rejoined the 'Bluecher' at Buenos Ayres, and then started for the North, stopping again at Montevideo, and then at Rio de Janeiro. Rio is a modern city in every way, with a population of 800,000, and, as you possibly know, is situated on the most beautiful and largest landlocked bay in the world.

"In Rio the entire party aboard were received by the Brazilian Minister of Foreign Affairs, Baron de Rio Branco, one of the great statesmen of South America. Then followed Pernambuco, Trinidad, Kingston and New York, where once again we had the pleasure of seeing the Stars and Stripes. I would not have missed the trip for a great deal, now that I know its value and can appreciate its true worth socially and commercially. The South Americans are truly a wonderful people, and it is a pity we do not know more of them."

Mr. Stevens has a large collection of photographs of the different places visited, almost all of which were taken by himself. It was really a difficult task to select the few in connection with this account of his travels from his very interesting collection.

SOME BIG LEAGUE STUFF

To Be Pulled Off During the Scheduled Baseball Game Between the Eastern and Western Jobbers at Atlantic City in July.

The lively members of the National Talking Machine Jobbers' Association are evincing much interest in the proposed game of baseball between the Eastern and Western jobbers, and a number of them have gone into active training with a view of securing places on the teams representing their respective localities. One of the rules laid down is that while every member of the association may compete for positions on the teams, only one representative of any one concern may play in the game.

J. Newcomb Blackman has been appointed captain of the Eastern team and announces that he is open for applications from good players, the only qualifications necessary being that they must be able to pitch like Mathewson, bat like Hans Wagner and look upon Bugs Raymond as a horrible example.

It is rumored that both Louis Buehn and E. H. Taft, who have been suggested as possible members of the Eastern team, are training hard to qualify. Mr. Buehn may be seen any sunny afternoon racing around the green spots in Spring Garden street, while they say that Mr. Taft, who is a candidate for shortstop, has pulled off twenty pounds by sprinting around the Common and the Public Gardens. The Western fellows will certainly have to play ball.



MASKED BALL ABOARD SHIP.

we entered, of course—was rather amusing, to say the least. The 'Bluecher's' voyagers had been described as 'arch' millionaires, and what we received in Brazilian money exchange certainly made us feel that way. As an instance, for \$32 of American gold 100,000 reis were received, but as we were obliged to pay 10,000 reis for carriages and the same for luncheon, the alleged wealth rapidly decreased. The exchange figured: In Brazil, 3,200 reis for \$1 American money; Chile, \$5 for \$1; Argentine, \$2.35 for \$1, while in Uruguay we had to pay \$1.03 of our coin for \$1 of theirs. Living expenses throughout South America are extremely high, especially so in Rio and in Buenos Ayres. When foreigners protest the reply is, with a shrug, everything is high in America. They do not hesitate a moment to palm off articles as being of American (United States) manufacture when they really were made in Europe, in order to command an increased price.

"On arriving in Sao Paulo the ladies of the American colony tendered us a reception, followed by a banquet in the open air, under an arbor of trailing vines, decorated with flowers and American flags. There was no concealing the delight of these thirteen ladies in meeting some of their own people under such pleasing circumstances. February 15 we reached Montevideo, capital of Uruguay, with a population of 350,000, where we were most cordially received by the president of the republic. Uruguay claims to have the most beautiful women in the world, and no one who is fortunate enough to see them will dispute the claim, as they are handsome physically and are charming from every



WOMAN CAR CONDUCTOR IN CHILI.

NEW VICTOR JOBBERS IN PEORIA.

The Putnam-Page Co., Inc., Take Over the Talking Machine Department of the C. Adams Co. Who Are Now Devoting All Their Attention to Pianos—Will Move to New and Attractive Quarters in That City in June—Both Gentlemen Recently Visited New York.

Fred H. Putnam and Roy Page, of the Putnam-Page Co., Inc., Peoria, Ill., were recent visitors to New York. These gentlemen have recently purchased the talking machine department of the C. Adams Co., piano dealers, and will move to new and larger quarters at 324 South Adams street on June 1, where they intend to have a splendid emporium for the jobbing of Victor talking machines, Edison phonographs and records.

During their stay in the city they visited all the leading talking machine stores for the purpose of getting pointers on the equipment of their own establishment, as well as the factories of the Victor Talking Machine Co. at Camden, N. J., and the National Phonograph Co. at Orange, N. J.

In a chat with Mr. Page in *The World* sanctum he expressed himself most optimistically regarding trade in his territory for the lines which his firm are representing. "We intend to get after trade and develop it," he said, "and are fully confident that there is a tremendous future not merely for the talking machine but for the business phonograph in our section of the country." Both Messrs. Putnam and Page left for home on Saturday last.

A BLACKMAN ANNOUNCEMENT.

New Style Place Record Brush for Use with the Exhibition Sound Box, Now Ready.

The Blackman Talking Machine Co. announce that the new style 10 Place record brush, for use with the exhibition sound-box, is now ready for the market, and orders for any quantity will be

filled promptly. The new brush differs from the previous styles in that it is equipped with a spring clamp which snaps over the edge of the sound-box and allows for the accurate adjustment of the brush, so that it will bear on the record surface with the proper pressure.

Owing to the changes being made in the brush, the Blackman Co., for a short time, got behind in deliveries, but all standing orders have now been filled and there will be no delay in the future in the shipment of any style of brush. Some live new advertising matter is now in preparation regarding the new style 10 brush, which will be ready for distribution at an early date.

Dealers who have received samples of the latest addition to the line of Place record brushes are enthusiastic over the manner in which it fills a long-felt want, and its success seems assured.

SOME DISTINGUISHED VISITORS.

President Williams, of the Gramophone Co. and Messrs. Clark and De La Rue Visiting Victor Co.'s Plant.

Friday of last week the Hon. H. Trevor Williams, president of the Gramophone Co., London, England, who assisted in framing the new copyright bill, which Parliament may pass before adjourning; Alfred Clark, managing director, and Ernest de La Rue, a director of the same company, arrived in New York on the "Mauretania" of the Cunard Line. They were met at the pier by Louis F. Geissler, general manager; Charles K. Haddon, vice-president and treasurer, and C. G. Child, manager of the recording laboratory of the Victor Talking Machine Co., Camden, N. J. These gentlemen are now in Philadelphia, staying at the Bellevue-Stratford Hotel, and are at the Victor Co.'s plant daily for the purpose of securing a larger percentage of the Victor outfit for the European trade.

JOHN A. B. CROMELIN A VISITOR.

John A. B. Cromelin, of London, England, European representative of the Columbia Phono-

graph Co.'s interests, and a nephew of Paul H. Cromelin, vice-president of the company, arrived in New York last Friday on the "Mauretania." He leaves for Liverpool again next Wednesday on the "Lusitania" of the Cunard Line. In chatting with *The World* this week, he said business in Europe was looking up and that by the fall he anticipated a splendid trade. Mr. Cromelin has not been over here for several years.

C. H. WILSON'S BUSINESS CHAT.

Business Active at National Co.'s Headquarters—National Political Conditions Interfere with the Restoration of Complete Confidence.

C. H. Wilson, general manager of the National Phonograph Co., Orange, N. J., at the factory the other day, in chatting about business, said: "We are very busy, but are not so crowded as in rush times; at the same time we are turning out a lot of goods, and have difficulty keeping up with orders. I do not believe confidence in business affairs has been entirely restored, and it will not be until the national political situation is settled. Financial men cannot sell bonds and other securities, and if they are slow in selling why there is no money to keep the wheels going around. That is about the way we size up current conditions."

WITH U. S. PHONOGRAPH CO.

John Kaiser, one of the best known men in the talking machine trade East, who was a prominent figure in its early history and development, is manager of the recording laboratory of the United States Phonograph Co., at 662 Sixth avenue, New York. C. L. Hibbard, formerly in charge, is now at the company's headquarters in Cleveland, O.

Look for the results of your advertising, not in the direct and traceable results of any special offer, but in the steady growth of the business month after month.

YOUR OWN PRICE!!

3000

Premium Machines

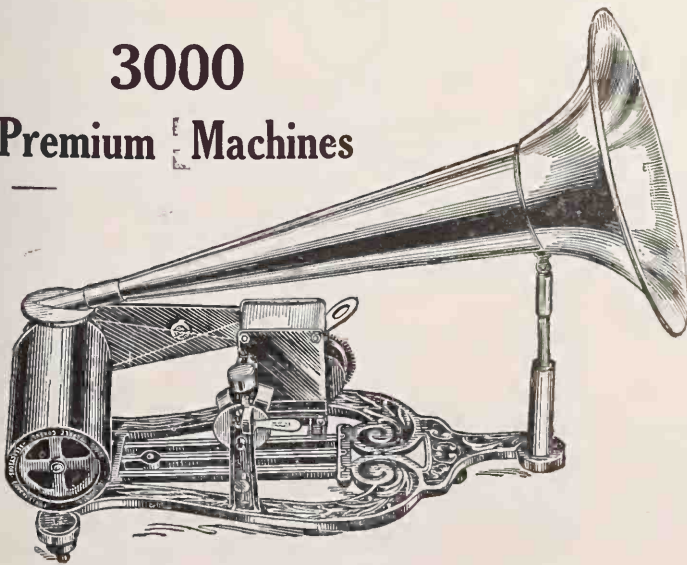

In order to make room for our rapidly growing business we will close out our entire stock of about 3000

Premium Talking Machines

AT A RIDICULOUSLY LOW PRICE

NO REASONABLE OFFER REFUSED!

They are perfect, good and high class in every respect. While made in Germany they must not be confounded with the ordinary cheap German importation.

Their Handling in No Way Interferes with any Existing Patents

Manufacturers Outlet Company, 89 Chambers Street, New York

Ralph Waldo Emerson

says:

"If a man can write a better book, preach a better sermon or make a better mouse trap than his neighbor, though he build his house in the woods, the world will make a beaten path to his door."

Ft. Bragg Music House

says:

Well, you can read for yourself the following fac-simile letter of March 28th, 1910, and accompanying order for 706 Records.

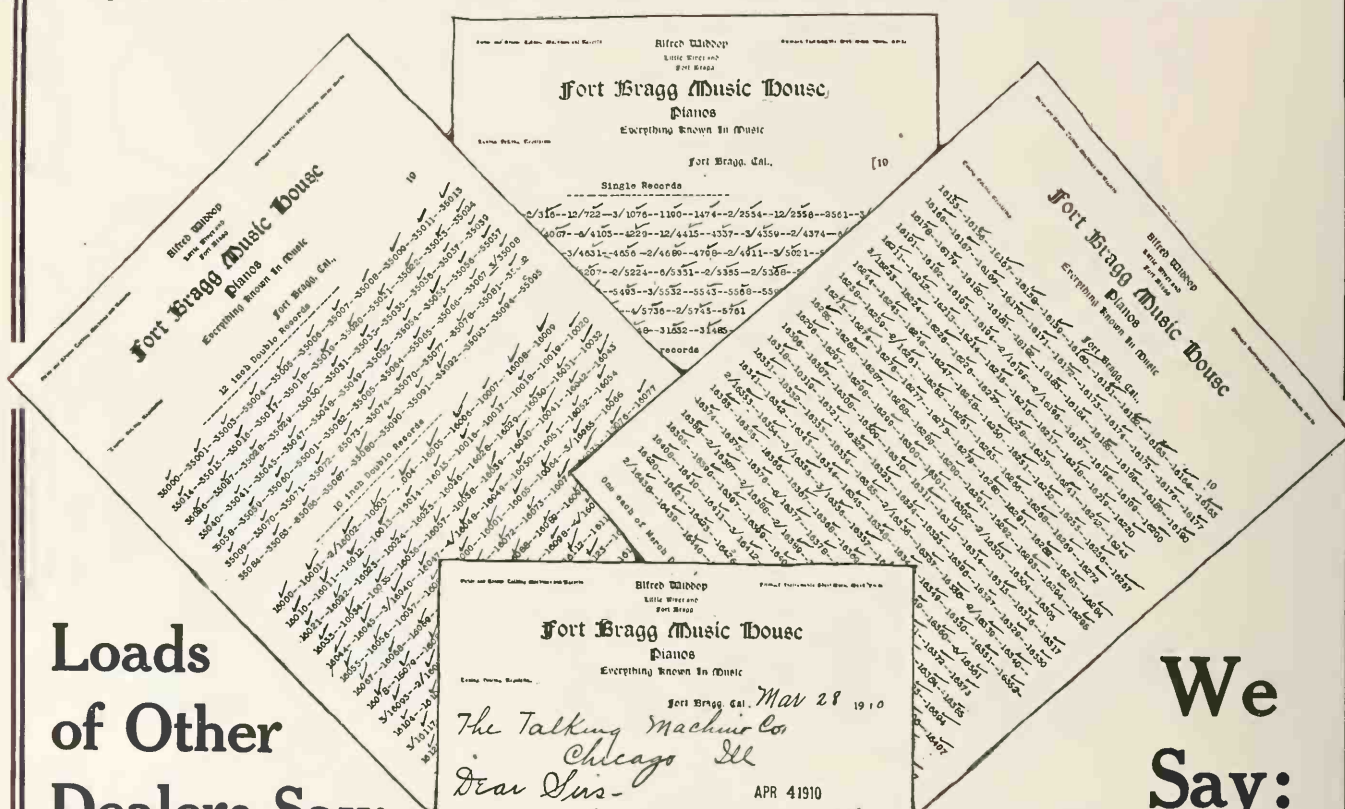

Loads of Other Dealers Say:

"We'd rather pay the extra freight and order from you because we know we are sure to **get the goods.**" "As you are *exclusive wholesalers* we *know* you are not trying to sell the same retail prospects that we are, therefore prefer to give you our *entire* Victor business."

"We appreciate the efficient work of your Sales Department in following up the retail prospects we sent you. Your personal letters have closed many retail sales for us."

We Say:

If The Talking Machine Company can fill orders complete, save you that profit you would lose by not having the goods, assist you in closing retail sales, though we are not

your nearest Distributor, you also ought to tread the "beaten path to our door" that other Victor Dealers have made in order to "**get the goods.**"

The Talking Machine Company
72-74 Wabash Avenue :: :: Chicago, Illinois

FROM OUR CHICAGO HEADQUARTERS

ROOM 806, NO. 156 WABASH AVENUE, E. P. VAN HARLINGEN, MANAGER.

The Trade Situation Reviewed—Fundamental Conditions Excellent—Growth of Musical Knowledge Helps Talking Machine Sales—Fibre Needles Increase in Favor—April Shows 25 Per Cent. Increase with Talking Machine Co.—Some Distinguished Visitors—Interesting Columbia Figures Regarding Business Growth at Important Points—Wiswell Wants Jobbers to Join Forces at Chicago for Convention at Atlantic City—Summary of the News of the Month.

(Special to The Talking Machine World.)

Chicago, Ill., May 7, 1910.

Take it all in all the Chicago jobbers have every reason to be satisfied with the volume of business coming forward. While April did not show quite the amount of business credited to March this is only a condition naturally to be expected and the decrease was exceptionally small. The month, on the other hand, showed a gain as compared with last year fully equal to that shown by previous months and can be placed at approximately twenty-five per cent. Fundamental conditions in the West are considered excellent. As reports come in from salesmen in the various sections the reports of damage by the recent cold weather to fruit and other crops, are found to be grossly exaggerated and the general attitude is one of decided optimism and belief in a good round, normal year's business. Judging from reports received here the talking machine factories are very busy and are having difficulty in supplying the demands for goods. Victrolas are hard to get as ever and there seems to be considerable shortage on other types of Victor machines. Jobbers report that the Edison proposition by which customers get ten special Amberol records with an Amberola attachment promises to prove one of the most profitable trade deals in years and that the demand is discounting all their expectations. Local retail business in April was peculiar. It was exceedingly quiet the first half of the month, but the latter part was exceptionally good, the last ten days making a finish that was something phenomenal considering the previous quietness and this was in spite of the decidedly unfavorable weather. So far this month business has been of very fair proportions and shows the usual emphasis on higher grade goods.

Grand Opera Season Helps Record Sales.

The grand opera at the Auditorium for a solid four weeks was taken full advantage of by all the large retail establishments in the way of exploitation by special advertising, newspapers and programs, window displays and other methods. The stimulating effect on opera record sales was not felt materially until the latter part of the month, but since the engagement closed is increasingly in evidence. The prospects for English opera at McVicker's for a large part of the summer with a single opera featured for an entire week will undoubtedly have much to do in cinching the good exploitive work already accomplished, and our permanent opera next fall, with the assurance of a list of stars, which we did not dream of at first, means the maintenance of the interest in opera at a white heat.

On Roosevelt's Trail.

C. A. Hughes, a former newspaper man of Chicago, who accompanied the W. D. Boyce expedition to Africa last year, has returned to the Windy City and relates that none of his jungle experiences were of more interest than the Victor concerts around the campfire every night. "We had two fine Victor machines with us," said Mr. Hughes, "and, thanks to A. D. Geissler, of the Talking Machine Co., a stack of the best records for keeping a camp gay and not a few to remind us of home. We would have considered missing our dinner as soon as passing up the big show around the blazing fire at night. The natives would crowd around to listen

to the 'little man' in the talking machine. For that is how those untutored minds account for the sound that comes out. They are quite certain that a human being is inside the box. They were greatly confused one night when we played that song about 'The Preacher and the Bear.' They heard the bear growl and the man shriek when the bear hugged him. Of course, that was too much for them. They had a lot of sympathy for the man struggling in there with the bear. Whenever a particularly laughable piece was played the natives would howl with mirth until they had to sneak away from the scene, for they appear ashamed when white men catch them laughing. British East Africa probably has more talking machines than any other country in the world in proportion to the number of white inhabitants. New records are received from England every three weeks and the agent of the Gramophone (the name under which the Victor is sold in England and her colonies) is nearly mobbed by anxious buyers whenever a new consignment arrives."

Good Publicity.

George and Cecil Davidson, proprietors of the Talking Machine Shop, 169 Michigan Boulevard, took advantage of the Grand Opera season to do some very classy Victor exploitation all along the line, but none more effective perhaps than a facsimile reproduction of a letter which George Davidson received from Riccardo Martin, the famous tenor who was heard here in a number of the operas. He called at the shop, listened to his records, went back to his hotel and on the Congress stationery wrote the following autograph letter which was reproduced in facsimile and enclosed in the regular monthly communication to the patrons of the store:

"My Dear Mr. Davidson:—The Victor records of my voice which you have been so kind to play for me, have pleased me exceedingly. What a truly wonderful invention! The mirror of the voice, I call it. With cordial greetings. Faithfully yours, Riccardo Martin."

Fred. D. Hall's Eastern Trip.

Fred. D. Hall, president of the B. & H. Fibre Co., returned on the 18th of last month from a two weeks' Eastern trip, during which he called on the jobbers in New York, Boston, Philadelphia, Baltimore, Pittsburg, Buffalo and other cities. He was more than gratified with the cordial reception accorded him and the many courtesies extended him. He found the East thoroughly interested in the Fibre needle and the jobbers glad to meet in person its inventor and manufacturer. While the trip was undertaken more as a means of getting acquainted than anything else, Mr. Hall was favored with some very substantial orders for his product, and is assured that the fibre needle, which is already widely recognized in the East, will be strongly featured and pushed by some of the strongest Eastern distributors.

Mr. Hall's visit to the large talking machine factories was fraught with particular interest to him. Since his return he has been telling everyone how thoroughly impressed he was with the fact that whatever is turned out by the factories is the very best that can possibly be produced under the existing conditions and that no pains or expense is spared to make every record that goes forth just as perfect as it possibly can be. He wishes that the general public knew how thorough the work of the factories in this regard is, and how absolute the attention to every detail in order to give every purchaser of a record the most perfect possible rendition of the voice of the artist.

B. & H. Fibre Needle Factory Moved.

The B. & H. factory moved the first of the month to the larger quarters in the present building at Dearborn and Kinzie streets, where they not only have the increased productive ca-

capacity that the growth of the business demands, but handsome offices and demonstration rooms shut off from the noise of the factory. Mr. Hall expects to leave in a week or so for a visit to the jobbers in Detroit, Cleveland, Columbus and Toledo and will shortly make journeys from time to time gradually covering the principal jobbing centers.

Edward A. Geissler a Visitor.

Edward A. Geissler, of the George J. Birkel Co., the large piano and talking machine dealers, Los Angeles, Cal., accompanied by his wife and son, has been in the city the past ten days, the guest of Arthur Geissler, general manager of the Talking Machine Co. Ted. Geissler, the son, although but 19 years of age, tips the scale at 185, is an all round athlete, is ranked as one of the best football players on the Coast and holds the broad jump and 100-yard dash records in high school circles in Los Angeles. Next week the party will continue their journeyings eastward.

Gus Eilers Visits Chicago.

Gus Eilers, who has general charge of the talking machine and small goods interests of the various Eiler's stores on the Coast, and who makes his headquarters at Portland, Ore., spent several days in Chicago on his way East, where he will visit the talking machine factories and spend several weeks combining business and pleasure.

Marquette Healy Home Again.

Marquette Healy, vice-president of Lyon & Healy, arrived in New York on April 19 after an enjoyable trip abroad, and was met by Vice-President Paul J. Healy, who ran up from Atlantic City for the purpose, and by L. C. Wiswell, manager of the company's talking machine department. The former remained in the East, but Marquette Healy and Mr. Wiswell on their return visited both the Victor and Edison factories. They found everyone decidedly optimistic regarding business, the plants crowded with orders and even working overtime in some departments.

George Davidson, of the Talking Machine Shop, accompanied by his wife, is spending a week's vacation with his parents at Decatur, Ill.

Evan Williams in Town.

Evan Williams, of the Victor Red Seal galaxy, who sang at Orchestra Hall in April, called at Lyon & Healy's, heard some of his records and chatted interestingly regarding his experiences at the Victor laboratories.

Remarkable Order Filling.

Arthur D. Geissler, general manager of the Talking Machine Co., states that April showed an increase of 25 per cent. as compared with the corresponding month of last year, which was a really excellent month for them, and came within 5 per cent. of the same month of 1907. An instance of remarkable order filling is found in the fact that they were recently able to fill an order for 706 records complete, with the exception of only two outs.

Samuel Goldschmidt, district manager of salesmen for the Victor Co., was a Chicago visitor the latter part of last month.

A. V. Chandler, Illinois representative for the National Phonograph Co., is on a visit to the factory at Orange.

Notes of the Dealers.

Con Hogan, the famous blind talking machine dealer of Ashland, Wis., paid one of his occasional visits to Chicago in April. He came alone as usual, but engaged a messenger boy to pilot him around the city. He is a perfect mine of optimism, is always ready with a good story or pungent witticism and is a far more inspiring visitor than many in full possession of their faculties.

W. A. Payton, of Baraboo, Wis., was a trade visitor recently. Mr. Payton is one of the large

Another

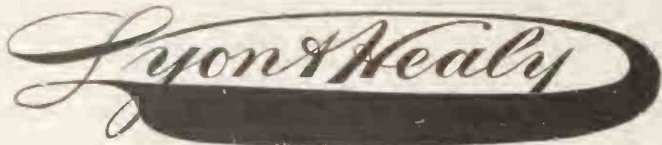

Innovation

THE DEALER who fails to have the new records on his shelves promptly on opening day is not catering to this feature of his business and will surely lose a big record trade which otherwise would be his. Quite often the failure to have the new records is apparently unavoidable.

With the new plan which we have just perfected such a misfortune as being without the new records is impossible. We do all the heavy work. All the dealer does is to sell the records and pocket the profits.

You will want to take advantage of this plan. And it is only one of many which Lyon & Healy are constantly carrying through for the benefit of dealers who buy their supplies of them.

Allow us to explain our new record delivery plan, together with the many superior features which have made our house America's foremost distributors of Victor Talking Machines and Edison Phonographs. Use the coupon for convenience sake.

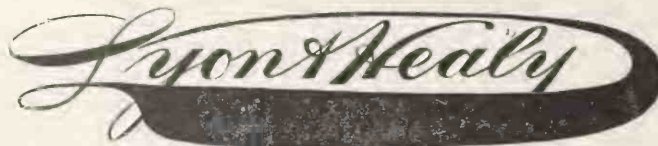

CHICAGO

Fill in, cut out, and mail this coupon to-day

MESSRS. LYON & HEALY,
Chicago.

Gentlemen:

I am interested in your Record Delivery plan and would like to know more about it.

Name

City

State

T M W

dealers of the Badger State, and not only sells talking machines at his main store at Baraboo, but also at prosperous branches at Lodi, Marshfield and Leedsburg.

L. D. Guest, of the Guest Piano Co., Burlington, Ia., was in the city a couple of weeks ago and brought reports of a prosperous talking machine business.

The Quincy Phonograph Co., of Quincy, Ill., have recently enlarged their retail department and have added several handsome demonstrating booths. Manager L. E. Caldwell is a hustler of first degree and reports an excellent wholesale business on Edison goods, for which they are the distributors.

To Atlantic City.

An effort is being made to get all the Western jobbers, who will attend the conventions of the National Talking Machine Jobbers' Association at Atlantic City July 5, 6 and 7, to come to Chicago and go in a special car with the local contingent. All those who favor the plan are invited to correspond with L. C. Wiswell, of Lyon & Healy, who has been asked by Secretary Roush to line up the Westerners. Mr. Wiswell is also on the lookout for good baseball talent among the Western jobbers. It is the intention to have a ball game between the Western and Eastern forces at Atlantic City and volunteers are in demand.

Good Columbia Business.

District Manager W. C. Fuhri, of the Columbia Phonograph Co., reports some remarkable increases in business for April in the various branch houses under his jurisdiction as compared with April of last year. The figures, which cover, of course, both wholesale and retail, run as follows: Chicago, 50 per cent.; Dallas, 90 per cent.; Des Moines, 20 per cent.; Denver, 60 per cent.; Kansas City, 50 per cent.; New Orleans, 25 per cent.; Omaha, 33-1-3 per cent.; St. Louis, 98 per cent. He attributed the remarkable showing to generally improved business conditions, improved product, popularity of the double disc record and the excellent gramophone business. As compared with March, April made about an even break.

C. F. Baer, manager of the Chicago office of the Columbia Co., recently went to Galesburg, Ill., and made arrangements with the Galesburg Piano Co. for the extensive handling of their line. The company is just fitting up a fine, large three-story building for their business, and the graphophone department will occupy large space with handsome demonstrating booths. H. H. Myers, Indiana traveler for the Columbia Chicago branch, has recently had eight counties added to his territory and has already established several new Columbia dealers and is getting increased business from those already established.

Among the recent visitors to the Columbia Chicago office were J. McCourt, Ludington, Mich.; A. D. Chattell, Beloit, Wis.; Myra T. Crane, Necedda, Wis.

Hobnobbed with the Artists.

L. Kean Comeran, manager of the retail talking machine department of the Rudolph Wurlitzer Co., as usual, spent a great deal of time behind the scenes during the engagement of the Metropolitan Opera forces. He renewed his acquaintances with many of the artists and incidentally increased his remarkable collection of autographs. Quite a few of the grand opera singers were visitors at the Wurlitzer warehouses.

New Salter Cabinet.

The Salter Mfg. Co., of this city, have just brought out a new low-priced cylinder cabinet embodying their idea of holding the records in the cartons which are placed between the pegs. The record is thus protected from breakage and dust and is easily found by the box label. There are six sliding shelves, each accommodating twenty-five records, thus giving the cabinet a capacity of one hundred and fifty. It is furnished either in oak, mission or mahogany finish. The company's new Victrola XII. cabinet, with the Salter horizontal felt-lined shelf ar-

range, is experiencing an excellent demand.

E. C. Plume Returns from New York.

E. C. Plume, western wholesale manager of the Columbia Phonograph Co., returned from a trip to New York last week. He is enthusiastic about some magnificent new operatic records which will soon be added to the Columbia list.

Victor Lecture-Recital.

John Otto, of the retail machine sales department of Lyon & Healy, gave a two hours' Victor lecture-recital before the Men's Club of Irving Park last month. He told about the manufacture

A GREAT ESTABLISHMENT.

The Lyon & Healy Department Considered a Model in Organization and Equipment—How the Department Is Arranged—System the Watchword—Something of the Manager.

(Special to The Talking Machine World.)

Chicago, Ill., May 7, 1910.

The talking machine department of the great house of Lyon & Healy is such a constant subject of comment in the trade and is so frequently referred to from Coast to Coast as a model in point of organization and equipment that the new photographs here reproduced will be found of great interest to those who have visited it and those who still have that delightful experience in prospect.

L. C. Wiswell, the manager of the talking machine department, is, by the way, always at the service of those who desire to study the most advanced methods of conducting a great "talker" business at first hand and to pilot the visitor in person through the department.

In the language of the store the talking machine department is known as "H." How much "H" means to Lyon & Healy is appreciated when it is known that the department is recognized throughout the establishment as one of the most important factors in the affairs of the business. Occupying the entire fifth floor in the immense building and annex at Wabash avenue and Adams street, as well as practically all of the Adams street side of the main floor, the Lyon & Healy talking machine department is one of the busiest places in downtown Chicago.

Facing on Wabash avenue are the spacious and luxurious record trial rooms of the retail division and which were described and illustrated in The World at the time of their construction. There are twelve large individual rooms, finished in mahogany and enclosed in plate glass, making them absolutely sound proof, enabling record purchasers to hear under the most favorable circumstances any record desired. M. N. Blackman, in charge of the retail record division, is known as one of the most proficient men in this branch of the business. A well trained and polite corps of assistants make record buying a real pleasure. Joseph Vesey, in charge of retail machine sales down on the main floor, is also to be reckoned with as a business producer worth while.

However, it is in the wholesale division where the clockwork system is seen working to best advantage. The wholesale occupies the greater part of the immense fifth floor, and in point of

of records, and chatted interestingly concerning the artists and their selections. Mr. Otto now has charge of the I. C. S. language course department at L. & H.'s, in addition to his other duties.

J. P. Seeburg Co. Remove.

The J. P. Seeburg Piano Co., manufacturers of electric pianos, have moved their general offices from the Republic building to suite 718-723 Steger building, corner Wabash avenue and Jackson boulevard. The new quarters give them ample space for displaying their complete line, and besides Mr. Seeburg enjoys the luxury of a commodious private office.

space occupied, arrangement and stock carried is one of the most notable of the country. Nothing has been left undone to facilitate the filling of dealers orders properly and promptly. It is a pleasure to watch the men who make this department a regular hive of industry. Every man has his work and does it. Some are to be seen collecting from the long rows of properly labeled and numbered bins, the records which are necessary to fill the multitudinous orders received in the latest mails. The Victor records are under the supervision of a man who knows the Victor catalog from A to Z. The Edison records are



MANAGER L. C. WISWELL AT HIS DESK.

under another man who is just as well acquainted with the Edison output.

Each order as it is received is stamped with time and date and sent immediately to the assembling rooms. It is attached to the assembling truck and no matter how varied are the items everyone is filled and checked with mathematical precision. It is almost accounted a criminal act to hold an order unfilled over a working day.

Most of the photographs here shown present views very familiar to visitors at the wholesale department and full of human interest. One of the most impressive is a view of the Victor record bins showing the record assembly clerks at work filling orders. Owing to the compact arrangement of the Edison record department it was difficult to get an adequate photograph of it. Another view shows the wholesale machine sales rooms, under the superintendence of Harry Hopkins and which the out-of-town or city dealer finds a very pleasant place to spend



A GROUP OF DEPARTMENT "HUSTLERS."



VIEW OF WHOLESALE MACHINE ROOMS WITH MR. HOPKINS AT HIS DESK.

a half hour and incidentally leave his orders for "talkers."

One glance at the portrait group tells plainly why one may expect good service from the Lyon & Healy talking machine department. Mr. Wiswell is surrounded by as efficient a corps of helpers as can be found. From the traveling salesman down to Max, the general utility man, every individual is thoroughly trained in his

house for twelve years and his promotion from assistant manager to manager was a logical one and richly deserved because of his conscientious and enthusiastic labors in the interest of the business. He has a personality that instantly attracts and is a man who not only elicits the loyalty of every employe of his department, but makes him exceedingly popular with the patrons of the house. Above all he is a systematic



PART OF LYON & HEALY RECORD STOCK ROOMS.

particular duties and has a deep interest in the successful working of the department.

Mr. Wiswell is a young man who has emphatically made good in the very responsible position he occupies. He has been a prominent factor in the talking machine department of the

hustler, a man bound to make his way in any department of life.

In conclusion, it is not amiss to say that the publicity put out by Lyon & Healy in the interest of the talking machine business has been of vital importance to the general trade. Daily concerts are given in the concert room on the first floor. Here all the latest records are played and the auditors are supplied with elaborate programs such as are only provided at the highest class entertainments. Hundreds of people visit these concerts daily. Every retail dealer who buys through Lyon & Healy is kept posted to the minute on matters which will enable him to give his customers the very best service. Only a slight idea can be given here of the facilities possessed by Lyon & Healy by reason of their organization and equipment and long experience for giving their immense number of wholesale customers a service both of goods and ideas calculated to help them to the utmost in the business game. A visit to the department and a careful investigation of their methods is bound to prove forcefully convincing.

GET PRIZE FOR WINDOW DISPLAY.

M. W. Waitt Co. Get Award in Class "D" During Horse Show—How the Display Was Arranged.

(Special to The Talking Machine World.)

Vancouver, B. C., May 5, 1910.

M. W. Waitt Co., the prominent music house of this city, are being congratulated on their window display during the Horse Show, which was arranged by Manager Bowes, and for which they

received the prize for windows in class D, open to all.

The display, with the colors of the Horse Show as a background, represented a little girl driving at the show. The body of the horse was made of a gramophone machine case and its legs were of record boxes. A large record box made the body of the rig, while gramophone horns composed the wheels, and music rolls the shafts. A life-sized doll occupied the seat. A "magic mirror" was placed at one side of the window, into which a doll and toy donkey were looking, while passing people could also have a good view of themselves. Close by the mirror were these lines:

We donkeys cannot sing or play,
But watch our smoke when'er we bray.
We're not quite in the horse show class;
We're just a simple, common ass.

ROYALTIES FOR ARTISTS.

Some Big Sums Received by Leading Opera Artists Who Sing for the Victor Talking Machine Co.—Figures That Stagger.

When the "Kaiser Wilhelm II." sailed from New York, May 10, and a number of operatic singers were aboard, it was a reminder that in addition to their salaries in opera they had enjoyed almost unbelievable incomes from making records. Of course, Caruso, in this respect stands at the head of the list as being the highest paid artist by the Victor Talking Machine Co., Camden, N. J., General Manager Geissler stating that during the past year his royalties amounted to \$68,000 on ten songs.

Mme. Eames has made enough out of the records to support her in luxury without touching her income from any other sources. Geraldine Farrar's account footed up \$17,000; Mme. Gadski, about \$10,000; Mme. Homer, \$20,000; Scotti, \$20,000; Mme. Tetrazzini, \$30,000.

POPE PIUS HEARS SPALDING RECORD.

His Holiness Pius X, as is well known, is particularly fond of music and his chapel master, Abbe Perosi, is one of the most distinguished composers and conductors in Europe. Thus surrounded by competent musical authorities the venerable pontiff keeps closely in touch with the higher class in the musical world and, learning the immense success this year in Europe of Albert Spalding, the celebrated violin virtuoso, he expressed the desire to hear him. As Mr. Spalding could not, on account of his engagements, go to Rome, an enterprising phonograph company offered to replace him with one of their instruments. After hearing the phonograph repeat Mr. Spalding's famous piece de resistance, the Sarasate Gipsy Airs, His Holiness, says the Pall Mall Gazette, said, "There is no doubt the violin is the finest instrument of all."

Complimentary Concerts.

LYON & HEALY

LYON & HEALY CONCERT PUBLICITY.

THIS IS THE FAMOUS

"TIZ-IT"



**All-Metal
Horn
Connection
for Phonographs**

WE WANT EVERY DEALER TO HANDLE THIS FAST SELLING ARTICLE. PRICE 50 CENTS.

Regular Discount to the Trade.
Send for descriptive Circular and printed List of Jobbers who keep "TIZ-IT" in stock.
If your Jobber does not handle this Connection yet we will supply you.

One dozen lots, prepaid, \$3.60
Free sample to Jobbers
KREILING & COMPANY
1504 North 40th Avenue
Cragin Station Chicago, Ill.

Every owner of a piano is a "prospect" for a Columbia Grafonola. Especially is every owner of a piano-player a "prospect". There are hundreds of live "prospects" in your territory. Sew 'em up!



Columbia Phonograph Co., Tribune Building, New York.

SOUTHERN CALIFORNIA NEWS.

Fine Weather Helps to Enliven Trade—Columbia Co. Take Over Fitzgerald Department—Holmes Music Co. in Handsome New Store—Demand for Red Seal Records—Southern California Music Co. Pushing the Amberola—Among the Visiting Dealers—Number of New Firms Handling Talkers—The News of the Month in Brief.

(Special to The Talking Machine World.)
Los Angeles, Cal., April 28, 1910.

Splendid weather, as usual, has prevailed throughout Southern California during the past three months, and with the exception of three days, during which there were light showers, every day has been a summer day.

Several important changes have taken place of late. The most important is possibly the Columbia-Fitzgerald affair, whereby the latter gives over his talking machine department to the Columbia Co., who will henceforth conduct it as their retail store, having closed their old store on Broadway, between Fifth and Sixth streets, and establishing an exclusive wholesale warehouse at 429 South Broadway on the fifth floor. The new wholesale department is exceptionally well appointed for handling the business, being large and systematically arranged. A large shipment of Grafonola Regents has been received and are rapidly being shipped to the trade.

Another item of marked interest is the removal of the Holmes Music Co. from their old location, No. 113 South Spring street, to a handsome new storeroom on South Broadway, No. 422. Their talking machine department is to be a main feature, and elaborate plans have been made for the fixtures and fittings. This move of the Holmes Co. makes them neighbors of the Wiley B. Allen Co., who are located on the same side of Broadway, a few doors north. This same block has gained the name of "Talking Machine Row," for beside the Holmes and Allen companies is also the home of the Victor distributors, Sherman, Clay & Co. and the Columbia Co., while a little later the Geo. J. Birkel Co. will occupy their new home in the same block. Broadway now has seven of the city's largest dealers and jobbers in a stretch of four blocks.

Sherman, Clay & Co. are having unusual success with the newly issued Red Seal records. The records of Maud Powell had a heavy run during her recitals in this section. The improved Victrolas have arrived and are being shipped and delivered to the many waiting dealers.

The Southern California Music Co. are receiving a shipment of the new Amberola, which have met with undaunted success, the demand being far greater in Southern California than can be supplied for sometime to come. Those dealers who have been fortunate in receiving the Amberola have placed further orders, till now there seems to be no end to the demand. The new combination attachments have met with much success, having been lately sent to the trade. W. L. Reynard, of the same company's traveling force, has succeeded in establishing

several new Edison dealers during a recent trip.

The J. B. Brown Music Co. have displayed the Regent Grafonola in an artistic manner, having transformed one of their show windows into a drawing room, wherein wax figures are poised as though listening to the instrument.

Contracts for the erection of the Geo. J. Birkel Music Co.'s building have been given, and preparations for occupancy of the new home are in mind.

Several out of town dealers have been visitors lately, among whom are: N. L. A. Cody, of Merced, where he says trade is growing better all the while. O. A. Brehler, of Sanger, made a short stay, meanwhile investigating new stock and fixtures. Arthur Burson, the brake-man of Santa Barbara, called with his latest model of the Burson brake. Chas. MacGregor, of MacGregor Bros., Ventura, called on the jobbers last week.

San Diego, one of the fastest growing cities in this southern section, is thereby attracting much attention.

A number of new firms have recently taken to the talking machine business, two of whom are Burbeck & Frank, at corner of Fourth and C streets, and The Bowers Music Co., at No. 1154 Fifth street. Both have met with much success and are enthusiasts in the Victor line.

The Wiley B. Allen Co. have had great success in their new location and have a splendidly equipped department.

Therle's music store have placed a nice order for Victor goods, and will extend their department considerably. Their store is one of the most handsome in the Southwest.

Loring & Co. have added a new section to their Edison department and will be better able to supply their trade.

The South California Music Co. have received one of the Regent grafonolas, which is the first to arrive in San Diego. A. J. Moore, manager, contemplates a heavy demand for these instruments.

O. P. Brady, of Redondo, has taken over the business of Helen Huston at Redondo Beach, Cal., where she has conducted an Edison store for several years.

W. S. Douset is a new dealer at Sierra Madre. E. A. Helyer, the Business phonograph man of the Southern California Music Co., is now using an automobile in his business rounds.

F. K. Babson, of Babson Bros., Chicago, passed through Los Angeles on a pleasure trip in company with Mrs. Babson.

W. L. Aylsworth, chief chemist of the experimental department of the Edison works at Orange, N. J., visited his brothers at Long Beach and incidentally dropped in to see the Los Angeles jobbers.

W. A. Voltz, Edison representative on the Coast, has had splendid success with the line, especially the Amberola.

The parents of Nora Bayes, famous for her purple label Victoria record. "Has Anybody Here Seen Kelly," are old residents of Los Angeles and are justly proud of her success.

A CLEAN UP OF PRICE CUTTERS.

The National Phonograph Co. Secures Injunctions Against Violators in the Greater New York Territory.

The National Phonograph Co. have just completed what has amounted to almost a crusade in New York and Brooklyn against price cutters, both dealers in their new goods and also those who have dealt in second-hand goods. The atmosphere throughout Greater New York has been thoroughly cleared up by injunctions which have recently been obtained against the following: In New York city—Frantz Prikovitz, Morris Workman and John Morchenross. In Brooklyn—J. J. Dixon, Jacob Workman, George Hausenbauer and Charles Fredericks.

Of the above, Prikovitz and Fredericks were second-hand dealers, and Morris Workman, of Vesey street, New York, was a regularly licensed dealer of the National Phonograph Co., who made use of his brother, Jacob Workman, in Brooklyn, for the disposition of the Edison goods at less than list prices. The investigation of the agents of the National Phonograph Co. in the case of the Workman Bros. resulted in the discovery of a previously unknown underground passage from Manhattan to Brooklyn, through which the Edison goods sold to the regularly licensed dealers of the National Phonograph Co. on the Manhattan side were passed to become part of a price cutter's stock in Brooklyn.

Since these injunctions have been obtained there has been practically no price cutting in Greater New York. The jobbers and dealers throughout the greater city have found that practical—not merely theoretical—protection is afforded them by this policy of the National Phonograph Co.

THE PEERLESS SUCTION CLEANER CO.

The charter for the Peerless Suction Cleaner Co., successors to the Manufacturers' Outlet Co., 89 Chambers street, New York, has been issued, and the new concern is officered as follows: Walter L. Eckhardt, president and general manager; Willard I. Hamilton, vice-president; J. H. Huntington, Jr., treasurer; James F. Meng, secretary; Albert P. Massey, director and general counsel. Henry E. Marschalk is assistant general manager, who will have charge of the office details. The company have factories in New York city, Newark, N. J., and in Connecticut. The capital of the company is \$400,000—\$150,000 preferred and \$250,000 common, and none for sale.

Mr. Eckhardt, for many years connected with the talking machine trade, East and West, occupying many positions of trust and responsibility, has removed his residence from Flatbush (Brooklyn) to Whitestone, up on the north shore of Long Island Sound. He has recently purchased a new seven-seat automobile, and takes pleasure in having his friends join him on extended trips on the superb roads of the island, visiting its many picturesque spots.

CINCINNATI'S BUDGET OF NEWS.

April Business Shows Drop—Rudolph Wurlitzer Co. Well Pleased with Conditions—May Musical Festival Helps Trade—Featuring the Fibre Needles—Edison Circular Stimulates Dealers—Columbia Co. Business Good—Milner Musical Co. Establishing New Agencies—Ohio Concertophone Co. Succeeds the National Concertophone—Other Interesting News Worthy of Record.

(Special to The Talking Machine World.)

Cincinnati, O., May 6, 1910.

April was not quite up to the standard of the first three months of this year, but compared with the corresponding period in 1909 the trade are well pleased with the month that was recently torn from the calendar. The outlook for business is satisfactory, the jobbers announcing plans for getting into closer touch with dealers. In

some instances additional men have been employed for this particular purpose.

The management of the Rudolph Wurlitzer Co. is well pleased with the results so far obtained in their talking machine department during the year 1910. The retail business, thanks to the musical activity in Cincinnati, has been very brisk. The volume of Victrola and Red Seal business is always proportionate to the number of musical affairs given, and the year 1910 has been particularly favorable in this regard. The Cincinnati May Festival, which is a feature of musical life in Cincinnati, brought home practically to every Cincinnati the work of the great masters and the art of such singers as Schumann-Heink, Evan Williams, Herbert Witherspoon, Louise Homer and Emmy Destinn, who were heard during the festival. Needless to say the records of these singers were in great demand during and after the festival.

Local dealers look forward to the month of May to be a record breaker in the talking machine business.

The Wurlitzer Co. are featuring the fibre needle on the main floor of their establishment. The Victrola is placed just within the front of the store, and the sweet music given by this instrument, upon which the fibre needle is used, fills the entire store without interfering in the least with the transaction of other business at the musical merchandise counter or office. This feature alone has sold many Victrolas, and the Wurlitzer Co. will hereafter give it a permanent place. The entire musical store was redecorated and a magnificent electrical display illuminated the front of the building during the festival season.

Schumann-Heink and Evan Williams were among the most popular of the artists who came to Cincinnati for the fall festival. In this connection it is quite a tribute to the Victor to state that the engagement of Evan Williams was secured through an enthusiastic purchaser of a Victrola, who appreciated Evan Williams' records, and recommended his selection as a May Festival soloist. The Wurlitzer Co. did some extensive advertising during the May Festival season, in which visitors were invited to call and hear the voices of the May Festival stars through the Victrola, with a view of being able to secure many prospects for dealers who are located in this city and Ohio, Indiana, Kentucky and other neighboring States. The artists who took part in the festival were invited to call at the Wurlitzer store to hear their records on the Victor Victrola.

The circular just issued to Edison dealers, calling attention to the immense number of small Edison machines which are scattered through the country, and suggesting that they take in trade these instruments on an Amberola, has been most stimulating to Edison trade in this city and locality. Every dealer should carry an Amberola and the jobbers stand ready to make this possible regardless of his capital, as long as he proves himself to be progressive and upright.

Manager S. H. Nichols, of the Columbia Phonograph Co., reports business for the month of April even better than he anticipated, and his anticipations were very high. He said: "The demand for the Grafonolas, especially the Regent, continues beyond the supply. At this time we are holding orders for Regents, awaiting shipment, although deliveries from the factory have been very satisfactory, but the sales have gone away beyond what we really planned for. We have been using a wide campaign of advertising, including the newspapers, billboards and street cars, and the effects of this publicity are being felt strongly in our retail department, where the sales have been satisfactory from every point of view. The demand for the Grafonolas is greater than before, and the Grafonolas carry with them a large demand for our Fonotopia double-disc records. With the opening of spring our dealers are being furnished with plenty of posters and advertising for outdoor work, and the signing up of exclusive Columbia dealers continues almost daily. The simplicity of our four-minute aluminum tone arm cylinder graphophones and the perfection of the four-

minute Indestructible records has been recognized and appreciated fully by our dealers, who are enthusiastic over them and who are doing a larger cylinder business with them than ever before. Conditions are good and business is good, and we are enjoying our full share of this prosperity, together with our hundreds of Columbia dealers. Our dealers are doing a splendid business with the Grafonolas, and are delighted with the wide working field these high-class instruments have opened for them."

The Milner Musical Co. intend to devote the most of their energies this month toward establishing new agencies. A new man has been taken on in order to enable Manager W. A. Timmerman to put one of his live wires out in the field. George Gross, who took on a line of Edison goods last month from the Milner house, has proven a winner at his new location, Woodward and Main streets. He has come back with new orders and promises to be one of the best agency buyers on the list of the company.

Manager Timmerman this morning stated that the Edison line of records for May is the best yet produced and predicts a record breaking business for the next thirty days. He said the house is ahead of last April's record. Several Amberolas were sold last week and he has plenty of good prospects in tow. Wm. J. Kenney, one of the hustlers of the Milner Co., carried off the honors during April for the largest aggregate sales of machines and supplies.

The Ohio Concertophone Co. have been succeeded by the National Concertophone Co., the two being the successors of the Victor Novelty Works, of Chicago, which was bought out recently by John C. Groene and others of this city. Arrangements were made last week for the establishment of a factory at Rising Sun, Ind., which will be in charge of Thomas Skelly, the inventor. The officers of the new concern are: President, J. W. Whitlock; vice-president, Charles Luhn; treasurer, Jno. C. Groene, and secretary, Frank K. Bowman.

John Arnold, 507 Elm street, believes the best thing that has happened to the trade in months is the offer of the National Phonograph Co. to place their new attachments on old machines for four-minute records. "People," he said, "tired of hearing the short selections, have come forth and are having a new attachment placed upon their machines. This has brought us a large volume of business."

The Salm Talking Machine Co. are disappointed at the lack of results in their publicity campaign, in which billboards were extensively used. This many claim is a roundabout way of reaching purchasers.

COLUMBIA GLEANINGS.

Feinberg's Southern Trip—Something New Coming.

B. Feinberg, who has been touring the South for the wholesale department of the Columbia Phonograph Co., general, for six weeks past, returned to New York Monday. He reports writing a lot of good business. Thursday last he went to Richmond, Va., via the water route and remain until the close of the Piano Trade Exhibition.

The Columbia Co. will shortly announce something that will be welcomed by their dealers and jobbers. It in no way interferes with their present strong line, but is an addition. The catalog or booklet is under way, and possibly the goods will be shown for the first time in their space at the Piano Trade Exhibition in Richmond, Va., May 16 to 21.

On May 2 Don Emilio Murillo, a distinguished composer of Bogota, Republic of Columbia, S. A., arrived in this country to supervise the recording of some of his best known works for sale in his native country. Not a few of Senor Murillo's compositions have been produced with éclat in Paris, France. He will remain here for three months, and devote his exclusive services to the Columbia Phonograph Co., General.

PROTECTORS for VICTROLAS and AMBEROLAS

HIGH PRICED MACHINES
are worth while taking care of

Our Protectors save them from Dust,
Damp and Injury

MADE IN TWO GRADES

Fleece-Lined Rubber—Fleece-Lined Mackintosh

Send for samples of material and prices

MAGNETIC NEEDLES

EVERY NEEDLE
GUARANTEED

MADE IN THREE GRADES

Regular Tone—Multi Tone—Mellow Tone

Send for free samples and prices

We are the oldest established

VICTOR and EDISON

Jobbers in Greater New York

S. B. Davega Co.
126 University Pl.
NEW YORK CITY, N. Y.

REVIEW OF JUNE RECORDS.

Issued by the Victor, National, Columbia and Universal Companies

In the National Phonograph Co.'s Grand Opera Amberol list for June there are many excellent numbers which will increase the army of Edison admirers. Marguerita Sylva, soprano, is represented by an excellent number in the "Ballatello" from "Pagliacci" (B194), which is sung with ease and effective style. Mme. Carmen Melis, soprano, give a most dramatic reading to the "Mamma" song from "Zaza" (B193). Another impressive number is "Eri tu" from "Ballo in Maschera," sung delightfully by Ernesto Caronna. The selection from Massenet's "Werther," sung by Luigi Cilla, tenor, is a splendid example of the lyric art most effectively recorded. Luigi Lucenti, basso, has made a fine record of an aria from Verdi's little known opera "Simon Boccanegra" (B197), which demonstrates the versatility of the great Italian master and the beauty of Signor Lucenti's voice. In the Edison Amberol list Victor Herbert and his orchestra are represented by selections from "The Tattooed Man" (440), which, as might be expected, are recorded in the most finished style. Another striking orchestral number is "Moraima, Spanish Caprice" (446), played by the American Standard Orchestra. This is a characteristic Spanish number, full of lights and shades, and most fascinating. Sousa's Band is represented by Strauss' "Morgenblätter" Waltzes (452), which are played with verve, charm and finish. Another excellent instrumental number in the lighter vein is the barn dance, "Dem Dear Old Days" (433), played by the United States Marine Band. Among the most striking numbers in the vocal list is a sacred selection, "My Jesus As Thou Wilt" (445), sung with fervor and charm by singers of recognized ability, composing the Edison Mixed Quartet. There are quite a number of the popular songs of the day listed, all of which are greatly in demand, and which, as usual, are well recorded. Among the striking numbers in the Edison Standard list is the harp solo, "Annie Laurie" (10368), by R. P. LaRocca. This charming old melody is given a new setting, beautifully embellished and artistically rendered. Other instrumental numbers are: "The Salute to Washington March" (10365), which is played in brilliant fashion by the United States Marine Band; Chaminade's "The Platterer" (10372) is given a very attractive orchestral reading by Victor Herbert. The recording of this little gem of the well-known French composer is a delight. The Gipsy waltz, "Love's Torment" (10376), so popular in London, is well rendered by the American Standard Orchestra. Under this heading, as in the Amberol list, there is to be found a goodly showing of all the standard songs of the day, sung by well-known composers, which will be found listed in the regular department of The World.

The Columbia Phonograph Co., in their list for June, introduce the famous Italian operatic soprano, Lina Cavalieri, whom they have signed exclusively. Her selections are from "La Boheme" and "Mefistofele" (A5172), in the 12-inch Symphony list. This famous artist is heard to great advantage. Every note is clear and true and musical, and marks the first of a series of double discs by Cavalieri to be issued by the Columbia Co. Kitty Cheatham, the great interpreter of songs of the South and childhood, is represented by the first of a number of records which she intends making for the Columbia Co. Her initial effort in the 12-inch list is "The Plaint of the Little Bisque Doll," "Visitors" and "The Sugar Dolly" (A5163). These songs and sketches are sung in that inimitable manner for which Miss Cheatham is famous. They are unique and therefore must win a big following. Raymond Hitchcock and George Lashwood, baritones, have two excellent numbers (A5167) this month. They are both character sketches, and anyone who has heard the well-known American and the popular Englishman will feel that he is again in their

presence when this record is heard. Manuel Klein's New York Hippodrome Orchestra is represented this month by "The Nut Cracker Suite," by Tschalkowsky, and "Meet Me Where the Lanterns Glow," sung by Miss Tillotson, contralto, and Harry Burr, tenor with the orchestra (A5169). In the 10-inch list there are some numbers of more than ordinary merit, notably the double record comprising "The Friar of Orders Gray" and "Rolling Down to Rio," sung by George Clarence Jell, baritone (A828). The former is an old-time favorite, while the latter is an English song which has created quite a sensation in the old country. Two operatic selections played by Prince's Orchestra—"Bright Eyes" and "The Arcadians" (A823)—are full of graceful, catchy melodies which are very popular. Space will not permit a detailed analysis of the other numbers, which, however, are worthy of careful consideration by dealers. The two-minute and four-minute Indestructible cylinder list for June contains thirty numbers instead of twenty, as heretofore. In the four-minute list appears the first five of a series of fifteen records of dance music played in strict dance time and issued in response to many demands. The general list, as will be noticed elsewhere, contains many numbers, both popular and standard, of real merit. It is well diversified and well selected.

The Victor Talking Machine Co. have turned out an excellent list of records for June sufficiently catholic to please all fancies. The Red Seal list is notable for three new Caruso records, two "Germania" airs by Franchetti (87053-87054) and the famous duel trio from "Faust" (95206), which Caruso sings with Scotti and Journet. John McCormack, the popular young Irish tenor, is represented by an English ballad by Harford-Marshall (64120) and selections from "Carmen" and "Faust" (88216-88230). Mme. Gadski, the great Wagnerian soprano, is heard to great advantage in a selection from "Götterdämmerung" (87052). The admirers of "Mme. Butterfly" will be delighted with the two selections, one a solo by Geraldine Farrar (87055) and the other the trio from Act II., admirably sung by Fonia, Martin and Scotti (87053). Mme. Sembrich, the incomparable soprano, and Sammarco, the baritone, are represented by a duet from "Rigoletto" (89042), a beautiful record. Another duet that will interest is that sung by Mmes. Gadski and Homer from "Orfeo ed Euridice" (89041). Mischa Elman, the clever violinist, who has just finished a tour of this country, has made new records of seven of his selections already listed, and played several new numbers, two of which are herewith presented, namely, Beethoven Minuet in G (64121) and Dvorak's Humoresque (74163). These, as well as the entire list, are splendidly played by this violin wizard. In the Purple Record Label list there is an interesting talk by Shackleton, the great English explorer (70014); two new Bayes-Norworth records, "Young Amer-

ica" (70015), "Come Along, My Mandy" (70016), and two new Lauder songs, "Killiecrankie" (60018), and "We Parted at the Shore" (70013). These are sung in Lauder's inimitable style with plenty of rolling "r's". Other records of merit listed include a selection from Massenet's "Hérodiade" (31786), played with brilliancy by Arthur Pryor's Band. Another interesting record is Wagner's "Lohengrin Fantasie" (31785), played by Victor Sorlin, 'cello, and C. H. Booth, pianist. In this record there is an admirable balance of tone and the ensemble effect is most pleasing. The Victor Light Opera Co. is represented this month by gems from "Pinafore" (31782), one of Gilbert and Sullivan's most successful operas. The old favorites from this opera are admirably sung and undoubtedly will appeal to hundreds of thousands of admirers. A new piano record, and a mighty good one at that, is the Strauss "Voice of Spring Waltz" (31784), played with some amazing variations by Alfred Grünfeld. M. Rocca, of the Opera Comique, Paris, is the singer of an aria from Massenet's "Manon" (5775). This record will give a great deal of satisfaction to opera lovers. Lucy Marsh and Harry Macdonough have two charming duets from current opera successes in "The Stepping Stones," from "The Belle of Brittany" (5776), and "Ring O'Roses" from "The Dollar Princess" (31783). Twelve double-faced records are listed for June, and as will be seen from the list elsewhere, they include a number of popular, classic and religious selections that are well worthy the consideration of dealers.

THE COLUMBIA WHOLESALE STAFF.

R. F. Bolton, manager of the Columbia Phonograph Co.'s wholesale branch, 89 Chambers street, New York, in speaking of business said: "The last week has shown a marked improvement over the preceding weeks. The demand for high-priced goods continues and the factory is behind on deliveries. As a whole the Columbia trade is getting steadily better. Last week we sold a nice bill of goods to Frank Storck, Red Bank, N. J., amounting to \$2,000.

"Our traveling staff consists of O. P. Graffan, who travels through New York State; C. M. Mallette, who looks after the trade in New Jersey and Connecticut; L. C. Ziegler, who sees the dealers in Greater New York, and C. M. Dolly, Jr., a special representative in the same territory. They are all live wires."

We are in receipt of a handsome photograph showing the interior of the talking machine display rooms of the Abelowitz Phonograph Co., Inc., at 510 East 138th street, New York. The instruments which they handle are most attractively displayed, the Victor being prominently featured with the famous trade-mark occupying the place of honor. The store is attractively arranged and bears all the evidences of careful and progressive management.



The THORN NEEDLE and HOLDER is Pleasing Everybody

ESPECIALLY THE DEALER WHO SELLS THEM

Put in a stock of Thorn Needles and Holders and give them a THOROUGH try-out with your trade. You will be as surprised with the results as other dealers all over the country who have taken the time to demonstrate them.

YOUR TRADE WANT THEM BECAUSE THEY ARE

Easy to Handle **Each Needle Plays Several Records**
No Scratching **No Change in Reproduction**
No Wear Upon the Record

THORN NEEDLES, Boxes of 100, RETAIL 35 CENTS
 THORN NEEDLE HOLDERS, EACH 25 CENTS
 Liberal Discounts to the Trade

Patented

We Sell Millions of Them at Retail. So Can You. Send for a Supply To-day. Don't Put It Off. DO IT NOW.

J. W. JENKINS' SONS MUSIC CO.
VICTOR TALKING MACHINE DISTRIBUTORS **KANSAS CITY, MO.**



**Every point of advantage that can be
claimed for any hornless machine, can
be proved in the Columbia Grafonola.**



Columbia Phonograph Co., Tribune Building, New York.

WITH THE TRADE IN CLEVELAND.

Business in the Talking Machine Field of Satisfactory Volume—Grand Opera Records Selling Well—Moving Pictures to Help Deaf and Dumb—A Talking Machine Enthusiast—W. J. Roberts, Jr., and W. H. Buescher & Sons Consolidate—Good Columbia Co. Business—How the Various Houses are Handling the Trade—General Increase in Business Reported—Expansion With May Co.

(Special to 'The Talking Machine World'.)

Cleveland, O., May 10, 1910.

Business in the talking machine trade is of moderate volume as usual at this season of the year, and if anything has been accentuated by the changeable, disagreeable, unseasonable weather. But from the fact that general business is good, the outlook is regarded as encouraging. However, opinions are somewhat mixed regarding conditions, and there are some who believe a quiet trade is the best the situation can boast of. Complaint is made that there are too many engaged in the talking machine business, engendering unnatural competition, and hints are dropped of underhanded price cutting and explanations of how it is done. But, as a general proposition, it is doubtful if much, or any, price cutting is resorted to in making sales.

These lovers of music who did not, and those who did, hear the famous singers at the recent brief grand opera season in this city are now, thanks to the May lists of records, hearing them sung at their homes, and as often as they like, as well as many other world-famed songsters in the popular field.

With the passing of the winter season, regardless of the weather, patrons of opera, concert, lecture and stage find fewer opportunities for indulging their tastes. In a lesser measure it is true even of the lovers of vaudeville. These patrons have learned that it is no longer necessary to store up their temperamental tastes, not to be brought out again until fall arrives. Throughout the summer they can, and do, depend on the never failing, always enjoyable music records, and find their wants satisfied.

In collaboration with the phonograph the deaf and dumb of Cleveland have determined to use the moving picture machine to preserve the work of their famous lecturers. In a lecture by Robert McGregor, a celebrated deaf and dumb reader on "The Helmet of Navarre," moving pictures were taken of his graphic sign language, which will be preserved for future generations of the deaf and dumb. Heretofore there has been no record of the sign language. Slang expressions have crept in, and through the instrumentality of educated lecturers the deaf and dumb hope to preserve purity of diction of the silent language.

E. F. Stafford, a prominent business man of this city, who resides in the suburban town of Lakewood, is an enthusiastic admirer of the talking machine. He has installed in his cozy home

a golden oak Victrola, and is the possessor of over one thousand records, including nearly every red seal record in the Victor catalog. Mr. Stafford, a musician of considerable local note, is baritone soloist at Emmanuel Episcopal Church and has participated in a number of operatic functions in recent years. Notwithstanding his large number of records they have been made with care, and constitute a repertoire of selections which would be difficult to duplicate, including the seven of the garden scene from Faust, by Caruso, Farrar, Gilbert and Journot.

W. J. Roberts, Jr., has merged his business with W. H. Buescher & Sons, and is now in charge of the Victrola sales department. This merging of the two businesses, while greatly decreasing the expenses of operation, will strengthen the forces, centering the trade in one of the finest equipped Victor stores in the country. W. H. Buescher stated business was giving daily evidence of improvement, many sales of Victrolas were made during the month.

Phil Doran, manager of the talking machine department of Collister & Sayle, said sales of machines were slow, but record trade, especially in red seals, was very good.

At the Columbia graphophone store of the G. J. Probeck Co. this month's business is reported excellent, and the trade holding up remarkably well. A. W. Robertson, of the company, said: "We are experiencing a growing demand for Columbia grand opera and other special records, made by exceptionally good talent, and the interest in Grafonolas is not abating, one prospective customer even proposing to so plan the arrangement of the library and living room portion of his new home, now under construction, as to most suitably accommodate the new library table Grafonola. The new 4-minute Columbia indestructible cylinder records are making friends every day, and, as Mr. Post would say, 'There's a reason.'"

Great activity is evident in all departments at E. McMillin's music store, especially in the talking machine department. Mr. O. E. Kellogg, the new manager, has perfected extensive improvements for the benefit of customers by greatly expanding the list of records carried, which now includes a large number of the foreign selections. Through Mr. Kellogg's up-to-date methods every record is always in stock. "Our sales of Red Seal records," he said, "has shown a steady increase and the demand now exceeds our most sanguine expectations. We also feature the entire Edison line, the same as the Victor, and are now the only Edison dealers in the Cleveland New Center."

Next to attractive demonstration rooms and an appropriate display of talking machines and cabinets, E. A. Friedlander, manager of the talking machine department of the Bailey Co., believes in as wide publicity as possible, and is alert in taking advantage of the liberal advertising by the different manufacturers in following up the various announcements in the daily papers with matters of local import. With the

extensive and varied stock of Victrolas, Phonographs, Zonophones and complete lists of the records. Mr. Friedlander is enabled to meet customers with propositions that meet their pocketbook. He states that business is very good and improving, the demand for the more expensive machines and records, especially, constantly increasing, and that he had more orders than he could fill for the special Amberola attachment offer. He stated the Zonophone foreign records were very popular and selling well.

The talking machine trade is very good at the store of B. L. Robbins & Co. "The special Amberola proposition is proving very popular, and is being taken advantage of by many of our customers," said Mr. Robbins.

The May Co. are building an addition to their already large store, and when completed will undoubtedly house the piano and talking machine departments in more accessible quarters than the present. The company are doing a fairly good business, and report a number of sales of Victrolas. The manager stated that, judging from inquiries, there would be a good continuous demand for the new Victor May Red Seal records, especially of the garden scene from Faust, as sales of the entire set of seven are being daily made.

Brown Bros., who handle the Columbia exclusively, report a very satisfactory trade during the past month. Miss L. Byrnes, in charge of this department, stated that while there had been a little slacking up, they had been making good sales right along, and that business was now steadily improving again.

H. E. Jones, formerly with the Columbia Co., is now engaged with the C. E. Zimmerman Co., publicity and sales promoters of Chicago. He is in charge of the State of Ohio territory, with headquarters in Cleveland.

The Goodman Piano Co. have increased their capital stock from \$25,000 to \$100,000. Mr. Goodman said business in both the talking machine and piano line was constantly improving.

A run around the trade generally reveals conditions as uneven with a tendency to betterment. The Flesheim-Smith Co. report increasing sales in Victrolas and Victor records; the Aldrich-Howey Co. make a similar report regarding Columbia graphophones and double disc records; Chas. I. Davis, of the Music and Novelty Shop, reports many sales of Victrolas and increasing record trade; Mr. Towle, of the Eclipse Musical Co., says machine sales are slow, but record trade is good; the Lewis-Welsh Piano Co., 5907 Euclid avenue, are giving talking machines quite a prominence as a side line; Mr. Rood, of the Talking Machine Store, reports business as seasonably good; Cobletz Bros., whose trade is largely in records of foreign languages, complains that business is very poor. So there you are.

The Columbia list of the foreign series of disc and cylinder records is proving a successful aid to dealers in securing patronage from that large class of our fellow-citizens who appreciate records in their own tongue.

TRADE IN THE PACIFIC NORTHWEST.

April a Record Month in Both Wholesale and Retail Lines—Looking for Good Summer Business—A Canadian Visitor—Conditions in Oregon—What the Various Dealers Are Doing—Jobbers Very Active—Talking Machine News of the Month in Brief.

(Special to The Talking Machine World.)

Seattle, Wash., May 1, 1910.

The month of April has been the biggest month so far this year in both wholesale and retail business. Probably the great activity shown by the country dealers is due to the special attachment proposition made by the Edison people. This offer has served to wake up quite a number of the "dead ones" and has spurred the "live ones" to greater effort than ever before. The Victor business, of course, is holding up in good shape, especially the Victrola and Red Seal records. The Columbia Regent Grafonola is also coming in for its share of attention by the trade.

From now on the dealers are looking for continued prosperity, as the summer homes and house-boats are rapidly being occupied and the talking machine will be more popular than ever with this class of people. Quite a number of sales have already been made by dealers to occupants of these summer homes.

Seattle enjoyed a visit by a distinguished talking machine man lately in the person of James P. Bradt, Canadian manager for the Columbia Phonograph Co. Mr. Bradt states that business is excellent across the line and that the Columbia product is "the one best bet" with the dealers. While in Seattle Mr. Bradt was entertained by Edw. P. Kelly, also by C. H. Hopper, who is one of the directors of the Eilers Music House.

Ed. Lyons, Northwestern representative for the National Phonograph Co., made a brief visit to Seattle a few days ago. He reports that the dealers in Oregon are at last beginning to show signs of life. It is the opinion of all travelers who have made this State that the possibilities

of the talking machine from a commercial standpoint are greater than any Coast territory. This will be apparent when it is considered that Oregon is just entering into a great era of railroad building which will naturally be followed by new towns and general prosperity when its millions of acres of the richest land in the world will be placed in direct outlet with Portland and San Francisco.

E. B. Hyatt, of the Portland Phonograph Agency, claims the record of the Coast for Amberola sales. He has purchased 24 and sold 19 since January 1. Mr. Hyatt handles Edison products exclusively.

Mr. Glenn, manager of the Columbia Phonograph Co., Portland, reports that the business of his branch is unprecedented. He is booking orders by the carload for immediate delivery.

The Edison business phonograph is gaining prestige every day in Seattle. A demonstration of its advantages was given by Eilers Music House to a gathering of 200 good-looking stenographers recently. They are establishing a training department where stenographers may receive free instruction in the operation of this device.

Manager Rice, of Kohler & Chase's talking machine department, states that their business for April exceeded that of any other month so far, with the exception of December, 1909.

Hugh Barrett Dobbs, late of New York city, who is traveling for Sherman, Clay & Co., is making quite a record for himself in establishing Victor dealers. Only "live wires" are wanted by Mr. Dobbs, and a few of his latest acquisitions into the Victor fold are such firms as A. L. Hotchkiss Co., Seabeck; E. C. MacReavy, Union City; Webster, Eckhardt, Sims Co., Enemclaw, and the Carbon Hill Coal Co., Carbonado, all in Washington.

J. H. Ferguson, traveler for Eilers Music House, Seattle, has just returned from the southern part of the State and Grays Harbor points, with his usual package of orders.

Ward & Co., the hustling dealers of Bremerton, Wash., have just sold seven Victors and

five Edisons to the battleships at the Navy Yard.

A. T. Raebeck, Olympia, Wash., has just completed the task of remodeling his warerooms to make room for his growing talking machine business.

White & Gabel, the dealers at Chehalis, Wash., have recently opened up a swell store in Centralia, Wash., with a full line of Edison machines and records. This firm have certainly done wonders toward developing the "talker" business in their territory.

Business in Alaska continues to go by leaps and bounds. The Seattle jobbers having received heavy orders from the leading dealers, among whom are the Ryus Drug Co., Ketchikan; J. Huebner, Douglas; Seward Drug Co., Seward; Owl Drug Co., Valdez, and W. W. Powell, Fairbanks.

Mr. Wilson, of White & Co., Cordova, Alaska, spent a few days in Seattle recently on his way to mining property in Oregon.

J. T. Spickett, a dealer of Juneau, Alaska, stopped off to call on Seattle jobbers on his way to Texas, where he is going on a short business and pleasure trip.

J. Woodburn, of Tideman & Woodburn, Everett, Wash., was a recent visitor at Eilers Music House, placing an order for three Amberolas.

HONESTY IN ADVERTISING.

Be absolutely honest in advertising. Be straightforward and honest. It may be true that misrepresentations will sell goods. Lying salesmen can sell shoddy stuff. These are men who have become rich by cheating. Dishonesty in the store or in advertising is not a sign of cleverness, but rather of business weakness. Transient trade will follow the alluring dishonest advertisement, but no permanently successful business has ever been built without honesty and integrity as foundation stones. P. T. Barnum's remark might have been true regarding a circus, but it can't be applied to merchandising.

THE NEW IDEA

Combination Disc Record Cabinet



A unique and practical cabinet with changeable cover to fit and match Victor I, II, III, IV, V or VI. Dealers who handle the New Idea Cabinet need carry but one or two in stock, and with extra tops, at a very small expense, be in a position to supply customers with a cabinet for any type Victor Machine.

A Jobber with ten New Idea Cabinets and a few extra tops, will be able to fill orders more promptly than he is to-day with a stock of 100 of the present style Disc Cabinets. The New Idea Cabinet holds 180 10-in. or 12-in. Records. There are twelve sliding files with indexed interiors, each holding fifteen records. Files are wood faced and finished to match cabinet, oak or Mahogany. Sold through the Jobbing Trade only.



Write for Catalog and Prices

NEW IDEA CABINET COMPANY

441-443 National Ave., Milwaukee, Wis.

RECORD BULLETINS FOR JUNE, 1910

NEW VICTOR RECORDS.

No.	ARTHUR PRYOR'S BAND.	Size.
31786	Héroclade—Grand Selection. Massenet	12
	BLACK DIAMONDS BAND OF LONDON.	
5777	Apache Dance (Danse des Apaches)	10
	VICTOR SORLIN, CELLO; C. H. H. BOOTH, PIANIST.	
31785	Lechgrün Fantasie. Wagner	12
	ALFRED GRUNFELD, PIANIST.	
31784	Voice of Spring Waltz (Frühlingstimmen) Strauss	12
	LUCY MARSH AND HARRY MACDONOUGH.	
5776	The Stepping Stones (From "The Belle of Brittany") Greenbank-Horne	10
31783	Ring o' Roses (From "The Dollar Princess") Fall	12
	THE FIRST GILBERT AND SULLIVAN MEDLEY.	
	VICTOR LIGHT OPERA CO.	
31782	Gems from "H. M. S. Pinafore": Opening Chorus, "We Sail the Ocean Blue"; Air, Ralph and Chorus, "A Maiden Fair to See"; Song, Captain, "I Am the Monarch of the Sea"; "I'm Called Little Buttercup." "Captain of the Pinafore." Finale. First Act, "His Foot Should Stamp" Gilbert-Sullivan	12
	M. ROCCA, OF THE OPERA COMIQUE, PARIS.	
5775	Manon—Ah, fuyez douce image (Depart, Fair Vision) Massenet	10

PURPLE LABEL RECORDS

No.	A RECORD BY SHACKLETON—THE ENGLISH EXPLORER TALKS OF HIS REMARKABLE FEAT.	Size.
70014	A Dash for the South Pole. NORA BAYES, WITH ORCH.	12
70015	Young America BAYES-NORWORTH	12
70016	Come Along, My Mandy. BAYES-NORWORTH	12
	SCOTCH SONGS BY HARRY LAUDER.	
60018	Killicrankie	10
70013	We Parted on the Shore.	12

VICTOR DOUBLE-FACED RECORDS.

No.		Size.
16462	Spring Flowers Waltz—Concertina. P. Frosinal	10
	Dill Pickles Rag (Johnson) Pryor's Band	10
16485	Popular Medley, No. 3: "Lonesome," "La la la Two-Step," "If I Had a Thousand Lives to Live" and "Lily of the Prairie" Pryor's Band	10
	Love's Caprice (Venuto)—Xylophone. William H. Reitz	10
16486	Nora Malone (A. Von Tilzer) Jones and Quartet	10
	Beerland (Murphy) Josie Sadler	10
16487	There is a Balm of Gilead. Fisk Jubilee Quartet	10
	The Great Campmeeting. Fisk Jubilee Quartet	10
16488	First Kiss Waltz (Sartori)—Ocarina. Mosé Tapiero	10
	Four Little Blackberries—Banjo. Vess L. Ossman	10
16489	Some Day, Melinda. Collins and Harlan	10
	The Farmer and the Hogs. Edwin Whitney	10
16490	I Heard the Voice of Jesus Say (Bonar-Dykes) Mr. and Mrs. Wheeler	10
	Ave Maria (Bach-Gounod) Elizabeth Wheeler	10
16491	Sleep, Little Baby of Mine. Walter Anderson	10
	I Want Someone to Play With. Byron G. Harlan	10

16492	He's a College Boy. Murray and American Quartet	10
	The Coleville Coon Cadets. Arthur Collins	10
35104	Cavalleria Rusticana—Prelude (Mascagn). La Scala Orch.	12
	Cavalleria Rusticana Selection: Opening of Act—"Alfio's Song." "Easter Chorus." "Intermezzo" (Mascagn). Pryor's Band	12
35105	Dragon Fly Mazurka (Strauss). Vienna Quartet	12
	Follies of Love Waltz (Folie d'amour). Victor Orch.	12
35106	Military Overture—Finale (Mendelssohn). Arthur Pryor's Band	12
	Funeral March of a Marionette (Gounod). Vienna Quartet	12

NEW RED SEAL RECORDS.

NEW CARUSO RECORDS.

	WITH ORCH.—IN ITALIAN.	
87053	Germania—Studenti, udite! (Students, Hear Me!) Paganini	10
87054	Germania—Non chioder i tuoi occhi vaghi (Close Not Those Dreamy Eyes) Paganini	10
	CARUSO, SCOTTI, JOURNET, WITH ORCH.—IN FRENCH.	
95206	Faust—Trio du Duel, "Que Voulez-vous, messieurs?" (What Is Your Will with Me?) (Trio, Act. III.—Duel Scene). Gounod	12

THE FAVORITE, "FORGOTTEN."

74160	Forgotten Cowles	12
-------	----------------------------	----

THREE NEW McCORMACK RECORDS.

	WITH ORCH.—IN ENGLISH.	
64120	I Hear You Calling Me. Harford-Marshall	10
86216	Carmen—Il fior che avevi a me (Flower Song) Bizet	12
88230	Faust—Salve, dimora (All Hail, Thou Dwelling Lowly) Gounod	12

A SCHUBERT SONG BY HOMER.

88231	Die Allmacht (The Almighty). Schubert	12
	JOHANNA GADSKI, SOPRANO, WITH ORCH.—IN GERMAN.	
87052	Götterdämmerung—Helle Wehr! Heilige Waffe! (Haft of War! Hallowed Weapon!—from "The Dusk of the Gods") Wagner	10

GERALDINE FARRAR, SOPRANO, WITH ORCH.—IN ITALIAN.

87055	Madama Butterfly—Sal cos' ebbe cuore (Do You Know, My Sweet One?) Puccini	10
	FORNIA, MARTIN, SCOTTI, WITH ORCH.—IN ITALIAN.	
87503	Madama Butterfly—Lo so che alle sue pene (Naught Can Console Her) (Trio from Act II) Puccini	10

JOHANNA GADSKI AND LOUISE HOMER, WITH ORCH.—IN ITALIAN.

89041	Orfeo ed Euridice—Su e con me vieni cara (On My Faith Relying) Gluck	12
	MARCELLA SEMBRICH AND G. MARIO SAMMARCO, WITH ORCH.—IN ITALIAN.	
89042	Rigoletto—Tutte le feste (On Every Festival Morning) Verdi	12

NEW RECORDS BY ELMAN.

64121	Minuet in G, No. 2. Beethoven	10
74163	Humoresque Dvorak	12
	ELMAN RECORDS REMADE WITH NEW SERIAL NUMBERS.	
64122	(Old No. 61182) Faust—Fantasie from Garden Scene Gounod	10
64123	(Old No. 61185) Serenade Drigo	10
74164	(Old No. 71039) (1) German Dance—Deutscher Tanz (Gosses). (2) Gavotte (Gosses) Dittersdorf	12
74165	(Old No. 71038) Introduction and Rondo Capriccioso Saint-Saëns	12
	ELMAN RECORDS REMADE WITH SAME SERIAL NUMBERS.	
74053	Melodie Tchaikowsky	10
74052	Nocturne in E flat. Chopin	10
74051	Souvenir de Moscow. Wieniawski	10

NEW EDISON AMBEROL RECORDS.

433	Dem Dear Ole Days—Barn Dance. United States Marine Band
434	The Garden of Roses. Joe Maxwell and Chorus
435	Larboard Watch. Stanley and Gillette
436	When He Sings the Songs My Mother Sang to Me. Ada Jones and Chorus
437	My Hero. Marie Florence
438	The German 5th. Josie Sadler
439	One More Day's Work for Jesus. Miss Marvin and Mr. Anthony
440	Selection from "The Tattooed Man. Victor Herbert and His Orch.
441	Molly Lee. Manuel Romani and Chorus
442	Two Gentlemen from Ireland. Len Spencer and Billy Murray
443	Poxy Kid—Cornet Duet. Edison Concert Band
444	Forgotten. W. H. Thompson
445	My Jesus, As Thou Wilt. Edison Mixed Quartet
446	Moraima—Spanish Caprice. American Standard Orch.
447	Red Clover. Frederic H. Potter and Chorus
448	Peaches and Cream. Ada Jones and Len Spencer
449	Motor King March. New York Military Band
450	Casey Jones. Billy Murray and Chorus
451	Farmyard Medley. Premier Quartet
452	Morgenhütter Waltz. Sousa's Band

EDISON GRAND OPERA AMBEROL RECORDS

B-193	Zaza—Mamma! non l'ho avata mai (Leon-cavallo)—Orch. Accomp. (Sung in Italian) Carmen Melis, Soprano
B-194	Pagliacci—Ballate (Leon-cavallo)—Orch. Accomp. (Sung in Italian) Marguerita Sylva, Soprano
B-195	Werther—Ah! non mi riedstar (Sung in Italian) Luigi Cilla, Tenor
B-196	Ballo in Maschera—Eri tu (Verdi)—Orch. Accomp. (Sung in Italian) Ernesto Caronna, Baritone
B-197	Simon Boccanegra—Preghiera di Fiesco (Verdi)—Orch. Accomp. (Sung in Italian) Luigi Lucenti, Bass

NEW EDISON STANDARD RECORDS.

10365	Salute to Washington March. United States Marine Band
10366	My Husband's in the City. Sophie Tucker
10367	Underneath the Monkey Moon. Collins and Harlan
10368	Annie Laurie. Romy P. LaRocca
10369	What's the Matter with Father. Billy Murray
10370	We Shall Meet Bre and Bye. Stanley and Gillette
10371	I've Set My Heart on You. Manuel Romani
10372	The Flatterer. Victor Herbert and His Orch.
10373	Dreamy Town. Joe Maxwell
10374	Cupid's I. O. U. Ada Jones and Billy Murray
10375	Don't Go Up in That Big Balloon, Dad. Murry K. Hill
10376	Love's Torment Waltz. American Standard Orch.
10377	In Looking for Angel. Marie Dressier
10378	The Bulldog—College Song. Peerless Quartet
10379	Bachelor's Button. Sousa's Band

COLUMBIA 10-INCH DOUBLE-DISC RECORDS.

A820	The Village Blacksmith.—Bass Solo by William McDonald, Orch. Accomp. Ed. Duston
	Old Dog Tray.—Baritone Solo by Carroll Clark, Banjo Accom. Foster
A821	Colt's Armory March.—By Prince's Band. C. W. Smith
	"Old Number One" March (Respectfully dedicated to New York Lodge, B. P. O. Elks). By Prince's Band. C. A. Prince
A822	Underneath the Monkey Moon.—Baritone and Tenor Duet by Collins and Harlan, Orch. Accomp. G. W. Meyer
	The Bull Dog (Old College Song).—Vocal Quartet, Male Voices, by Columbia Quartet, Unaccomp. (One side copyrighted; additional price, 2c.)
A823	Bright Eyes (Selections).—By Prince's Orch. Karl Hoschna
	The Arcadians (Selections).—By Prince's Orch. Lionel Monckton and Howard Talbot
A824	I'm on My Way to Reno.—Baritone Solo by Fred Duprez, Orch. Accomp. Jerome and Schwarz
	Oh, You Blondy.—Soprano Solo by Ada Jones, Orch. Accomp. Ed. Edwards
A825	Whip and Spur Galop.—Banjo Solo by Vess L. Ossman, Orch. Accomp. Theo. S. Allen
	Little Sweetheart (Polka Caprice).—Piccolo Solo by Marshall I. Lutsky, Orch. Accomp. J. O. Prokenschire
A826	You'll Come Back.—Contralto Solo by Miss Elida Morris, Orch. Accomp. George Meyer
	Temptation Rag.—Baritone Solo by Arthur Collins, Orch. Accomp. Henry Lodge
A827	The Old Time Religion.—Vocal Quartet, Male Voices, by the Columbia Quartet, Unaccomp. I Want to See the Old Home.—Baritone Solo by Carroll Clark, Banjo Accom. Stewart
A828	The Fric of Orders Gray.—Baritone Solo by George Clarence Jell, Orch. Accom. William Shield
	Rolling down to Rio.—Baritone Solo by George Clarence Jell, Orch. Accomp. Kipling and German

COLUMBIA 12-INCH DOUBLE-DISC RECORDS

A5167	So What's the Use.—Baritone Solo by Raymond Hitchcock, Orch. Accomp. Ed. Montague
	Send for a Policeman.—Baritone Solo by George Lashwood, Orch. Accomp. Fred Leigh
A5168	I've Got a Pain in My Sawdust (The Print of the Little Bisque Doll).—Soprano Solo by Kitty Cheatham, Orch. Accomp. Herman Avery Wade
	(a) Visitors.—Soprano Solo by Kitty Cheatham, Orch. Accomp. W. Cooke
	(b) The Sugar Dolly.—Soprano Solo by Kitty Cheatham, Orch. Accomp. Gaynor
A5169	A Trip to Japan (at the New York Hippodrome)—Meet Me Where the Lanterns Glow.—Contralto and Tenor Duet by Miss

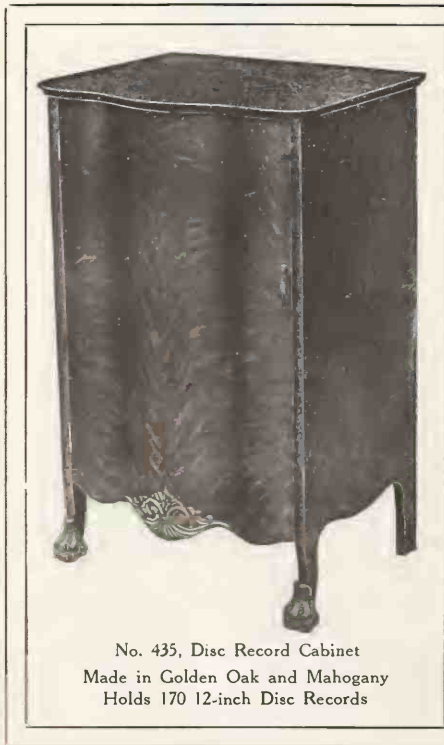

No. 435, Disc Record Cabinet
Made in Golden Oak and Mahogany
Holds 170 12-inch Disc Records

UDELL CABINETS

for DISC RECORDS CYLINDER RECORDS

310 Udell Disc Record Cabinets to one dealer in 1909
150 Udell Disc Record Cabinets to this same dealer so far this year

Almost 500 Cabinets to this one dealer. It means something and we are glad to tell you what. He has found that to get Cabinets properly machined, well finished, and promptly shipped that he cannot buy any cheaper or as cheap than of the Udell Works. All things being equal means much to you when buying Cabinets. Our contention that point for point we have them all bested is illustrated by this dealer whose order for 25 Cabinets a month is practically as certain as that when you read this you will write for our beautiful sale-helping Catalog. It is so attractively gotten up that the arguments that you need to make in Catalog Sales are reduced to the minimum.

Right now is the time to write

THE UDELL WORKS
INDIANAPOLIS, INDIANA

- Merle Tillotson and Henry Burr, Orch. Accomp. Manuel Klein
 Suite of Casse-Noisette (Nut-Cracker Suite)
 —Dance Chinese and Danse des Mirrites
 (Chinese Dance and Flute Dance).—By
 Manuel Klein's N. Y. Hippodrome Orch.
 P. Tschalkowsky
 (One side copyrighted; additional price, 2c.)
 A5170 Some Day.—Baritone and Tenor Duet by
 Harrison and Anthony, Orch. Accomp.
 Chas. H. Gabriel
 Go to Sleep.—Contralto Solo by Mrs. A.
 Stewart Holt, Orch. Accomp. Wm. Arms Fisher

**COLUMBIA 12-INCH SYMPHONY, No. 2,
 DOUBLE-DISC RECORDS.**

- A5172 La Boheme—Mi chiamano Mimi (Mimi They
 Call Me).—Soprano Solo, in Italian, by
 Lina Cavalieri, Orch. Accomp. Puccini
 Meisostele—L'altra notte in fondo al Mare
 (The Other Night Into the Deep Sea).—
 Soprano Solo, in Italian, by Lina Cavalieri,
 Orch. Accomp. Boito

**COLUMBIA 2-MINUTE INDESTRUCTIBLE
 CYLINDER RECORDS.**

- 1342 Kaiser Friedrich (March).—By Band. Friedmann
 1343 Cupid's I. O. U.—Soprano and Tenor Duet by
 Ada Jones and Walter Van Brunt. Meyer
 1344 The Bandleiro.—Baritone Solo by Stanley
 Kirby
 1345 Come After Breakfast.—Baritone Solo by Ar-
 thur Collins
 1346 Traumerei.—By String Quartet. Schumann
 1347 It's Moonlight All the Time on Broadway.—
 Tenor Solo by Walter Van Brunt.
 1348 Two Little Brown Eyes.—Tenor Solo by
 Harry Anthony
 1349 Simple Confession (Simple Aveu).—By Orch.
 Thome
 1350 Red Clover.—By Potter and Chorus. Morse
 1351 Tell Mother I'll Be There.—Vocal Quartet,
 Mixed Voices, by Mixed Quartet) Fillmore
 1352 Tell Me, Mary, How to Woo Thee.—Tenor
 Solo by Thomas Jackson
 1353 Moszkowski Serenade.—Violin Solo by Charles
 D'Almaine
 1354 A Jovial Monk Am I.—Baritone Solo by Nor-
 man Williams
 1355 Nora Malone.—By E. J. Brown. A. Von Tilzer
 1356 The Jolly Coppersmith (March).—By Band. Peter

**COLUMBIA 4-MINUTE INDESTRUCTIBLE
 CYLINDER RECORDS.**

- 3070 My Old Kentucky Home (Fantasia).—By La-
 calle's Band.
 3071 Moonlight in Jungland.—Baritone and Tenor
 Duet by Arthur Collins and Byron G.
 Harlan
 3072 Thora.—Baritone Solo by Frederick Wheeler
 3073 Kimmel Medley.—Accordion Solo by John
 Kimmel
 3074 Skylark! Skylark!—Soprano and Tenor Duet
 by Edith Chapman and Harry Anthony Rogers
 3075 Carolina Minstrels No. 2.—By Minstrels.
 3076 A Vision of Salome (Fantasia).—By Lacalle's
 Orch.
 3077 A Race for a Wife.—Vaudeville by Ada Jones
 and Len Spencer. Mrs. Boone
 3078 The Coleville Coon Cadets.—Baritone Solo by
 Arthur Collins.
 3079 By the Suwanee River.—Baritone Solo by Ar-
 thur Collins and Accomp. by Lacalle's
 Band
 3080 A Signal from Mars (Two-Step).—Dance Mu-
 sic by Lacalle's Band.
 3081 Morning, Cy! (Barn Dance).—Dance Music
 by Lacalle's Band.
 3082 La Gitana (Waltz).—Dance Music by La-
 calle's Band
 3083 Southern Smiles (Two-Step).—Dance Music
 by Lacalle's Band.
 3084 Blue Danube (Waltz).—Dance Music by La-
 calle's Band.

BOGART CONCERTS TRADE BUILDERS.

Wallace F. Bogart, dealer in talking machines, pianos, etc., at 1263 Ogden avenue, is numbered among those who believe in holding concerts with a view of bringing his customers in closer touch with his store and incidentally exploit his

line of goods. Over 200 people accepted his invitation to the concert and later complimented him on the strength of his program. The Bogart player-piano was used during the evening and proved an attraction. Mr. Bogart was so well pleased with the results that he intends to hold another at an early date.

VICTOR CO.'S GREAT BUSINESS.

Unprecedented Activity in Every Department at Camden—Best Proof That There Are No Dull Times with Progressive Talking Machine Dealers—Big Call for Victrolas.

(Special to The Talking Machine World.)

Philadelphia, Pa., May 2, 1910.

Never in its history has the Victor Talking Machine Co., Camden, N. J., been so busy in every one of its departments. Shipments are very much in arrears, and the congestion is likely to continue for months to come. For years the company have not been in a position to ship 100 per cent. of the orders received. General Manager Geissler recently made the statement to a prominent distributor of this city that at present they were 97,000 machines behind on orders.

It is also reported that the company said that while it was gratifying to know they were doing such a tremendous business, the future promising a still further increase, at the same time it was embarrassing—an "embarrassment of riches," as it were. Explanations to distributors not acquainted with the situation at the factory were daily occurrences, and this is not an altogether pleasant feature. As it stands, not a few departments are working overtime, and to compensate for this extra pressure on their employes a voluntary increase of wages had been made by the company.

The demand for Victrolas is not only extraordinary, but is greater now than during the holiday period. Regular shipments on the allotment plan are made daily, but the supply is and has been so inadequate that drastic action to remedy the deficiency was rendered necessary. This step was taken recently relative to the cabinet making plant, the board of directors, after careful consideration of the matter, instructing the building committee of the company to not only run up the present structure (now six stories and a hundred feet or more square) to its original intended height, but to also put up an additional building adjoining. This will double the capacity of the cabinet making factory. Excavating has been under way for a week or more, and work on the foundations will follow immediately with the building rushed to completion as rapidly as substantial construction, in keeping with the numerous other buildings of the marvelous Victor plant, will permit.

H. C. Brown, manager of the advertising department of the Victor Co., has been detained at his home for a couple of weeks by illness. He is expected to report for duty in a few days.

"There are many ways to do a thing wrong, but only one way to do it right."

1866 **NYOIL** 1910
 FOR



Talking Machines, Typewriters, Phonographs, Adding Machines, Cash Registers, Guns and Tools, and on all Polished Instruments. The Finest Oil Made.

It Absolutely Prevents Rust.

NYOIL

Now Sold Everywhere By All Hardware Men

WILLIAM F. NYE
 NEW BEDFORD, MASS.

SWITKY'S NEW QUARTERS.

The Victor, Edison and Zonophone Dealer Will Occupy New Quarters in the Fifth Avenue Building, New York, on May 15.

Benj. Switky, handling the Edison, Victor and Zonophone lines, at 27 E. 14th street, New York, for many years, on May 15 will remove to the new Fifth Avenue building, at the junction of Broadway, Fifth avenue and Twenty-third street, one of the most prominent locations in the city. His store, on which he has taken a long lease, will be on the Twenty-third street side, adjoining the Garfield National Bank's quarters. As Mr. Switky remarked: "Business has been good with me, and I have made money, else I could not be in a position to move into such a swell place. I'll make good, of course, and I will have a dandy store."

COLUMBIA LITHOGRAPH HANGERS.

The first of a series of elaborate colored lithographed hangers—the finest and most artistic ever sent the trade—was mailed Columbia dealers this week. They are an ornament to any store and really deserve framing. The initial of this splendid stroke of enterprise on the part of the Columbia Phonograph Co., General, is that of Constantino, the famous Spanish tenor, in costume of the character he has adorned in "La Gioconda." The others to follow are Campanari, David Bispham and Lina Cavalieri. The pose of the latter prima donna is one that is well worth preservation for its artistic value. In fact, this is true of the entire series, the portraits being excellent and the coloring faithful and delicate. The posters are lithographed on splendid heavy colored stock, and in size are about 20 x 30 inches.



SEEBURG ART STYLE ELECTRIC
 First in the Field

SEEBURG ELECTRIC PIANOS

- A revelation in coin-controlled instruments.
- A perfect player mechanism in a high class sweet-toned piano.
- No obstructive boxes front or back.
- Unique speed regulation and expression devices.
- The piano is constructed throughout to withstand the heavy requirements placed upon it.
- Made in three attractive styles.

Write for catalog giving full descriptions and illustrations, and let us tell you how to increase your business by handling the right electric piano in the right way.

J. P. SEEBURG PIANO CO.

718-23 STEGER BUILDING

Wabash Ave. and Jackson Blvd.

CHICAGO

A WIDE-AWAKE CANADIAN.

Robert Shaw Managing Director of Western Talking Machine Co., Winnipeg, Believes in Up-to-Date Methods—What He Says in the "Western Talking Machine News."

(Special to The Talking Machine World.)
Winnipeg, Man., April 30, 1910.

While the talking machine jobbers of the States are acknowledged to be a live and progressive lot of men as a body, it may be interesting for the readers of The World to learn that there are a number of distributors on the other side of the border who conduct their business in a decidedly up-to-date manner and might in some instances give pointers to their brethren in the States. One such house in this city is the Western Talking Machine Co., western whole-sale Victor-Berliner distributors, who, under the management of Robert Shaw, have steadily forged to the front in the Canadian trade.

The excellent publicity campaign carried on by the company has in a large measure contributed to their success, one of the features being a monthly magazine entitled "The Western Talking Machine News," which is full of valuable information and "ginger talks" for the dealer and is distributed free of charge. The material printed in the booklet is excellent, and the following is an extract from a talk on "the good old times" which appeared in a recent number:

"Some people like to talk about them, but you never heard me do it. I was in the talking machine business in—the good old times—that's why!

"I tell you, there's no time like 'the present time,' when the whole musical world is waiting breathlessly to see what the Victor is going to give them next.

"And what has March brought forth? Read my selling letter—and tell me (you old timers in the business) do you want to come back with me and do 'His Master's Voice' (as we used to say) in front of a 'talker' asking, 'What do you think of Hoolahan, Hoolahan, Hoolahan.'



ROBERT SHAW.

"You can have your 'old times,' when it broke a man's heart to put \$15 into a gramophone. I live in 'the present' when an agent in a town of 800 population in Manitoba can sell \$1,000 in 10 days. That thing was done last week! Do you believe it? Ask Parker of Manitoba.

"It may not interest you, but listen! I am only two and a half years up here and I have sold more Victor-Berliner goods in the month of February than I expected to do during my first twelve months in the country. More in one month than I hoped to in a year.

"I thank you all, from the bottom of my heart, for this. But I deserve some thanks, too—don't I?—for waking you all up to the possibilities of replacing the sales of player-pianos with Victrolas and Victor records. But I must not forget that this is a general letter and I'm going to ask

a personal question. Have you sold a Victrola? Will you let me help you try?

"I'm putting the sample copy of the 'Selling Letter' this month on my letterhead paper to show how much nicer it looks that way. Why not have it on your letterhead paper? It costs you nothing. I'll hold it in type for a week from the day you read this in case you want it. Free, mind you, 'Scot free.'"

NEW WORD NECESSARY

To Describe the Merits of the New Victor Records Say the Victor Co.

The Victor Talking Machine Co. have been carrying some very cleverly written advertisements in the daily papers. Under the caption of the famous trade-mark, "His Master's Voice," and above their name the following text recently attracted our notice. The matter was very strikingly displayed and must have caught the attention of hundreds of thousands of people who were no doubt impelled to consider the talking machine question with beneficial results to the dealer. The text ran as follows:

"PERFECT-EST.

"A new word! But a new word is needed to describe the height of perfection reached in the new Victor records.

"So great is the improvement that we made over, at a cost of a half-million dollars, practically our entire list of Victor records—records universally acknowledged to be perfect.

"And the result is a record that plays clearer and sweeter and better than ever before.

"Take one of your old Victor records to any dealer's and hear it in comparison with a new Victor record of the same selection.

"The Victor record catalog lists more than 3,000 selections—both single and double-faced records. Same quality—only difference is in price. Buy double-faced if the combination suits you. And be sure to hear the Victrola."

Idleness is the sepulcher of the living man.

TALKING MACHINE SUPPLY COMPANY

MANUFACTURERS OF

High Grade—Made by
Skilled Mechanics

High Grade English Steel,
each Needle Warranted as
to Point and Finish

SPECIALTIES

BELTS

For Commercial Phono-
graphs. STITCHED.

REPAIR PARTS

NEEDLES

put up in Lithographed Envelopes
and Tin Boxes in Cartons

SAPPHIRES

FOR DICTATING MACHINES
ALL MAKES

For all Kinds of Phonographs
or Talking Machines

We are Sole Agents for
the Largest Needle
Factory in EUROPE

SPECIALTIES

FEED NUTS

For All Makes, Made of
the Best Steel

NOTE: WE SELL TO JOBBERS ONLY. WRITE FOR CATALOG TO-DAY.

400 FIFTH AVENUE, NEW YORK, N. Y.

LATEST PATENTS RELATING TO TALKING MACHINES AND RECORDS

(Special to The Talking Machine World.)

Washington, D. C., May 10, 1910.

APPARATUS FOR COATING SOUND RECORDS WITH ELECTRO-CONDUCTIVE MATERIAL. Isaac W. Norcross, New York. Patent No. 952,753.

This invention relates to the art of making sound-records and to the production of numerous duplicates from an original or master record.

The invention is directed to that portion of the operation of making duplicate sound-records from an original, which consists in preparing the surface of the original record by coating it with an electro-conductive substance so that a matrix may be made thereon by electro-plating. Original sound-records are commonly formed of a waxy substance and in order to form a matrix on this original it is common to provide a coating of graphite upon the surface of the original record to make its surface conductive prior to putting the record in the electro-plating bath.

Heretofore it has been the practice to apply graphite to the surface of a sound-record manually with a camel's-hair brush by wiping the brush against the record at one point and then another repeatedly to coat the record with the graphite and rub the latter into the grooves of the record as thoroughly as possible. The application of the graphite to the surface of the original record in this way has not been satisfactory, both because of the character of the results obtained and because of the amount of time required, and it is the object of the present invention to provide an improved process and apparatus whereby this step in the manufacture of sound-records may be performed in a much superior manner and in much less time than is required under the method heretofore employed.

This invention consists in loading the surface of an original sound-record with the electro-conductive material and then, in an operation distinct from the loading operation, burnishing the surface of the record.

In this way a very much superior coating of the material is obtained, this coating having a bright, burnished surface similar to an enamel. Furthermore, the particles of the graphite are so closely laid upon the surface of the record that the coating is impervious to moisture; this is an advantage of considerable importance, for the record, after being coated, must be placed in the electro-plating bath, and if the water of the bath finds

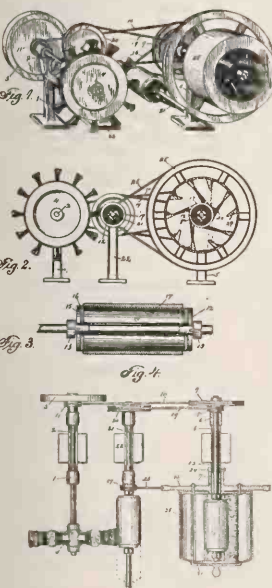

its way through the graphite coating the record is quite apt to be spoiled by the water coming in contact with alkali in the sound-record and forming what is known as a "soft spot." Furthermore, the coating of graphite obtained in accordance with this invention is such that the coated record may be handled with little danger of affecting the coating thereon, whereas with records coated under the process heretofore commonly employed, great care had to be exercised to keep from touching the surface of the coated record.

In these drawings, Figure 1 is a perspective view of the apparatus; Fig. 2 is an elevation of the same, with one member in vertical section; Fig. 3 is a sectional view of the mandrel, and

Fig. 4 is a plan view of the machine with one of the parts shown in horizontal section.

ATTACHMENT FOR TALKING MACHINES. William S. McNamara, San Francisco, Cal. Patent No. 954,455.

This invention relates to sound reproducing in machines of the disc type and has special reference to a mechanism adapted to be applied to such machines for the purpose of stopping the machine after the reproducing needle has covered a definite part of the record.

In the accompanying drawings, like characters of reference indicate like parts in the several views, and Figure 1 is a top plan view of a portion of a disc sound reproducing machine equipped with the invention. Fig. 2 is a partial side elevation of such a machine.

Fig. 3 shows the collar or clip adapted for application to the sound-box of a talking machine. Fig. 4 shows a view of a modified form of brake end. Fig. 5 is a second modification of the brake end such as is used for machines employing discs or records larger than the revolving plate. Fig. 6

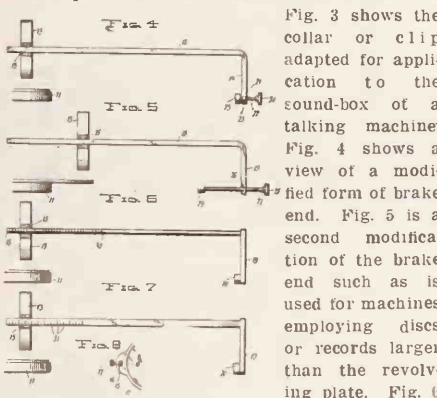

is a modified form of the brake arm or standard. Fig. 7 is another modification thereof. Fig. 8 is a modification showing a lug cast on the sound-box of a talking machine for the attachment of the stop.

SOUND-BOX FOR TALKING MACHINES. Robert L. Gibson, Philadelphia, Pa. Patent No. 954,953.

The object of this invention is to provide a construction of sound-box for talking machines which shall have great sensitiveness, whereby the volume of sound may be increased without loss of timbre or accuracy of articulation.

This invention consists in supporting the stylus bar on a pivotal connection formed by a spring whose length is in a plane at right angles to the plane of the diaphragm. In providing the sound-box with a stylus bar secured to or in contact with the diaphragm and suspended from the frame of the sound-box by a wire structure under tension. In providing an expandible frame to which the wire structure is secured, combined with adjusting devices for the expandible frame whereby the wire structure may have its tension adjusted.

Figure 1 is an elevation of a talking machine embodying the invention; Fig. 2 is a front elevation of the sound-box; Fig. 3 is a bottom view of the sound-box; Fig. 4 is an enlarged sectional view on line 4-4 of Fig. 2, showing the improved

manner of suspending the stylus bar; Fig. 5 is a bottom view of a sound-box showing a modification of the invention, and Fig. 6 is a sectional elevation of the same.

SOUND-MODIFIER FOR TALKING MACHINES. Edward P. Shepard, San Diego, Cal. Patent No. 953,557.

This invention relates to an improvement in sound-modifiers for talking machines, and its object is to provide means whereby the sound can be modified or reduced without in anywise producing a detrimental muffling effect.

In the accompanying drawings, Figure 1 is a fragmentary view of the goose-neck of a talking machine, showing the invention applied; Fig. 2 is a plan view of the modifier, and Fig. 3 is a sectional view of the same.

DUPLICATE SOUND-RECORD. Jones W. Aylsworth, East Orange, N. J., assignor to New Jersey Patent Co., West Orange, N. J. Patent No. 953,454.

The purpose of the present application is to describe and claim an improved sound-record as a new article of manufacture. As such, the invention may be defined as a duplicate sound-record formed of celluloid (in which term is included all so-called indestructible materials for the

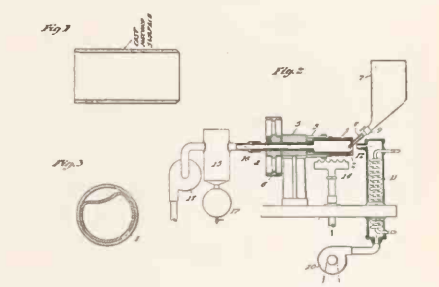

purpose, such as collodion, pyroxylin and cellulose acetate, and having homogeneous or non-laminated walls and with a cast permanent record surface, as distinguished from one in which the material is merely distorted or displaced.

Figure 1 is a longitudinal sectional view of the improved record, Fig. 2, a diagrammatic view of a suitable apparatus for producing the same, and Fig. 3, a cross-sectional view through the matrix showing one way of removing the finished records therefrom.

DIAPHRAGM. Clark Zarr, Newberry, Pa. Patent No. 953,889.

This invention relates to diaphragms for sound-conveying instruments, and is particularly applicable to use in talking machines.

The object of the invention is to provide a diaphragm which will transmit the human voice, instrumental music and other sounds without detracting from the tonal qualities or adding any unpleasant sounds. The diaphragm will be made of suitably prepared and treated fiber sheet material. If a center post is employed this may be made of similar material. The fibrous sheet material diaphragms and post may be assembled and fastened together by a coating of some resilient waterproof material. In practice the diaphragm may have applied to it a gasket of yield-

able material to prevent the parts which will normally clamp the diaphragm in position interfering with the proper working of the diaphragm.

Figure 1 is a perspective view showing one side of the improved diaphragm, namely the lower or post-carrying side. Fig. 2 is a similar view of the other or upper side of the diaphragm. Fig. 3 is a broken-away, enlarged central cross-sectional

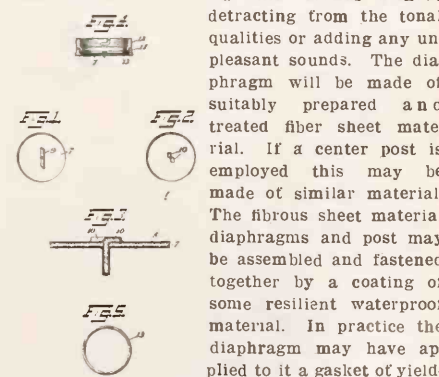

view of the diaphragm and center post. Fig. 4 is a central sectional view of a sound-box illustrating the diaphragm and gasket in position, and Fig. 5 is a perspective view of a form of gasket which may be employed with the diaphragm.

PHONOGRAPH. Henry T. Oliver, Newark, N. J., assignor to New Jersey Patent Co., West Orange, N. J. Patent No. 955,424.

This invention relates to phonographs and has for its object the provision of interchangeable means for feeding the traveling carriage upon which the sound-box is mounted at either of two rates of speed; one of which may be suitable for operating upon a record having one hundred threads per inch. The particular means employed in a general way embodies the invention disclosed in the application of Peter Weber, Serial No. 425,844, filed April 8, 1908, in that there is a hollow rotary feed screw mounted concentrically with respect to an inner shaft and capable of being locked to said shaft so as to rotate therewith, or of being unlocked therefrom and driven thereby through interposed gearing so as to rotate at a different rate of speed.

This invention relates more particularly to improvements in the mounting of the hollow shaft, the means for locking the same to the inner shaft and for gearing the two shafts together, with a view to obtaining a structure in which the movable parts are protected to a great extent, are few in number, and capable of operating at the desired high rate of speed without undue wear or noise, such as would be objectionable in a phonograph, and in which the arrangement of the parts is compact and capable of being applied

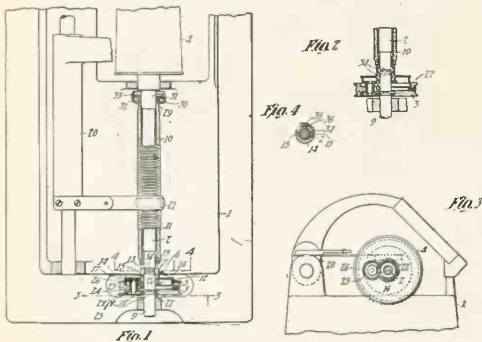

to phonographs of ordinary construction without any changes in the frame or stationary parts of such machines, and without the provision of any supplementary or auxiliary frame for attachment to the phonograph body.

Figure 1 is a plan view, partly in section, of a phonograph constructed in accordance with the invention, the parts being arranged for feeding the sound-box carriage at a suitable speed for operating upon records having one hundred threads per inch; Fig. 2 is a view of a portion of Fig. 1, except that the parts occupy the positions which are assumed when the carriage is to be fed at a speed suitable for operating upon records having two hundred threads per inch; Fig. 3 is a section on line 3—3 of Fig. 1, and Fig. 4 is a section on line 4—4 of Fig. 1.

SOUND-RECORDING AND REPRODUCING MACHINE. Charlie E. West, Hopkinsville, Ky. Patent No. 956,460.

This invention has reference to improvements in sound-recording and reproducing machines of the type where the recorder or reproducer is constrained to move in a right line across the record tablet.

The object of the present invention is to adapt to such a machine the type of sound-amplifier wherein either the amplifier as a whole is movable in one plane only about a vertical axis, or one member only is movable to any point of the horizon and the other member is moved by the sound-box as it travels across the record tablet, and both members coact to constitute a single continuously-expanding sound-horn or amplifier.

The invention consists in providing a sound-reproducing or recording machine of the type wherein the sound-box is positively propelled across the record in a straight line with a taper horn movable in one plane only or with a swing-

ing taper arm connection forming a part of a sound-amplifier, the other part of which connects at its smaller end with the large end of the taper arm and is expanded into an open mouth or bell of usual type.

The invention comprises a connection between the sound-box and the taper arm, whereby the latter is permitted to move about a vertical axis so that its smaller end, adjacent to the sound-box,

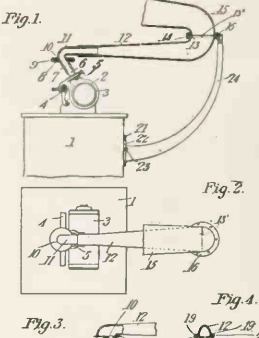

describes an arc and, therefore, changes its relation with the sound-box. This connection is so related to the taper arm that it will move relatively into and out of the same to permit the arm to travel through a curved path, and it will also have a relative movement to the sound-box itself, so as to have a relative movement to the sound-box about an axis perpendicular to the axis of the sound-box.

Figure 1 is a side elevation, partially in section, of a sound-reproducing machine with the invention applied thereto, unessential parts being omitted; Fig. 2 is a plan view of the same; Fig. 3 is a longitudinal section, partly in elevation, of a modified form of the invention, and Fig. 4 is a cross section of the structure shown in Fig. 3.

SOUND-BOX FOR TALKING MACHINES. Edwin H. Mobley, Hillside, Pa. Patent No. 955,894.

This invention relates to sound-boxes for use in connection with records having grooves of the "hill-and-valley" type, the objects of the invention being to provide for the secure connection of the stylus lever to the diaphragm, and for the proper contact of the stylus with the undulating bottom of the groove without impairing the desired freedom of movement of said stylus and without affecting the purity of the reproduction. Reference is made to the accompanying drawing, in which—

Figure 1 is a view partly in side elevation and partly in vertical longitudinal section of a sound-box constructed in accordance with the invention; Fig. 2 is a perspective view showing certain elements of said sound-box detached therefrom; Fig. 3 is an enlarged perspective view of the blank from which the diaphragm connection is made; Fig. 4 is a perspective view of the same after it has been bent for application to the diaphragm and connecting ling, and Fig. 5 is a sectional view illustrating a modification of one of the features of the invention.

SOUND-AMPLIFIER FOR PHONOGRAPHS. Vito Ettore D'Urso, New York. Patent No. 956,235.

The objects of the invention are to provide a simple and compact device in which the enclosing casing may be utilized as a sound-amplifier.

A further object is to provide a device which will dispense with the ordinary horn type of amplifier and secure the necessary amplification of sound by utilizing a direct channel for the transmission of

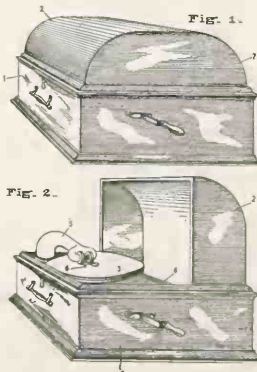

sound from the disc or record through the enclosing casing of the device.

A still further object is to provide a casing in the form of a sound-amplifier, which, in normal position, will inclose the parts of the mechanism, and when opened for use will provide an amplifying or sound-board effect, which will give clear unobstructed tones.

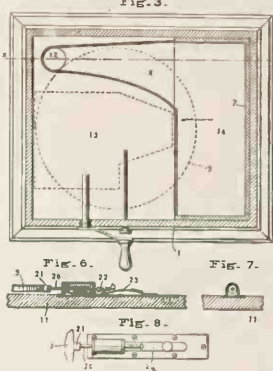

Referring to the drawings: Figure 1 is a perspective view of the device illustrating the application of the amplifier. Fig. 2 is a similar view showing the casing in position to produce the amplification of sound. Fig. 3 is a plan view of the device illustrated in Figs. 1 and 2, partially cut in section and broken away to illustrate the sound-conducting channels. Fig. 4 is a transverse sectional view on the central line of Fig. 3. Fig. 5 is a sectional view on the line x—x of Fig. 3. Fig. 6 is a detail view illustrating a stop for the record. Fig. 7 is a cross-sectional view through the mechanism illustrated in Fig. 6. Fig. 8 is a plan view of the mechanism illustrated in Fig. 6.

"FROM BRAIN TO TYPE."

Something of the Handsome and Admirably Written Volume Just Issued by the Edison Business Phonograph Co., of Orange, N. J., Bearing Upon the Edison Commercial System Conducted with the Edison Business Phonograph.

The Edison Business Phonograph Co. have just sent out a volume of unusual interest bearing upon the Edison commercial system conducted with the Business Phonograph. It is a work of art from a typographical standpoint, being superbly printed in two colors with specially designed borders on heavy coated paper.

The volume is made up of a series of essays under the following headings: "The Progress of Voice Writing"; "Independent Dictation"; "Stenographic vs. Voice Writing"; "Centralized Transcribing"; "Importance of Design"; "Equipment."

It is only necessary to read these interestingly written essays to conceive the broad field which the Business Phonograph covers and to realize its great future in the commercial world. Progressive business institutions have tried and found the Business Phonograph an indispensable part of their equipment and an accelerator in clearing up correspondence.

The illustrations throughout the volume are in two colors and afford a splendid idea of the perfection of this remarkable mechanism for use in the commercial field. The volume must be productive of excellent results in compelling a larger measure of interest being concentrated on the possibilities of the Business Phonograph. Heads of departments cannot read this volume without being convinced that no modern business is complete without an adoption of the Edison commercial system.

The price-cutter is always in hot water, for no salesman ever had enough ingenuity to keep cut prices secret. Let it be known that you cut prices and the news will travel fast.

Leading Jobbers of Talking Machines in America



Dealers who buy these **NEEDLES** are assured of a **Good Profit**
Correspond with us.
OLIVER DITSON COMPANY
150 Tremont Street BOSTON, MASS.
CHAS. H. DITSON & Co. Nos. 8, 10, 12 E. 34th St. New York, N. Y.
J. E. DITSON & Co. No. 1632 Chestnut St. Philadelphia, Pa.

This is a Columbia year in the Talking Machine business

We are **EXCLUSIVE COLUMBIA JOBBERS**

and handle the full line. All orders given immediate attention. Write for our special Columbia Dealer Proposition.

R. C. SMITH & CO.
Burlington, Vt.

HARGER & BLISH
JOBBER

VICTOR EDISON

It's worth while knowing we never substitute a record. If it's in the catalog we've got it.

Des Moines **IOWA** Dubuque

Exclusive Columbia Jobbers

We have the full Columbia line, and job Columbia Products exclusively. All orders promptly filled. Exclusive territory assigned. : : :

KIRK, GEARY & CO., Sacramento, Cal.

Southern Talking Machine Co.
MEMPHIS, TENN.

We assign exclusive territory to progressive dealers for the sale of

Columbia Double-Disc and Indestructible Cylinder Records and Columbia Disc and Cylinder Graphophones

Write for offer. All orders filled the very day received.

EXCLUSIVE COLUMBIA JOBBERS

STANDARD TALKING MACHINE COMPANY EDISON PITTSBURG, PA. VICTOR

"If it's made we ship it the same day order is received"

PACIFIC COAST DISTRIBUTORS OF
Victor Talking Machines and RECORDS
STEINWAY PIANOS—LYON & HEALY
"OWN MAKE" BAND INSTRUMENTS
Sherman, Clay & Co. San Francisco Oakland Portland Los Angeles

Jacot Music Box Co.,
25 W. 35th St., New York
Mira and Stella Music Boxes.
Edison and Victor Machines and Records

CHASE & WEST

Eighth Street, between Walnut and Locust

DES MOINES, IA.

Victor Distributors

Talking Machines, Records and Supplies.
Everything in stock all the time.

The best service in **IOWA**

Try Our Hurry-Up Service



on **VICTOR, EDISON and REGINA.**

We make a specialty of getting the order out on time—every time.

The Rudolph Wurlitzer Co.
Cincinnati and Chicago

Two points of supply; order from the nearer

F. M. ATWOOD

123 MONROE AVENUE

MEMPHIS, TENN.

EDISON JOBBER

BUFFALO - N. Y.

NEAL, CLARK & NEAL CO.

Jobbers of

EDISONS

AND

VICTORS

Columbia Jobbers

We carry at all times a complete line of Columbia Graphophones and Columbia Double-Disc and Indestructible Cylinder Records. We give all orders prompt and careful attention. Dealers can be assured of our co-operation at all times.

Scheuber Drug Company
LIVINGSTON, MONT.

KLEIN & HEFFELMAN CO.
Canton, OHIO.

Edison & Victor

MACHINES, RECORDS AND SUPPLIES

Quickest service and most complete stock in Ohio

IF YOU'RE IN WESTERN MICHIGAN it will be money in your pocket to order

Victor Machines and Records

...of...
JULIUS A. J. FRIEDRICH

30-32 Canal Street, Grand Rapids, Michigan

Our Motto: Quick Service and a Saving in Transportation Charges

Exclusive Columbia Jobbers

Our stock of Columbia Graphophones and Records is very complete and covers the full line. We receive all the records as fast as they are issued. We are in a position to fill orders promptly. Dealers purchasing from us get the benefit of our central location and effect a large saving in time and money.

Phillips & Buttorff Mfg. Co.
NASHVILLE, TENN.

Mr. Dealer

WE ARE

COLUMBIA JOBBERS

We are in a position to put you on the right course to successfully handle these universally used instruments and records. If interested, "pop the question." Catalogues, prices and complete information upon request.

HOLLENBERG MUSIC CO.
LITTLE ROCK, ARK.

The Geo. J. Probeck Company
420 Prospect Avenue, CLEVELAND, O.

COLUMBIA JOBBERS

Complete Stock Prompt Service

Dealers Wanted Write To-day

Every Jobber in this country should be represented in this department. The cost is slight and the advantage is great. Be sure and have your firm in the June list.

Leading Jobbers of Talking Machines in America

Paste This Where You Can Always See It!

MR. DEALER:

We refer all Talking Machine inquiries coming from towns where we are represented by dealers to the dealer or dealers in that town.

VICTOR and EDISON JOBBERS

CHICAGO

Peter Bacigalupi & Sons, SAN FRANCISCO, CAL.
Wholesale 941 MARKET STREET Retail
Jobbers **Edison, Zonophone**
Dealer **Victor**
All Kinds of Automatic Musical Instruments and Slot Machines.

NEW ENGLAND
JOBBER HEADQUARTERS
EDISON AND VICTOR
Machines, Records and Supplies.
THE EASTERN TALKING MACHINE CO.
177 Tremont Street BOSTON, MASS.

Daynes-Beebe Music Co.
45 Main Street
Salt Lake City, Utah

Send your orders to us and you are always sure of quick action. We are

Exclusive Columbia Jobbers

We handle the full line of Columbia Double-Disc and Indestructible Cylinder Records; Disc and Cylinder Graphophones.

Edison Phonograph Distributors
for the SOUTHWEST

All Foreign Records in Stock

Houston Phonograph Co., HOUSTON, TEXAS

PERRY B. WHITSIT L. M. WELLER
PERRY B. WHITSIT CO.,

213 South High Street, Columbus, Ohio.

Edison Phonographs and Records **JOBBERS** Victor Talking Machines and Records

VICTOR DISTRIBUTORS
WASHINGTON, D. C.
The ROBT. C. ROGERS CO.

FINCH & HAHN,
Albany, Troy, Schenectady.
Edison Jobbers and Victor Distributors
MACHINES and RECORDS
Complete Stock Quick Service

C. B. HAYNES & CO.
EDISON JOBBERS

ALL SUPPLIES

5 N. 7th Street. Richmond, Va.

D. K. MYERS
3839 Finney Avenue ST. LOUIS, MO.
Only Exclusive Jobber in U. S. of
Zon-o-phone Machines and Records

We Fill Orders Complete Give us a Trial!

BOSTON CYCLE & SUNDRY CO.
EXCLUSIVE EDISON JOBBERS
TRY OUR
"Special Summer Service"
48 Hanover St. BOSTON

Every Jobber in this country should be represented in this department. The cost is slight and the advantage is great. Be sure and have your firm in the June list.

TALKING MACHINE JOBBERS MEET.

Executive Committee Hold Meeting in Columbus, O., on April 17 with a Full Attendance—Convention Outlook Most Satisfactory—Look for a Tremendous Fall Trade—Ask Factories to Prepare—Visitors Entertained by Mr. Whitsit.

A meeting of the executive committee of the National Association of Talking Machine Jobbers was held in the offices of the Perry B. Whitsit Co., Columbus, Ohio, on April 17, when a number of matters of importance to the association were discussed at length, and suitable action taken where possible. Every officer and member of the executive committee was present at the meeting, namely: President Perry B. Whitsit, Vice-President J. Newcomb Blackman; Secretary J. C. Roush, Treasurer Louis Buehn, E. F. Taft, J. F. Bowers, Lawrence McGreal and Rudolph Wurlitzer and H. H. Blish. Others present at the meeting were: W. F. Davison, vice-president of the Perry B. Whitsit Co.; P. J. Towle and T. Towle, of the Eclipse Musical Co., Cleveland, O.; Laurence H. Lucker, Minneapolis Phonograph Co., Minneapolis, Minn.; E. J. Heffelman and P. Shrake, Klein & Heffelman Co., Canton O.

One of the more important works taken up by the committee was the completing of the final arrangements for the convention at Atlantic City. Those present at the meeting were very enthusiastic over the outlook for a large attendance, especially from the West, where the jobbers have had a good business and feel inclined to bear the expenses of the trip.

It was the unanimous opinion of the jobbers attending the jobbers' meeting, that while the business for the holidays and thus far this year had been very satisfactory, the trade in the fall would open in a way that would surprise even the most optimistic and it was urged that the factories take advantage of any dull time during the summer to make up as large a reserve stock of machines for the fall trade as possible.

On their part the jobbers are asked to aid the factories in providing for the coming demand by placing orders as far ahead as possible and carrying a maximum amount of stock in their stores.

The meeting was divided into morning and afternoon sessions, those present being entertained at lunch at the Ohio Club by Mr. Whitsit. In the evening those of the committee and visitors who stayed over for the night, had dinner at the Southern Hotel, after which they were invited to witness the press review of the moving pictures taken during the Roosevelt hunt in the African jungles, and other films of timely interest that were to be released the following morning.

Louis Buehn and J. N. Blackman left Columbus on Monday, April 18, dropping off at Cincinnati, where they visited the Wurlitzer Co.'s establishment. They arrived in Philadelphia next day for the purpose of serving on the committee appointed to confer with the Victor Co. on several matters of interest. The committee was subsequently received by Louis F. Geissler, general manager of the company, and a satisfactory understanding arrived at.

REHEARING IN STENCILING CASE.

Motion Granted for Rehearing of Case of Victor Talking Machine Co. vs. American Graphophone Co. for Infringement of Berliner Patent.

April 22 a motion for a rehearing in the so-called record stenciling case of the Victor Talking Machine Co. against the American Graphophone Co. was argued and granted by Judge Lacombe, United States Circuit Court, southern district of New York. The decision of Judge Lacombe was published in The World of April 15, in which the Federal court said that in relabeling a quantity of Leeds & Catlin Co.'s records as "Sir Henry" and selling them under this title

to the Simpson-Crawford Co., a New York department store, the defendants had infringed the Berliner patent.

C. A. L. Massie, of the American Graphophone Co.'s legal staff, has associated with him in this proceeding Richard N. Dyer, elder brother of Frank L. Dyer, president of the National Phonograph Co., Orange, N. J. Horace Pettit appeared for the Victor Co. When the case is made up the hearing will be held before Judge Lacombe in chambers. In the event of the judge not reversing himself, which is rare, the case will be immediately taken to the Circuit Court of Appeals for review and final adjudication.

"THE PHONOGRAPHIC CLOCK."

Swiss Device Announces the Hour to Any Room When Desired—Phonographs in German Reichstag.

A German trade journal says, under the headline "The Phonographic Clock," that Switzerland has gained a point over America in the clock industry by placing on the market a timepiece which bears that name. It is valuable as a novelty and "a source of comfort to the blind and the lazy." The clock may be placed in any room in connection with a phonograph and a person in an adjoining room, having no clock and where connection has been made with the timepiece by electric wires, needs merely to press a button to hear the time called aloud by the instrument. The same principle has been employed in the German Reichstag, where by touching a button the members in distant parts of the building are told by phonograph the name of the next speaker.

J. W. Moody, brother of V. W. Moody, sales manager of the New York Talking Machine Co., has gone to Birmingham, Ala., to take charge of the talking machine department of the E. E. Forbes Co. in that city. Mr. Moody formerly traveled for the Victor Talking Machine Co.

The TA SIDING MACHINE SECTION

AND
NOVELTY
NEWS

NEW YORK, MAY 15, 1910

TRAINING SUCCESSFUL MEN.

What Part the Employe Can Play in Helping a Man Succeed and How He Profits by His Work.

Out of a certain 1,000 business men who have made a success in life, that is, have done something besides make money that is worth taking notice of, only 50 had wealthy parents to give them a start. That means that only 5 per cent. of these men who have amounted to something of real usefulness to the world have come from homes where wealth was able to purchase anything wanted and where financial prospects were good enough to give the boy a start. The other 95 per cent. have to hustle for themselves and dig out of the whirl and twist of the doings of life the thing which has made them prominent in one way or another. They demonstrated the stuff they were made of and proved that the only way a man can reasonably expect to rise above the ordinary level is to push himself along without specific aid. What has that got to do with retailing? Just this—there are thousands of young men who are clerks in stores who have in them the making of just successful business men as these one thousand mentioned, but they don't know it themselves, and there is prospect that a good deal of good material will be allowed to go to waste for that very reason. These young people need not so much the pushing and assistance of their employers as they need to come to a realizing sense of what there is in themselves for the building of a useful and profitable future. It is very true that the best material will show itself in time and that those who have the ability and the natural gift of business will eventually pull through as remarkable business men, but it is also true that they might reach that goal much sooner and much better equipped if the men who employ them at present would take enough interest in the upbuilding of not only the future of these young people but also their own present business to discover what sort of natural material there is working behind their counters and what can be made out of it. Why is it that great retail houses in a score of big cities maintain schools for their younger employes, lecture courses for the older employes and have frequent conferences with their heads of departments on stated and special subjects? Is it all philanthropy and personal interest? Not much. If we give that point of view all that is due it—and there is a great deal due it—we must consider that it is all primarily a matter of good business, of most excellent business, says the Sporting Goods Dealer. Out of it all, these big stores will develop more business men in five years than could "just grow" in 20 years. If they don't retain them for their own stores, they know the general good of the business world is enhanced through it all. This is what dealers should consider above all things.

HOW TO POLISH BRASS STORE FIXTURES.

Brass store fixtures, through handling or unnecessary cleaning, frequently become tarnished as the lacquer wears off, and attempts to brighten

up the dull spots or places by polishing make conditions worse because of the remaining lacquer, which must be entirely removed in order to give a uniform polish. If entirely removed or on a certain part, this must be kept polished frequently, which means more unnecessary work.

The dealer usually sends the tarnished part back to the makers, but this is unnecessary. The dealer can do the work himself if ordinary care is used in using the following solution: Gum shellac, dissolved in alcohol makes a thin varnish which is applied with a small brush; 10 cents' worth of shellac is enough to cover many fixtures and the work can be done in less than an hour.

THE VOGUE OF MOVING PICTURES.

A Revolution in Popular Amusement—Legitimate Productions Undermined—Moving Pictures Amuse the Crowds in Smallest Towns as Well as Largest Cities.

The Moving Picture Revolution is the apt title of a very interesting article which appears in the current issue of "Success," telling how the man at the crank has brought about a crisis in the theatrical business of America. It is a remarkable story in a way, for but few know how the legitimate theatrical business has been undermined, not merely in the larger cities, but in the leading towns throughout the country by the moving picture show which brings drama and amusement to the public at from ten cents to a quarter a seat.

Not since Gilbert and Sullivan brought into vogue the popular comic opera and thus revolutionized the drama has such a sudden and extraordinary change in the stage amusements of this country and of Europe taken place as is culminating this year, says this writer. The switch from the rigid drama of our granddads to the lighter, gayer, more fantastical musical representations of the present time was gradual and explainable. The hothouse development of the motion-picture industry was so inexplicable to the powers that be in the dramatic and musical comedy world, and was so nearly instantaneous, that not one of these mighty men had the acumen or the alacrity to climb aboard the band-wagon when it started. As most of them are business men rather than experts in the histrionic arts, and as everyone of them has had a dent made in his bank account by the motion-picture industry, they all regret sincerely that a lot of real estate men, grocers, delicatessen venders, ticket takers and stage hands rather than they, the lawful owners of the amusement field, recognized the value of a simple invention and the drawing powers of a sign reading "Admission ten cents: Orchestra seats a quarter of a dollar."

A Bad Season for the Theaters.

Has anyone told you or have you discovered for yourself that this is the worst season the stage has known in years? Were you aware of the fact that one of the most picturesque forms of theatrical entertainment we ever have had—the blood-curdling, hands-up-or-I'll-shoot melo-

HAND COLORED

Local View Post Cards MADE TO ORDER



Made from any fair photo and delivered in 2 to 3 weeks. **\$7.20** for 1000

The Best Made in America
SEND FOR SAMPLES

Blue Delft (two colors) **\$5.00** for 1000

Season, Floral, Comics, Greeting Cards, etc.,
Direct from Factory

NATIONAL COLORTYPE COMPANY
Department 9 CINCINNATI, OHIO

drama—has all but disappeared from our midst? Do you know that during the six weeks prior to last Christmas more American theatrical companies disbanded for lack of business than disbanded during any mid-season twelve weeks in the previous history of our stage?

It's a horrible thing to say and it's a hard thing to understand, but it's a fact: a spool of photographic film projected on a white canvas from a humming picture machine has wrought more havoc to the arts of Sarah Siddons, David Belasco and Theodore Kremer than did Oliver Cromwell, the Iroquois Theater fire and the late financial panic combined.

This effect has been felt in several ways, and although you may take little or no interest in acrobatic snap-shots and may not be an habitual theatergoer, you cannot help being amazed at the decisive manner in which a clump of inventors and some sagacious business men, unused to the underground methods of theatricals, have put what is vulgarly known as a "crimp" into what Broadwayites term the show business and all its ramifications.

Extent of the Moving-Picture Industry.

To appreciate what has happened, is happening, and is likely to happen, you must understand something of the picture industry itself. There are at present between 11,000 and 12,000 motion-picture houses in the United States—auditoriums, big and little, where moving film photographs thrown on a screen are the main or only source of amusement. In New York alone there are approximately seven hundred. Chicago, Philadelphia and Boston each possesses upward of five hundred. In every little and big city, in every country, in every State in the Union, the picture machine has settled and is literally coining money. The beauty of the business is its simplicity. An empty store, some chairs, a white curtain, a machine, half a dozen films and a ticket taker are all that the impresario really needs. As his bank-roll and his ambition increase, he may find other means of spending money on his property, but even then he is limited. If he has anything like a good location and is not an idiot, he is bound to make more than he spends. To begin with, it is not necessary for him to buy anything save his machine, and he may rent even that.

The writer, in enumerating the theaters that have given up the legitimate drama and taken on moving pictures in the last two years, add that the motion-picture people are after the Academy of Music, and that for months a standing offer of \$90,000 rental has been held over the heads of the lessees, and the other day the temptation was raised to \$100,000—the biggest price ever offered for a legitimate theater in the United States.

How can they afford to pay such colossal sums? The answer is easy. Where it costs \$2,500 a week to operate the average first-class theater while a dramatic or musical piece is the attraction, the same house can be run nicely for \$500 with pictures as the offering. Excepting at holiday seasons, eight performances weekly is the limit in a theater where entertainments other than vaudeville prevail. In any motion-picture house twenty-eight "shows"—four a day—can be given. In many of them hourly exhibitions from eleven in the morning until eleven at night are the rule. Suppose the manager does throw in a few variety "turns" as extra attractions. If he has a good location and

an adequate knowledge of the tastes of his public, he cannot lose. That is why the owners of the Harlem Opera House, the best of all the New York playhouses north of the New Theater, were able to lease their property for five years at an annual rental of \$50,000. It is why the proprietors of five other "legitimate" houses—Circle, Majestic, Lincoln Square, Yorkville and Metropolis—none of which have been successful ventures in the past, have found an easy road to monthly dividends by turning over their handsome auditoriums to the men with the spinning reels of film. It is the reason why hundreds of the theaters throughout the country—whole circuits of them—have ceased to be homes of music and drama. It is why every business man is rapidly becoming an amusement magnate, and it is why hundreds of theatrical companies disbanded before the last season was half over, and left thousands of experienced actors and actresses out of work, with hardly a chance of obtaining histrionic employment for another year.

A DEALER'S VIEW OF SALESMANSHIP.

A Sporting Goods Man Offers Some Candid Opinions on How to Sell Goods.

I have seen a so-called salesman shake his head to a customer, saying, "We are all out," just because he didn't know his stock or his business. He was probably happy in the thought that he had gotten rid of one trouble, never thinking of the reflection on the house or the disgust of the customer. Learn to say "I have it," or "I will get it for you." On the other hand, I have seen clerks, by introducing goods other than those asked for, accomplish most satisfactory results. Make up your mind to be a salesman—not an order-taker.

This will illustrate what I mean.

You are standing in the front of the store, by the sweater counter. A customer asks, "Have you a 'Jimcrack' air rifle?" You say, "No," and out he goes. Result—loss of sale and dissatisfied customer.

Just suppose you had answered, "I will show you our air rifles," and escorted the customer back to the counter where air rifles are sold. Result—you would probably have sold him a "Daisy" and made a satisfied customer. Impress this everlastingly on your mind, "Show the goods."

I have noticed some men meet customers with a "No" expression on their countenances before they know what is wanted. Others have a "Yes" look about them which attracts. The "No" man drives trade away; the other is a business-builder.

Salesmanship is a science and you can't master it unless you think and study and work.

Some talk a customer into buying and then talk him out. Others don't talk enough. There is no rule to follow.

Every buyer likes the close attention of a salesman and no two people can be handled exactly alike.

LOCAL VIEW CARDS IN DEMAND.

The local view card is the card that never goes out of style. Other cards have their day and are forgotten, but the local view is the backbone of the business, the cause of the business, in fact.

The National Colortype Co., of Cincinnati, O., are turning out better cards every year and increasing their output as fast as they can install suitable machinery. They can now deliver their high grade hand-colored card in two to three weeks. Ask them for samples and they will gladly send them, if you mention The Talking Machine World.

IMPORTANCE OF SELF-CONTROL.

When Manager Gets Excited He Loses Control of Employees—How One Irascible Character Got in Bad with a Customer.

The man who gets excited in the management of his business not only is liable to lose control of himself but he also burns up uselessly an amount of nervous energy that ought to be used to better purpose and advantage in the conduct of the business. Not only may he lose control of himself but he almost invariably loses control of his employees in such a way that they are careless of immediate consequences. During the rush of trade at a certain season a retailer acquaintance got excited over the incoming of so many people at once and endeavored to do managing to the extent of directing each clerk where to wait upon customers and when. One clerk took a particular customer to another counter than where he had been expected to serve the trade, because that customer was worth pleasing at just that moment. The retailer came along and found the clerk out of regular place and immediately began an excited mass of orders to the effect that he should leave his counter under no sort of inducement and customers must be waited upon by clerks at the respective counters where the goods were for sale. In a sense he was right, but he did not have reason enough at the time to tumble to the fact that he was making an ass of himself not only before that one customer but before all others who were within hearing. The one customer left the store in high dudgeon and the clerk went back to his counter with the feeling that he didn't care about results for the rest of that day at least. This retailer did the same thing on another occasion and allowed his voice to raise so high in making his directions and giving all his orders that it sounded somewhat like a megaphone on a baseball ground, says a writer in the Sporting Goods Dealer. All of which not only showed a disregard of gentlemanly behavior but had a grating effect upon the minds of the people who had witnessed and heard. Clerks were distracted and annoyed and assumed the attitude of "don't care," with the result that the retailer lost far more business than could have been gained by his hornet-like activity. Anything important enough to get excited over is important enough to handle calmly and with considerable judgment. What's the use of boiling over, anyway?

A man who has a natural personality that is attractive is to be envied. Just as the man who hasn't is to be pitied. But it is an ill wind that blows no one good.

Taking everything into consideration, I am of the belief that more men have been successful because of the work they did than because of the talents they inherited.

NOW IS THE TIME TO PLACE

ELECTRIC-PLAYERS

to advantage and make easy money and big profits.
They earn money with very little attention.

Write for Catalogue and prices, also Perforated Music Rolls

THE ELECTROVA CO., 117-125 Cypress Ave., NEW YORK

60 YEARS' EXPERIENCE

PATENTS

TRADE MARKS
DESIGNS
COPYRIGHTS & C.

Anyone sending a sketch and description may quickly ascertain our opinion free whether an invention is probably patentable. Communications strictly confidential. HANDBOOK on Patents sent free. Oldest agency for securing patents. Patents taken through Munn & Co. receive special notice, without charge, in the

Scientific American.

A handsomely illustrated weekly. Largest circulation of any scientific journal. Terms, \$3 a year; four months, \$1. Sold by all newsdealers.

MUNN & Co. 361 Broadway, New York
Branch Office, 625 F St., Washington, D. C.

To Business Men

Business men in every line admit the value of good trade papers.

A trade paper must be original—it must contain a variety of matter including news service—technical information—in fact it must crystallize the entire news of the special business world, and be a helpful adjunct to every department of trade.

Scan the columns of *The Talking Machine World* closely and after you have completed an analysis of the contents of this publication see if you can duplicate its value in any other trade!

The World is a help to the talking machine business.

It exerts an healthful optimism.

It wields an influence for the good and every man who sells talking machines, no matter in what part of the universe he may be located, should receive this publication as regularly as it is issued. He is missing a vital business point if he fails to do this.

Thousands of dealers not only in the United States but in every country on earth consult the pages of the *World* regularly.

They draw from the *World* pleasure and profit.

The talking machine business has a brilliant future, and this publication is doing much to enlarge the business horizon of every retail talking machine man in the world.

To receive this paper annually costs but \$1.00. All foreign countries \$1.25.

EDWARD LYMAN BILL

1 MADISON AVENUE, NEW YORK

The Edison Phonograph

It matters not whether your customers prefer Carmen Melis, grand opera prima donna; Harry Lauder, vaudeville top liner or Stella Mayhew, musical comedy "scream"—the instrument is the thing. And the instrument that is best able to bring the work of these great artists into the homes of your townspeople is the Edison Phonograph.

HARRY
LAUDER



STELLA MAYHEW



CARMEN
MELIS

PHOTO BY
BETTINI, ROME

Put your efforts behind the Edison. It is the line of least resistance; the instrument that attracts the finest talent and the one that wins the choice on a hearing.

There is an Edison Jobber near you if your stock of Phonographs or Records is low.

National Phonograph Company
59 Lakeside Ave., Orange, New Jersey